

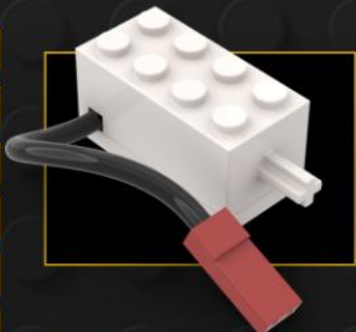

# INSTALLATION GUIDE

**Alien with Pizza Planet  
Rocket Ride 43307**



**Lego-compatible power sets**



# Section 1-New parts preview

# new parts

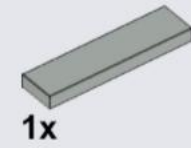
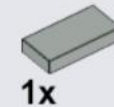
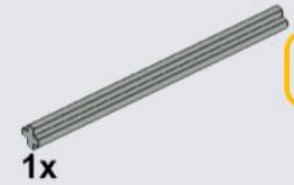
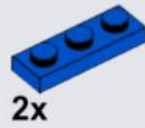

7

## new parts

---

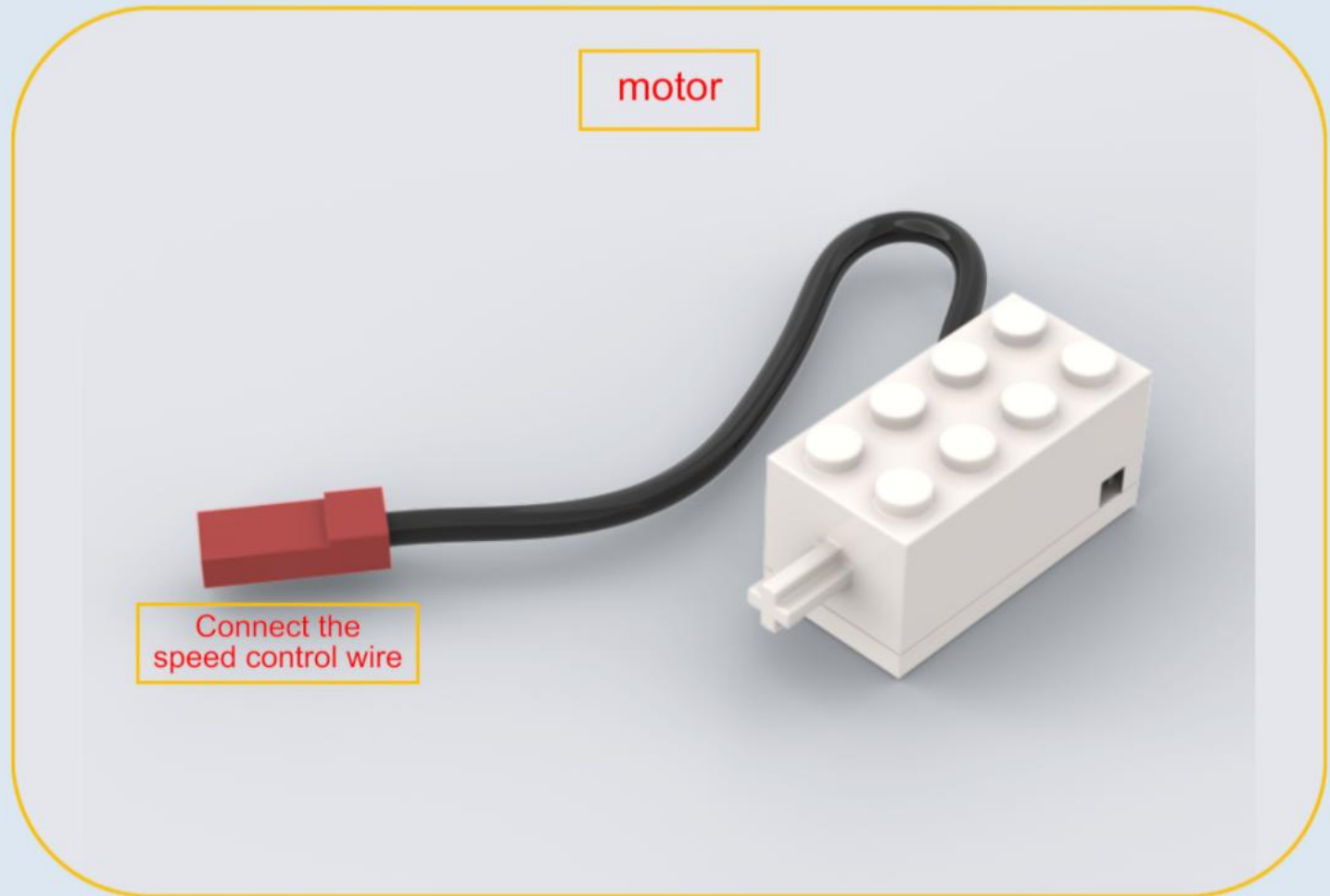

## new parts

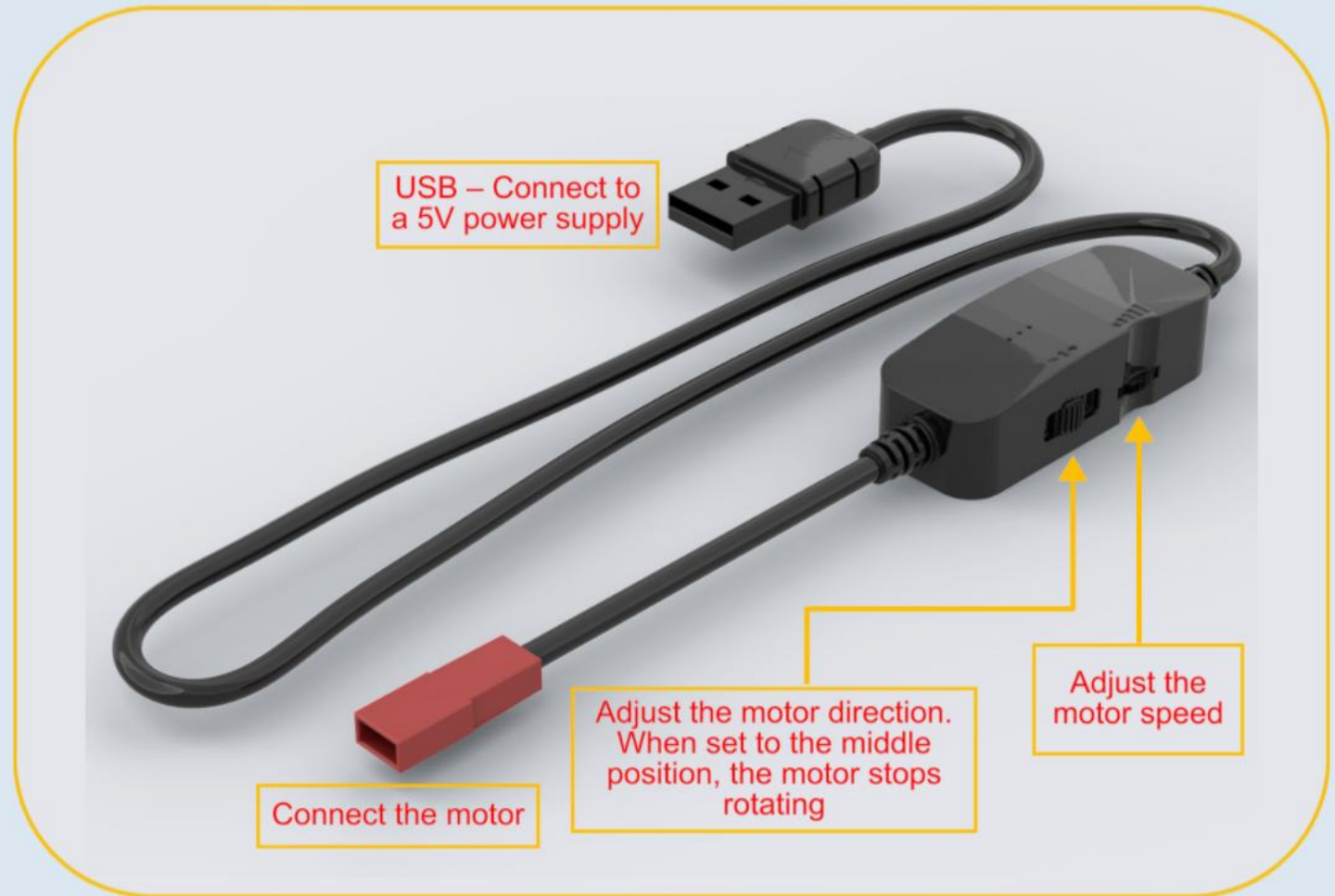

## Section 2-Testing the power system

# Testing

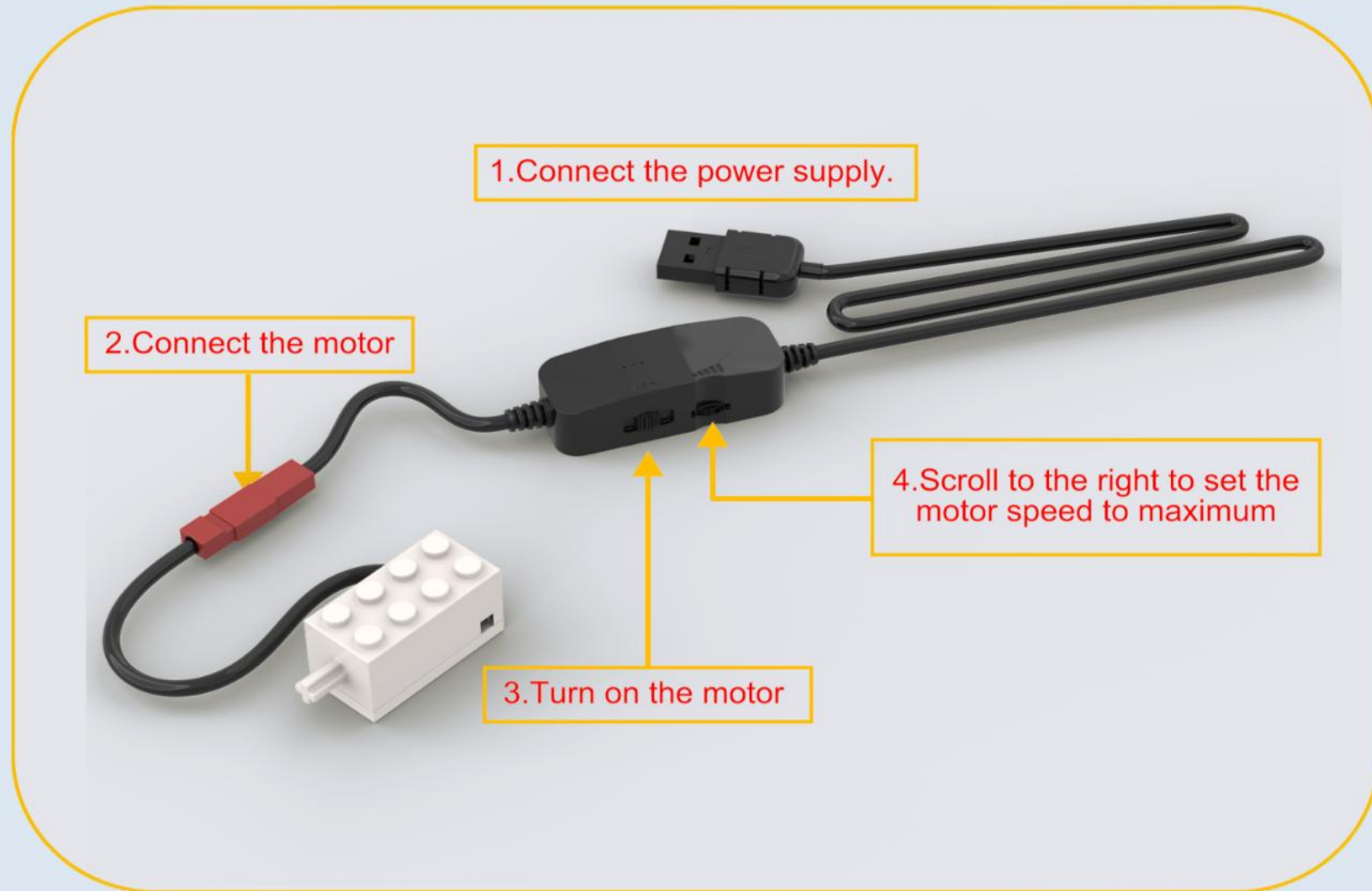

## Section 3-Preparation before building



2

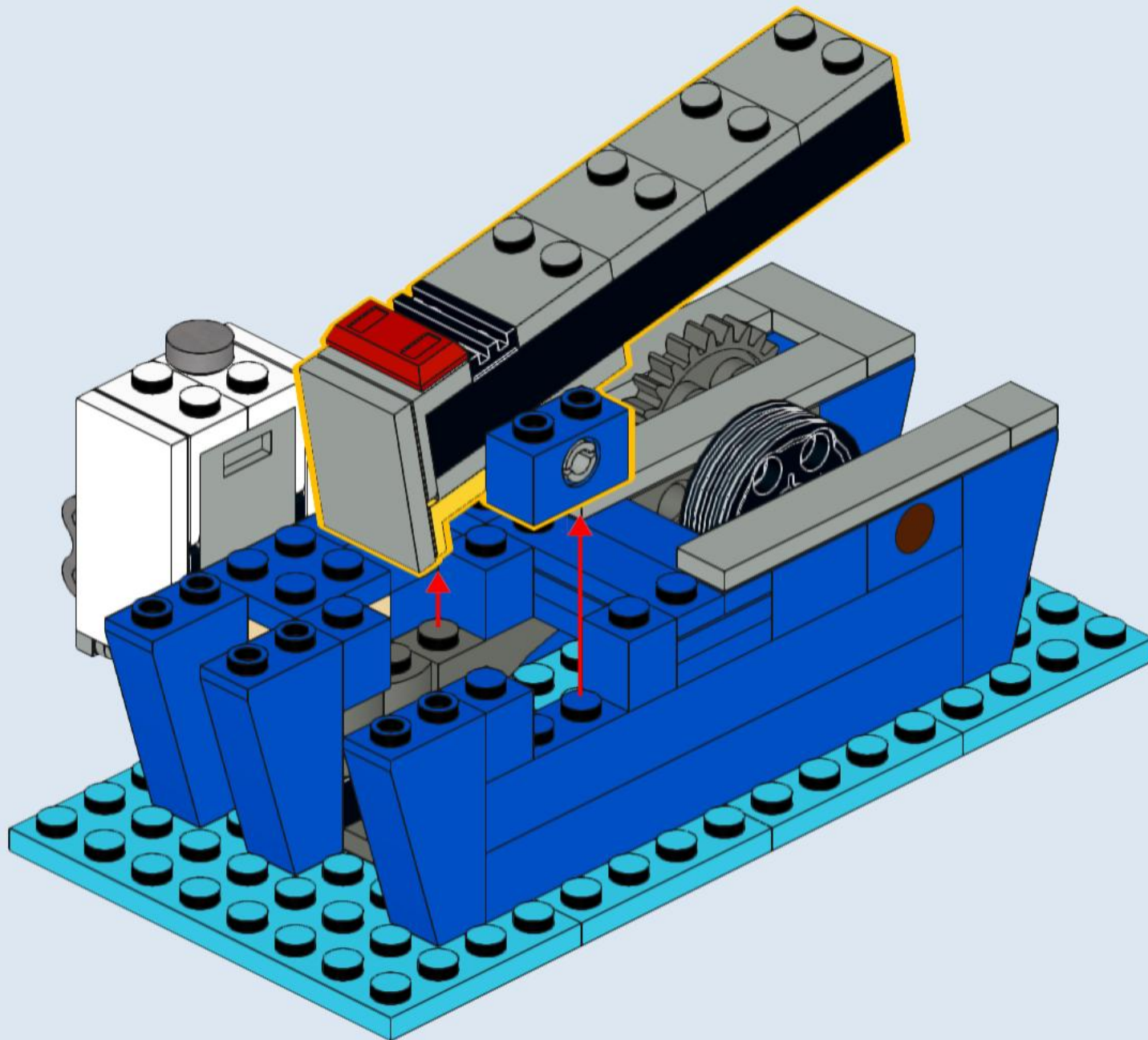

Keep this part

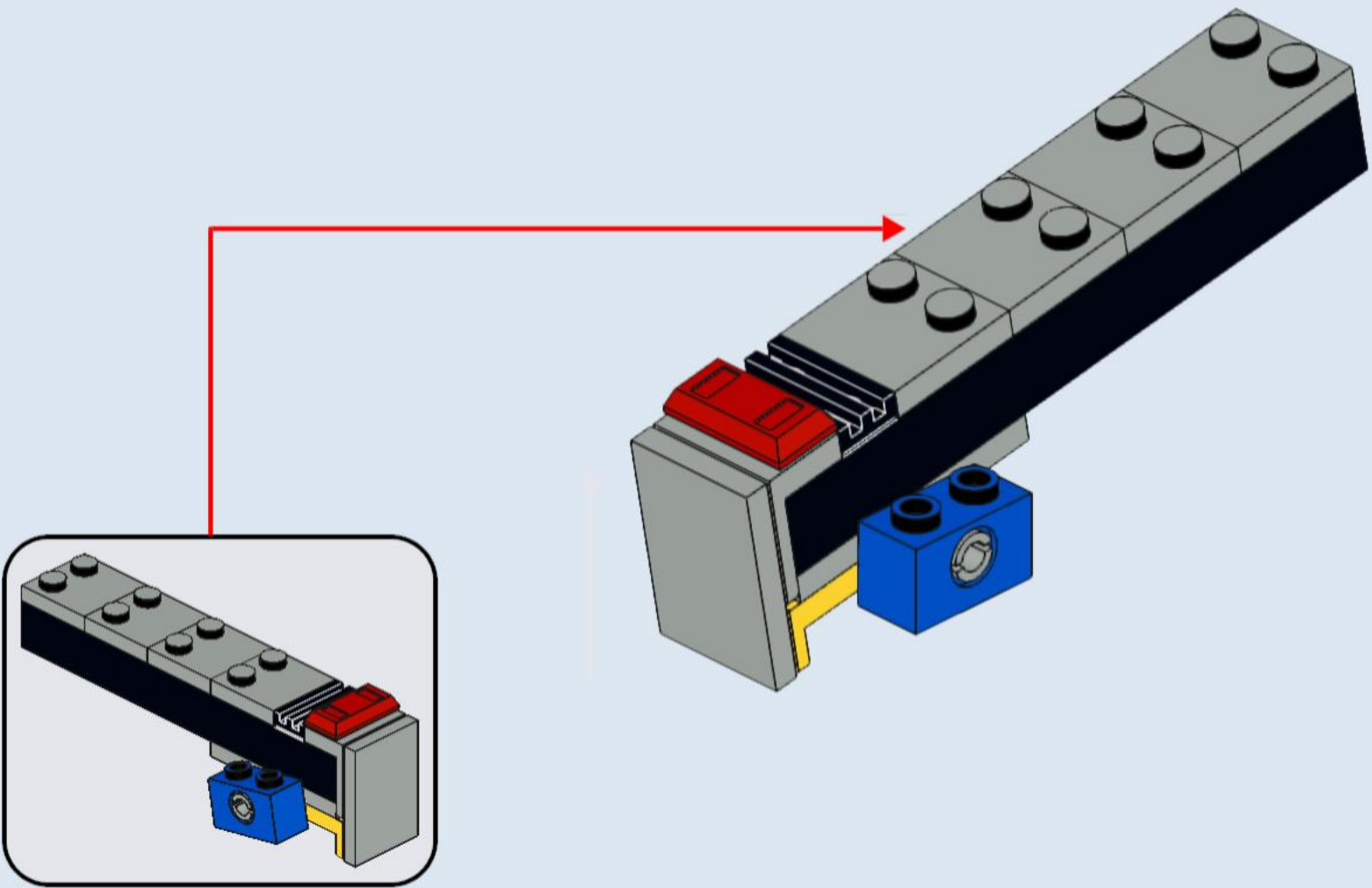

4

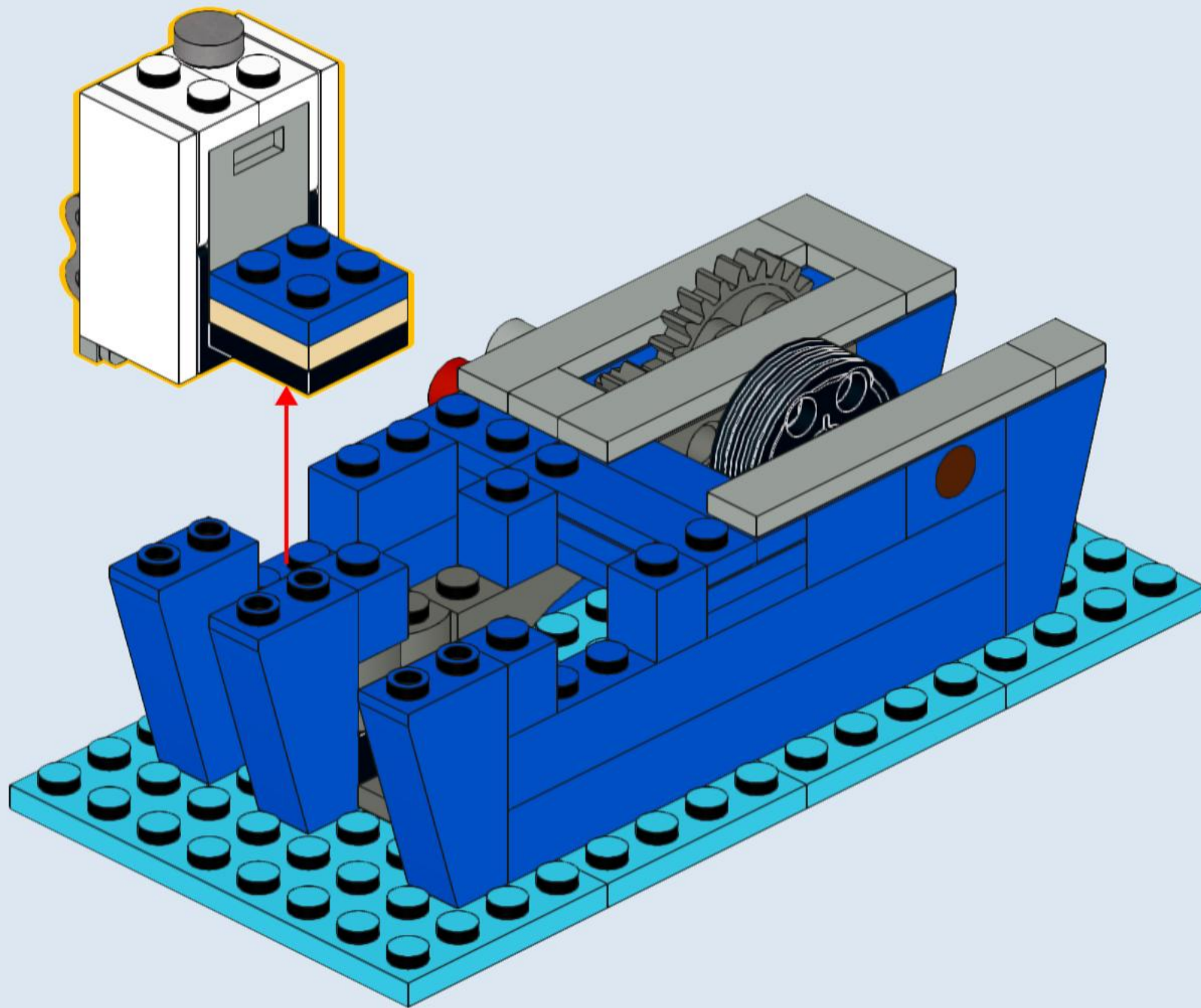

5

Keep this part

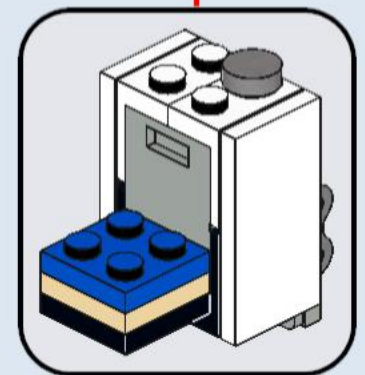
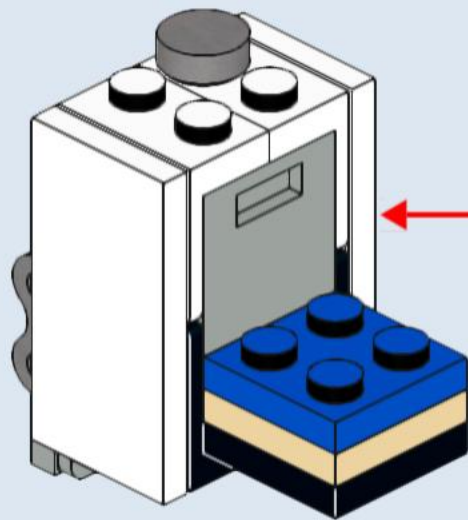

6

Remove all the remaining parts

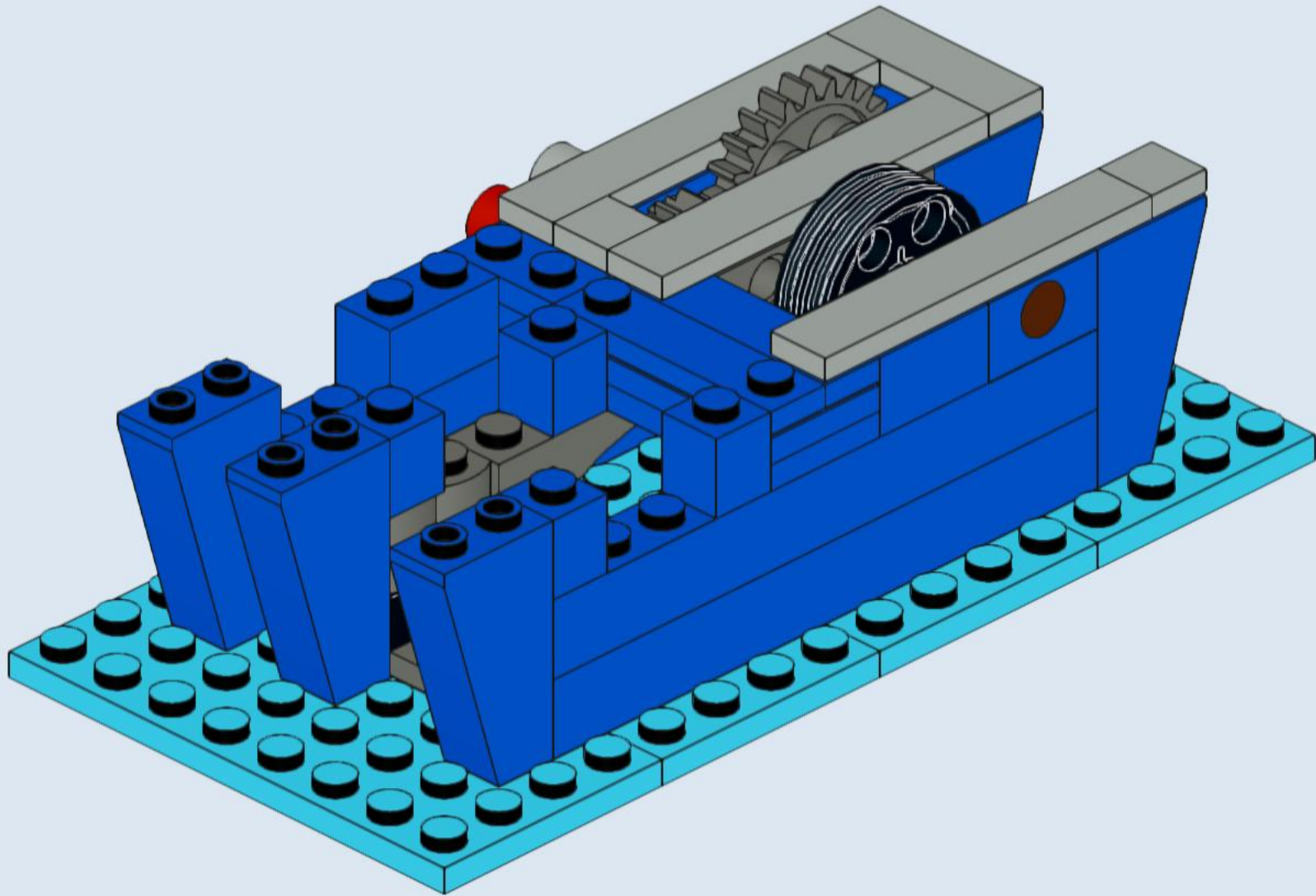

## Section 4- Let's start building

Original parts

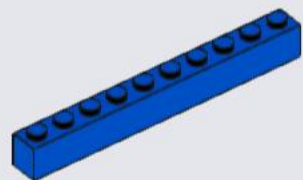

3x

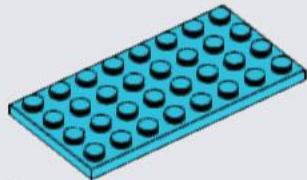

2x

1

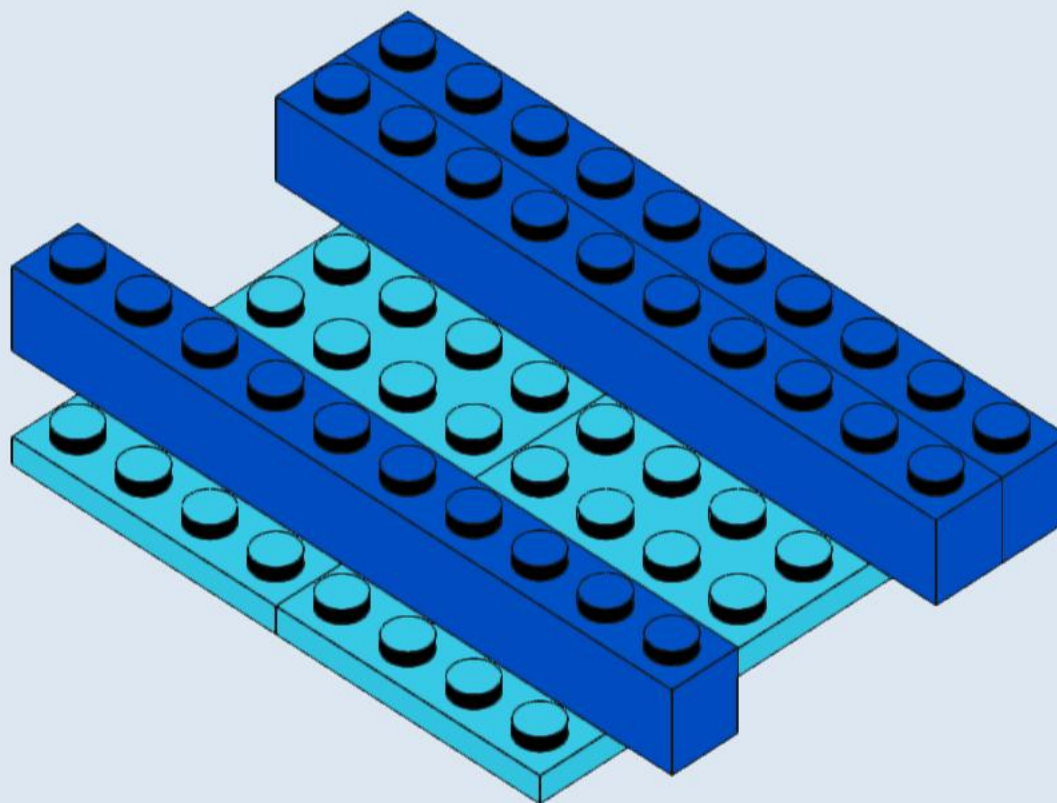

Original parts

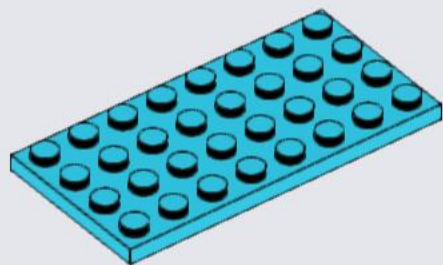

2x

2

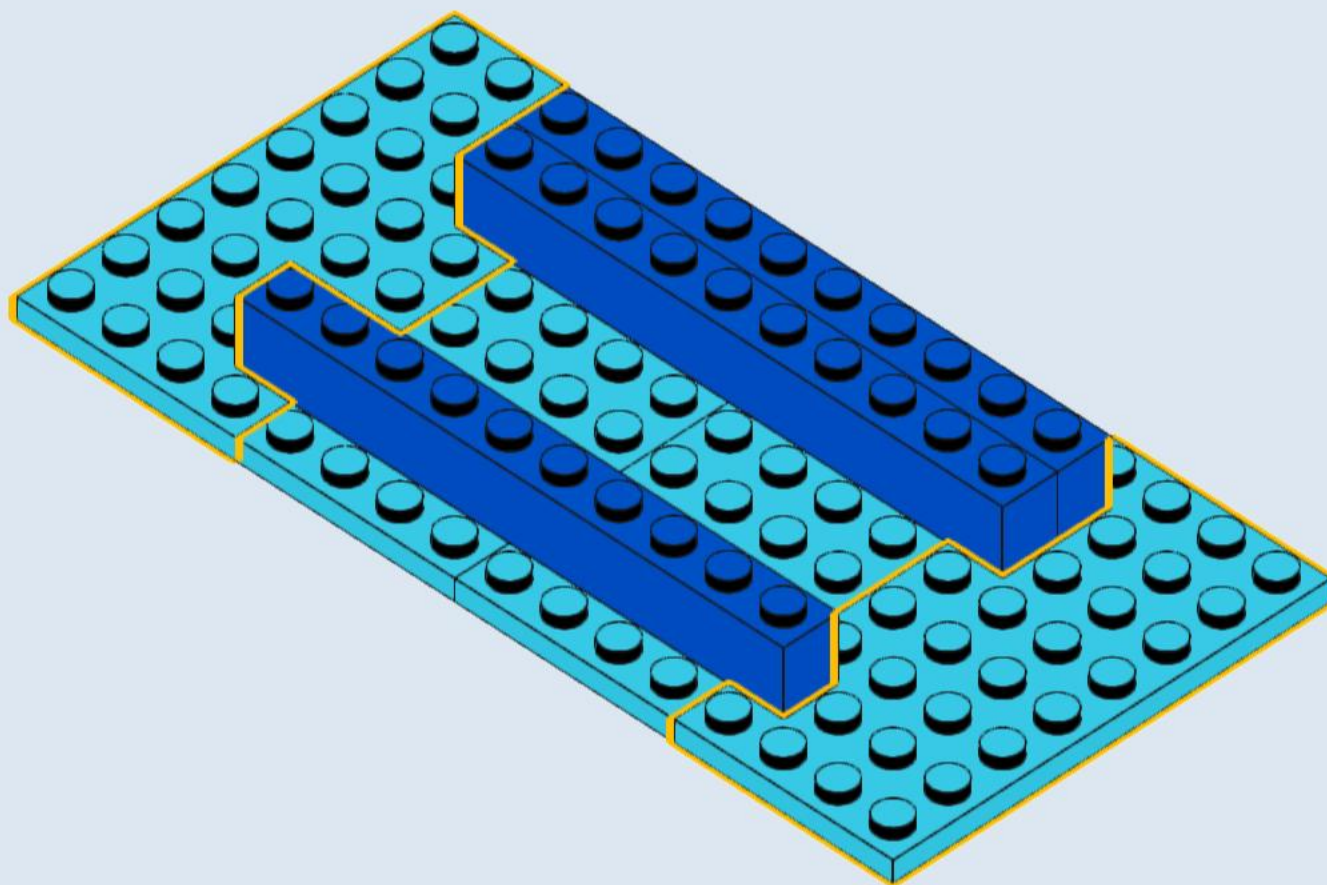



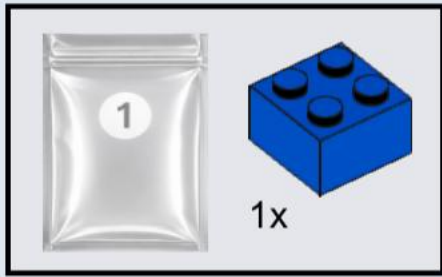

4

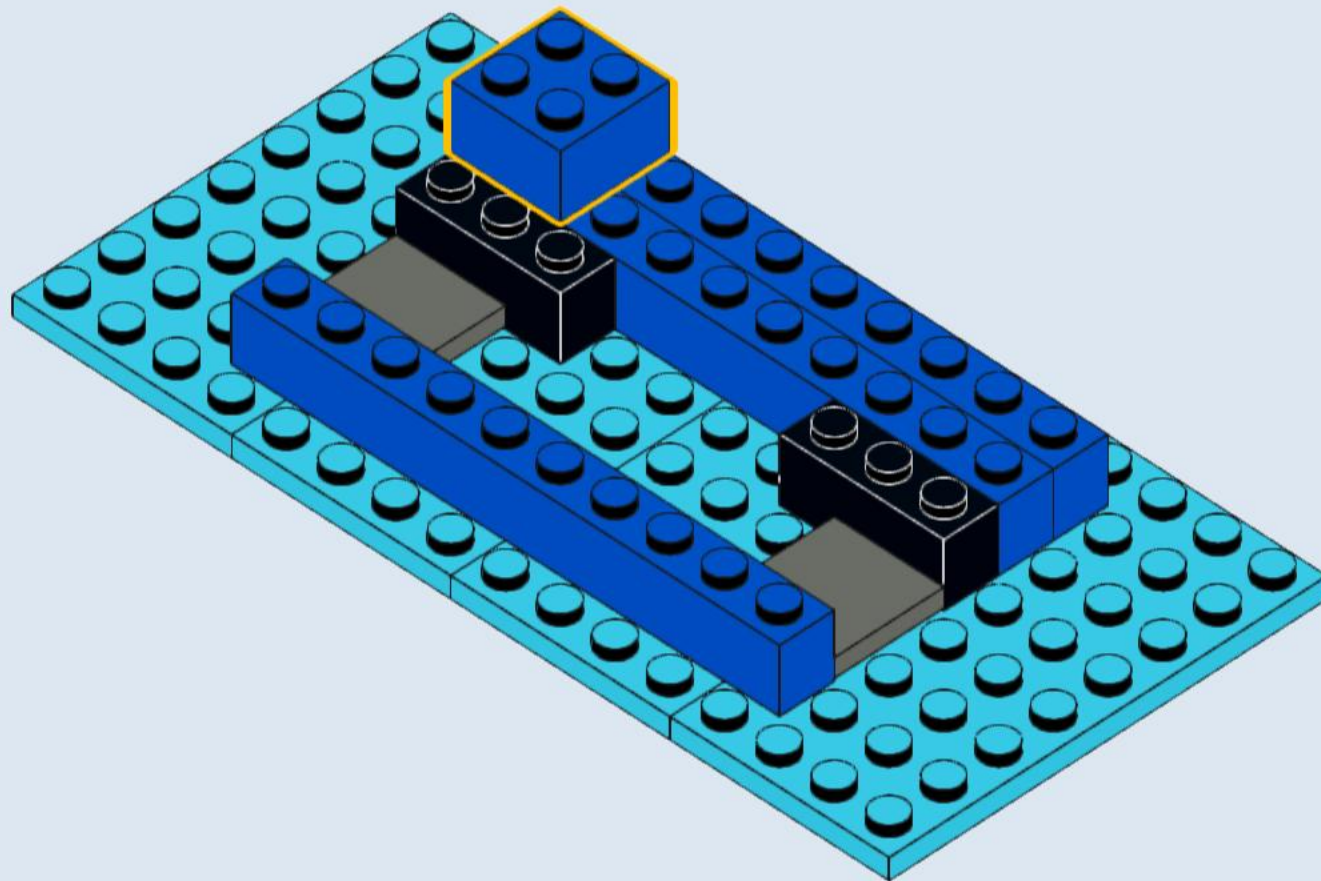

Original parts

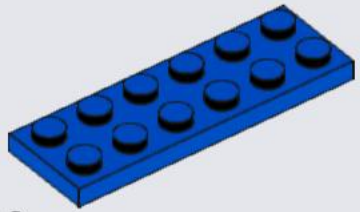

2x

5

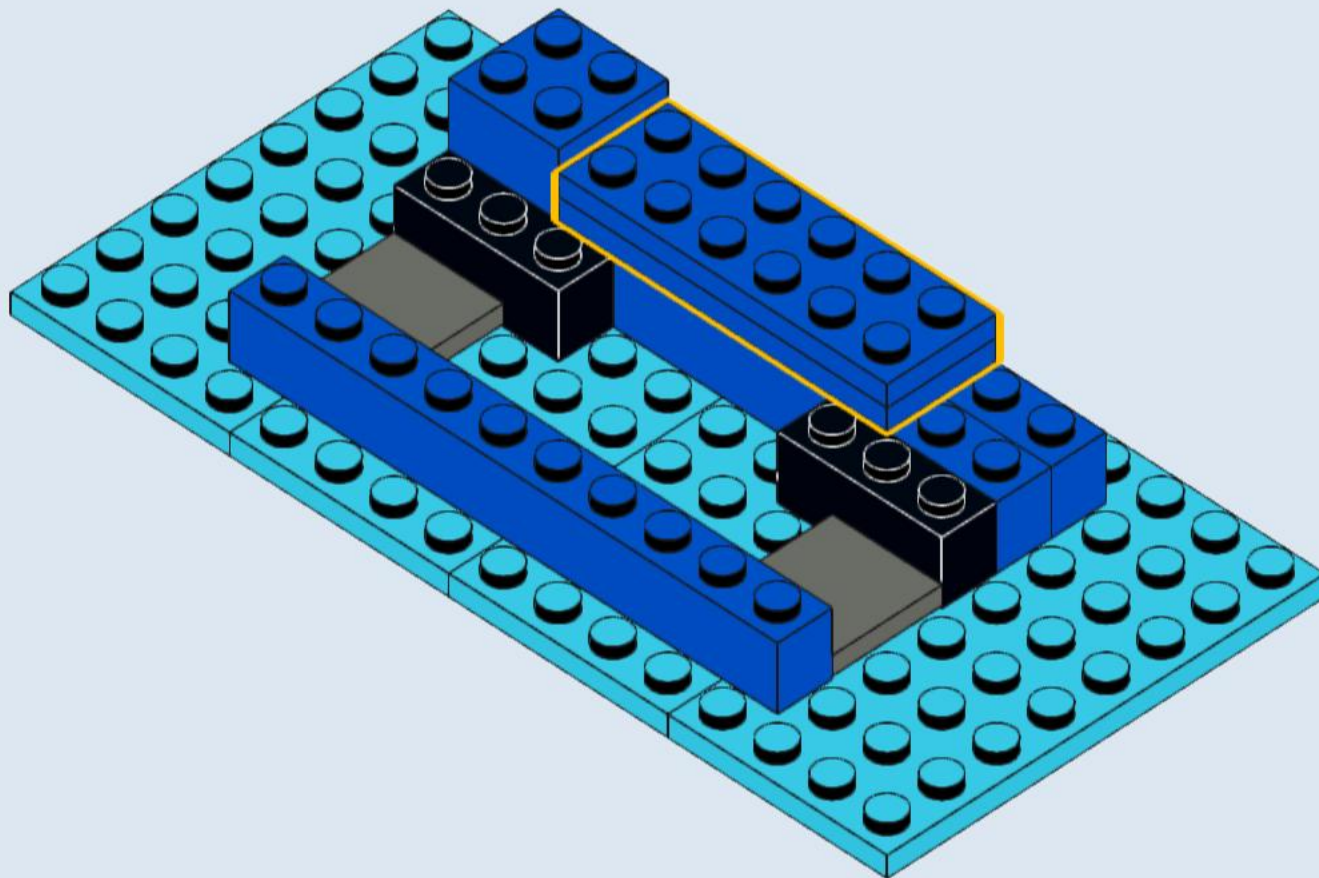

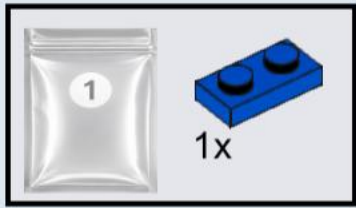

6

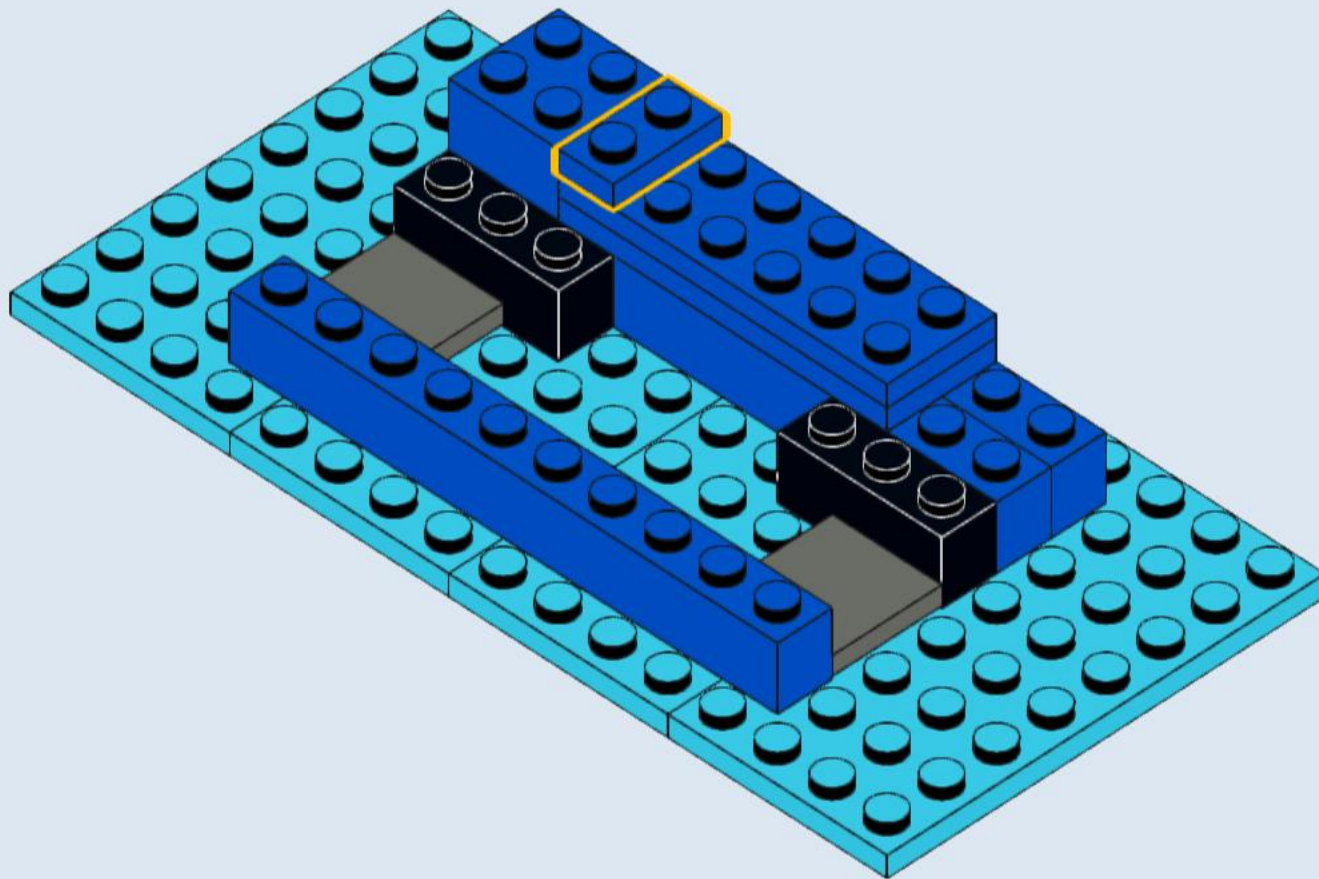

7

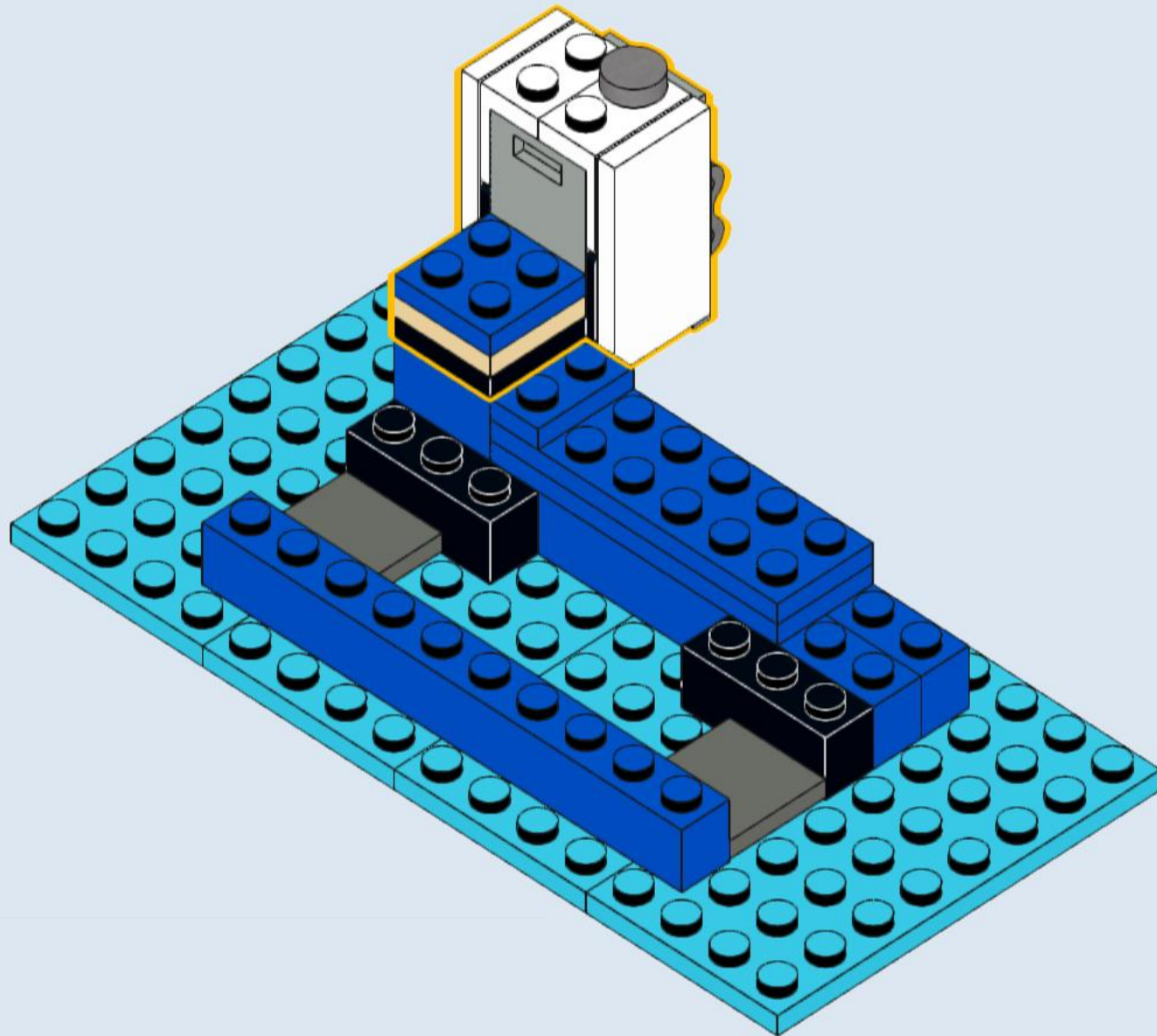

Original parts

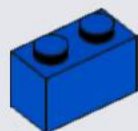

1x

8

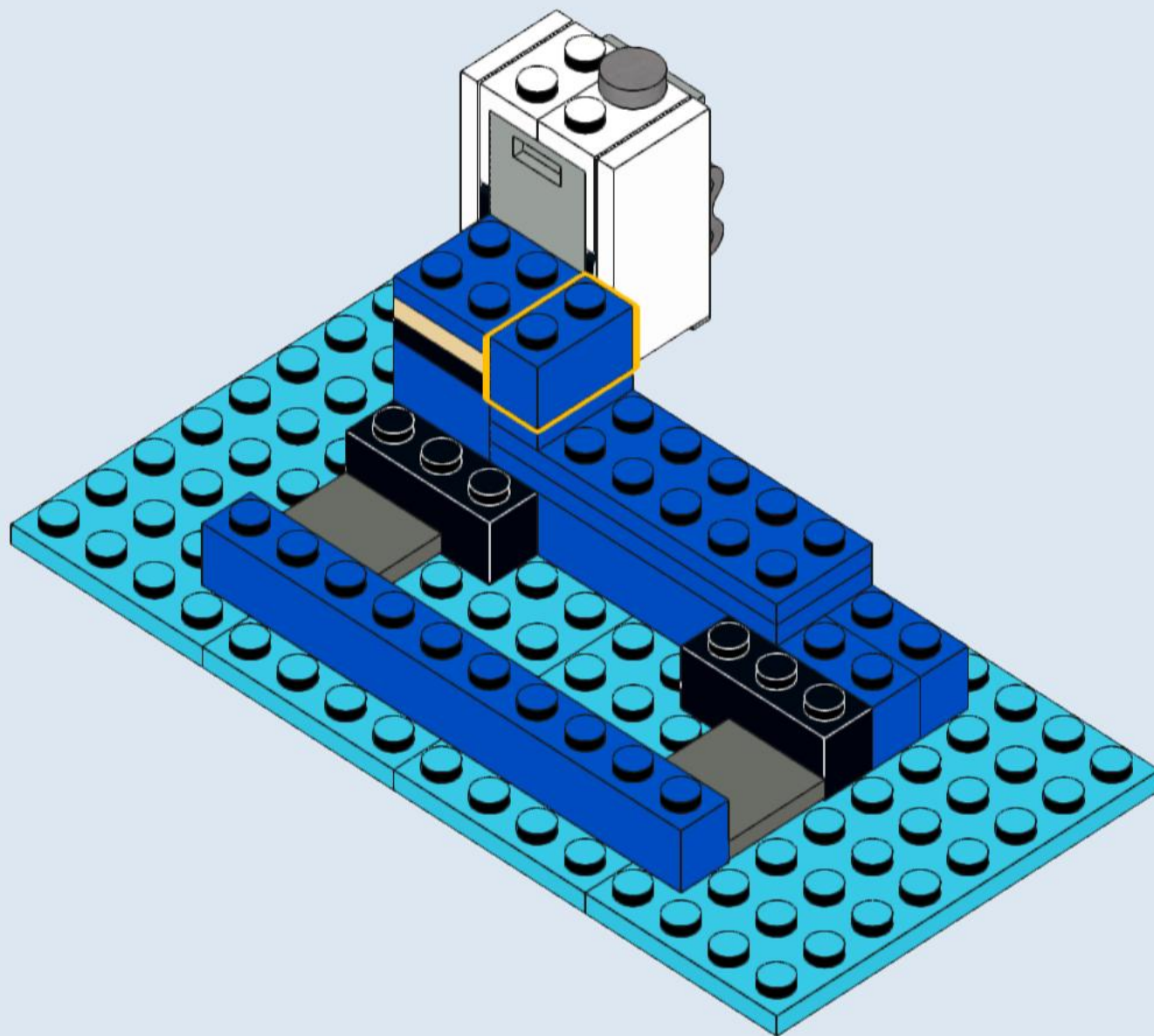

Original parts

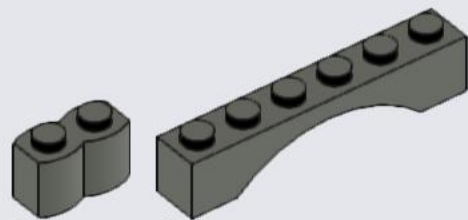

2x

1x

9

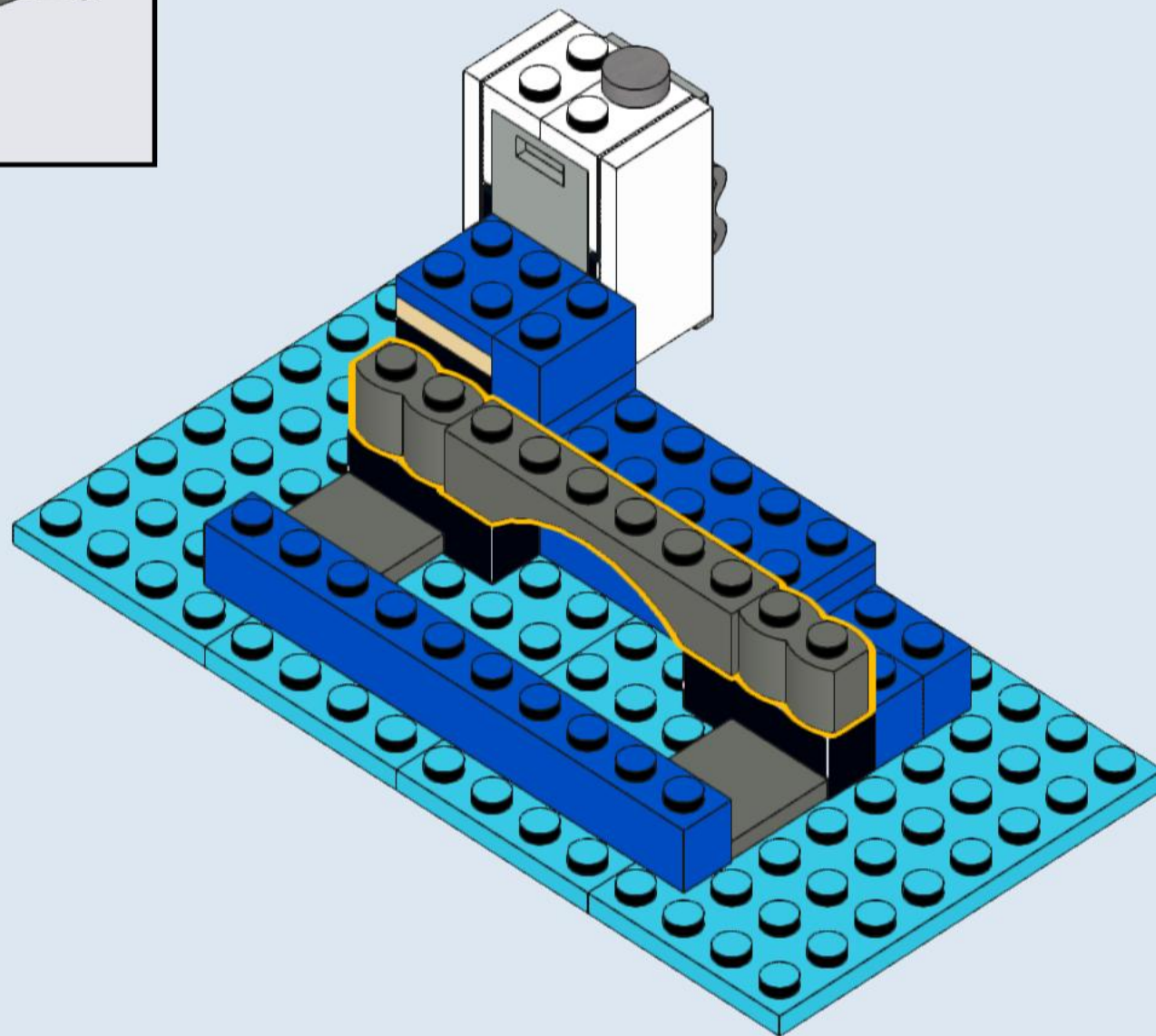

Original parts

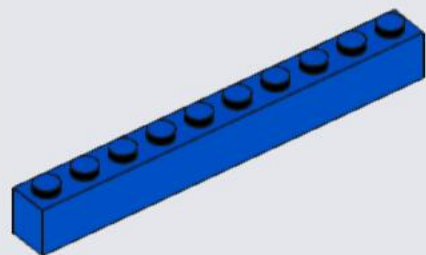

1x

10

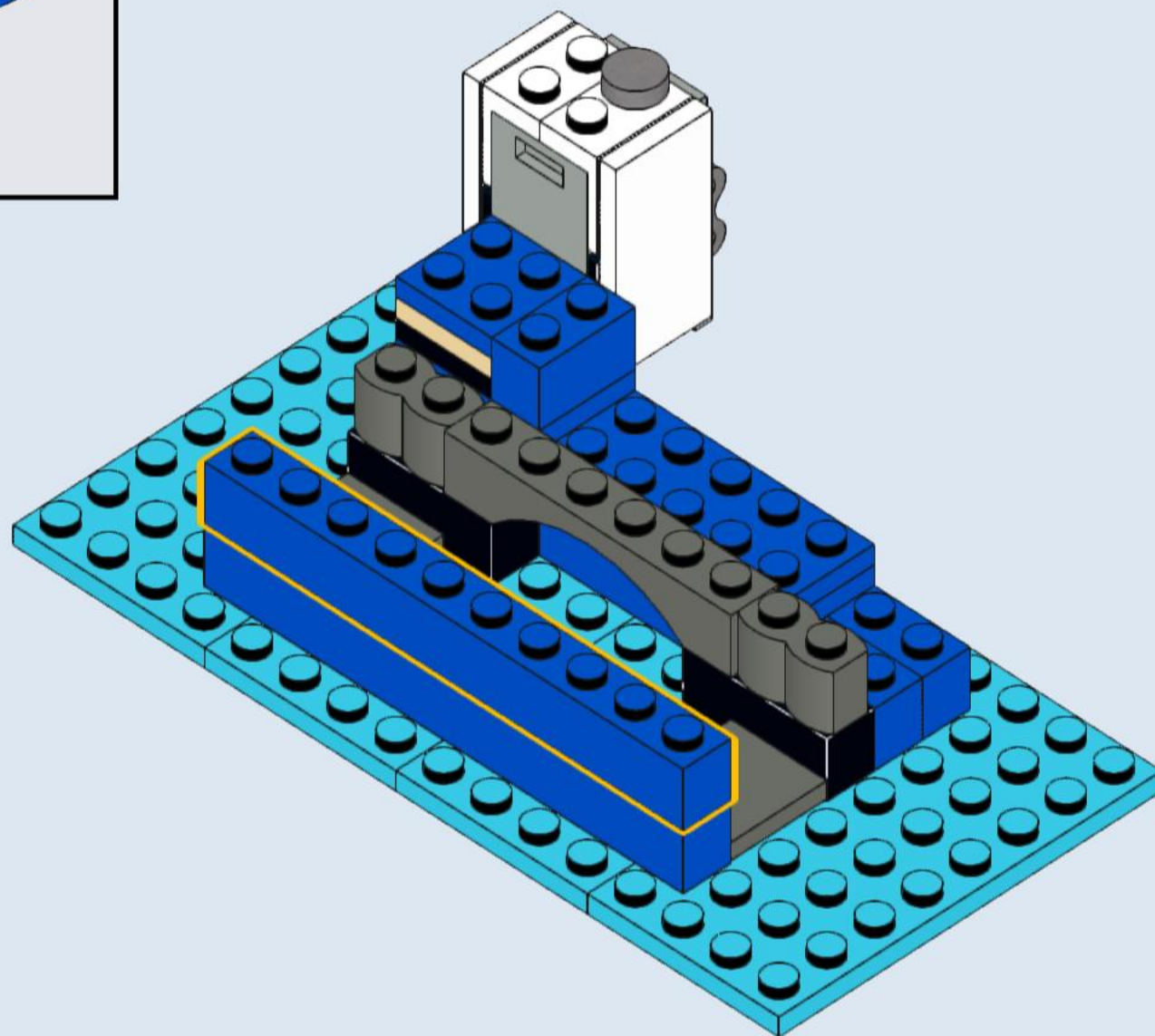

11

Take out the motor

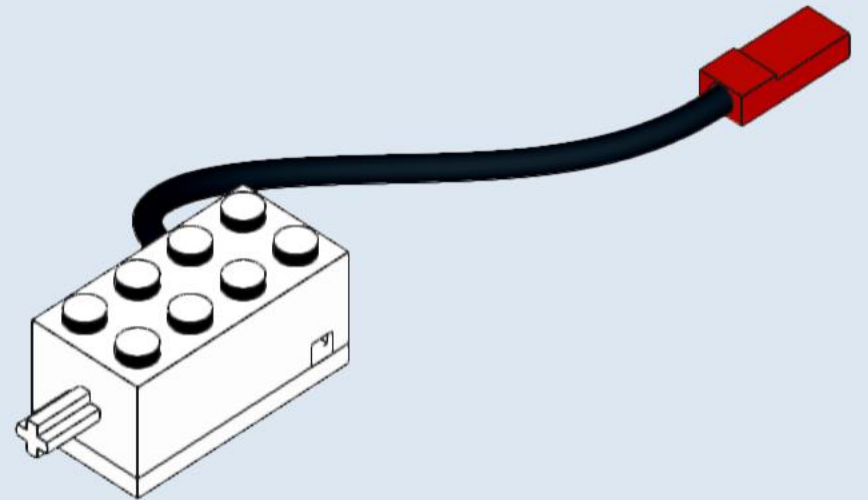

12

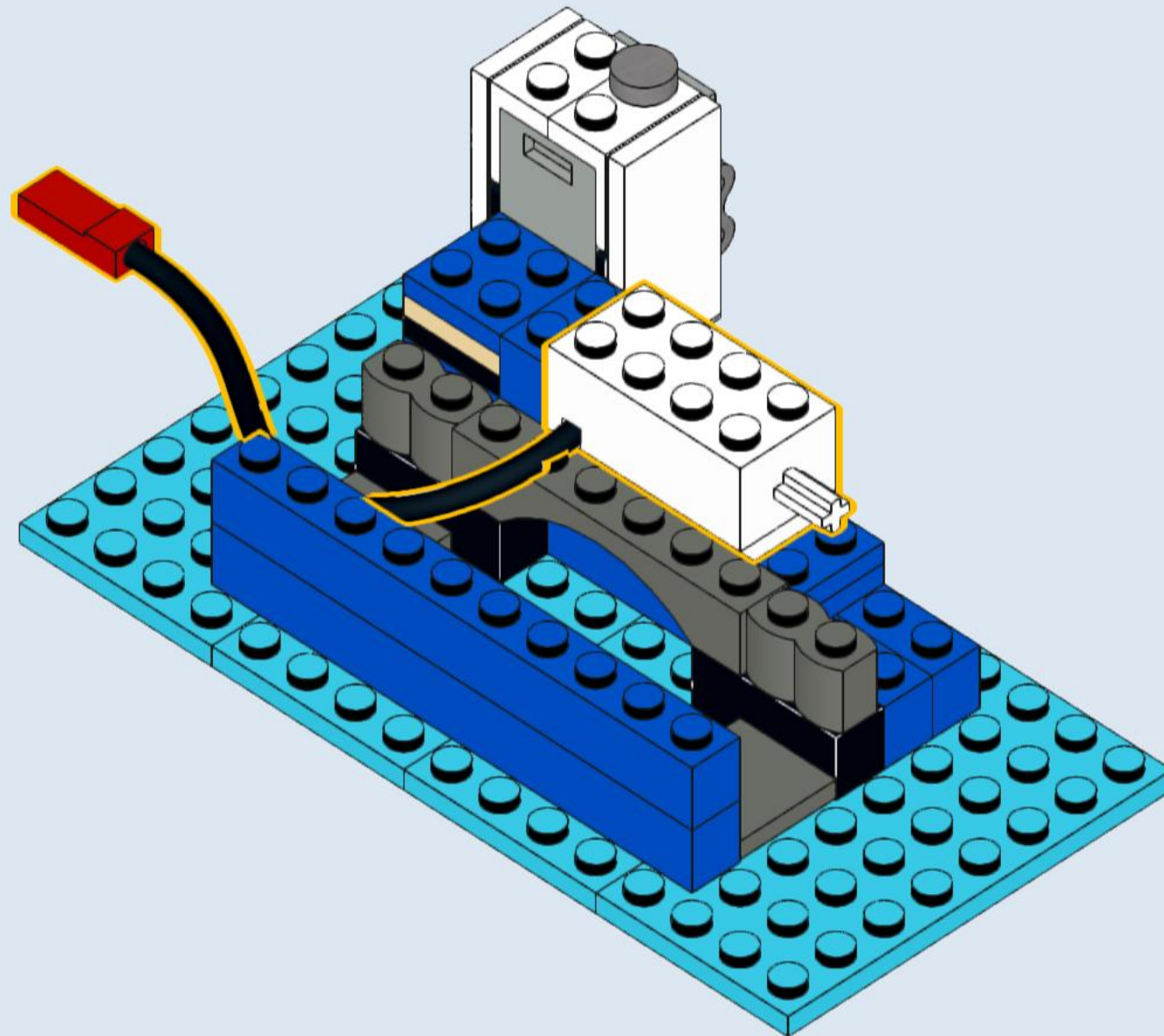



13

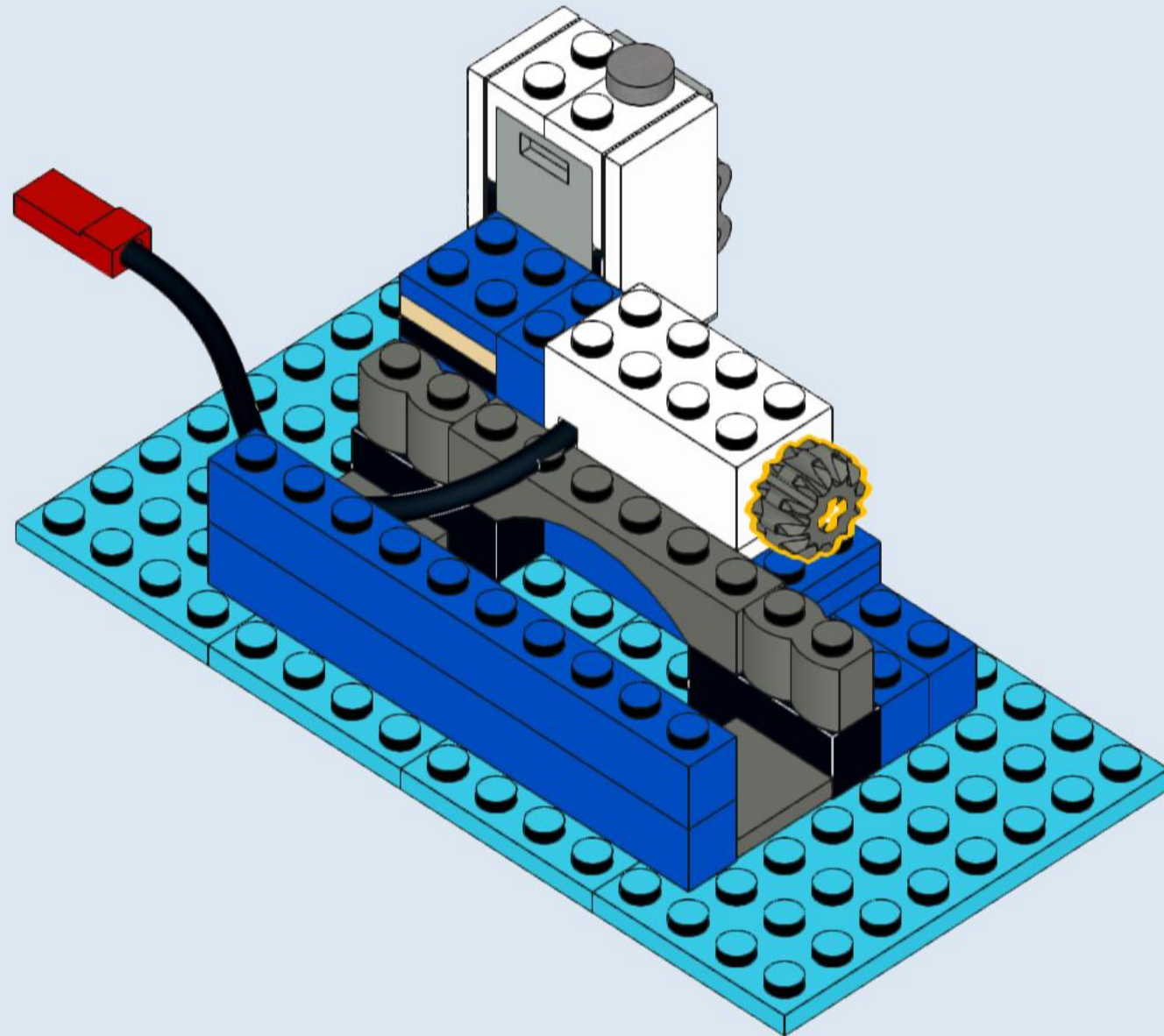

Original parts

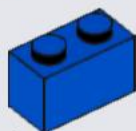

1x

14

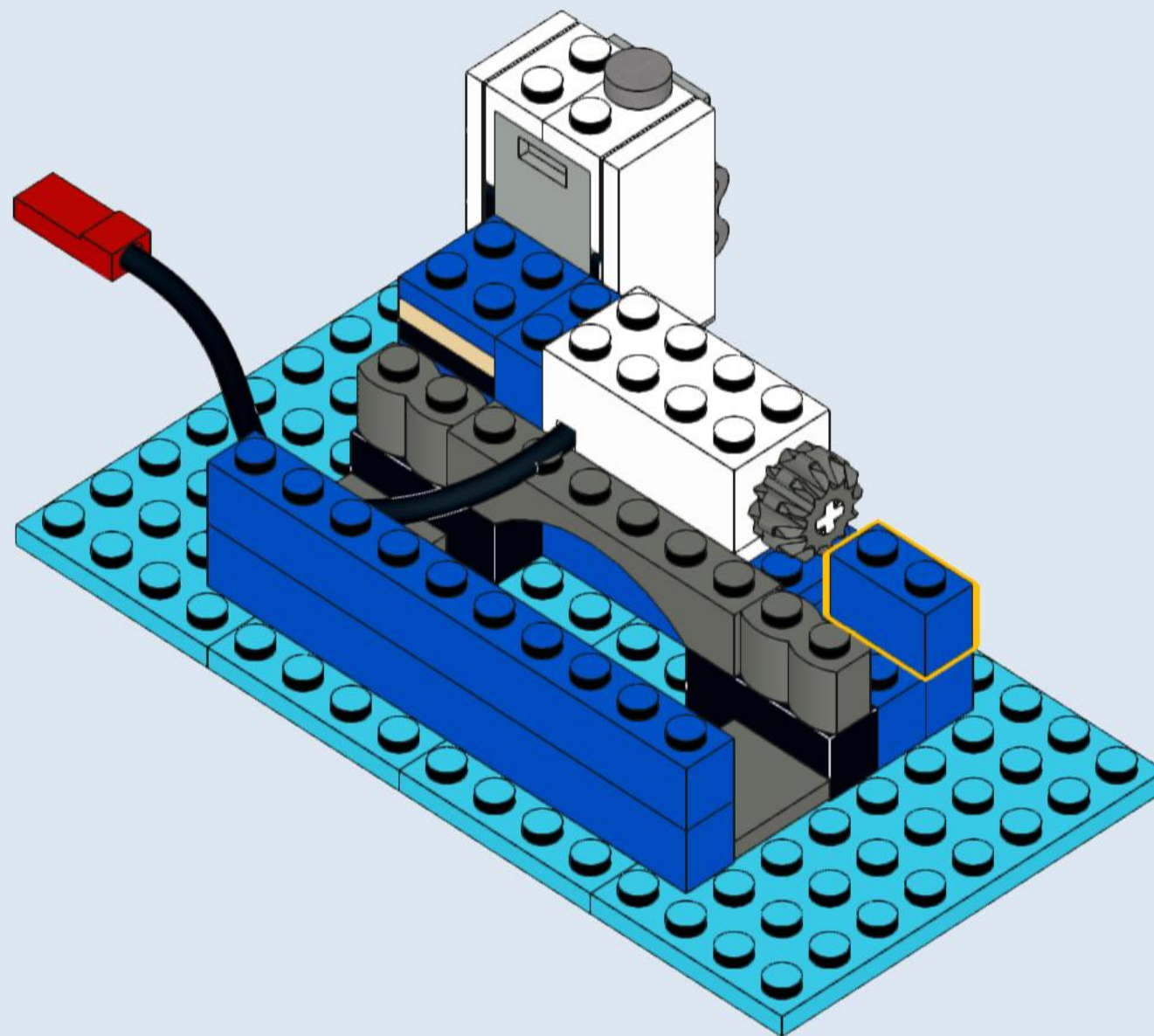

Original parts

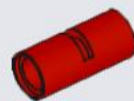

1x



1x

15

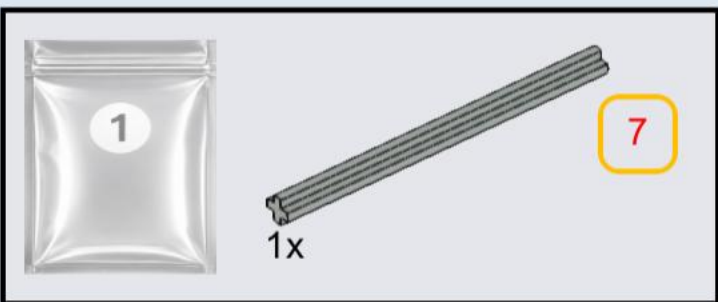
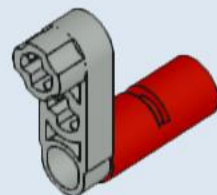

16

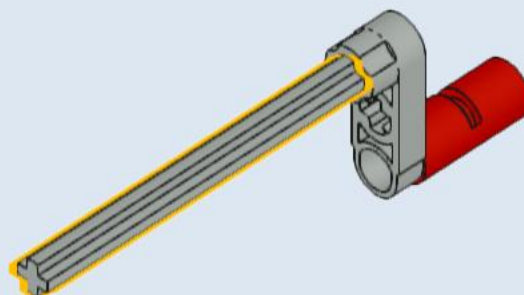

Original parts

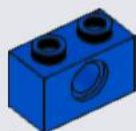

1x

17

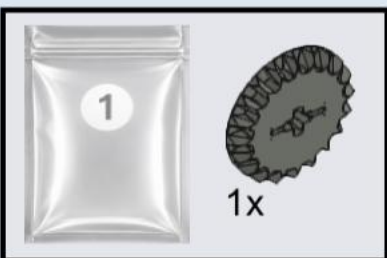
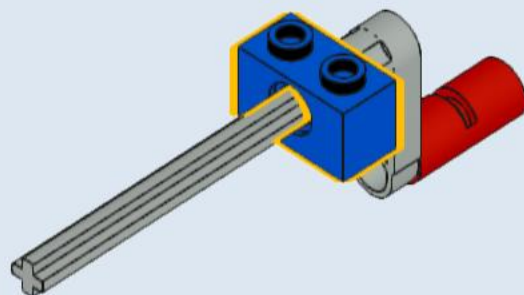

1x

18

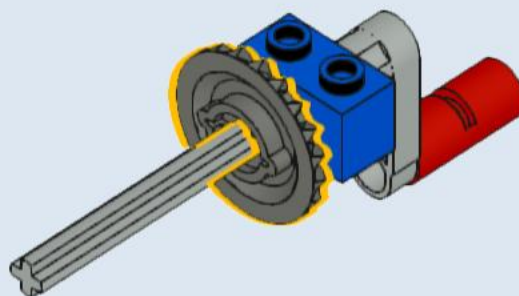

Original parts

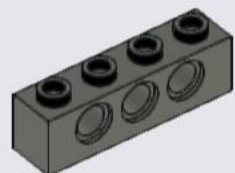

1x

19

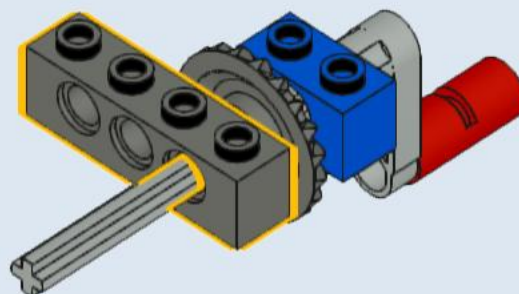

Original parts



1x

2x

2x

20

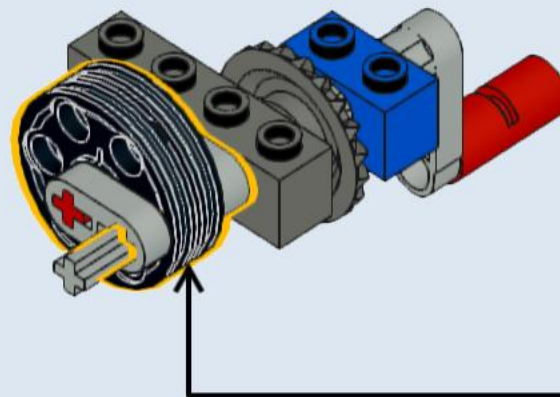

1

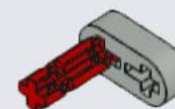

2



Original parts

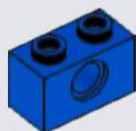

1x

21

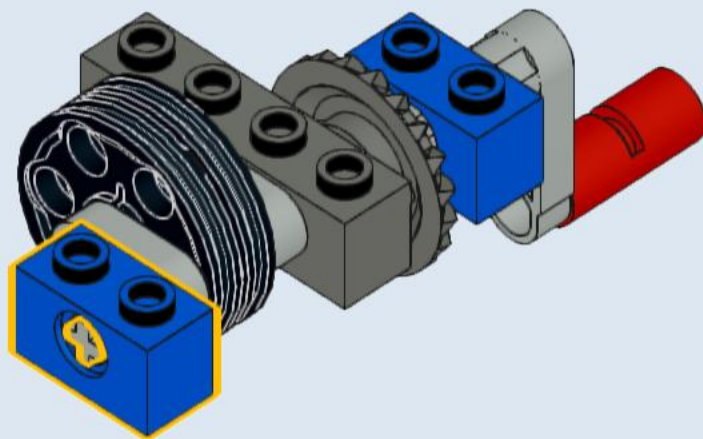

22

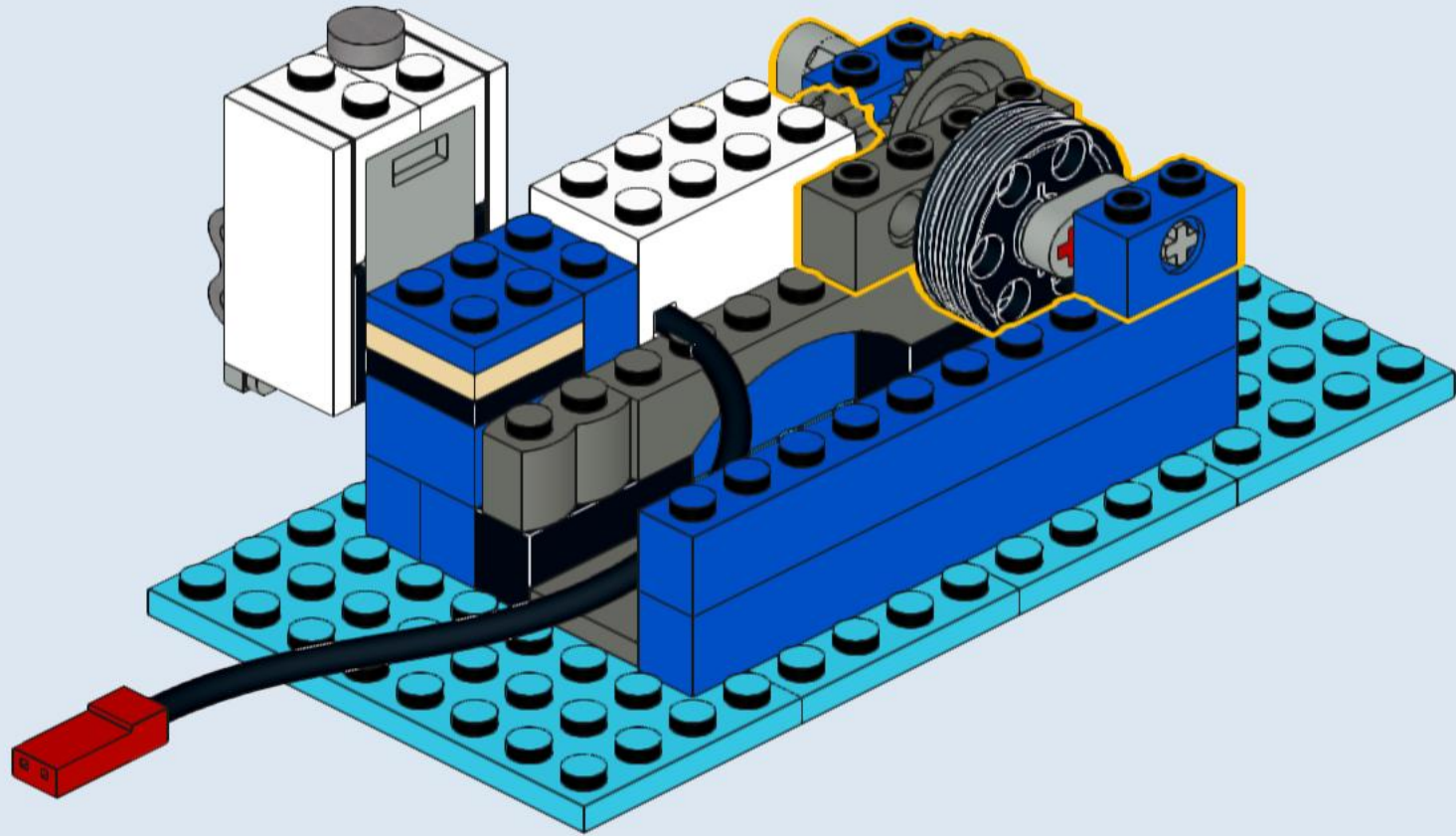

Original parts

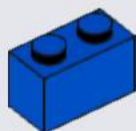

1x

23

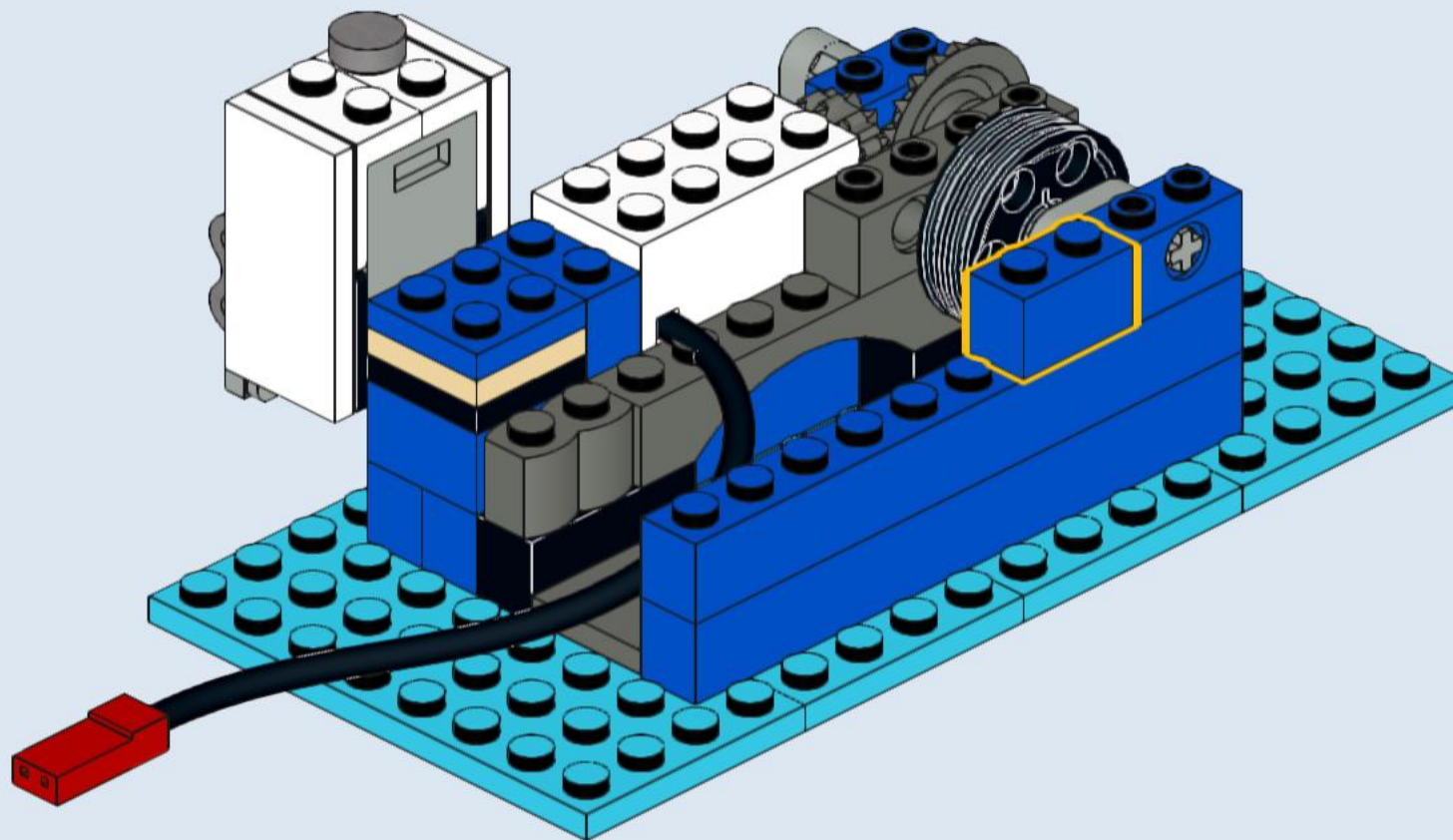

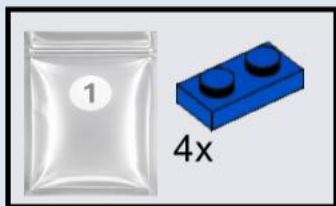

24

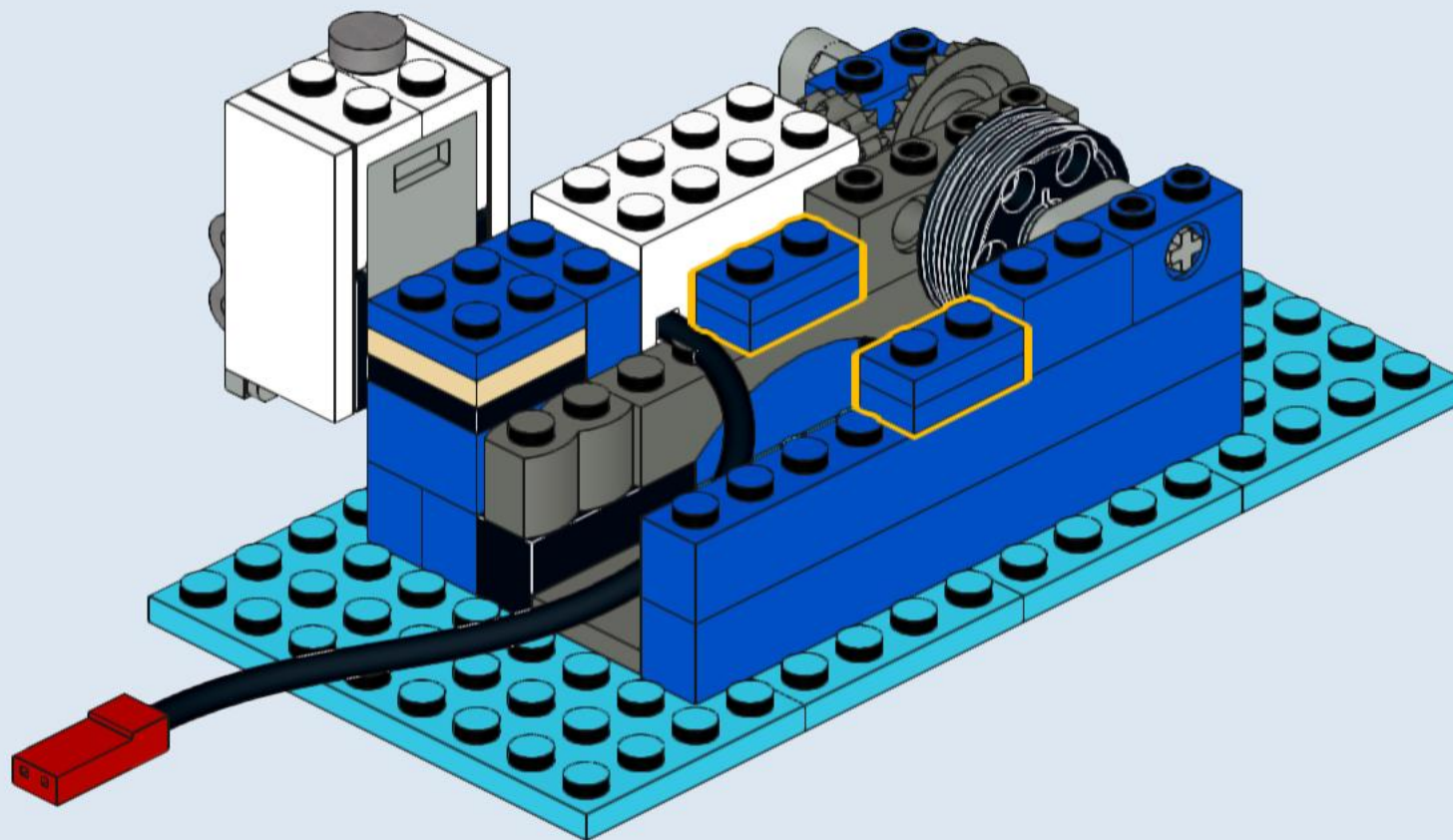

Original parts

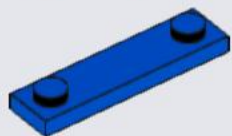

2x

25

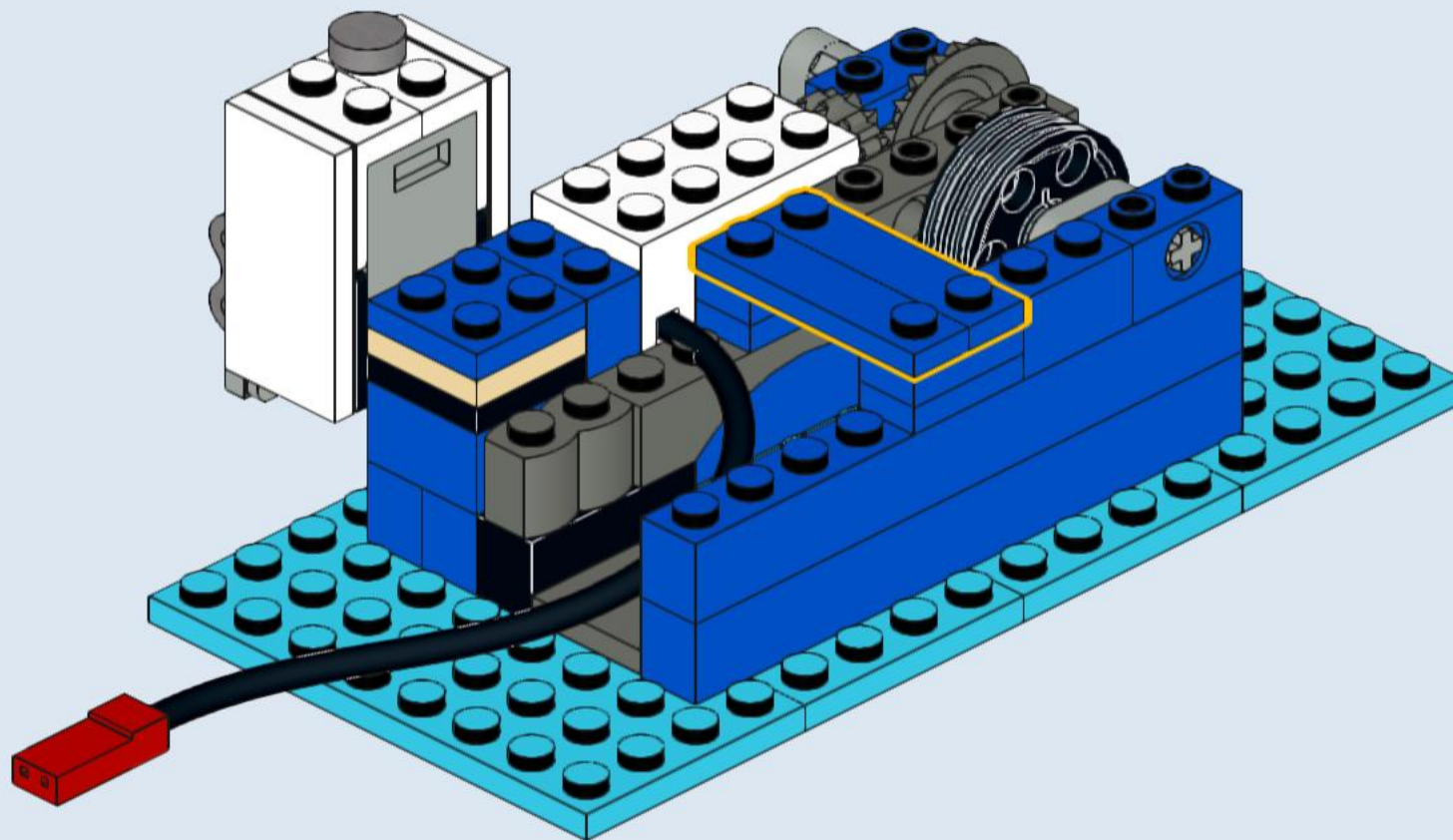

Original parts



3x

26

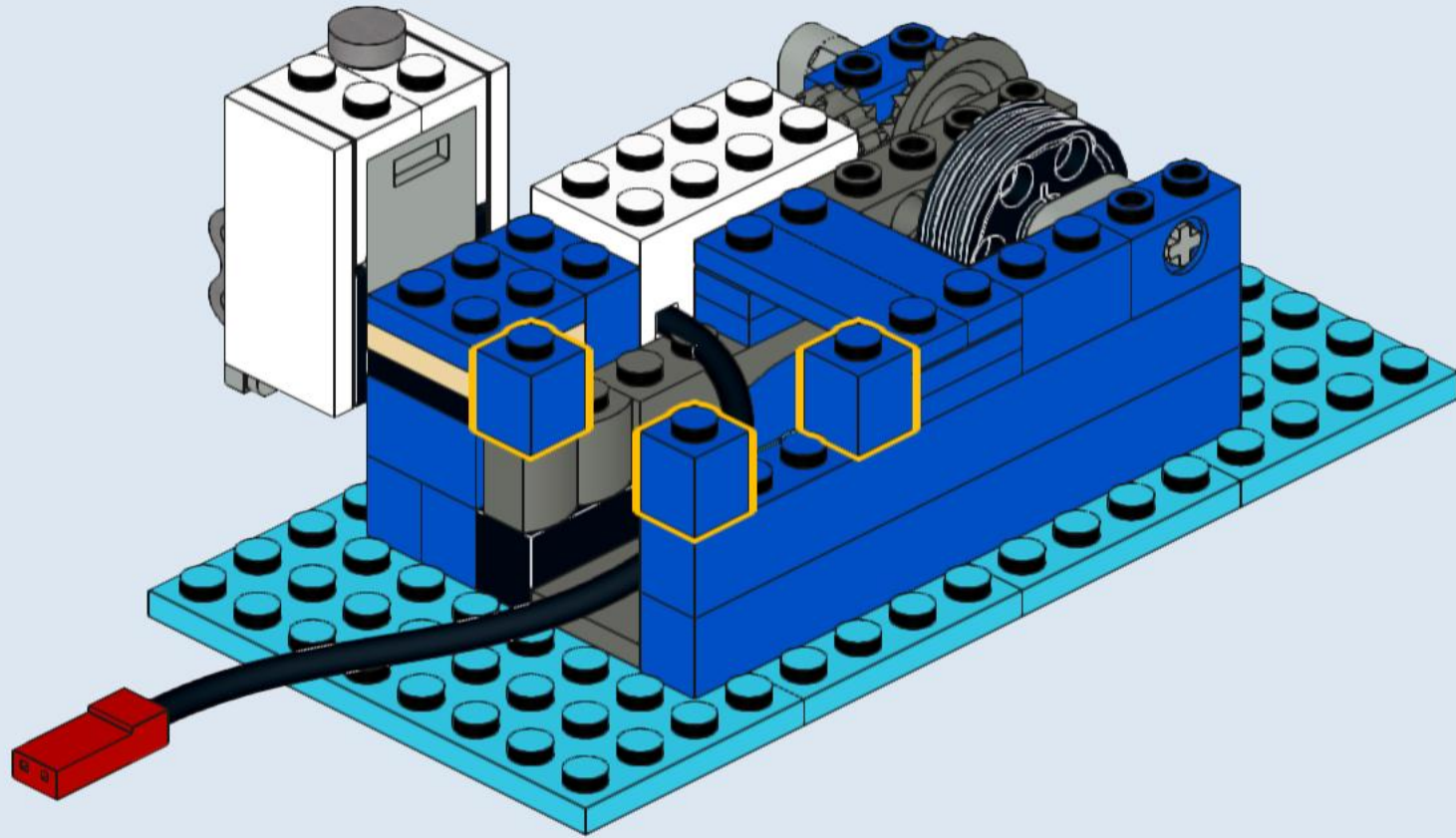

Original parts



6x

27

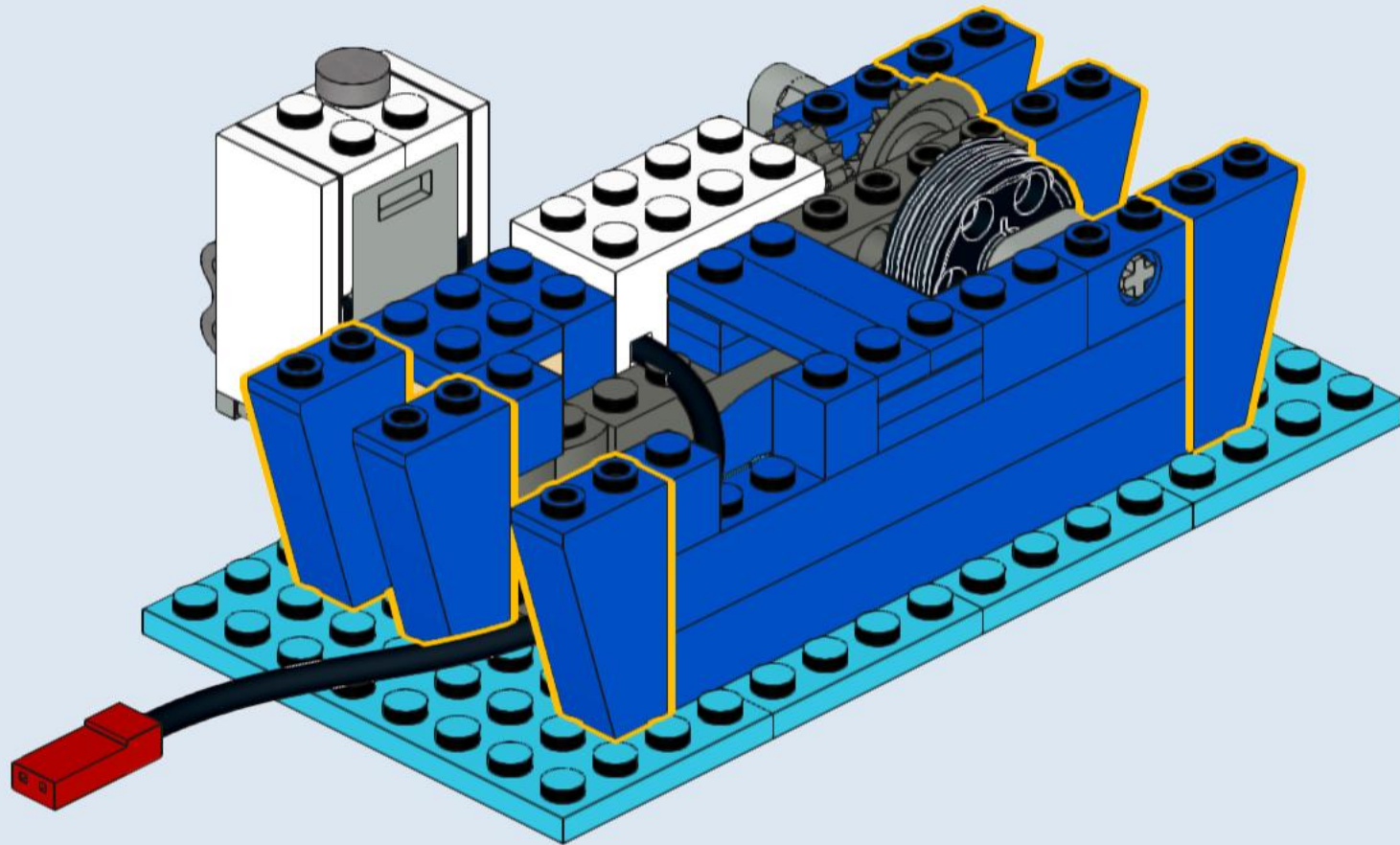

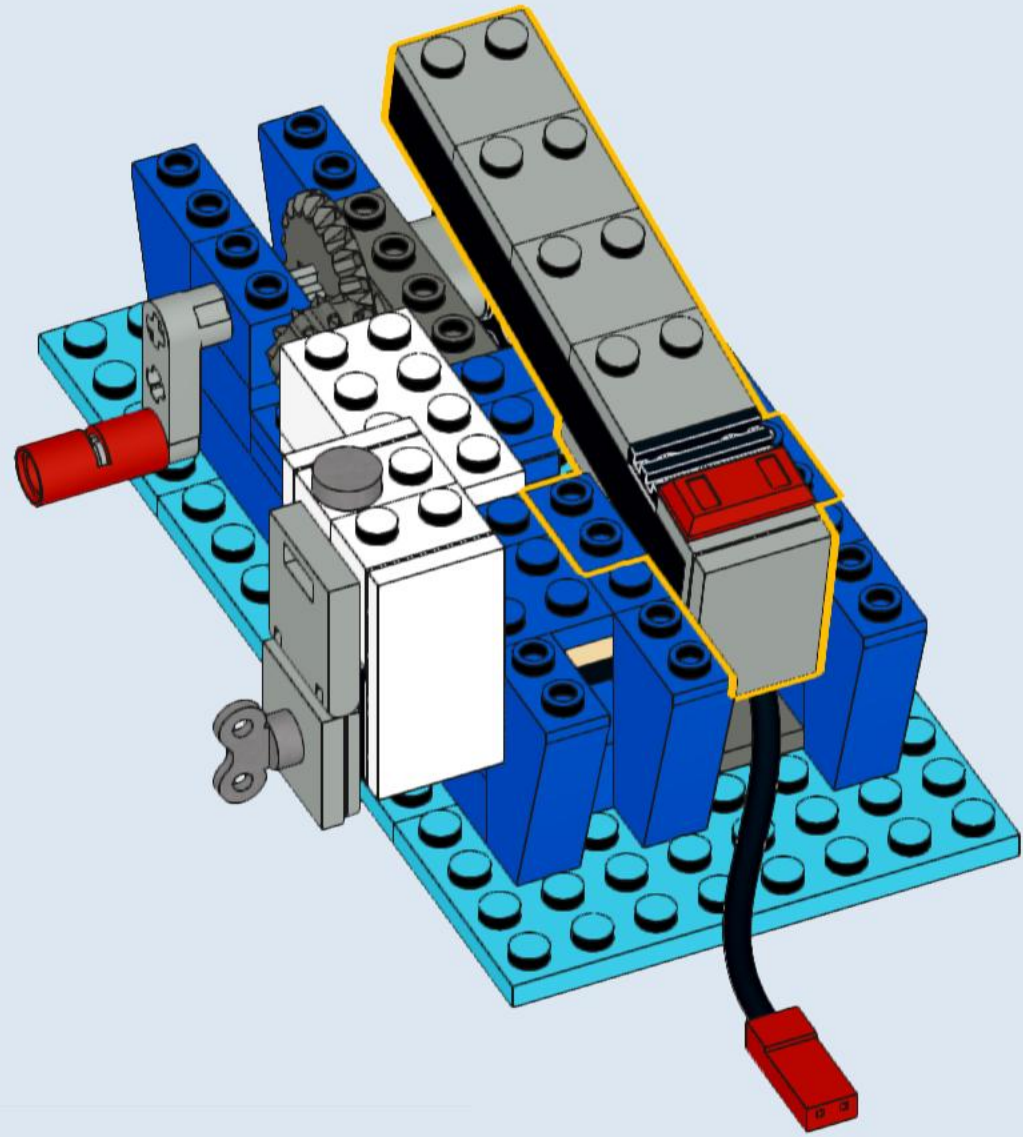

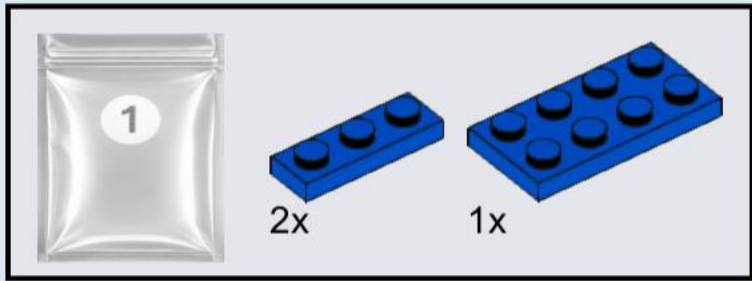

29

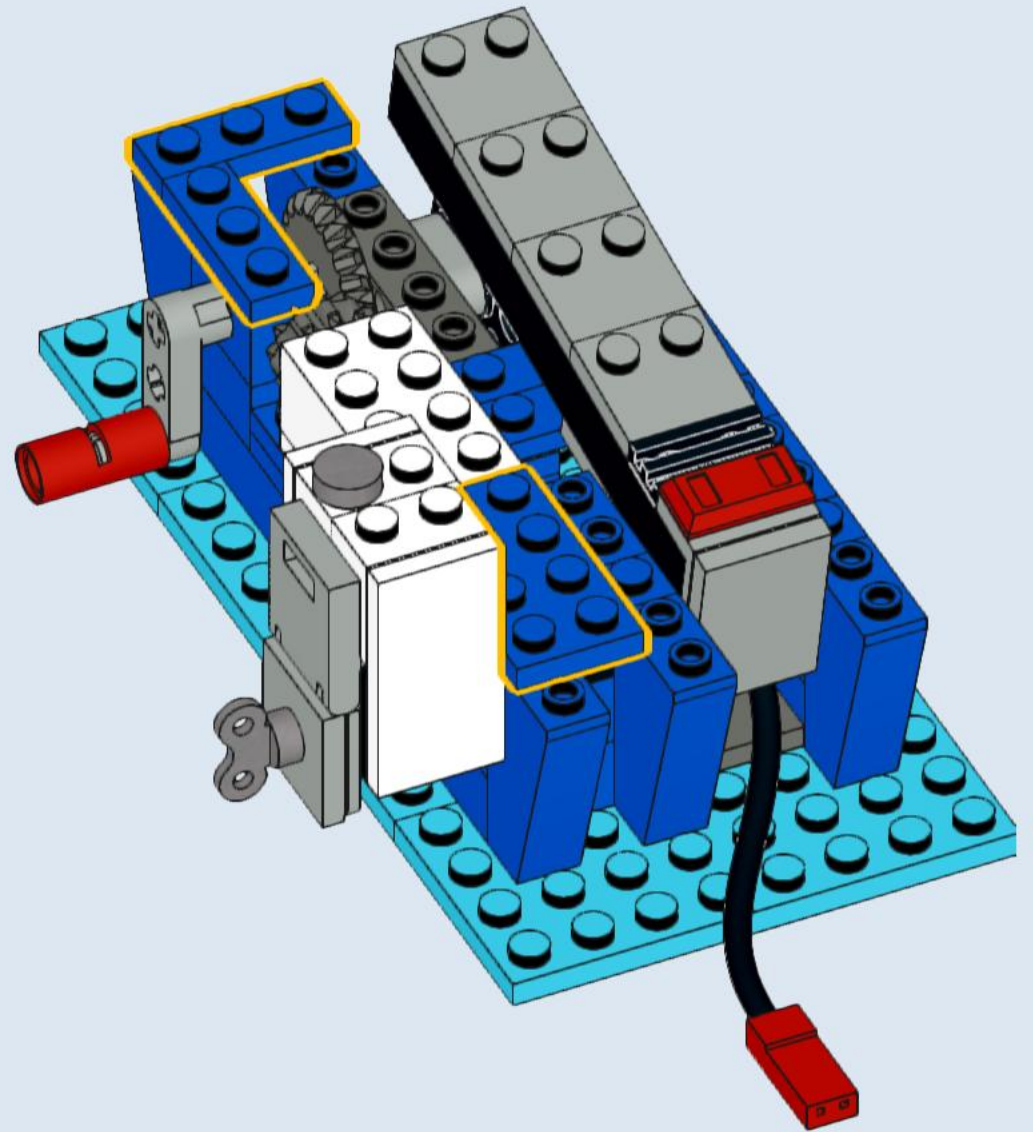

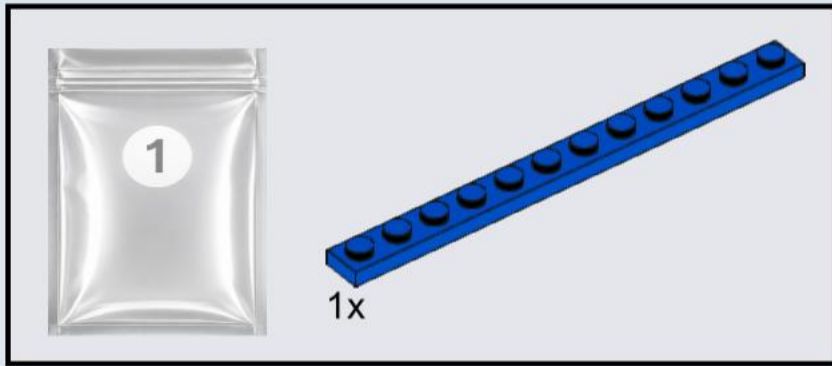

30

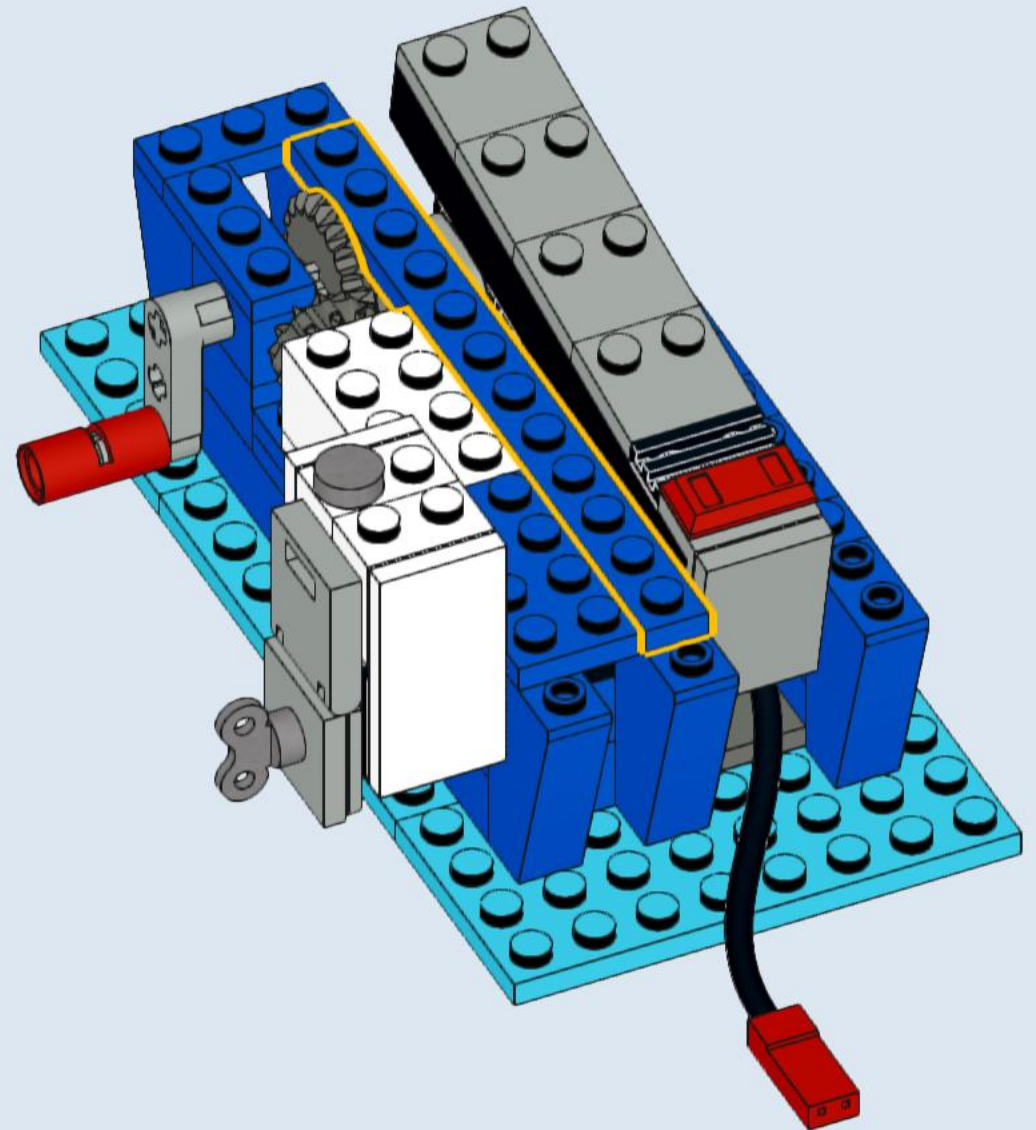

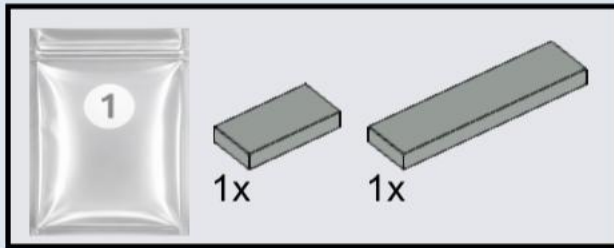

31

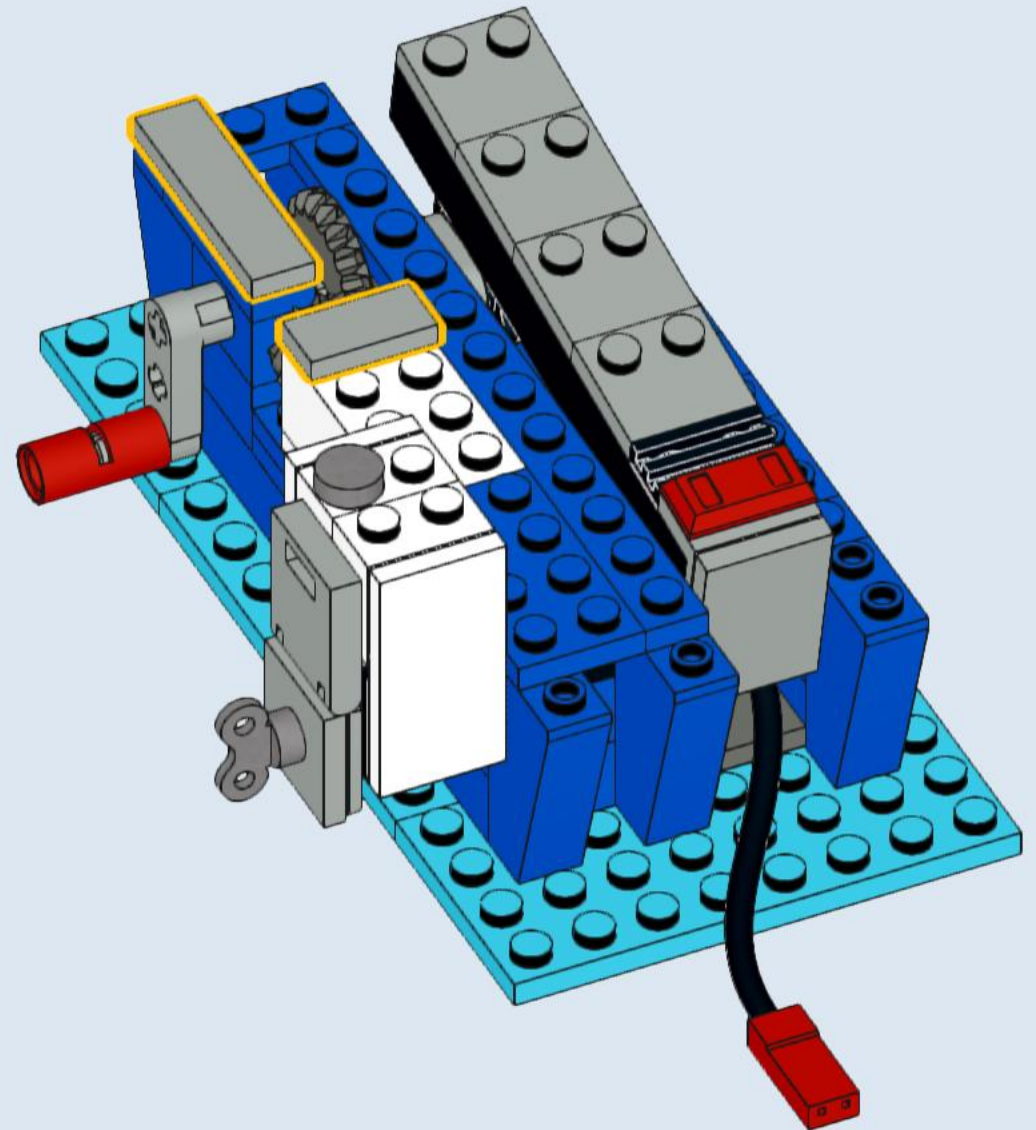

Original parts

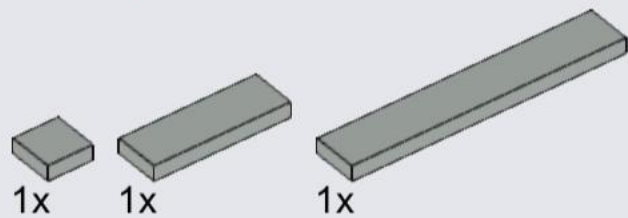

32

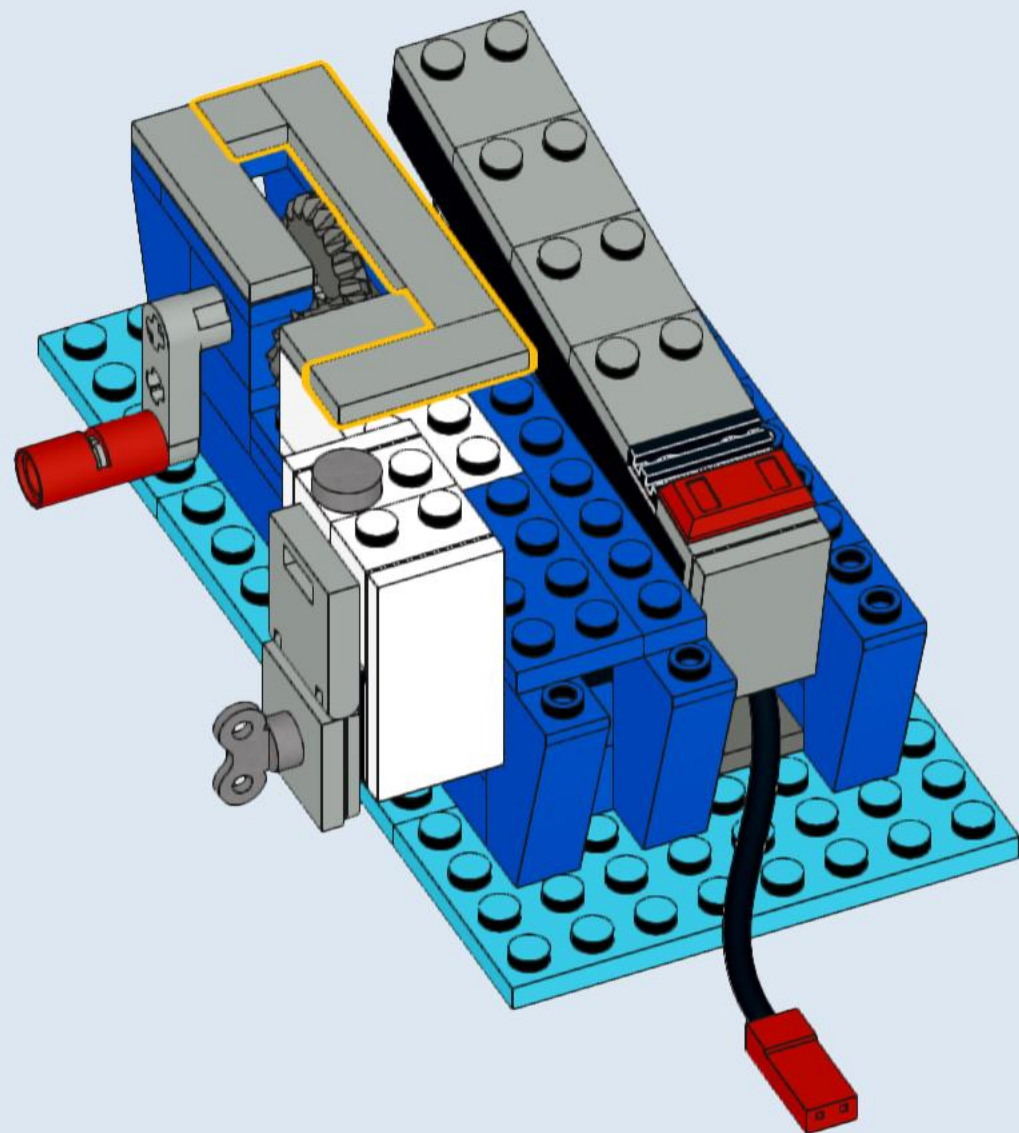

Original parts

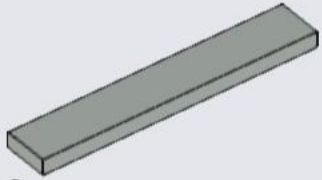

3x

33

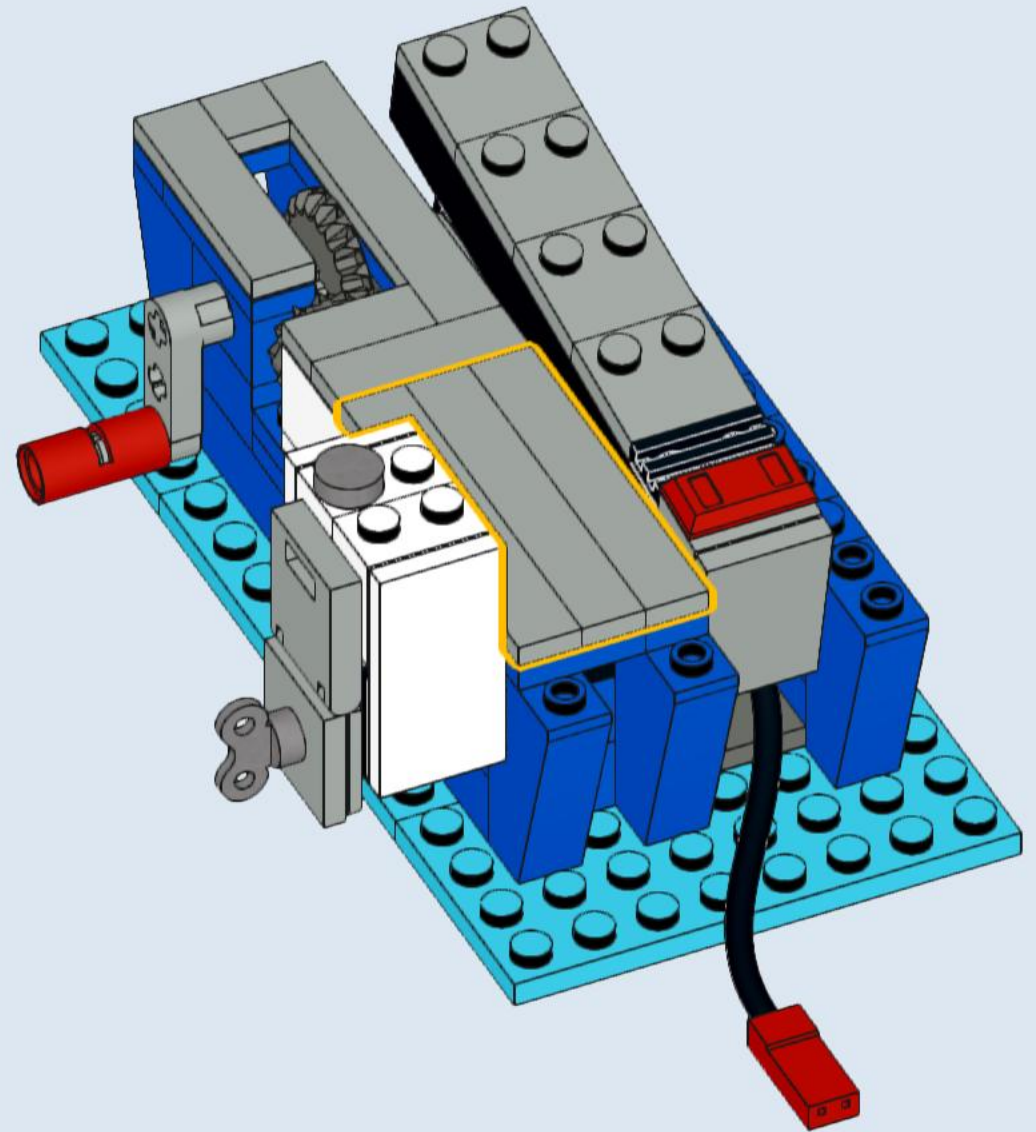

Original parts

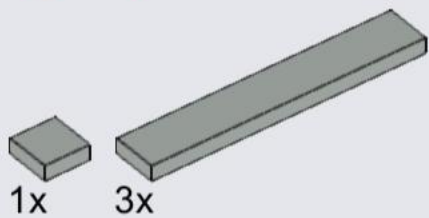

34

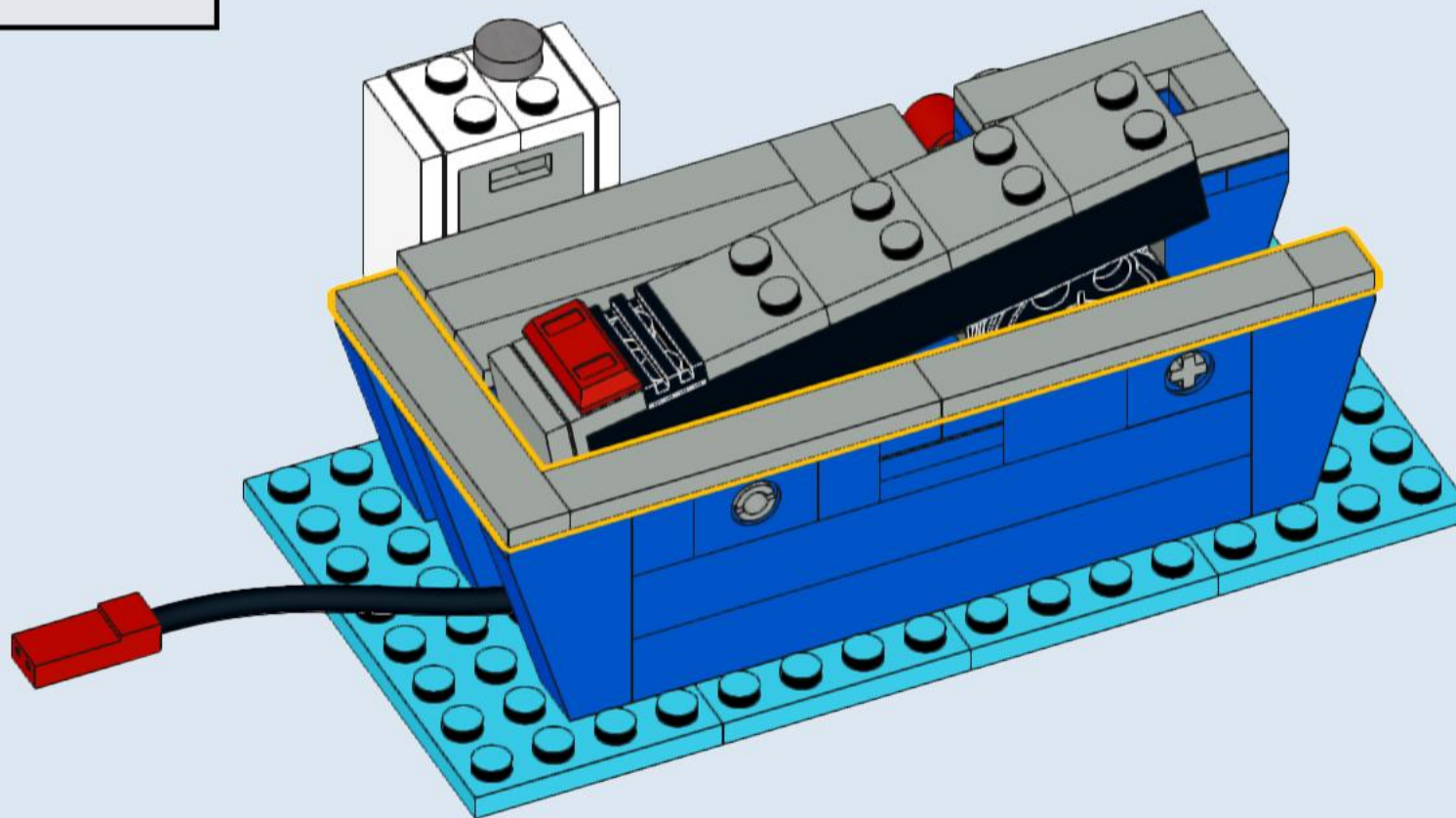

35

Take out the speed control switch



36

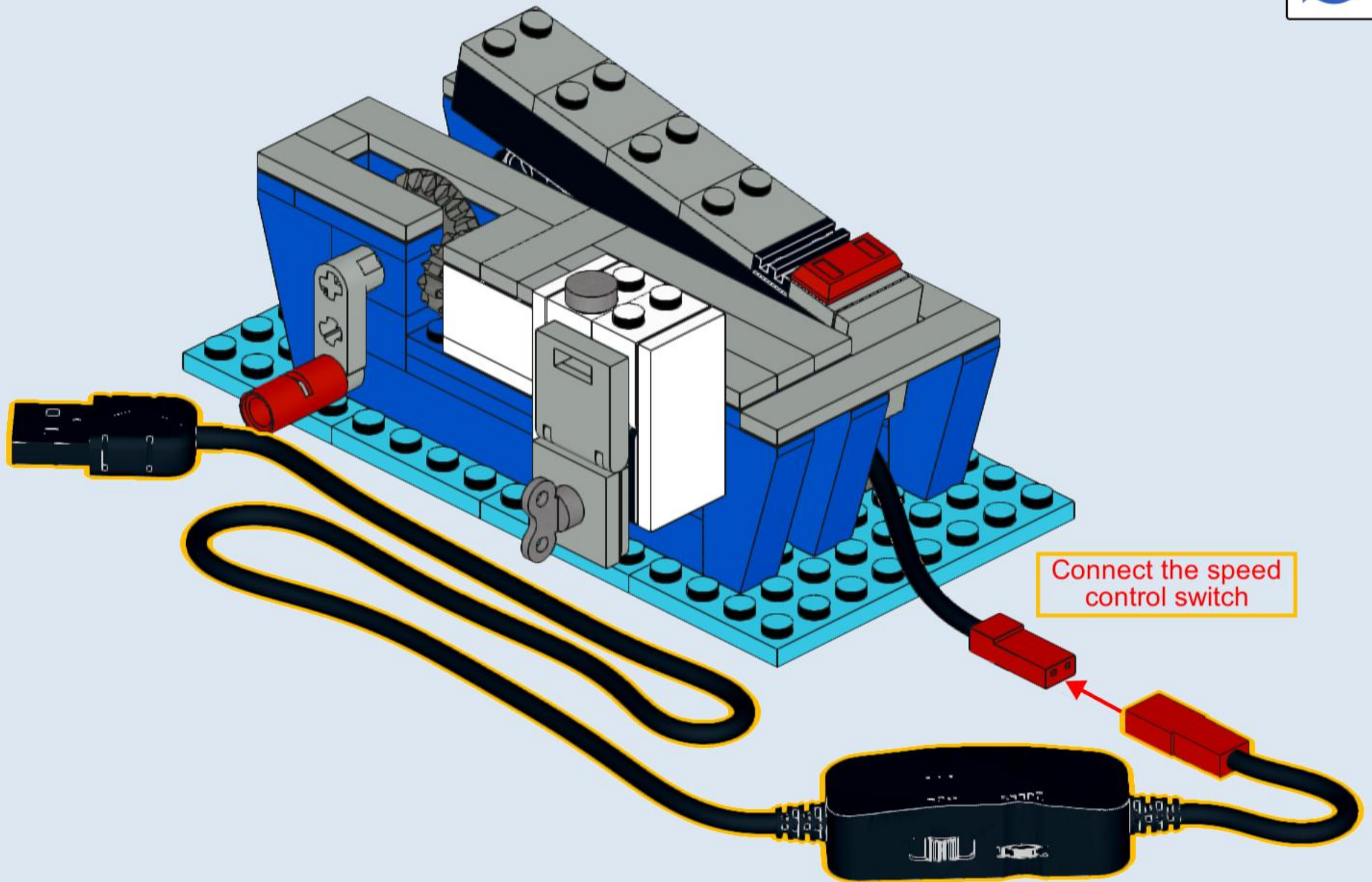

Connect the speed control switch

# 37



Building Position Preview

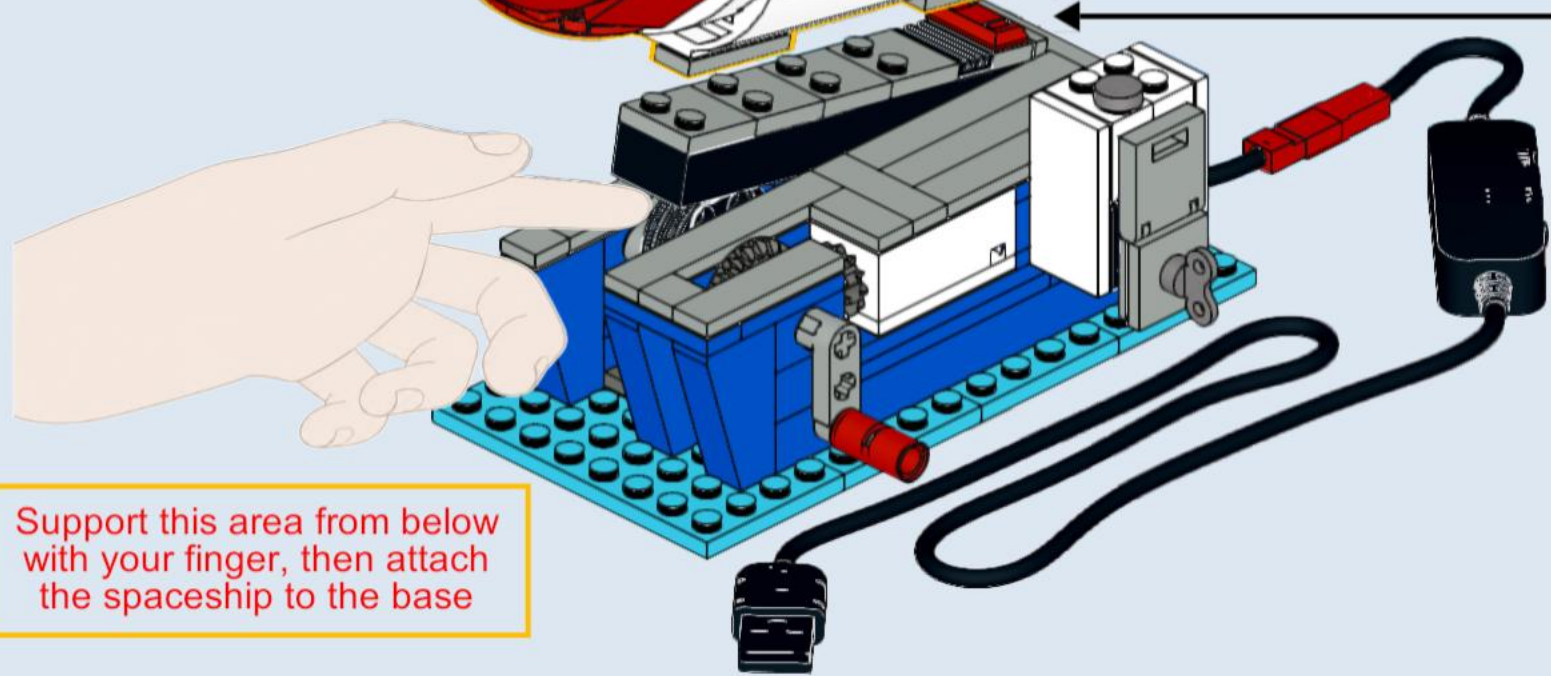

Support this area from below with your finger, then attach the spaceship to the base

38

Put the alien into the spaceship

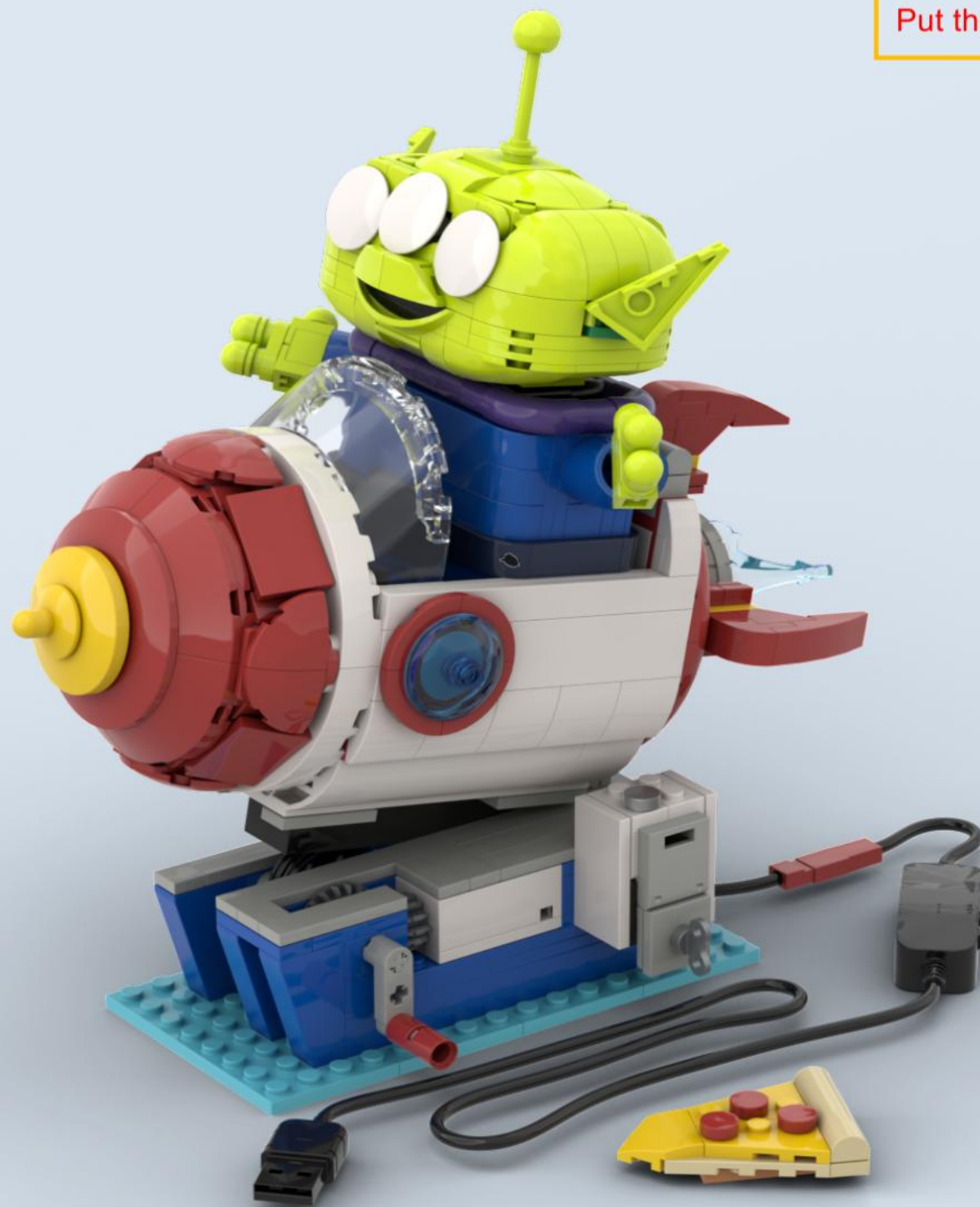

installation complete

