

75375 Millennium Falcon

- Installation requires a lot of patience and great observation that your LEGO bricks will come alive when you get this finished. The bricks with lighting as below, so make sure you're ready and let's get started.



Strategies for the Installation

This instruction divides three sections to complete the installation of the lighting set.

Section A: Check the type and quantity of components.

The quantity and type of components of each products are different and it needs to be carefully checked to make sure there do have enough material. The type of components is indicated by the label on the bag.

Section B: Test that each components is working properly.

Each components is made individually so it is necessary to test that each components is working properly to avoid the situation that the lighting does not work .

Section C: laying out components following the instruction.

Our material is very small but not fragile, just be reminded that don't to pull the wires too hard. For different people, there may be some installation steps that you can't understand. Please look at the previous and later installation step.

Section A: Check the type and quantity of components.

There are 14 bags in this set. The name and quantities of specific components are as shown , please check carefully.

Label	Content	Quantity
A01001 Light-15CM Warm White	Light-15CM Warm White	1
A01003 Light-15CM Red	Light-15CM Red	2
A01105 LED Strip Warm White	LED Strip Warm White	1
A012 Expansion Board	6 Socket Expansion Board	1
	8 Socket Expansion Board	2
A01305 Power Supply	Power Supply	1
A01501 Connecting Cable 5CM	Connecting Cable 5CM	2
A01505 Connecting Cable 10CM	Connecting Cable 10CM	2
A02103 Flash Light-15CM Red	Flash Light-15CM Red	1
A02513 Light Strip-Cyan-COB	Light Strip-Cyan-COB	1
A03801 Remote Control	Remote Control	1
A1033 High-Brightness Light 15CM-Green	High-Brightness Light 15CM-Green	2
A1035 High-Brightness Light 15CM-Blue	High-Brightness Light 15CM-Blue	6
A1037 High-Brightness Light 15CM-Cyan	High-Brightness Light 15CM-Cyan	4
Components		

Please contact us immediately if there have any missing components.

Section B: Test that each components is working properly.

We need a structure to test all lights, so take out the bag with label “USB Power Cord” and “Expansion Boards” as follows.



It is worth reminding that our products are all customized. They have a unique way of connecting. The white plug on wire and the socket of the expansion board need to be connected together to transmit power.

Note that on one side of the white plug you can see two very small golden wires that should be connected to the two golden needles in socket of the expansion board. shown as blow.

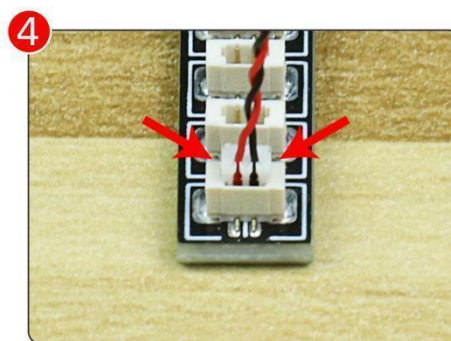
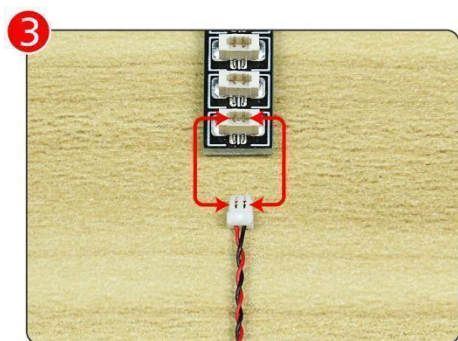

All our connections between plug and socket are all the same as shown above. So for any such structure with plug and socket, please pay attention to the golden wire of the plug and the golden needle of the socket, they must be touched together.

The connection method between the USB Power Cord and Expansion Boards is as follows:



The USB Power Cord can be powered by phone chargers, power banks, etc.

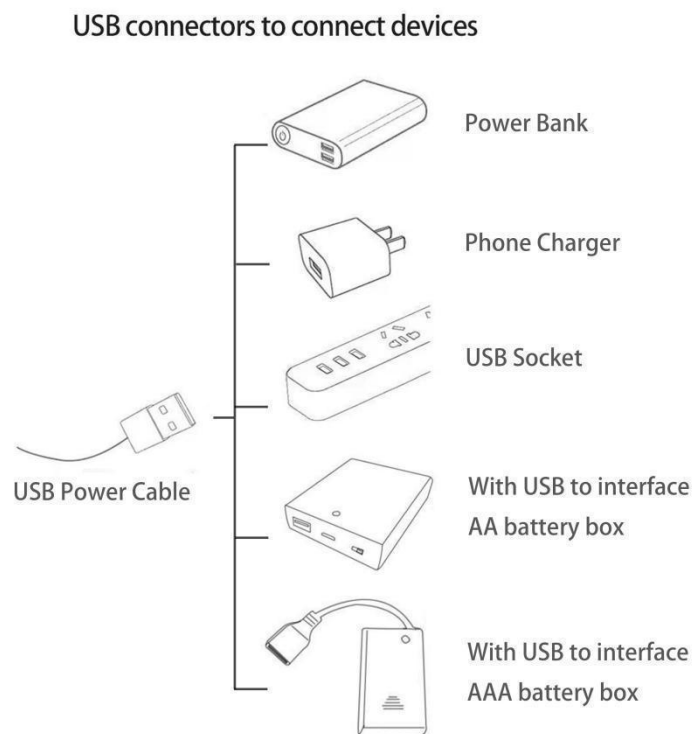

Remote control test:

Take out the remote control and the remote control module.



Please purchase CR2025 model batteries in advance at the store.



Take out the lights.(Attention:The lights shown are for demonstration purposes only and are not included in the package.)



Take out the USB power cable.



Connect them to the remote control module.

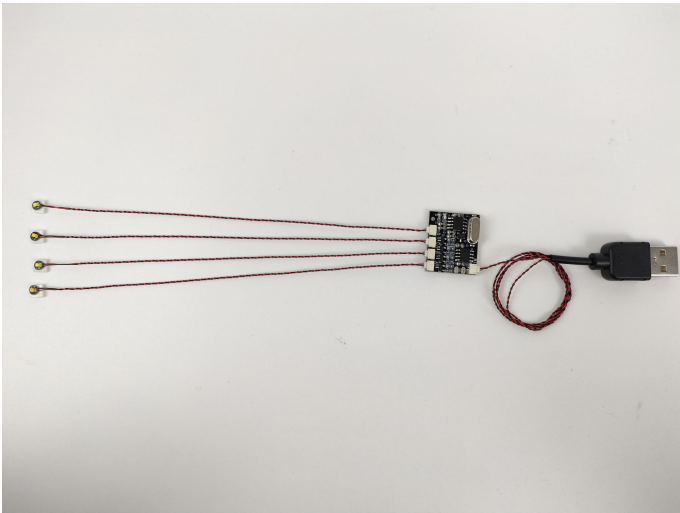

Connect the power.



**Press the on button and the light will come on normally.
If there is any problem with the parts, please contact our after-sales service for replacement.**



**If there is any problem with the spare parts,
please contact our after-sales service for replacement!**

This instruction will use the power bank as power supply . The test structure is shown as follow. All lamp in this set will be tested by this structure.



When we test "A01001 Light-15CM Warm White" particles,Take out the bag labelled "A01001 Light-15CM Warm White".Take out one of the light and connect it to the socket. Turn on the power bank, the light will turn on normally as shown below.

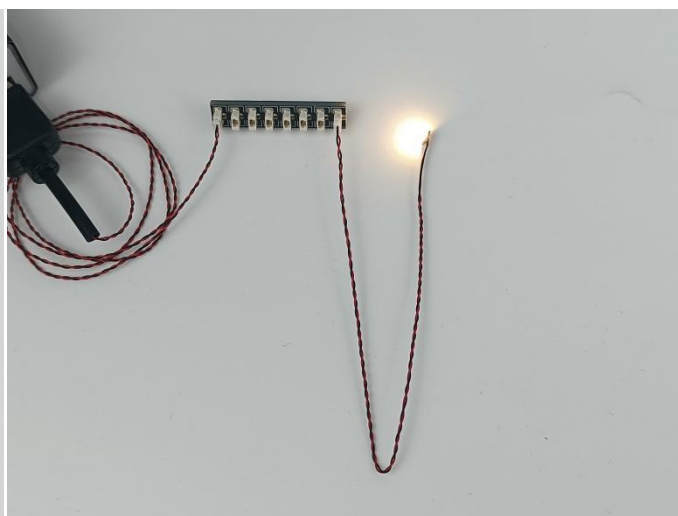

Test each lamp according to this method. It should be noted that after the test, the lamp must be returned to the corresponding bag to avoid confusion of types.



LED strip test:

Take out the bag labeled "A01105 LED Strip Warm White". Take out the LED light bar, connect the USB power cable, turn on the mobile power supply, the light will be on normally, as shown in the figure below.



The components needs to be tested in this set is 2*Light-15CM Red,1*LED Strip Warm White,1*Flash Light-15CM Red,1*Light Strip-Cyan-COB,2*High-Brightness Light 15CM-Green,6*High-Brightness Light 15CM-Blue,4*High-Brightness Light 15CM-Cyan.
Please contact us immediately if any components don't work.

Section C: laying out components following the instruction.

1



2



3



4

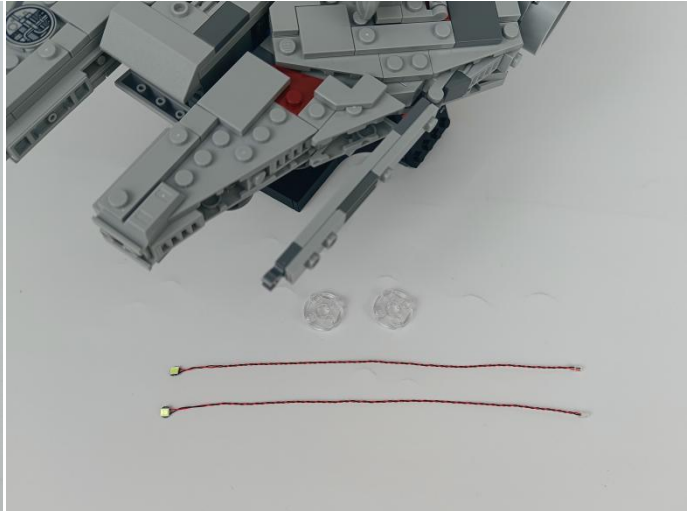

5

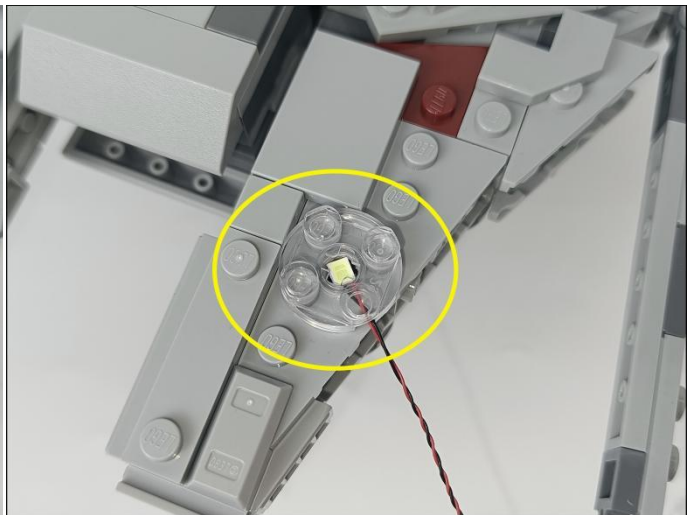
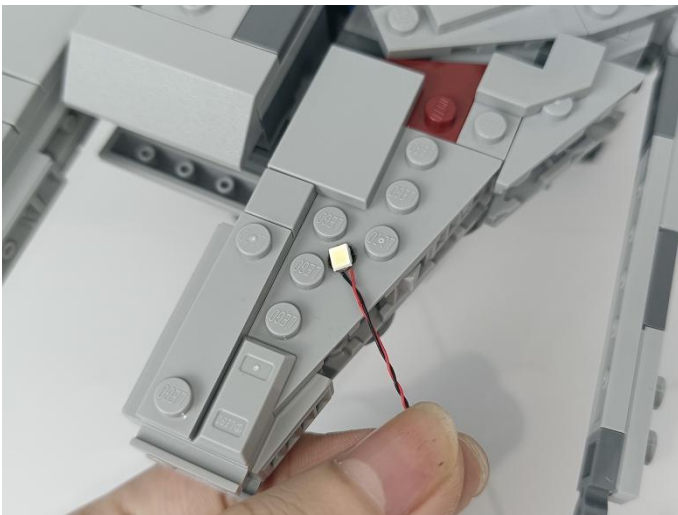

6

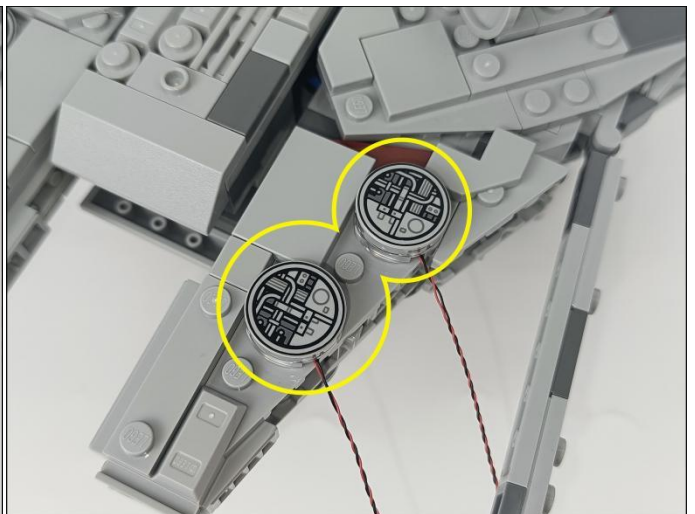
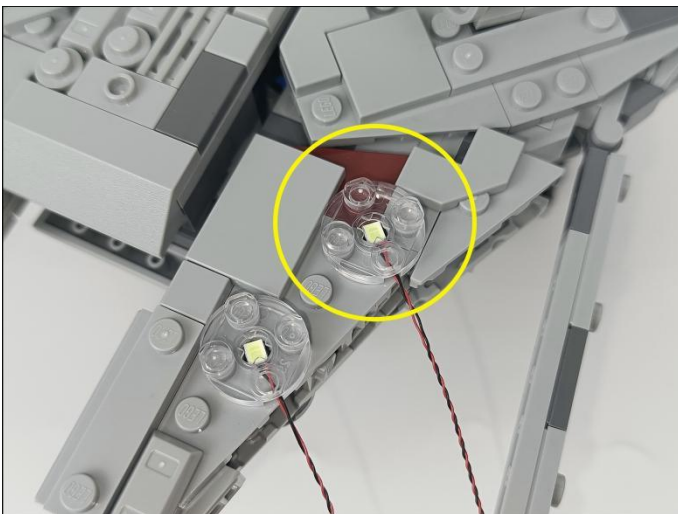

7

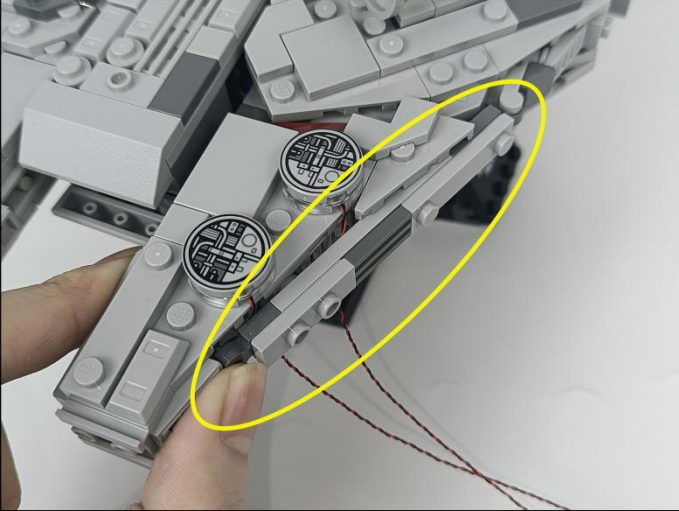

8



9

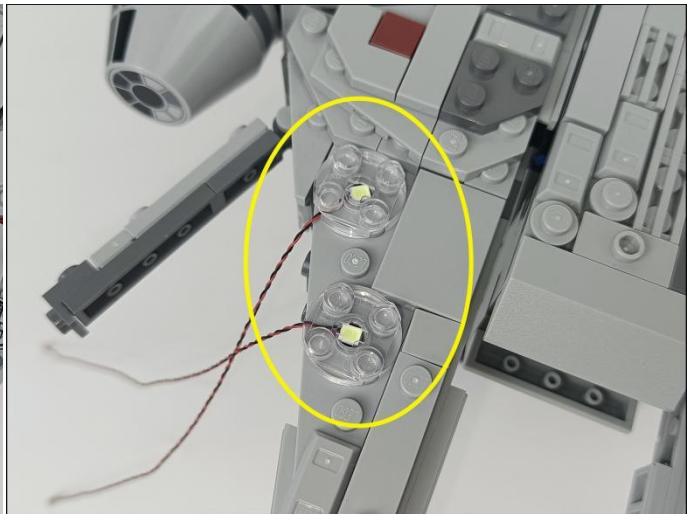

10

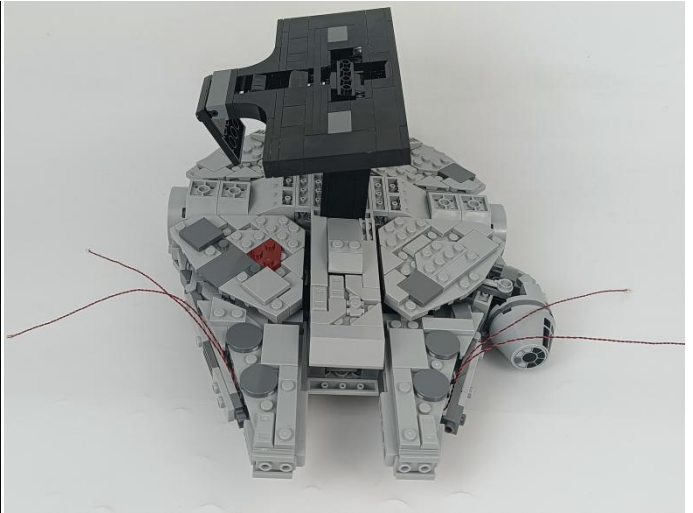

11

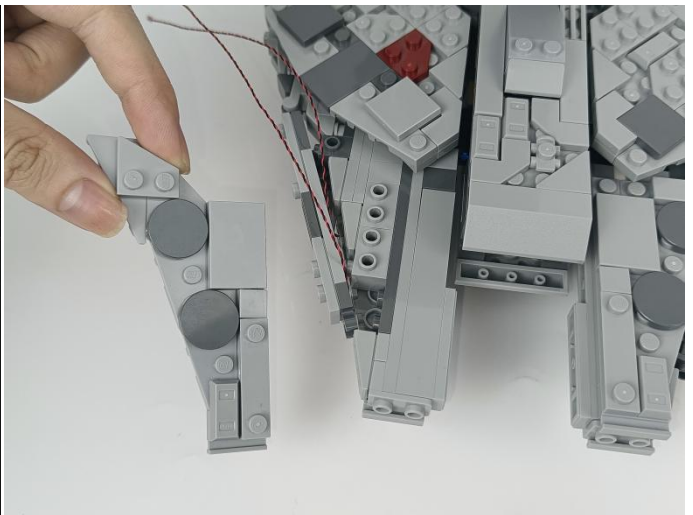
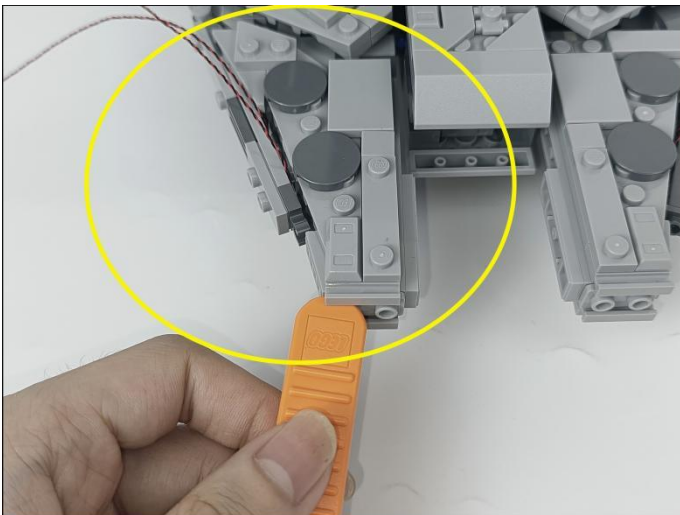

12

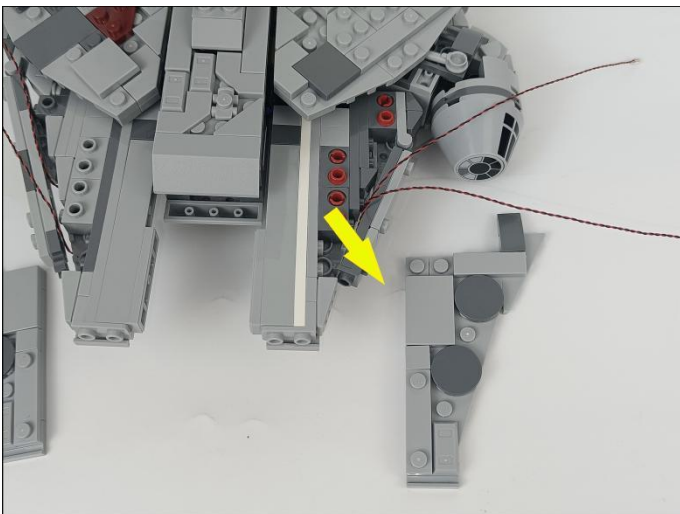

13

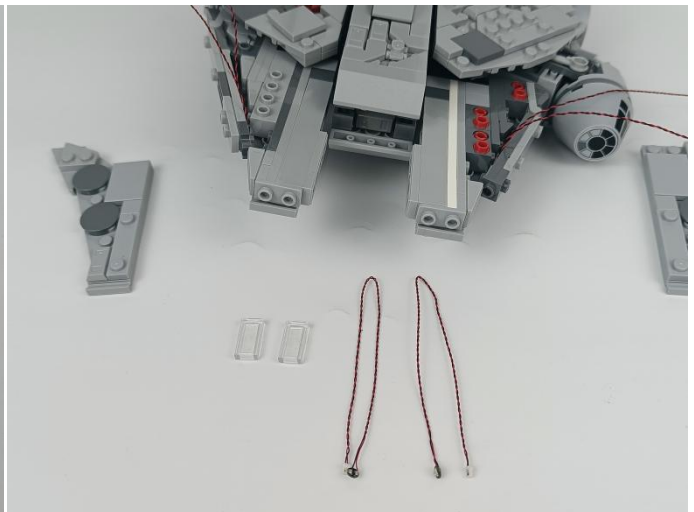

14

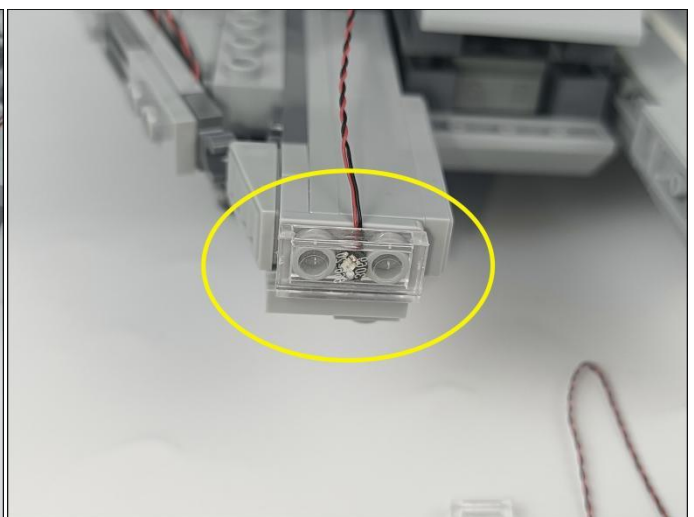
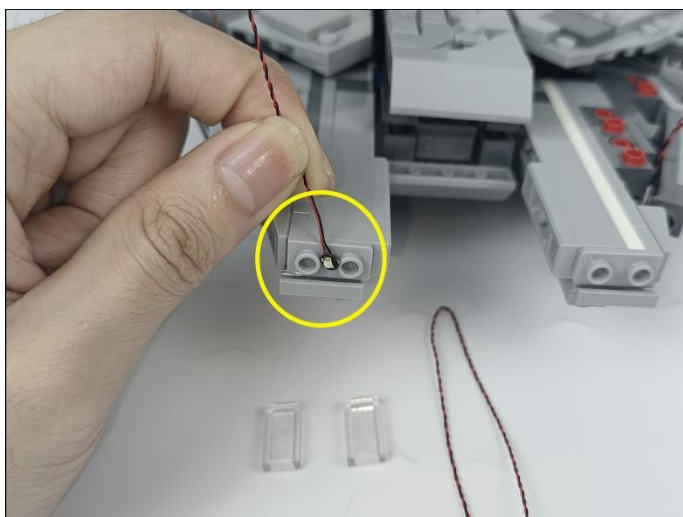

15

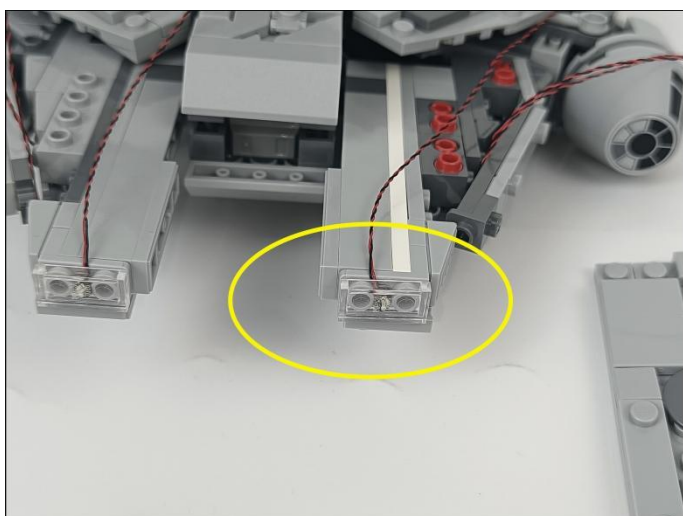

16

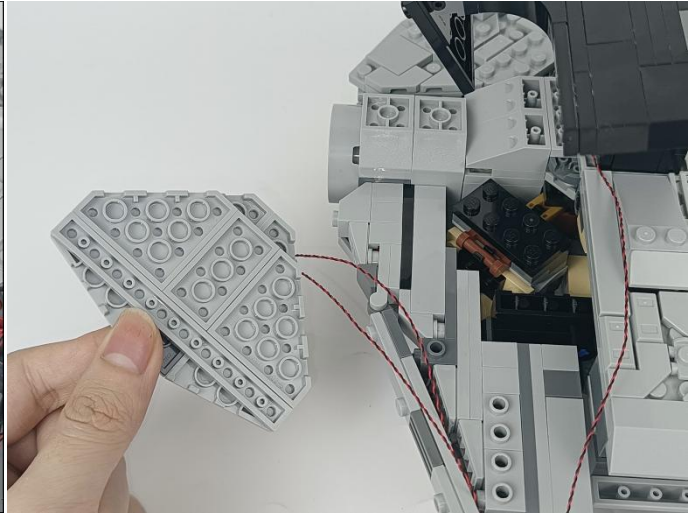
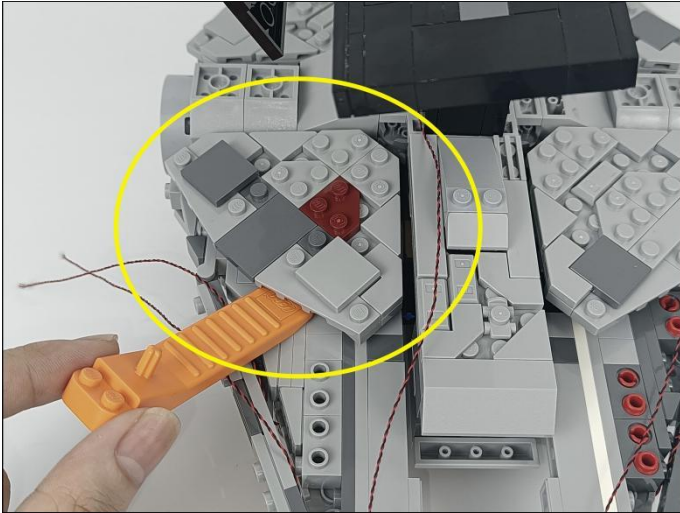

17

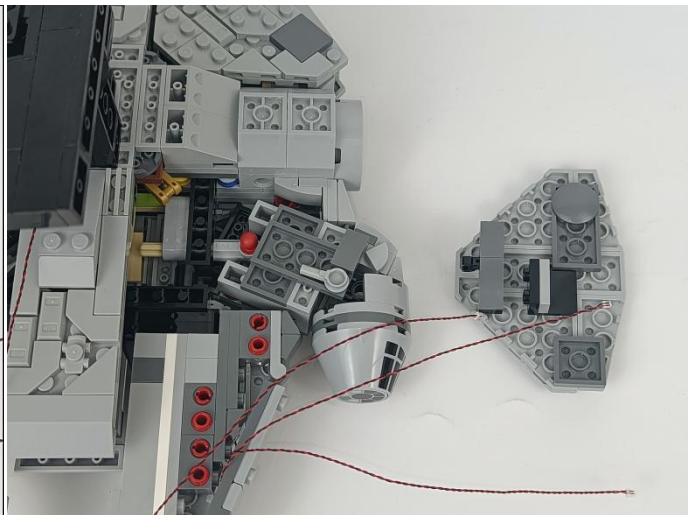
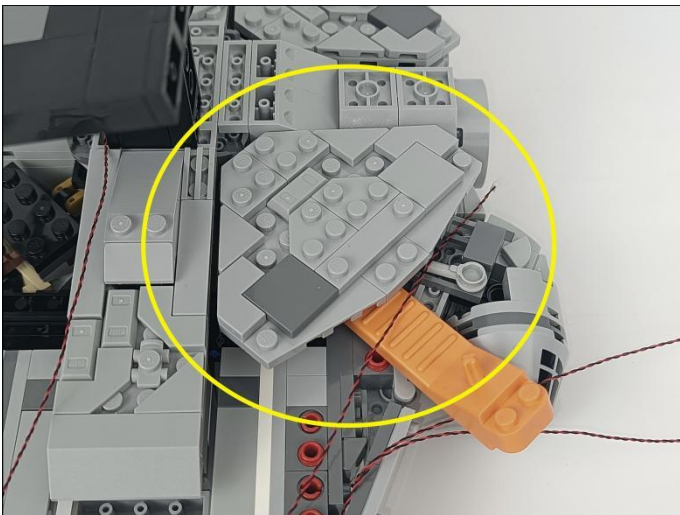

18

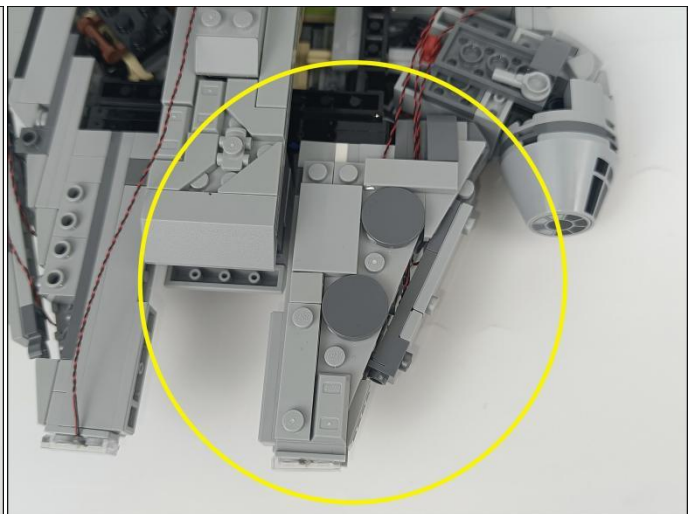
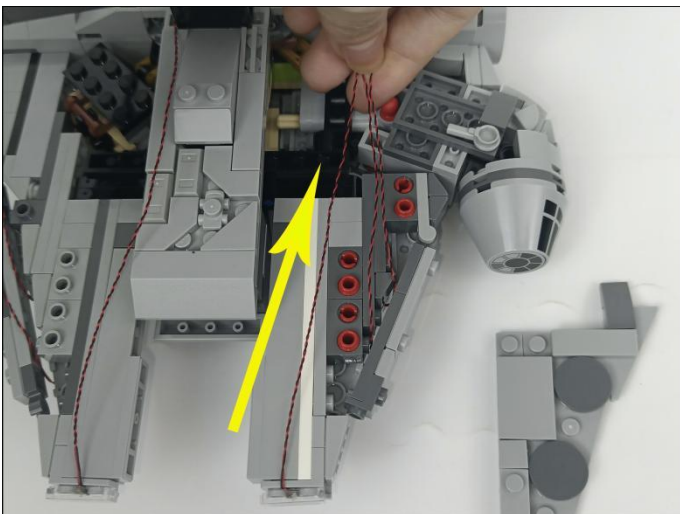

19

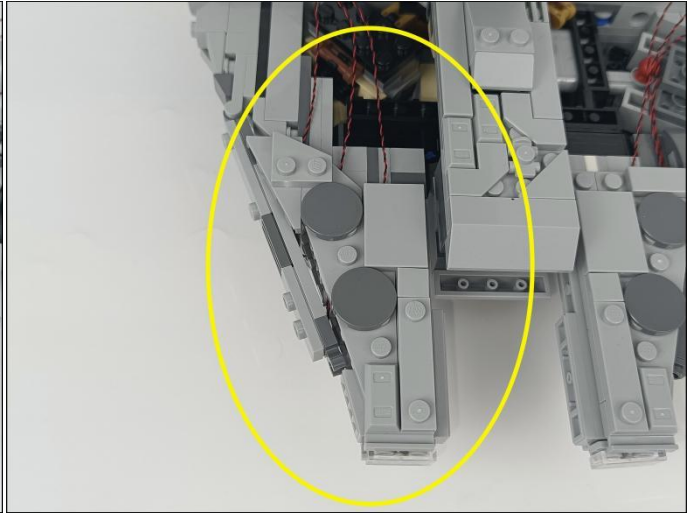
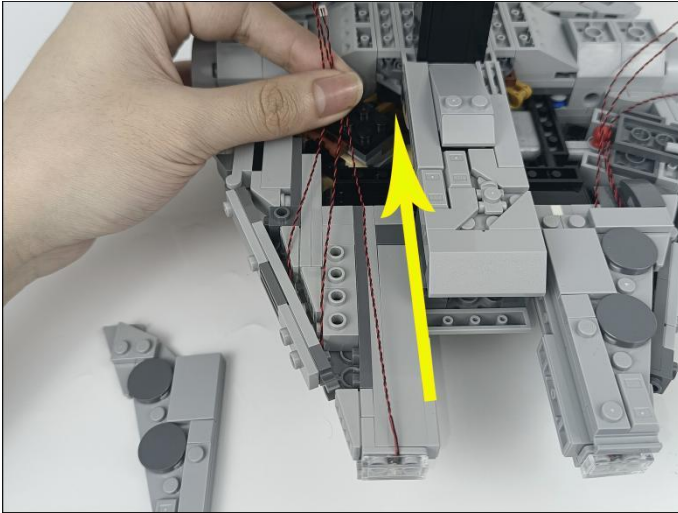

20

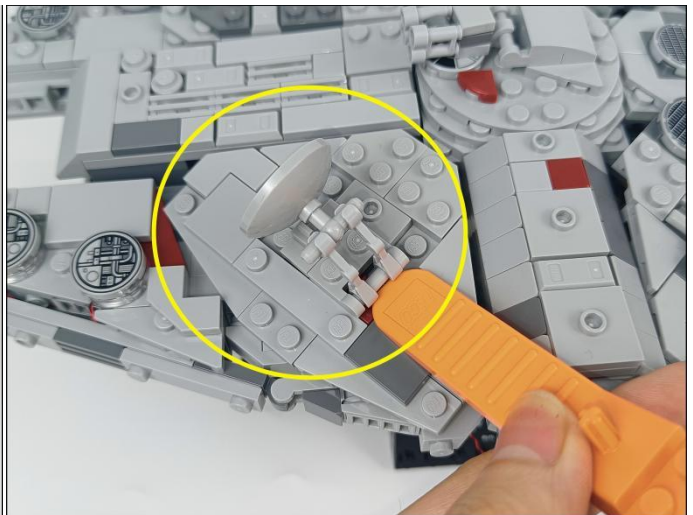

21

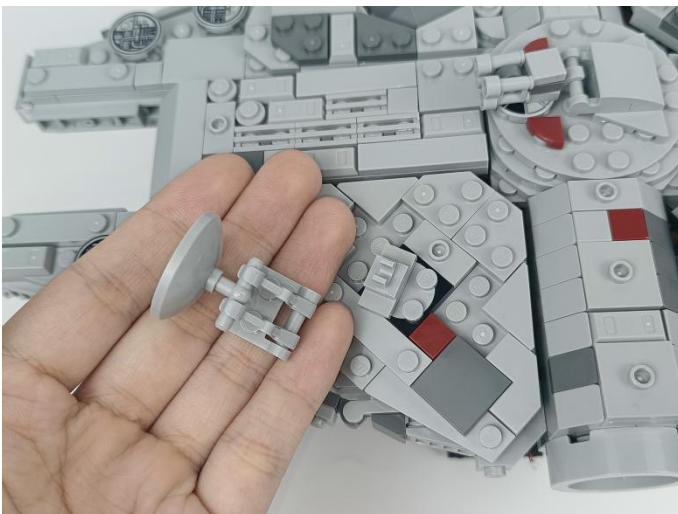

22

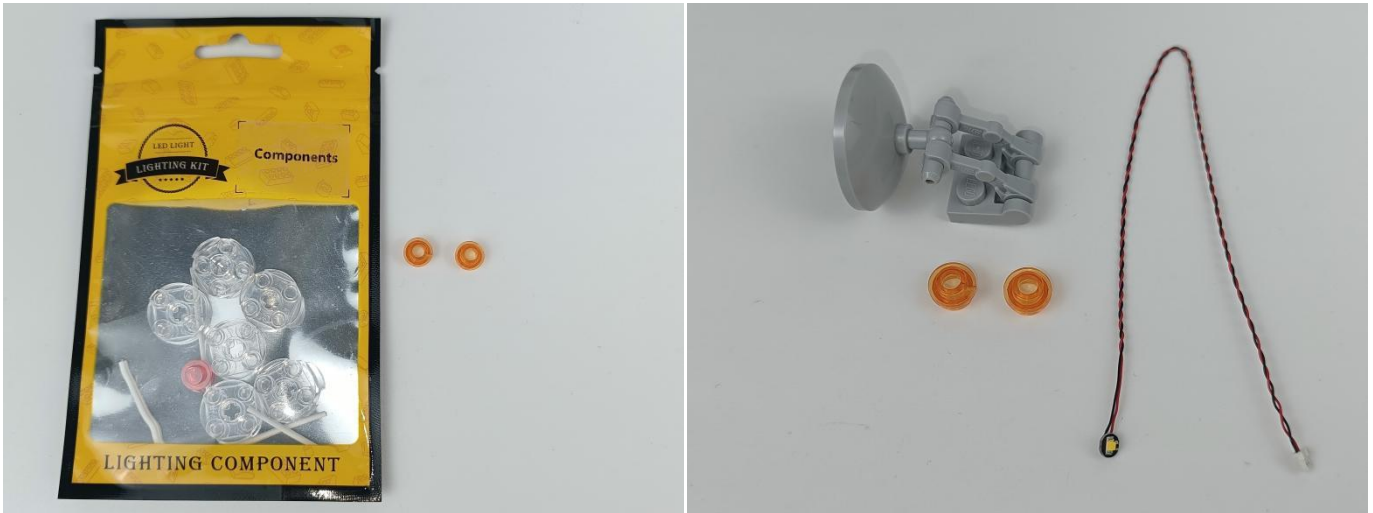

Tips

The plate without slit:

The plate without slit:

The squeeze causes the protective layer of the wire to be torn apart, the positive and negative wires touch together, and the set is short-circuited and the hot wire is crushed, the wire to be disconnected and don't work.



The plate with slit:

The plate with slit:

The wire has enough space to avoid being squeezed endowed with longer service life and more stable effect.



The slit on the the plate round 1X1 are hand-made to avoid squeeze the wire and cause short circuit and abnormal heat during installation.

23

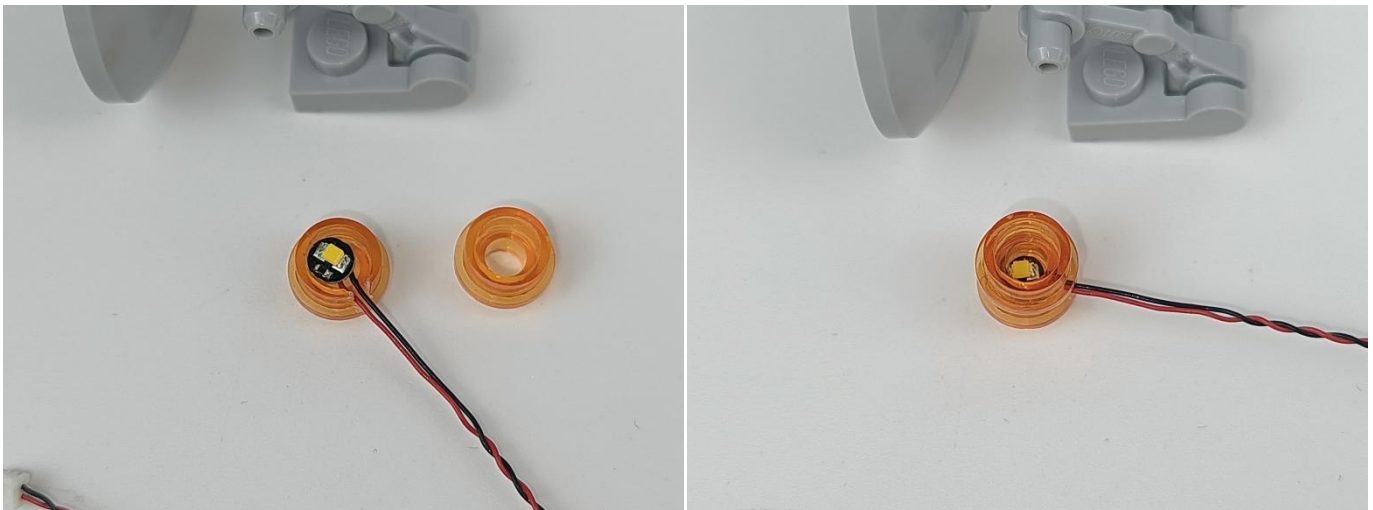

24

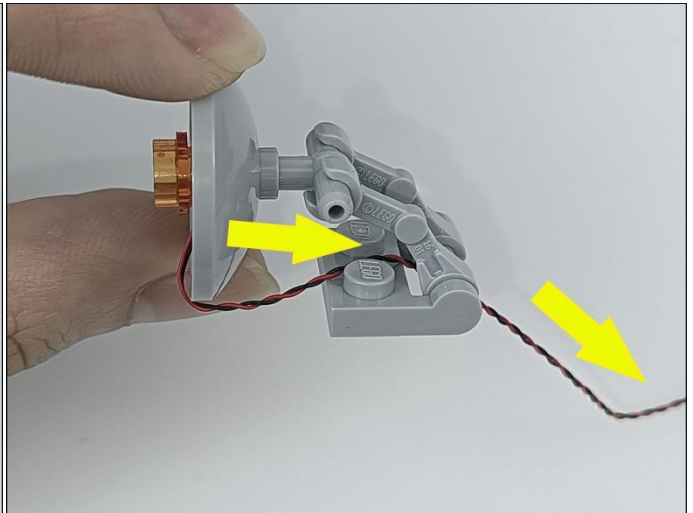
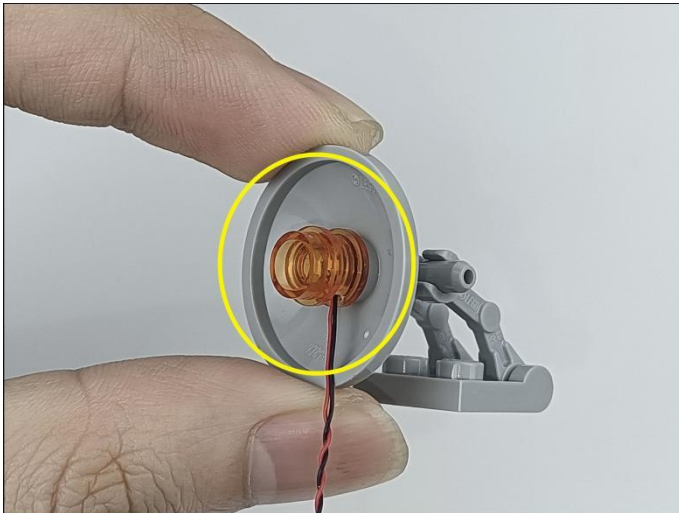

25

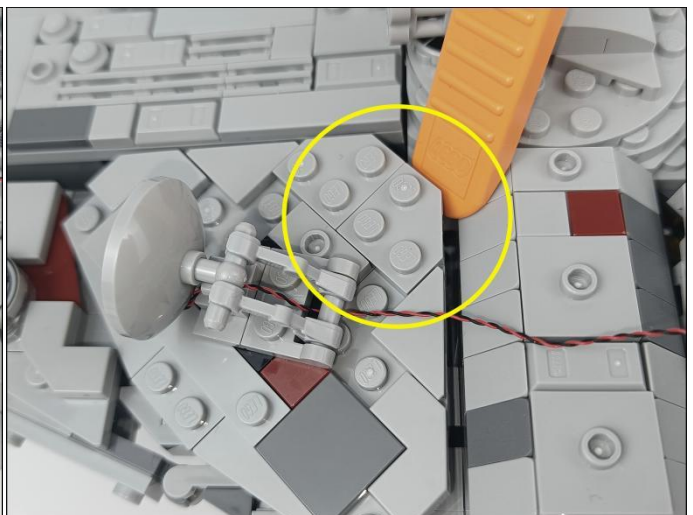
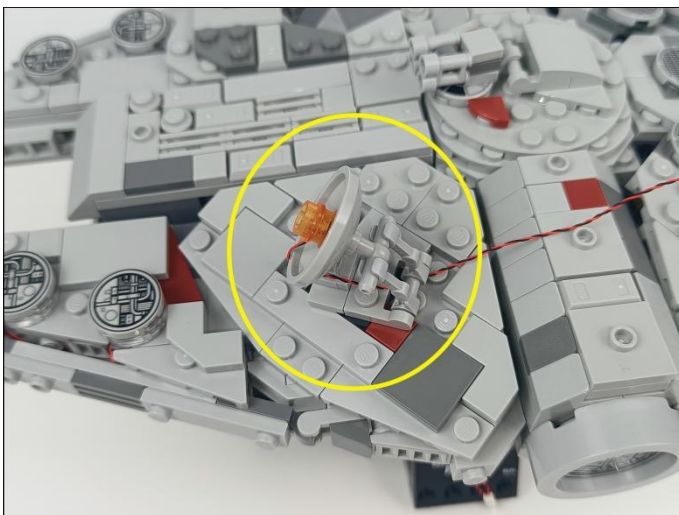

26



27

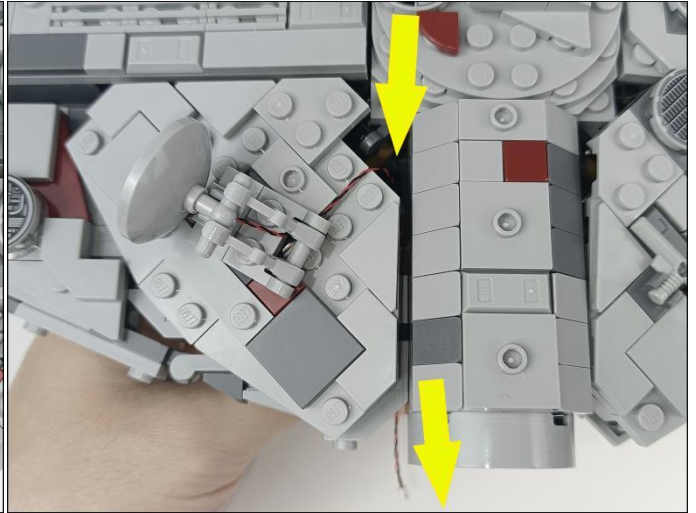
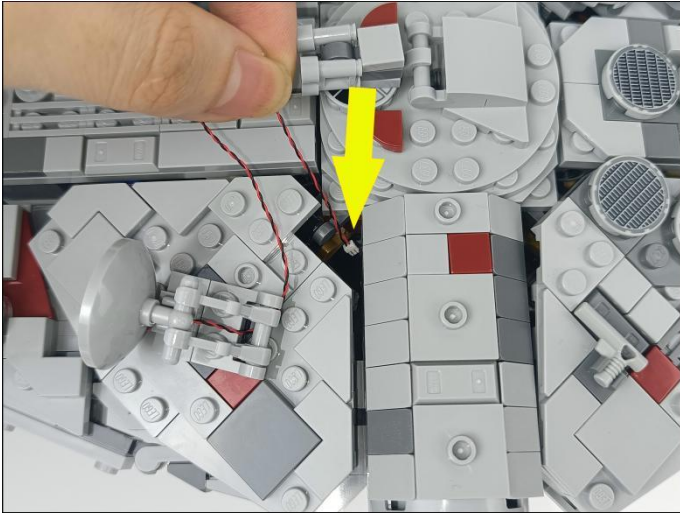

28

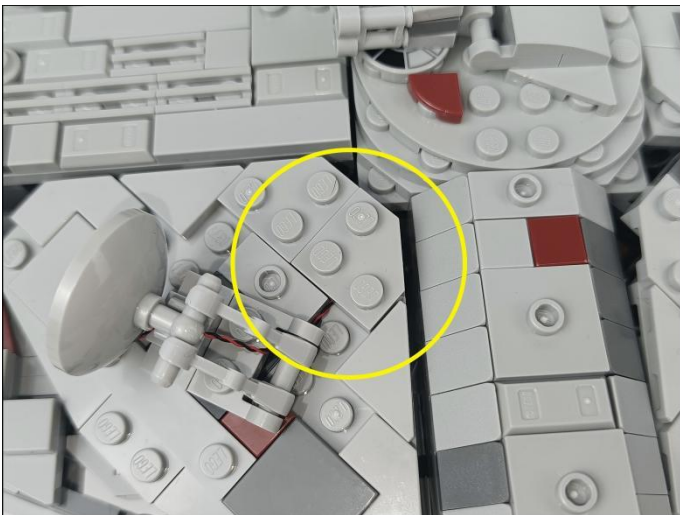

29

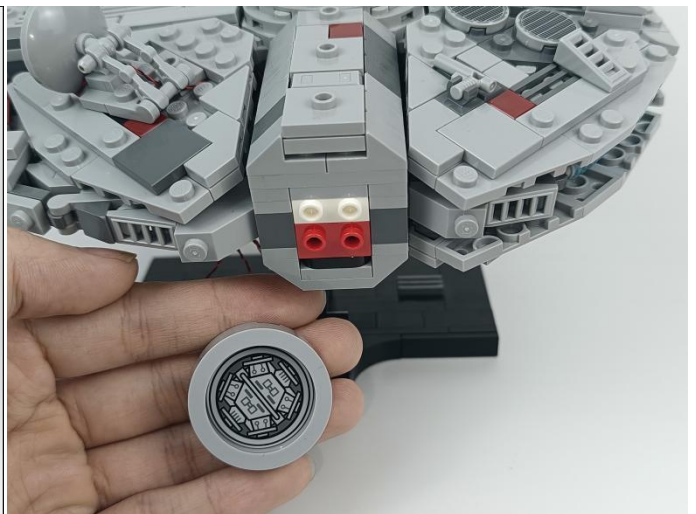
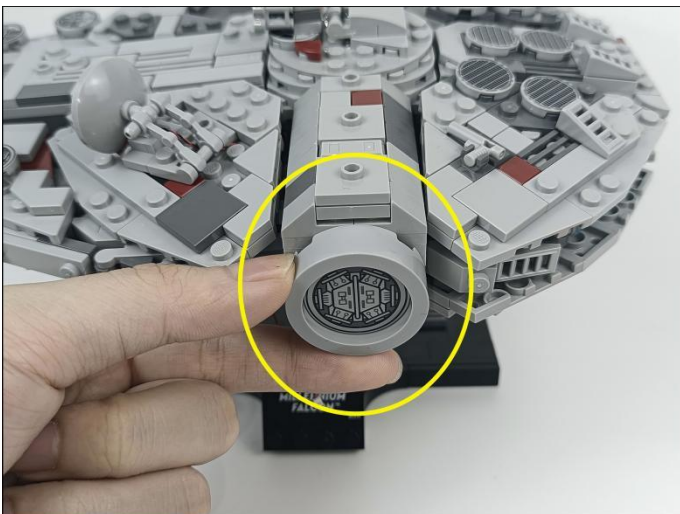

30

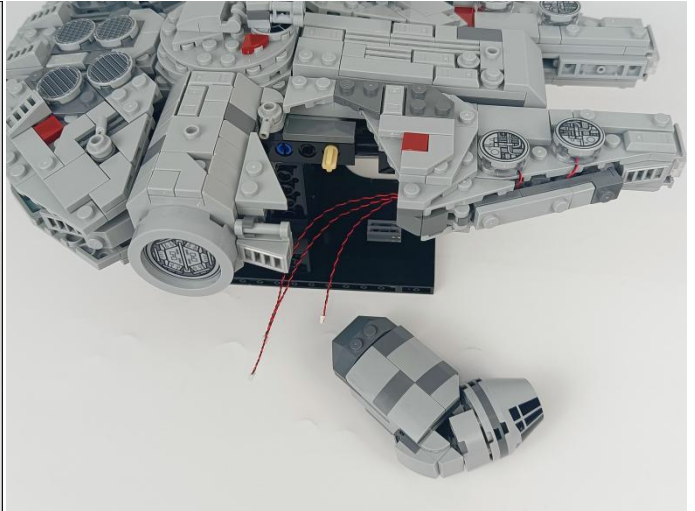
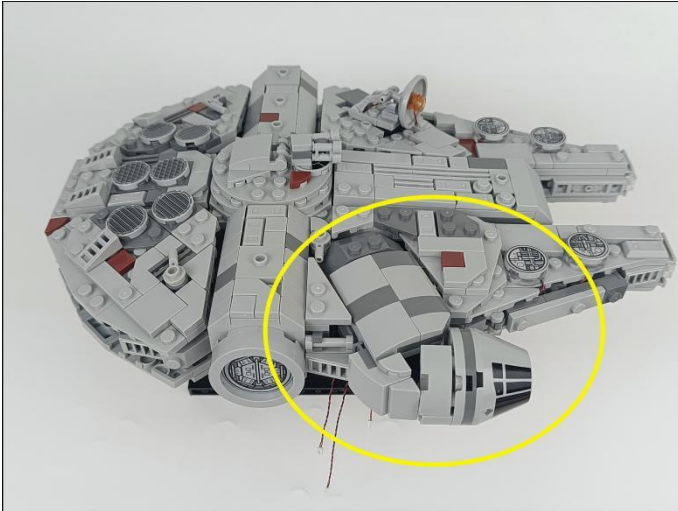

31

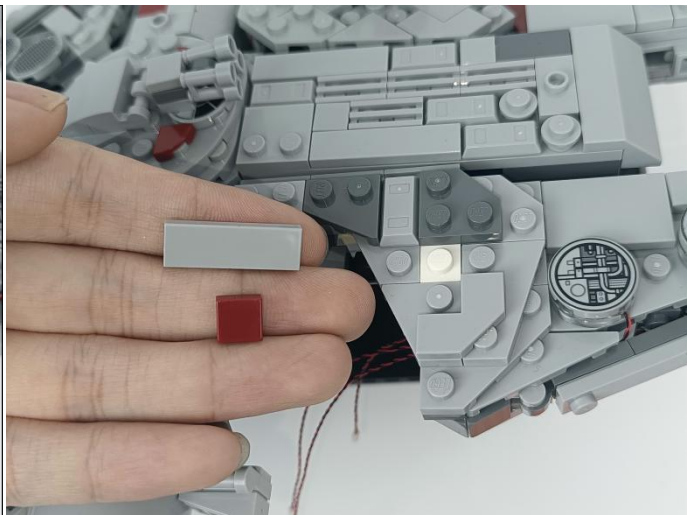
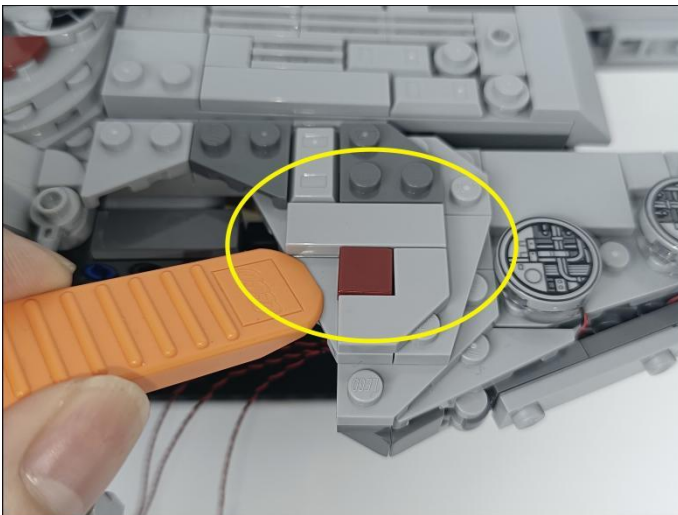

32



33

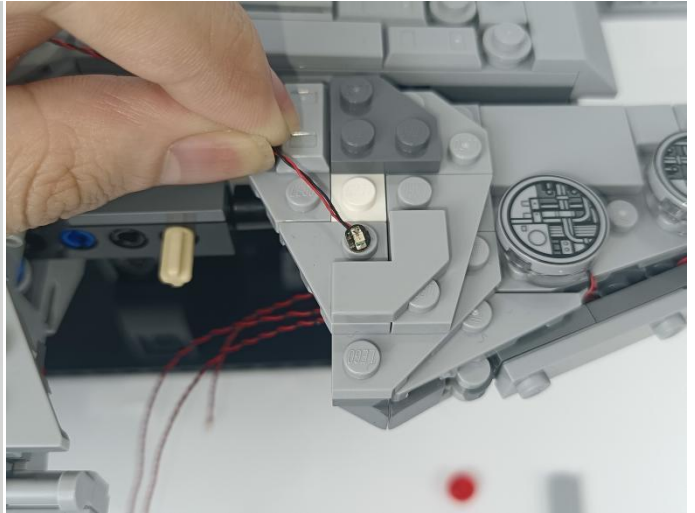
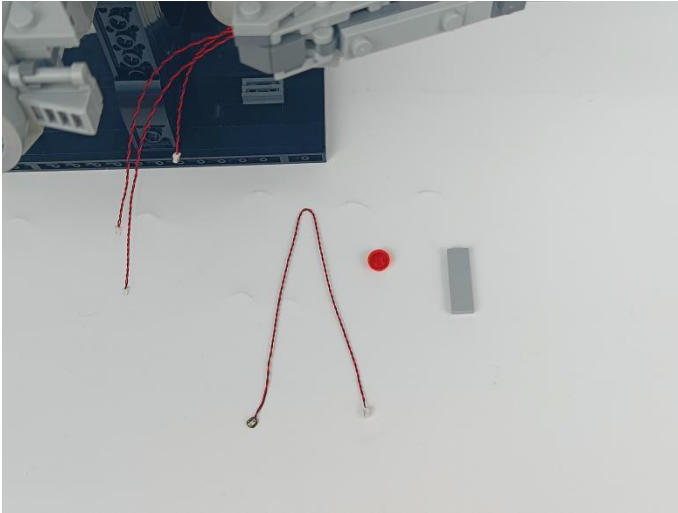

34

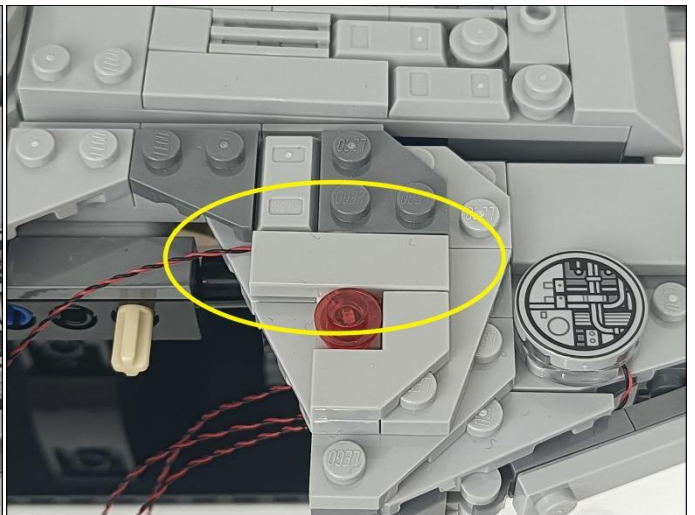
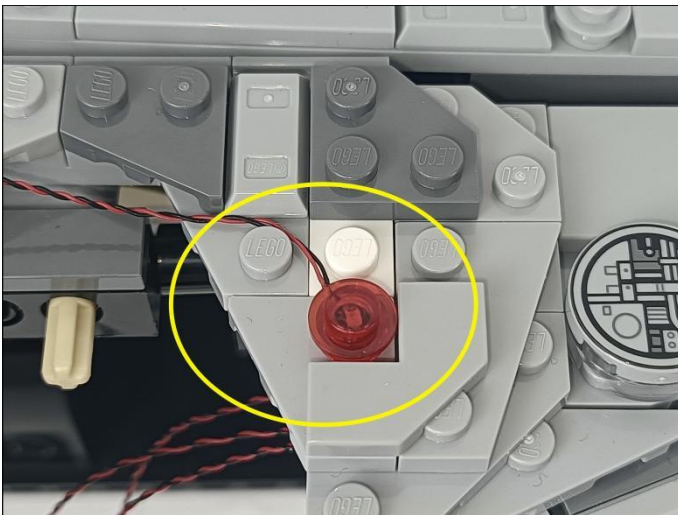

35

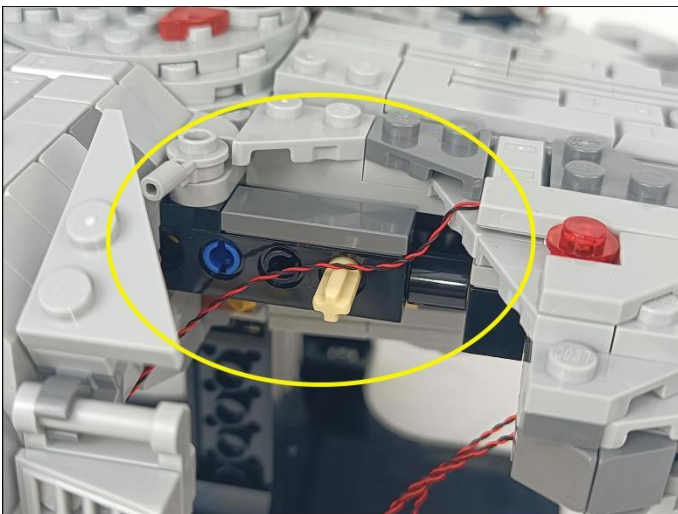

36

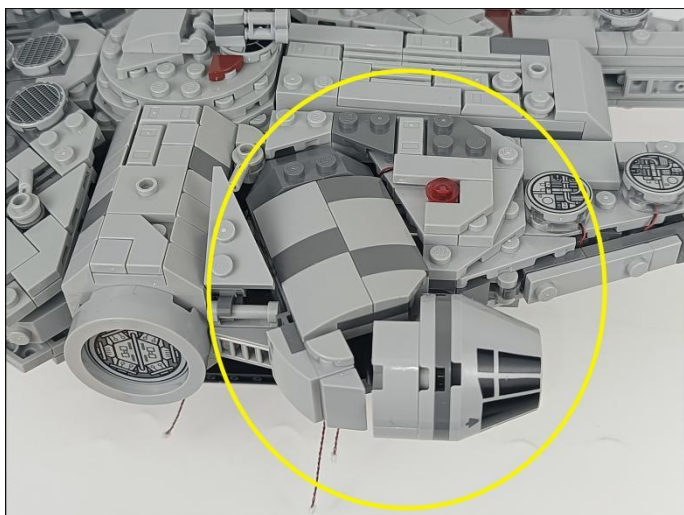

37

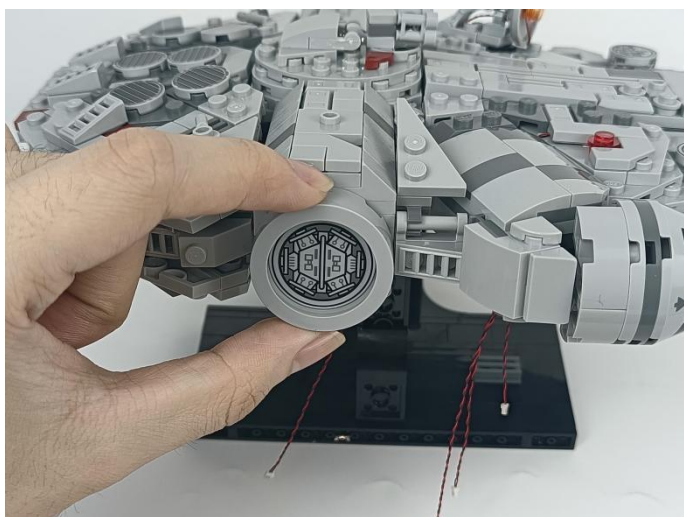

38

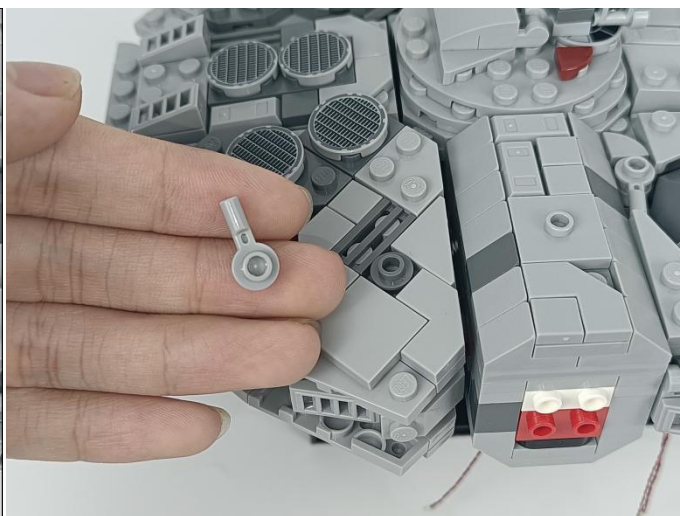
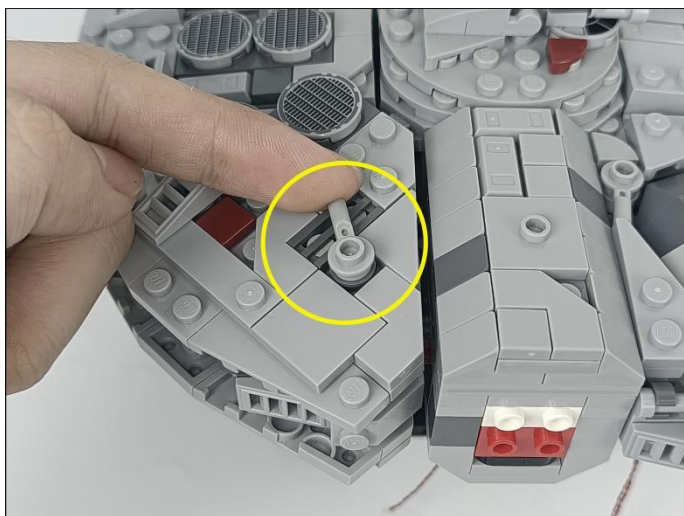

39



40. Look at the middle block hole and use the gray block pieces to push out the lower block pieces.



41



42

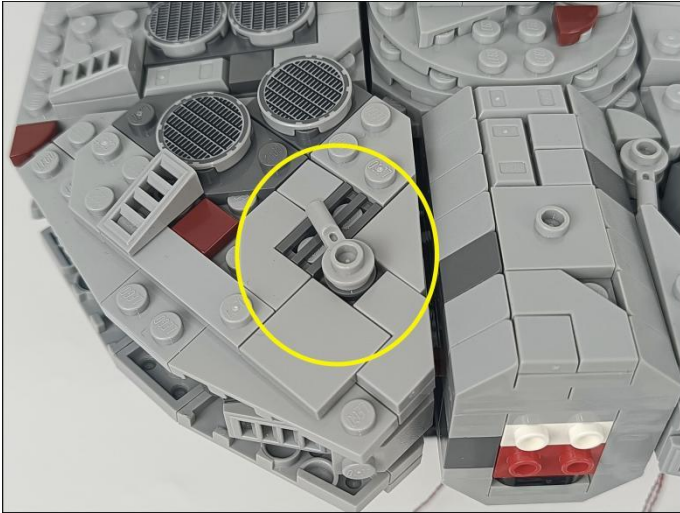

43

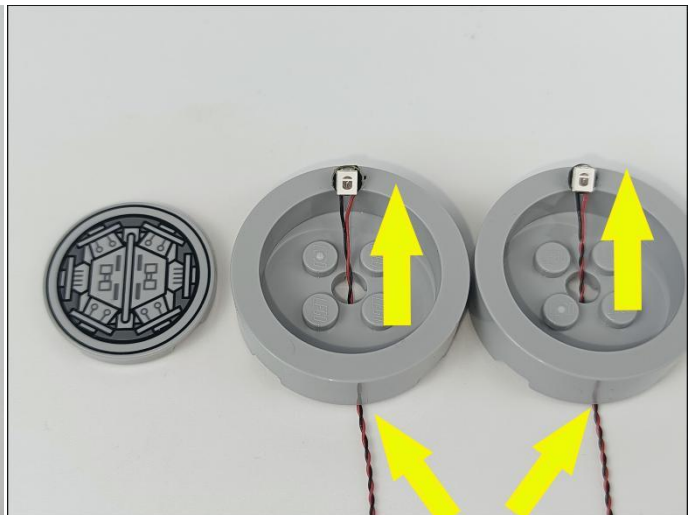

44

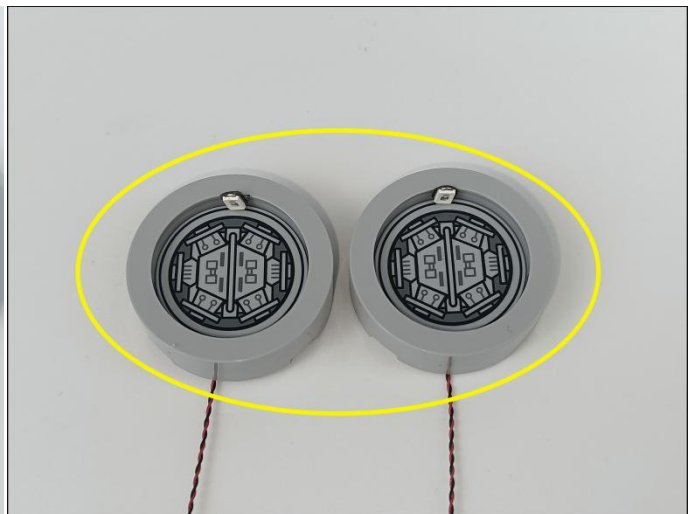
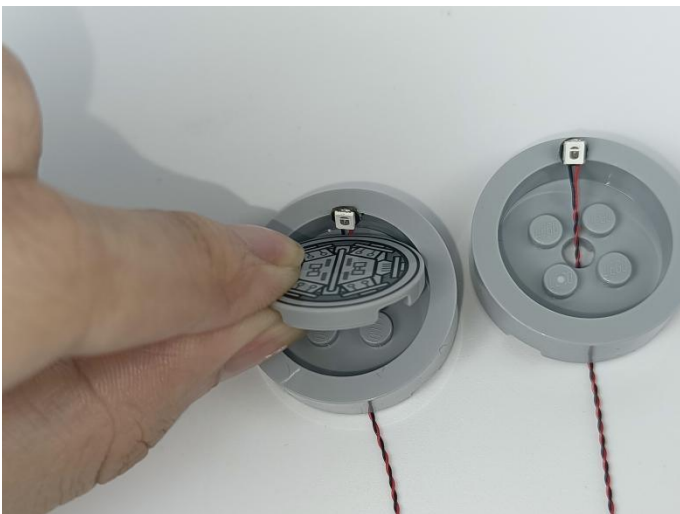

45

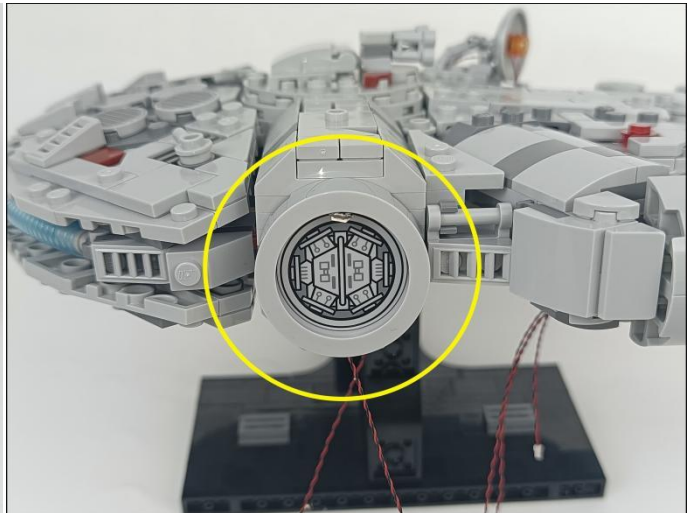

46



47

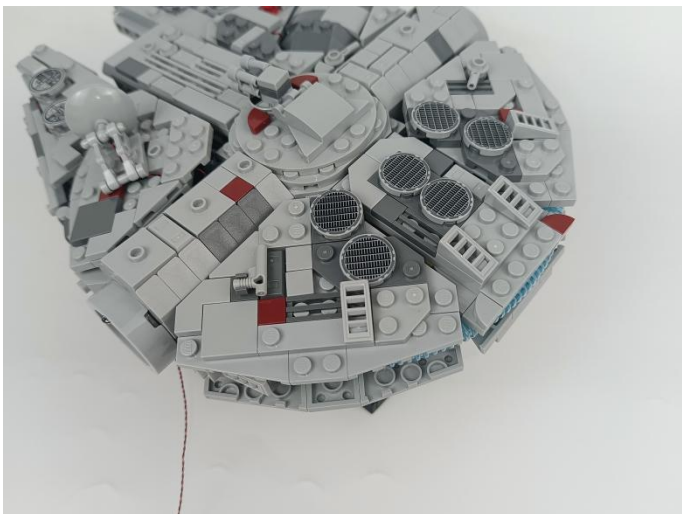

48

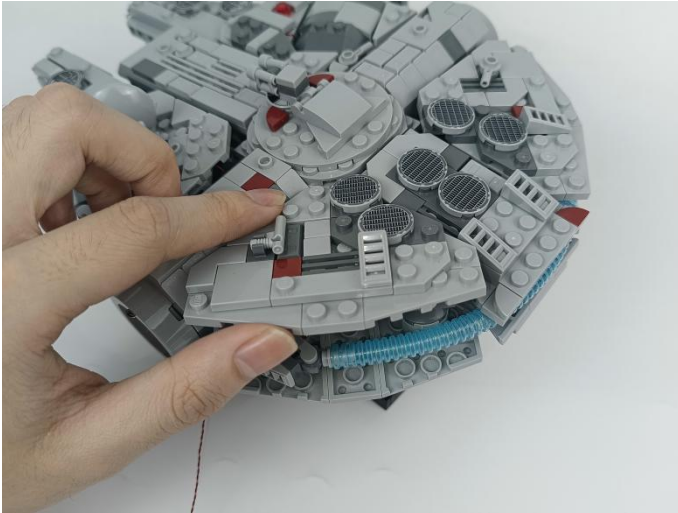

49

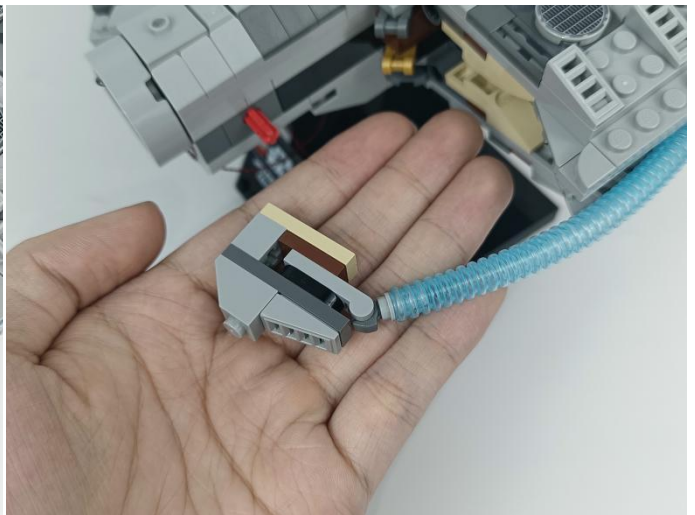

50

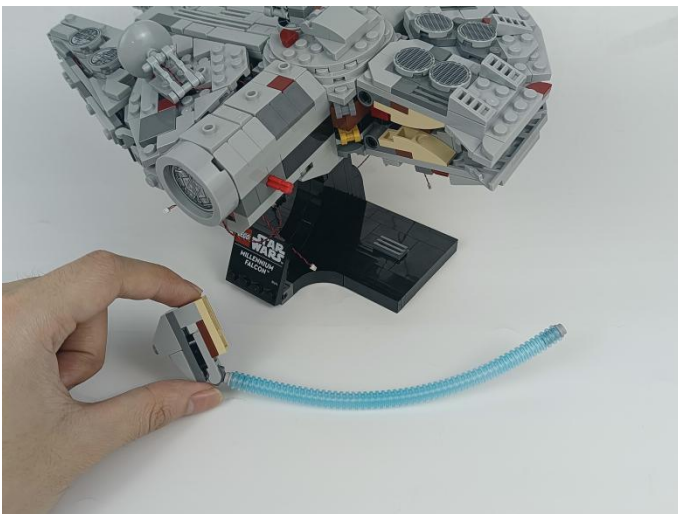

51

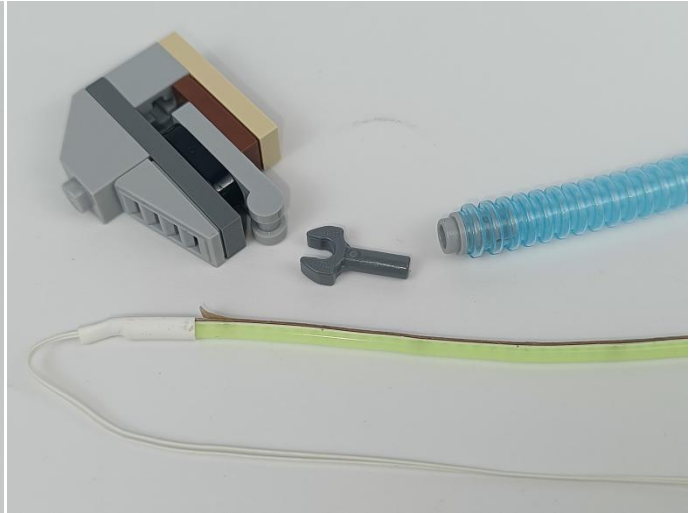
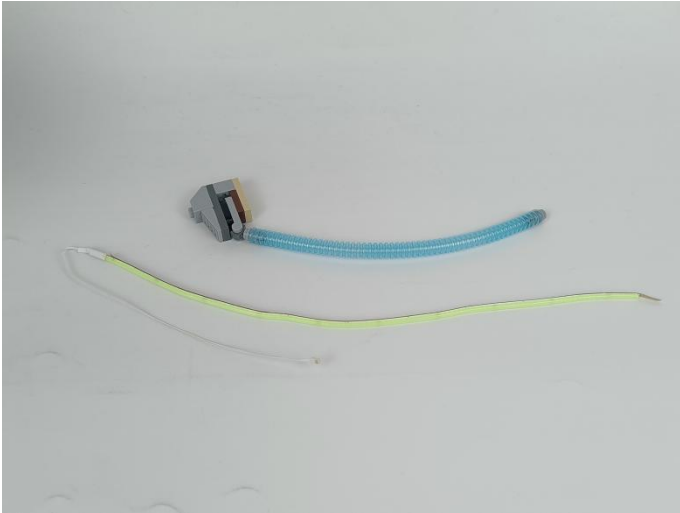

52

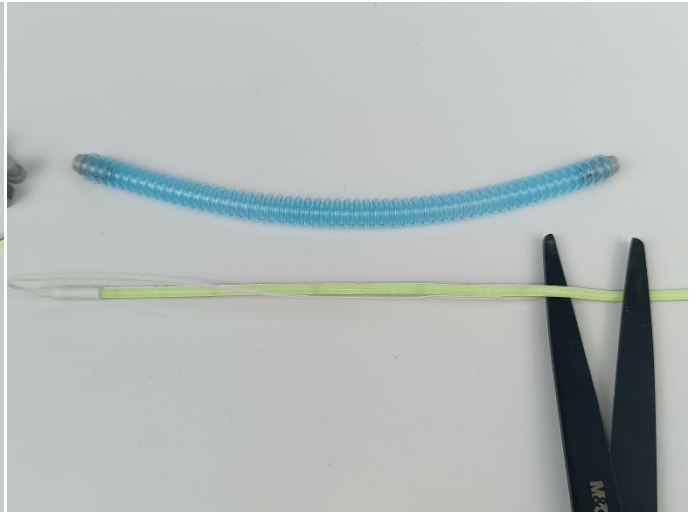
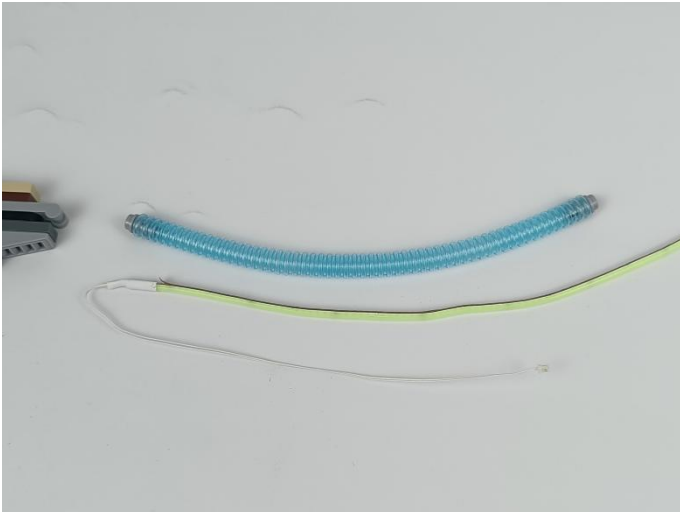

53

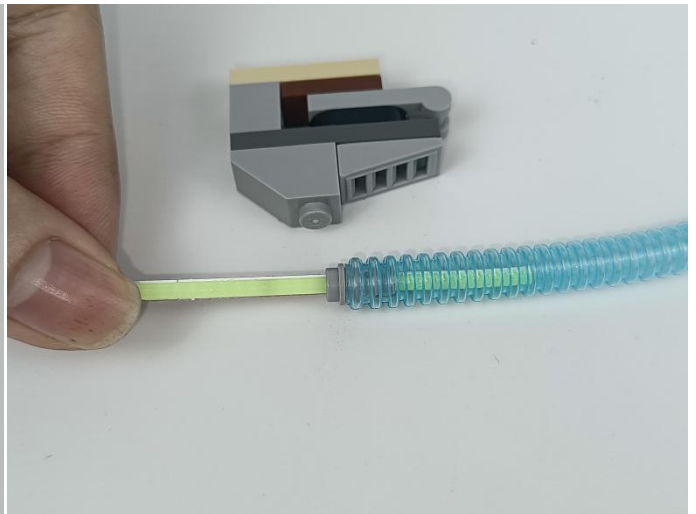
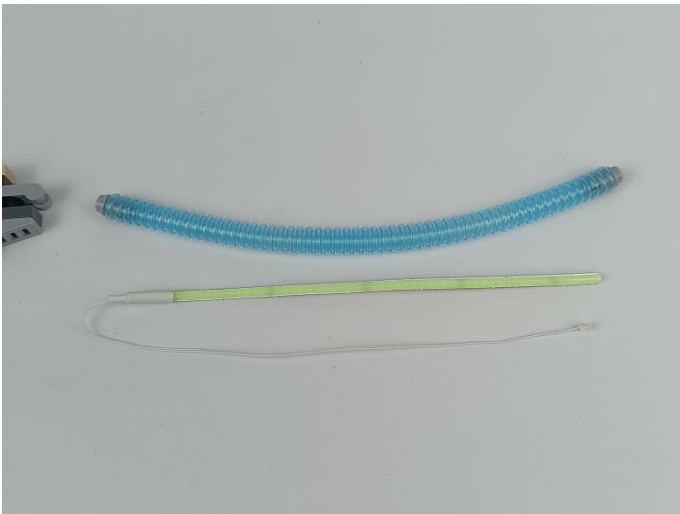

54

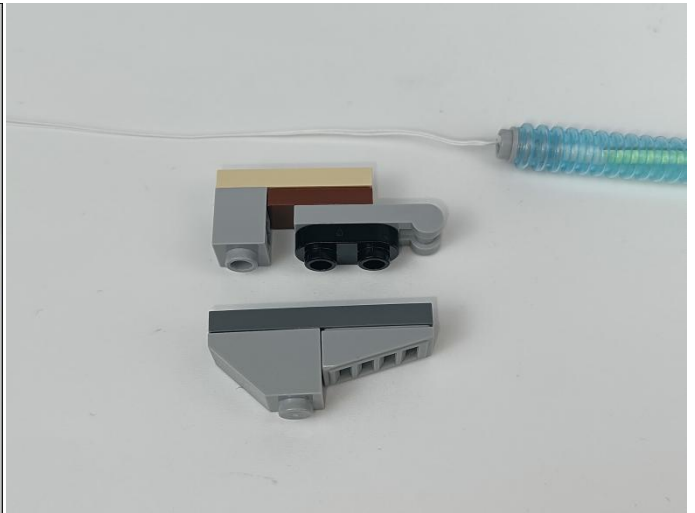
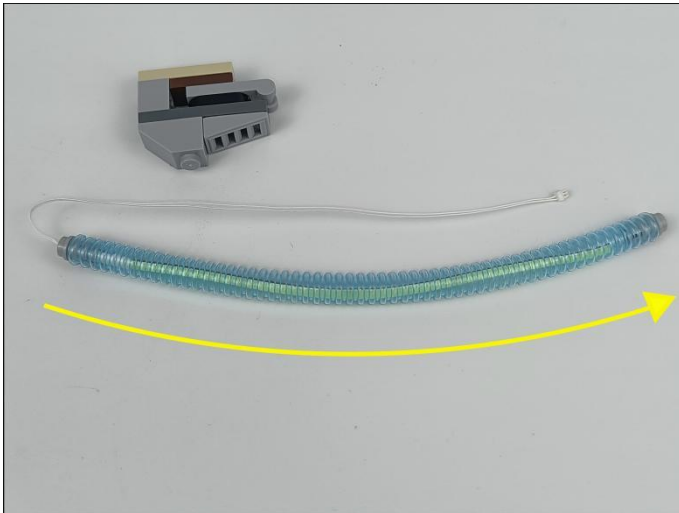

55

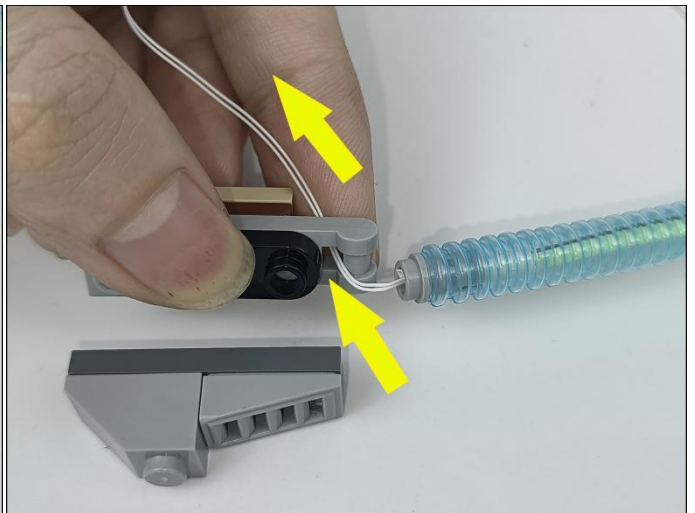
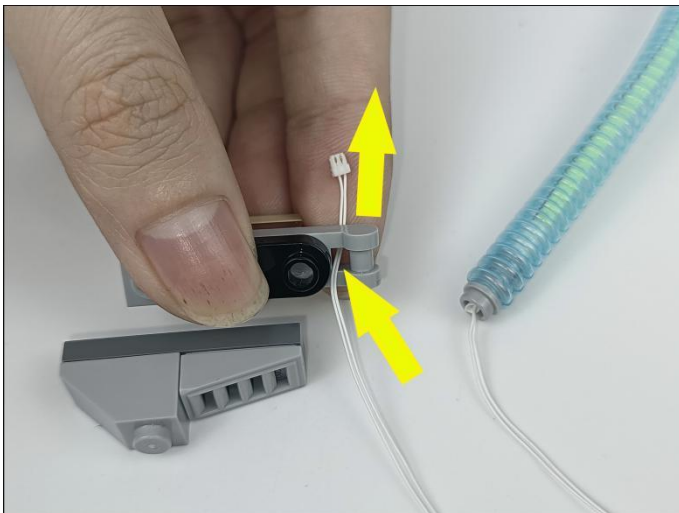

56

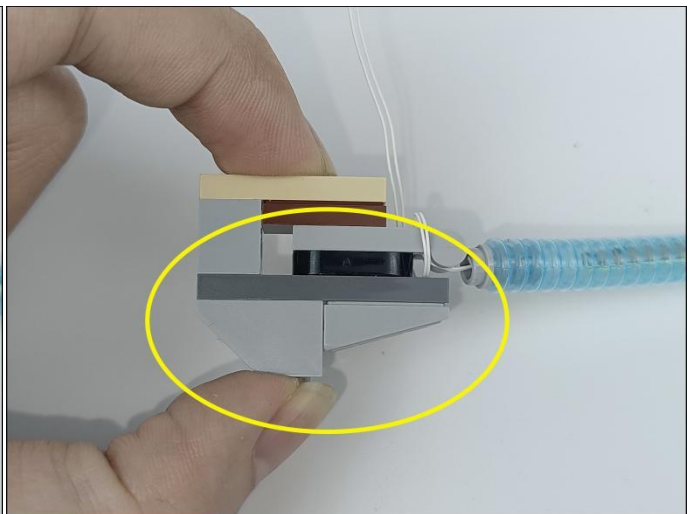
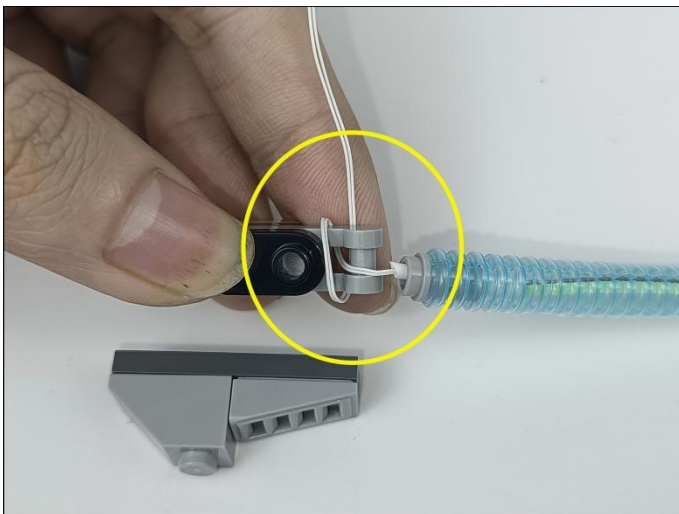

57

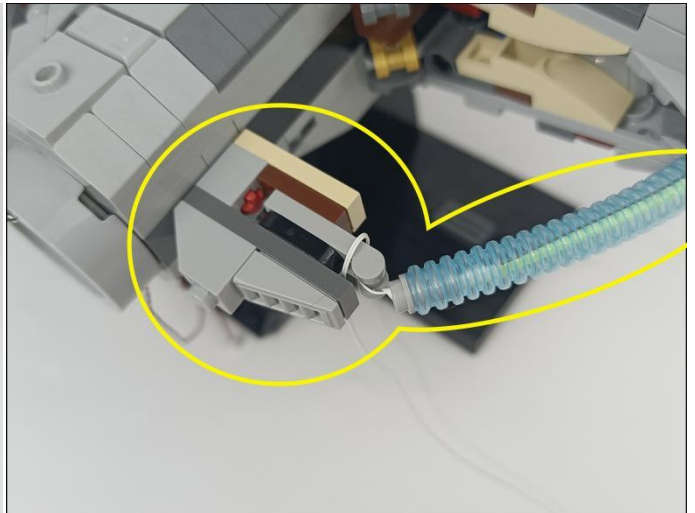
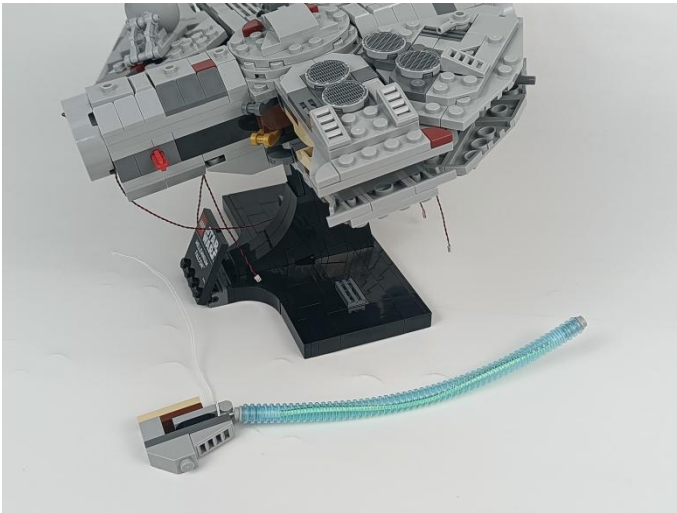

58

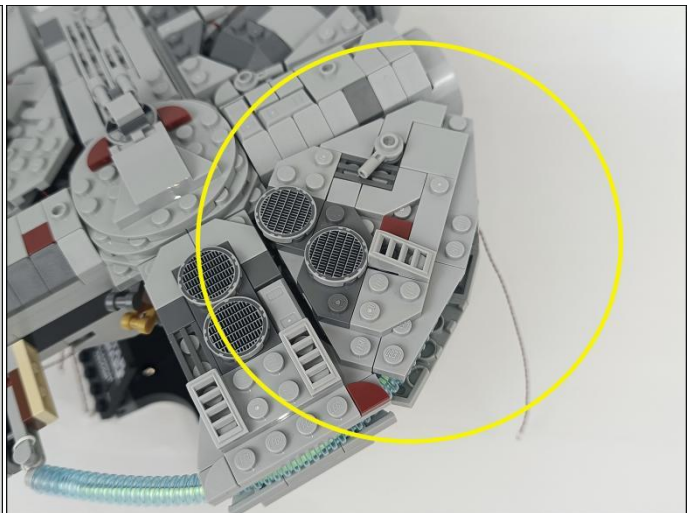
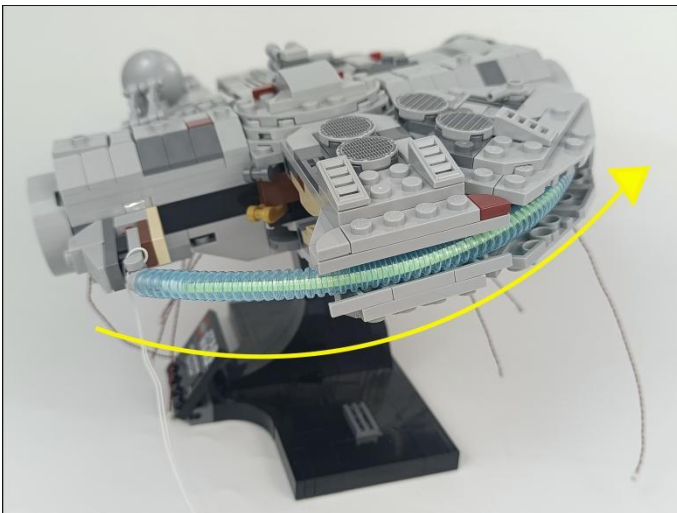

59

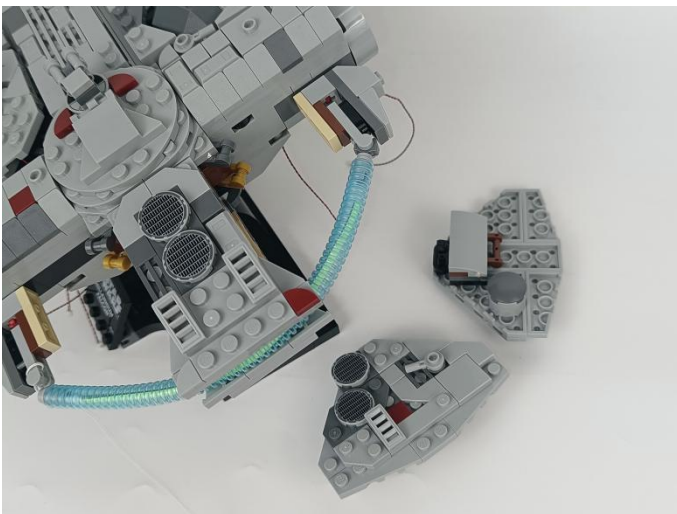

60

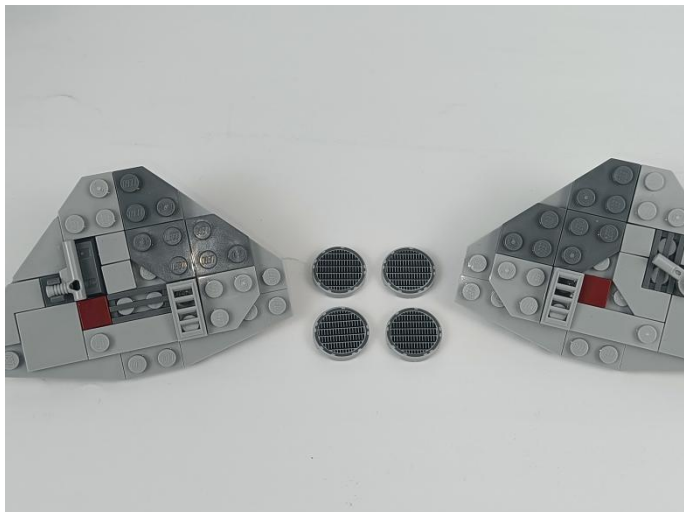

61



62

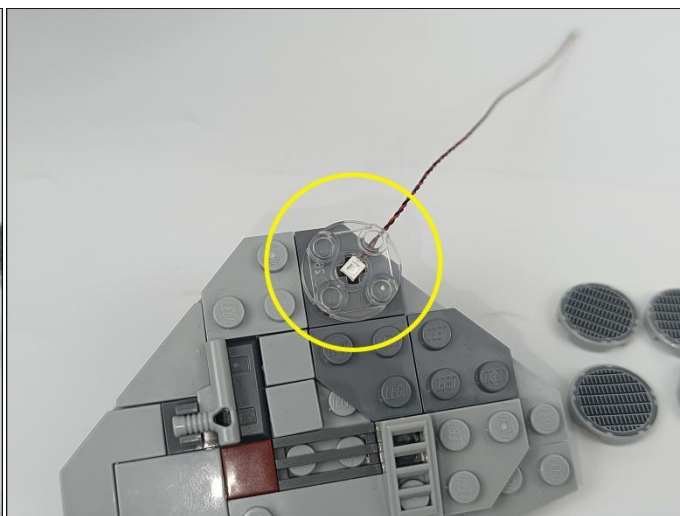
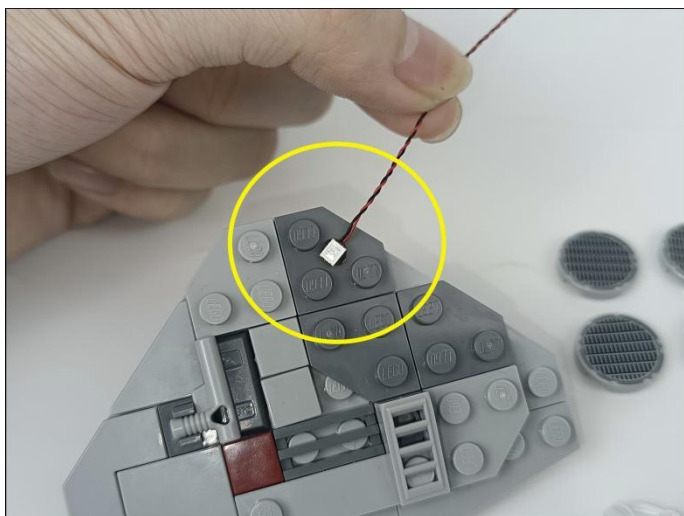

63

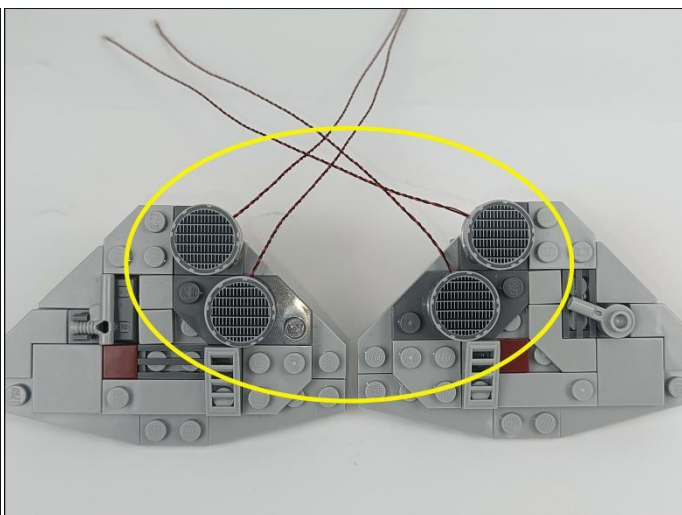
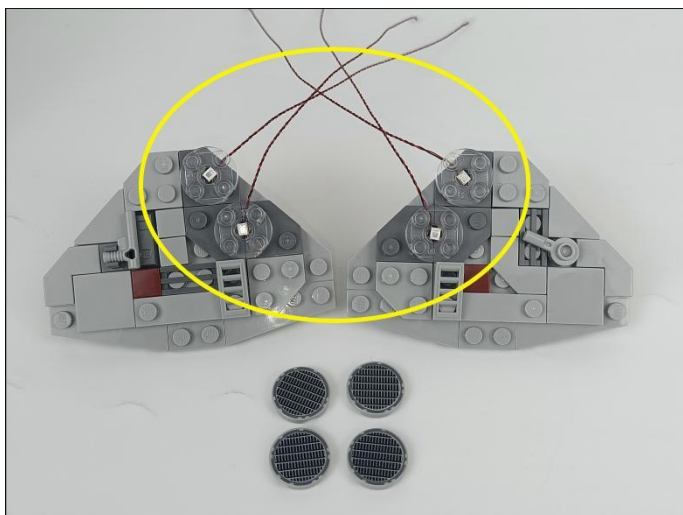

64

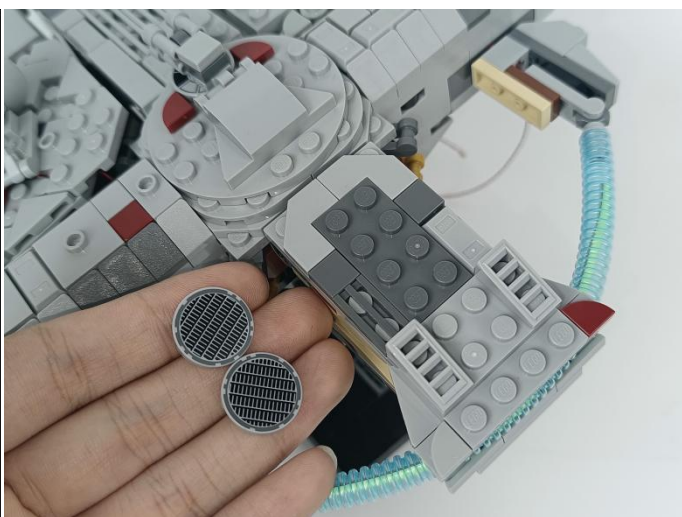
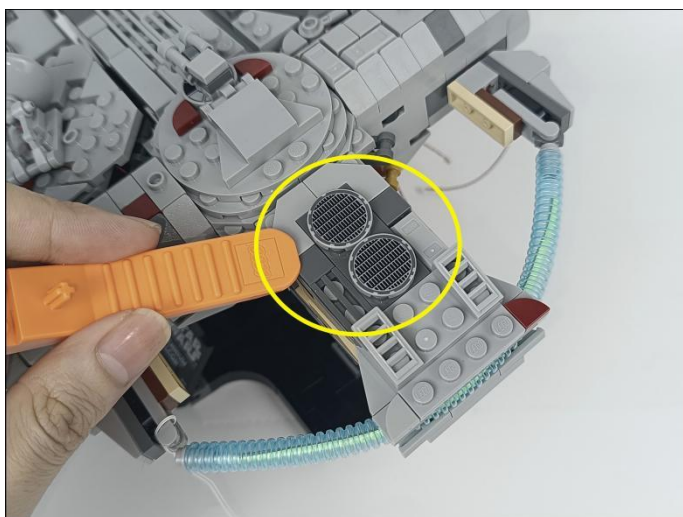

65

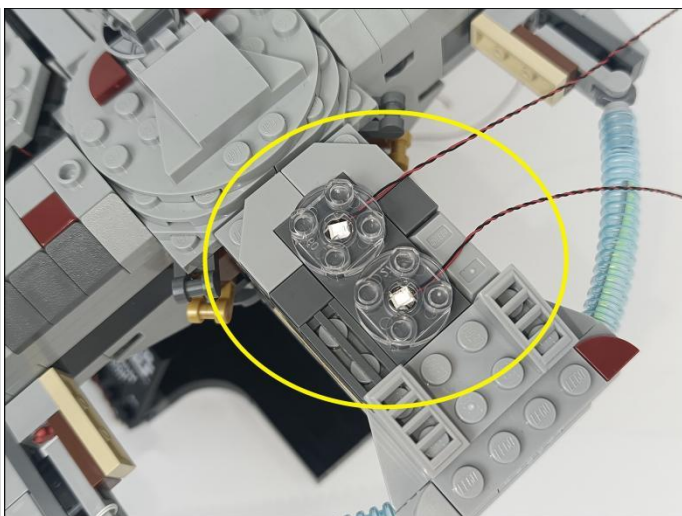
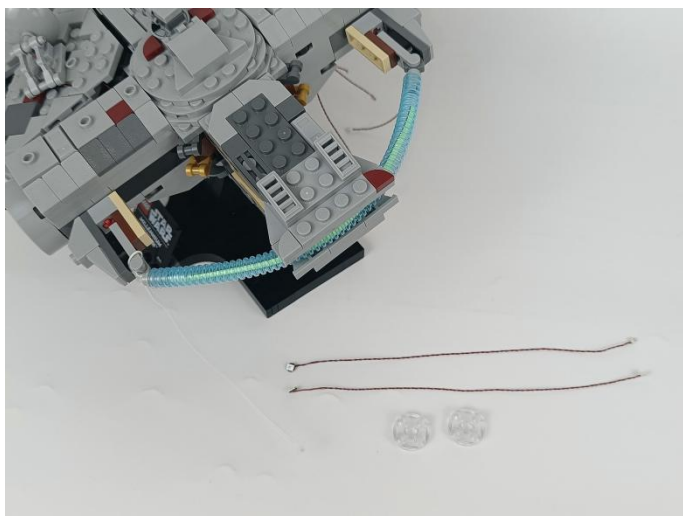

66

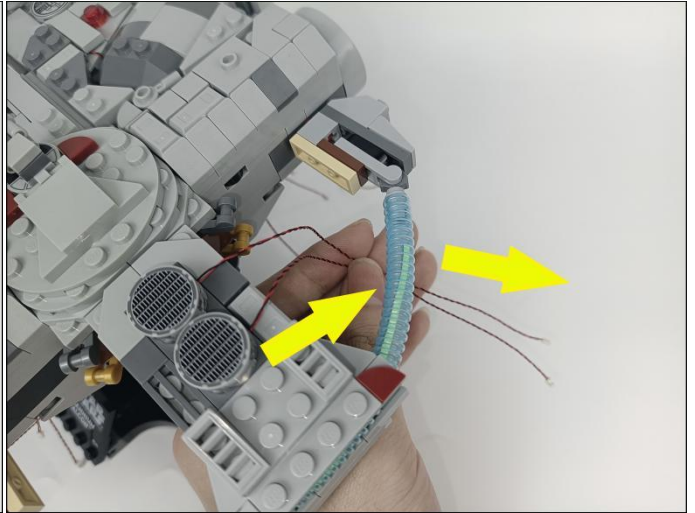
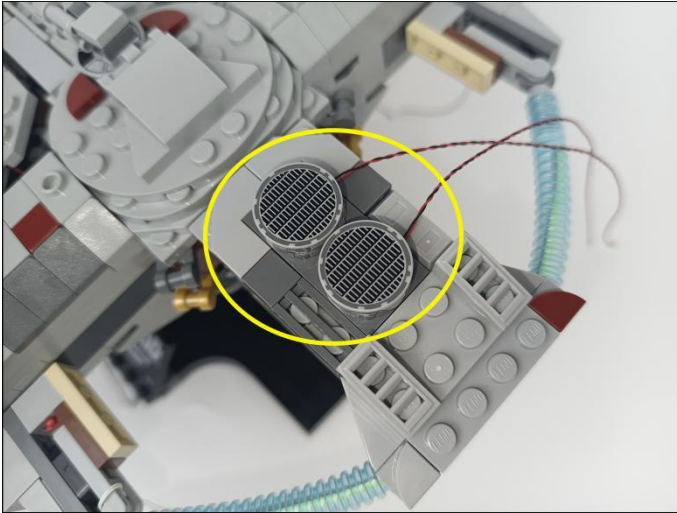

67

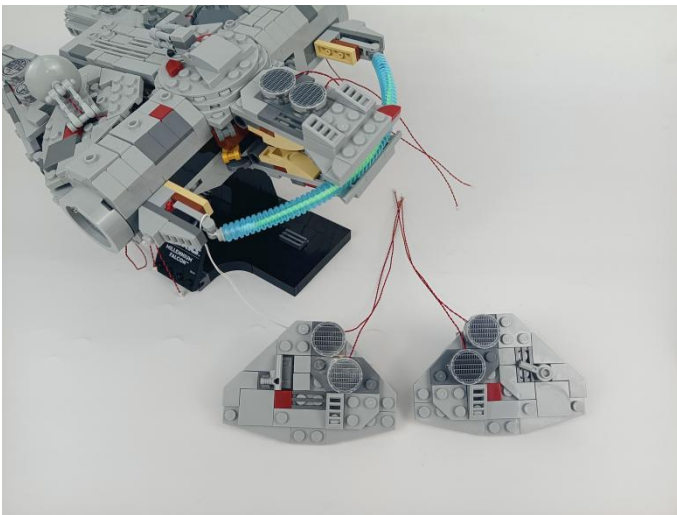

68

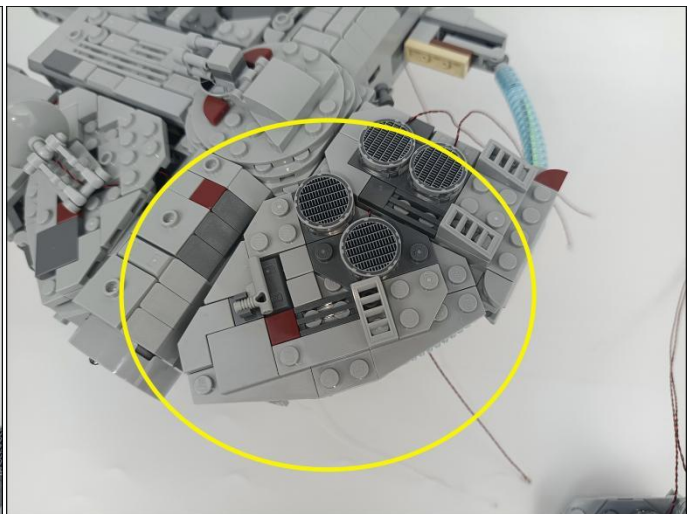
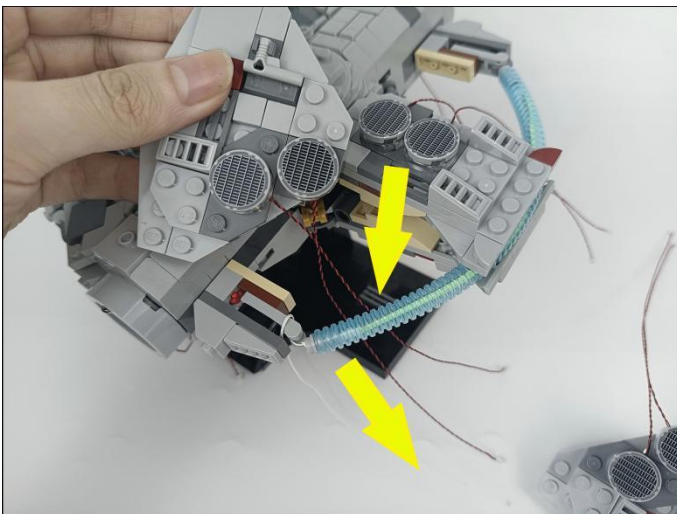

69

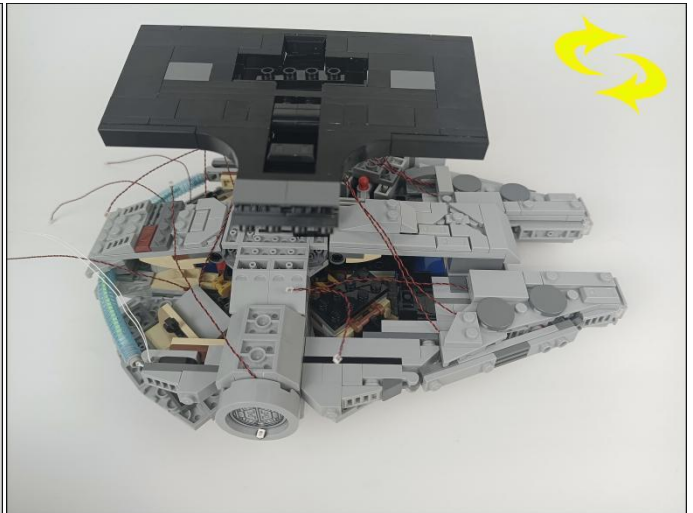
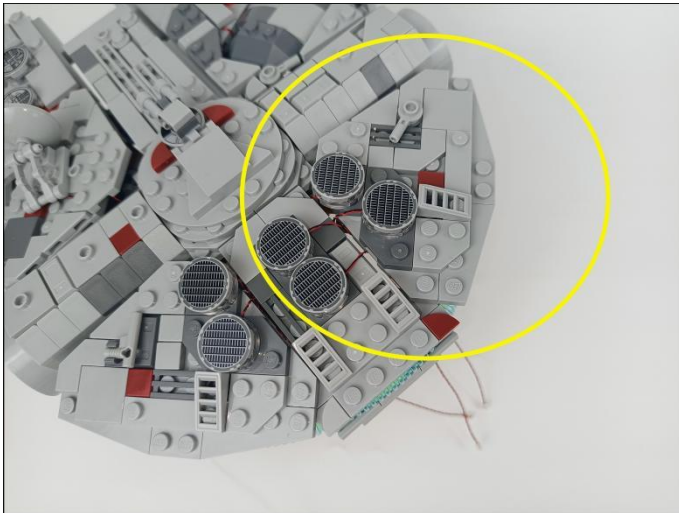

70



71

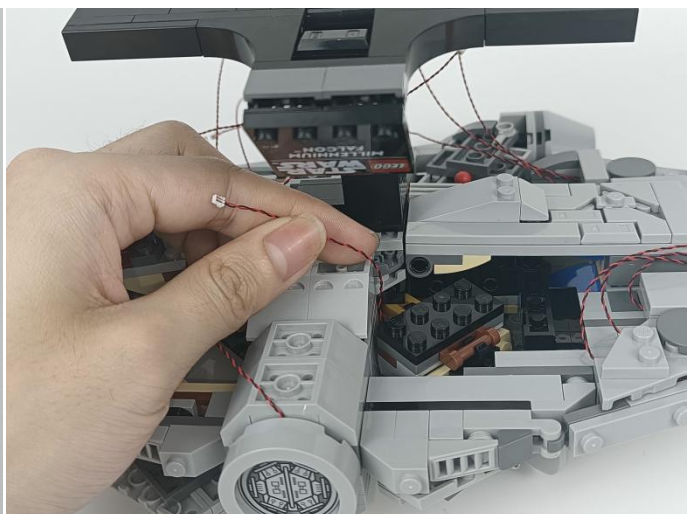
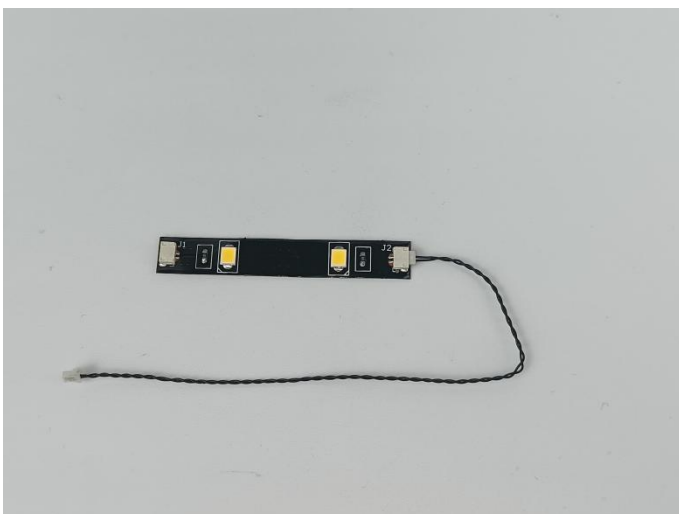

72

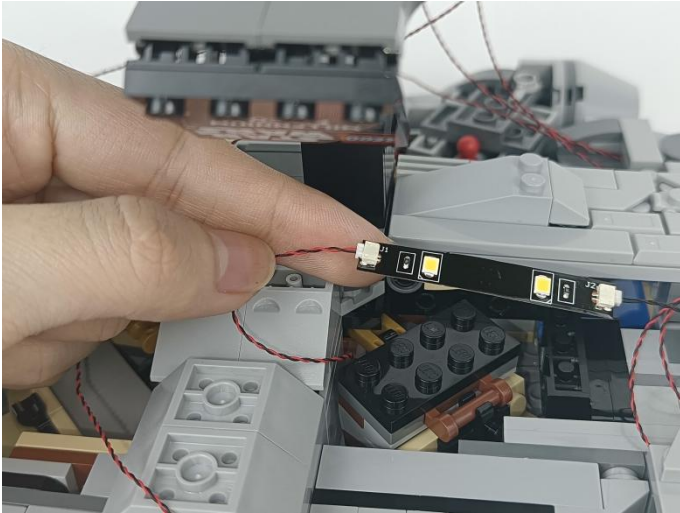

73

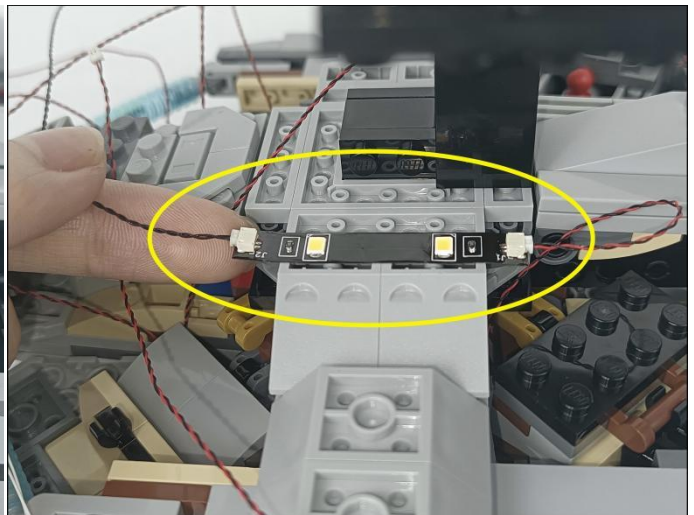
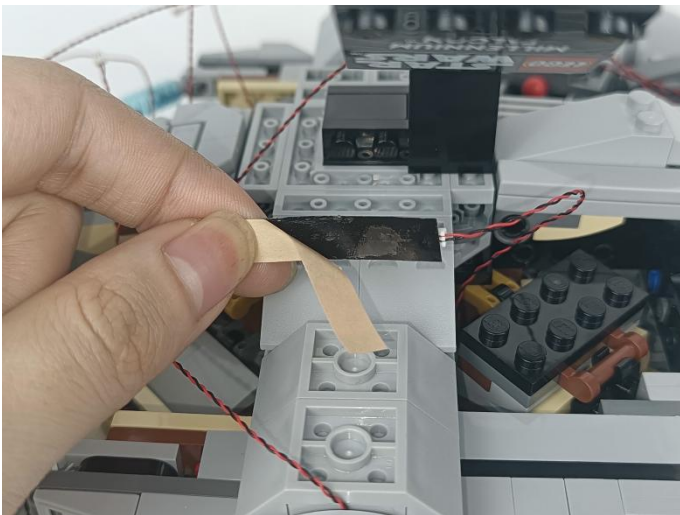

74. Hide the lamp cord in the gap.



75

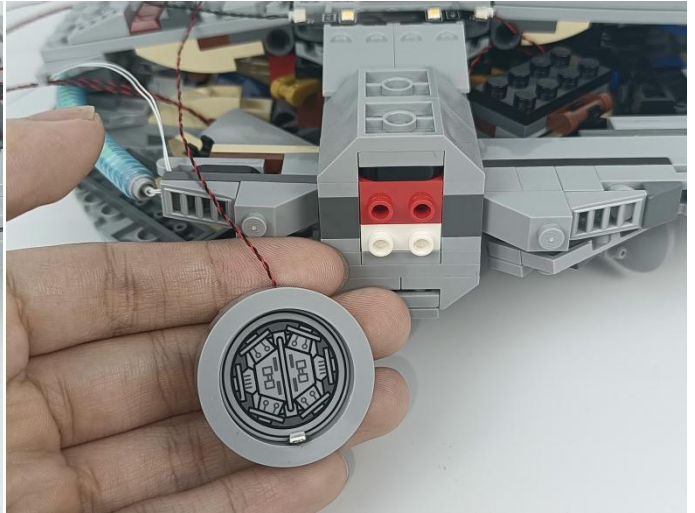

76



77

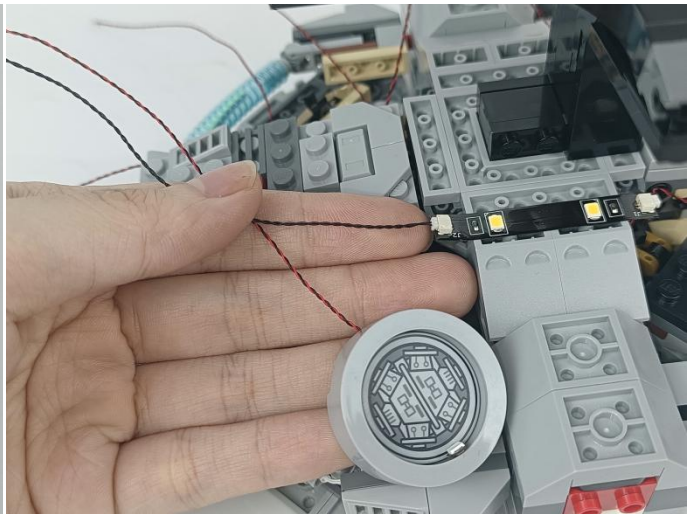

78

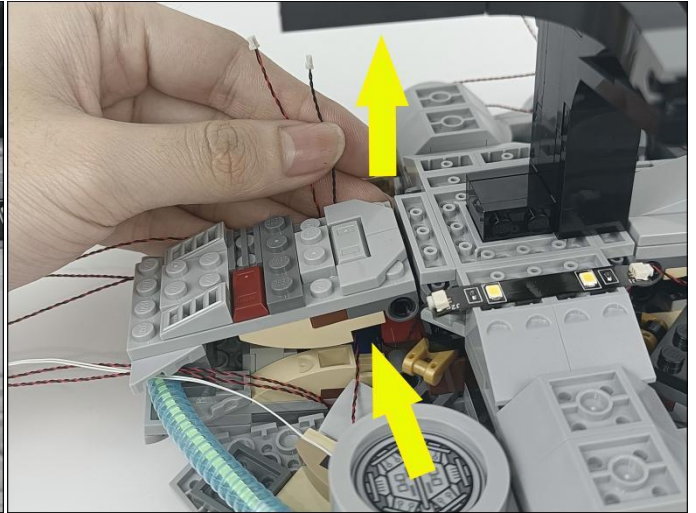
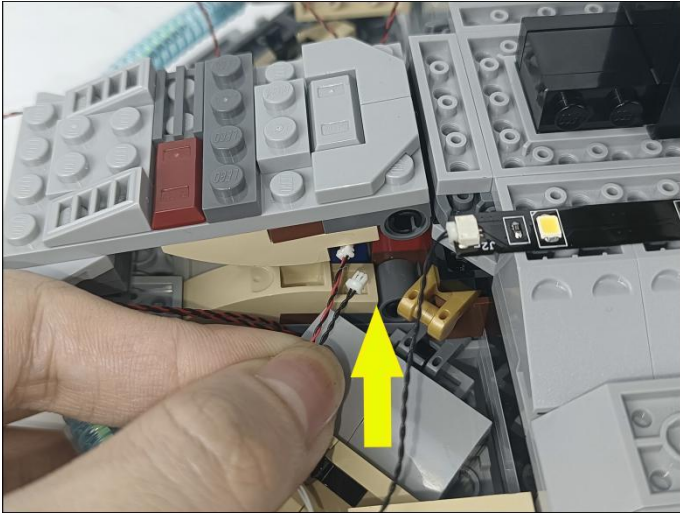

79

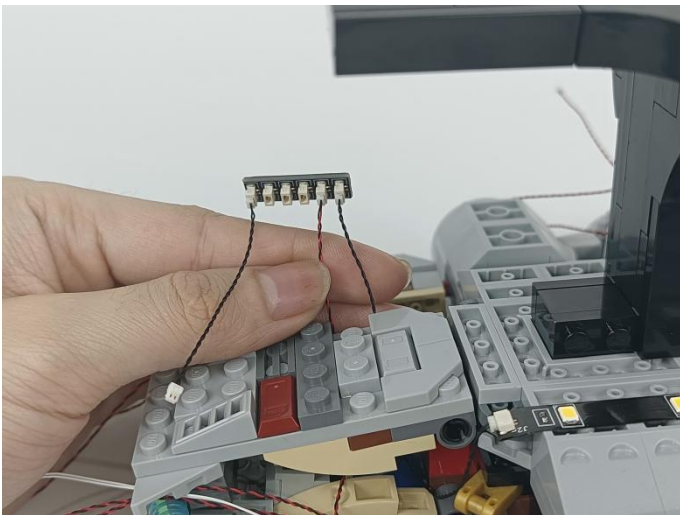

80

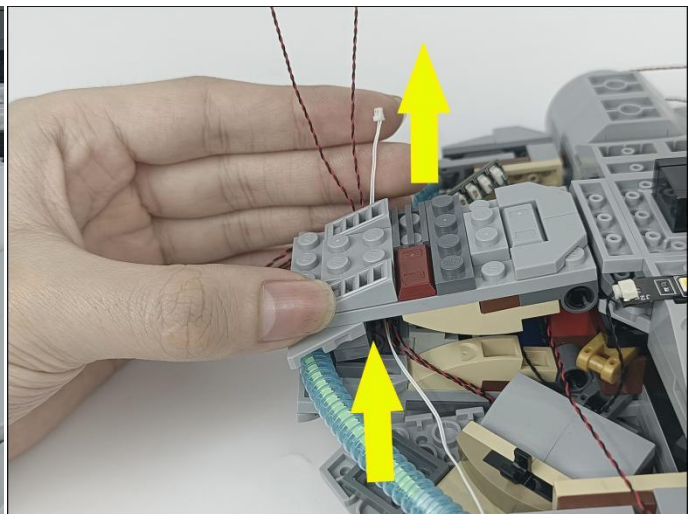
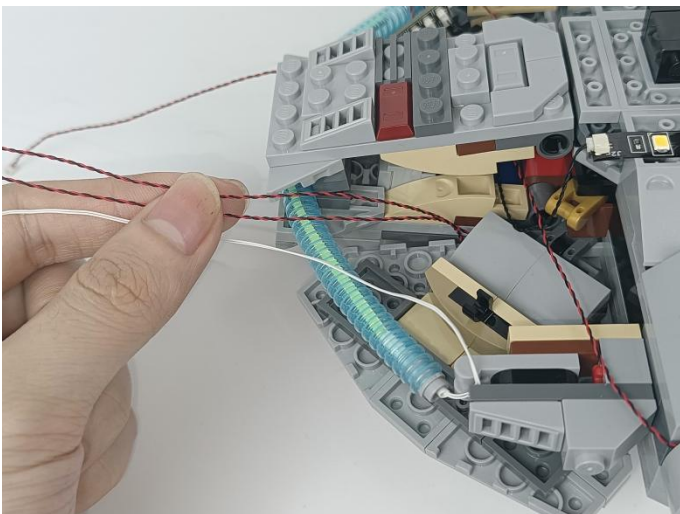

81

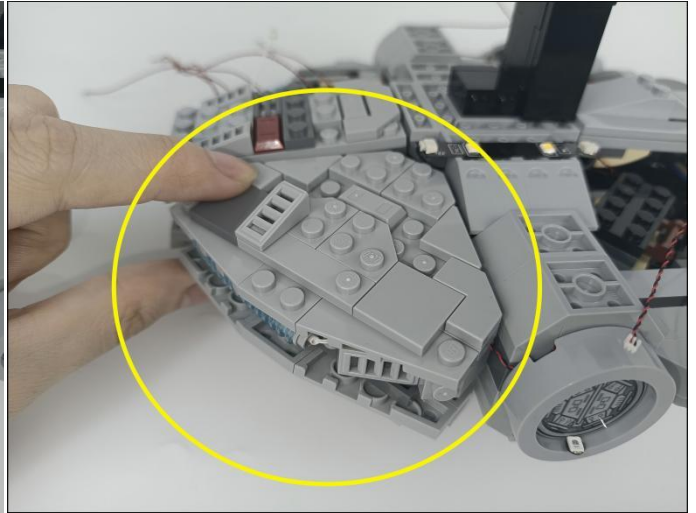

82

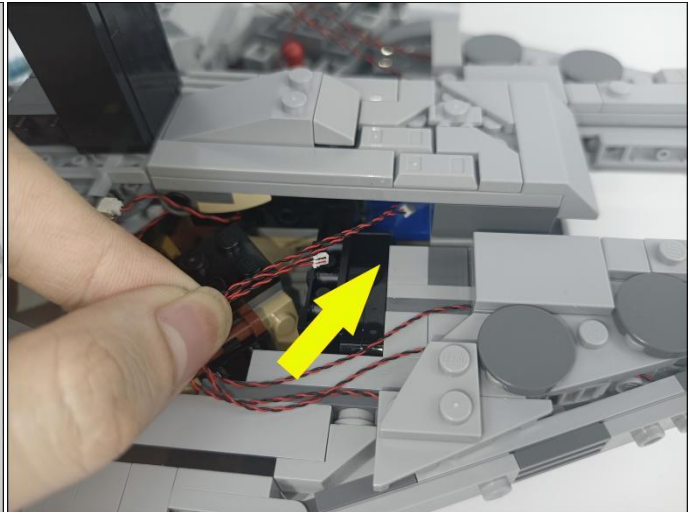
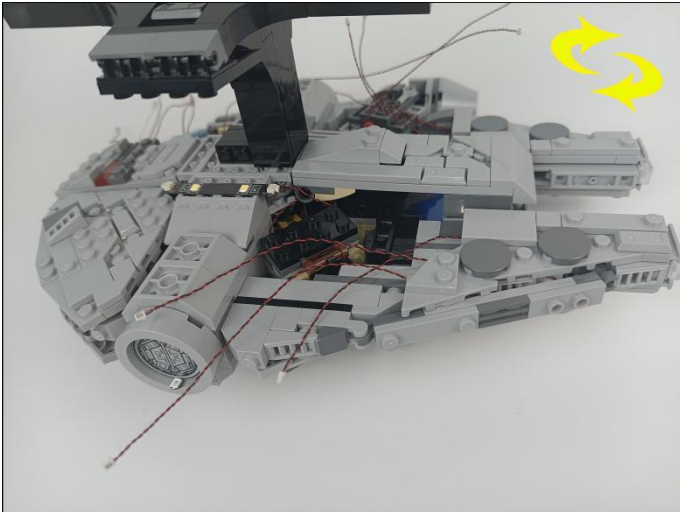

83

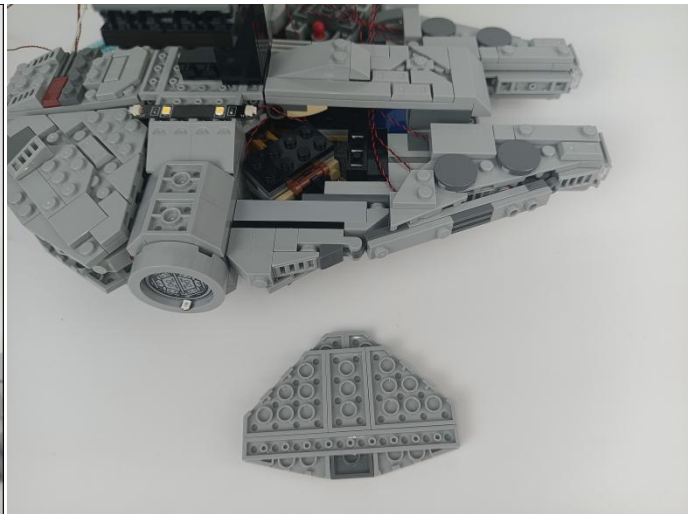
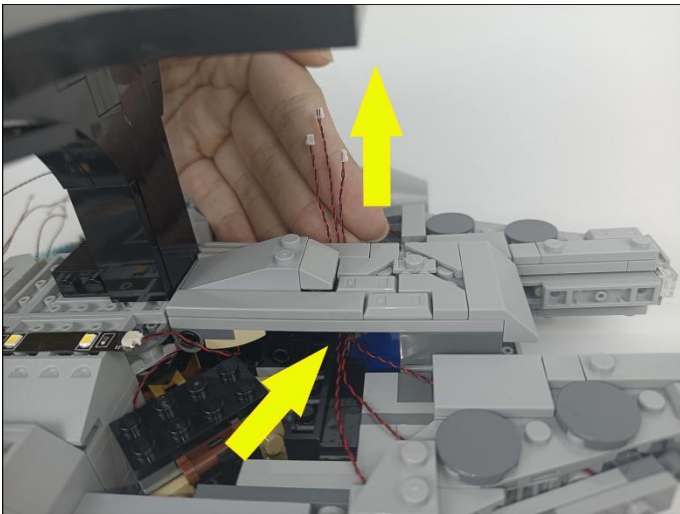

84

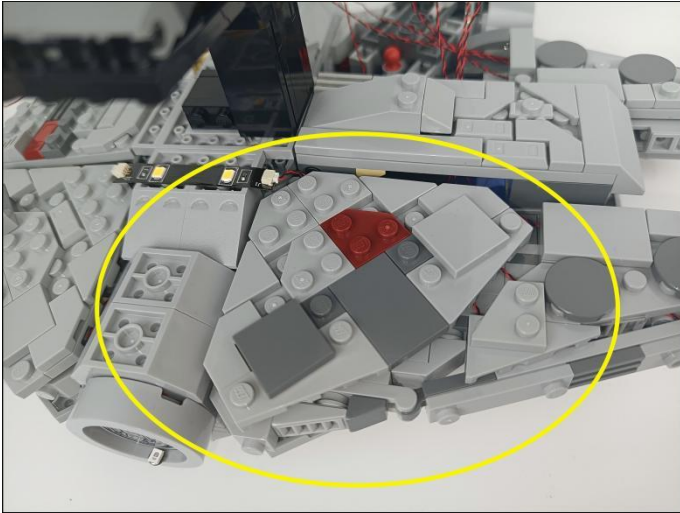

85



86

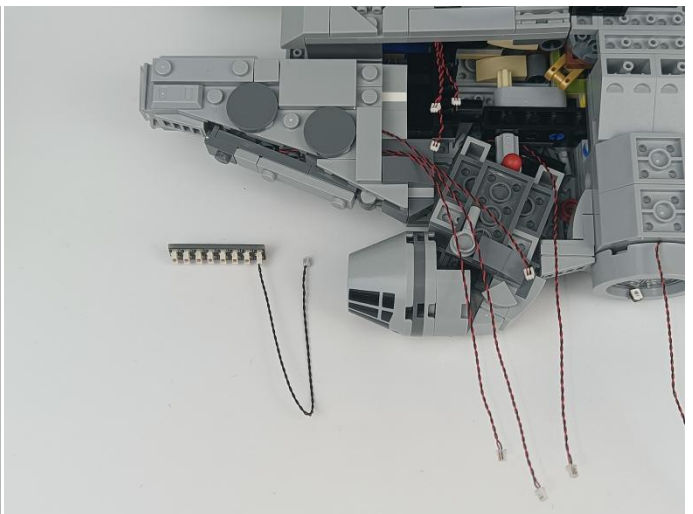

87

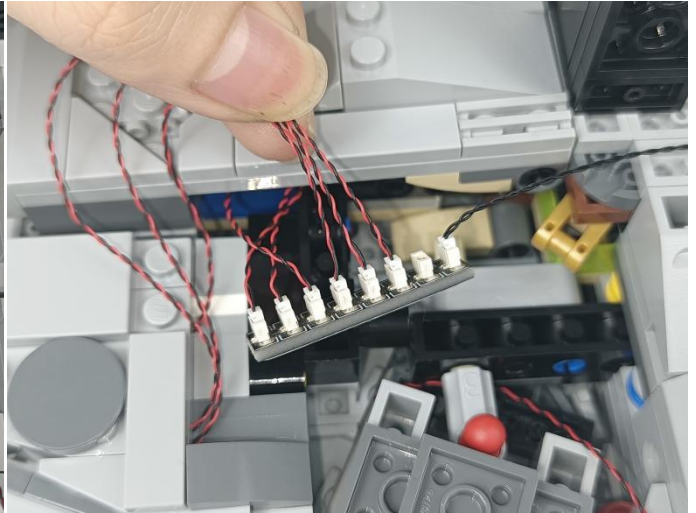
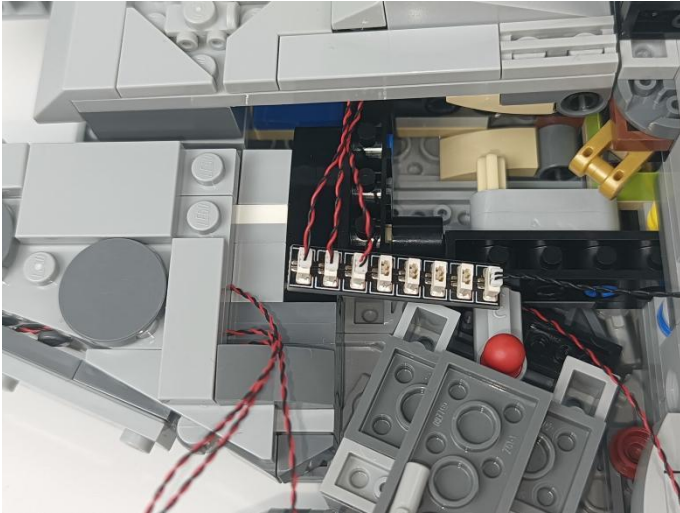

88

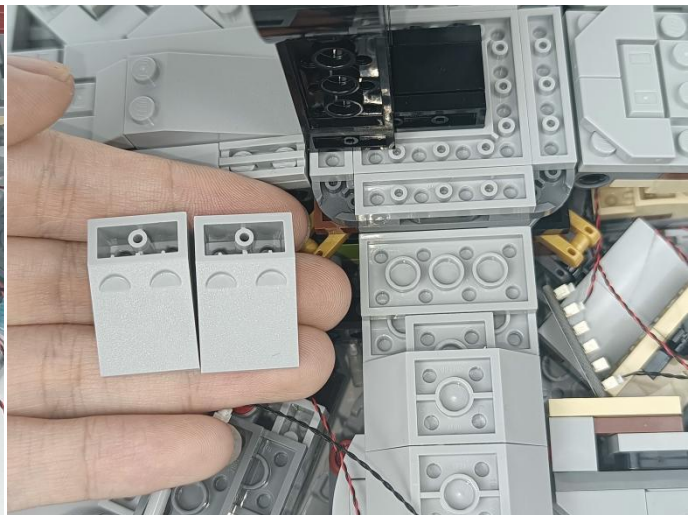
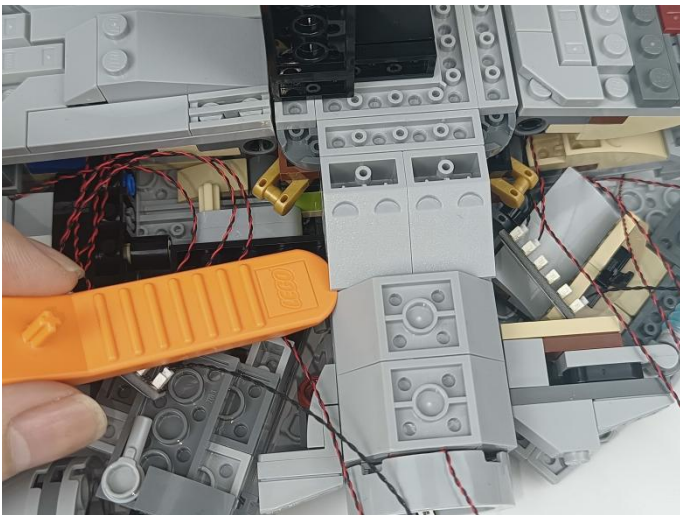

89

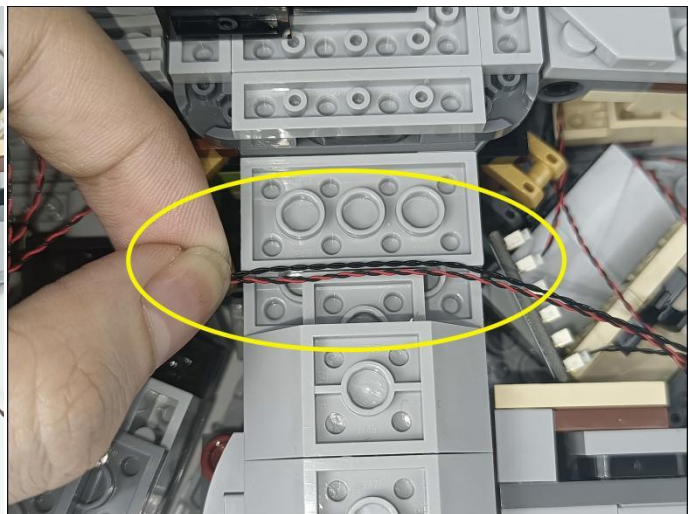
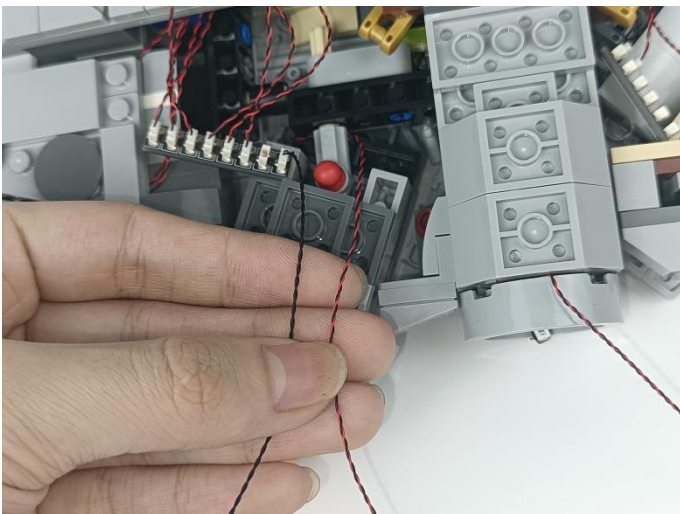

90

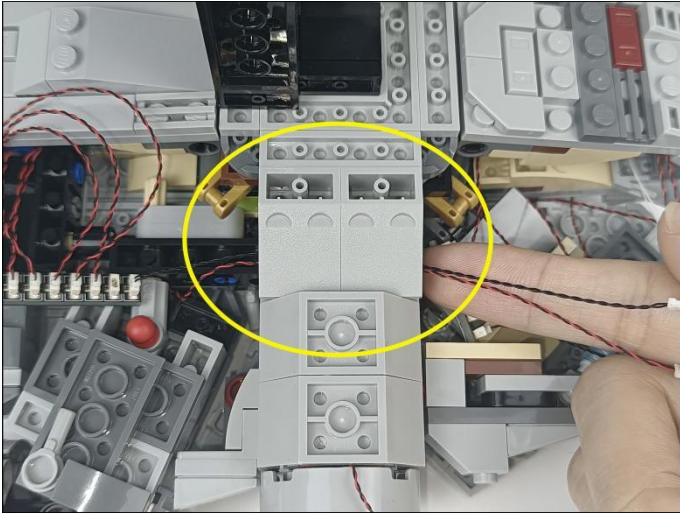

91. Expansion boards and wires are placed inside the empty crevices of the blocks.

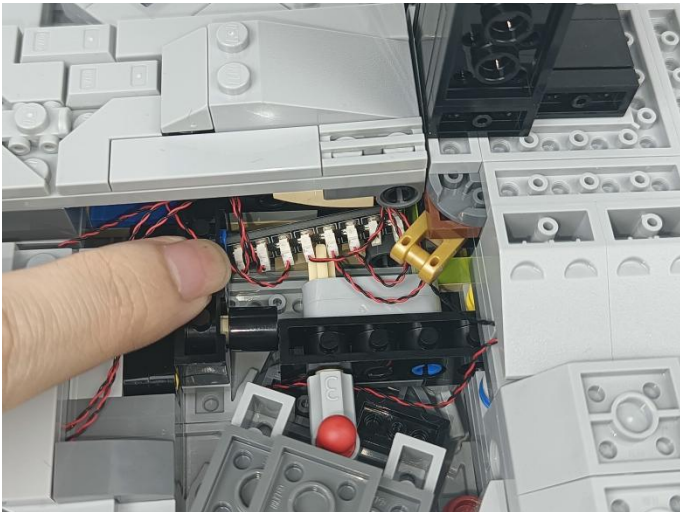

92

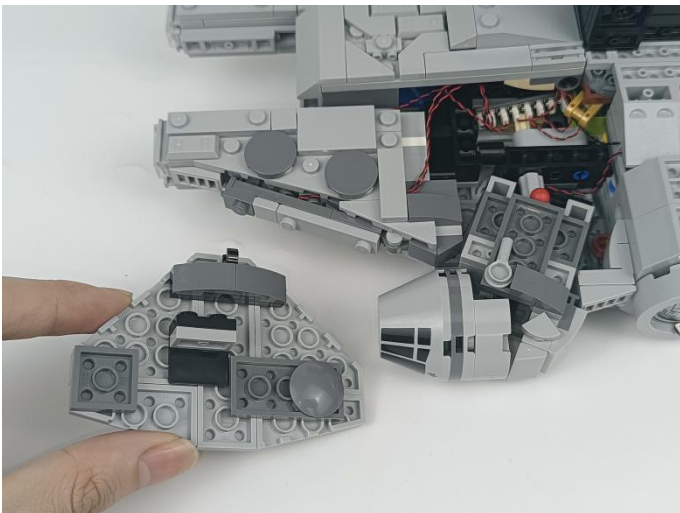

93

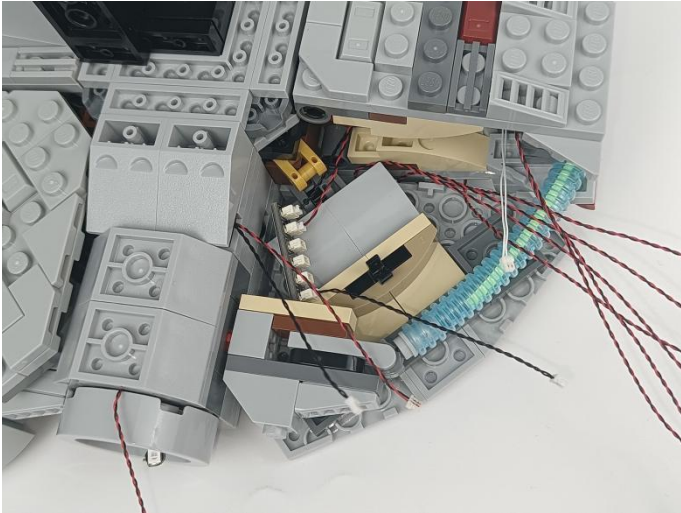

94



95

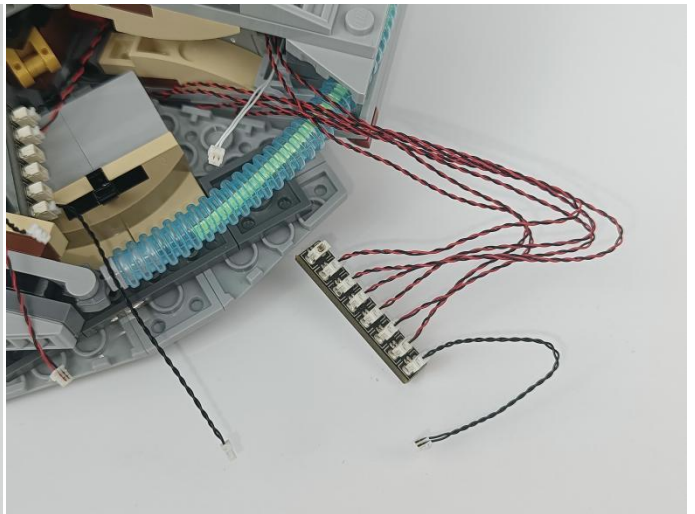
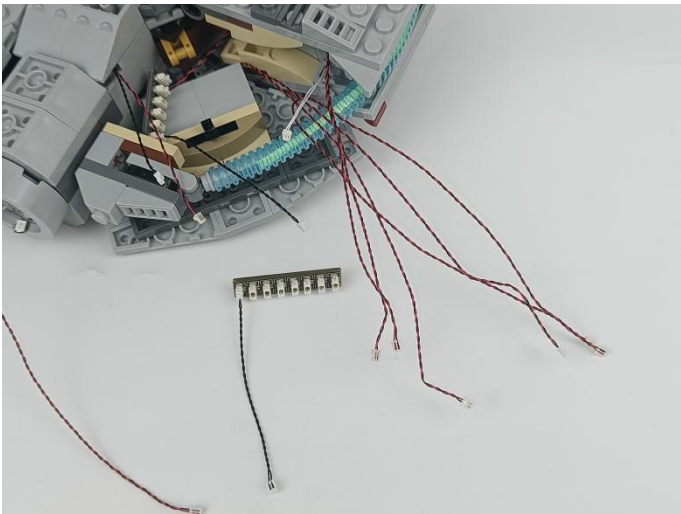

96

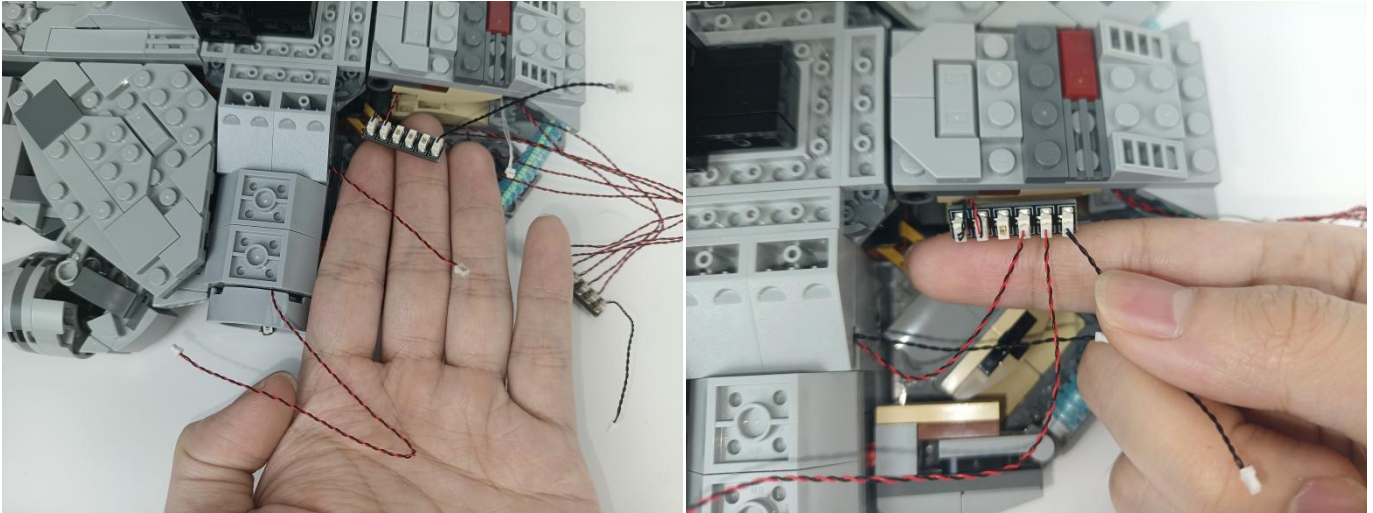

97



Remote control function introduce



- ON:** All lights turn on sequentially. **OFF:** All lights are off.
- ☼ Function 1: A, B, C, D are turned on slowly in sequence.
 - ☼ Function 2: Breathing light mode.
 - ☼ Function 3: A and D the light is on and C and B flash alternately. **A:** Turn A on/off.
 - ☼ Function 4: A the light is on, B, C, D flow light effect I. **B:** Turn B on/off.
 - ☼ Function 5: A the light is on, B, C, D flow light effect II. **C:** Turn C on/off.
 - ☼ Function 6: Quickly open from A to D in turn. **D:** Turn D on/off.
 - ☼ Function 7: A, B, C, D flow light effect. ↑ : Increase frequency.
 - ☼ Function 8: A, B, C, D flash alternately. ↓ : Decrease frequency.
 - ☼ * : Brightness+ : Increases brightness
 - ☼ * : Brightness- : Decreases the brightness

- ON:** Alle Lichter werden nacheinander eingeschaltet. **OFF:** Alle Lichter sind aus.
- ☼ Funktion 1: A, B, C, D werden langsam nacheinander eingeschaltet.
 - ☼ Funktion 2: Atemlichtmodus.
 - ☼ Funktion 3: A und D bleiben an und C und B blinken abwechselnd. **A:** Turn A on/off.
 - ☼ Funktion 4: A ist immer eingeschaltet, B, C, D fließendes Wasser Lichteffect I. **B:** Turn B on/off.
 - ☼ Funktion 5: A ist immer eingeschaltet, B, C, D, fließendes Wasser Lichteffect II. **C:** Turn C on/off.
 - ☼ Funktion 6: Schnell nacheinander von A nach D öffnen. **D:** Turn D on/off.
 - ☼ Funktion 7: A, B, C, D fließendes Wasser Lichteffect. ↑ : Increase frequency.
 - ☼ Funktion 8: A, B, C, D blinken abwechselnd. ↓ : Decrease frequency.
 - ☼ * : Brightness+ : Increases brightness
 - ☼ * : Brightness- : Decreases the brightness

The remote control does not contain batteries, please buy a CR2025 or CR2032 button battery in the nearest store and install it in the remote control.

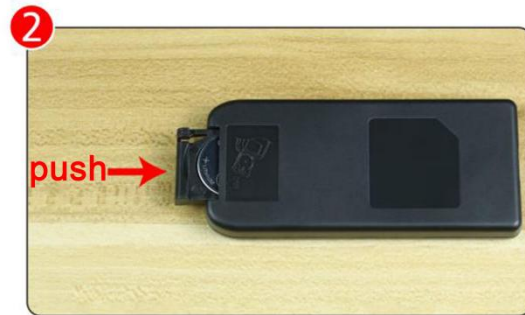
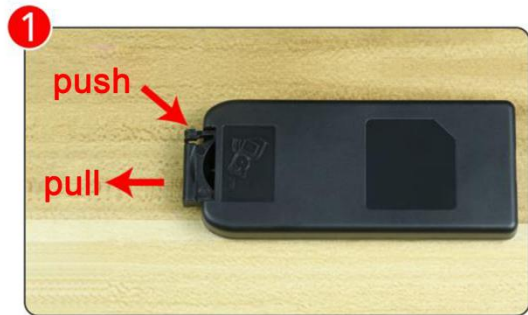

98

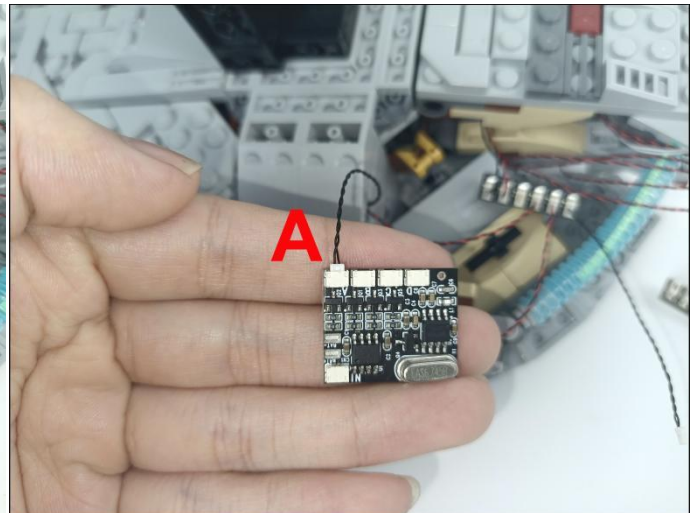
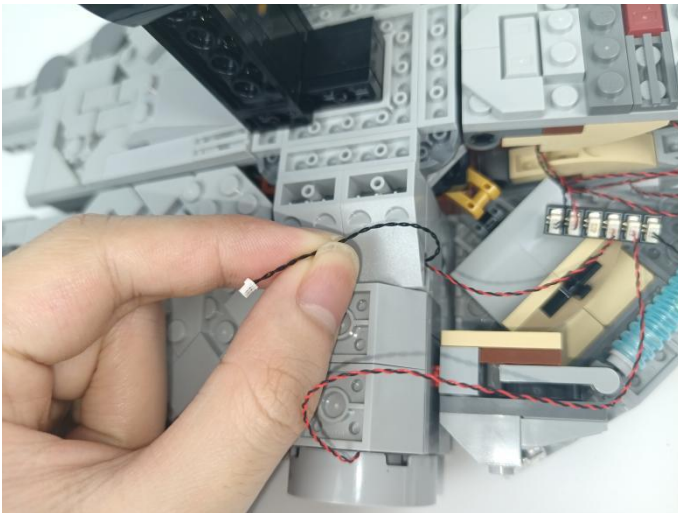

99

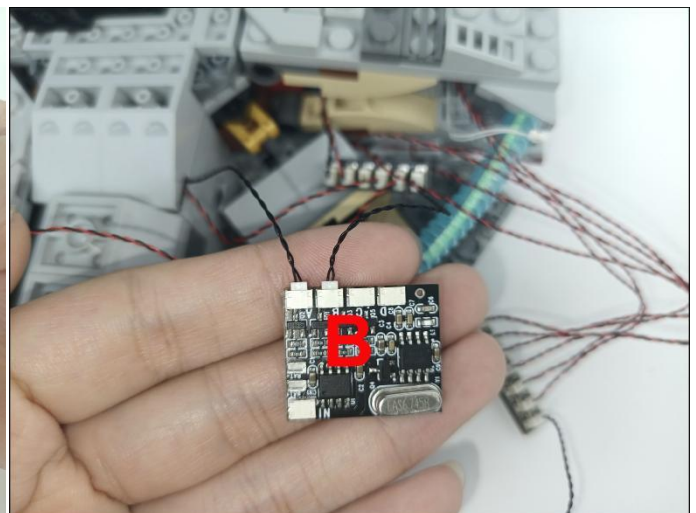
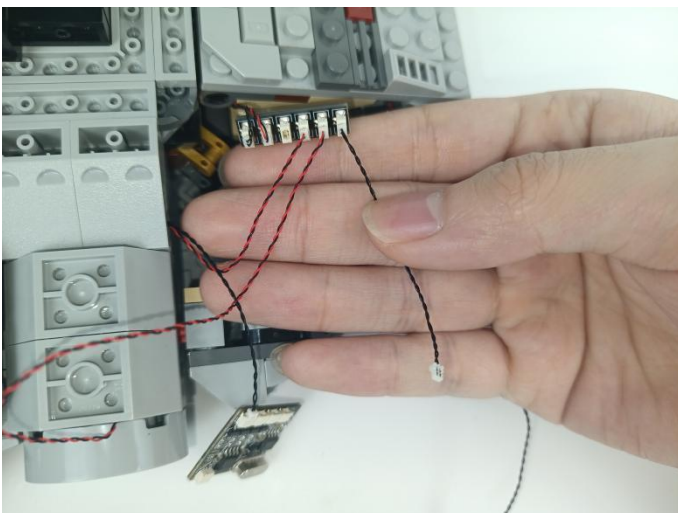

100

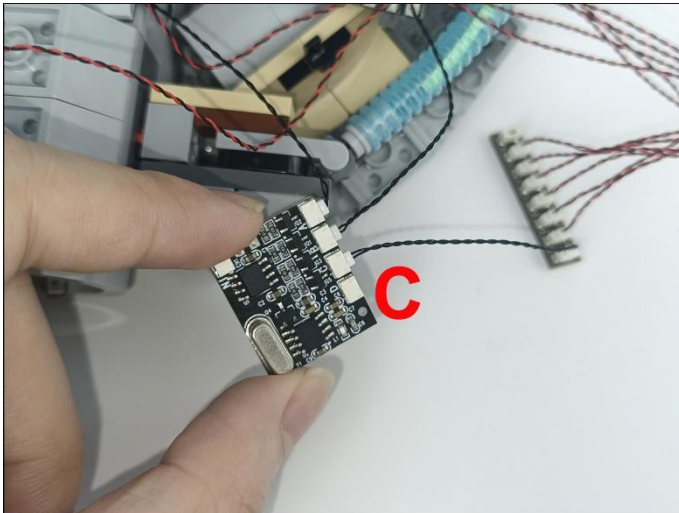

101

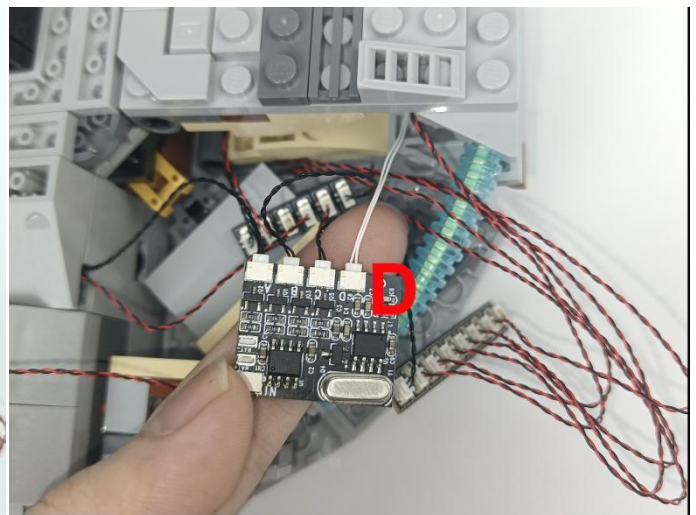
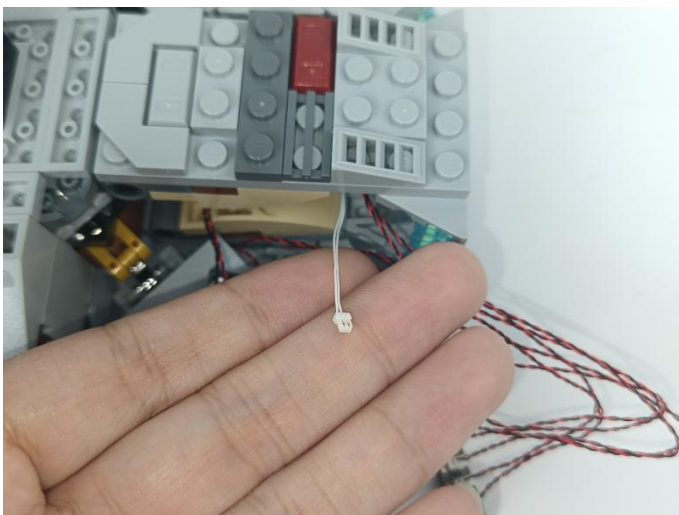

102

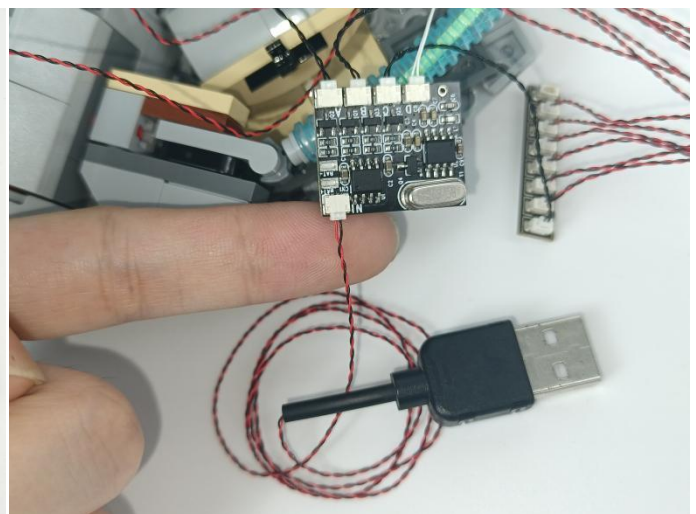

103. Hiding Expansion Boards in the Blocks' Empty Seams.

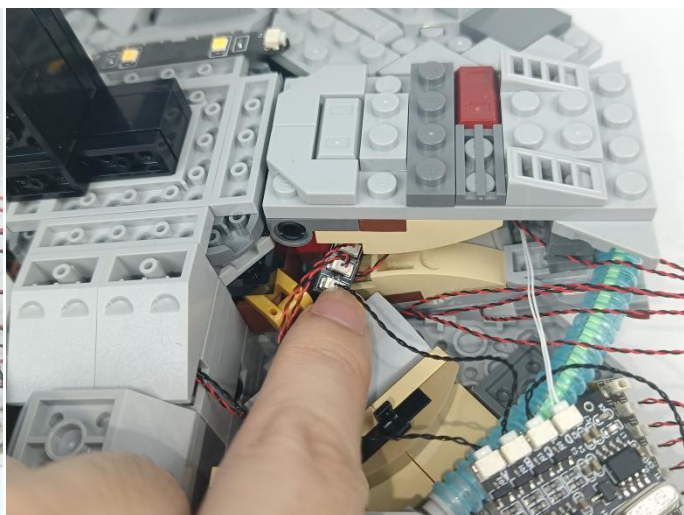
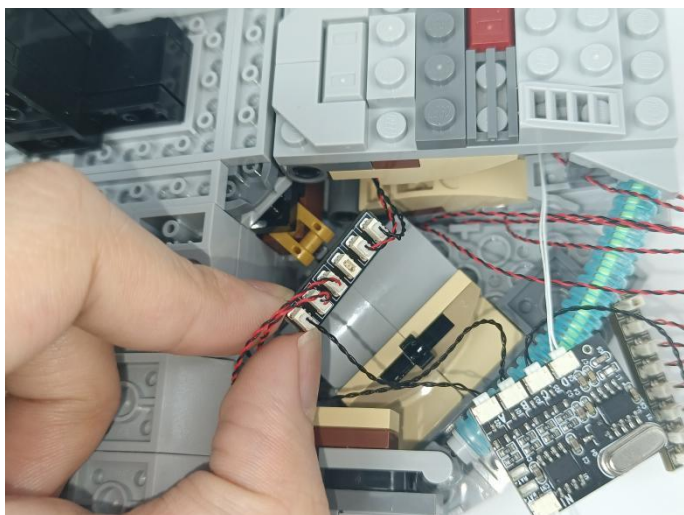

104

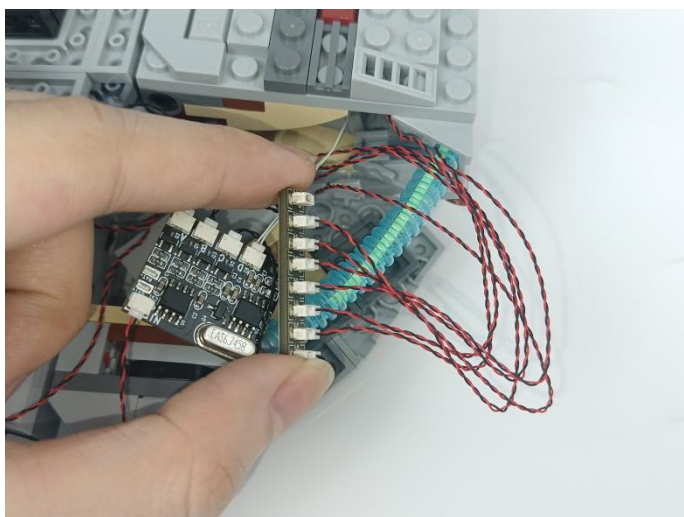

105

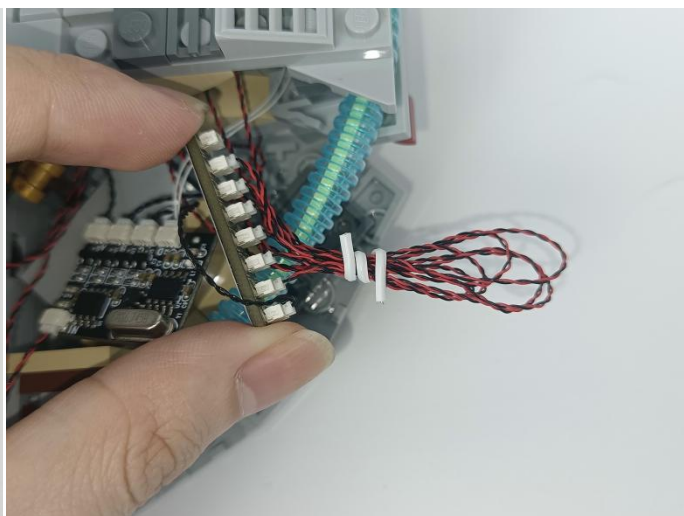

106. Hiding Expansion Boards in the Blocks' Empty Seams.

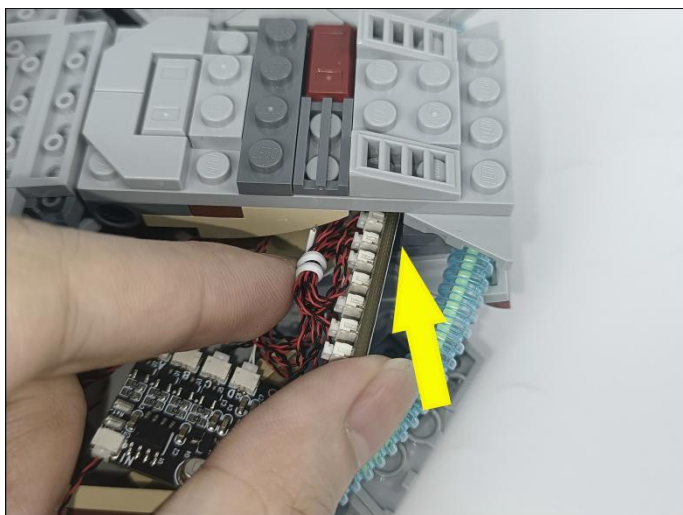

107. Organize the light wires and modules according to the meaning of the picture.

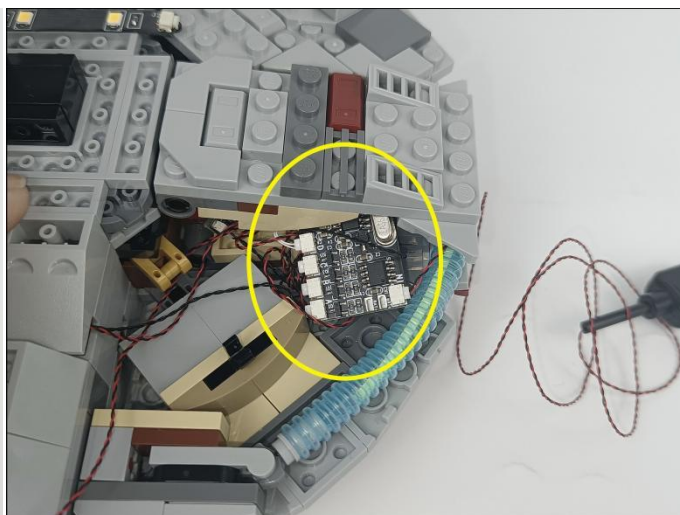
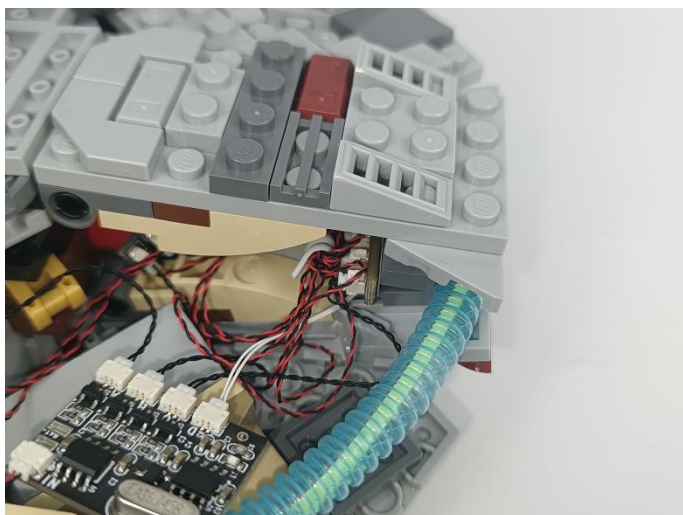

108

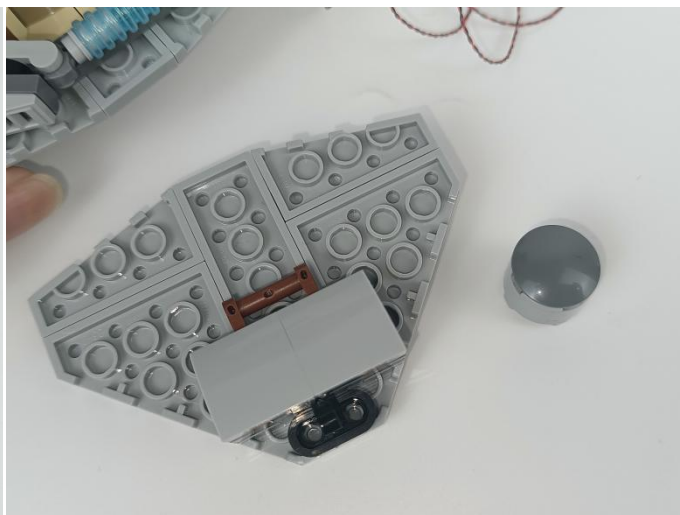
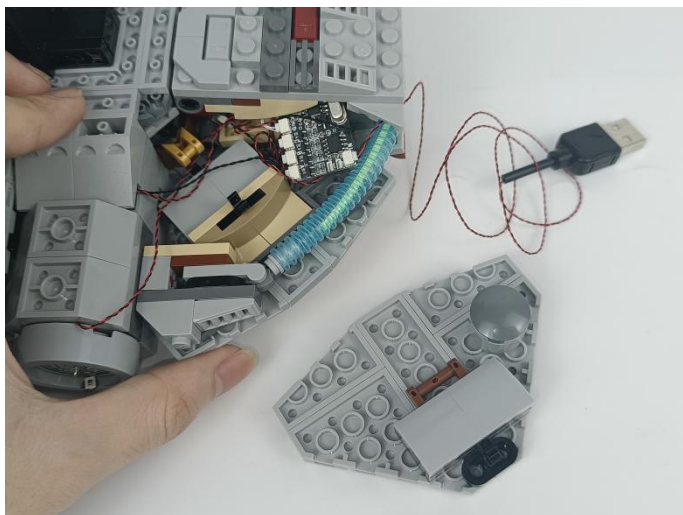

109

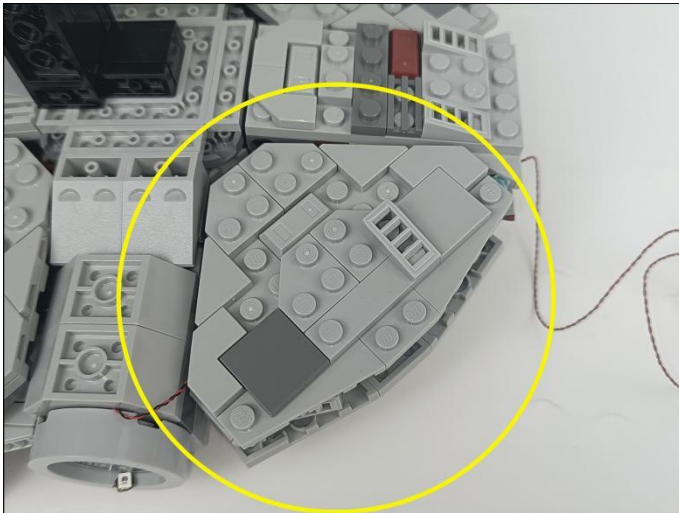

110



111

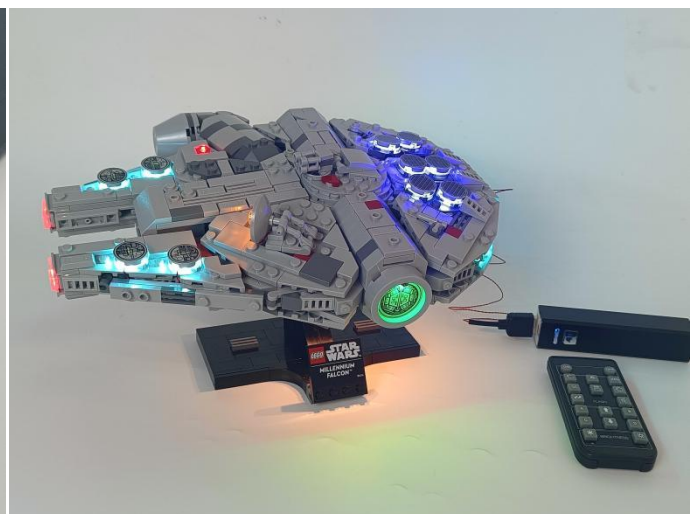

**If there is any problem with the spare parts,
please contact our after-sales service for replacement!**

Good job, you've done all the installation steps, power it up and enjoy your work.



The battery box can also power the set. If it is necessary to change the power supply , prepare three AAA batteries, install them in the battery box, turn on the switch on the battery box, remove the plug of the USB Power Cable from the socket of the expansion board,plug the plug of the battery box to the same socket in the expansion board to power the suit as well.

THANKS