

76252 Batcave – Shadow Box P50402

- Installation requires a lot of patience and great observation that your LEGO bricks will come alive when you get this finished. The bricks with lighting as below, so make sure you're ready and let's get started.

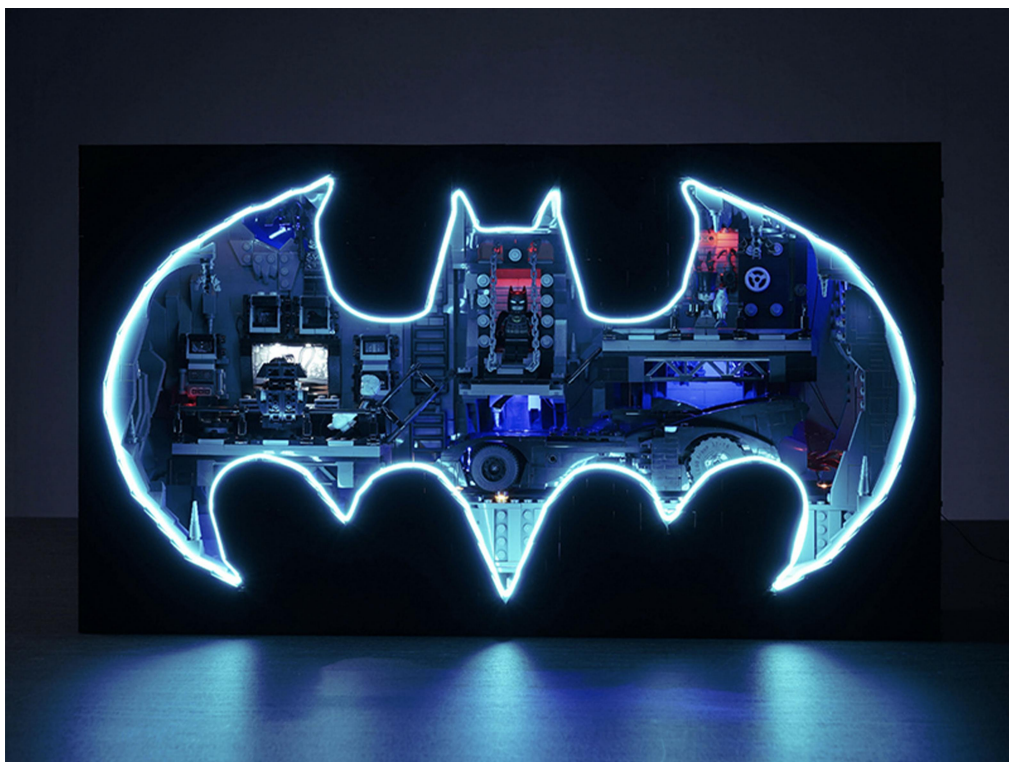

Strategies for the Installation

This instruction divides three sections to complete the installation of the lighting set.

Section A: Check the type and quantity of components.

The quantity and type of components of each products are different and it needs to be carefully checked to make sure there do have enough material. The type of components is indicated by the label on the bag.

Section B: Test that each components is working properly.

Each components is made individually so it is necessary to test that each components is working properly to avoid the situation that the lighting does not work .

Section C: laying out components following the instruction.

Our material is very small but not fragile, just be reminded that don't to pull the wires too hard. For different people, there may be some installation steps that you can't understand. Please look at the previous and later installation step.

Section A: Check the type and quantity of components.

There are 21 bags in this set. The name and quantities of specific components are as shown , please check carefully.

Label	Content	Quantity
A01001 Light-15CM Warm White	Light-15CM Warm White	17
A01011 Light-30CM Warm White	Light-30CM Warm White	8
A01024 High-Brightness light 15CM-Warm White	High-Brightness light 15CM-Warm White	2
A01101 LED Strip Red	LED Strip Red	2
A01103 LED Strip Blue	LED Strip Blue	4
A01104 LED Strip White	LED Strip White	1
A012 Expansion Board	4 Socket Expansion Board	3
	6 Socket Expansion Board	4
	8 Socket Expansion Board	1
	12 Socket Expansion Board	1
	2 Socket Expansion Board	1
	6 Socket Expansion Board-flat	1
A01305 Power Supply	Power Supply	1
A01501 Connecting Cable 5CM	Connecting Cable 5CM	3
A01502 Connecting Cable 15CM	Connecting Cable 15CM	5
A01503 Connecting Cable 30CM	Connecting Cable 30CM	3
A01504 Connecting Cable 50CM	Connecting Cable 50CM	2
A01506 Connecting Cable 20CM	Connecting Cable 20CM	6
A01906 Music Module	Music Module	1
A02103 Flash Light-15CM Red	Flash Light-15CM Red	1
A02517 Light Strip-Blue	Light Strip-Blue	1
A02552 Light Strip-Blue-COB	Light Strip-Blue-COB	1
A02553 Light Strip-Cyan-COB	Light Strip-Cyan-COB	1
A1031 High-Brightness Light 15CM-Red	High-Brightness Light 15CM-Red	1
A1035 High-Brightness Light 15CM-Blue	High-Brightness Light 15CM-Blue	2
Components		

Please contact us immediately if there have any missing components.

Section B: Test that each components is working properly.

We need a structure to test all lights, so take out the bag with label “USB Power Cord”and “Expansion Boards”as follows.



It is worth reminding that our products are all customized. They have a unique way of connecting. The white plug on wire and the socket of the expansion board need to be connected together to transmit power.

Note that on one side of the white plug you can see two very small golden wires that should be connected to the two golden needles in socket of the expansion board. shown as blow.

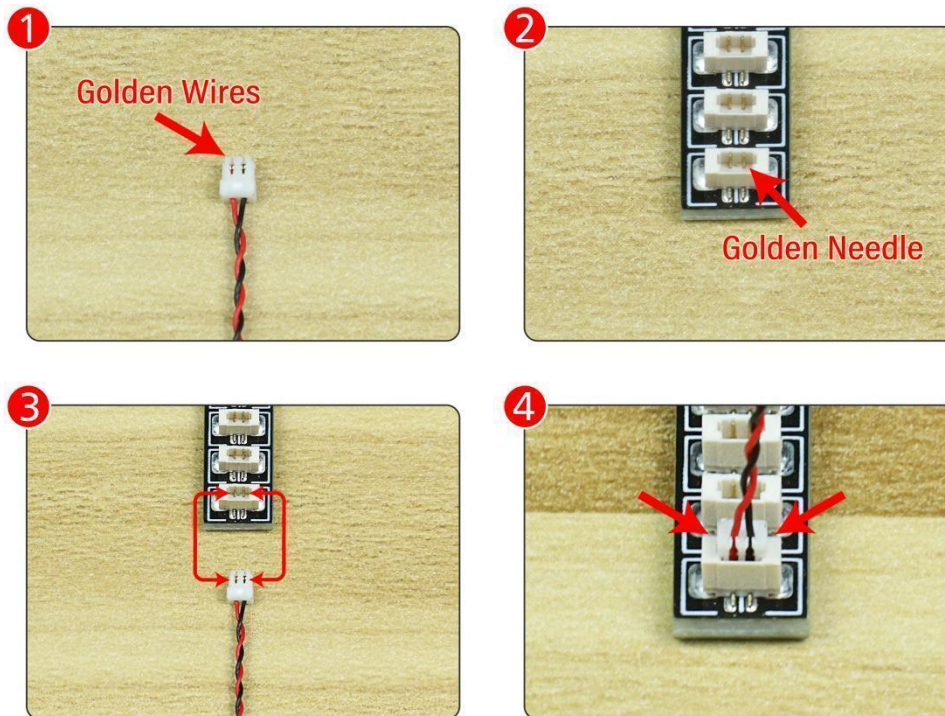

All our connections between plug and socket are all the same as shown above. So for any such structure with plug and socket, please pay attention to the golden wire of the plug and the golden needle of the socket, they must be touched together.

The connection method between the USB Power Cord and Expansion Boards is as follows:

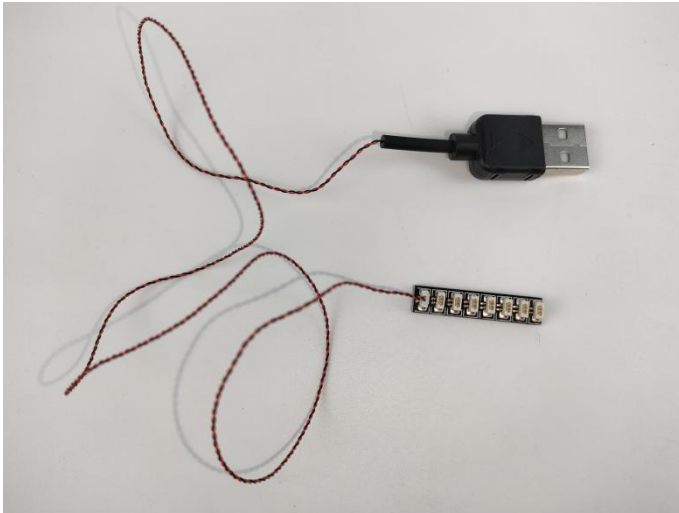

The USB Power Cord can be powered by phone chargers, power banks, etc.

USB connectors to connect devices

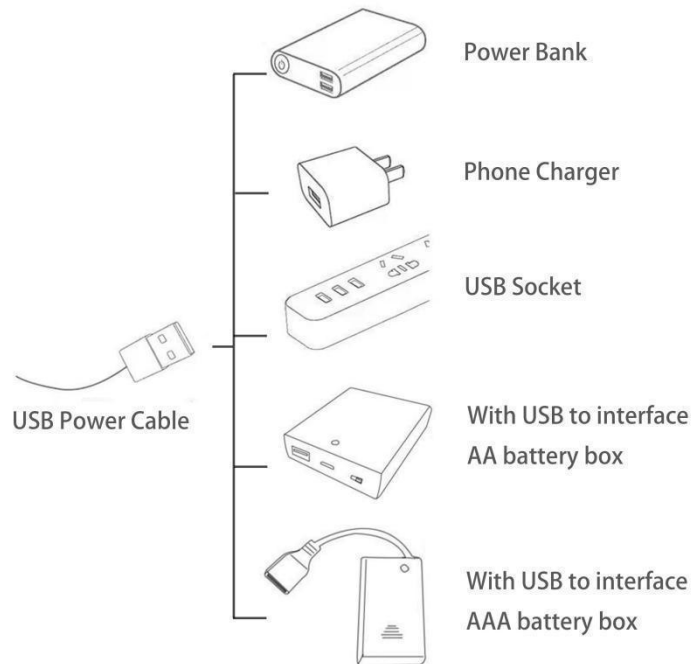

This instruction will use the power bank as power supply . The test structure is shown as follow. All lamp in this set will be tested by this structure.



When we test "A02517 Light Strip-Blue" particles,Take out the bag labelled "A02517 Light Strip-Blue".Take out one of the light and connect it to the socket. Turn on the power bank, the light will turn on normally as shown below.

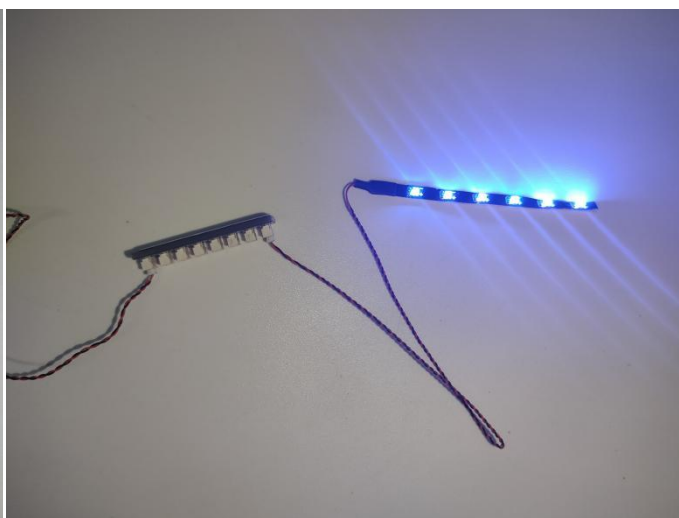

Test each lamp according to this method. It should be noted that after the test, the lamp must be returned to the corresponding bag to avoid confusion of types.



LED strip test:

Take out the bag labeled "A01104 LED Strip White". Take out the LED light bar, connect the USB power cable, turn on the mobile power supply, the light will be on normally, as shown in the figure below.



The components needs to be tested in this set is 16* Light-15CM Warm White,8* Light-30CM Warm White,2*High-Brightness light 15CM-Warm White,2* LED Strip Red,4* LED Strip Blue,1* Flash Light-15CM Red,1* Light Strip-Blue-COB,1* Light Strip-Cyan-COB,1* High-Brightness Light 15CM-Red,2* High-Brightness Light 15CM-Blue.

Please contact us immediately if any components don't work.

Section C: laying out components following the instruction.

1

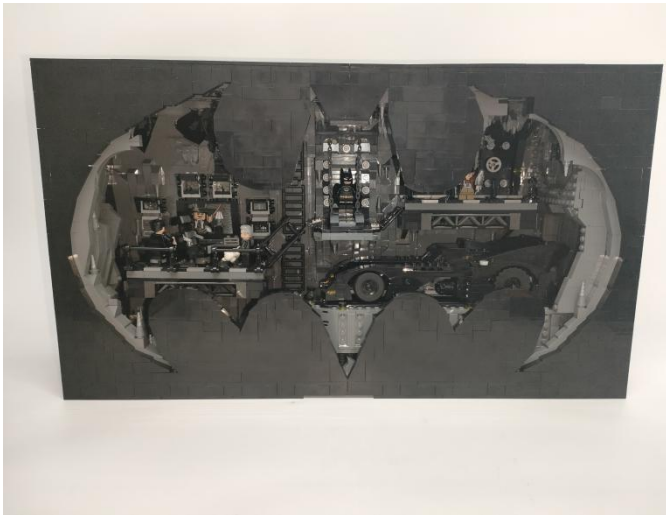

2

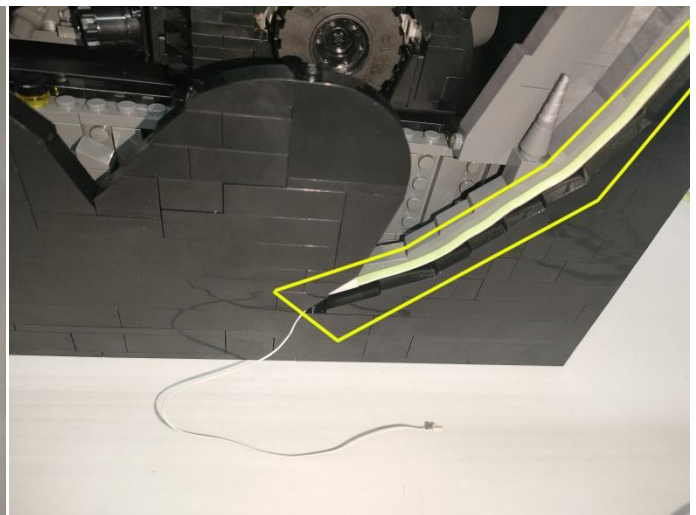
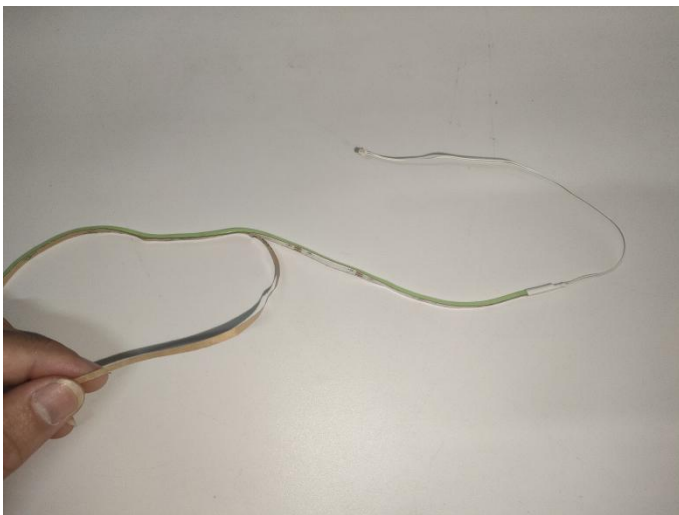

3

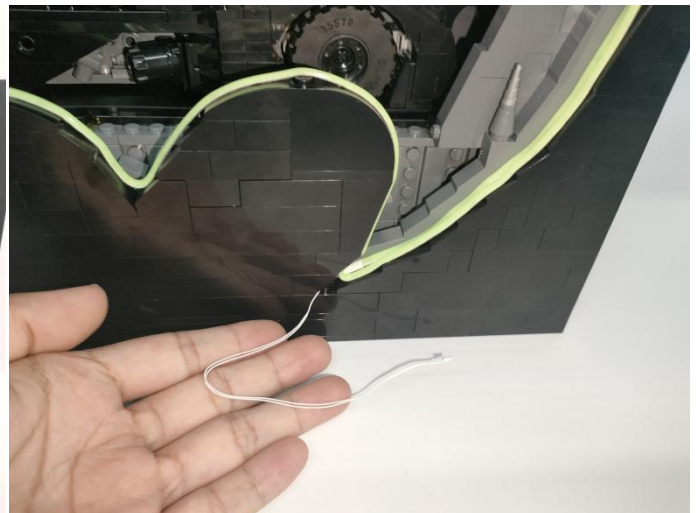
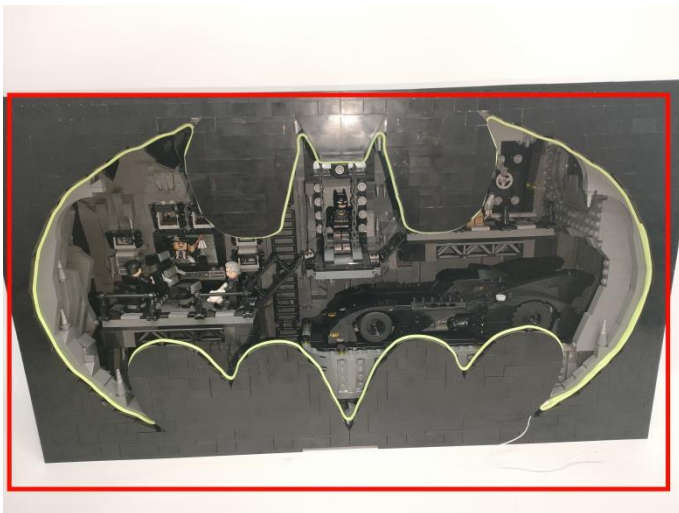

4

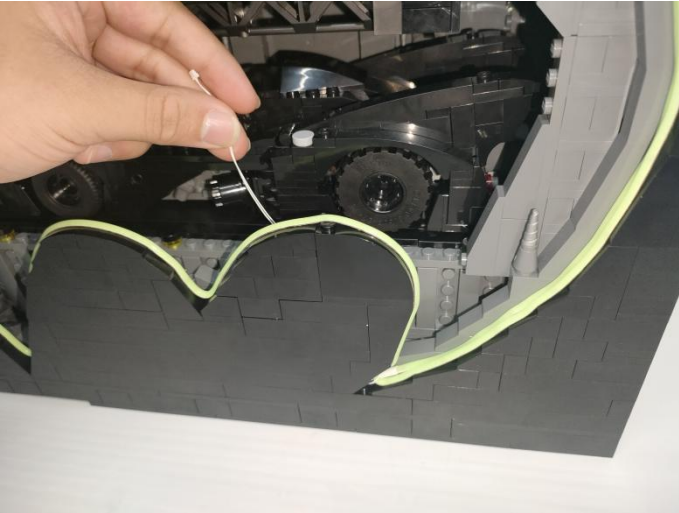

5

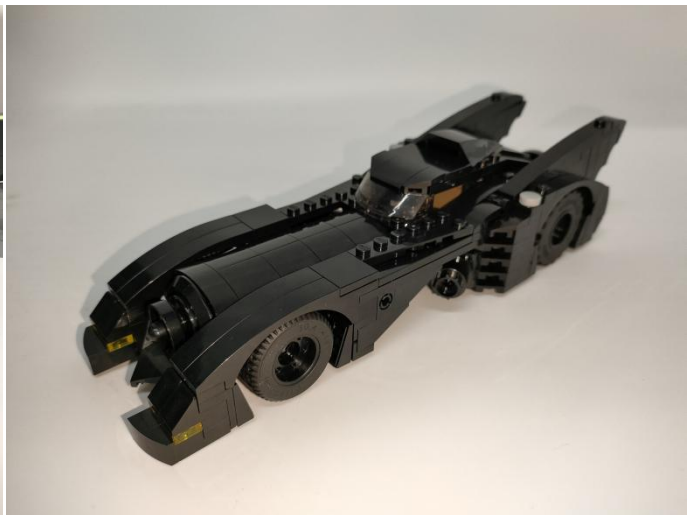
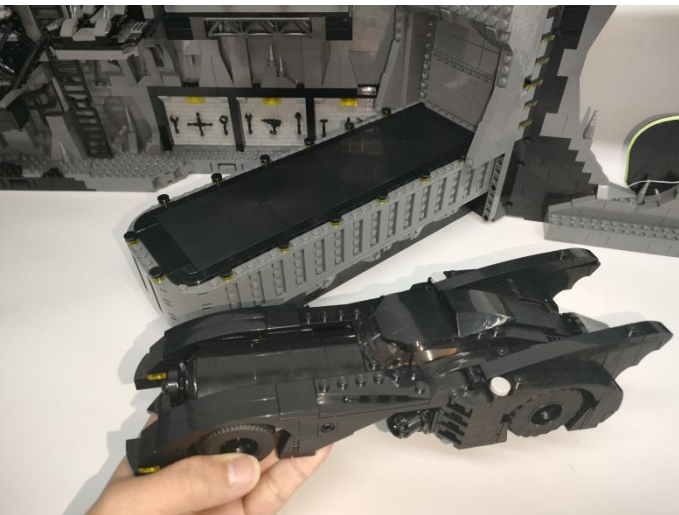

6

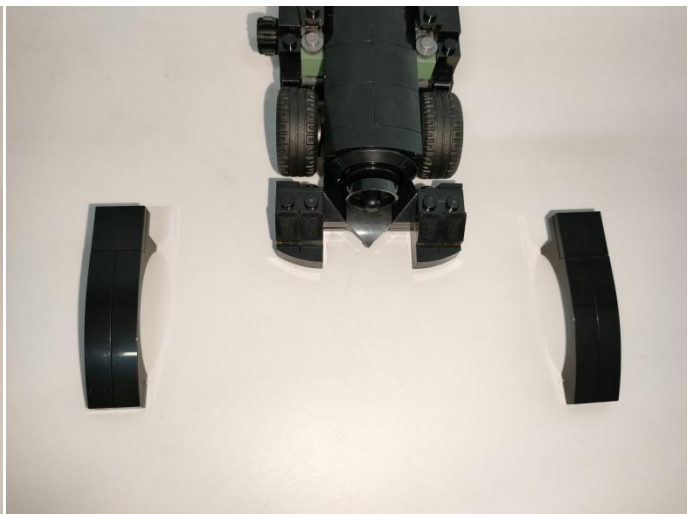
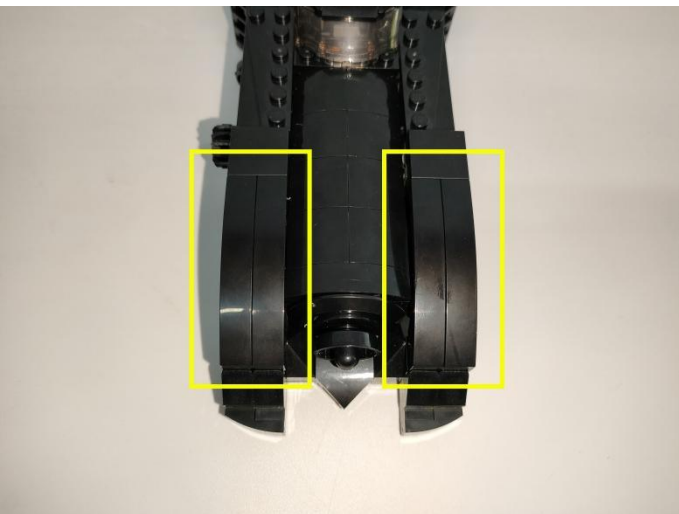

7

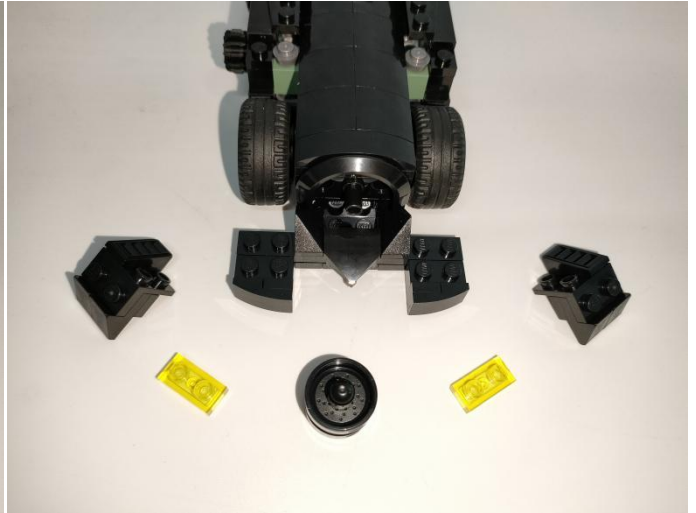
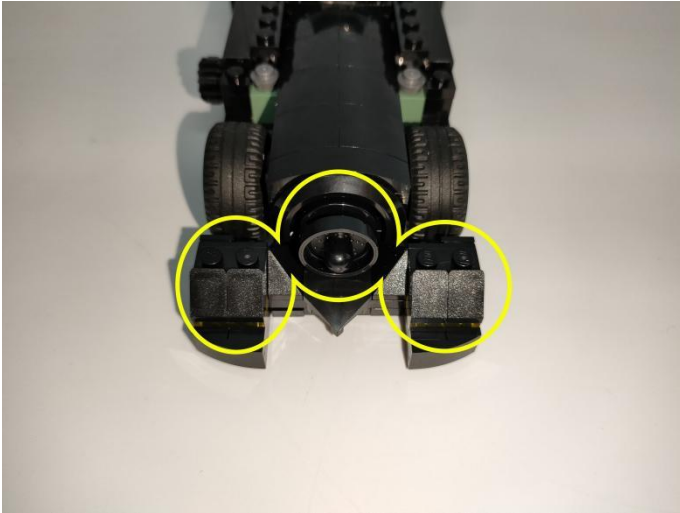

8



9

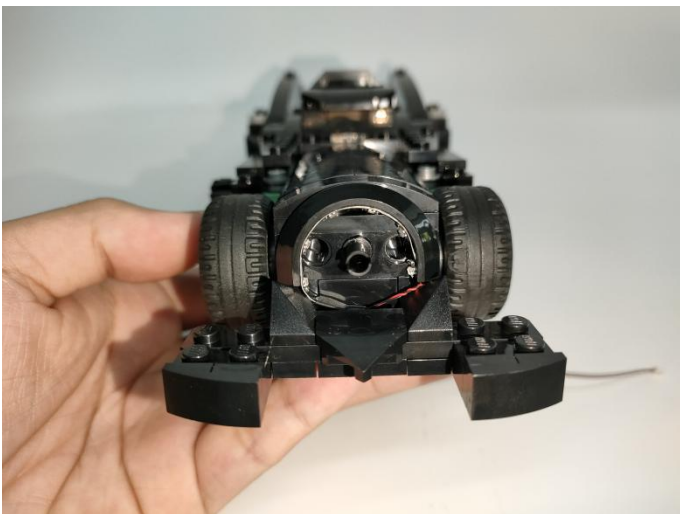

10



11



12

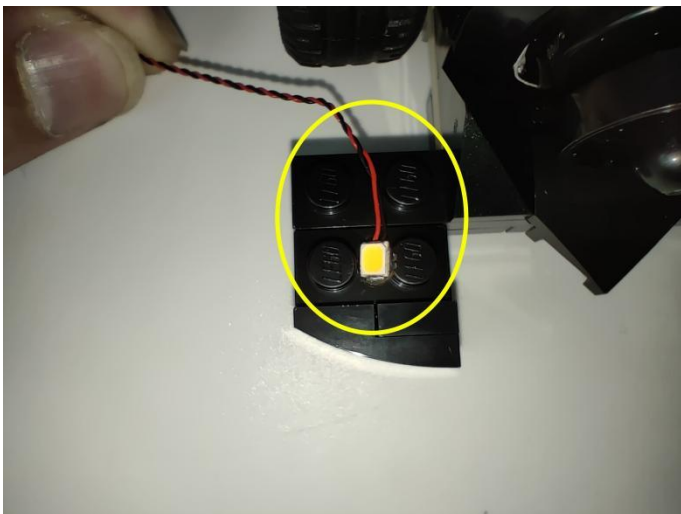

13

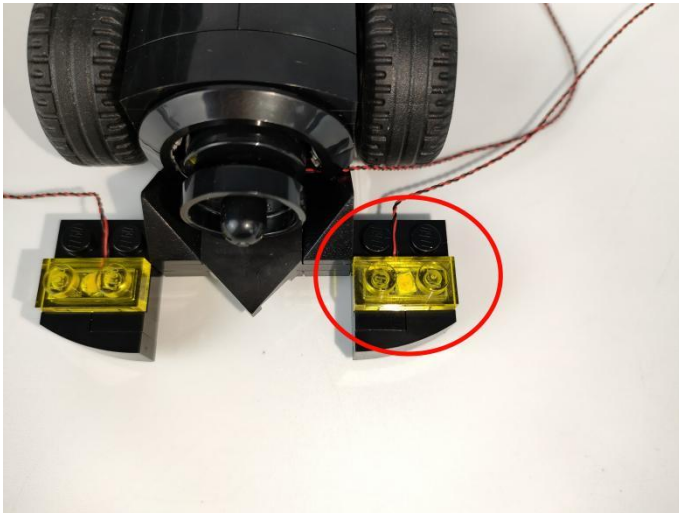

14

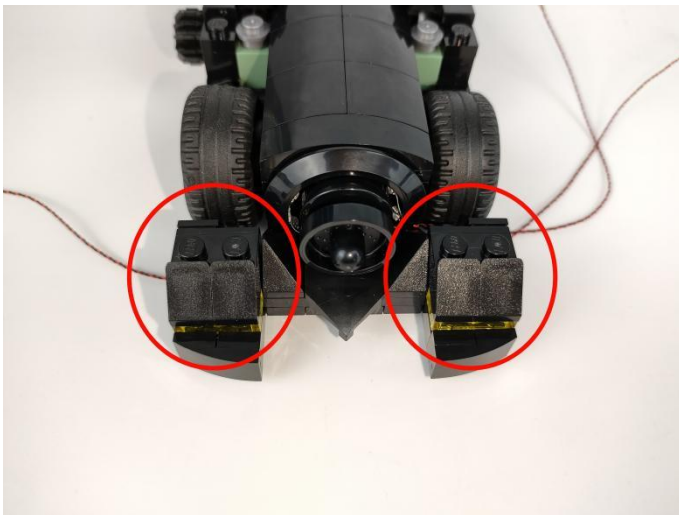

15

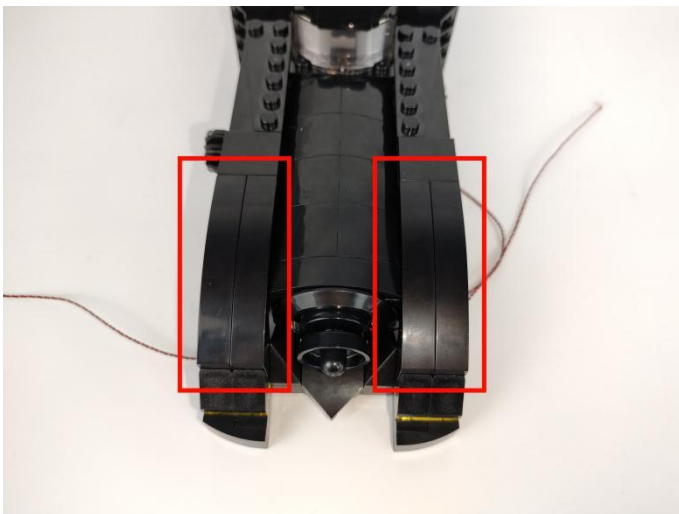

16



17

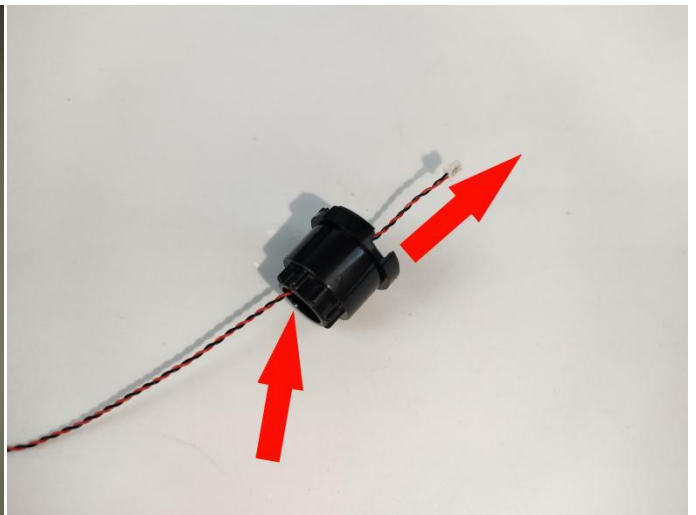

18

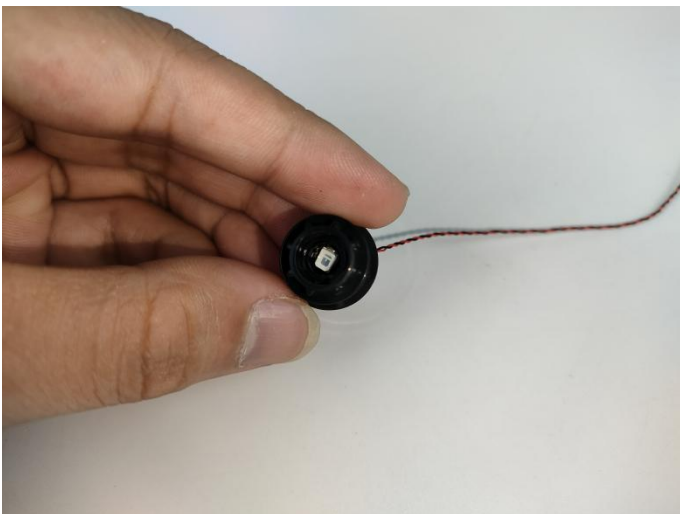

19

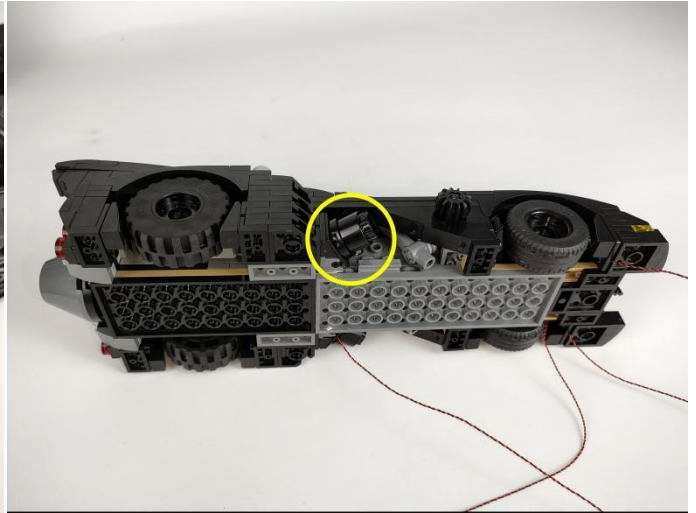
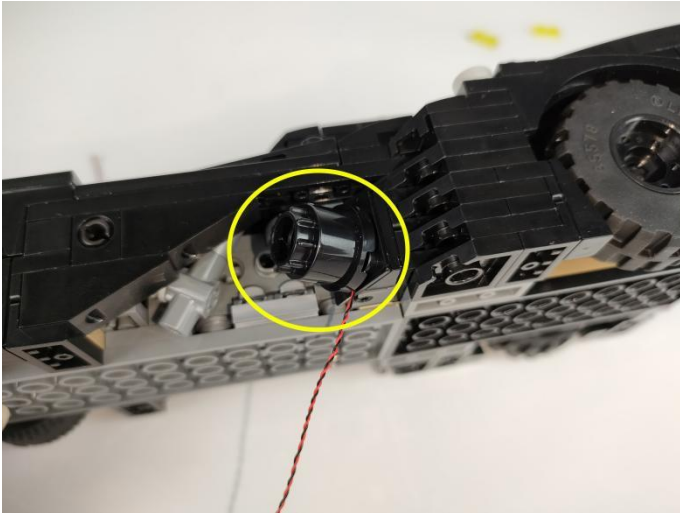

20

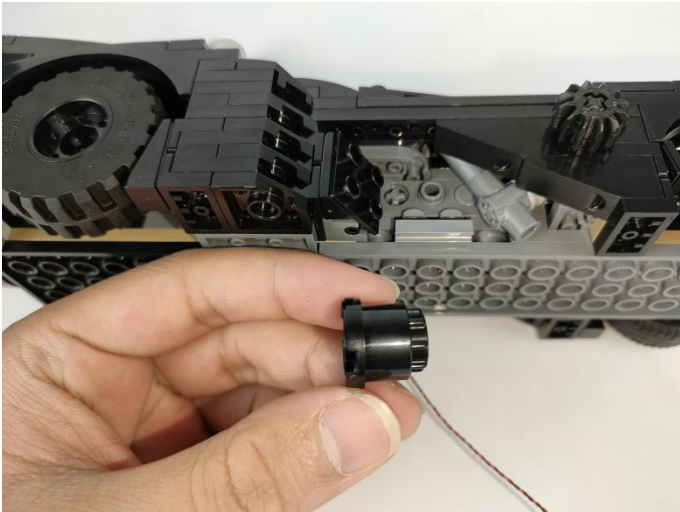

21

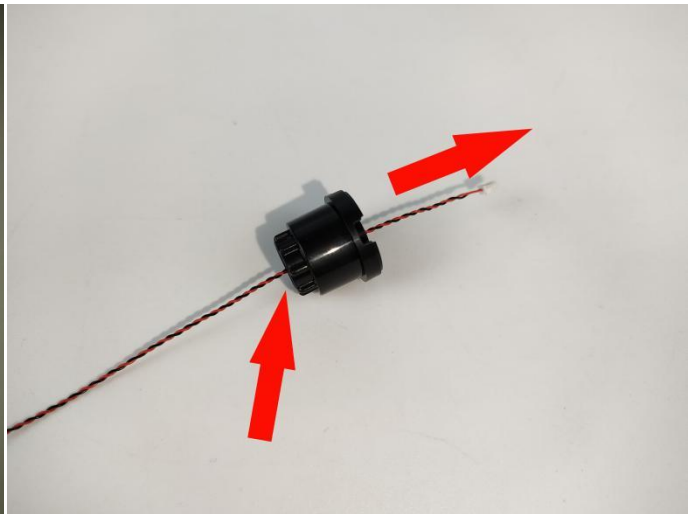

22

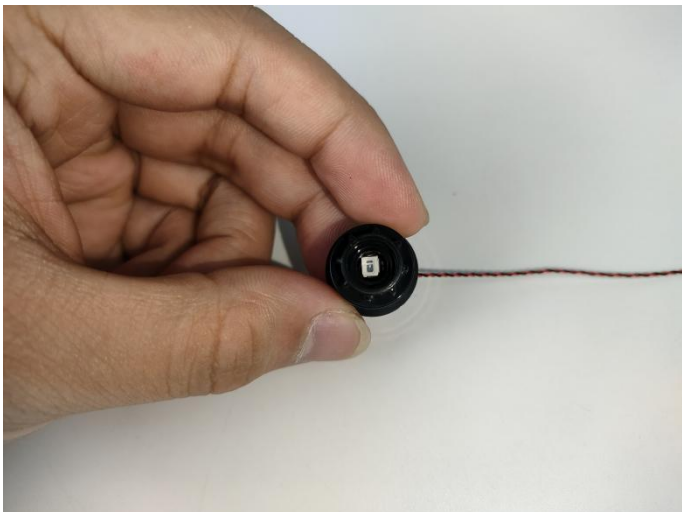

23

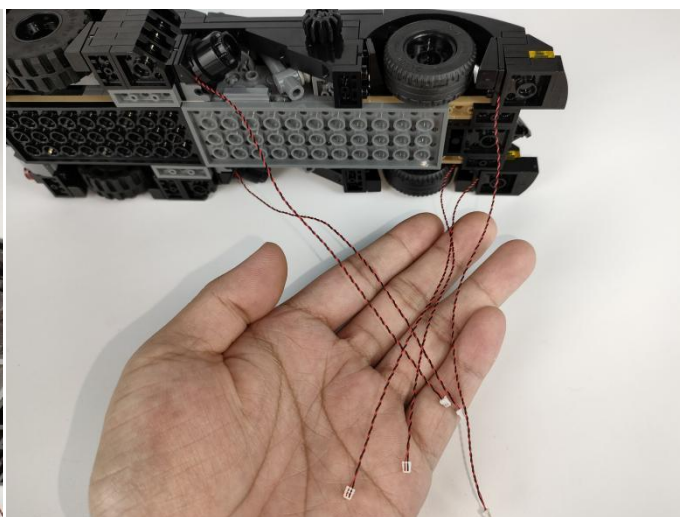
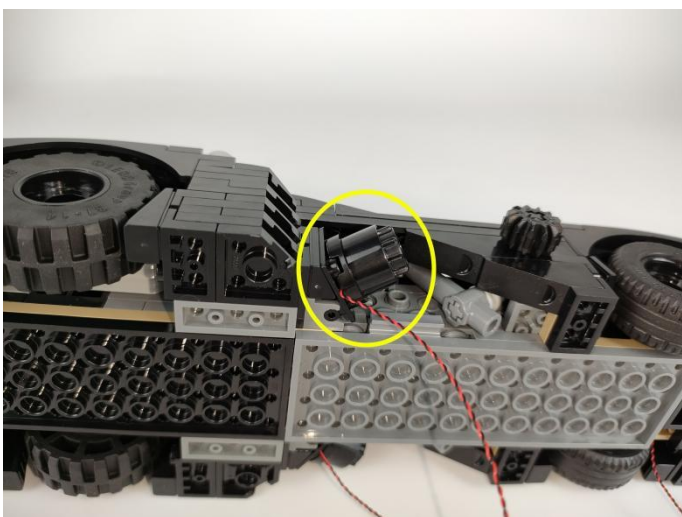

24

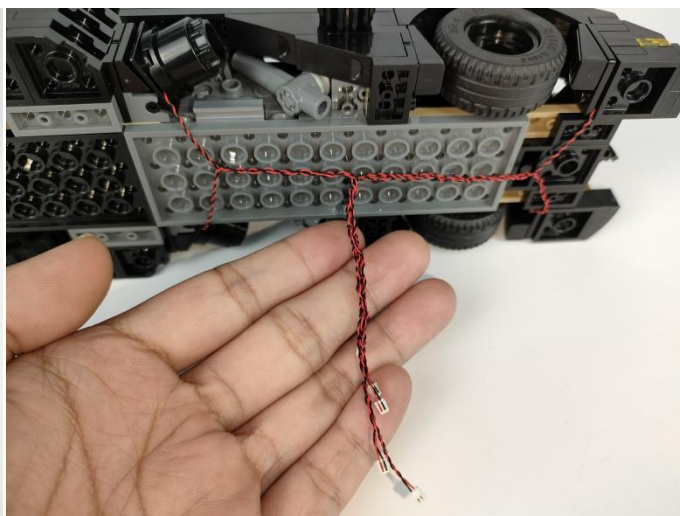
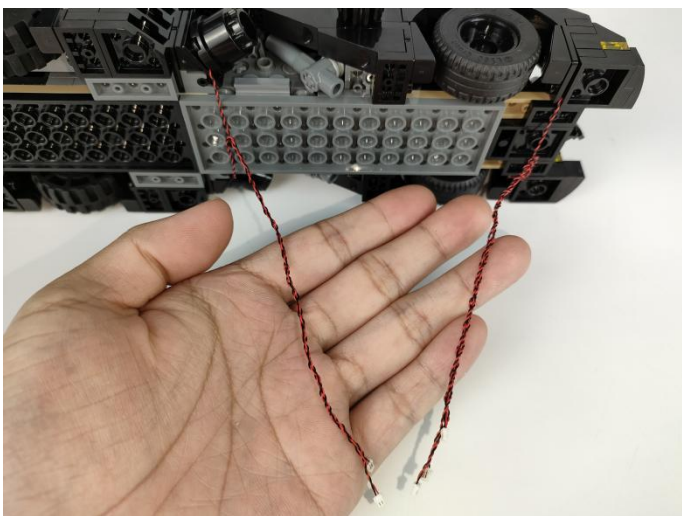

25



26

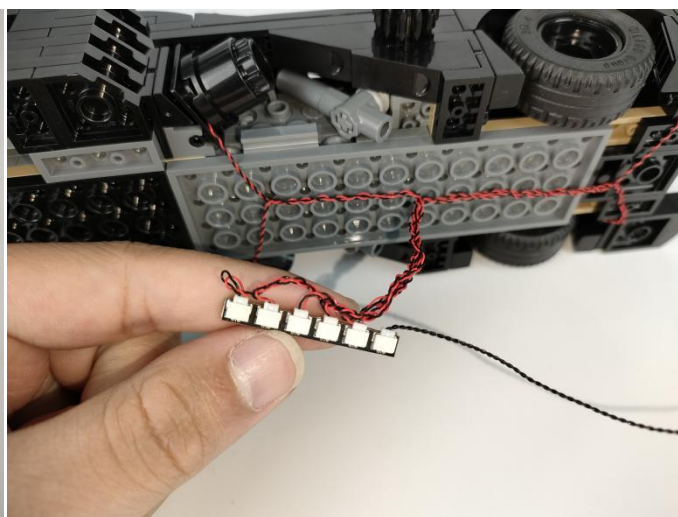
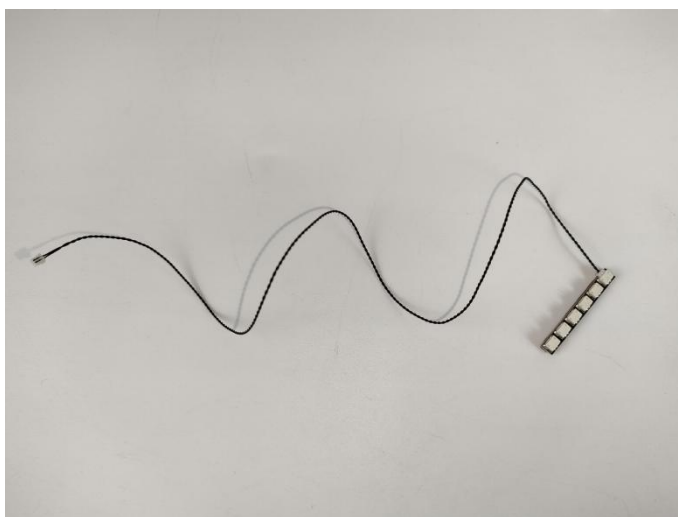

27

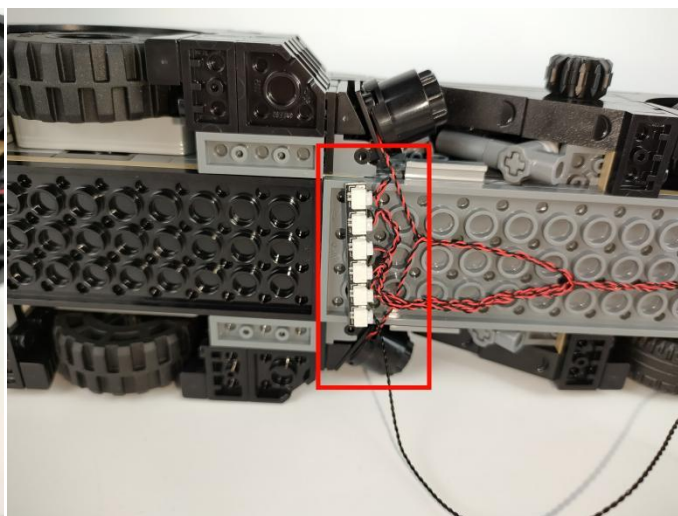
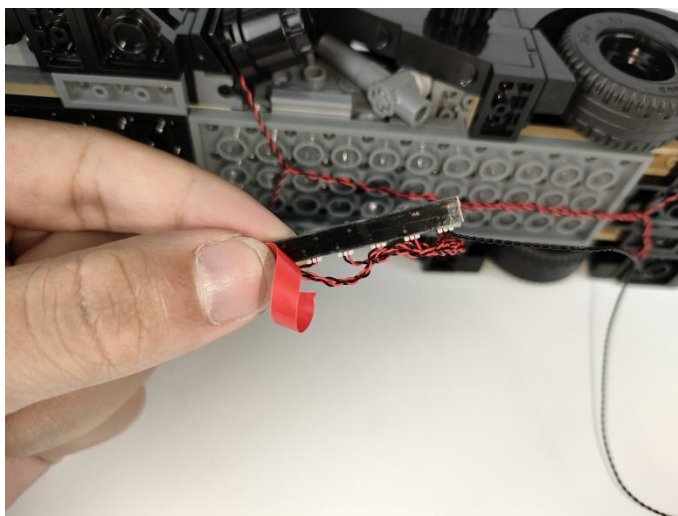

28



29



30

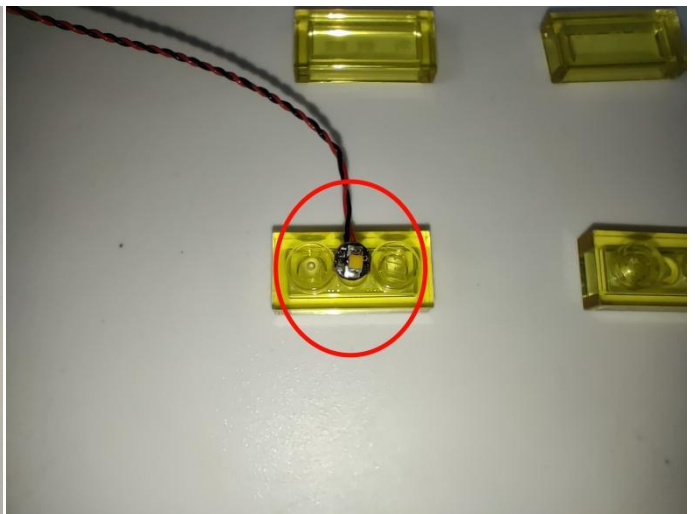

31

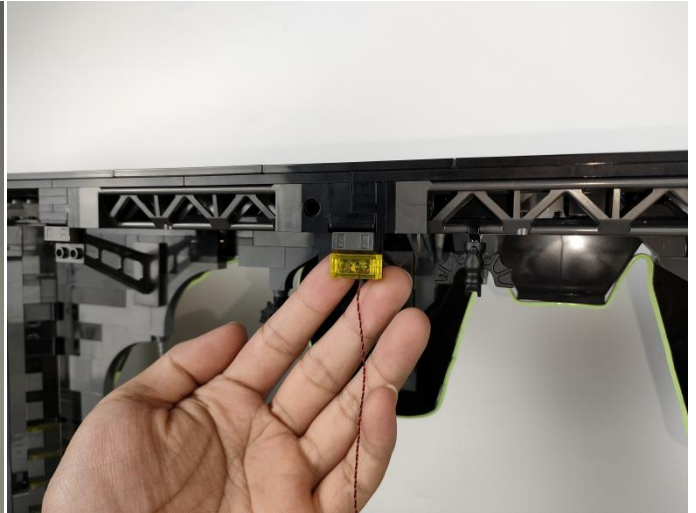

32

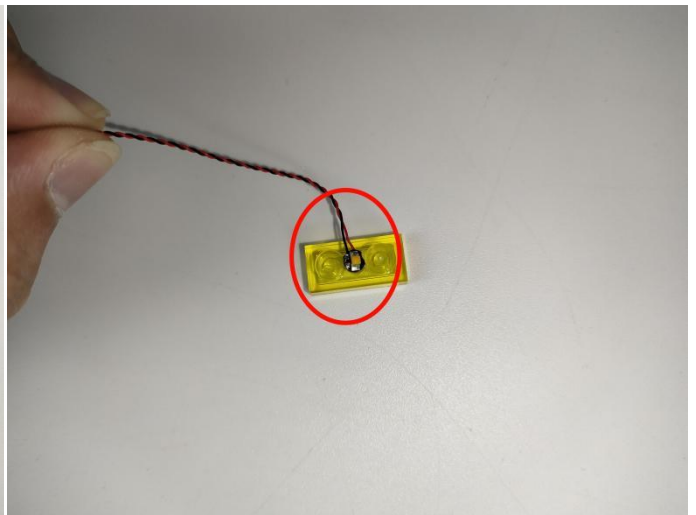

33

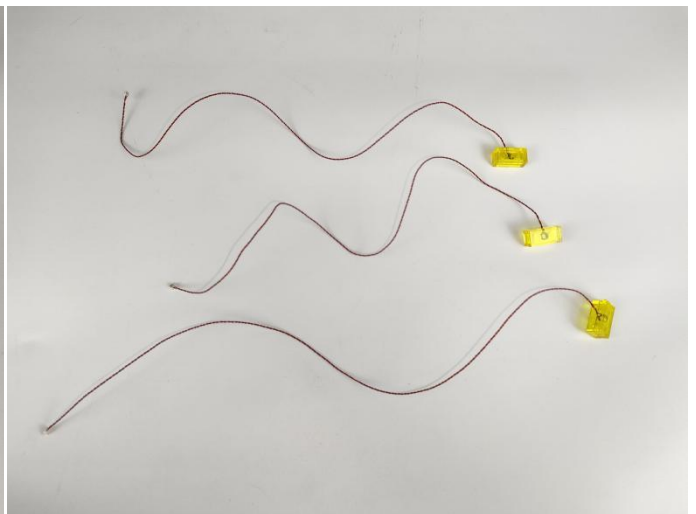
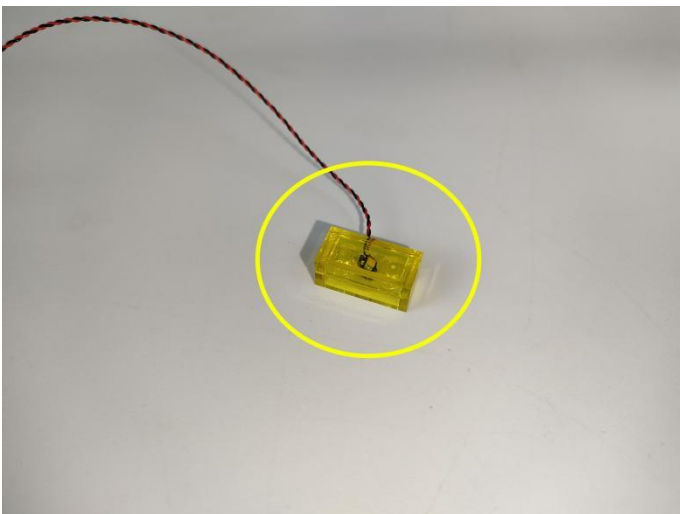

34

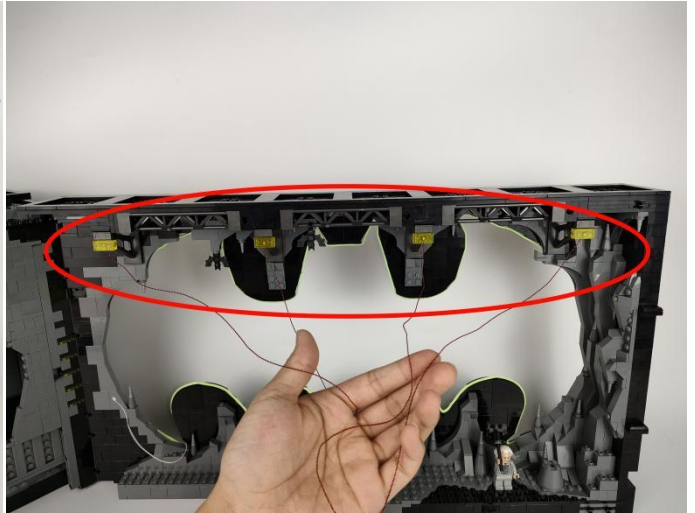
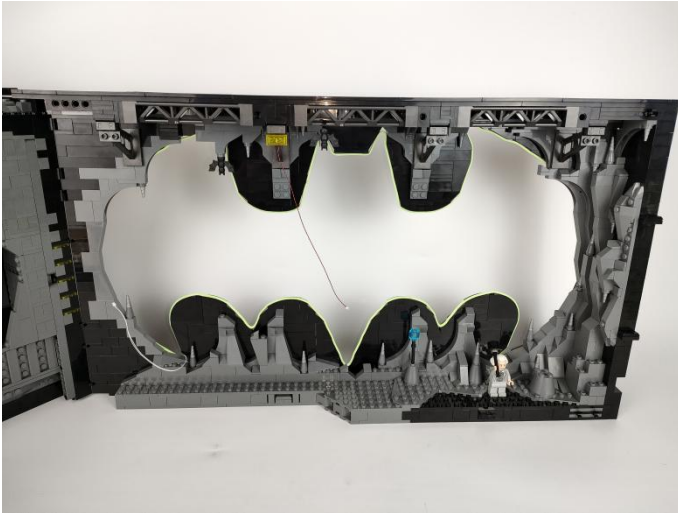

35

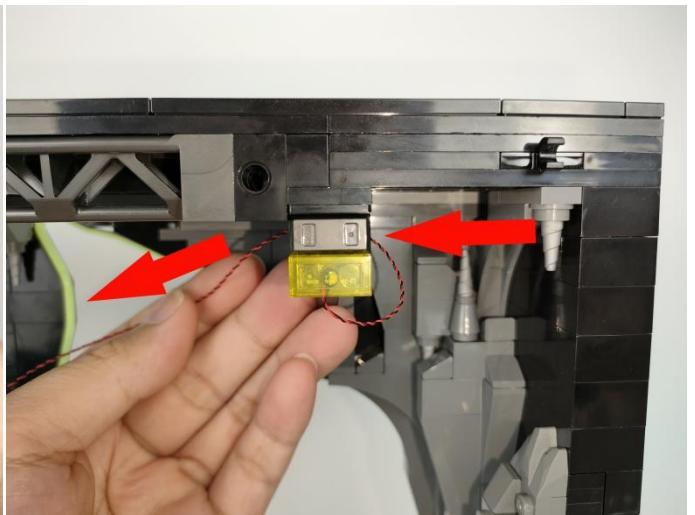
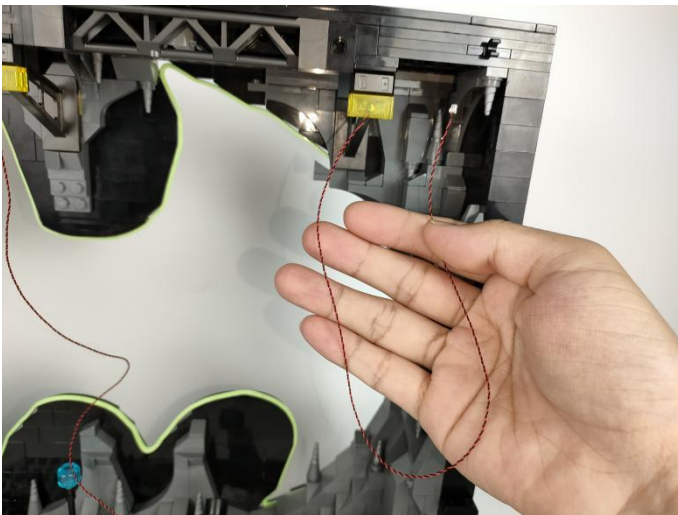

36

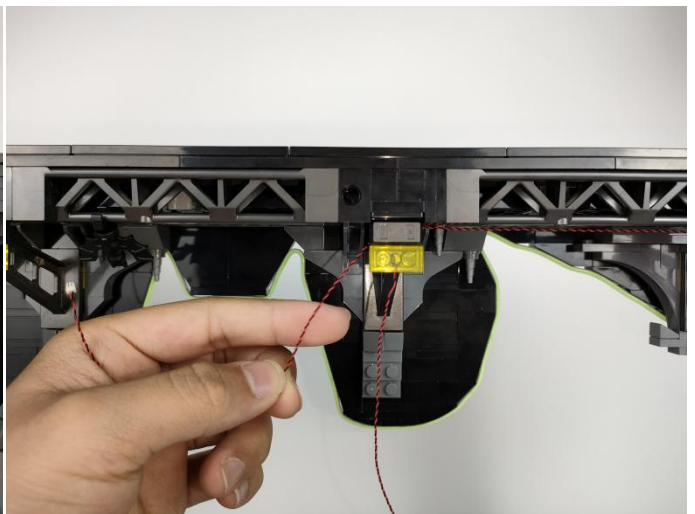
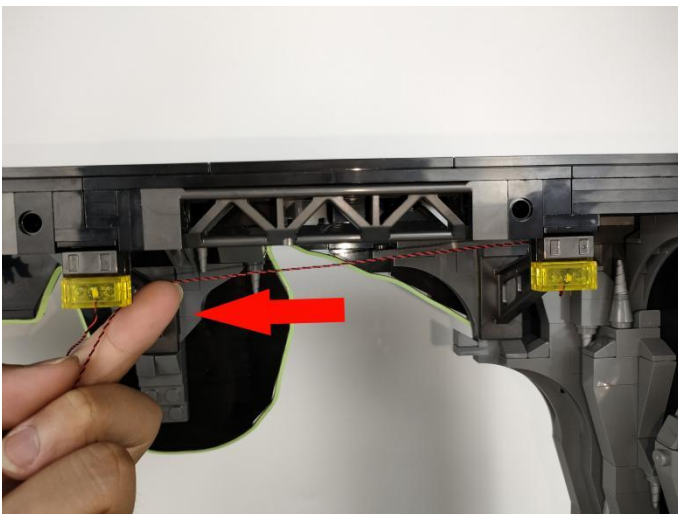

37

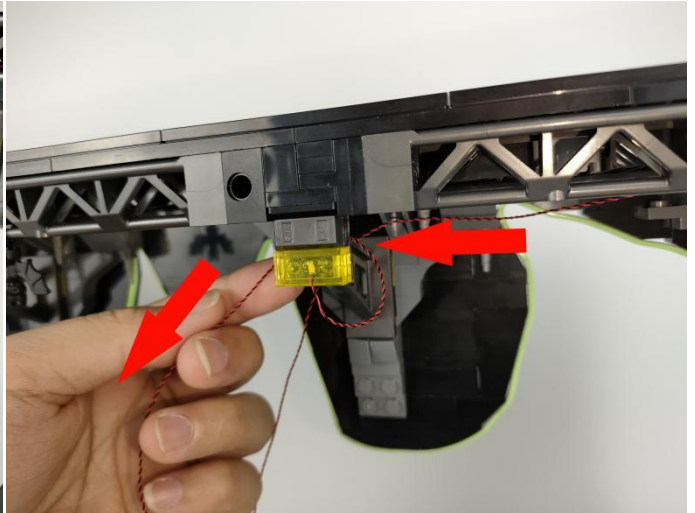
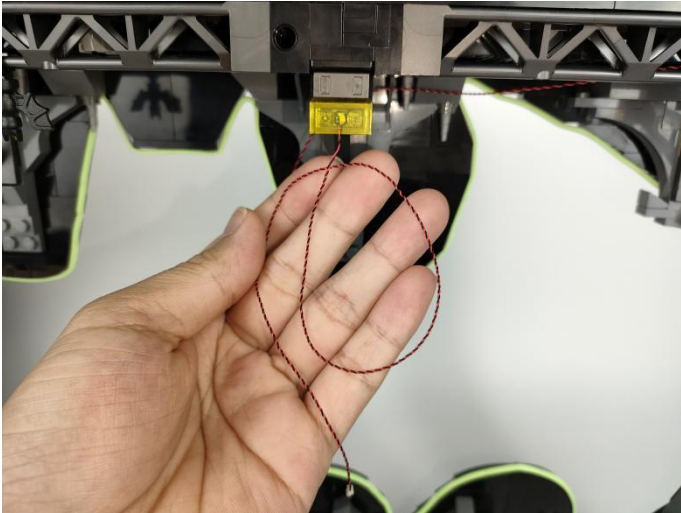

38

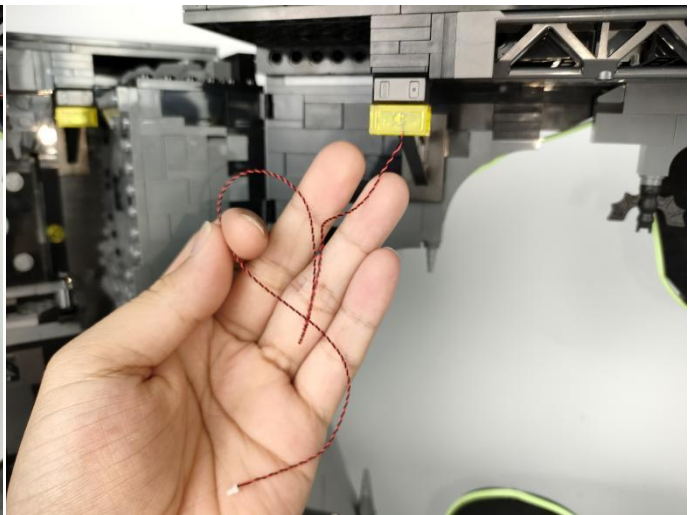
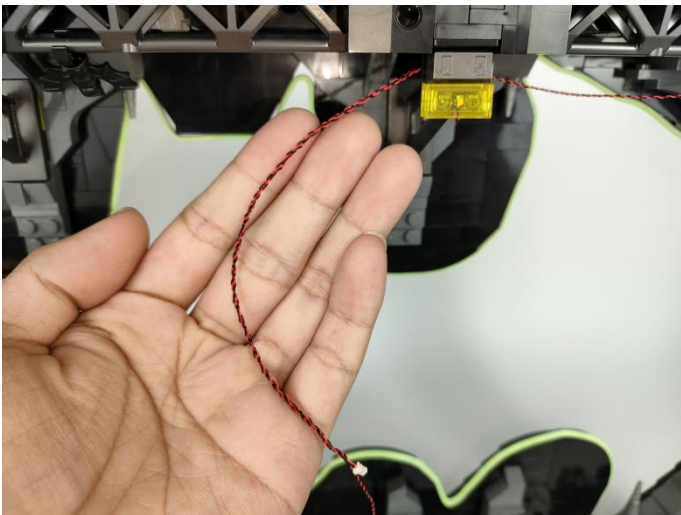

39

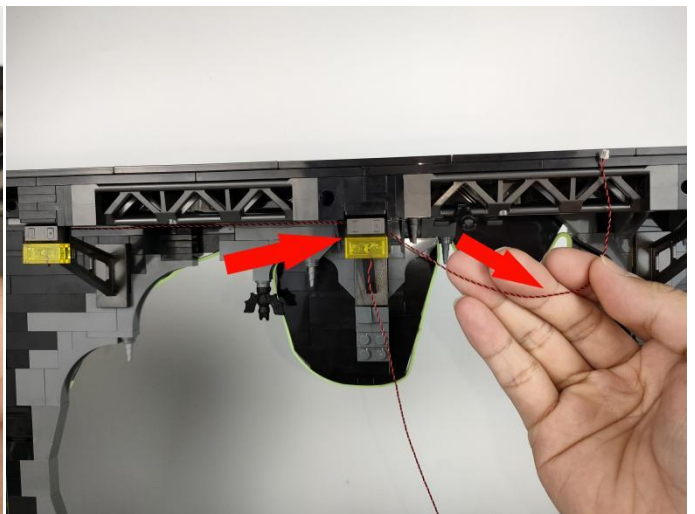
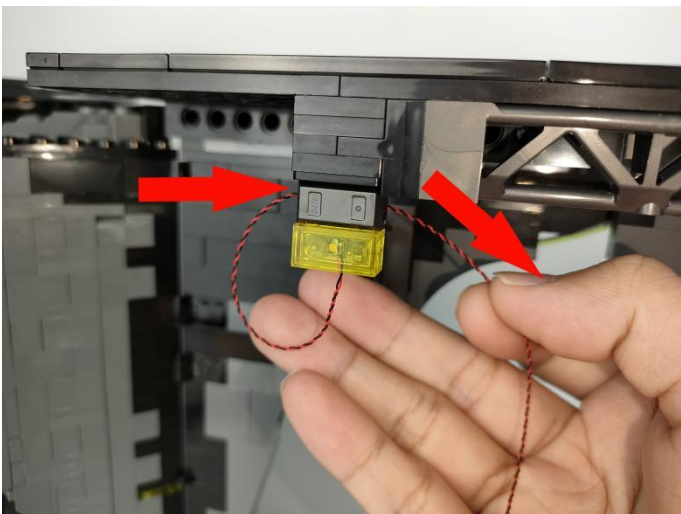

40

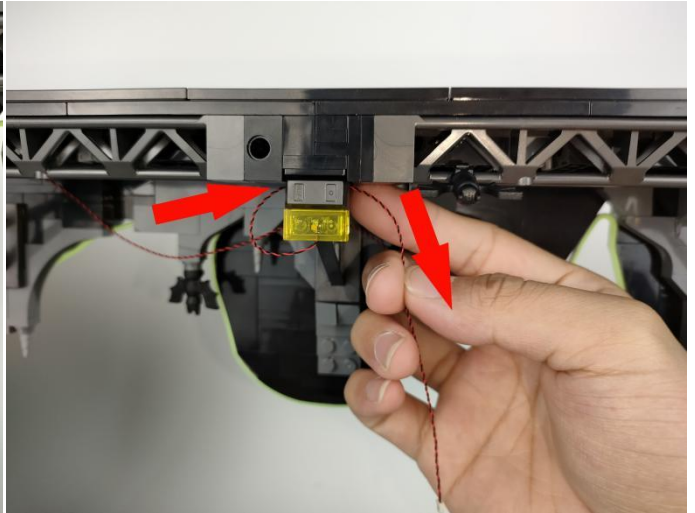
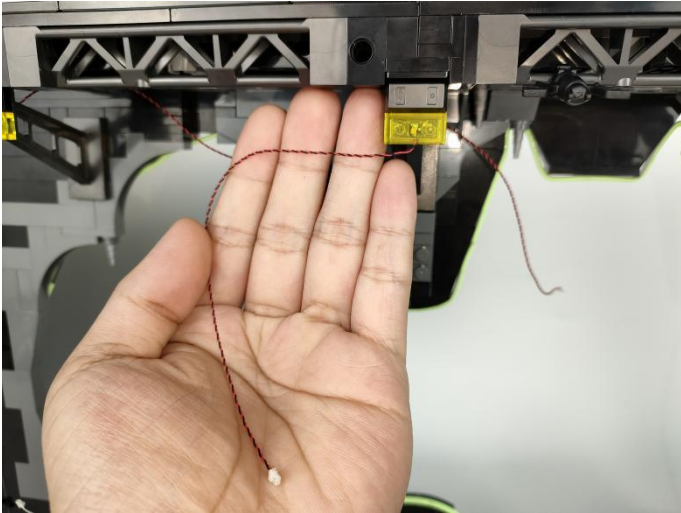

41

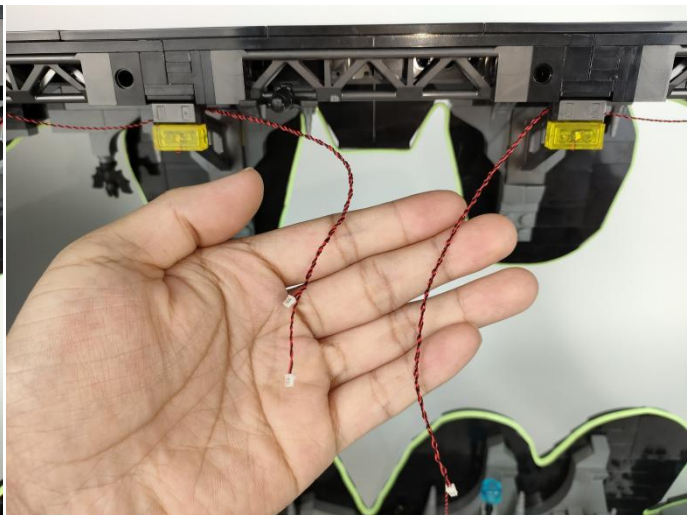
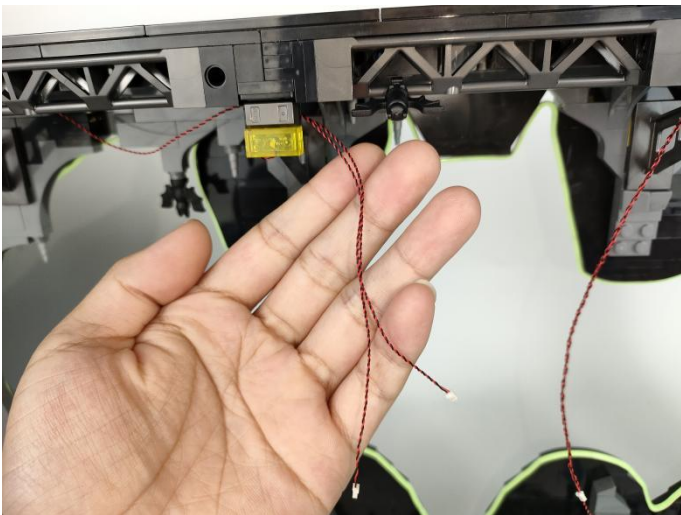

42

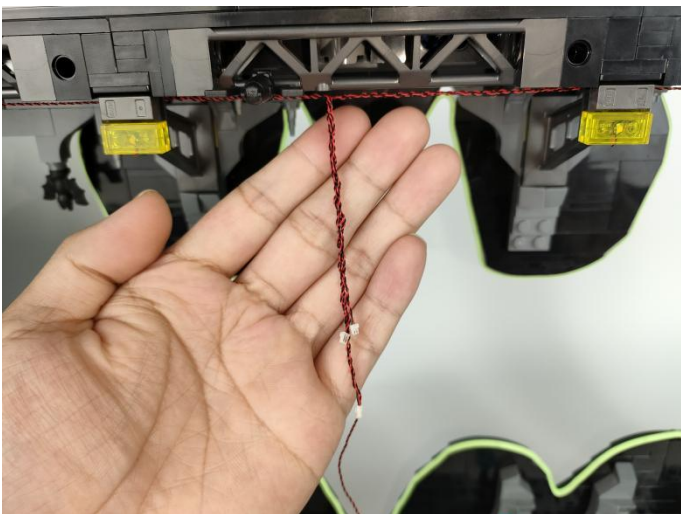

43

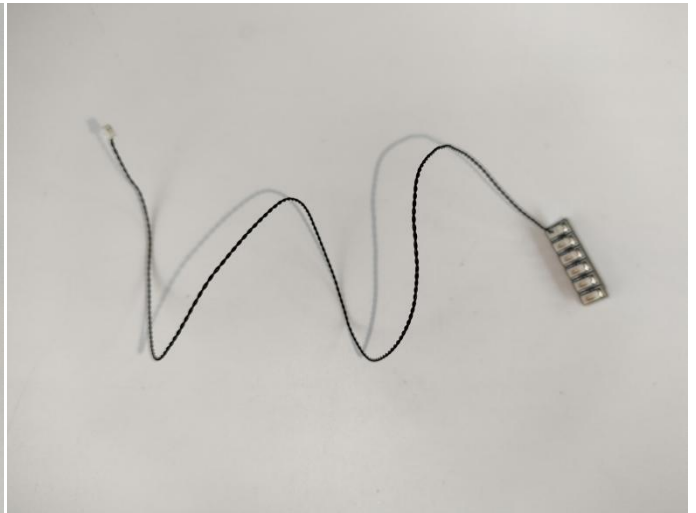

44

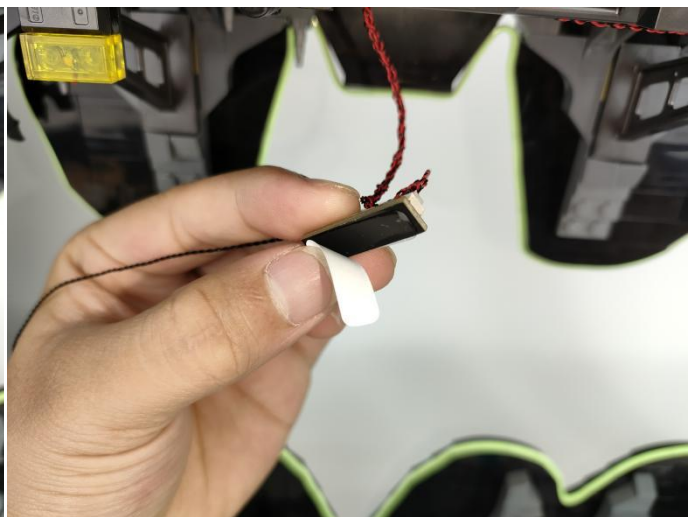
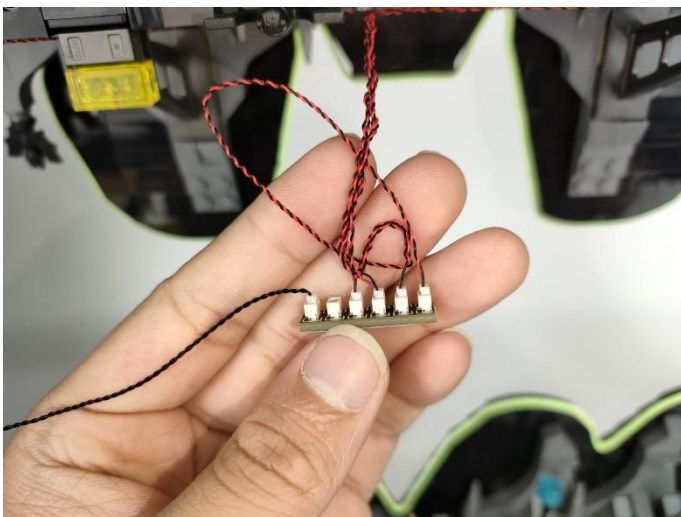

45

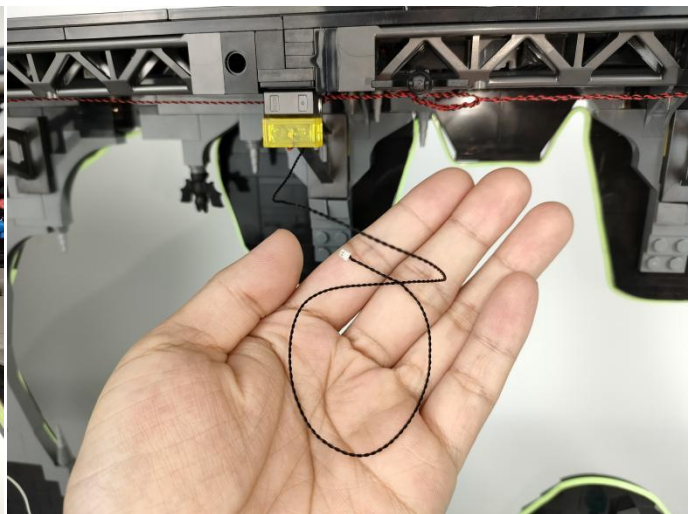
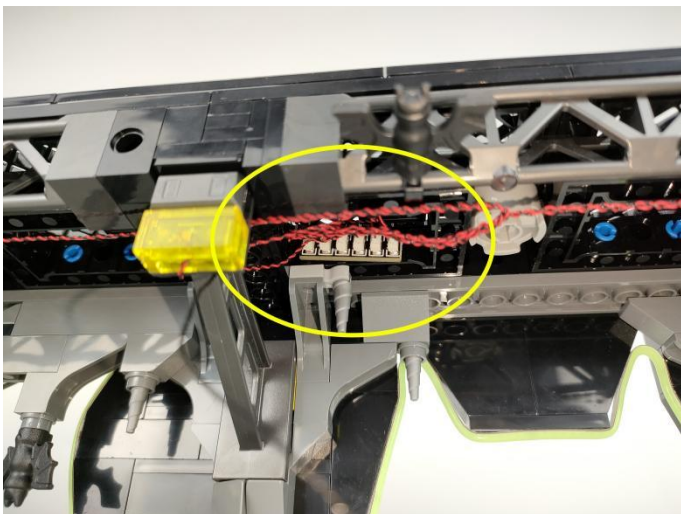

46

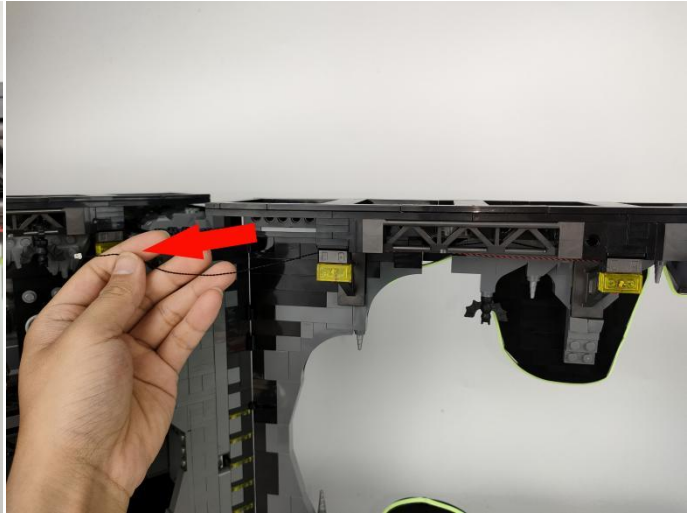
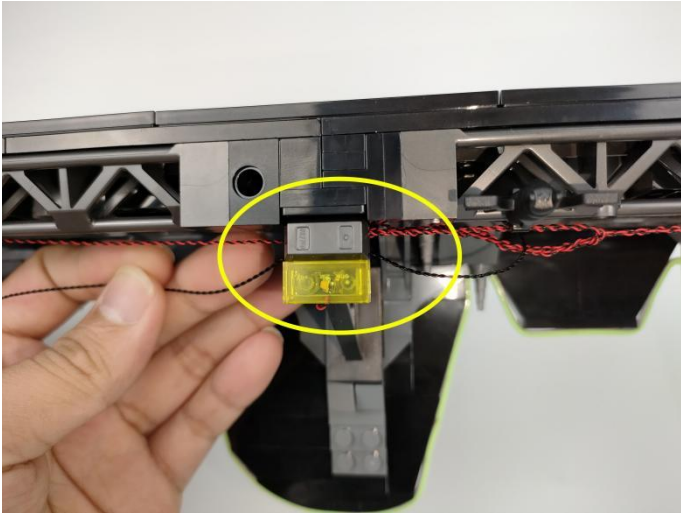

47

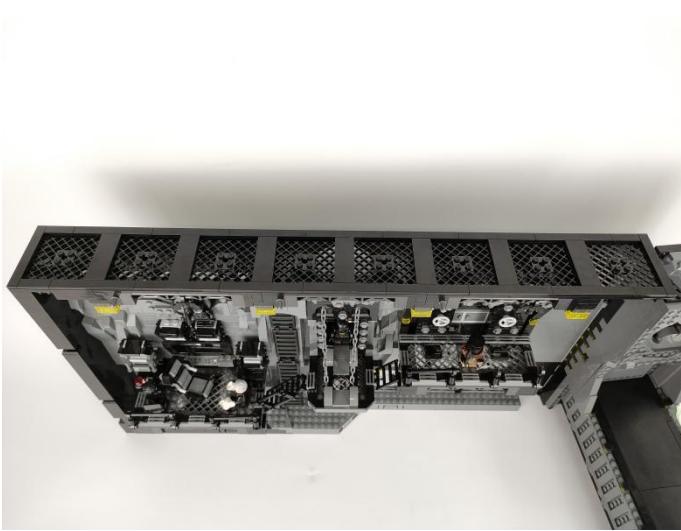

48



49

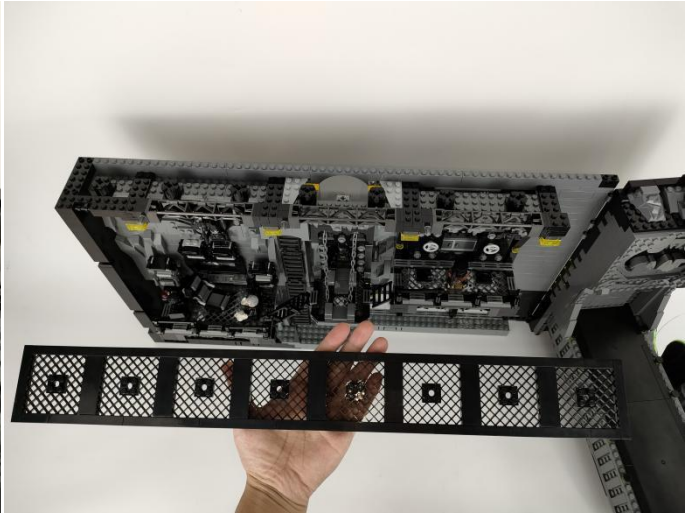

50

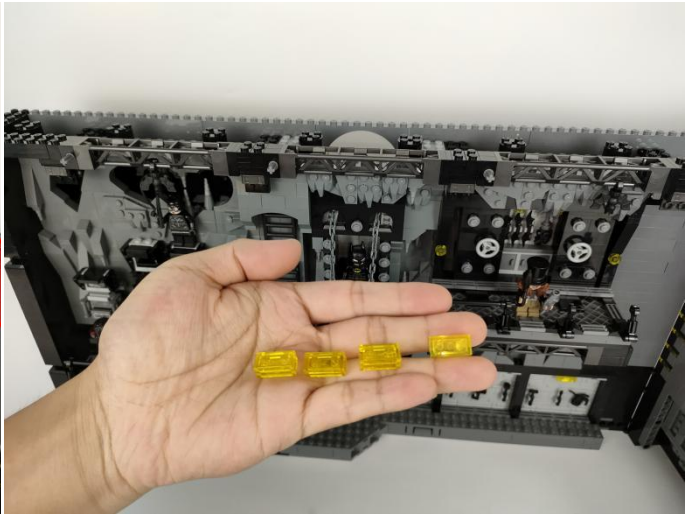
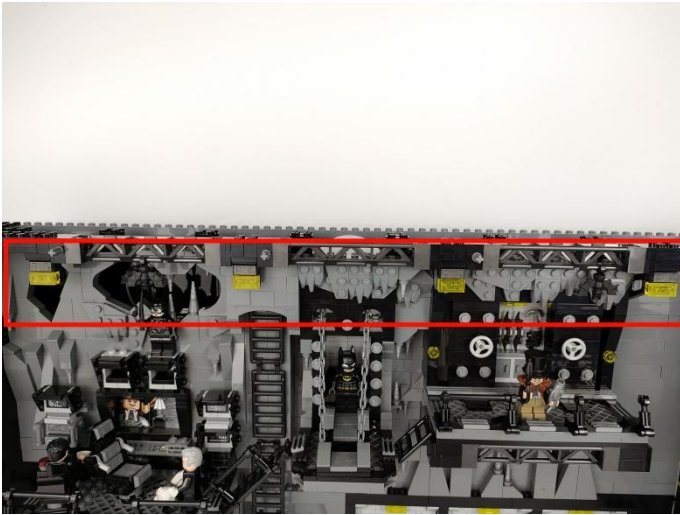

51



52

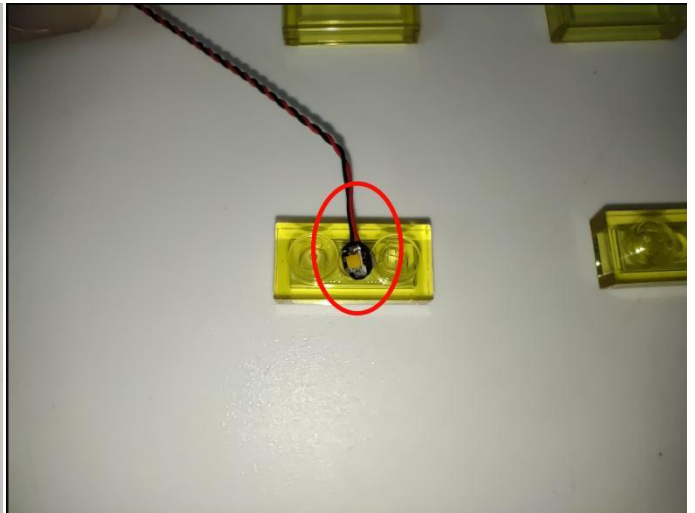

53



54

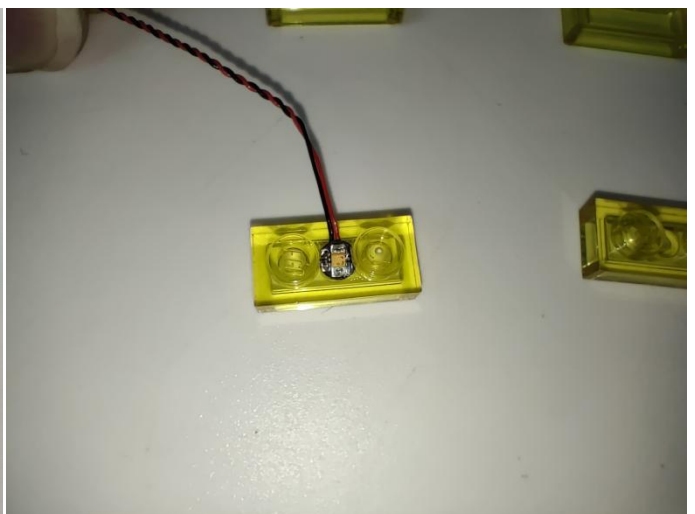

55

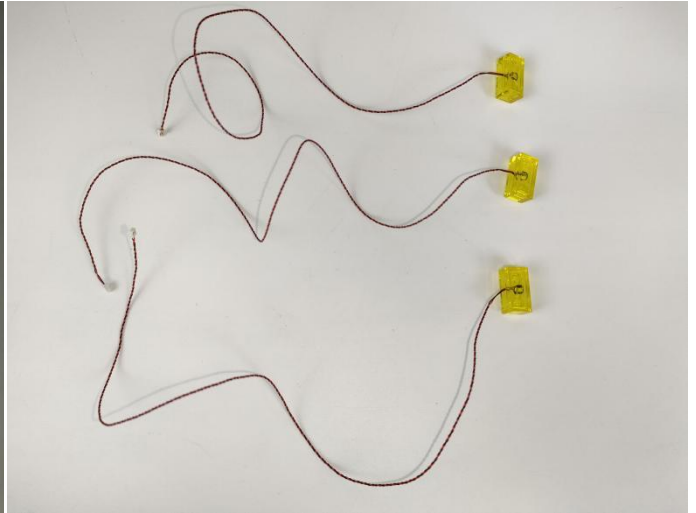

56

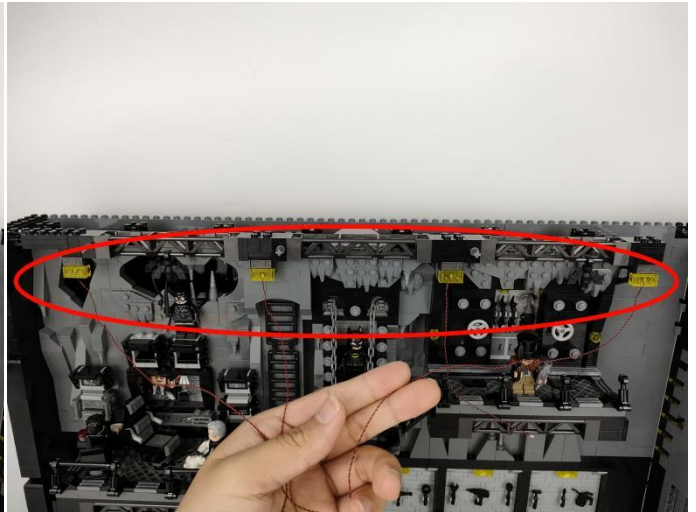
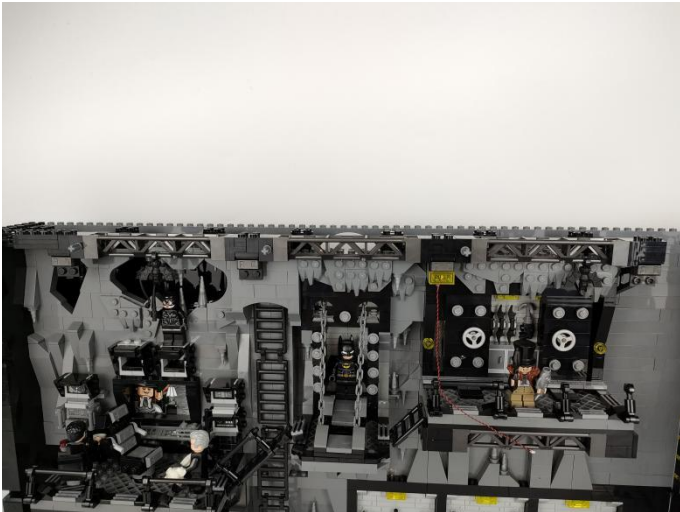

57

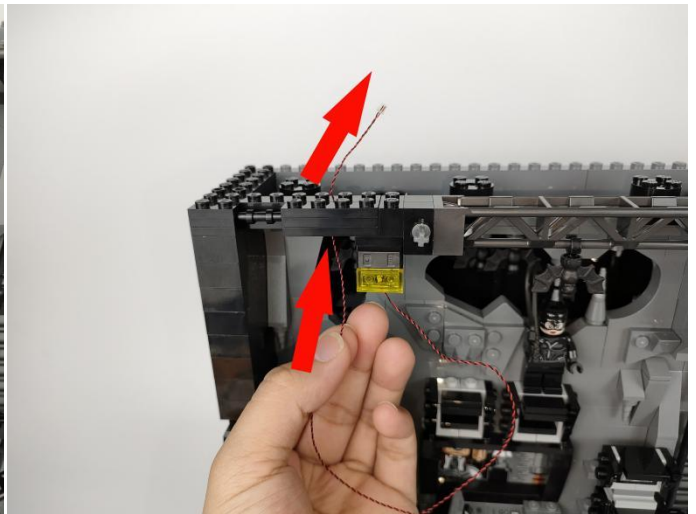
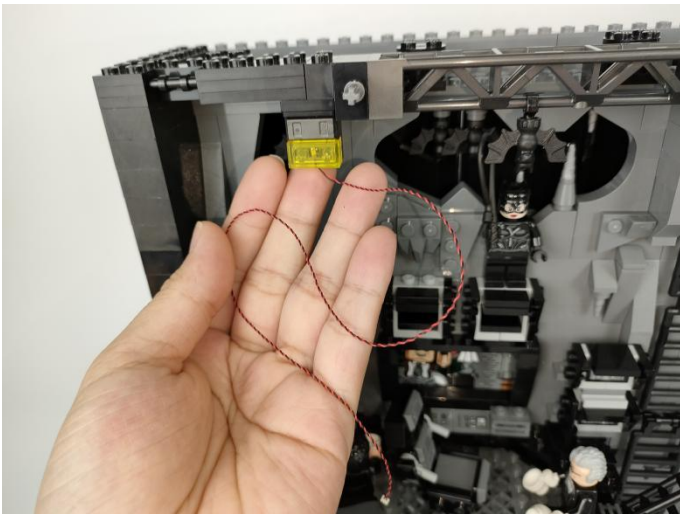

58

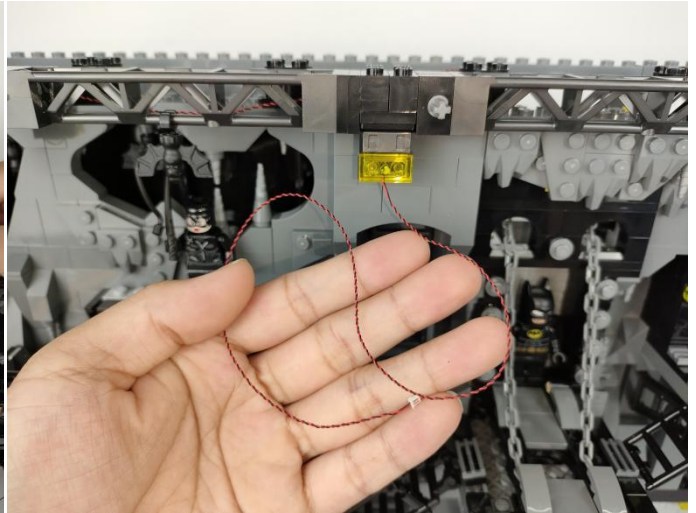
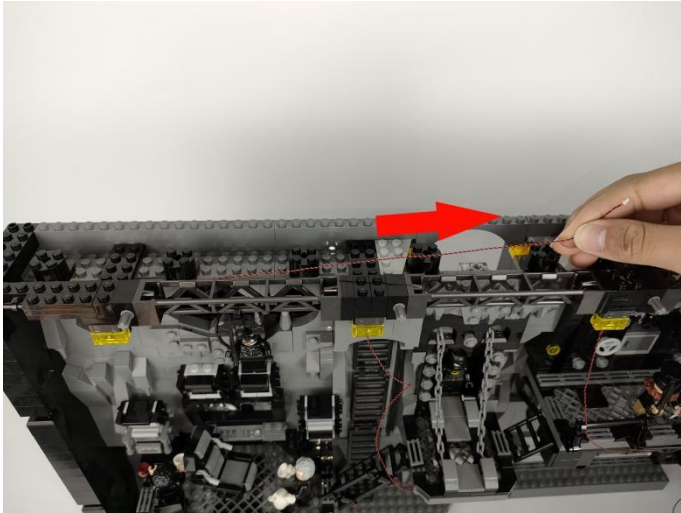

59

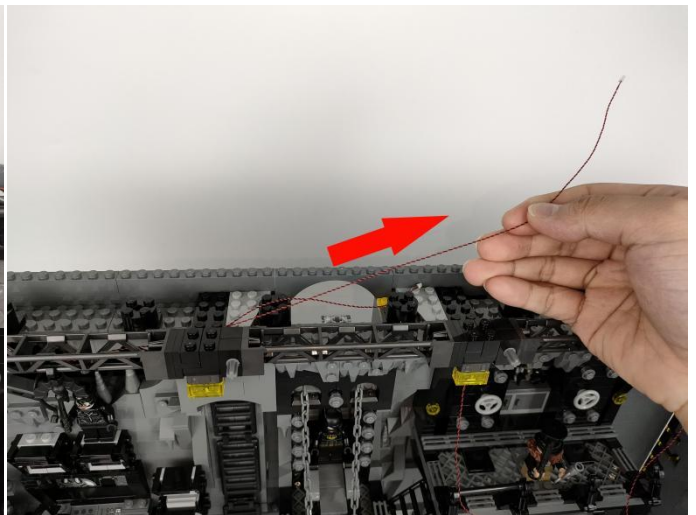
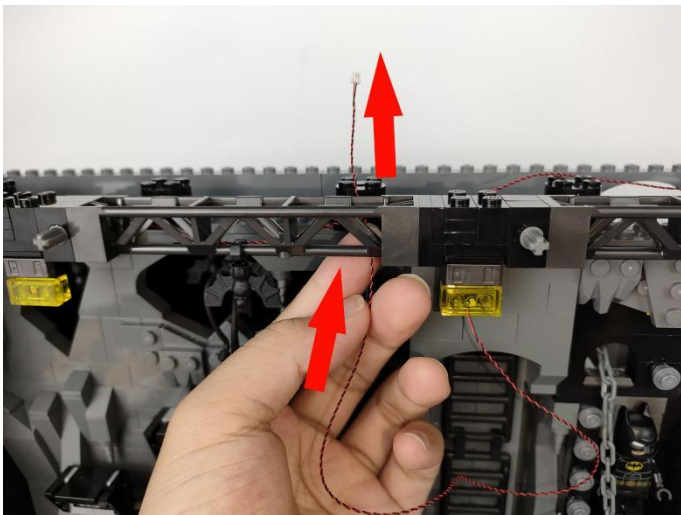

60

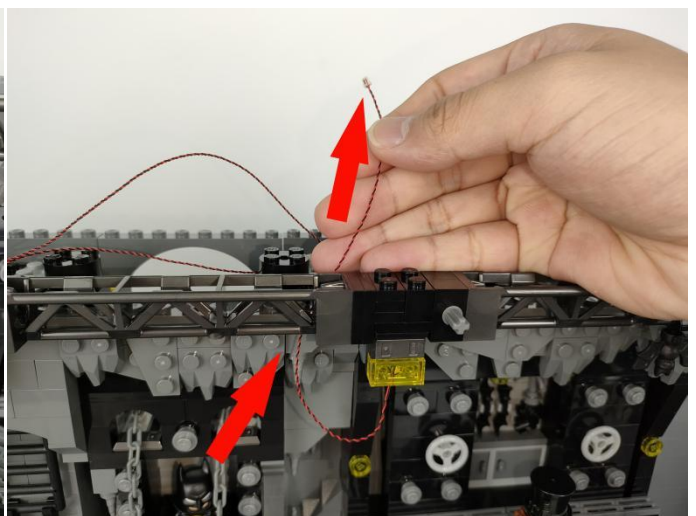
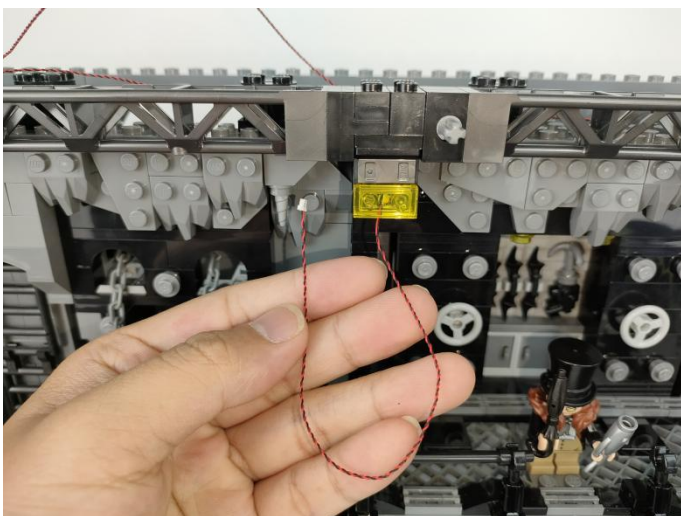

61

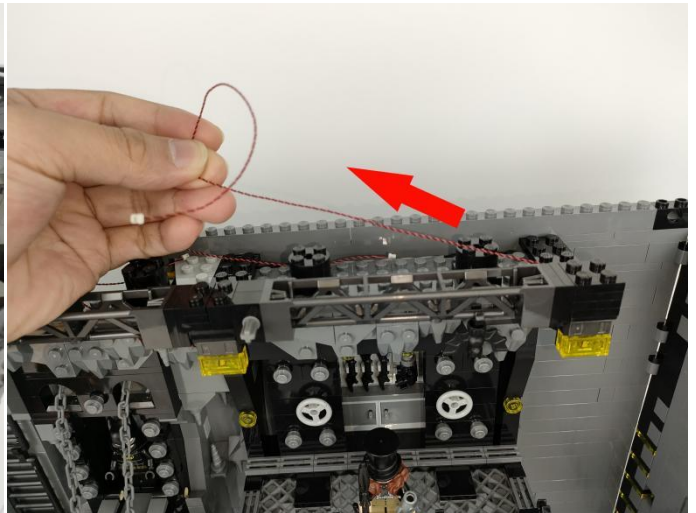
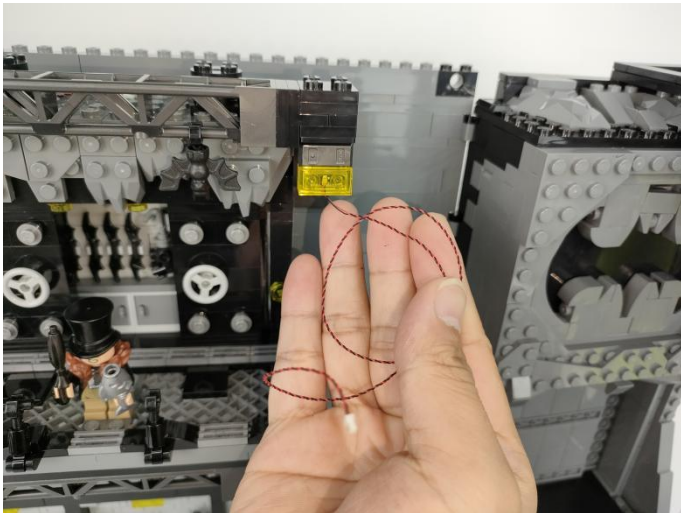

62

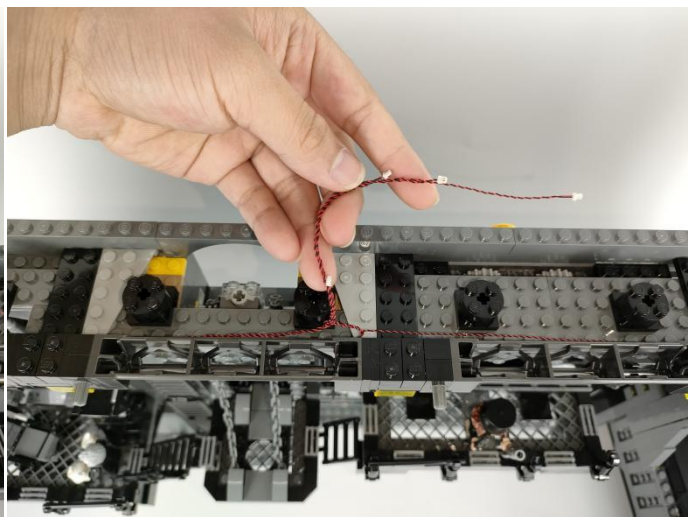
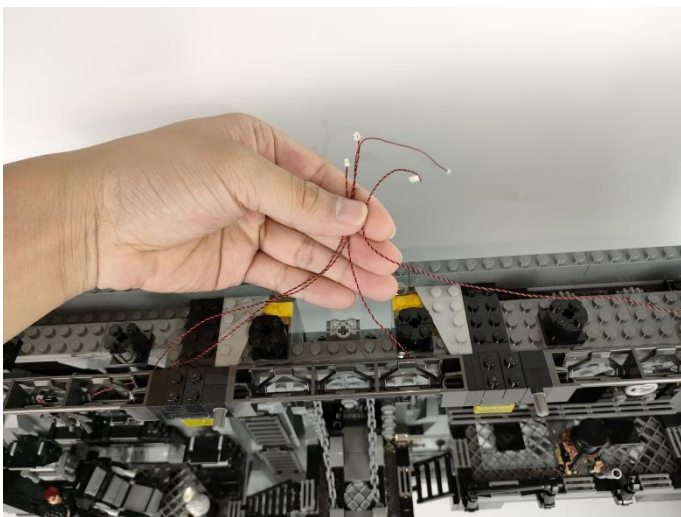

63



64

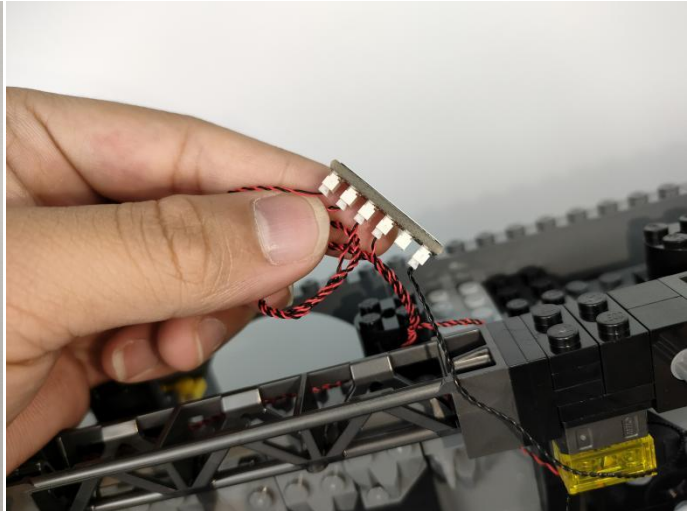

65

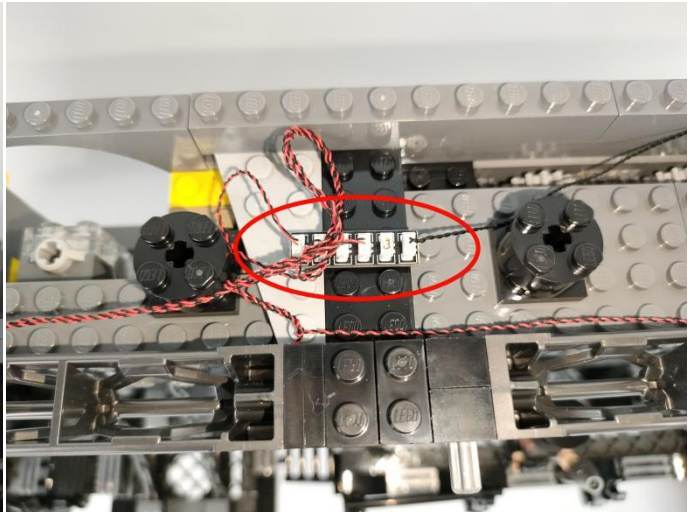
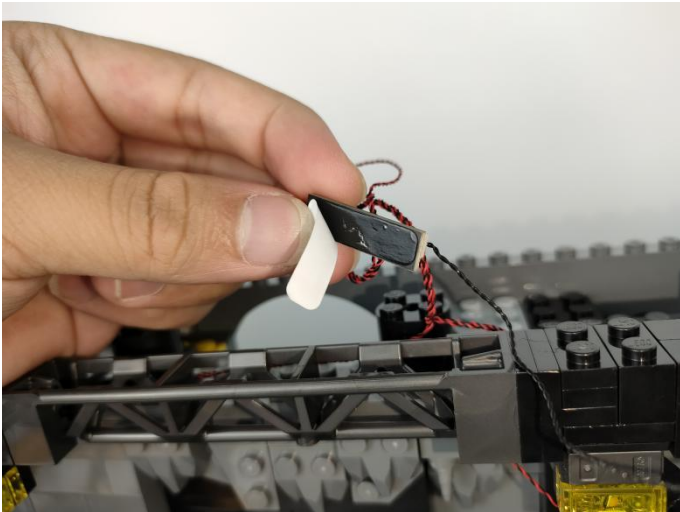

66

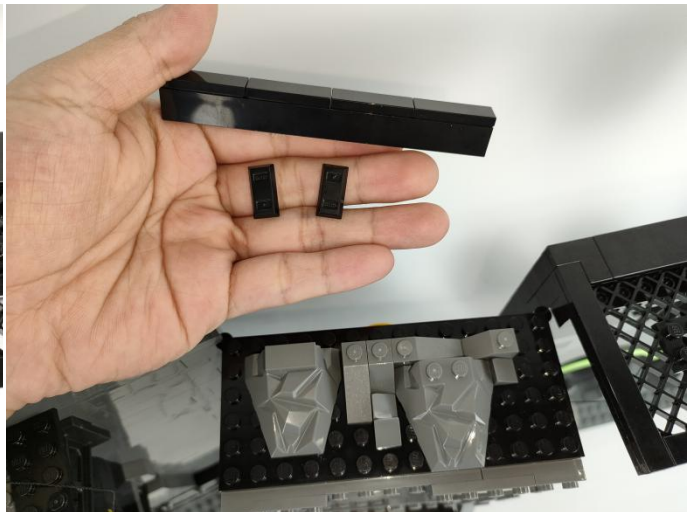
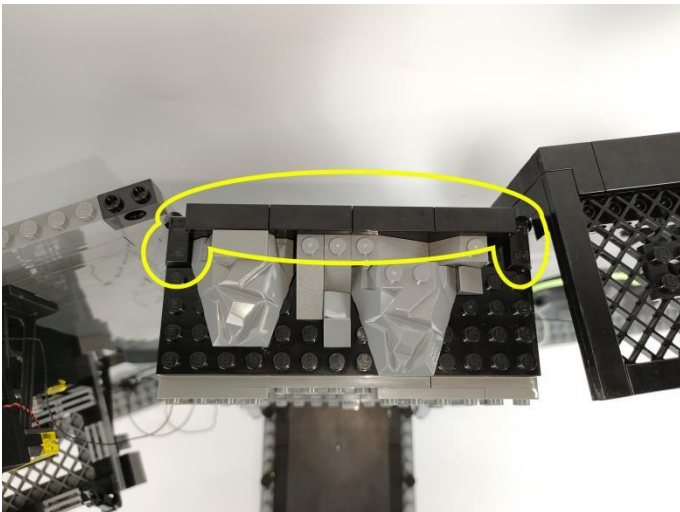

67

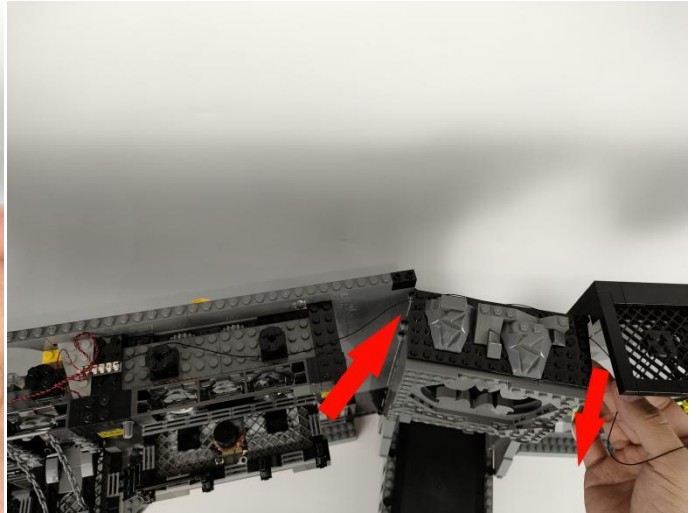
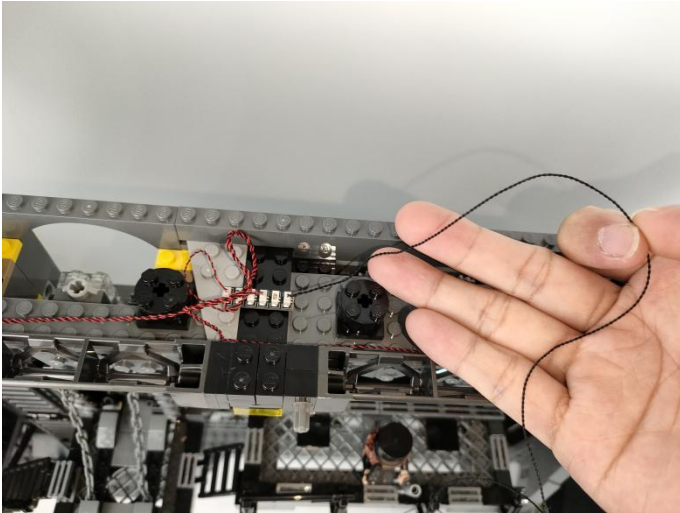

68

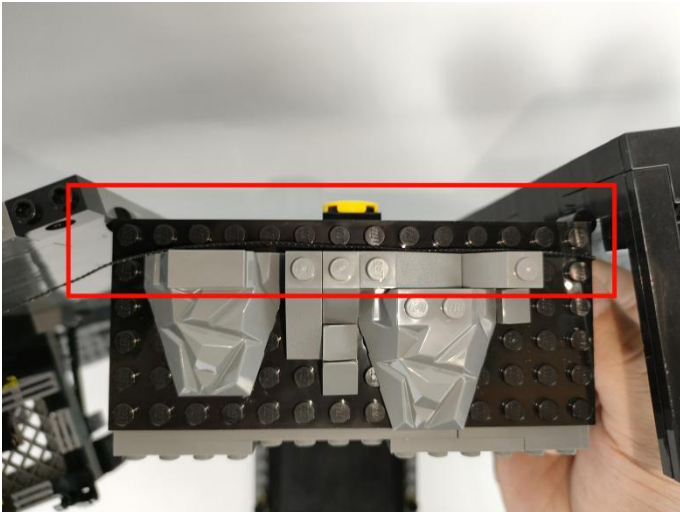

69

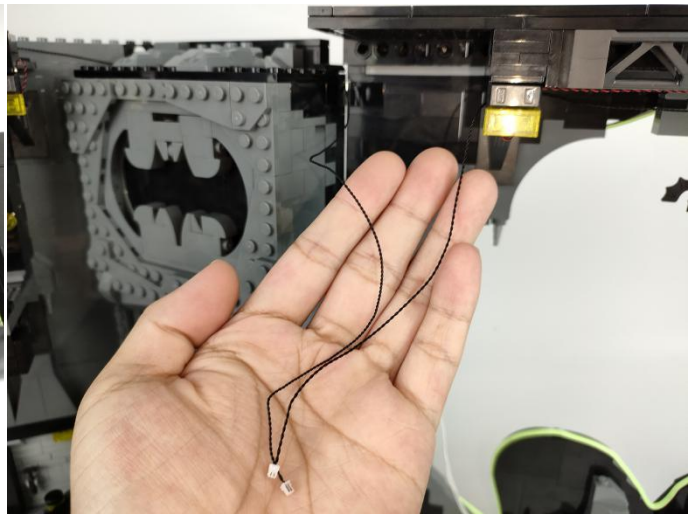
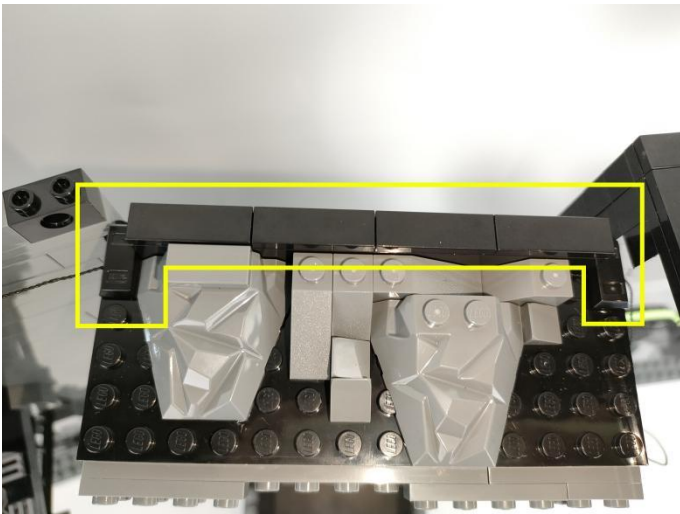

70

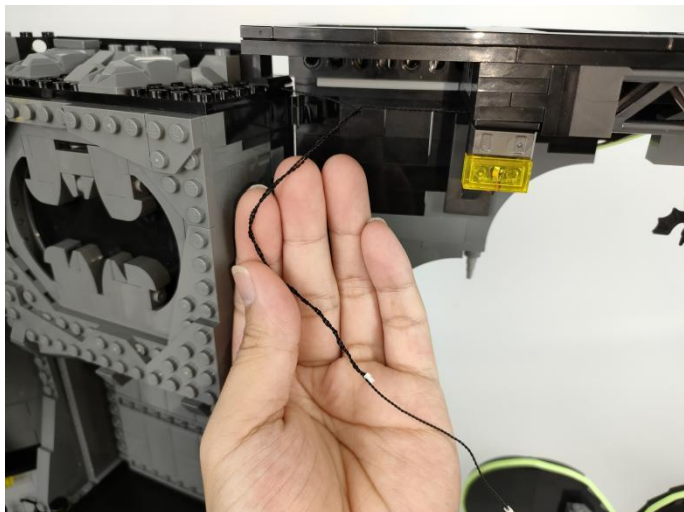

71

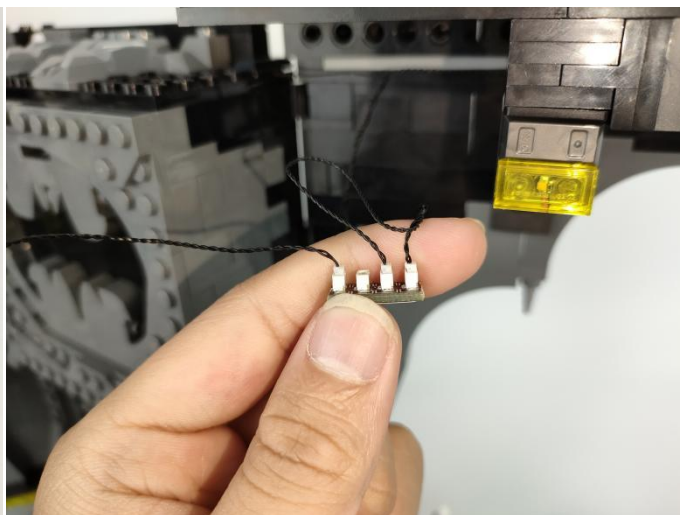

72

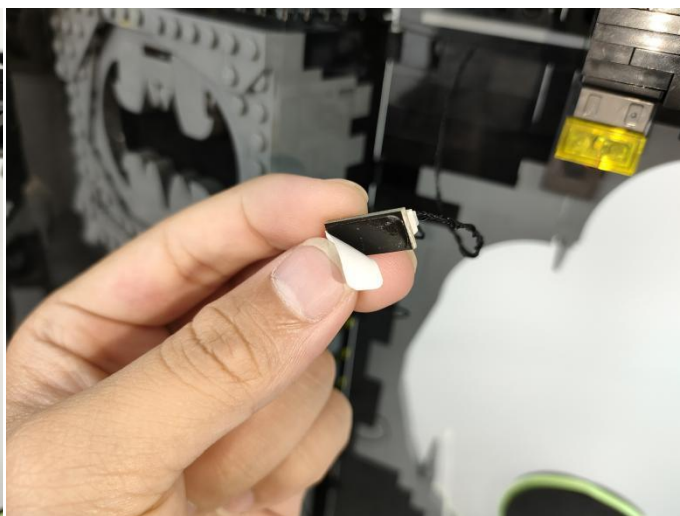
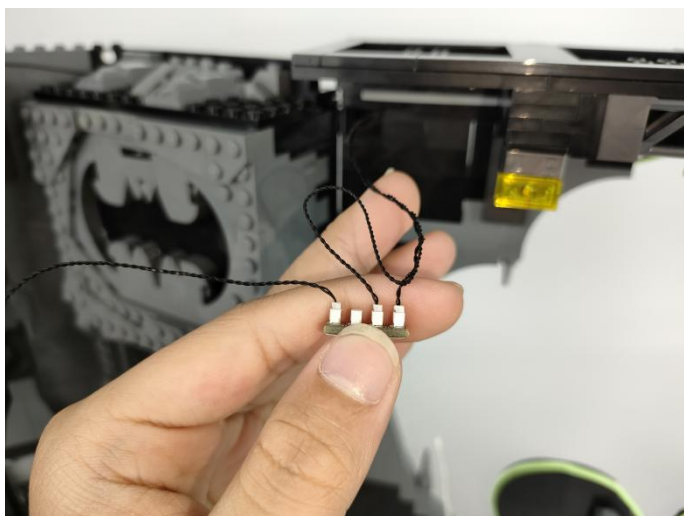

73

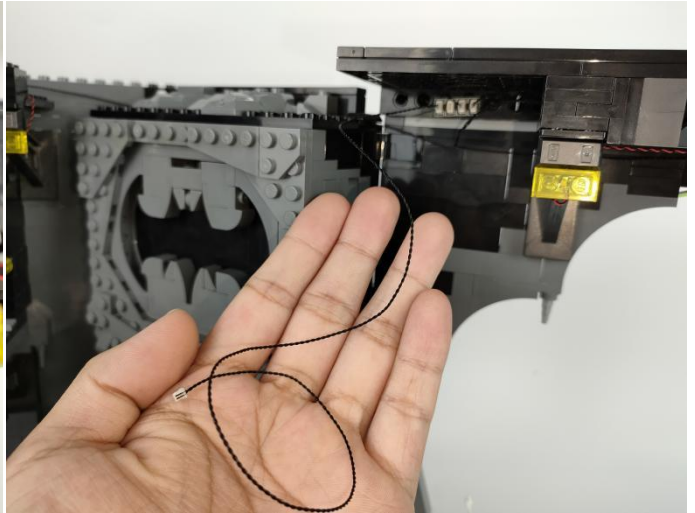

74

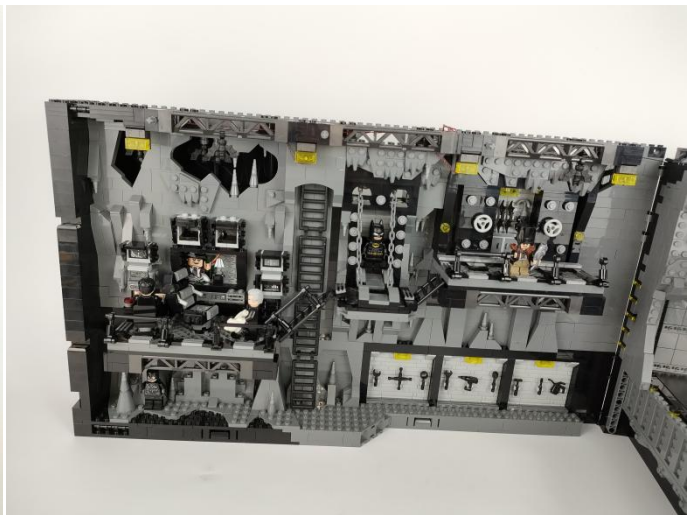
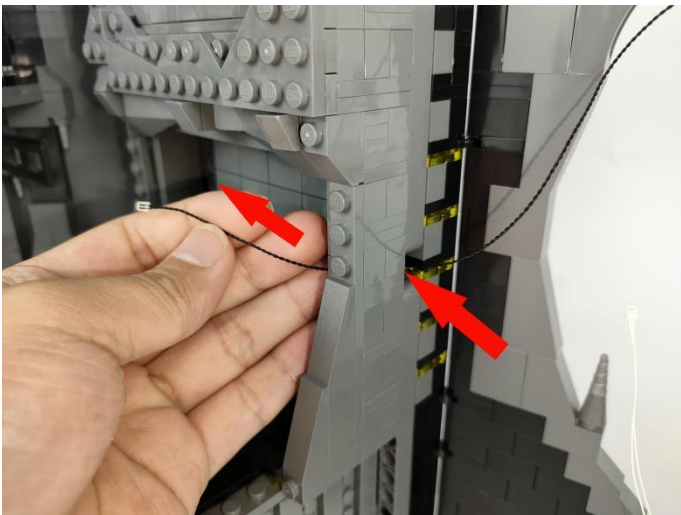

75

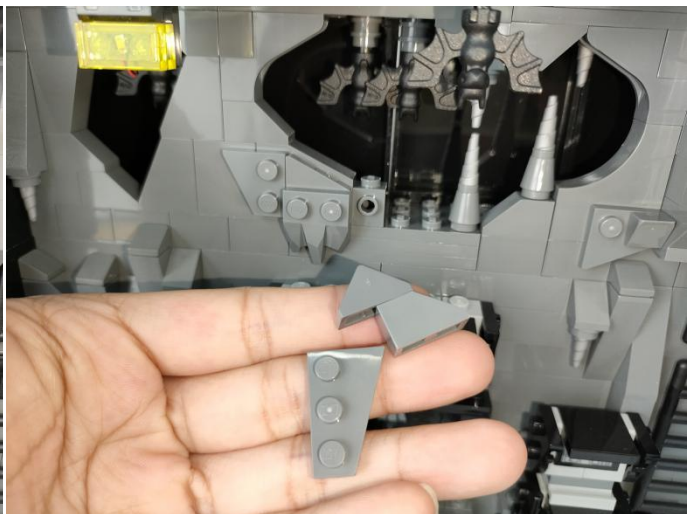
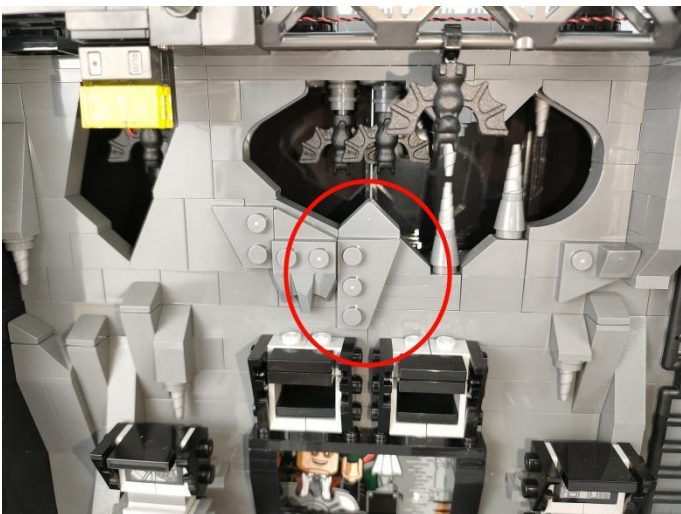

76



77



78

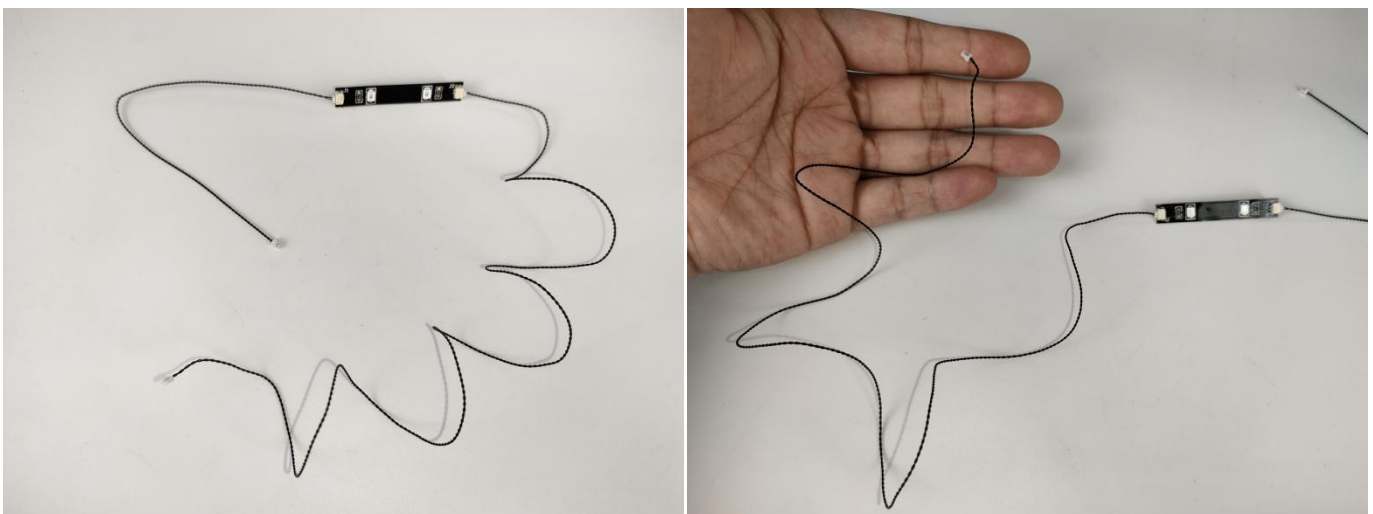

79

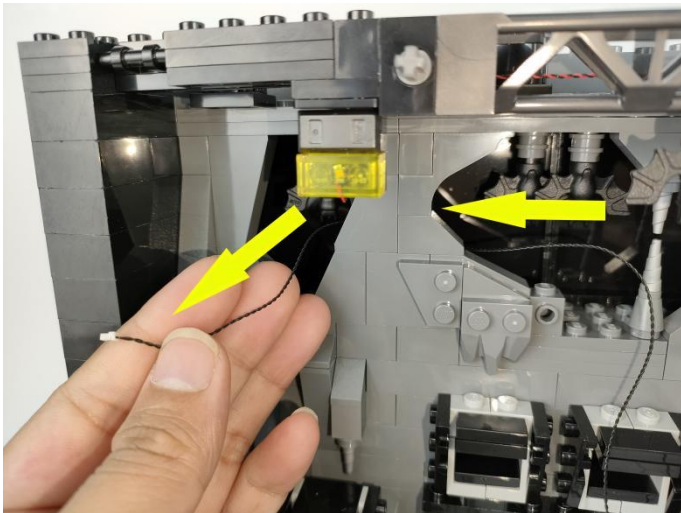

80

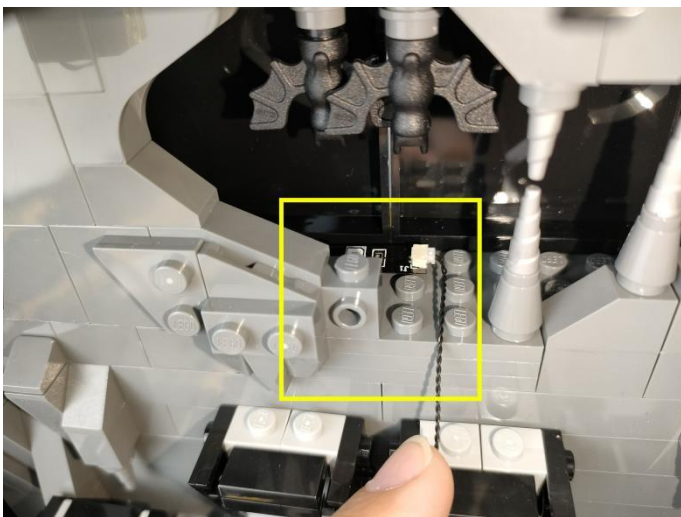

81

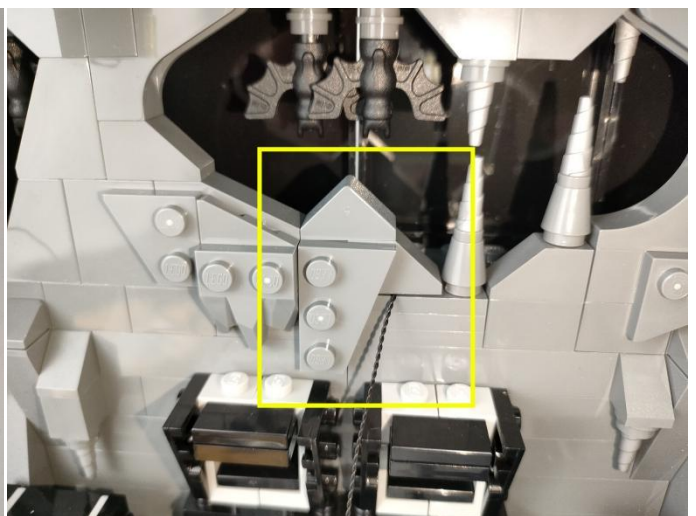

82

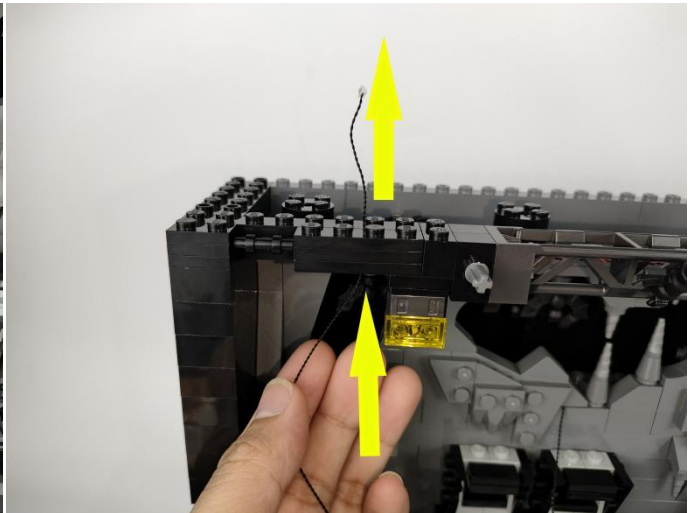
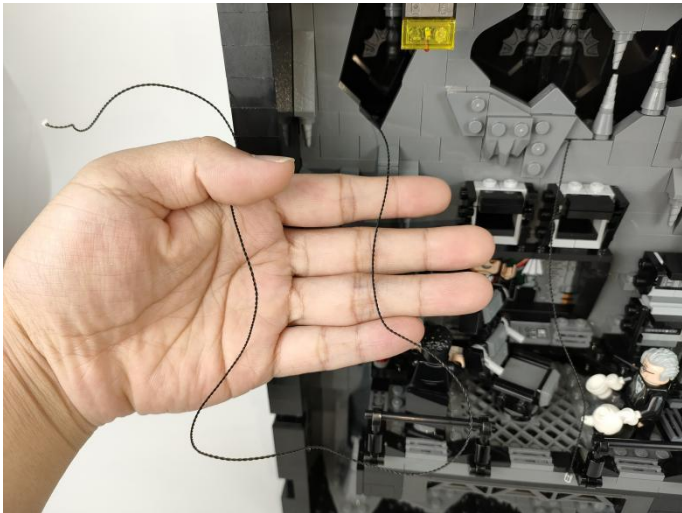

83

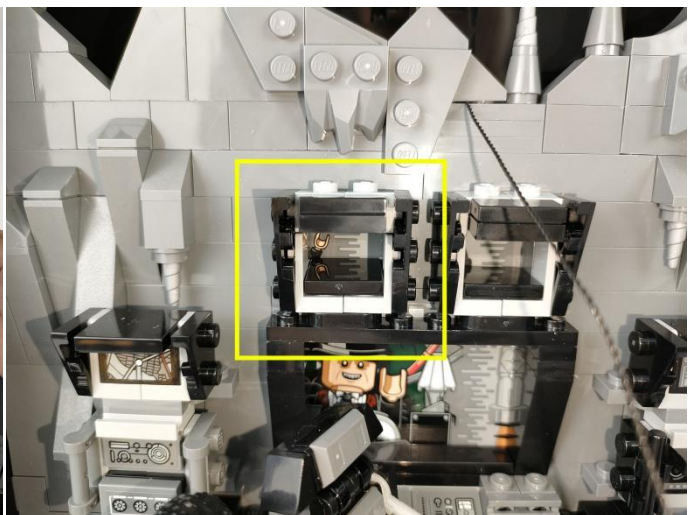
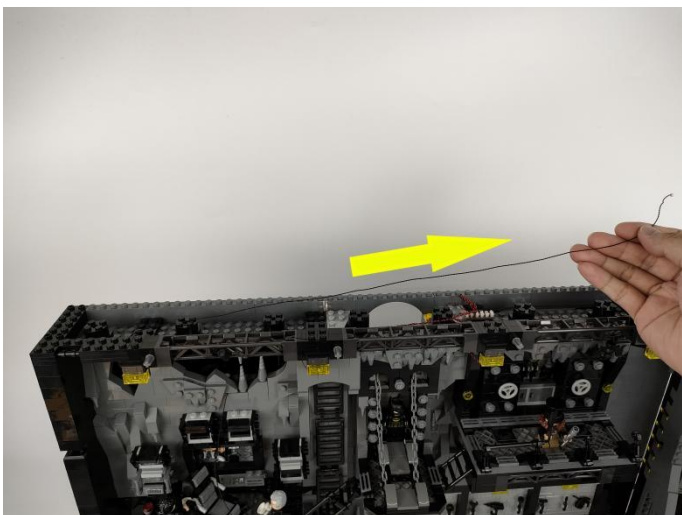

84

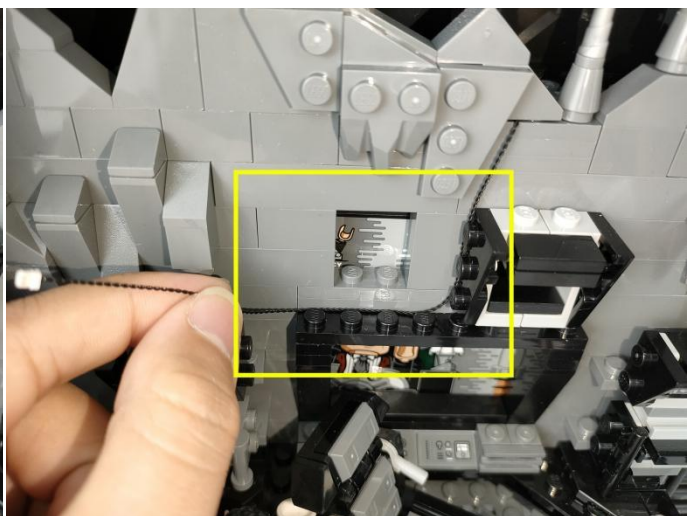
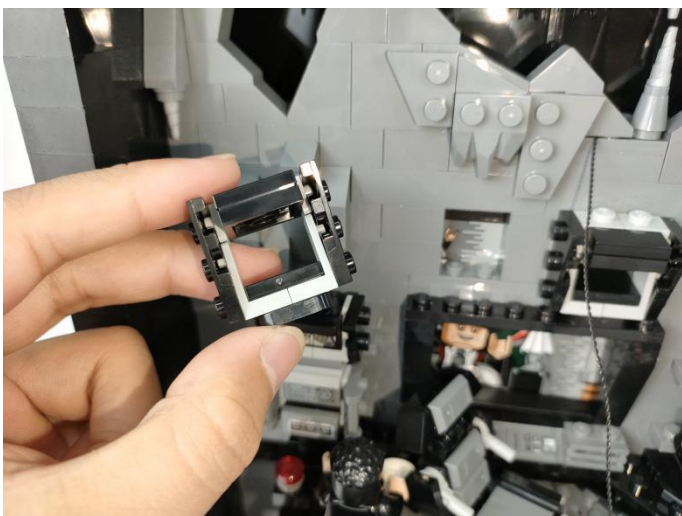

85

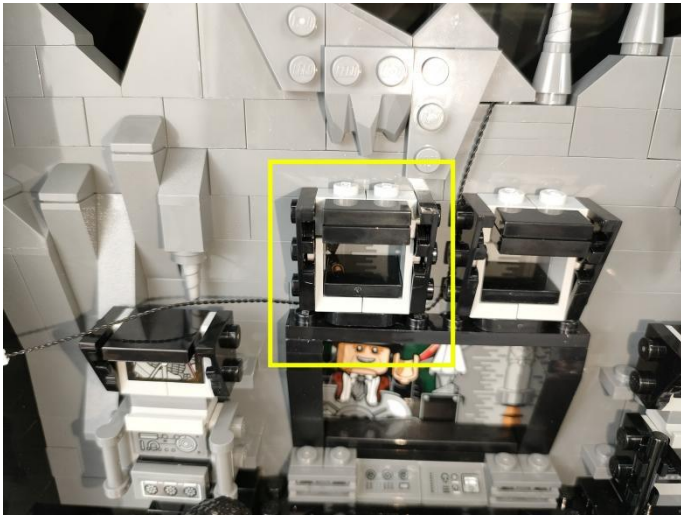

86



87

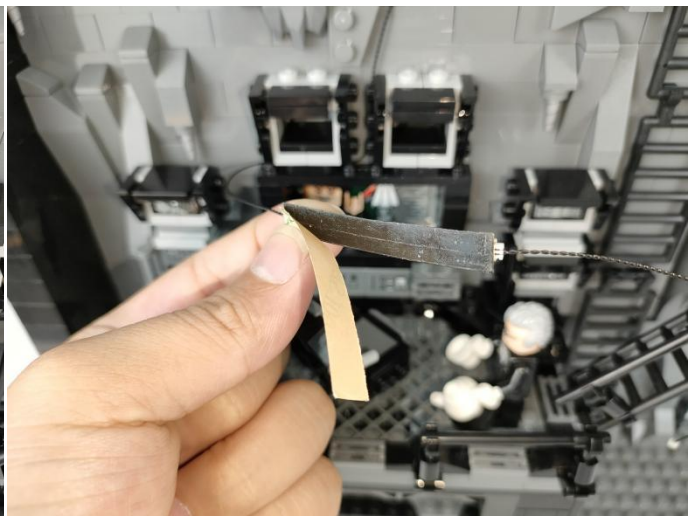
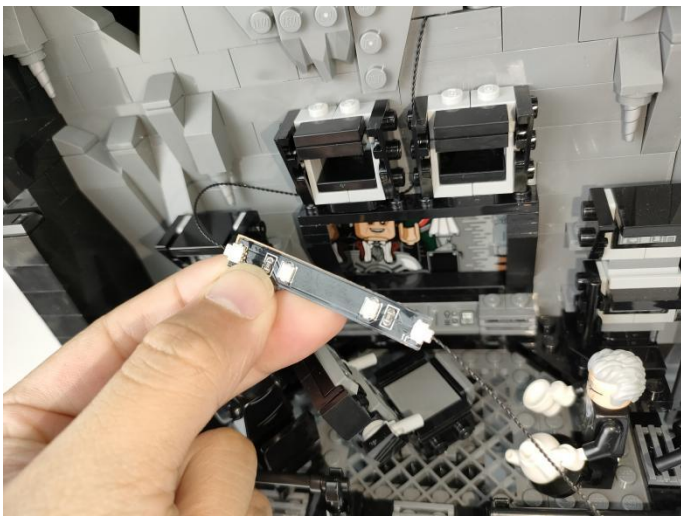

88

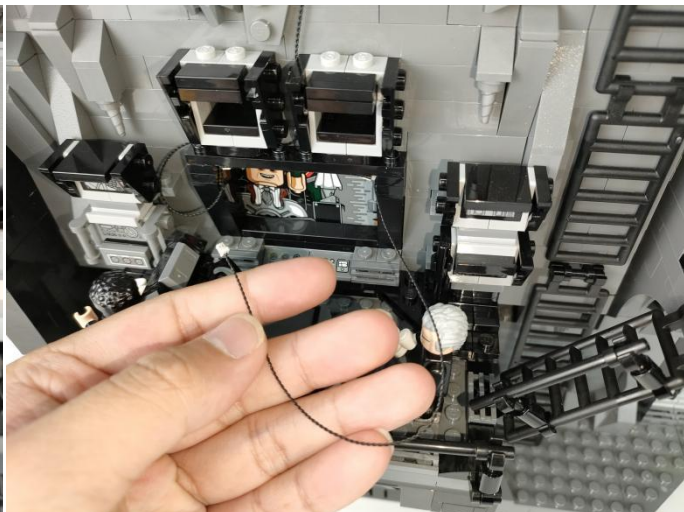
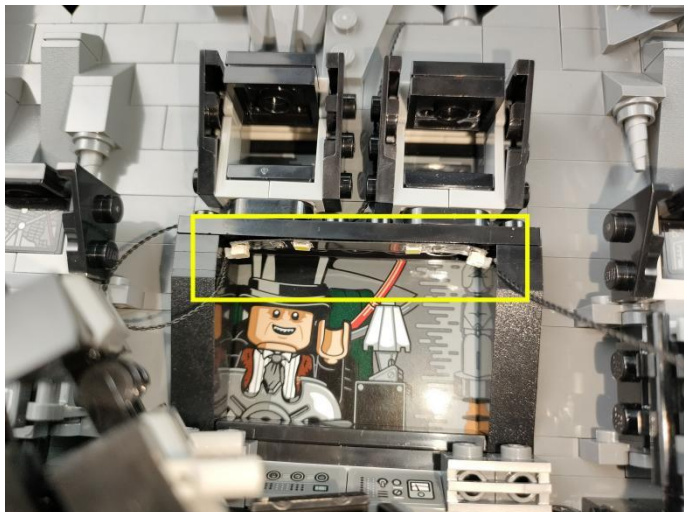

89

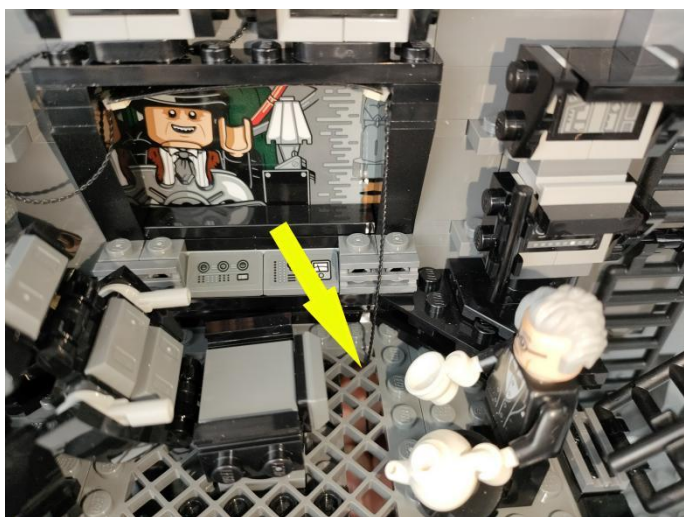

90



91

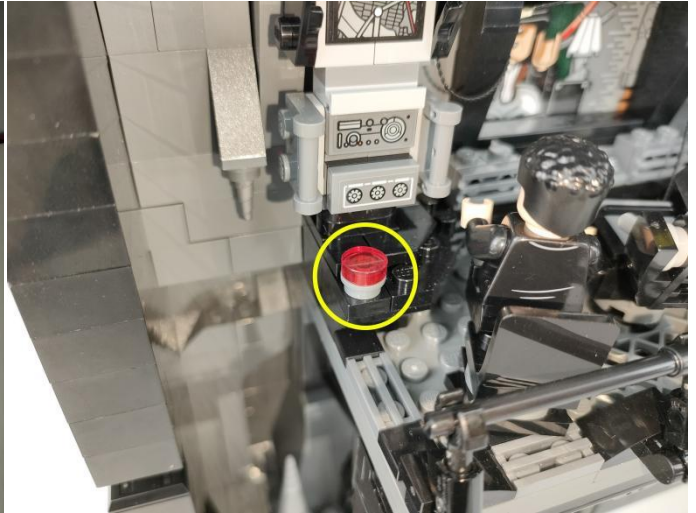

92

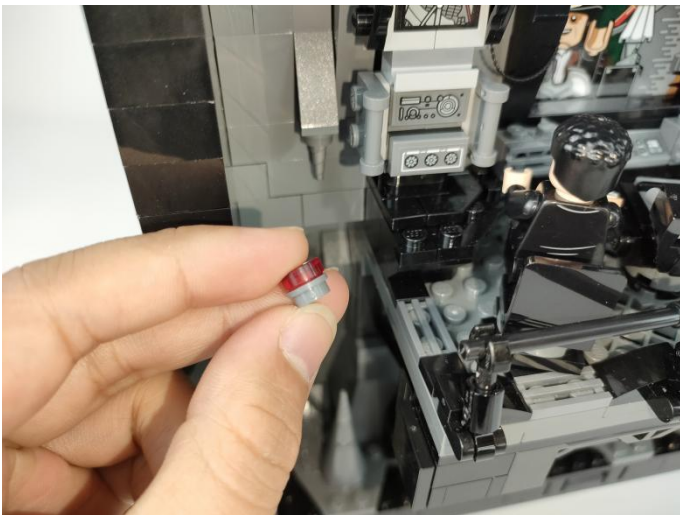

93

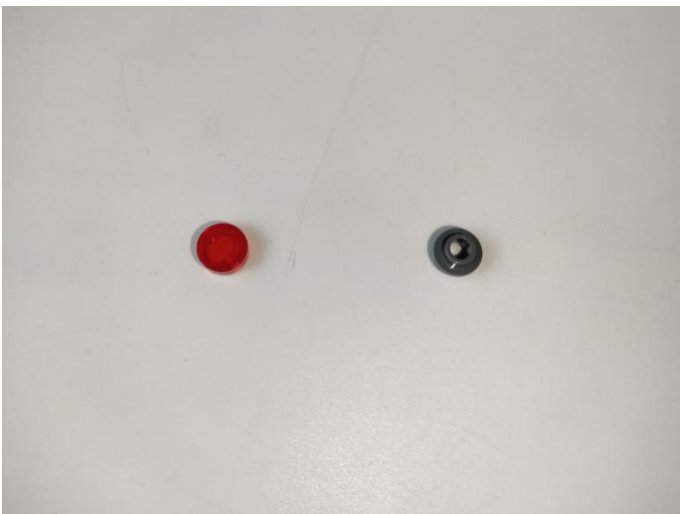

94

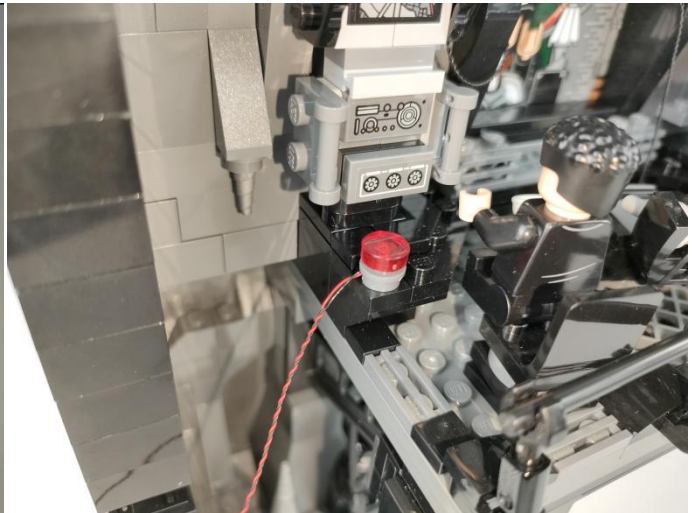
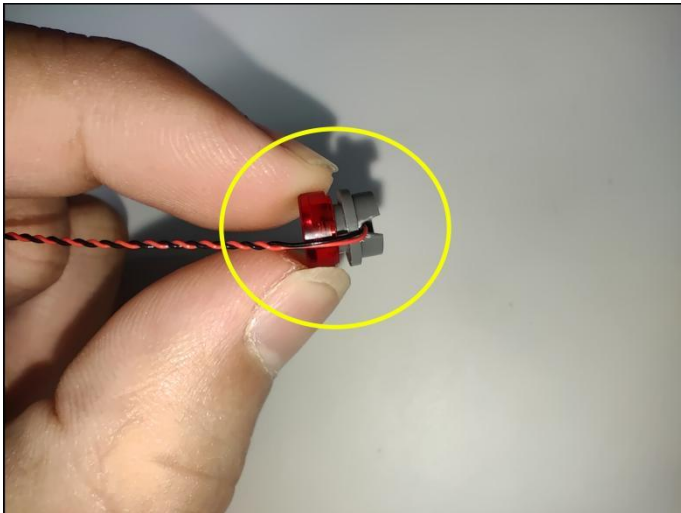

95

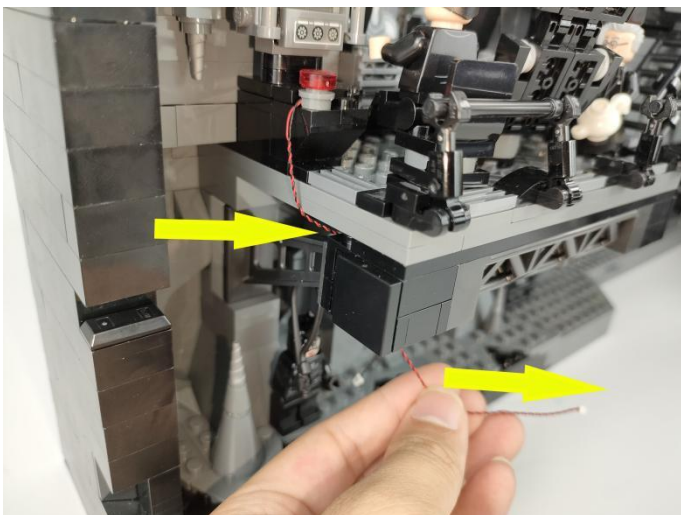

96

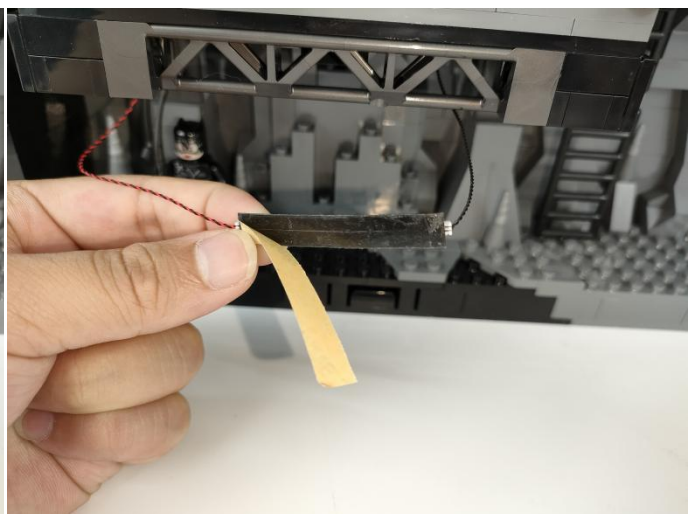
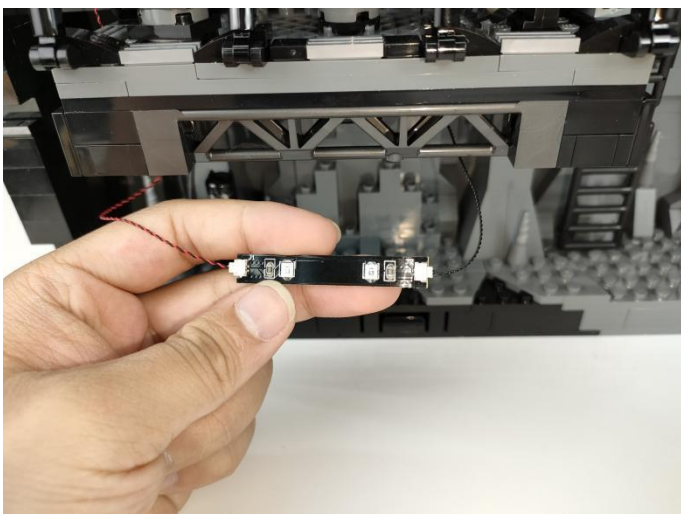

97

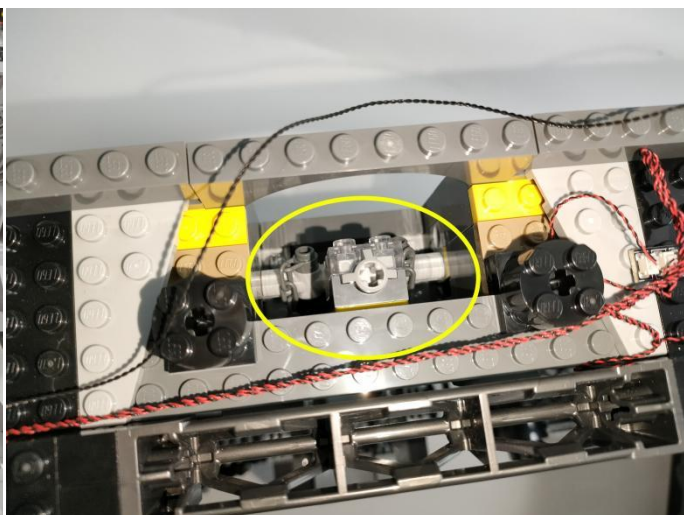
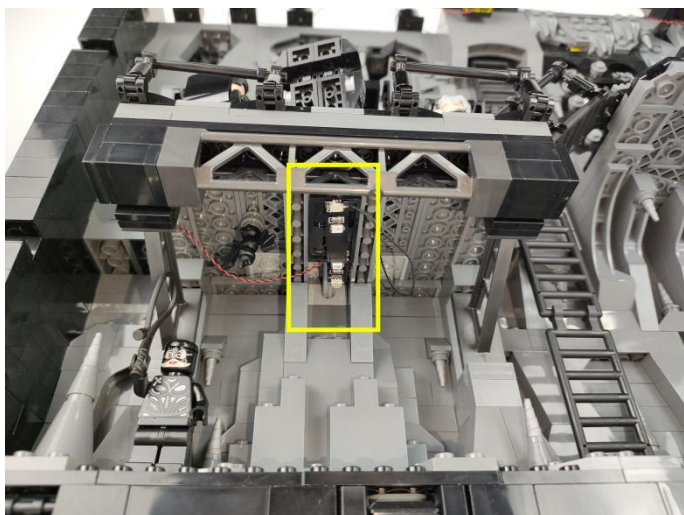

98

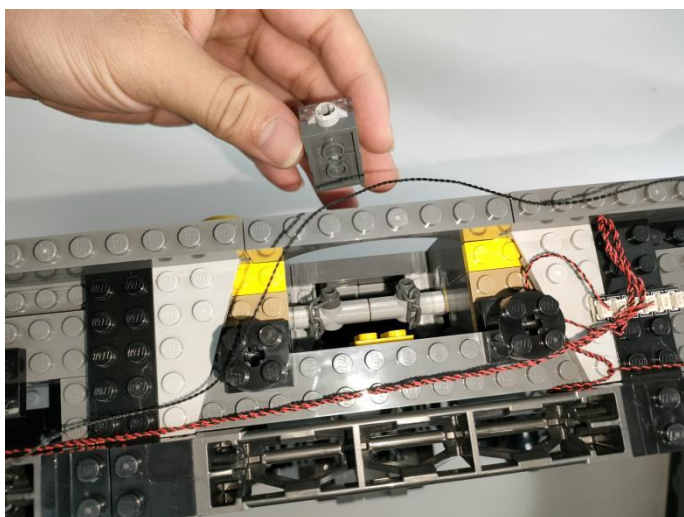

99

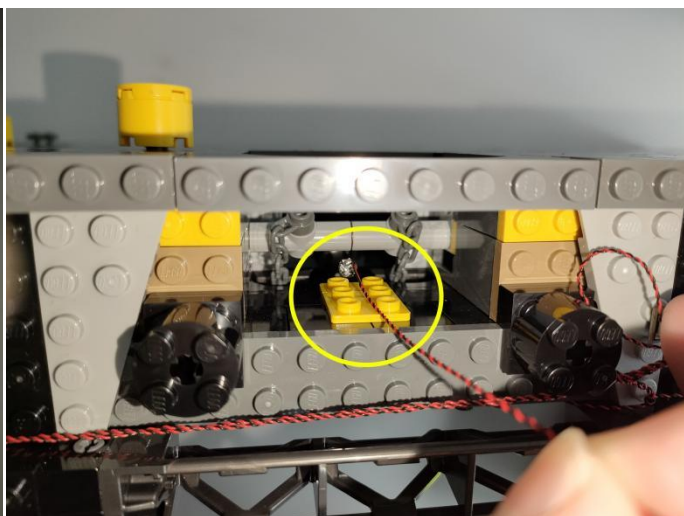

100

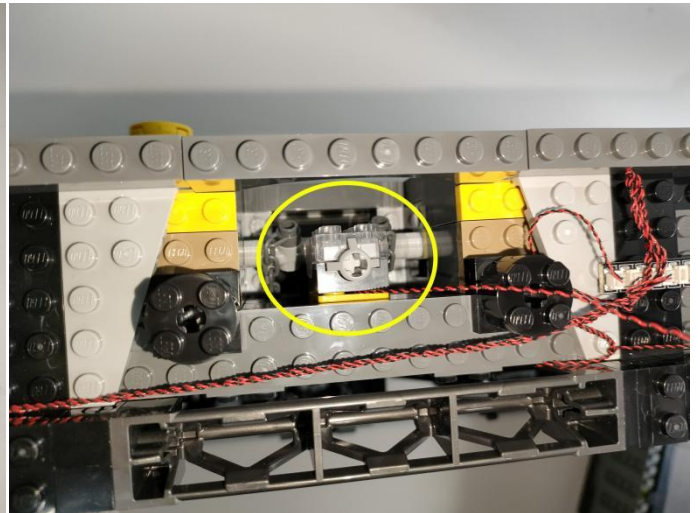

101



102

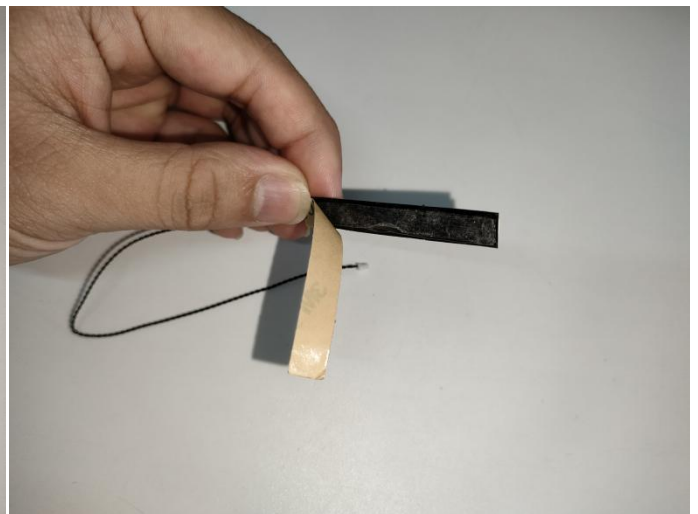
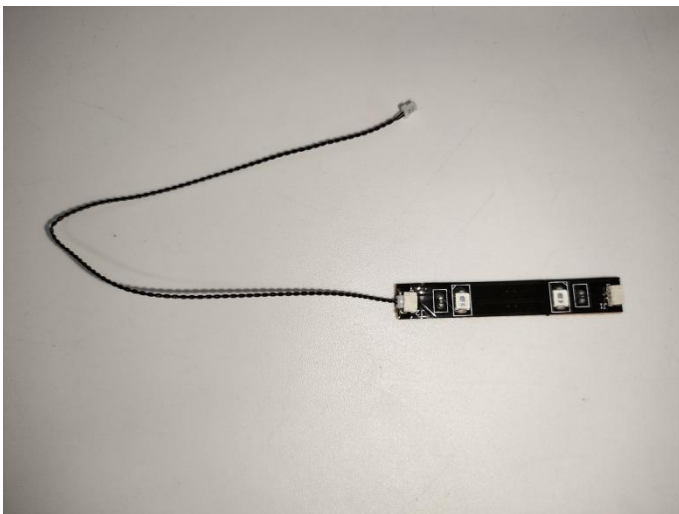

103

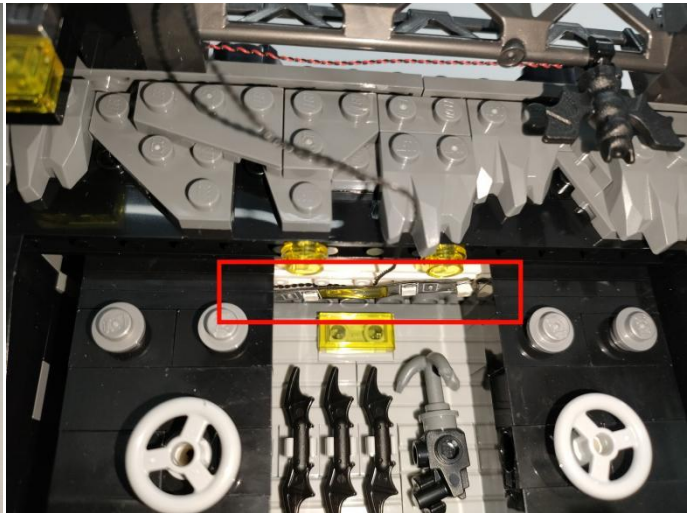

104

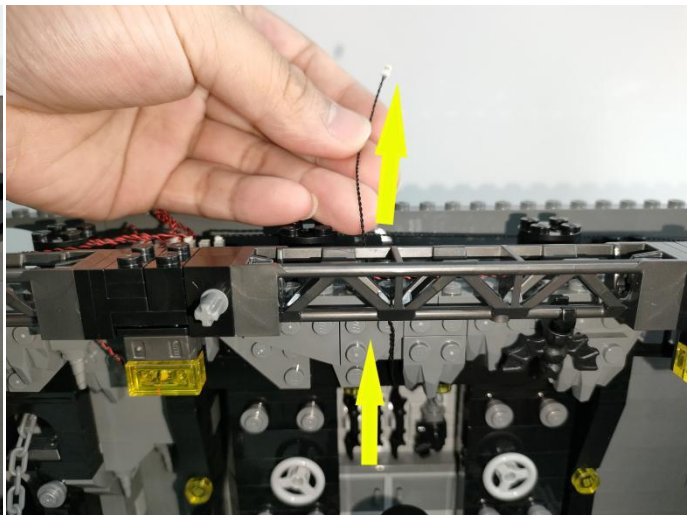
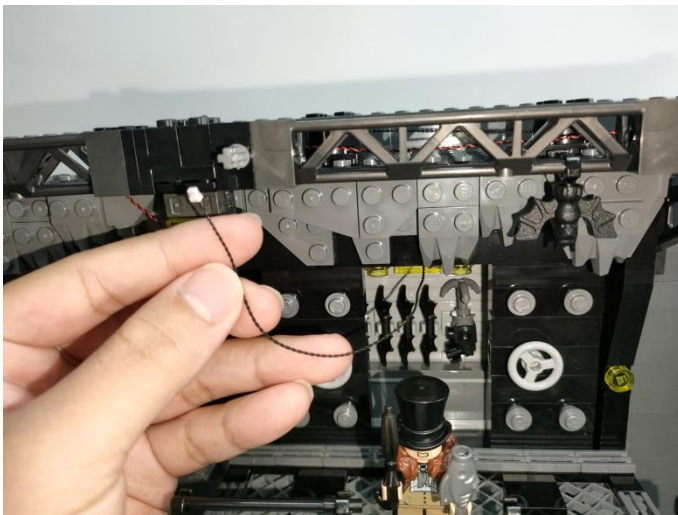

105



106

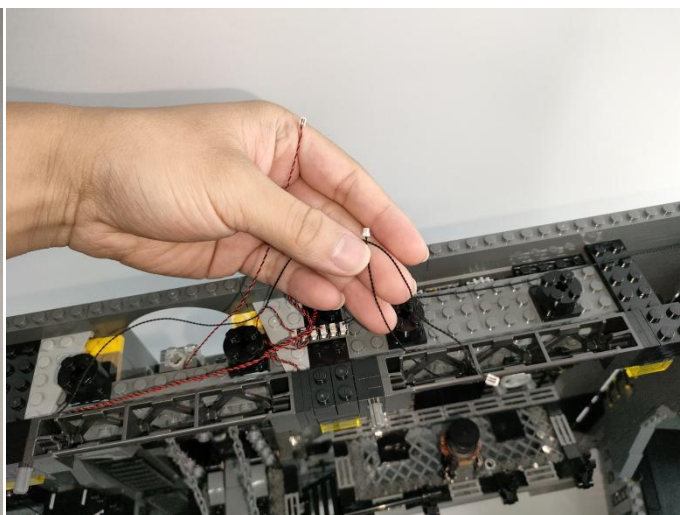
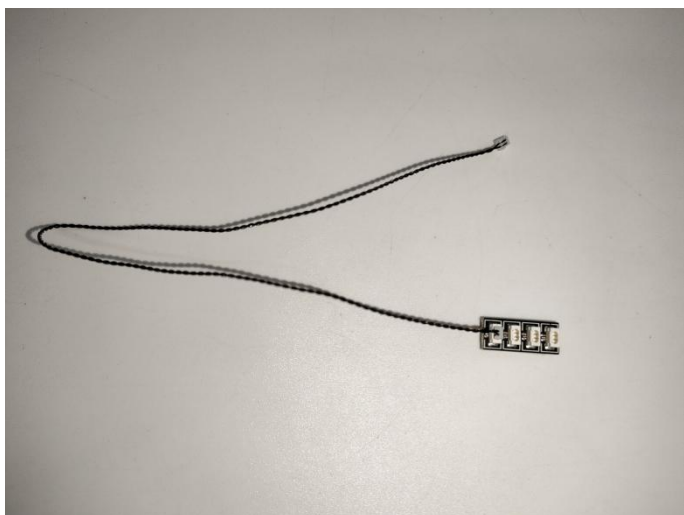

107

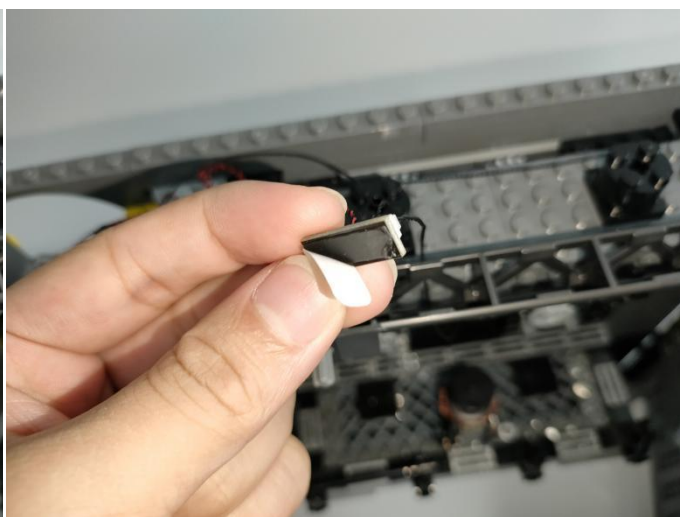
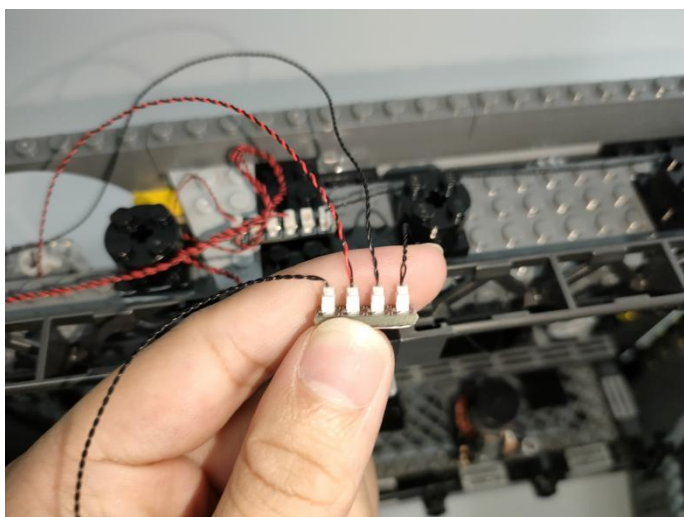

108

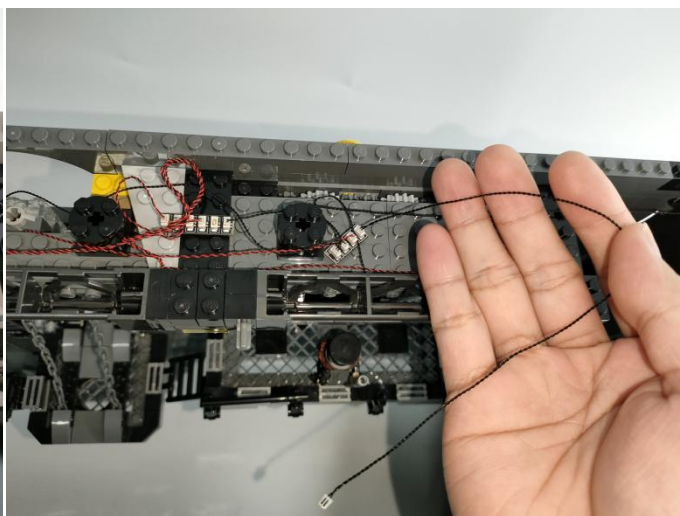
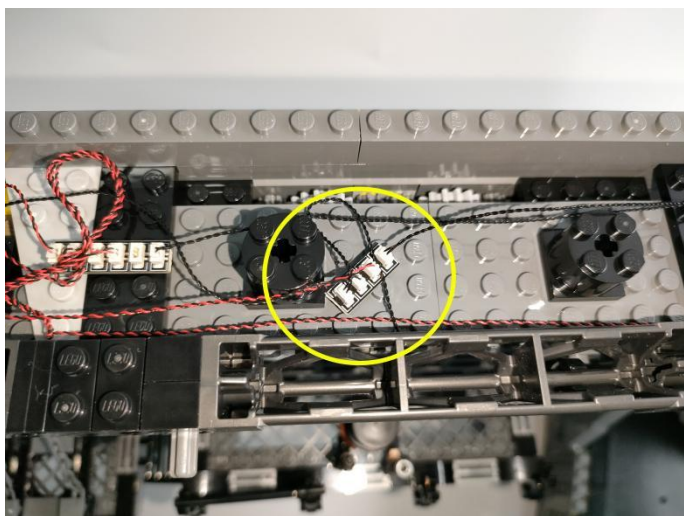

109

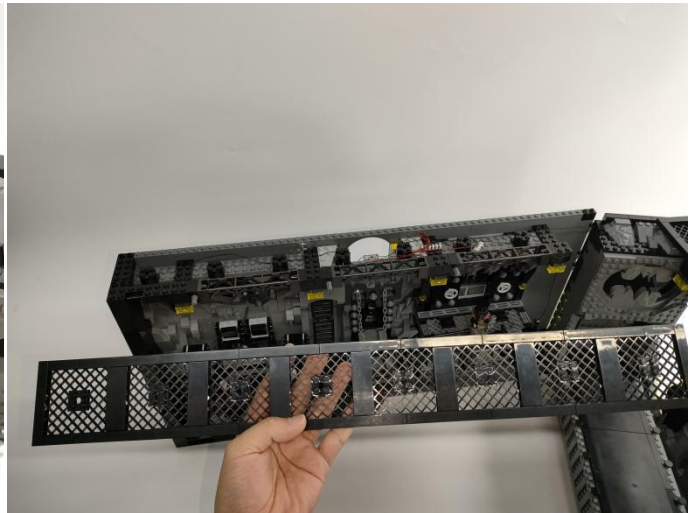
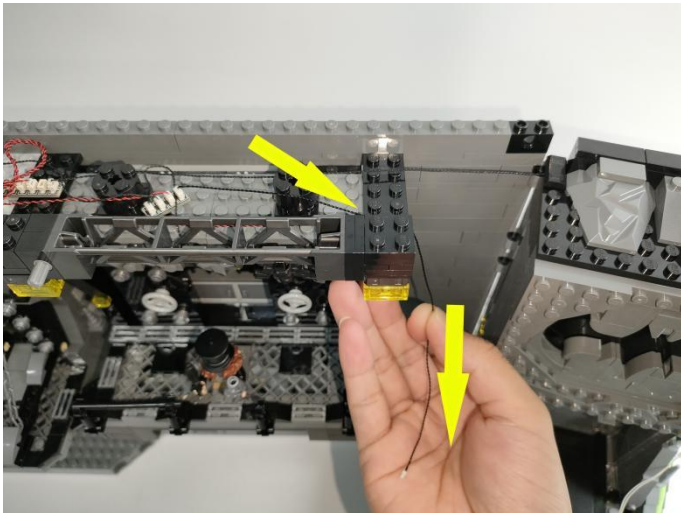

110

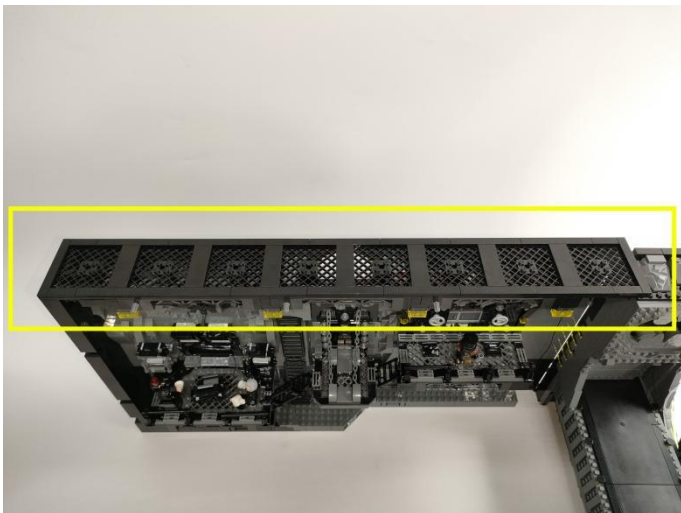

111

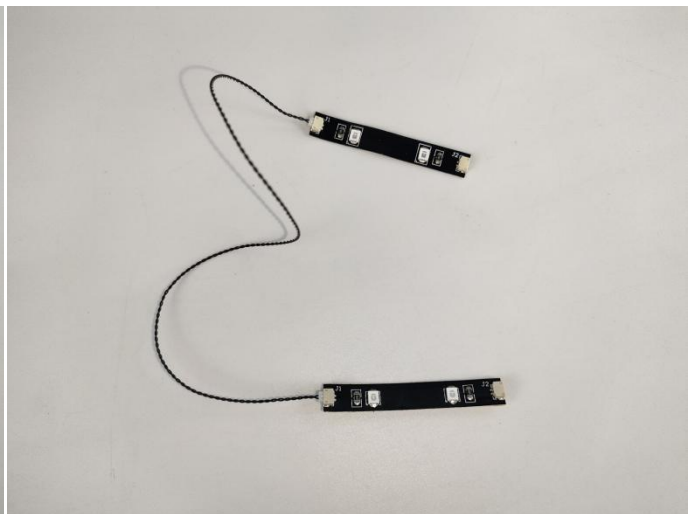

112

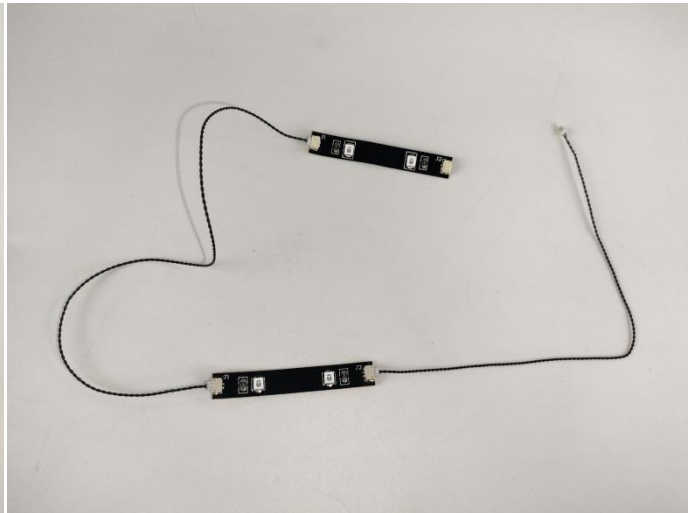

113

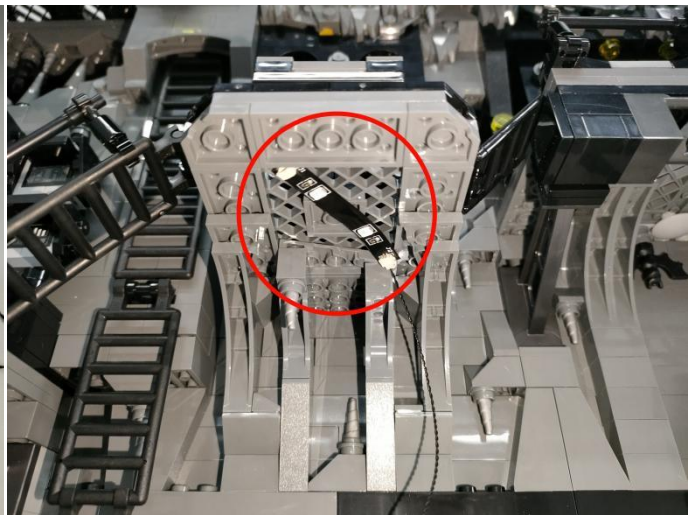
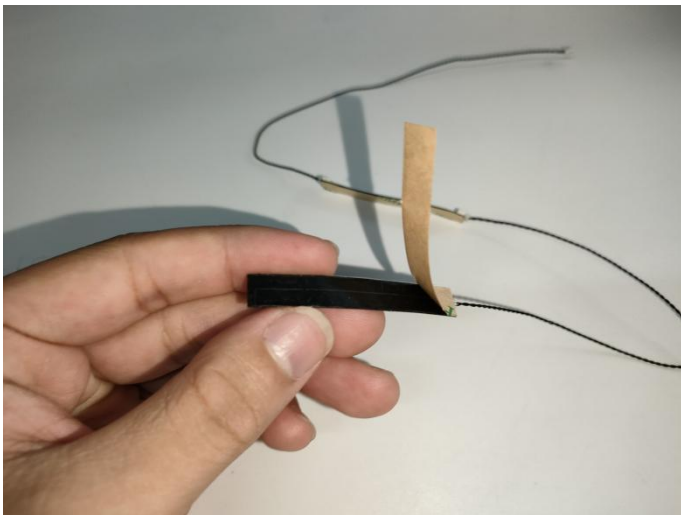

114

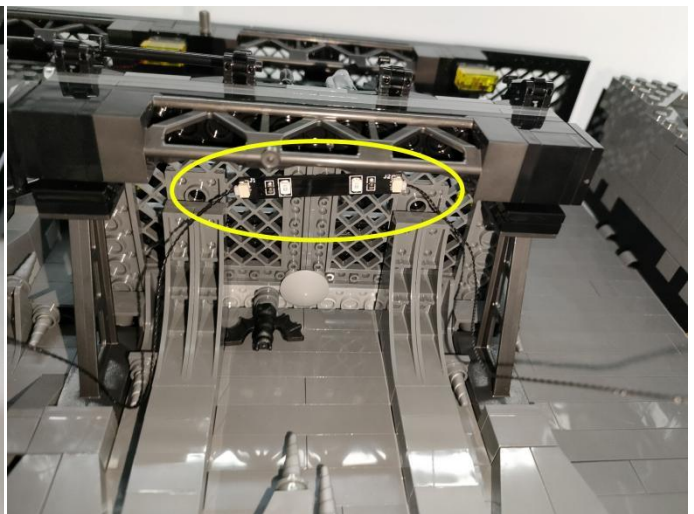
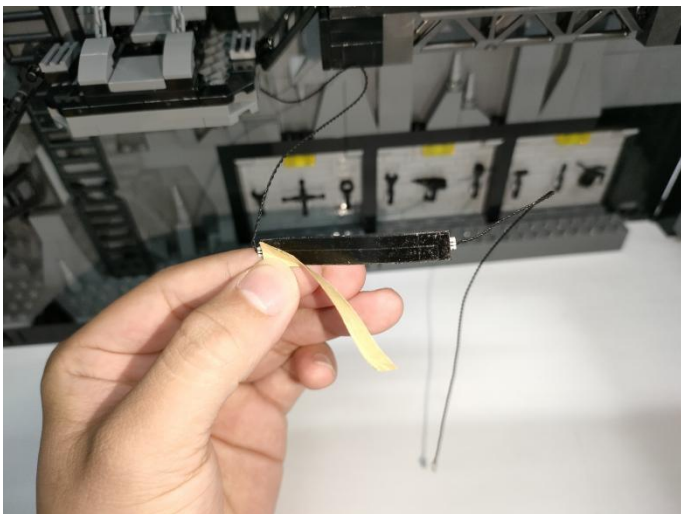

115



116

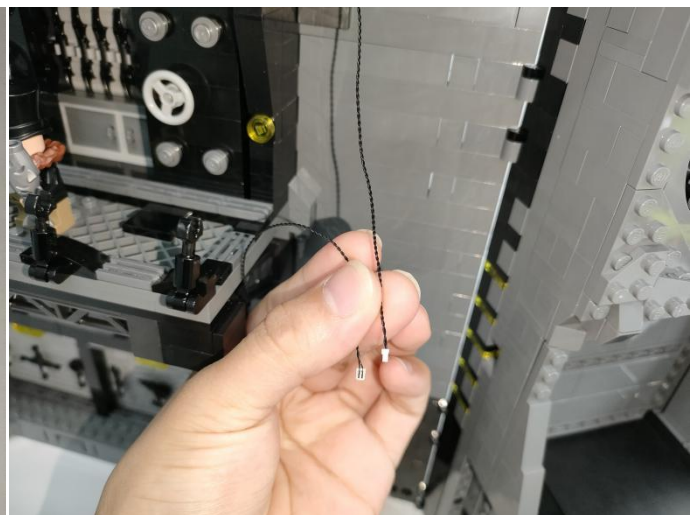

117

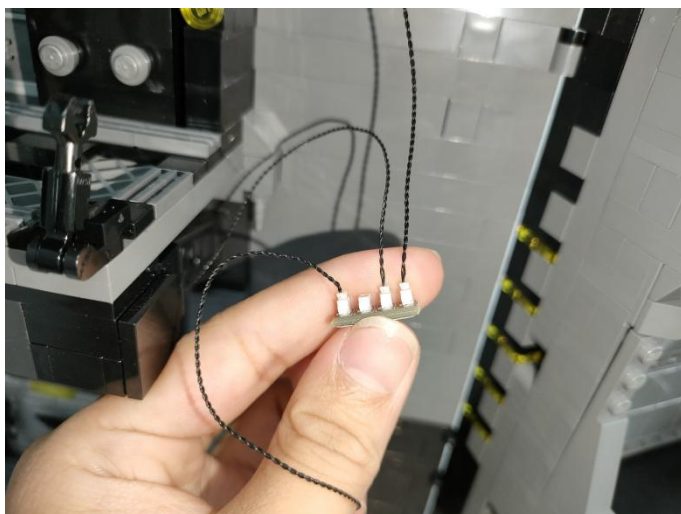

118

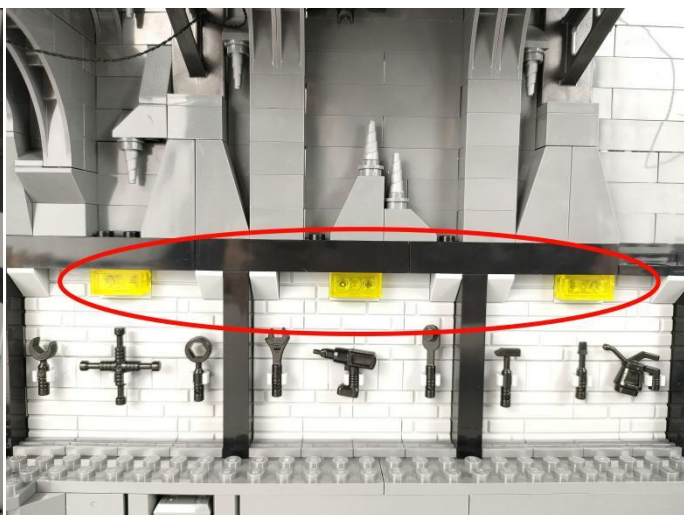

119

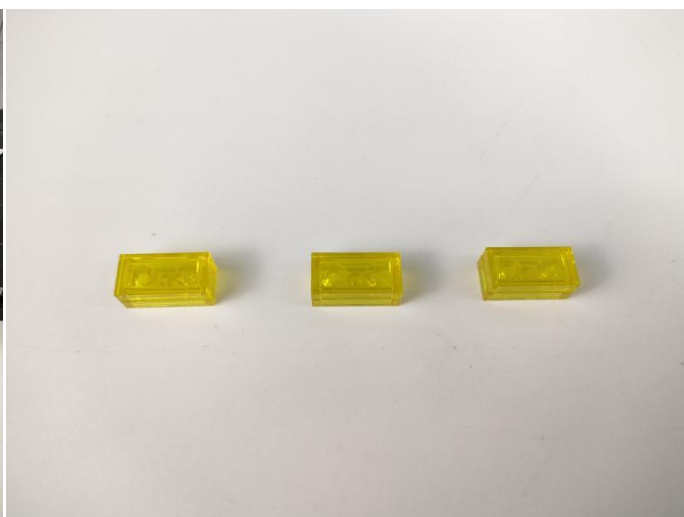
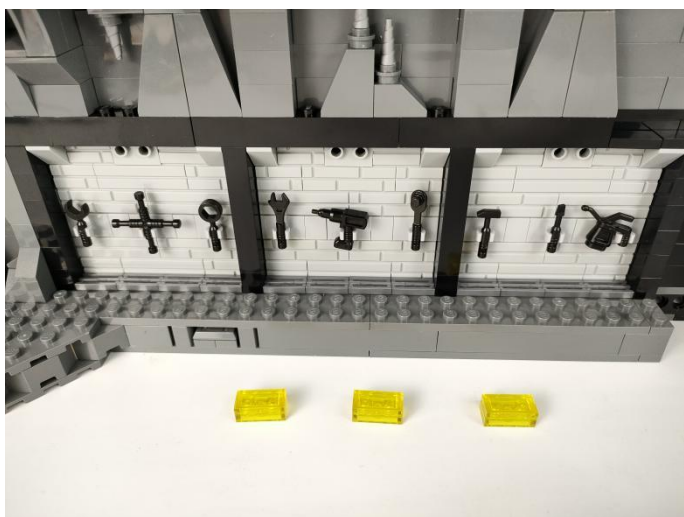

120



121

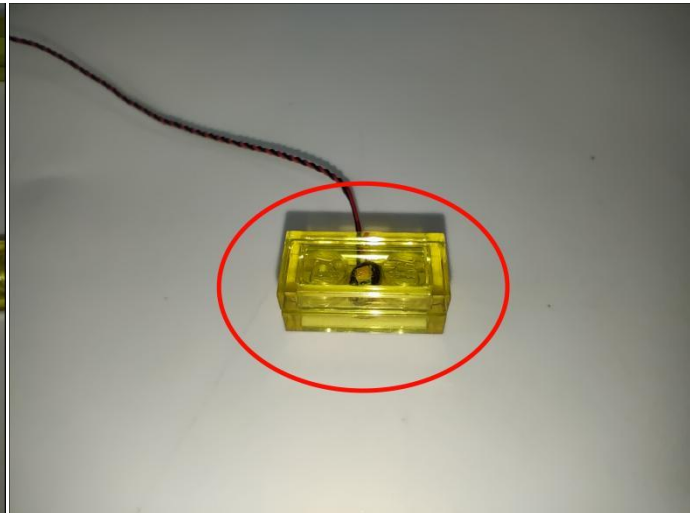
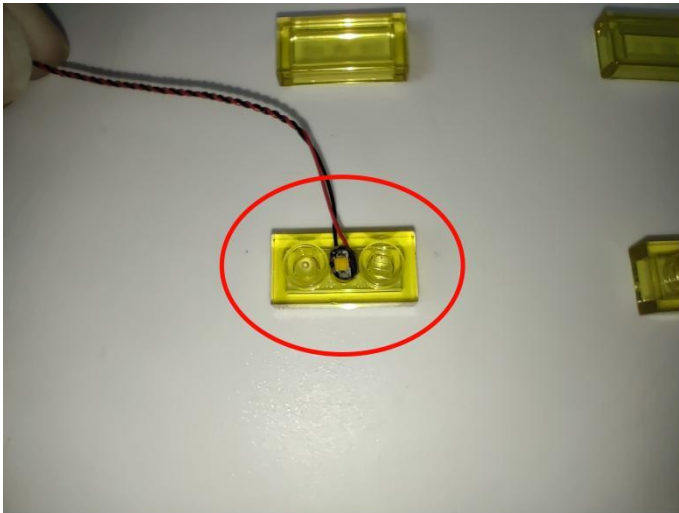

122

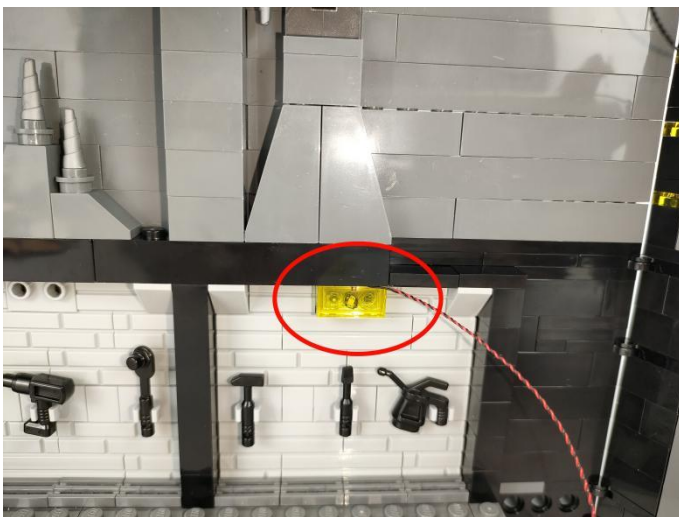

123

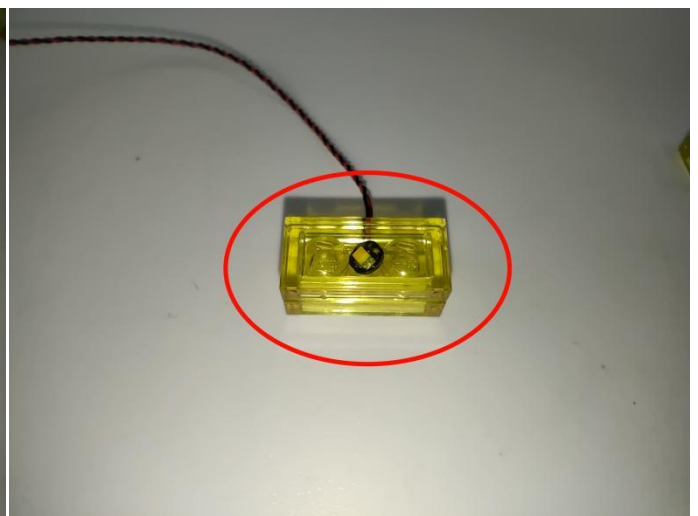
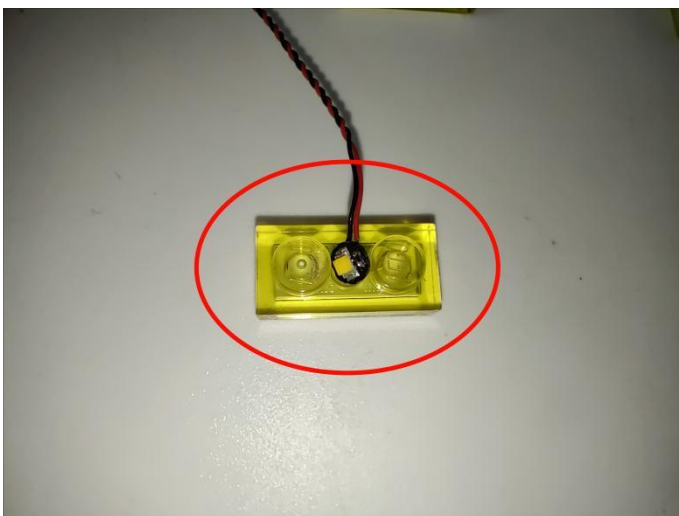

124

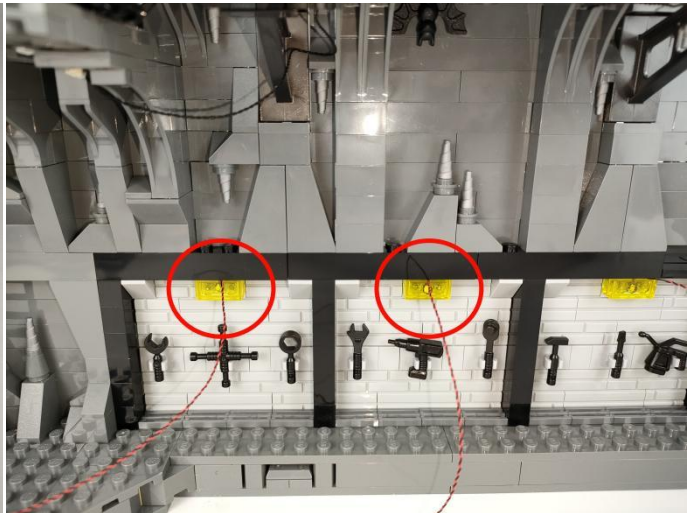
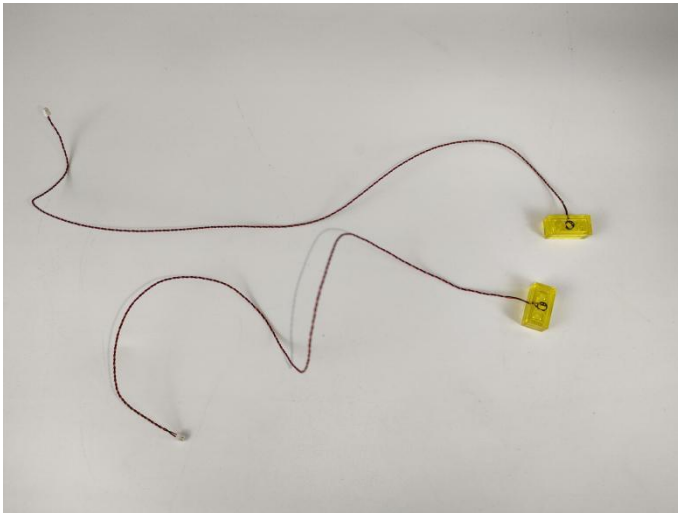

125

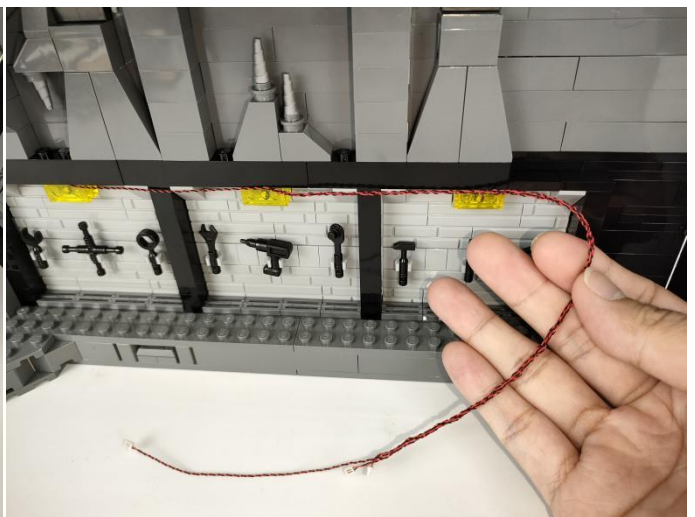
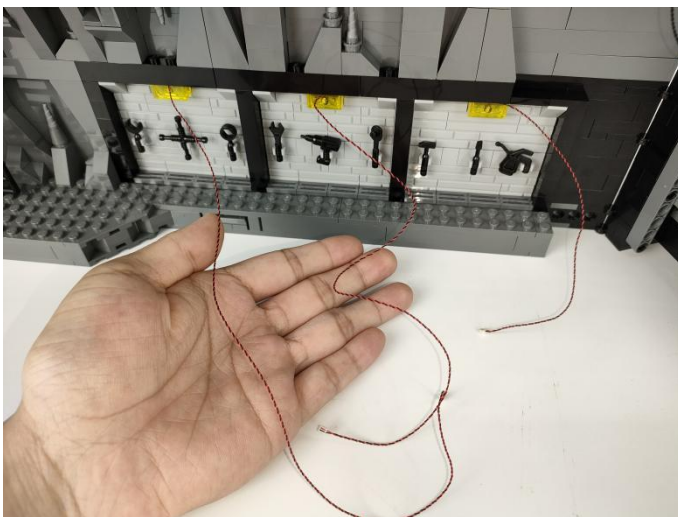

126



127

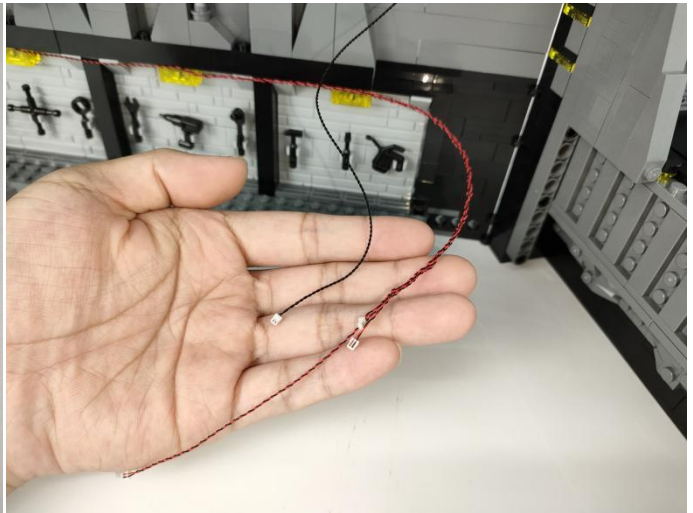

128

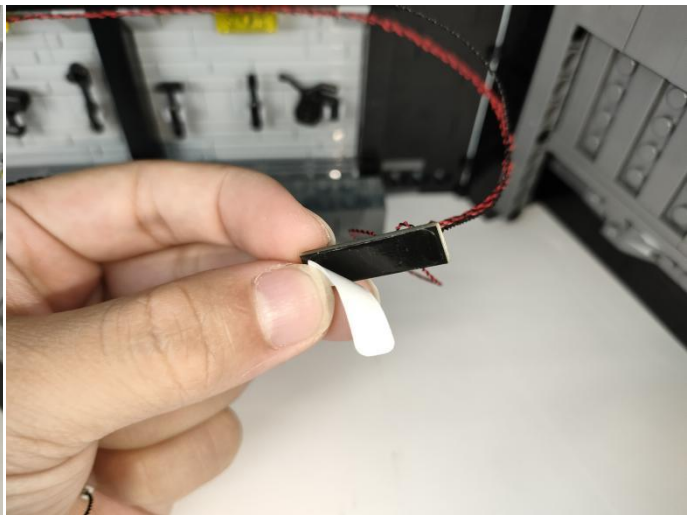
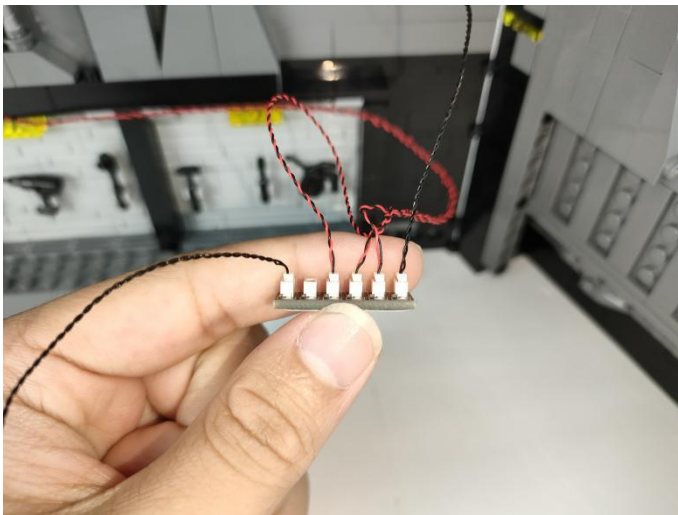

129

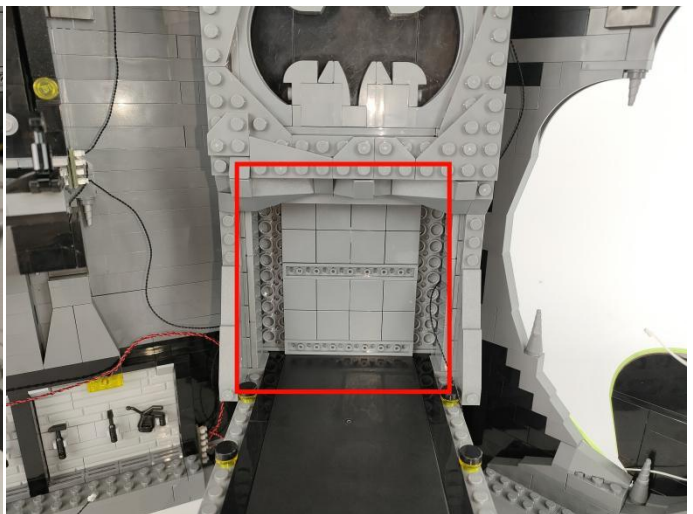
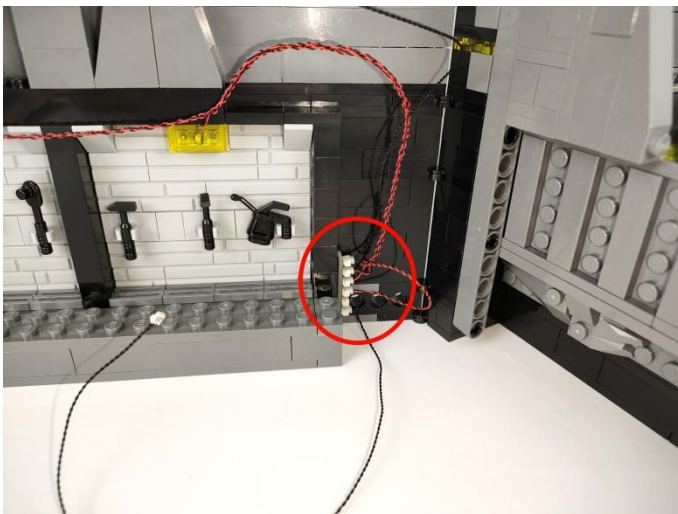

130

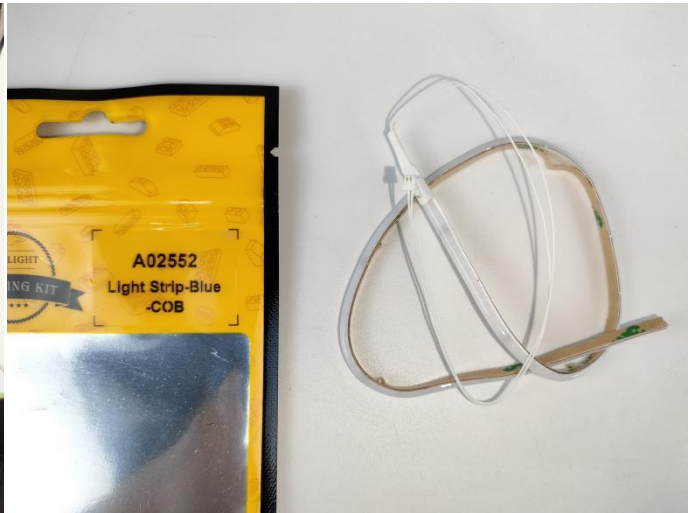
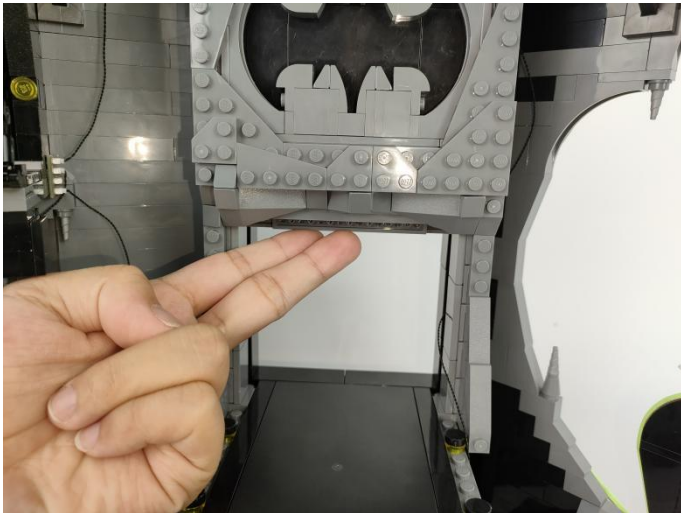

131

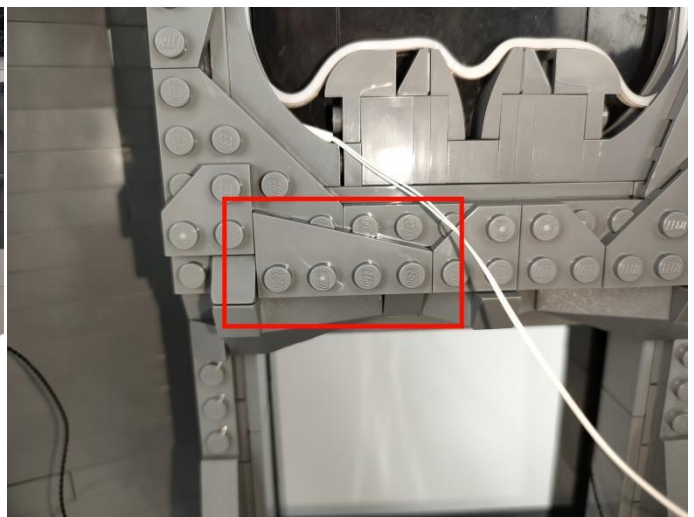
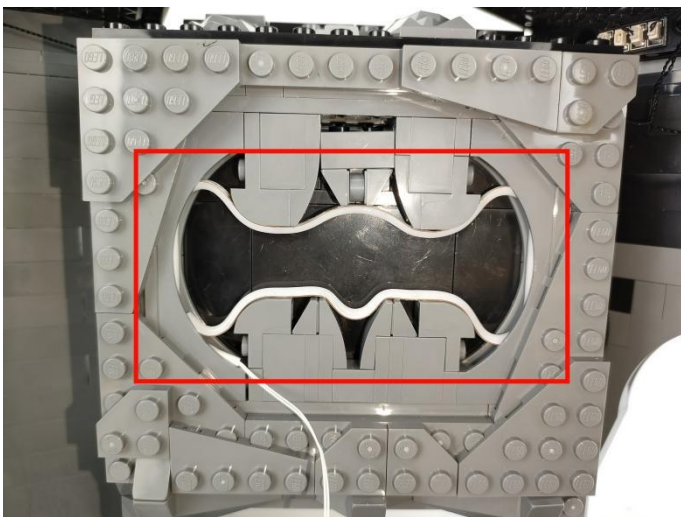

132

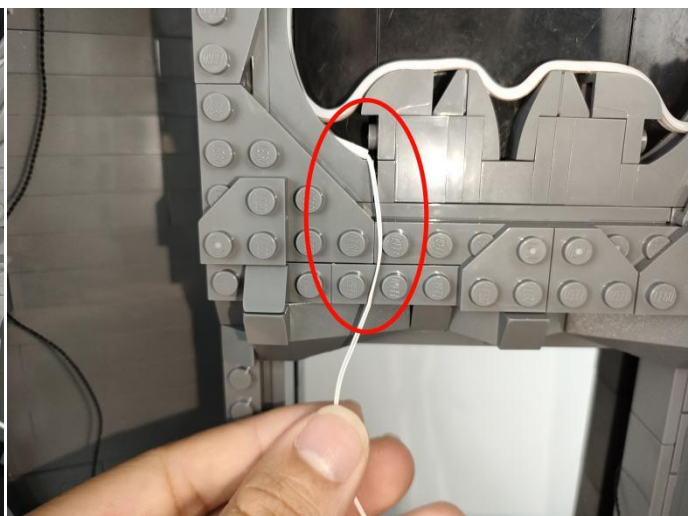
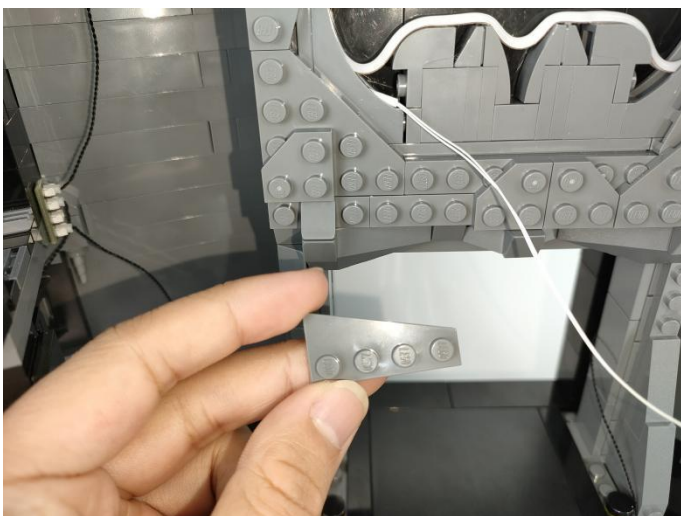

133

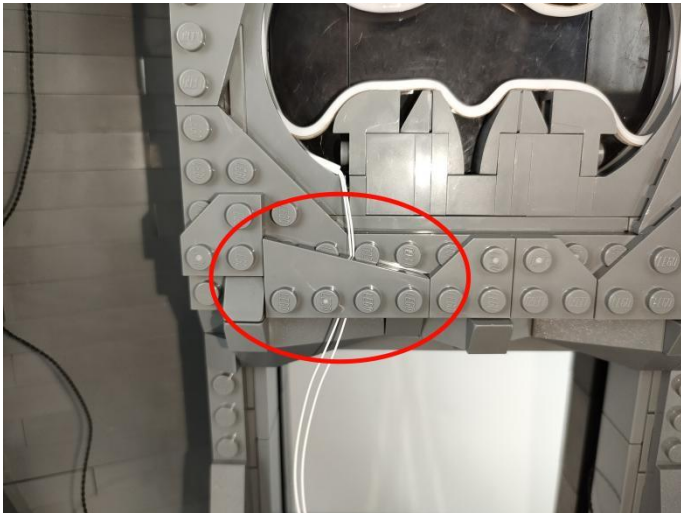

134



135

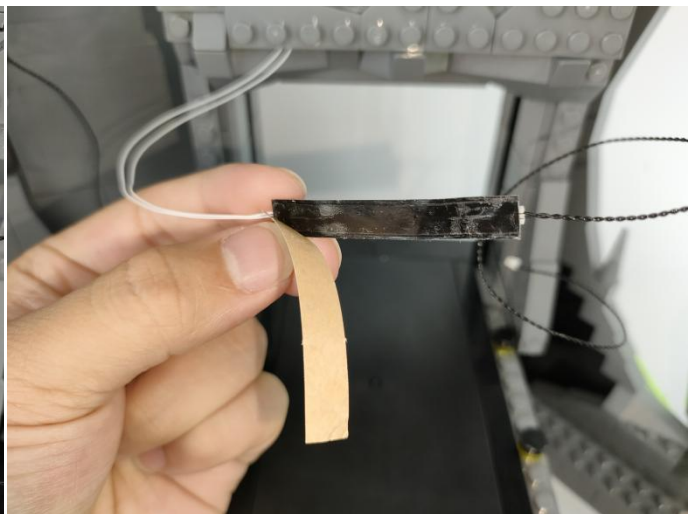
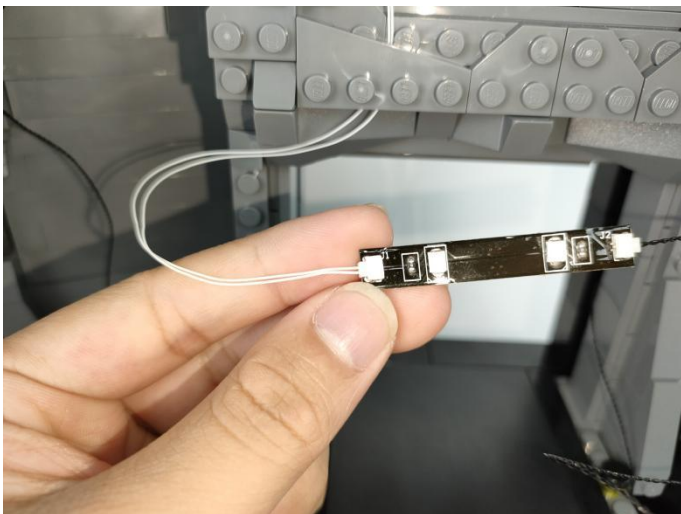

136

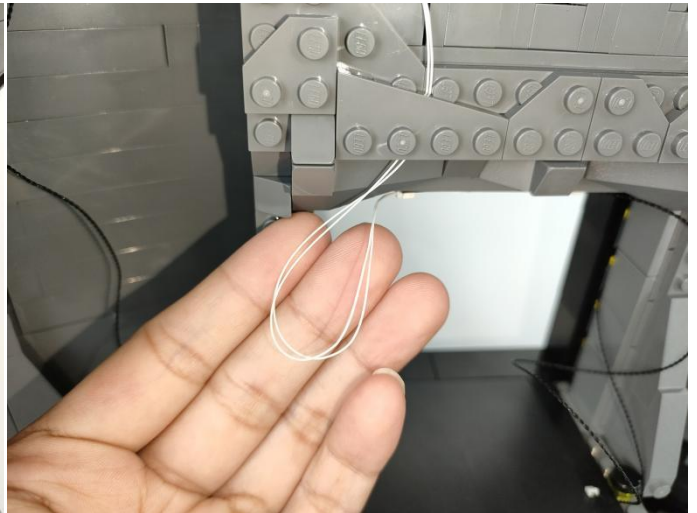
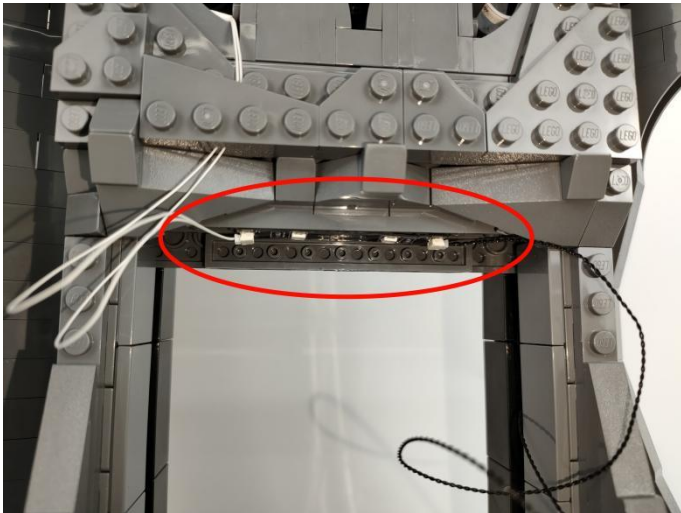

137

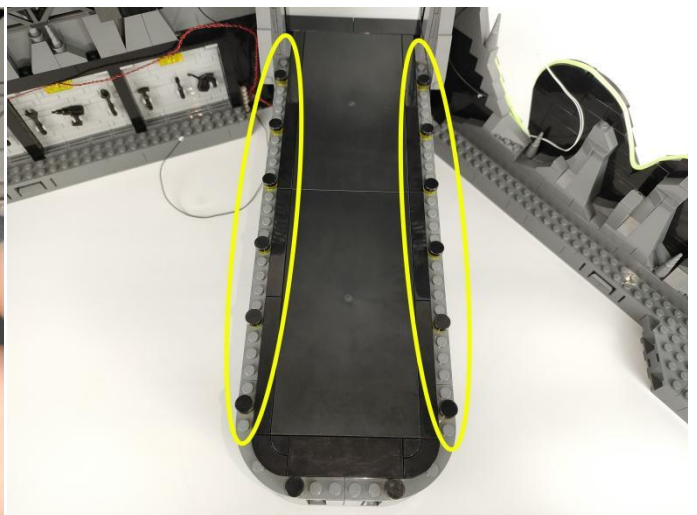
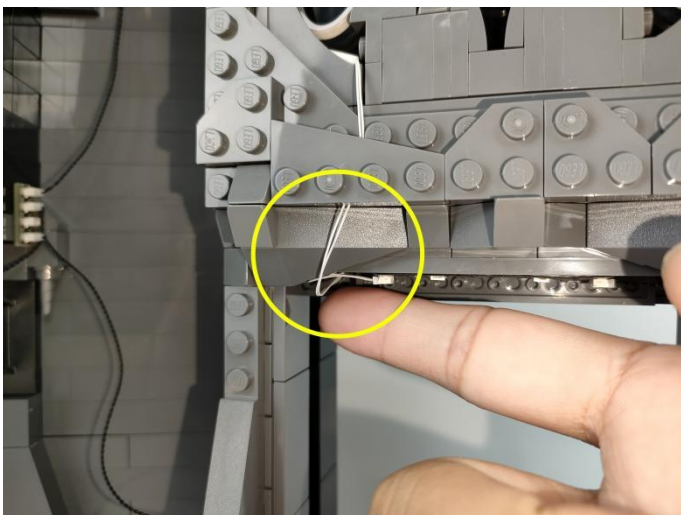

138

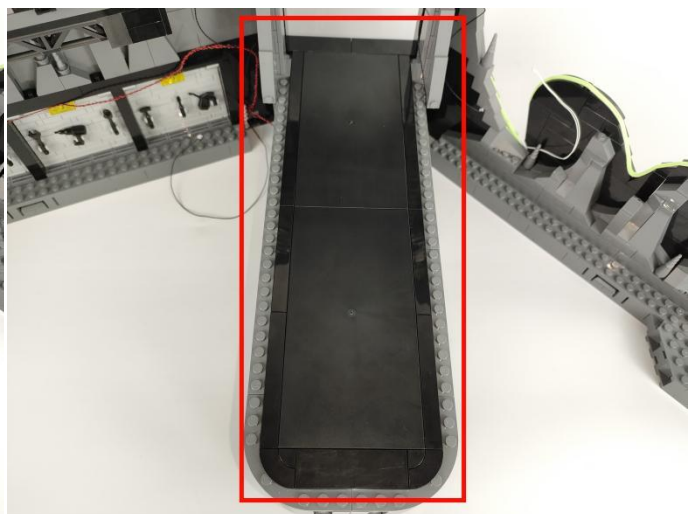
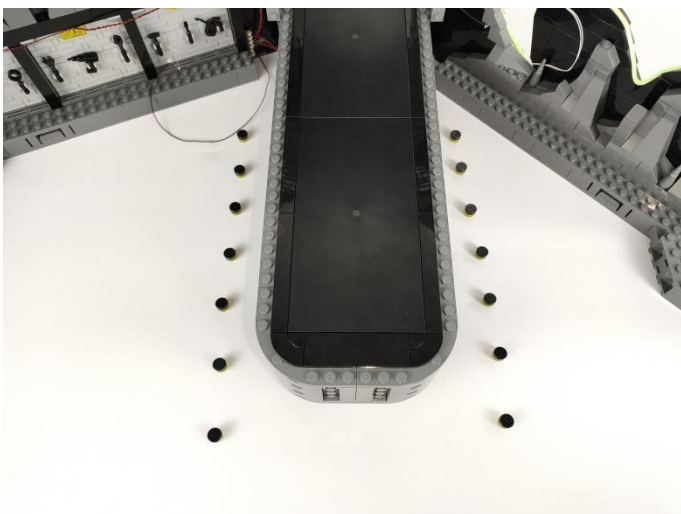

139

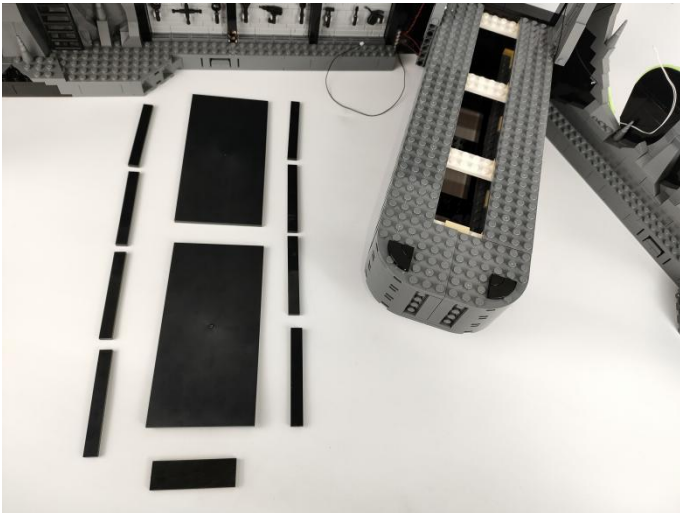

140

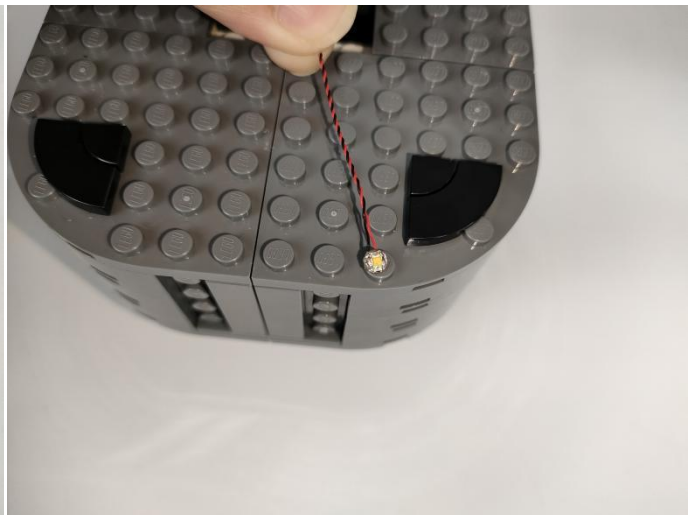

141

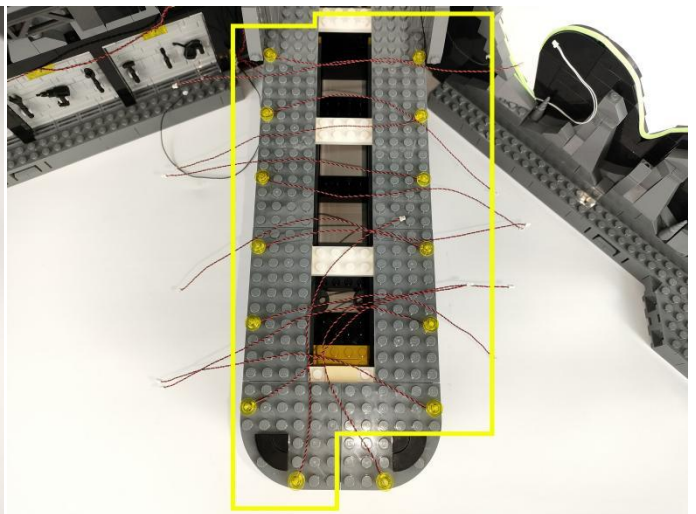
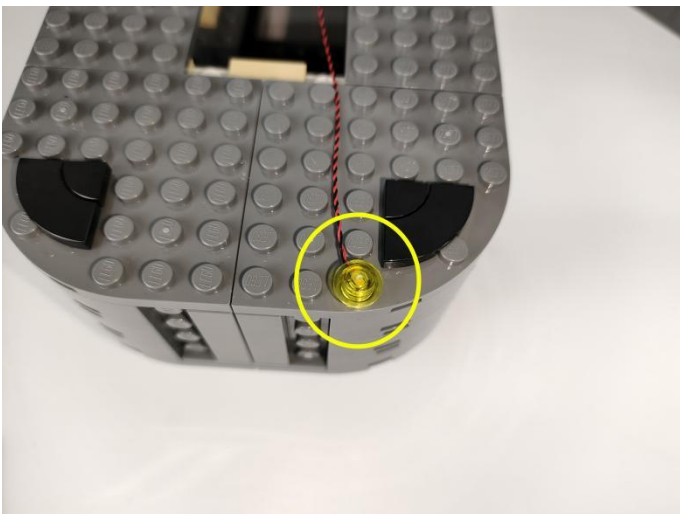

142

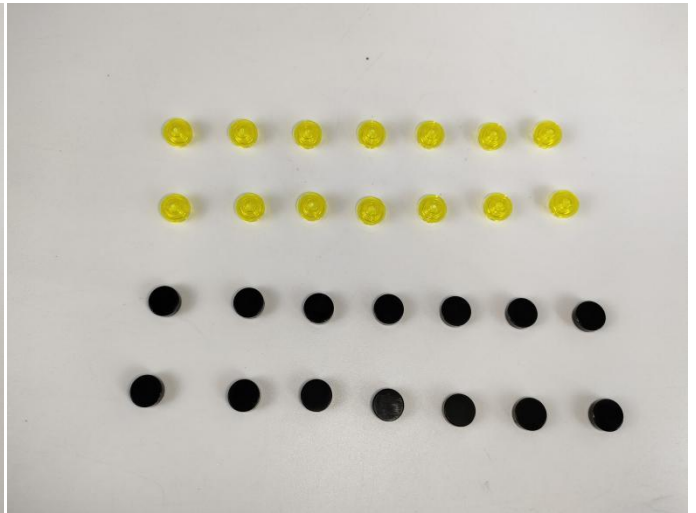

143

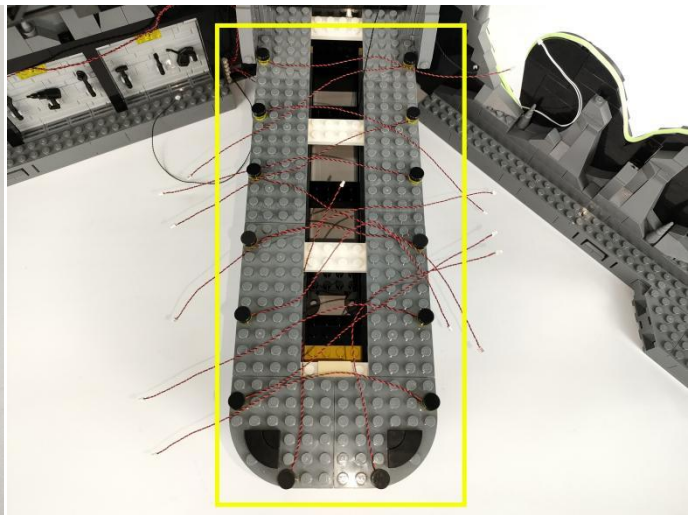
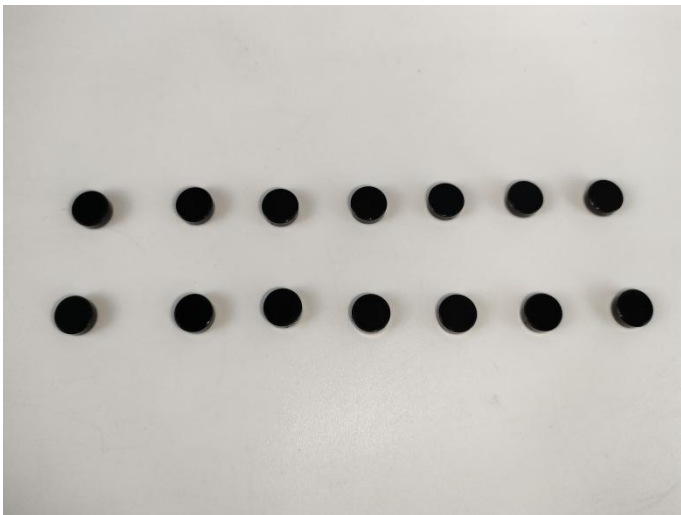

144

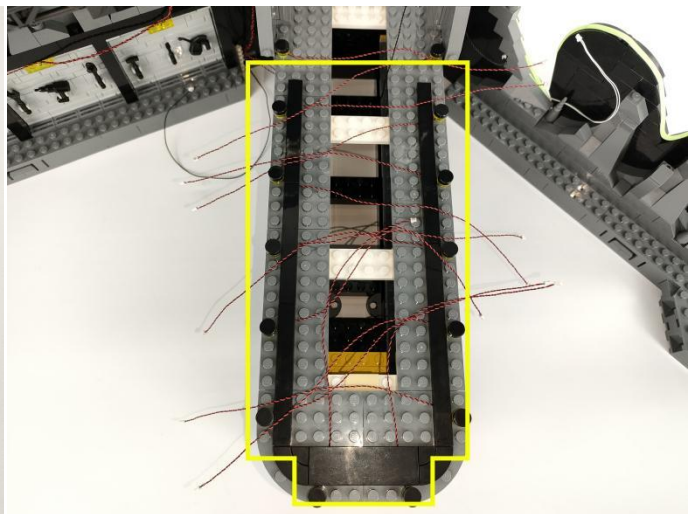
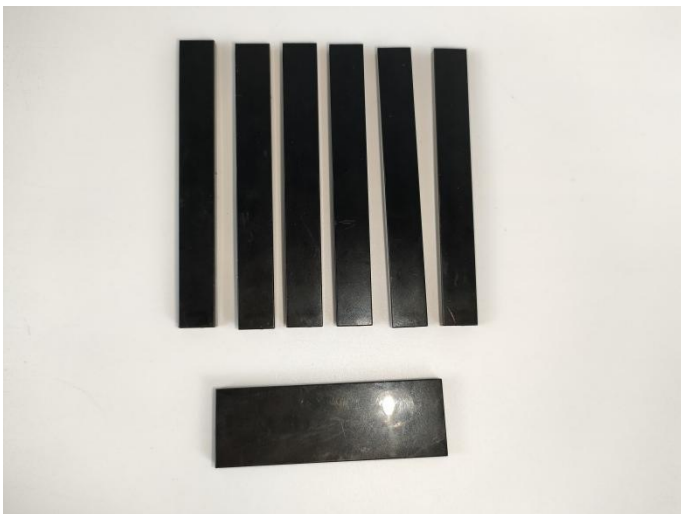

145

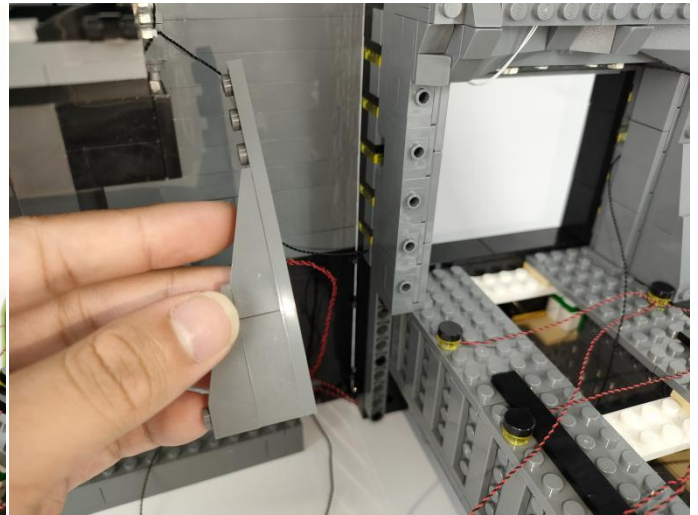
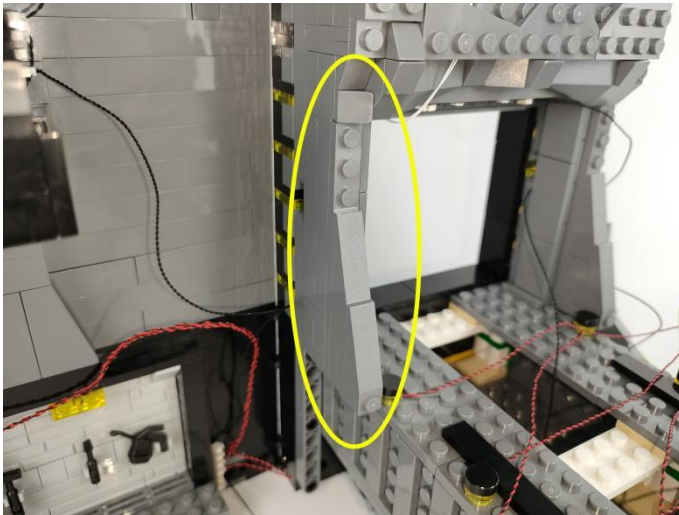

146

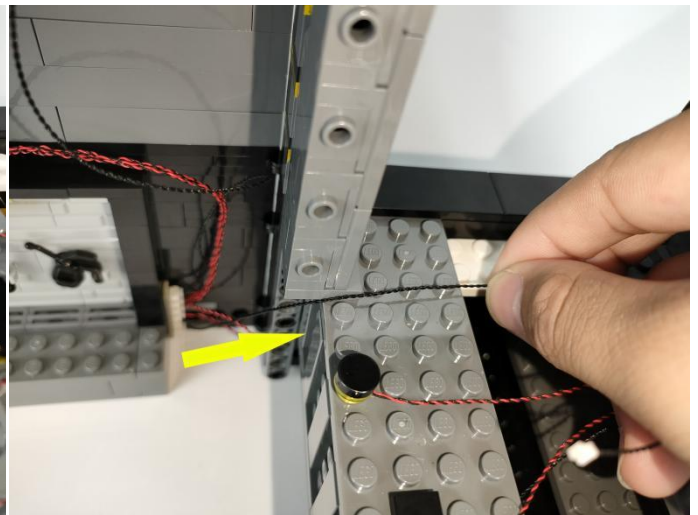
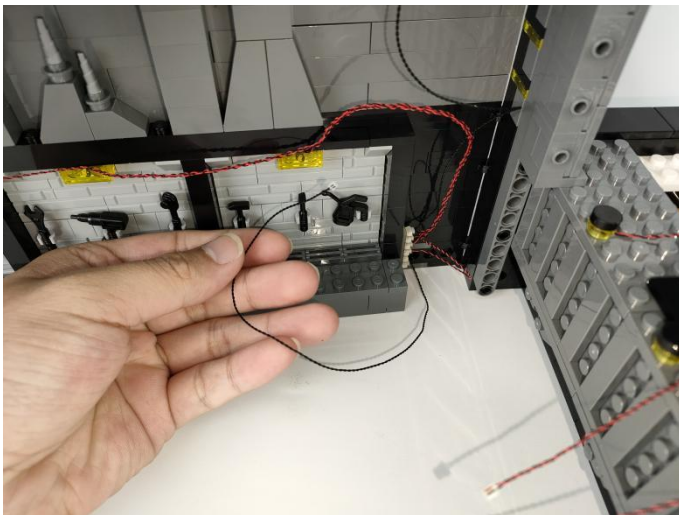

147

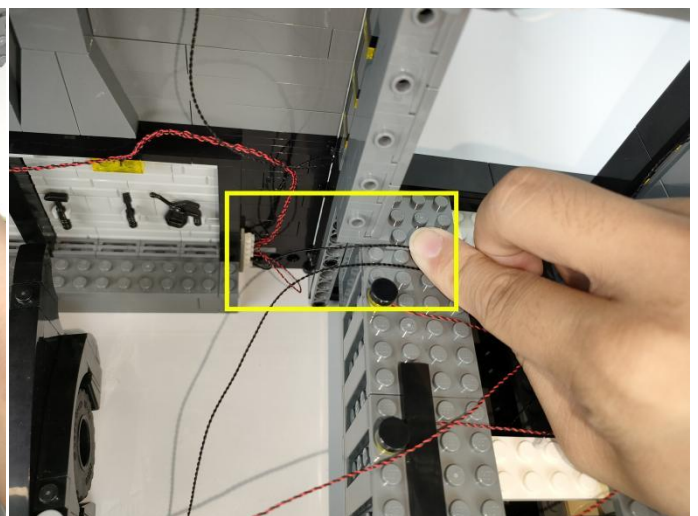
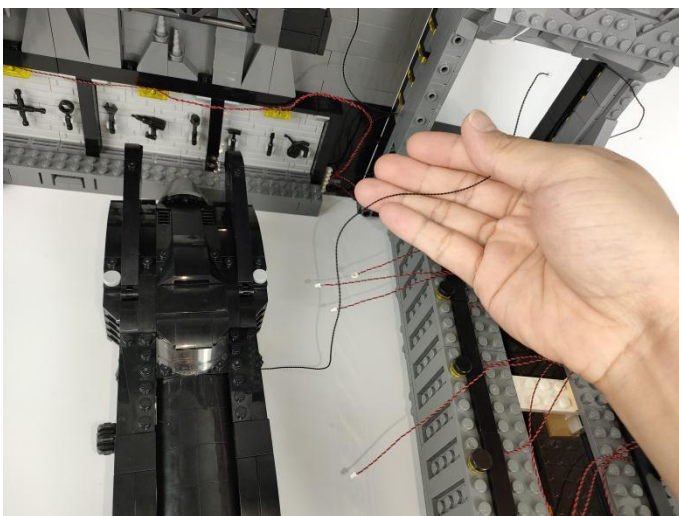

148

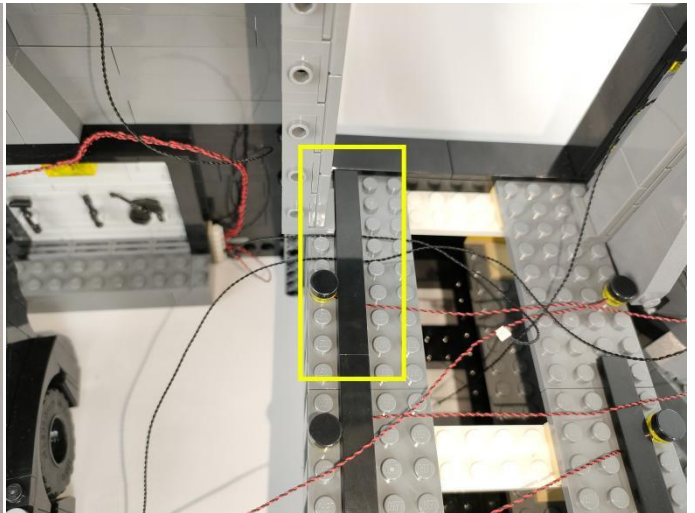

149

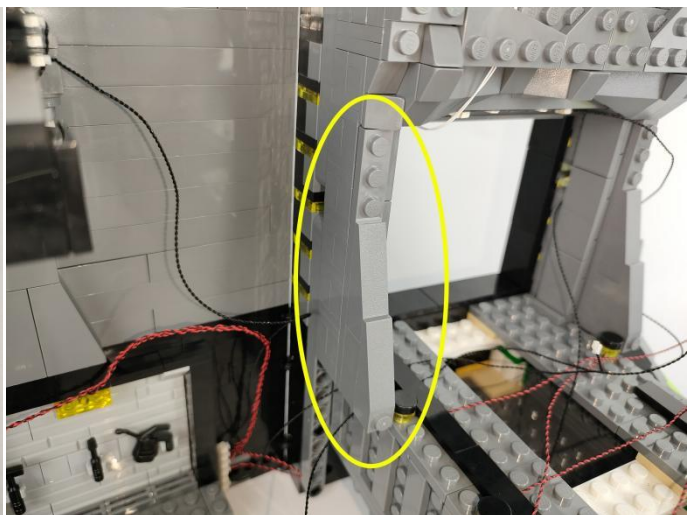

150



151

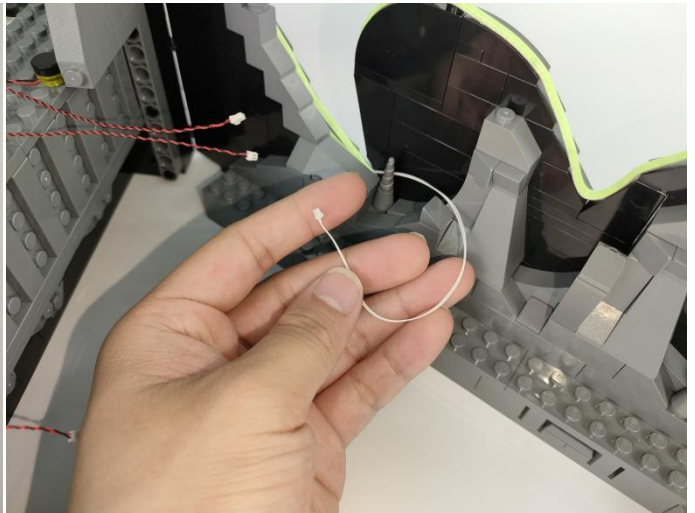
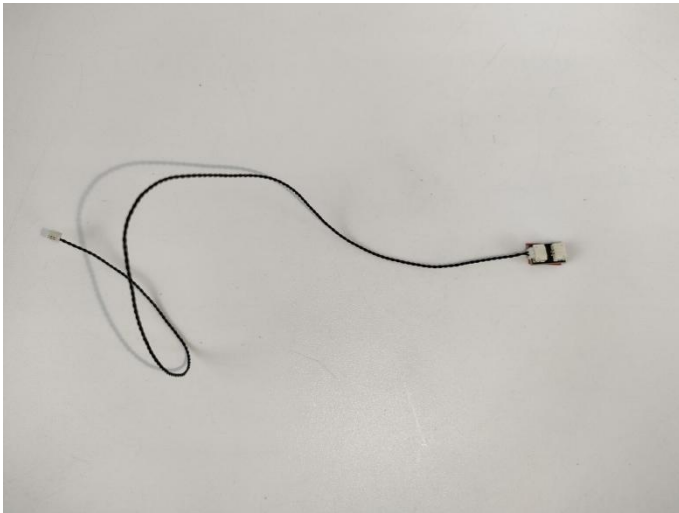

152

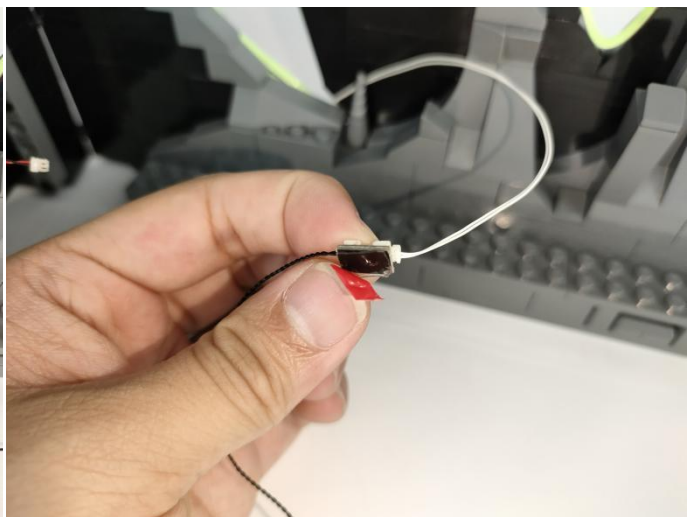
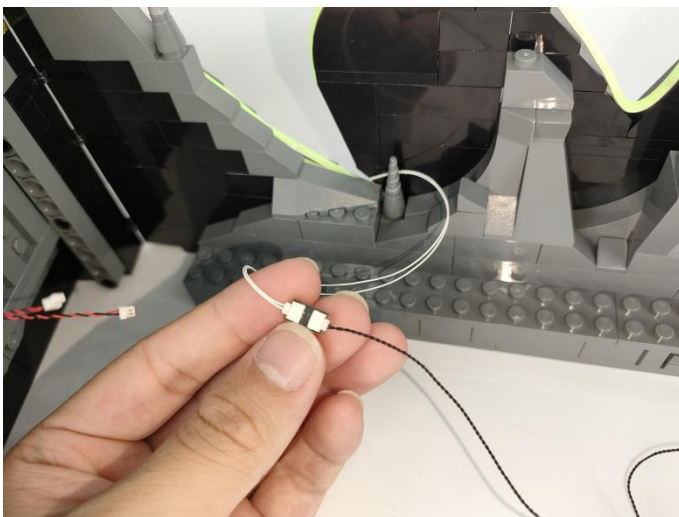

153

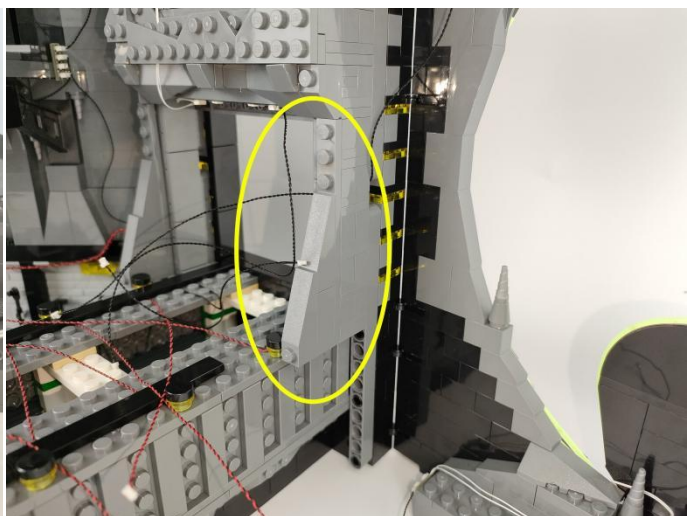
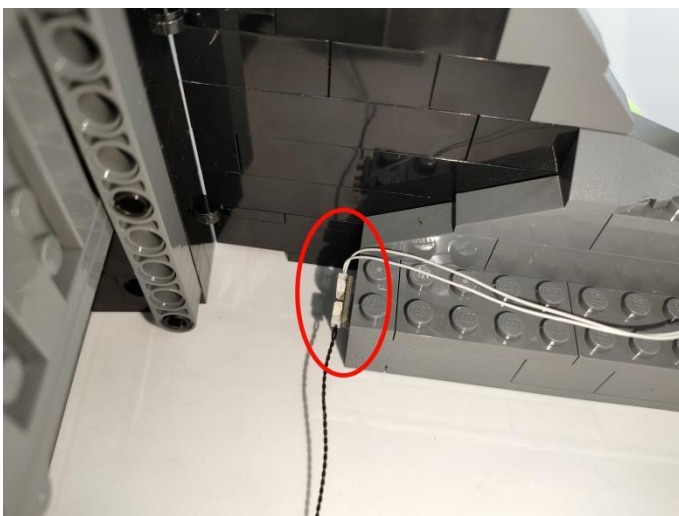

154

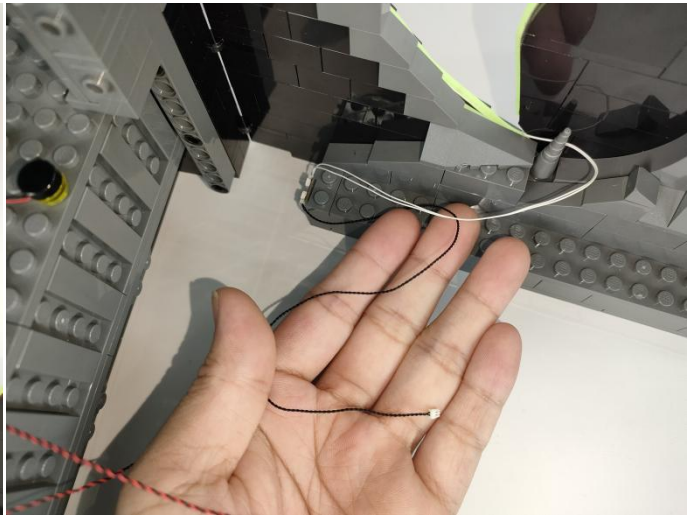
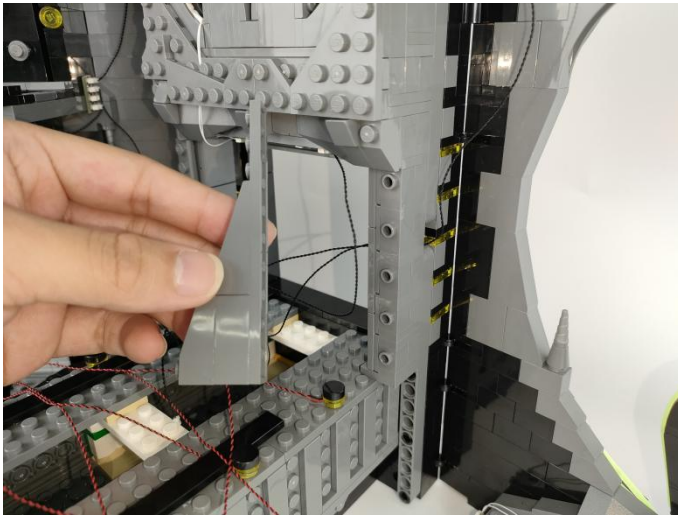

155

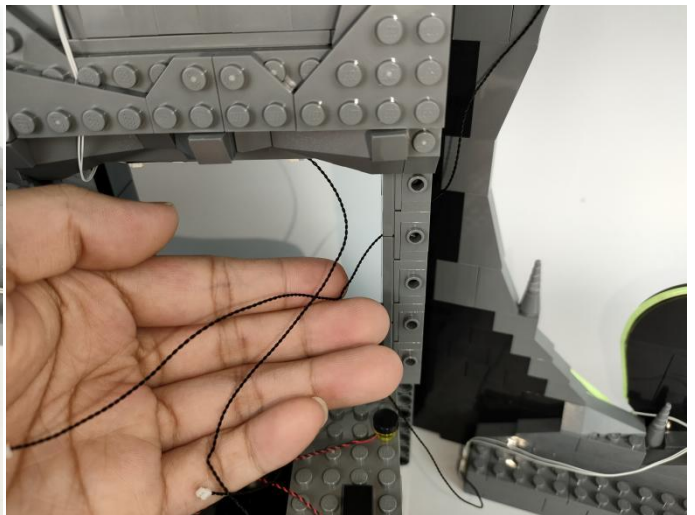
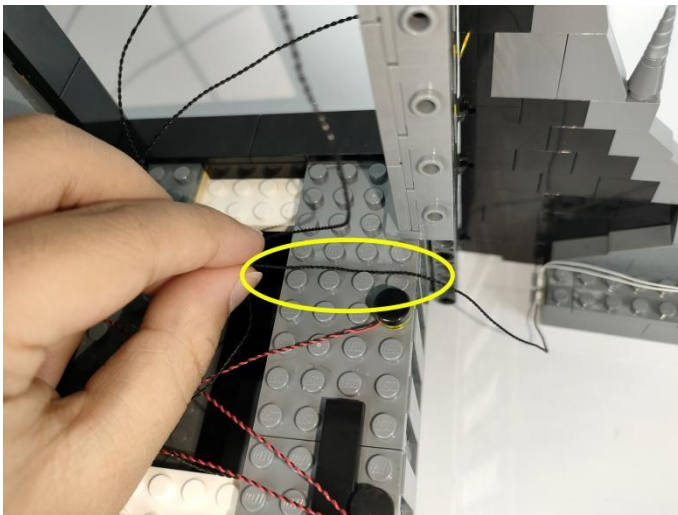

156

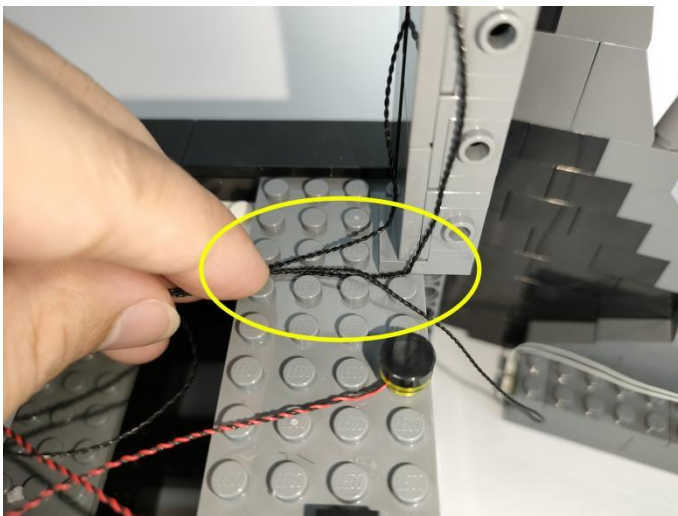

157

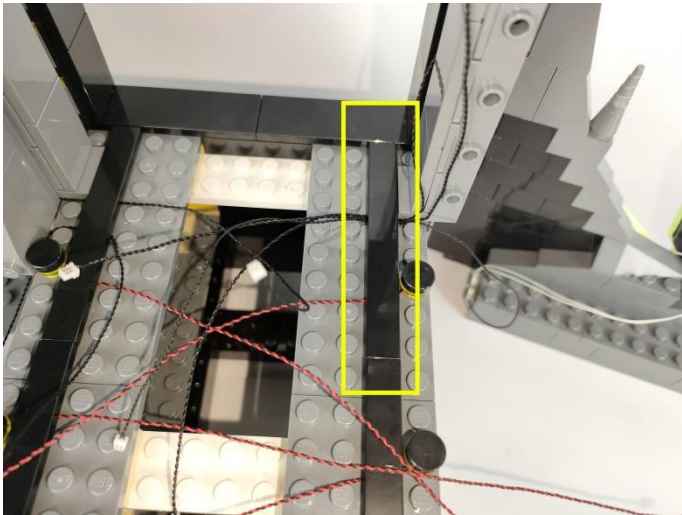

158

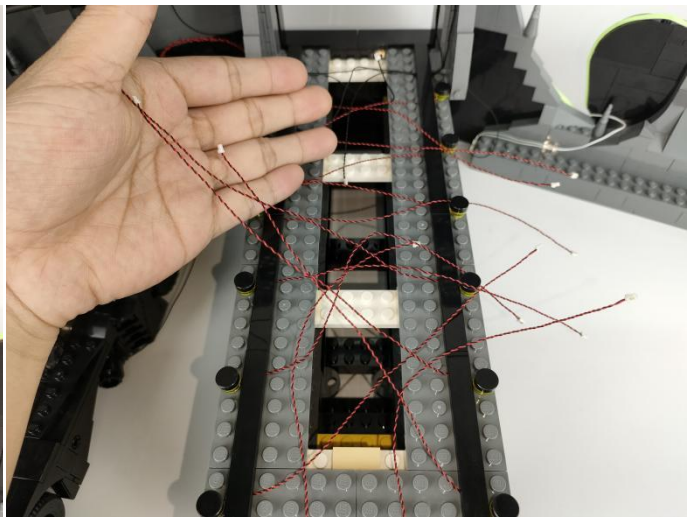
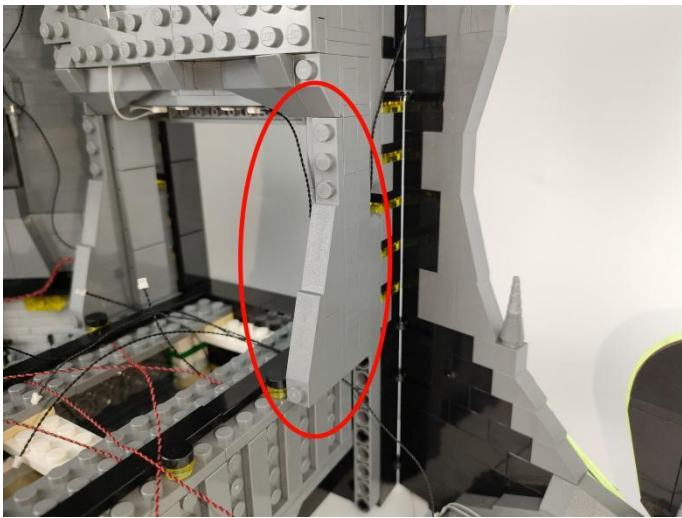

159

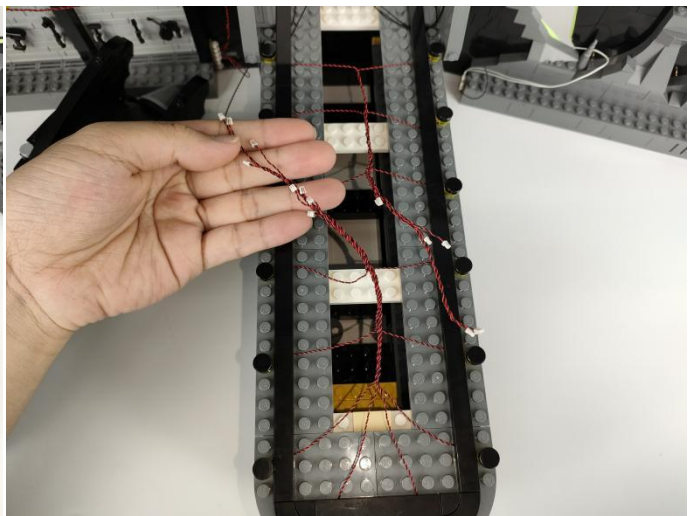
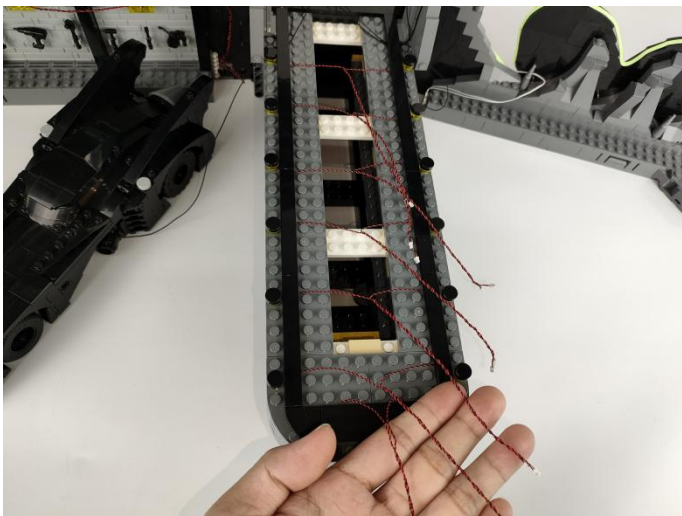

160



161

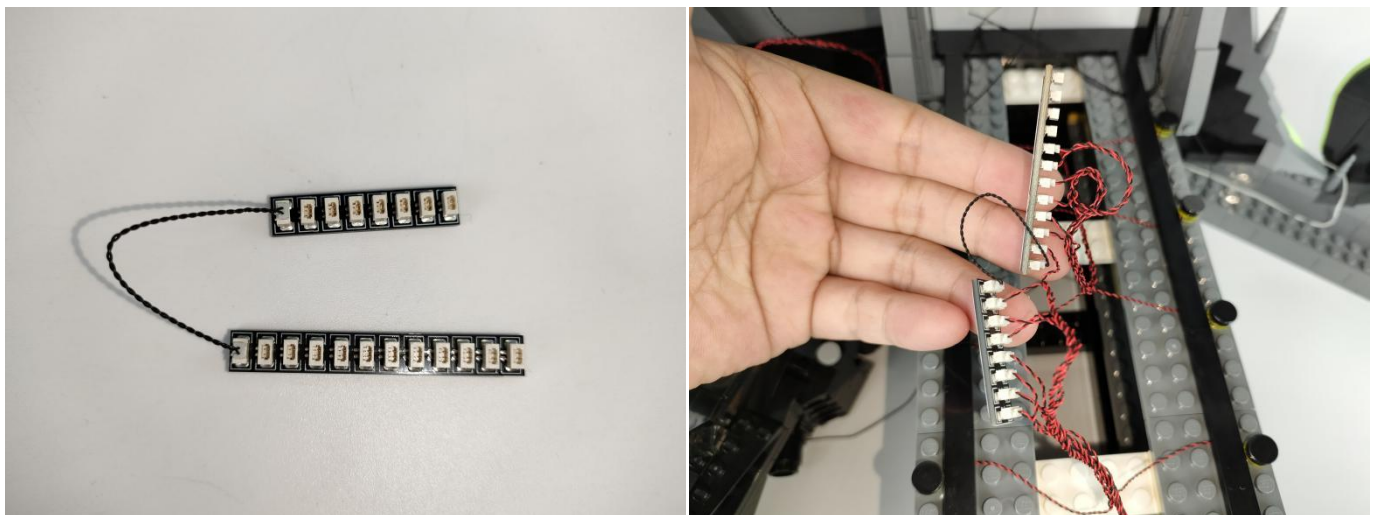

162

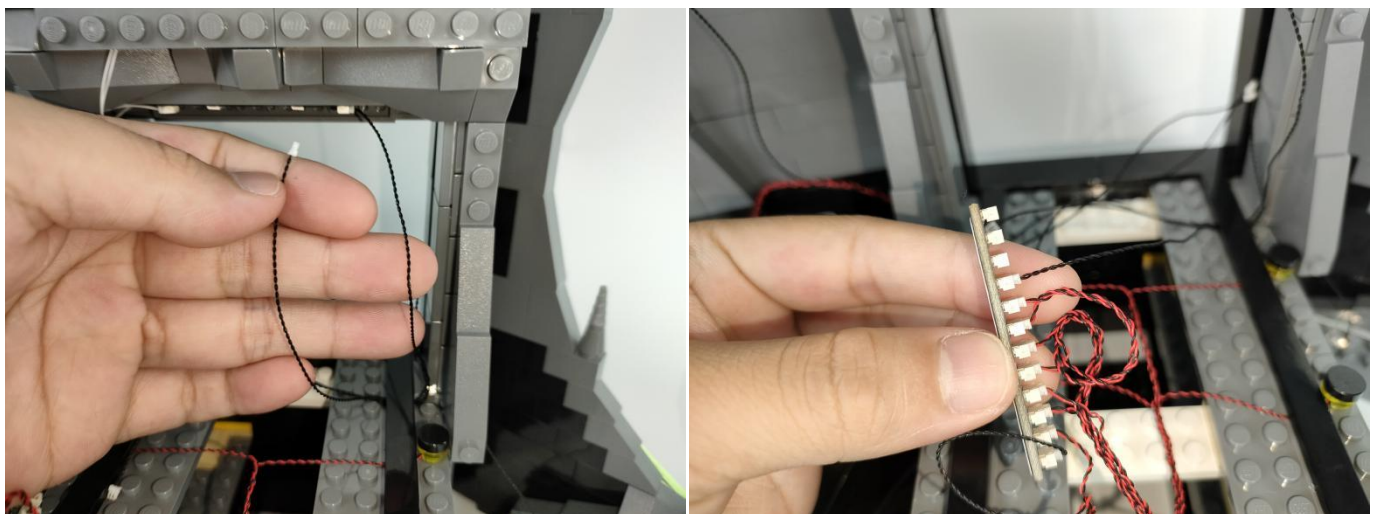

163

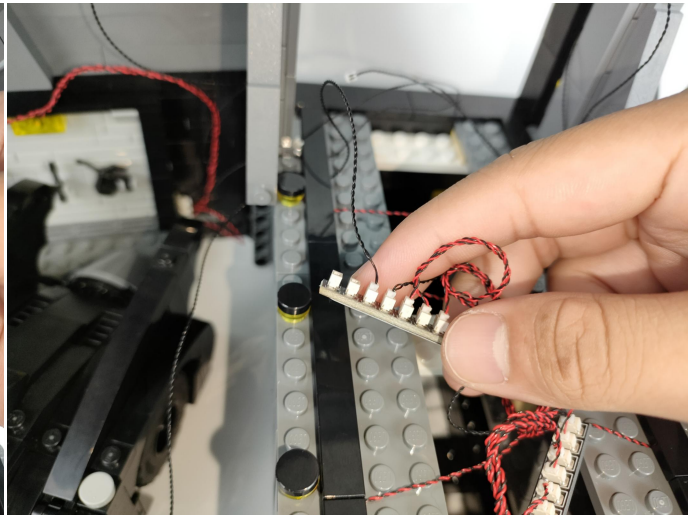
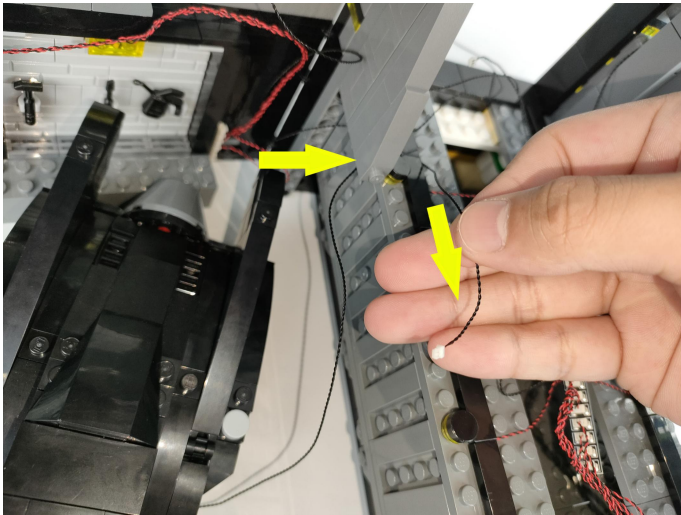

164

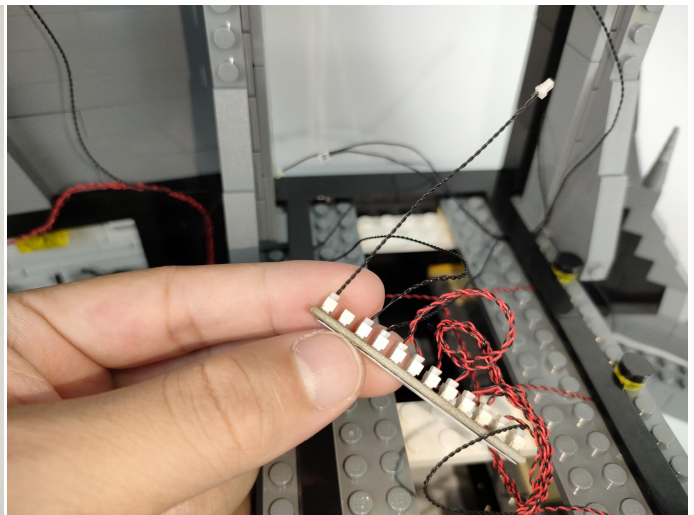

165



166

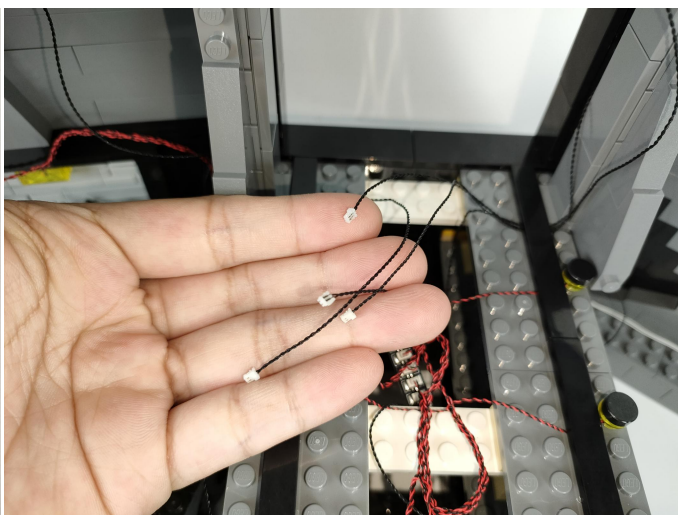
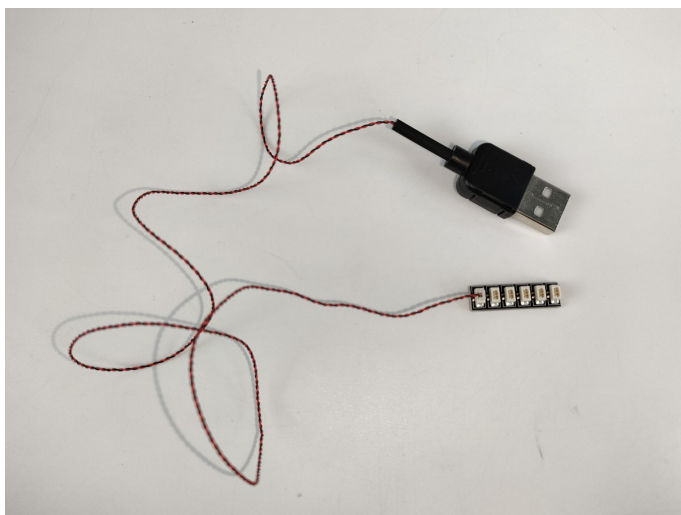

167

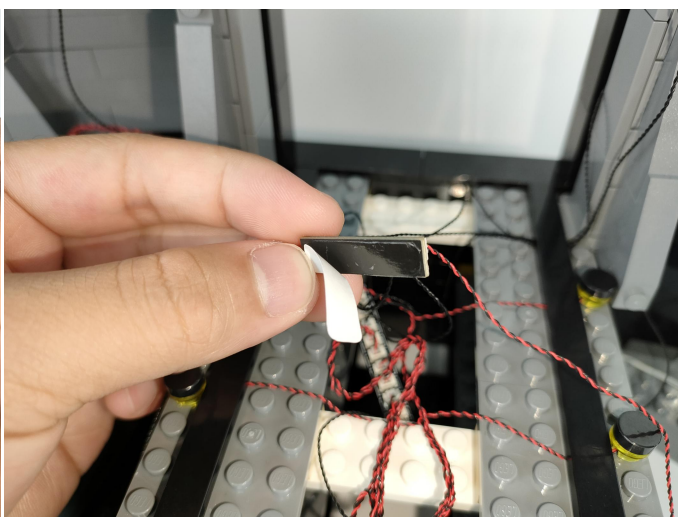
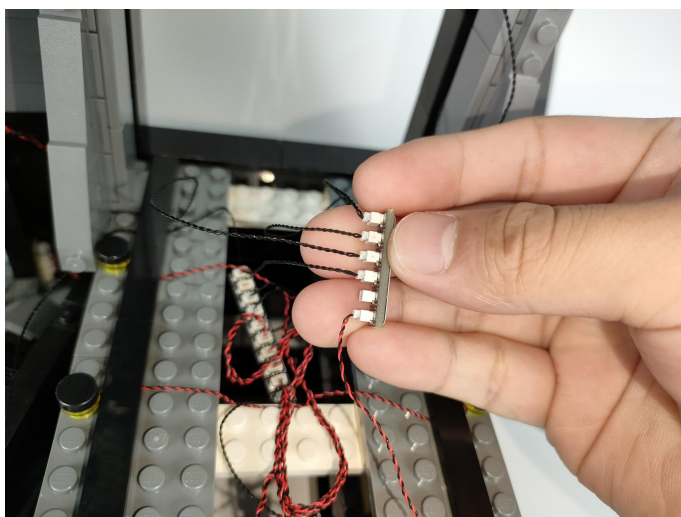

168

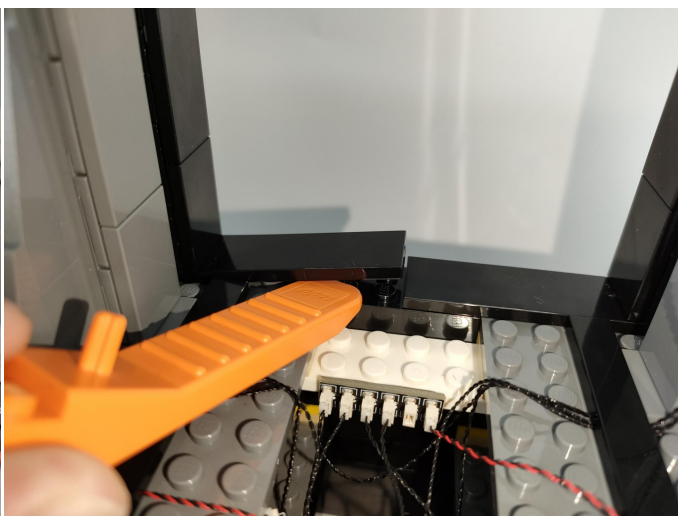
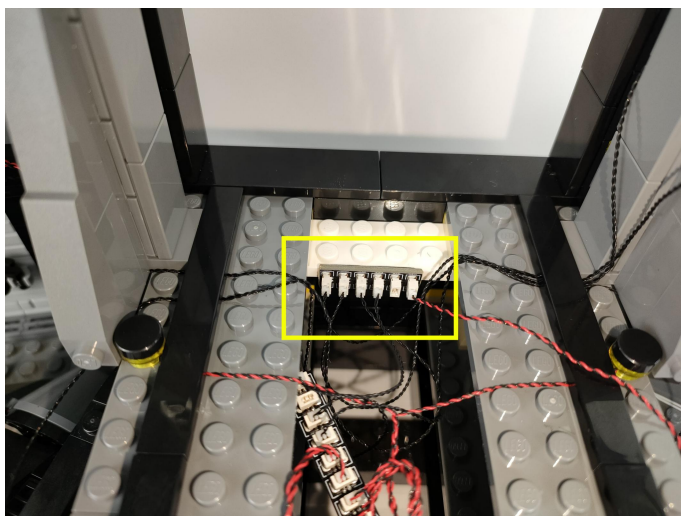

169

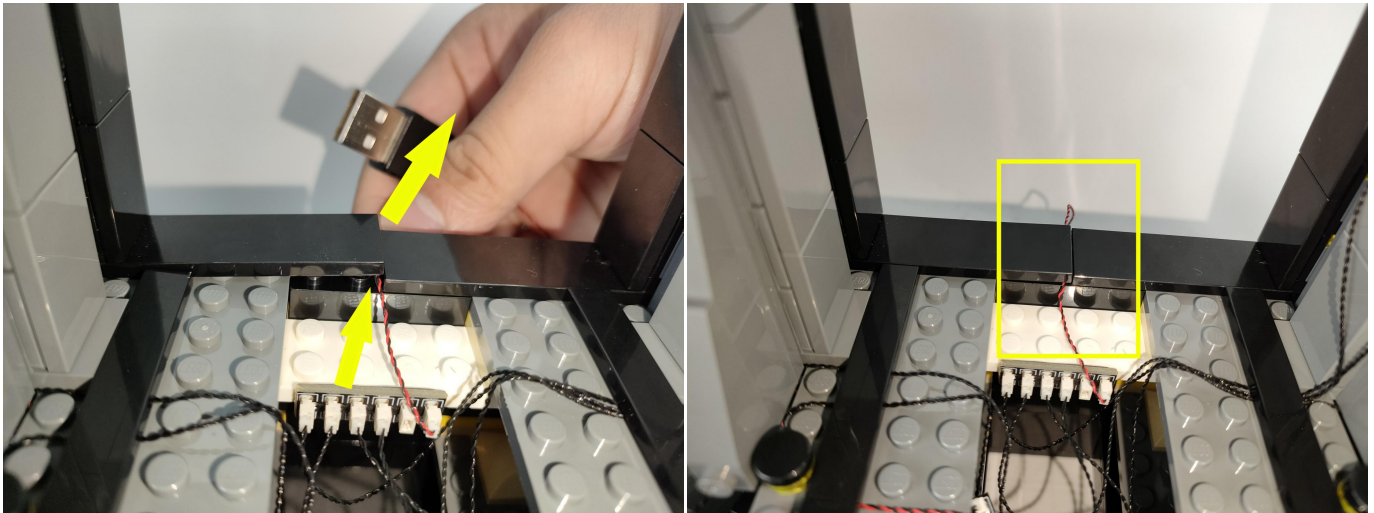

170



Music Module

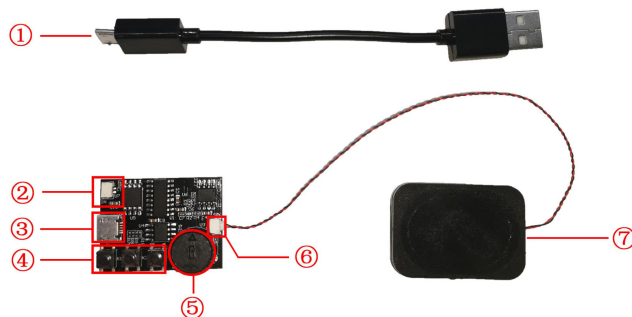

- ①: USB data cable is used to connect modules to the computer to replace music files.
- ②: The power input port is used to supply power to the module, and the voltage is 5V DC power.
- ③: Micro-USB port, music transmission port, it is recommended to use the music format MP3 file, the built-in capacity of the module is 16MB.
- ④: The music control button, from left to right, is "previous song", "pause/play", "next song".
- ⑤: The volume control button, rotate button to adjust the volume .
- ⑥: The speaker interface.
- ⑦: The speaker.

This module function is similar to MP3. Imports your favorite music files into the module through the data cable, and then switch on the module to play the stored music. Music files can be replaced arbitrarily.

171

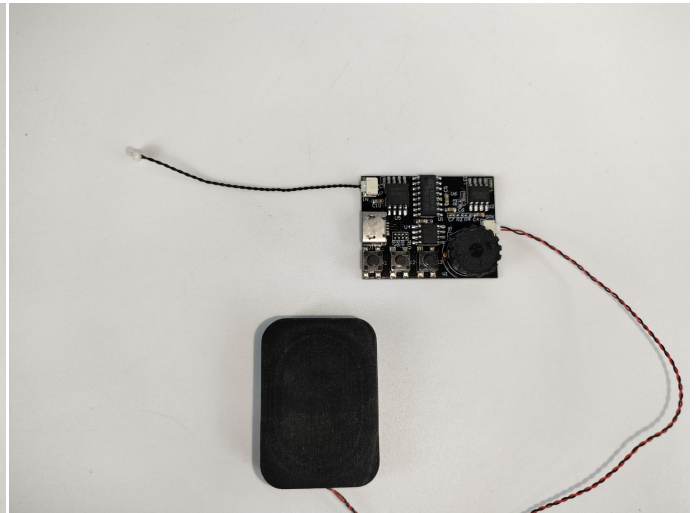

172

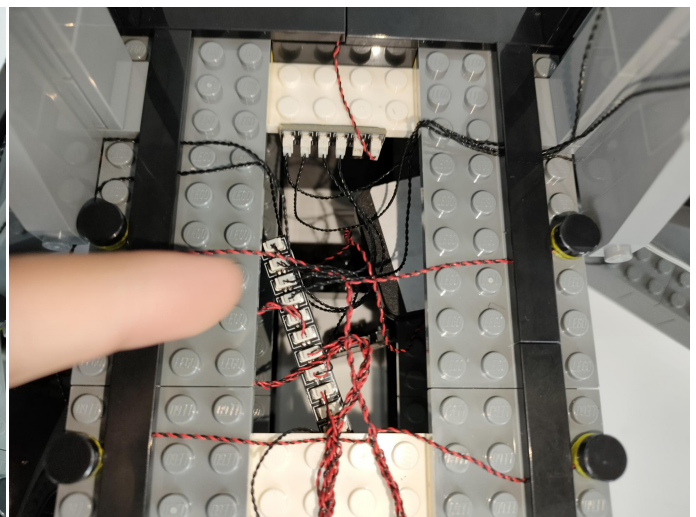
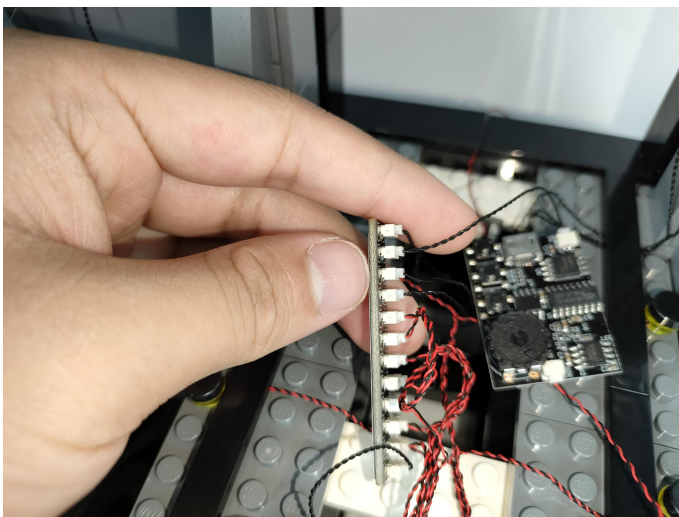

173

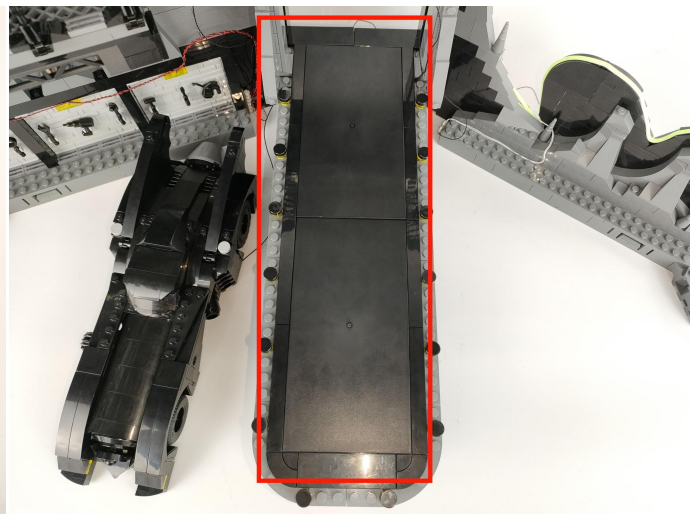

174

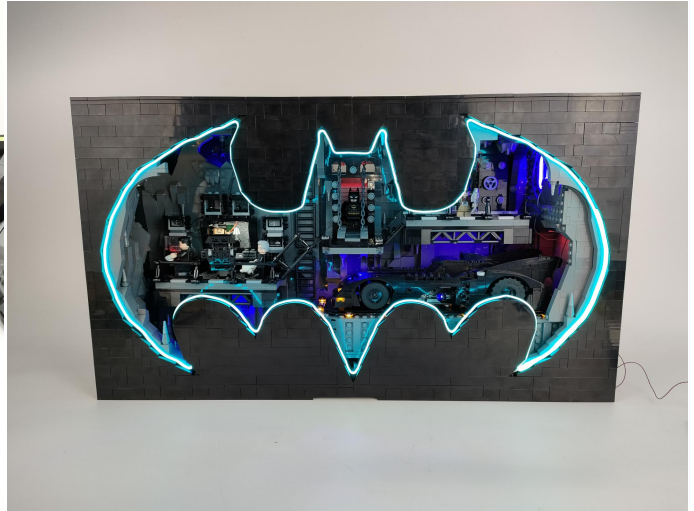
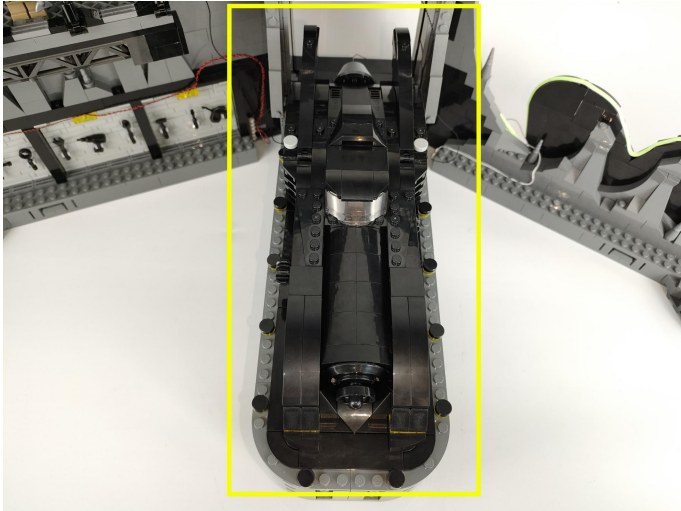

Good job, you've done all the installation steps, power it up and enjoy your work.

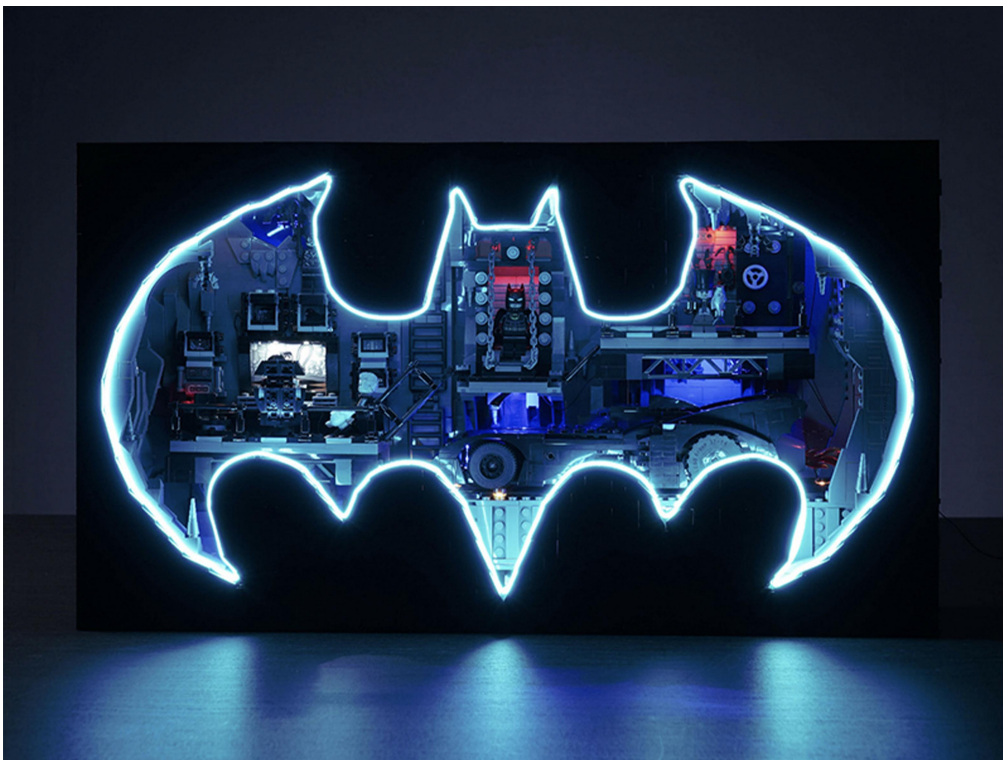

The battery box can also power the set. If it is necessary to change the power supply , prepare three AAA batteries, install them in the battery box, turn on the switch on the battery box, remove the plug of the USB Power Cable from the socket of the expansion board,plug the plug of the battery box to the same socket in the expansion board to power the suit as well.

THANKS