

42152 Firefighter Aircraft P46601

- P46601 is the unique code of lighting set, we use this to accurately identify the product you purchased and the corresponding manuals and services you need to obtain. Please make sure your product code is the same as the label on the back of the box shown “42152 P46601”.
- Installation requires a lot of patience and great observation that your LEGO bricks will come alive when you get this finished. The bricks with lighting as below, so make sure you're ready and let's get started.



Strategies for the Installation

This instruction divides three sections to complete the installation of the lighting set.

Section A: Check the type and quantity of components.

The quantity and type of components of each products are different and it needs to be carefully checked to make sure there do have enough material. The type of components is indicated by the label on the bag.

Section B: Test that each components is working properly.

Each components is made individually so it is necessary to test that each components is working properly to avoid the situation that the lighting does not work .

Section C: laying out components following the instruction.

Our material is very small but not fragile, just be reminded that don't to pull the wires too hard. For different people, there may be some installation steps that you can't understand. Please look at the previous and later installation step.

Section A: Check the type and quantity of components.

There are 16 bags in this set. The name and quantities of specific components are as shown , please check carefully.

Label	Content	Quantity
A01010 Light-30CM Red	Light-30CM Red	2
A01024 High-Brightness light 15CM-Warm White	High-Brightness light 15CM-Warm White	1
A01105 LED Strip Warm White	LED Strip Warm White	2
A012 Expansion Board	4 Socket Expansion Board	2
	6 Socket Expansion Board	3
A01305 Power Supply	Power Supply	1
A01501 Connecting Cable 5CM	Connecting Cable 5CM	1
A01503 Connecting Cable 30CM	Connecting Cable 30CM	1
A01505 Connecting Cable 10CM	Connecting Cable 10CM	3
A01506 Connecting Cable 20CM	Connecting Cable 20CM	1
A01801 Flash Light 30CM-White	Flash Light 30CM-White	1
A01803 Flash Light-30CM Red	Flash Light-30CM Red	2
A01804 Flash Light-30CM Green	Flash Light-30CM Green	1
A02506 Light Strip-Warm White	Light Strip-Warm White	2
A02526 Light Strip-Warm White	Light Strip-Warm White	2
A1029 High-Brightness Light 15CM-White	High-Brightness Light 15CM-White	1
Components		

Please contact us immediately if there have any missing components.

Section B: Test that each components is working properly.

We need a structure to test all lights, so take out the bag with label “USB Power Cord”and “Expansion Boards”as follows.



It is worth reminding that our products are all customized. They have a unique way of connecting. The white plug on wire and the socket of the expansion board need to be connected together to transmit power.

Note that on one side of the white plug you can see two very small golden wires that should be connected to the two golden needles in socket of the expansion board.shown as blow.

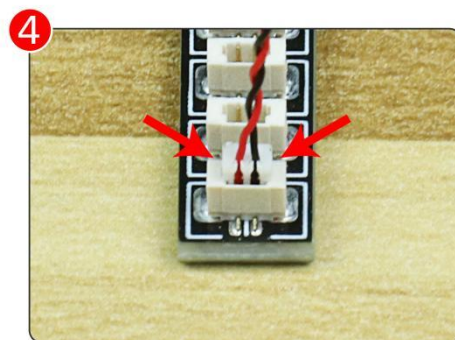
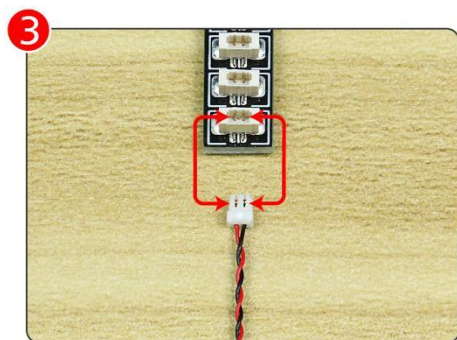
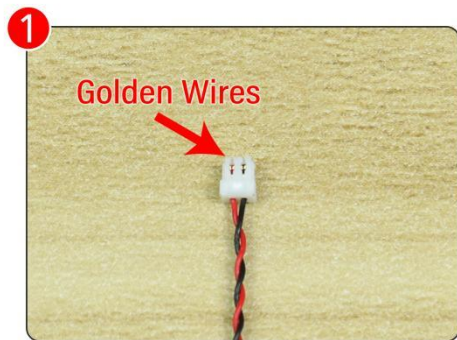

All our connections between plug and socket are all the same as shown above. So for any such structure with plug and socket, please pay attention to the golden wire of the plug and the golden needle of the socket, they must be touched together.

The connection method between the USB Power Cord and Expansion Boards is as follows:



The USB Power Cord can be powered by phone chargers, power banks, etc.

USB connectors to connect devices

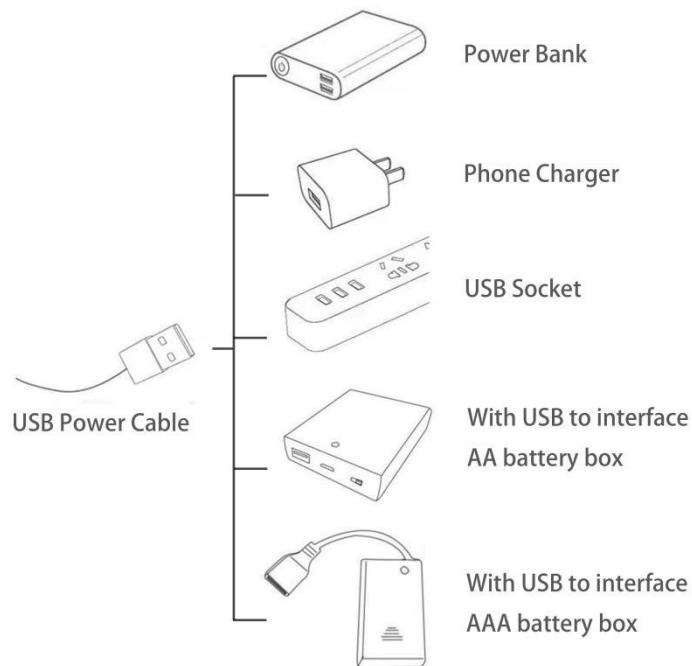

This instruction will use the power bank as power supply . The test structure is shown as follow. All lamp in this set will be tested by this structure.



When we test "A01024 High-Brightness light 15CM-Warm White" particles,Take out the bag labelled "A01024 High-Brightness light 15CM-Warm White".Take out one of the light and connect it to the socket. Turn on the power bank, the light will turn on normally as shown below.



LED strip test:

Take out the bag labeled "A01105 LED Strip Warm White". Take out the LED light bar, connect the USB power cable, turn on the mobile power supply, the light will be on normally, as shown in the figure below.

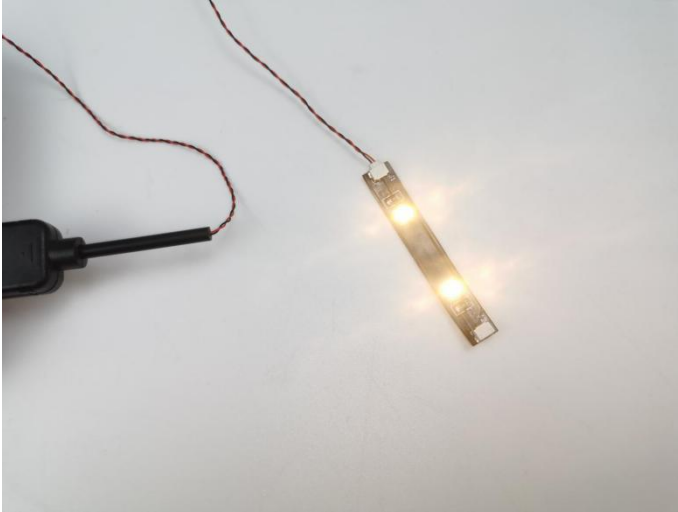

Test each lamp according to this method. It should be noted that after the test, the lamp must be returned to the corresponding bag to avoid confusion of types.



The components needs to be tested in this set is 2*Light-30CM Red,1* Flash Light 30CM-White,2* Flash Light-30CM Red,1* Flash Light-30CM Green,1* Light Strip-Warm White,2* Light Strip-Warm White,1* High-Brightness Light 15CM-White.

Please contact us immediately if any components don't work.

Section C: laying out components following the instruction.

1



2



3



4



5



6

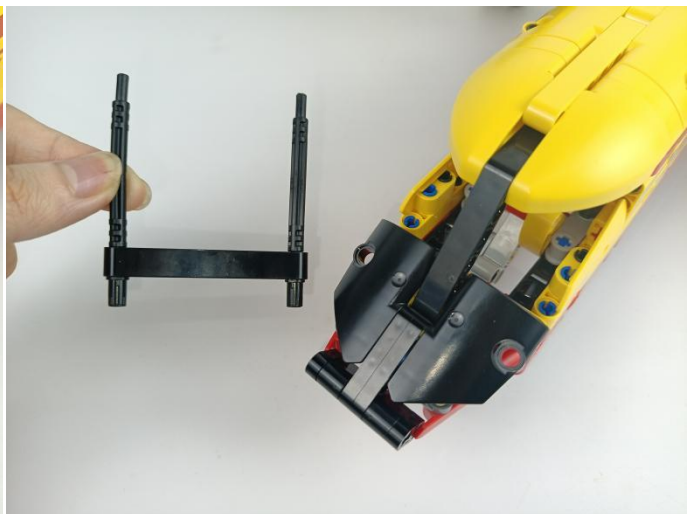
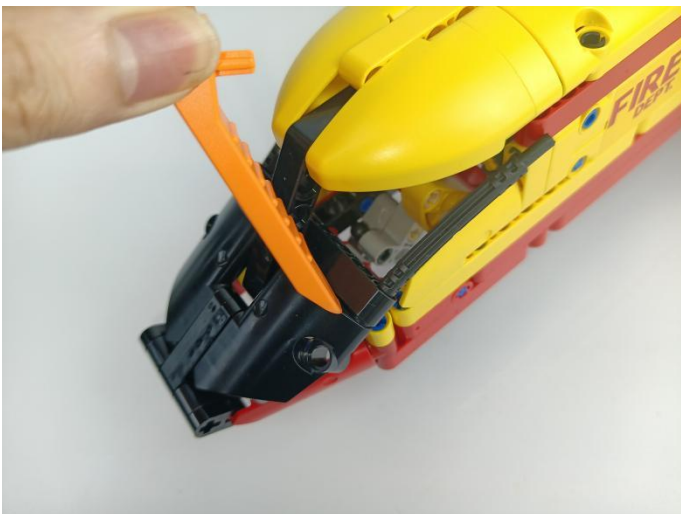

7

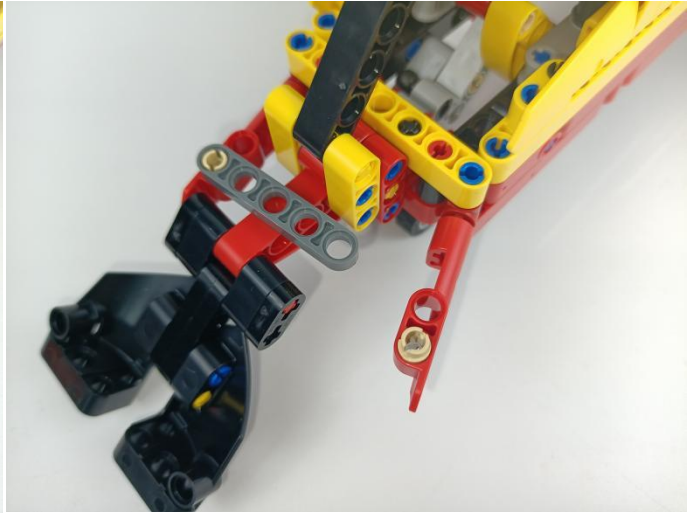

8

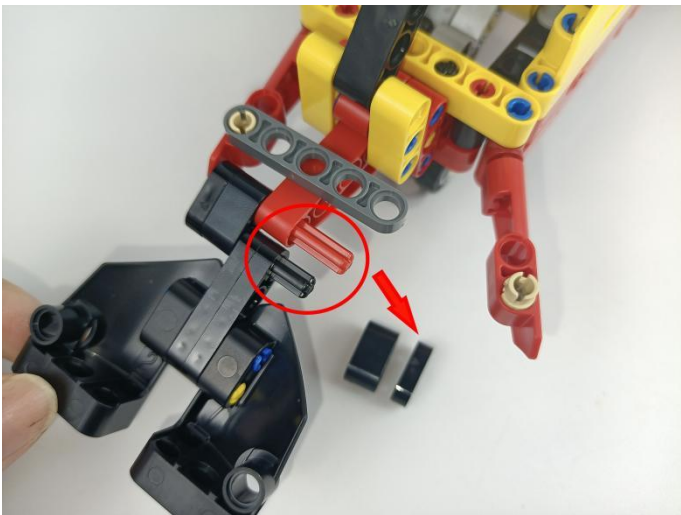

9

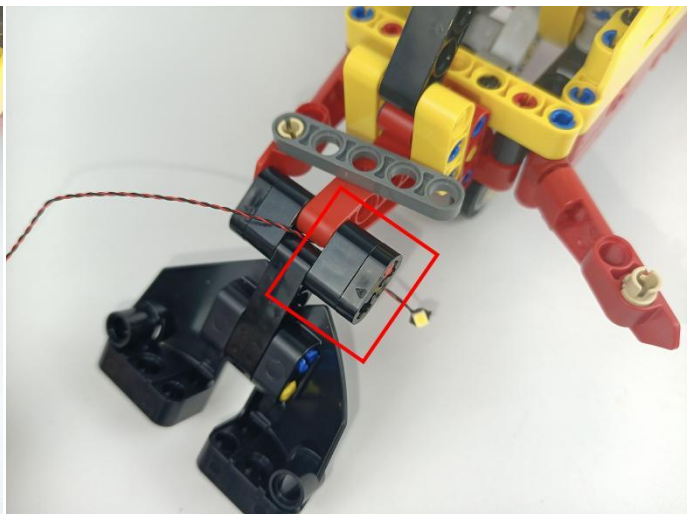
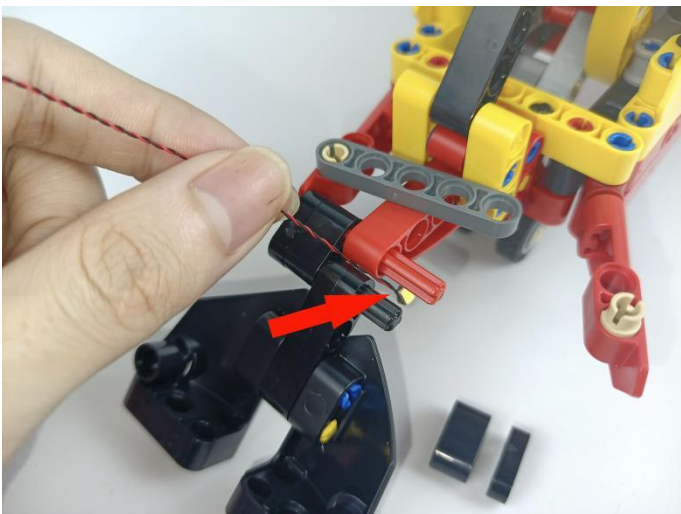

10. Pass the light wire through the bottom of the building block, and restore the gray building block.

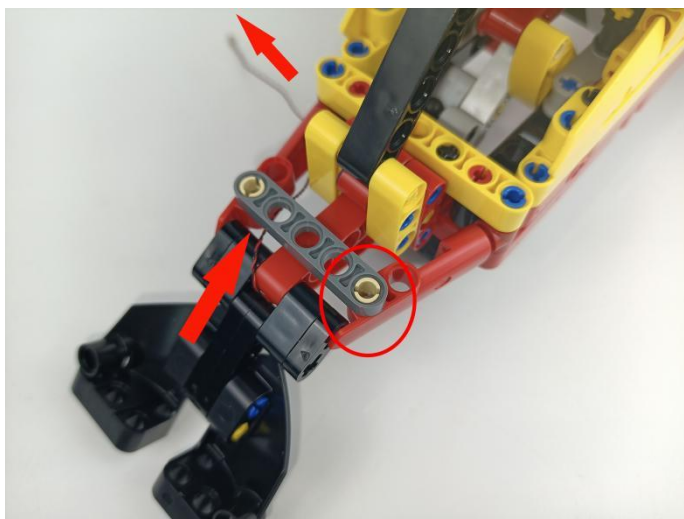

11

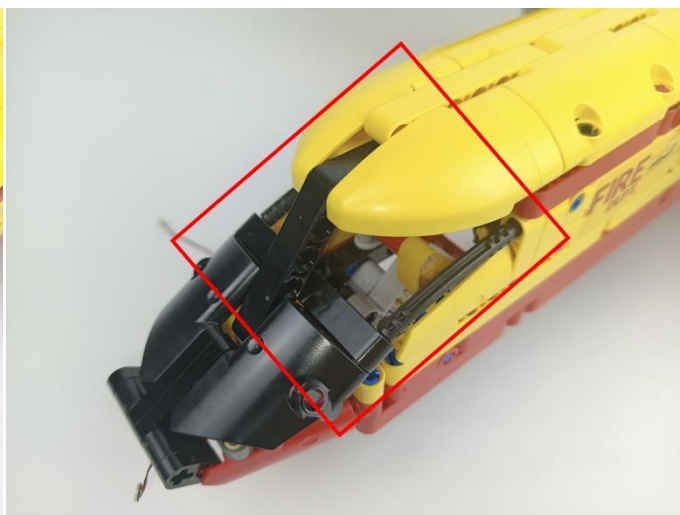

12

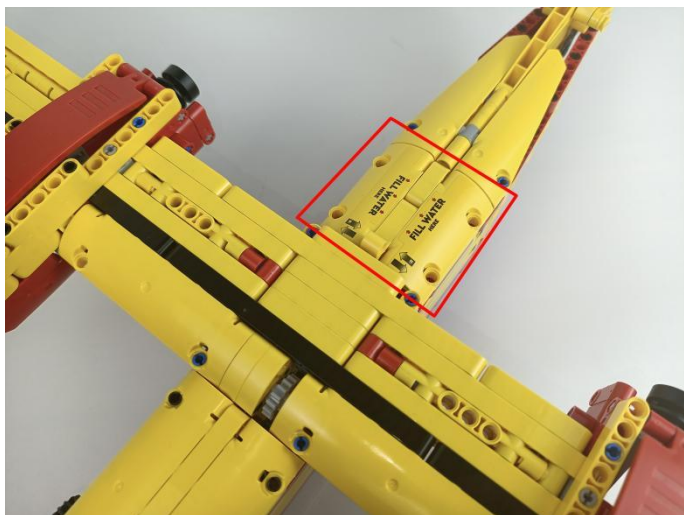

13

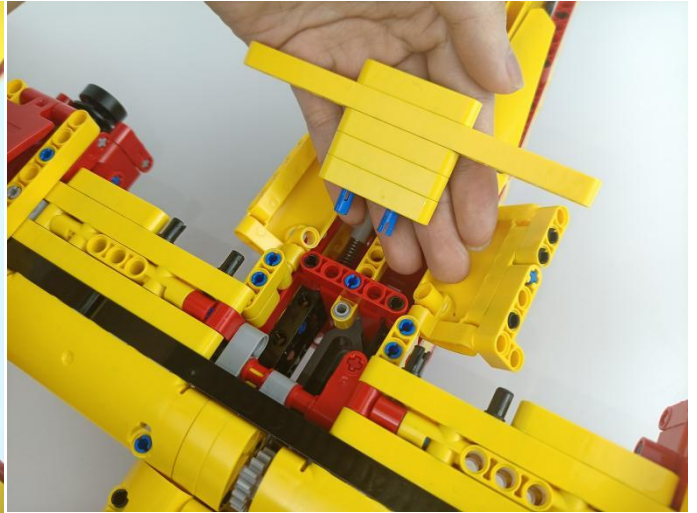

14

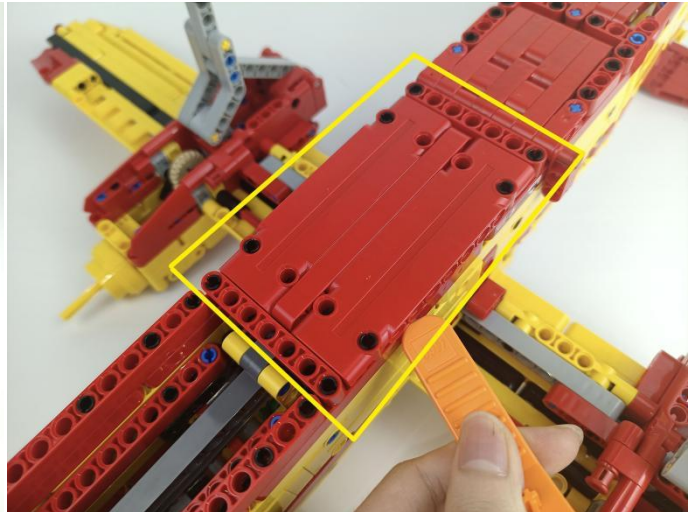

15

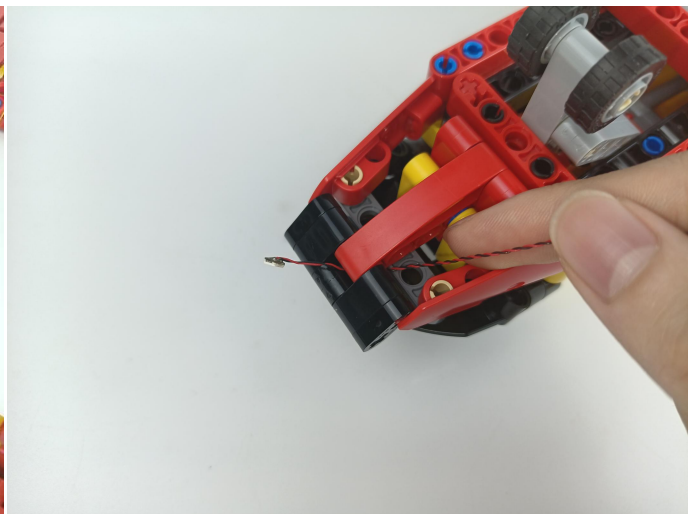
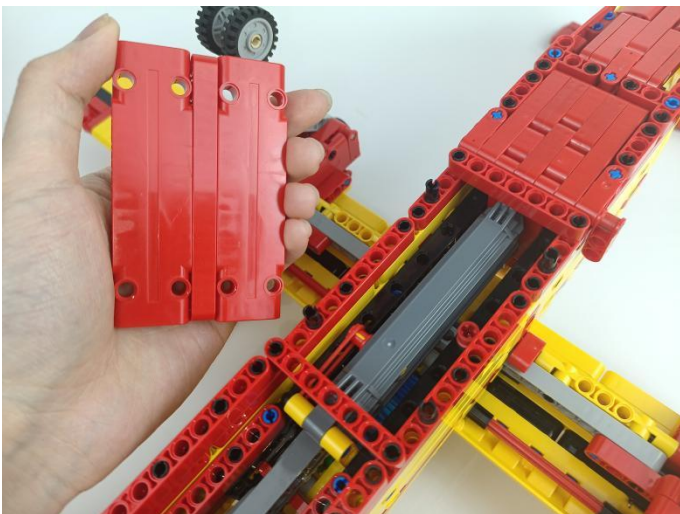

16

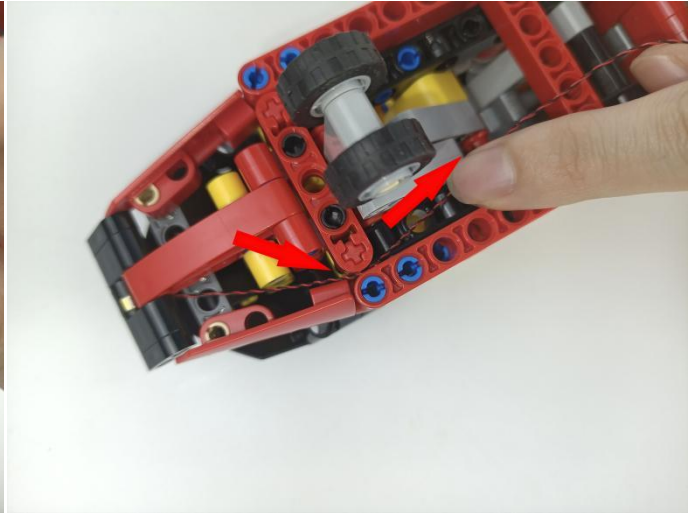
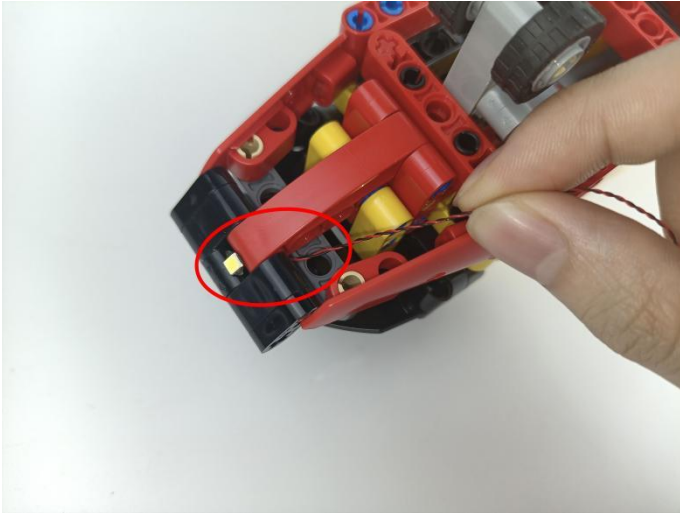

17



18



19

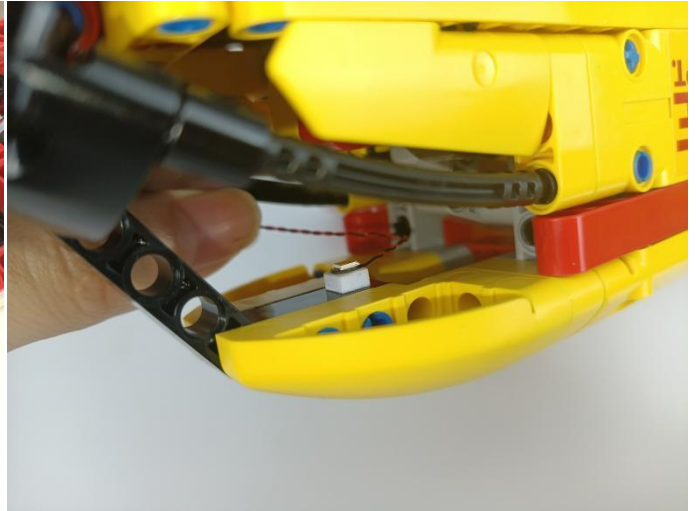
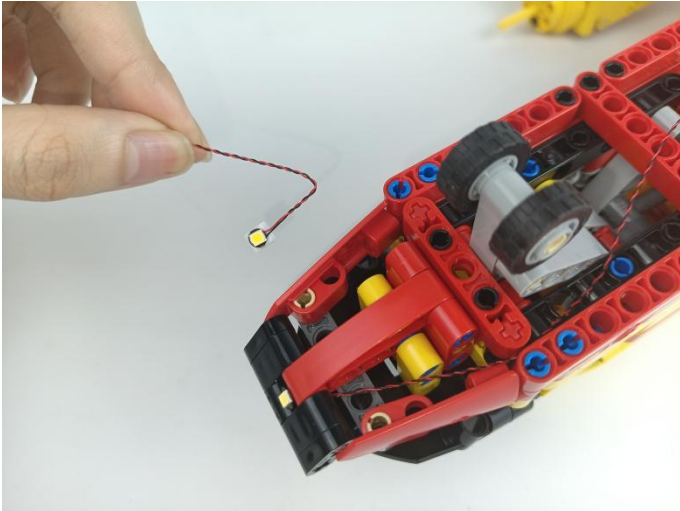

20

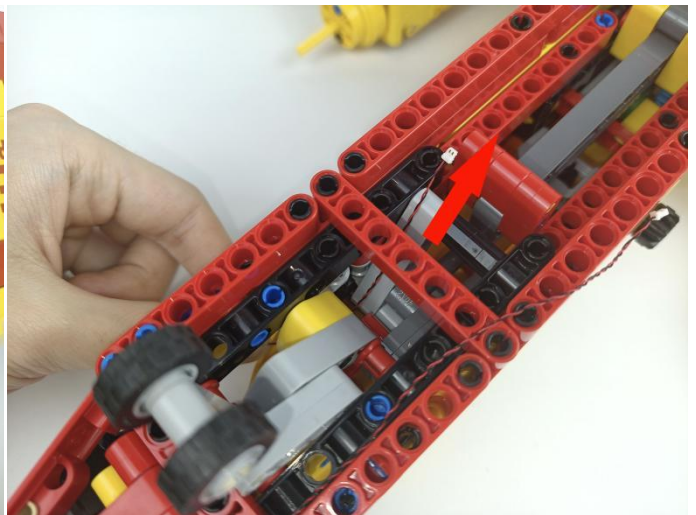
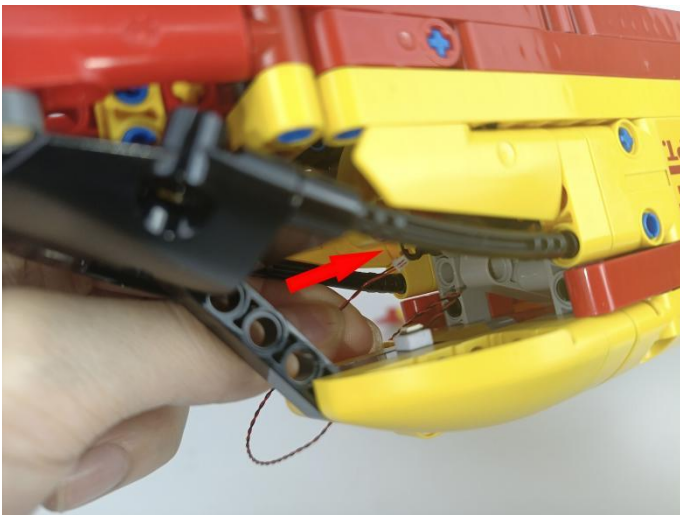

21

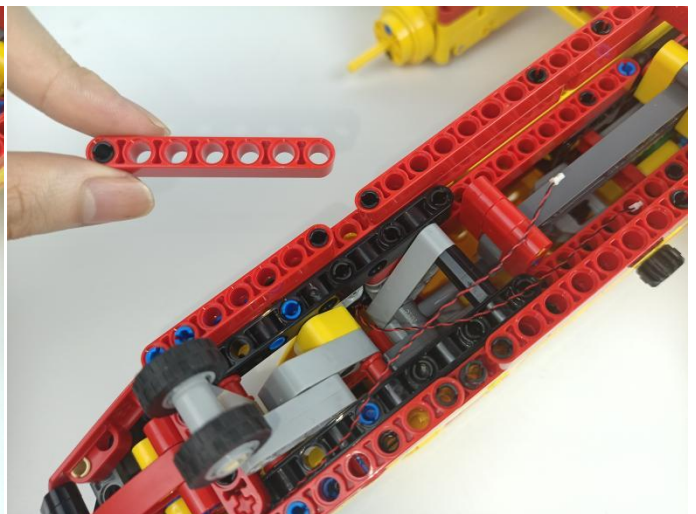
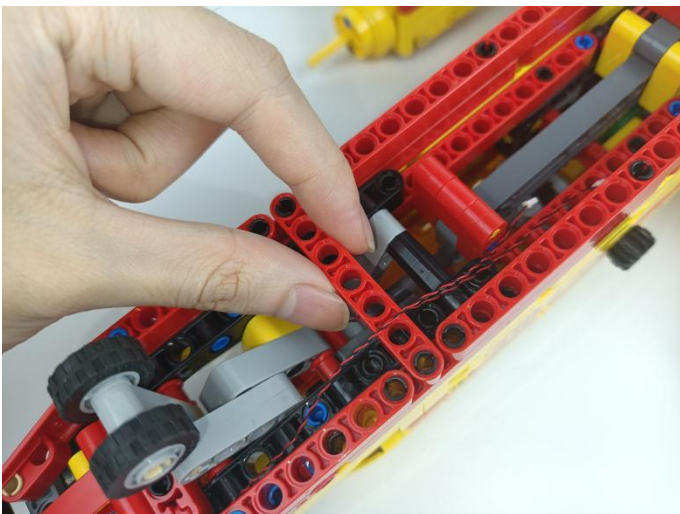

22

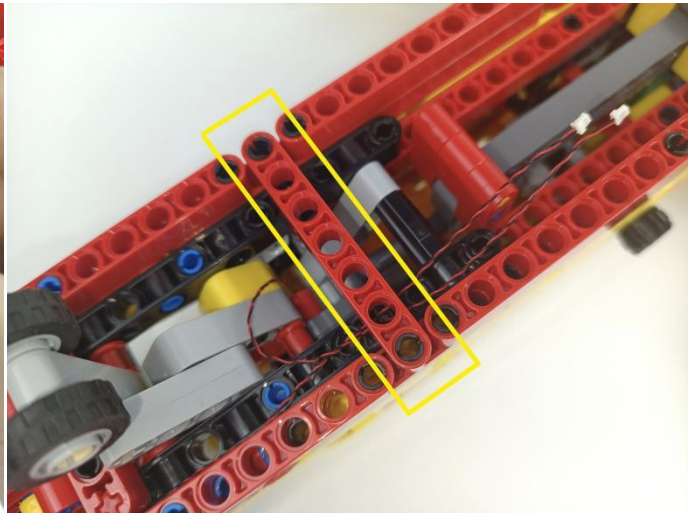
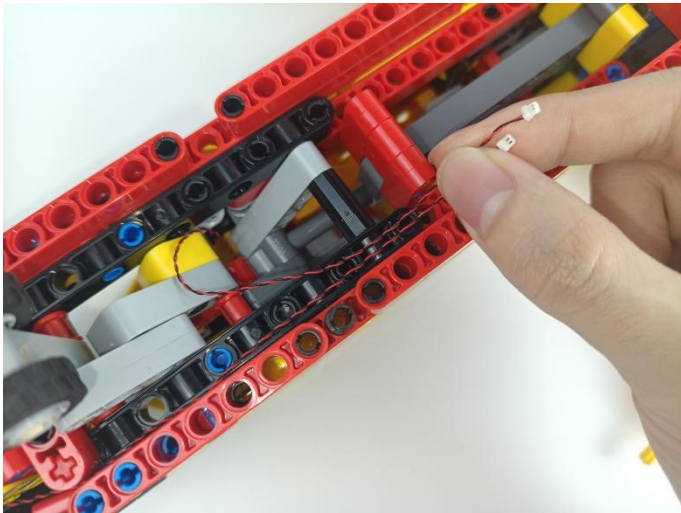

23



24

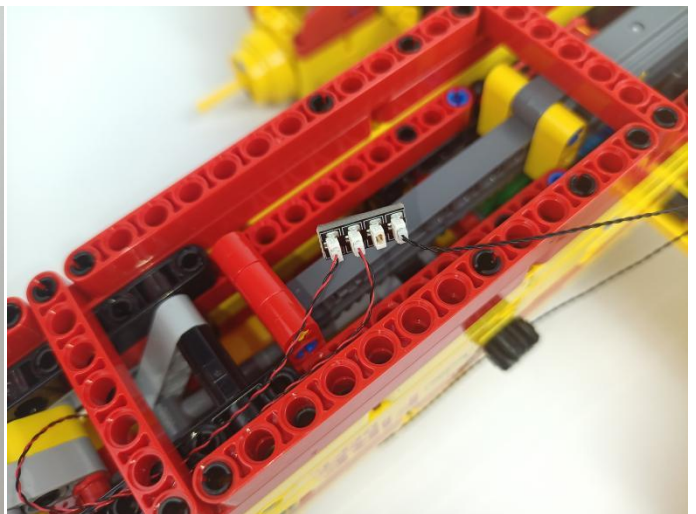

25

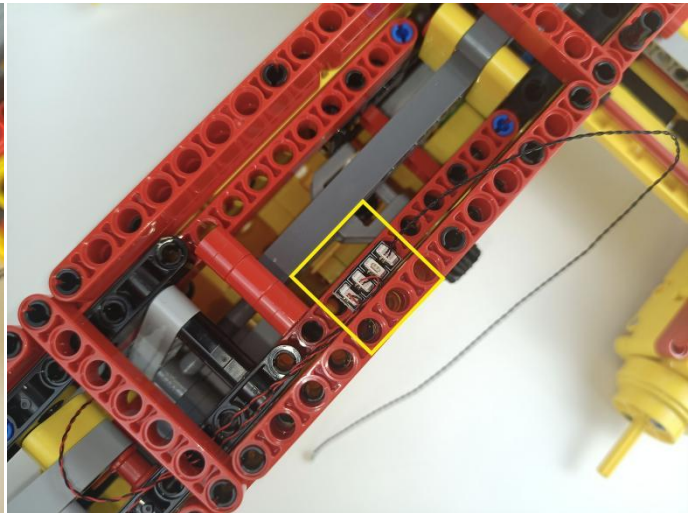
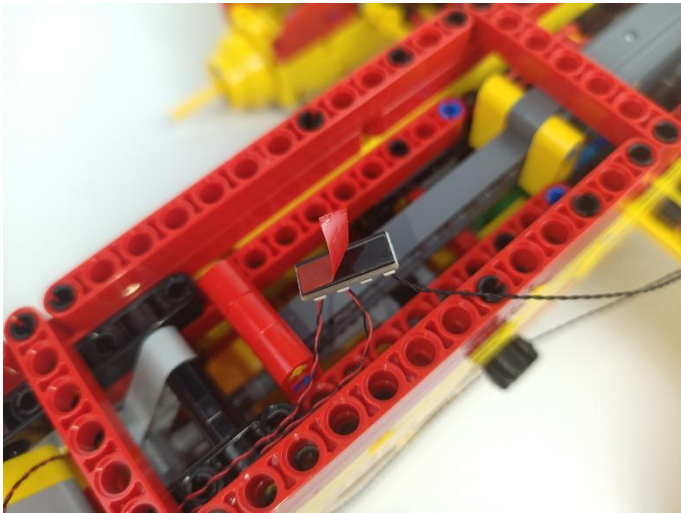

26

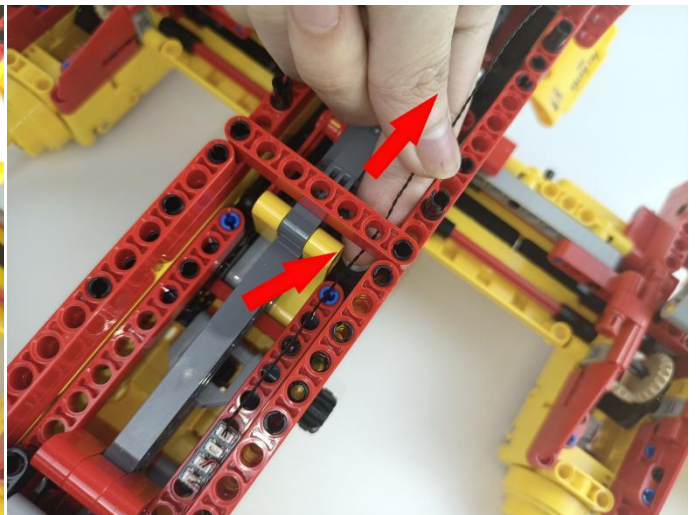
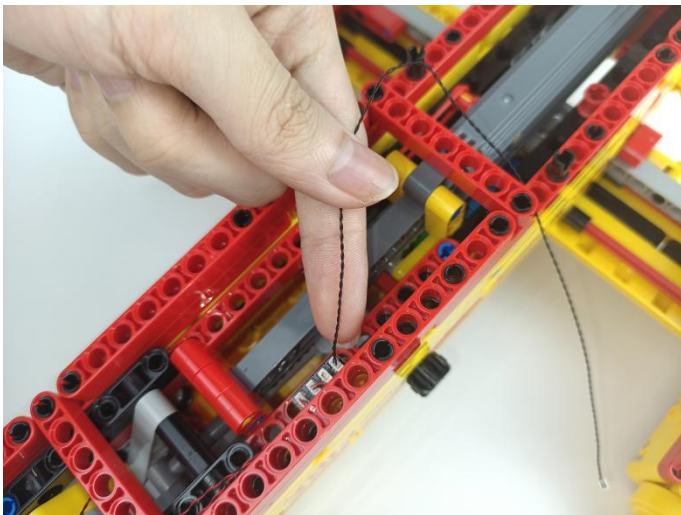

27

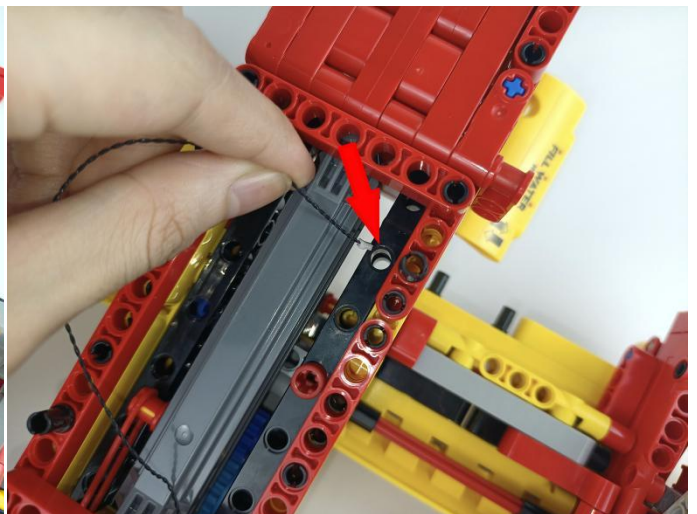
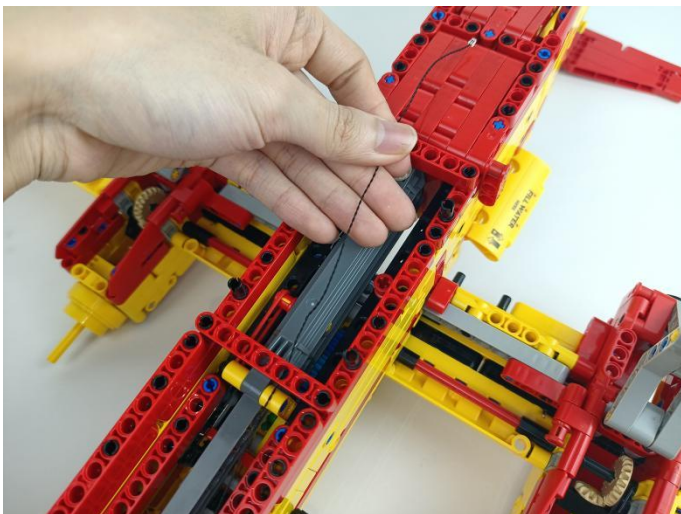

28

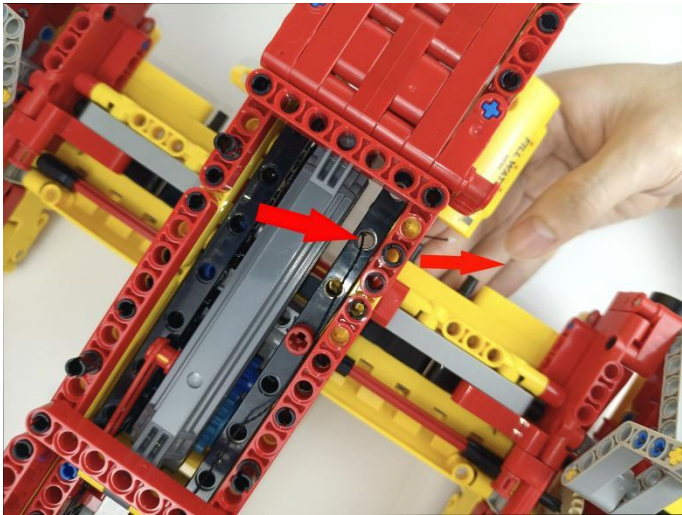

29

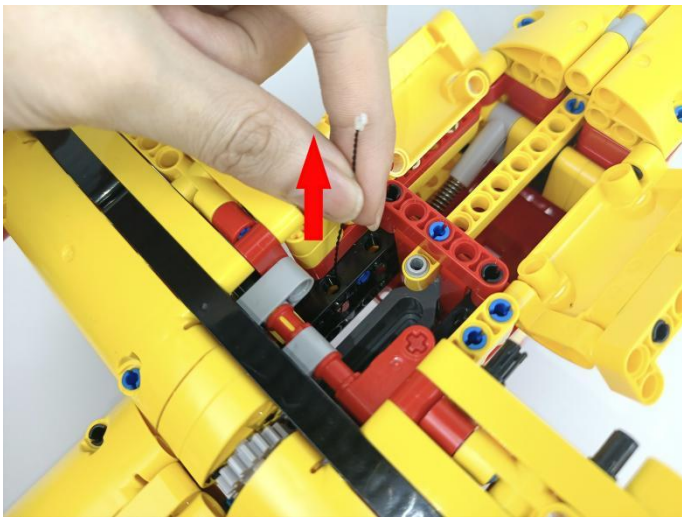

30



31



32



33

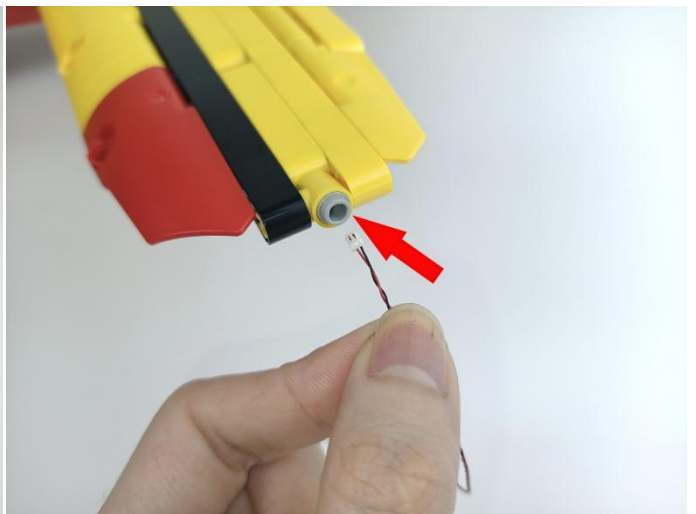

34

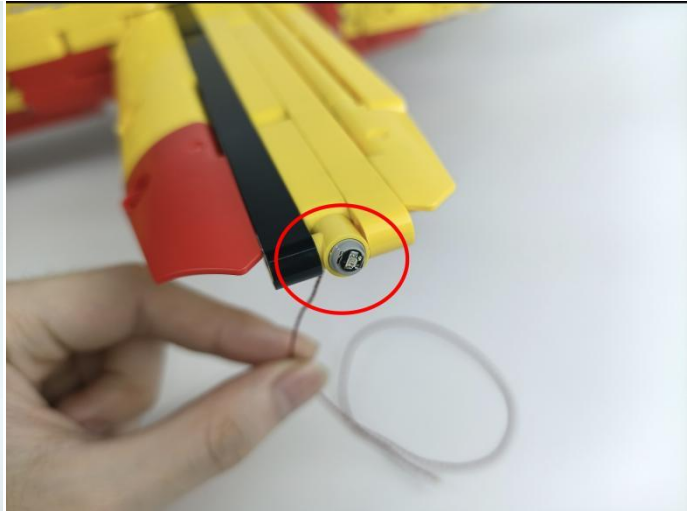
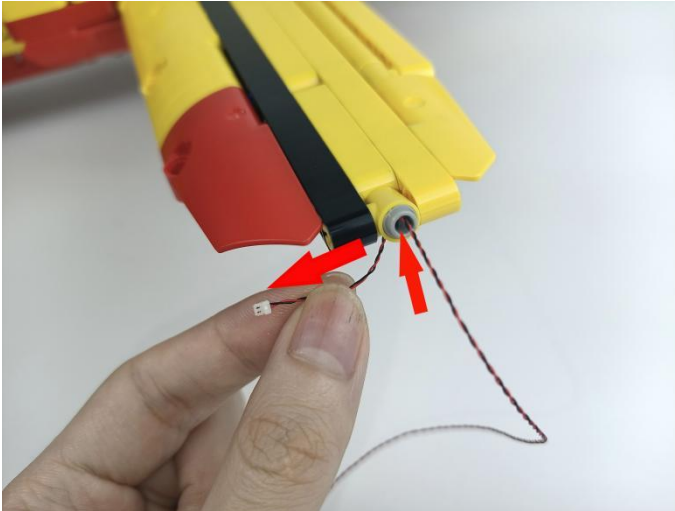

35

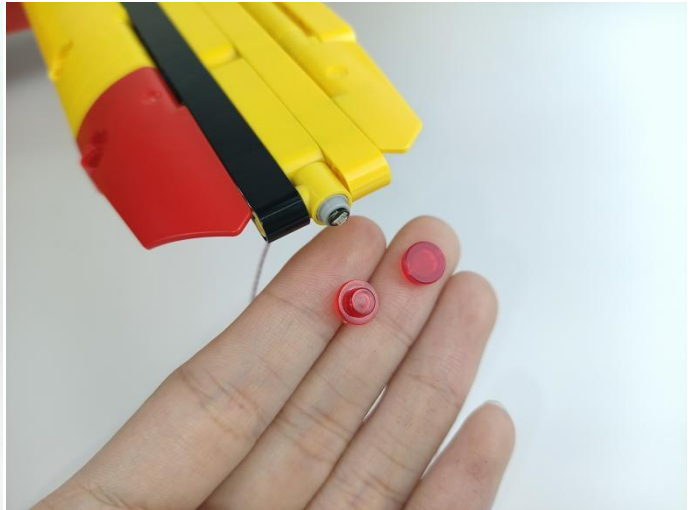

36

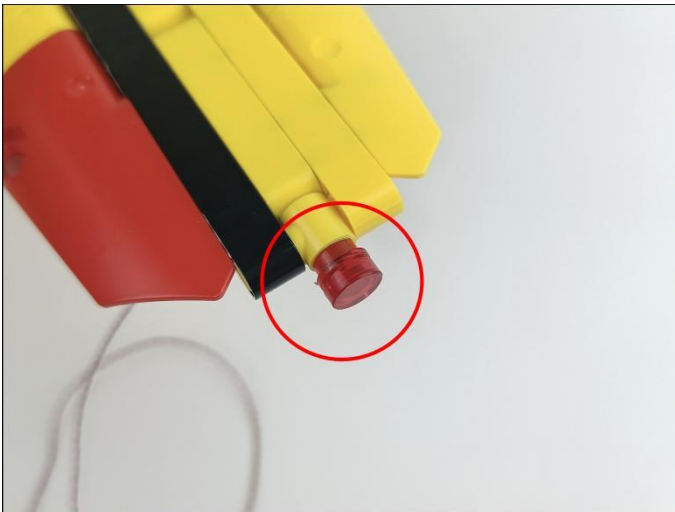

37

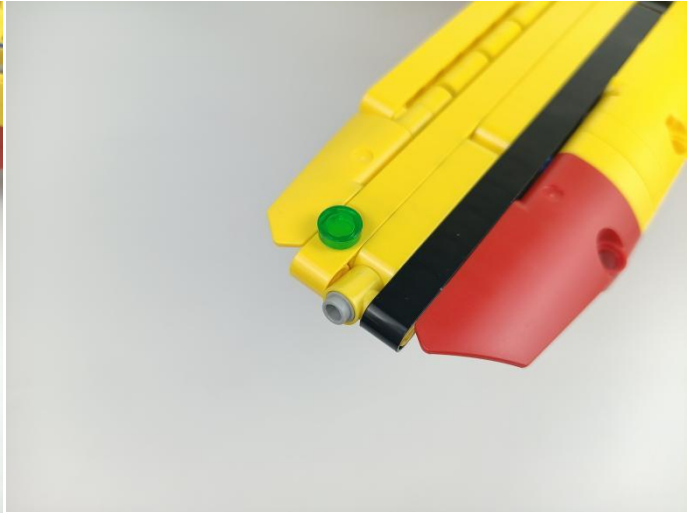
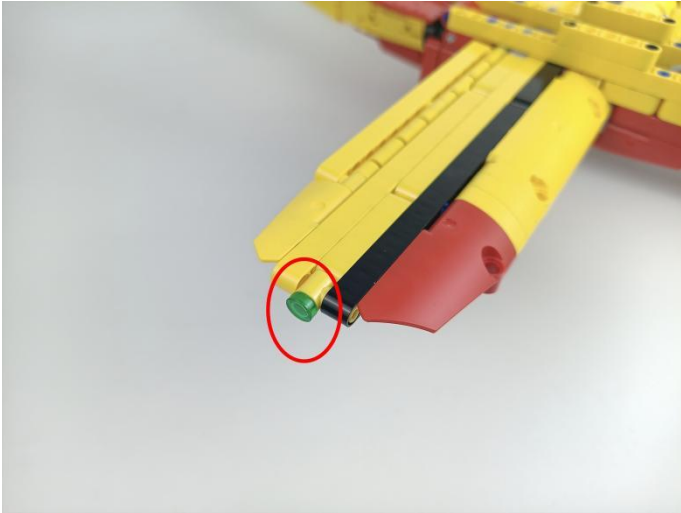

38

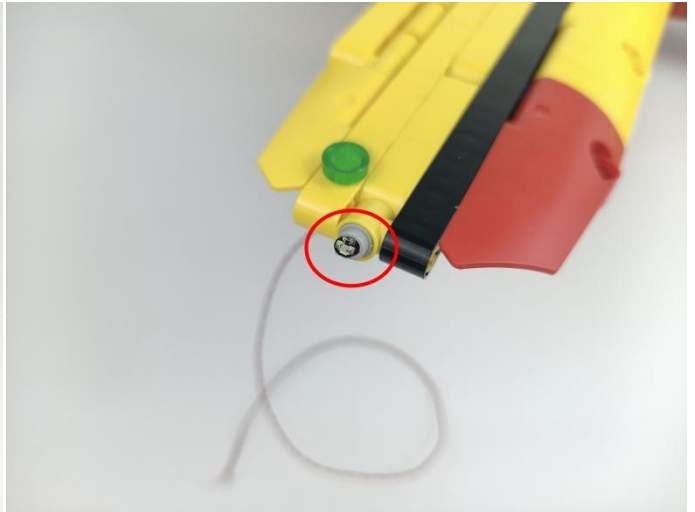

39

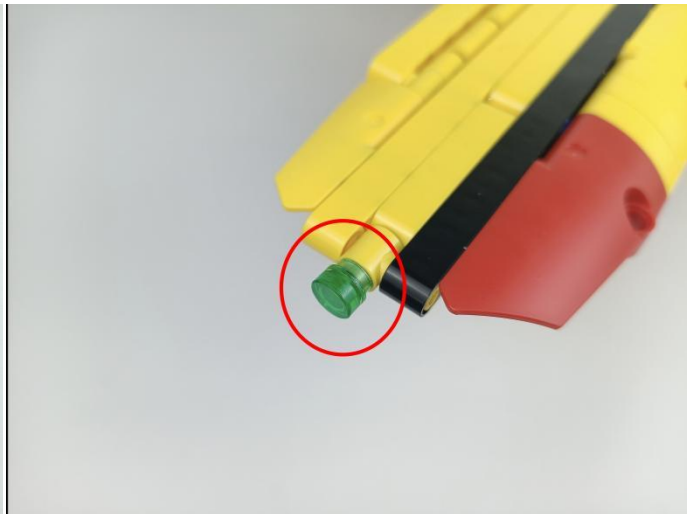

40

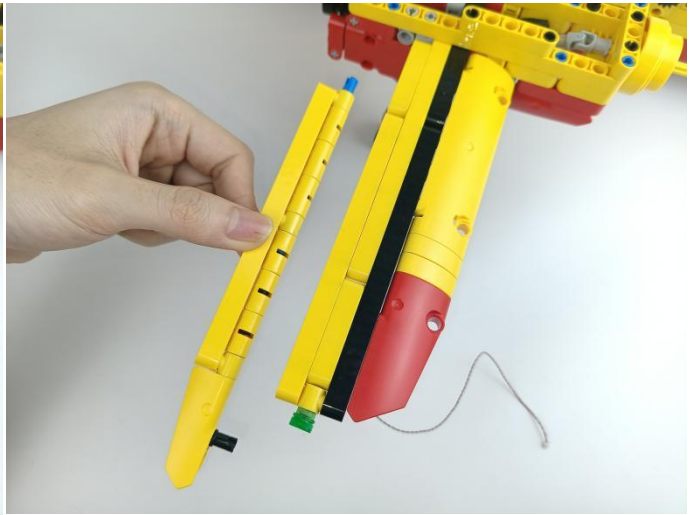
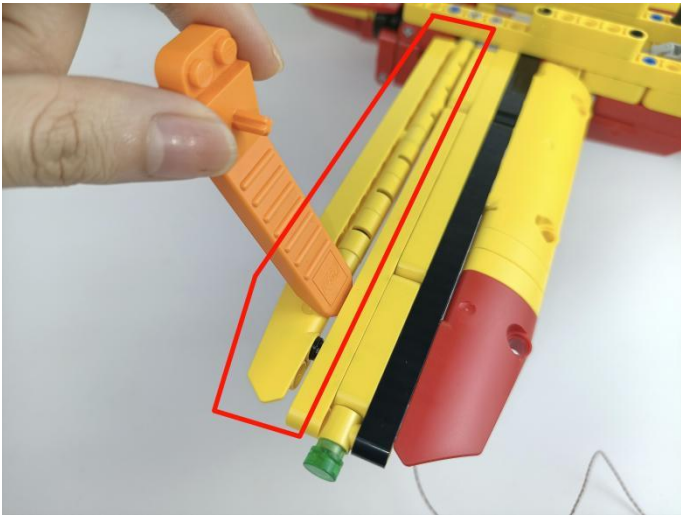

41

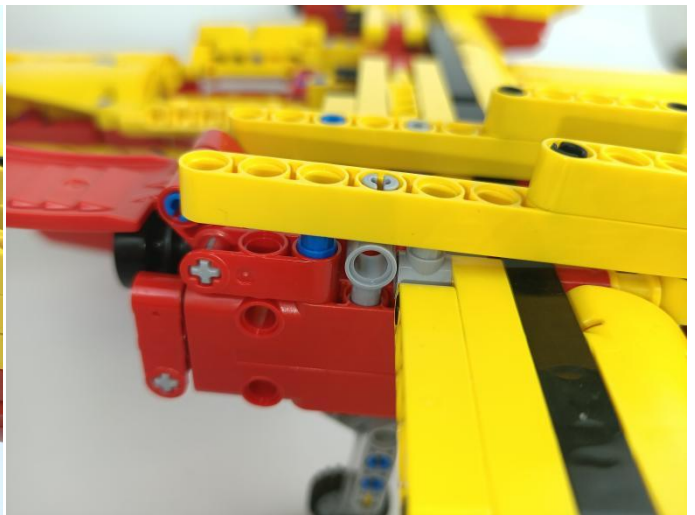
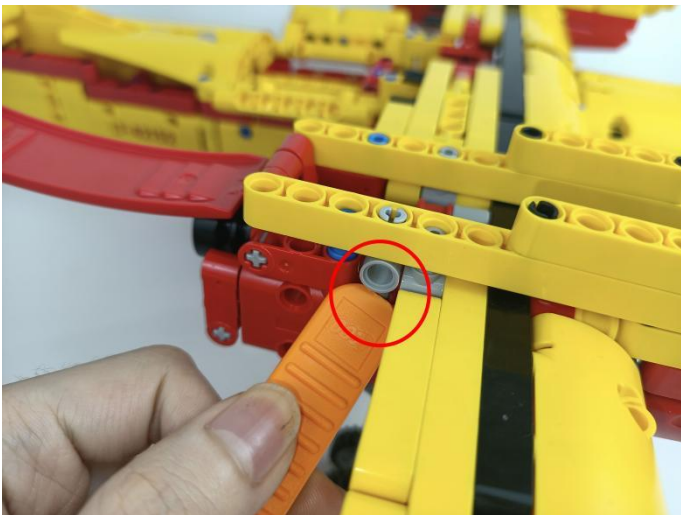

42

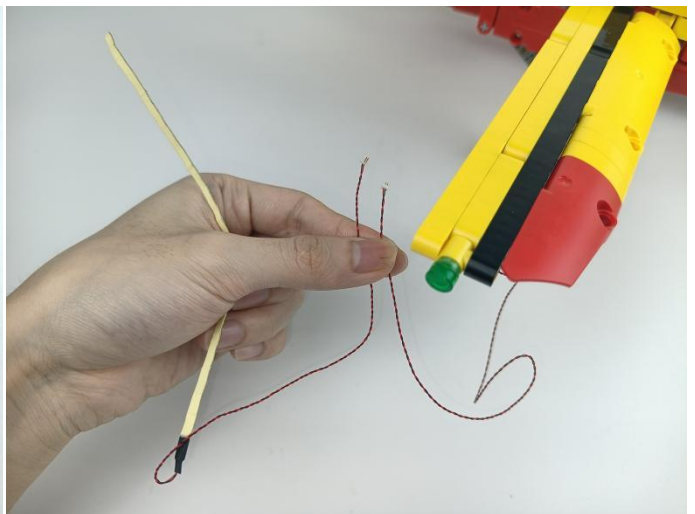

43

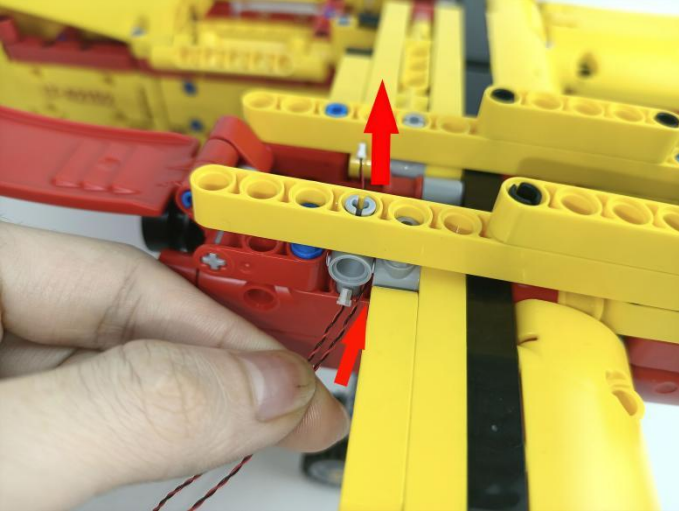

44

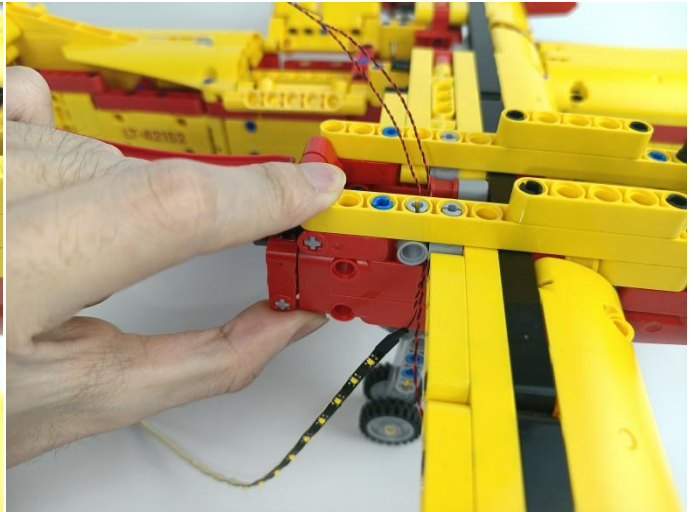
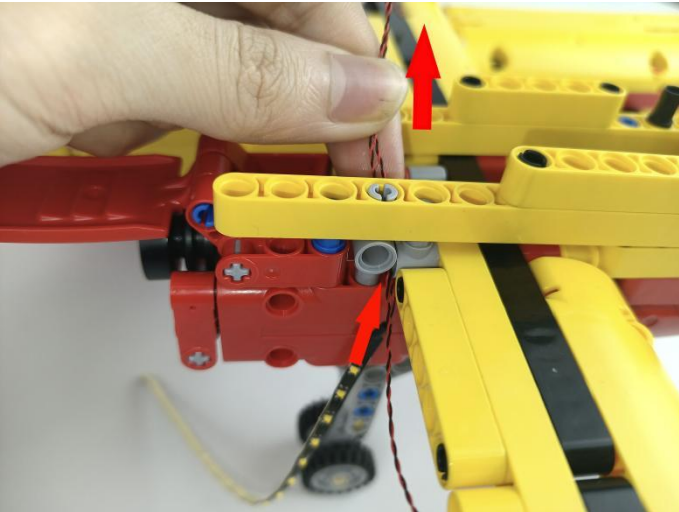

45

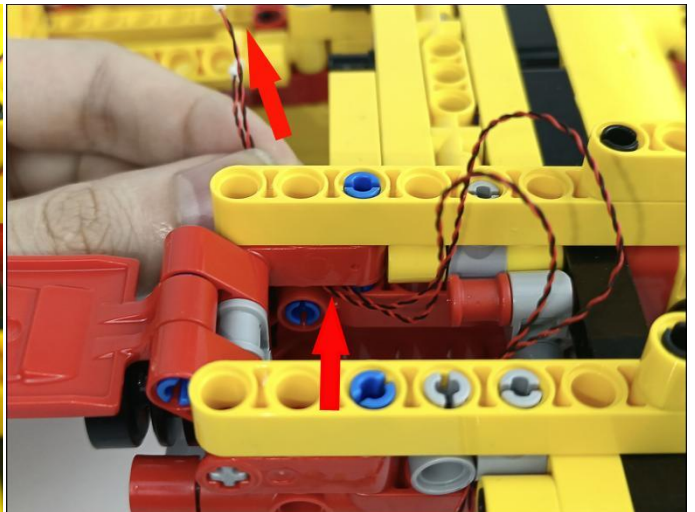

46

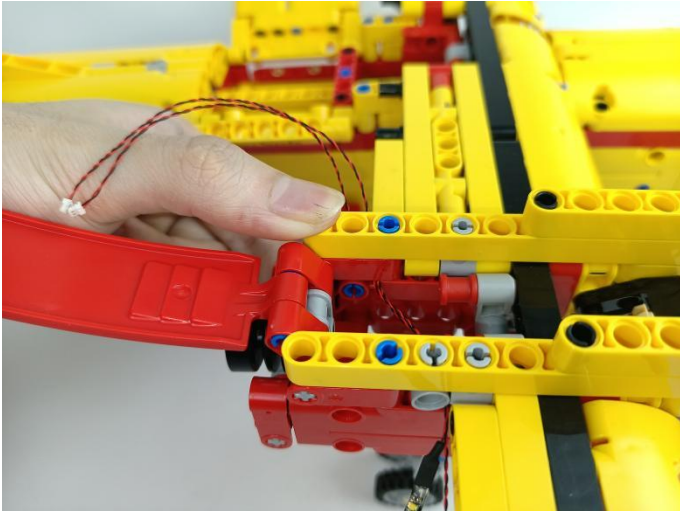

47

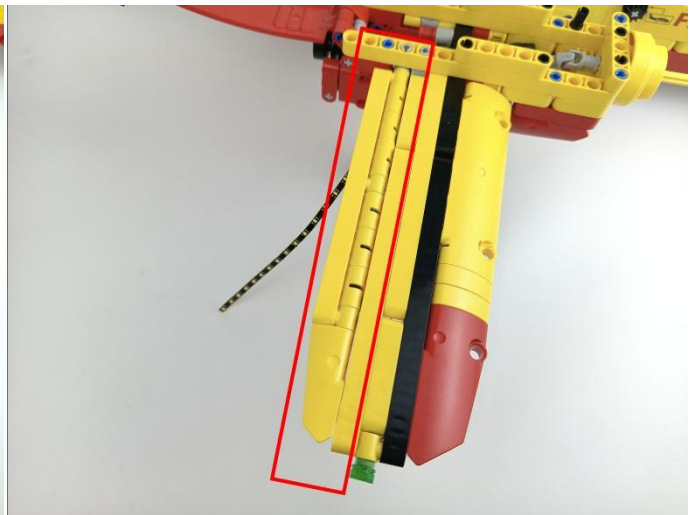

48

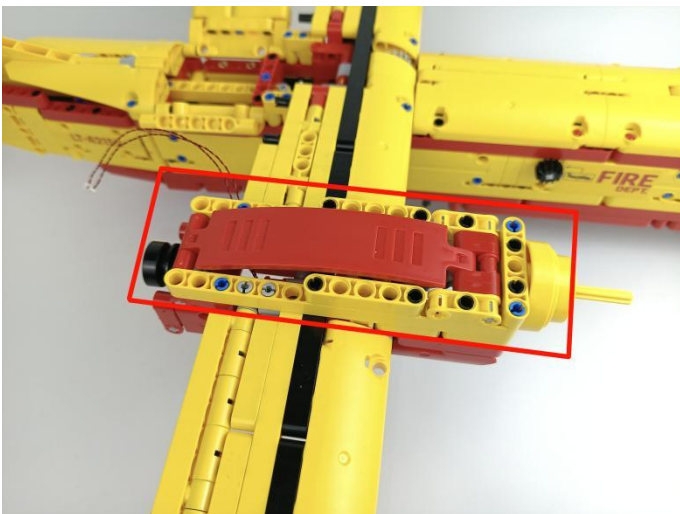

49

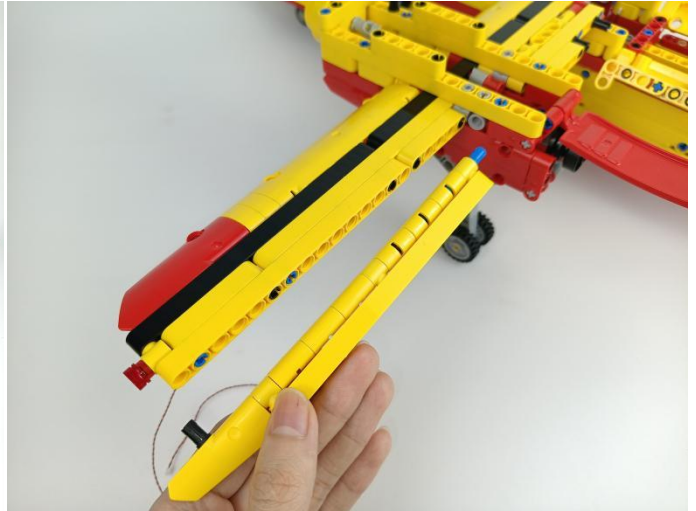

50. Use a starter to pry the blocks apart.



51

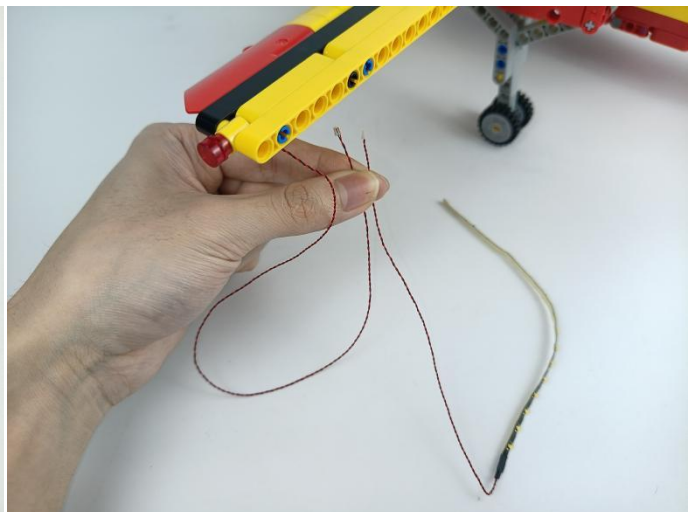

52

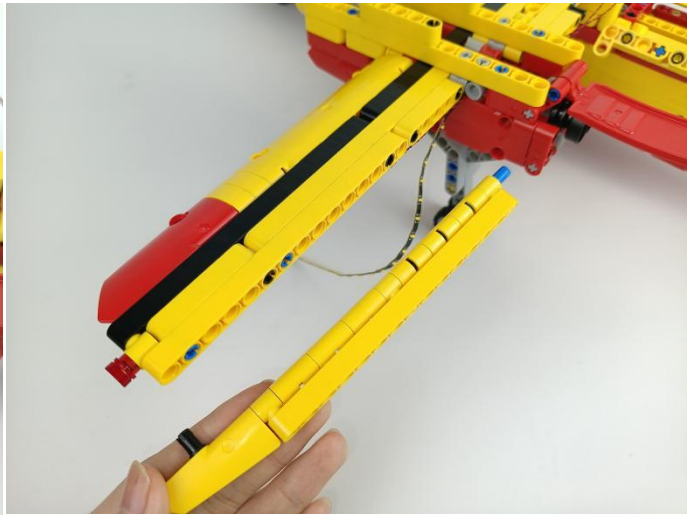
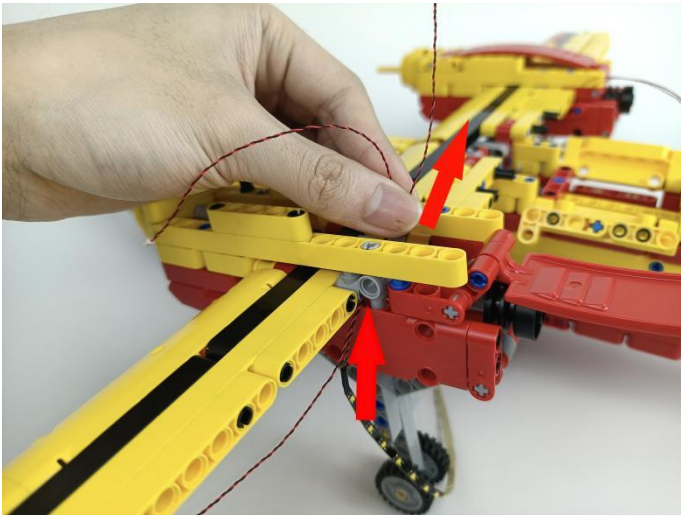

53

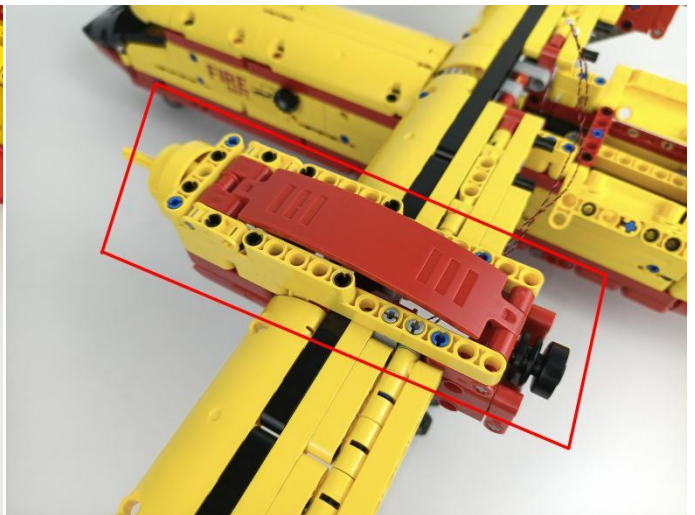

54

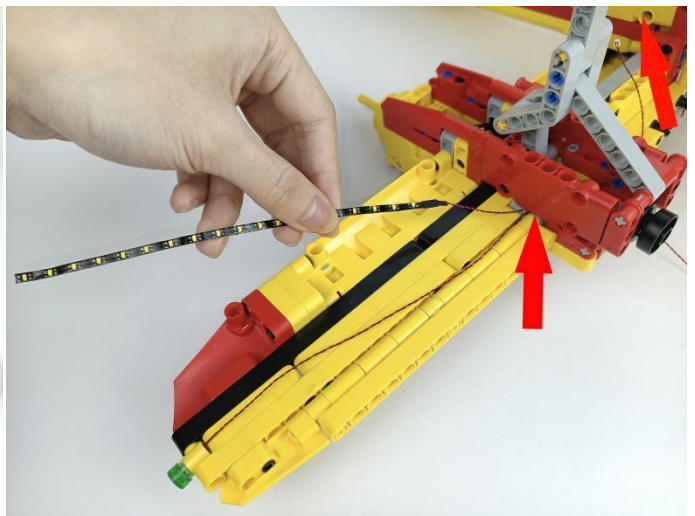
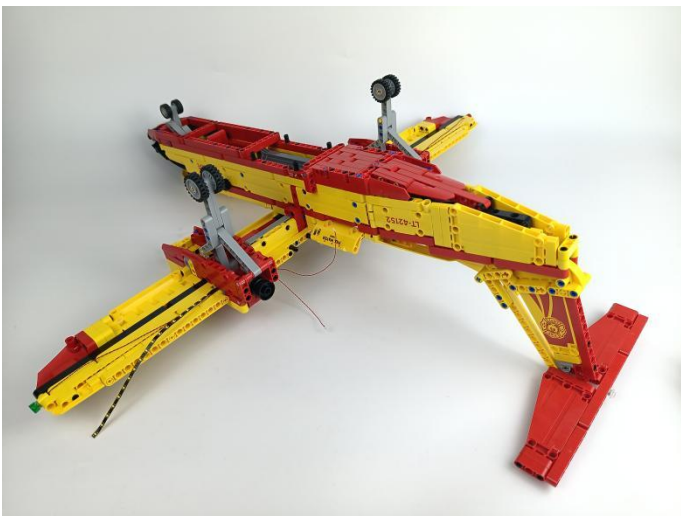

55

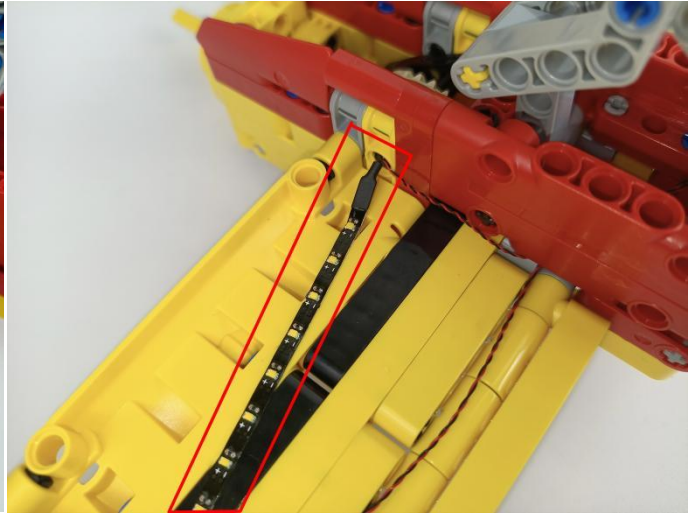
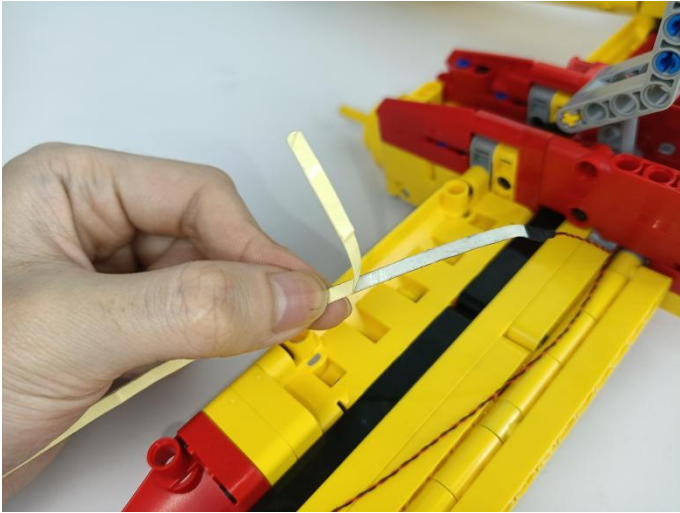

56



57



58

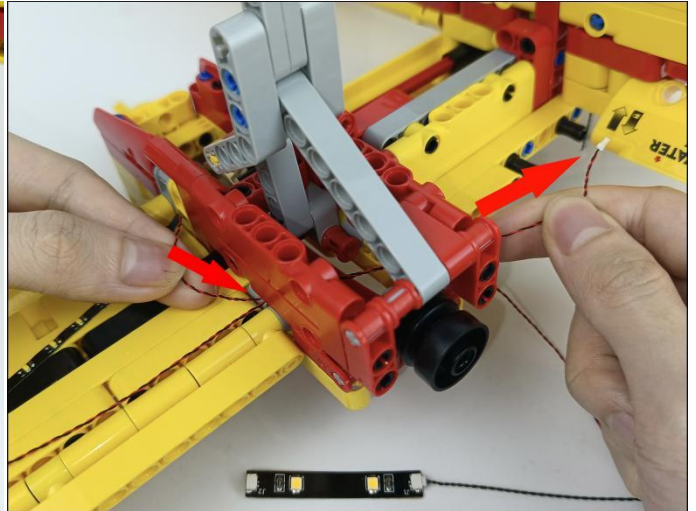
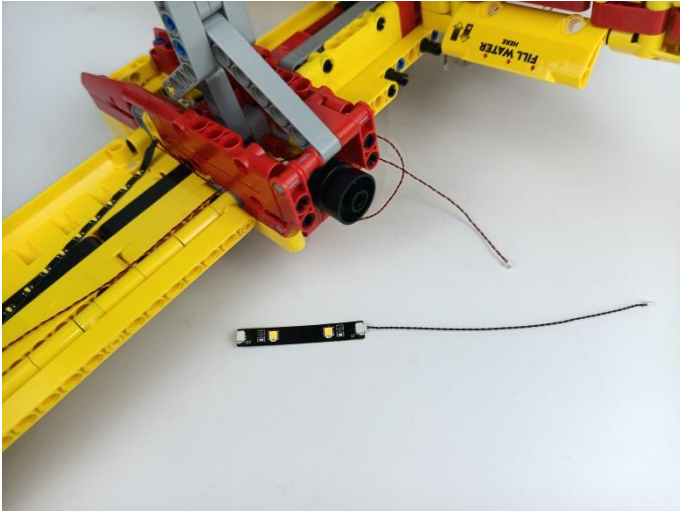

59

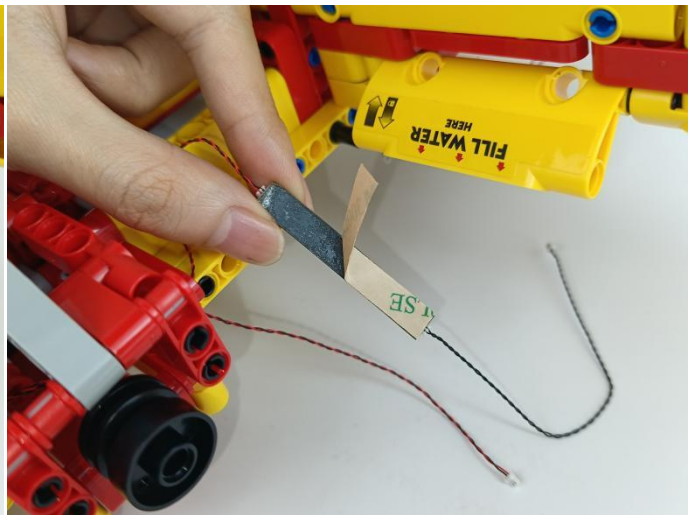
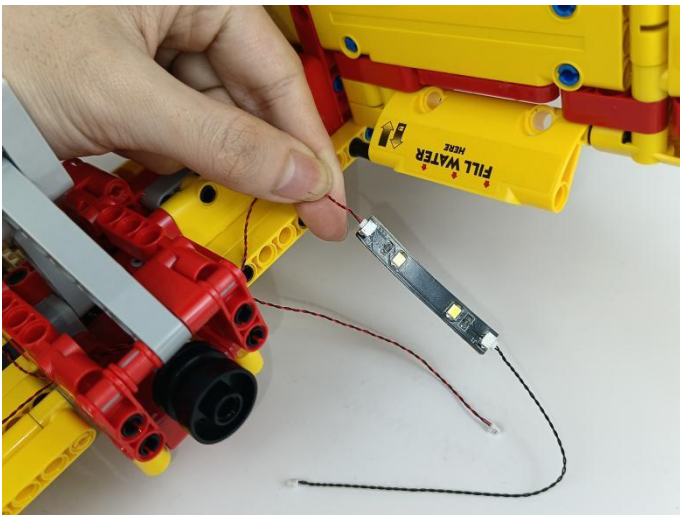

60

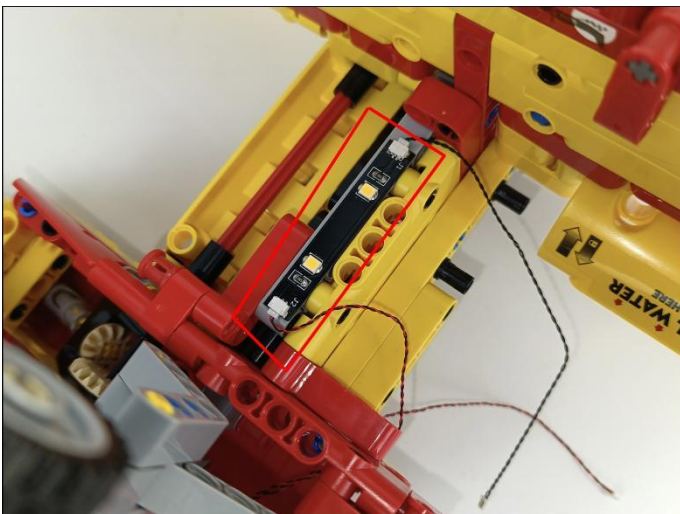

61

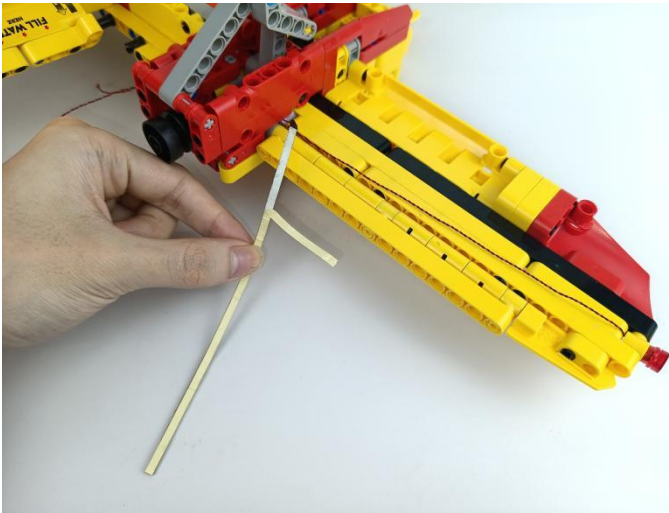

62

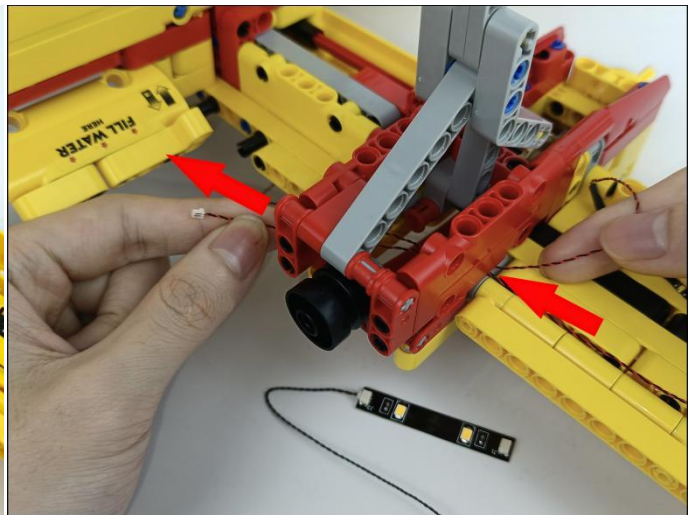
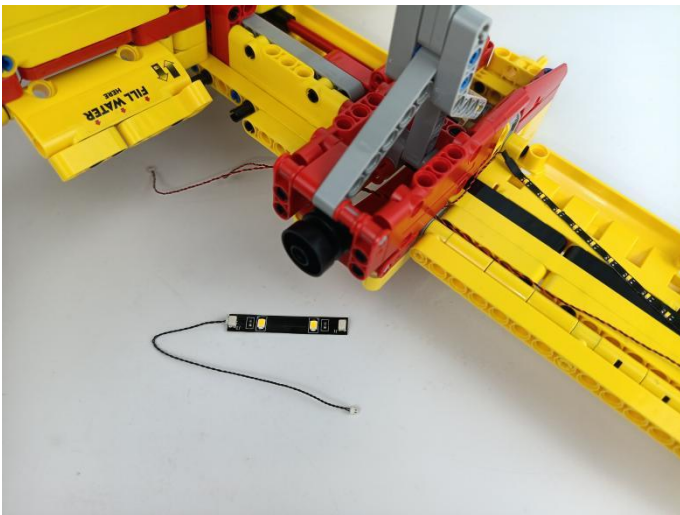

63

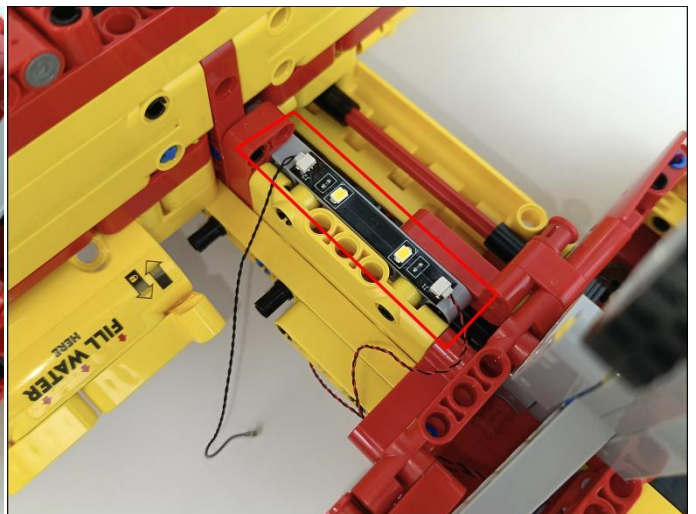
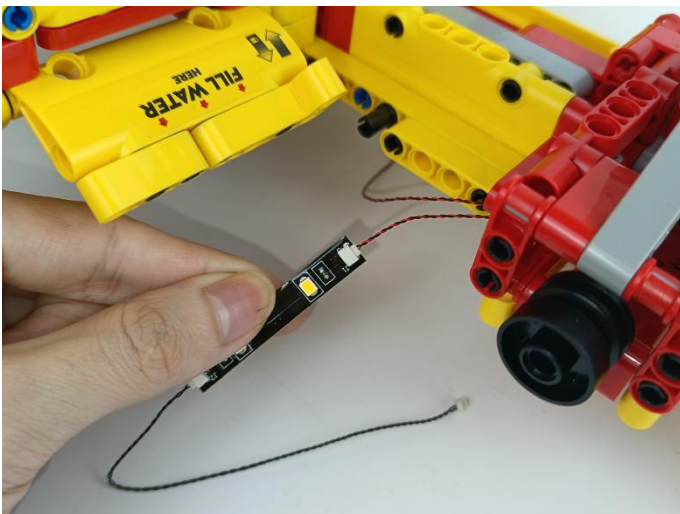

64



65



66

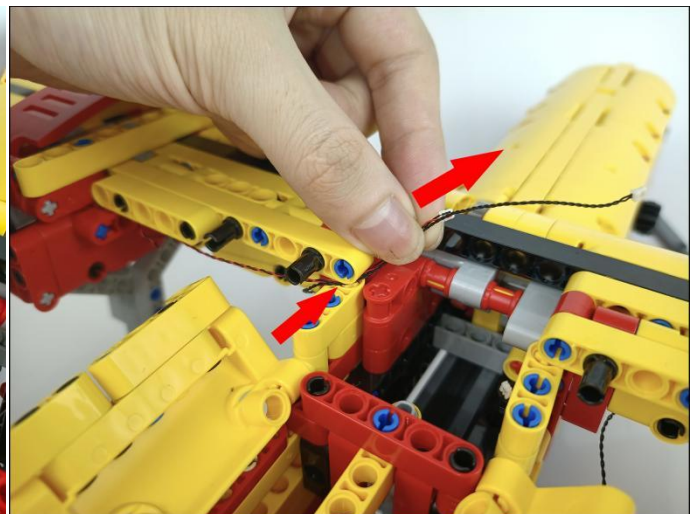

67

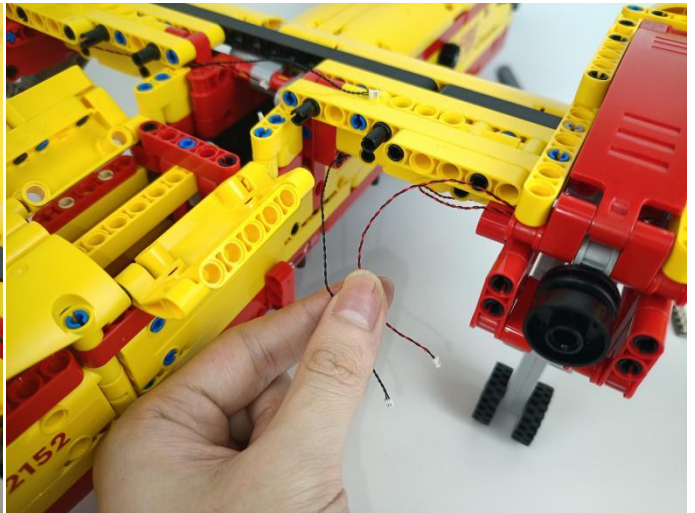

68

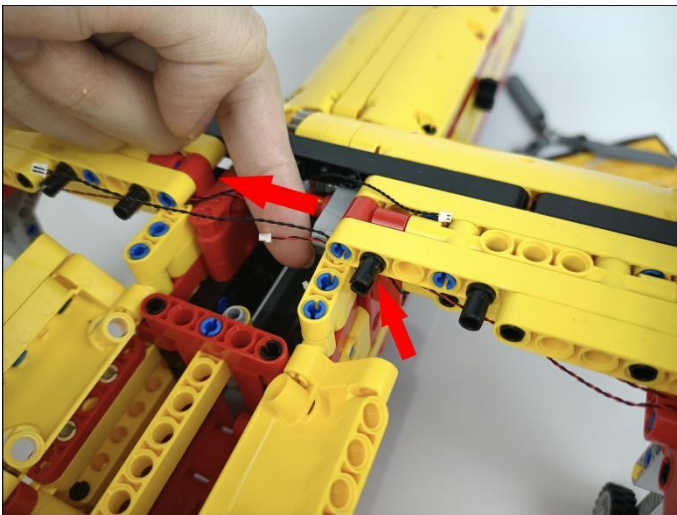

69



70

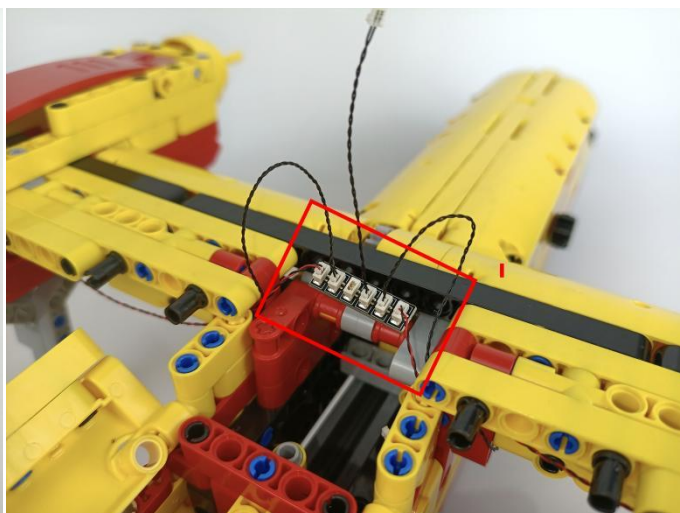

71

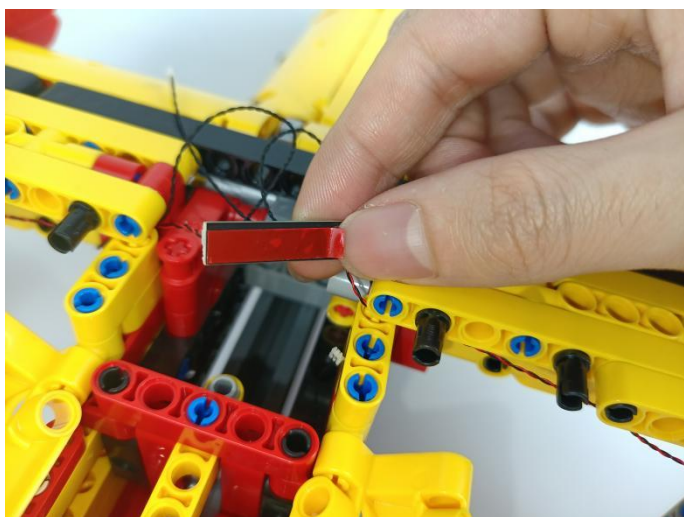

72

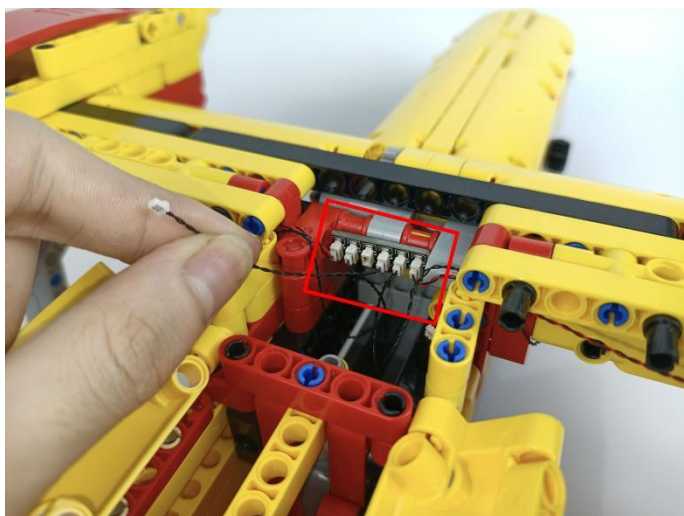

73



74

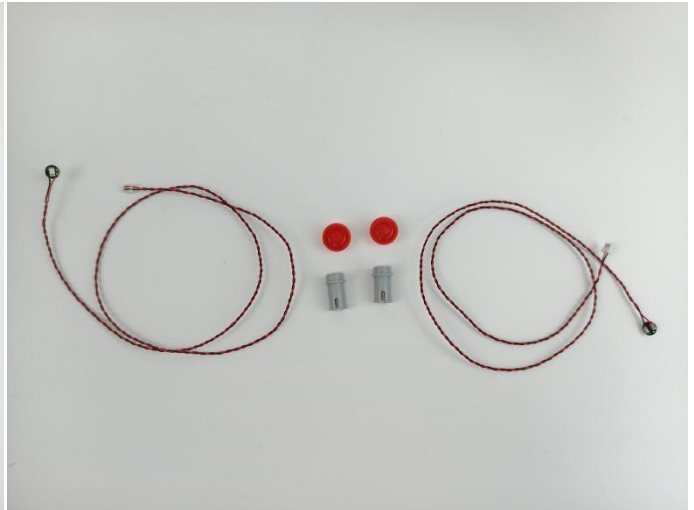

75

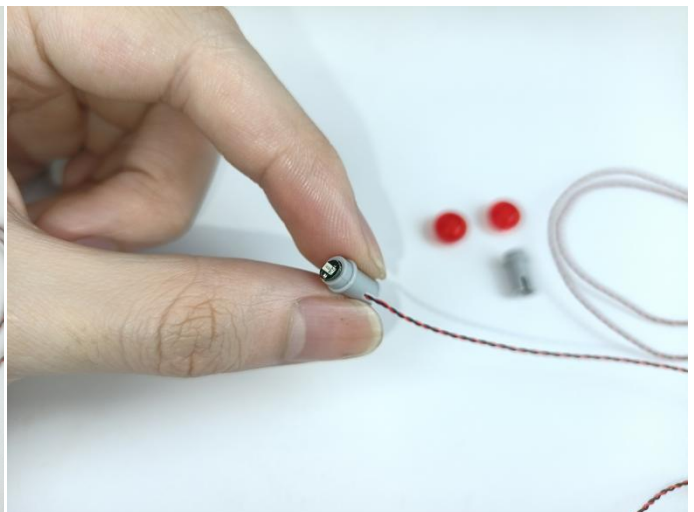
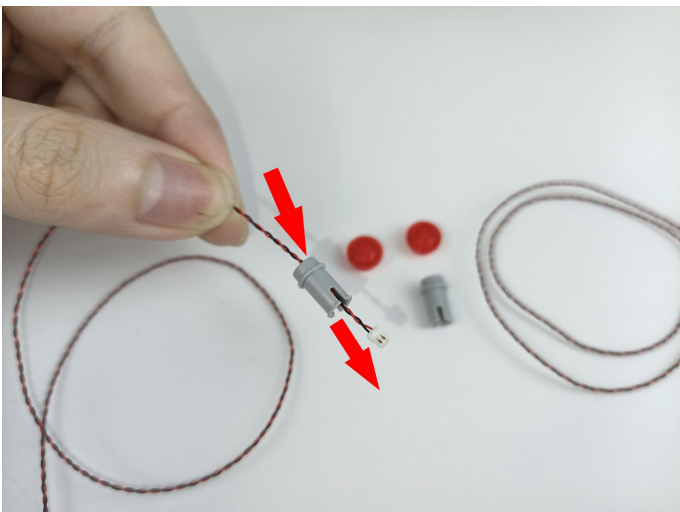

76

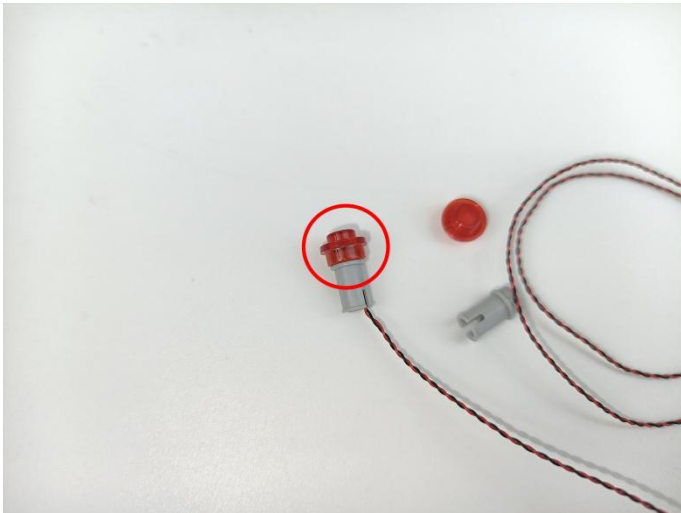

77

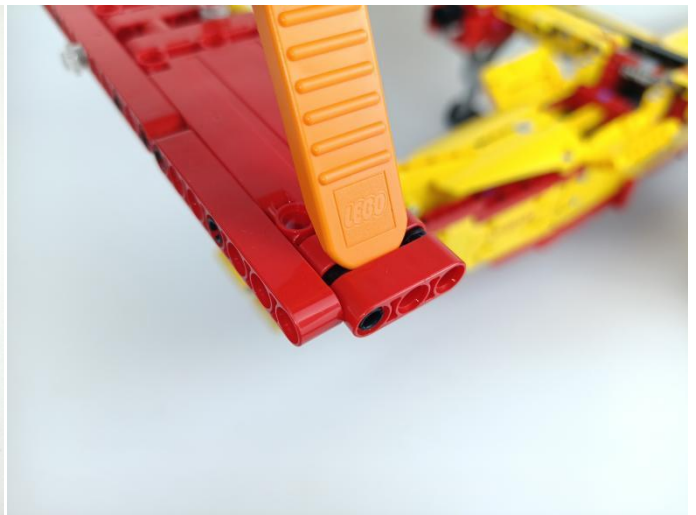

78

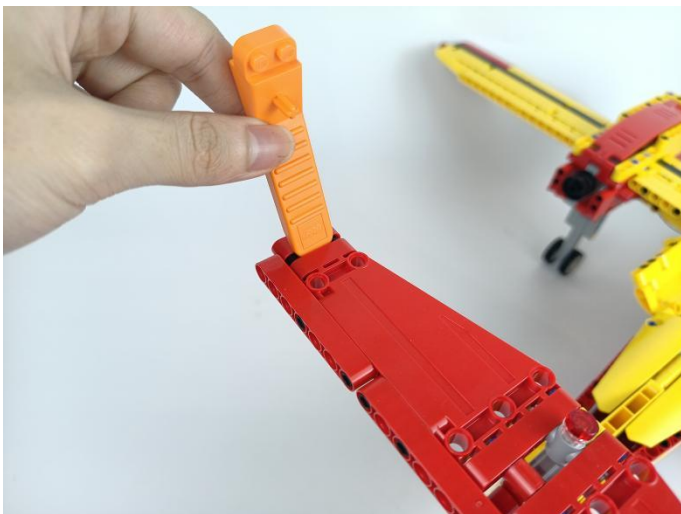

79

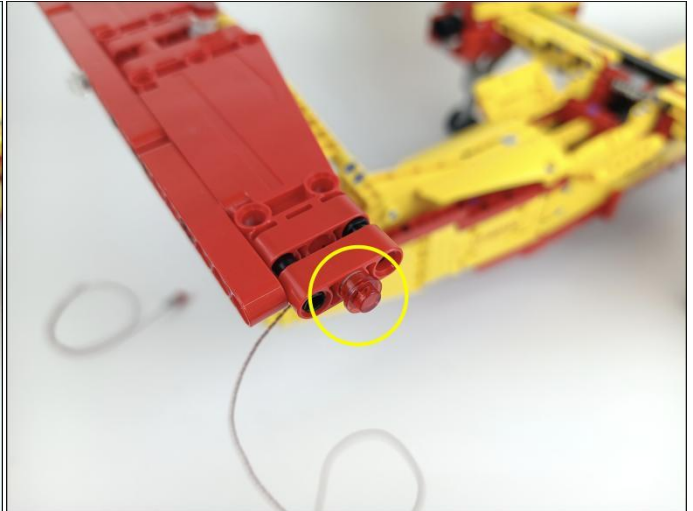
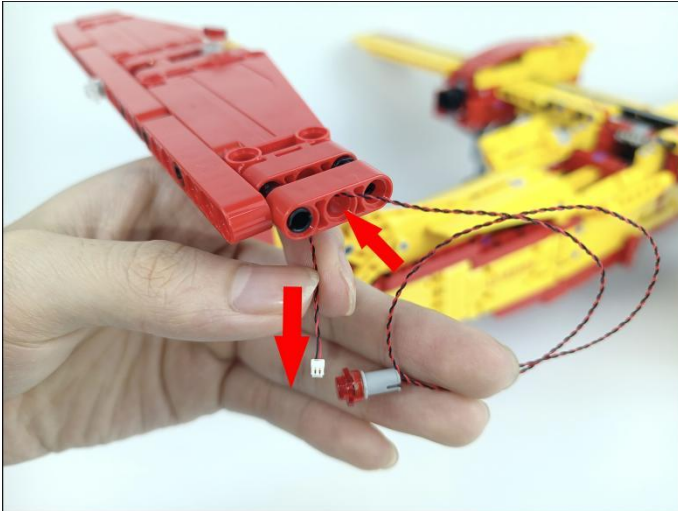

80

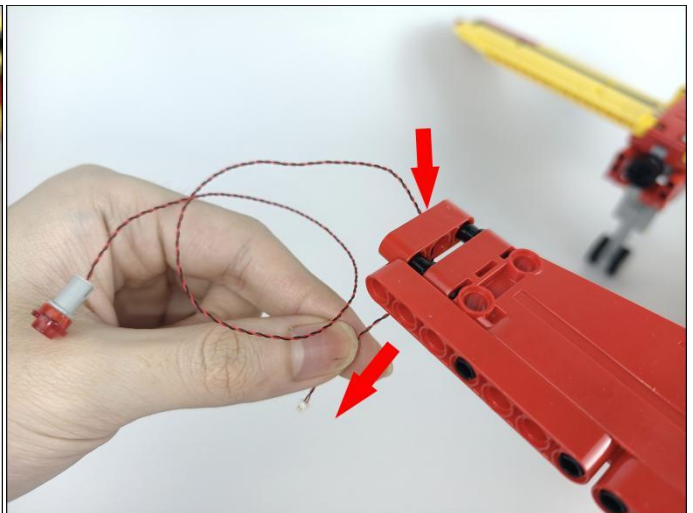
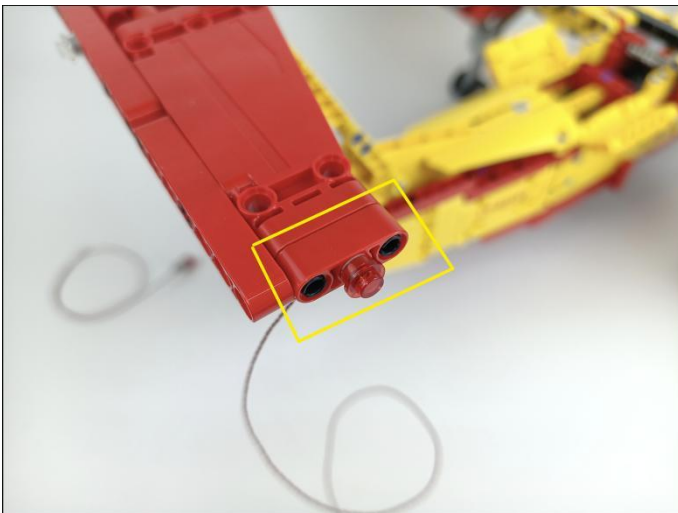

81. Same method as above.

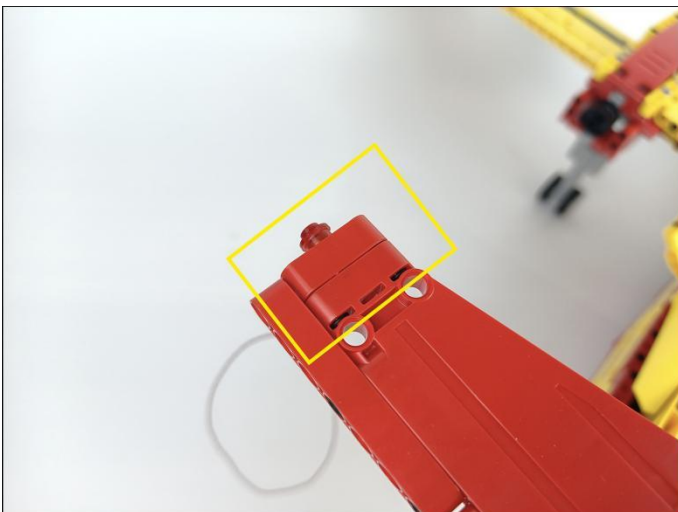

82

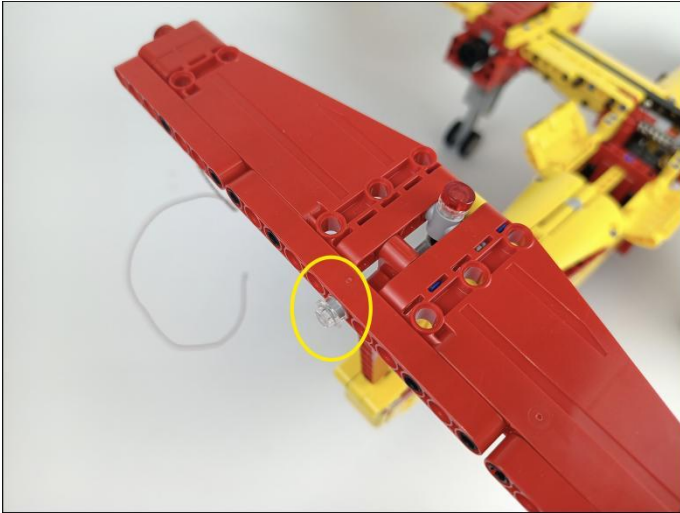

83

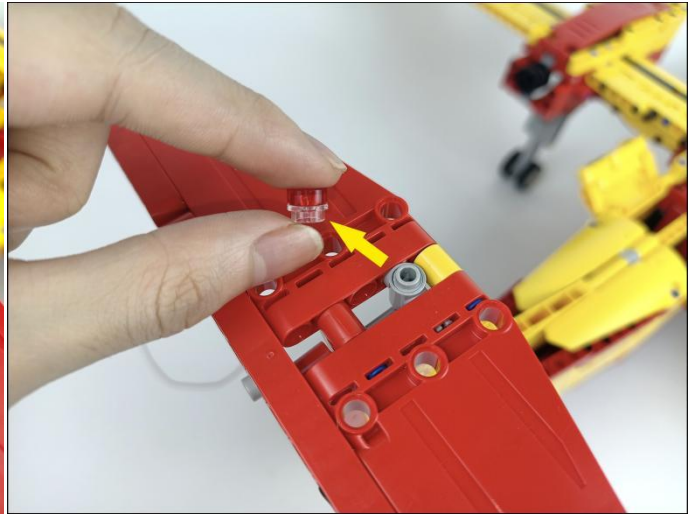
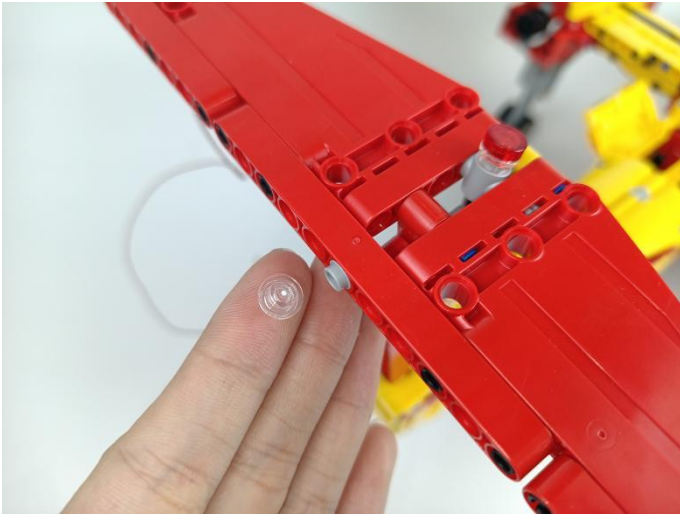

84



85

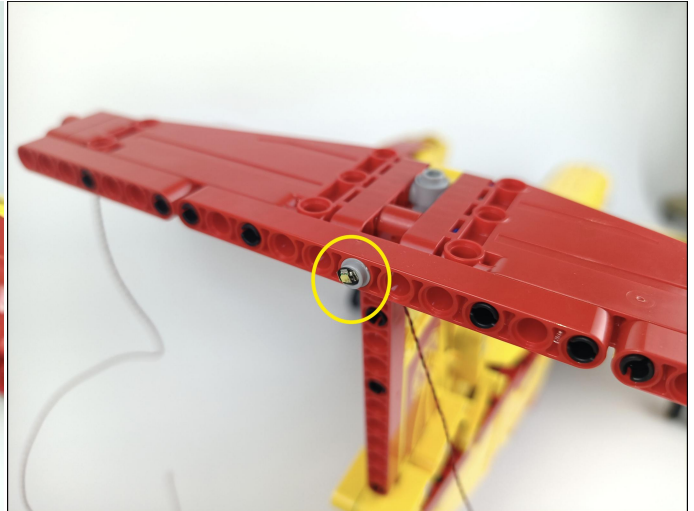
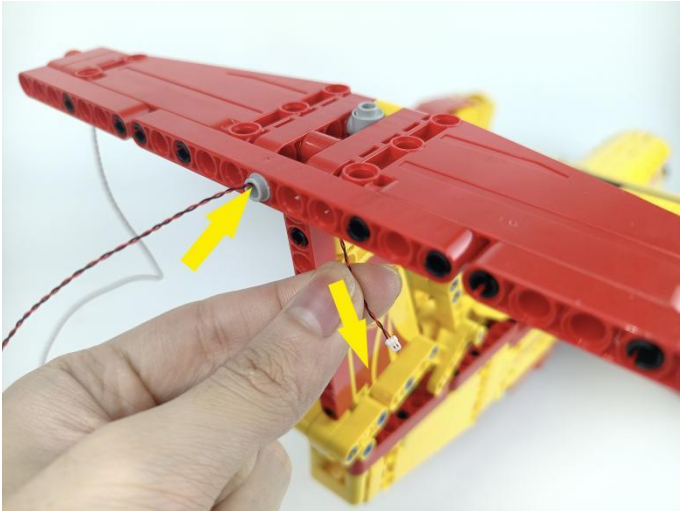

86

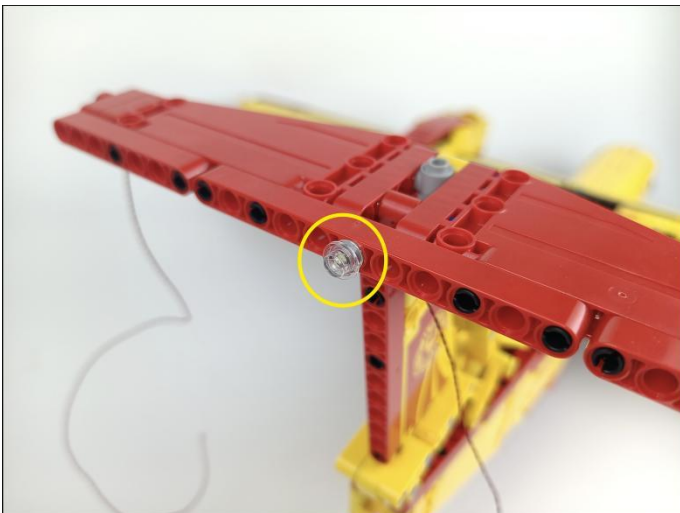

87

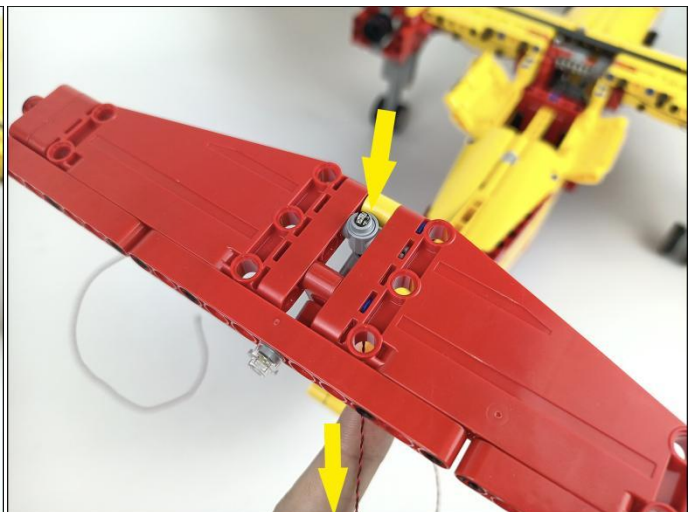
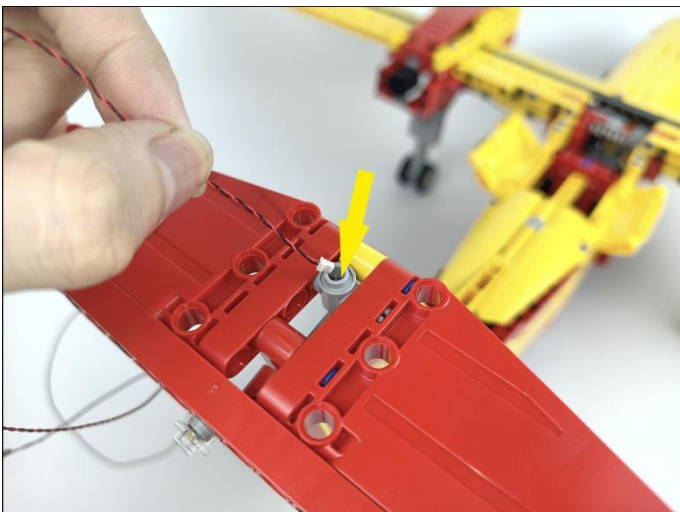

88

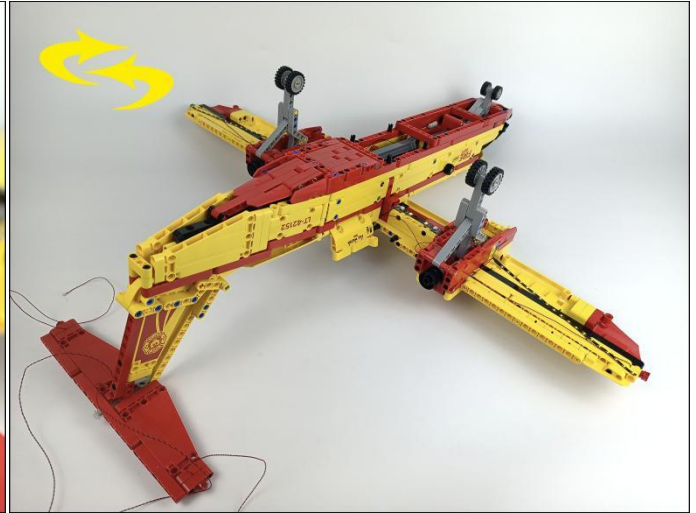
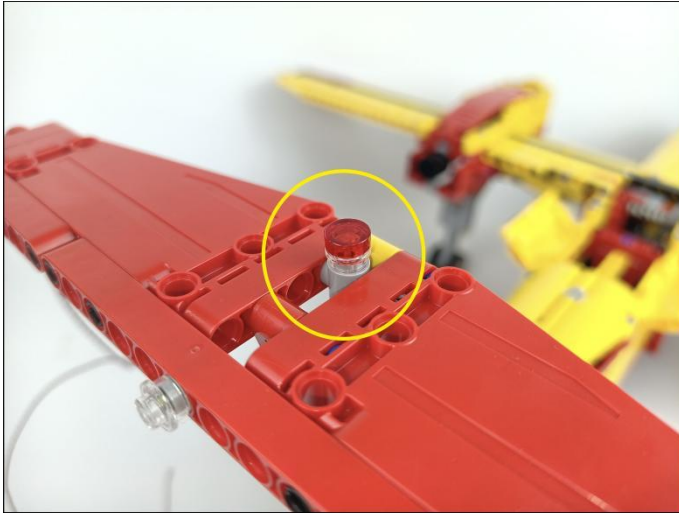

89

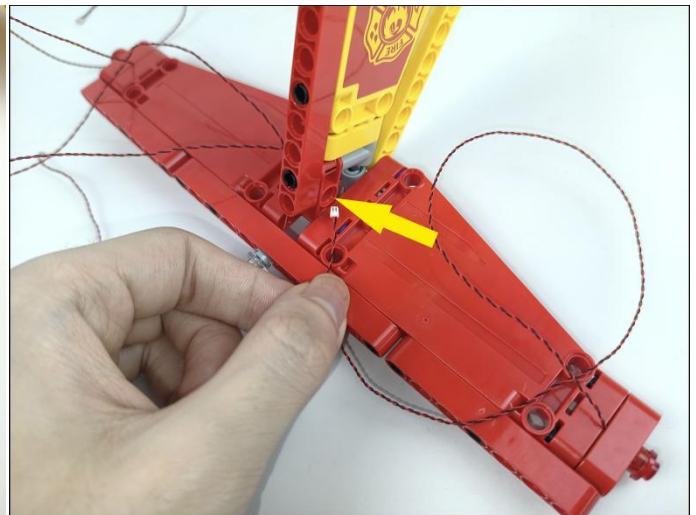
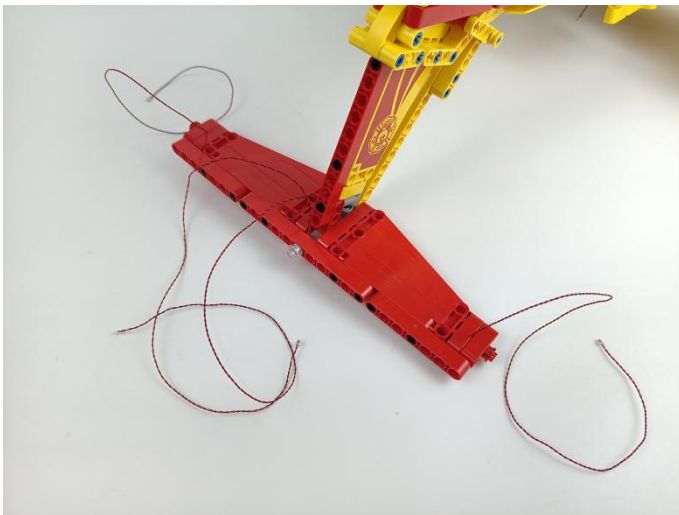

90

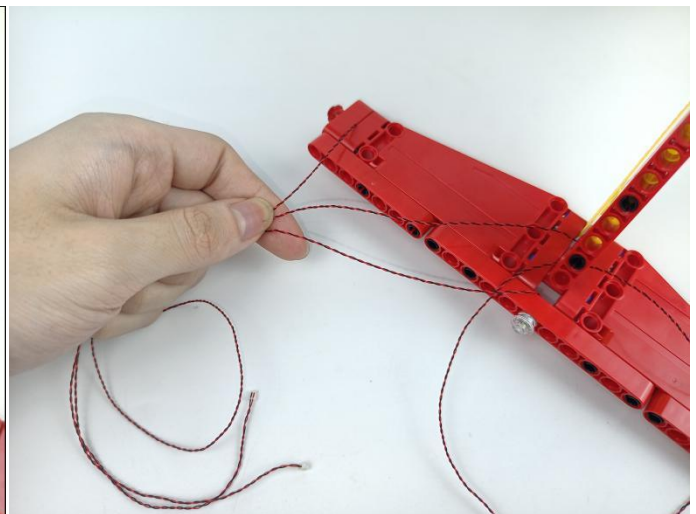
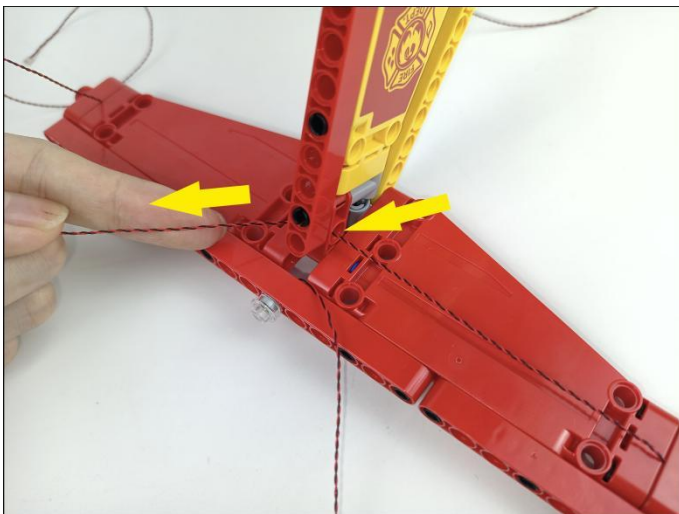

91

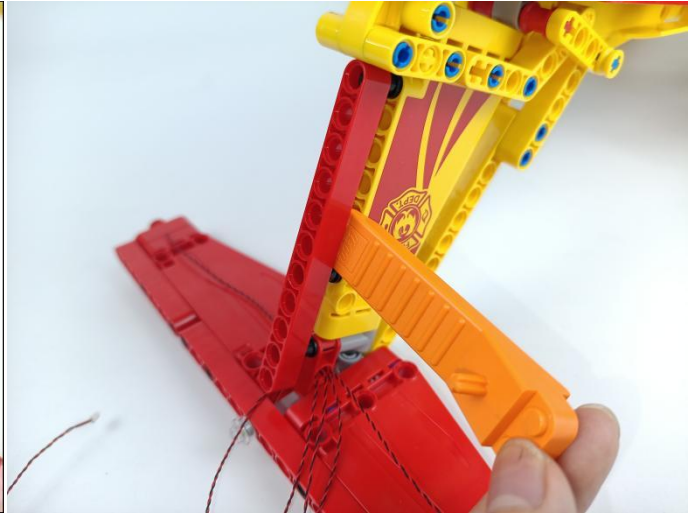
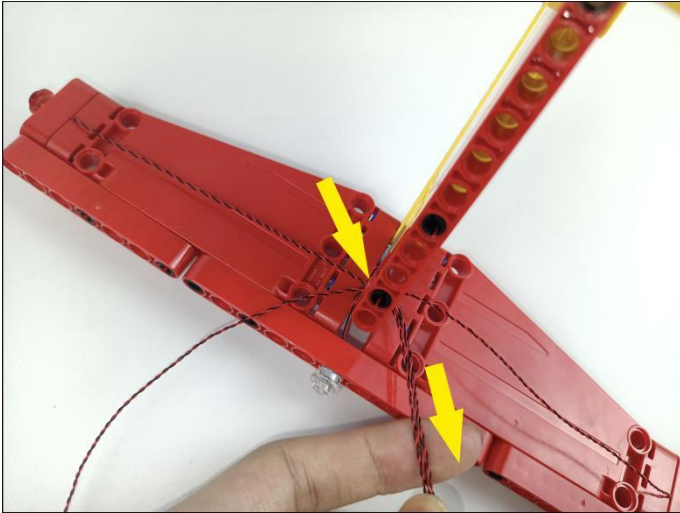

92

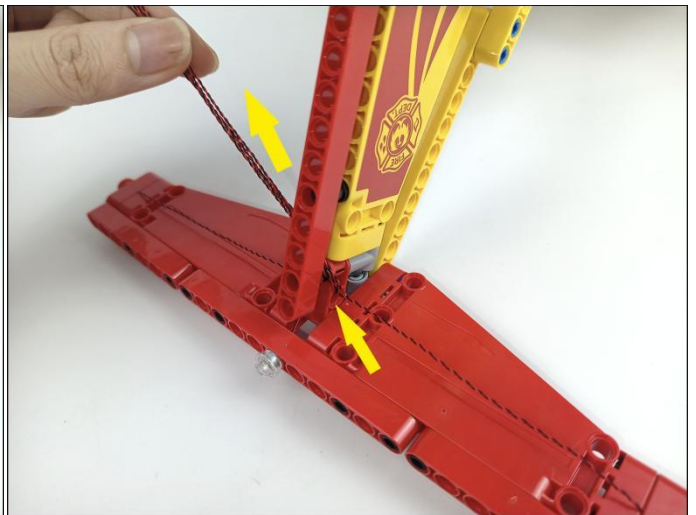
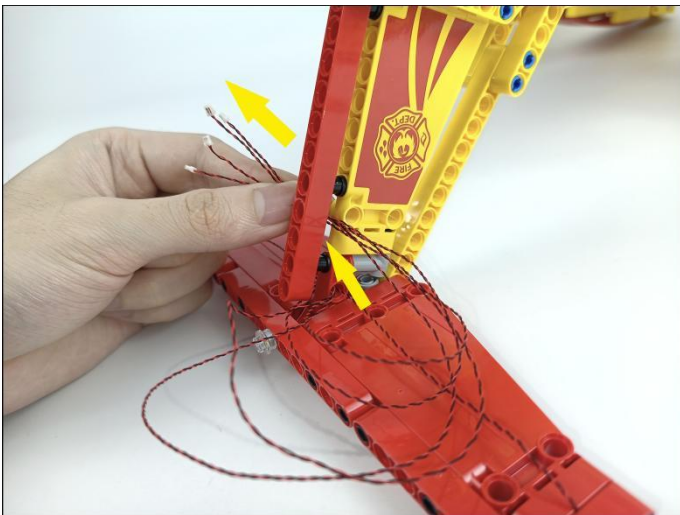

93

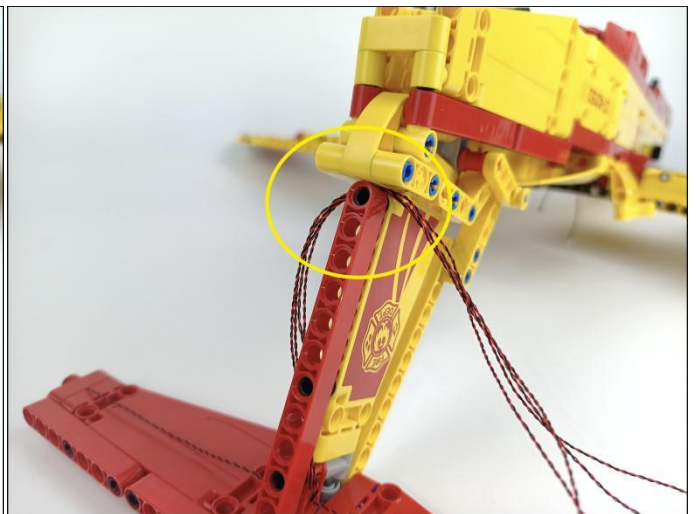
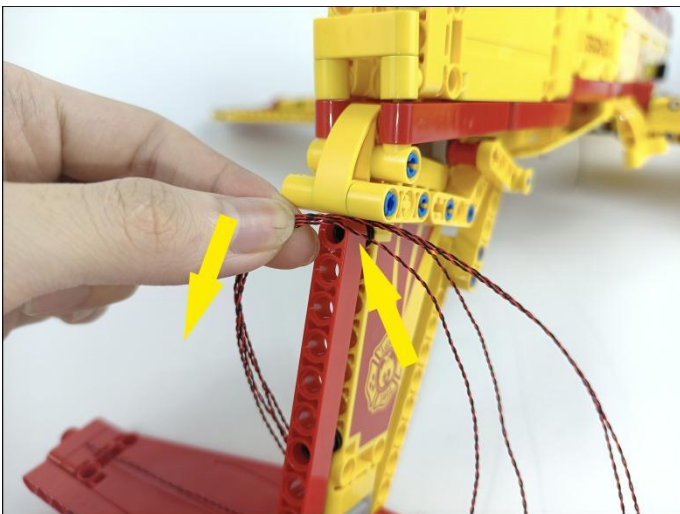

94



95

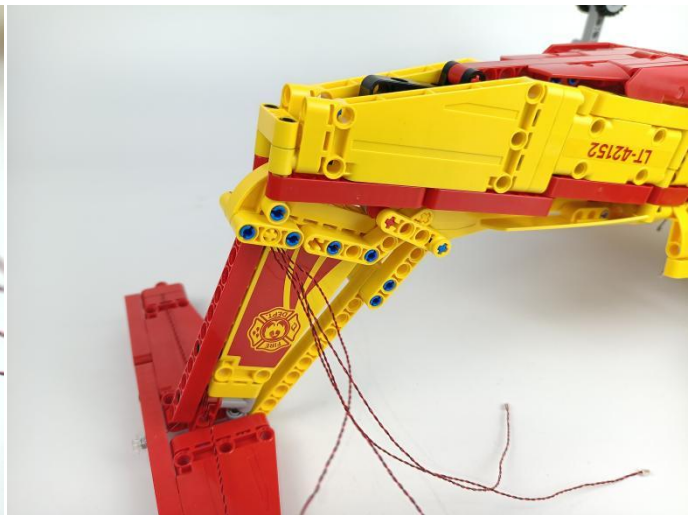

96



97

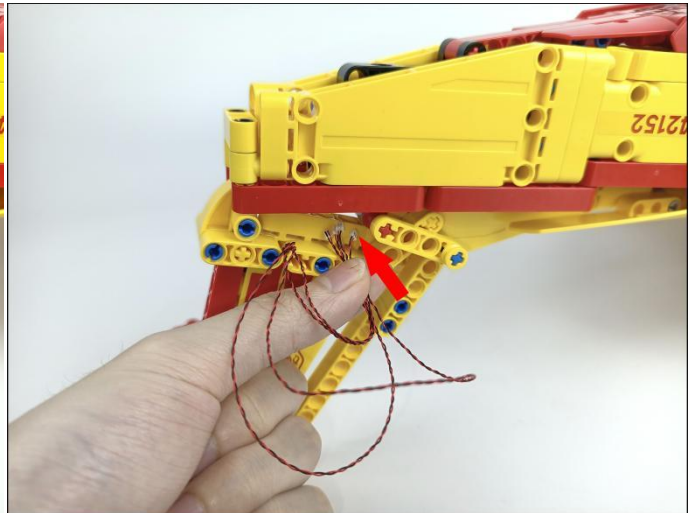
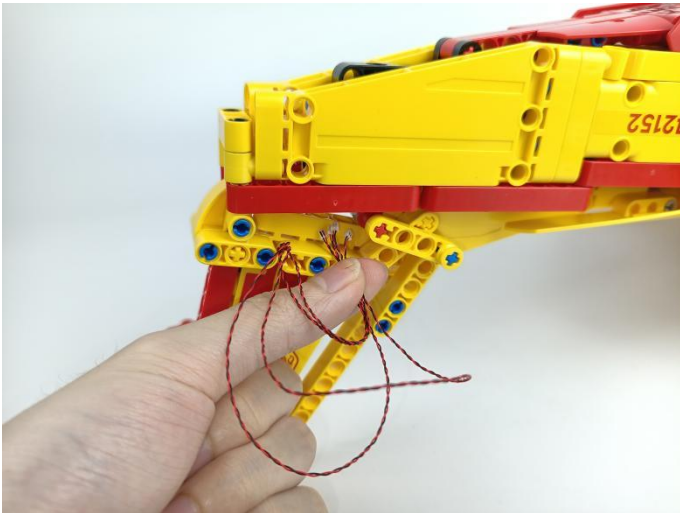

98

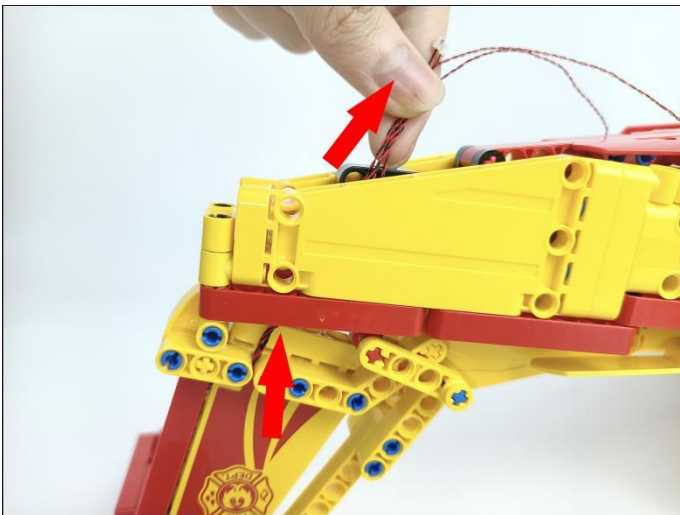

99



100



101

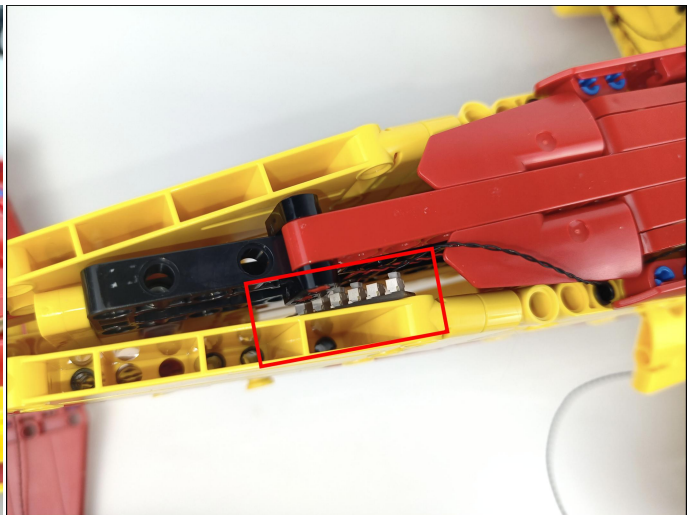

102

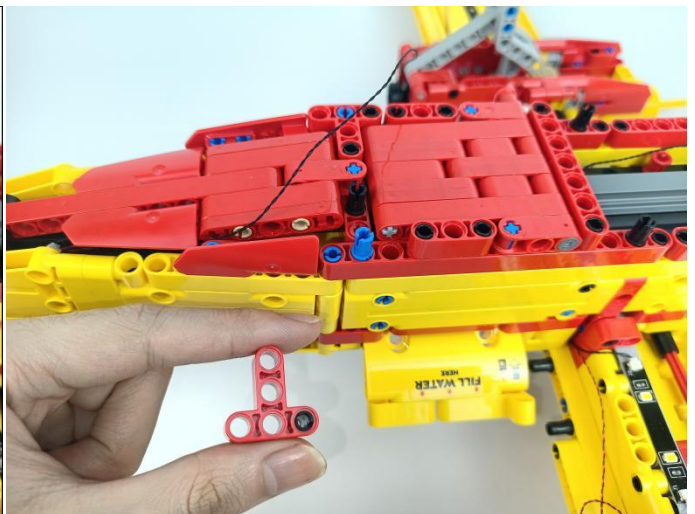
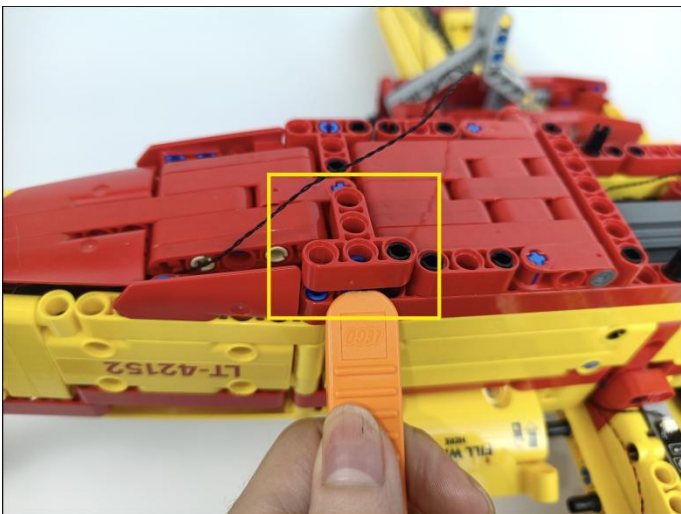

103

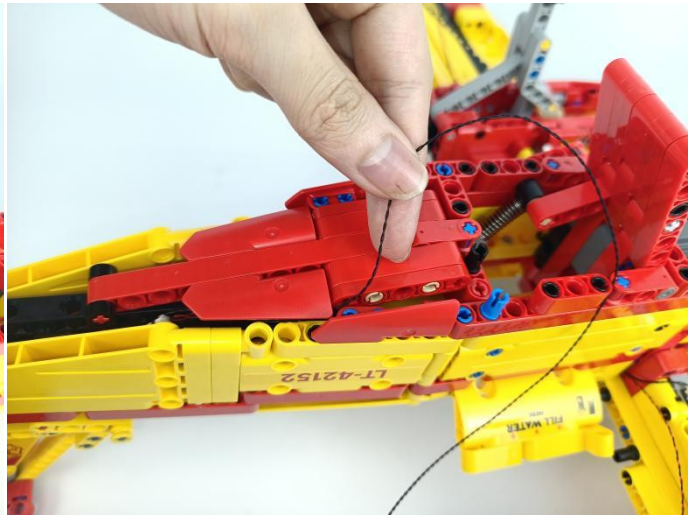

104

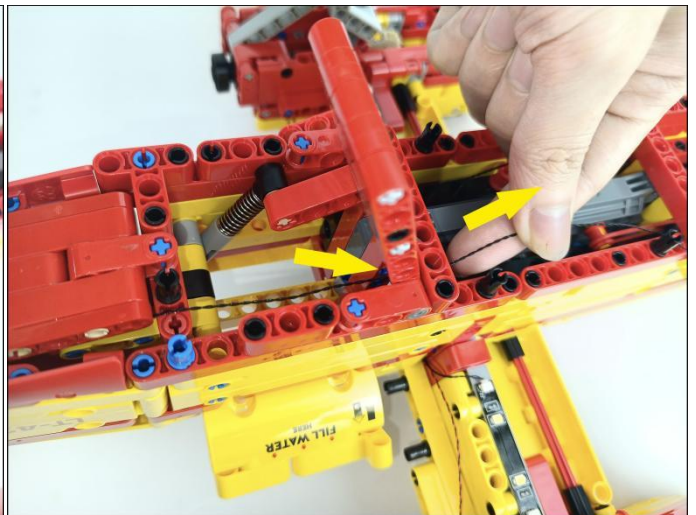
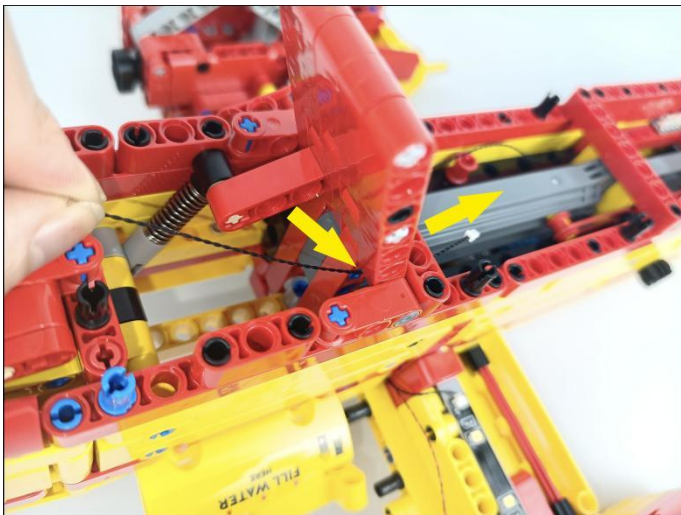

105

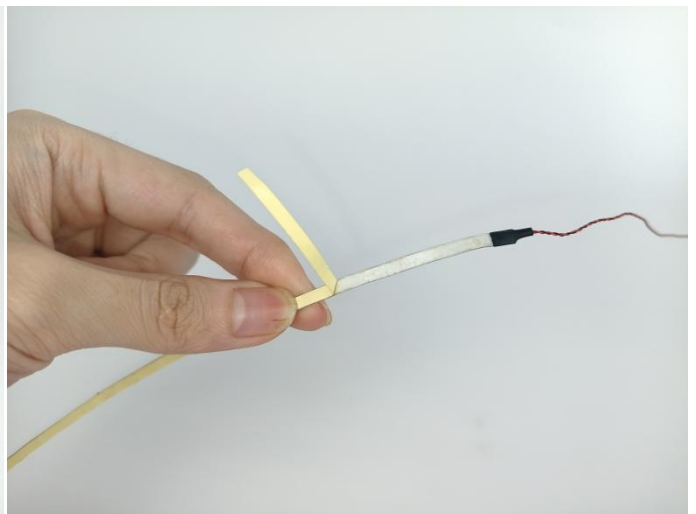

106

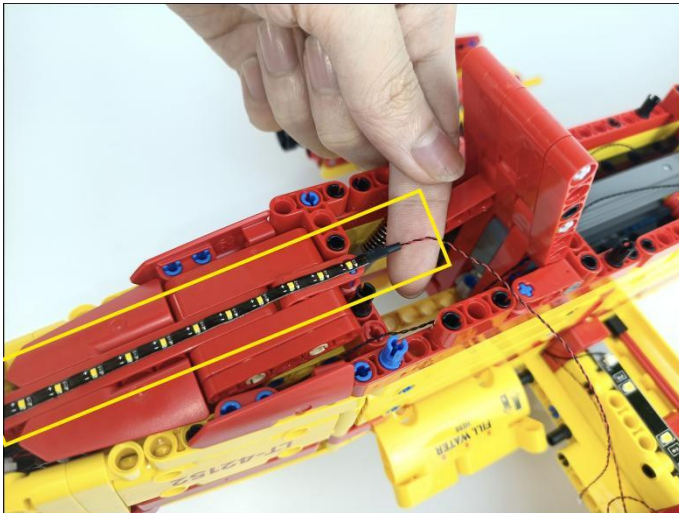

107

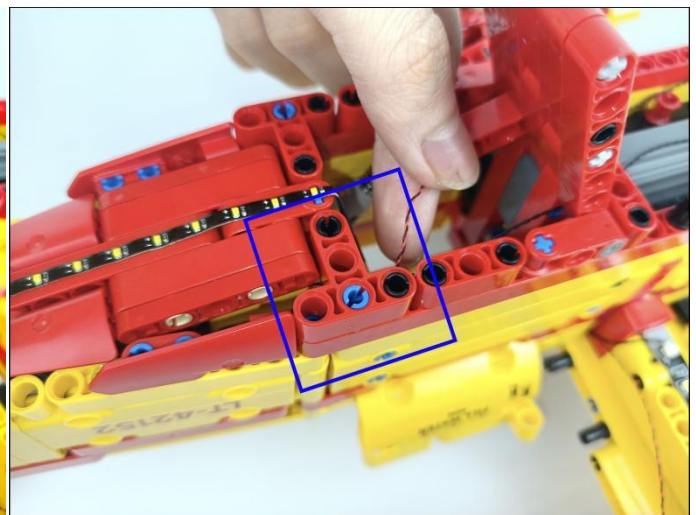
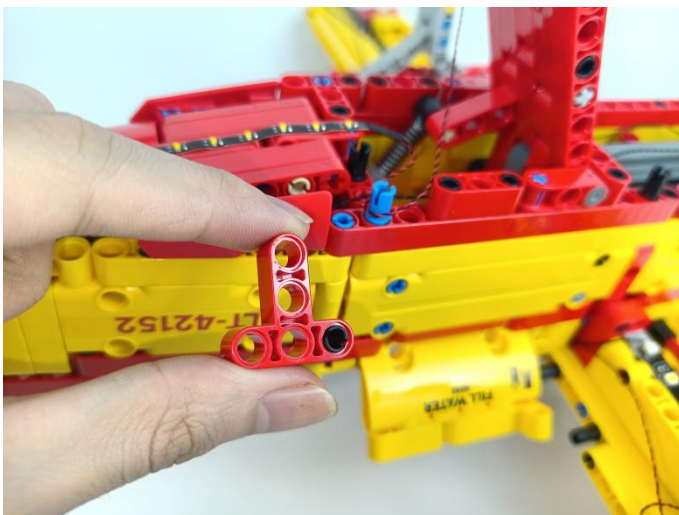

108

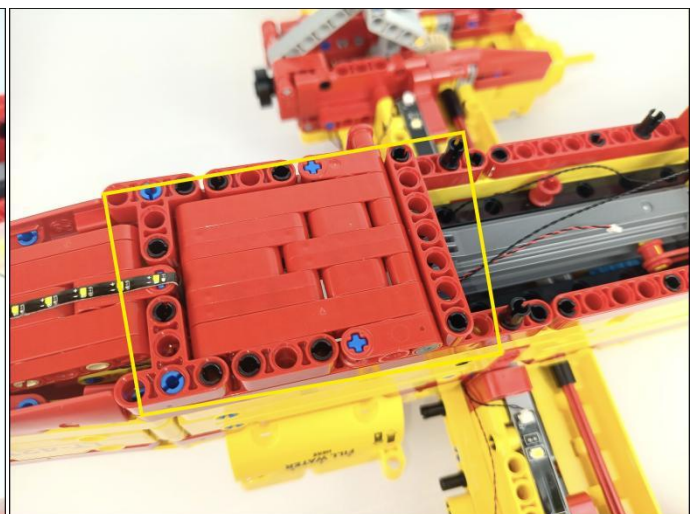
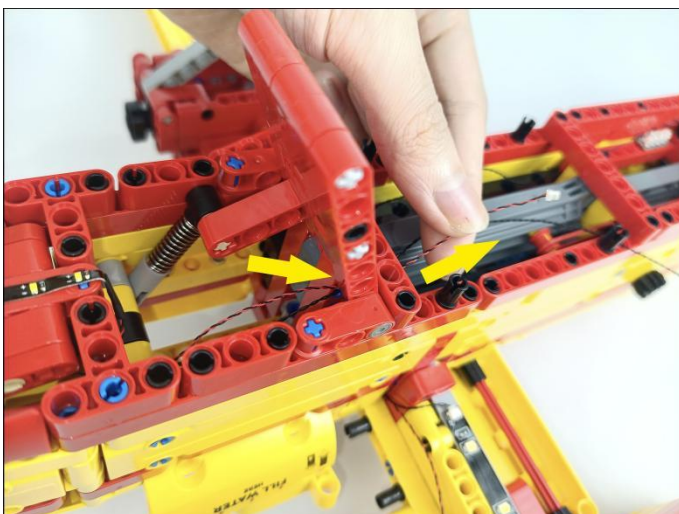

109

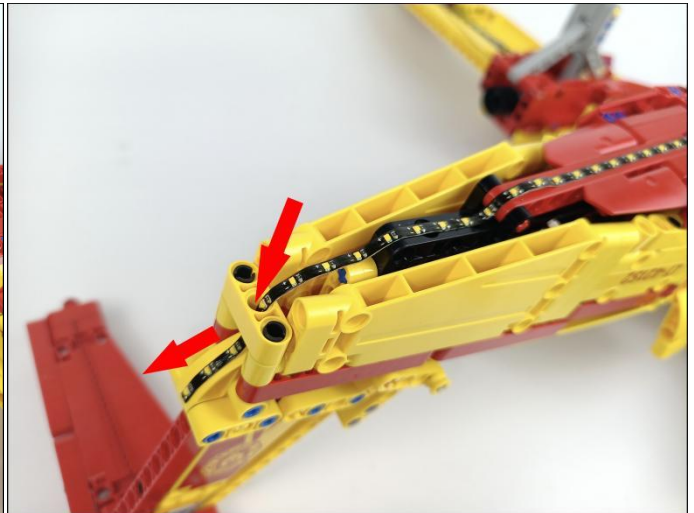
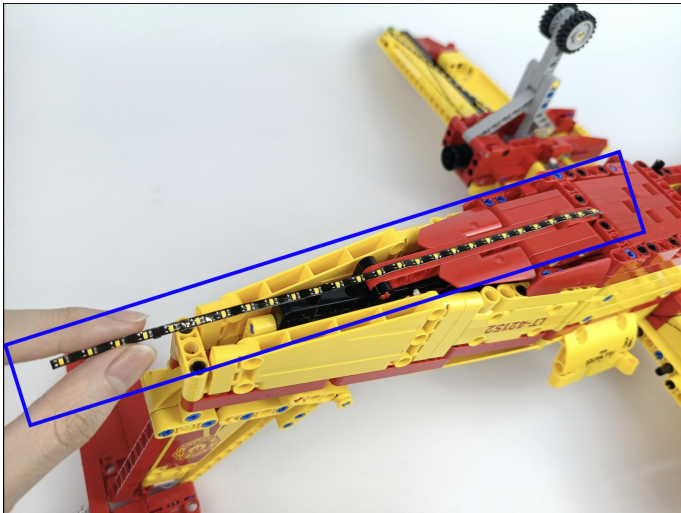

110

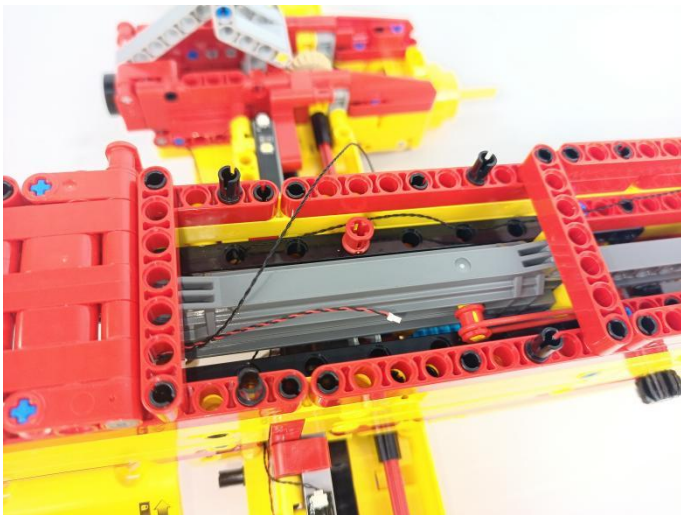

111



112

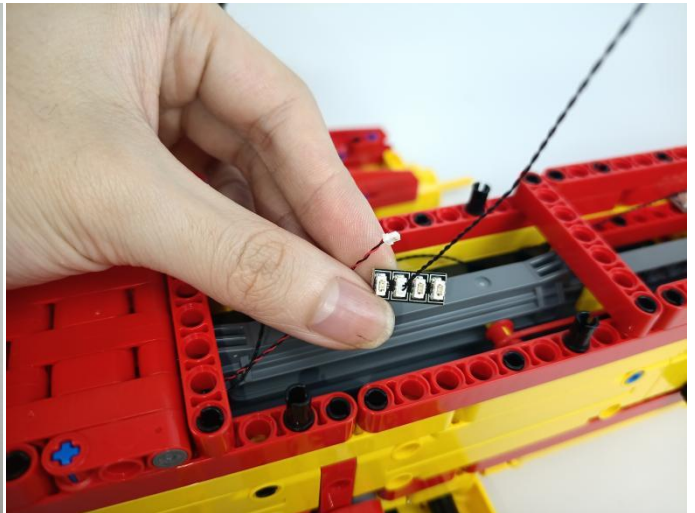

113

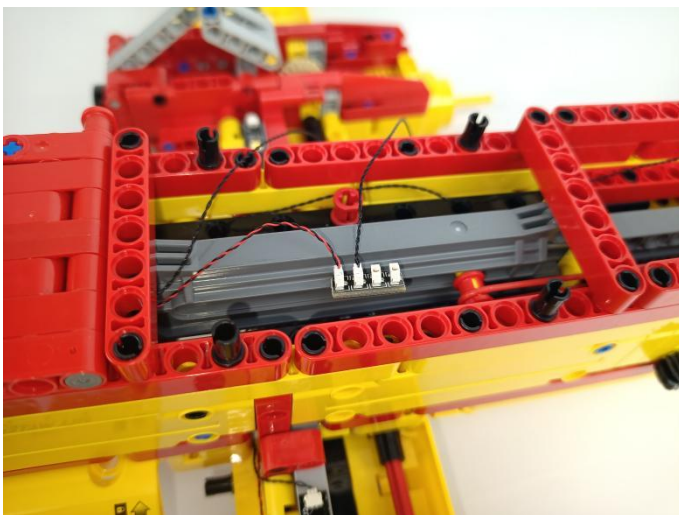

114

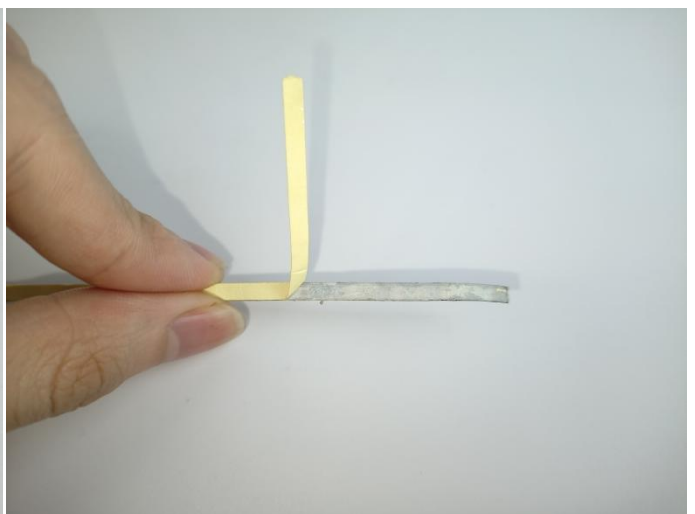

115

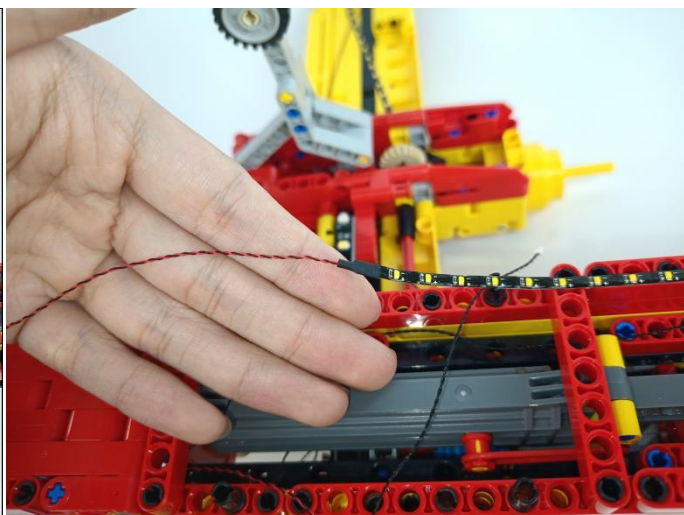
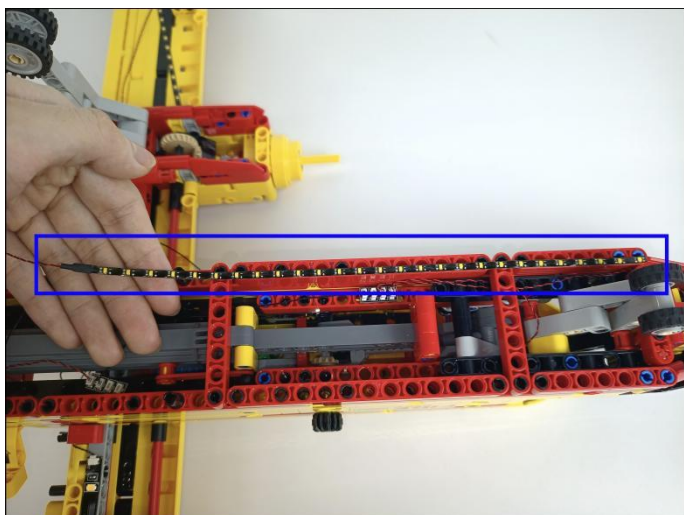

116

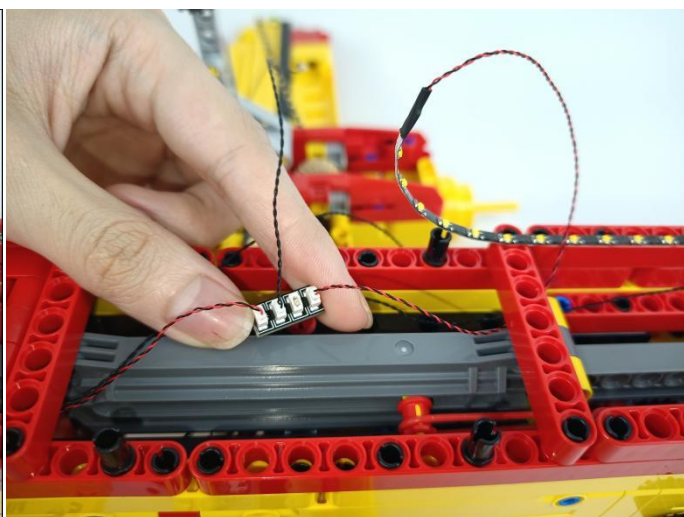
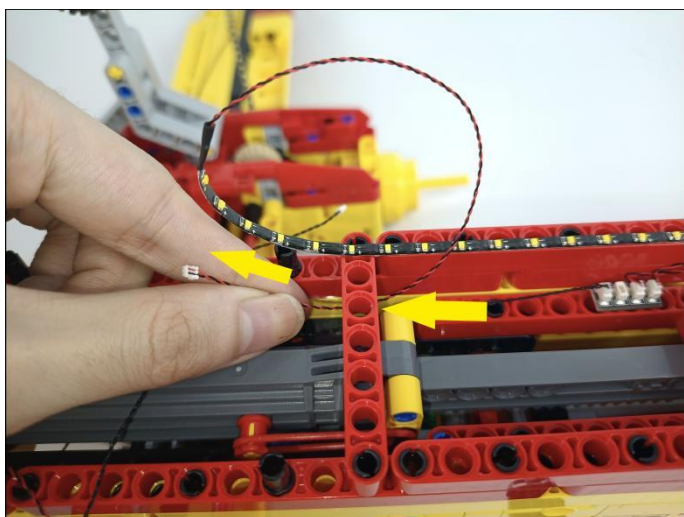

117

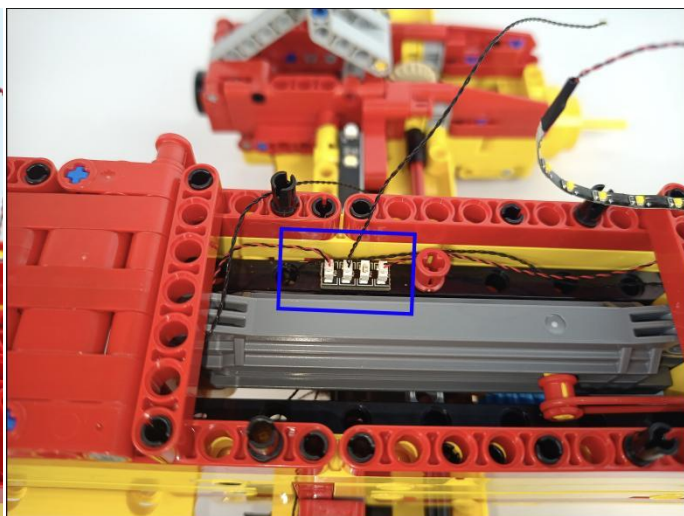
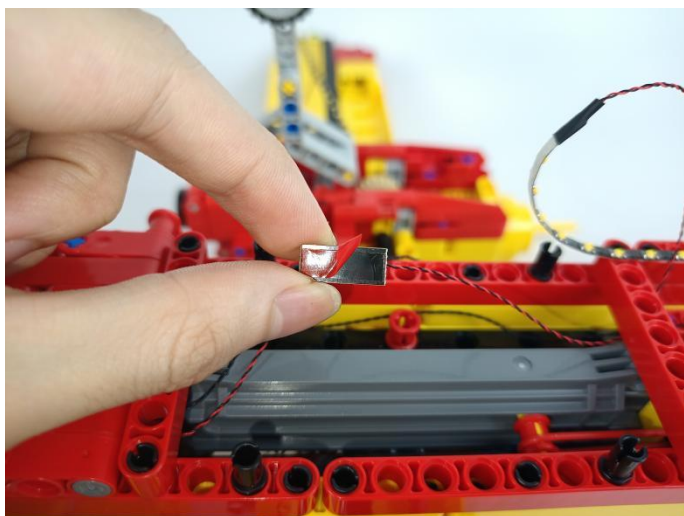

118

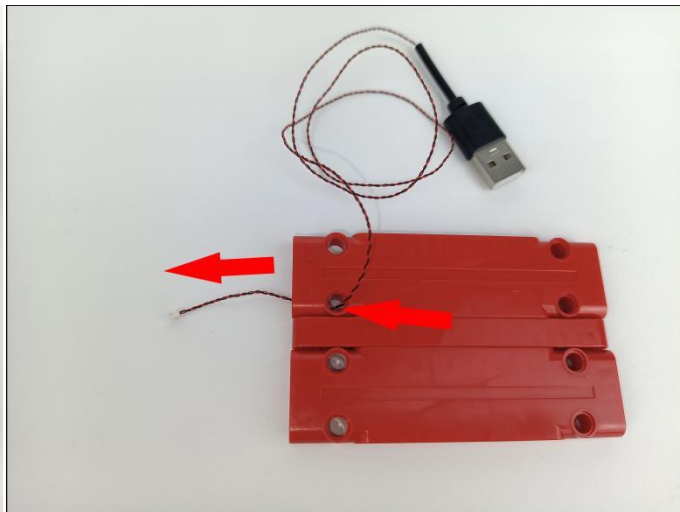

119

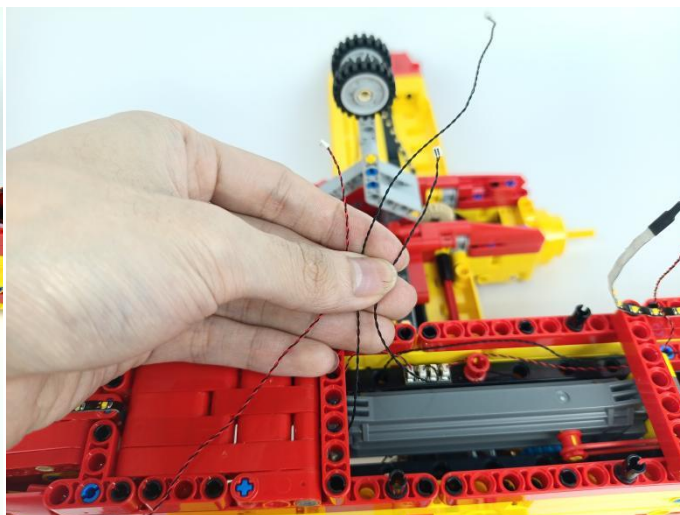
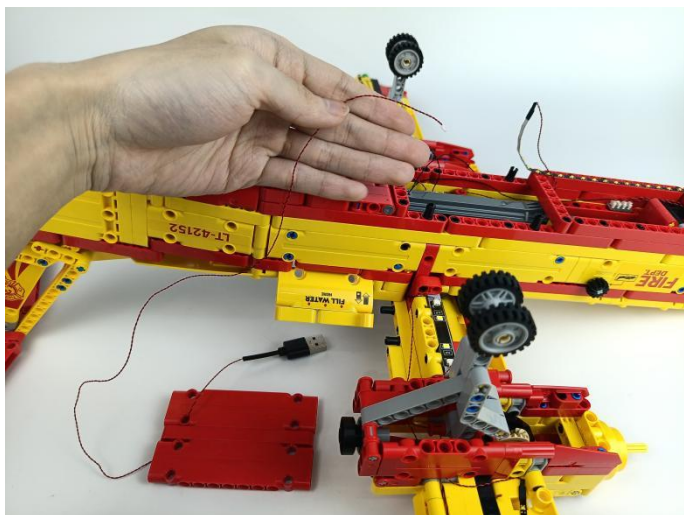

120

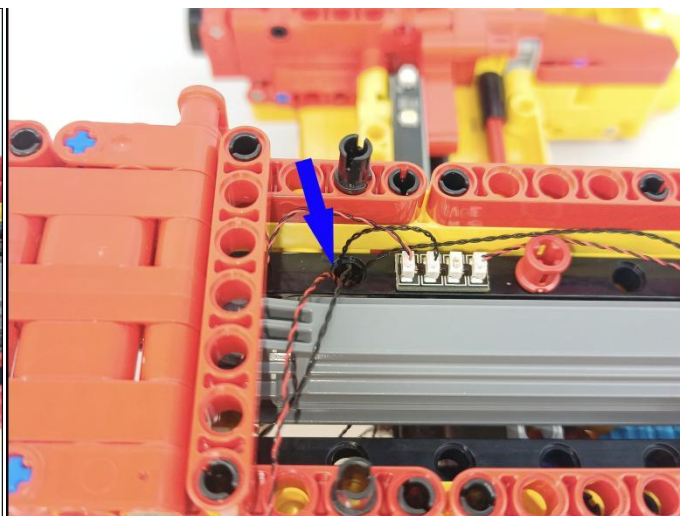
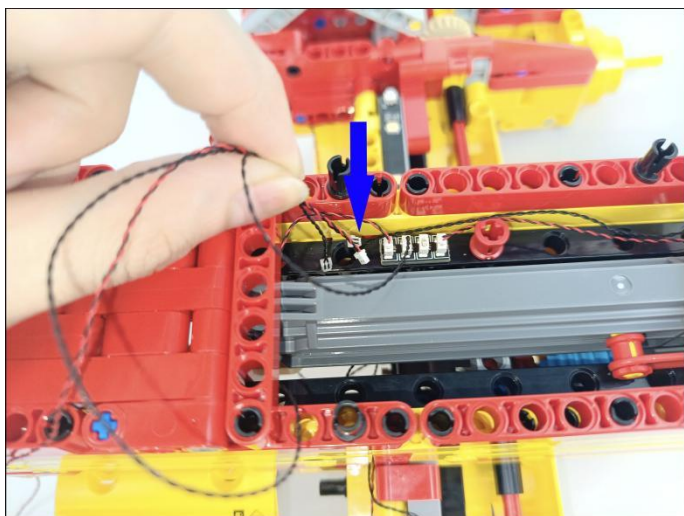

121

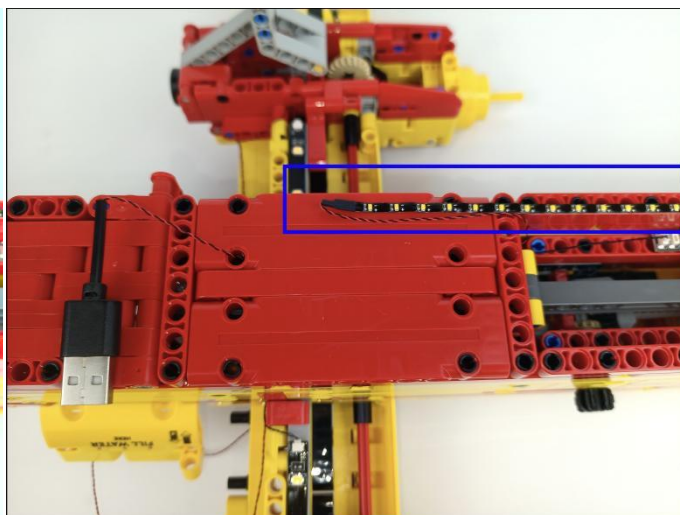
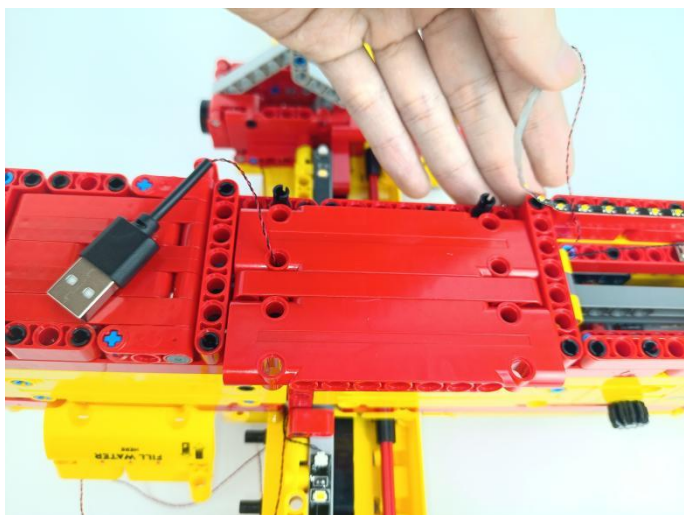

122

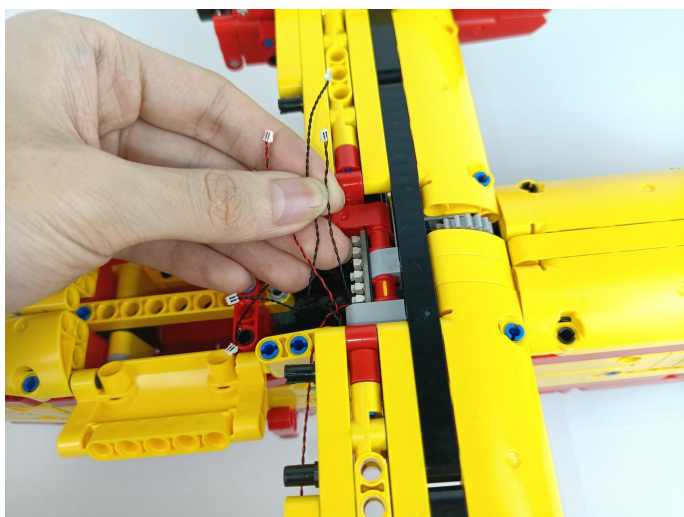

123

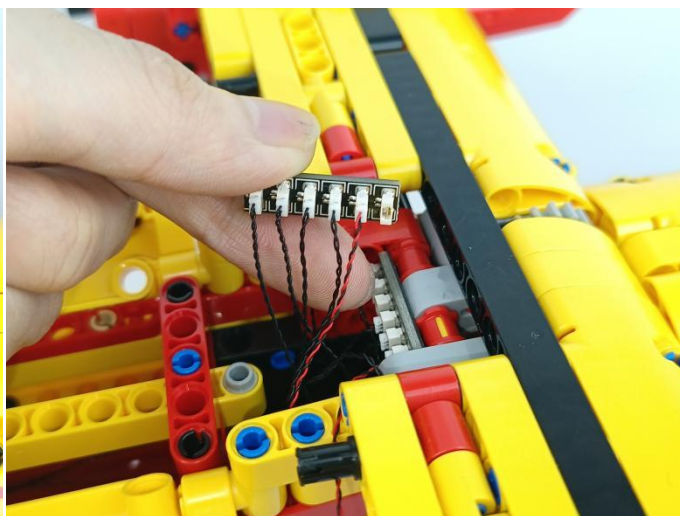
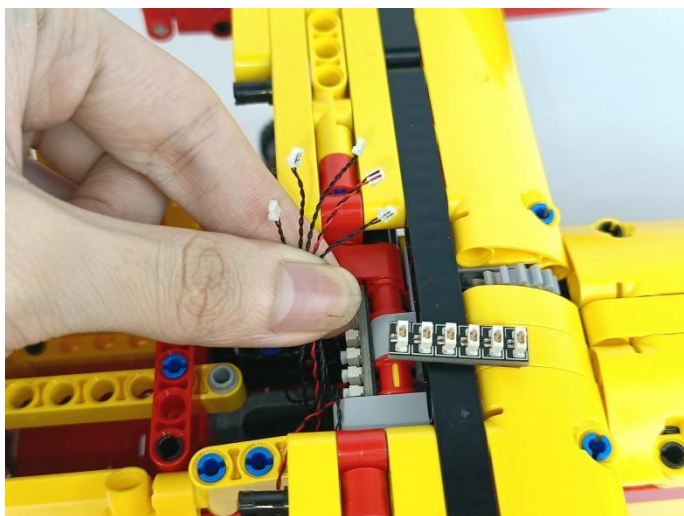

124

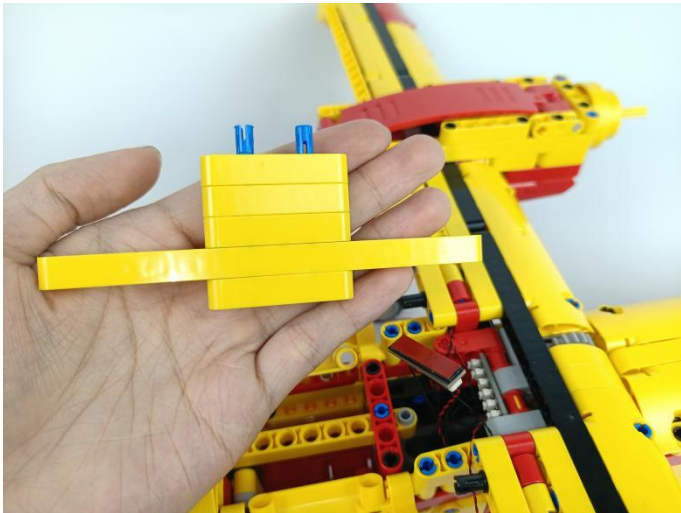

125

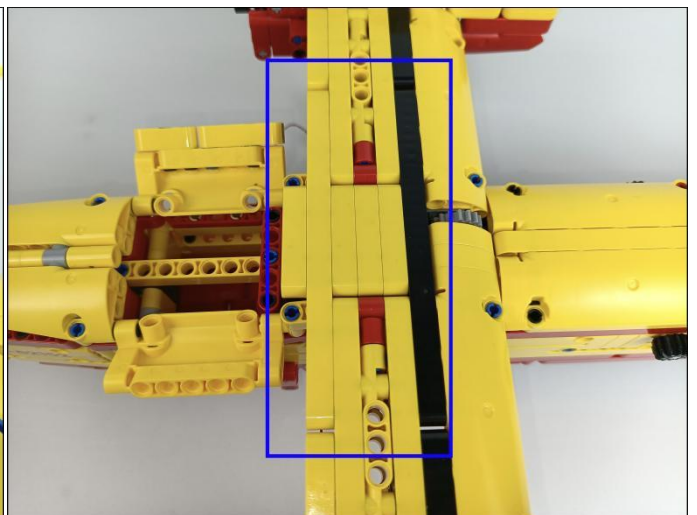
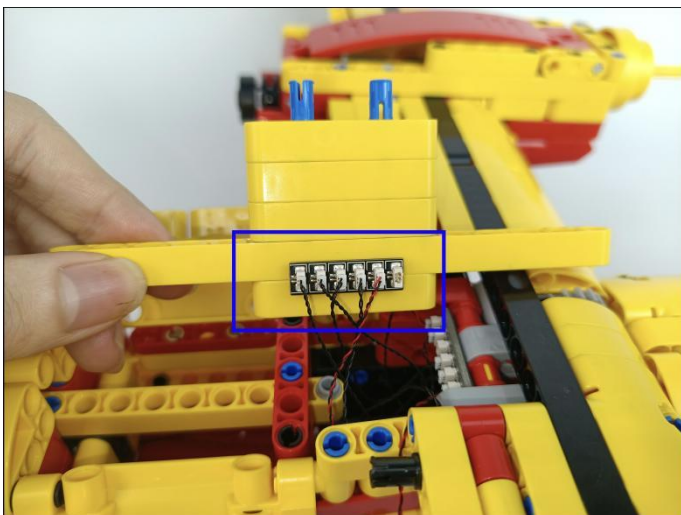

126



127



Good job, you've done all the installation steps, power it up and enjoy your work.



If it is necessary to change the power supply , prepare three AAA batteries, install them in the battery box, turn on the switch on the battery box, remove the plug of the USB Power Cable from the socket of the expansion board,plug the plug of the battery box to the same socket in the expansion board to power the suit as well.

THANKS