

# 10307 Eiffel Tower P43502

- **P43502 is the unique code of lighting set, we use this to accurately identify the product you purchased and the corresponding manuals and services you need to obtain. Please make sure your product code is the same as the label on the back of the box shown “10307 P43502”.**
- **Installation requires a lot of patience and great observation that your LEGO bricks will come alive when you get this finished. The bricks with lighting as below, so make sure you're ready and let's get started.**



# Strategies for the Installation

This instruction divides three sections to complete the installation of the lighting set.

## **Section A:** Check the type and quantity of components.

The quantity and type of components of each products are different and it needs to be carefully checked to make sure there do have enough material.

The type of components is indicated by the label on the bag.

## **Section B:** Test that each components is working properly.

Each components is made individually so it is necessary to test that each components is working properly to avoid the situation that the lighting does not work .

## **Section C:** laying out components following the instruction.

Our material is very small but not fragile, just be reminded that don't to pull the wires too hard. For different people, there may be some installation steps that you can't understand. Please look at the previous and later installation step



## Section A: Check the type and quantity of components.

There are 13 bags in this set. The name and quantities of specific components are as shown , please check carefully.

Label	Content	Quantity
High-Brightness Light 30CM-Warm White	High-Brightness Light 30CM-Warm White	9
High-Brightness light 15CM-Warm White	High-Brightness light 15CM-Warm White	12
LED Strip Warm White	LED Strip Warm White	2
Expansion Board	6 Socket Expansion Board	5
	8 Socket Expansion Board	6
	2 Socket Expansion Board	5
	4 Socket Expansion Board	4
USB Power Cable	USB Power Cable-50CM	1
Connecting Cable 30CM	Connecting Cable 30CM	10
Connecting Cable 50CM	Connecting Cable 50CM	6
Connecting Cable 10CM	Connecting Cable 10CM	4
Connecting Cable 20CM	Connecting Cable 20CM	2
Flash Light-30CM Red	Flash Light-30CM Red	1
Music Module	Music Module	1
Light Strip-Warm White	Light Strip-Warm White	32
Components		

Please contact us immediately if there have any missing components.

## Section B: Test that each components is working properly.

We need a structure to test all lights, so take out the bag with label “USB Power Cord”and “Expansion Boards”as follows.



It is worth reminding that our products are all customized. They have a unique way of connecting. The white plug on wire and the socket of the expansion board need to be connected together to transmit power.

Note that on one side of the white plug you can see two very small golden wires that should be connected to the two golden needles in socket of the expansion board. shown as blow.

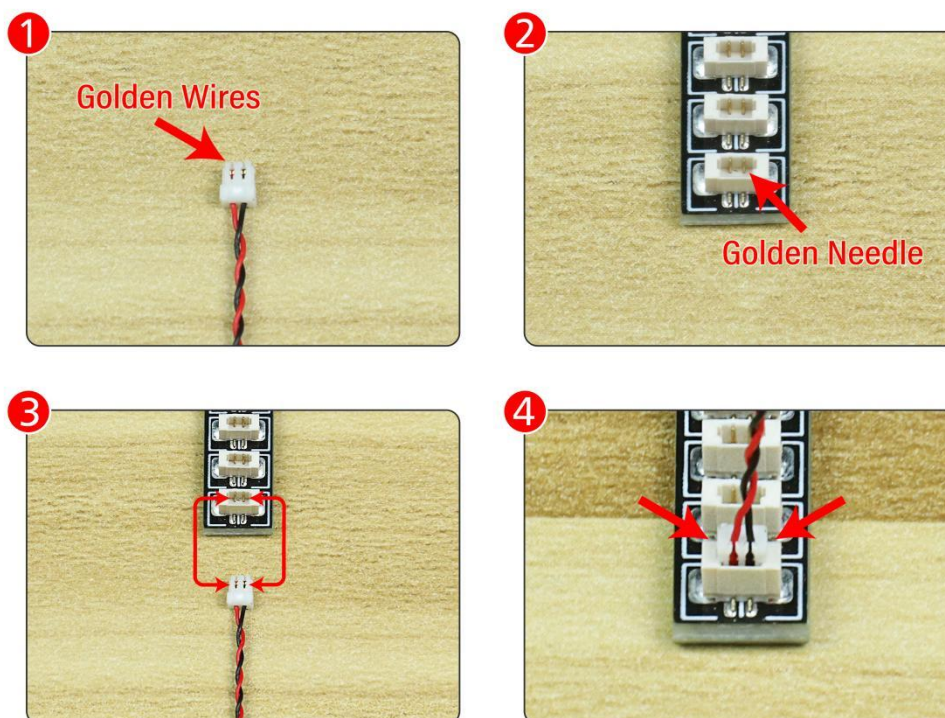

All our connections between plug and socket are all the same as shown above. So for any such structure with plug and socket, please pay attention to the golden wire of the plug and the golden needle of the socket, they must be touched together.

The connection method between the USB Power Cord and Expansion Boards is as follows:

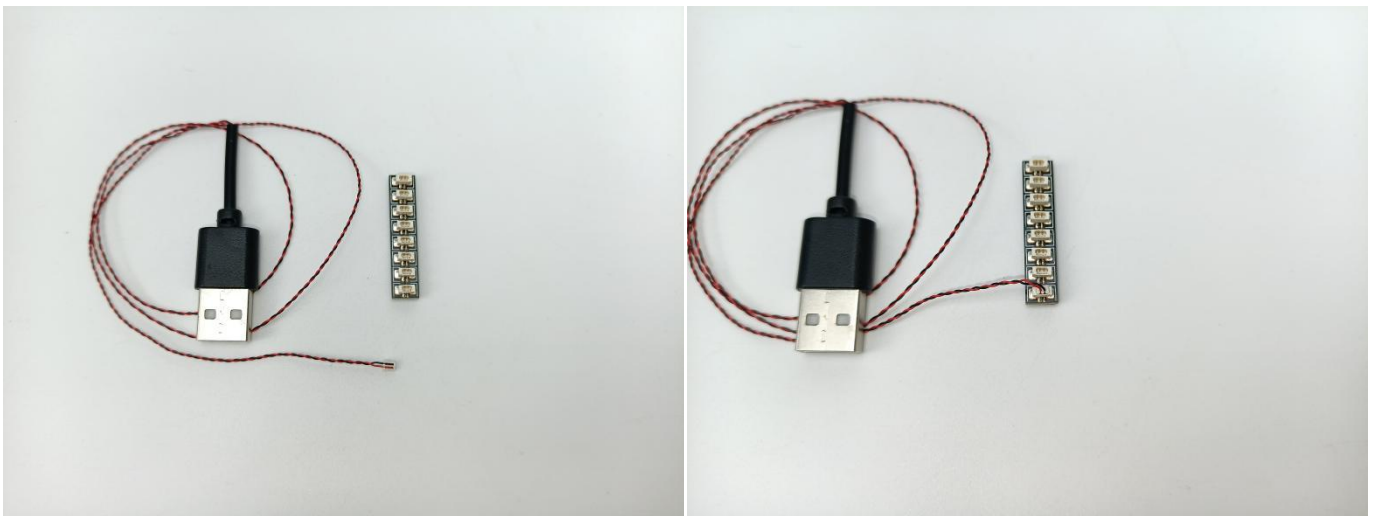

The USB Power Cord can be powered by phone chargers, power banks, etc.

### USB connectors to connect devices

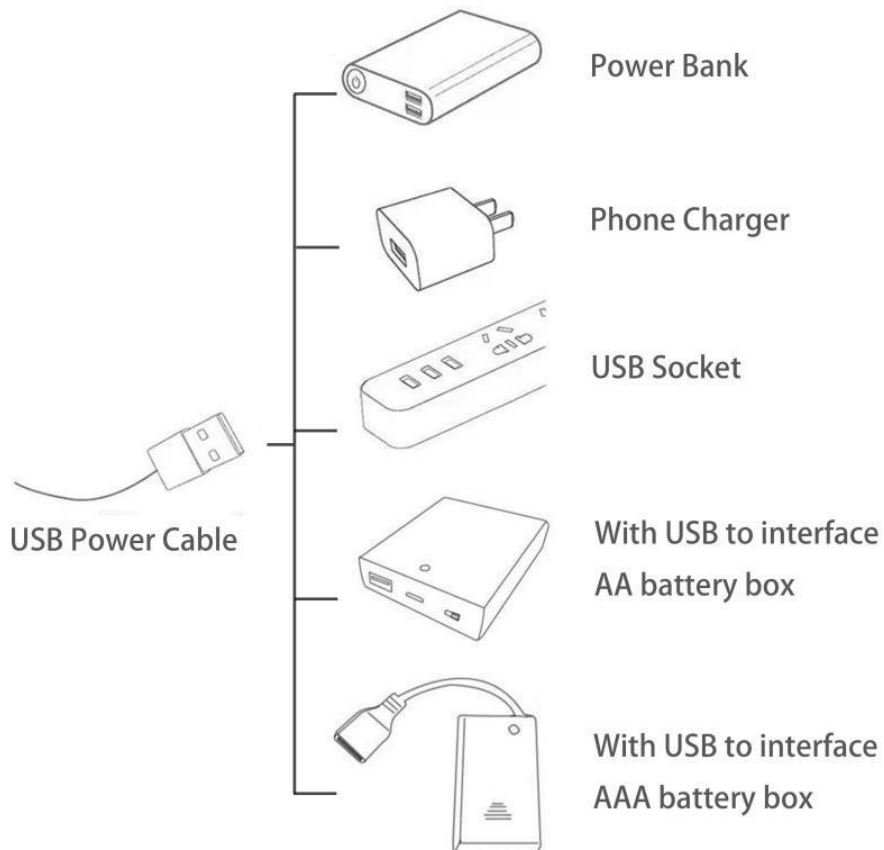

**This instruction will use the power bank as power supply . The test structure is shown as follow. All lamp in this set will be tested by this structure.**



**When we test " Flash Light-30CM Red" particles,Take out the bag labelled " Flash Light-30CM Red".Take out one of the light and connect it to the socket. Turn on the power bank, the light will turn on normally as shown below.**

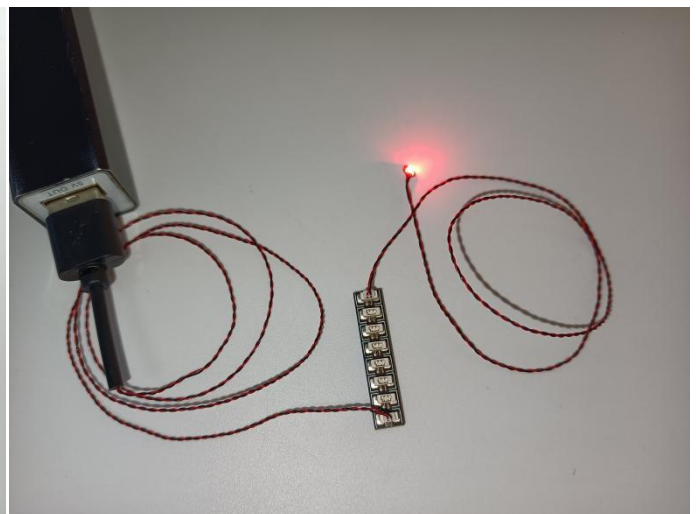

**Test each lamp according to this method. It should be noted that after the test, the lamp must be returned to the corresponding bag to avoid confusion of types.**



**The components needs to be tested in this set is 9\*High-Brightness Light 30CM-Warm White,12\*High-Brightness light 15CM-Warm White,2\*LED Strip Warm White,32\* Light Strip-Warm White.**

**Please contact us immediately if any components don't work.**



**Section C:** laying out components following the instruction.

1

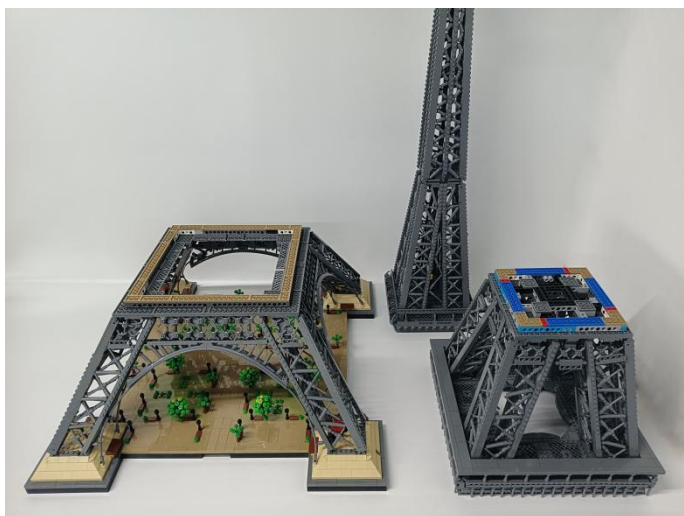

2

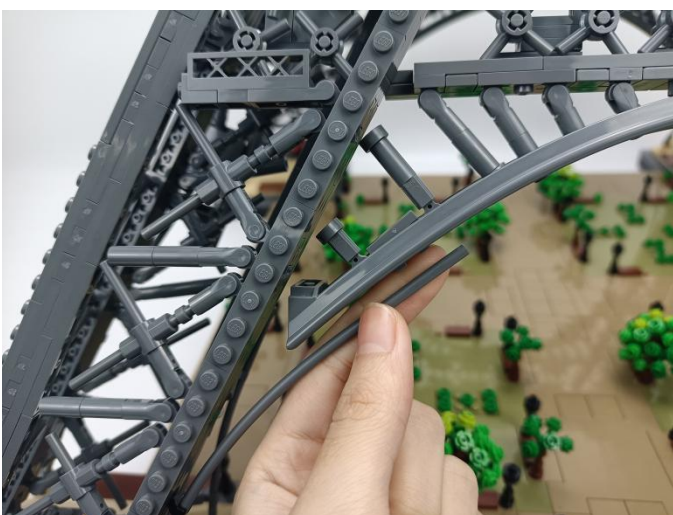
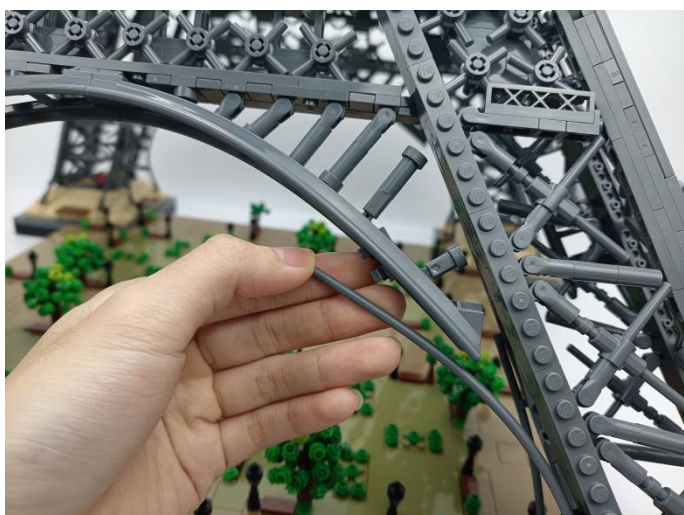

3

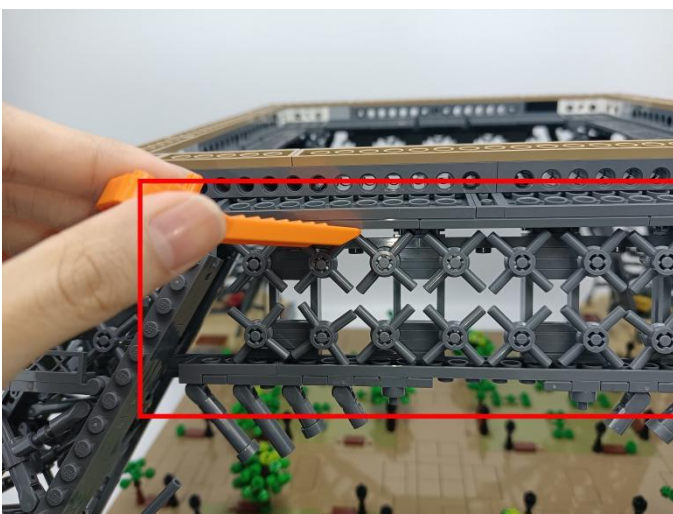
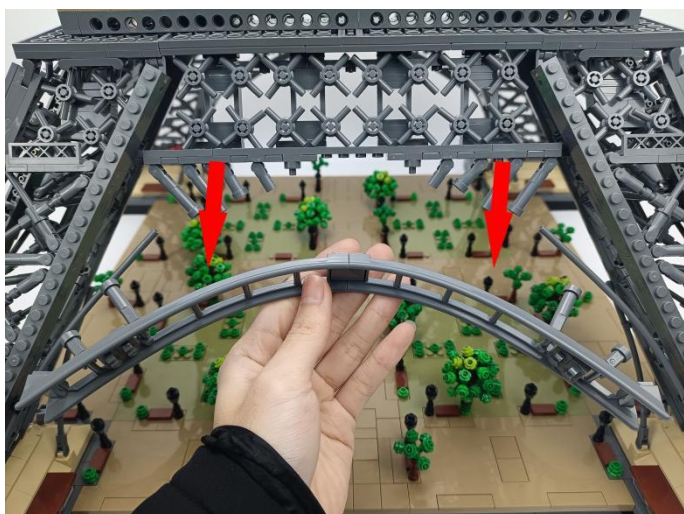



4

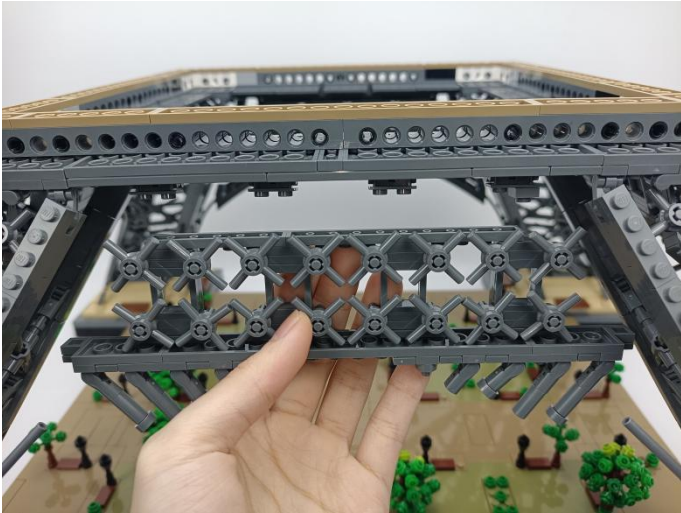

5

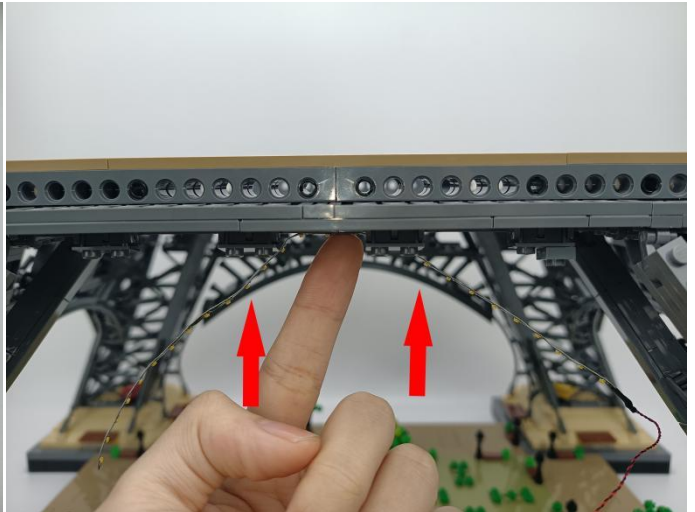
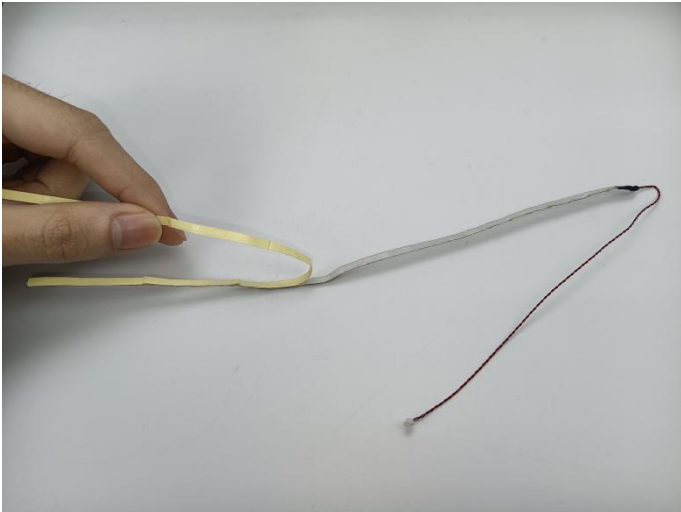

6



7

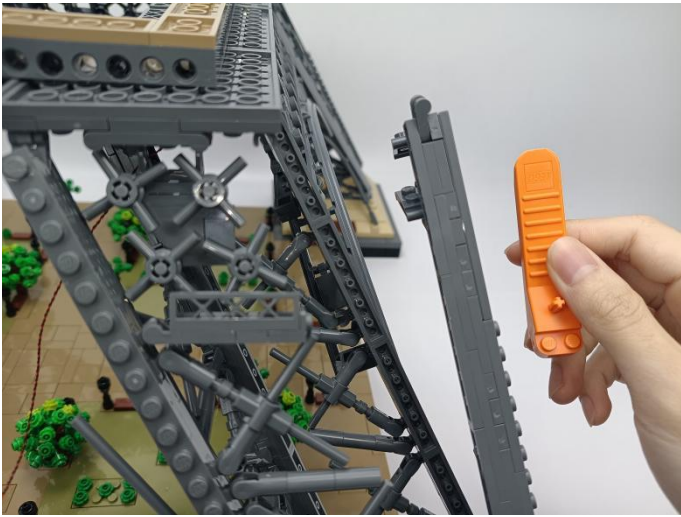

8

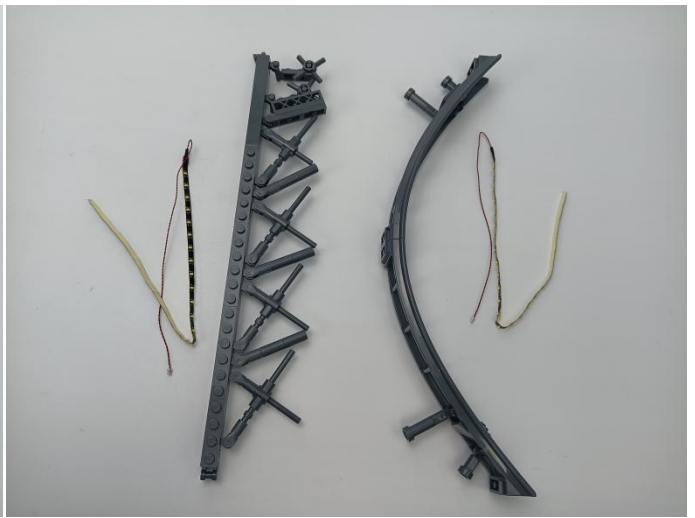

9

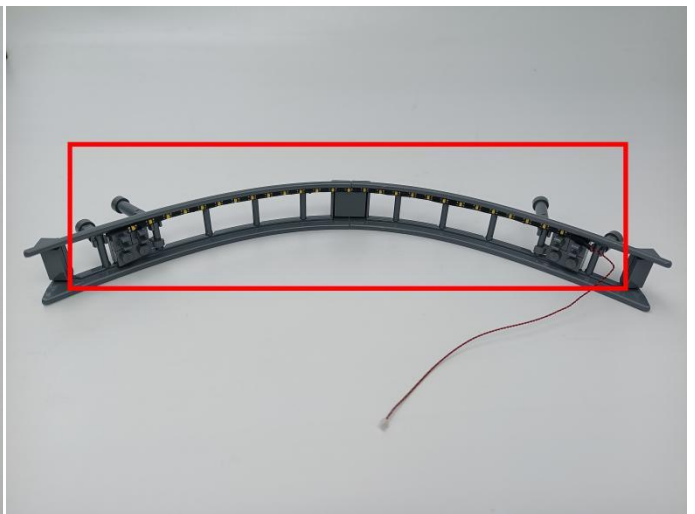
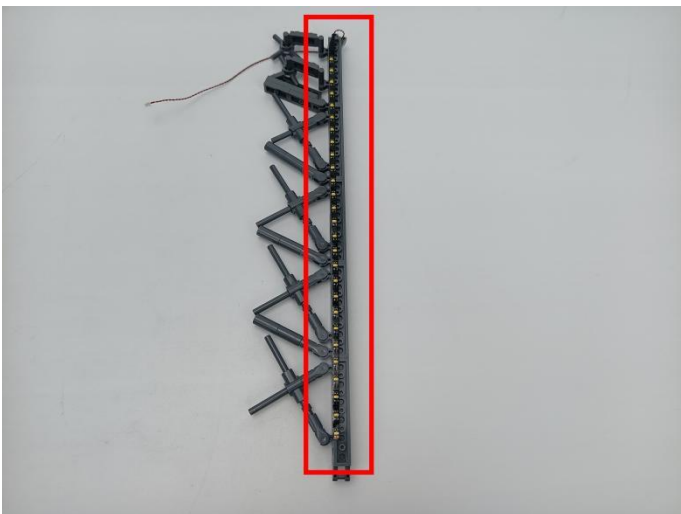



10

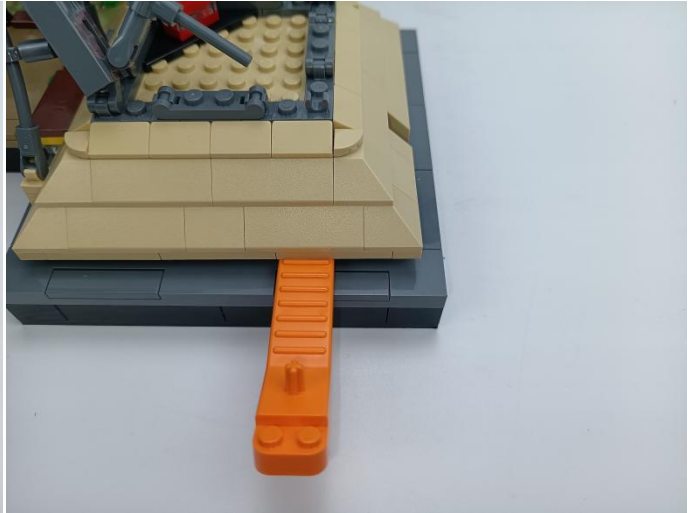

11

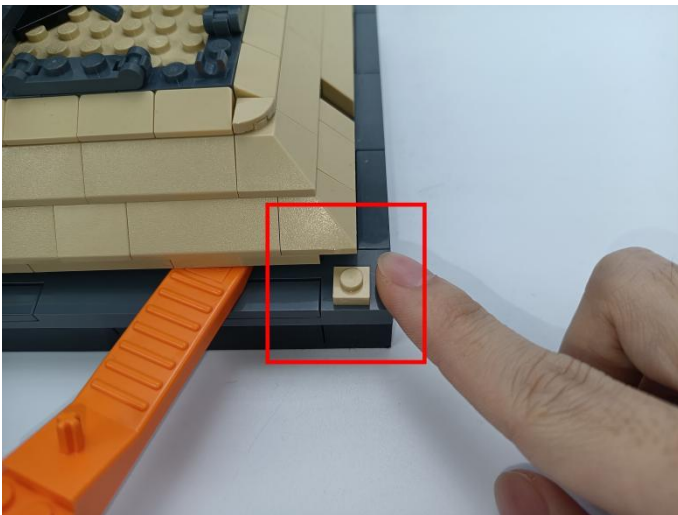

12



13

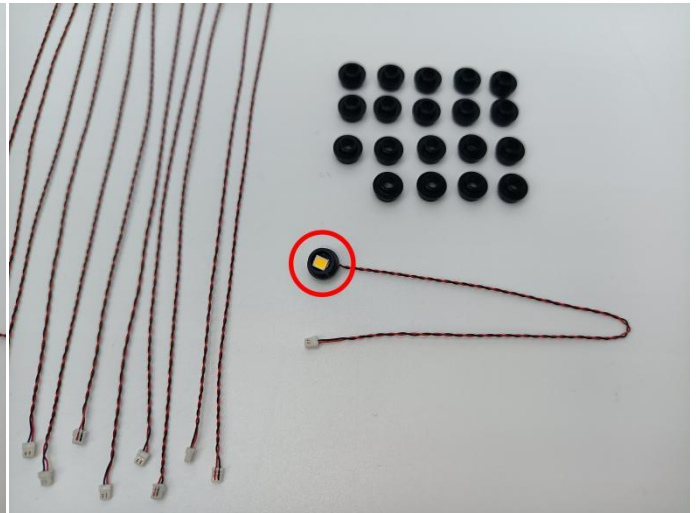
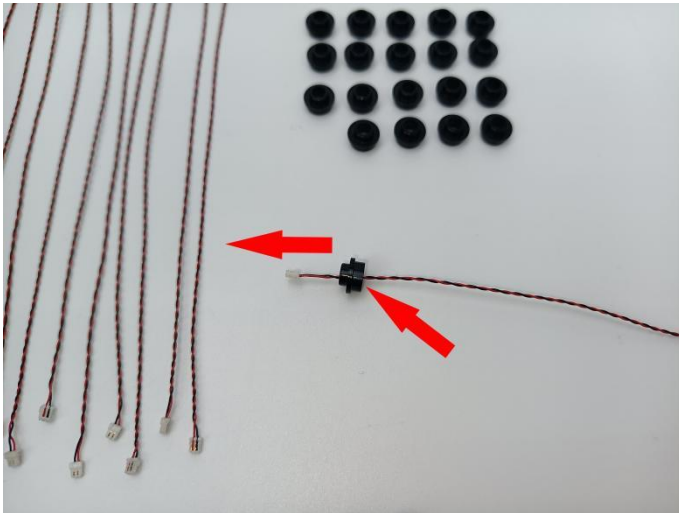

14

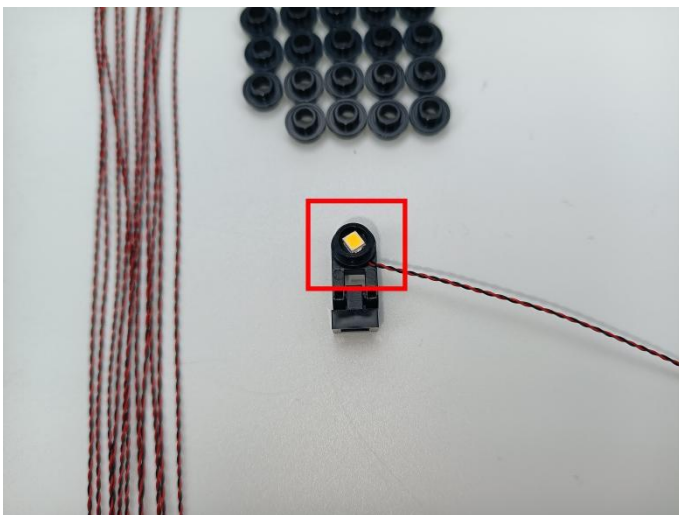

15



16



17



18

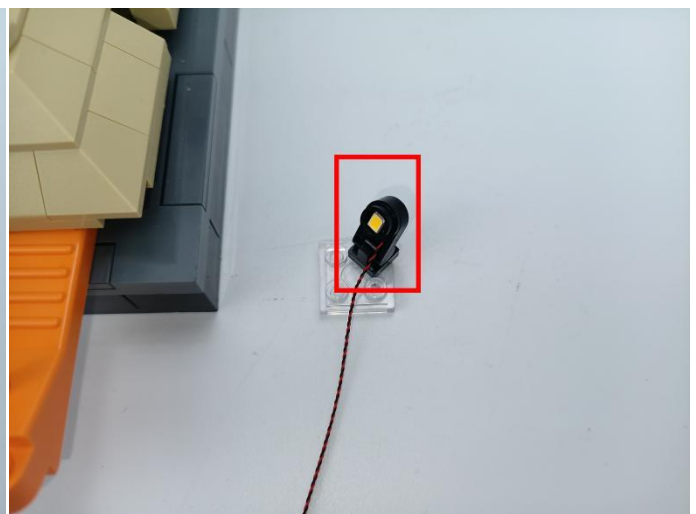
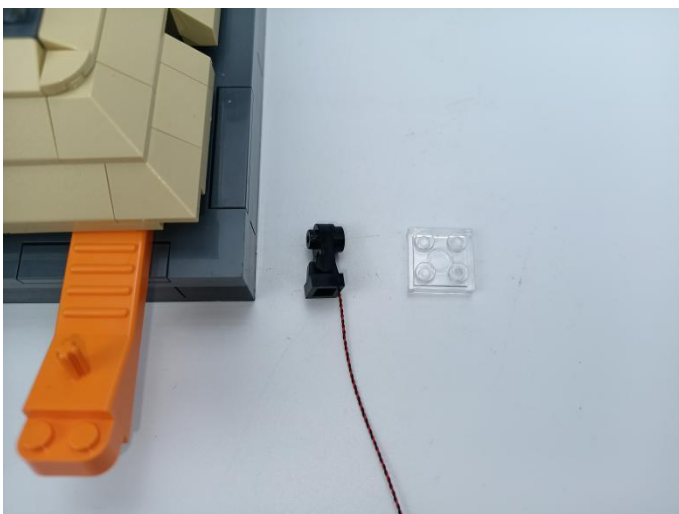



19

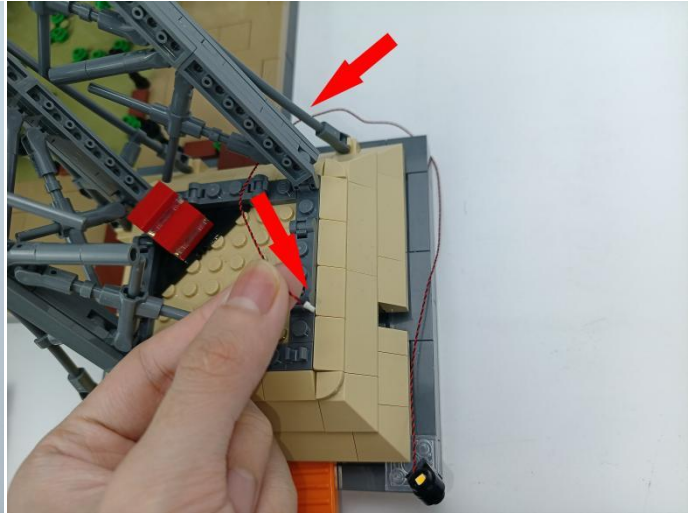
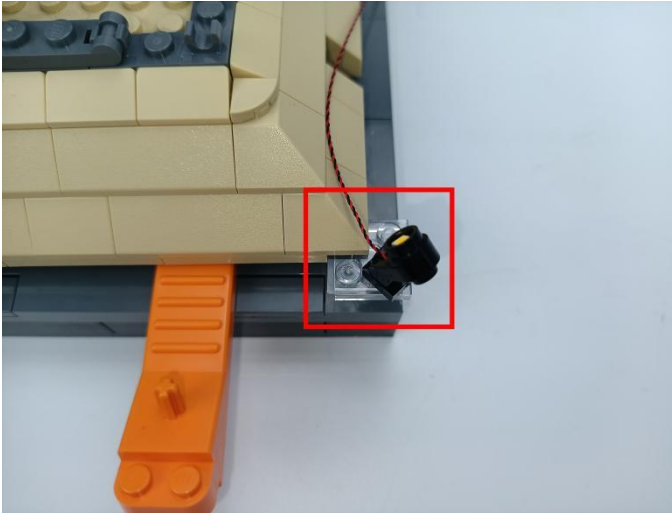

20

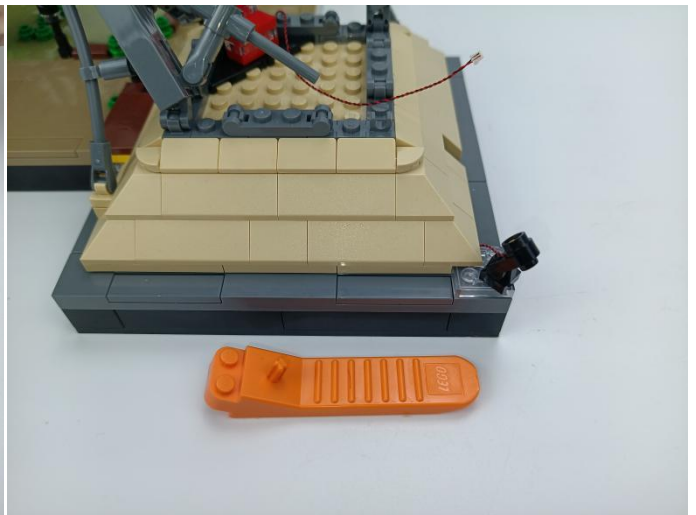
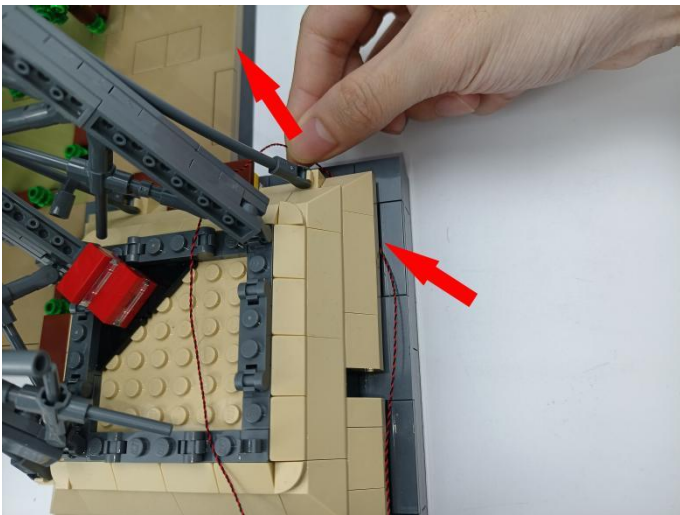

21

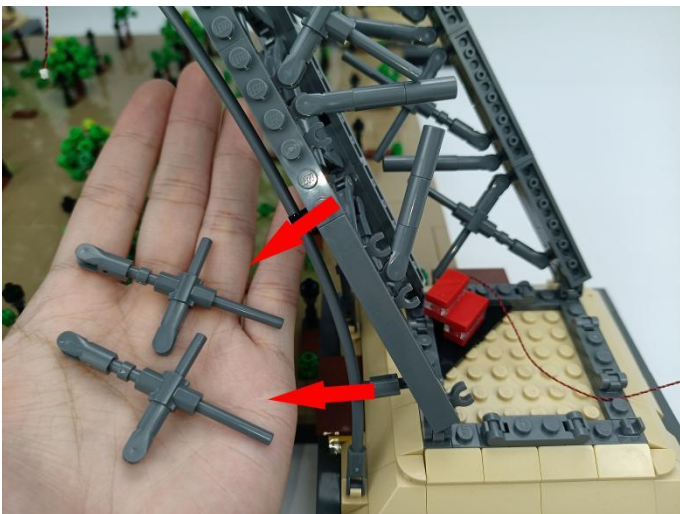

22

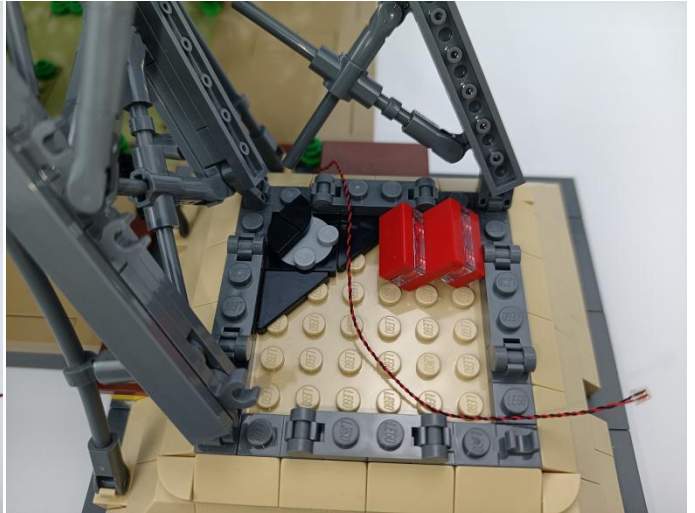
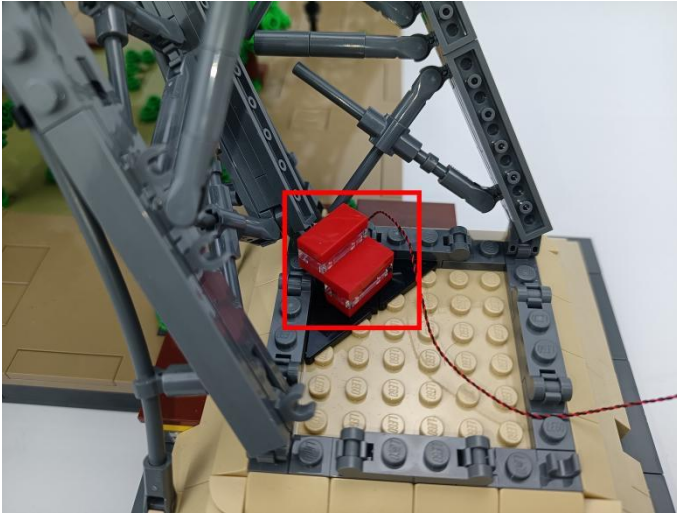

23

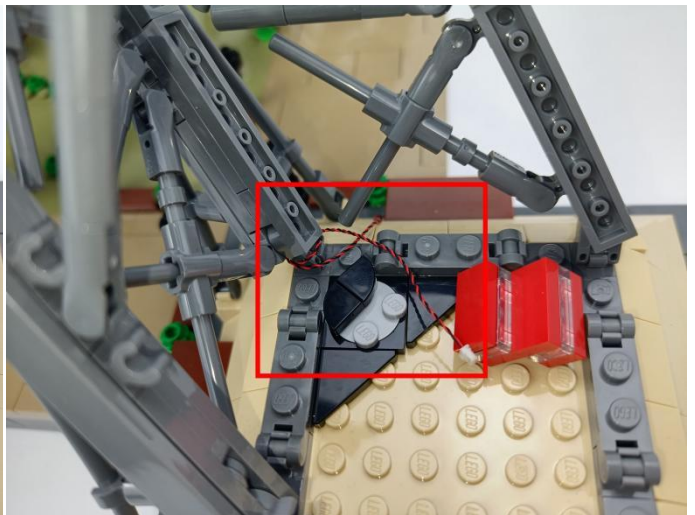
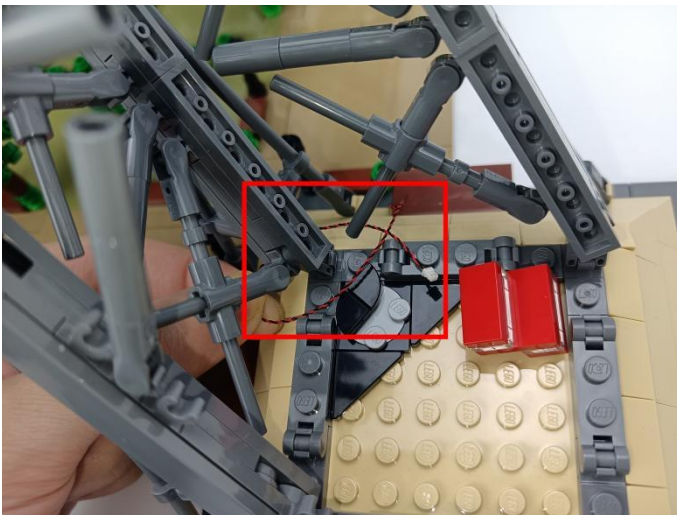

24





25

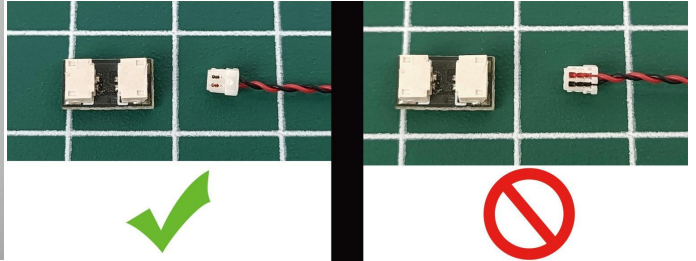

26

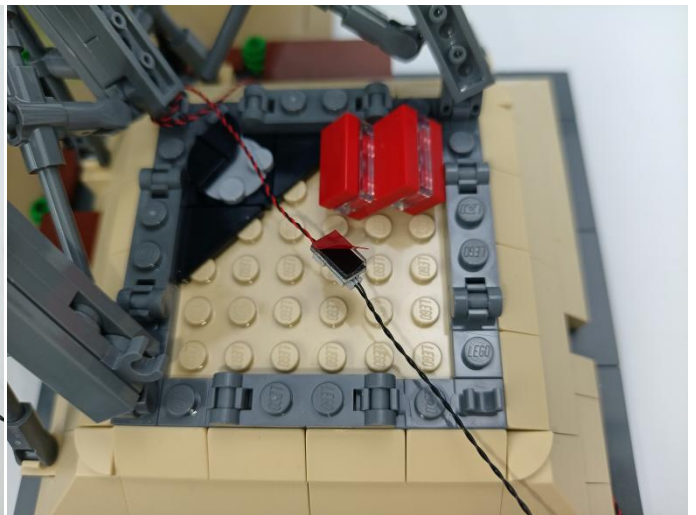
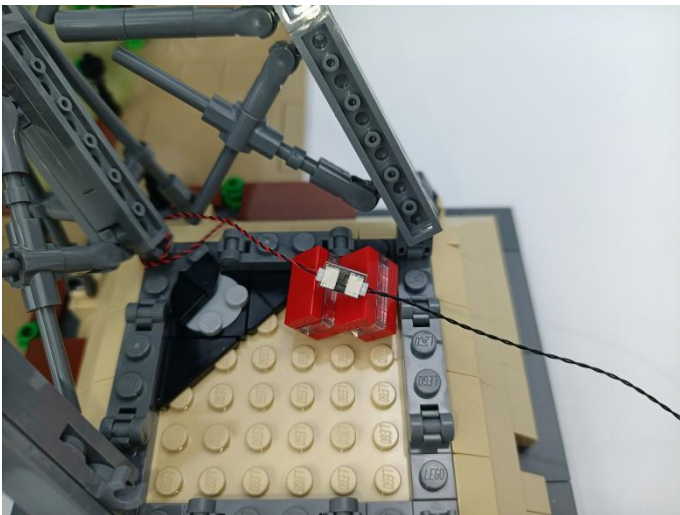

27

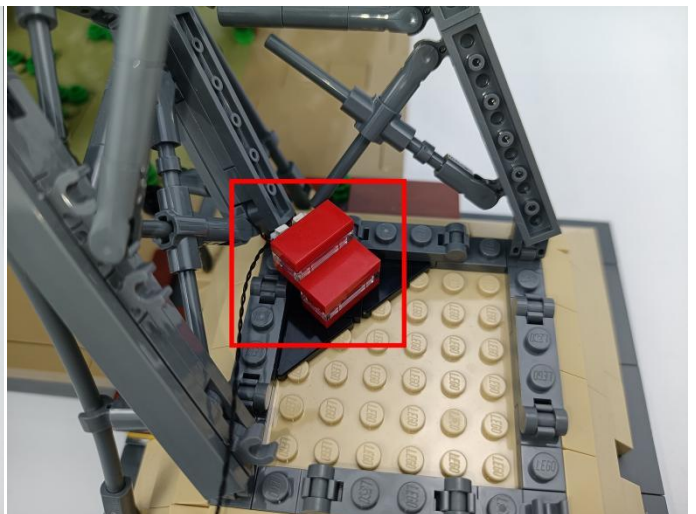
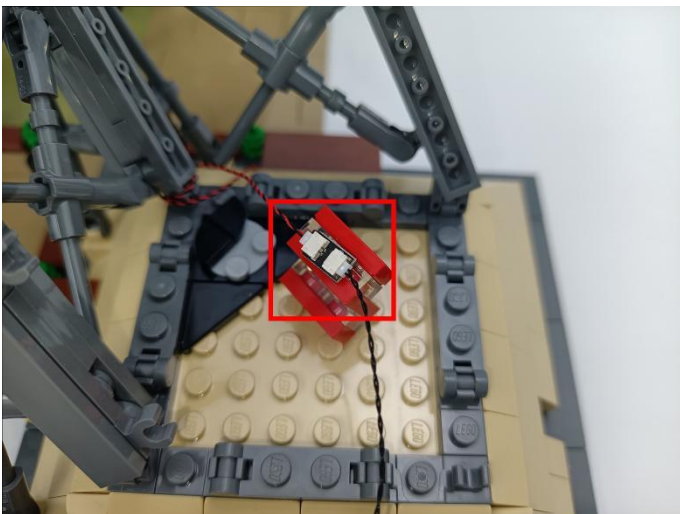

28

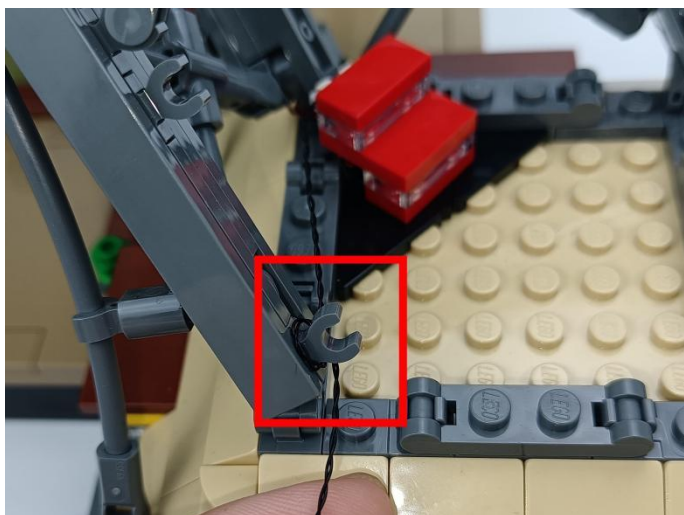

29

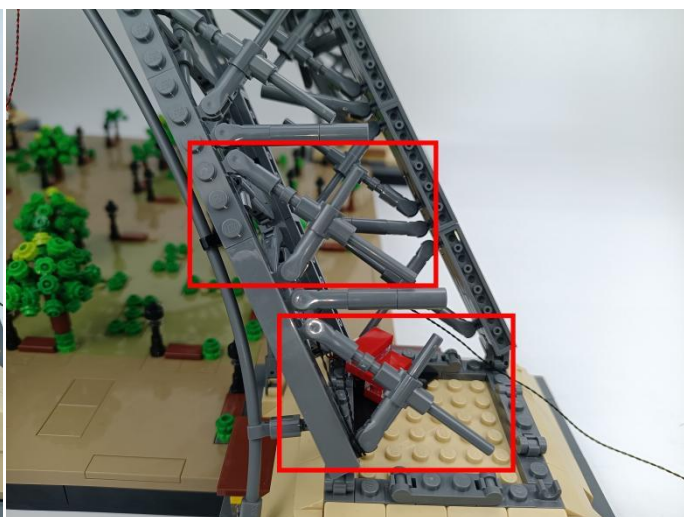

30





31

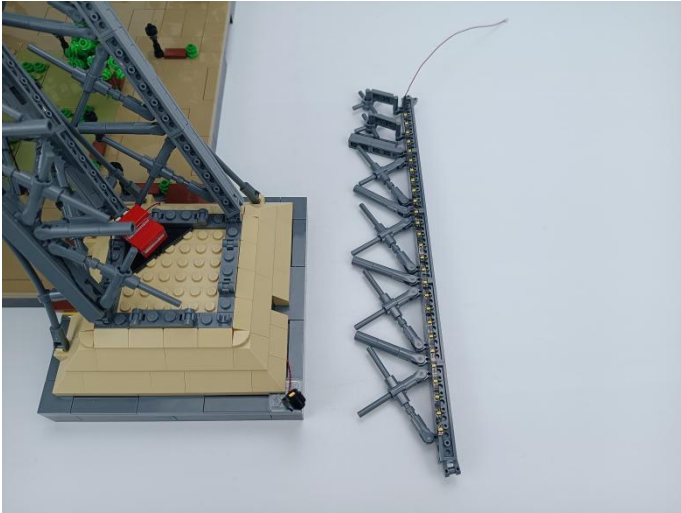

32

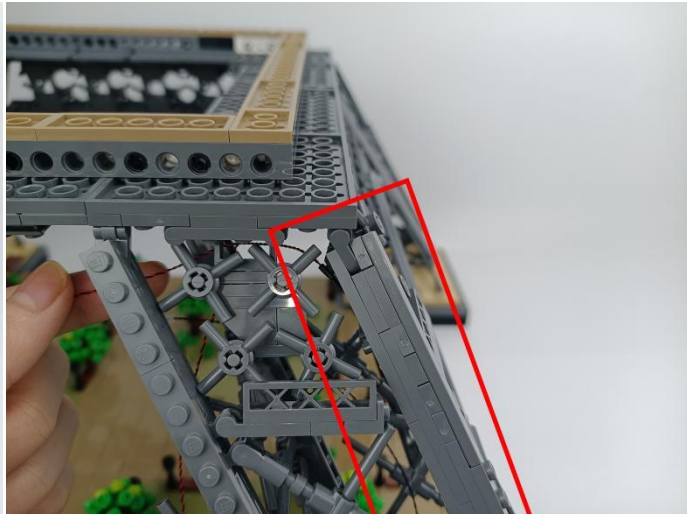
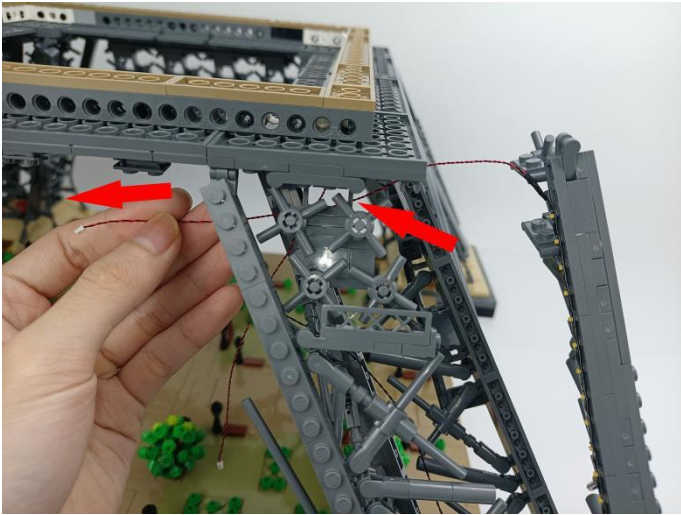

33

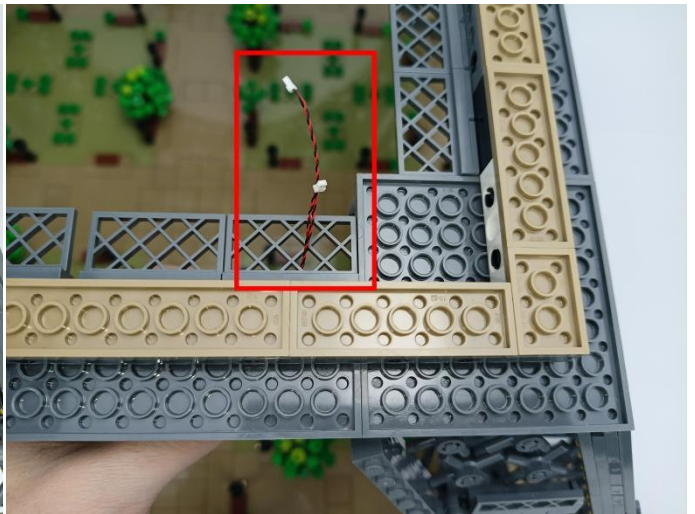
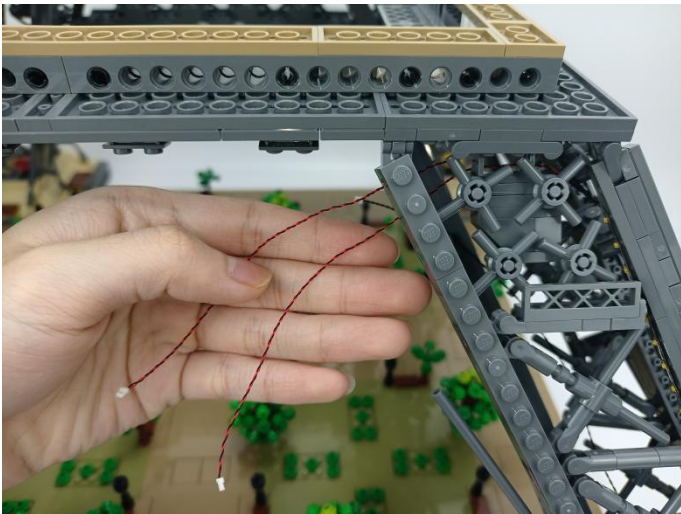



34

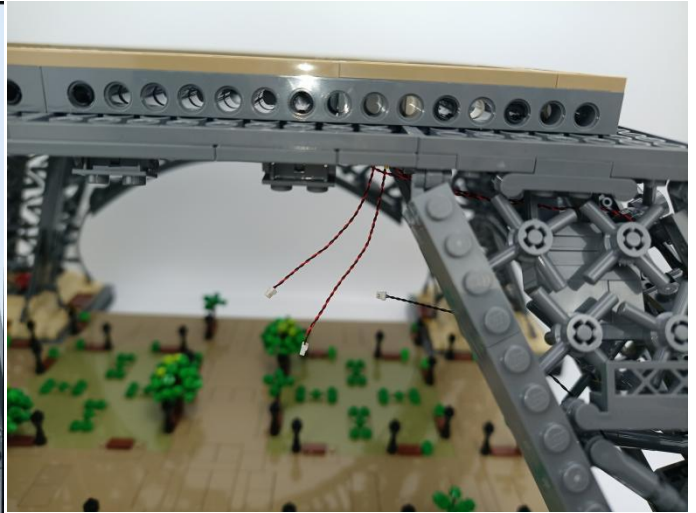

35



36

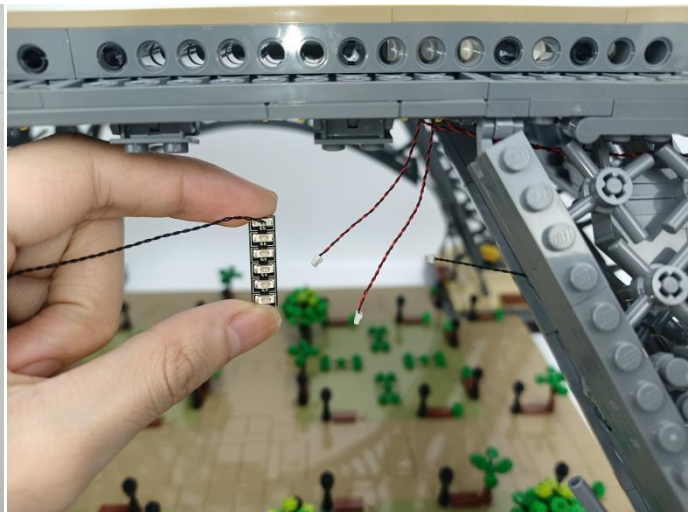

37

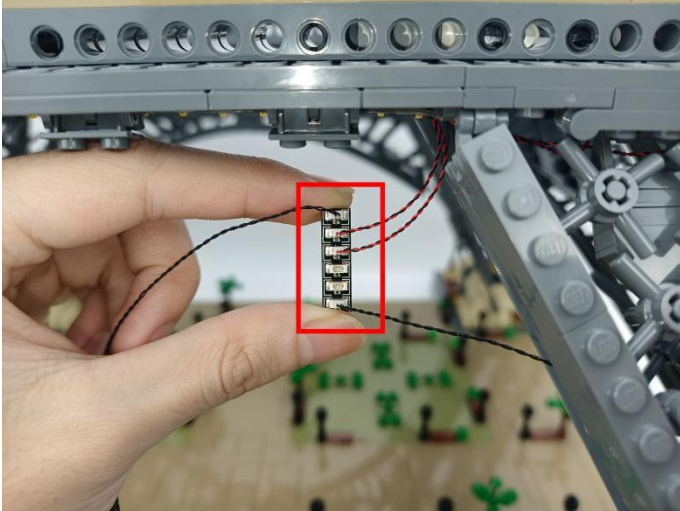

38

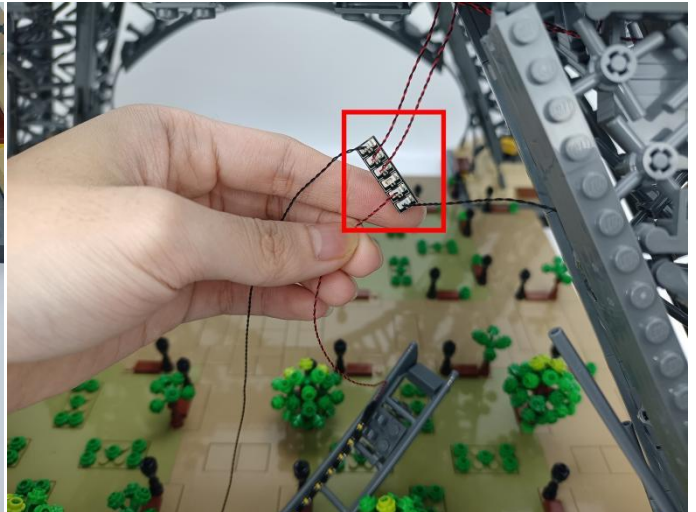

39

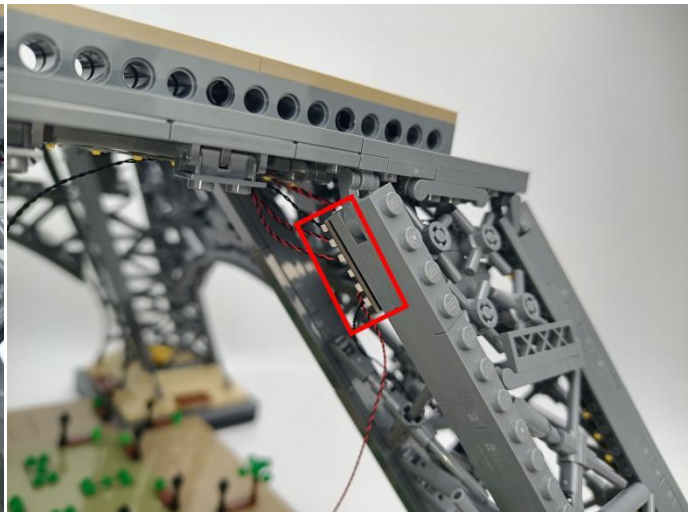
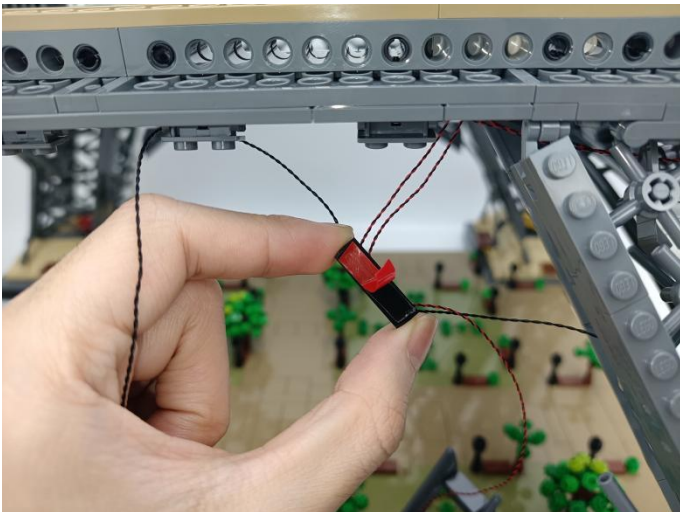



40

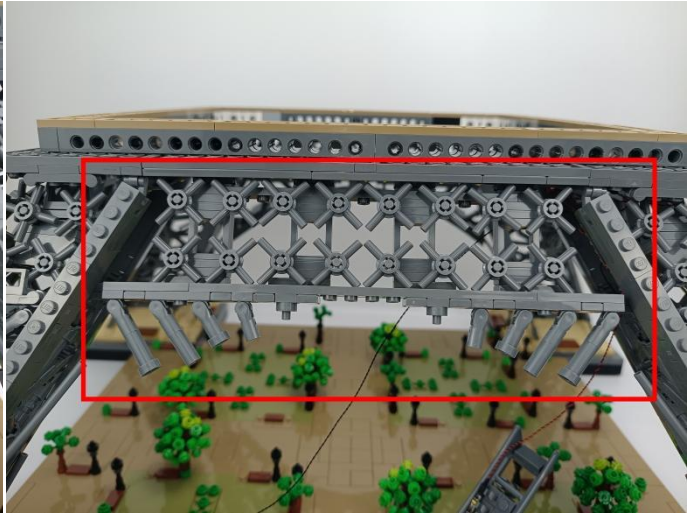
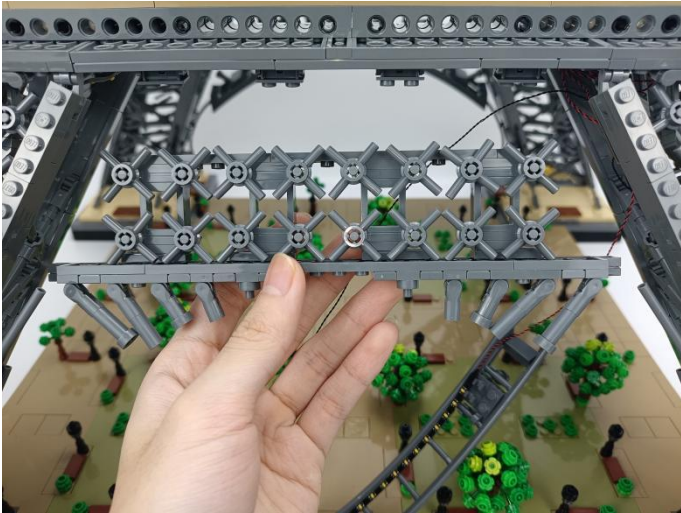

41

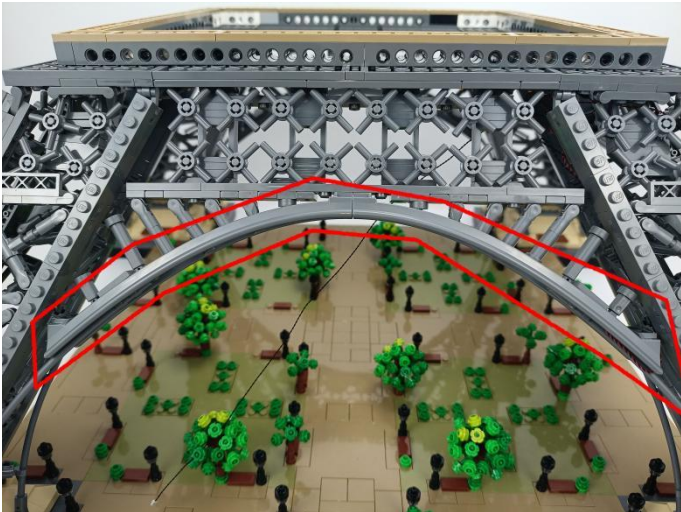

42

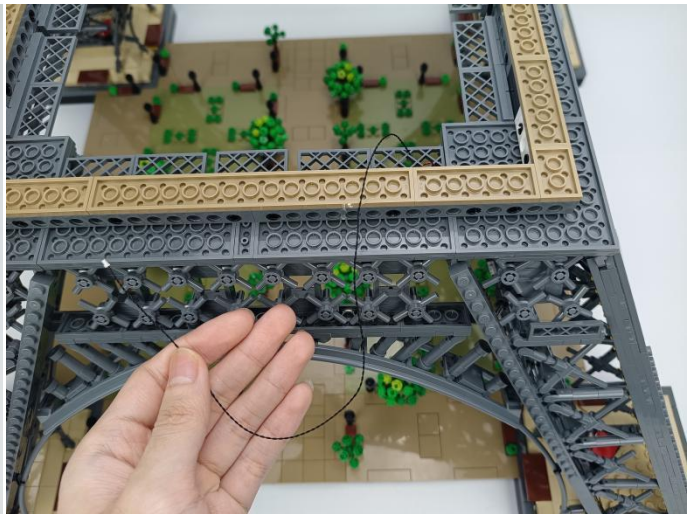



43

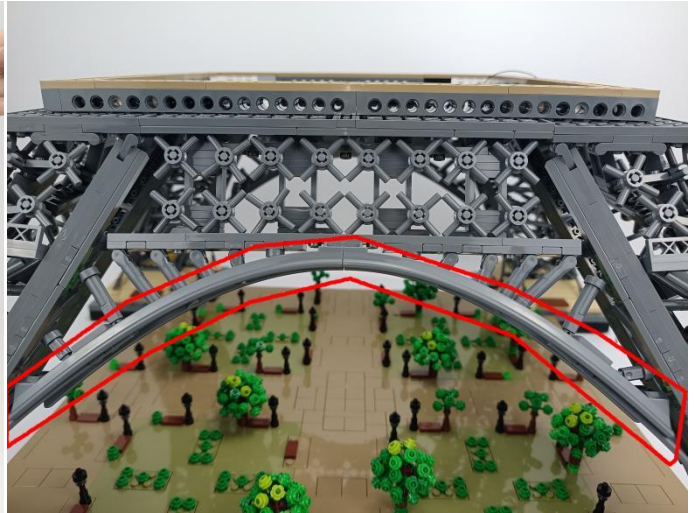
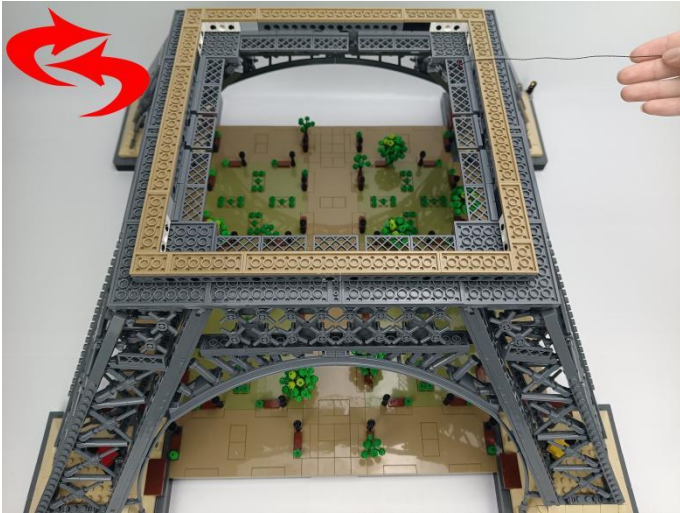

44



45





46

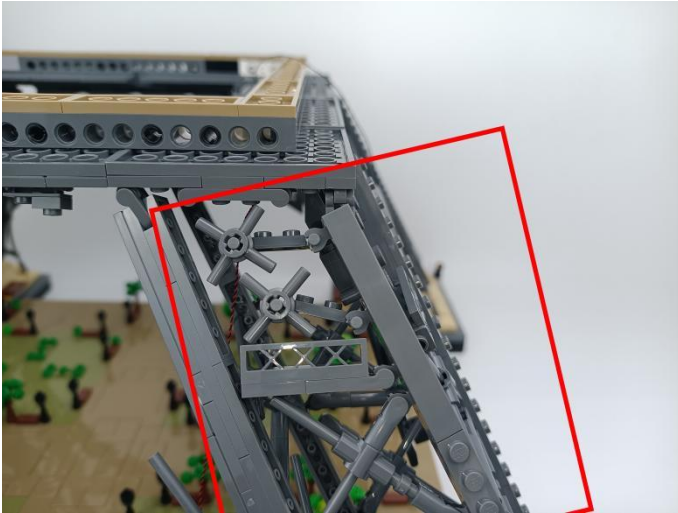

47

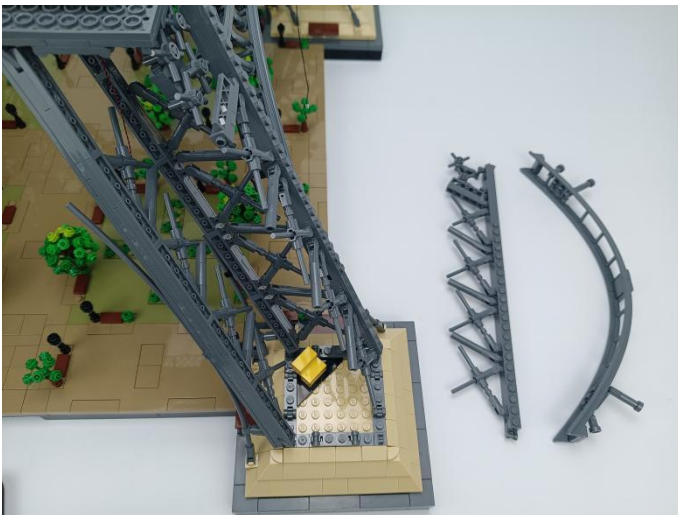

48

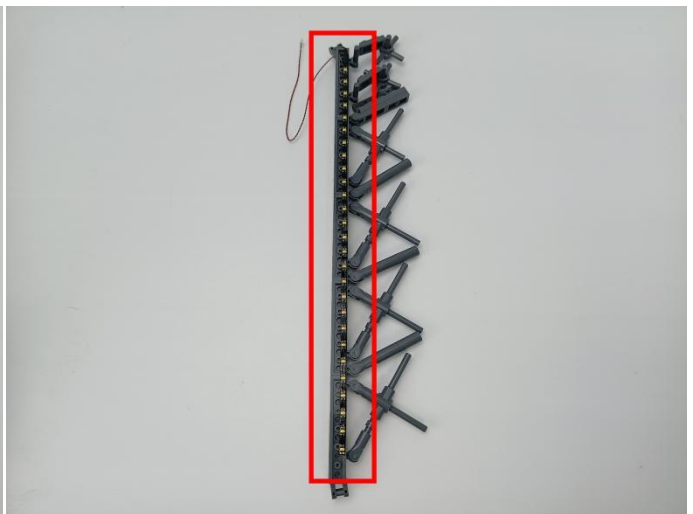

49

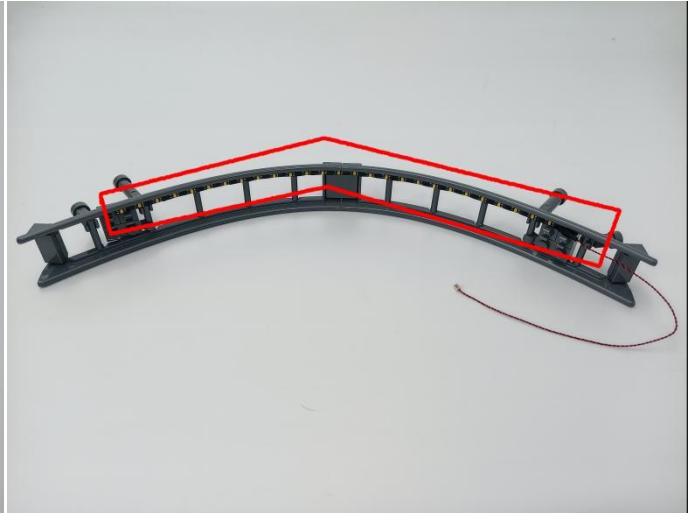

50



51





52

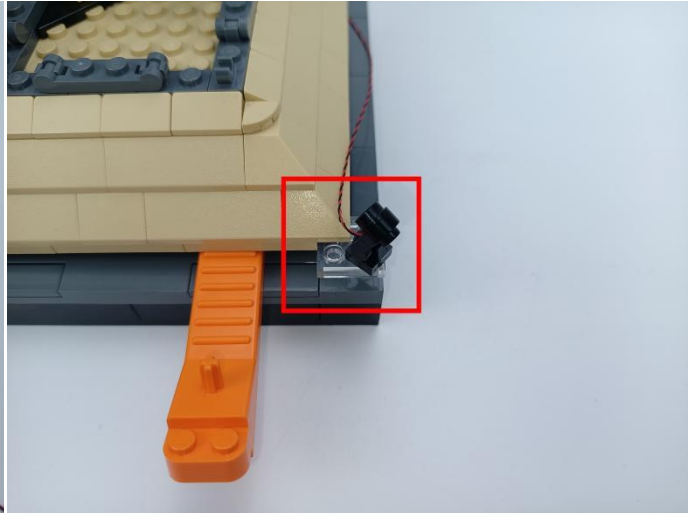
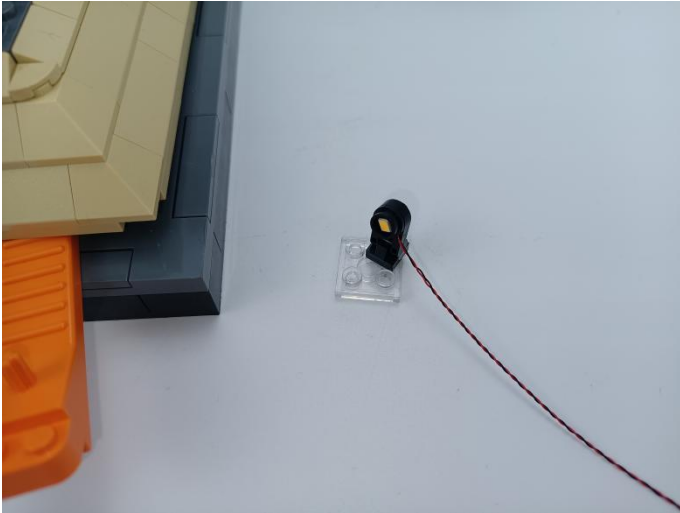

53

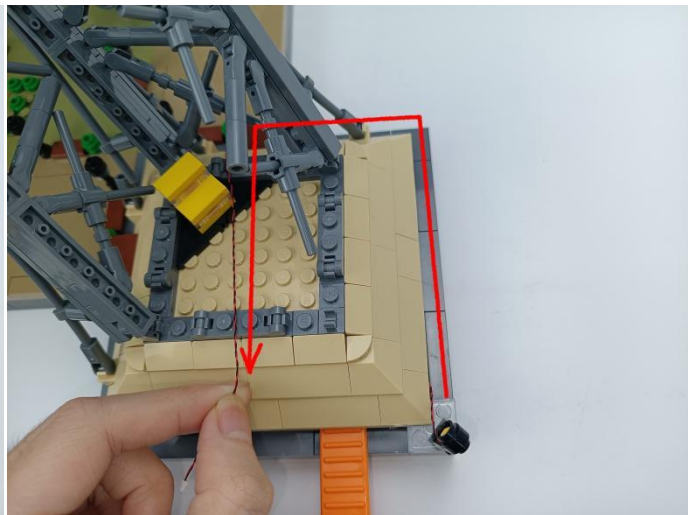
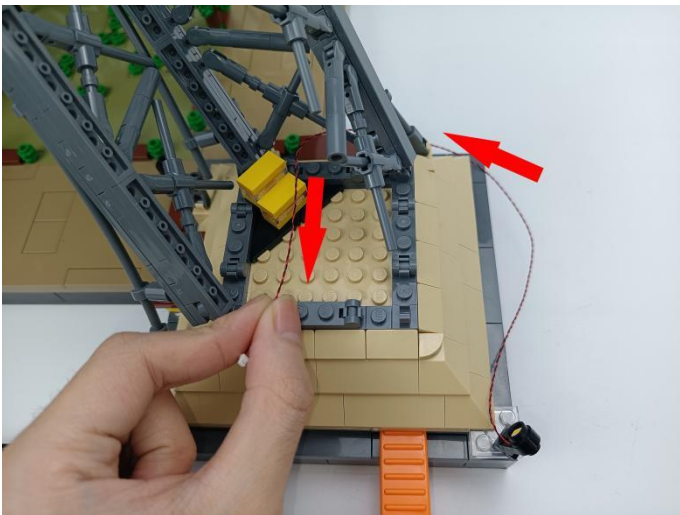

54

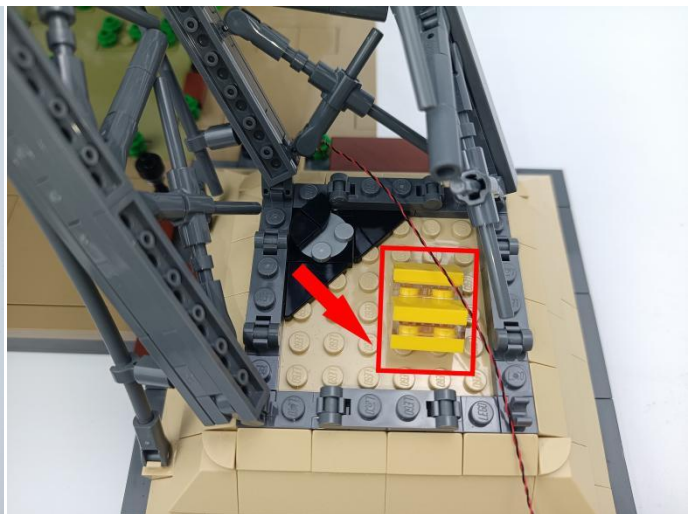
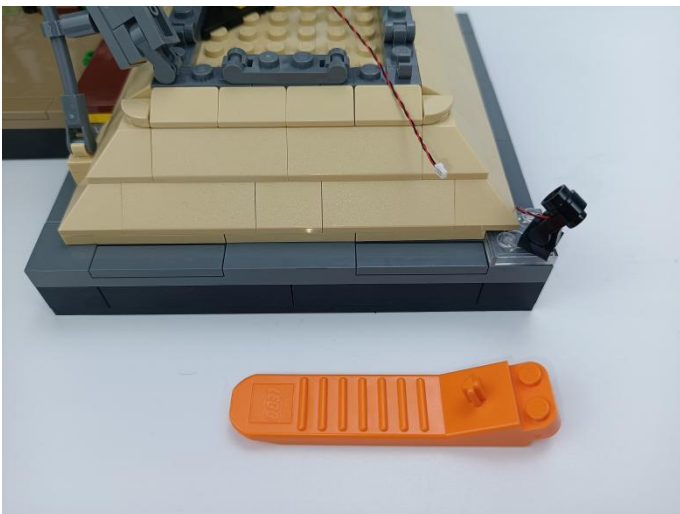

55

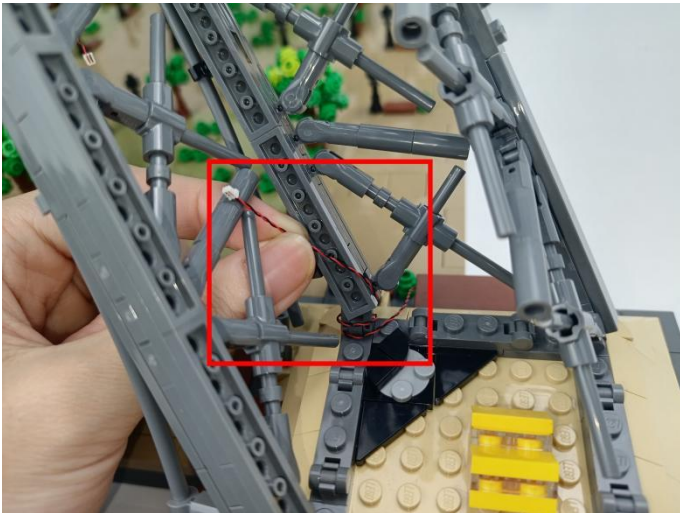

56



57

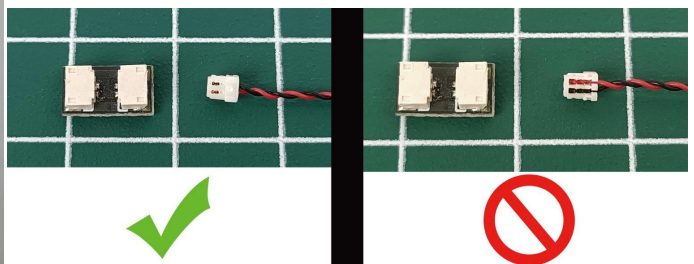



58

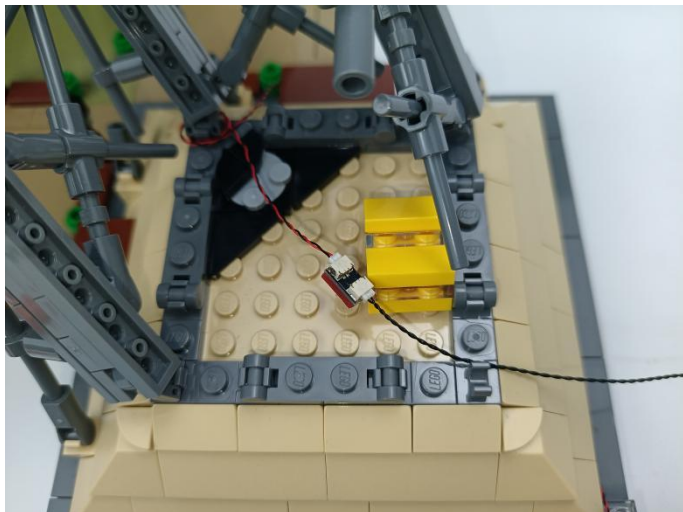

59

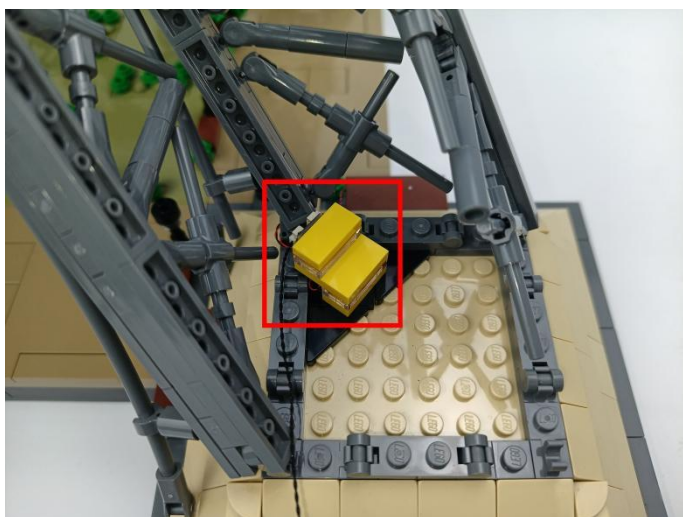

**60.** Put the connecting wire through the bottom of the block piece and pull it upward.

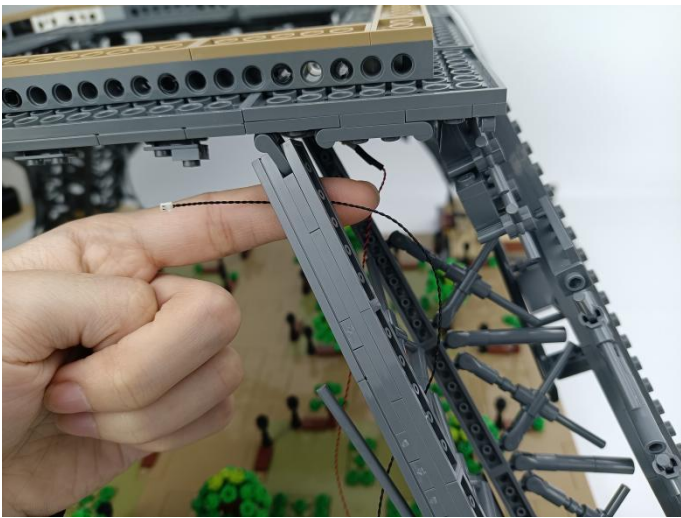
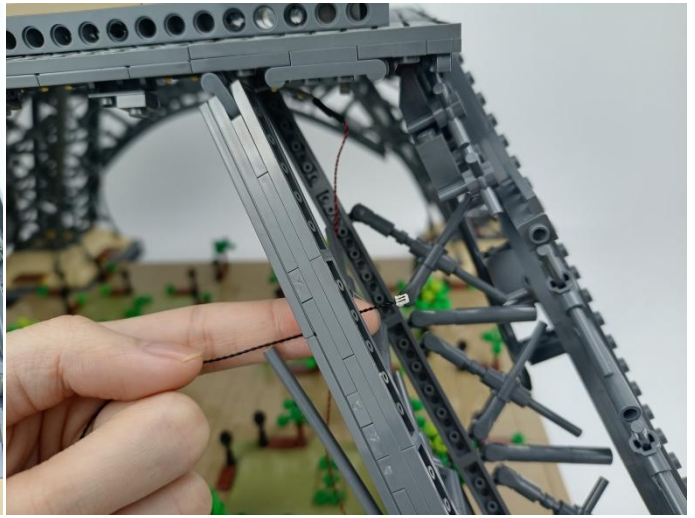
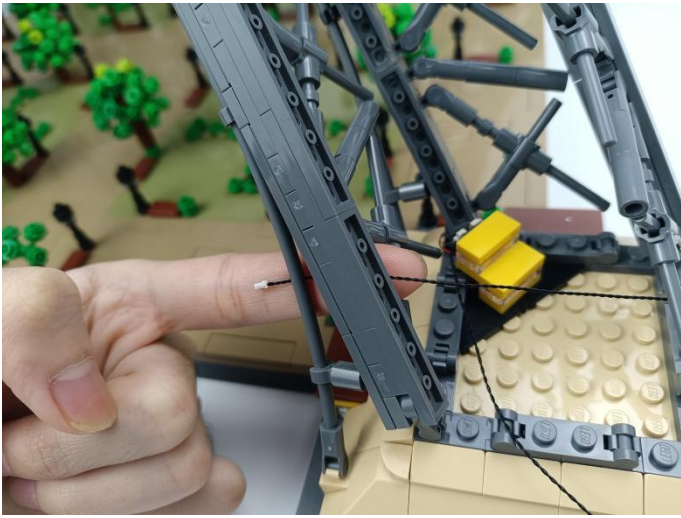

**61**

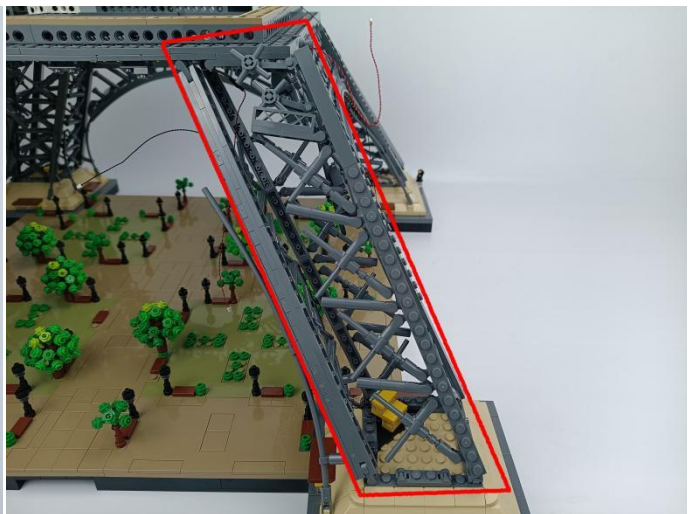
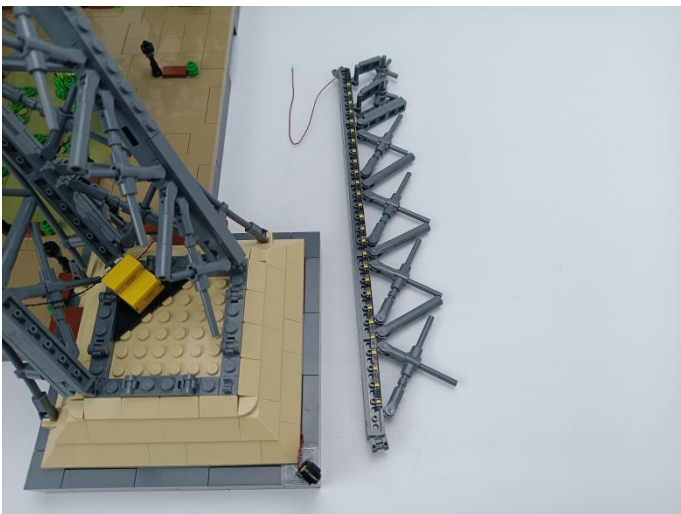



62

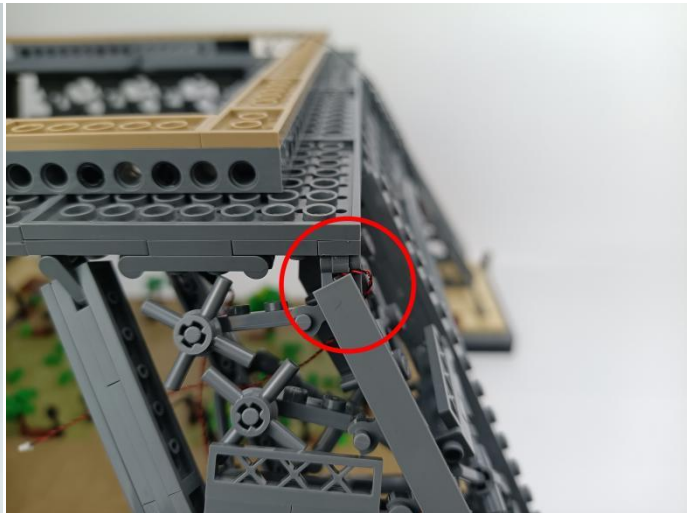
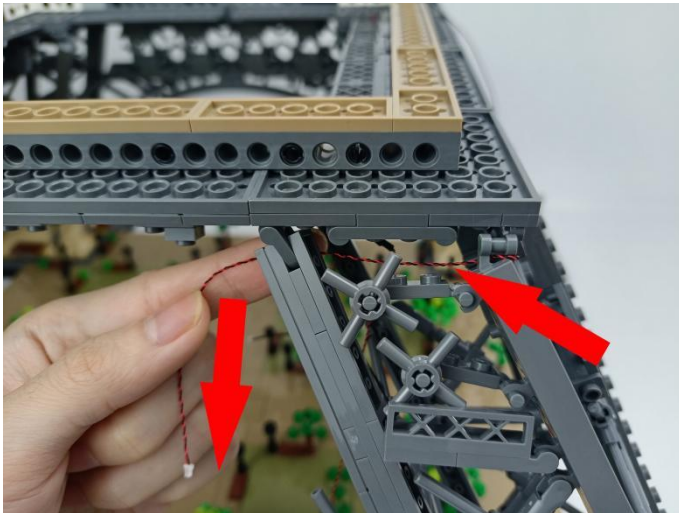

63

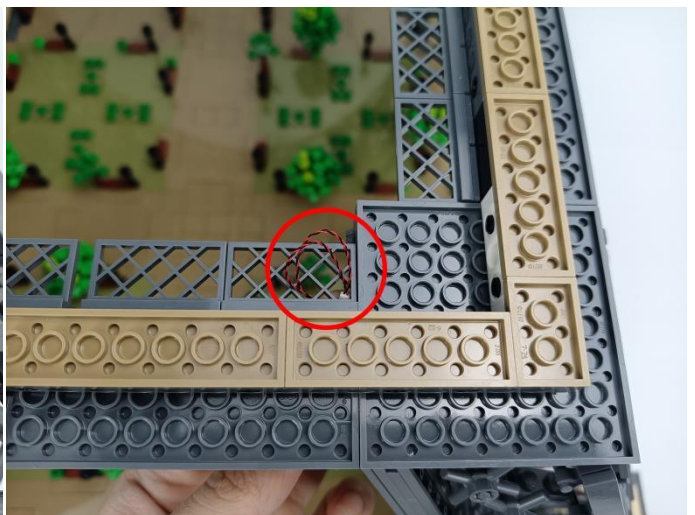

64

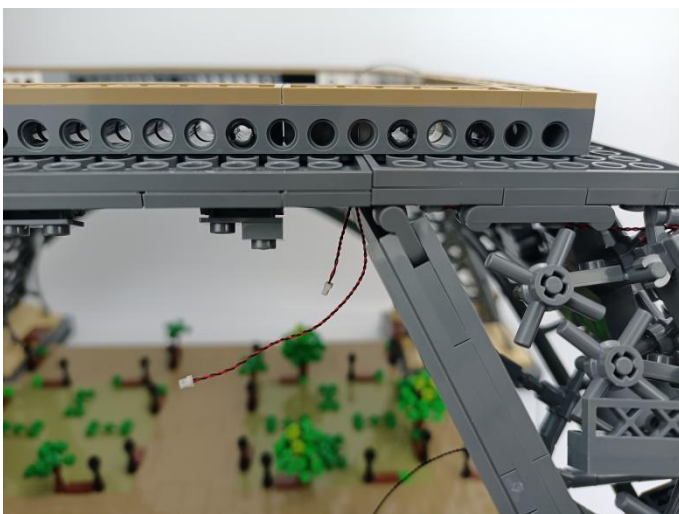

65



66

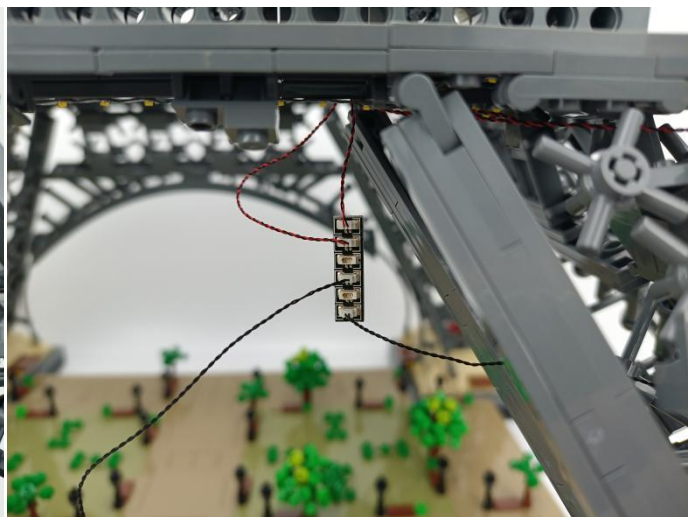
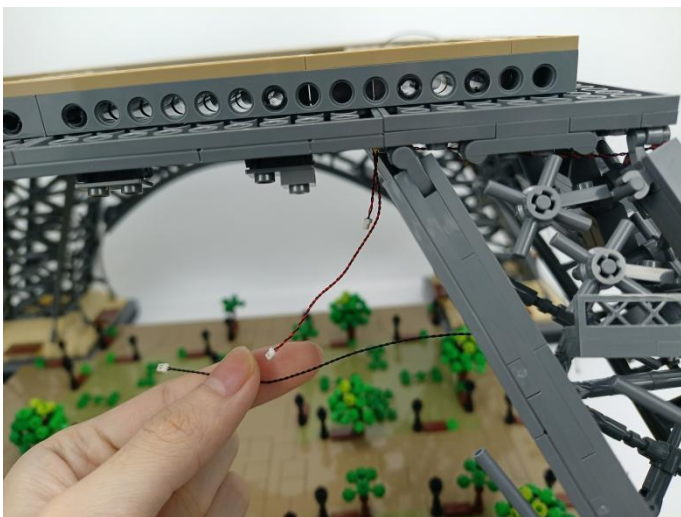

67

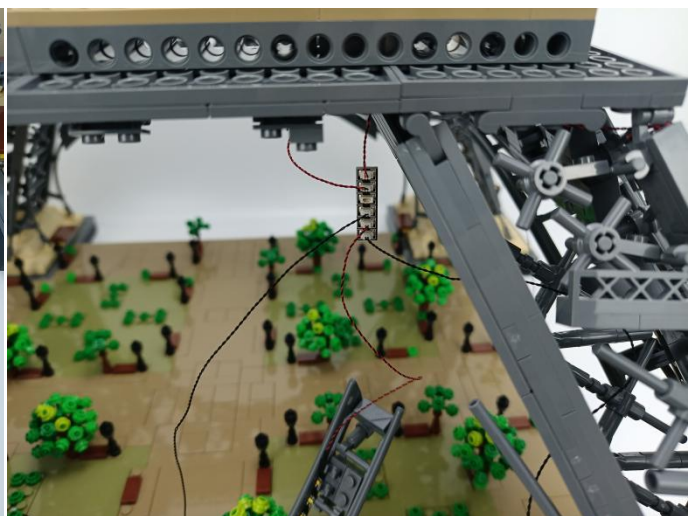
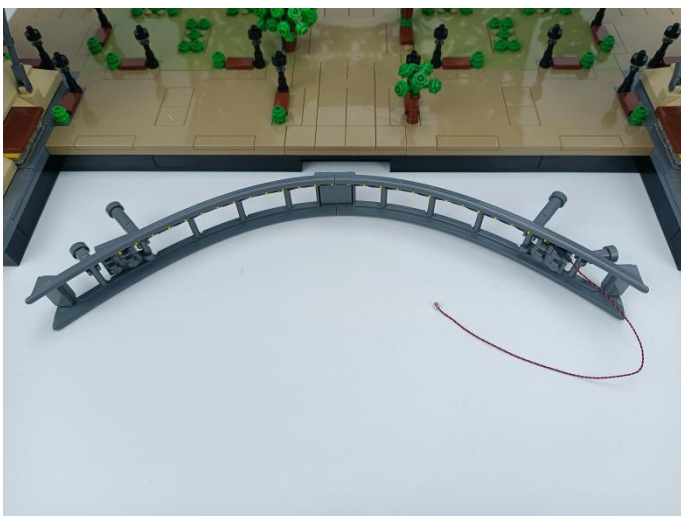



68

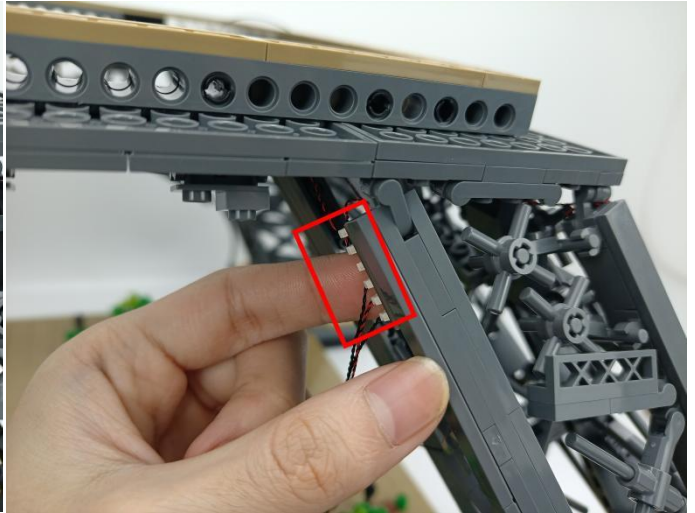
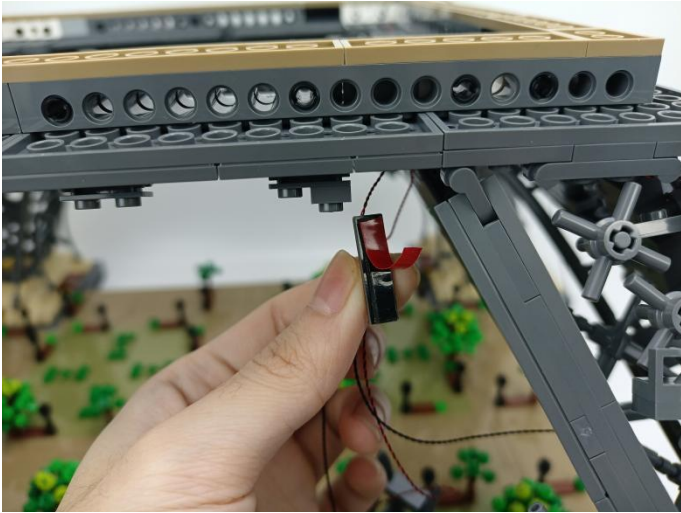

69

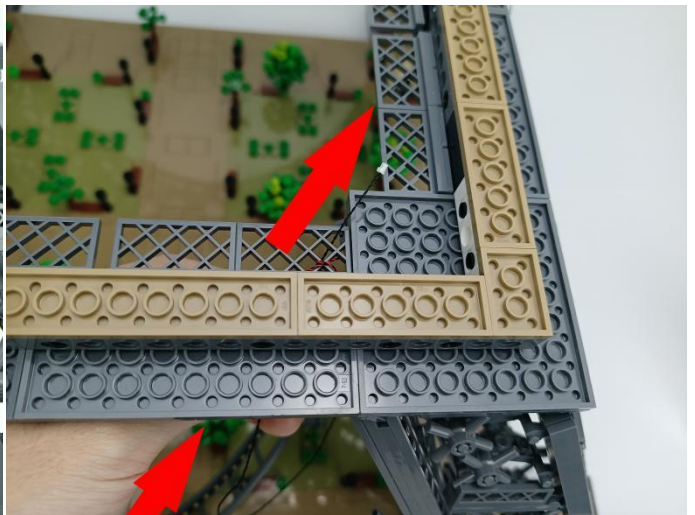

70

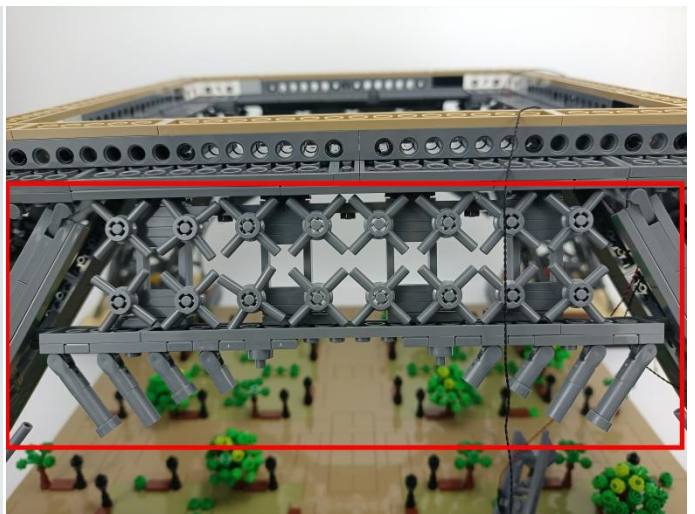
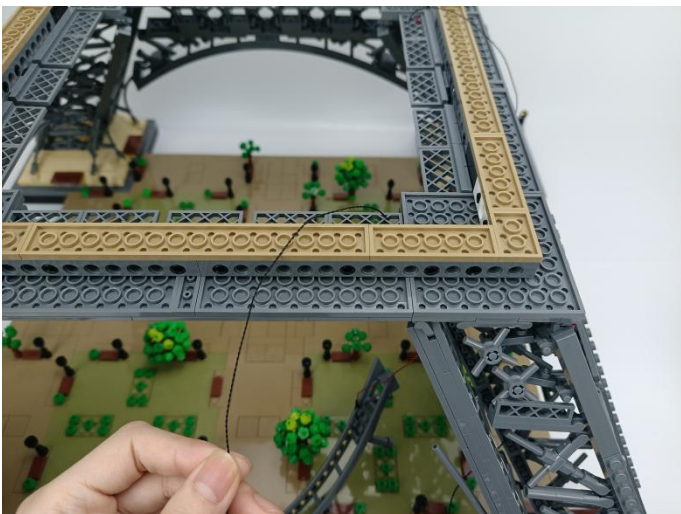



71

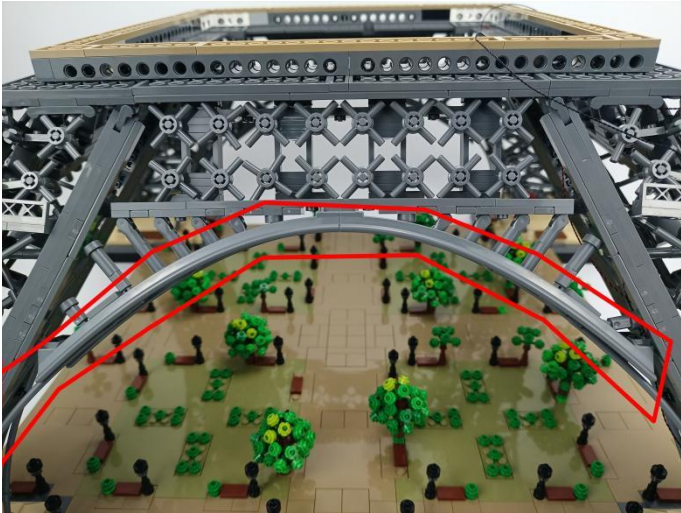

72

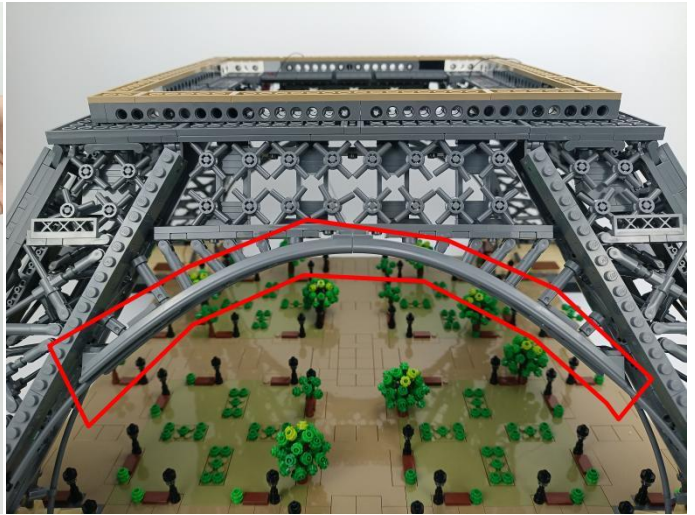

73

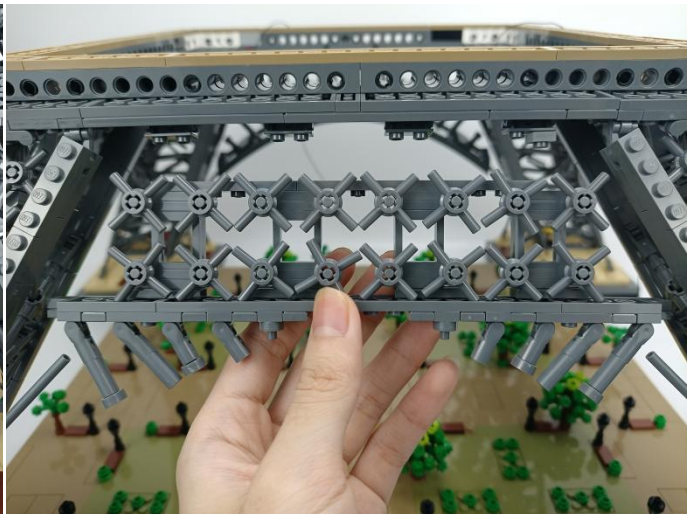
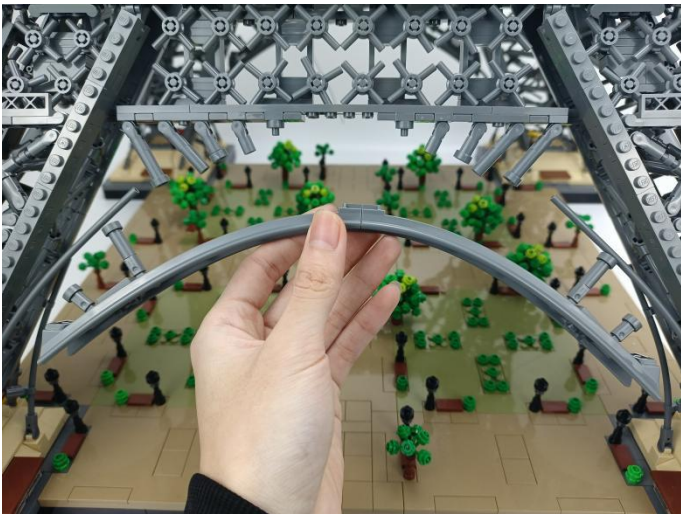



74

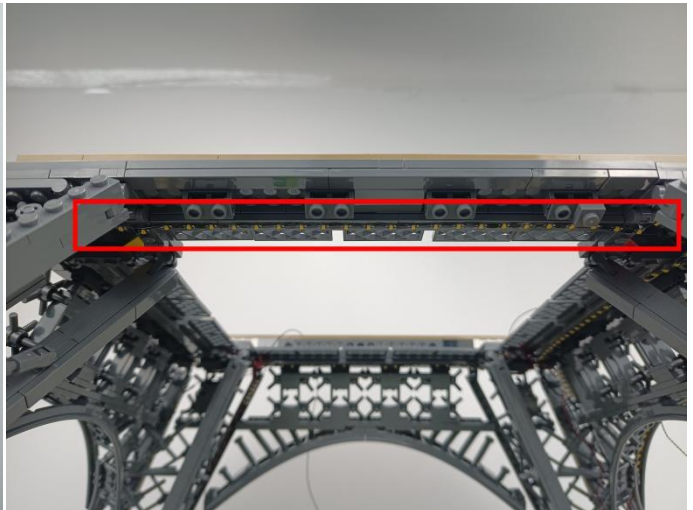

75



76



77

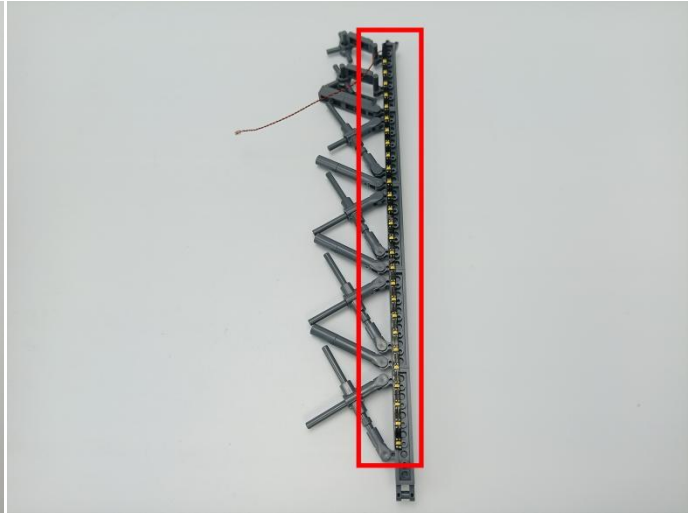
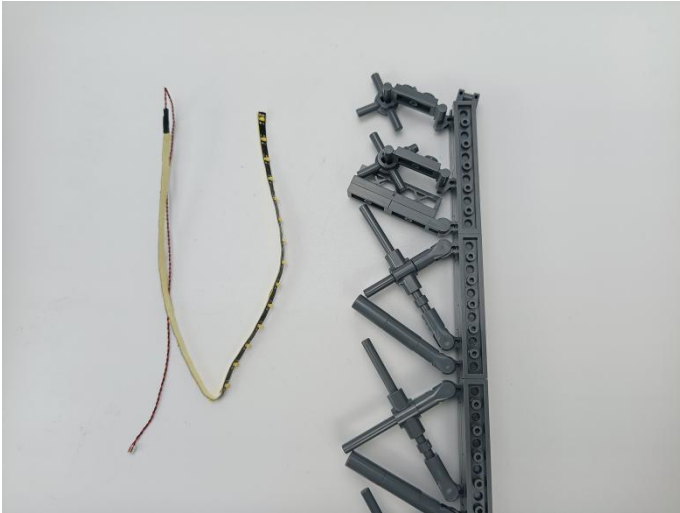

78



79

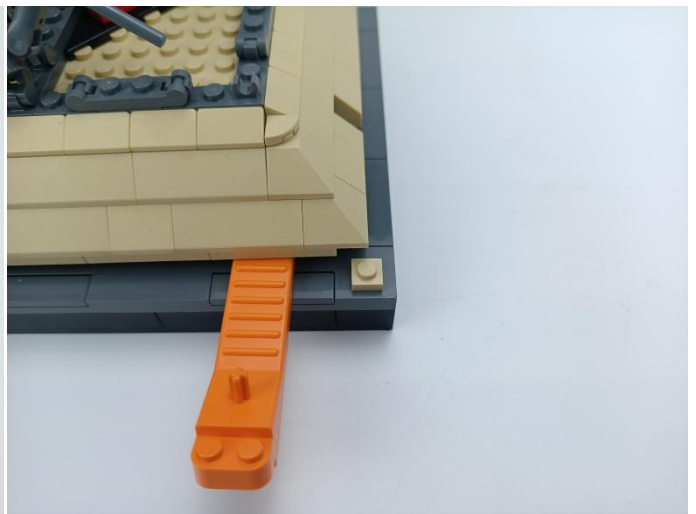



80



81

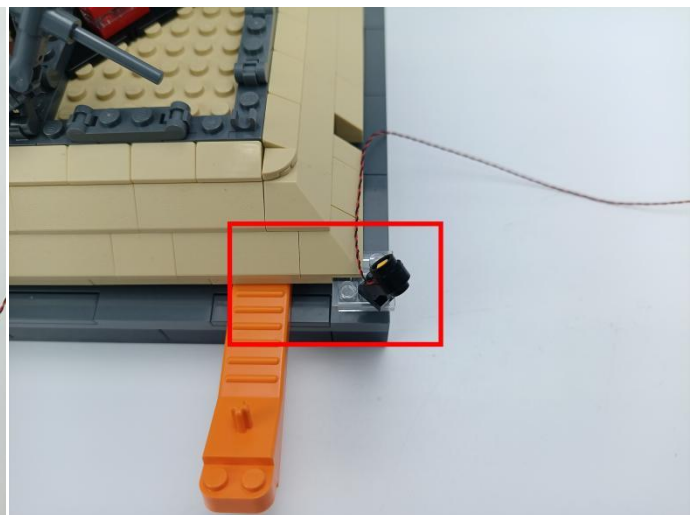
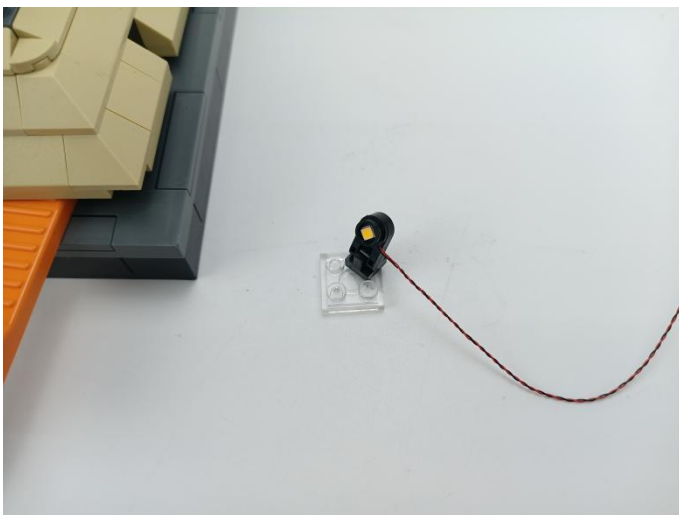

82

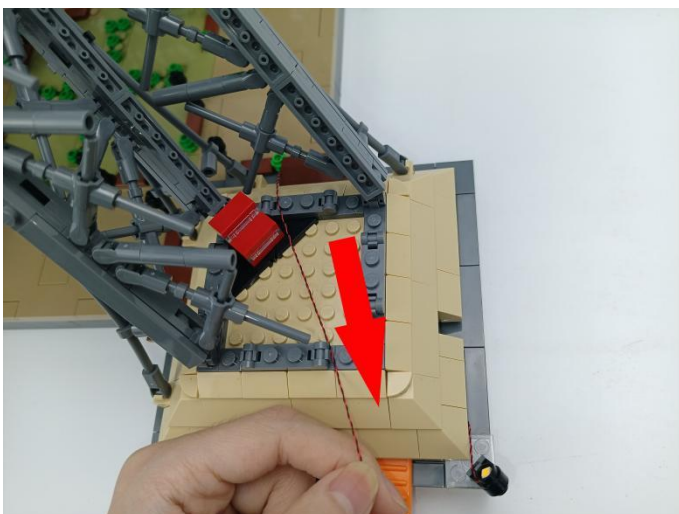

83

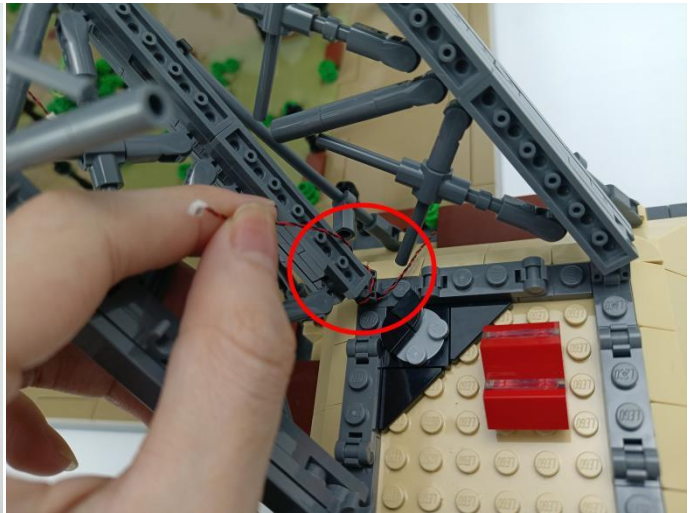
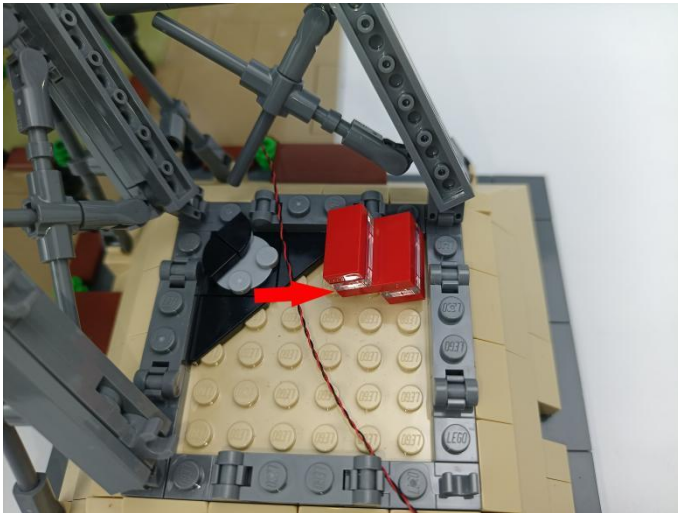

84



85

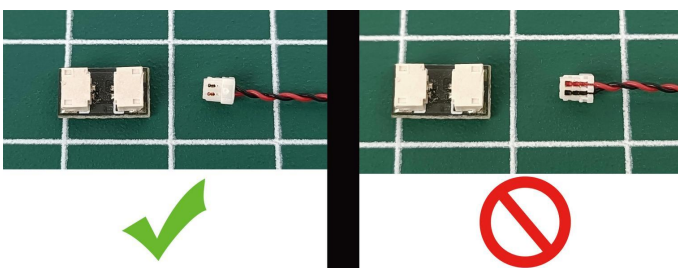



86

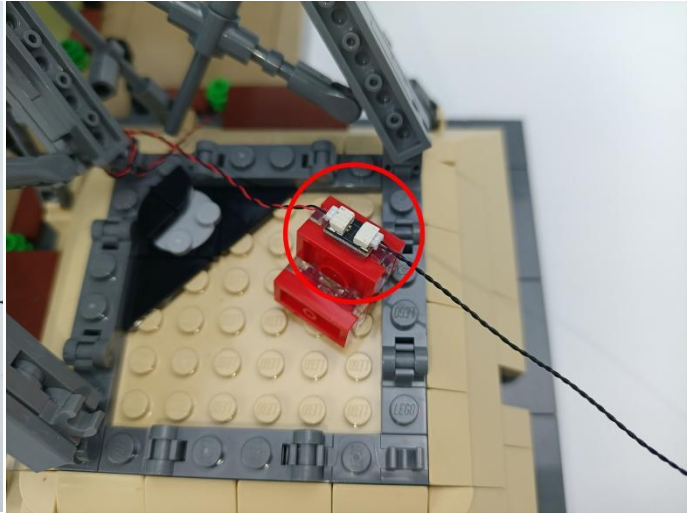
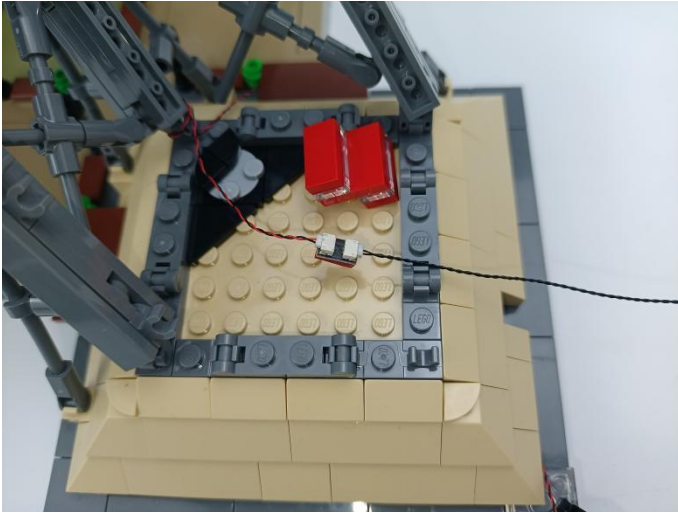

87

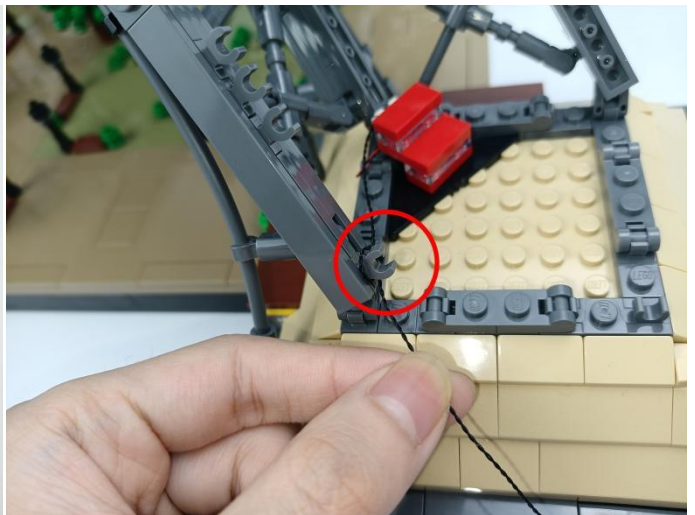
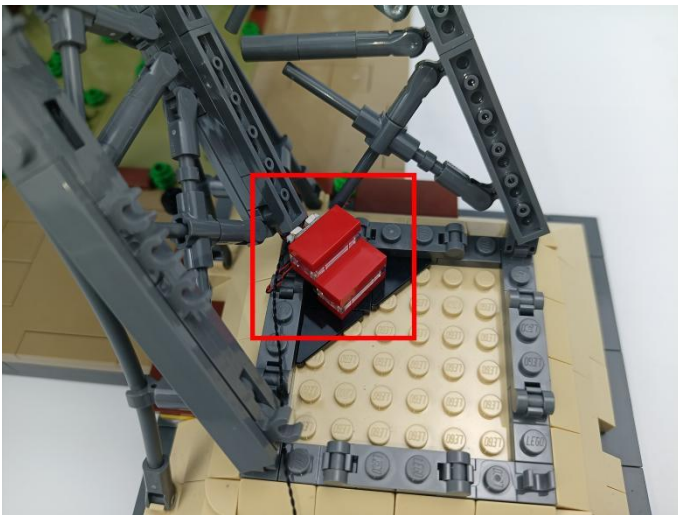

88

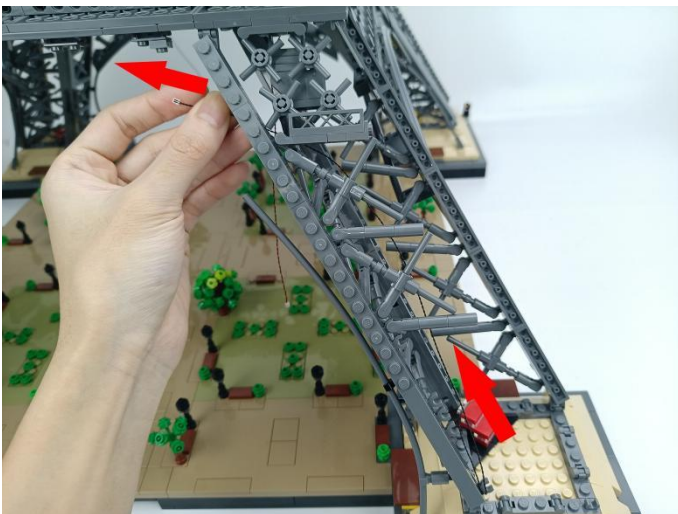



89

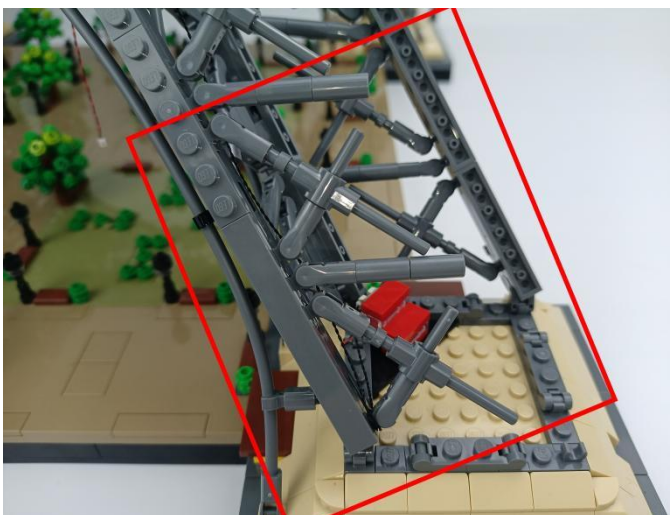

90

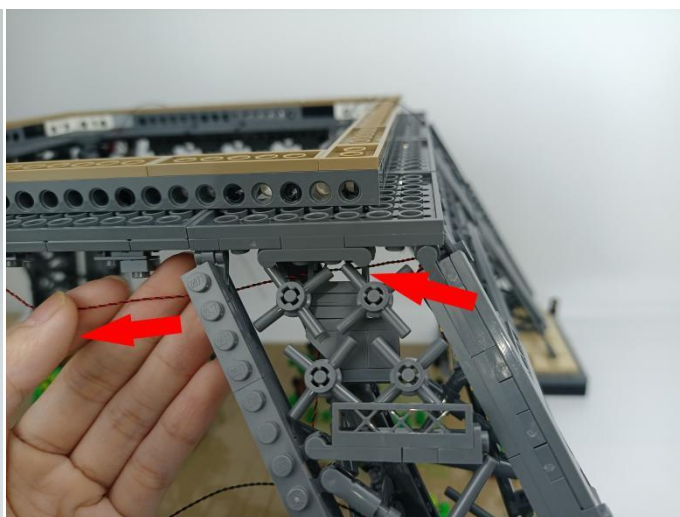

91

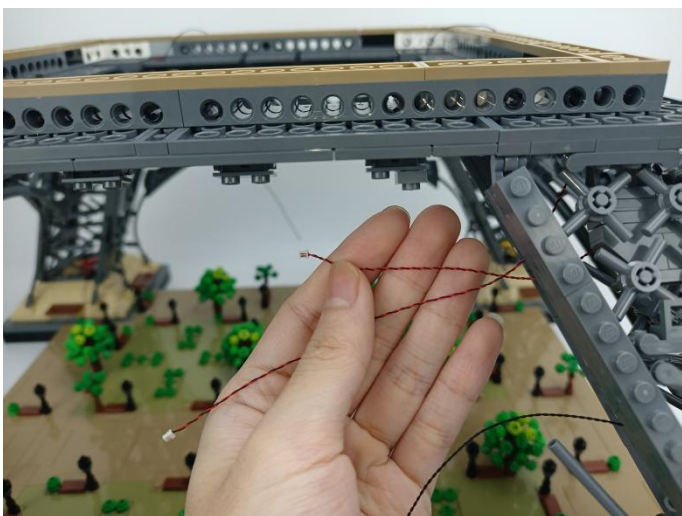



92

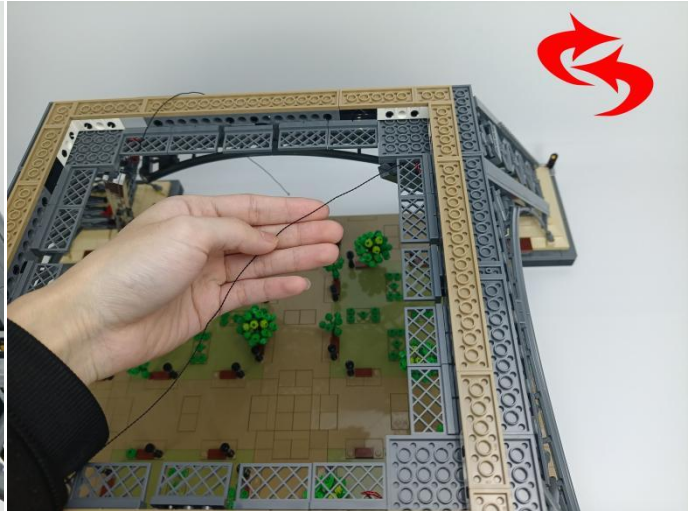
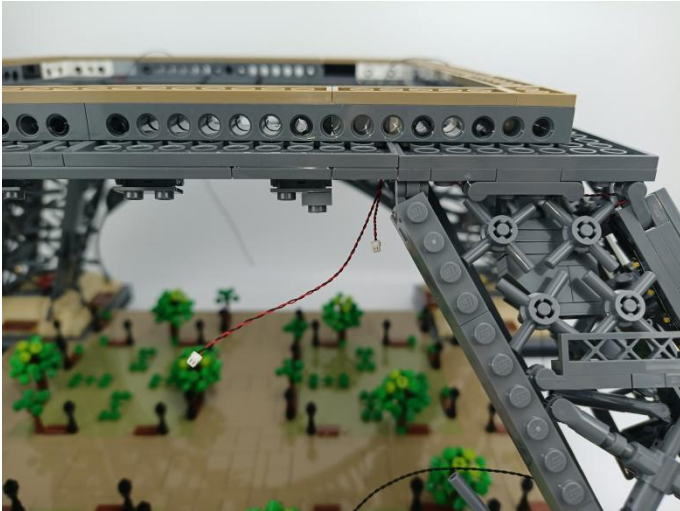

93

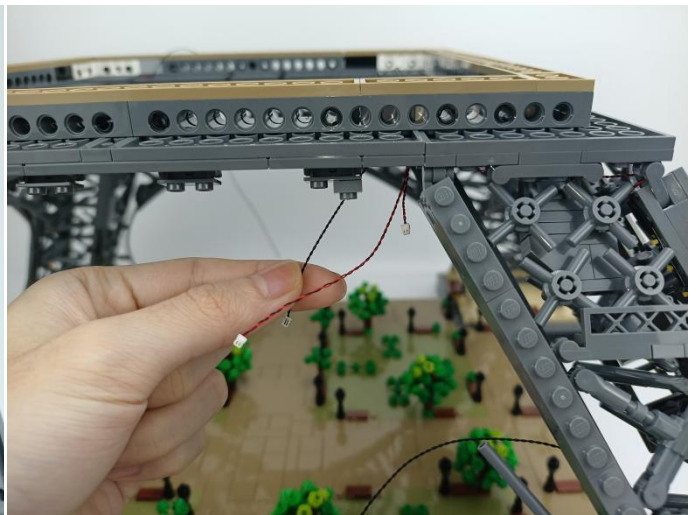
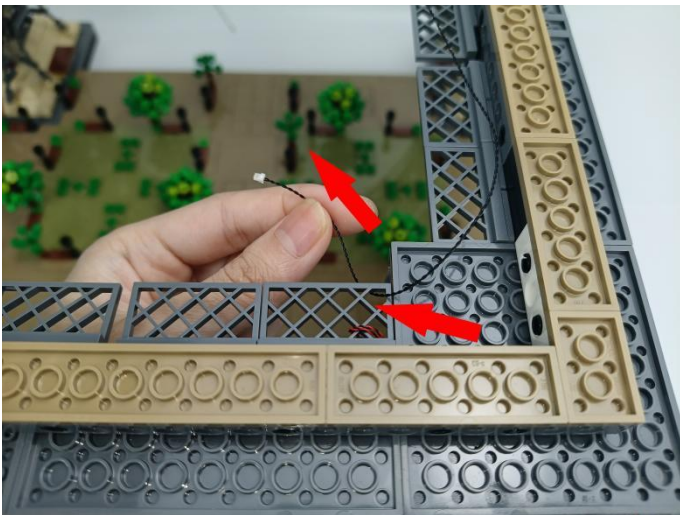

94





95

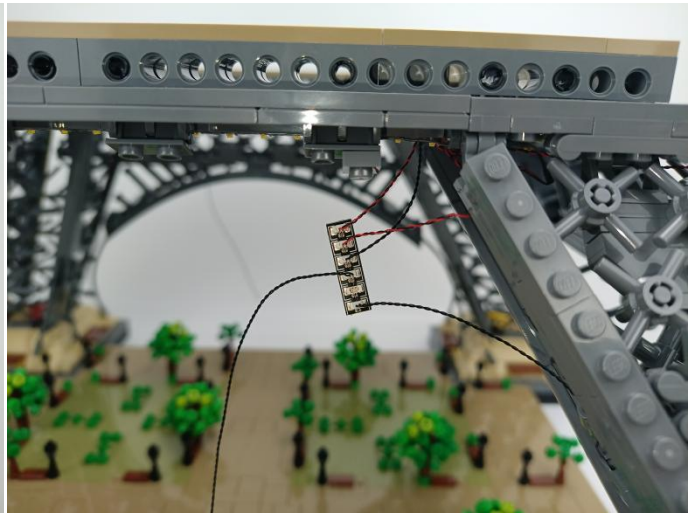

96

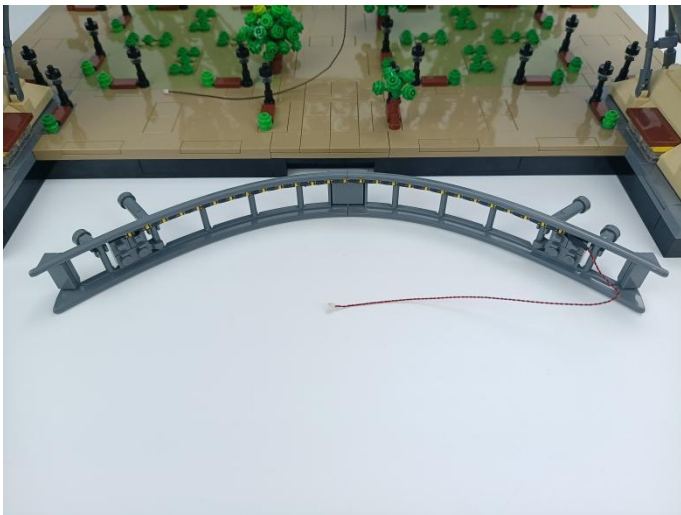

97

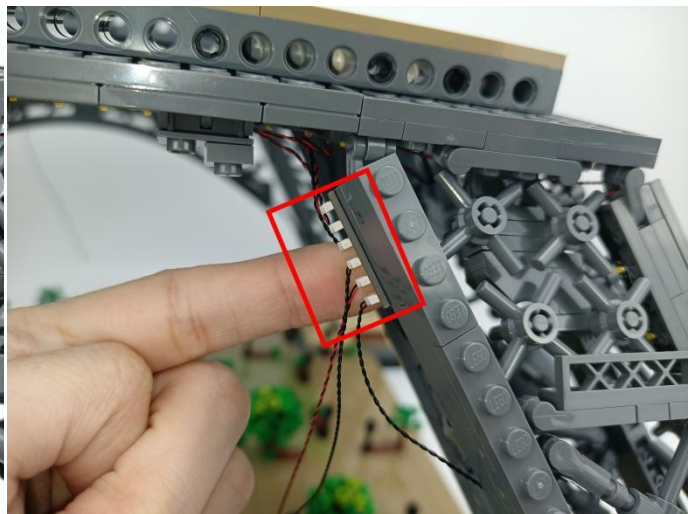
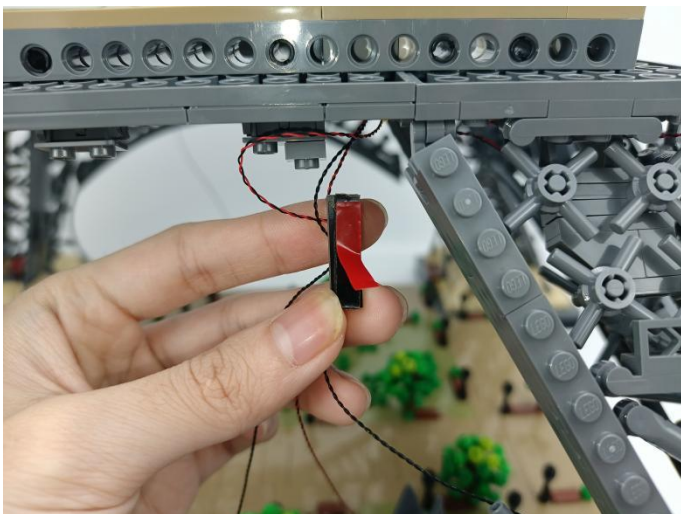



98

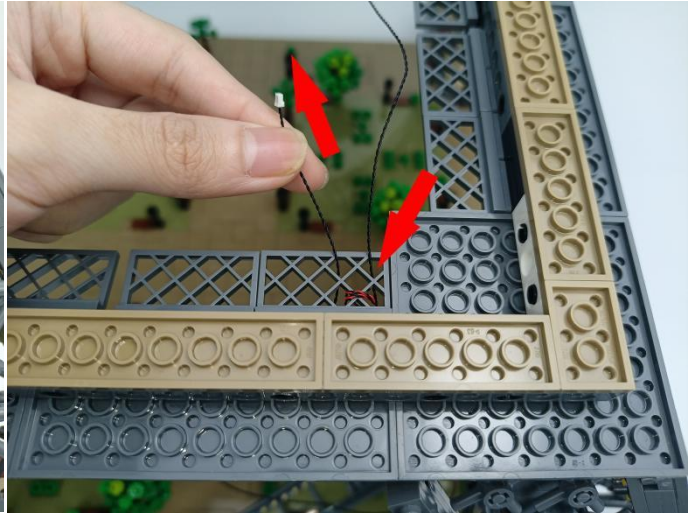
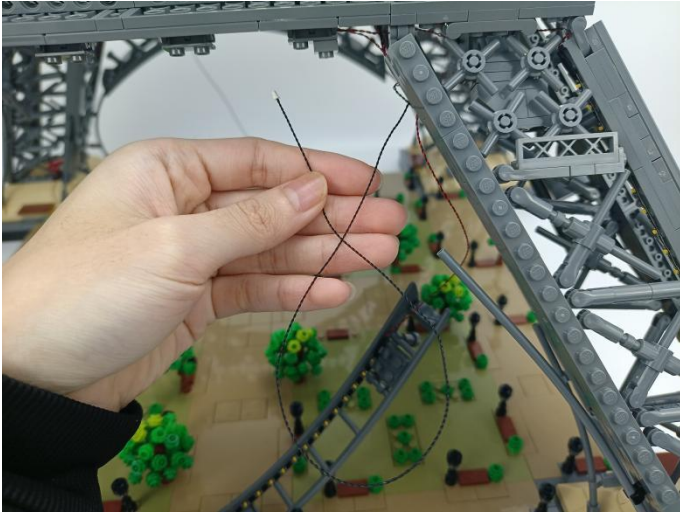

99

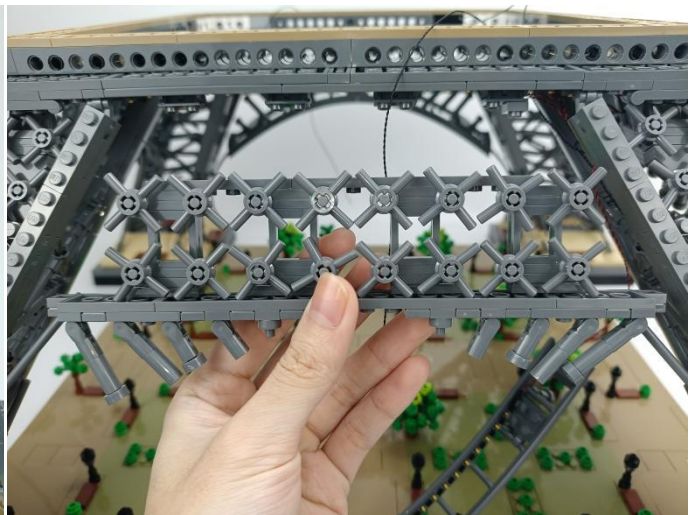
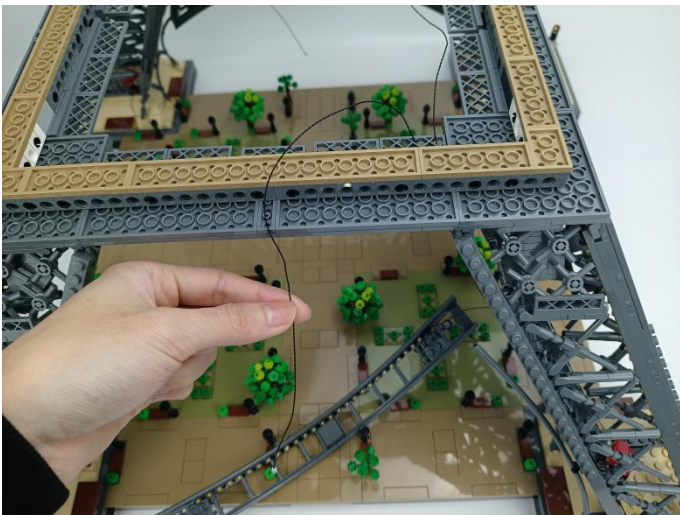

100

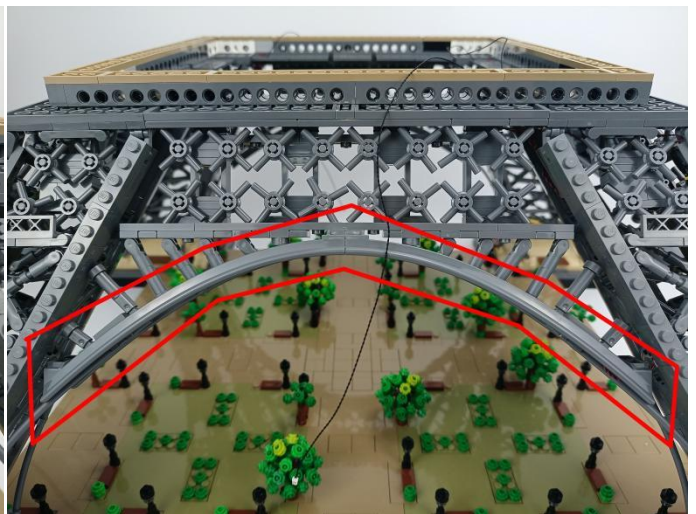
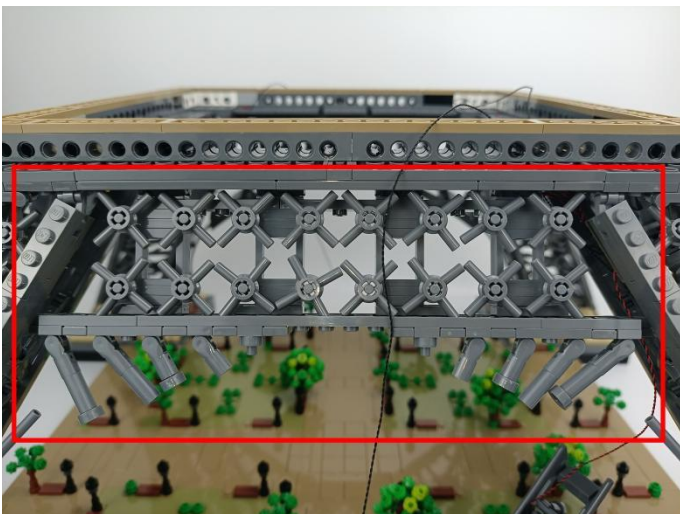



101

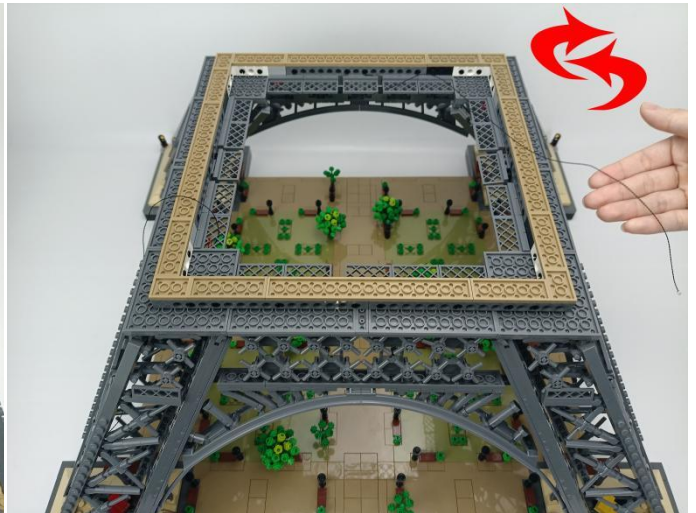

102

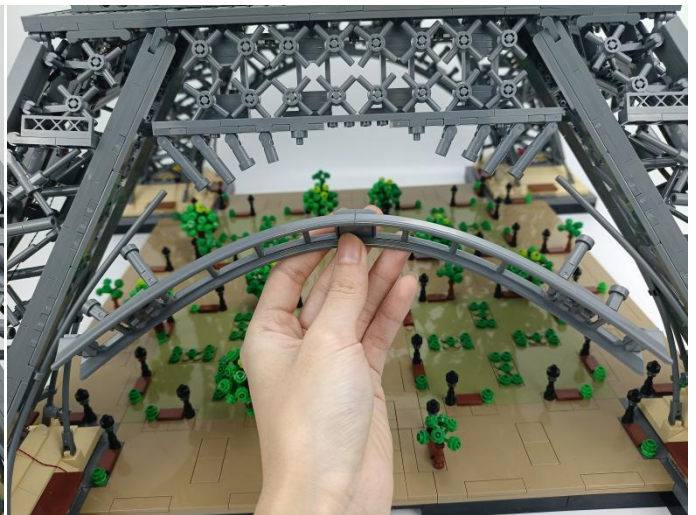

103

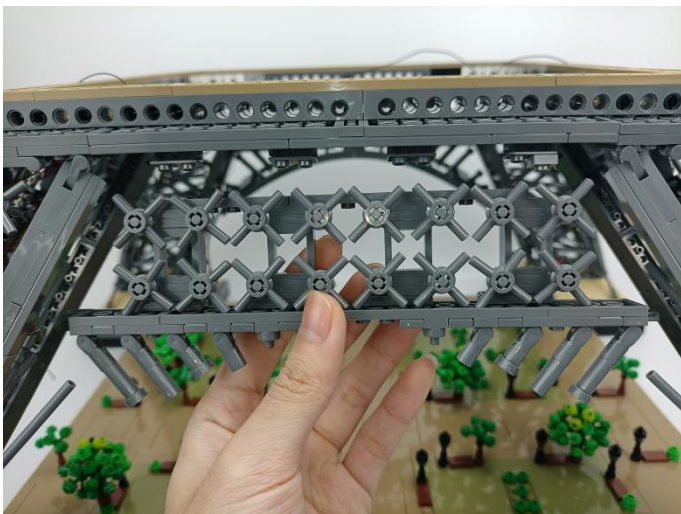



104



105



106



# 107

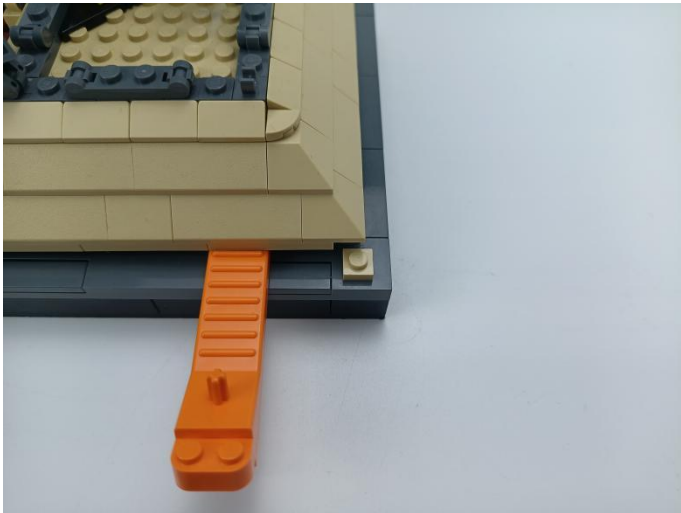

# 108



# 109

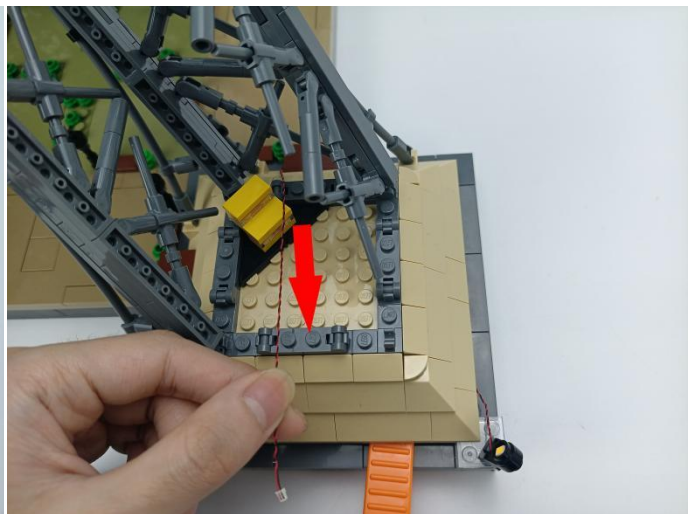
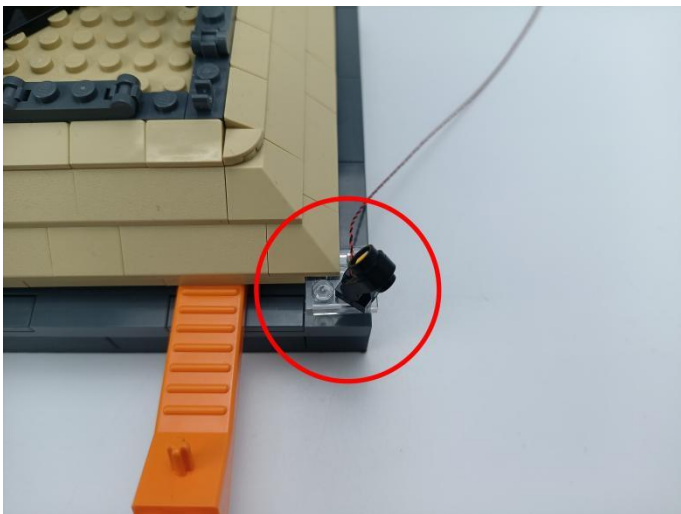



# 110

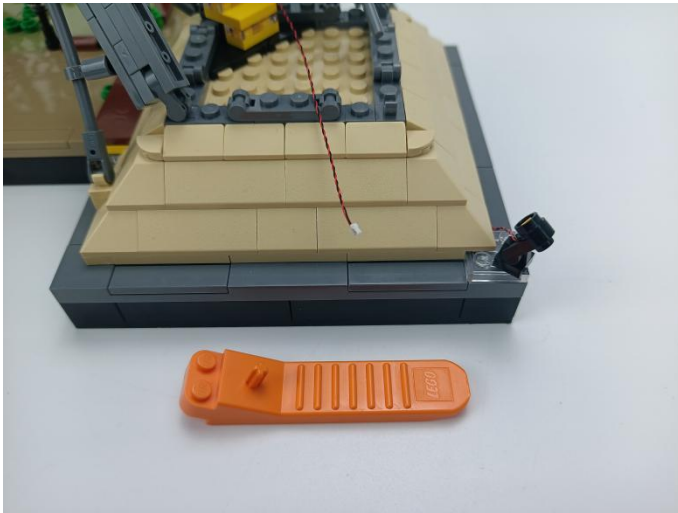

# 111

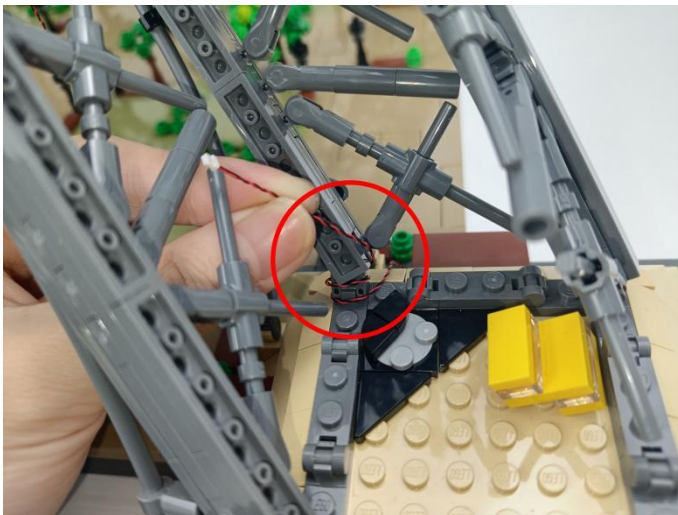

# 112



113

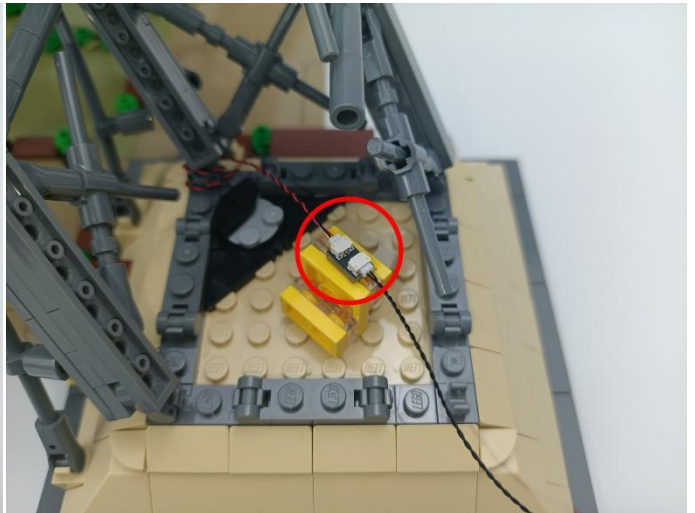
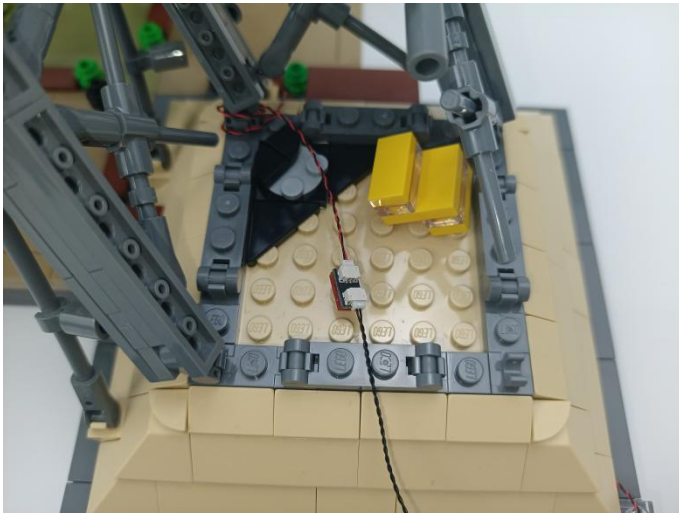

114

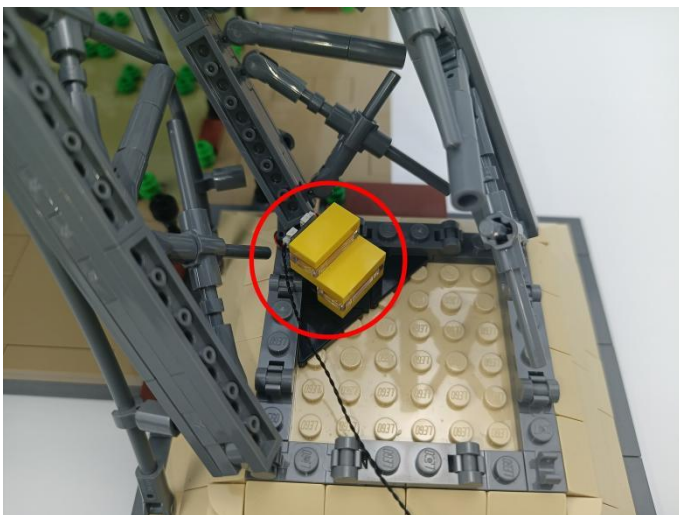



**115.** Put the connecting wire through the bottom of the block piece and pull it upward.

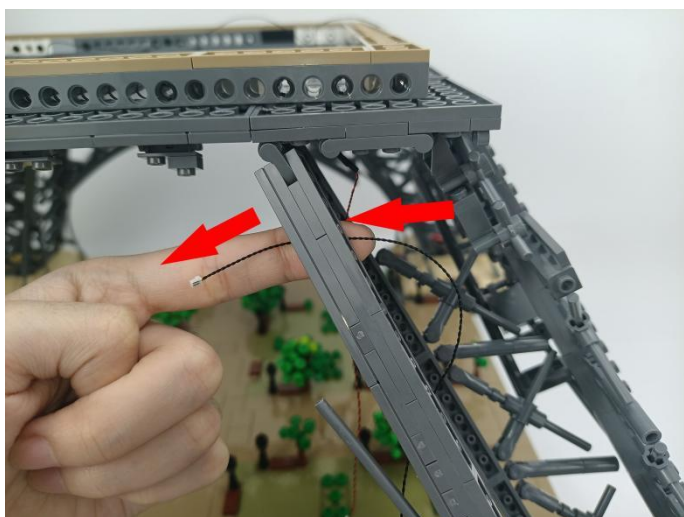
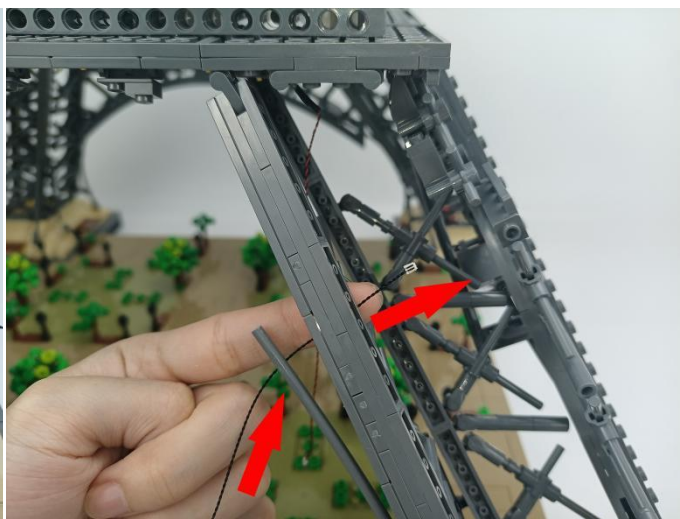
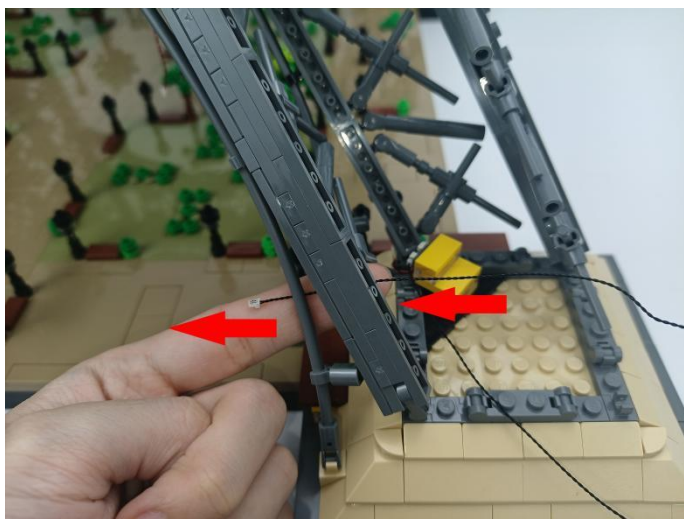

**116**

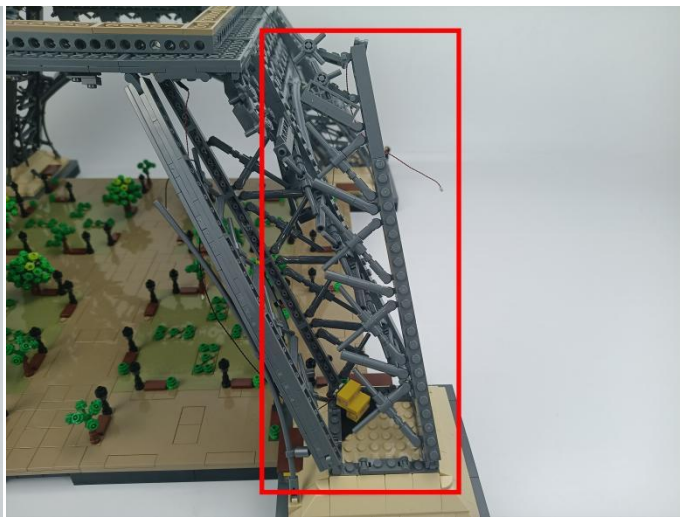
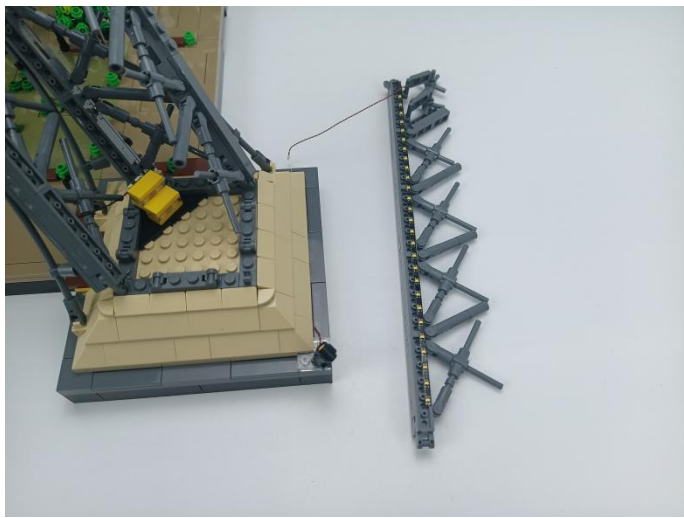



117

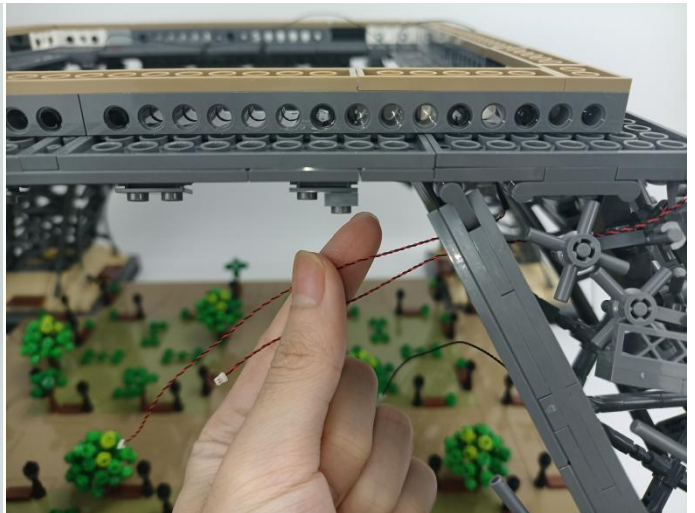
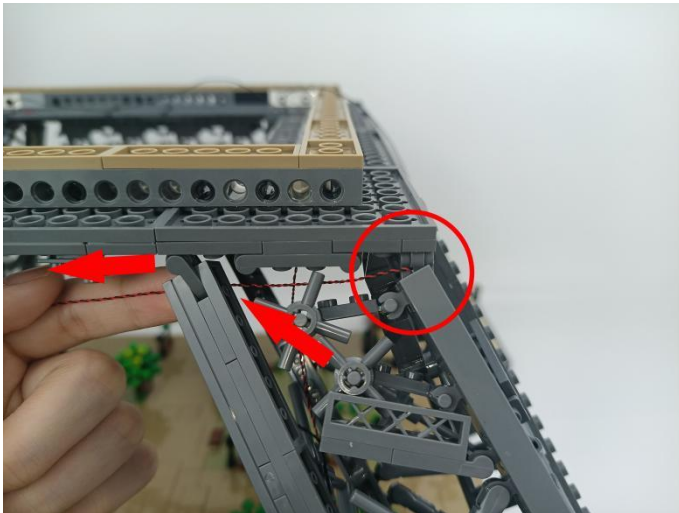

118

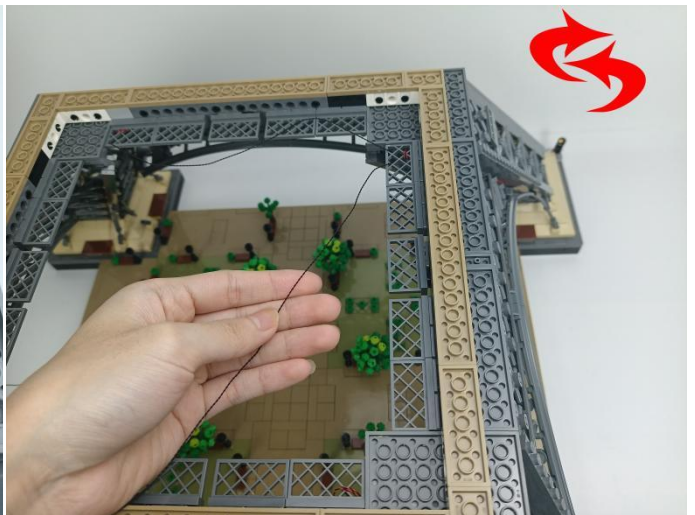

119

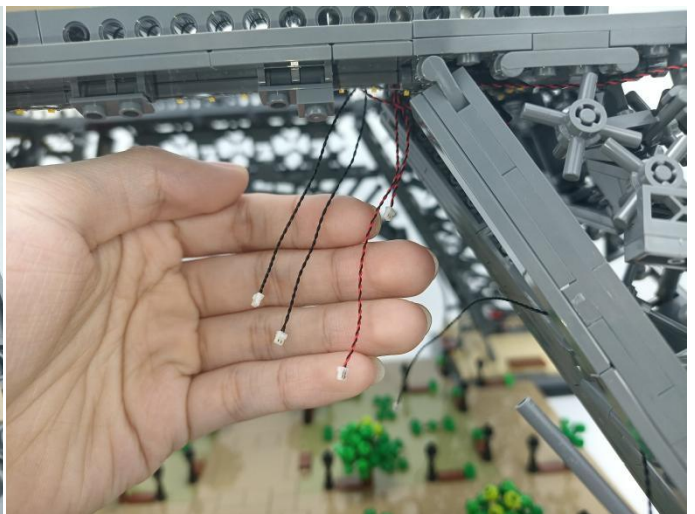
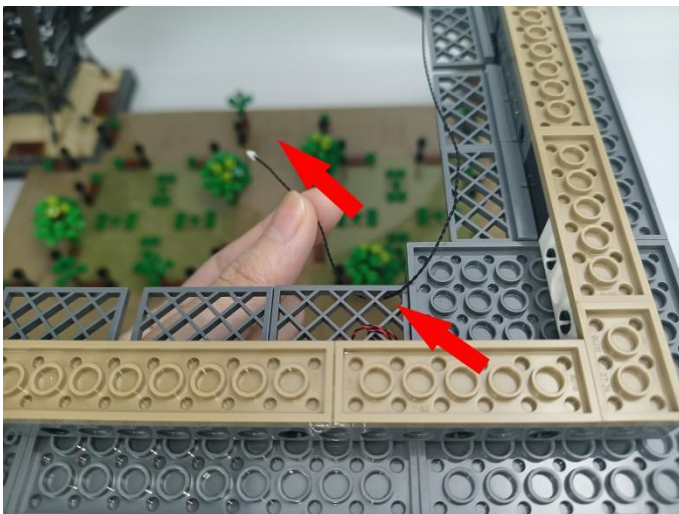



# 120



# 121

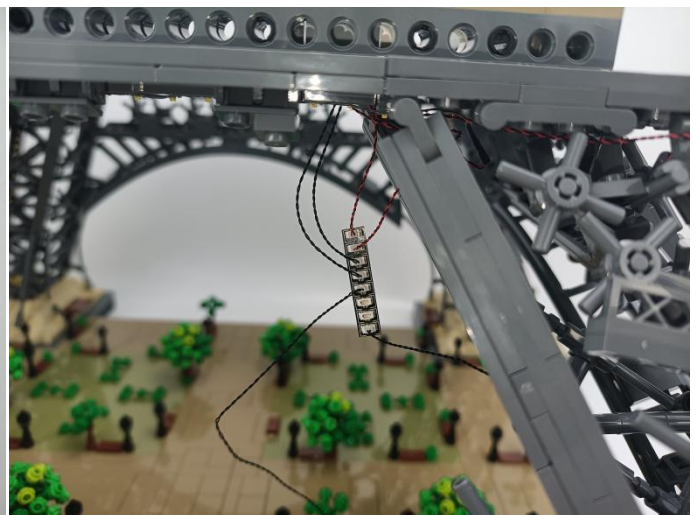

# 122

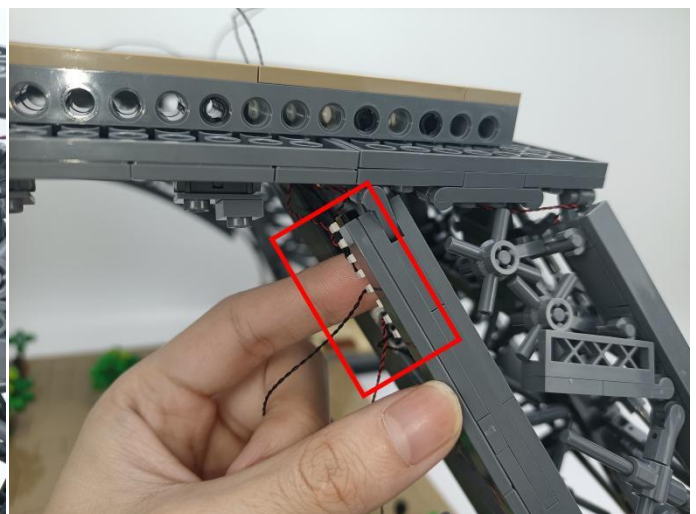
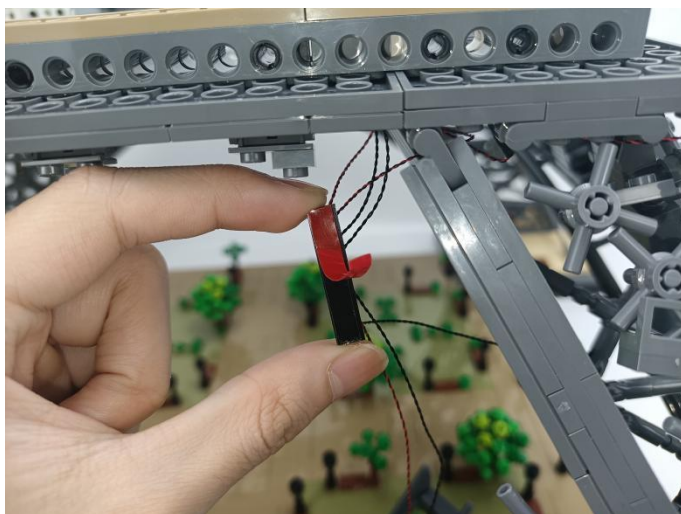

123

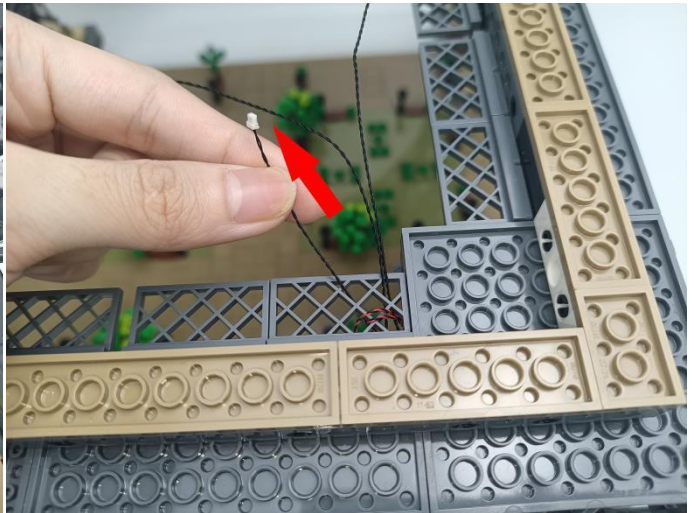

124

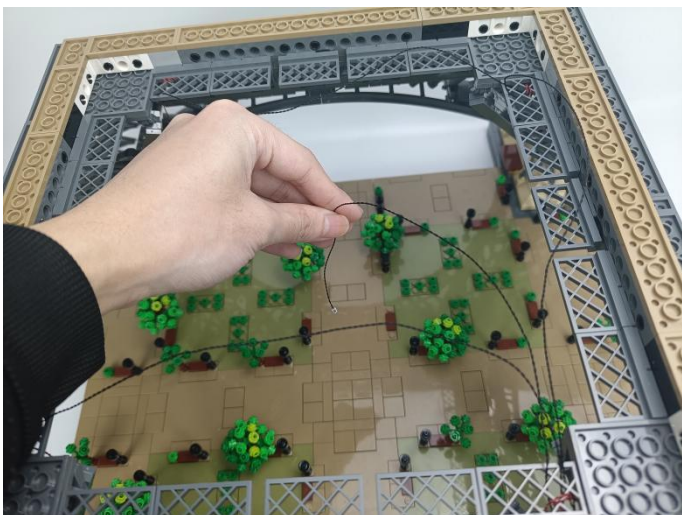



**125.** Wrap the connecting wire around the block piece to prevent it from falling off.

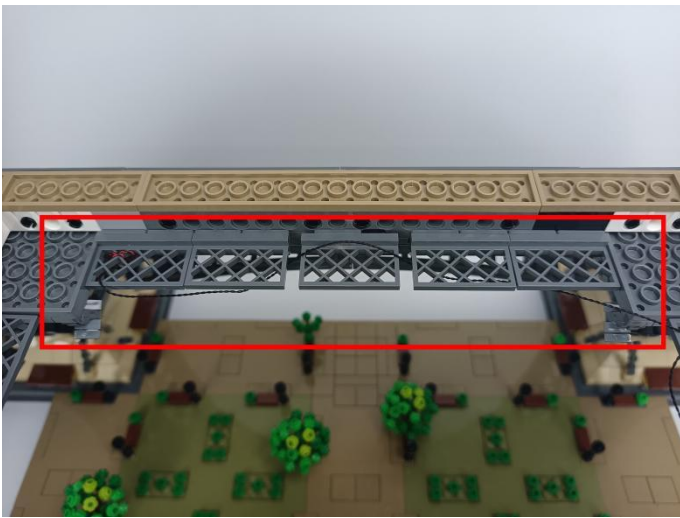
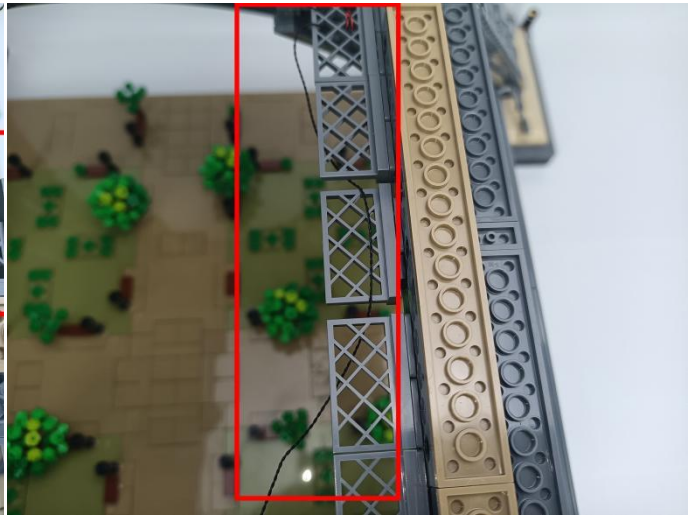

**126**

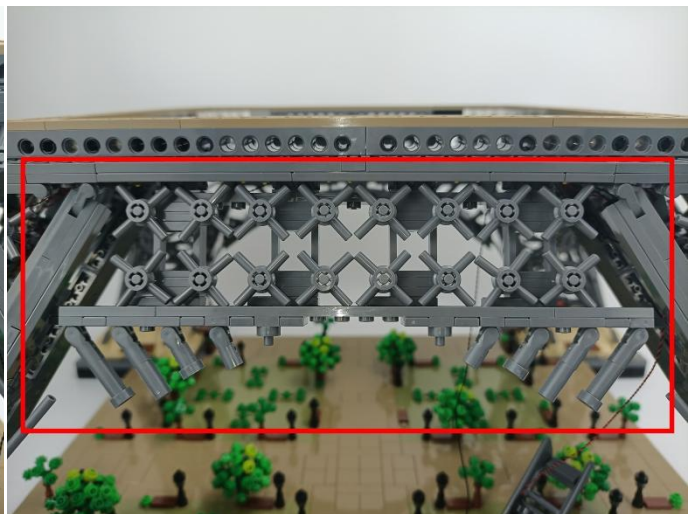
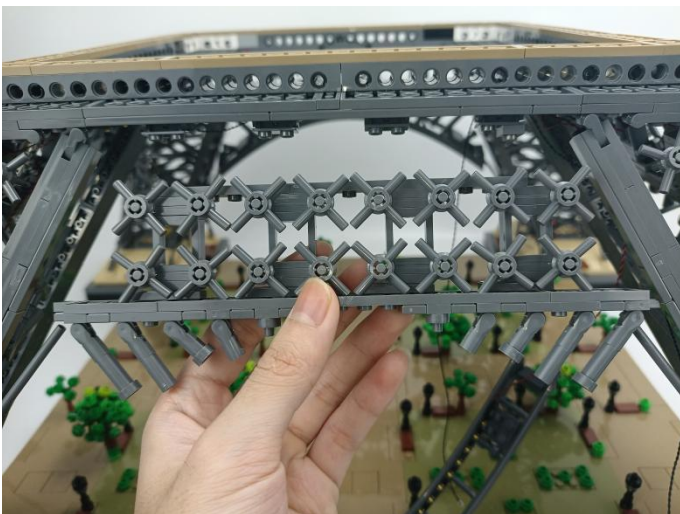



127



128

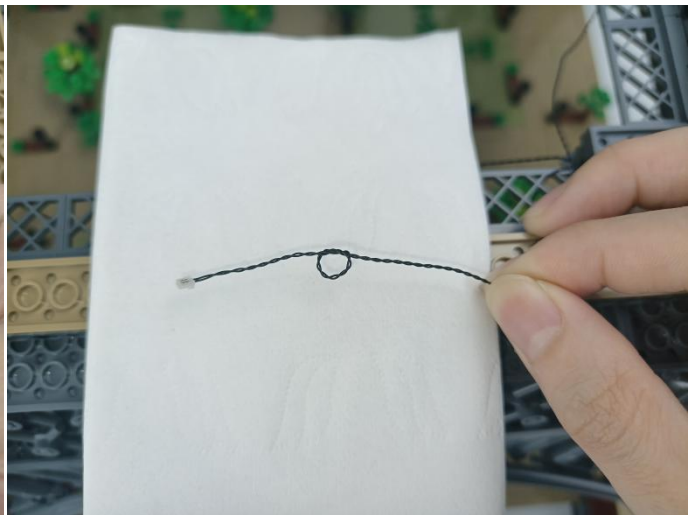
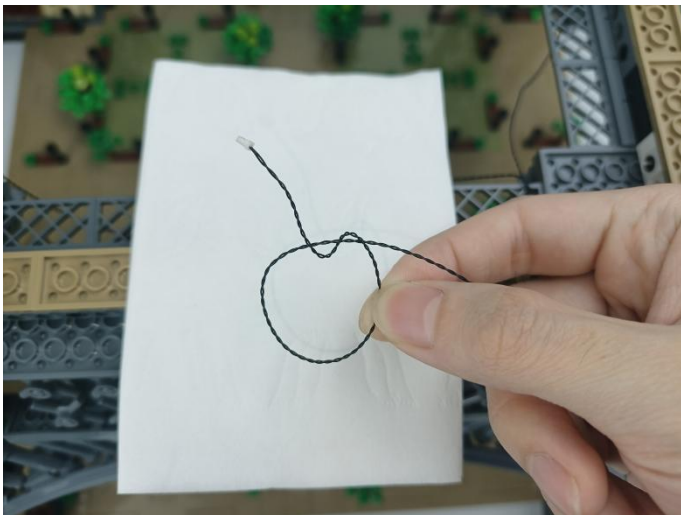

129

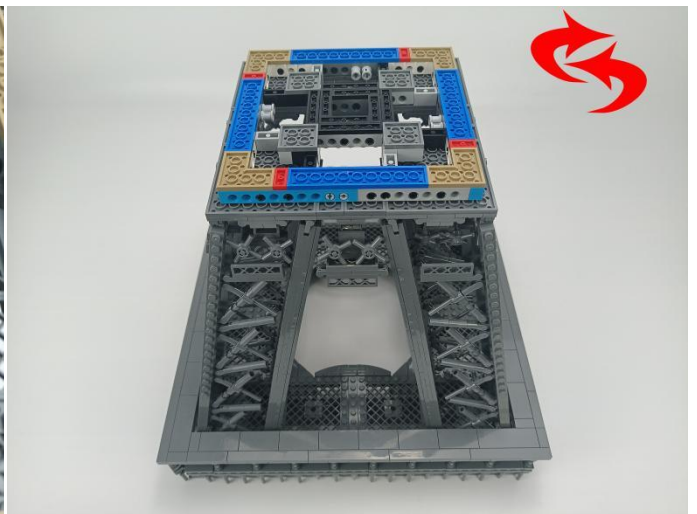
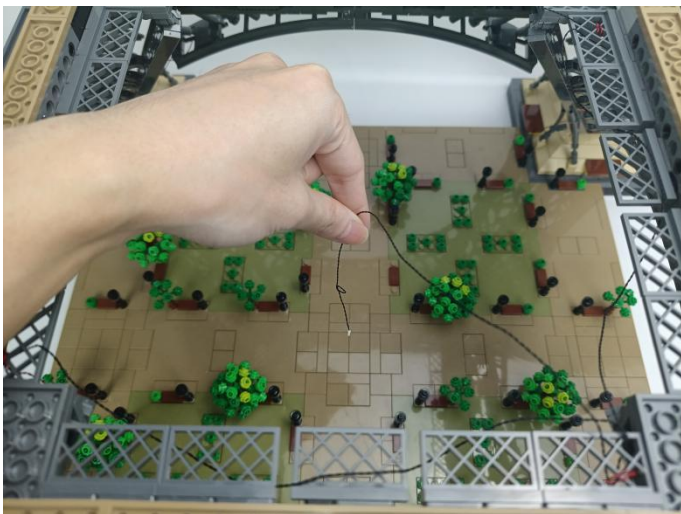



130

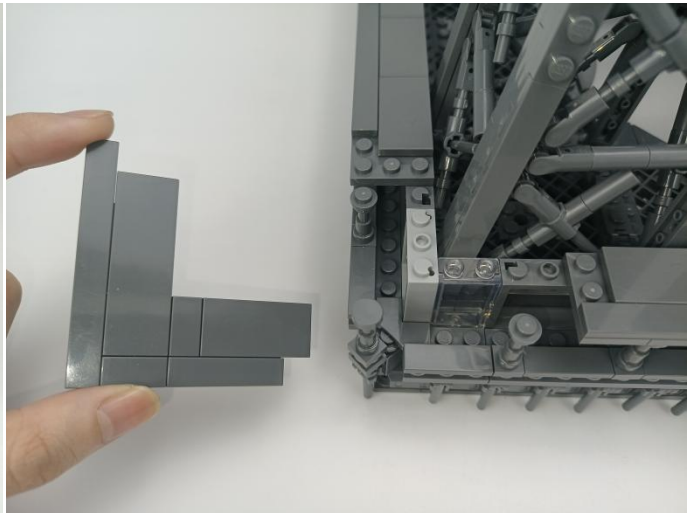
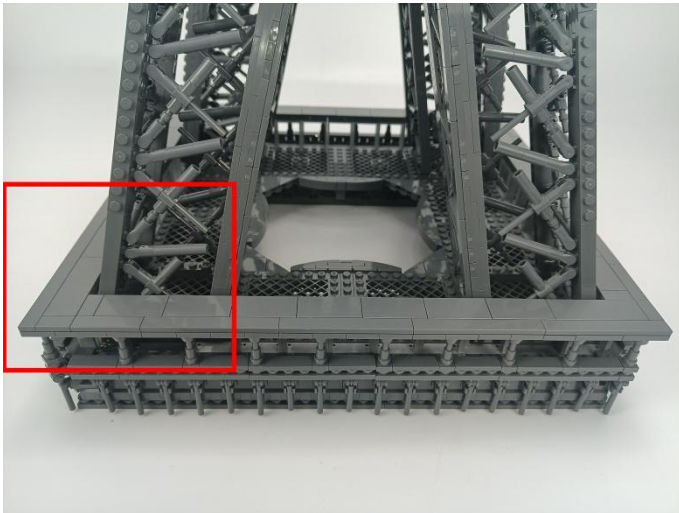

131

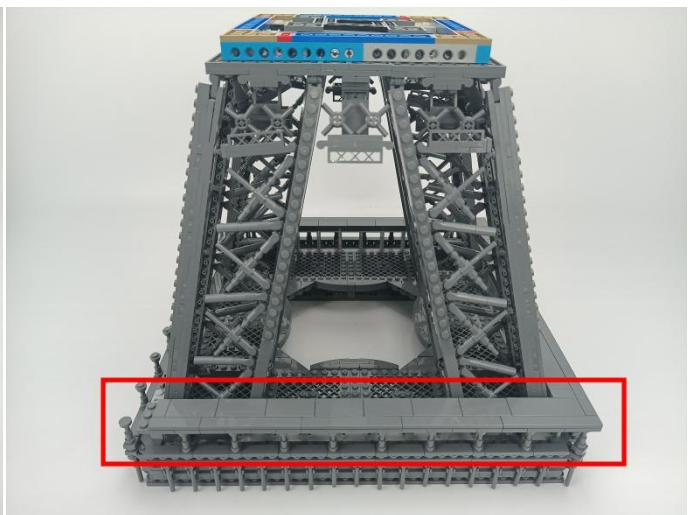
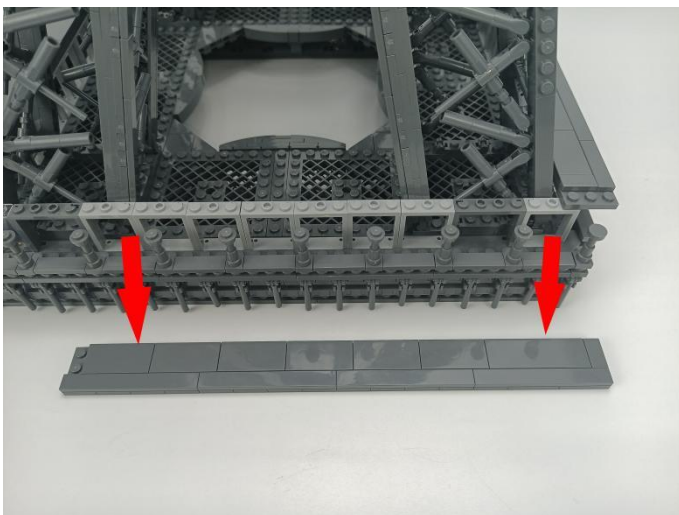

132

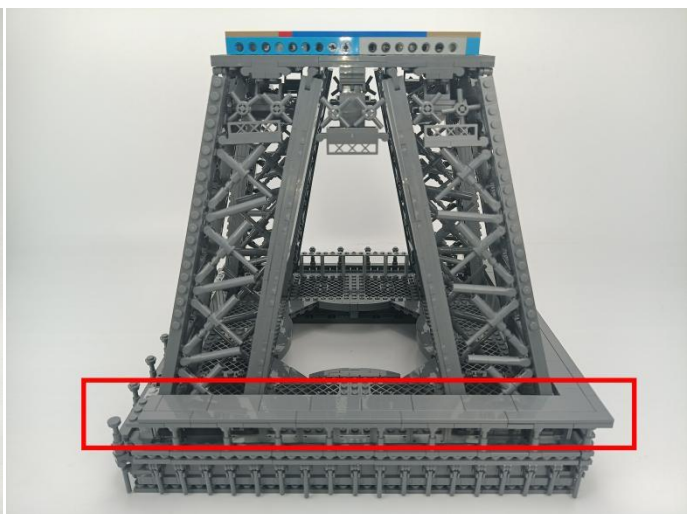
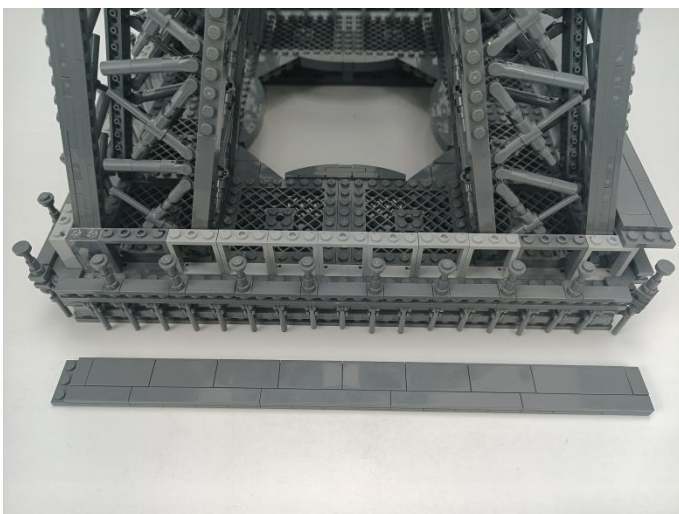

133

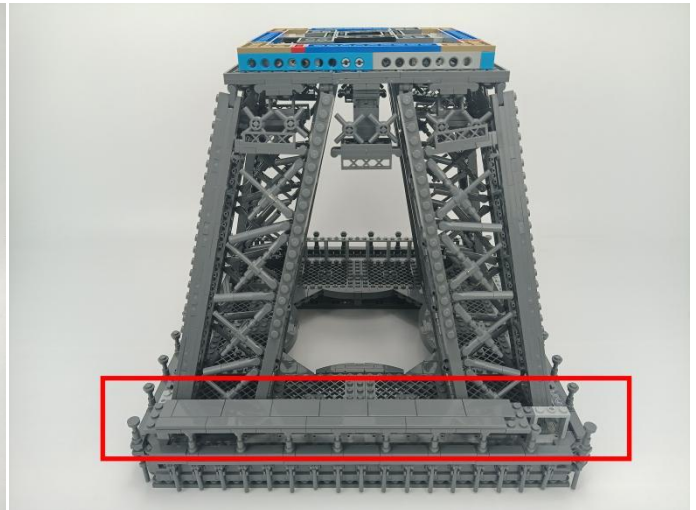
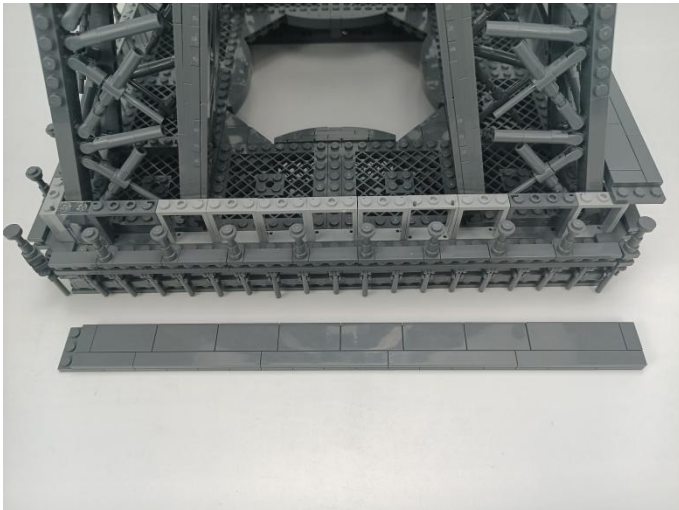

134

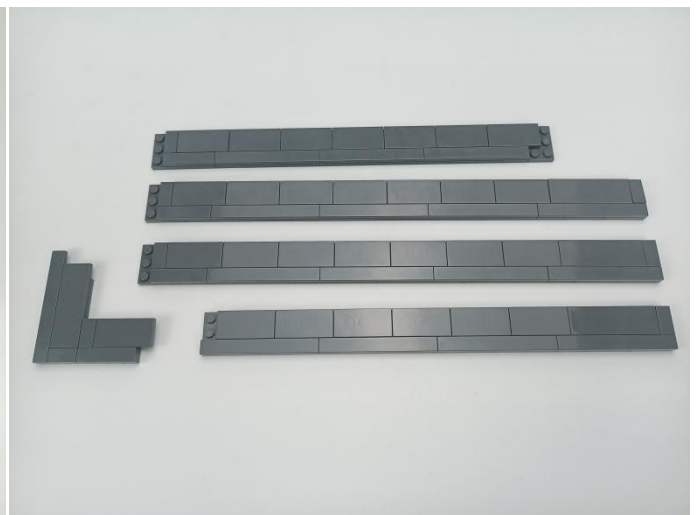
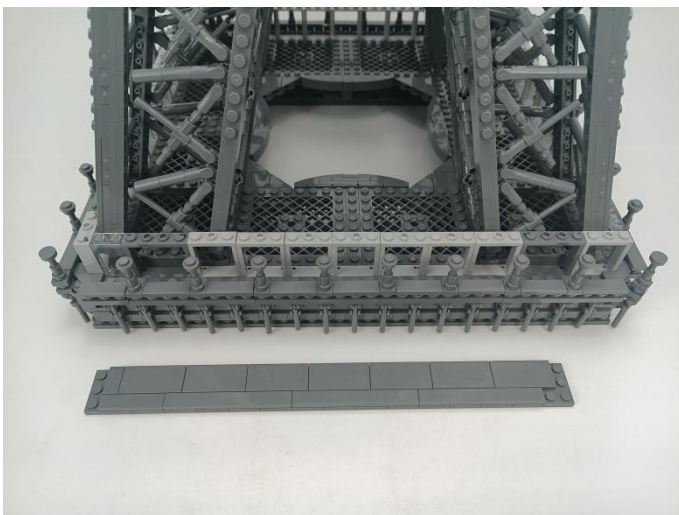

135

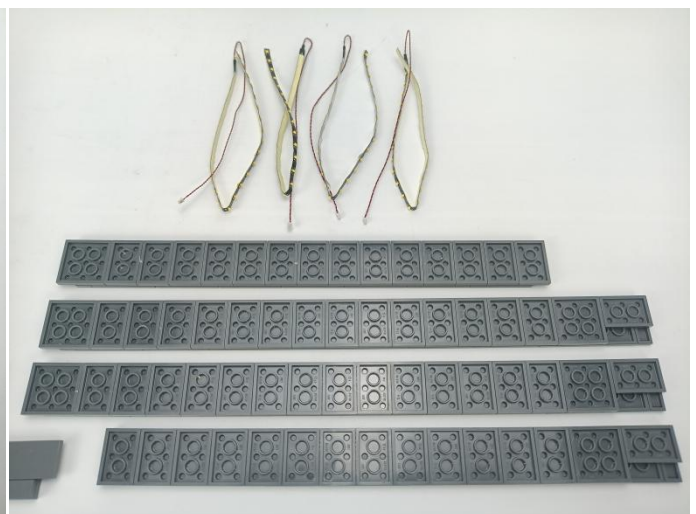



136

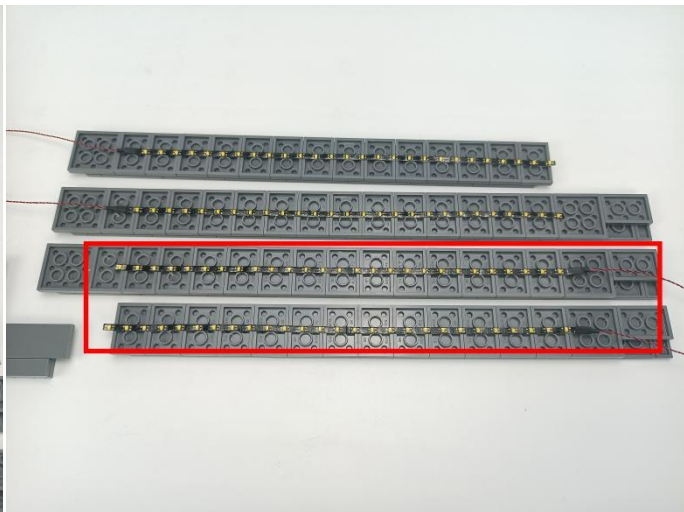
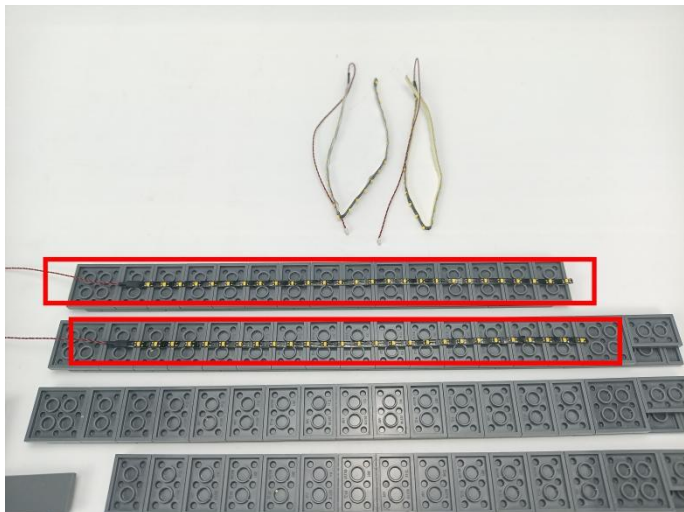

137

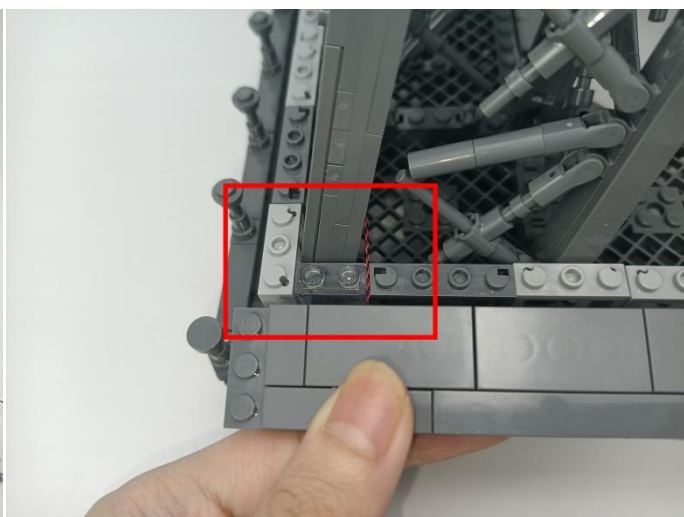
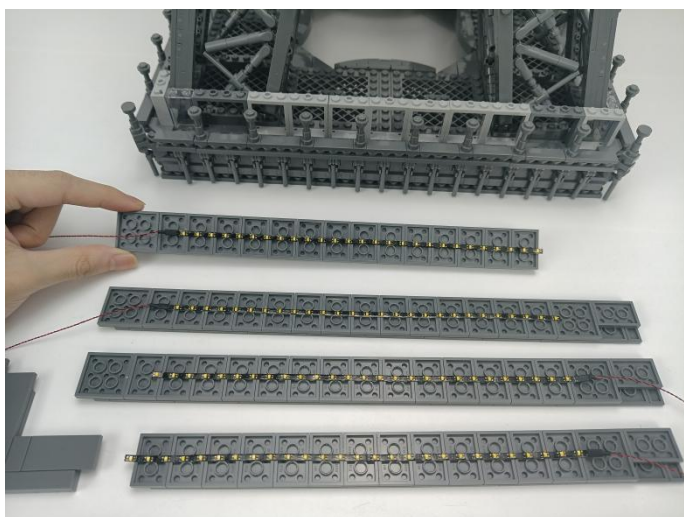

138

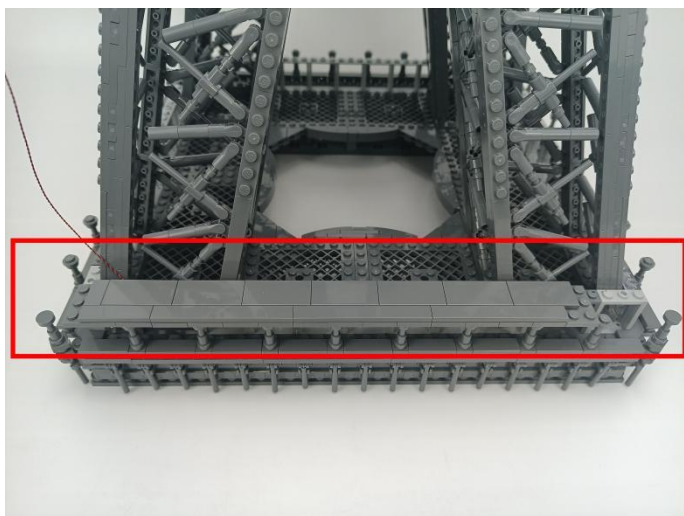

139

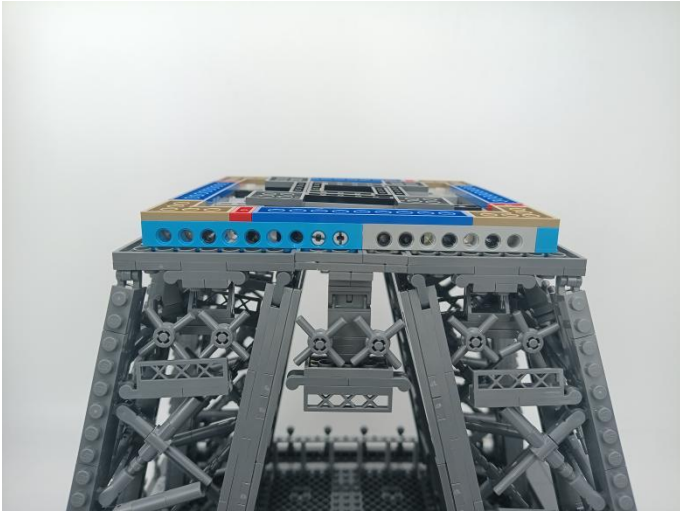

140

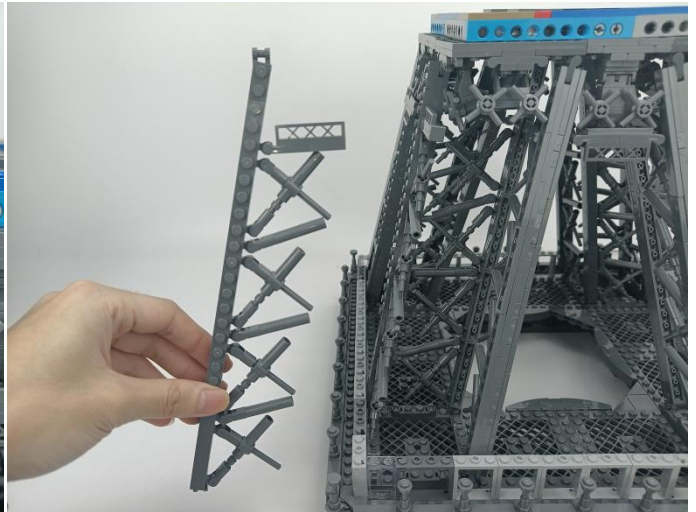
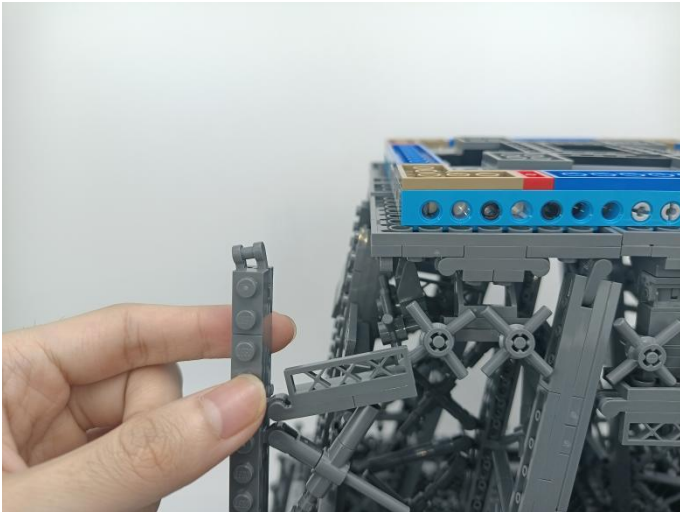

141

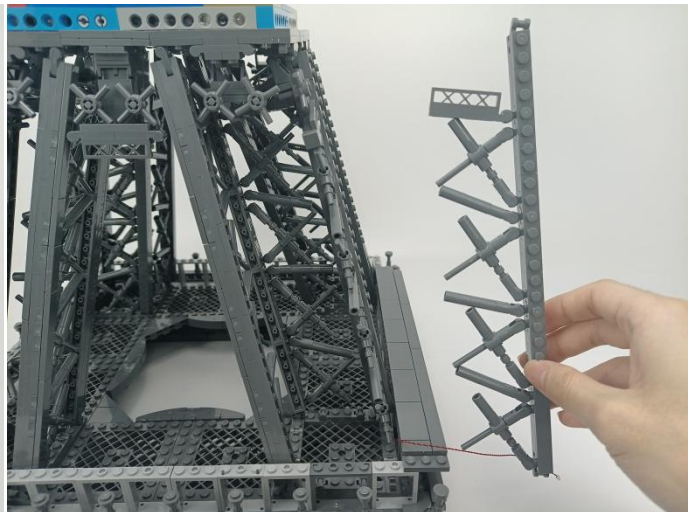
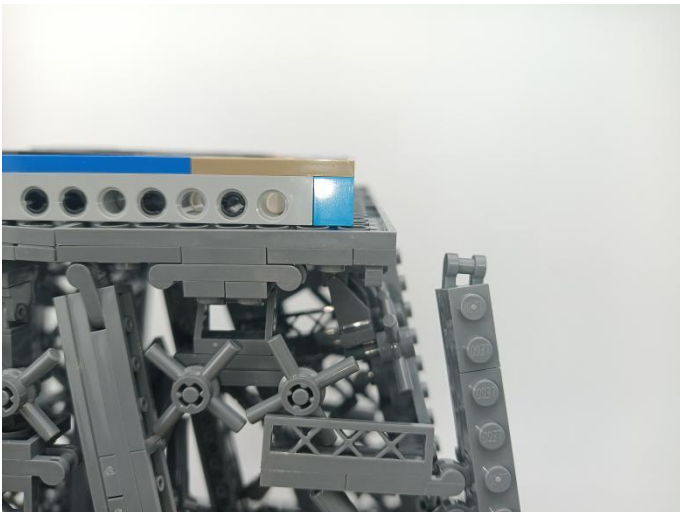



142



143

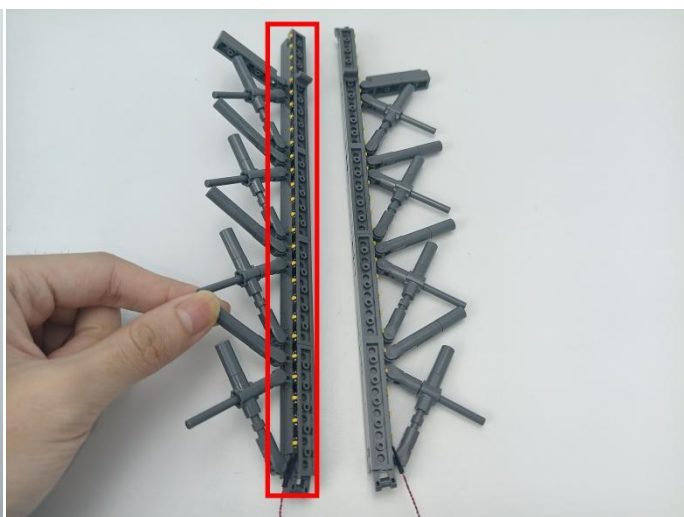

144

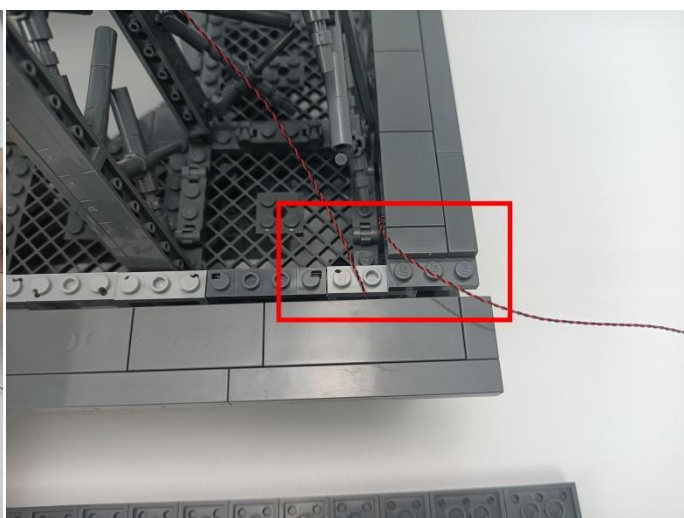
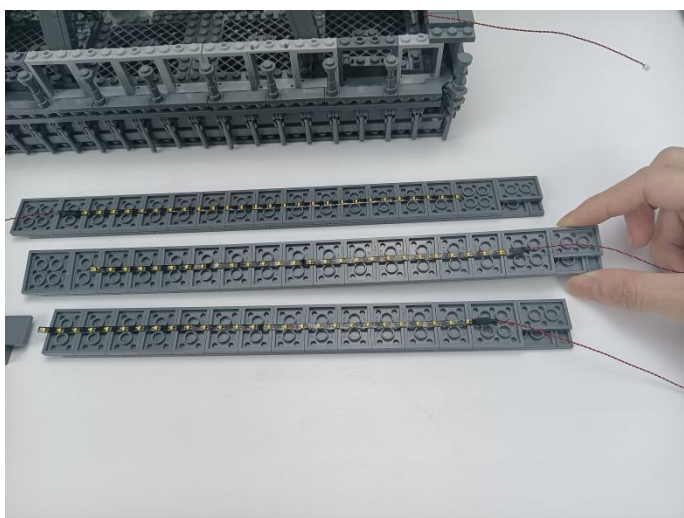

145

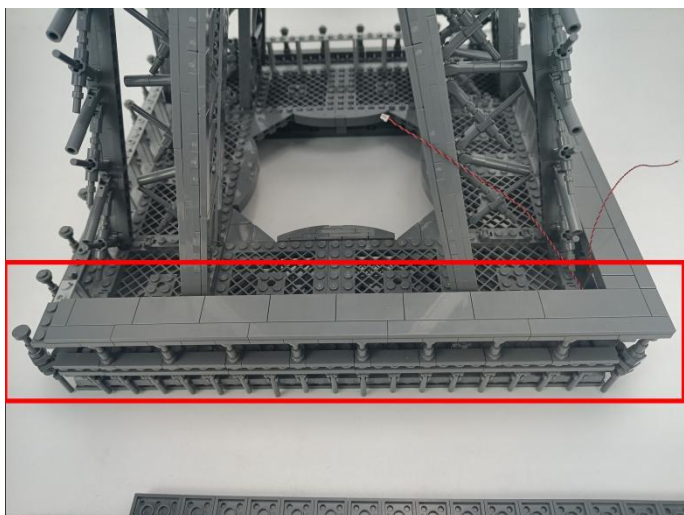

146

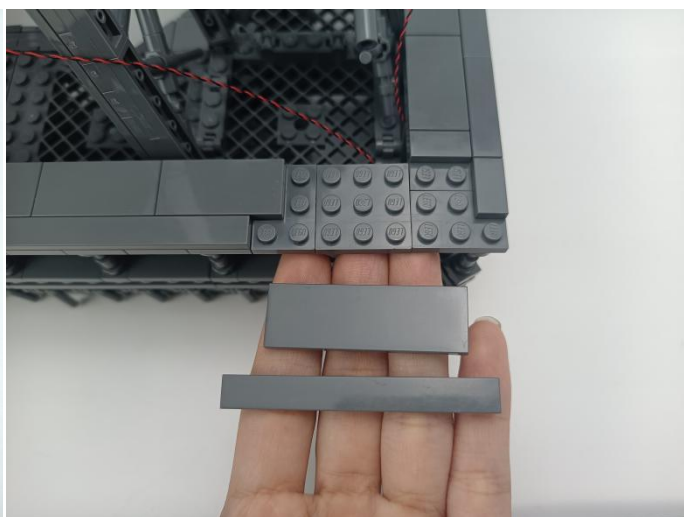
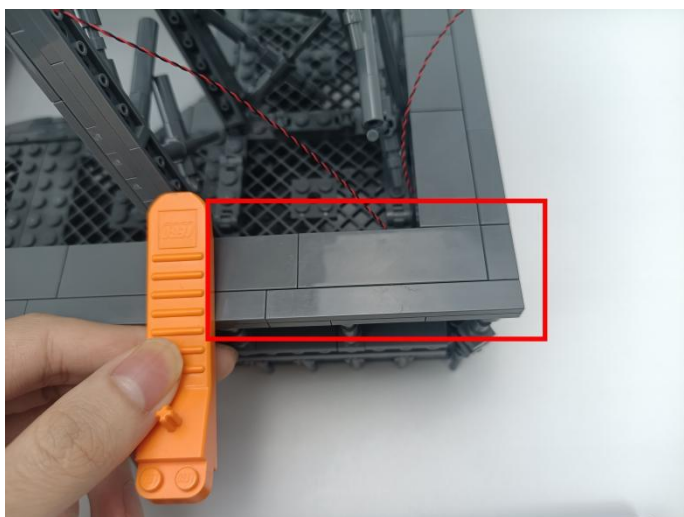

147





148

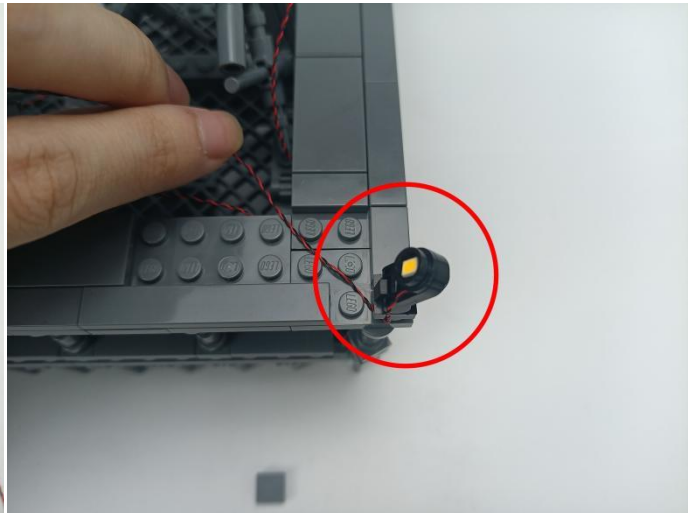
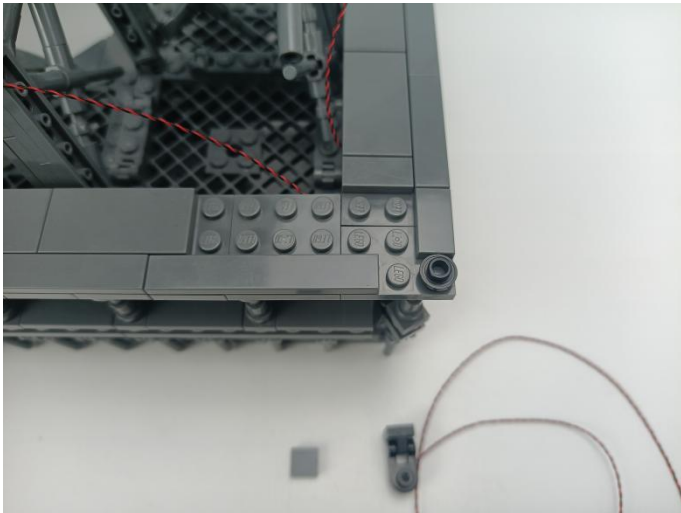

149

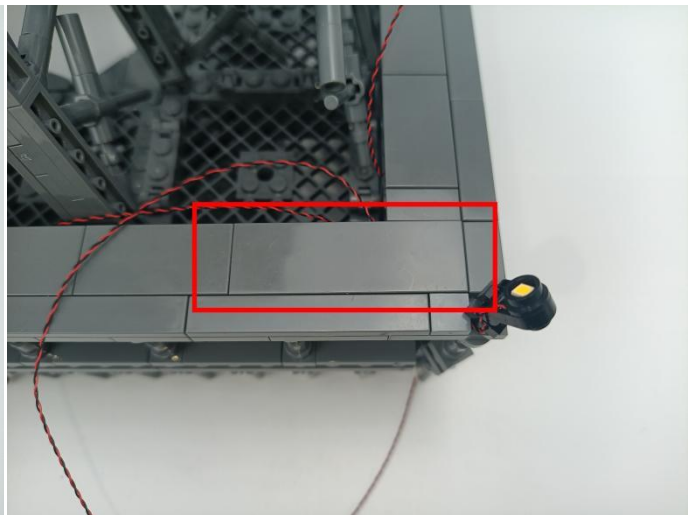

150

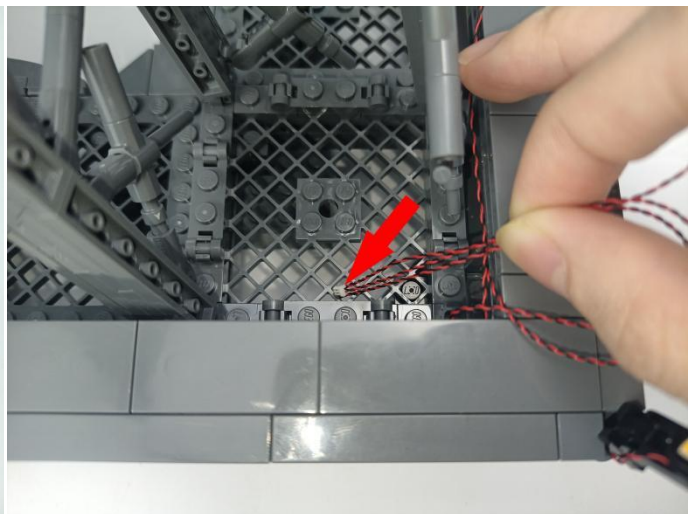
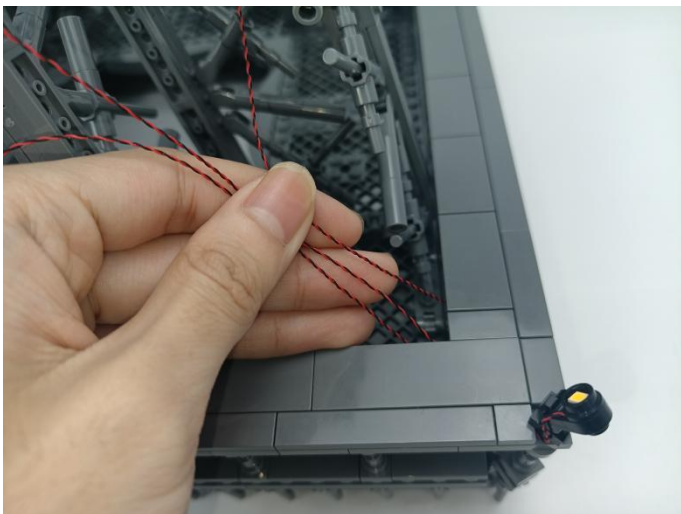

151

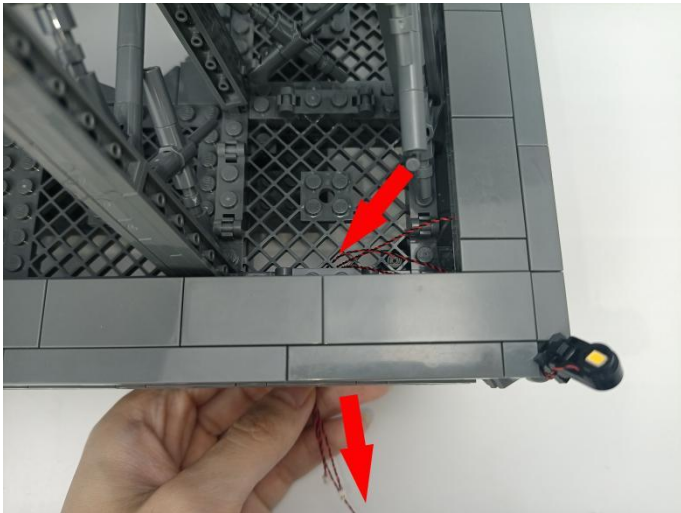

152

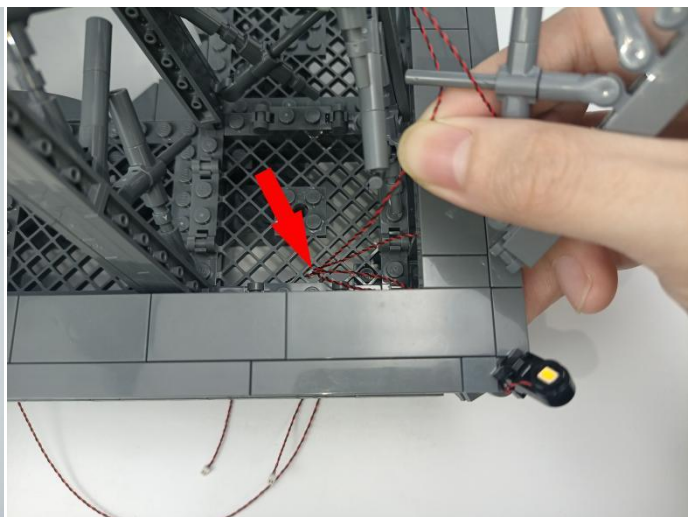
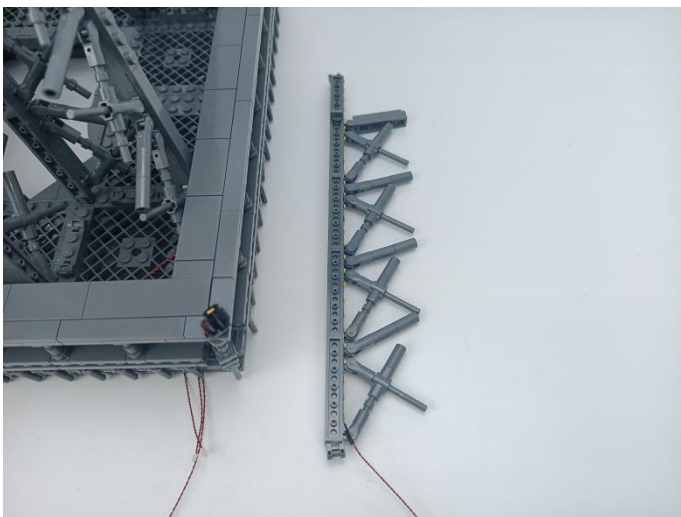

153

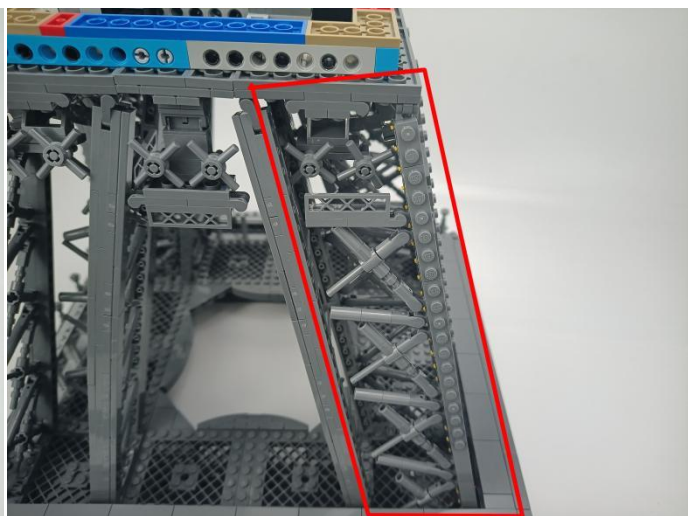
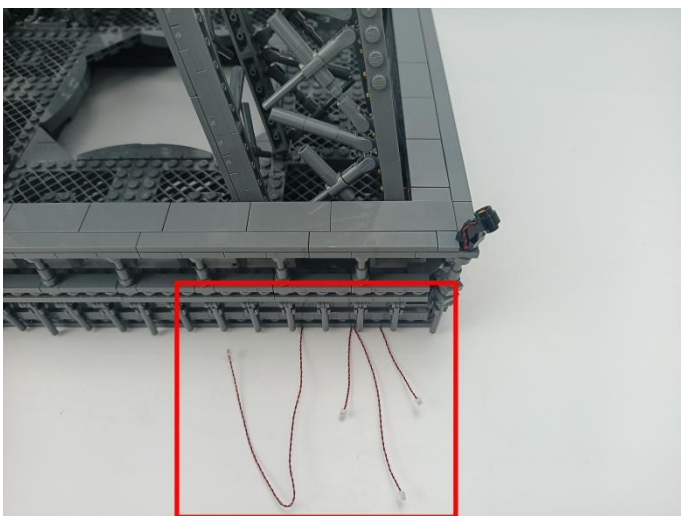



154

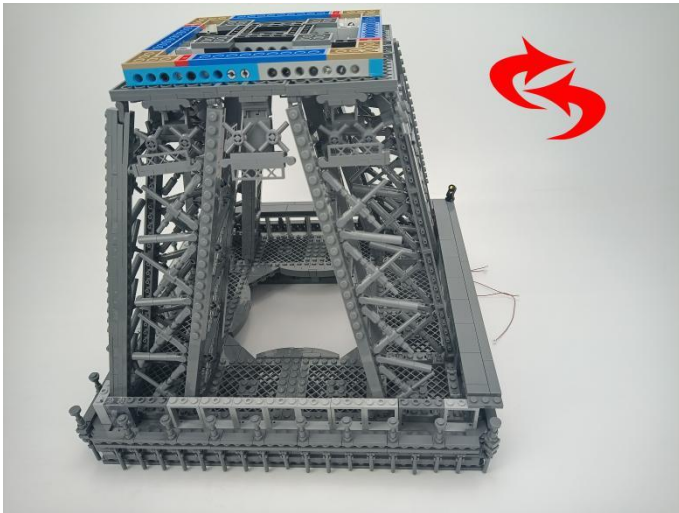

155

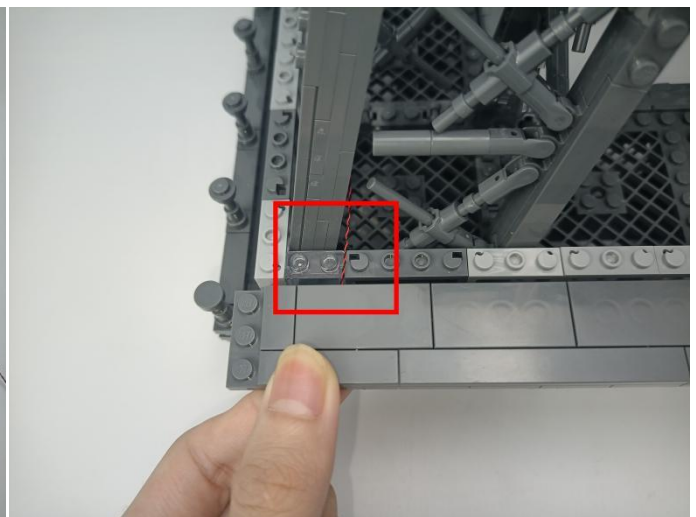
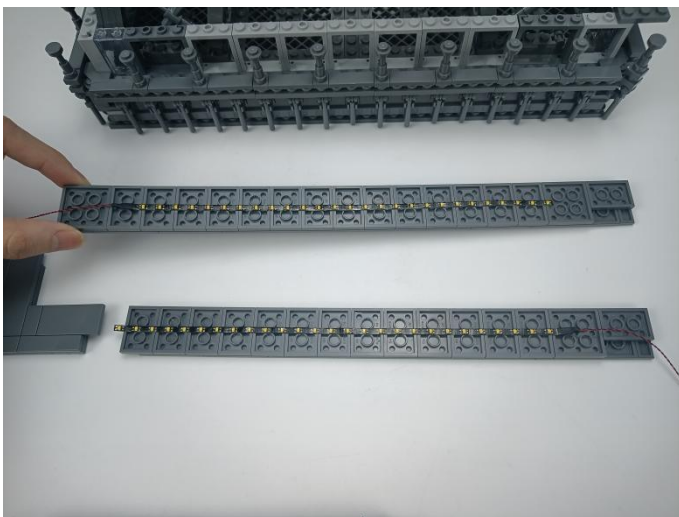

156

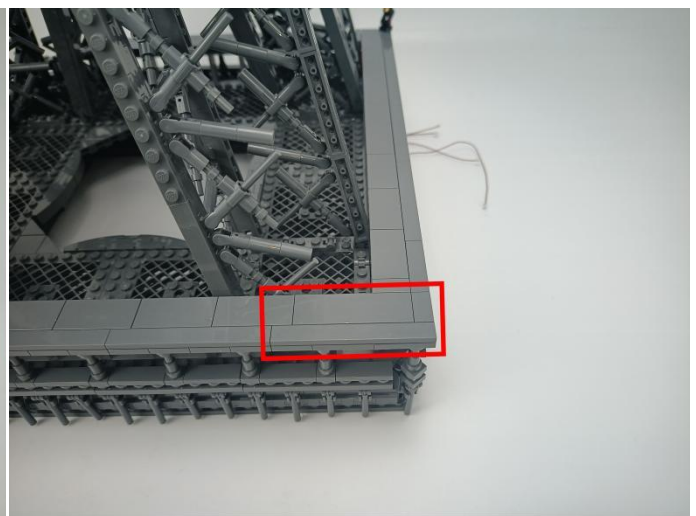
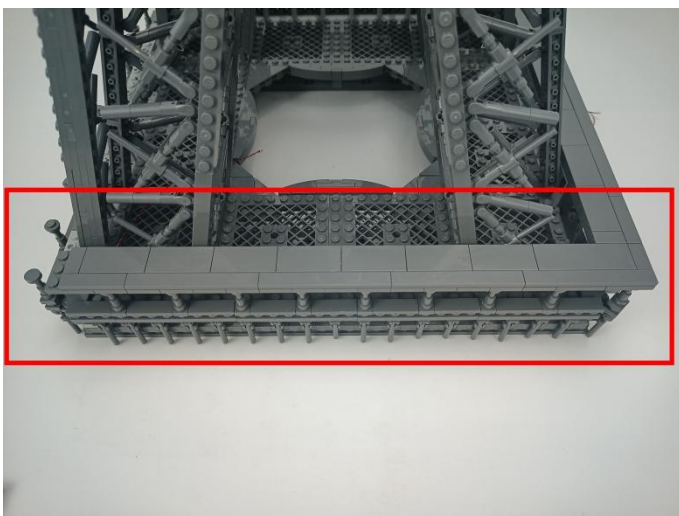

# 157

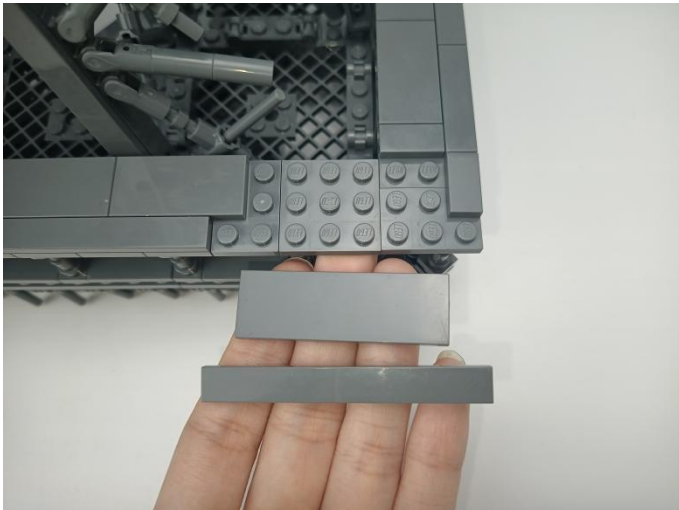

# 158

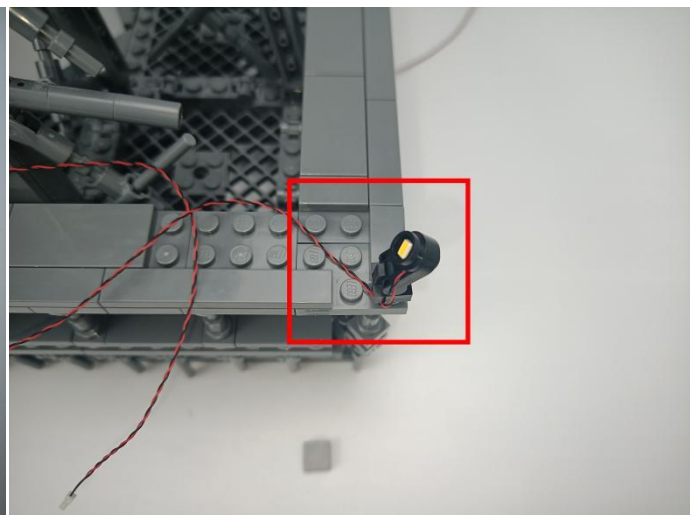

# 159

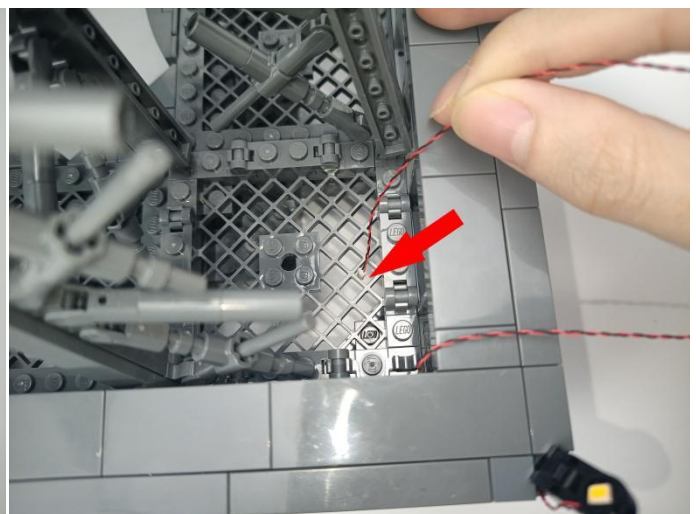
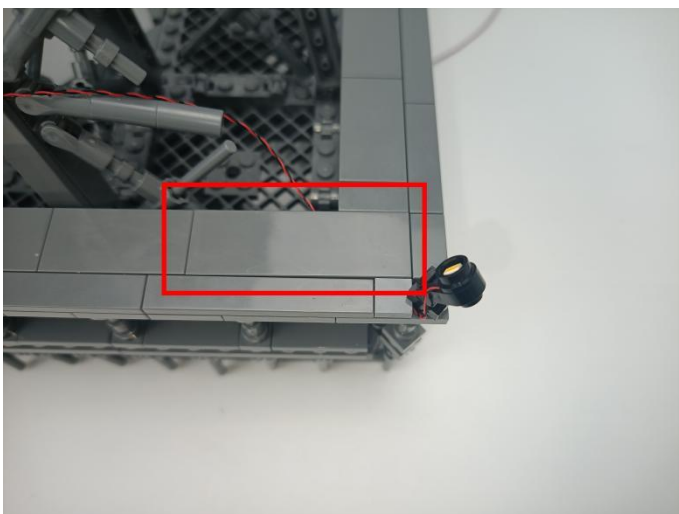



160

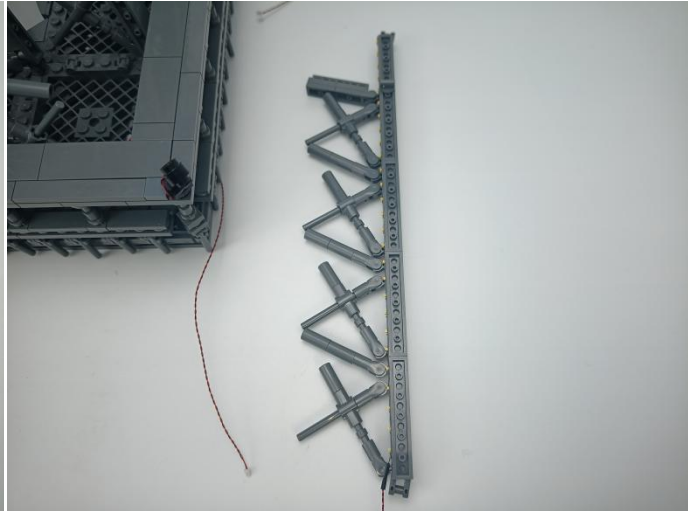
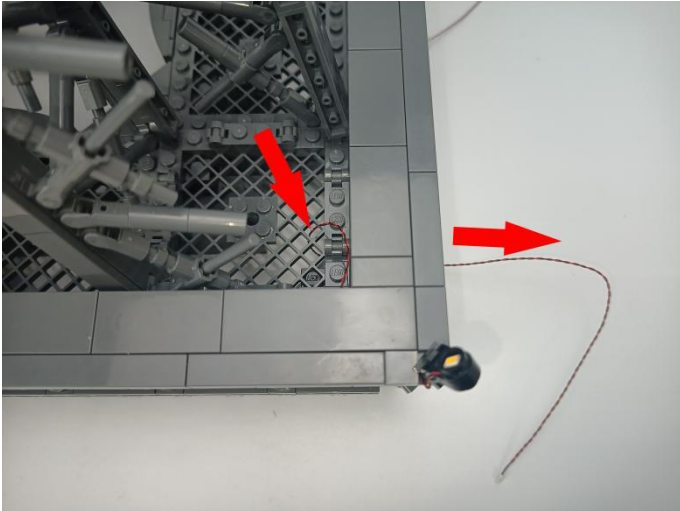

161

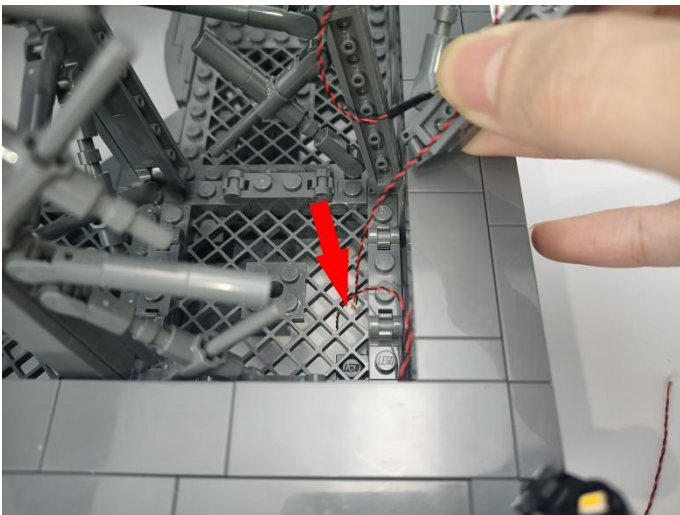

162

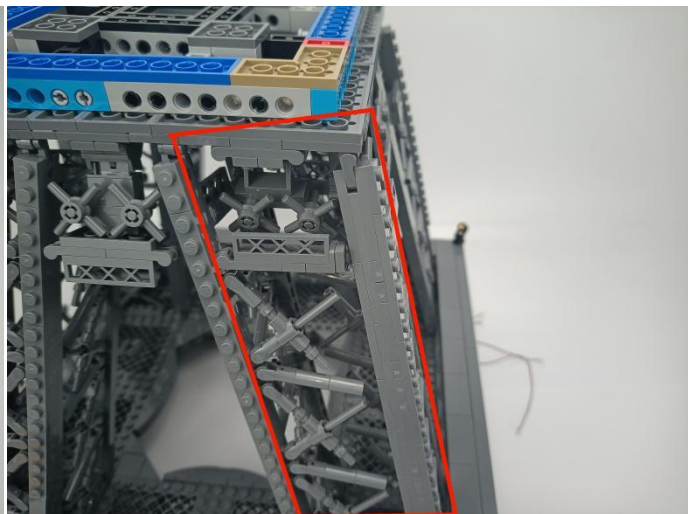
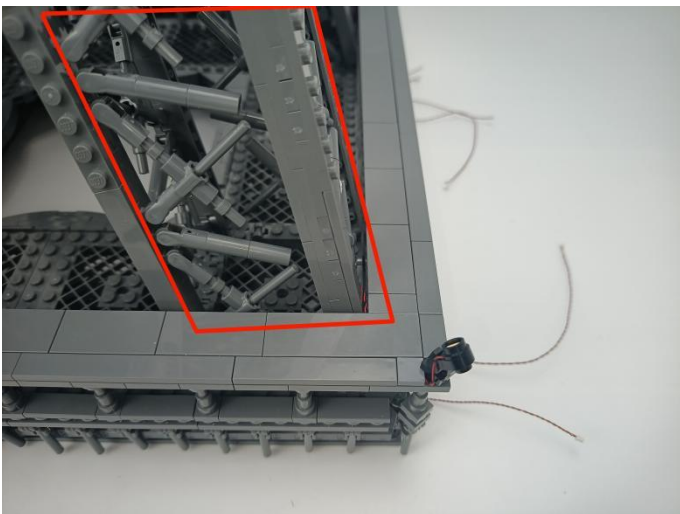

163

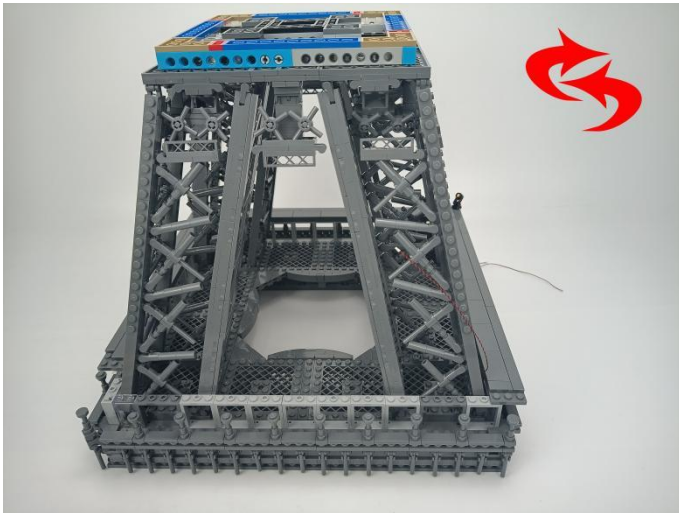

164

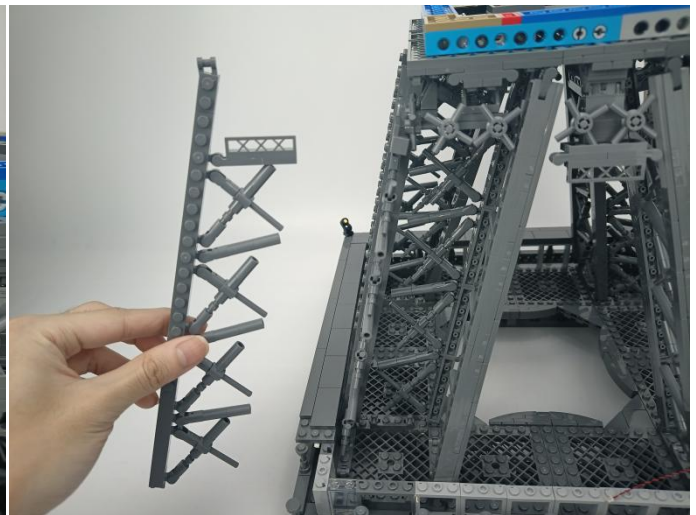

165

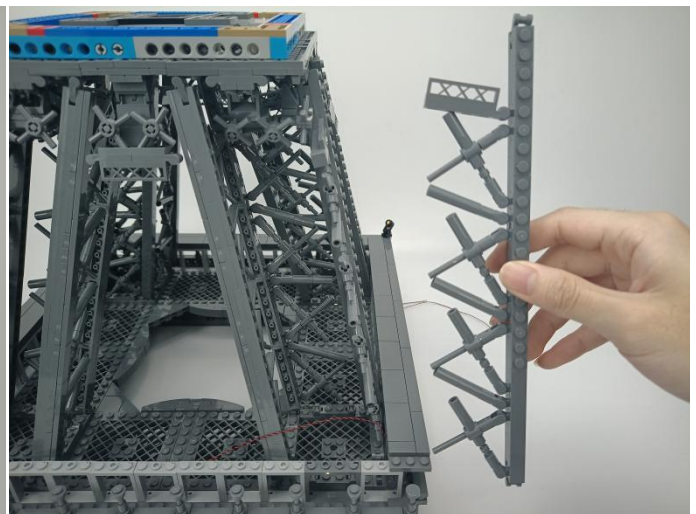



166

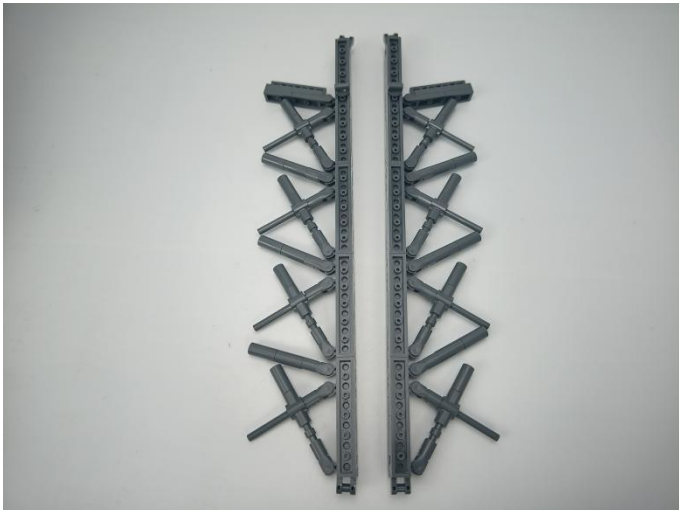

167

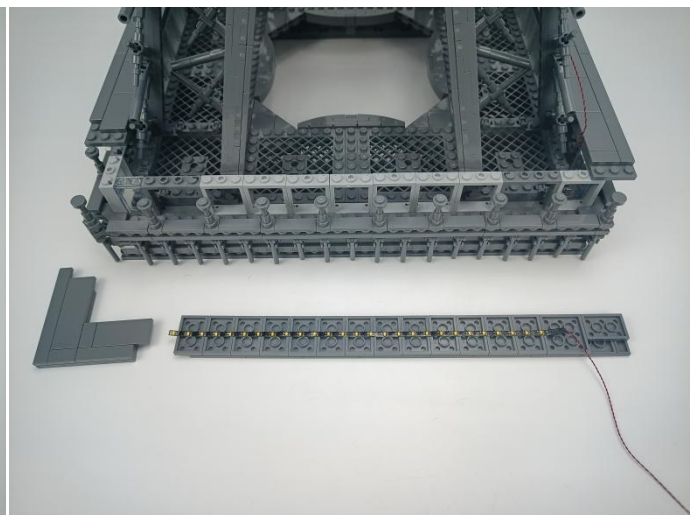
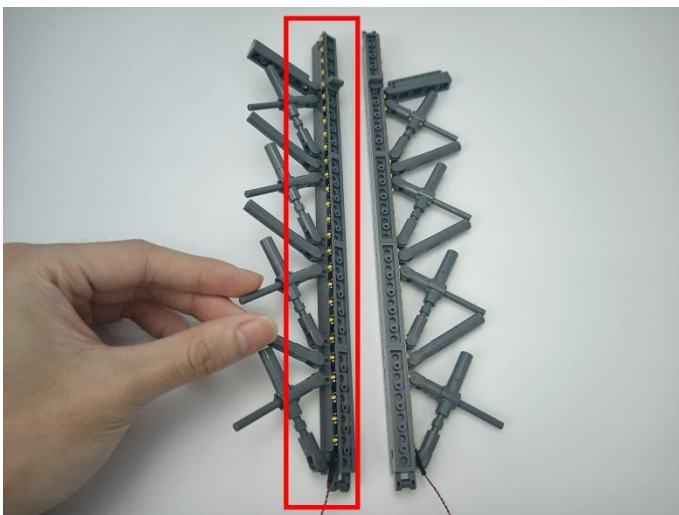

168

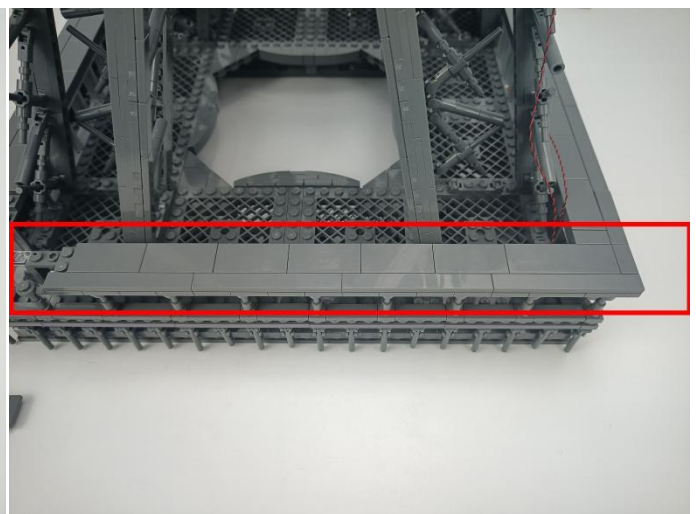
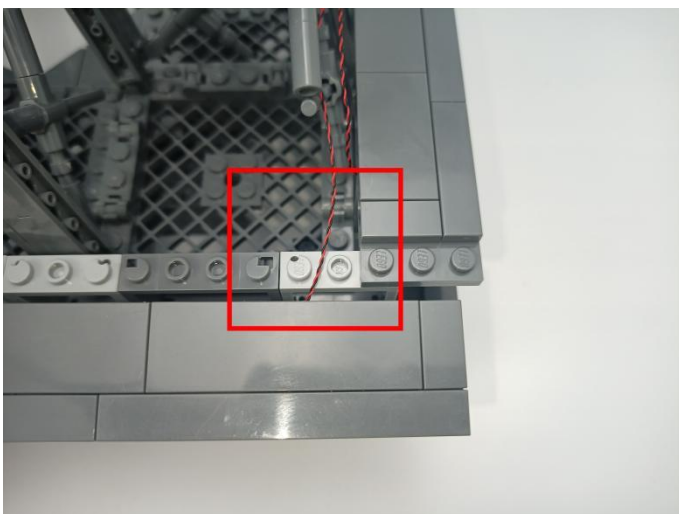

169

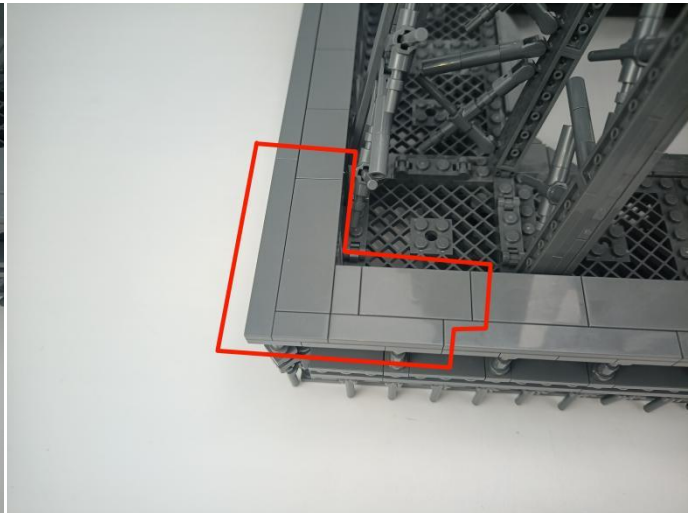
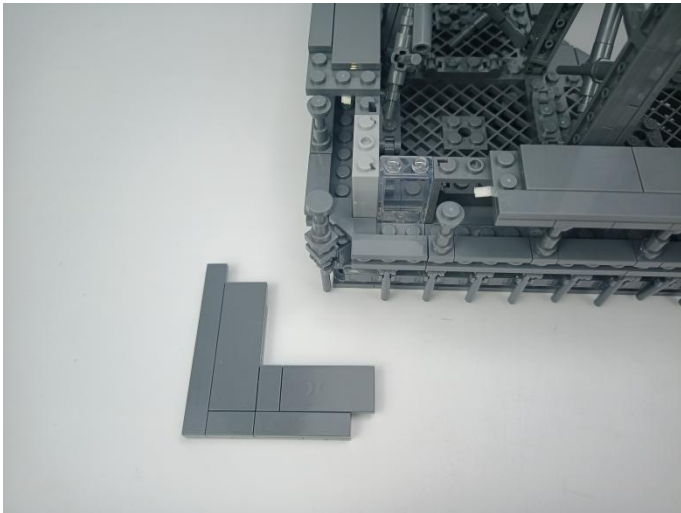

170

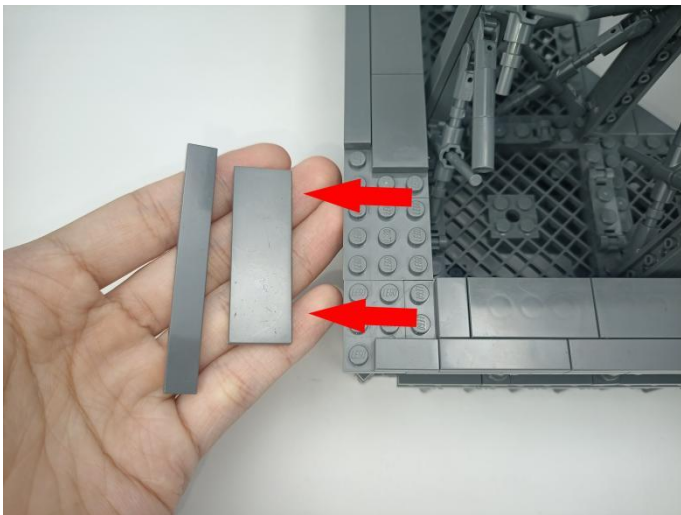

171

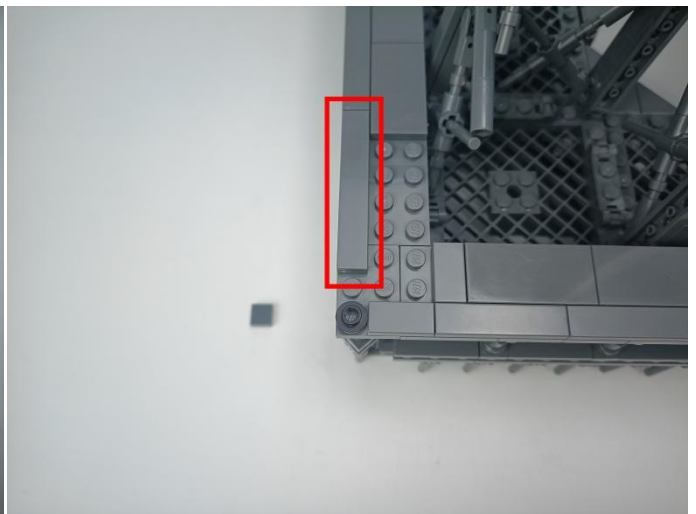



172

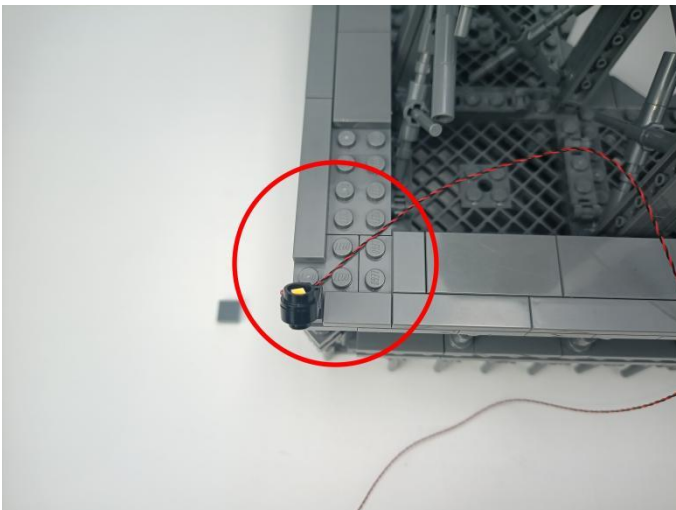

173

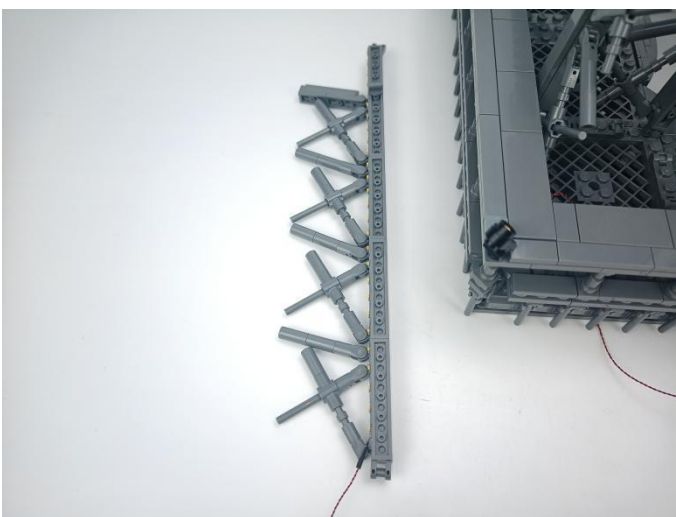
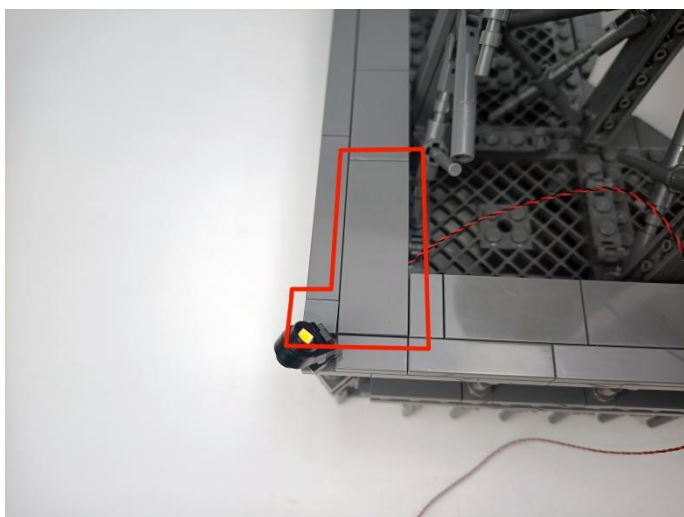

174

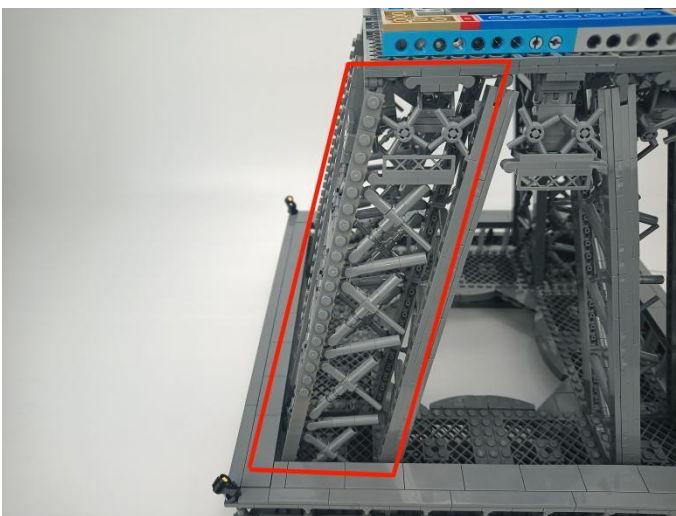
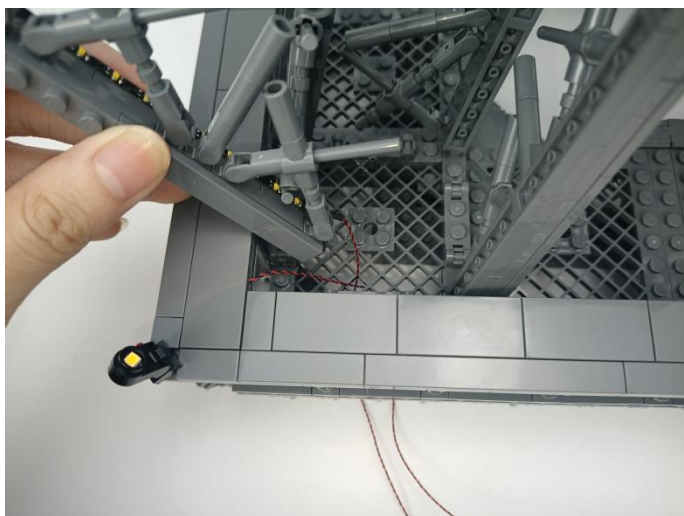

175

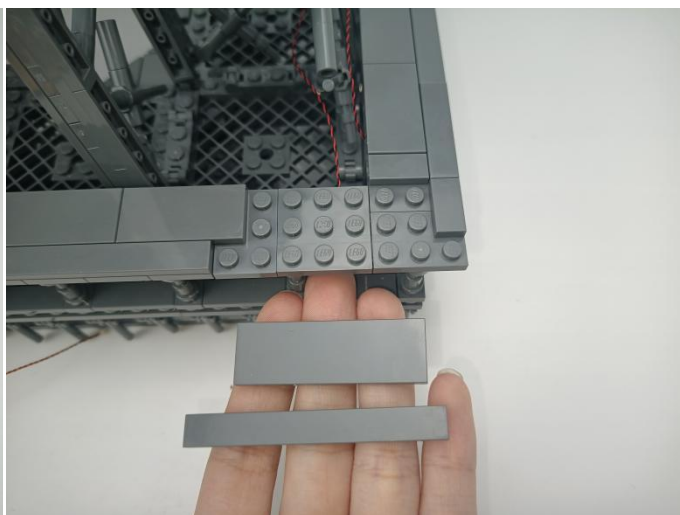
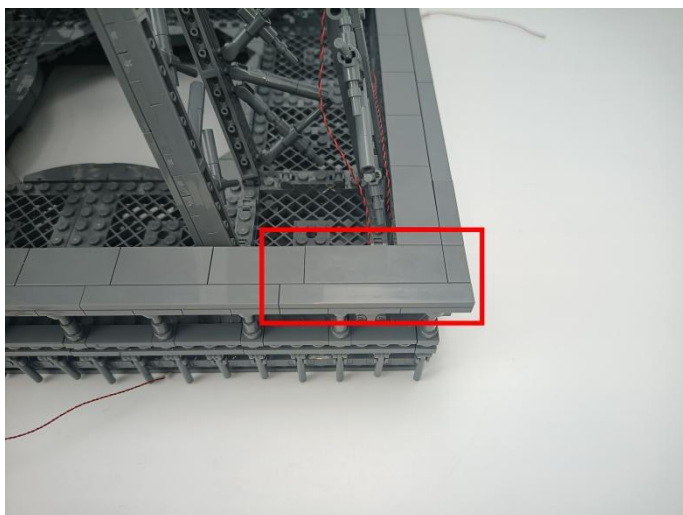

176



177

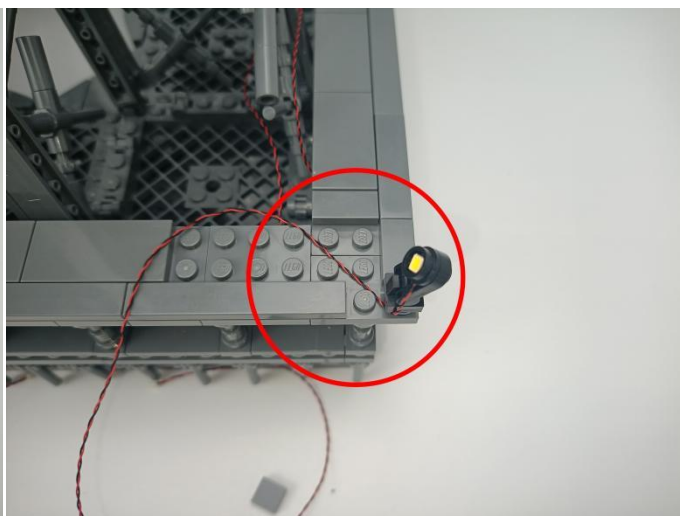
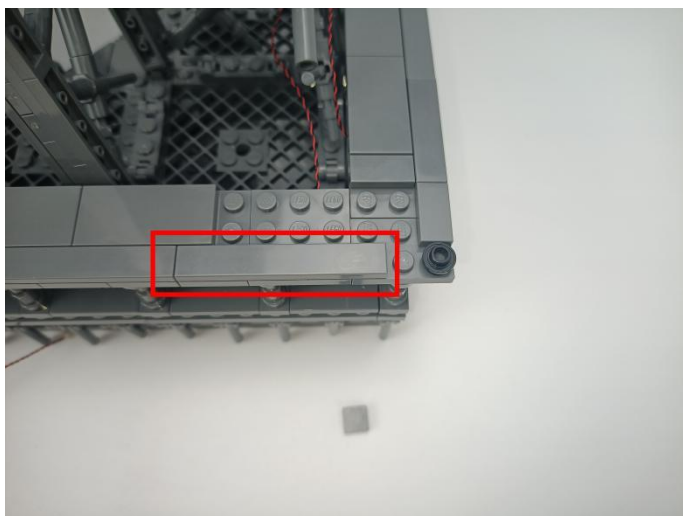



178

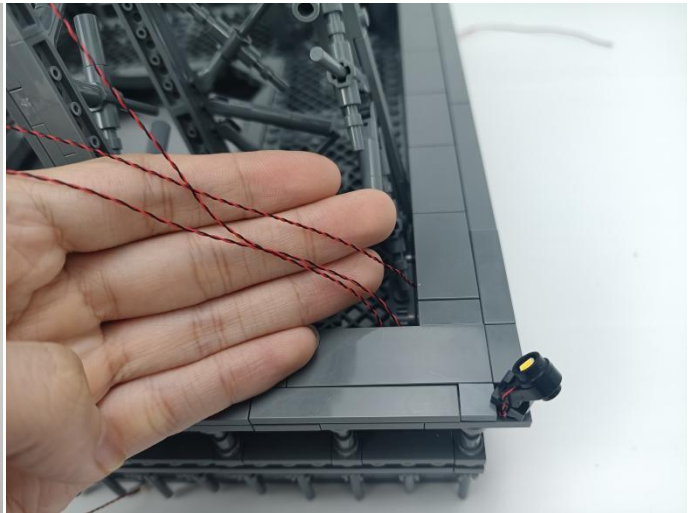
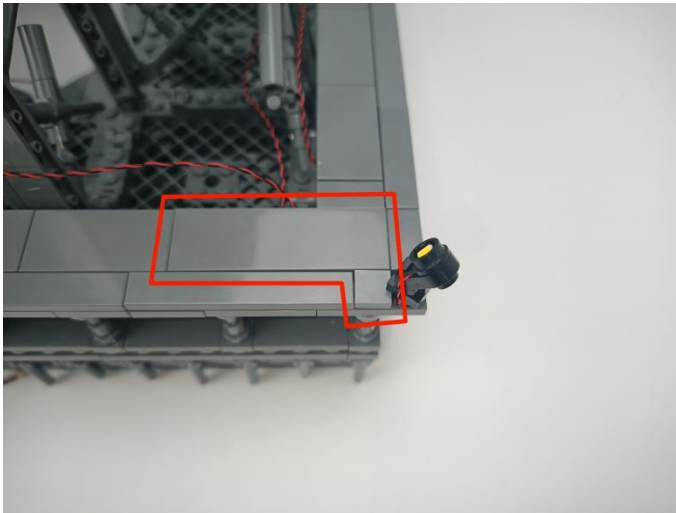

179

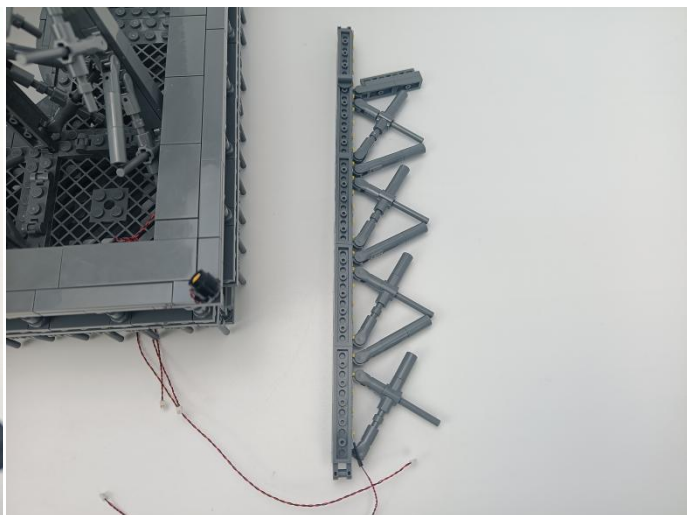
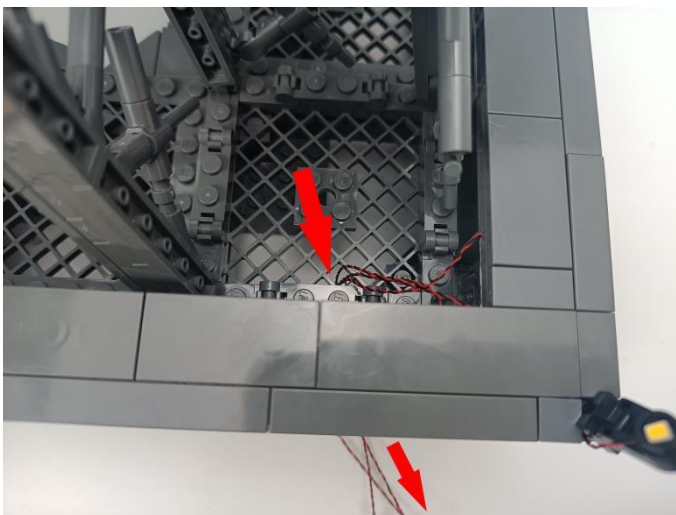

180

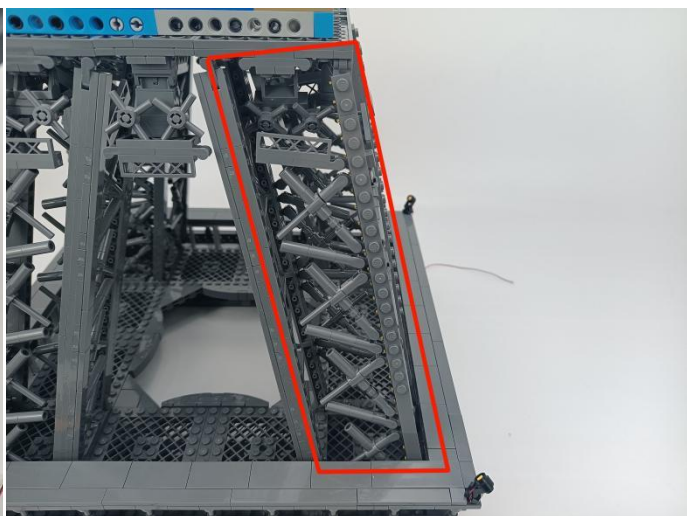
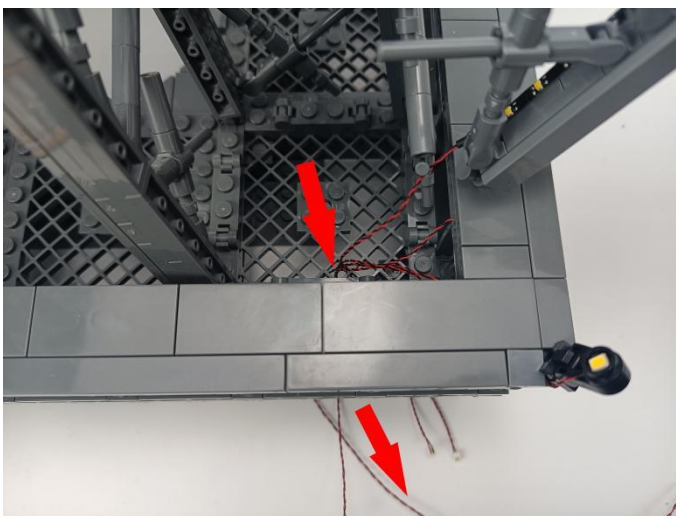

# 181

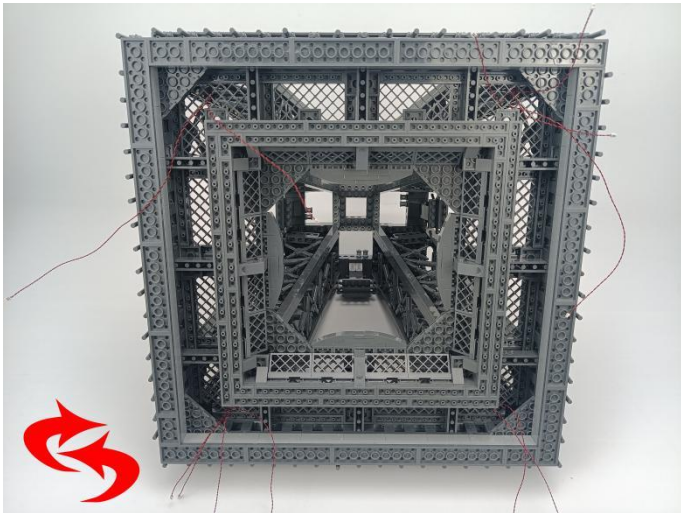

# 182



# 183

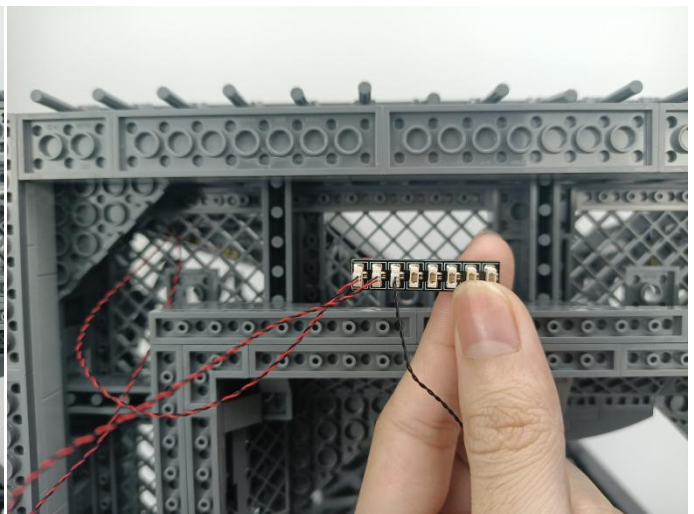
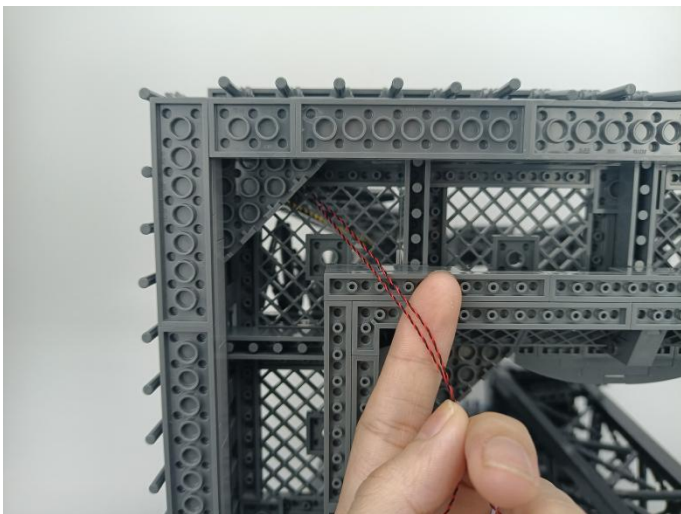



184

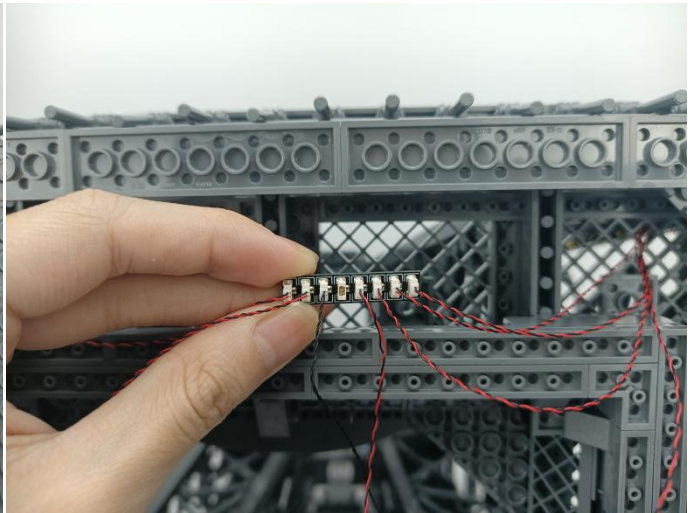
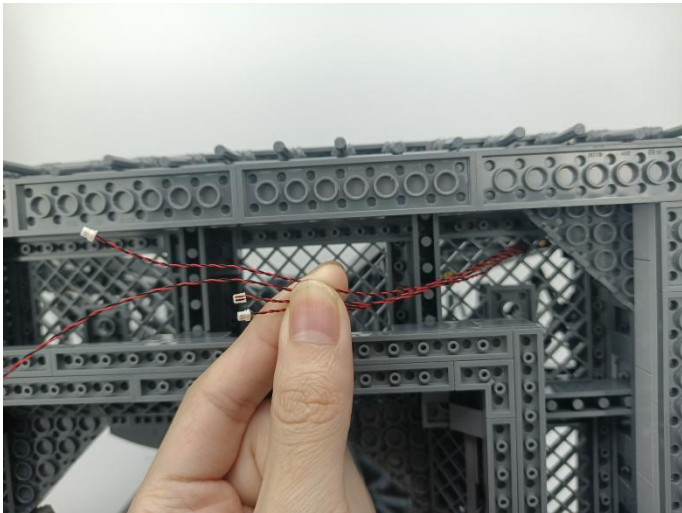

185

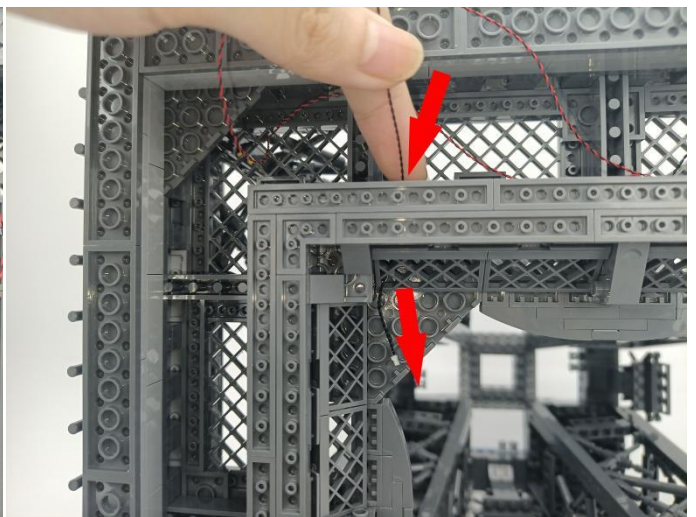
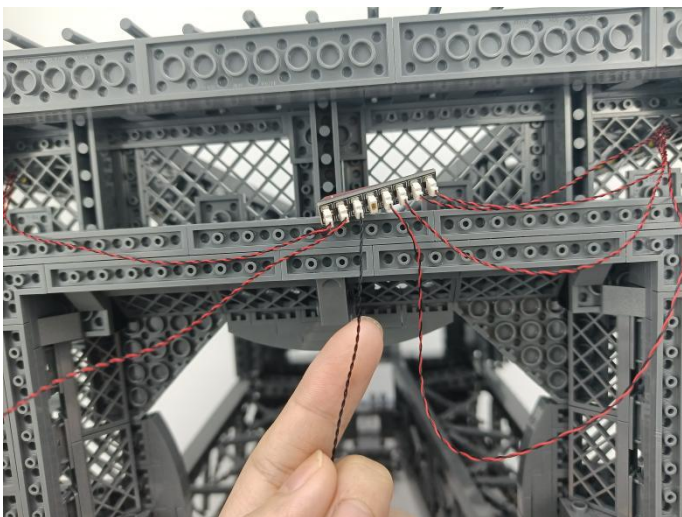

186

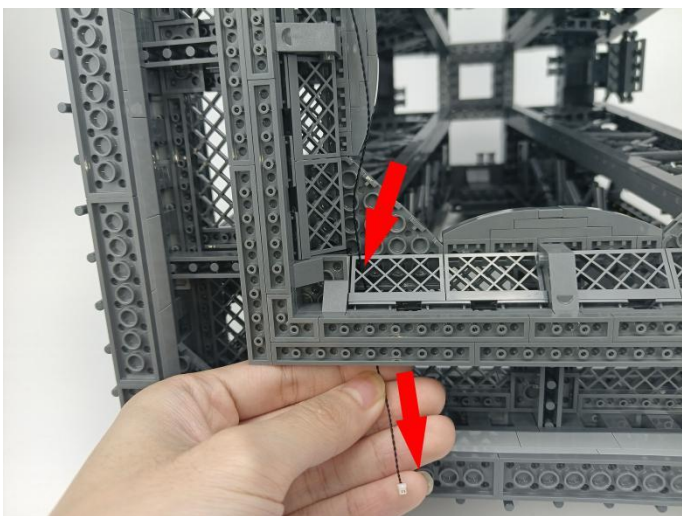



187

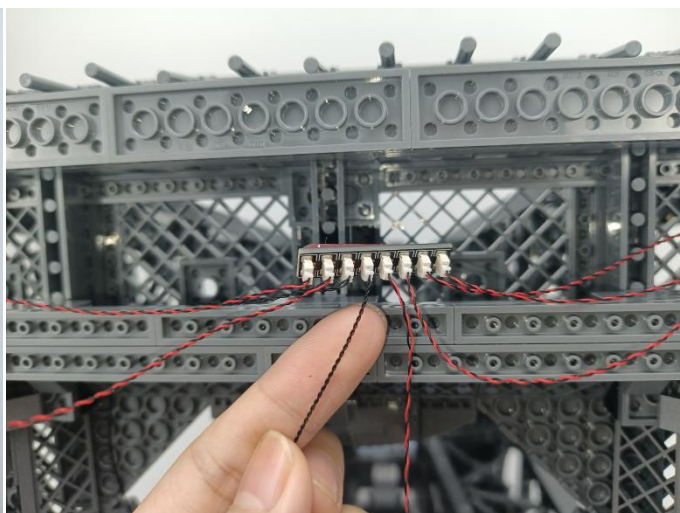

188

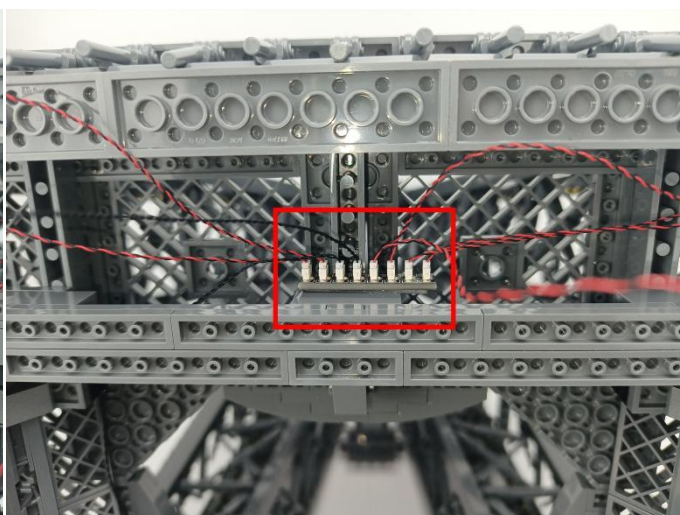
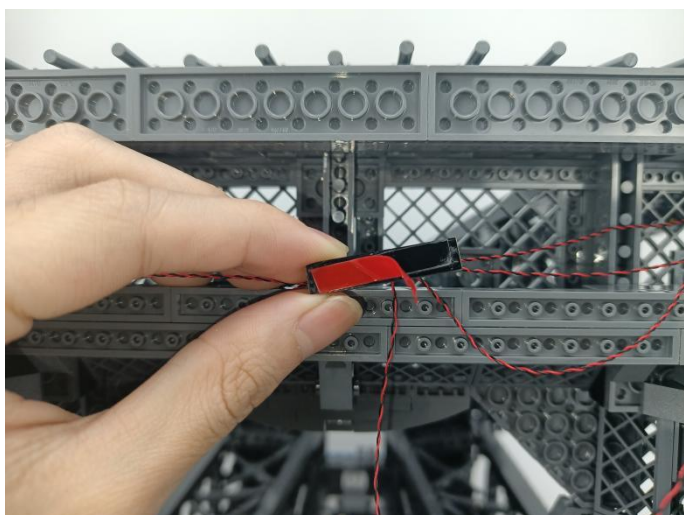

189

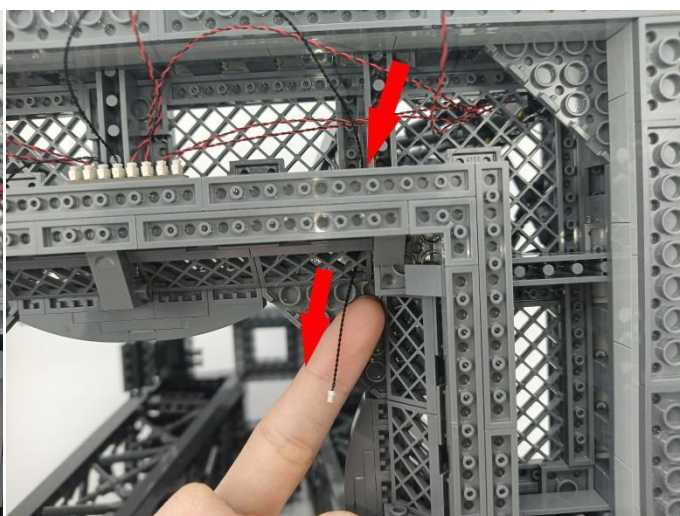
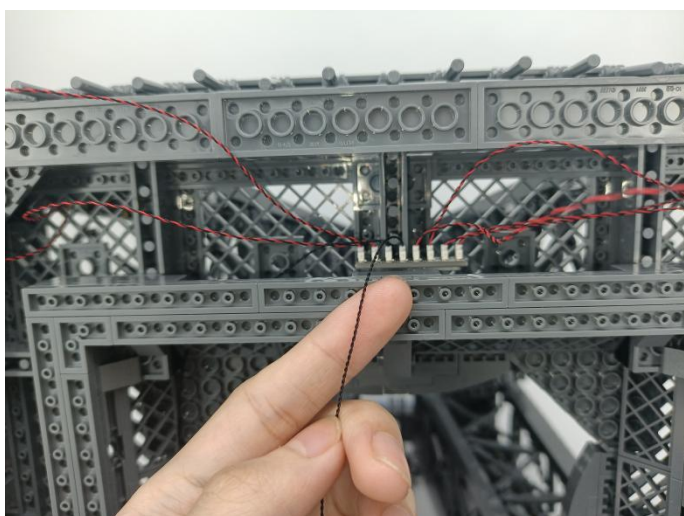



190

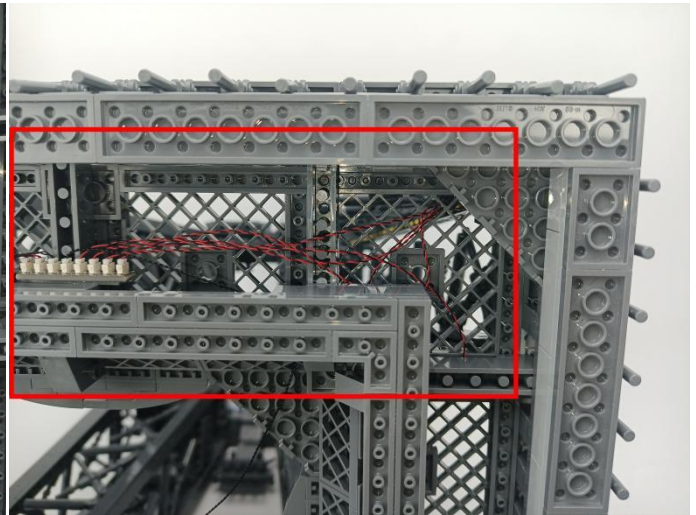
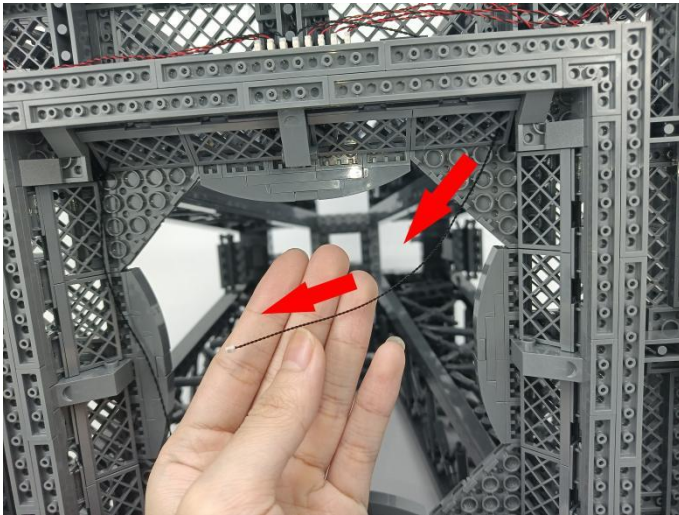

191

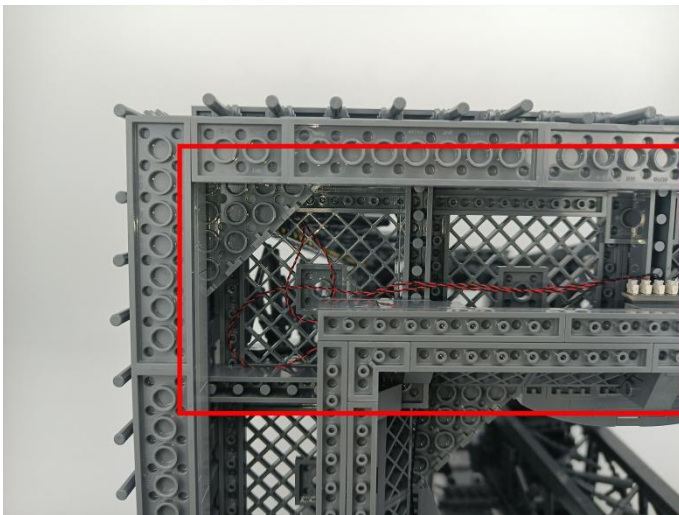

192

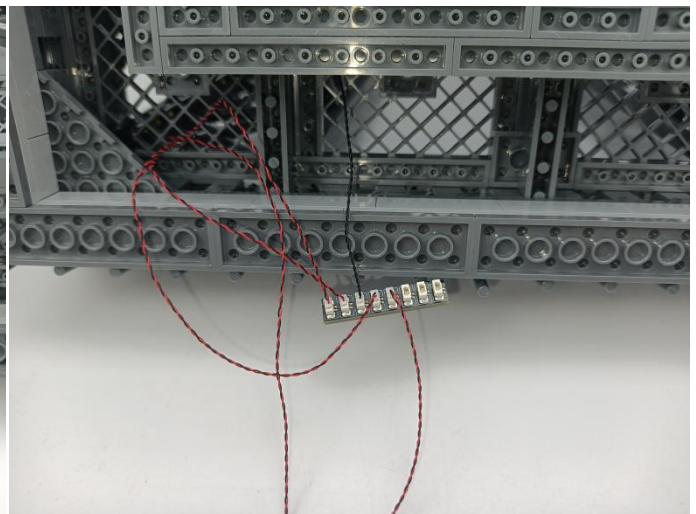
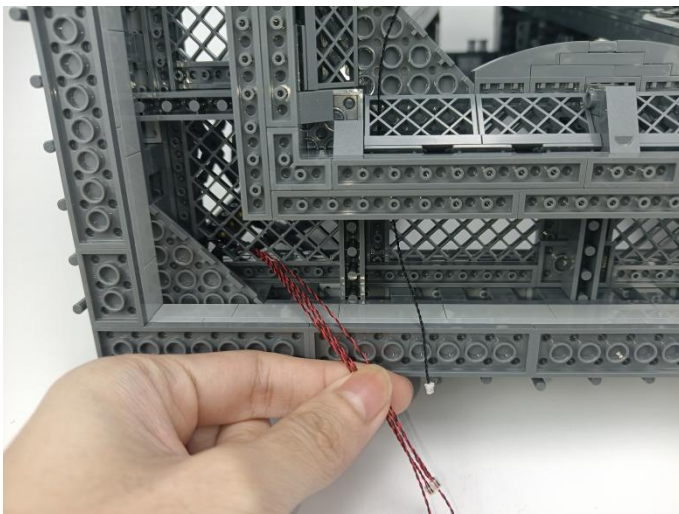



193

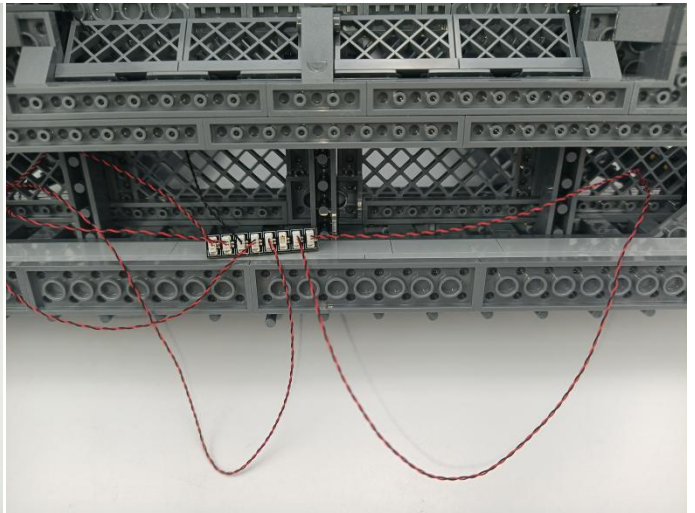
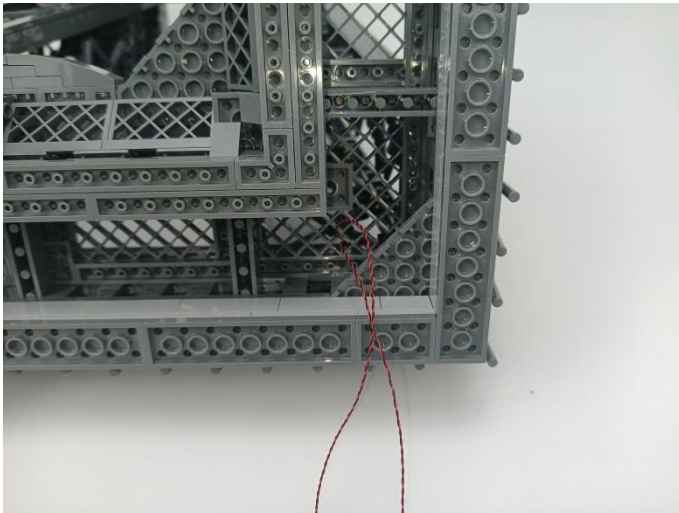

194

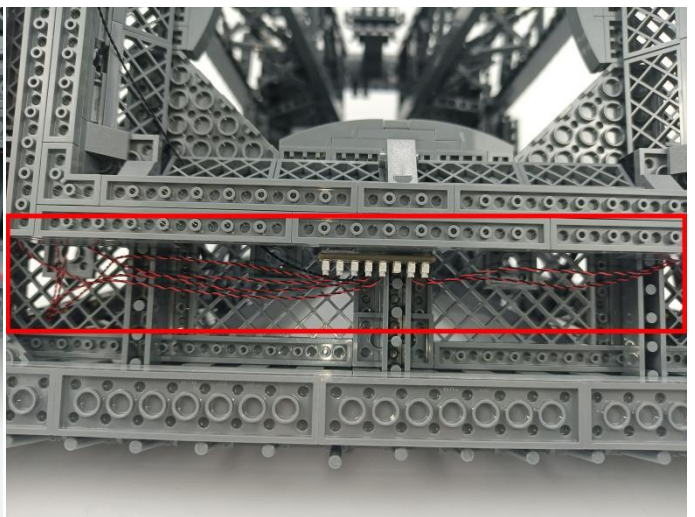
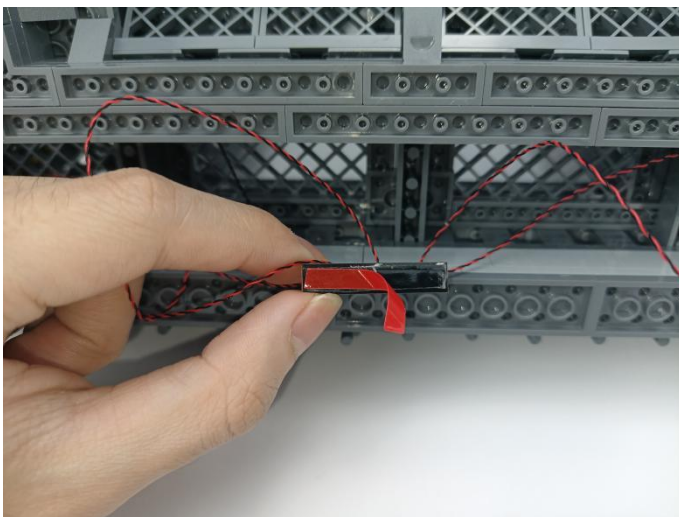

195

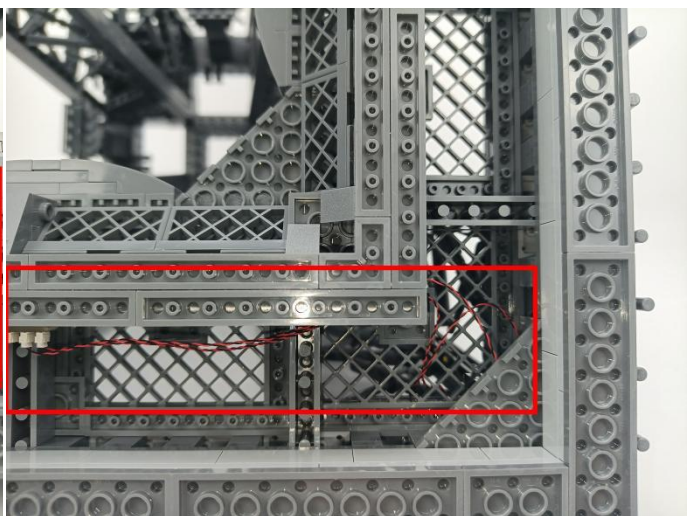
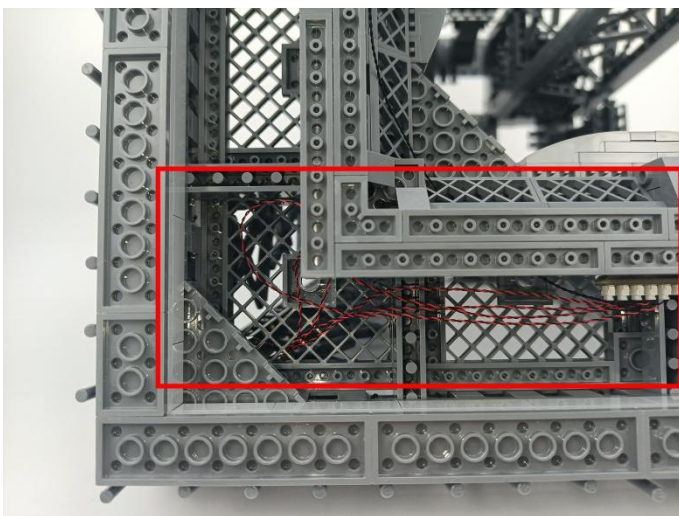



196

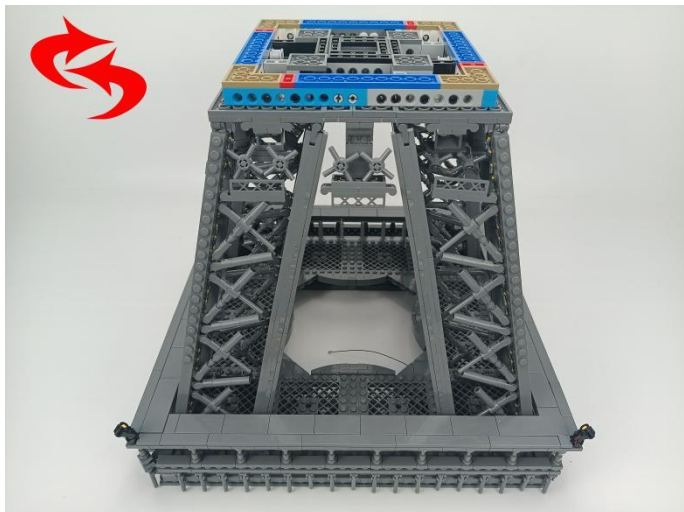

197

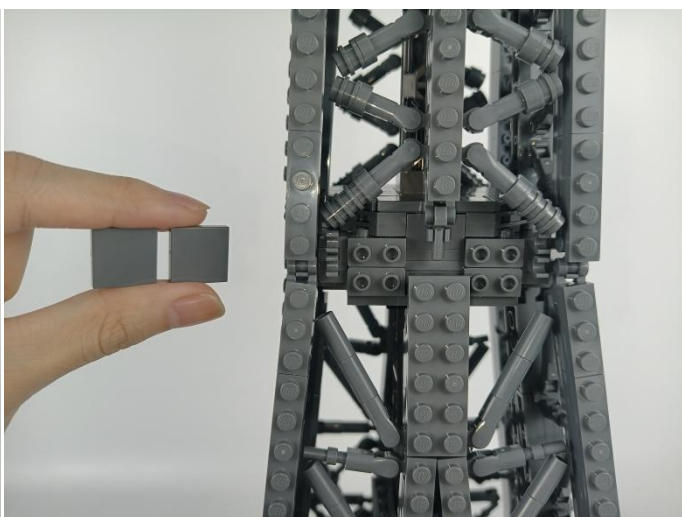
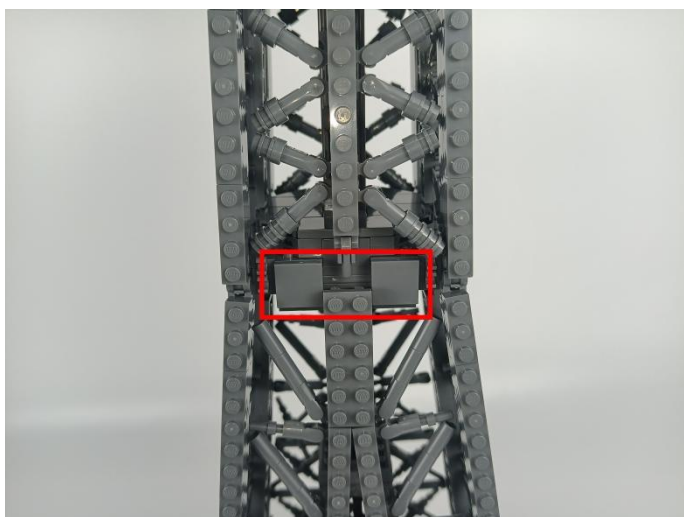

198

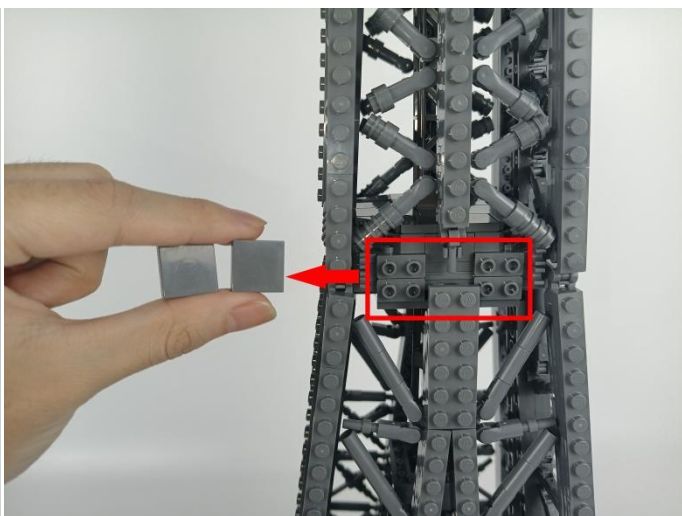

199



200

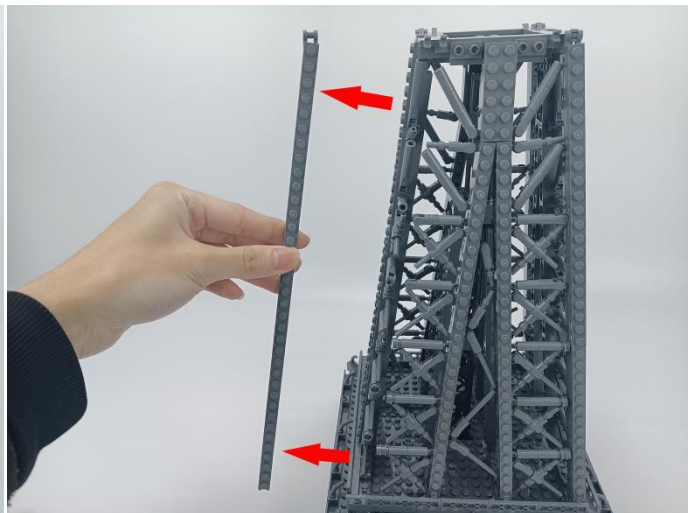
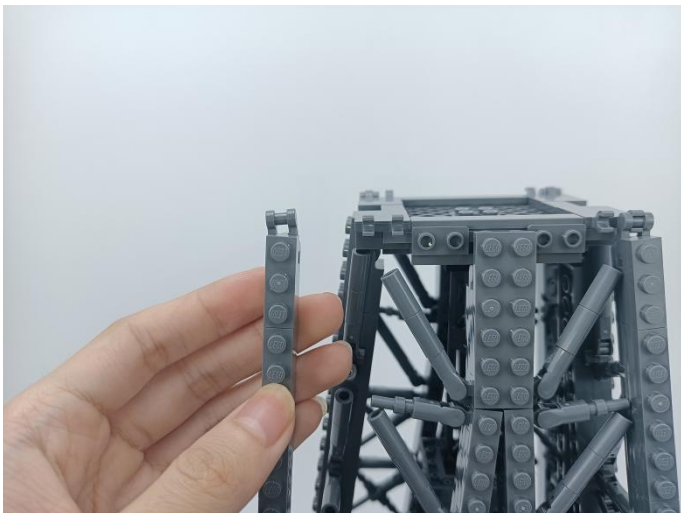

201

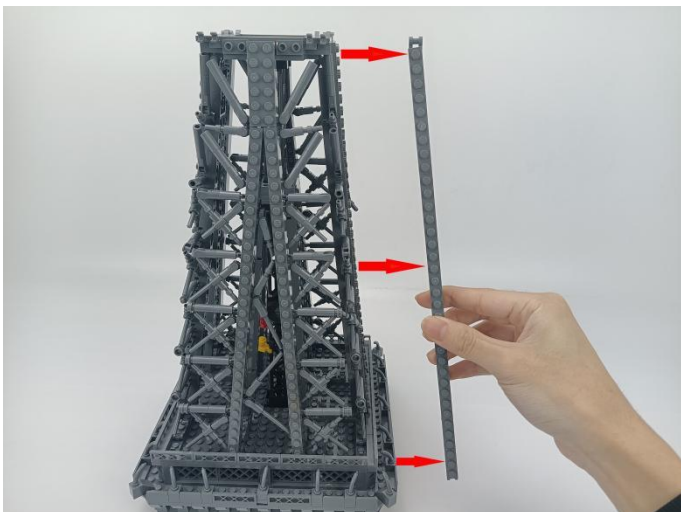



# 202

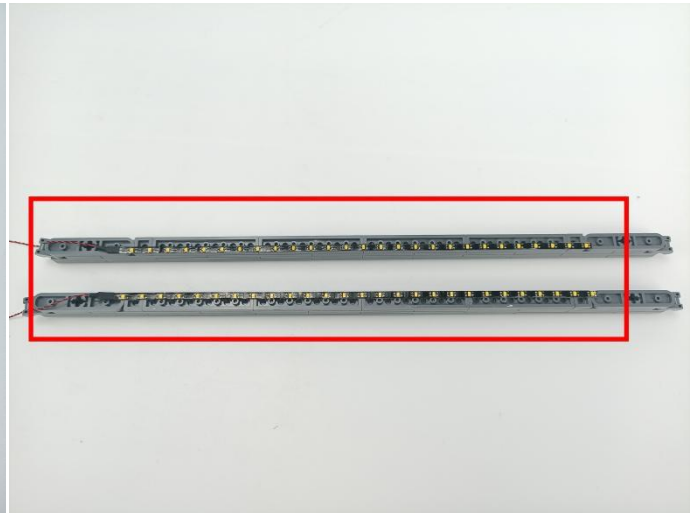

# 203

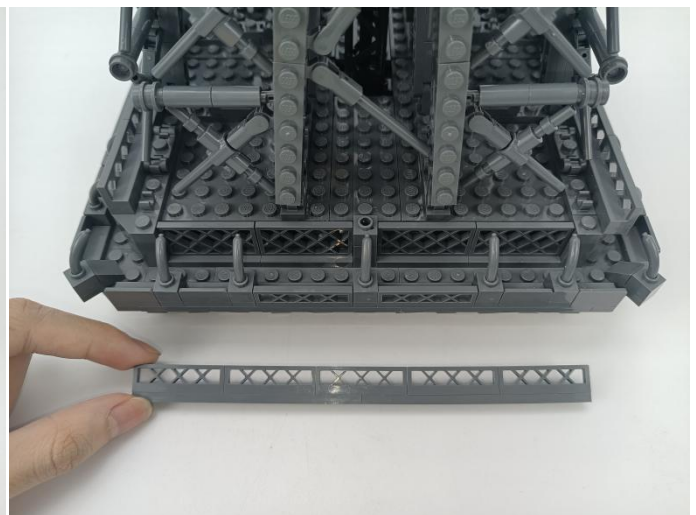
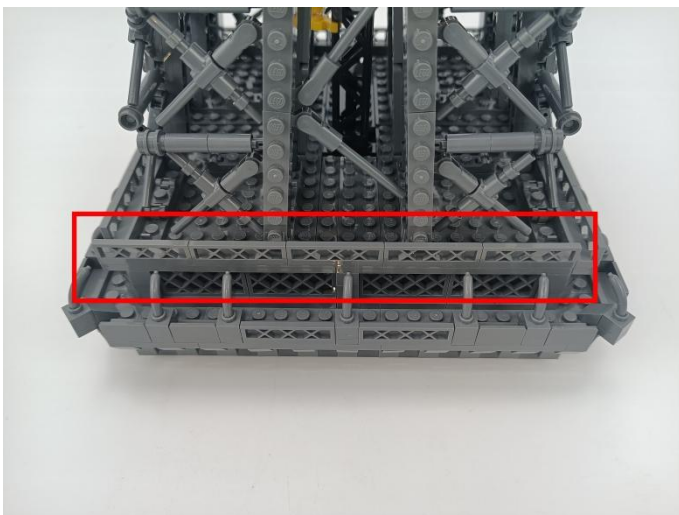

# 204

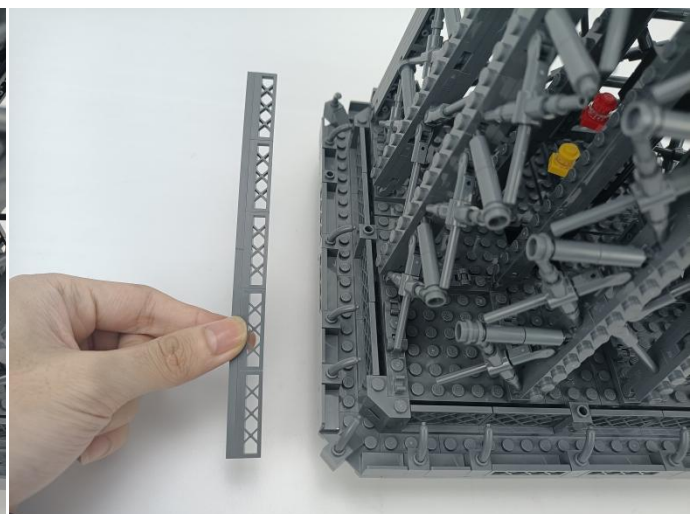
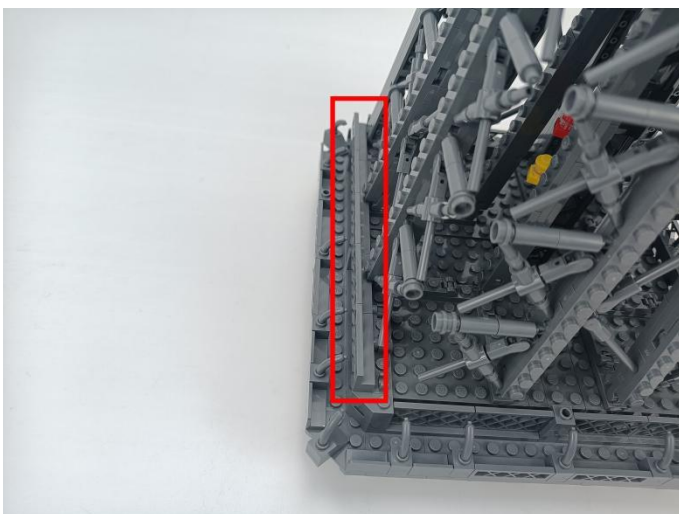

205

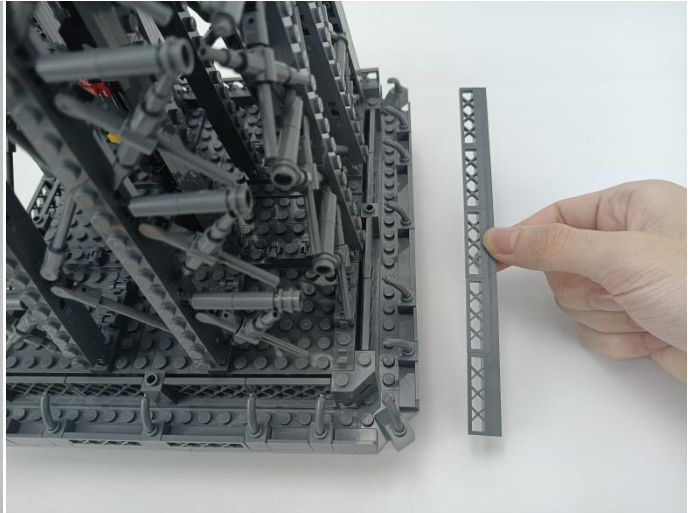
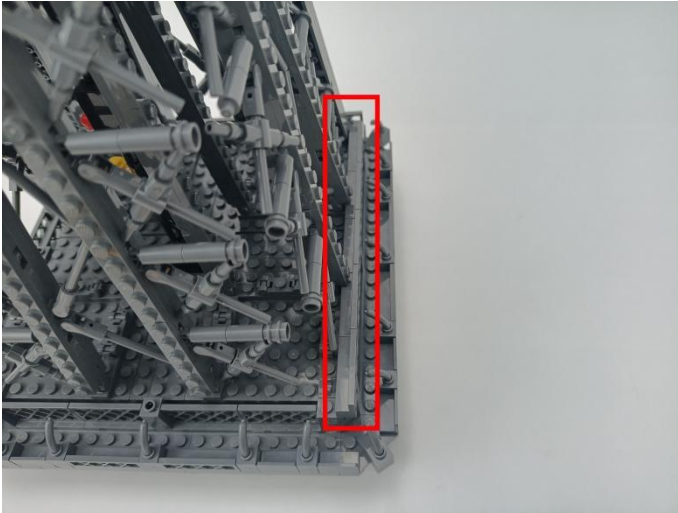

206

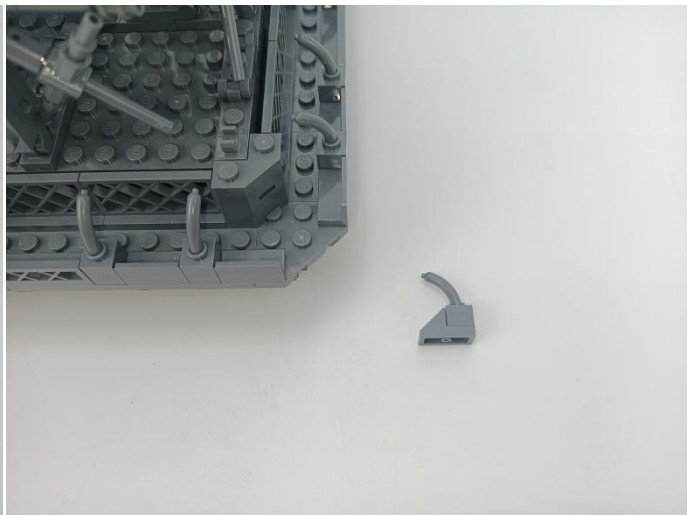
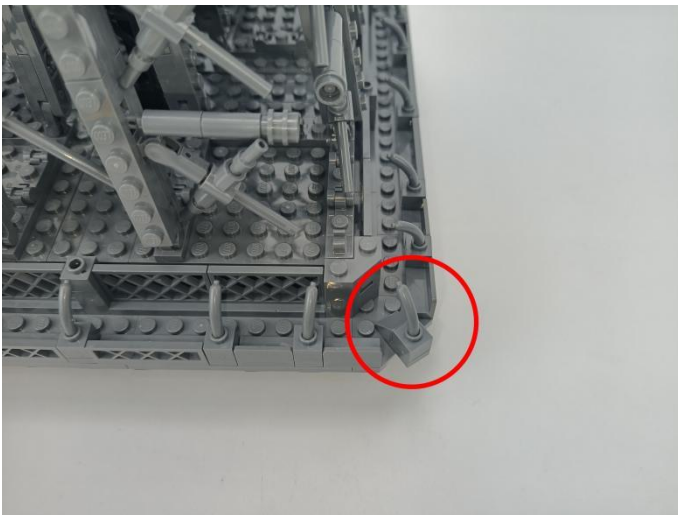

207

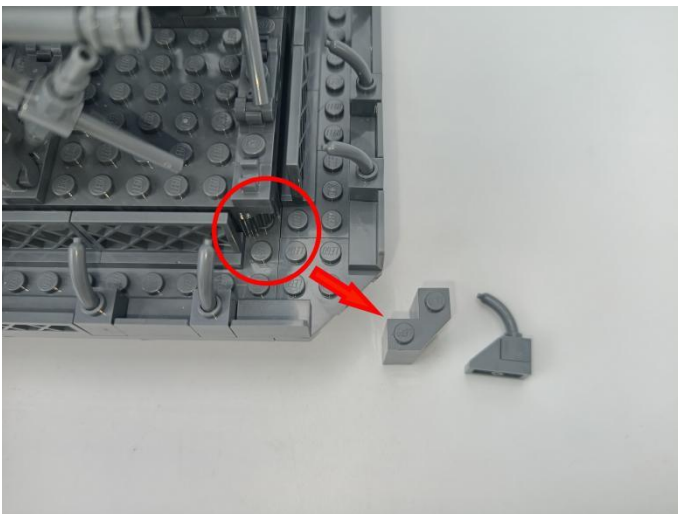



208

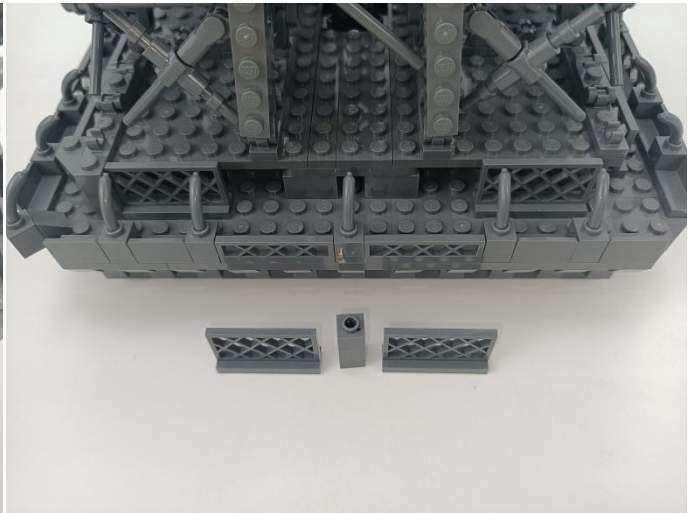
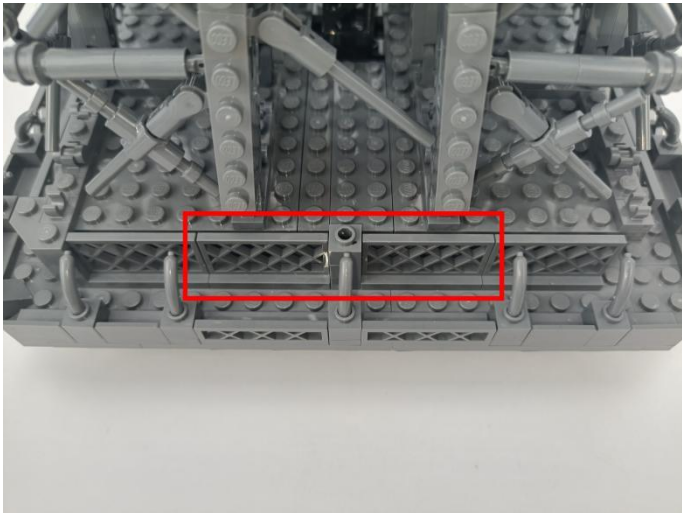

209

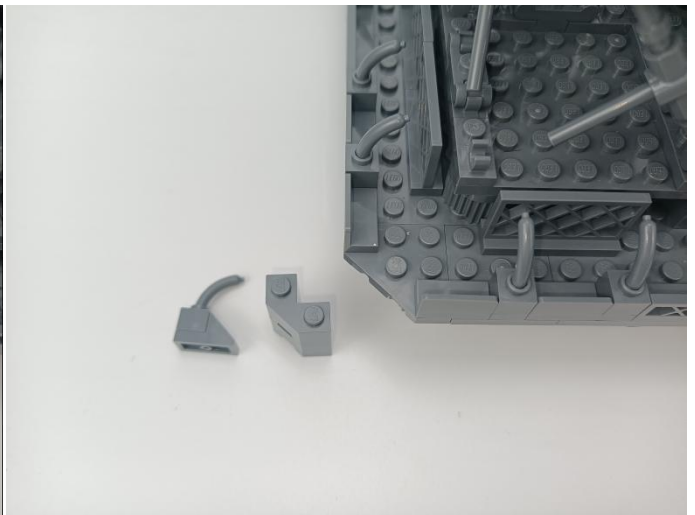
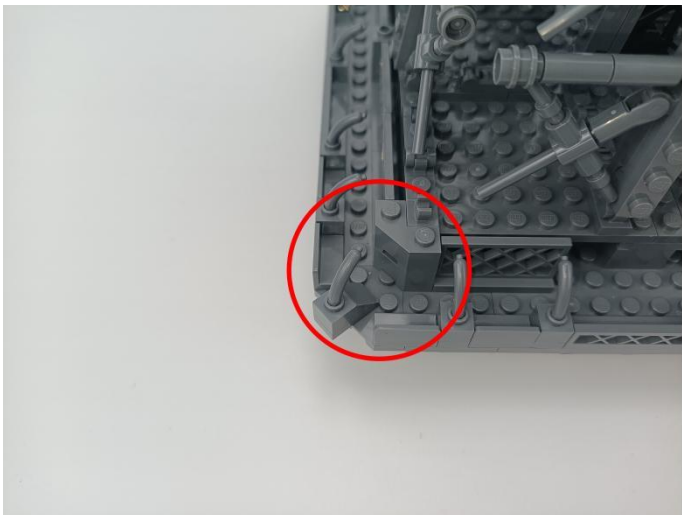

210



# 211

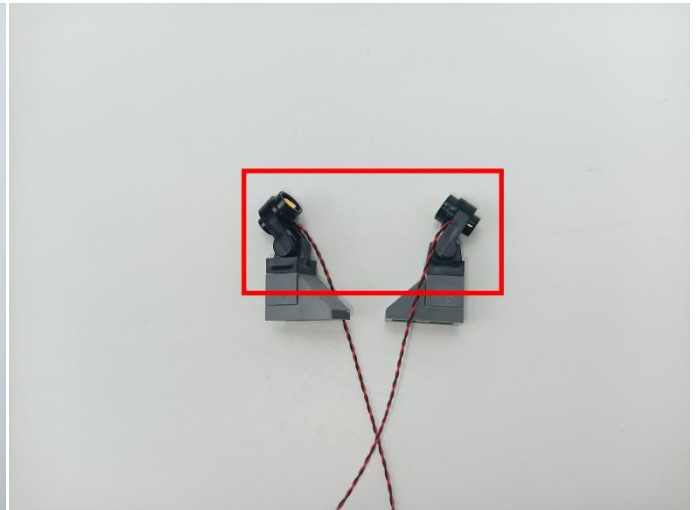

# 212

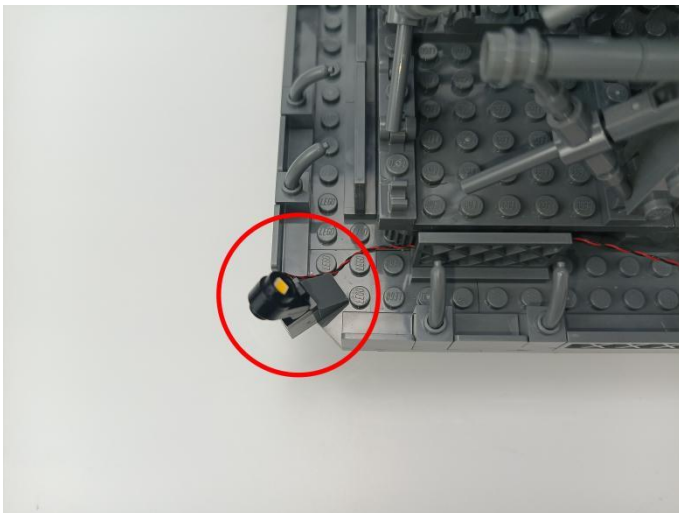

# 213

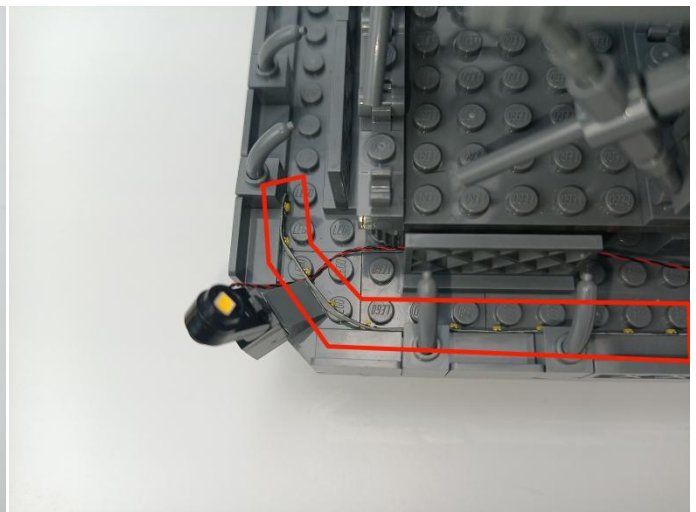



214

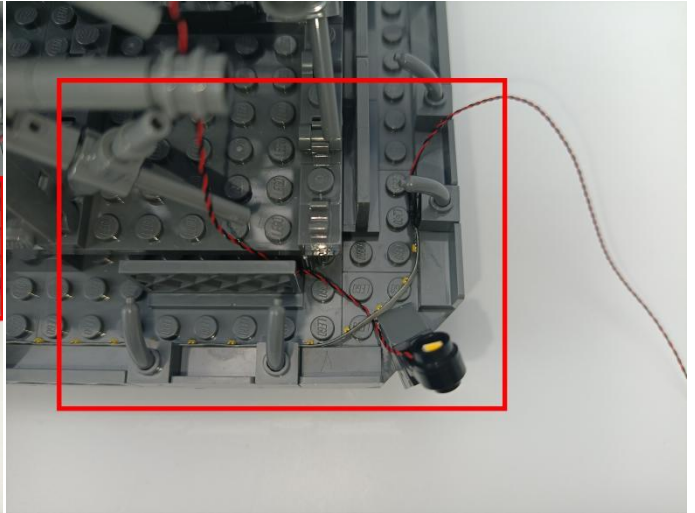
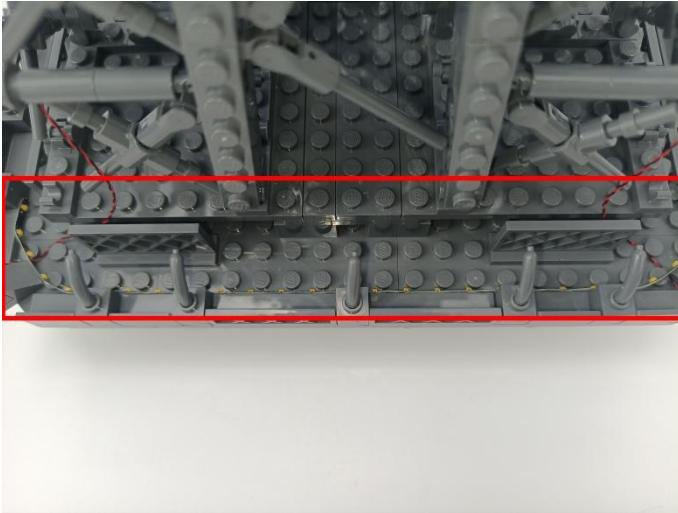

215

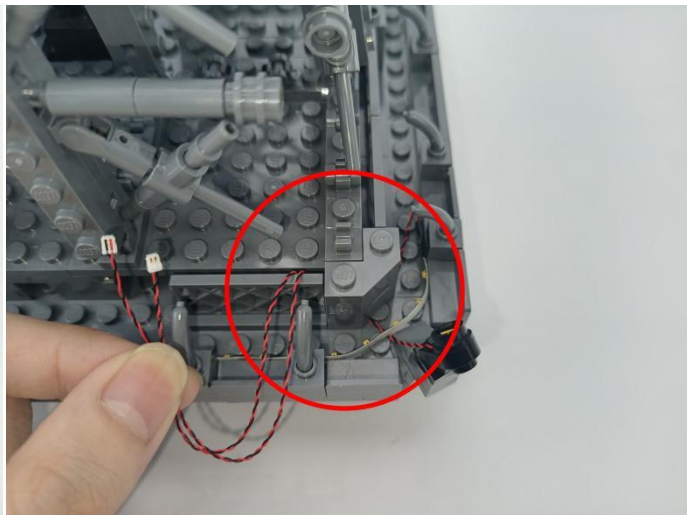
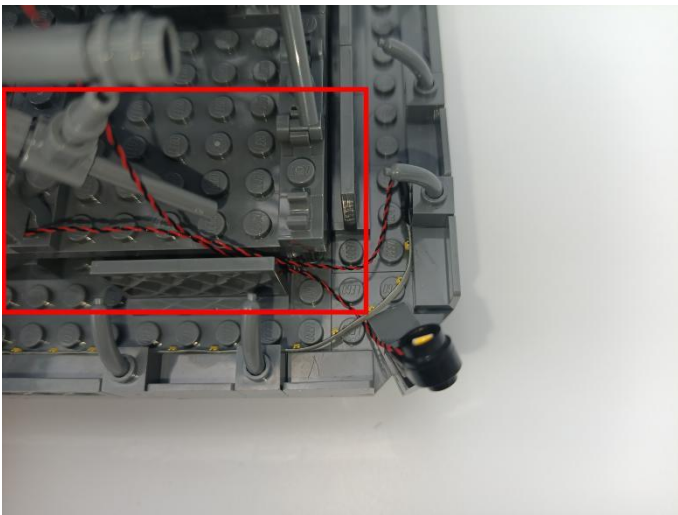

216

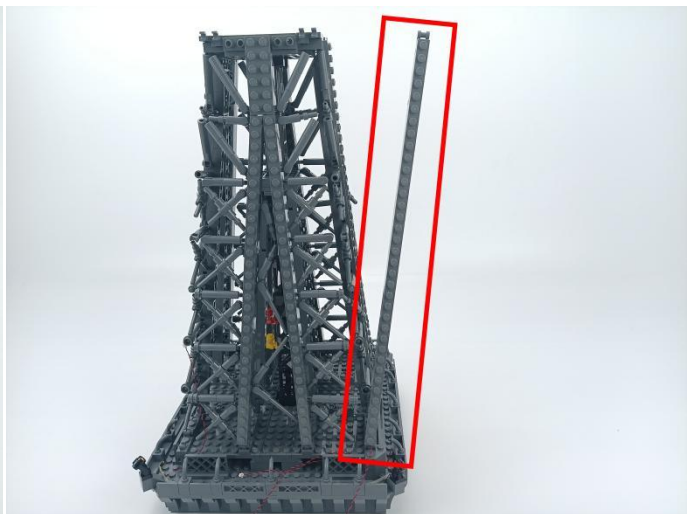
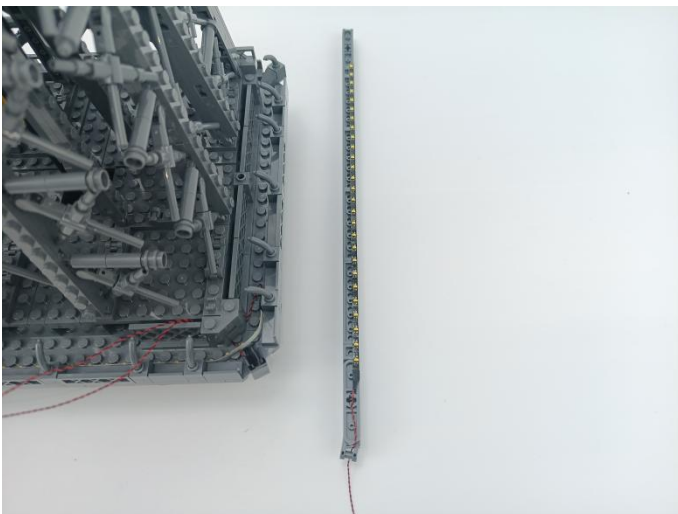

217

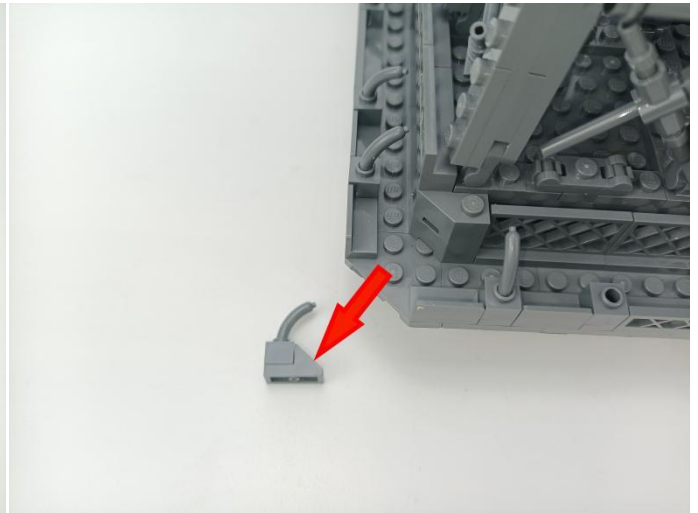
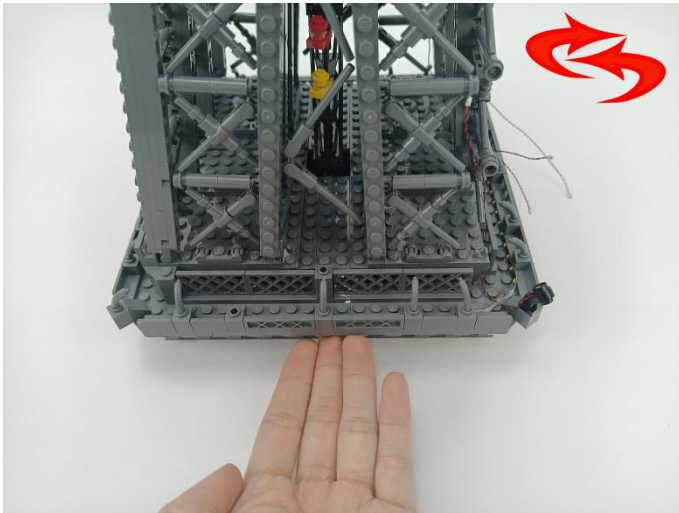

218



219

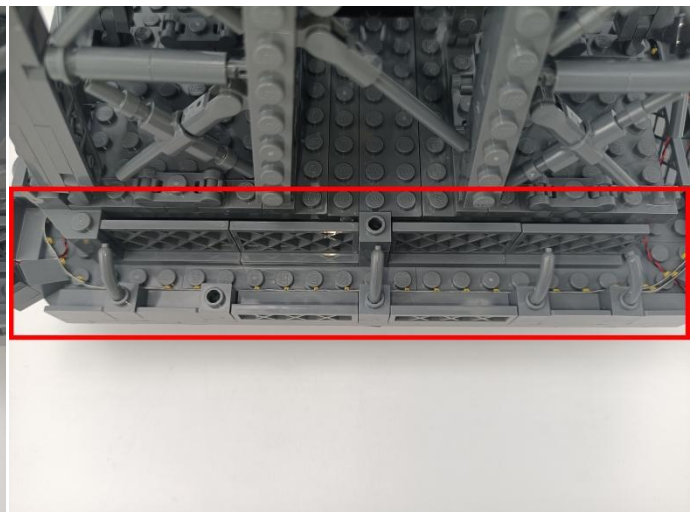
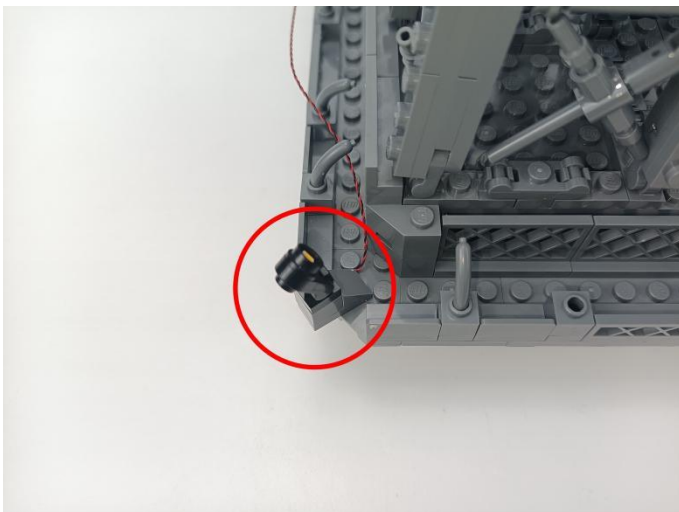



220

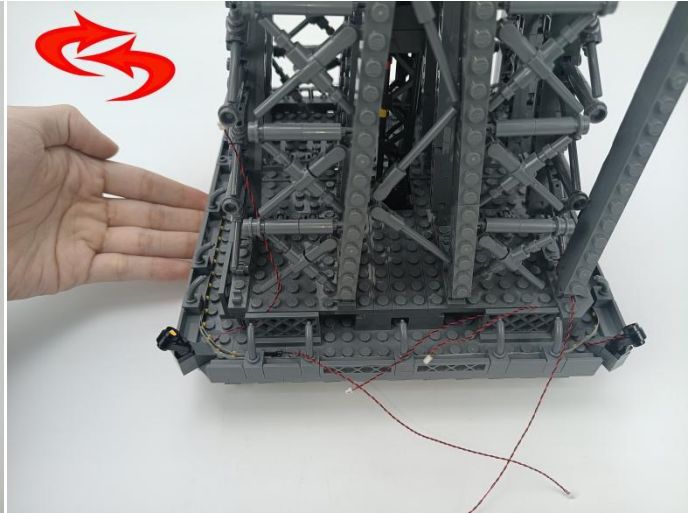
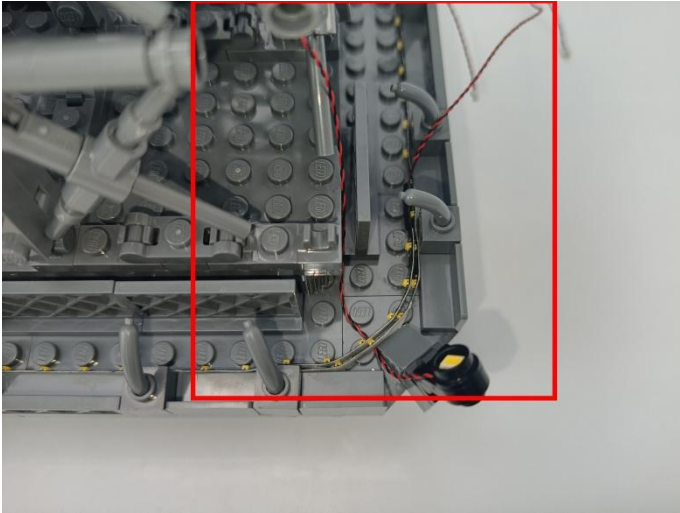

221

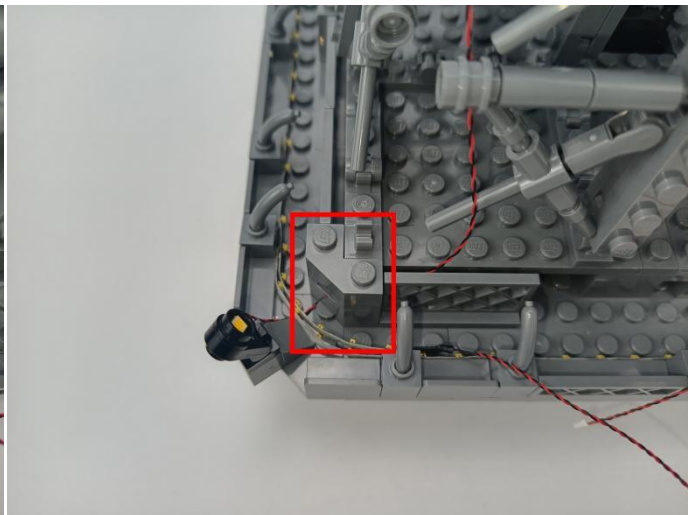
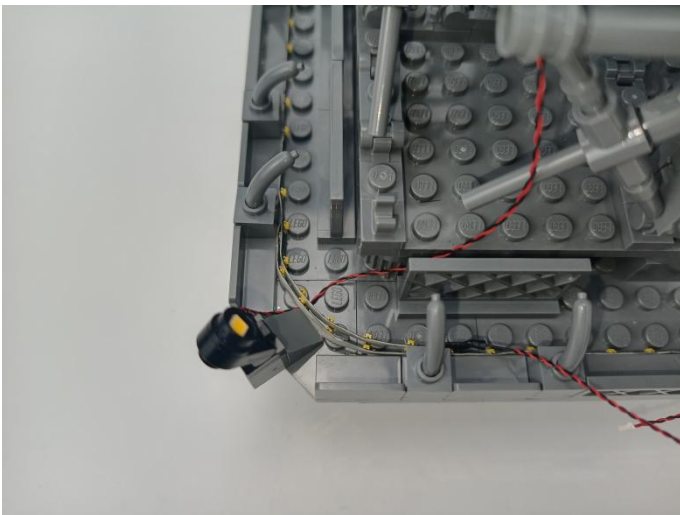

222

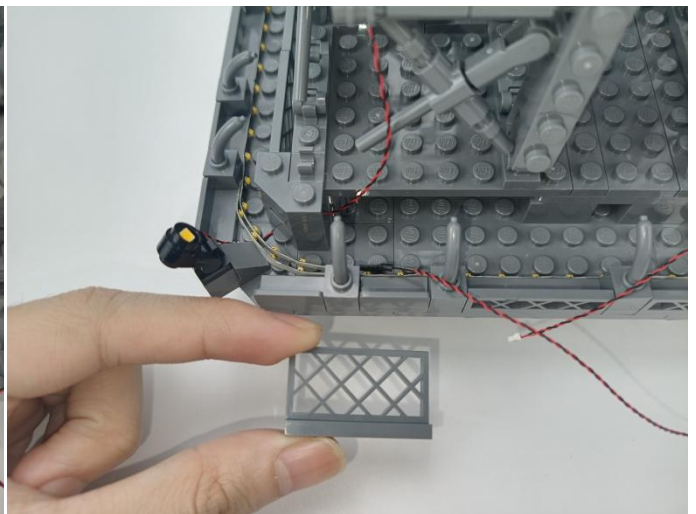
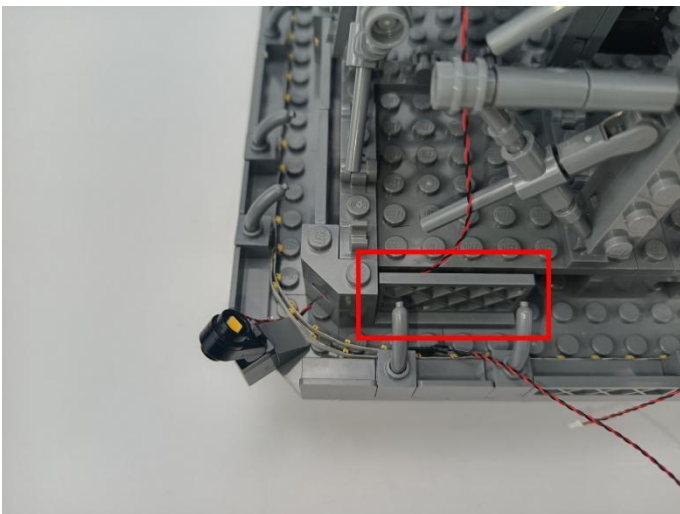

223

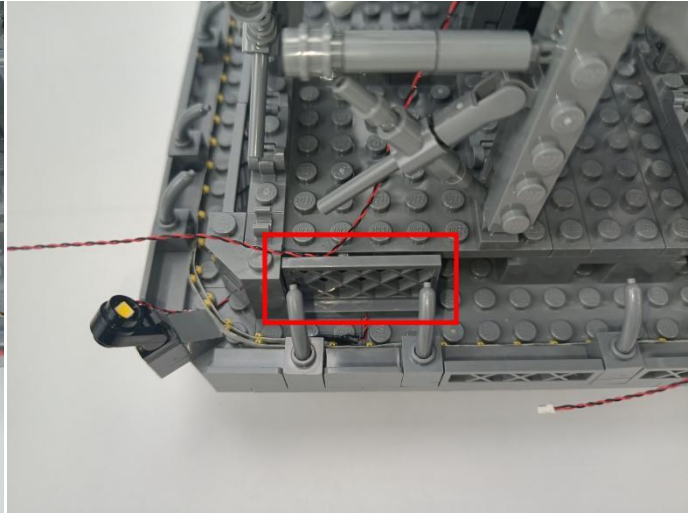
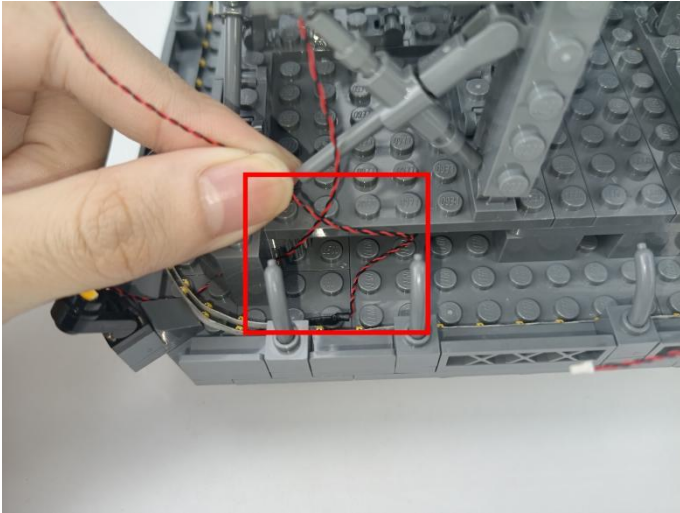

224

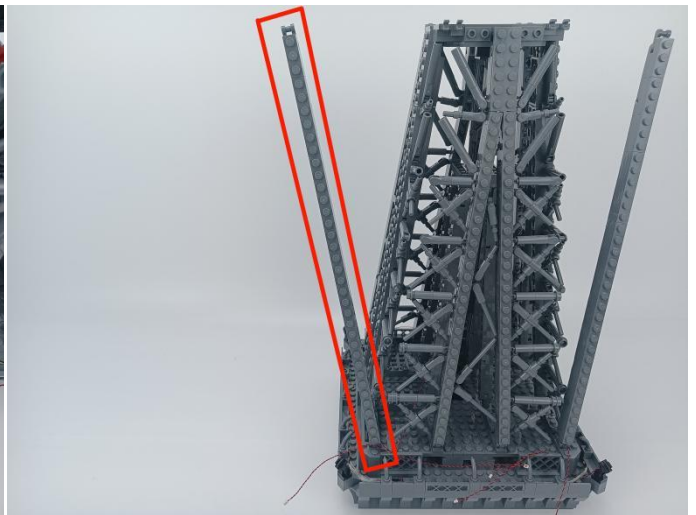
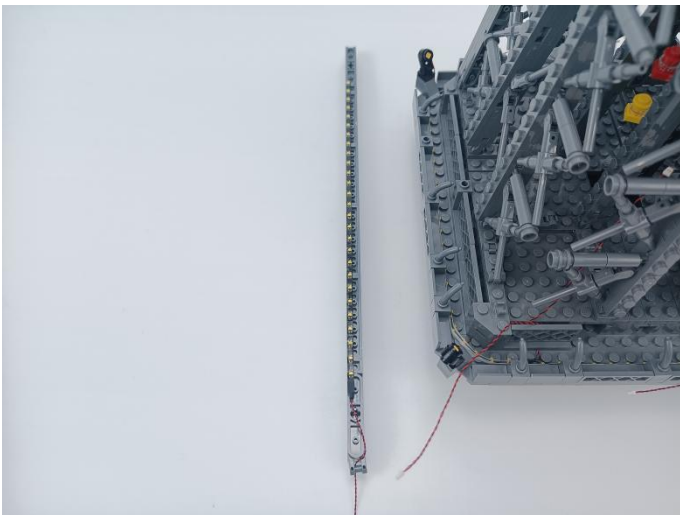

225





226

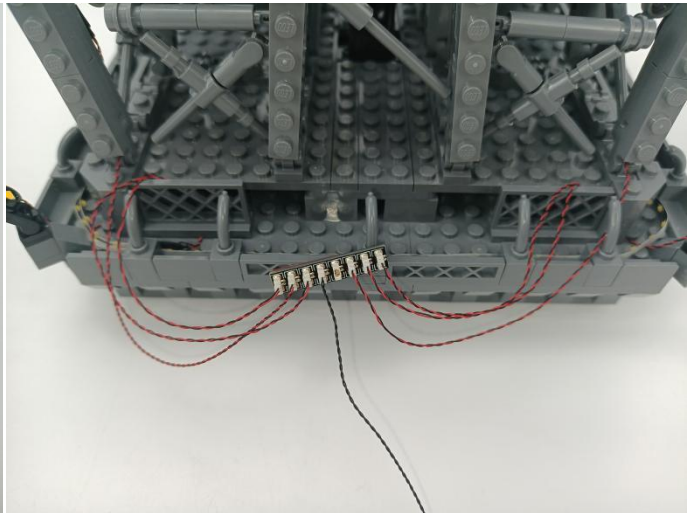
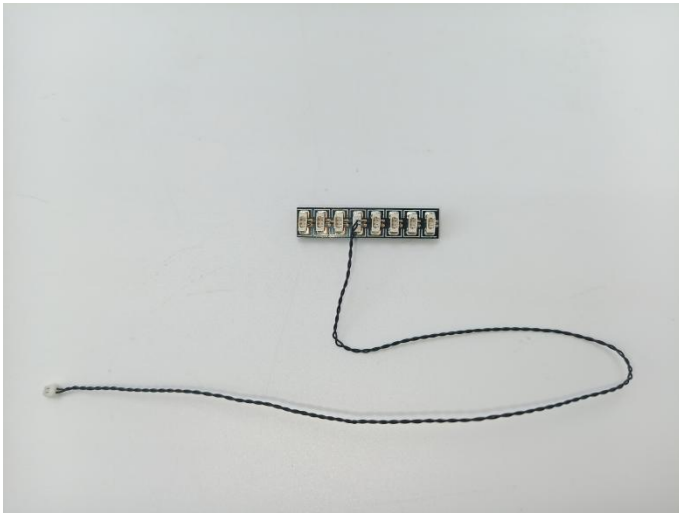

227

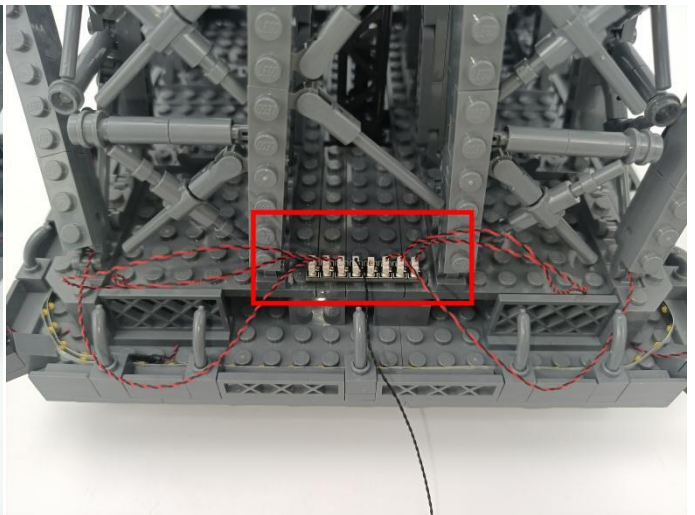
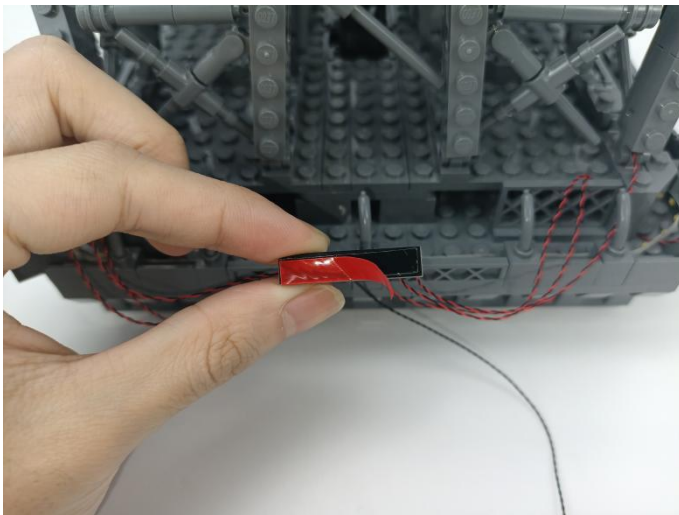

228

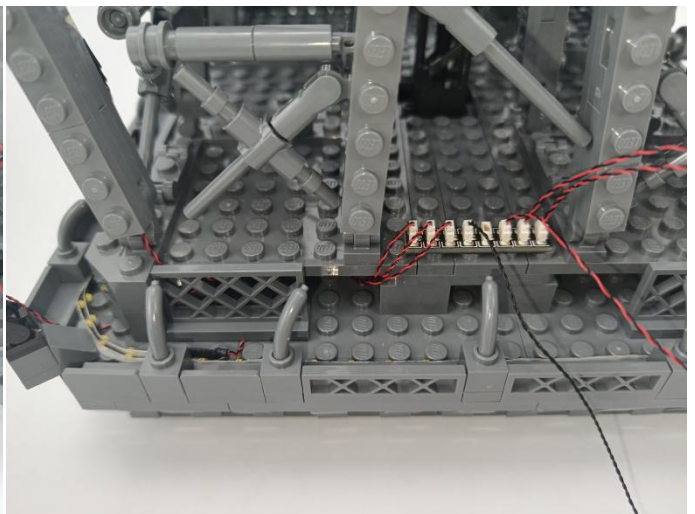
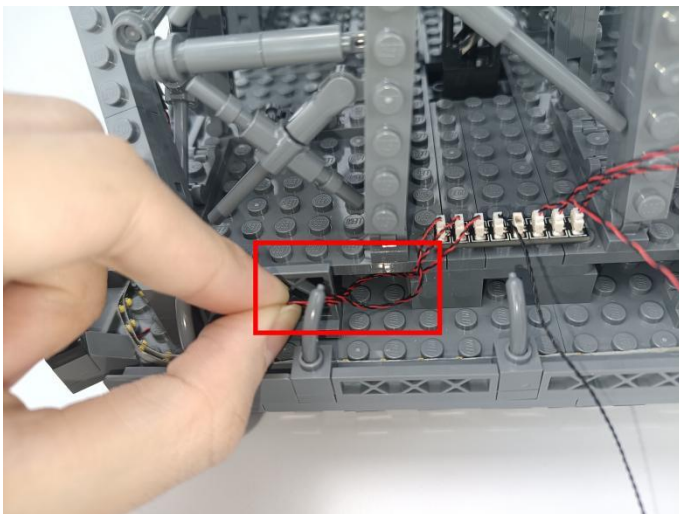

229

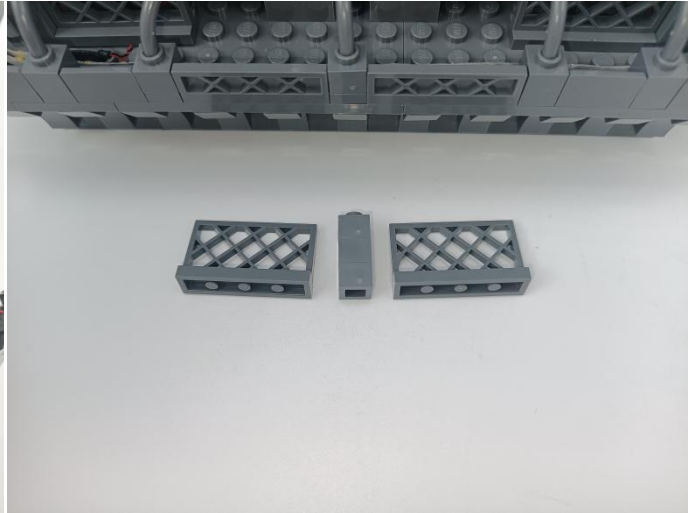
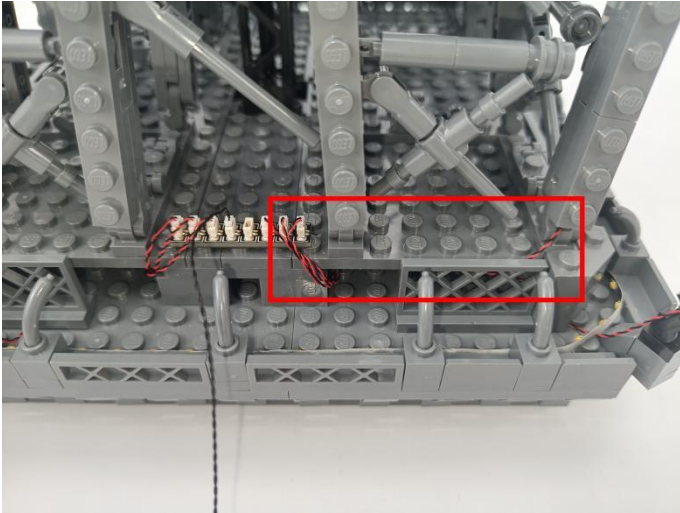

230

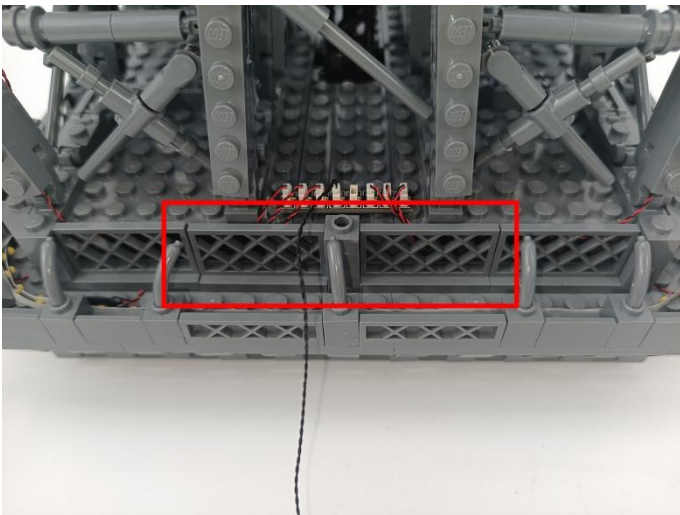

231

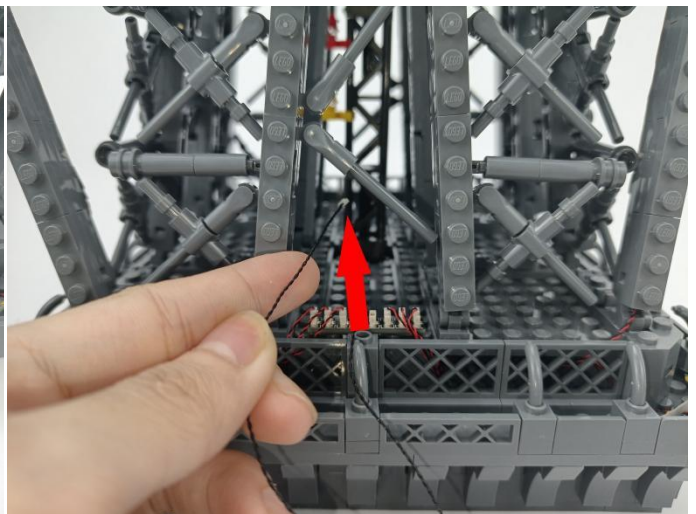
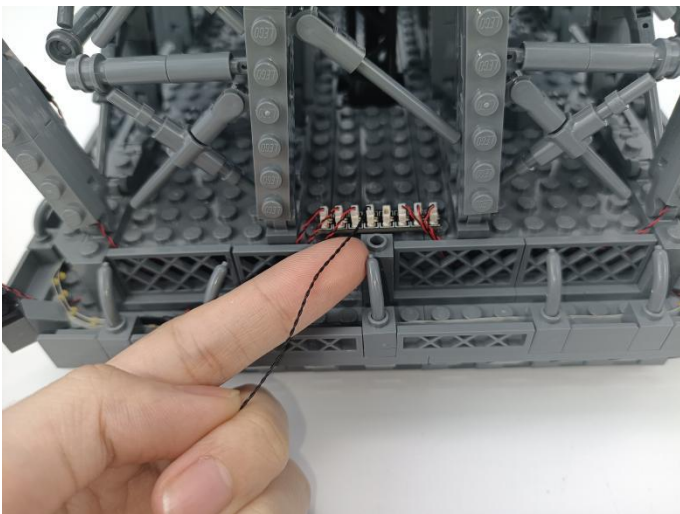



232

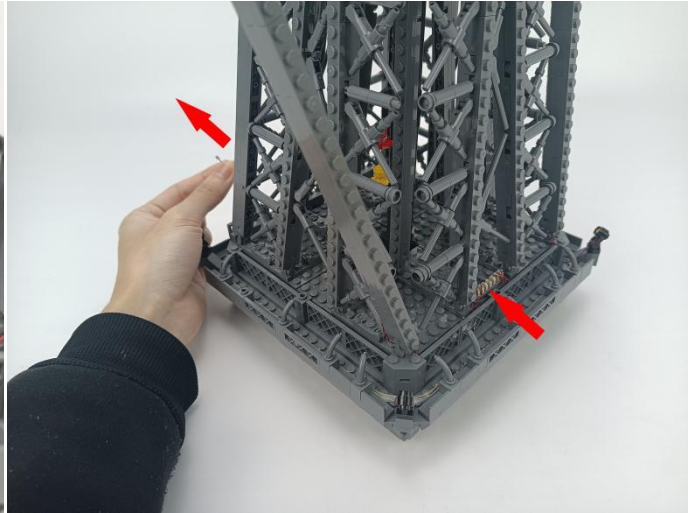

233

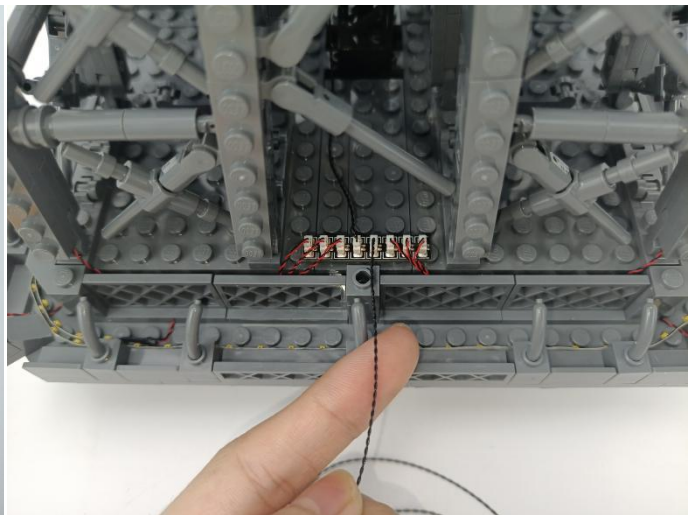

234

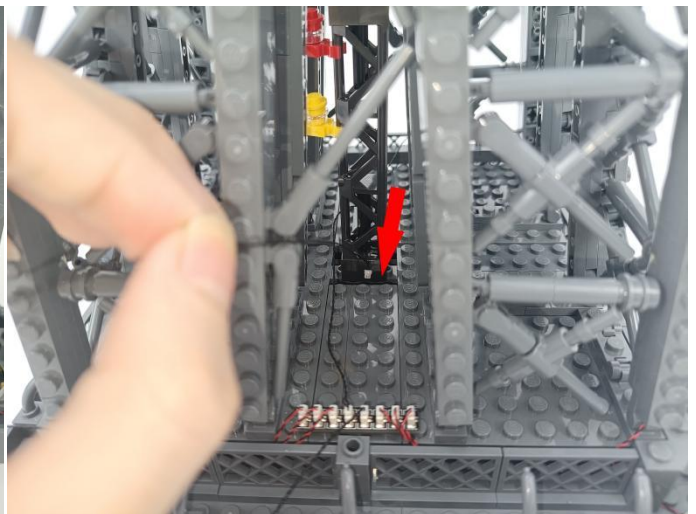
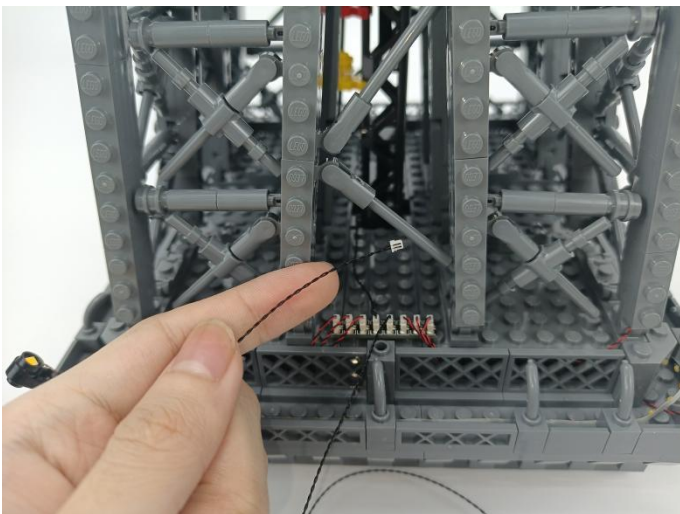

235

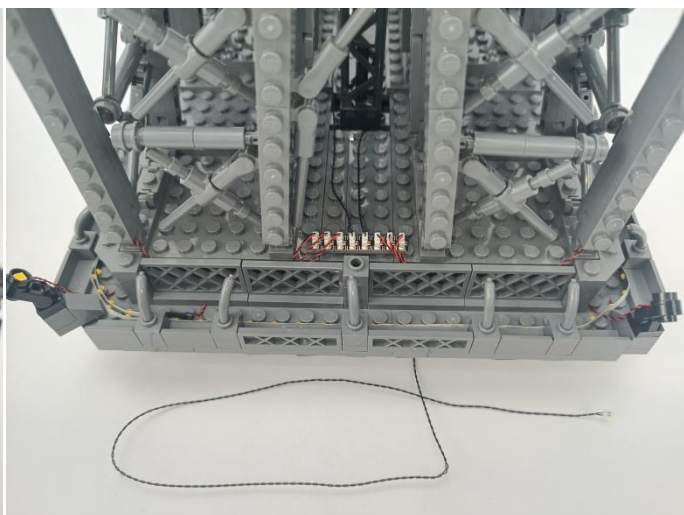
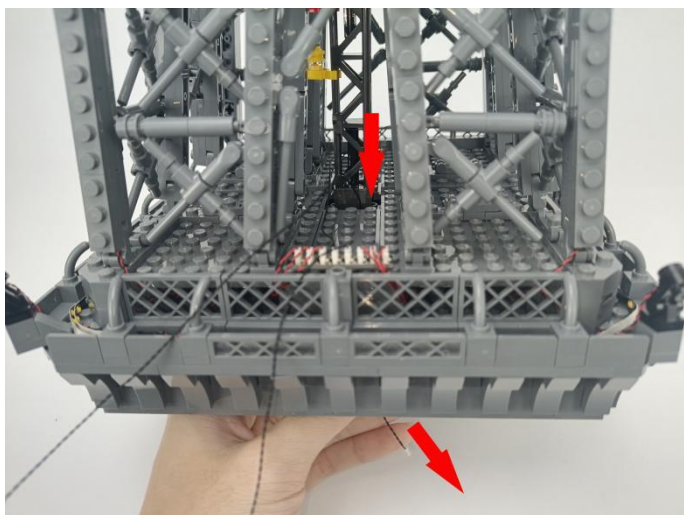

236

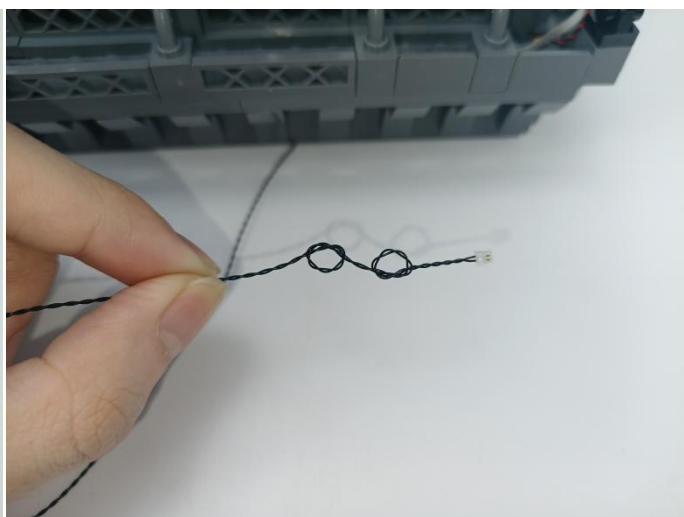
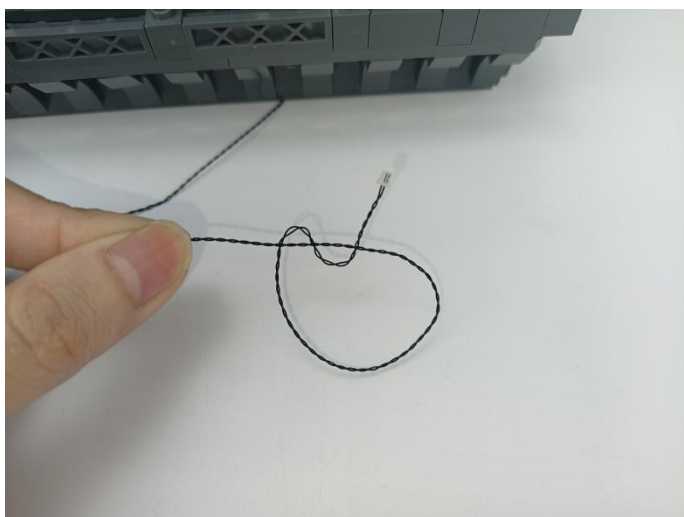

237

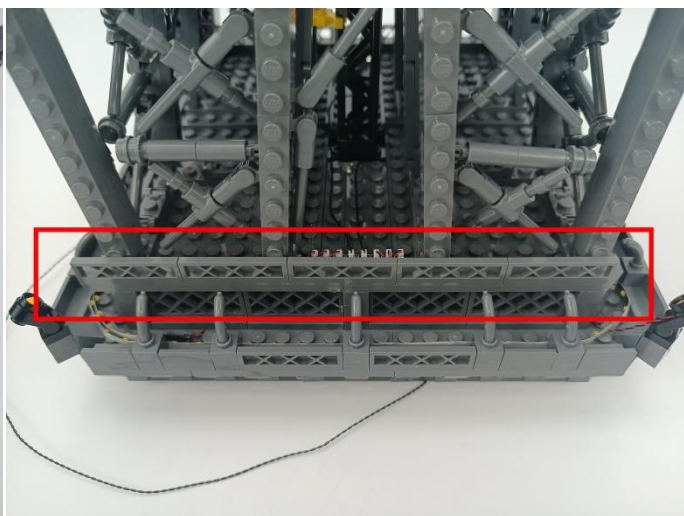
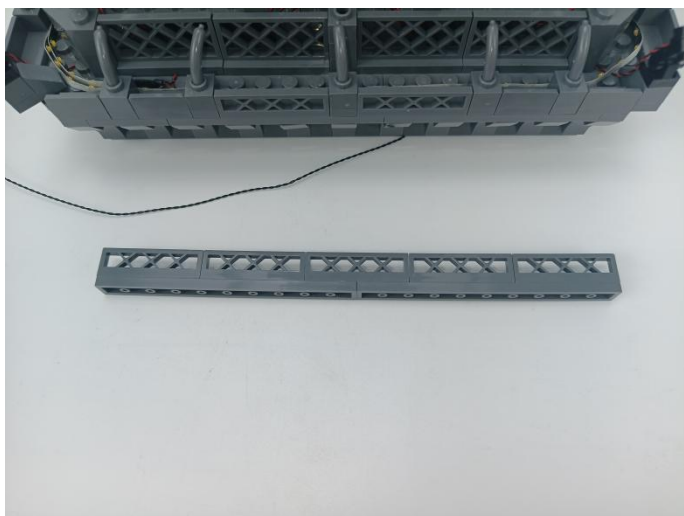



238



239

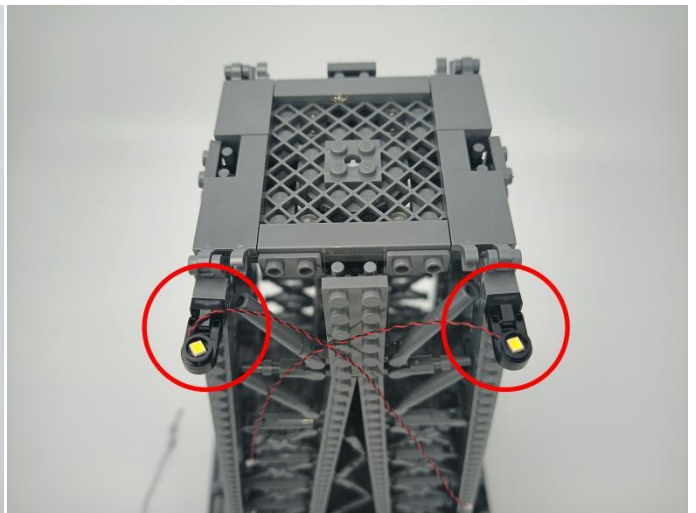

240

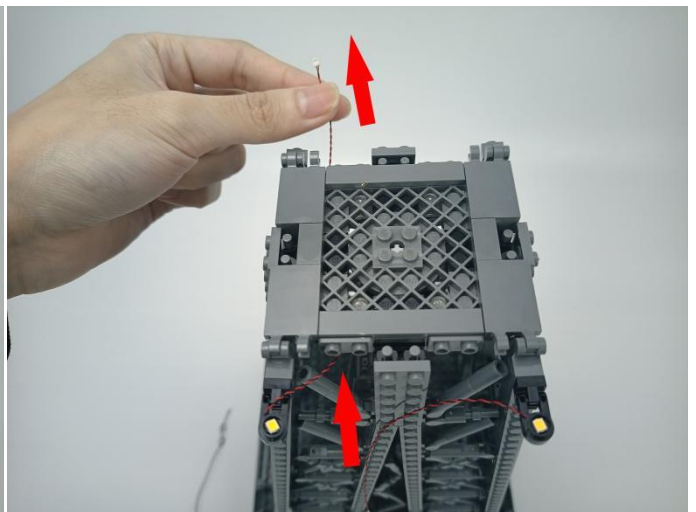
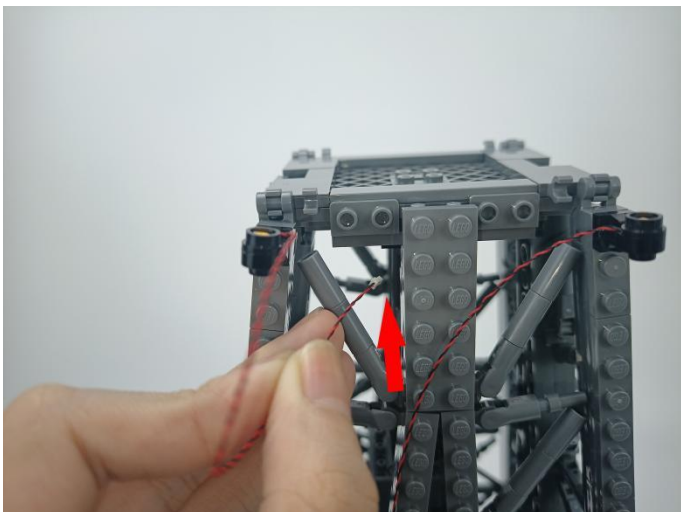

# 241

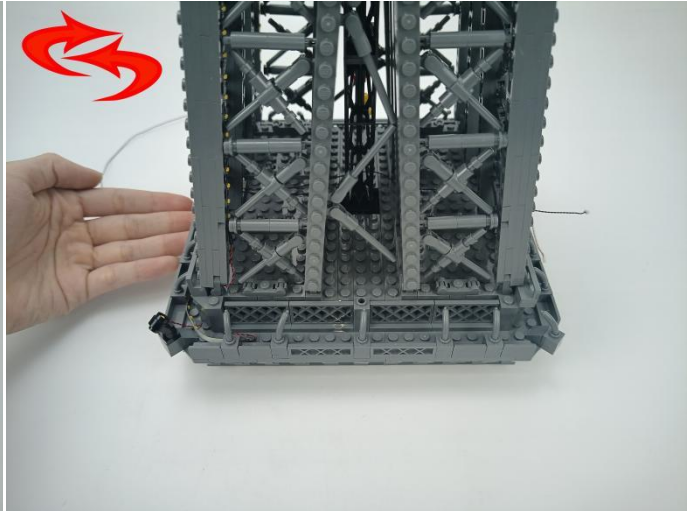
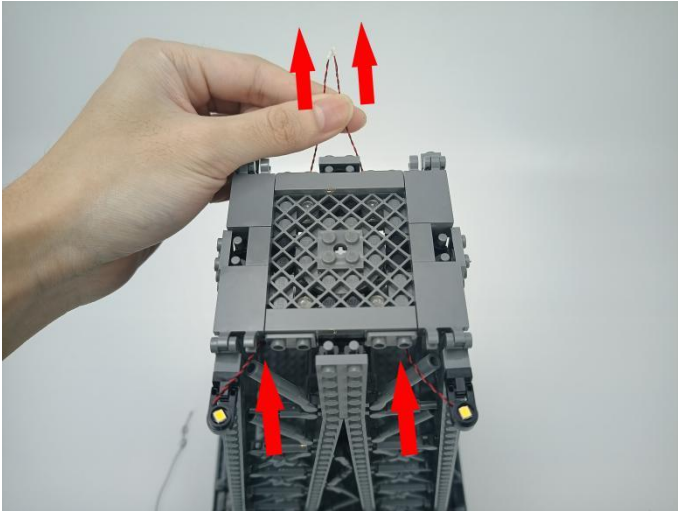

# 242

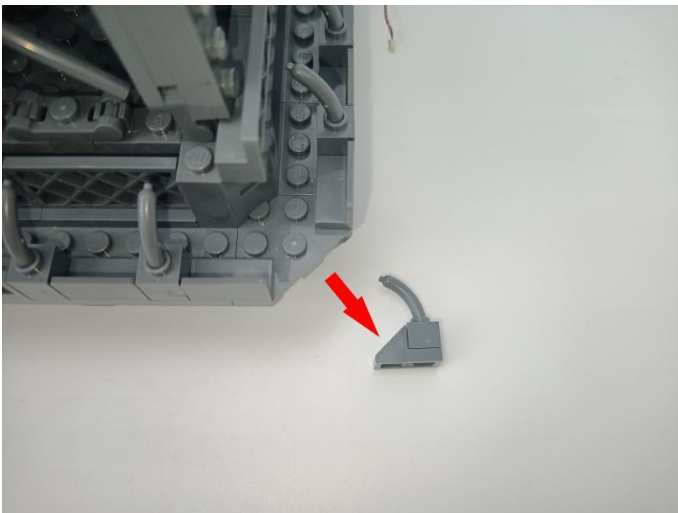

# 243

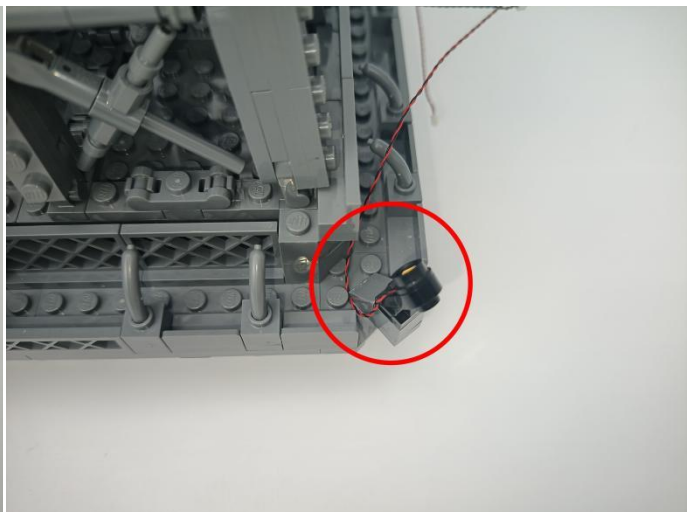
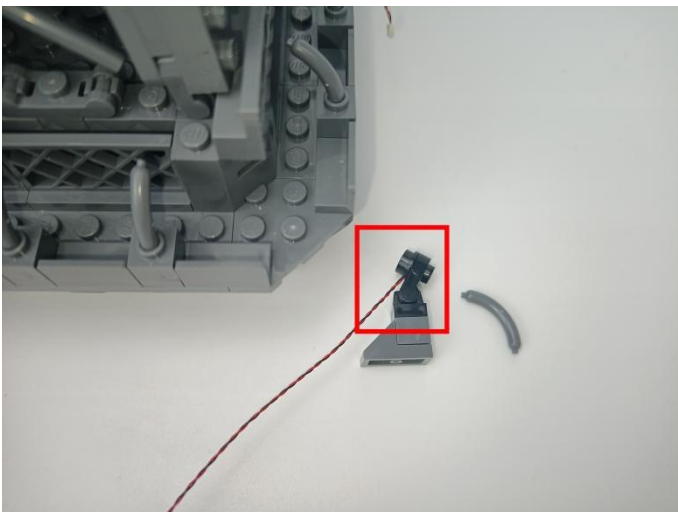



# 244

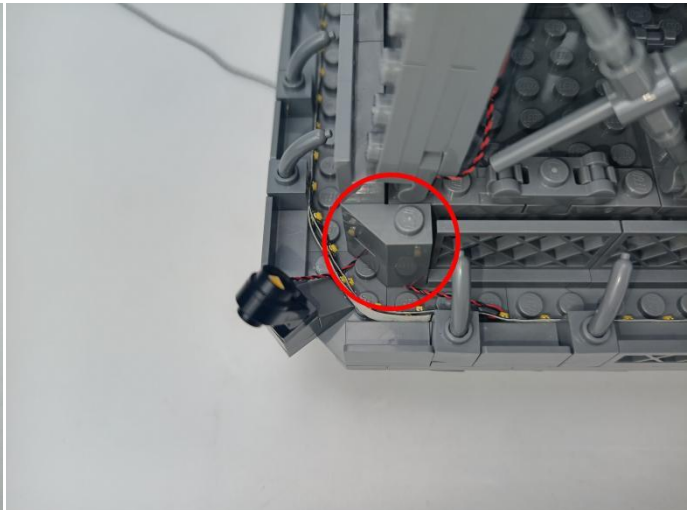

# 245

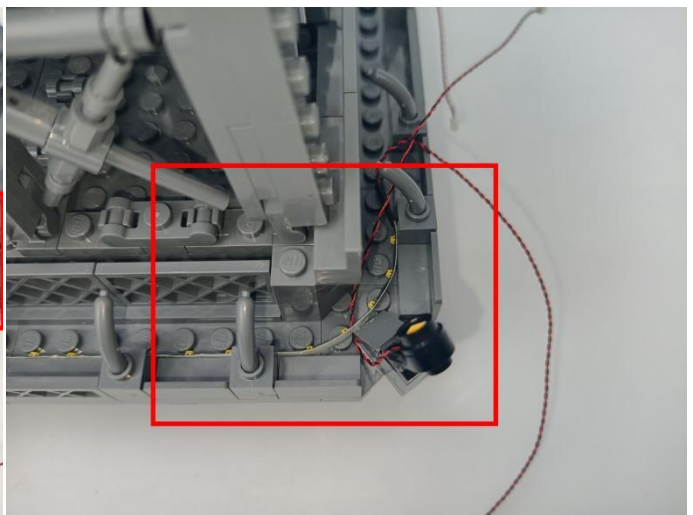
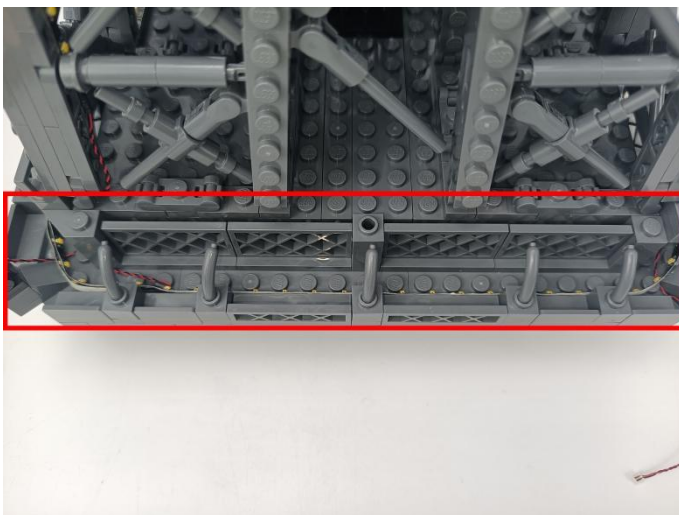

# 246

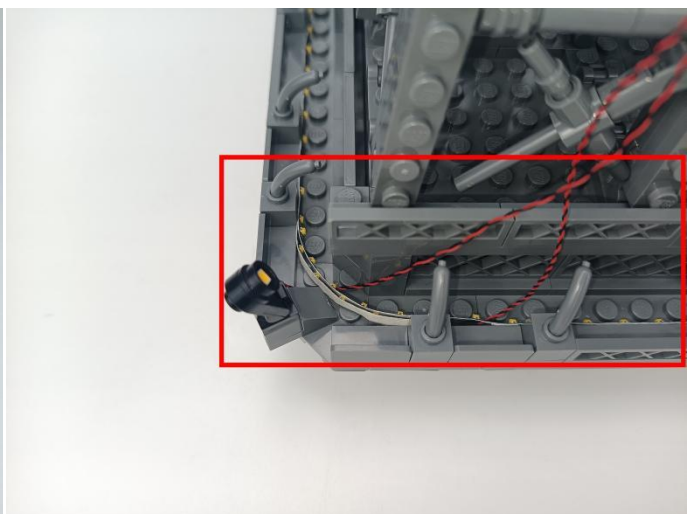
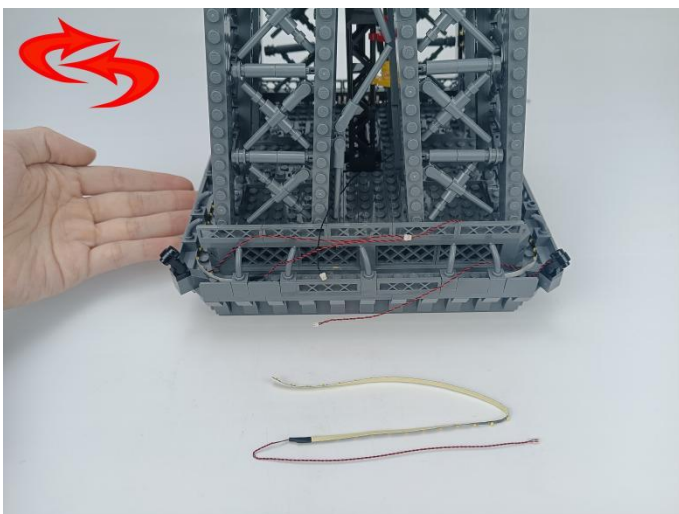

247

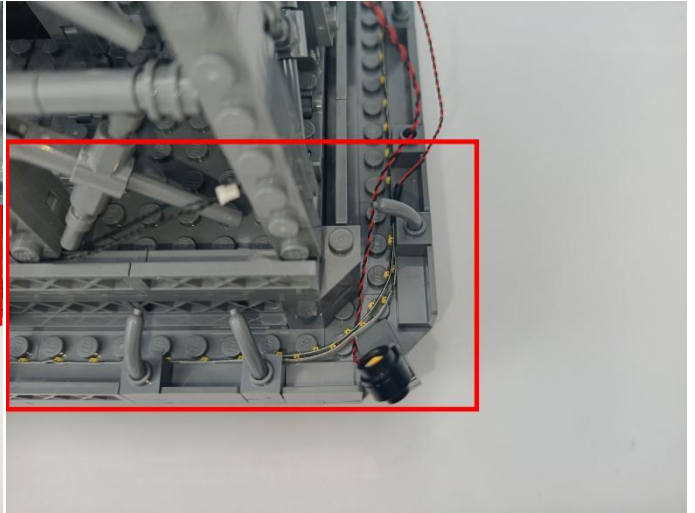
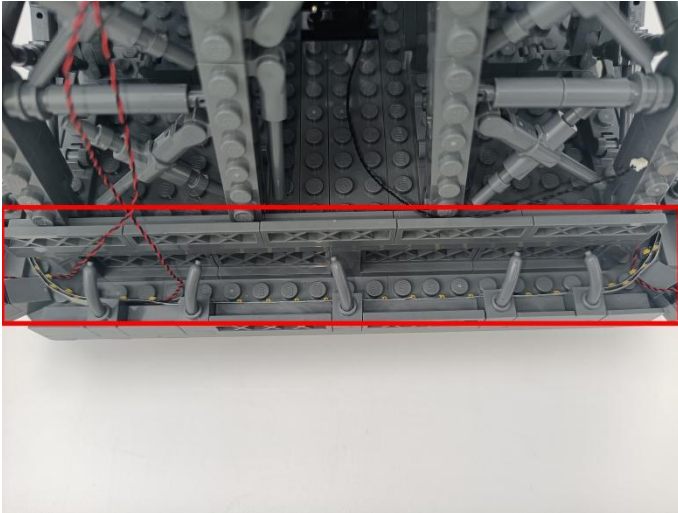

248



249

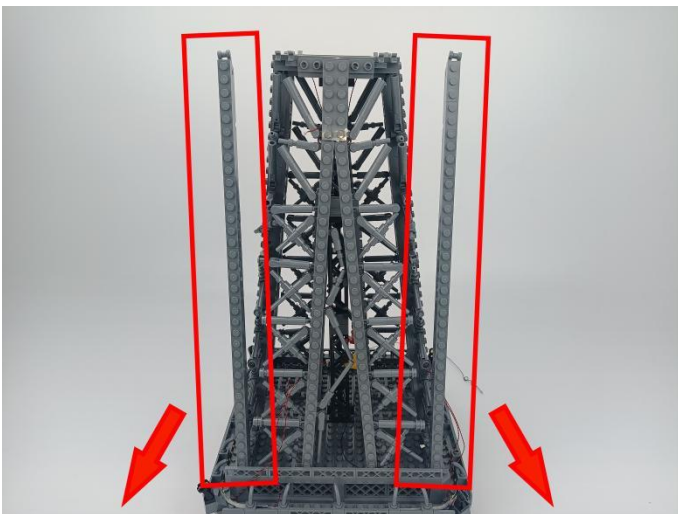



250

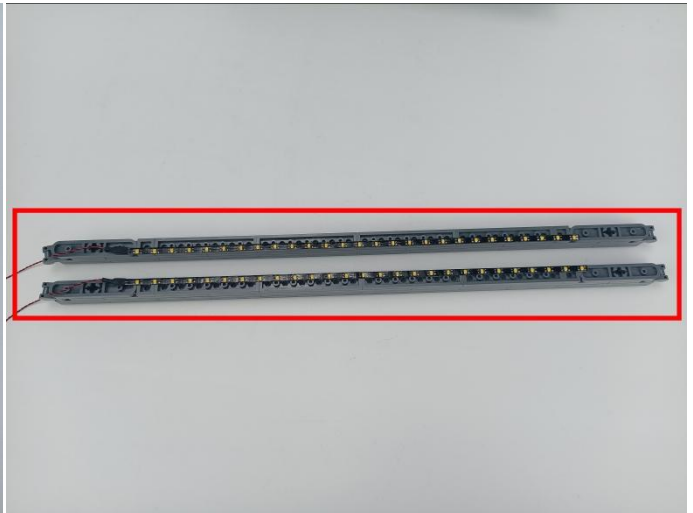

251

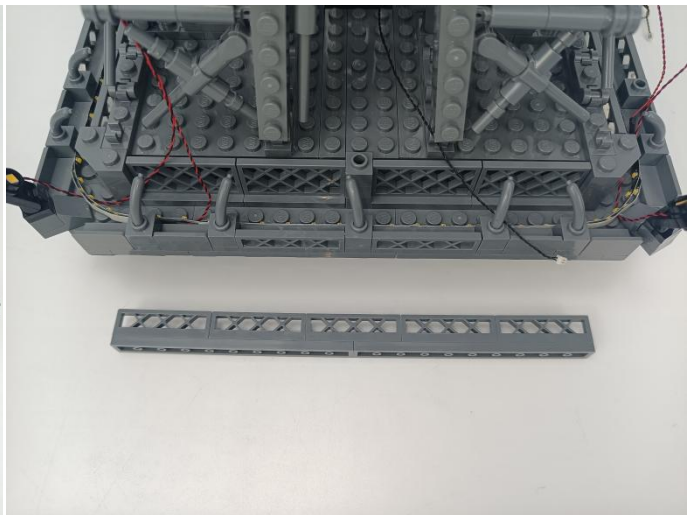
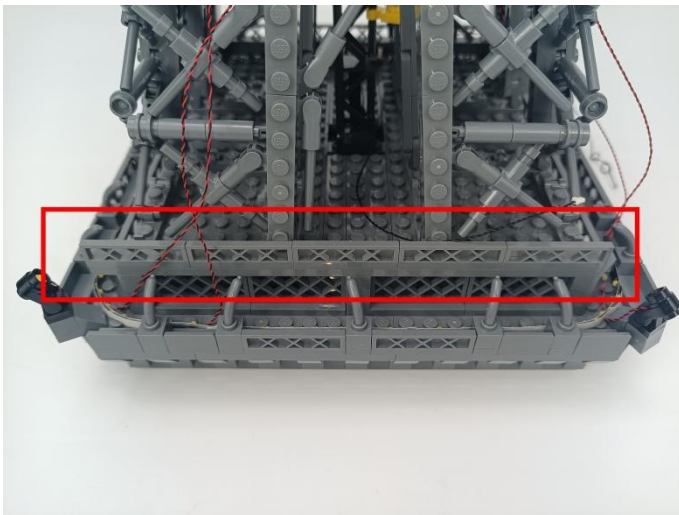

252

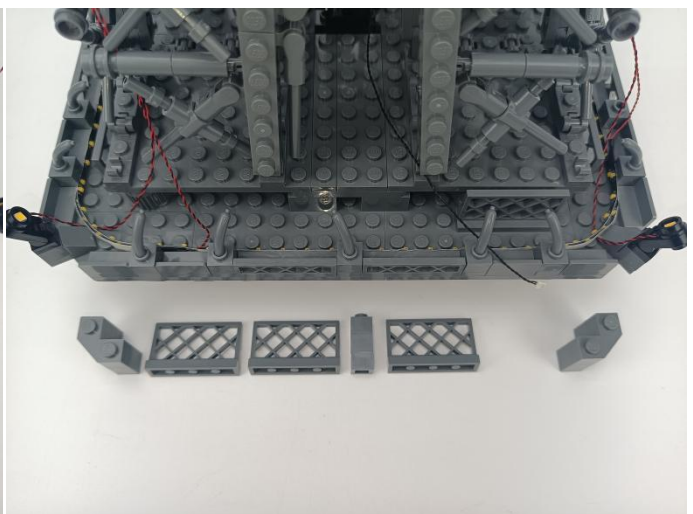
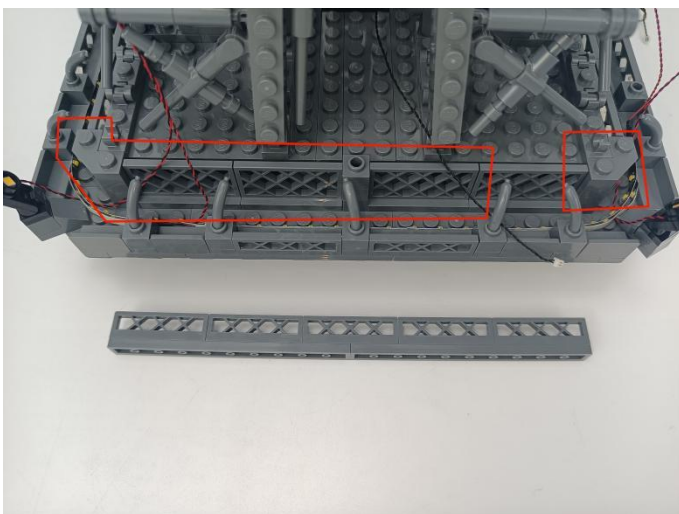

253

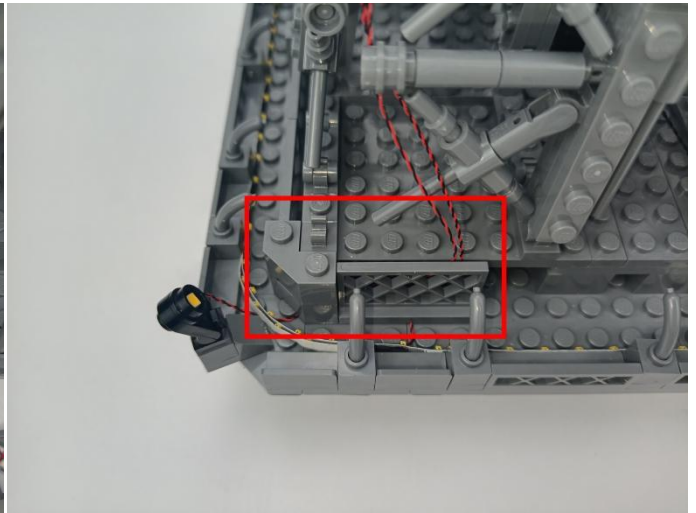
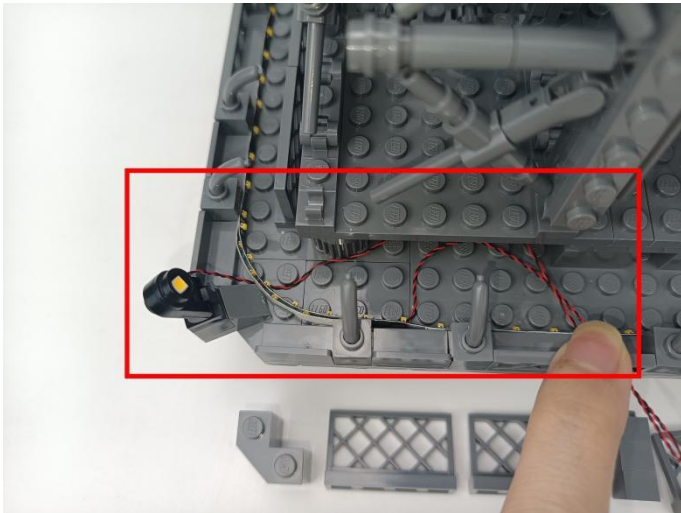

254

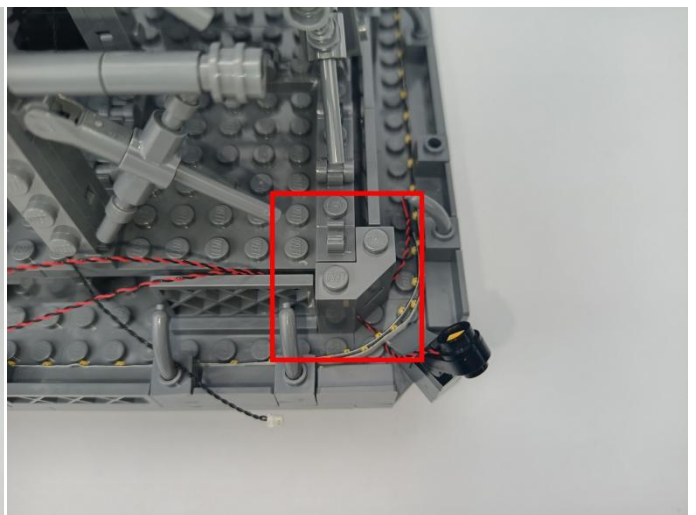
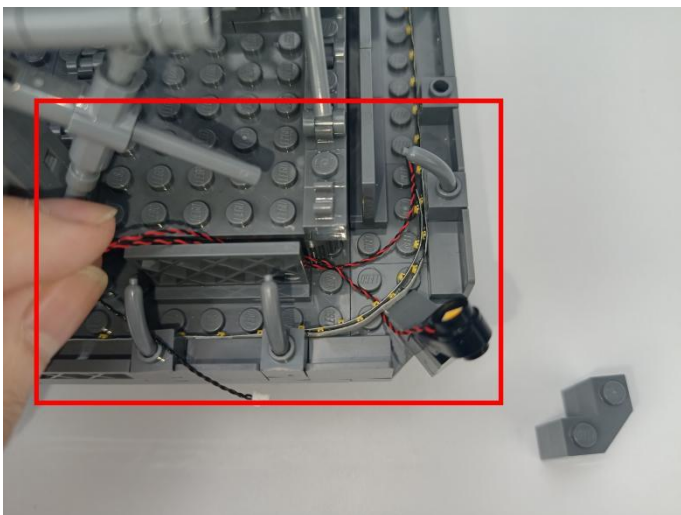

255

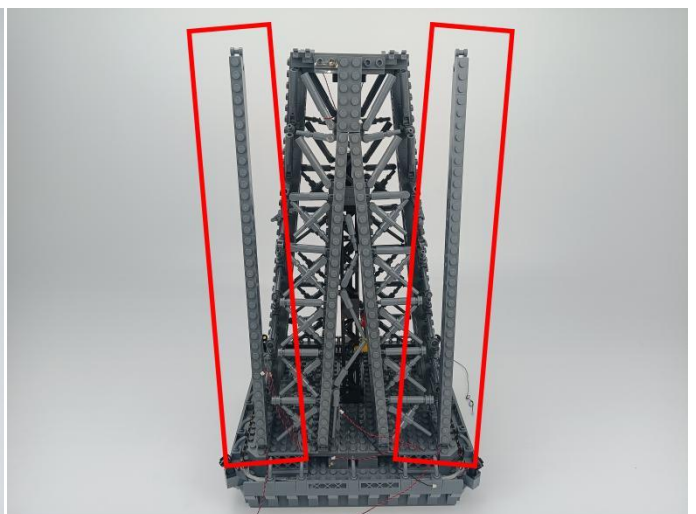
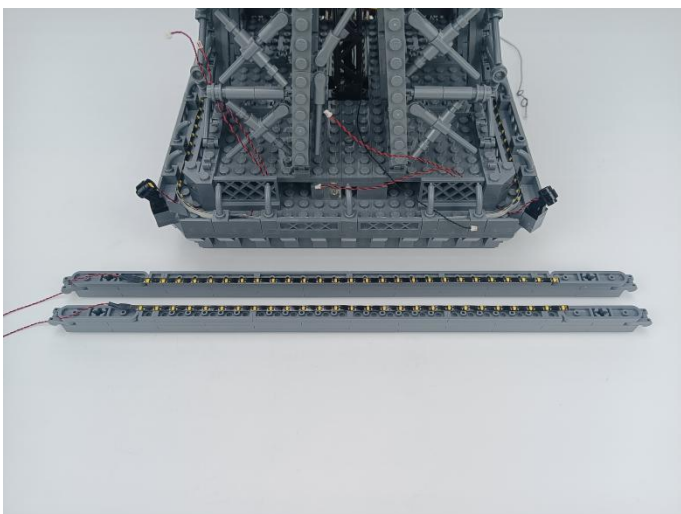



256



257

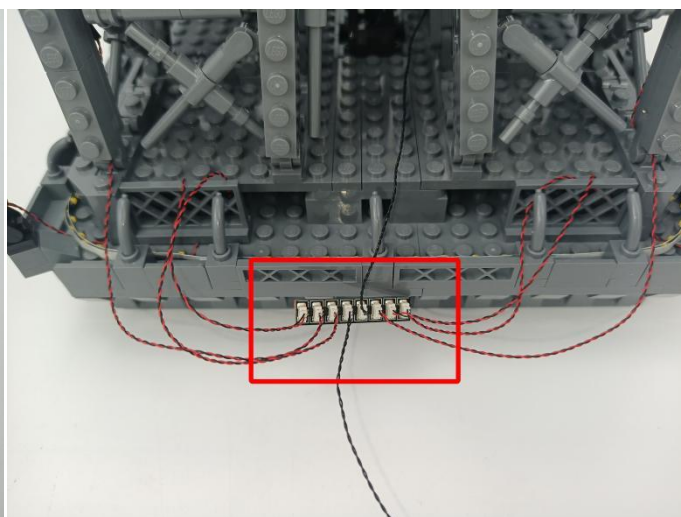
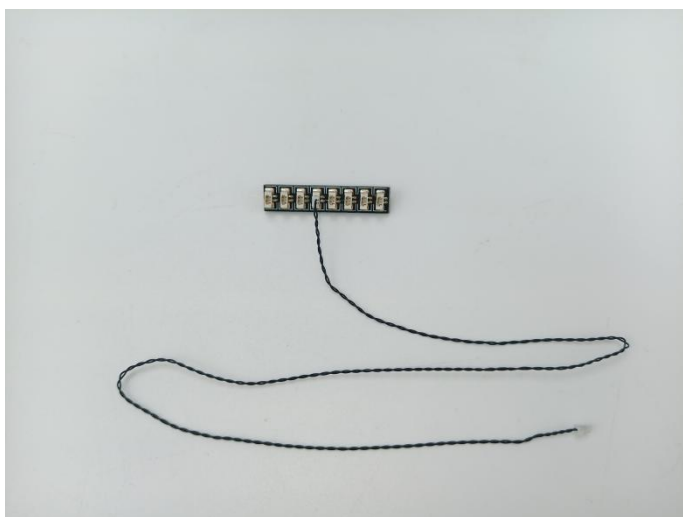

258

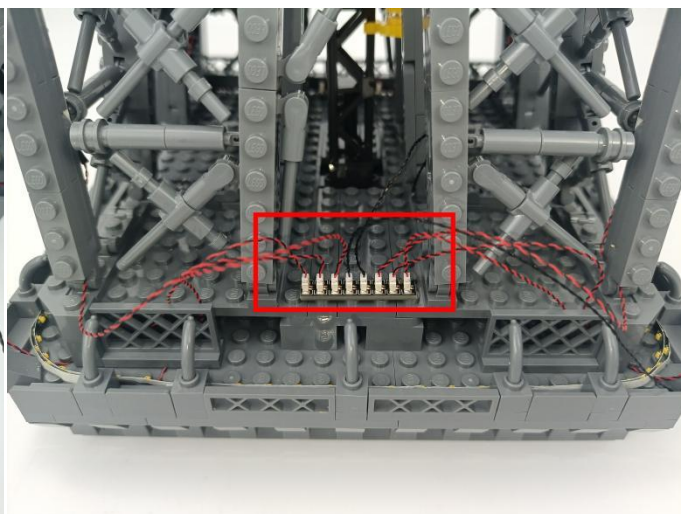
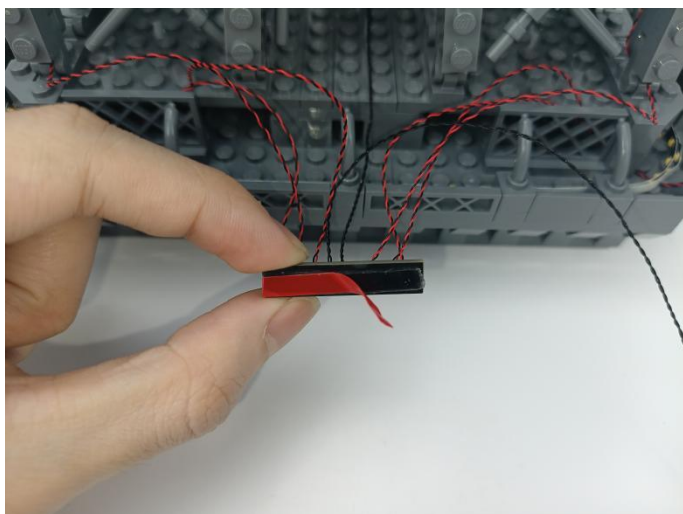

259

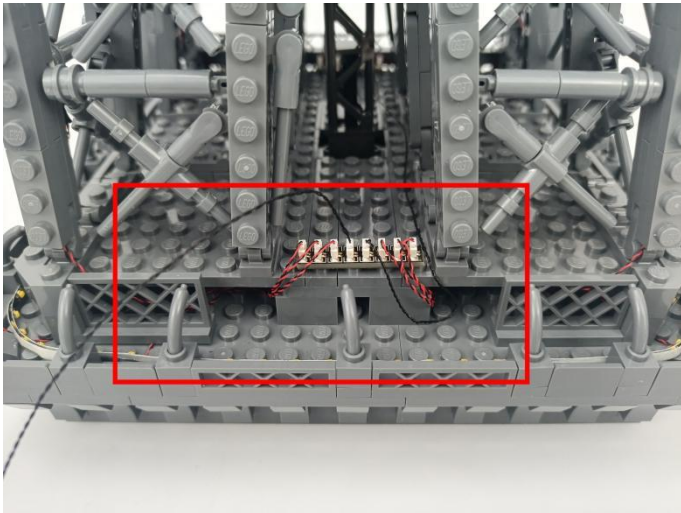

260

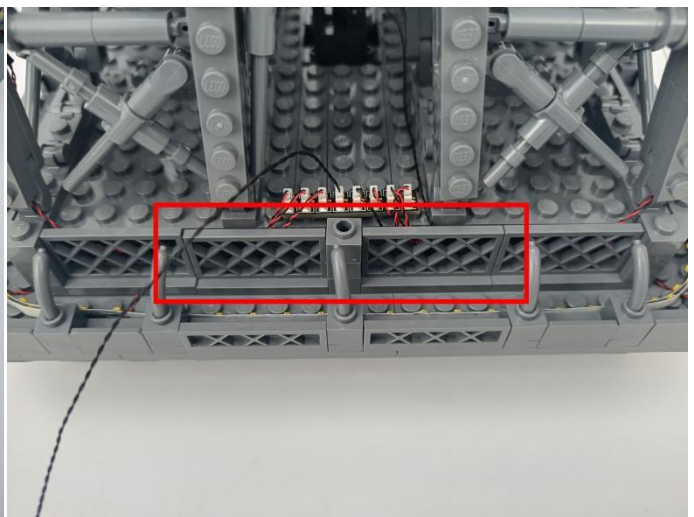
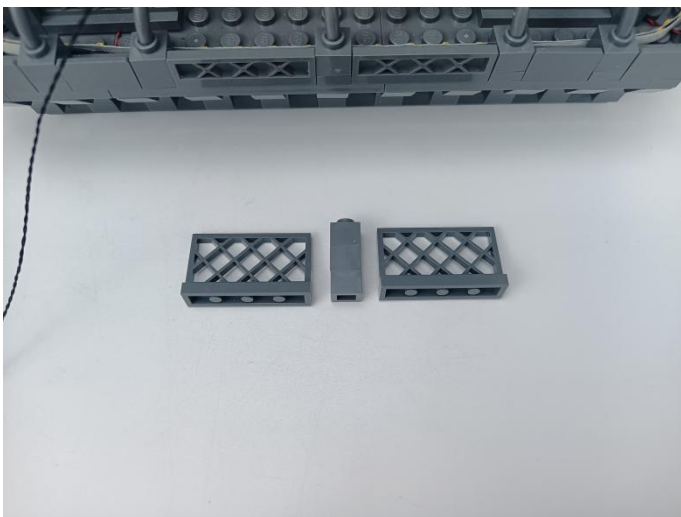

261

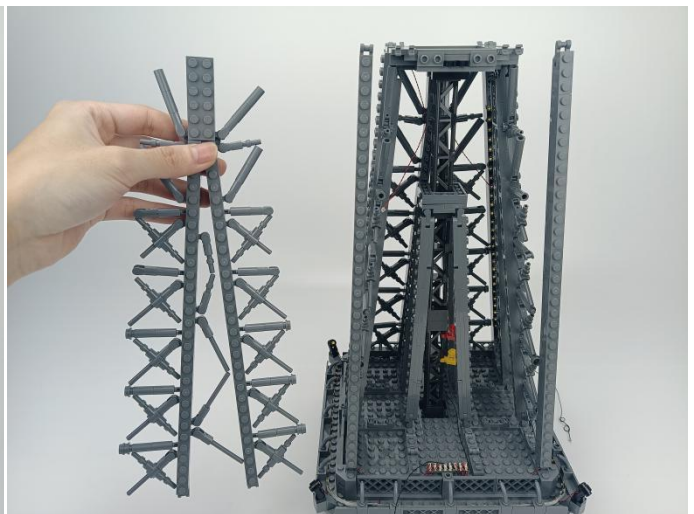
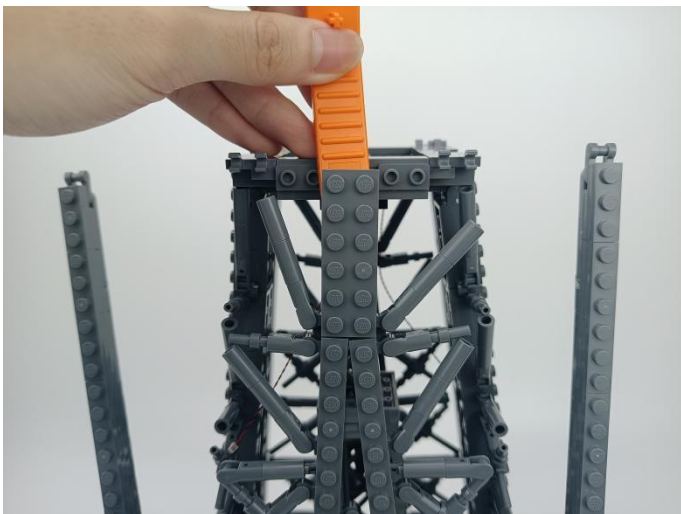



262

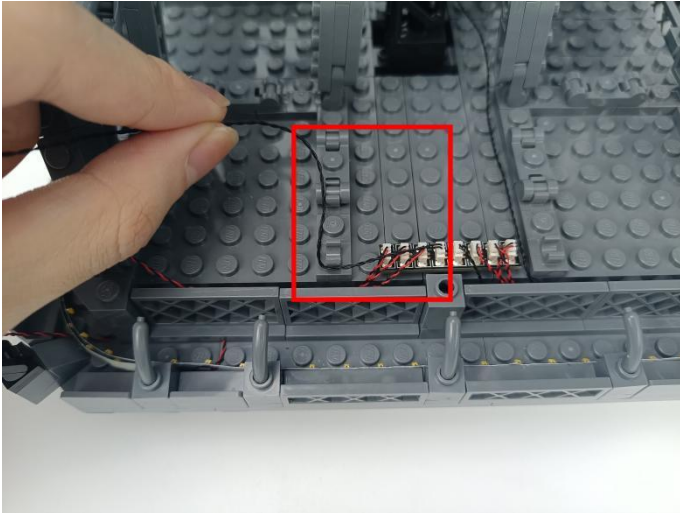

263

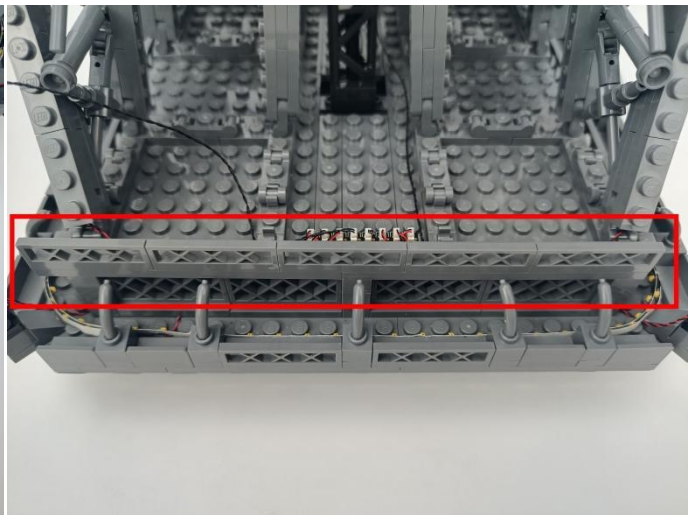

264



265

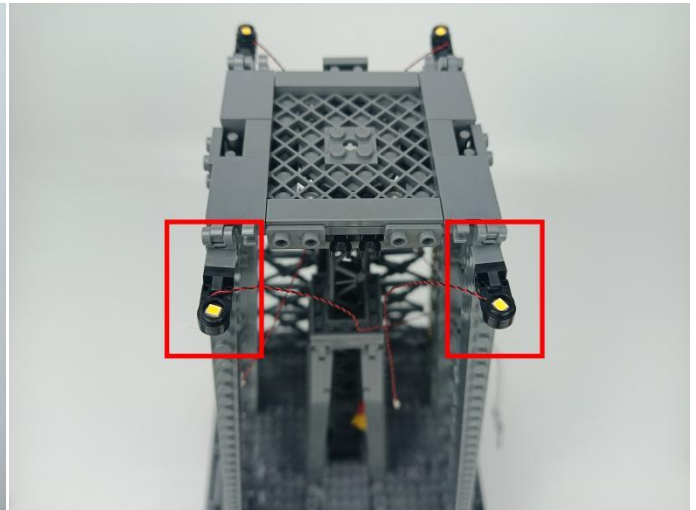

266

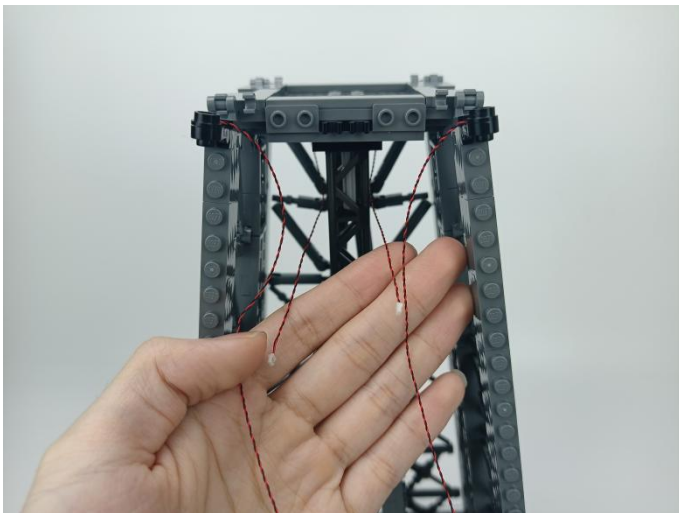

267

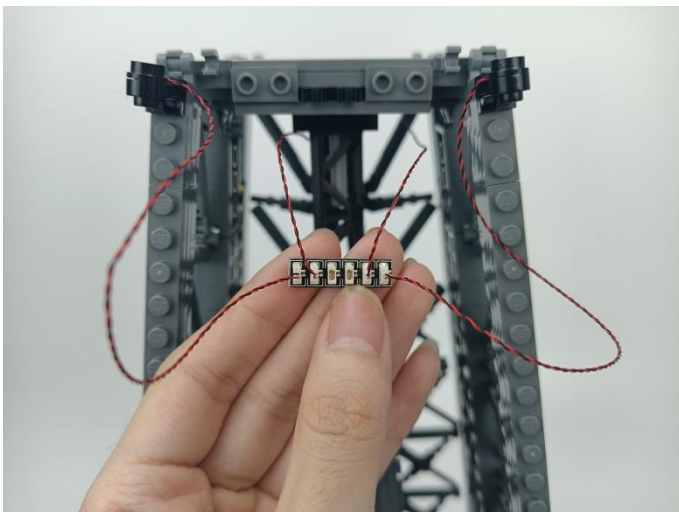



268

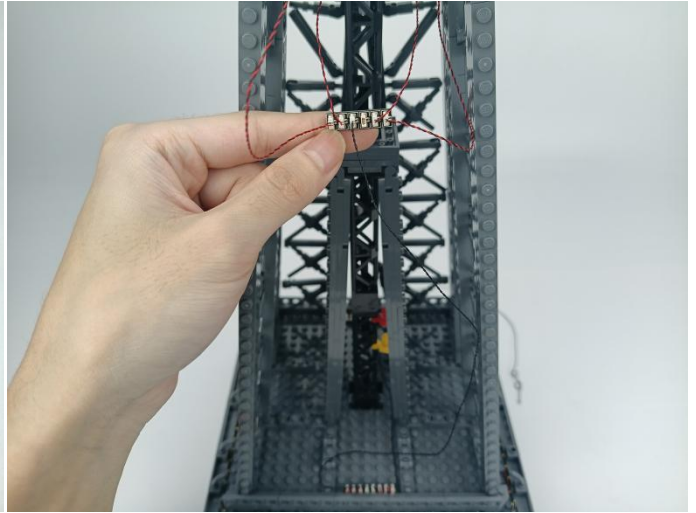
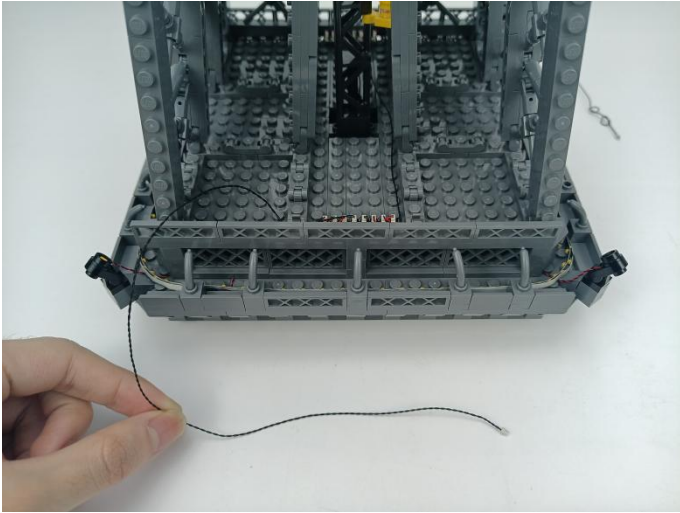

269

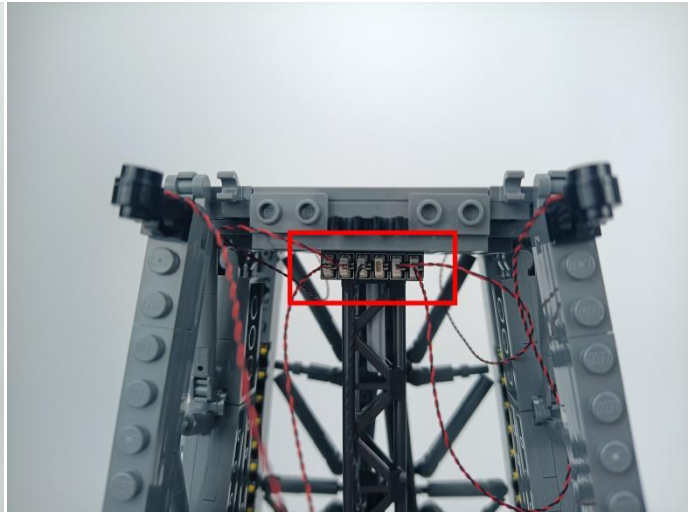
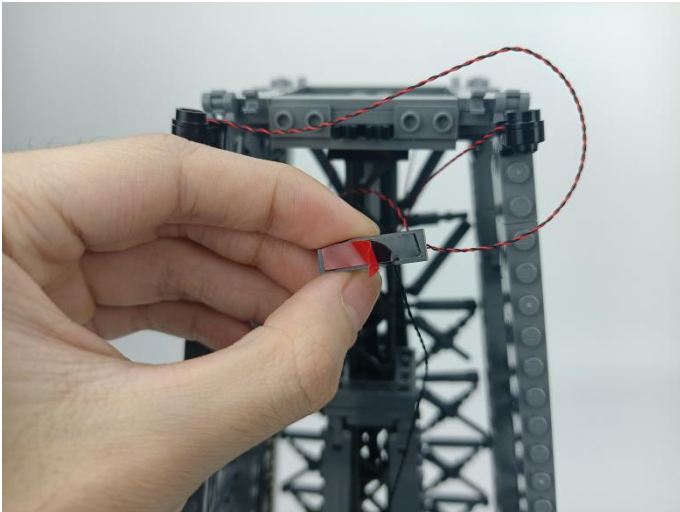

270

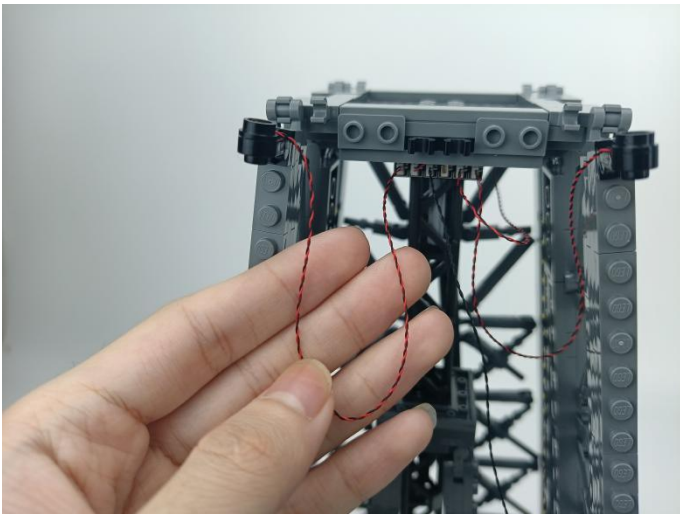

271

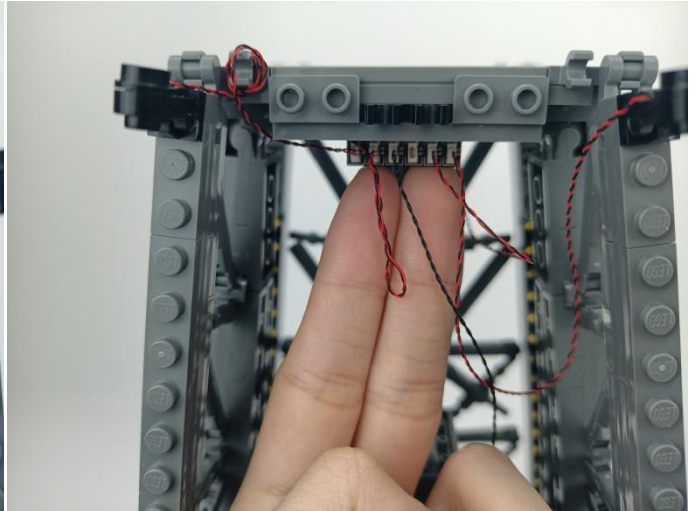
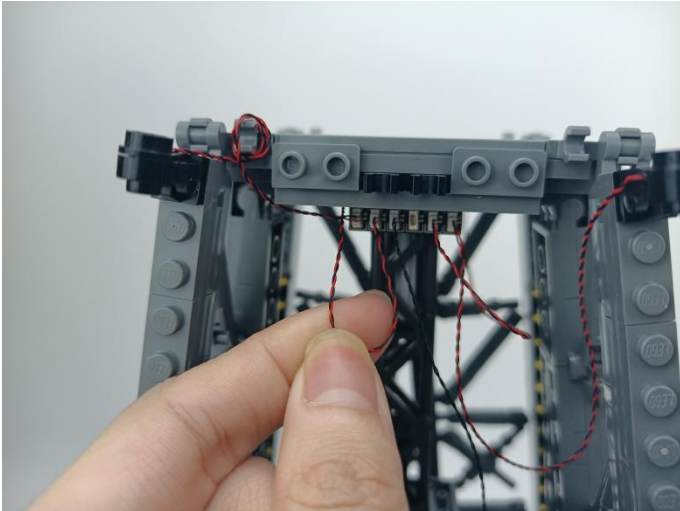

272

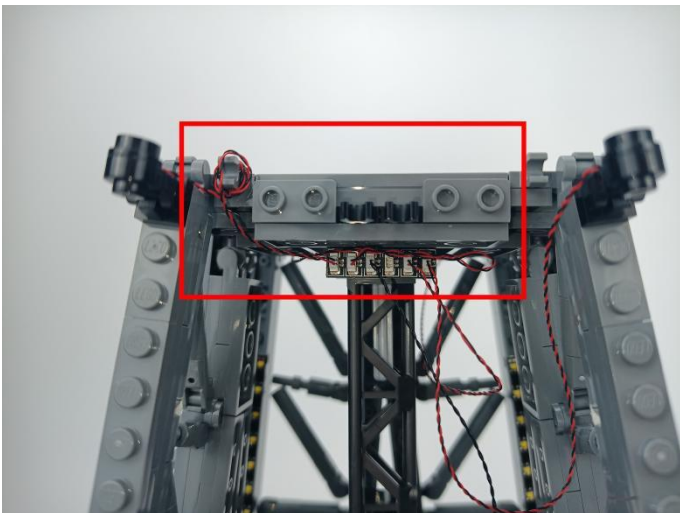

273

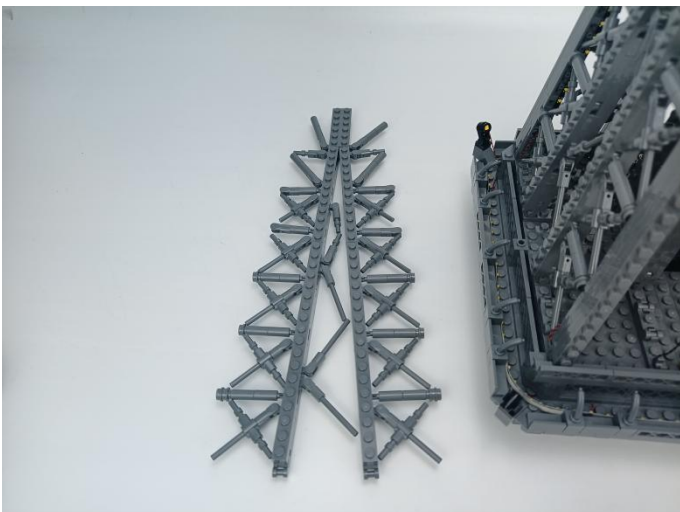



274



275

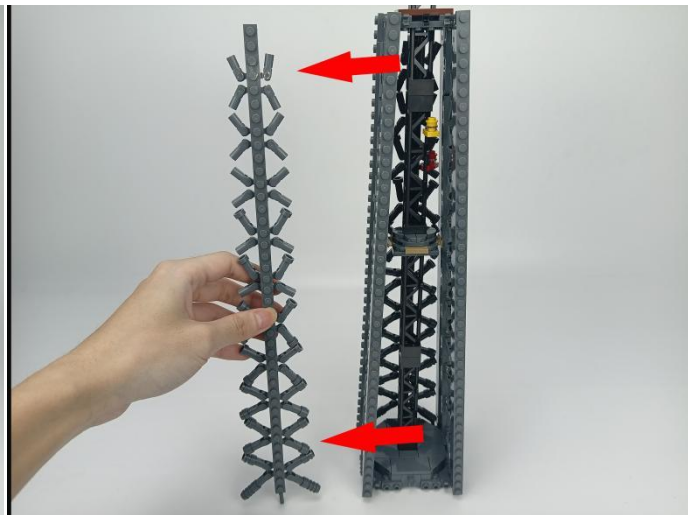

276

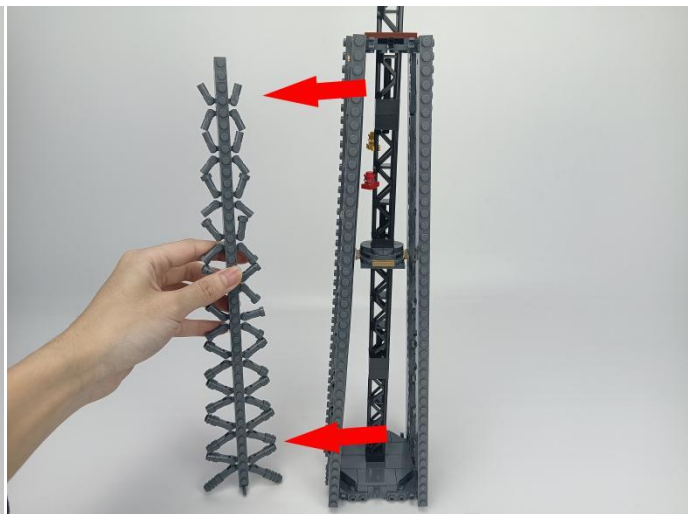
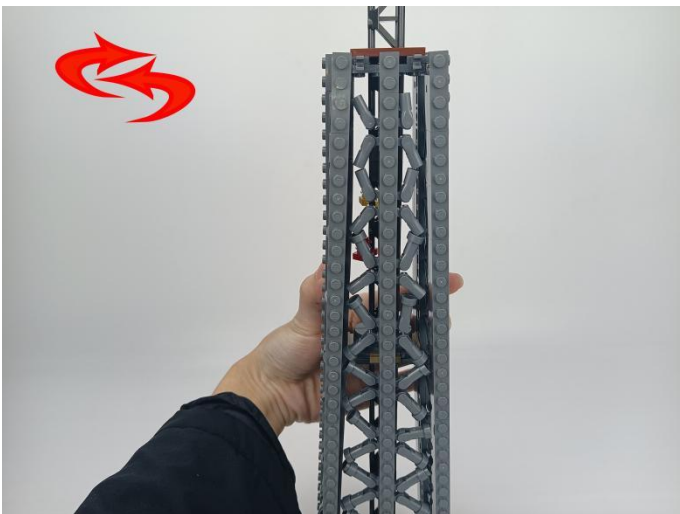

277



278

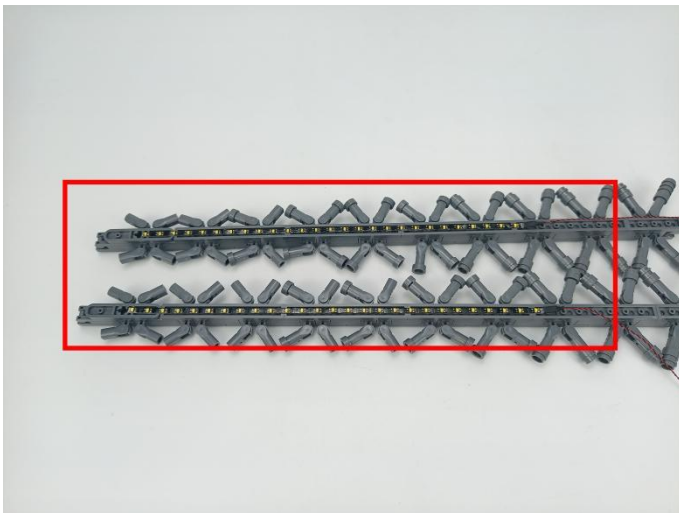

279

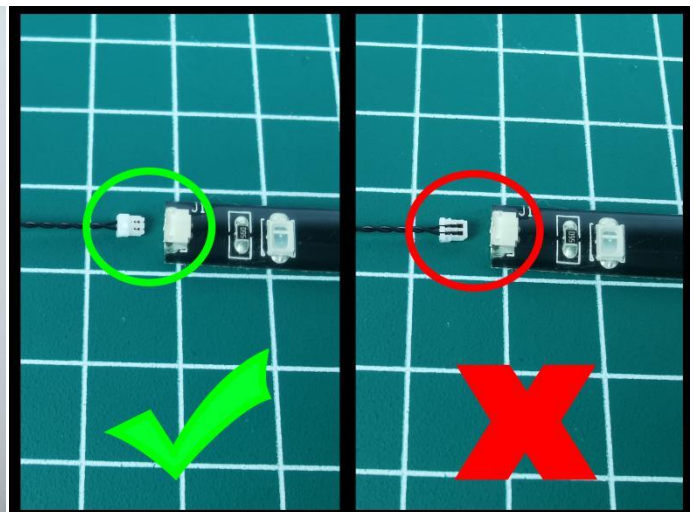



280

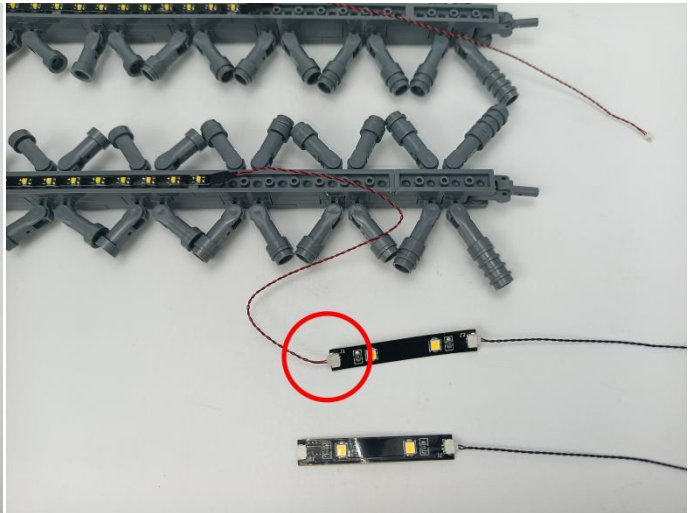
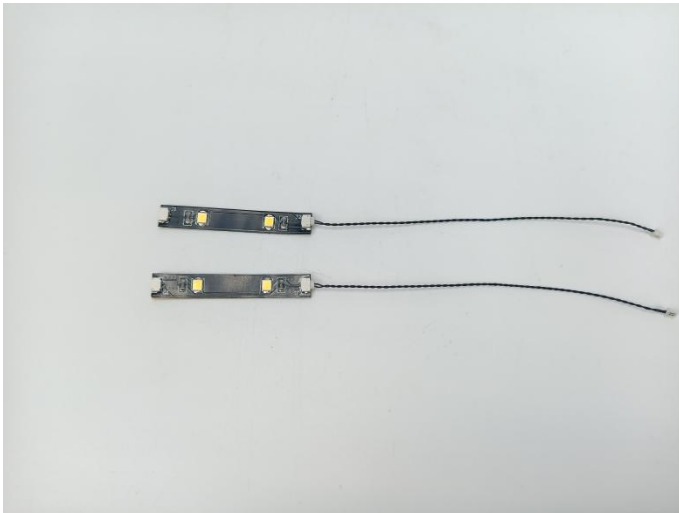

281

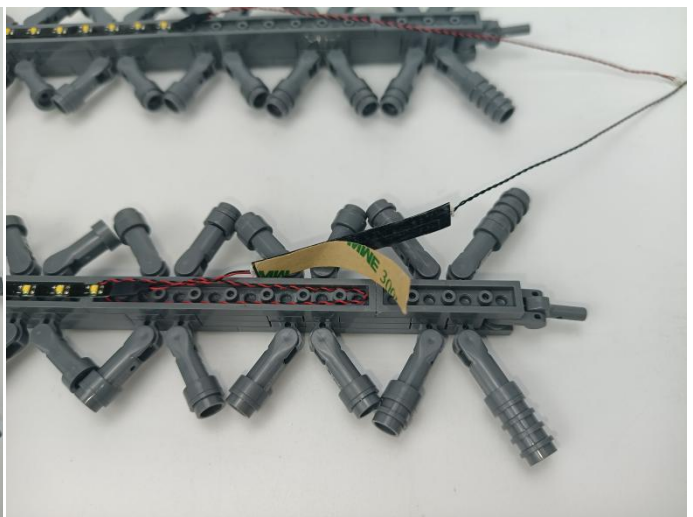
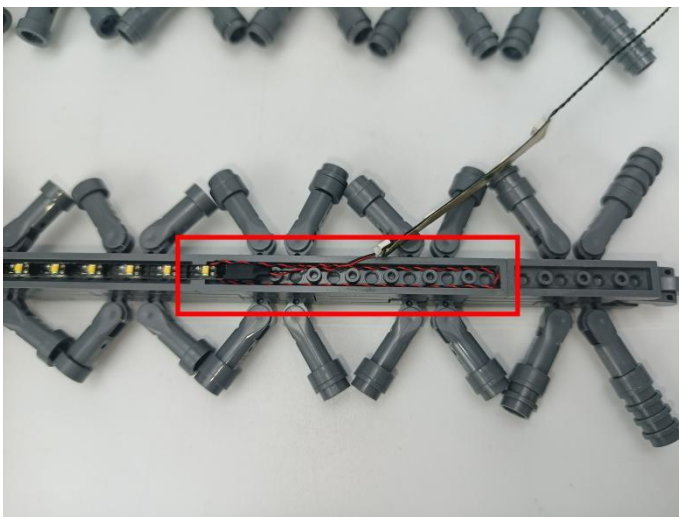

282



283

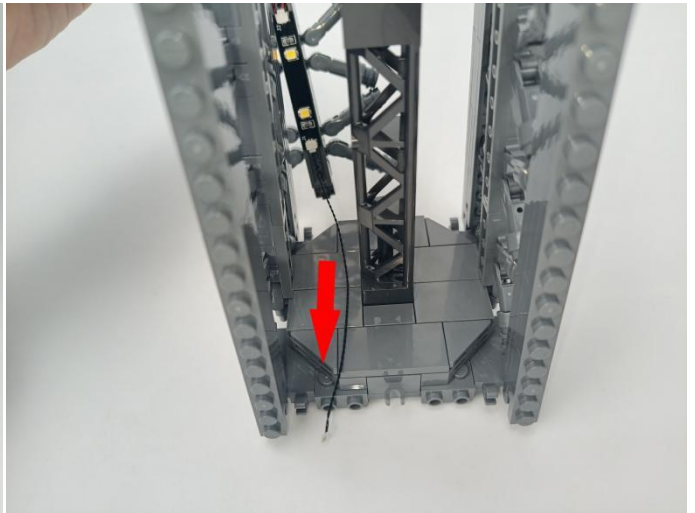
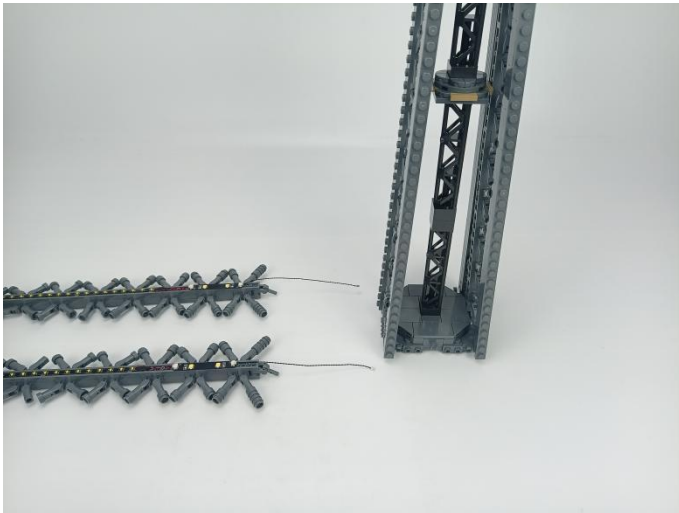

284

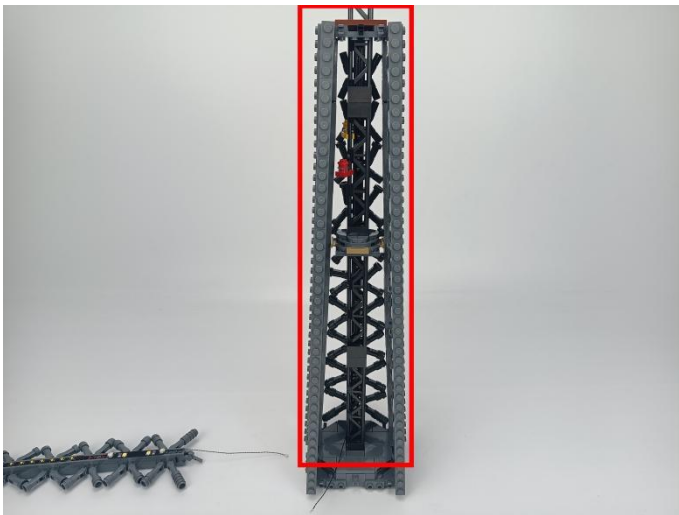

285

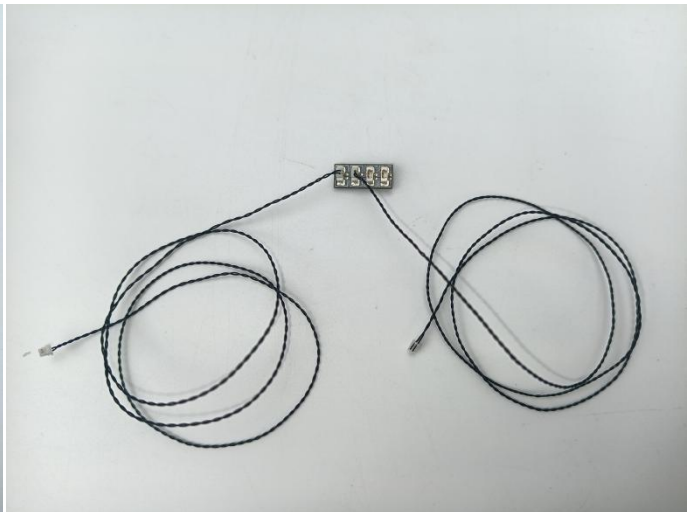



286

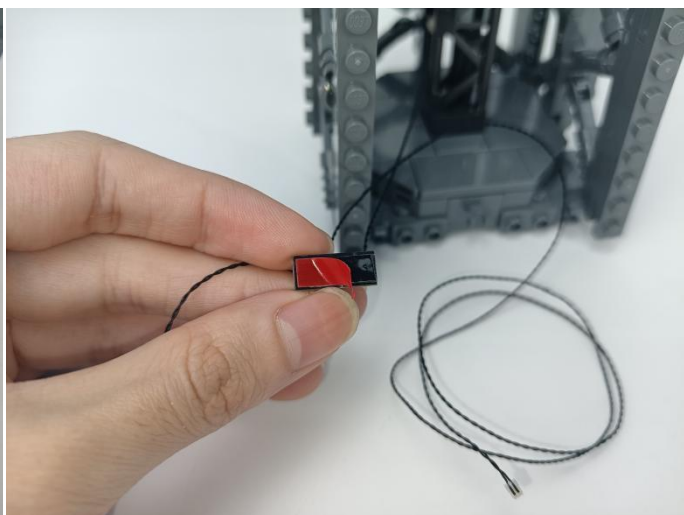
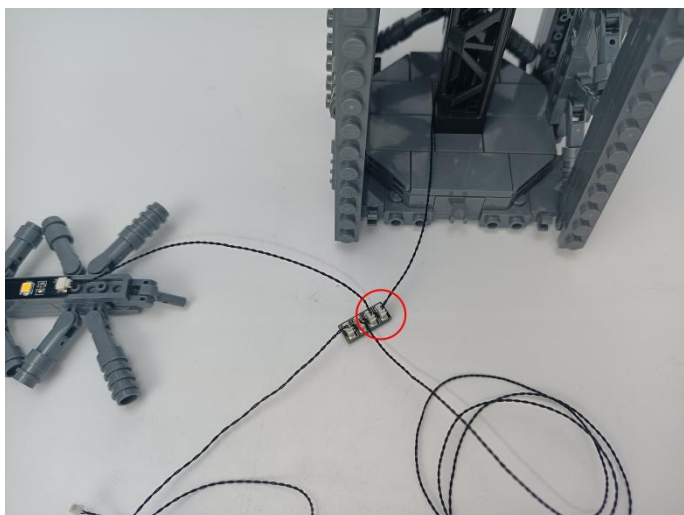

287

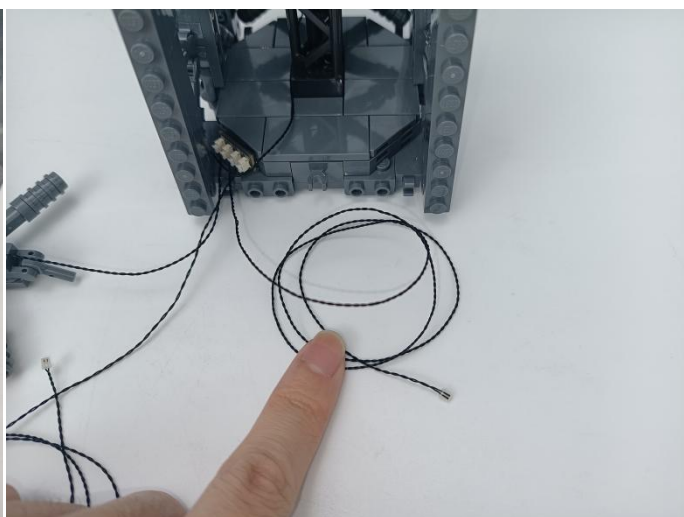
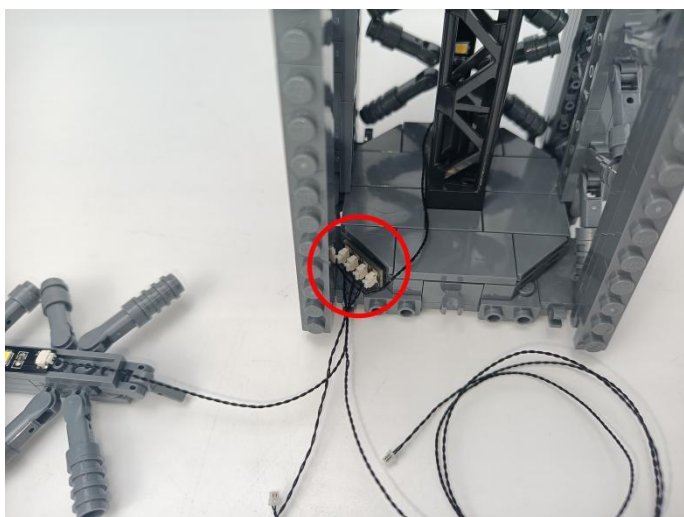

288

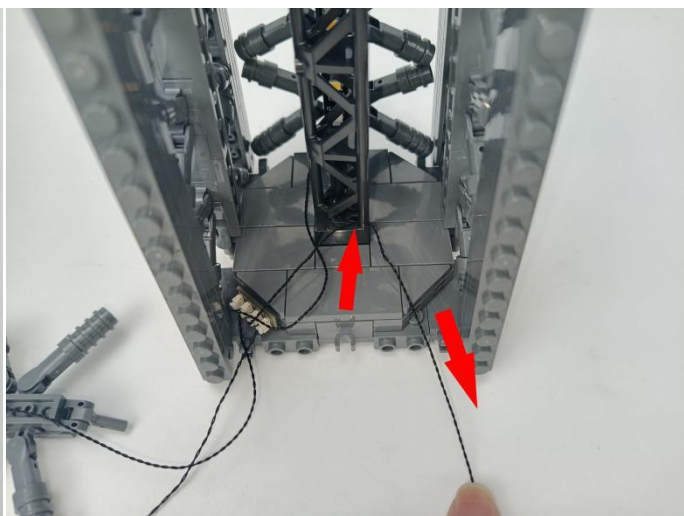
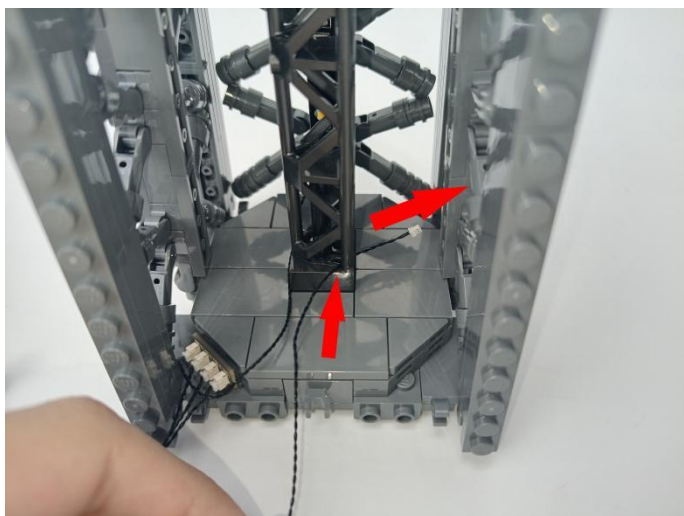

289

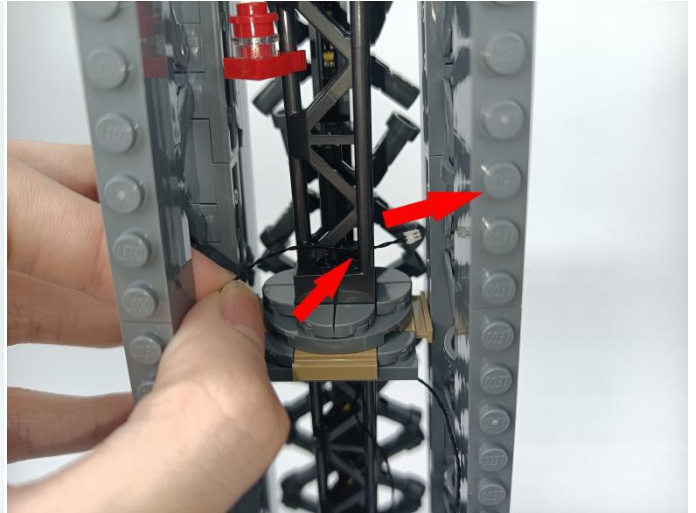
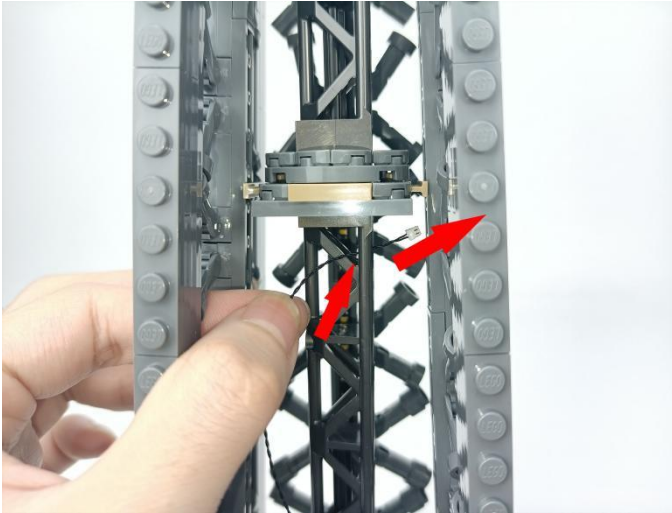

290

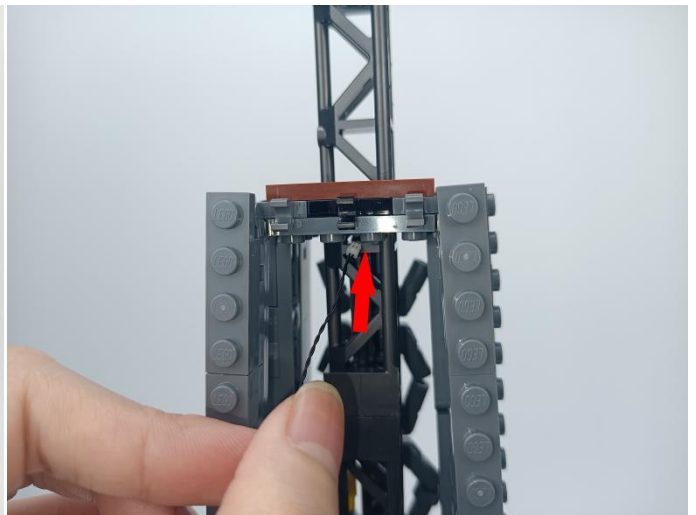
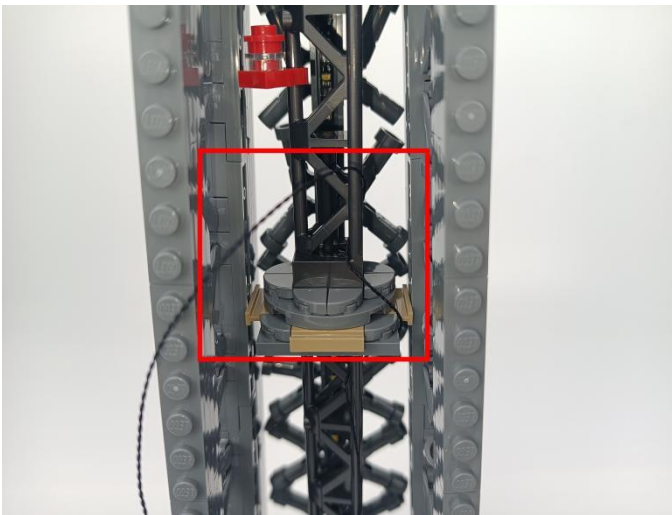

291

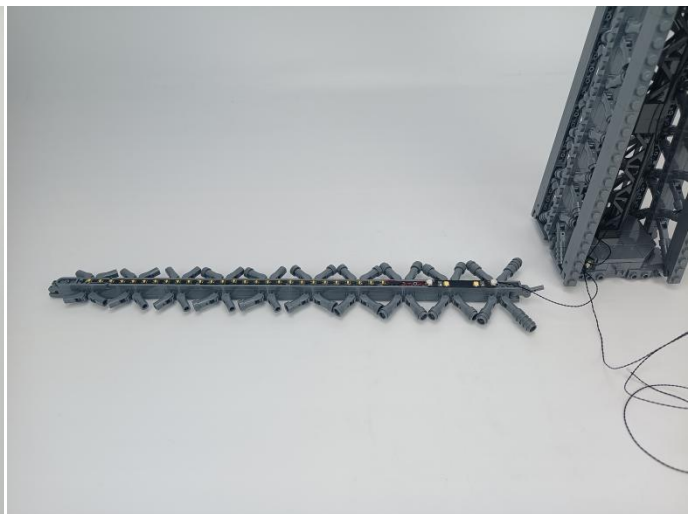
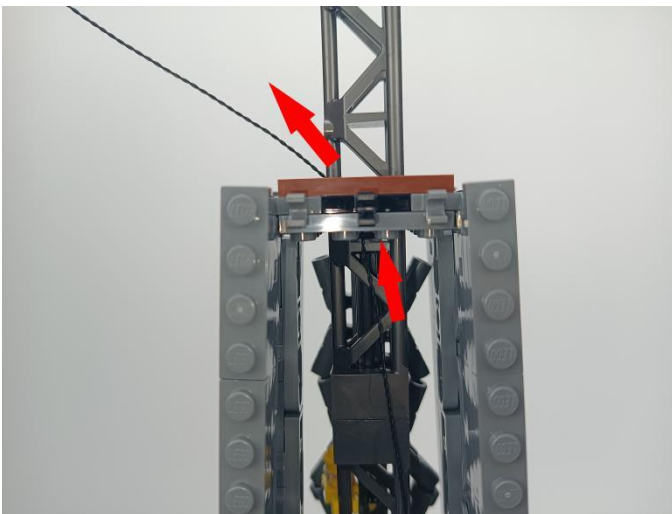



292

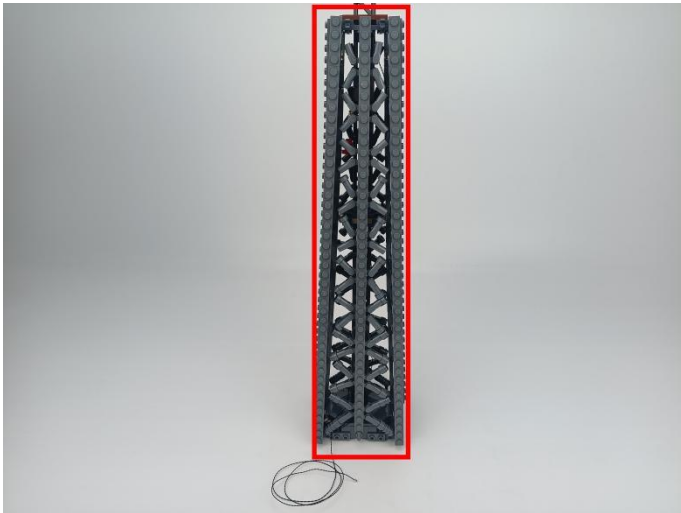

293

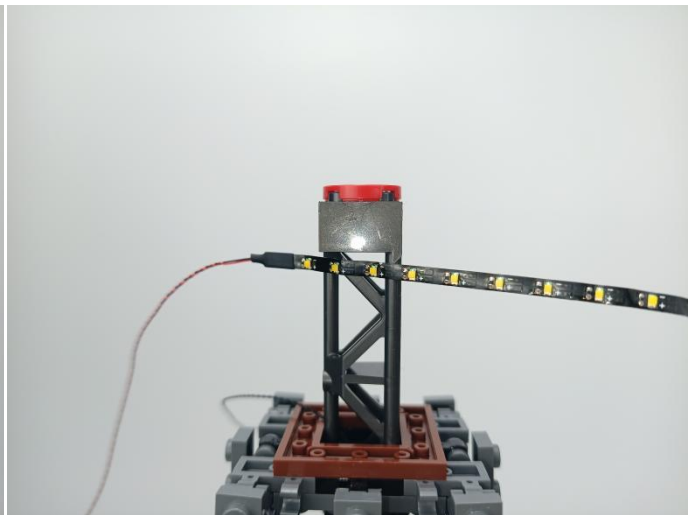

294

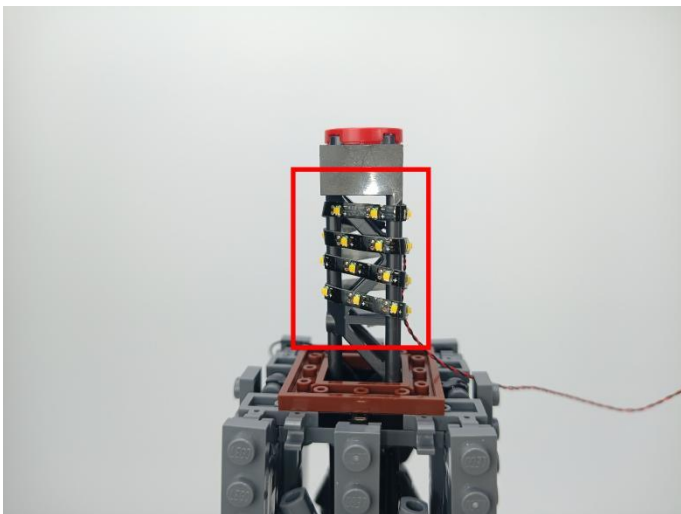

295

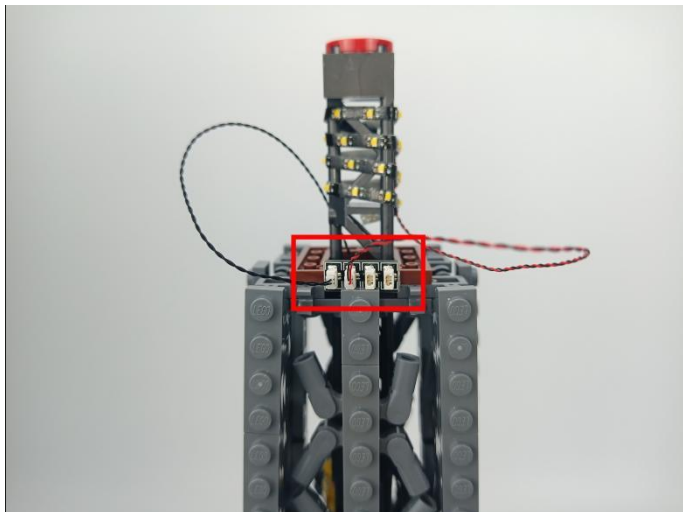

296



297

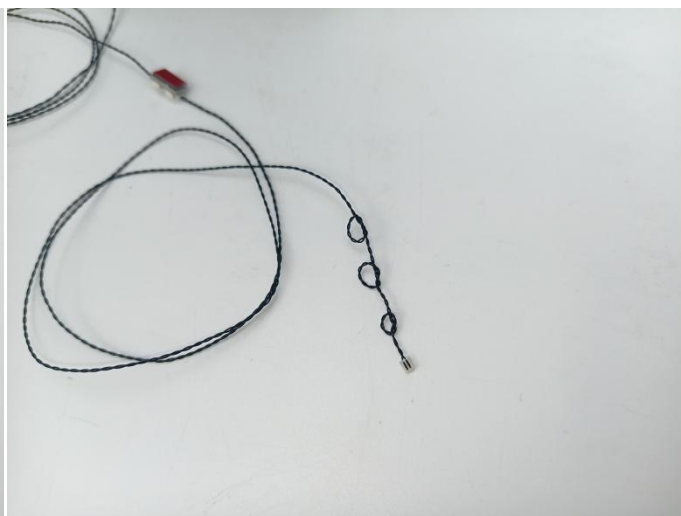
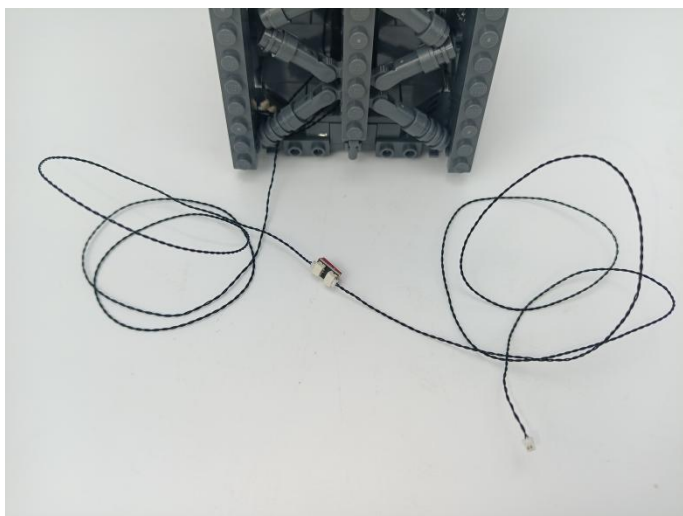



298



299

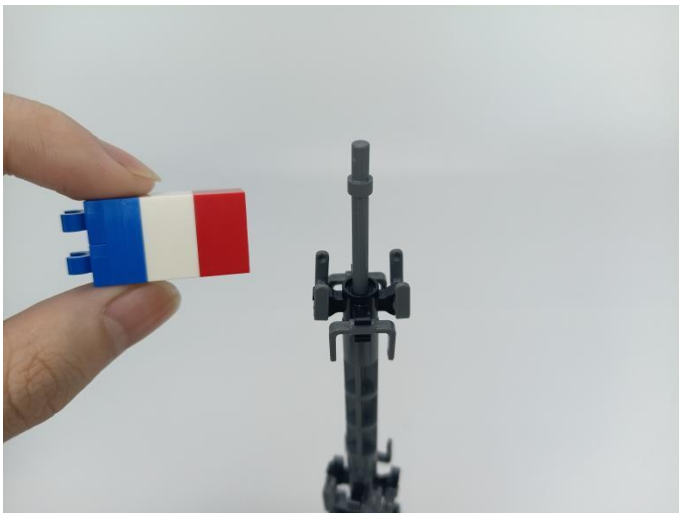

300

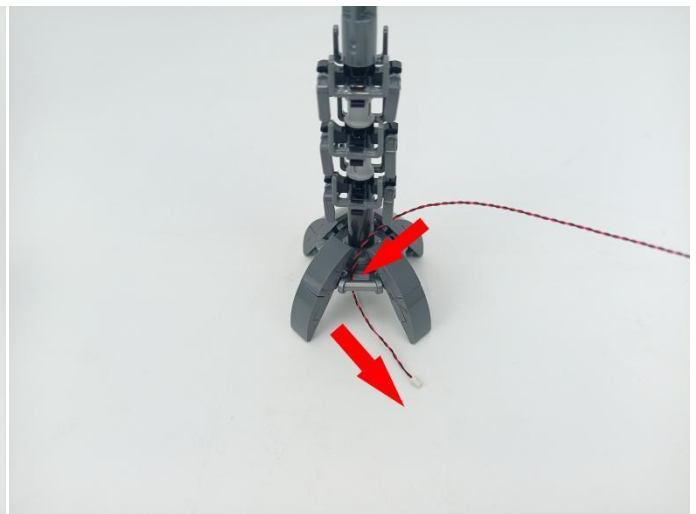
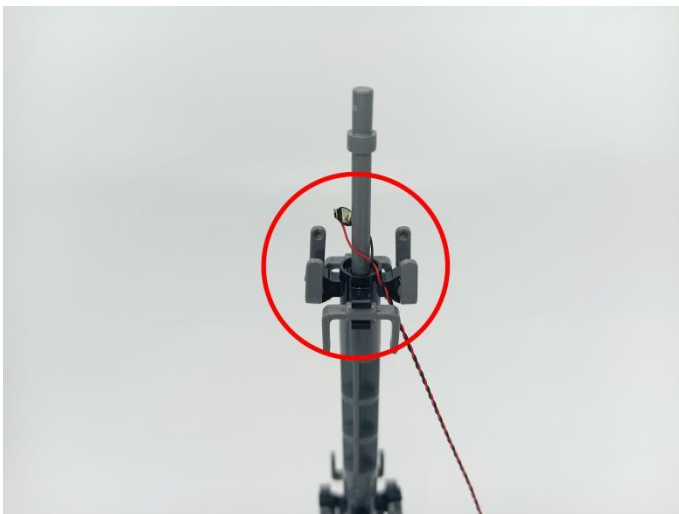

# 301



# 302



# 303

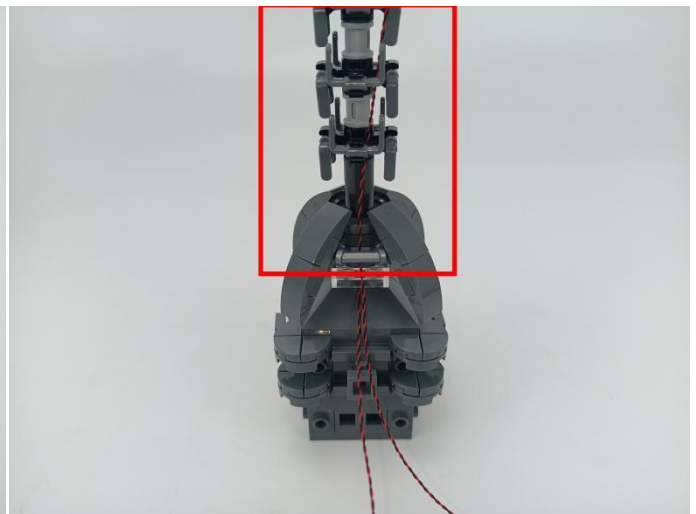



304

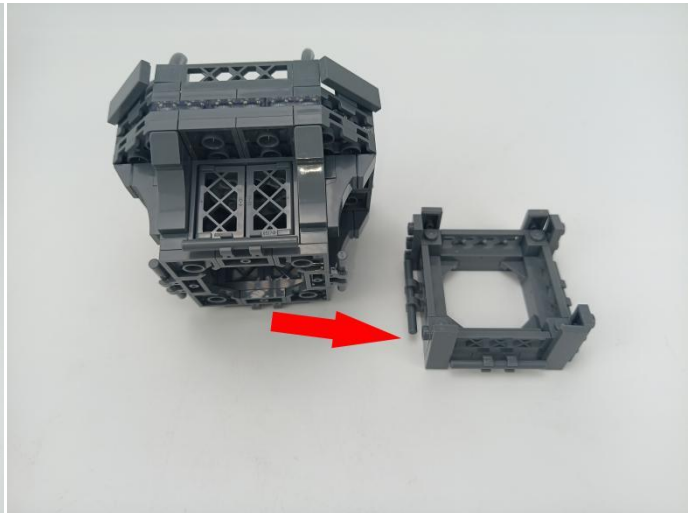
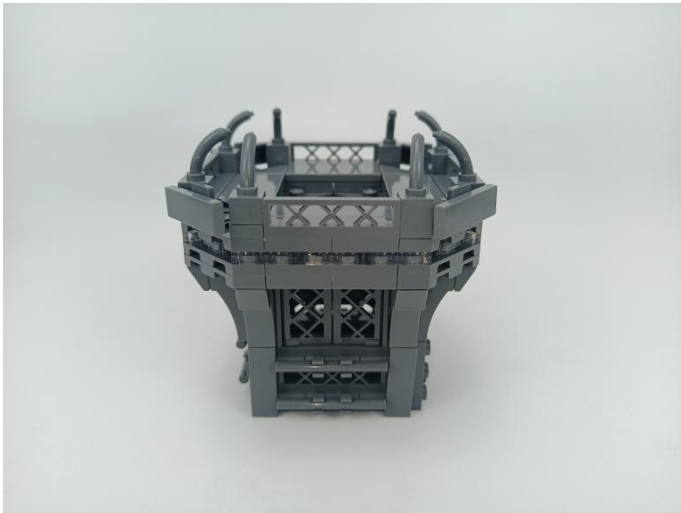

305

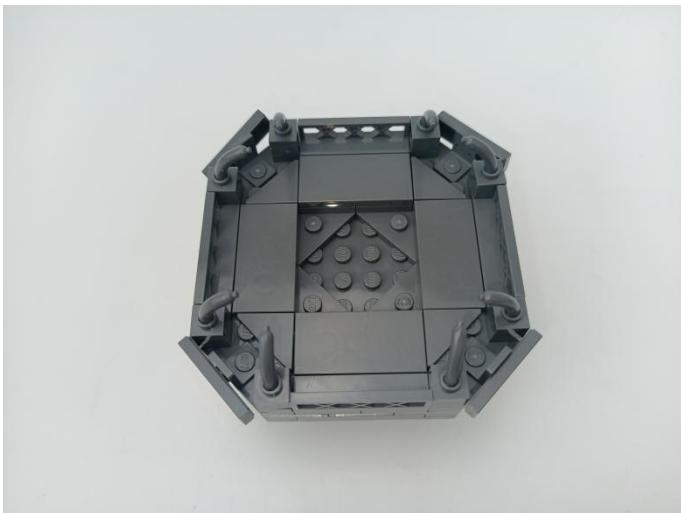

306

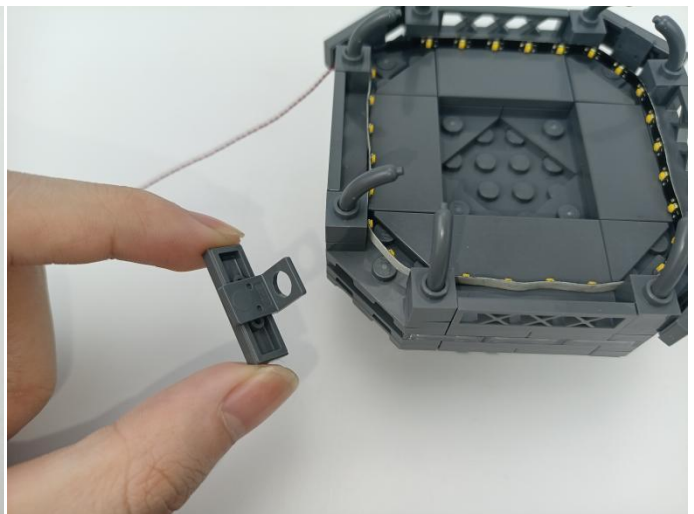
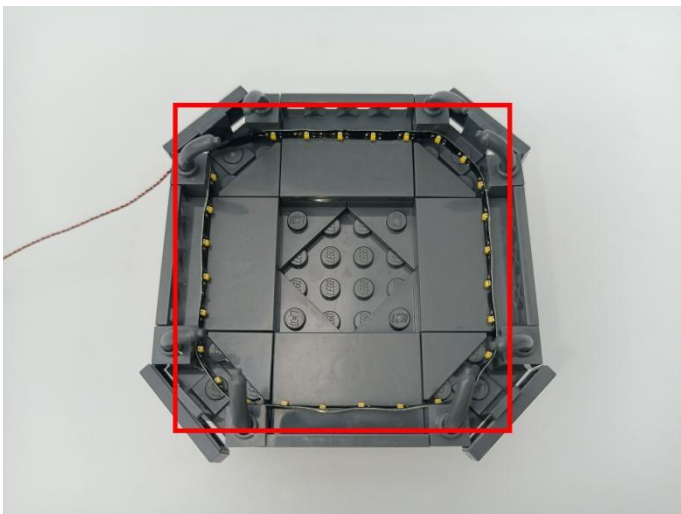

307

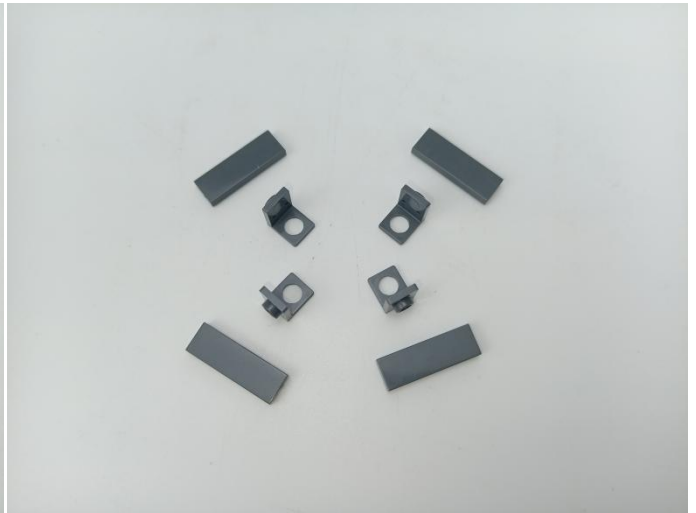
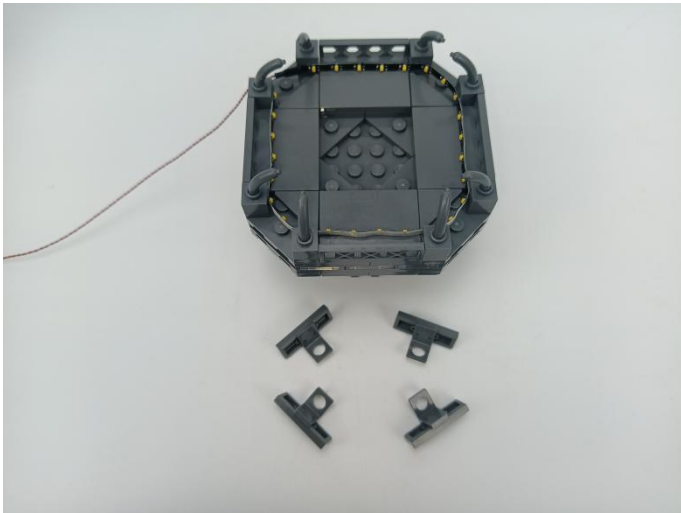

308



309

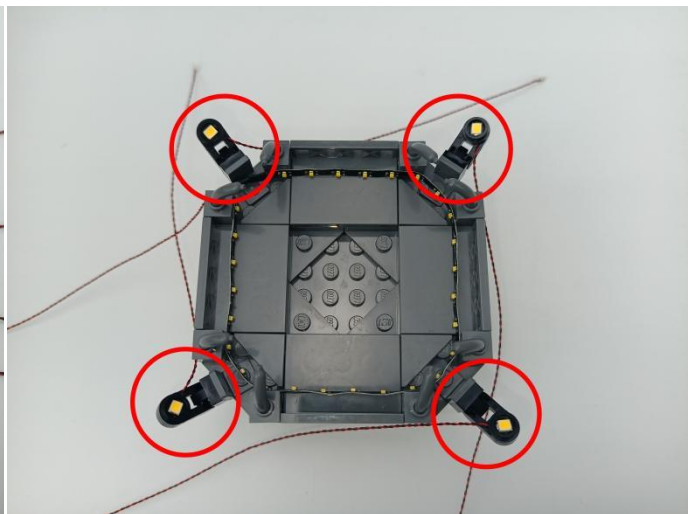



310

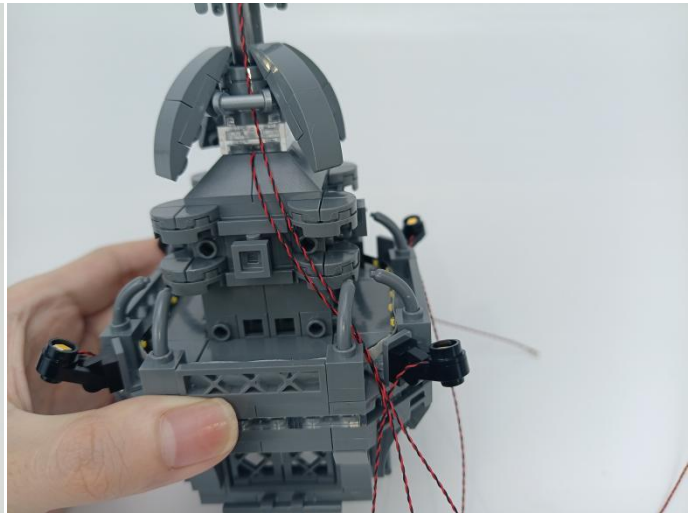
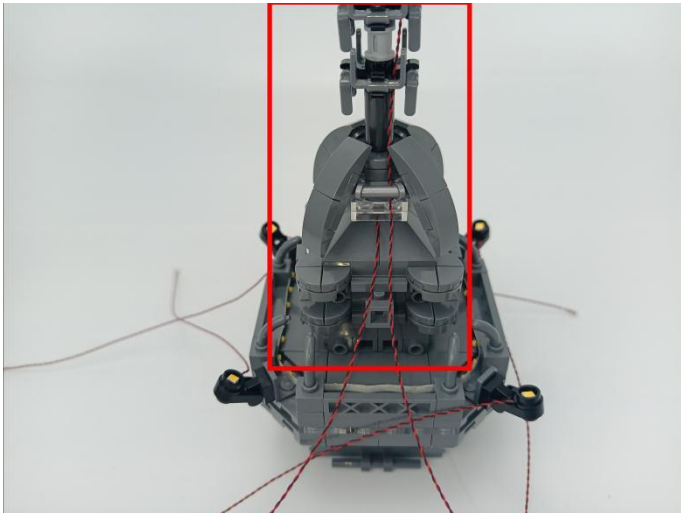

311

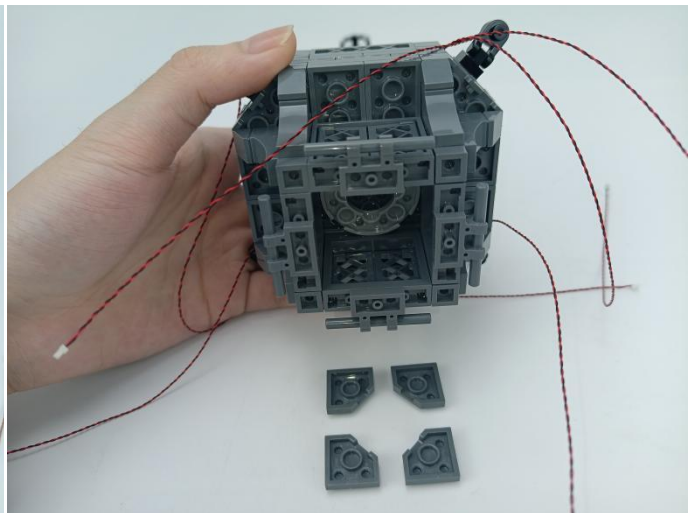
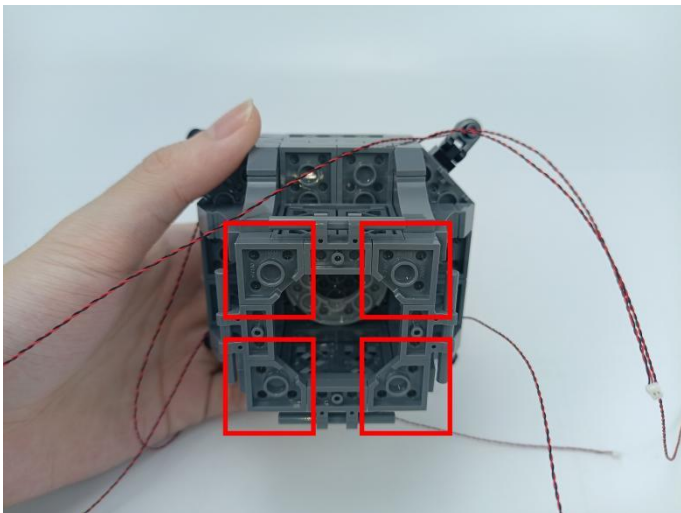

312

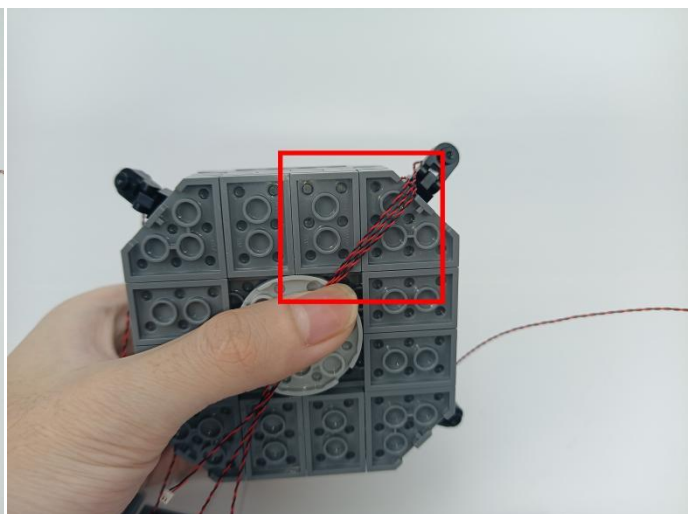
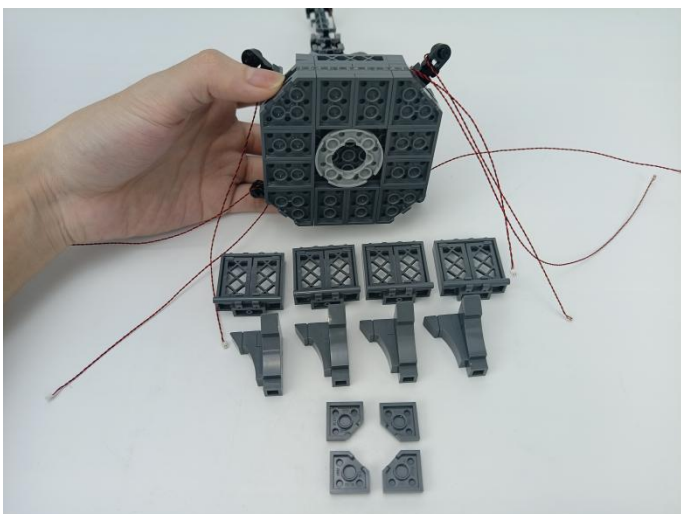

313

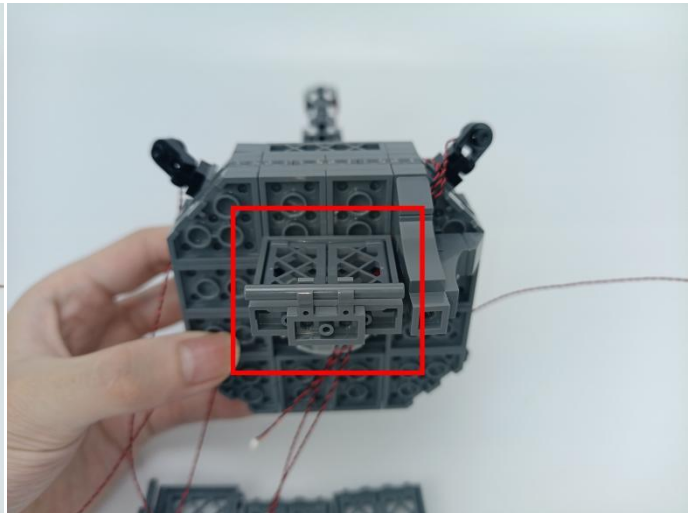
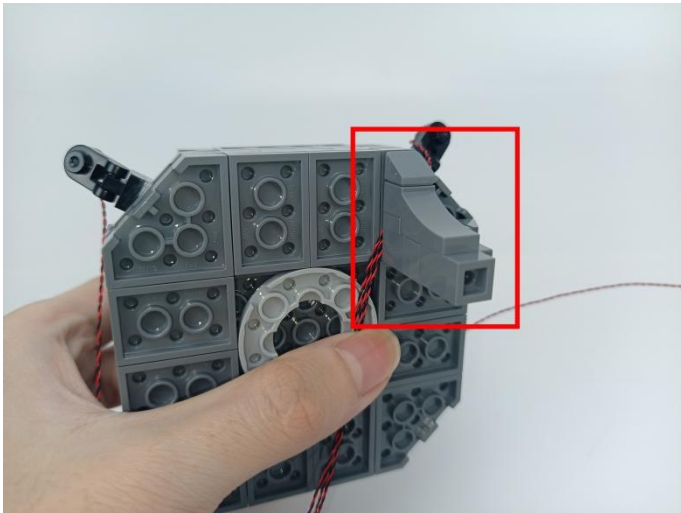

314

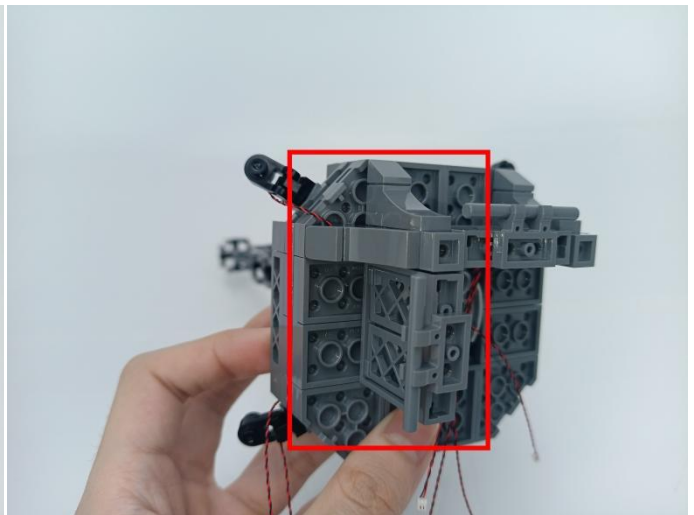
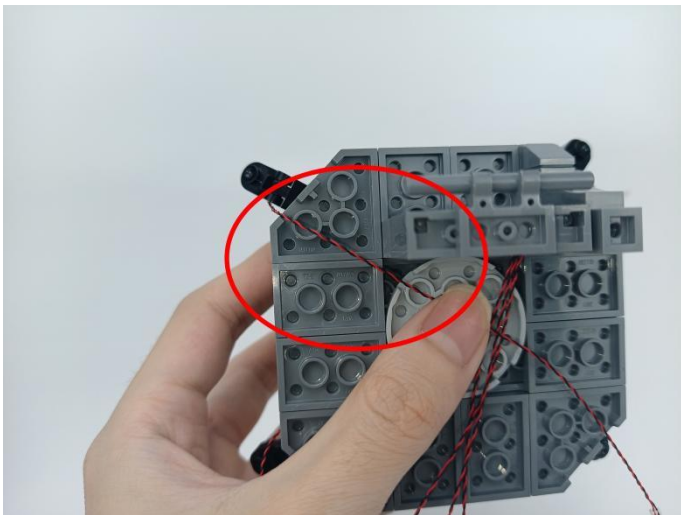

315

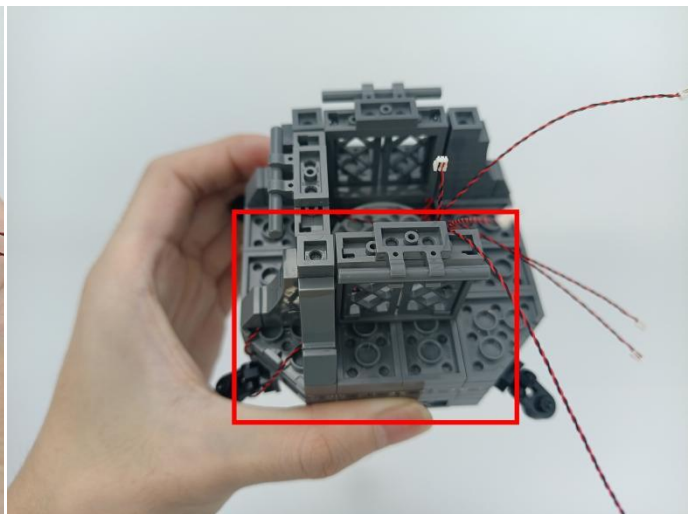
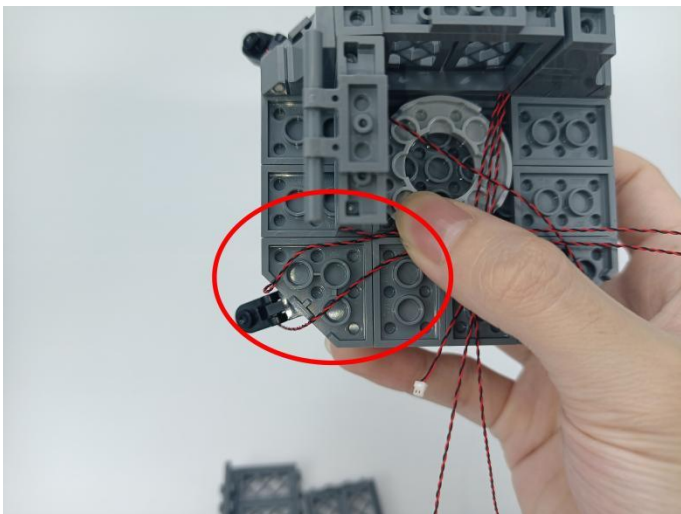



316

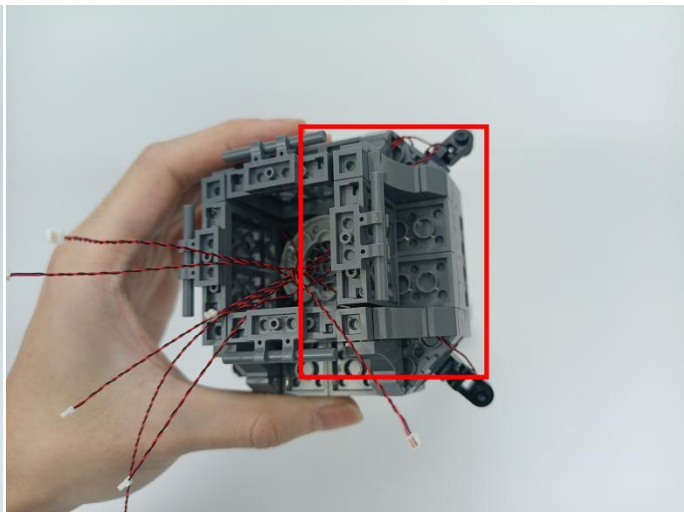
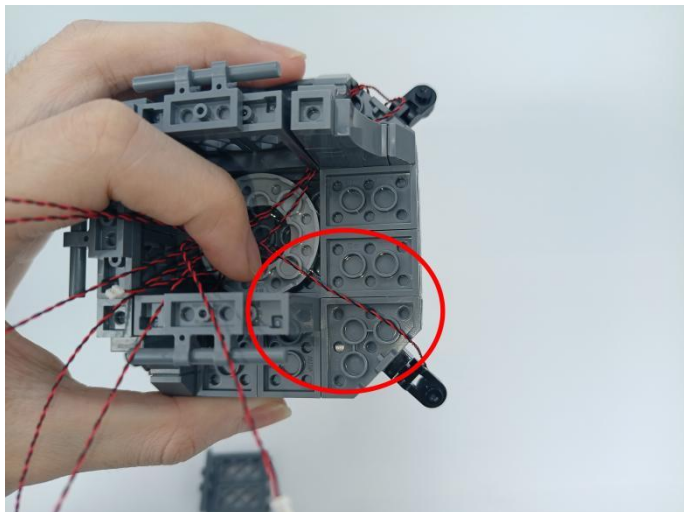

317

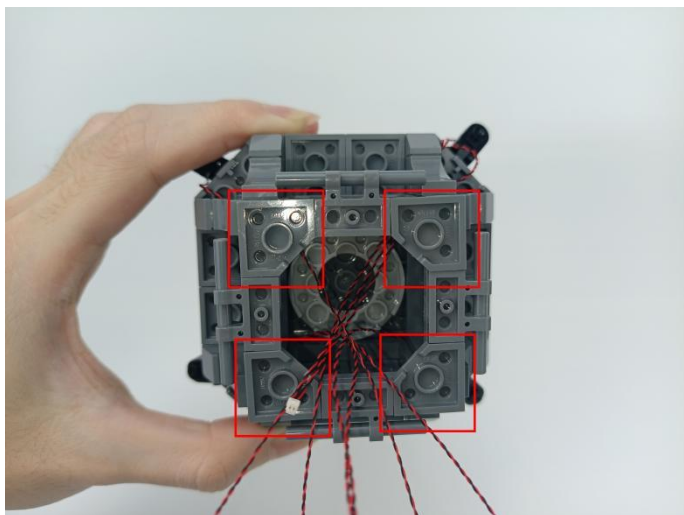

318

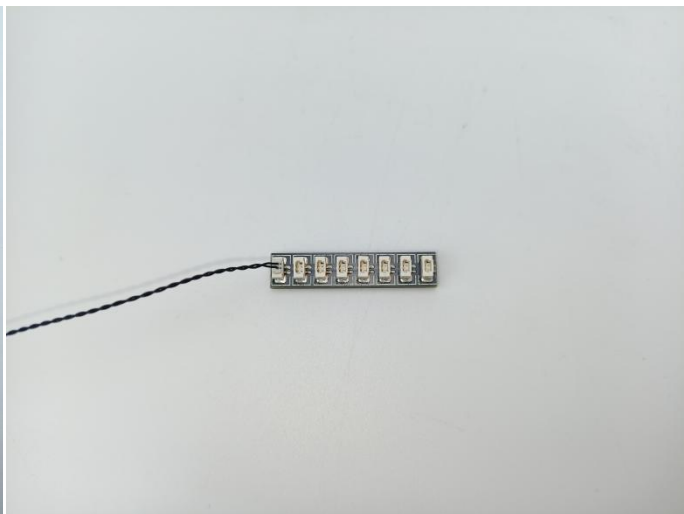

319

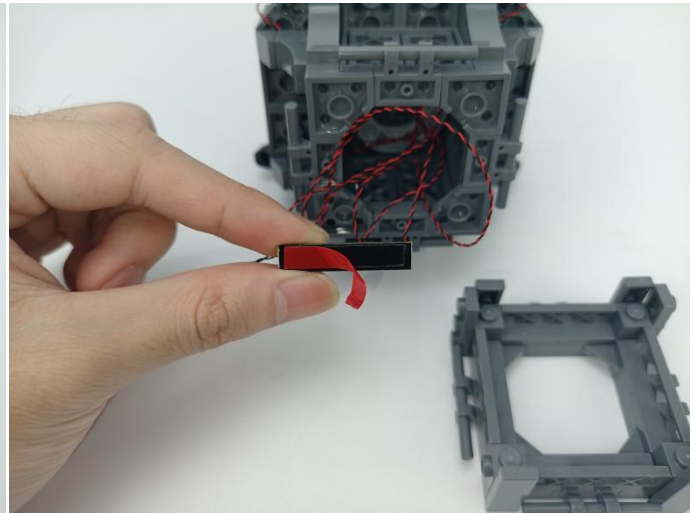
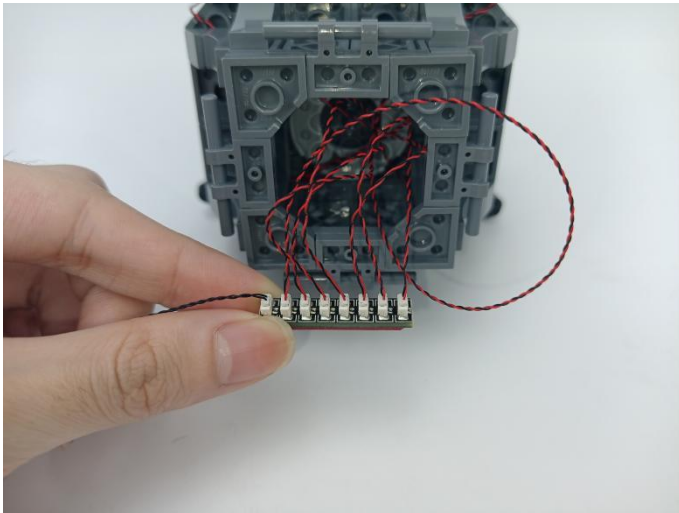

320

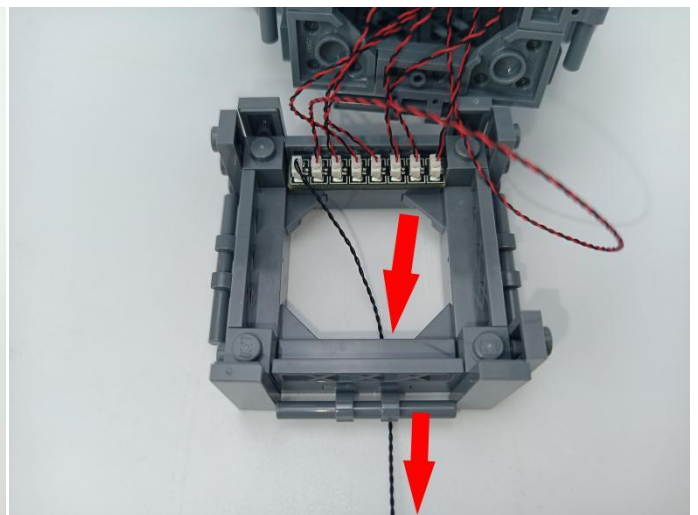
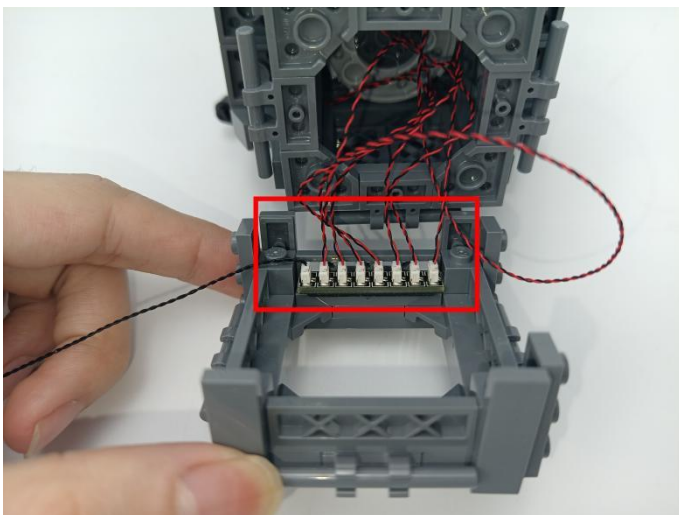

321

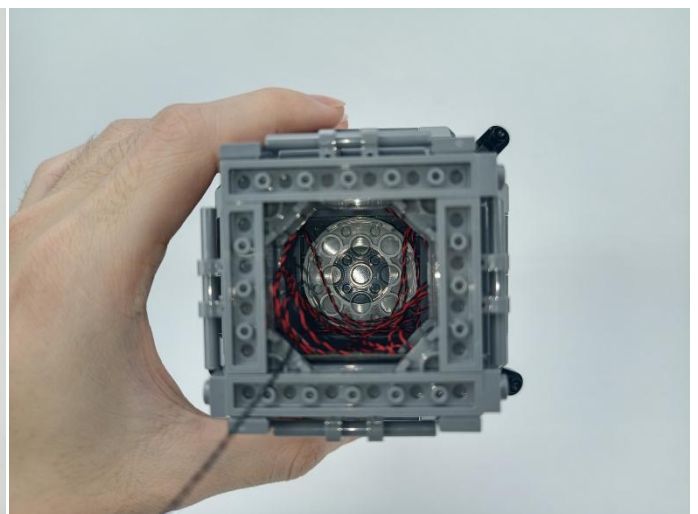
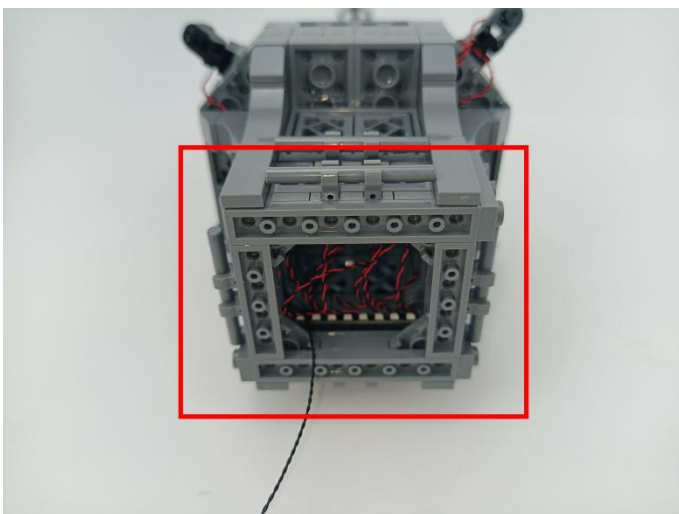



322

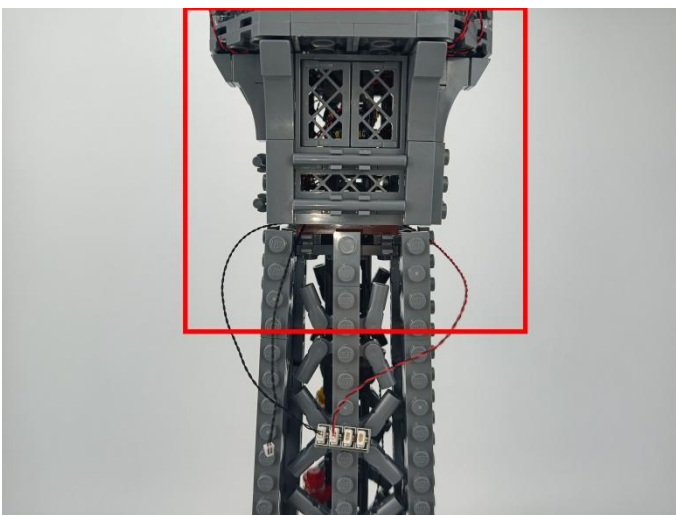
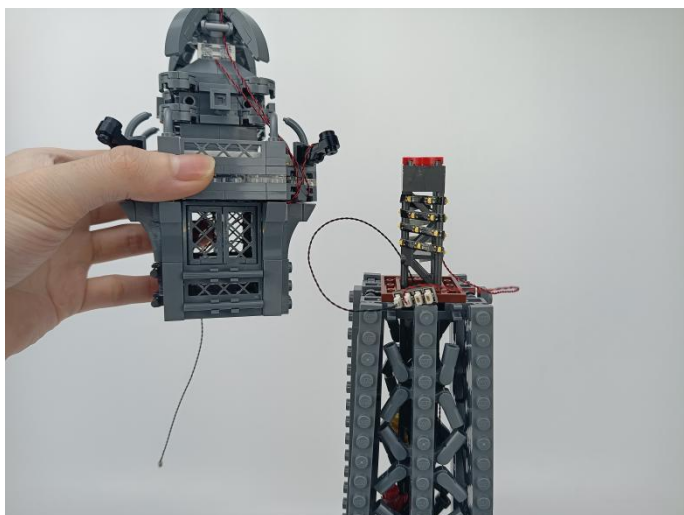

323

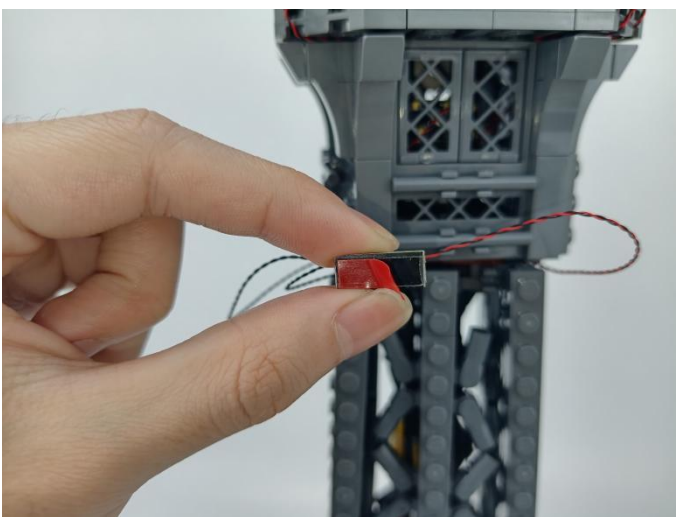
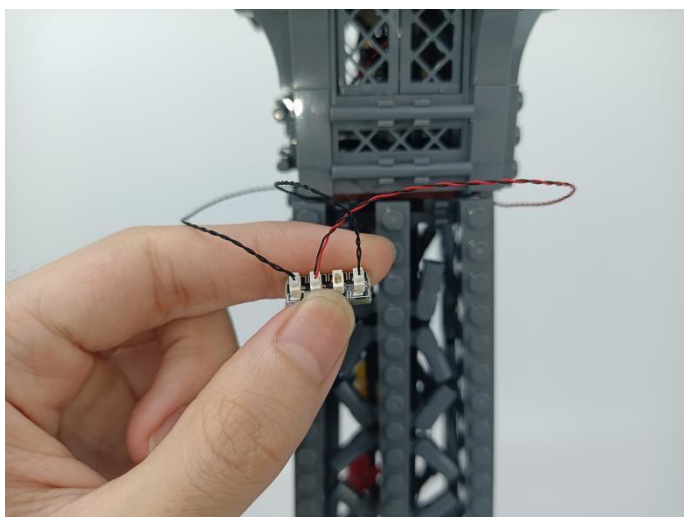

324

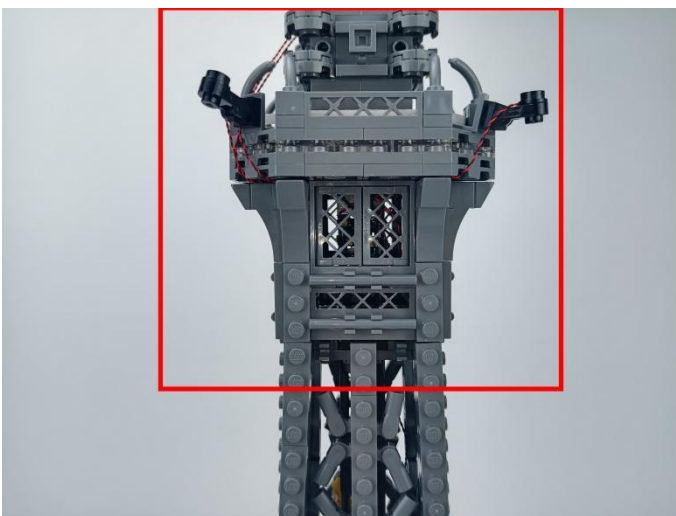
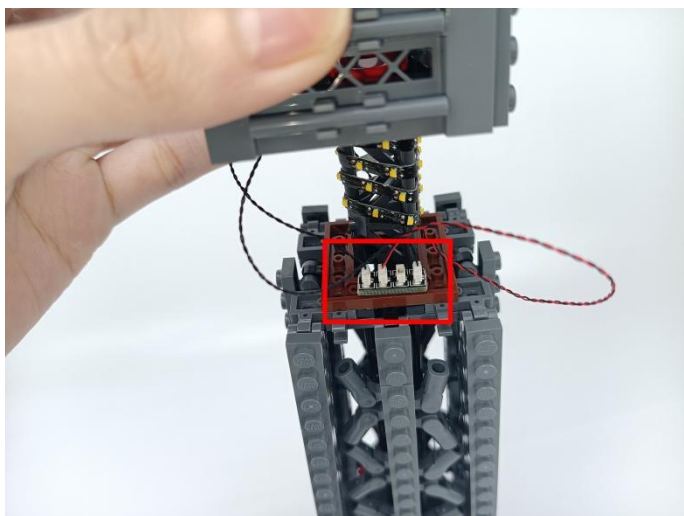

325

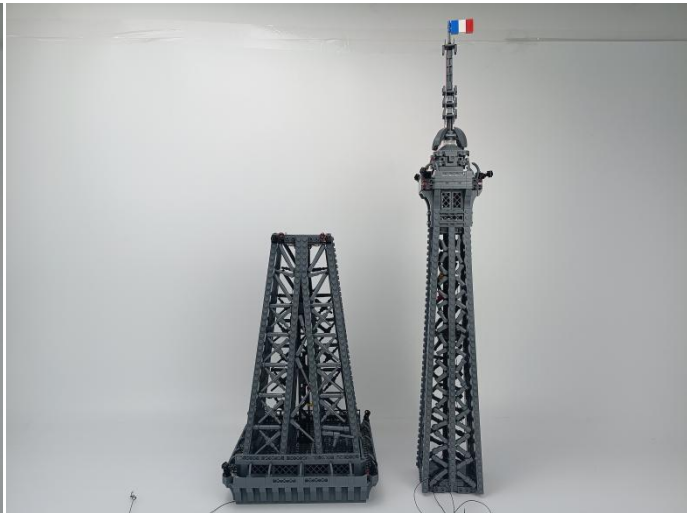
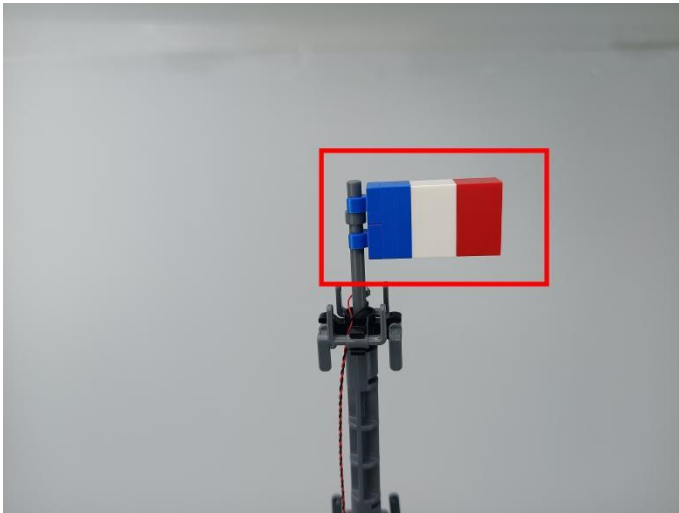

326



327

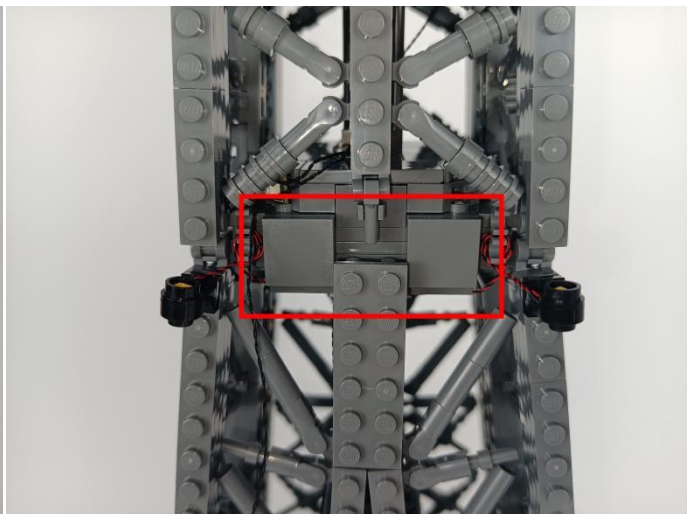
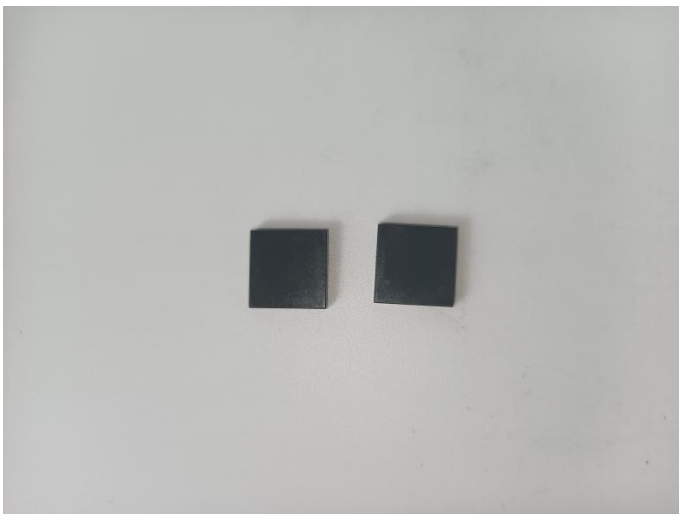



**328**

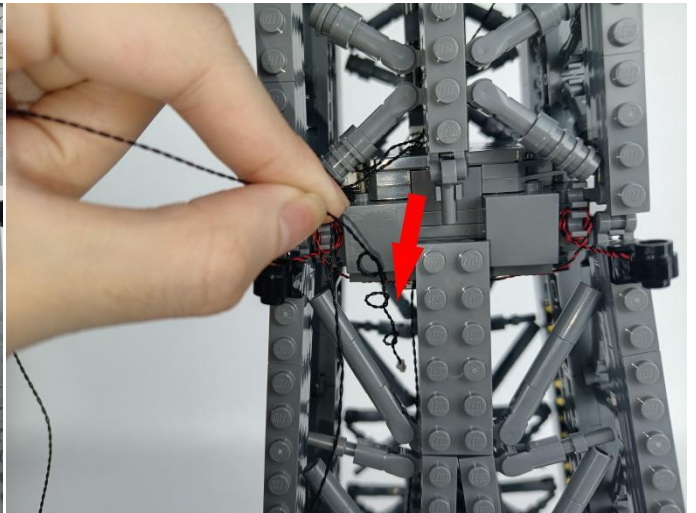
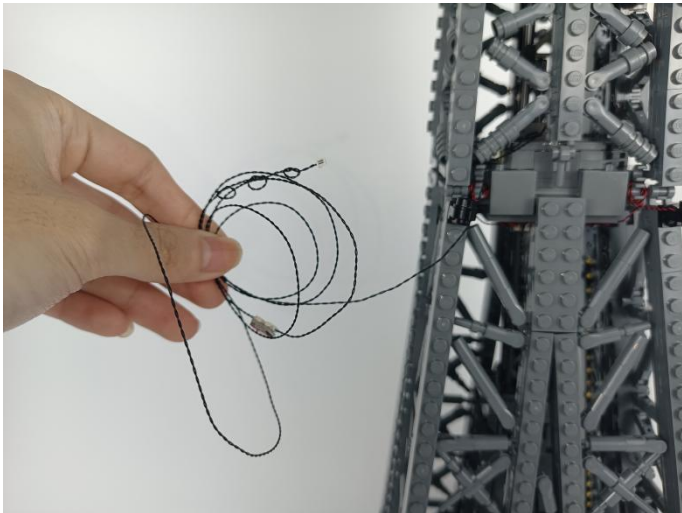

**329**

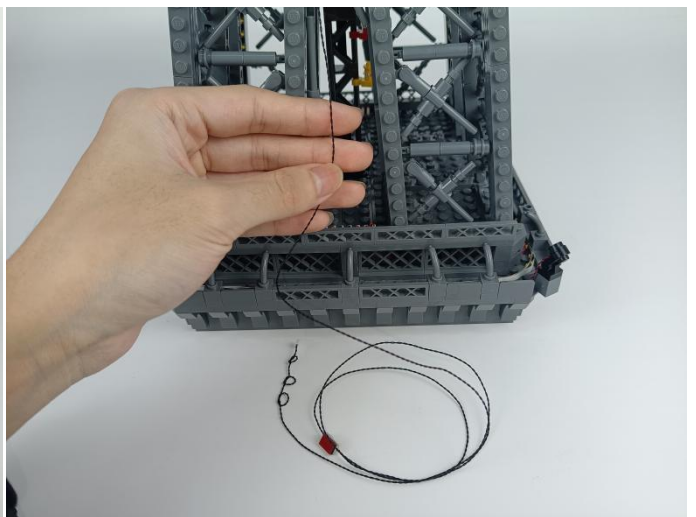
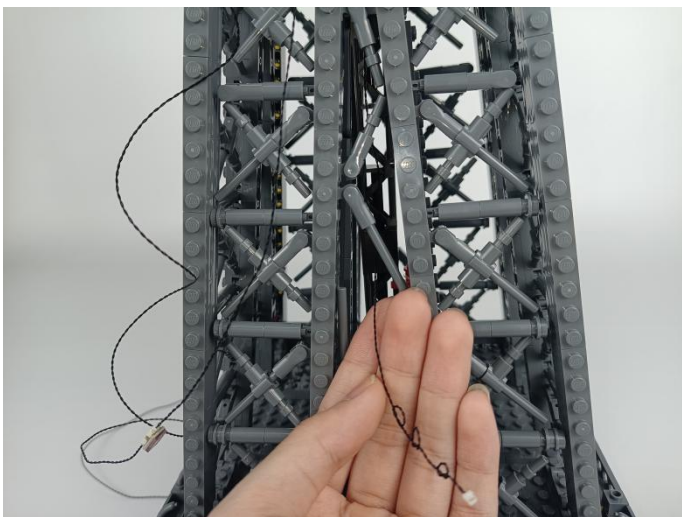

**330**

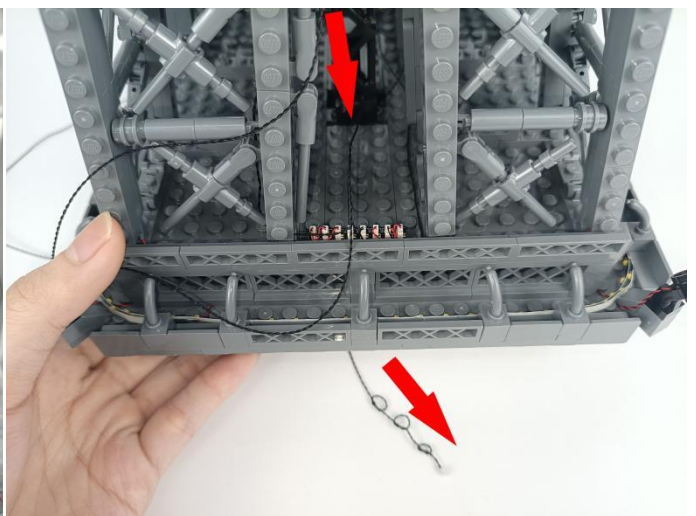
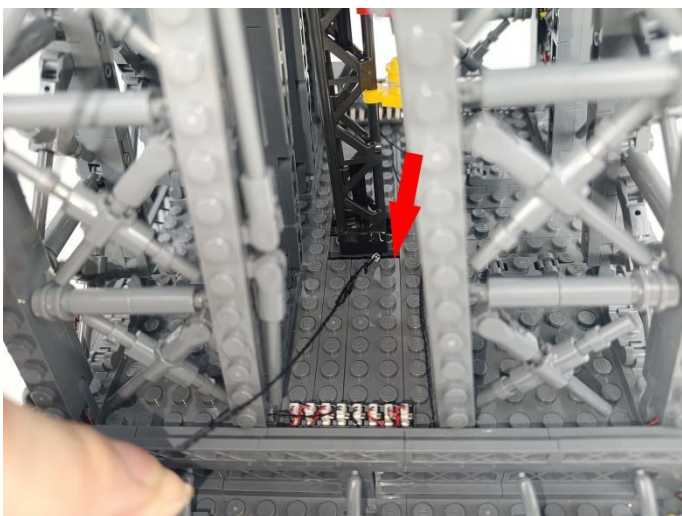

**331**

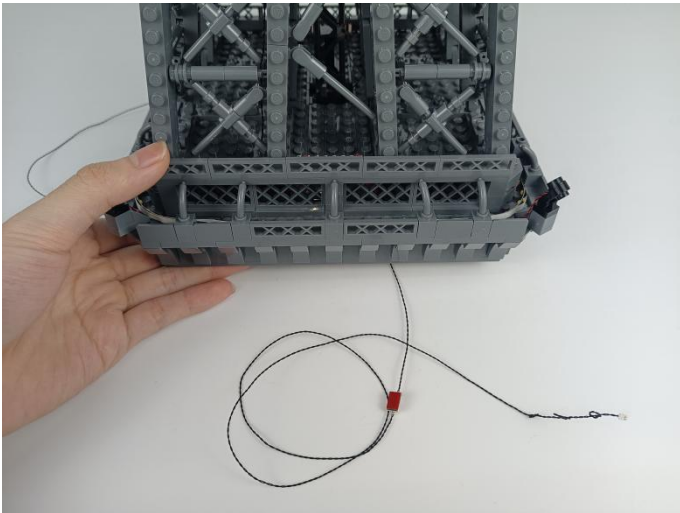

**332**

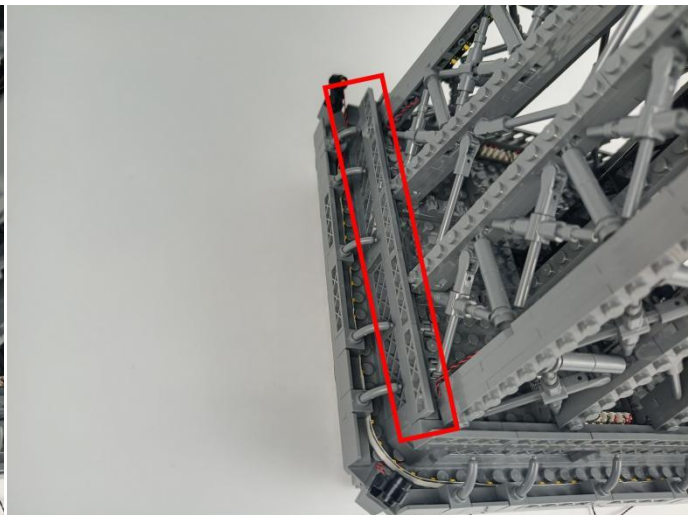
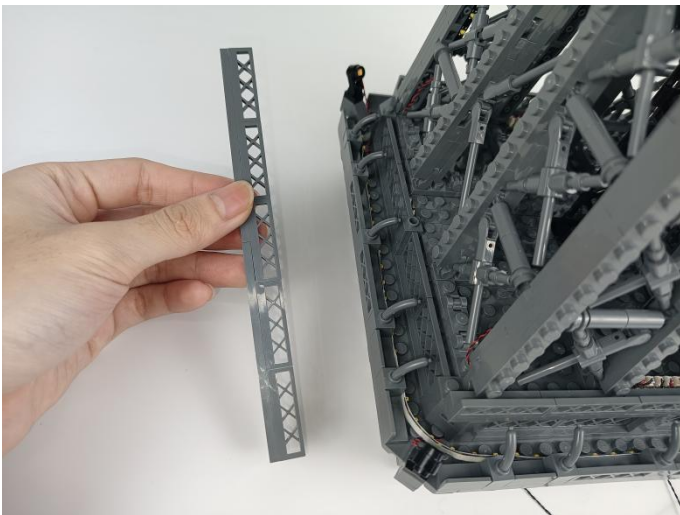

**333**

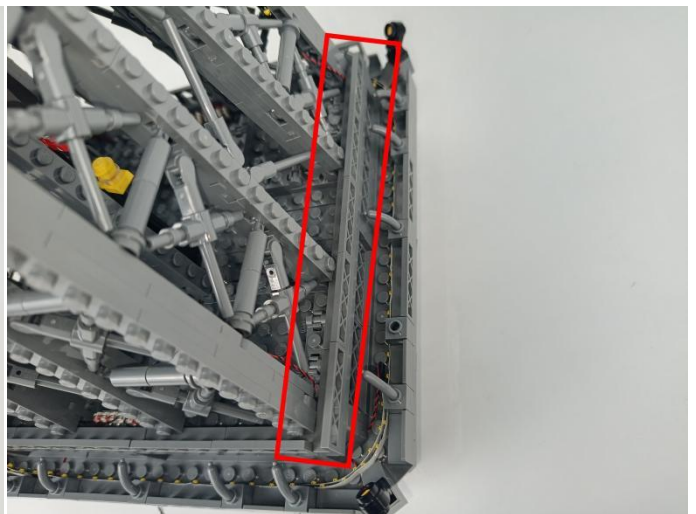
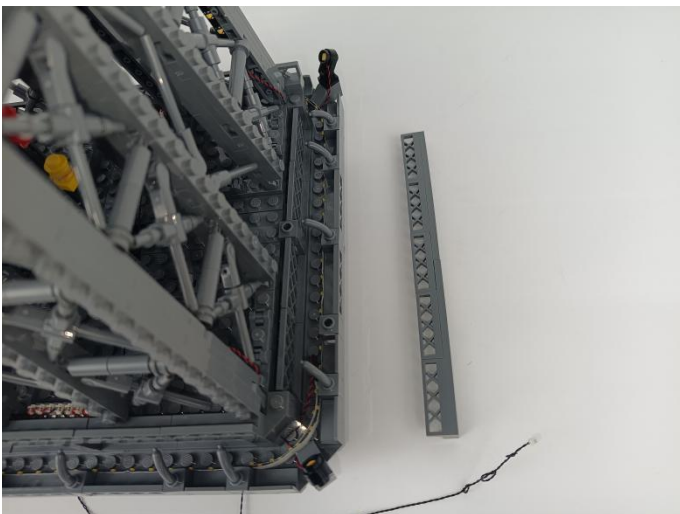



334

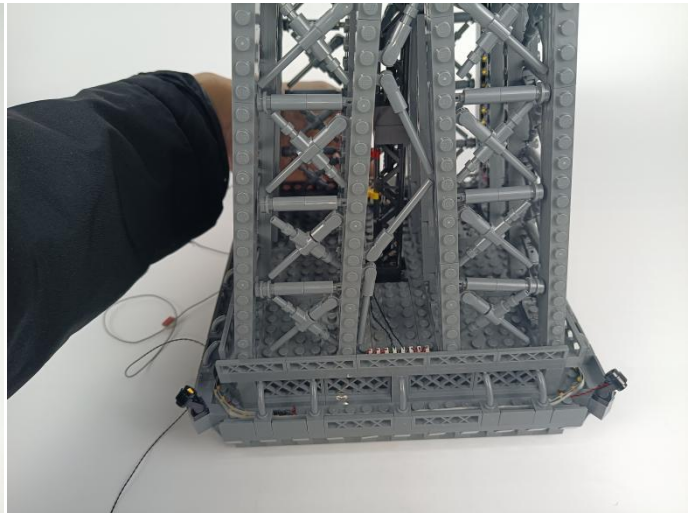
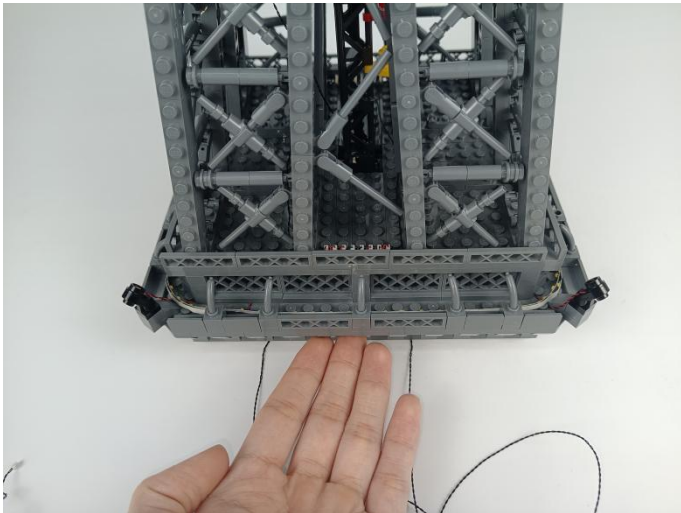

335

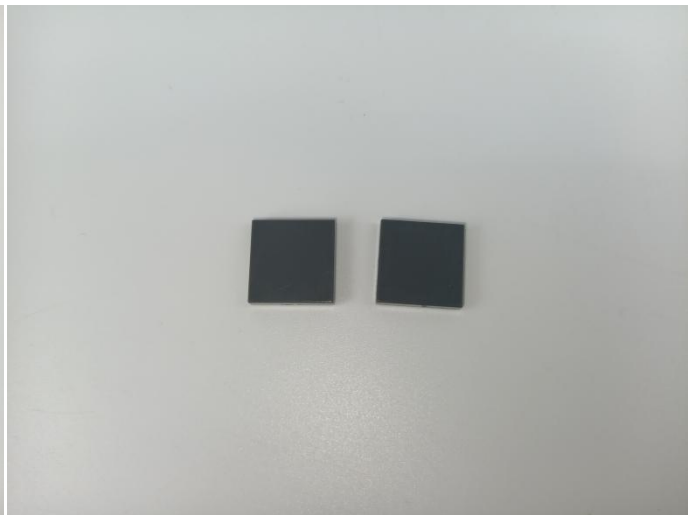

336

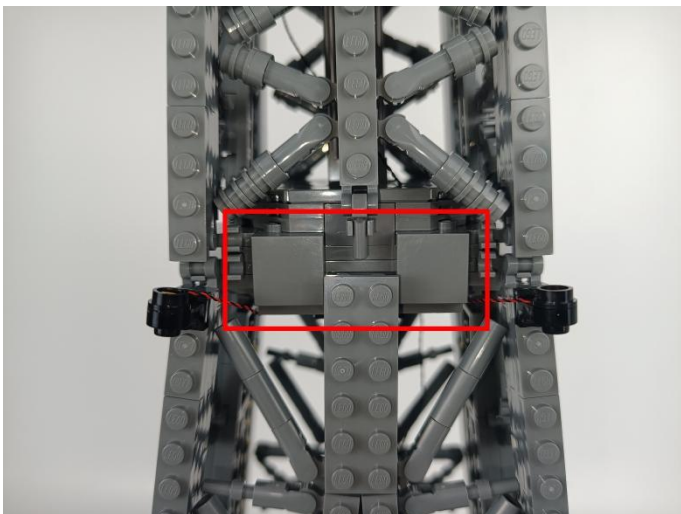

337

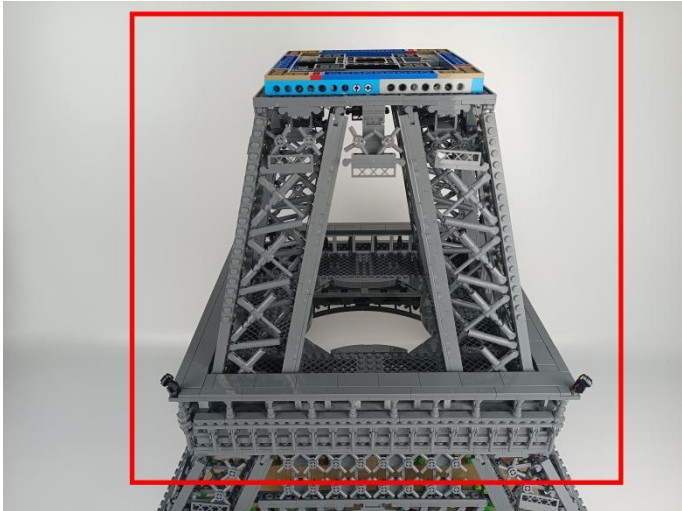

338

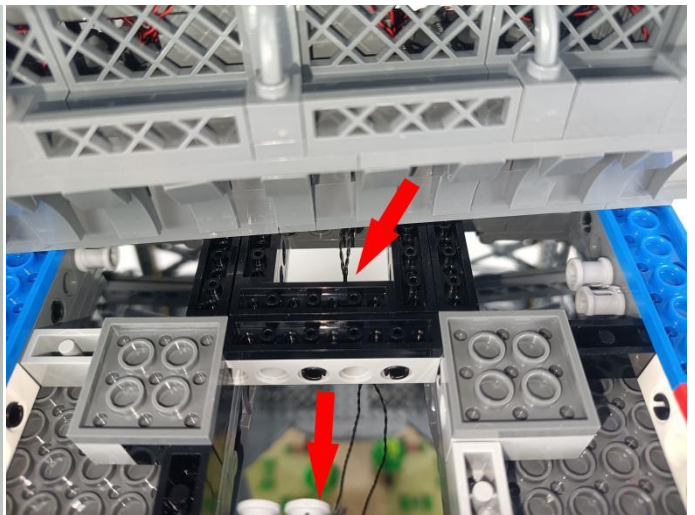
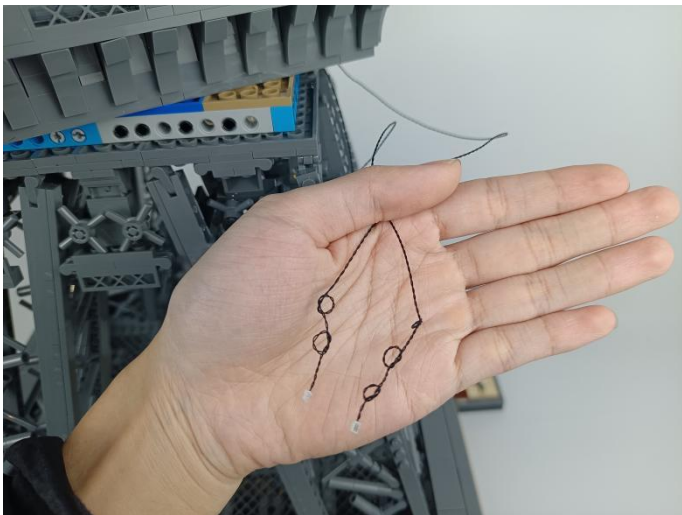

339

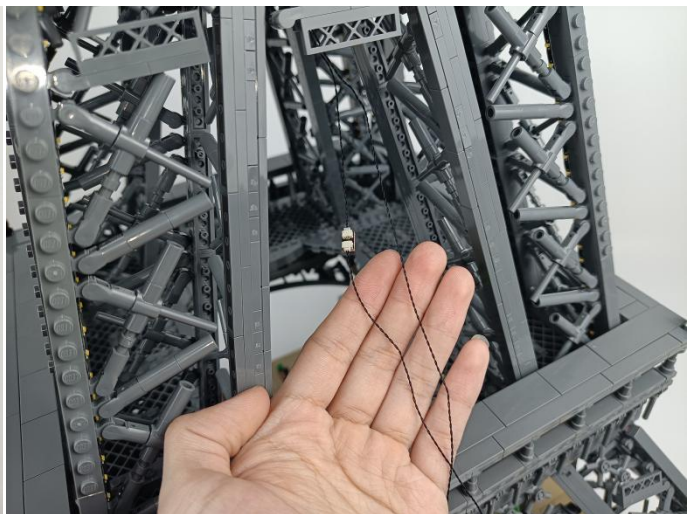



# 340

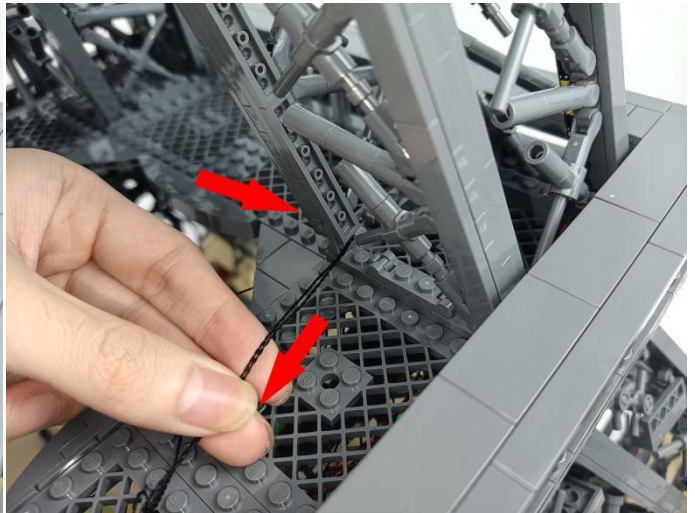
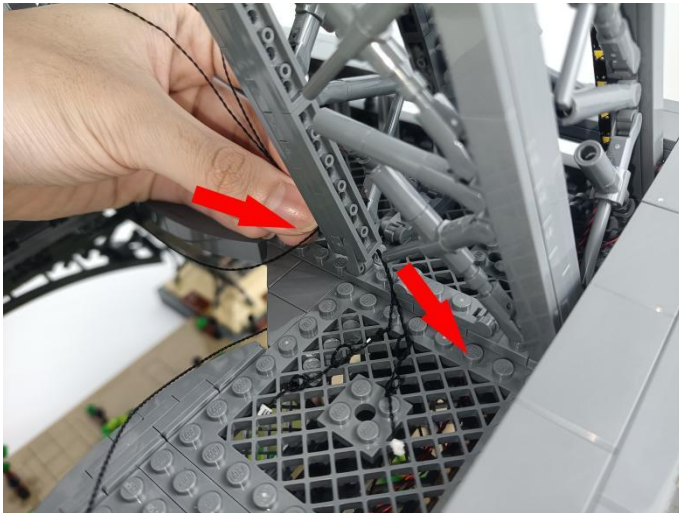

# 341



# 342

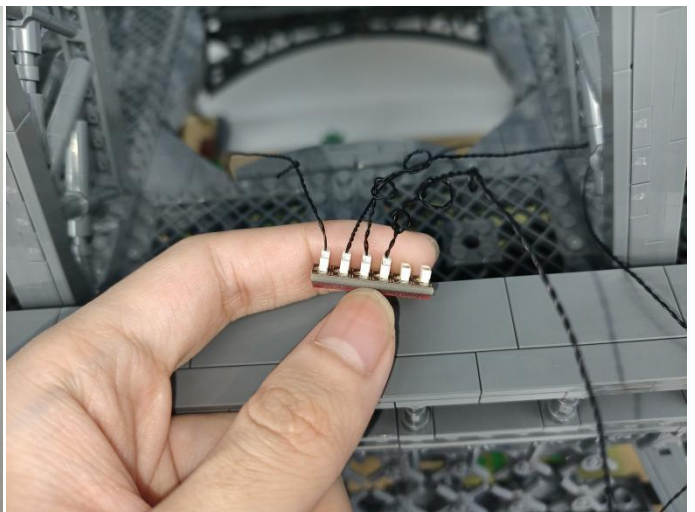

343



344



345

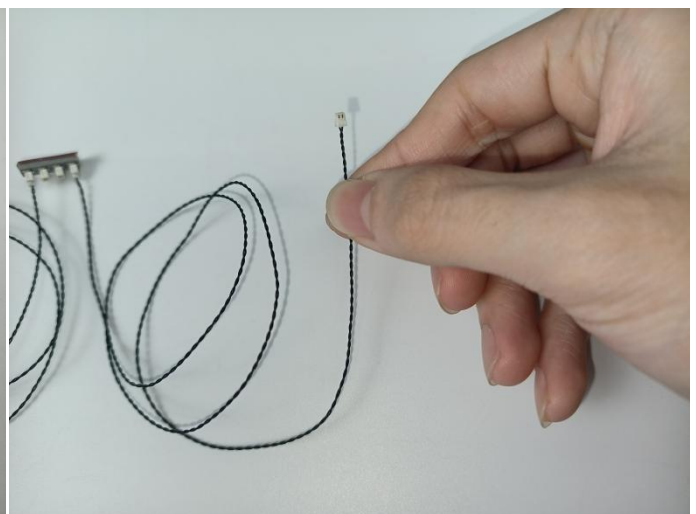
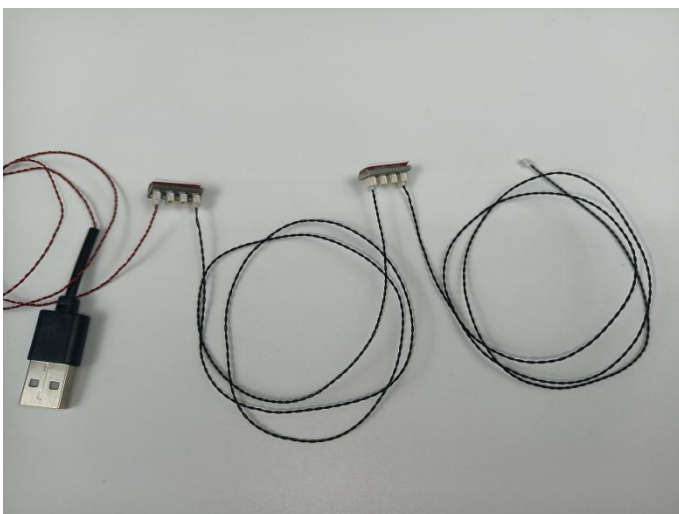



# 346

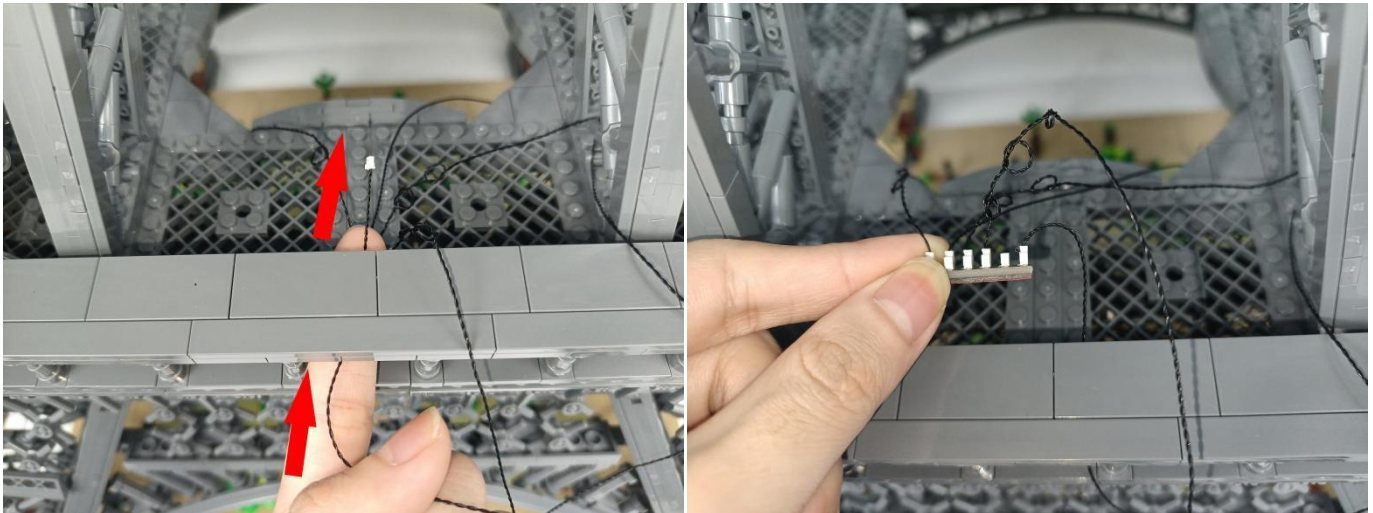

# 347

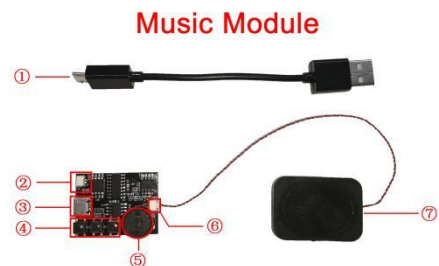

- ①: USB data cable is used to connect modules to the computer to replace music files.
  - ②: The power input port is used to supply power to the module, and the voltage is 5V DC power.
  - ③: Micro-USB port, music transmission port, it is recommended to use the music format MP3 file, the built-in capacity of the module is 16MB.
  - ④: The music control button, from left to right, is "previous song", "pause/play", "next song".
  - ⑤: The volume control button, rotate button to adjust the volume .
  - ⑥: The speaker interface.
  - ⑦: The speaker.
- This module function is similar to MP3. Imports your favorite music files into the module through the data cable, and then switch on the module to play the stored music. Music files can be replaced arbitrarily.

# 348

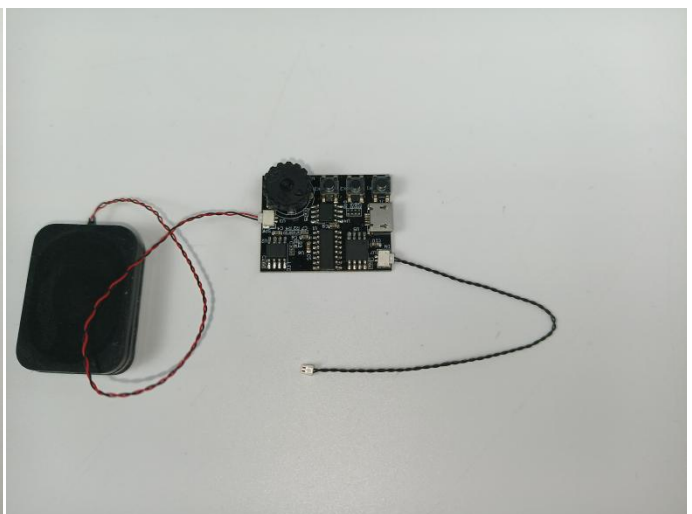

349

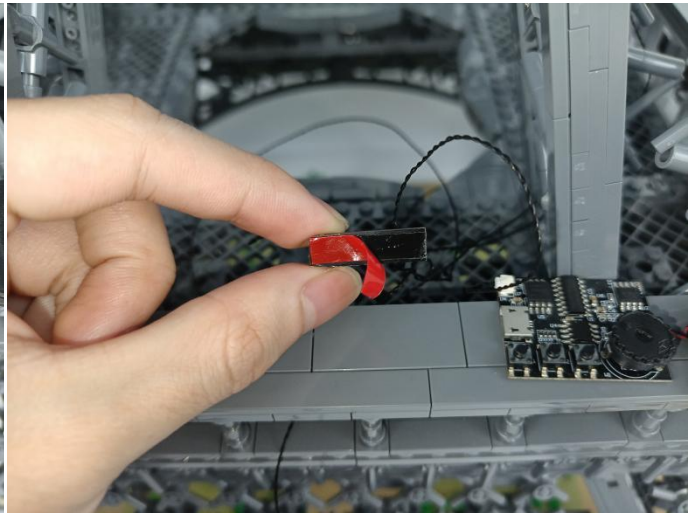
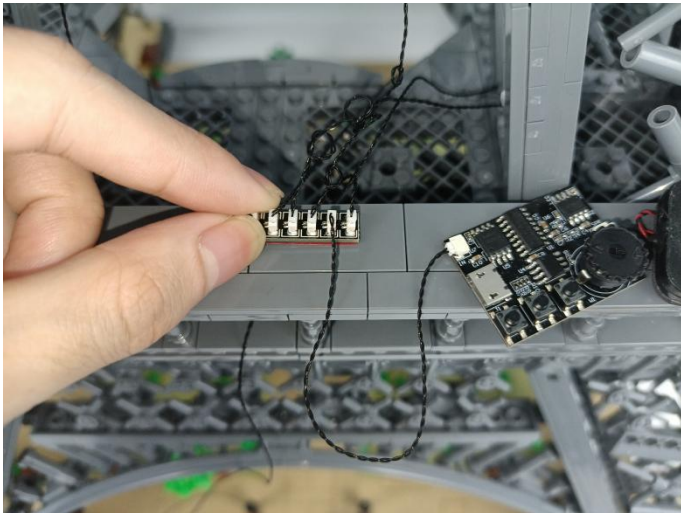

350

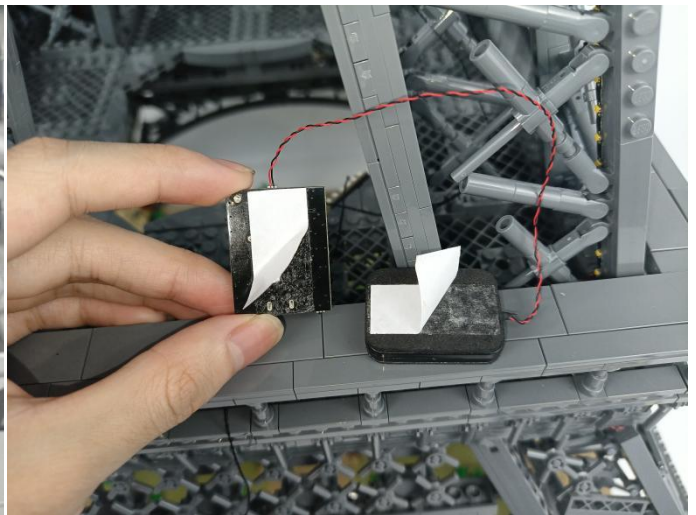
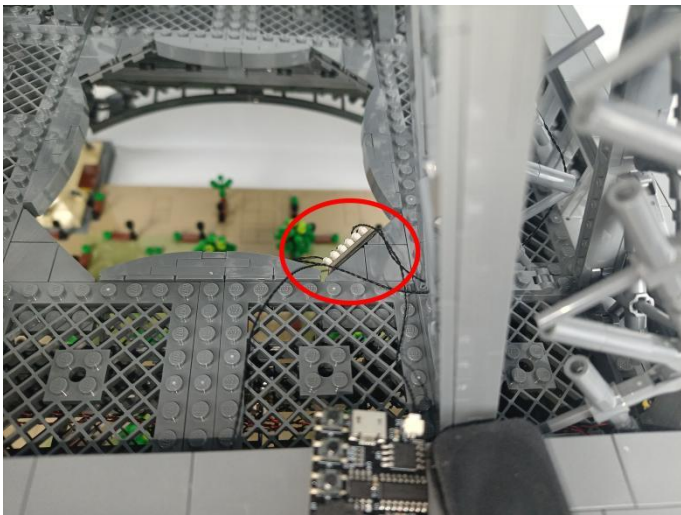

351

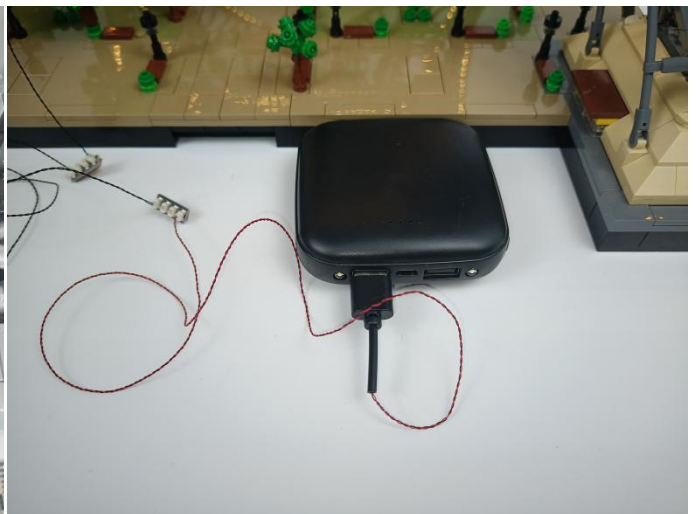
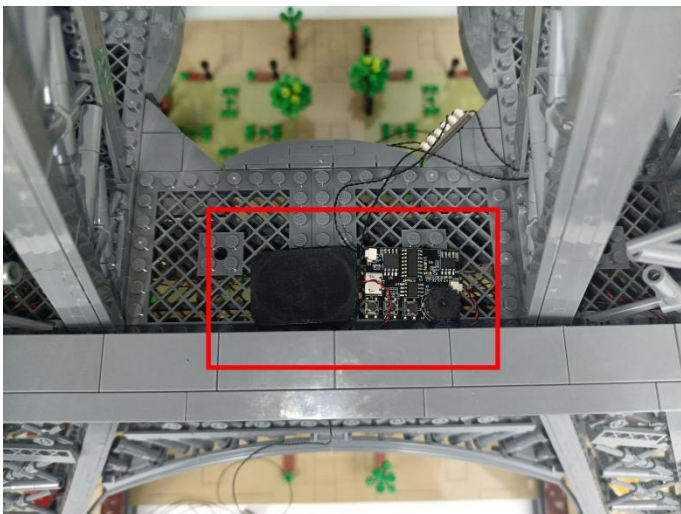



**352**



**Good job, you've done all the installation steps, power it up and enjoy your work.**

