

# 42127 The Batman - Batmobile

## LED lighting Kit (Remote Control Version)

### P30702

#### Installing Instructions:

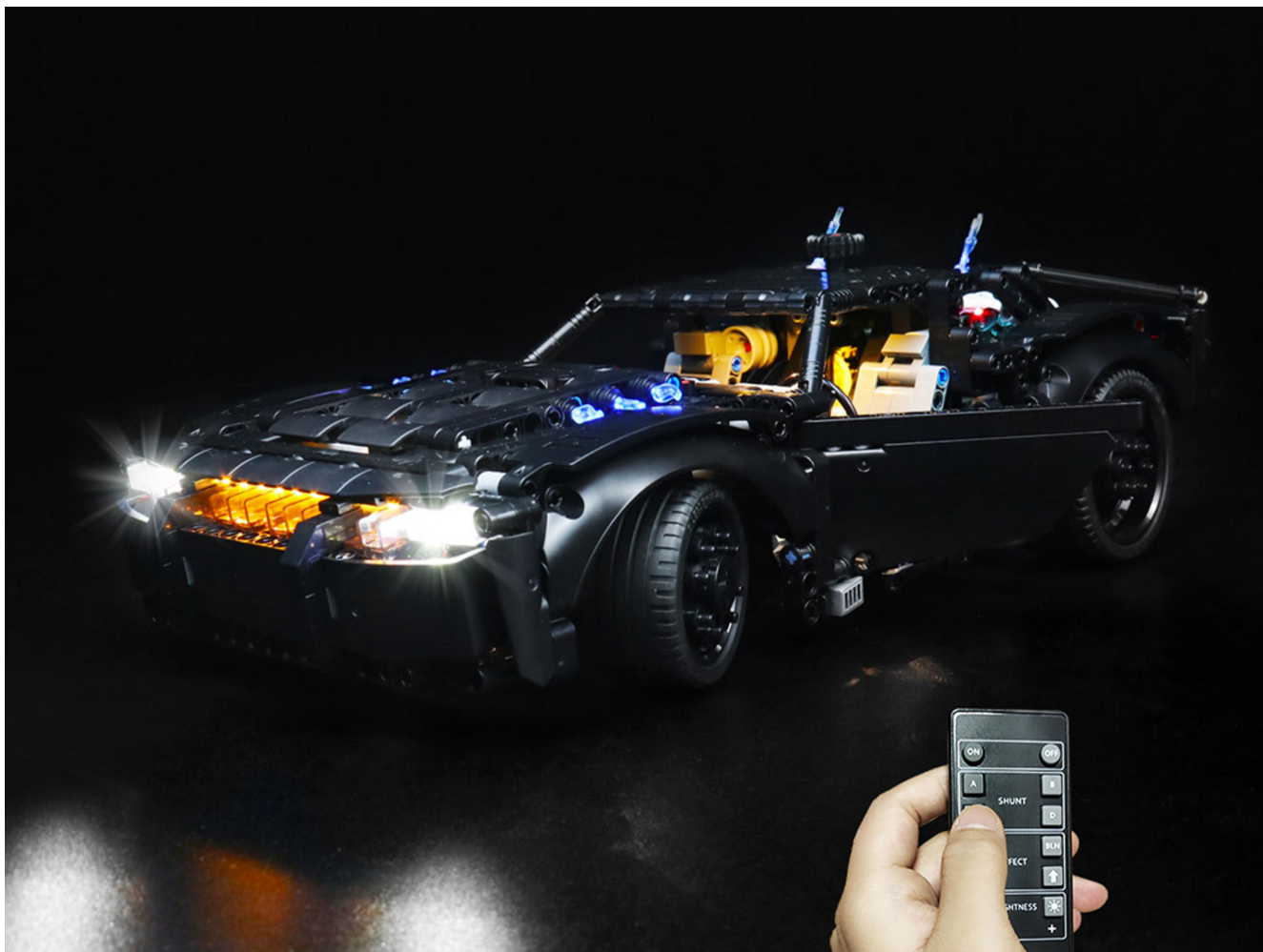

Please follow below two parts to finish the installation of the lighting

Step 1 : Test

Step 2 : Installation

Let us start.

## Step 1 : Test

The lighting materials are as follows, please confirm the quantity of lighting.

Quantity	Attribute name
6	Bit Lights-15CM-Blue
1	Headlights-15CM-Warm White
1	LED Strip Lights-Warm White
1	6-Port Expansion Boards
1	8-Port Expansion Boards
2	4-Port Expansion Boards
1	USB Power Cable-30CM
1	AA Battery Pack
2	Connecting Cables-5CM
4	Connecting Cables-20CM
1	Multi-Effects Board
1	Light Strips-Warm White-28
1	Remote Control Boards
2	Headlights-15CM-White
3	Headlights-15CM-Red
4	Headlights-15CM-Blue
Other parts	

This set has a total of 15 bags. Take out the USB power cord and a 6-seat expansion board, and then tear off the seal of the expansion board. Coming with usb cable and battery box for choose, can be powered by power bank/wall charger or you can also use it with the battery.





**Available power supply devices for USB power cord.**

## USB connectors to connect devices

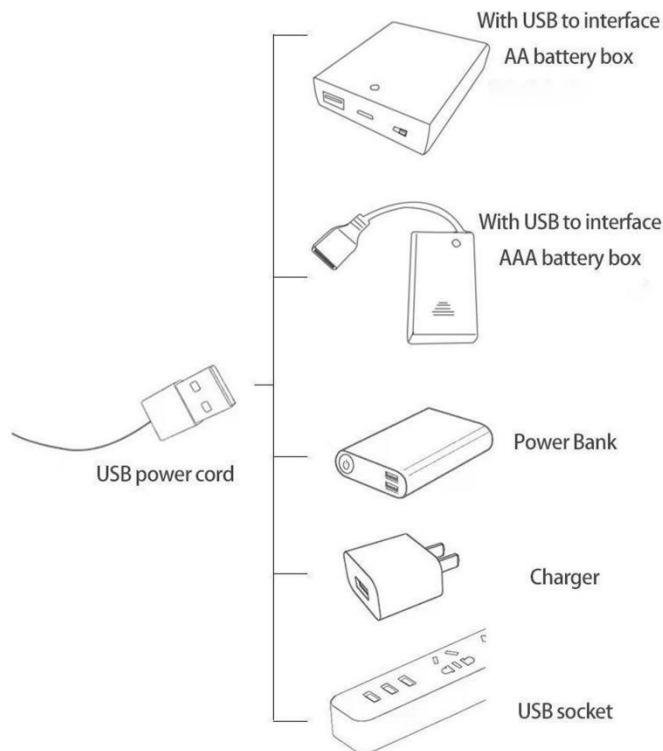

Please pay more attention and carefully using the connector for it is small. The “=” of the 2P interface is aligned with the “=” of the expansion board. The “=” on the expansion board refers to the two outside solder joints, not the two metal pins inside the jack.

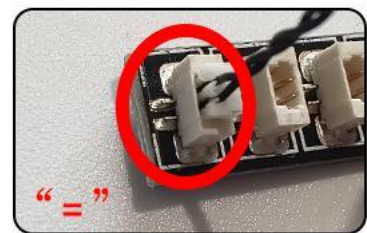
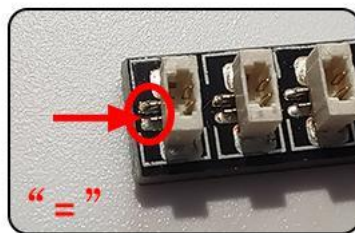
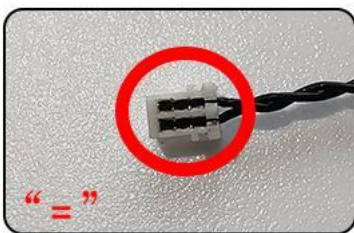

Connect the USB power cord and expansion board together.

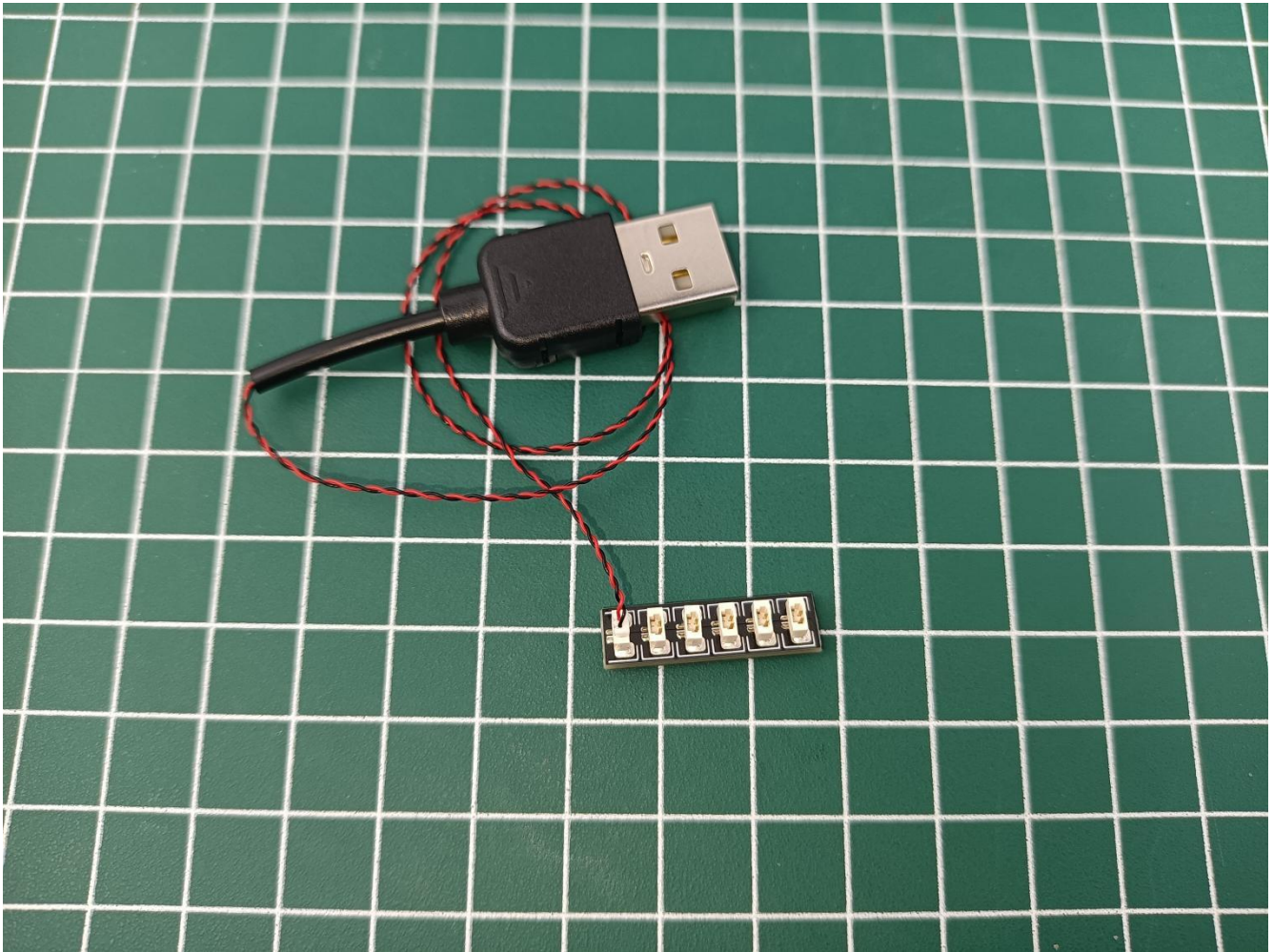

**Connect the other side of the USB power cord to the mobile power supply (power prepare by yourself).**





**Remove the light bar from the bag and prepare for testing.**





**Connect the lighting to the expansion board then turn on the power switch. Testing whether the lighting is normal, if there is any problem, please contact us timely.**



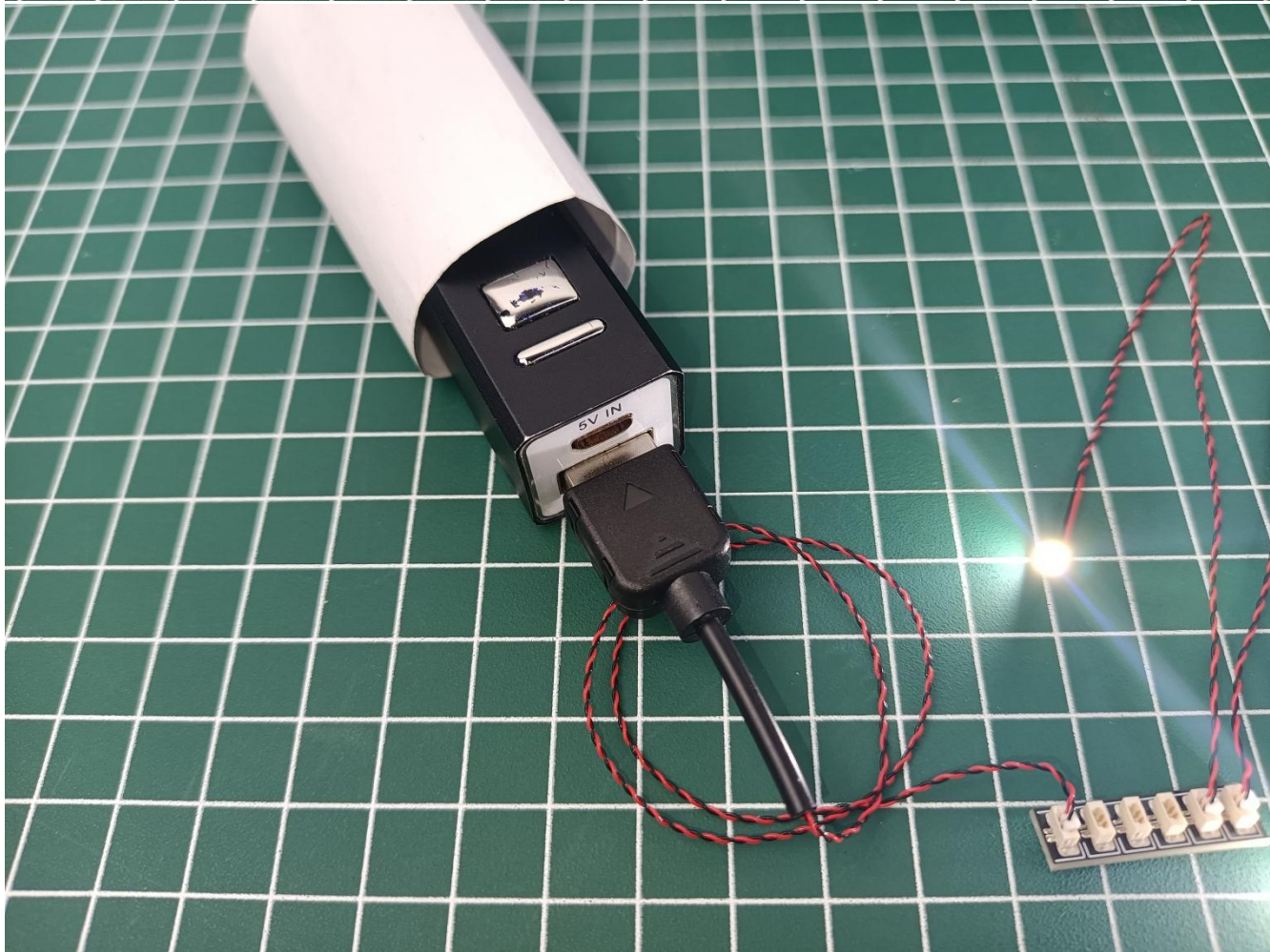
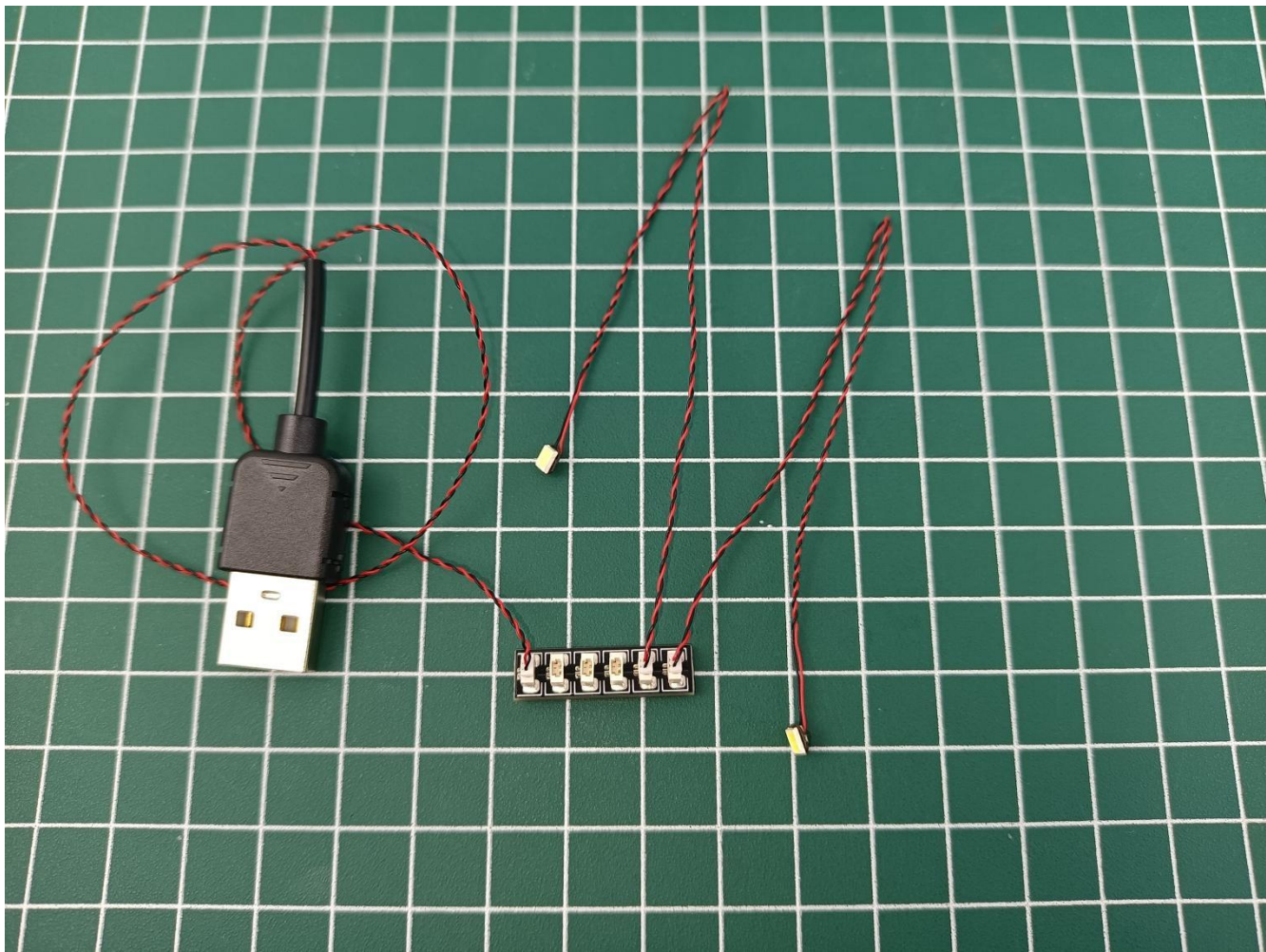



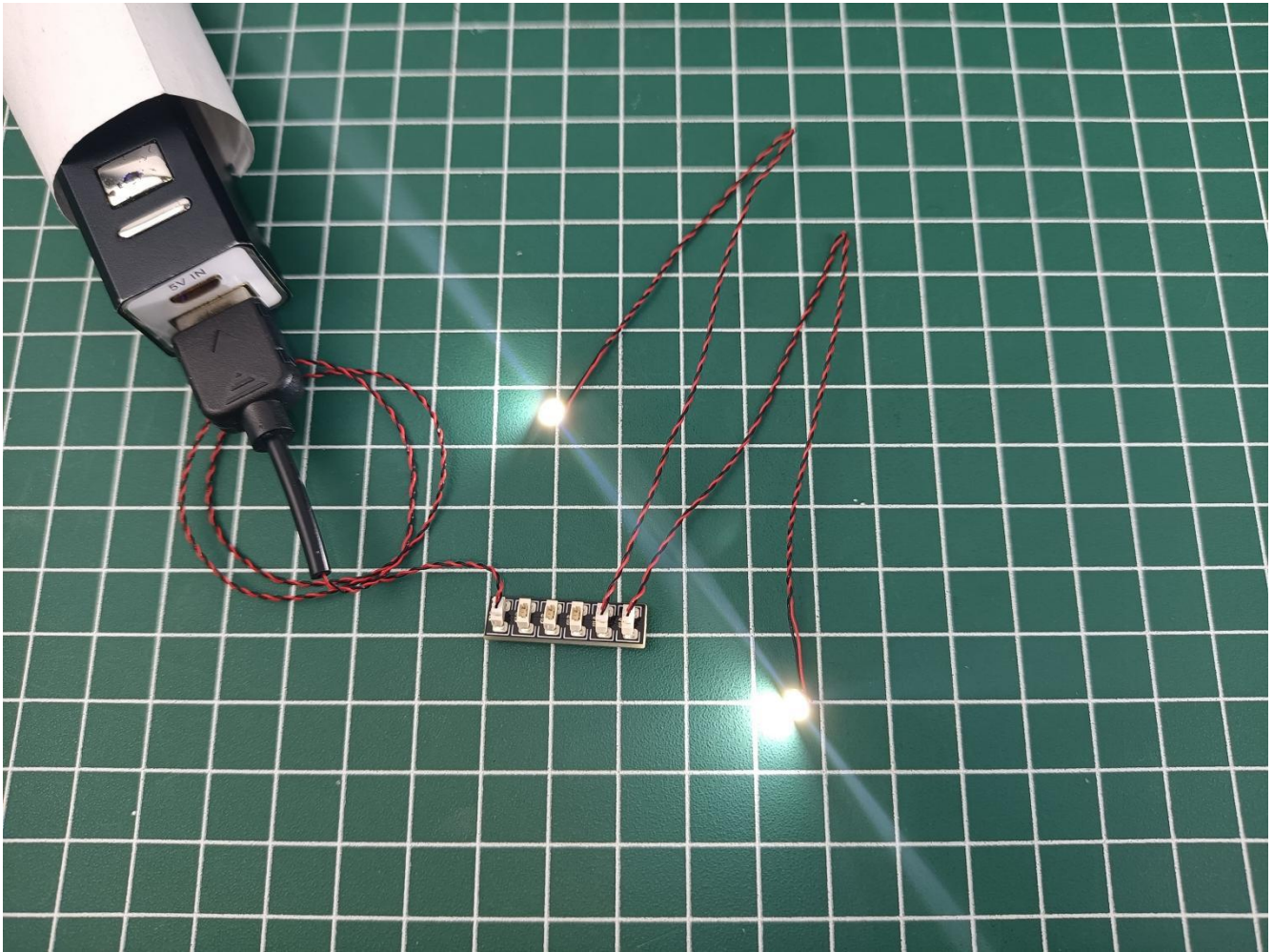

**Unplug the lighting from the expansion board after finish testing and put it in back to the bag.**

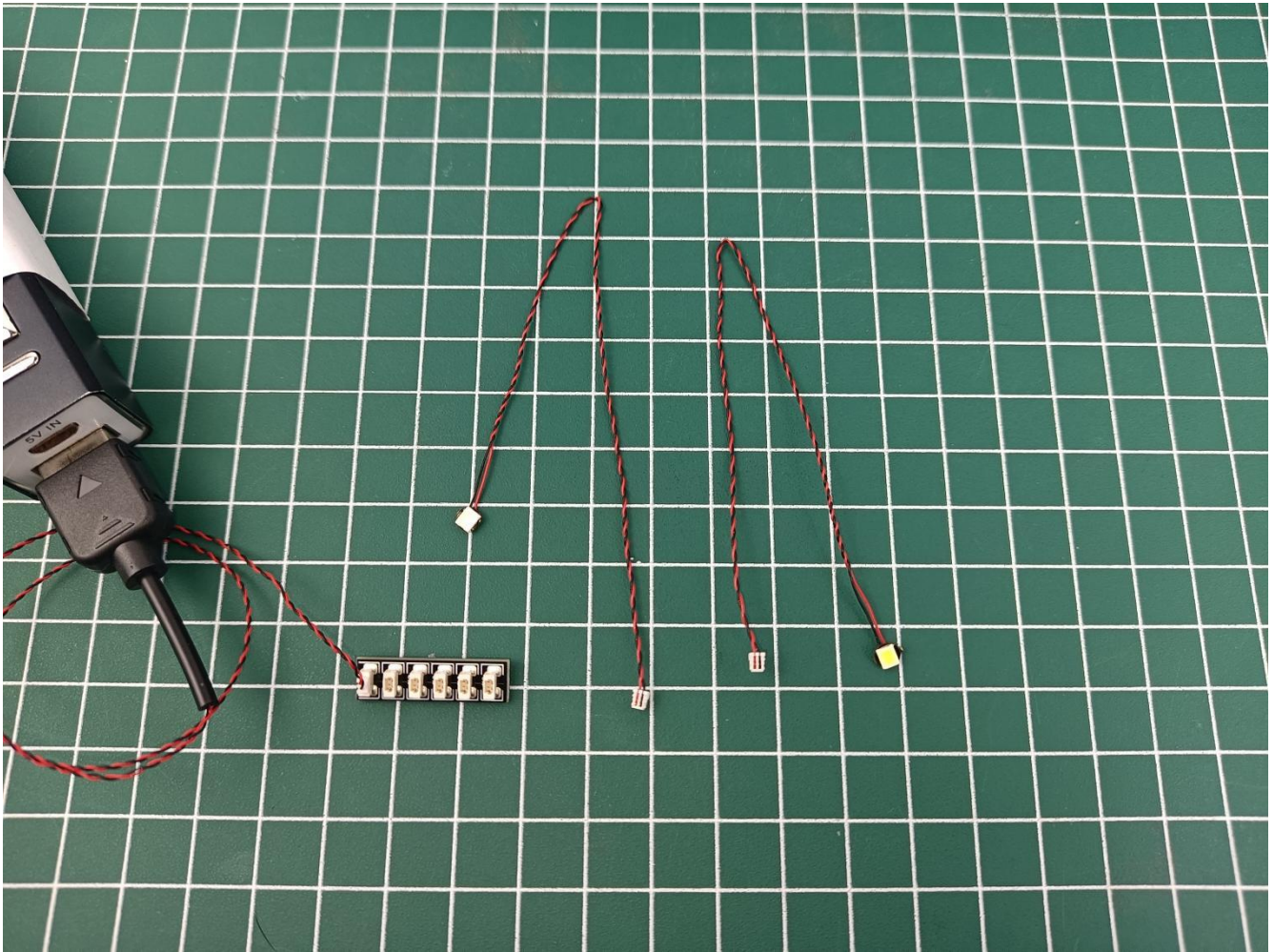

**Put the okay lamp pellets back in the original packaging bag. To avoid the lighting kit can not work normally, please follow above method to test the other packs lighting kit before install it.**





### Attention:

Please be careful when installing since the lamp thread is slender. Cannot be pressed against the raised position of the building block. It should pass along the gap, otherwise the lamp wire will be pinched.

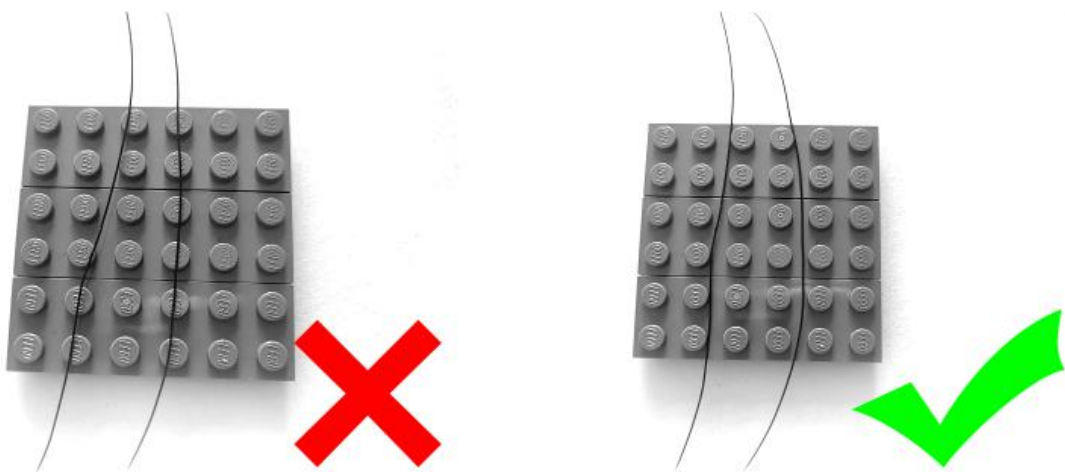

### Step 2 : Installation

**start installation:**





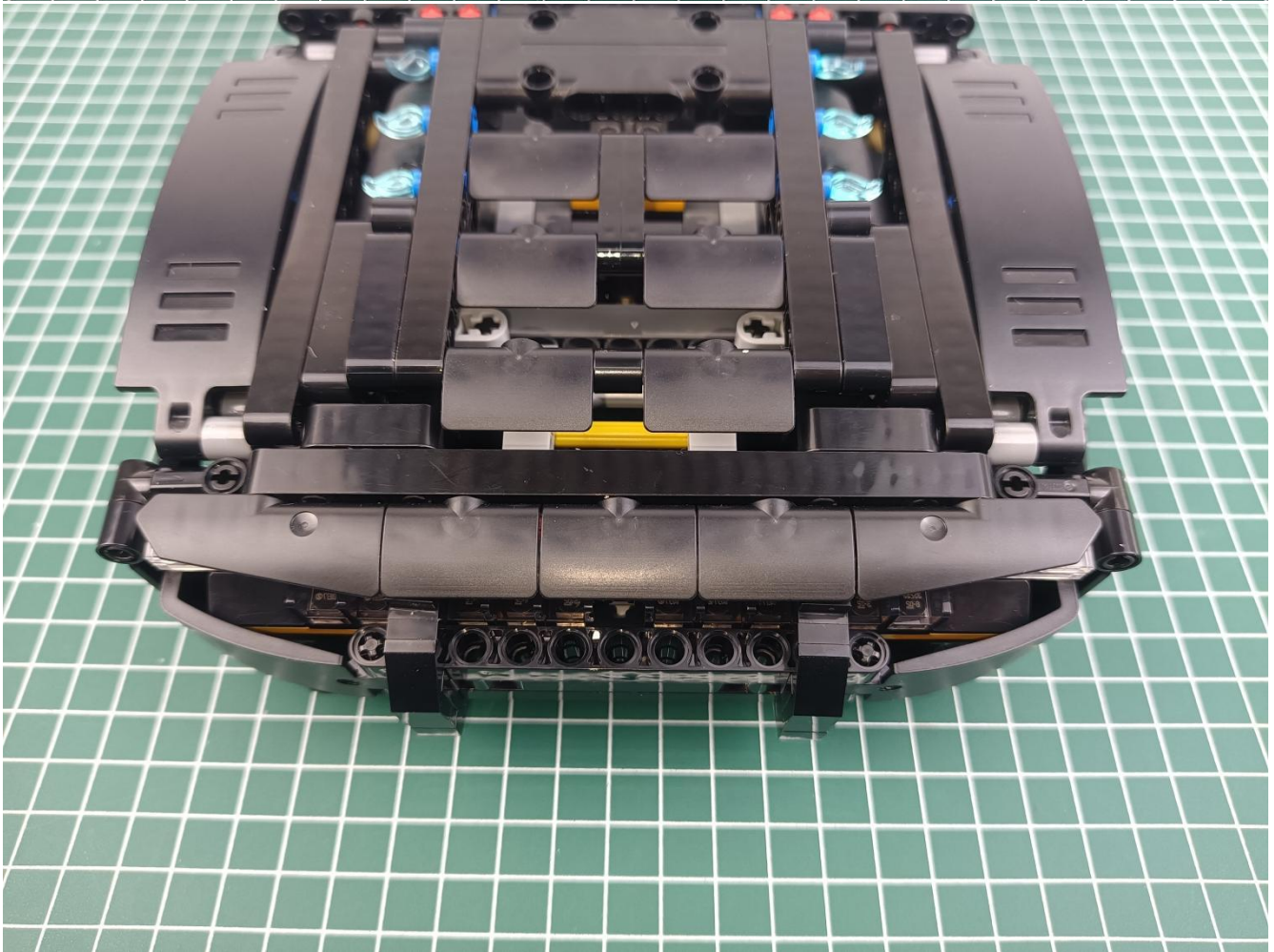
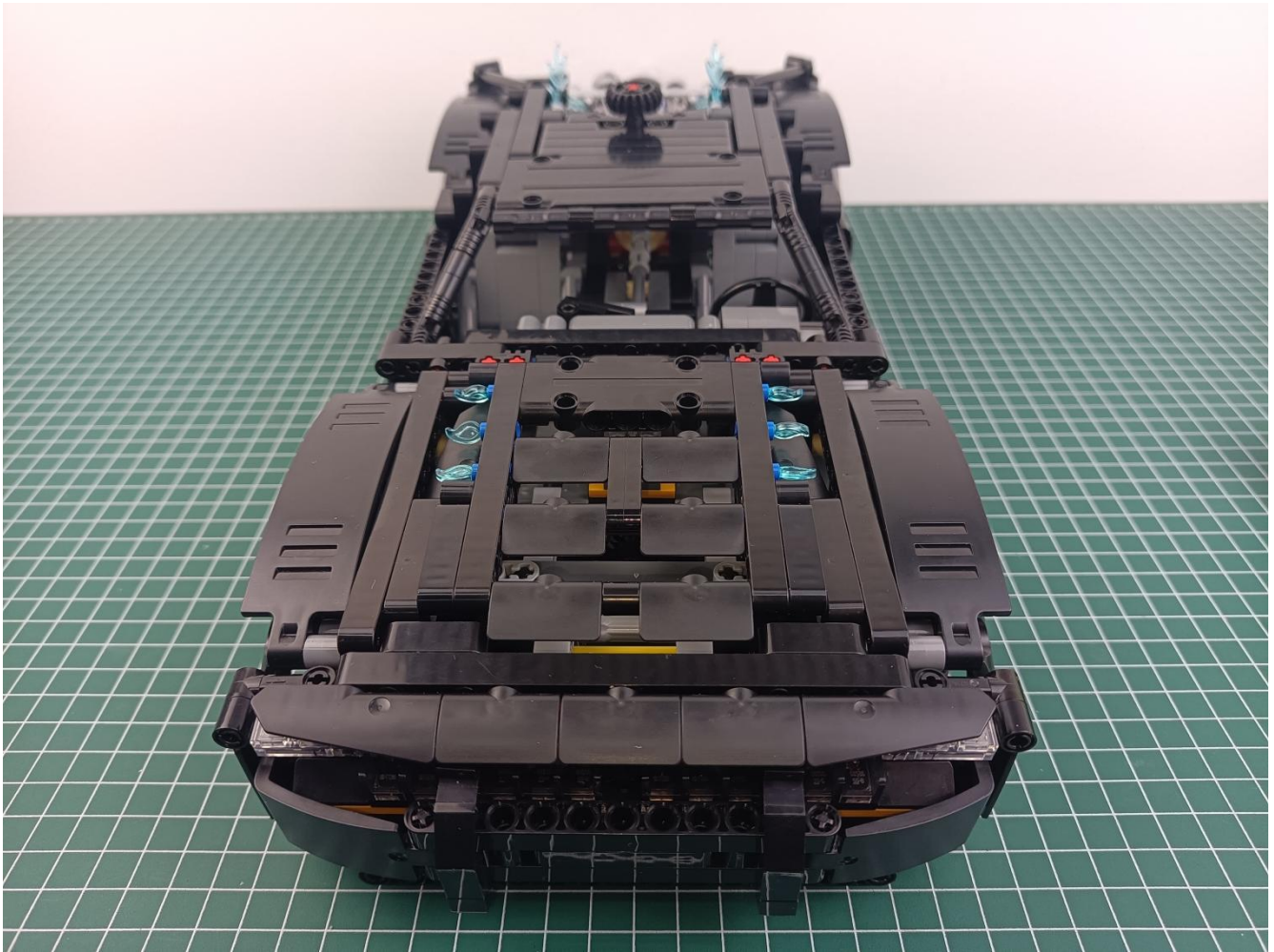



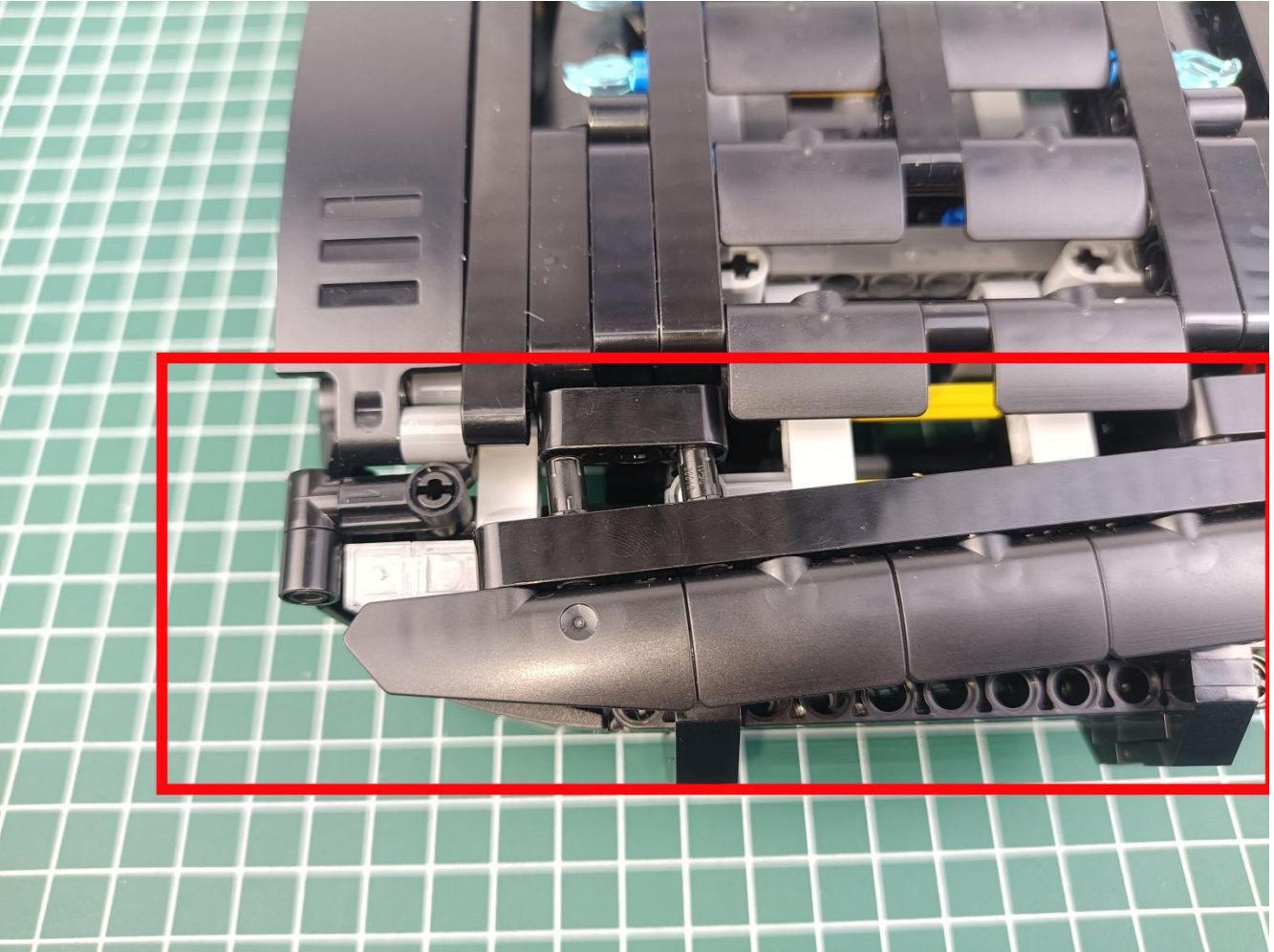
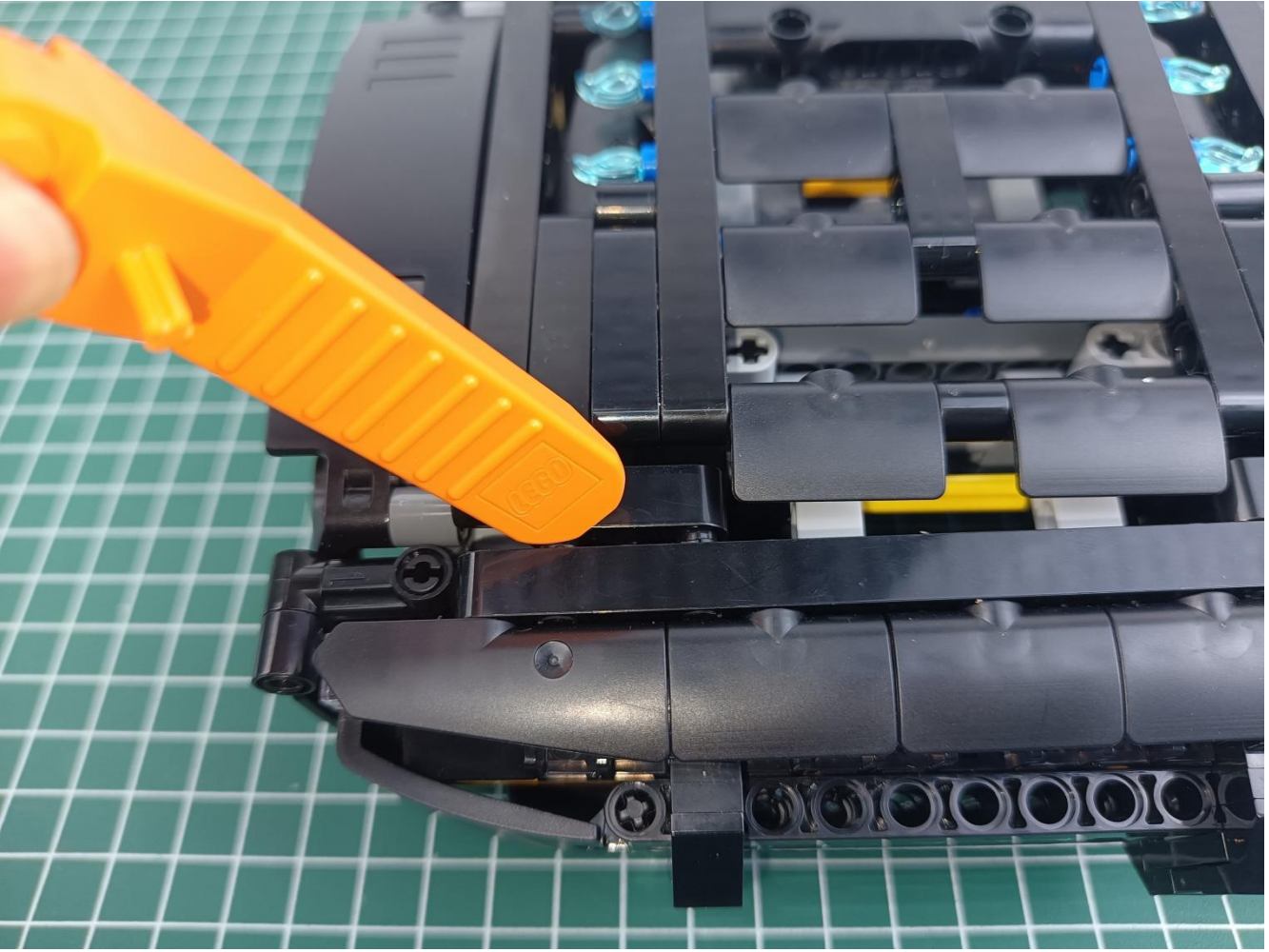



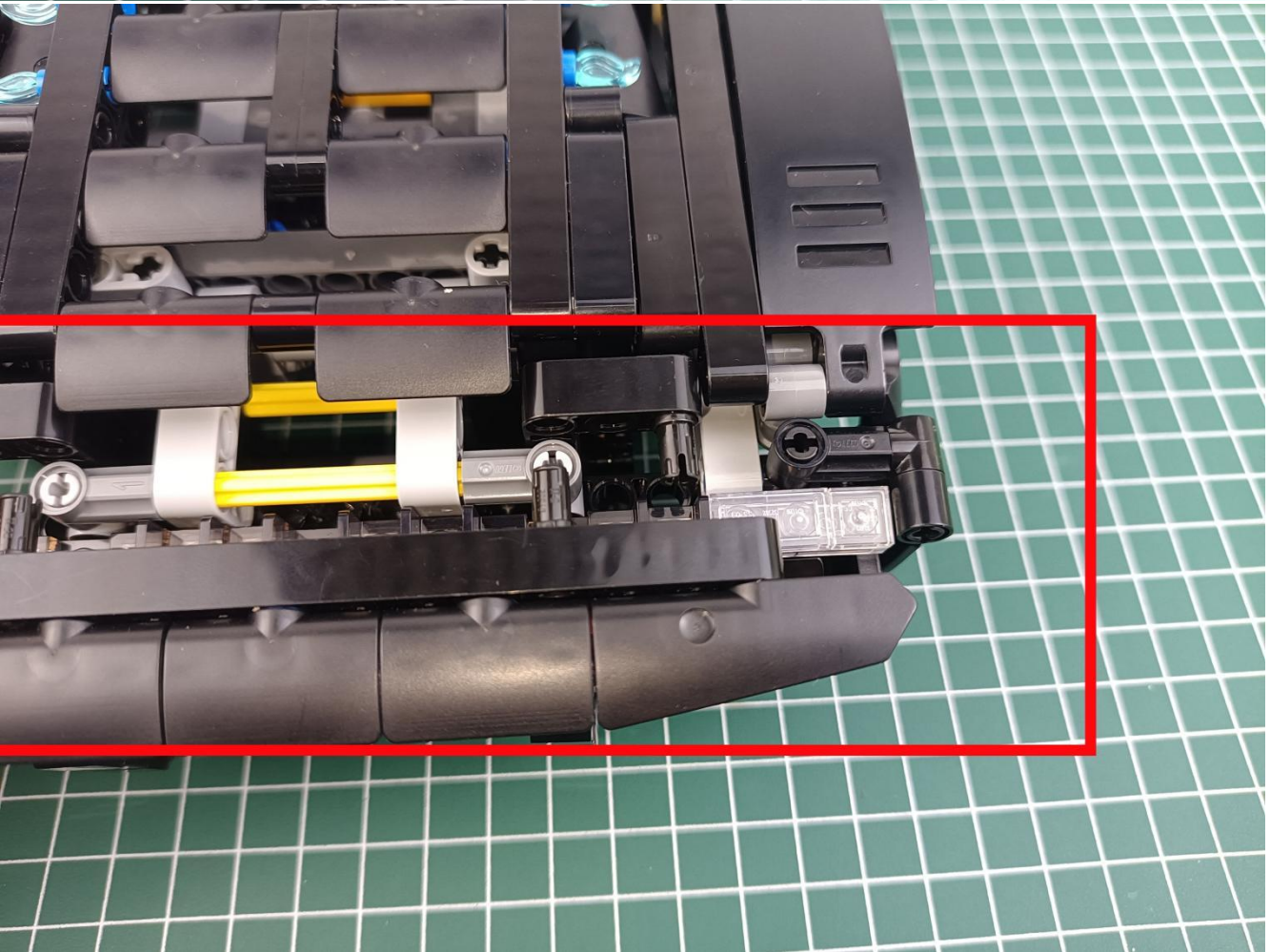
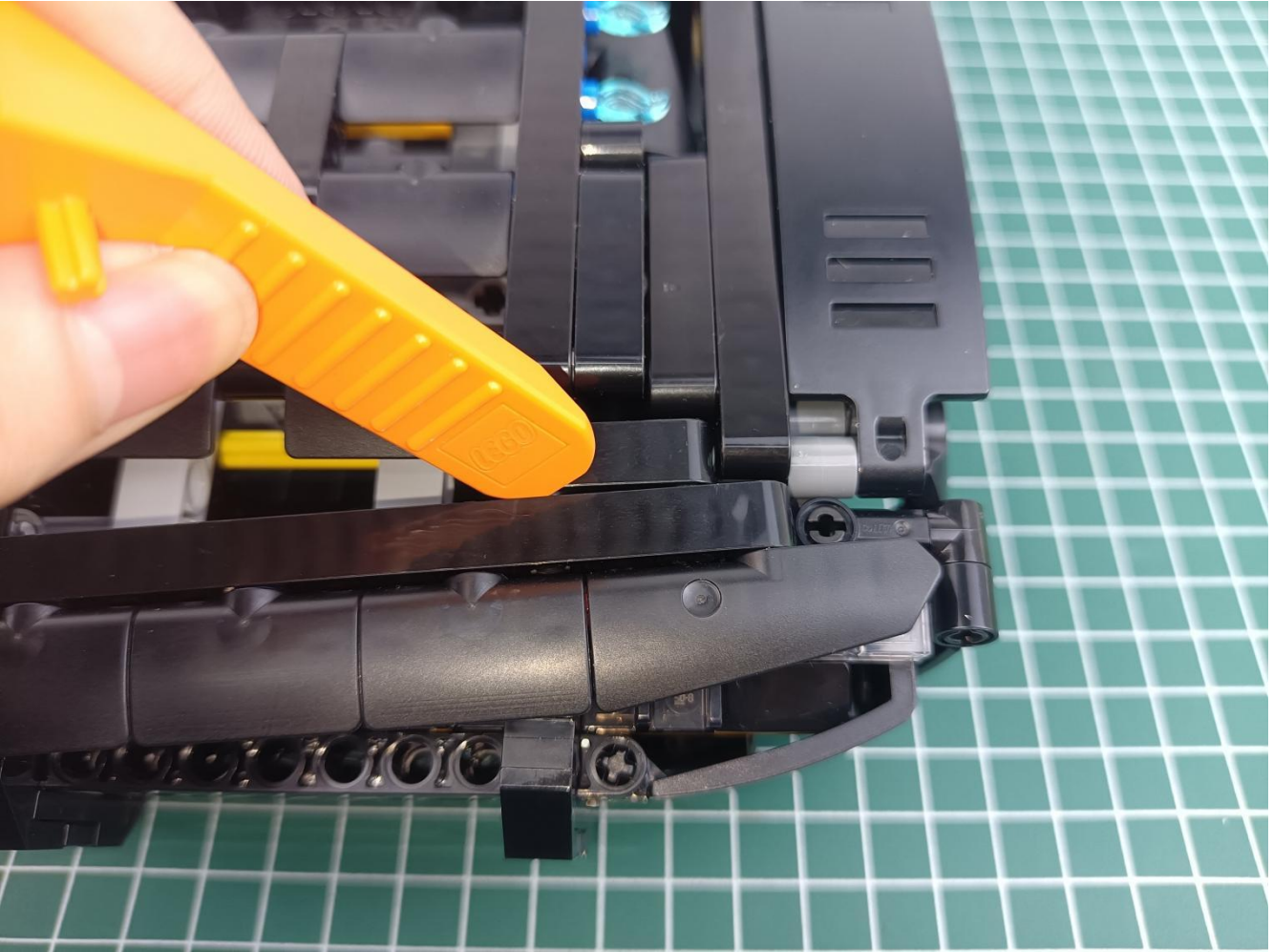



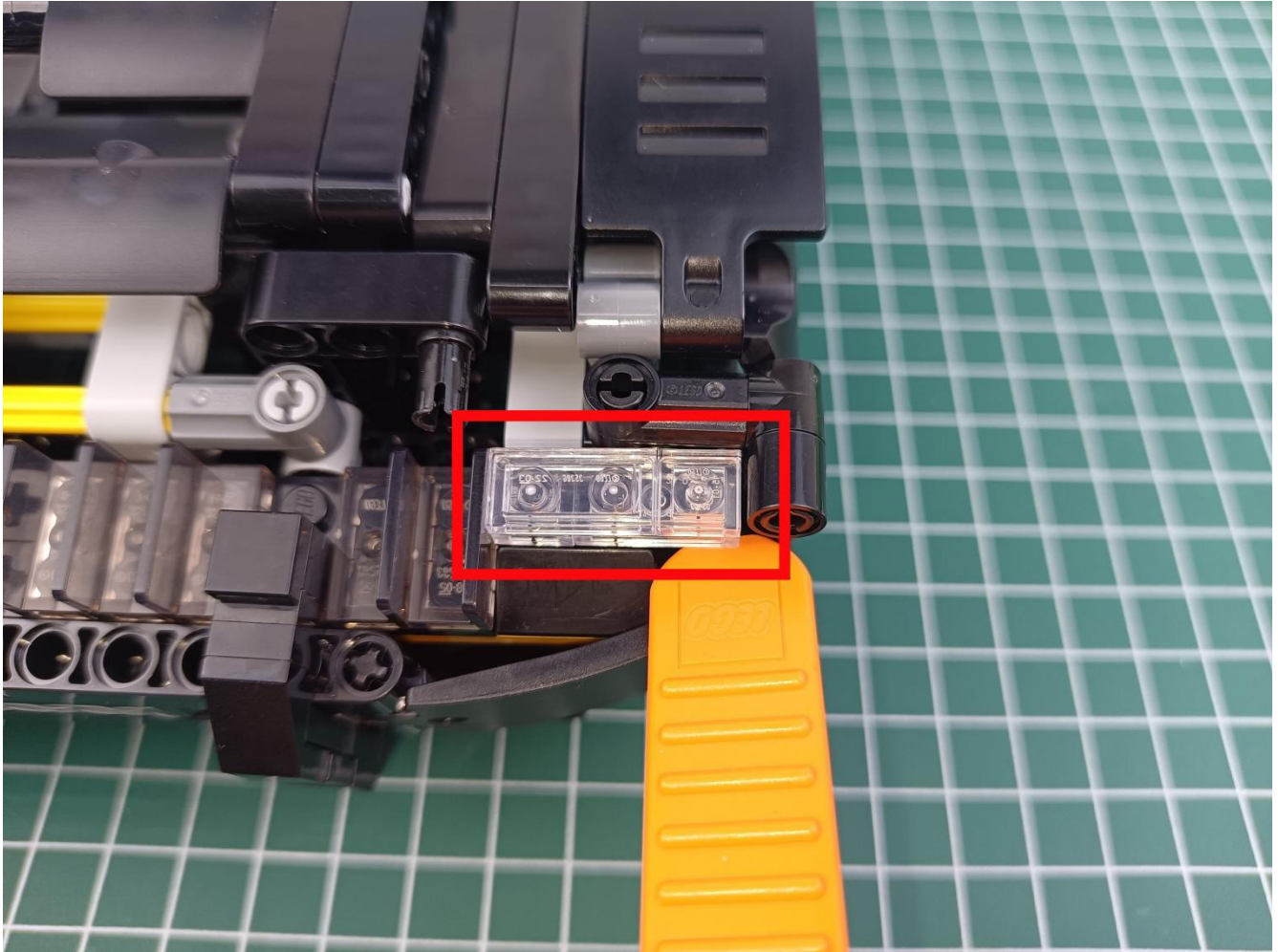
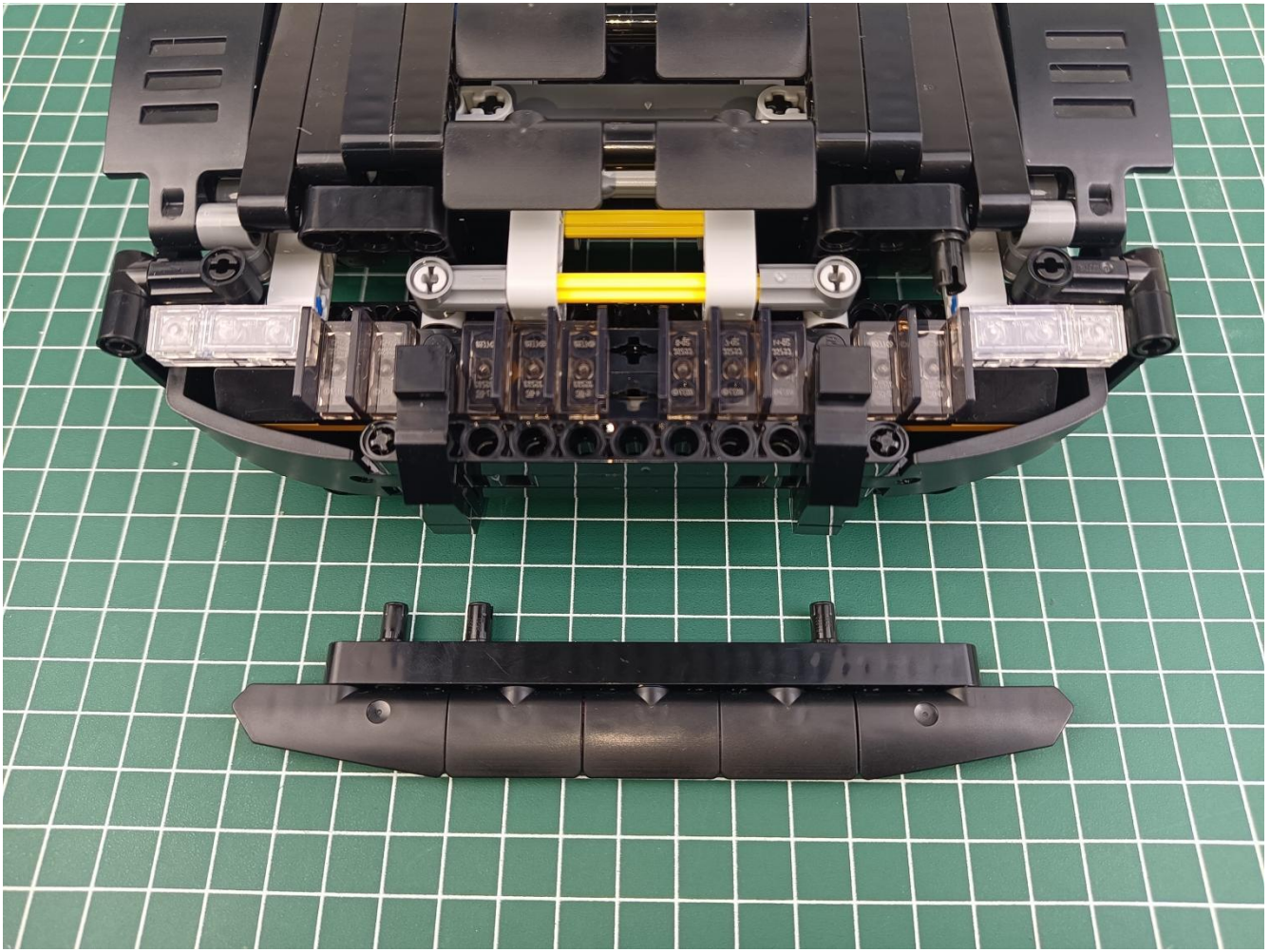



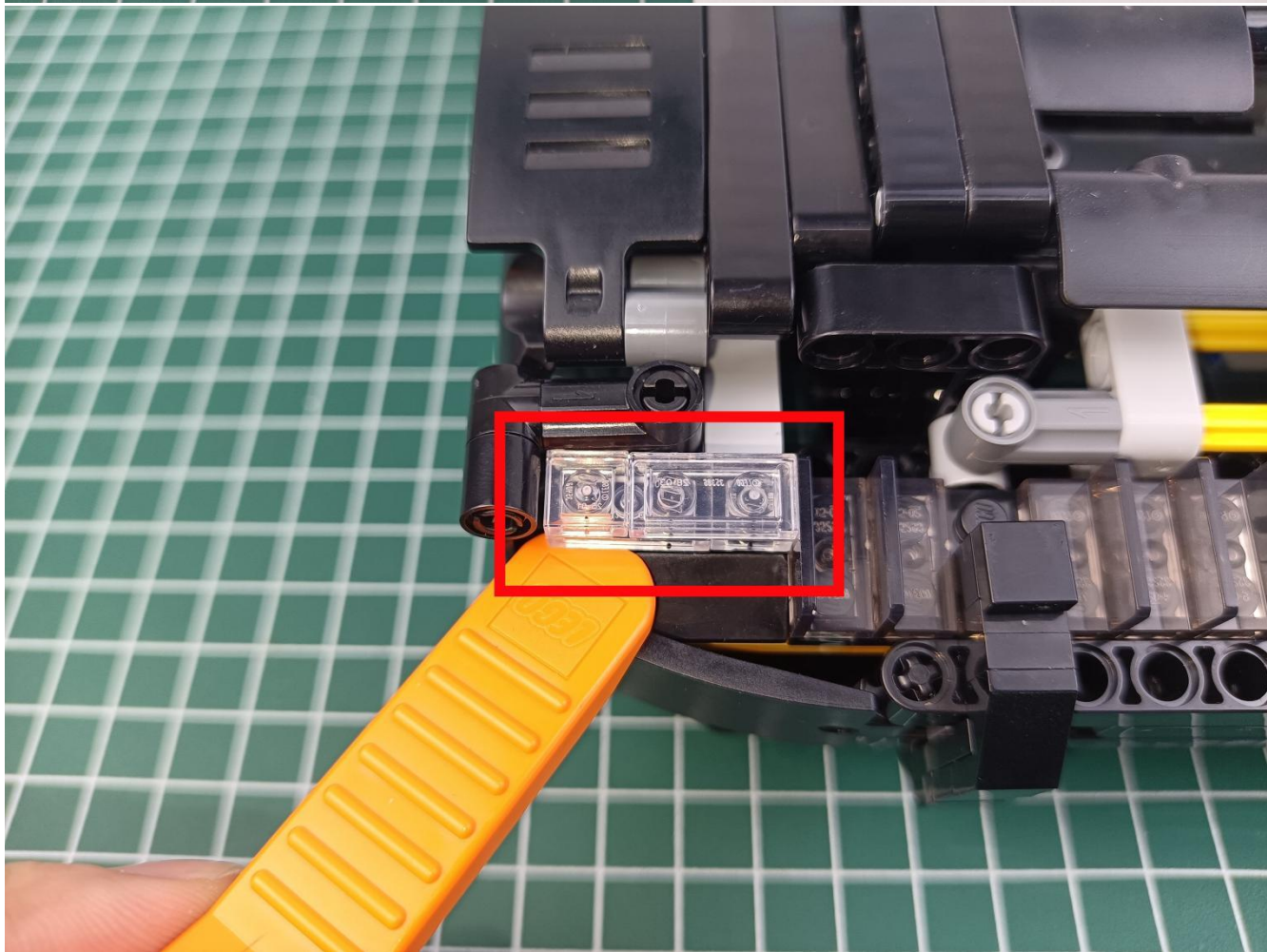
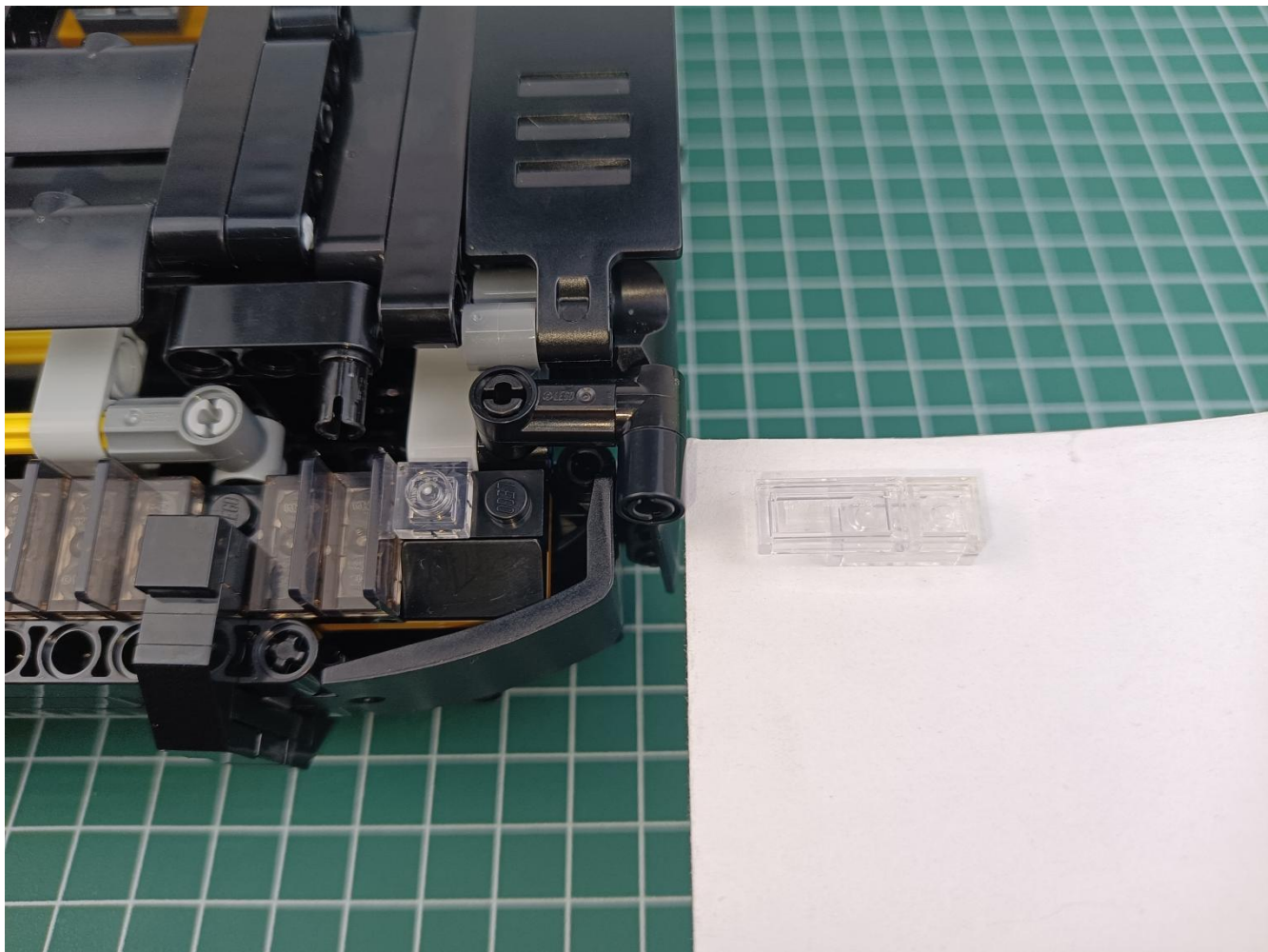



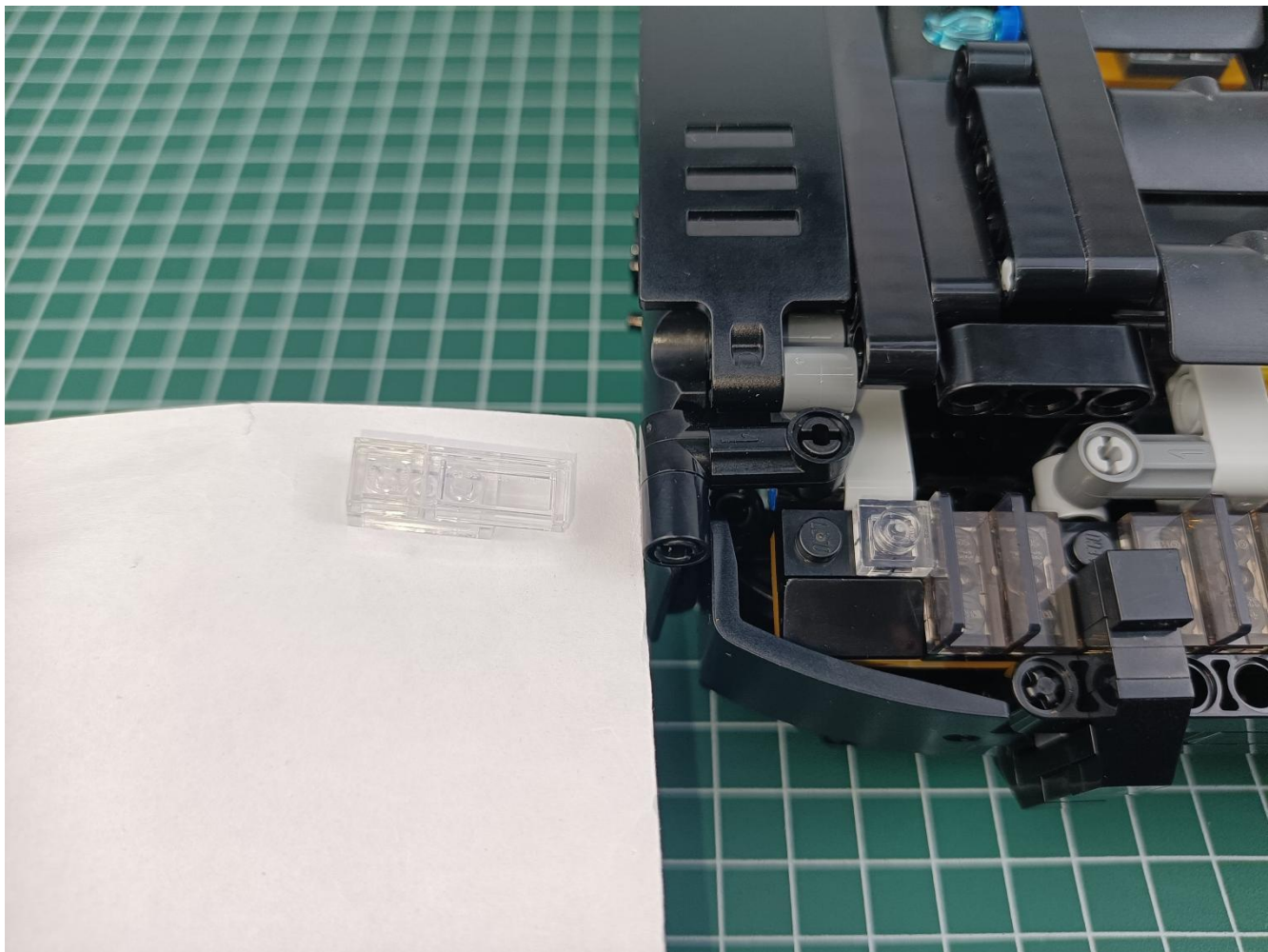



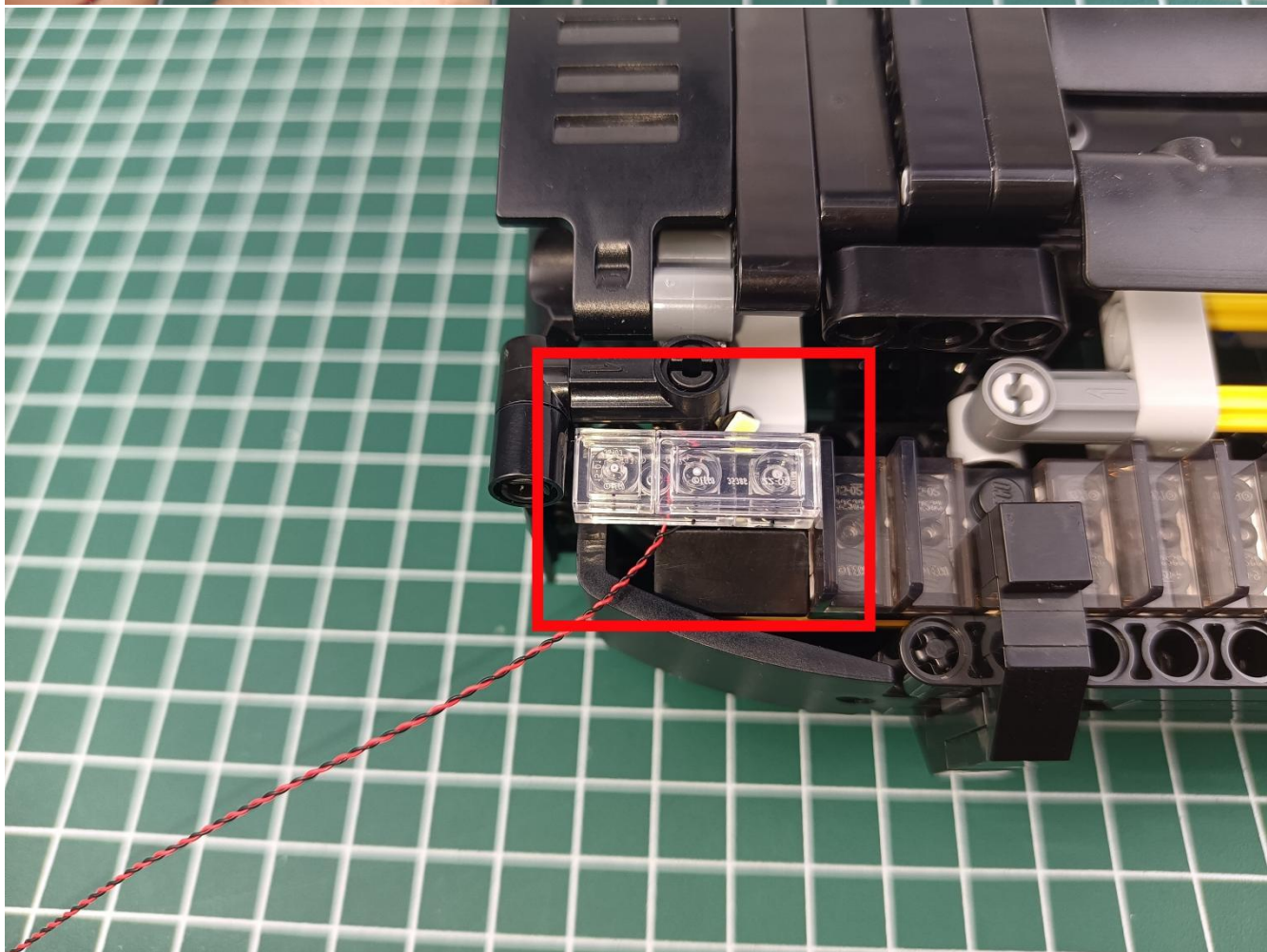
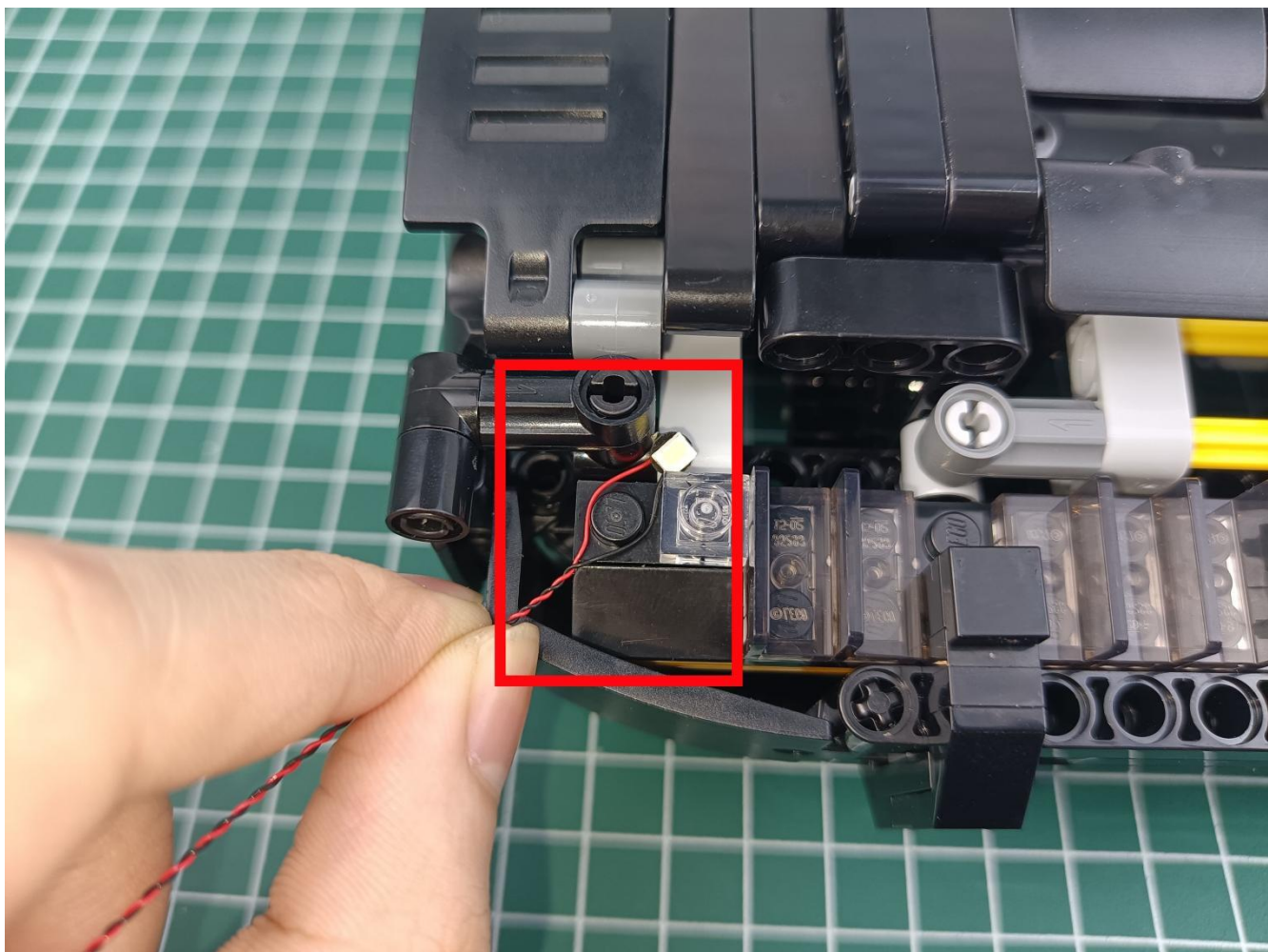



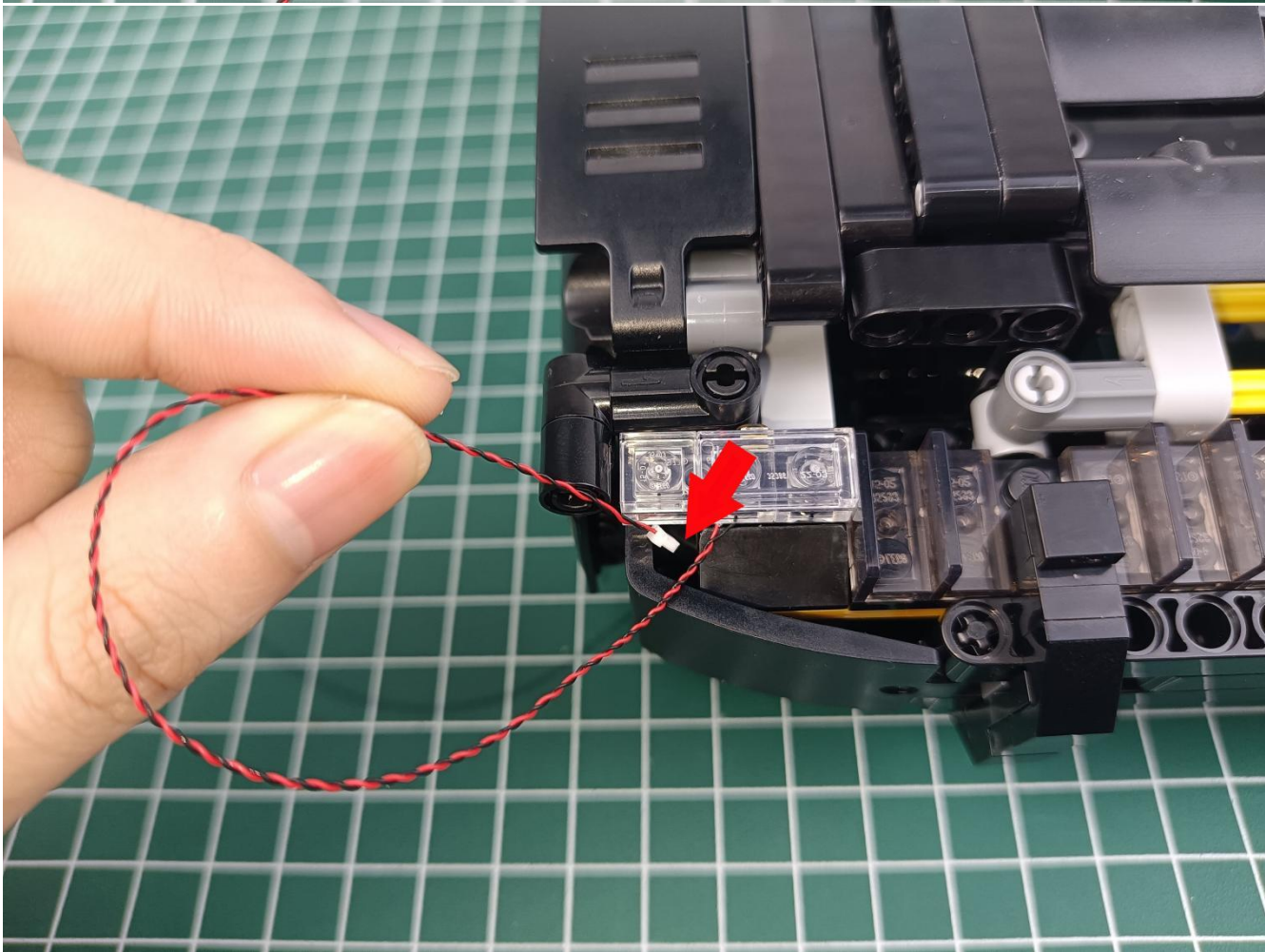
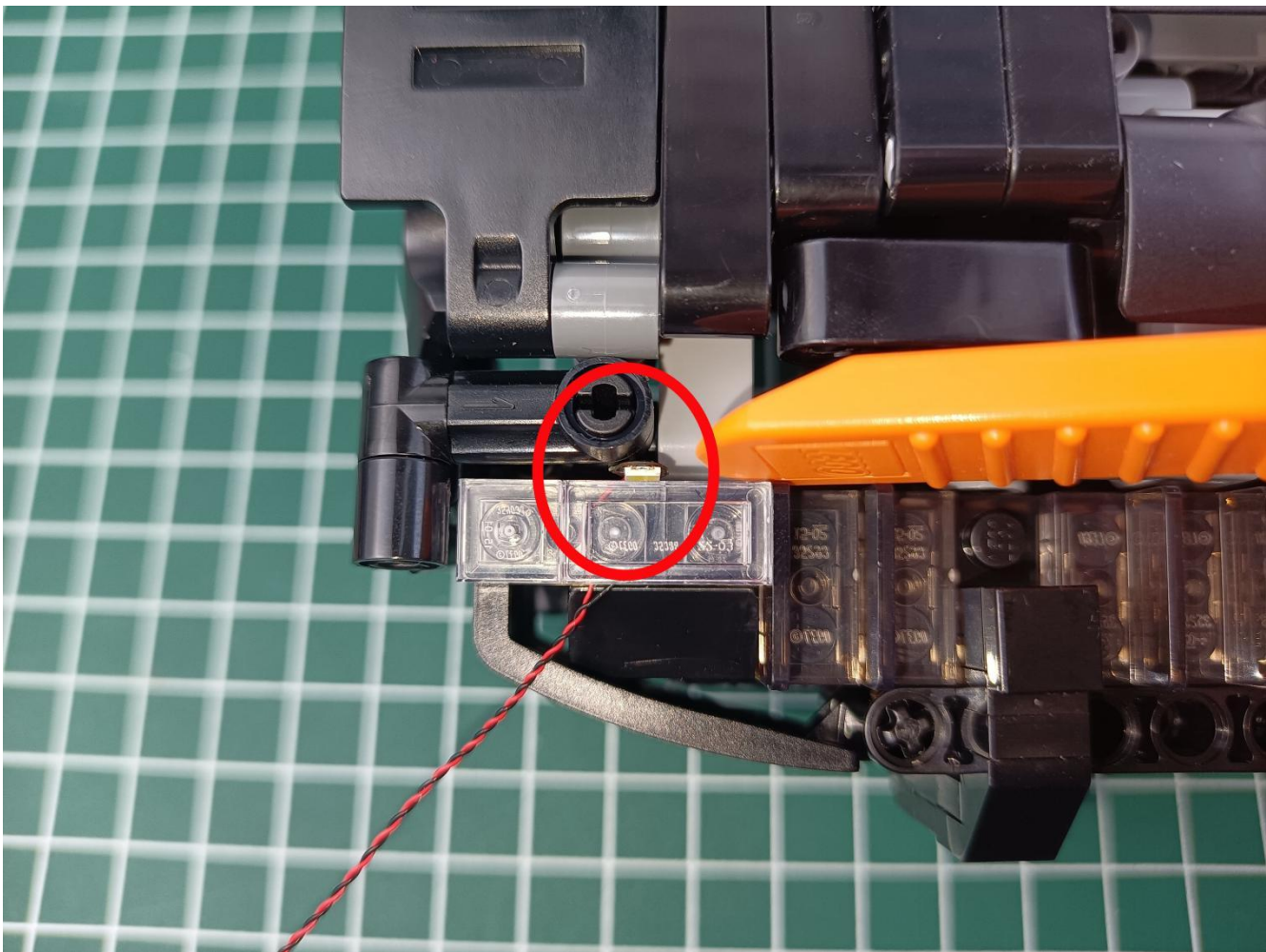



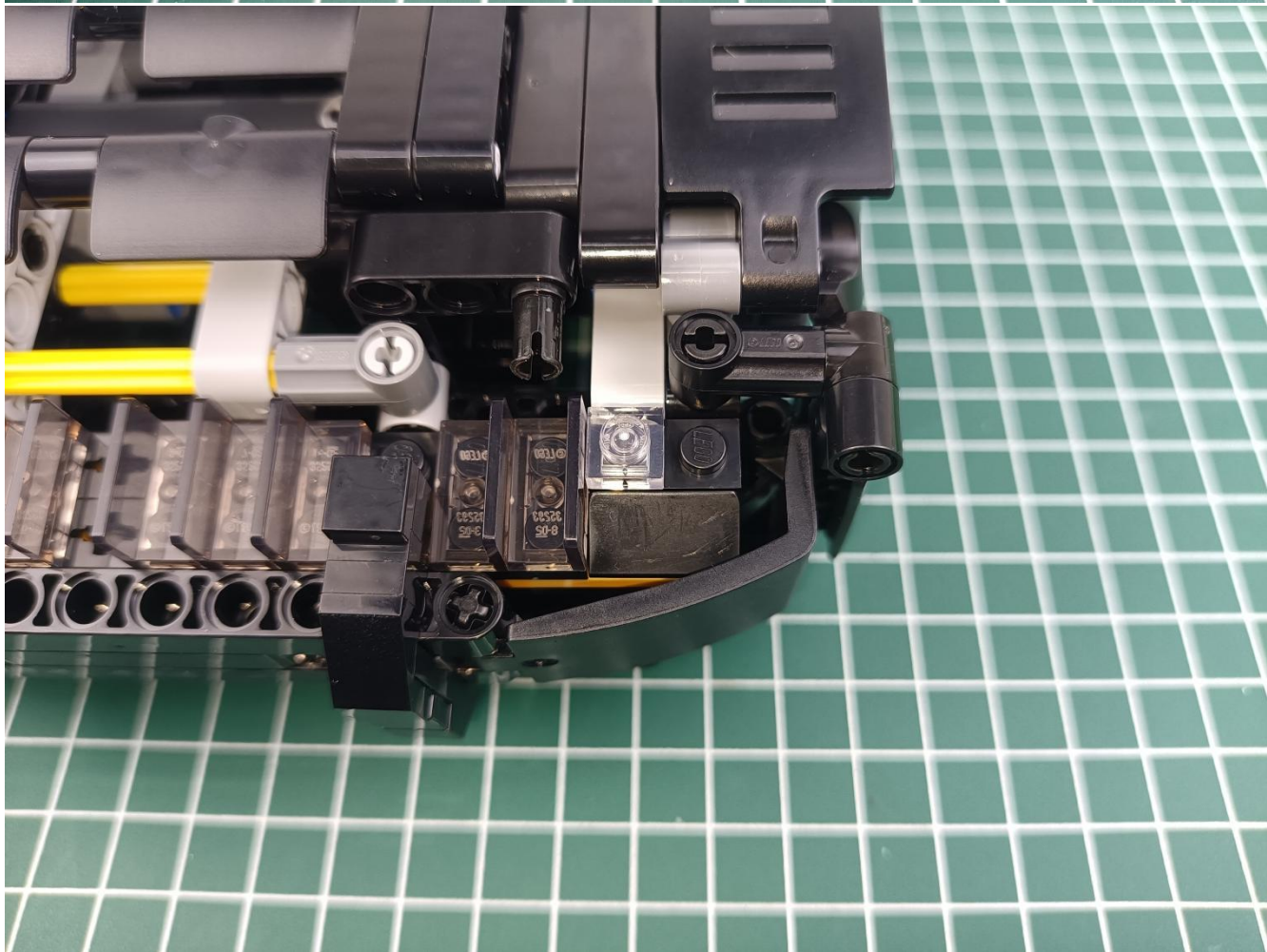
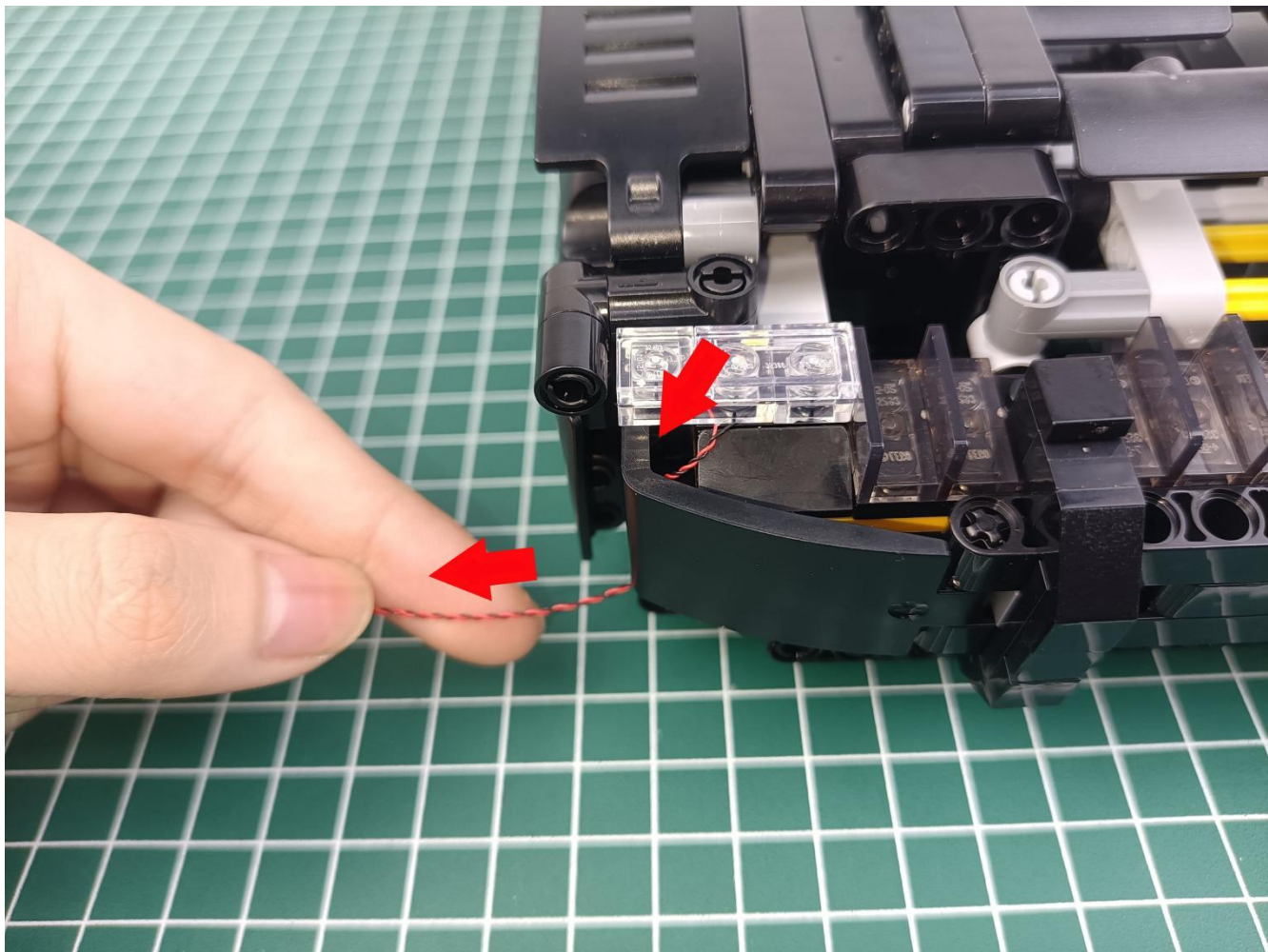



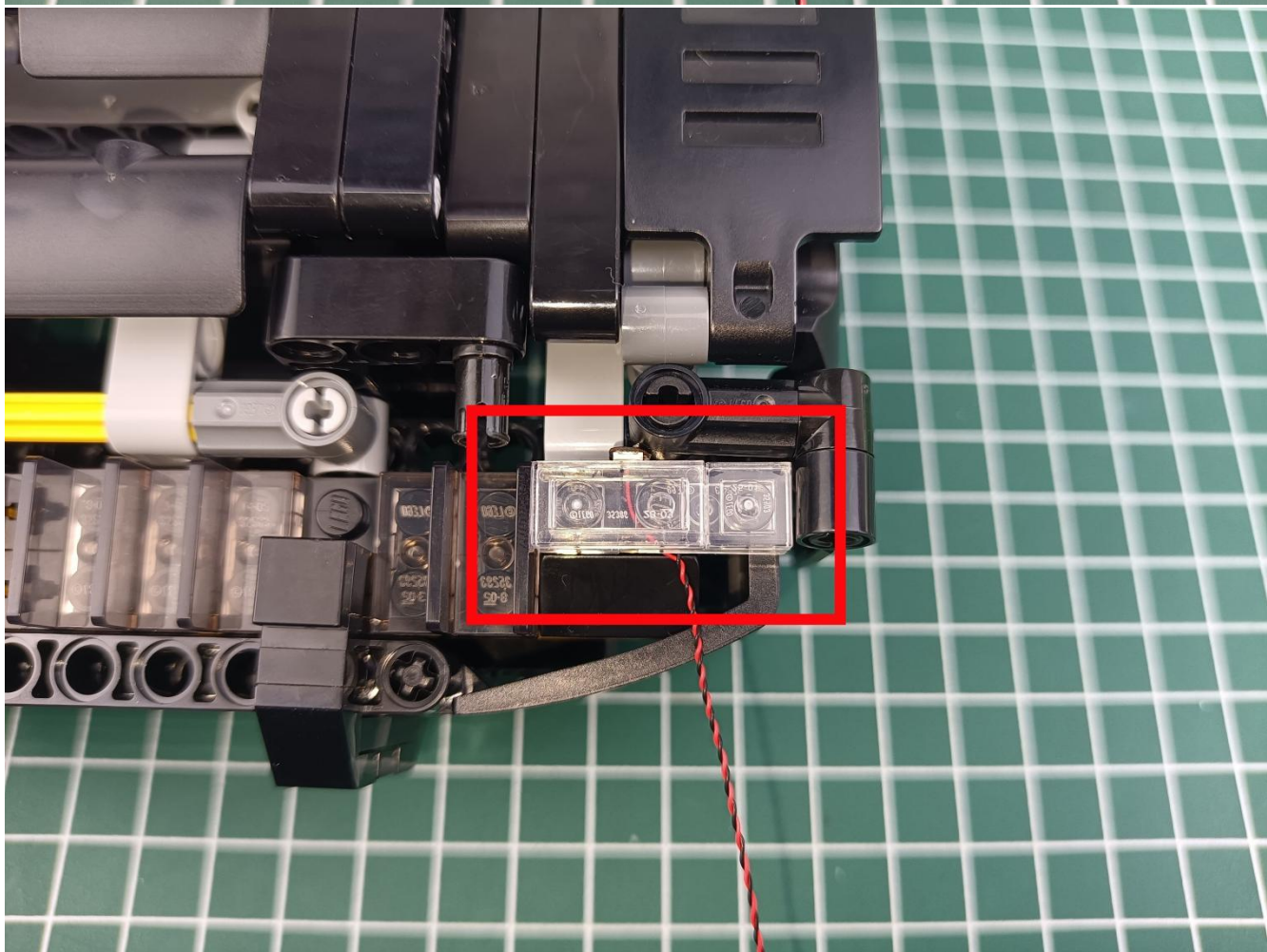
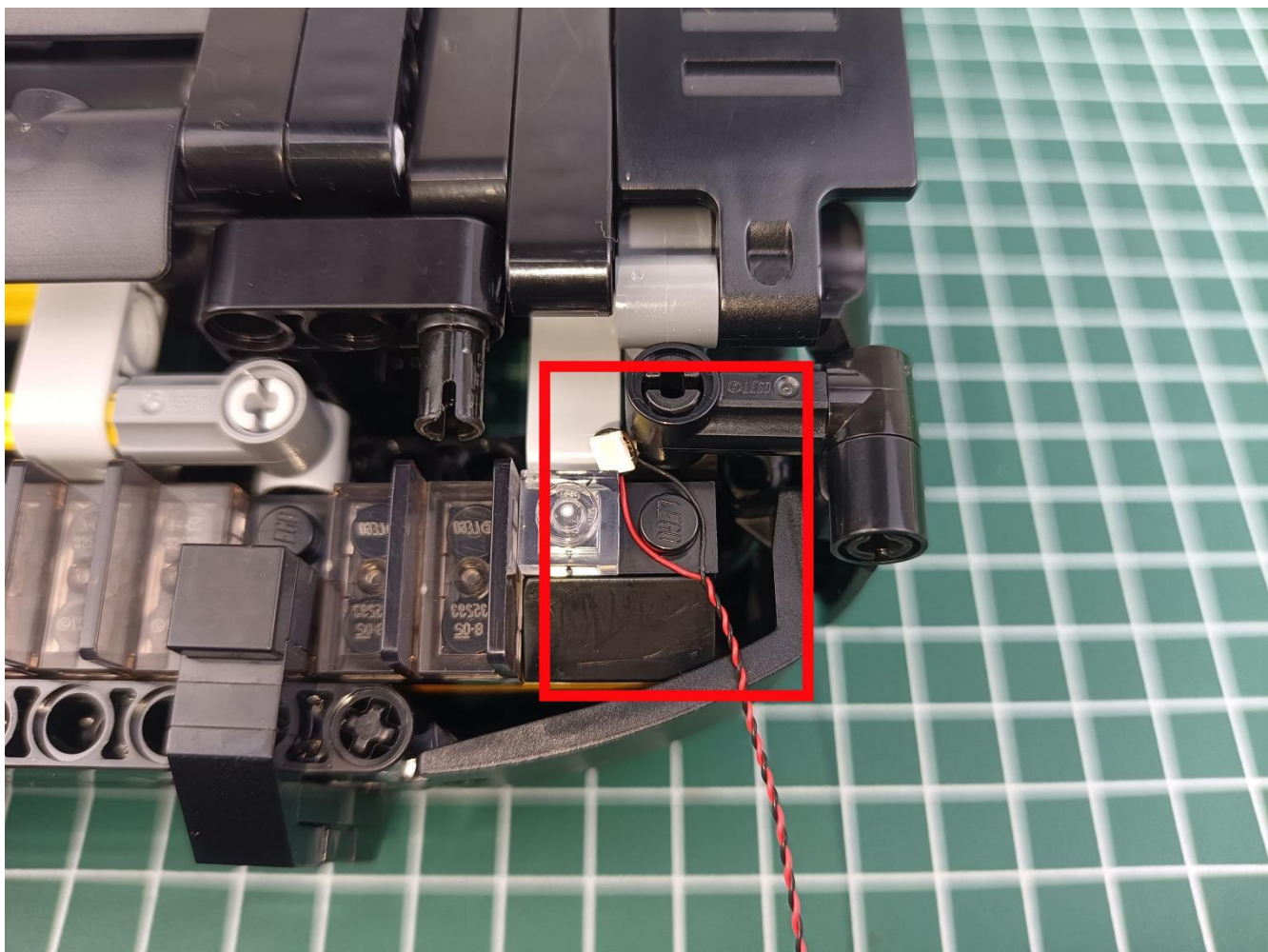



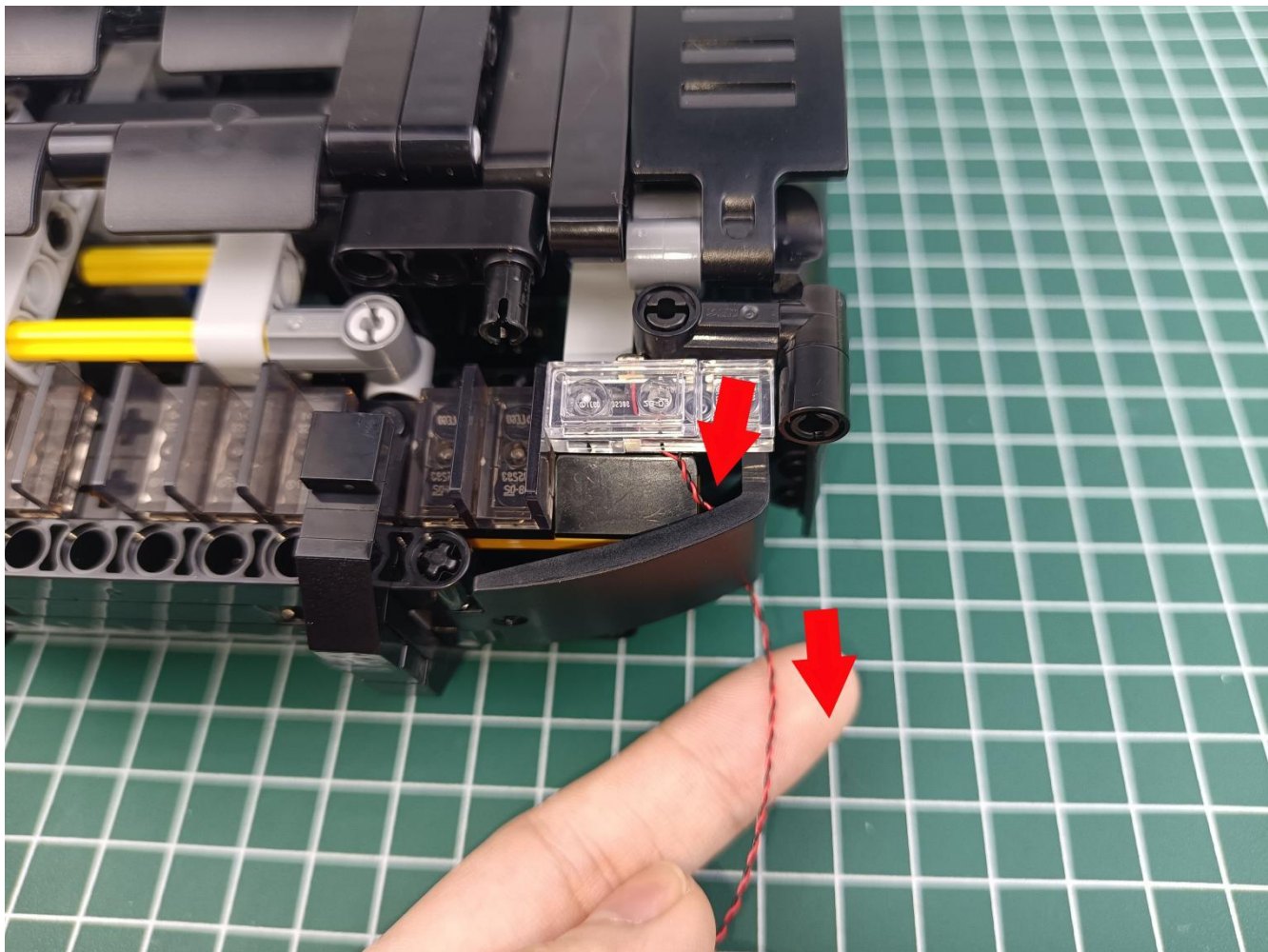







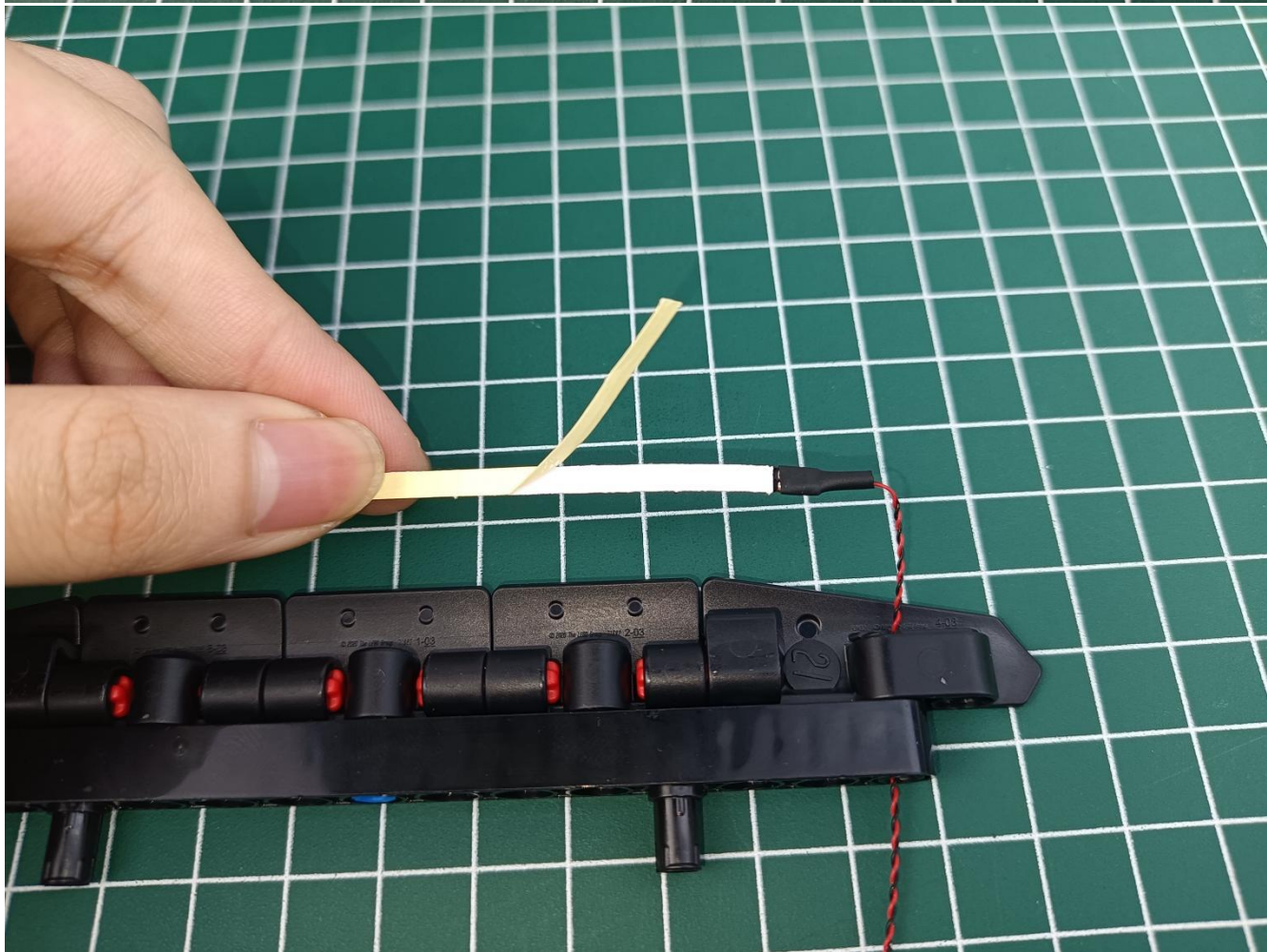
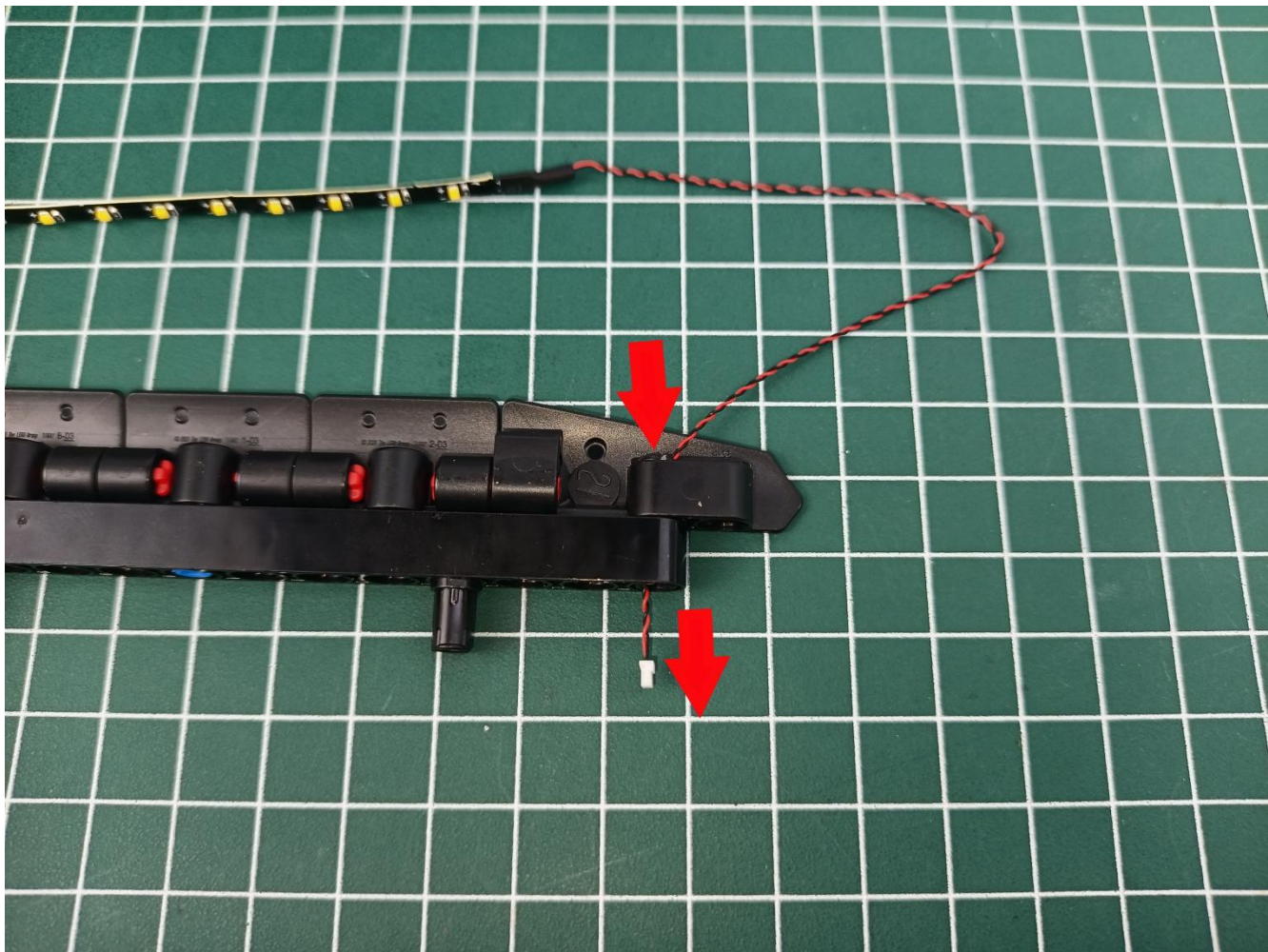







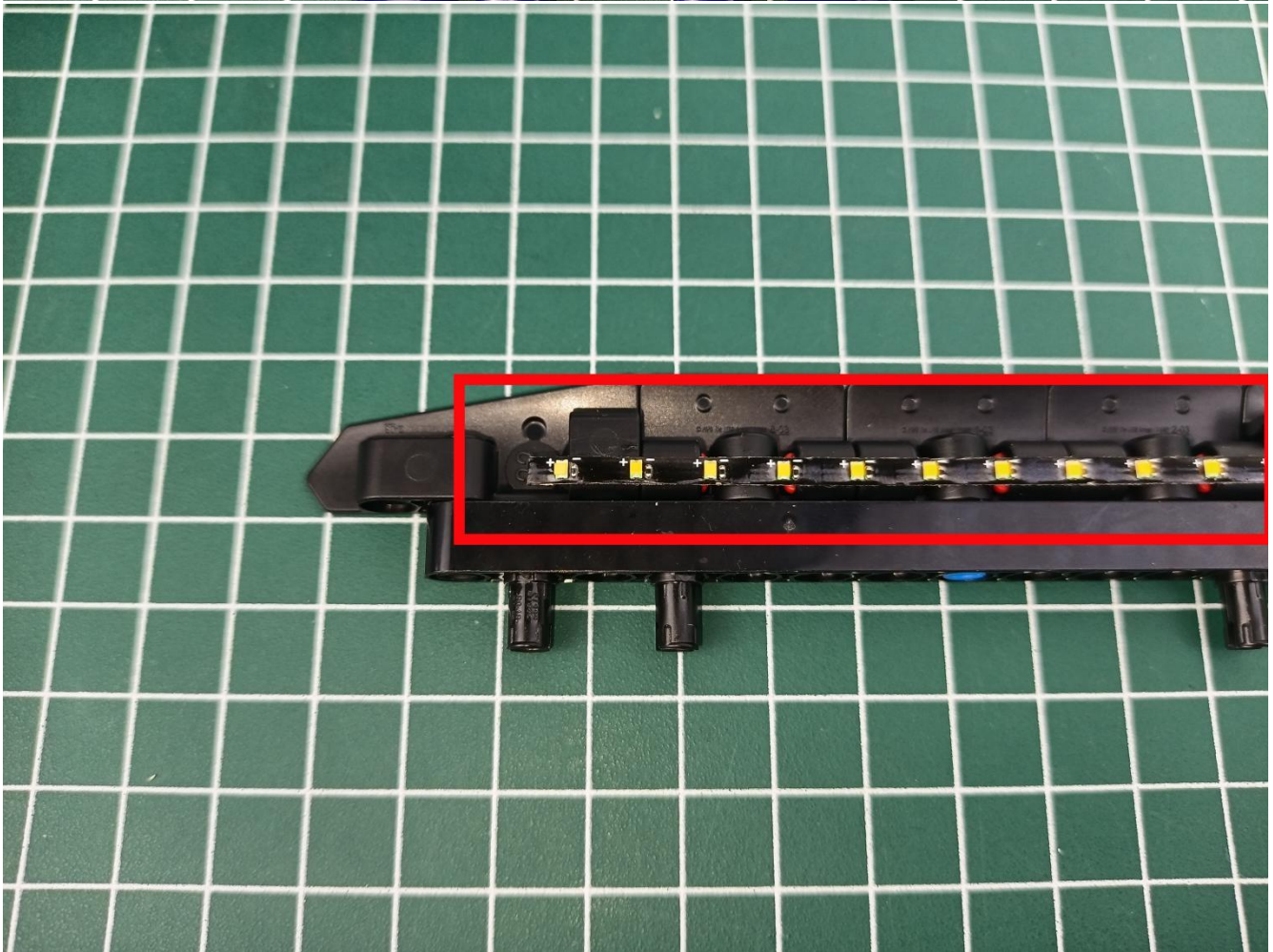
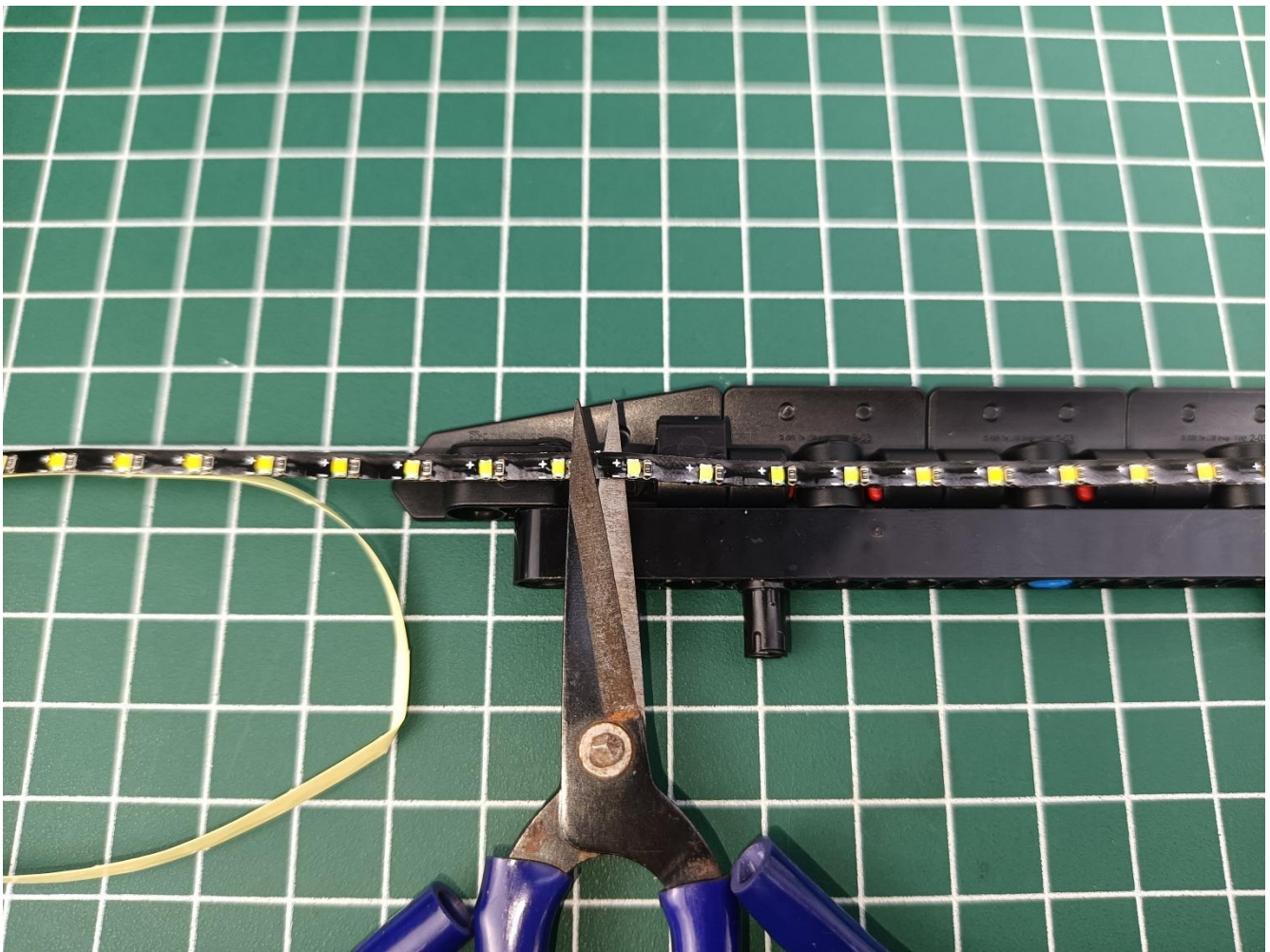



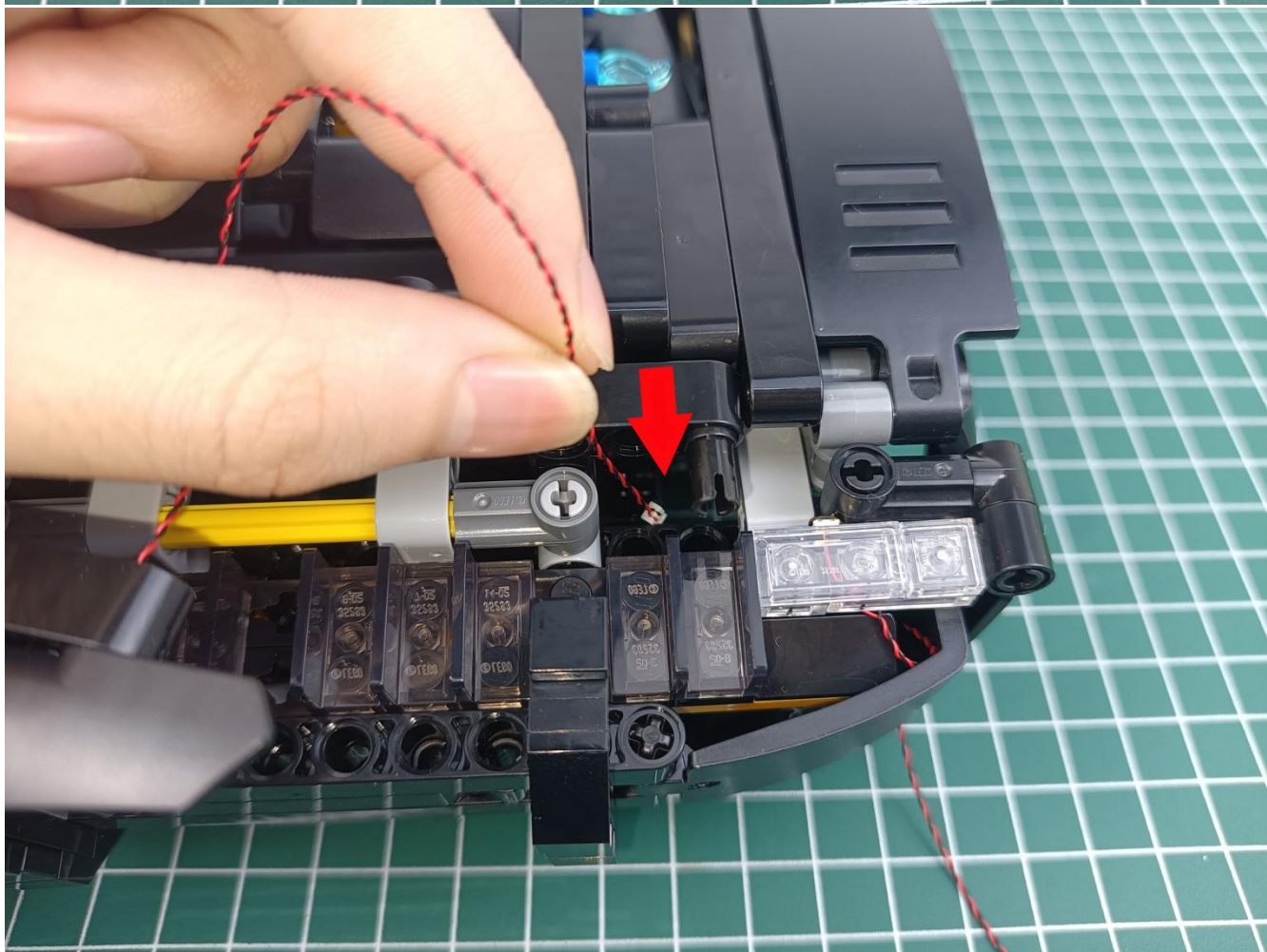
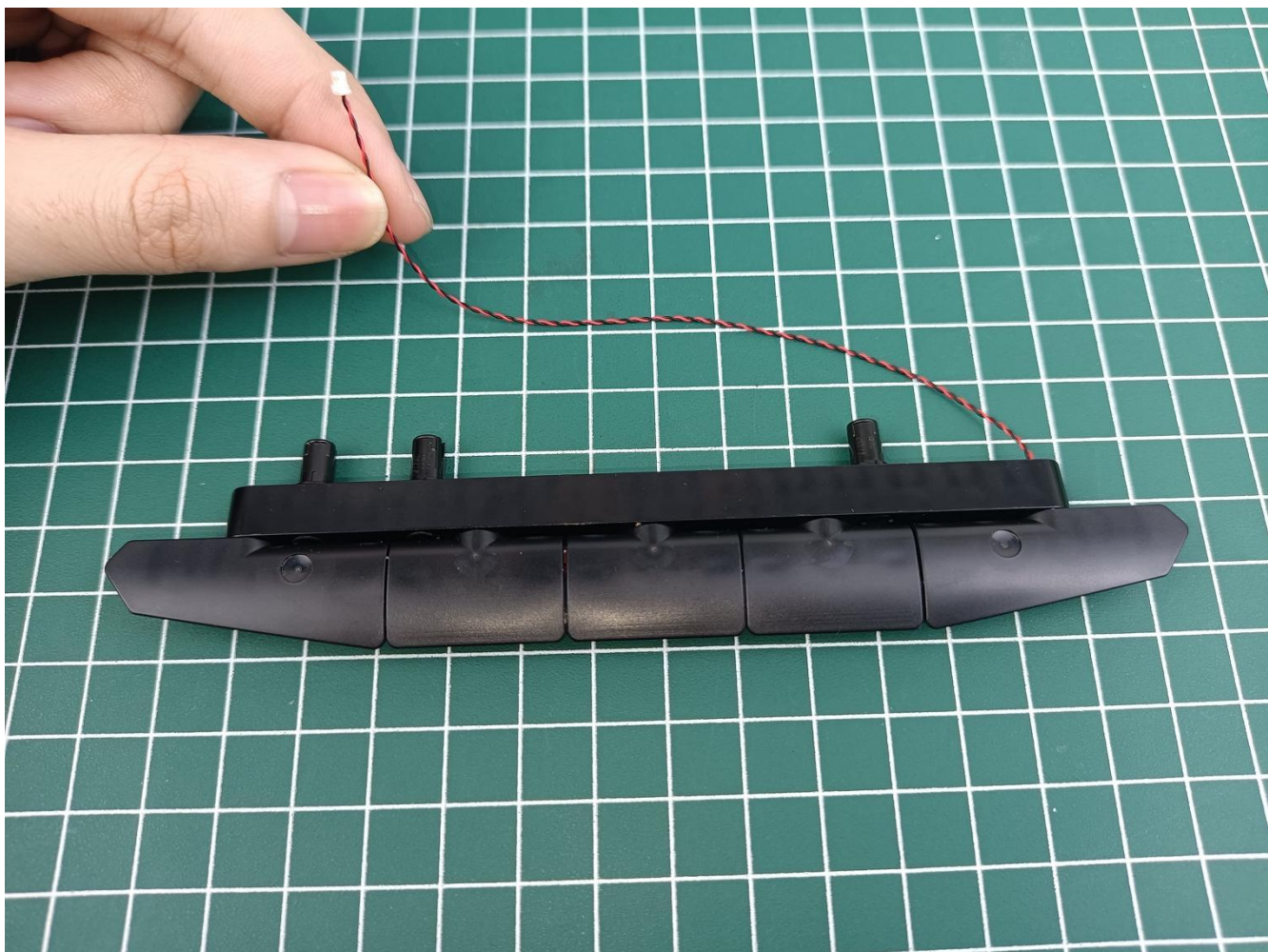



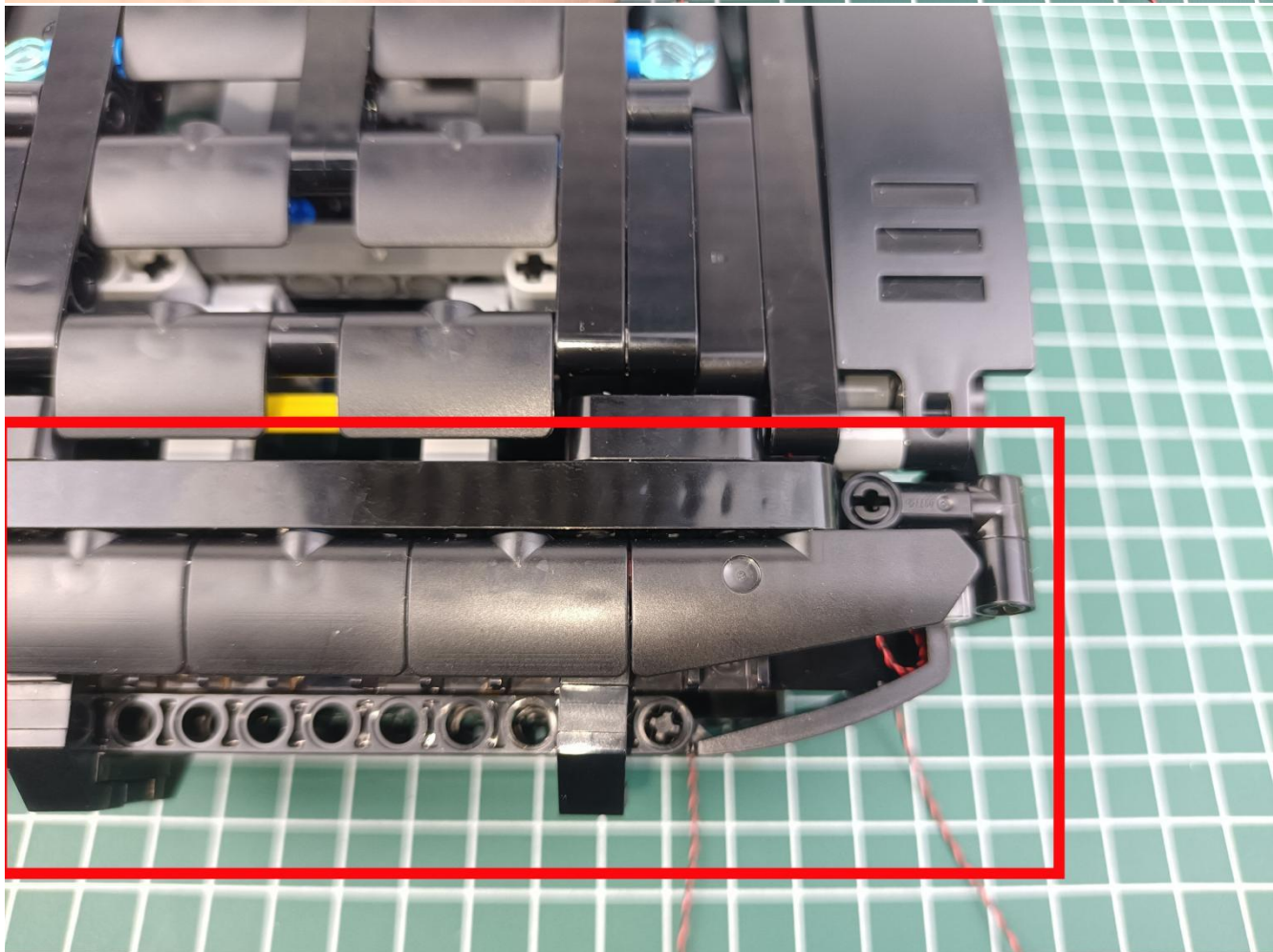
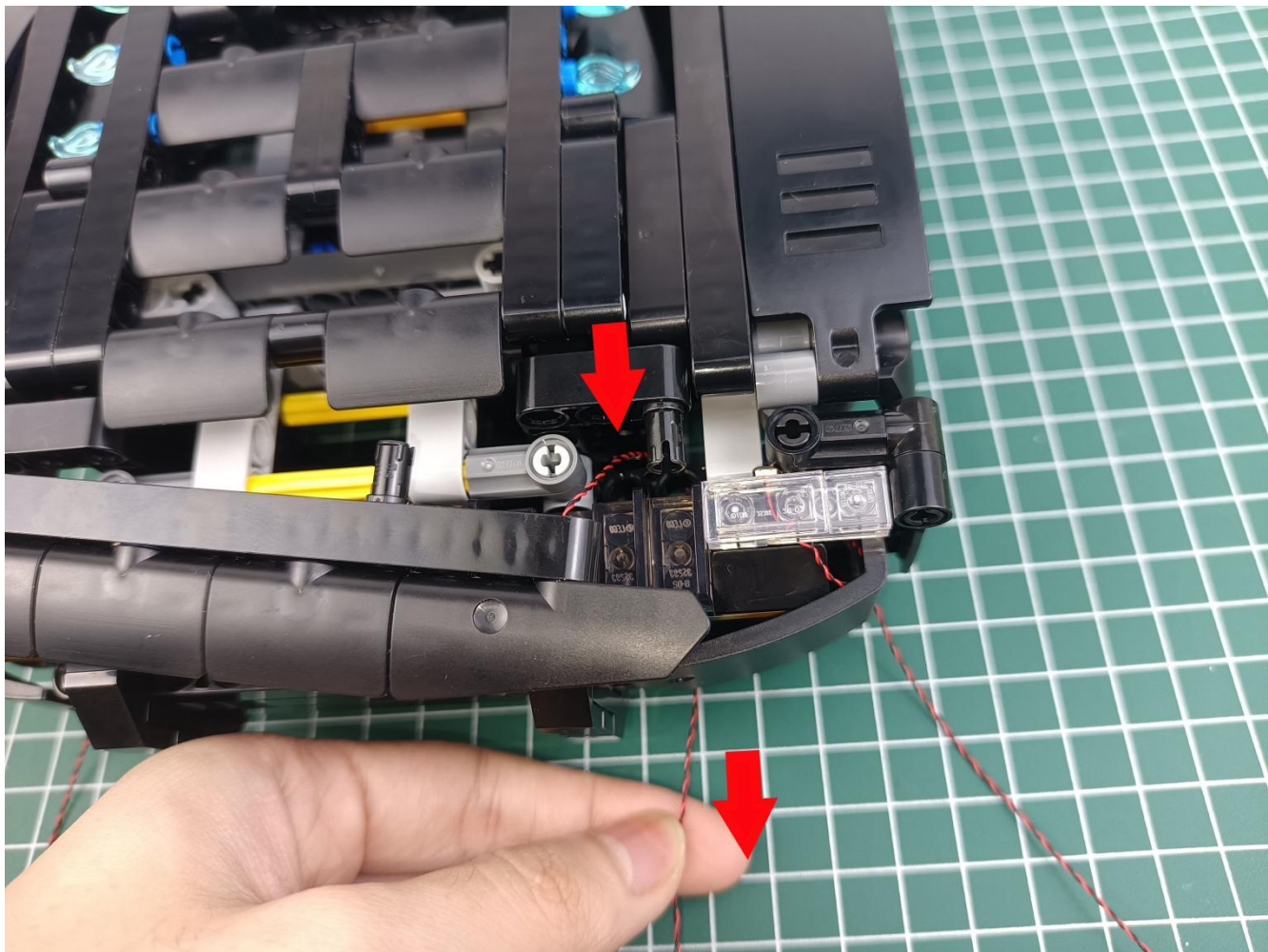



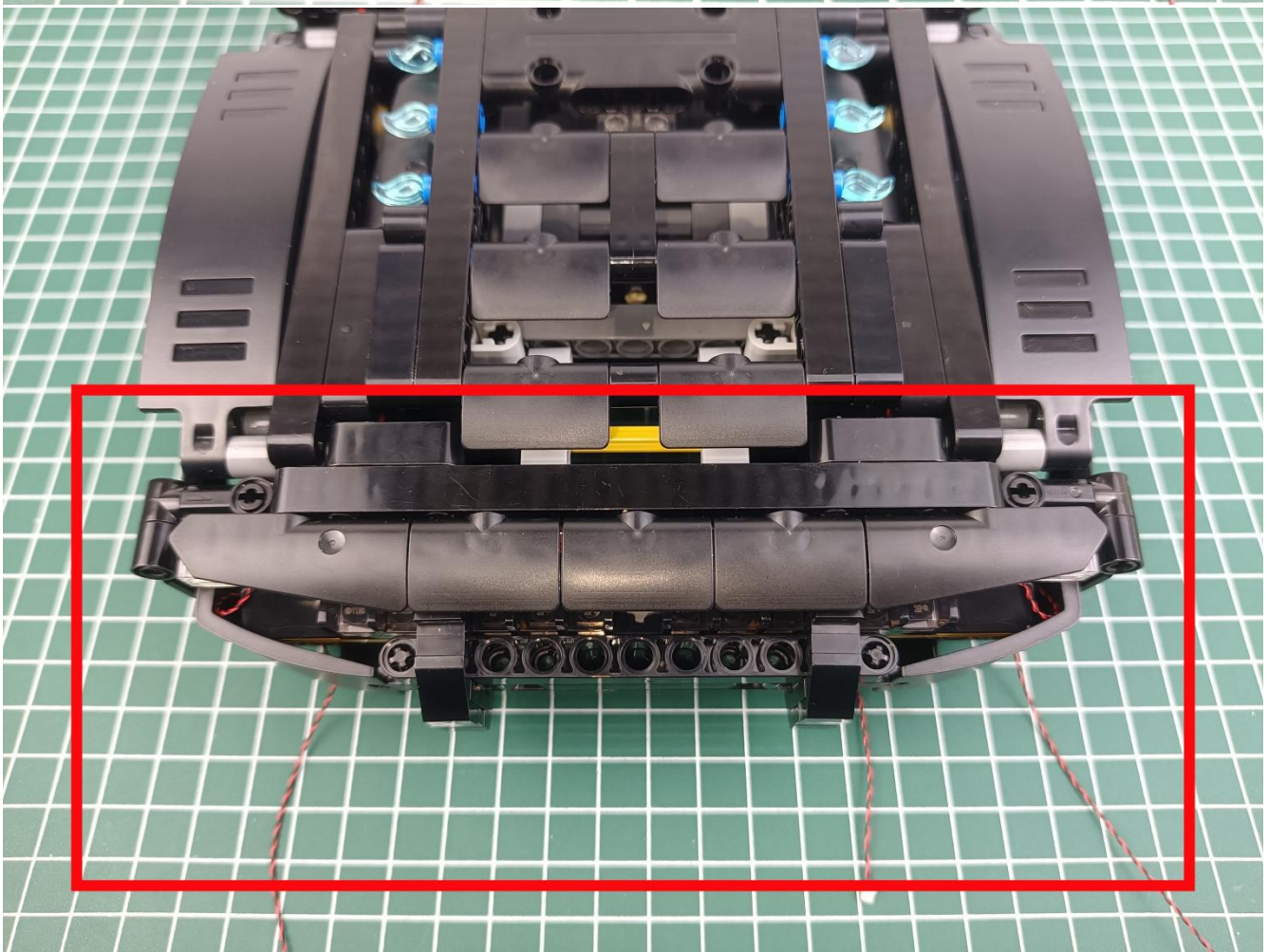
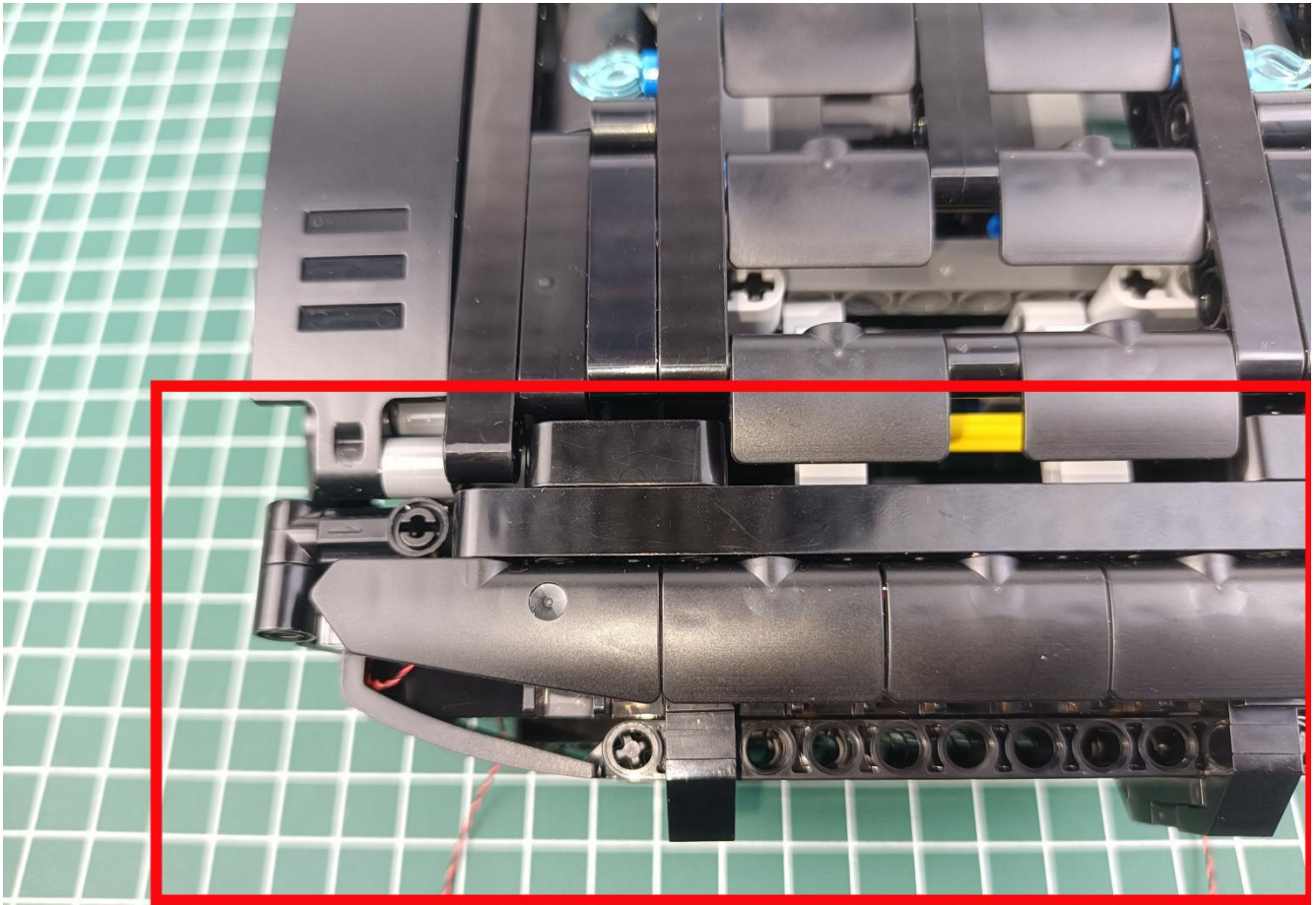



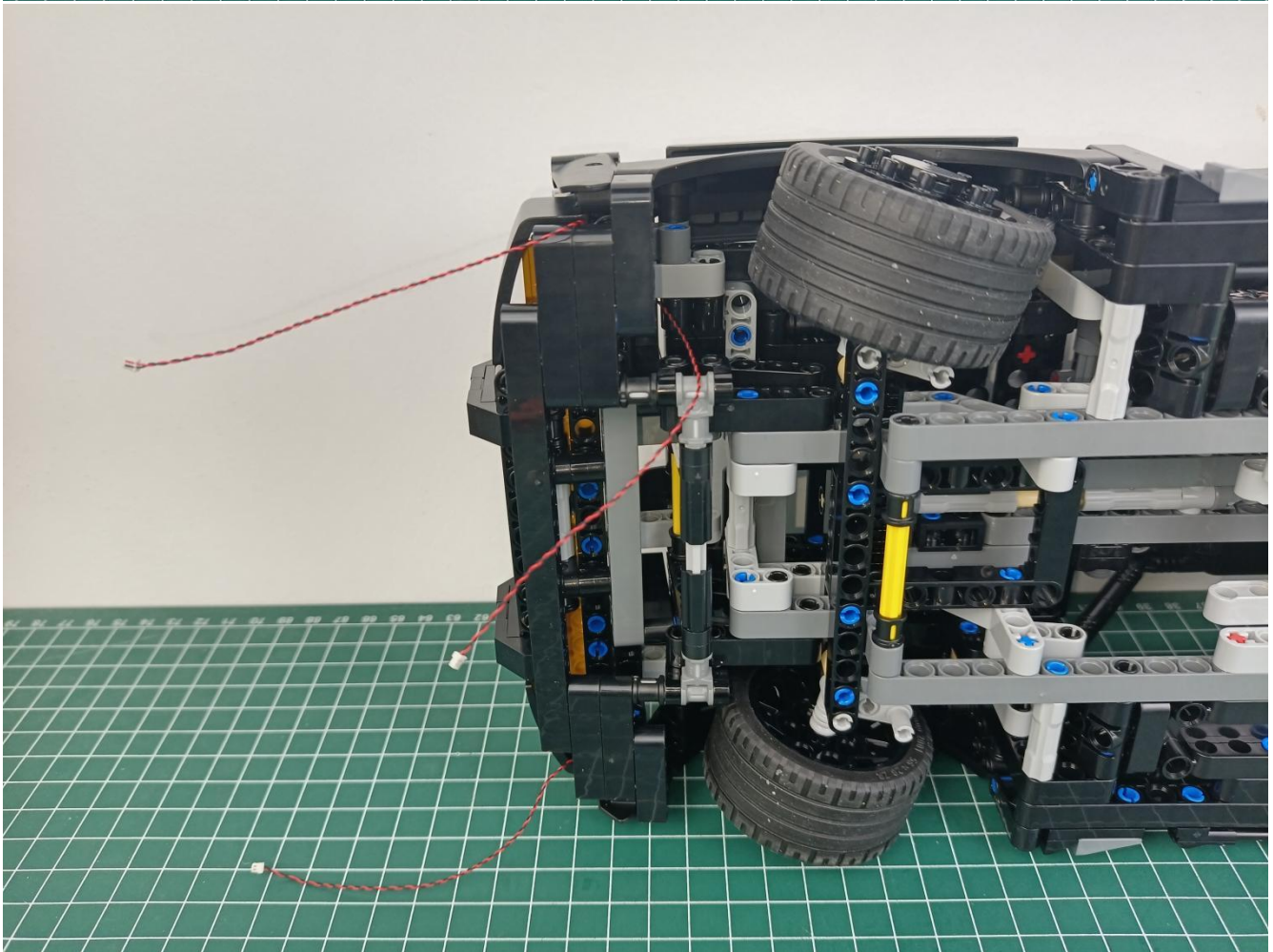
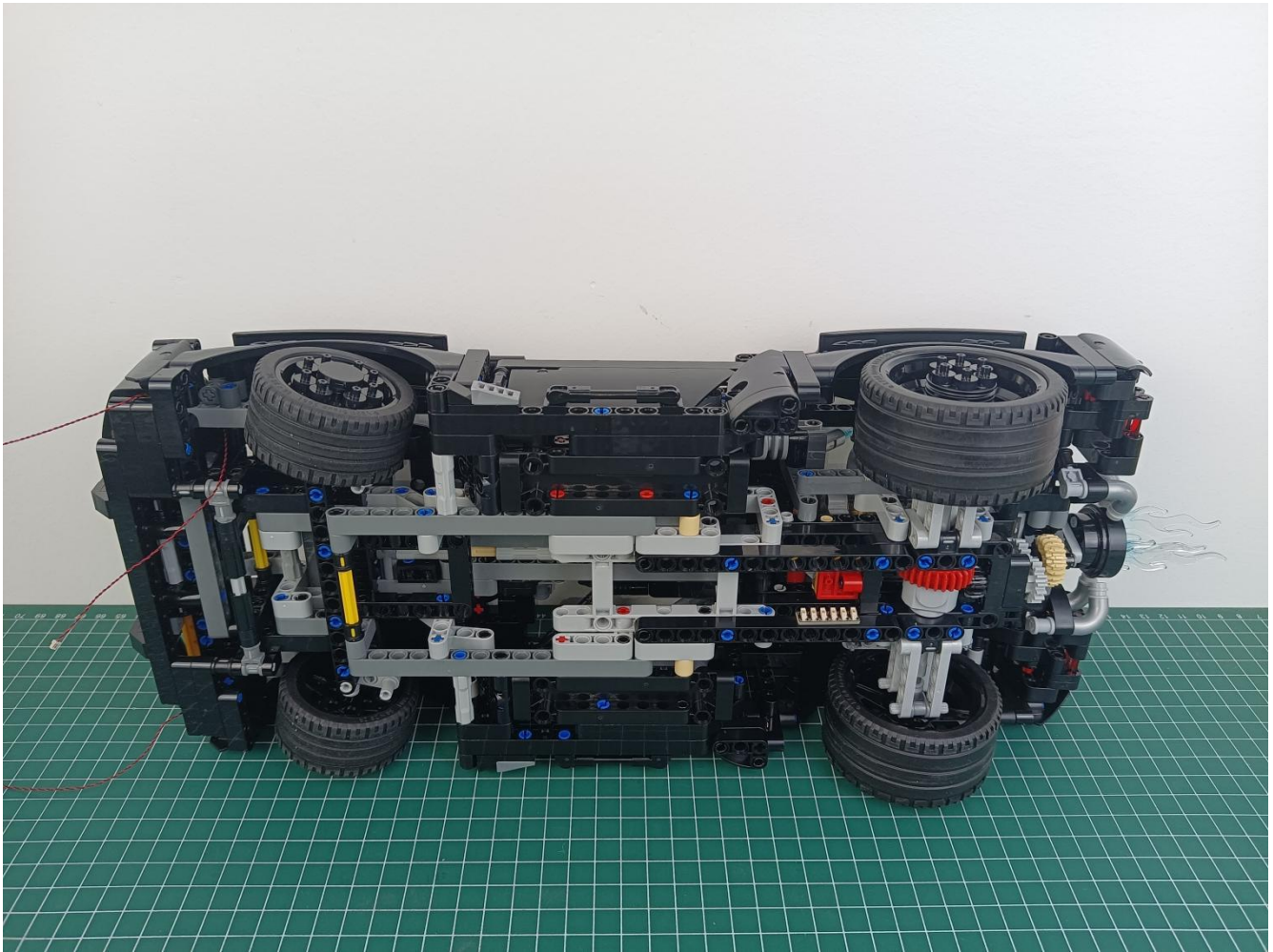



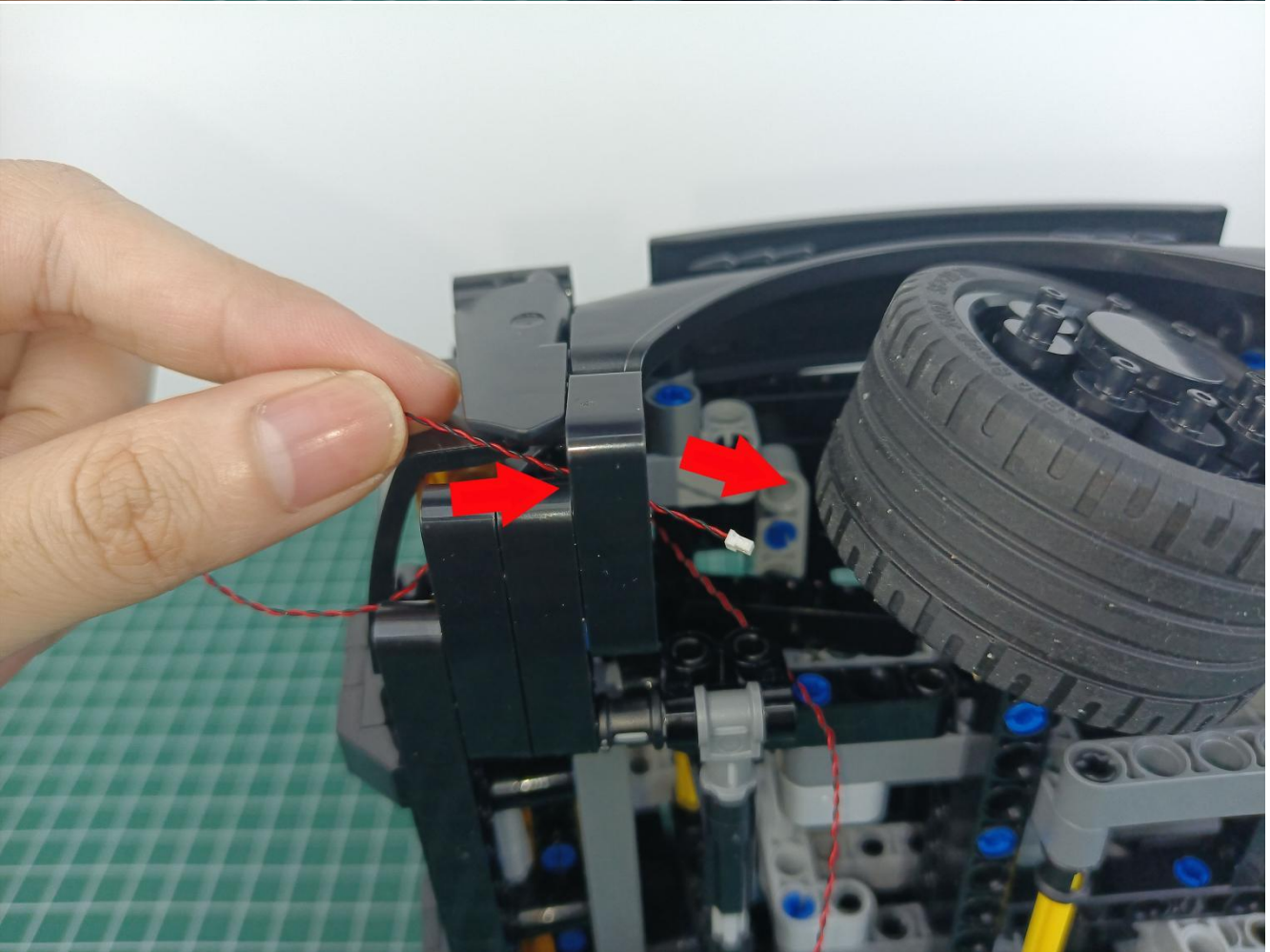
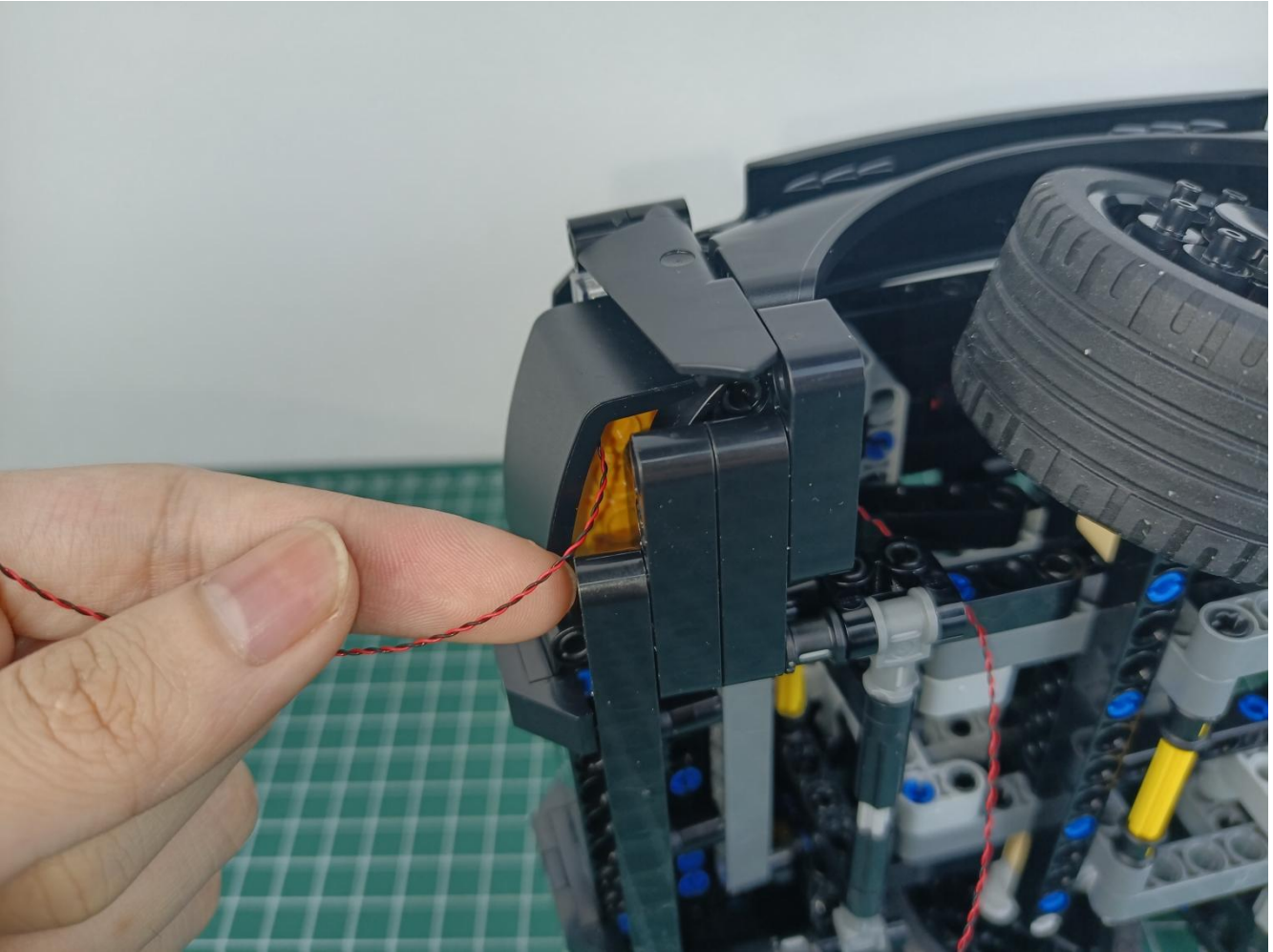



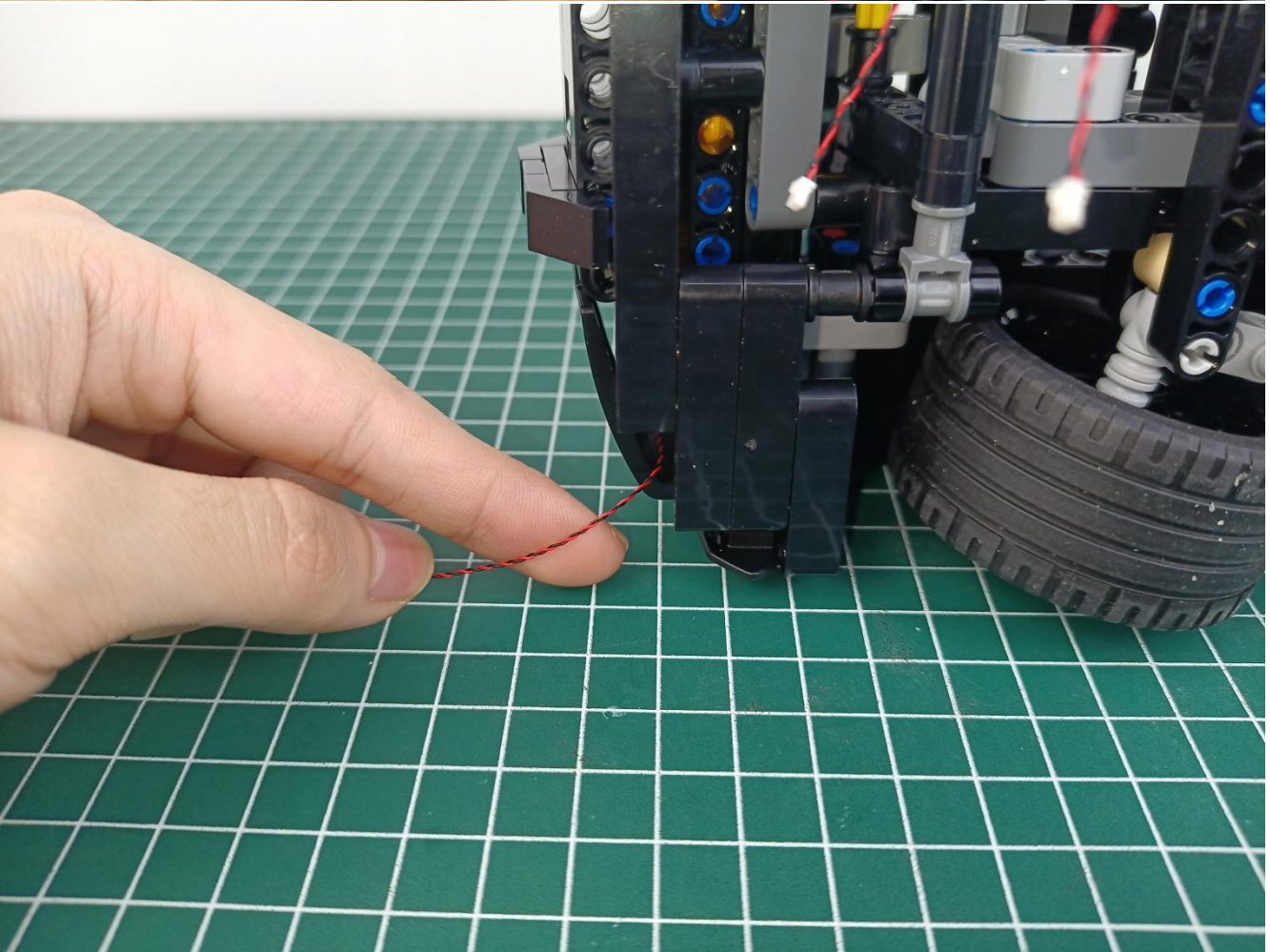
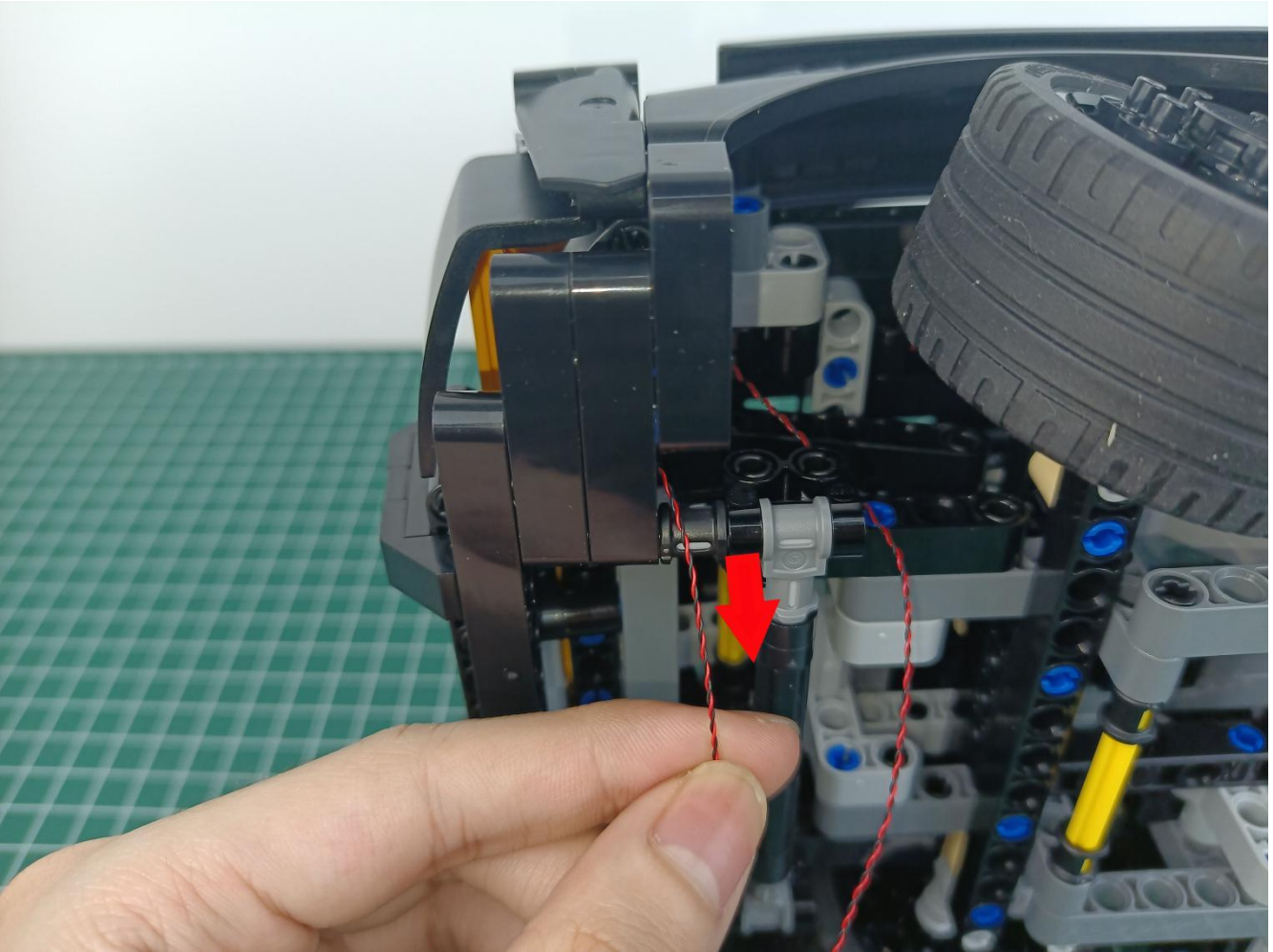



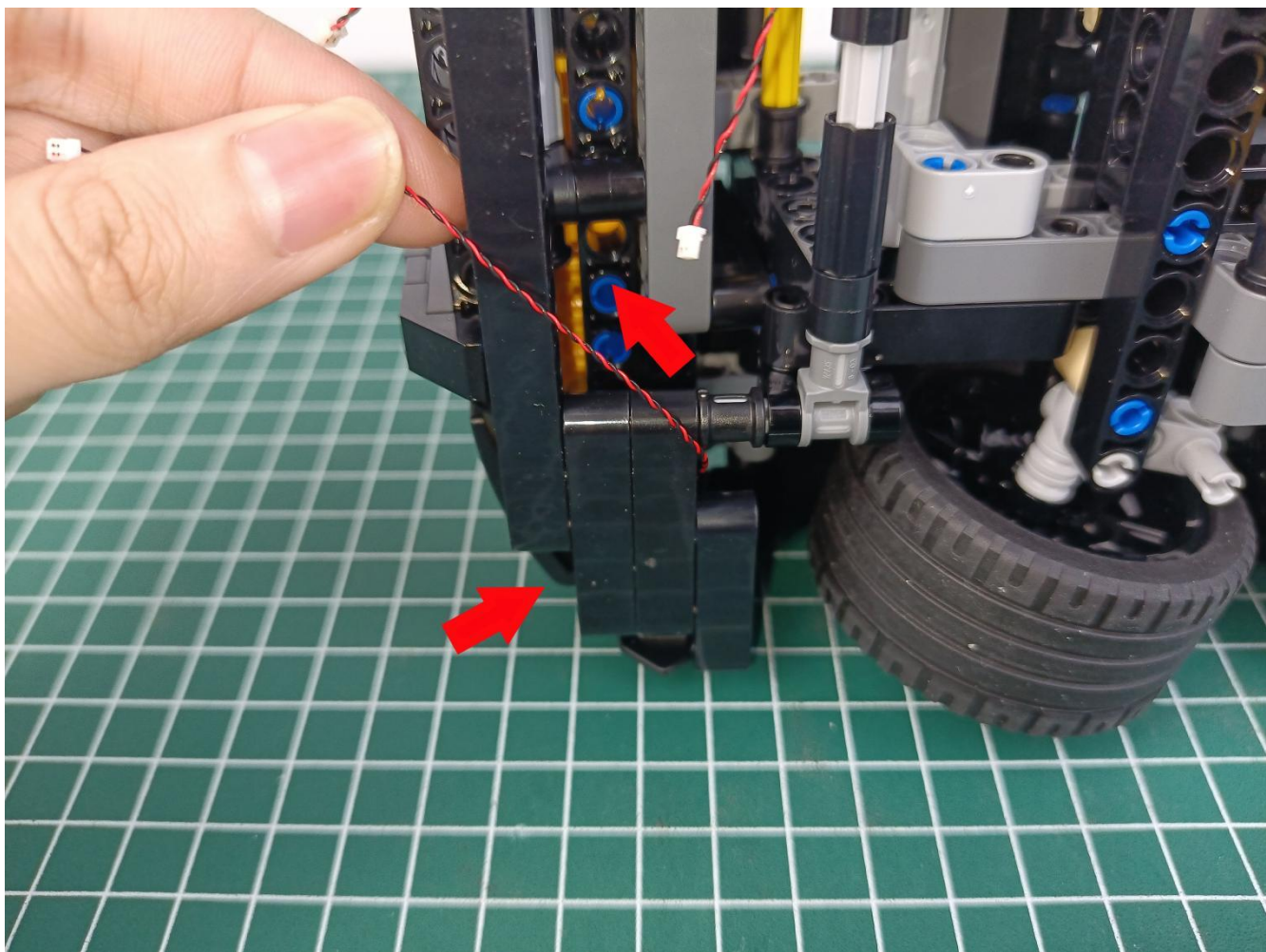



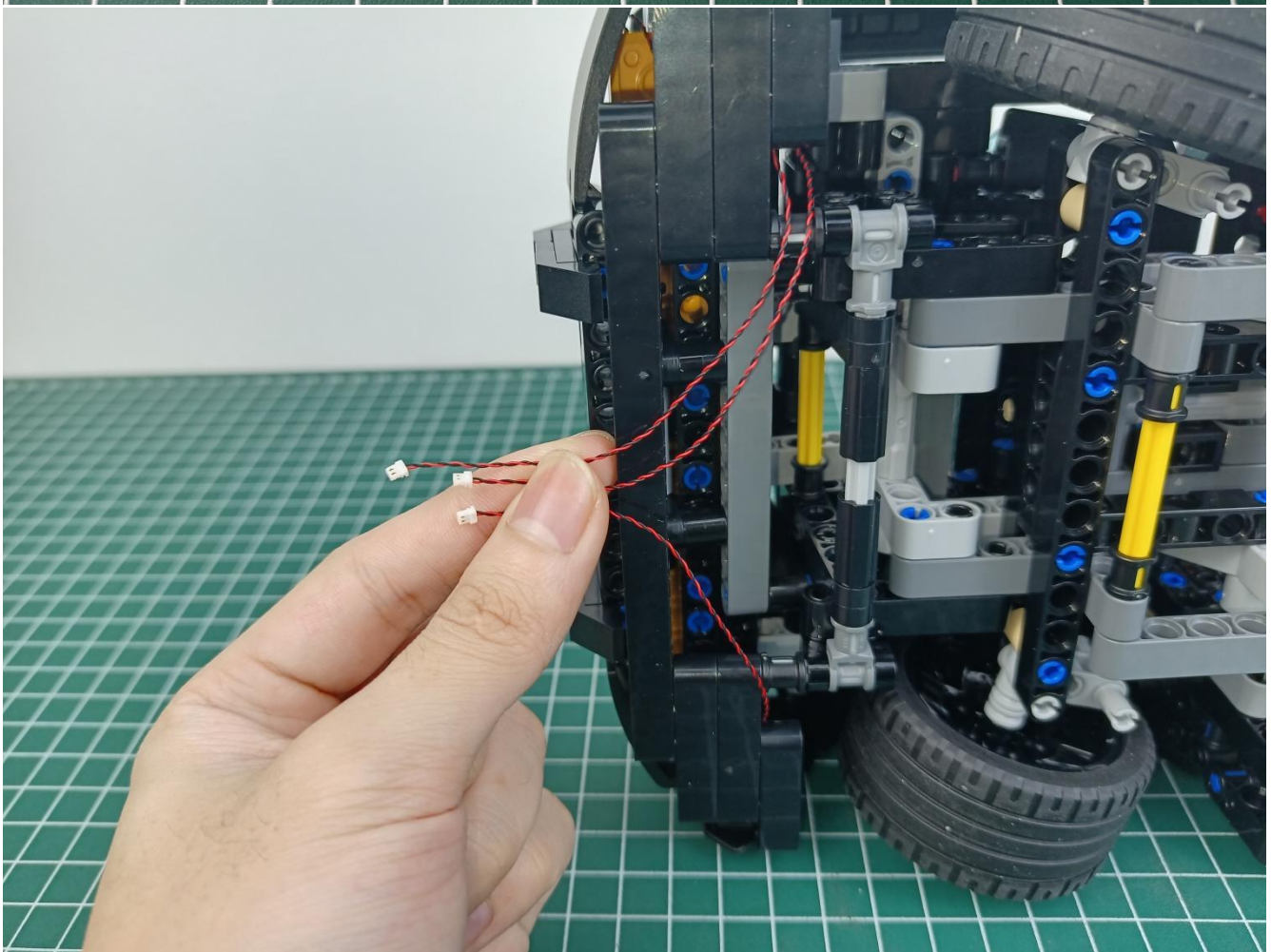
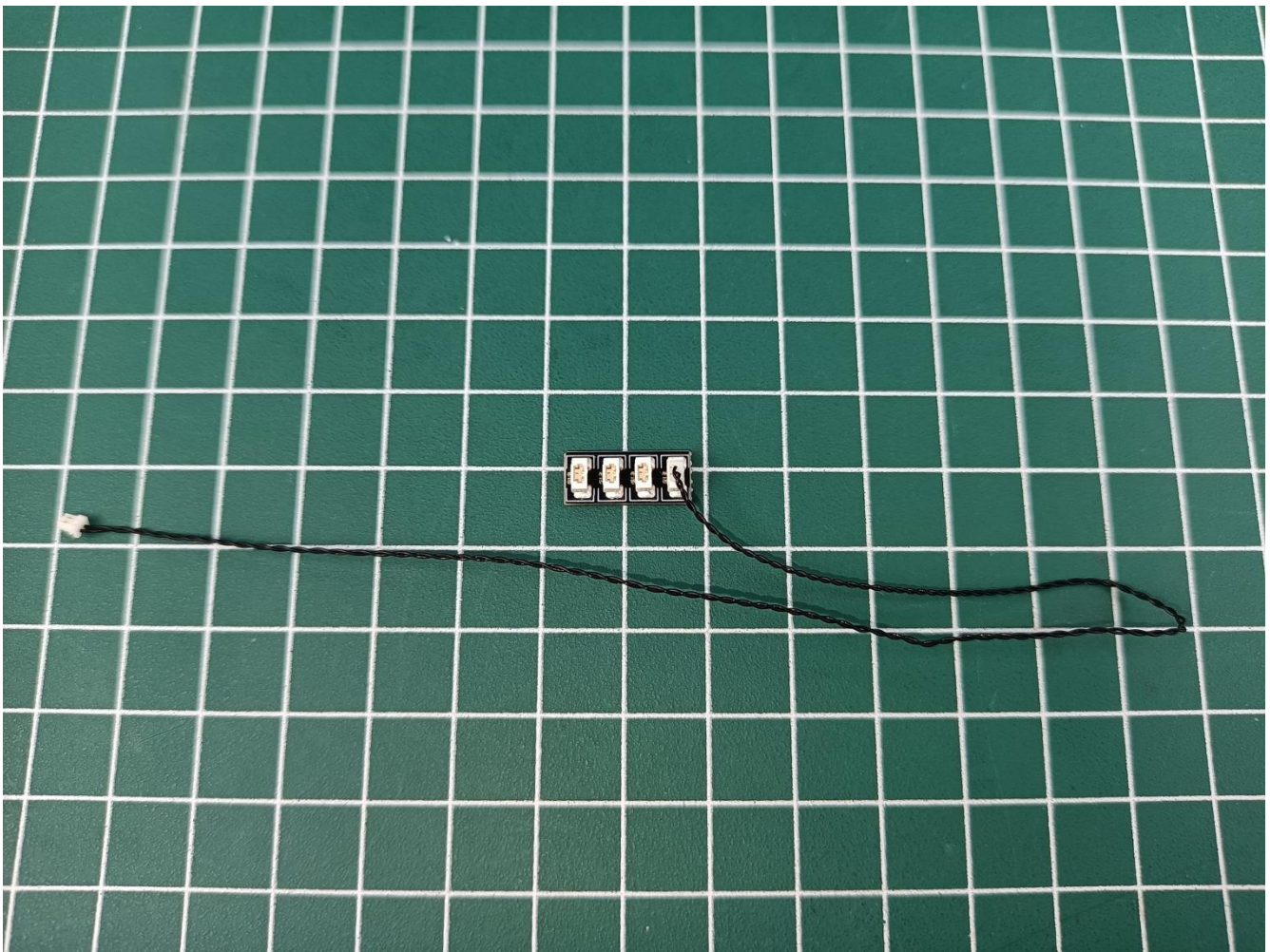



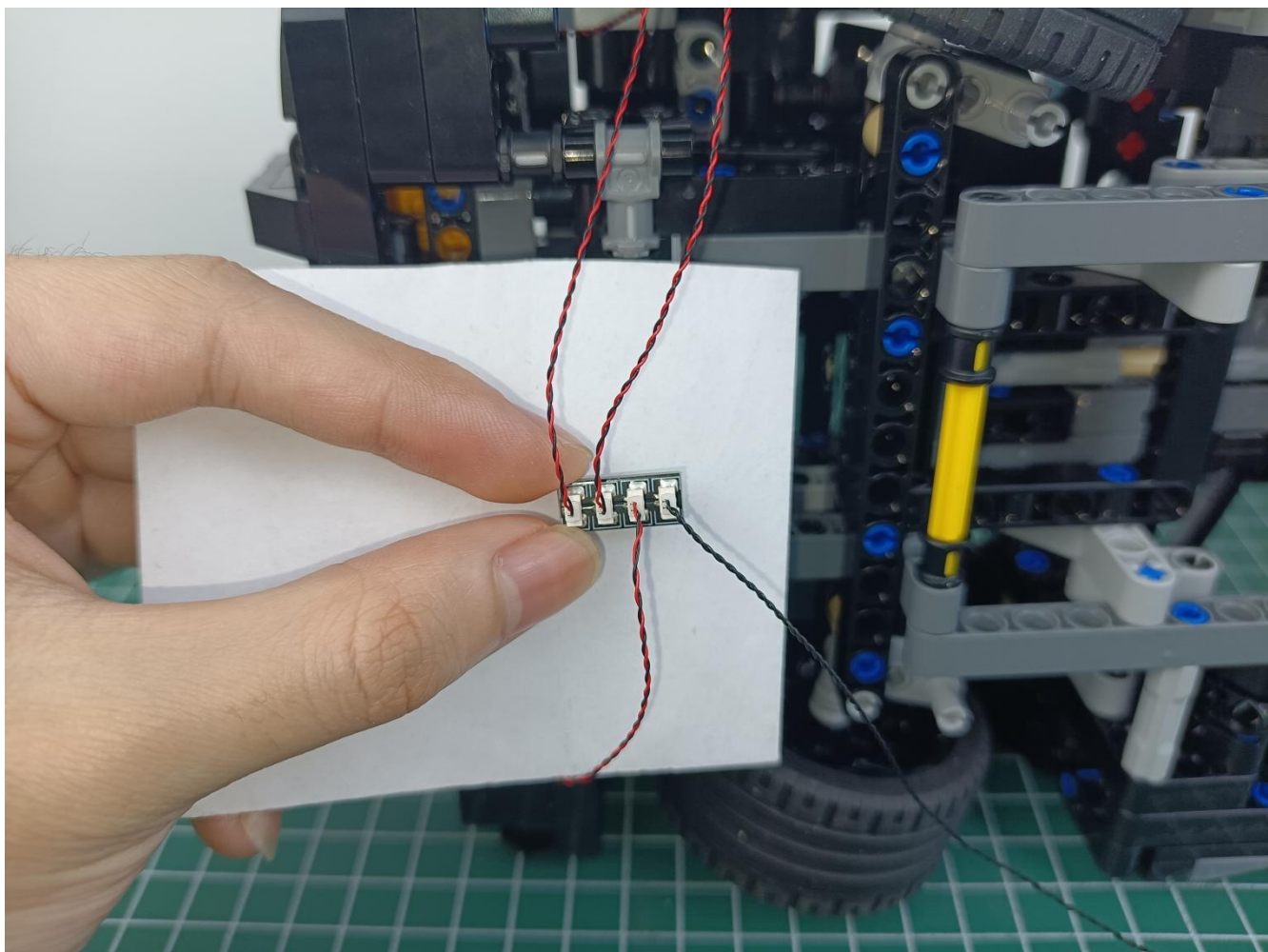



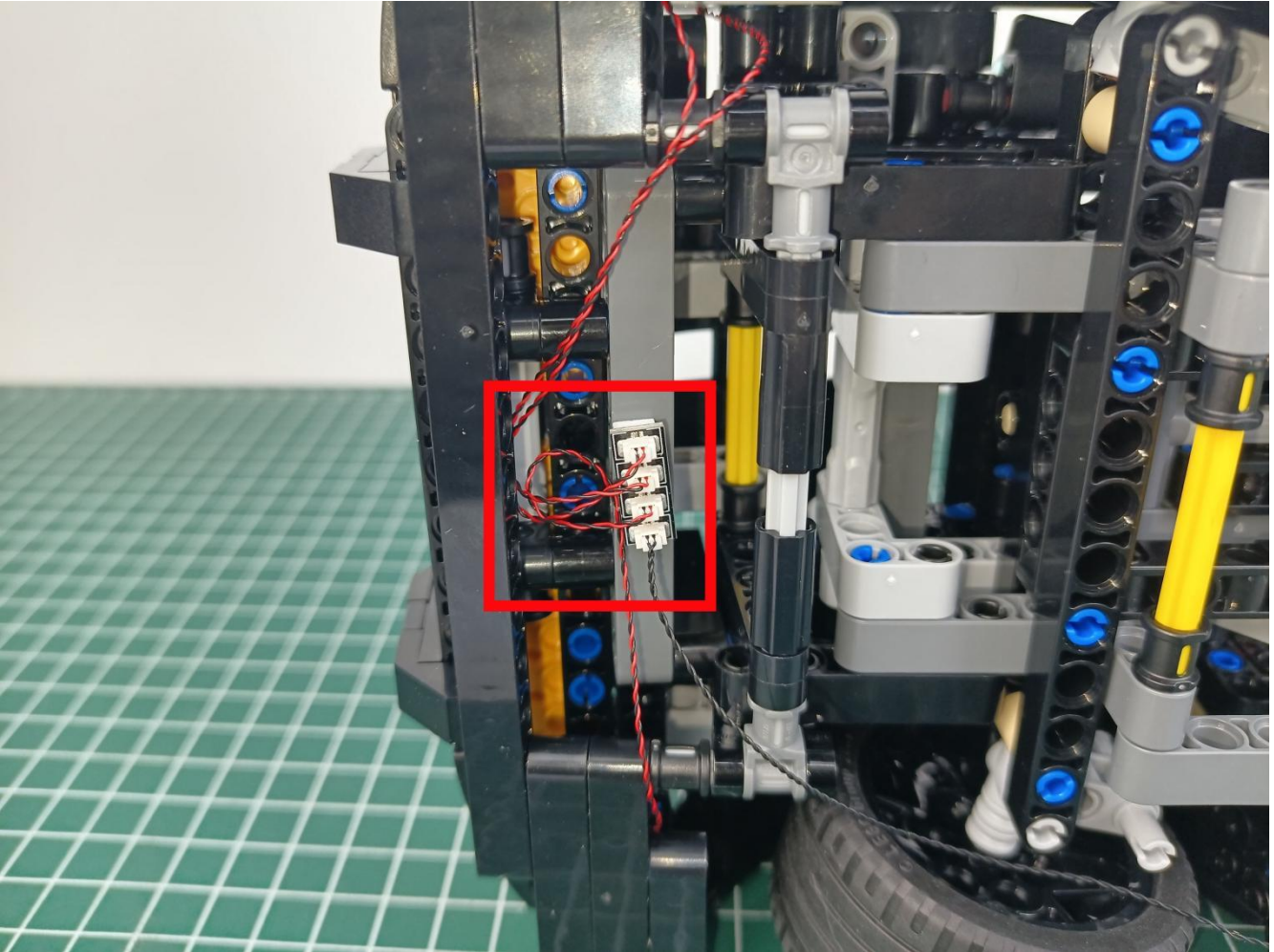
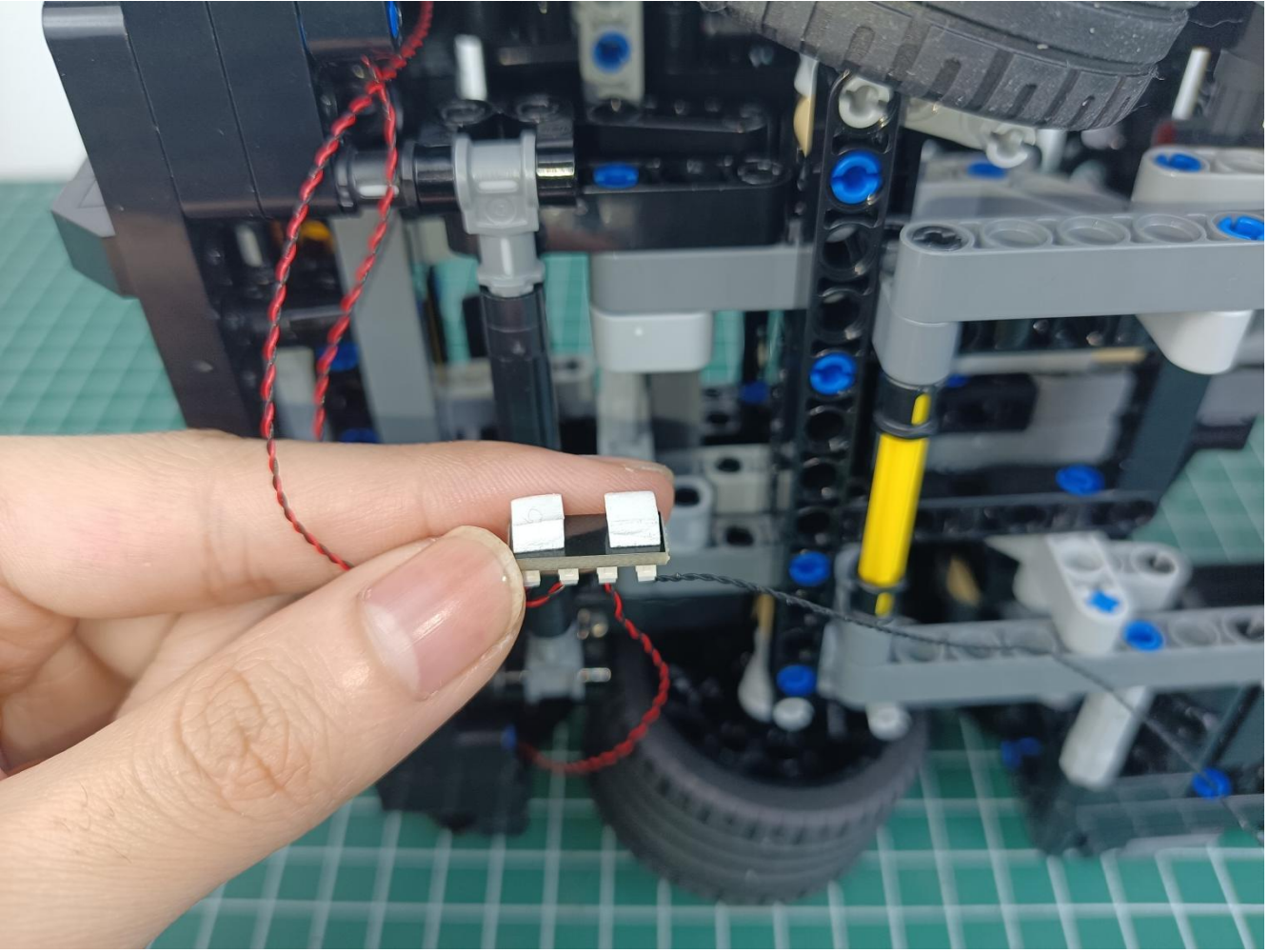



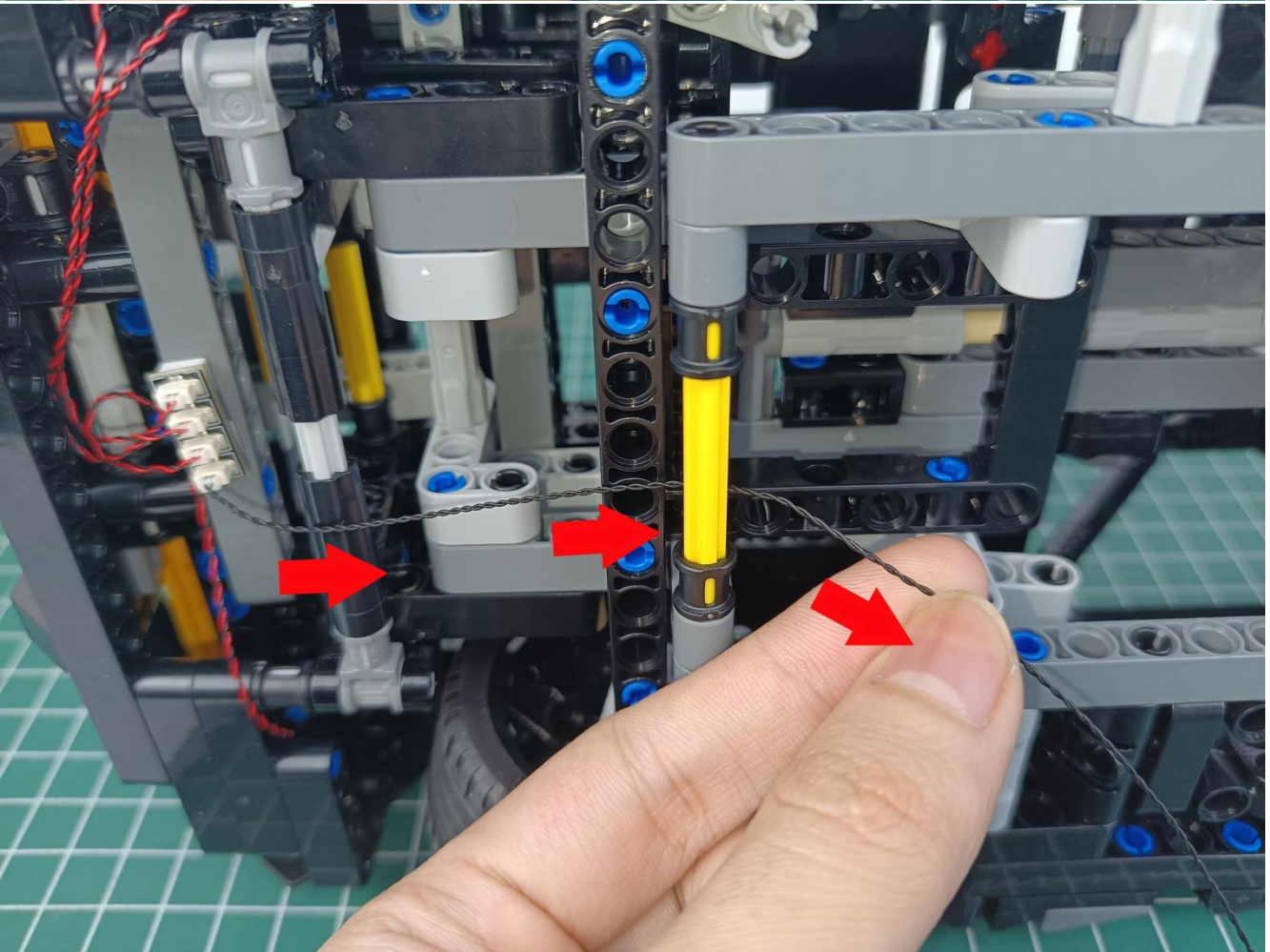
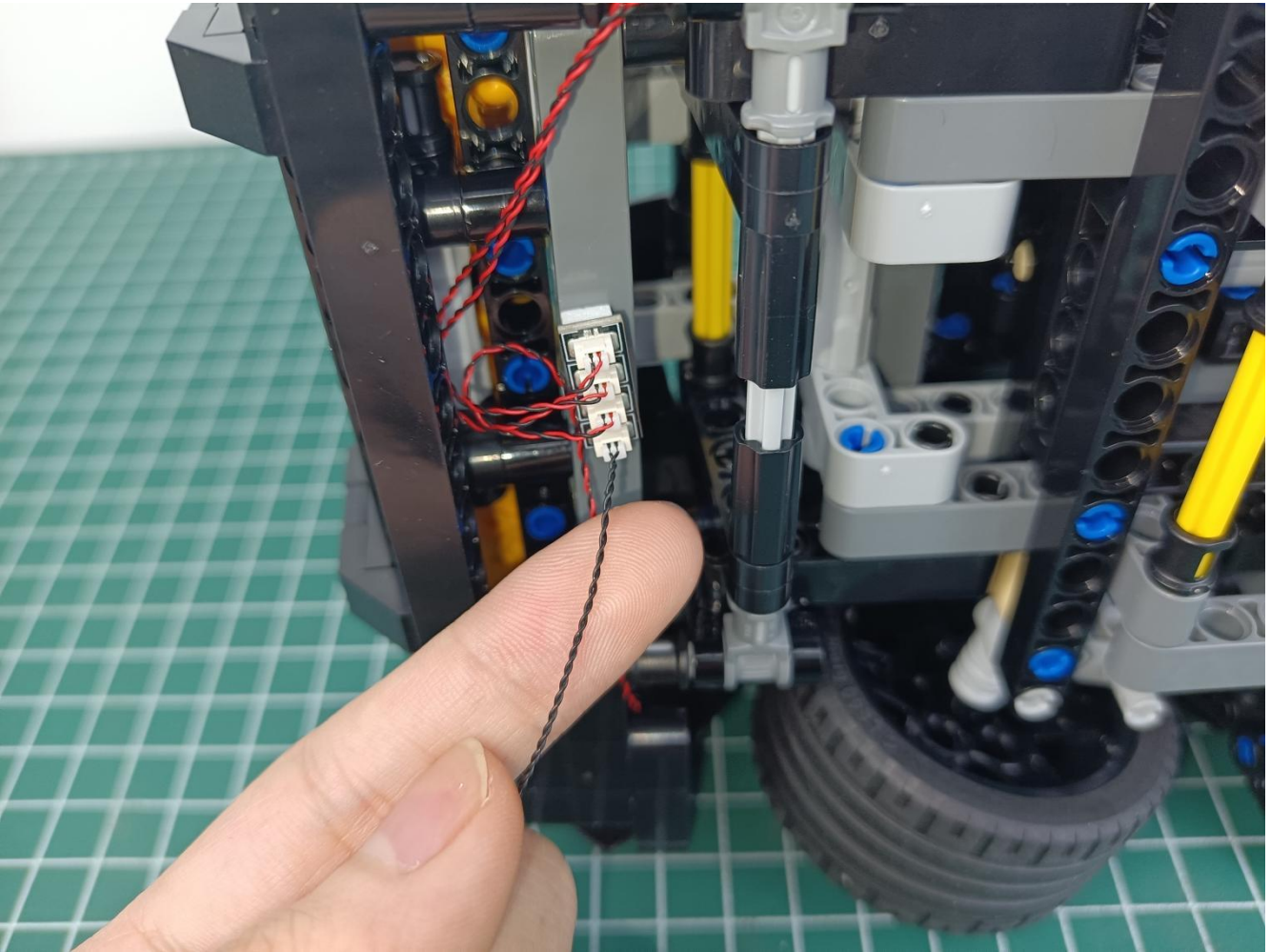



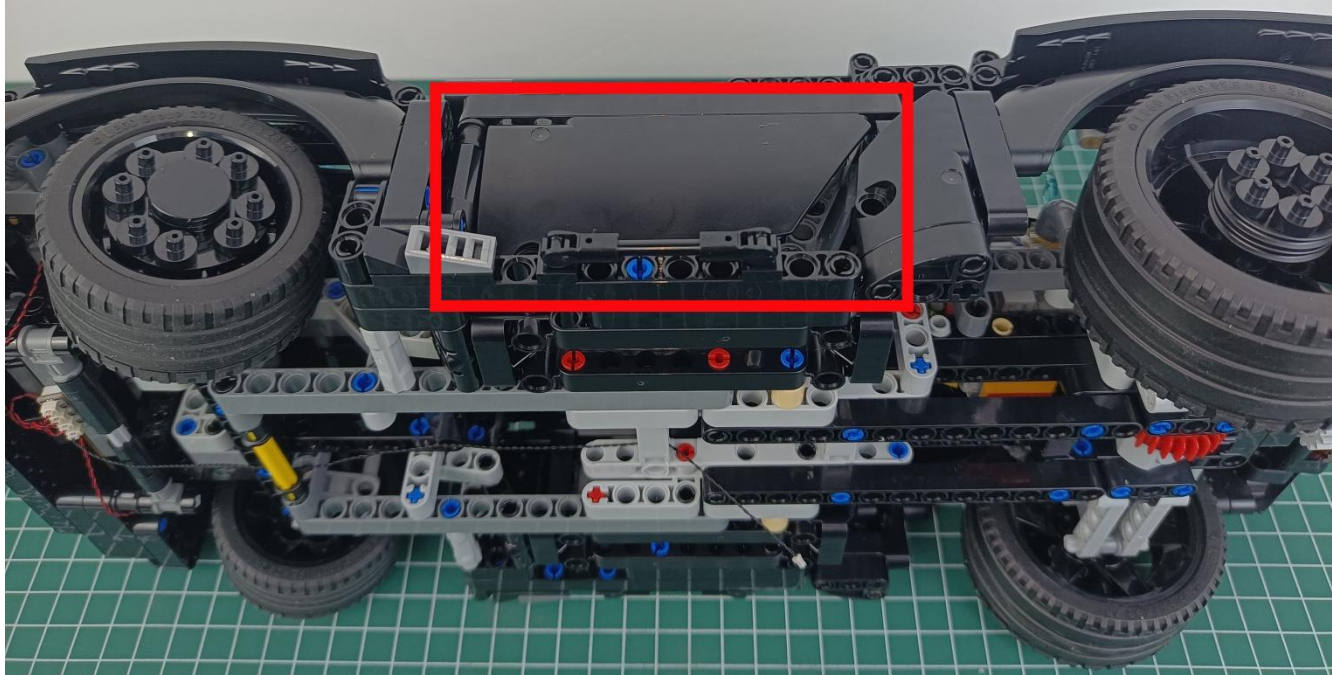
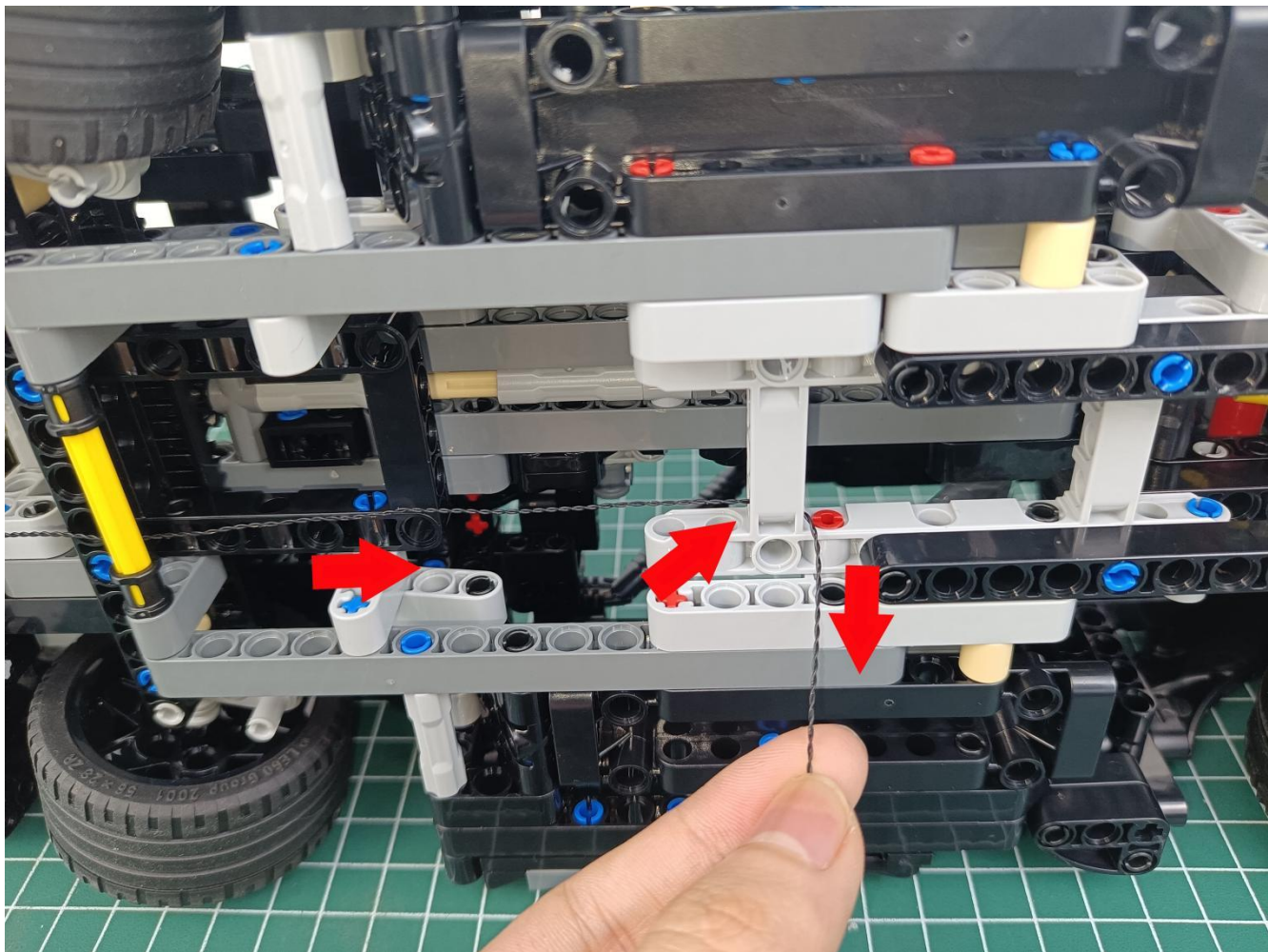



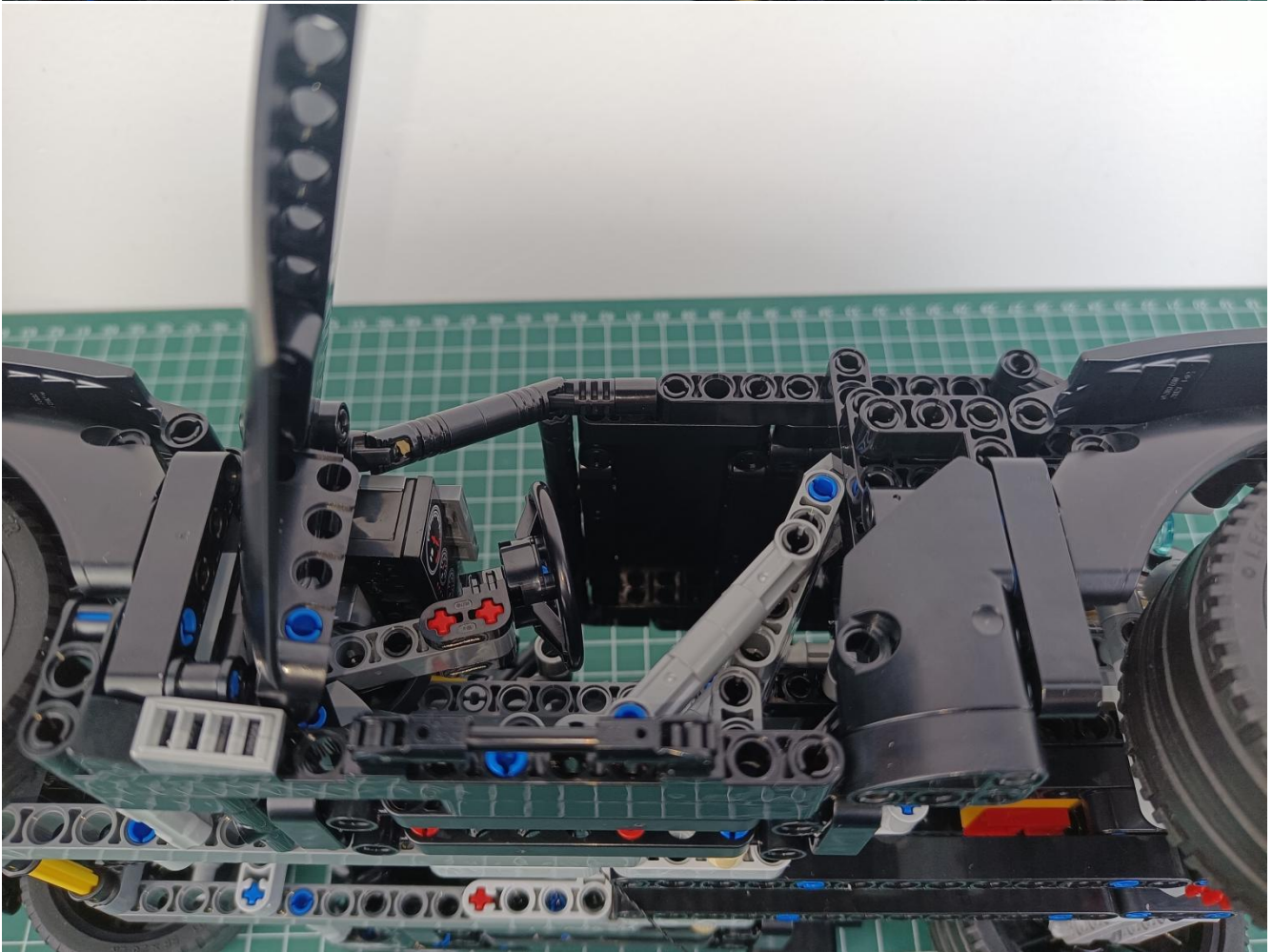
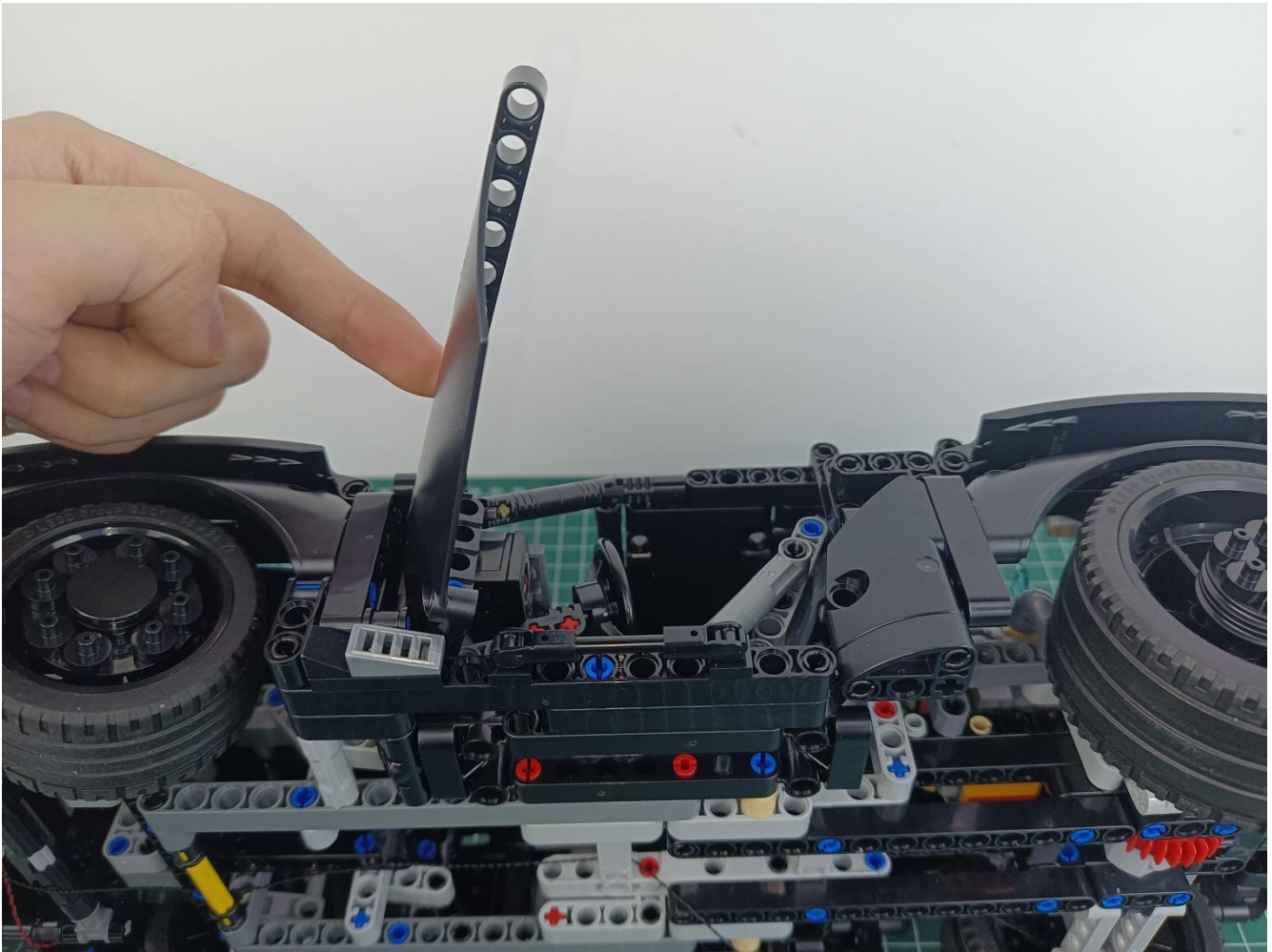



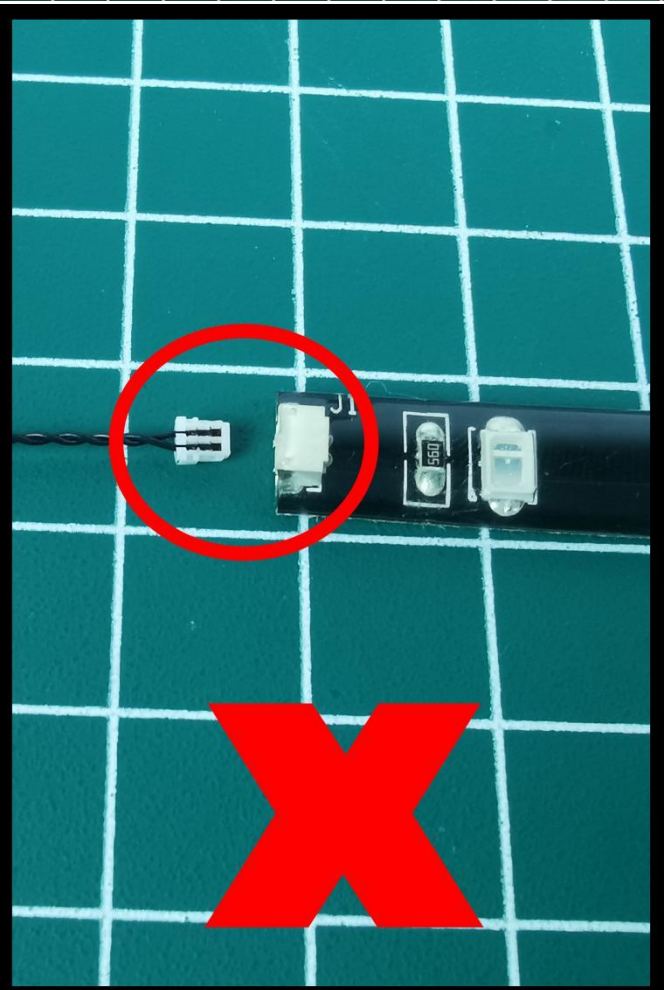
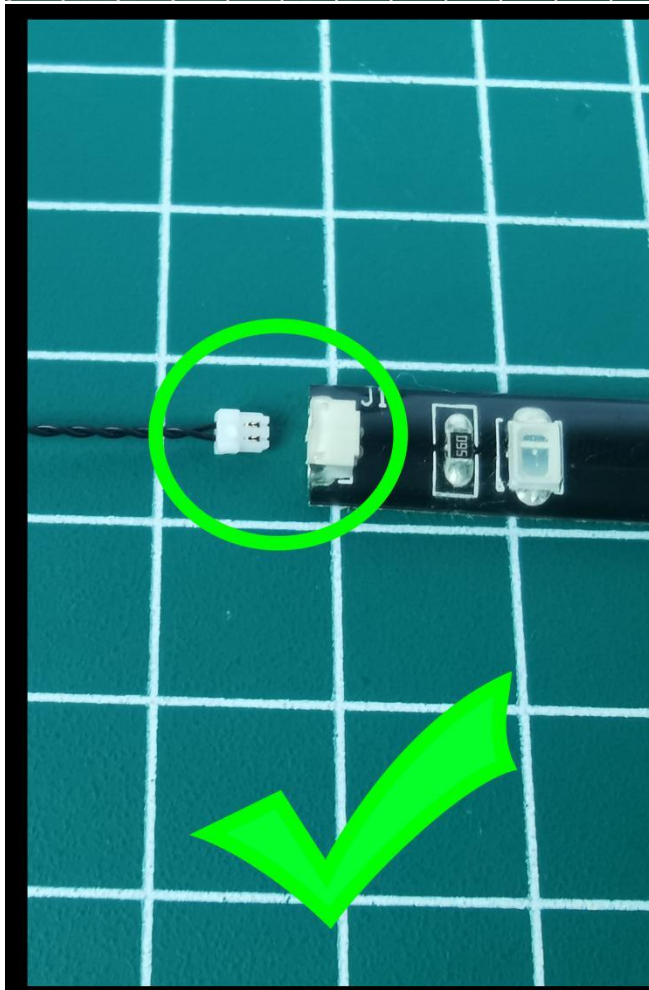



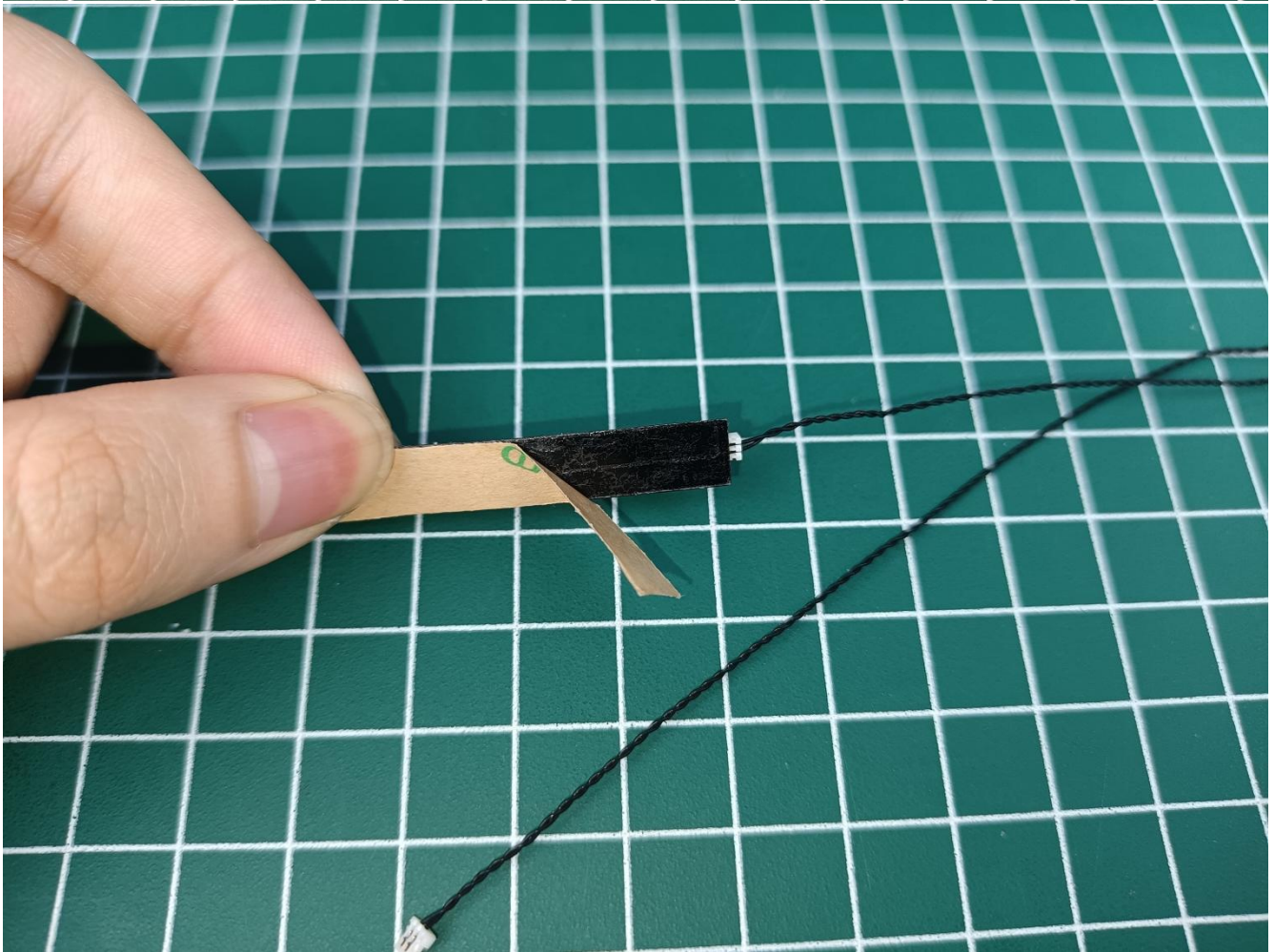
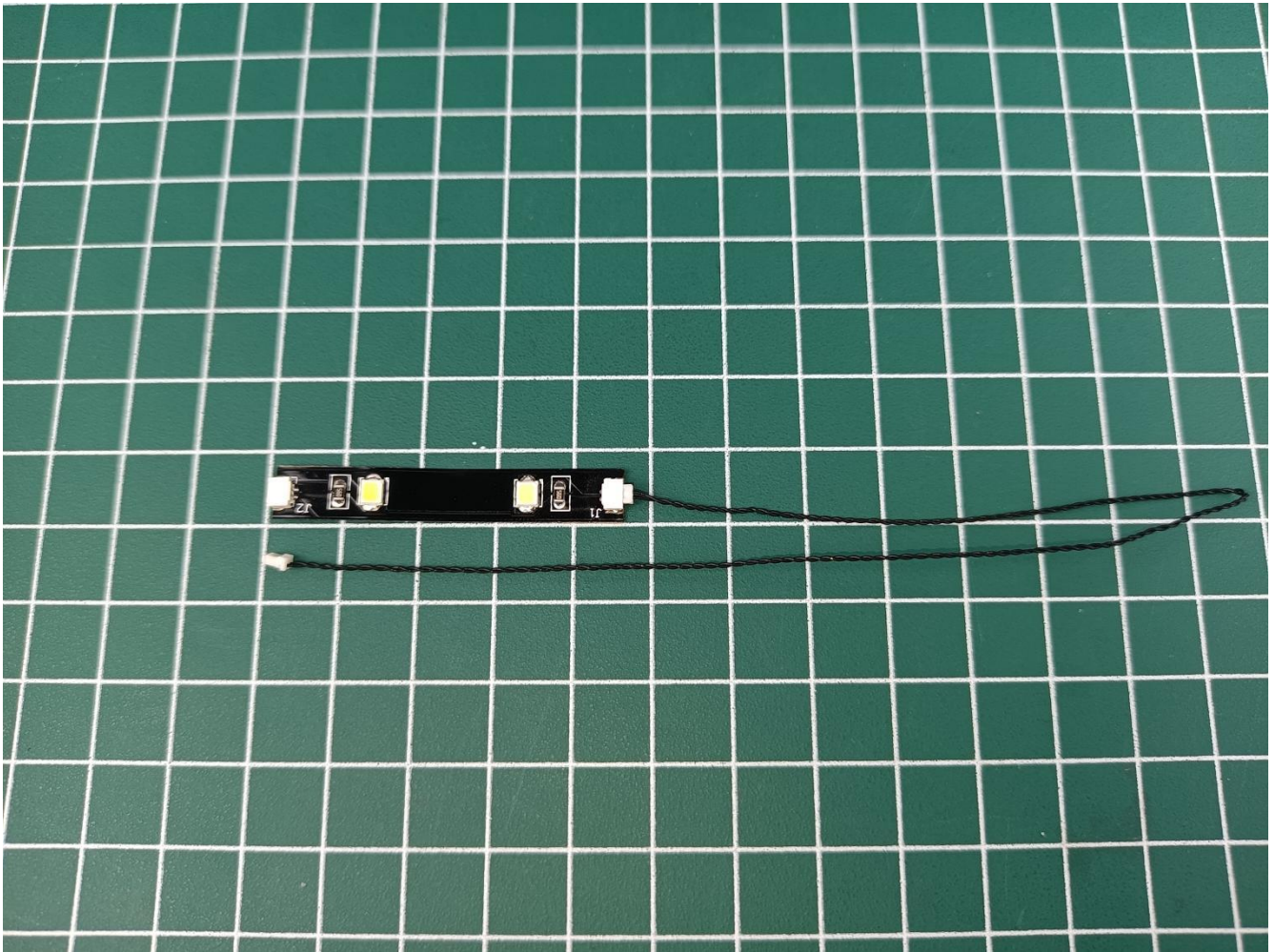



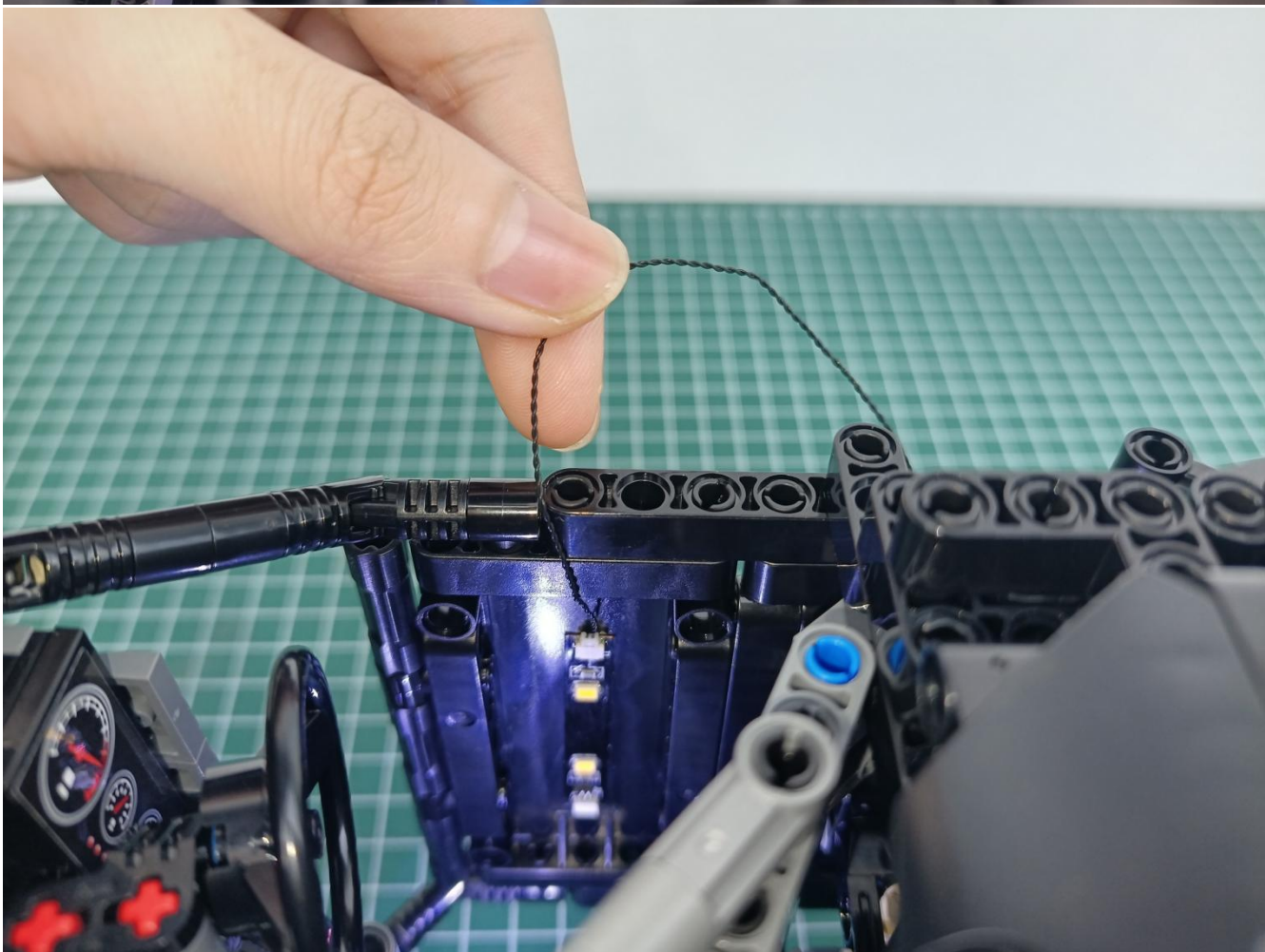
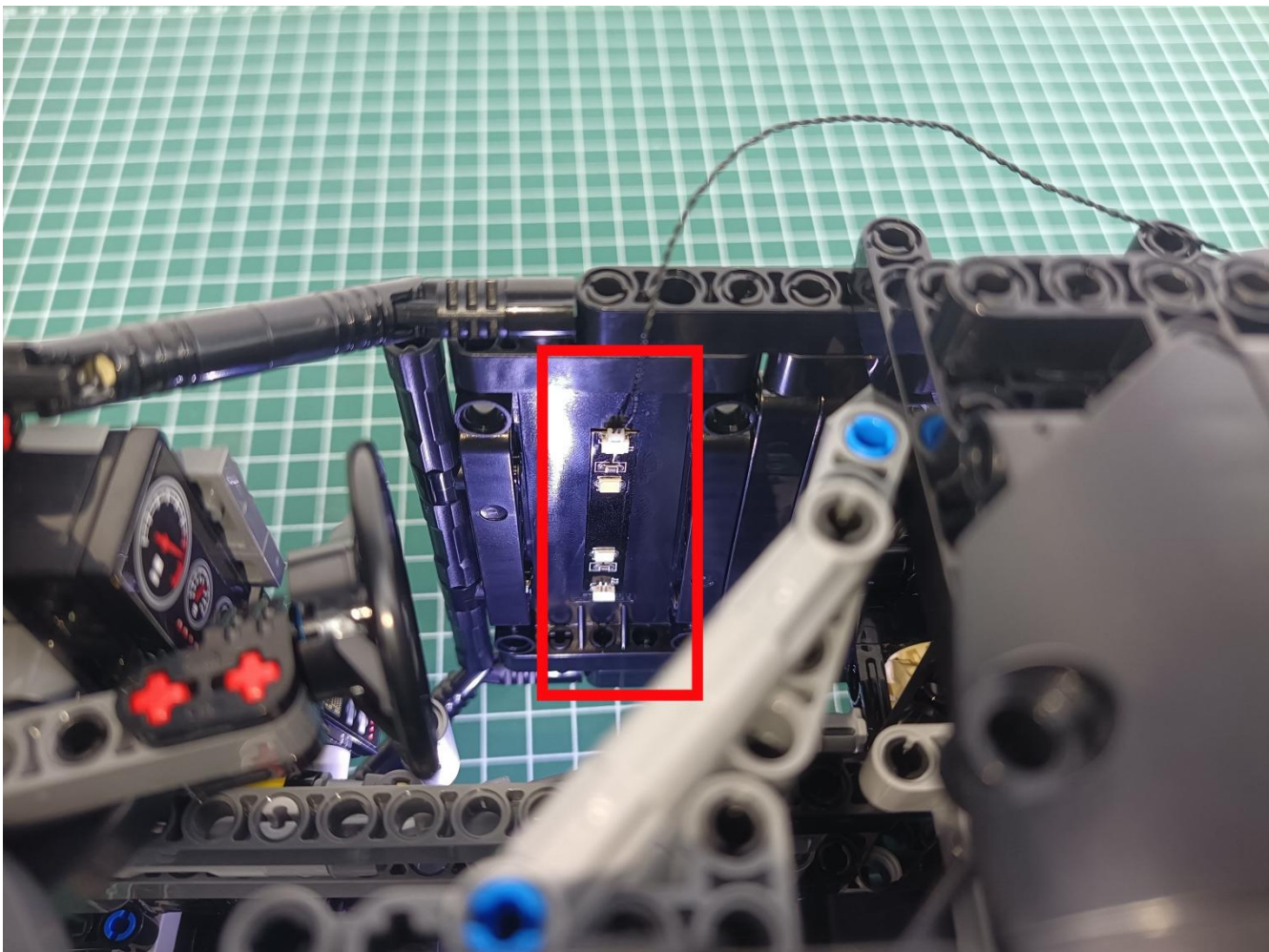



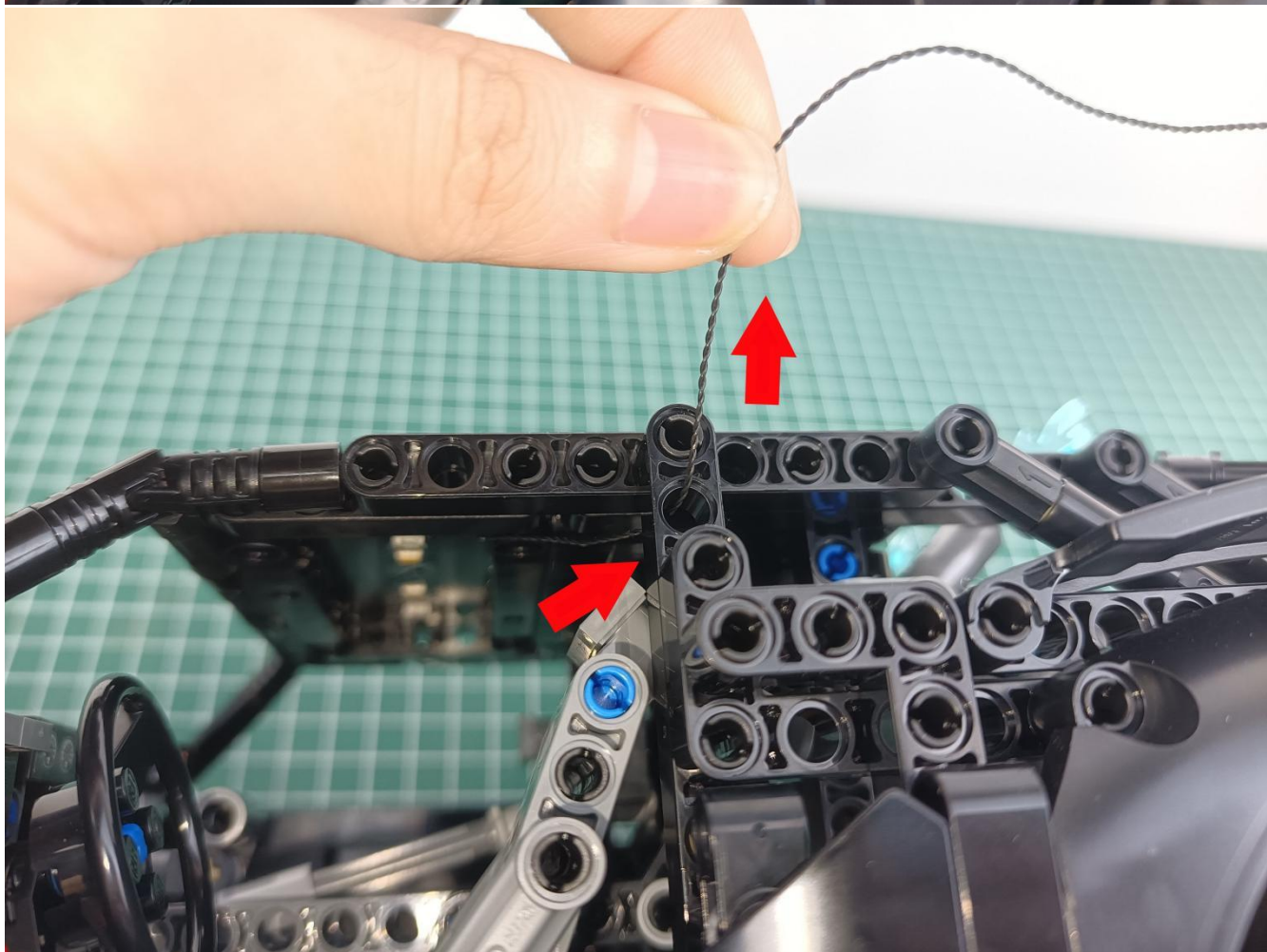
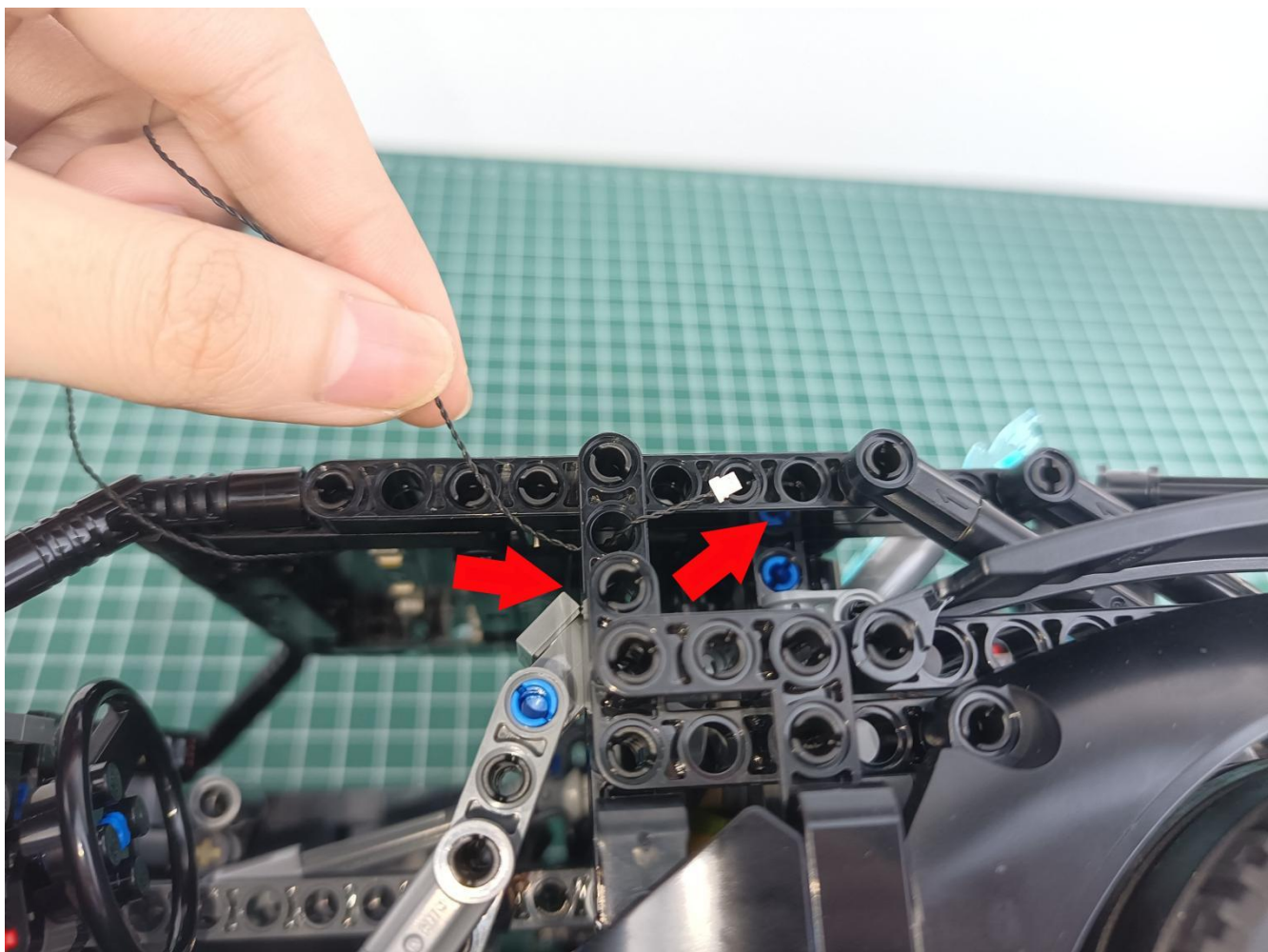



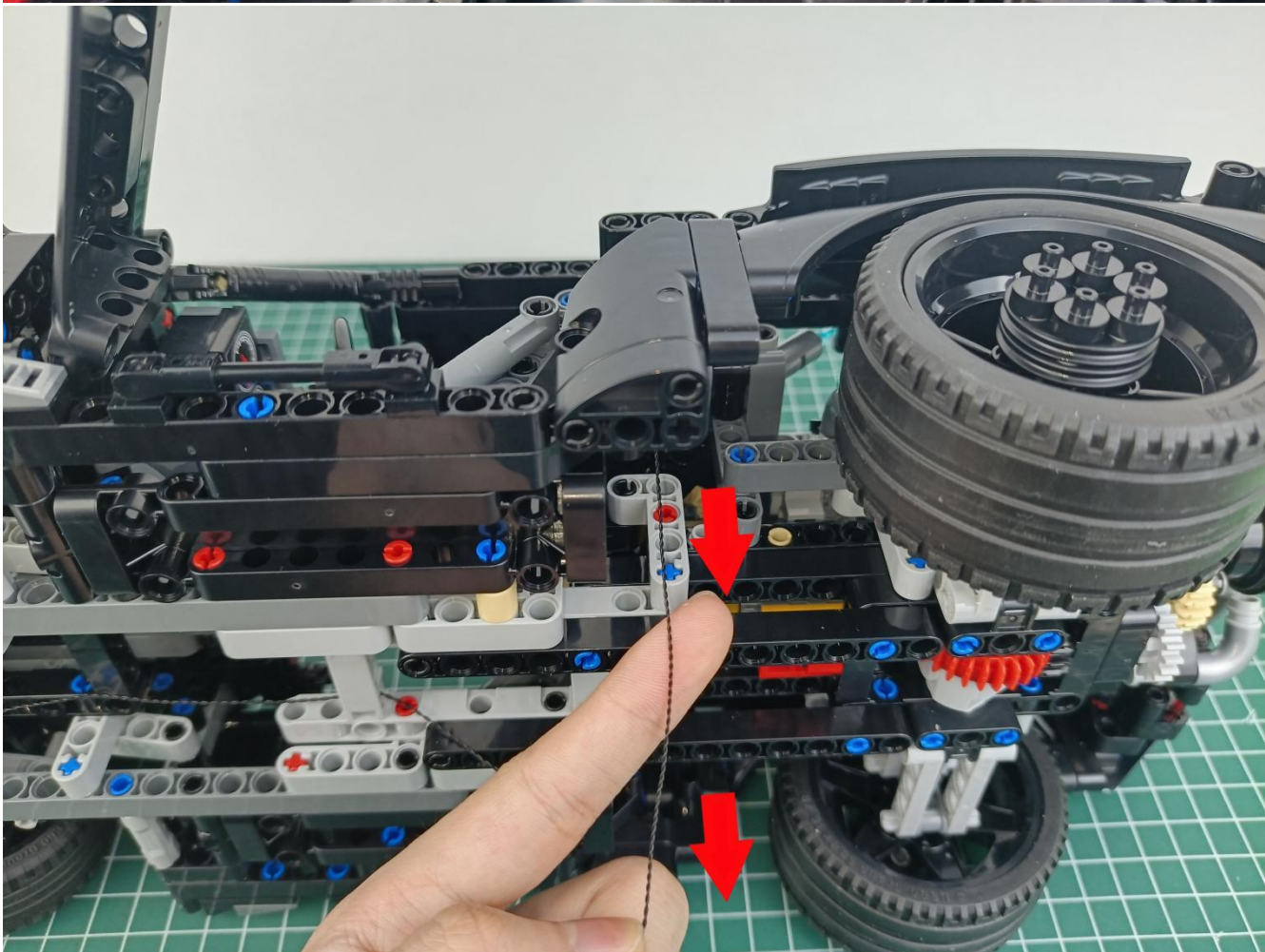
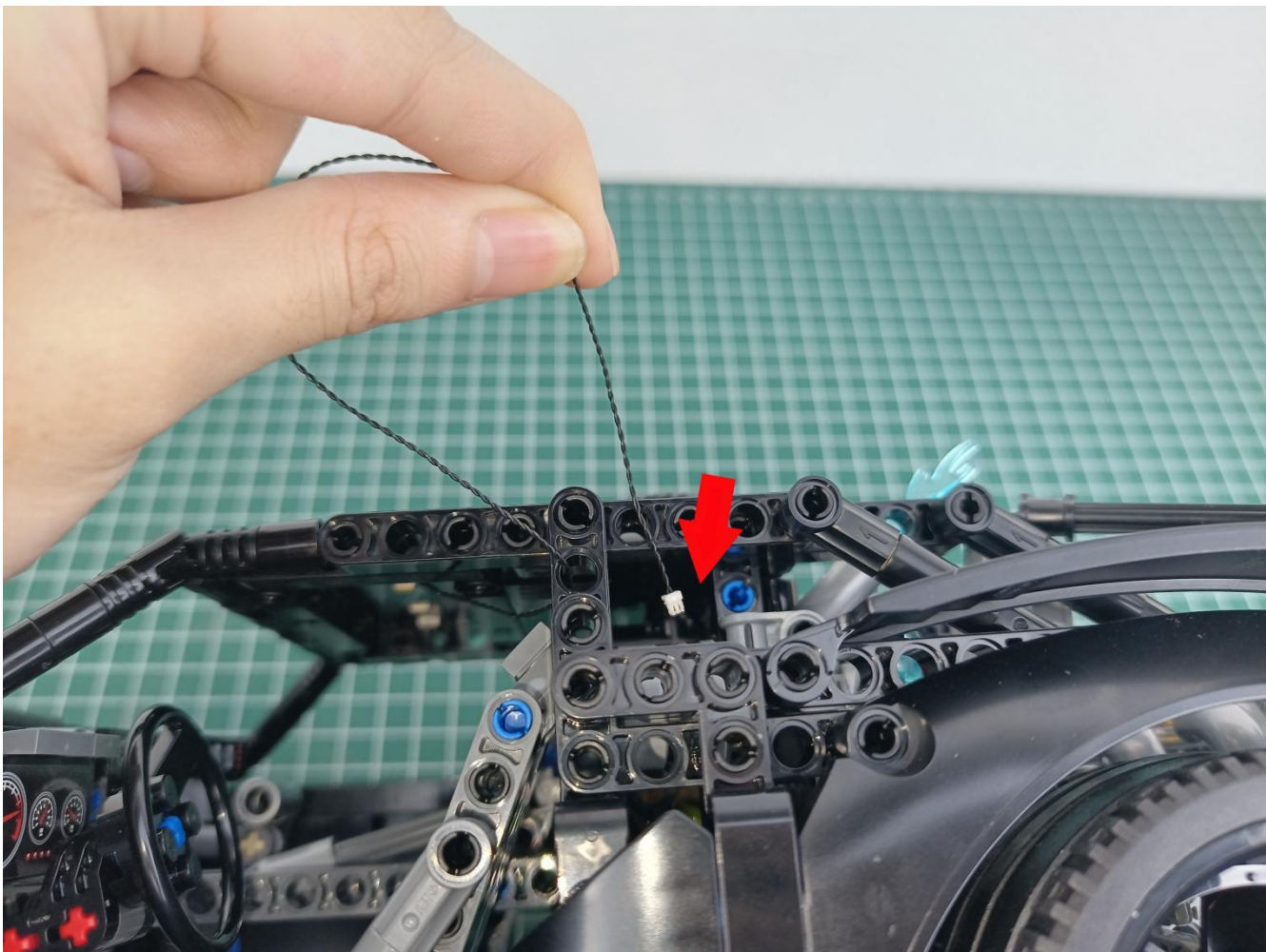



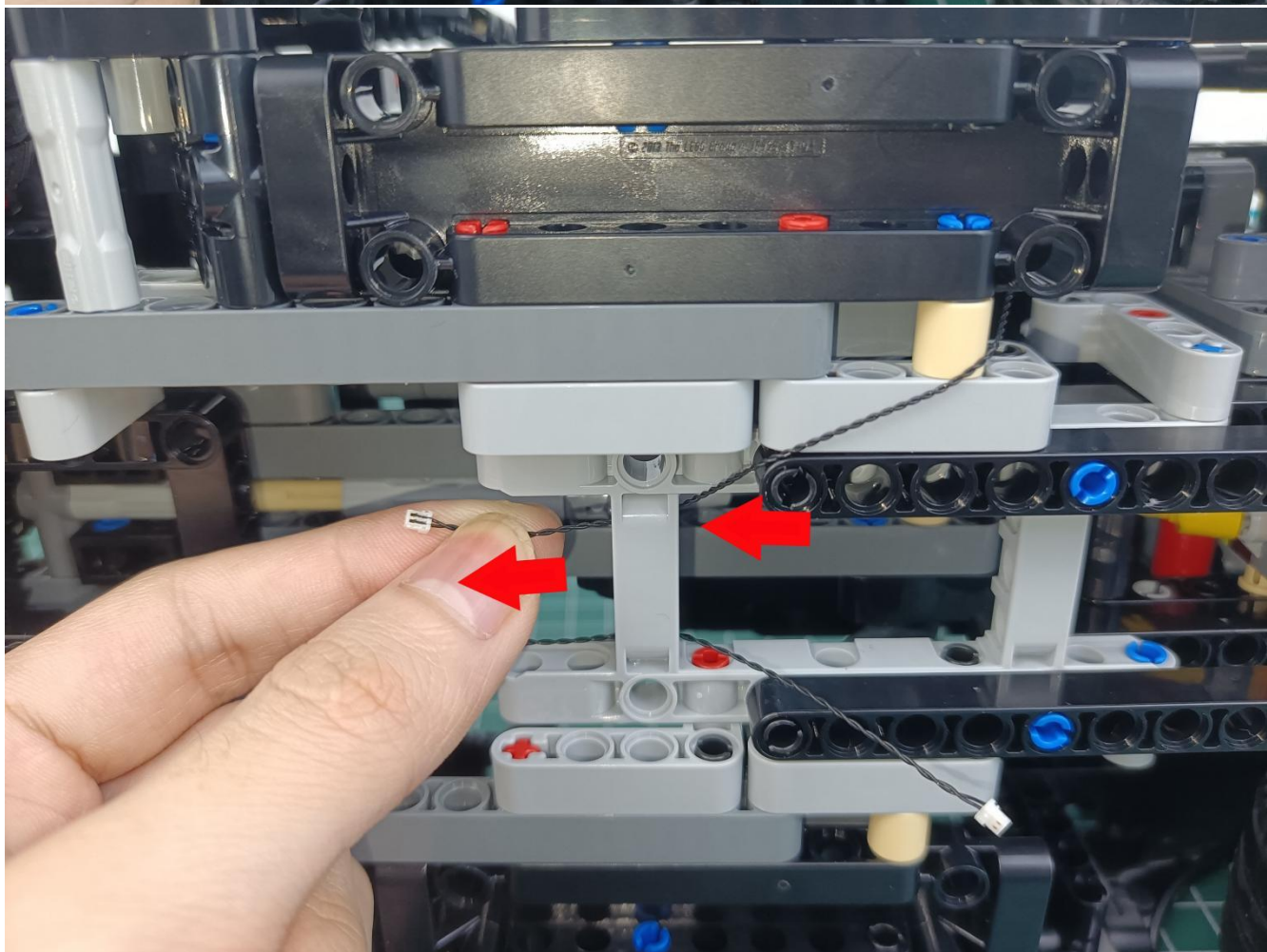
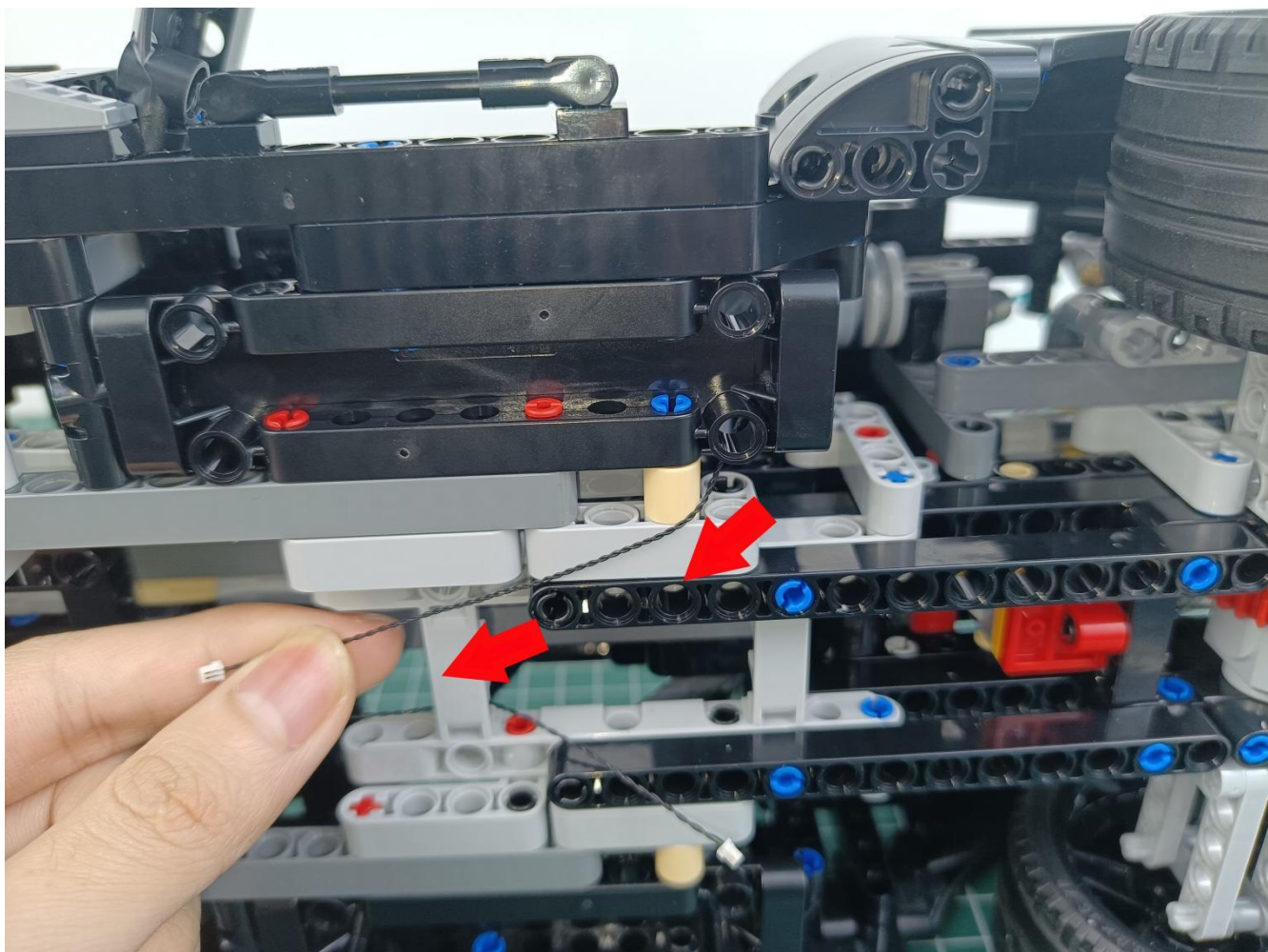



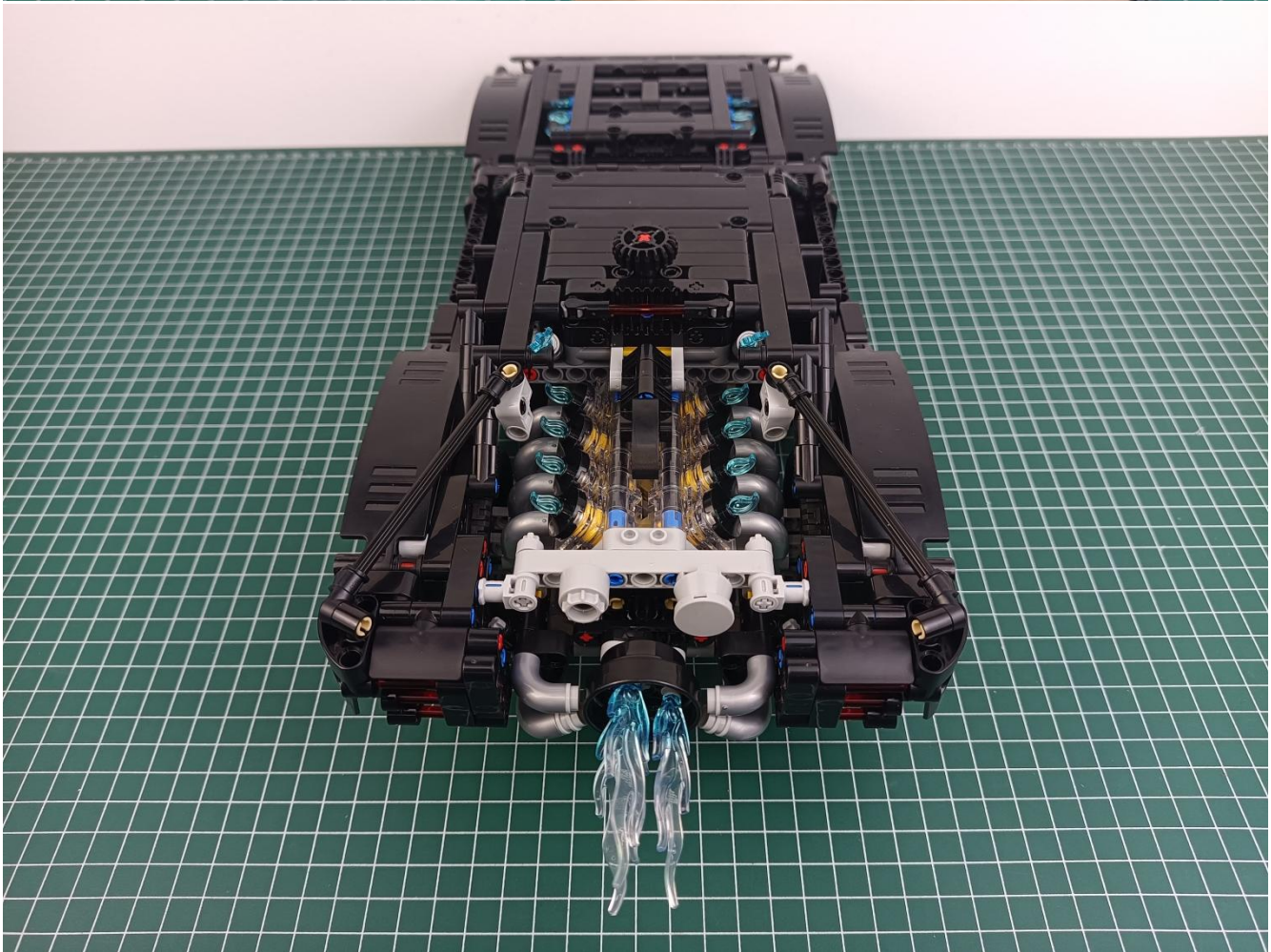
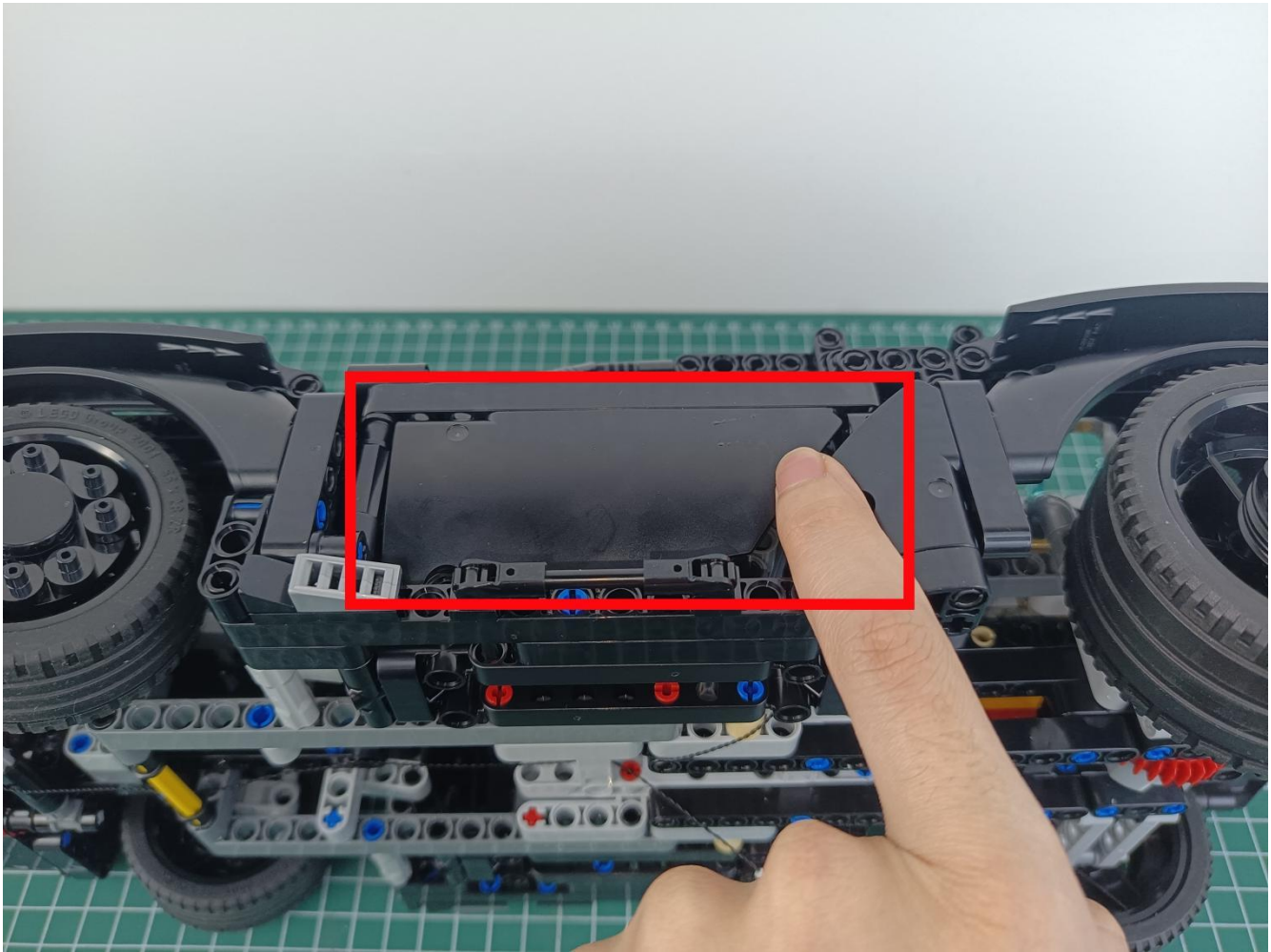



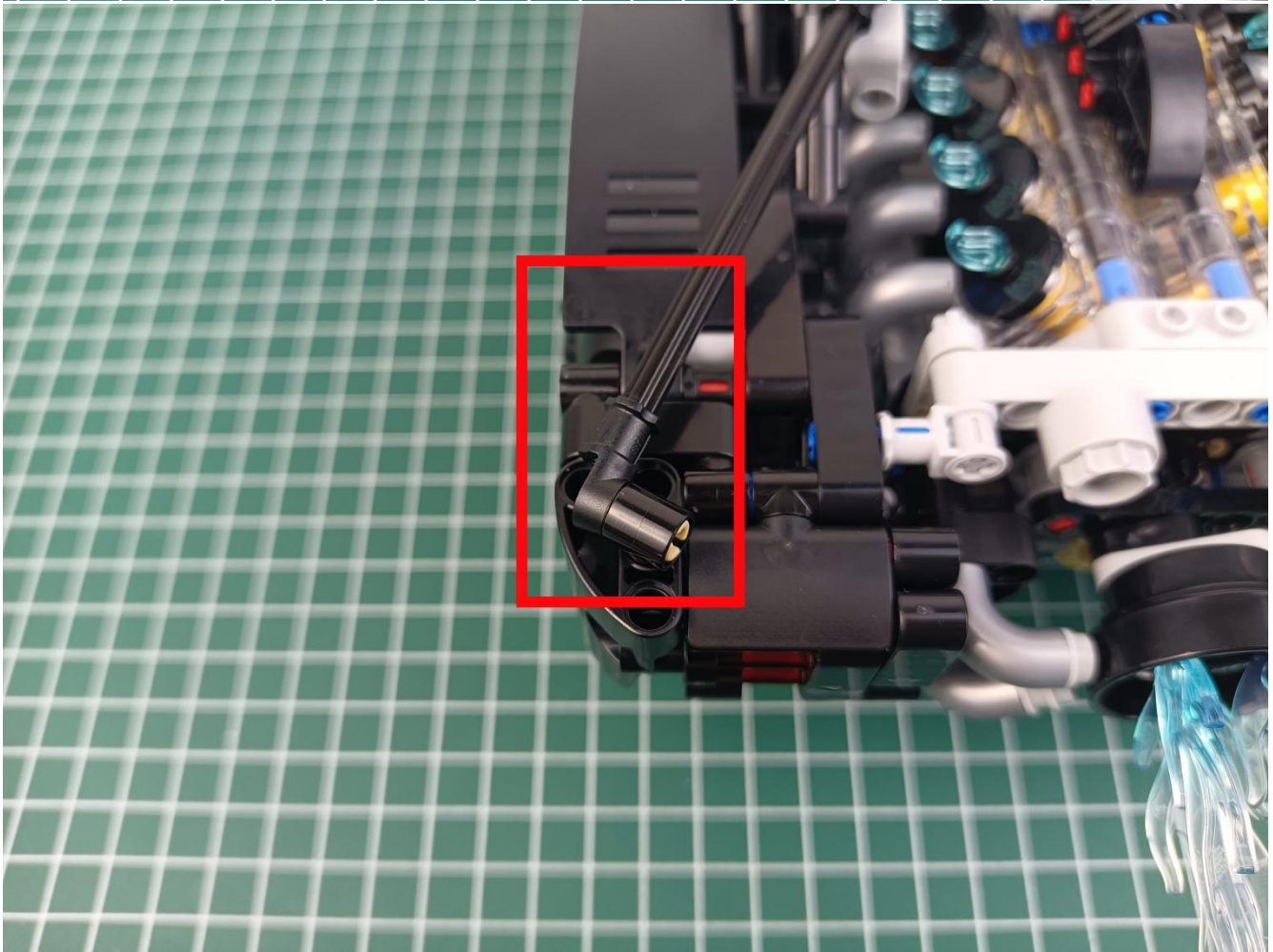
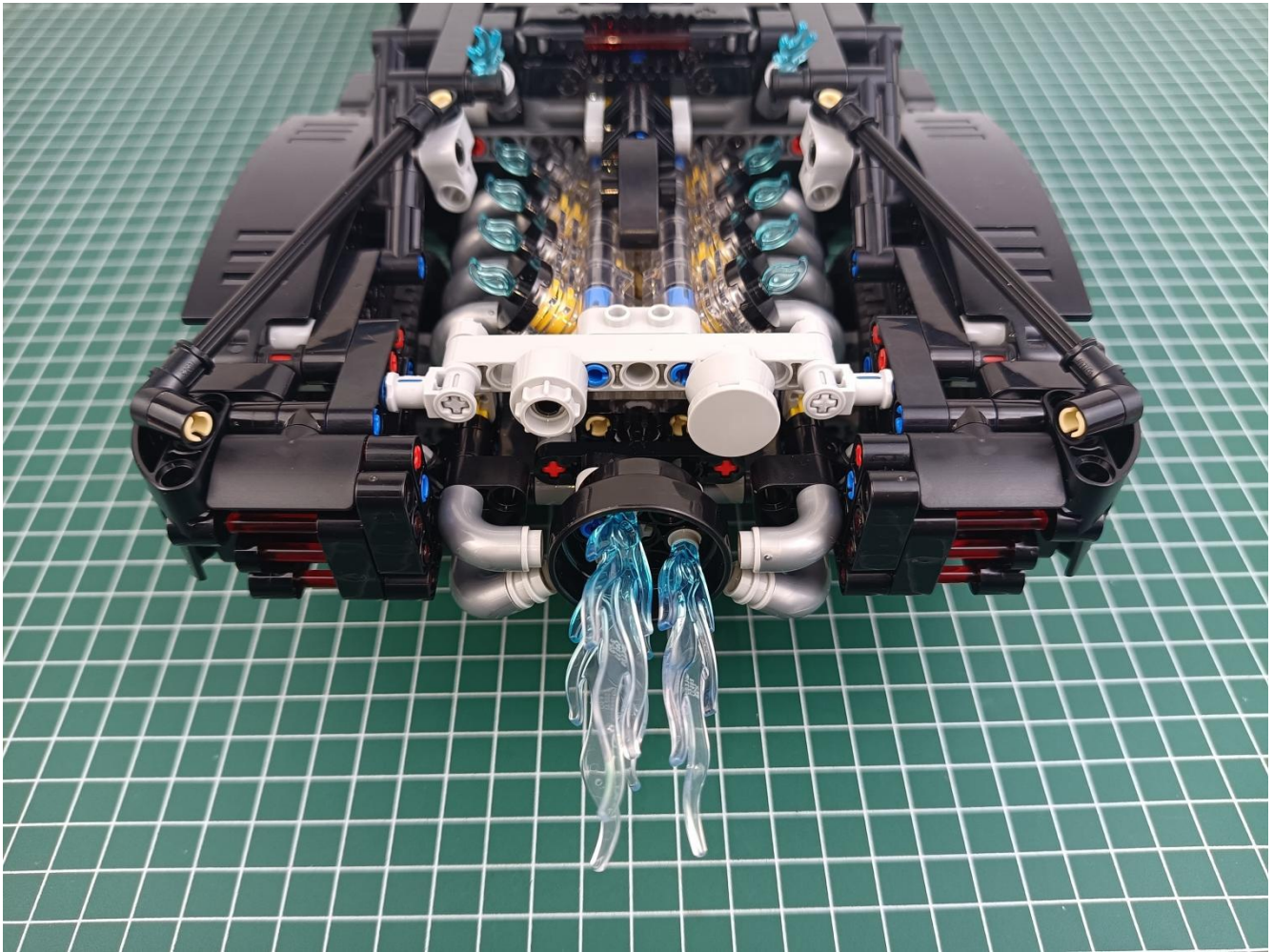



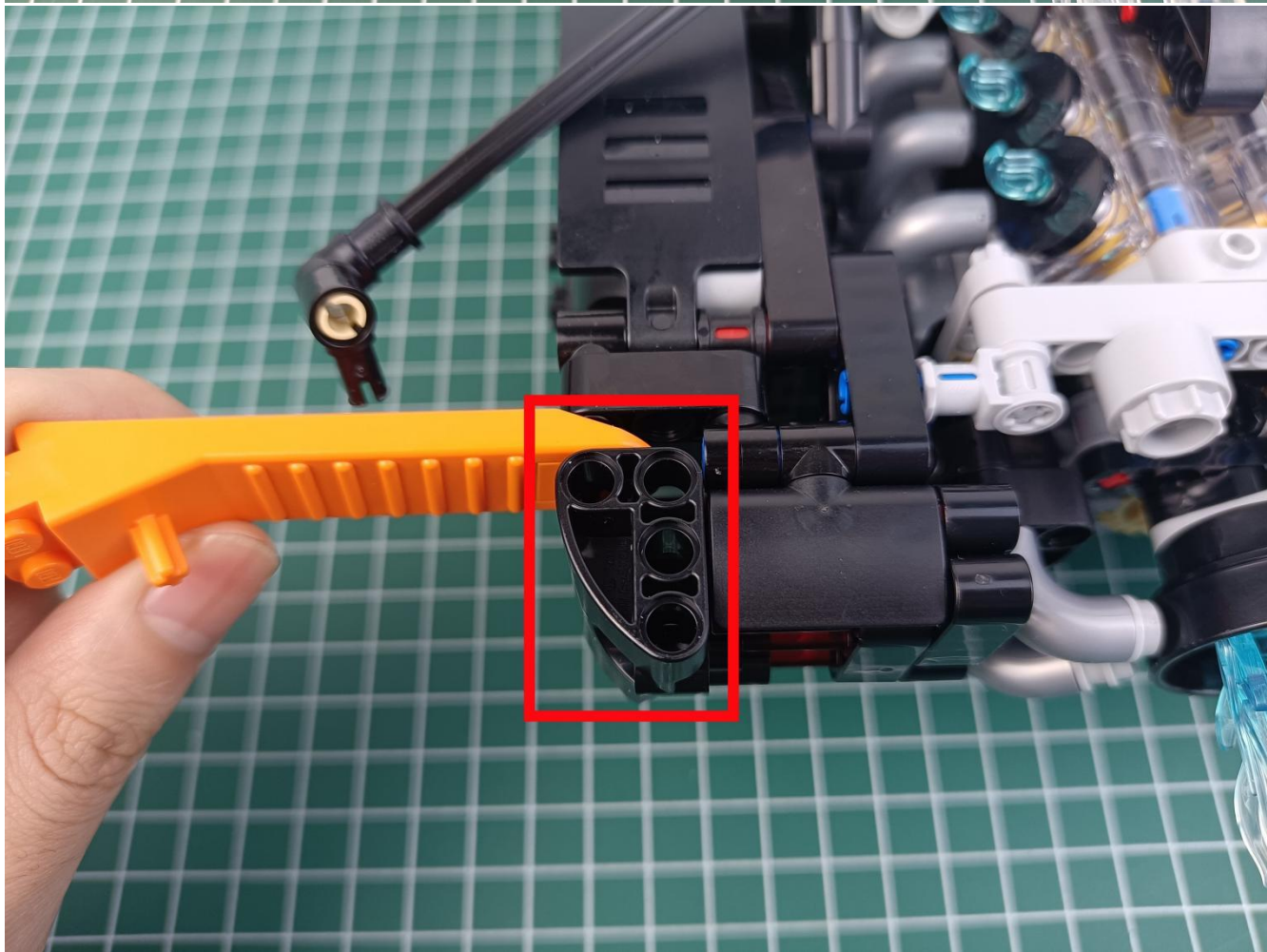
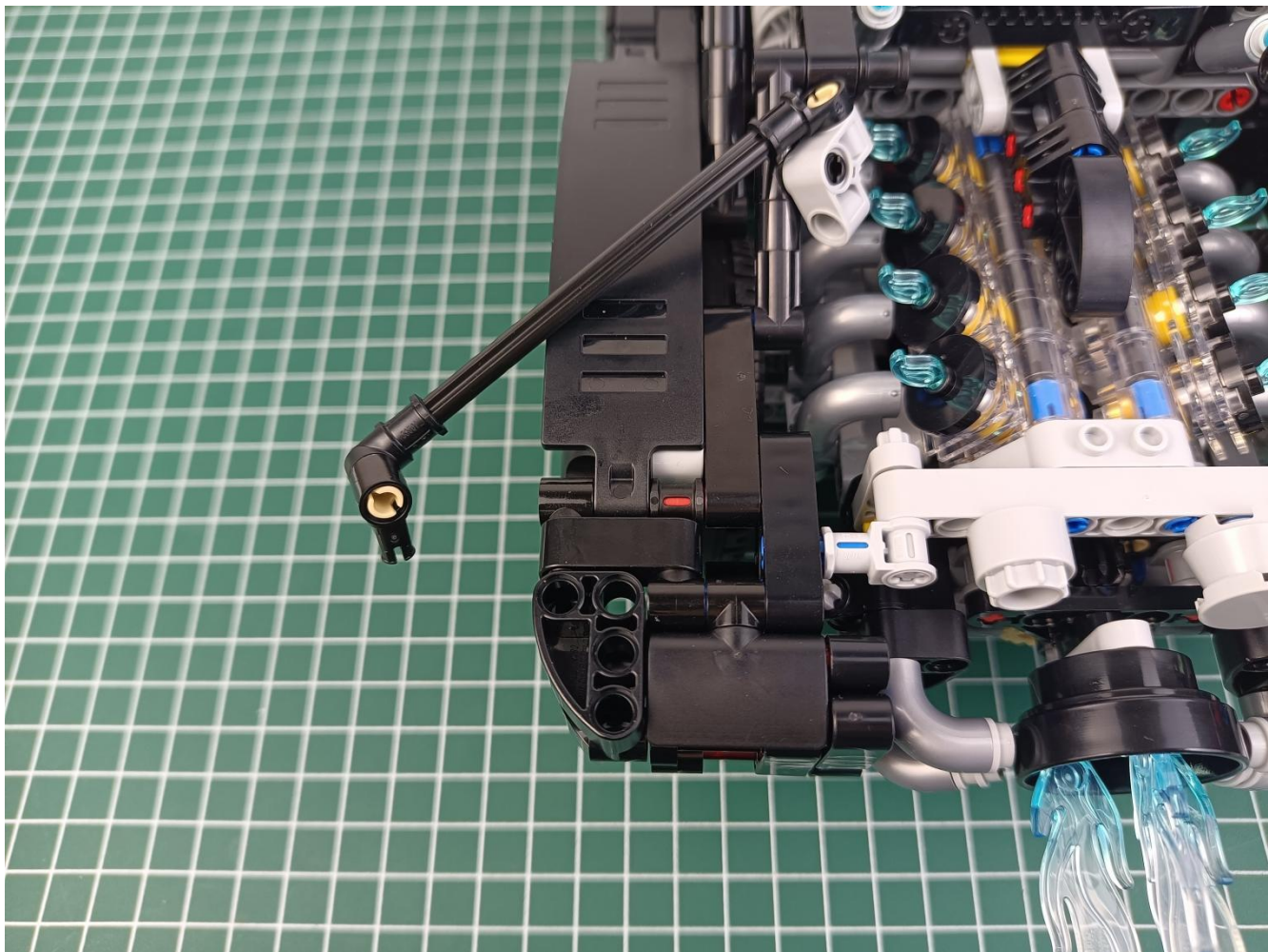



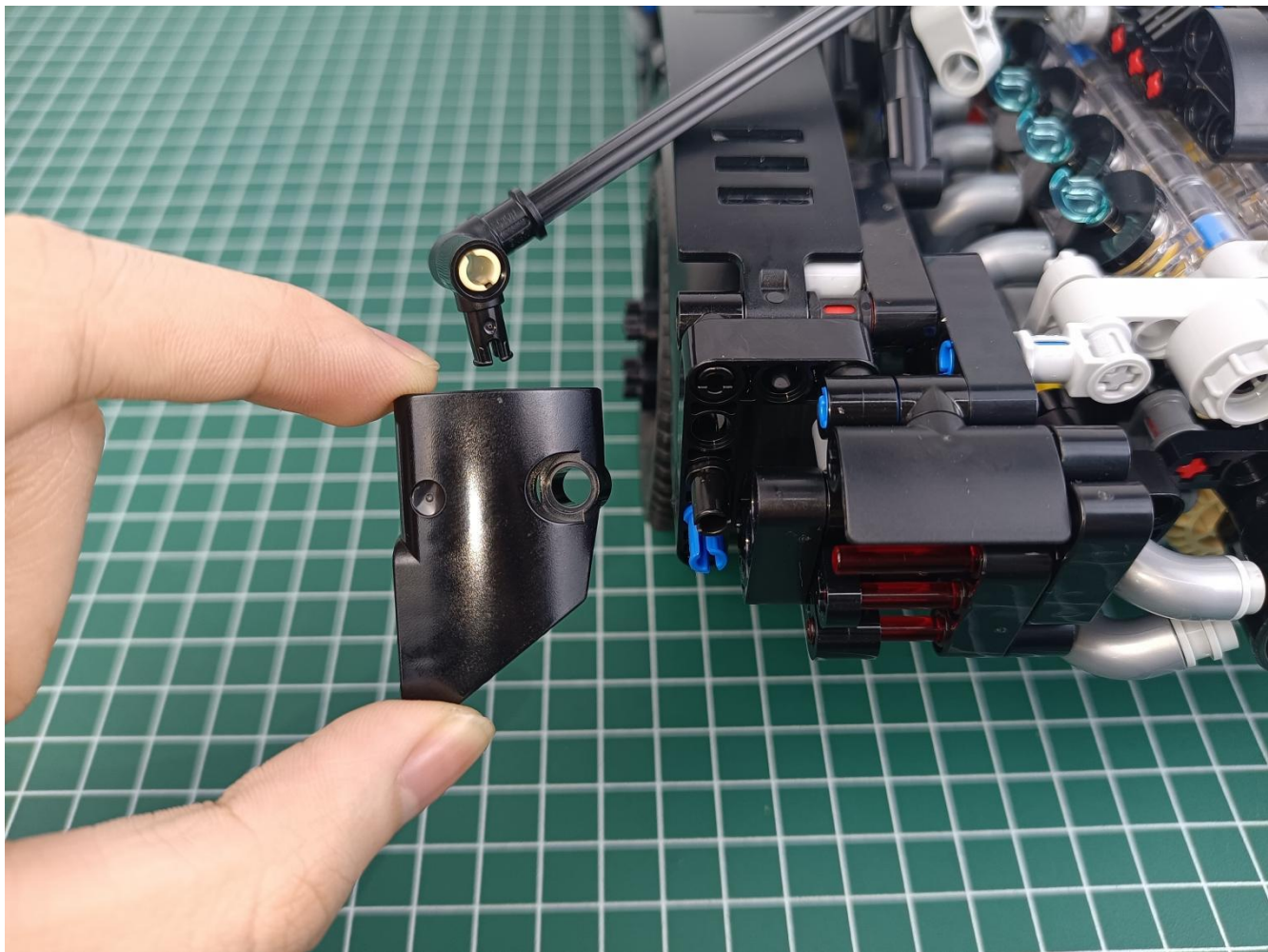



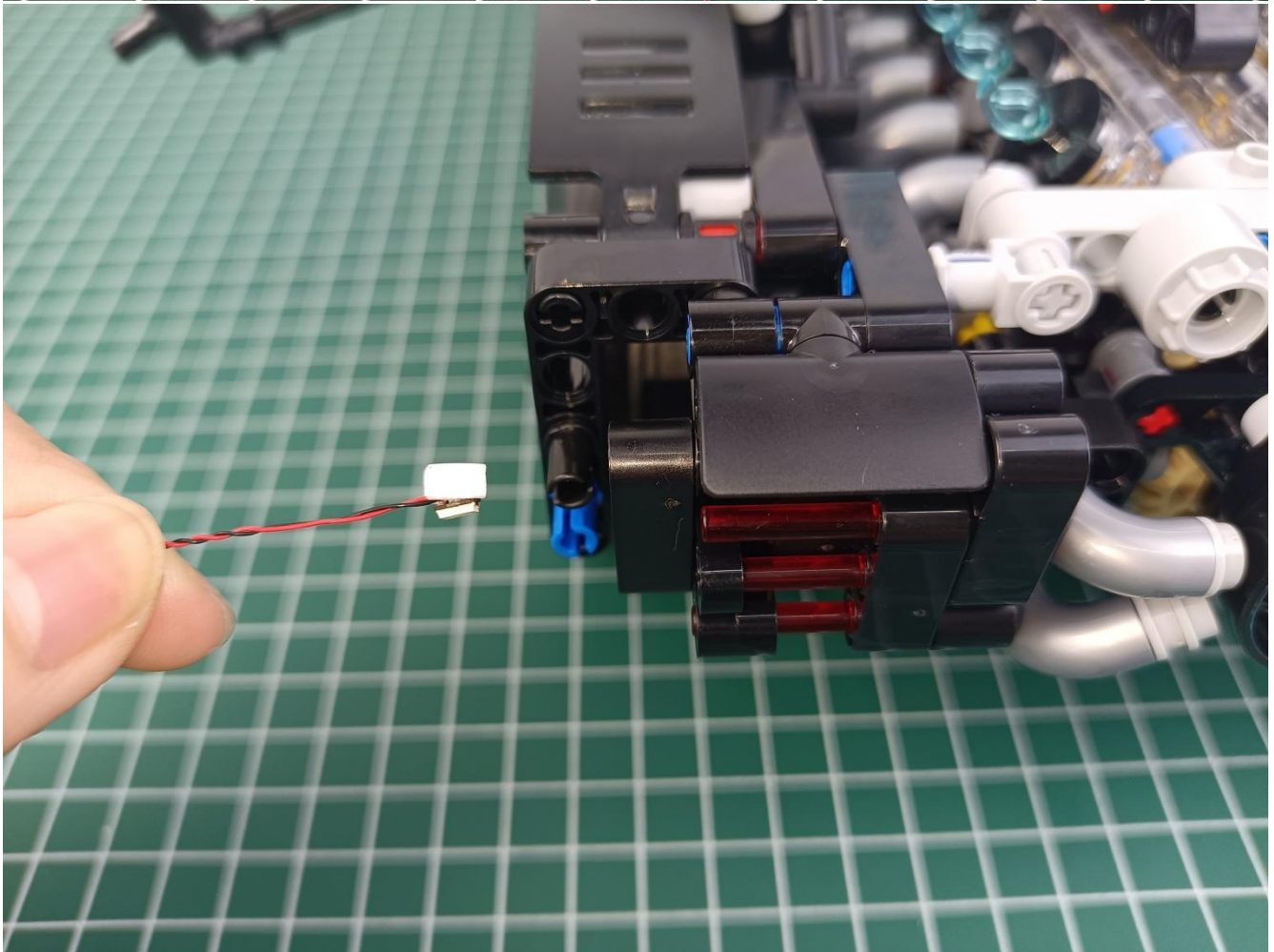
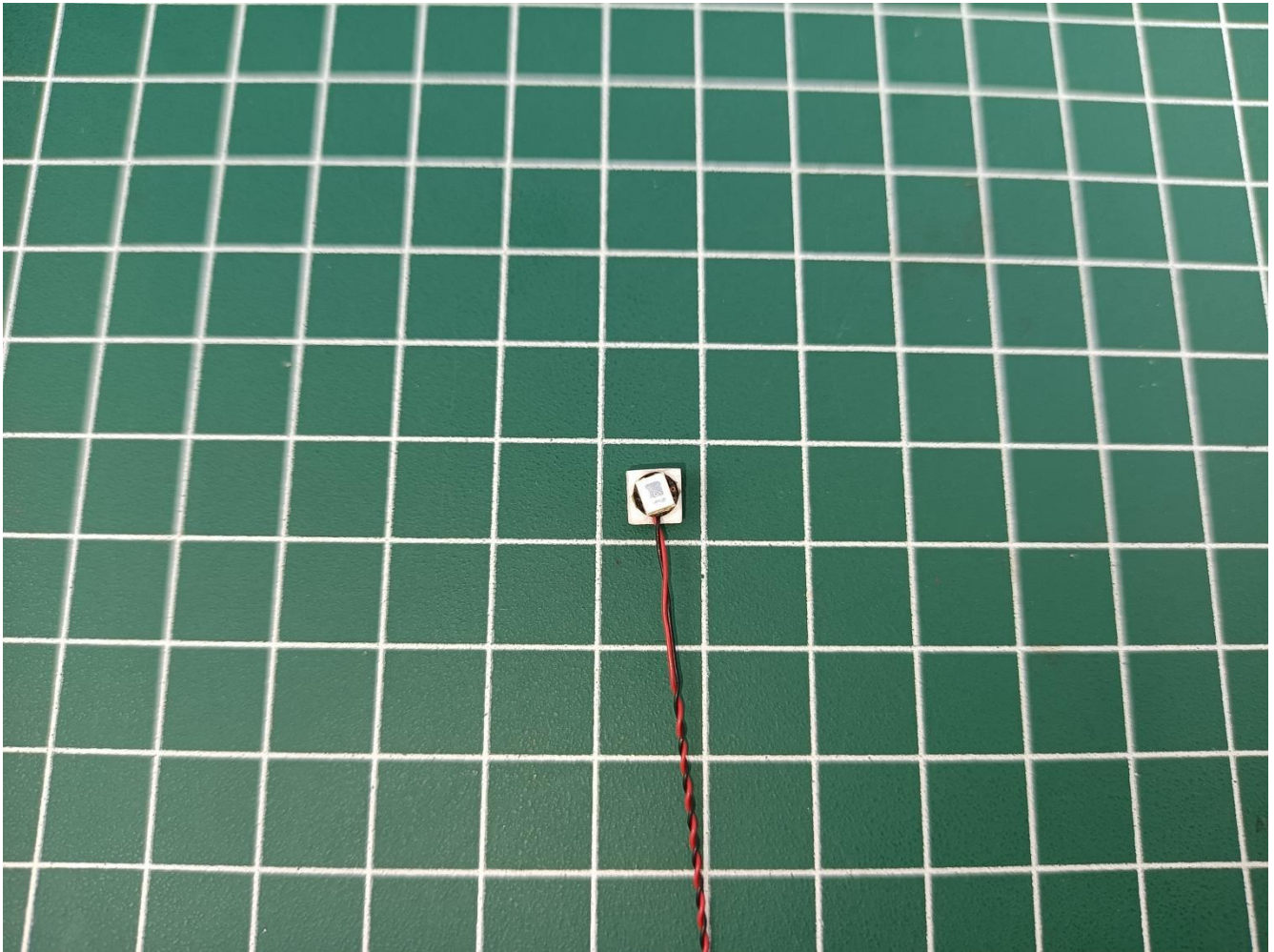



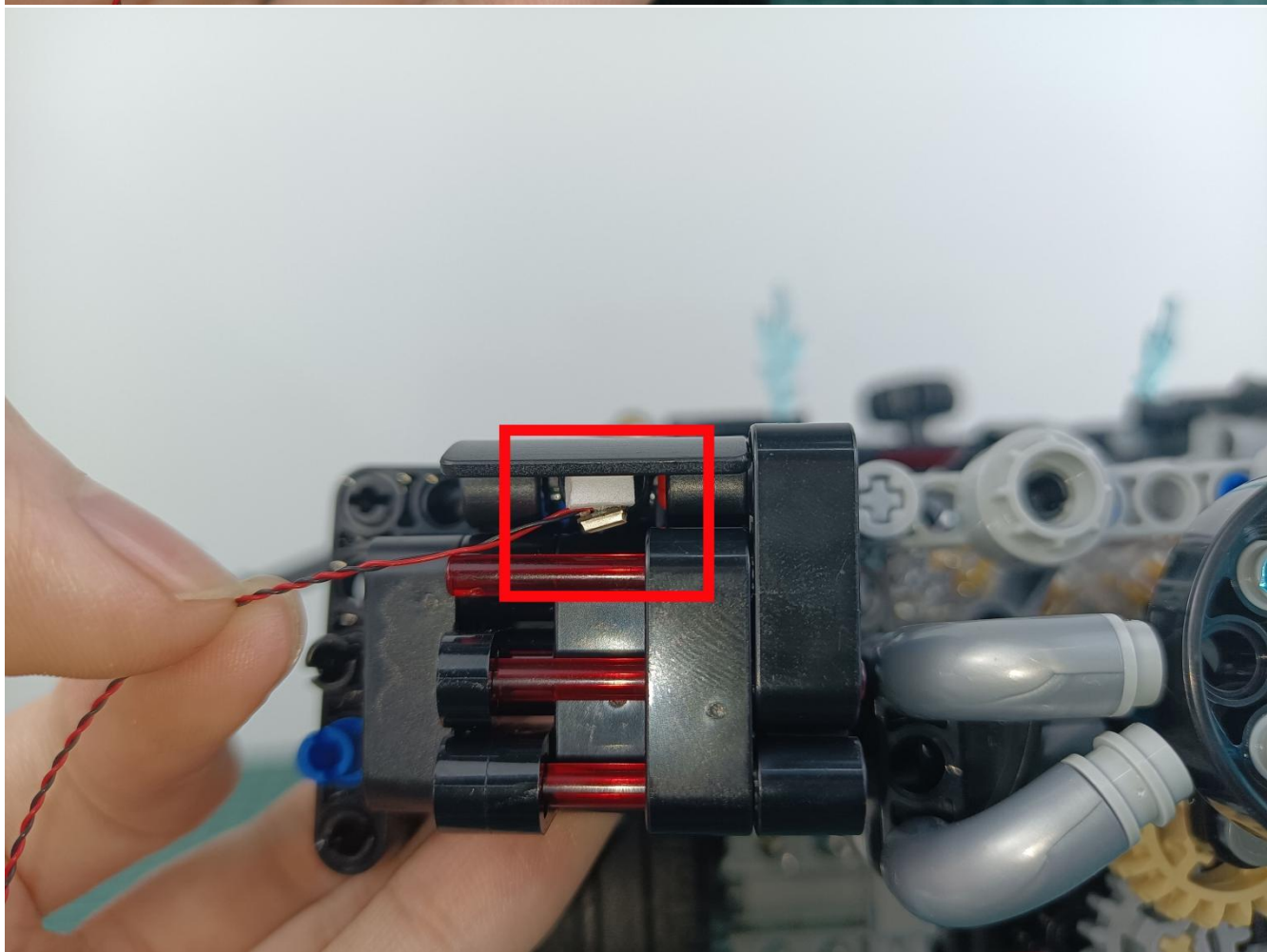
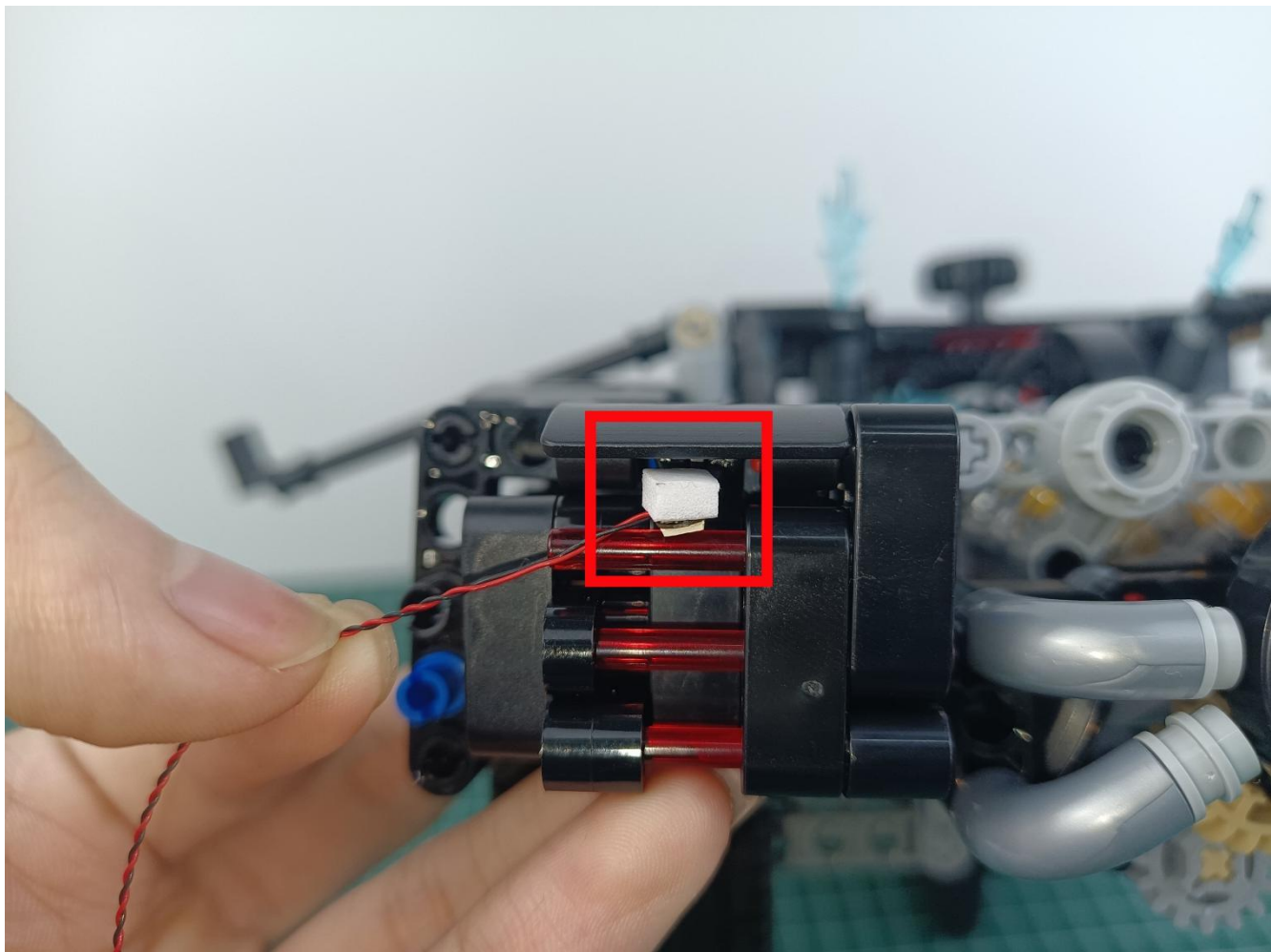



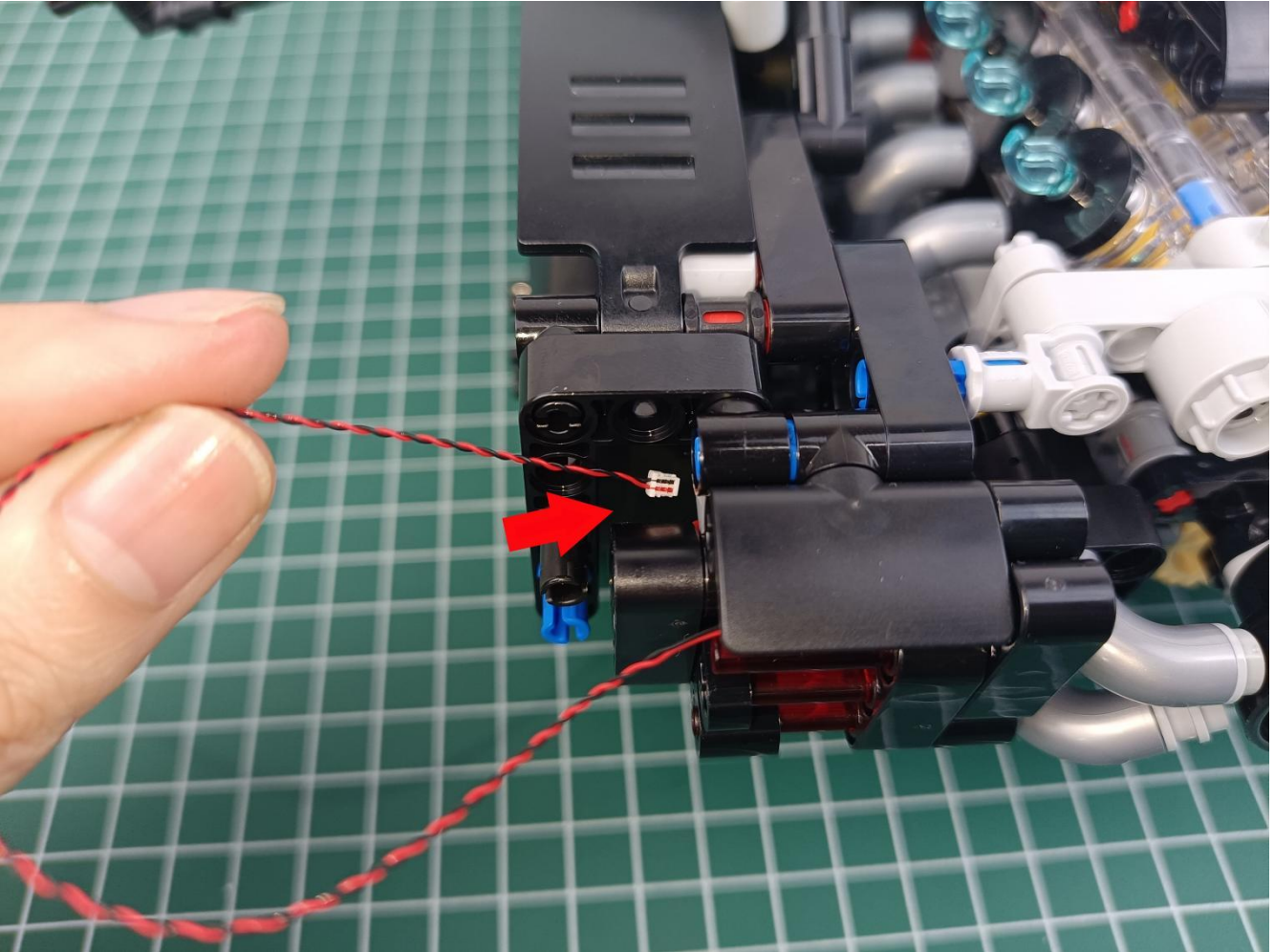
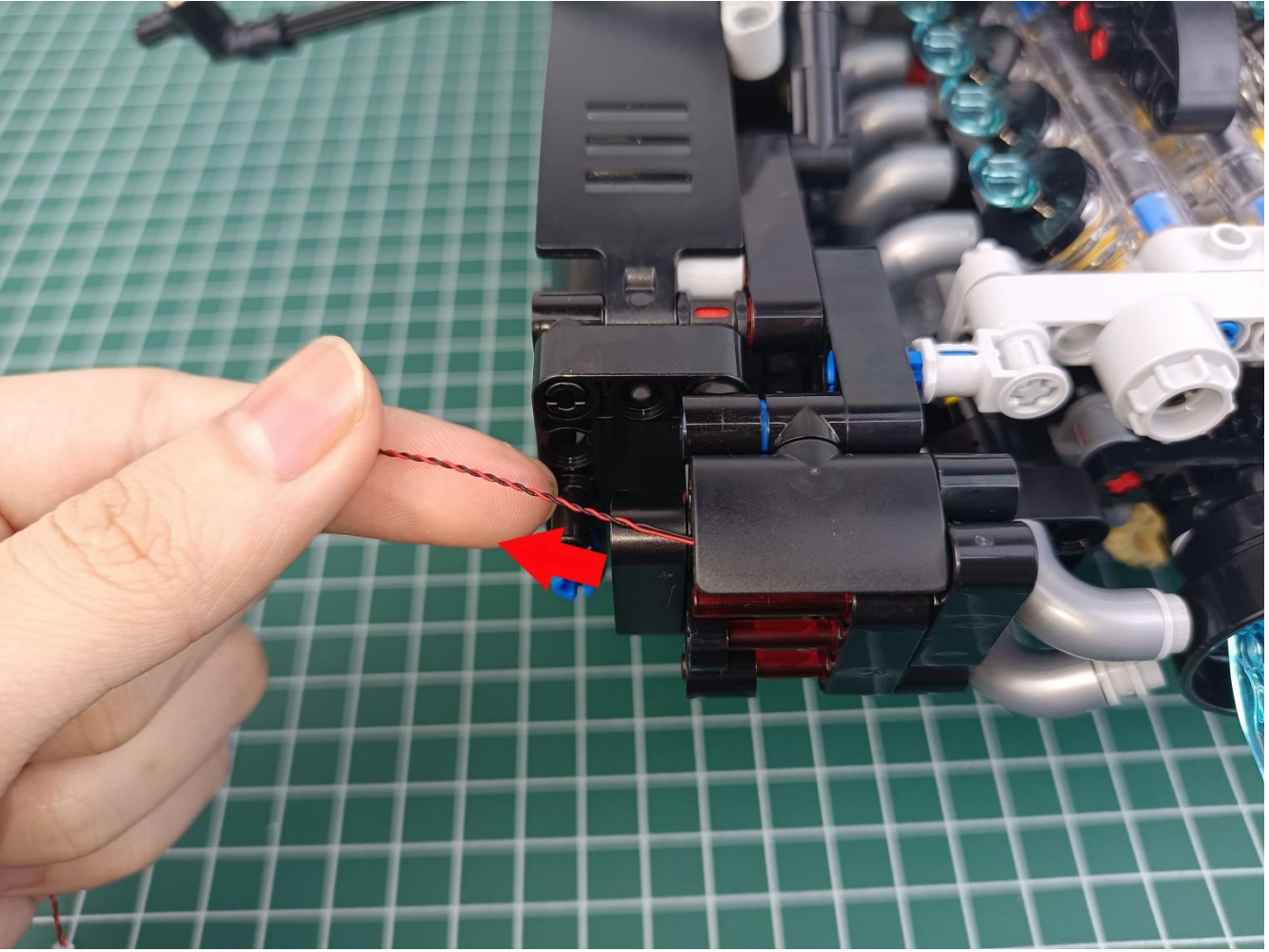



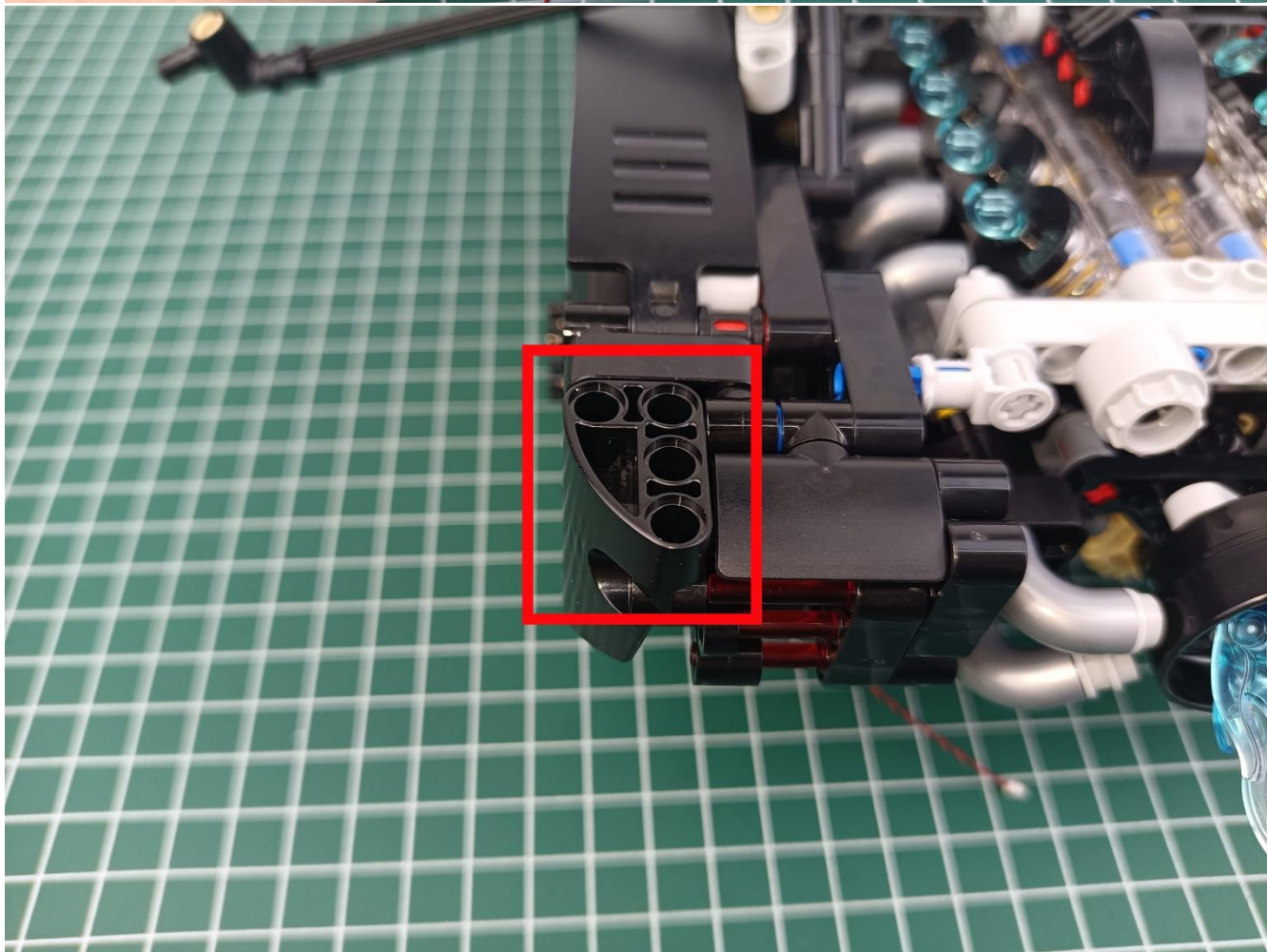
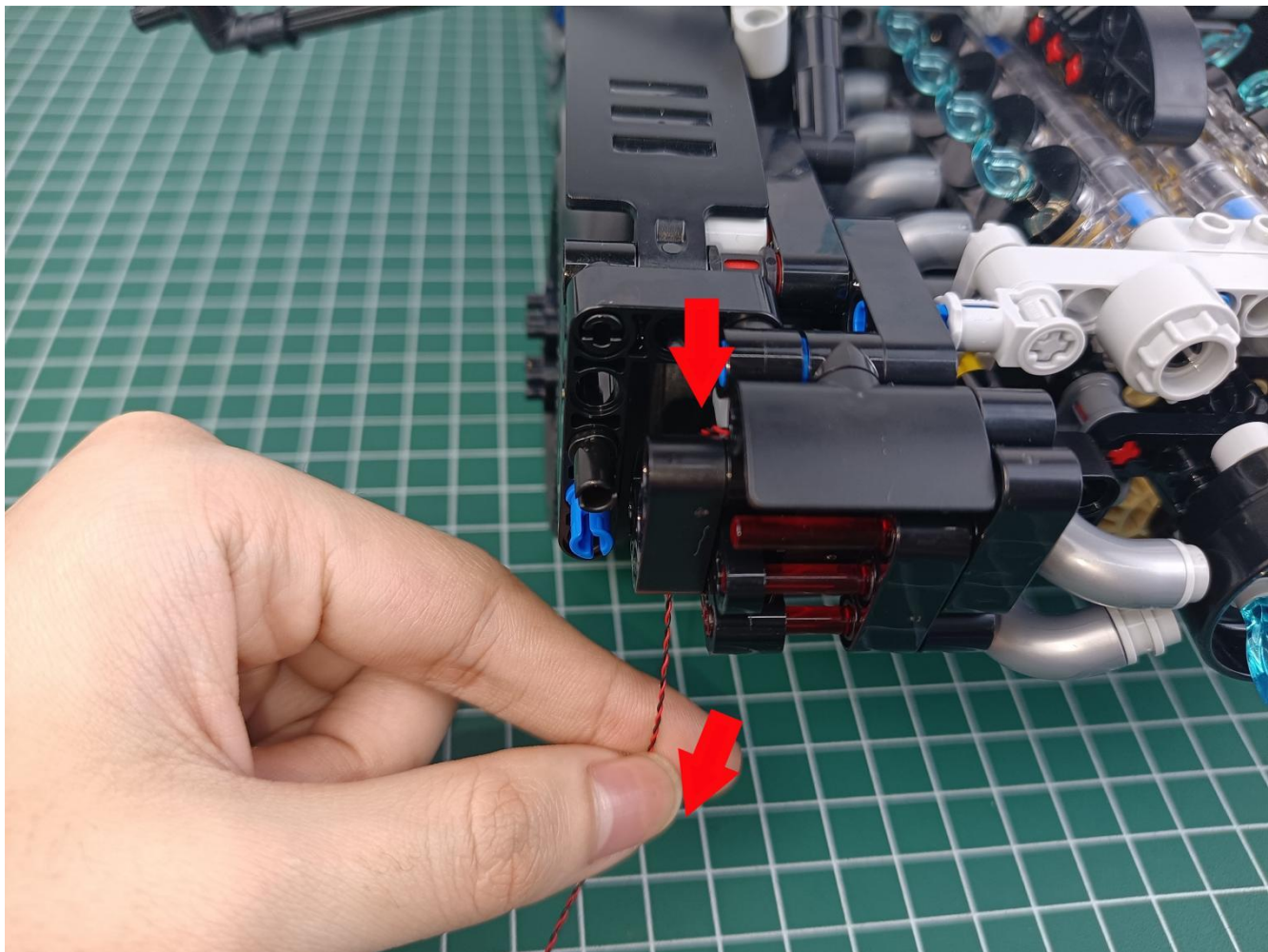



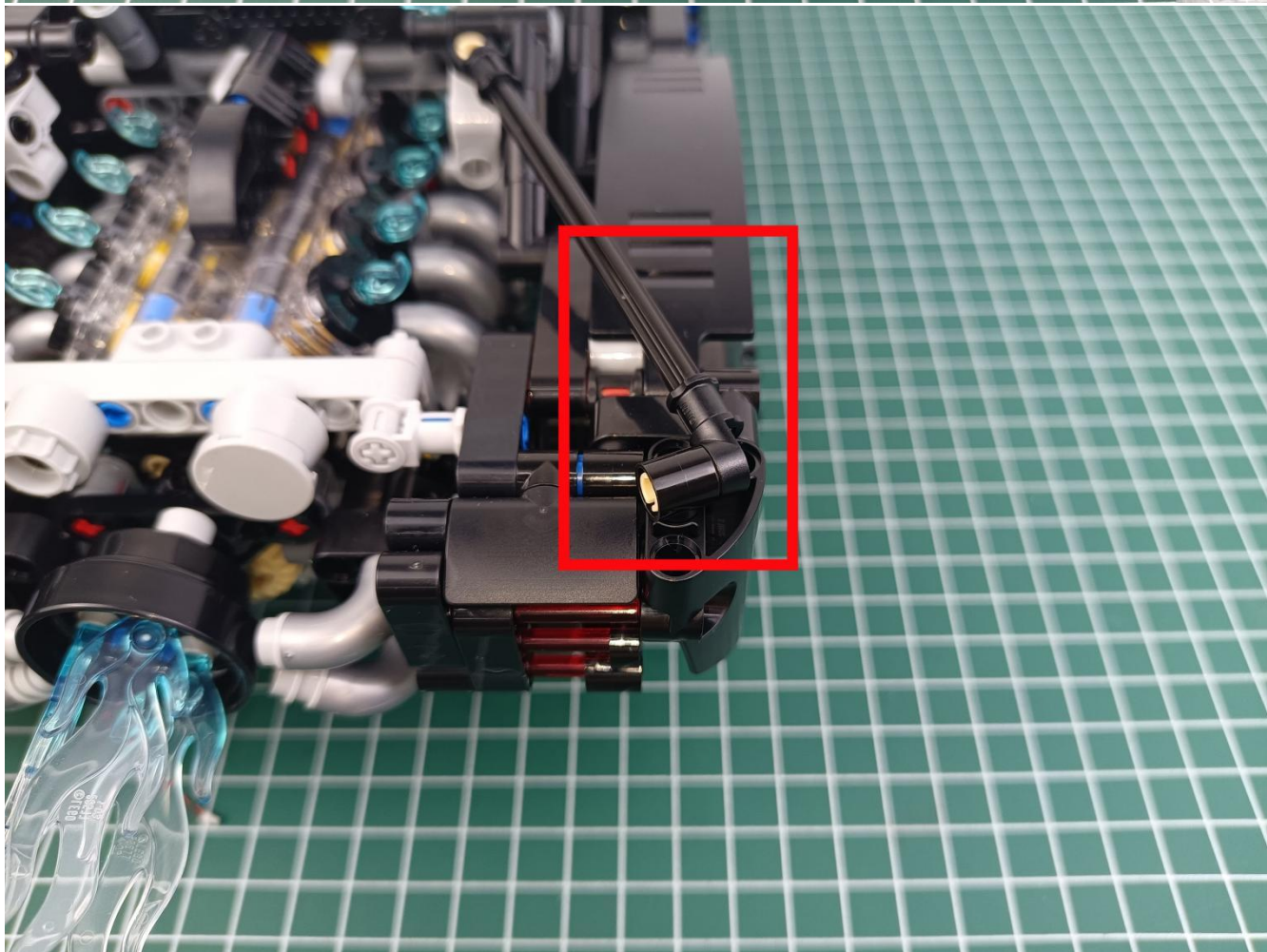
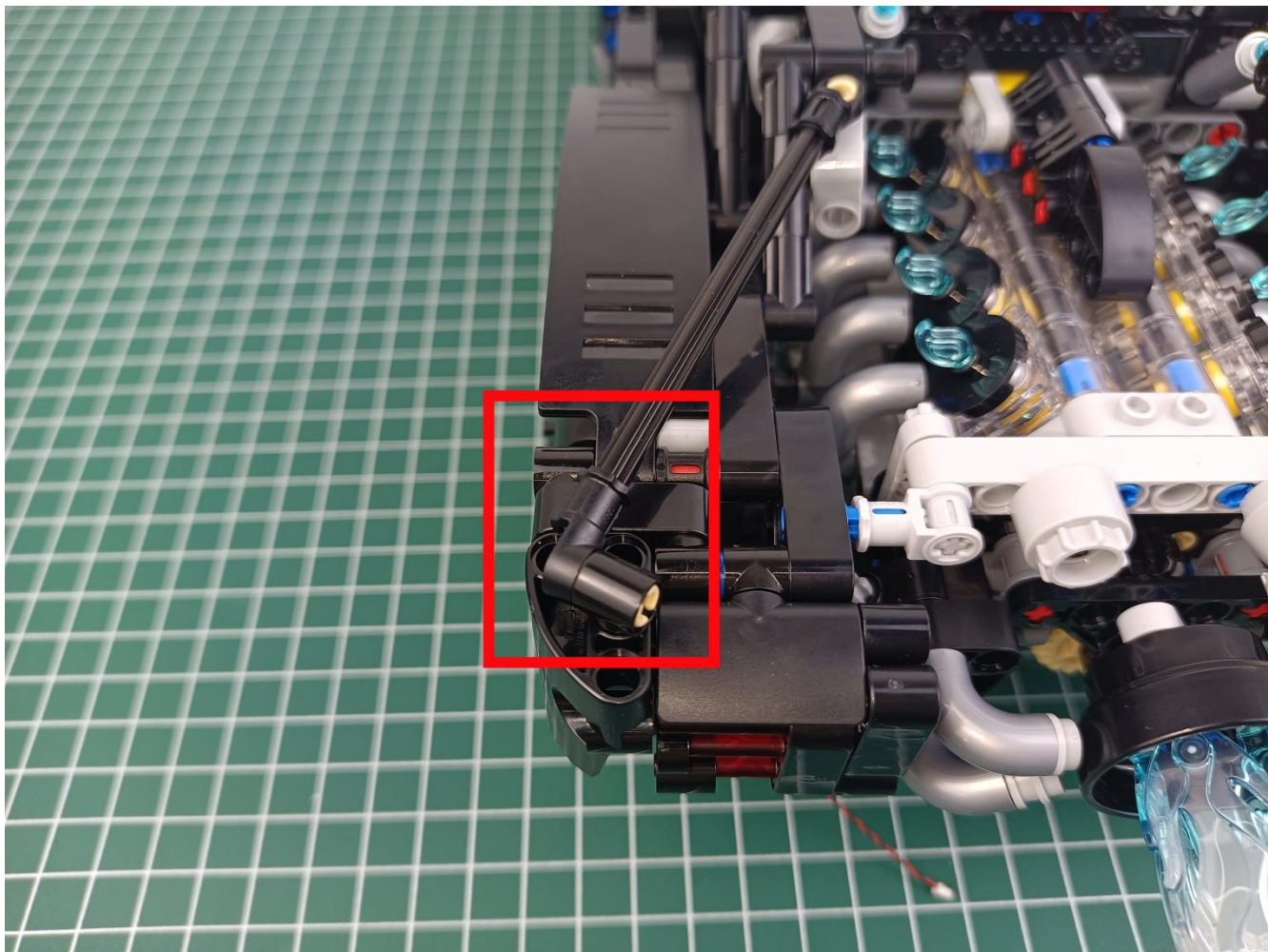



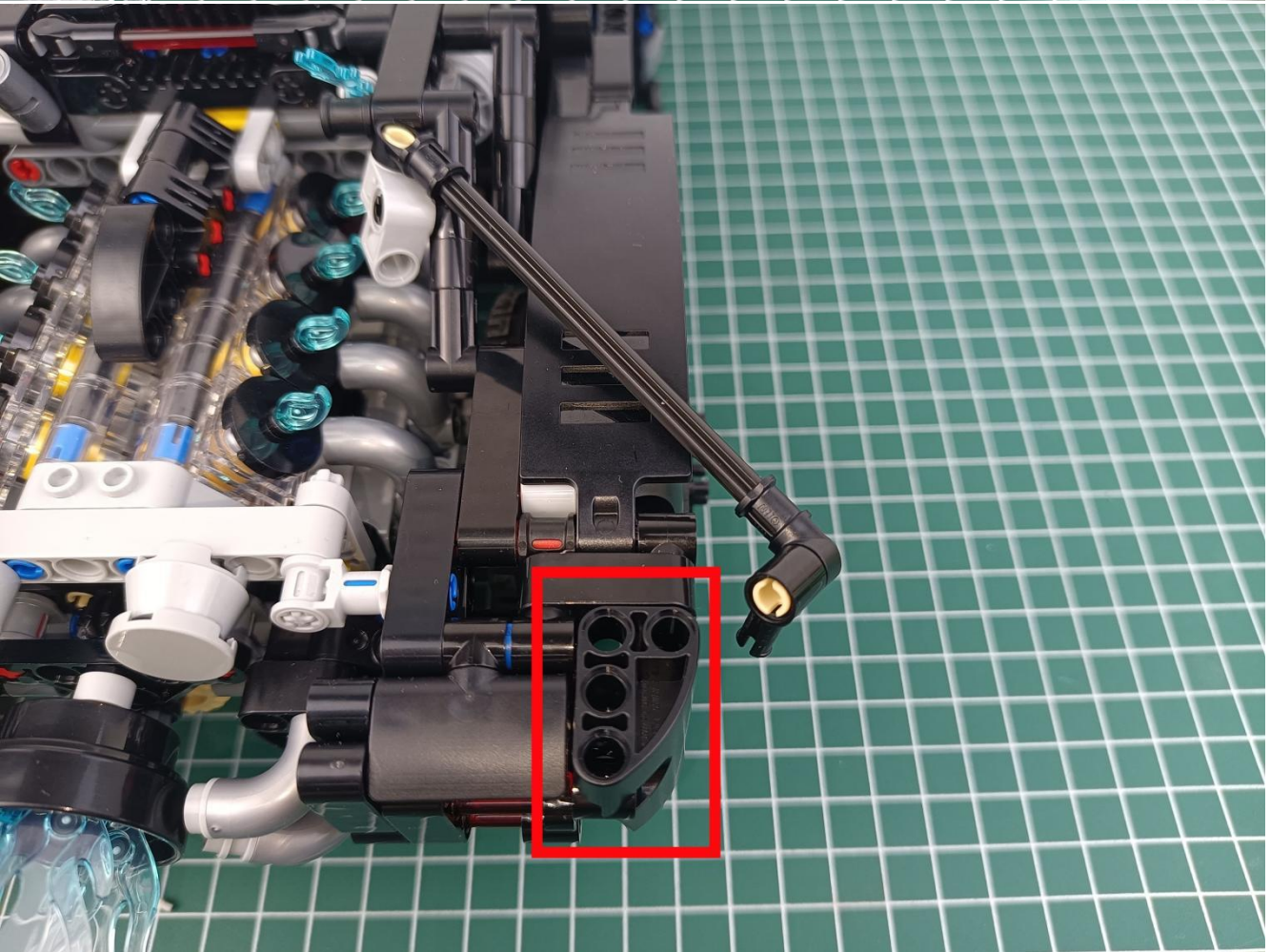
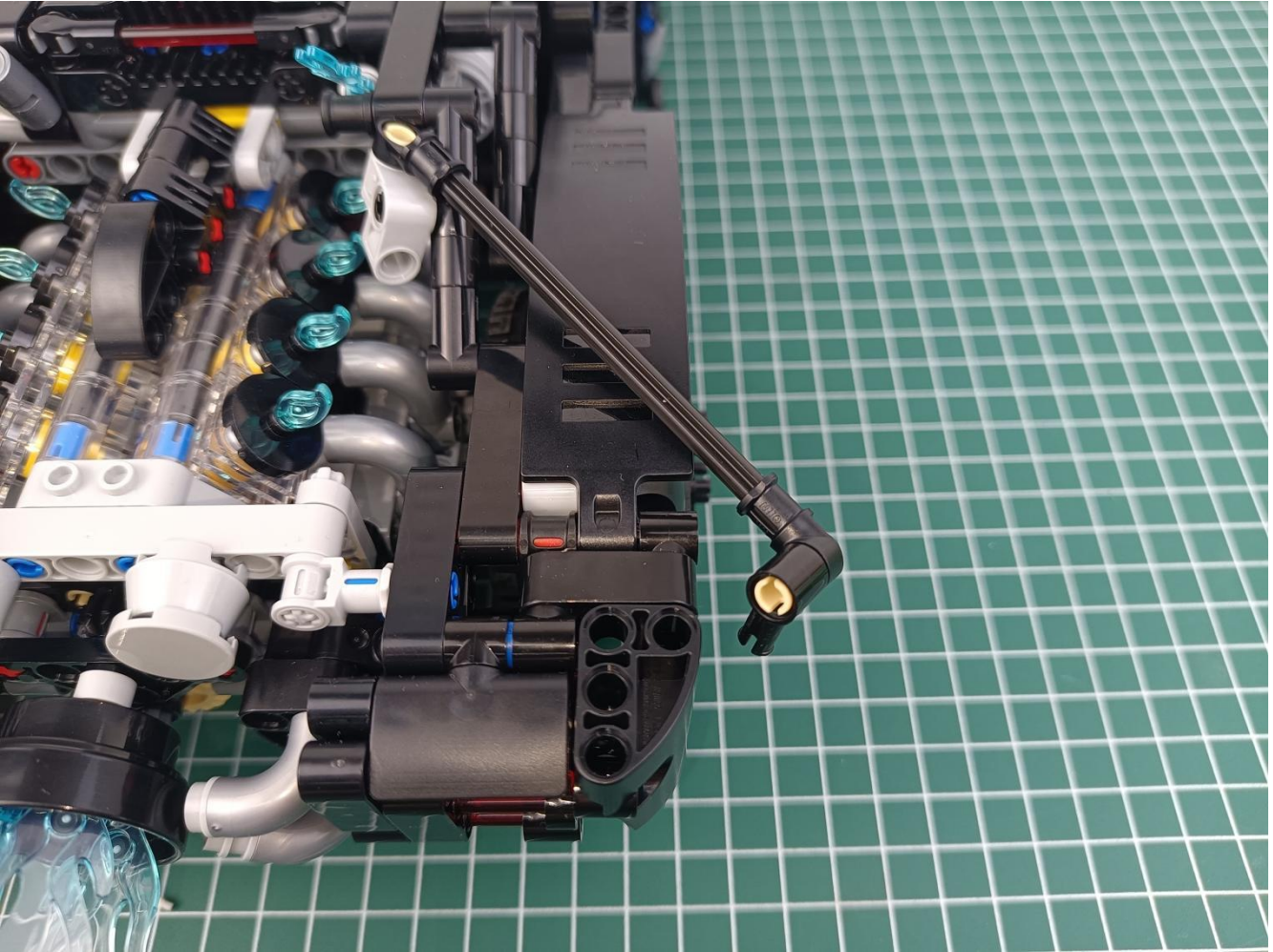



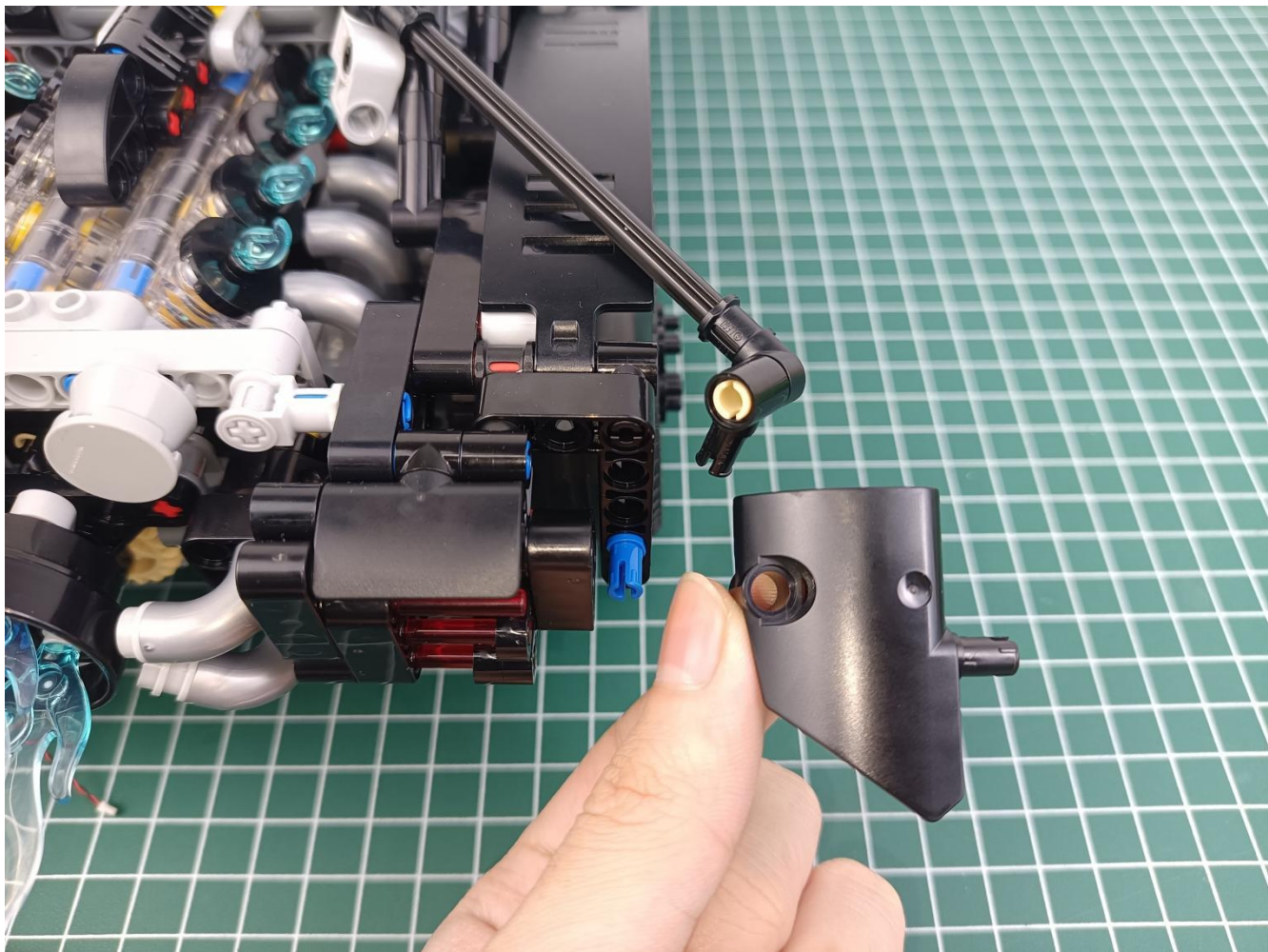



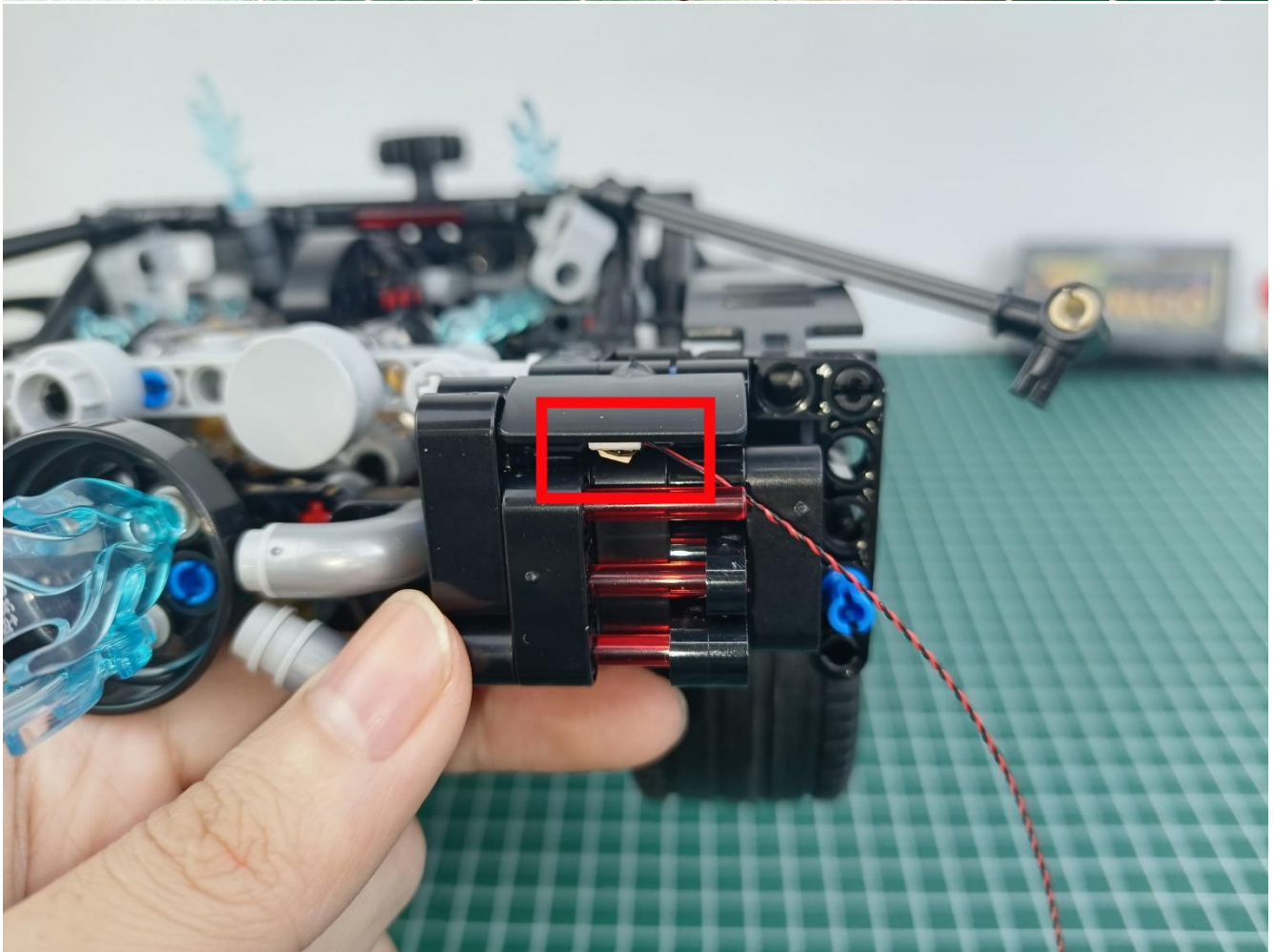
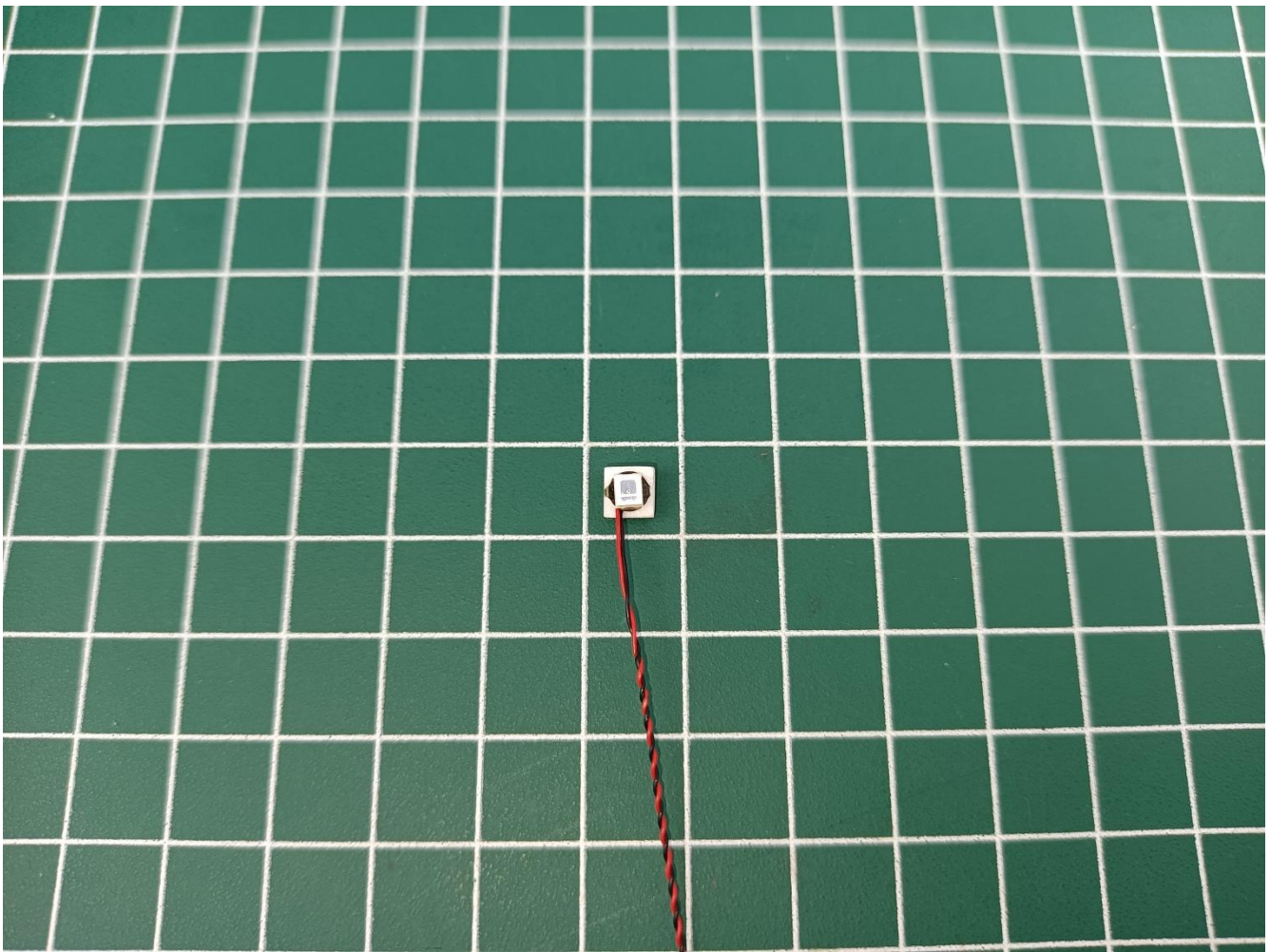



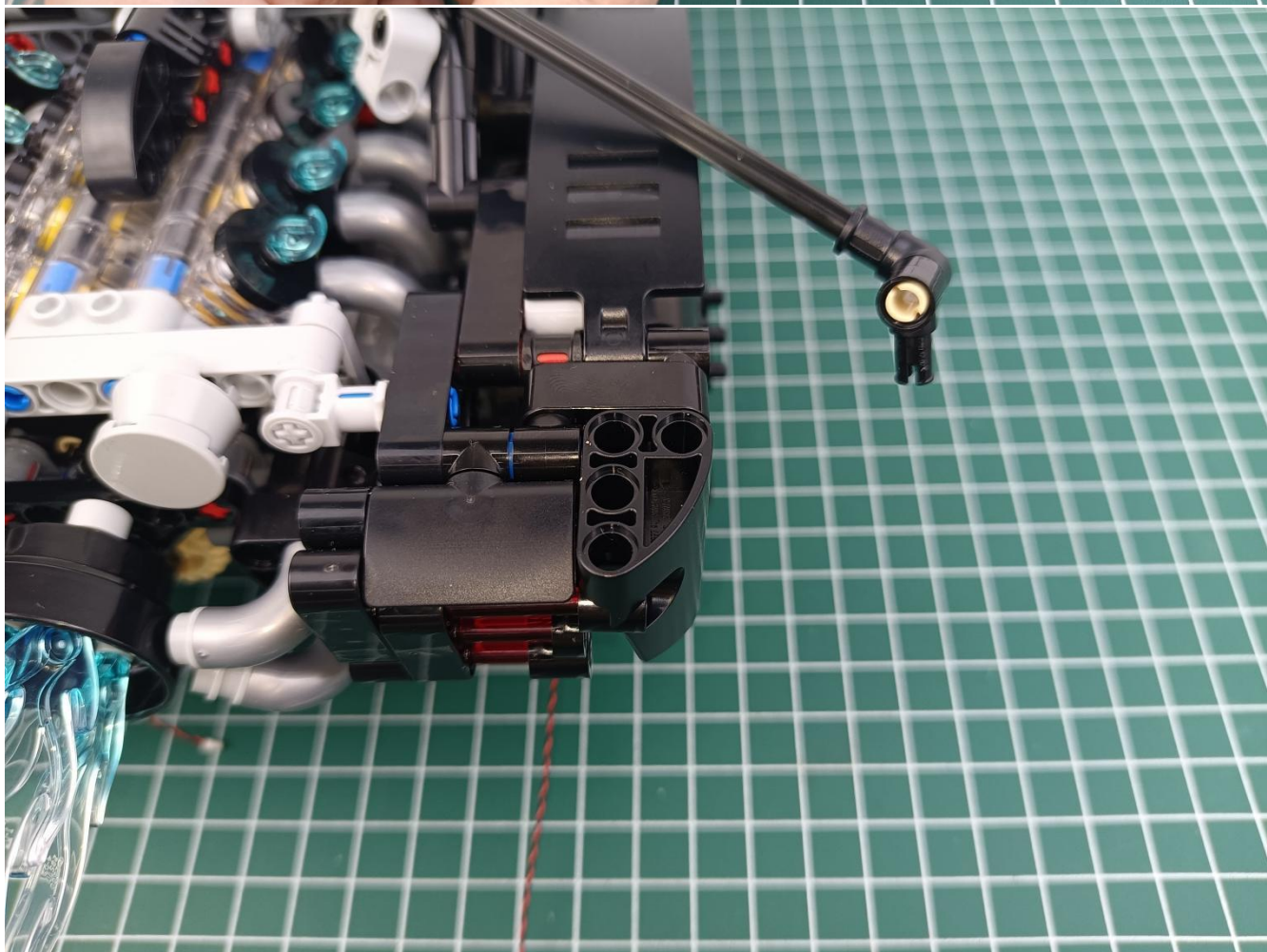
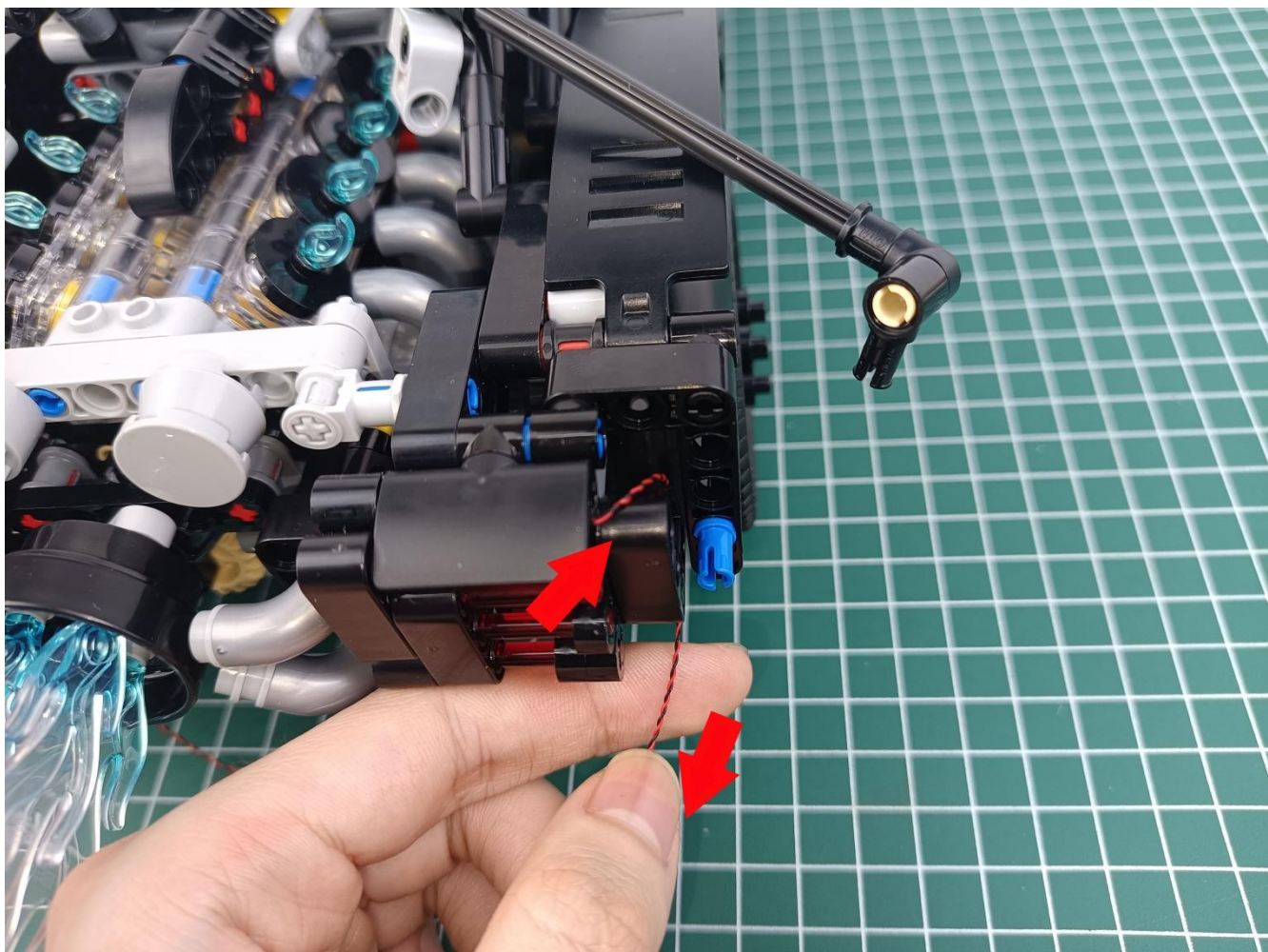



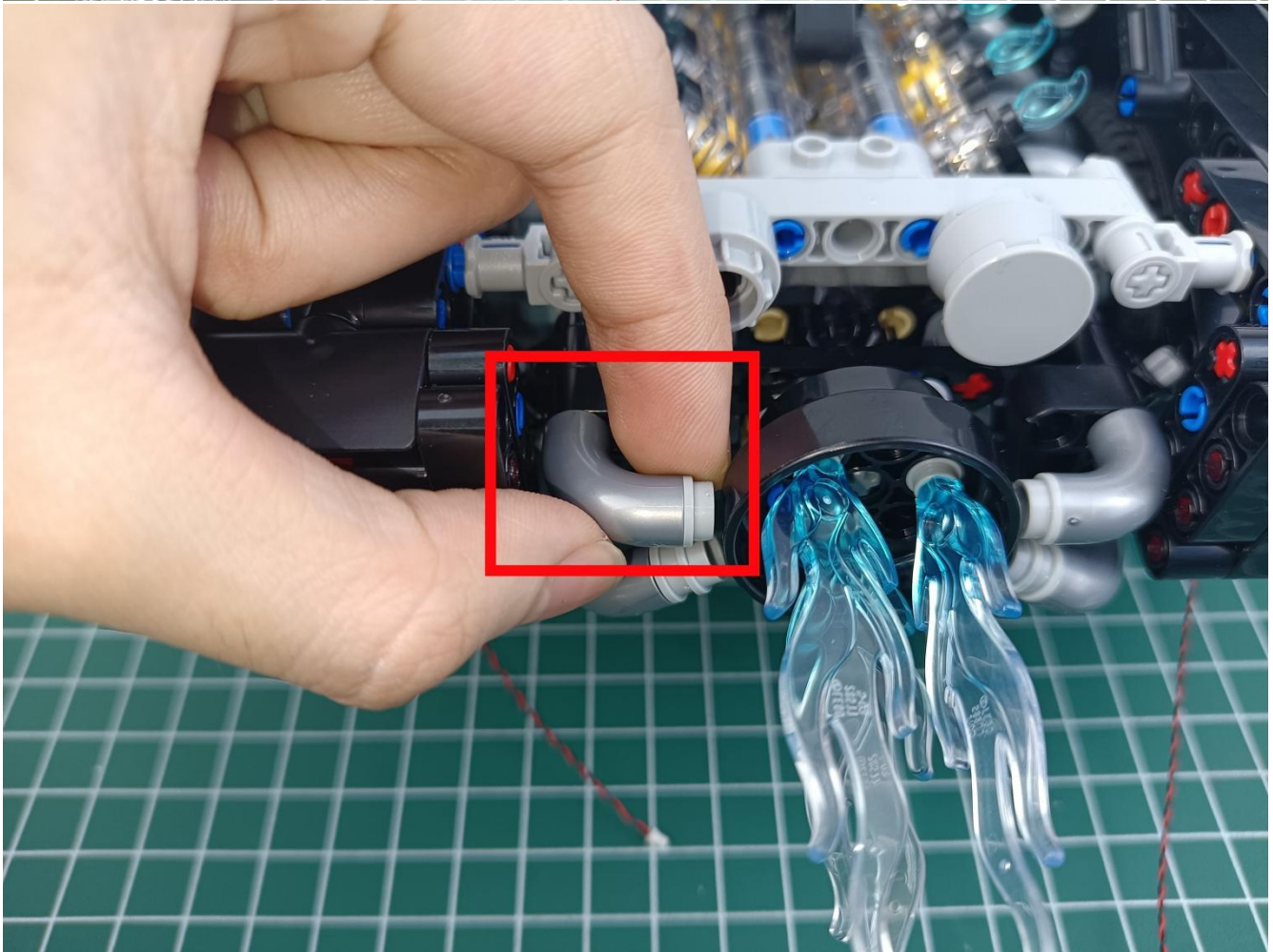
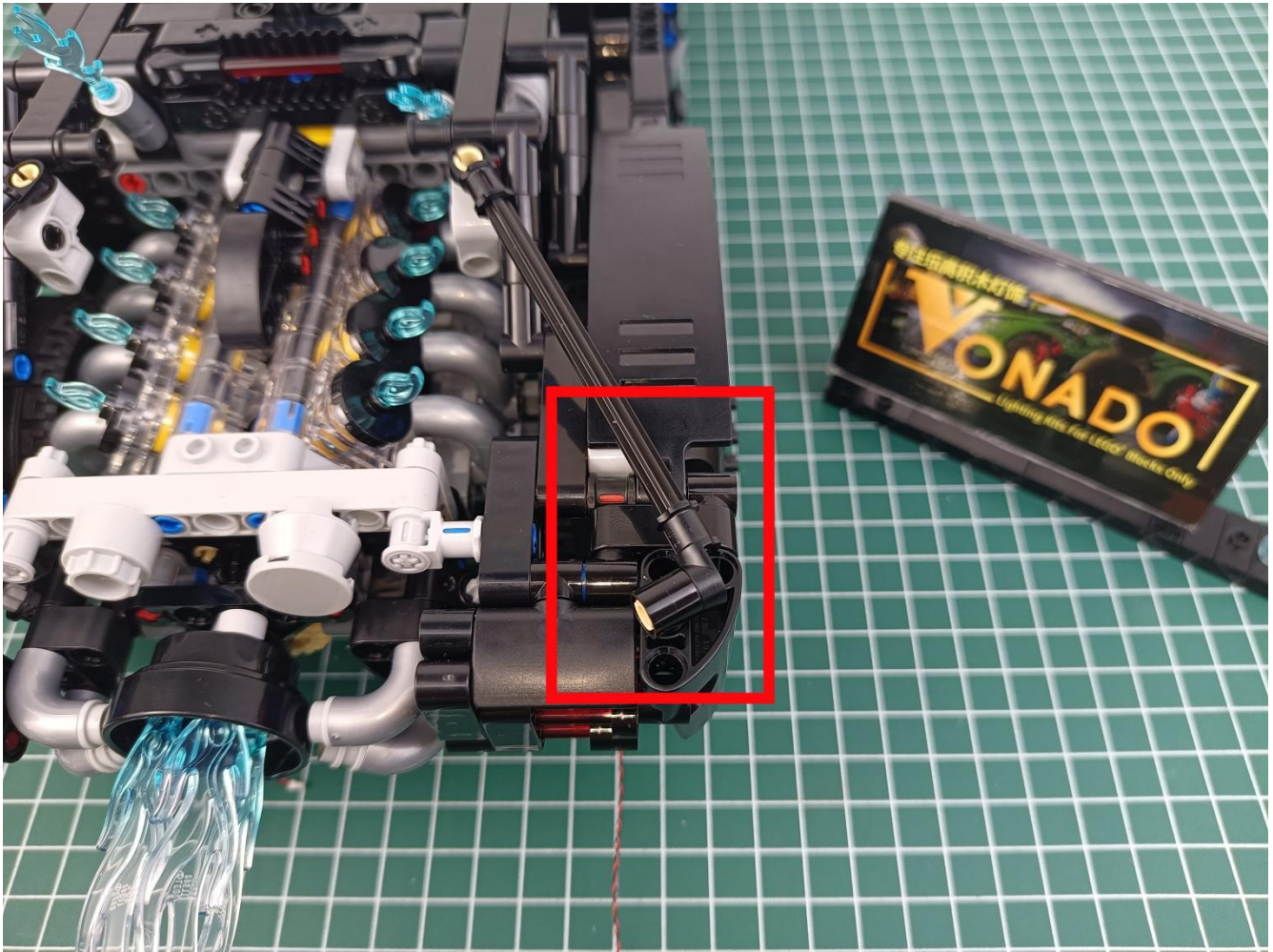



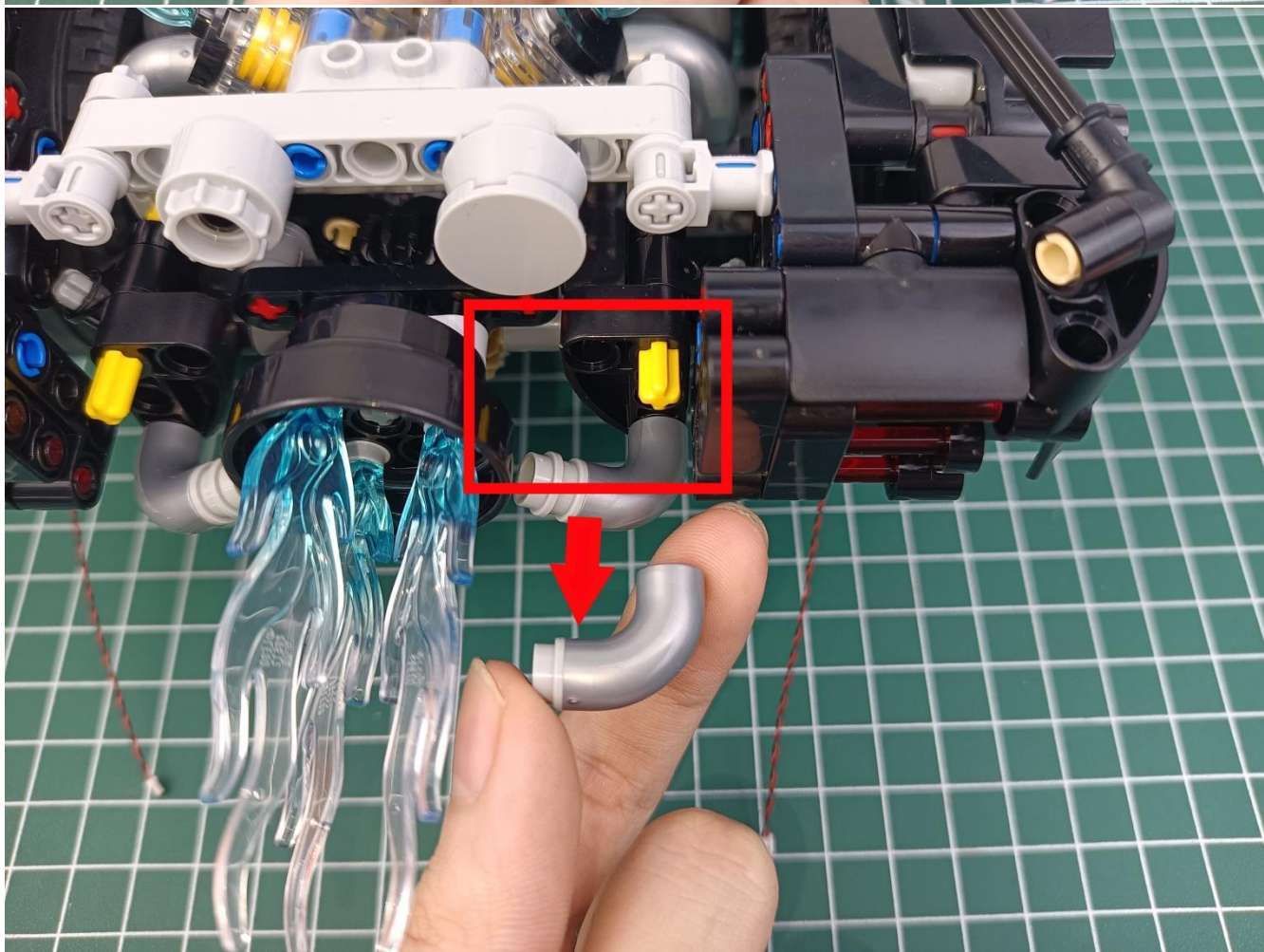
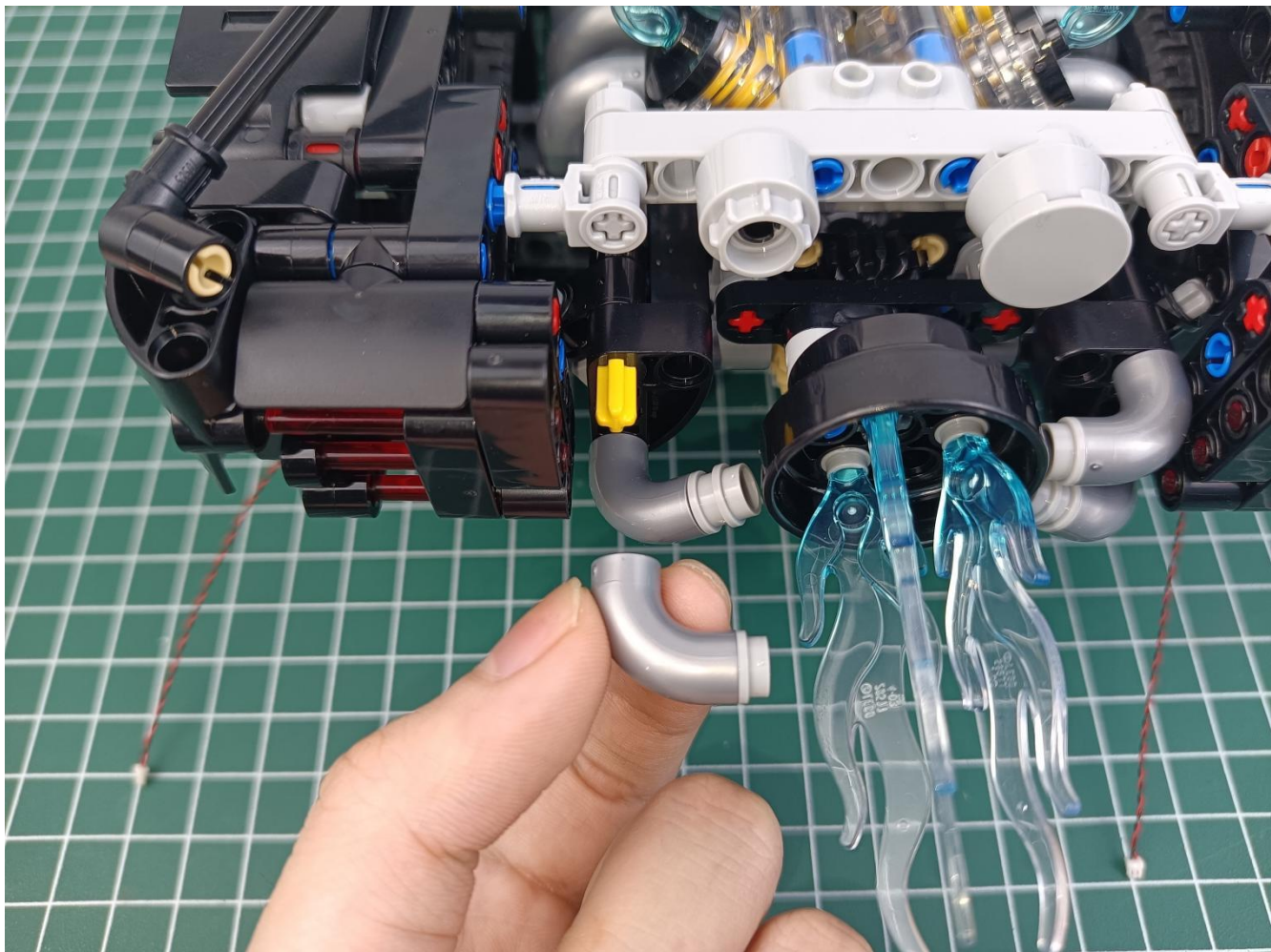



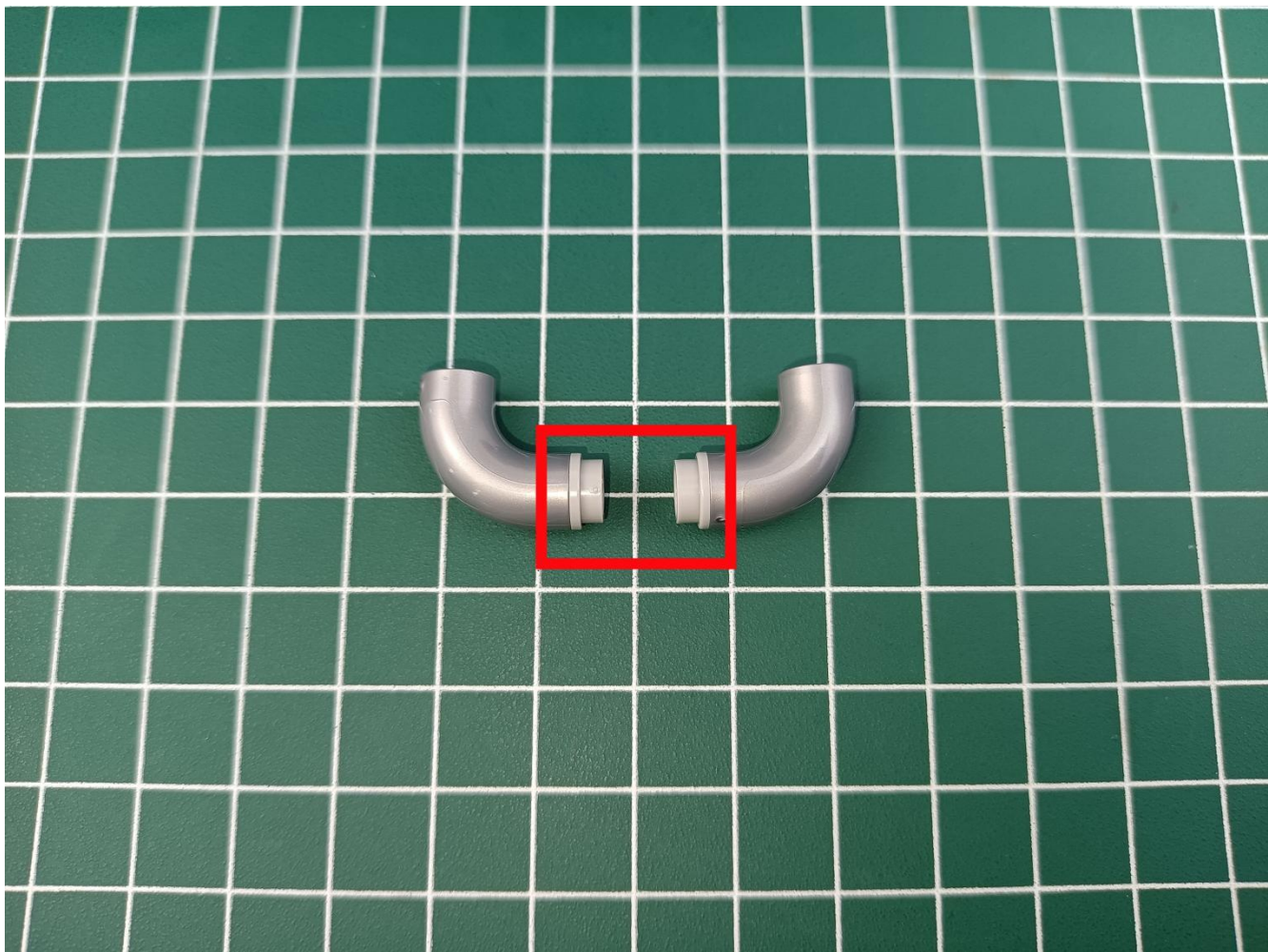



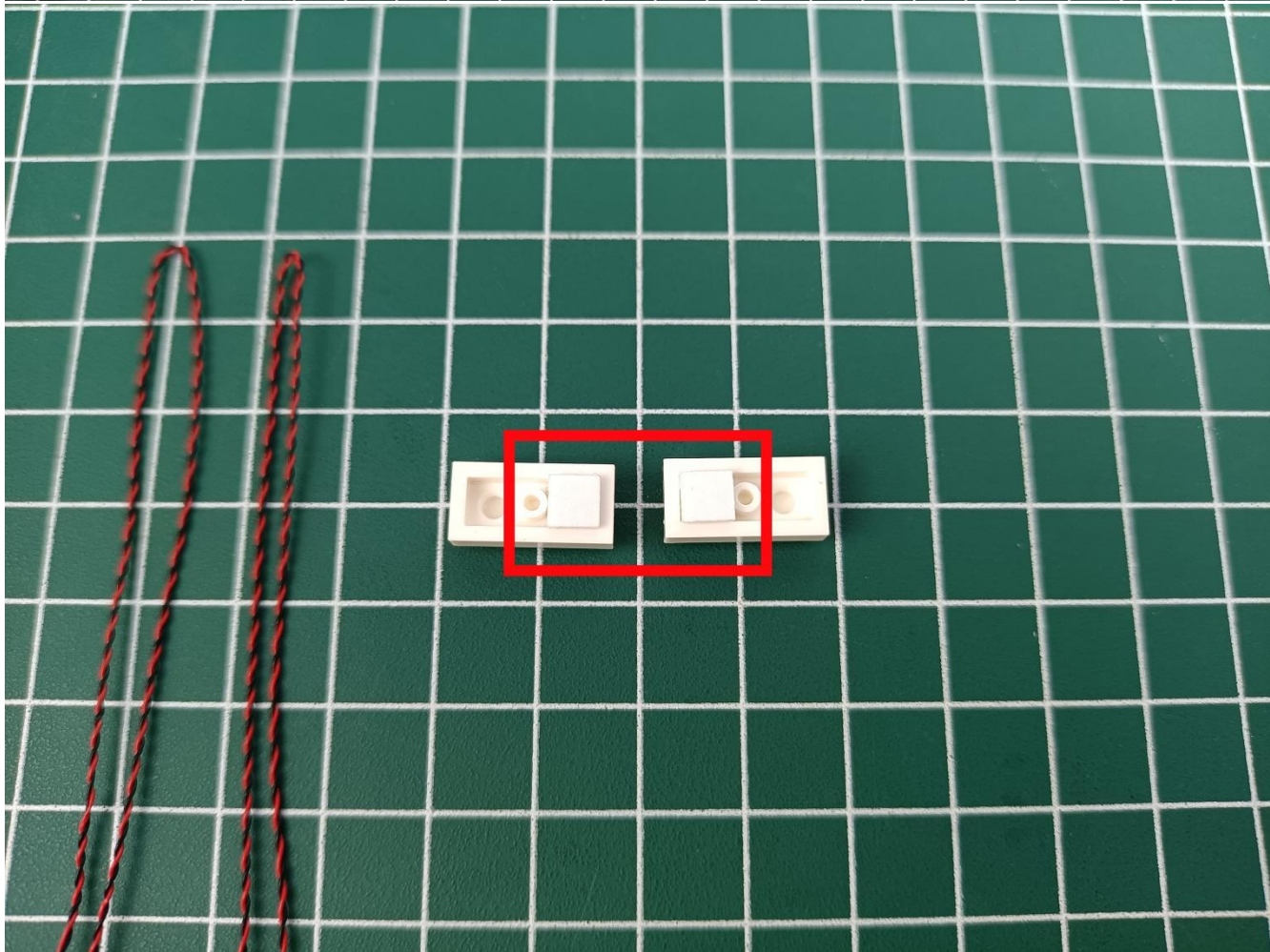



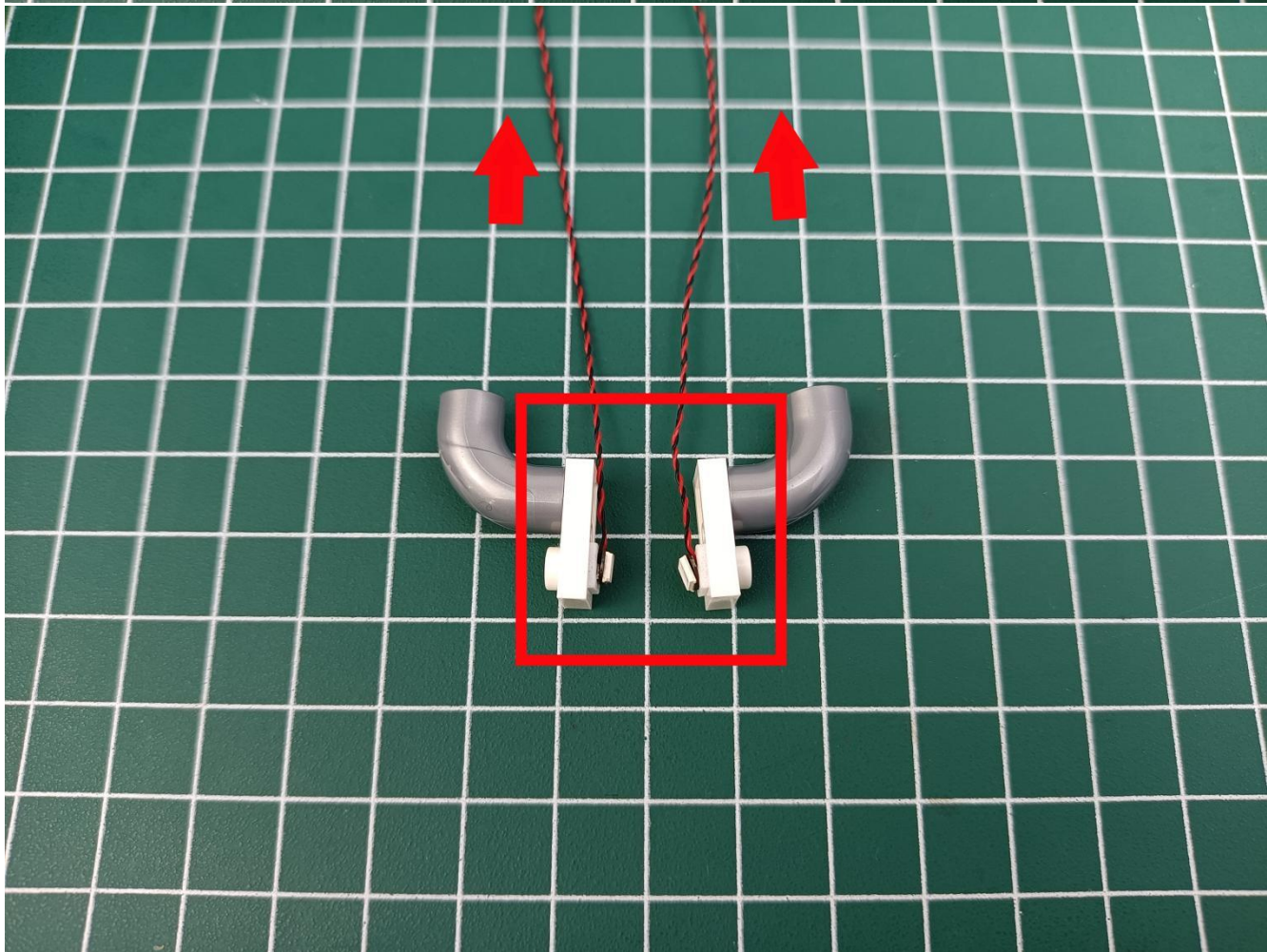
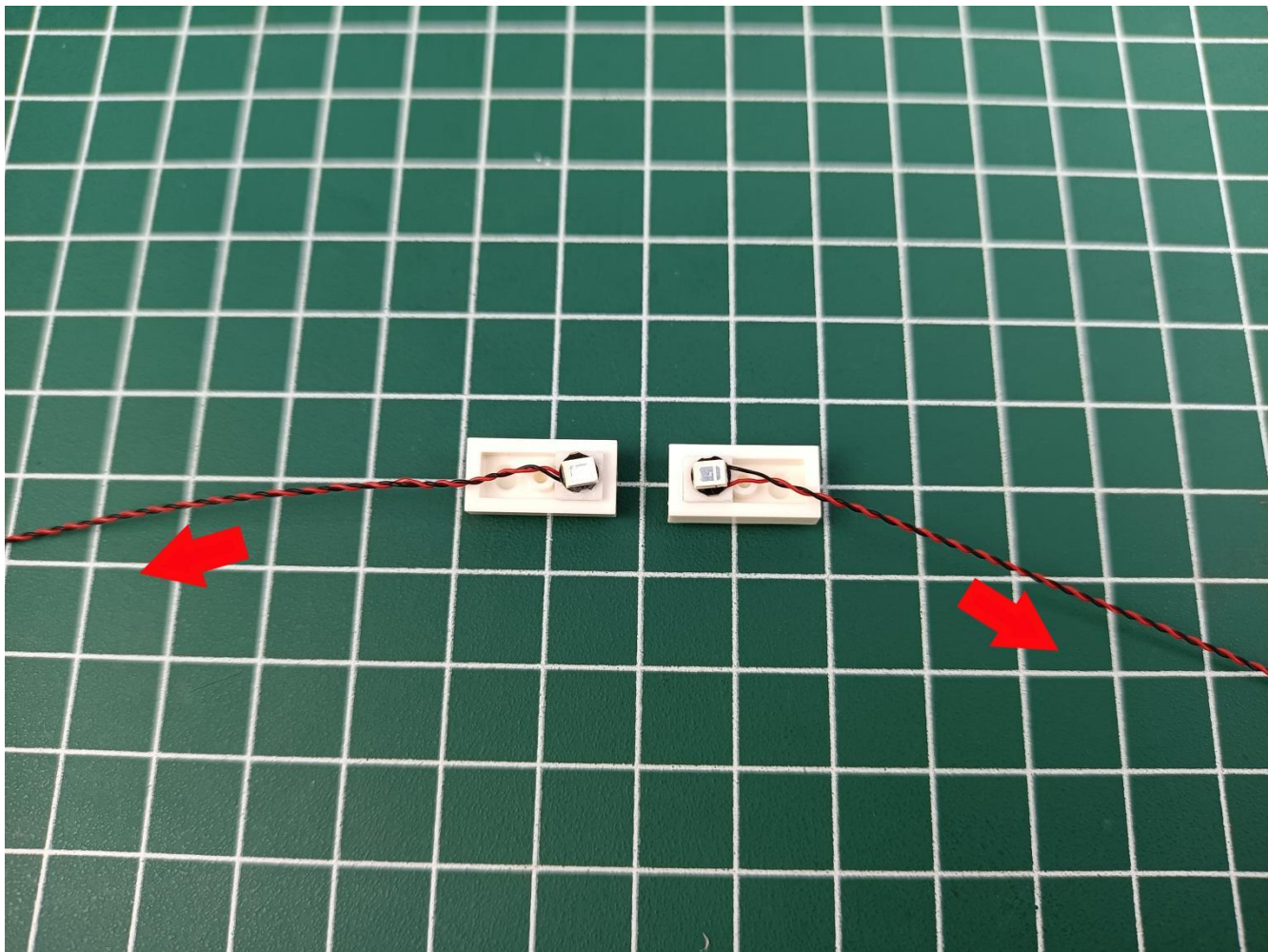



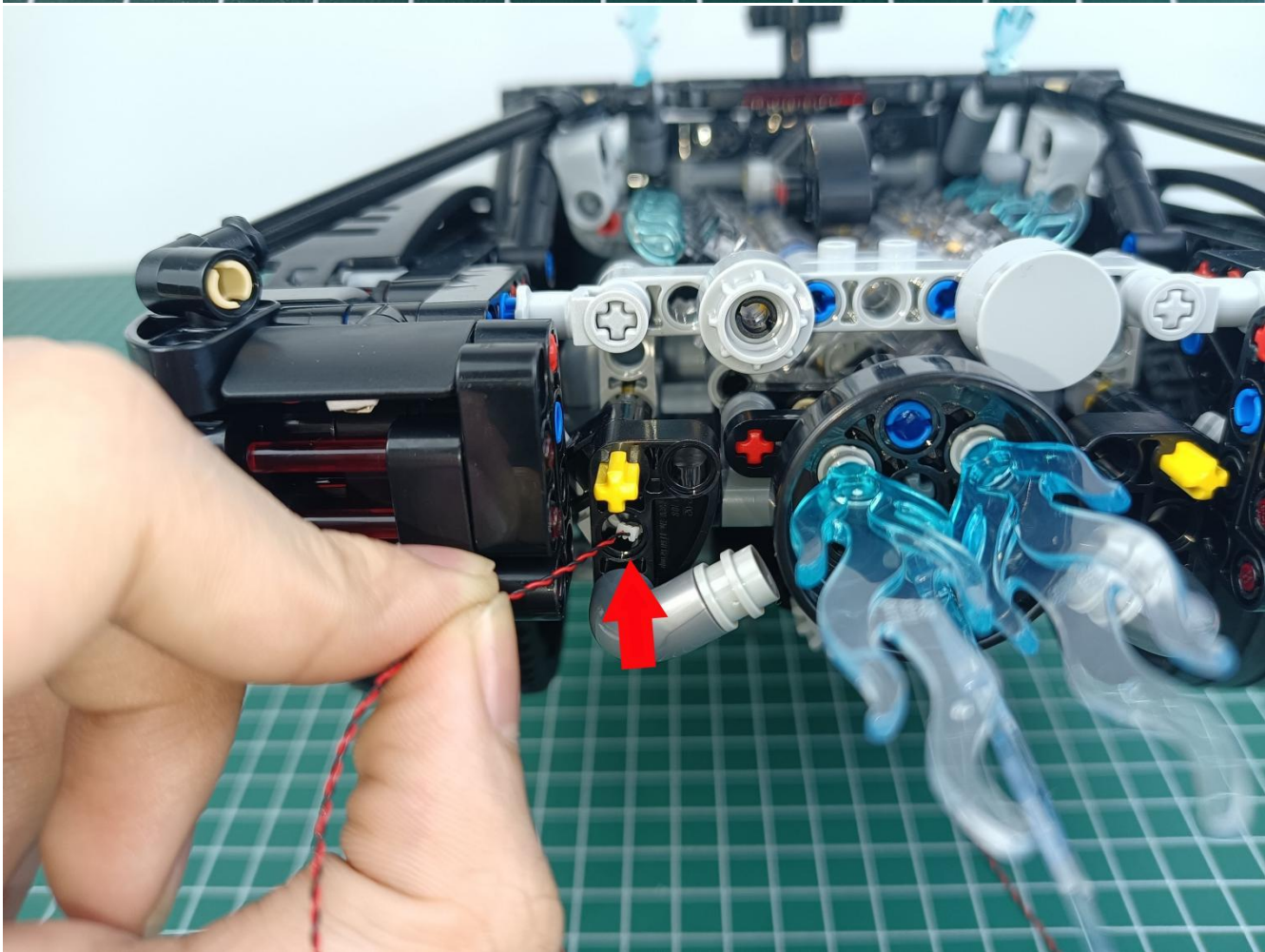
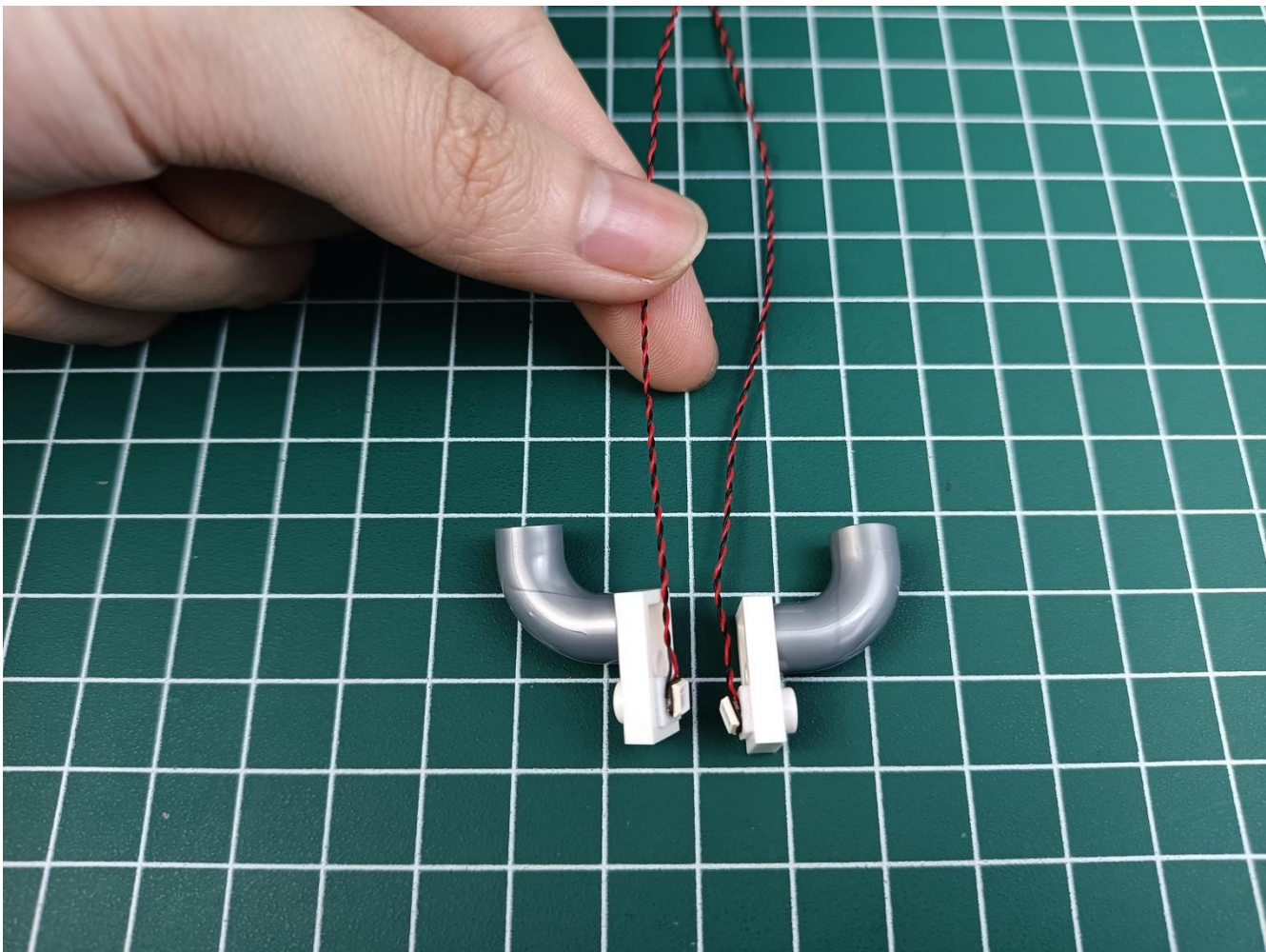



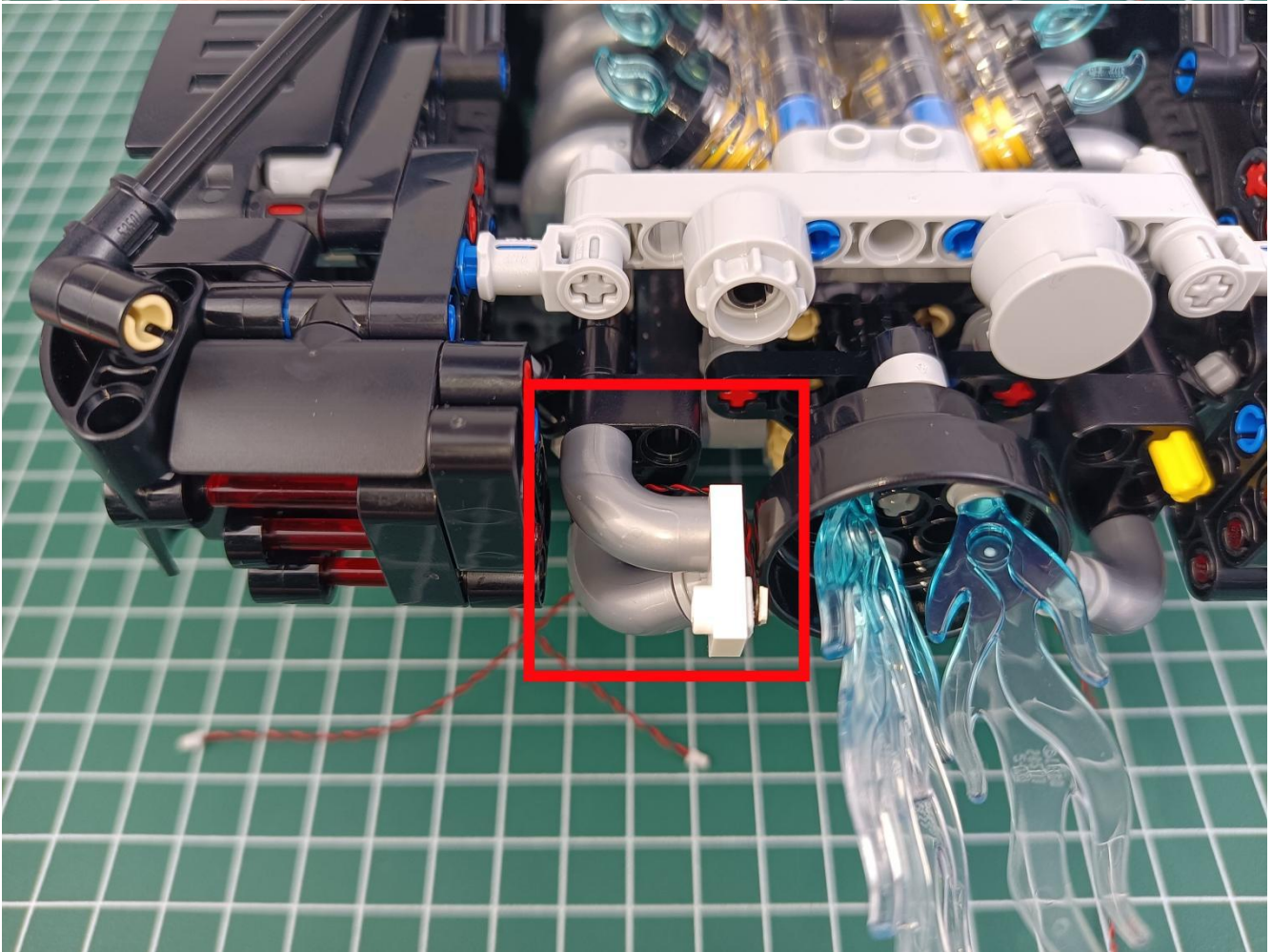
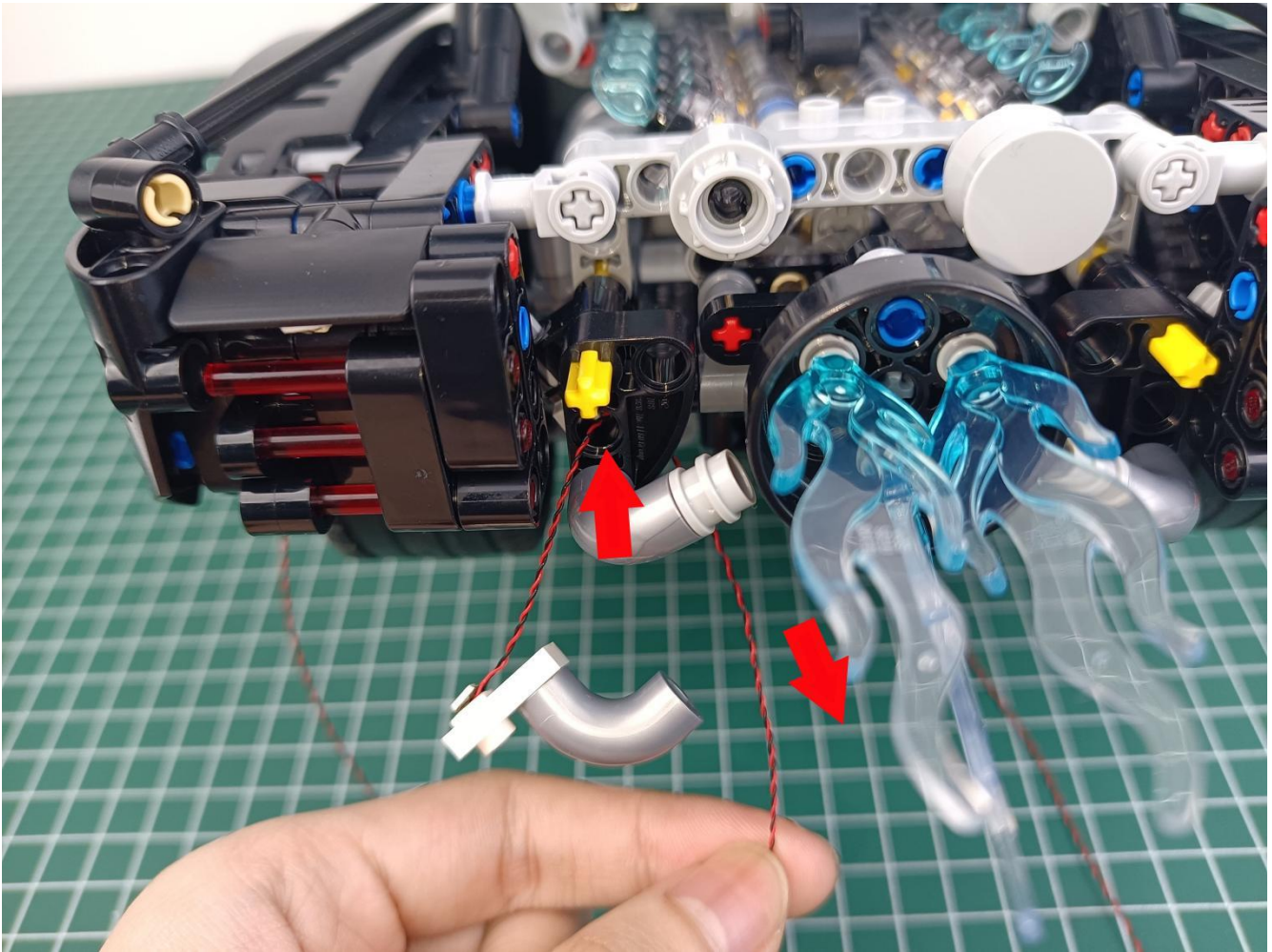



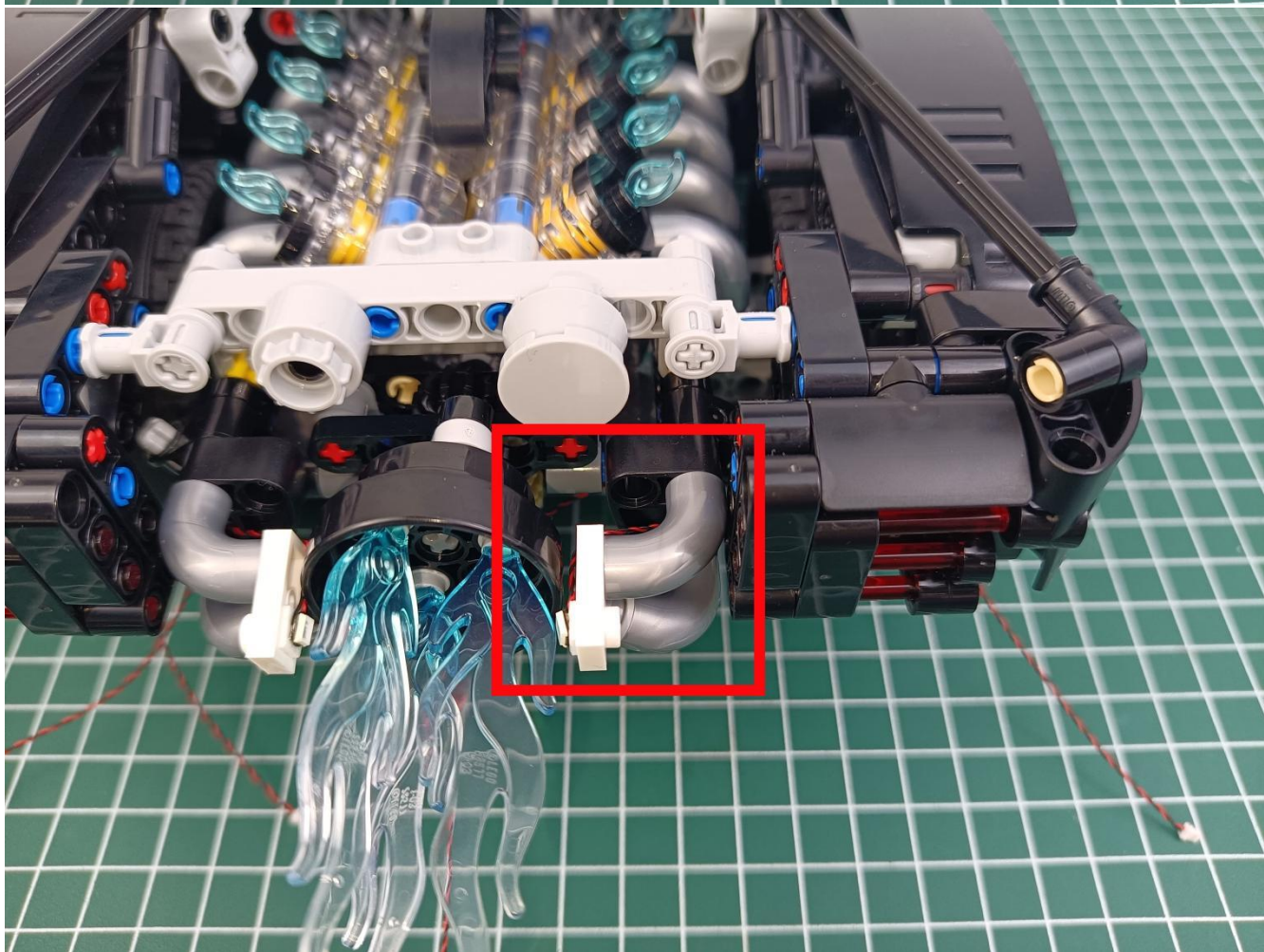
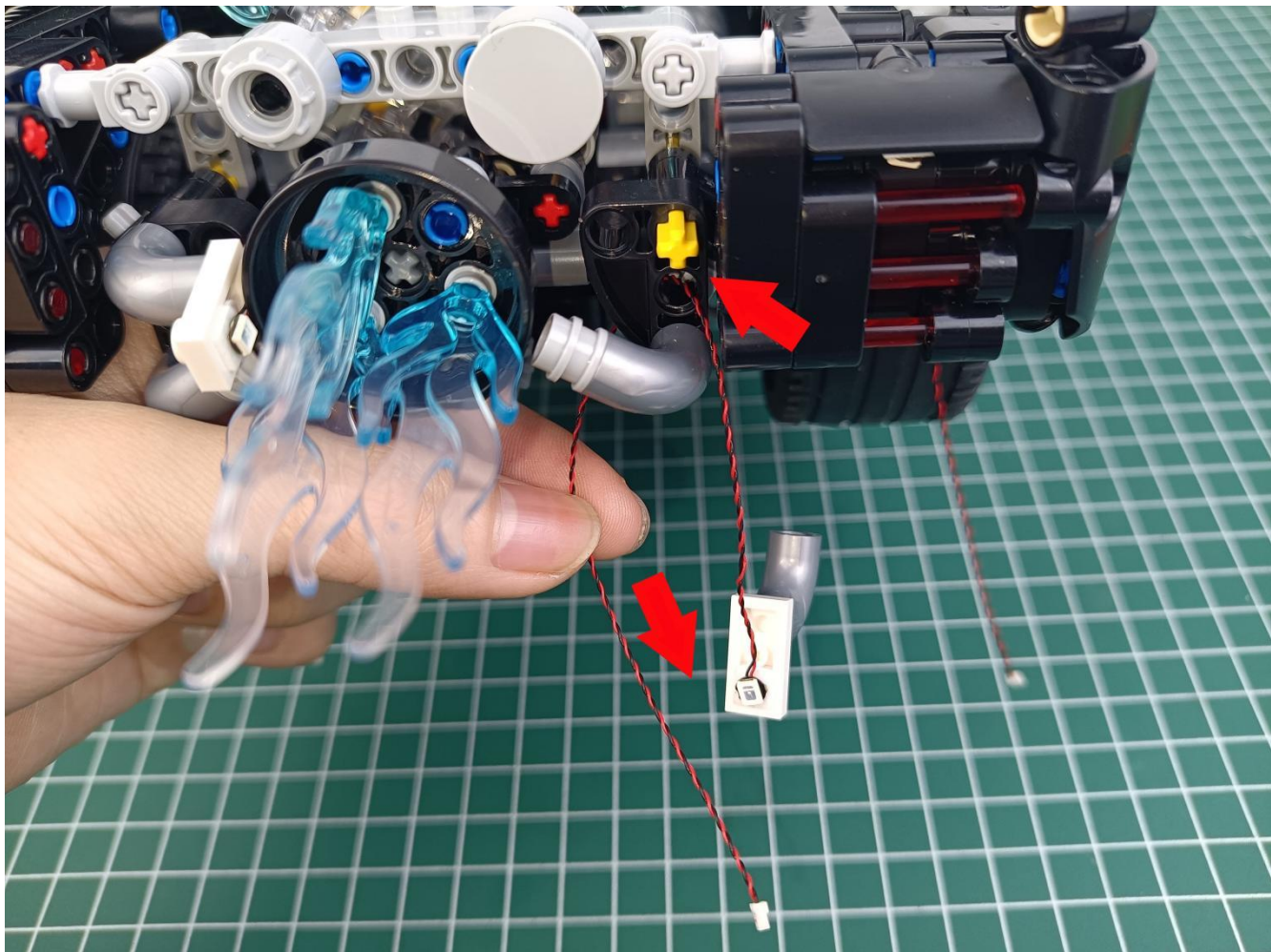



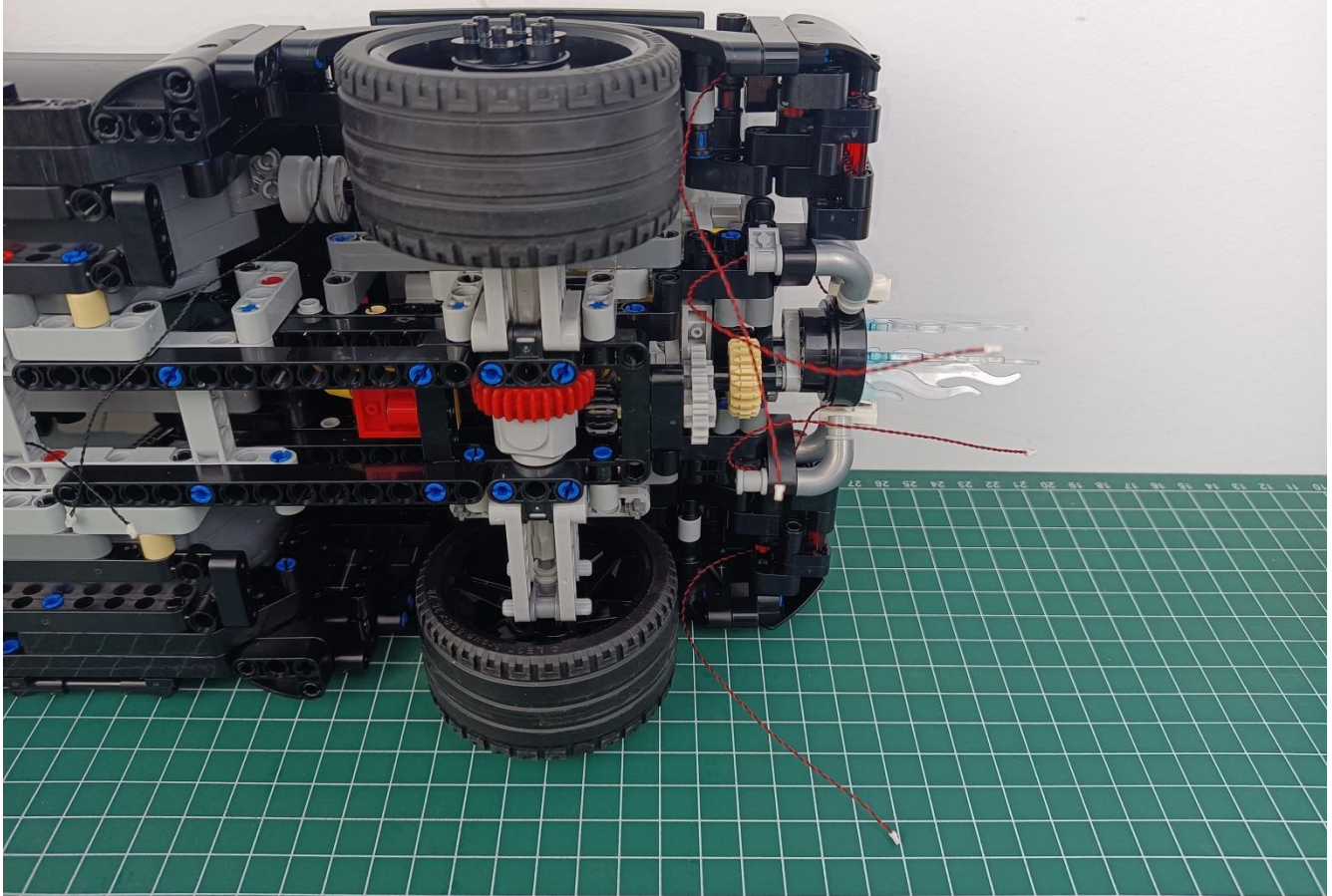
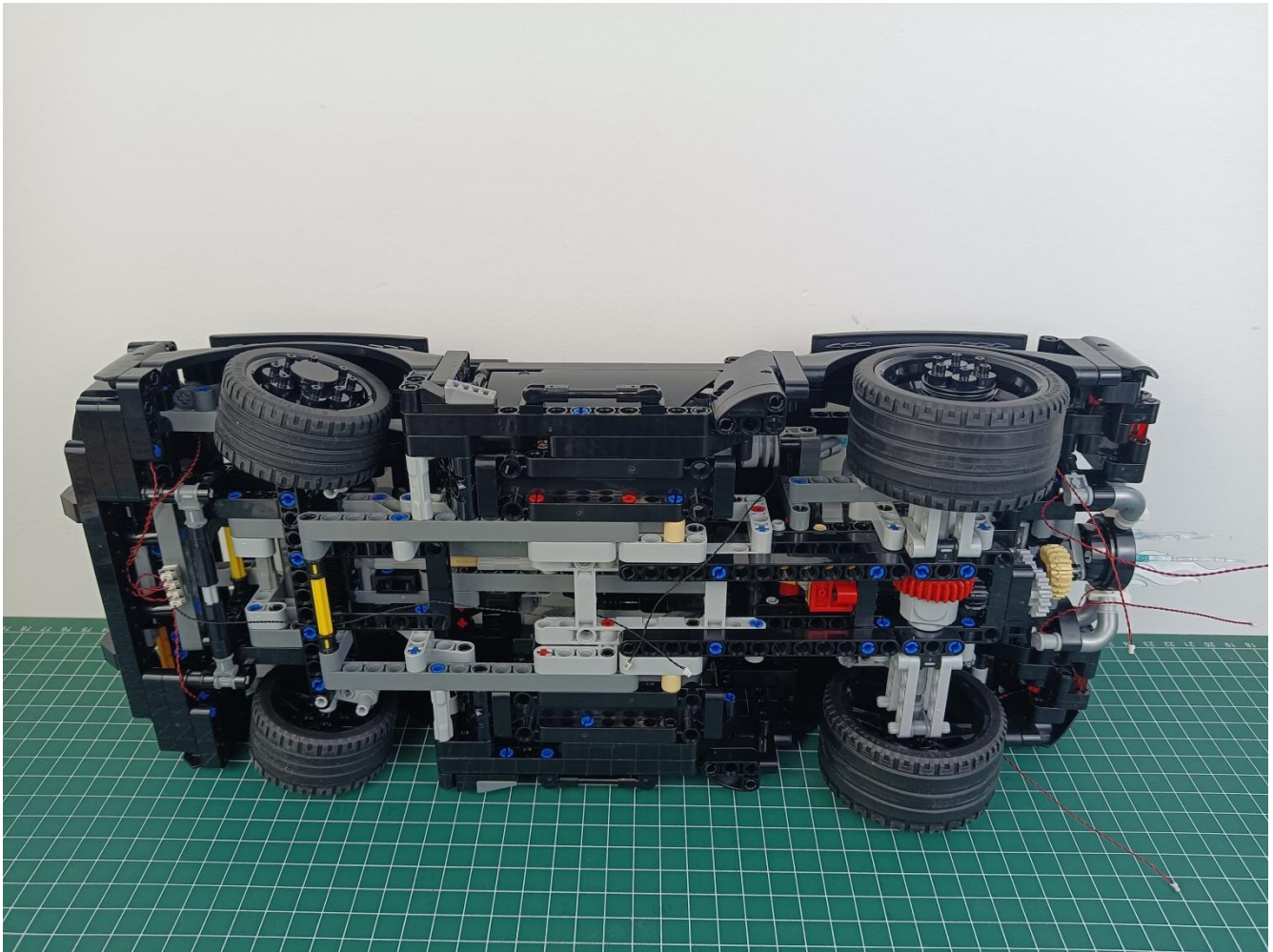





Please pay more attention and carefully using the connector for it is small. The “=” of the 2P interface is aligned with the “=” of the expansion board. The “=” on the expansion board refers to the two outside solder joints, not the two metal pins inside the jack.

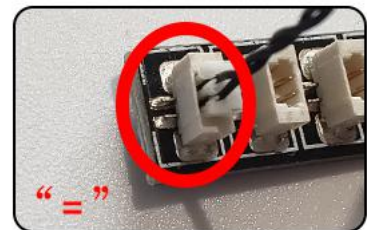
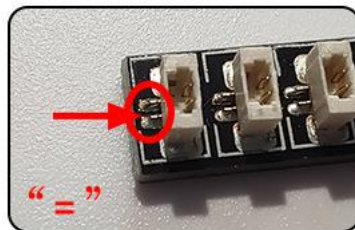
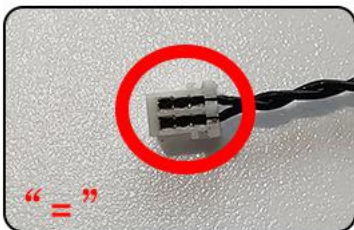



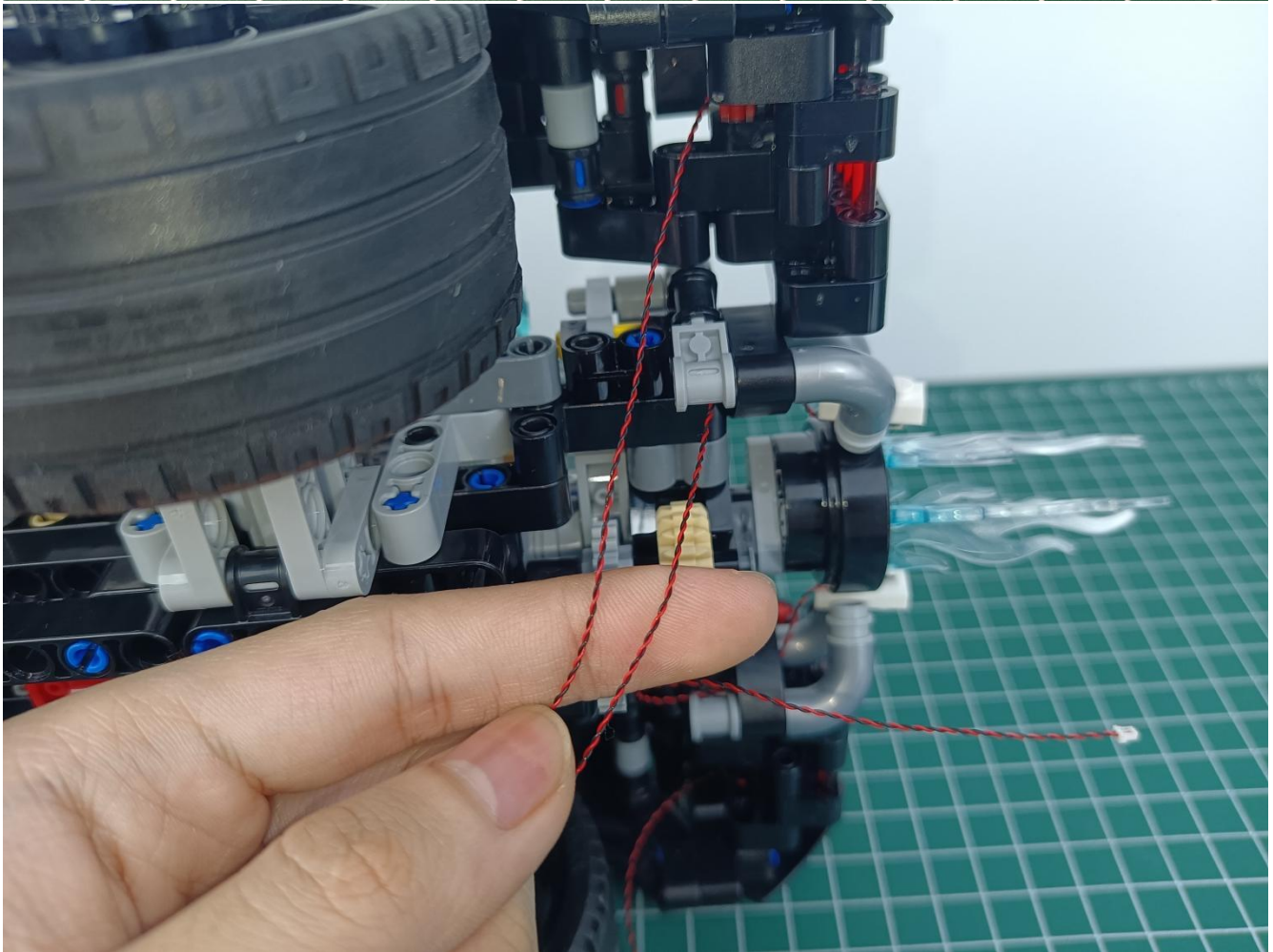
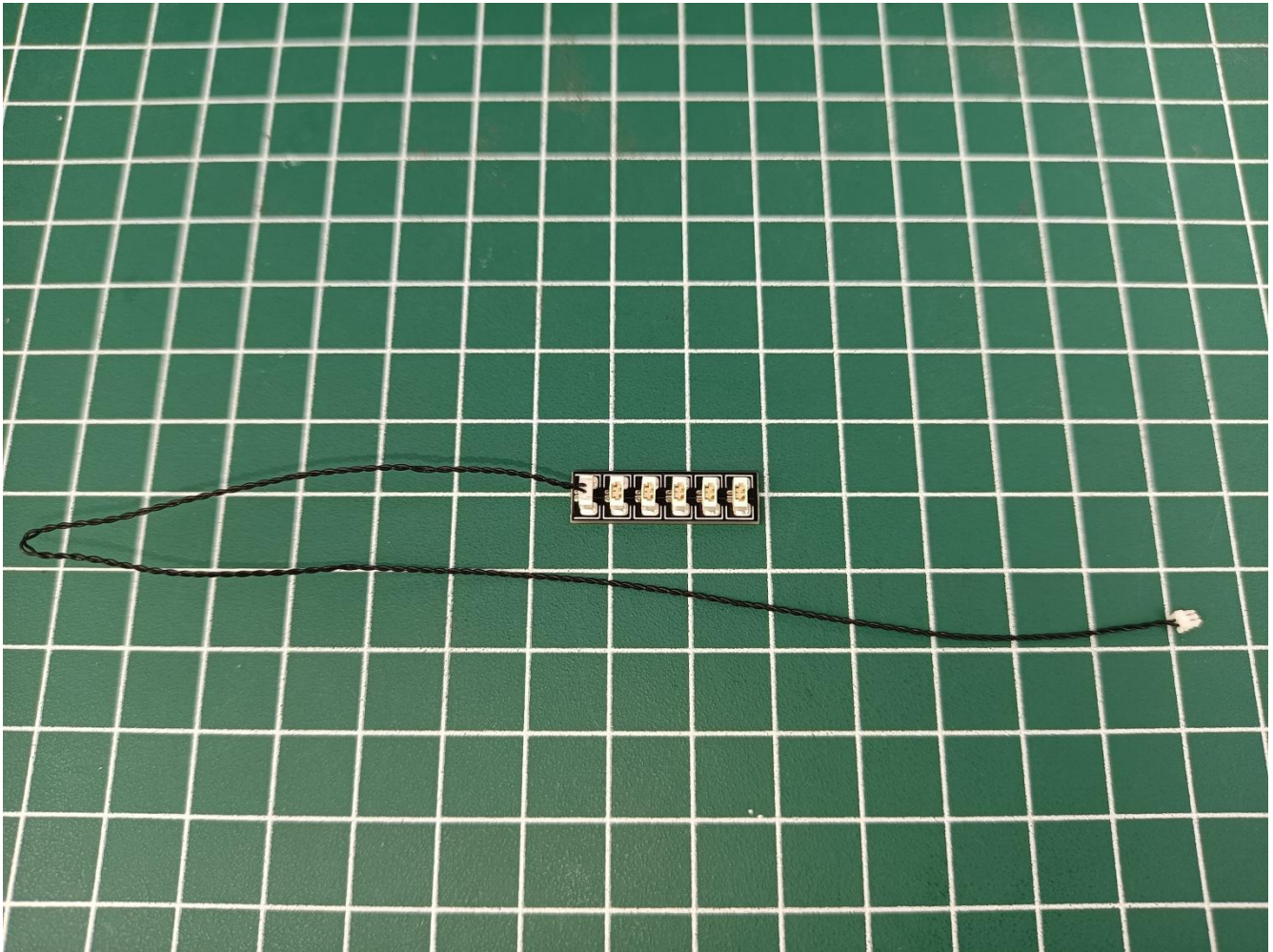



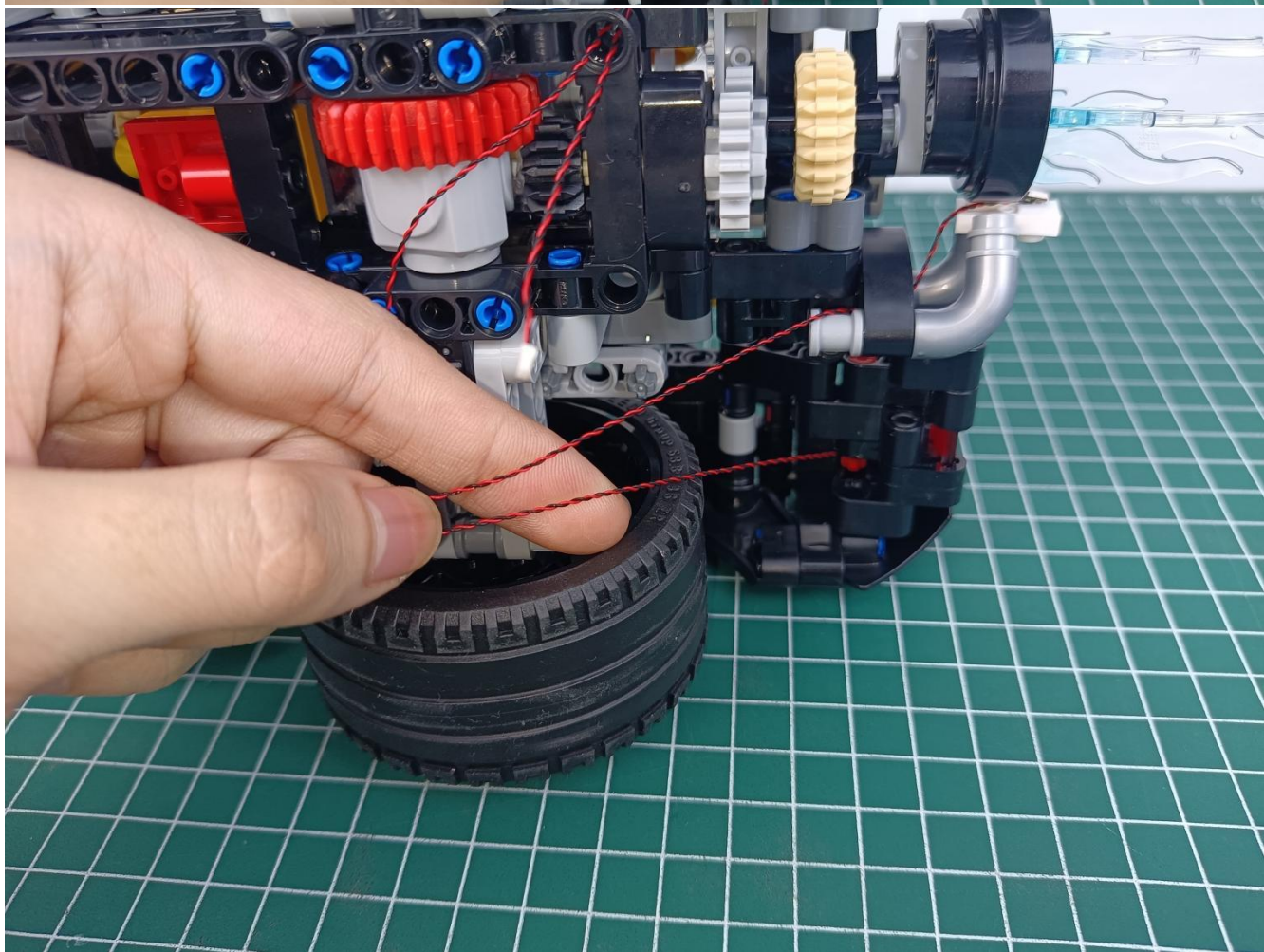
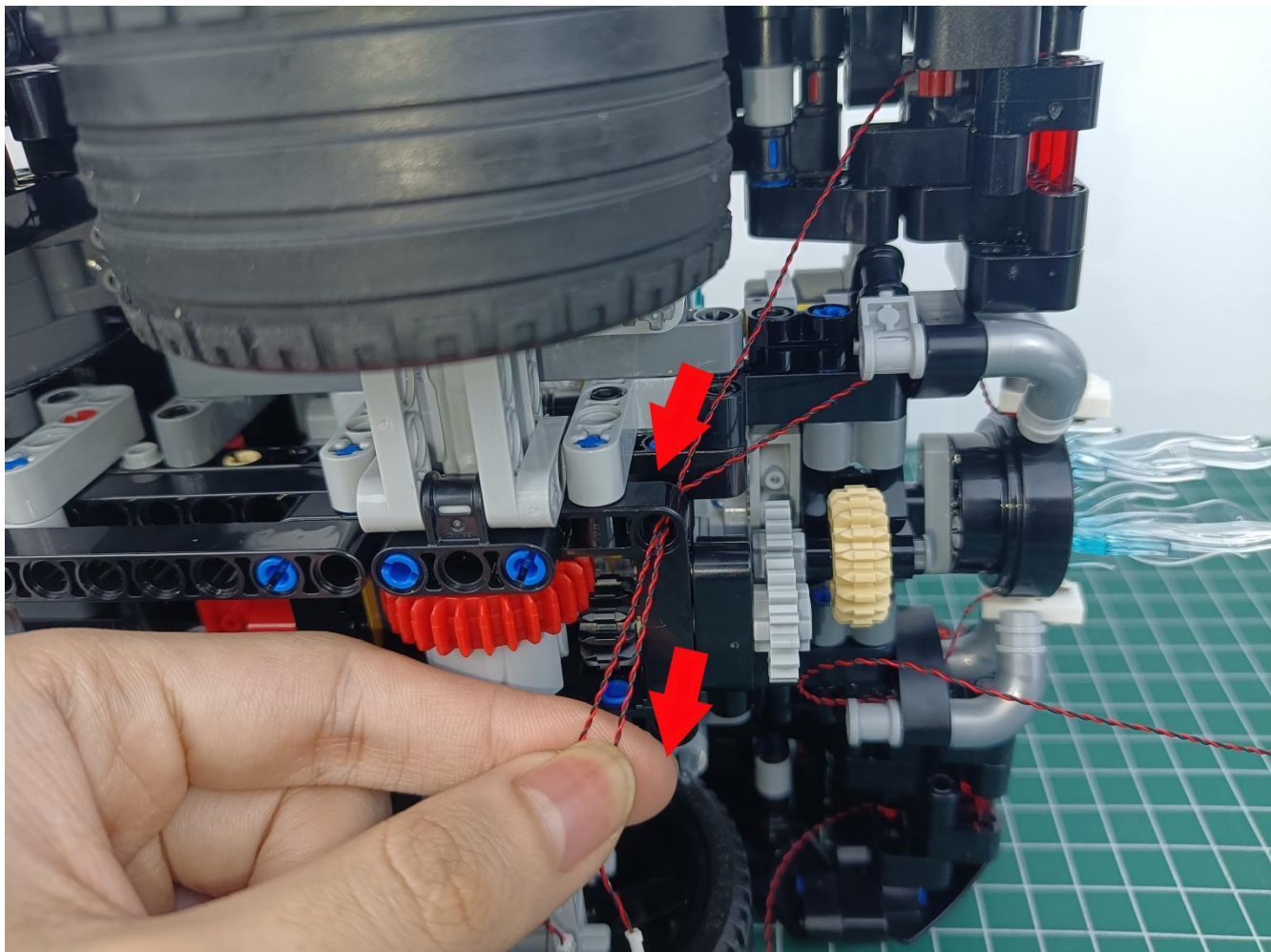



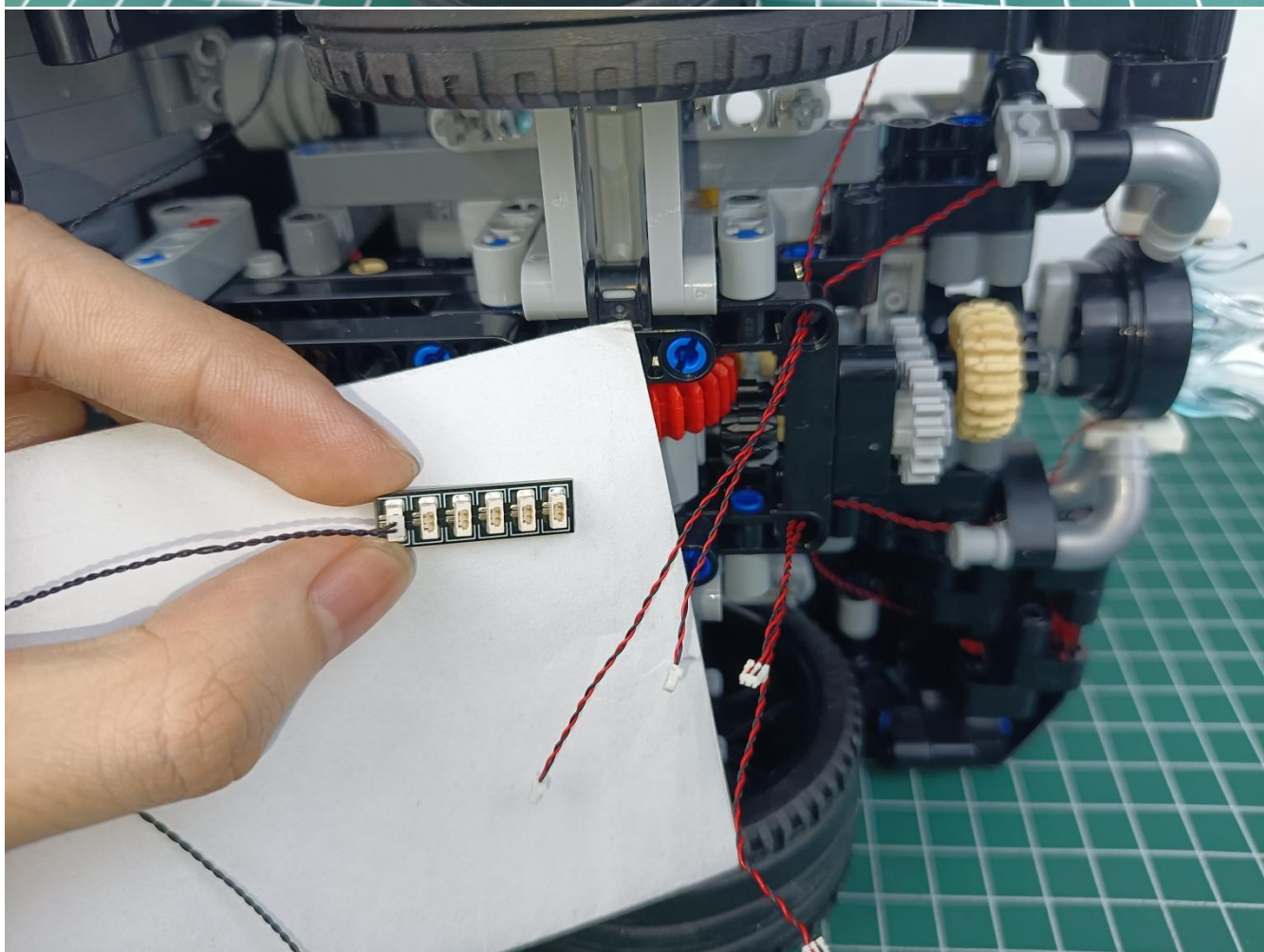
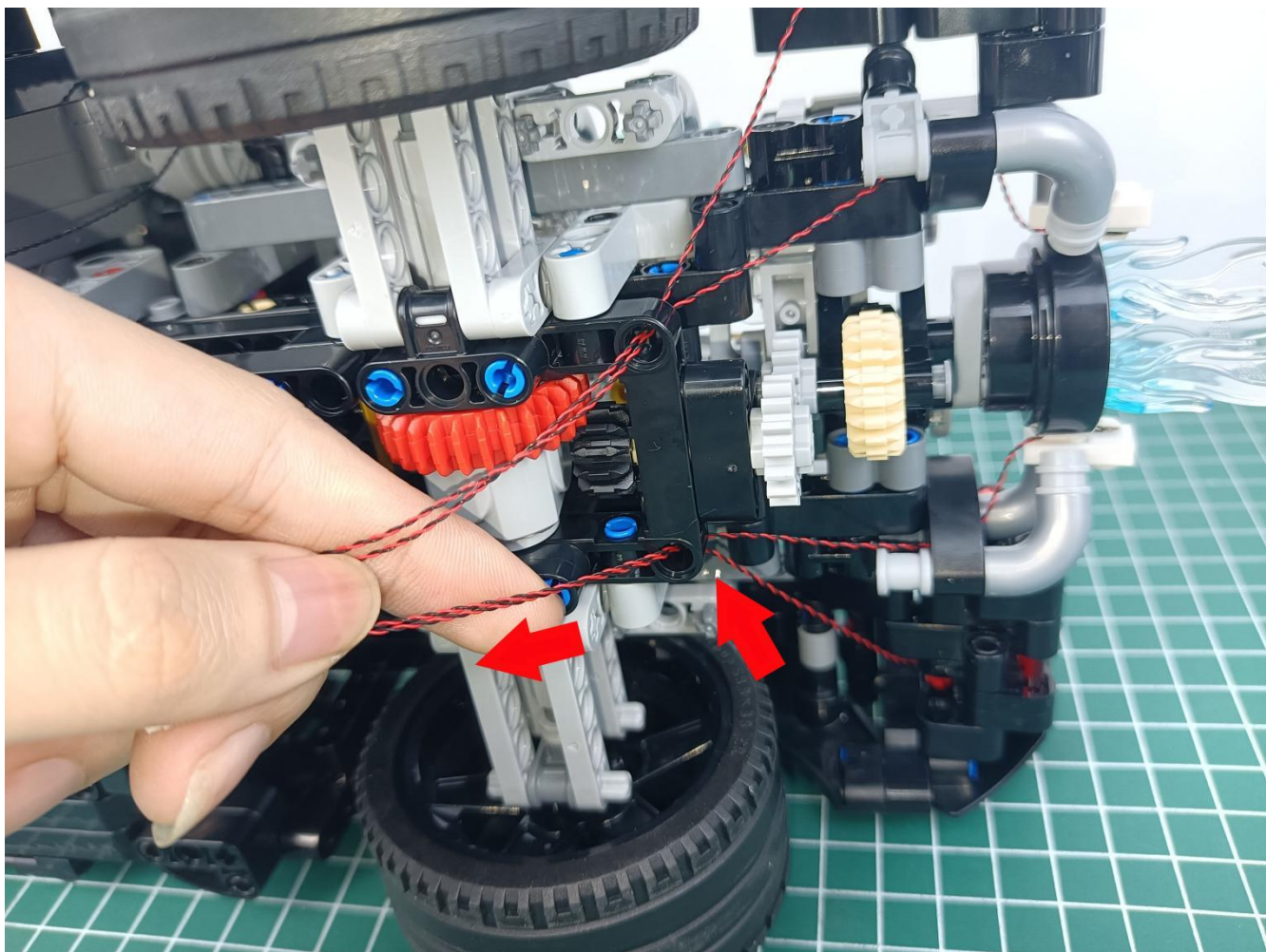



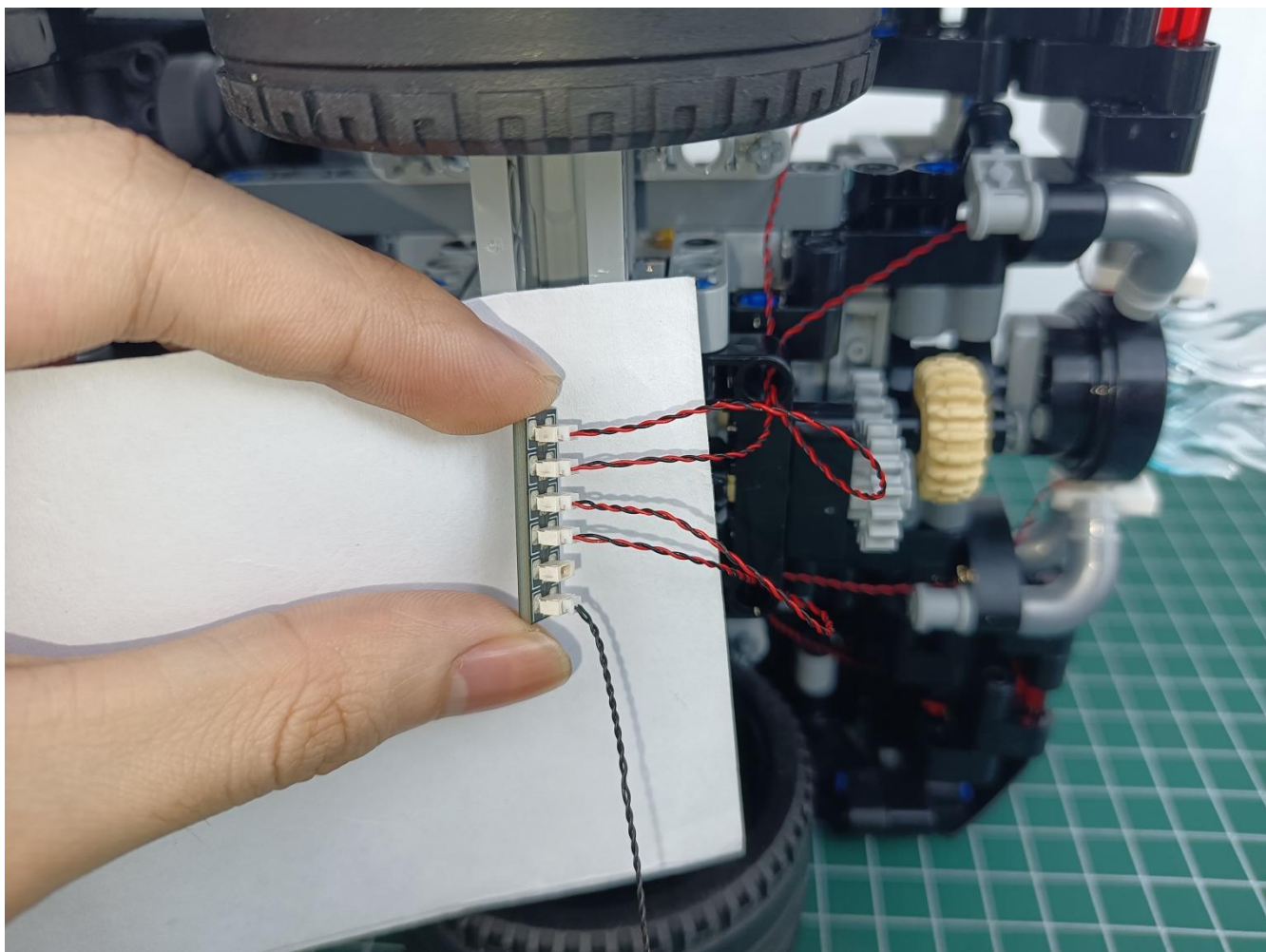



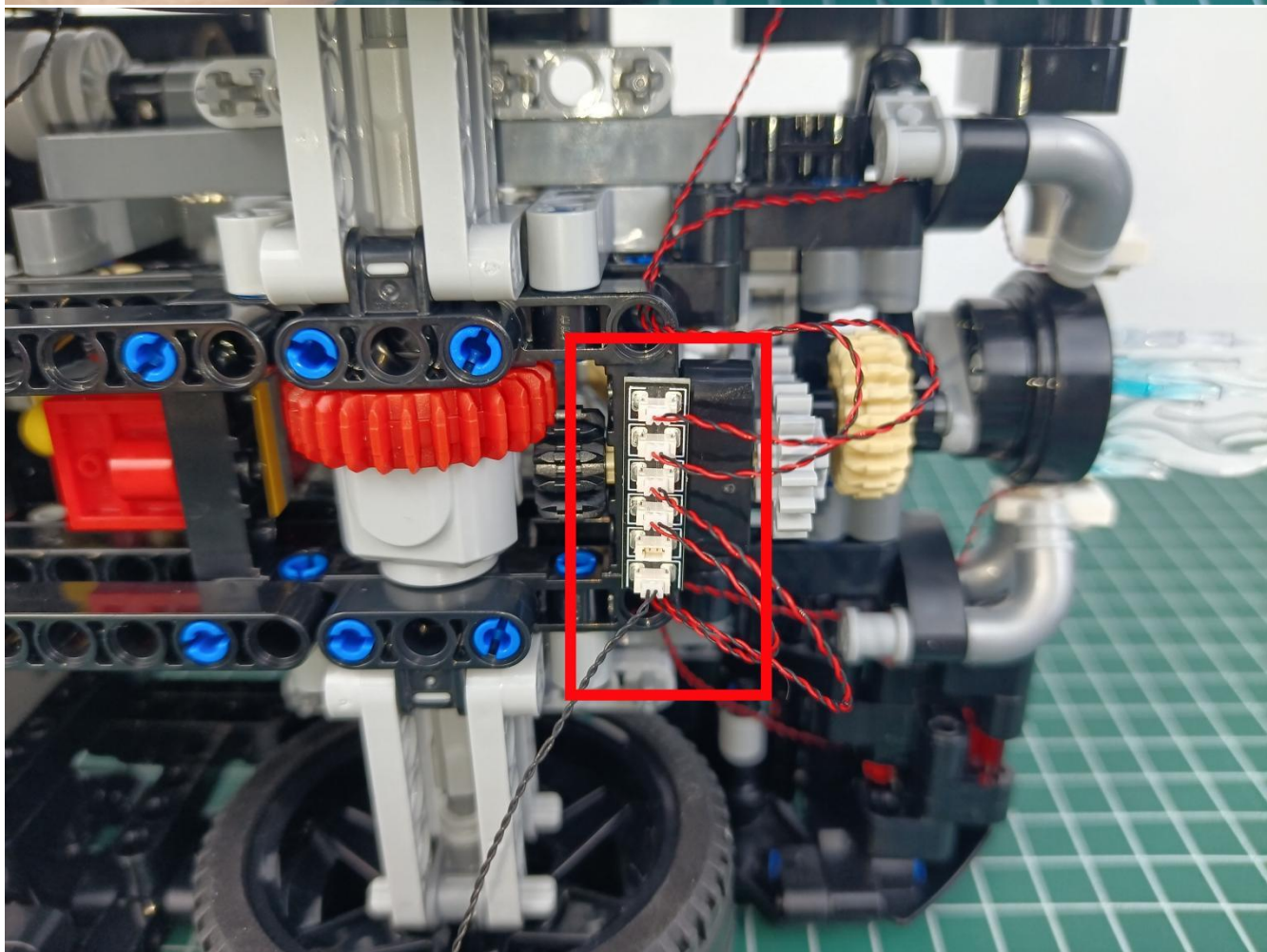
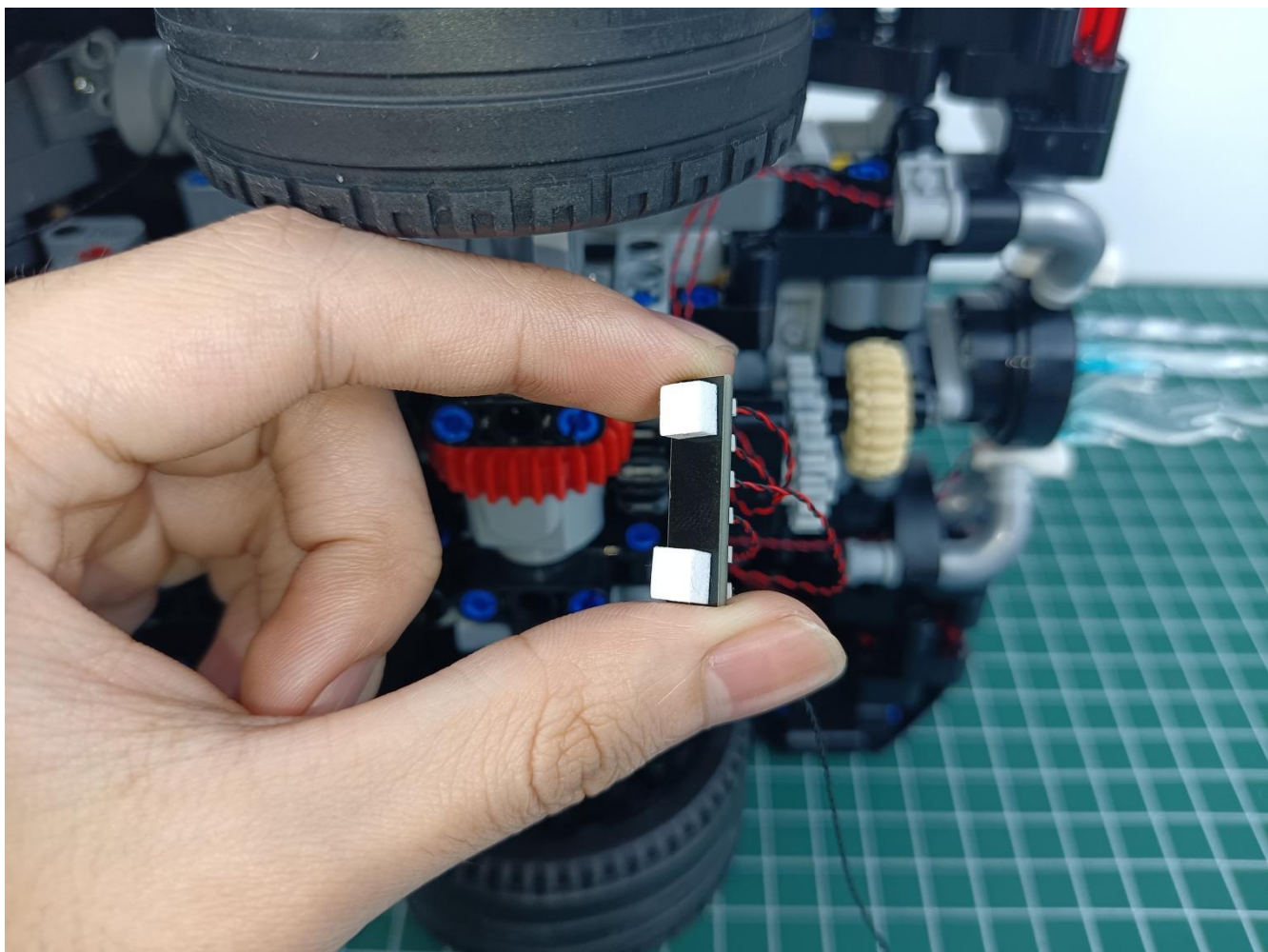



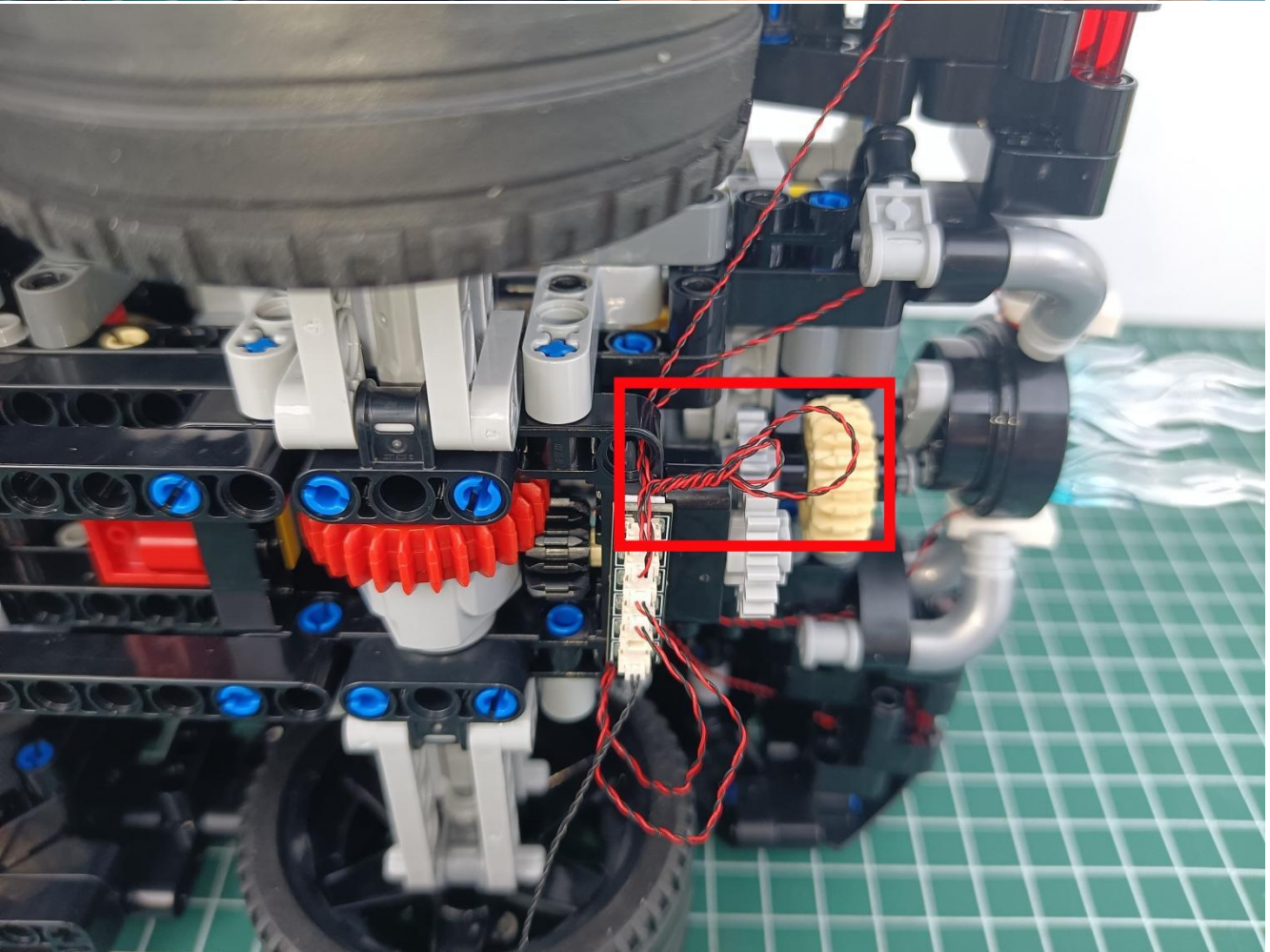
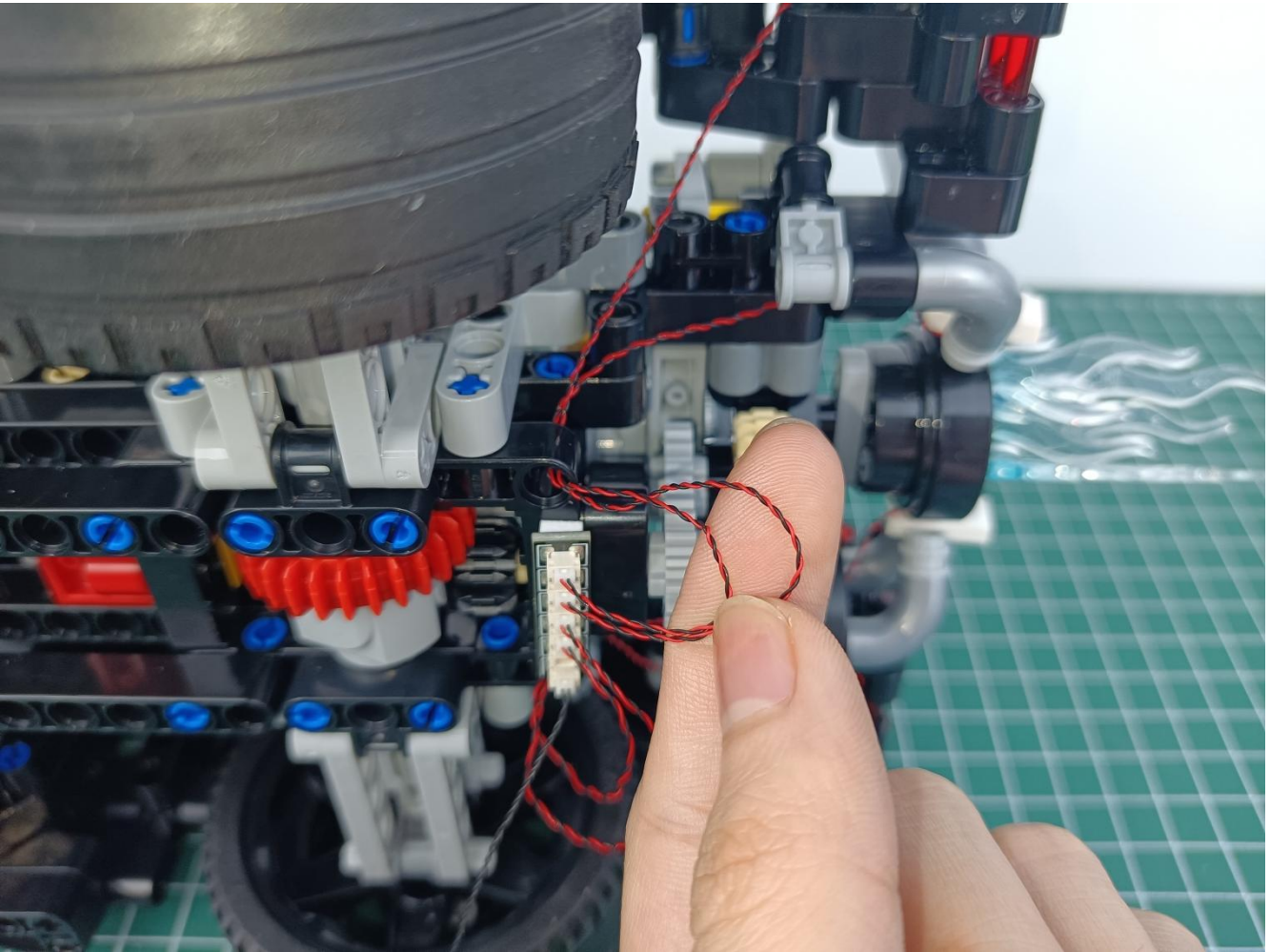



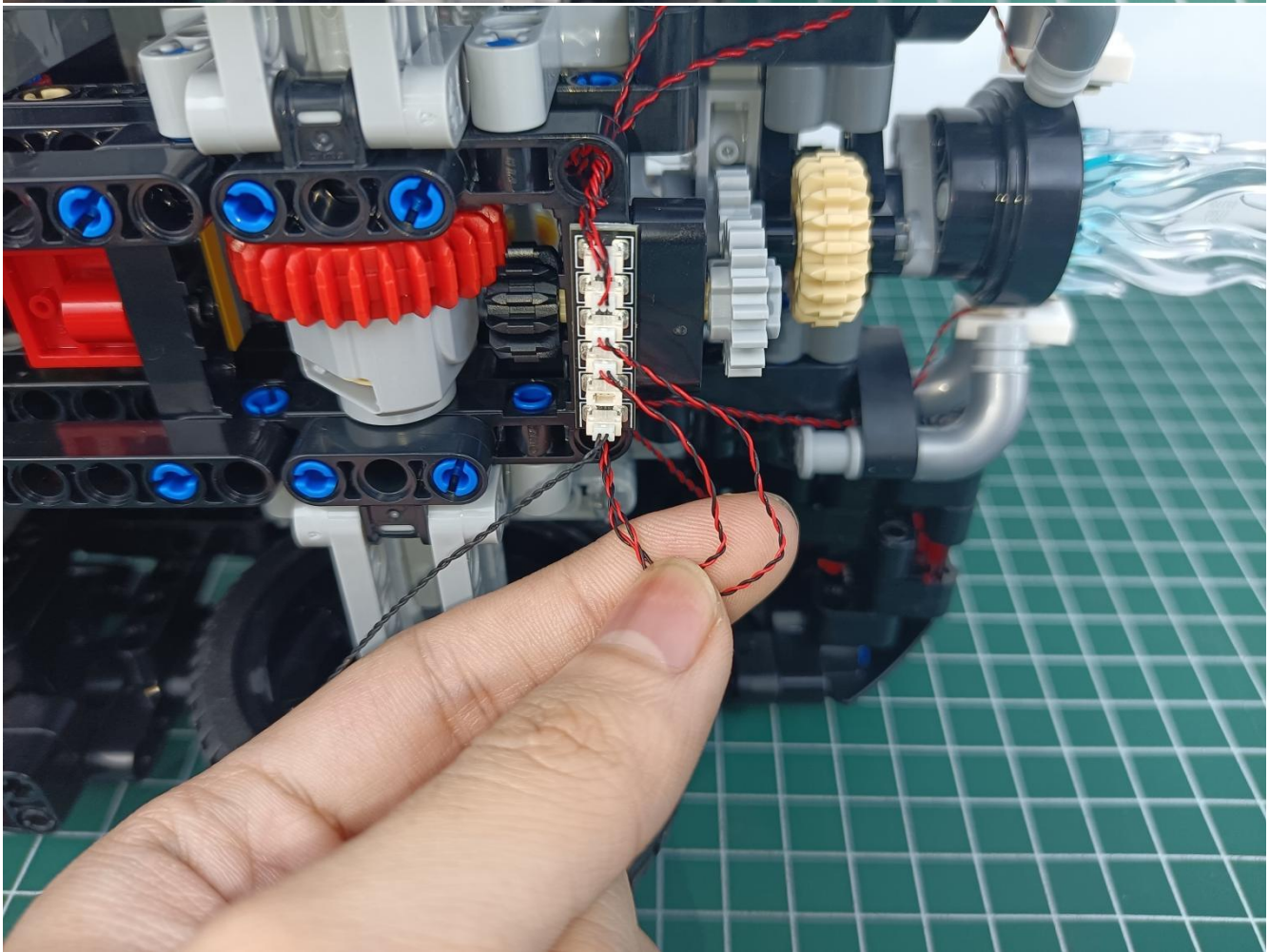
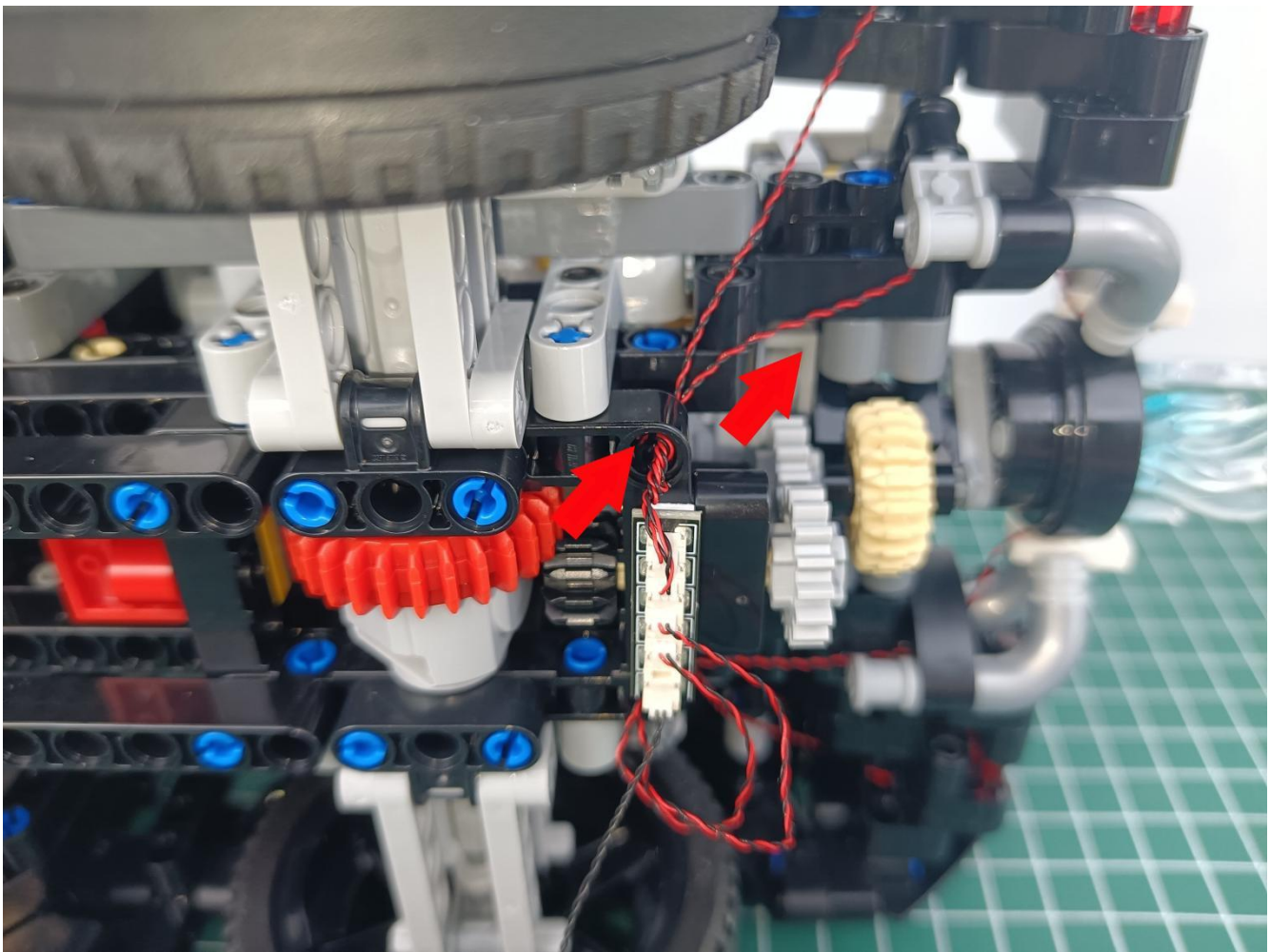



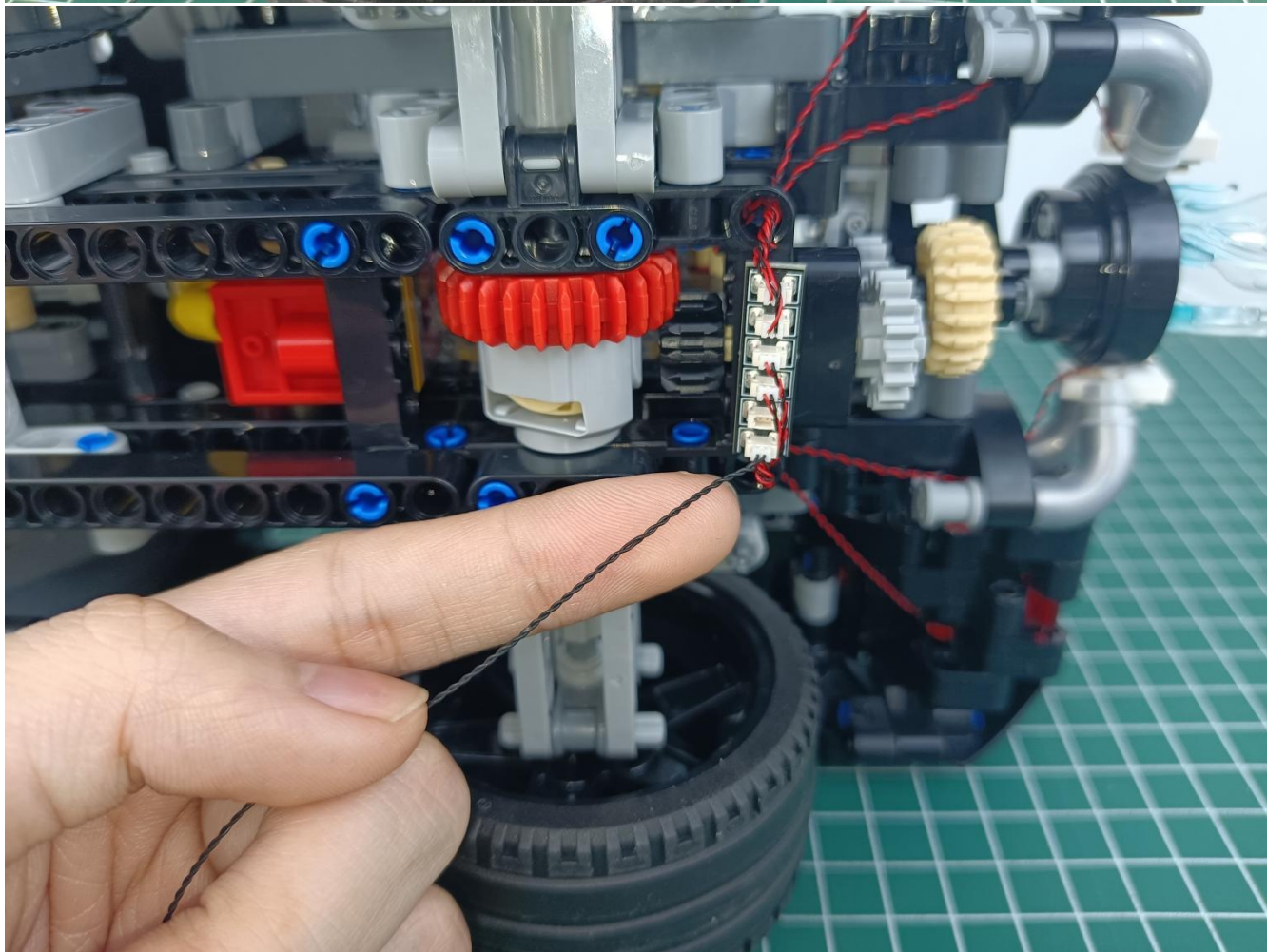
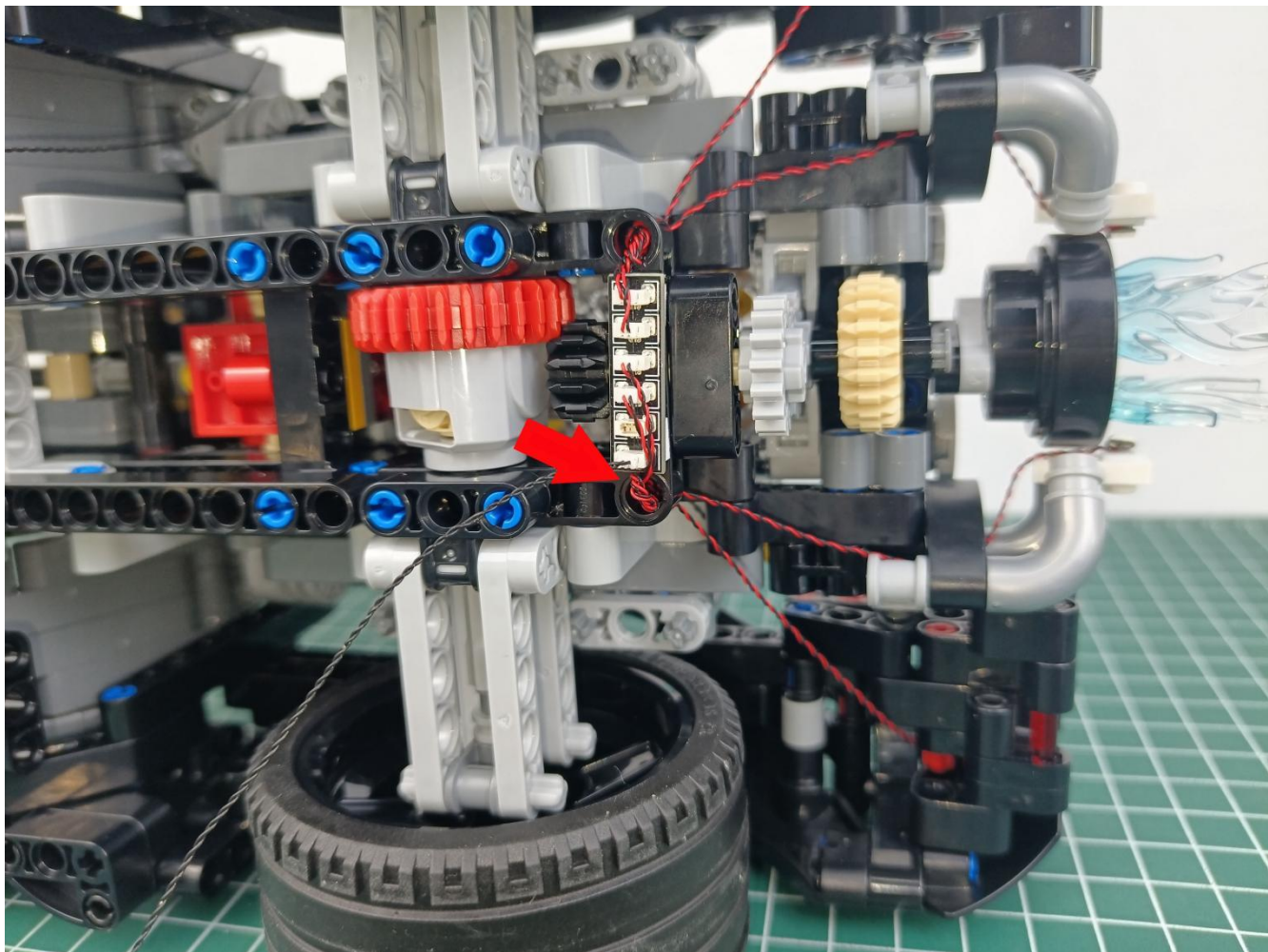



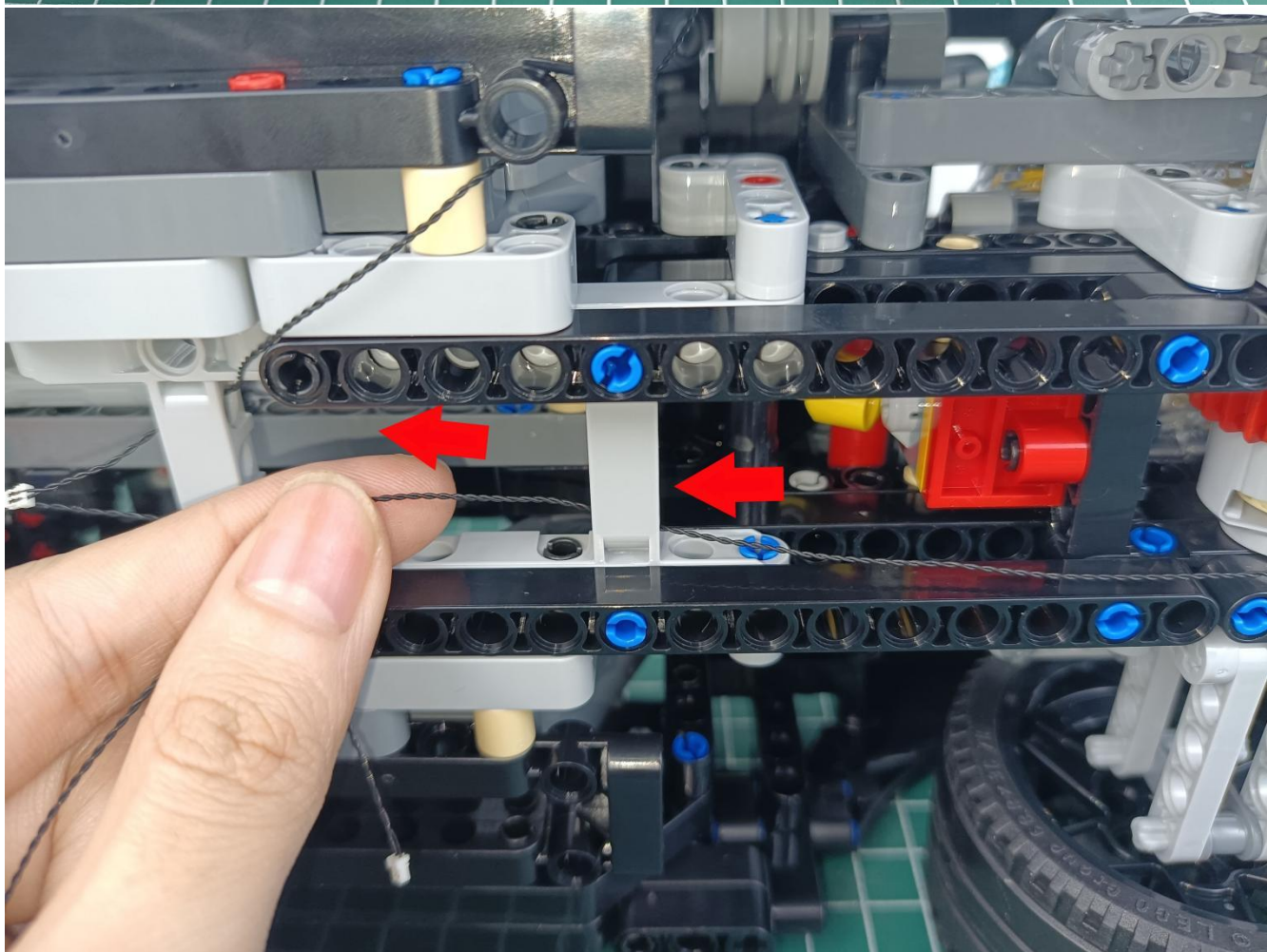
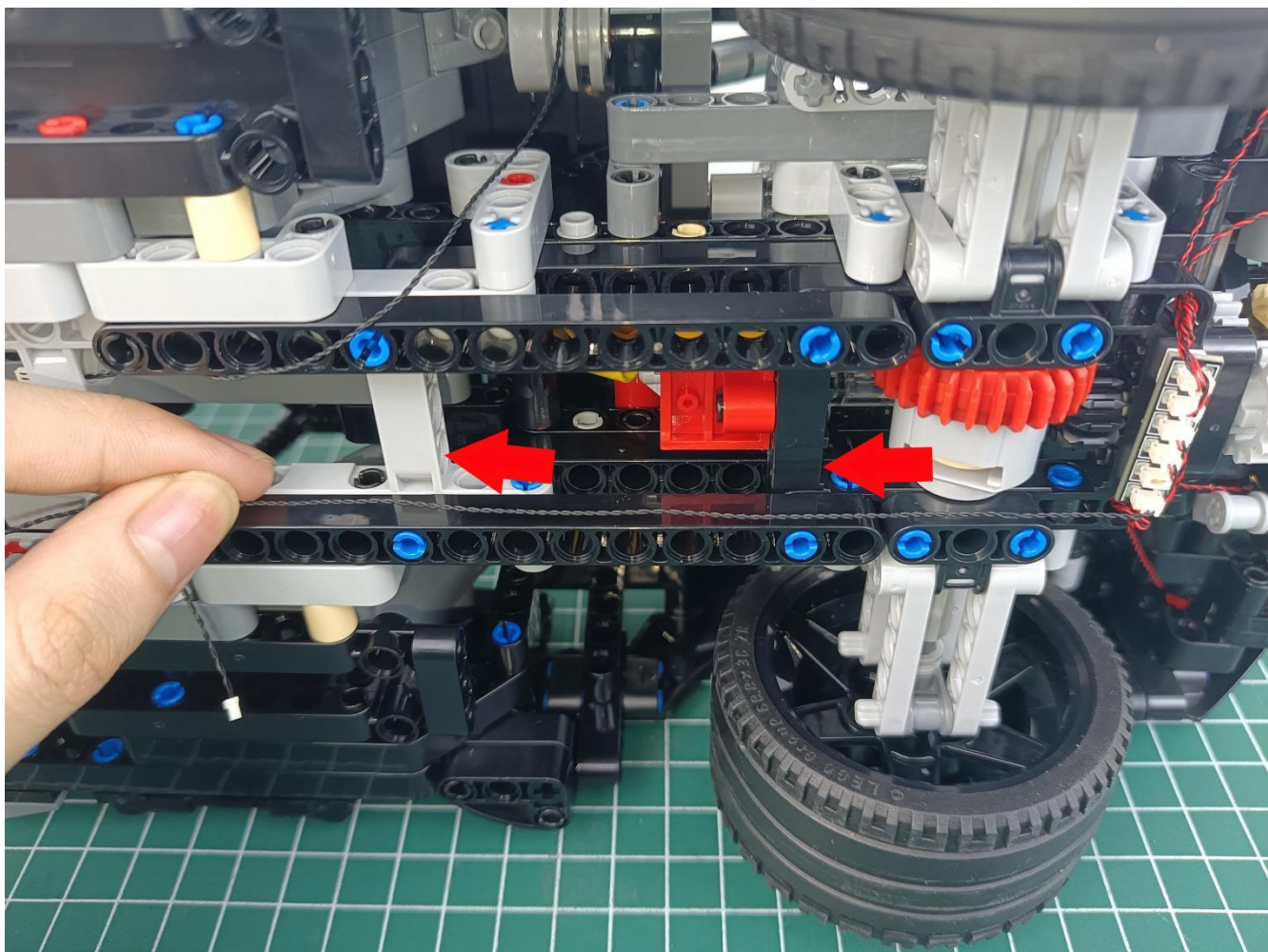



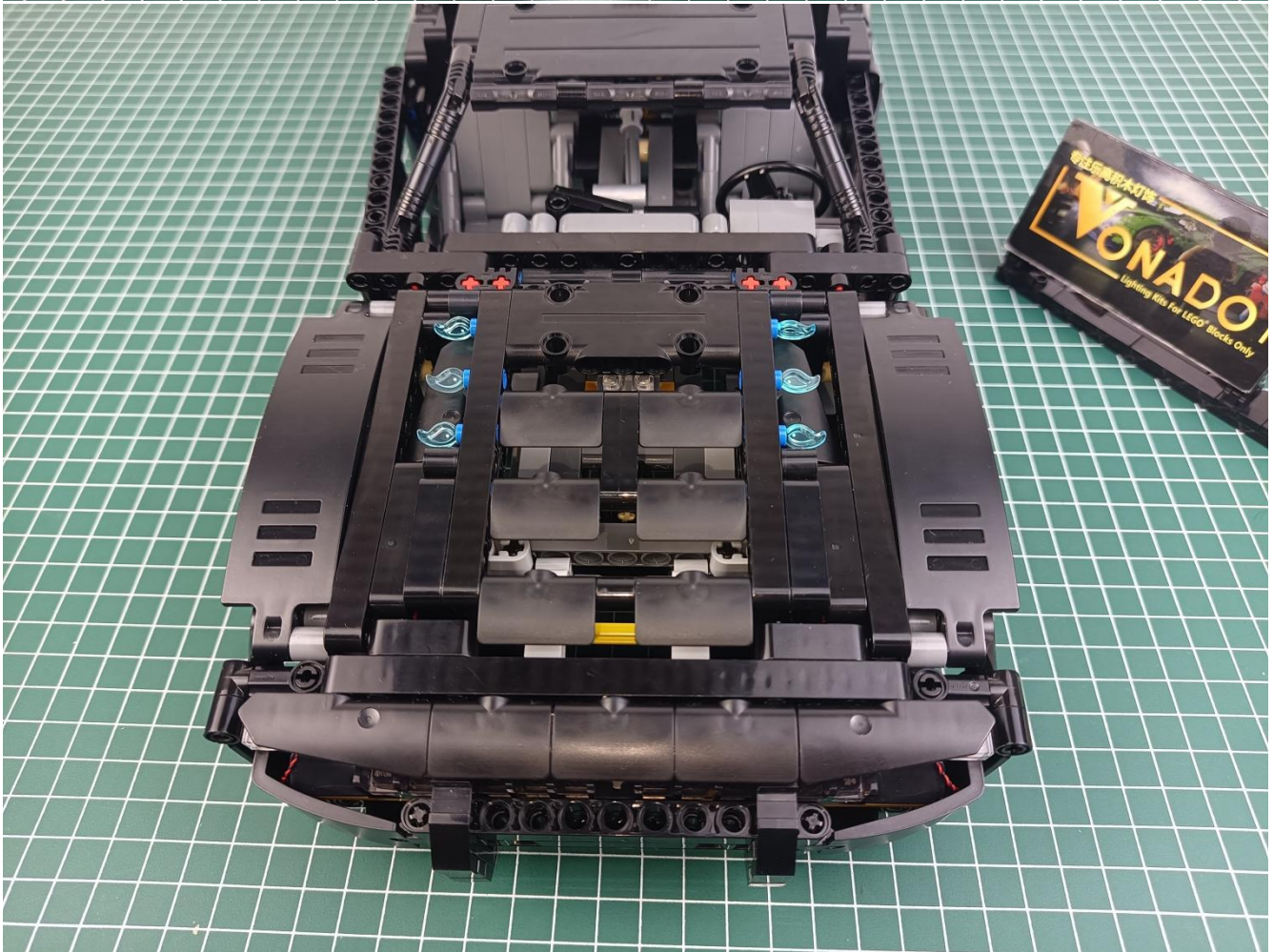
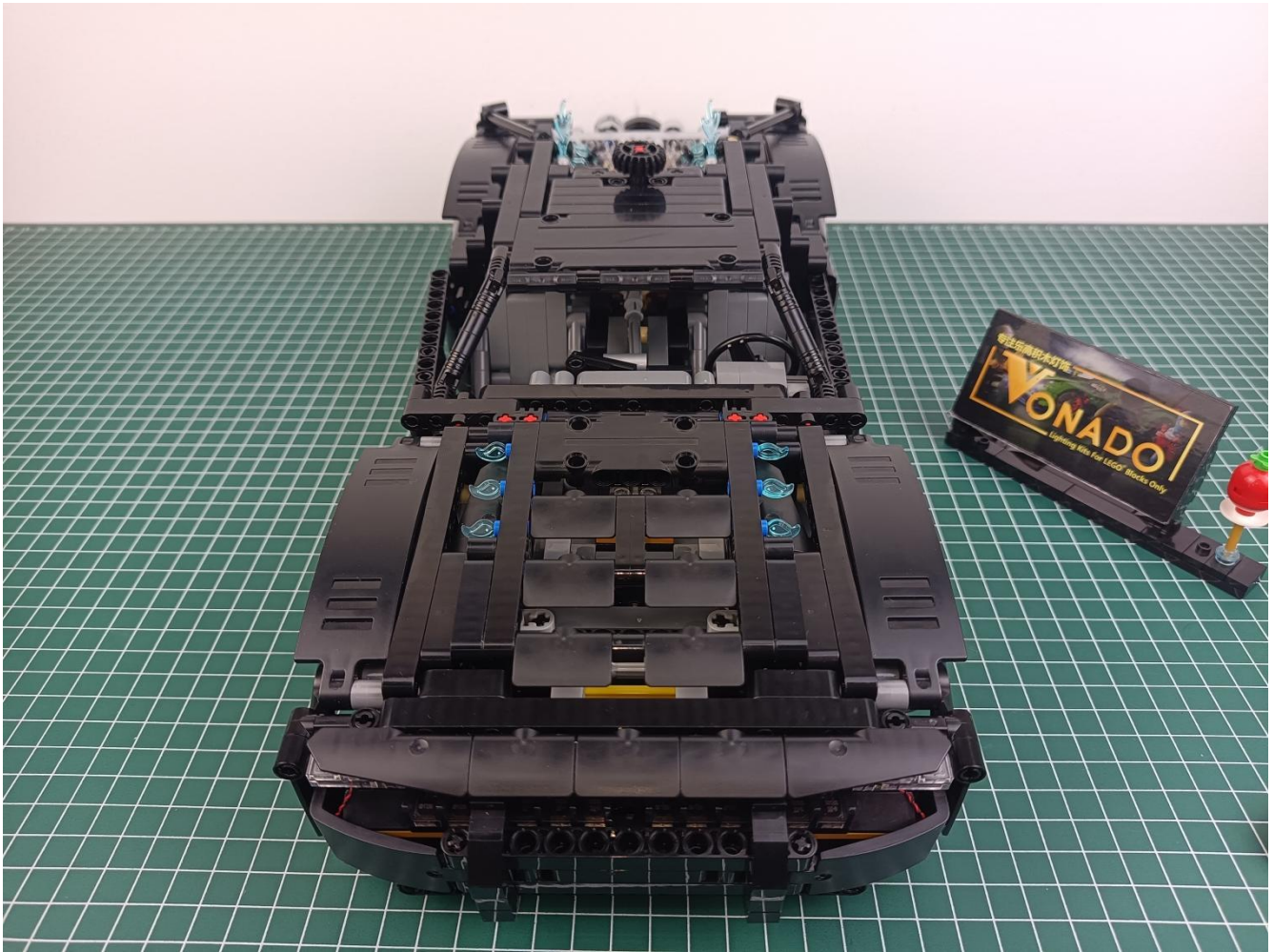



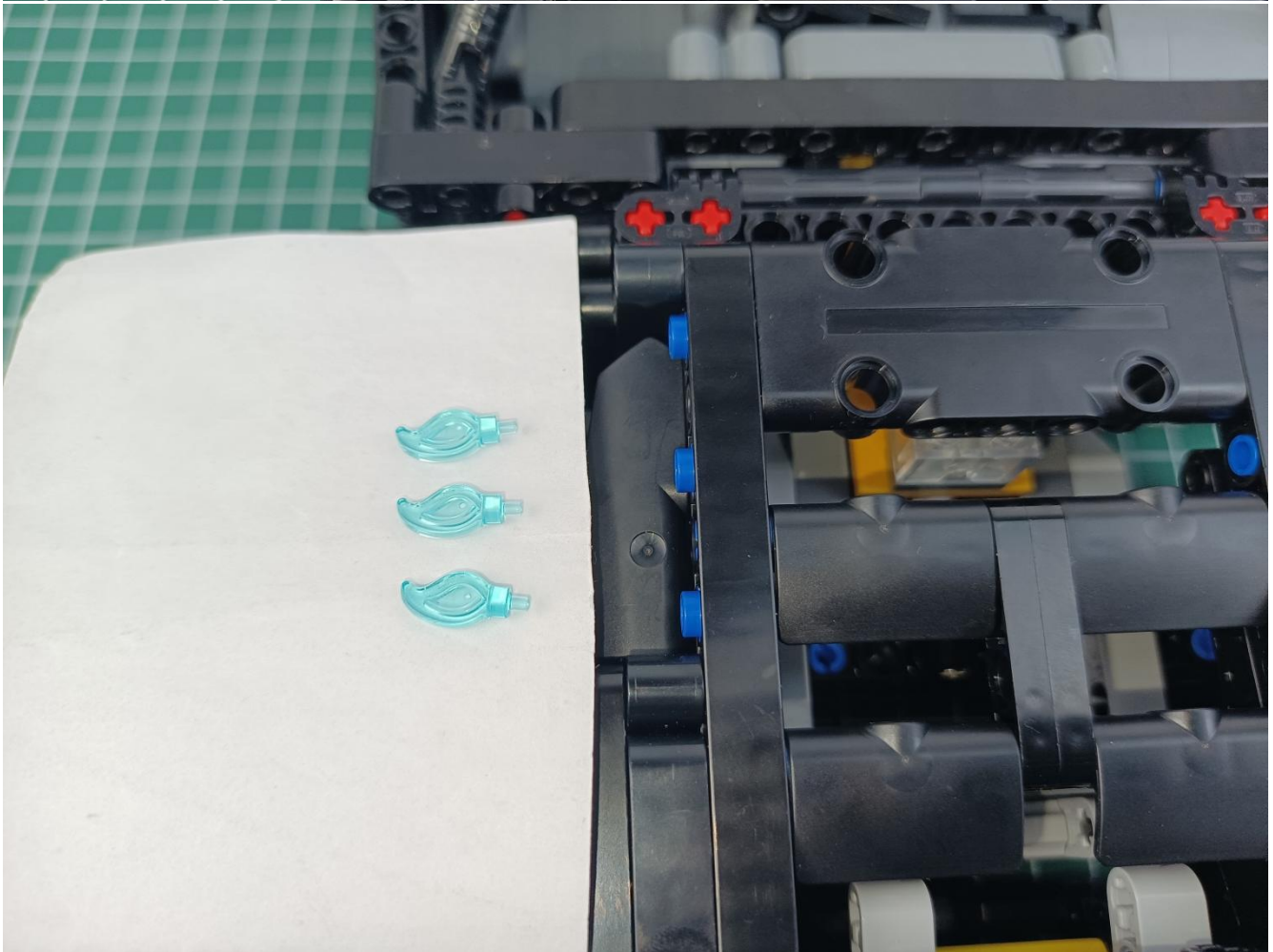
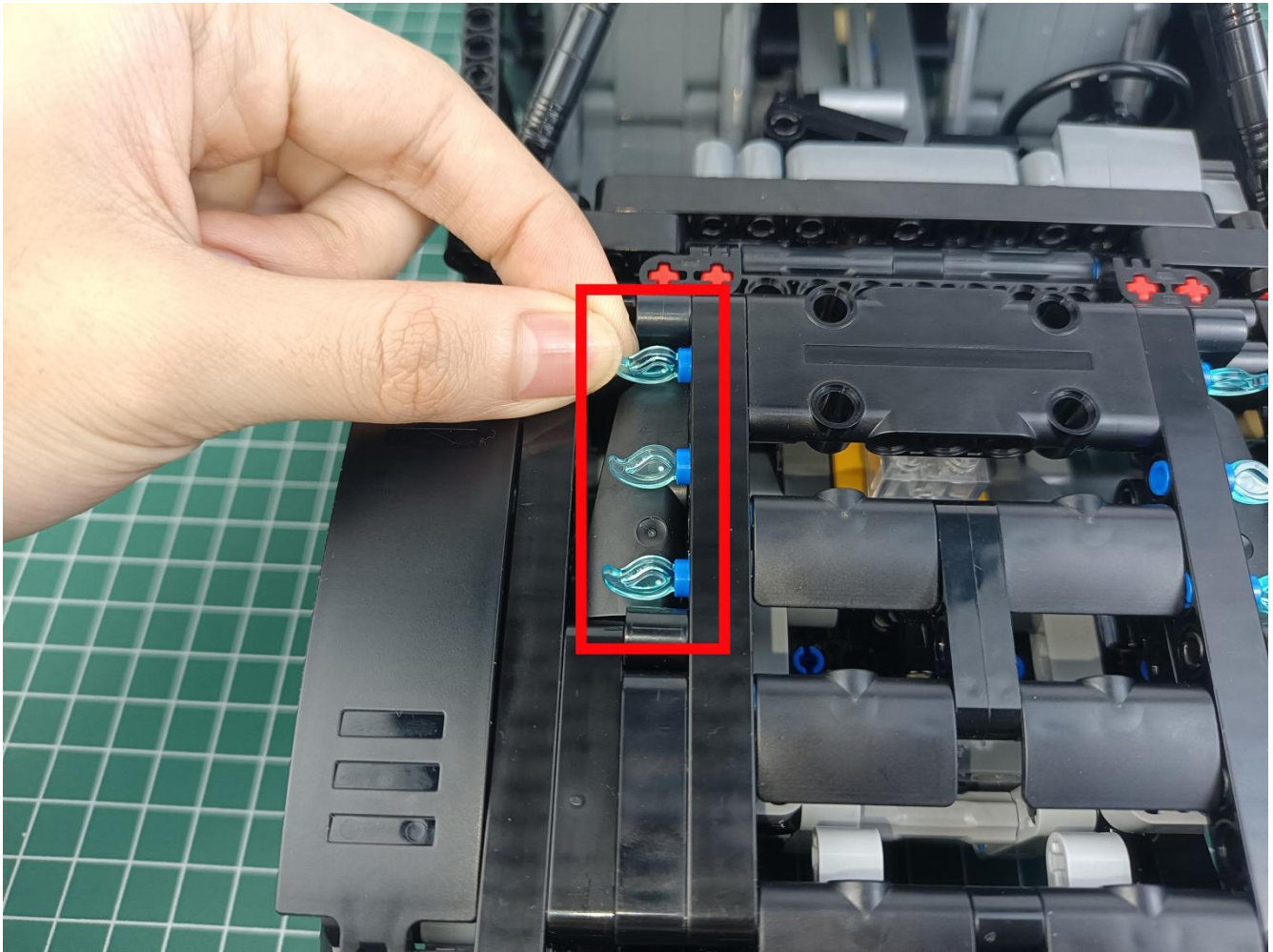



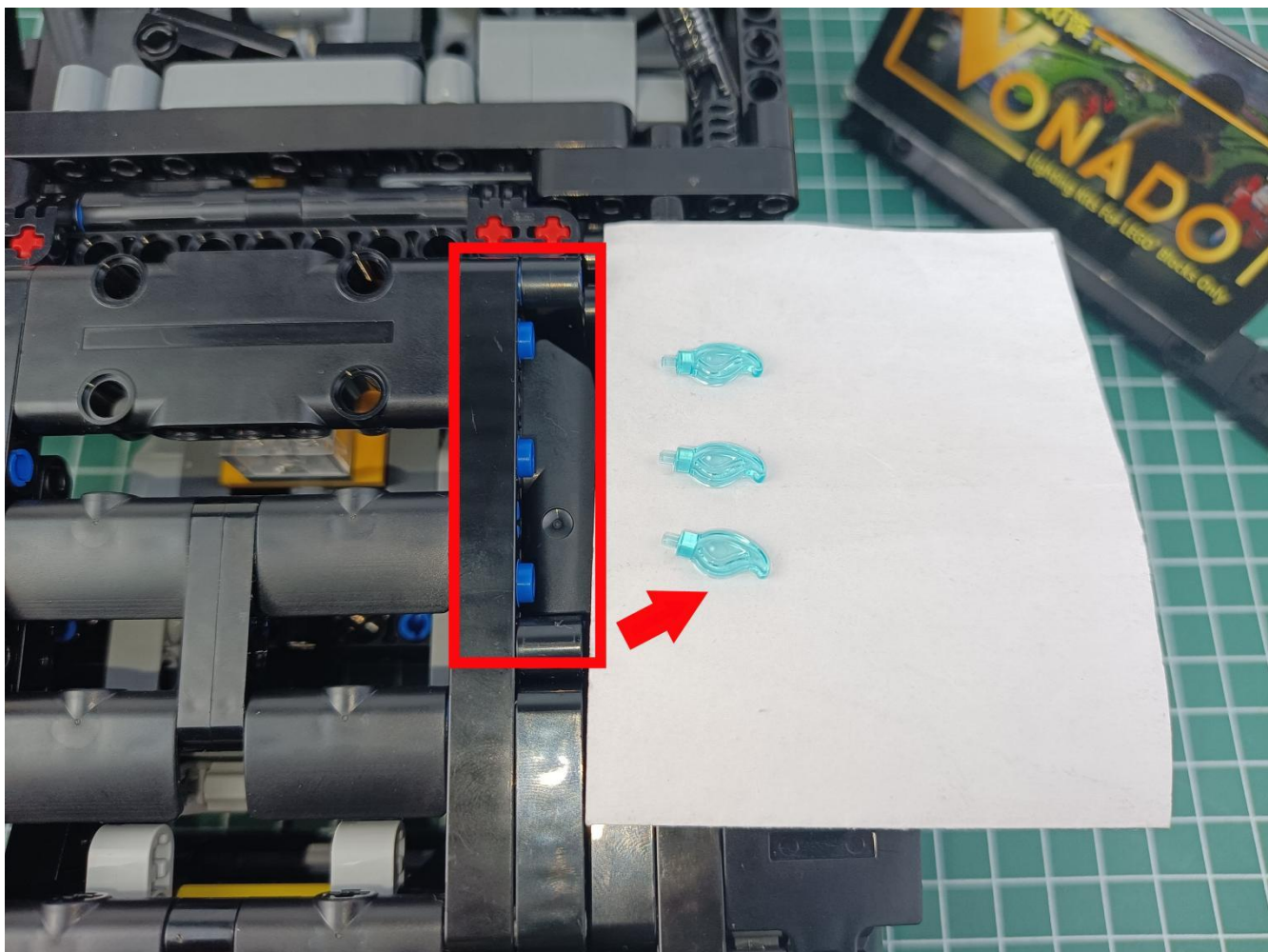



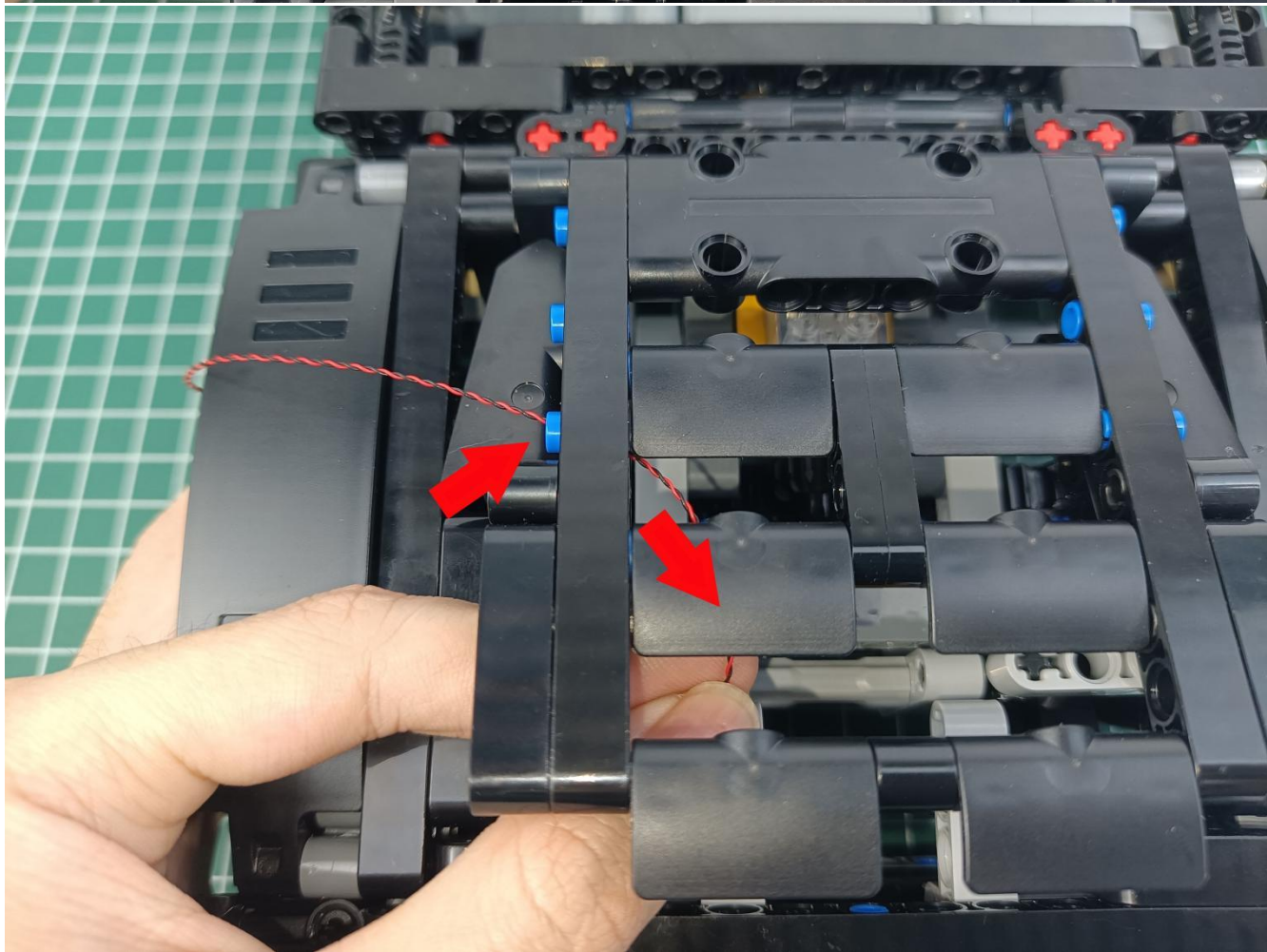
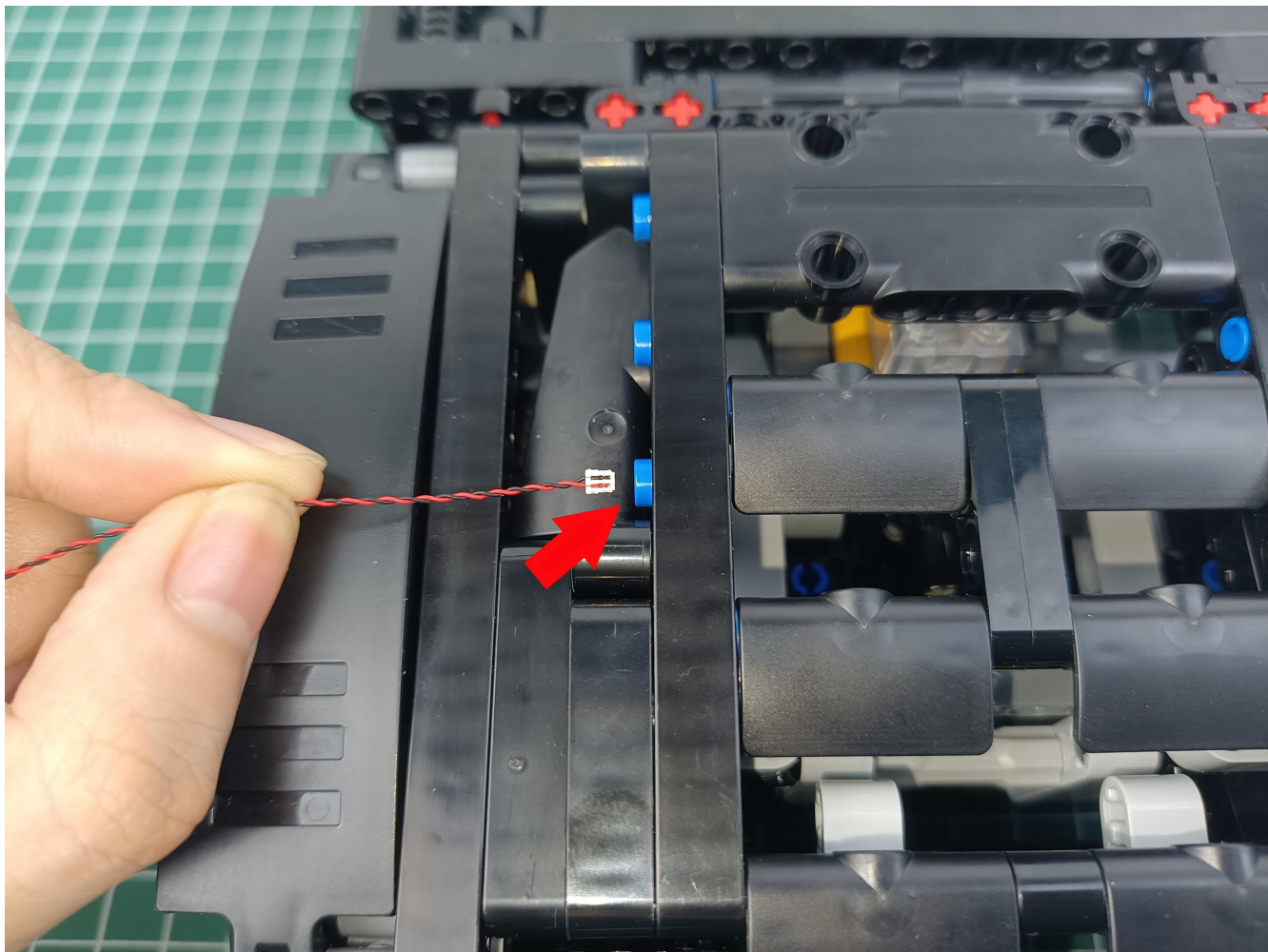



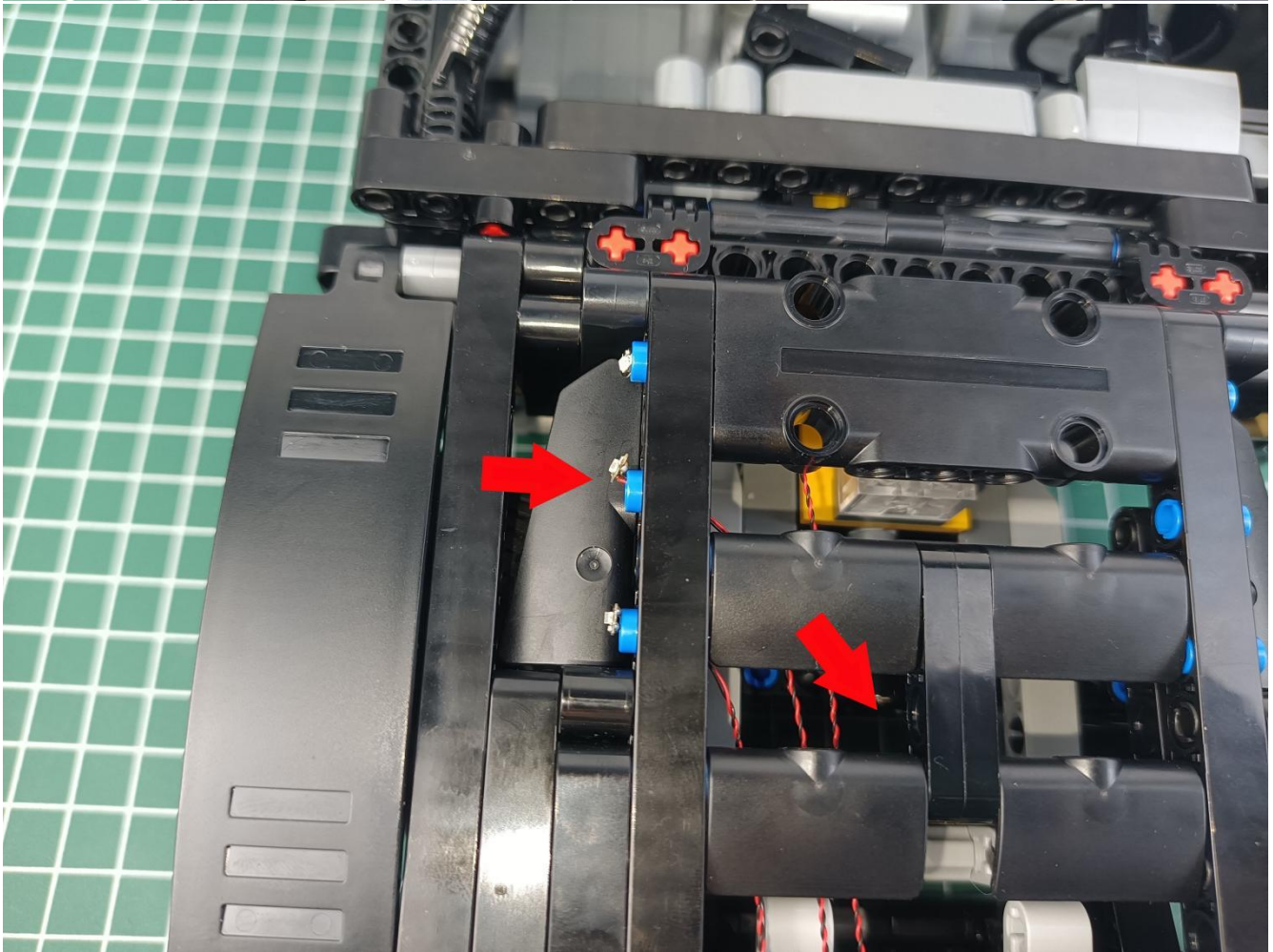
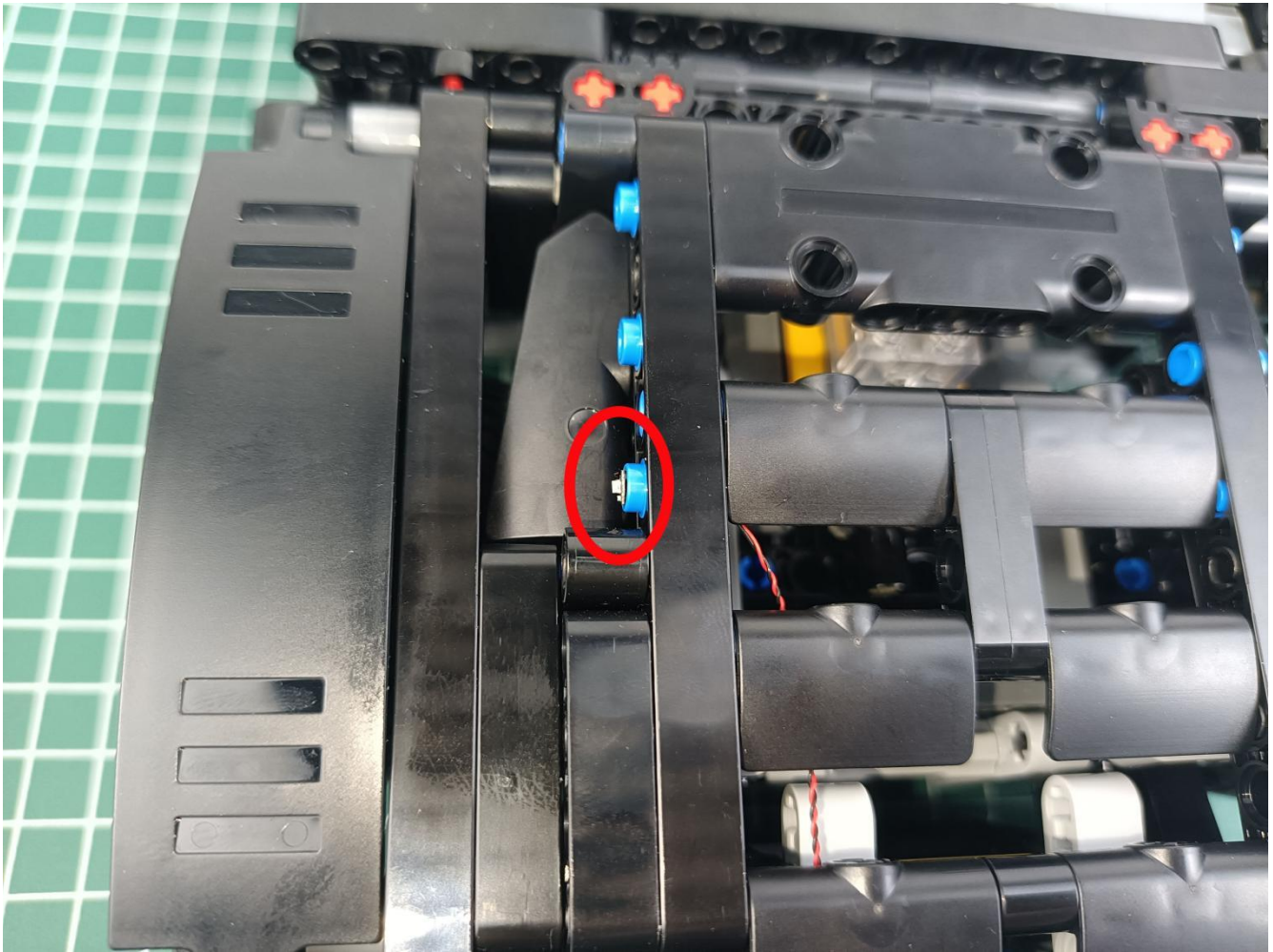



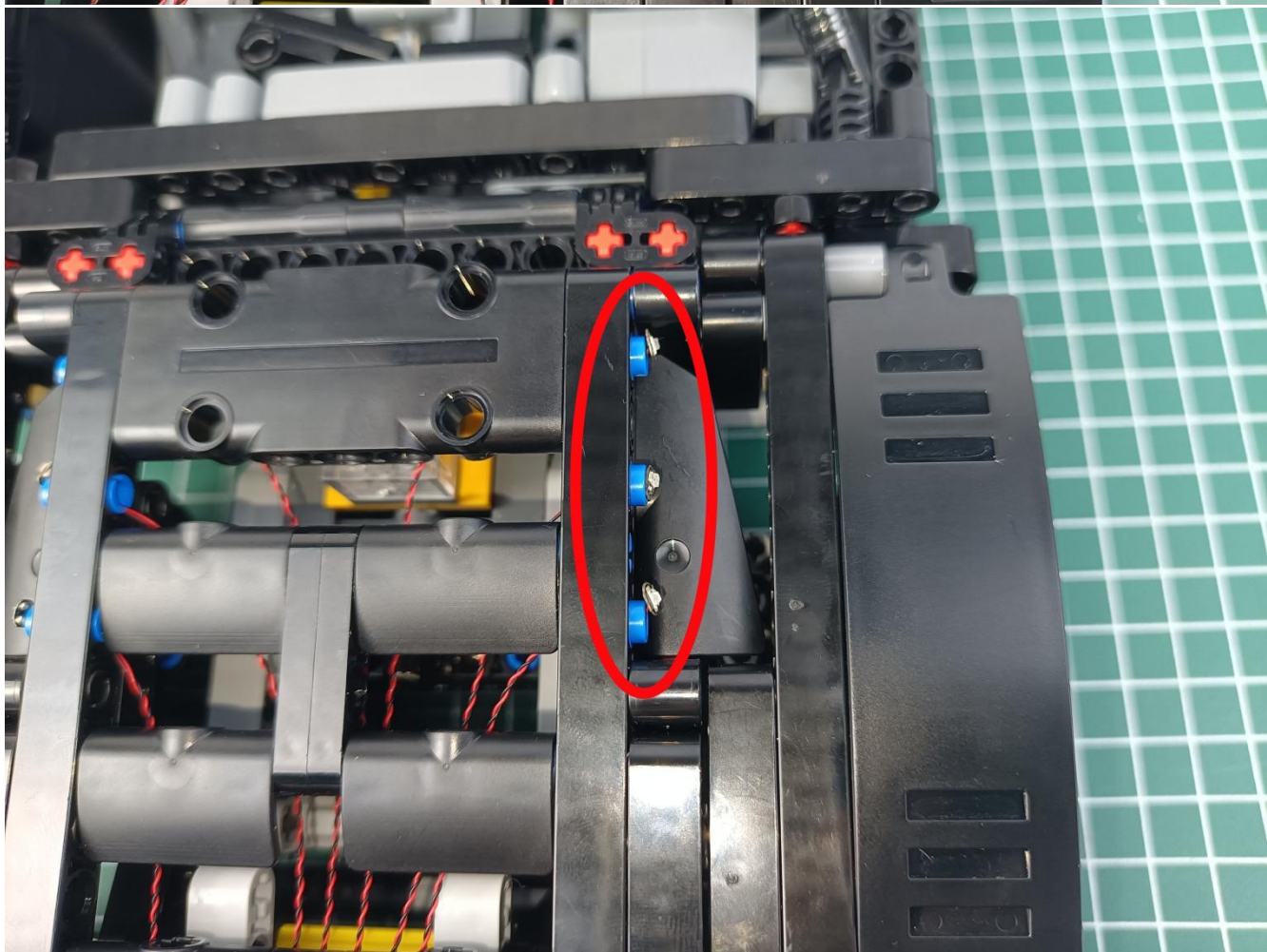
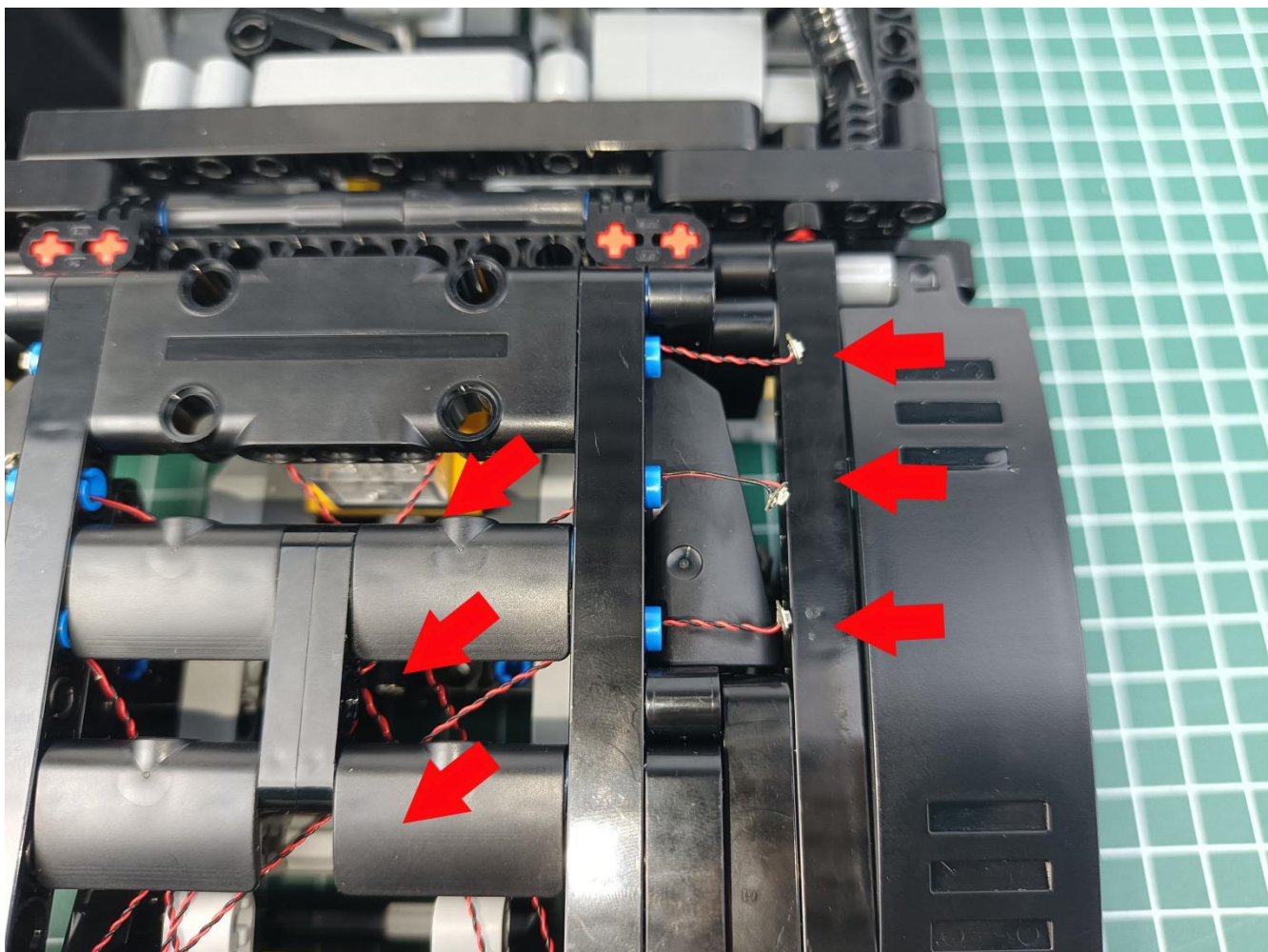



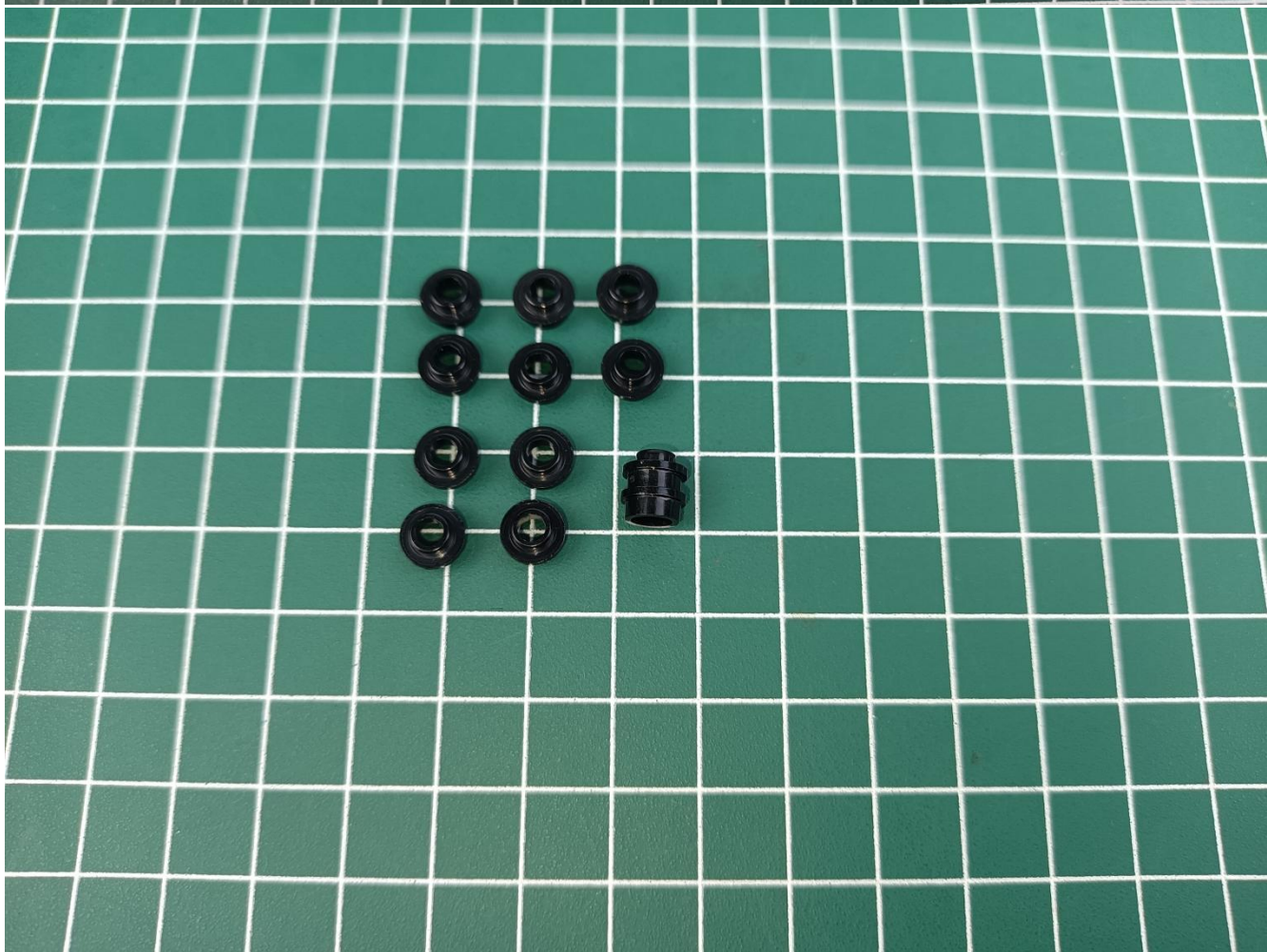







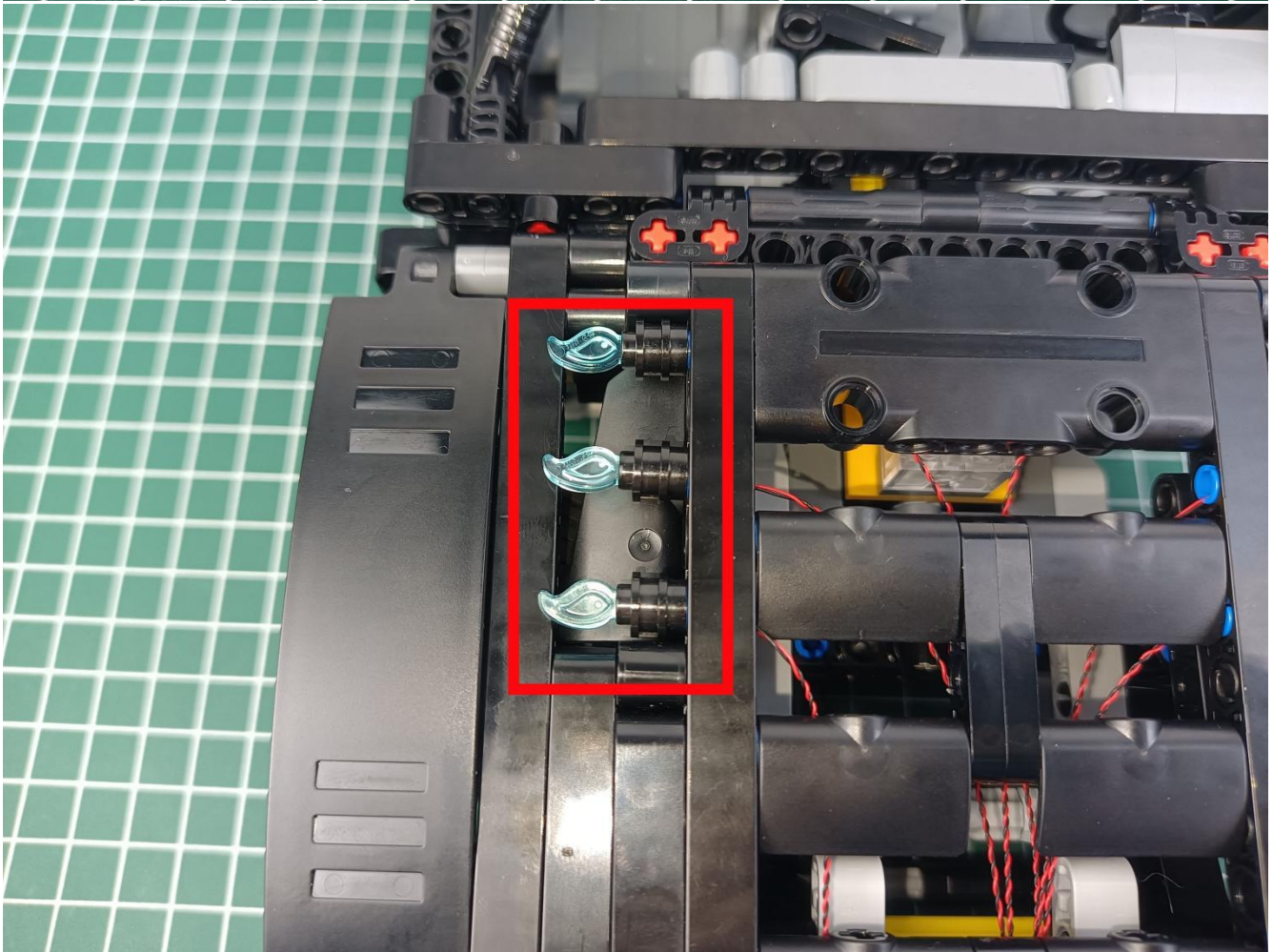



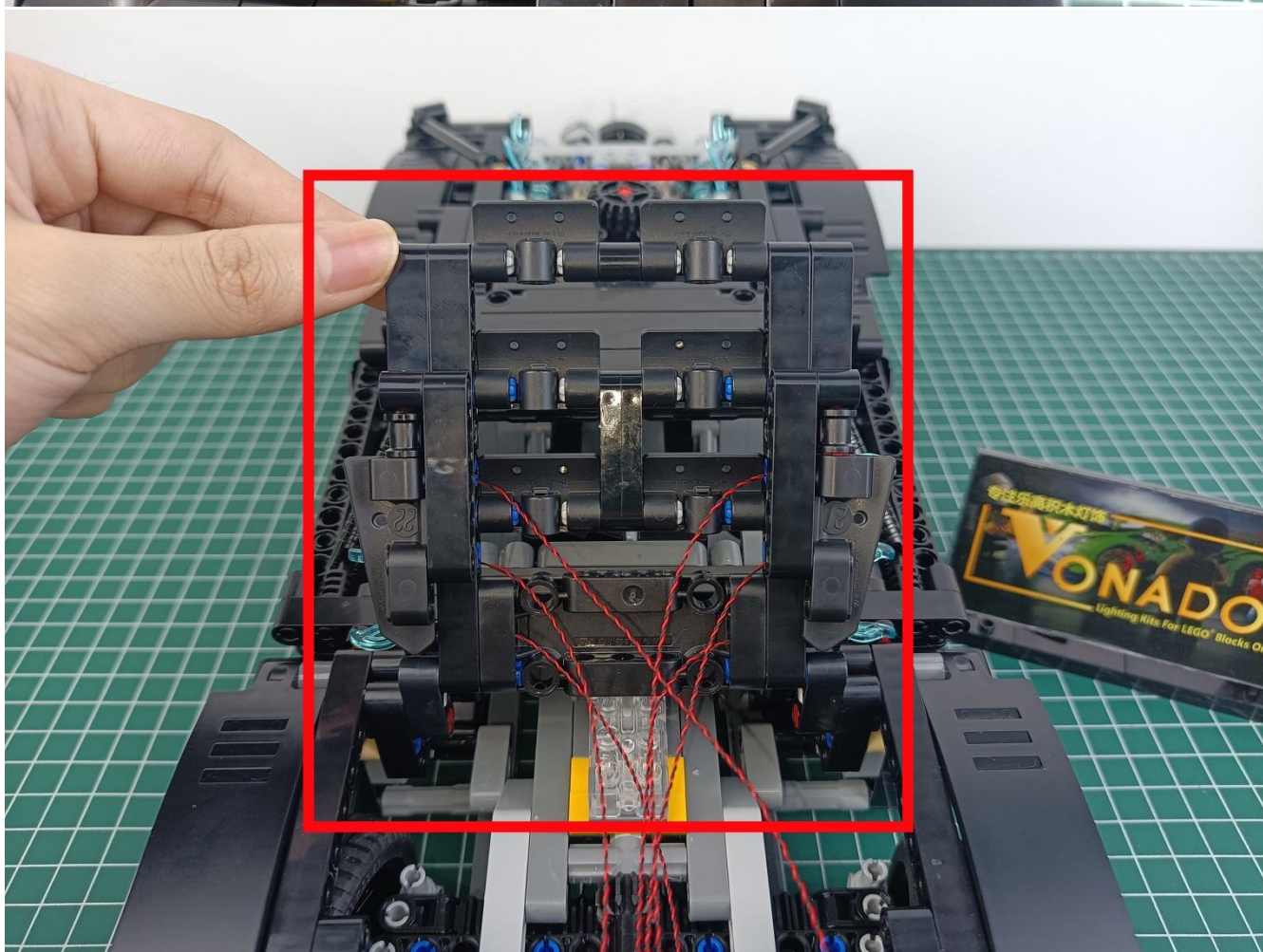
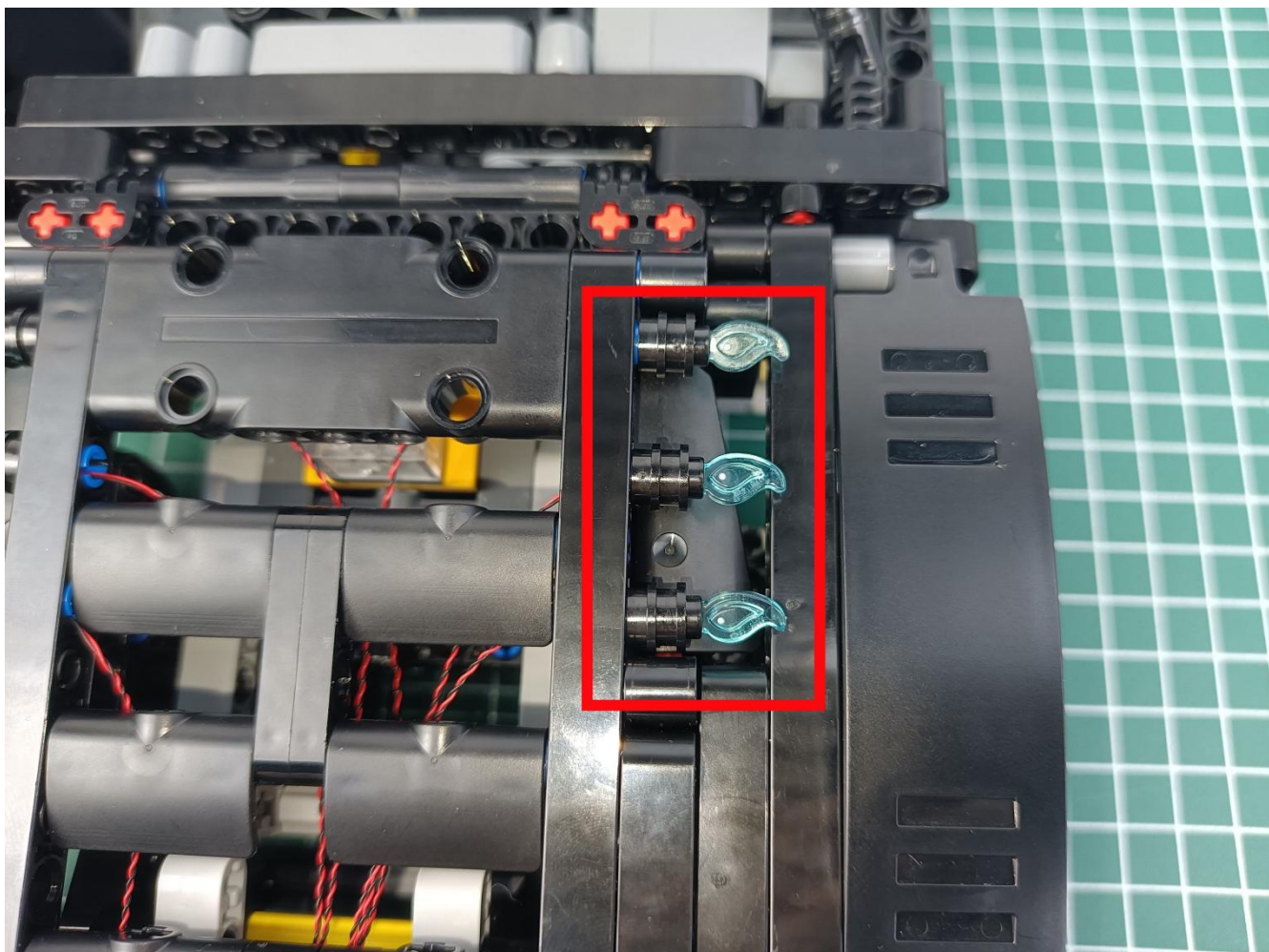



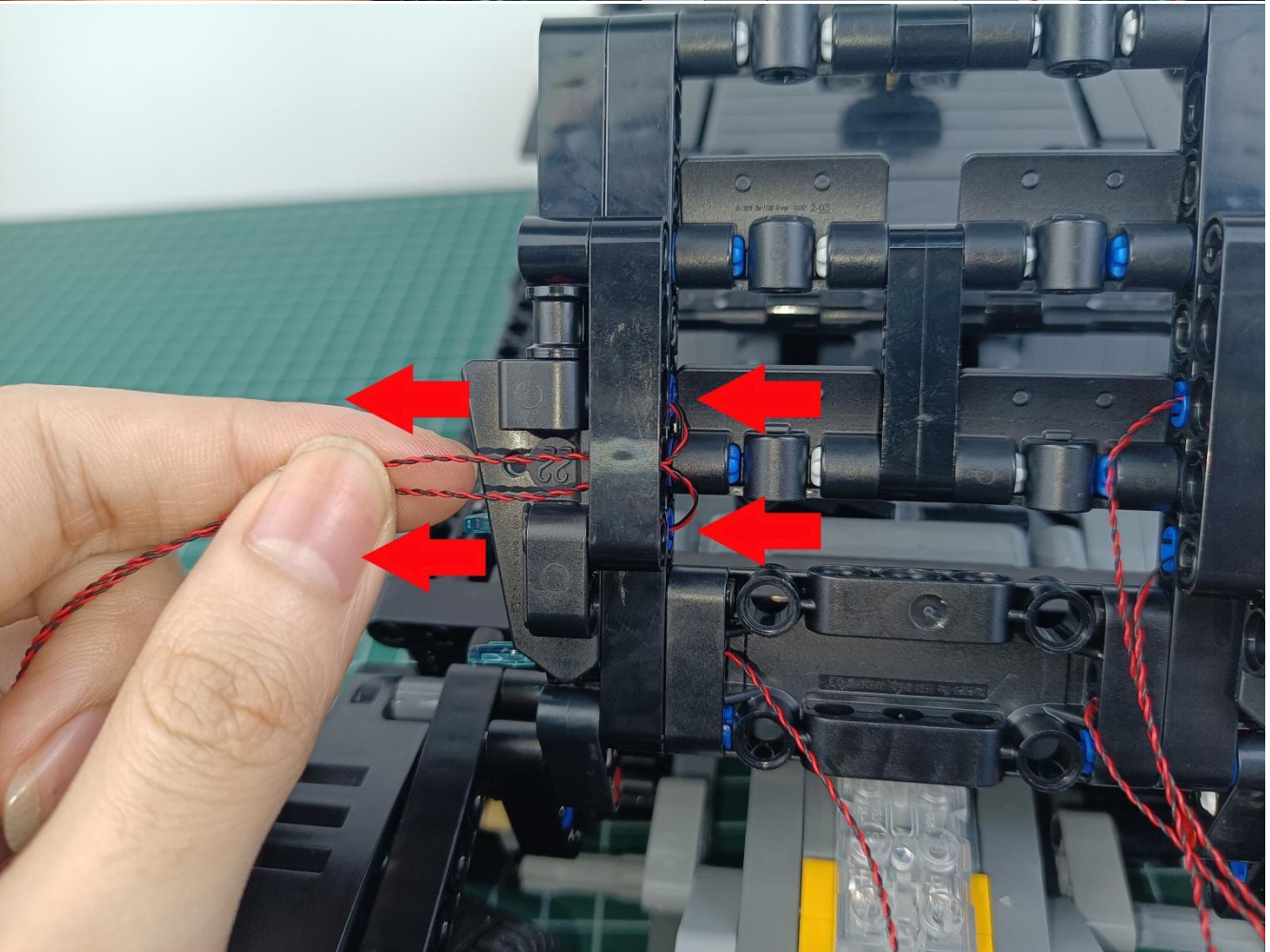
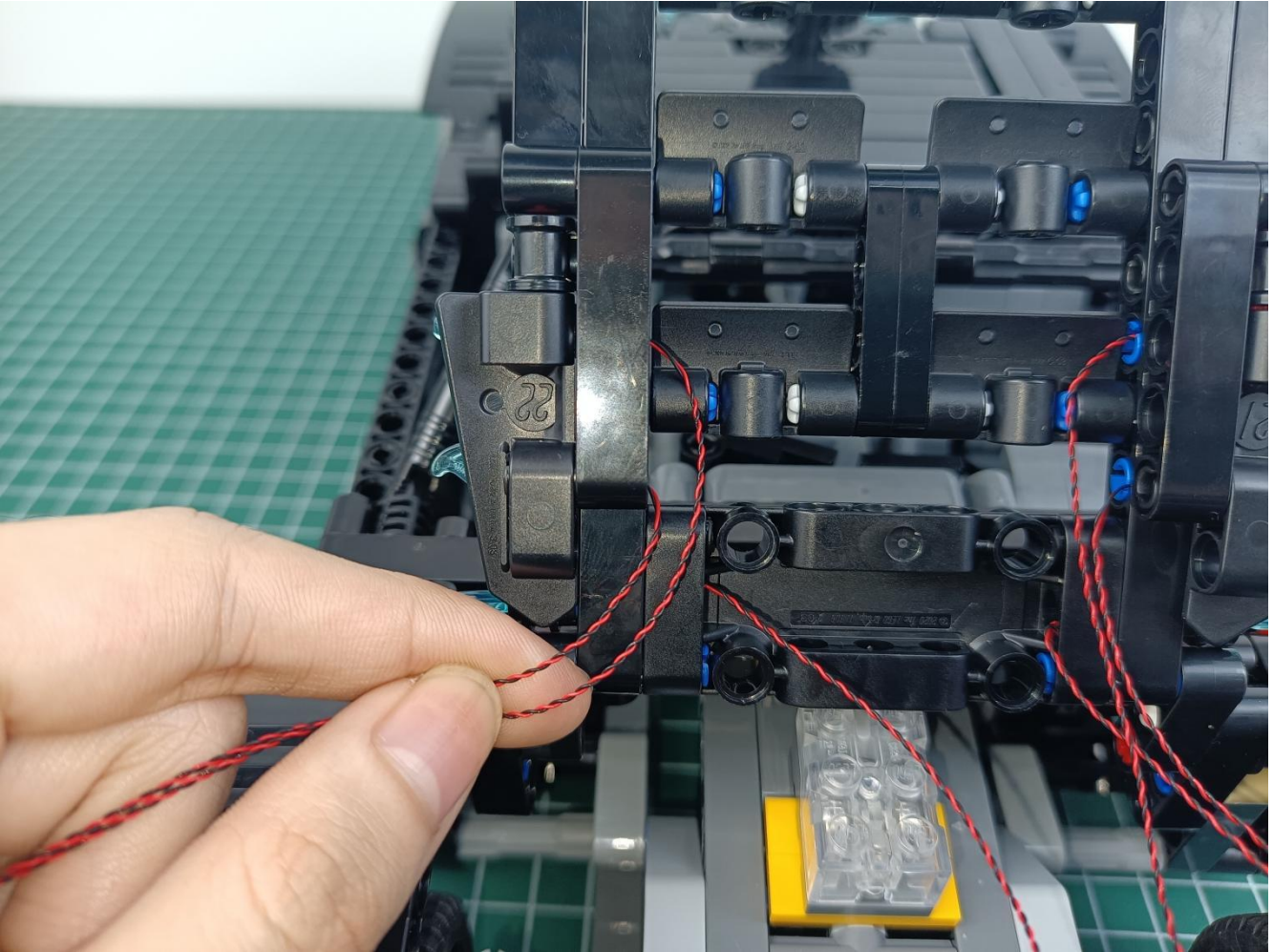



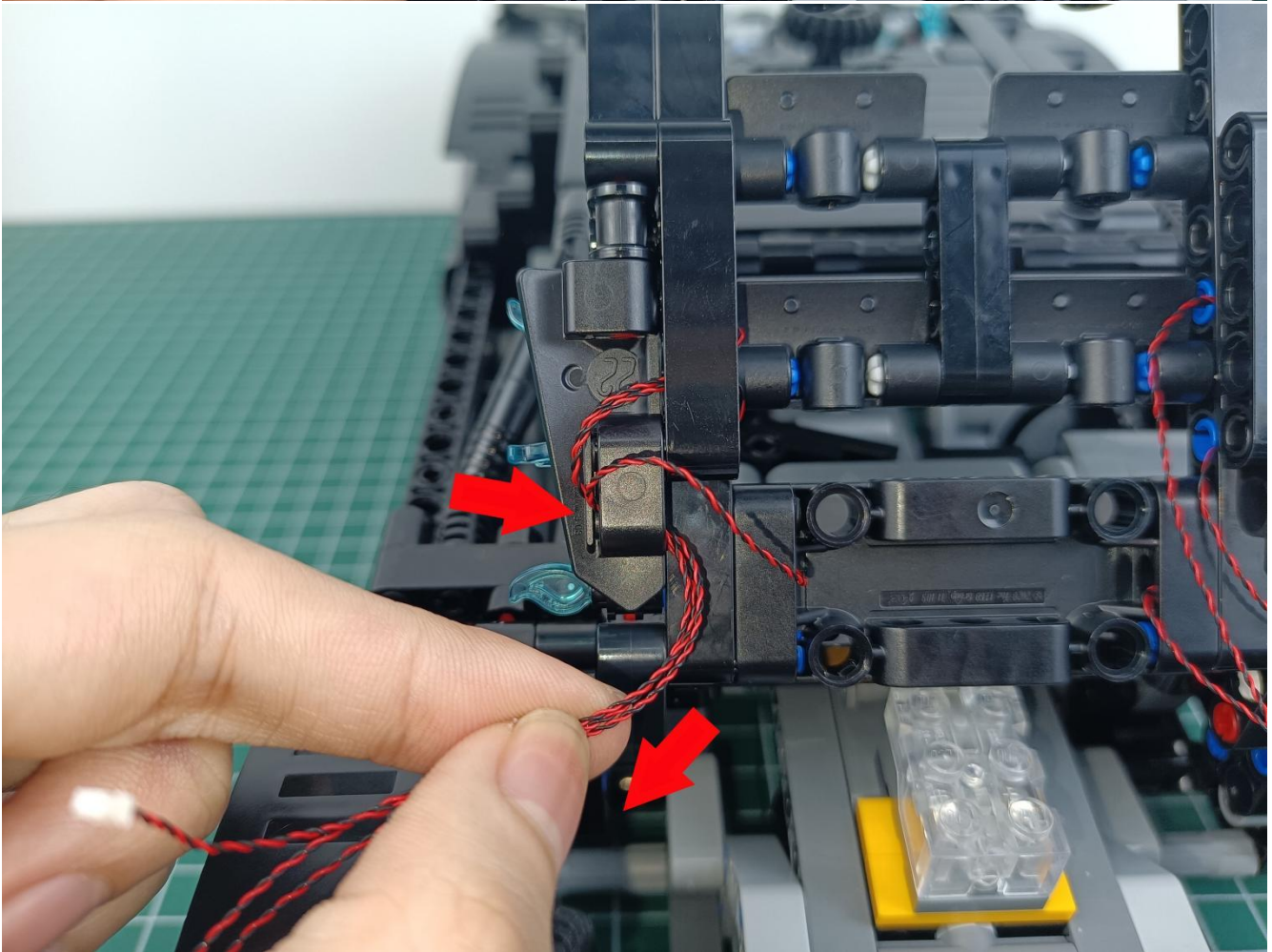
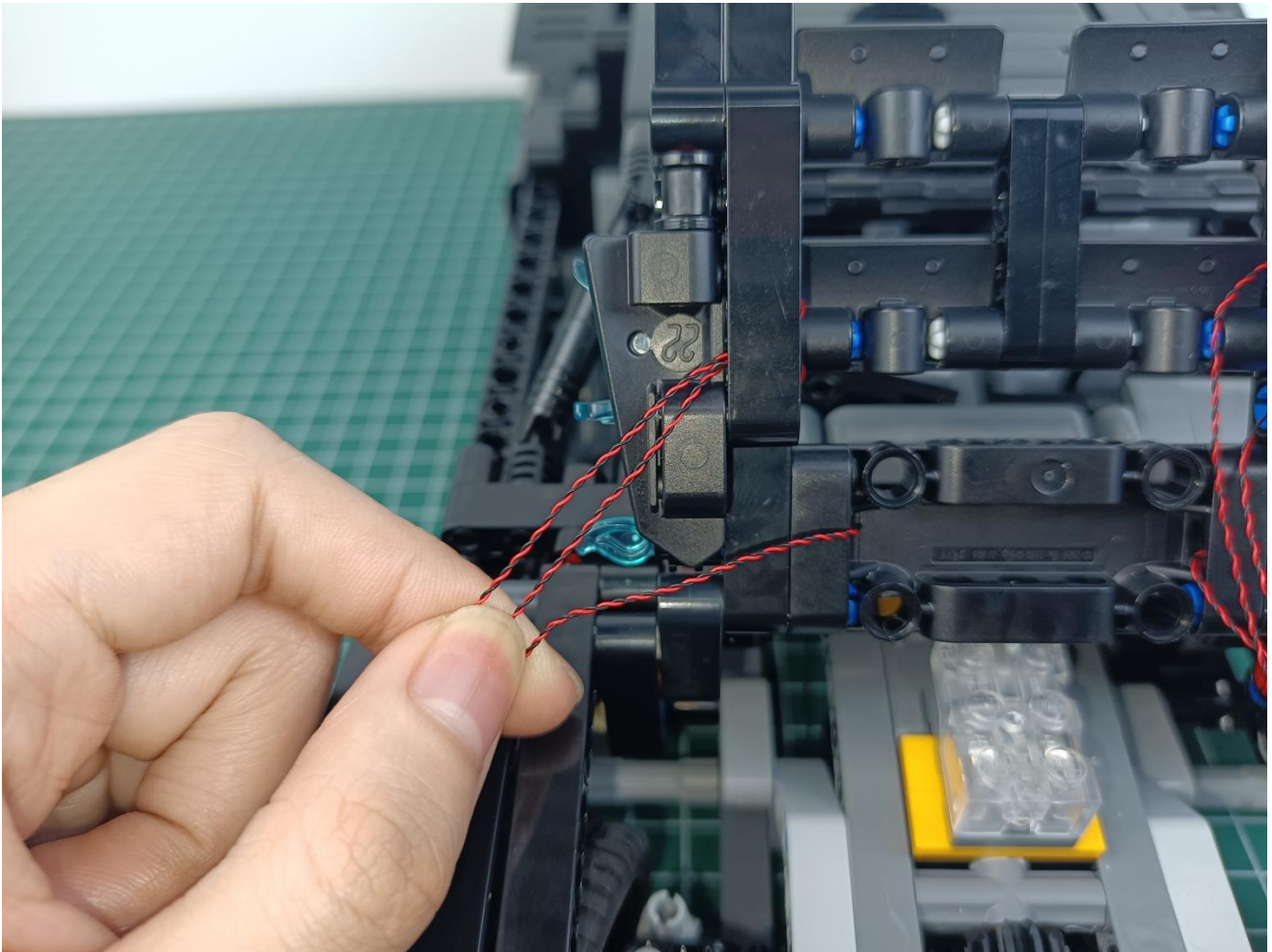



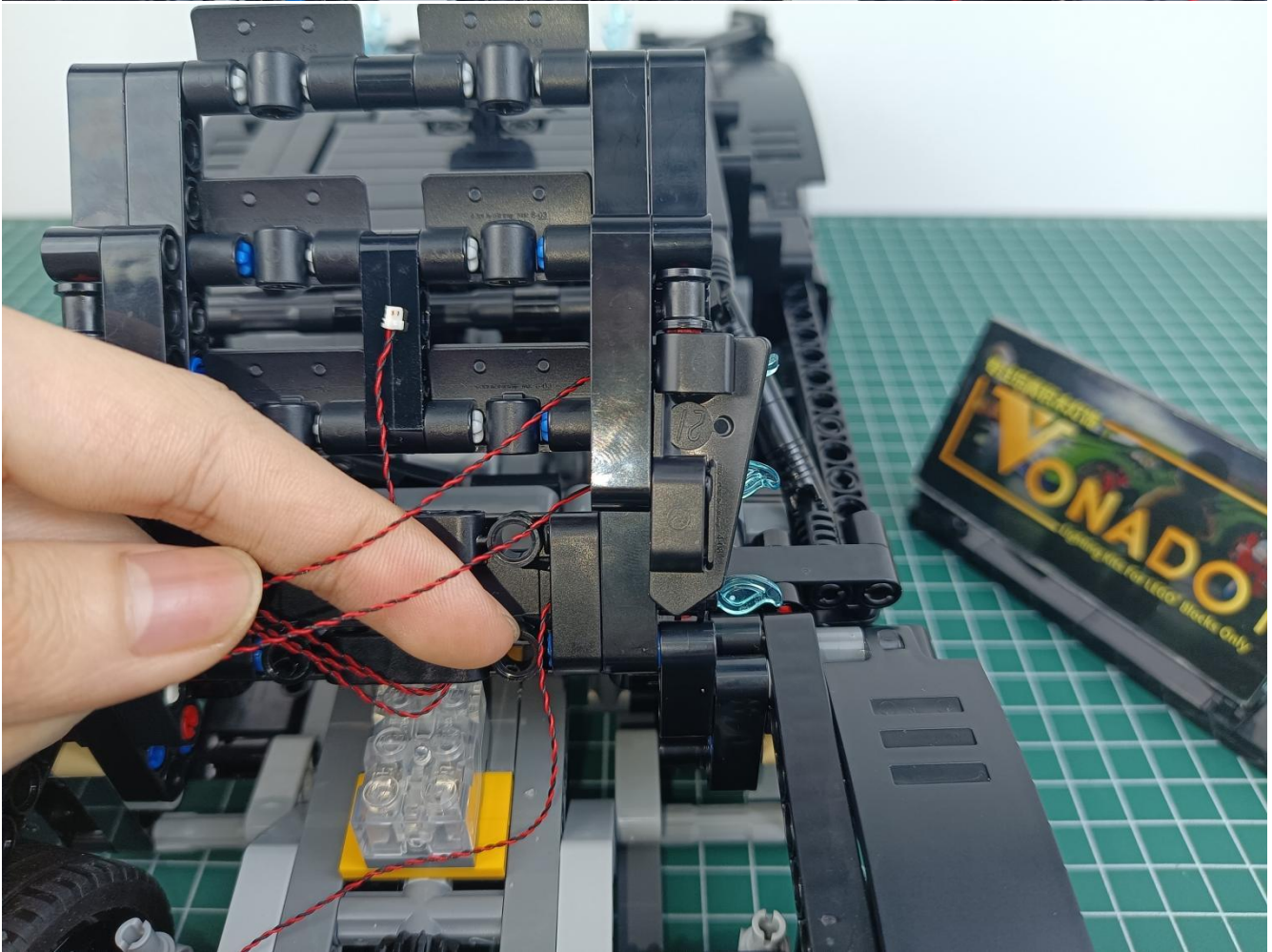
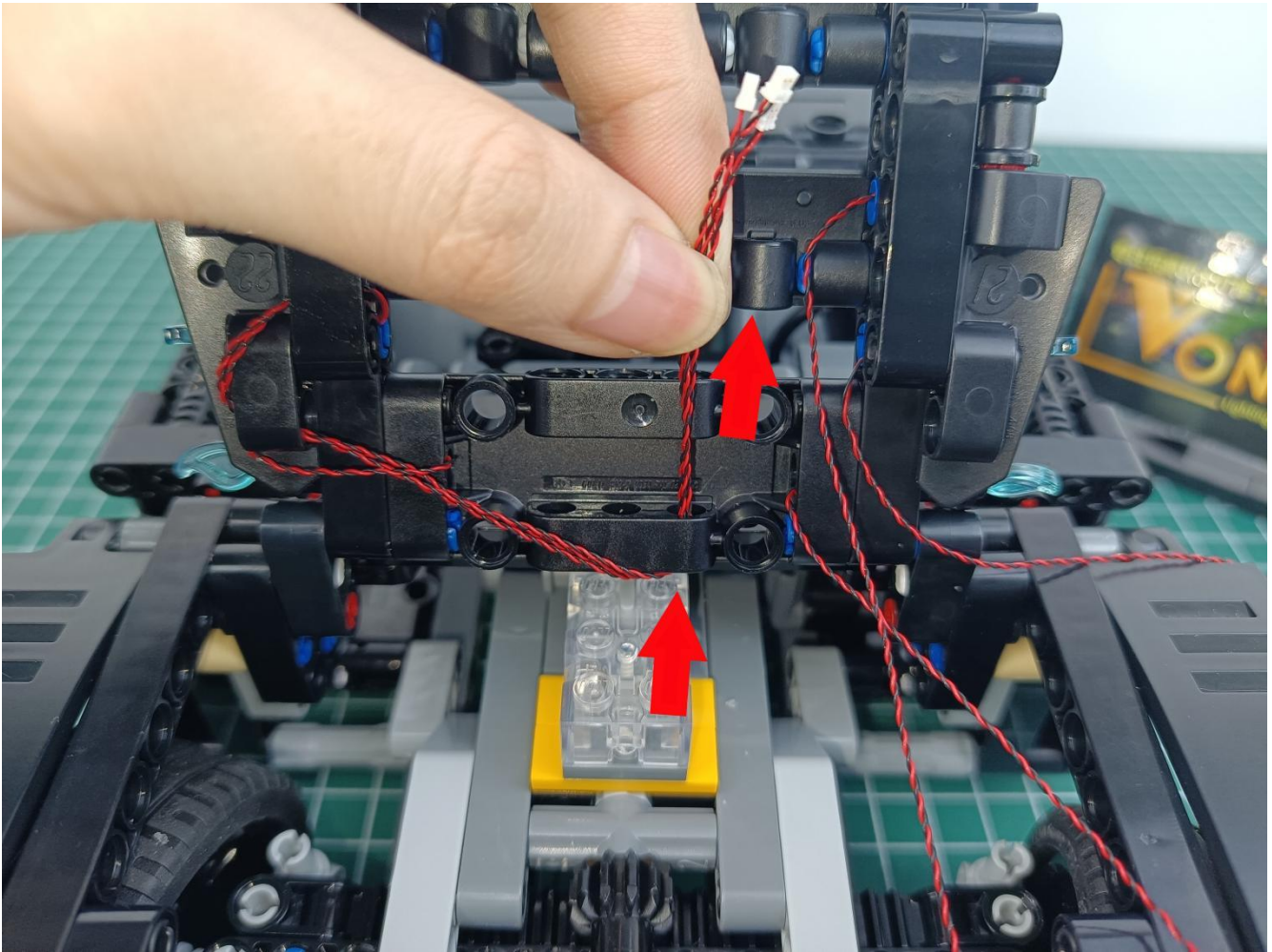



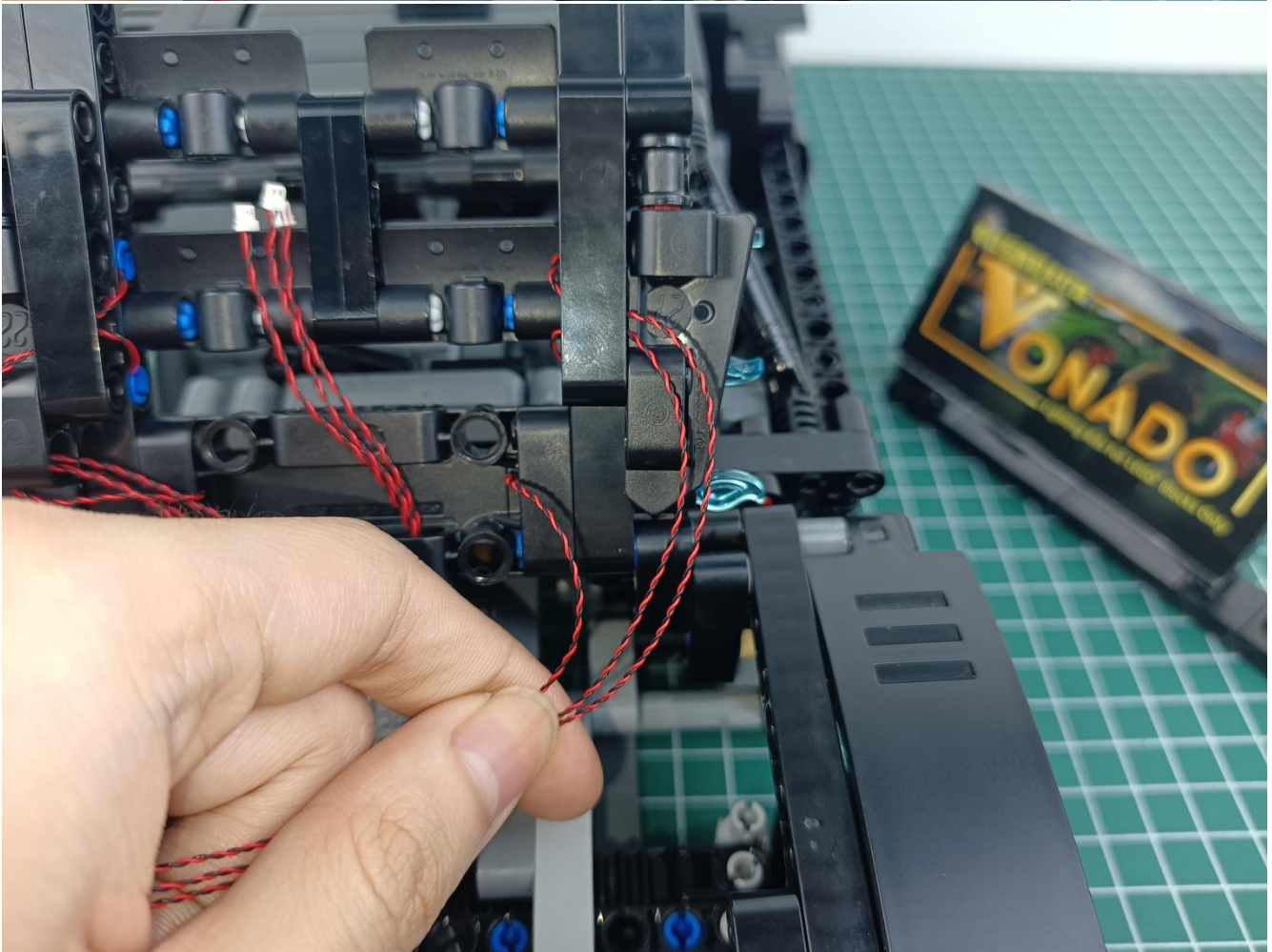
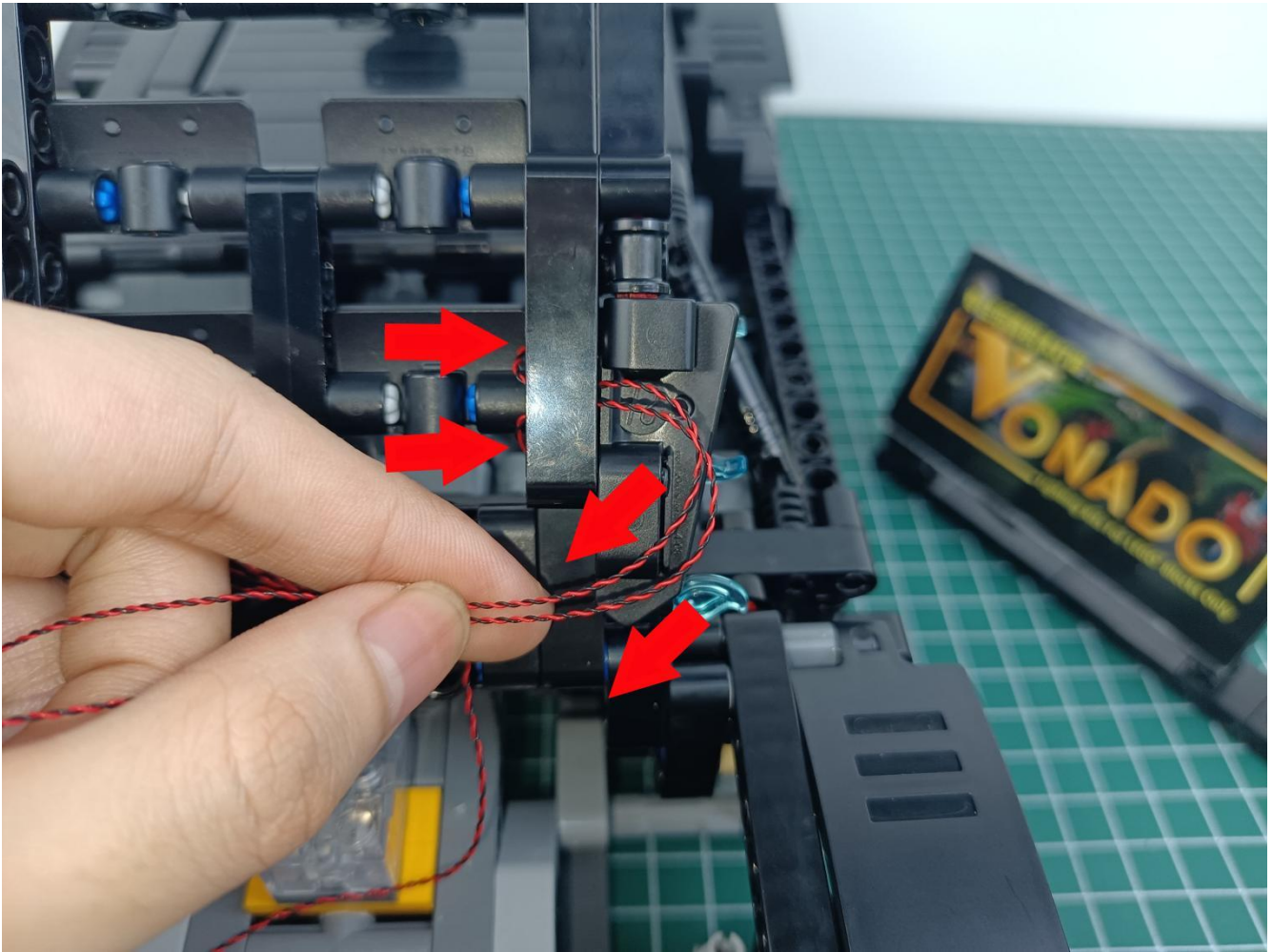



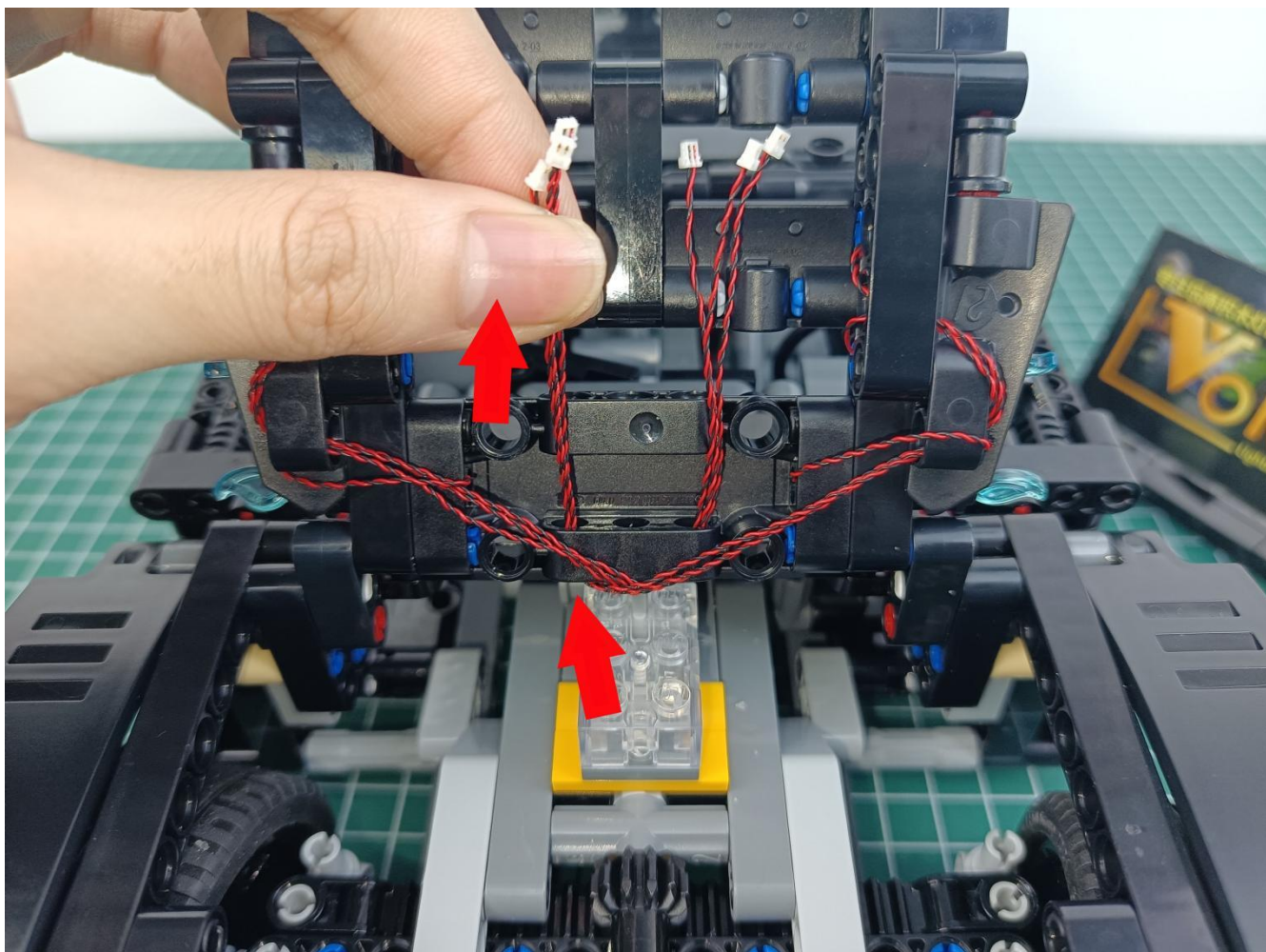



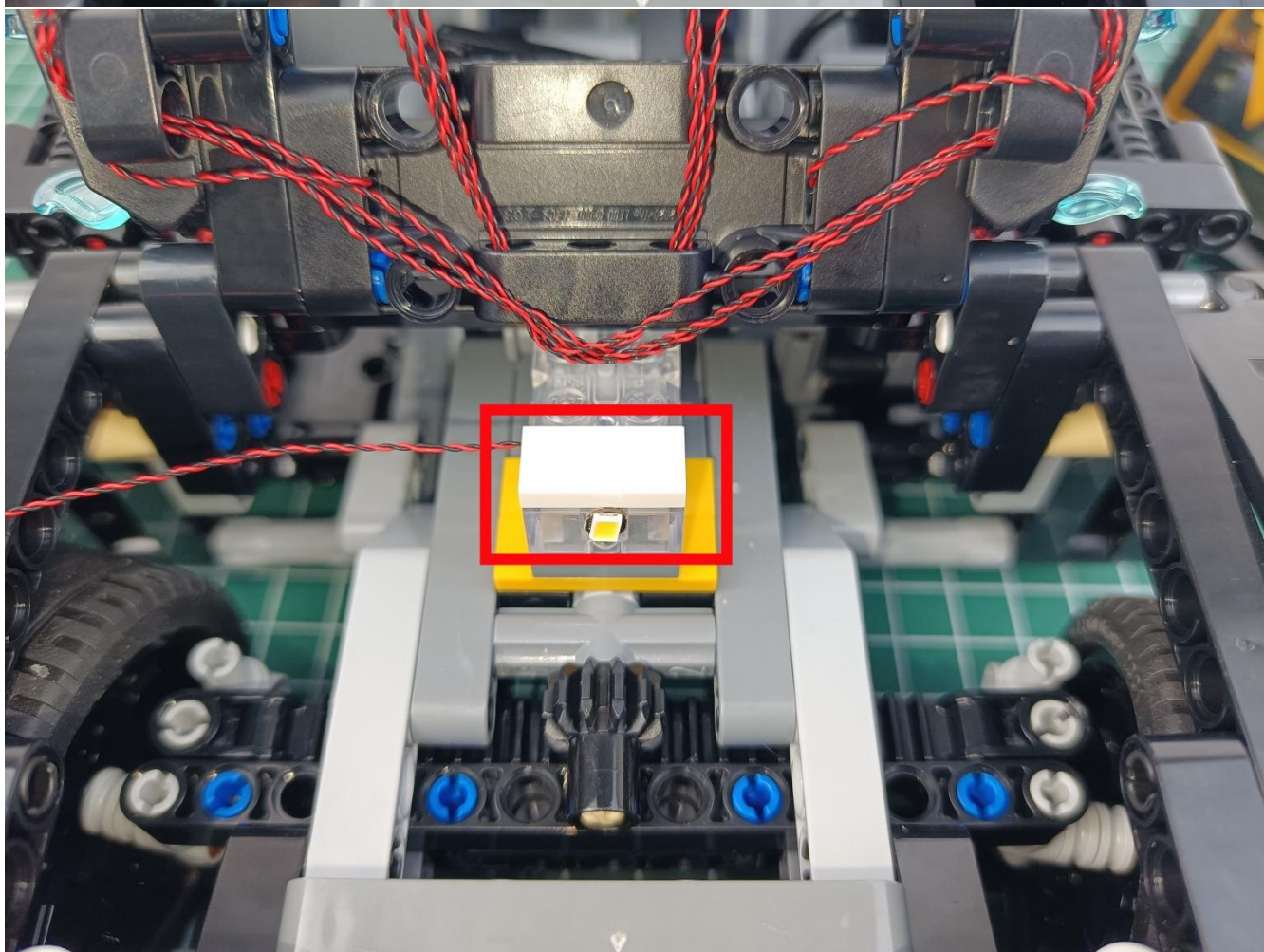
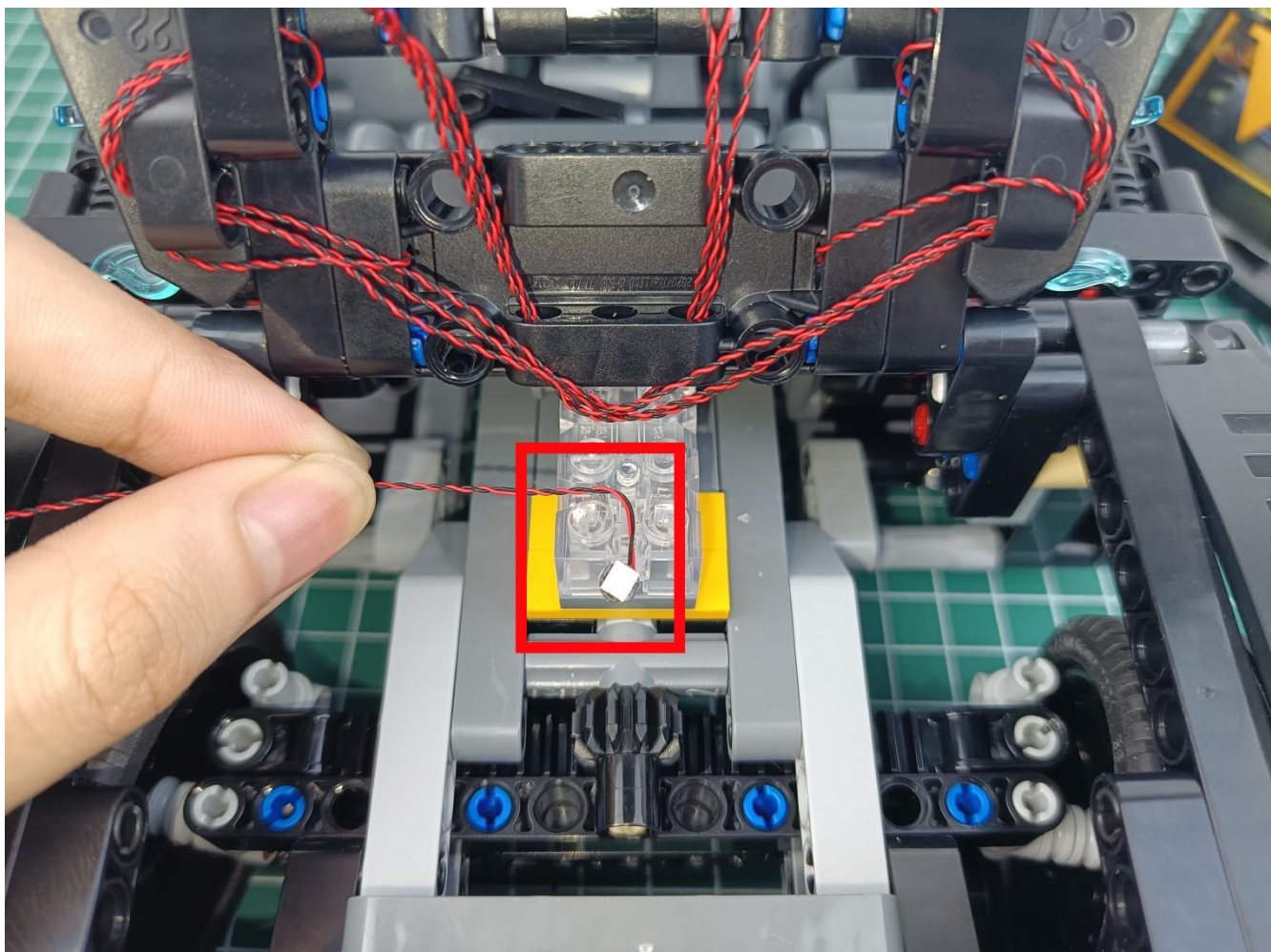



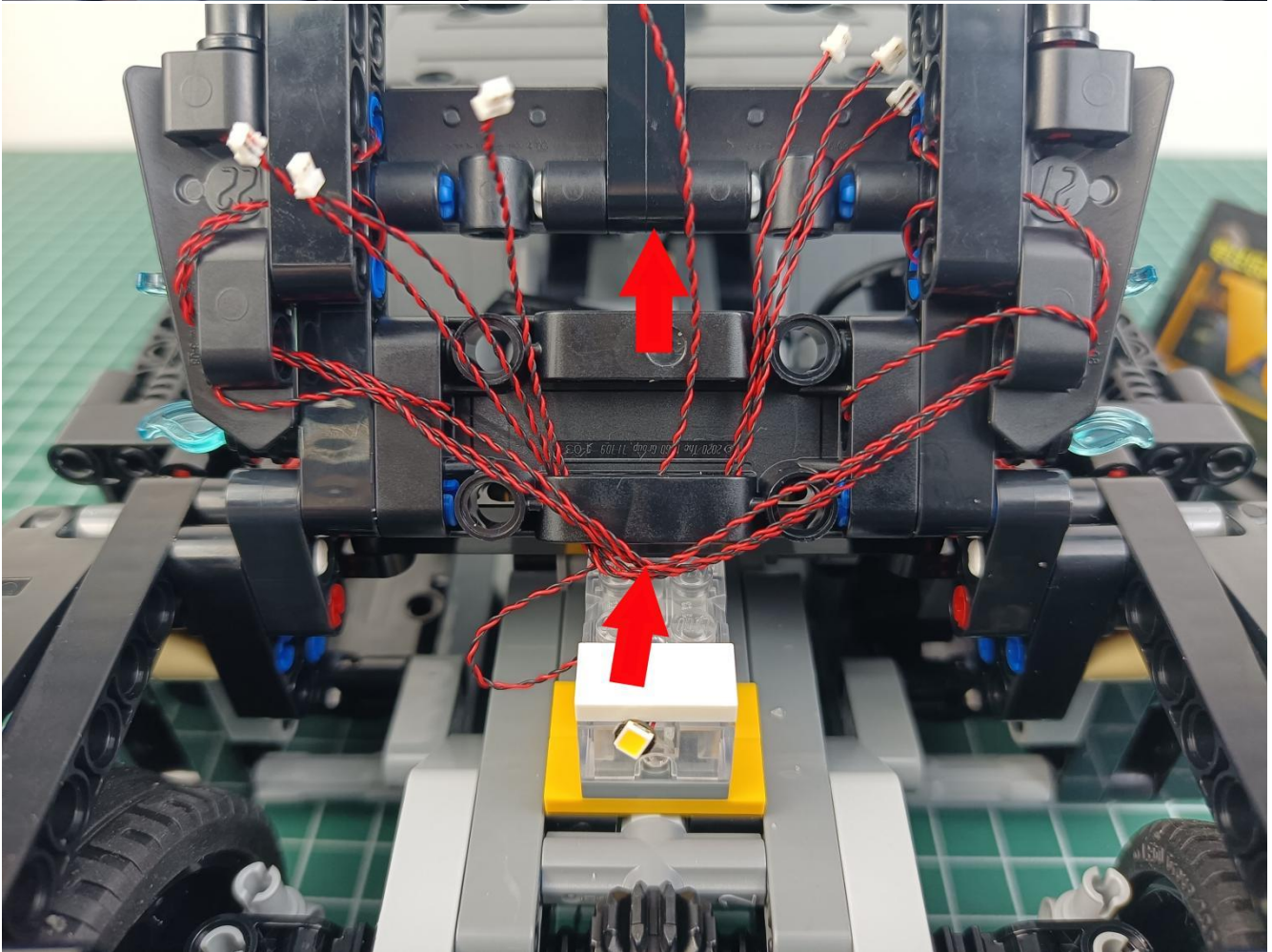
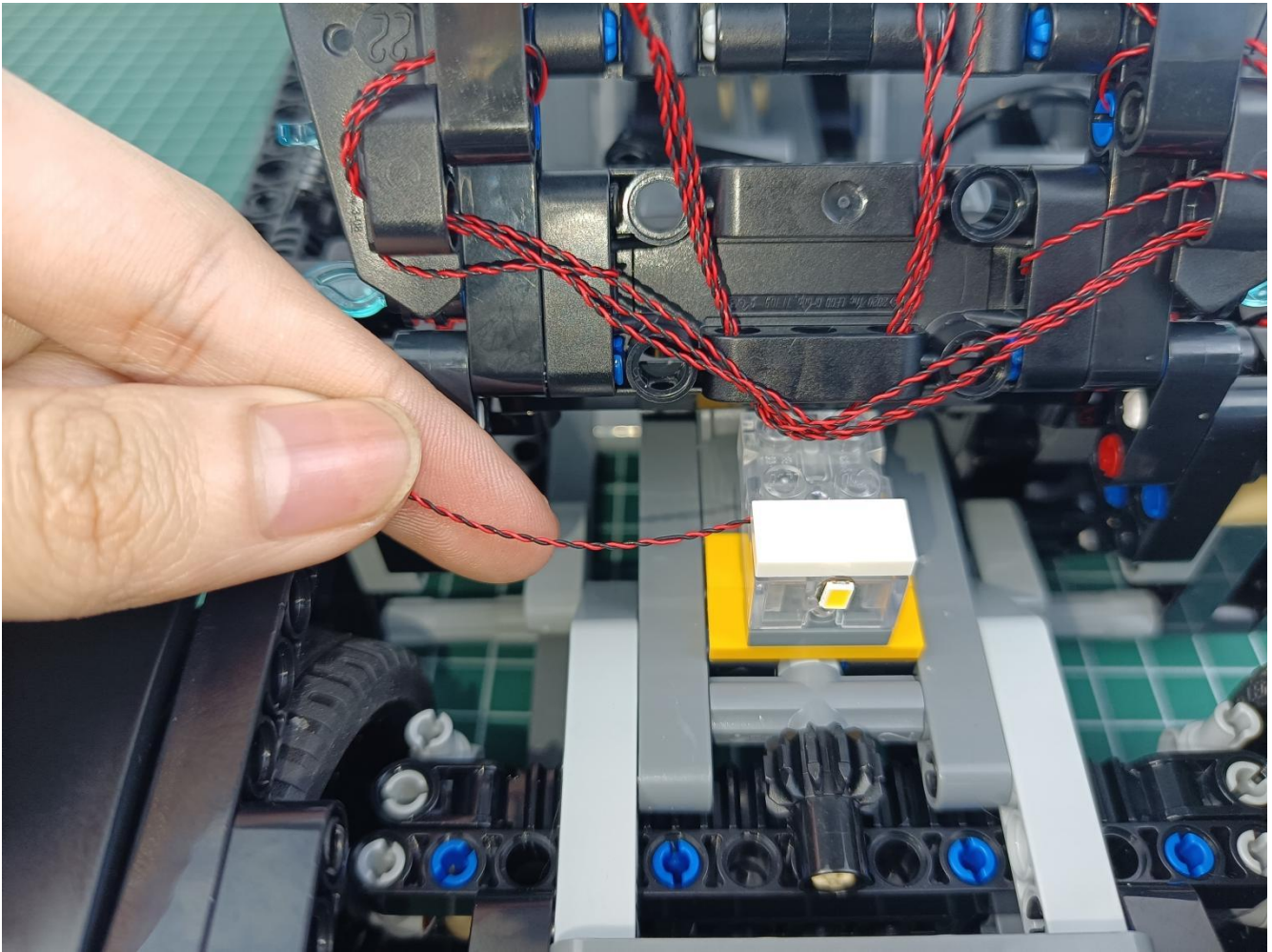



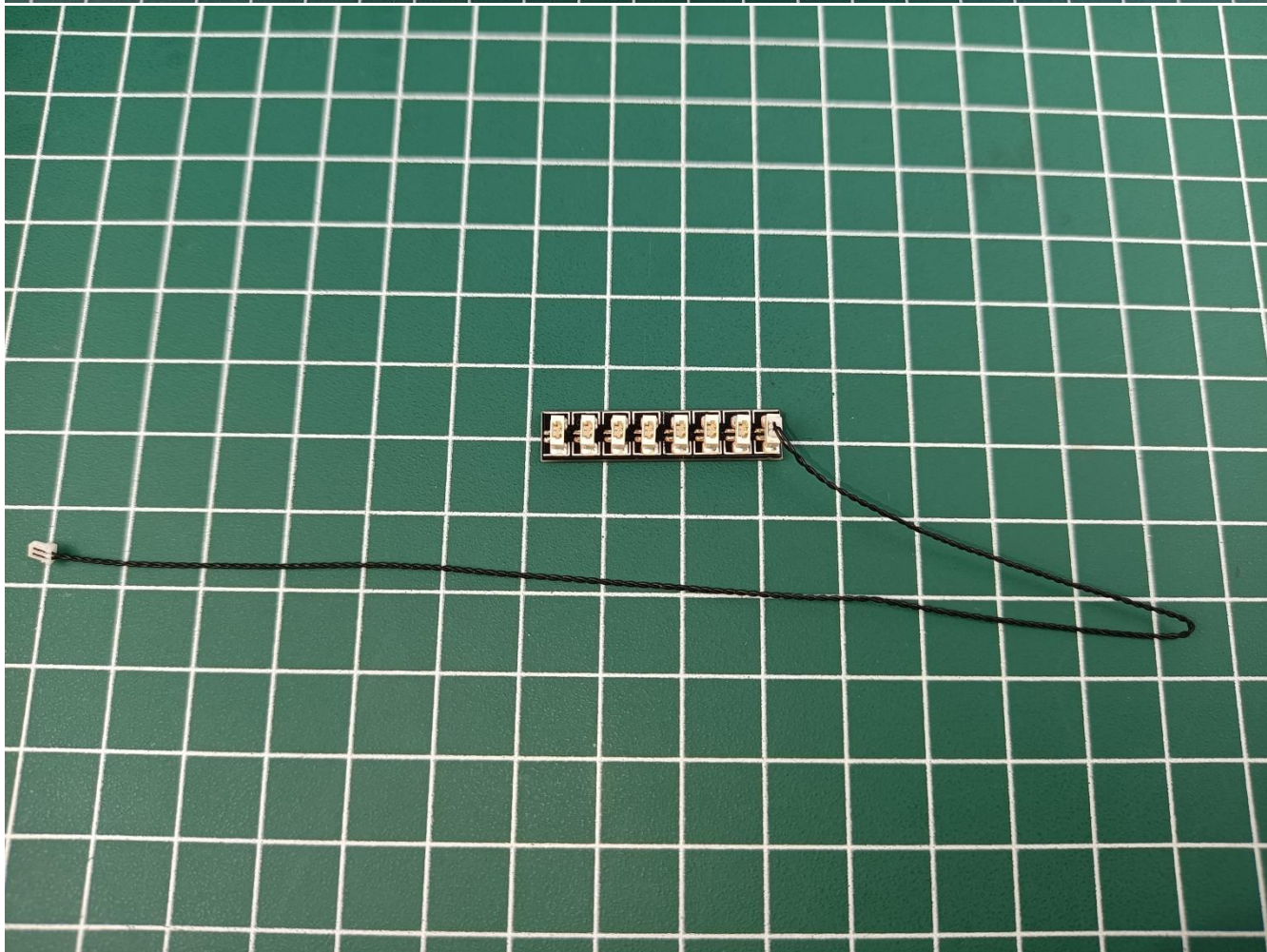



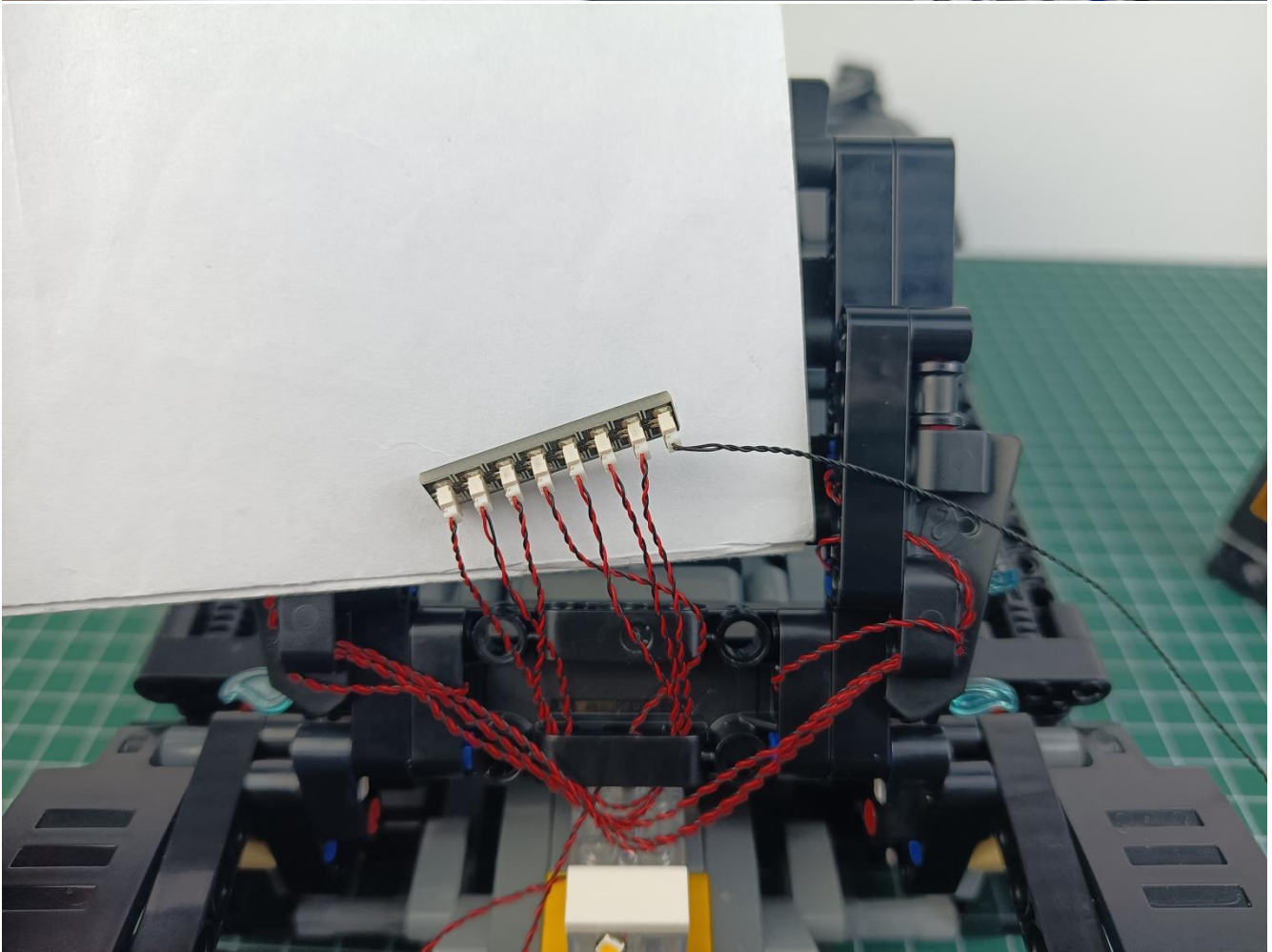
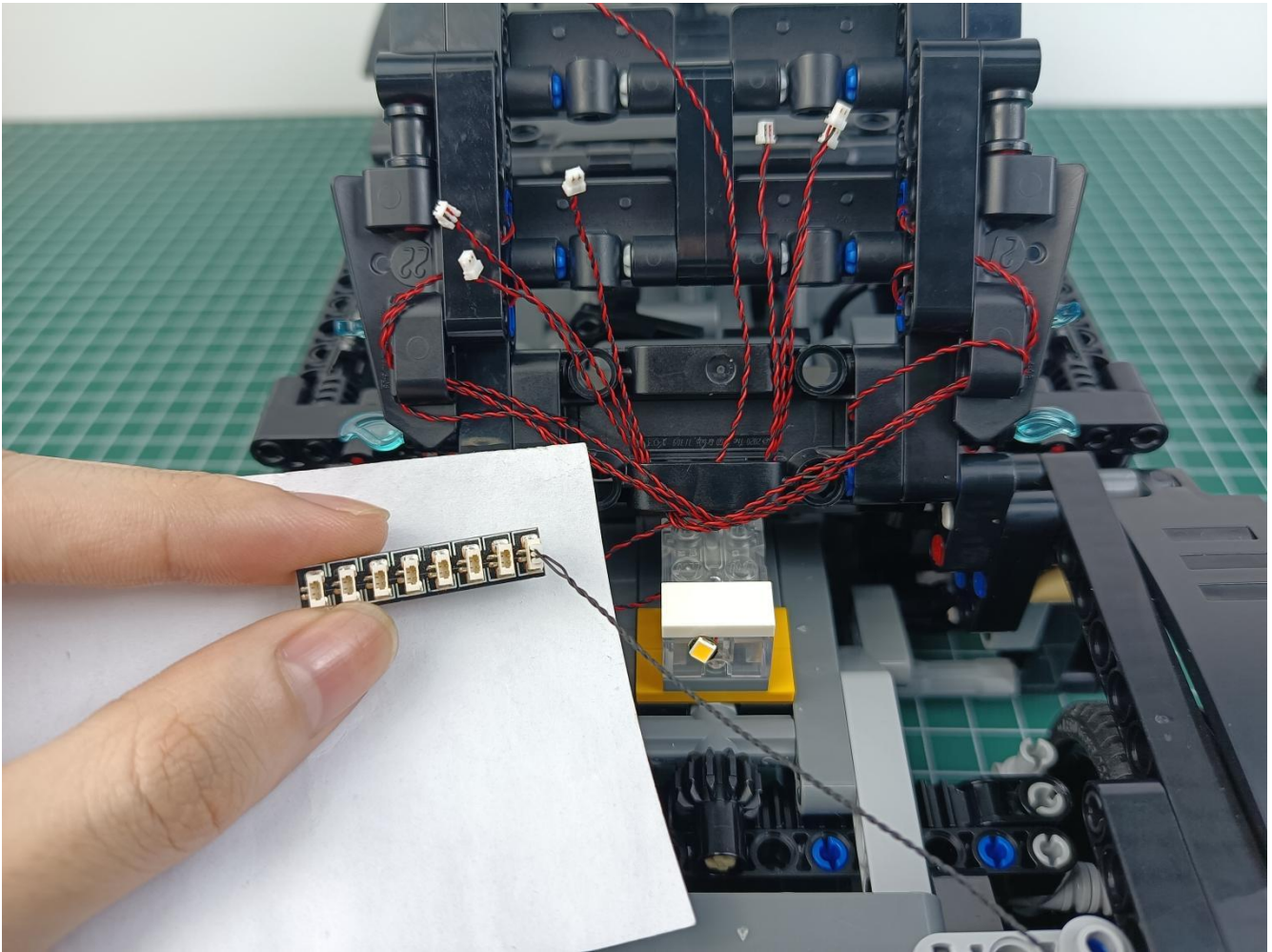



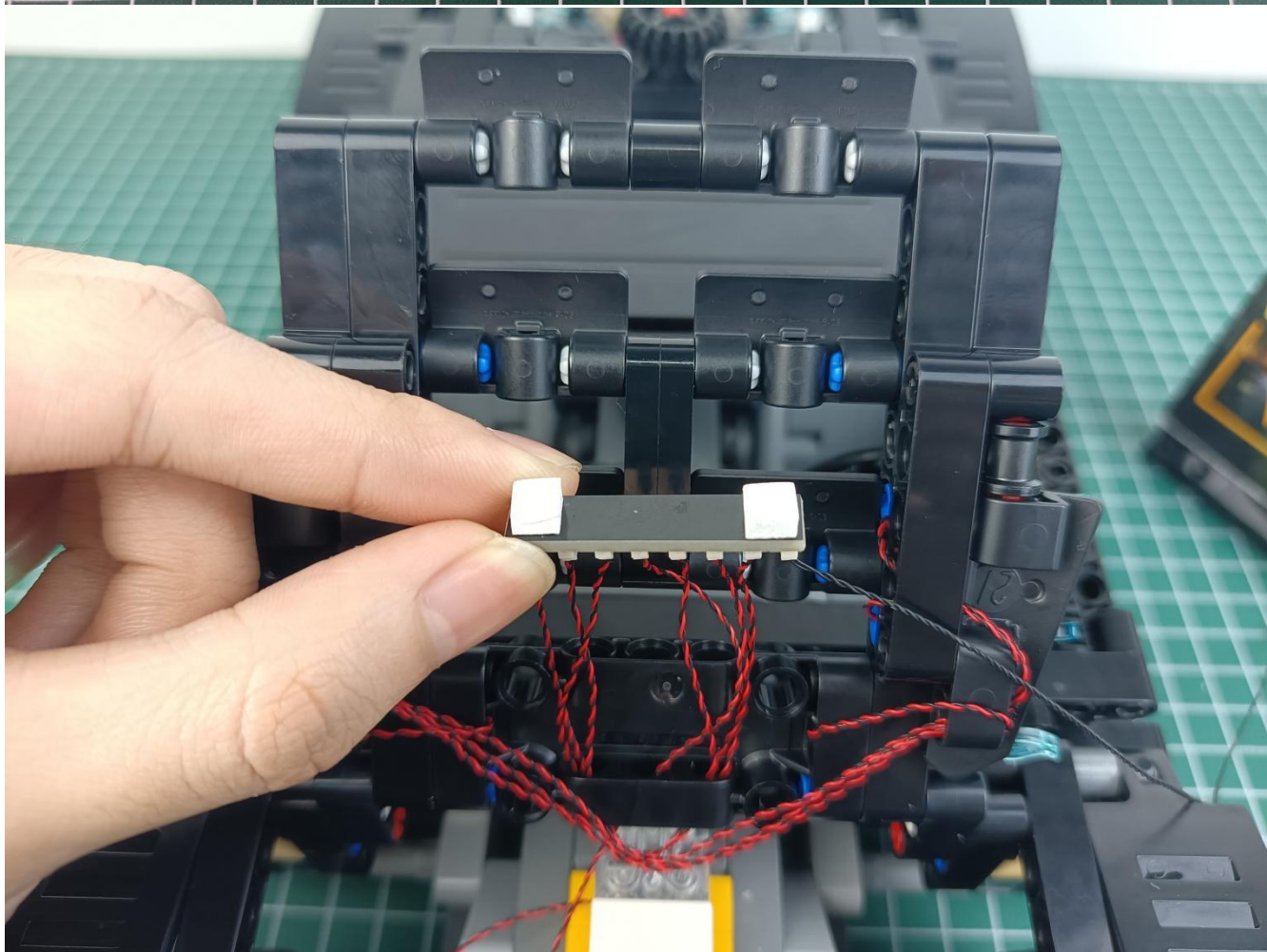



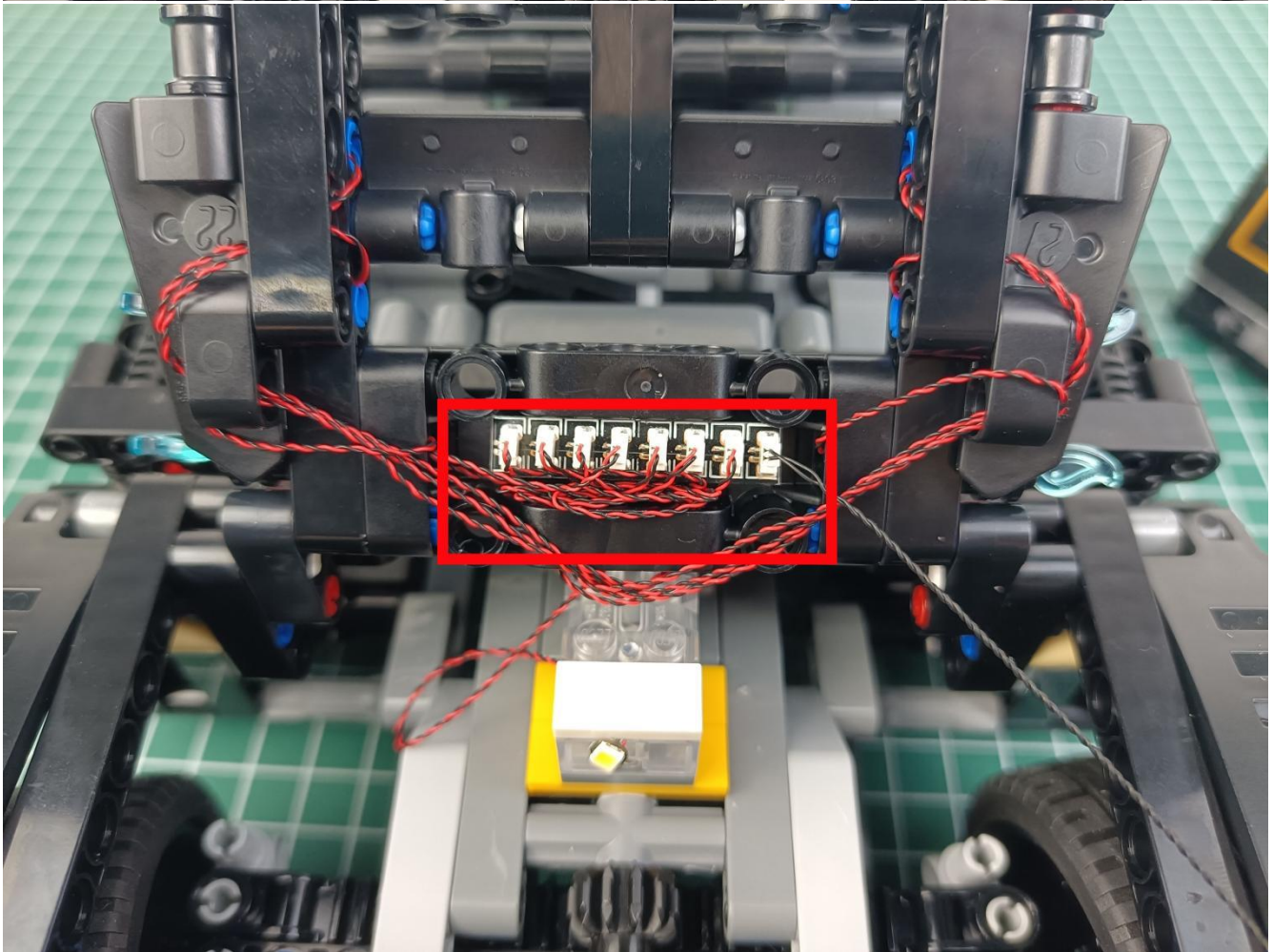
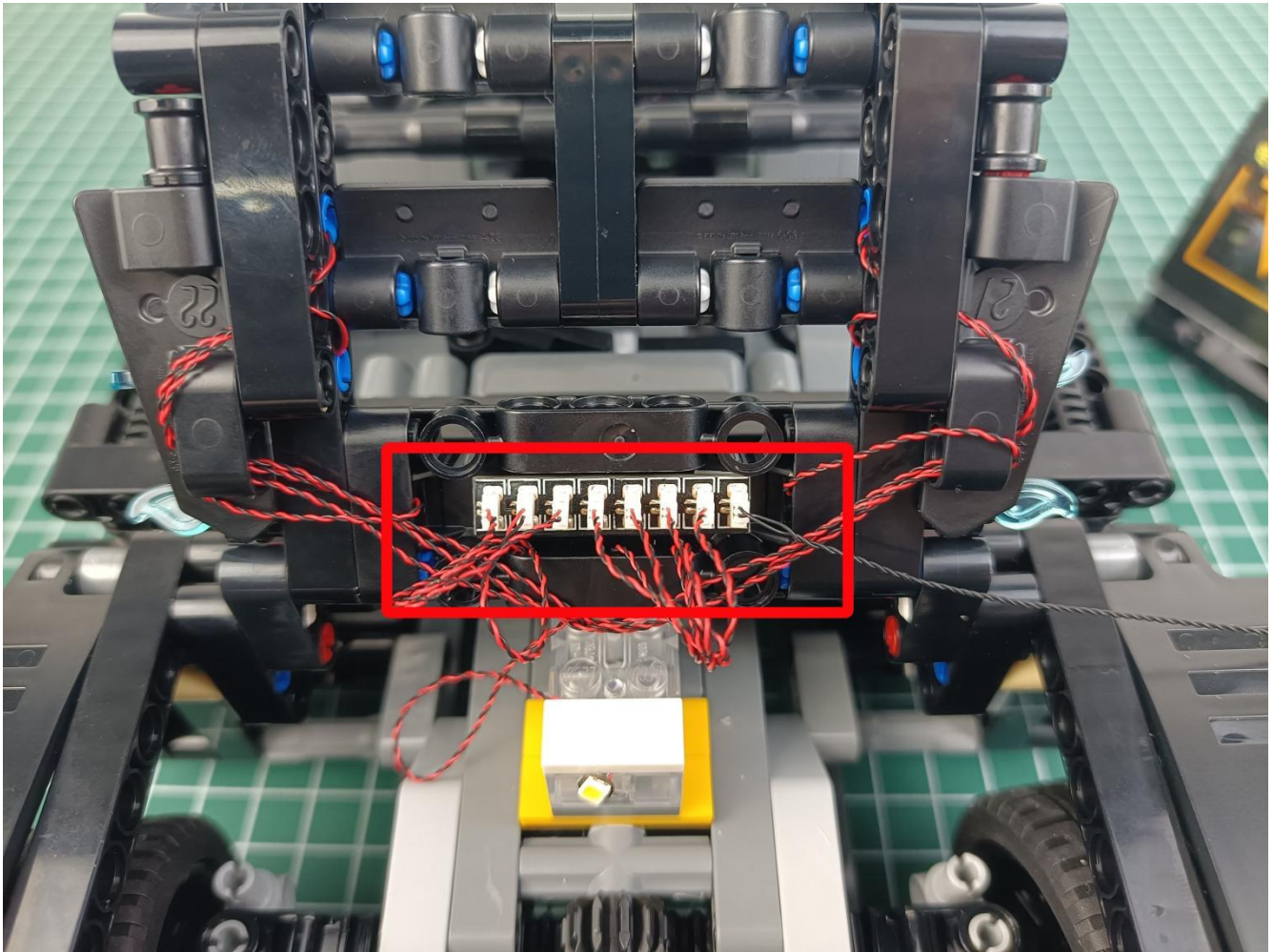



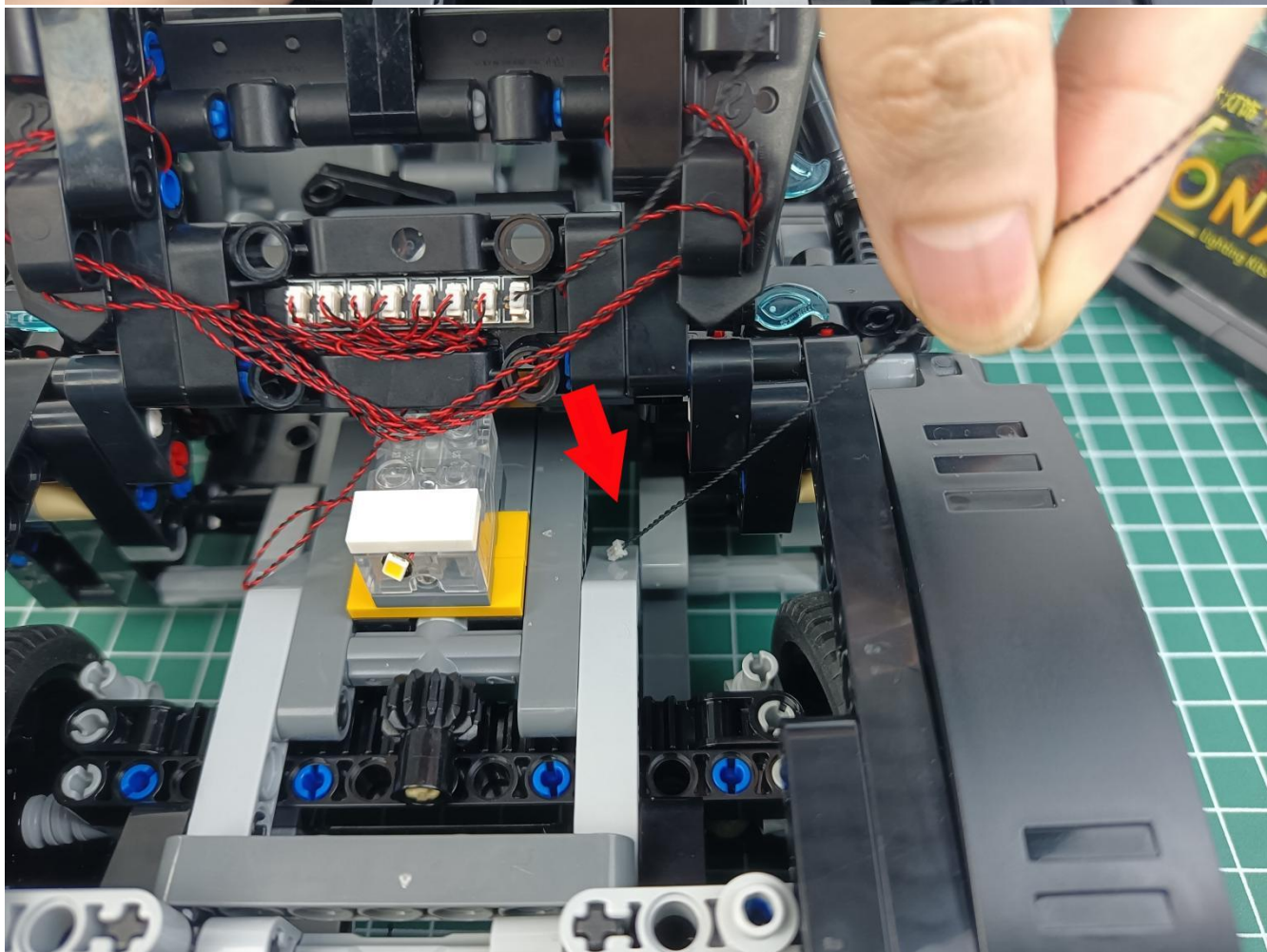
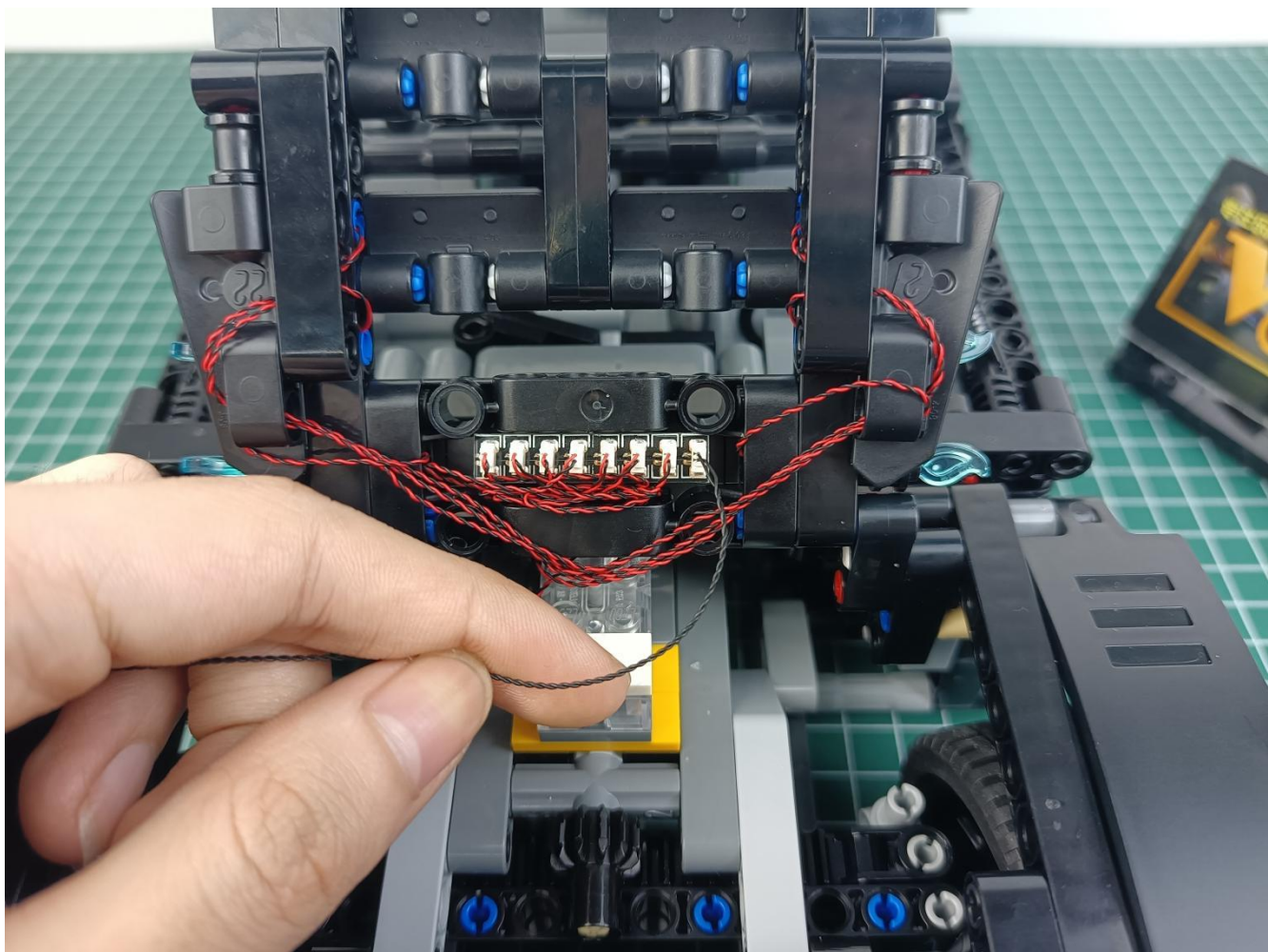



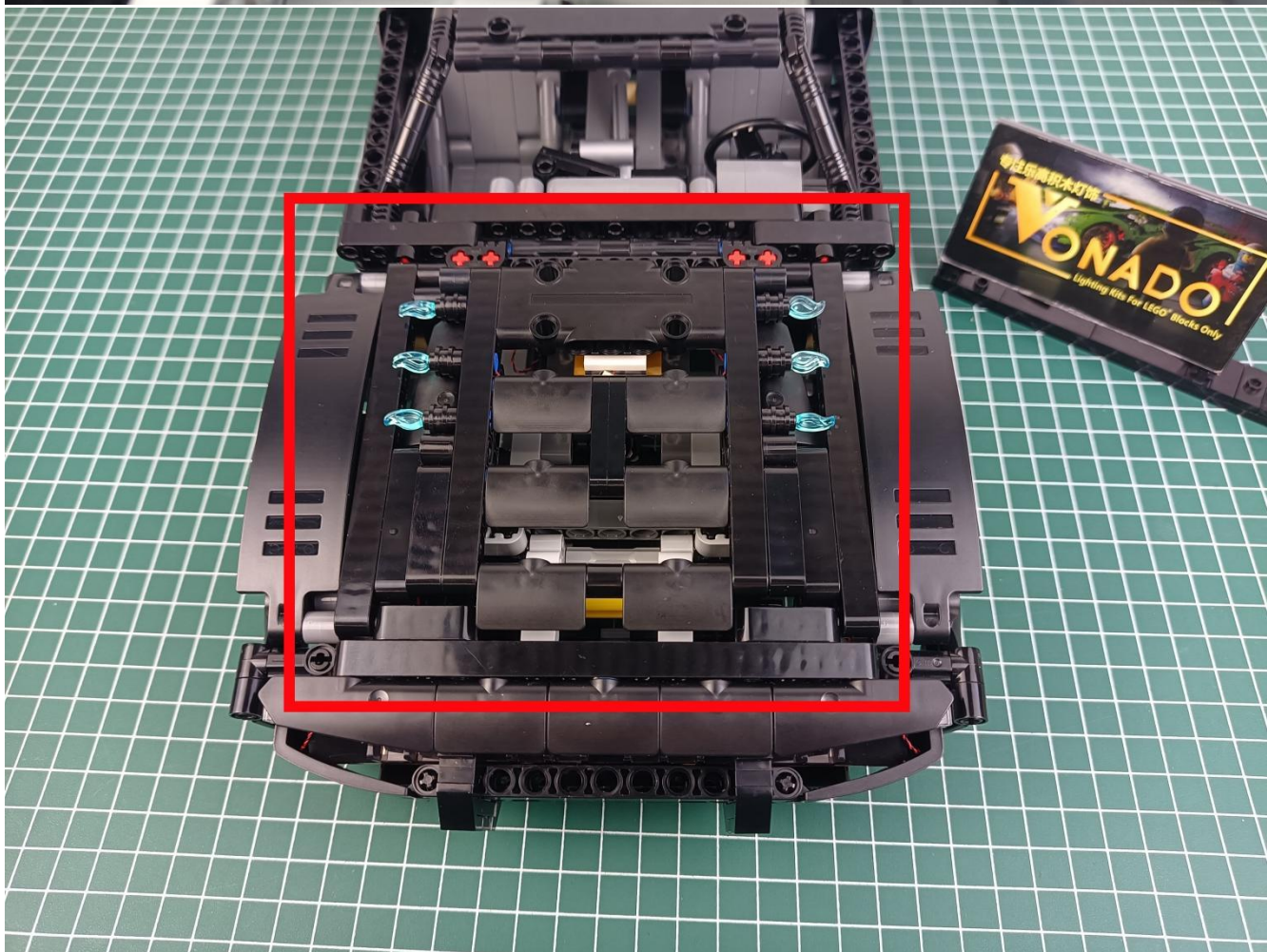
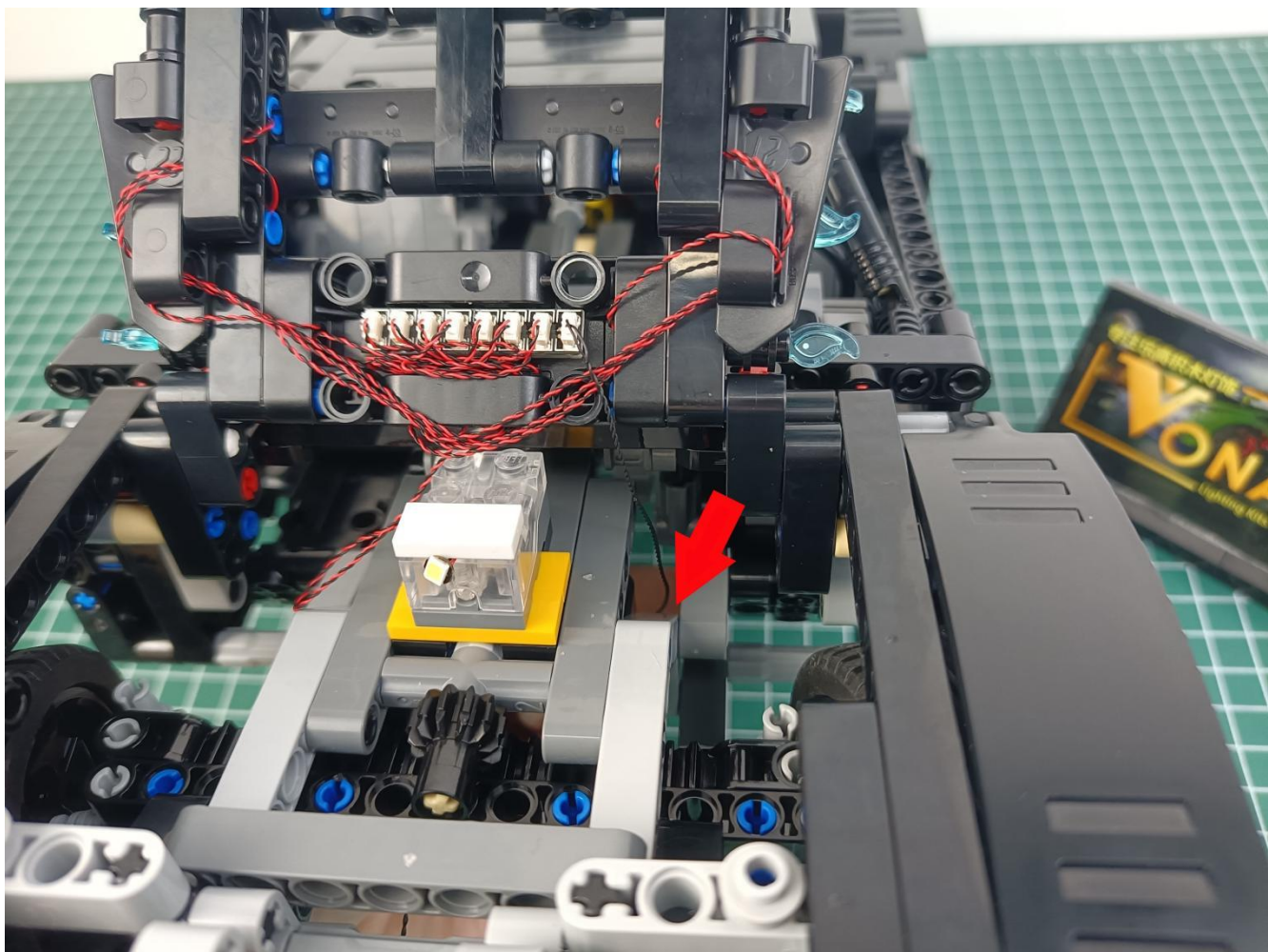



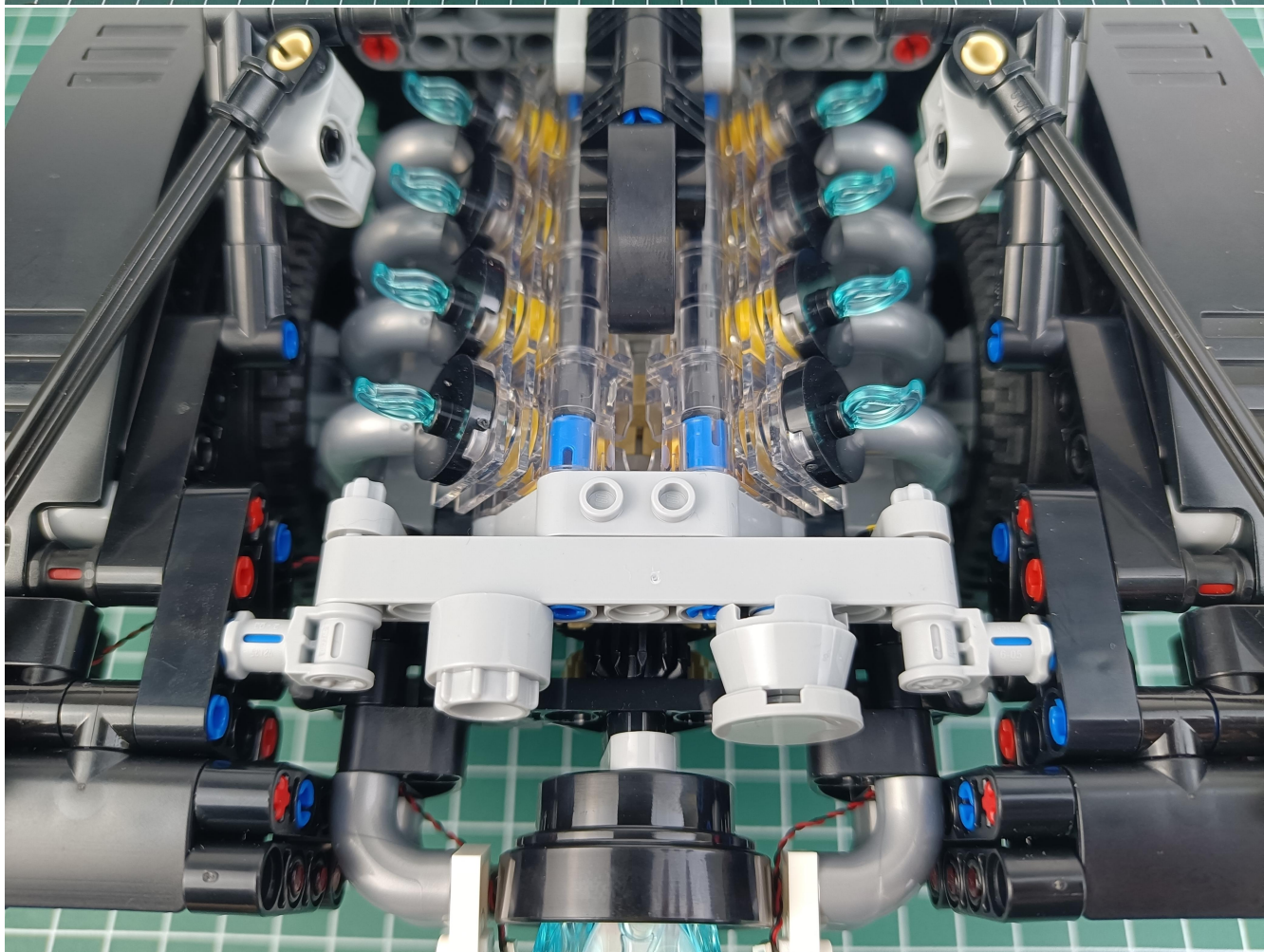
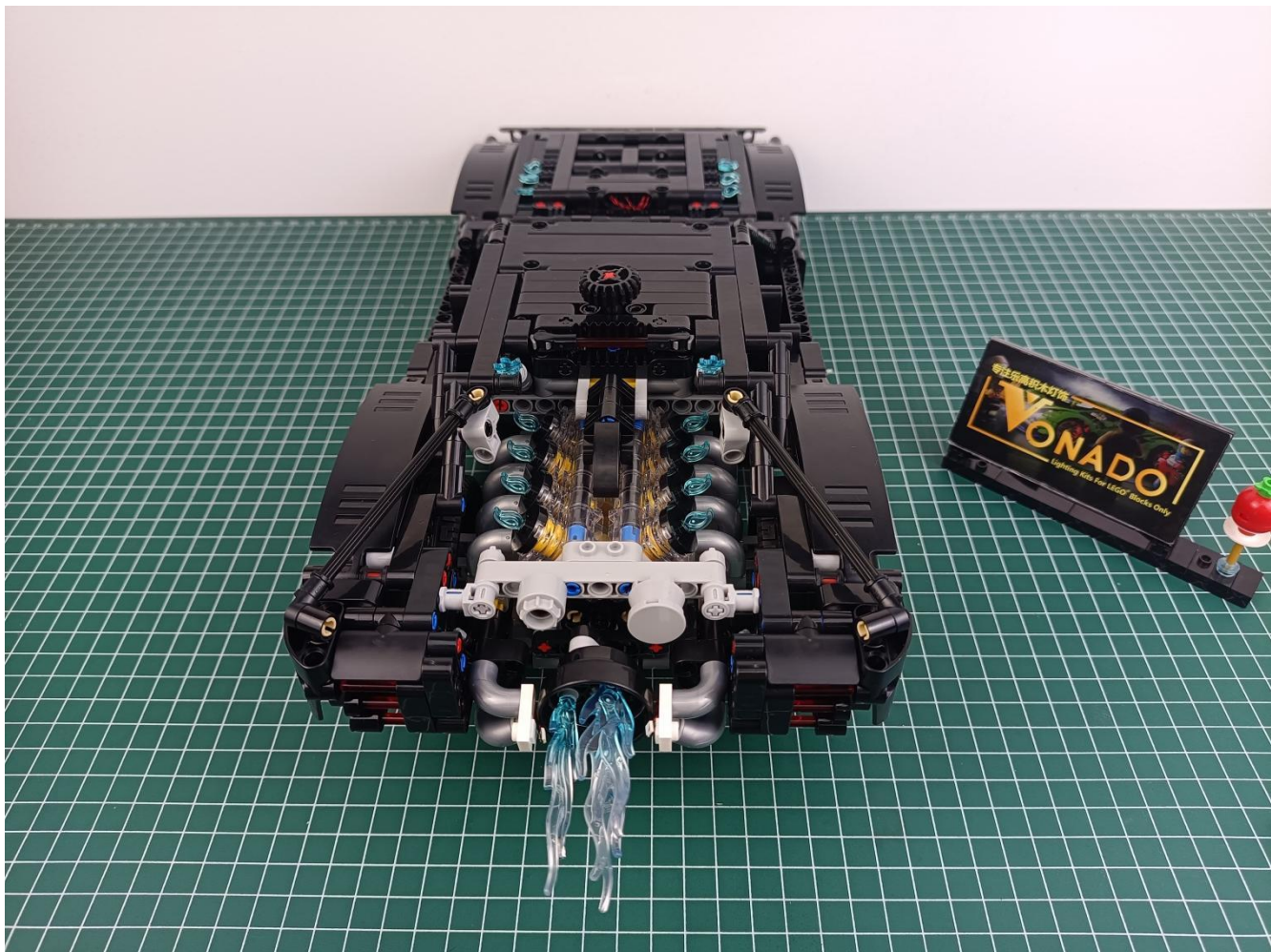



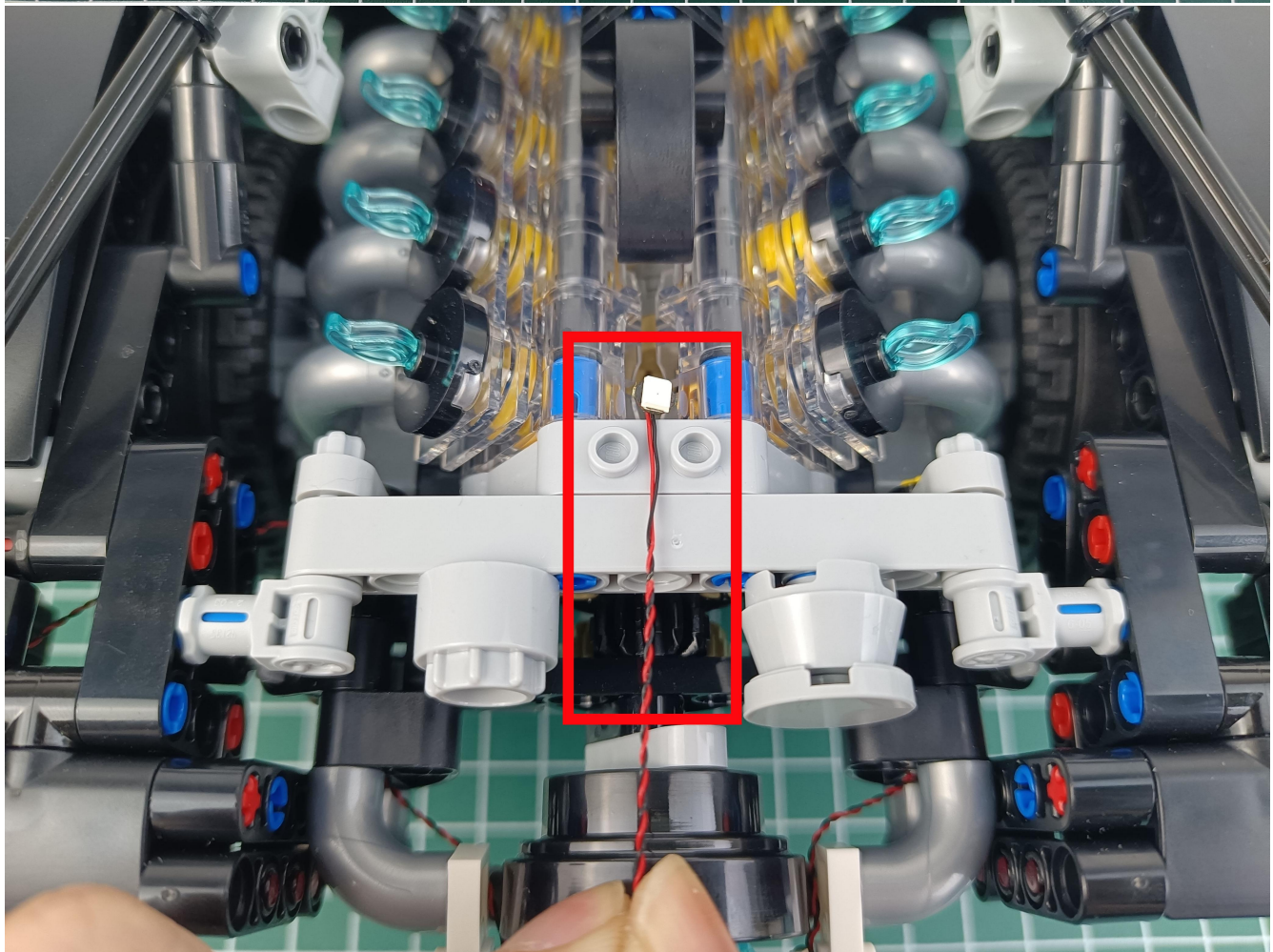



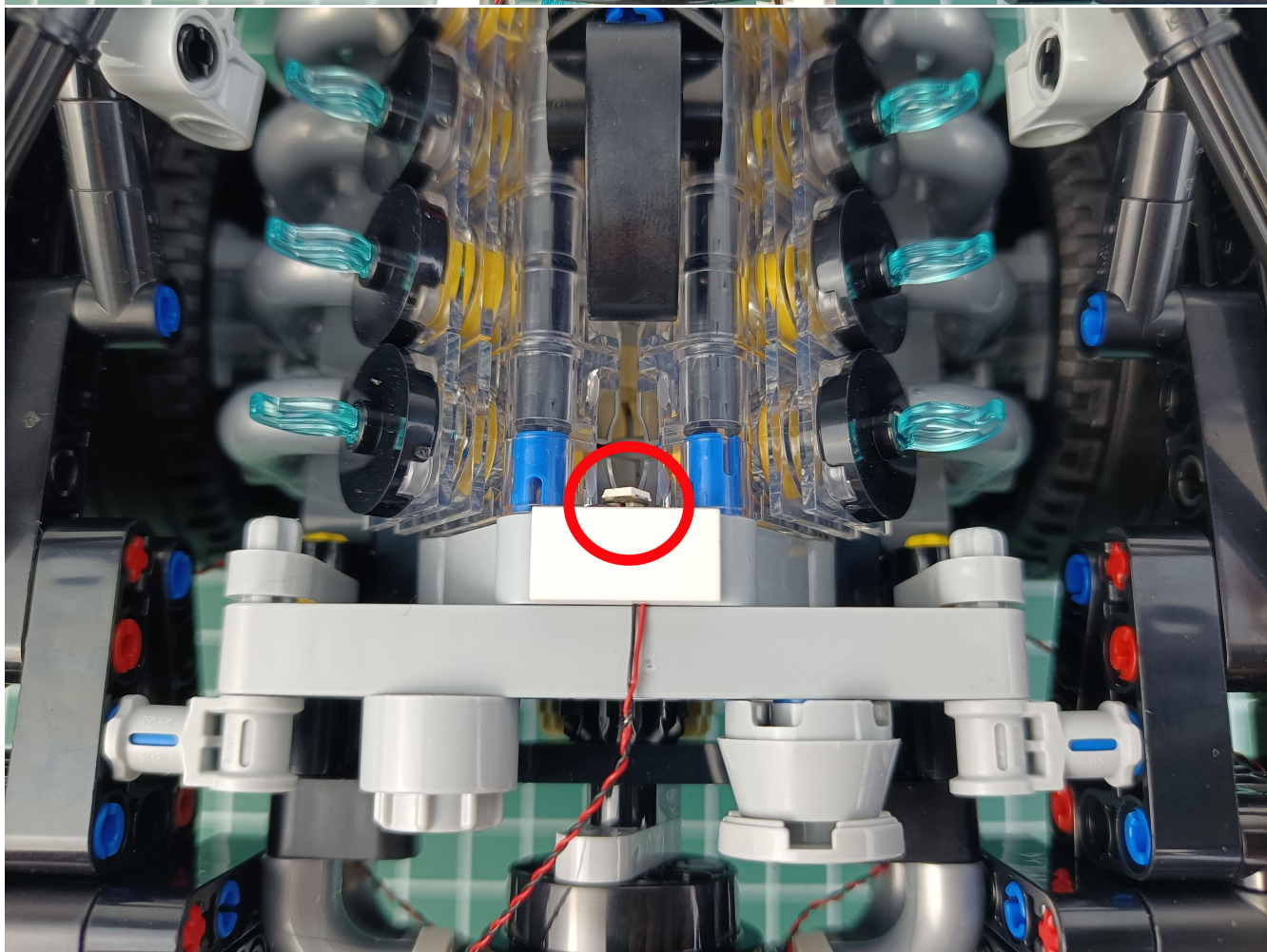
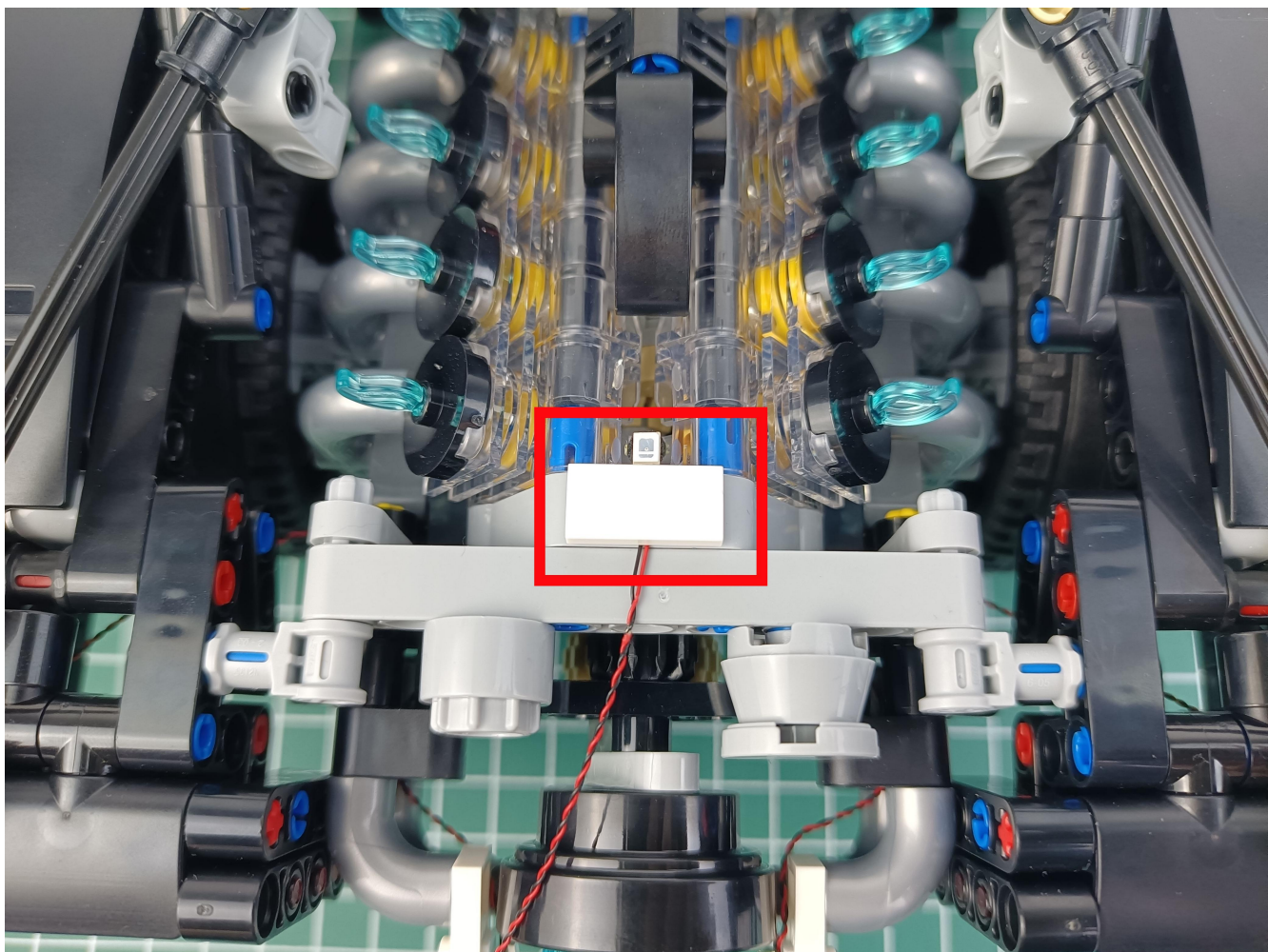



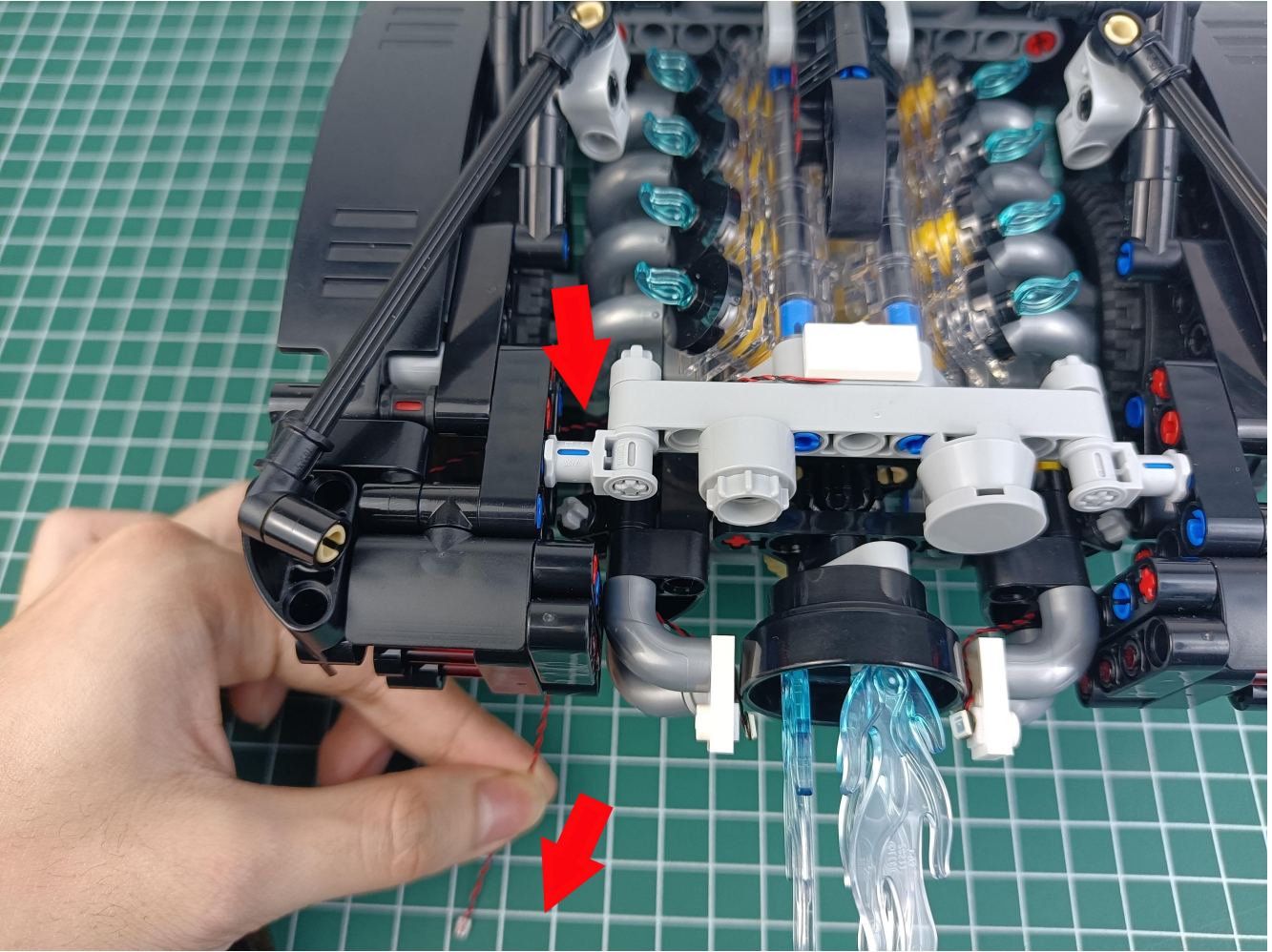
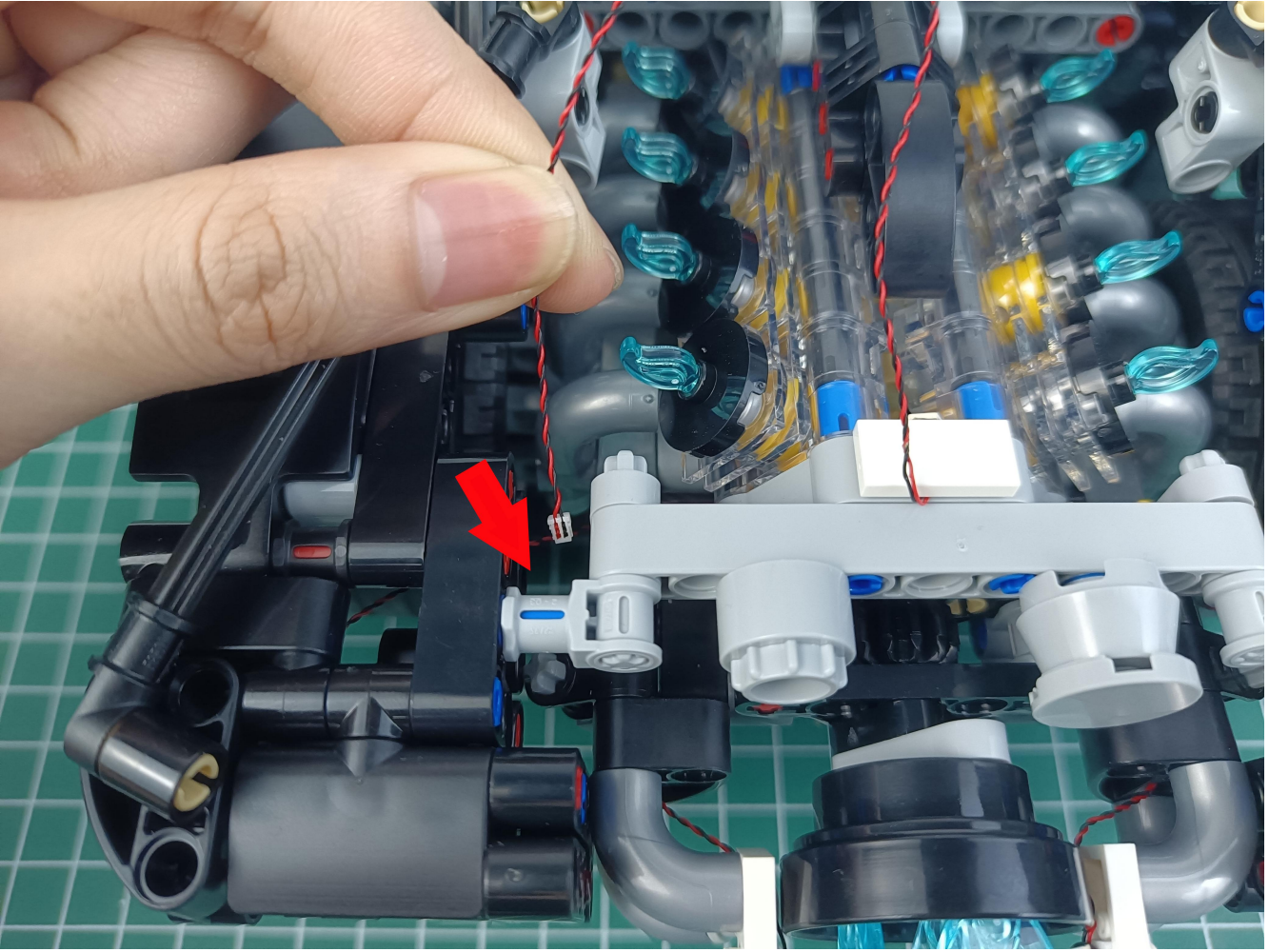



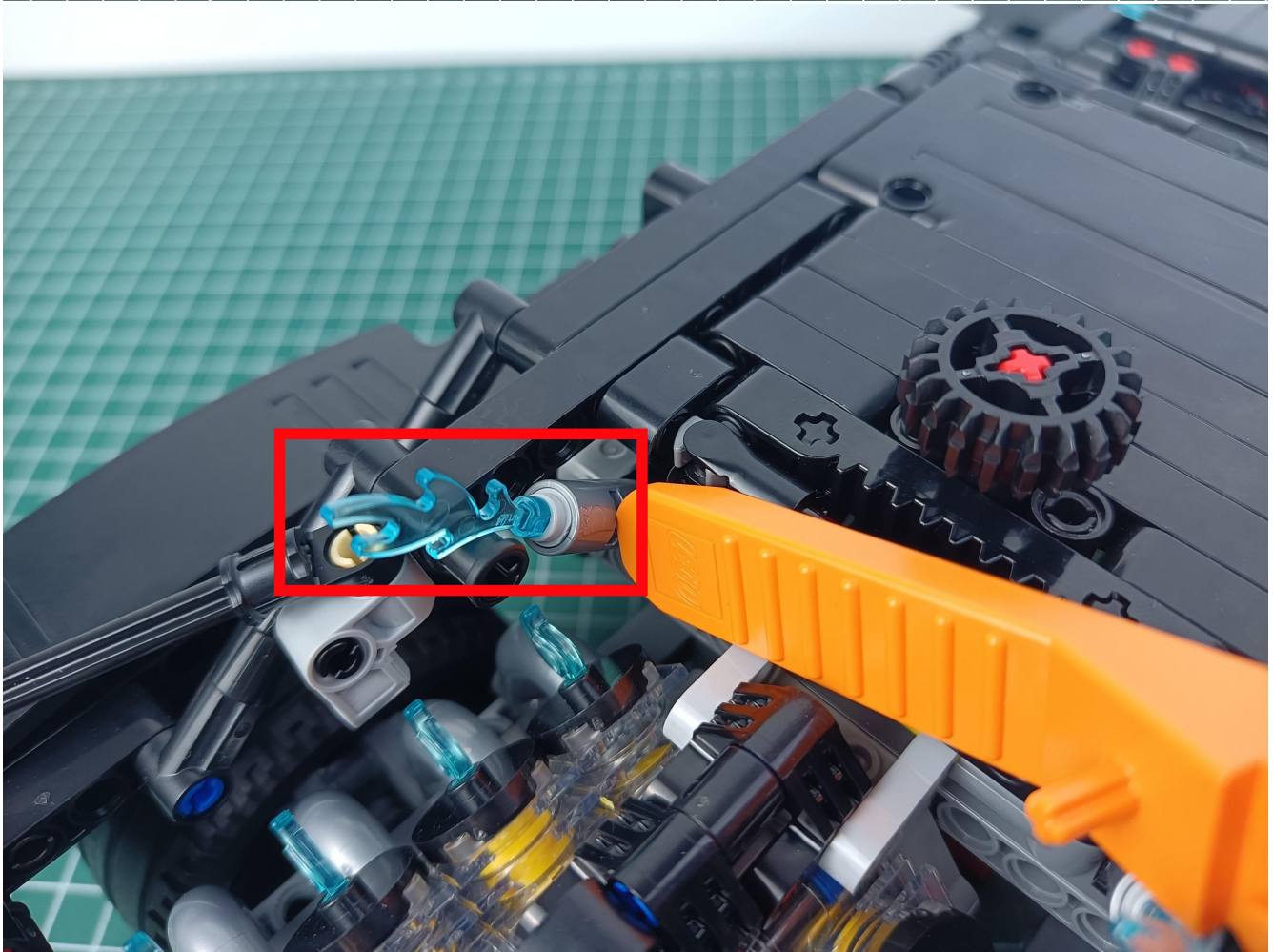
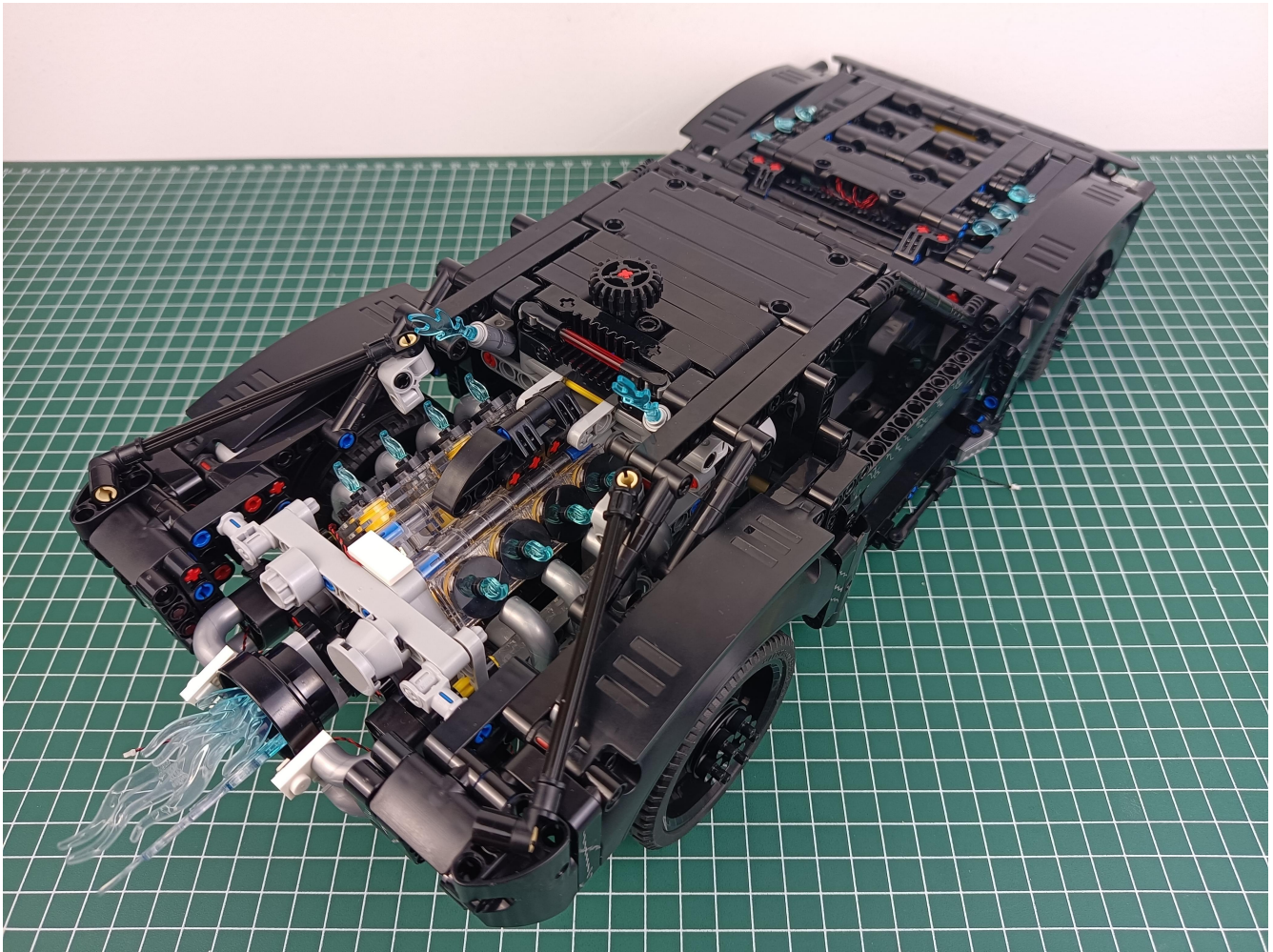



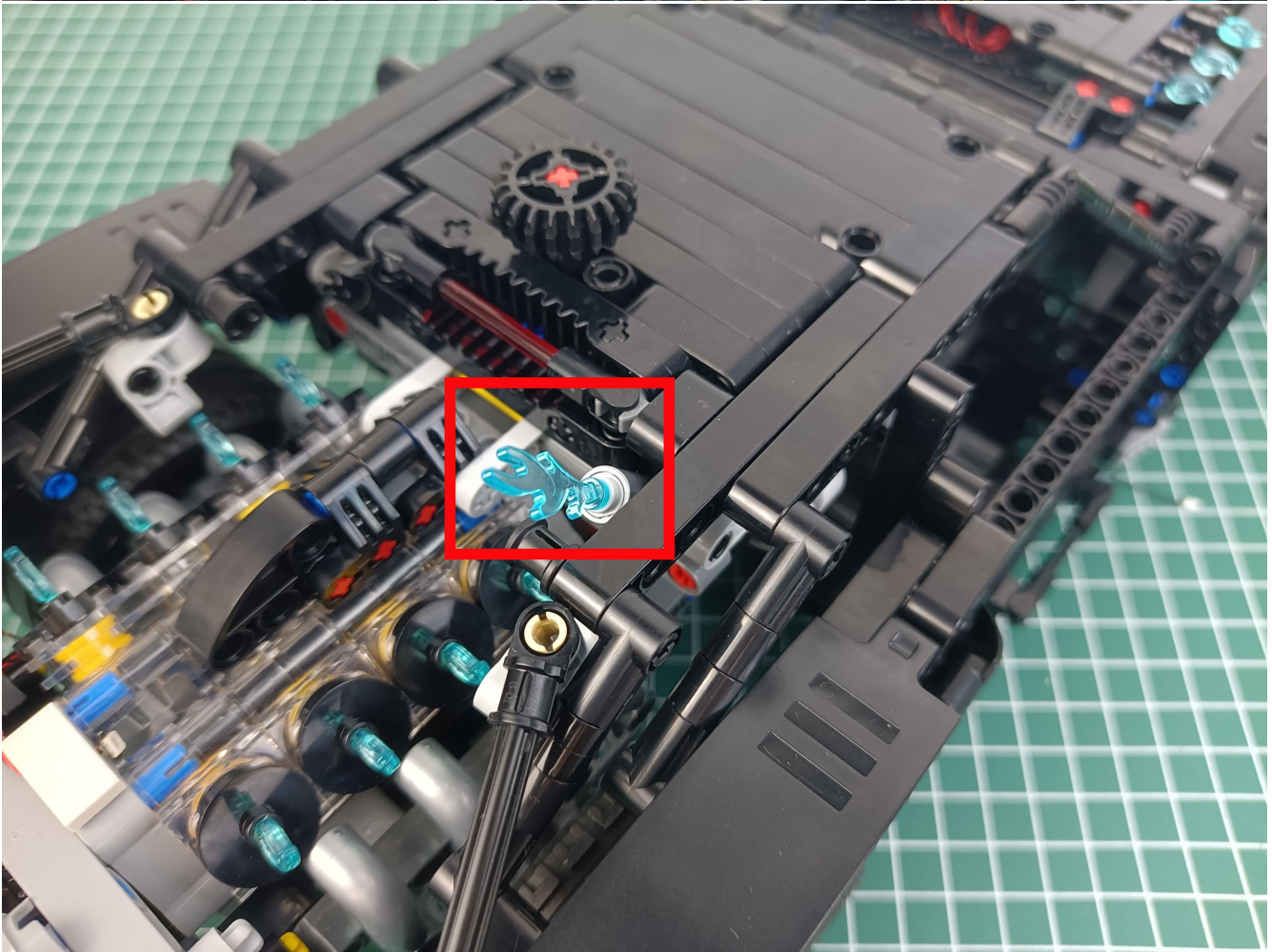
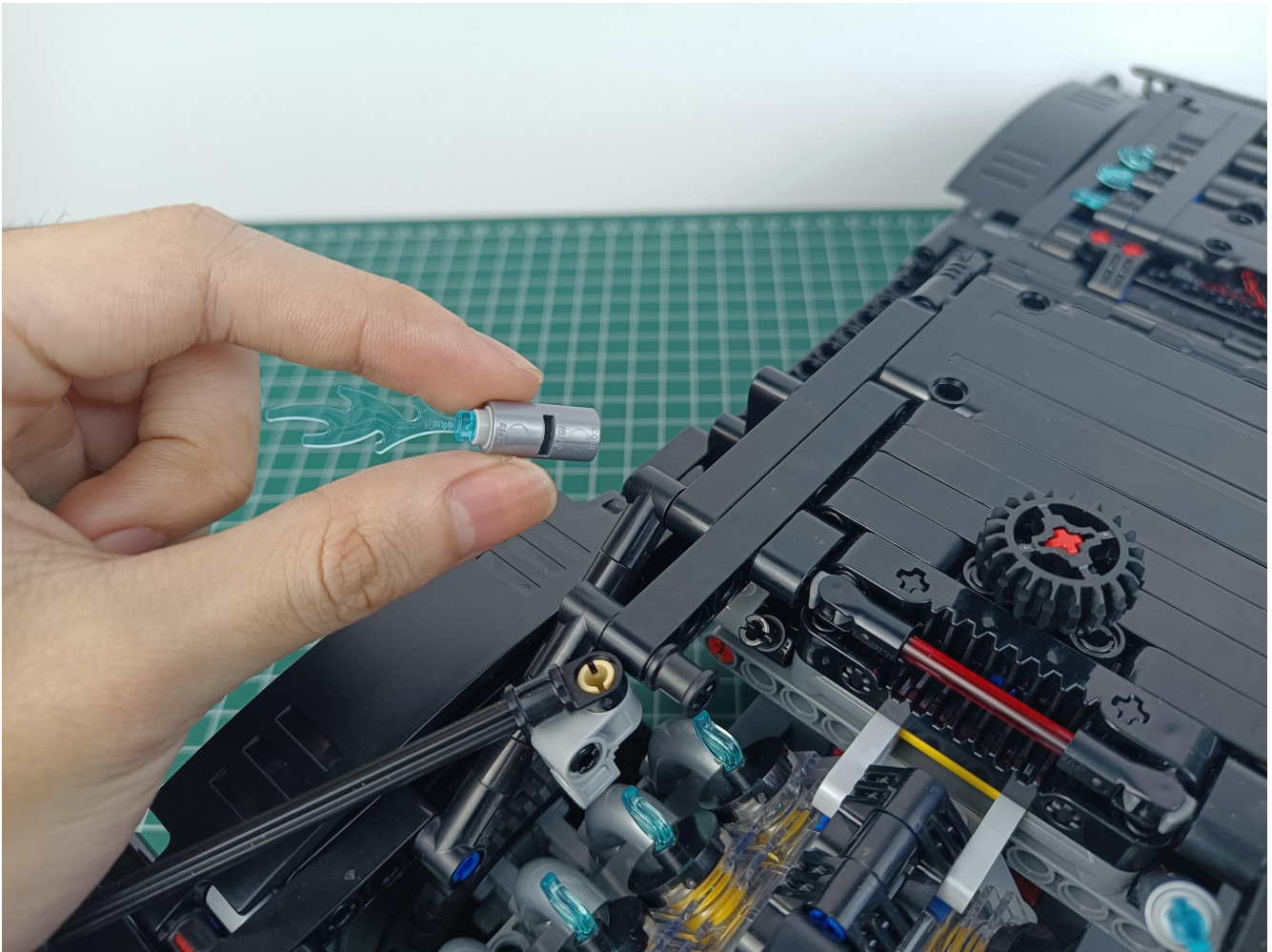



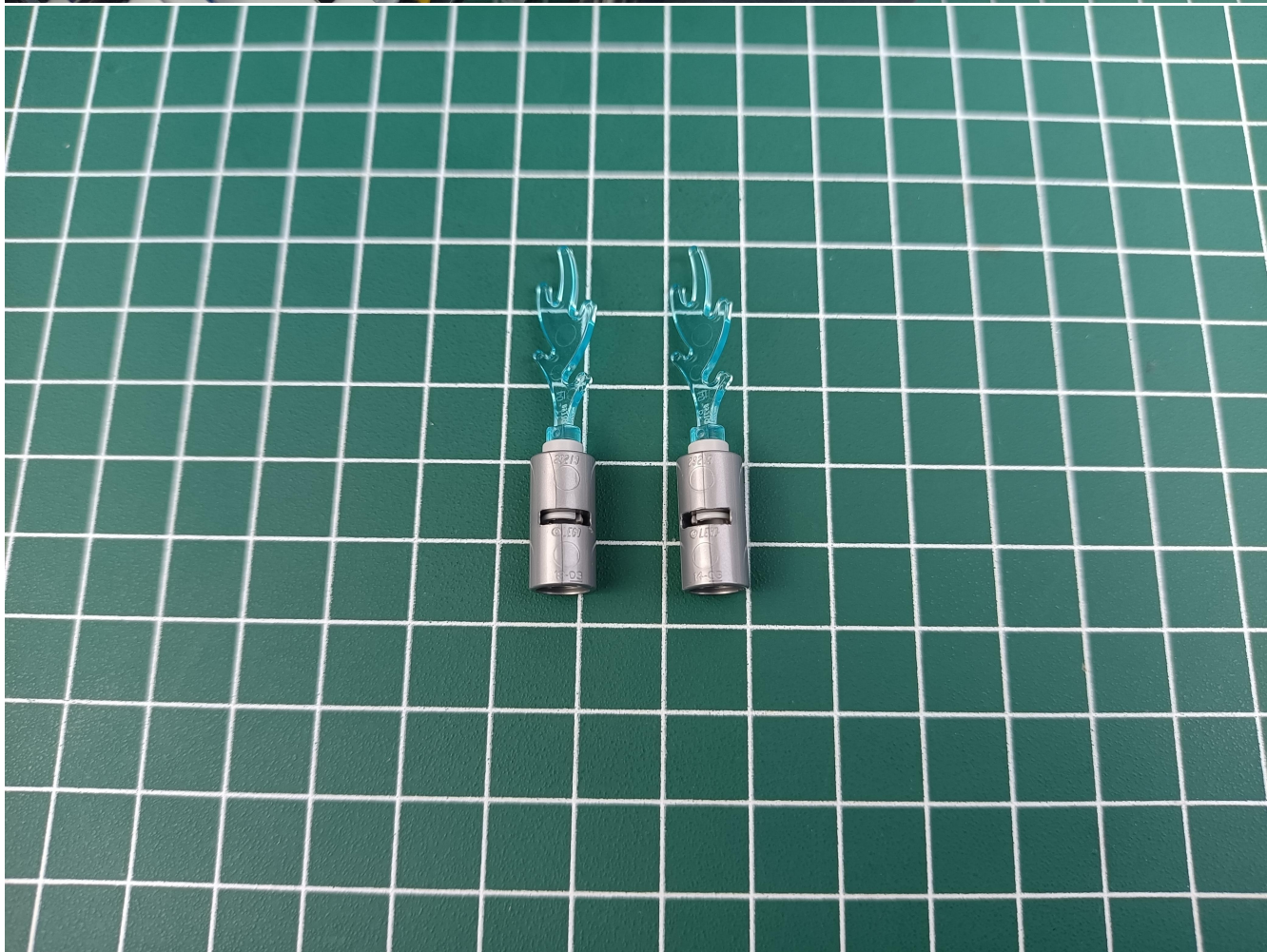
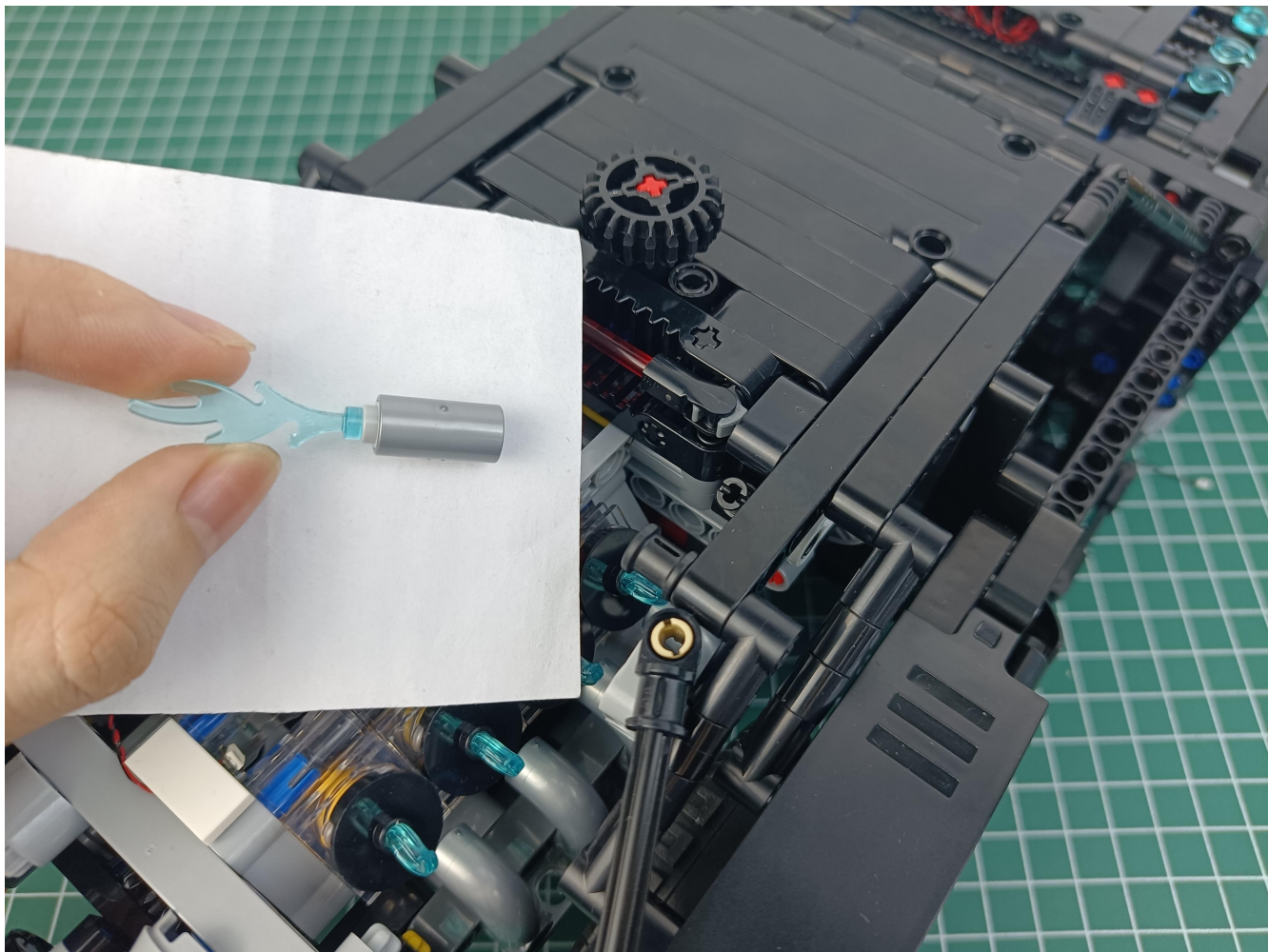



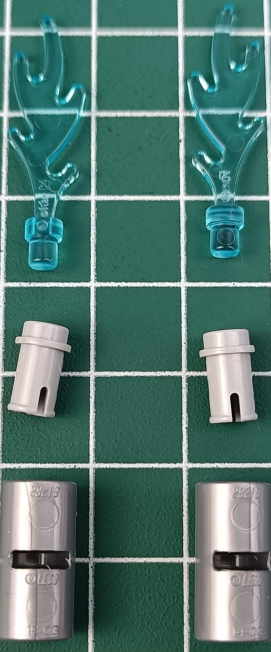



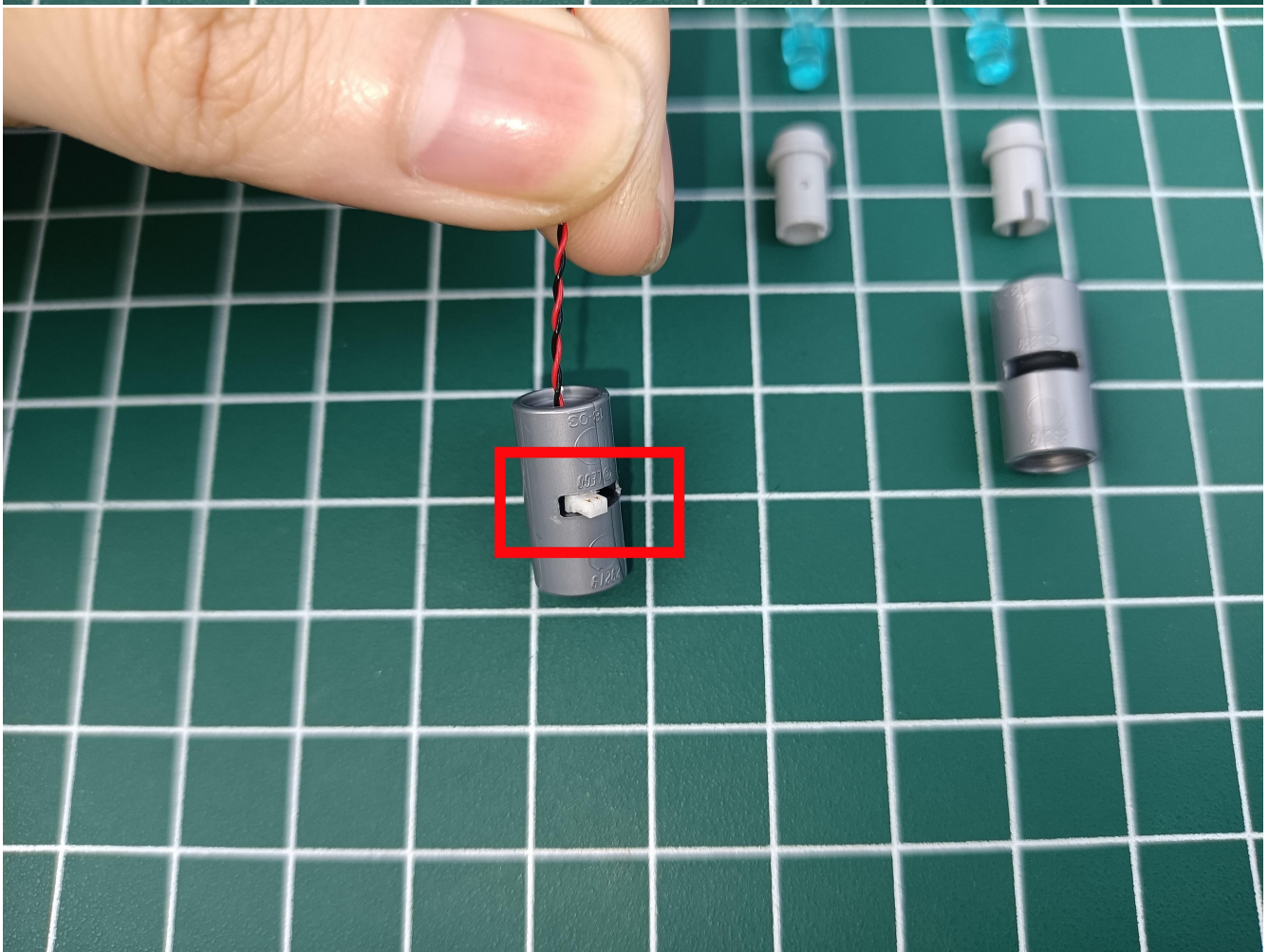
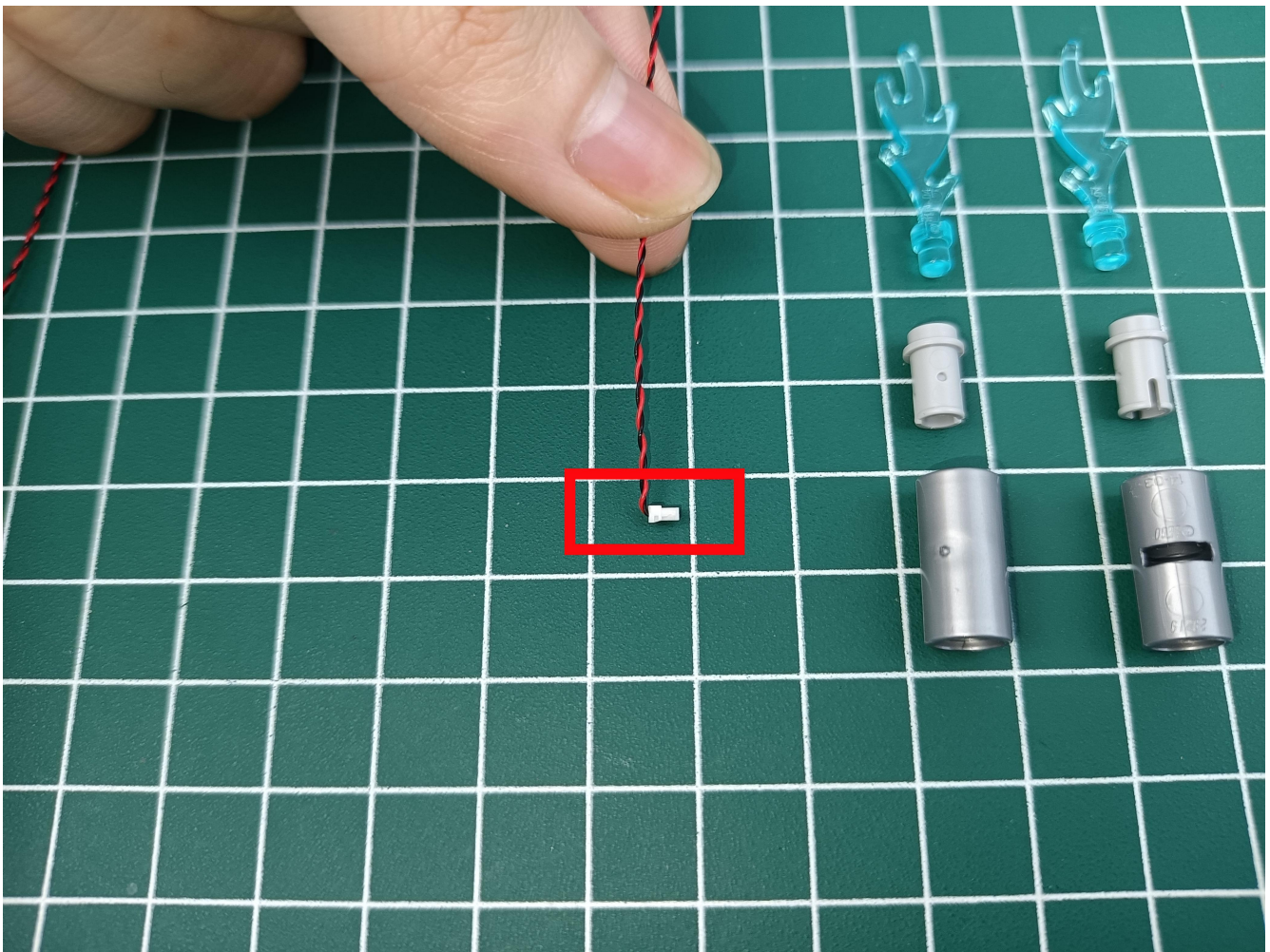



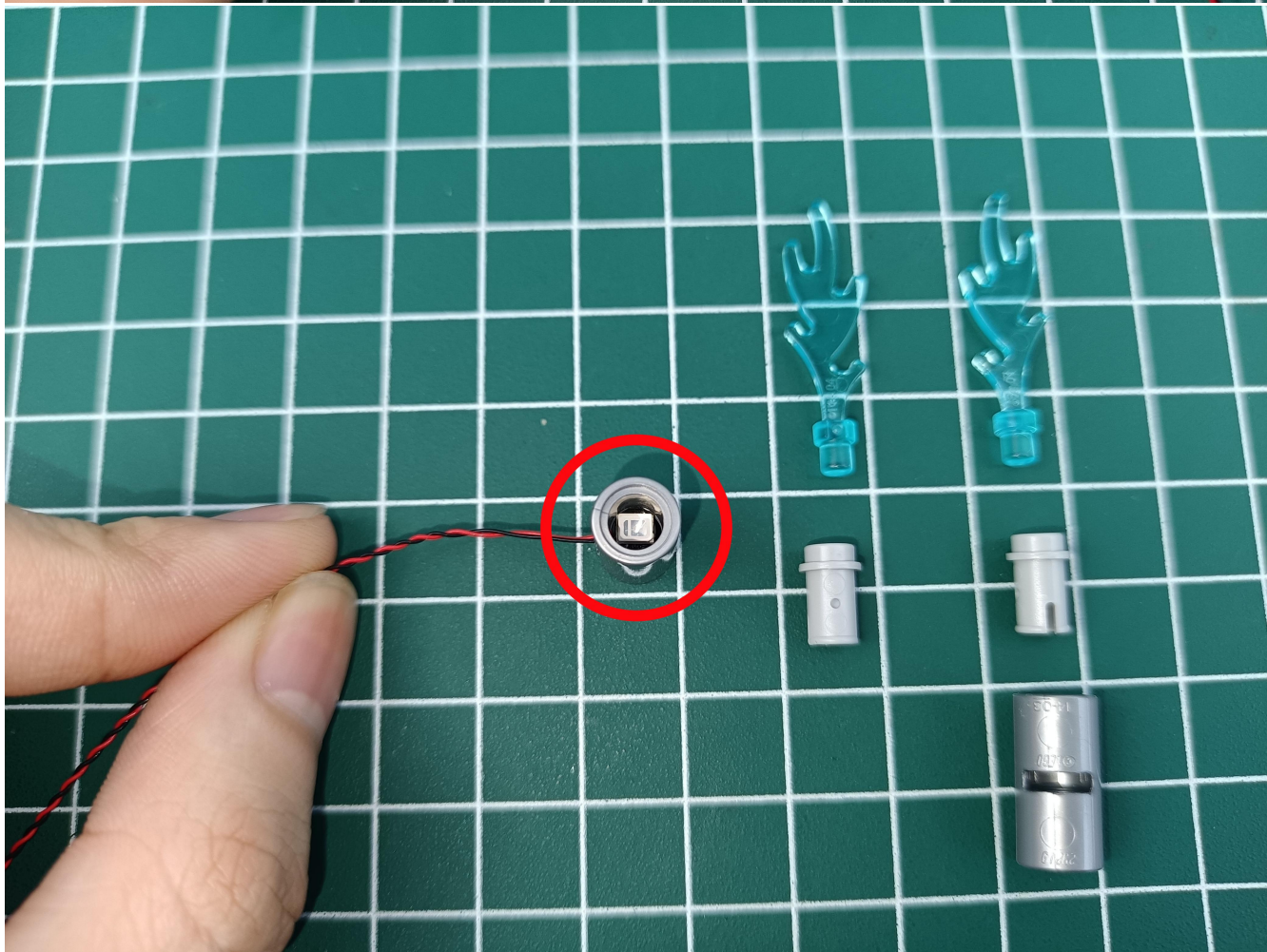
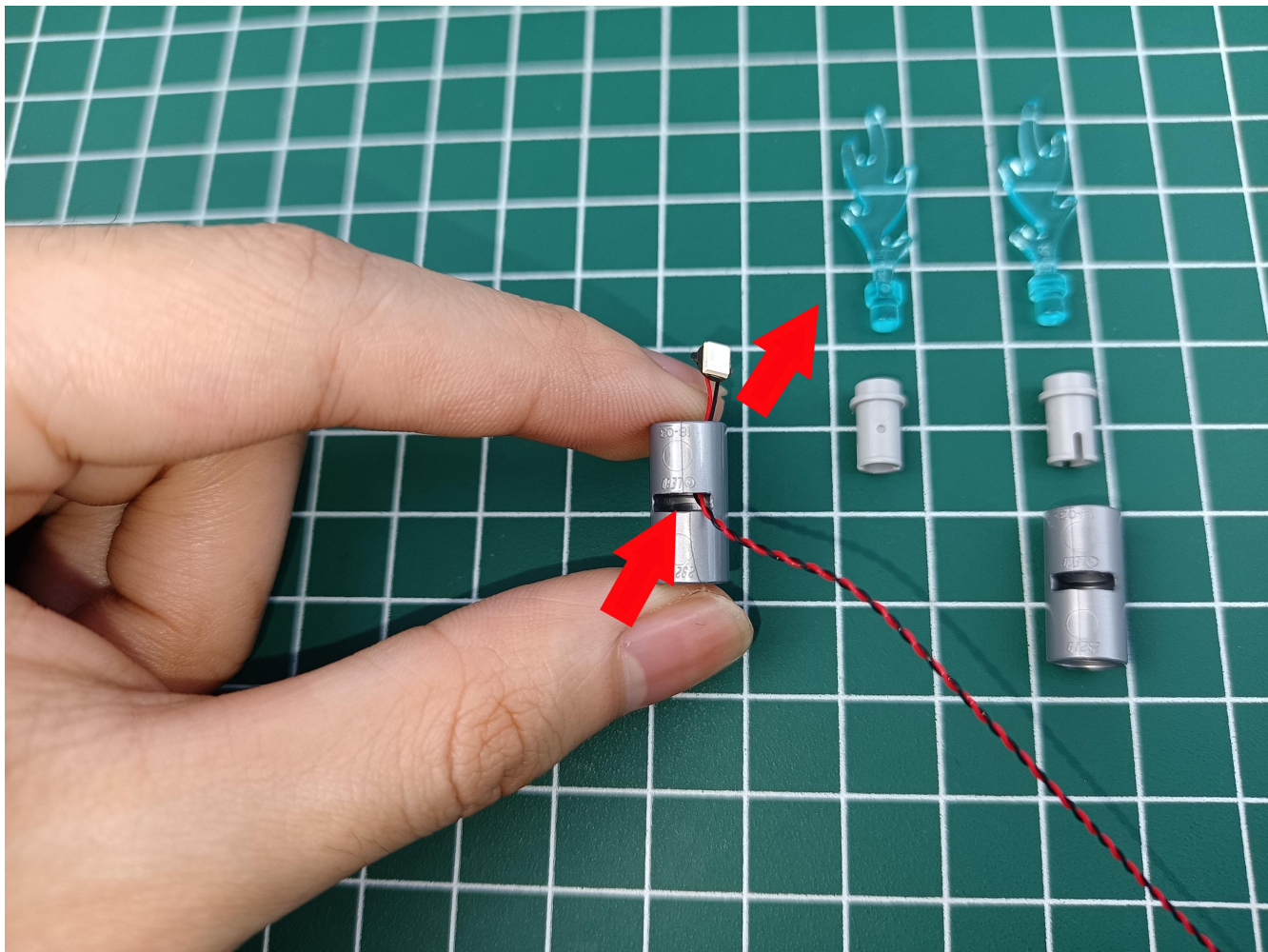



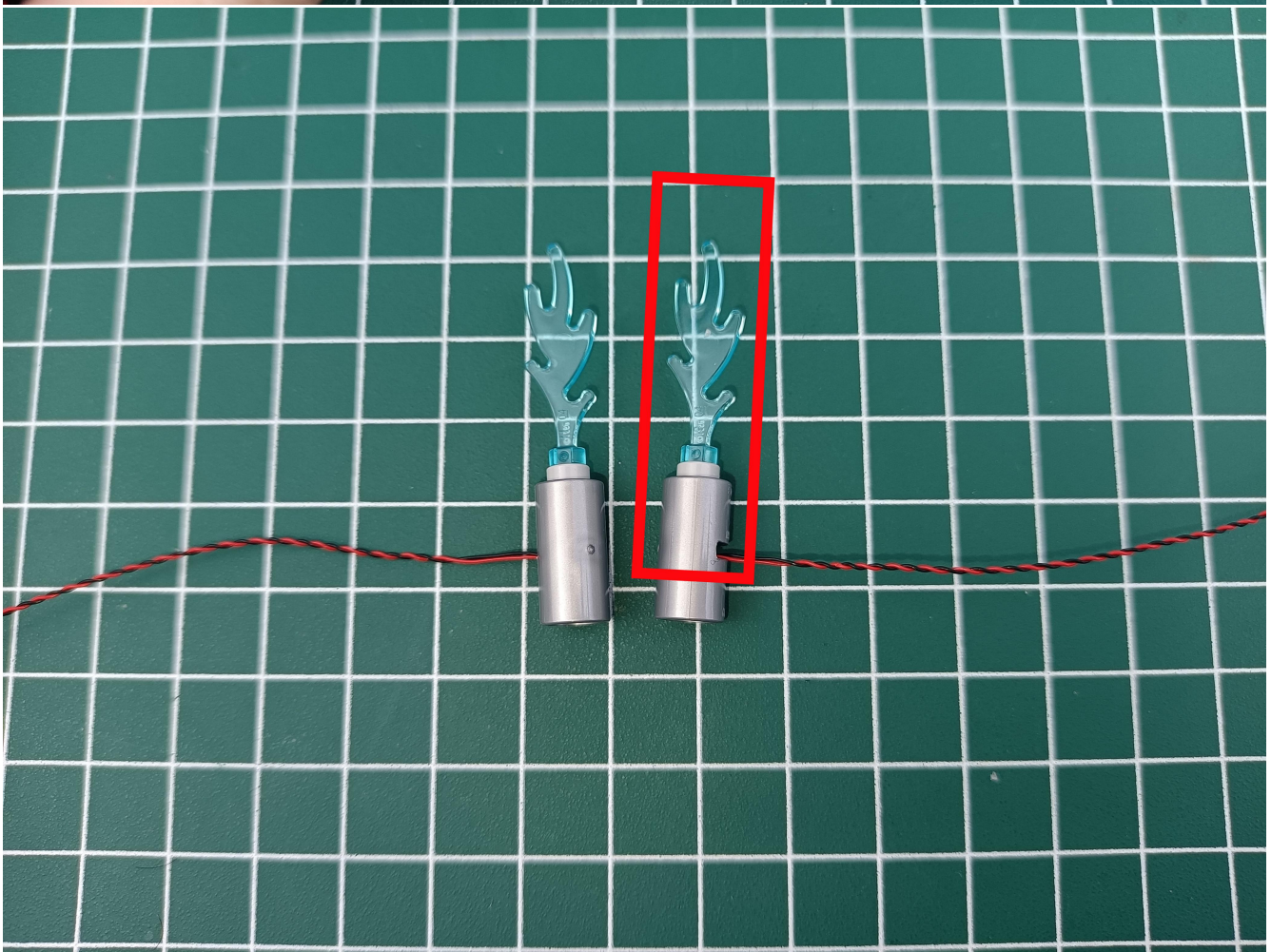
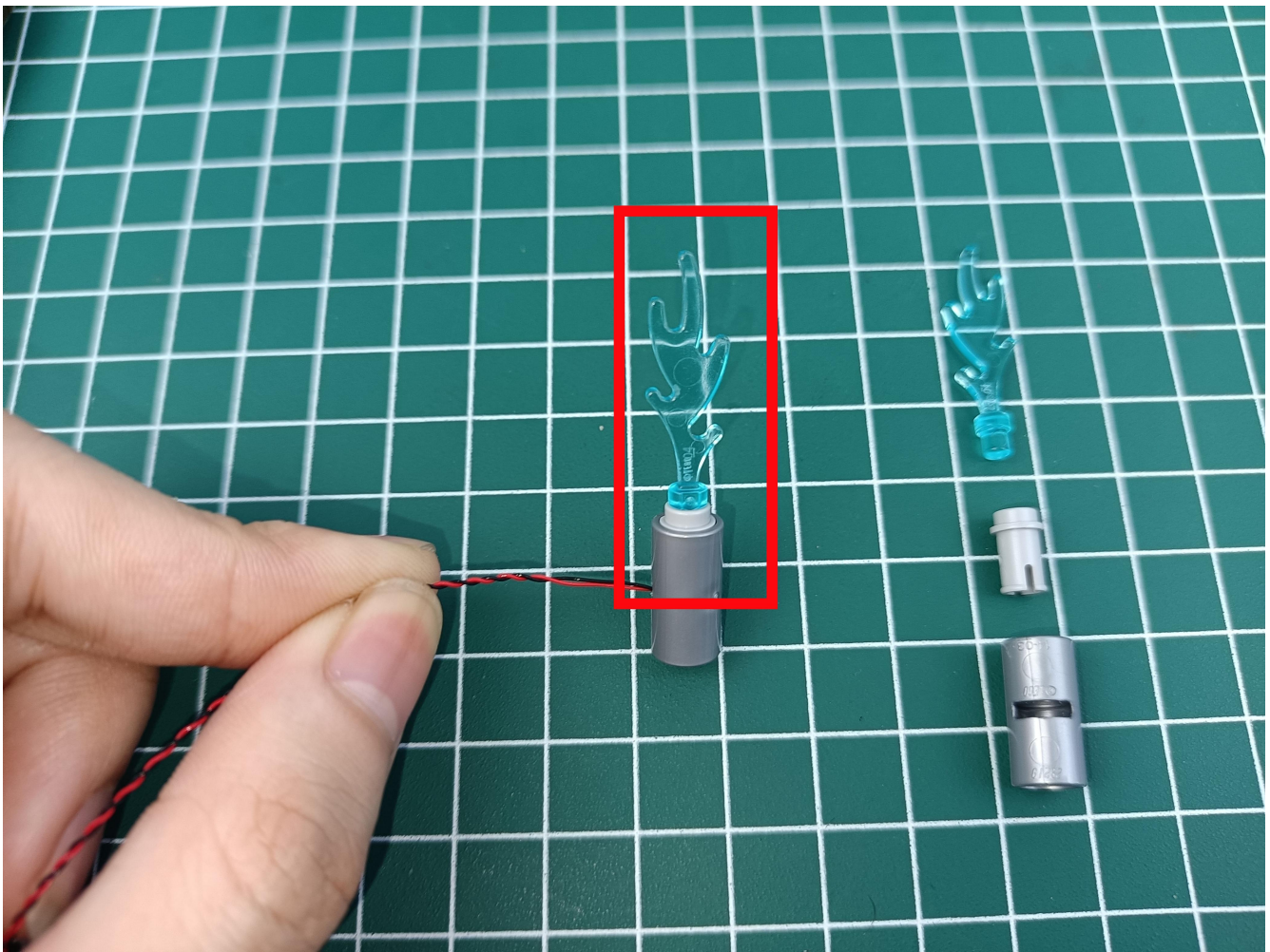



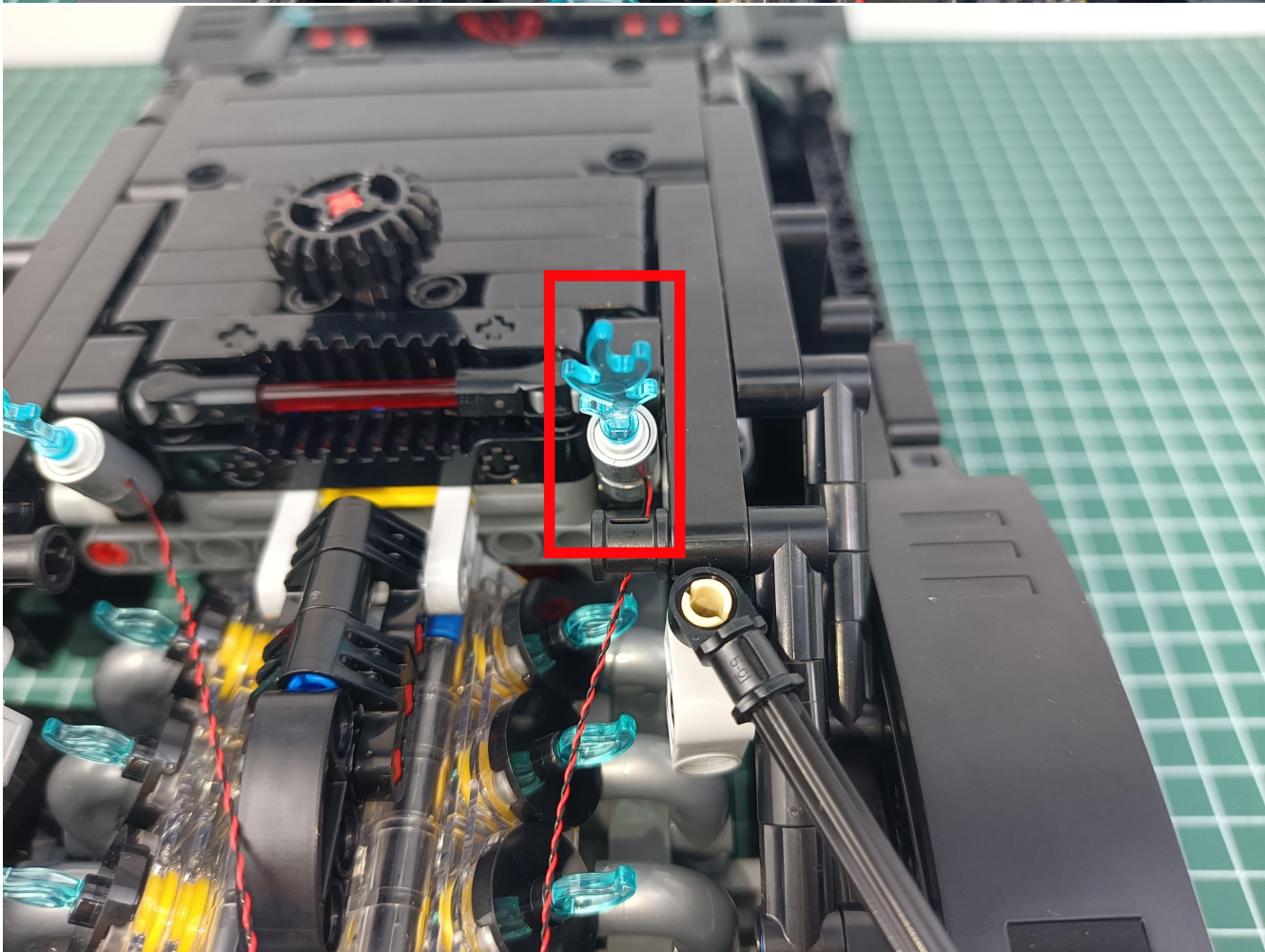
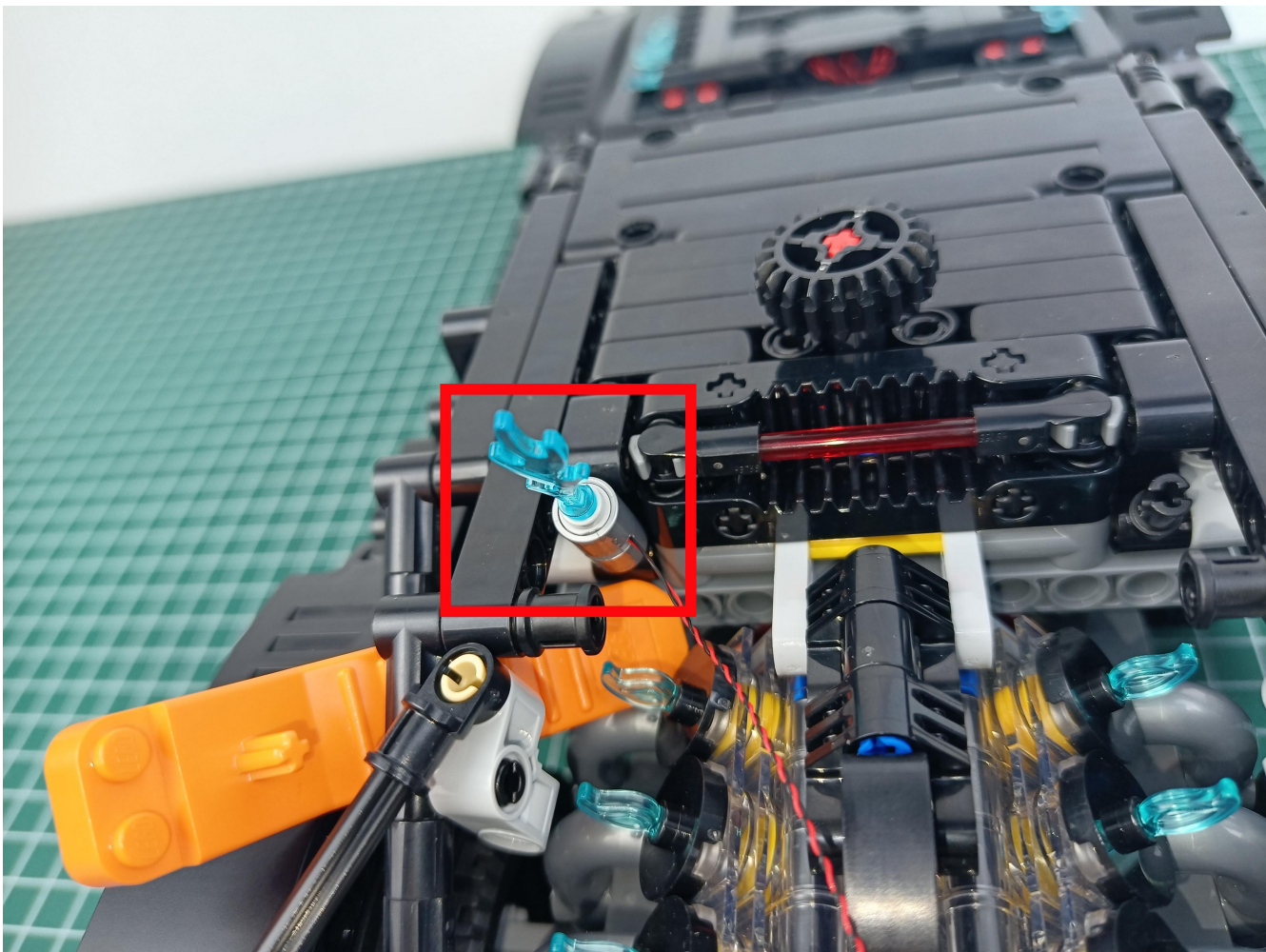



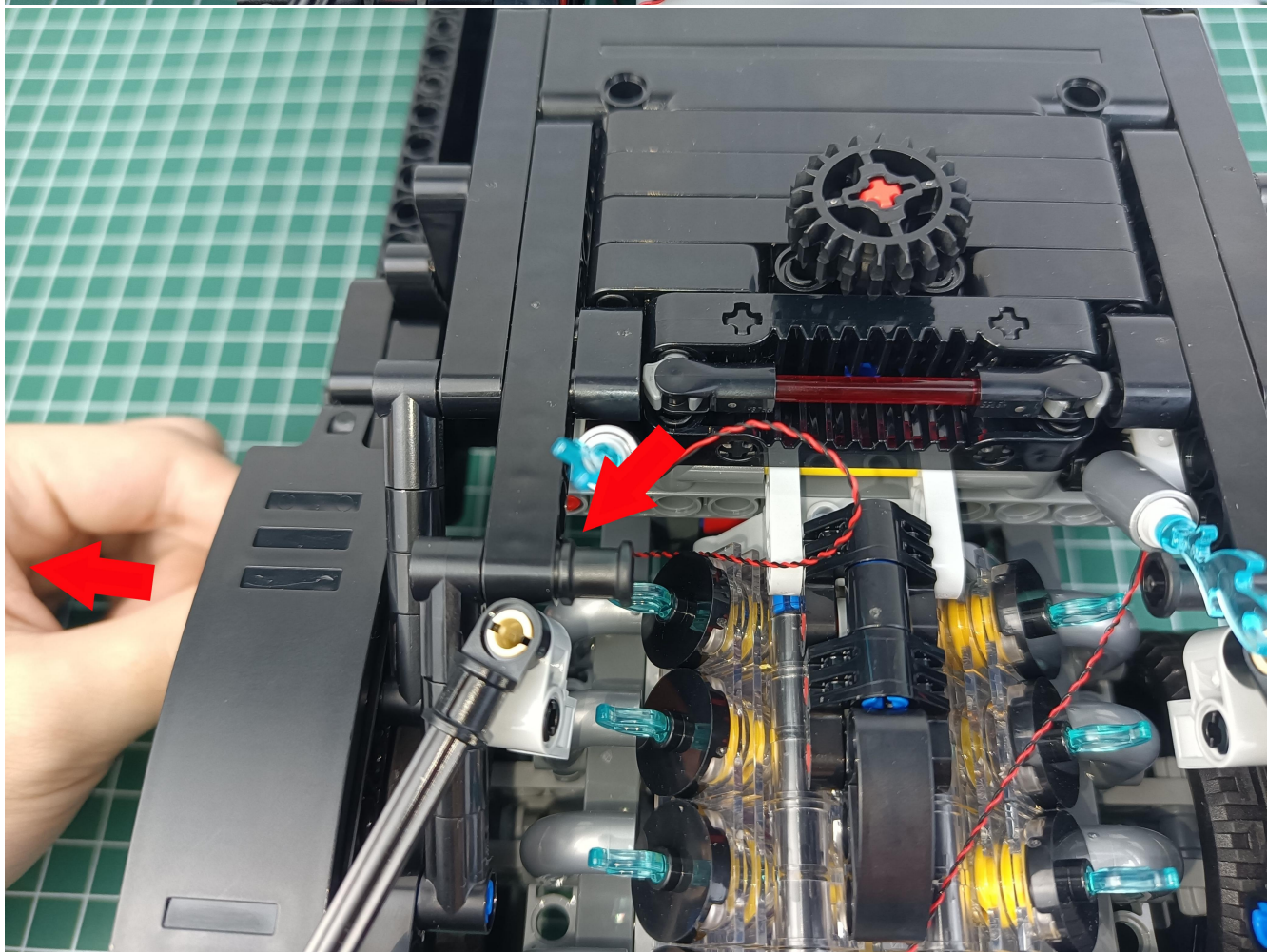
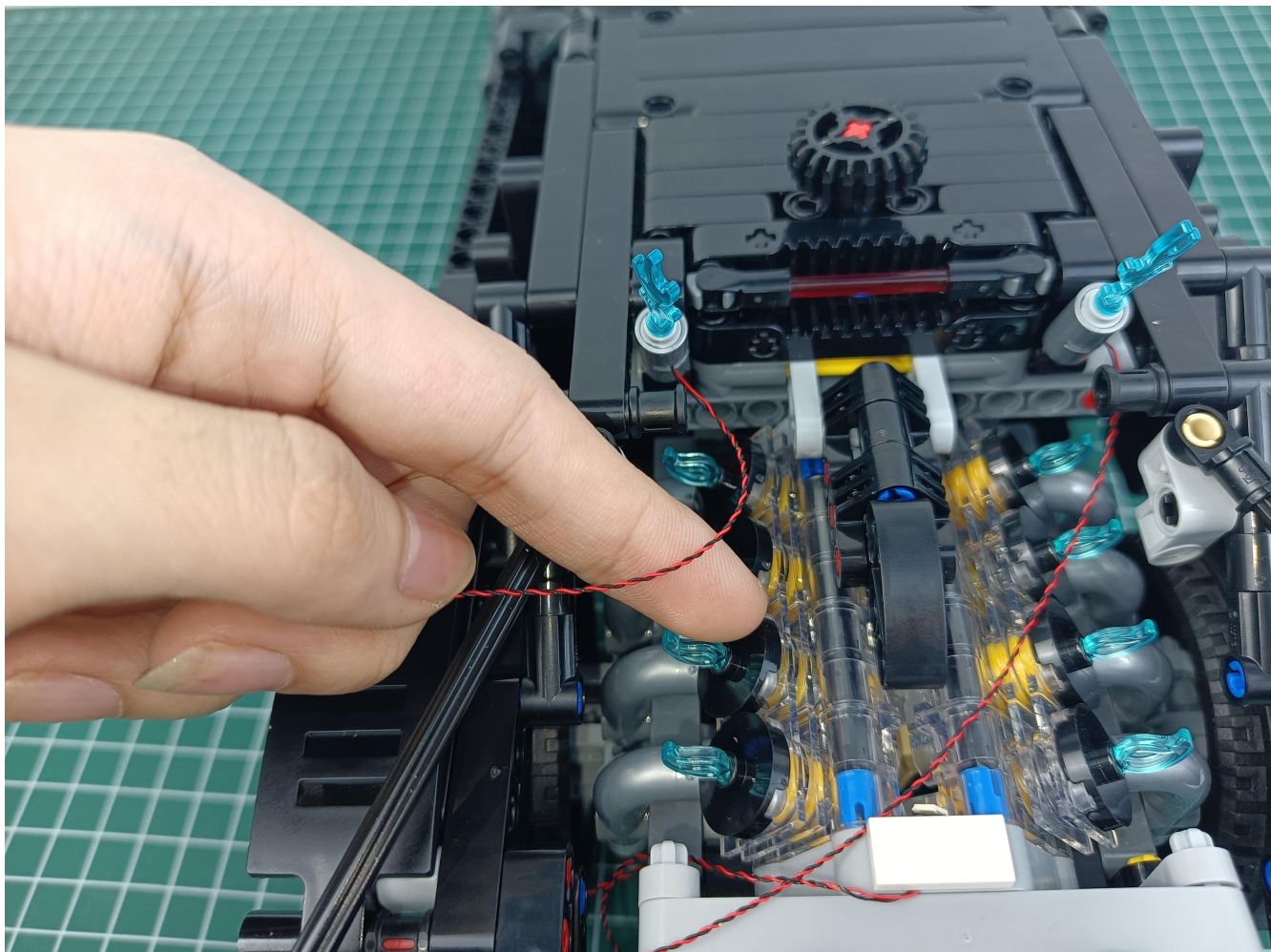



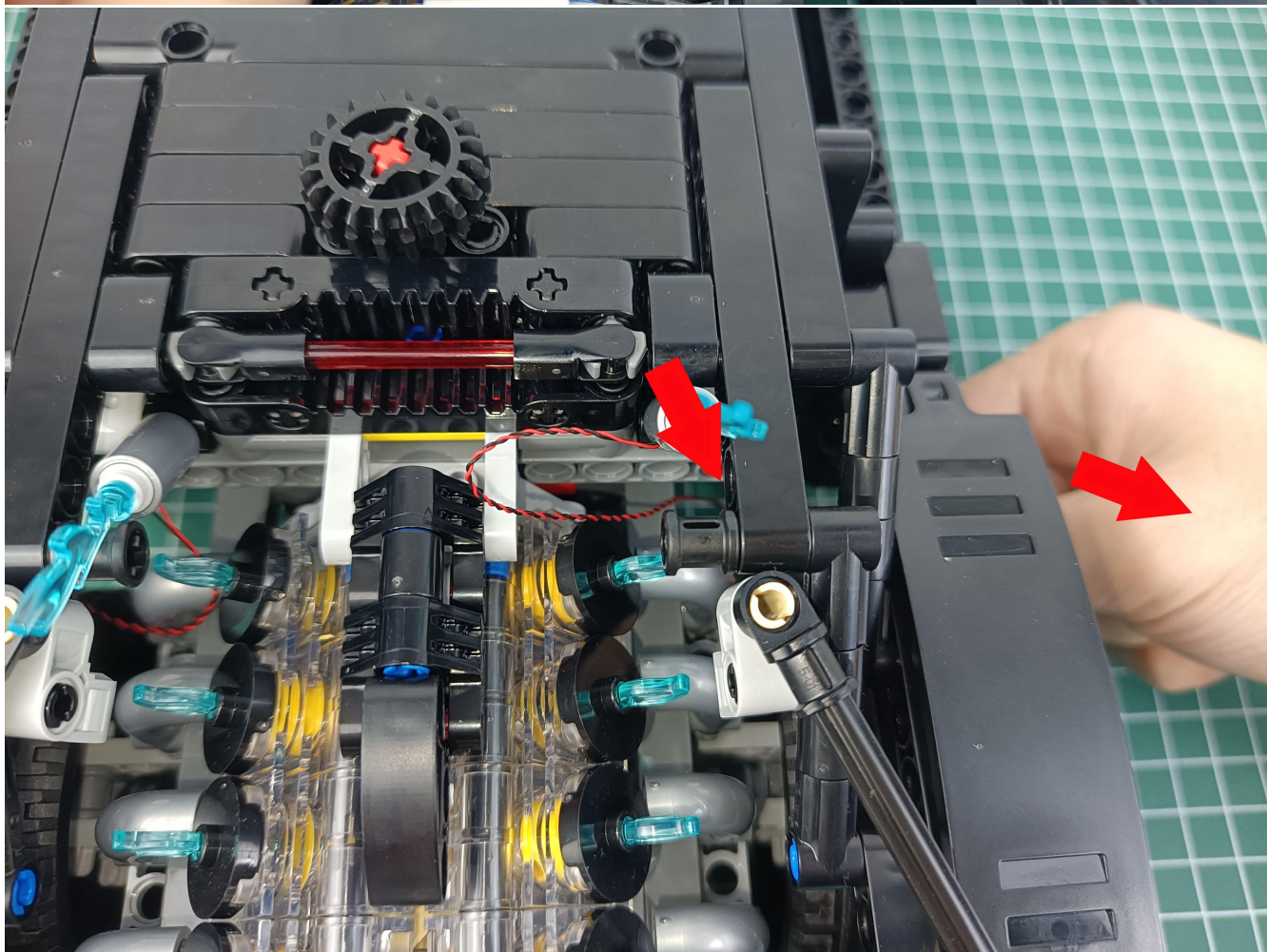
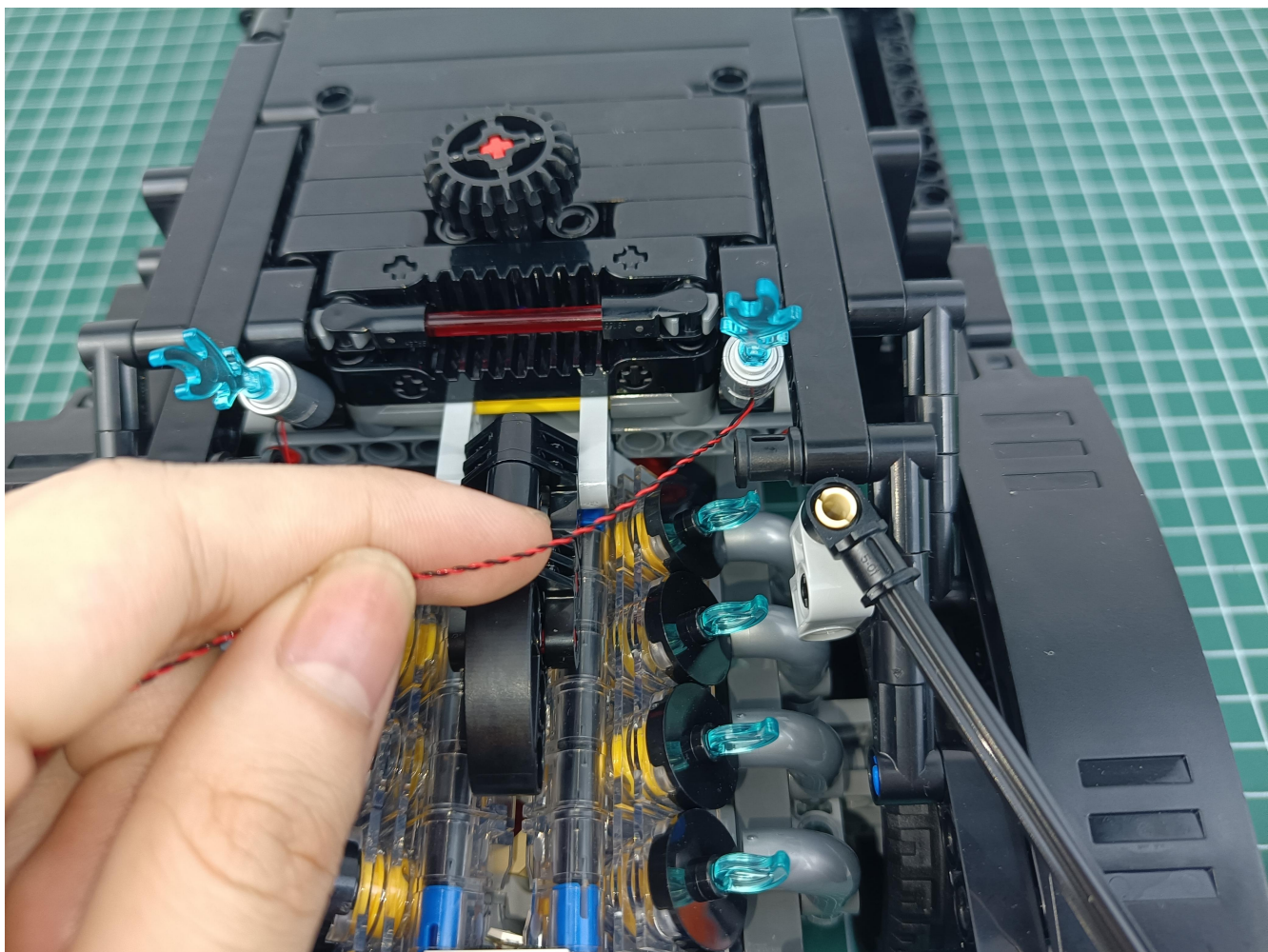



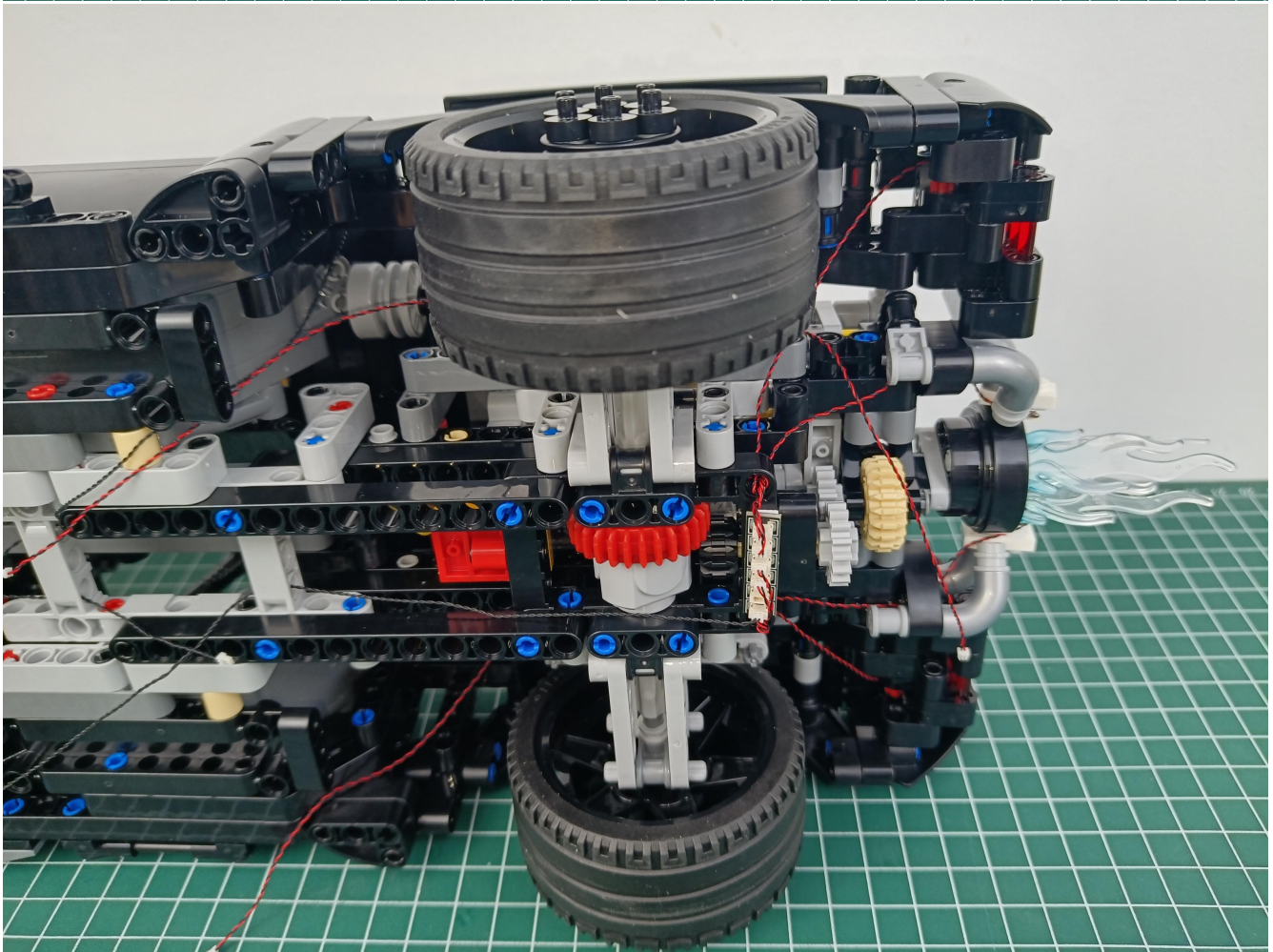
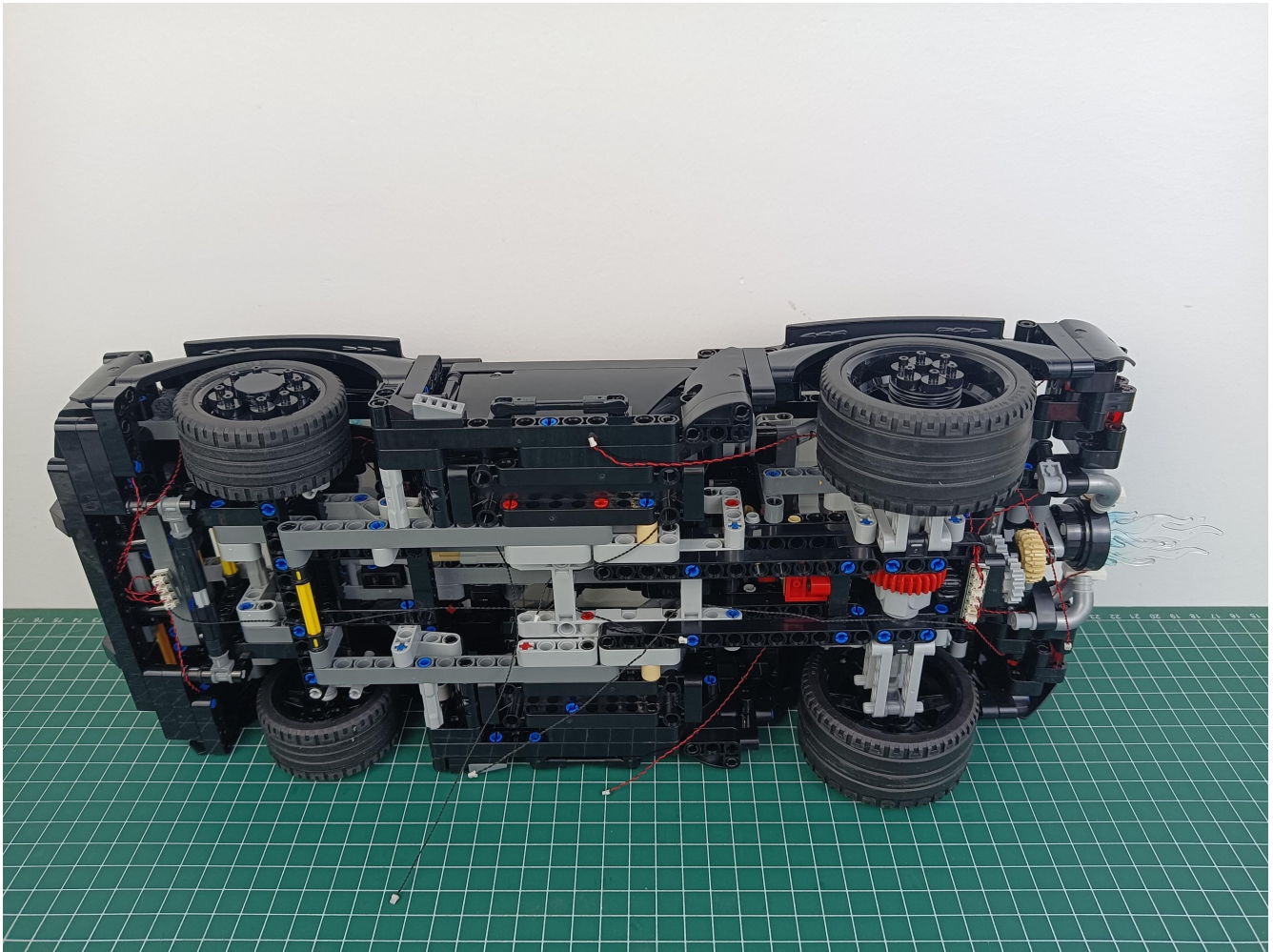



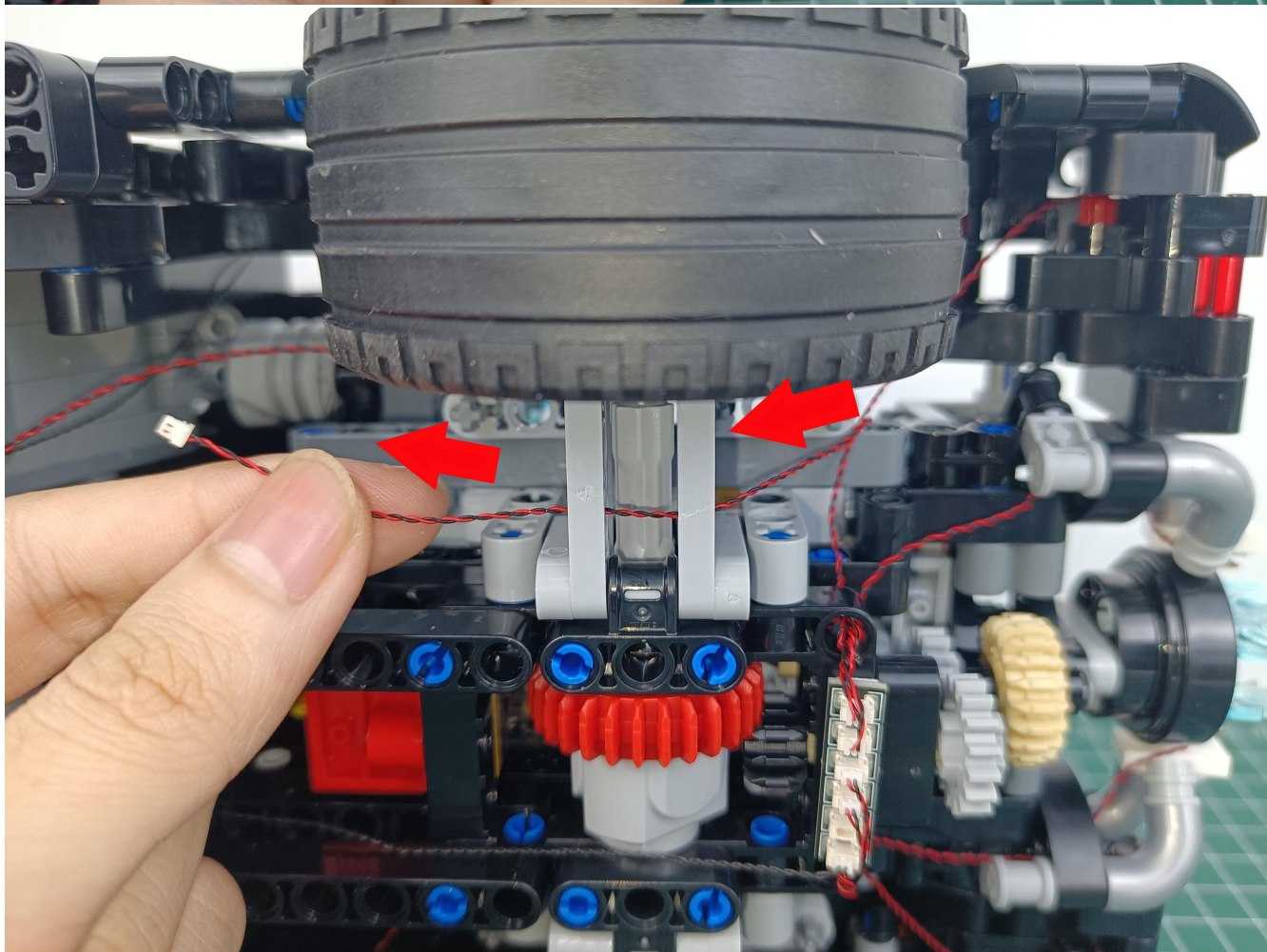
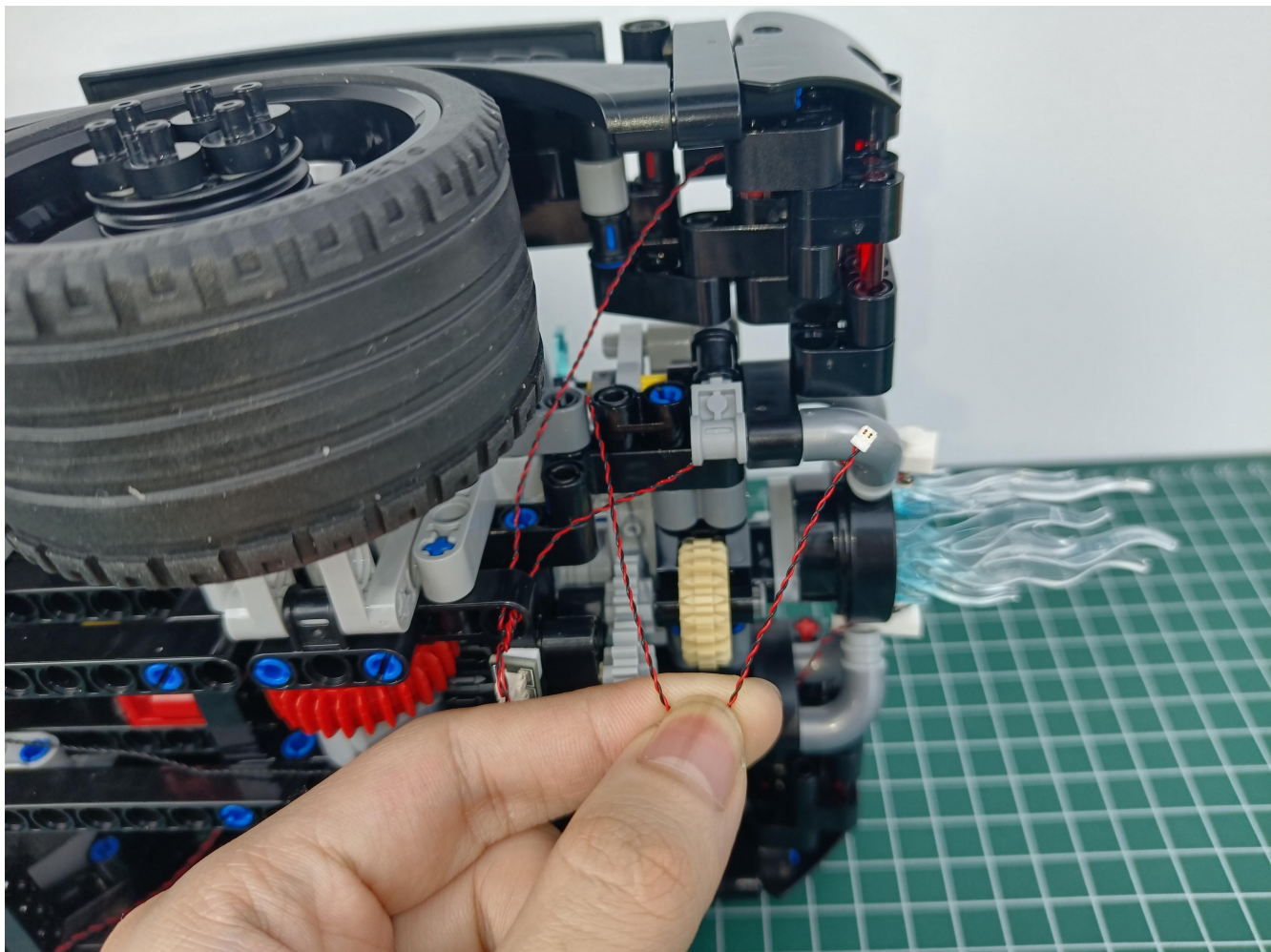



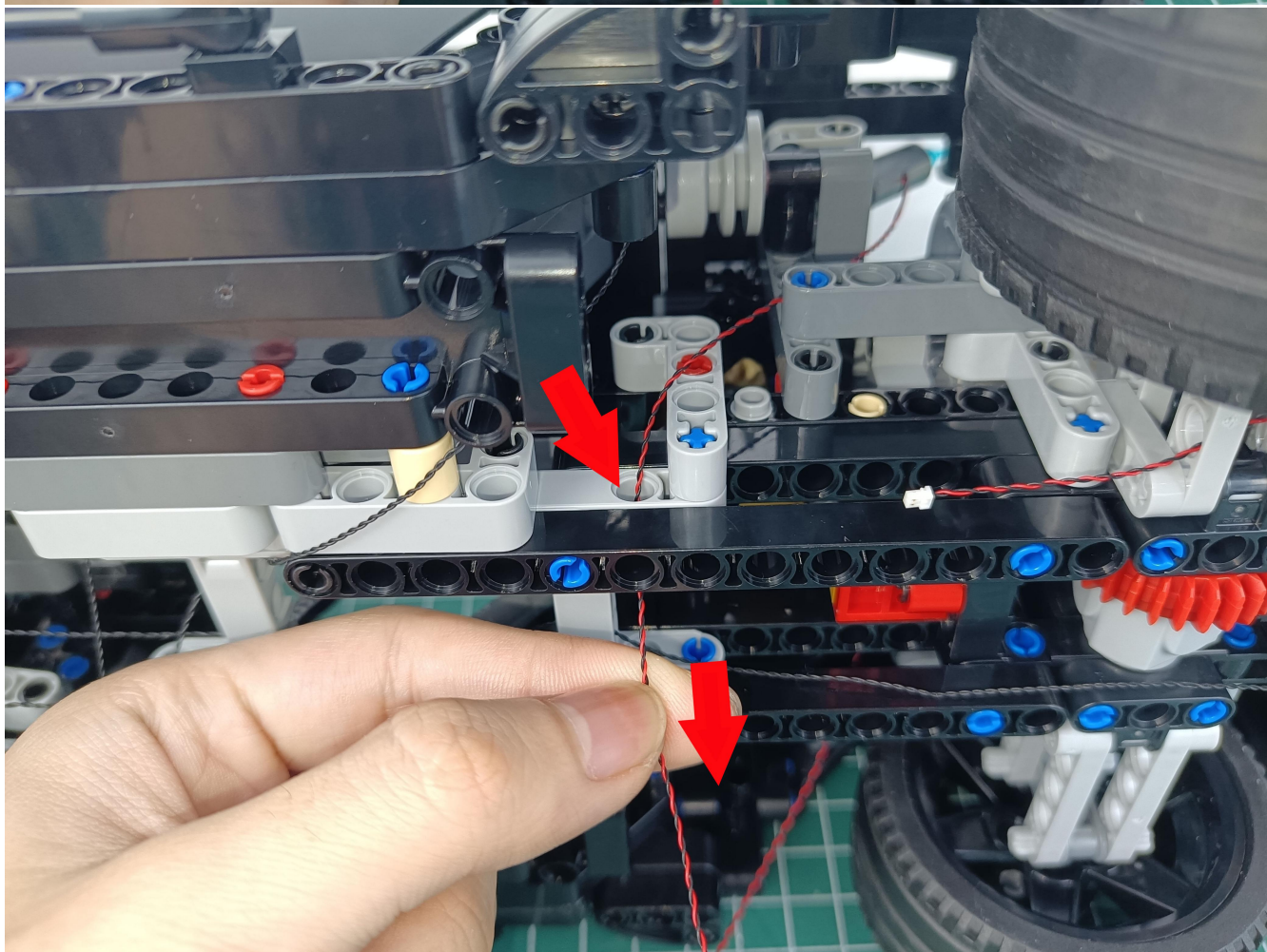
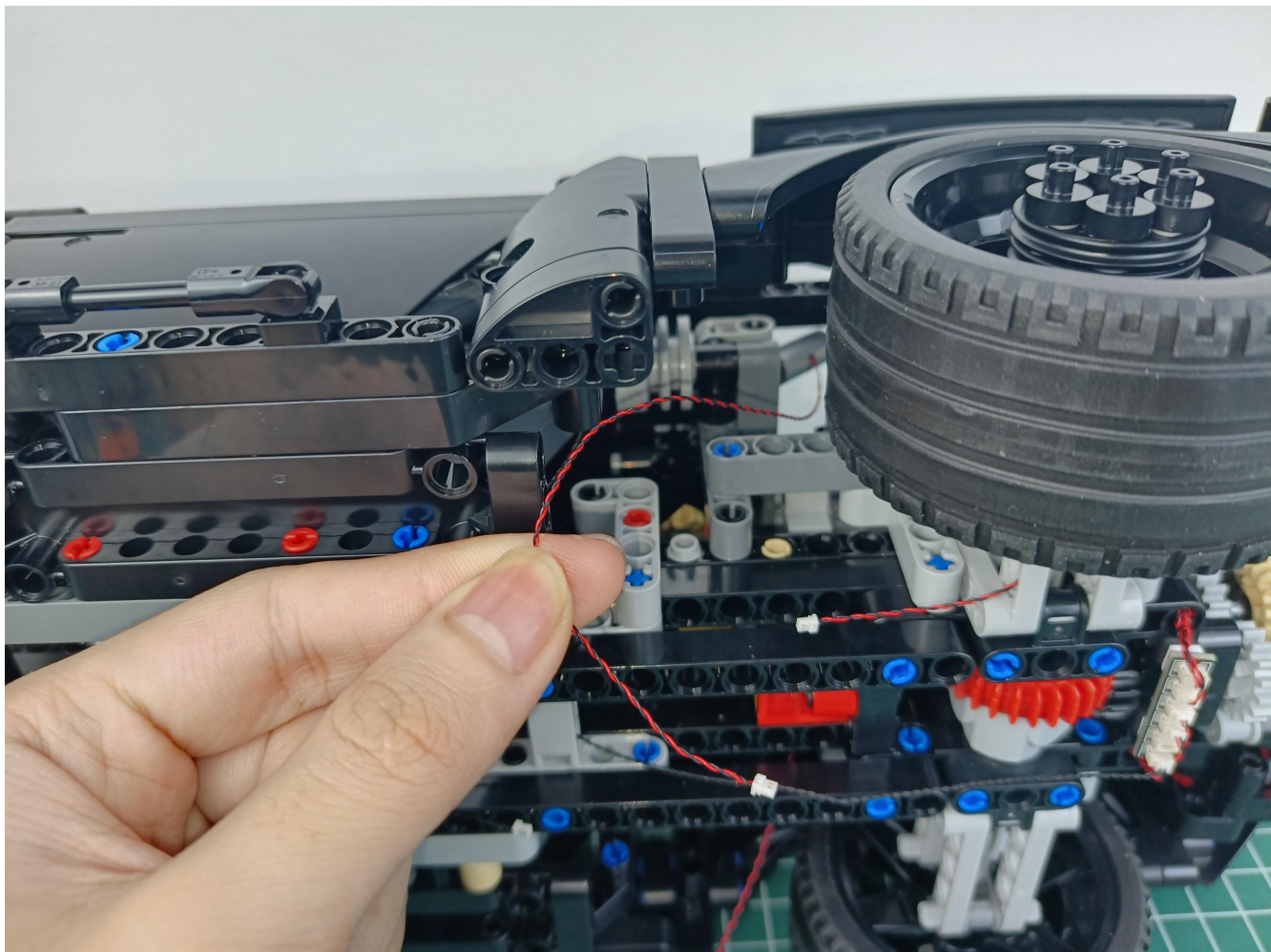



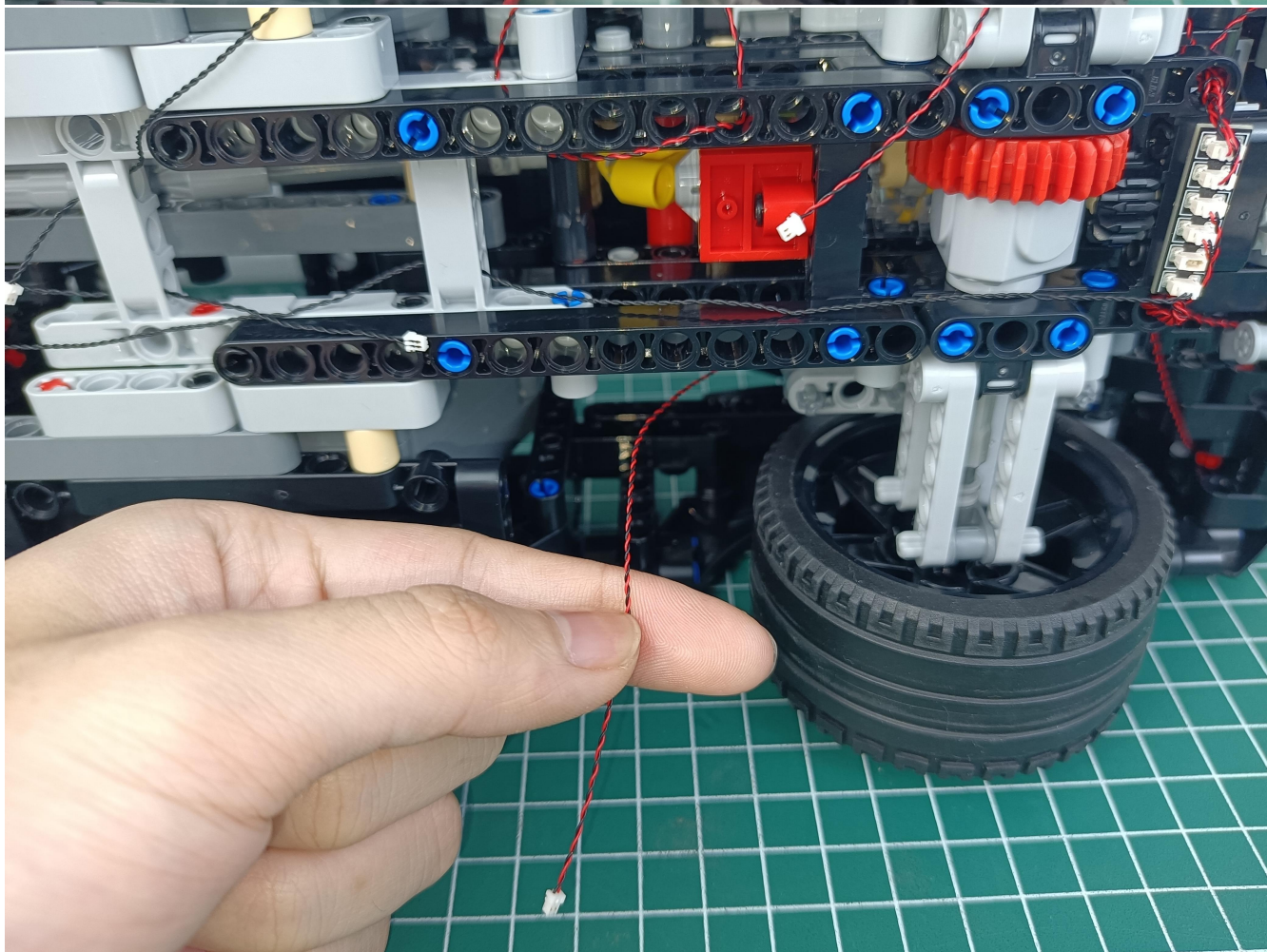
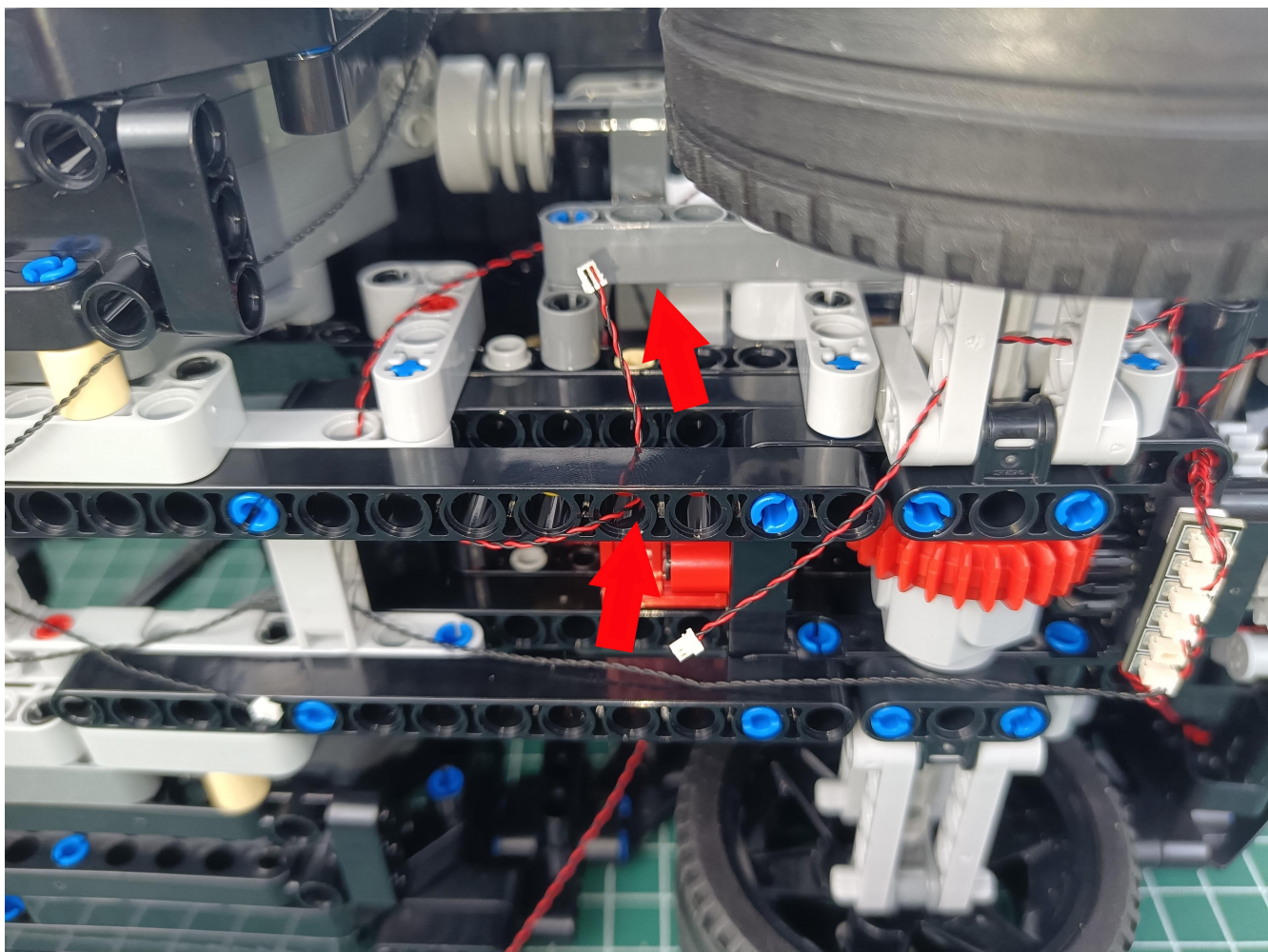



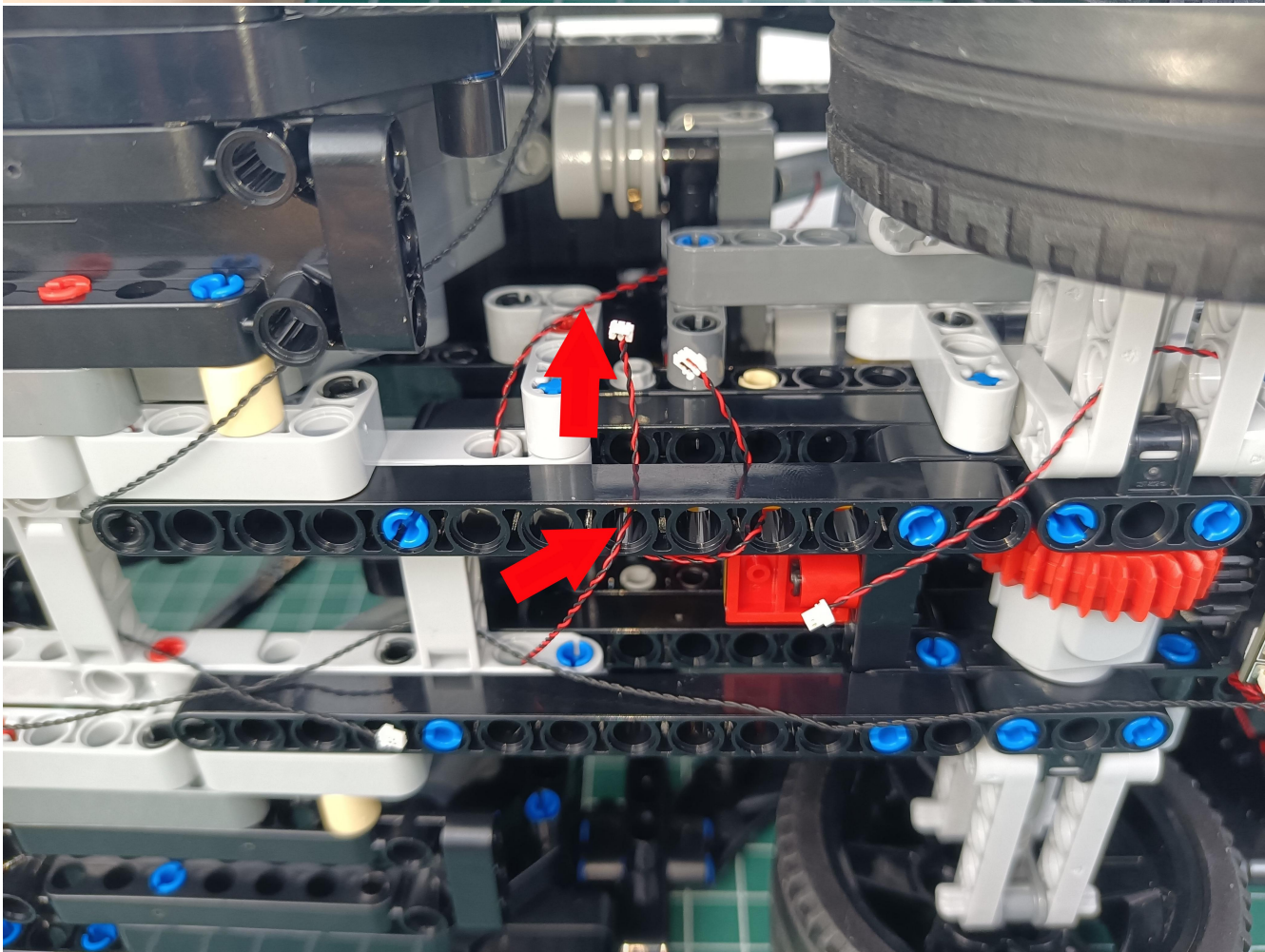
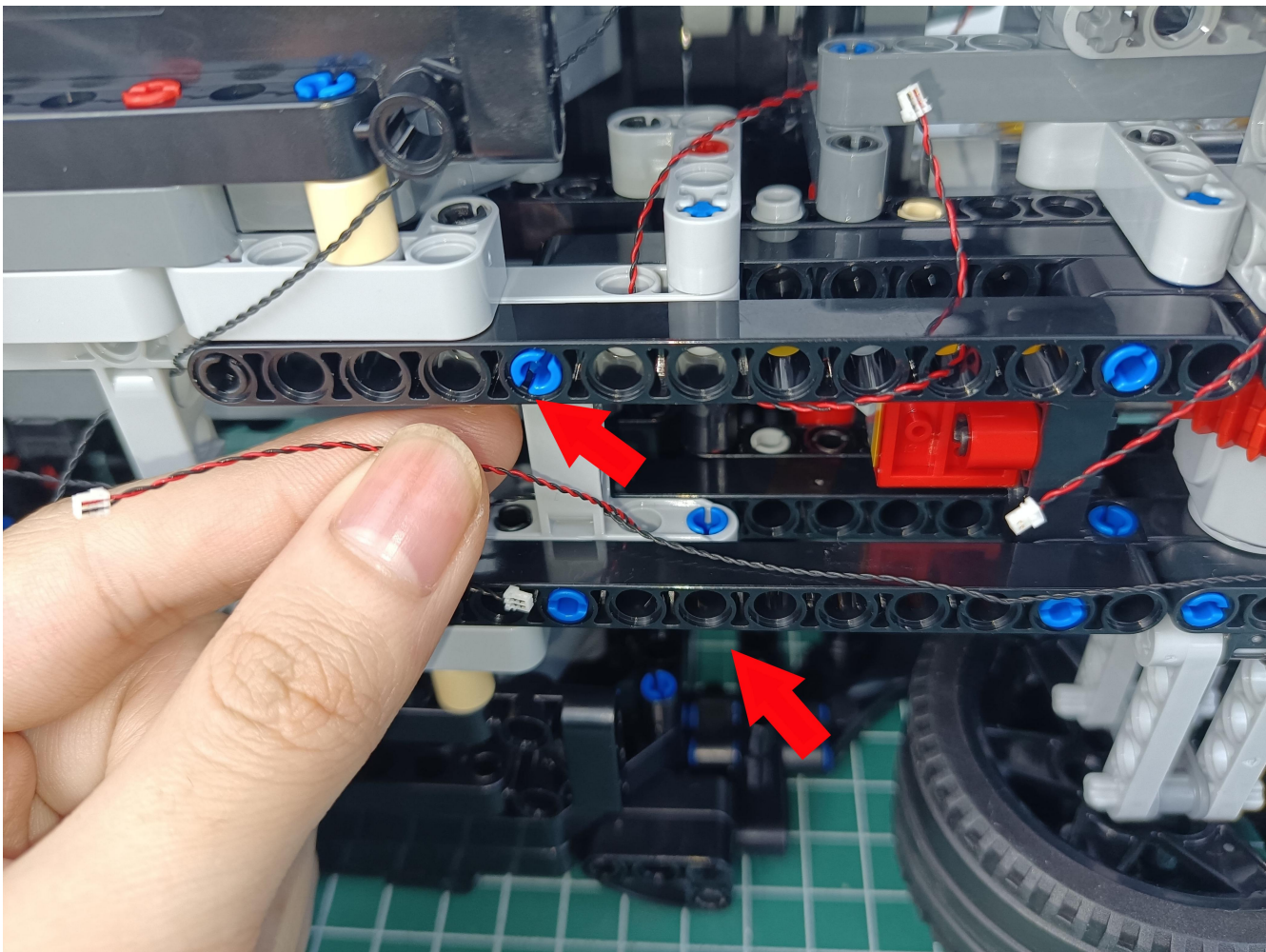



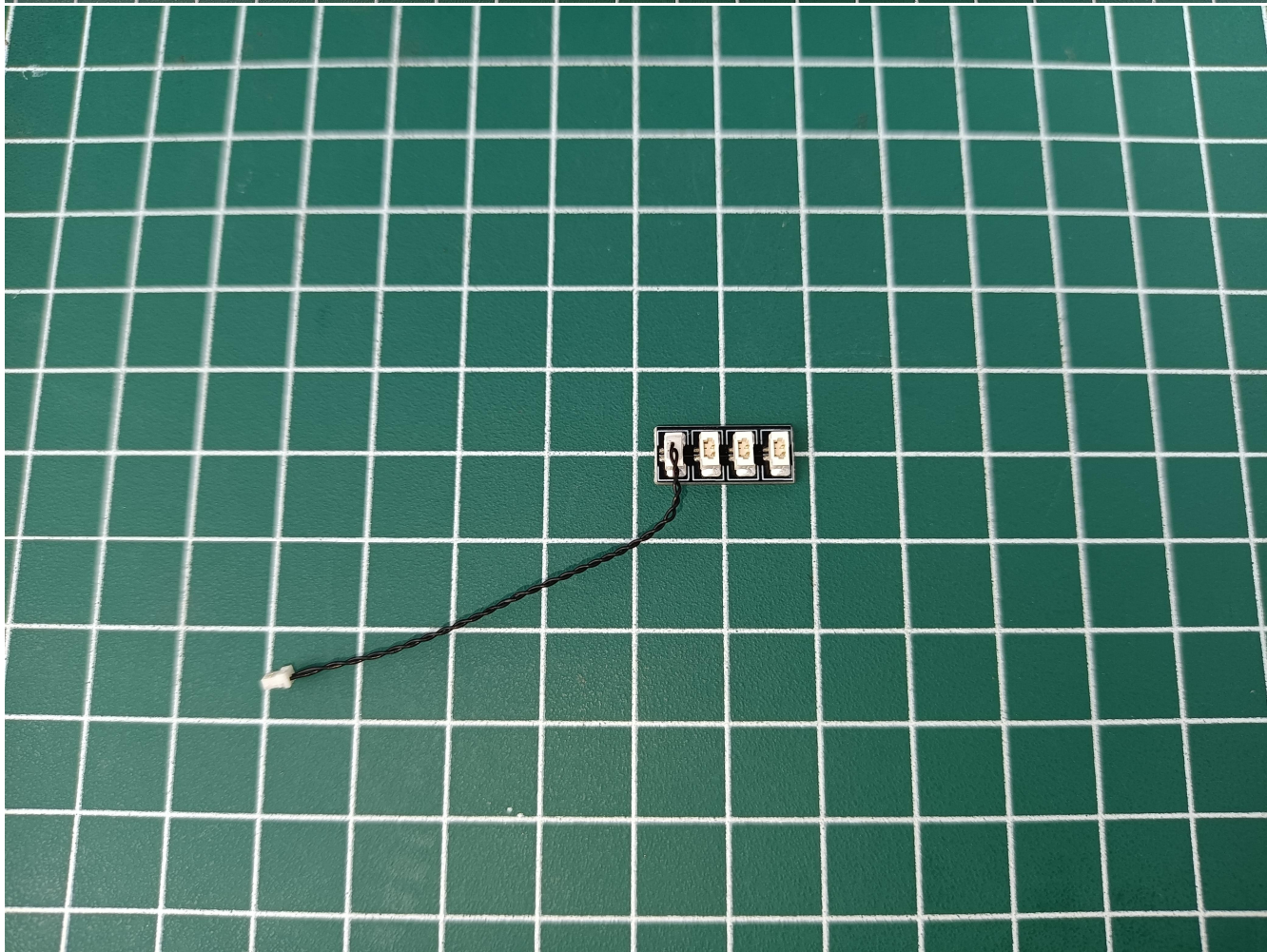



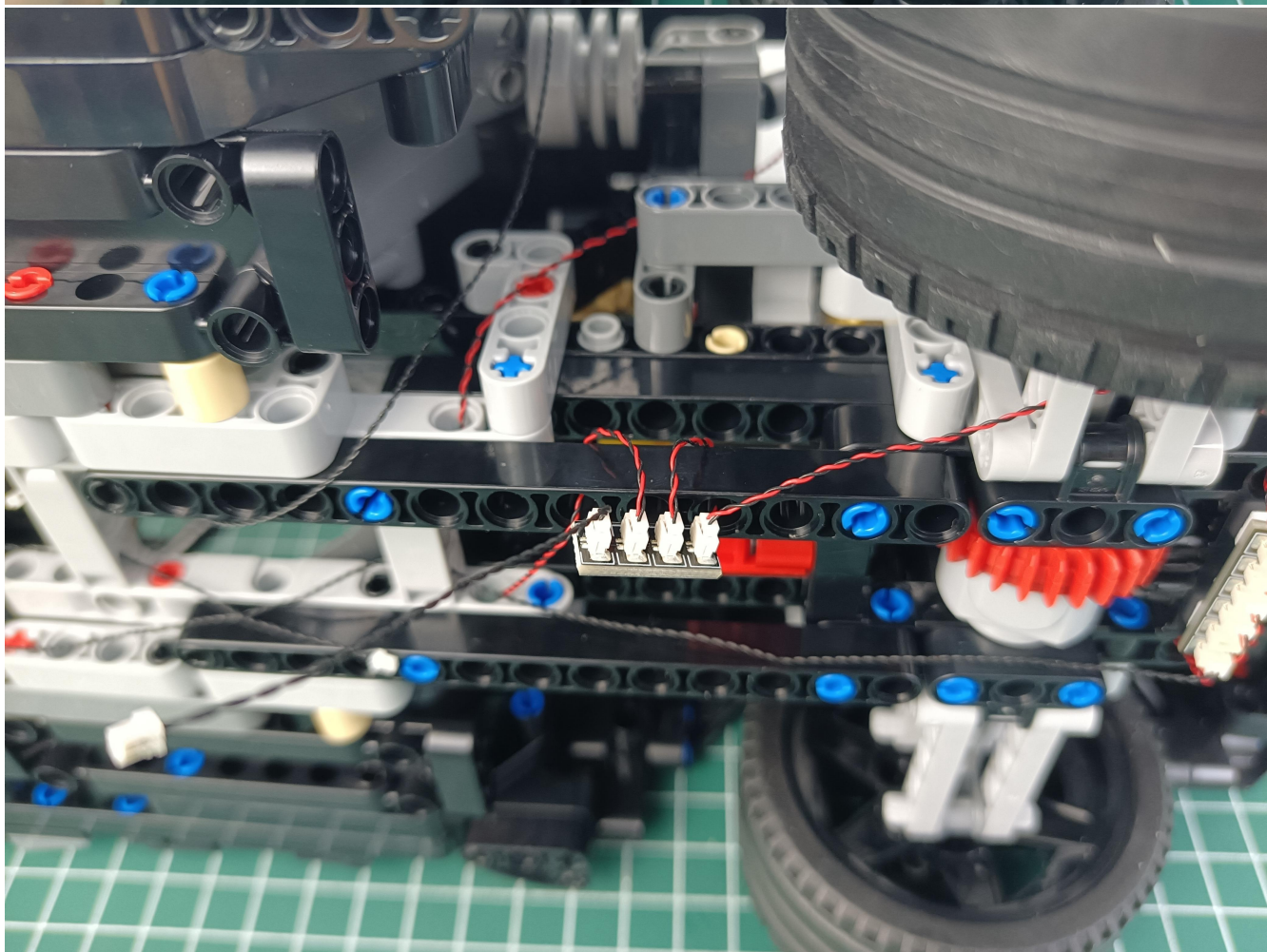
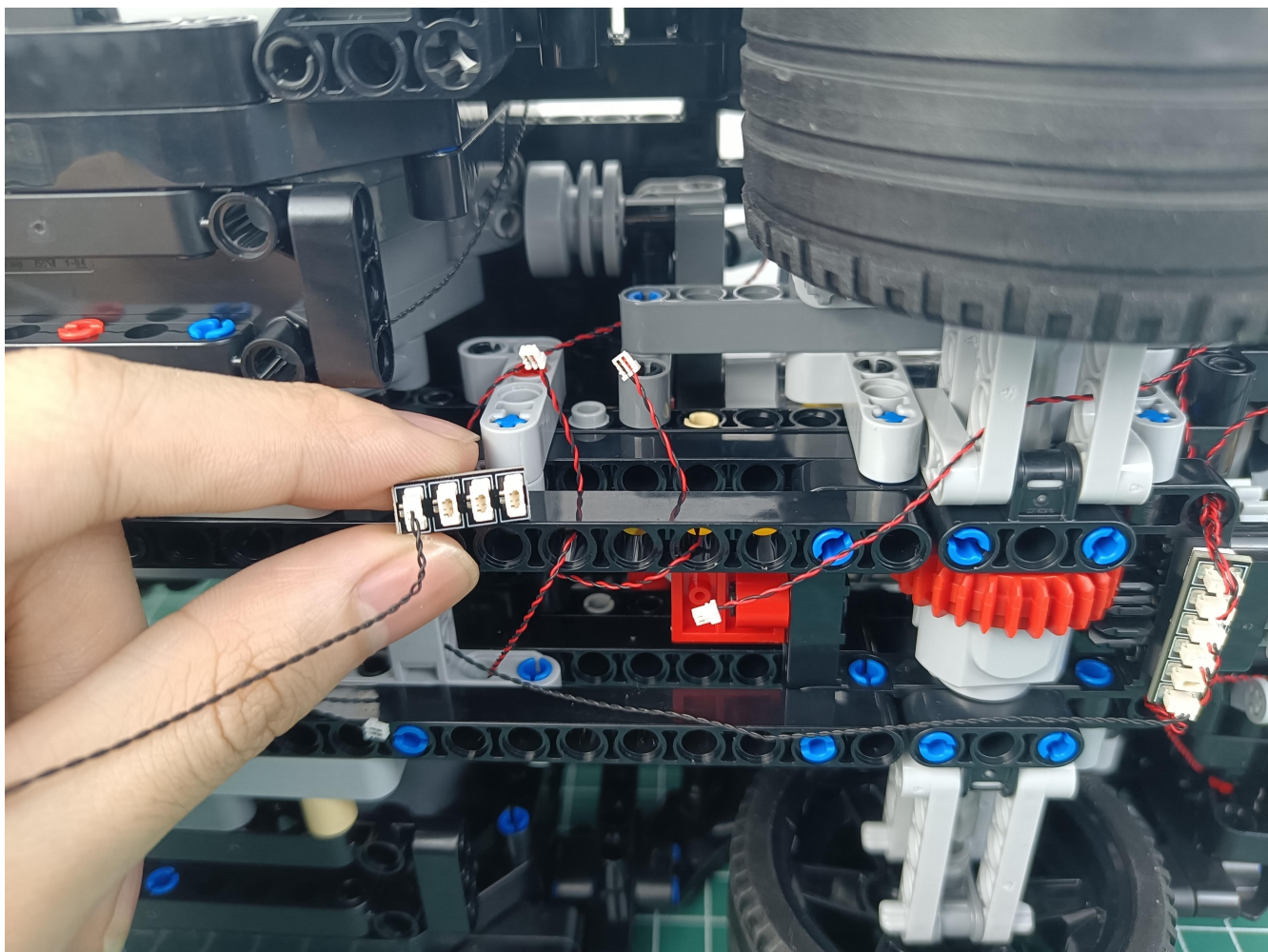



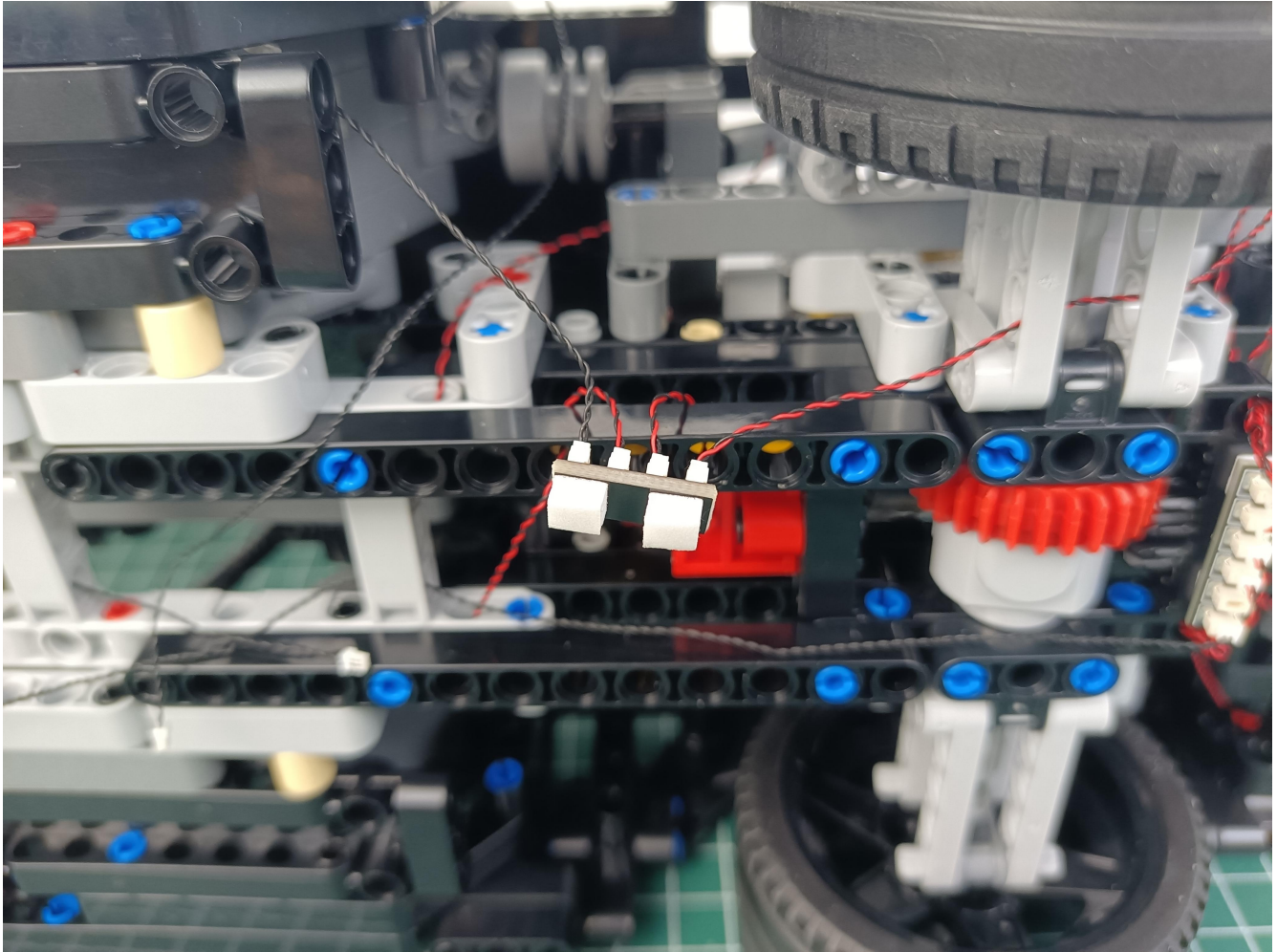



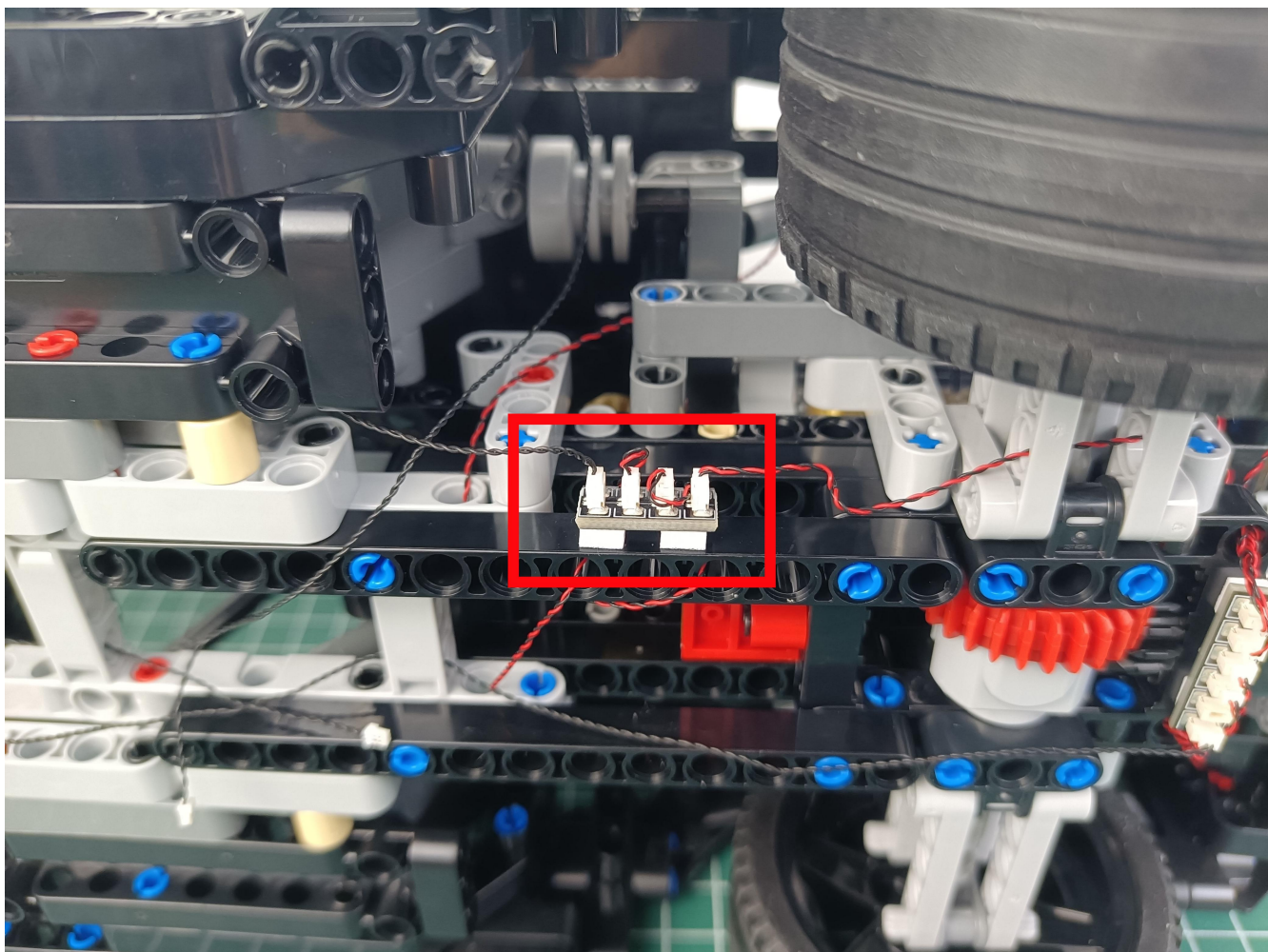



## Breathing light module

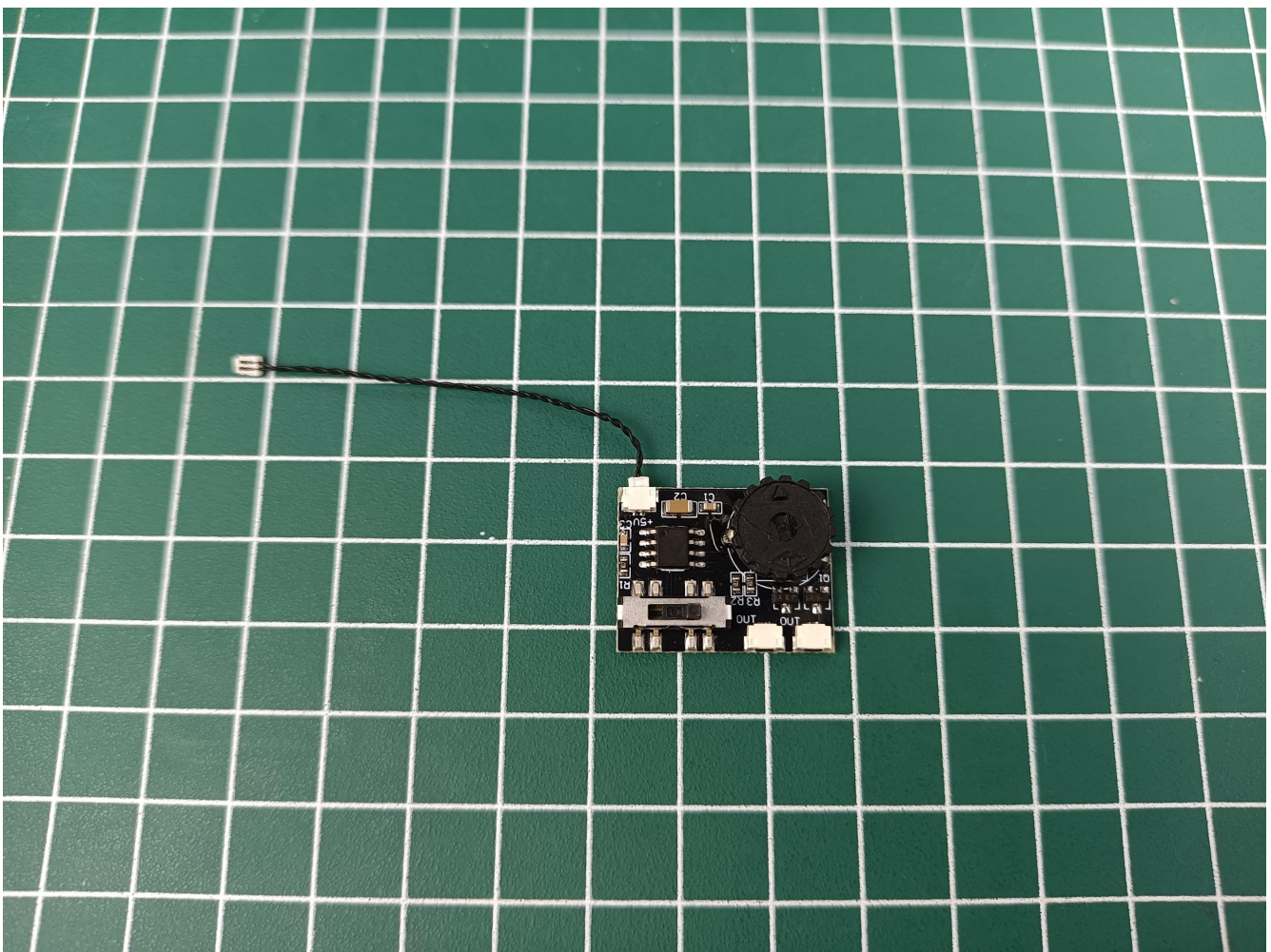
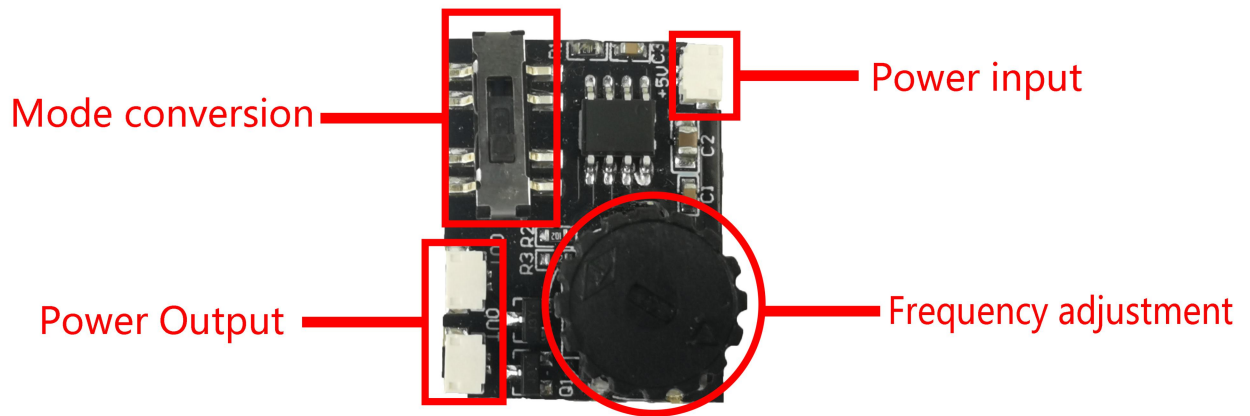



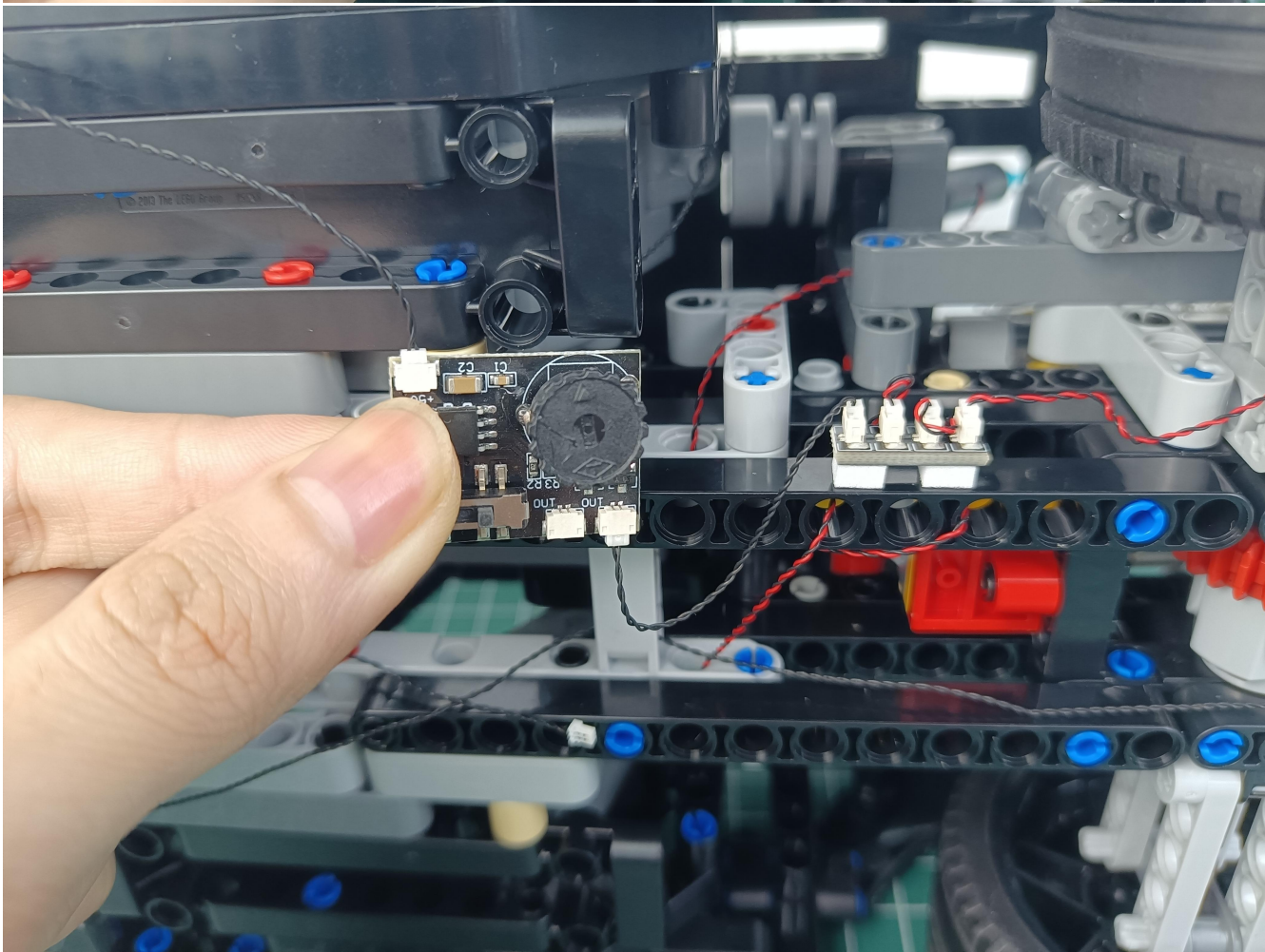
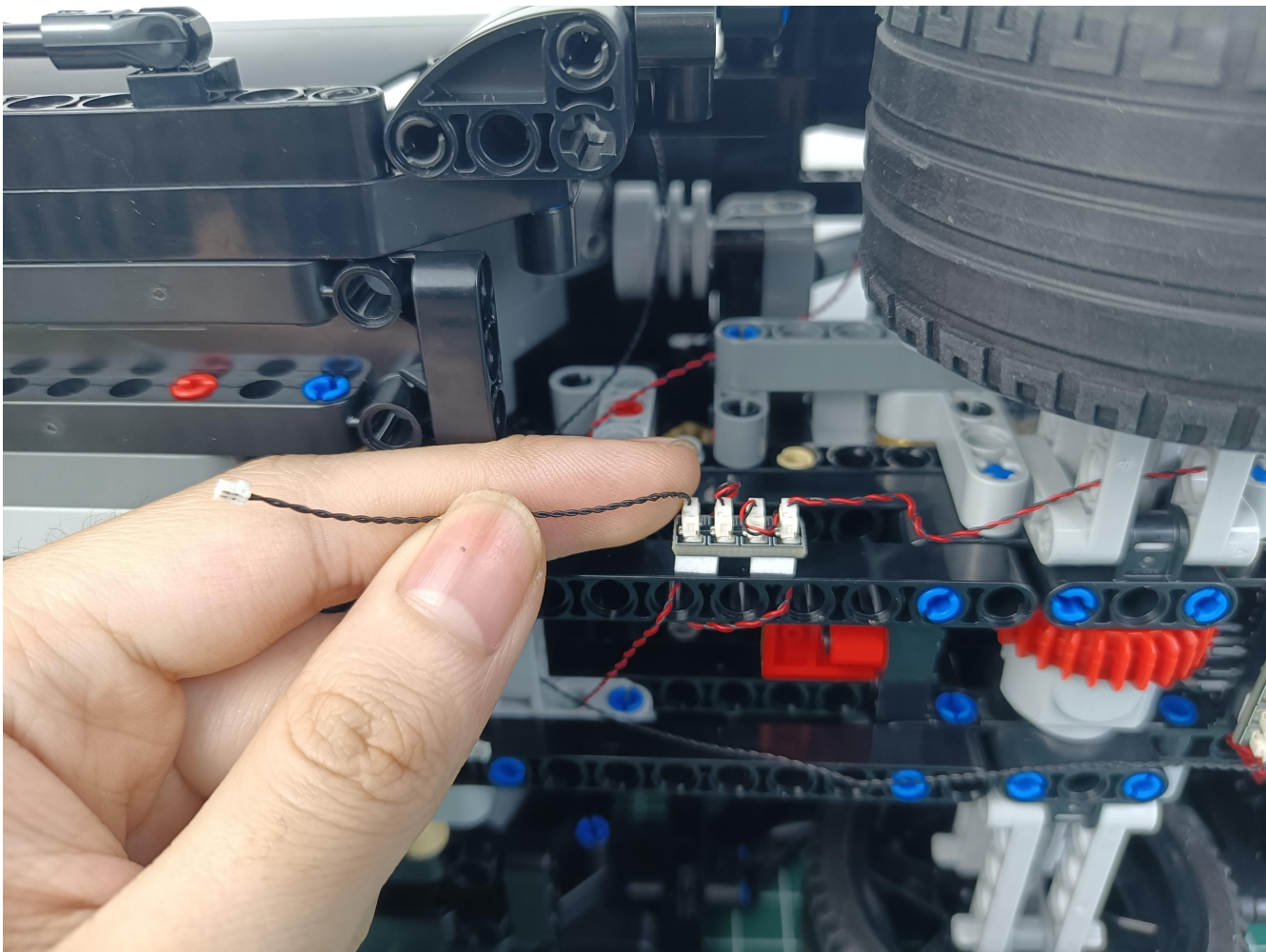







## Remote control function description

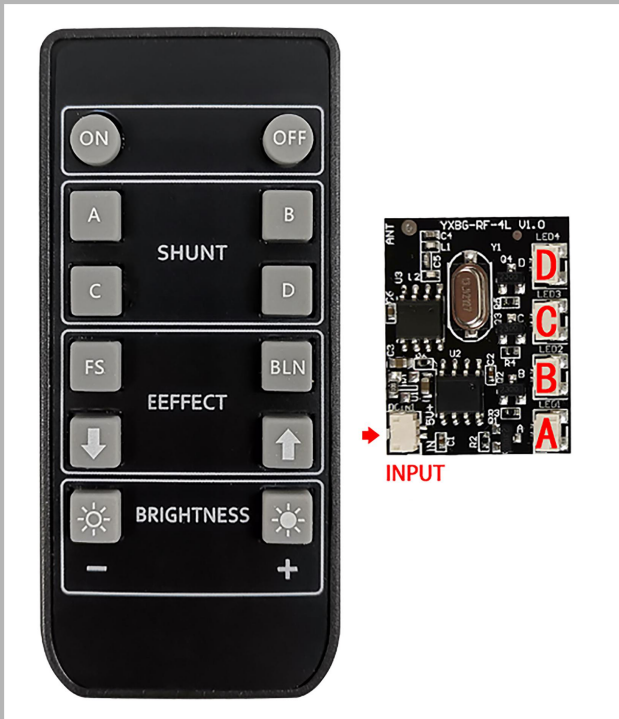

ON: All branches are opened

OFF: all branches are closed

A: open/close A road

B: open/close B road

C: open/close C road

D: open/close D road

FS: Turn on blinking for the last open channel

BLN: Start breathing for the last opened path

↑: Increase blinking/breathing rate

↓: Increase blinking/breathing rate

Brightness+: Increase brightness

Brightness -: Reduce brightness

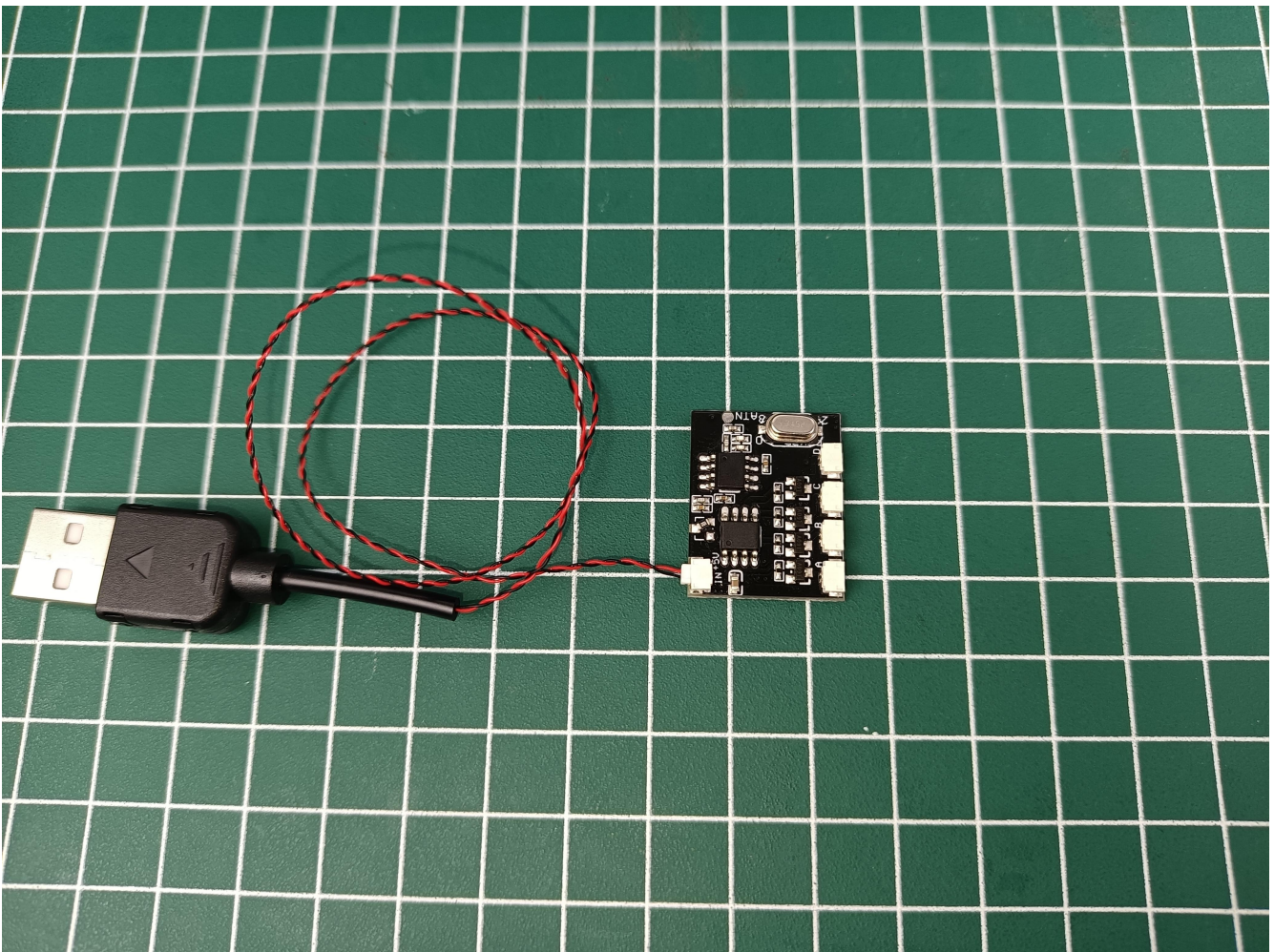



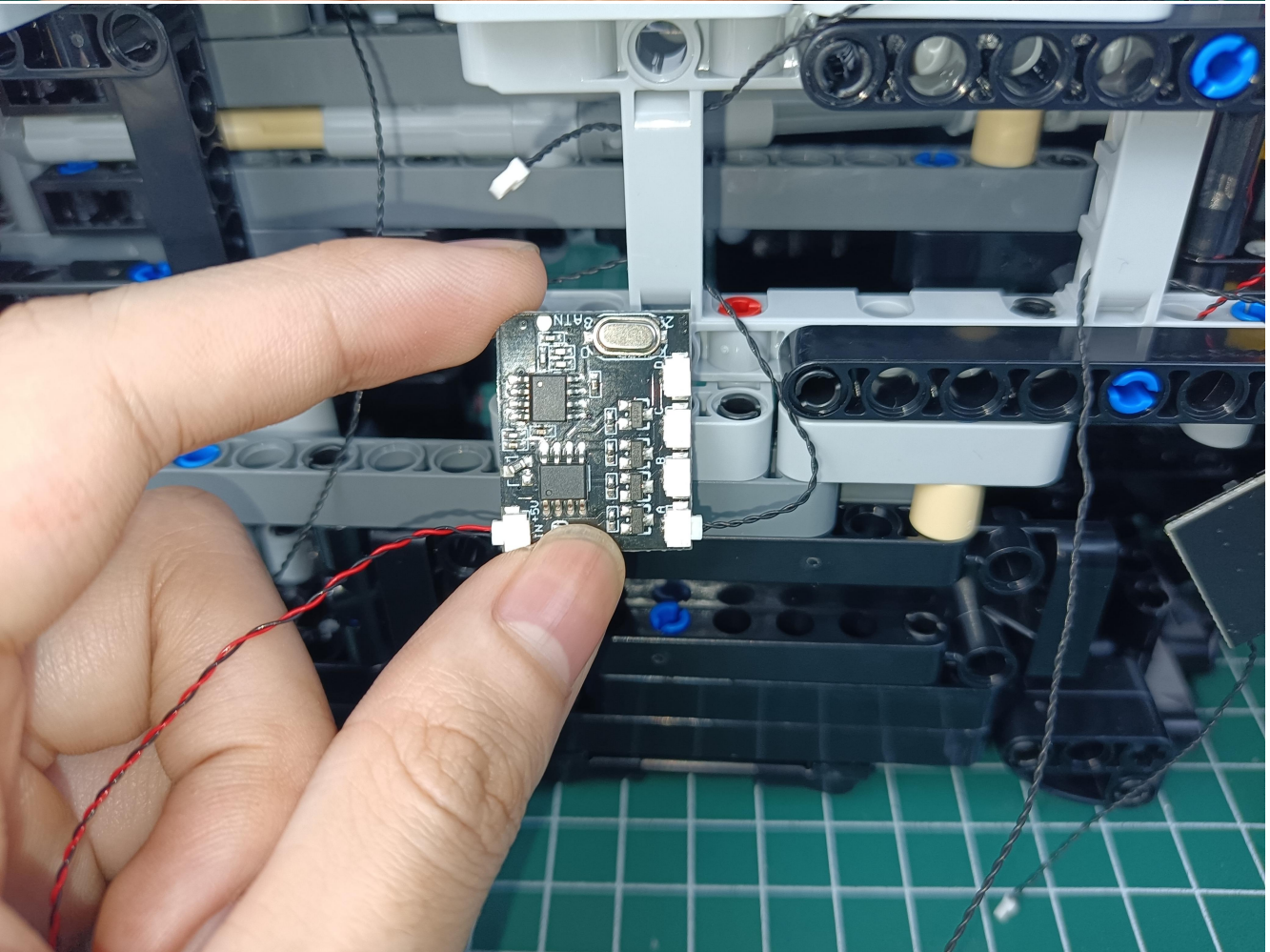
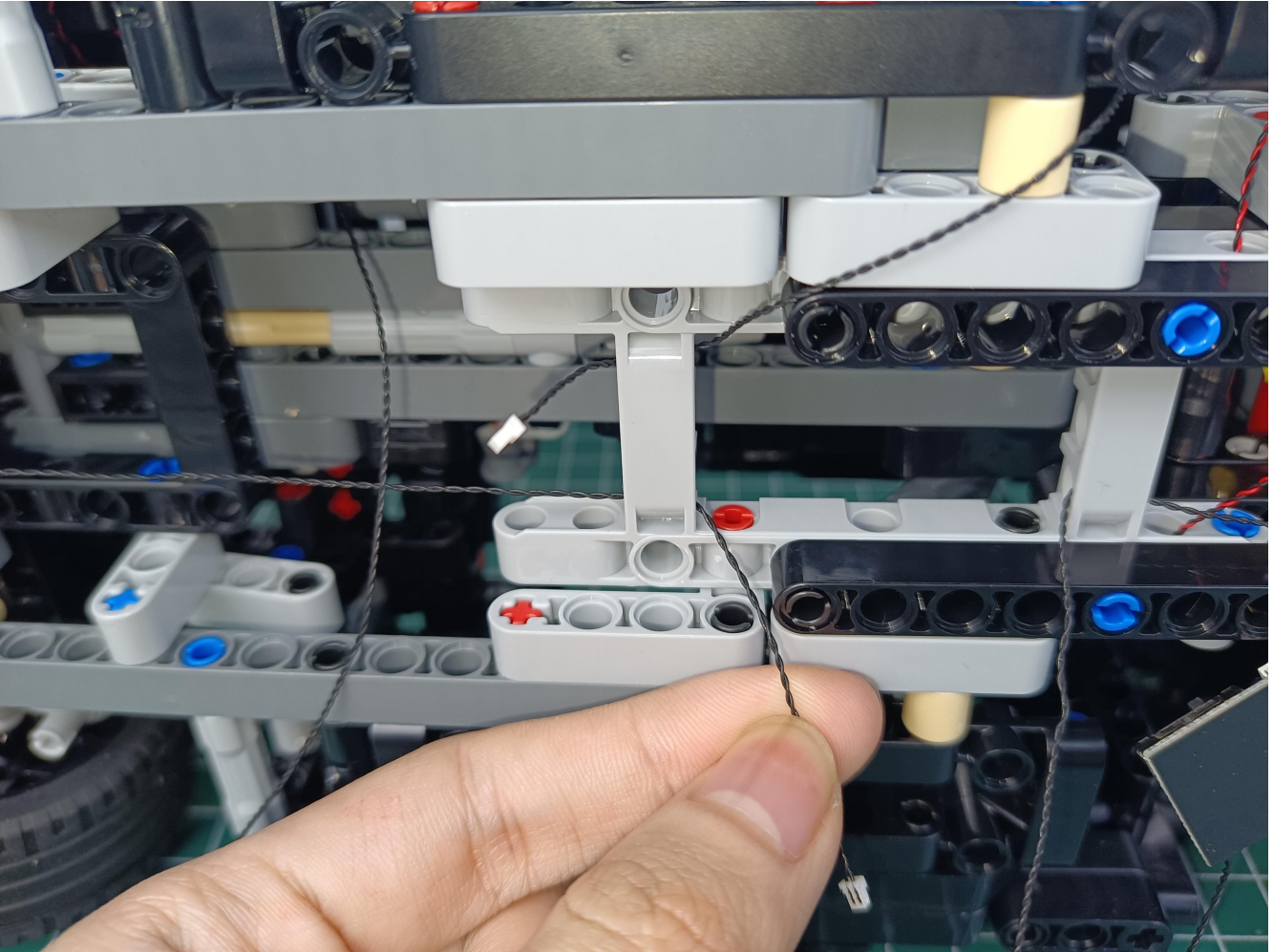



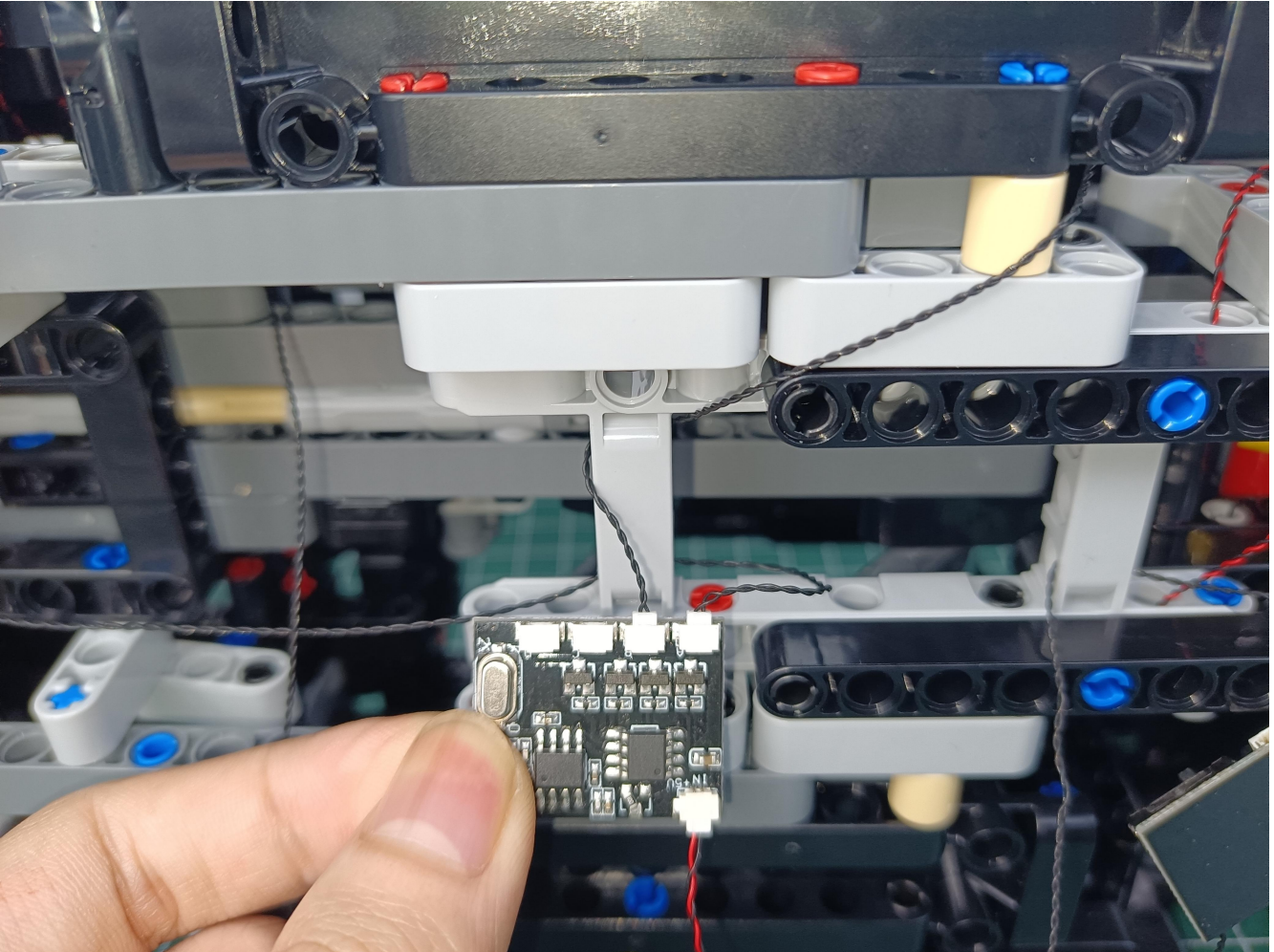
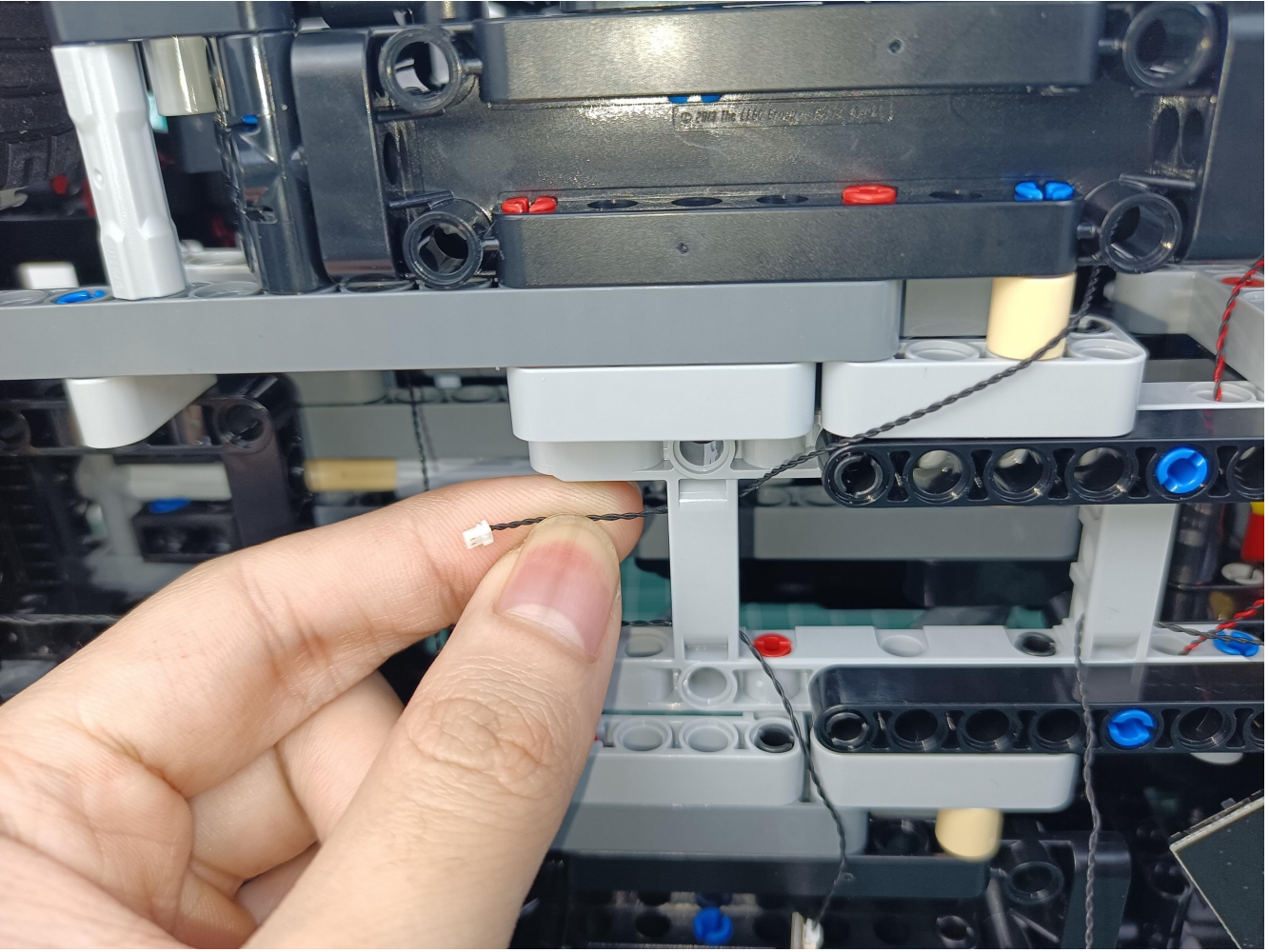



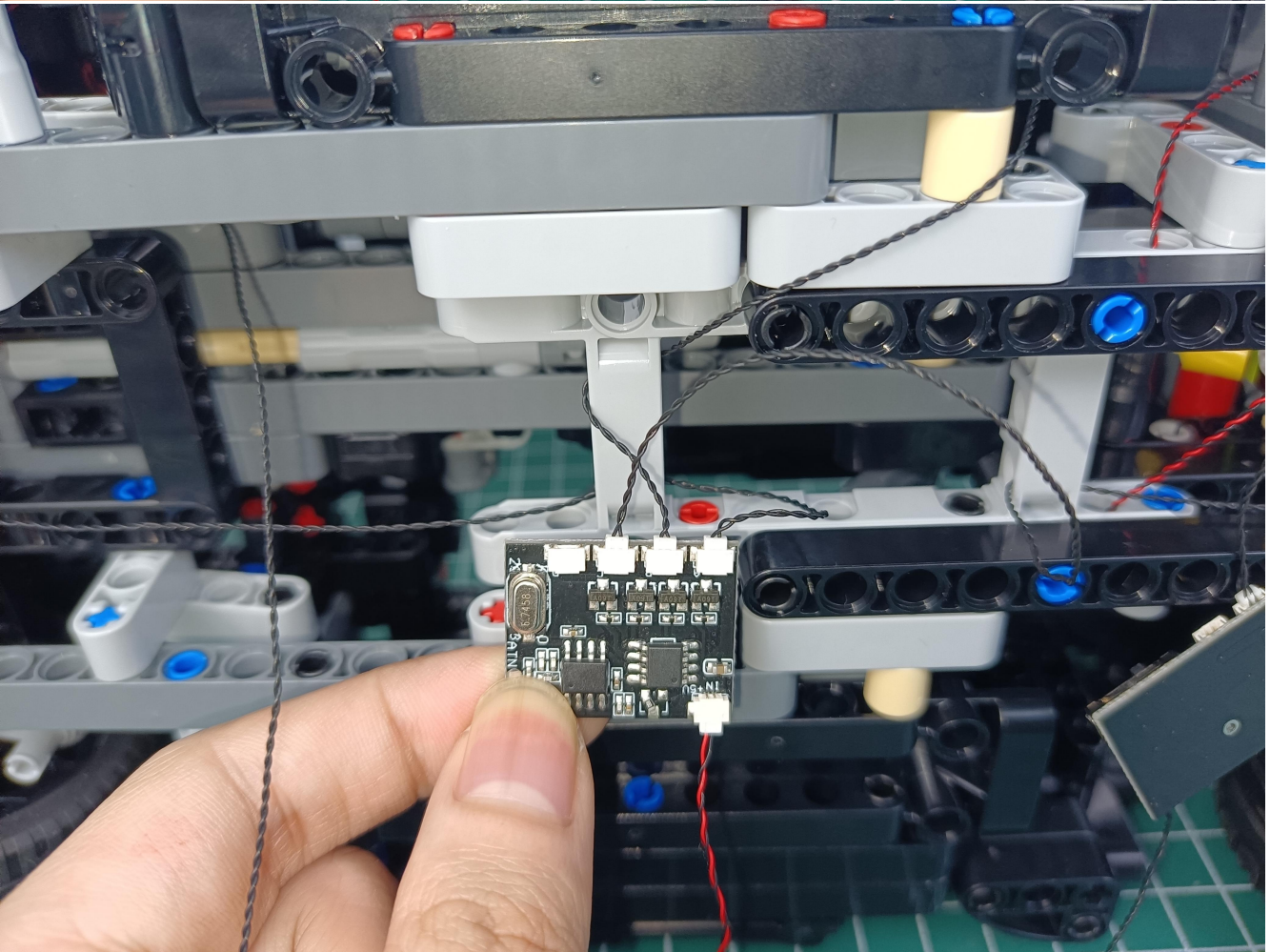
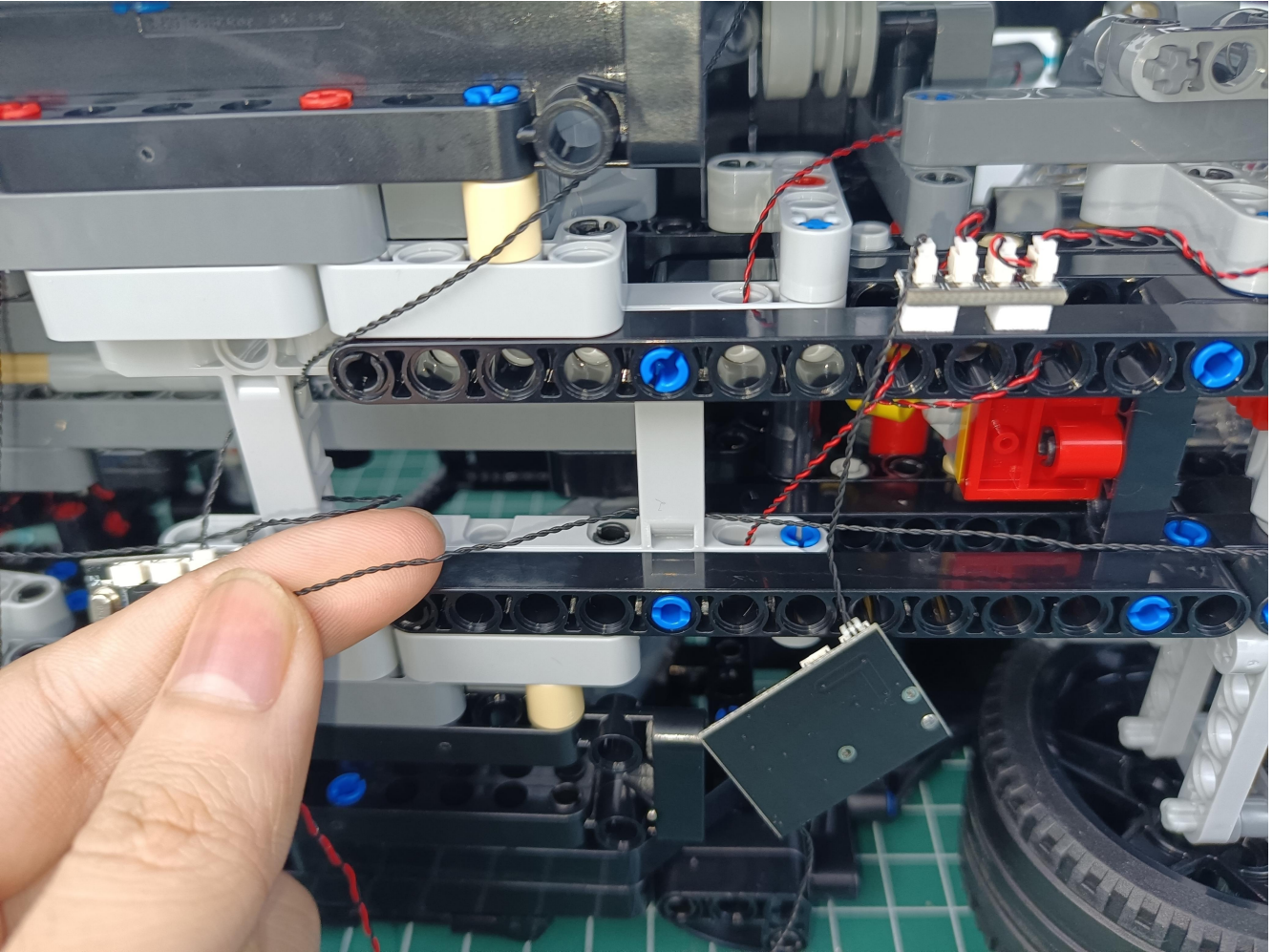



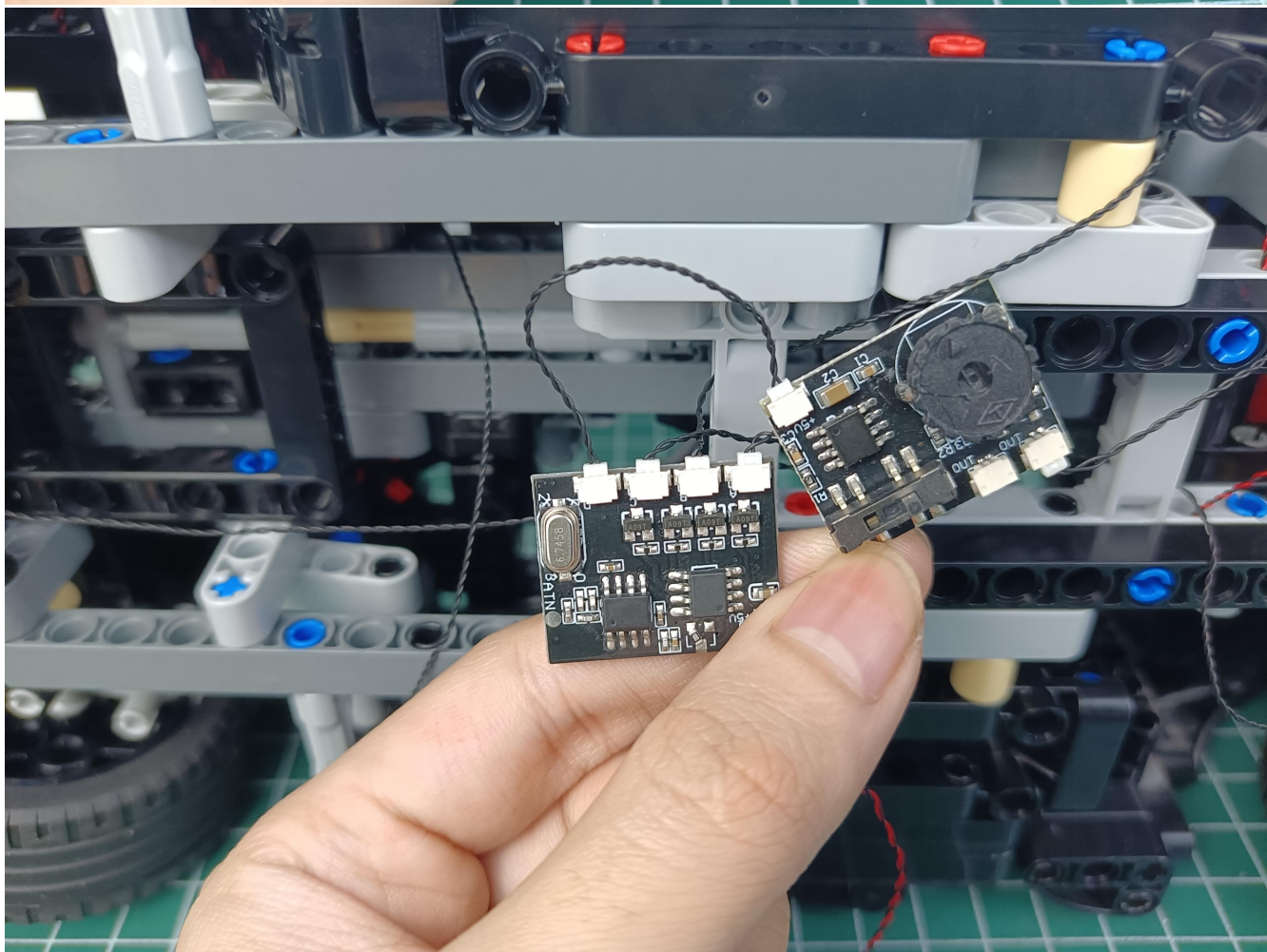
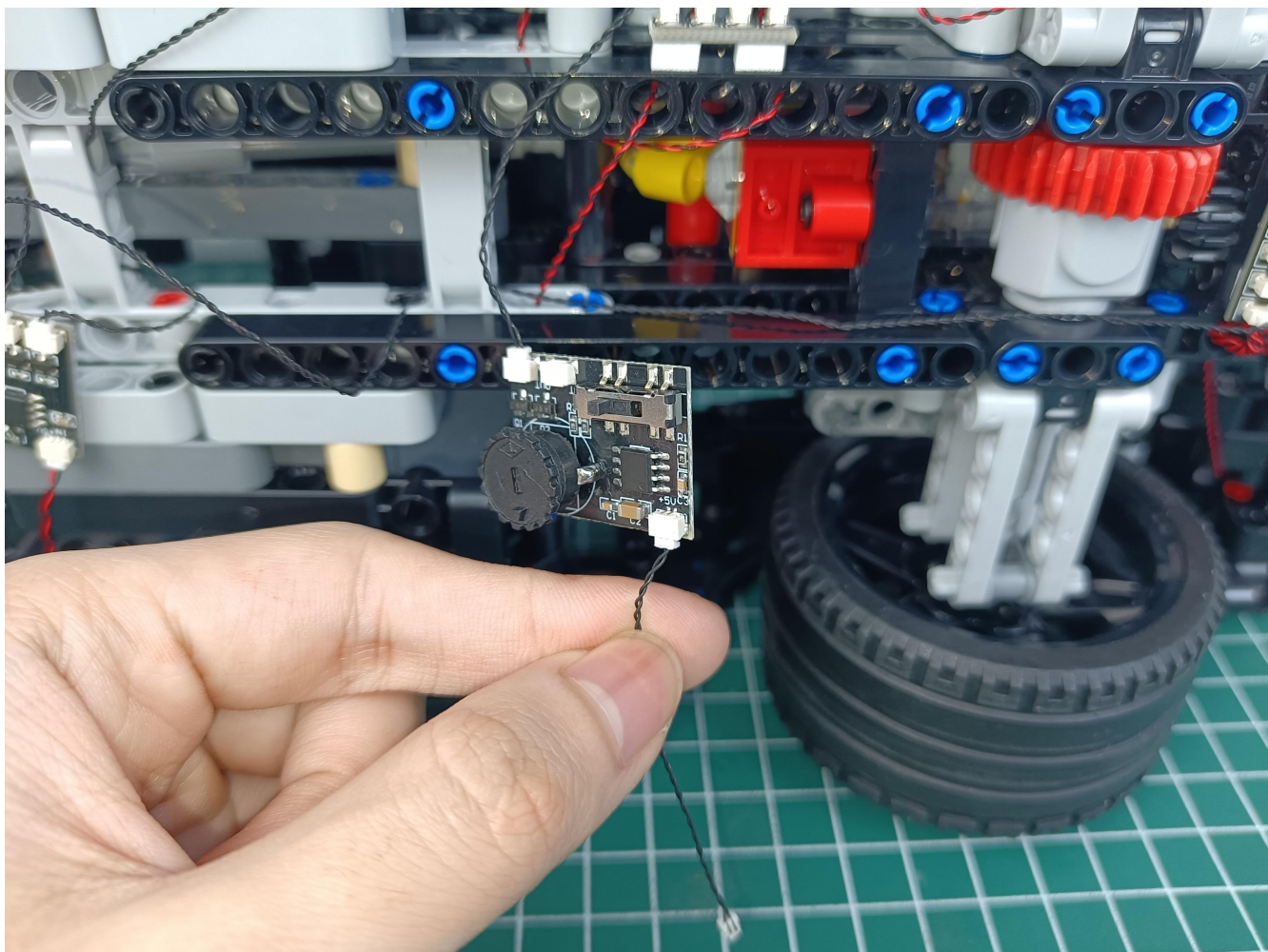



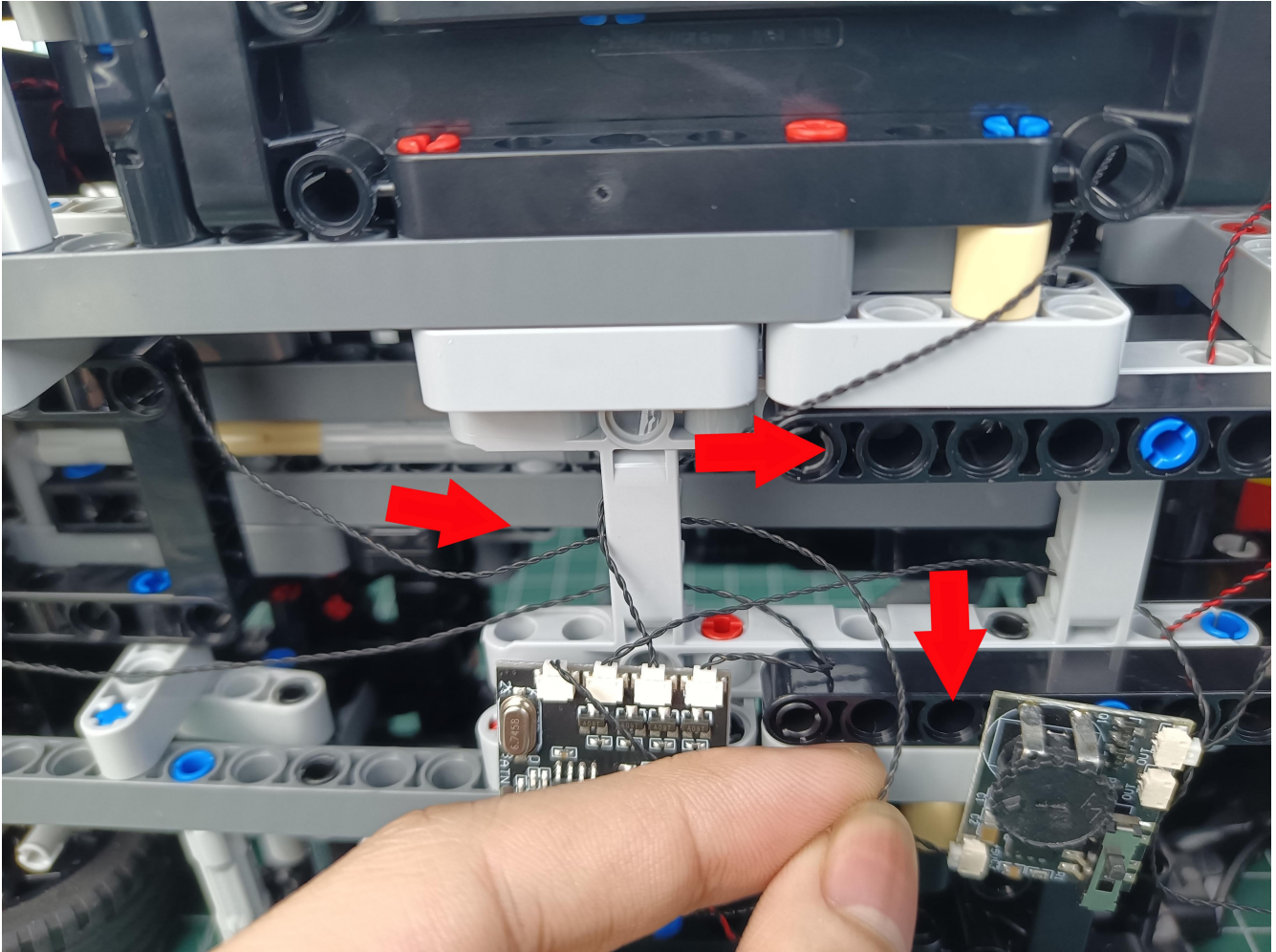
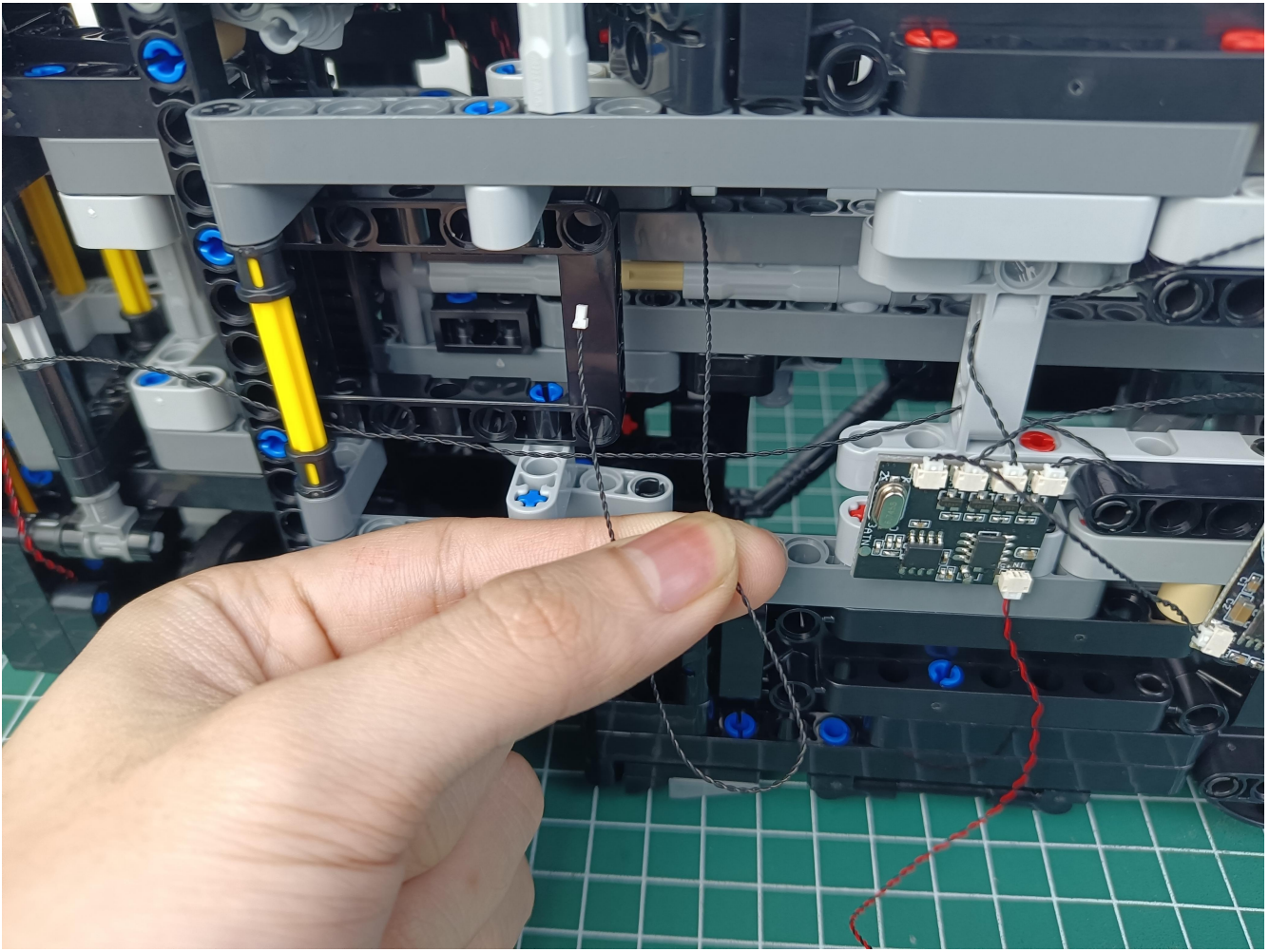



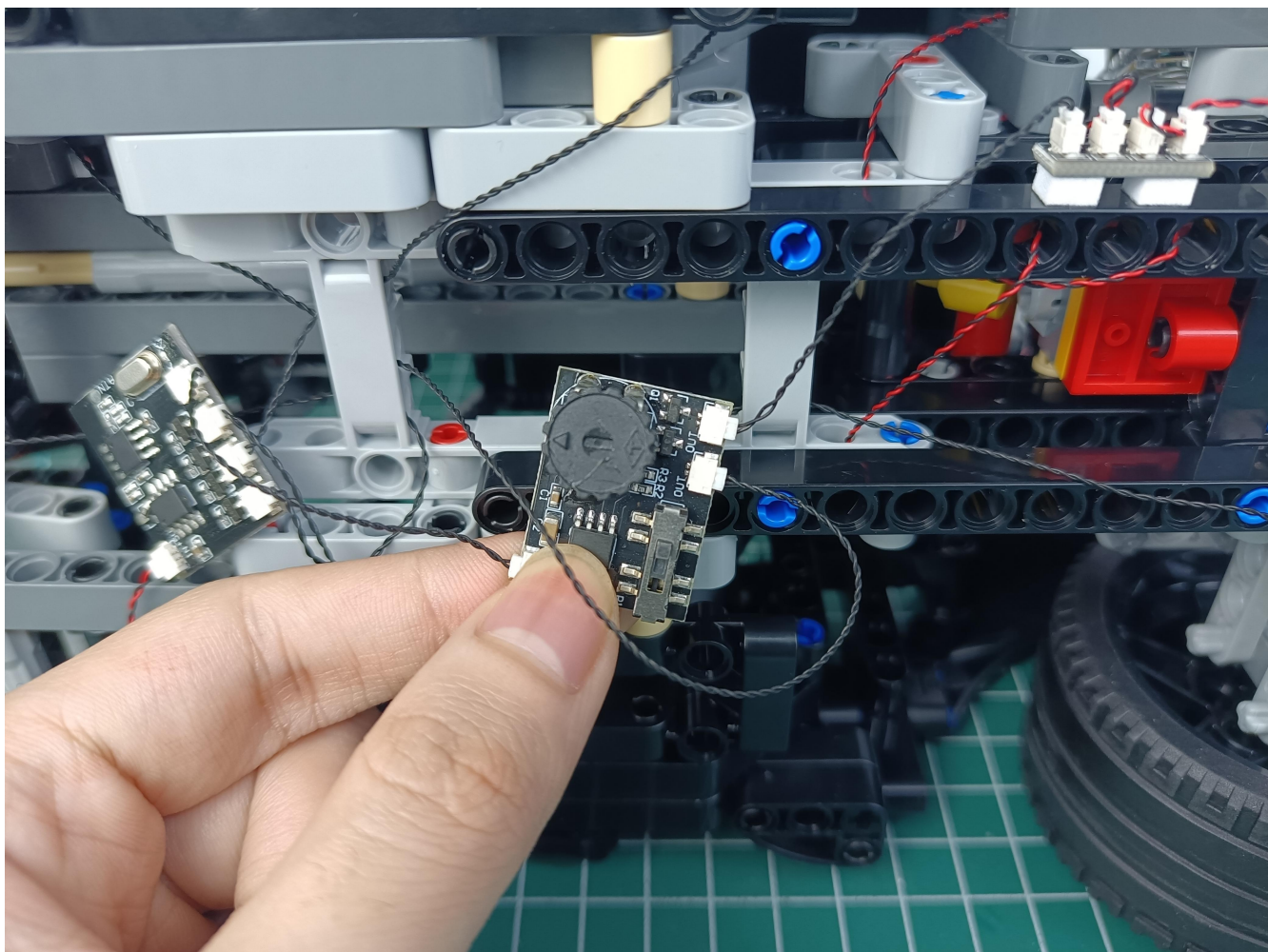



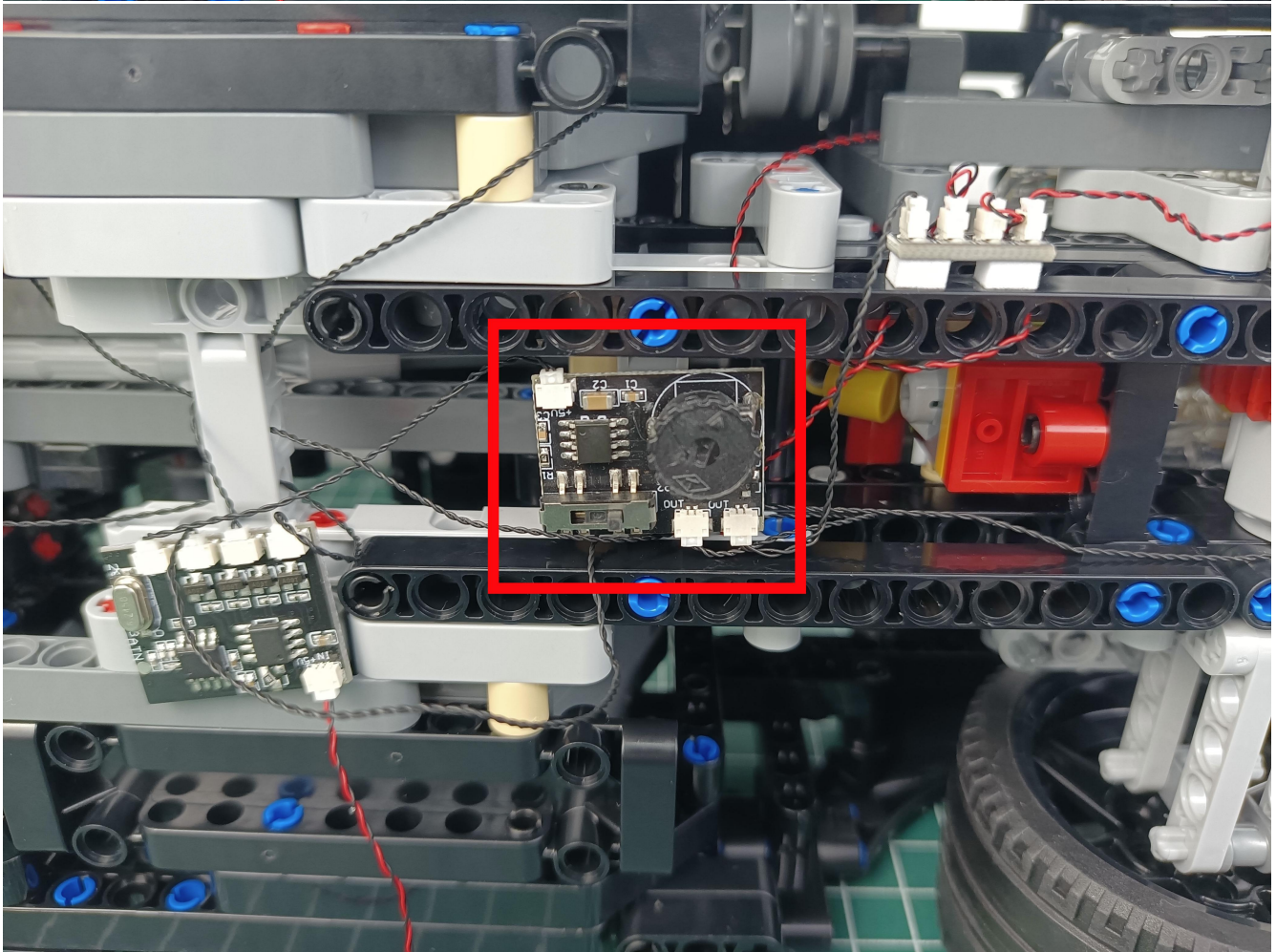
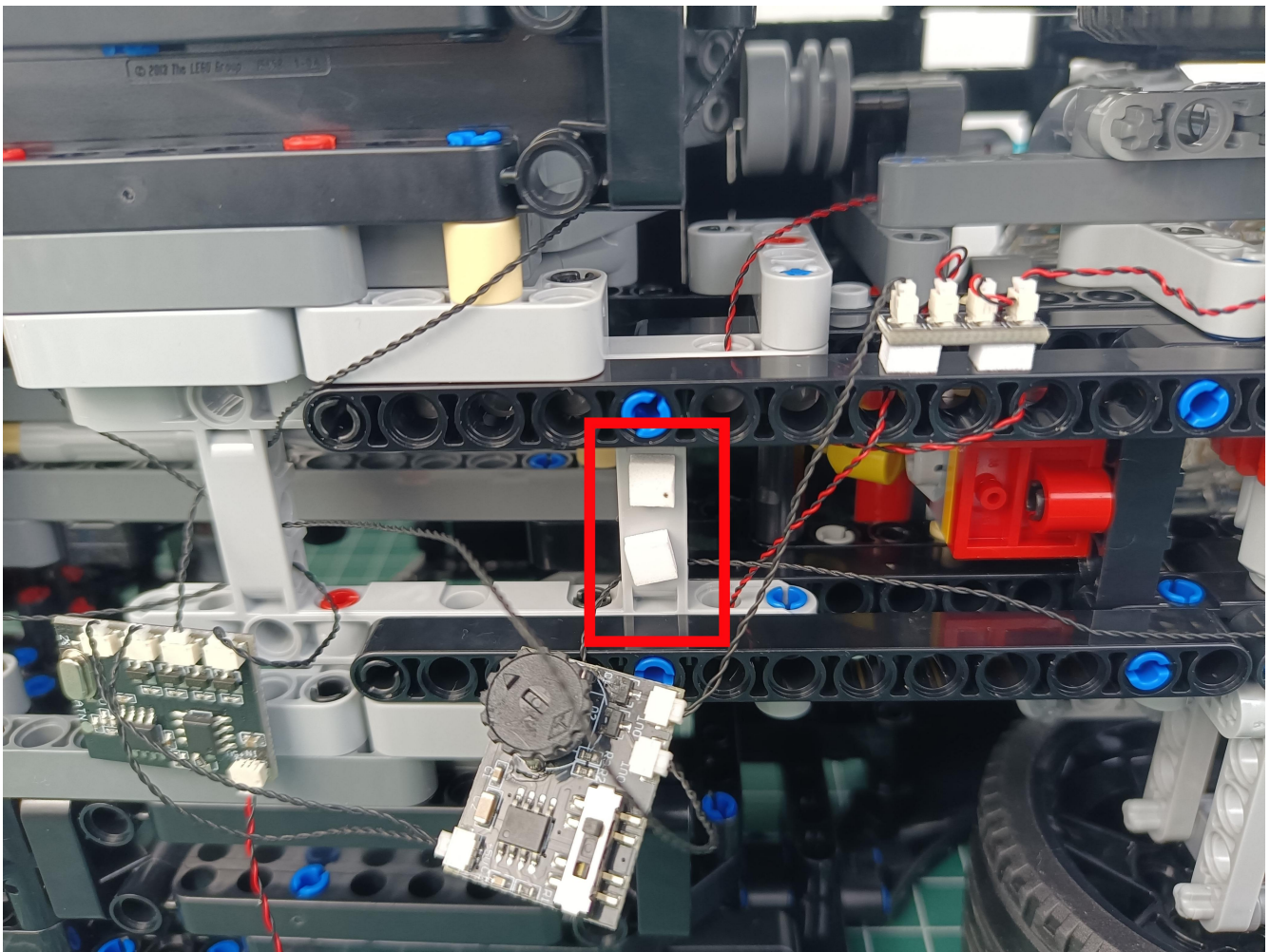



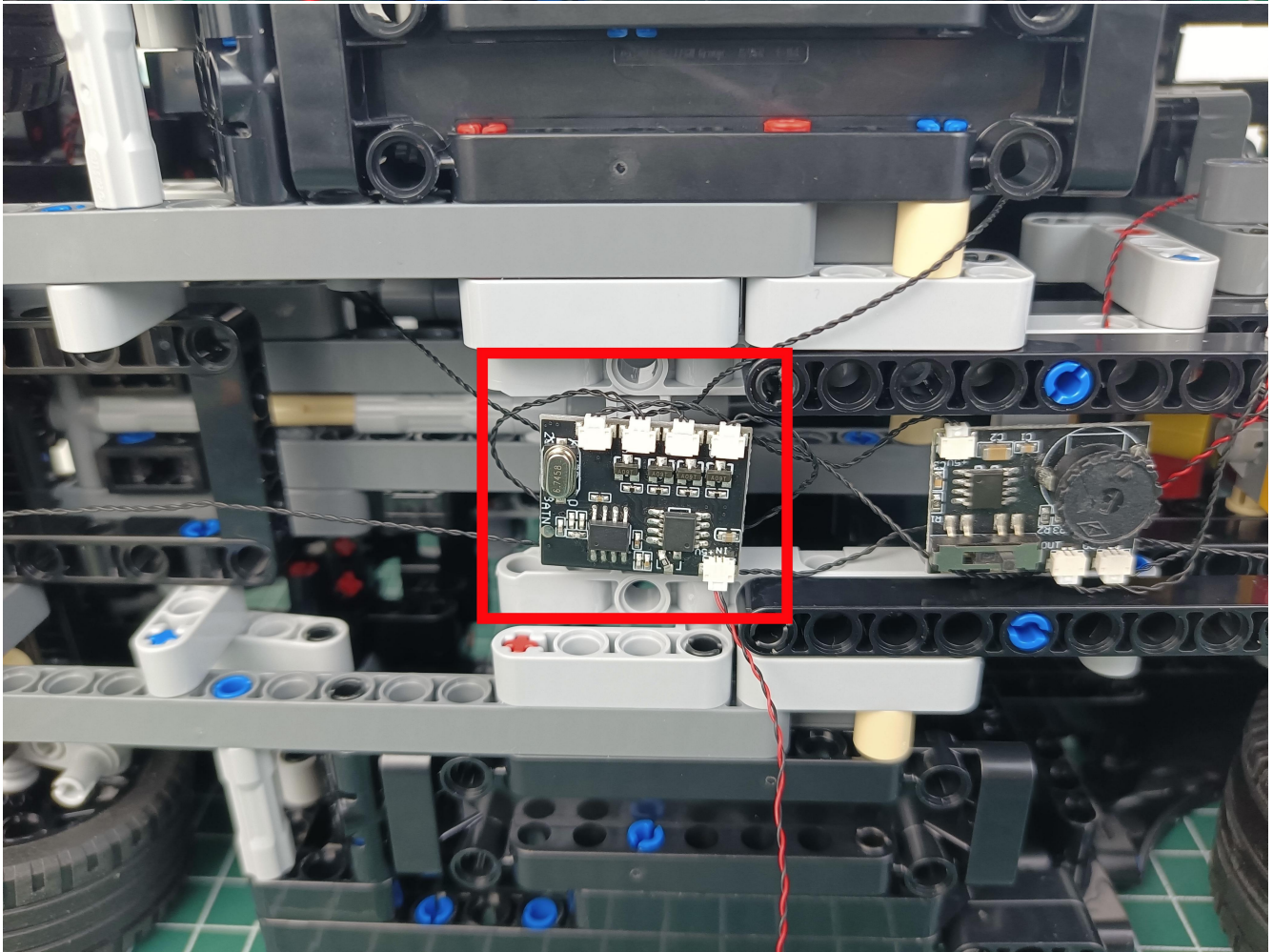
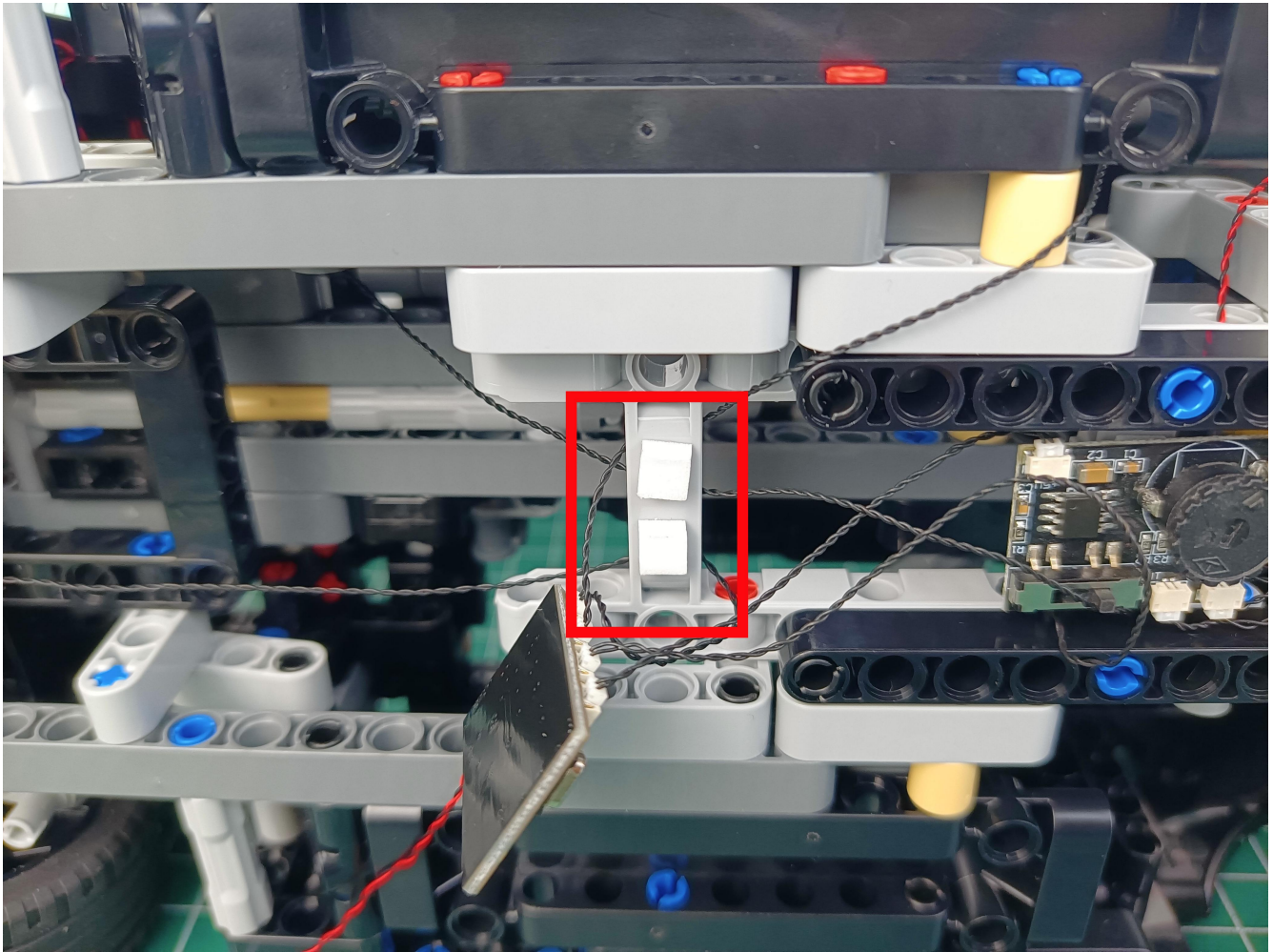



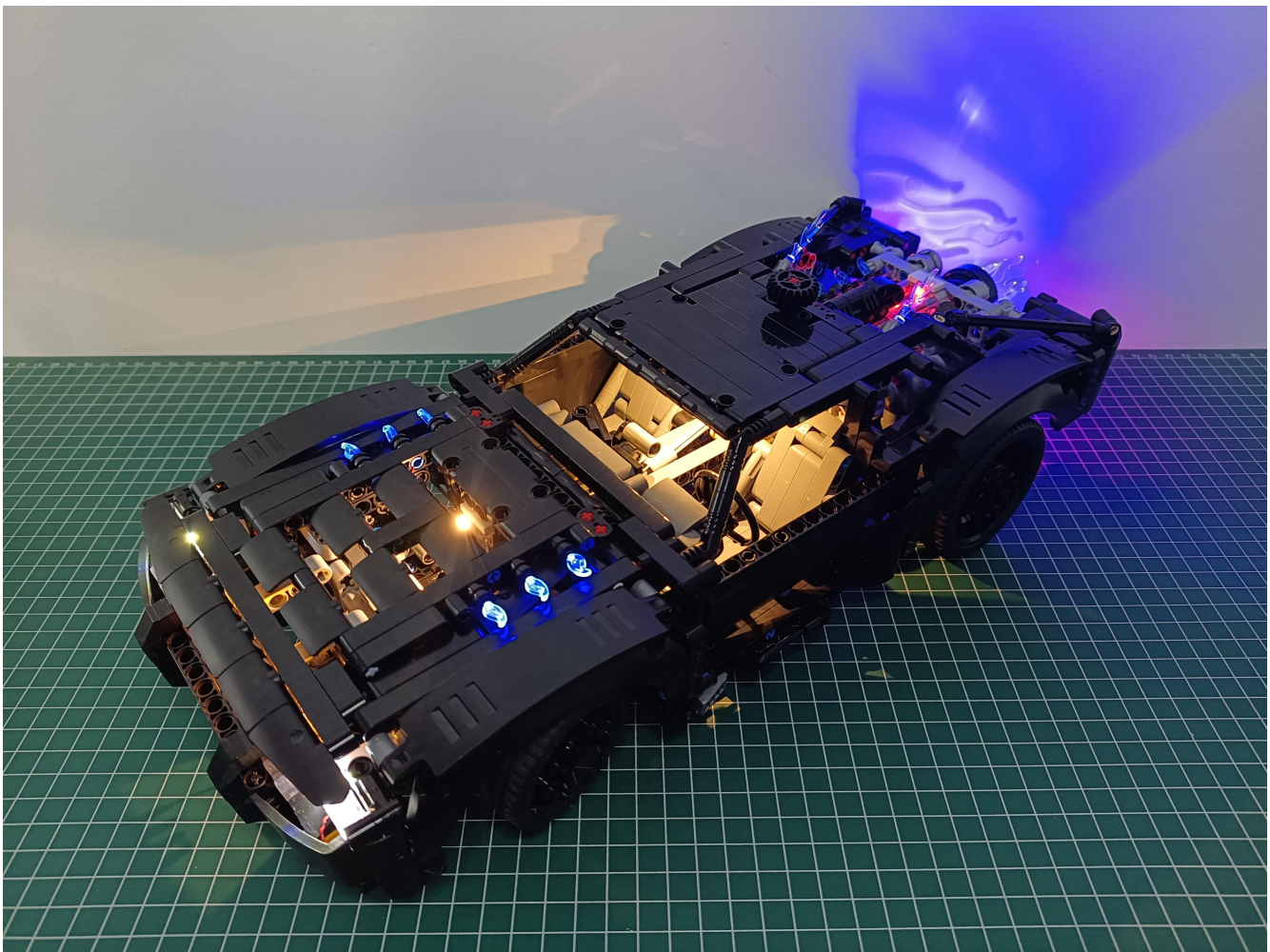

## Remote control function description

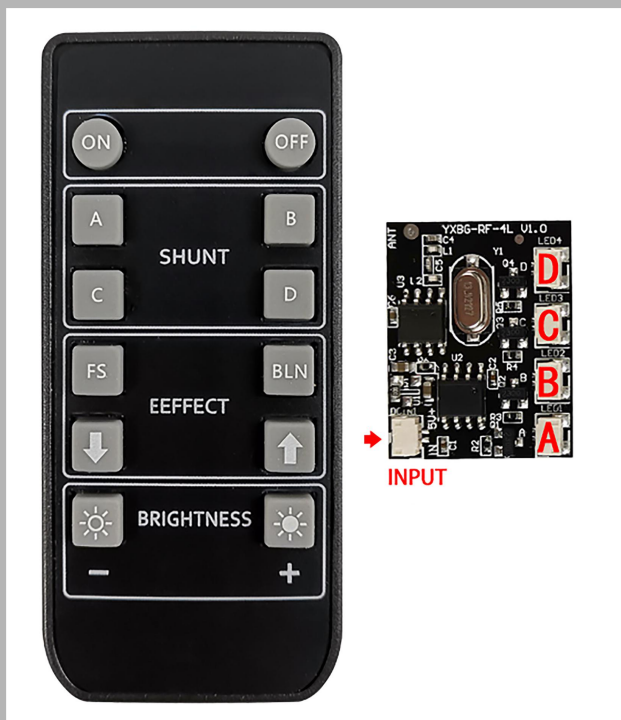

ON: All branches are opened

OFF: all branches are closed

A: open/close A road

B: open/close B road

C: open/close C road

D: open/close D road

FS: Turn on blinking for the last open channel

BLN: Start breathing for the last opened path

↑: Increase blinking/breathing rate

↓: Increase blinking/breathing rate

Brightness+: Increase brightness

Brightness -: Reduce brightness



Complete install and plug in the power to try it.



Above creative ideas and instructions are provide by our designers.

But we treasure your suggestions or opinions on below.

1. Parts materials, product quality,others about our company?
2. Installation instructions of this product and the difficulty during install?
3. If you encounter any problems during using our product, please contact us in time.