

10294 Titanic

LED lighting Kit (Remote Control Version) P29103

Instructions for installing this kit:



Step 1

Test:

The lighting materials are as follows:

Label	Content	Quantity
Bit Lights-30CM-Warm White	Bit Lights-30CM-Warm White	31
Bit Lights-30CM-White	Bit Lights-30CM-White	4
Headlights-15CM-Warm White	Headlights-15CM-Warm White	3
Expansion Board	6 Socket Expansion Board	4
	8 Socket Expansion Board	3
	12 Socket Expansion Board	3
	2 Socket Expansion Board	6
	4 Socket Expansion Board	11
USB Power Cable	USB Power Cable	2
Connecting Cables-15CM	Connecting Cables-15CM	8
Connecting Cables-30CM	Connecting Cables-30CM	3
Connecting Cables-50CM	Connecting Cables-50CM	14
Connecting Cables-20CM	Connecting Cables-20CM	5
Light Strips-Warm White-28	Light Strips-Warm White-28	17
Light Strips-Cyan-28	Light Strips-Cyan-28	5
Light Strips-Warm White-7	Light Strips-Warm White-7	2
Light Strips-Warm White-21	Light Strips-Warm White-21	5
Remote Control Board	Remote Control Board	1
Spray Module	Spray Module	4
Parts package		

This set has a total of 16 bags. Take out the USB power cord .



The power supplies that can be used with the USB power cord are as follows (the voltage for normal use is 5V).

USB connectors to connect devices

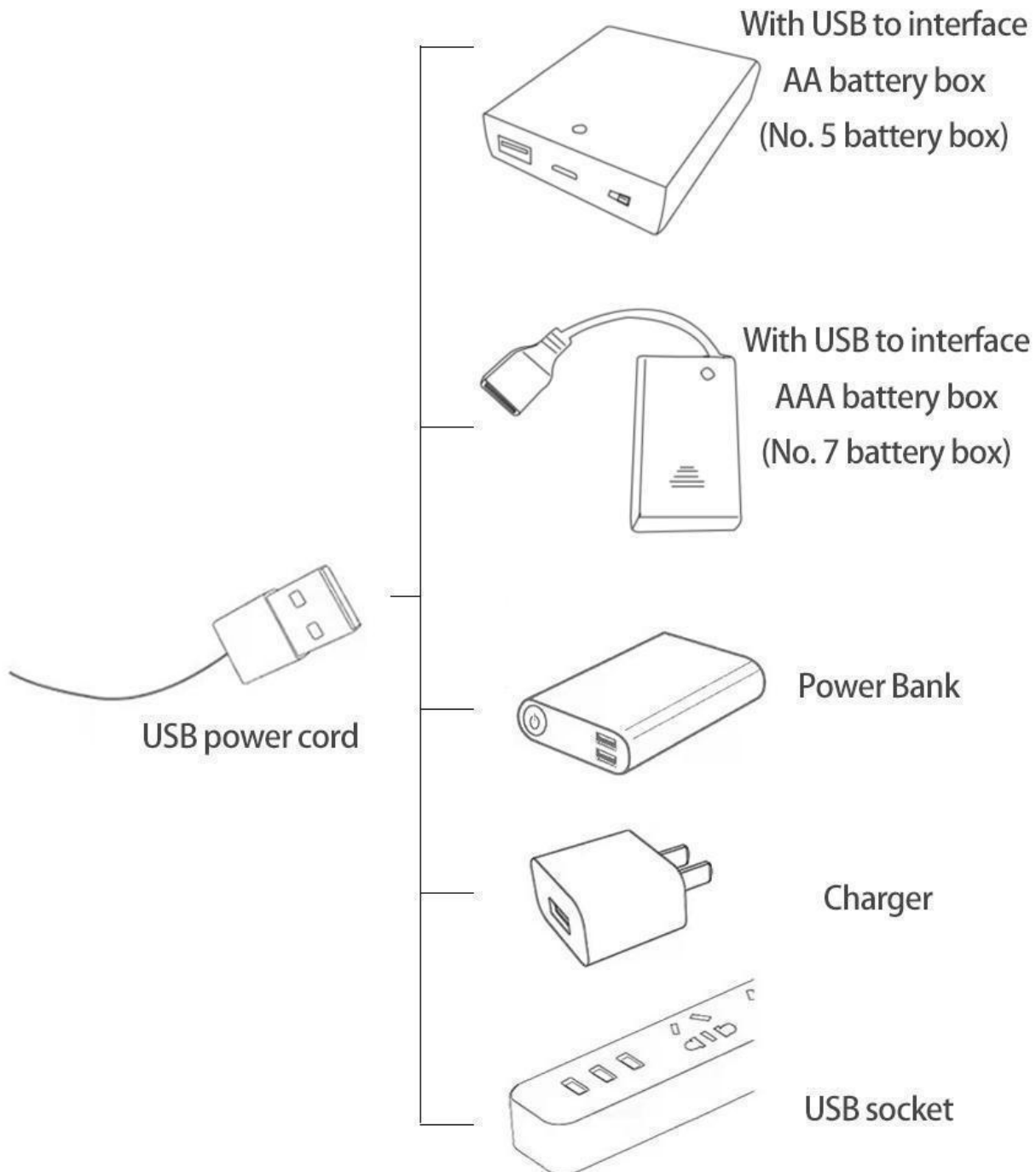

Connect the USB power cord to the mobile power supply (the power supply is self-provided, this article uses the mobile power supply, other power supply methods are shown in the figure above).



Take out a 8-seater expansion board. (Lift the seal of the expansion board.)



Please pay attention to the use of the interface. The interface is small. Please use it carefully: the = number of the 2P interface is aligned with the = number of the expansion board. The equal sign on the expansion board refers to the two solder joints on the outside, not the two inside the jack Metal pin.

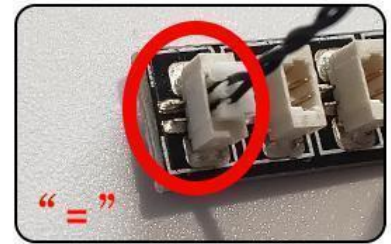
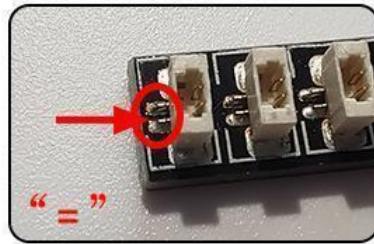
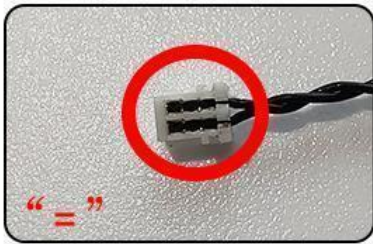

Connect the small plug of the USB power cord to the expansion board.

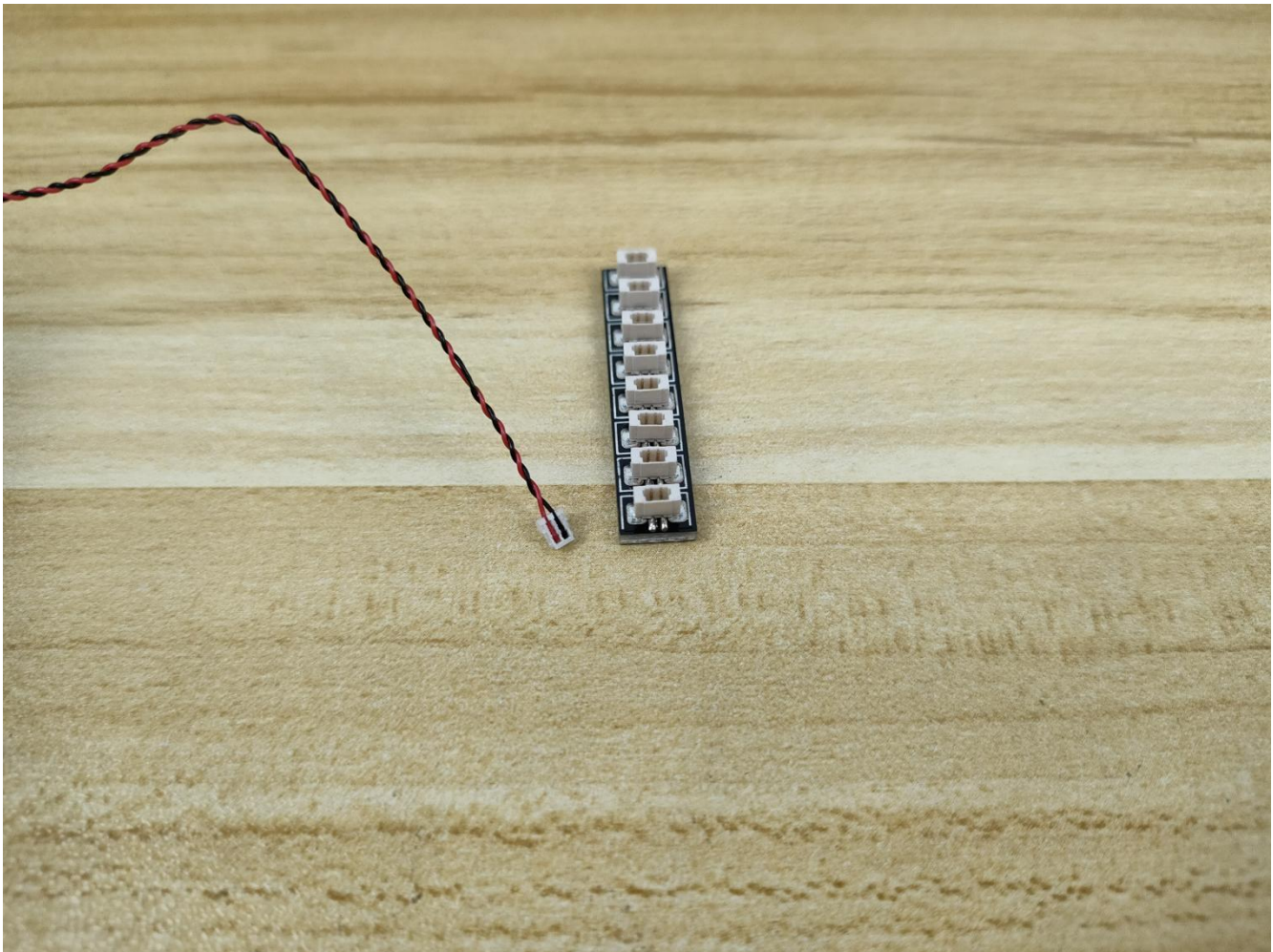

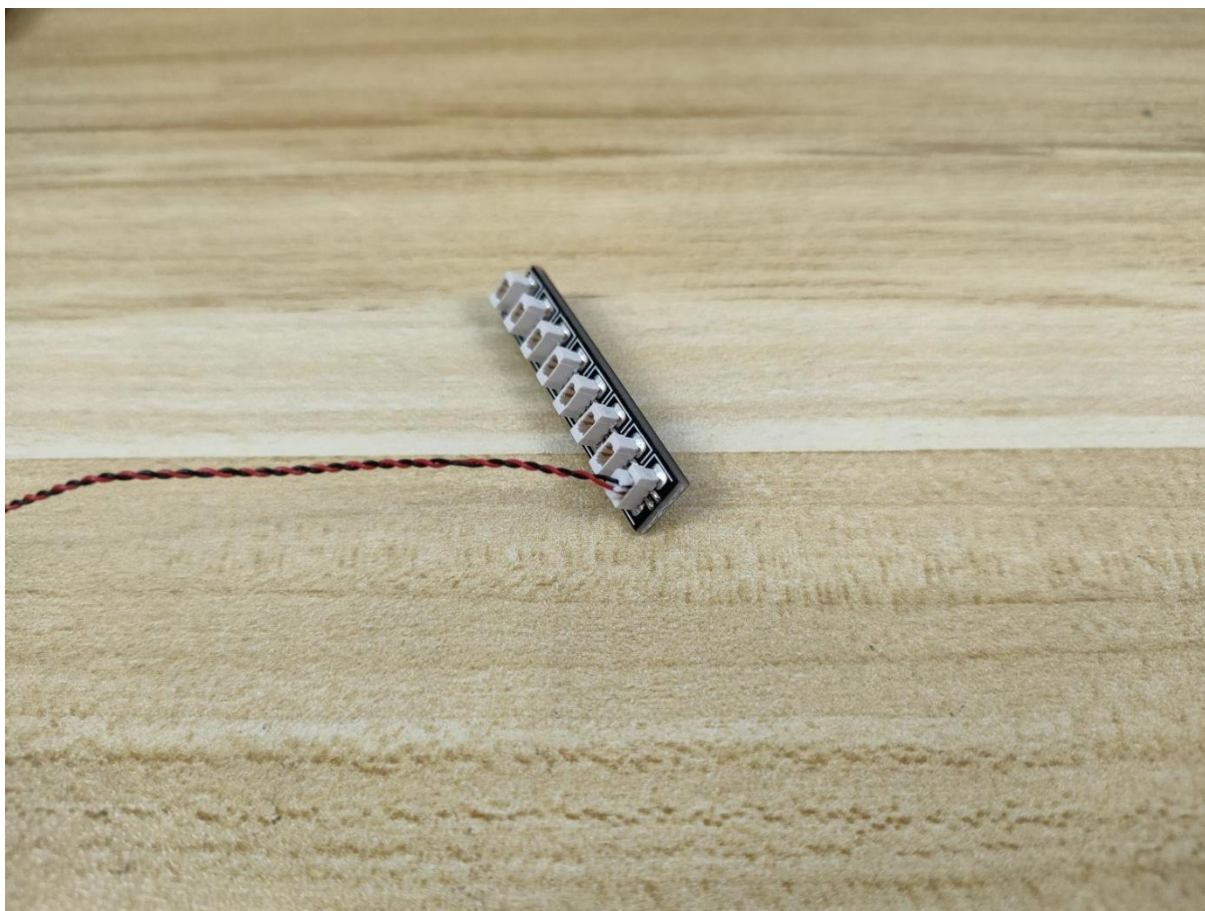

Remove the light bar from the bag and prepare for testing.



Connect them to the expansion board (you can test one by one). Turn on the power, test the lighting, and check whether it is normal. If there is any abnormality, please contact us in time.

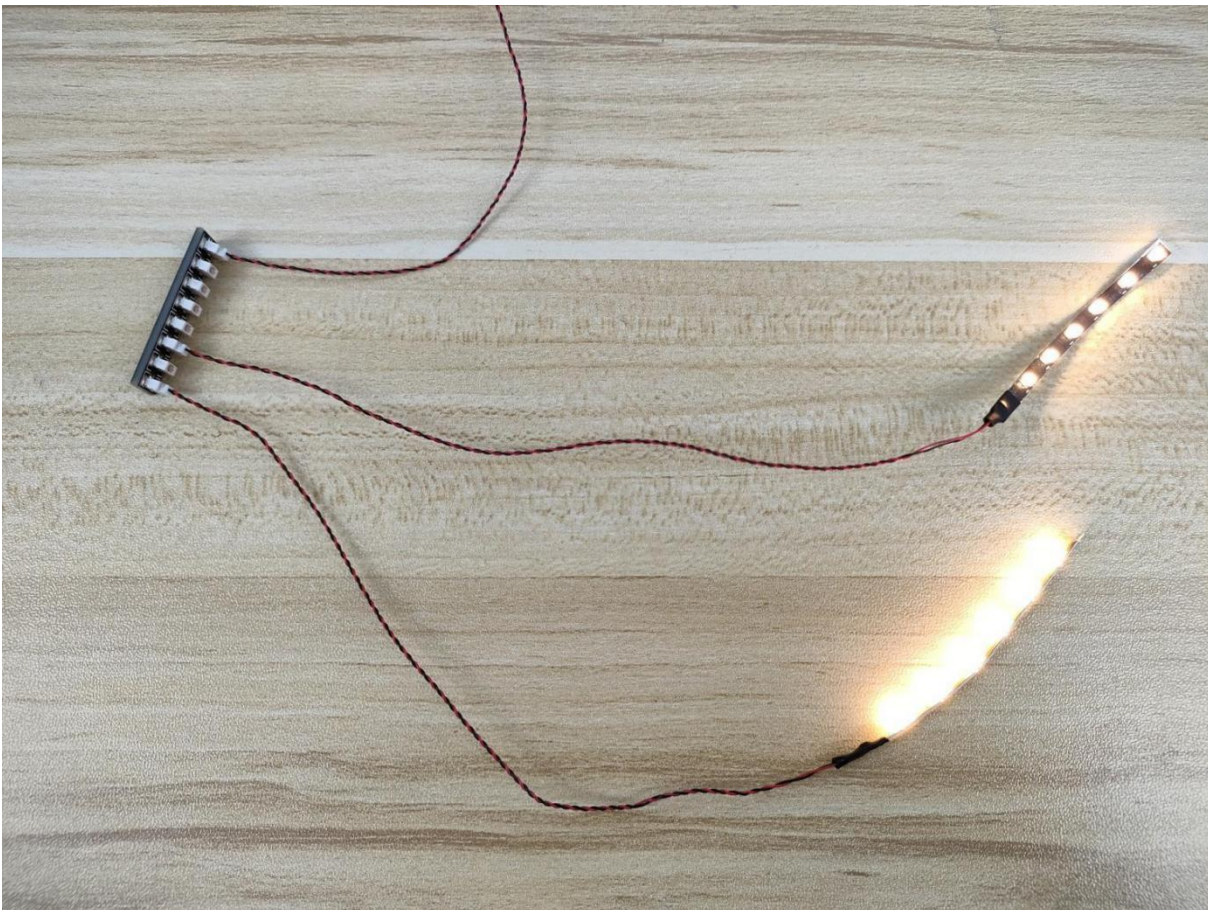
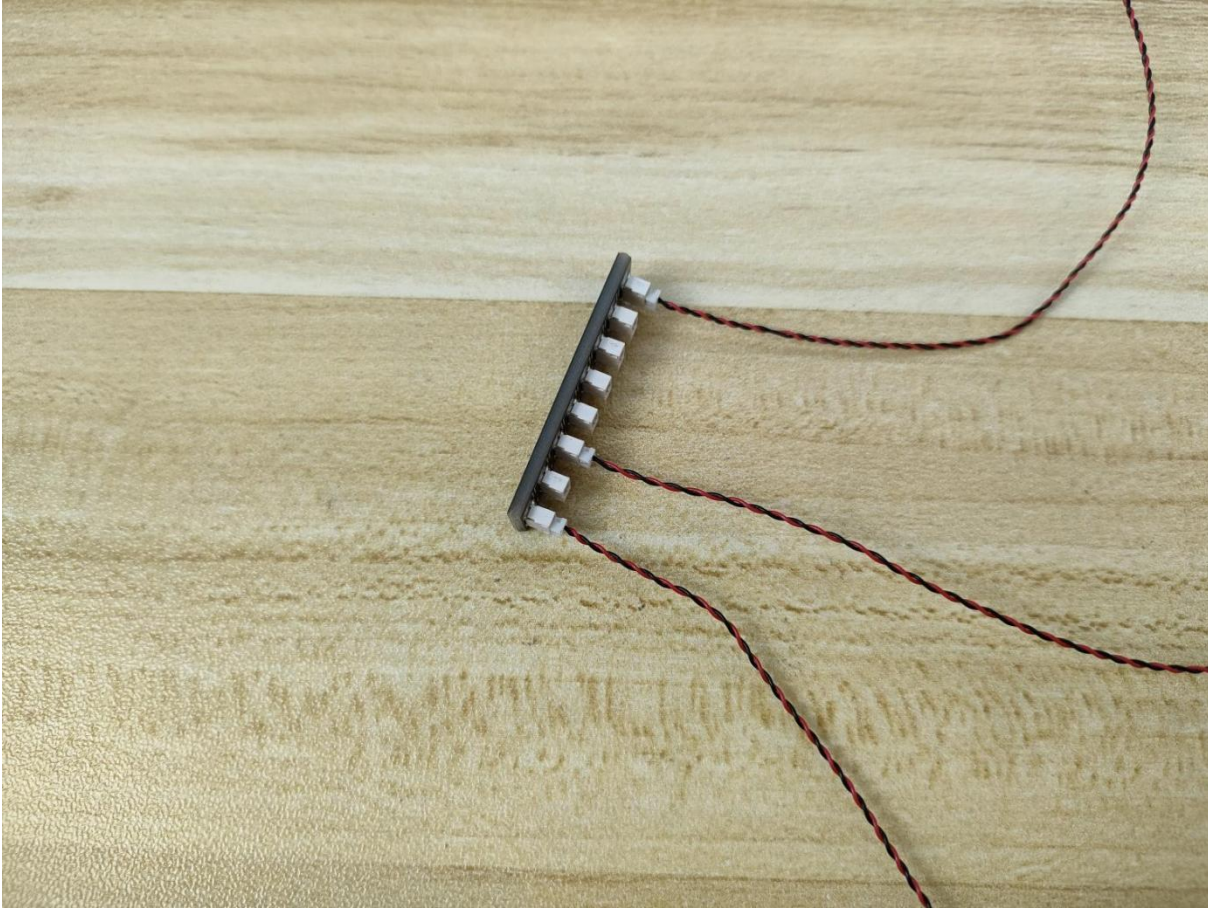

Pull out the lighting after the test is normal. After there is no abnormality, first temporarily put the lighting back into the original bag, and prepare to test other lighting parts. In order to prevent the lighting from not bright after installation, the lighting in other bags are also tested in the same way. After testing a bag, please temporarily put it back in the original bag to avoid confusion with each other.

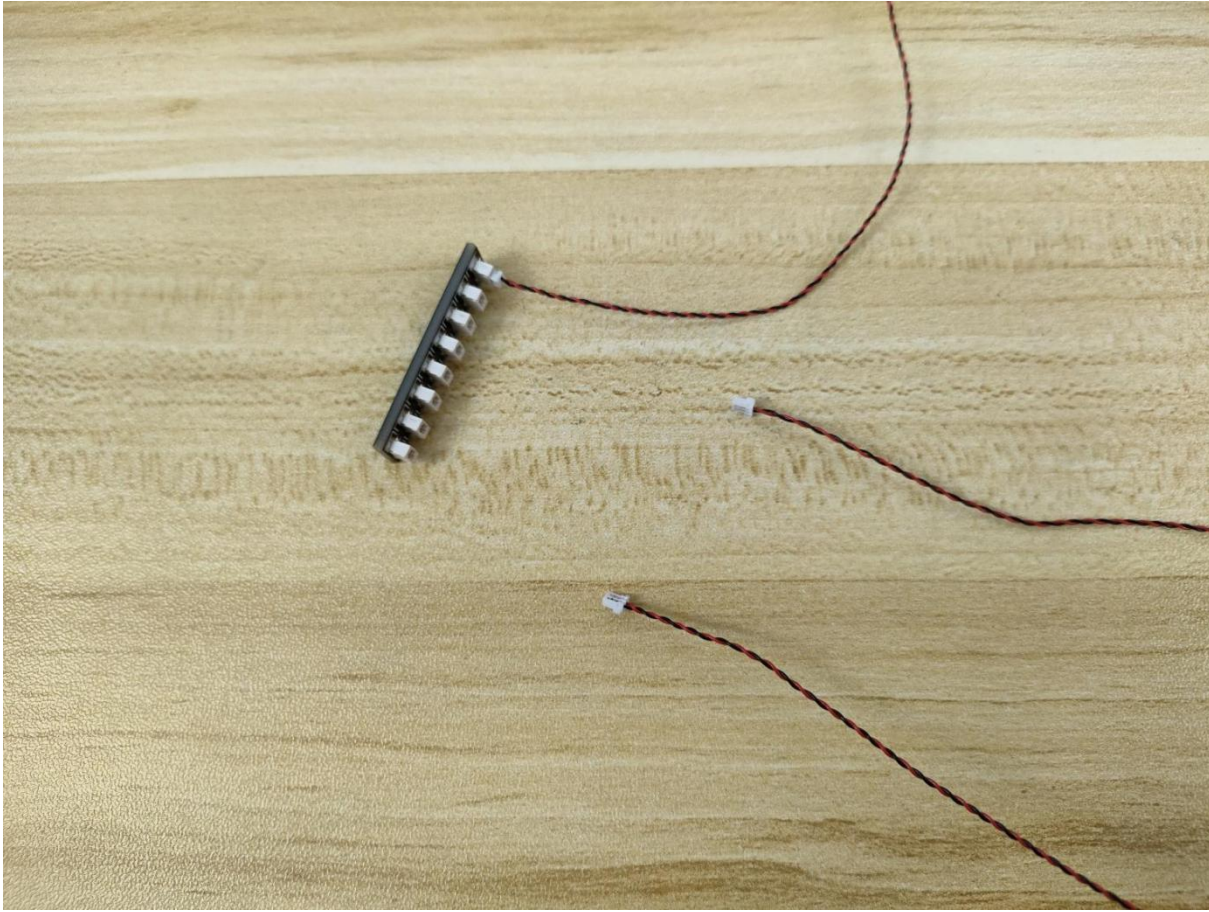

Note:

Please be careful when installing. The lamp wire is relatively slender and cannot be pressed on the raised position of the building block. It should pass along the gap, otherwise the lamp wire will be pinched.

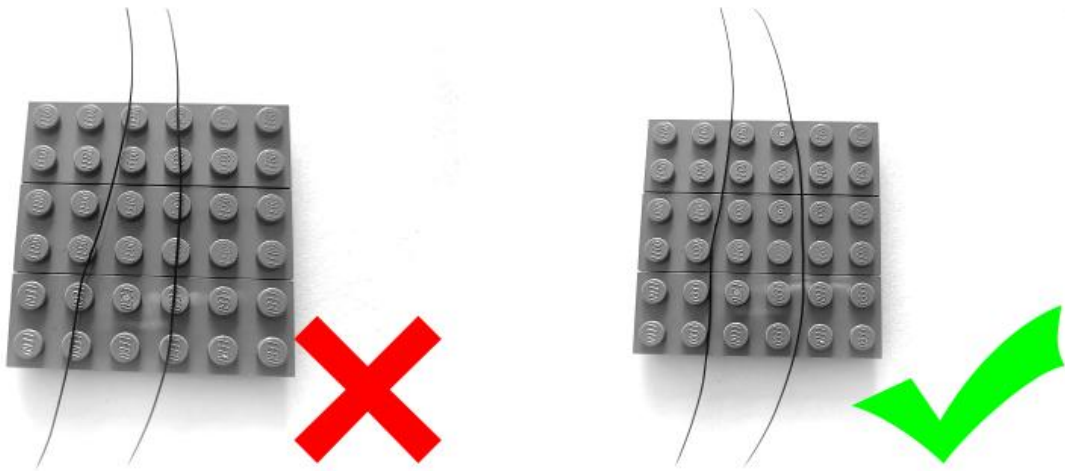

start installation:

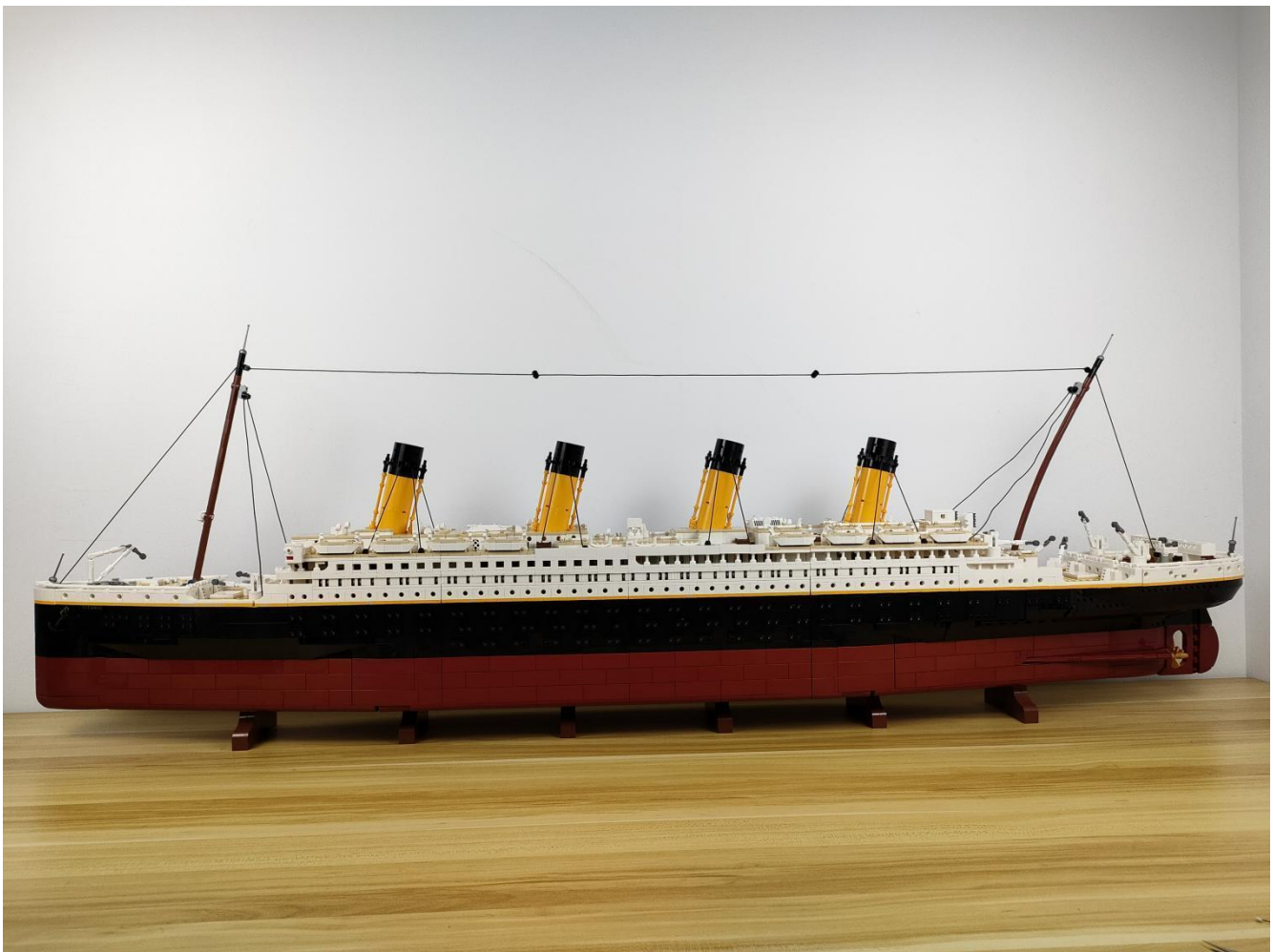

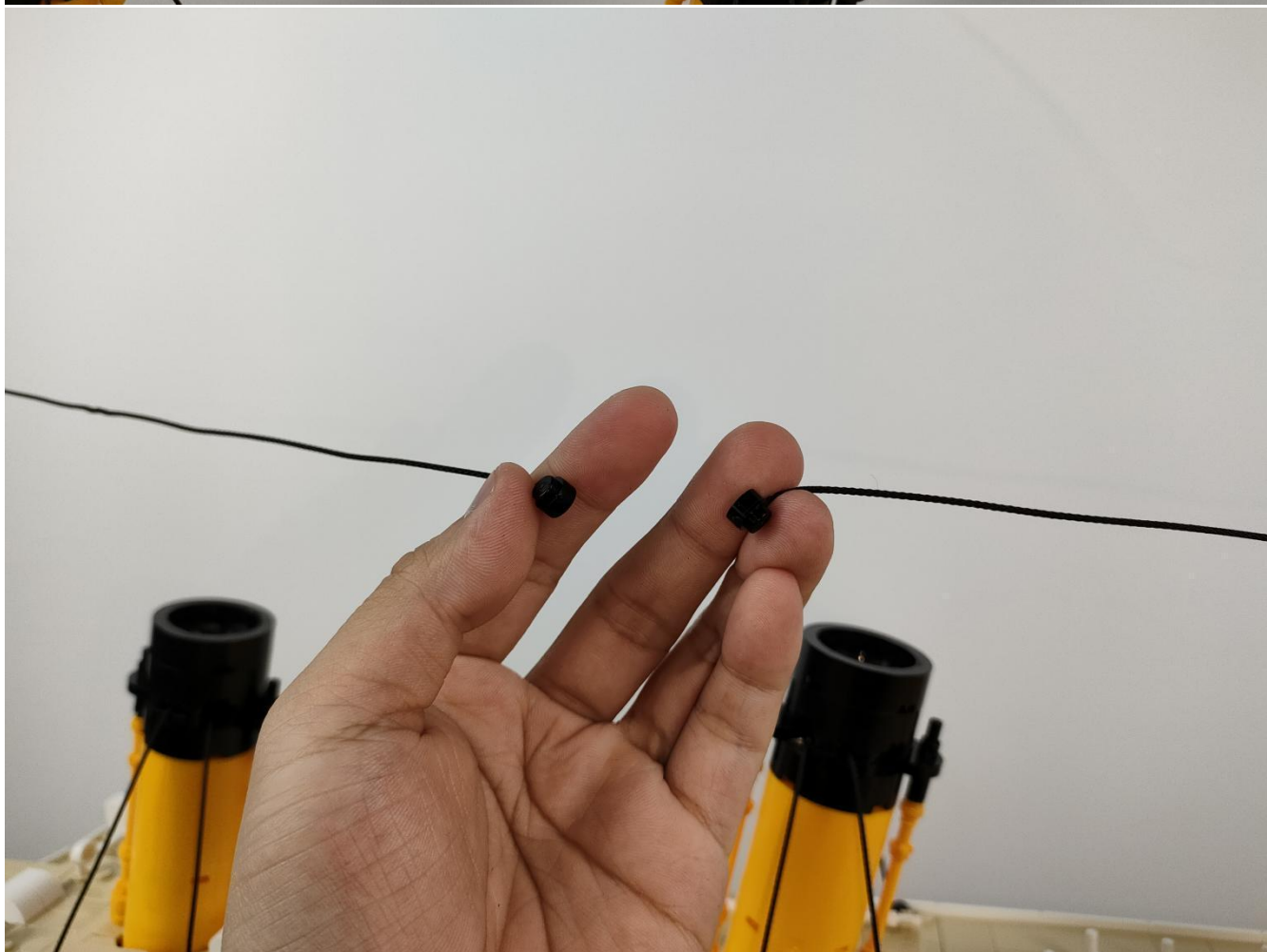
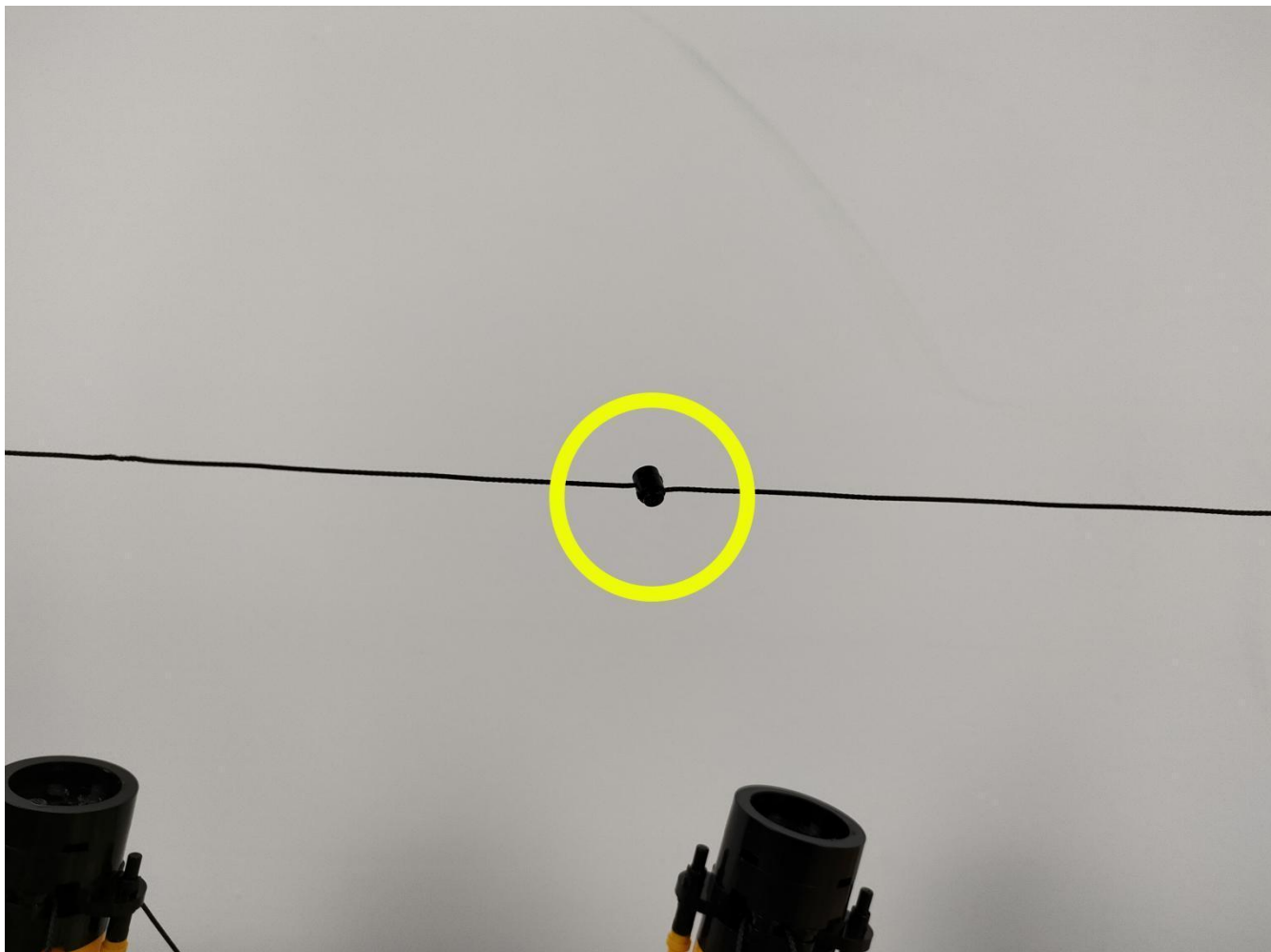

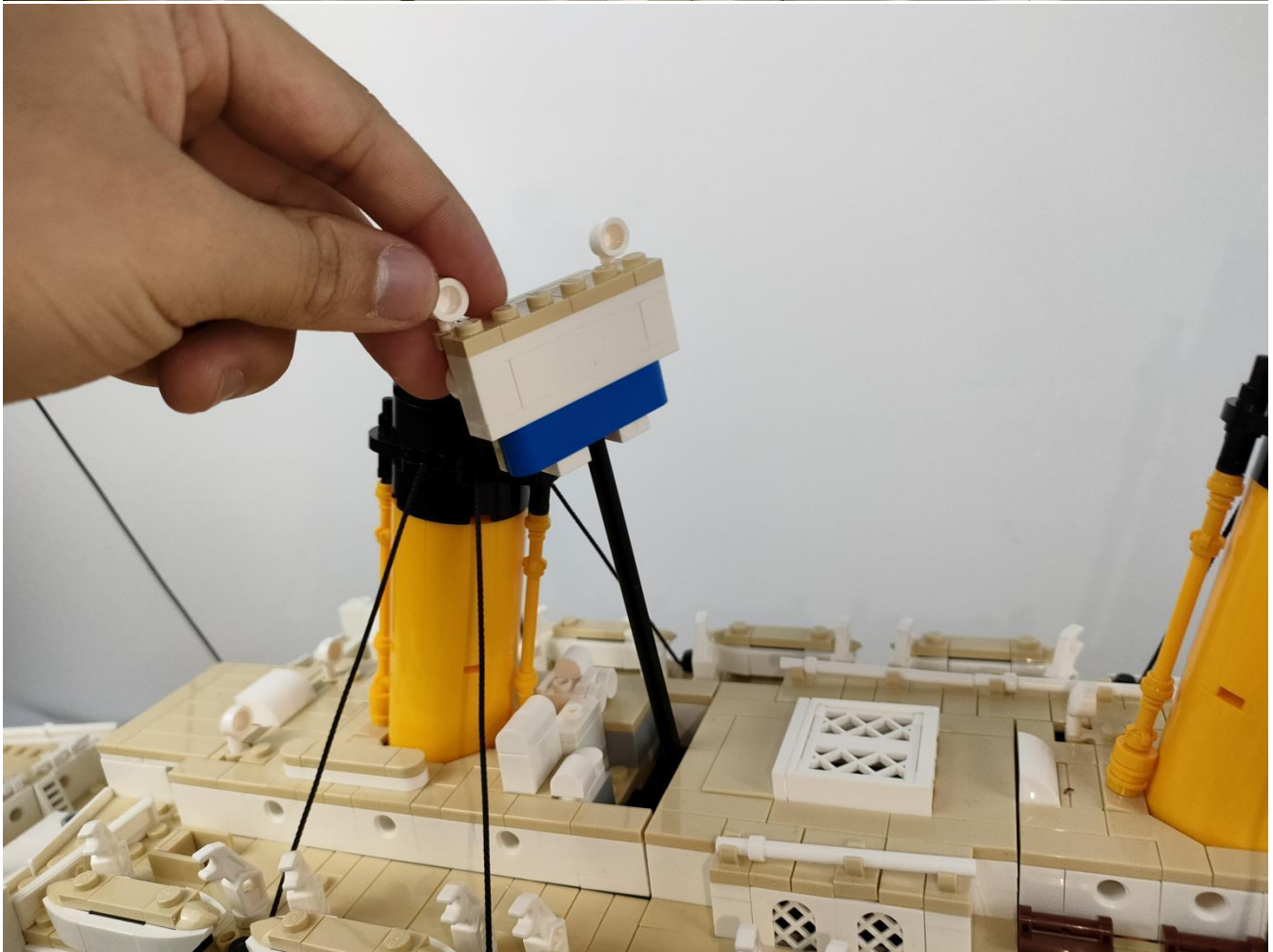
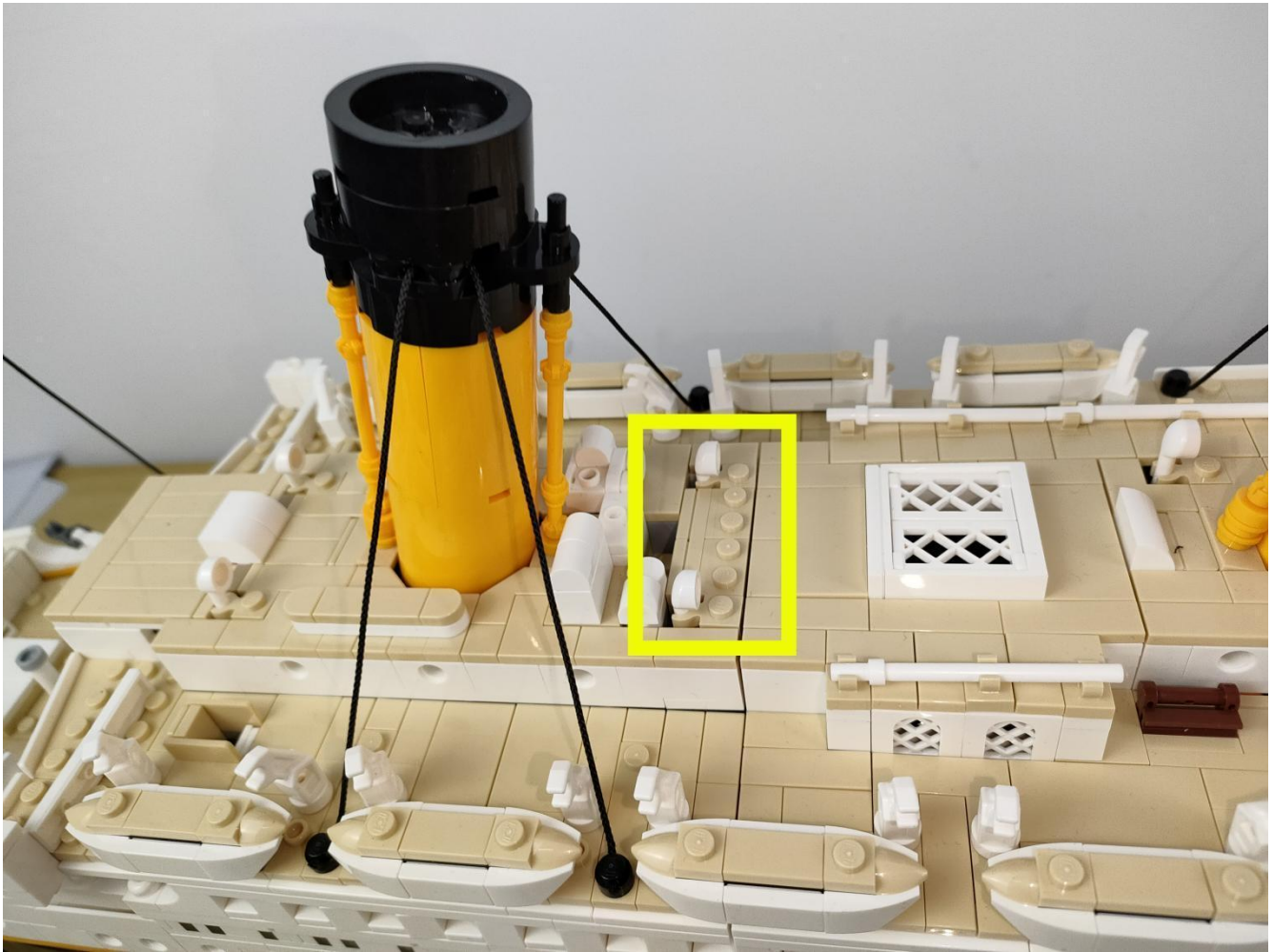

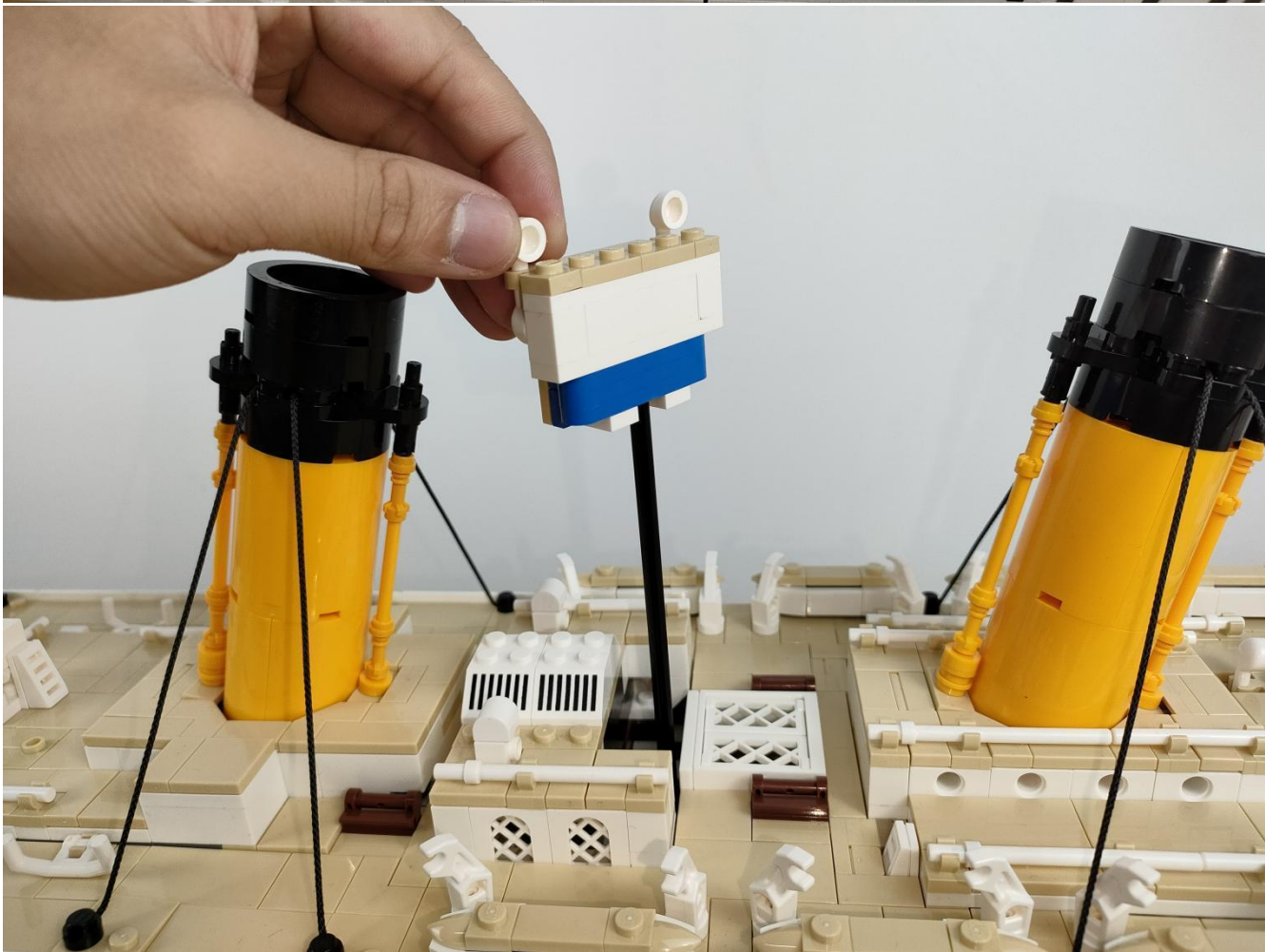
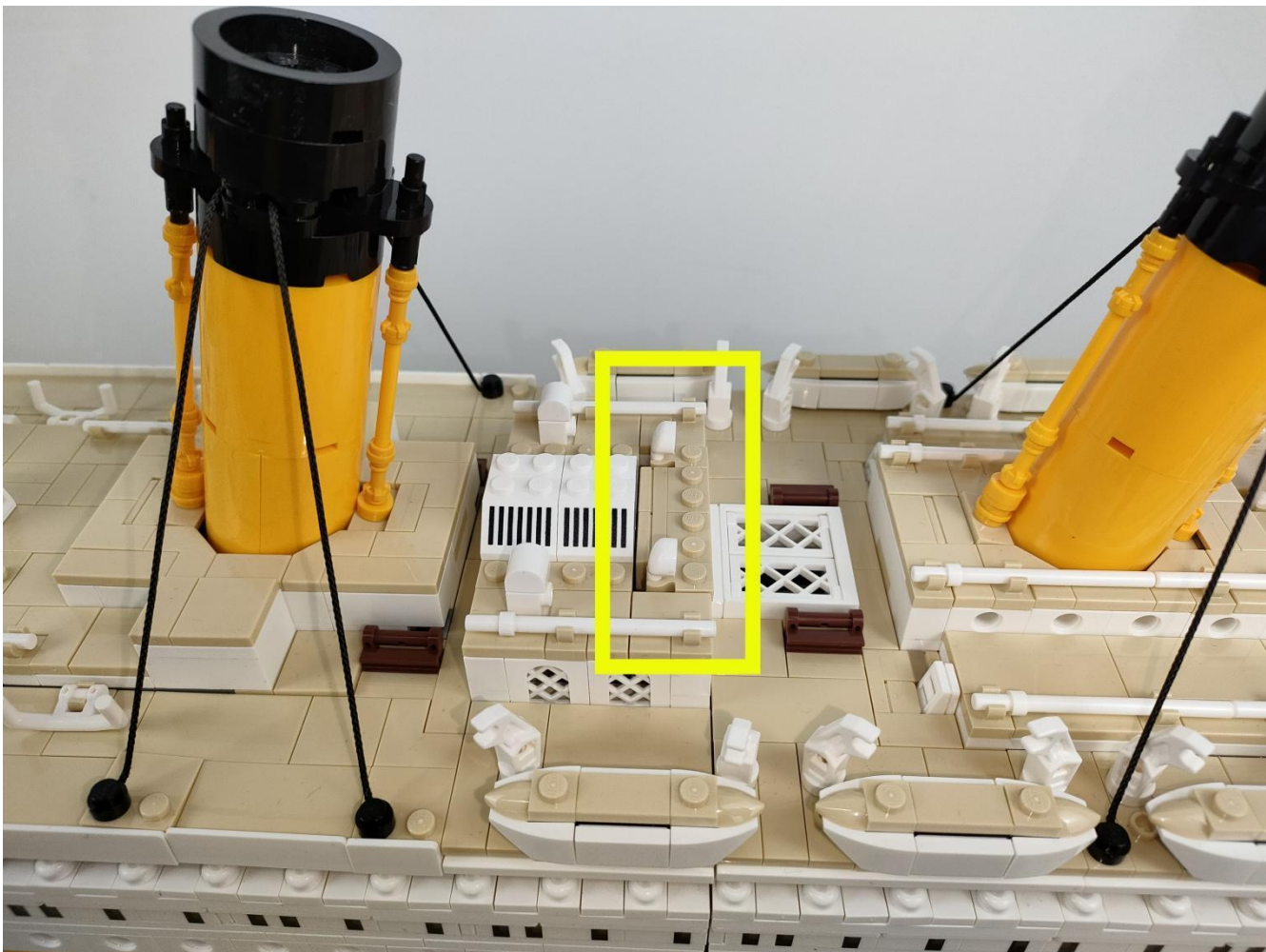



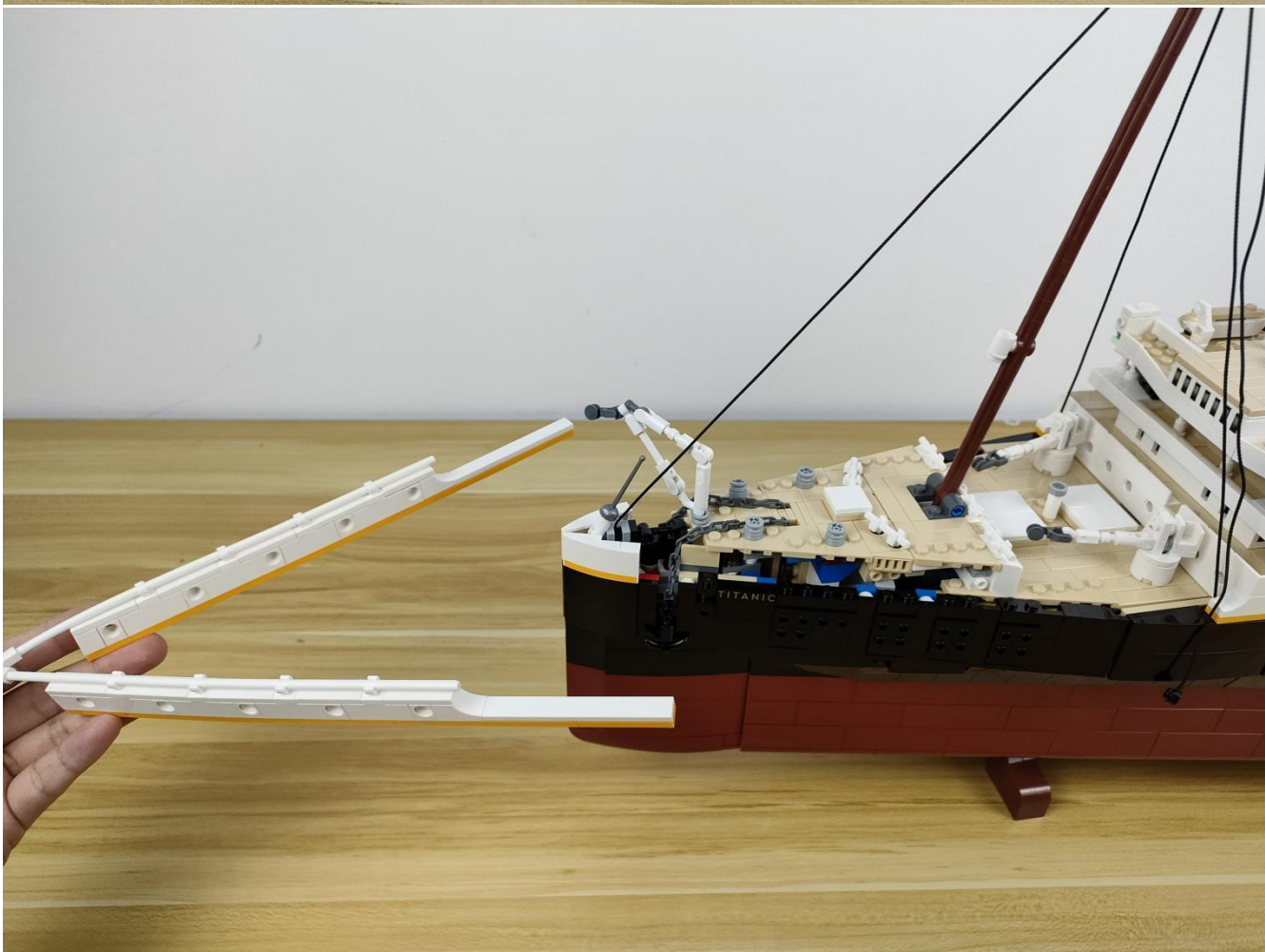
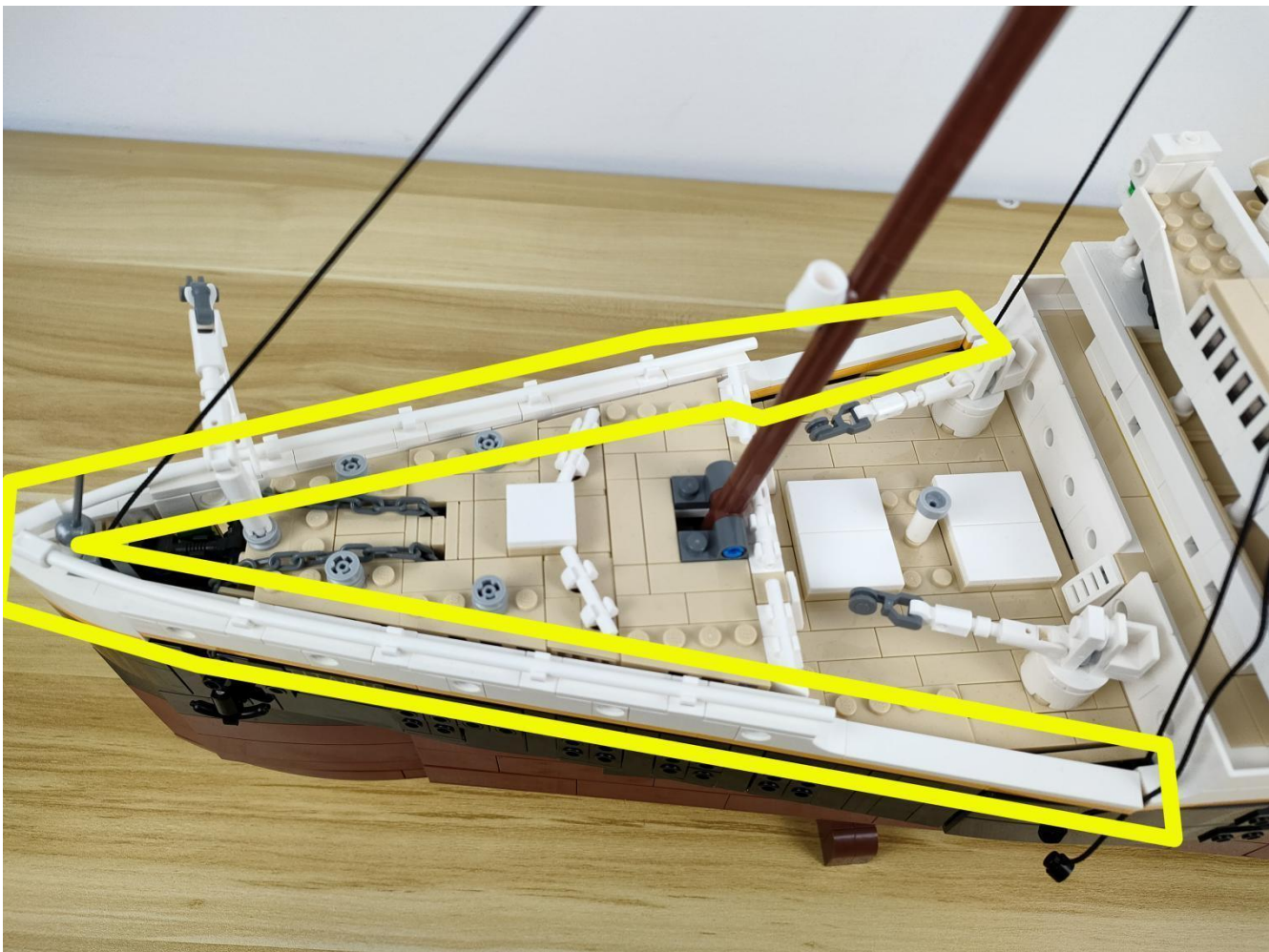

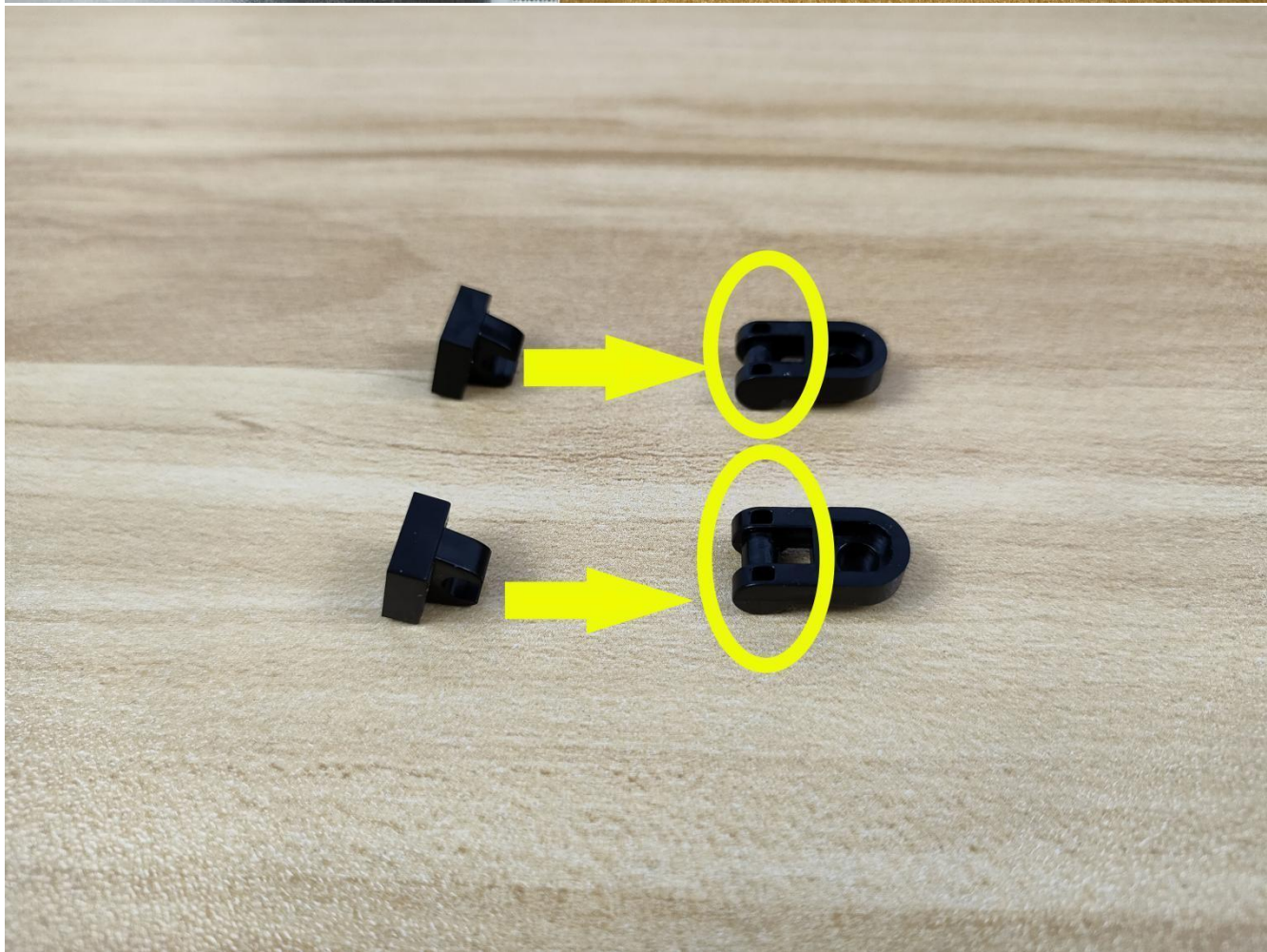
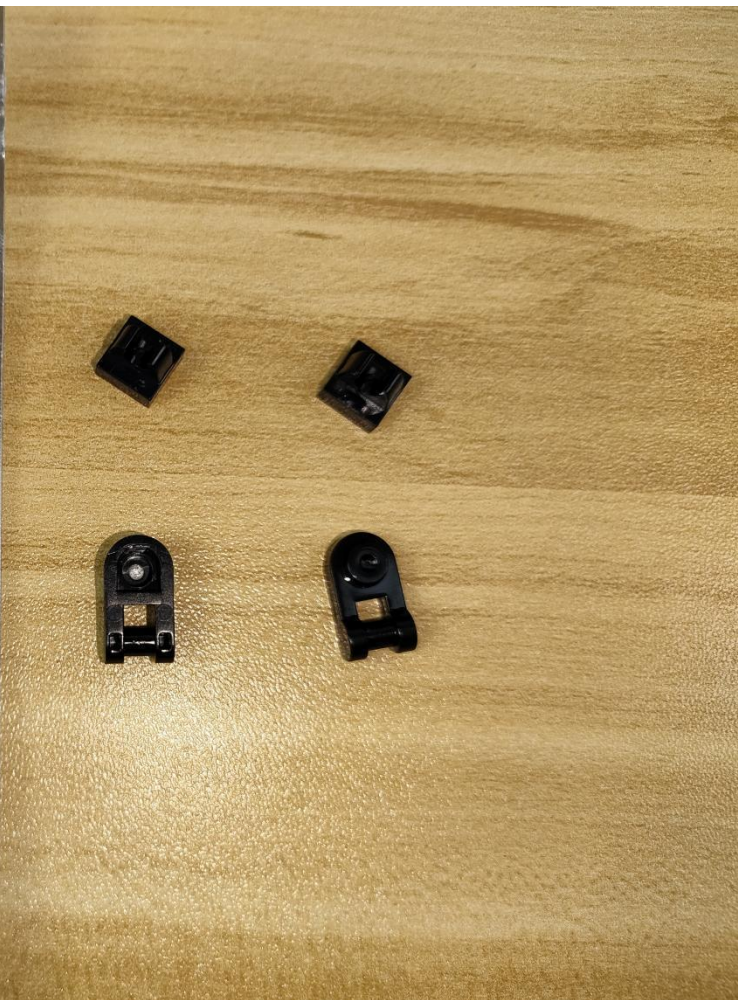

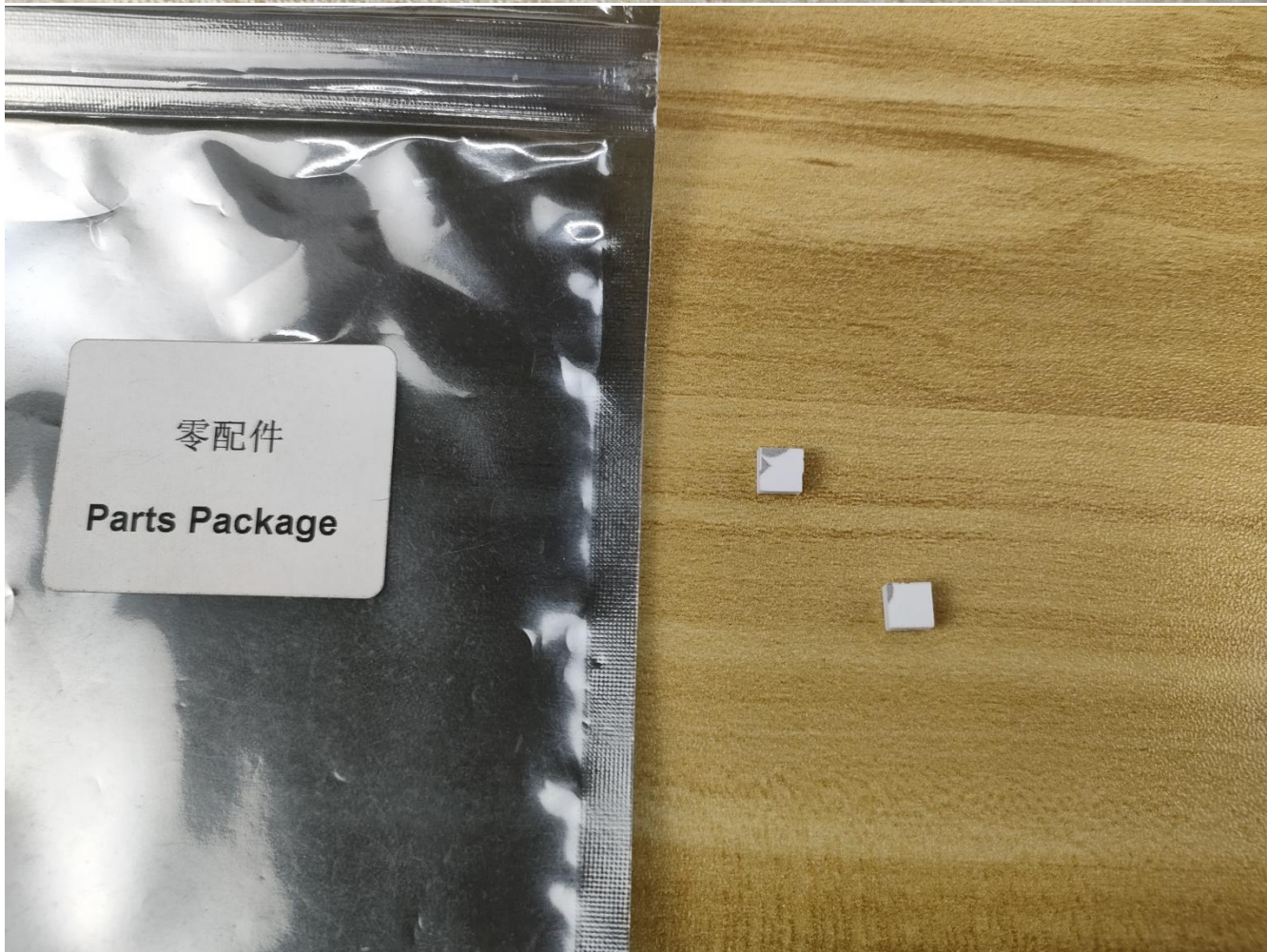

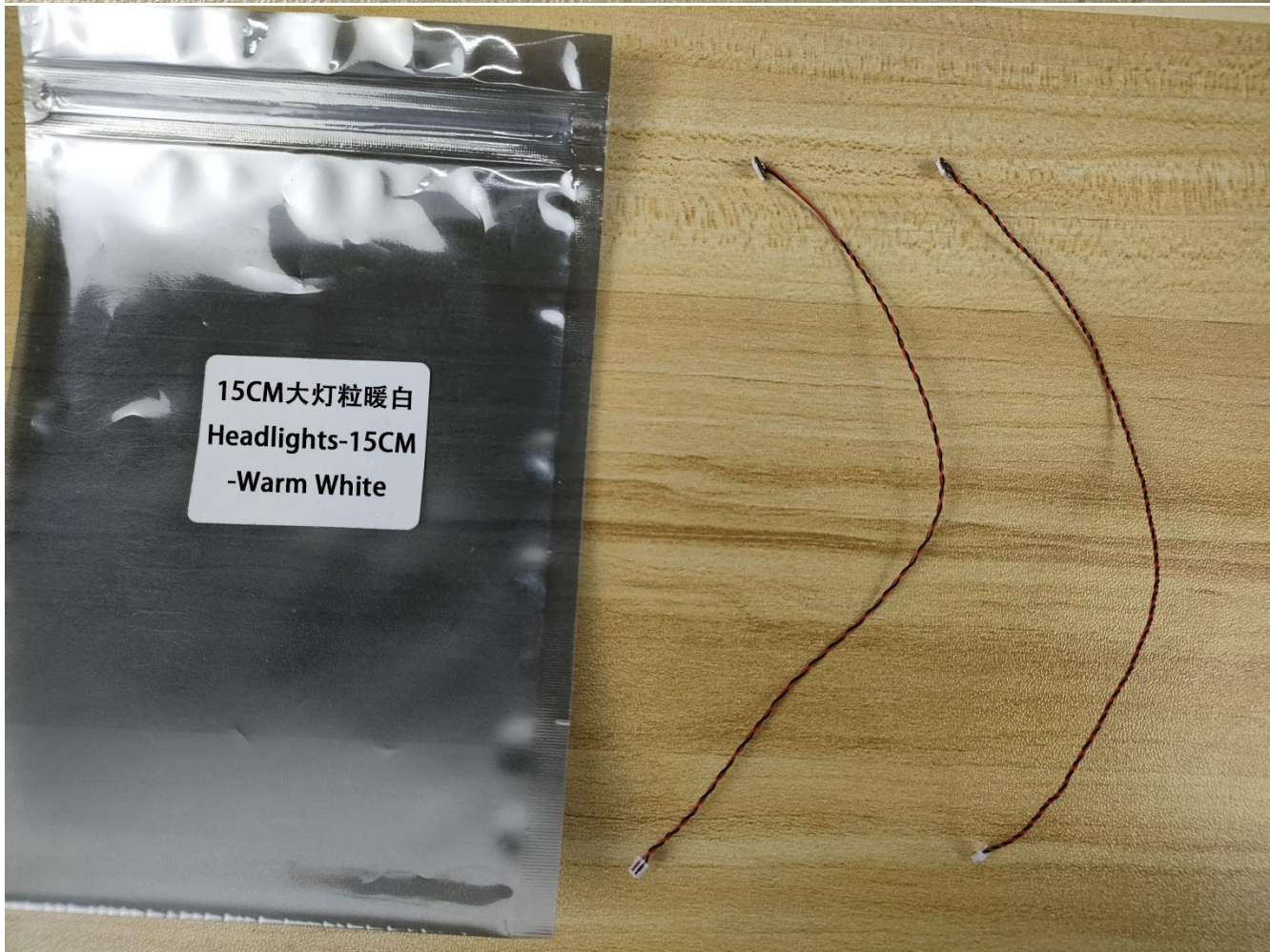

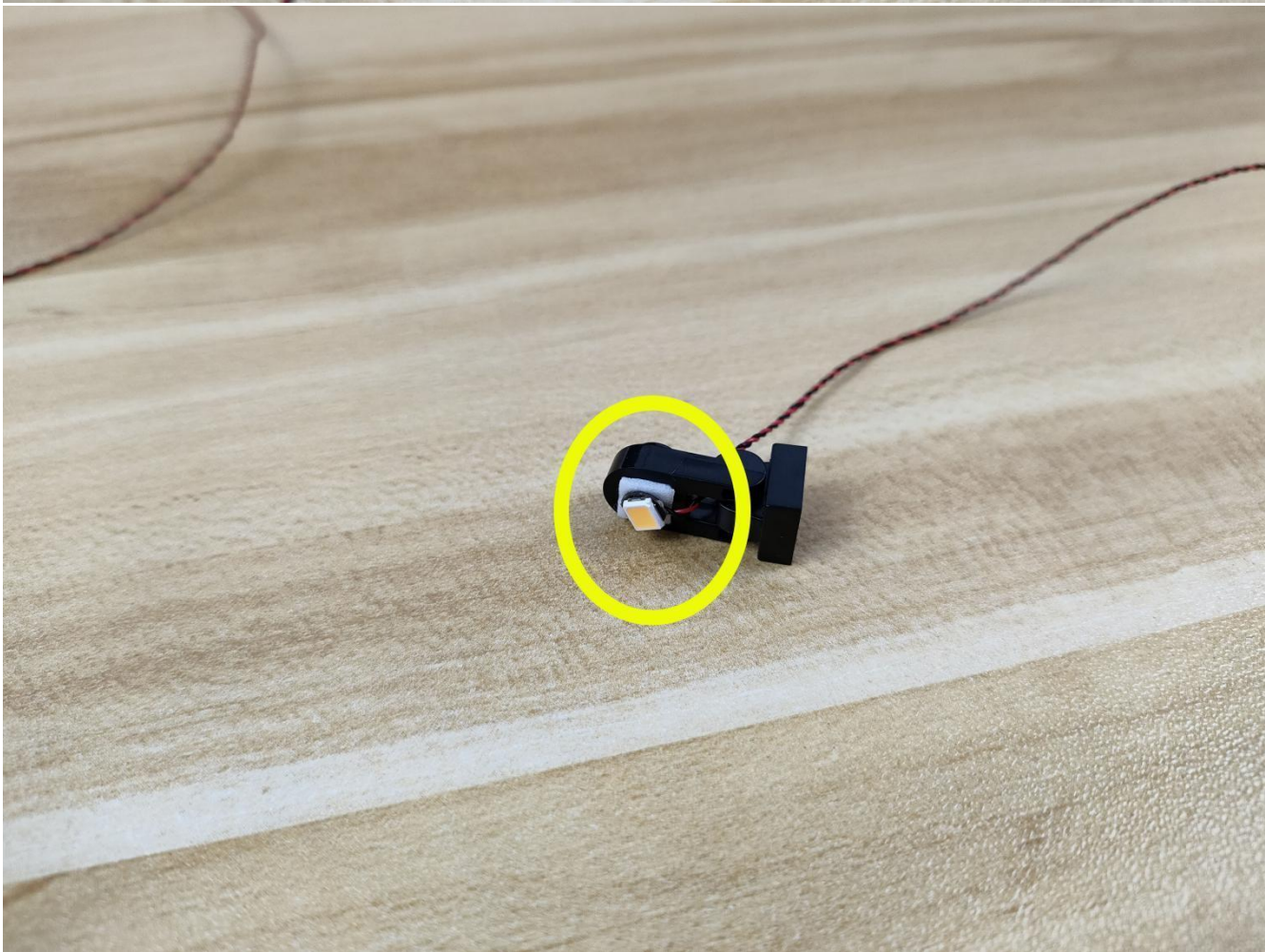

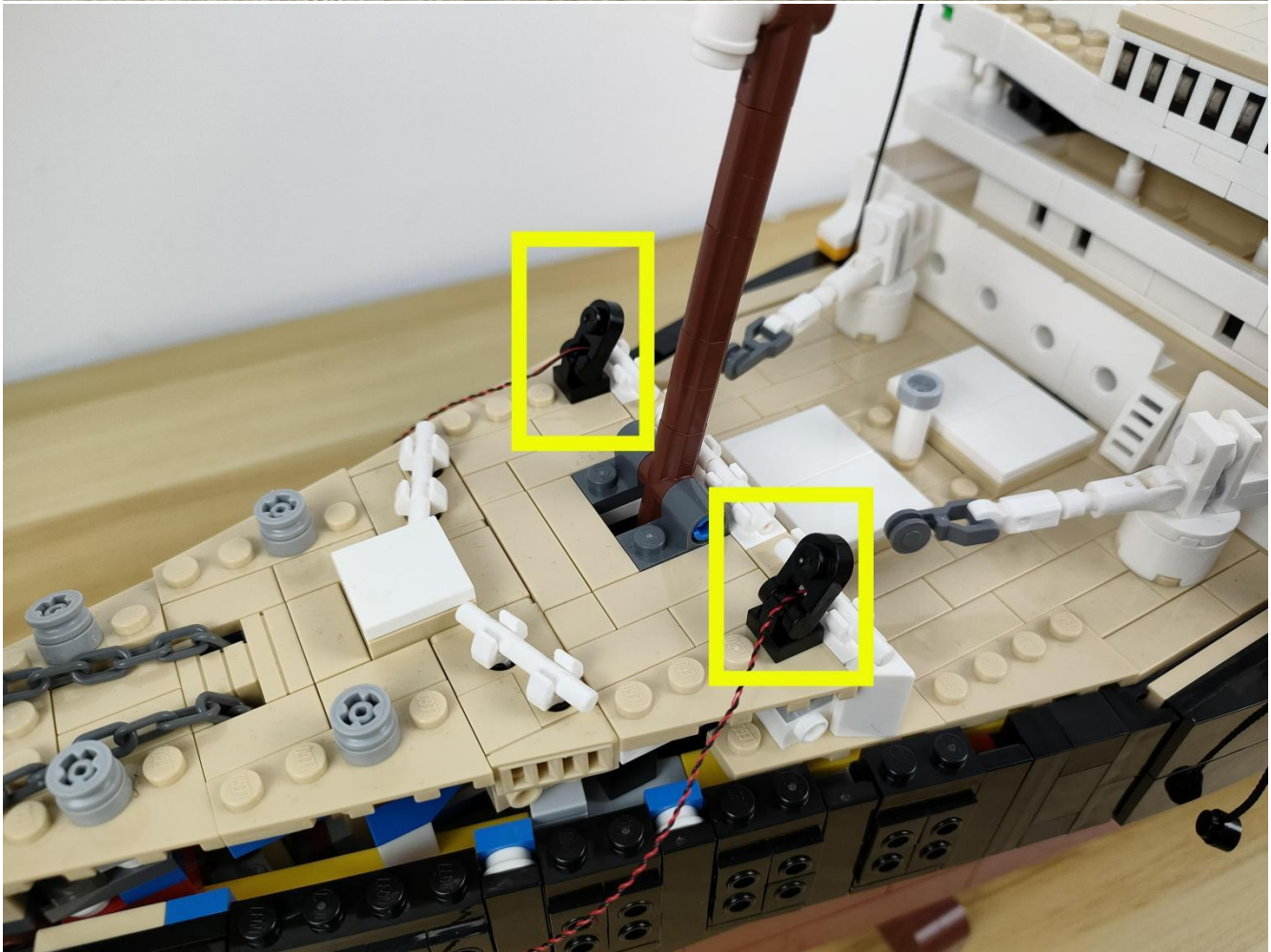
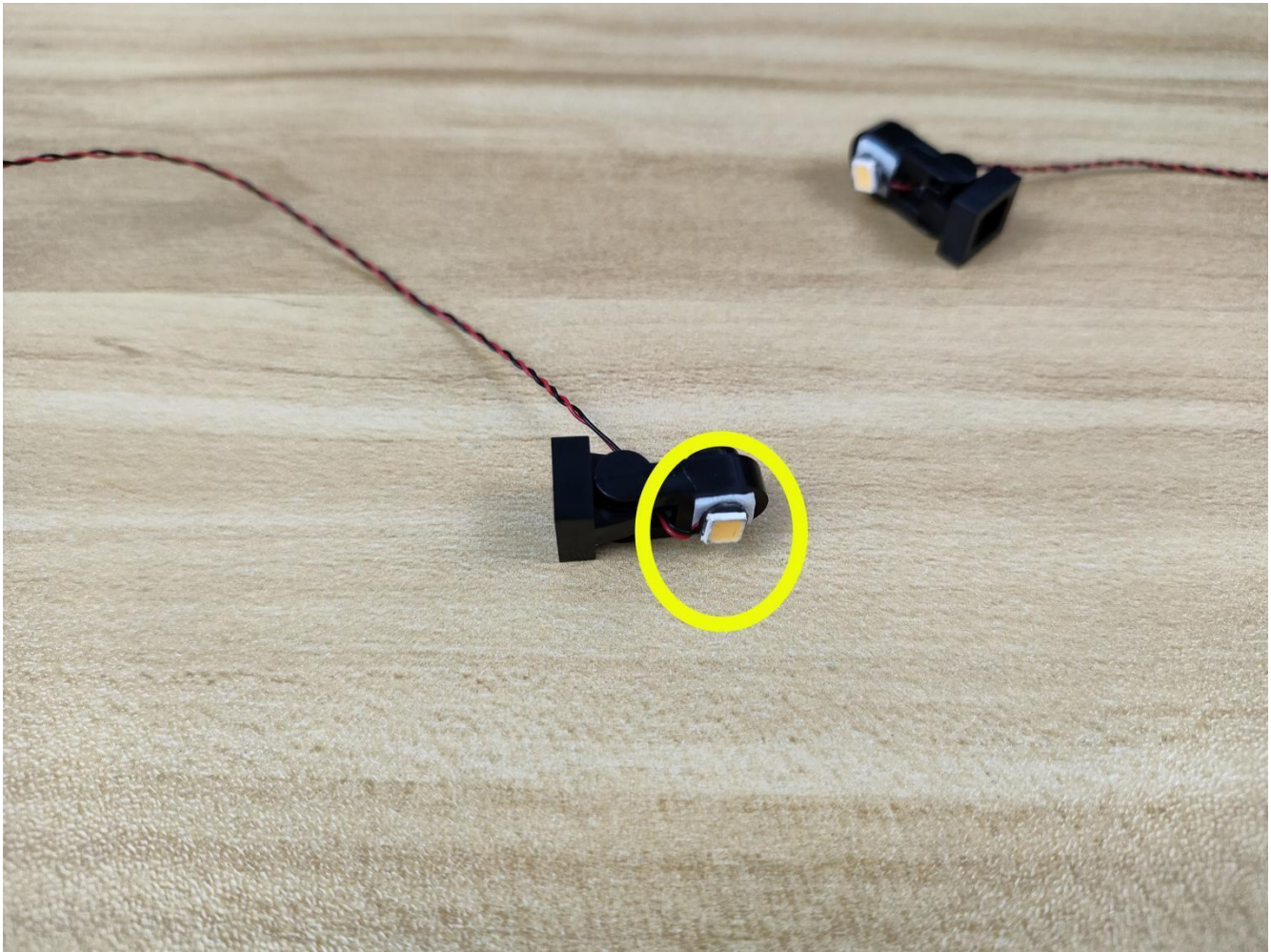

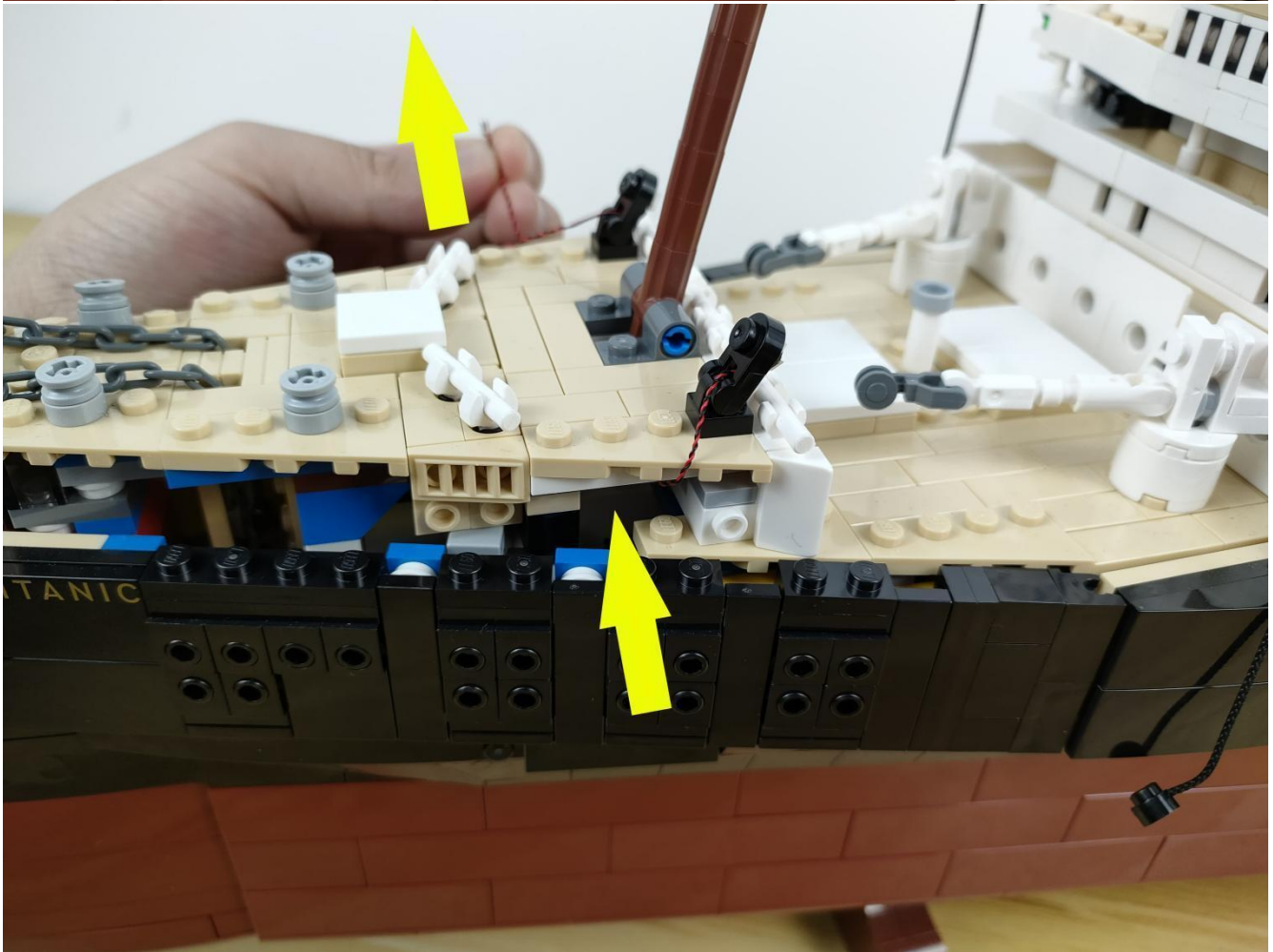
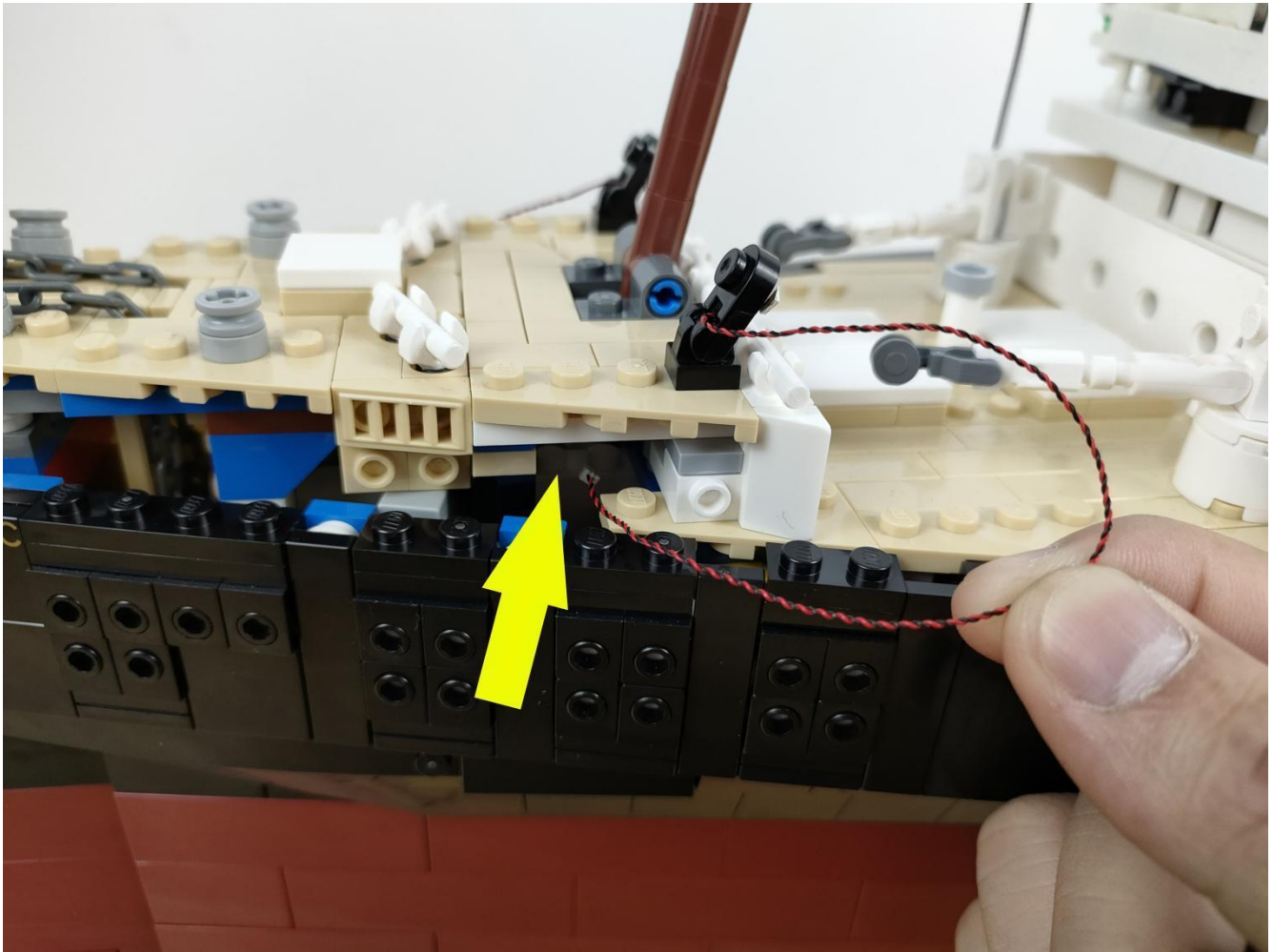

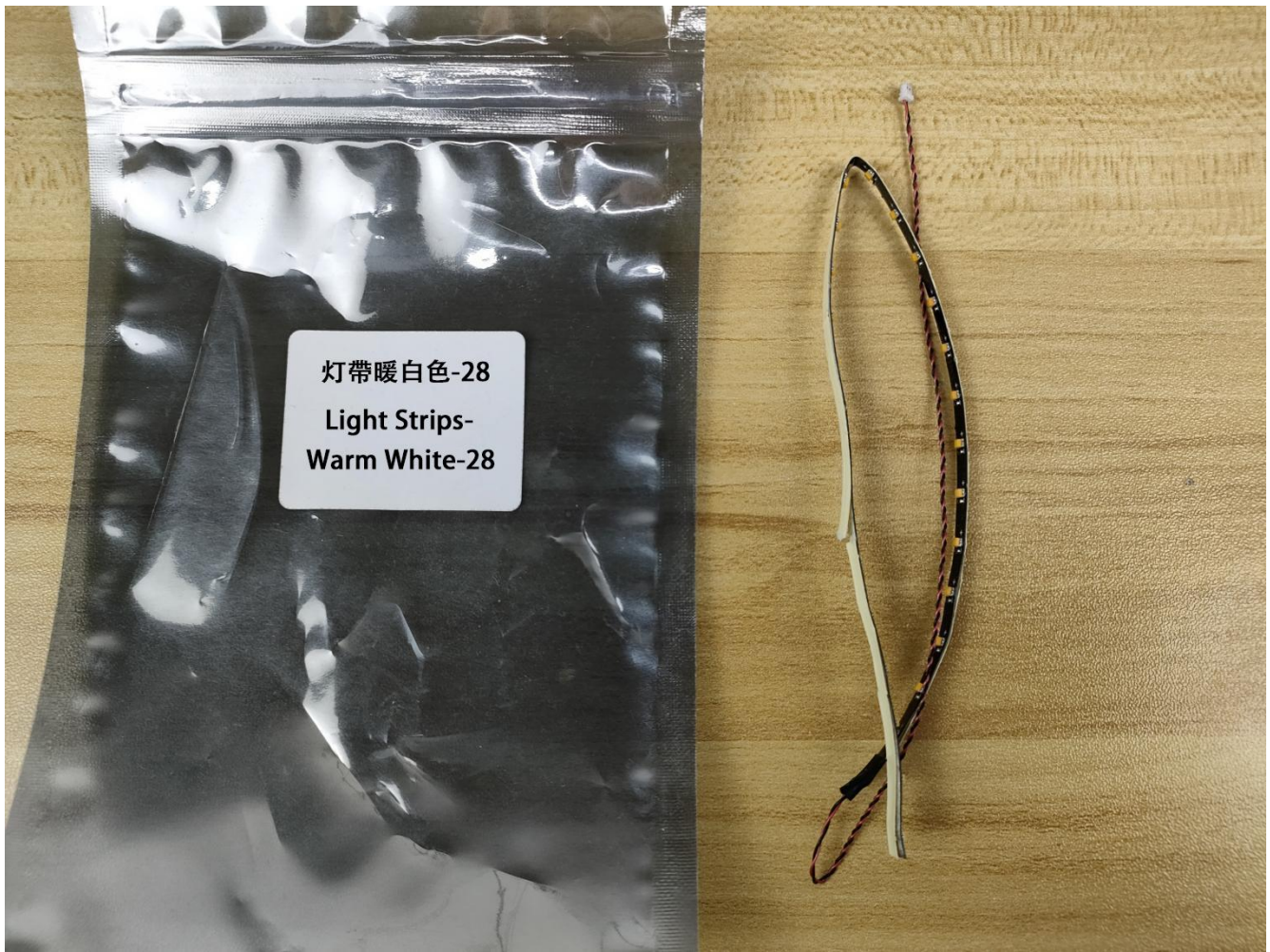

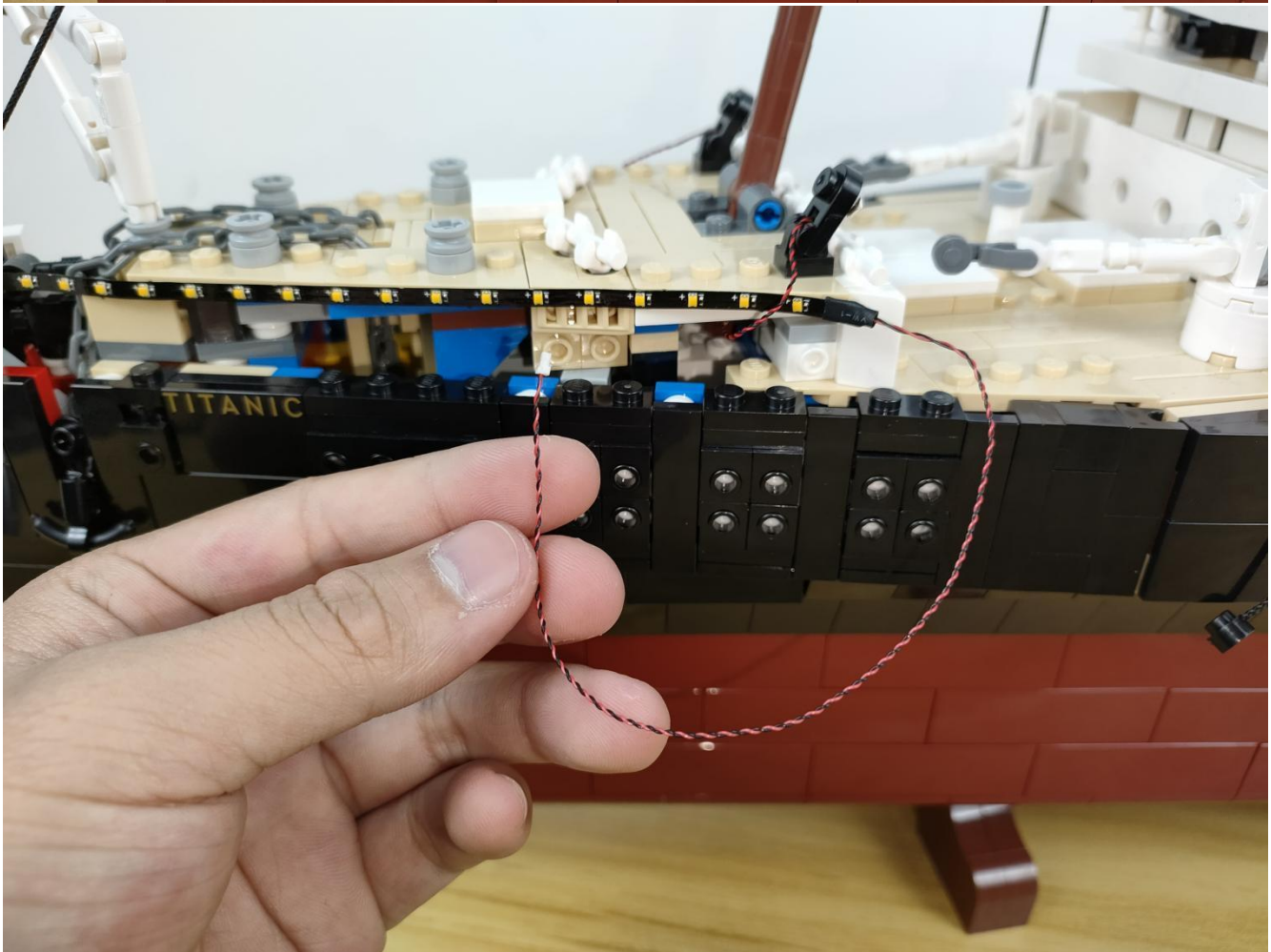
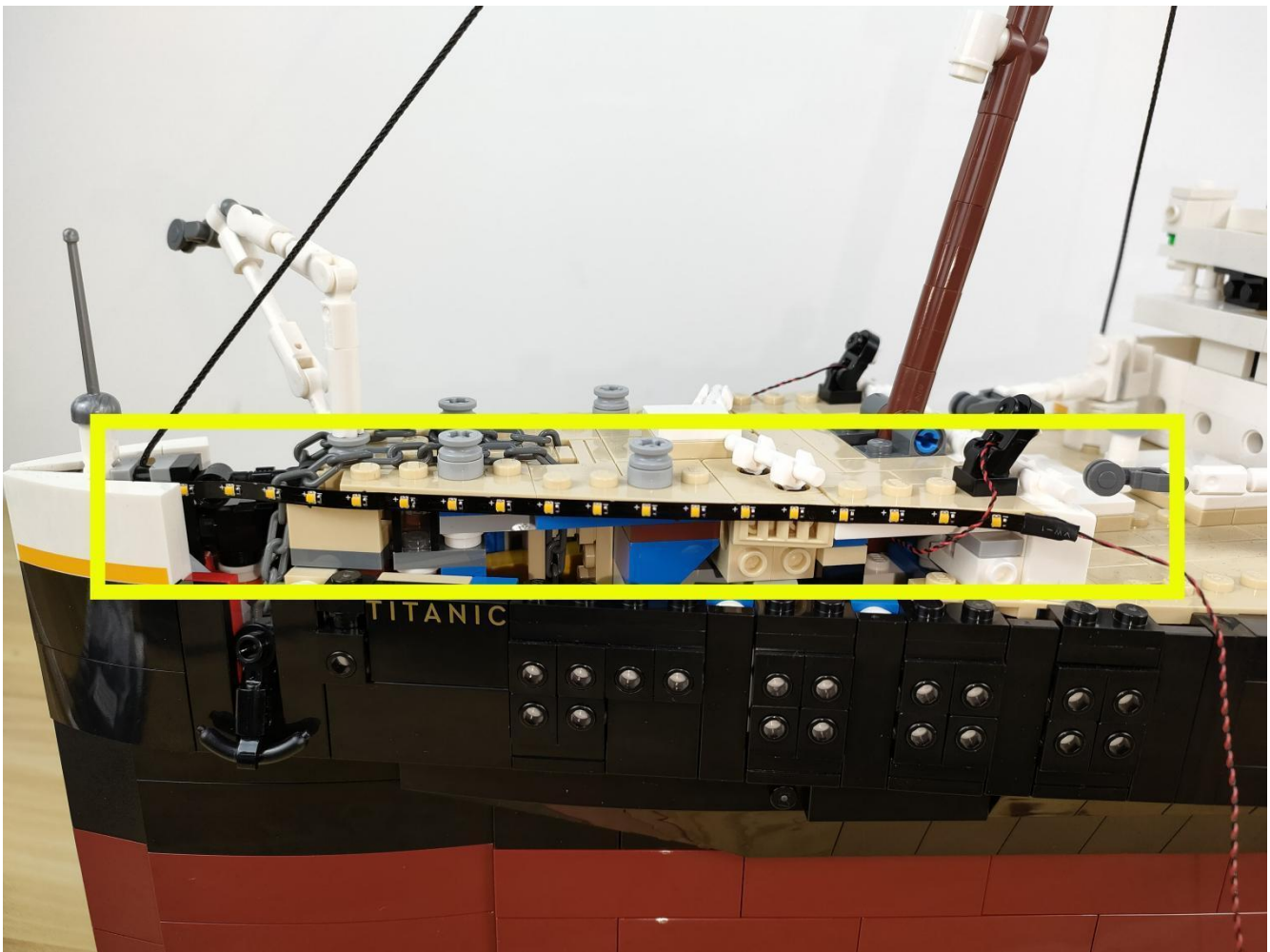

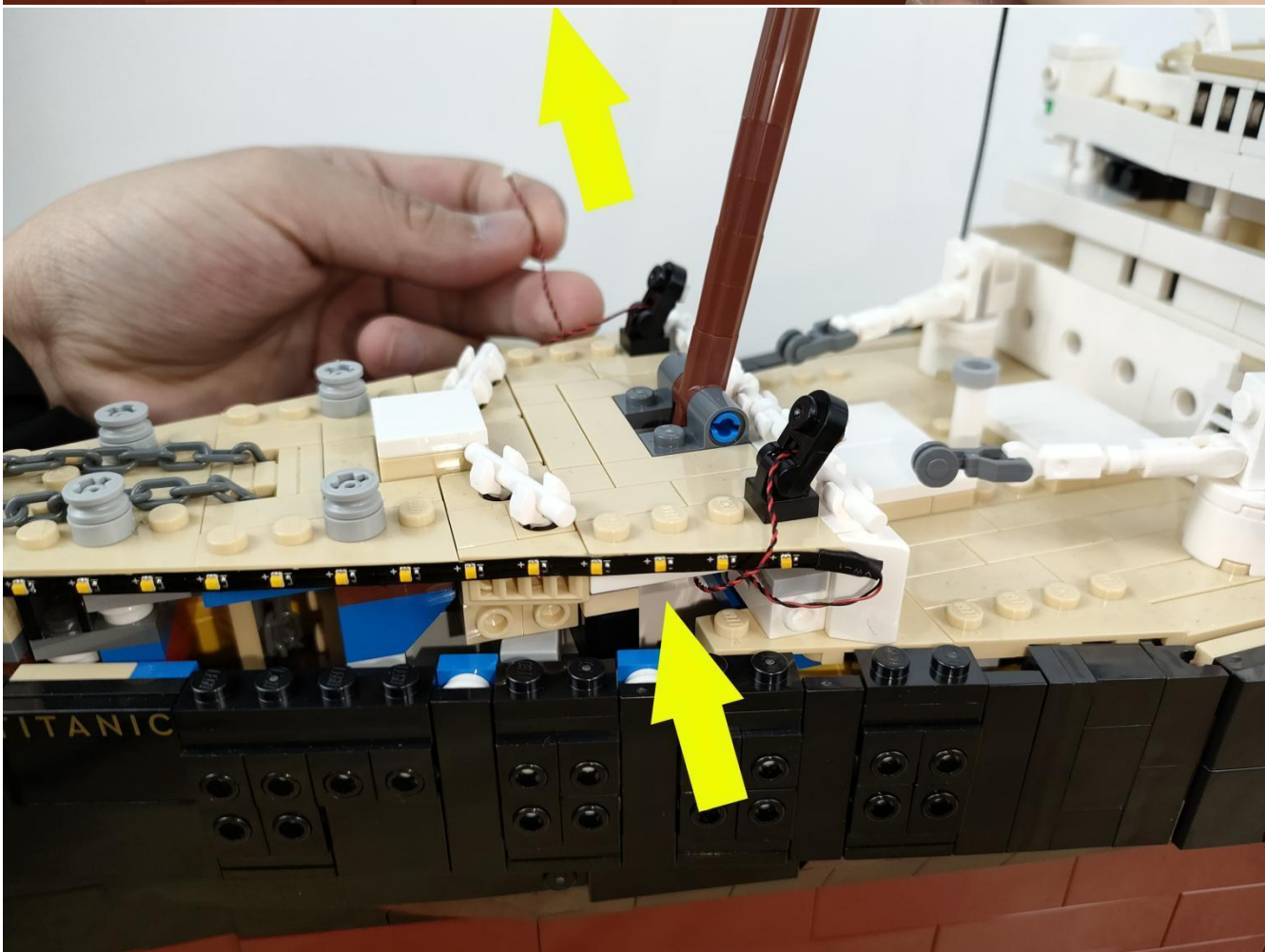
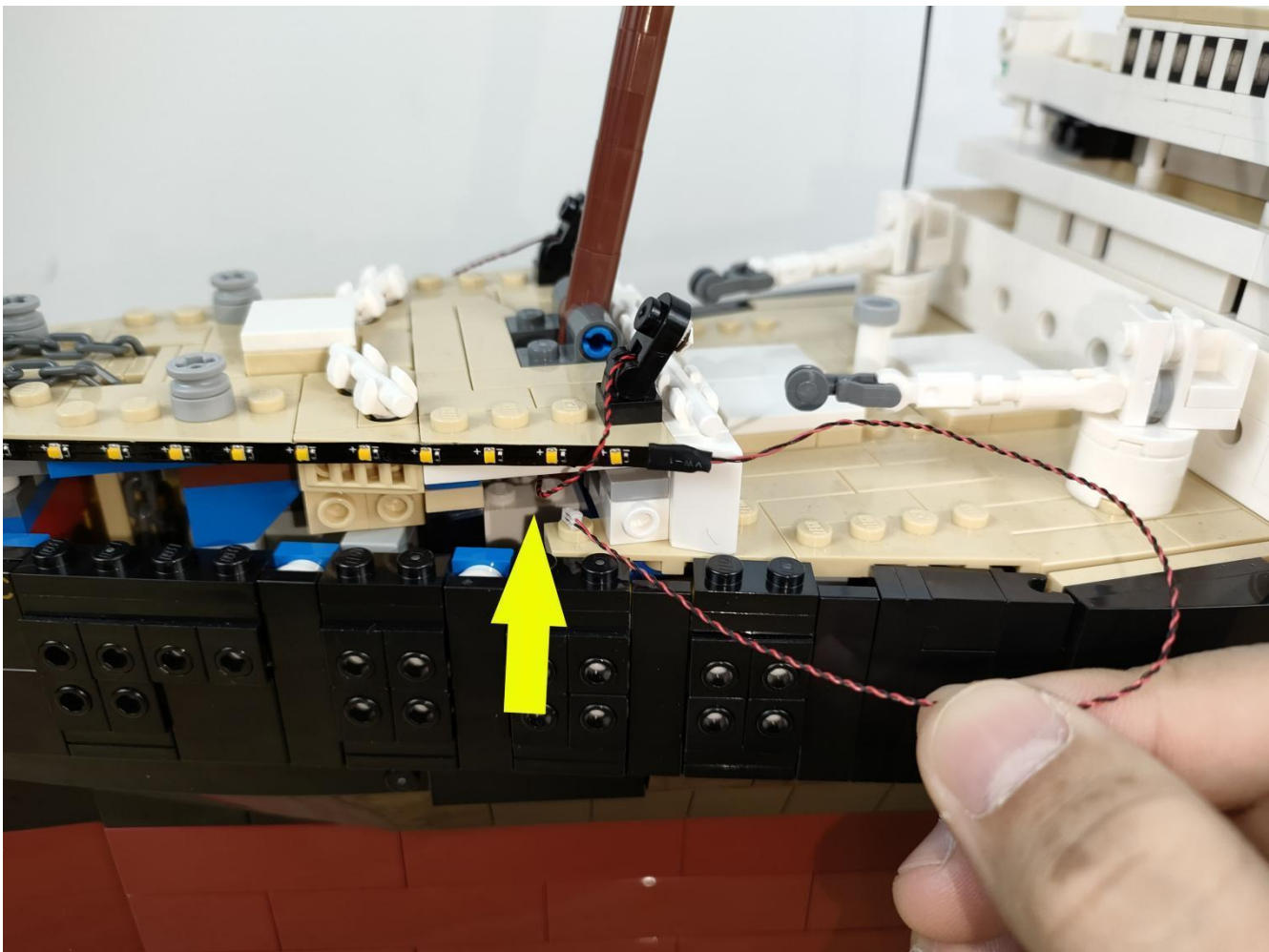



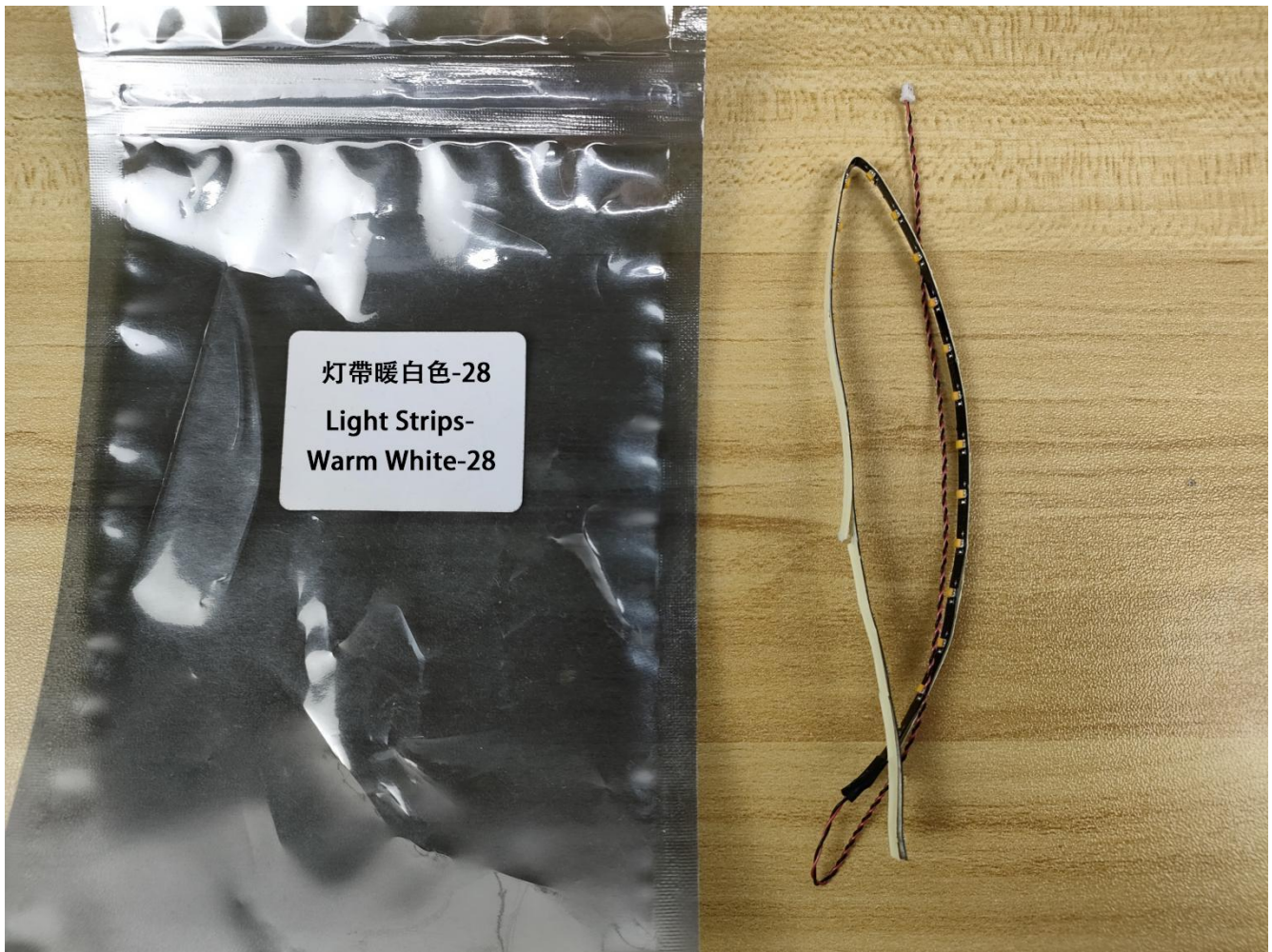



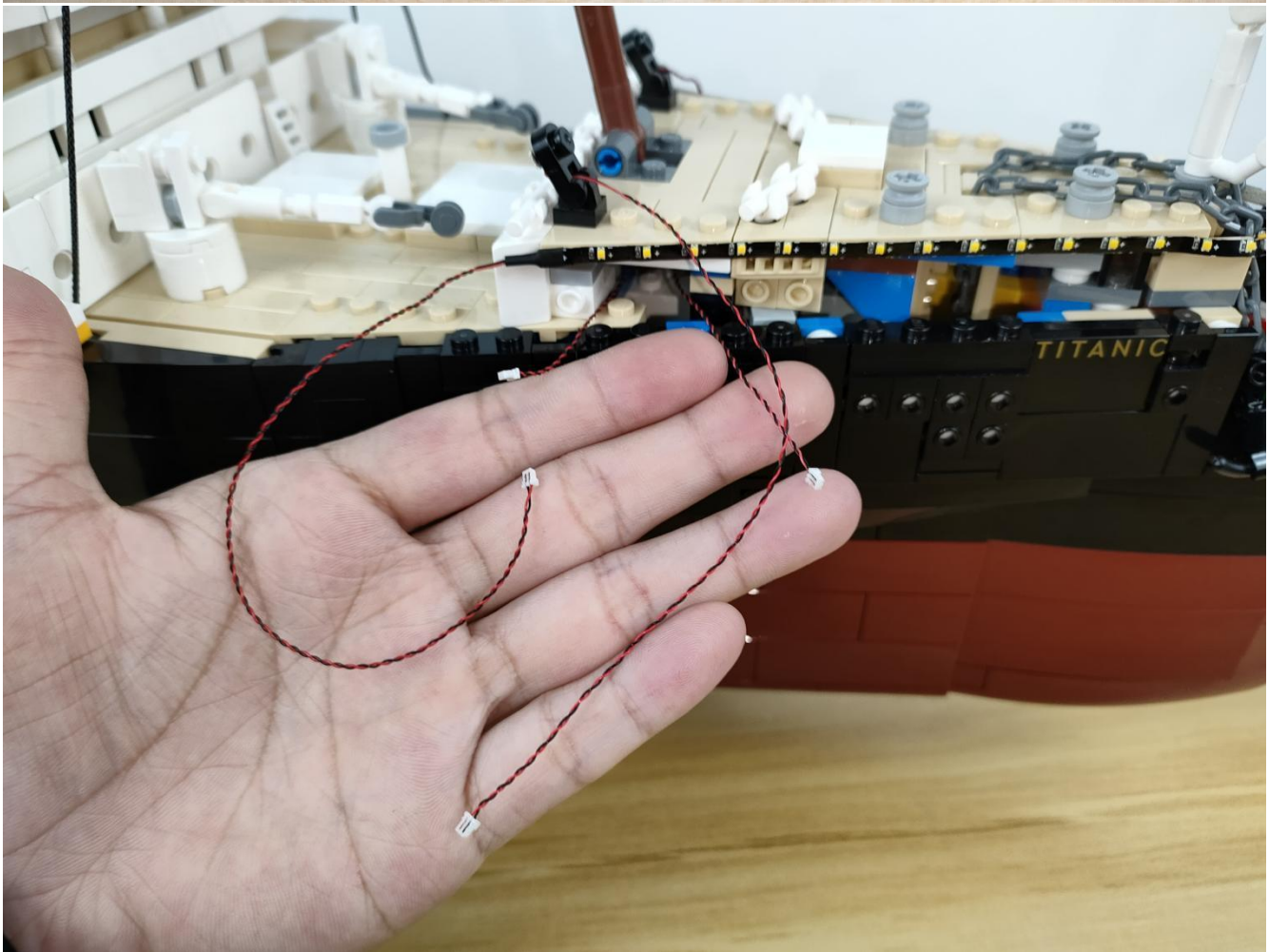
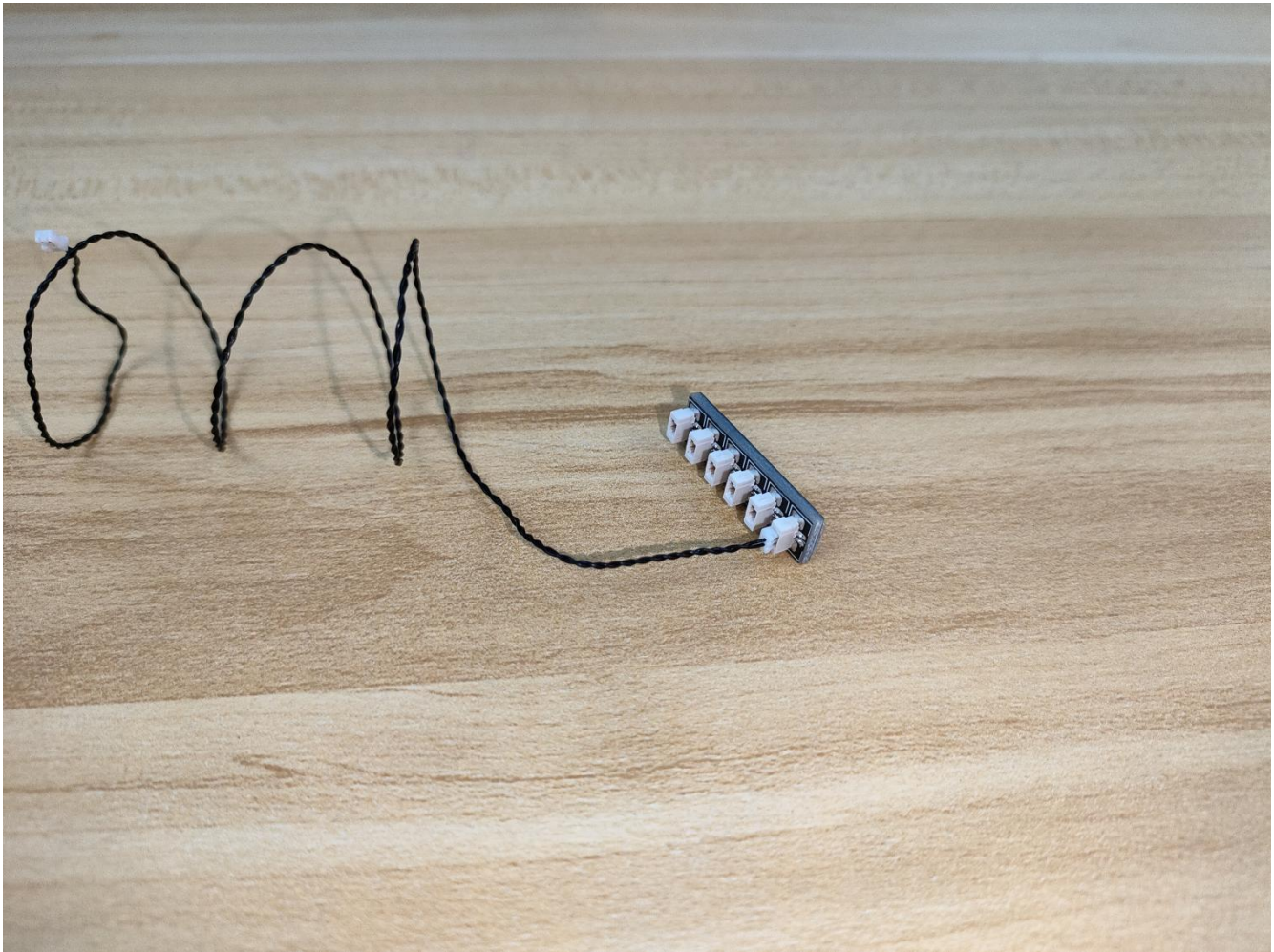

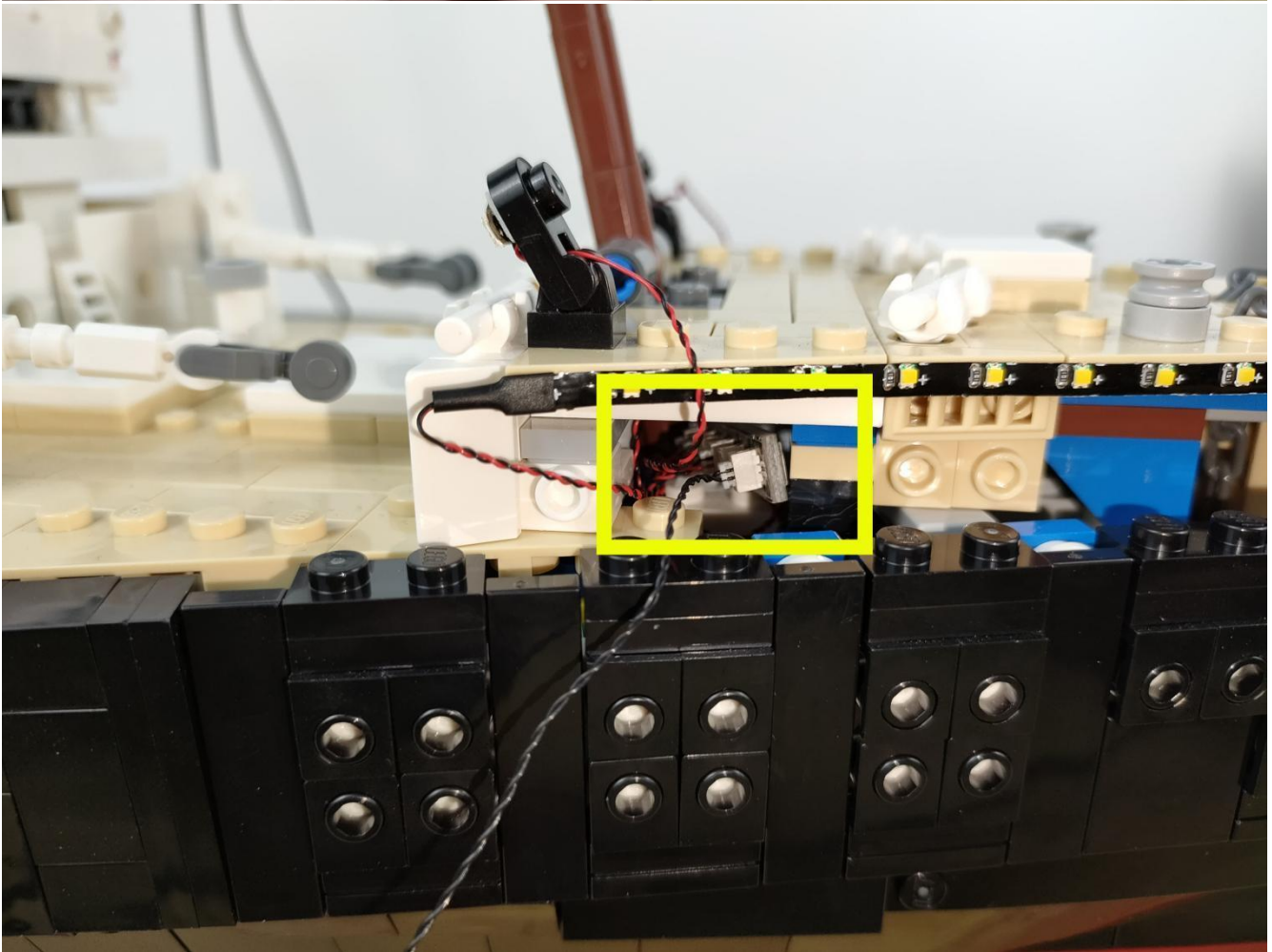
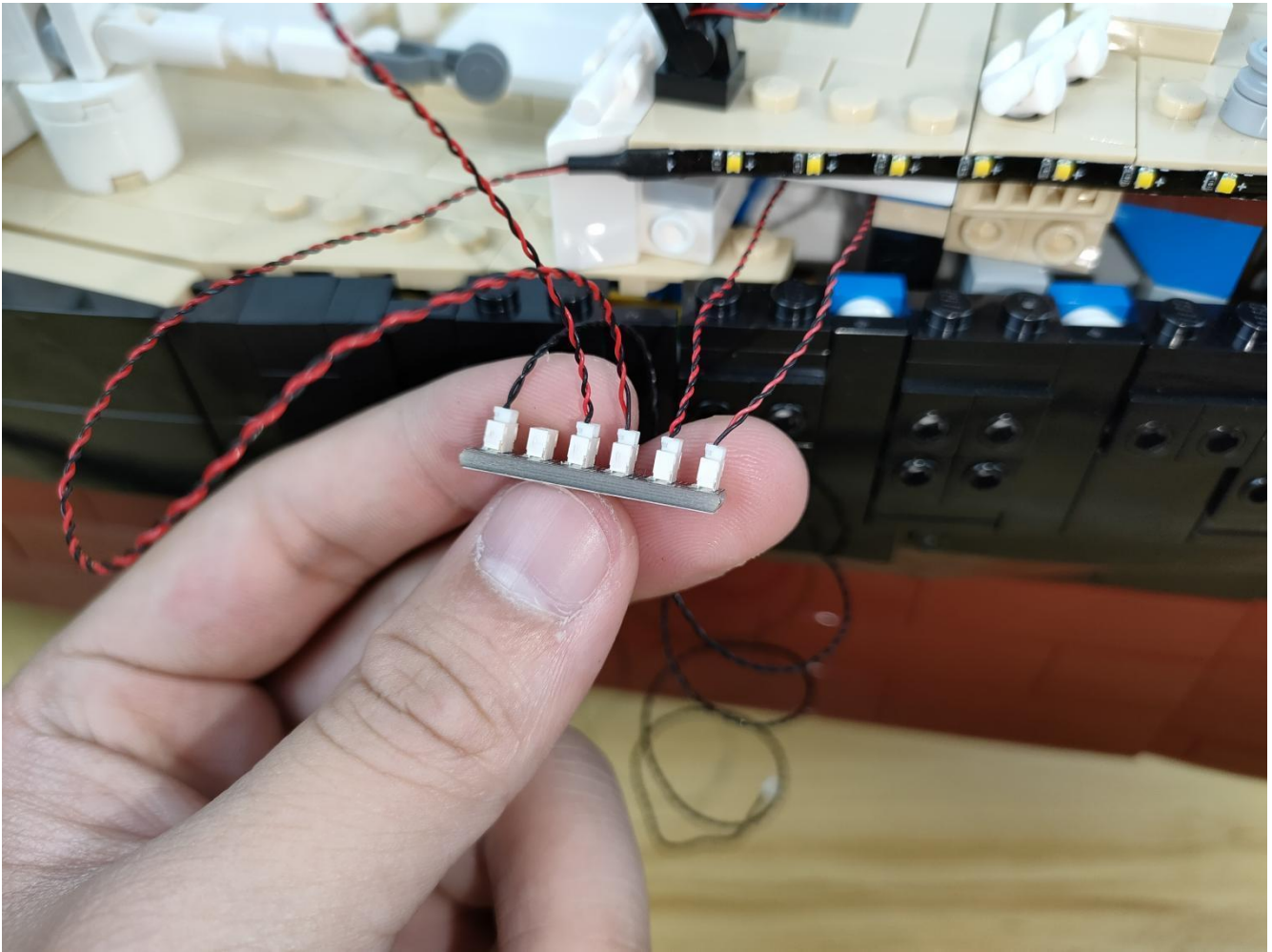

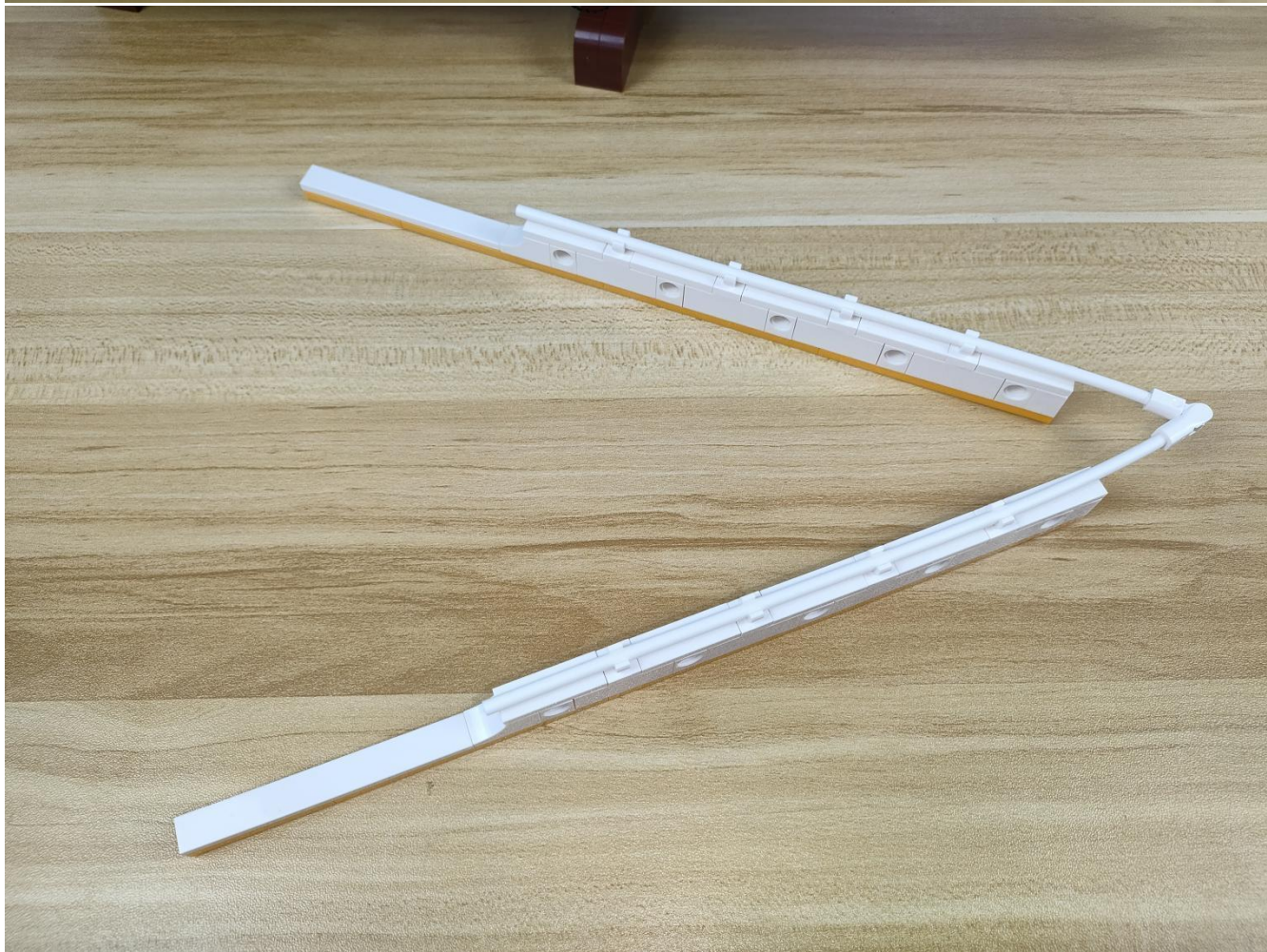
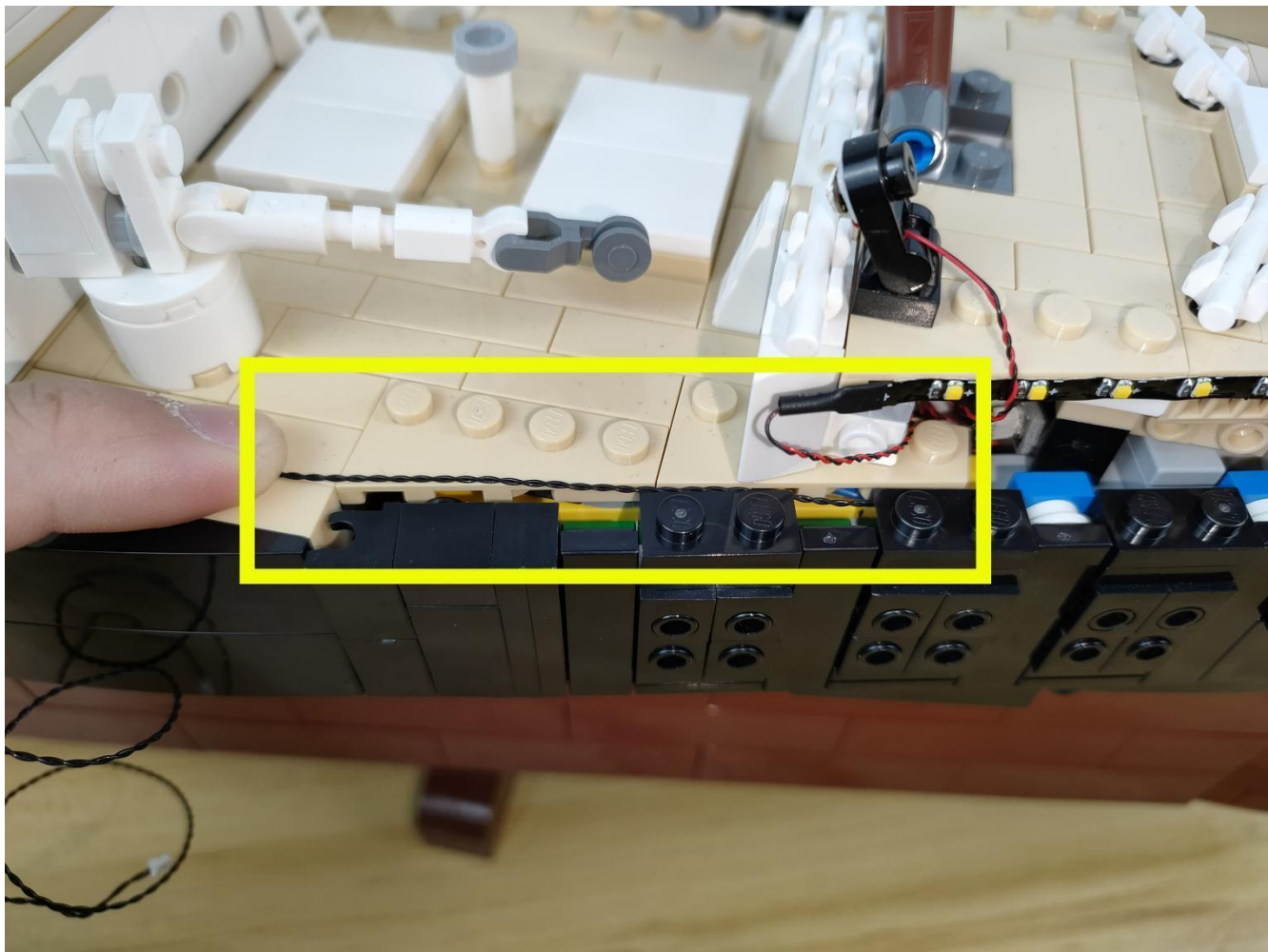

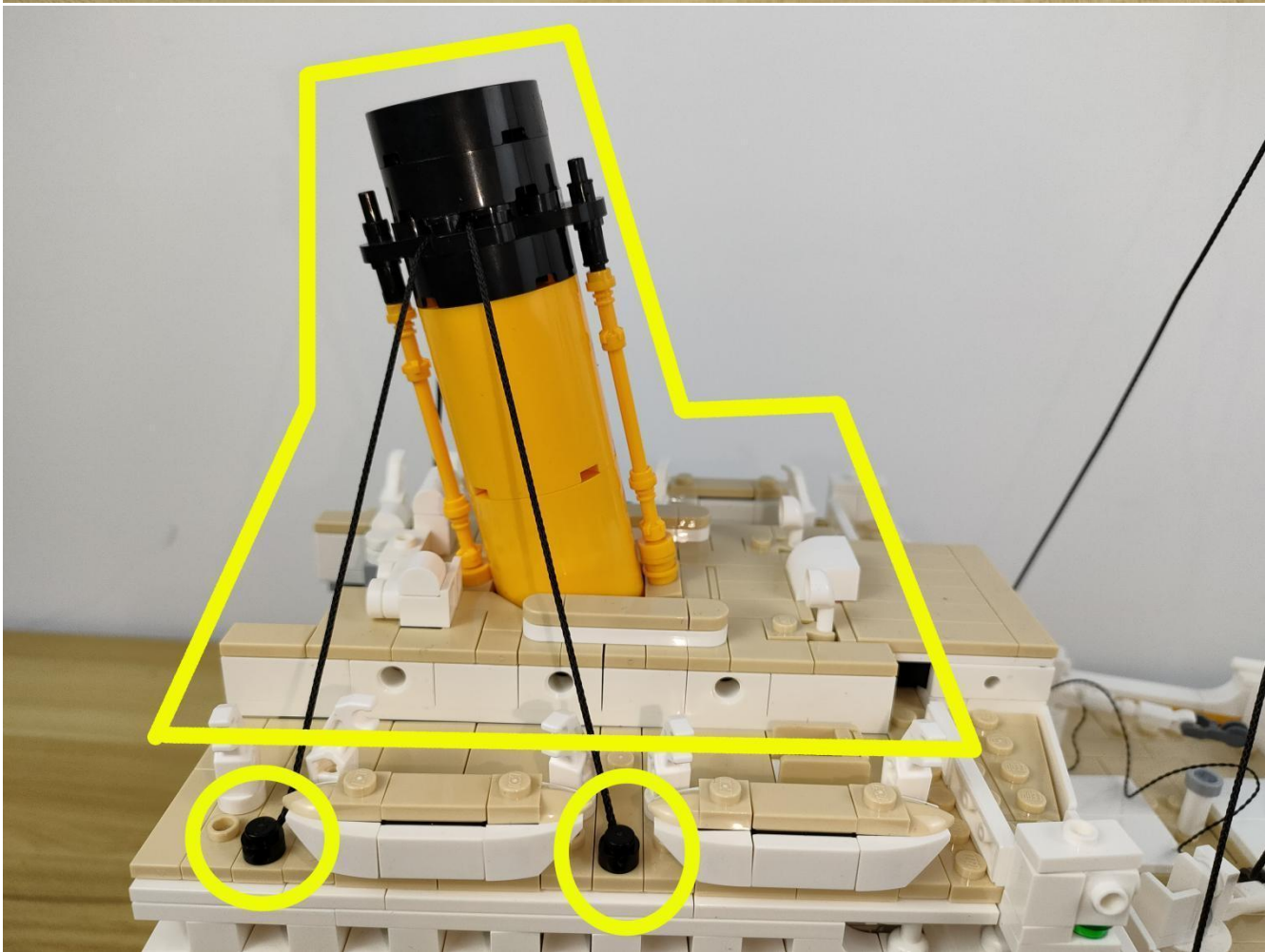

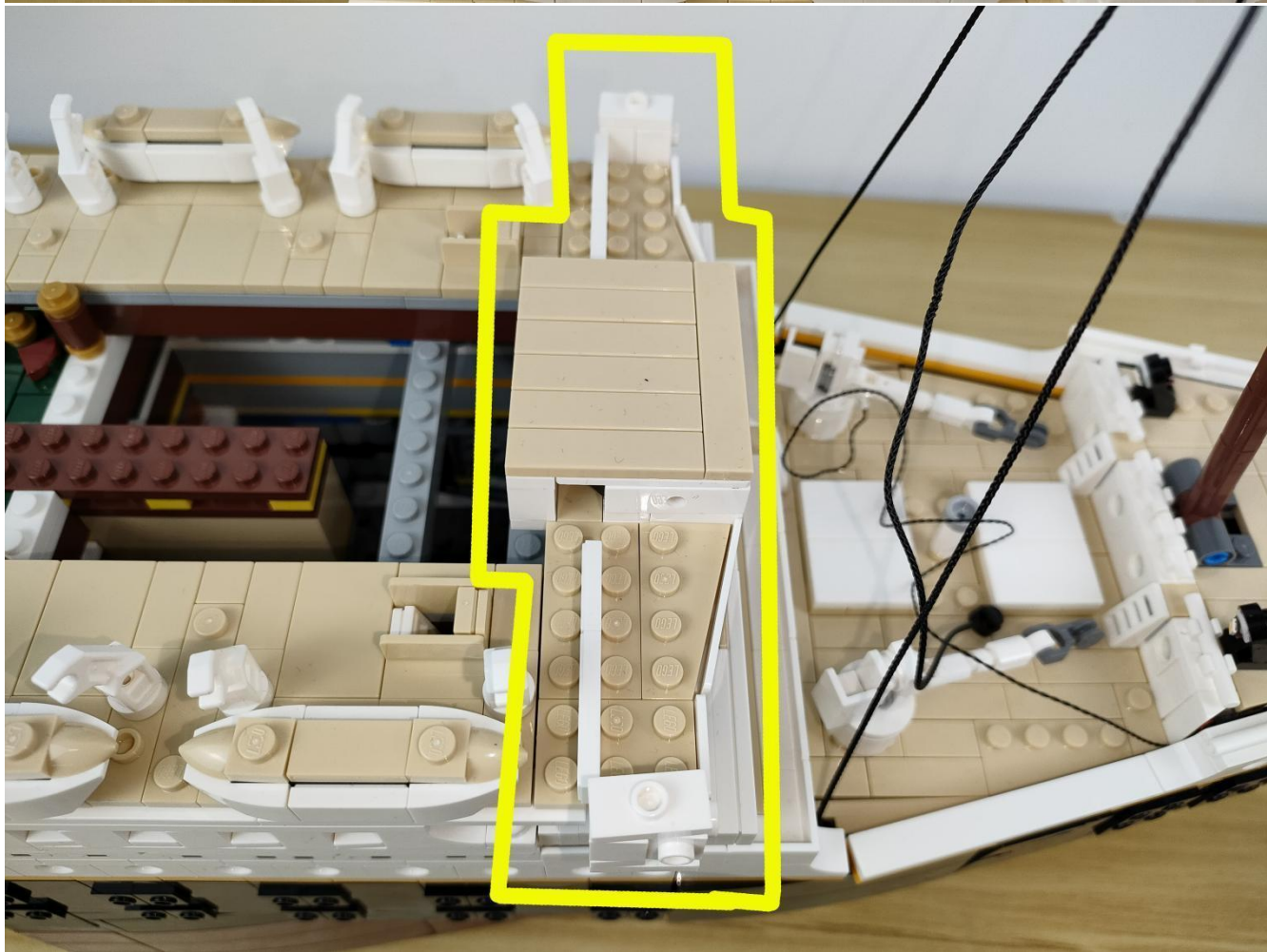
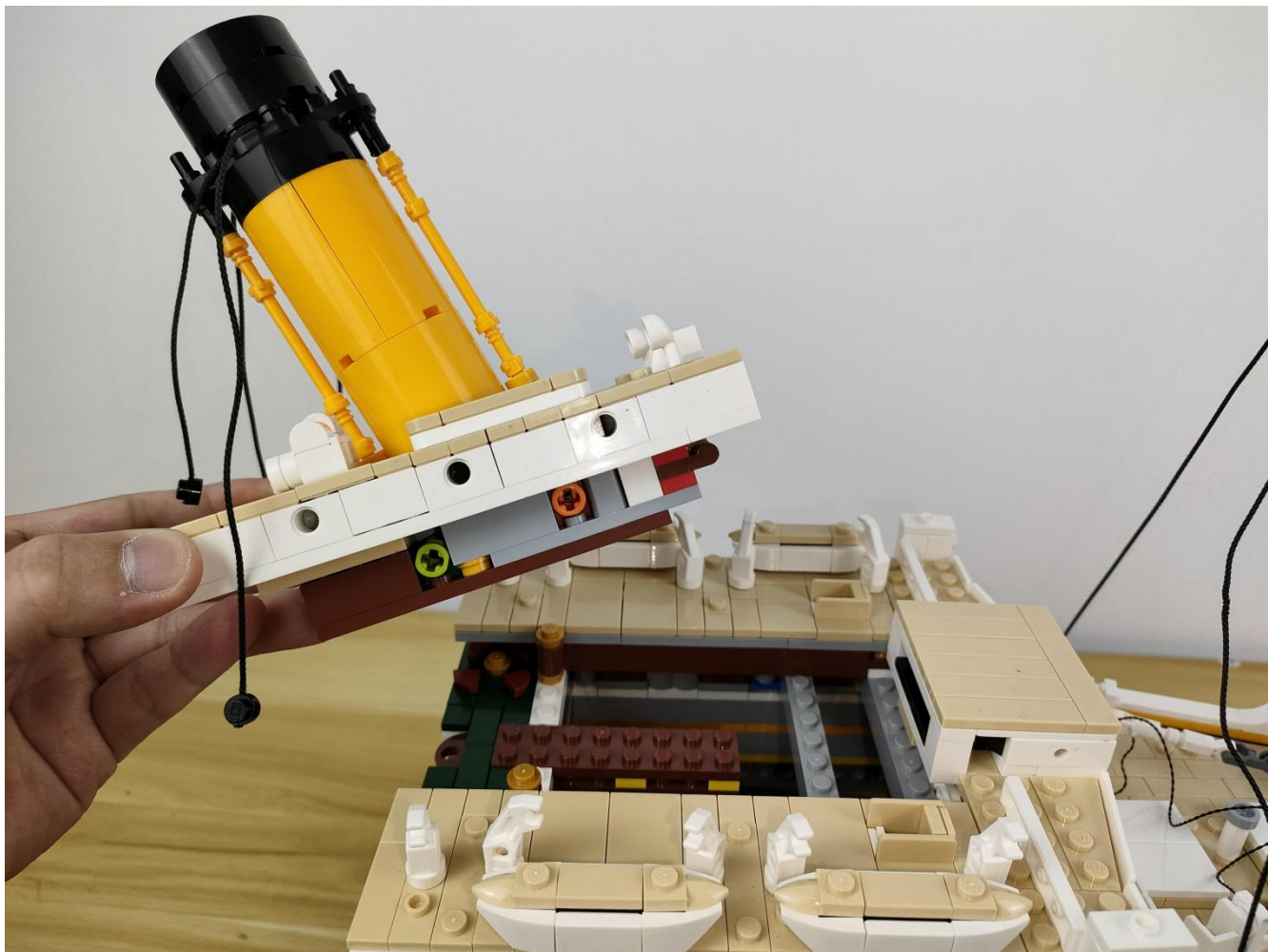

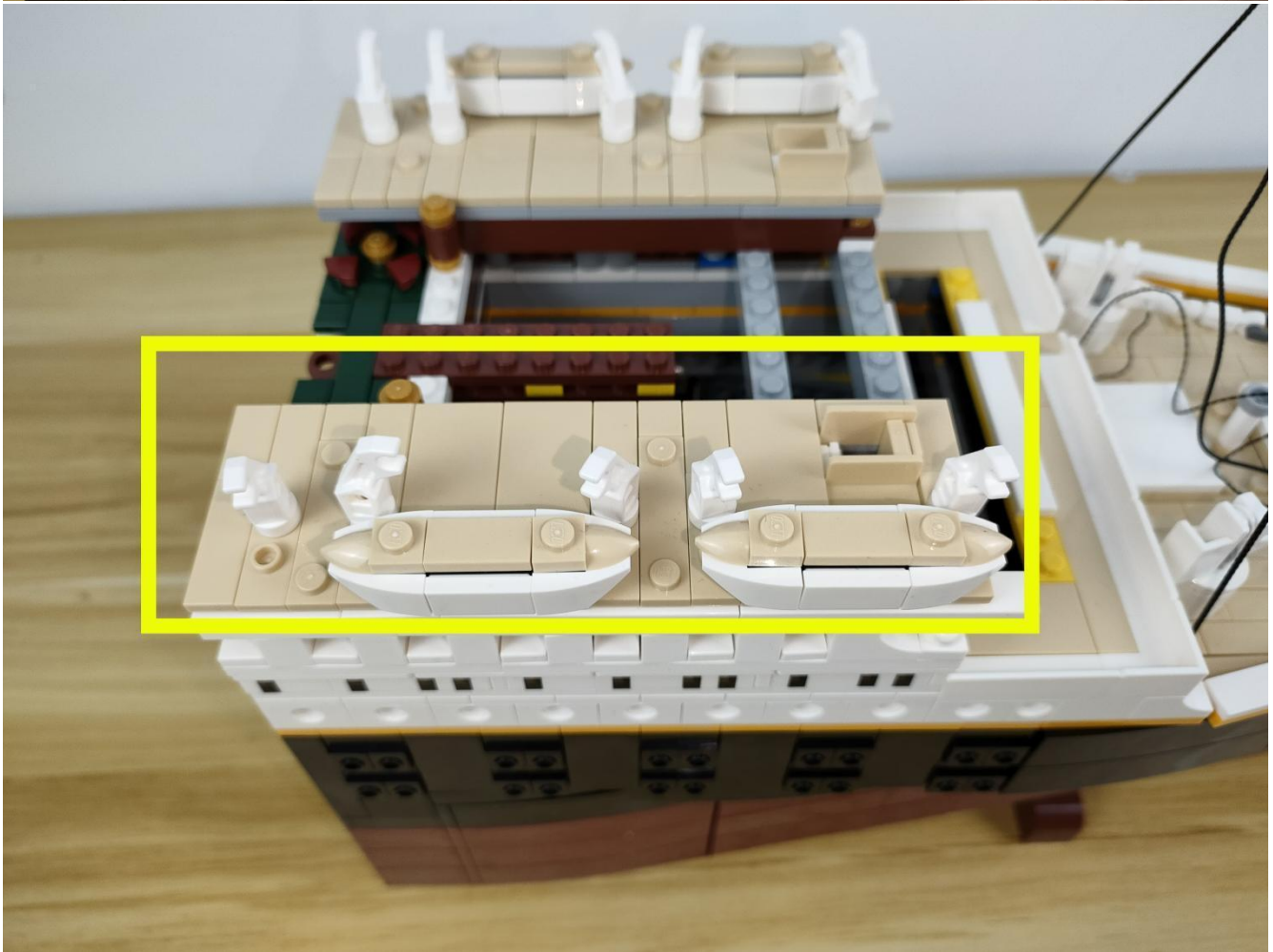
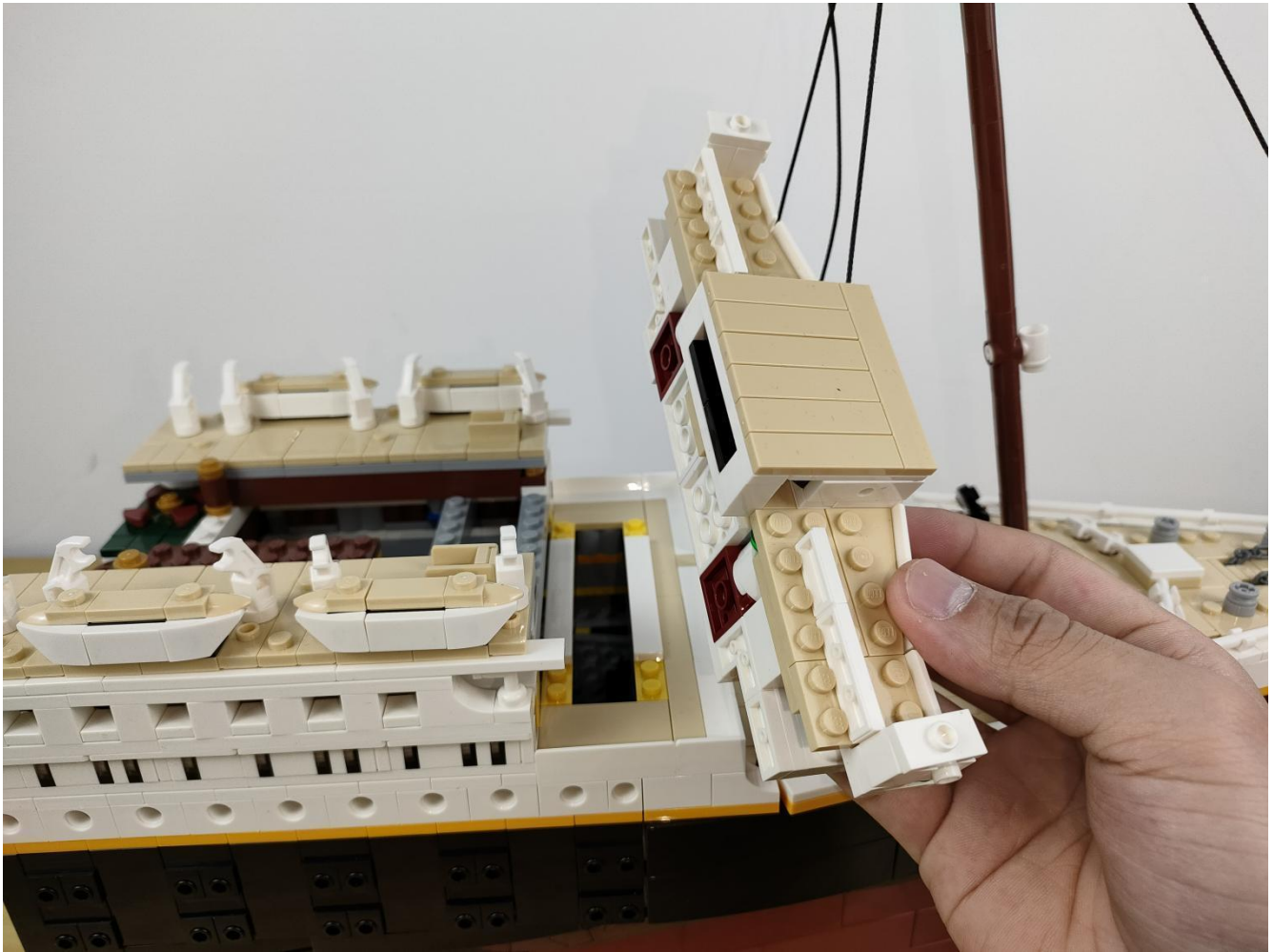

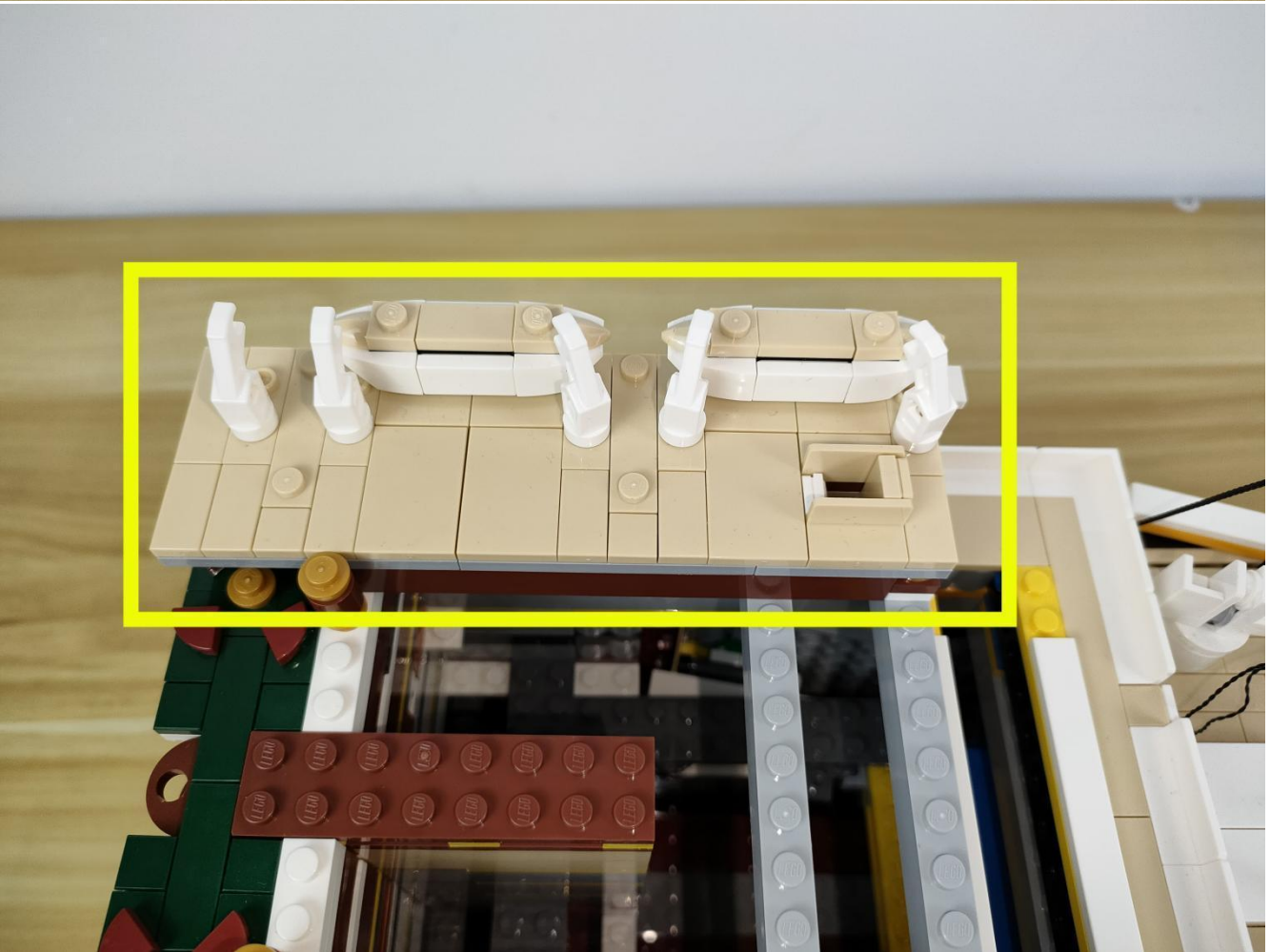
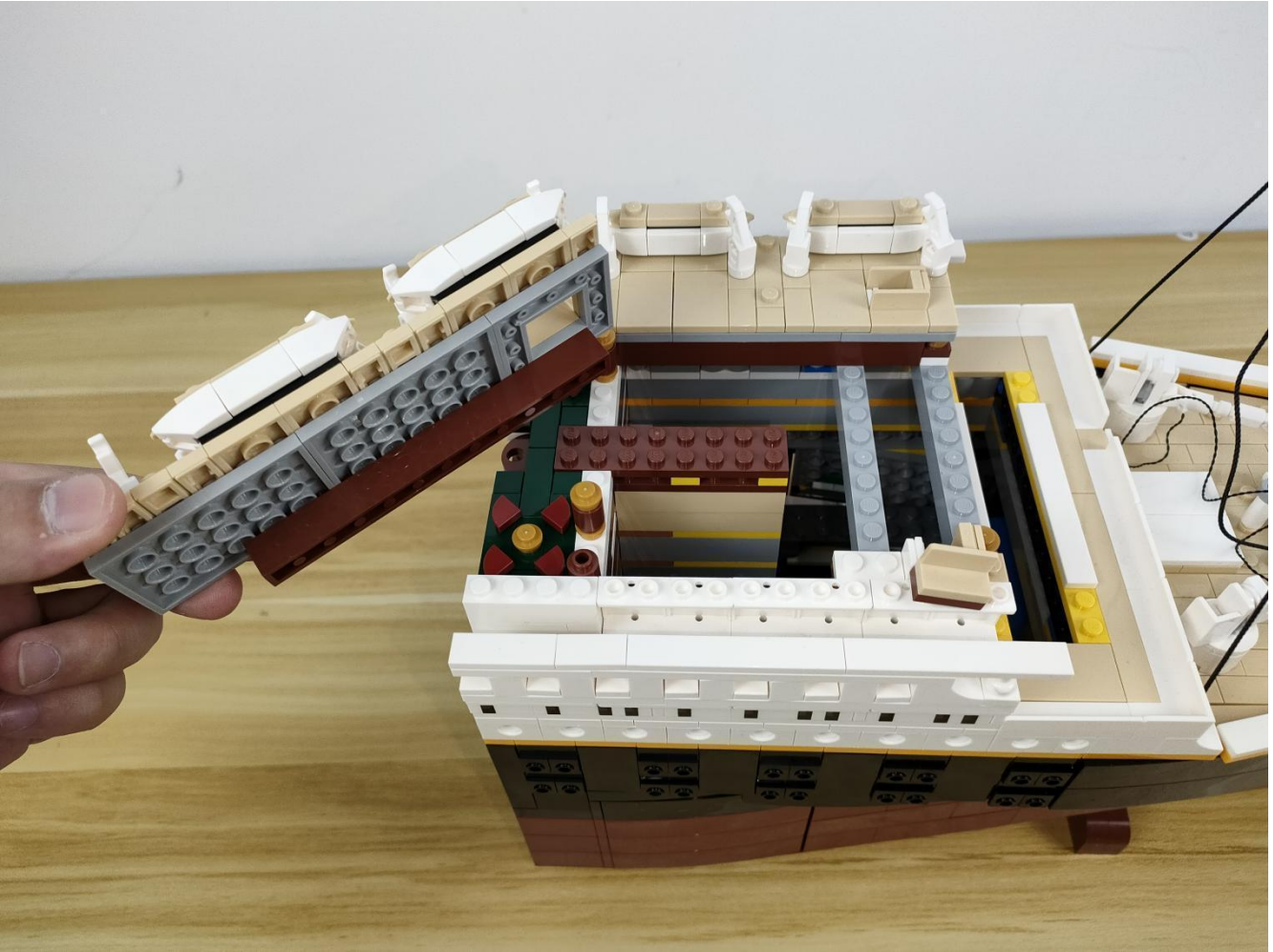

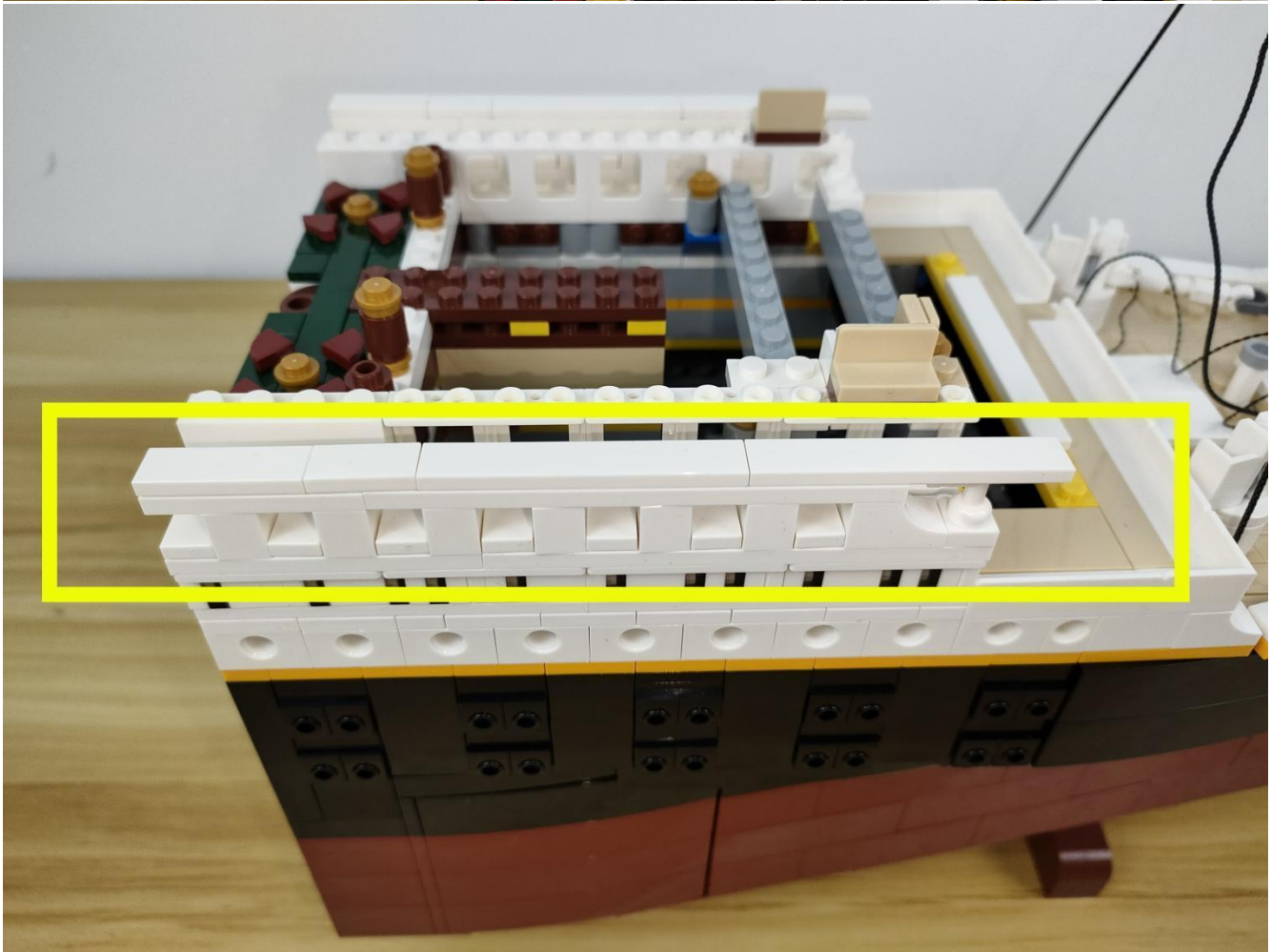

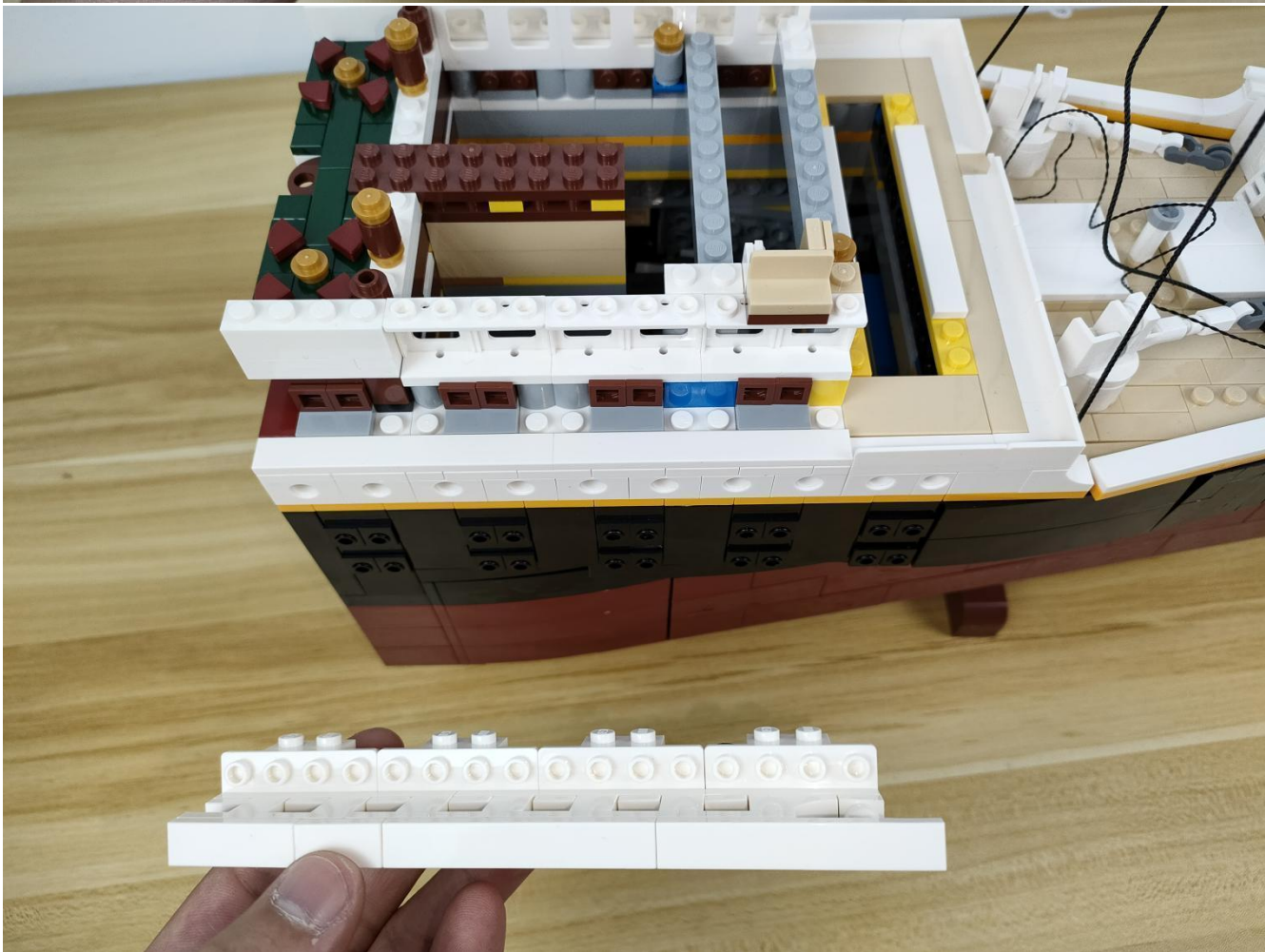
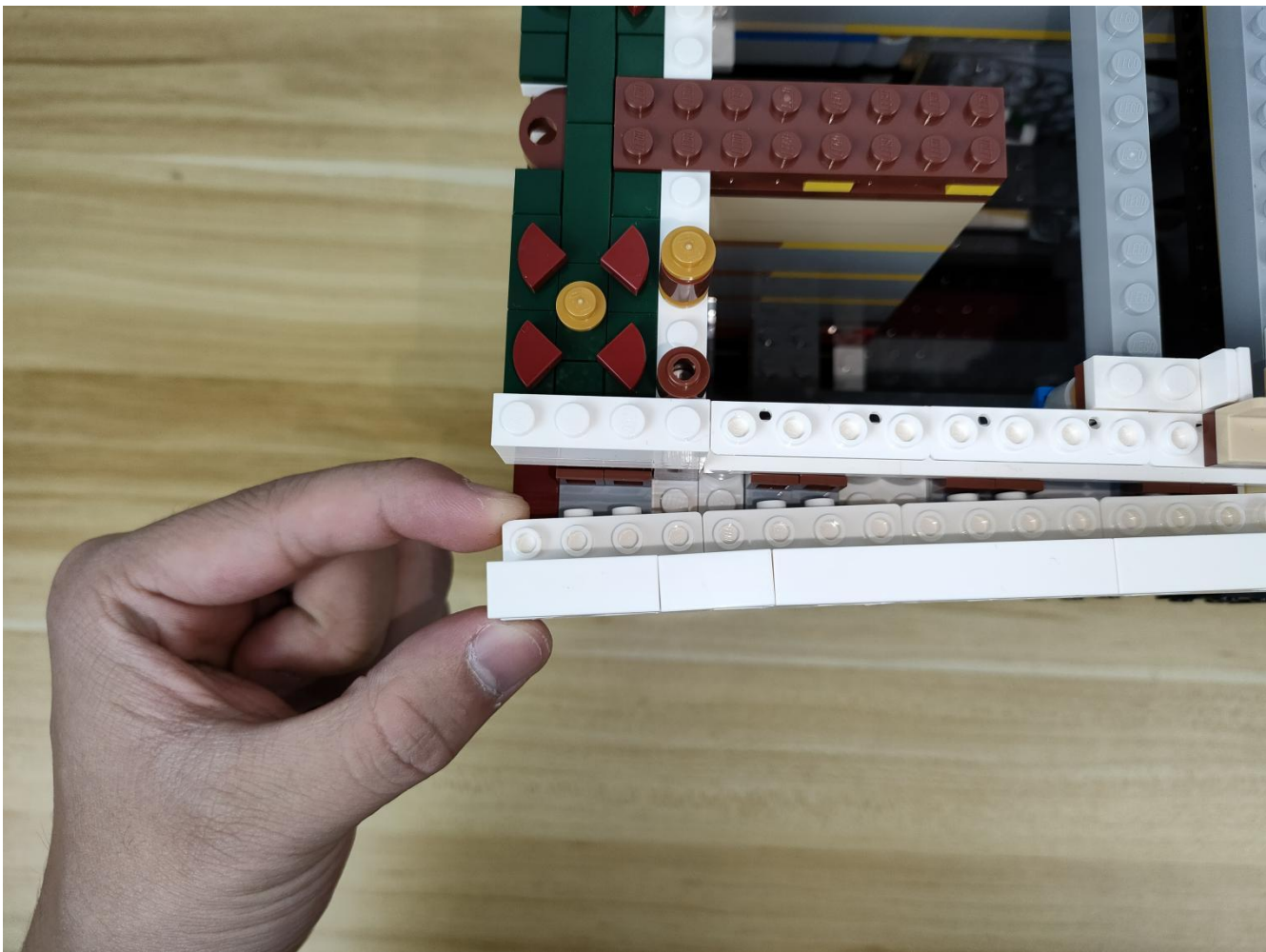

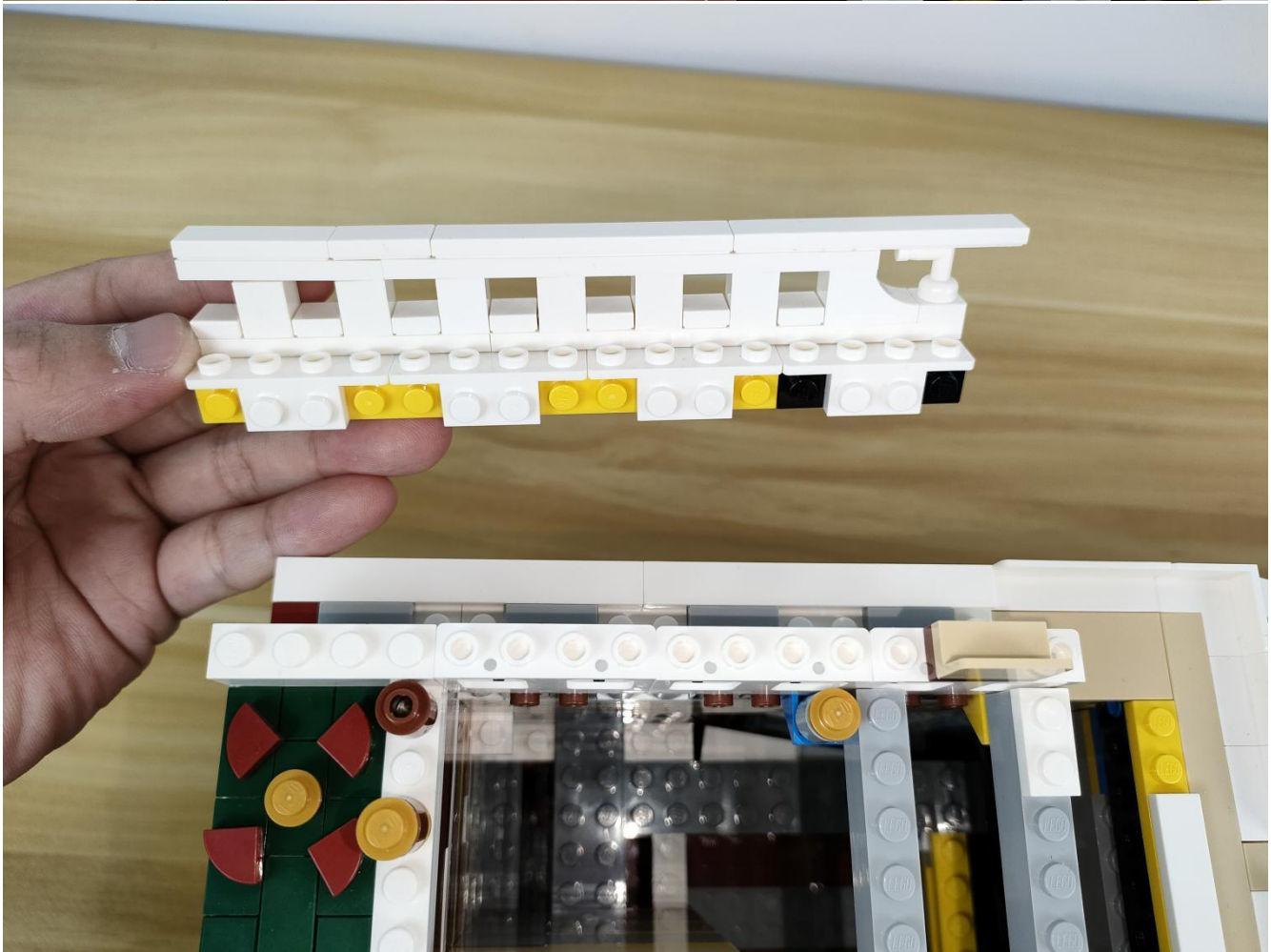
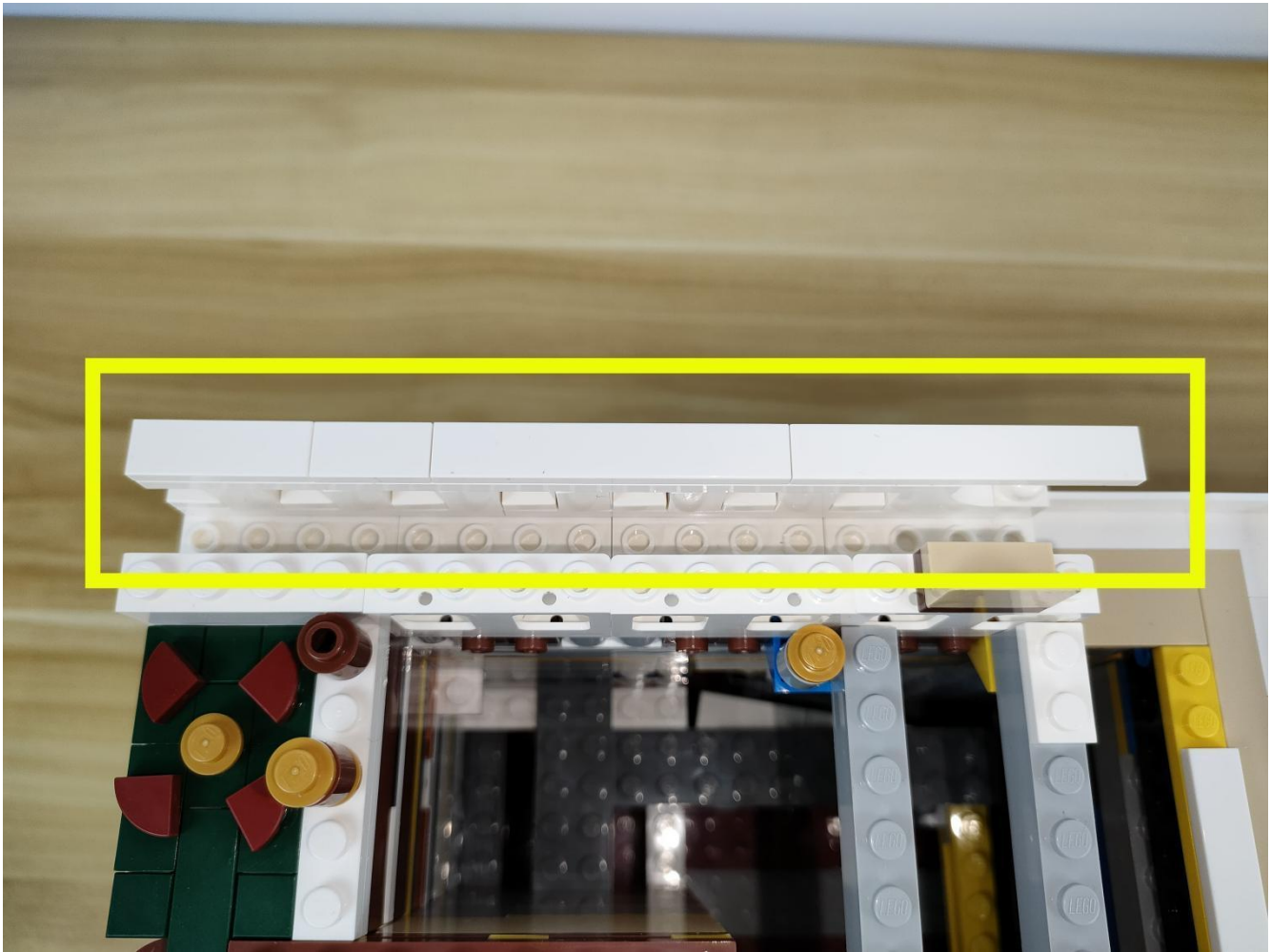

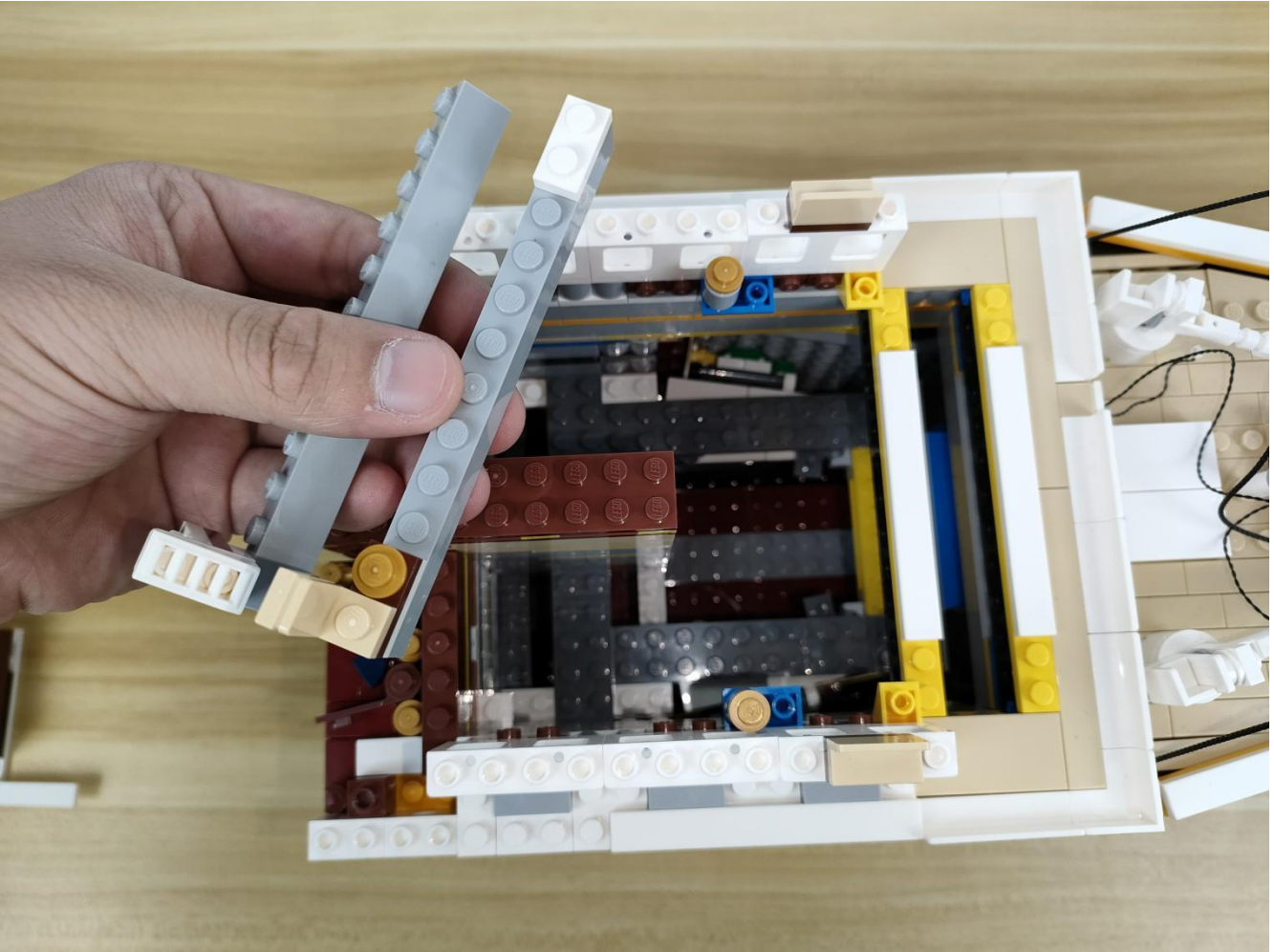
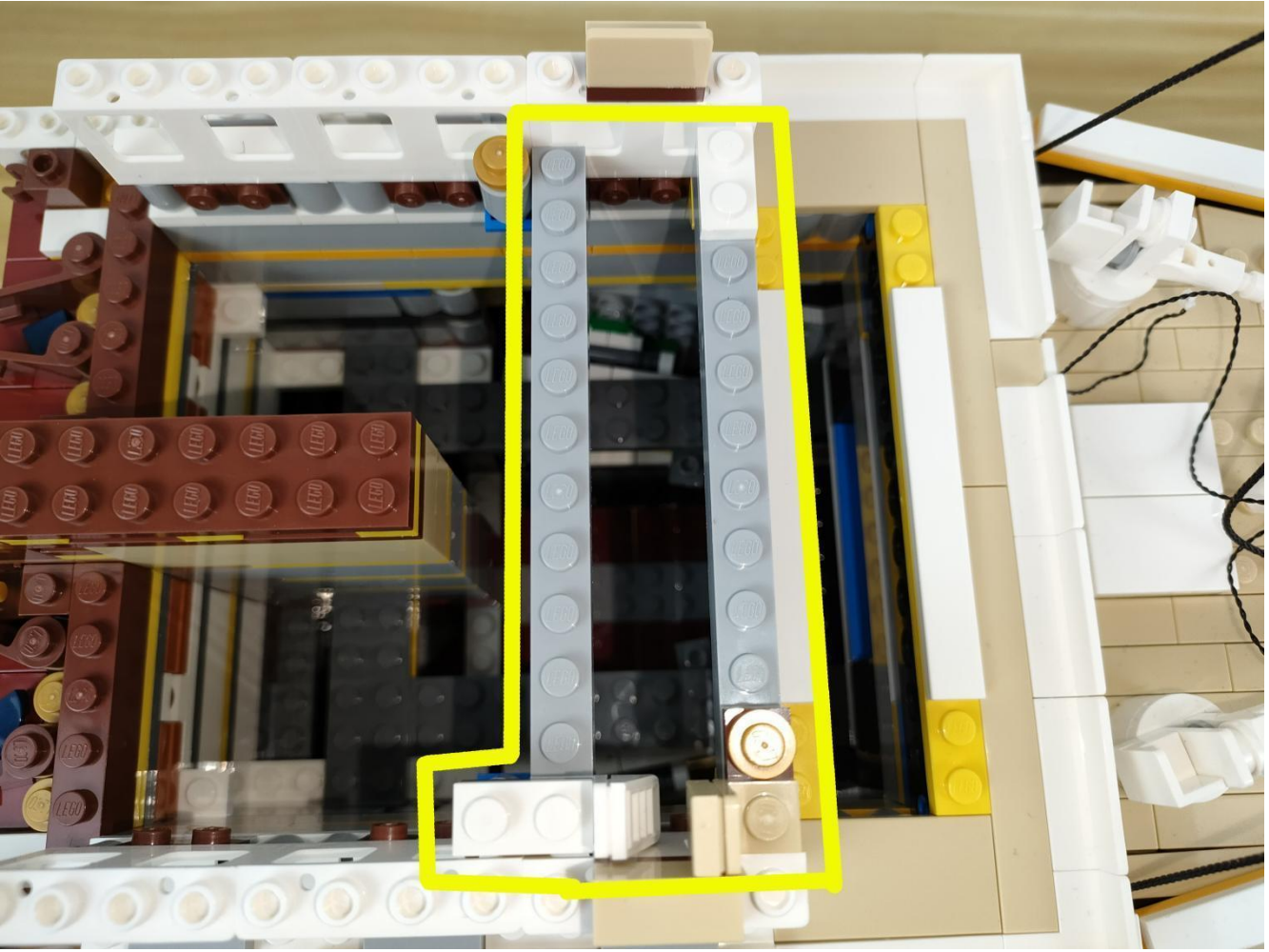

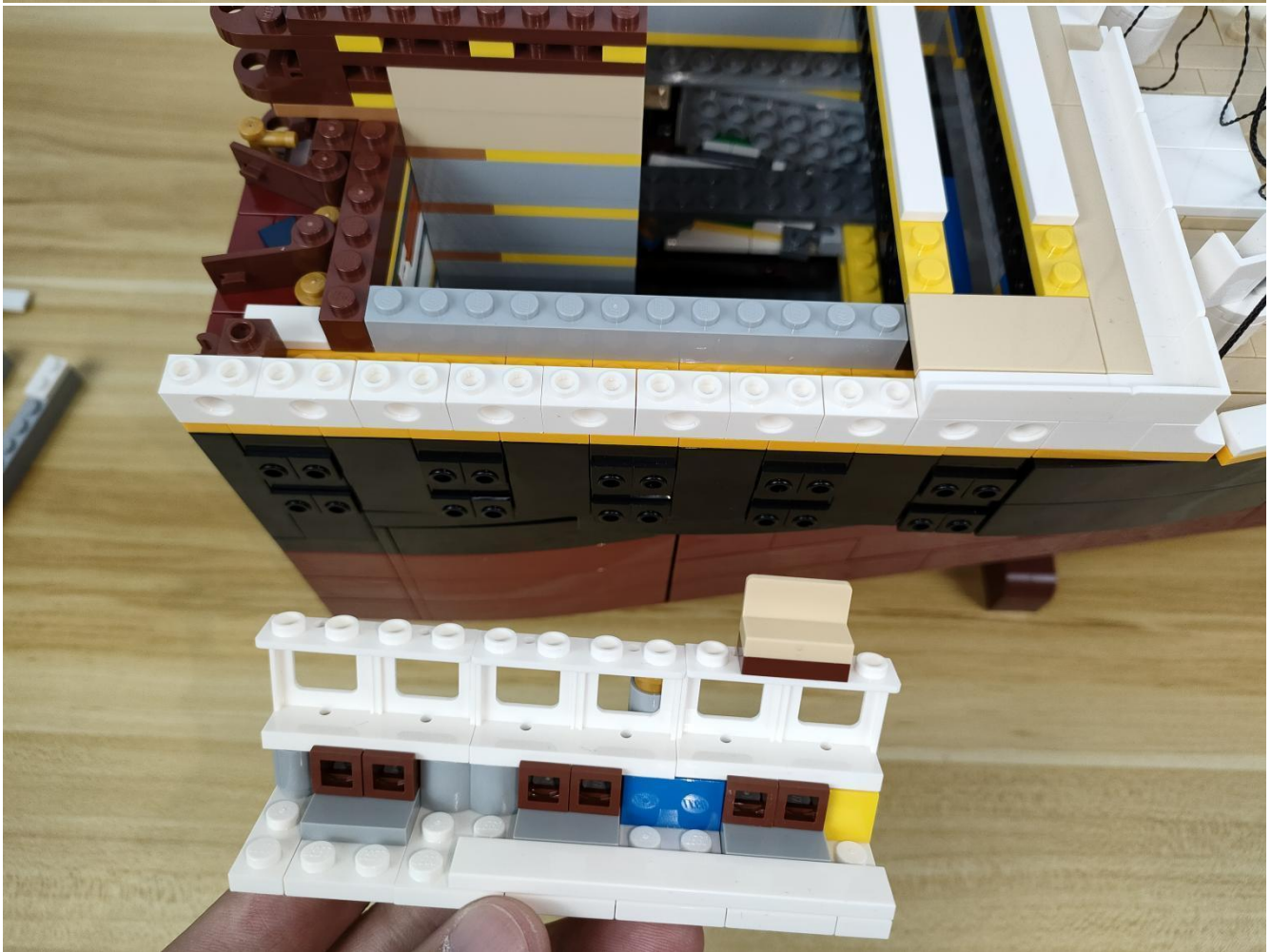
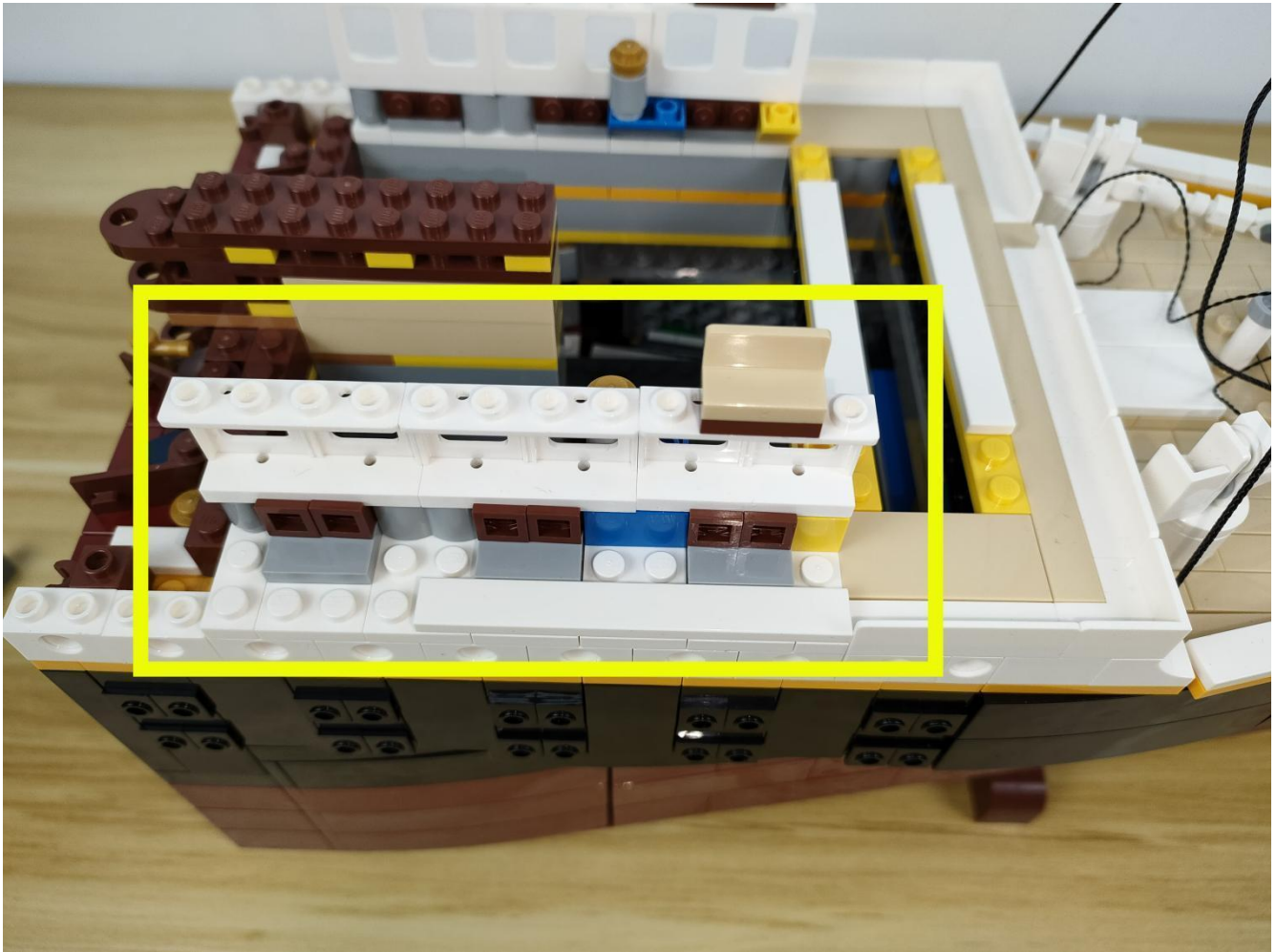

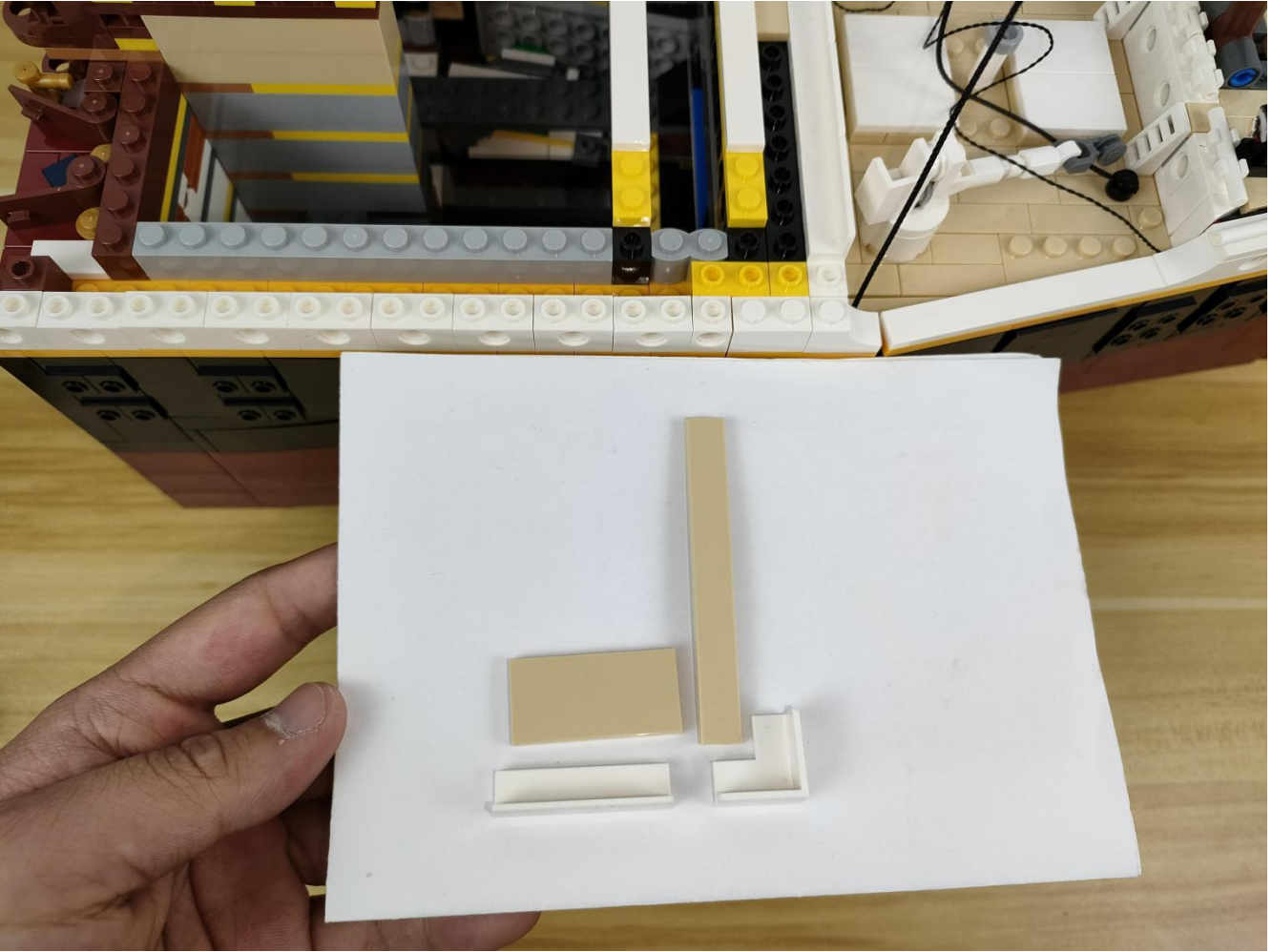
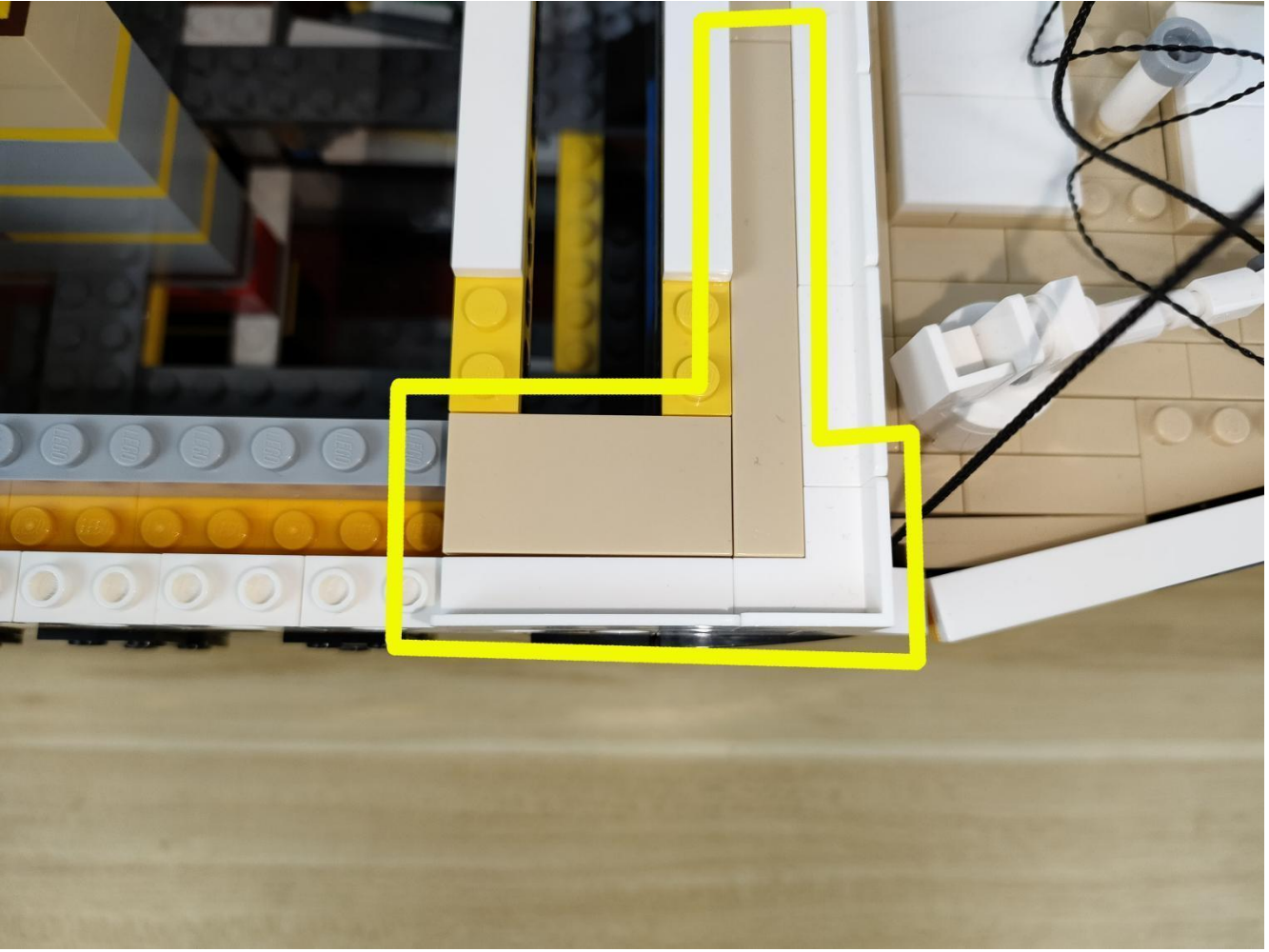

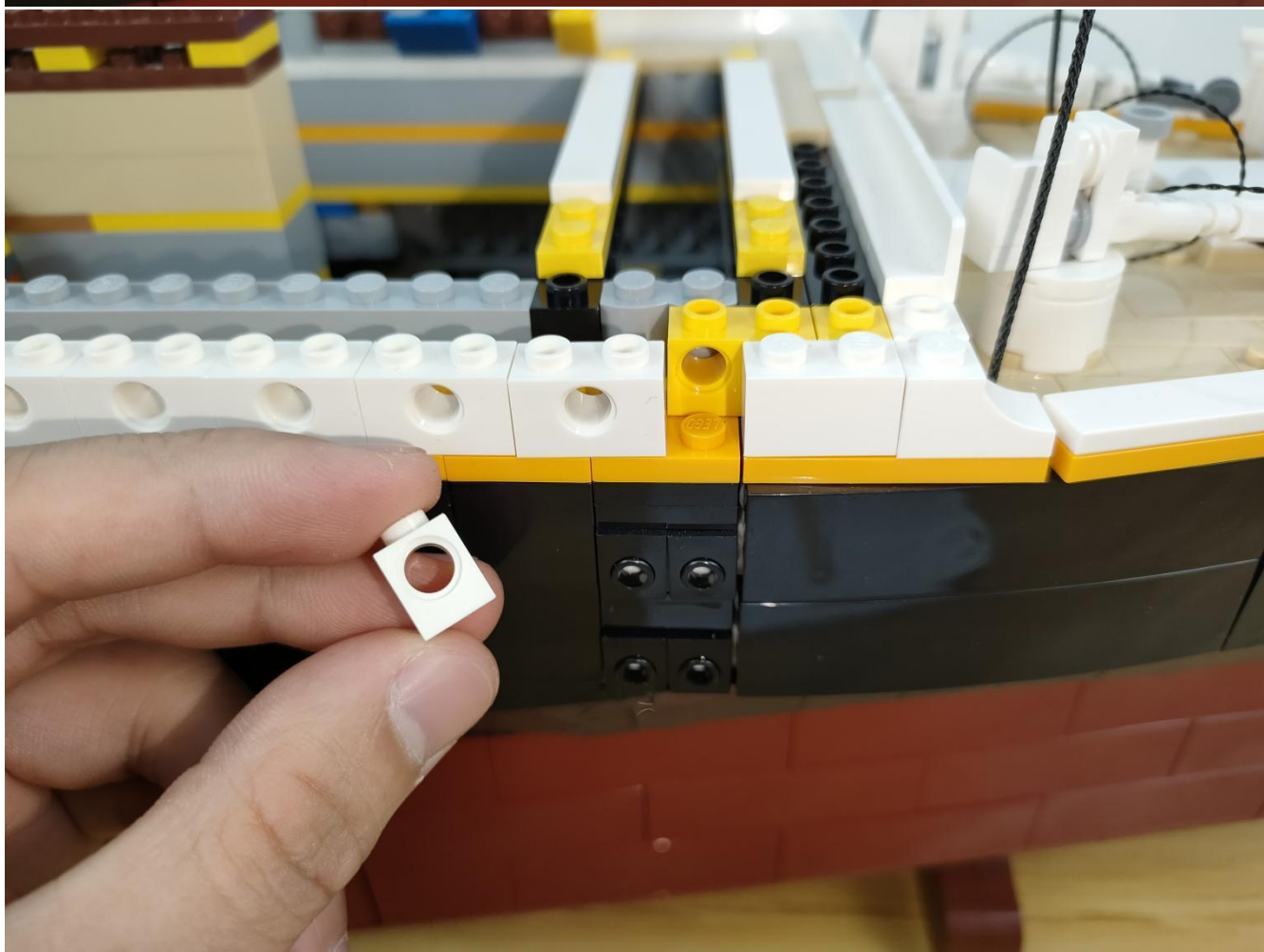

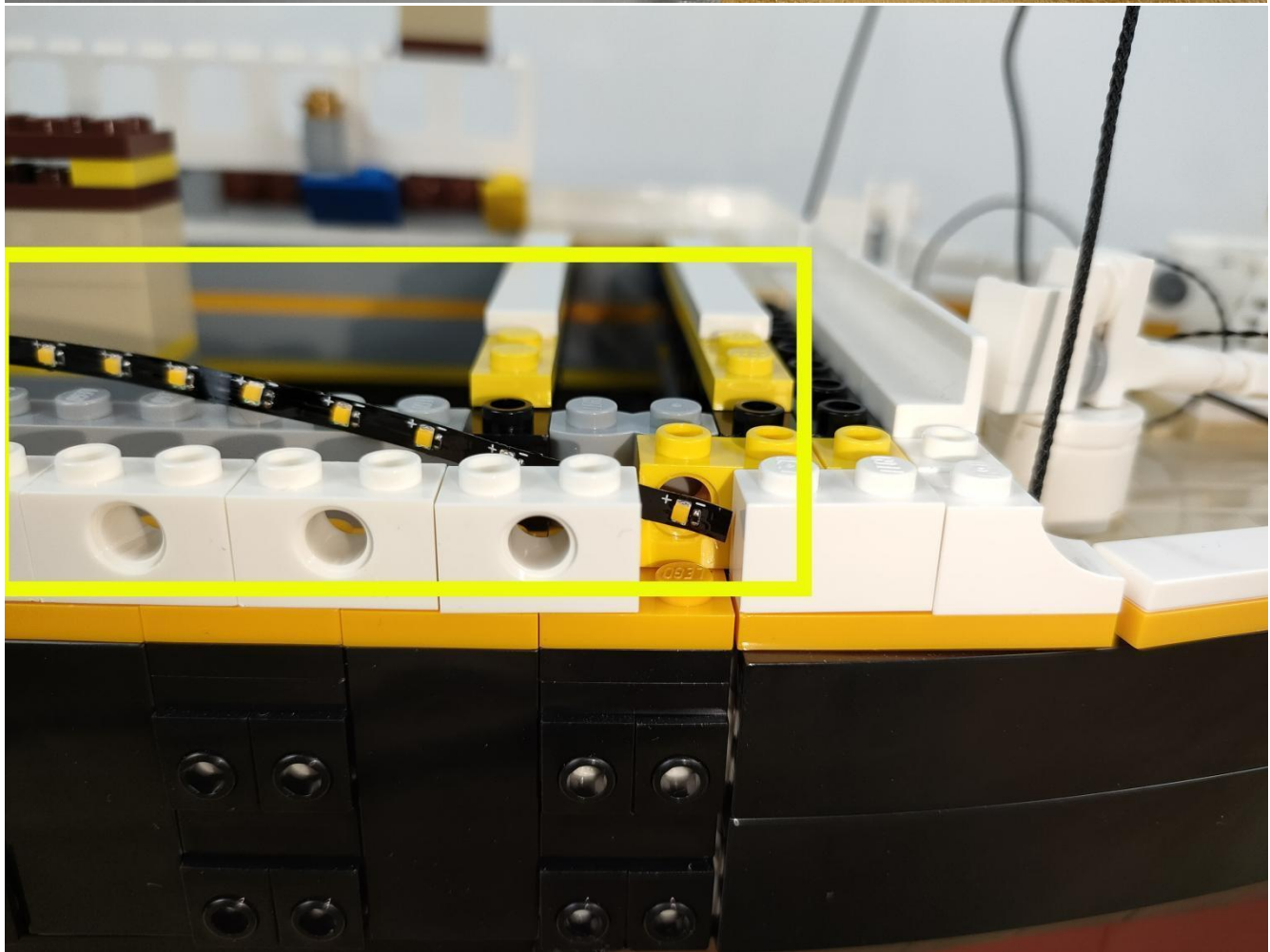

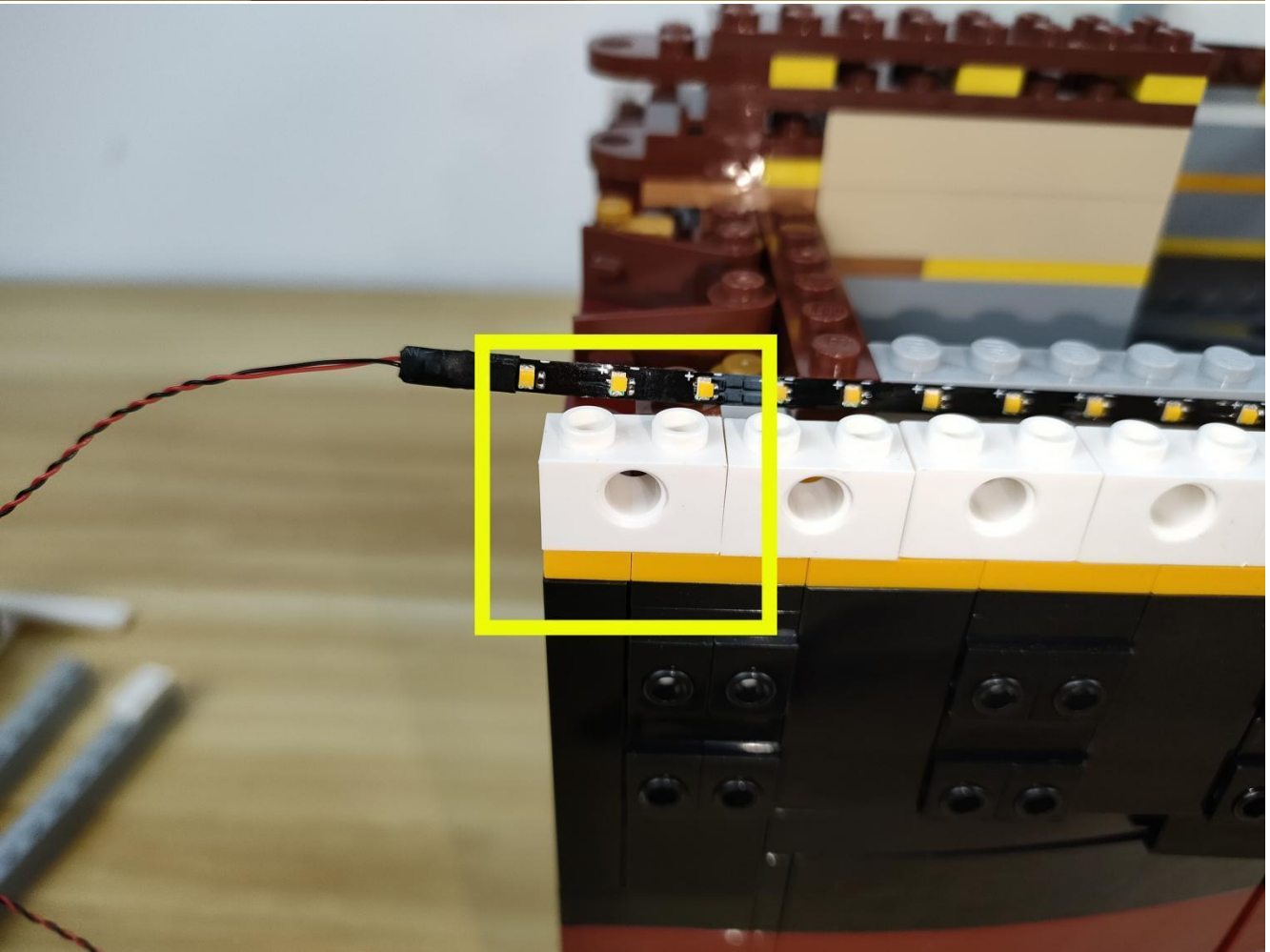

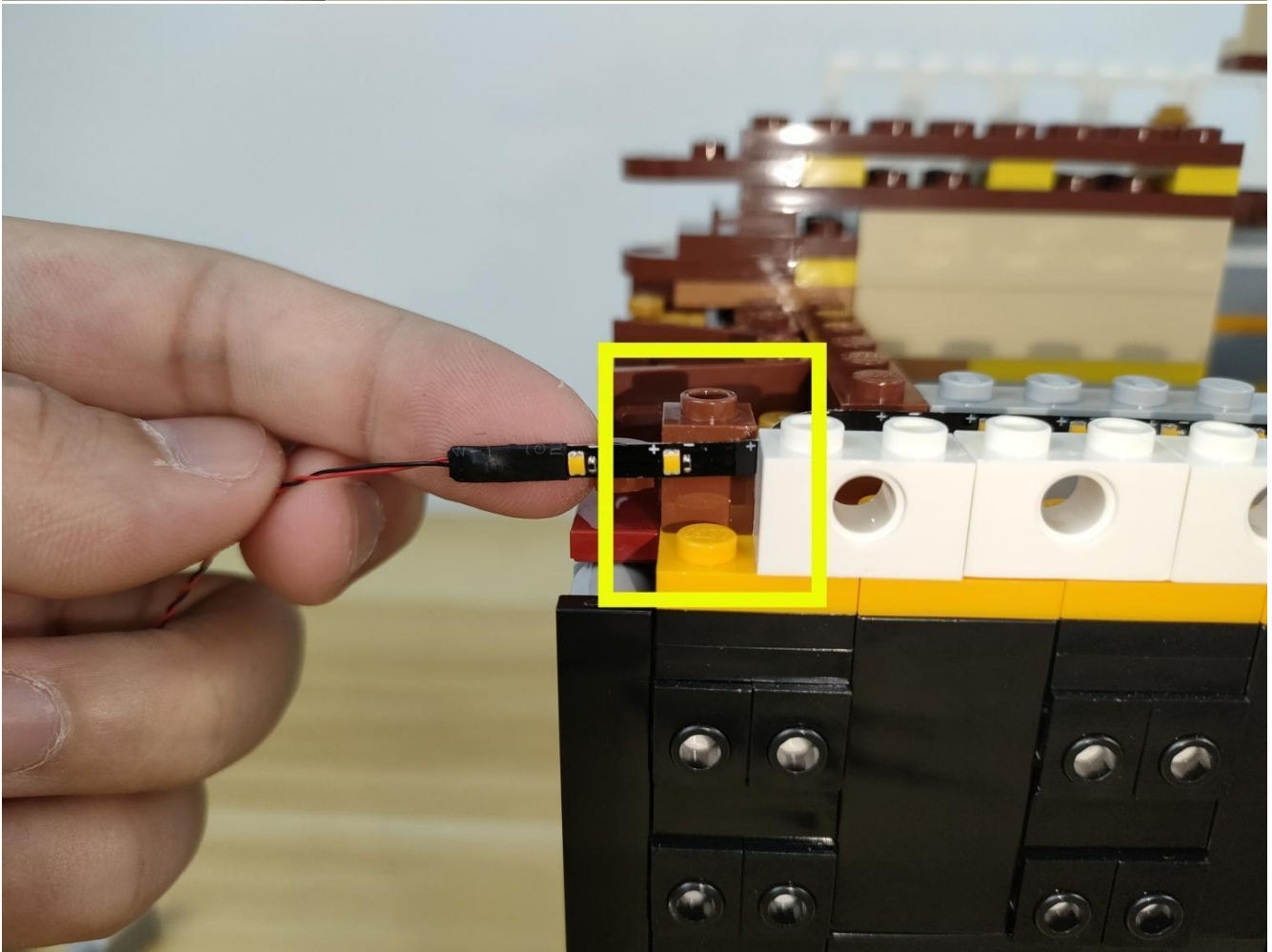
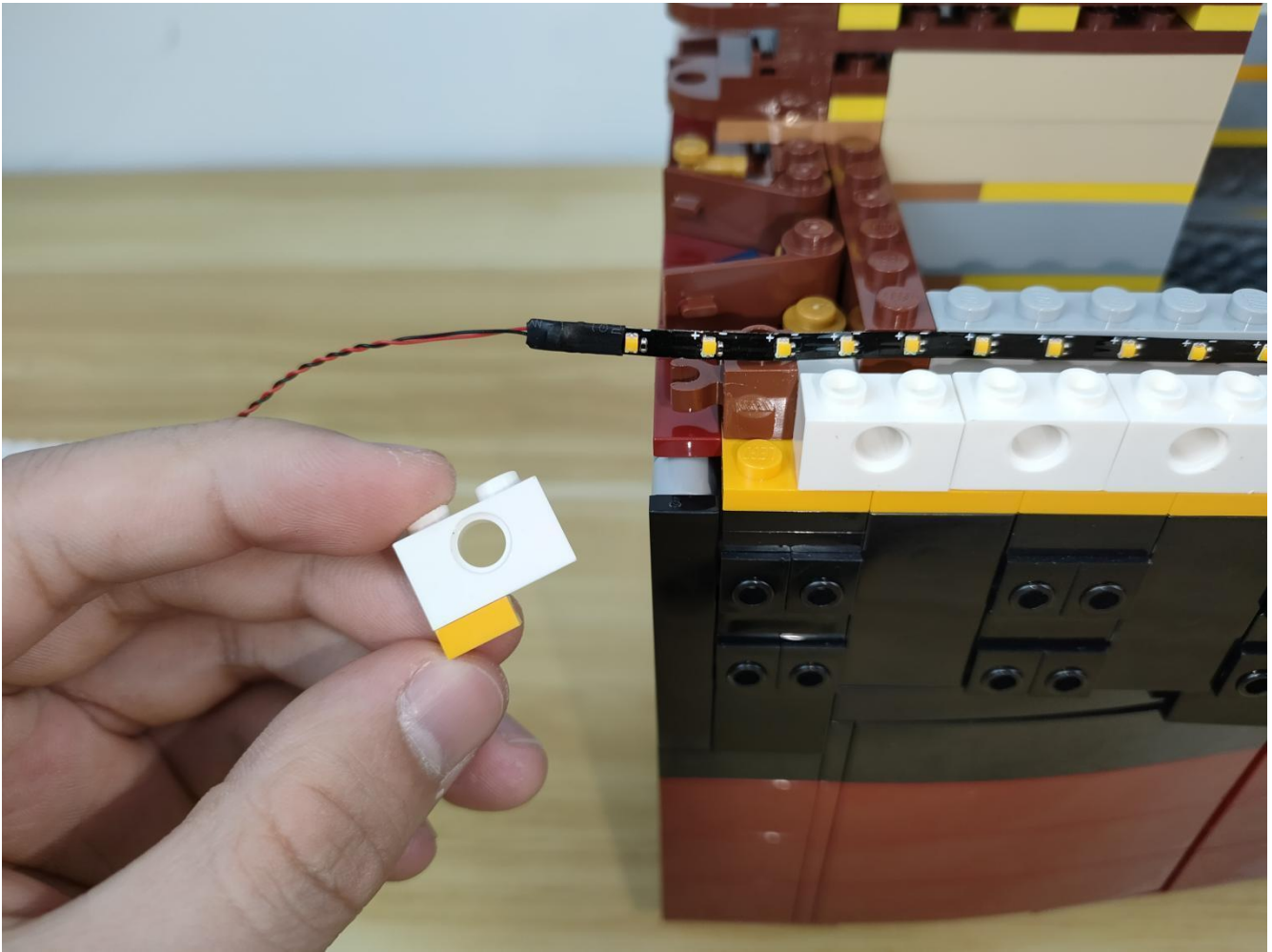

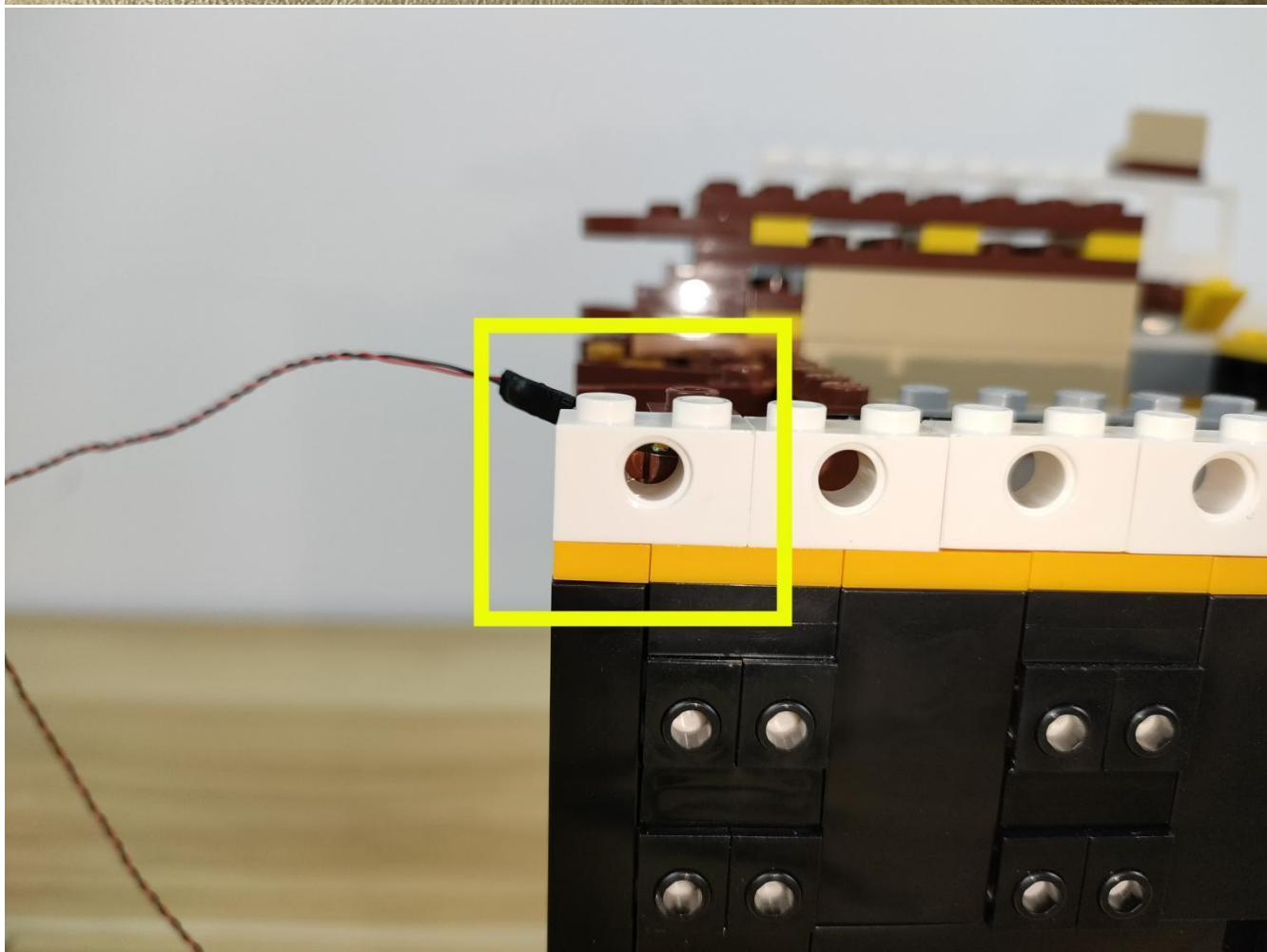
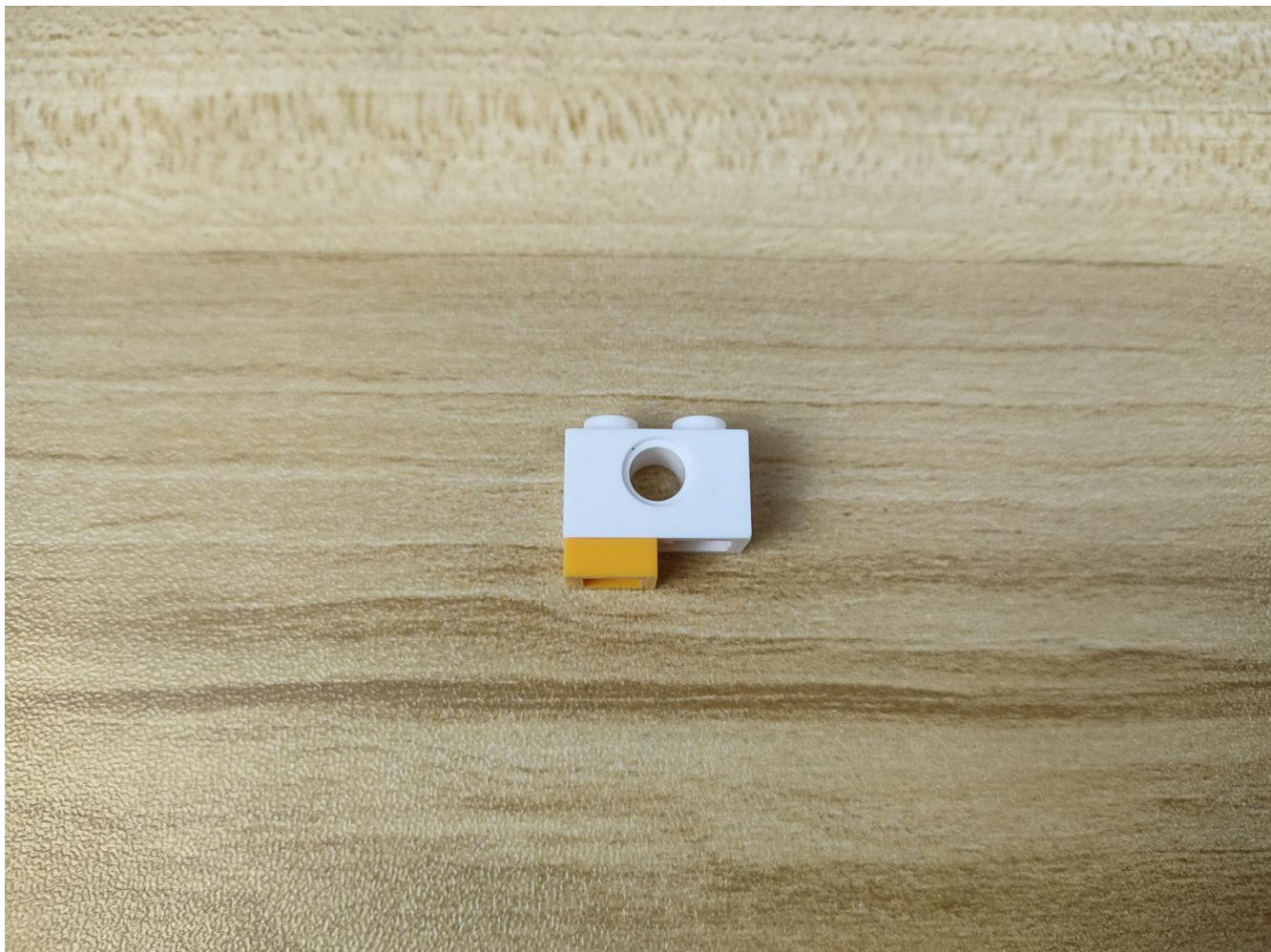

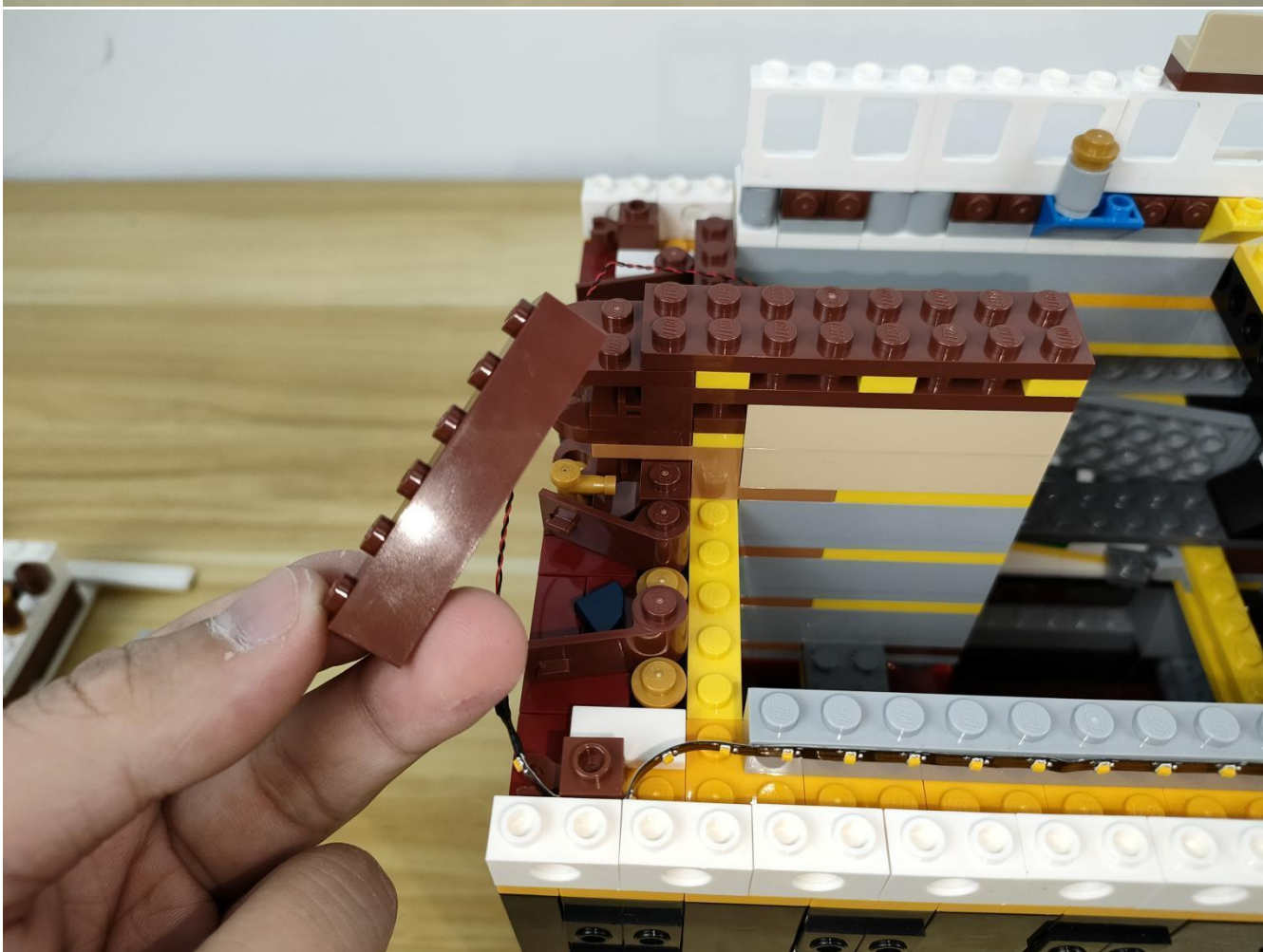
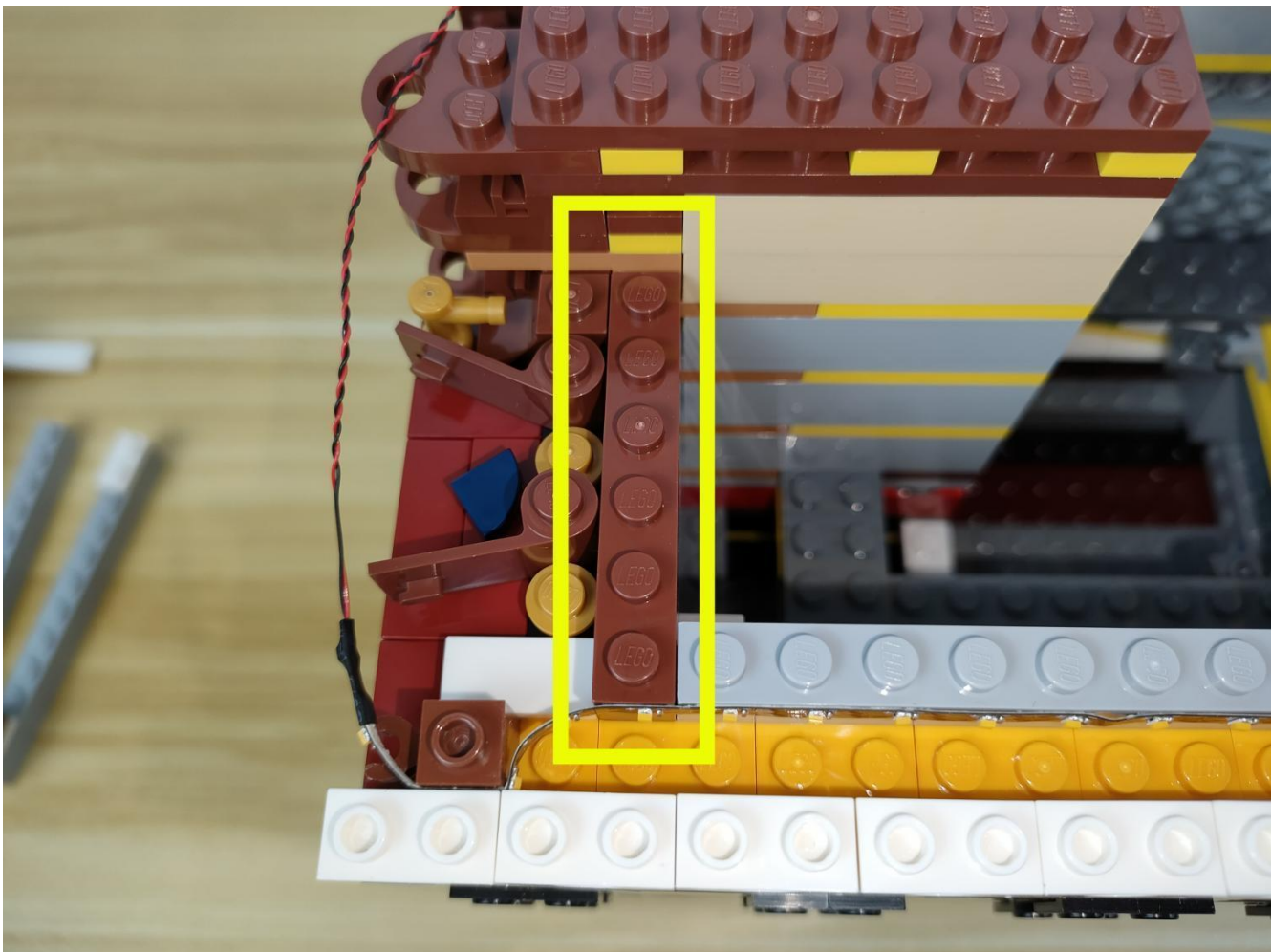

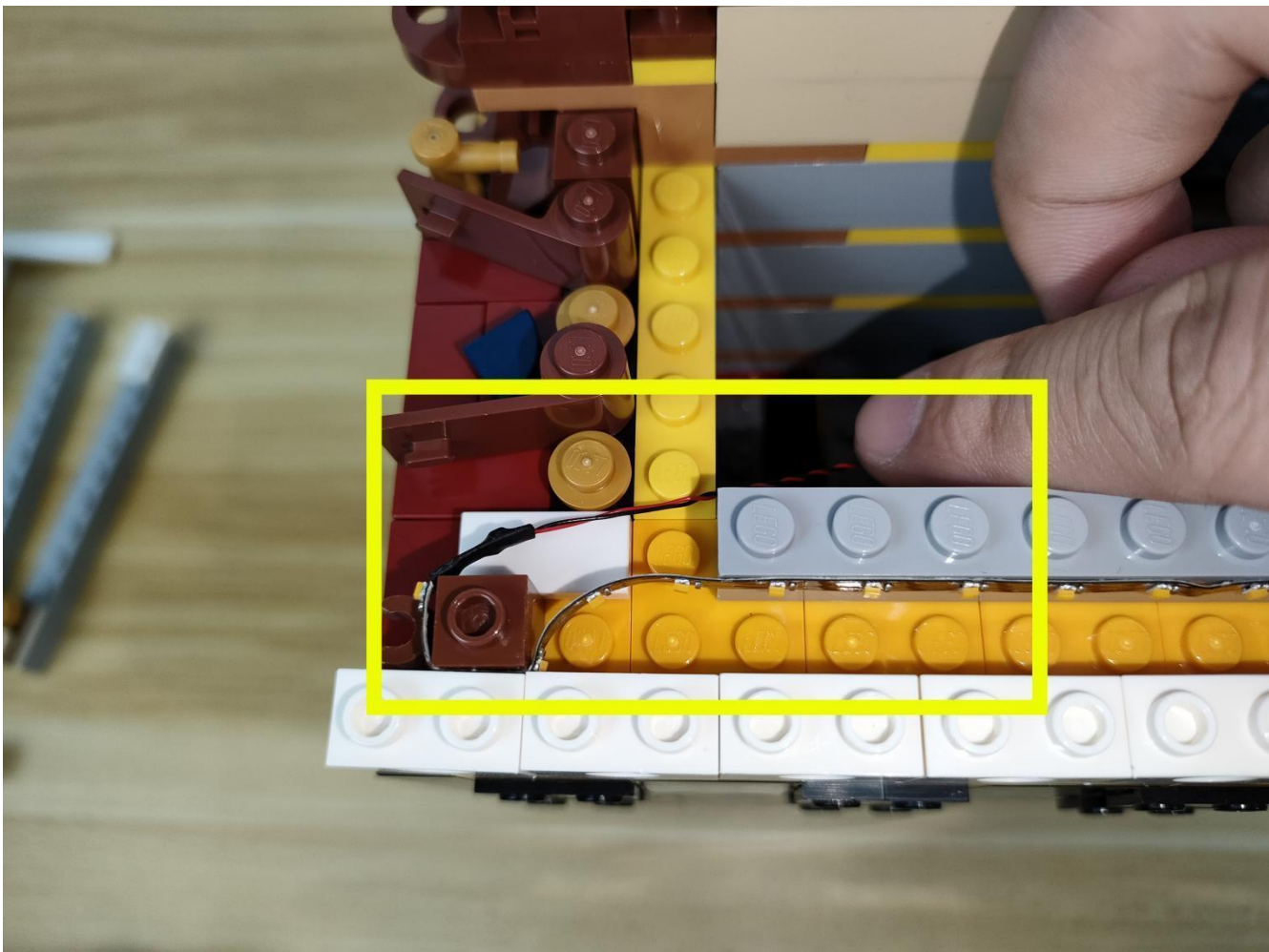

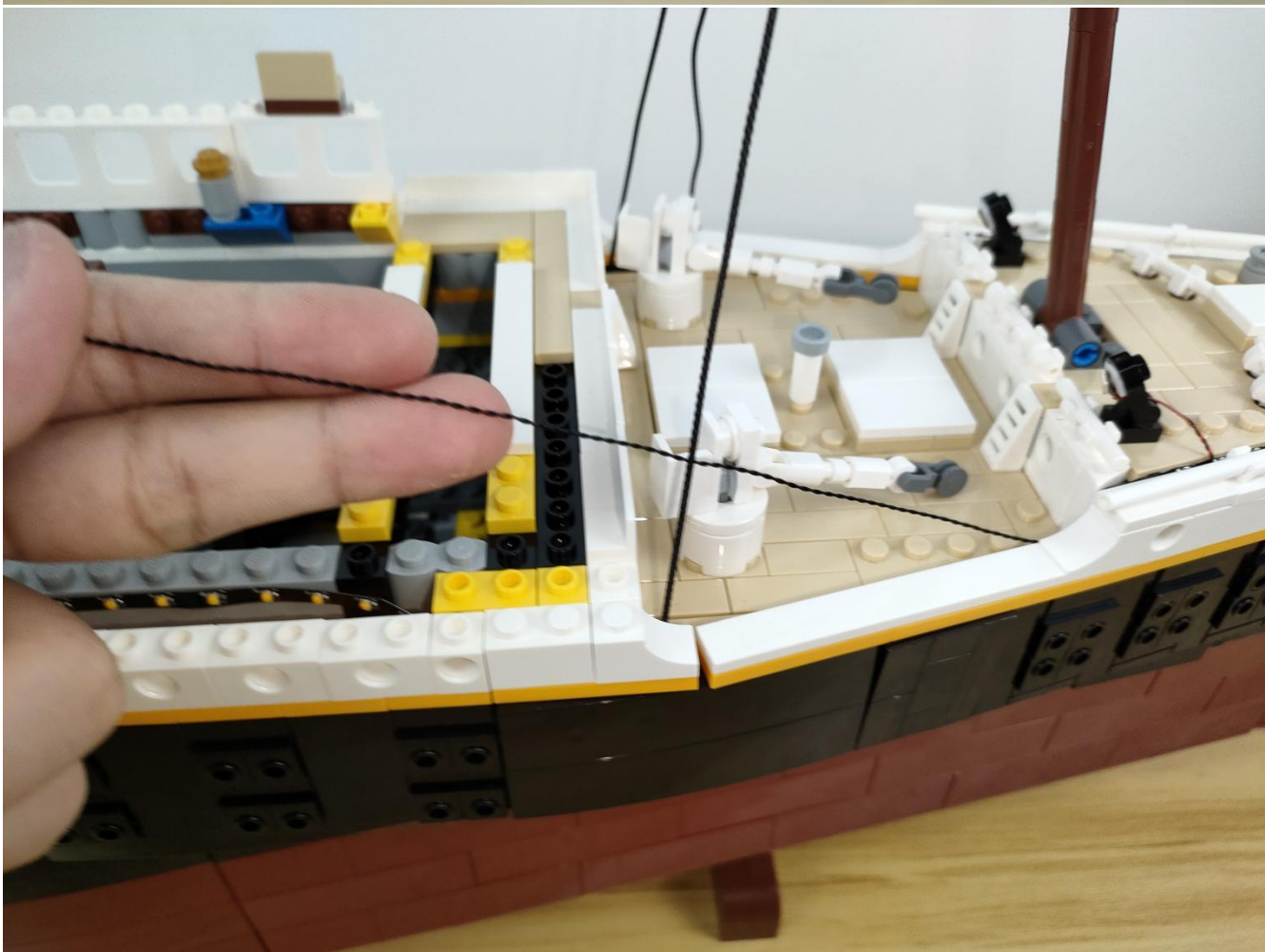
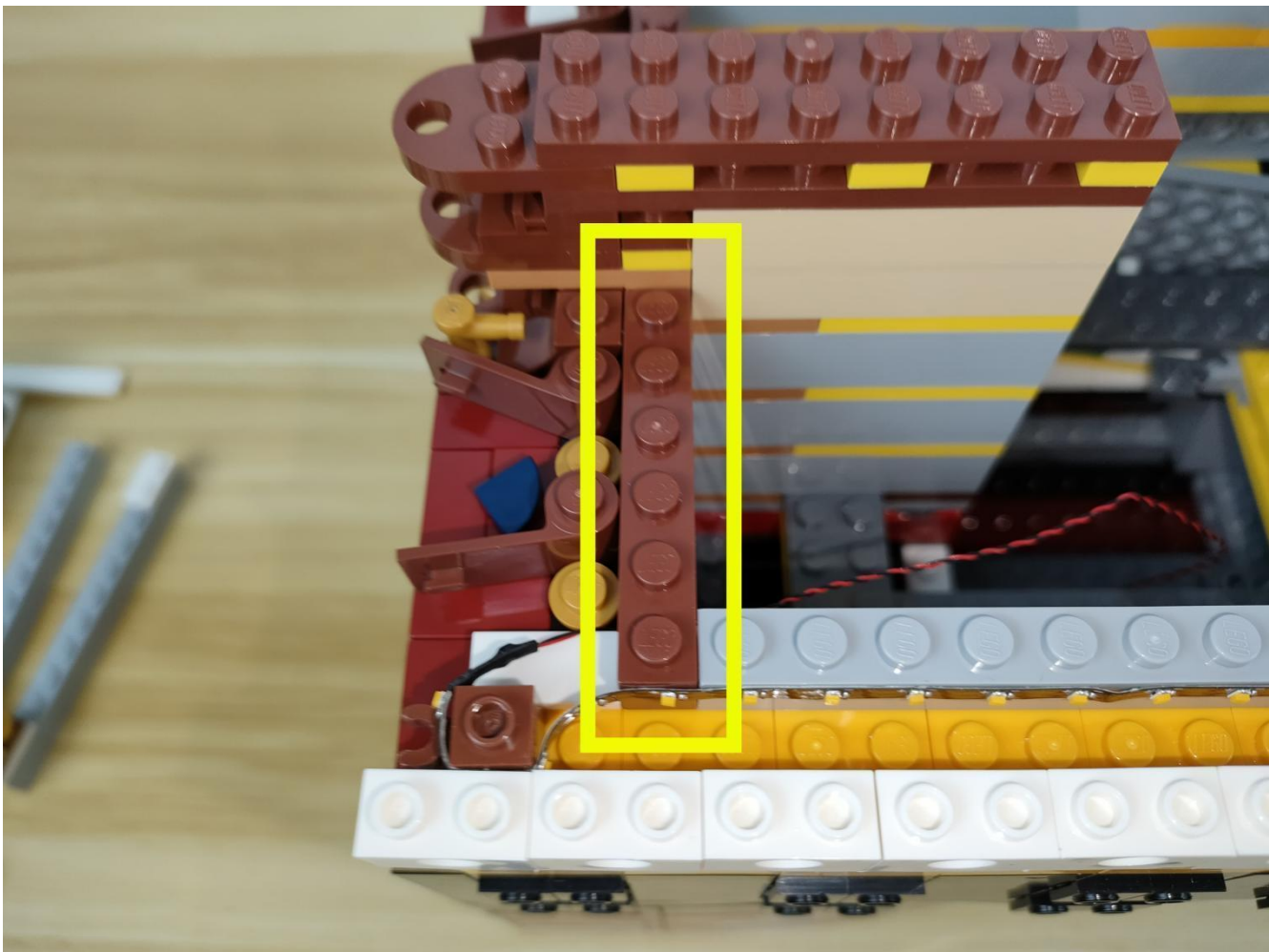

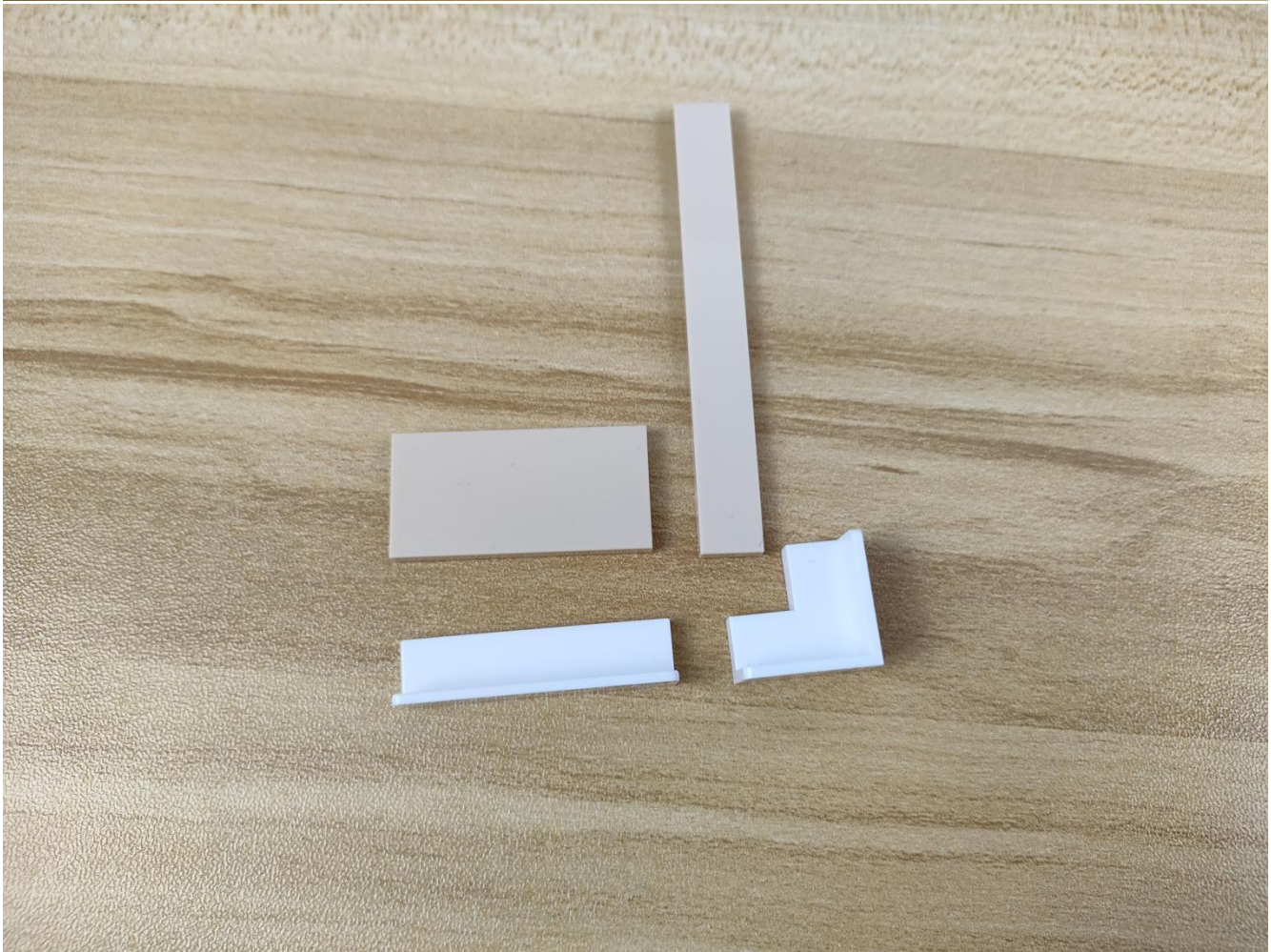
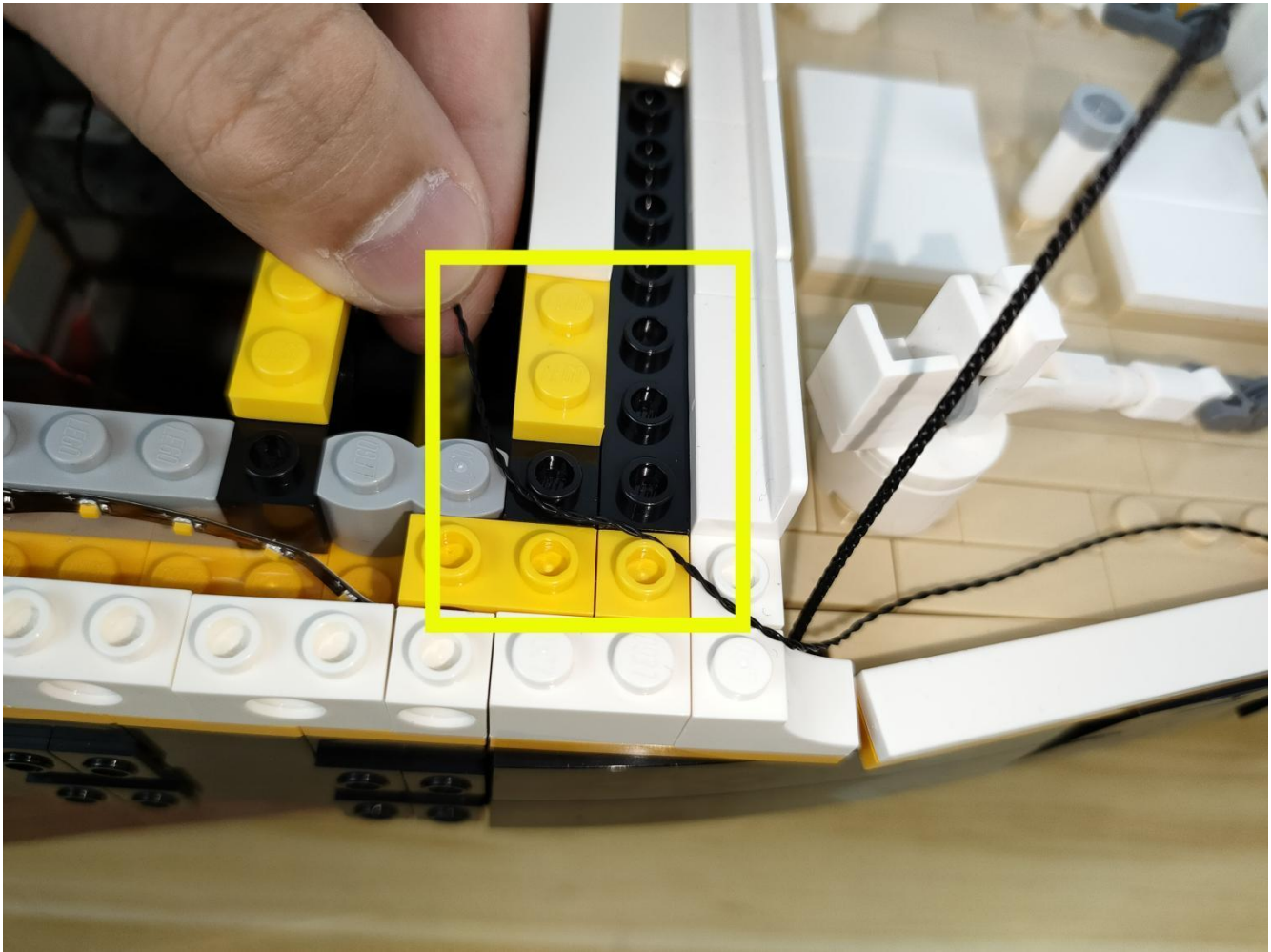

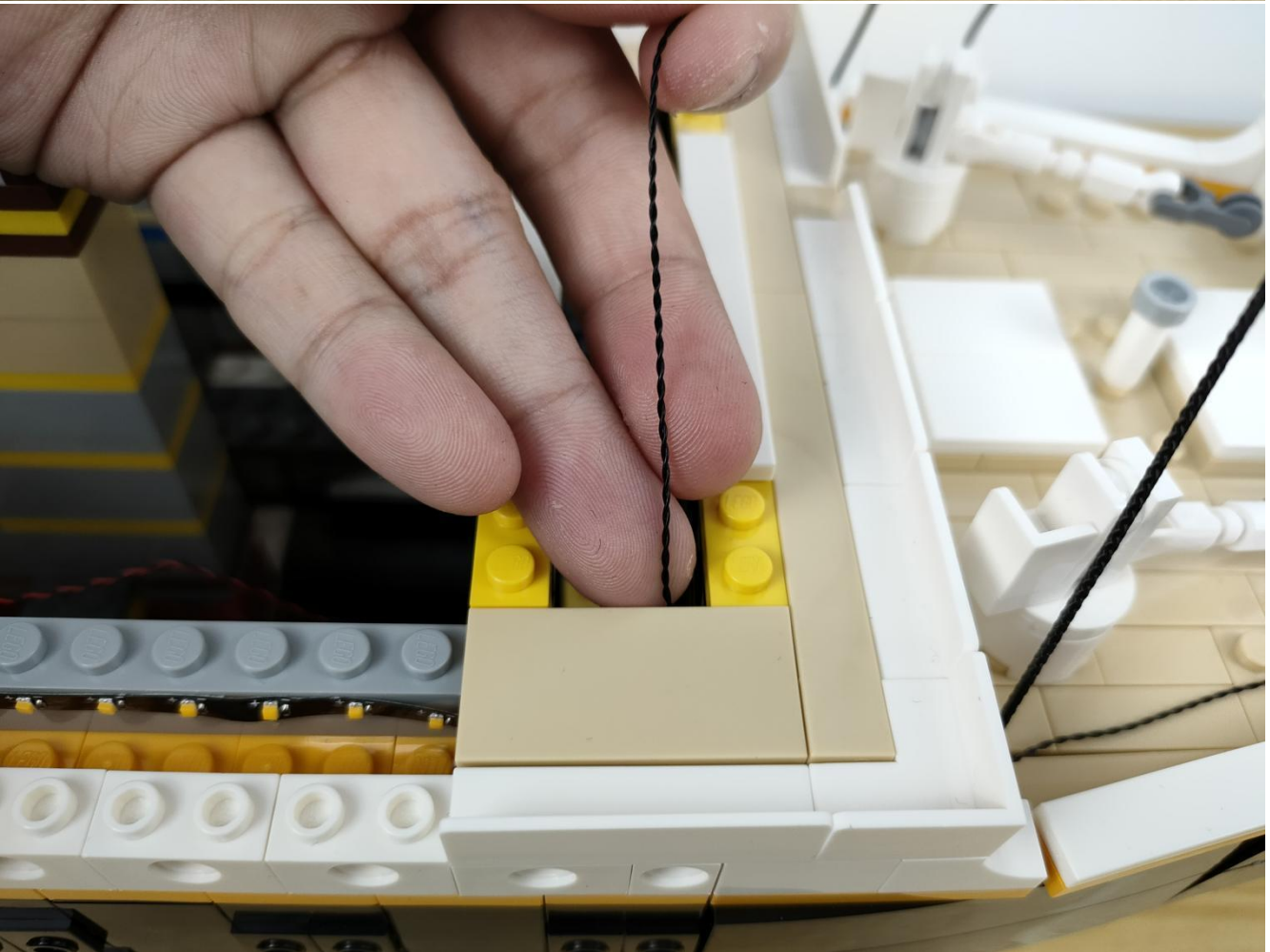
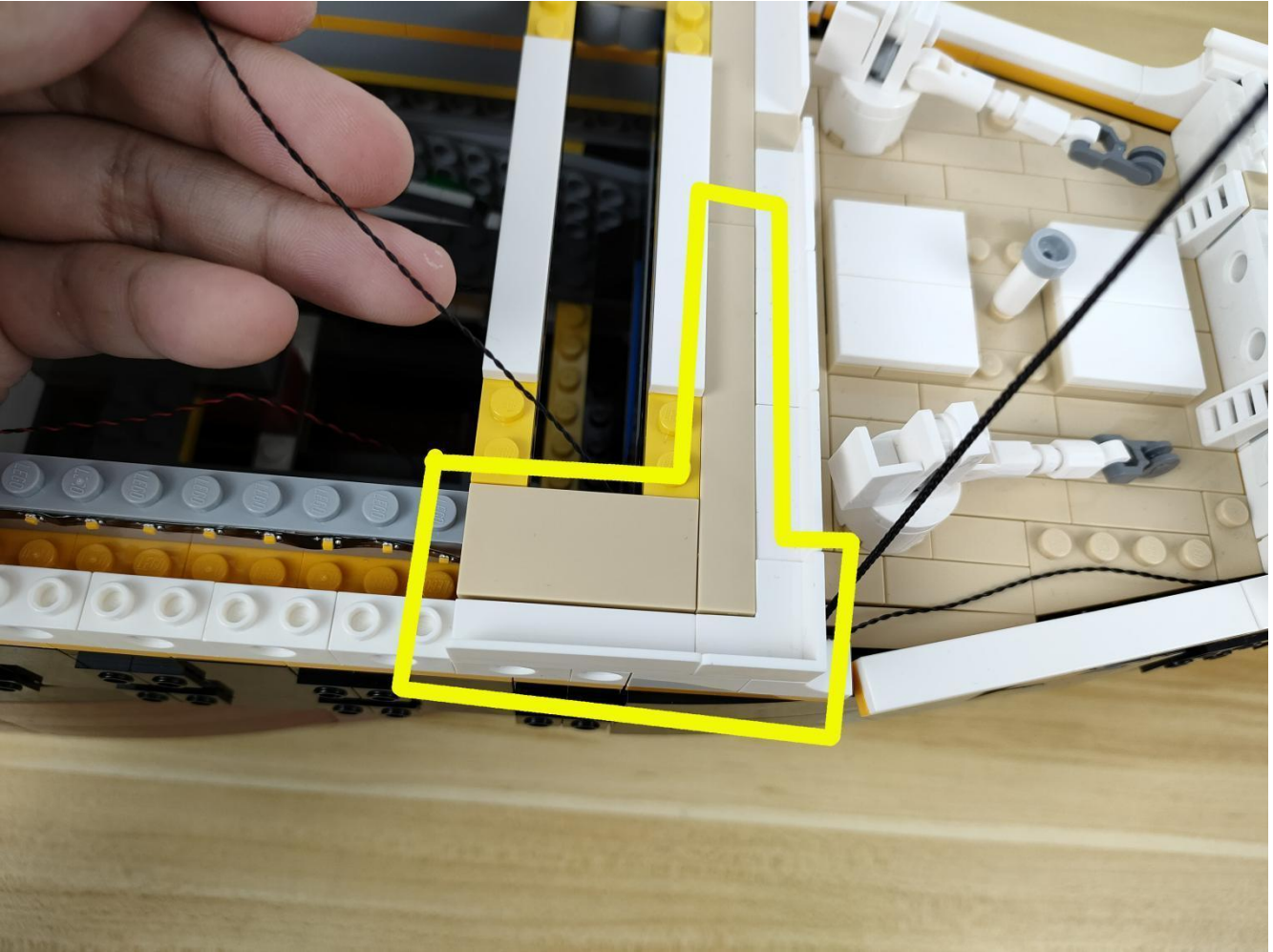

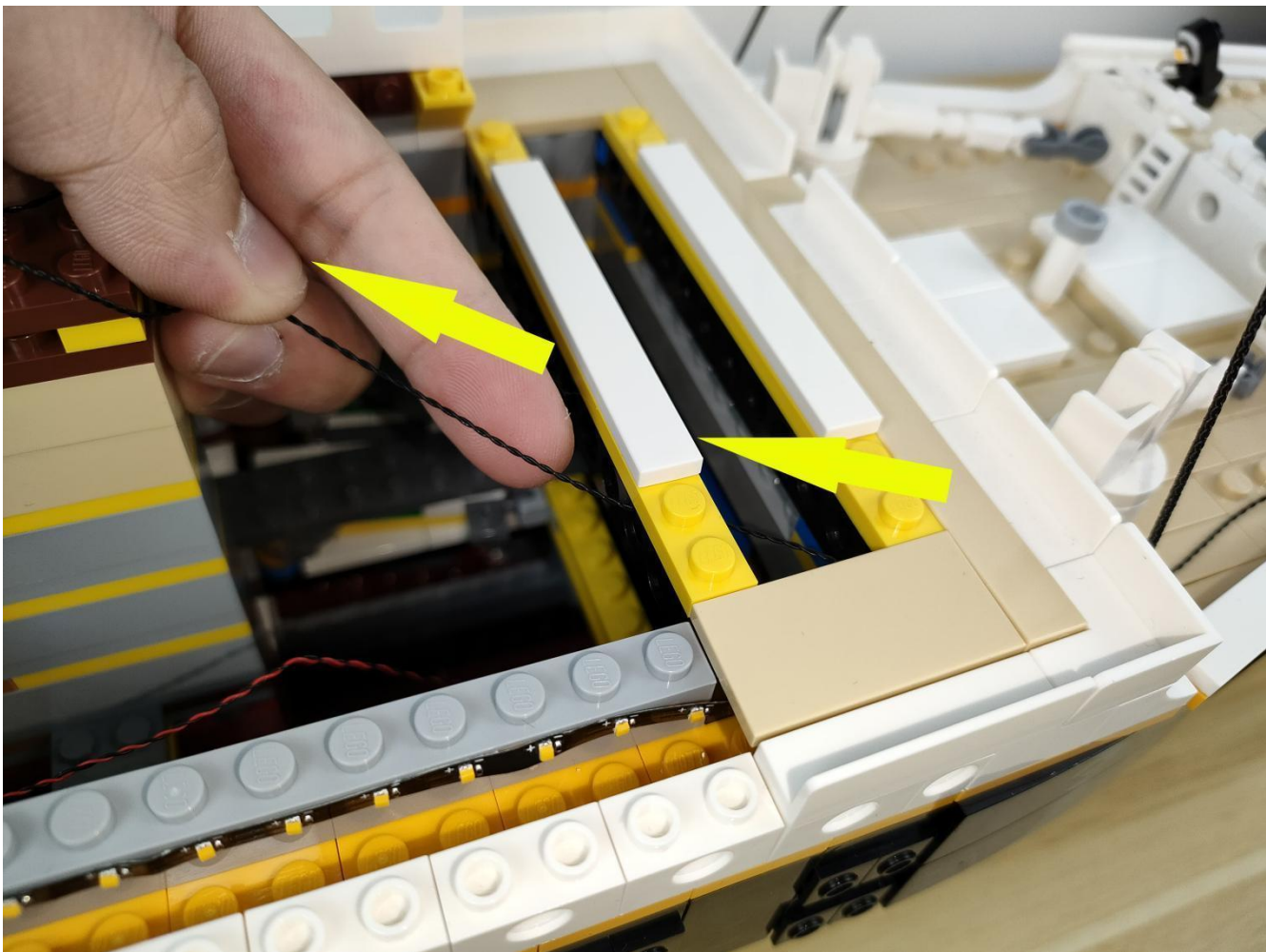

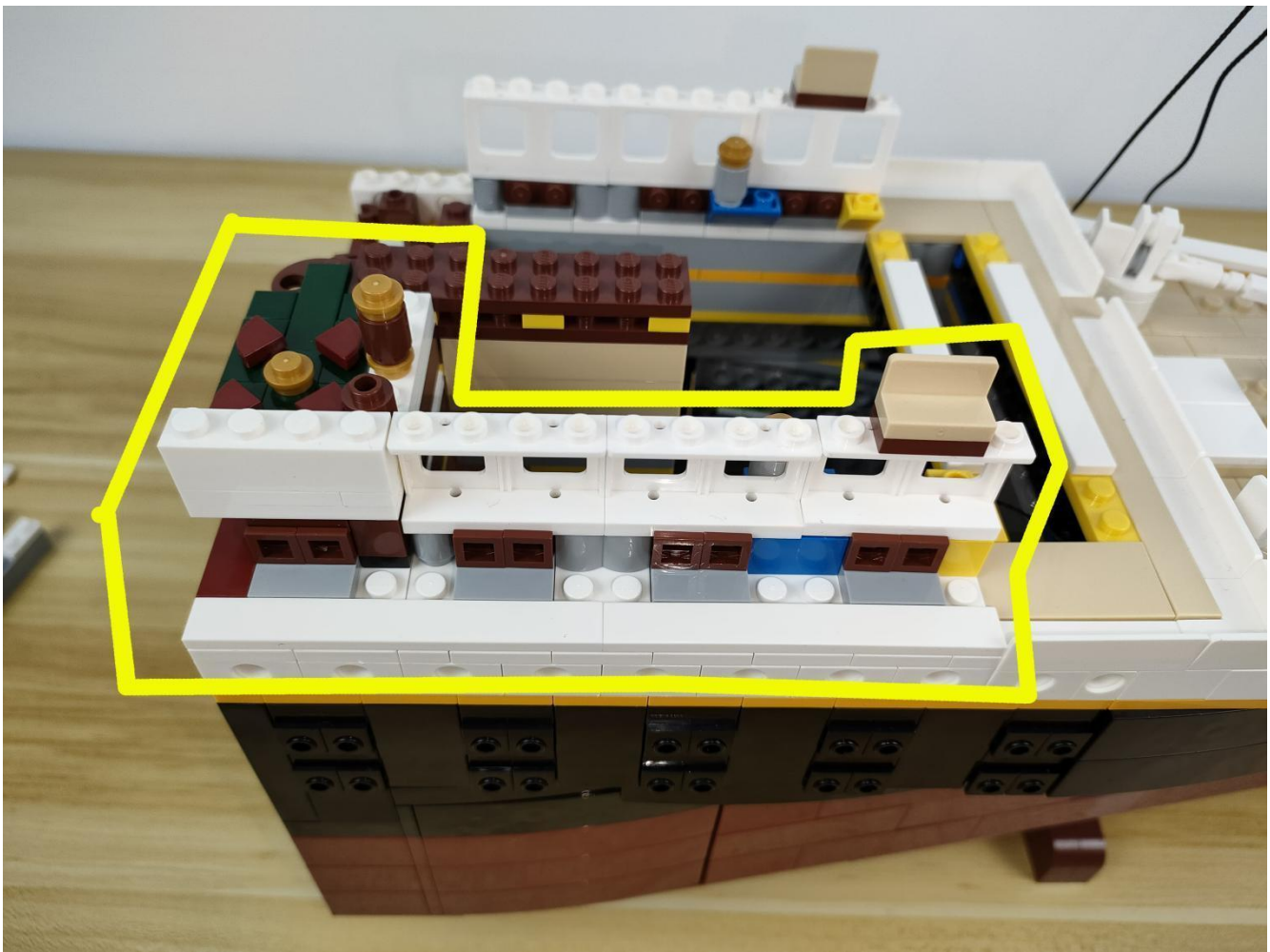

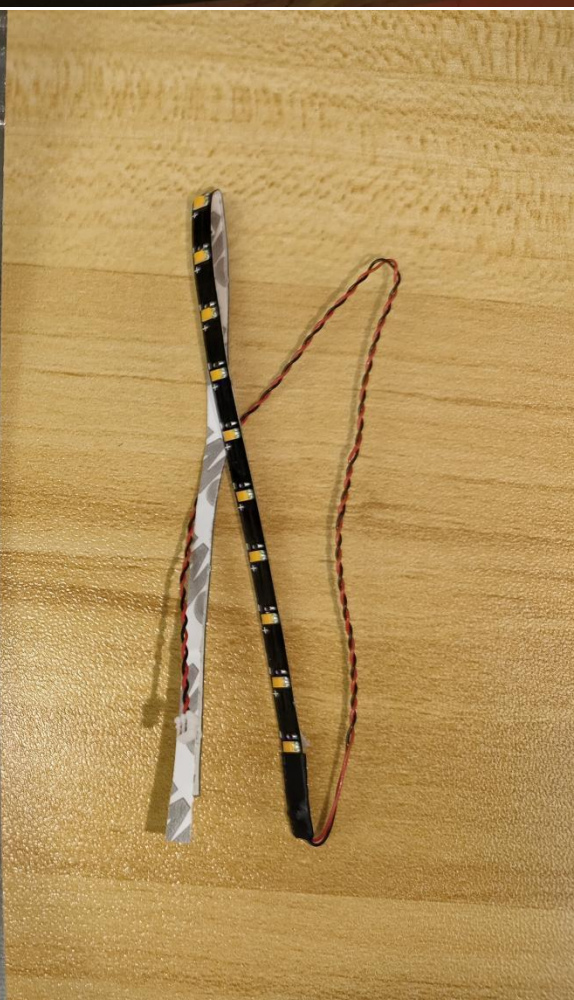
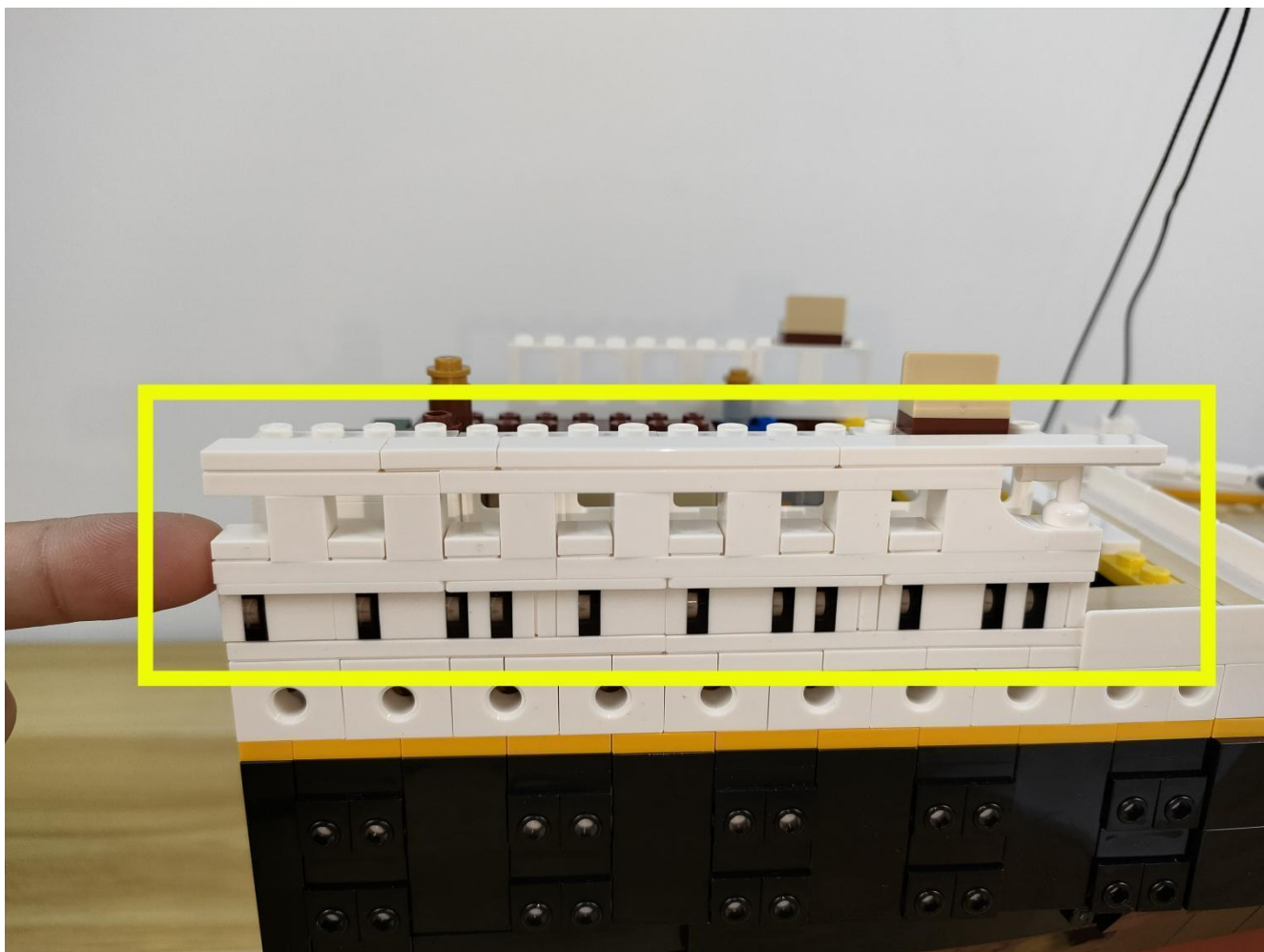

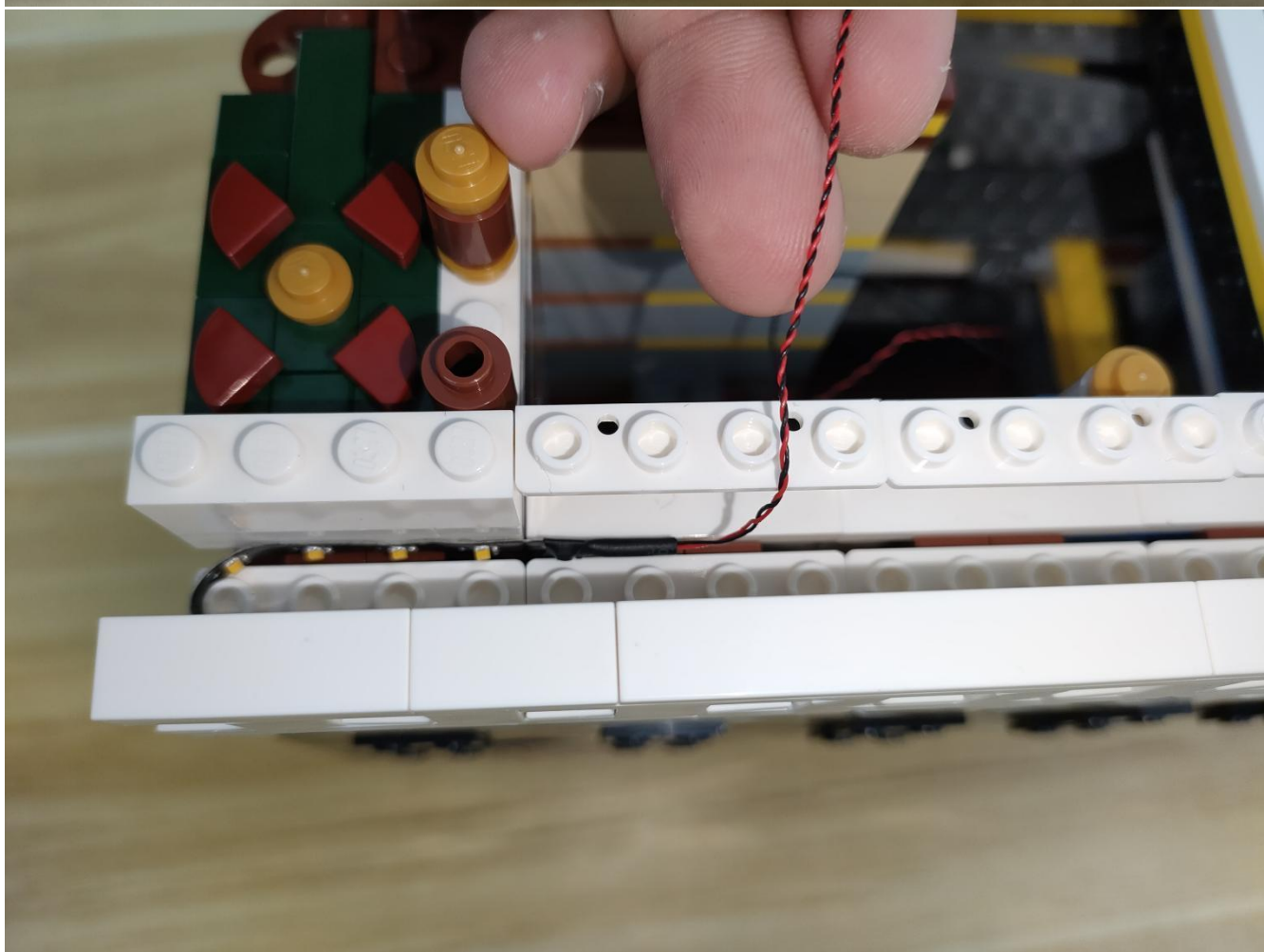
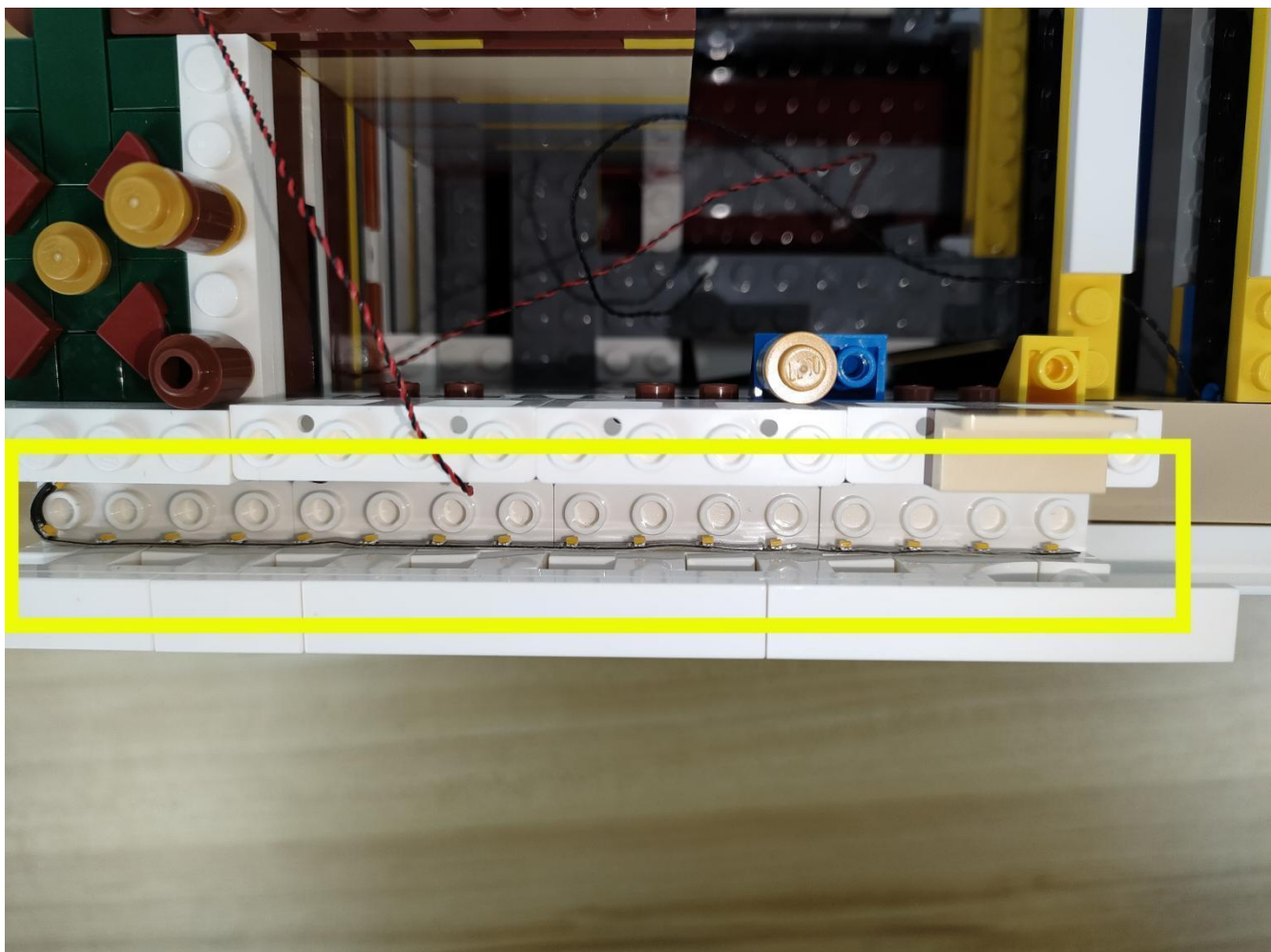

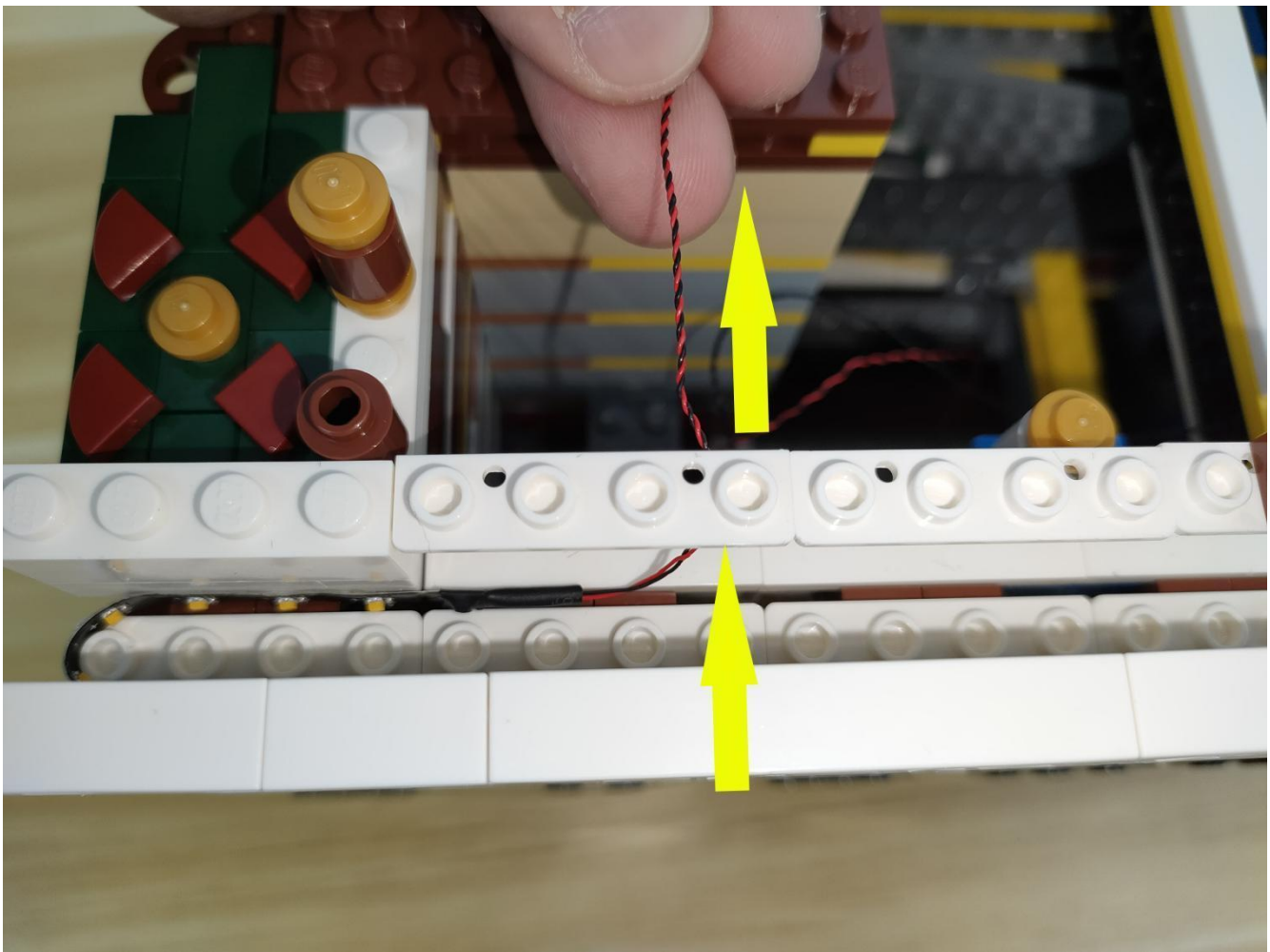

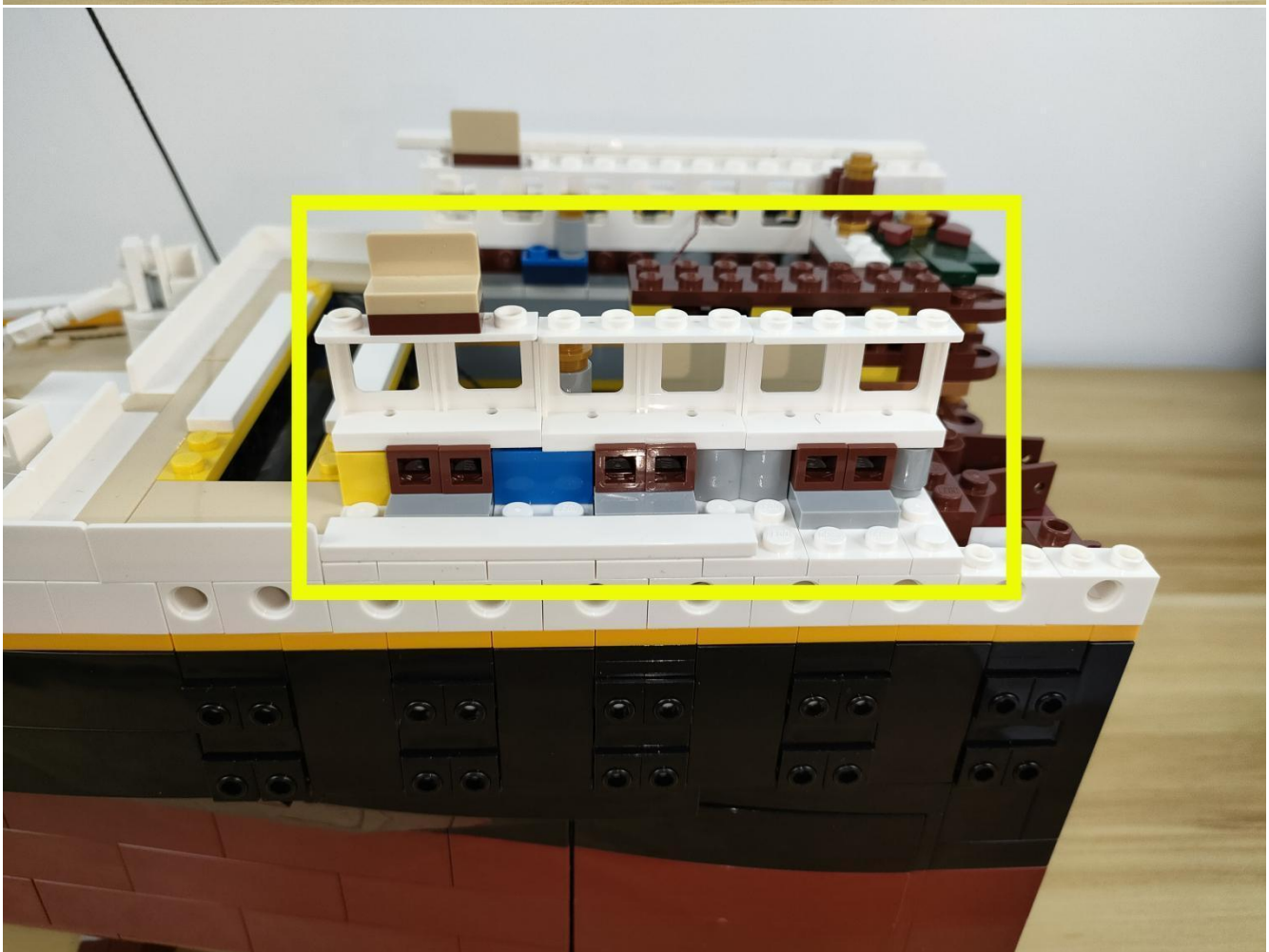

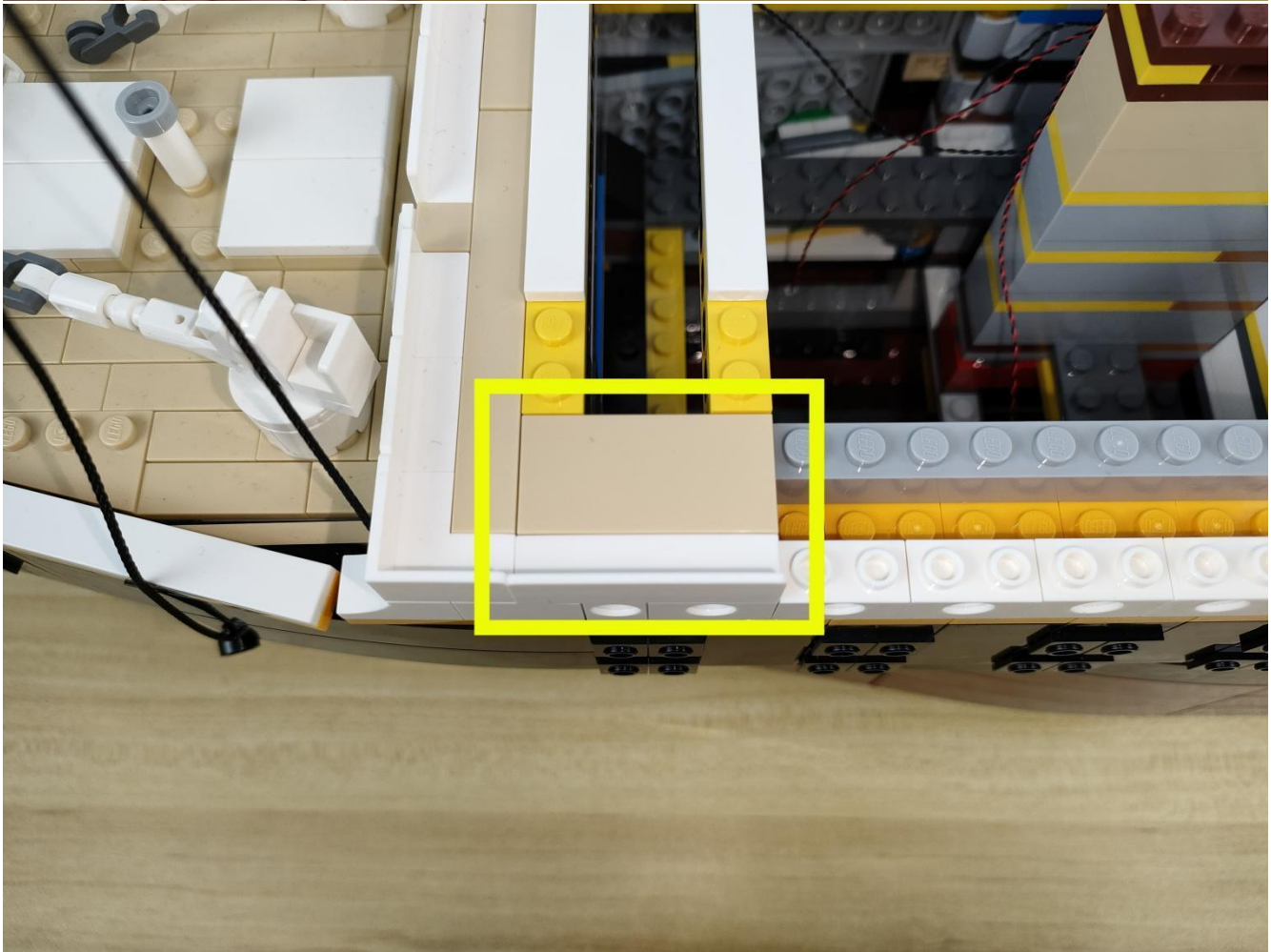
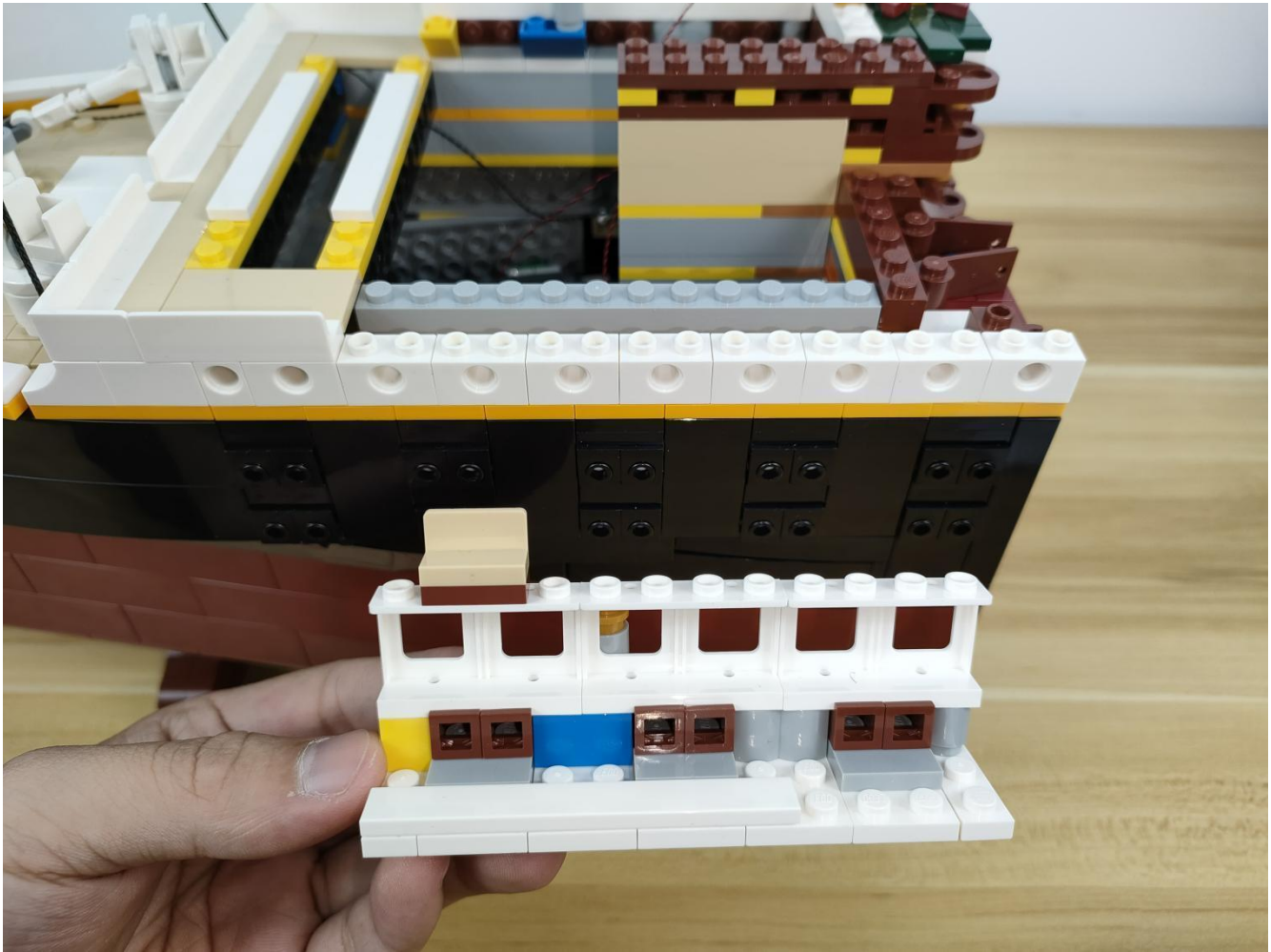

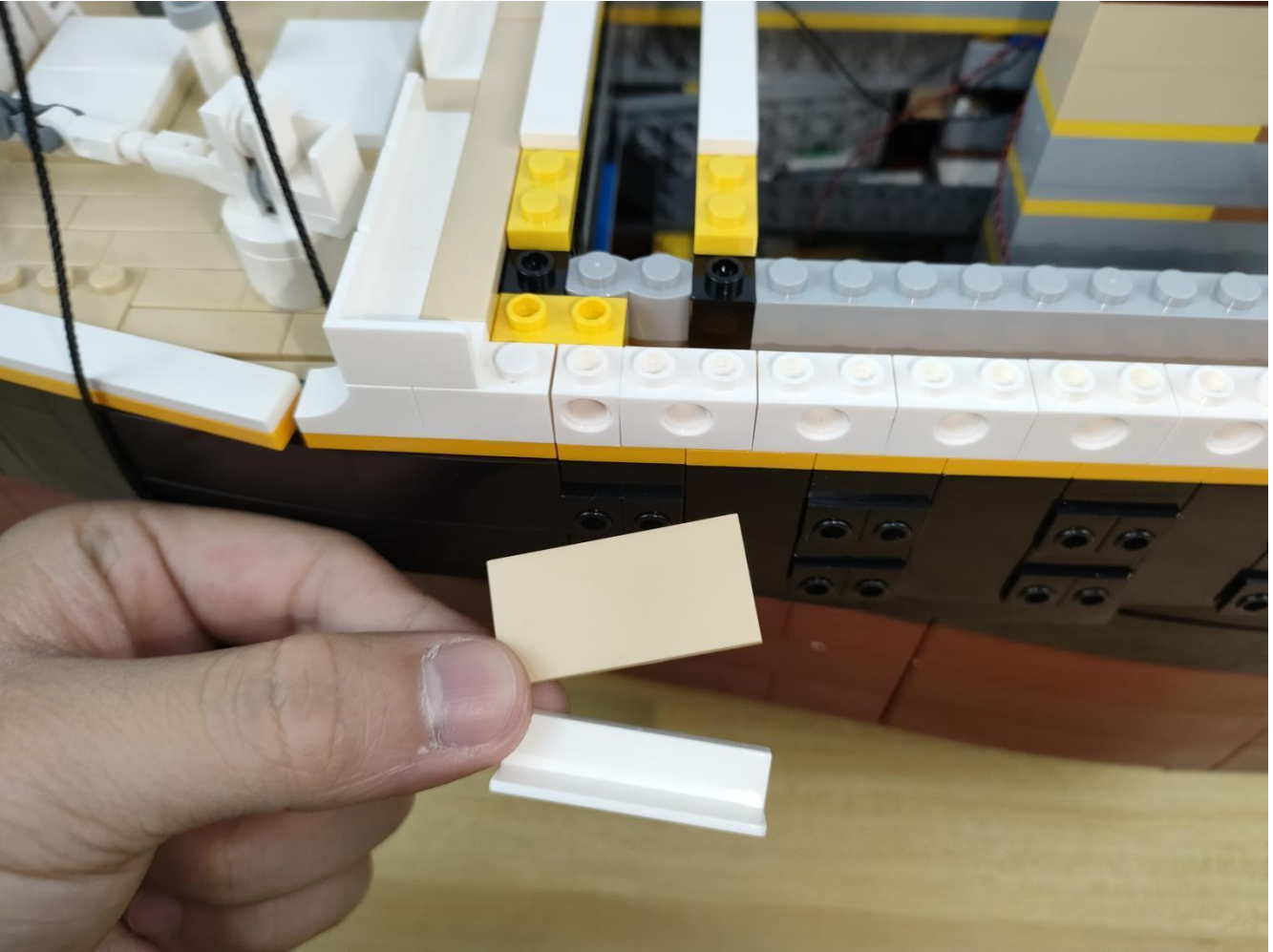

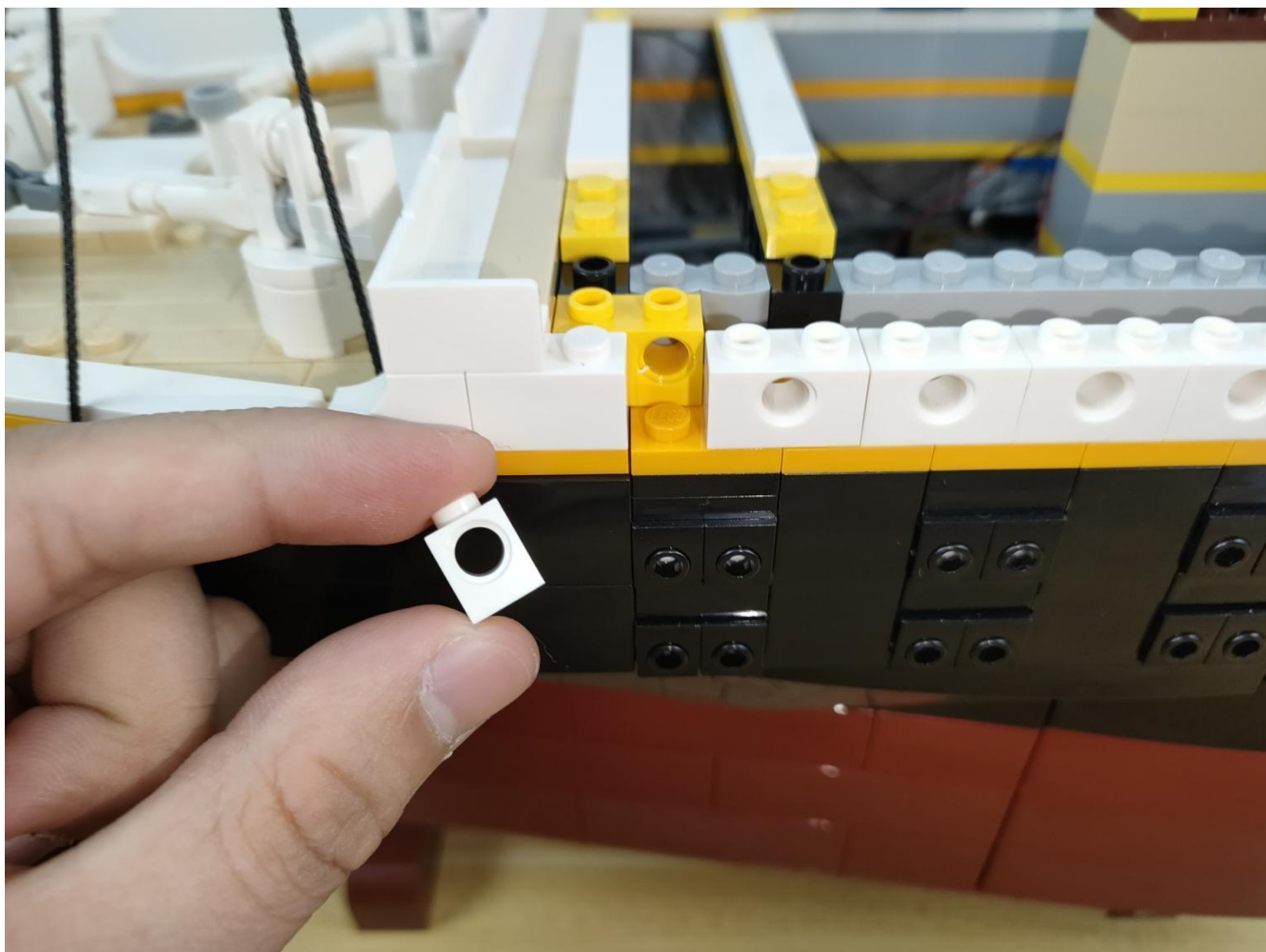

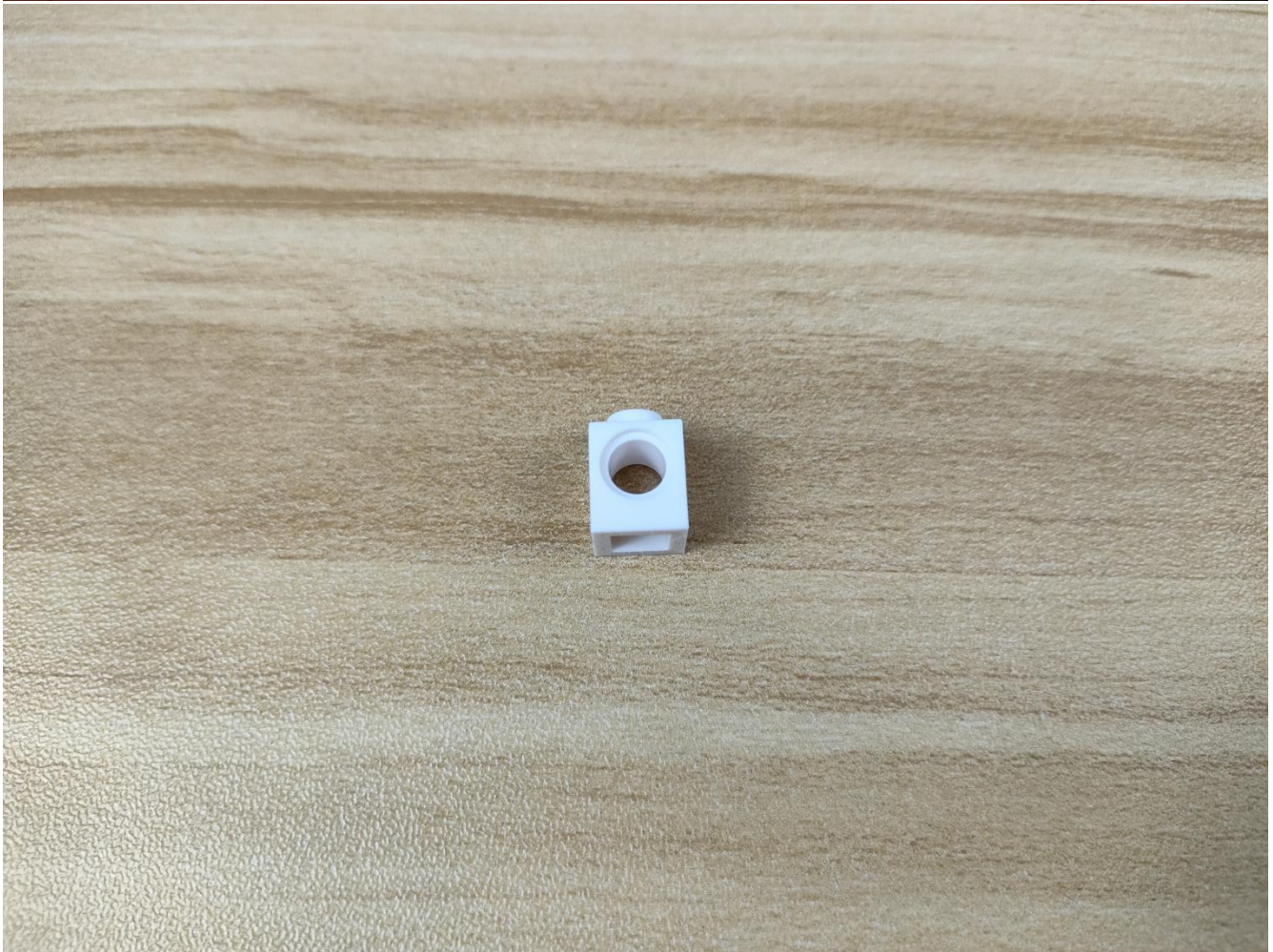

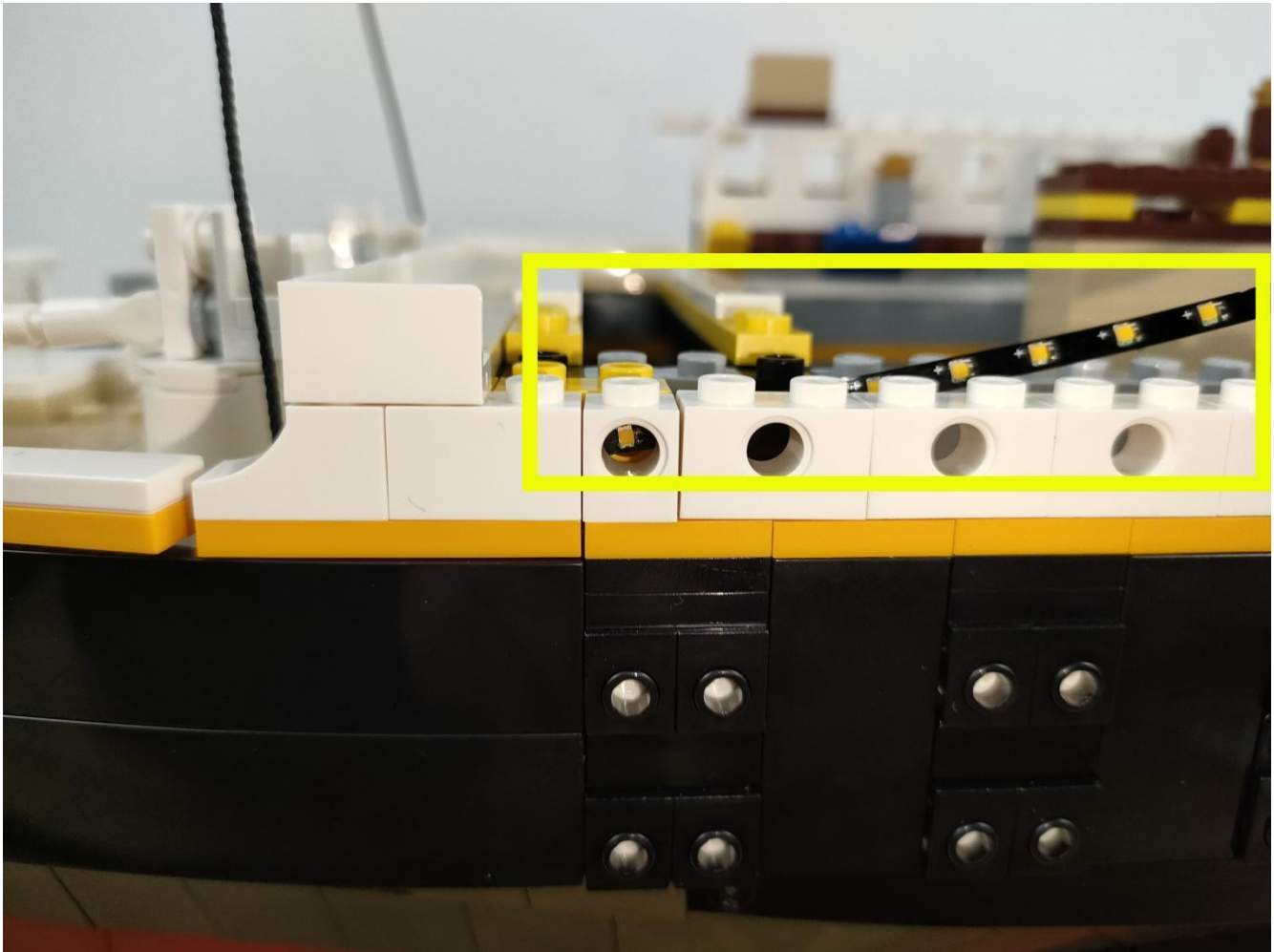

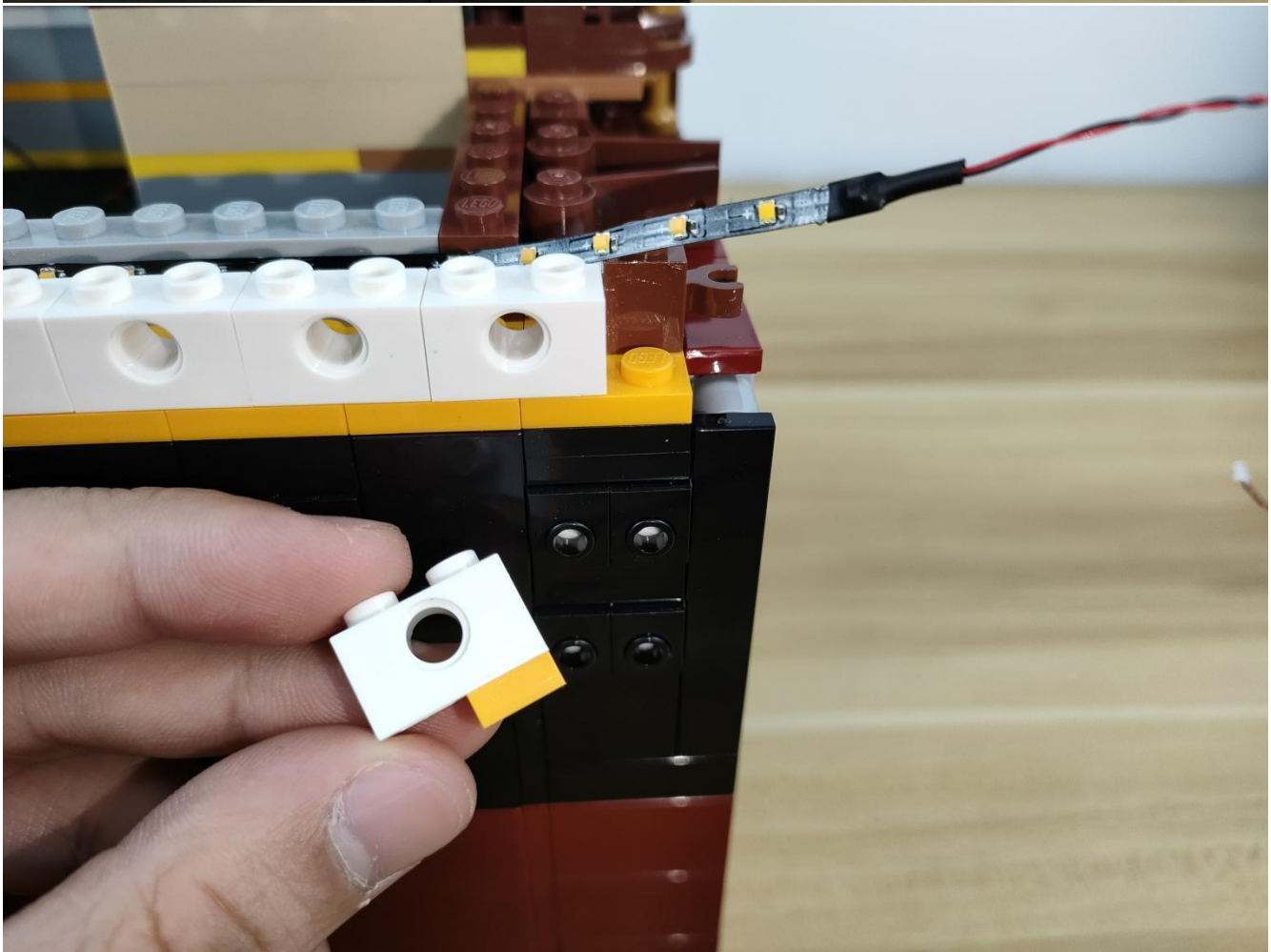
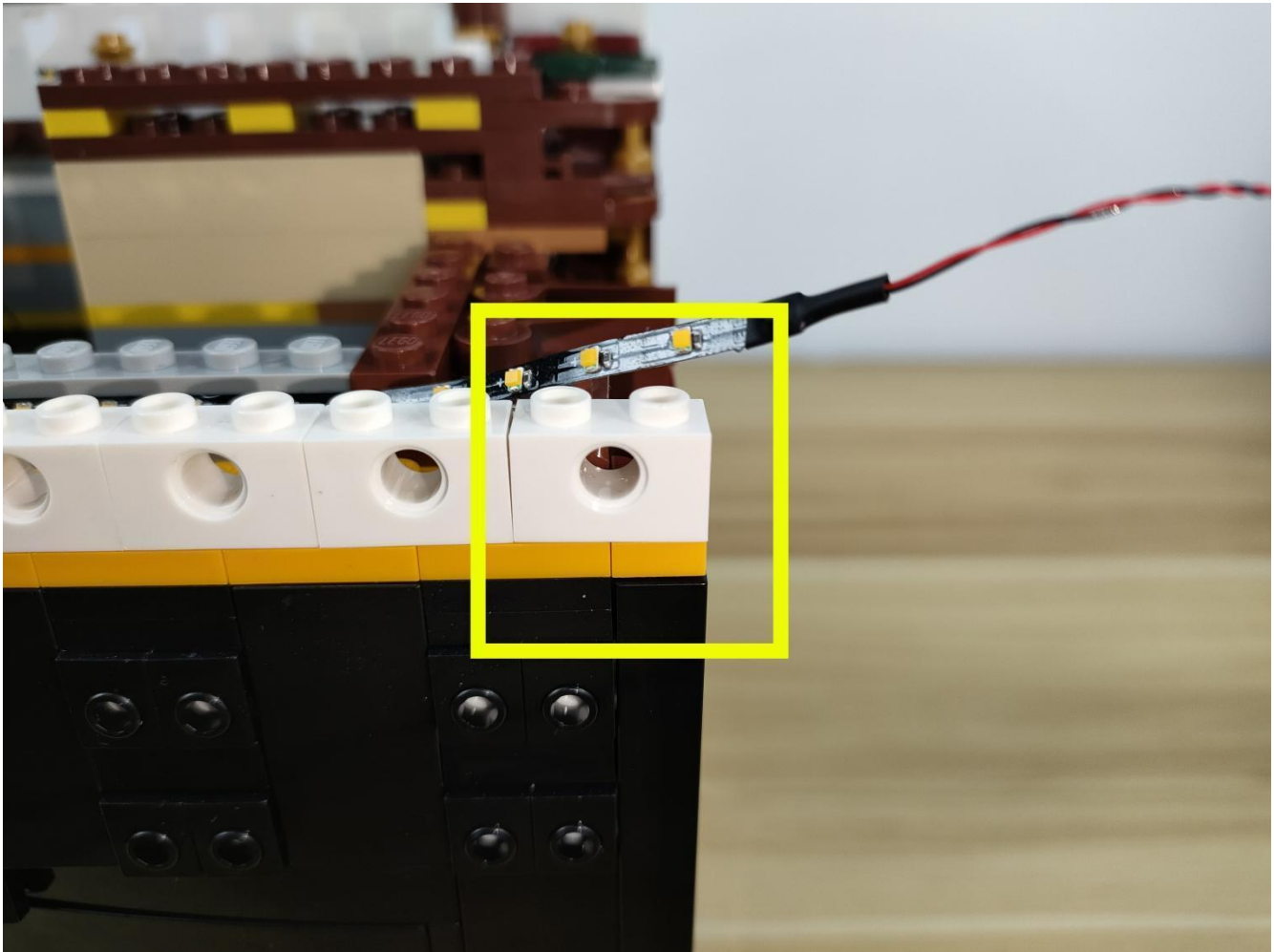

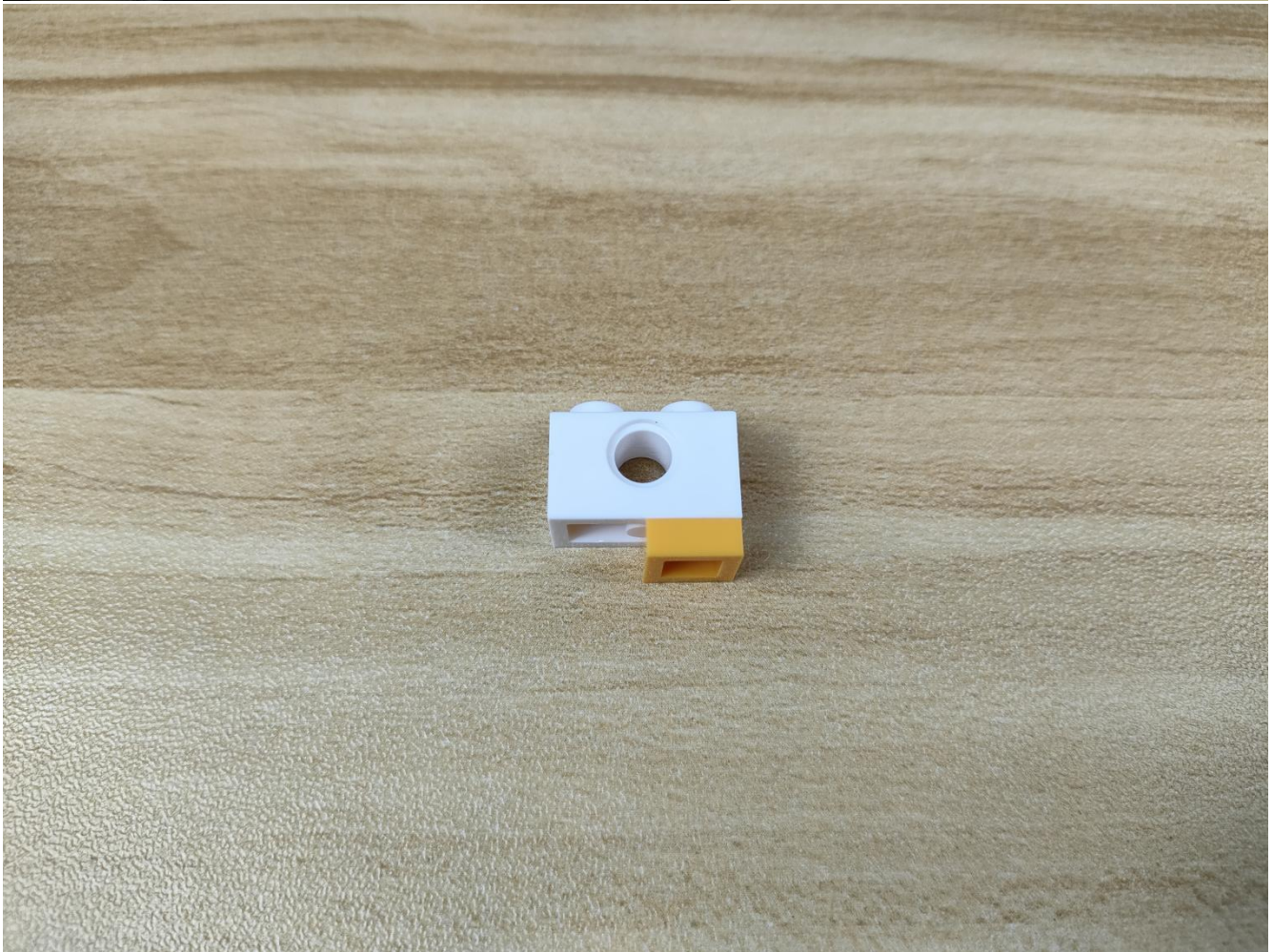
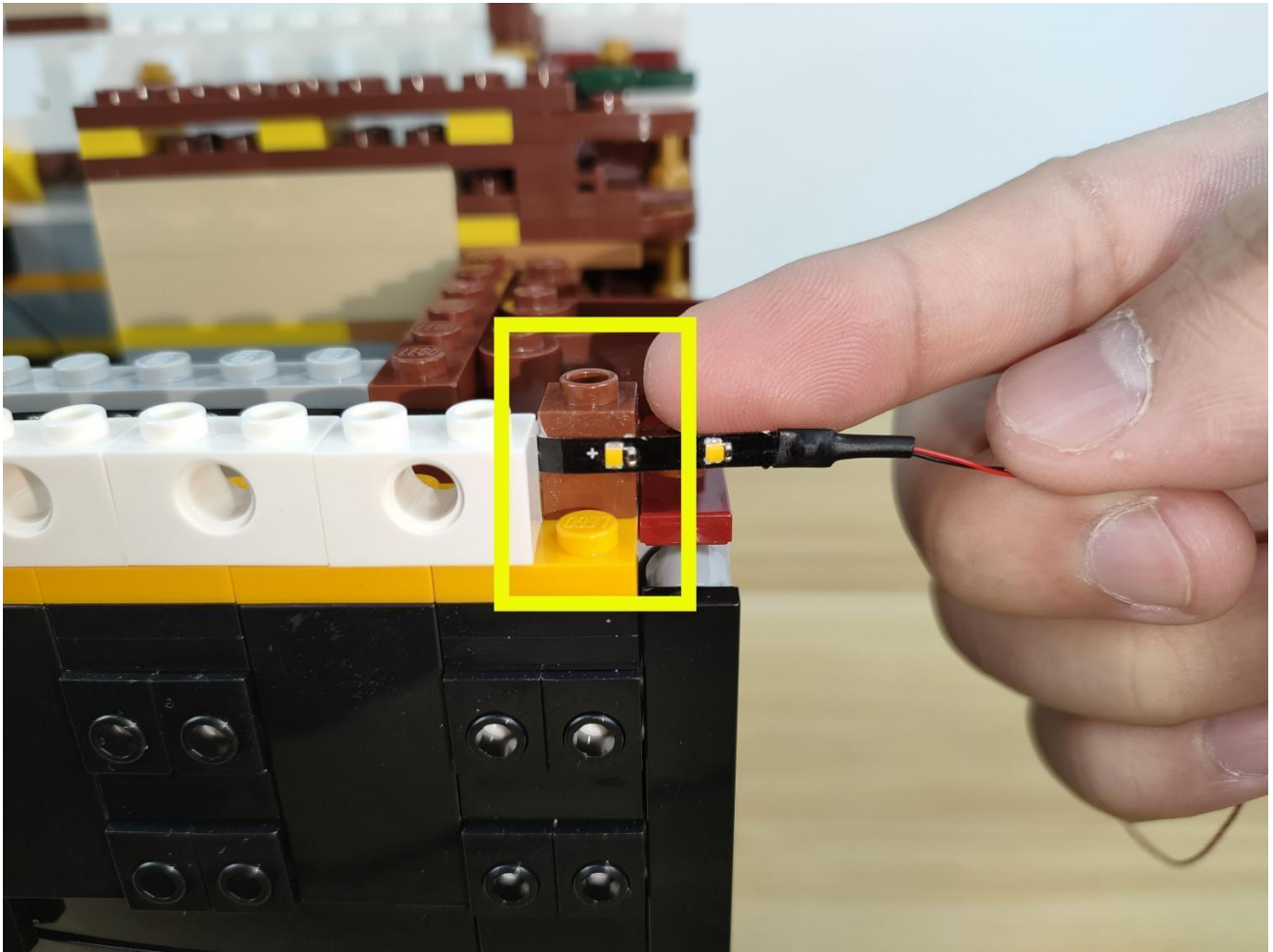

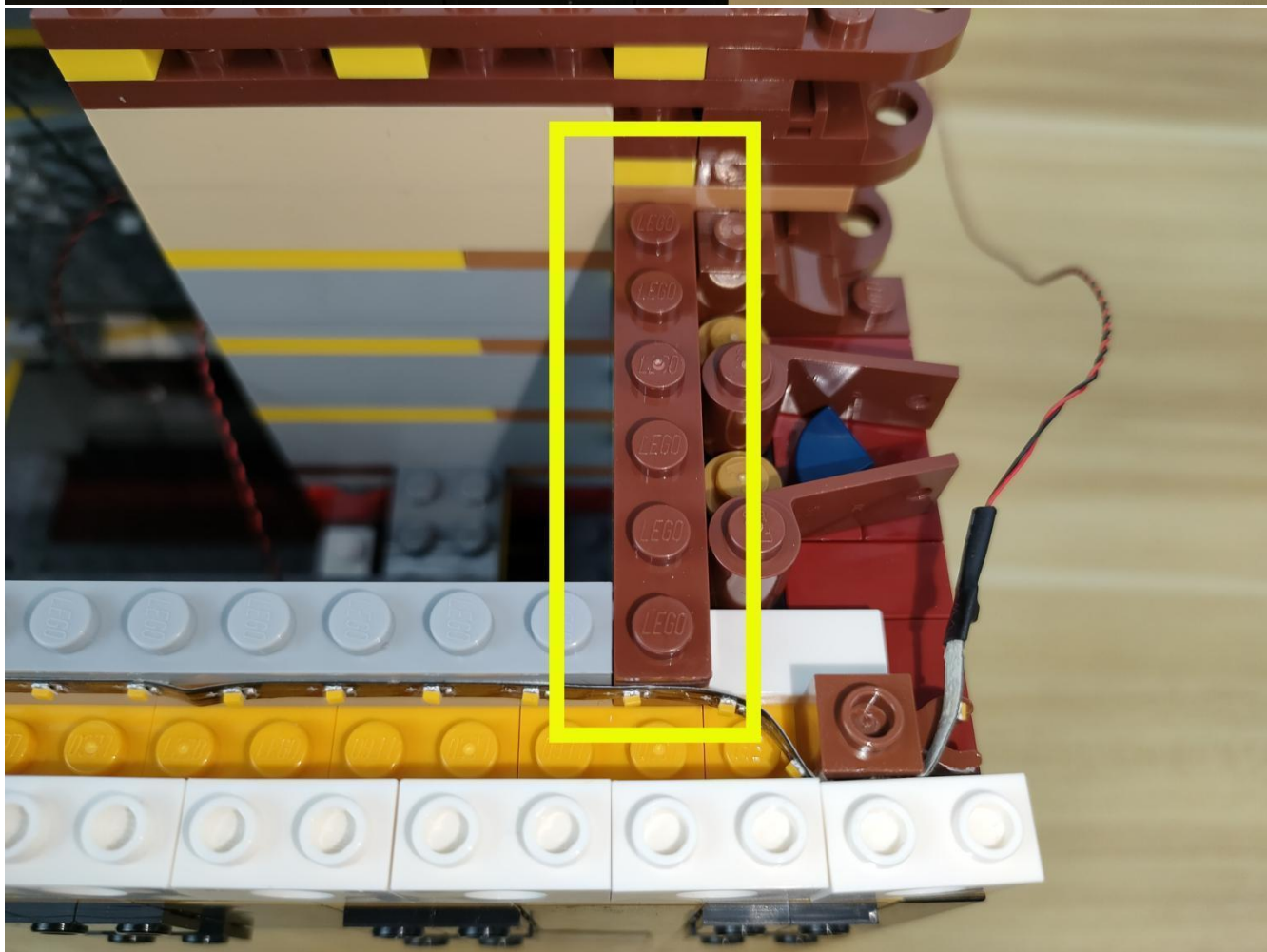
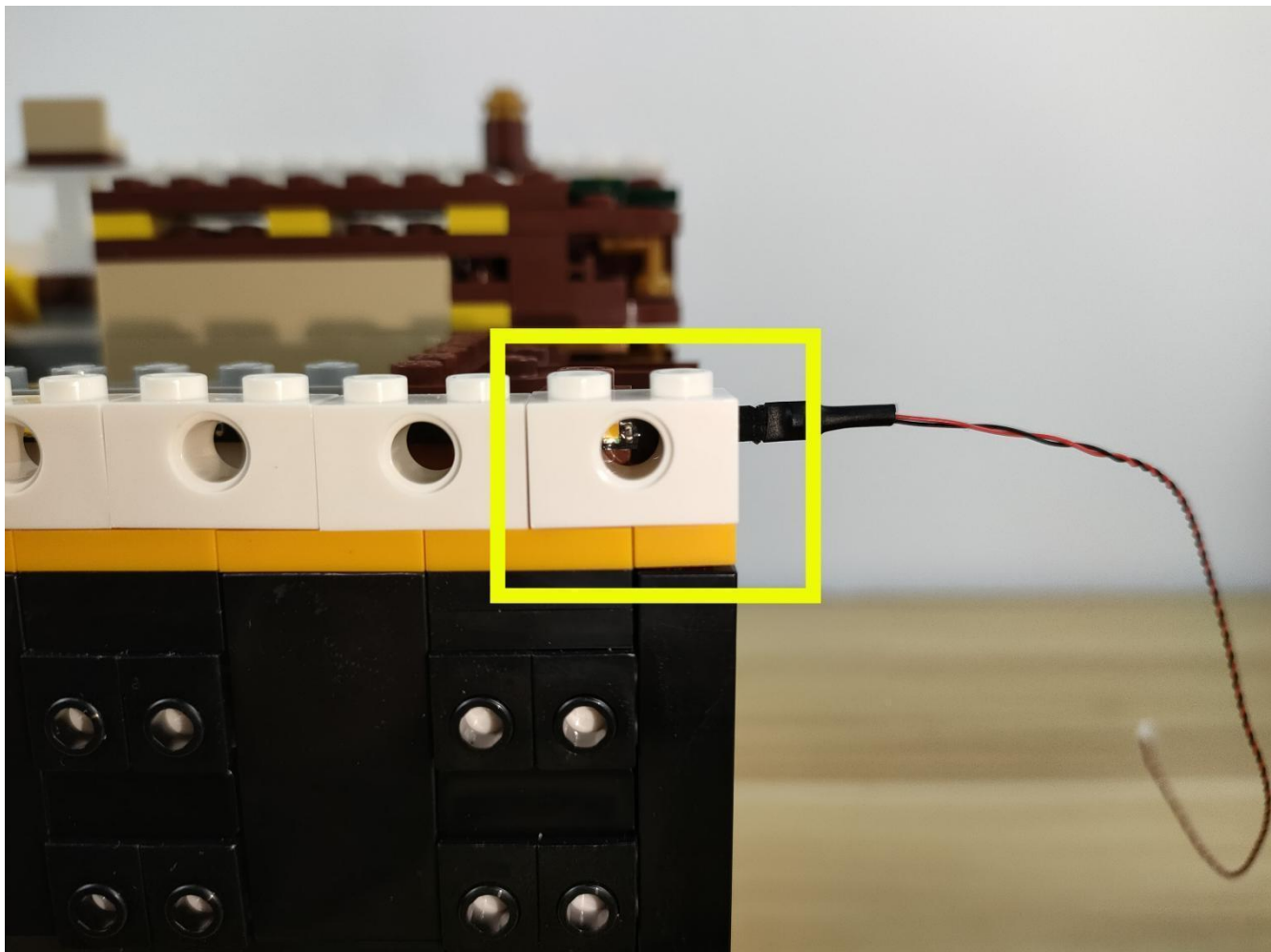

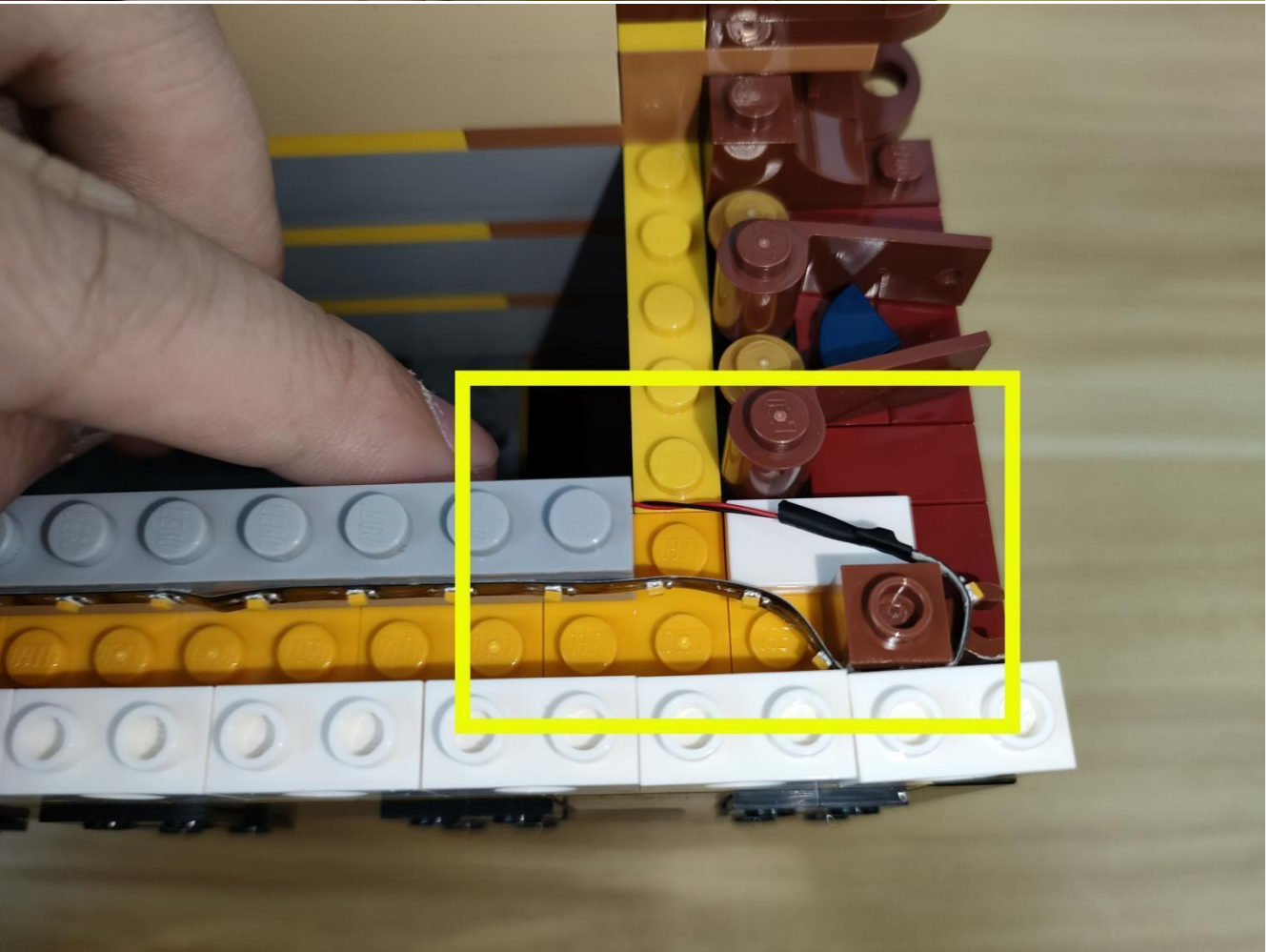
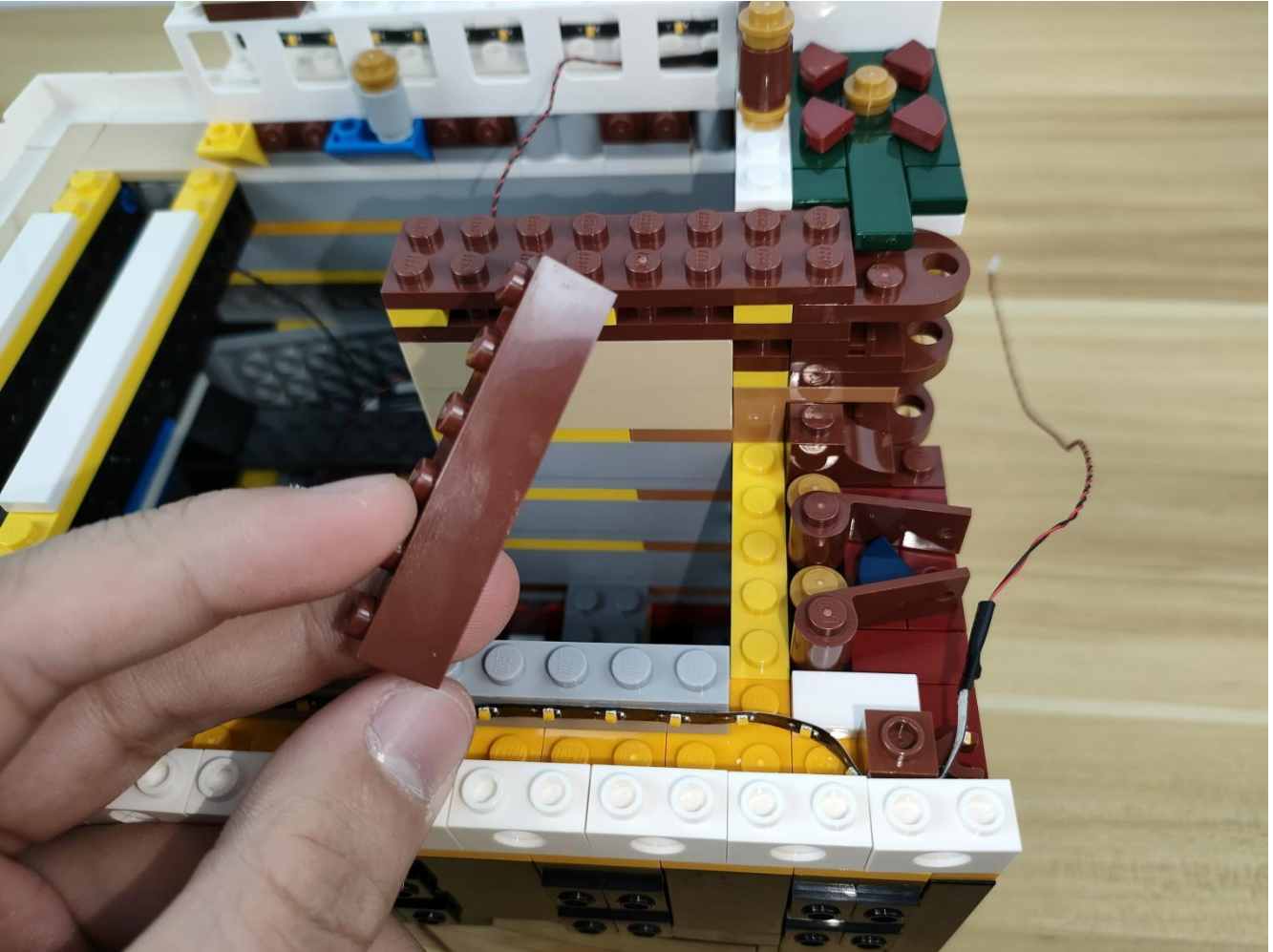

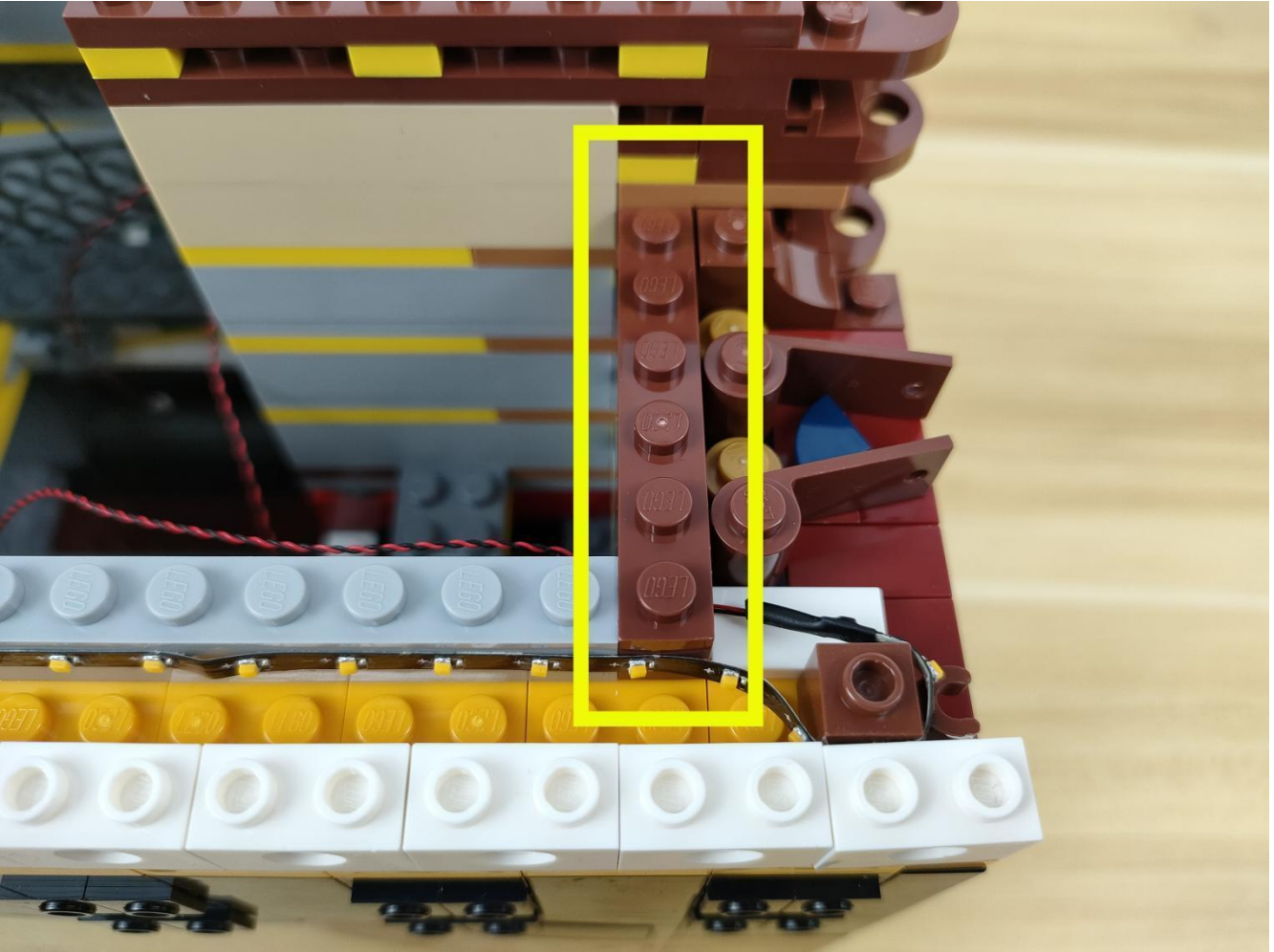
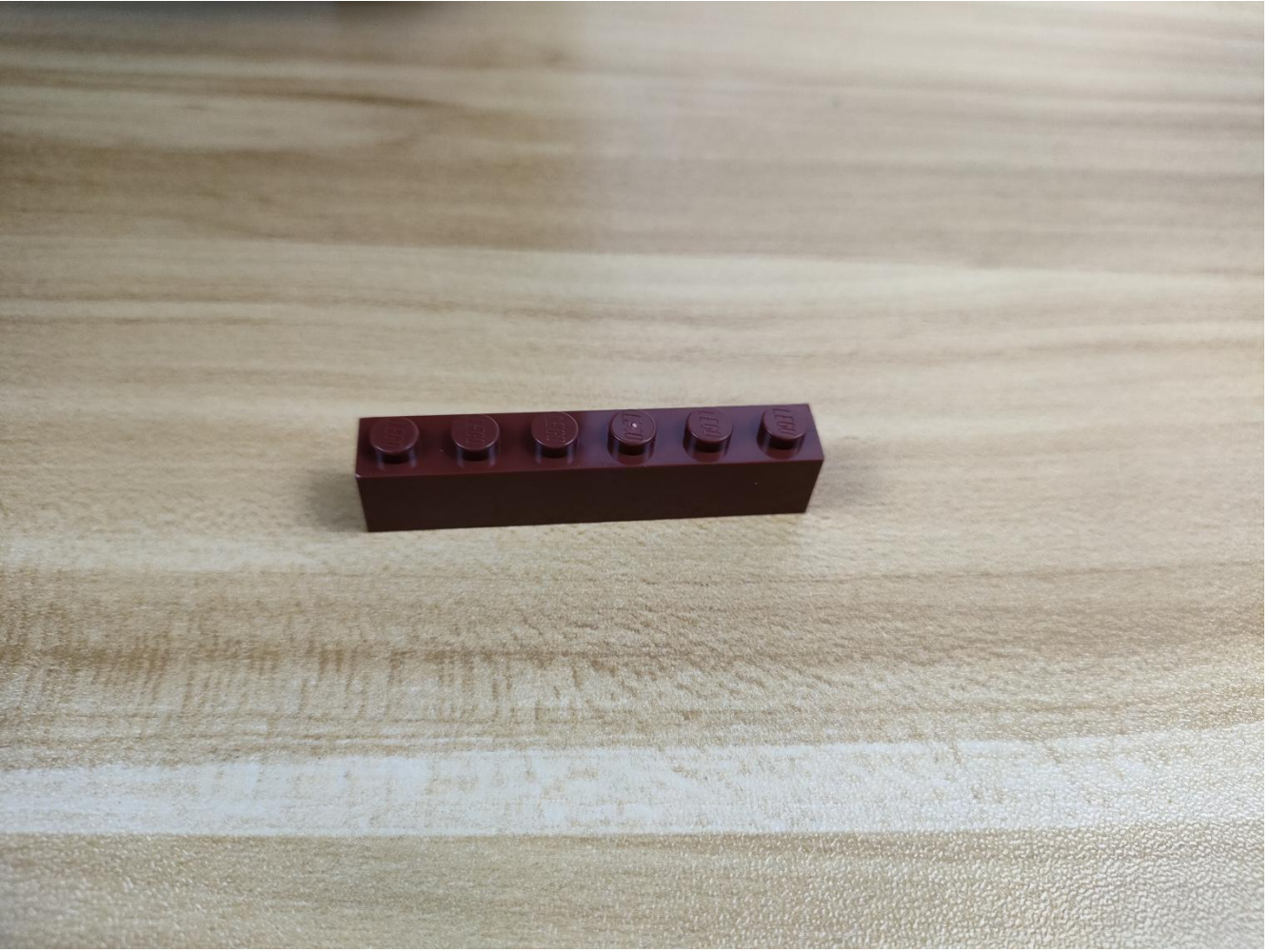

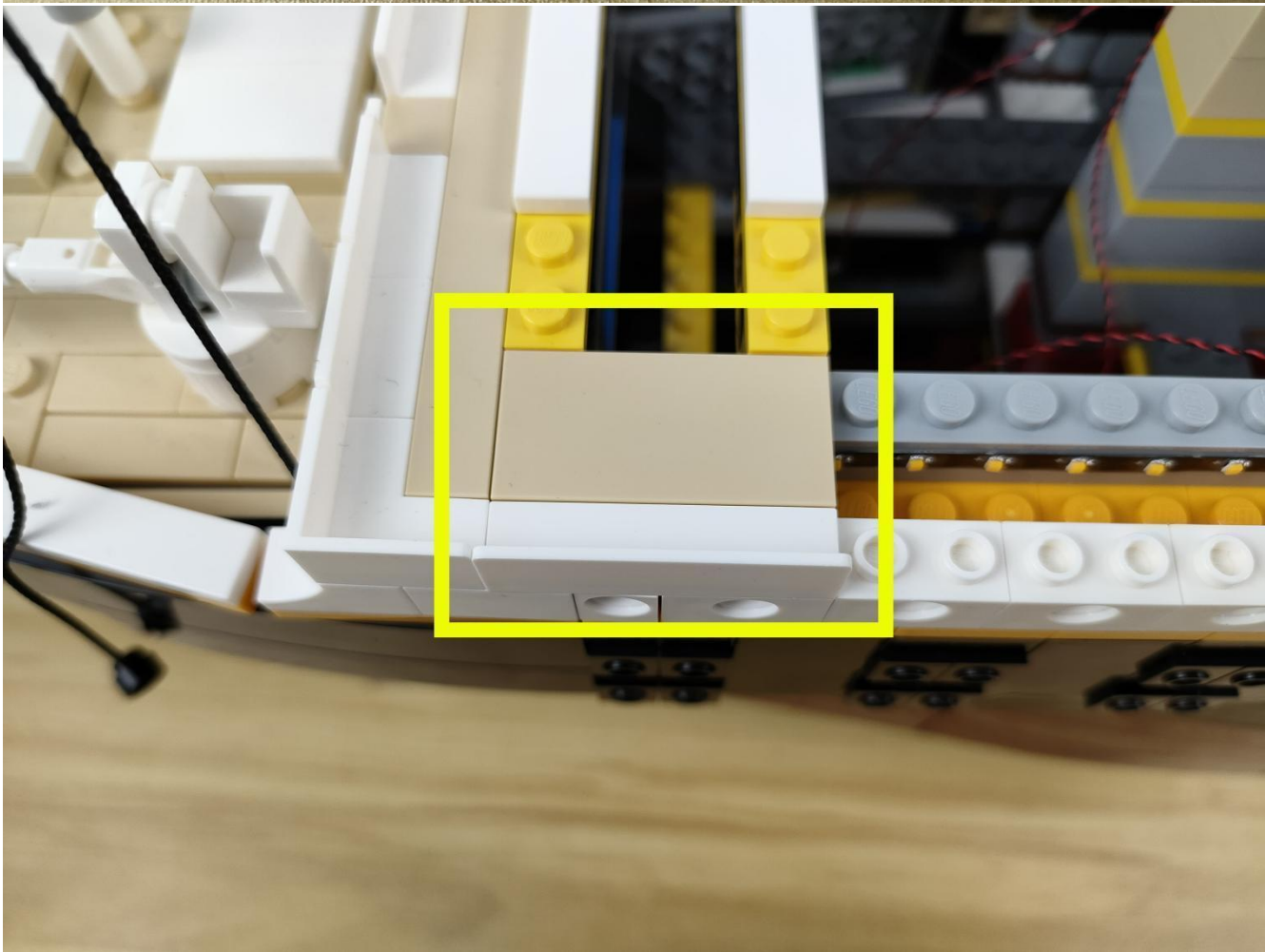
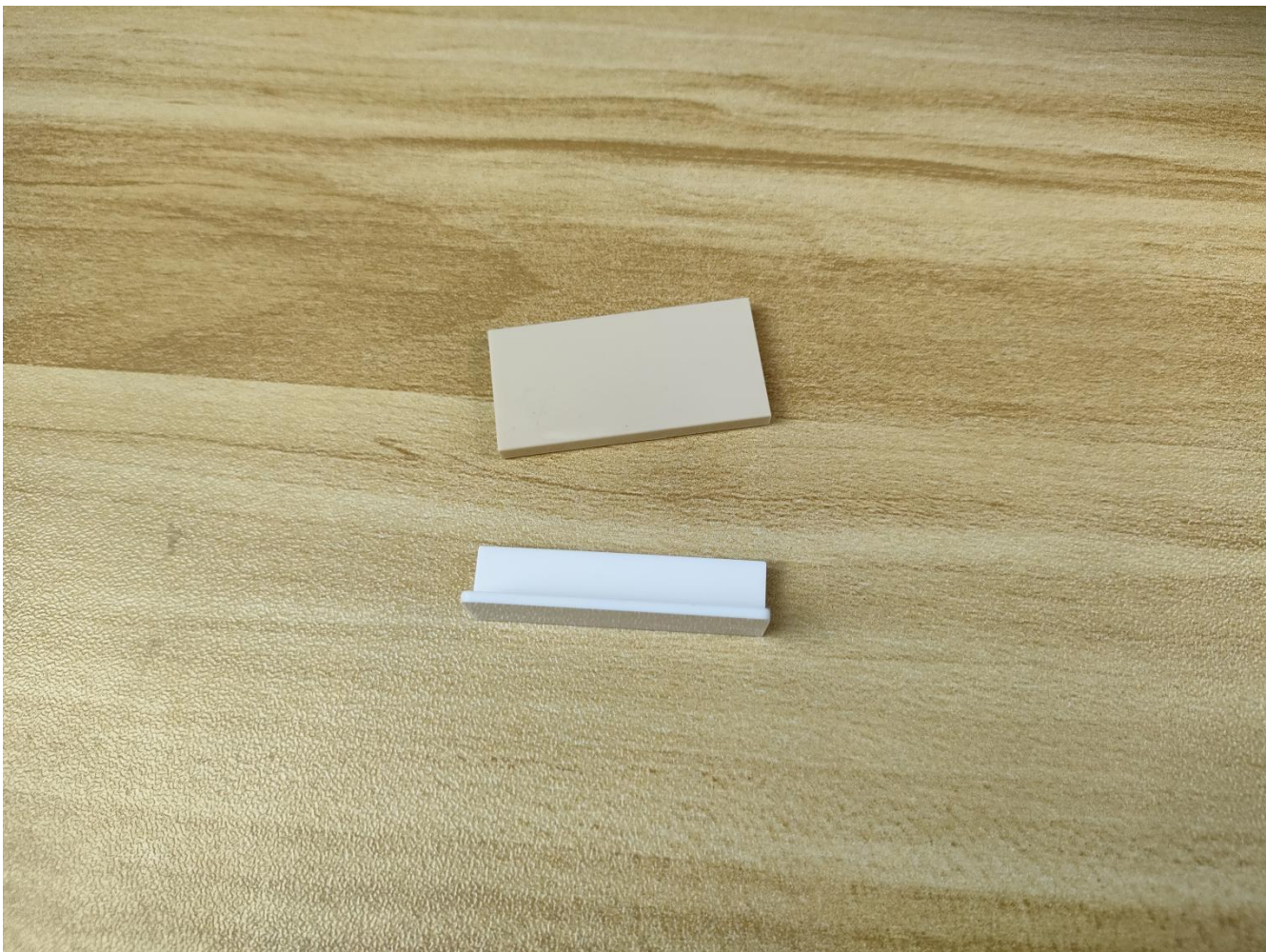

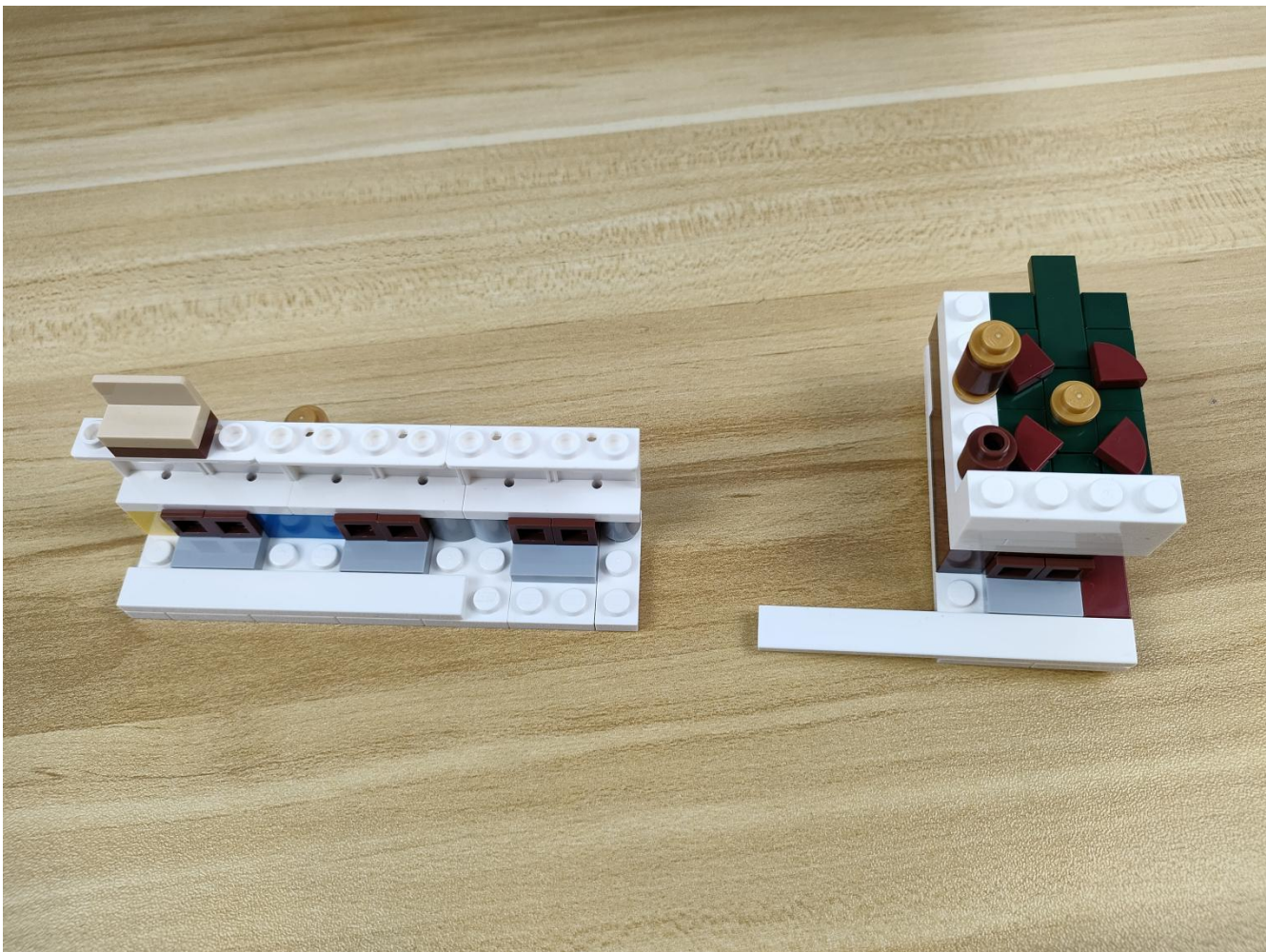

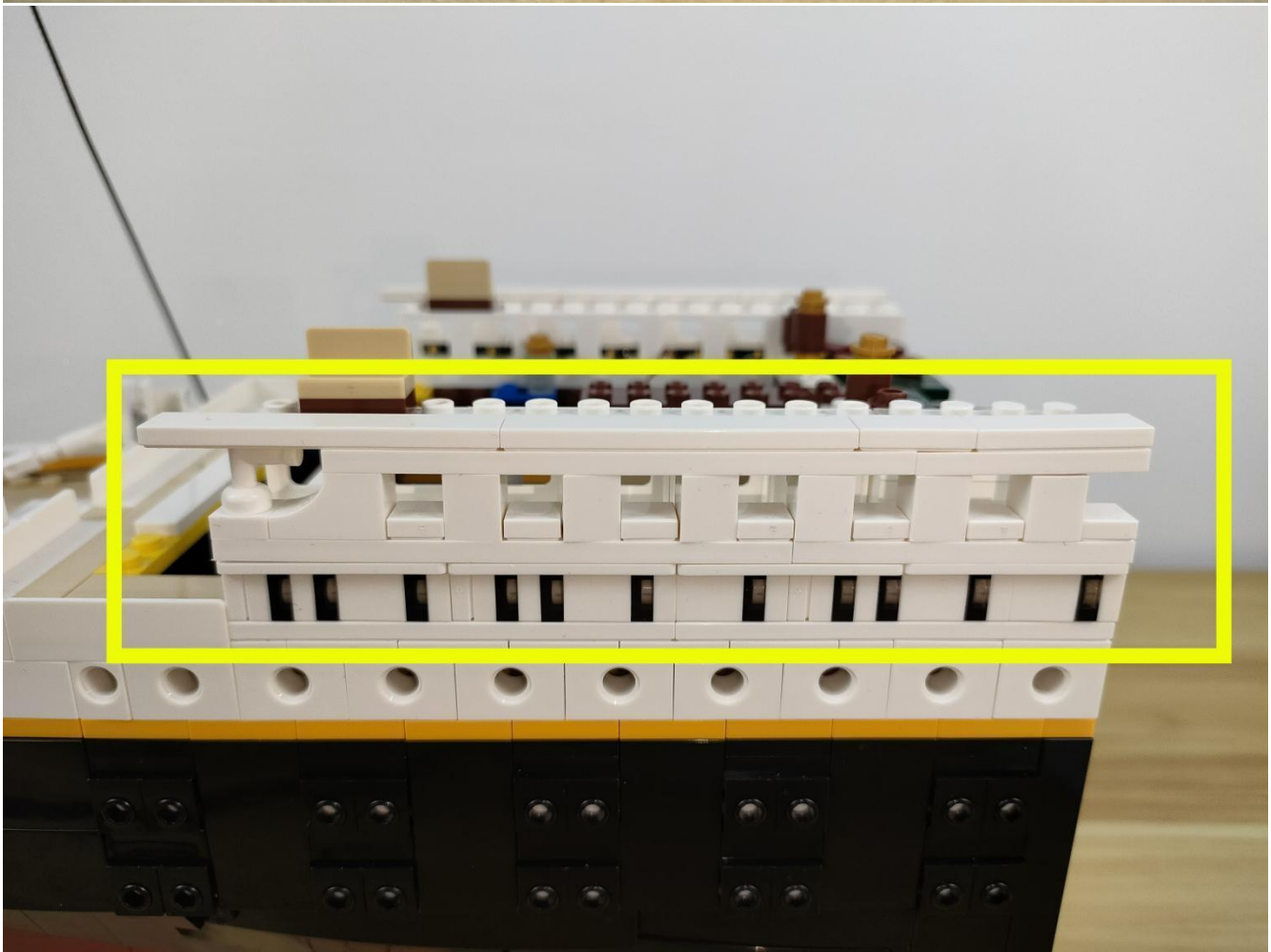
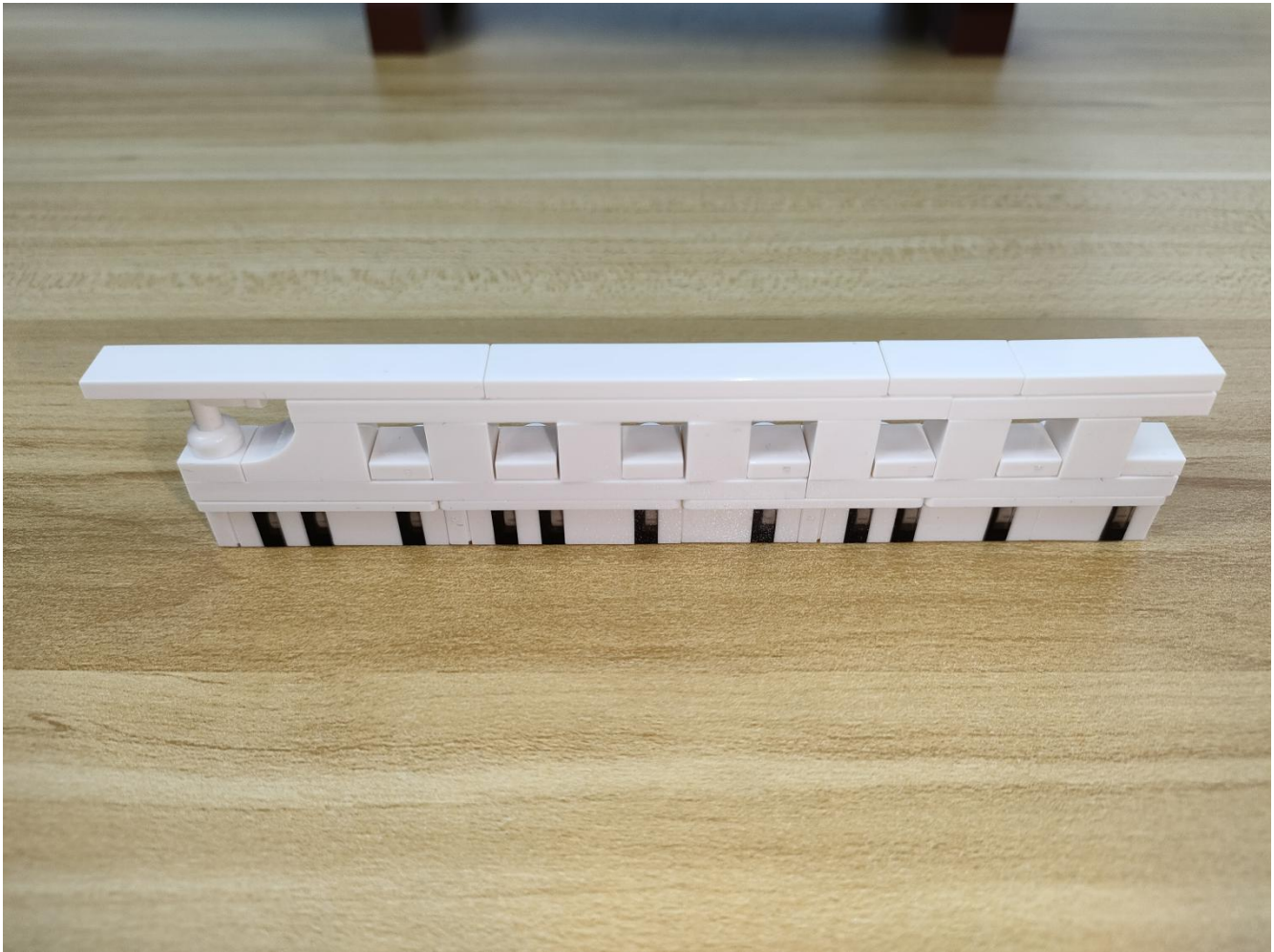

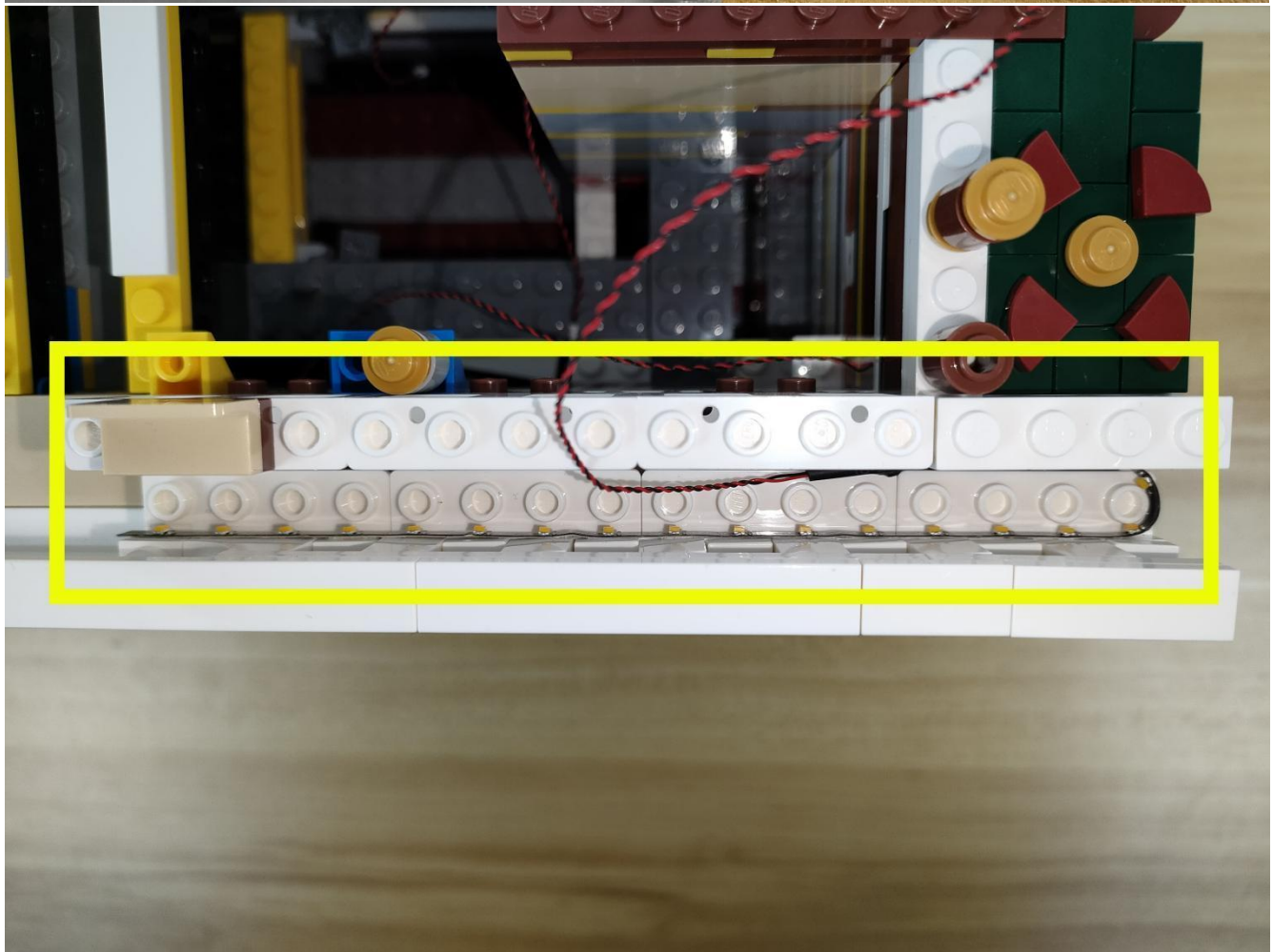

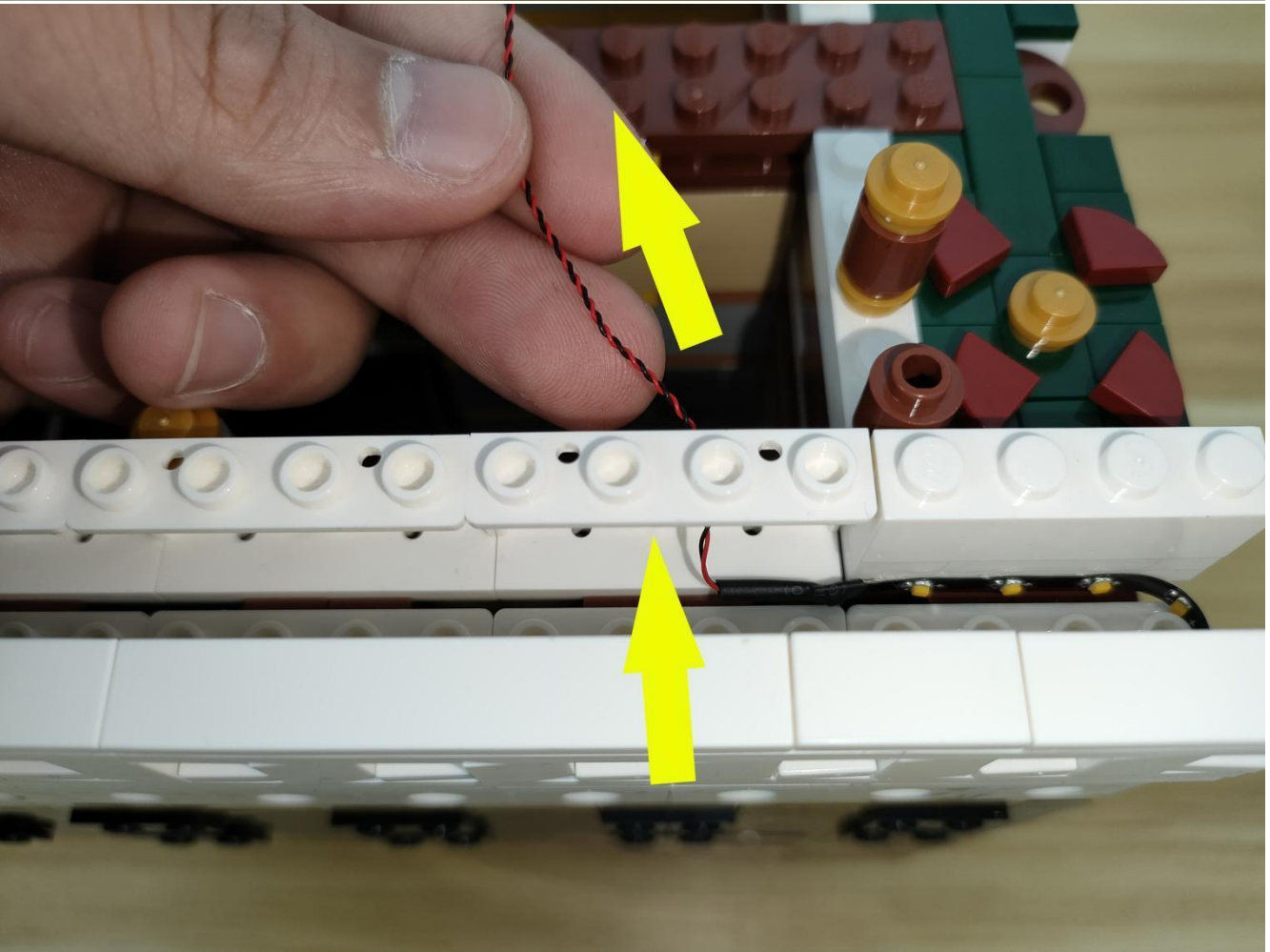
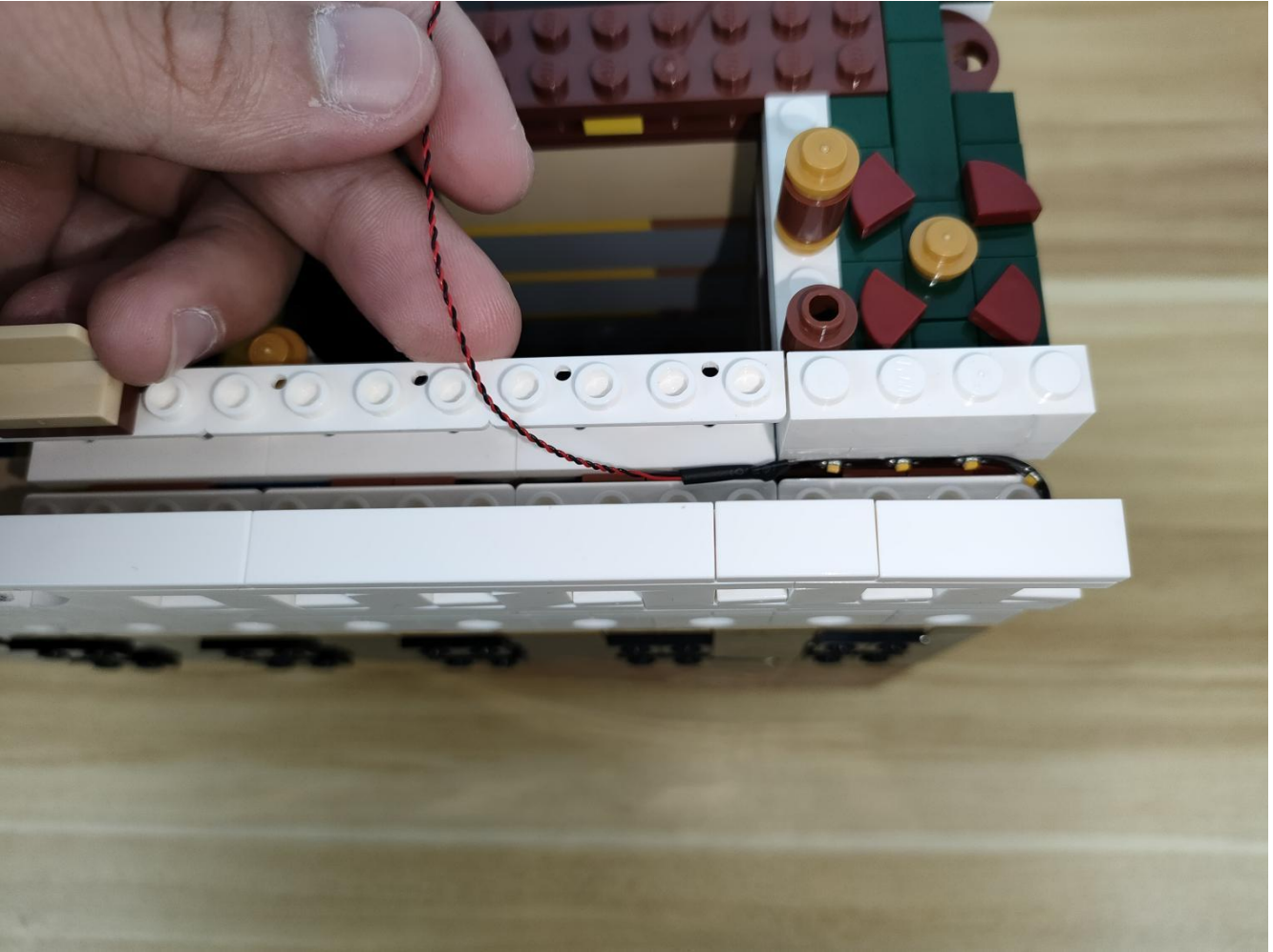



擴充板
Expansion Boards

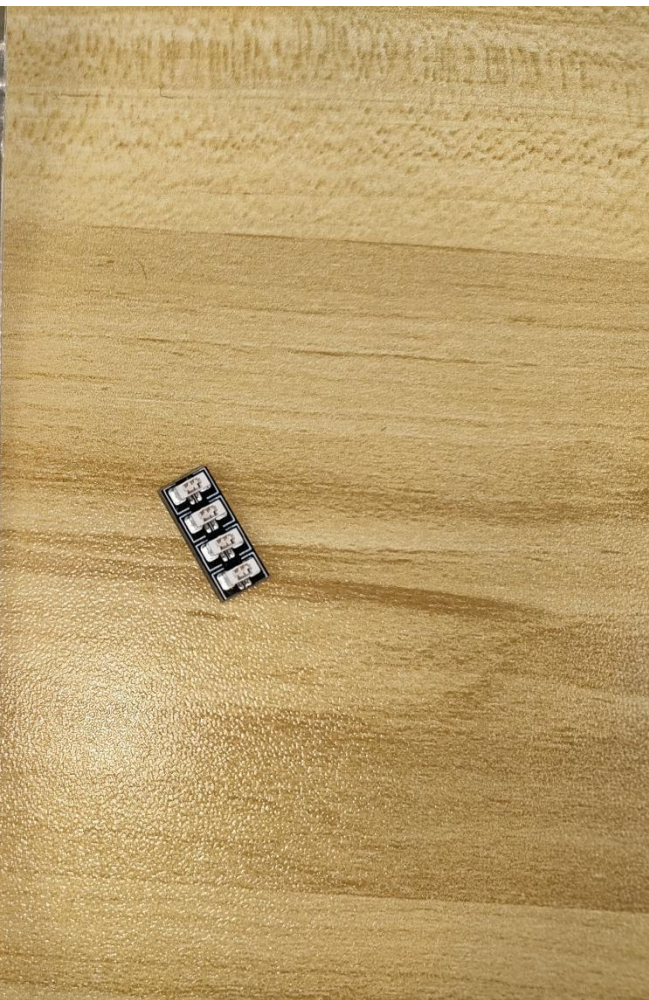

連接線 50CM
Connecting Cables
50CM



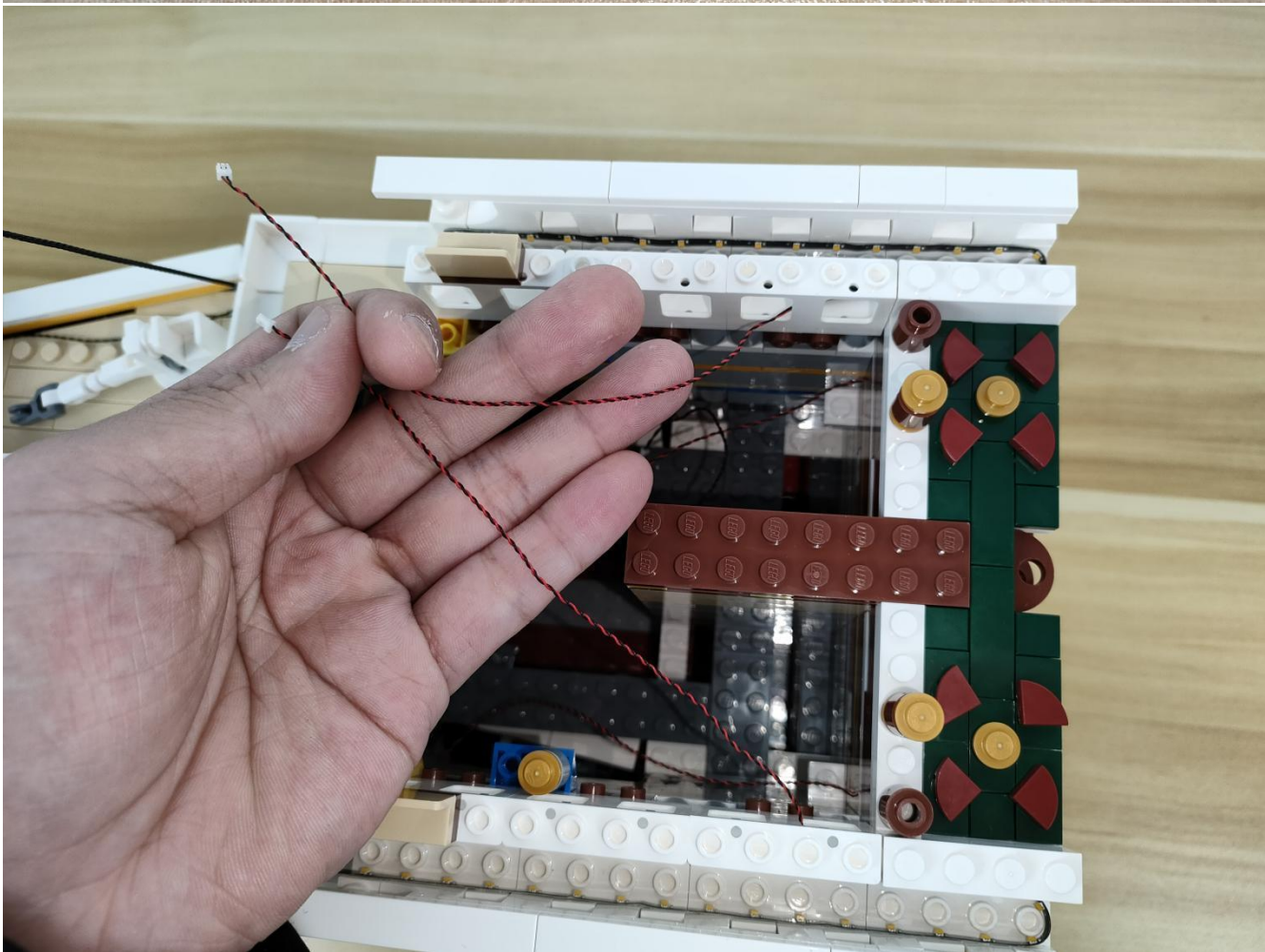
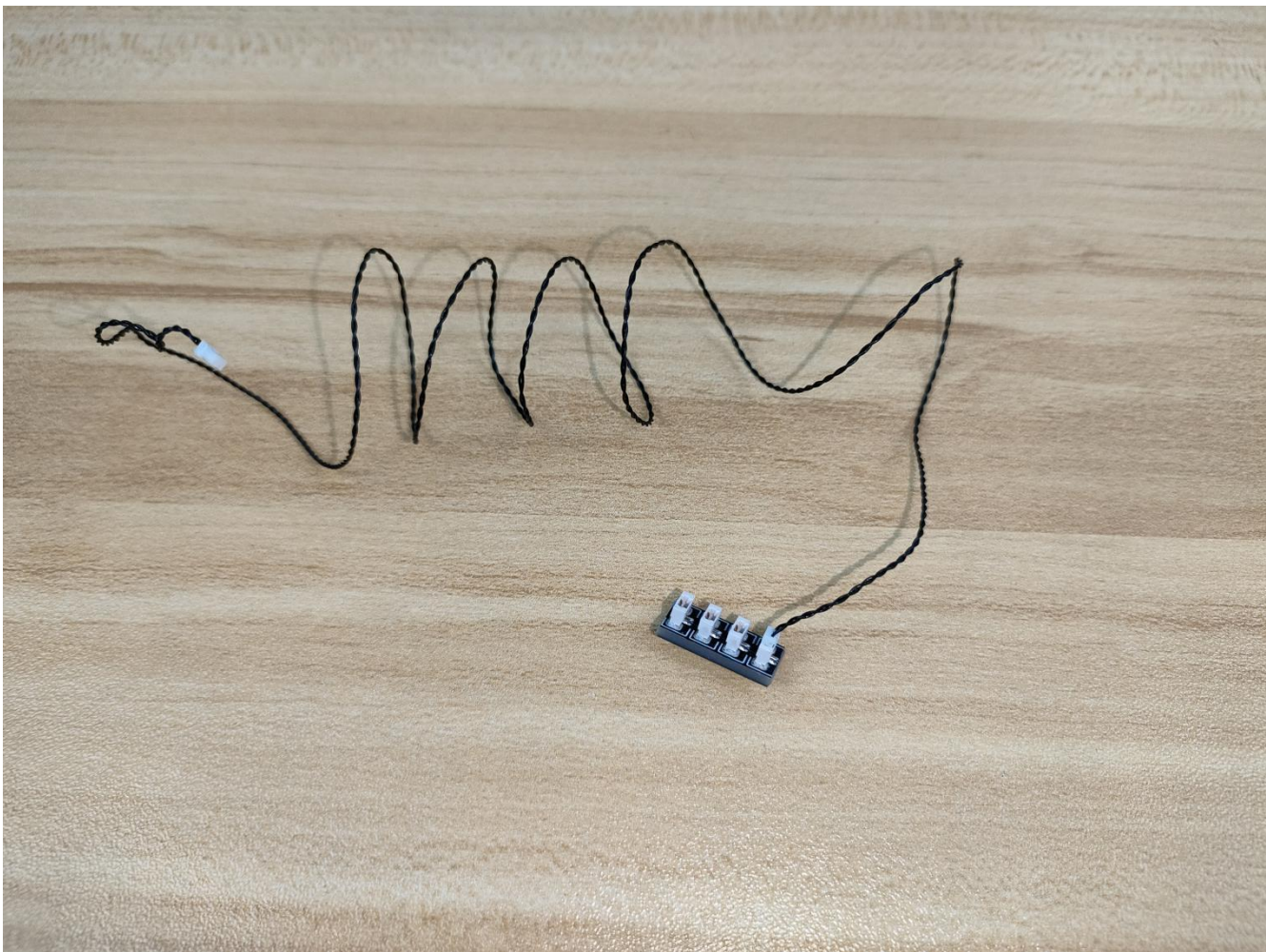

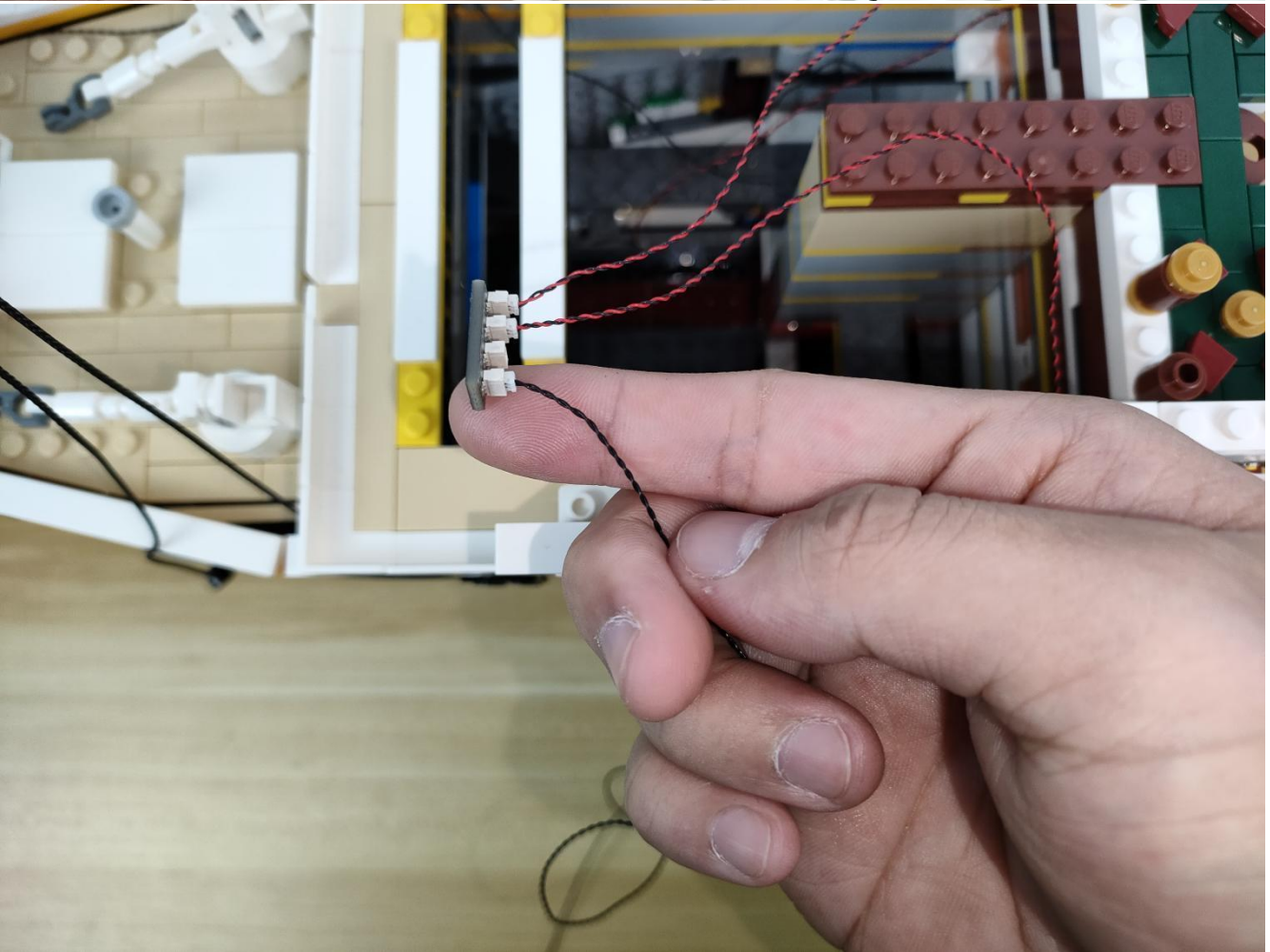
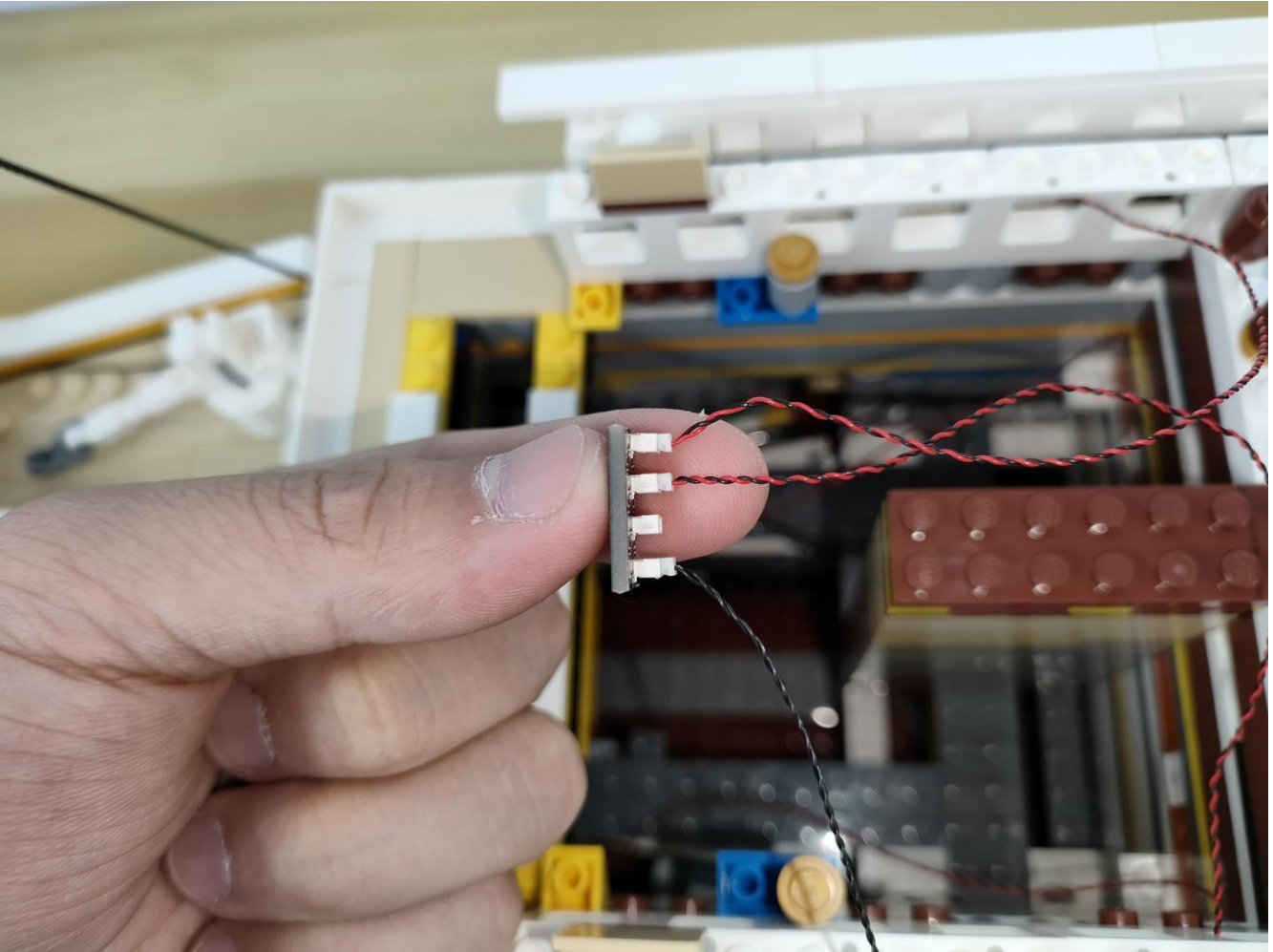

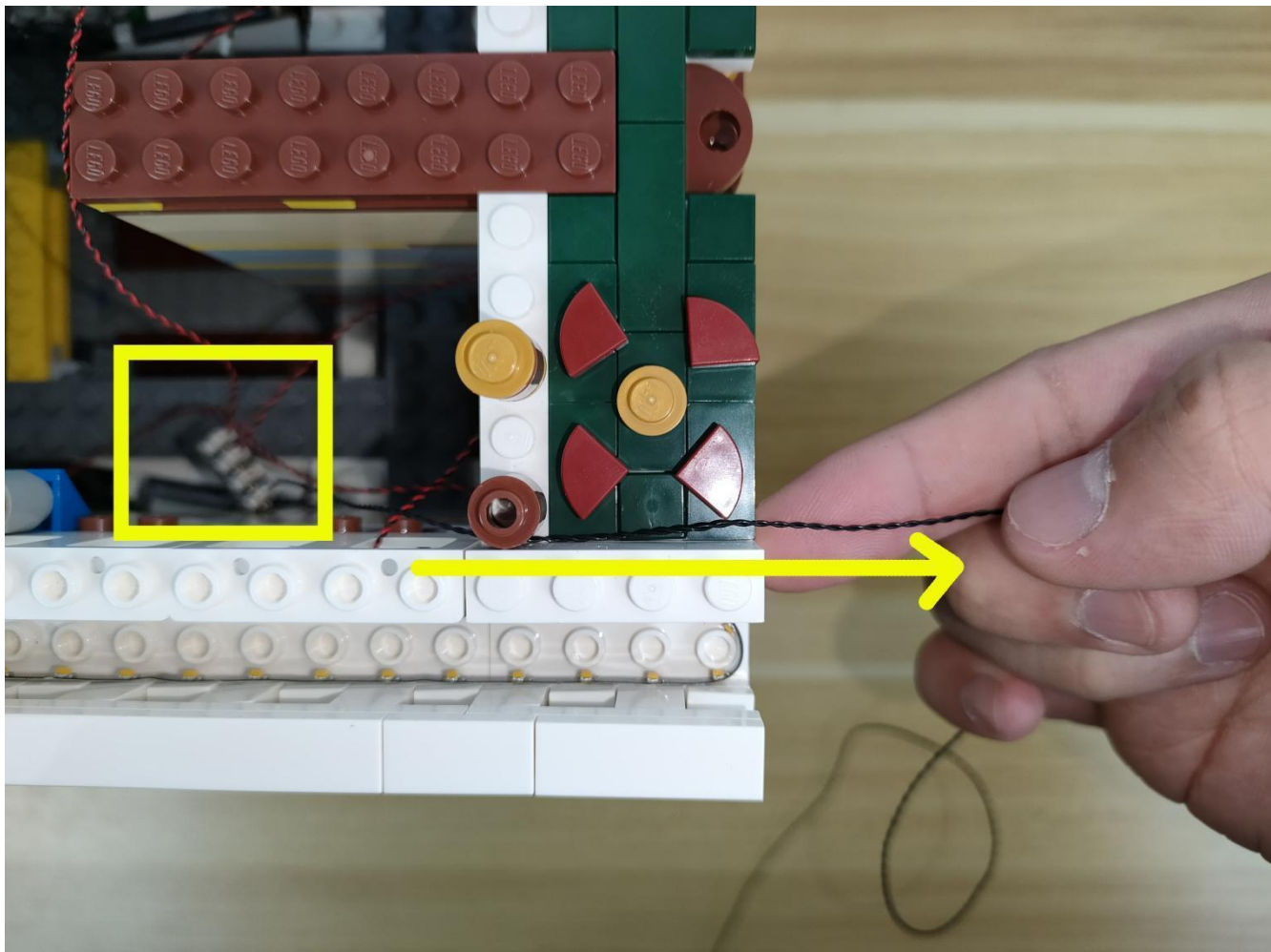

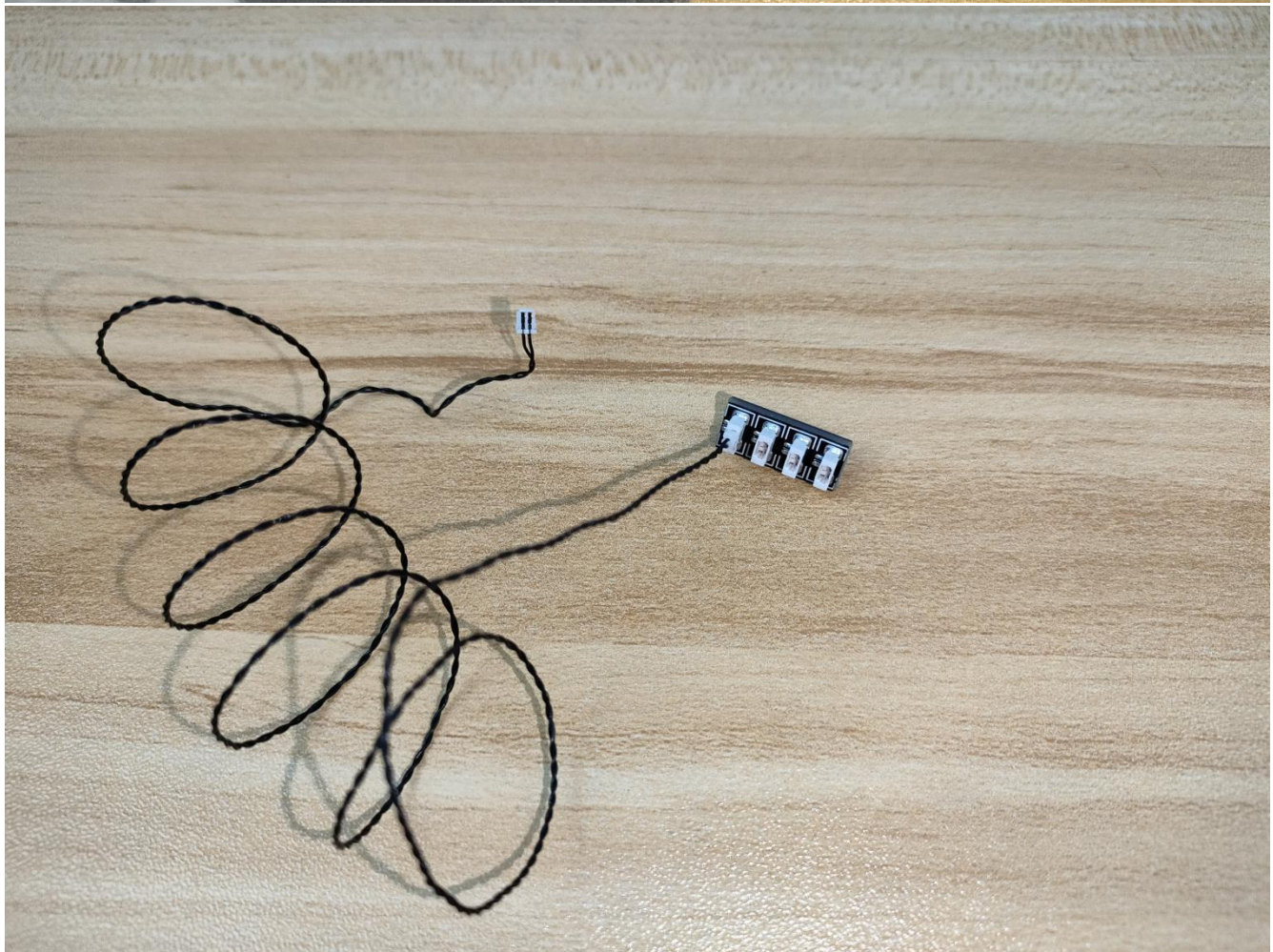

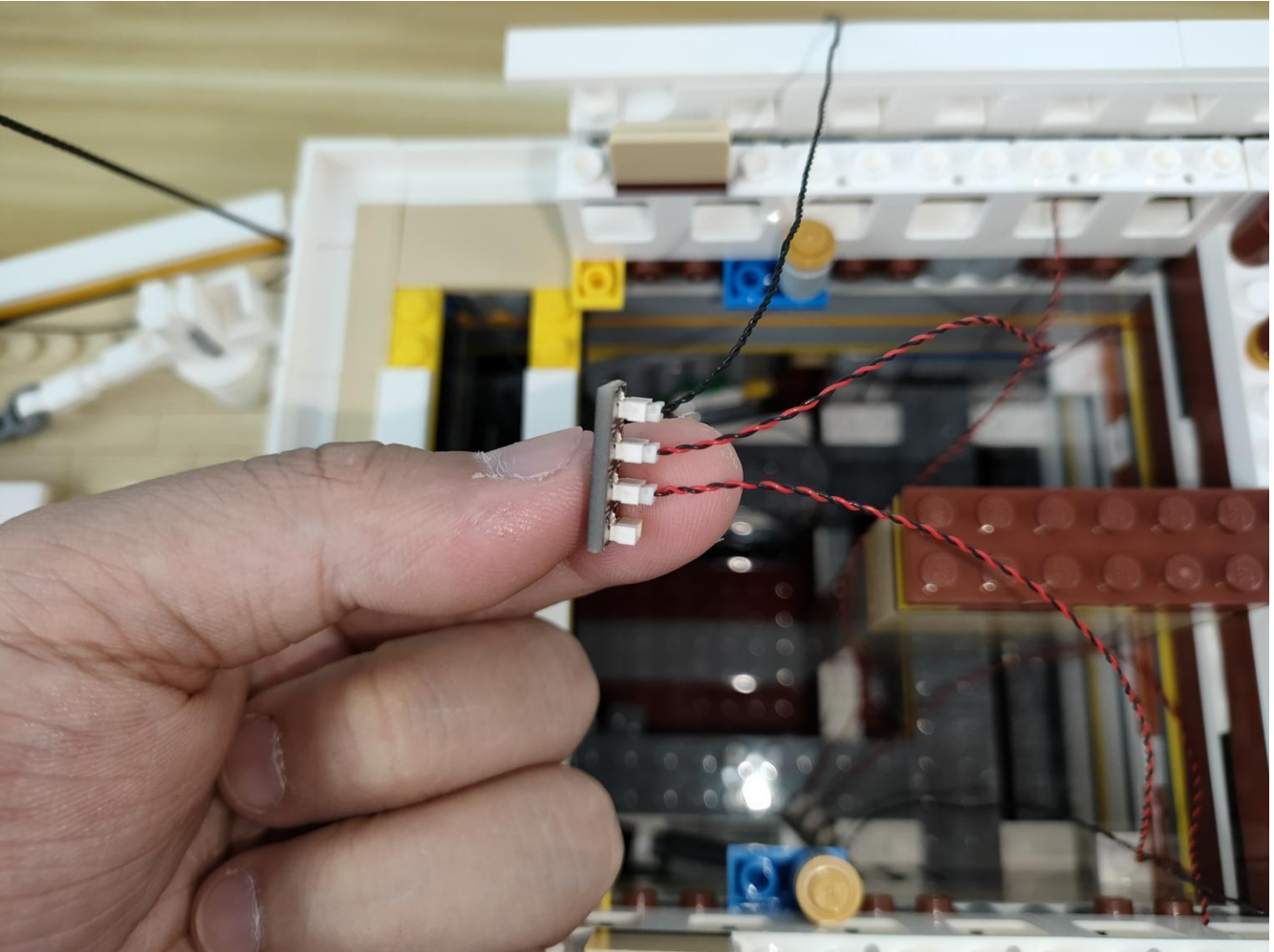
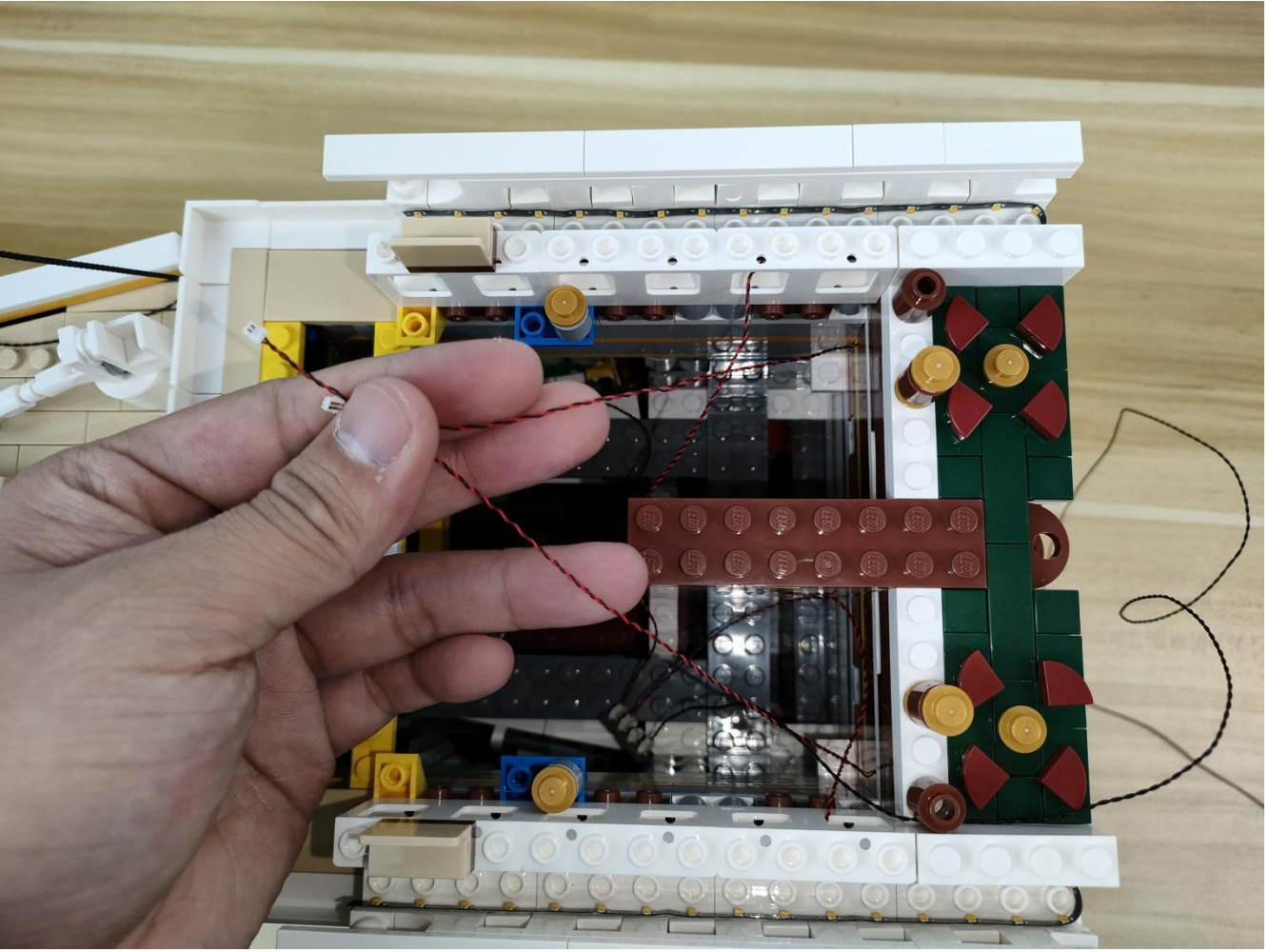

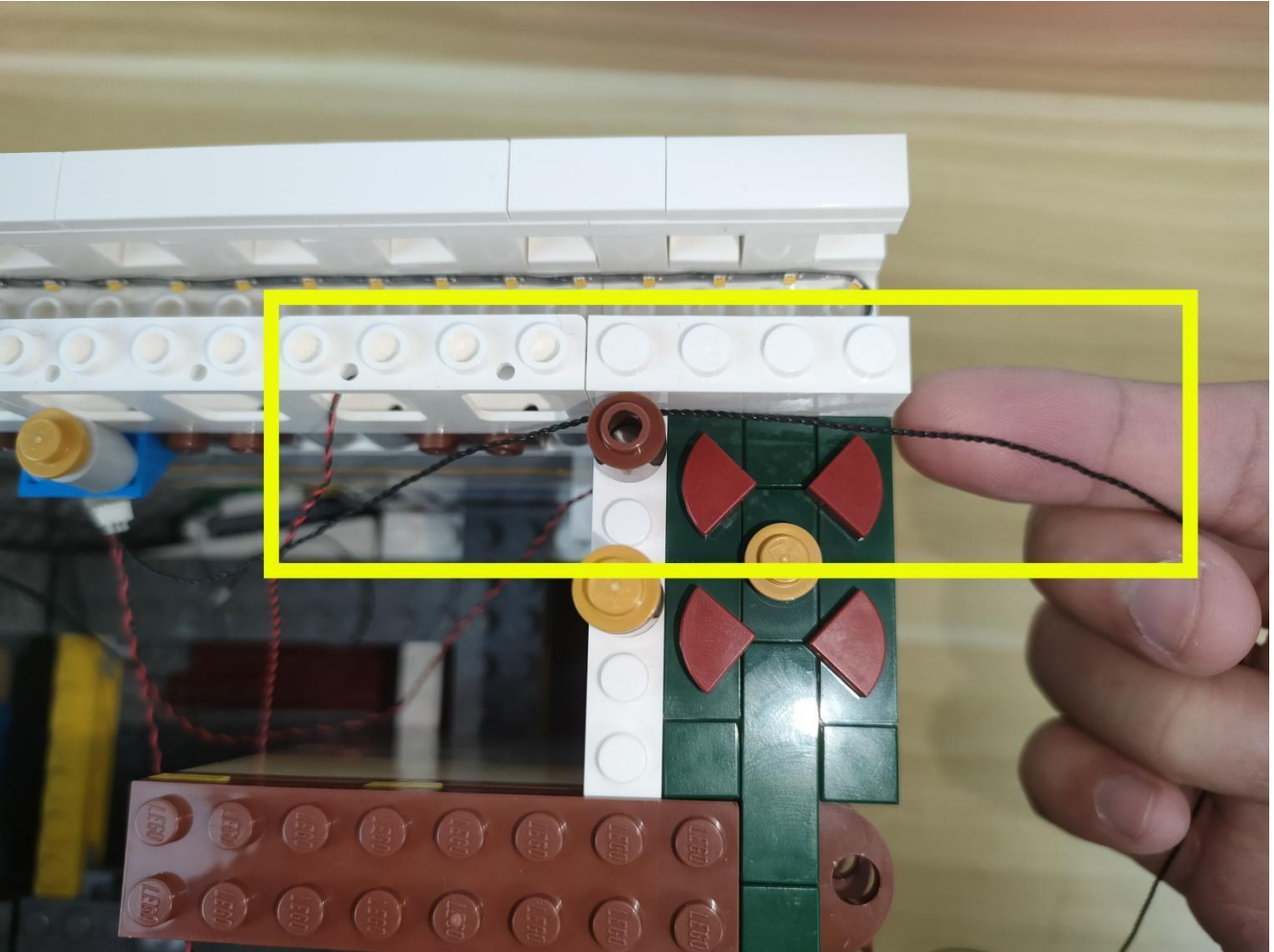
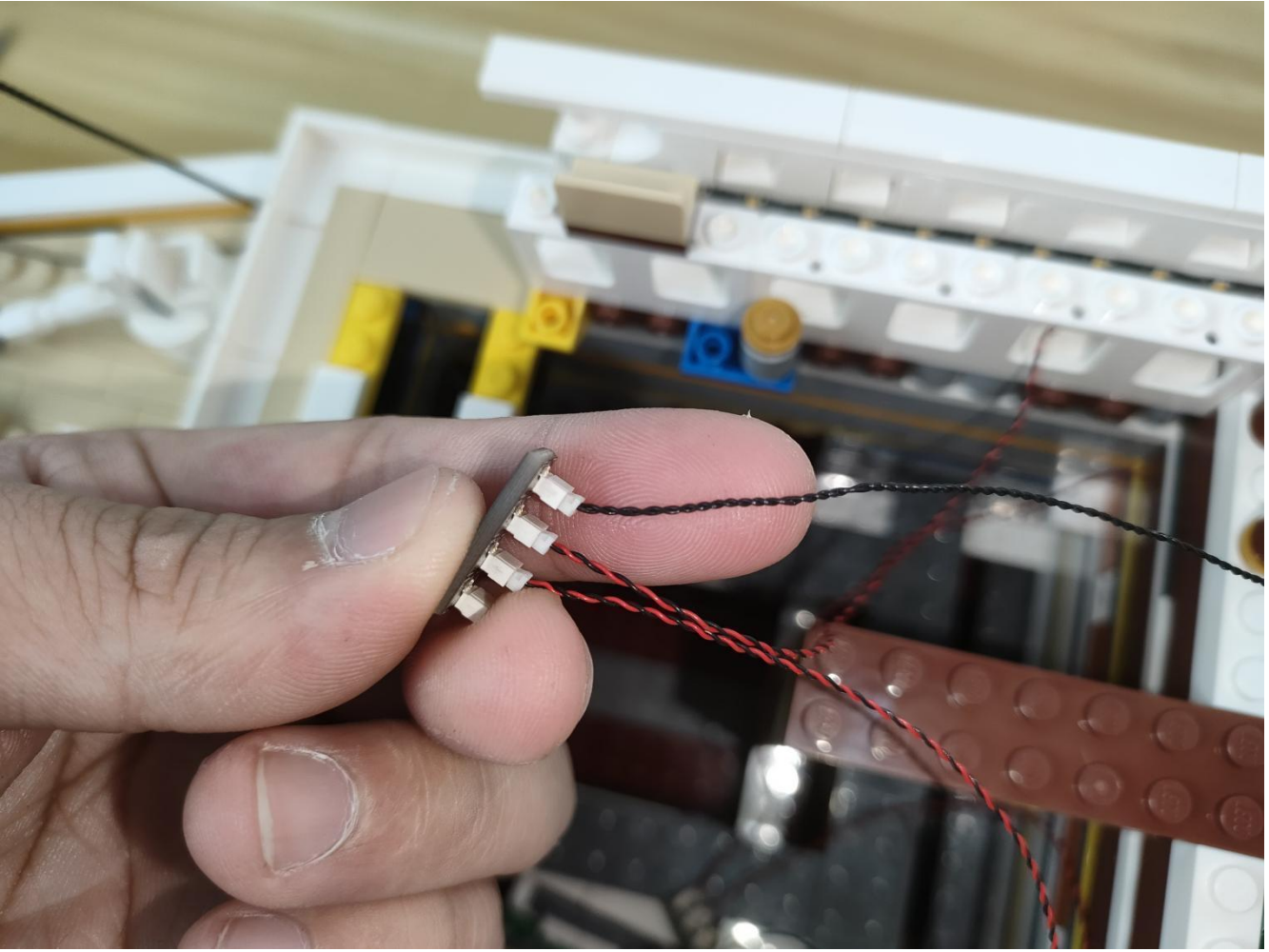

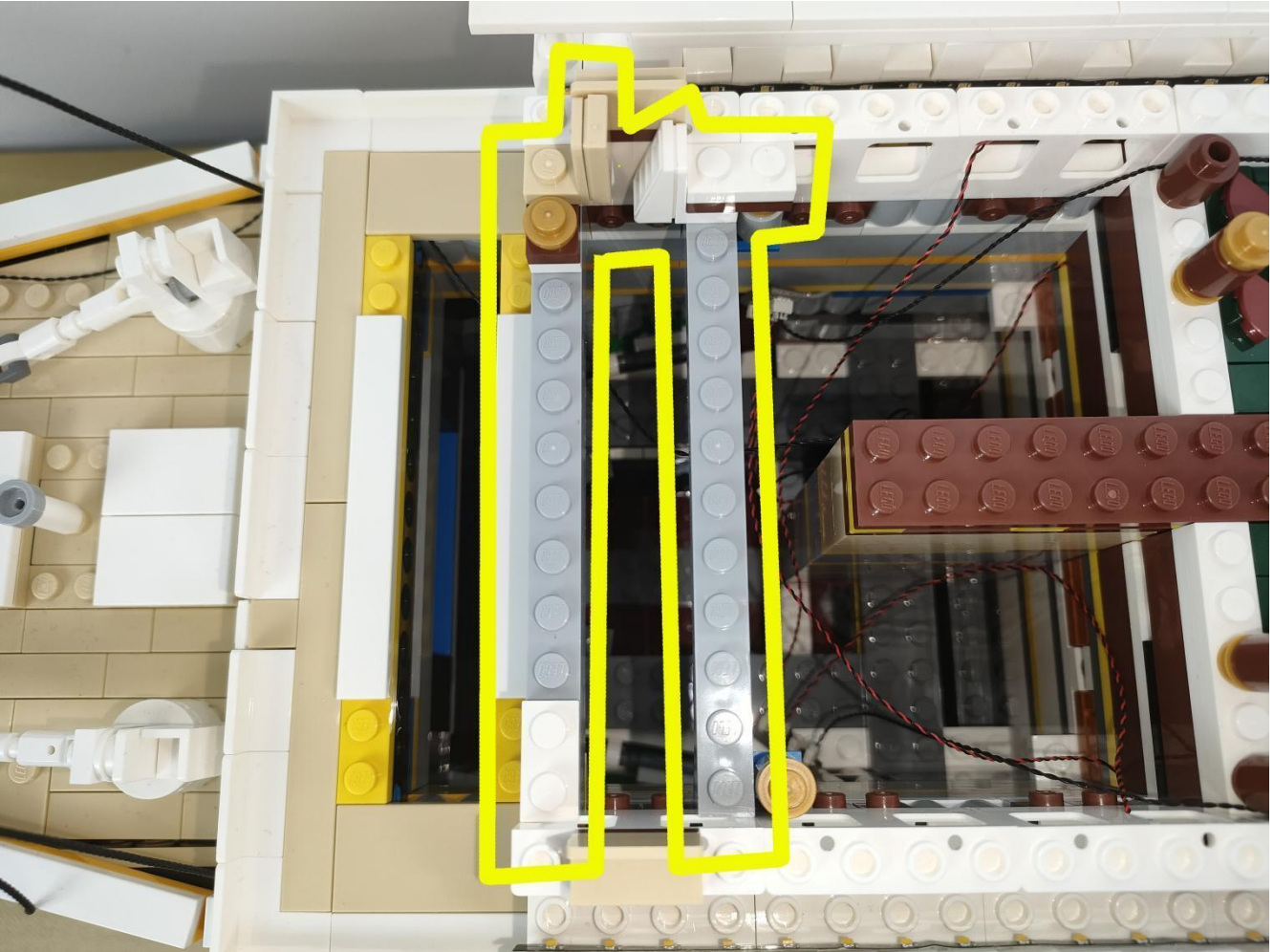
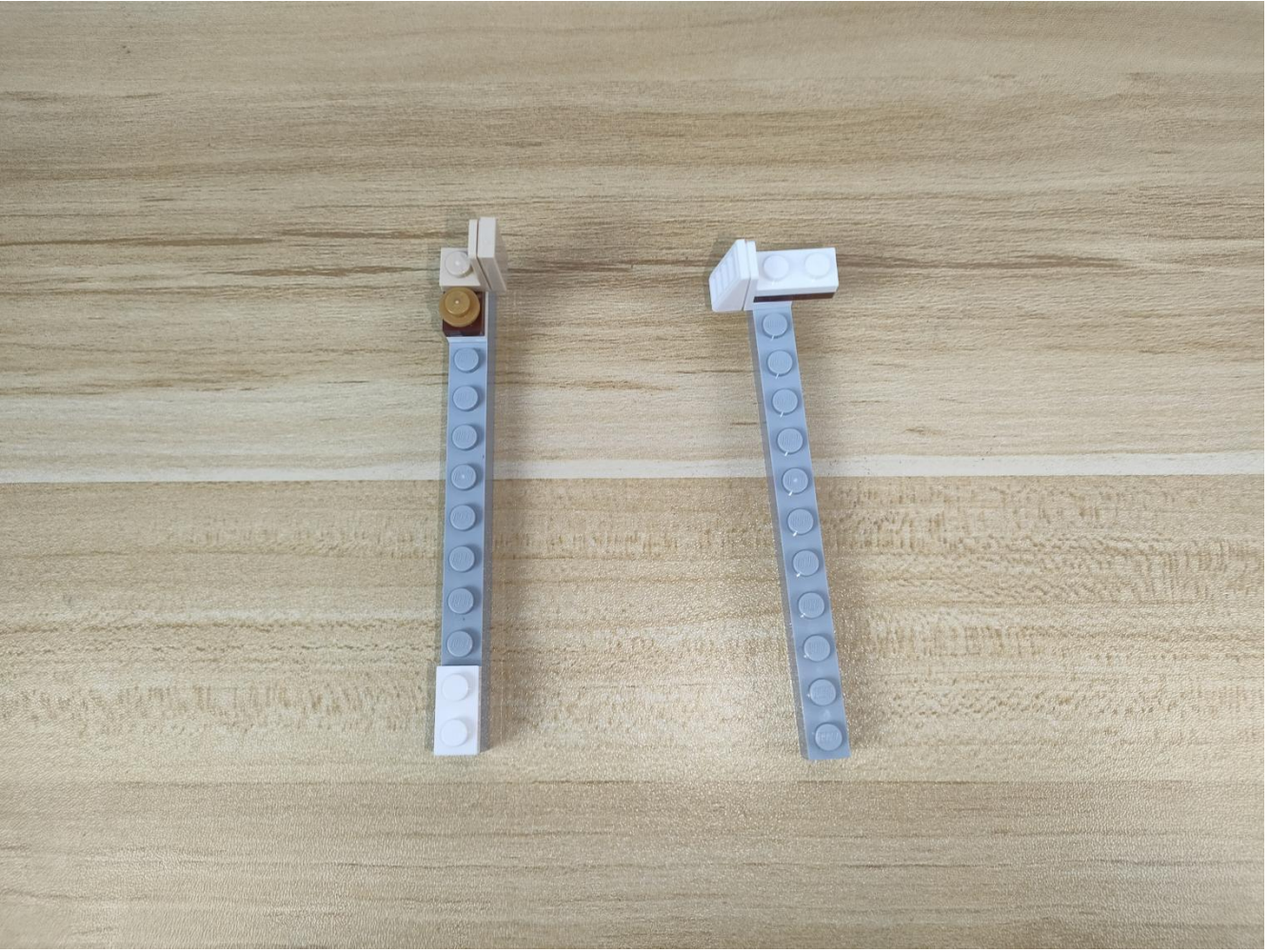

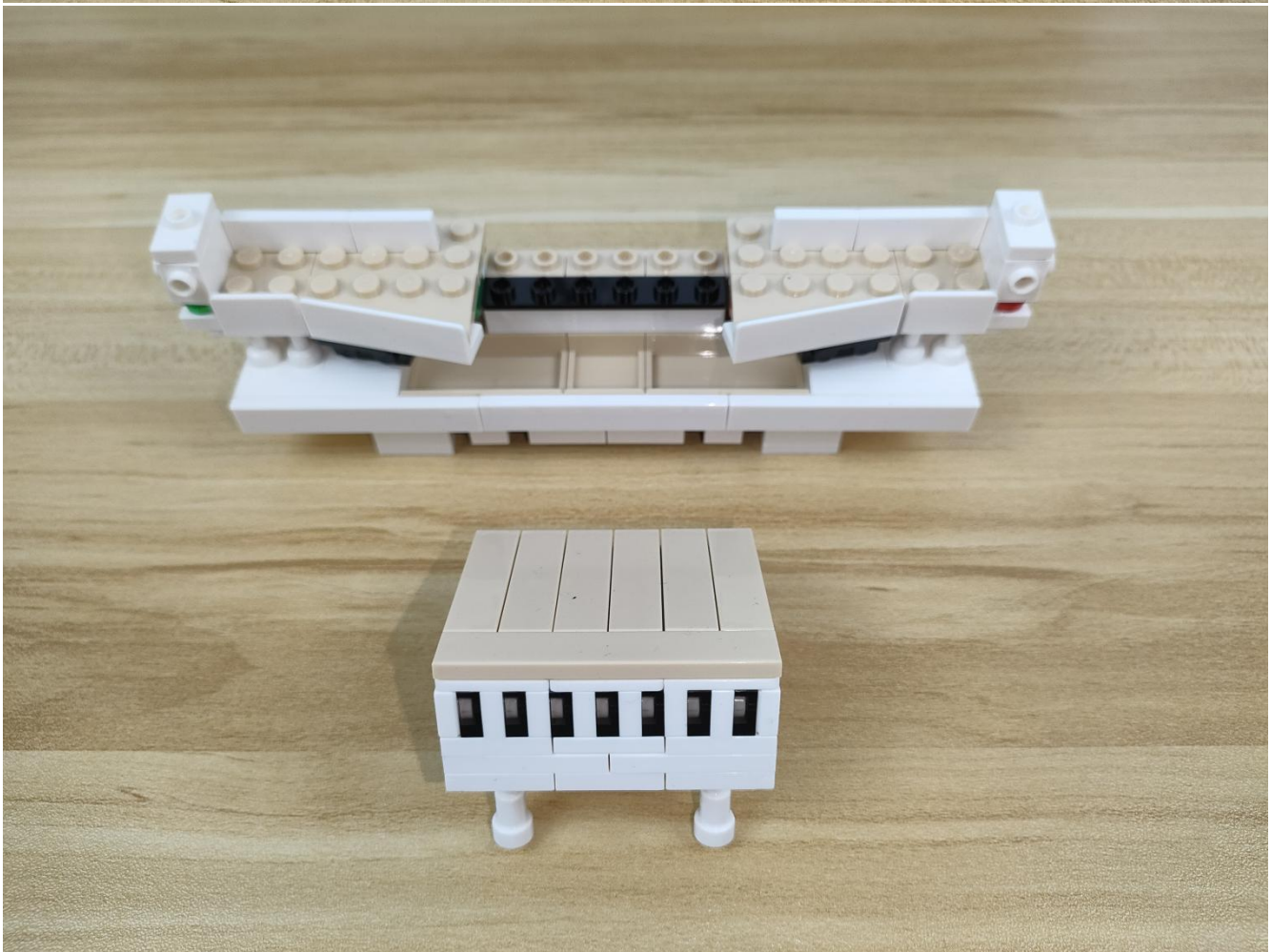
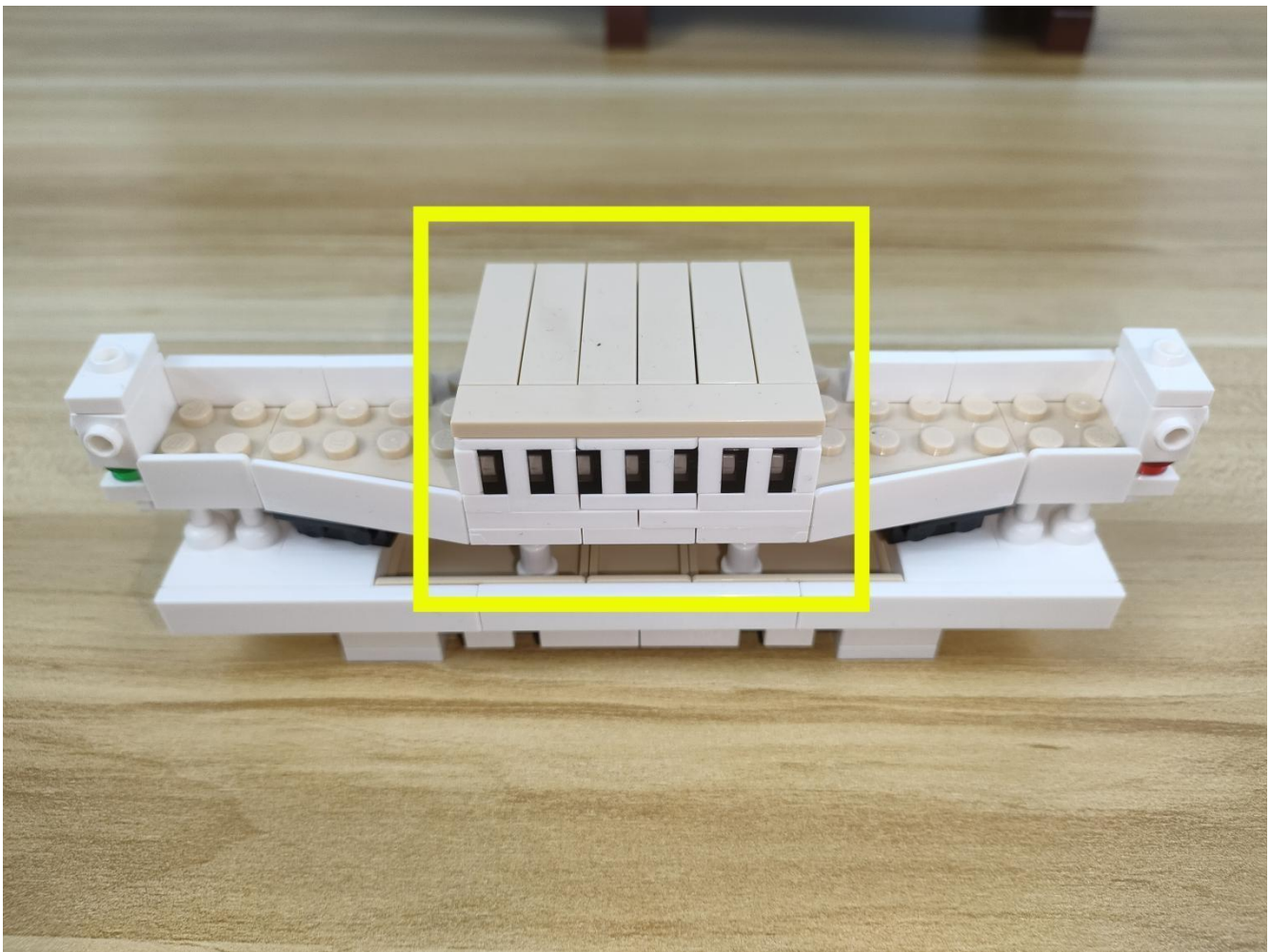

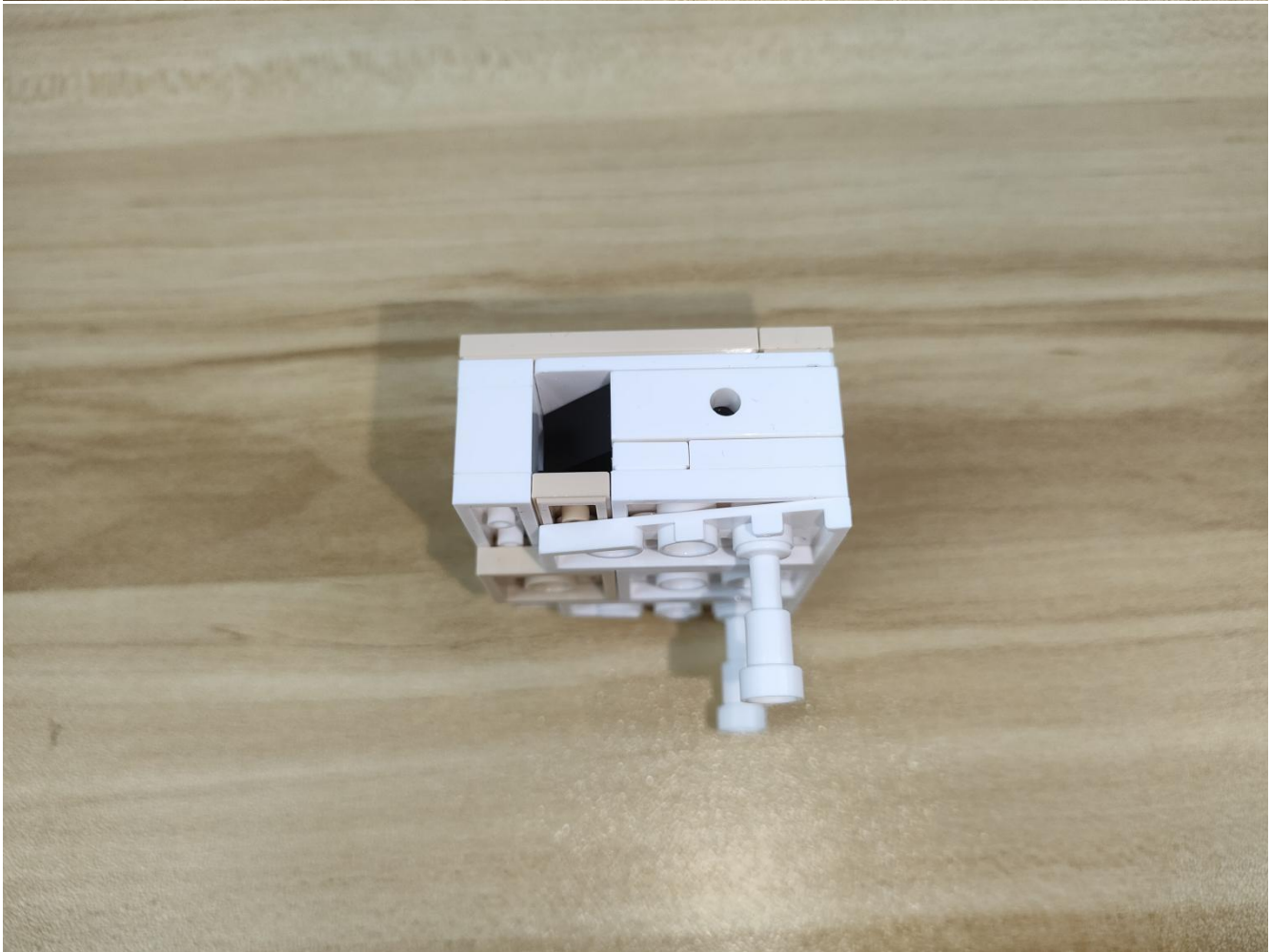
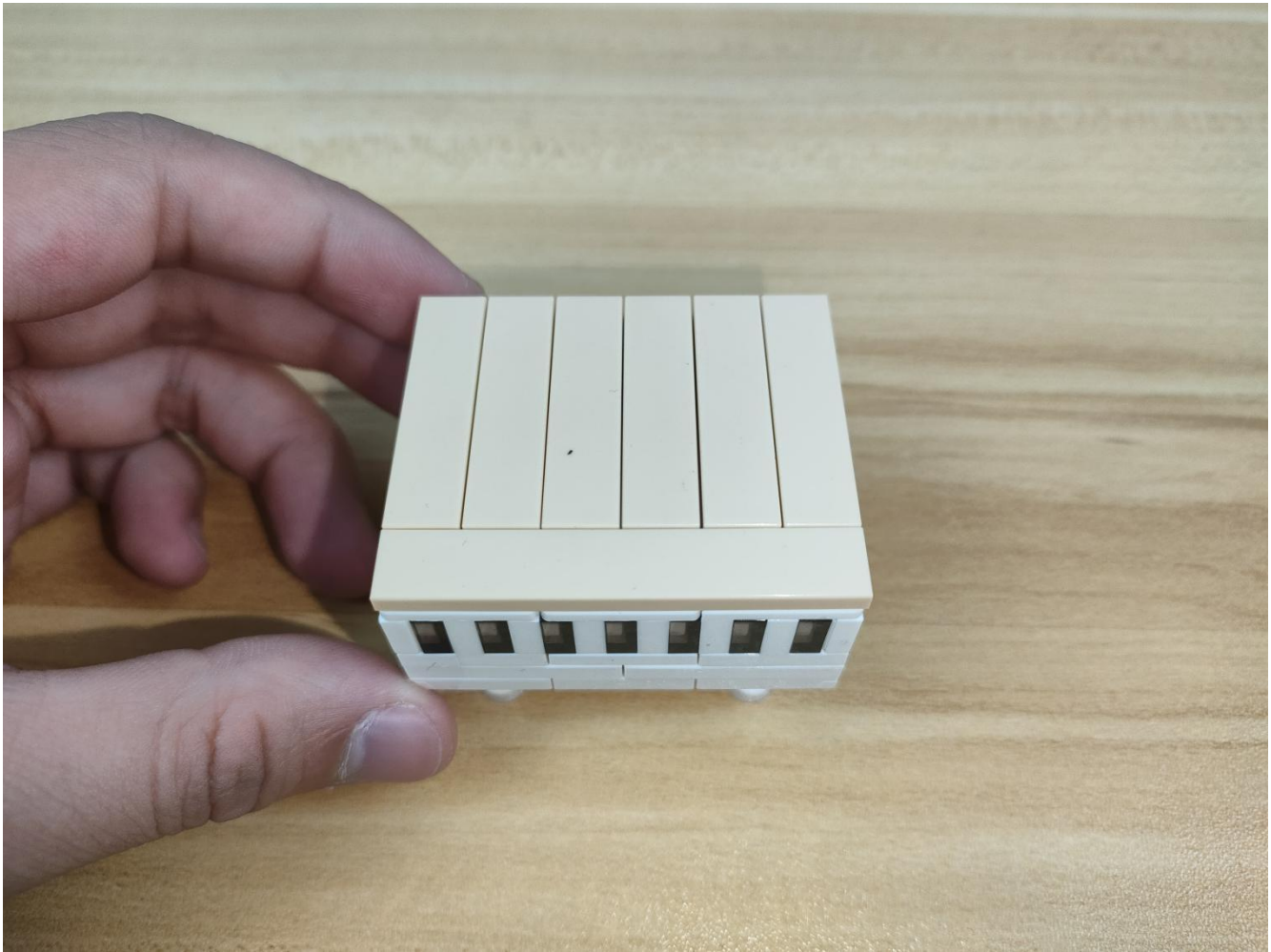



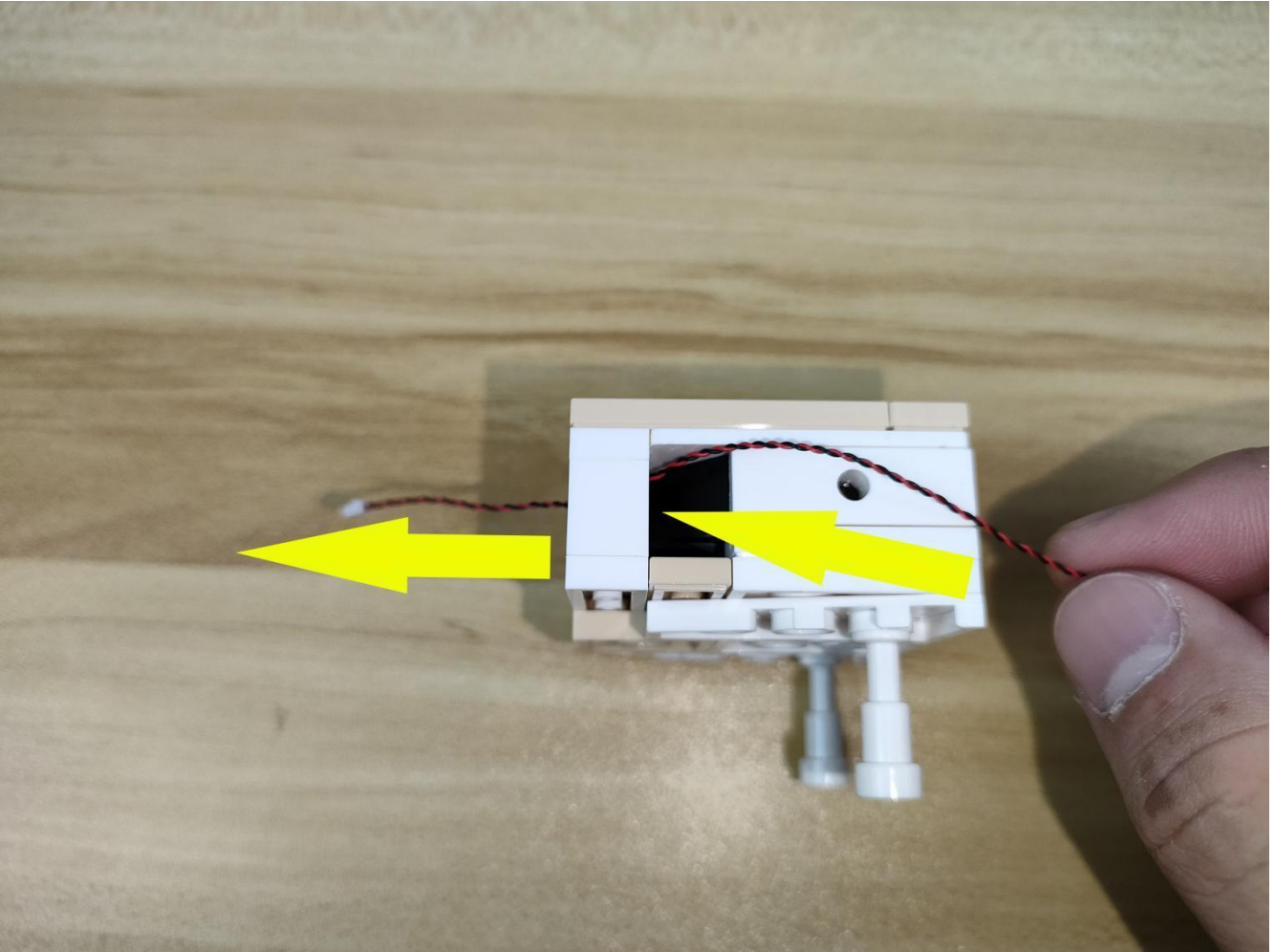
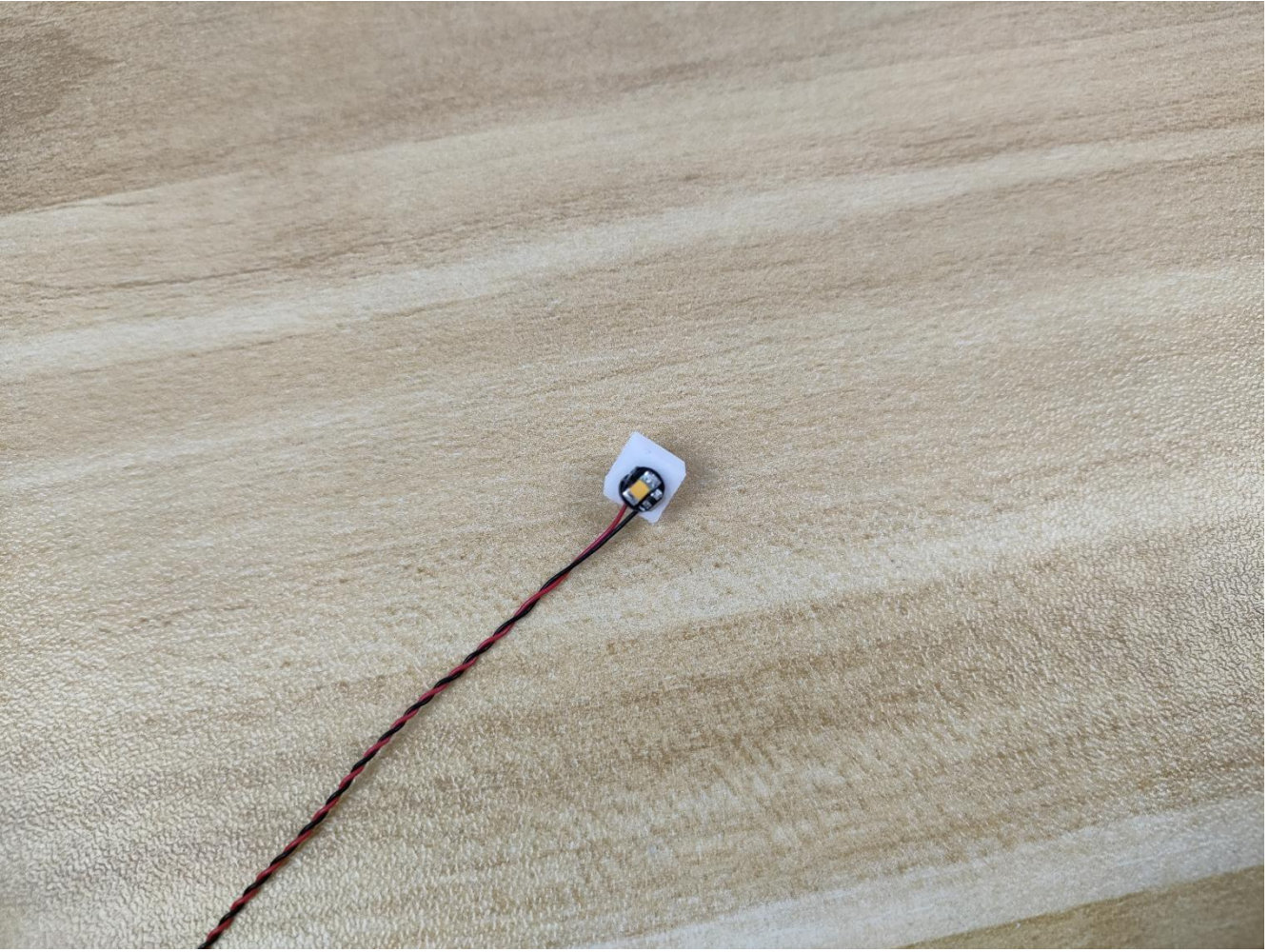

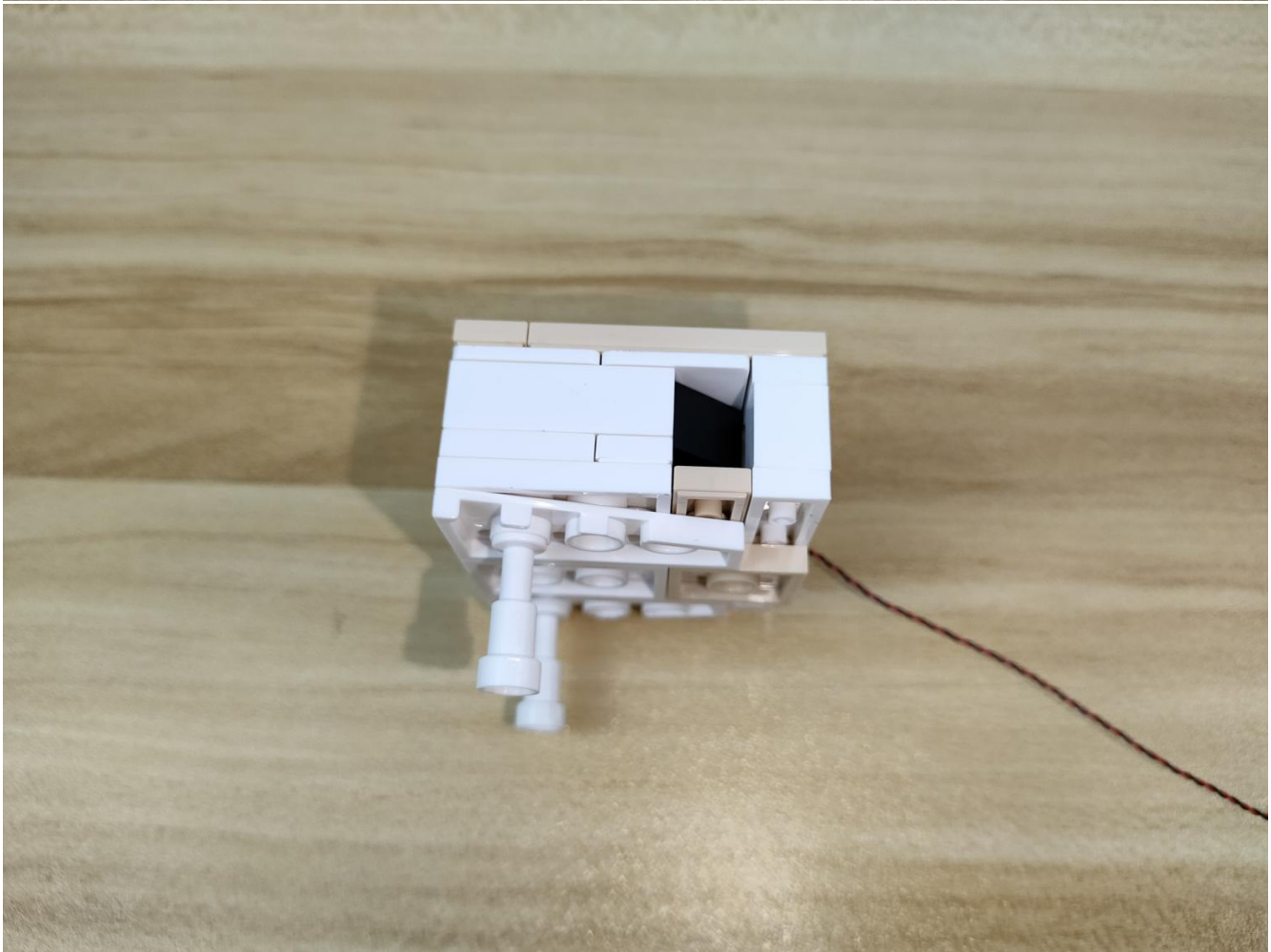
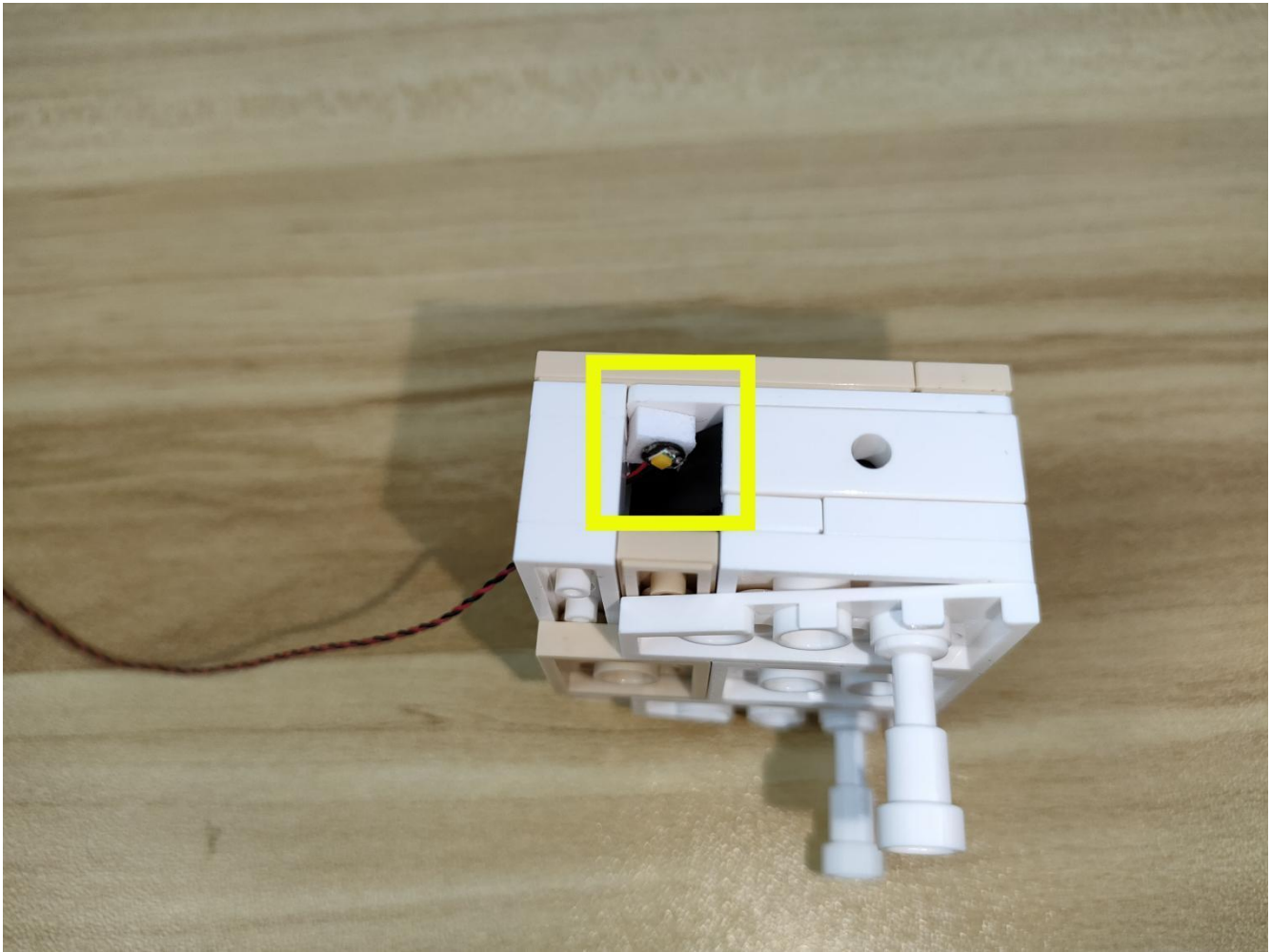



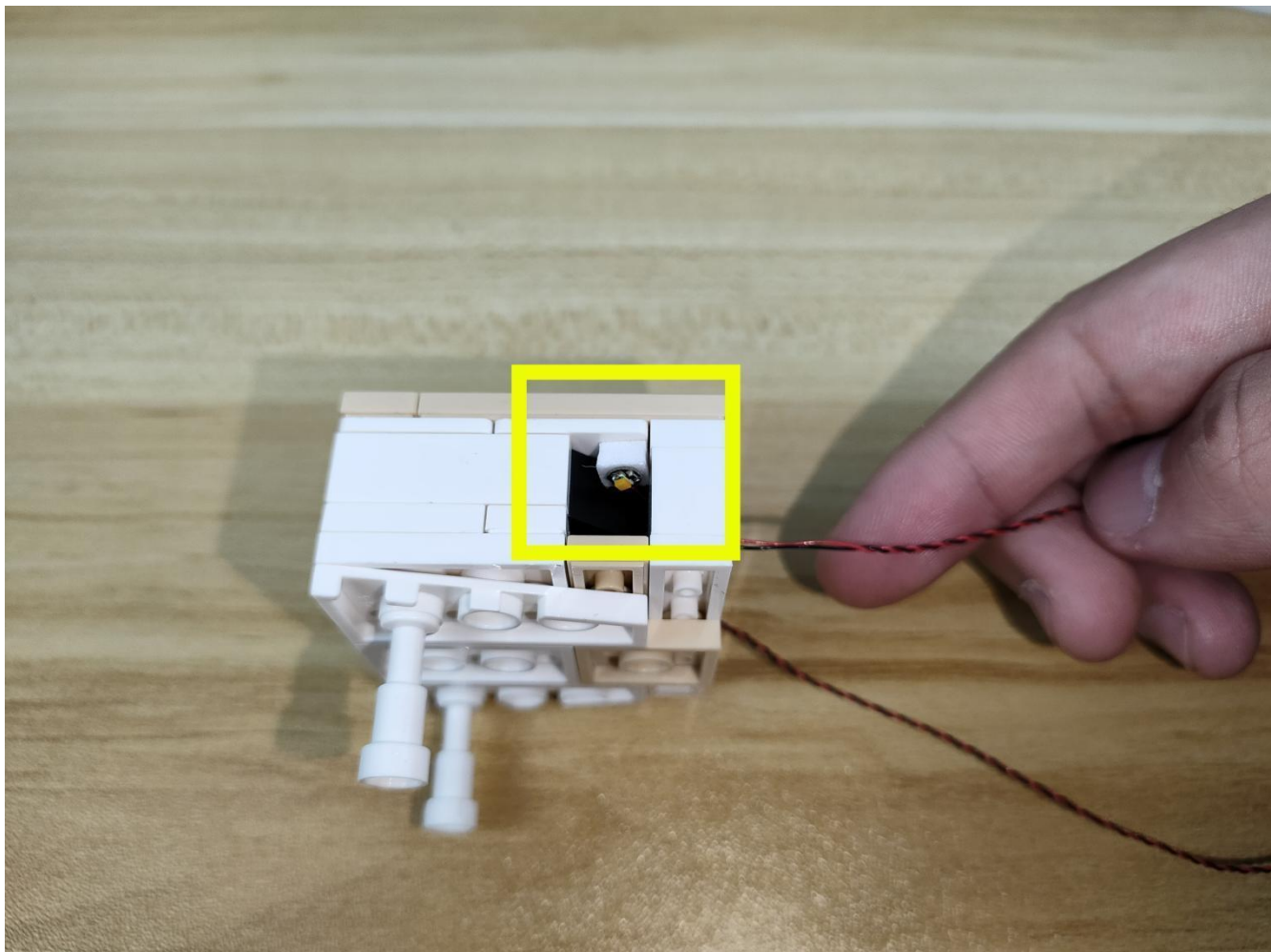

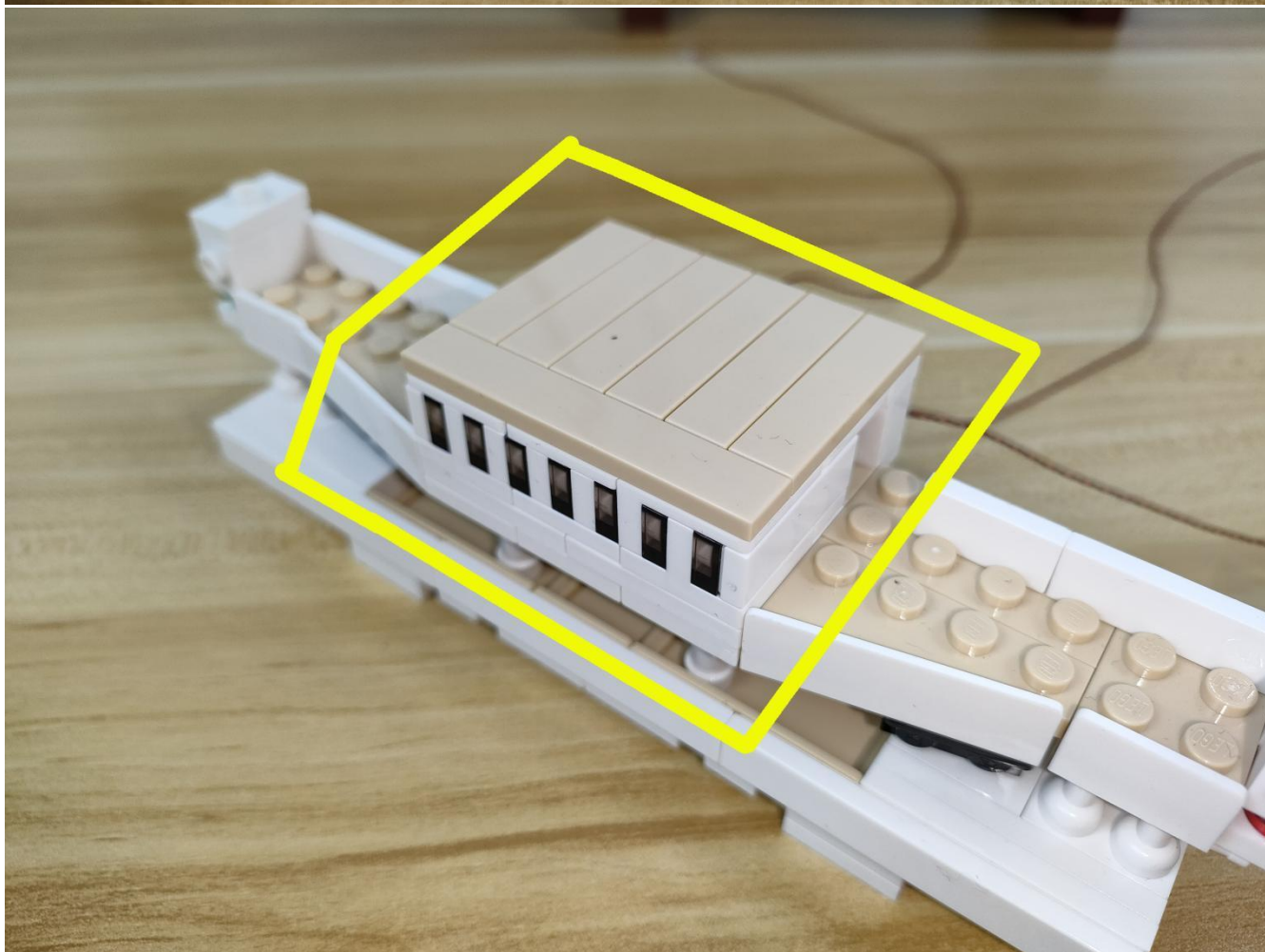
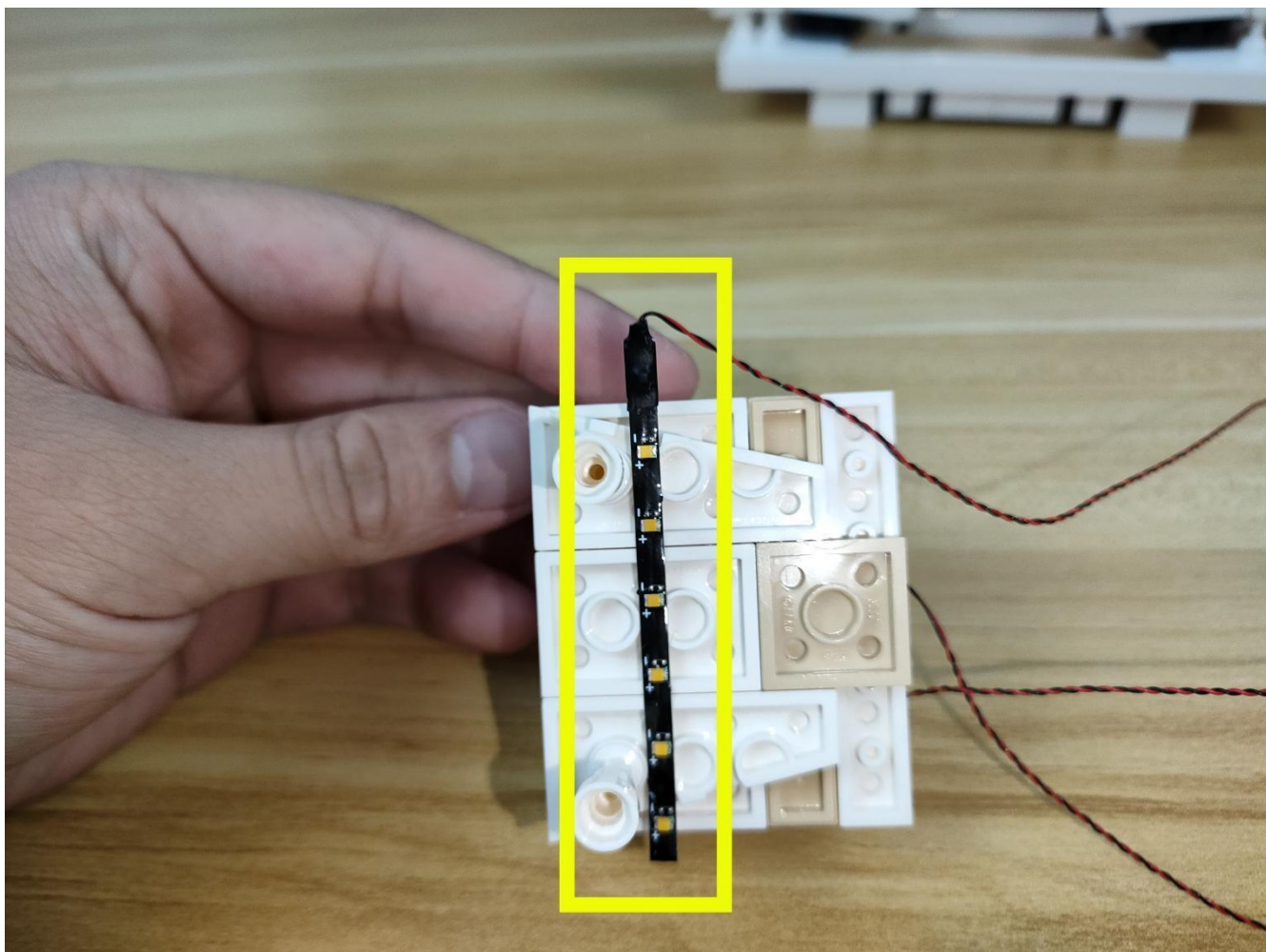

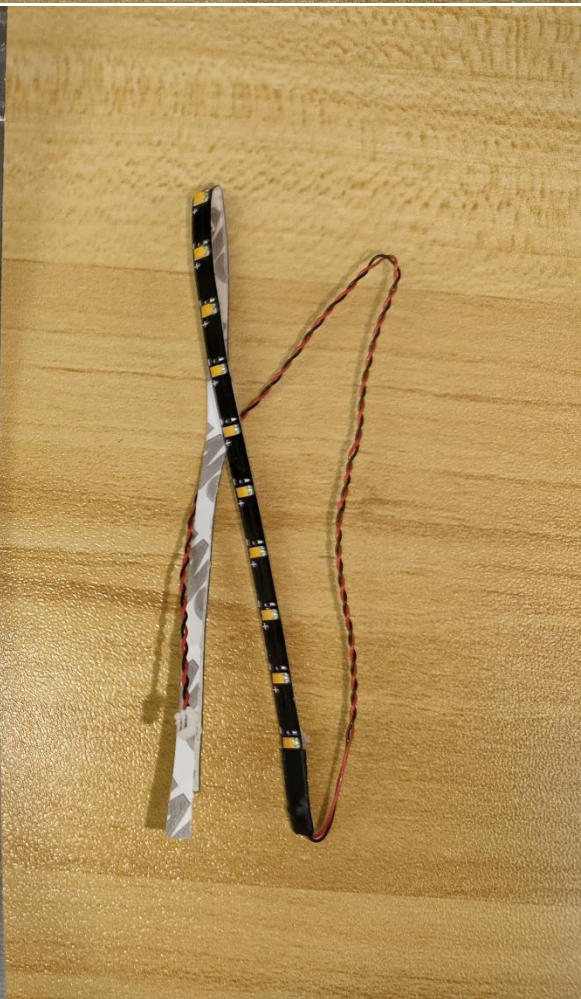
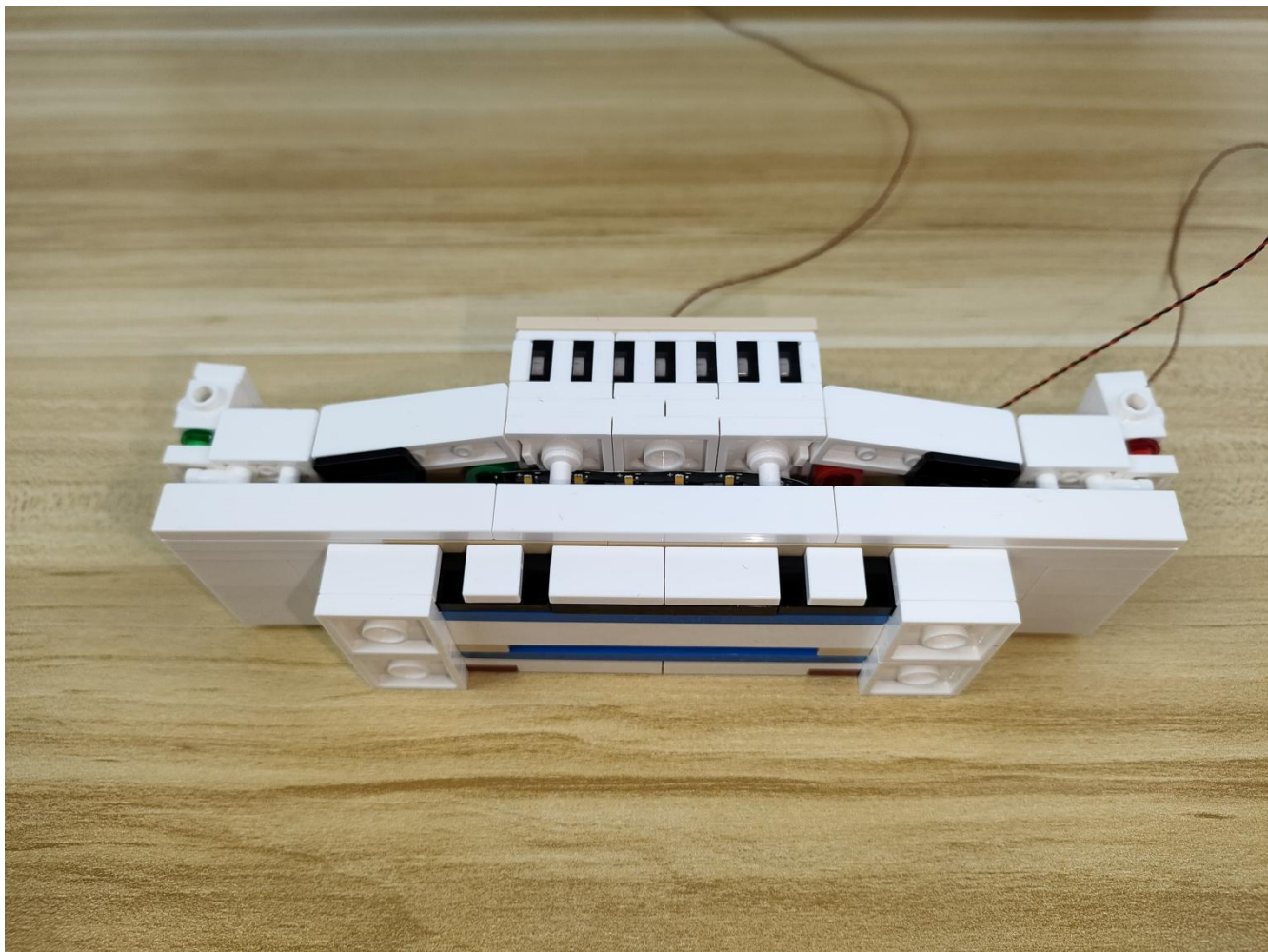

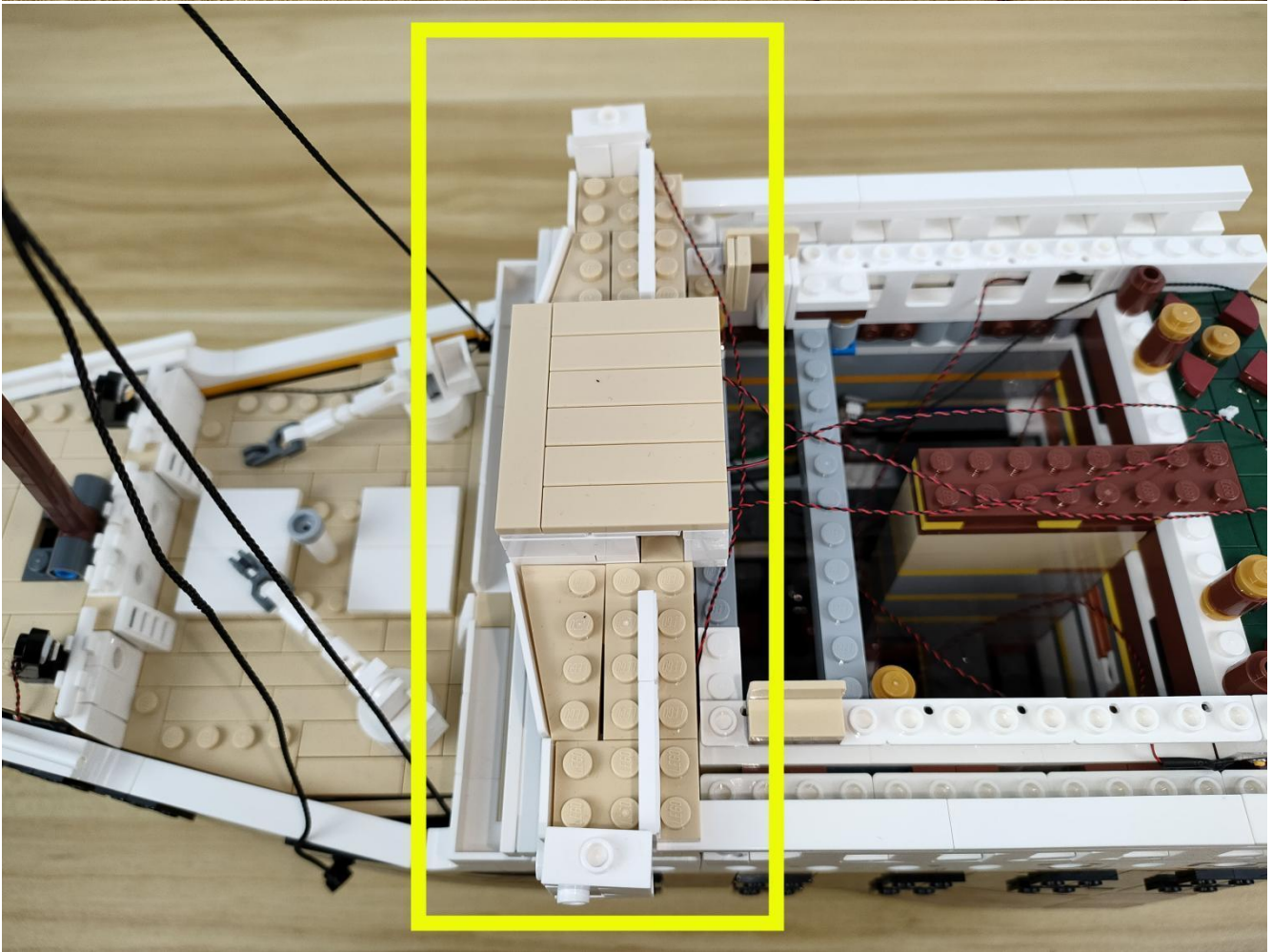
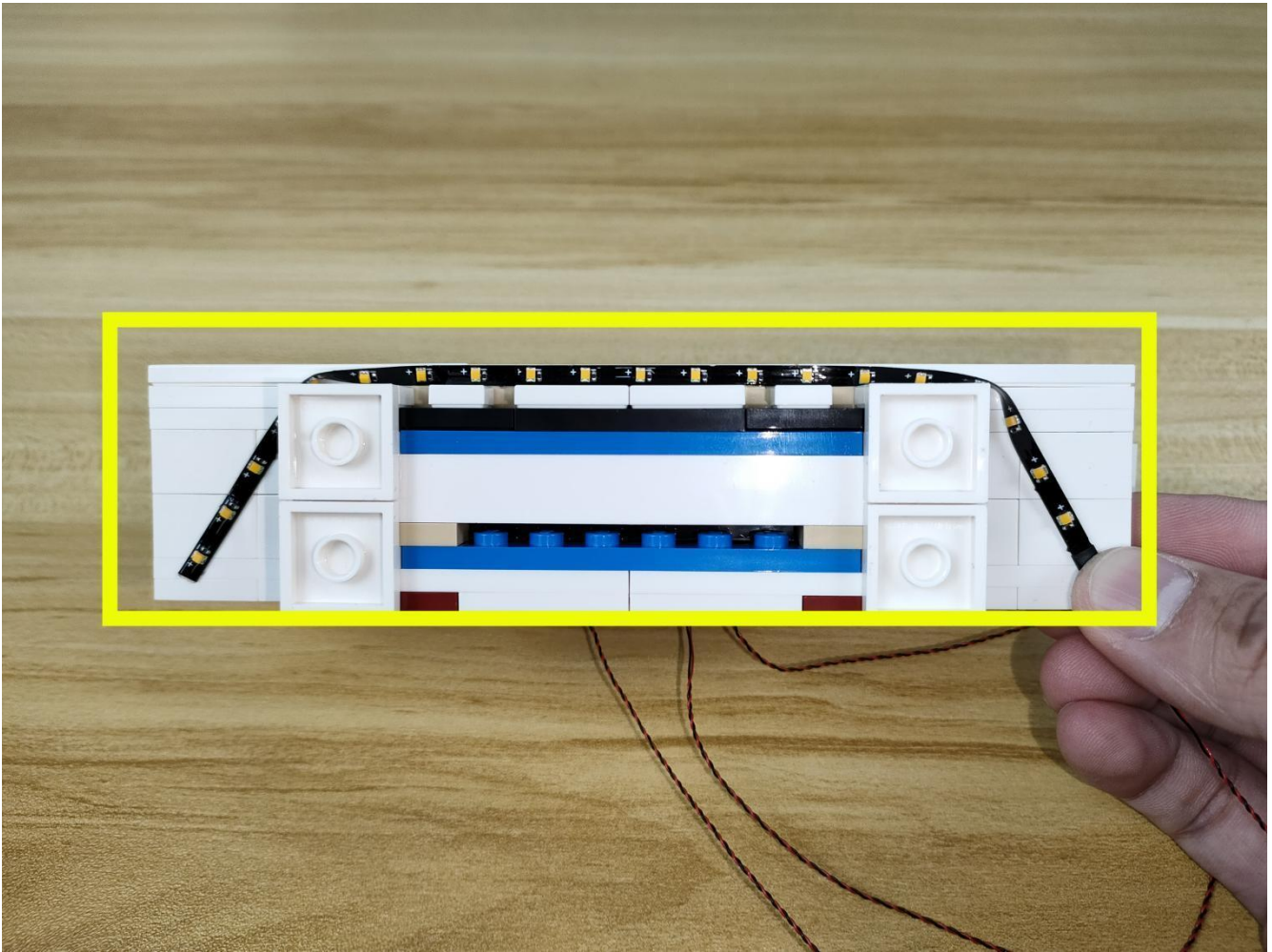

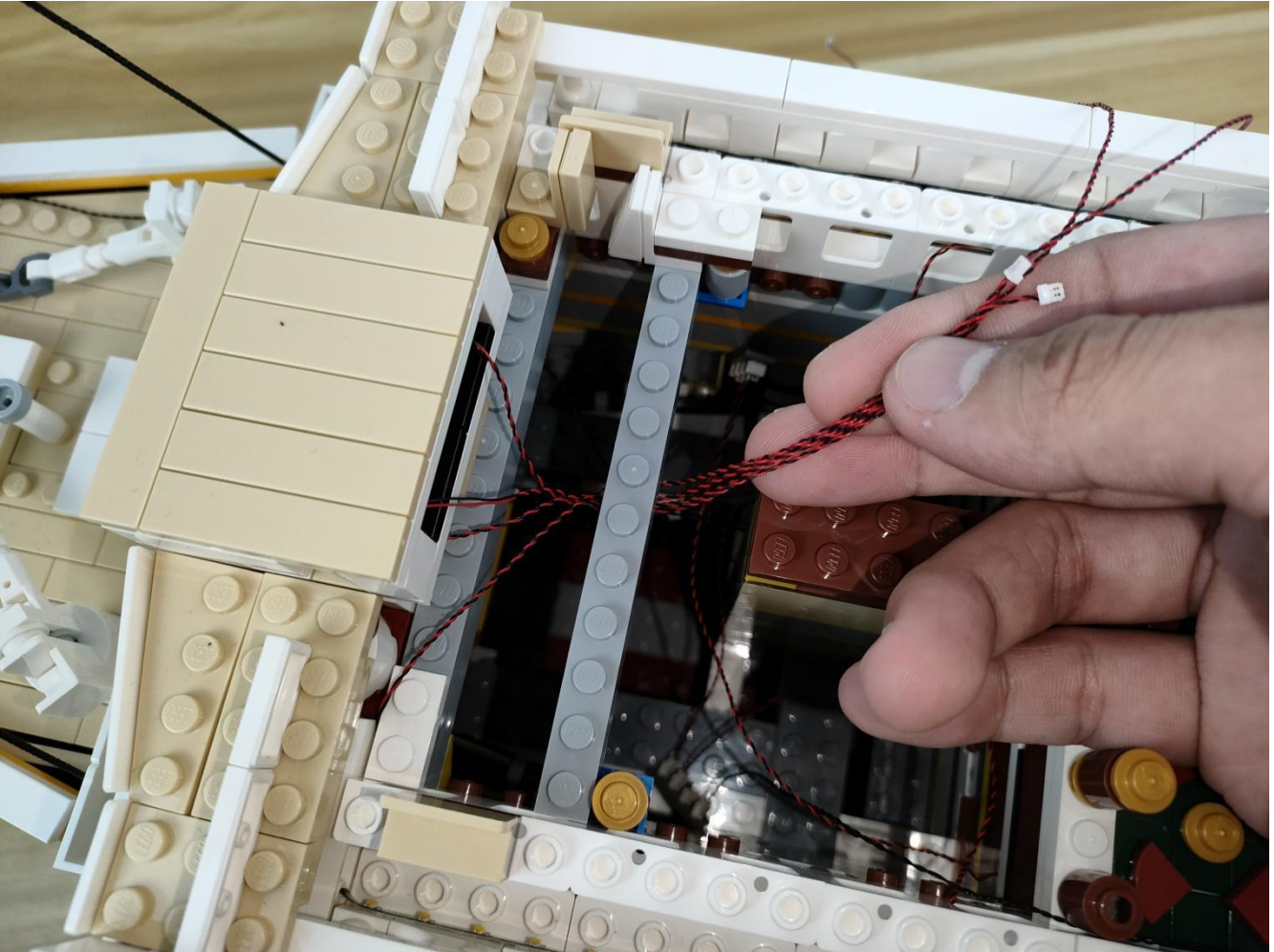
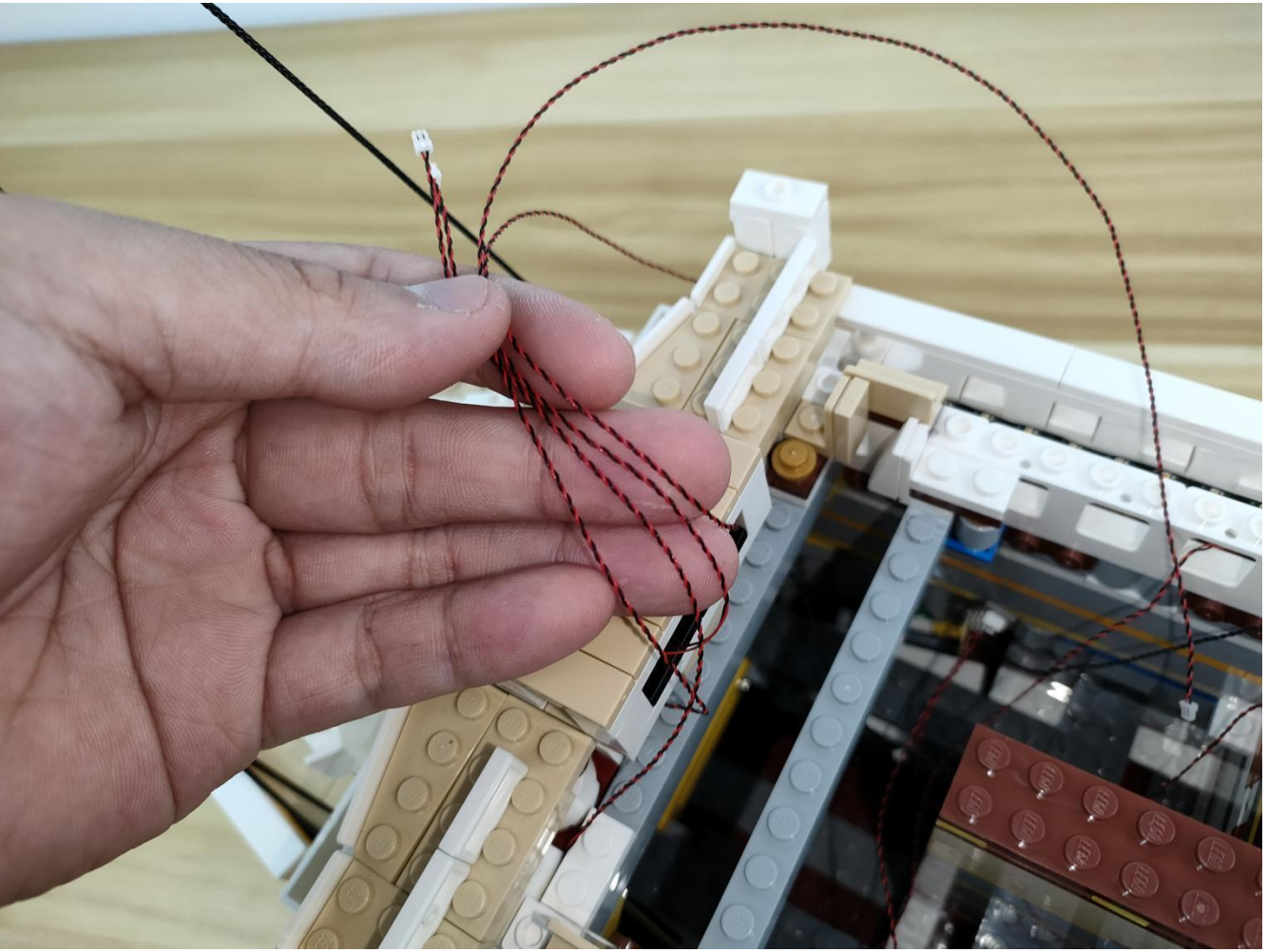



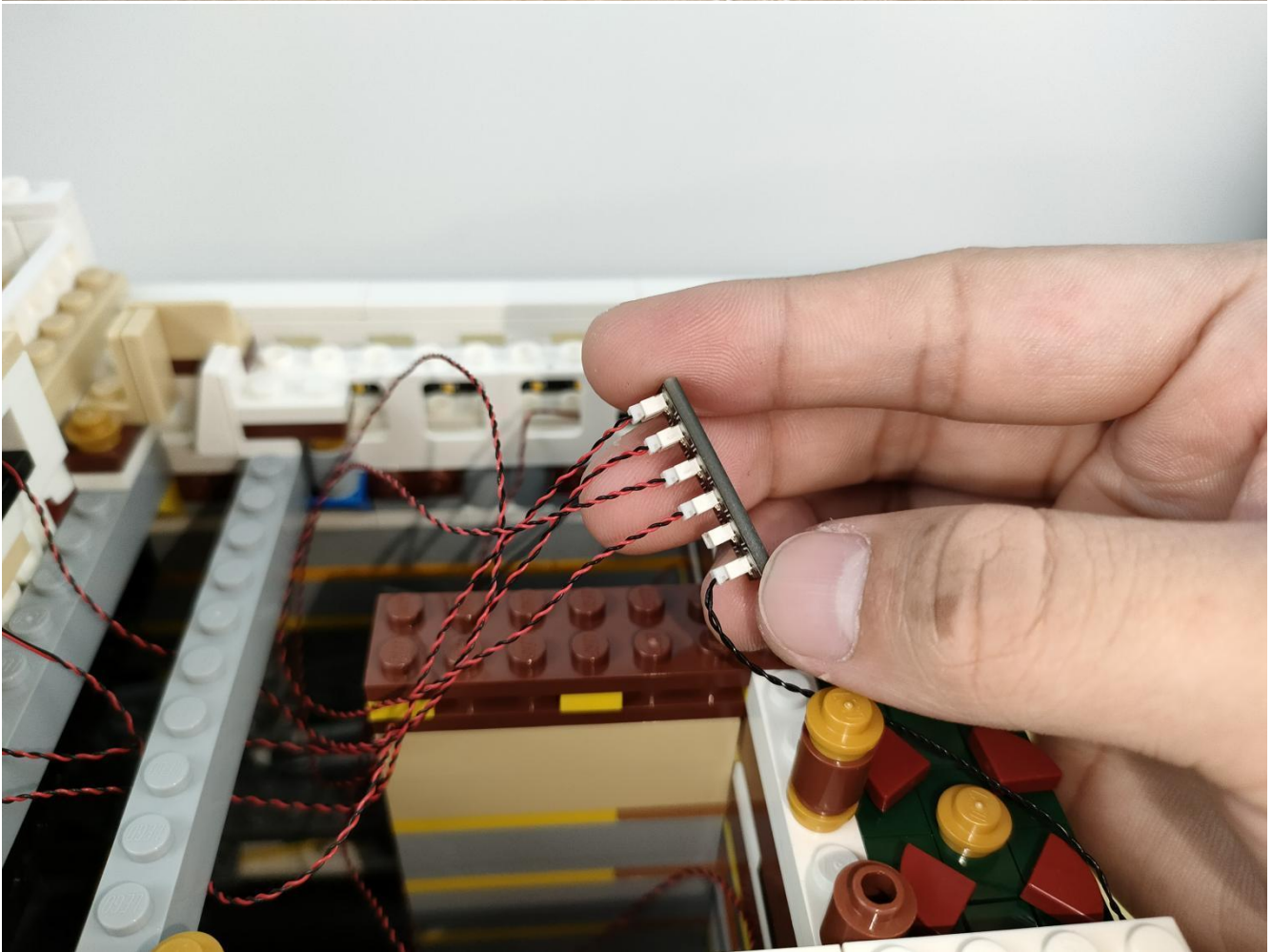

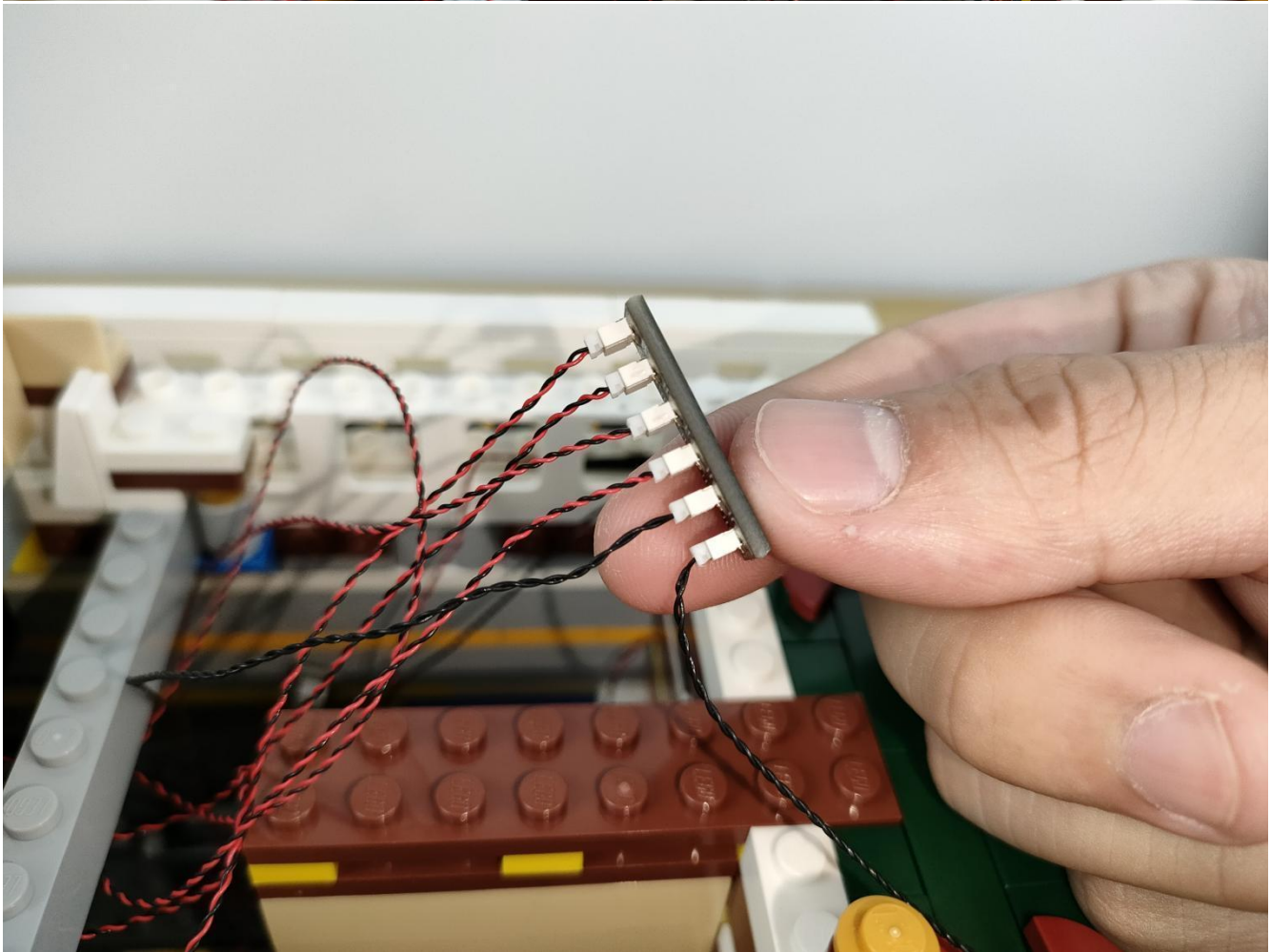
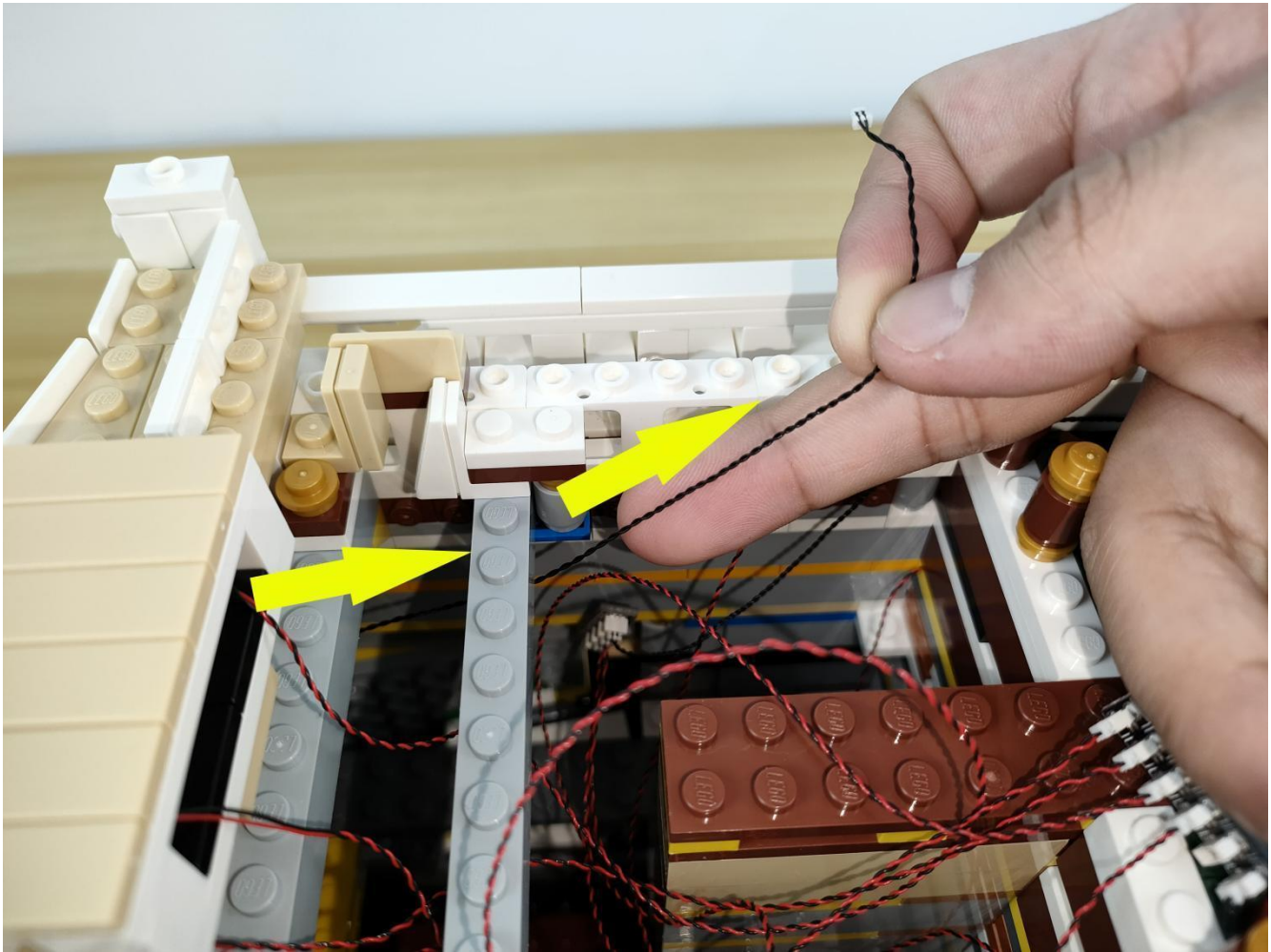

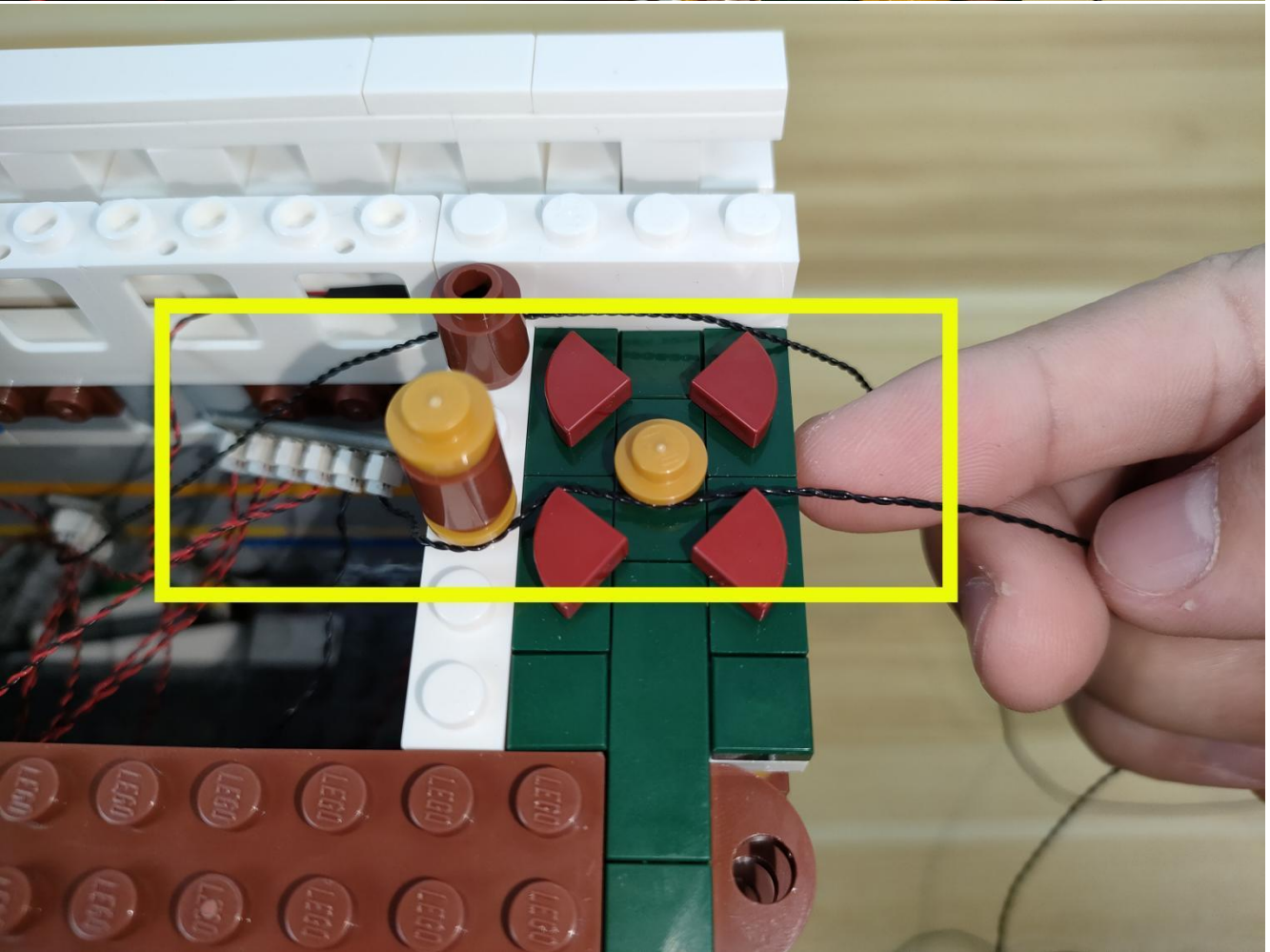
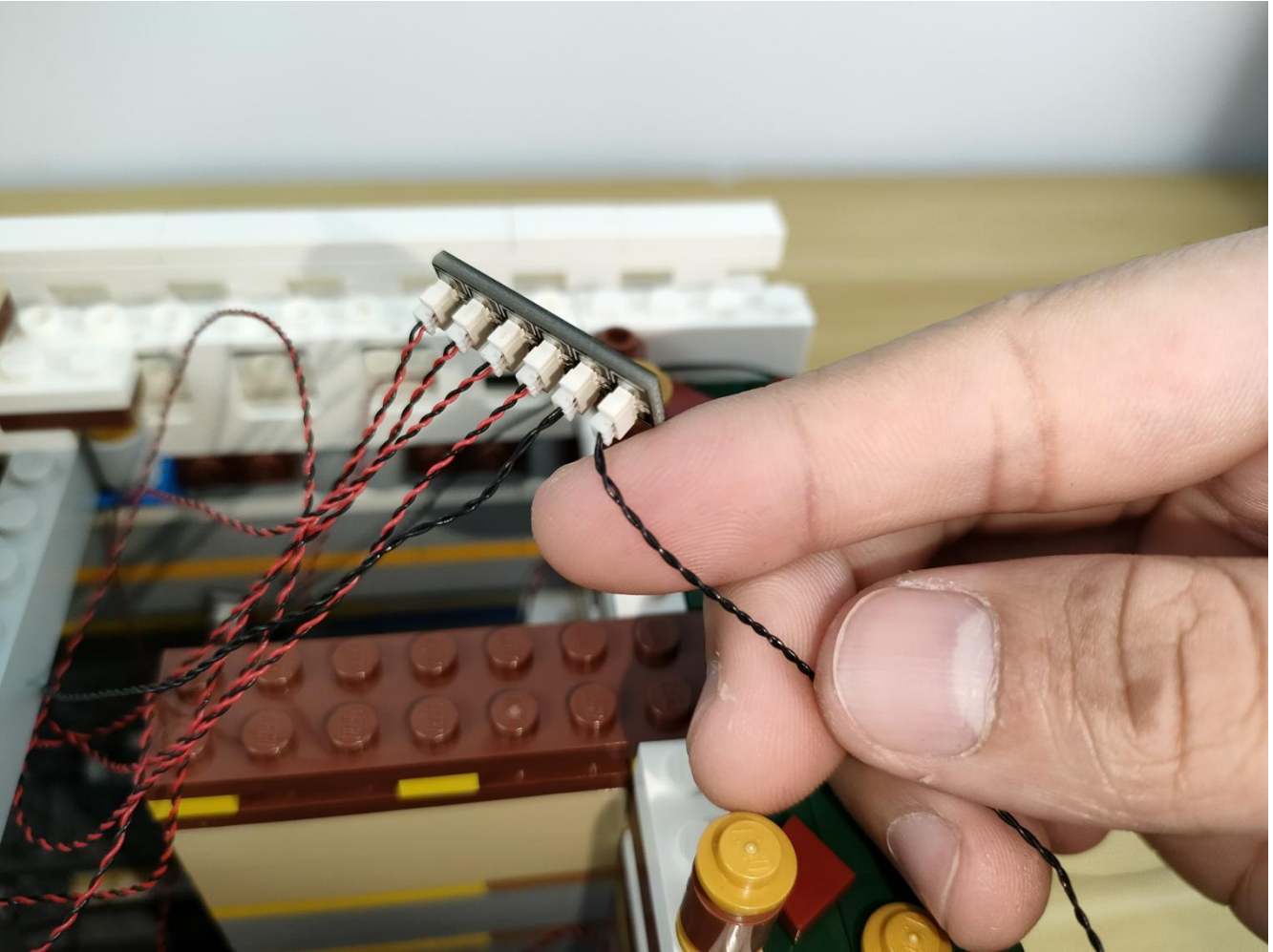

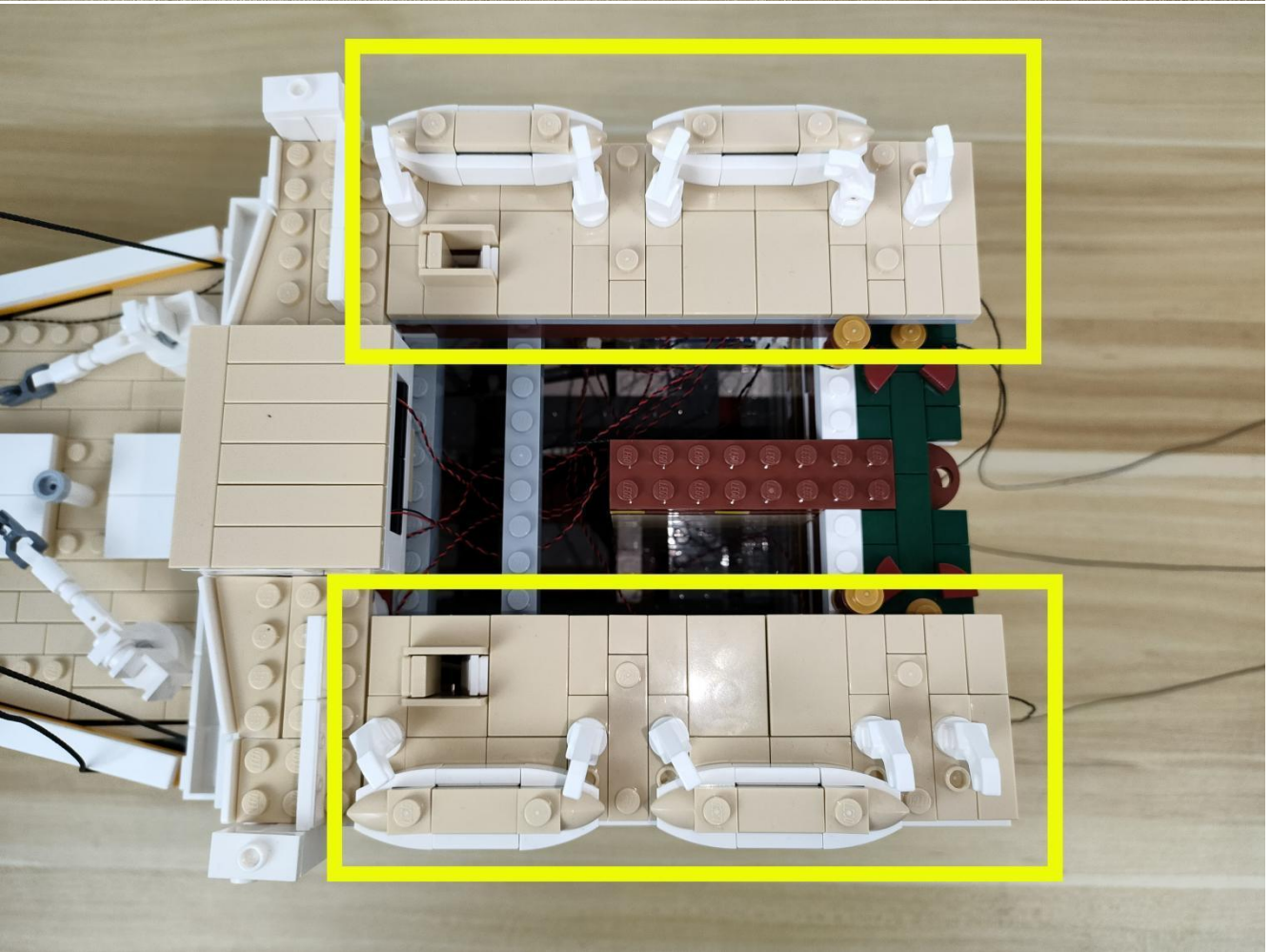
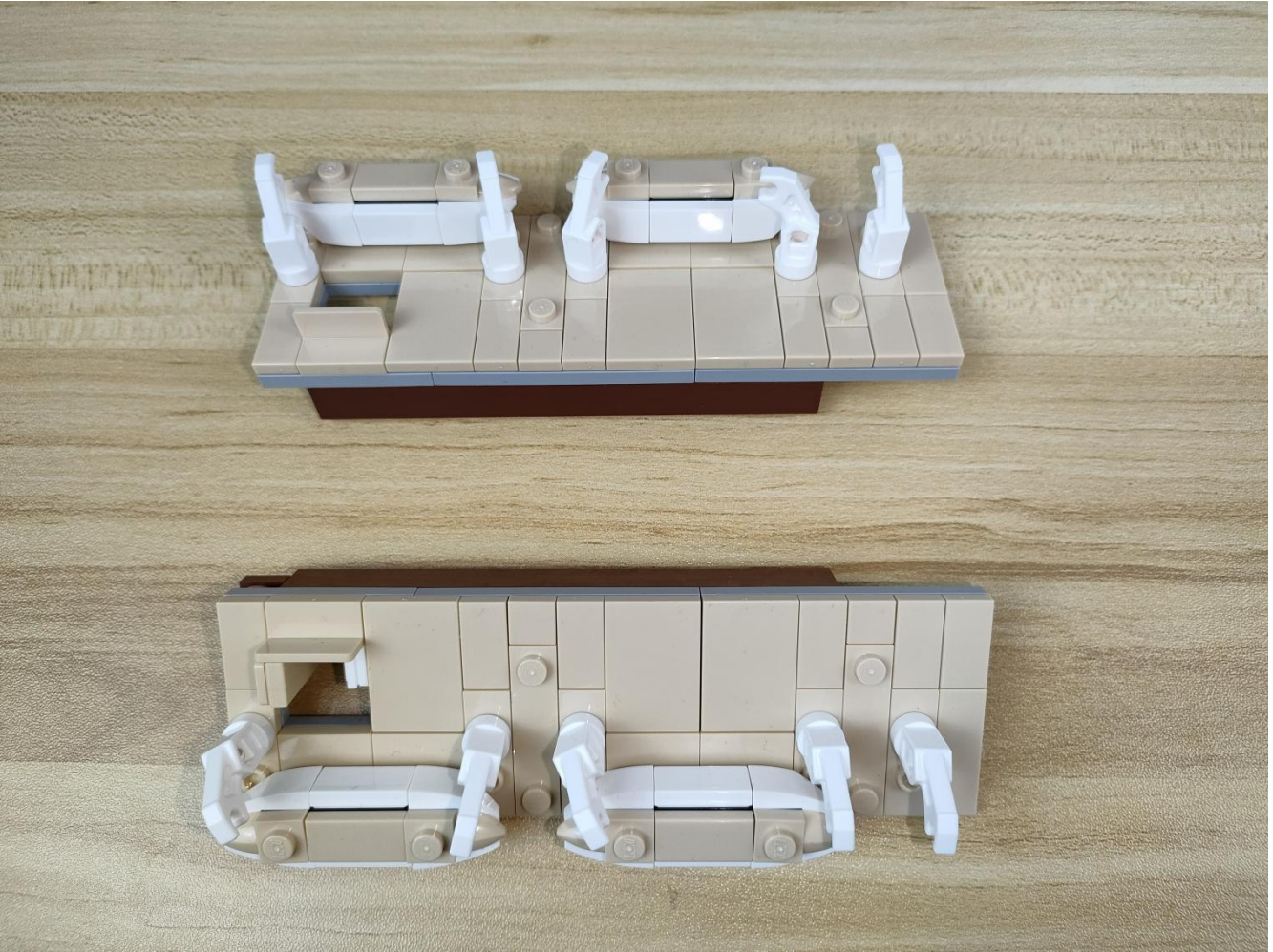

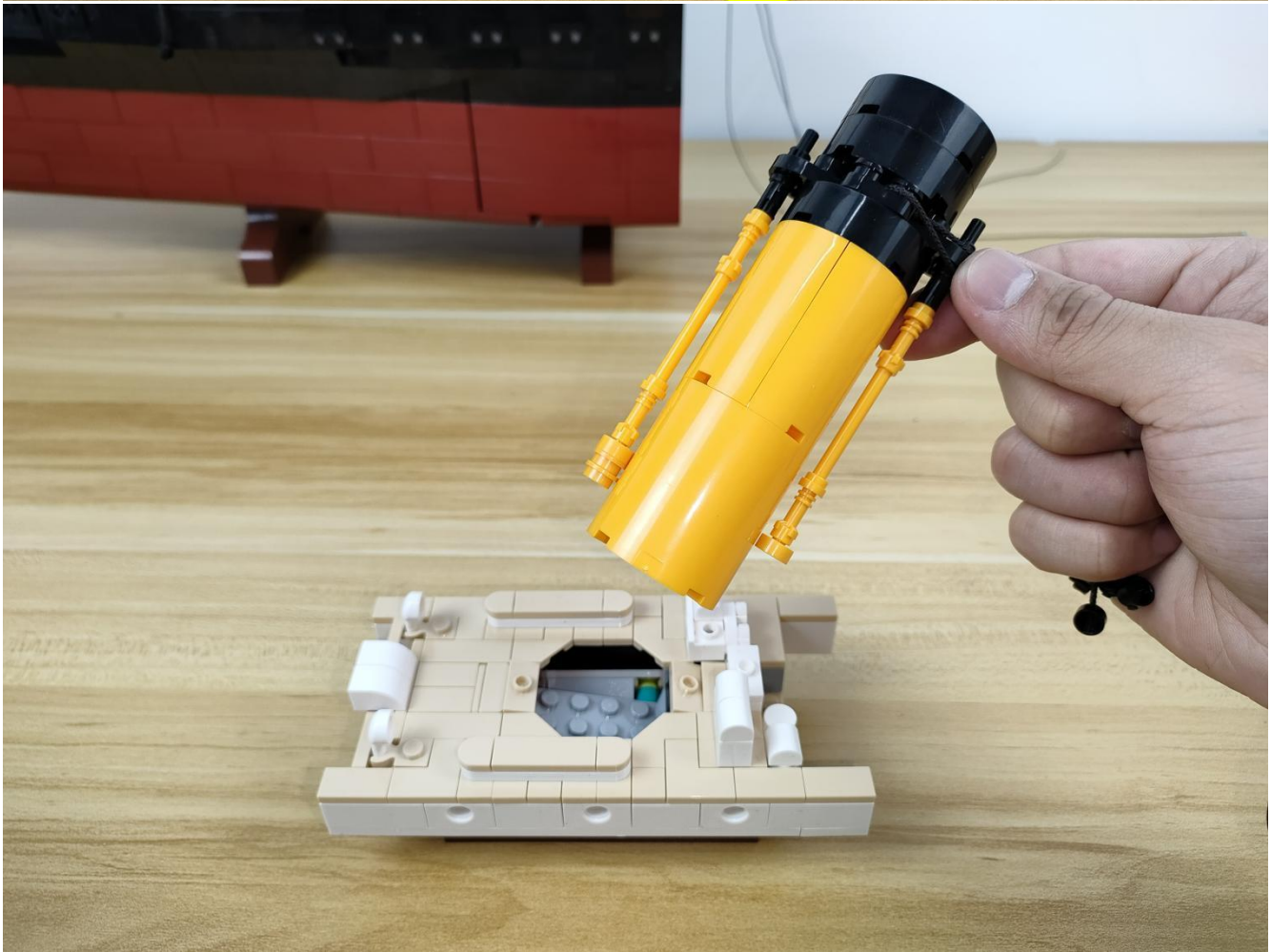
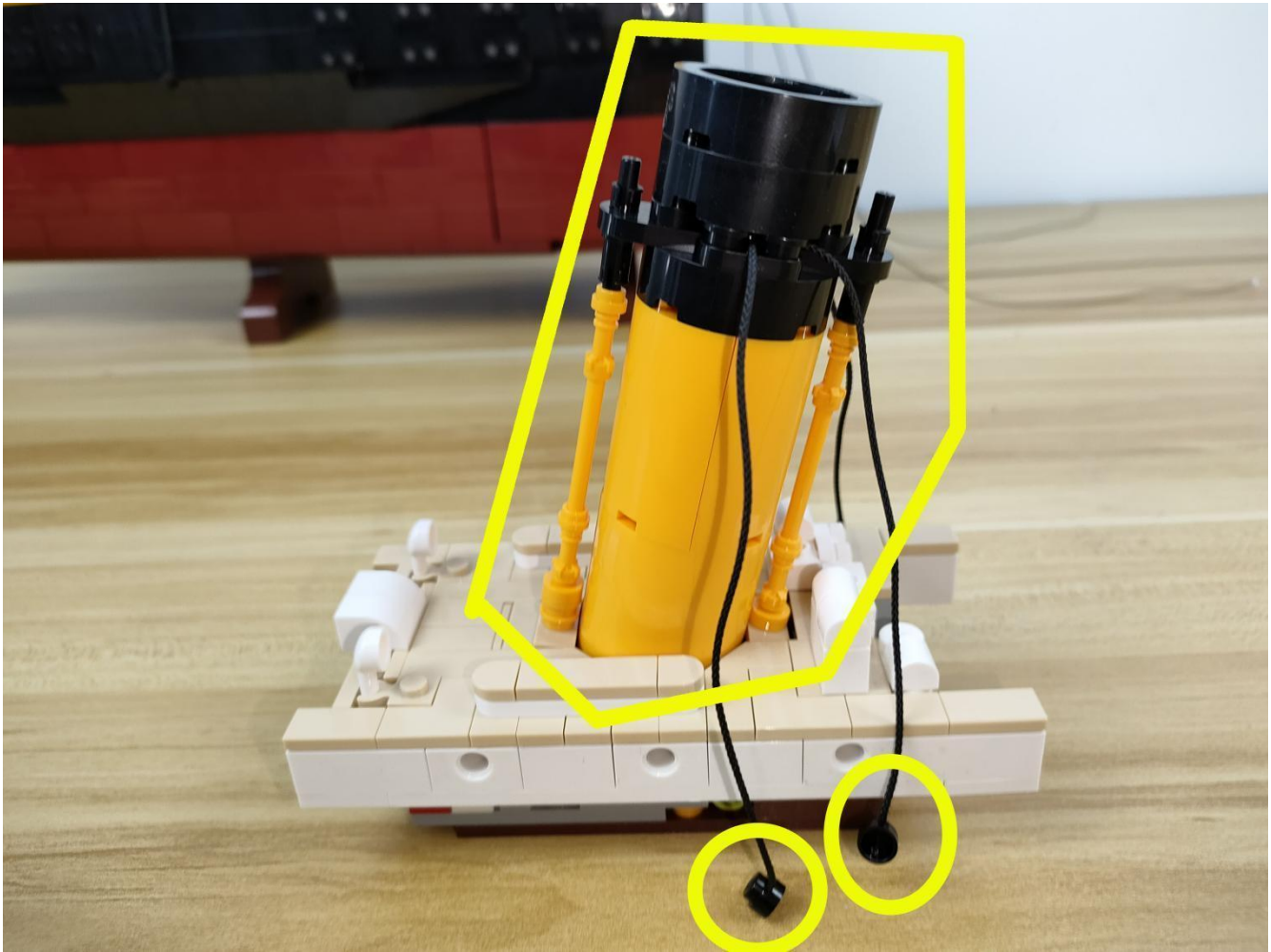

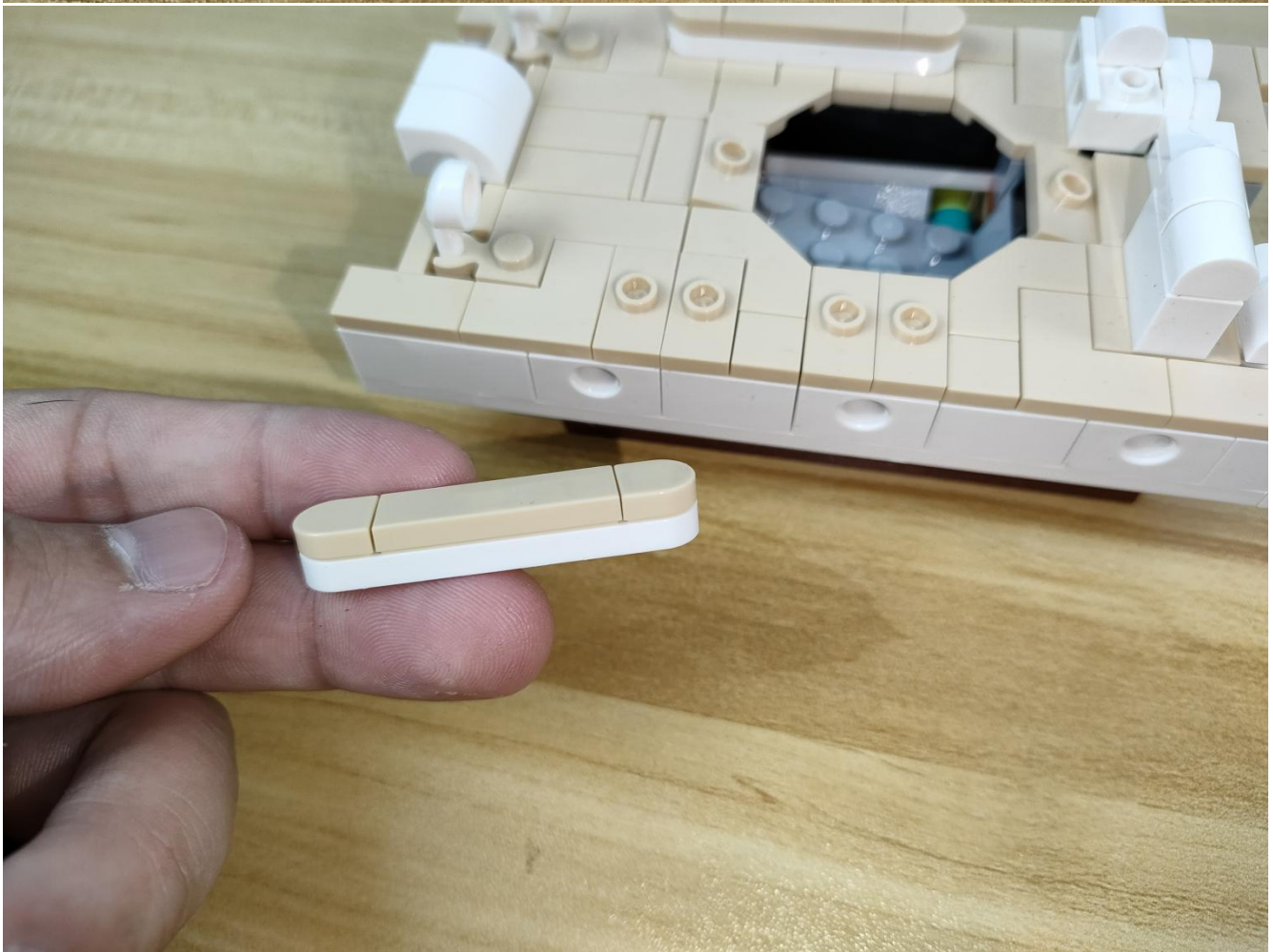
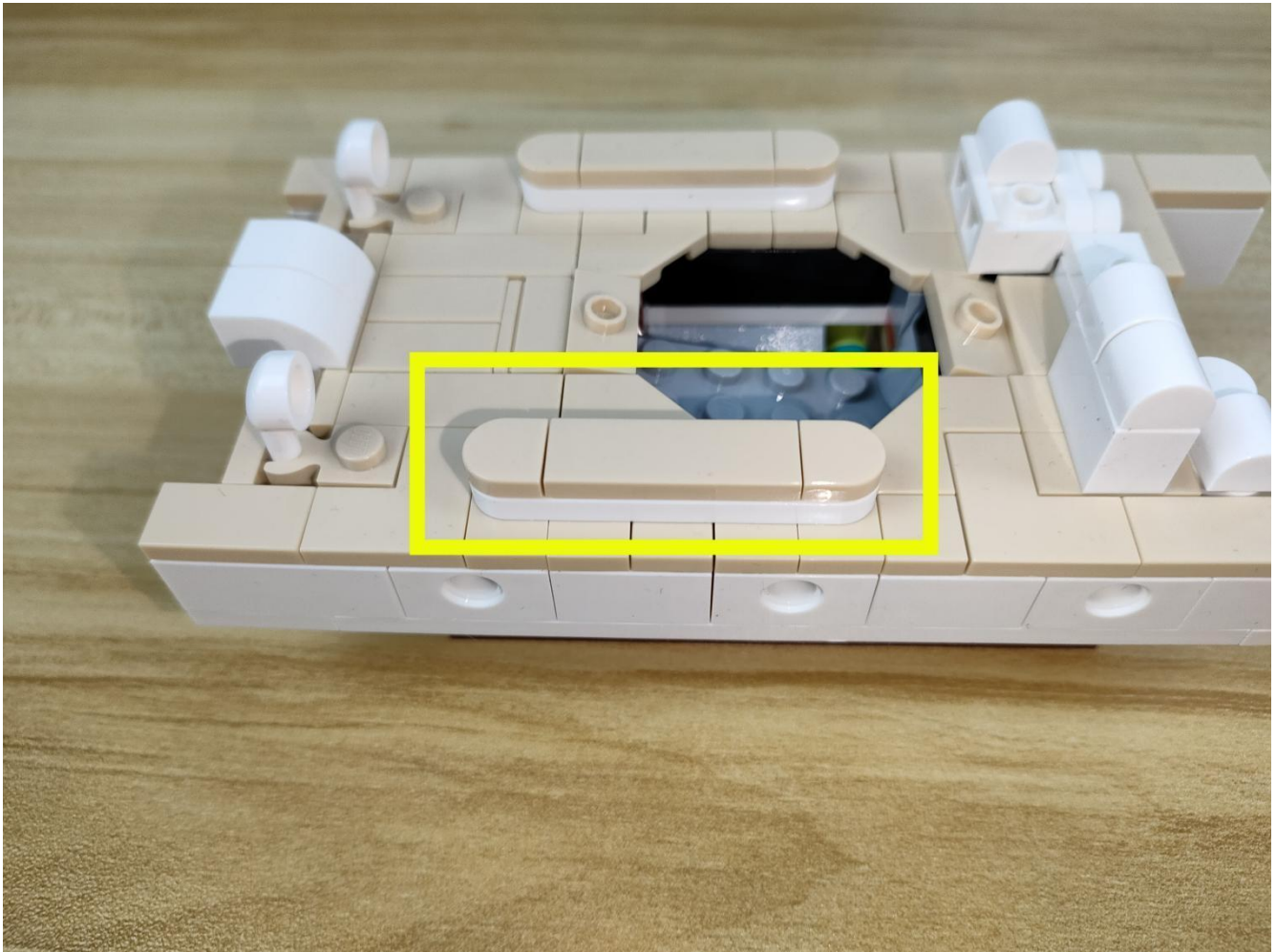

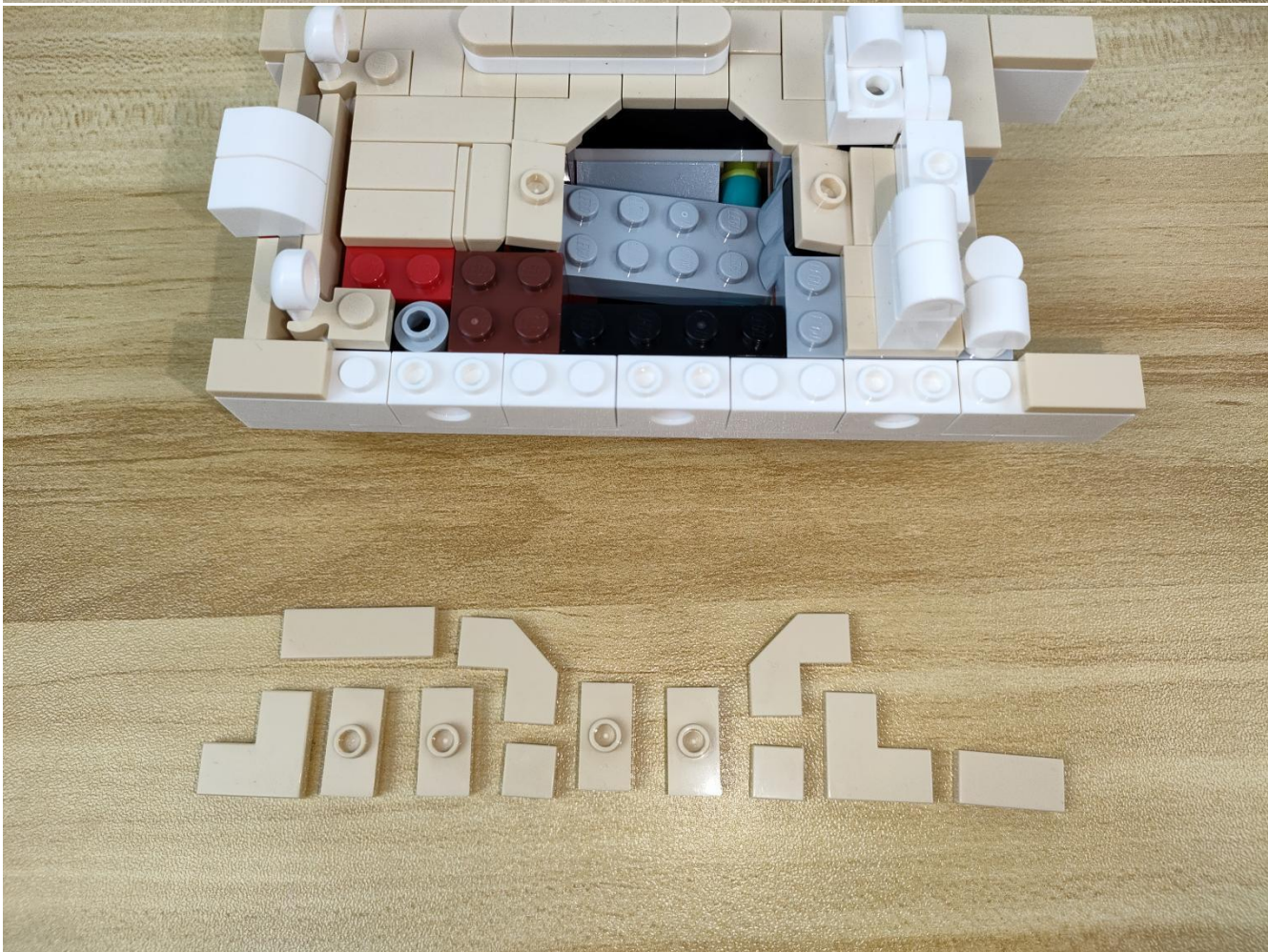
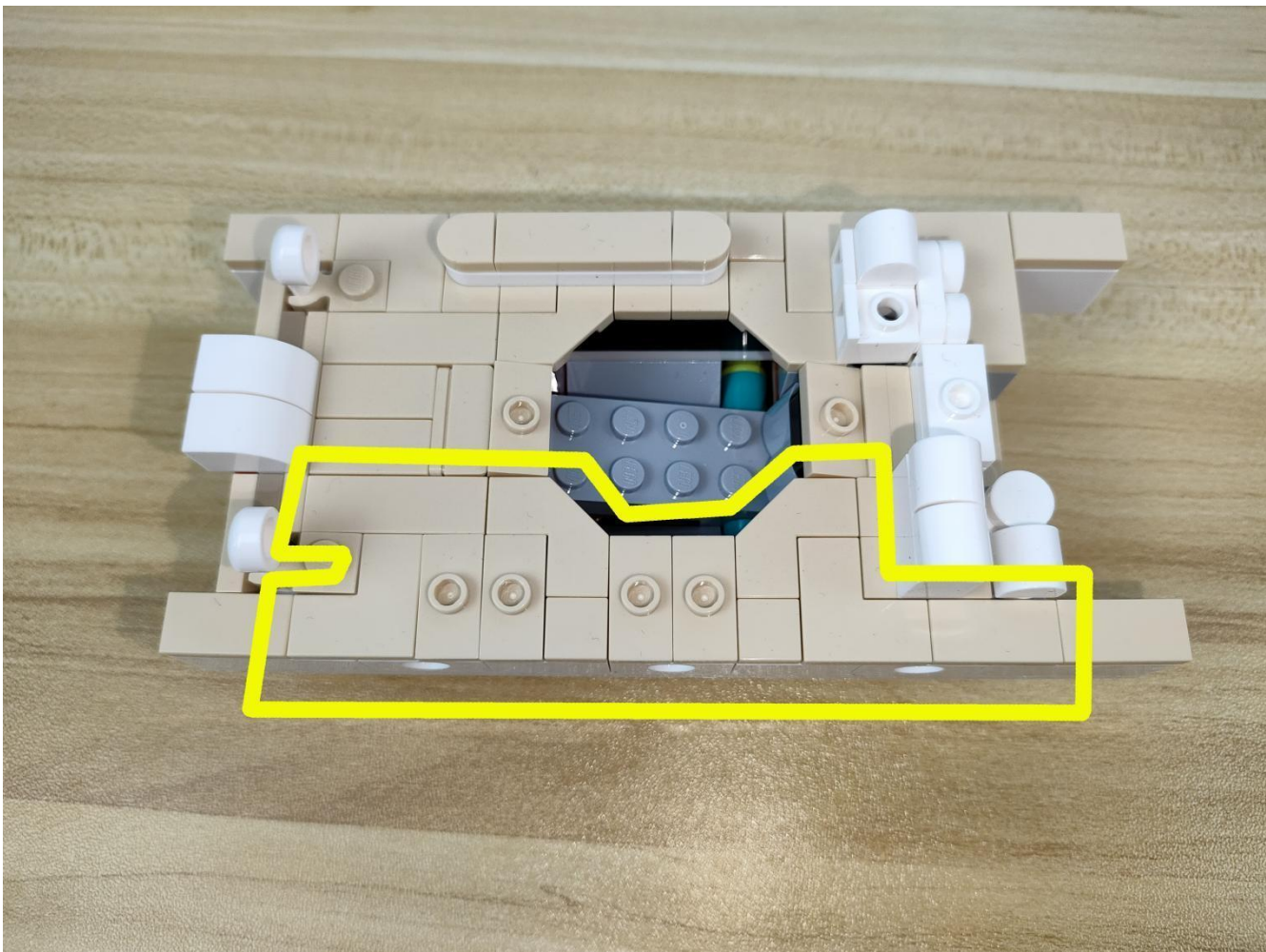

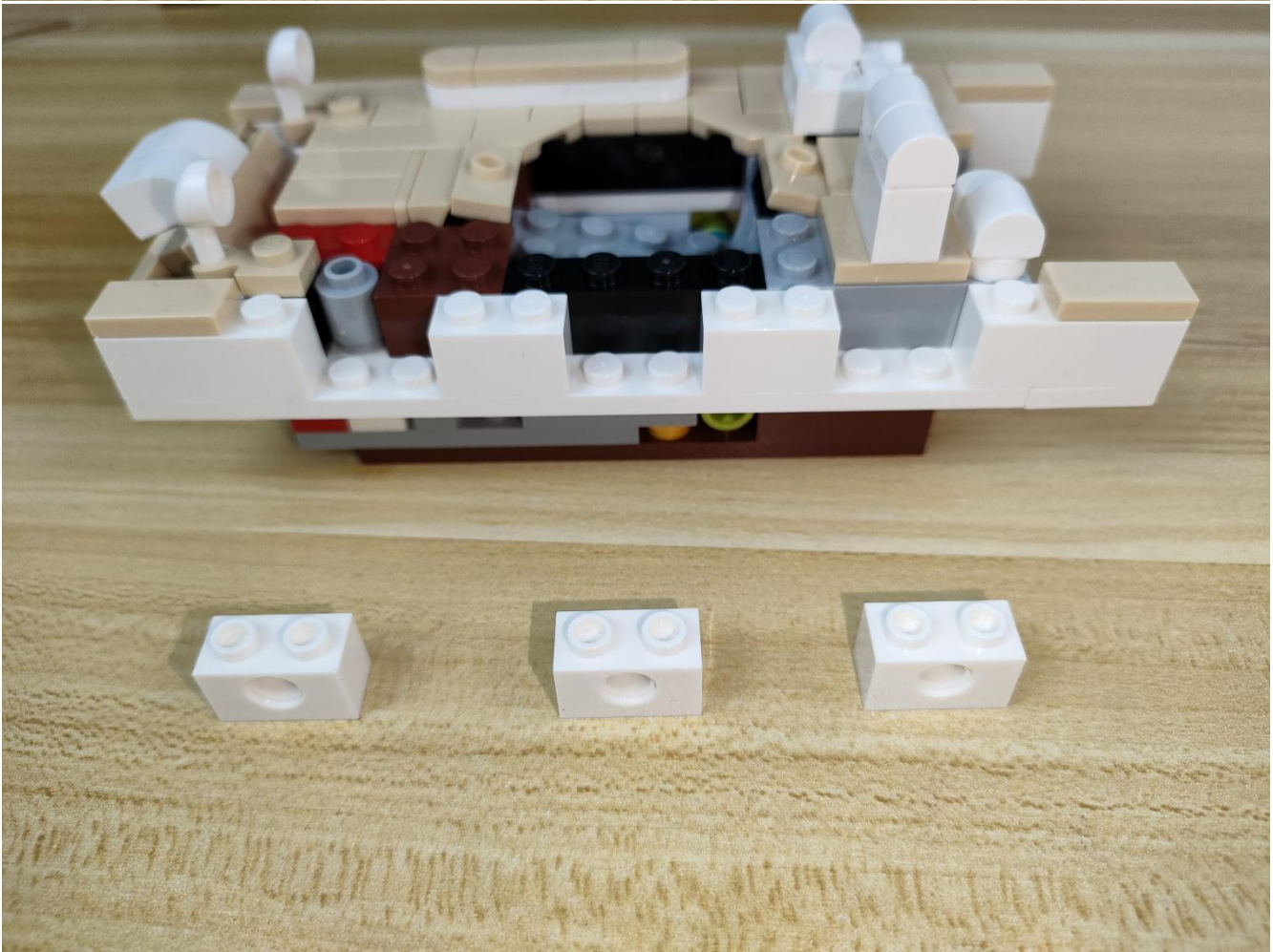
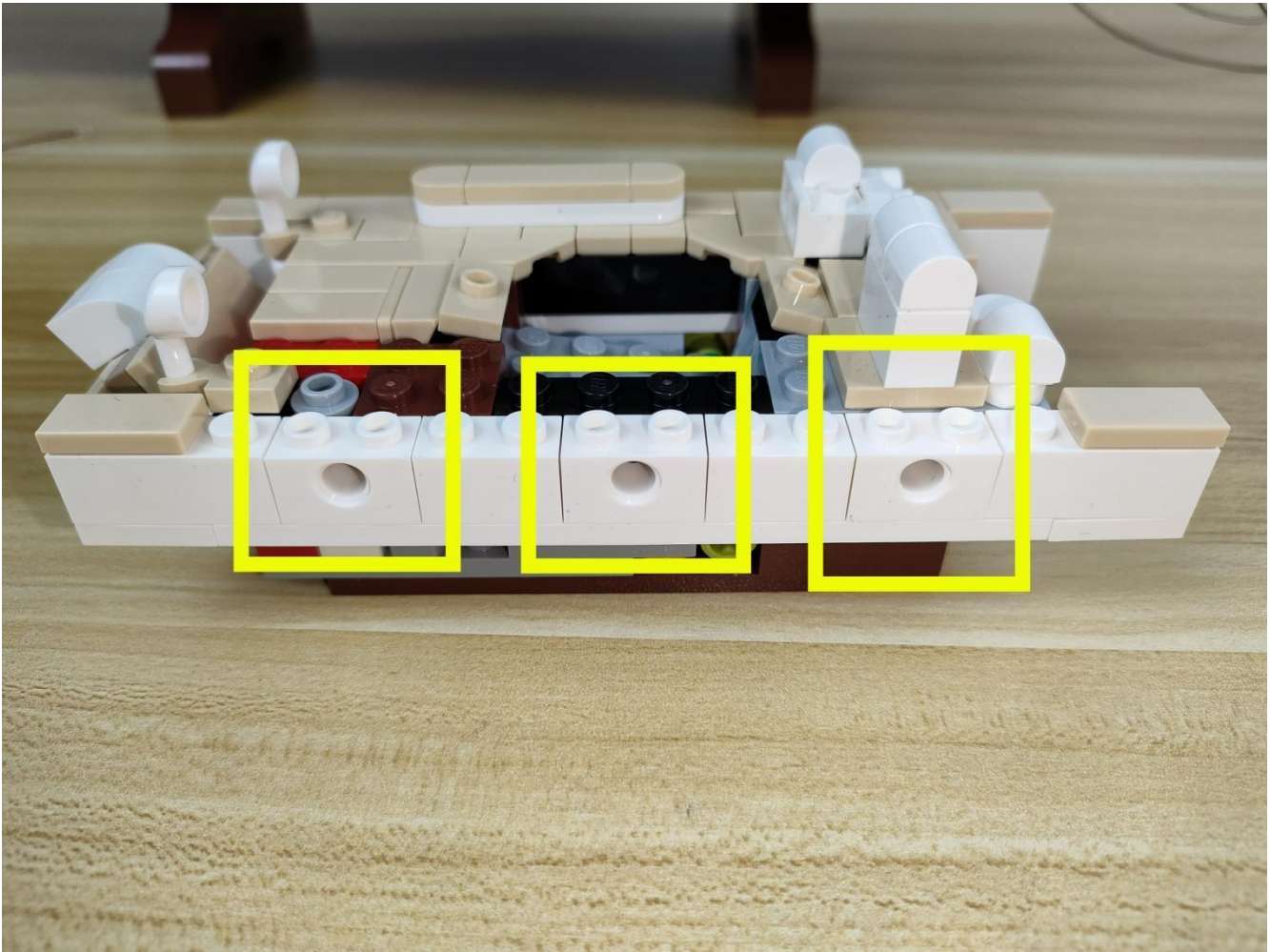

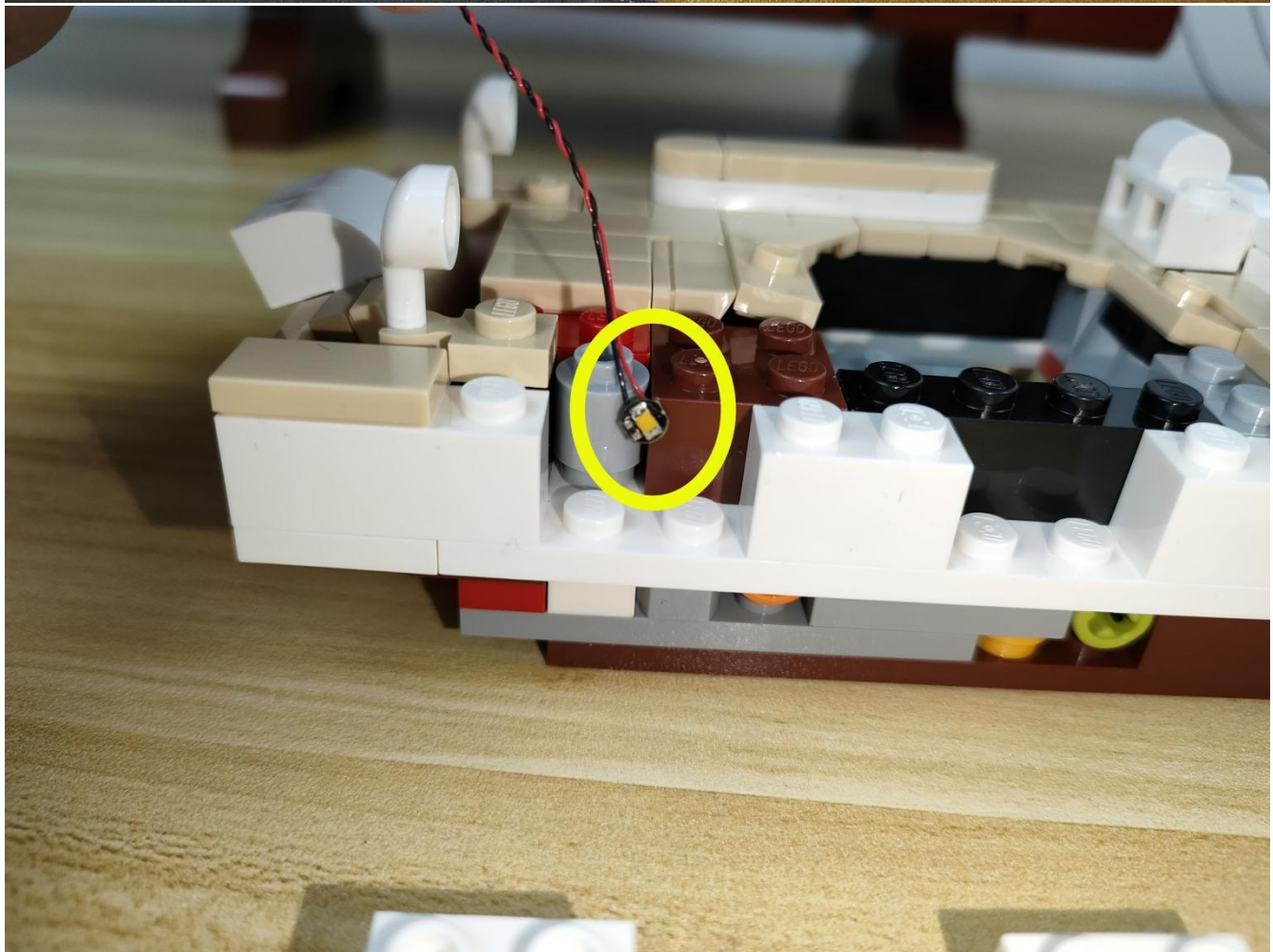

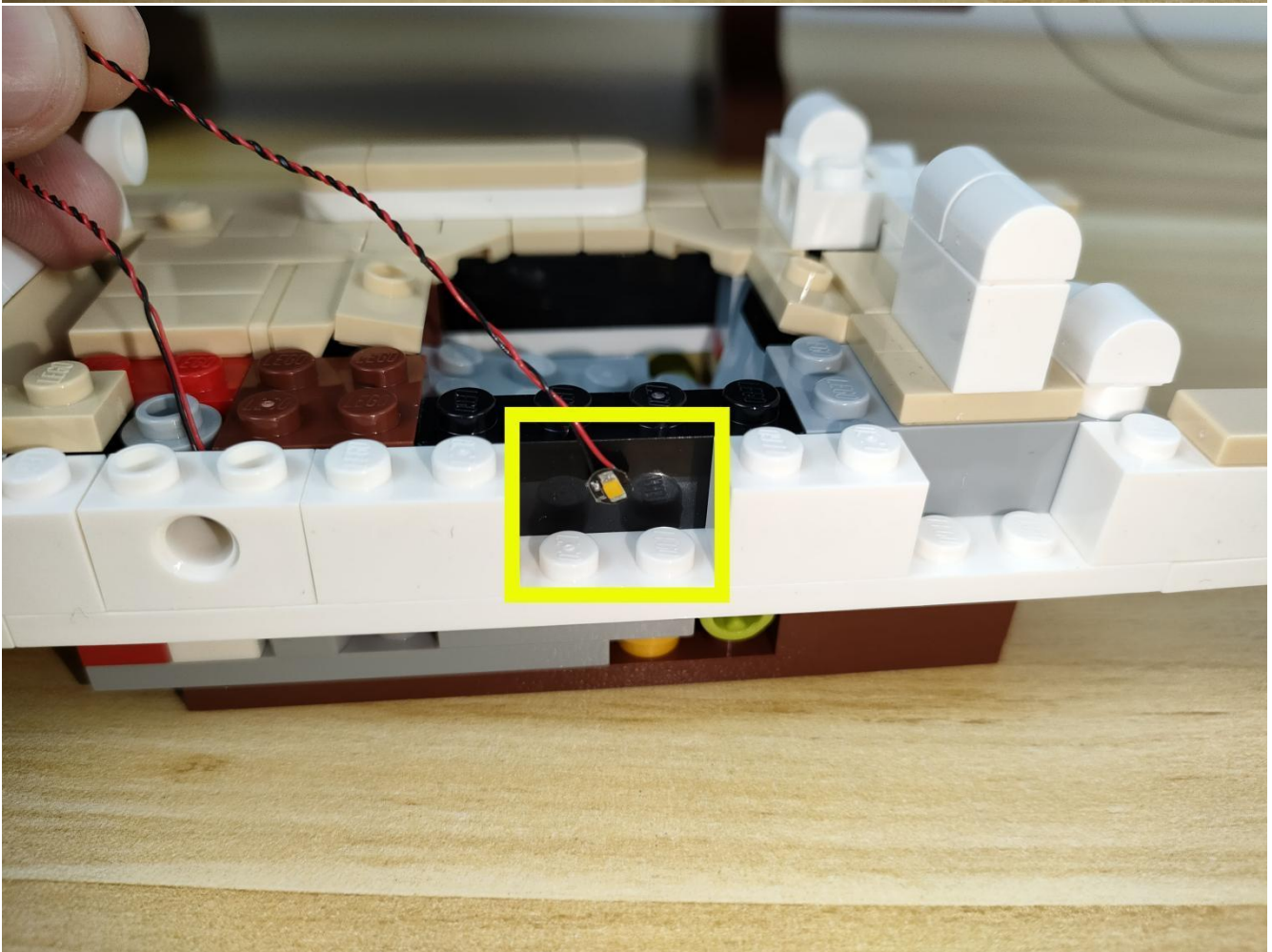
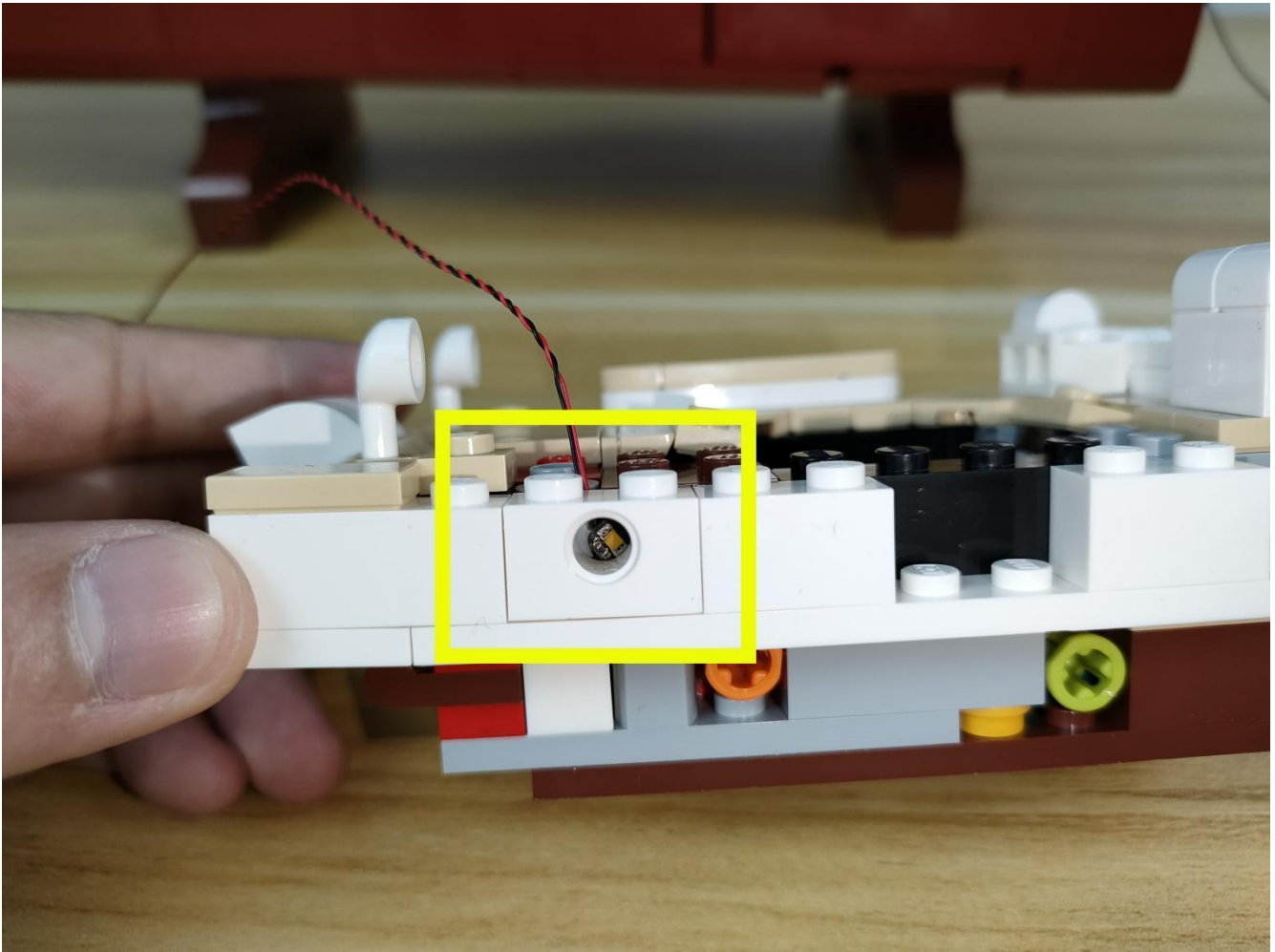

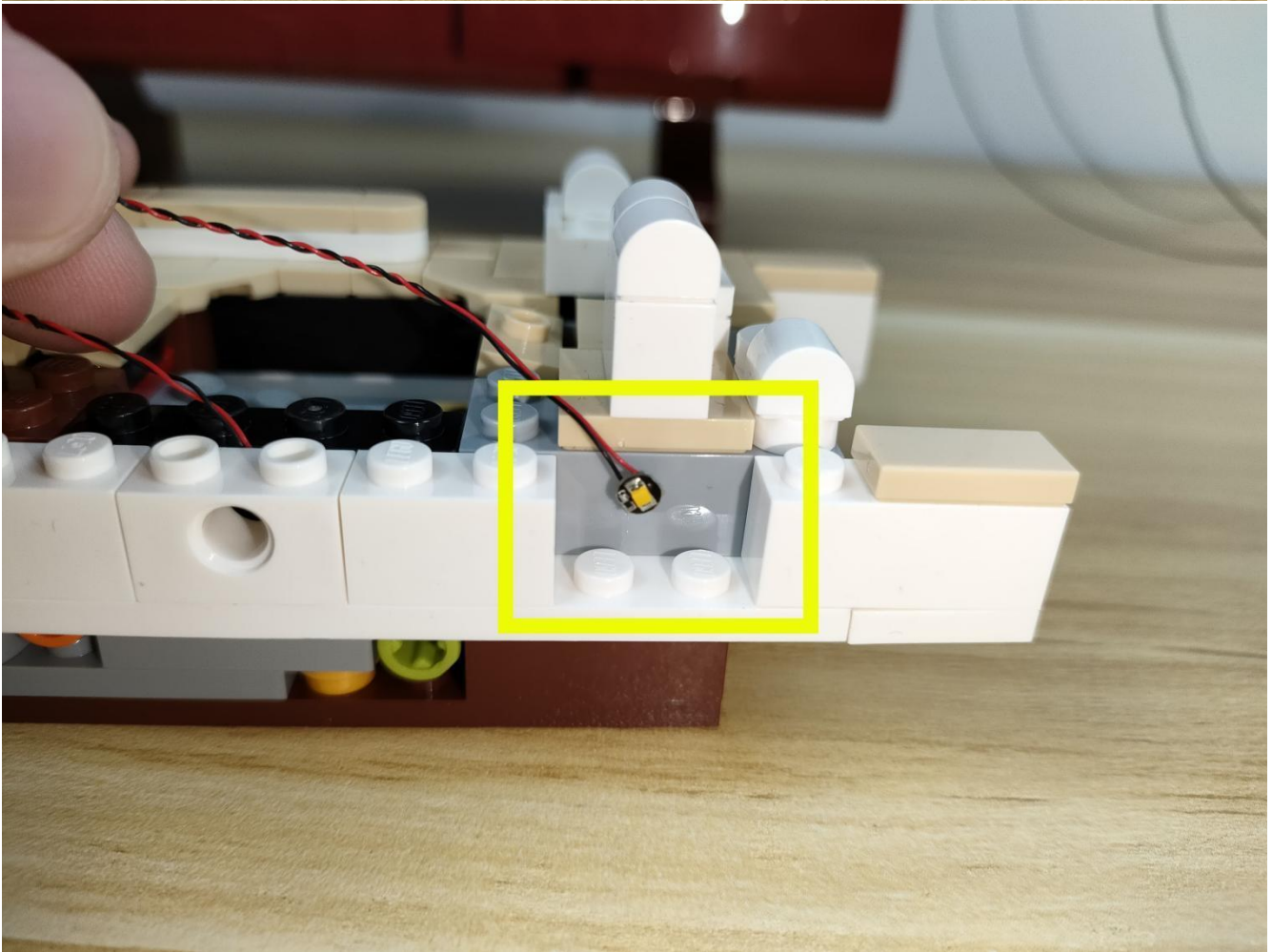
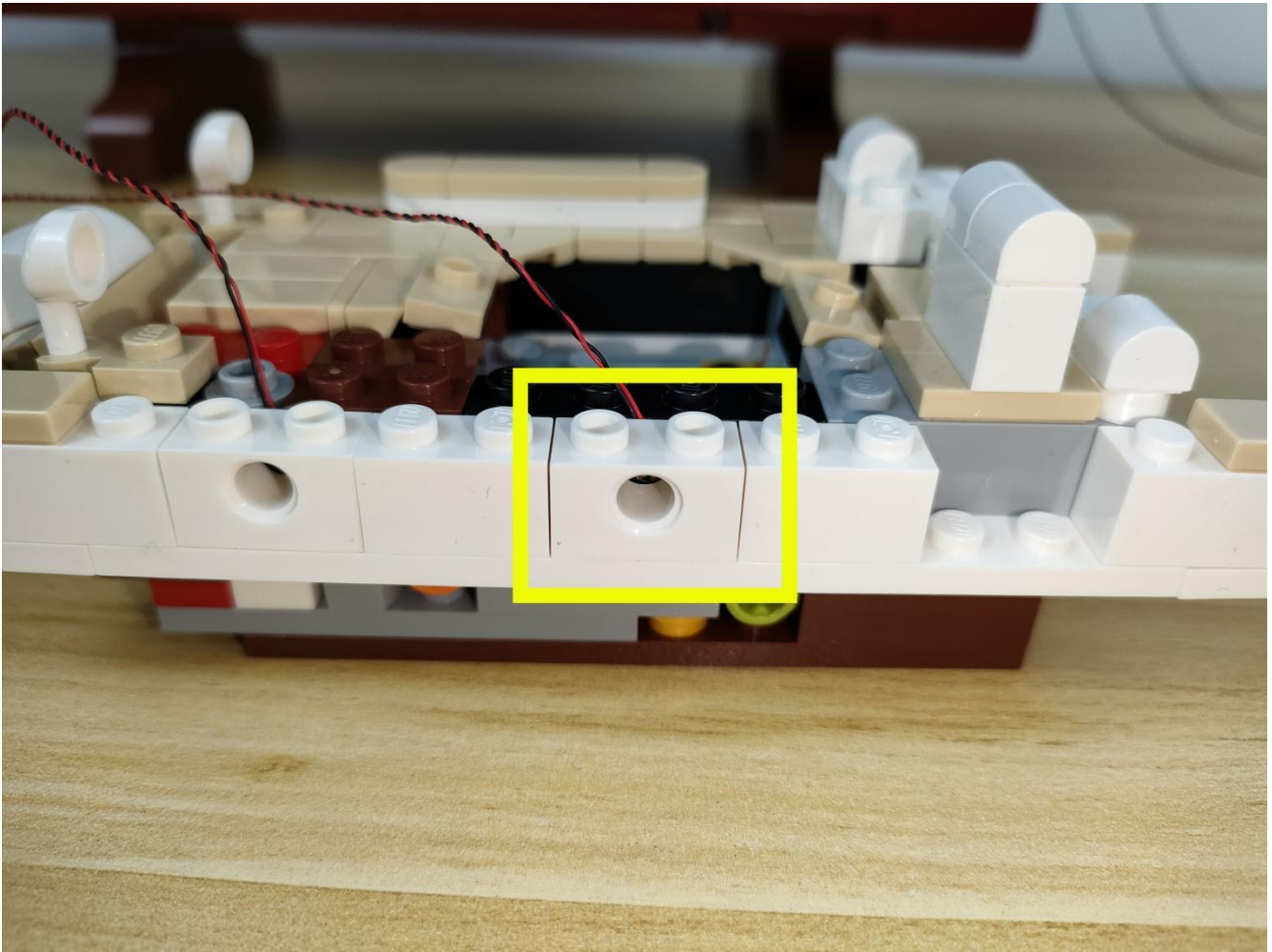

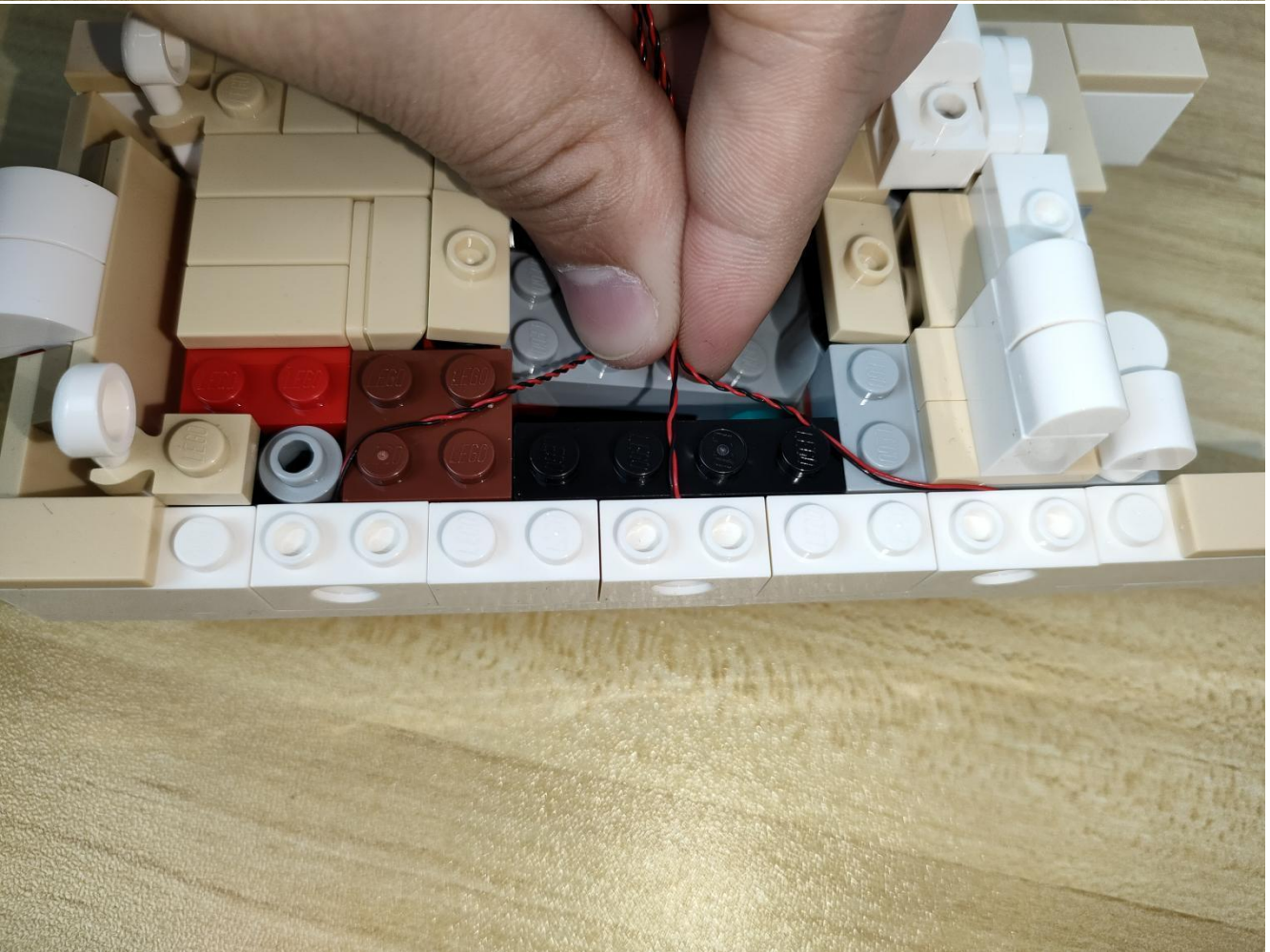
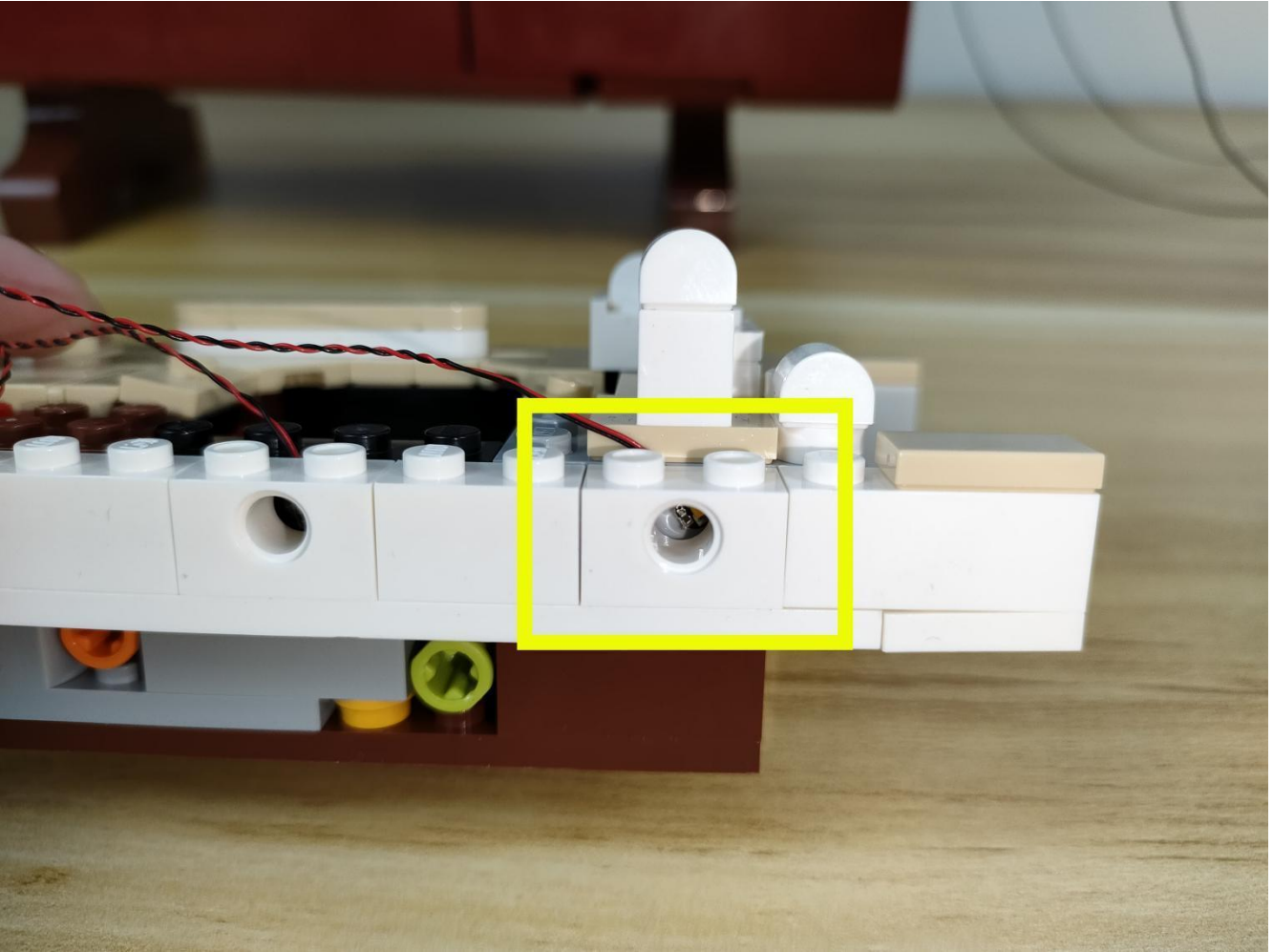

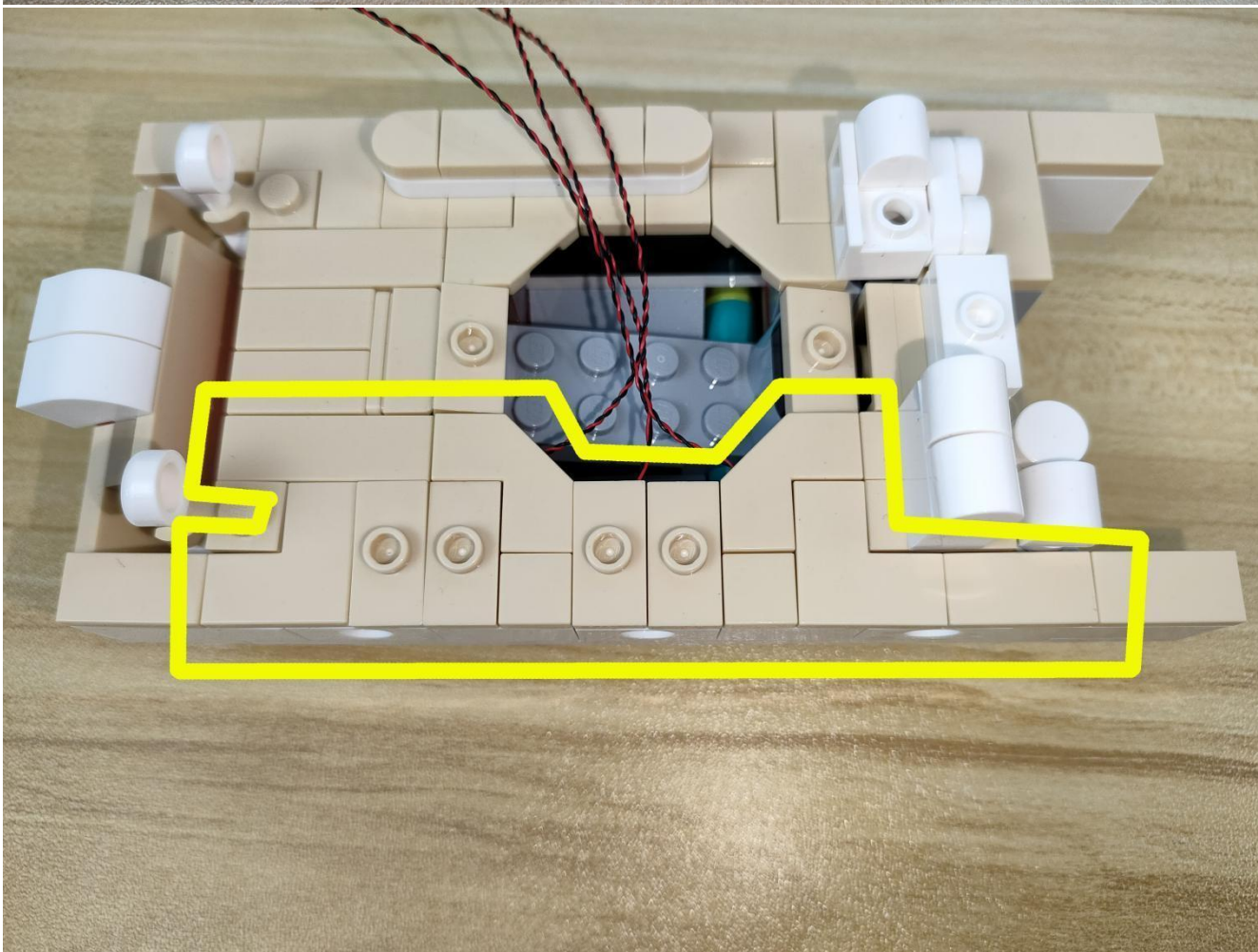
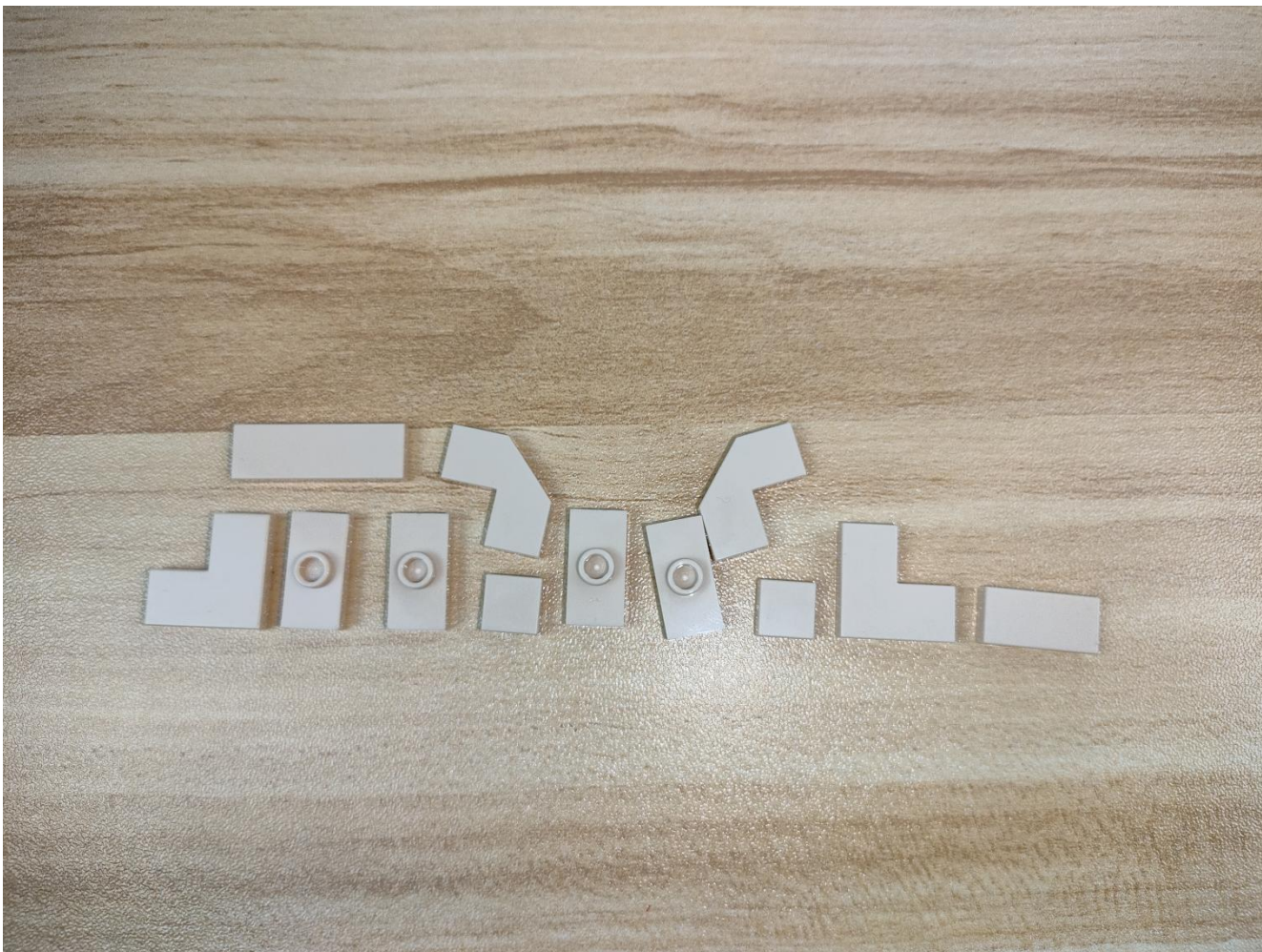

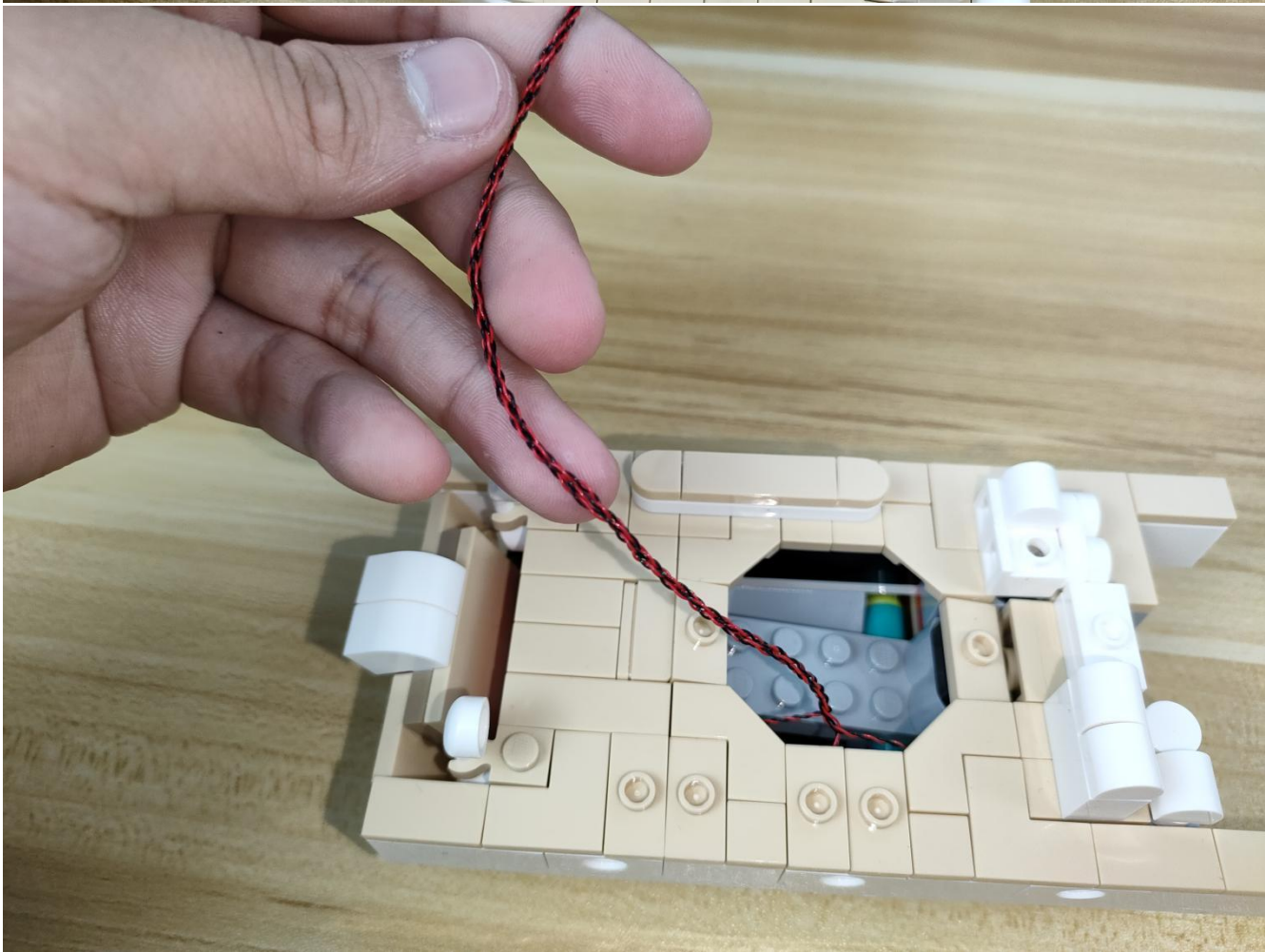
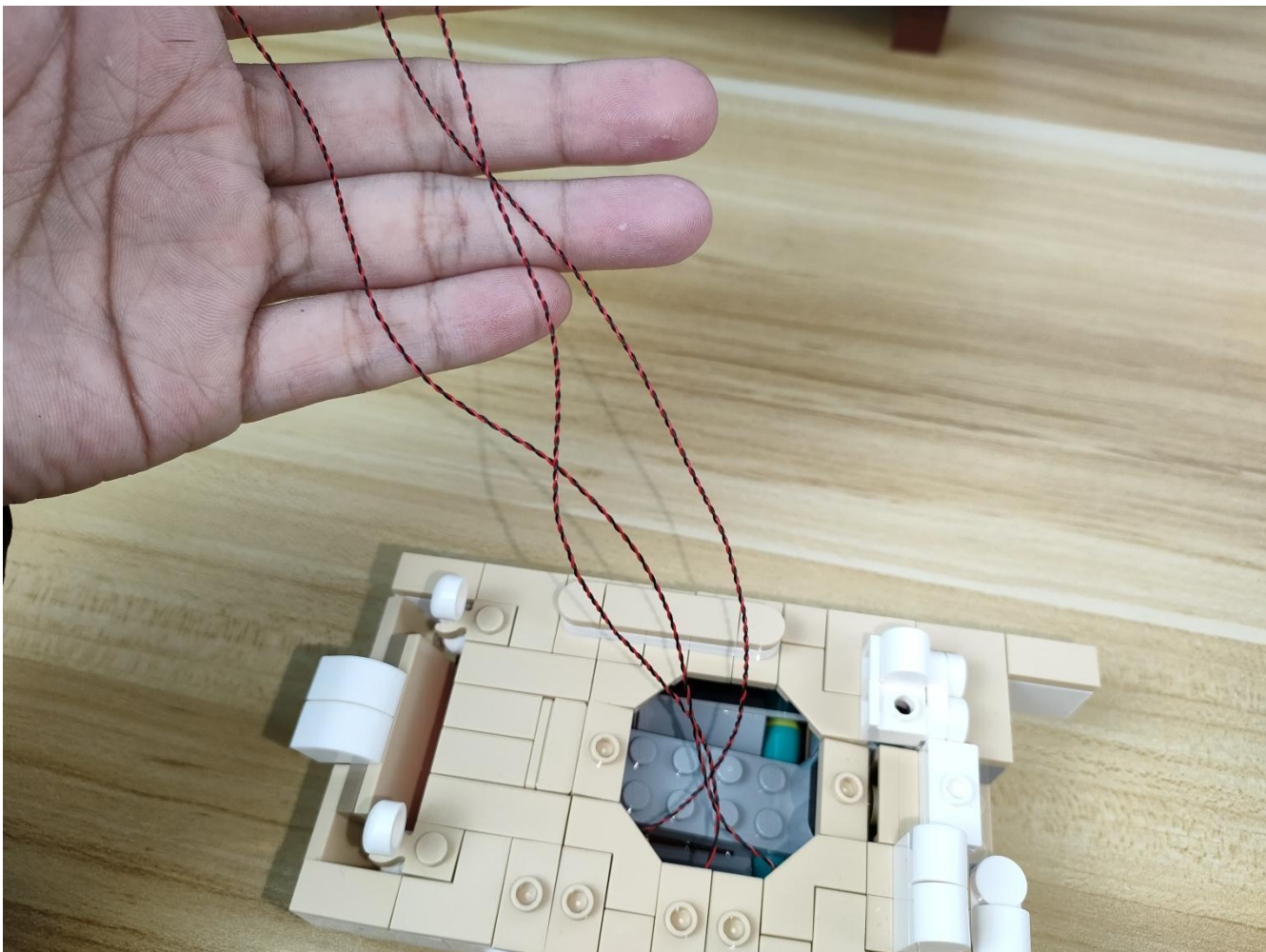

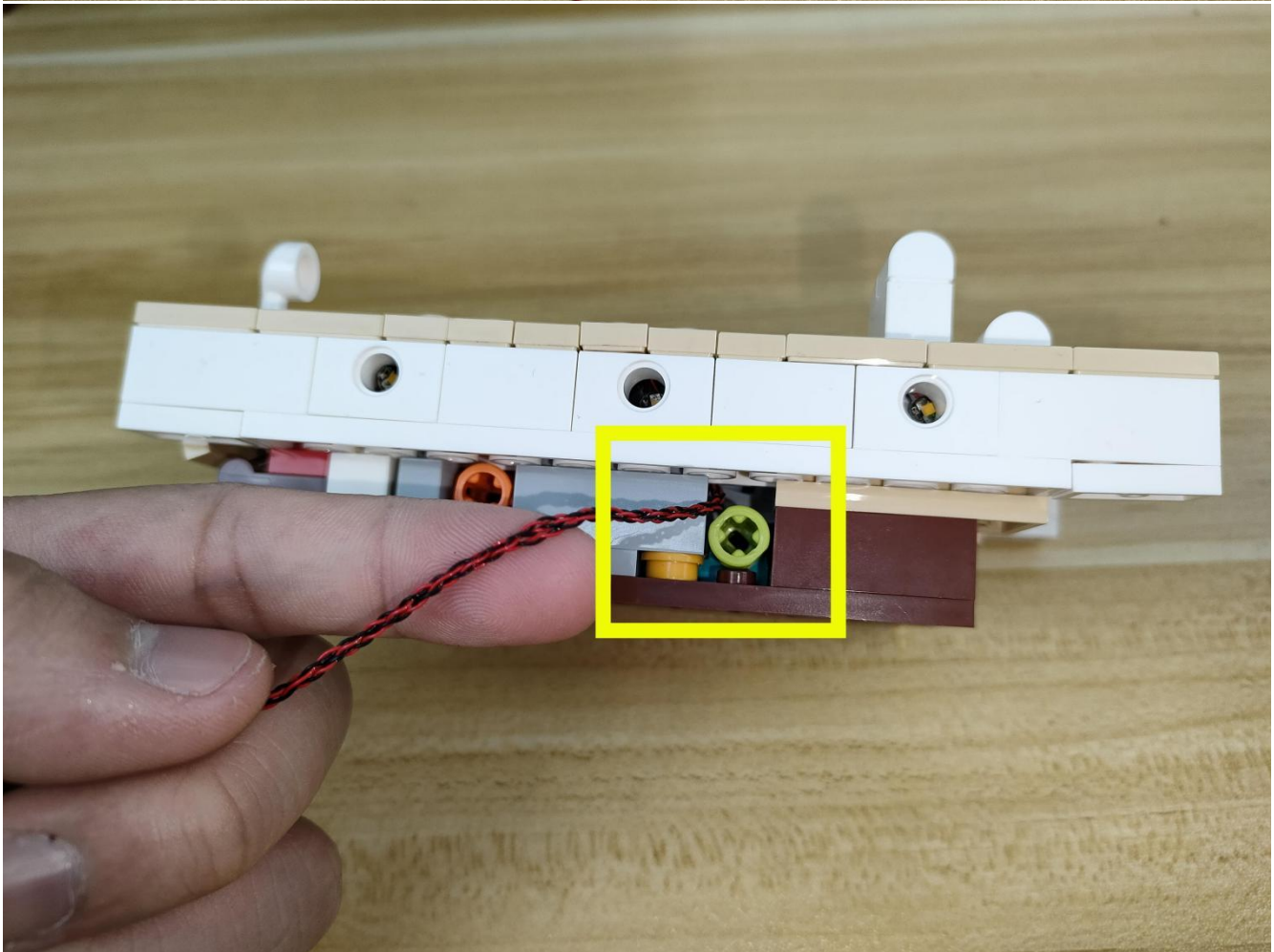
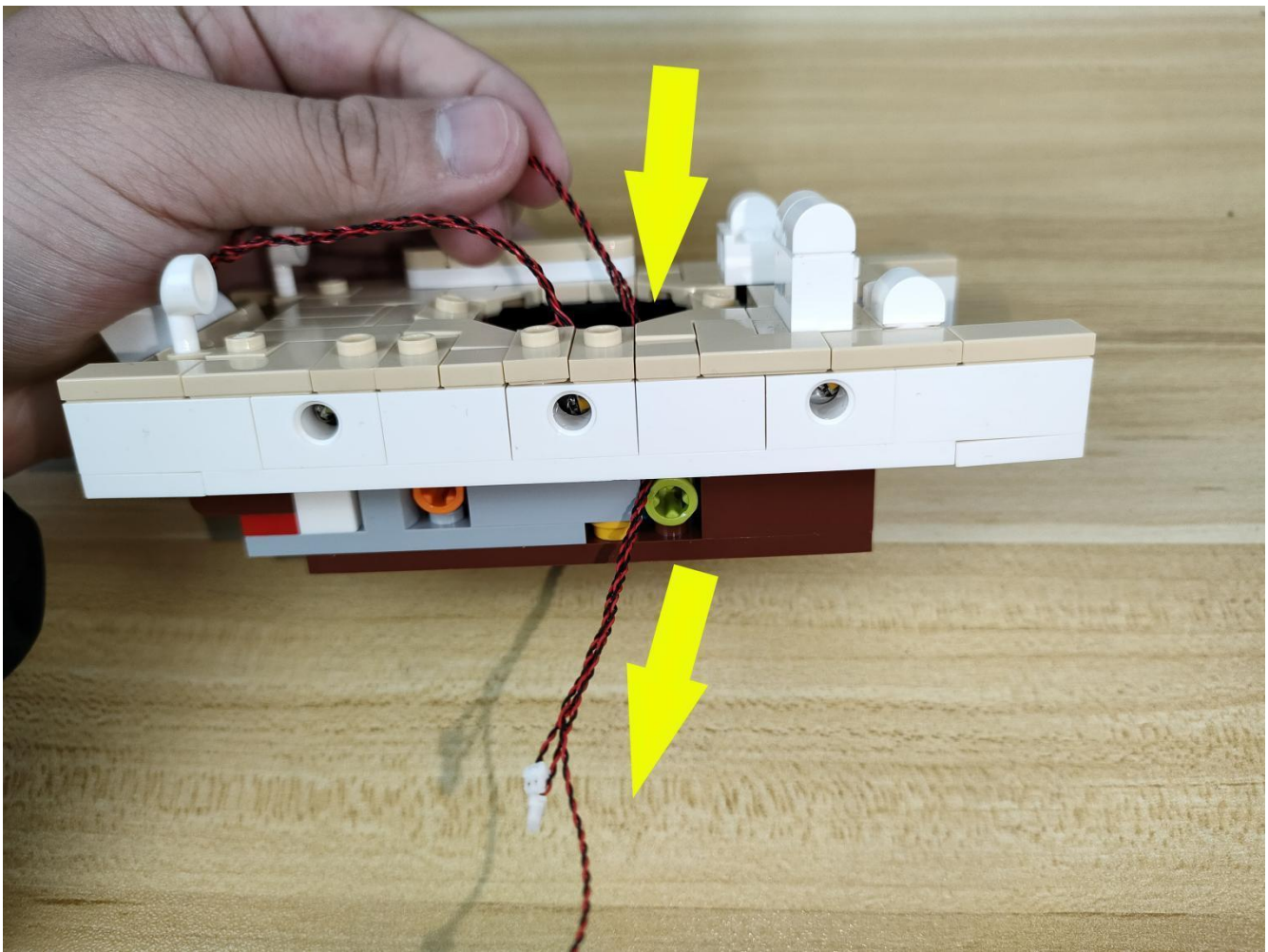

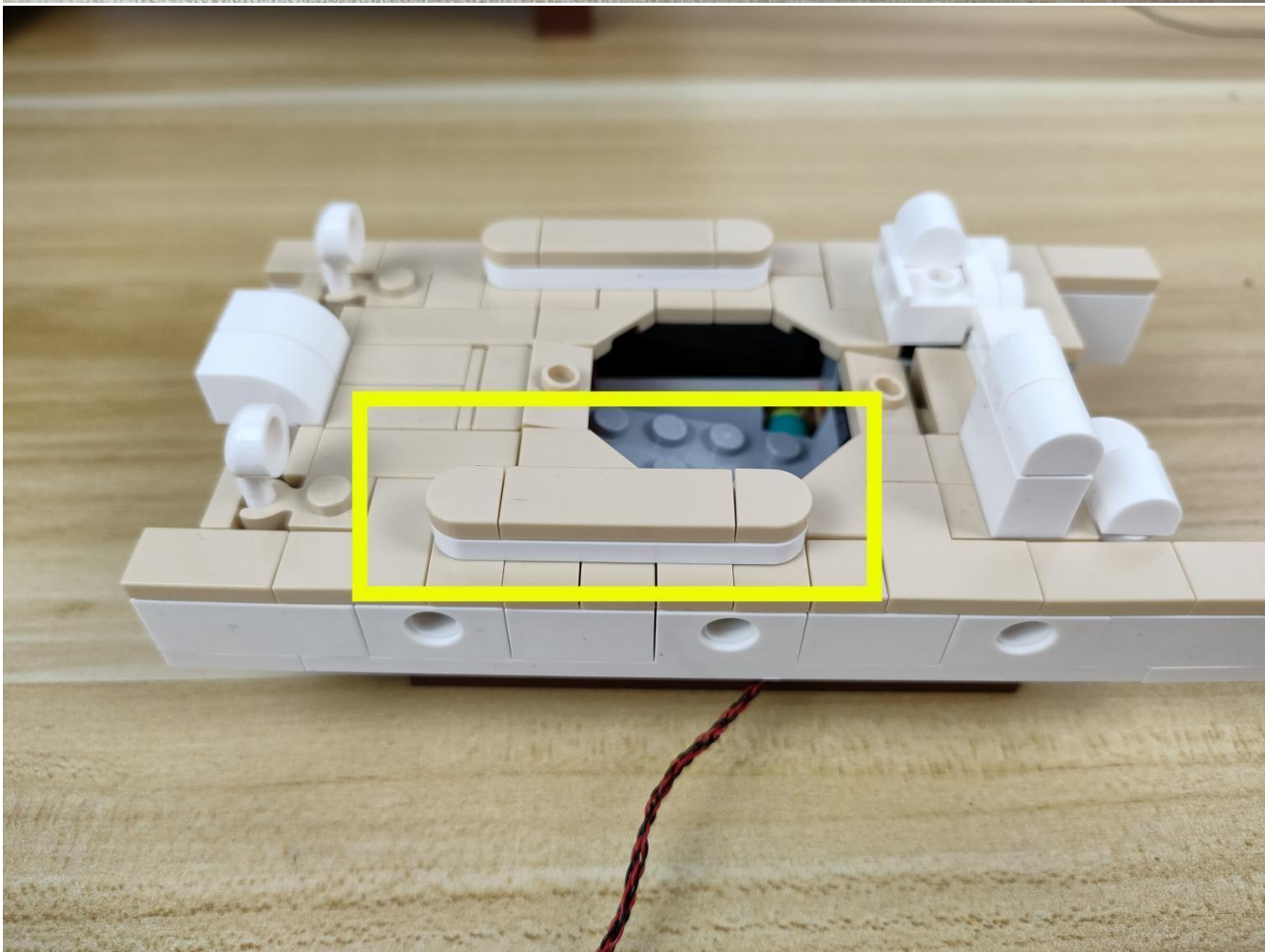

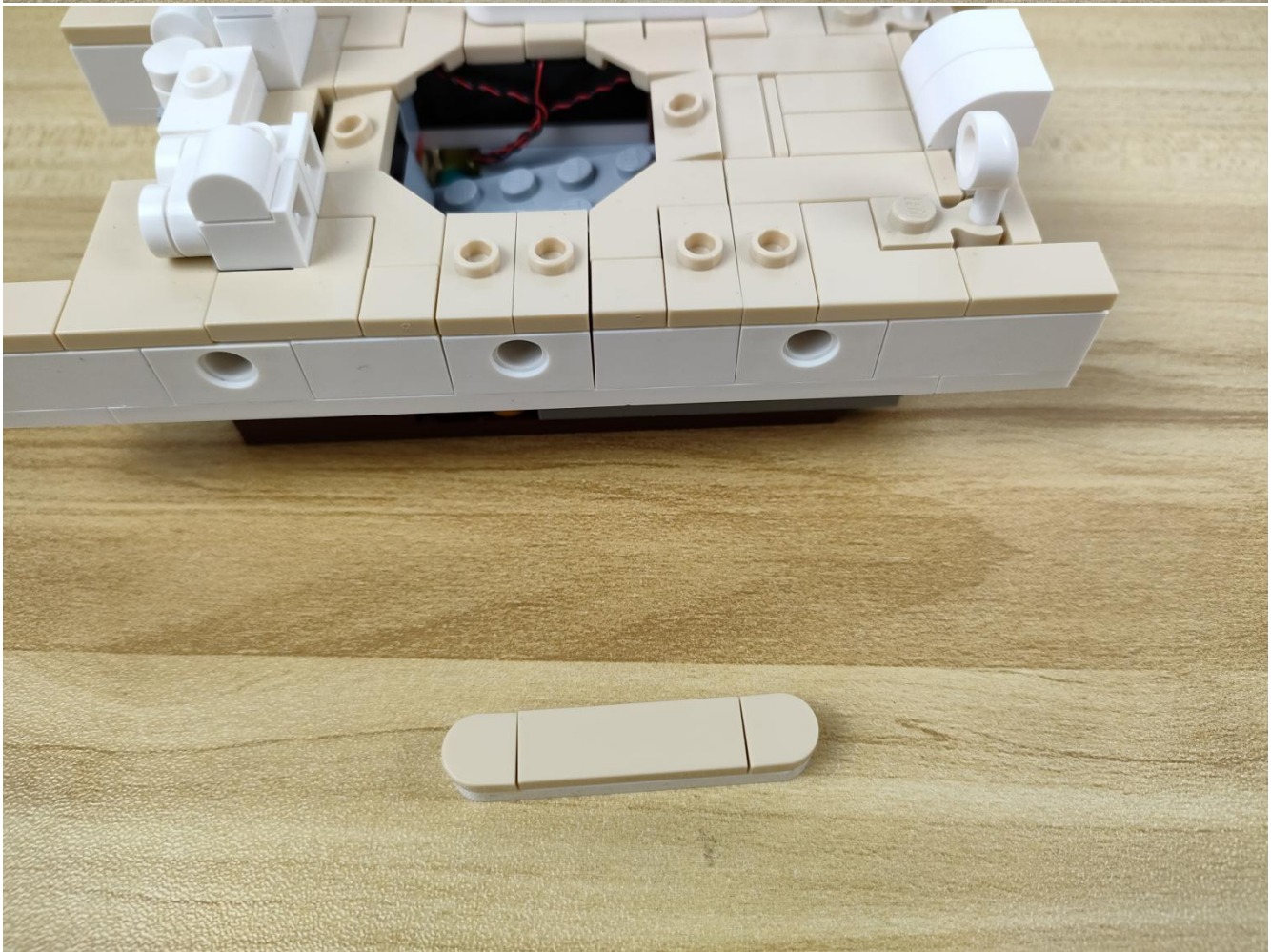
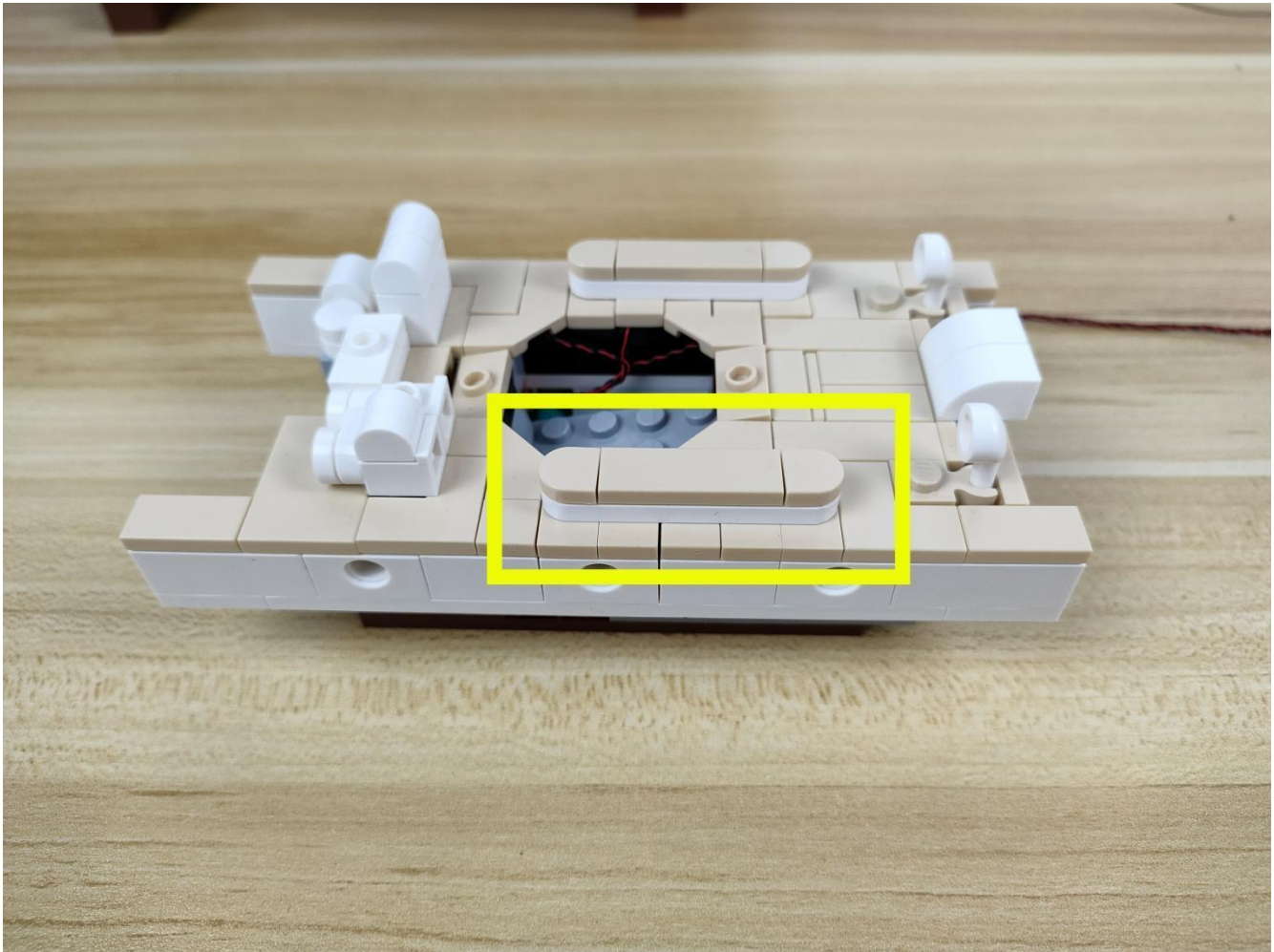

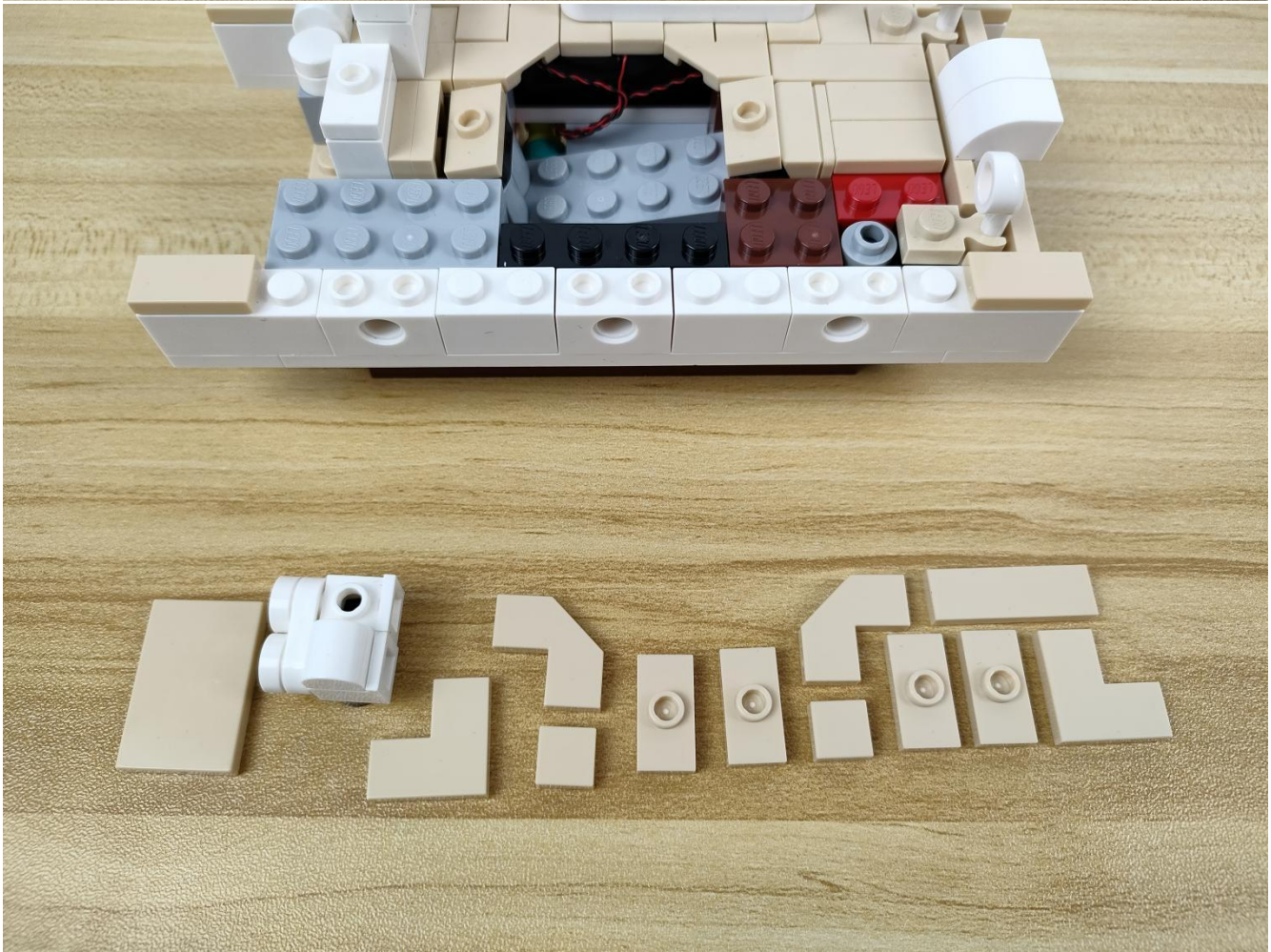
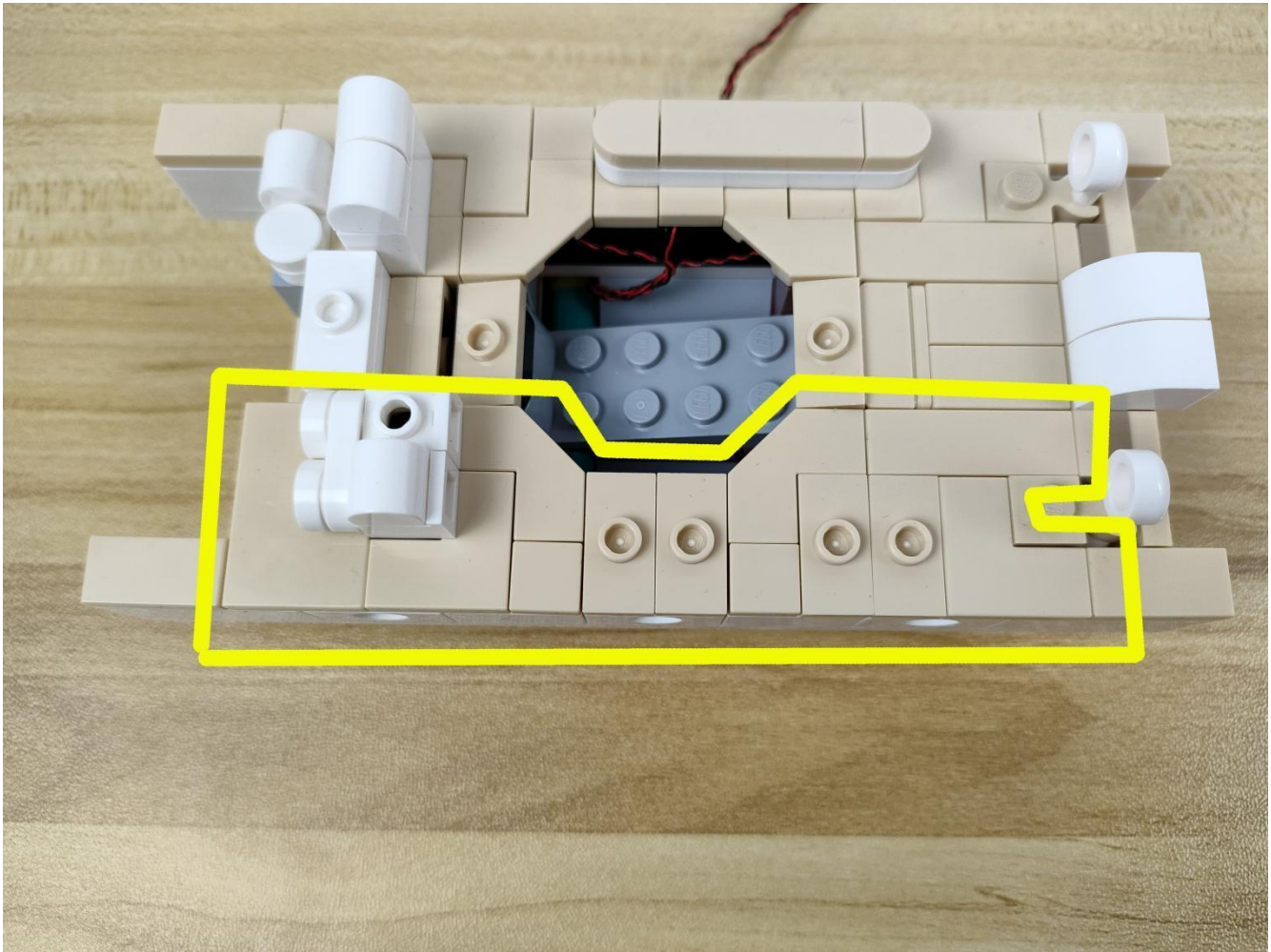

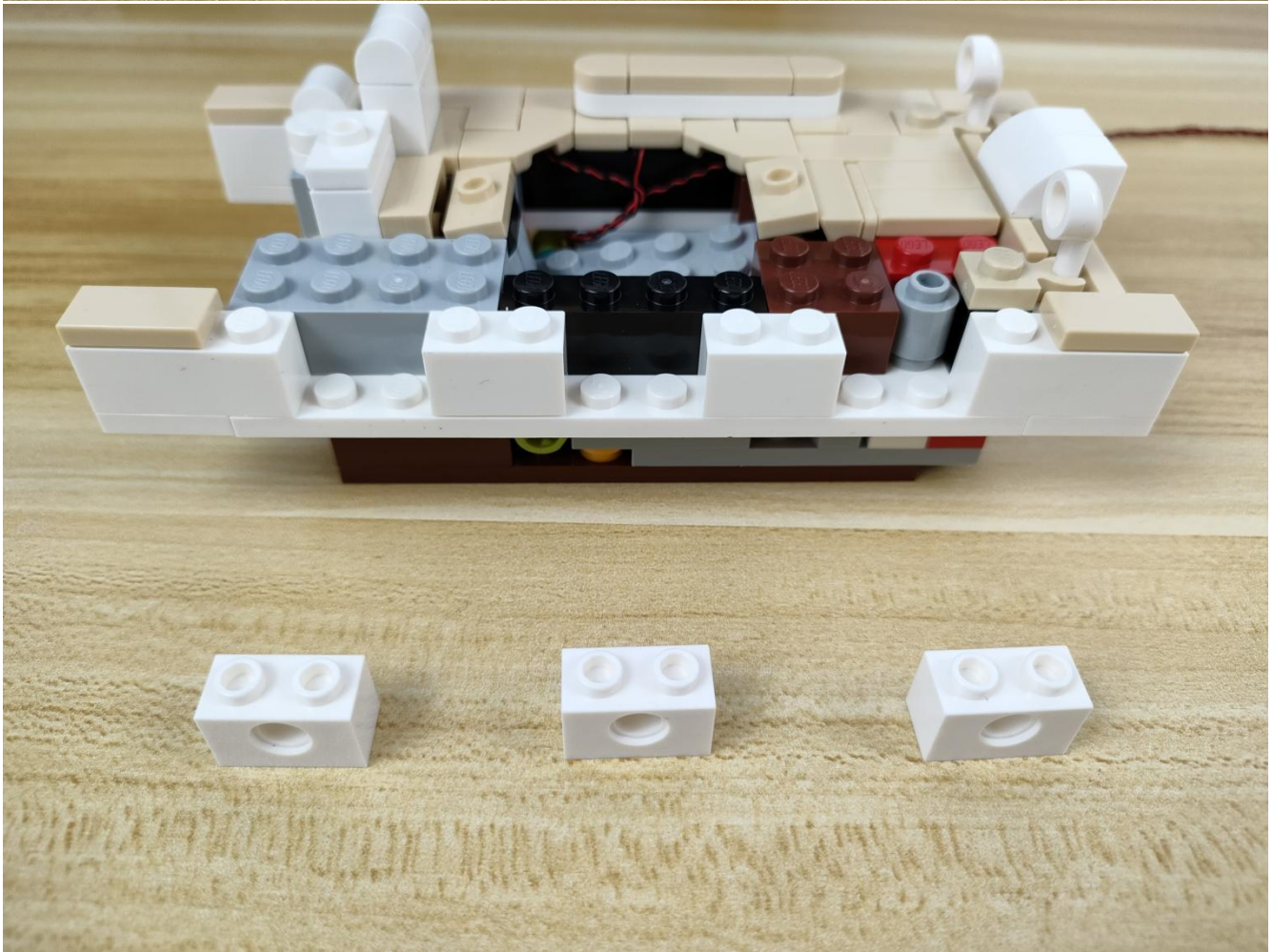
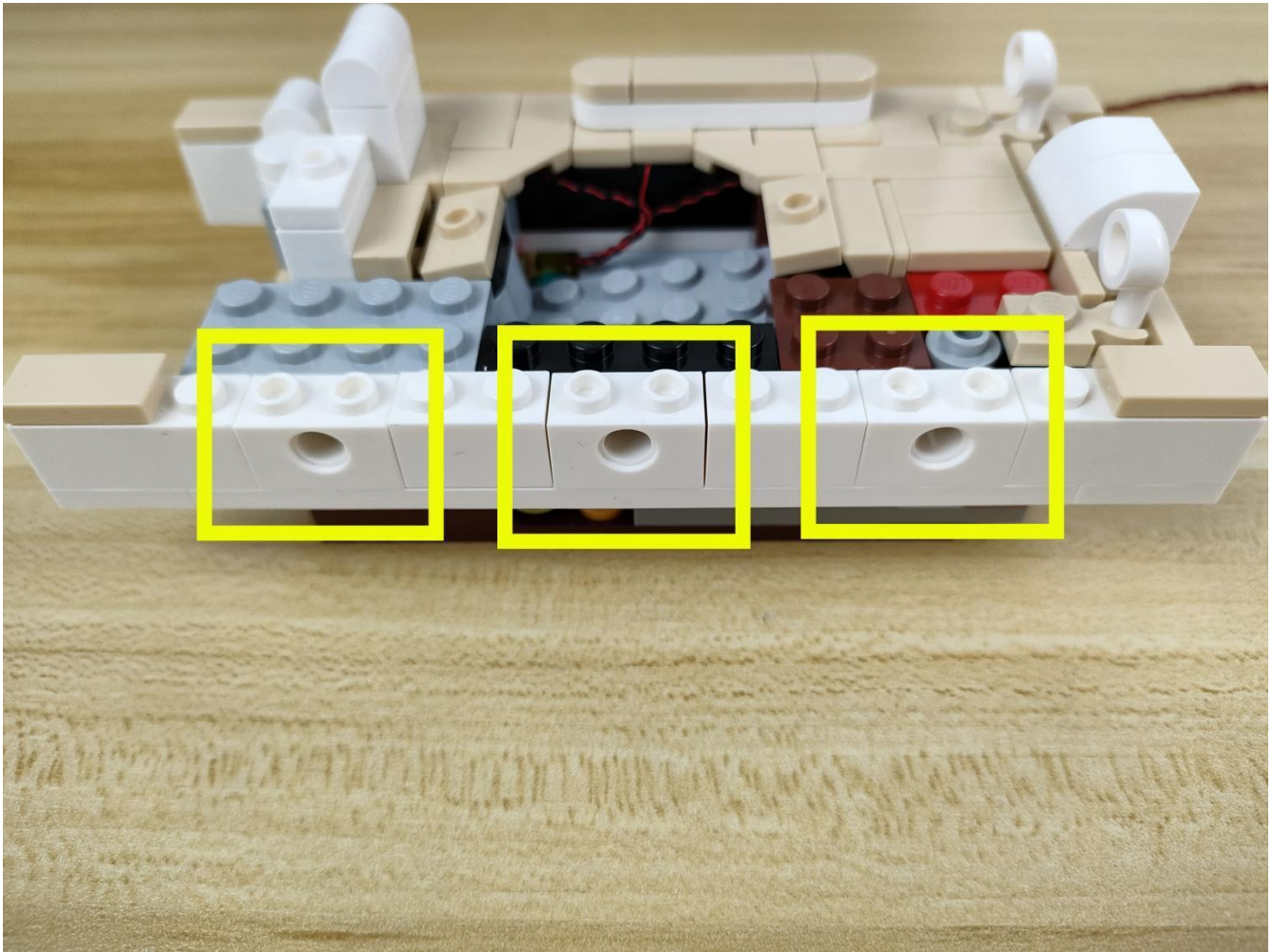

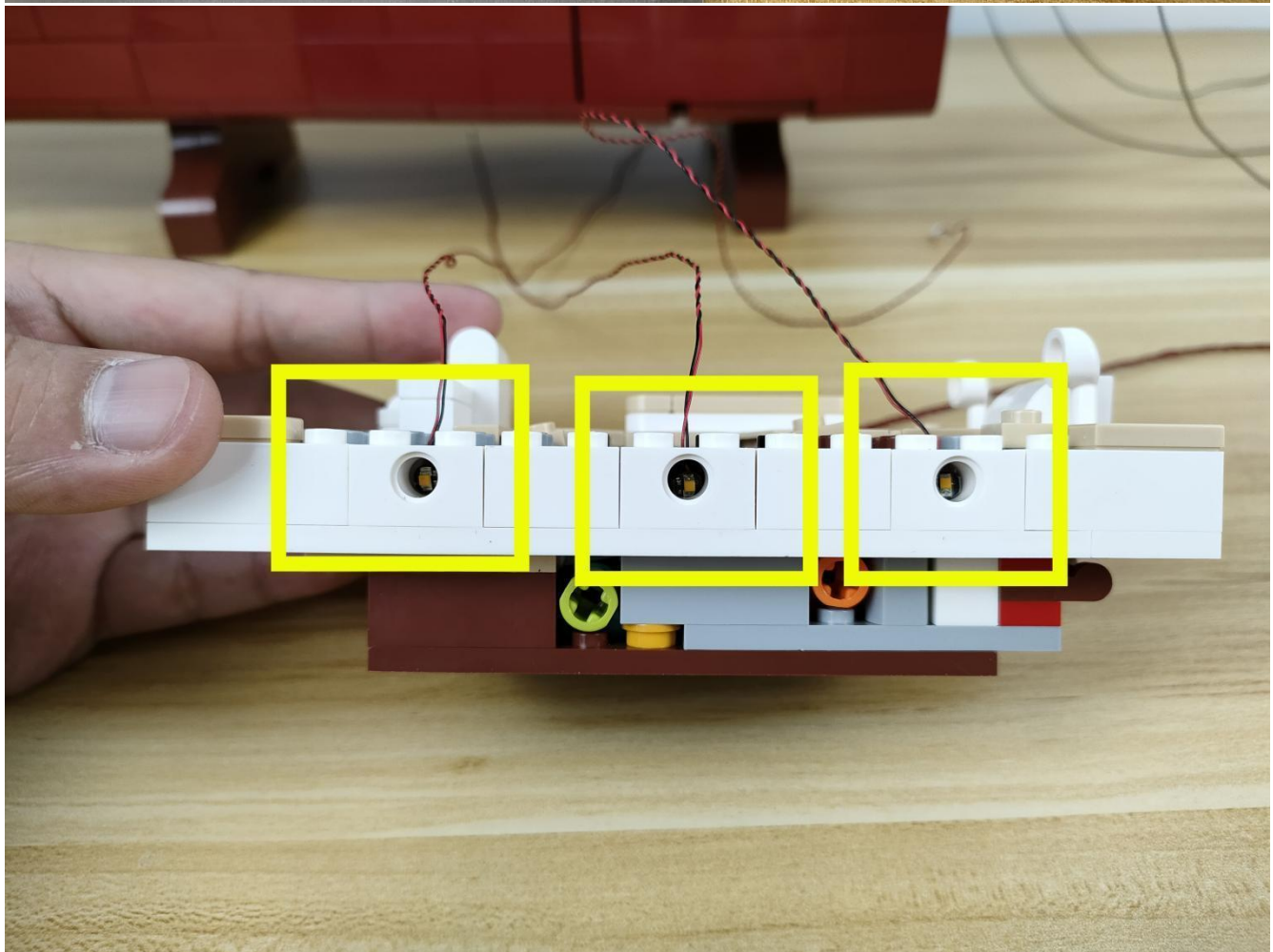

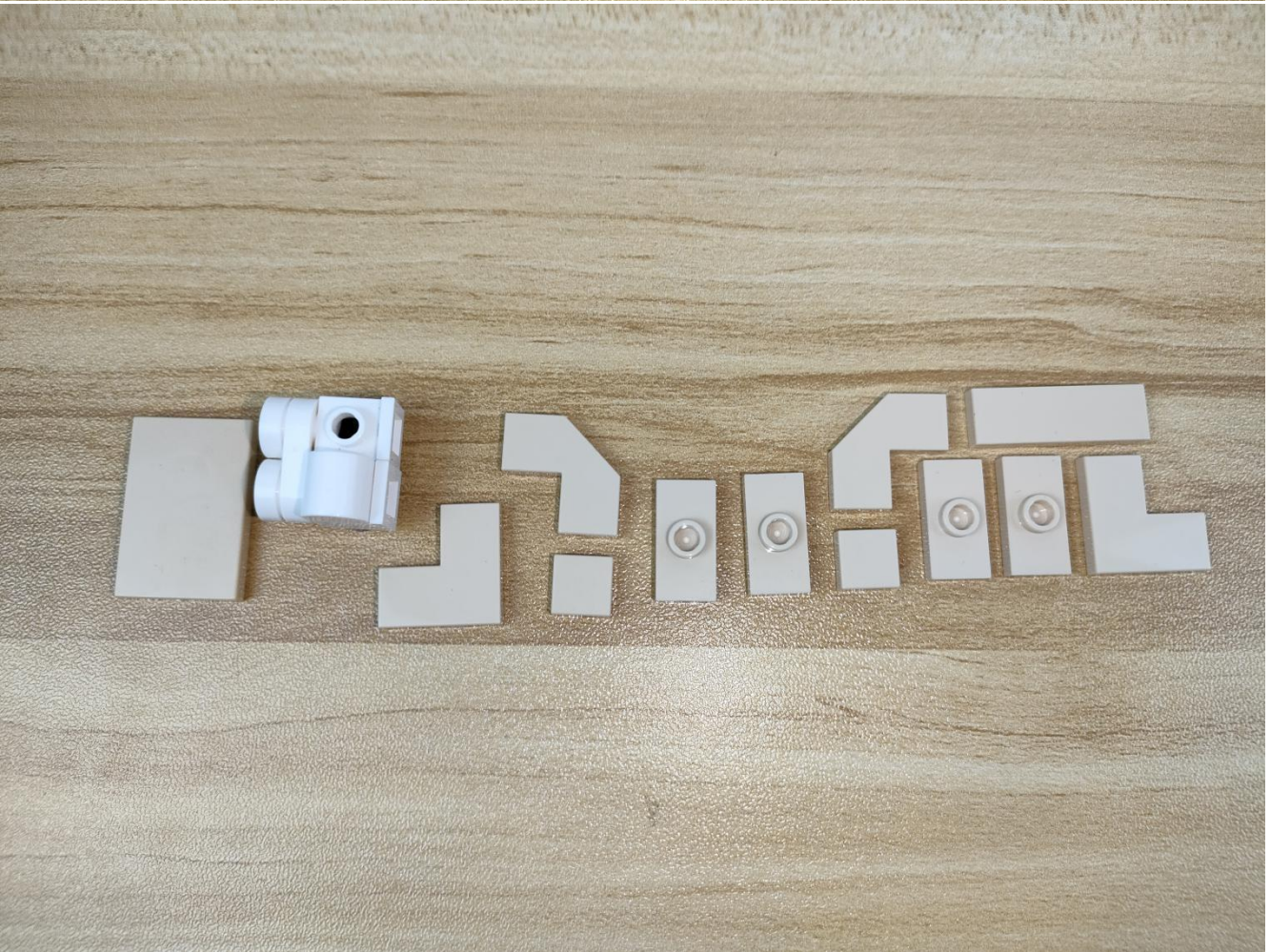
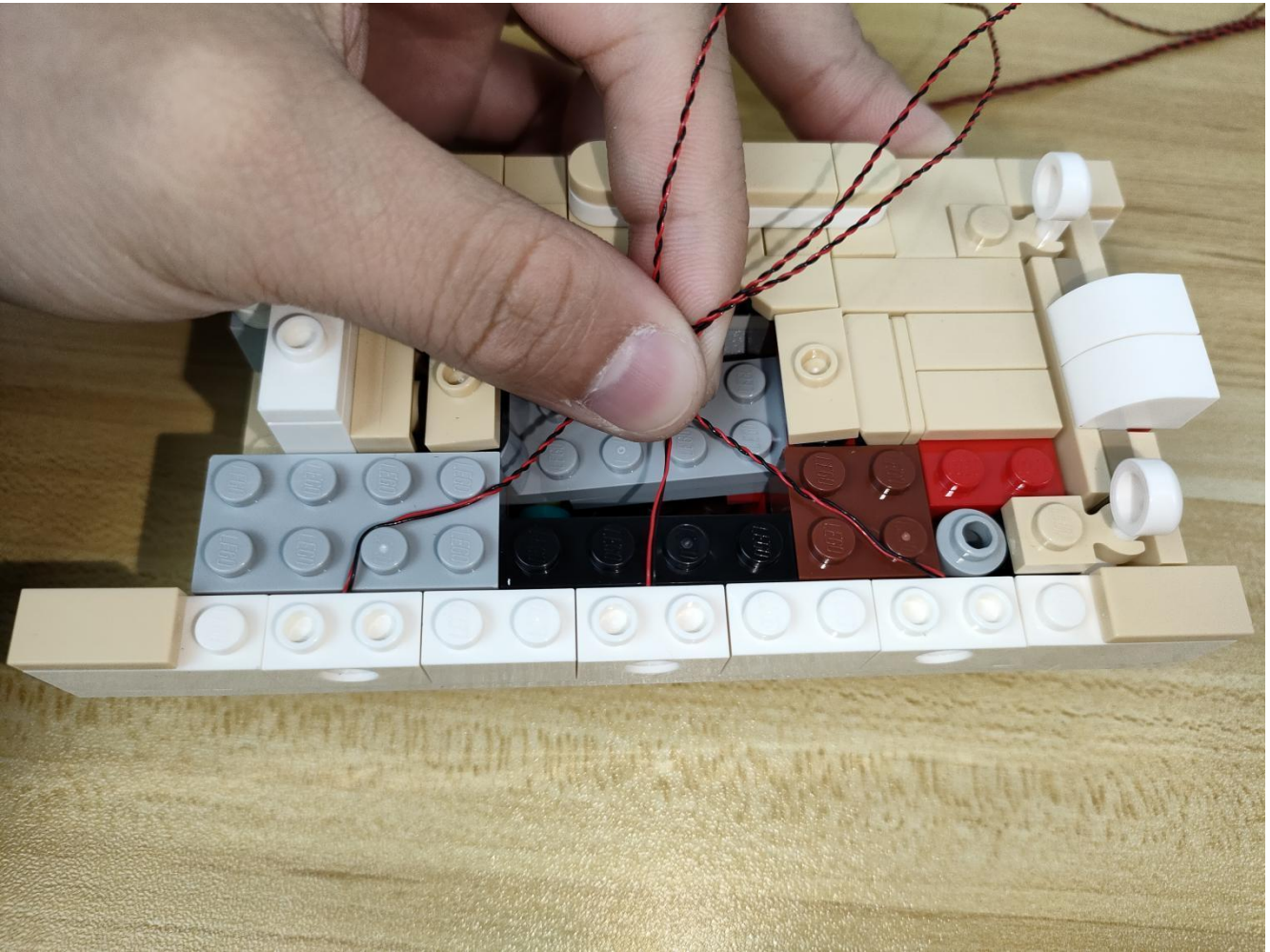

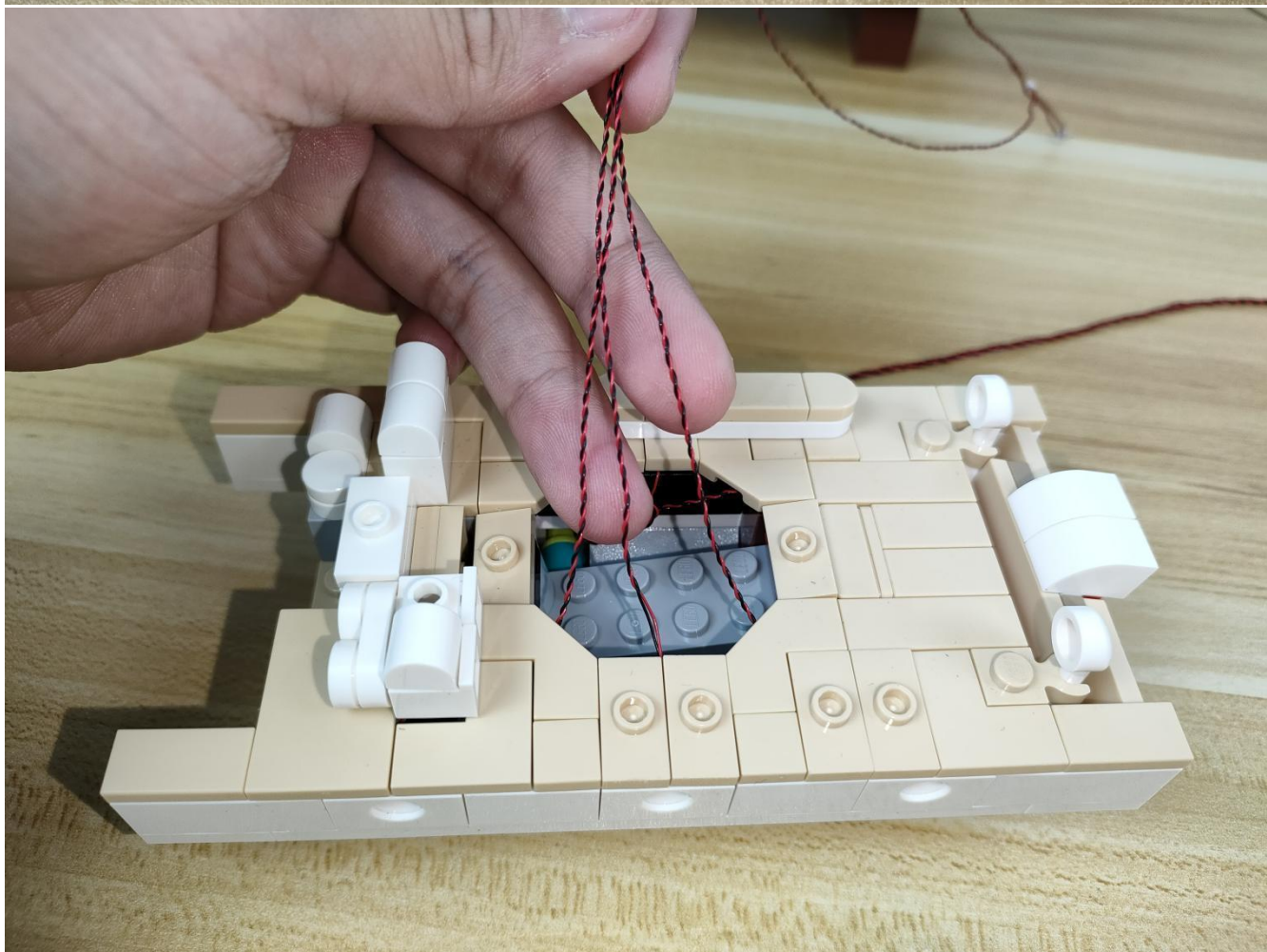
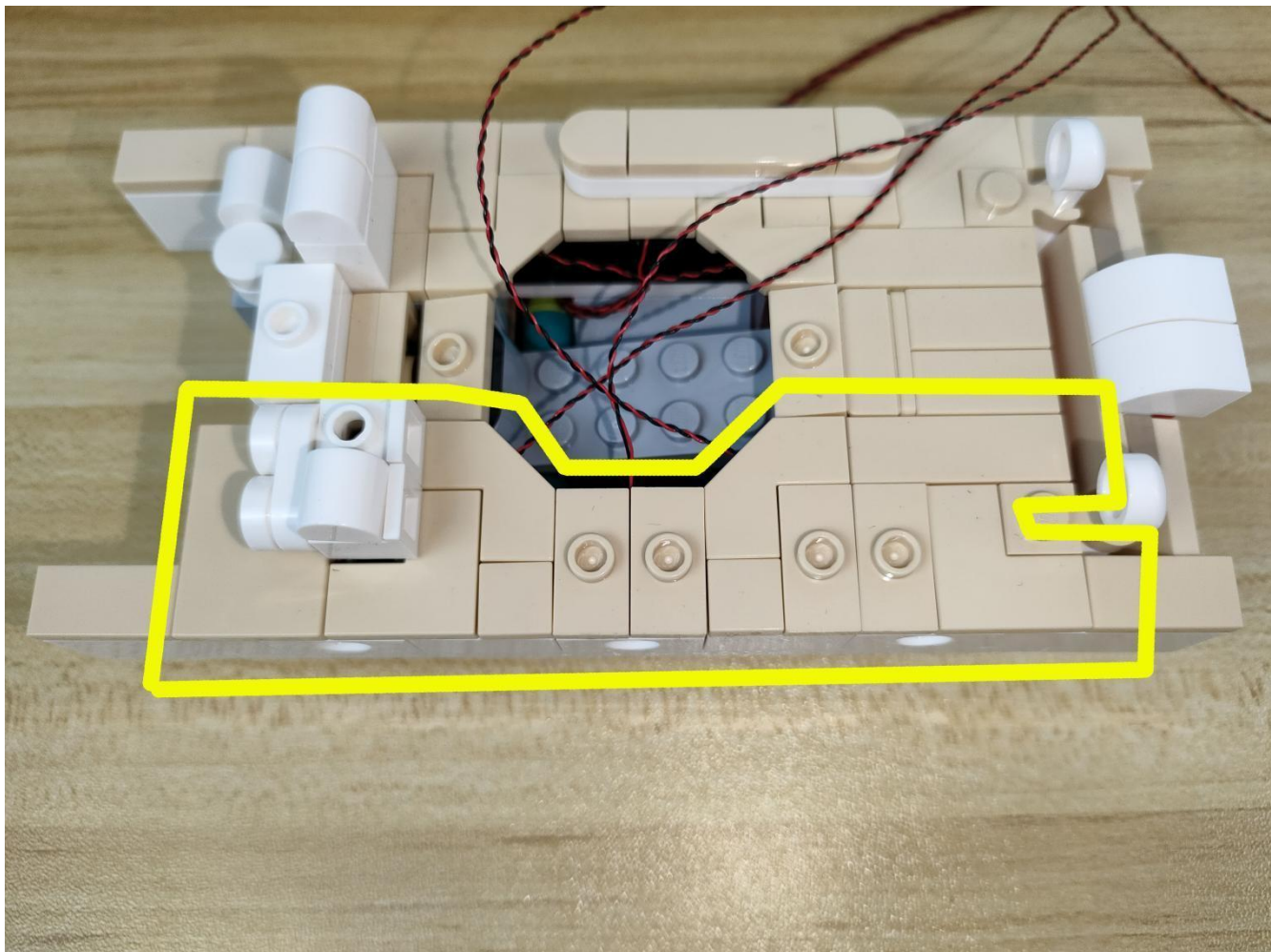

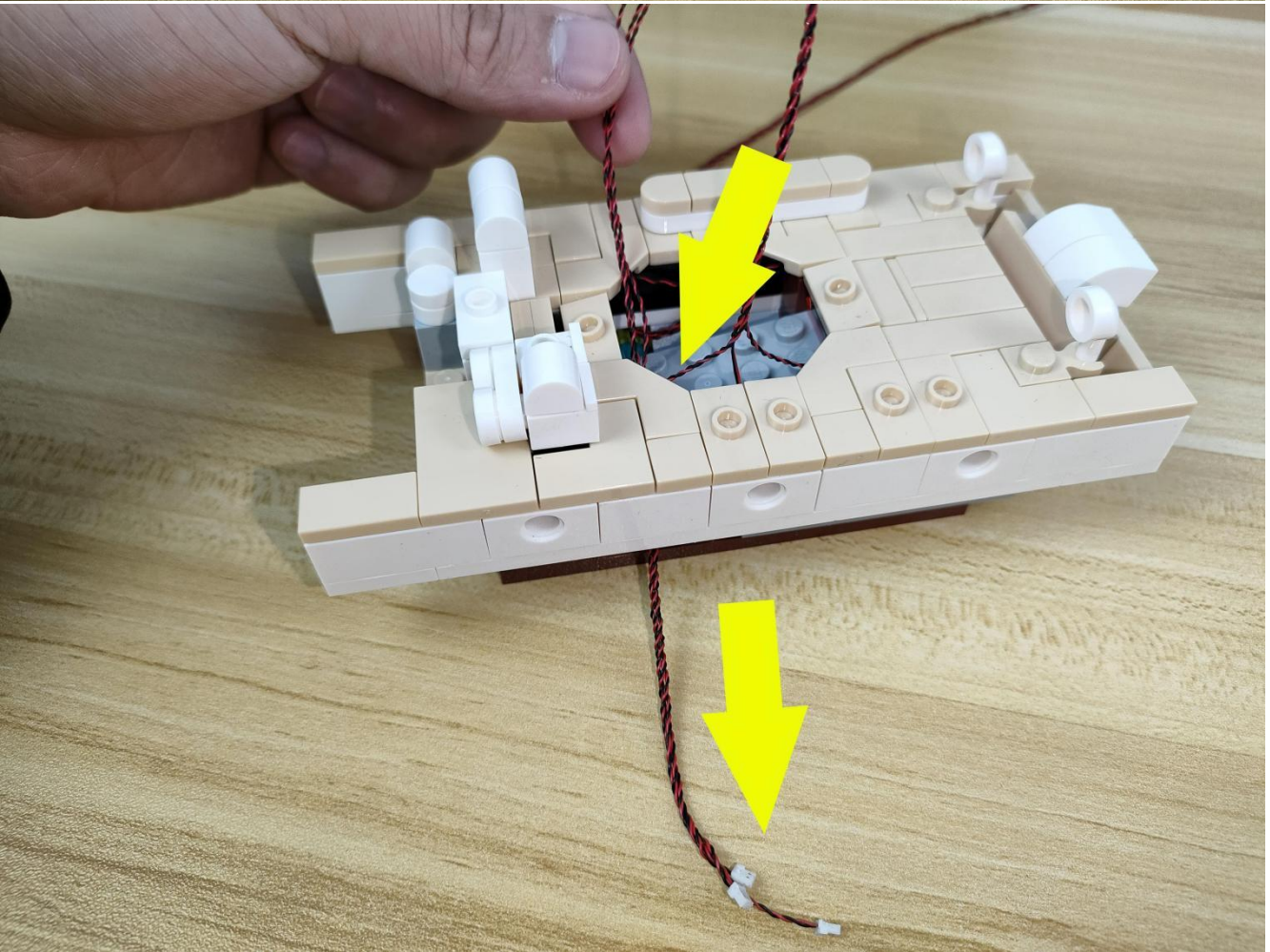
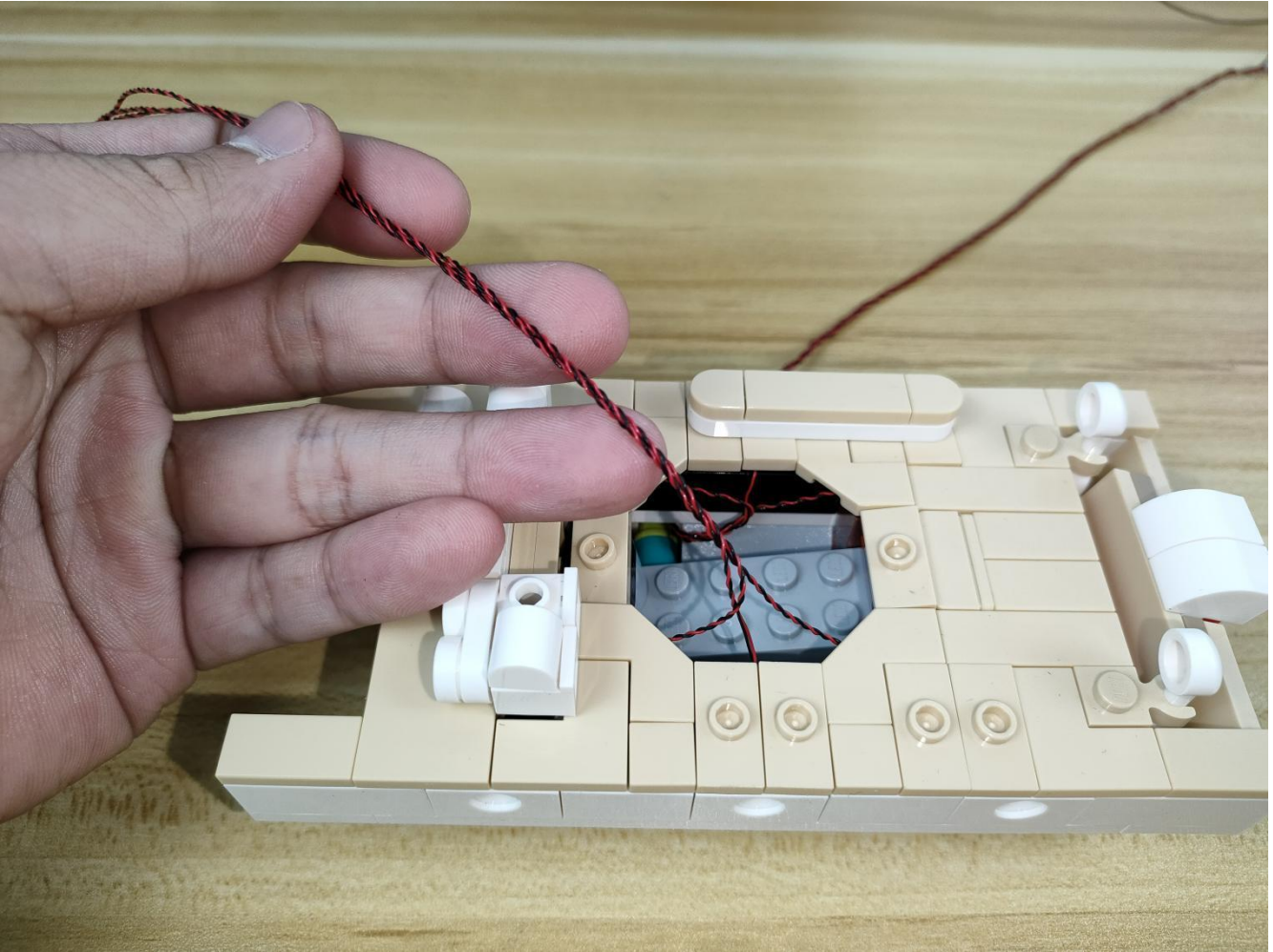

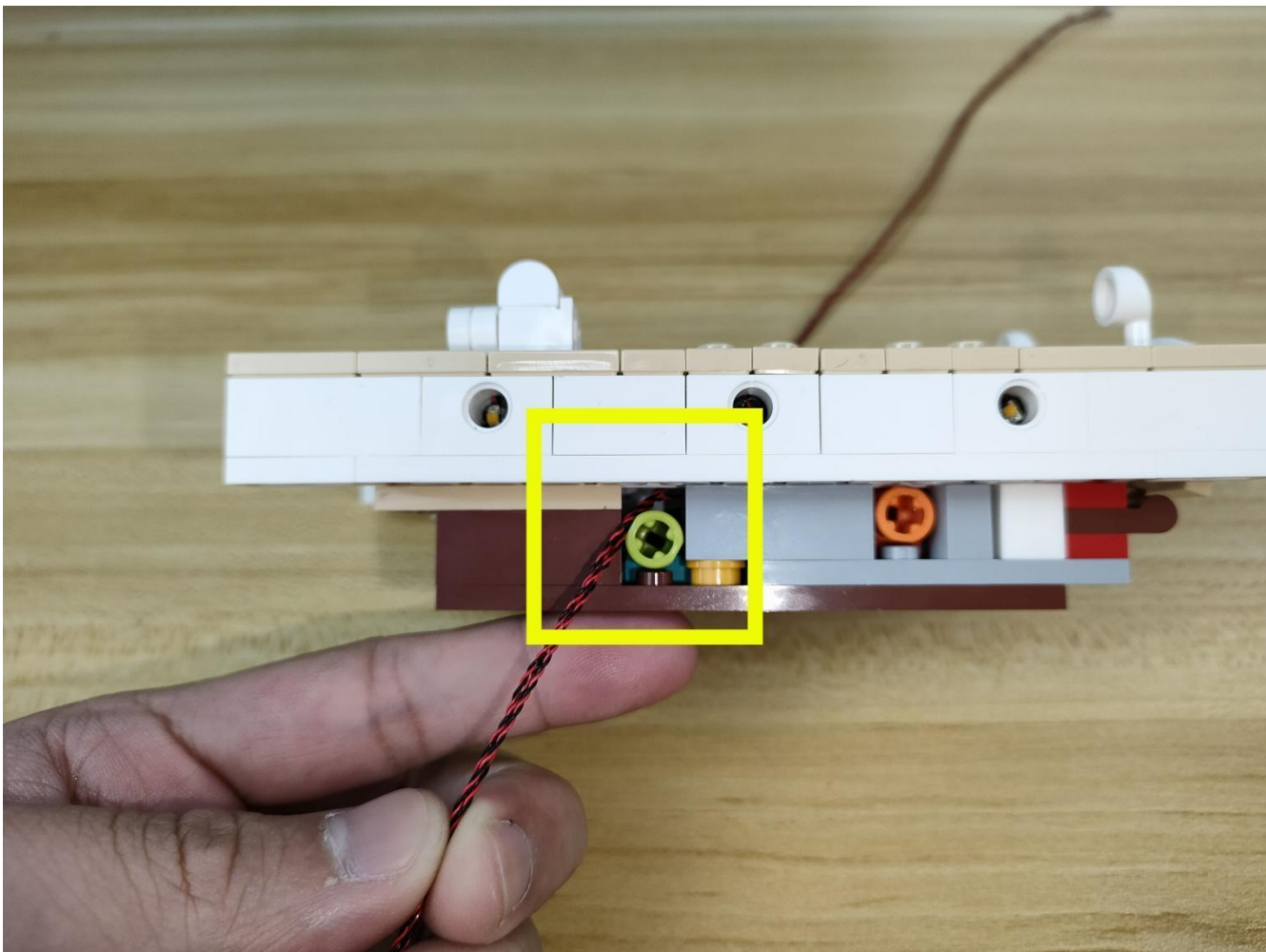

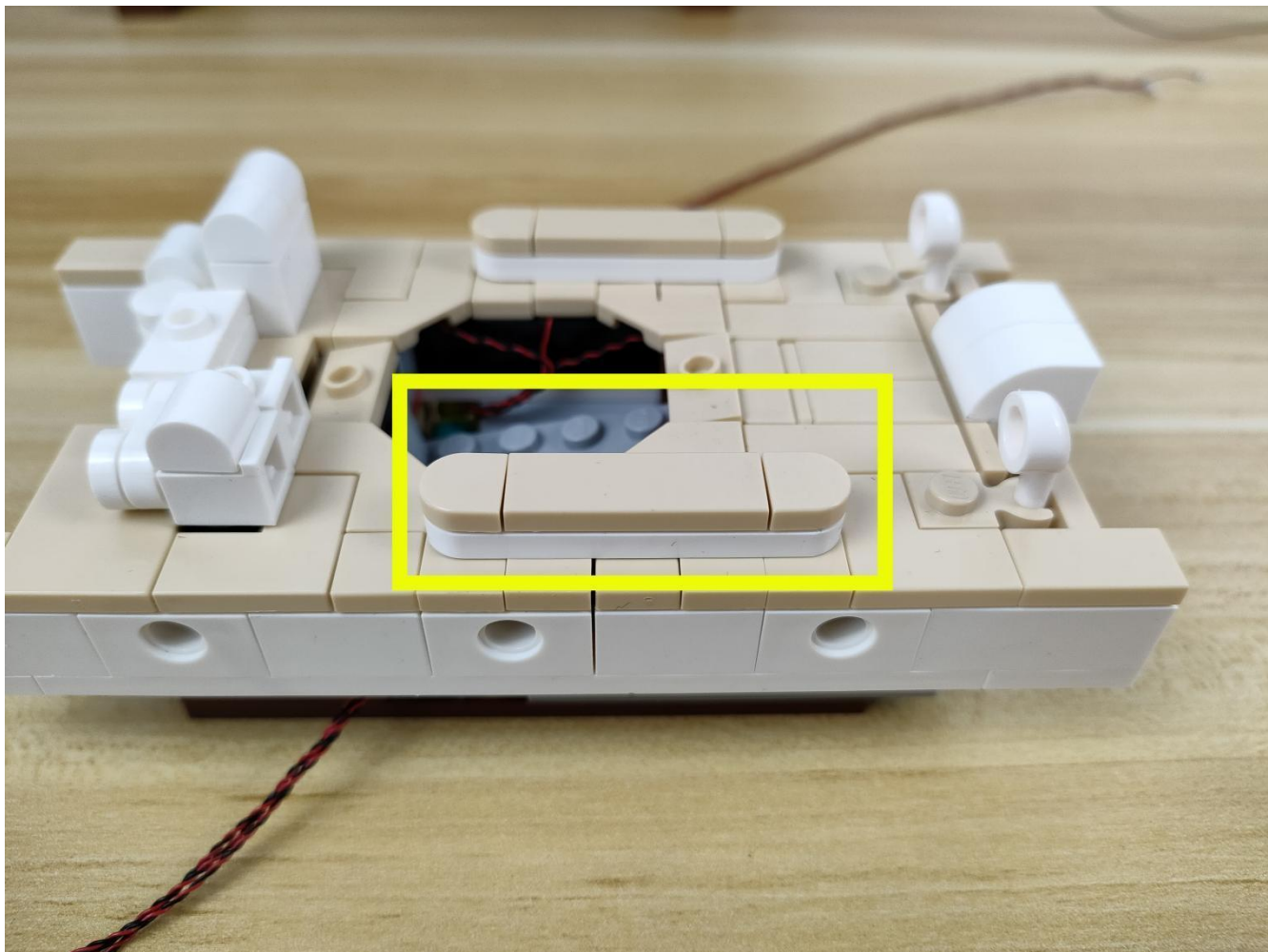

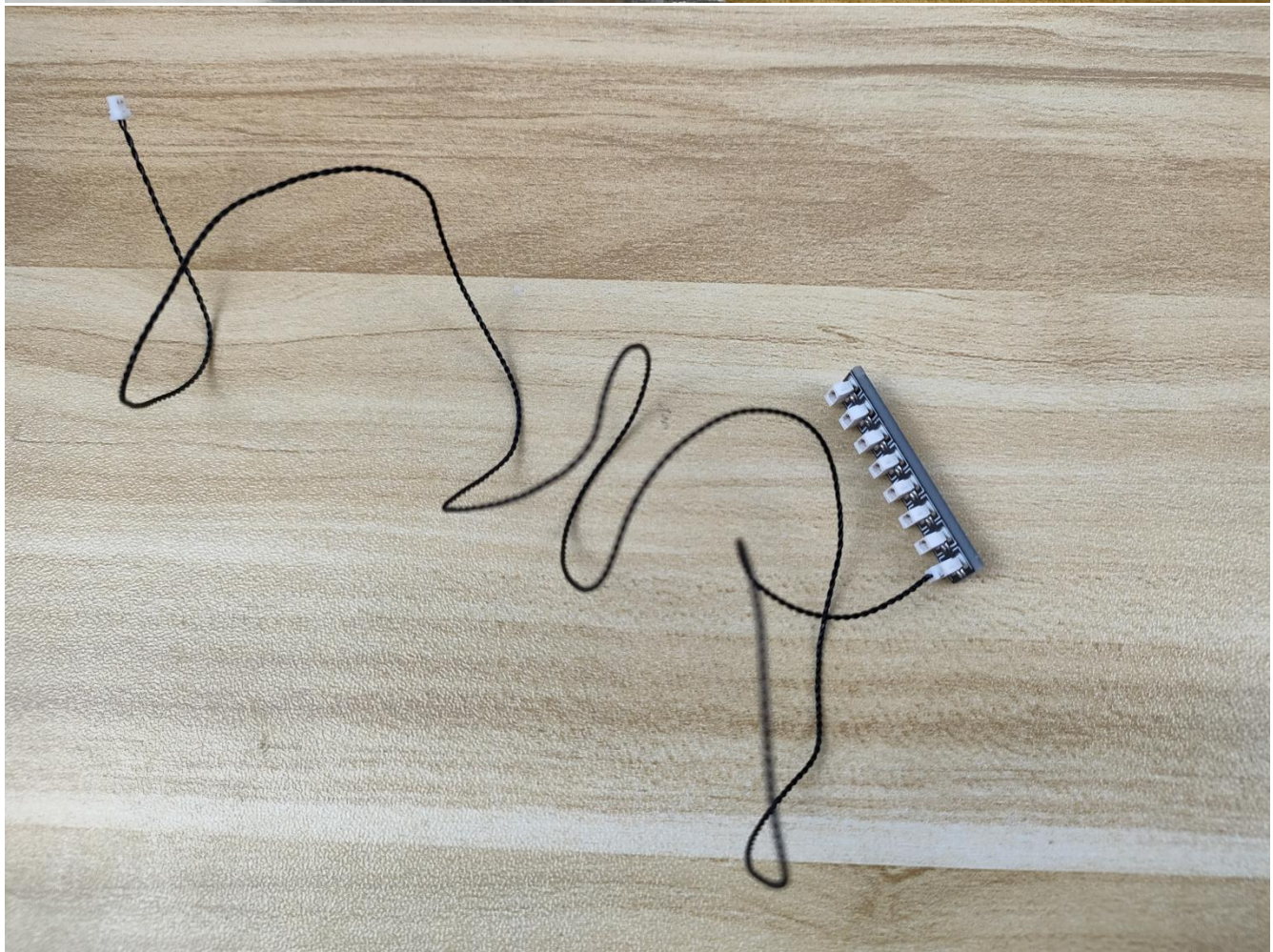

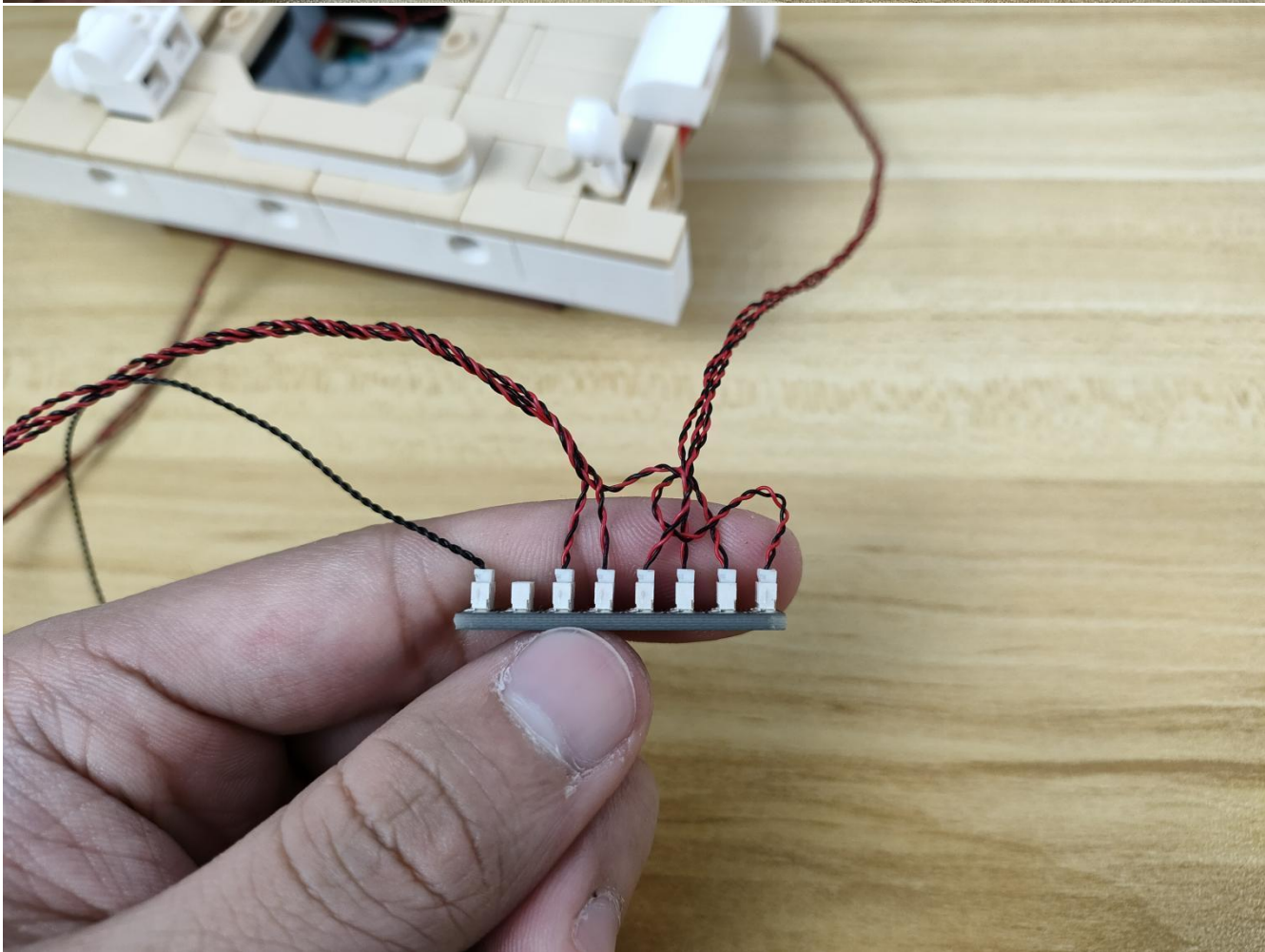
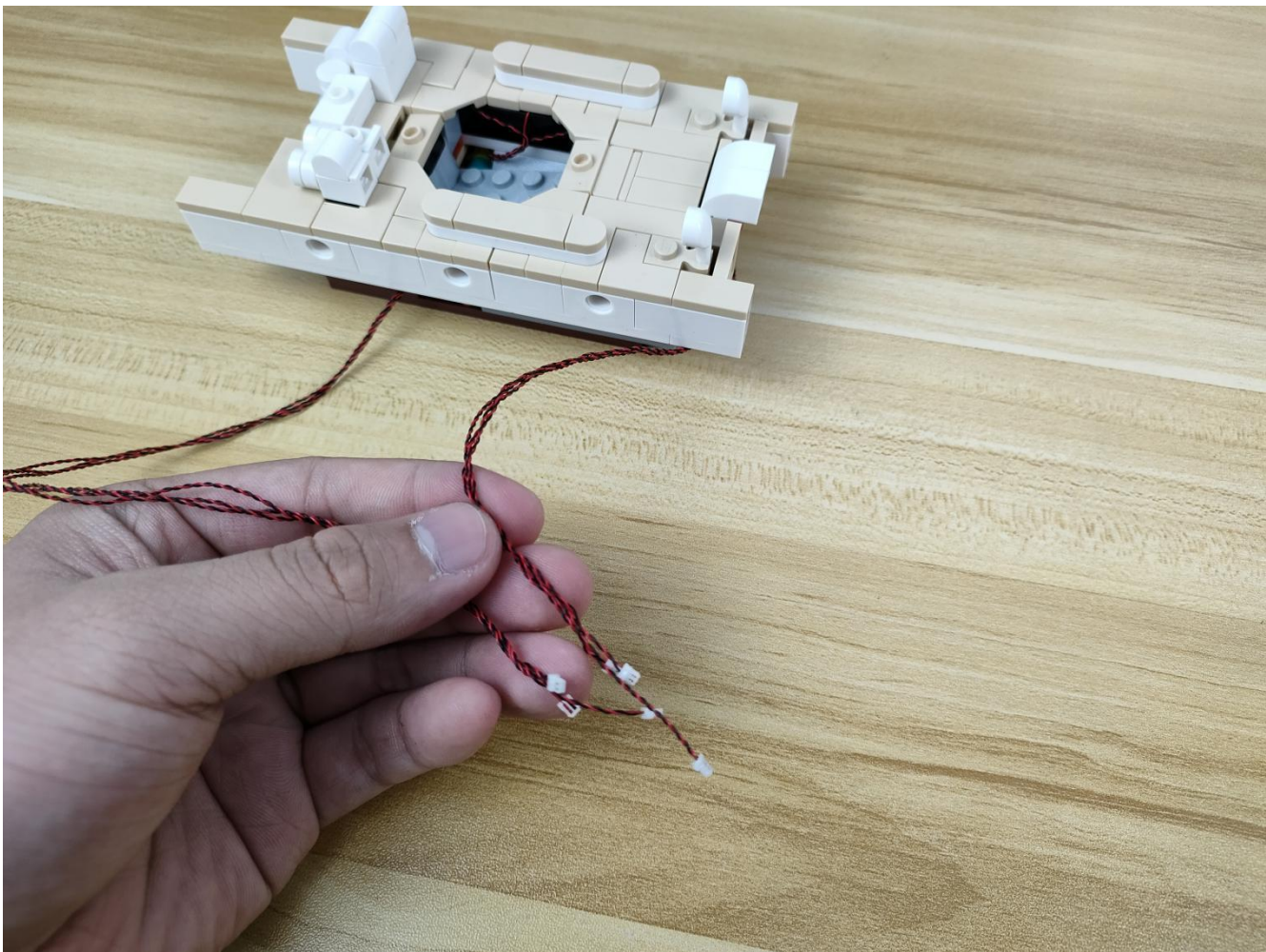

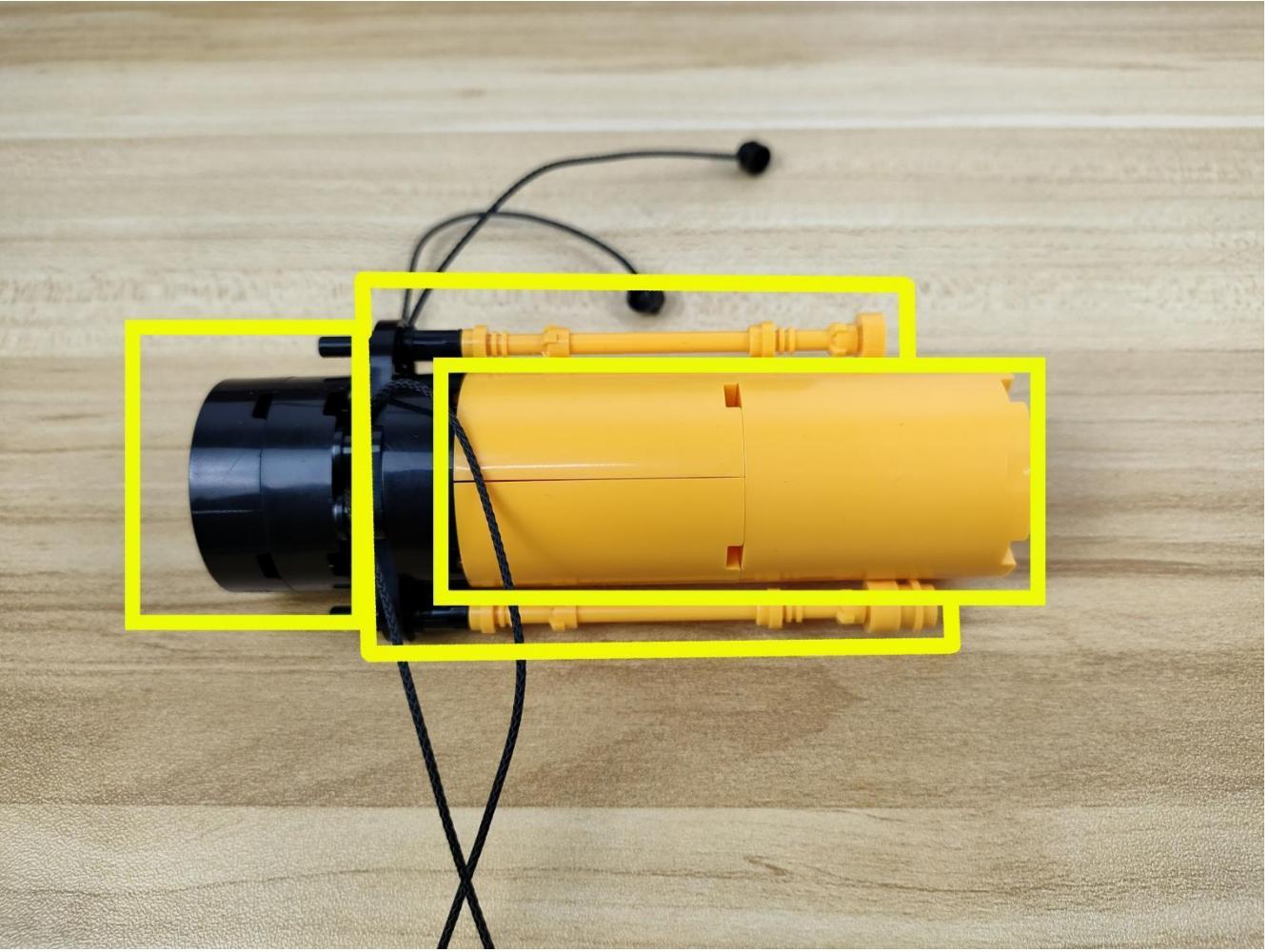



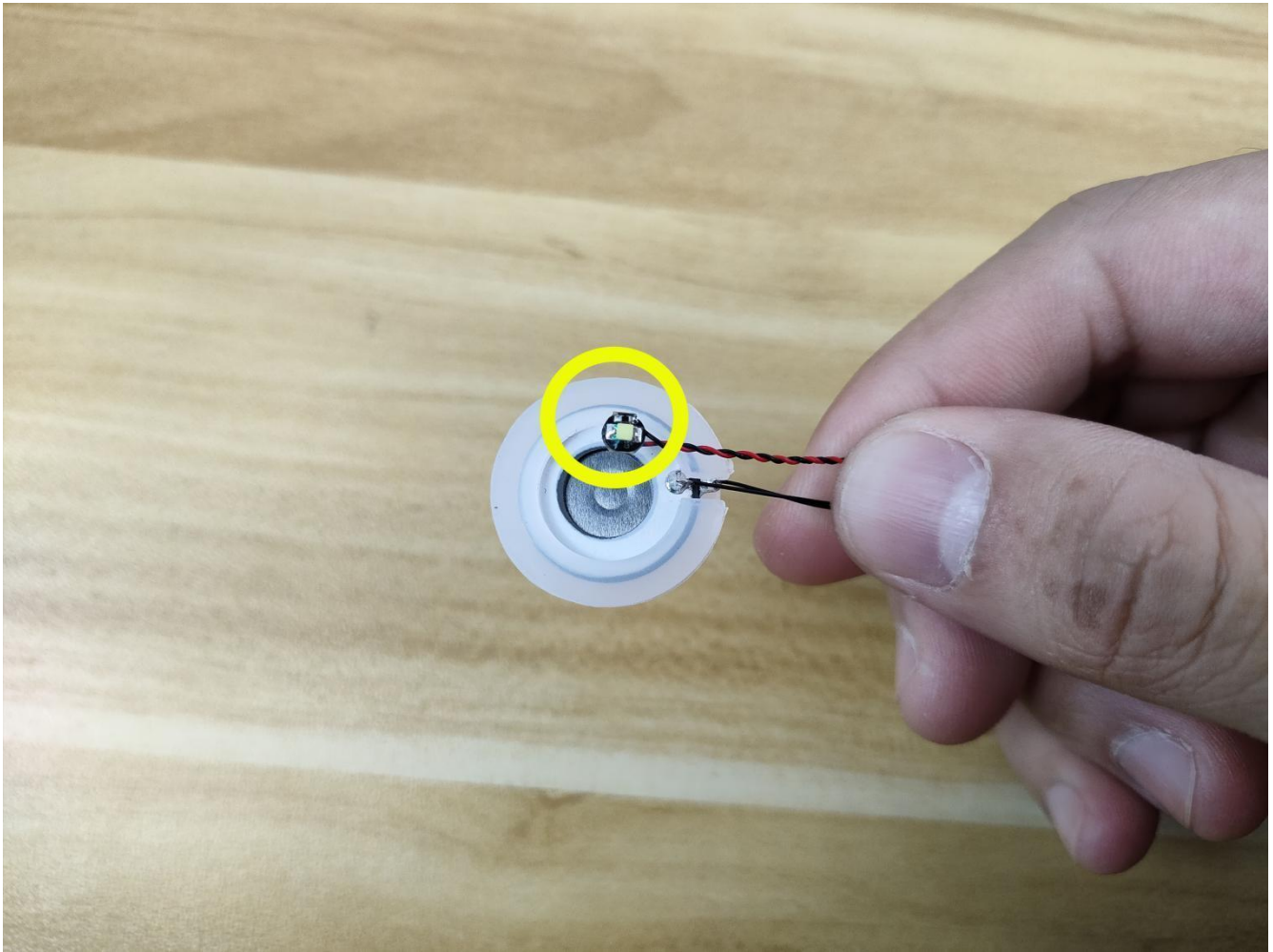

Fix the lamp pellet at the position selected by the frame in the figure, with the solder joints of the spray module components facing upwards.

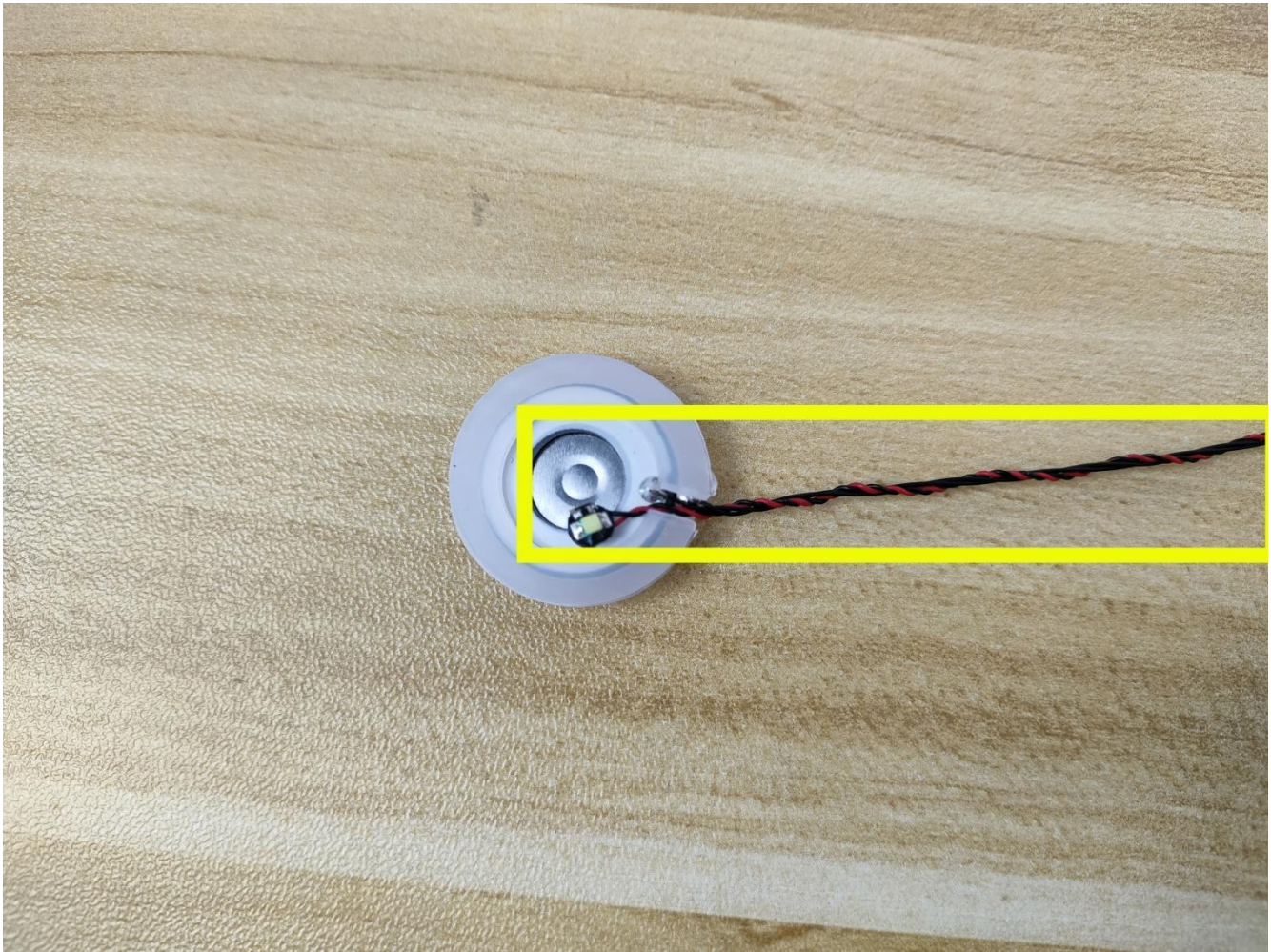

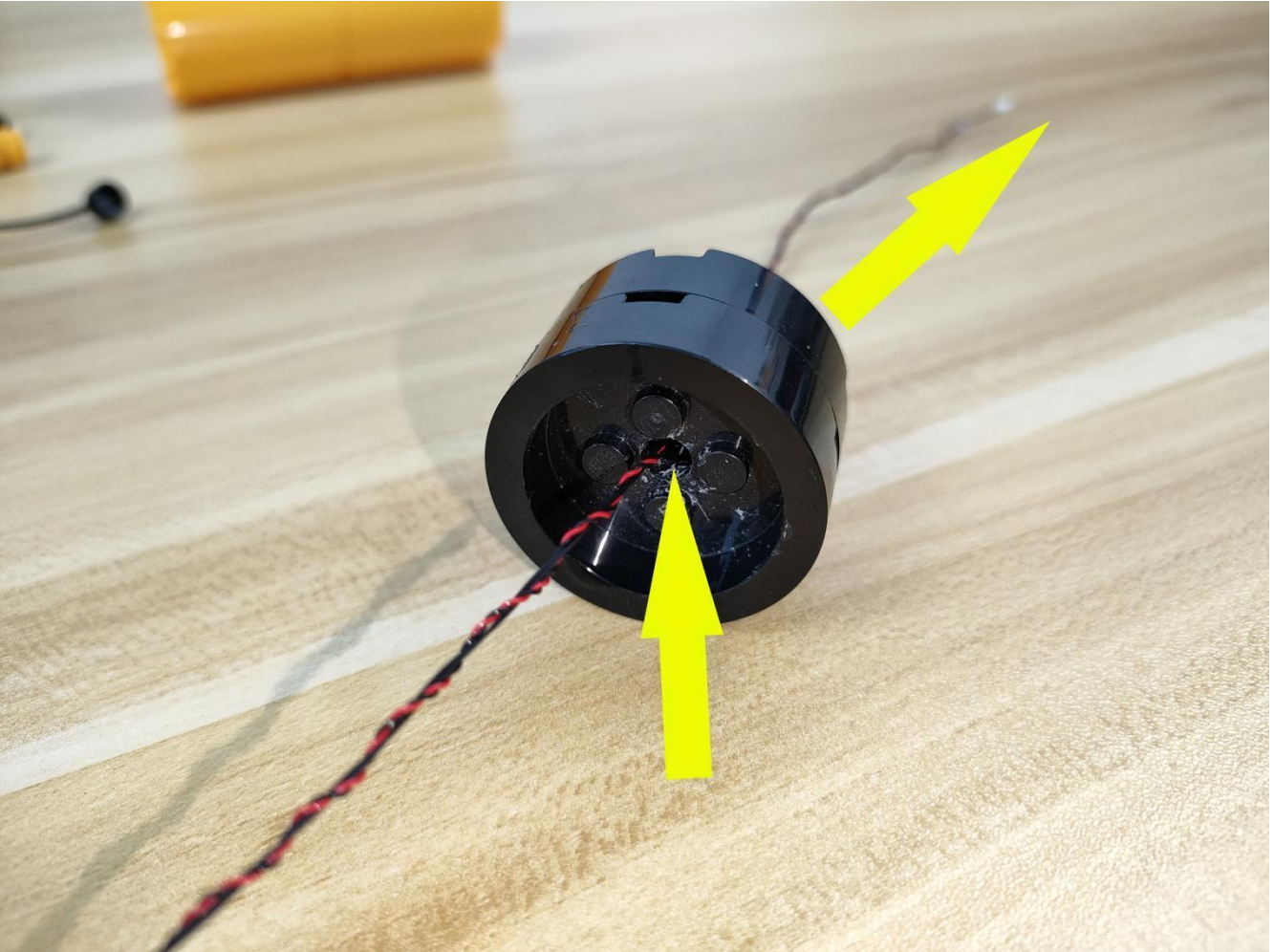
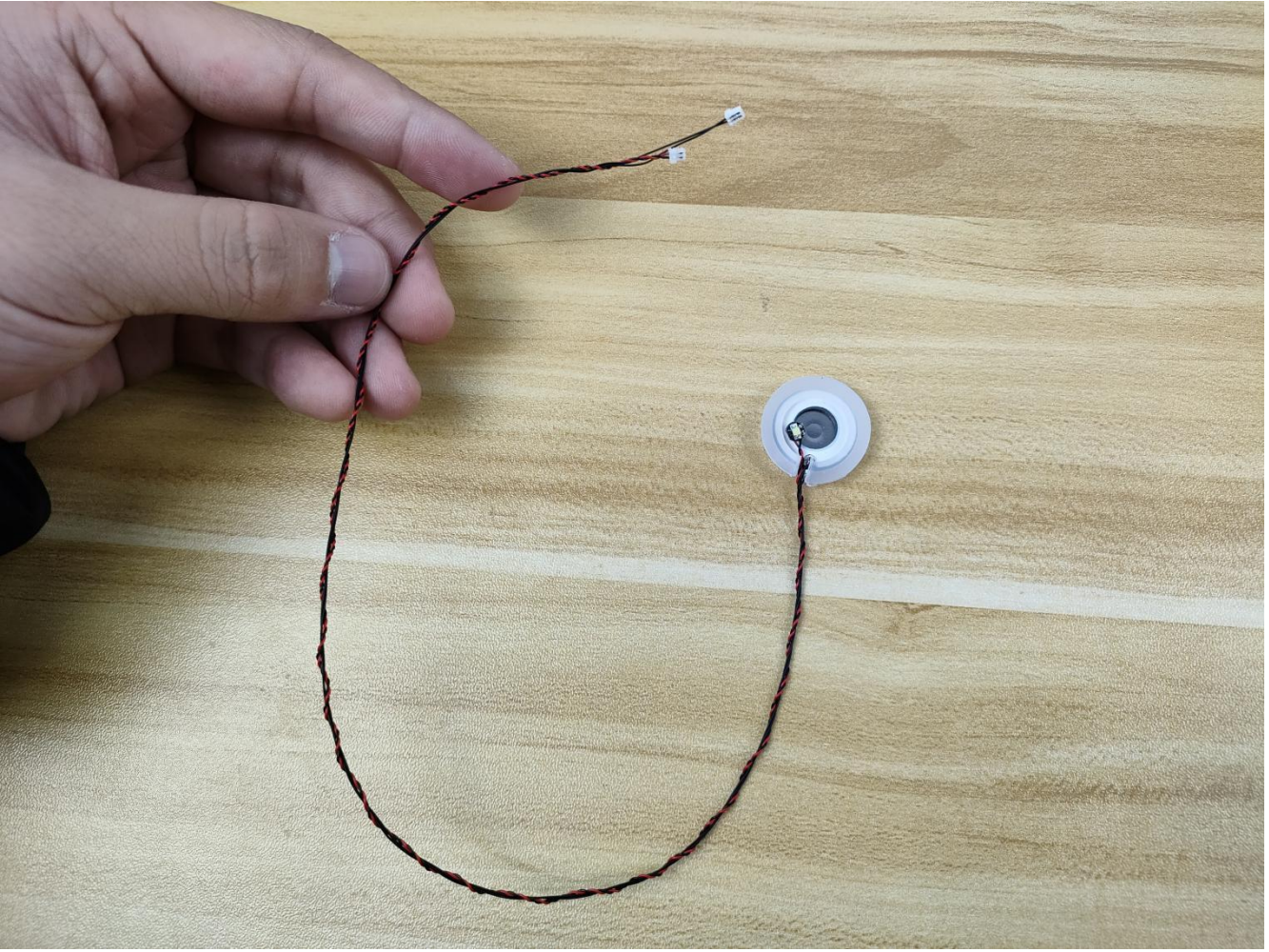

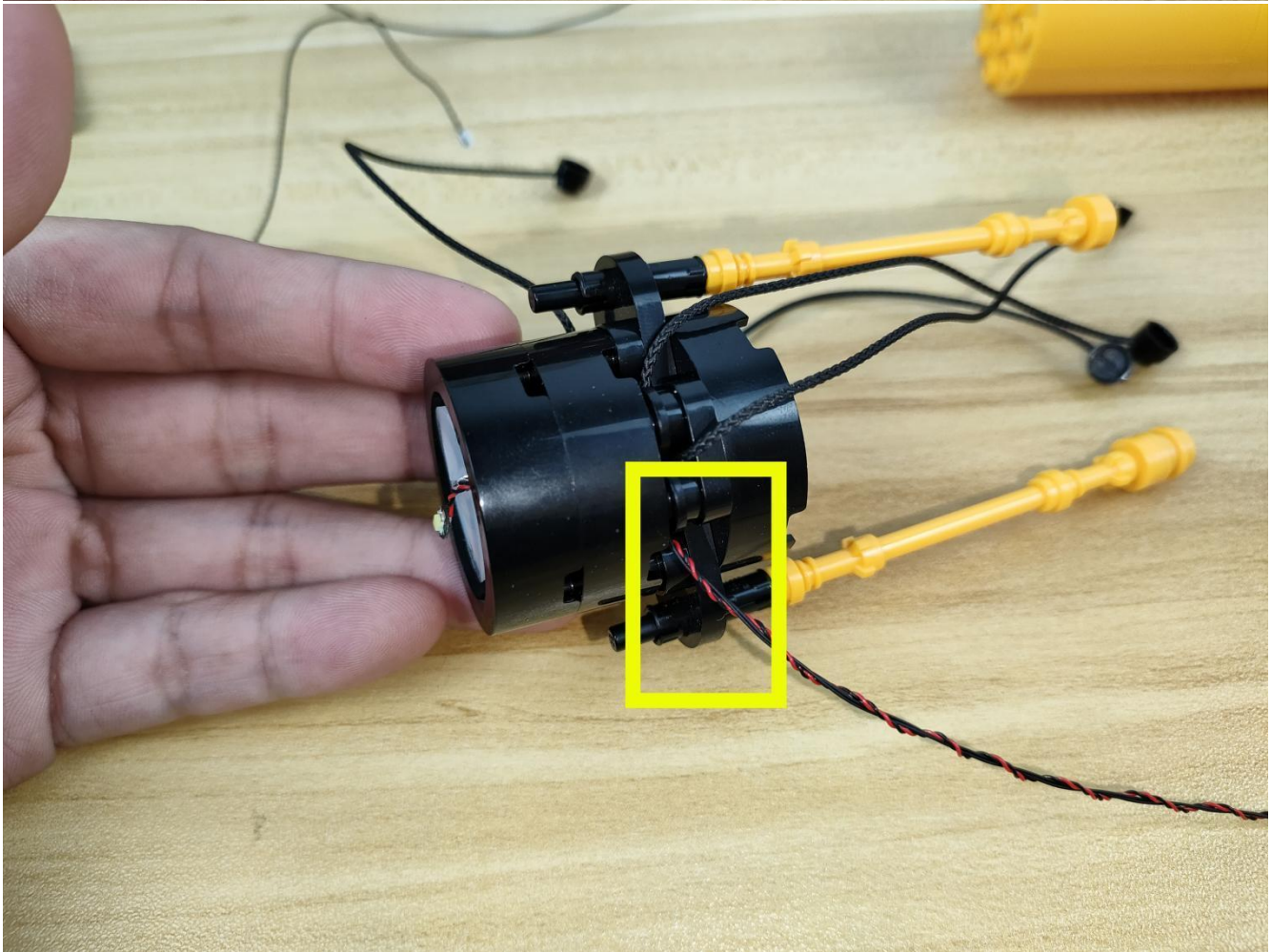
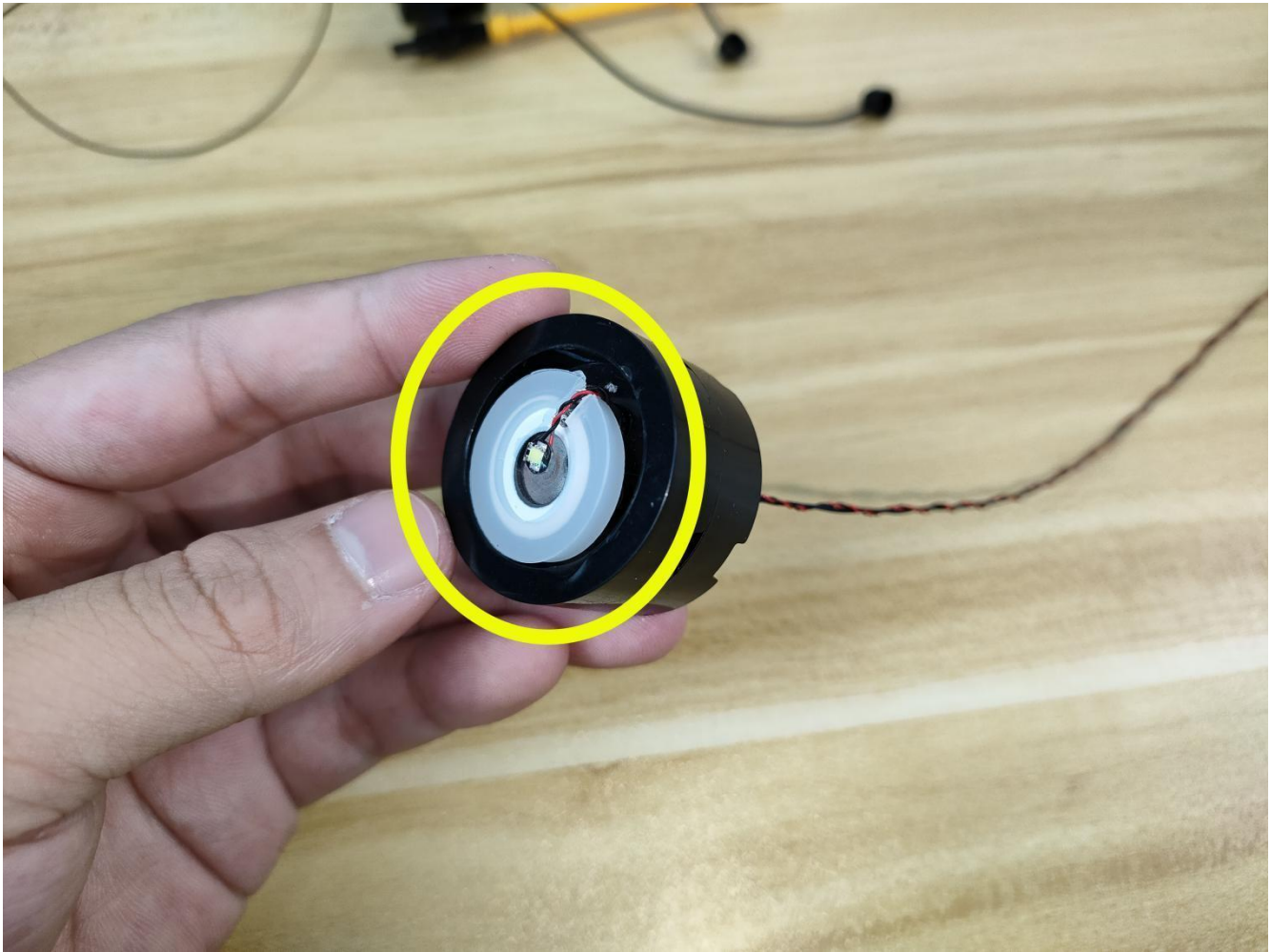

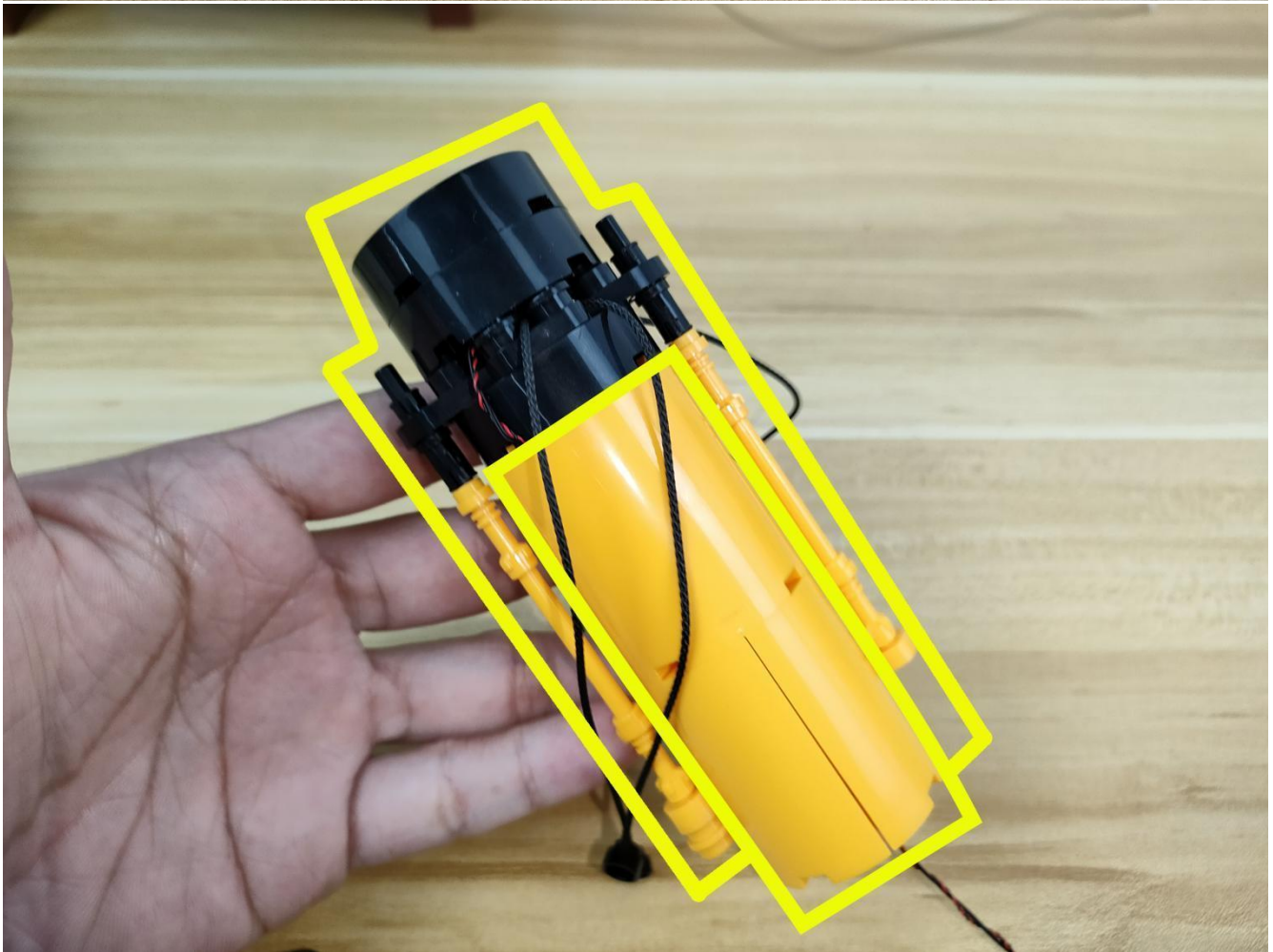
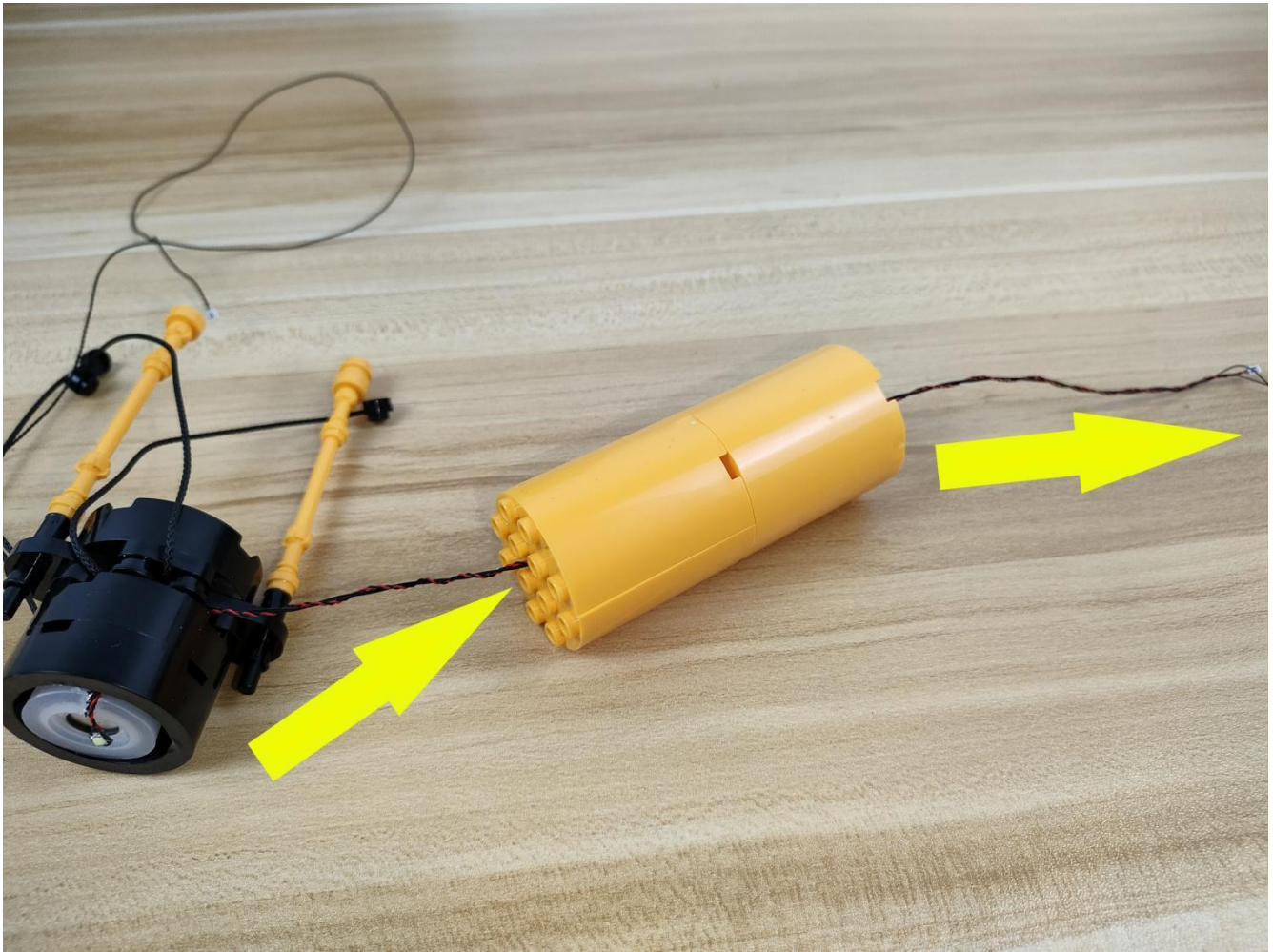

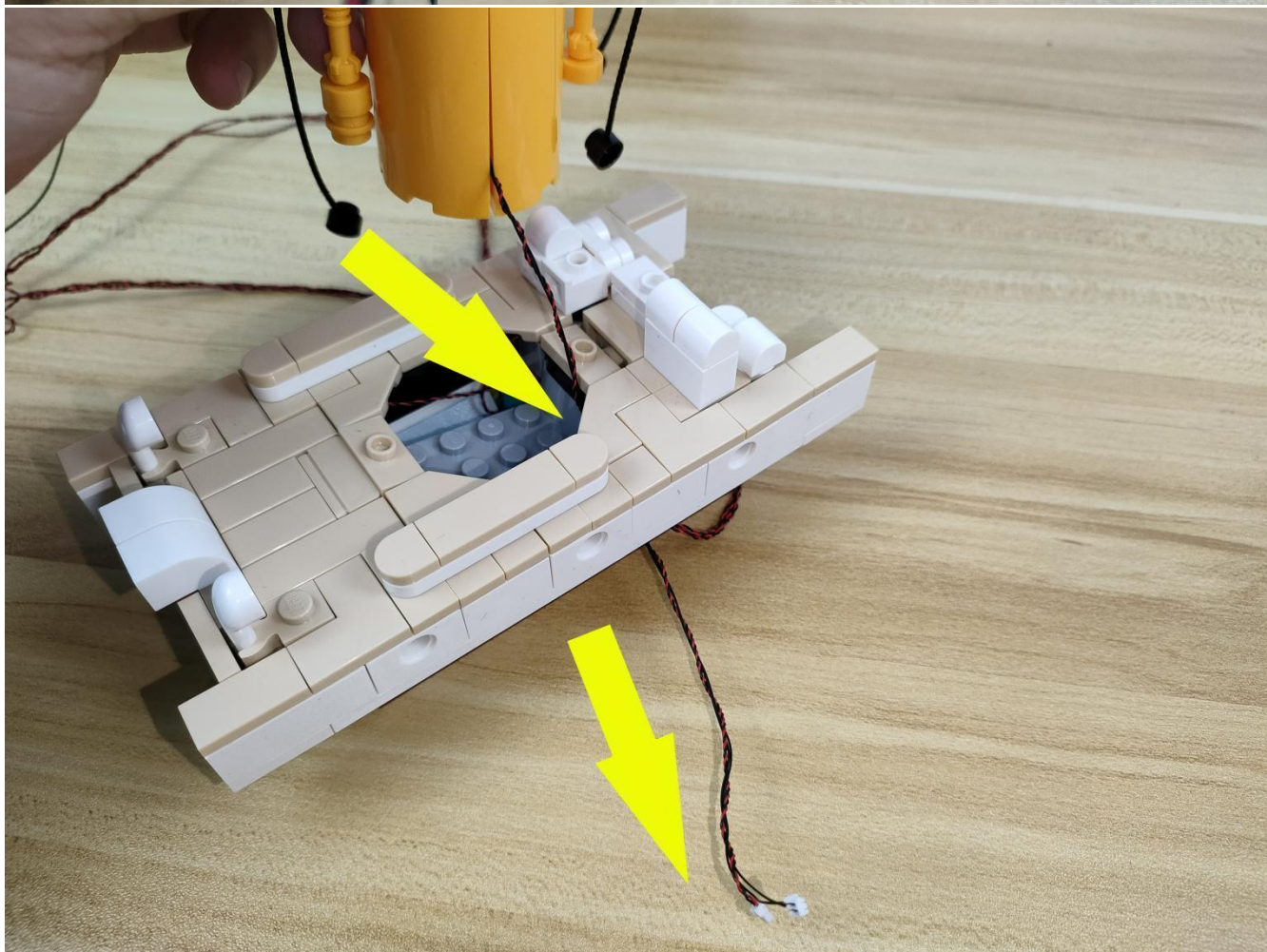
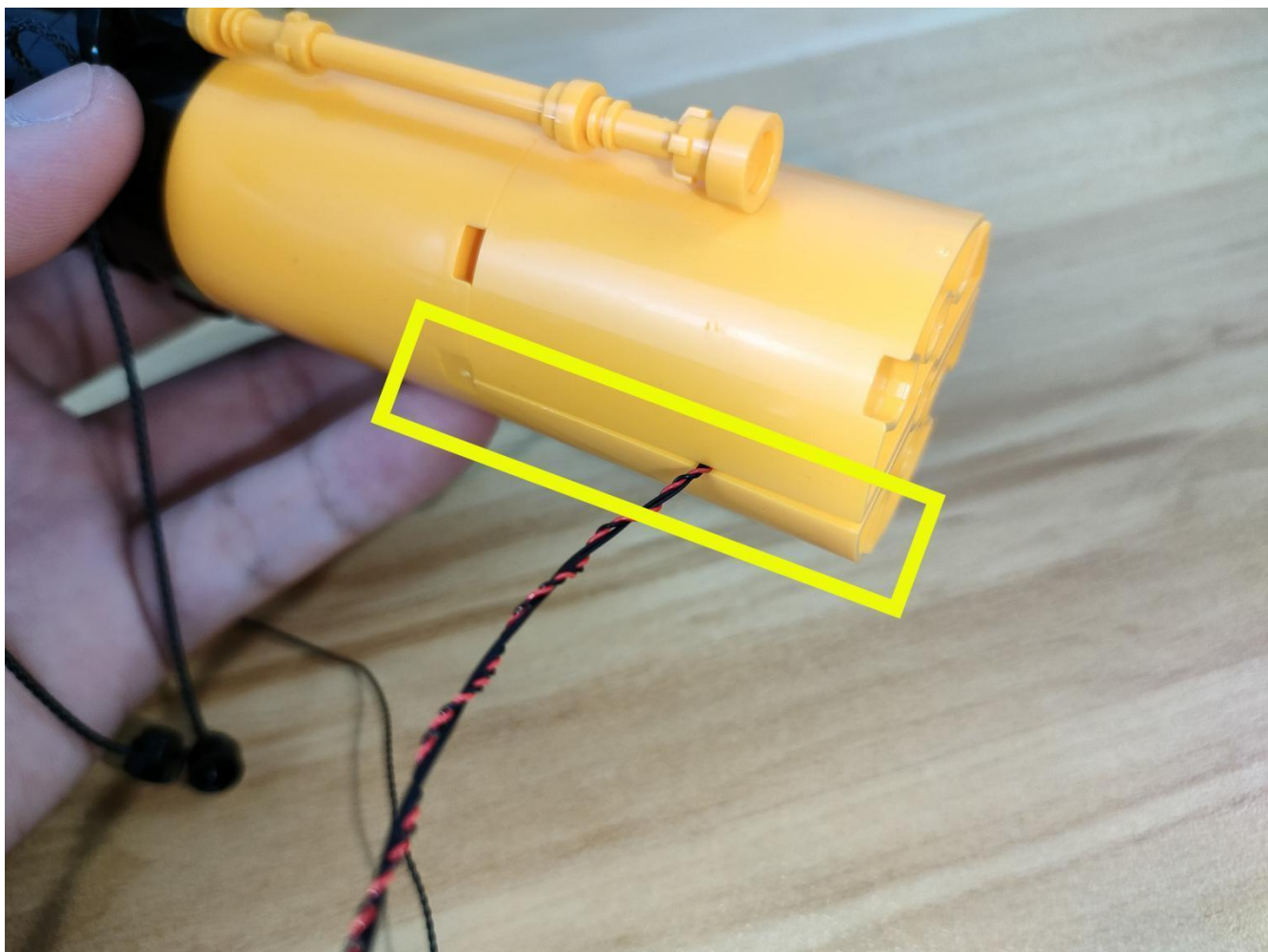

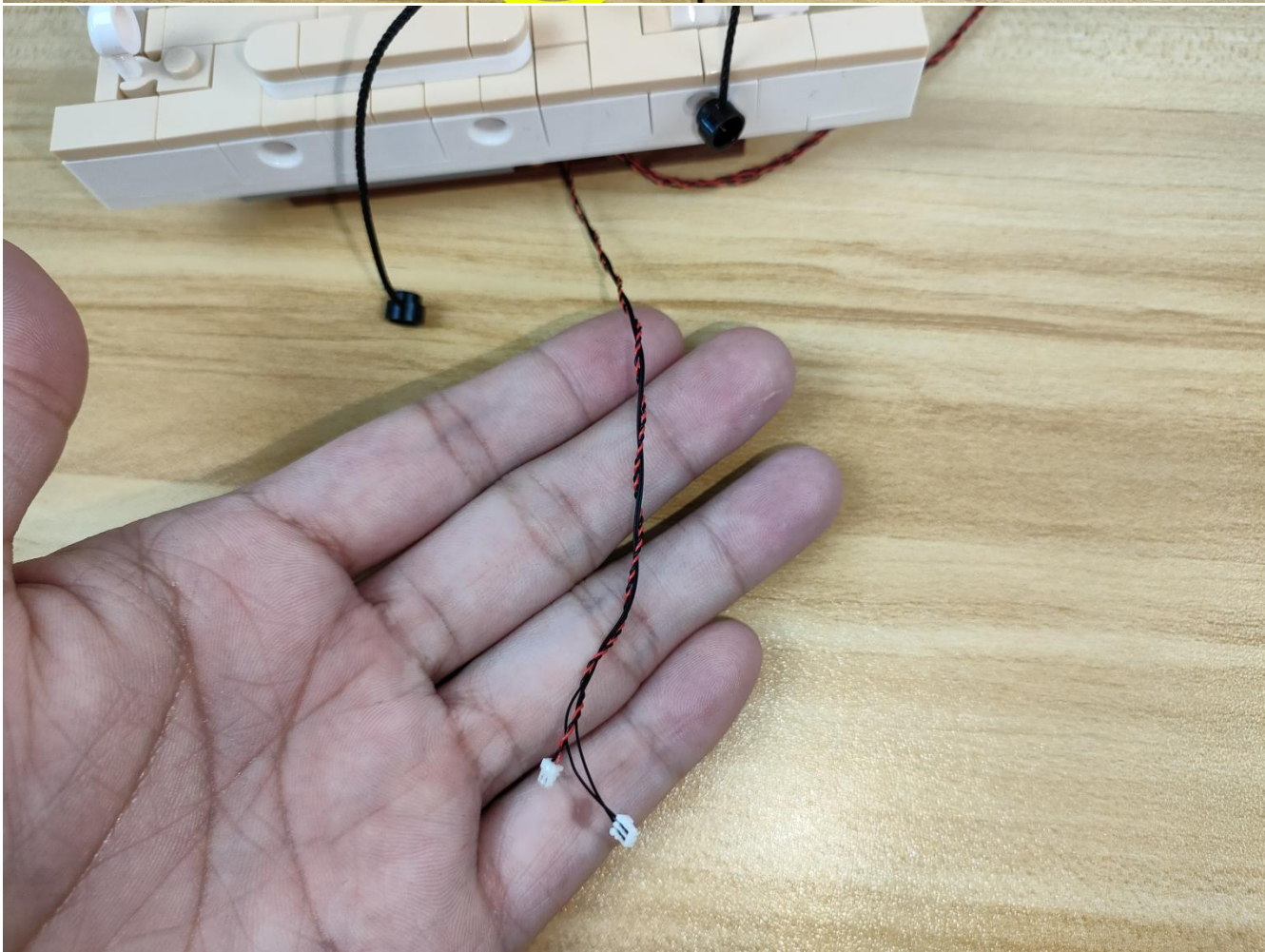
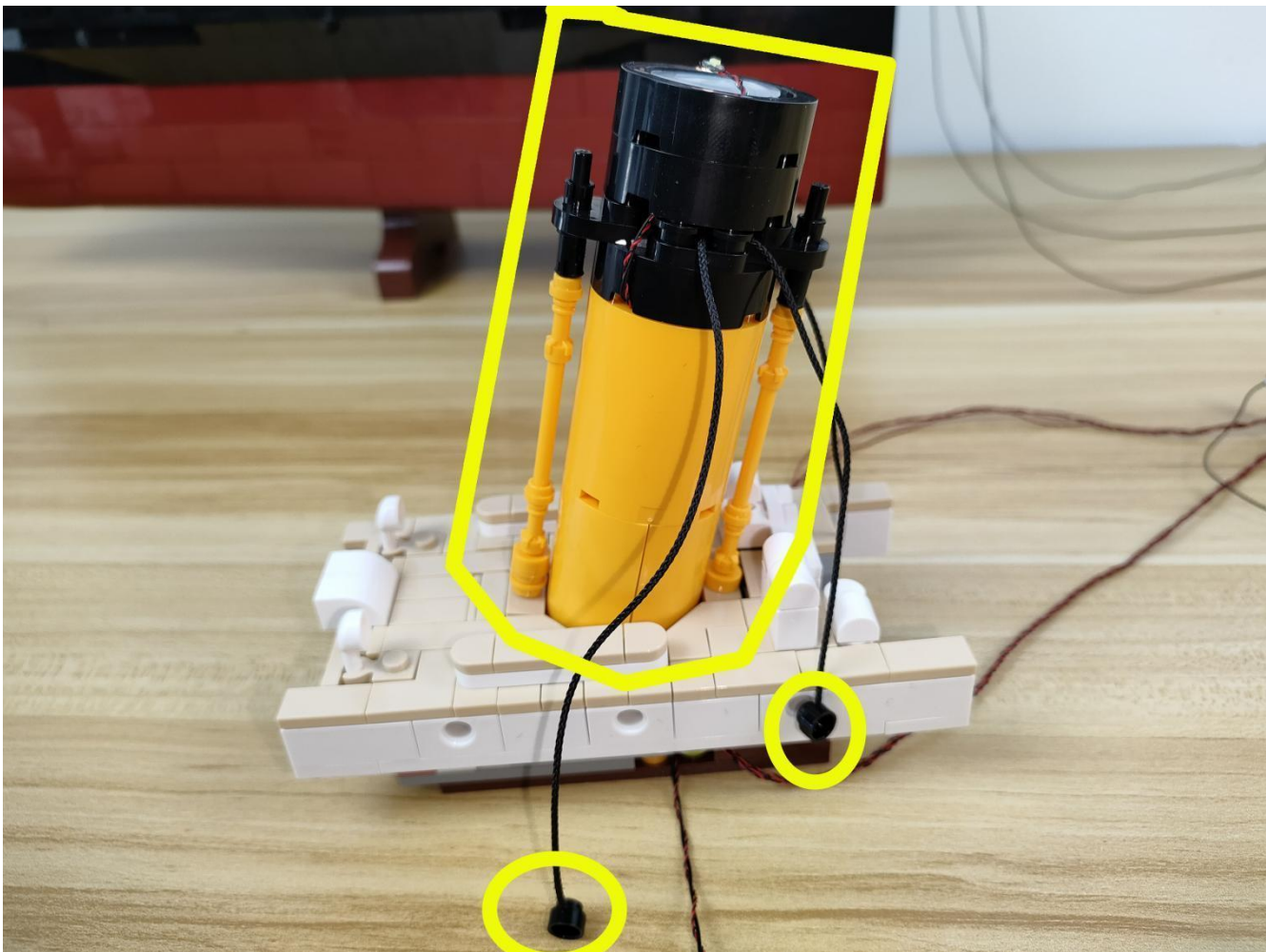

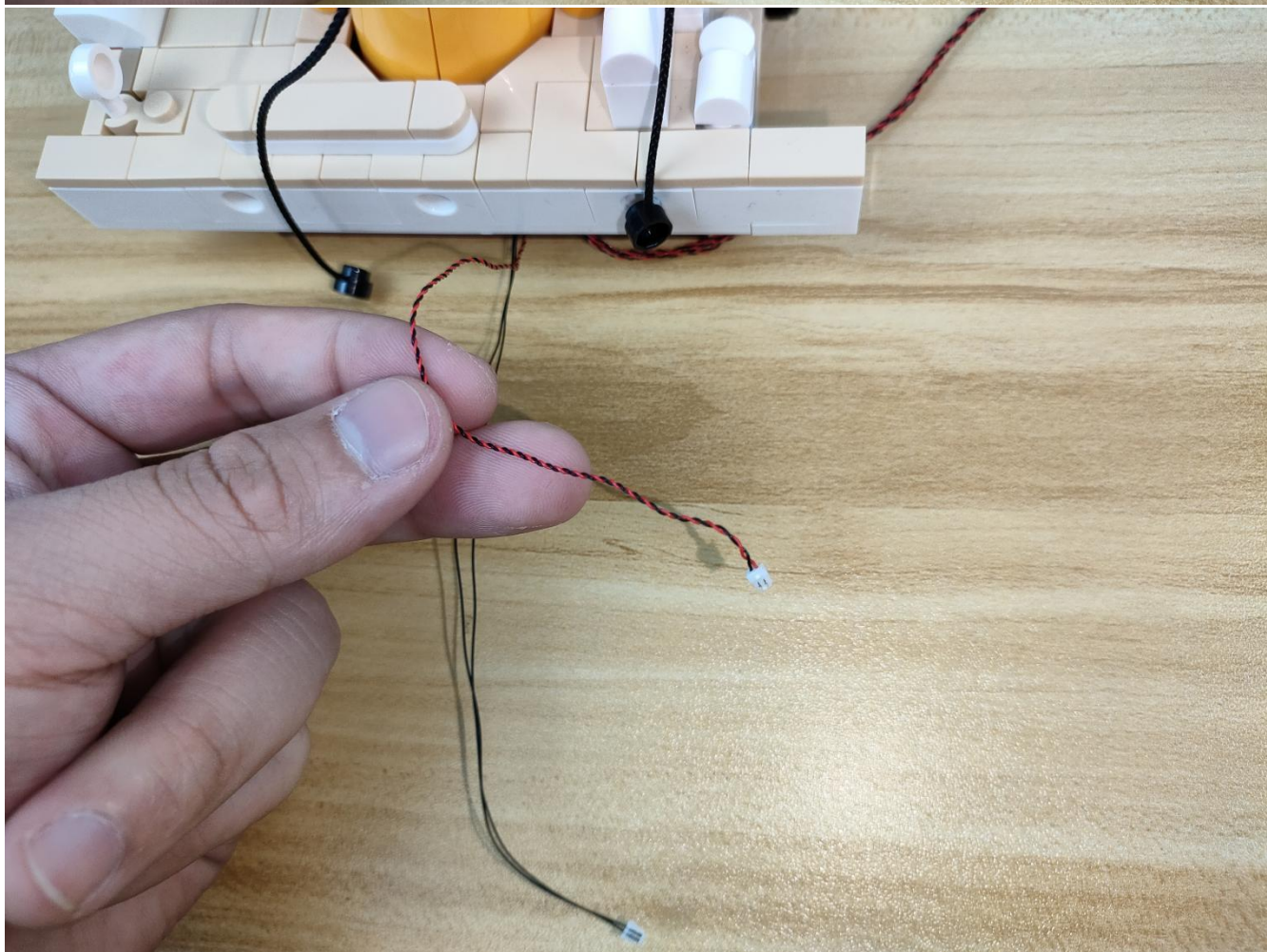
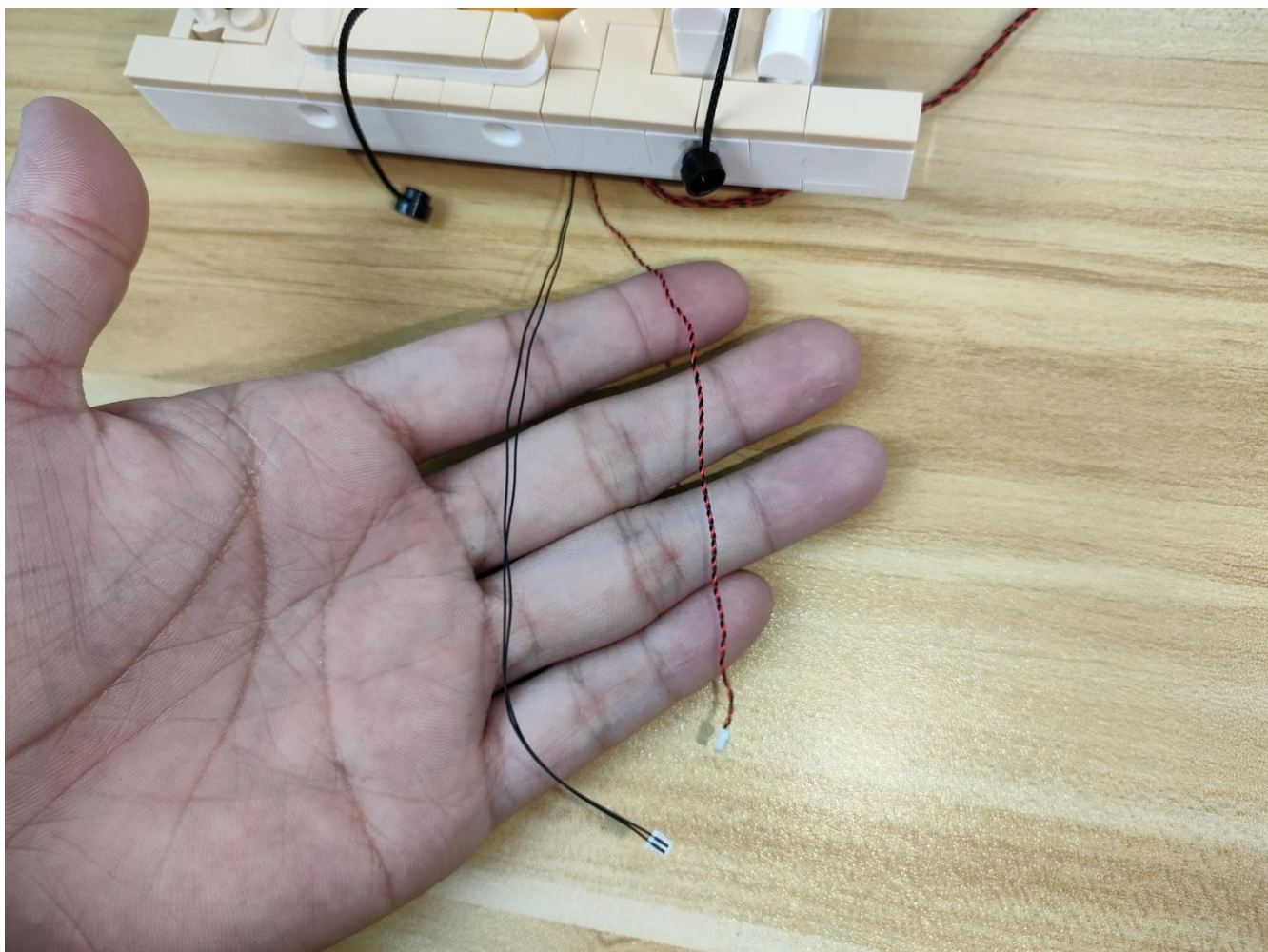

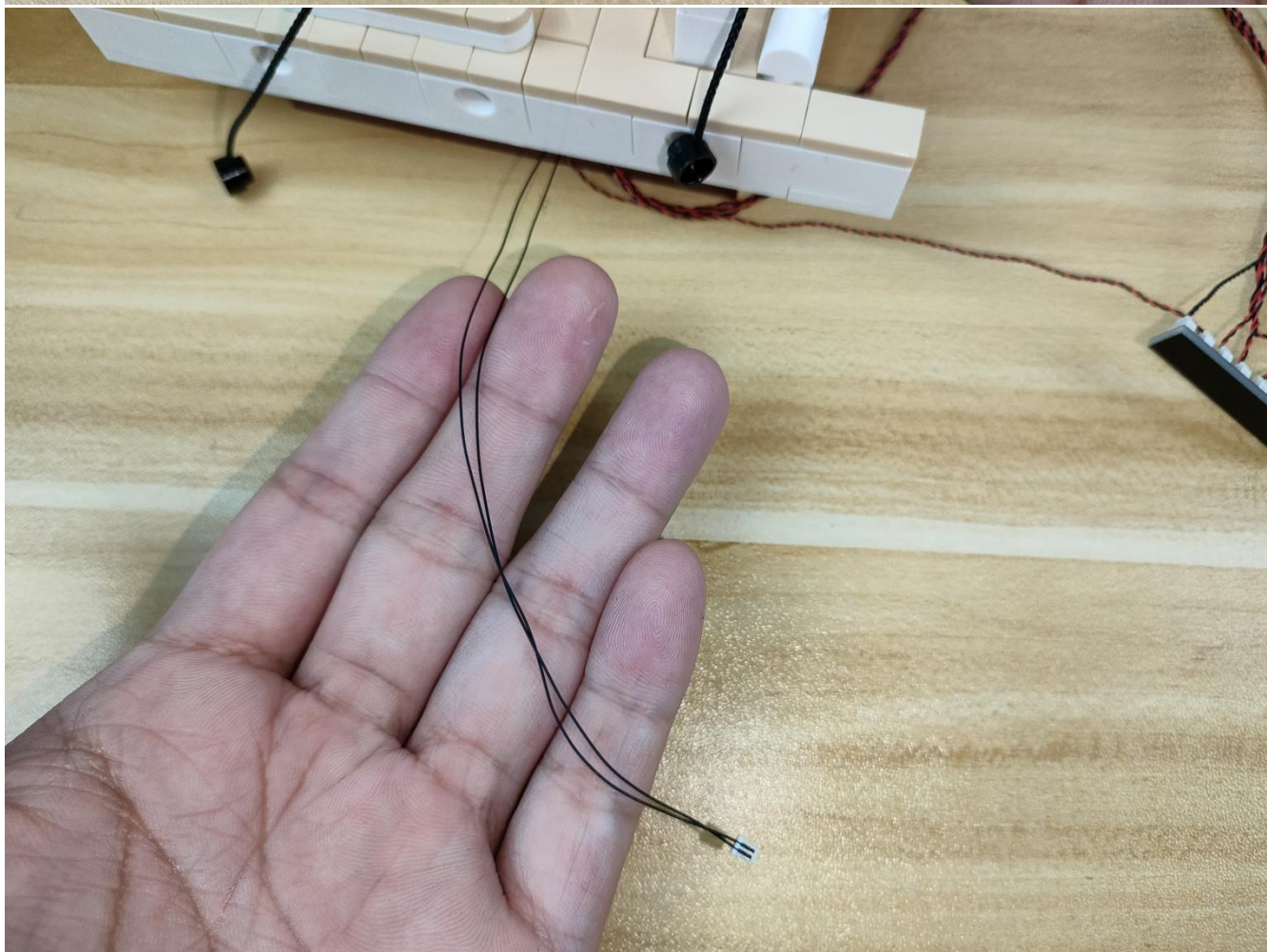
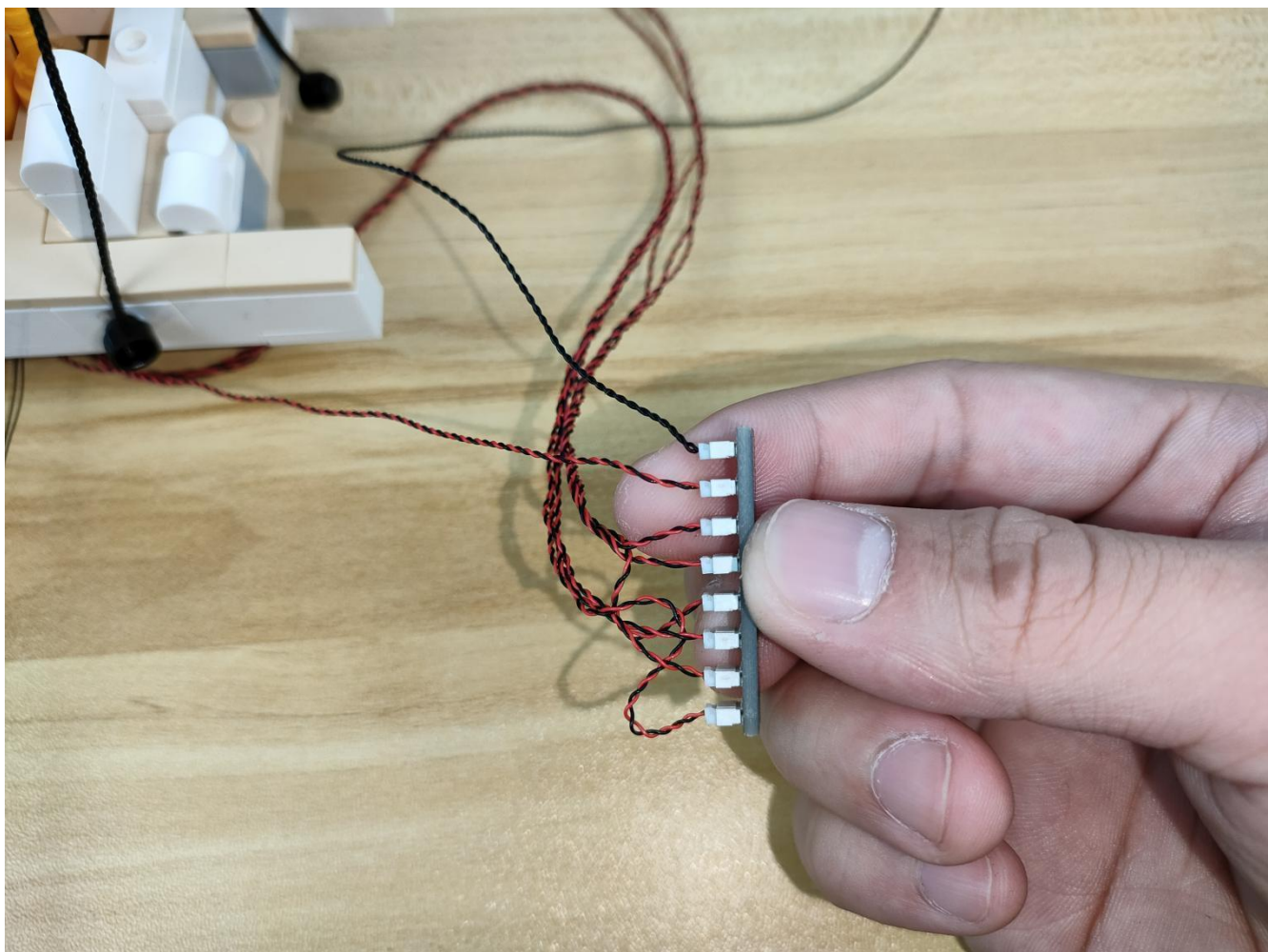

Pull the connecting line on the expansion board to the right, and place the connecting line between the bumps of the blocks.

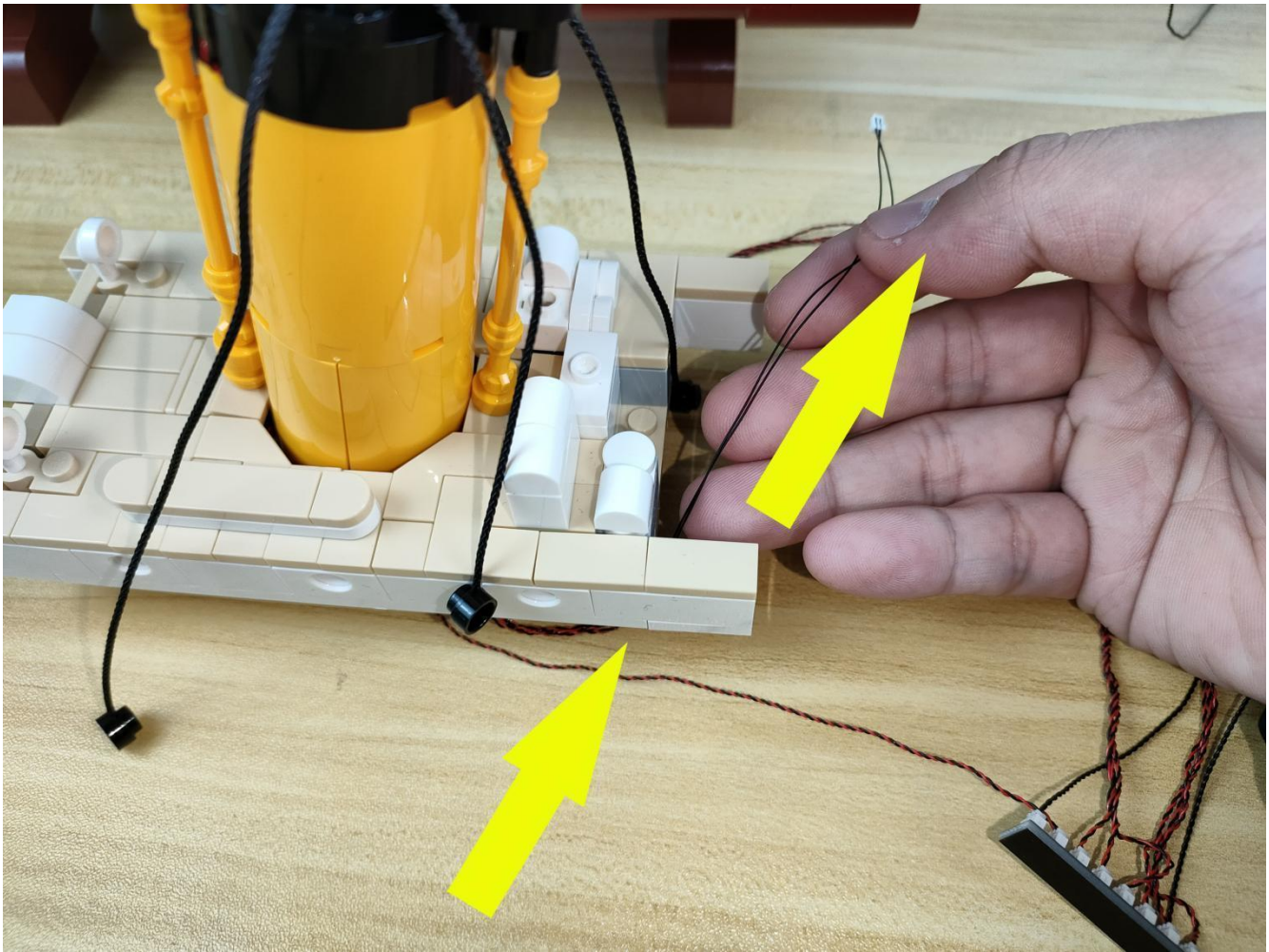

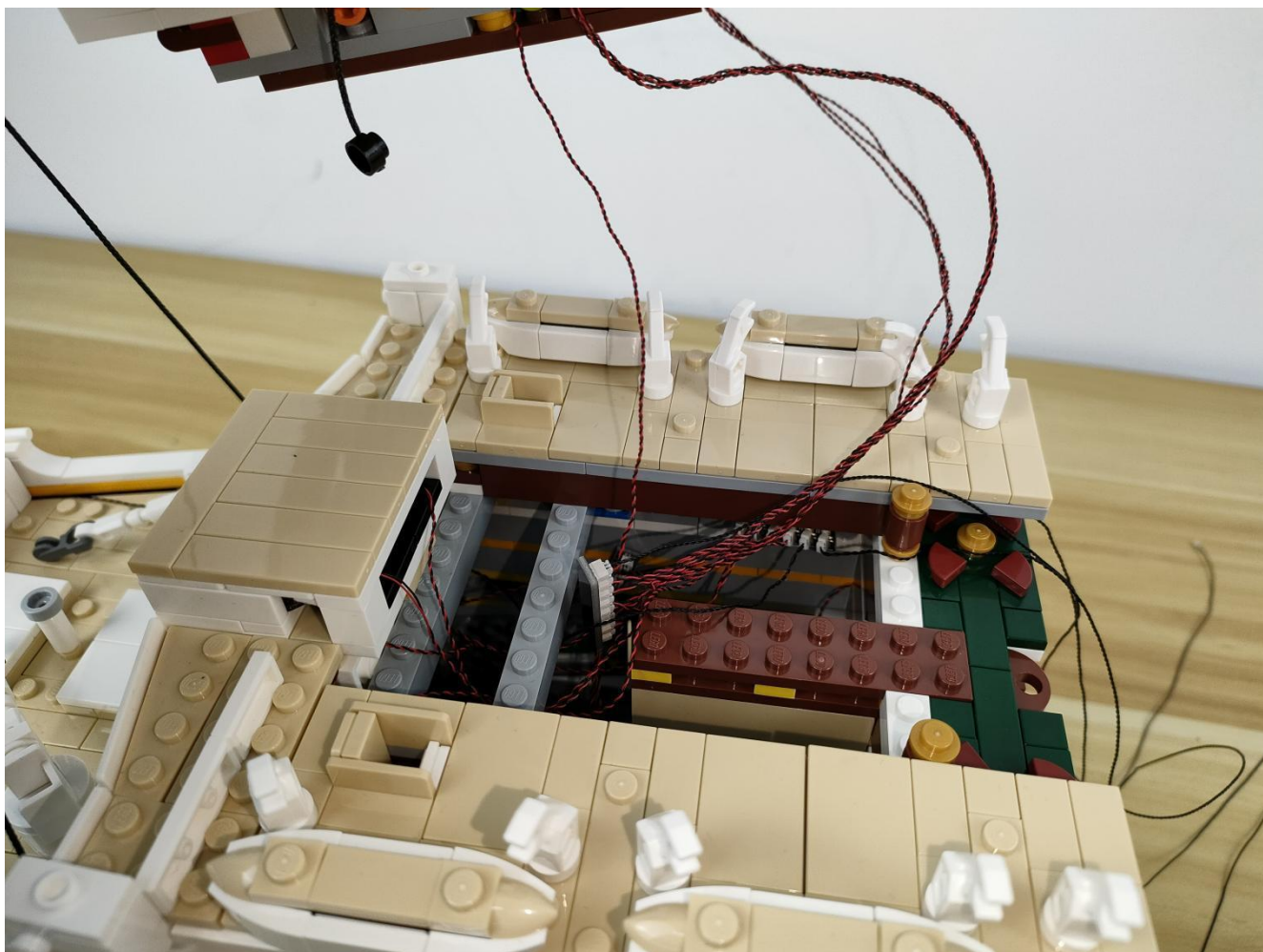

Note:

Please be careful when installing. The lamp wire is relatively slender and cannot be pressed on the raised position of the building block. It should pass along the gap, otherwise the lamp wire will be pinched.

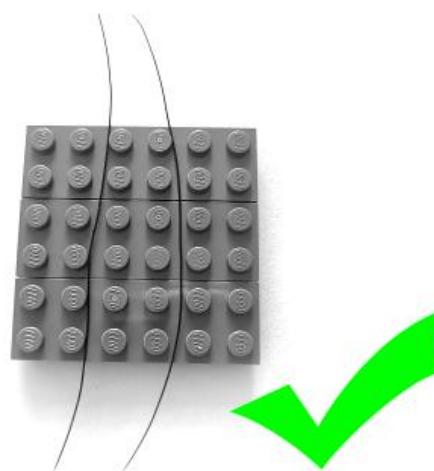
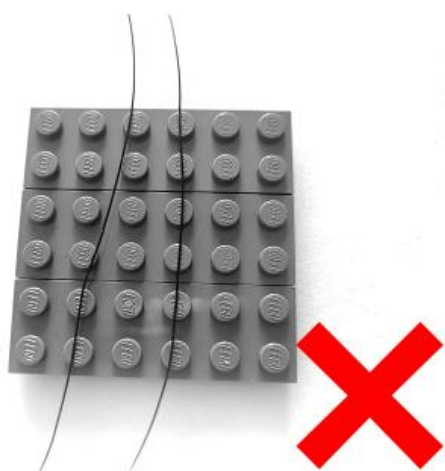

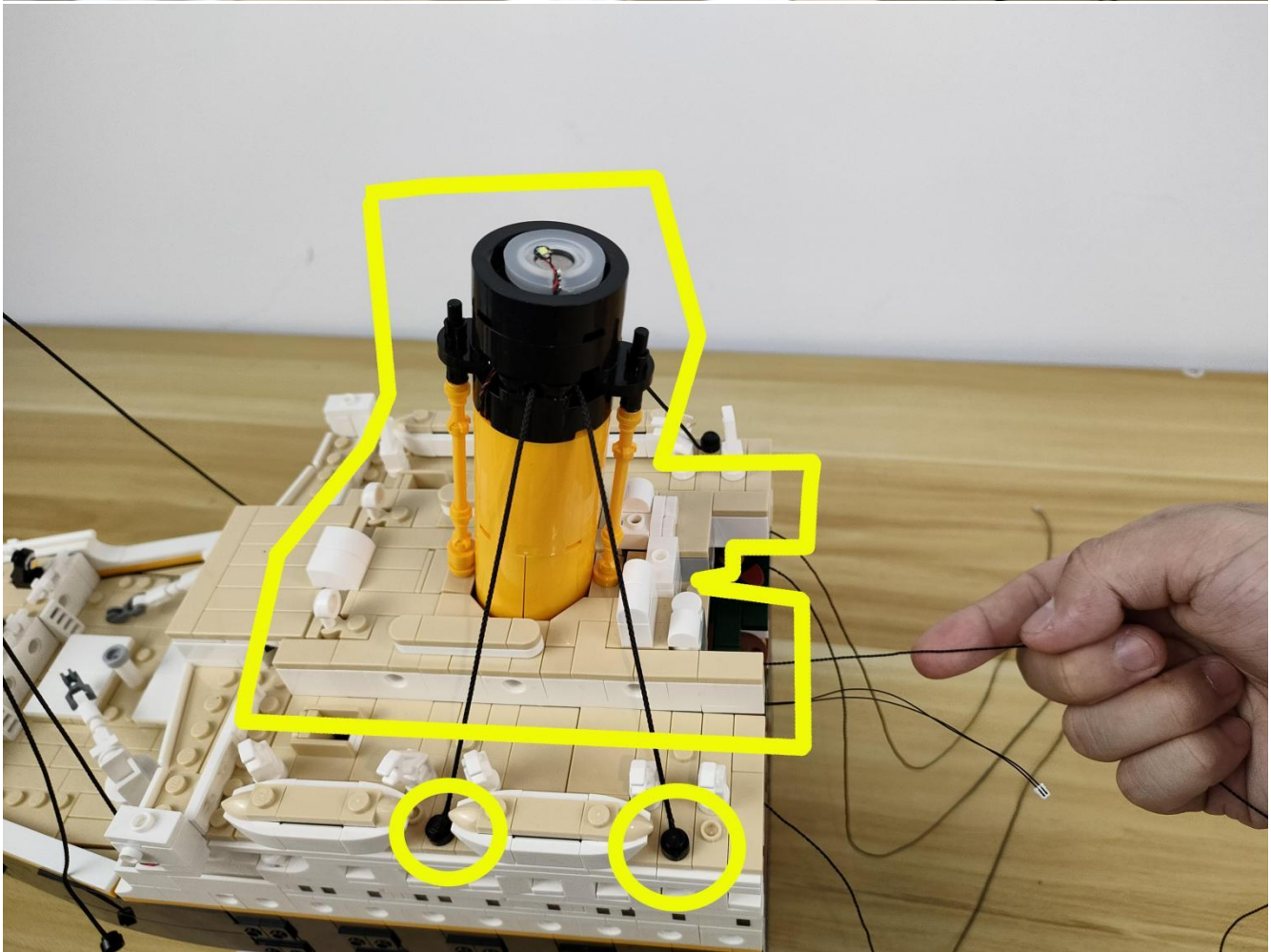
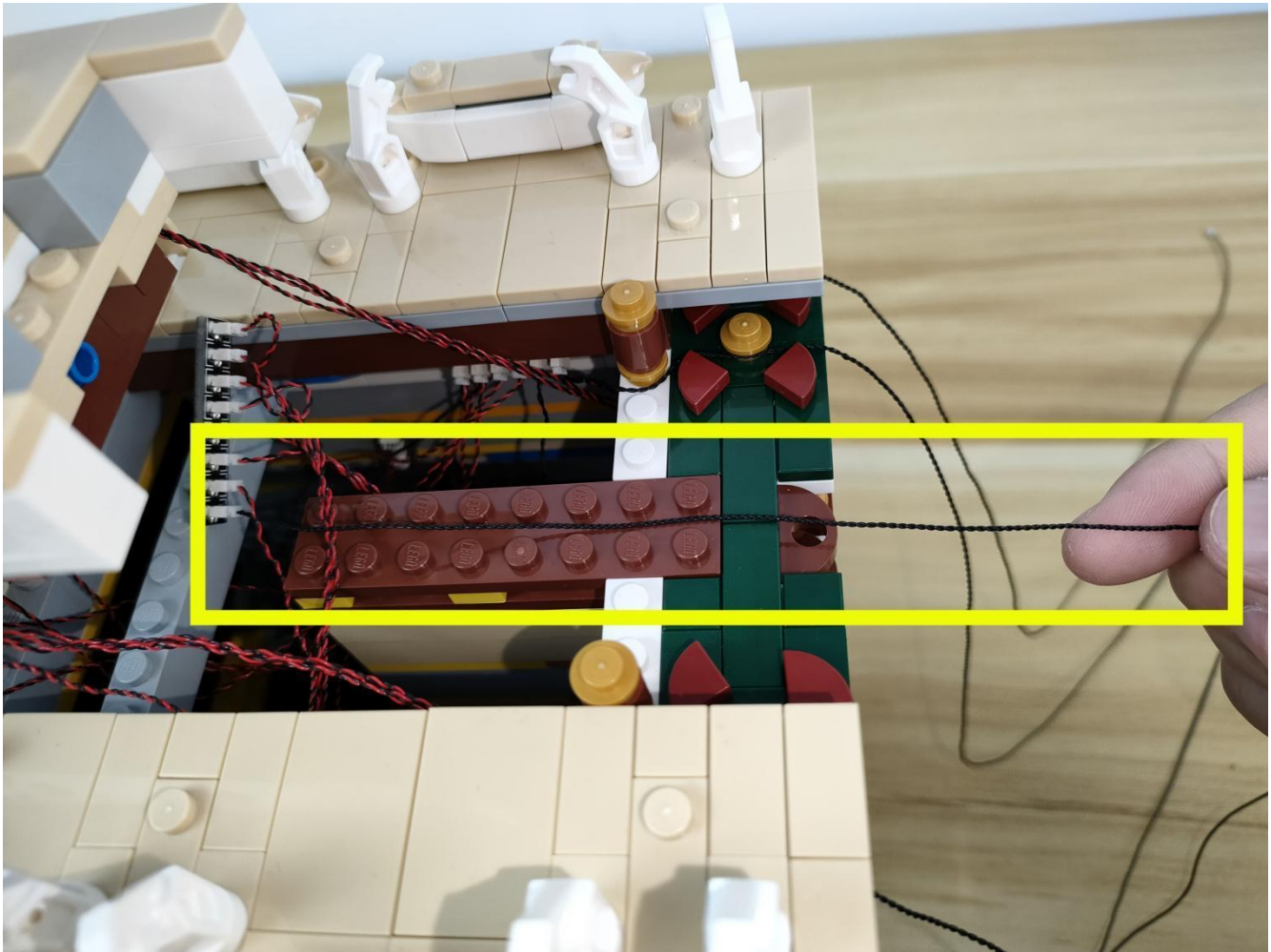

Pull the spray module line at the bottom to the top.

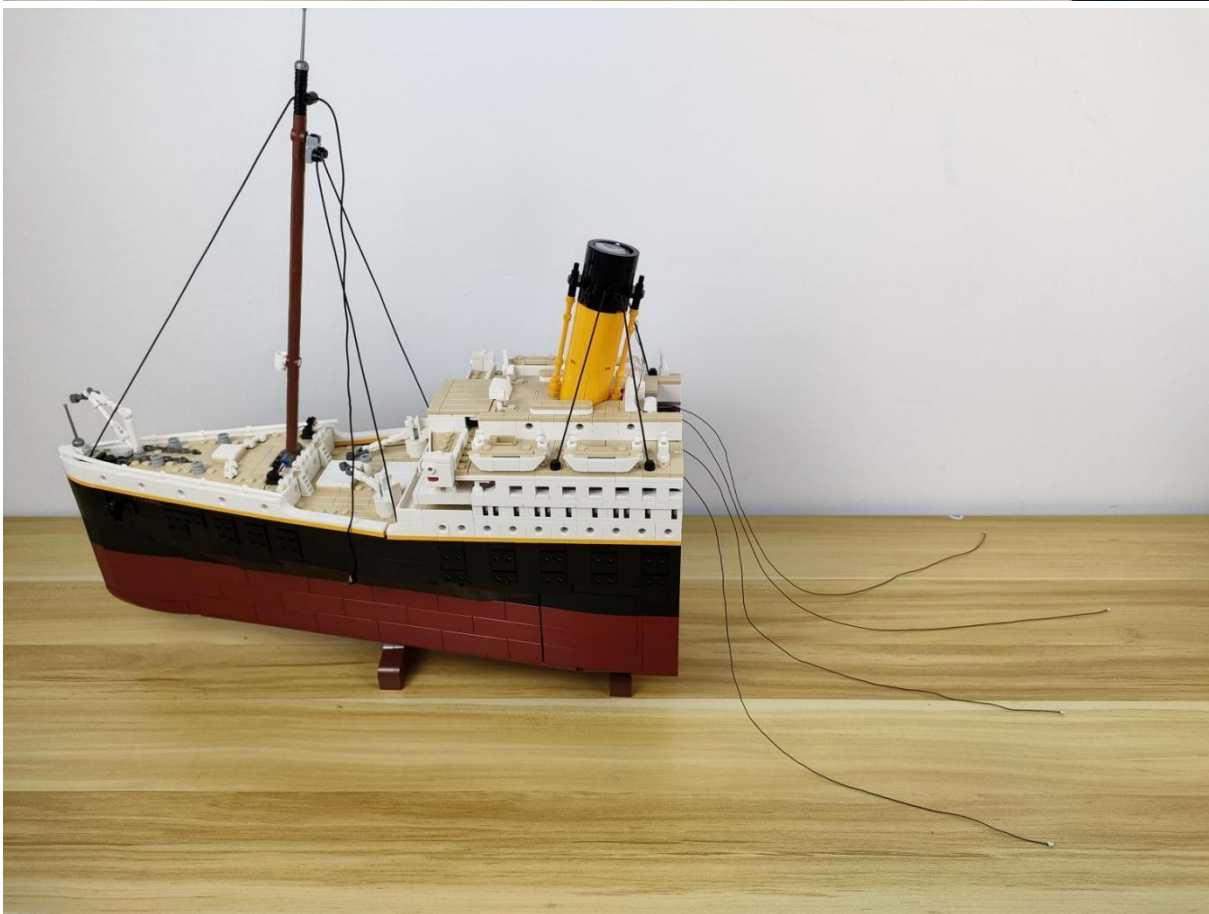
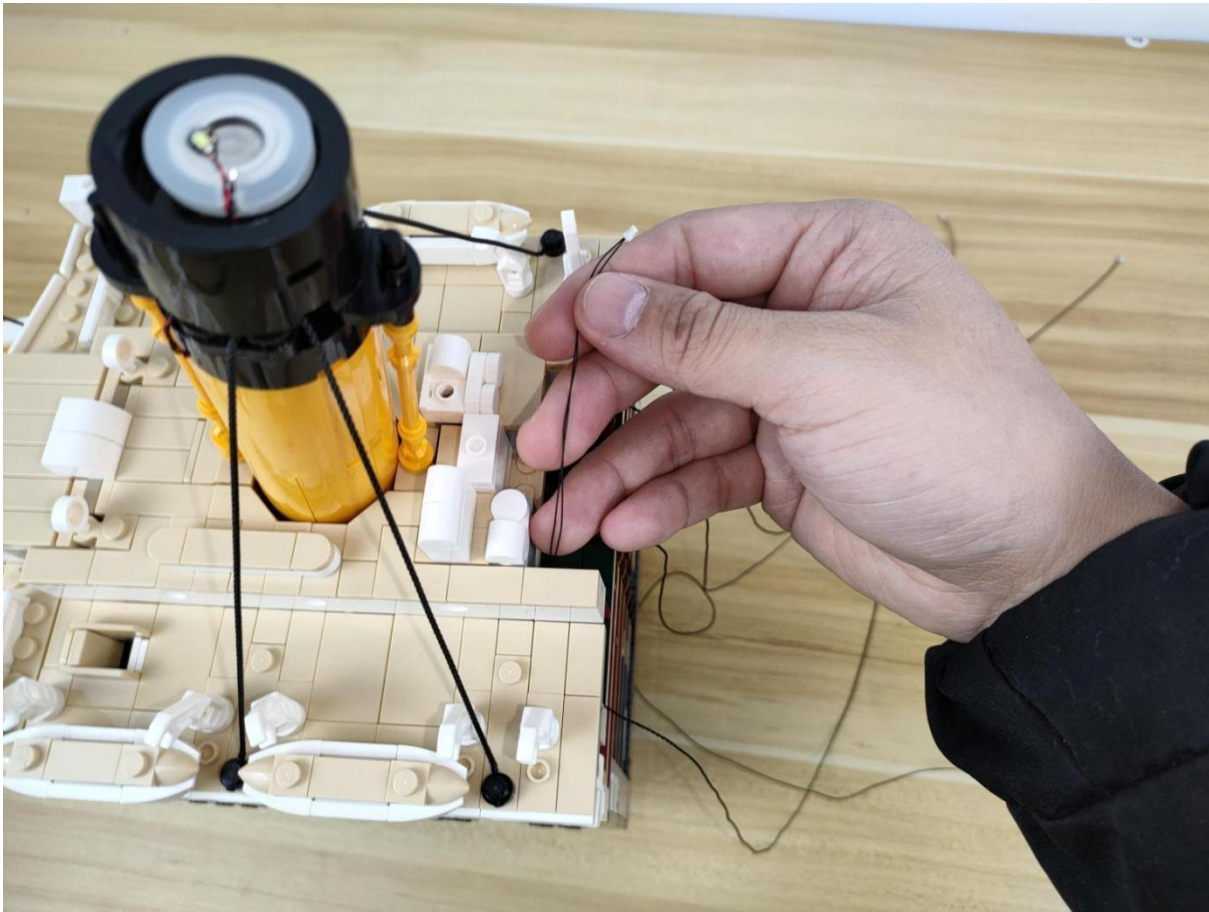

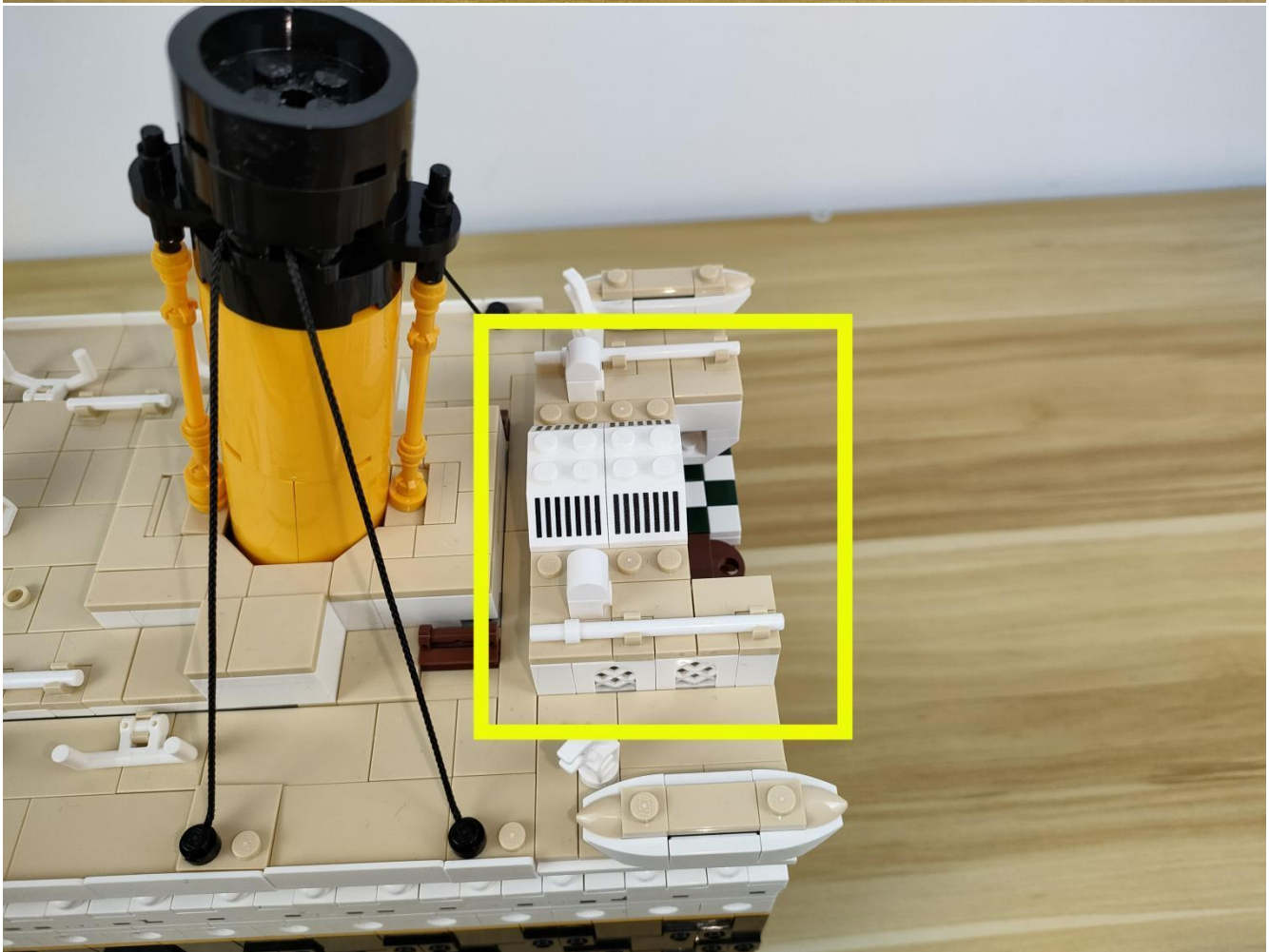

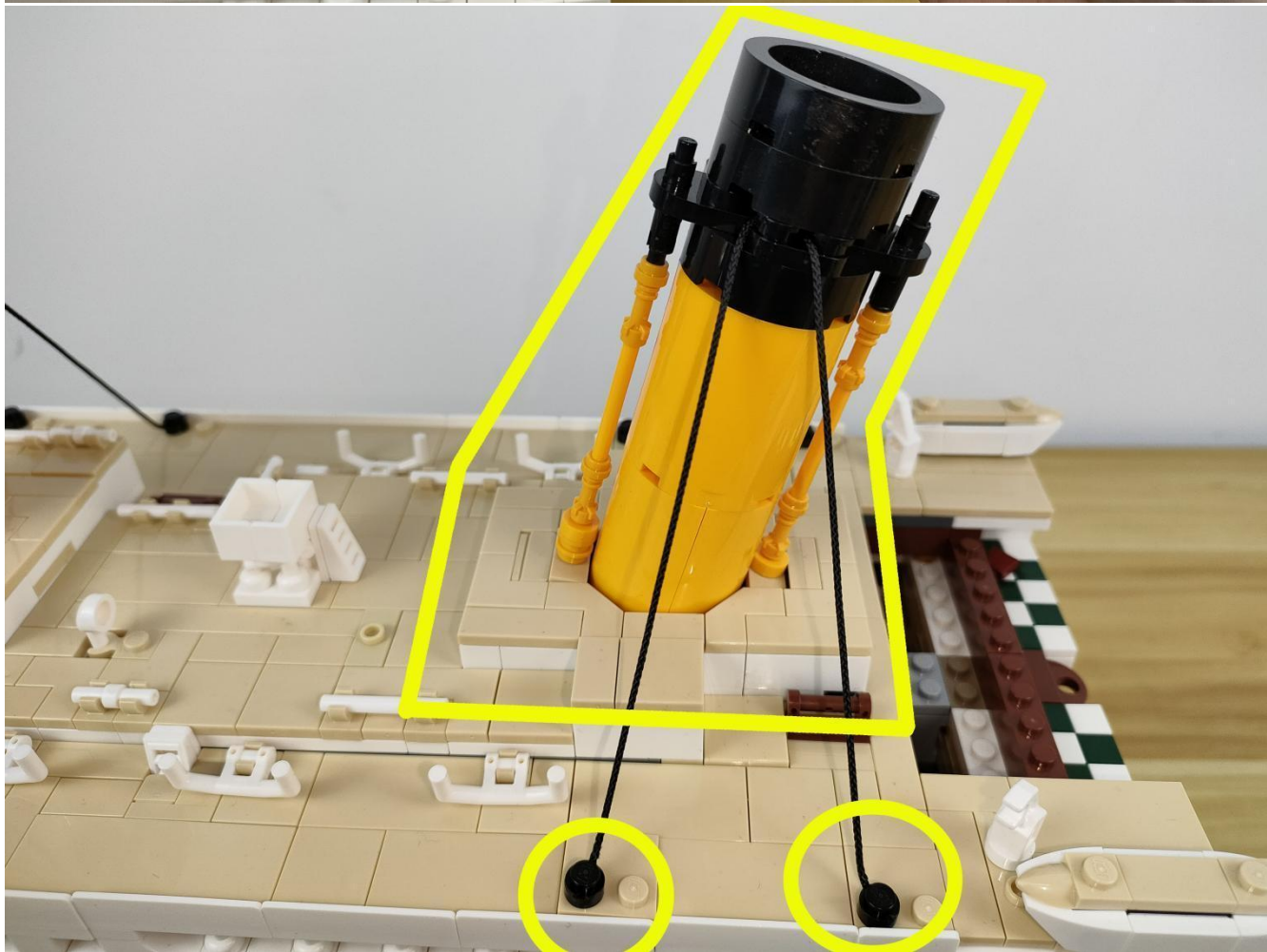

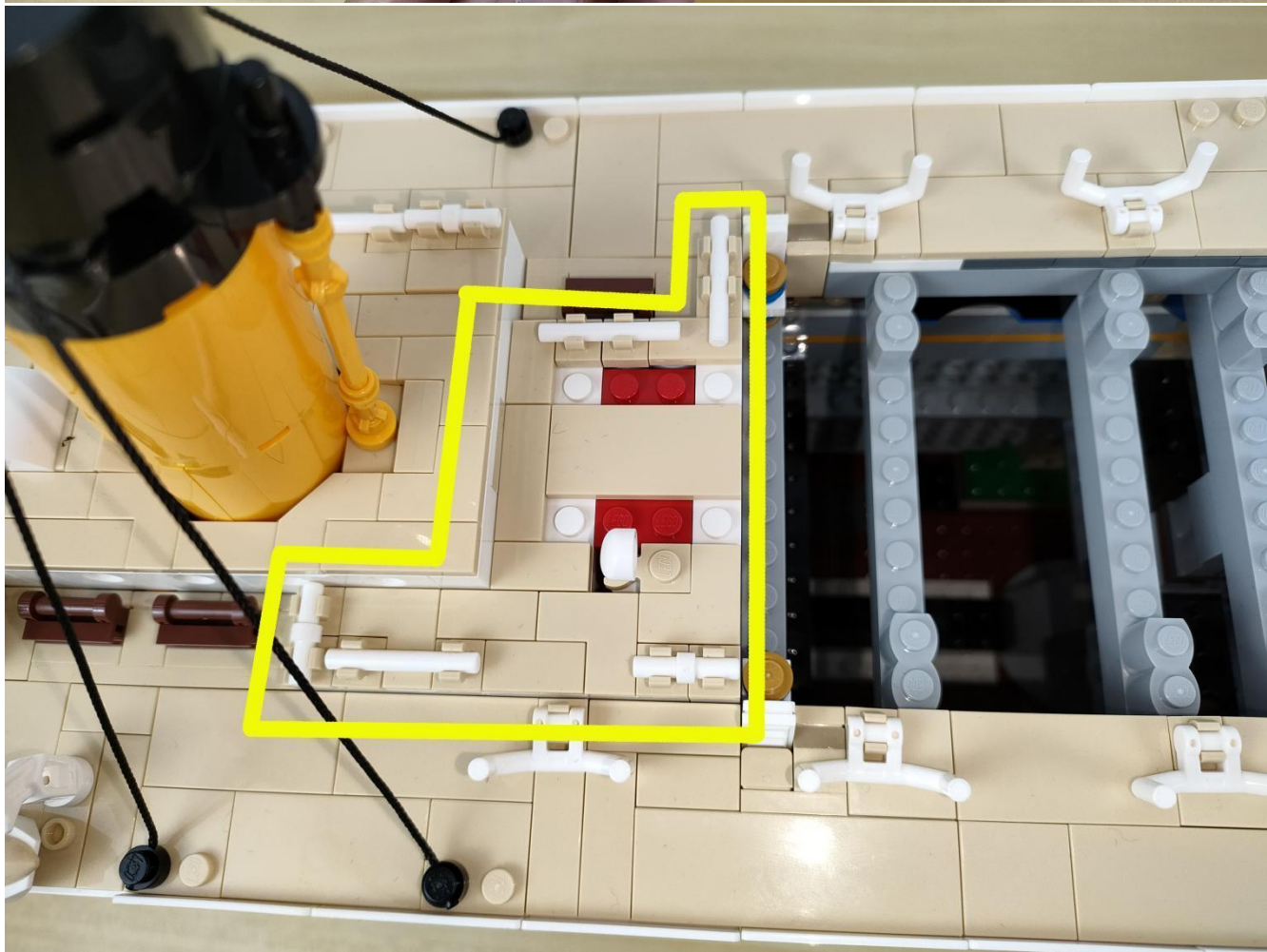
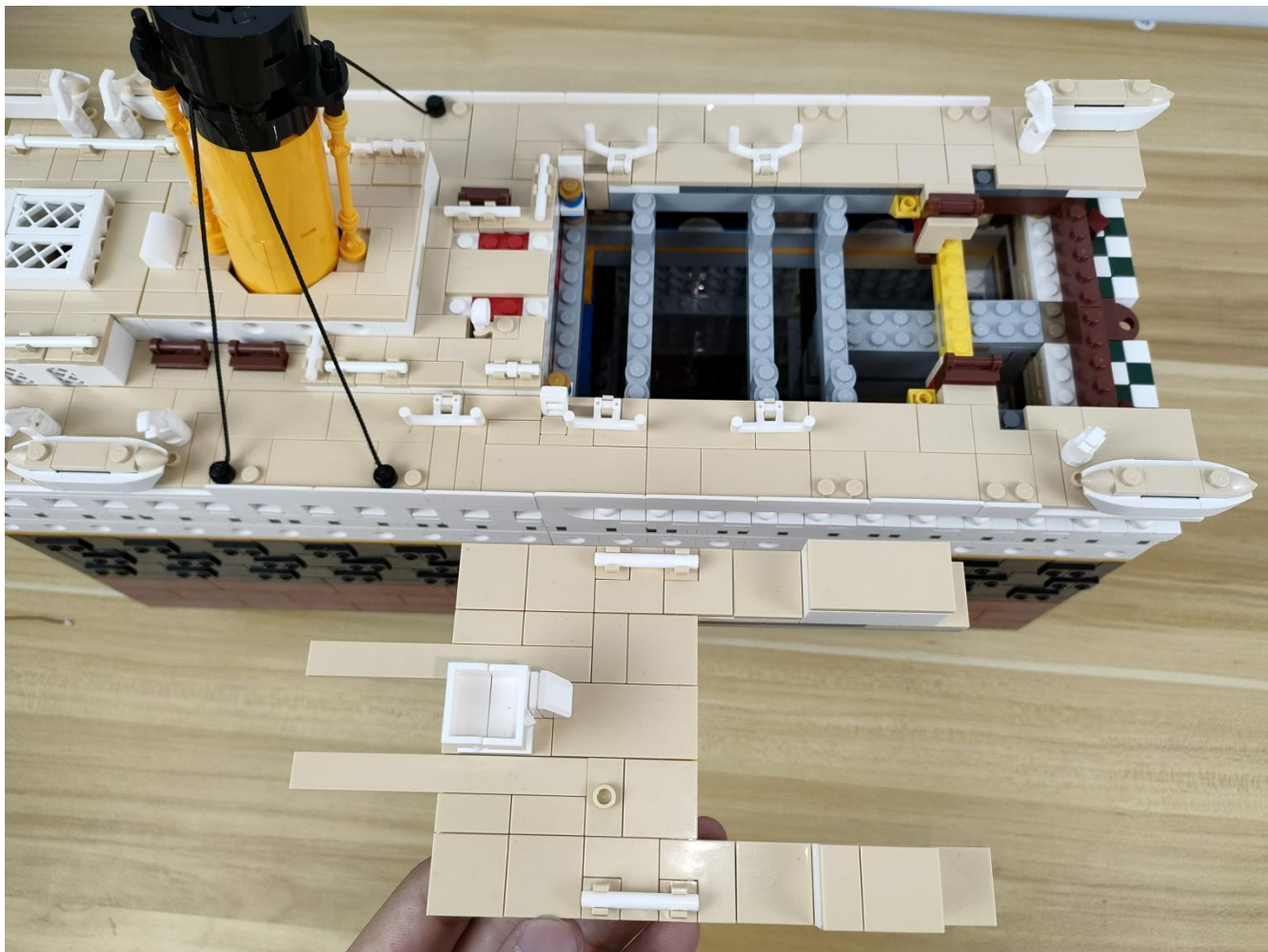

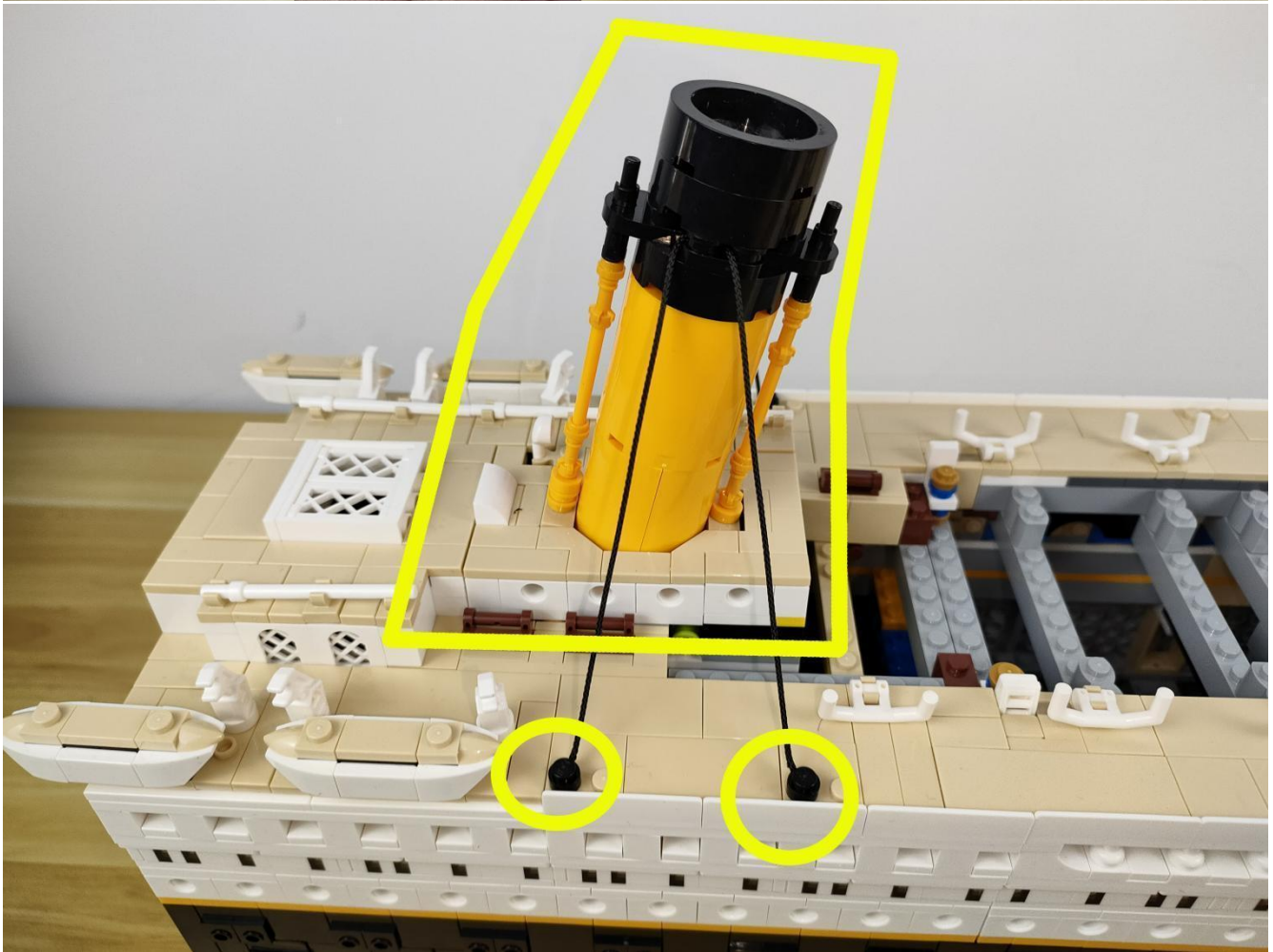
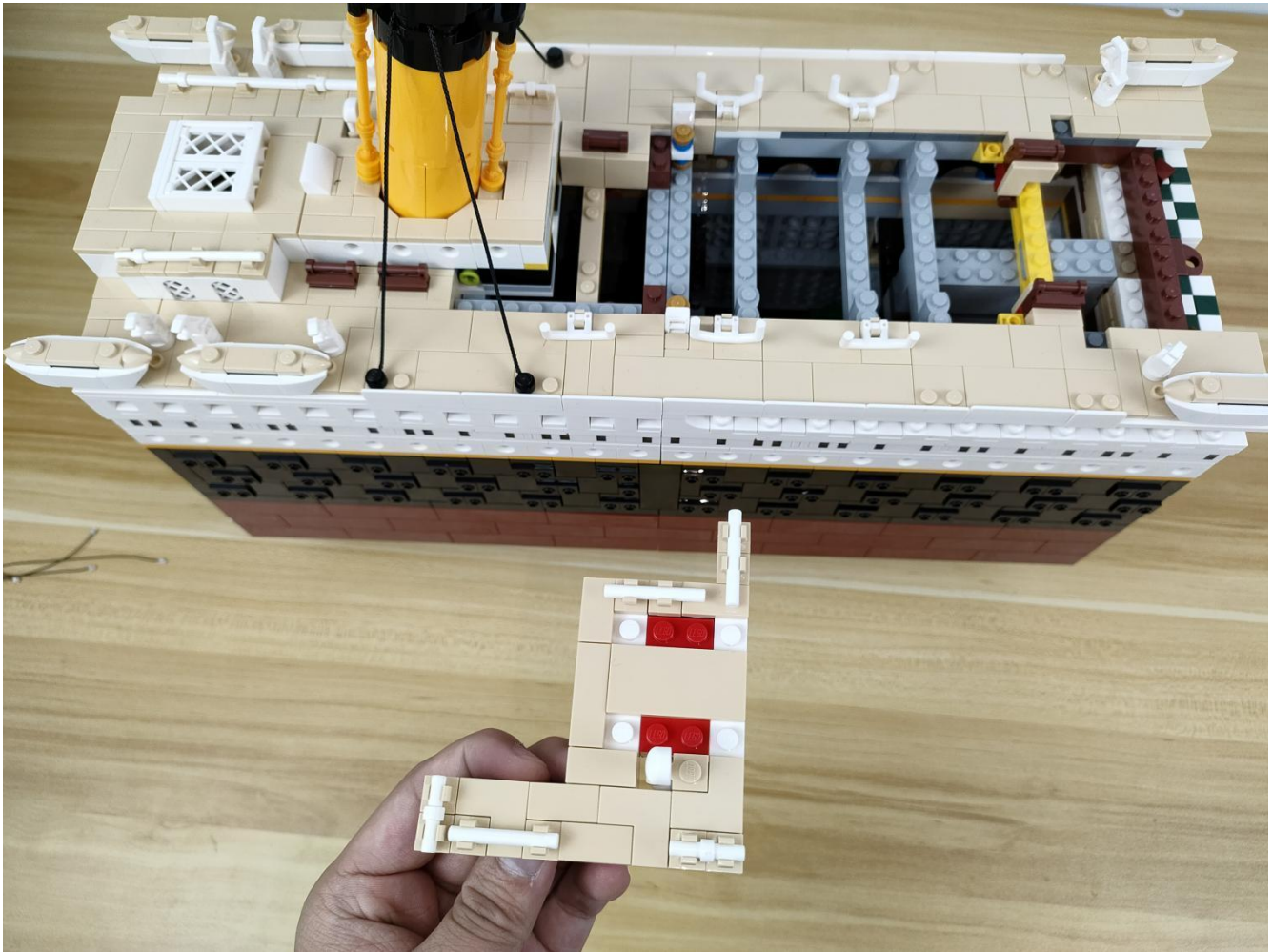

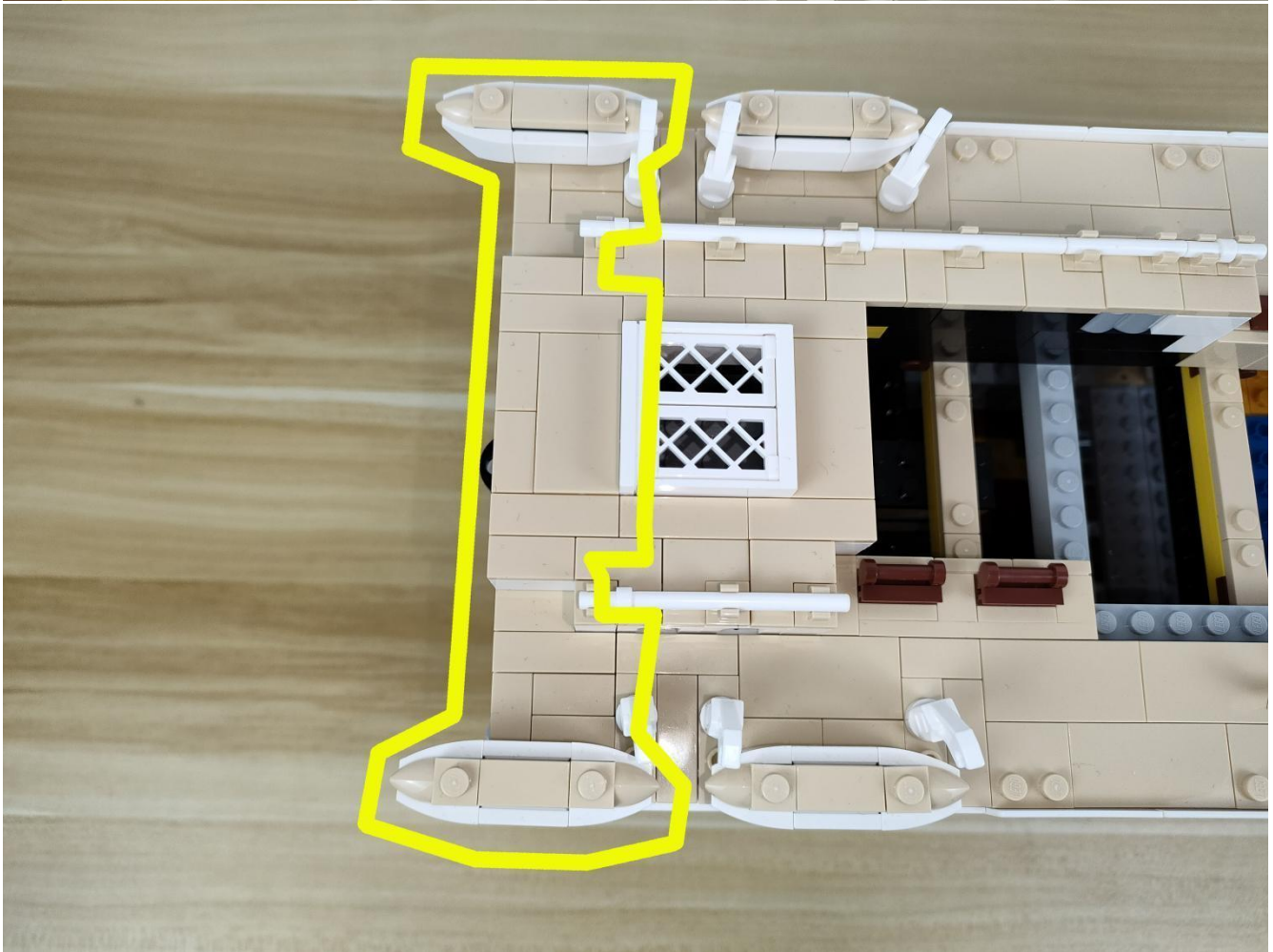
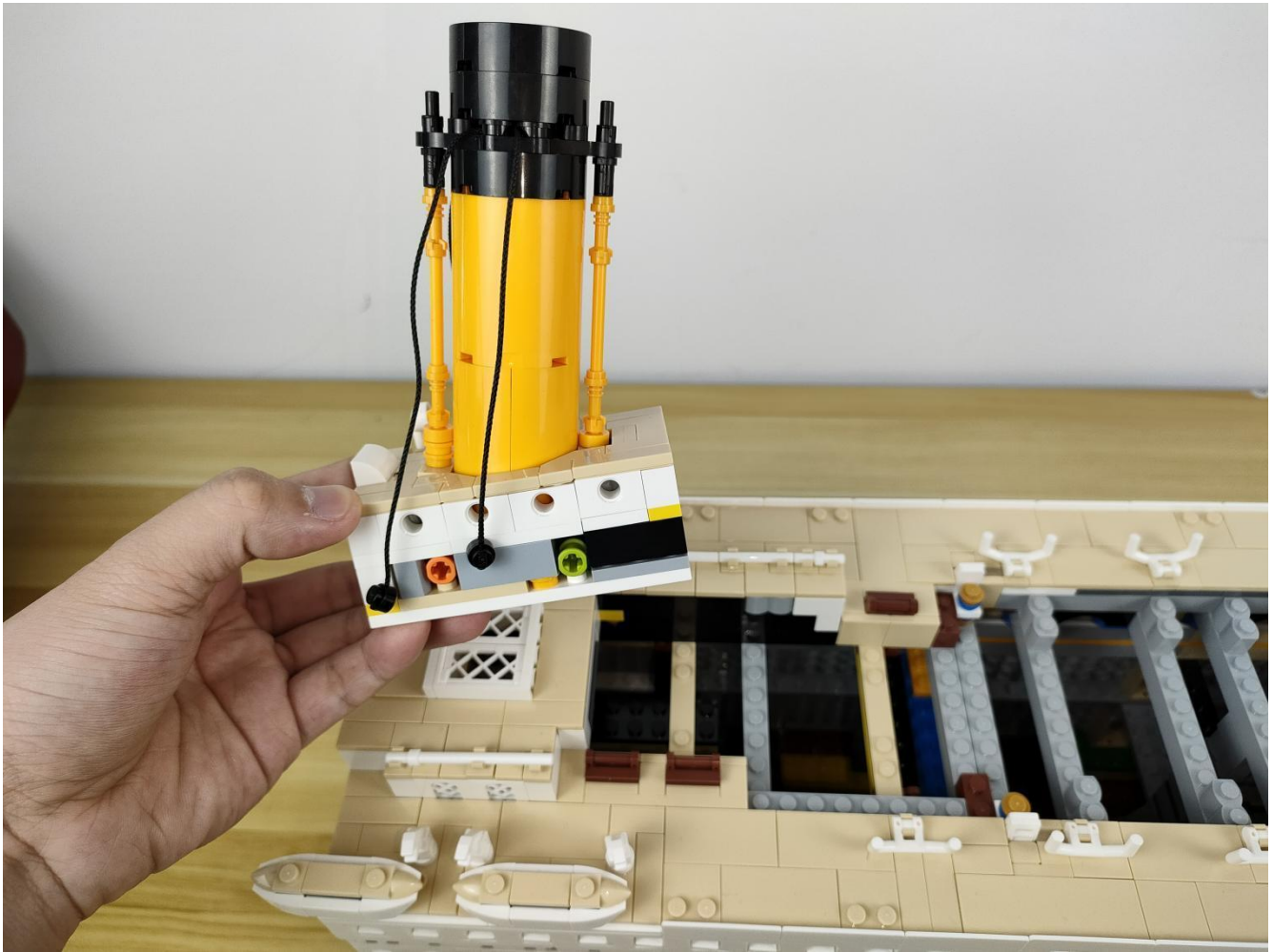

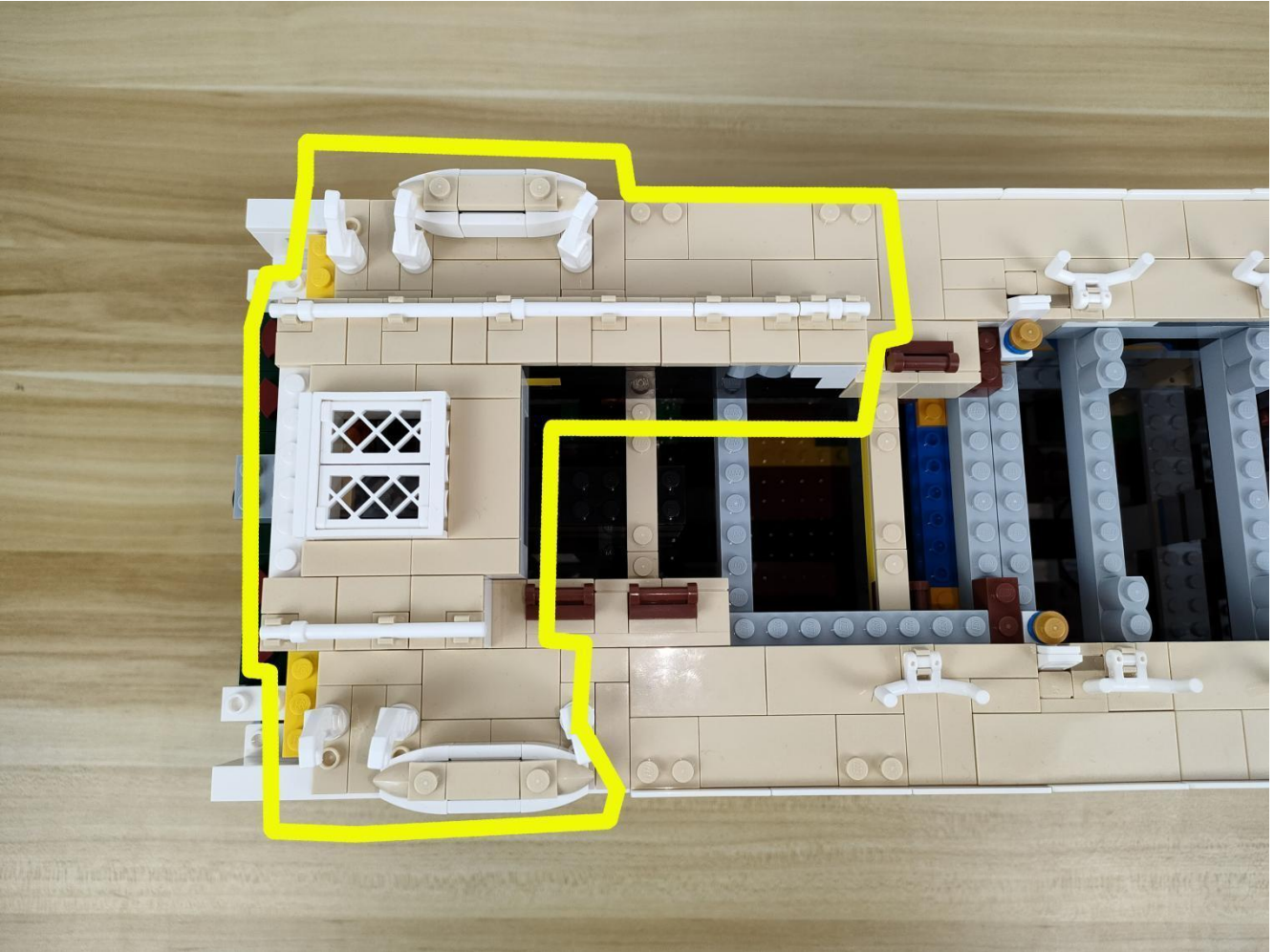
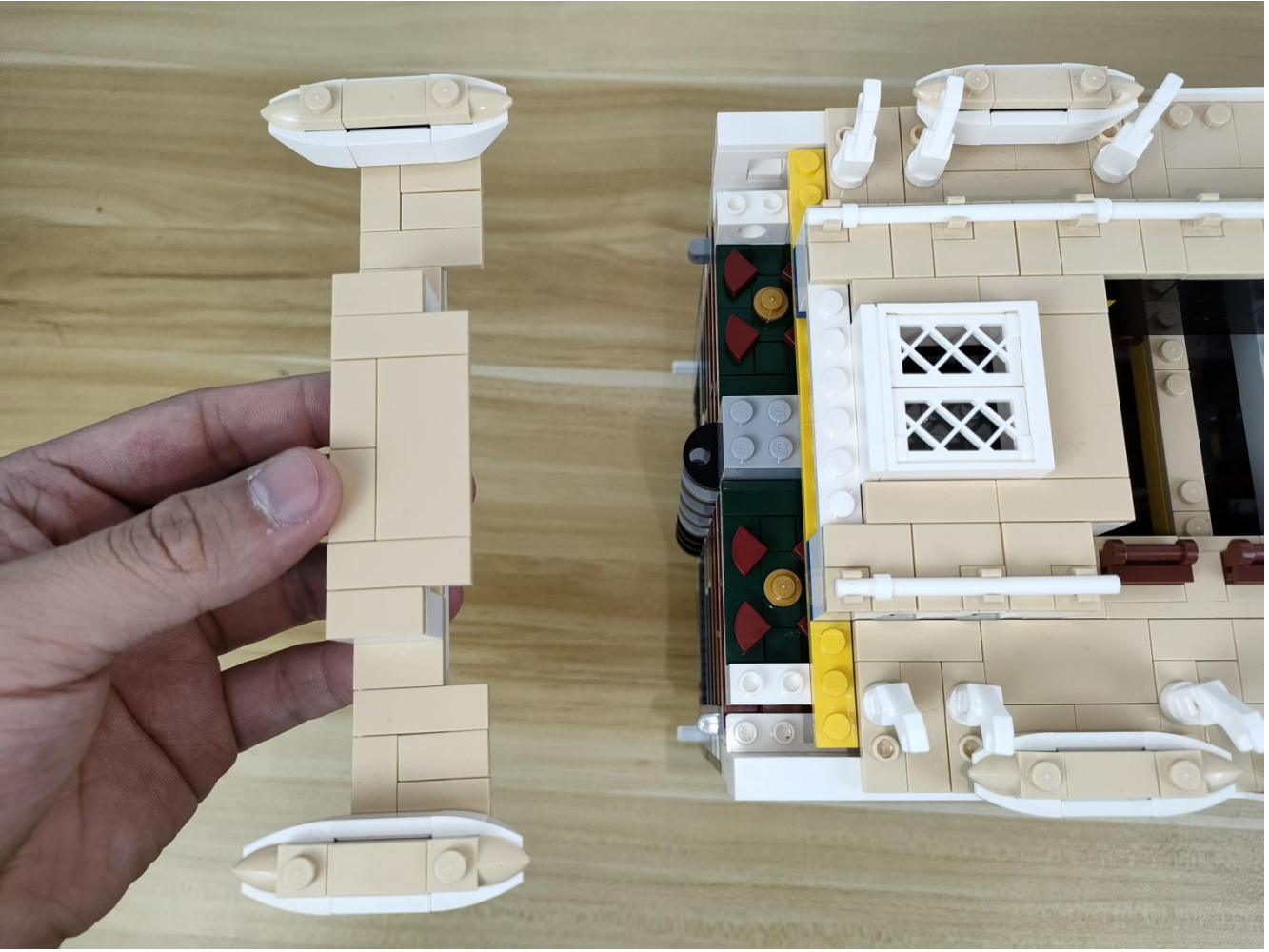

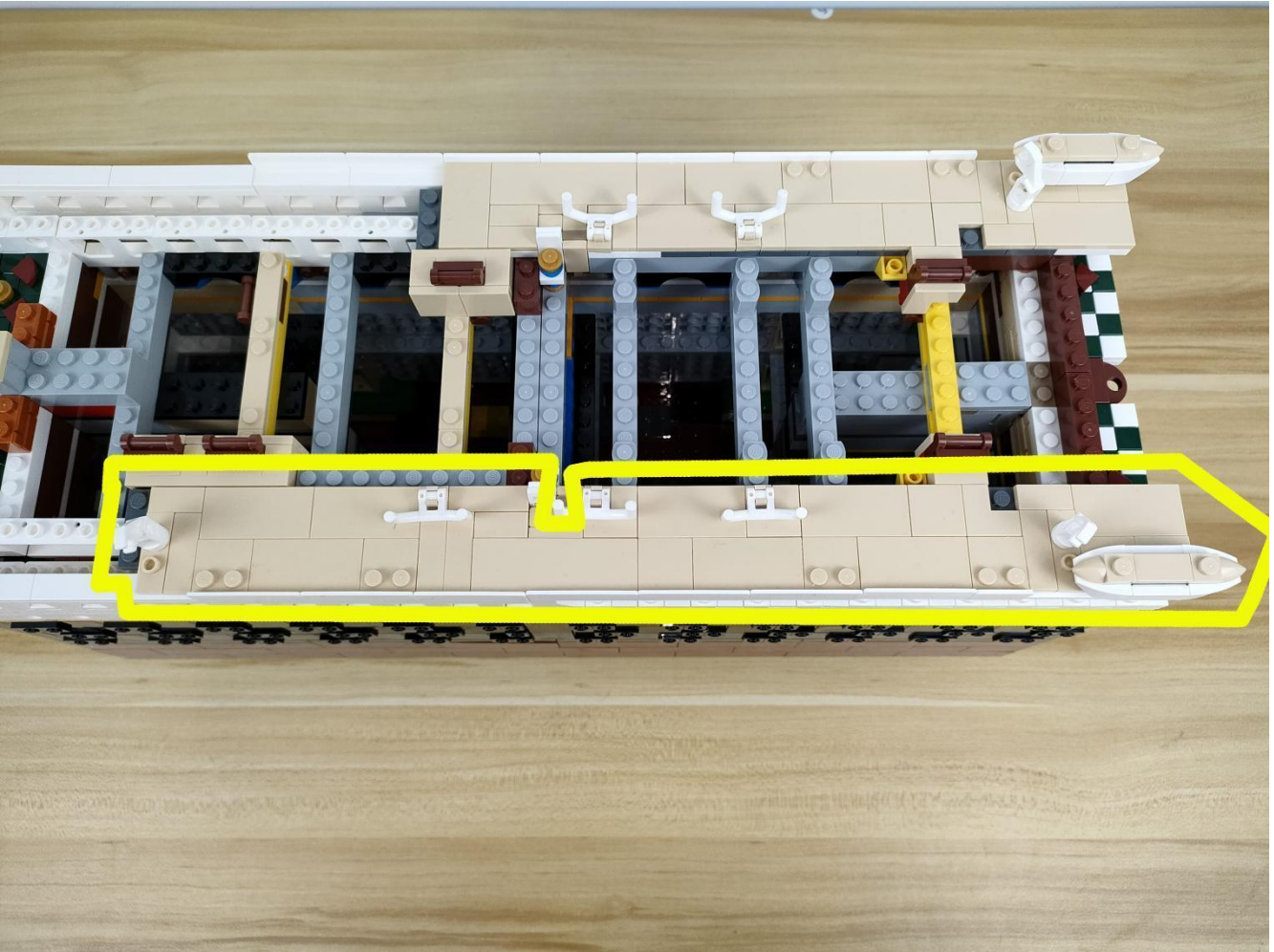
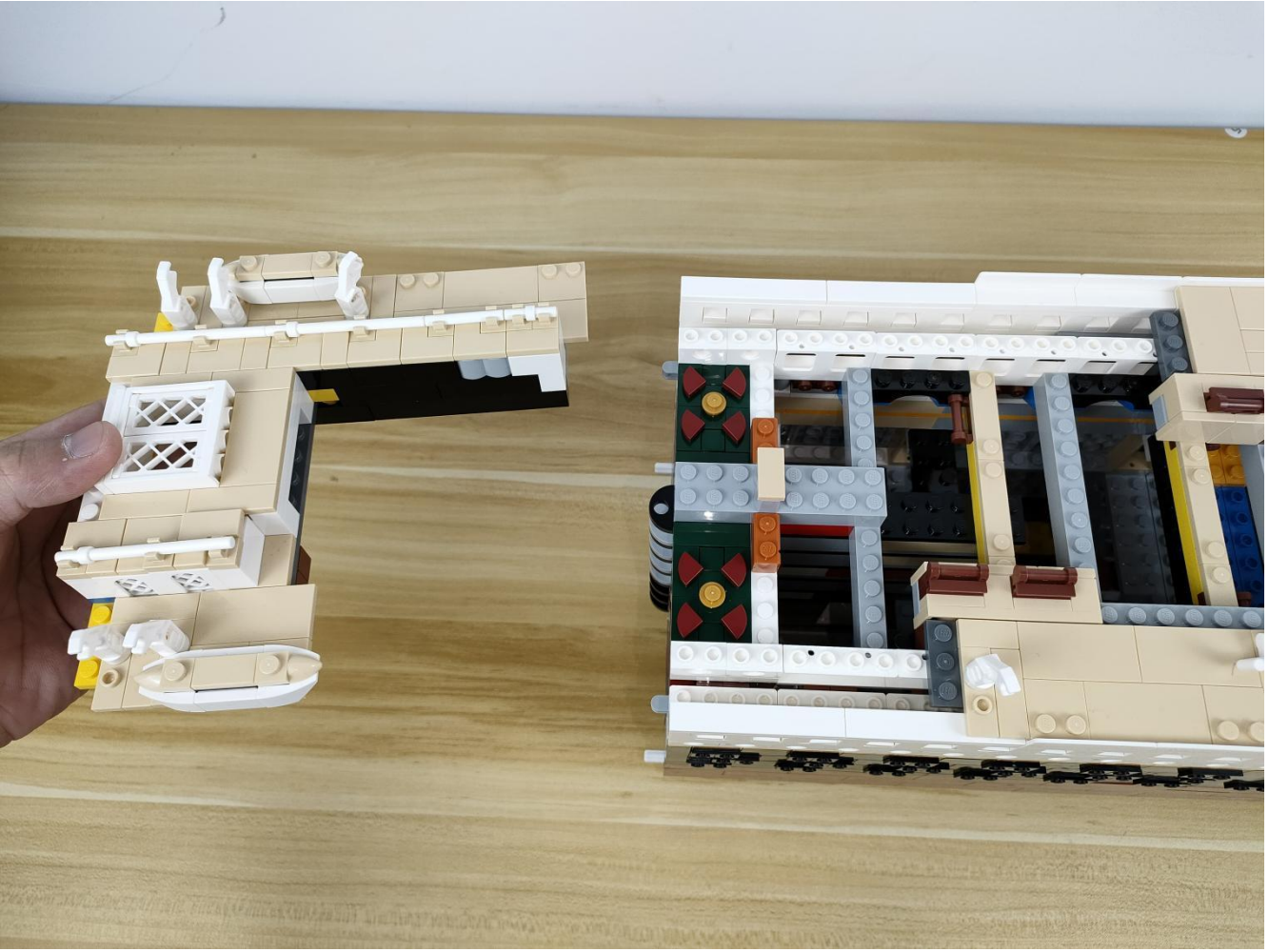

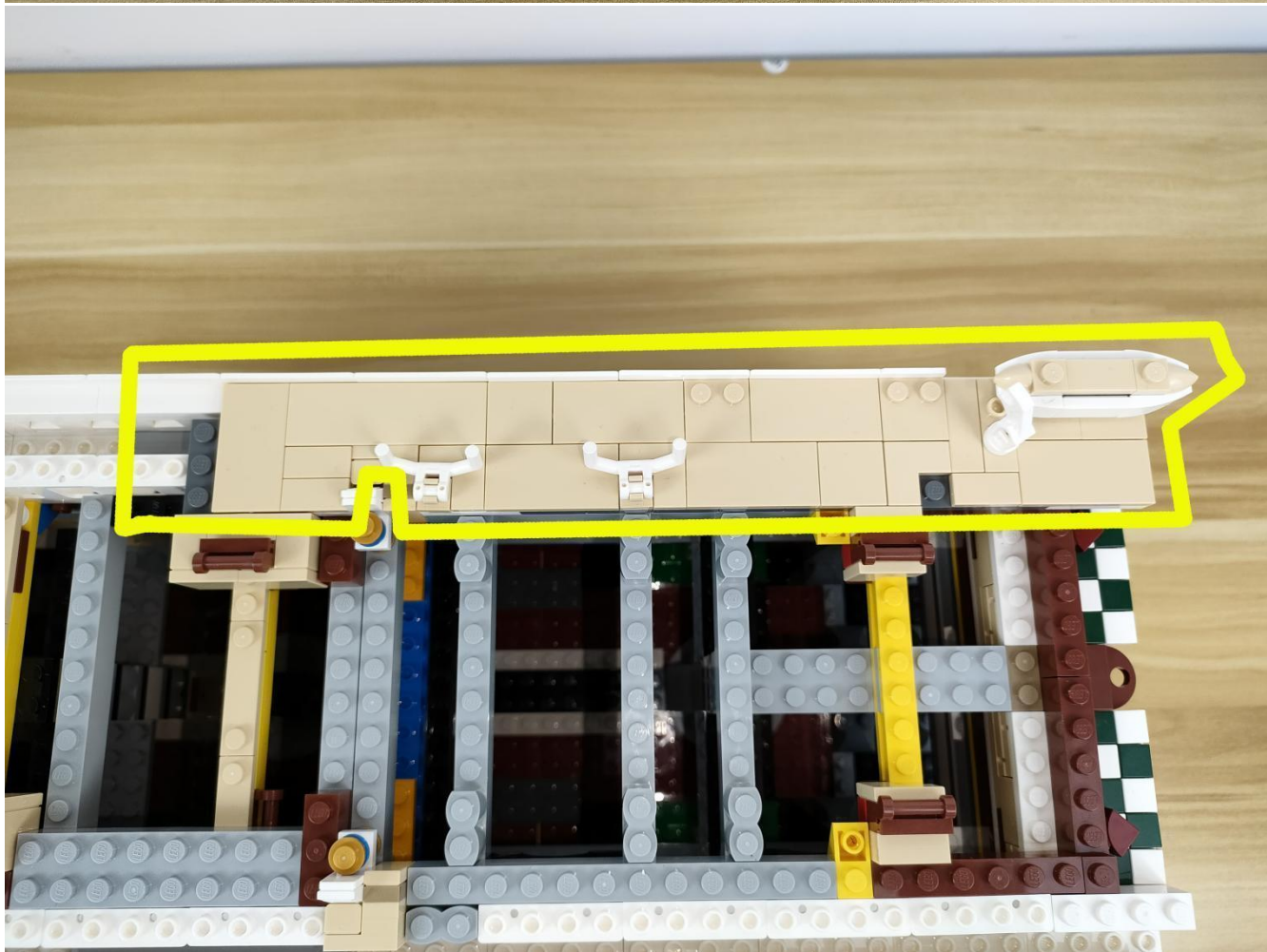
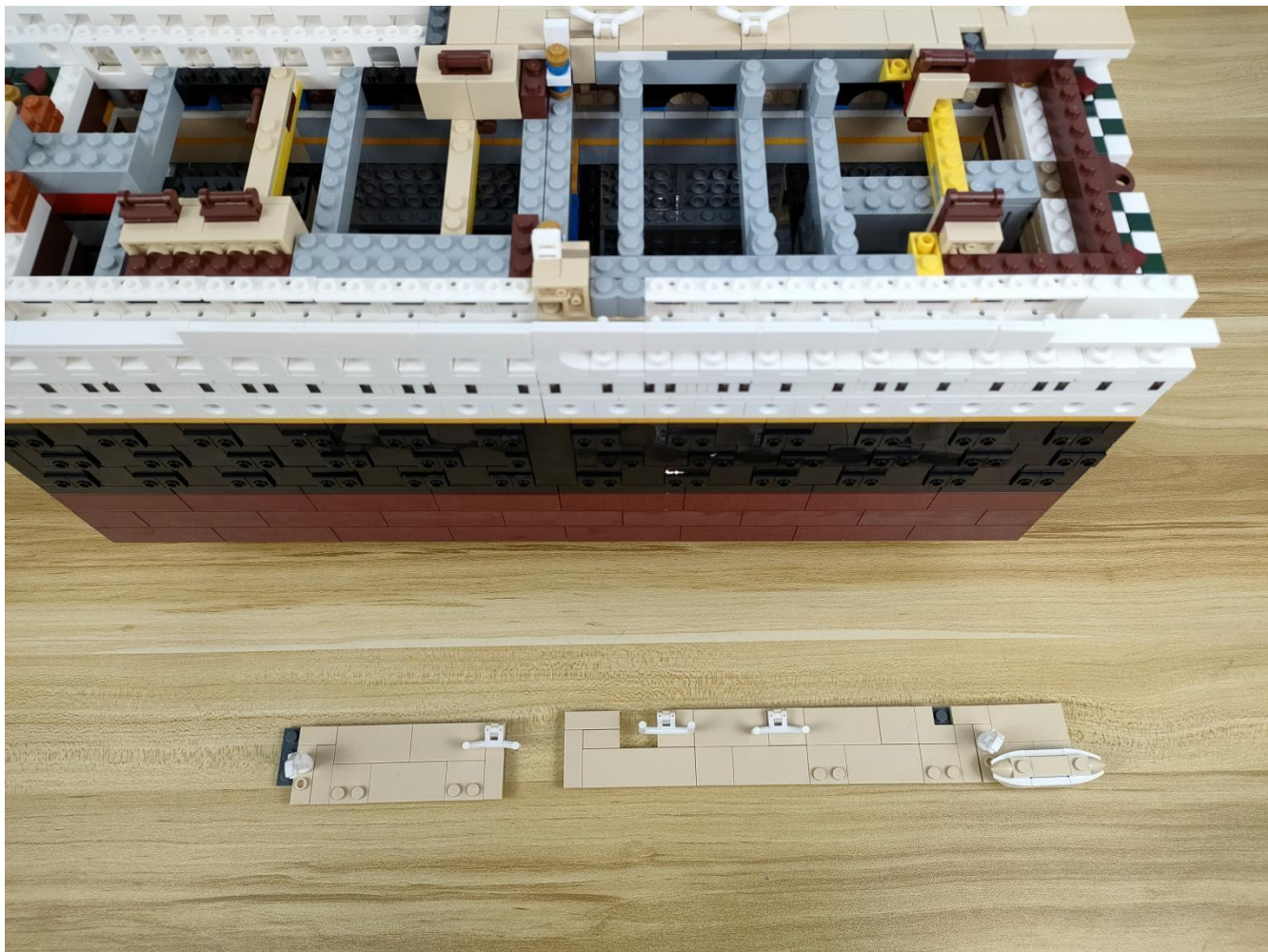



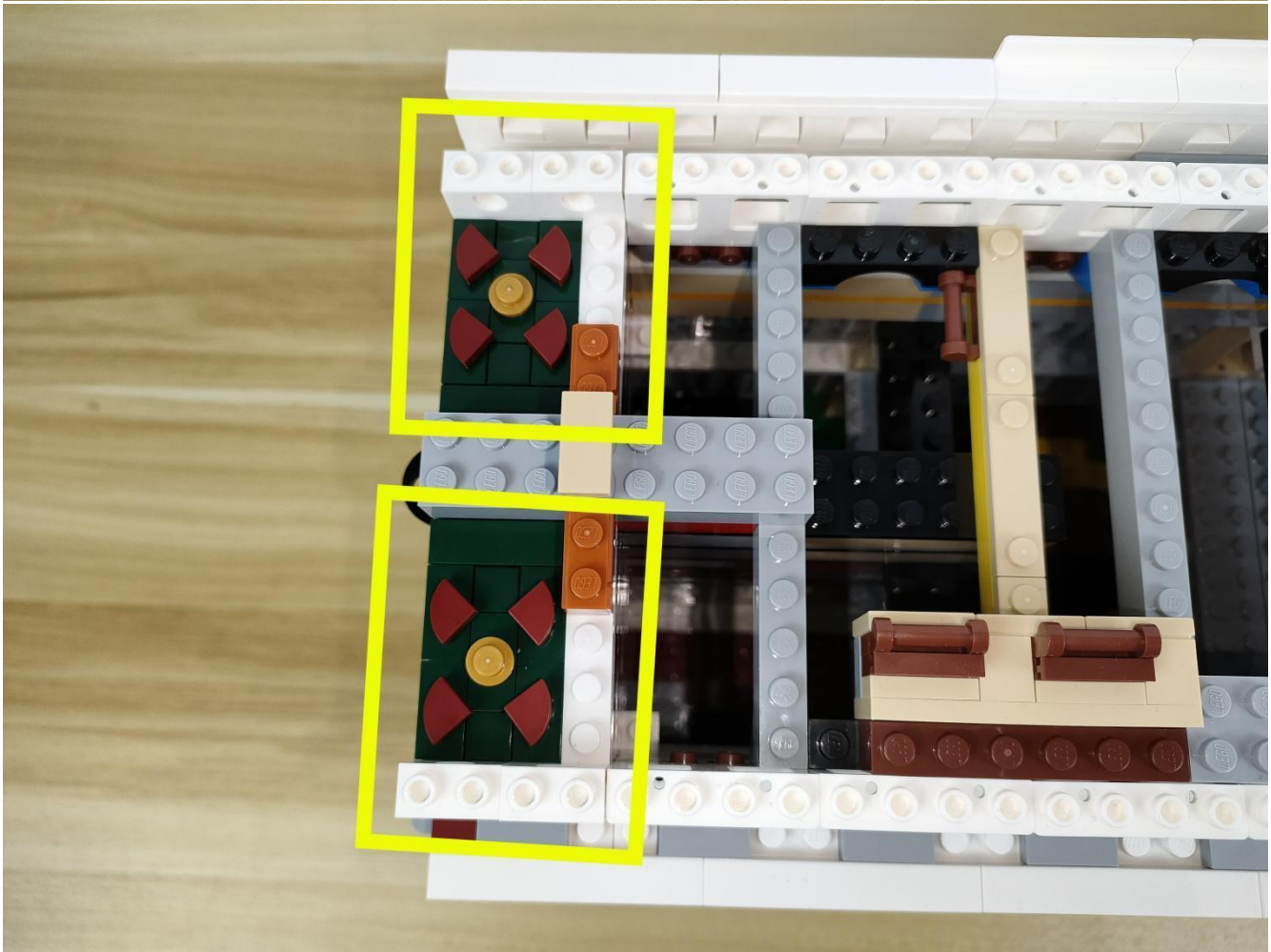
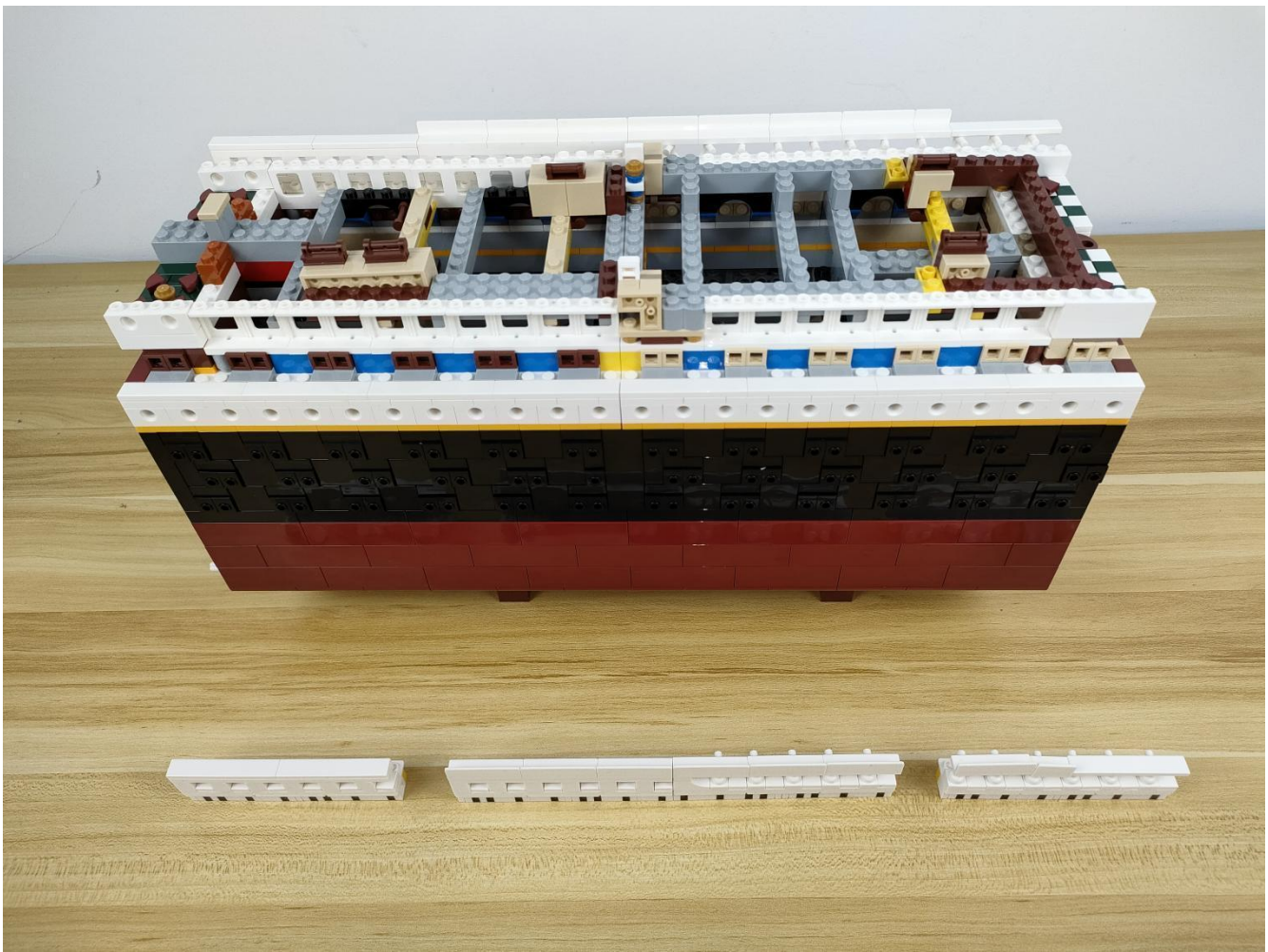

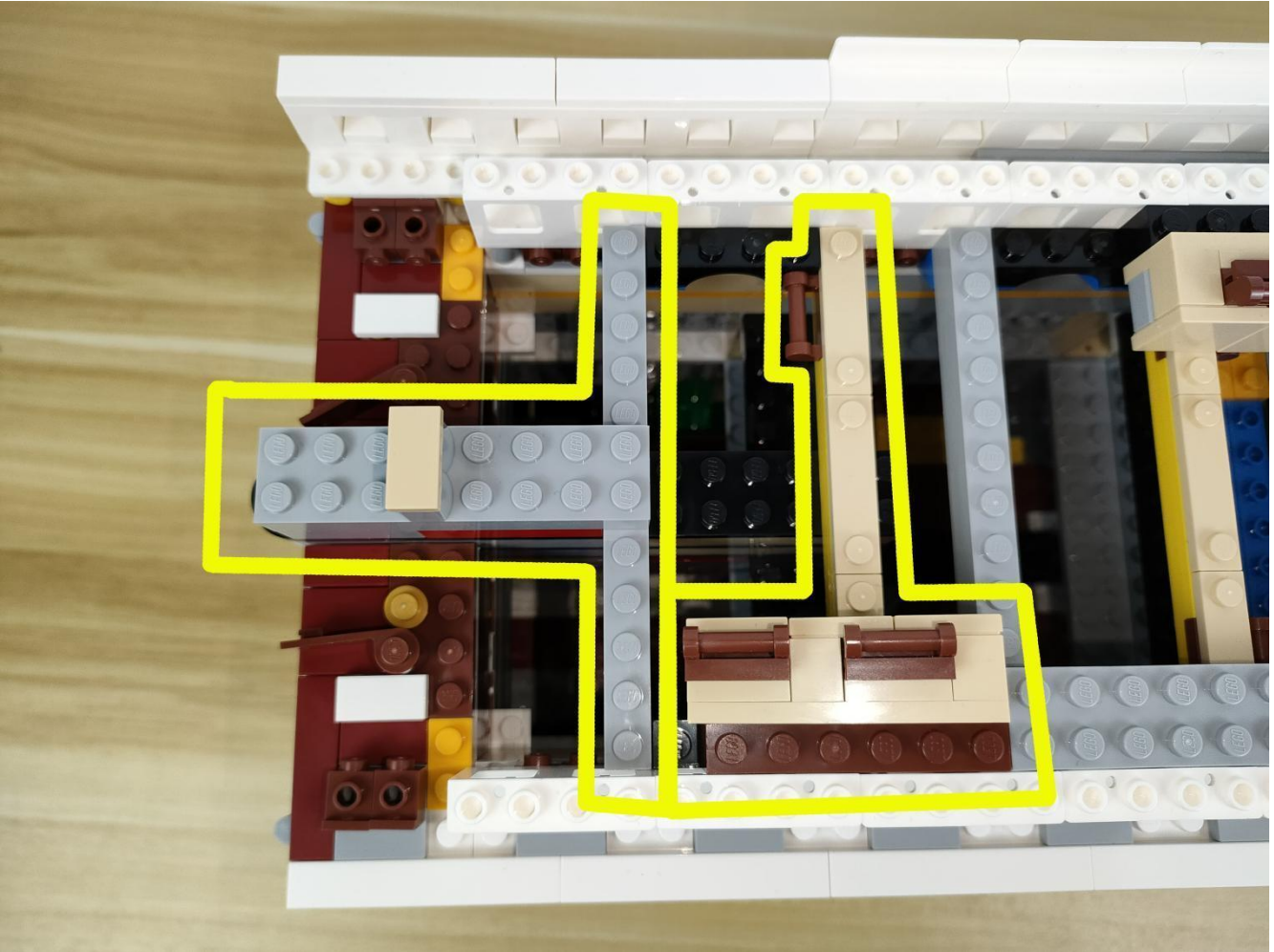
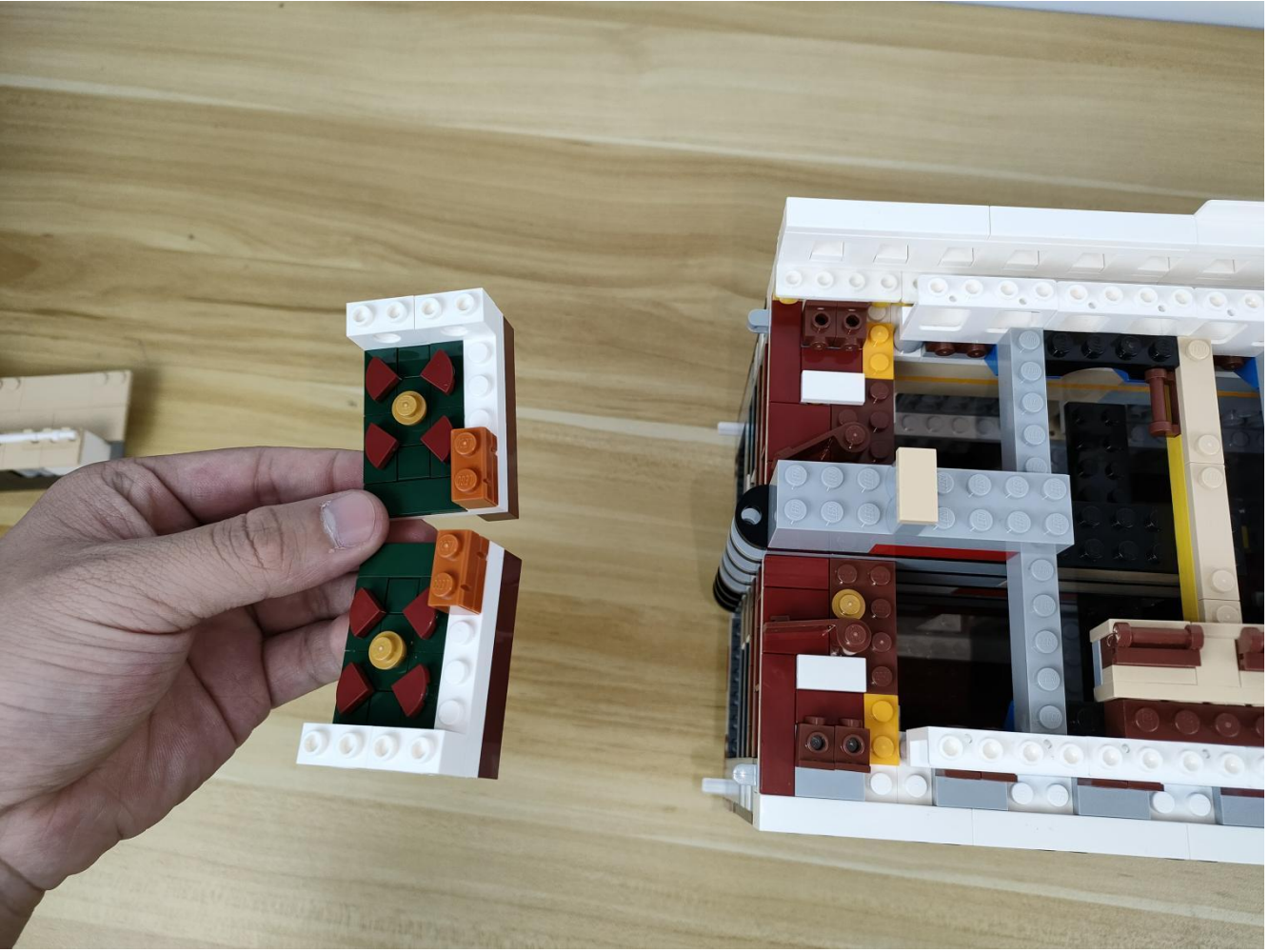

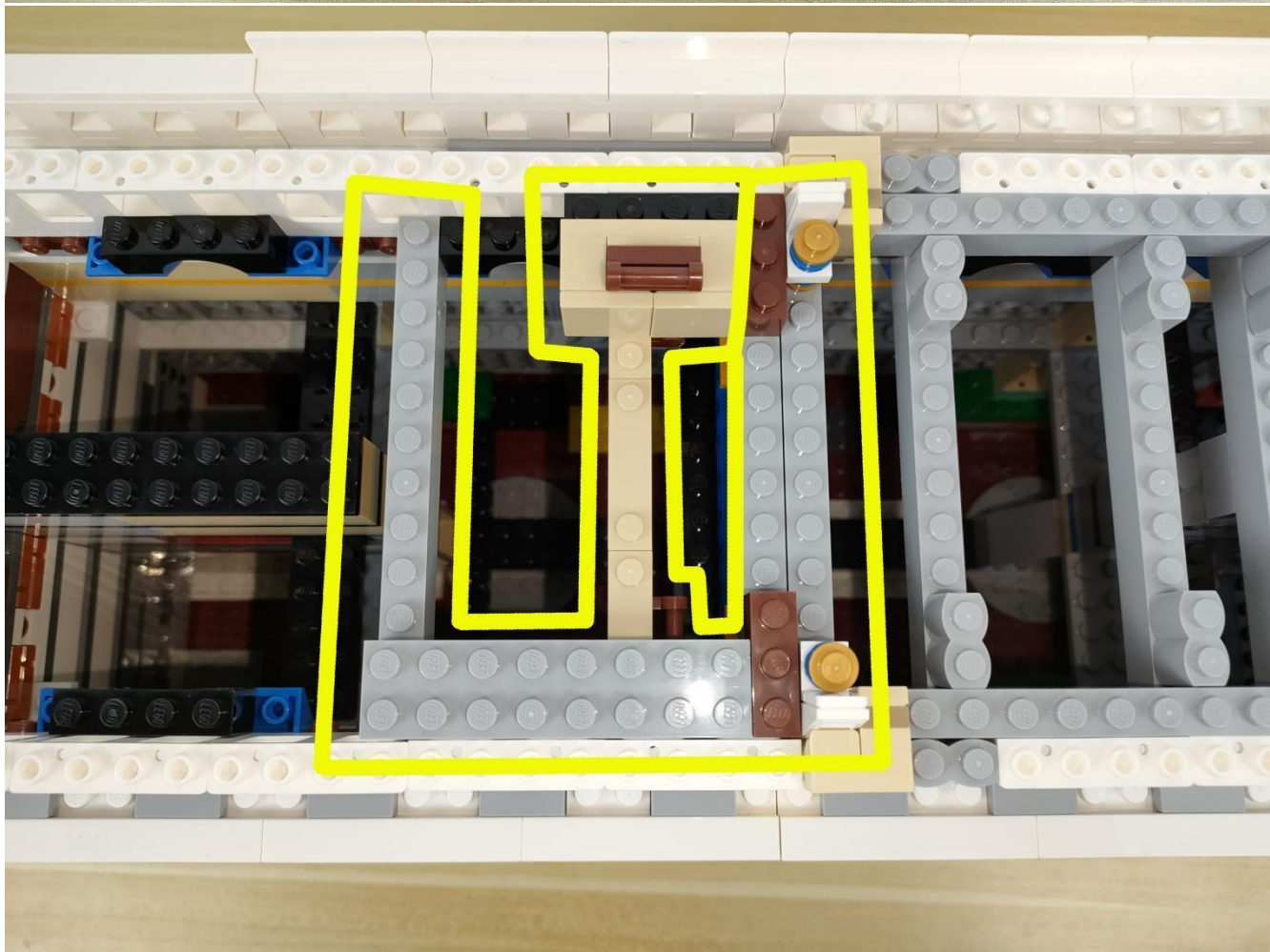
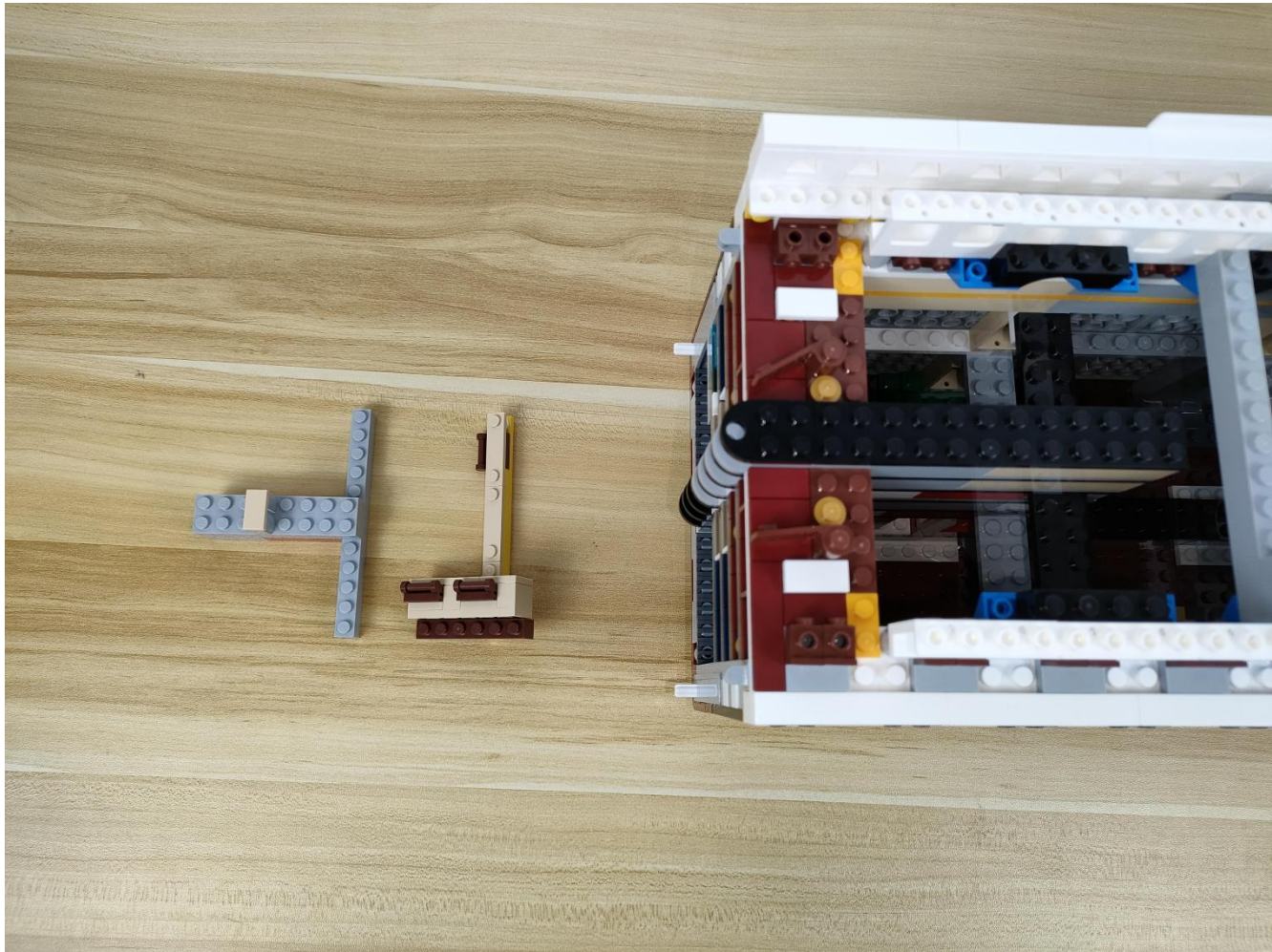

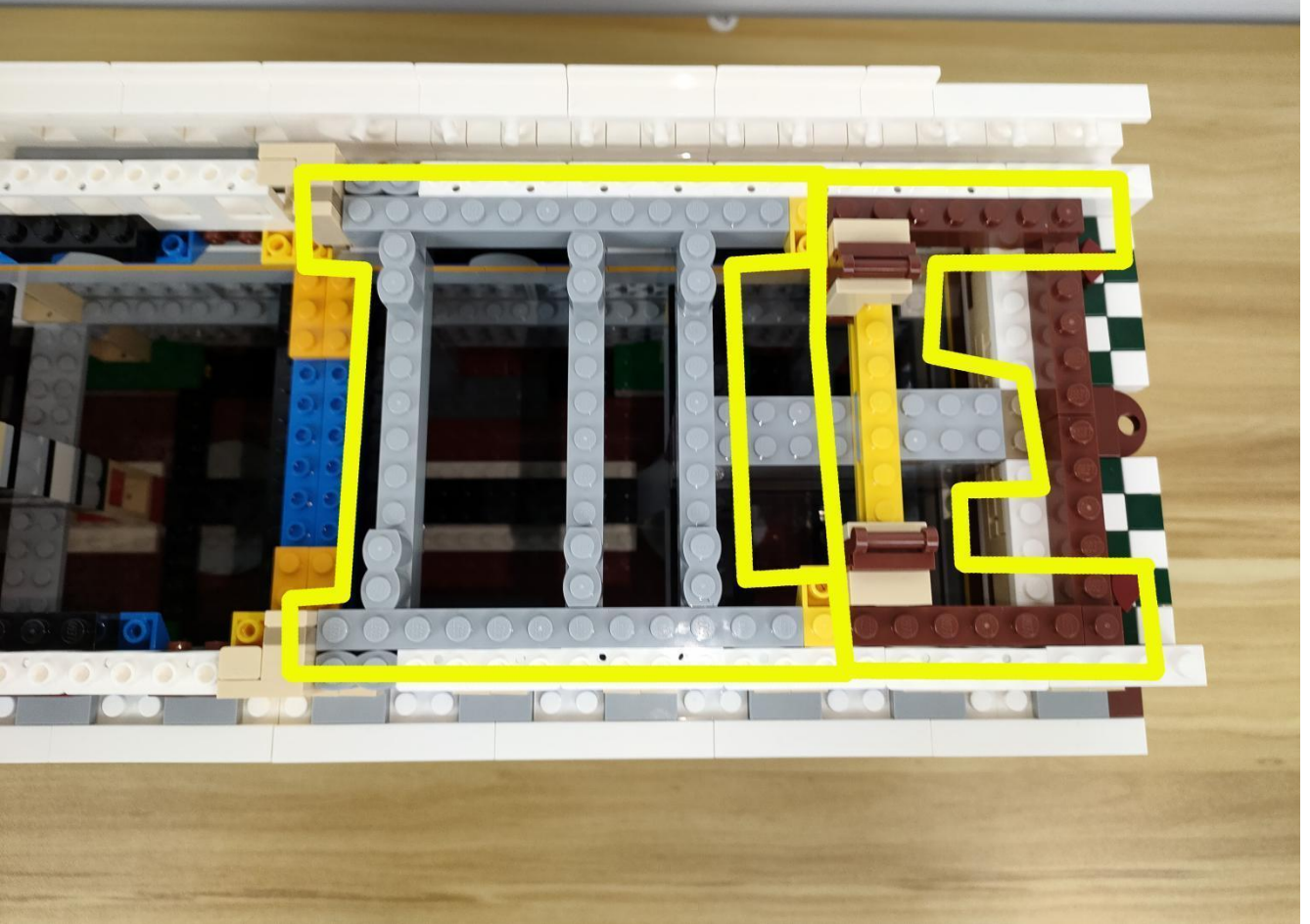
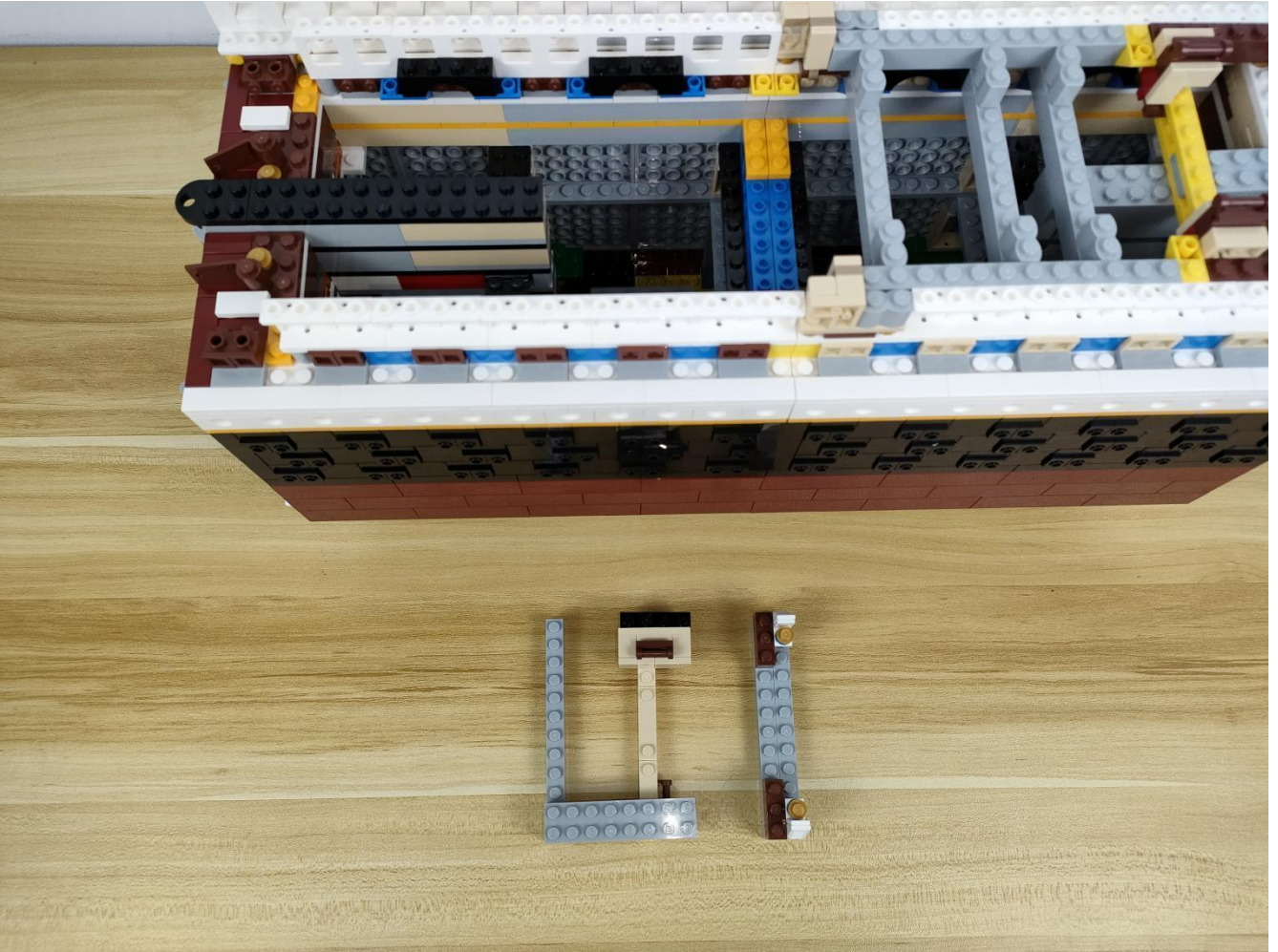

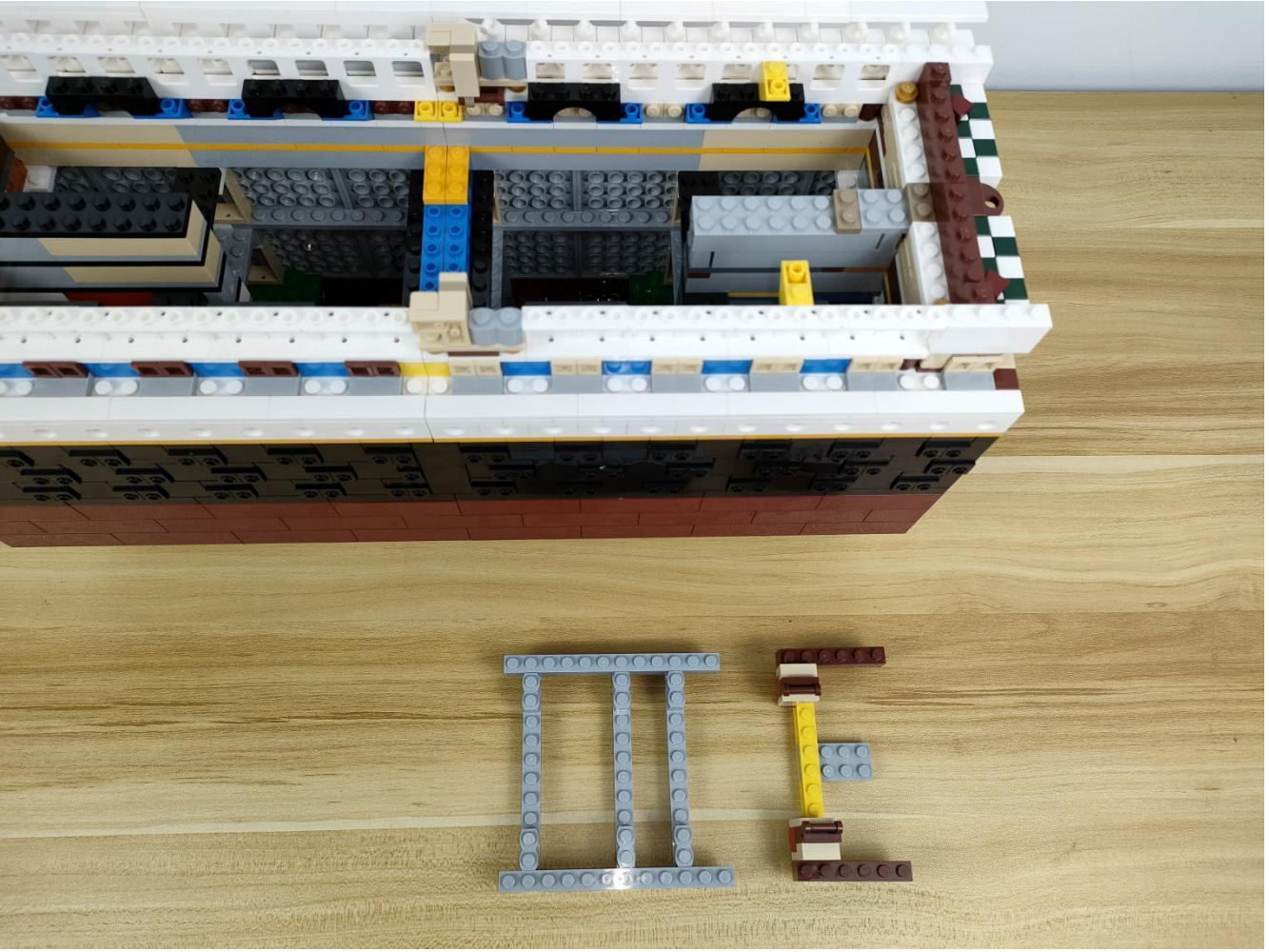

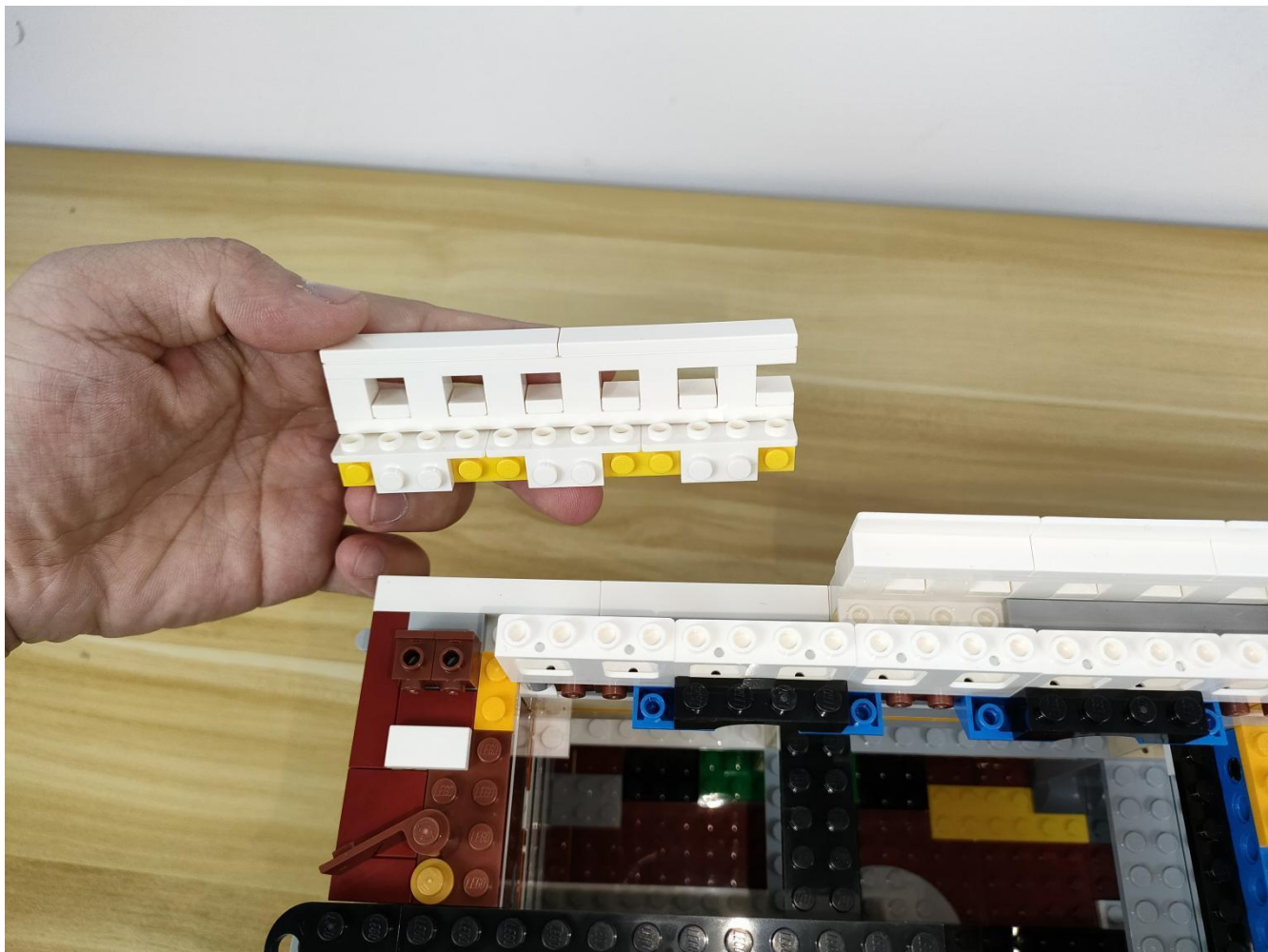

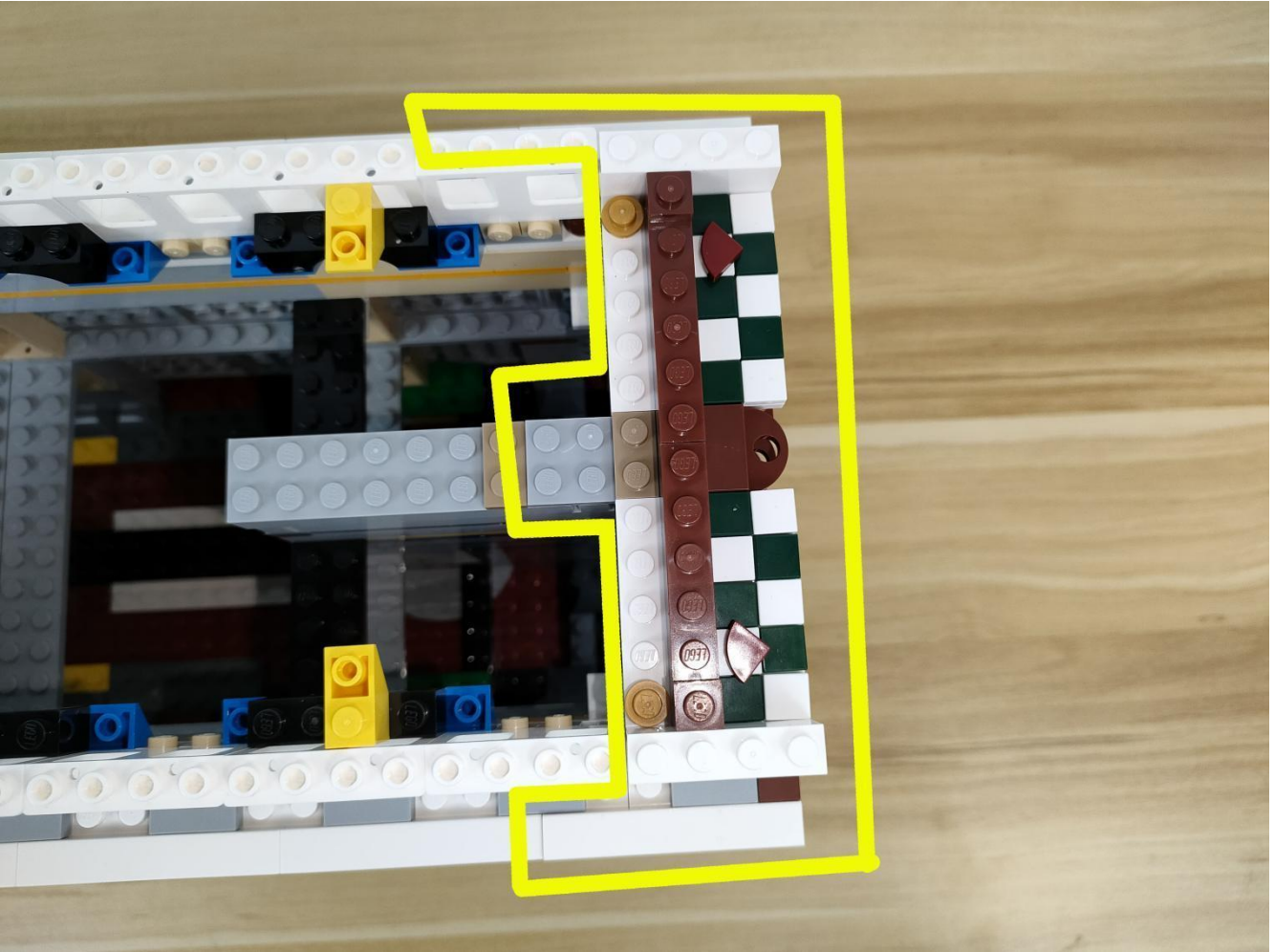

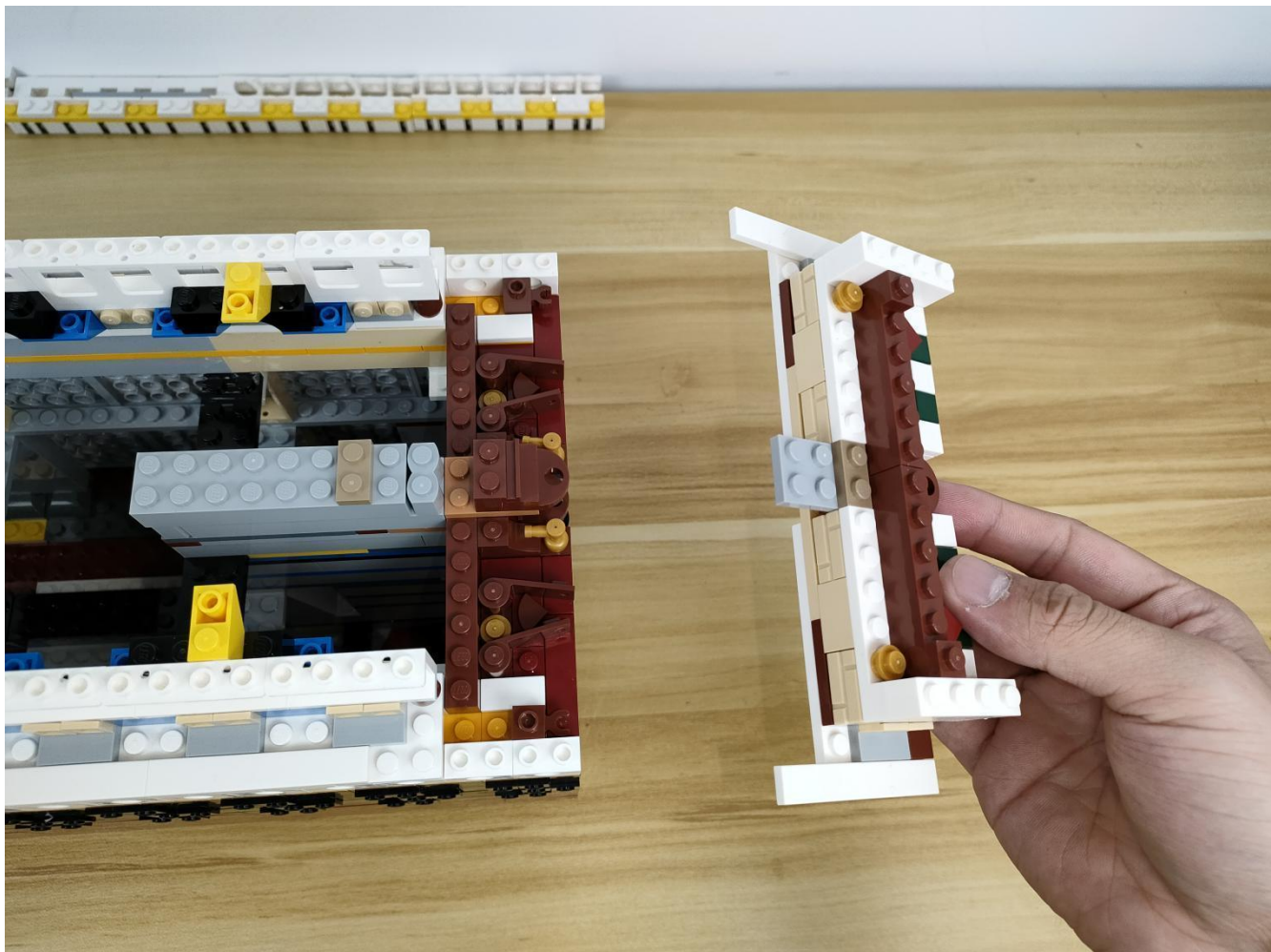

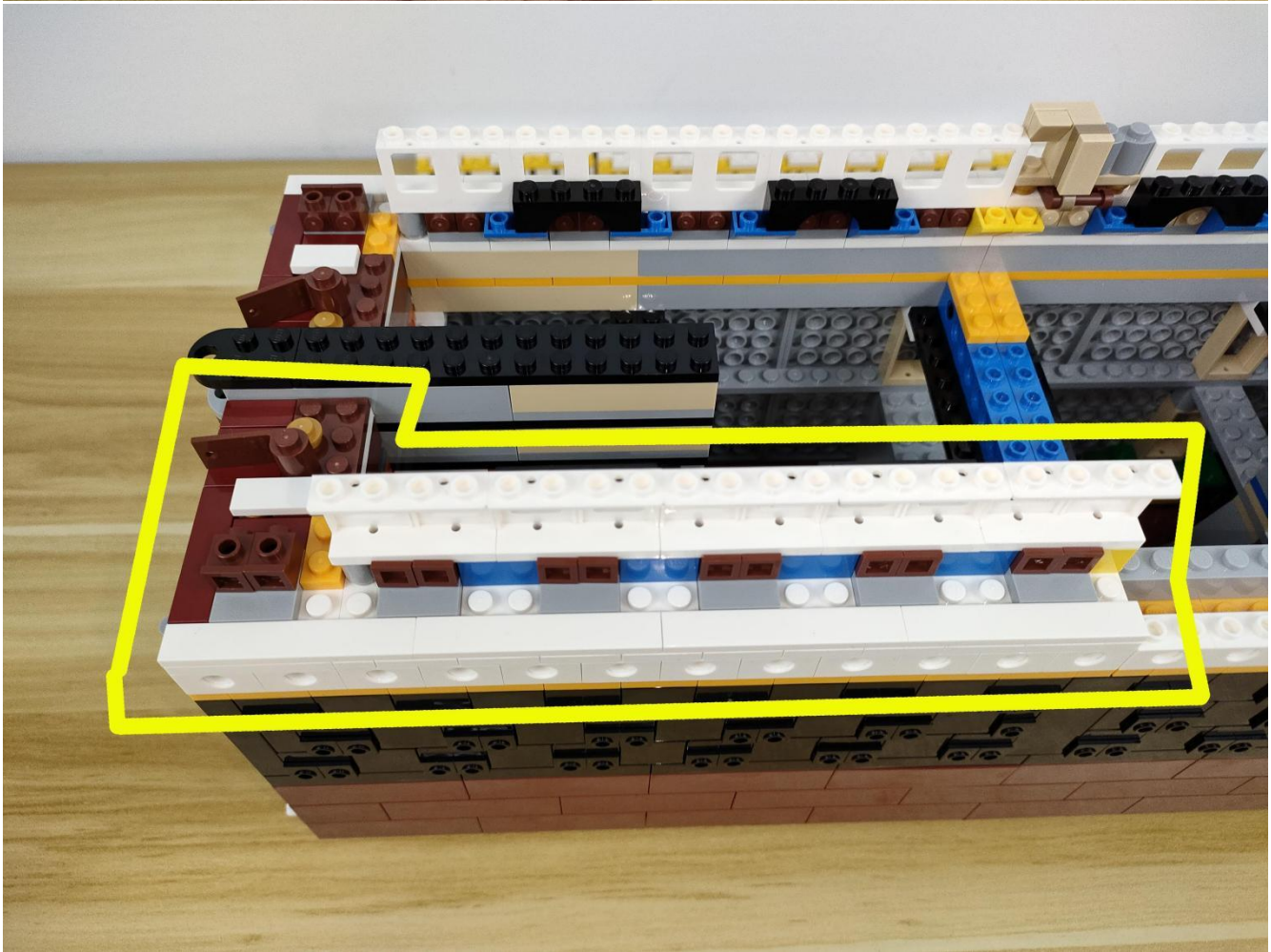
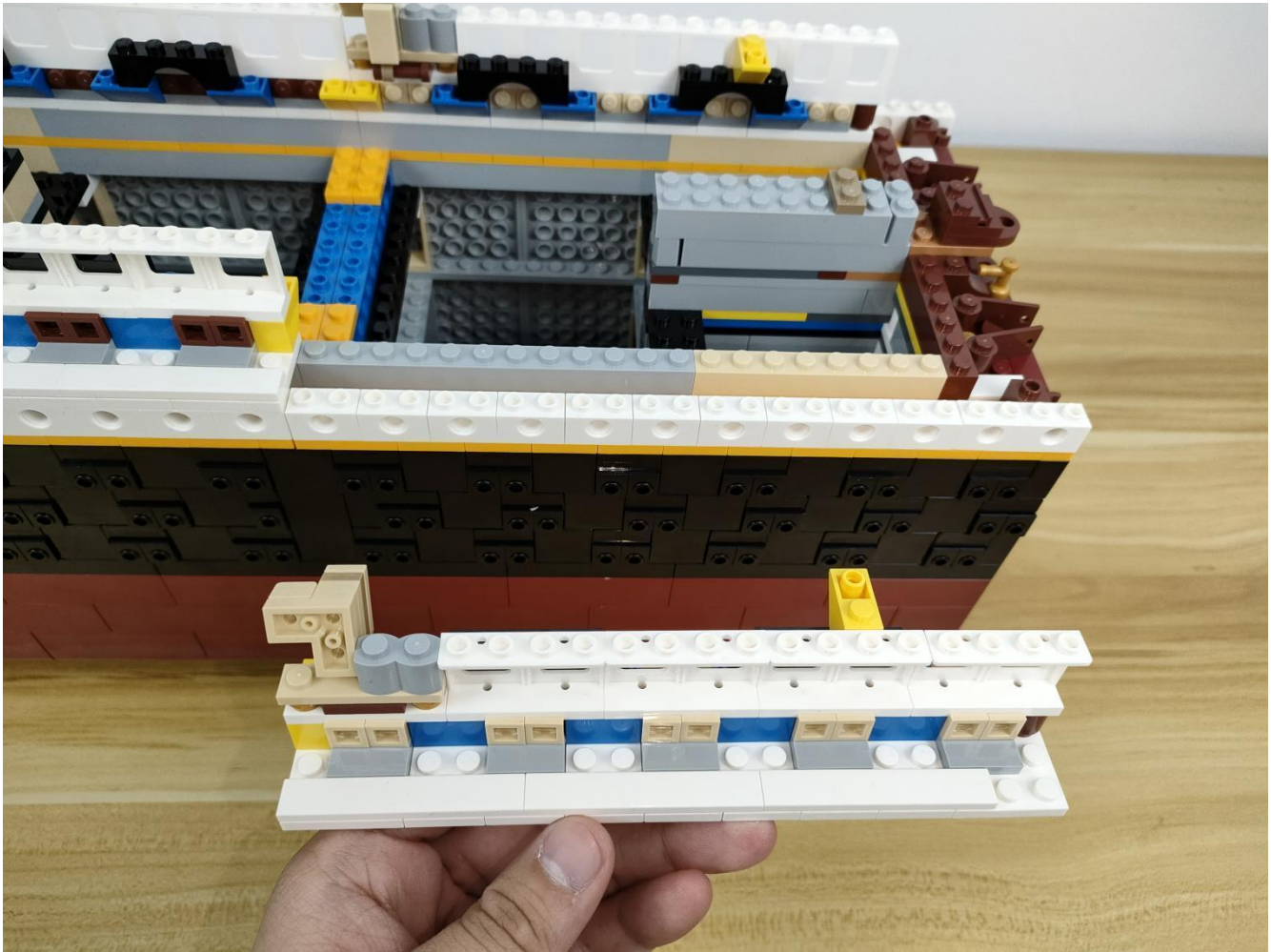

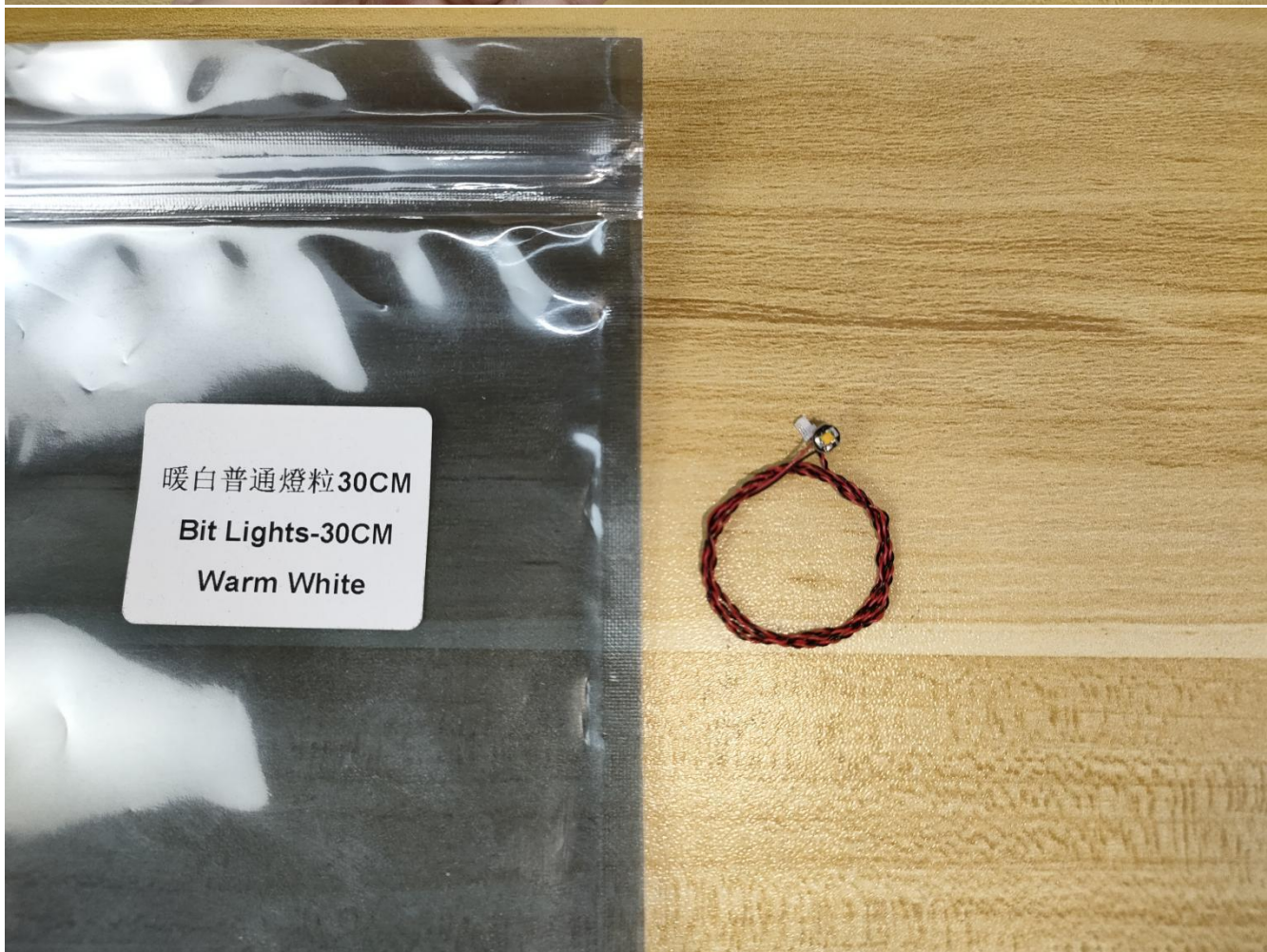
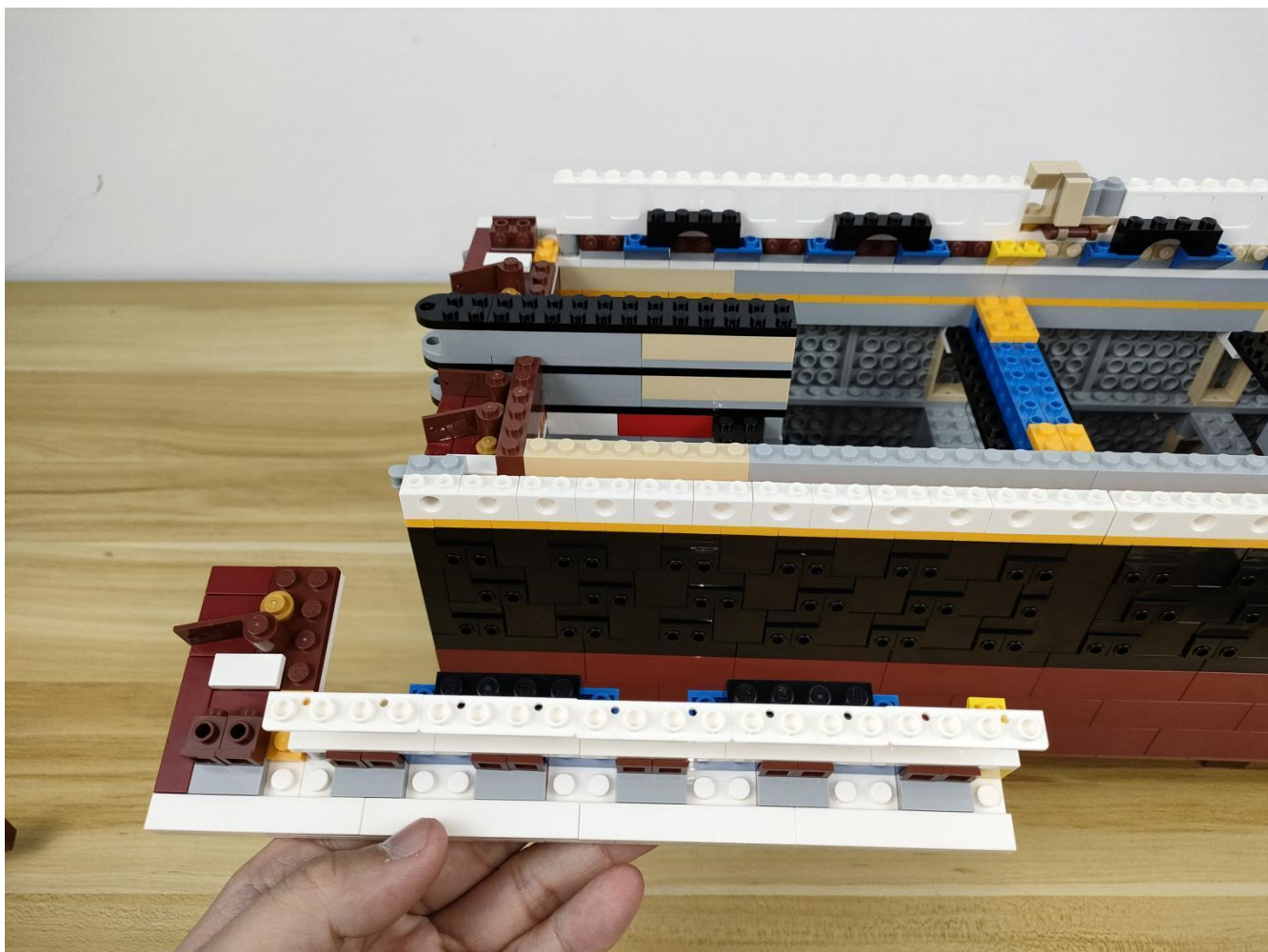

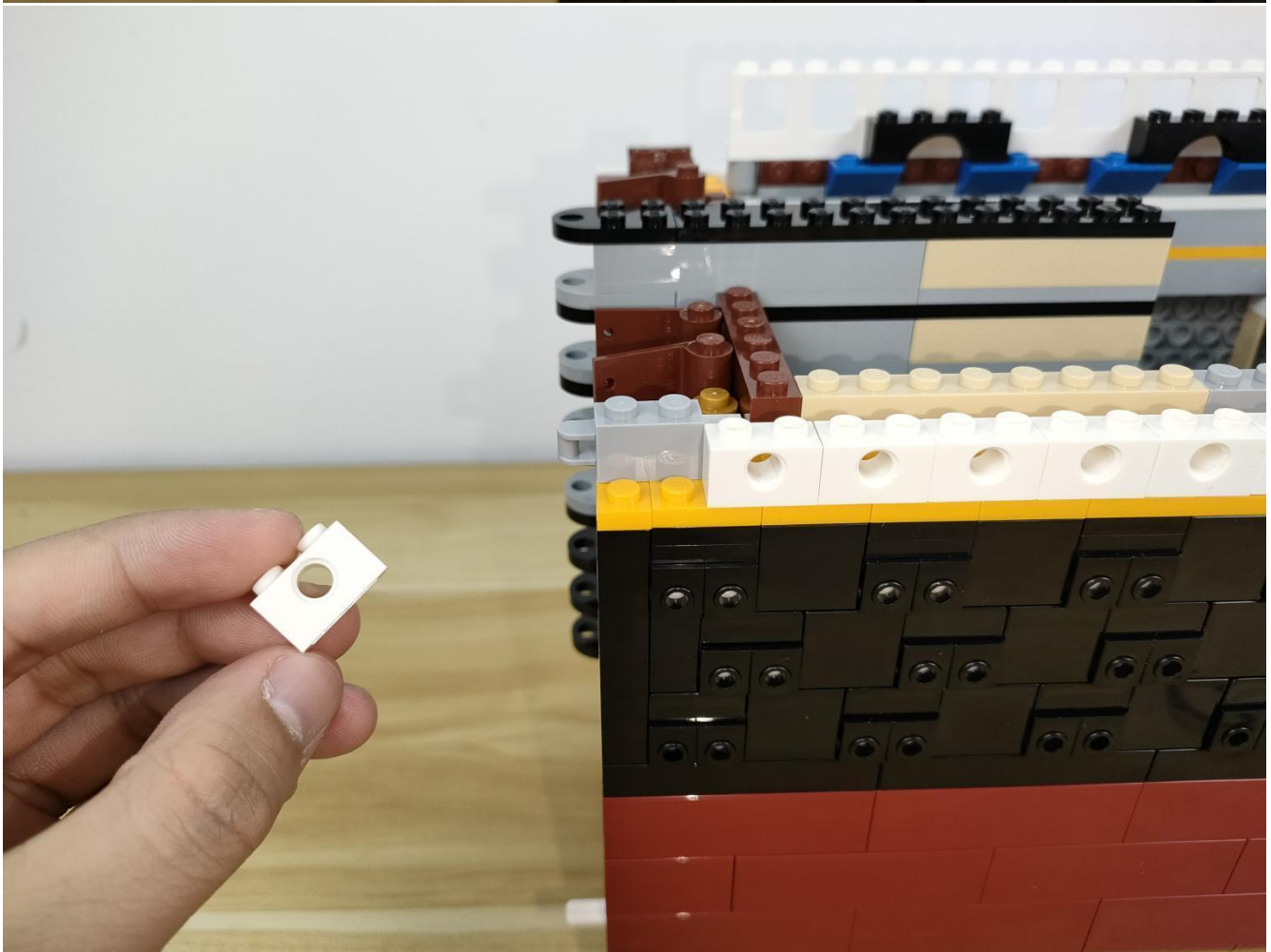
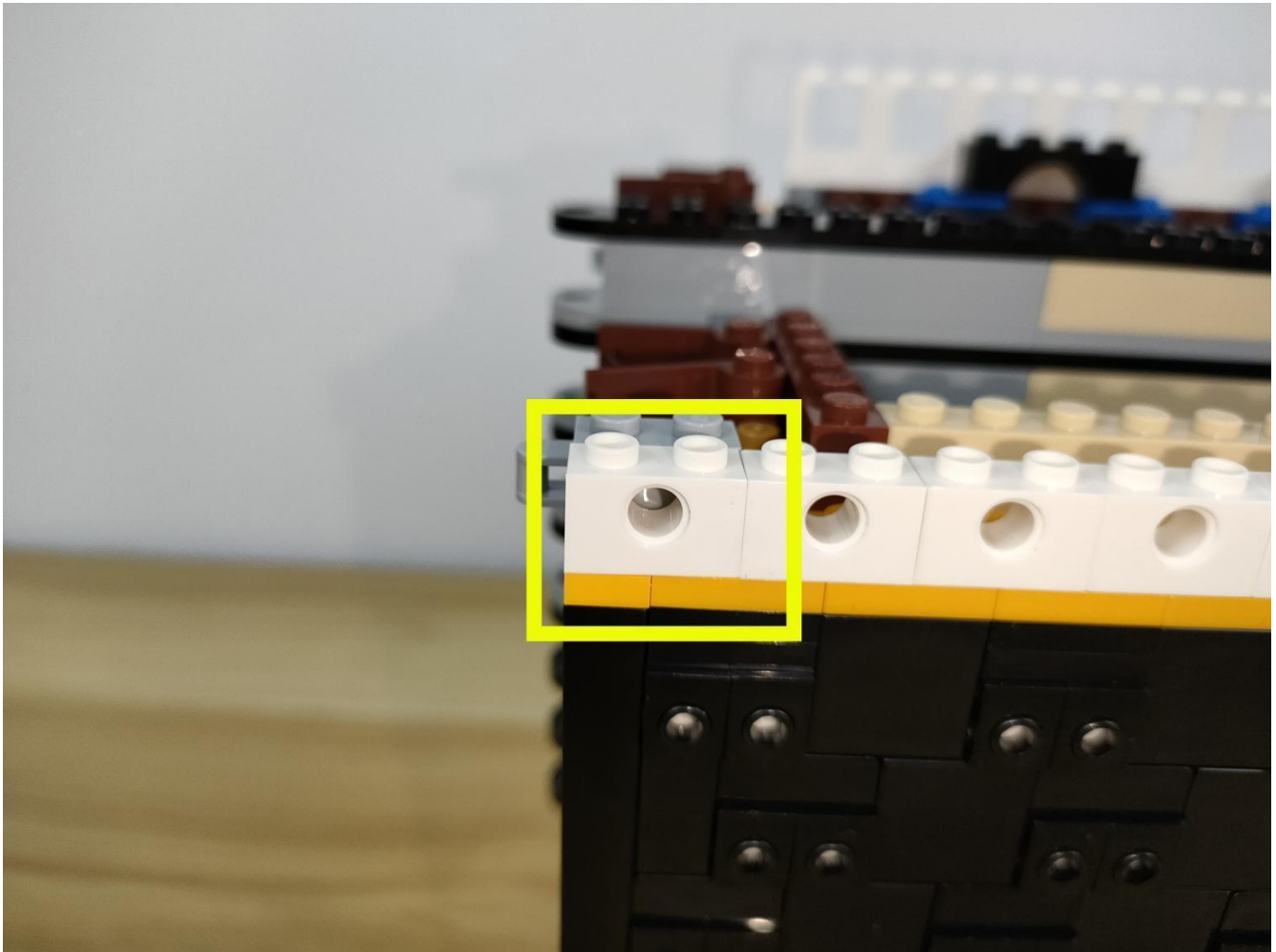



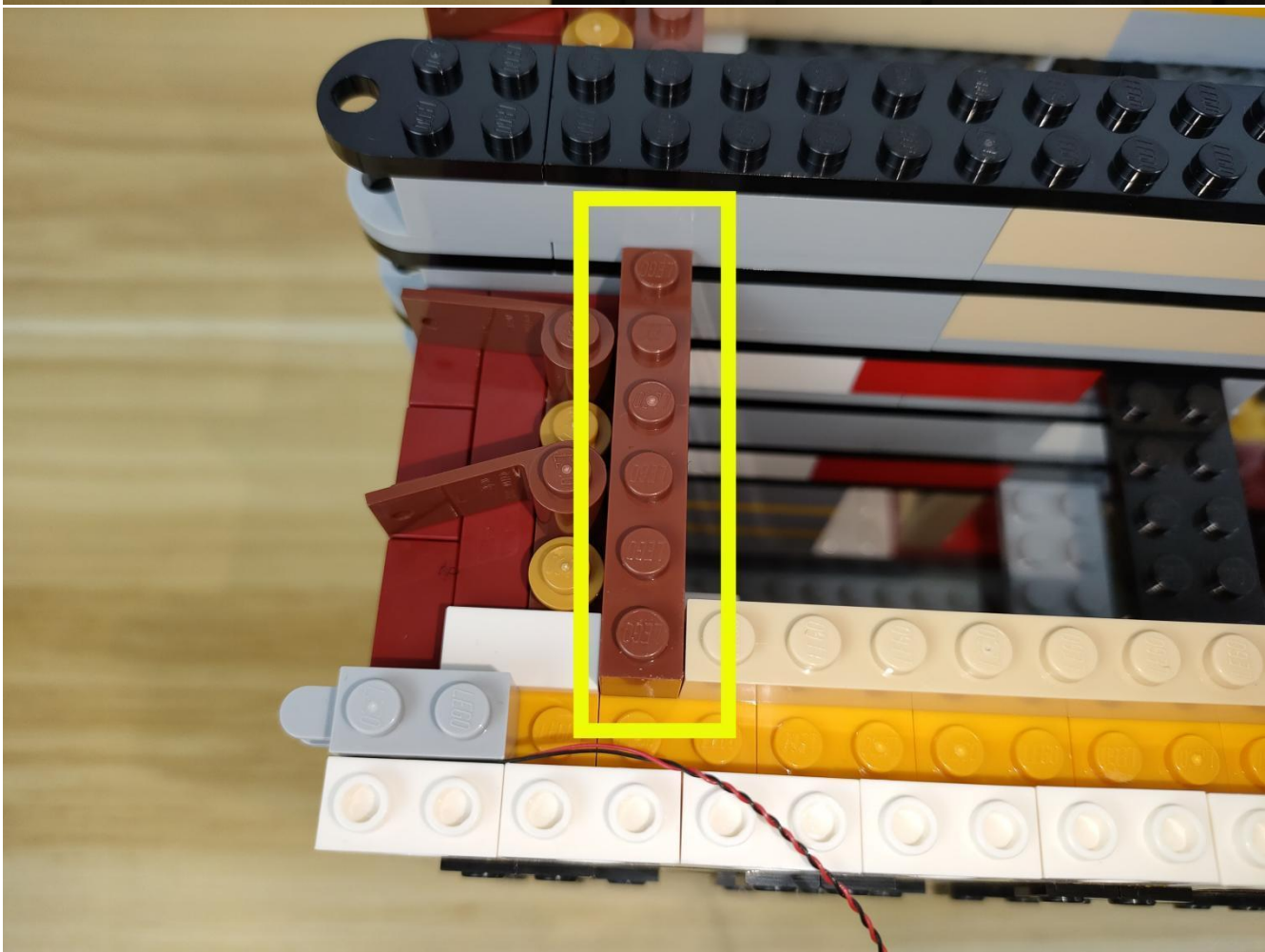
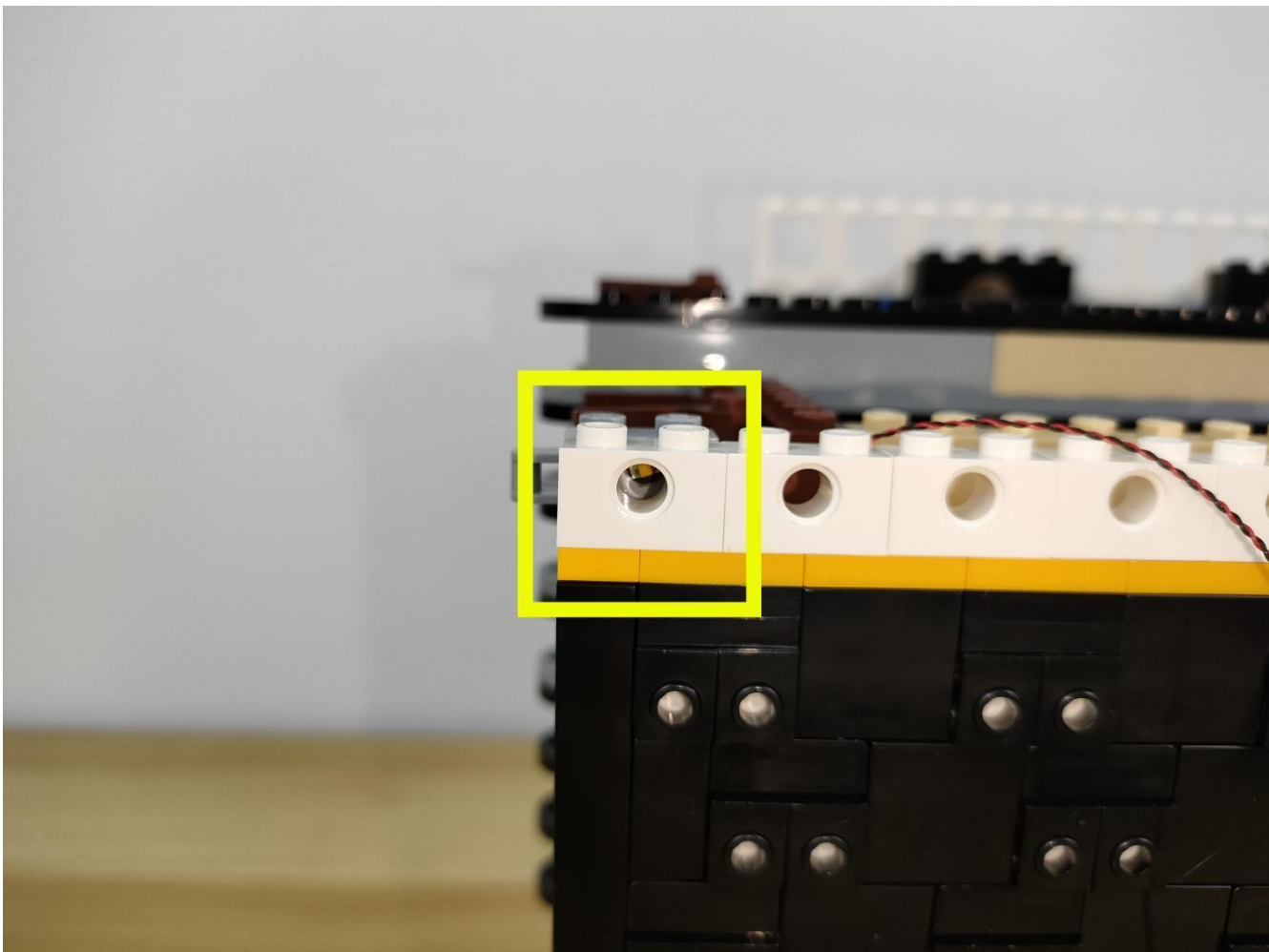

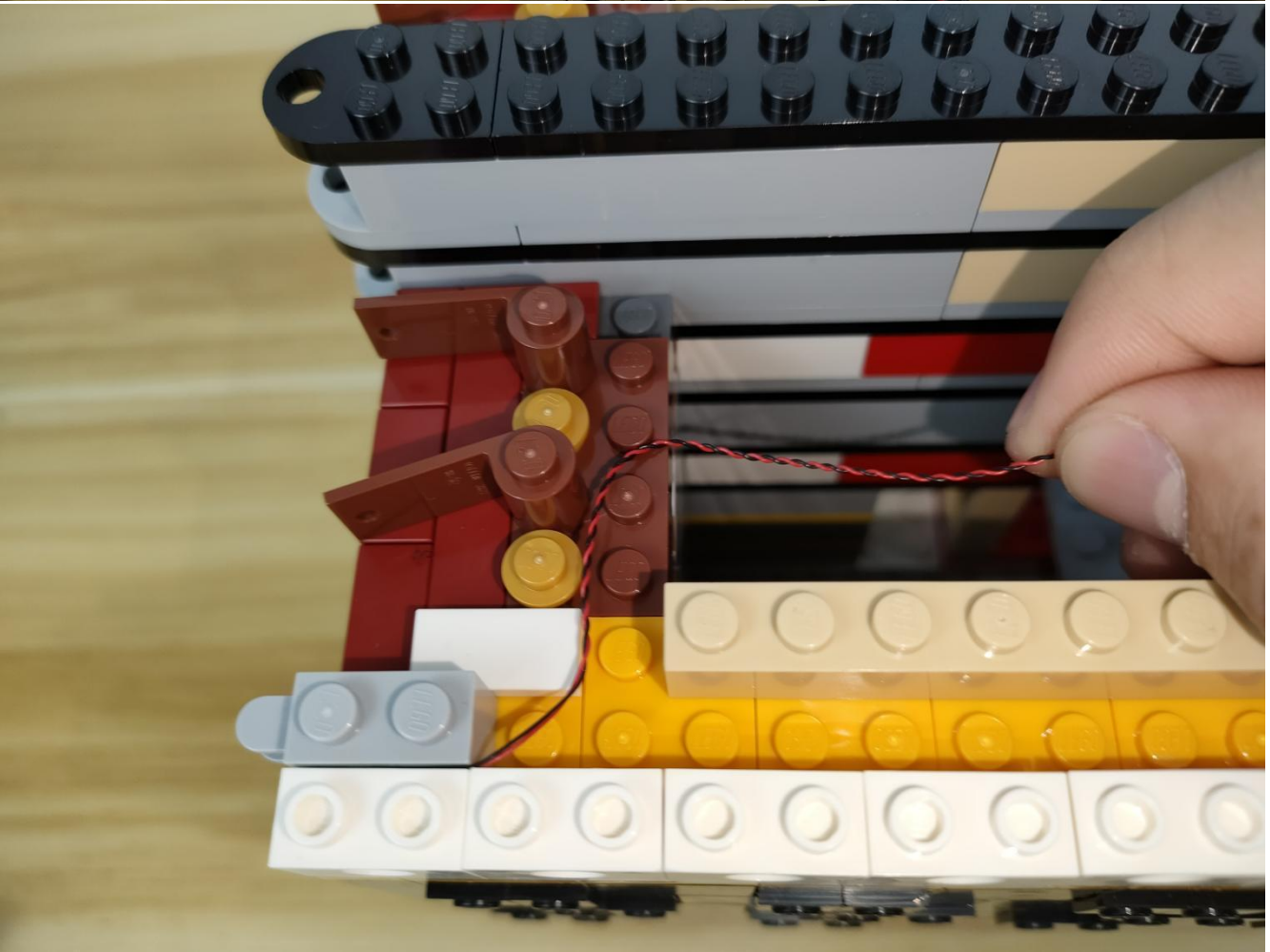
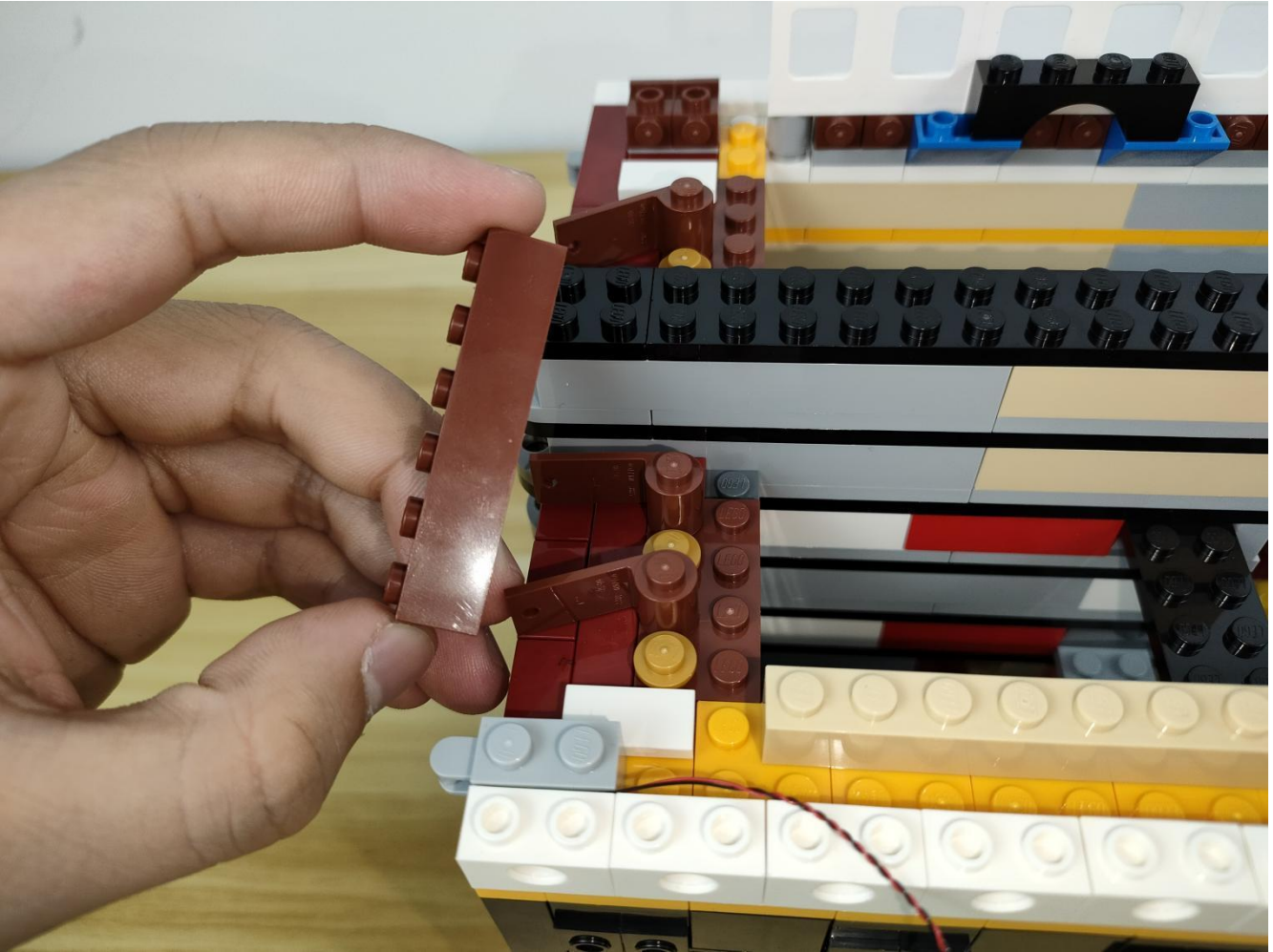

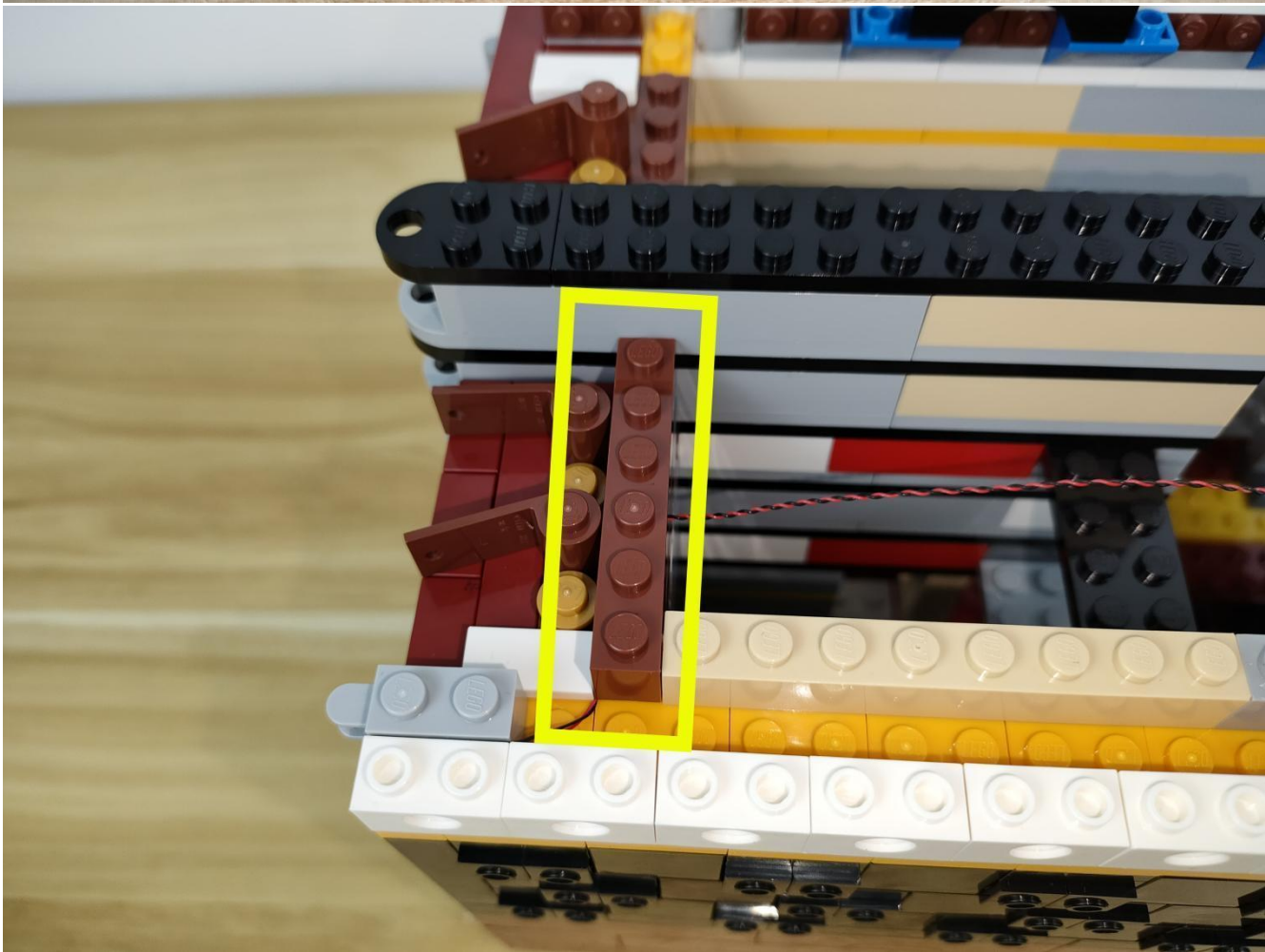
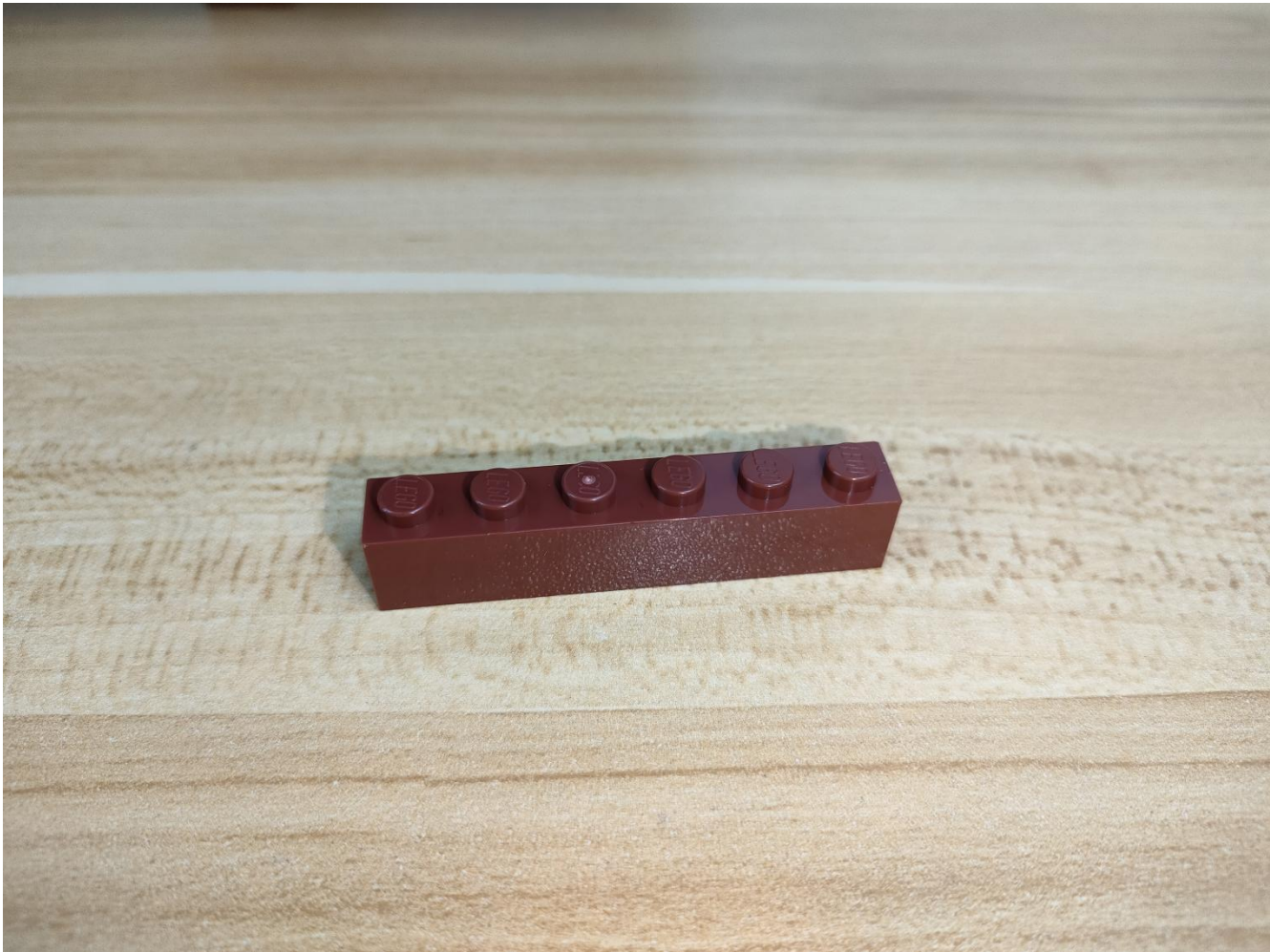

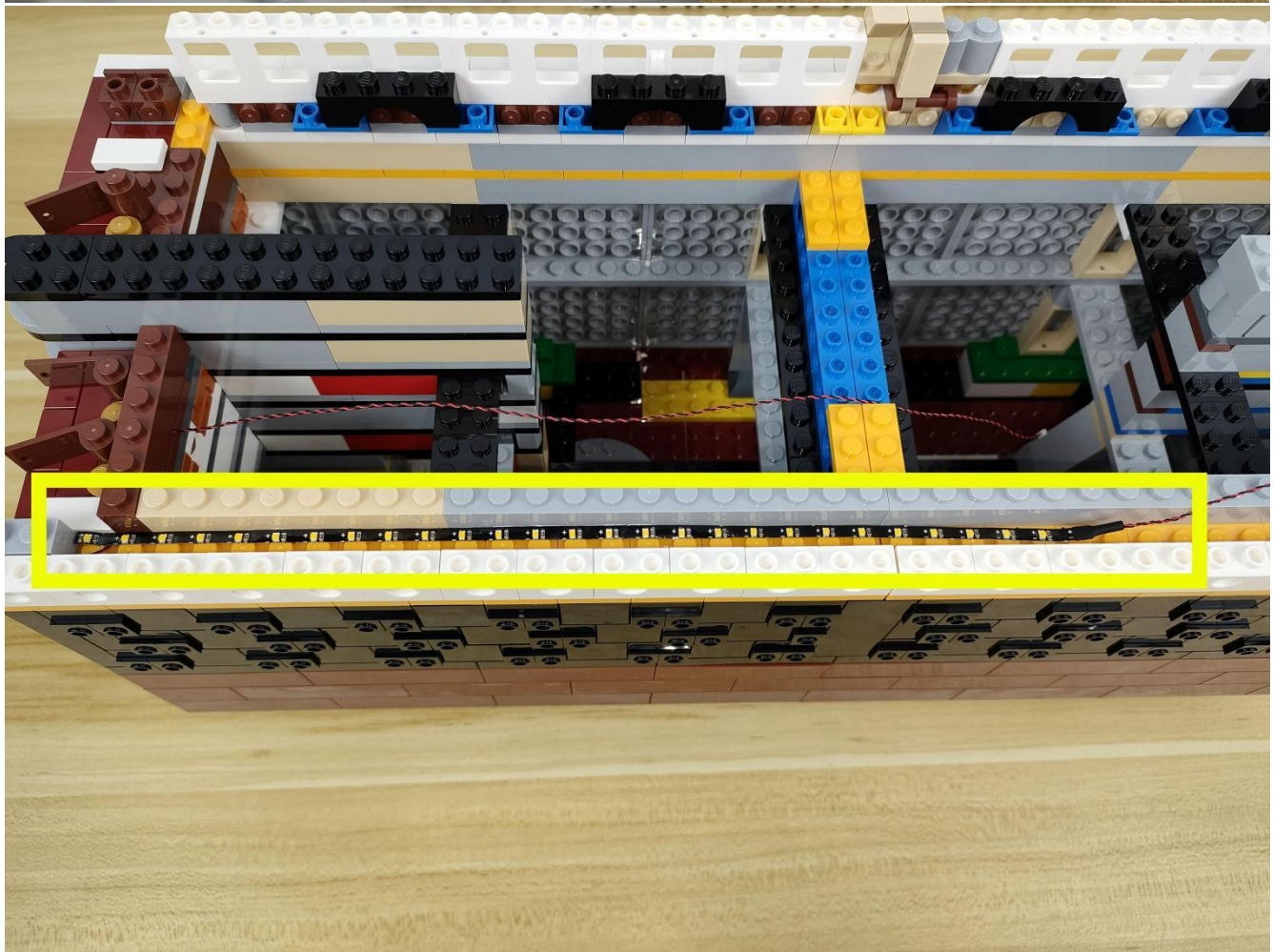
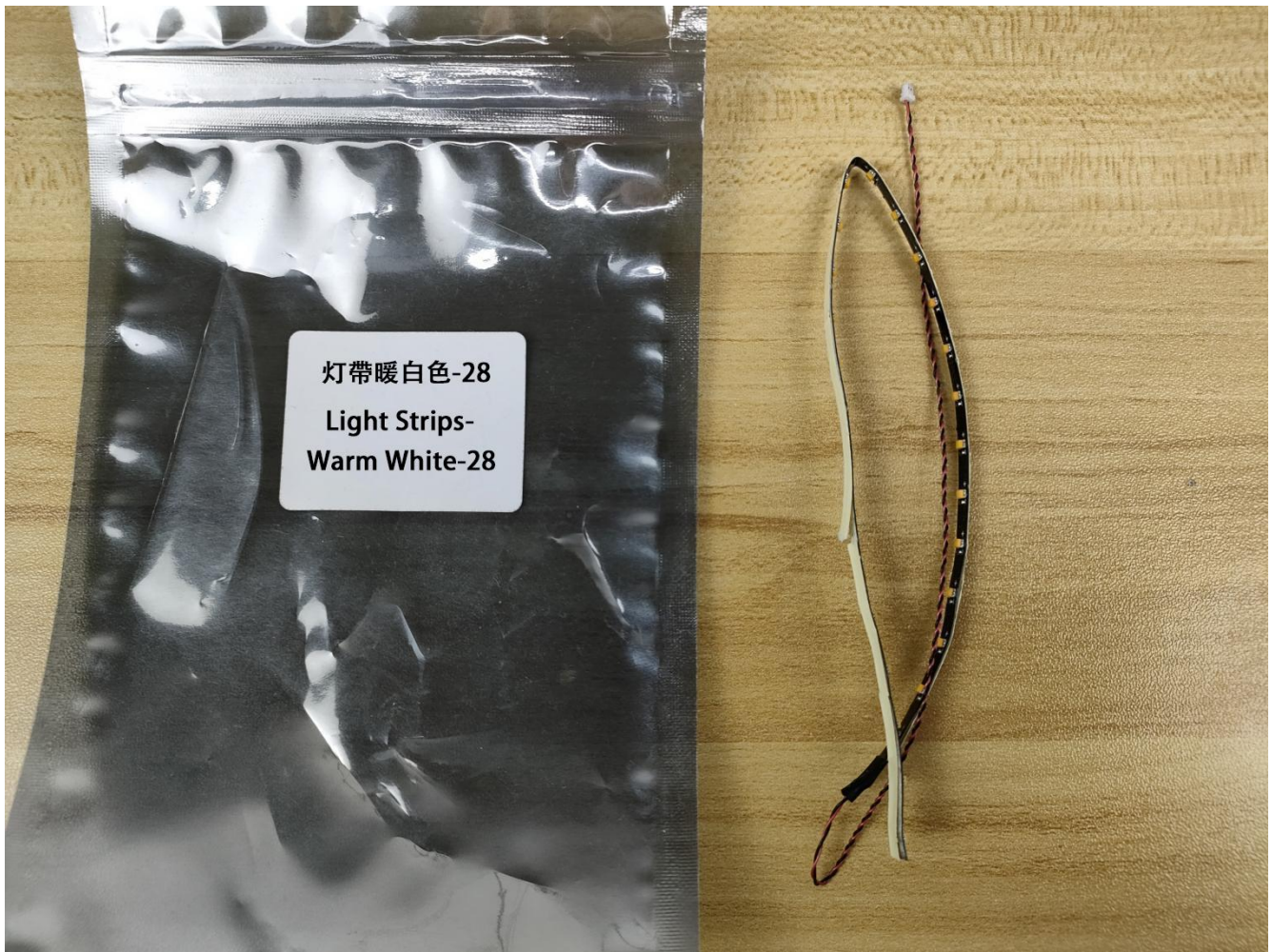

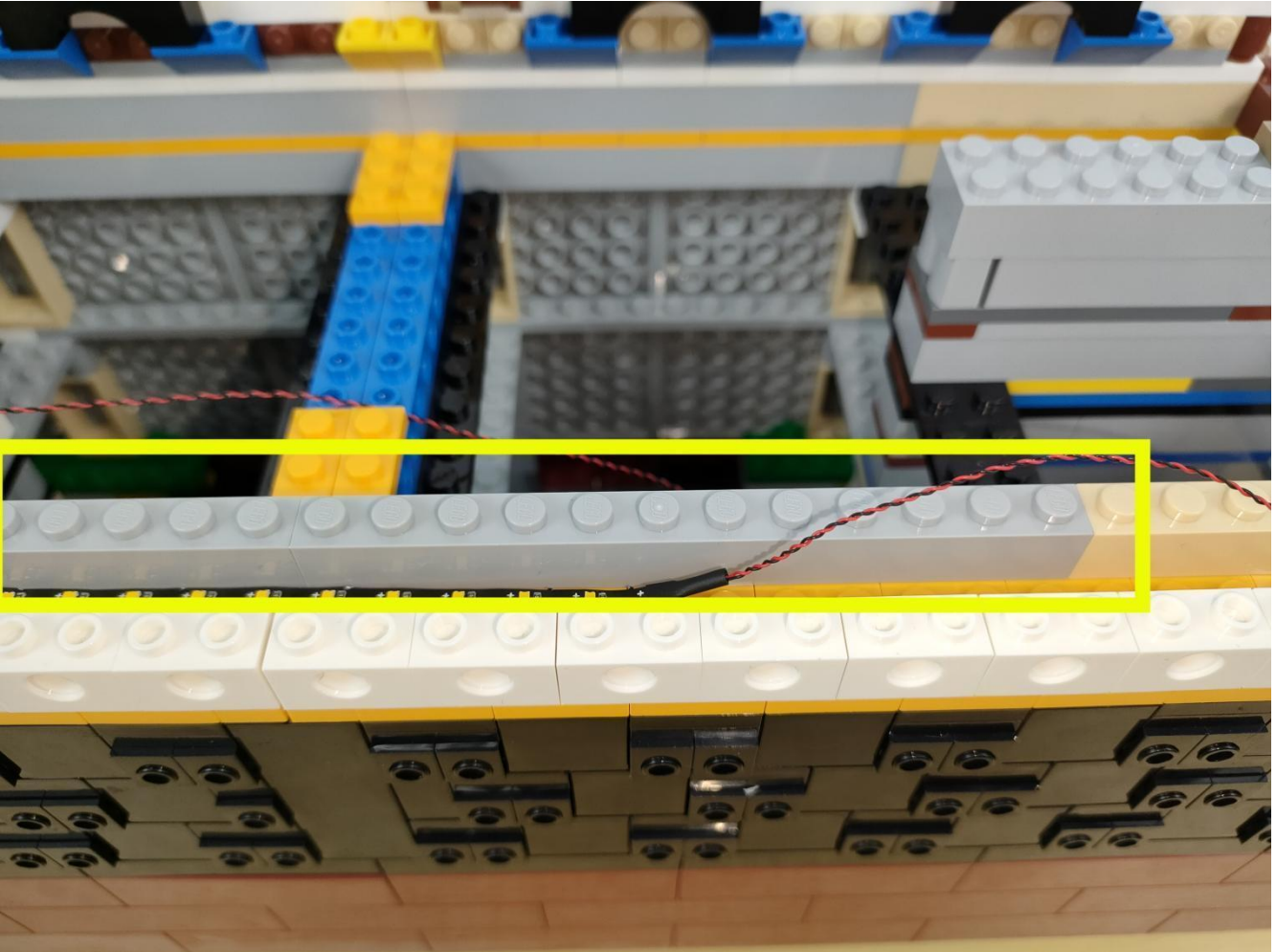

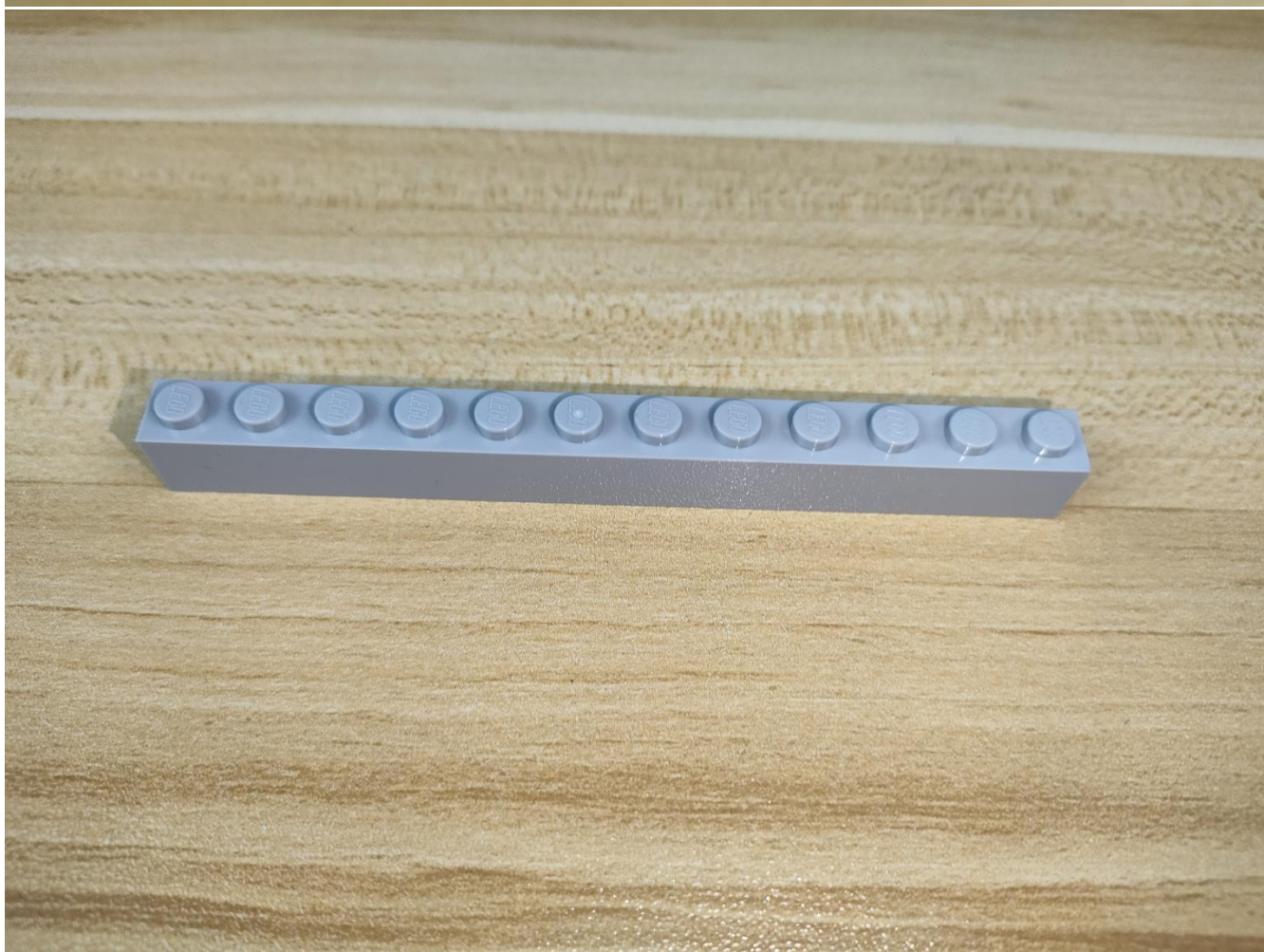
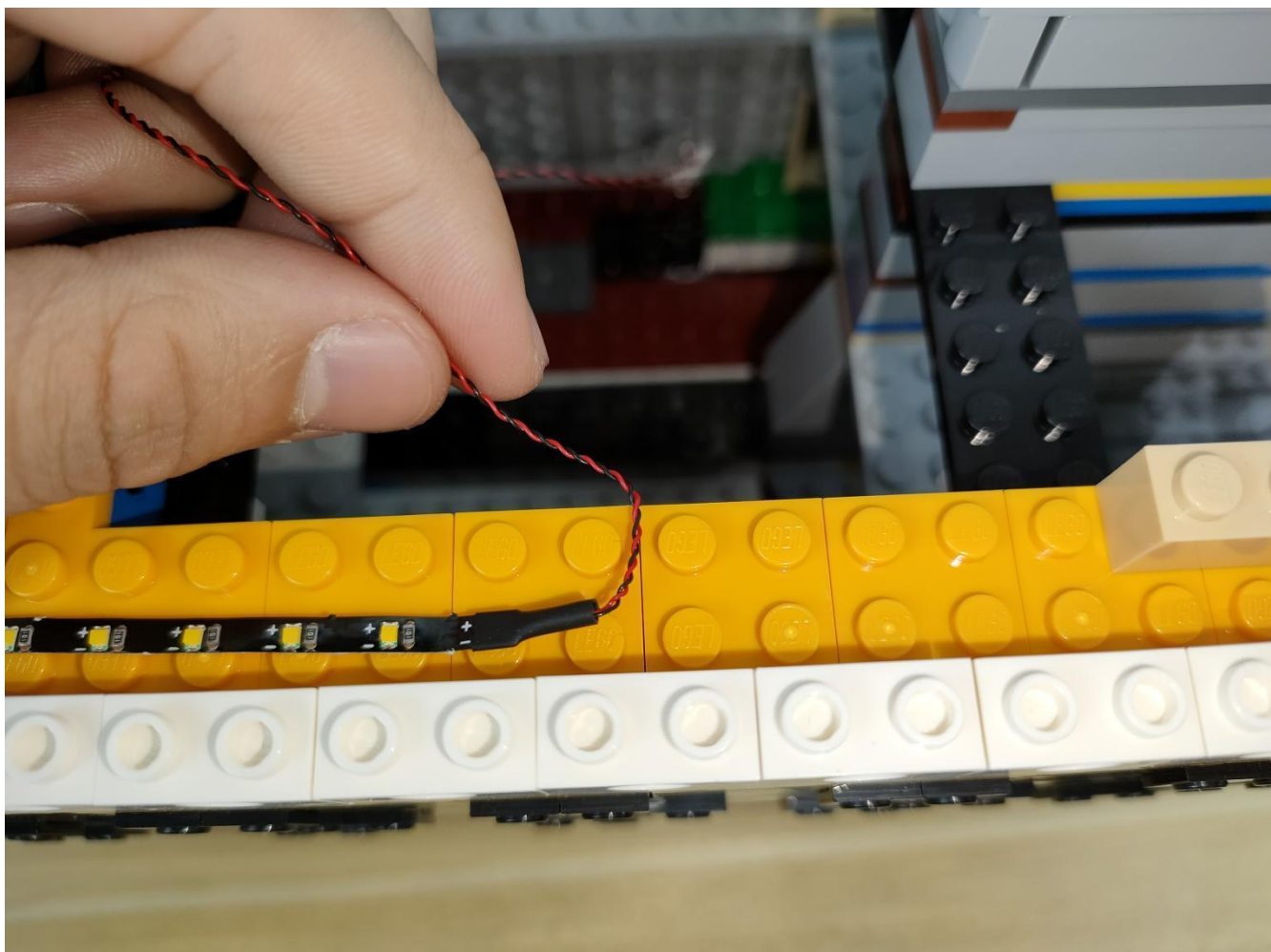

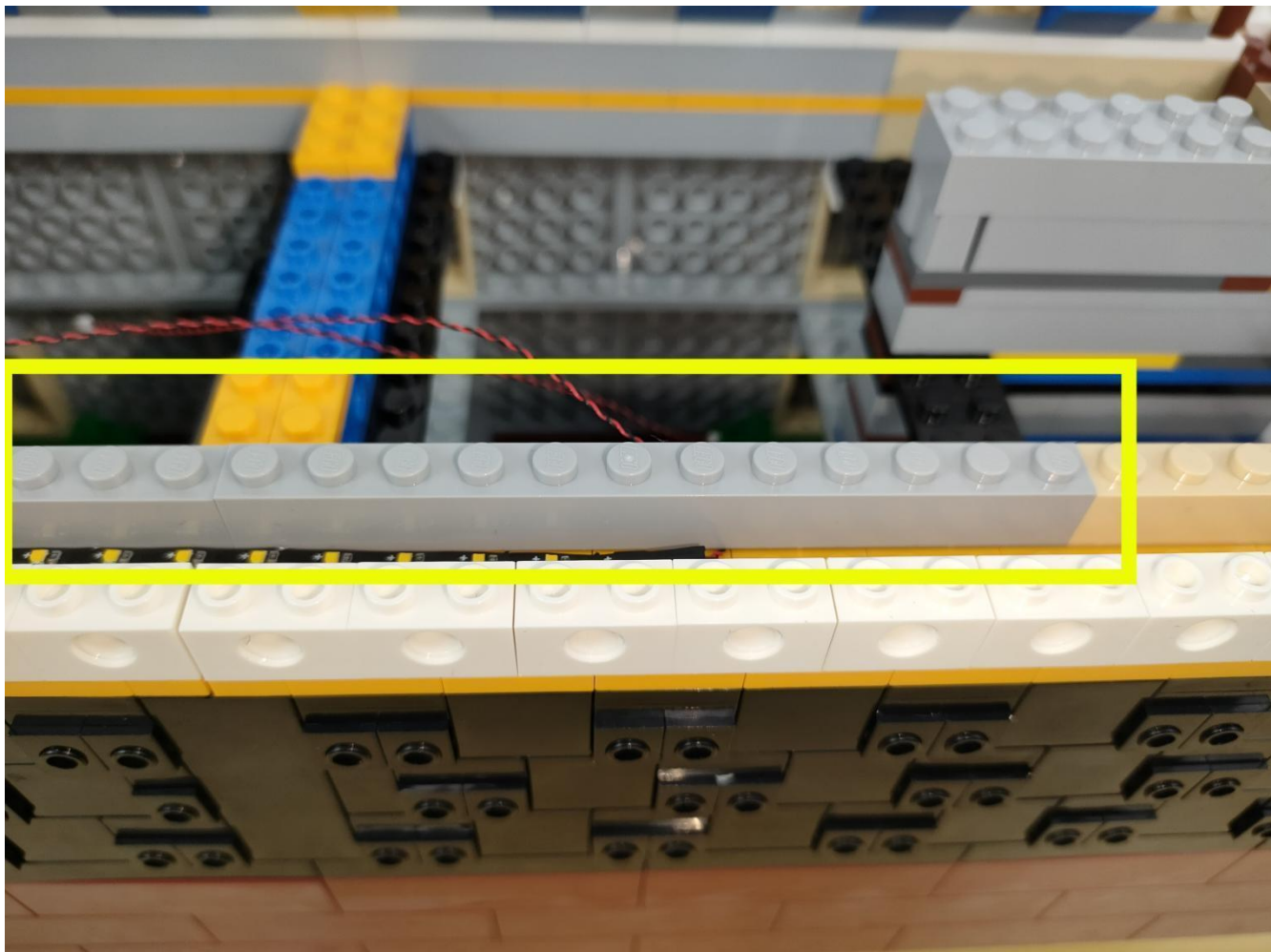



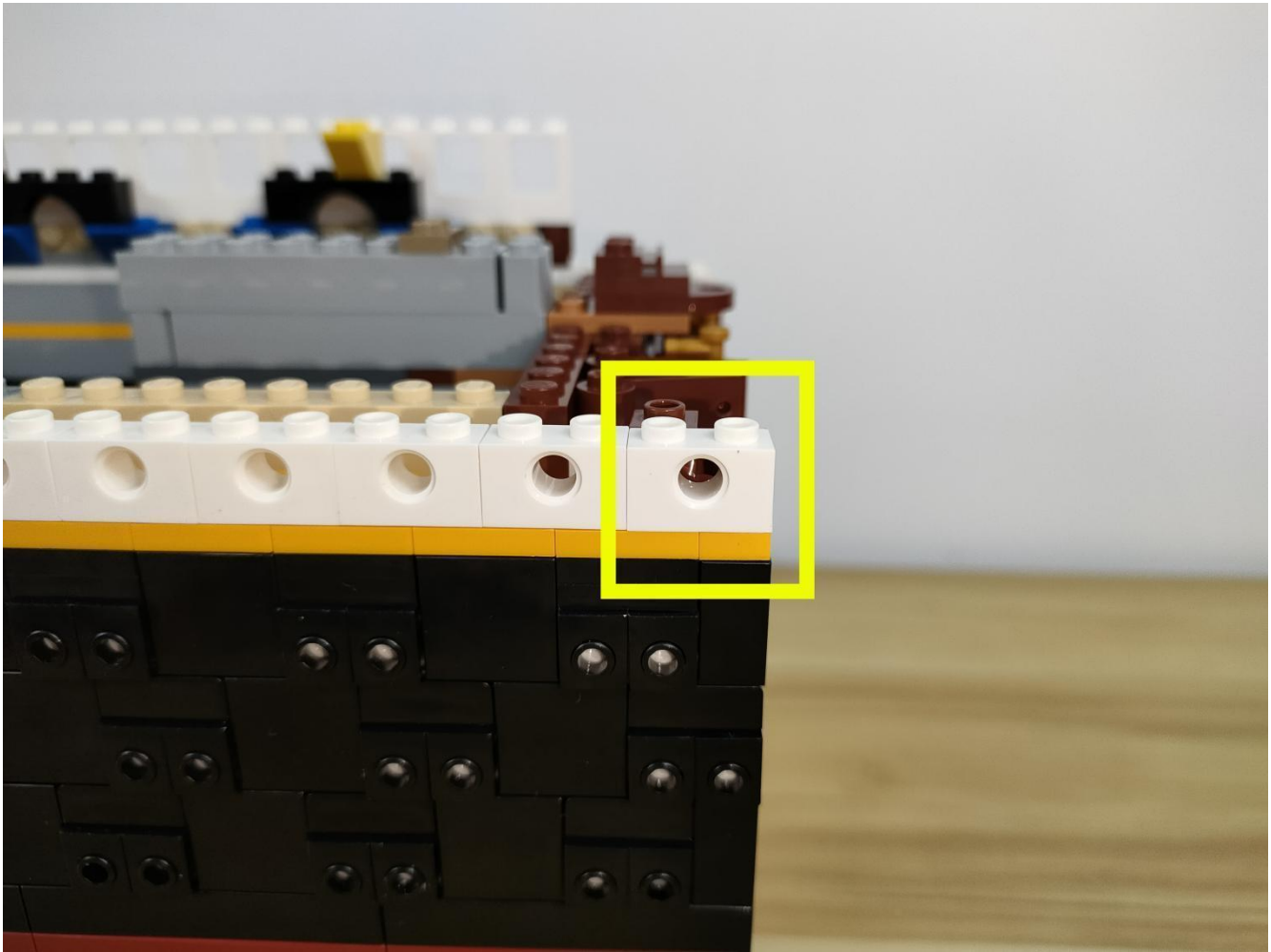

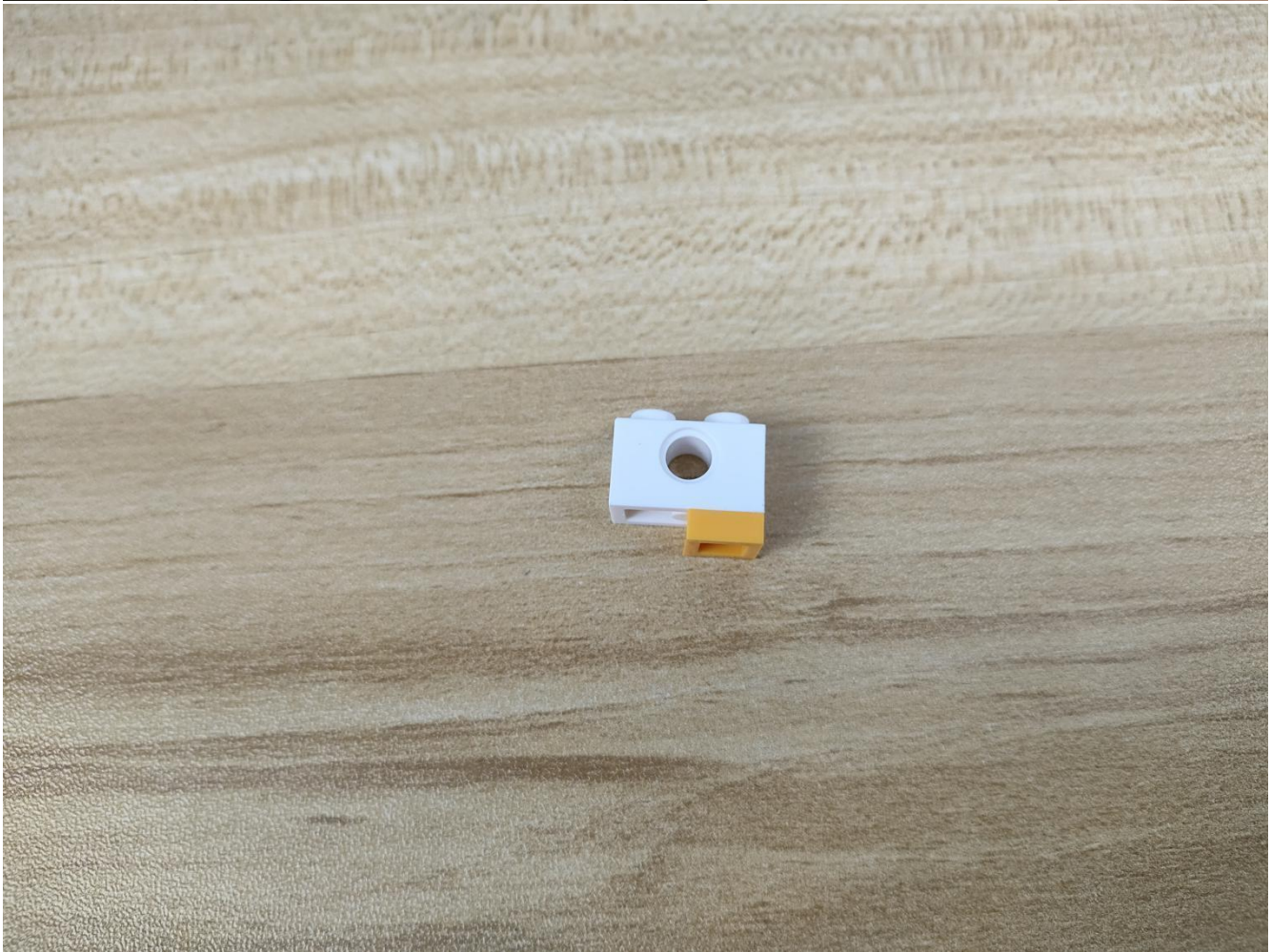
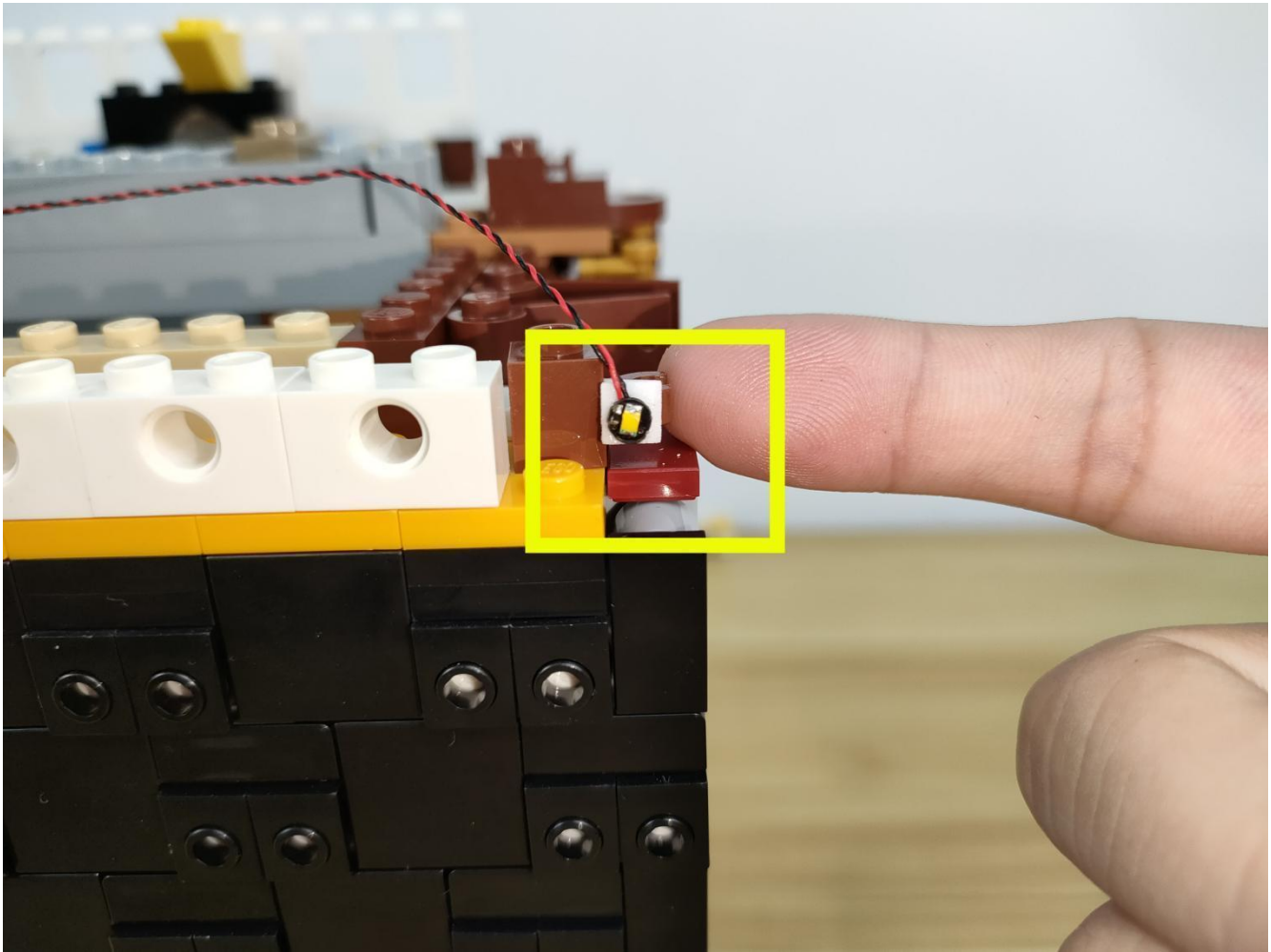

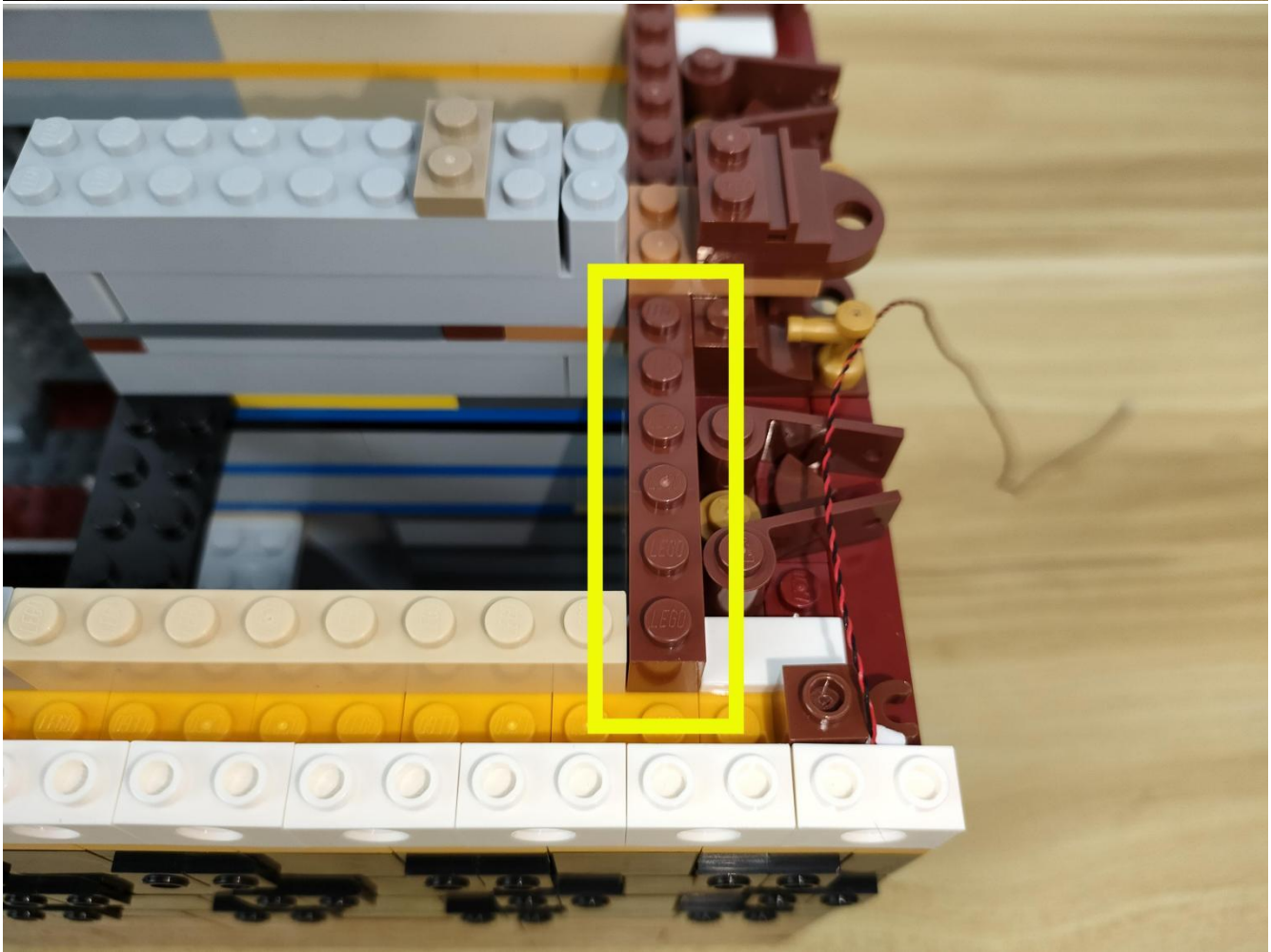
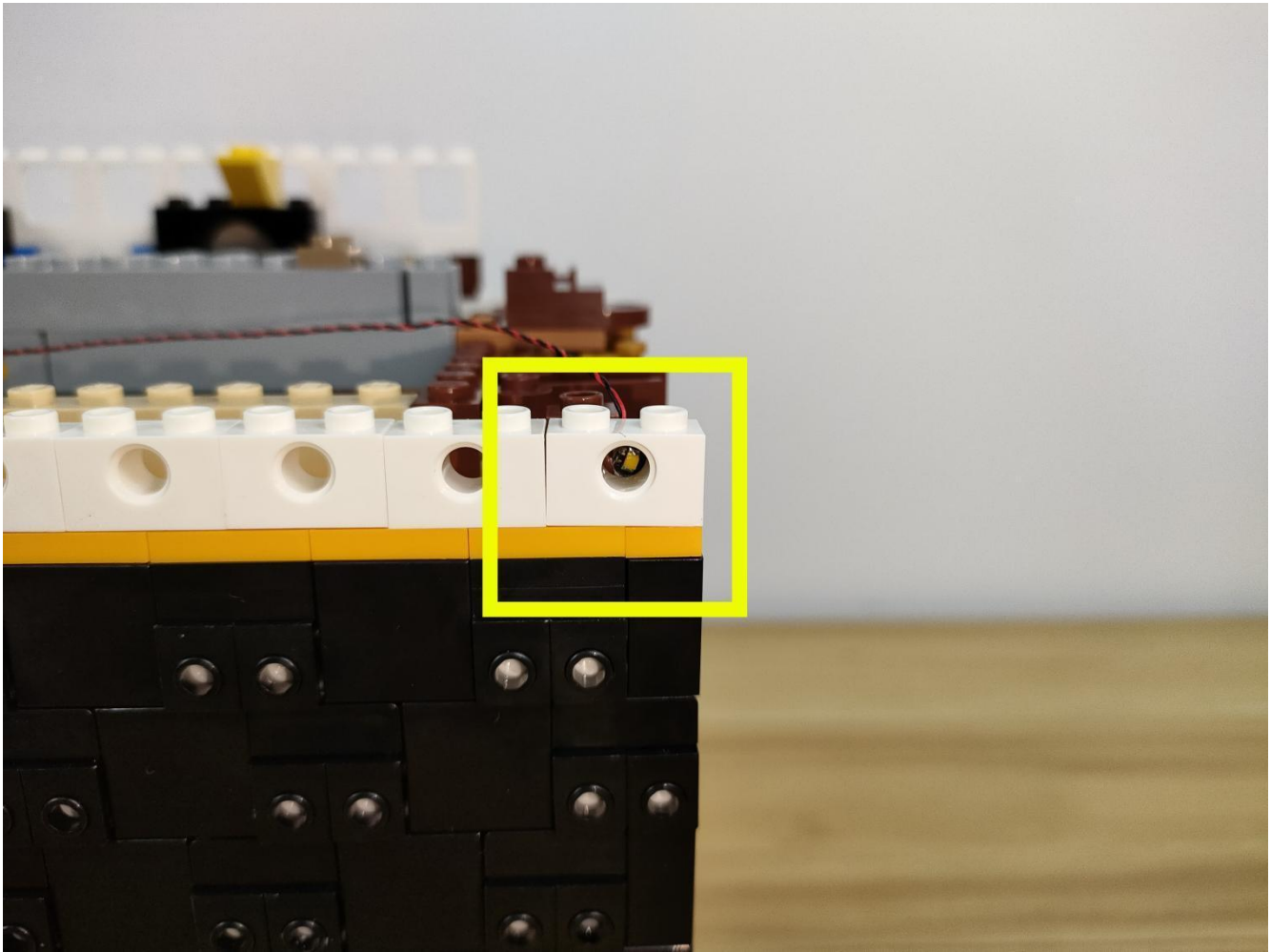

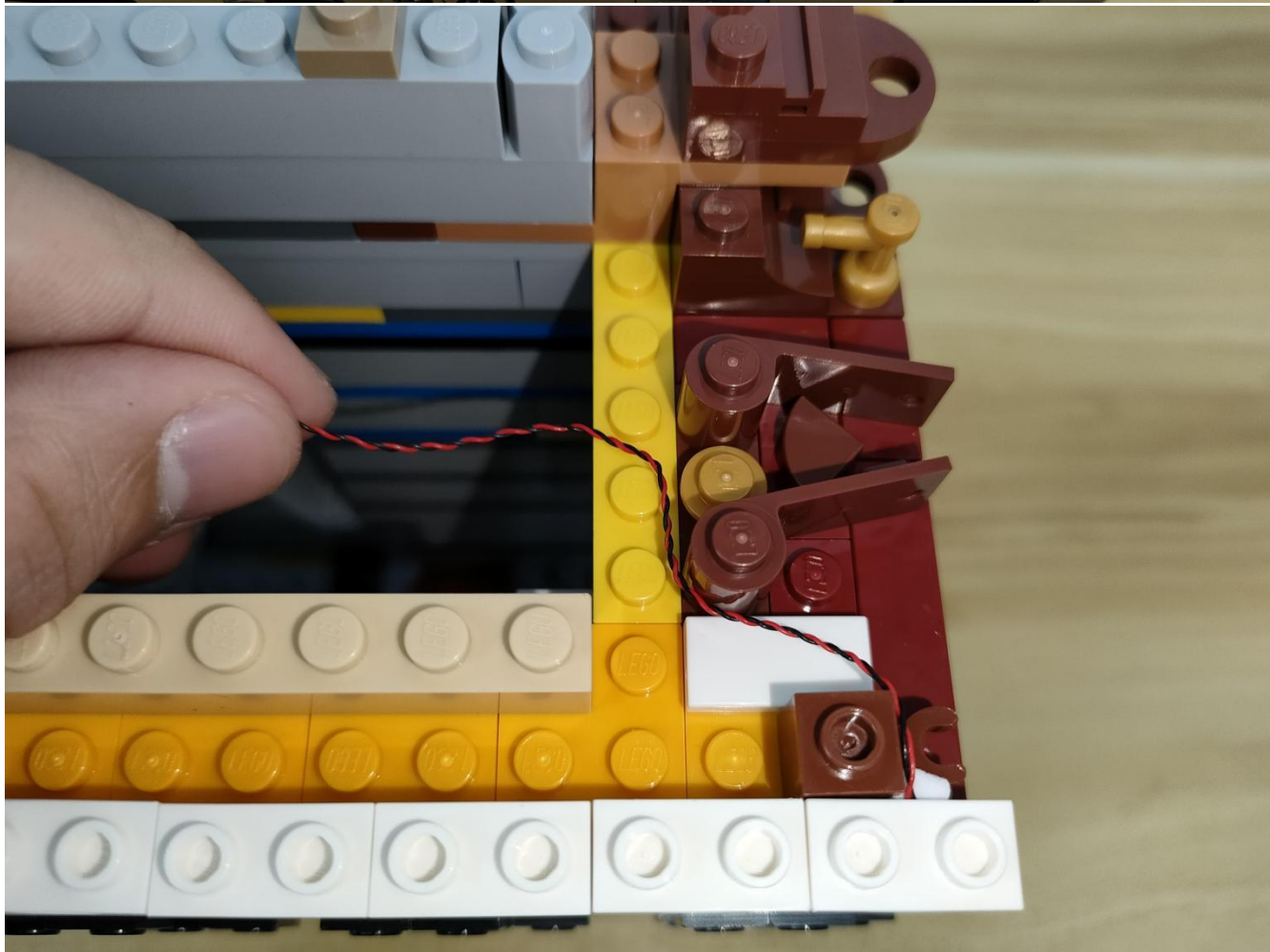
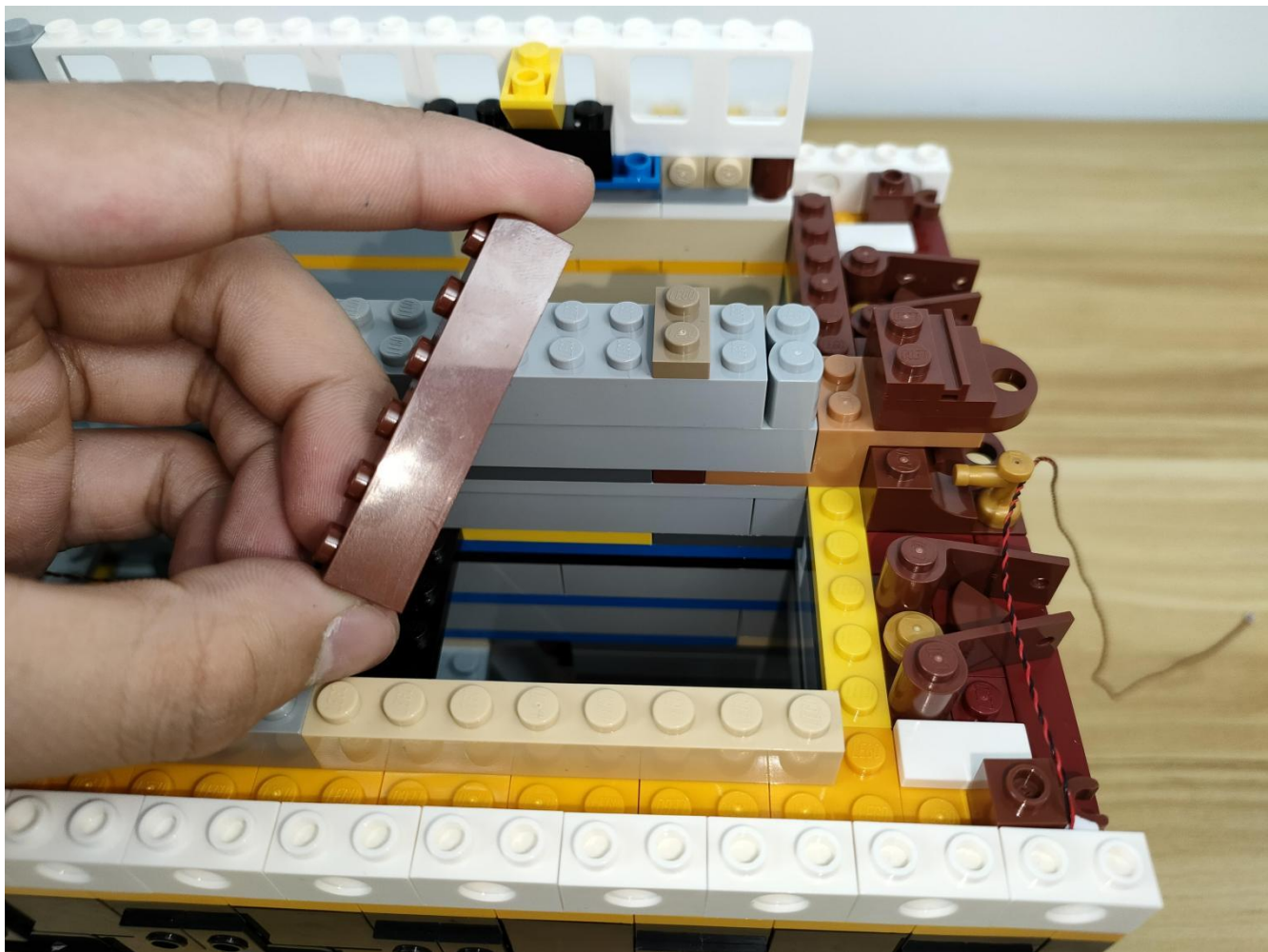

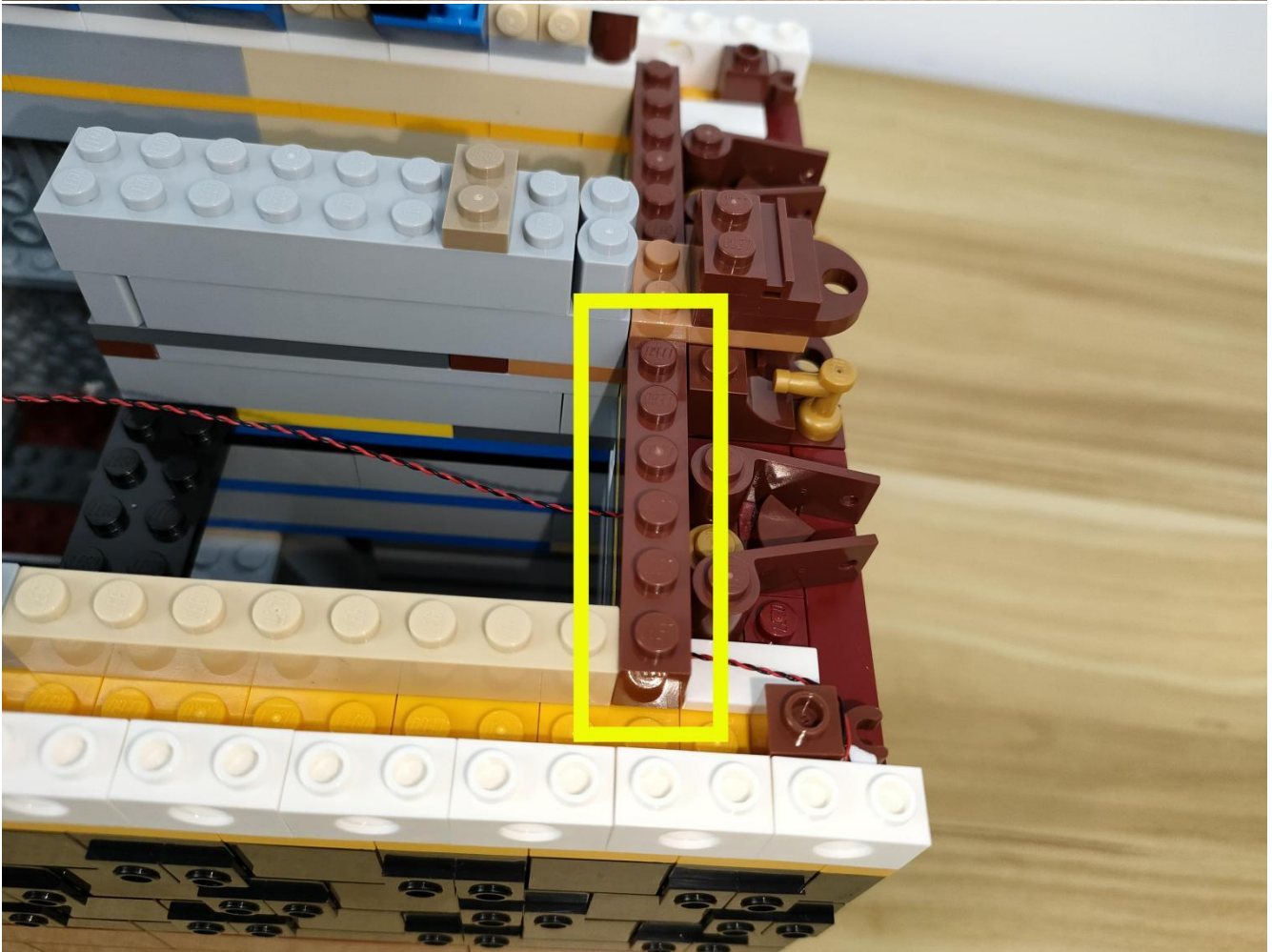

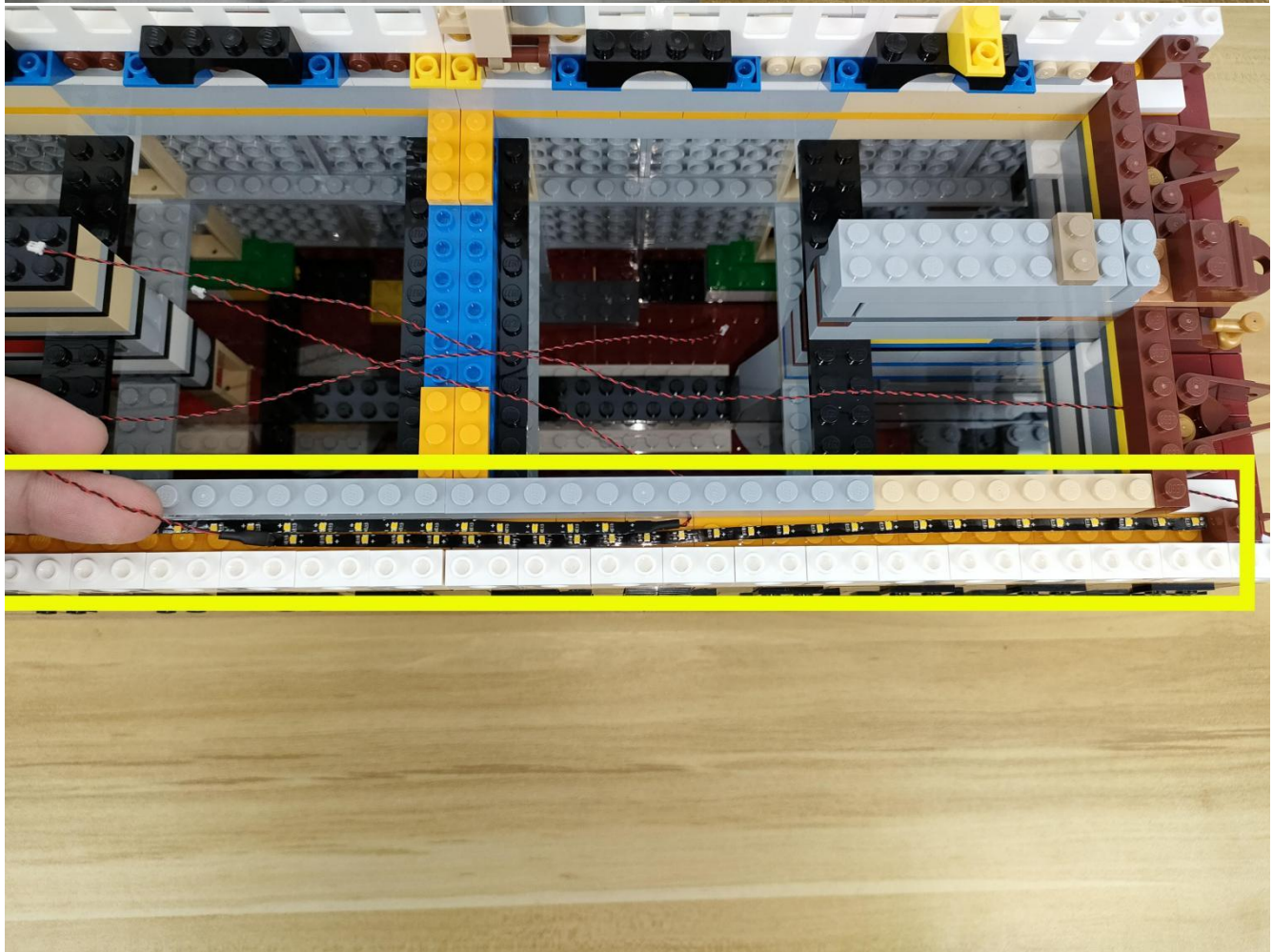
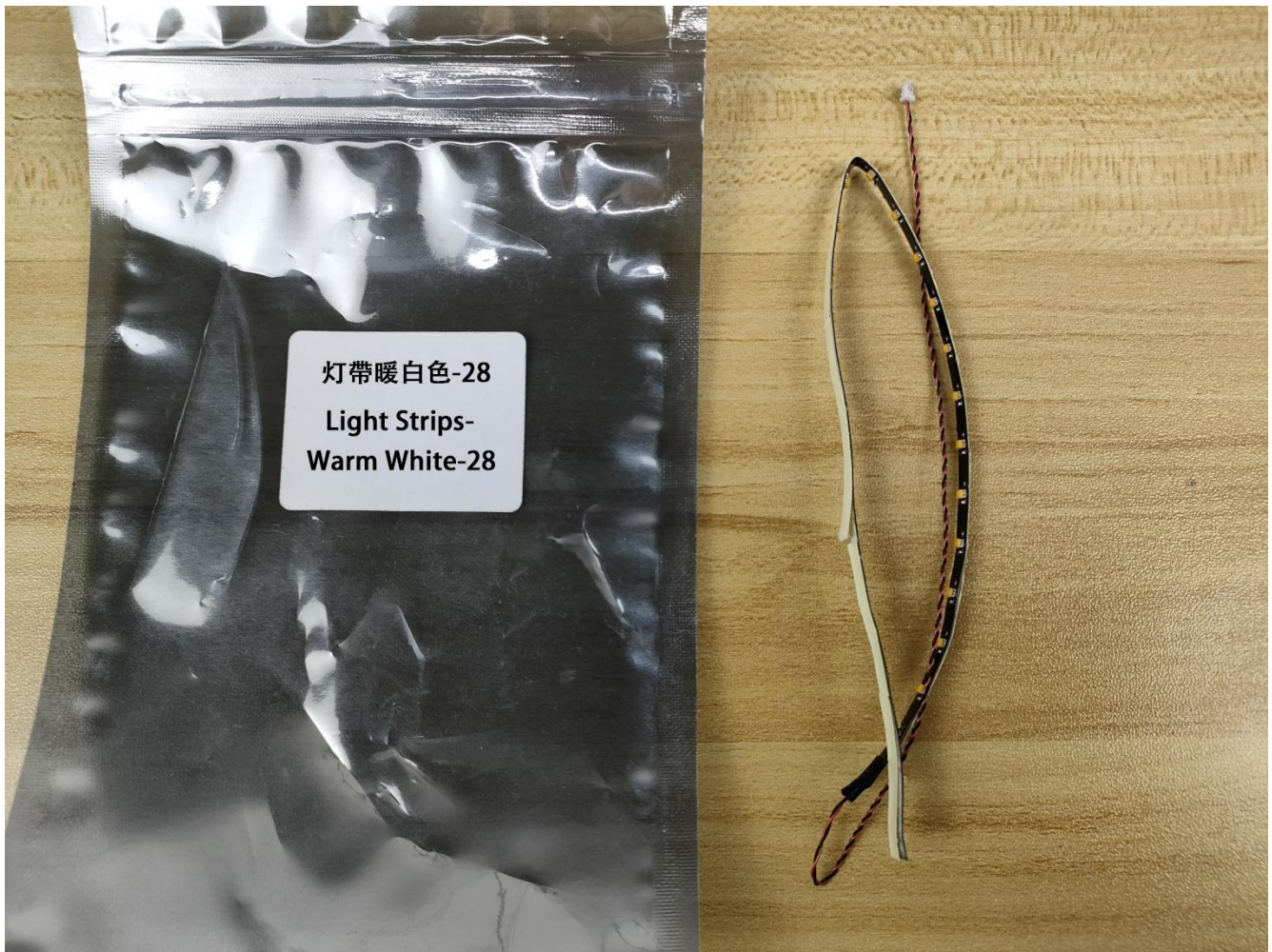

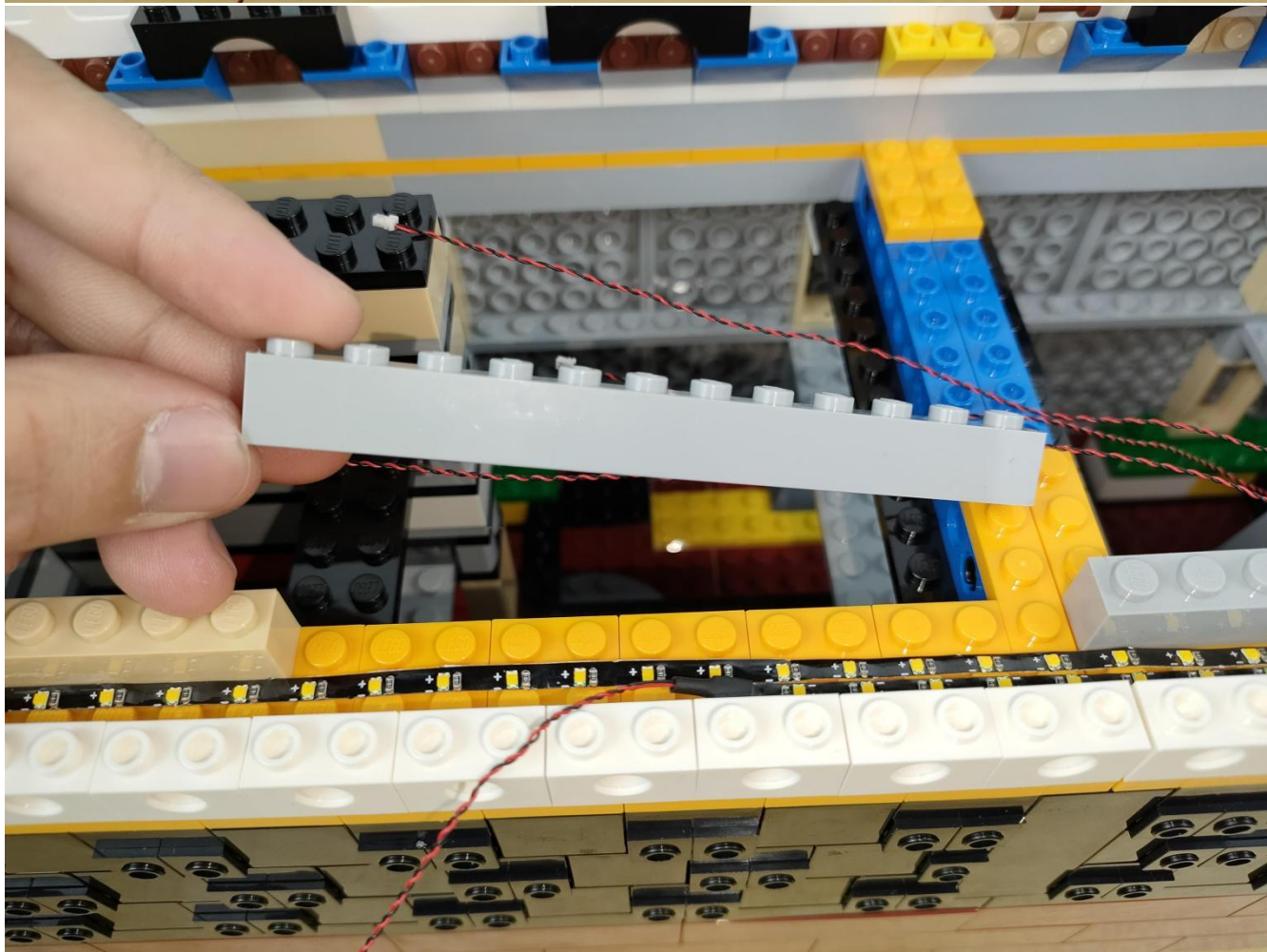
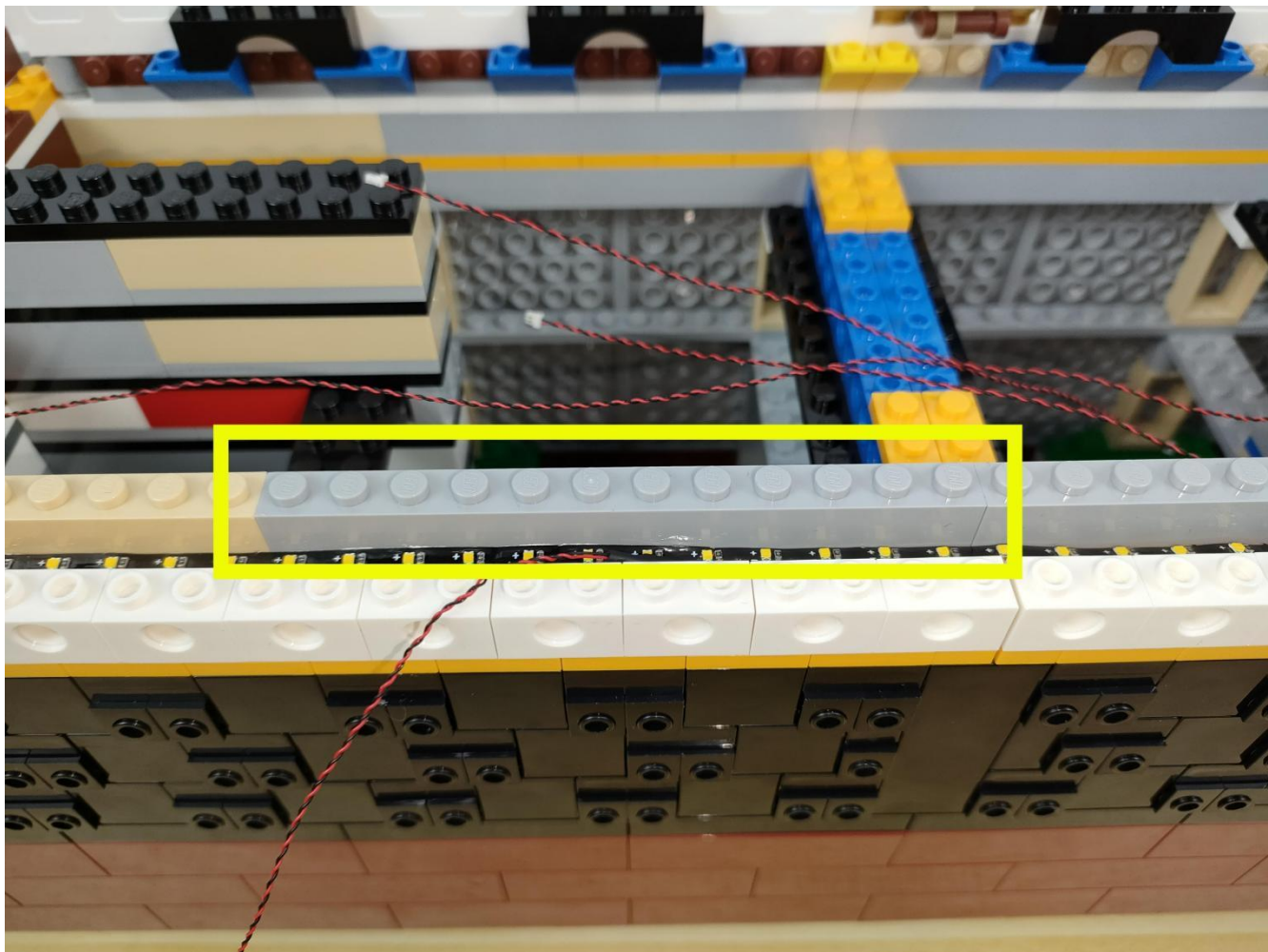

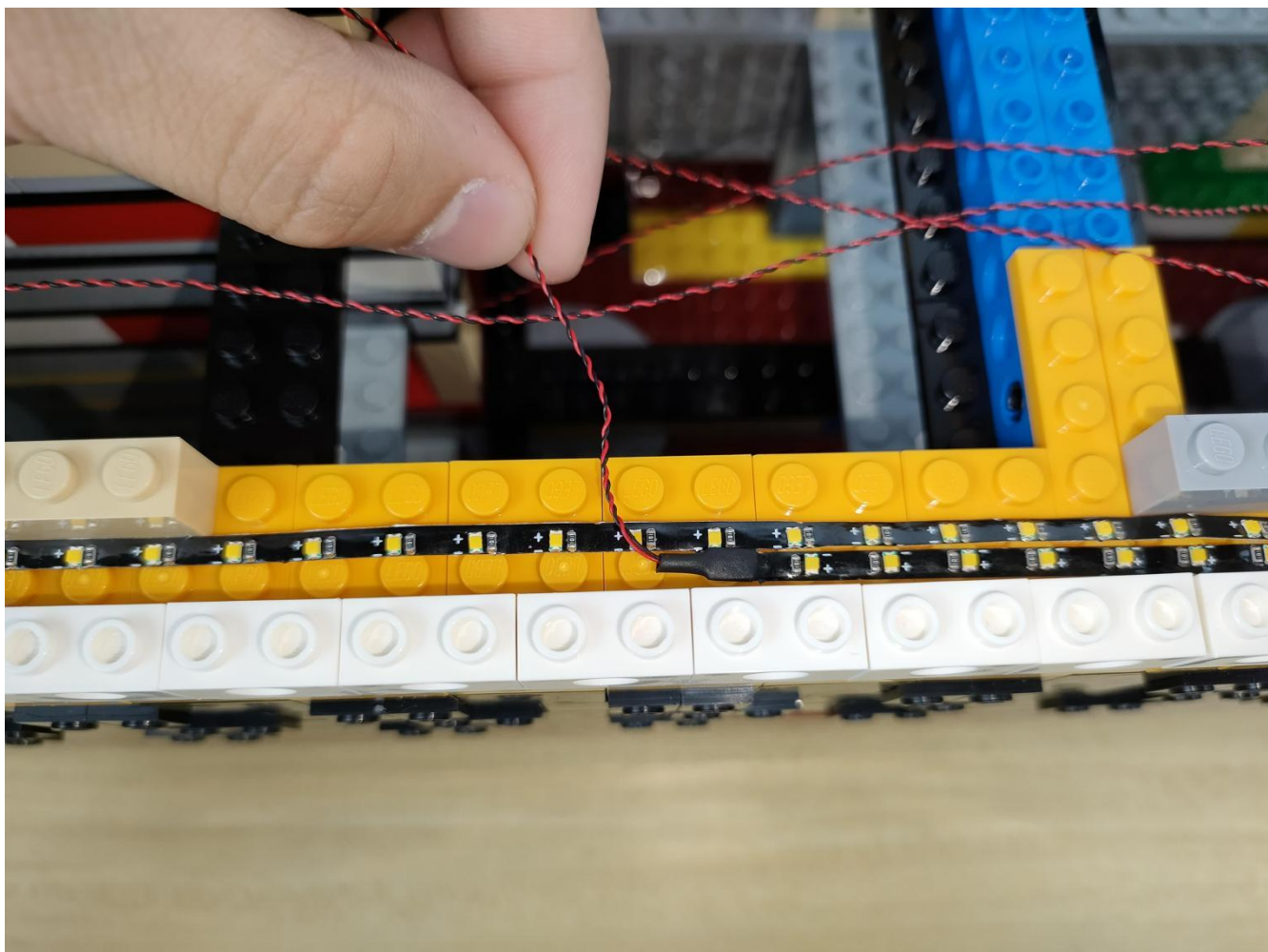

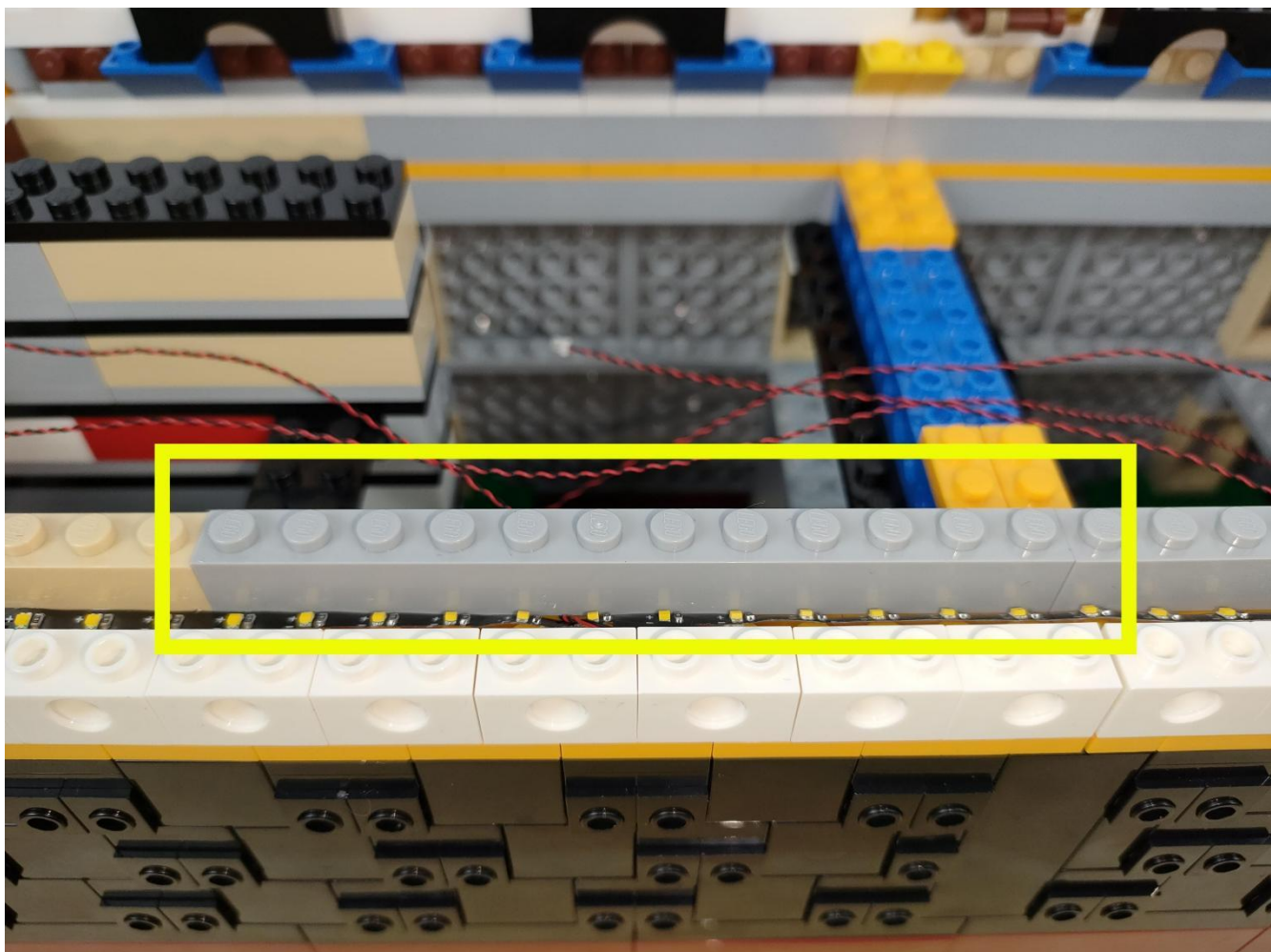



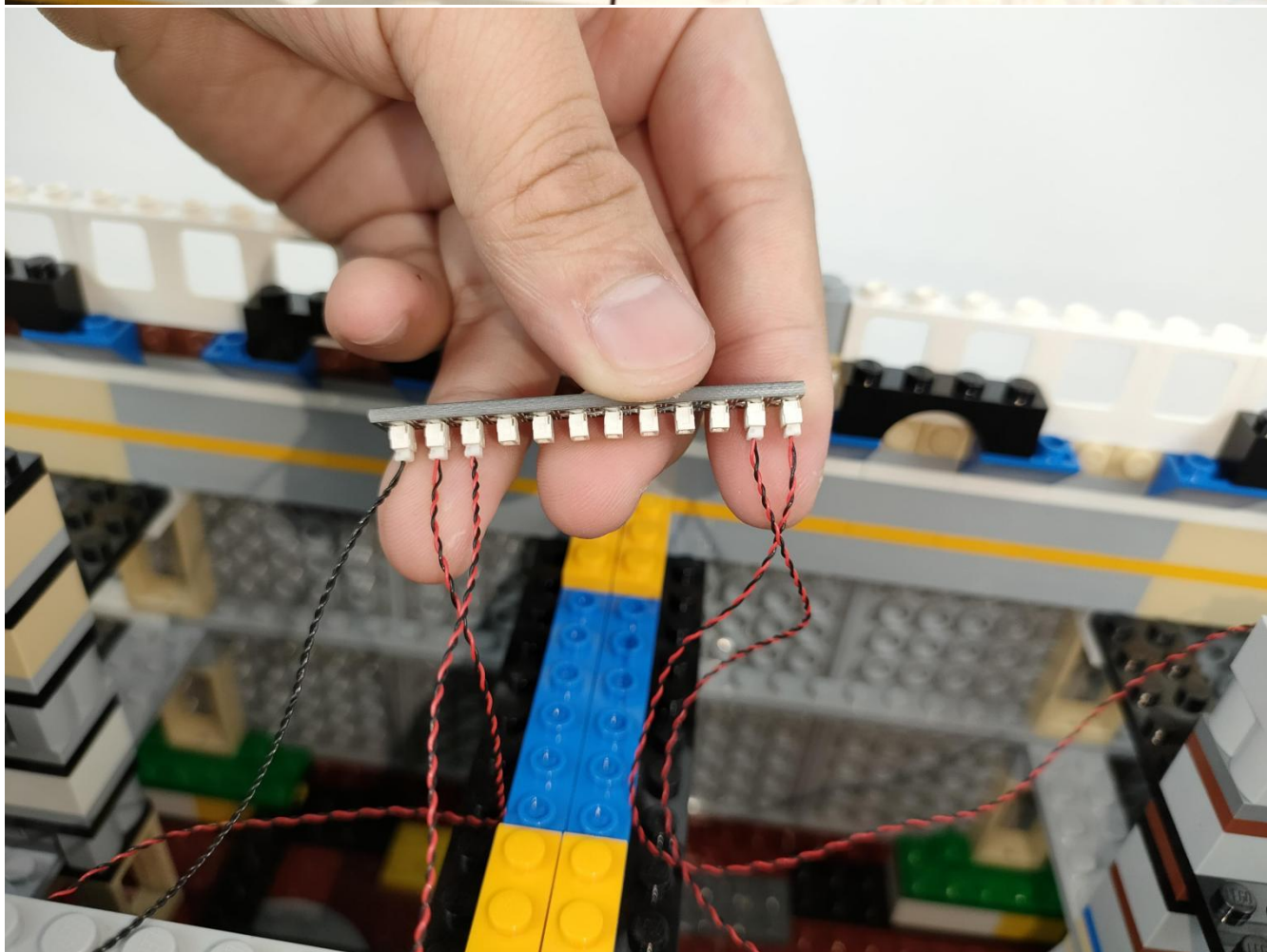
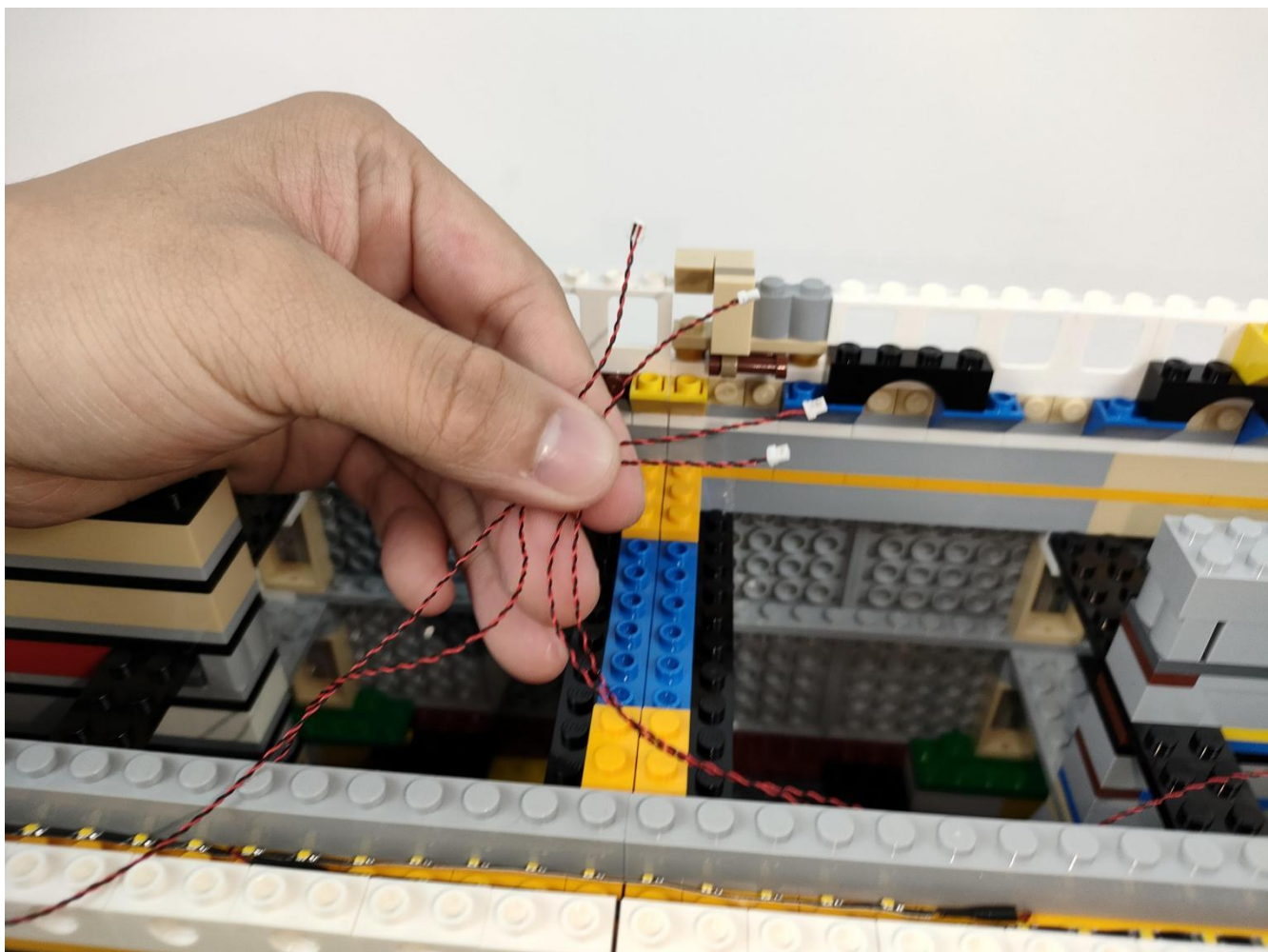

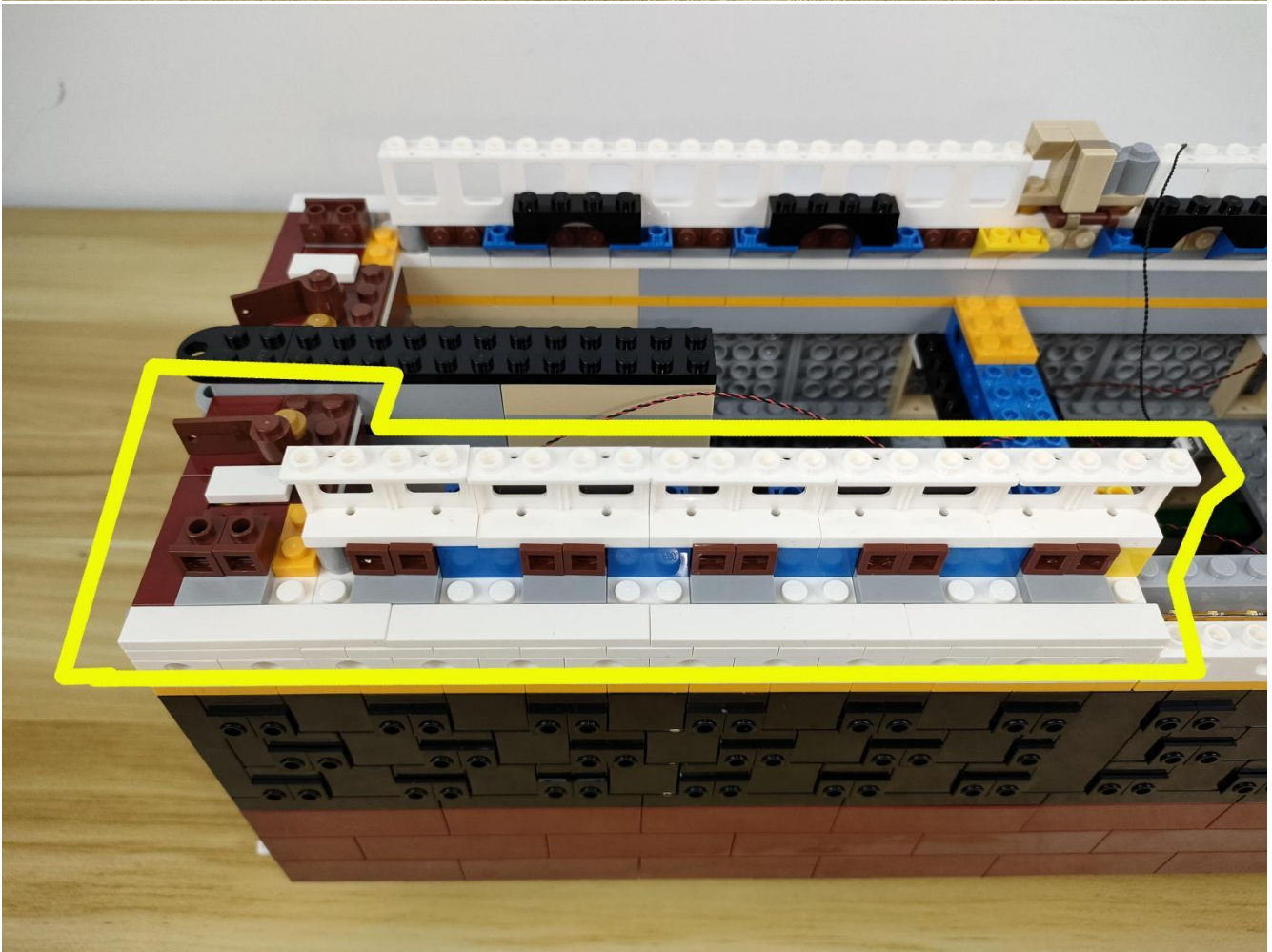

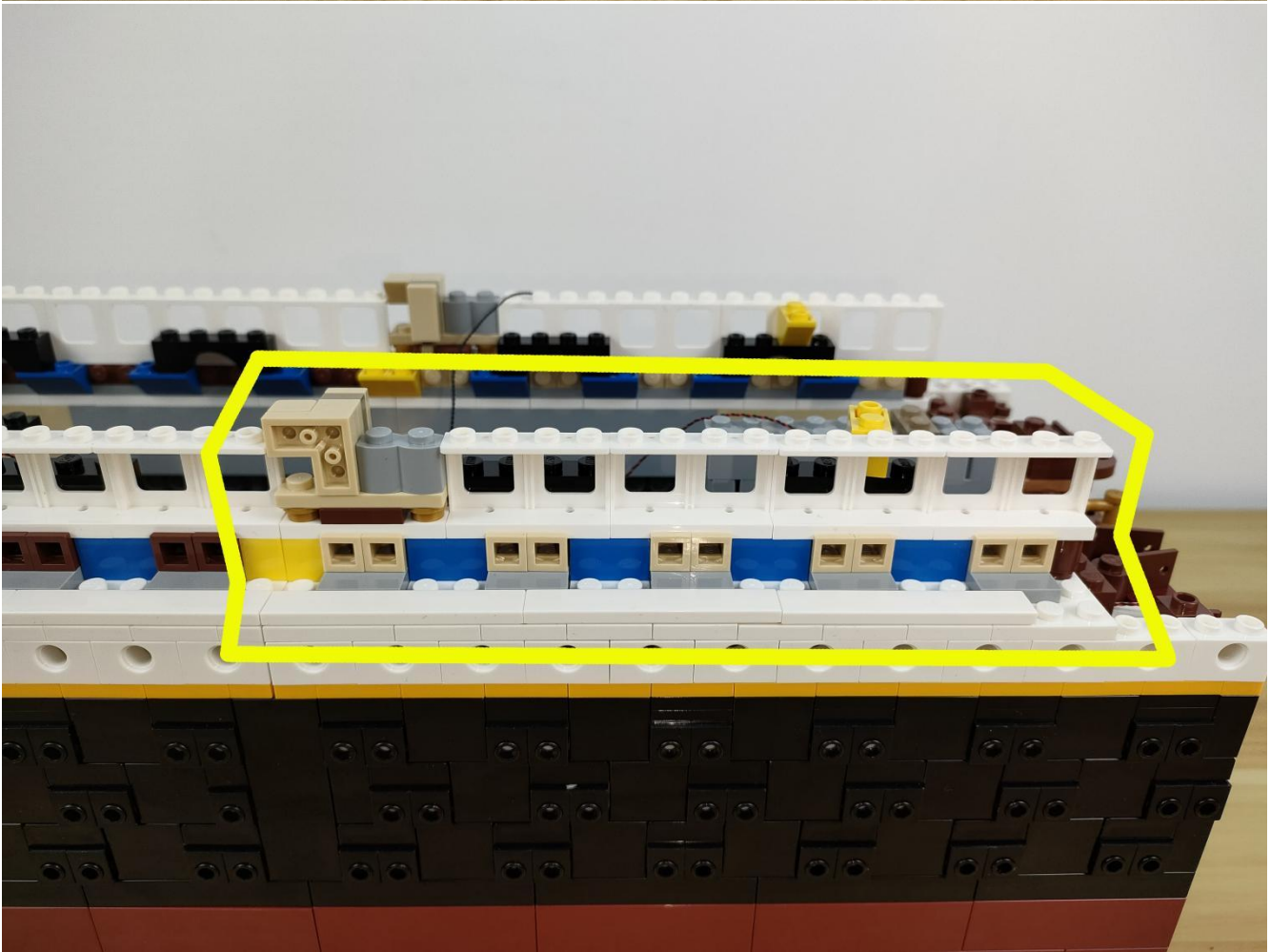

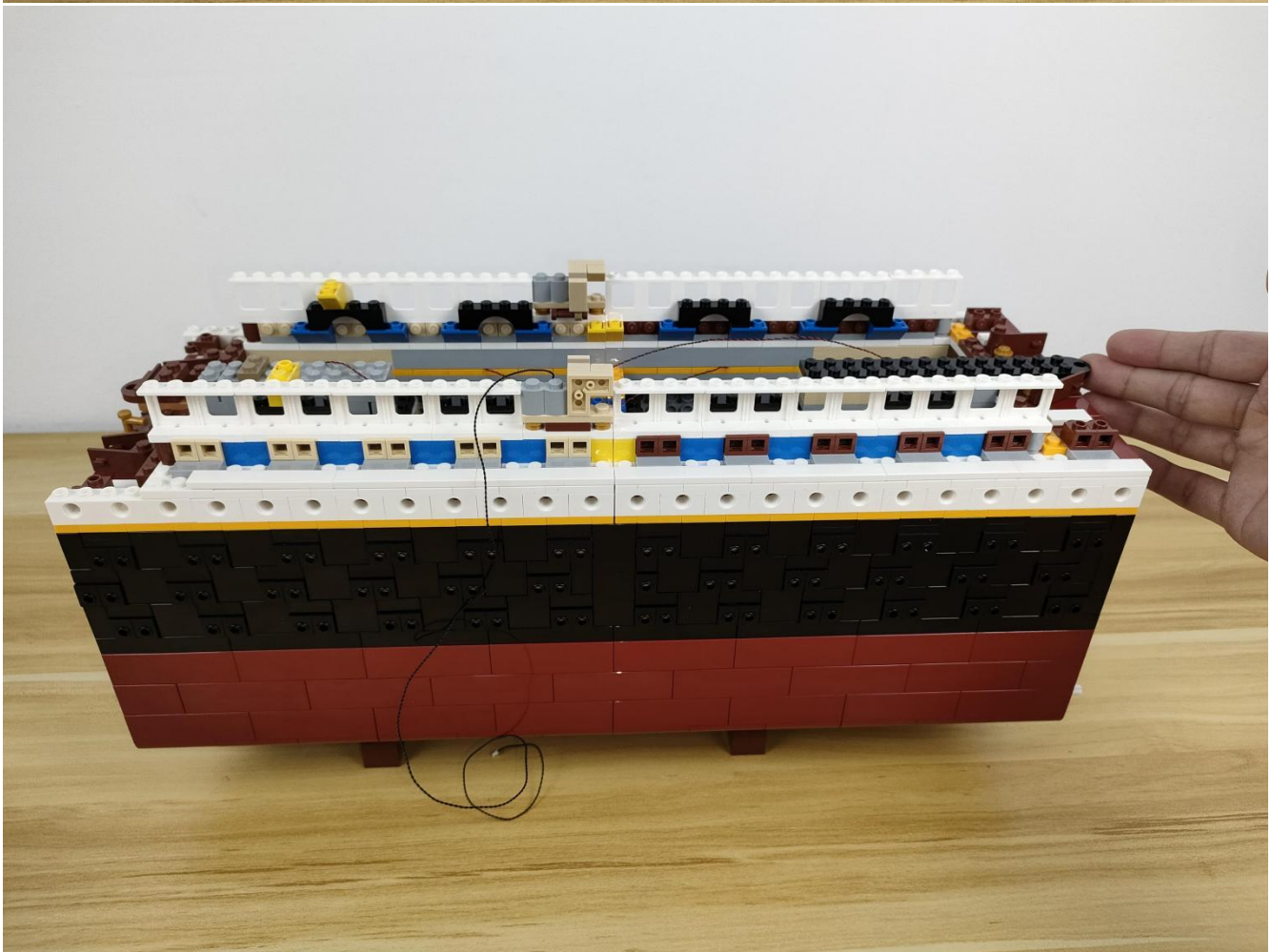

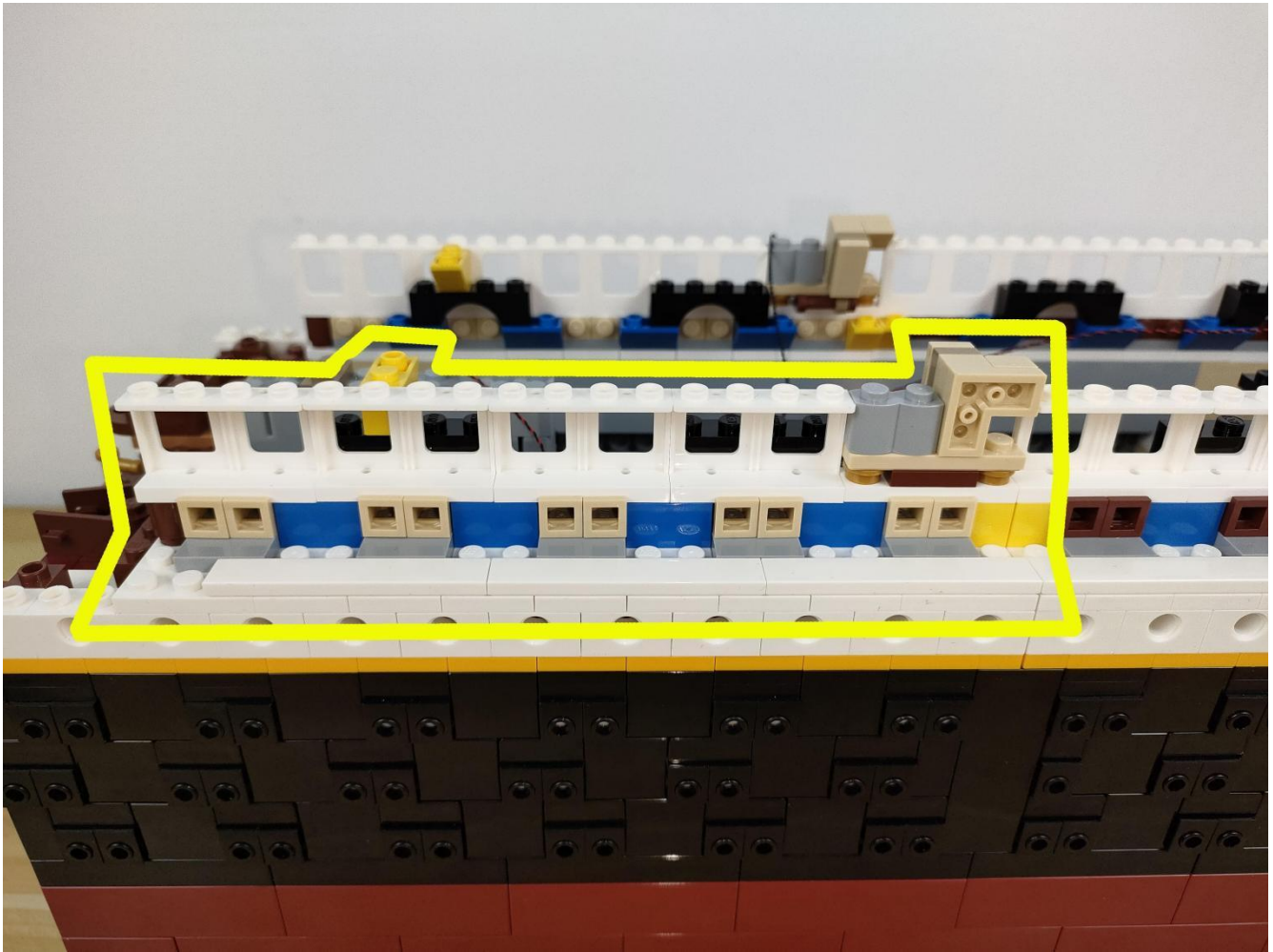

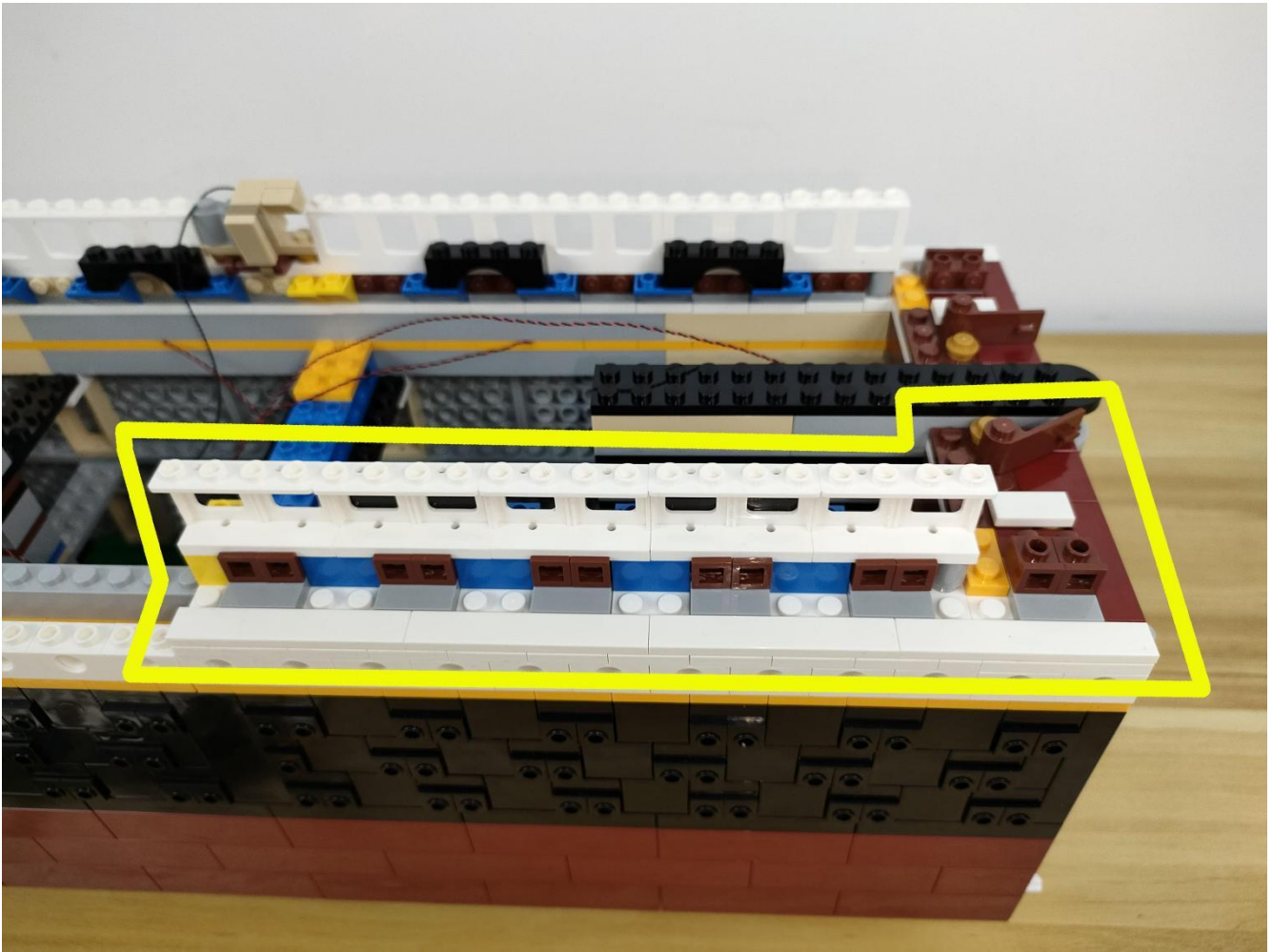

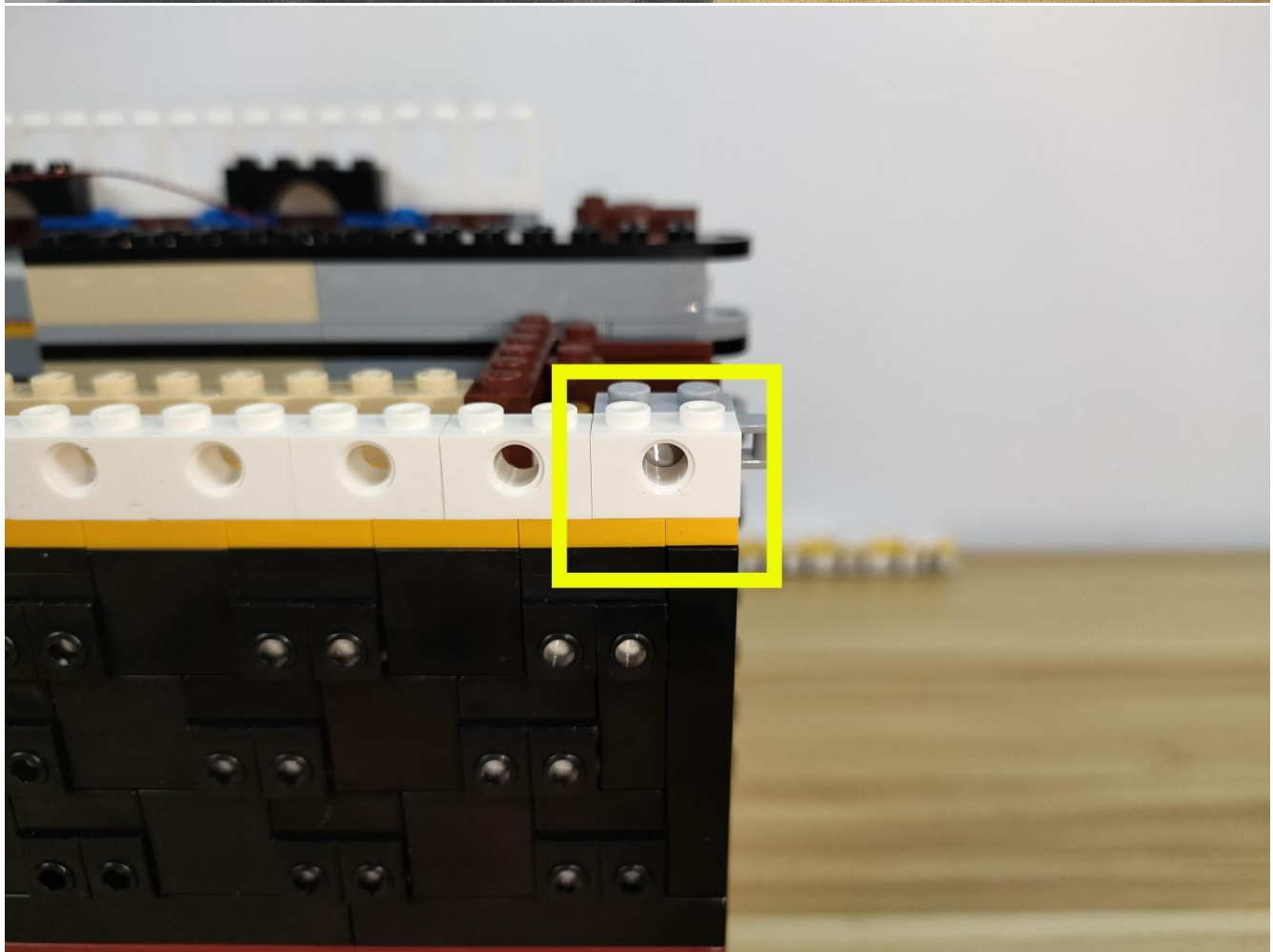

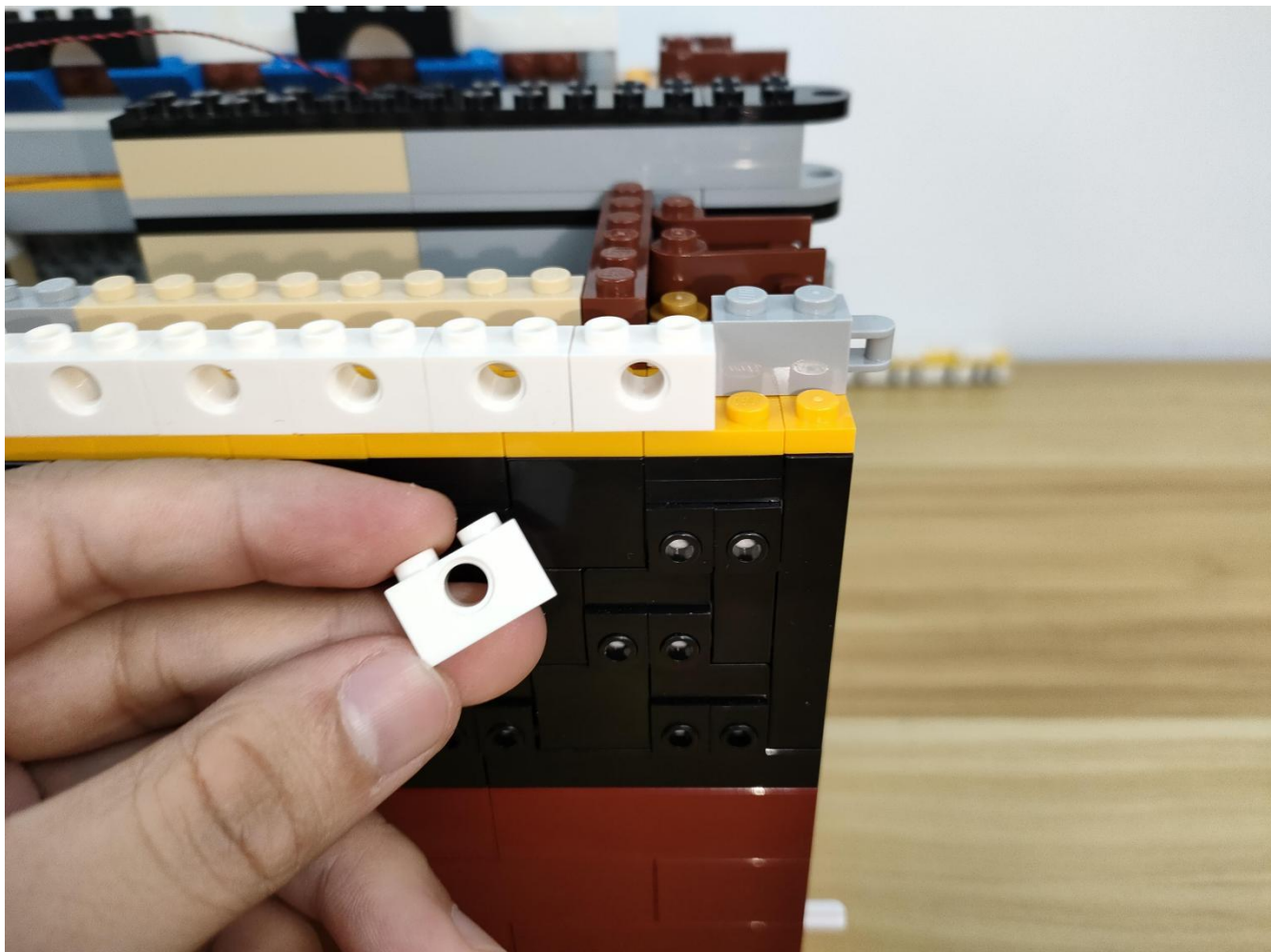

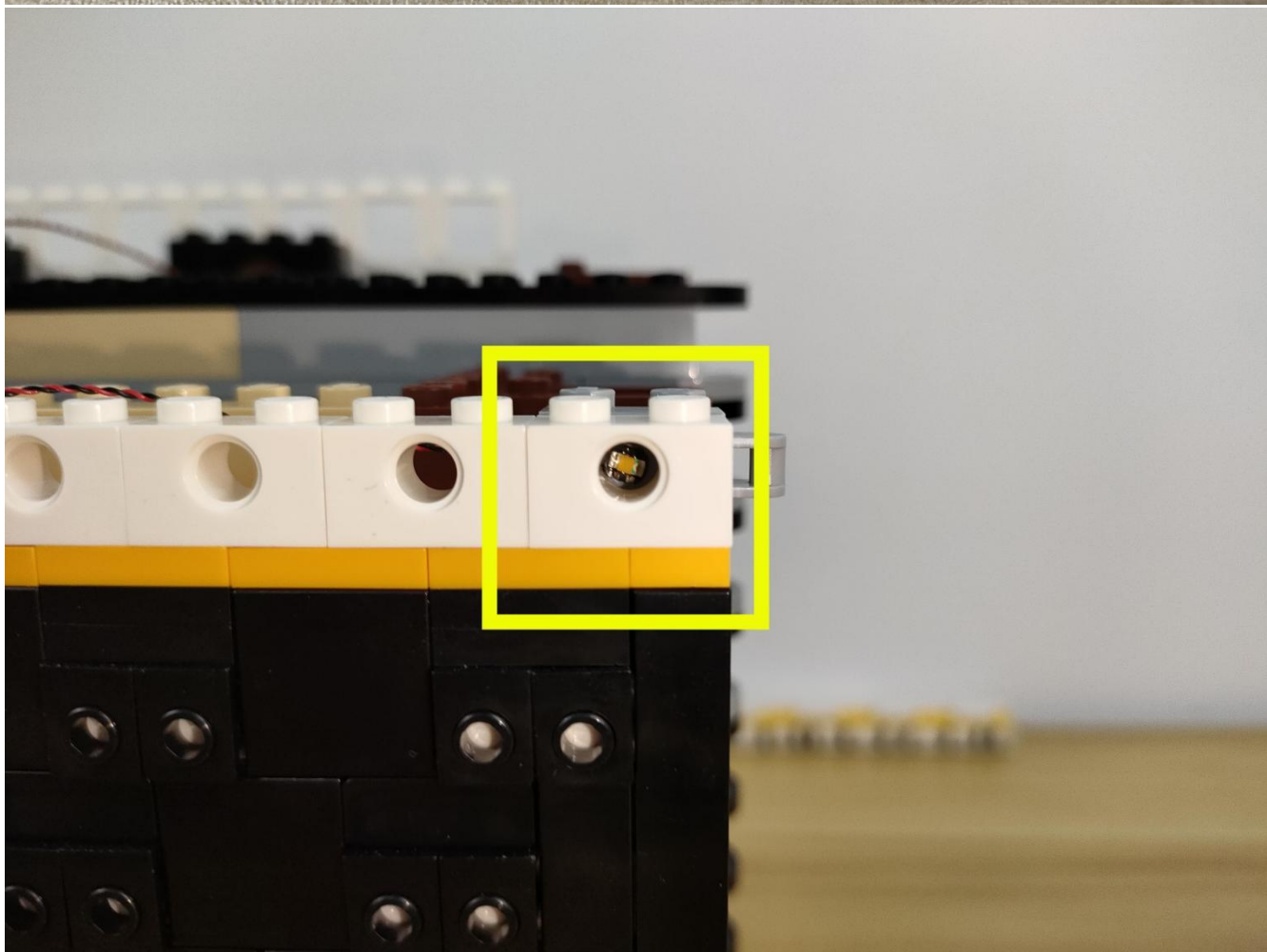

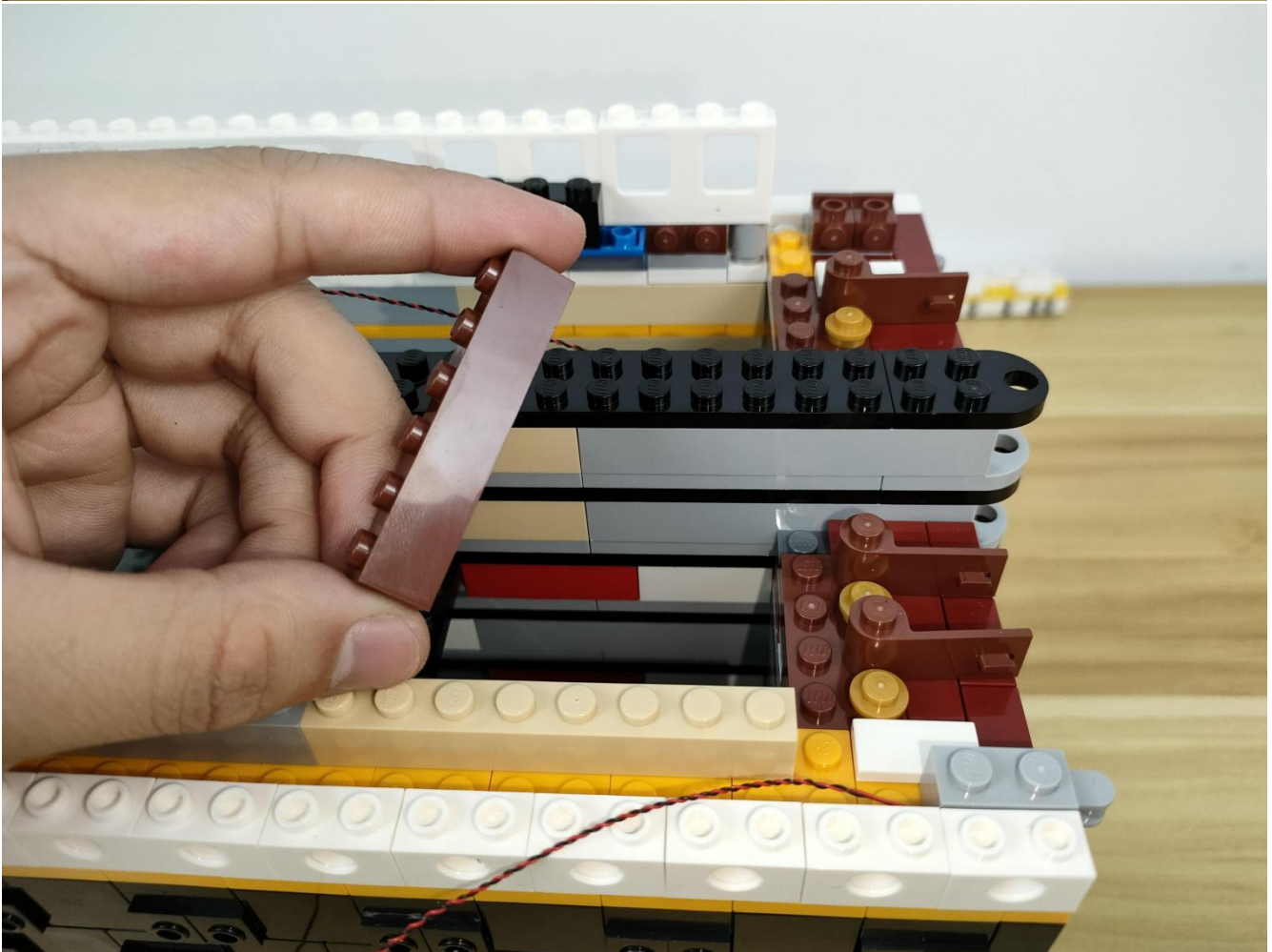
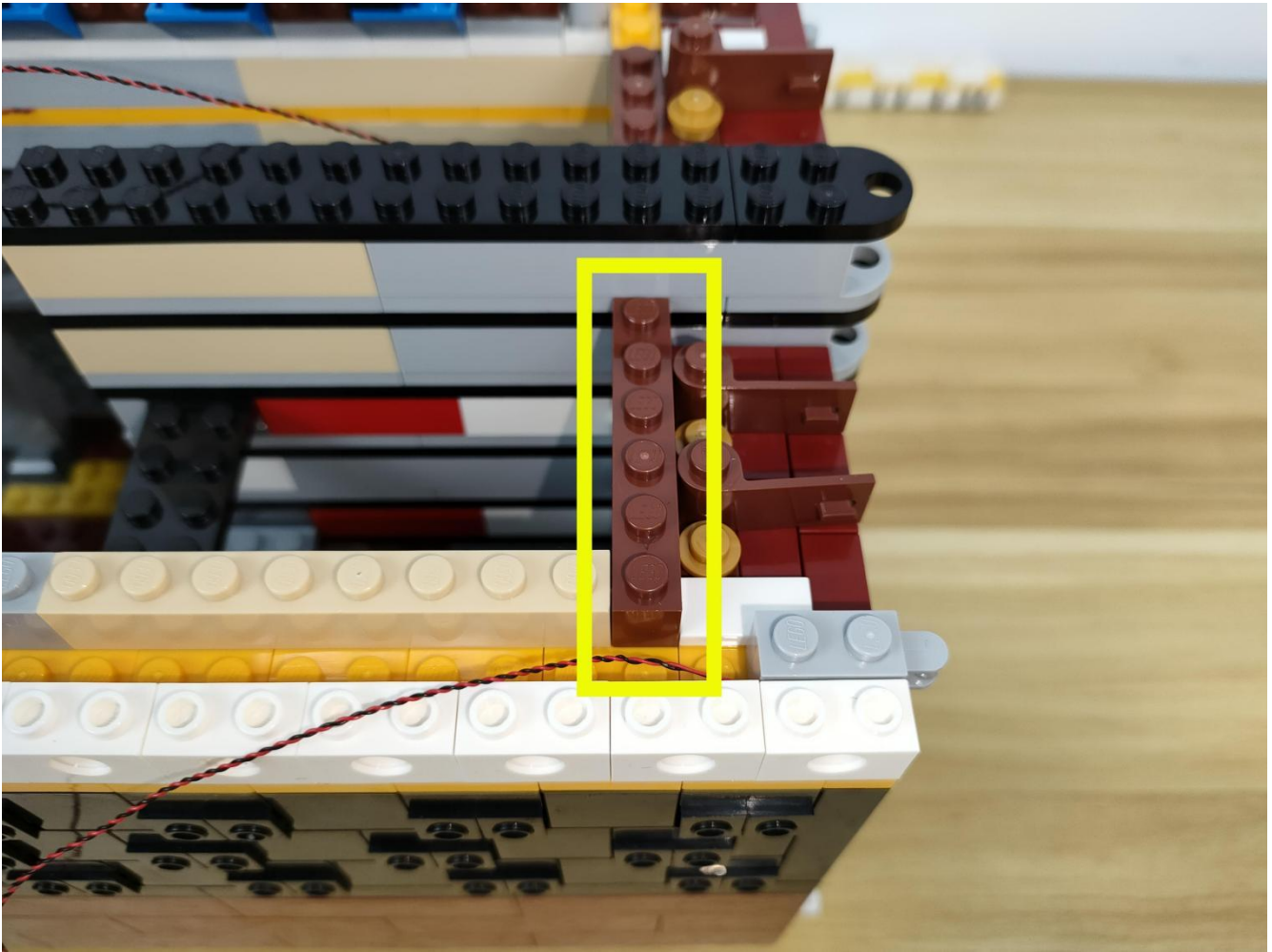

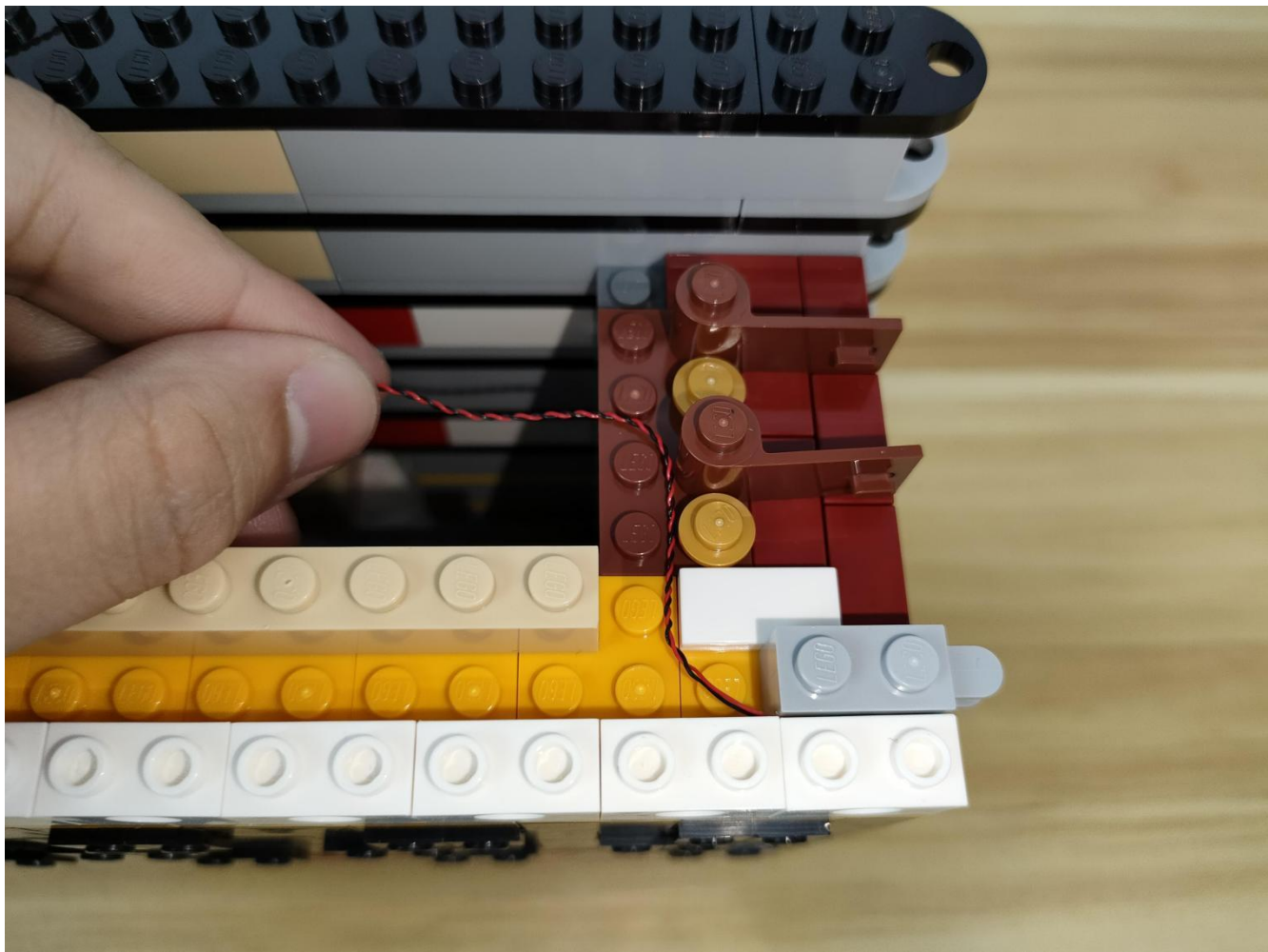

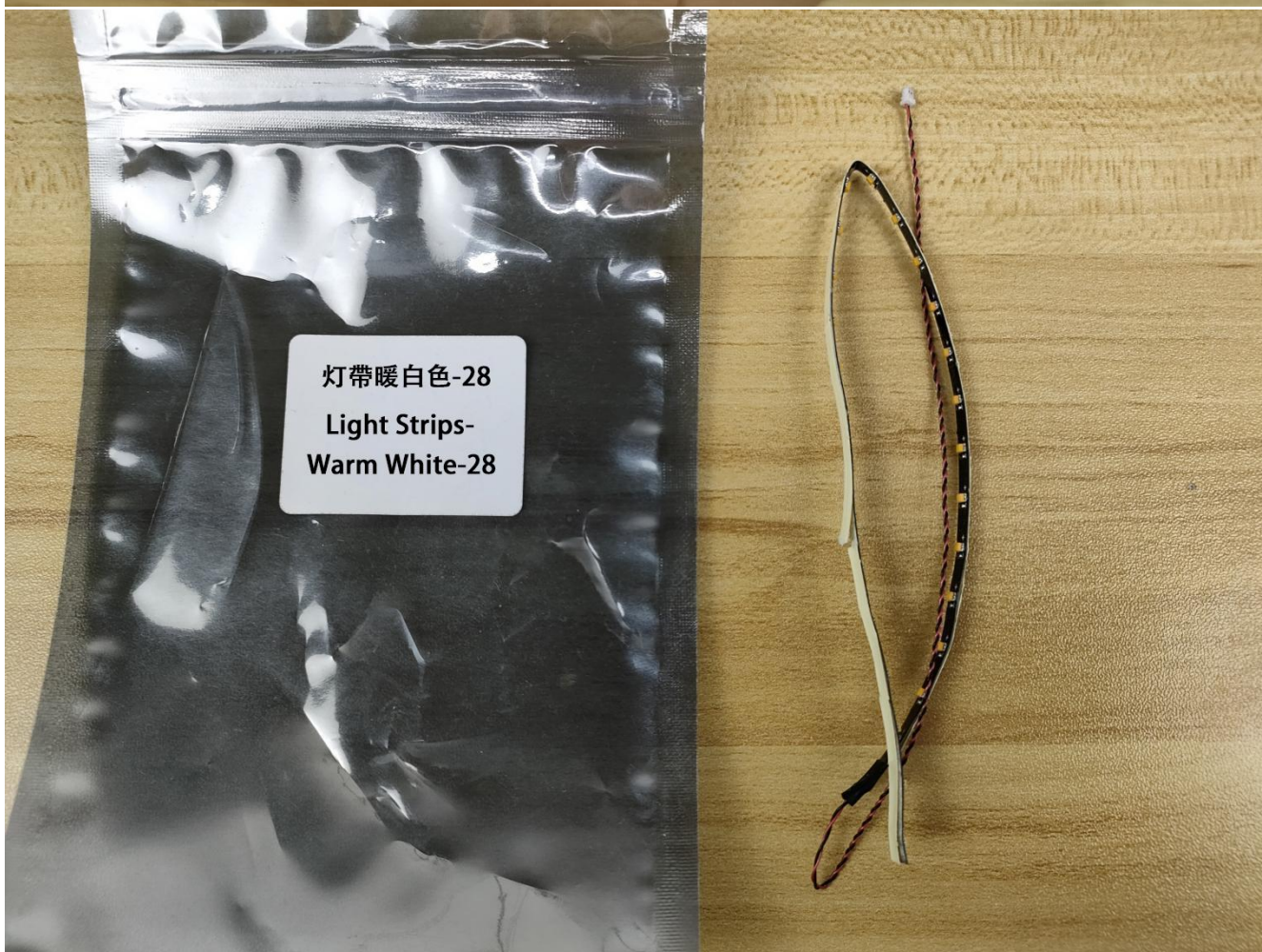
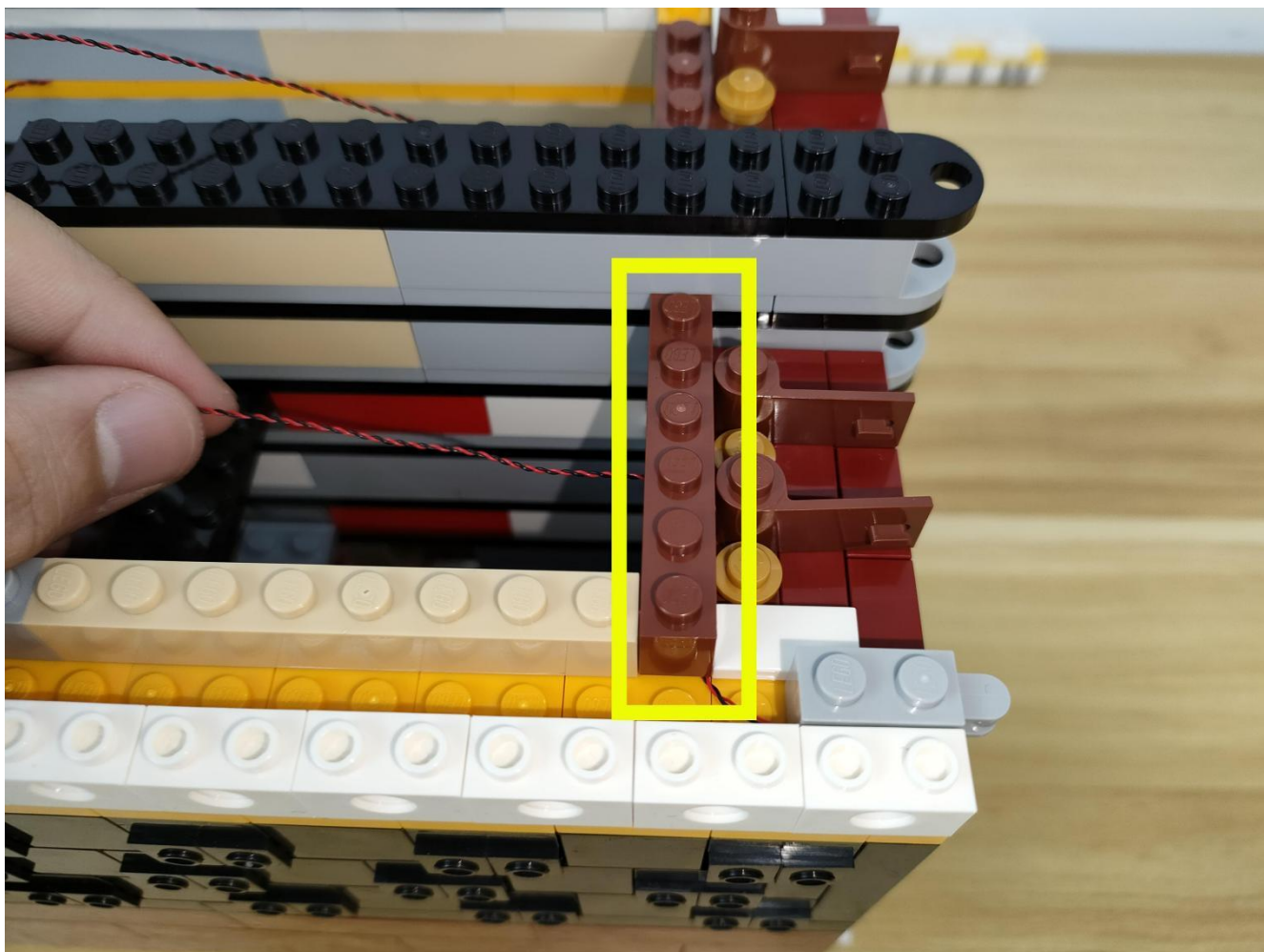

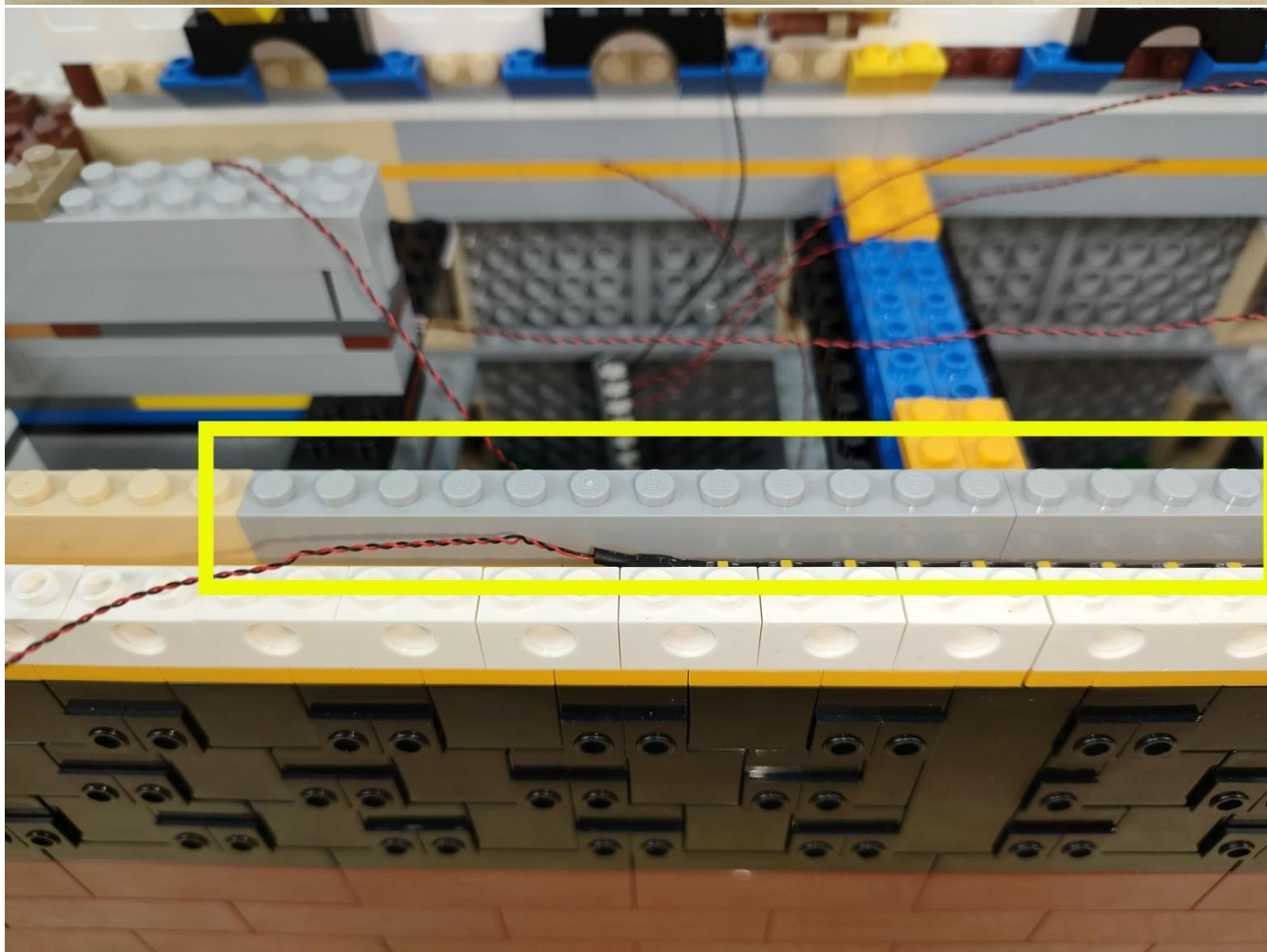
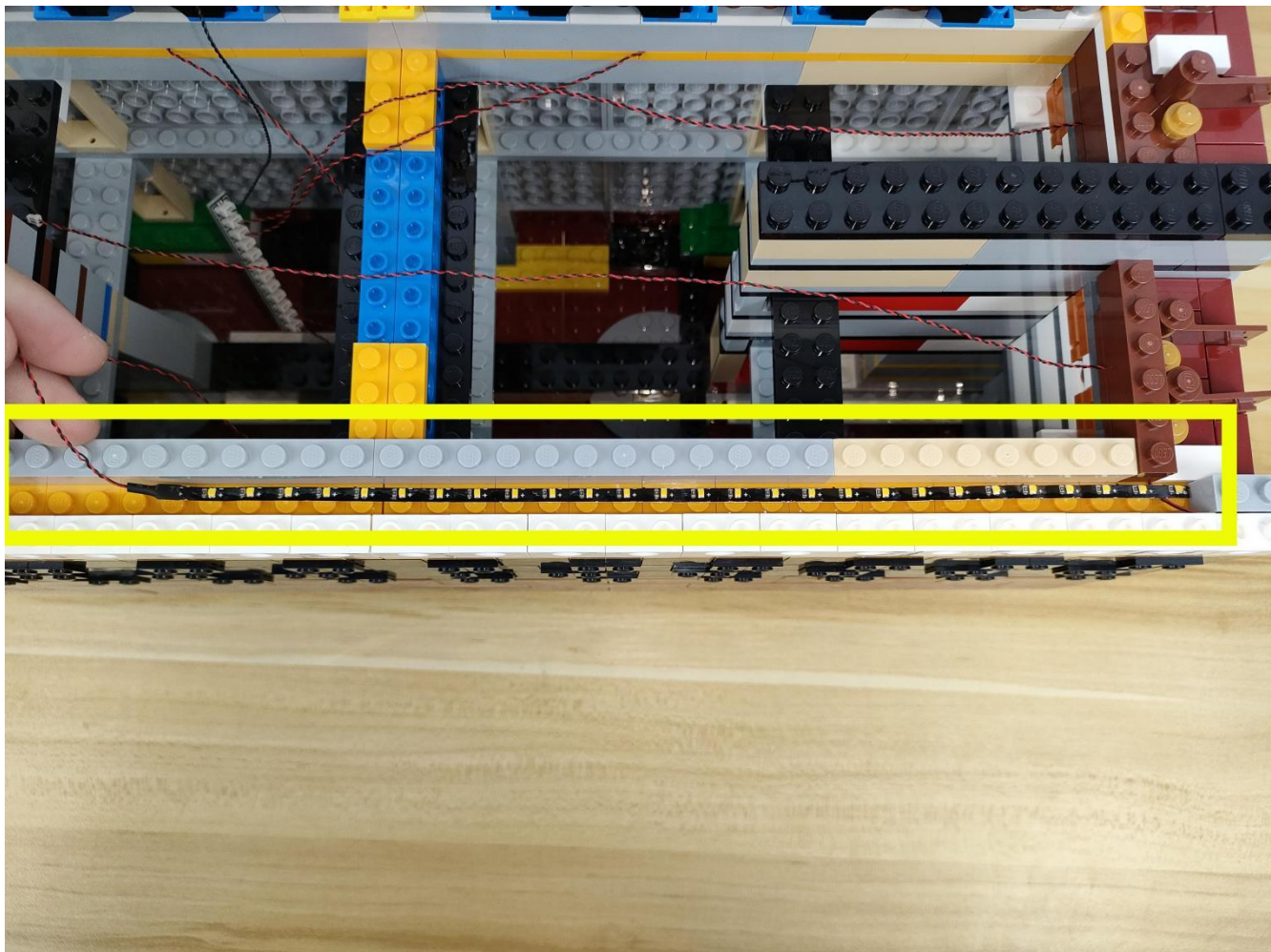

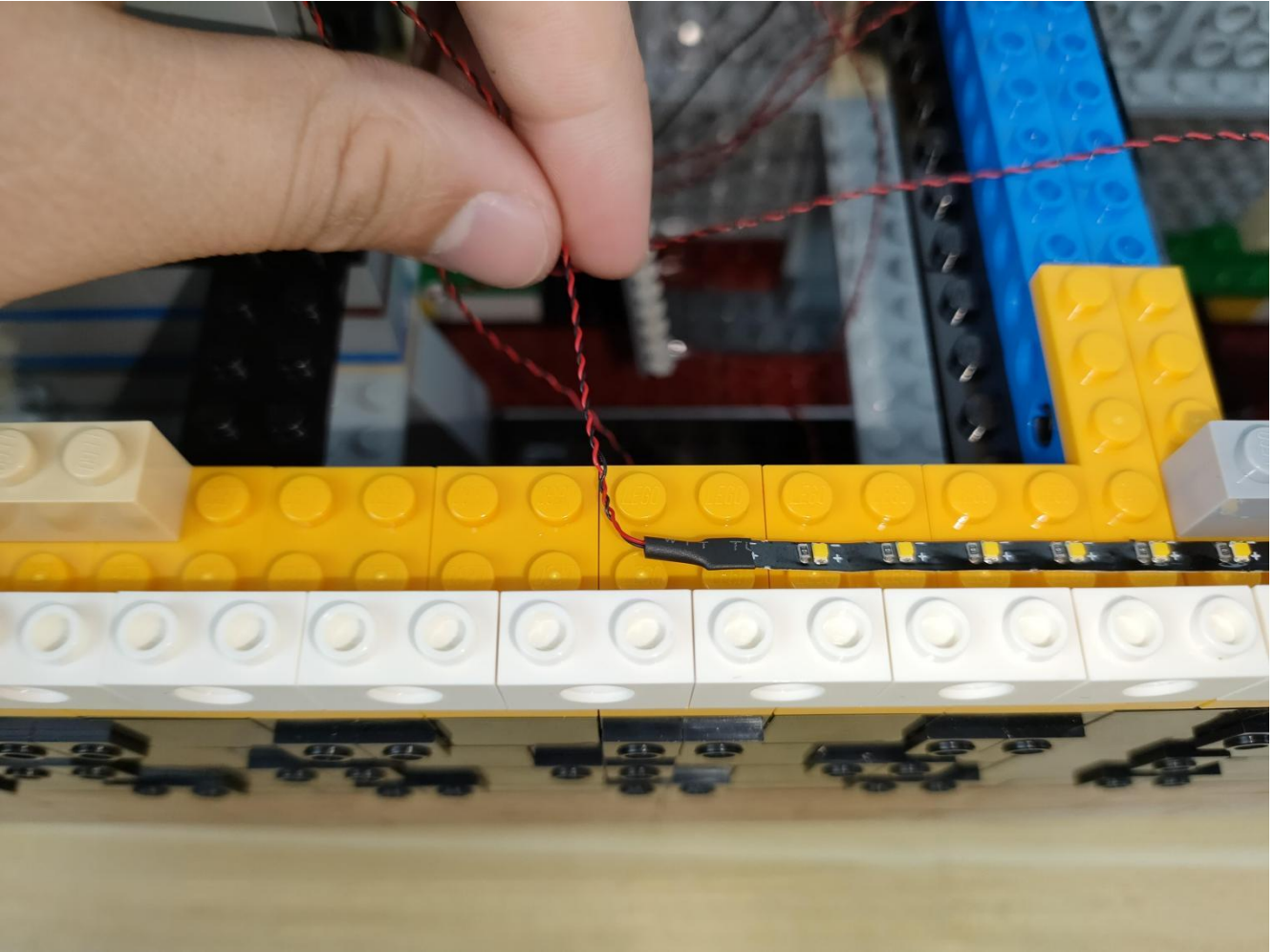
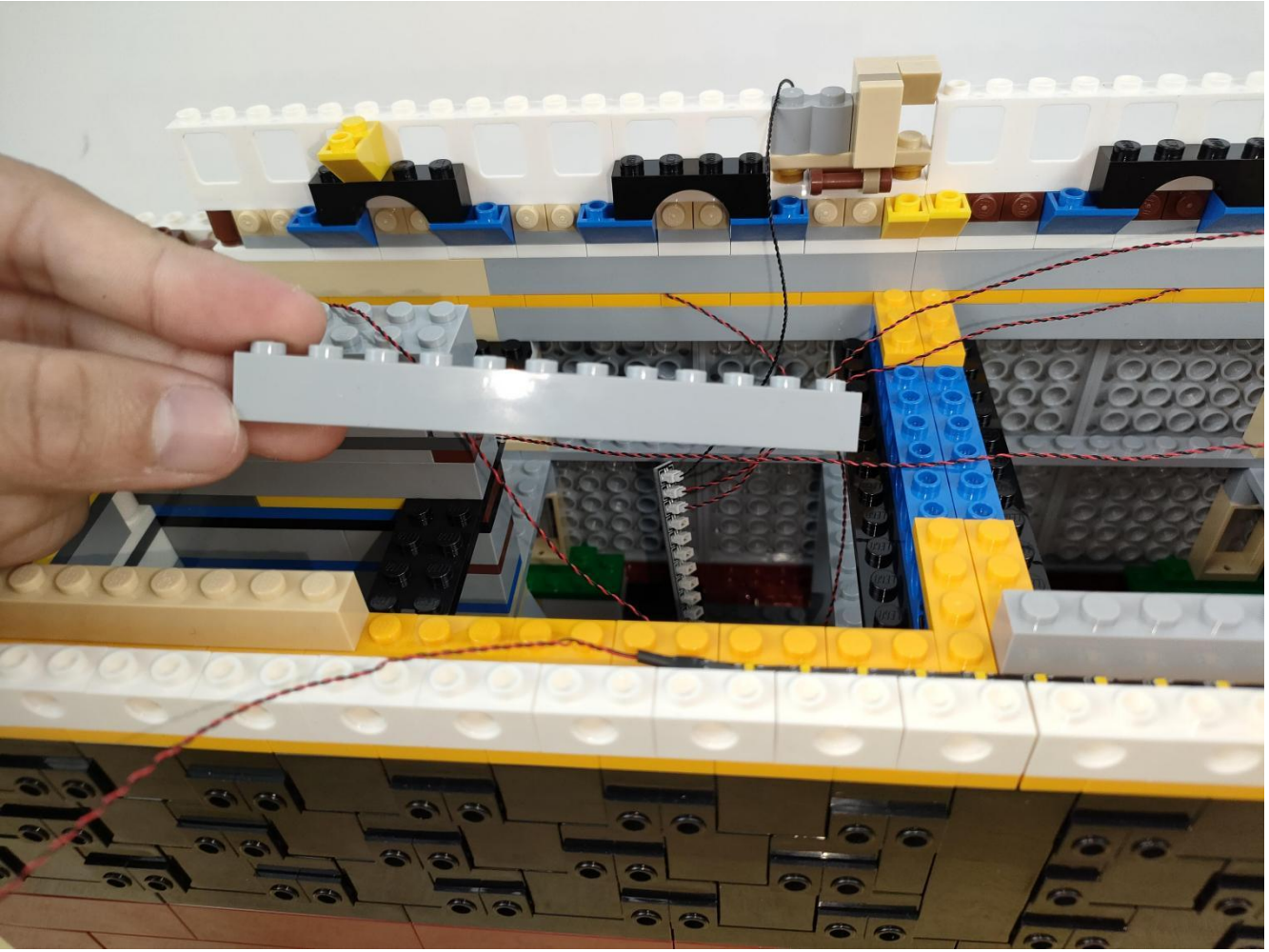

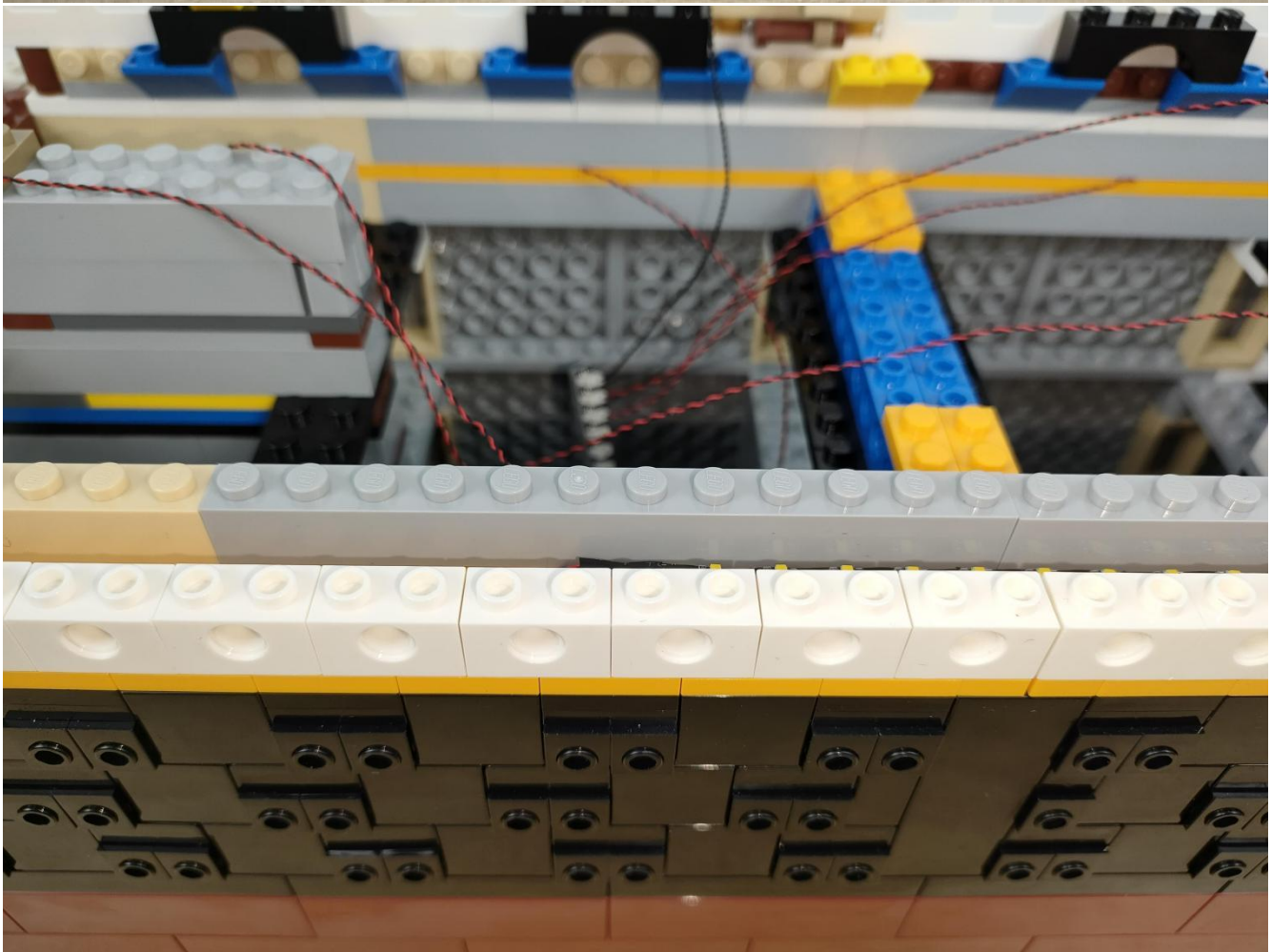
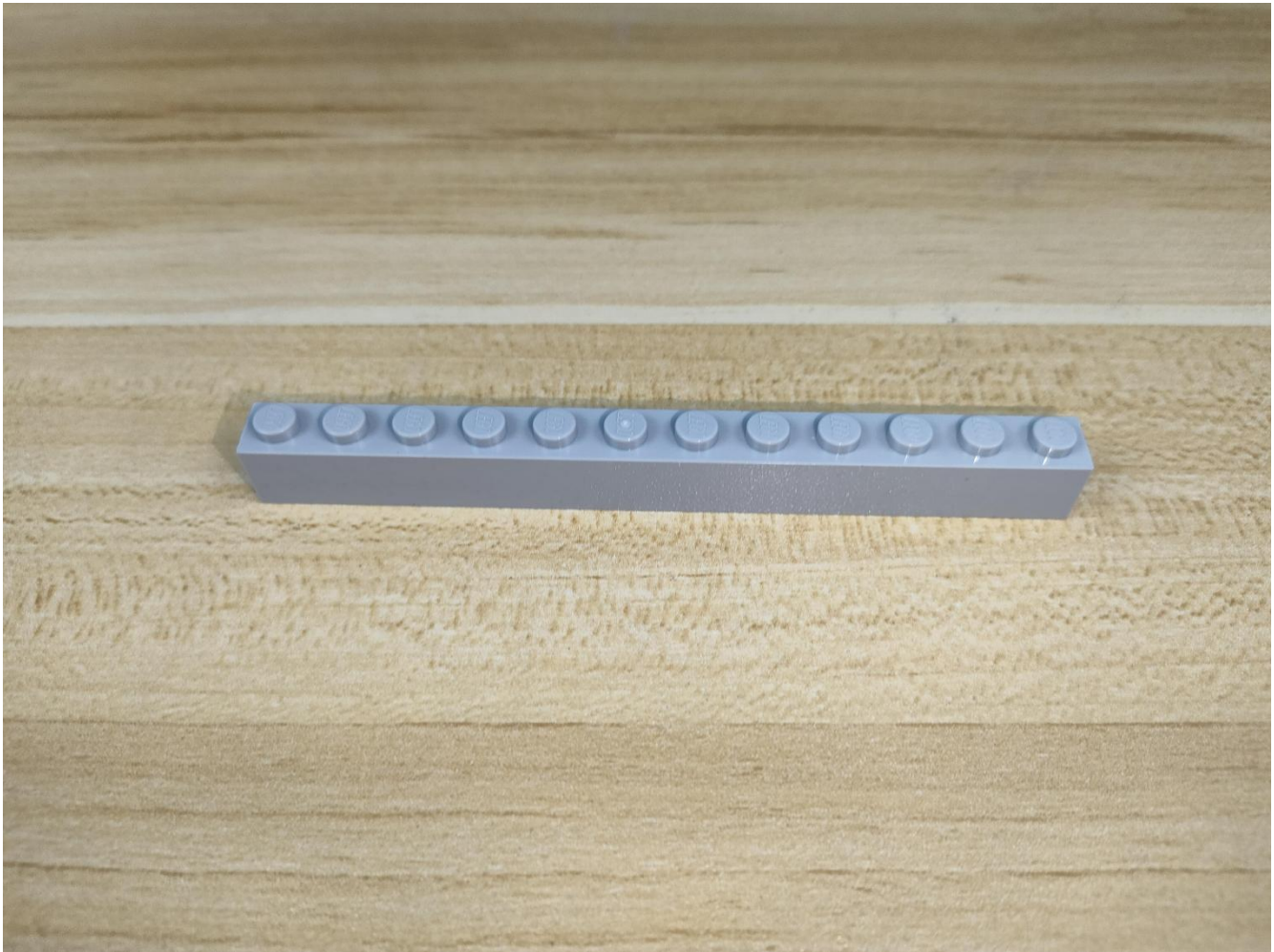

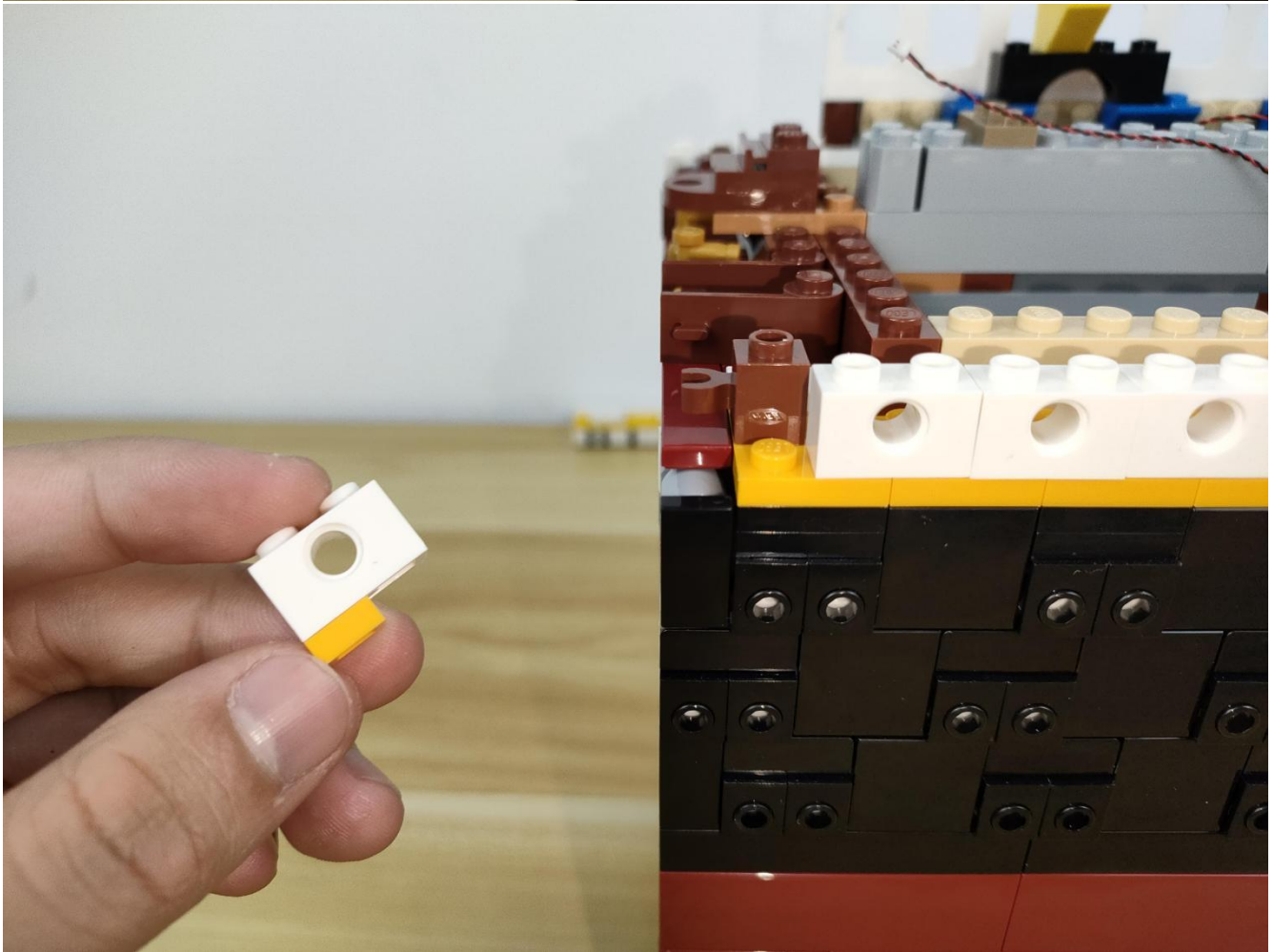
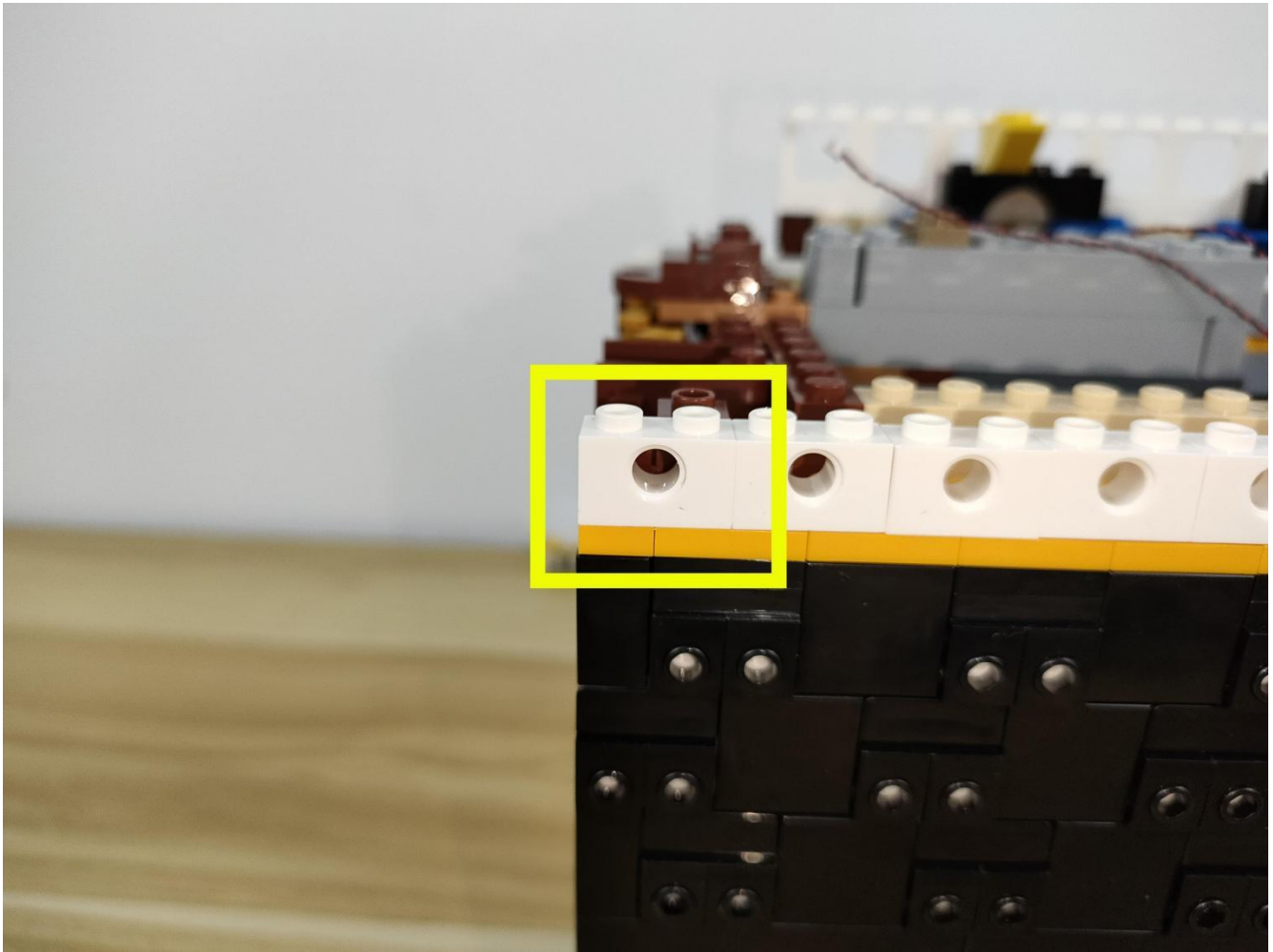



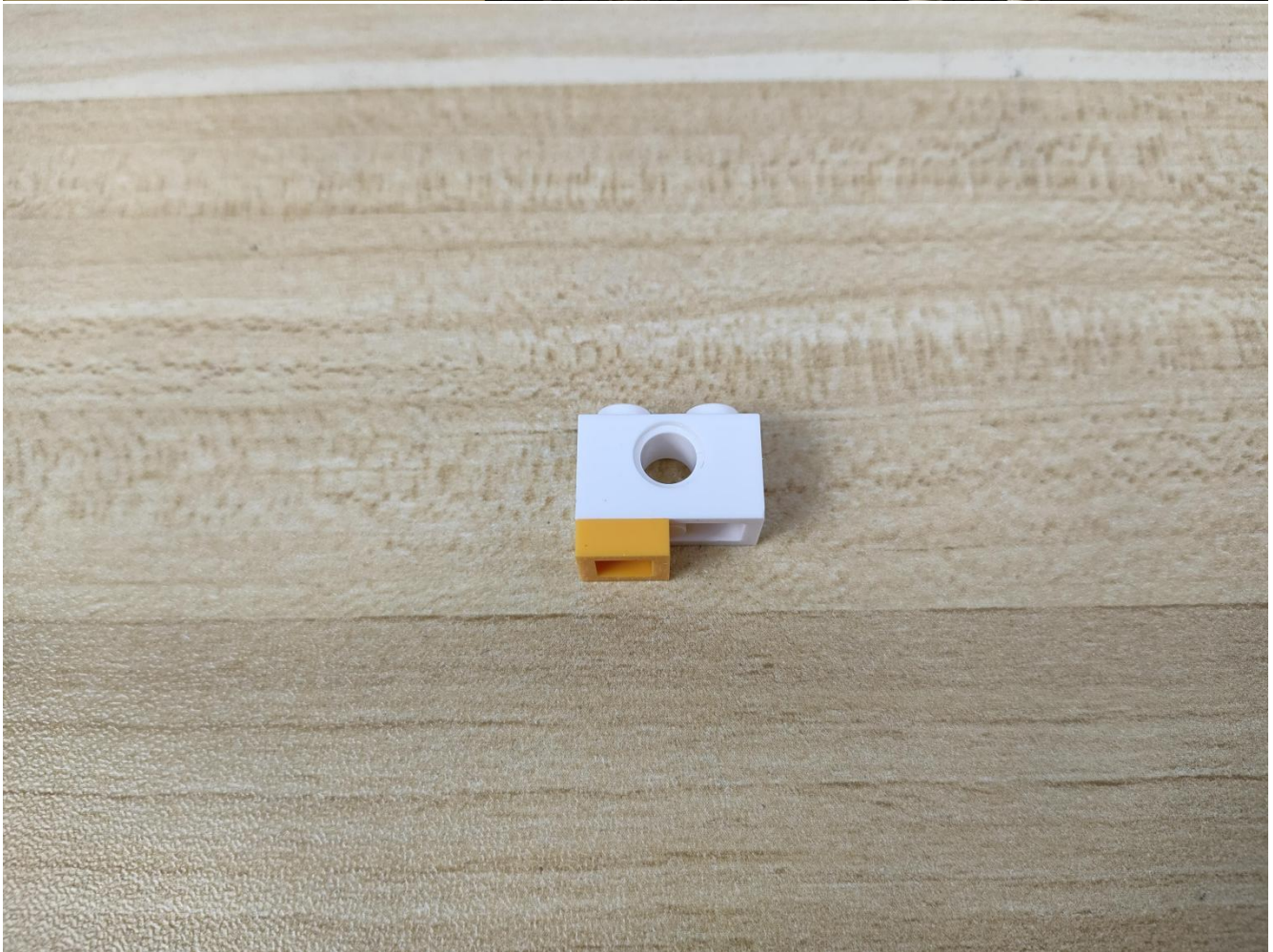
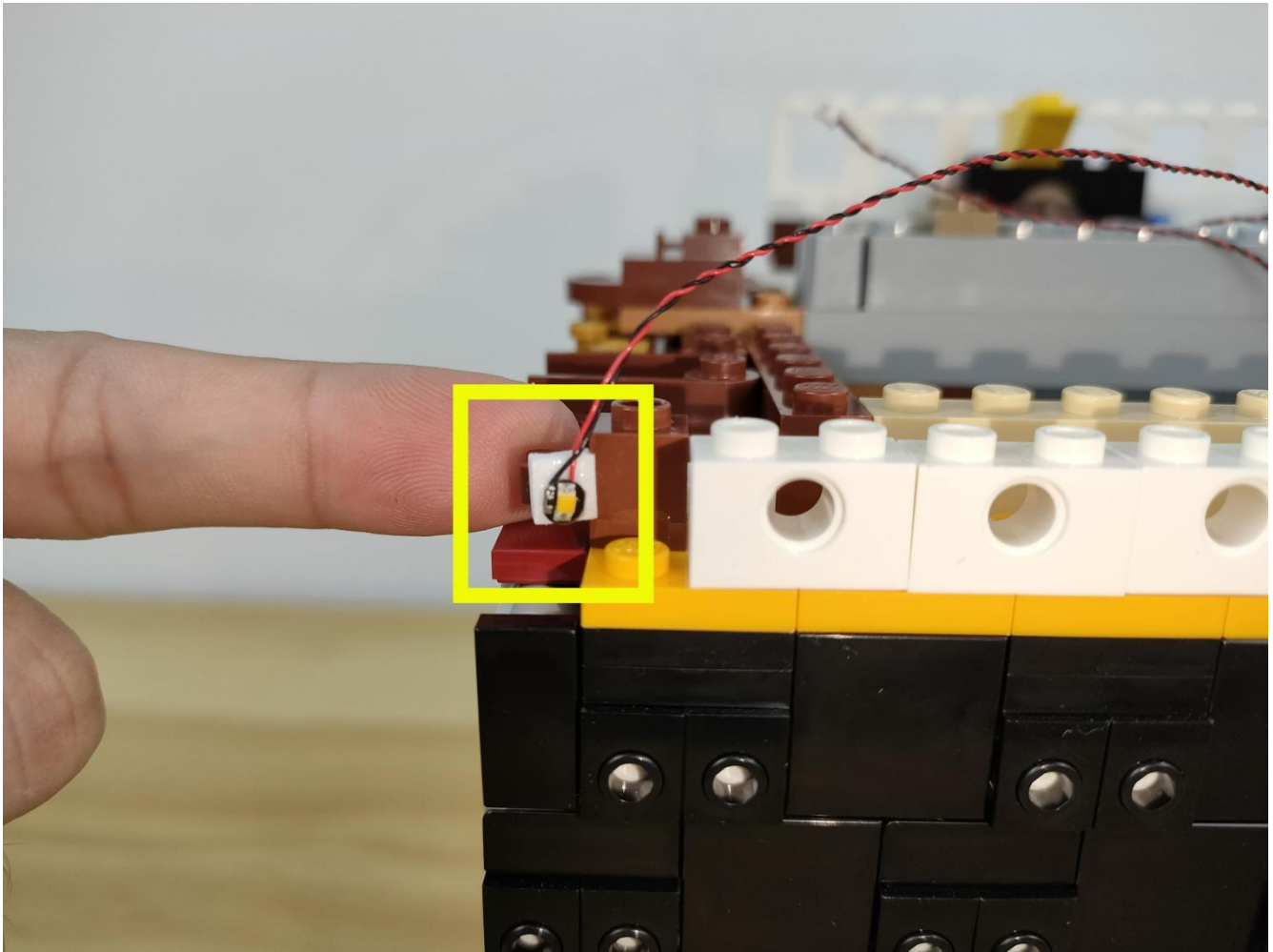

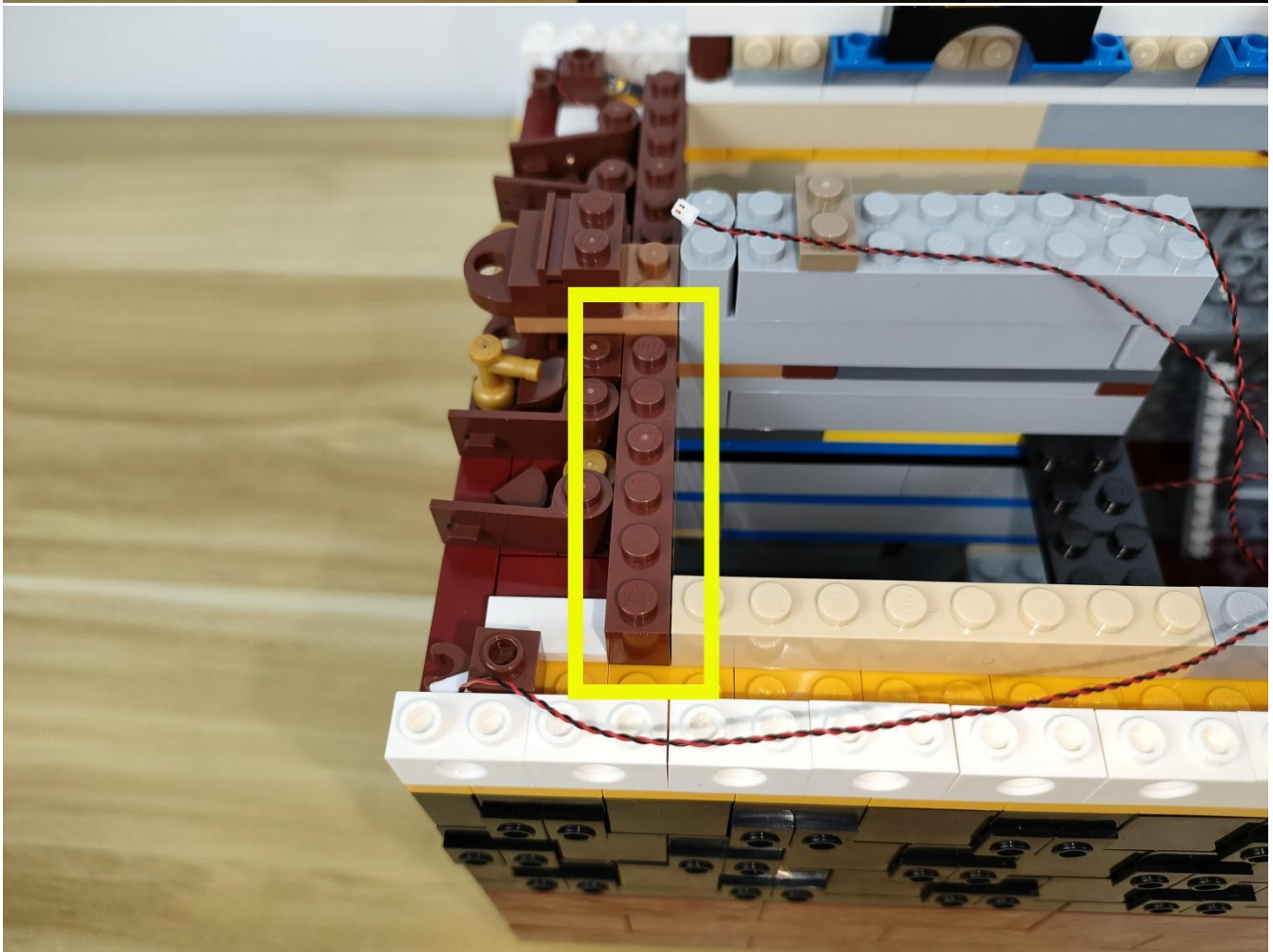
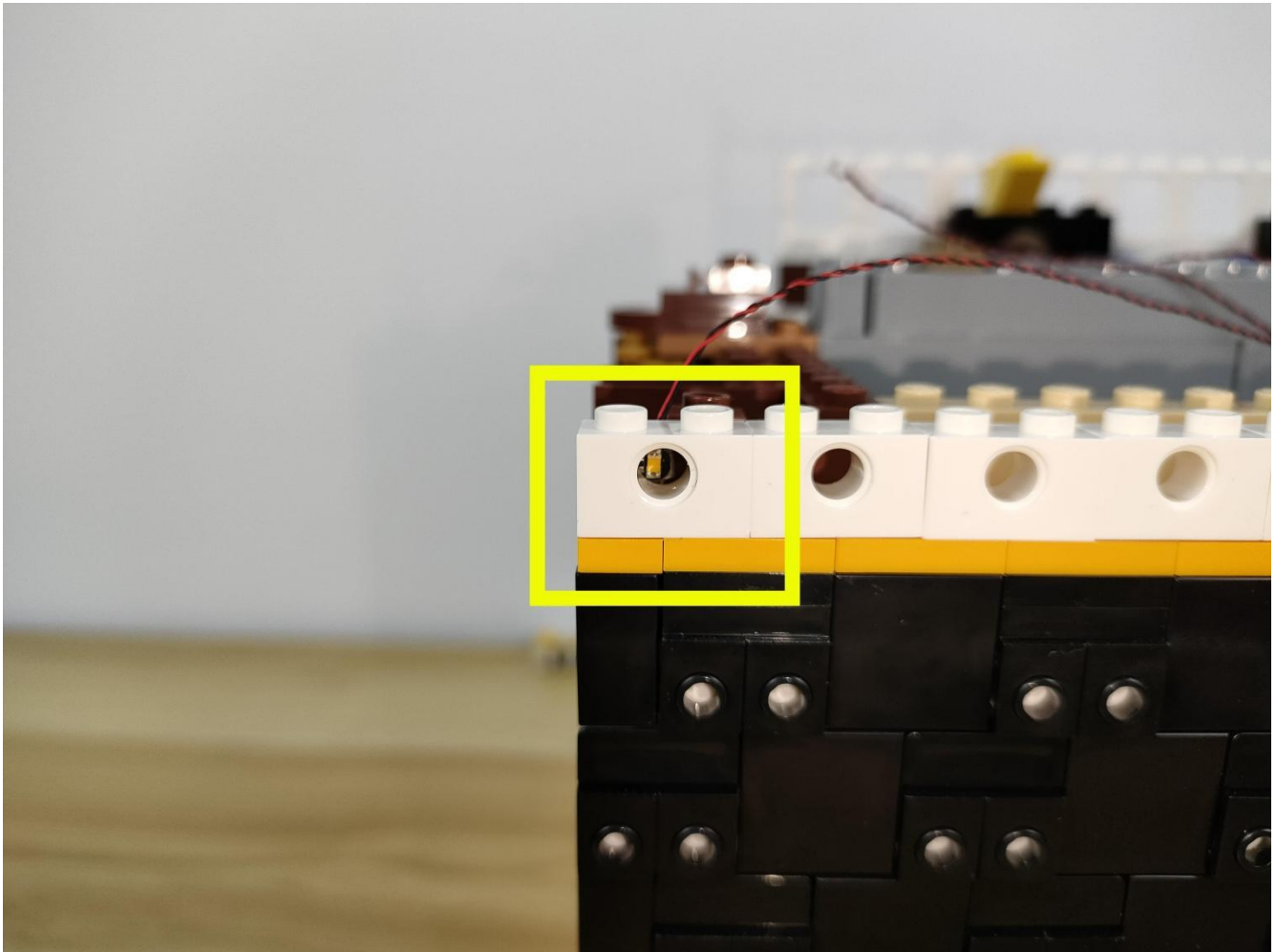

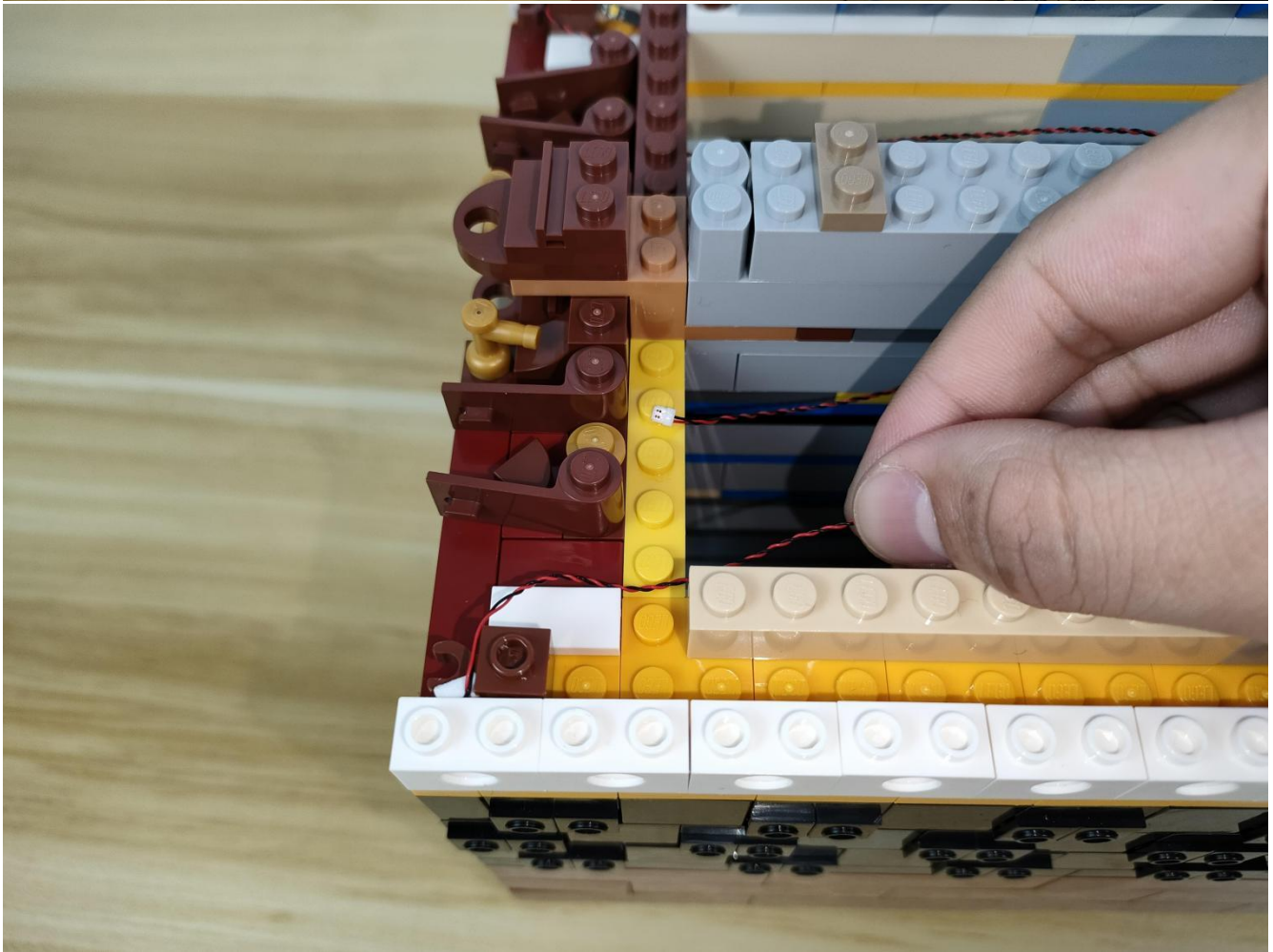
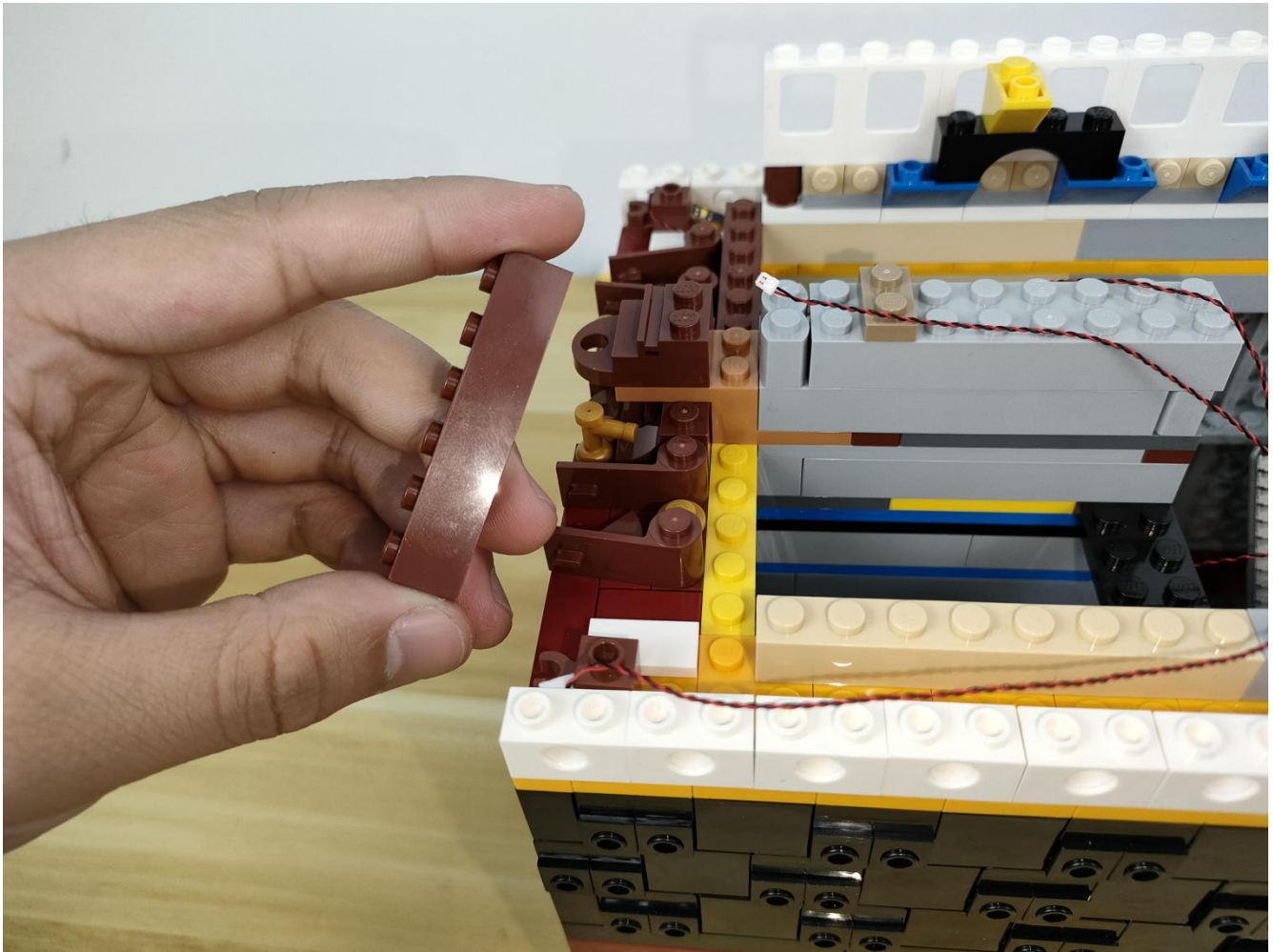

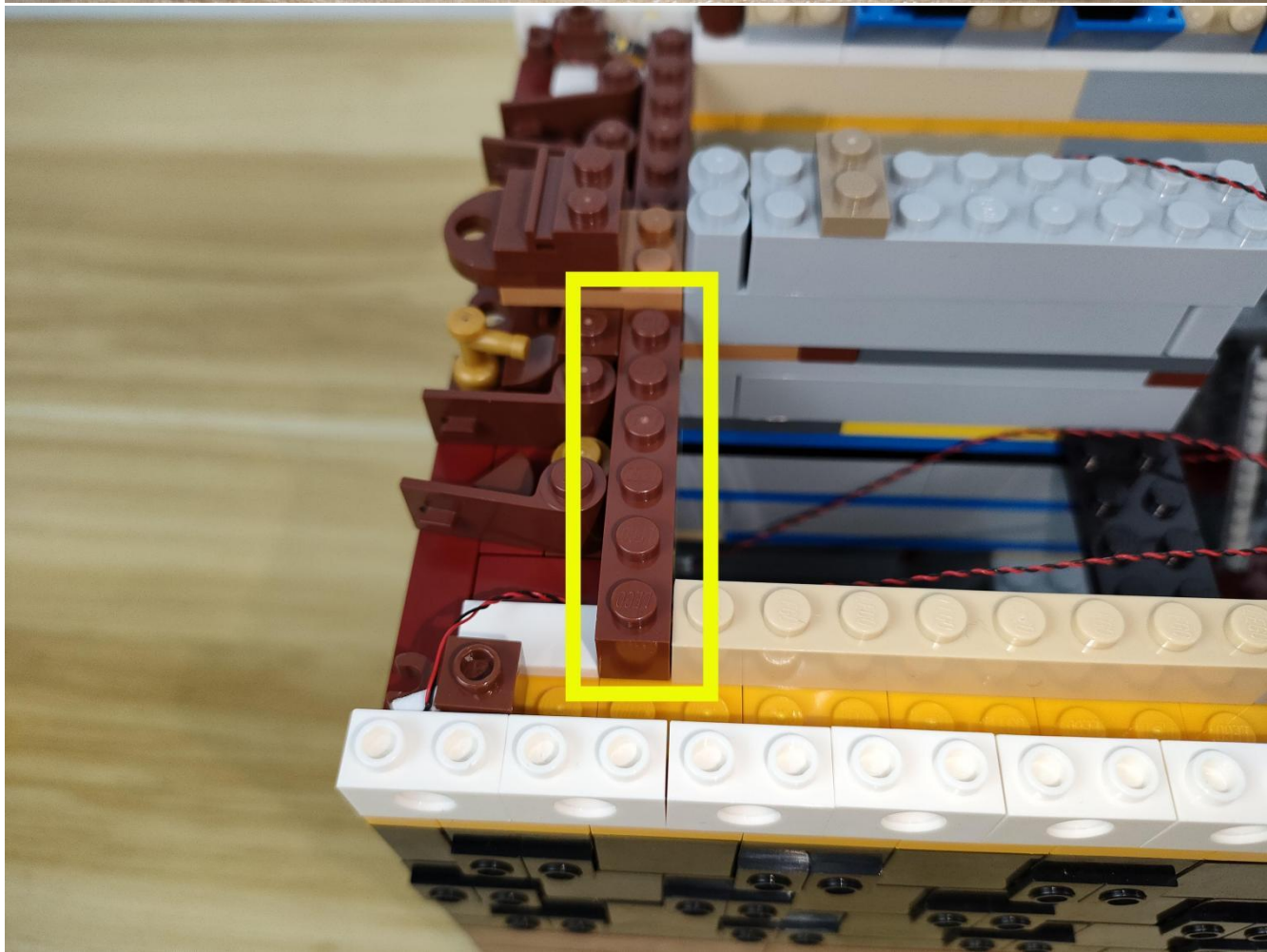

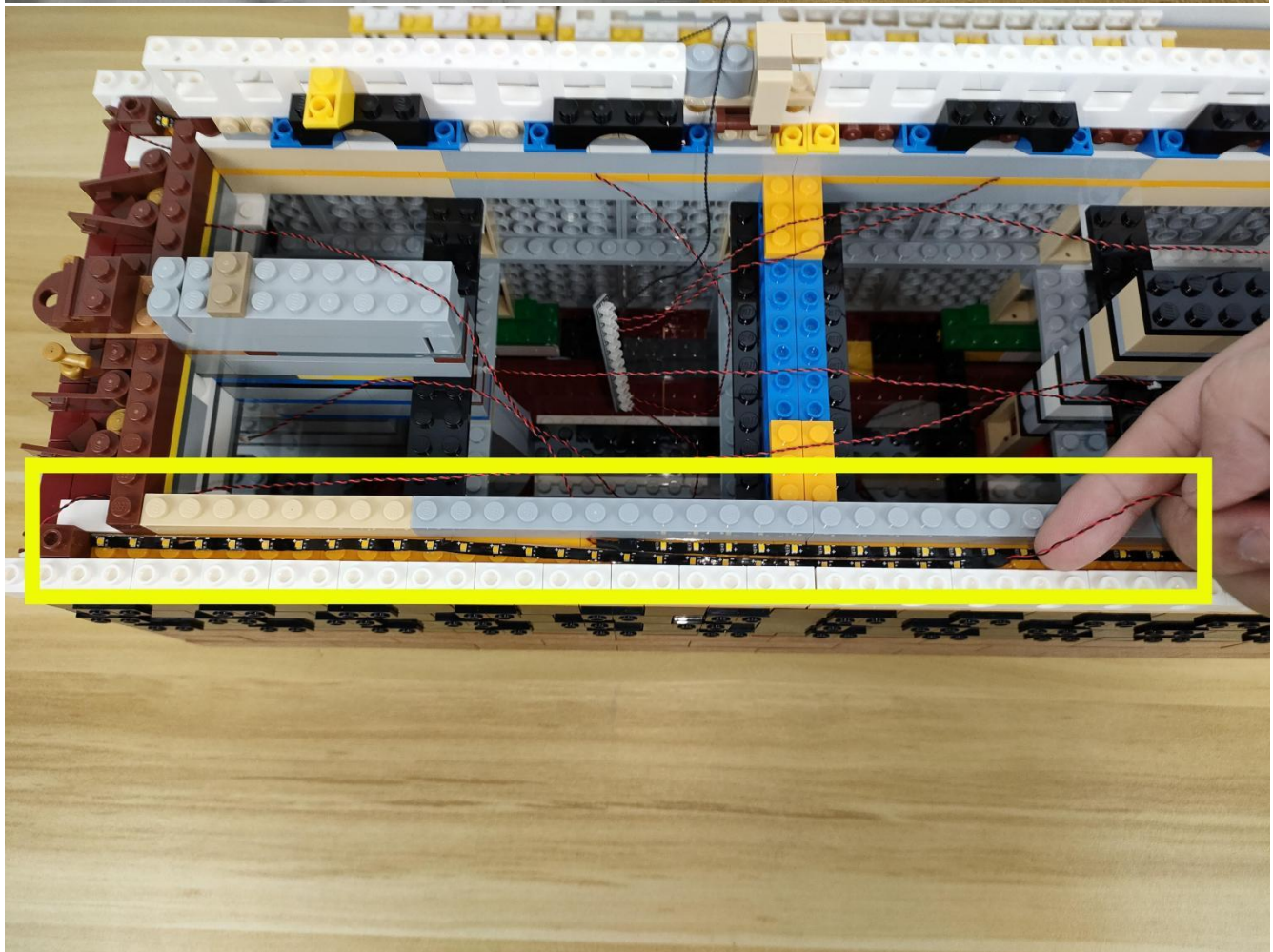
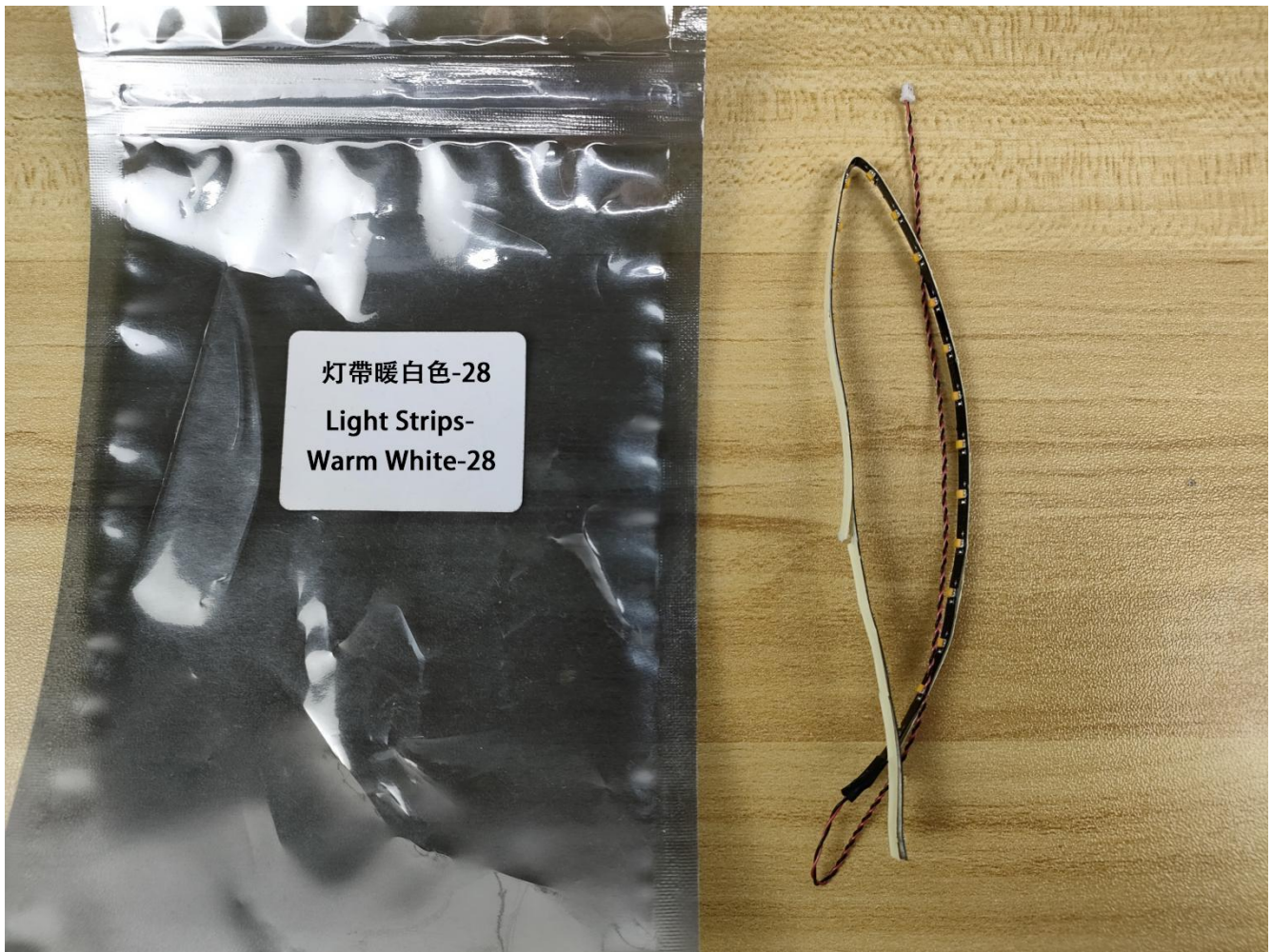

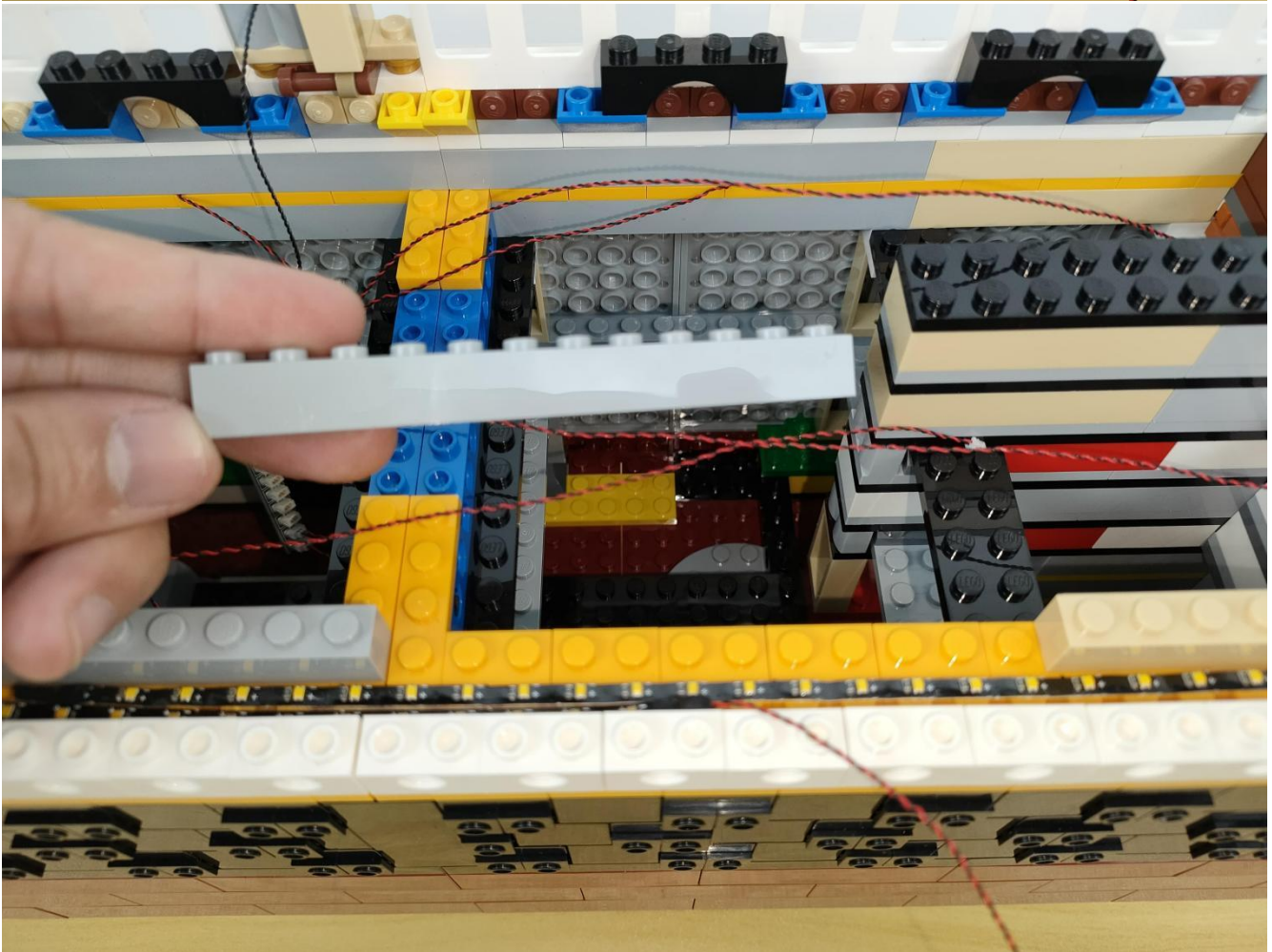
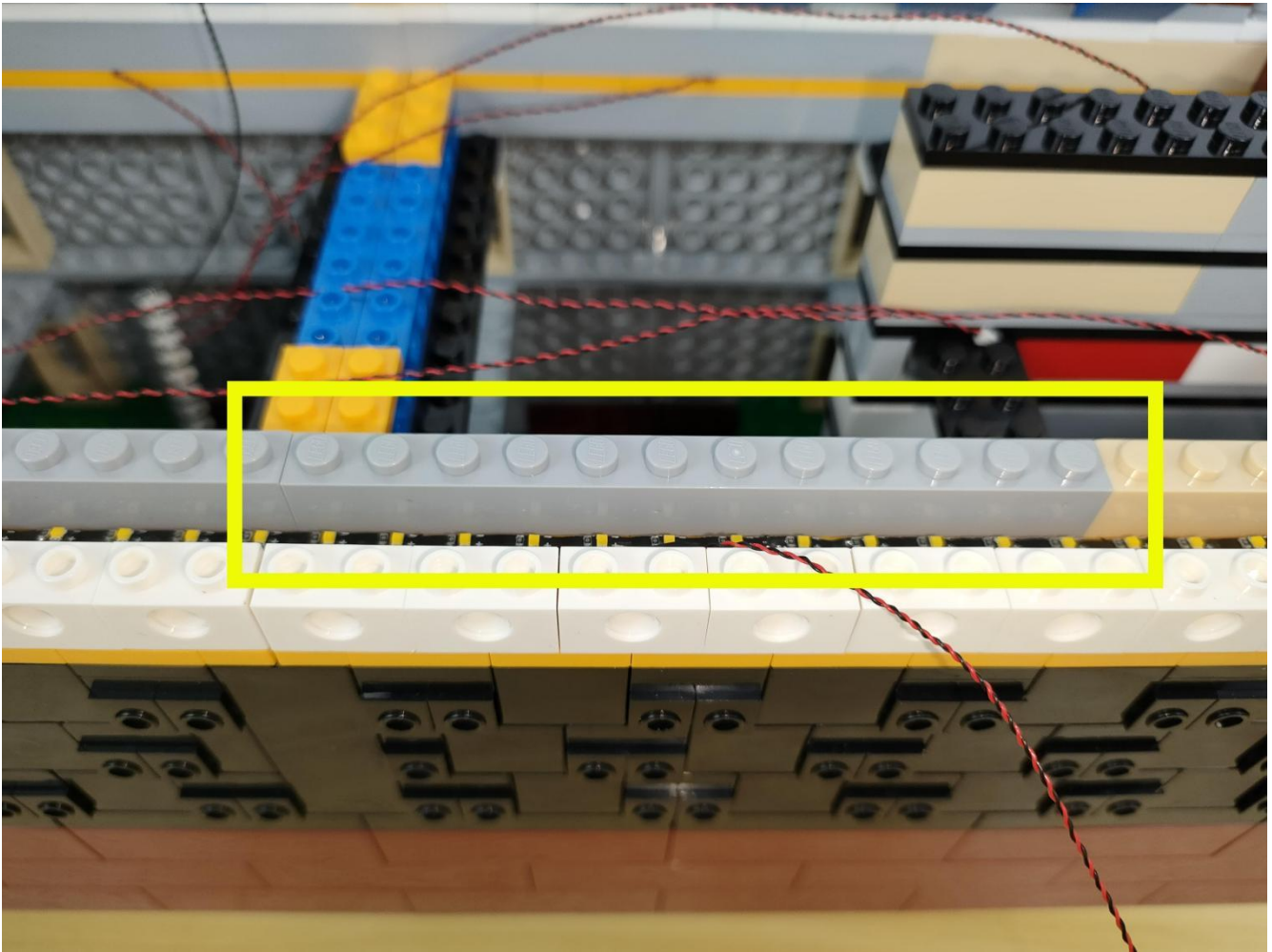

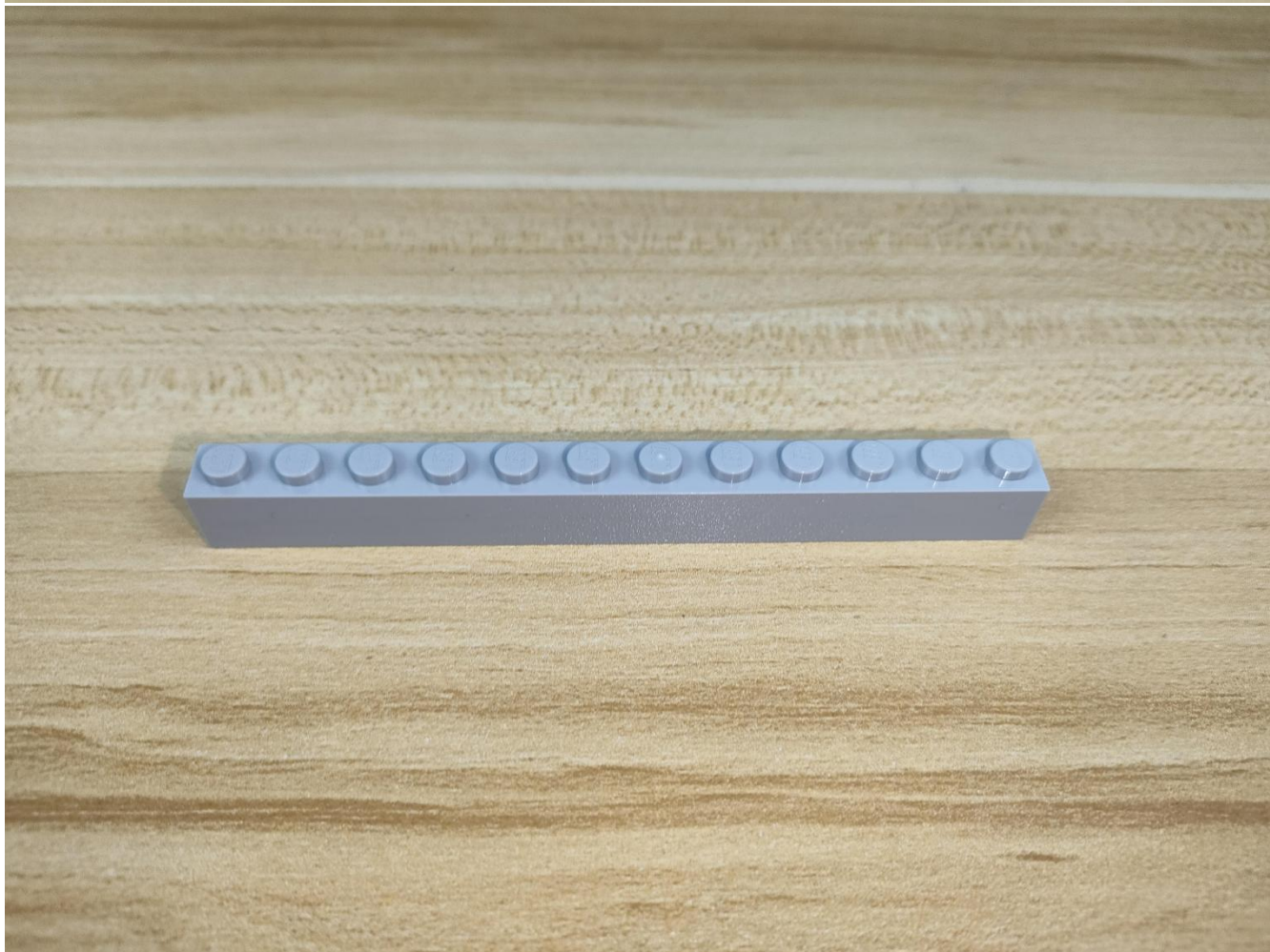
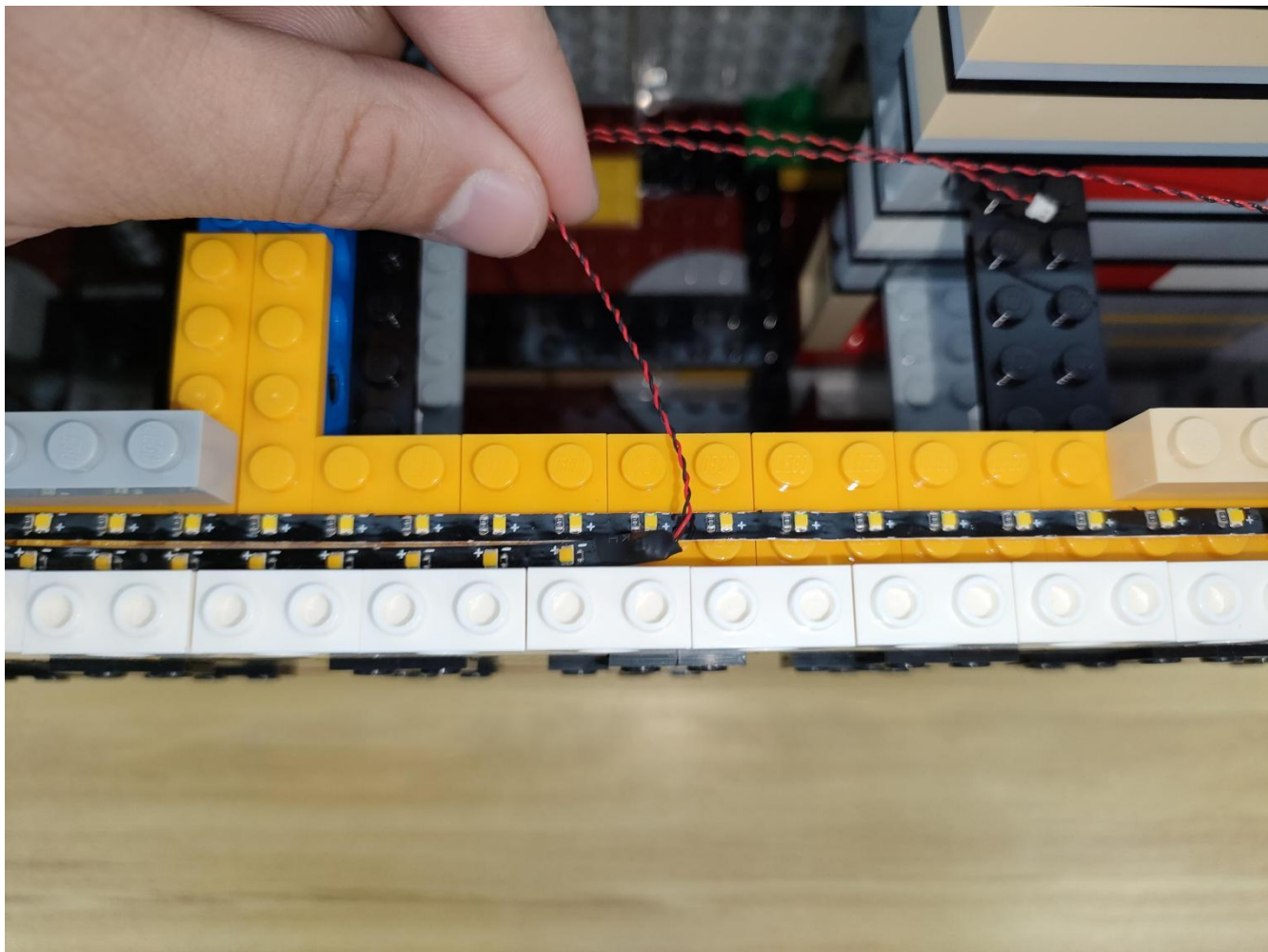

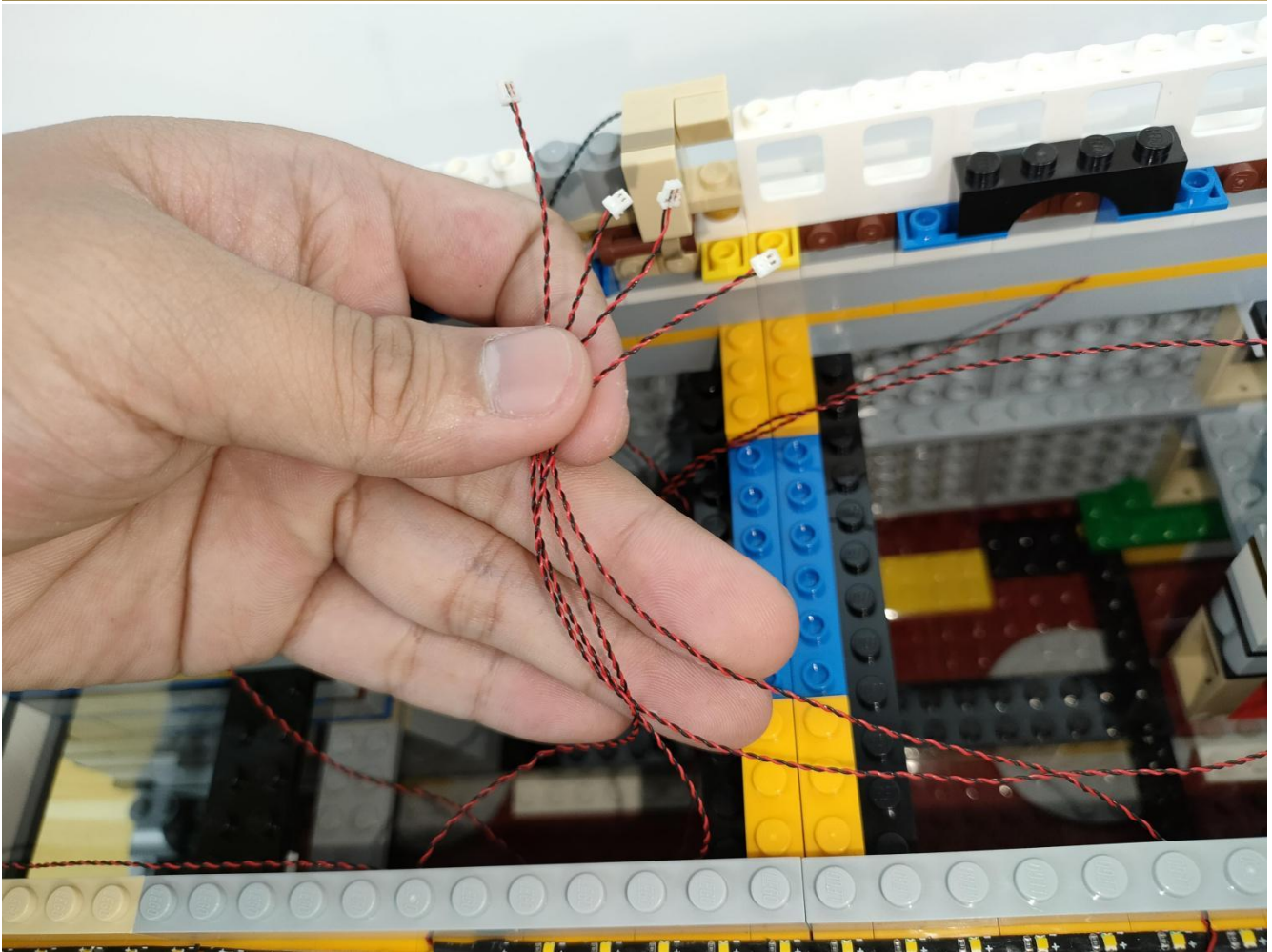
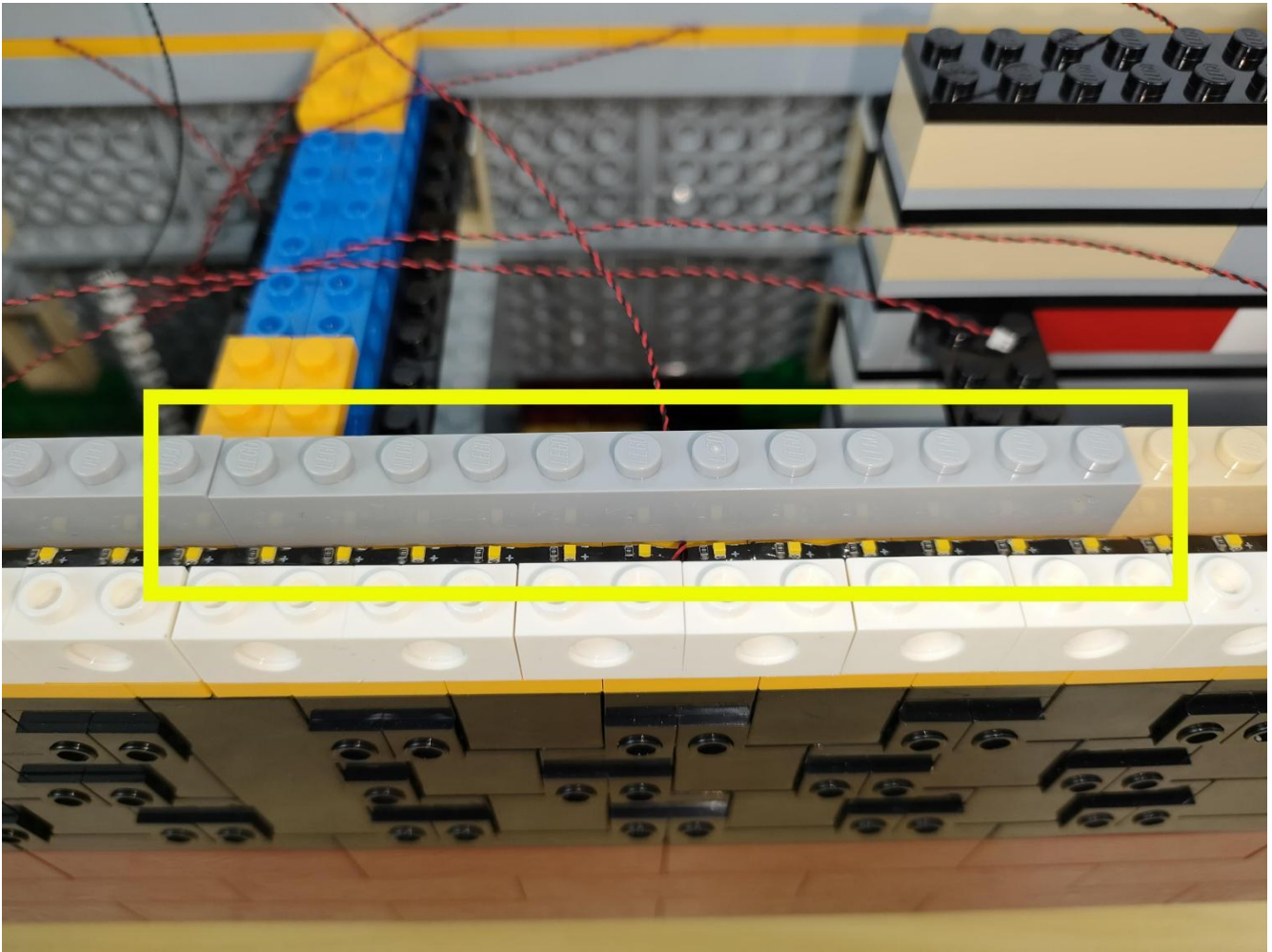

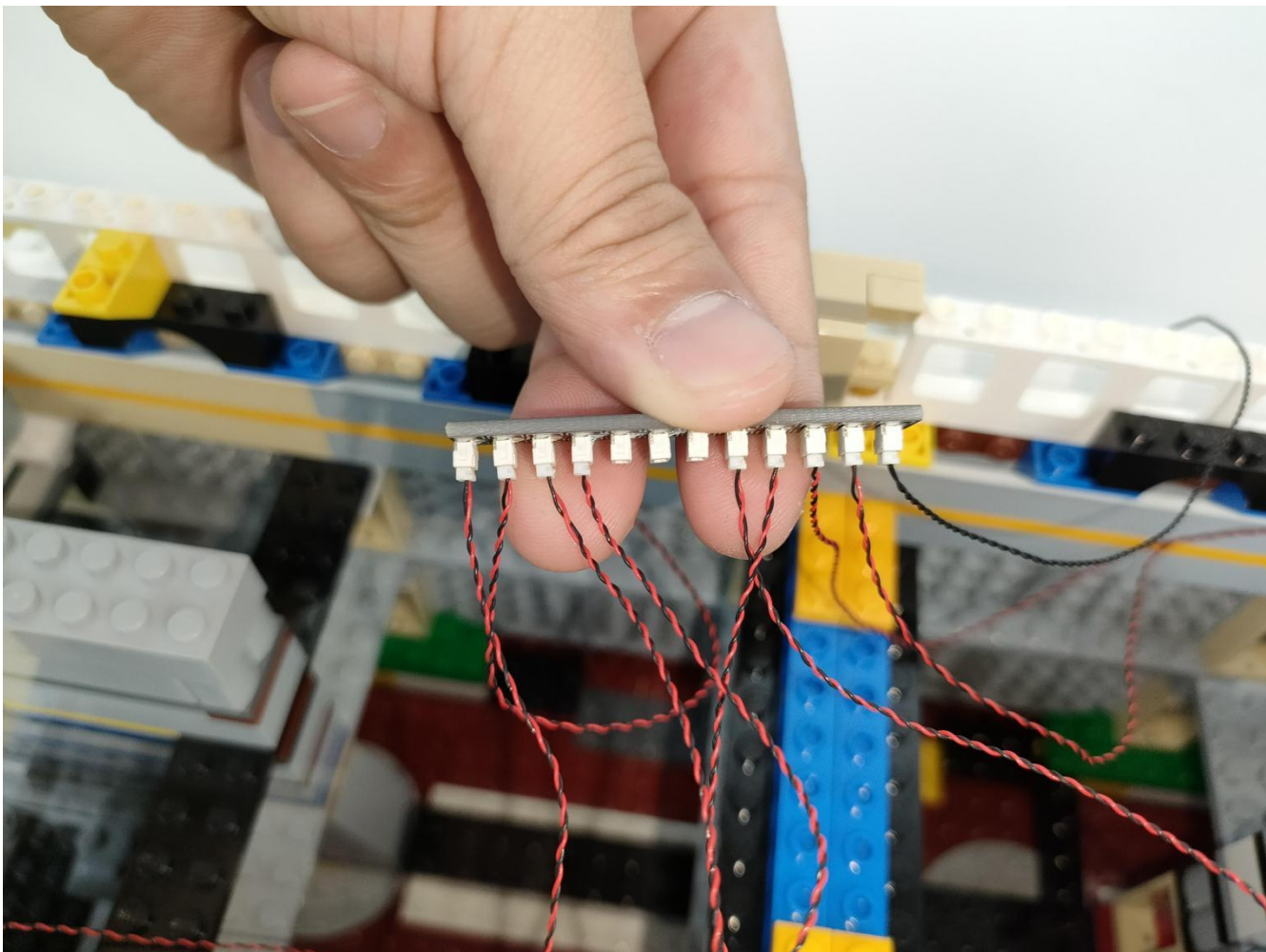

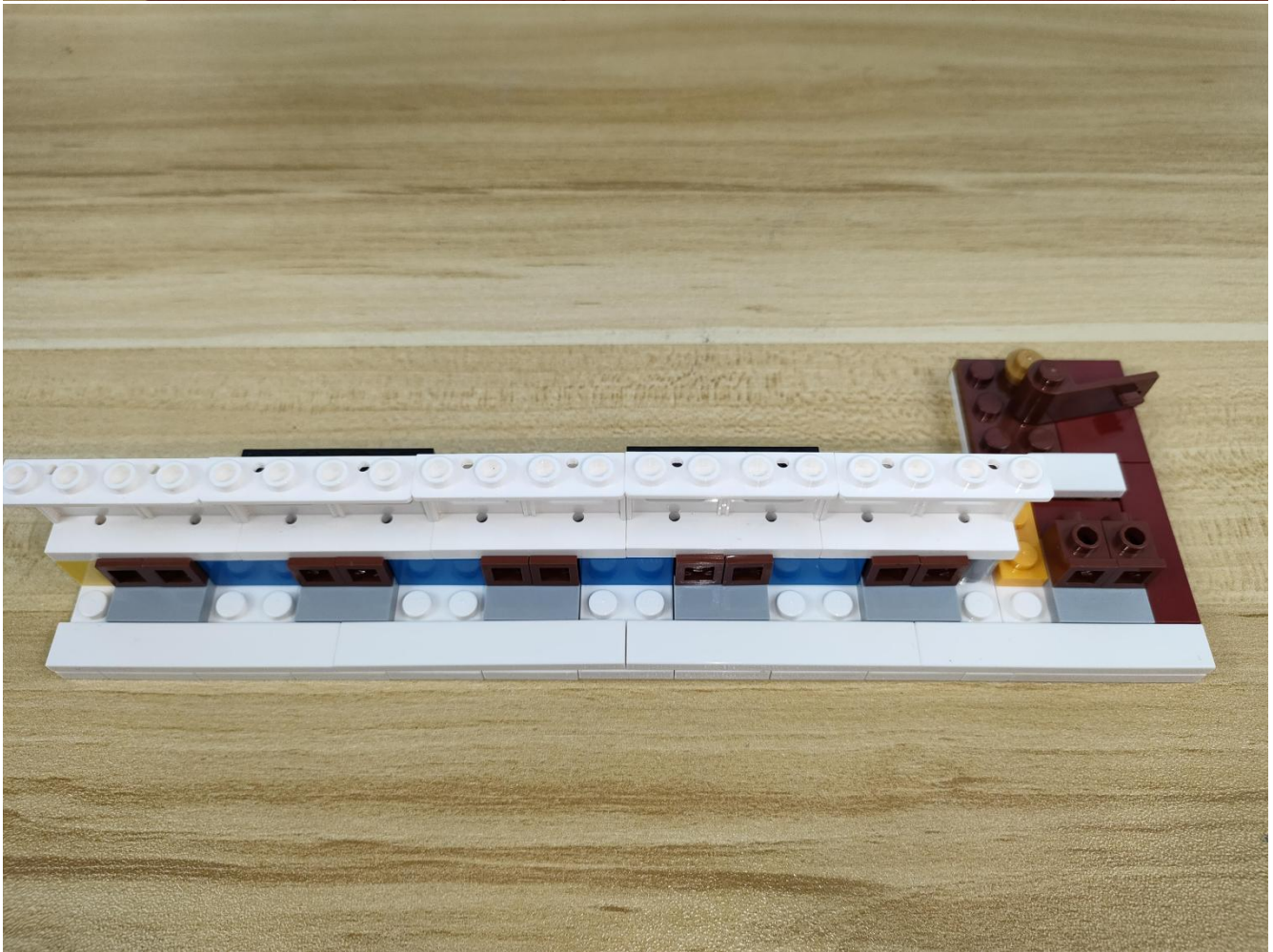

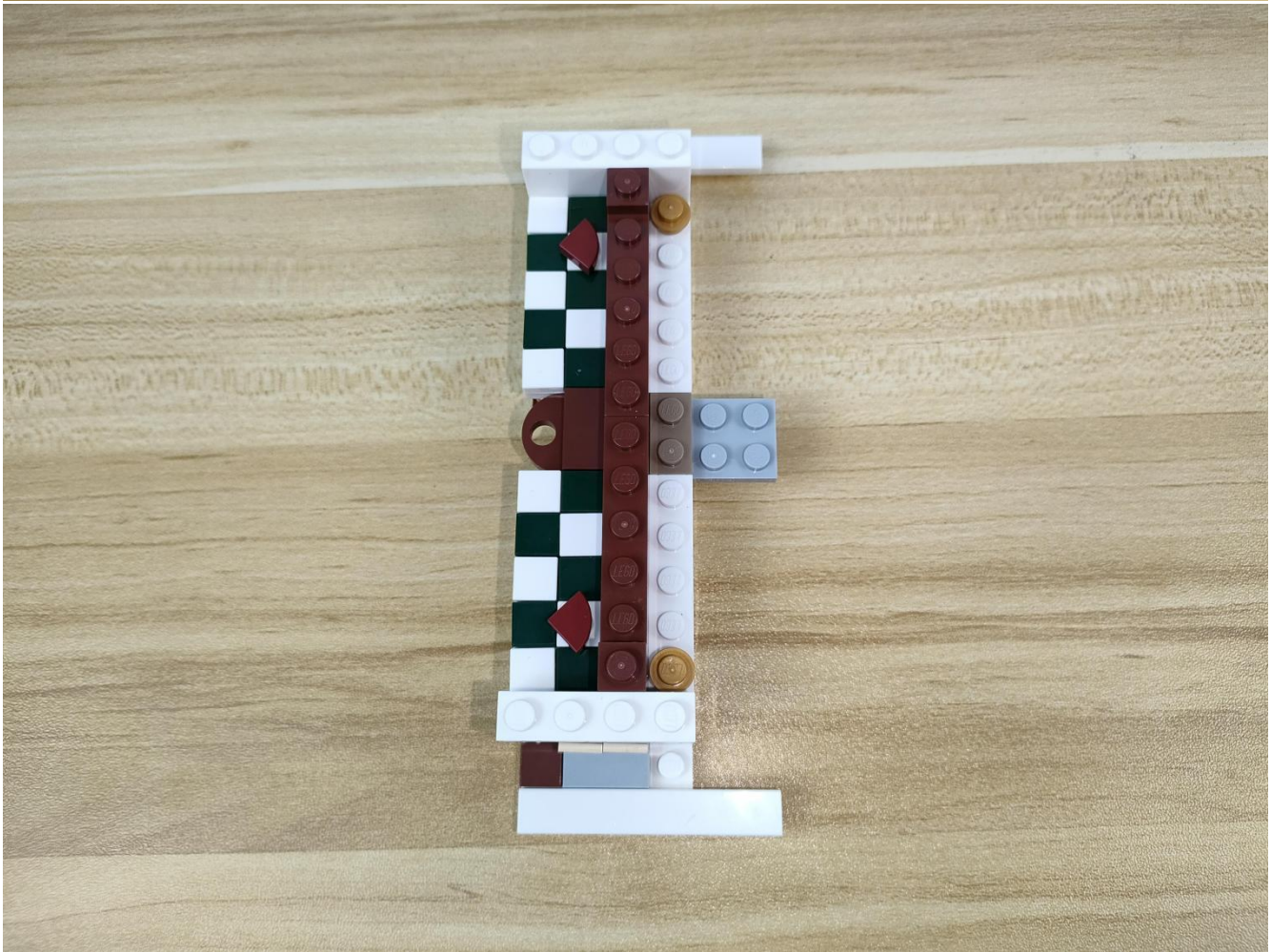
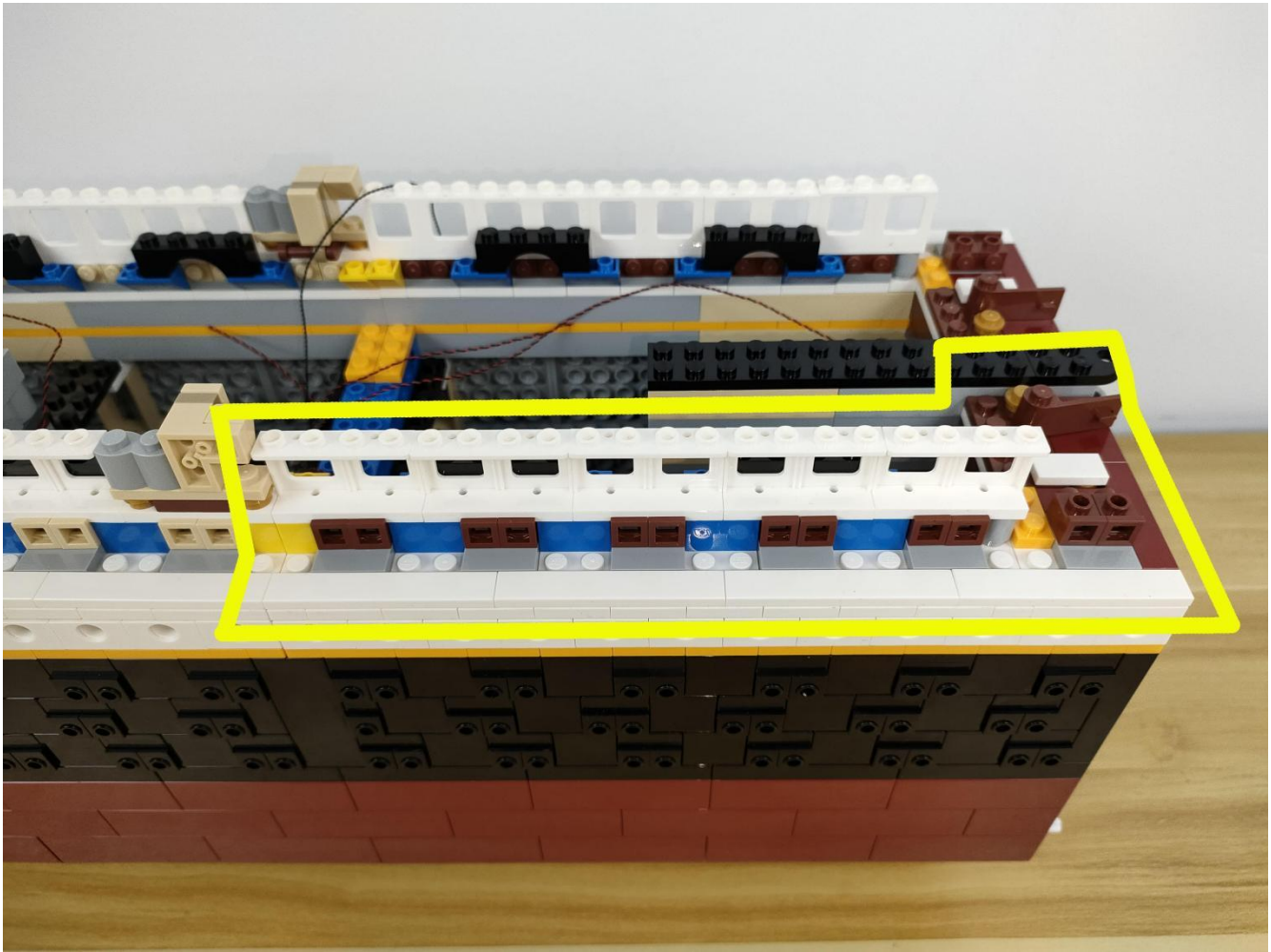

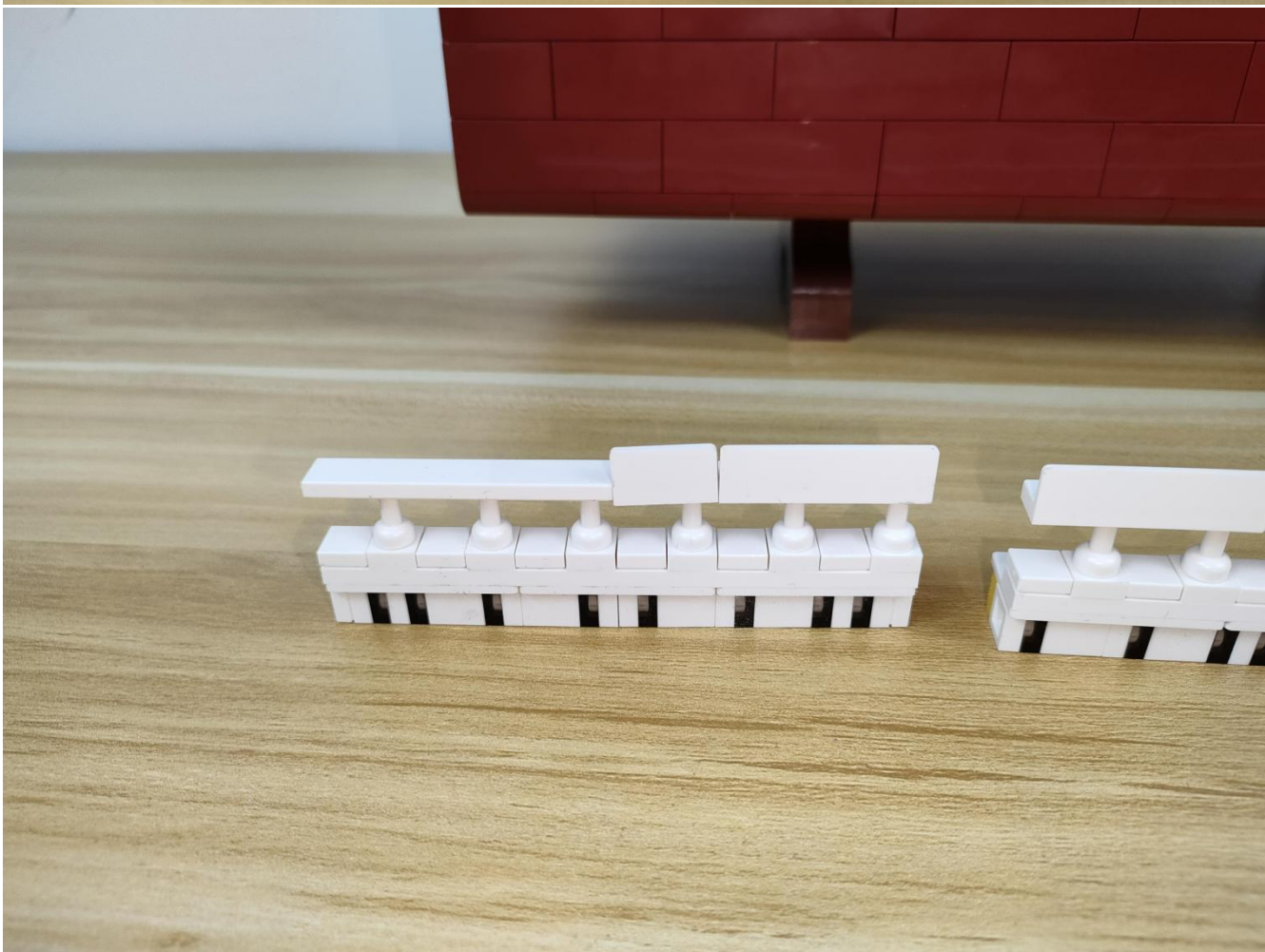
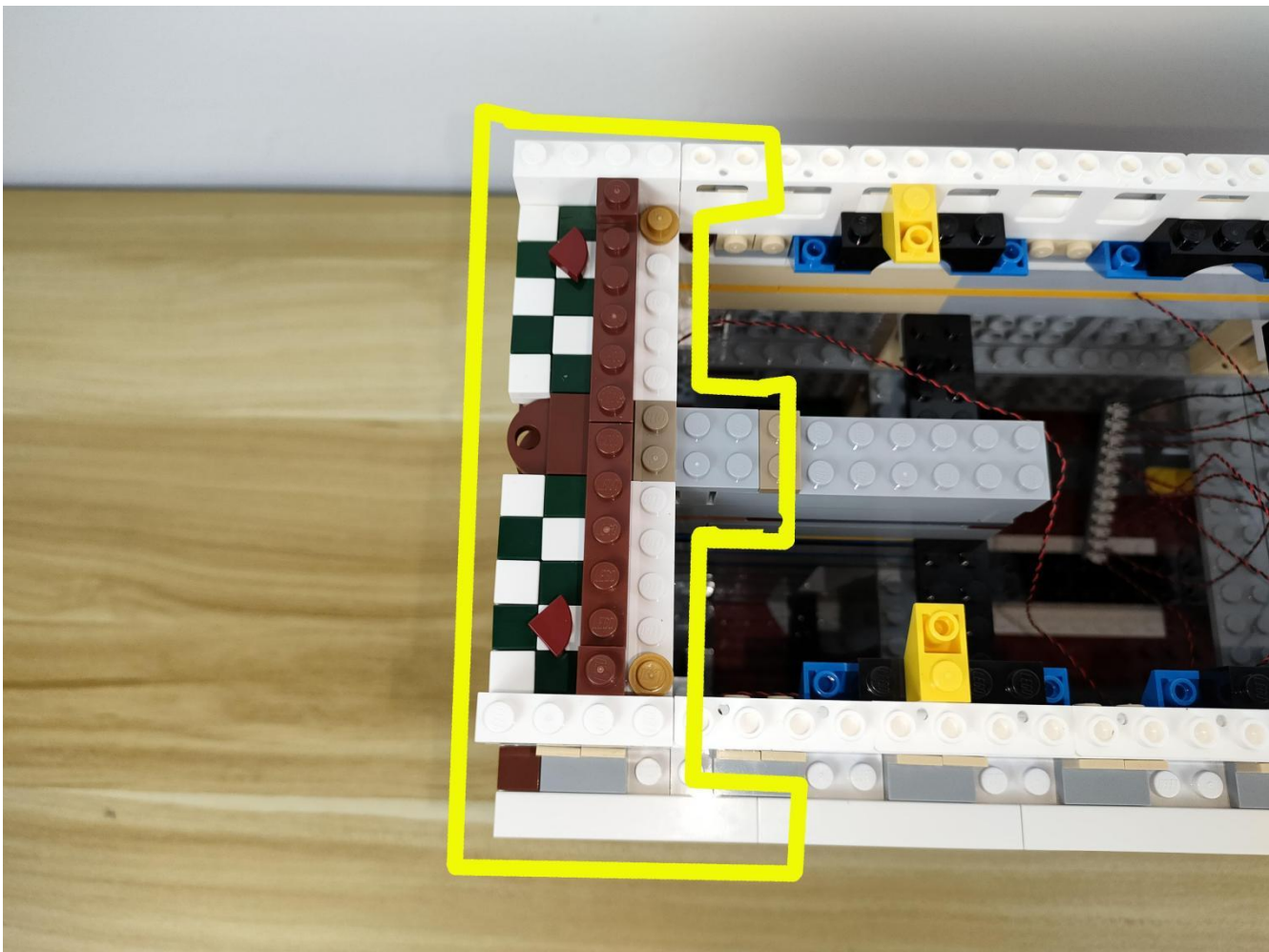

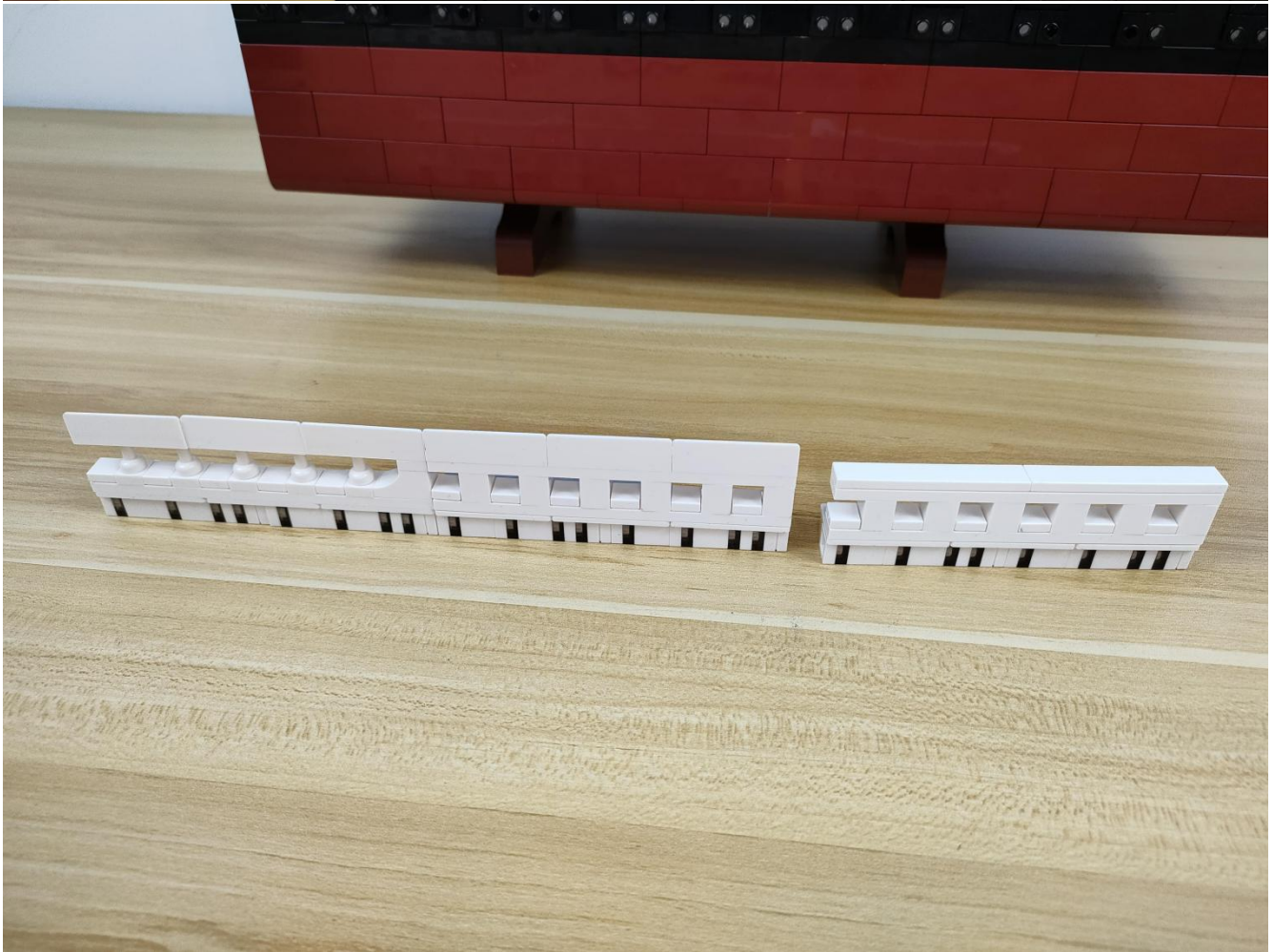
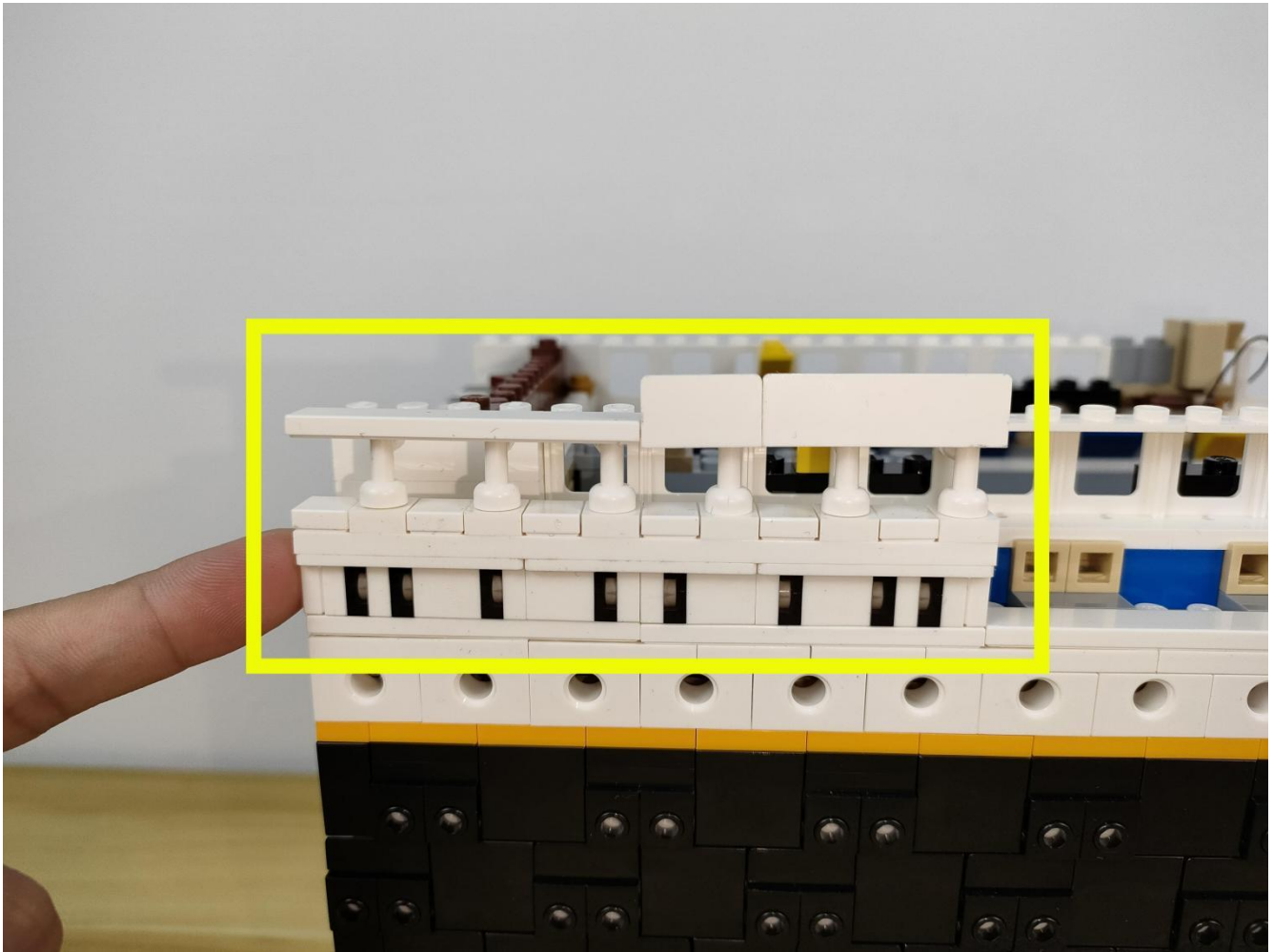

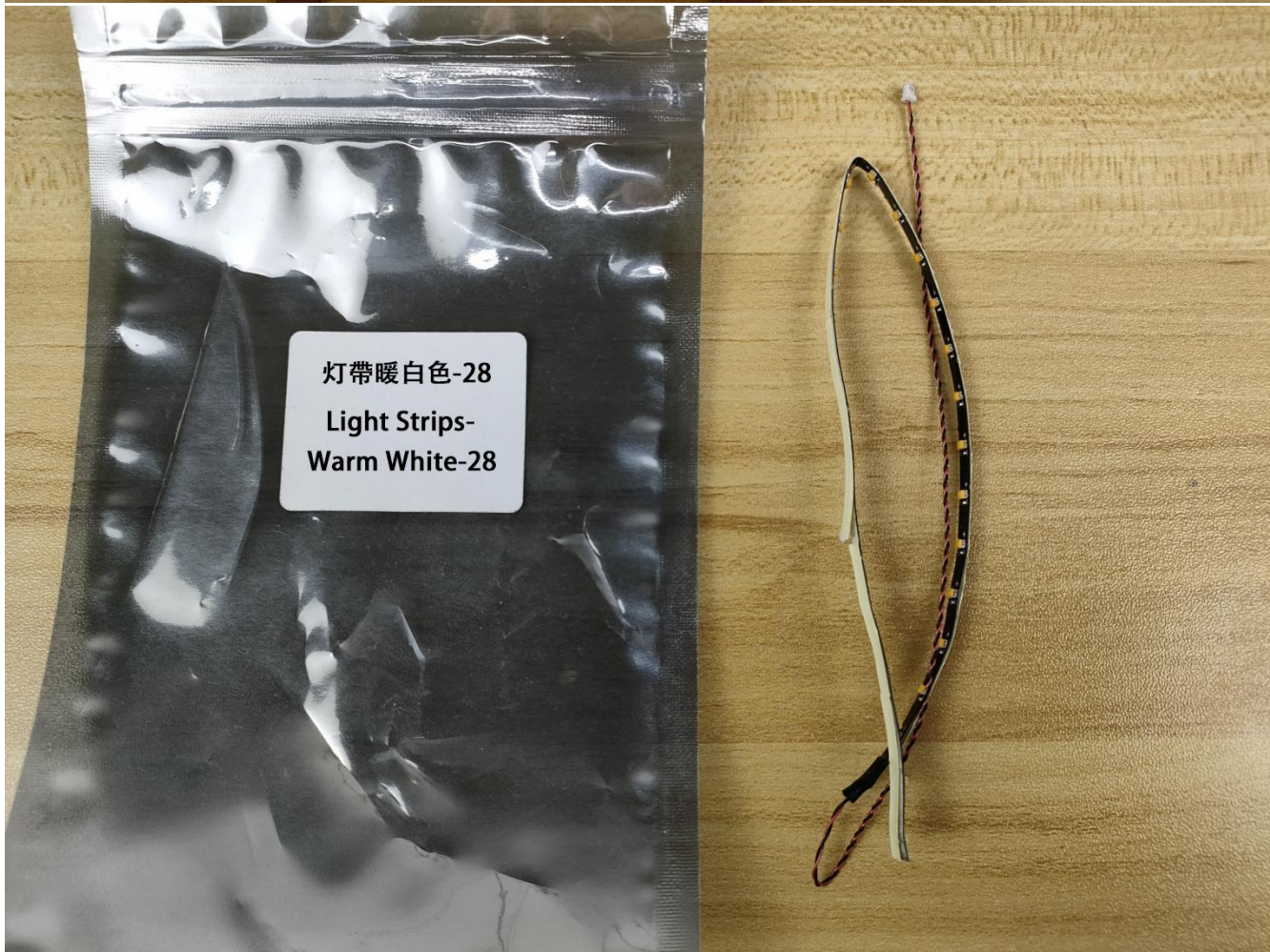
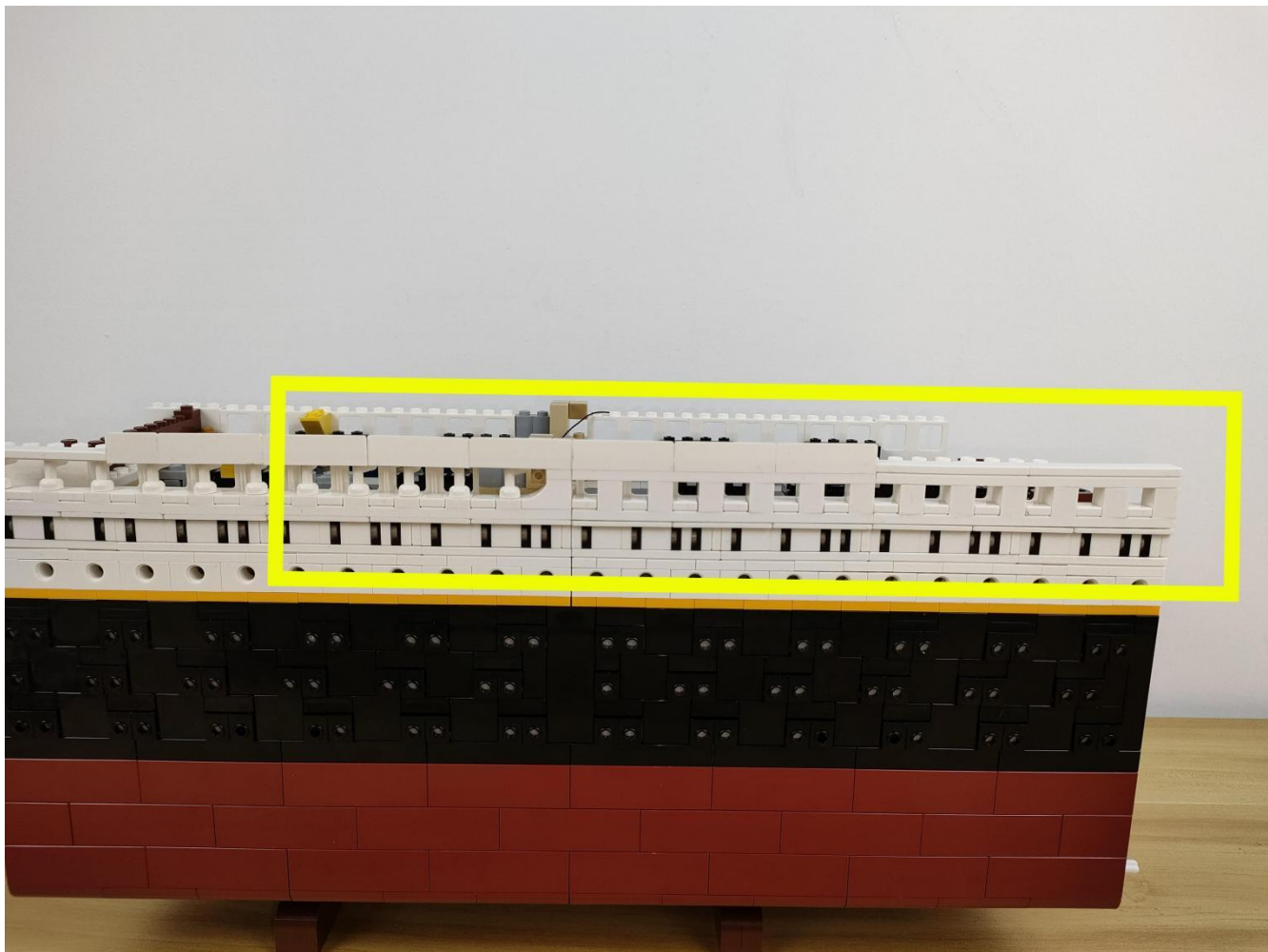

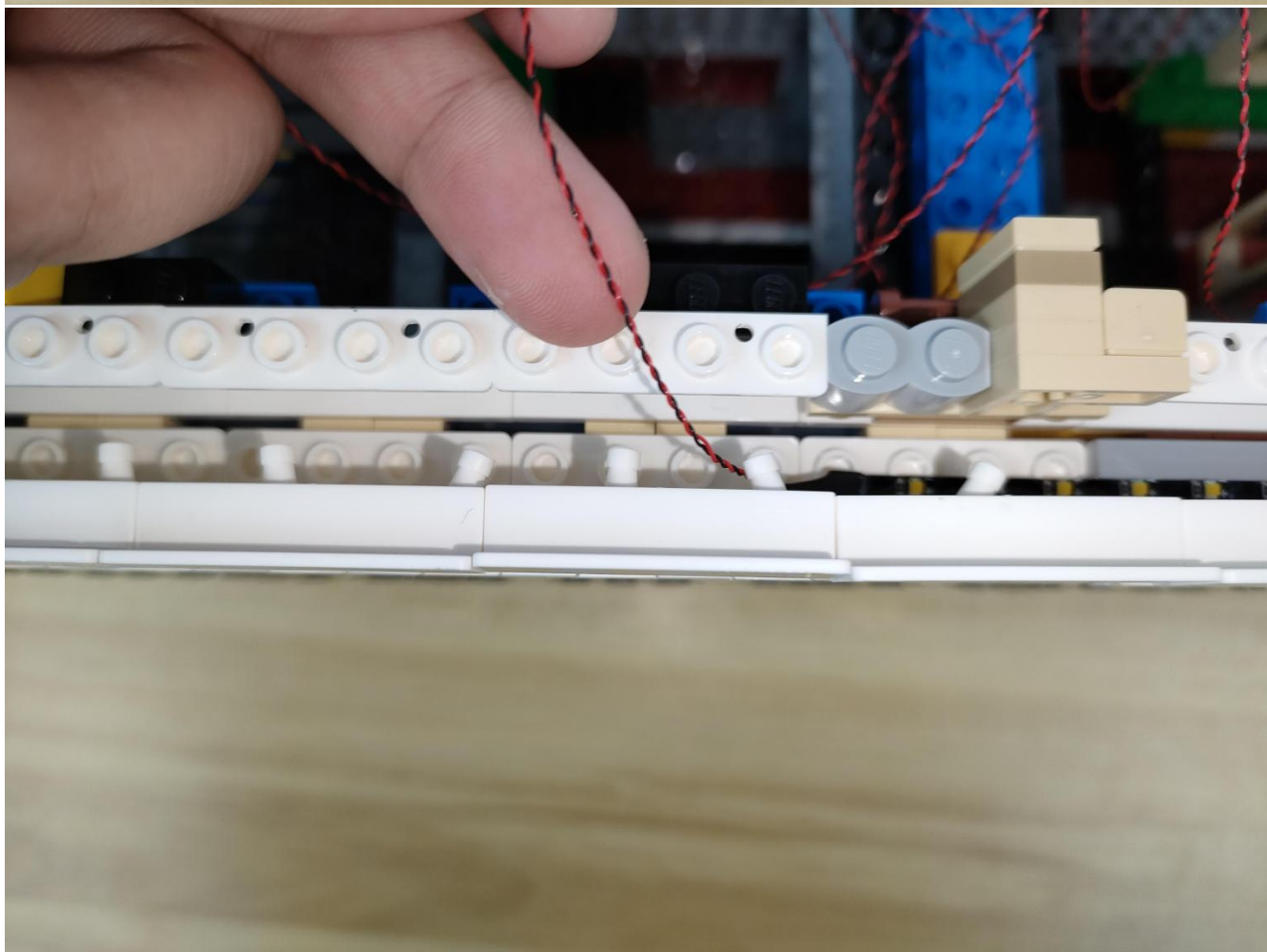

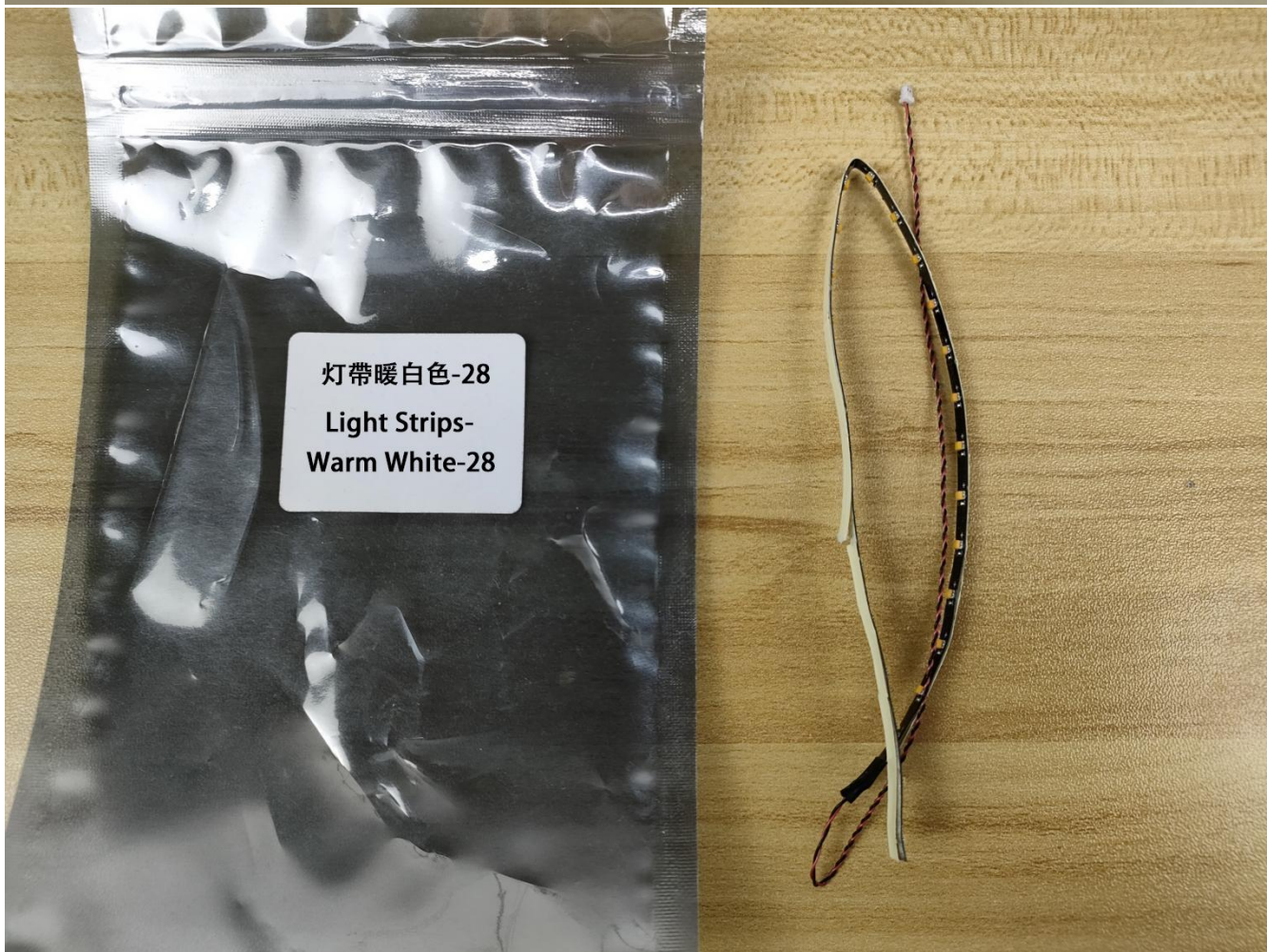
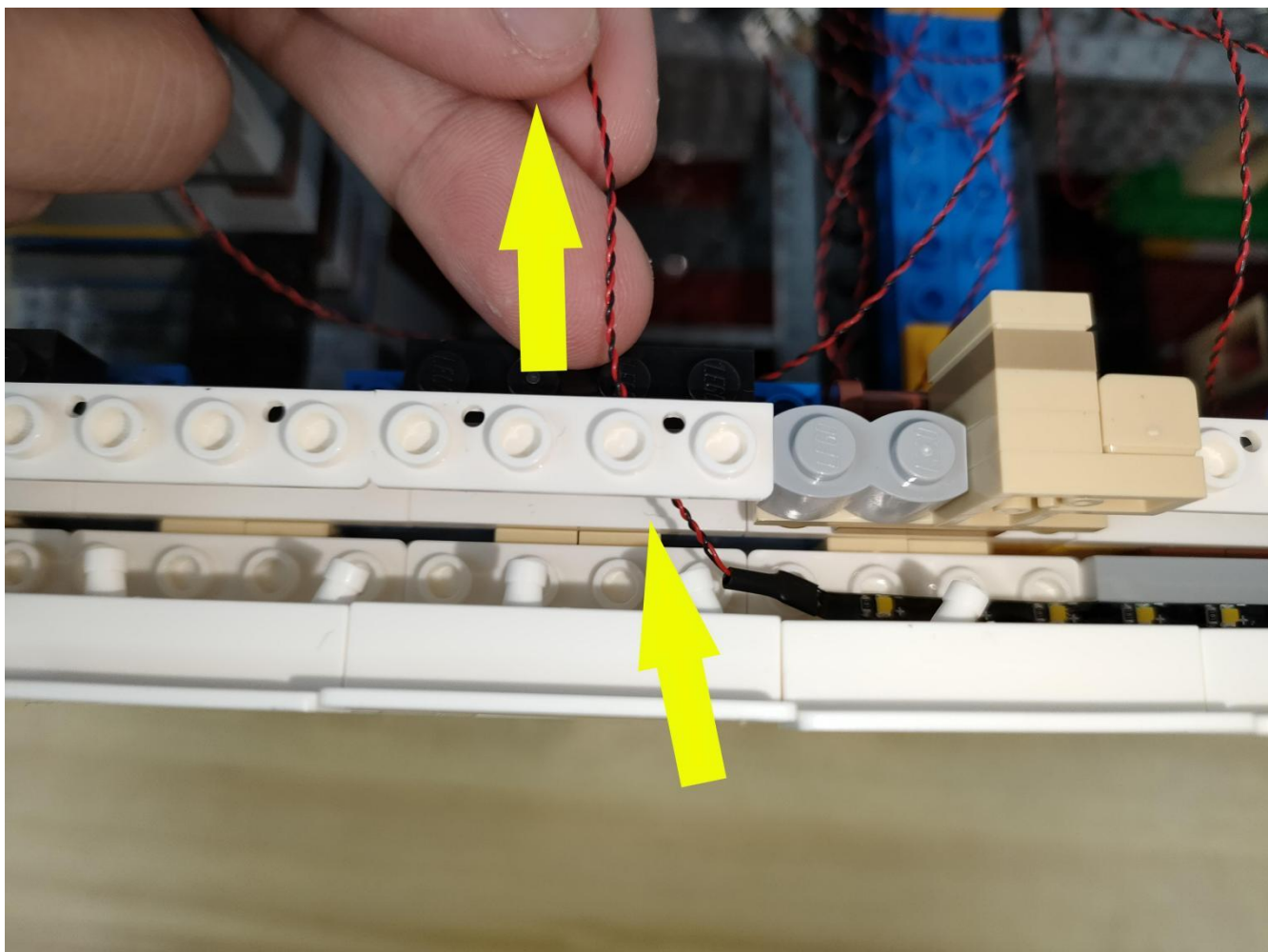

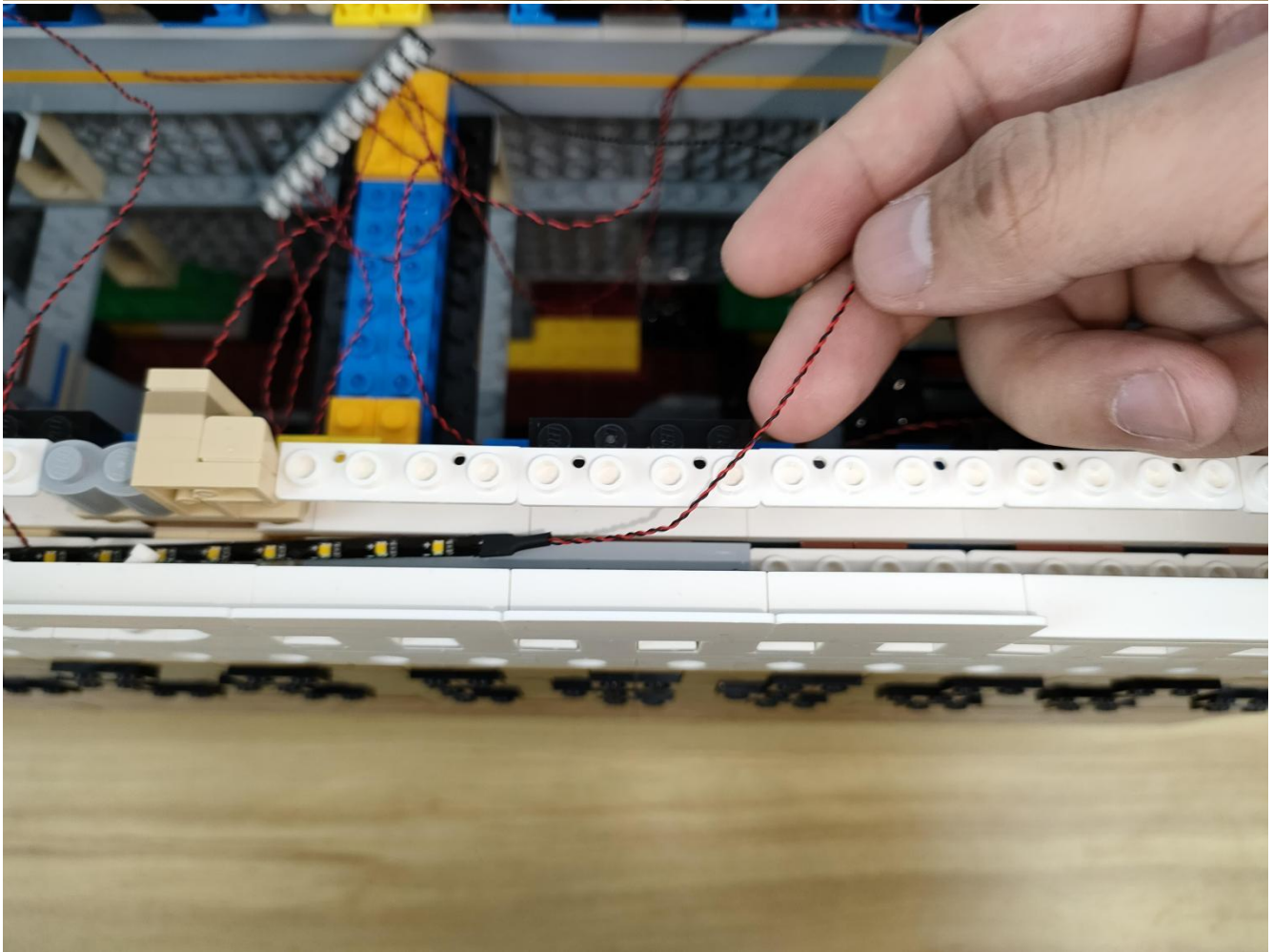
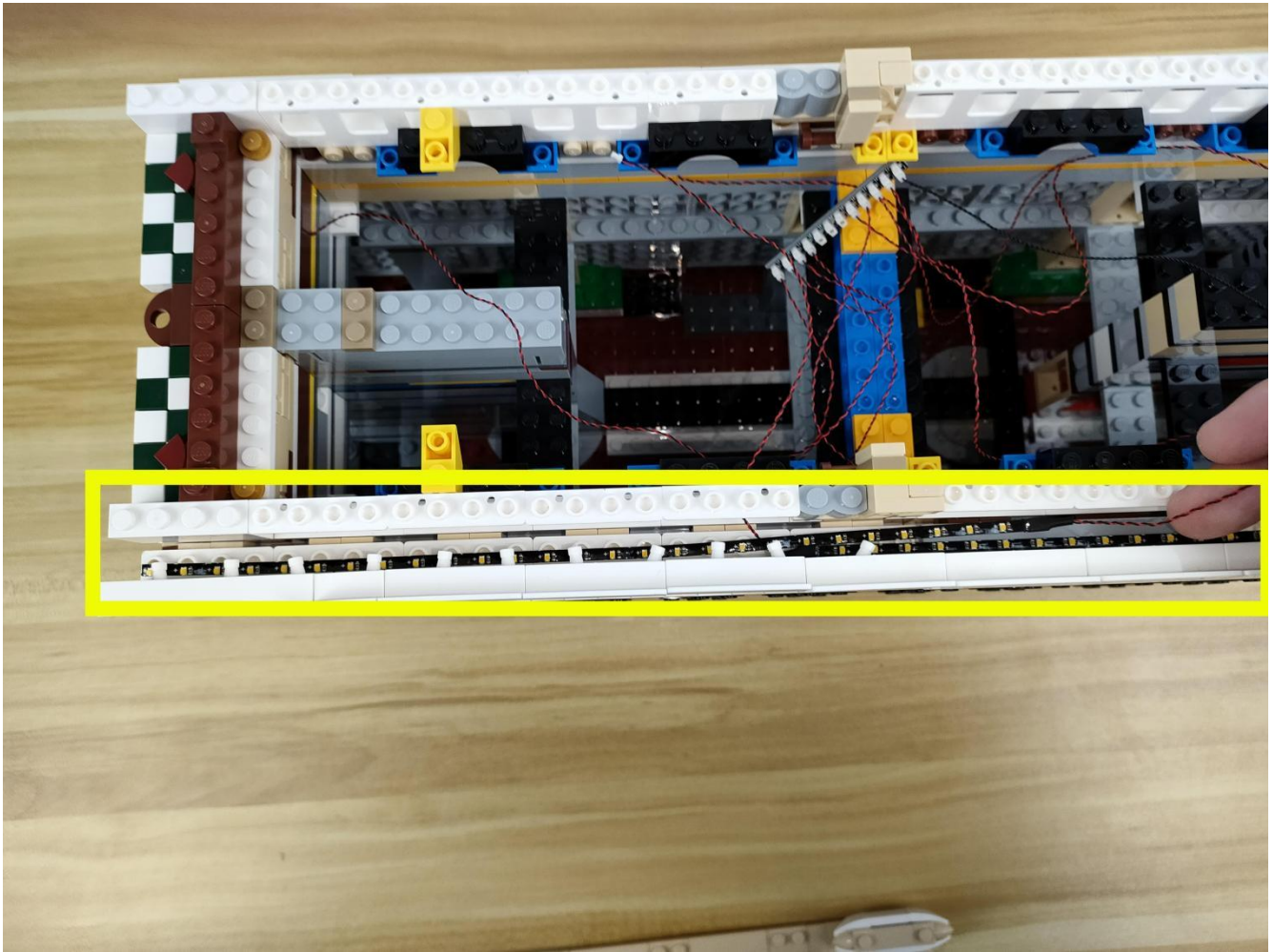

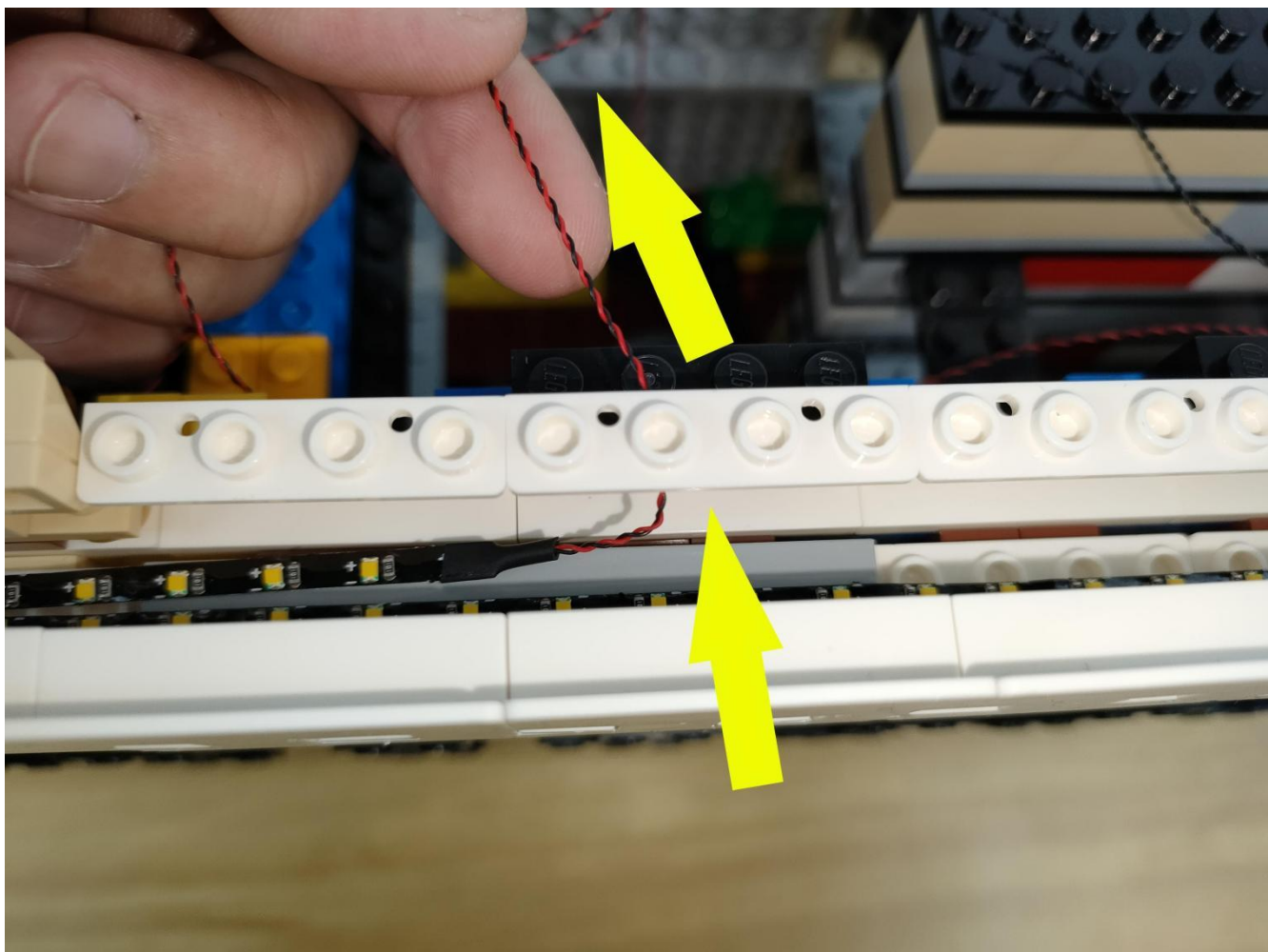

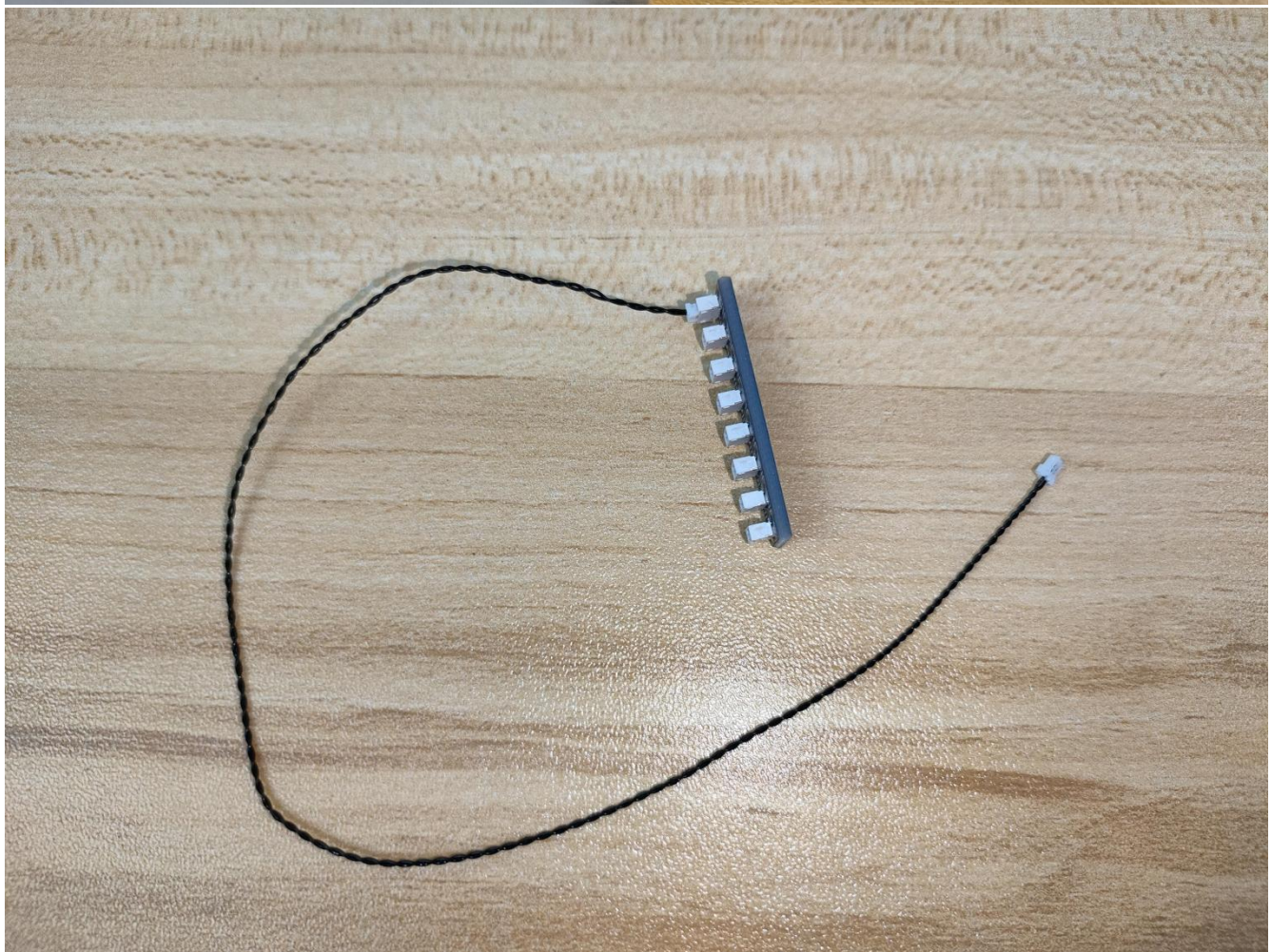

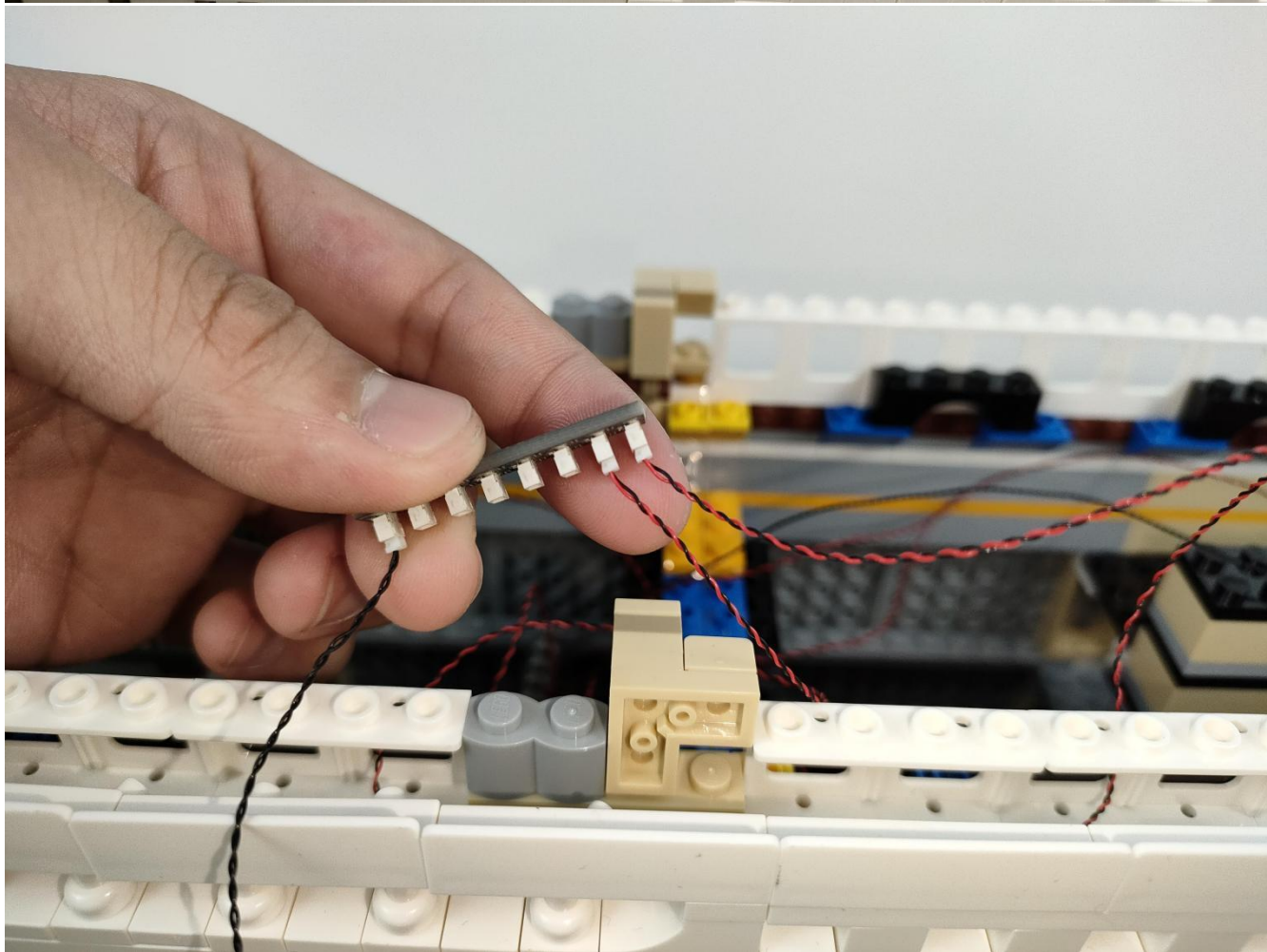
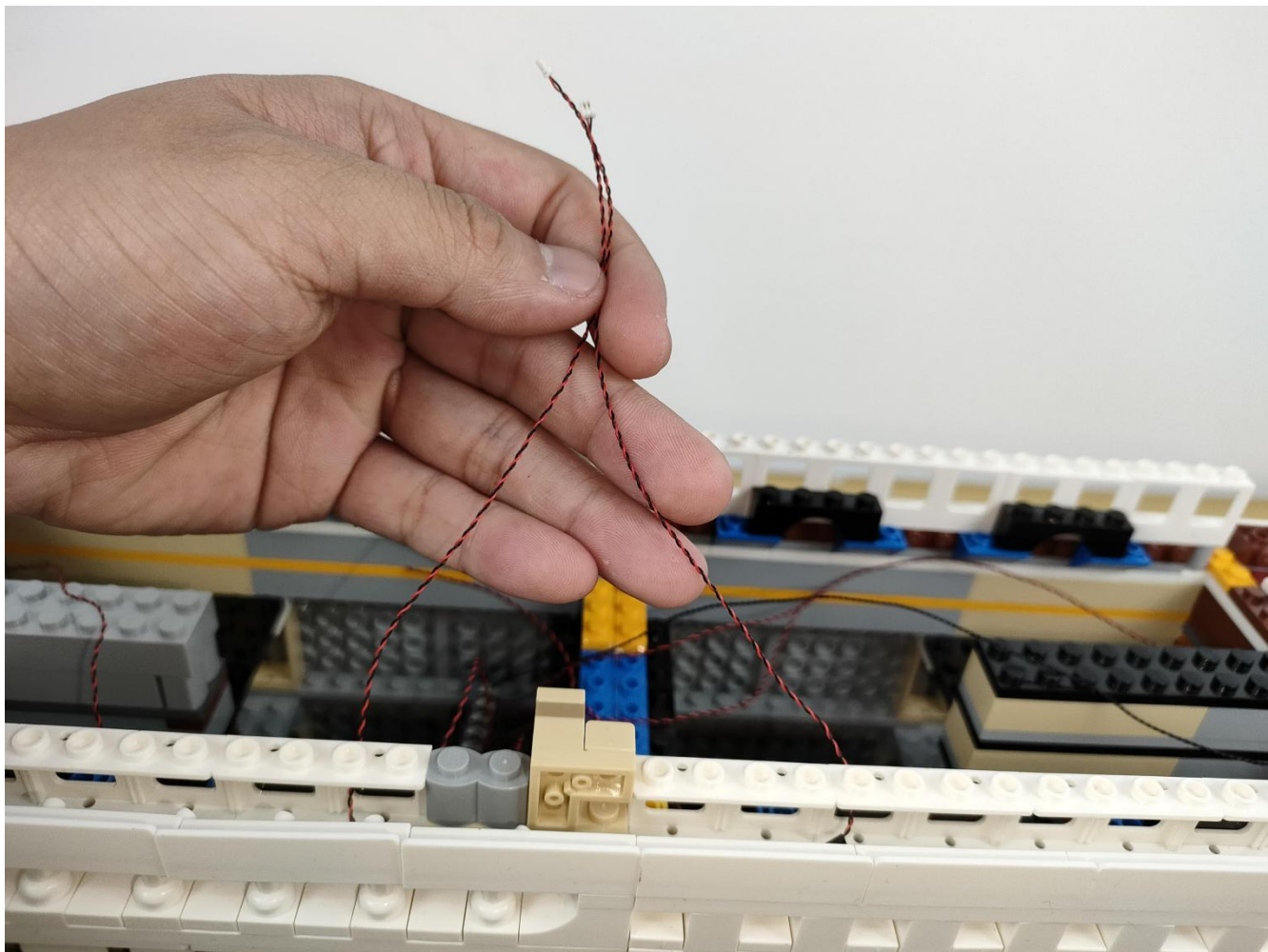

Remove the 50 cm cable from the 12 expansion board and replace it with a 20 cm cable.

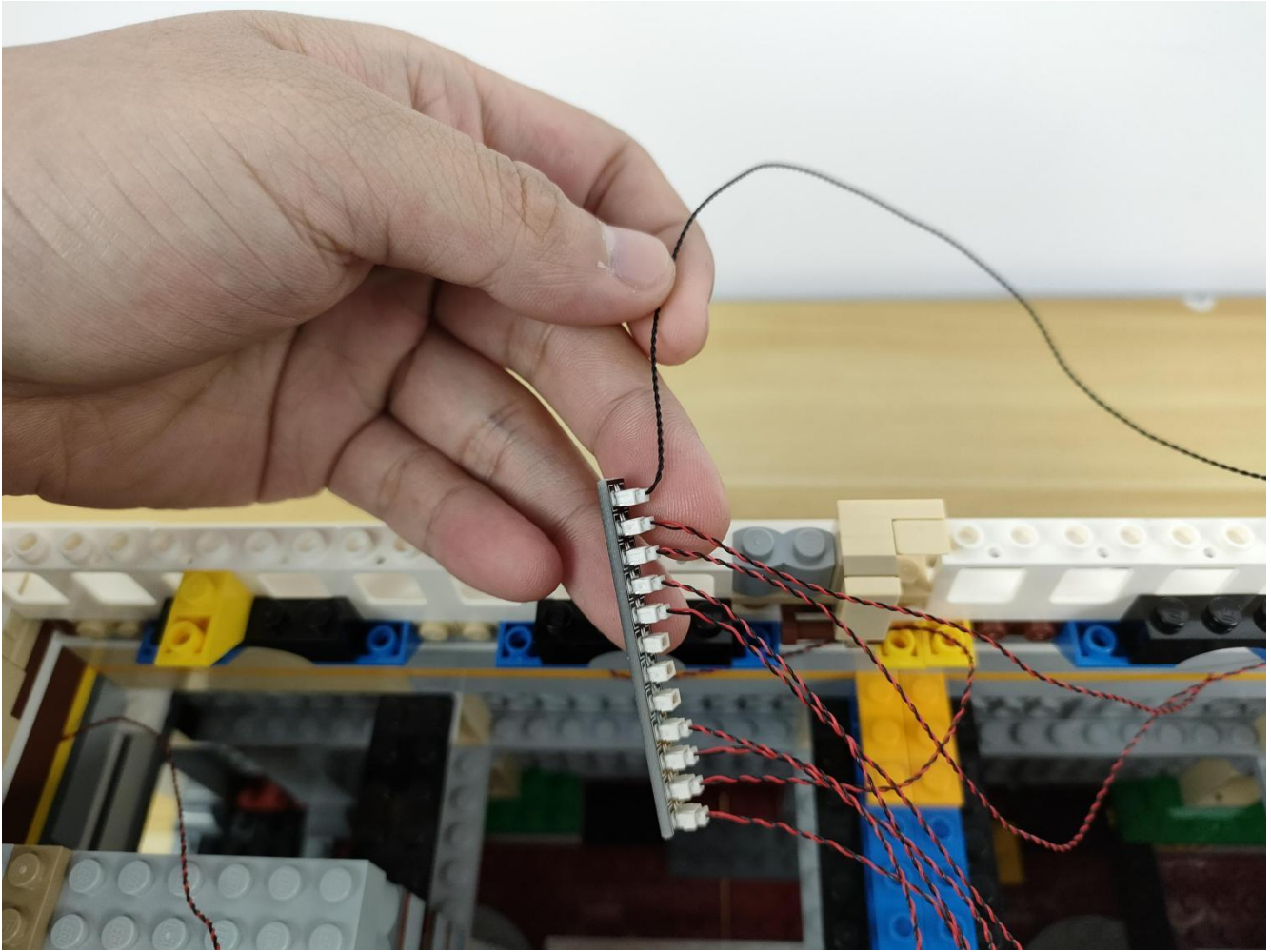

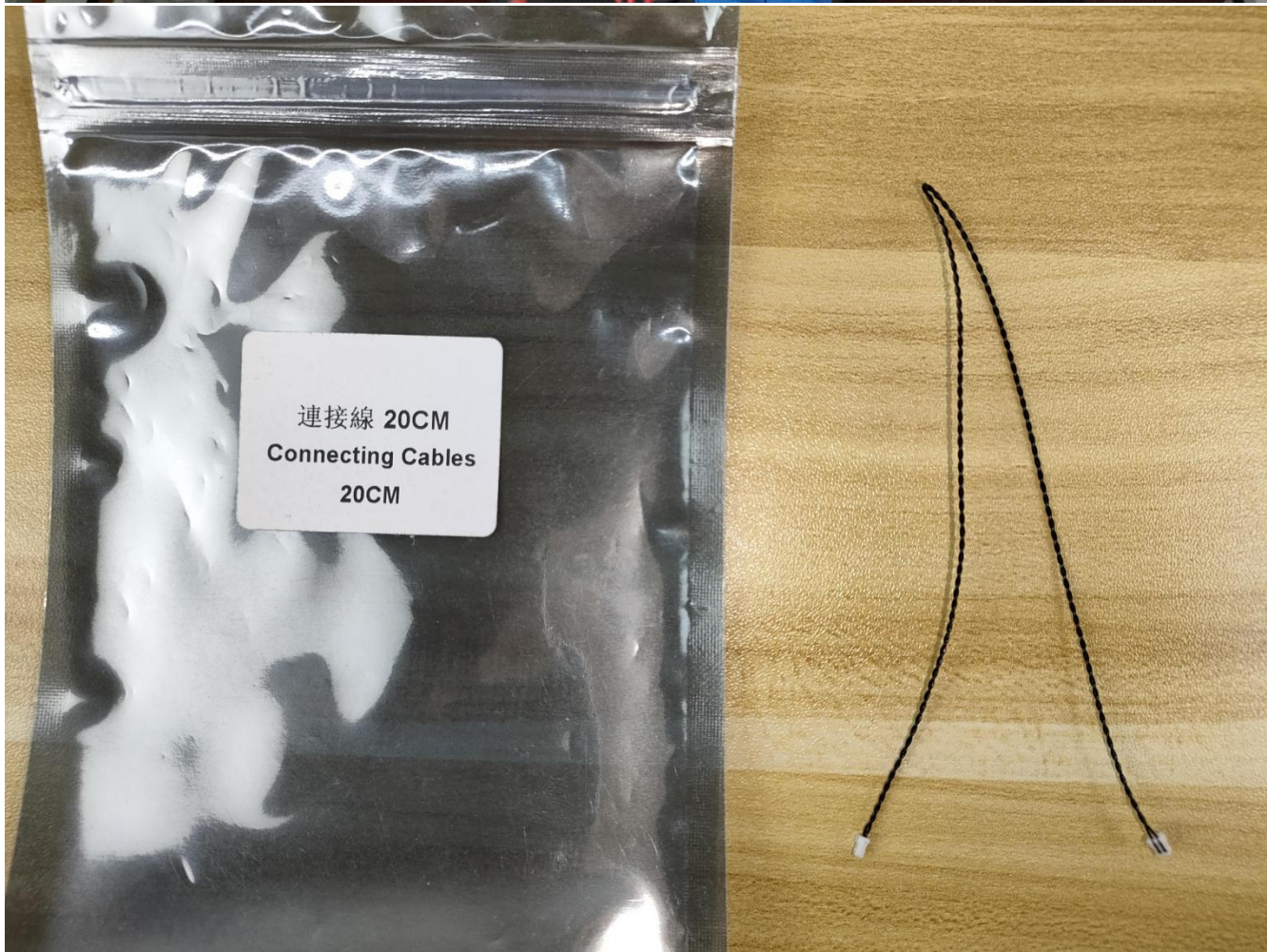
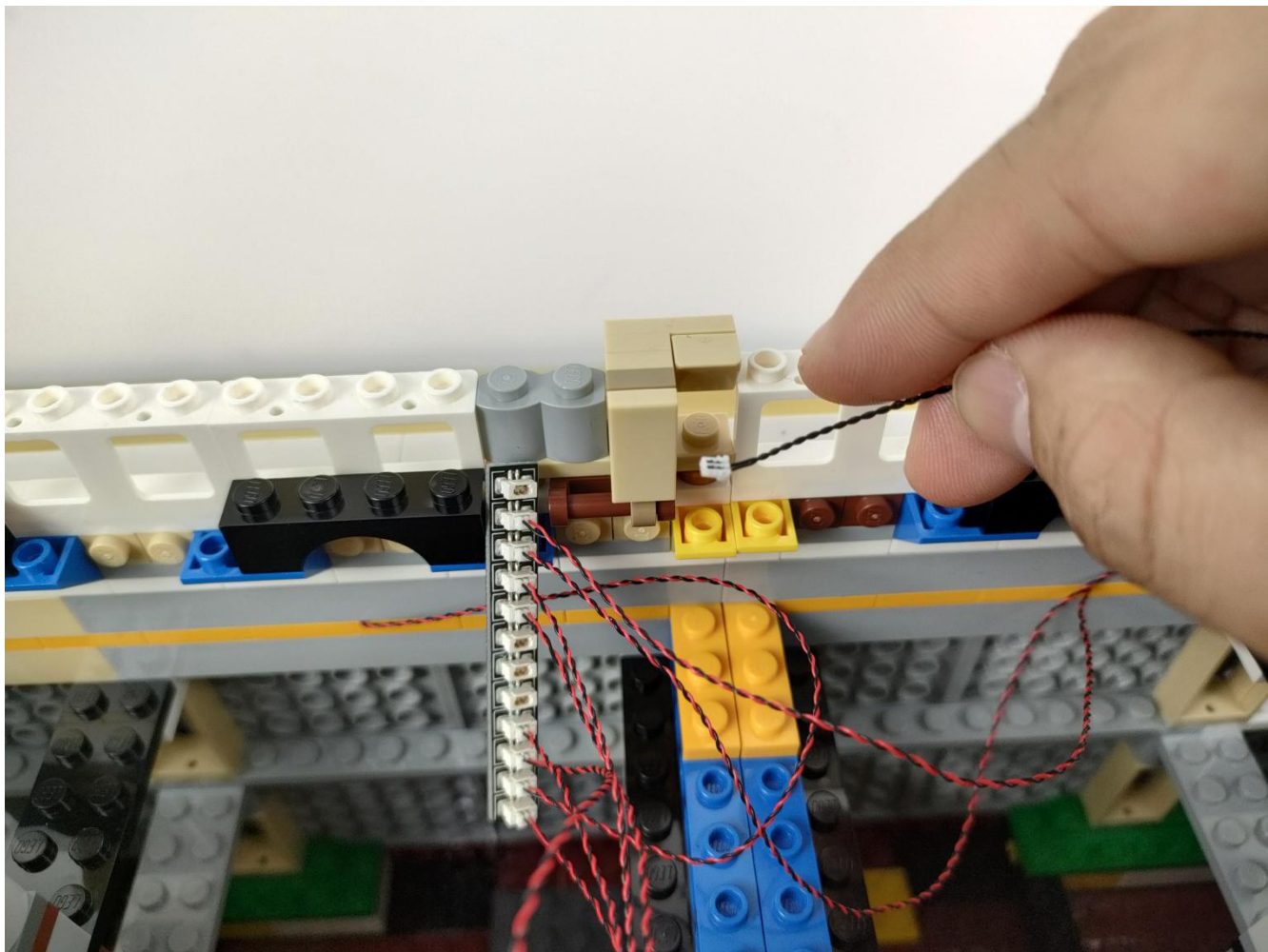

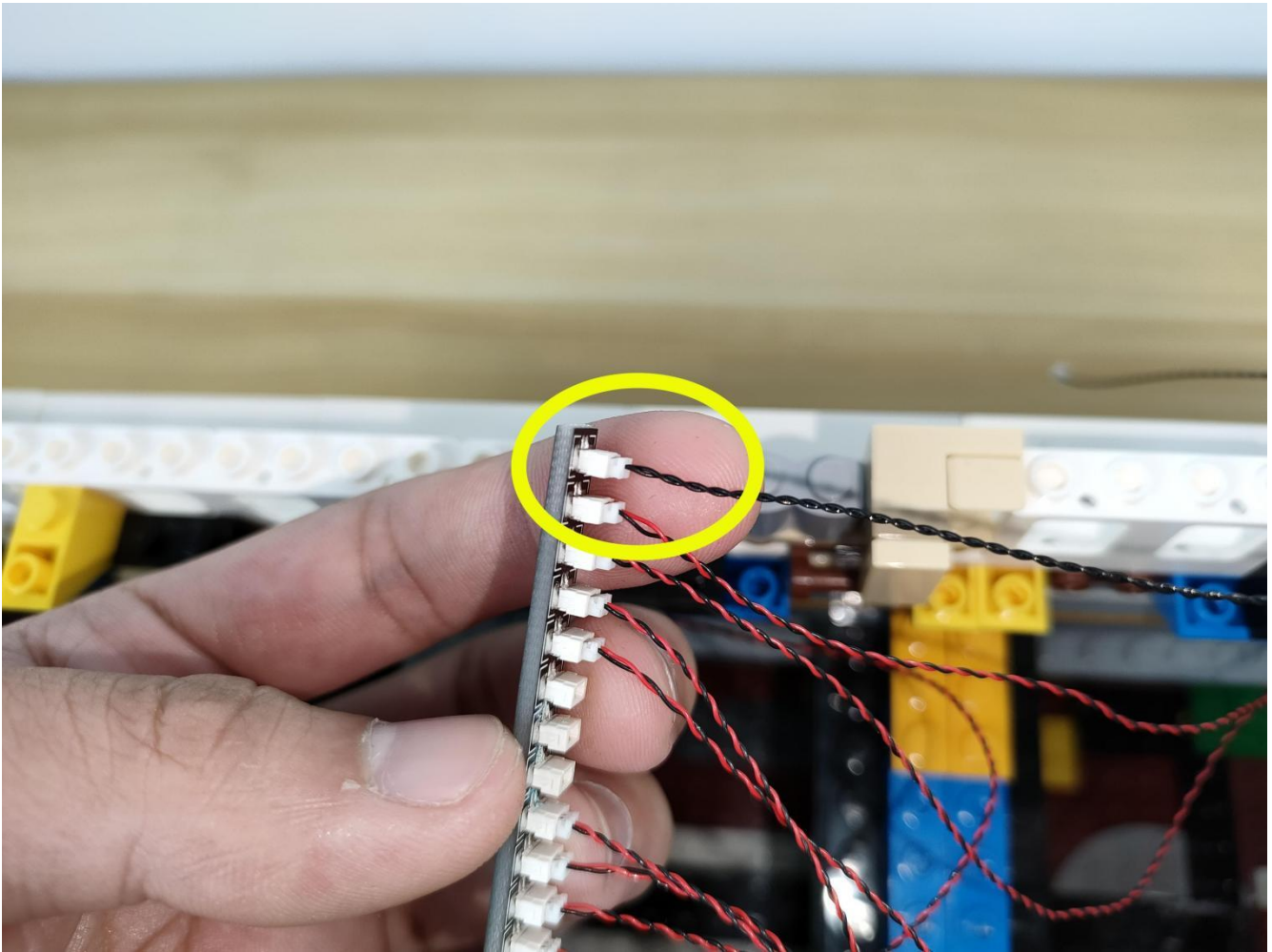

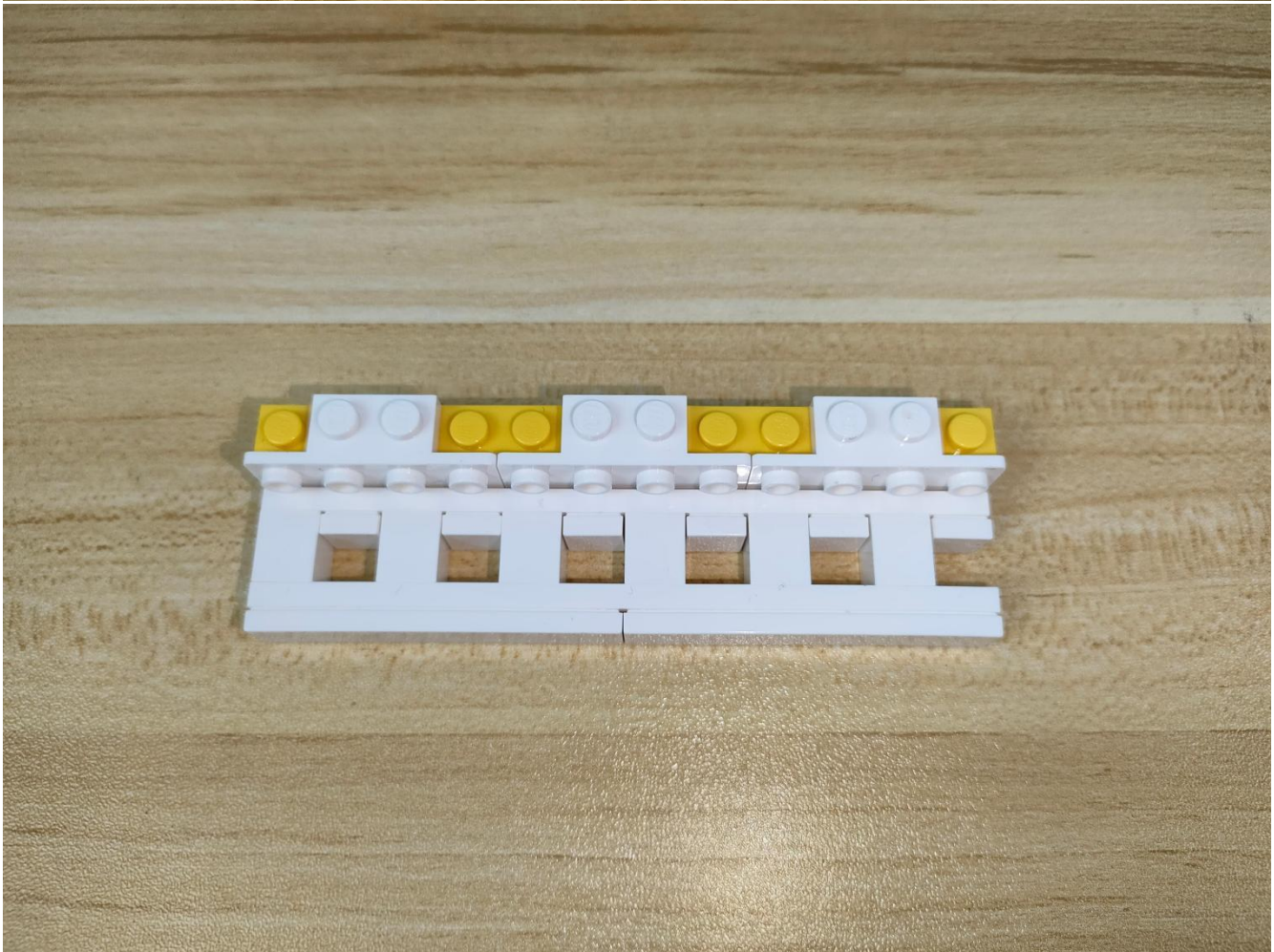

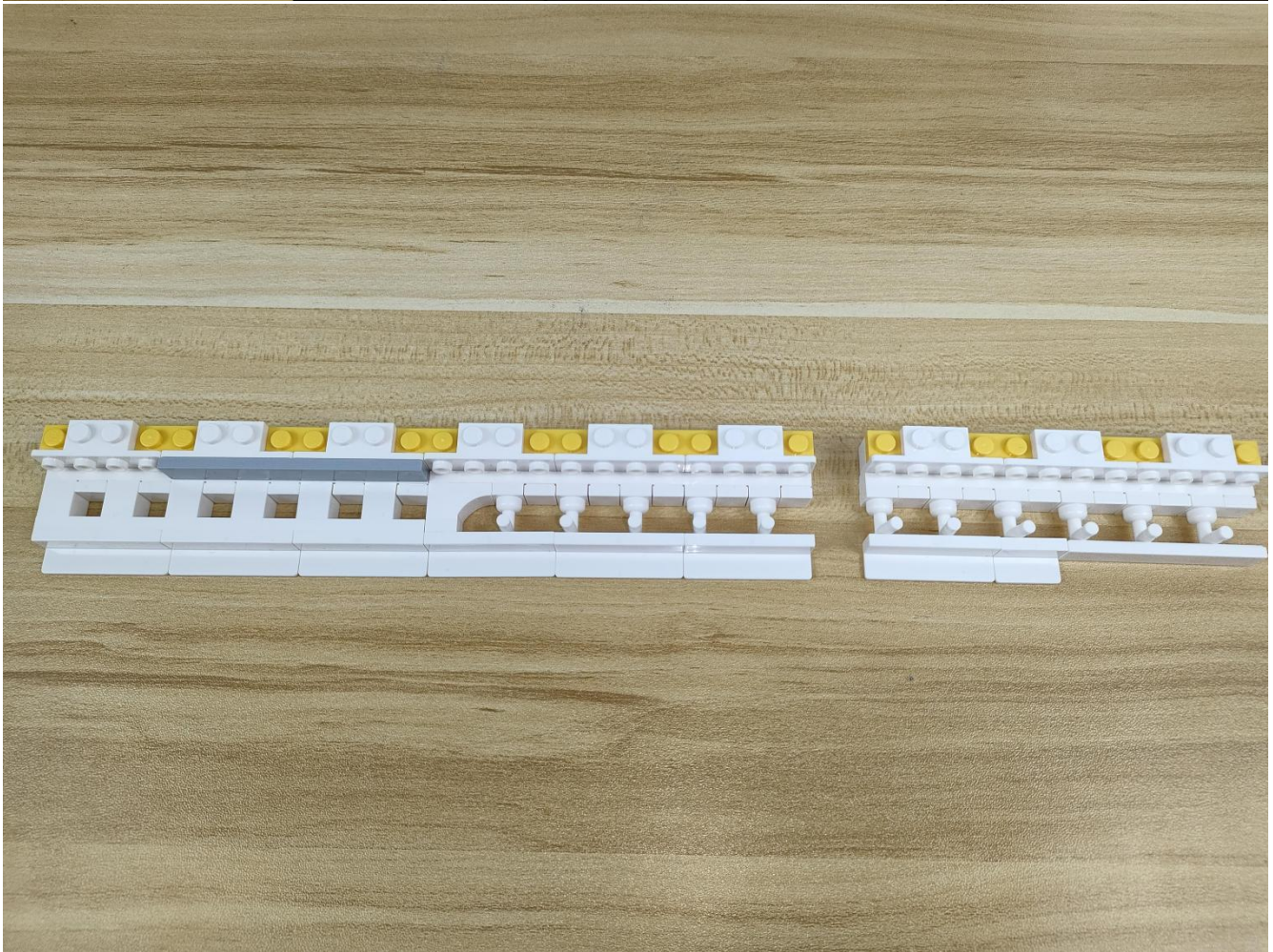
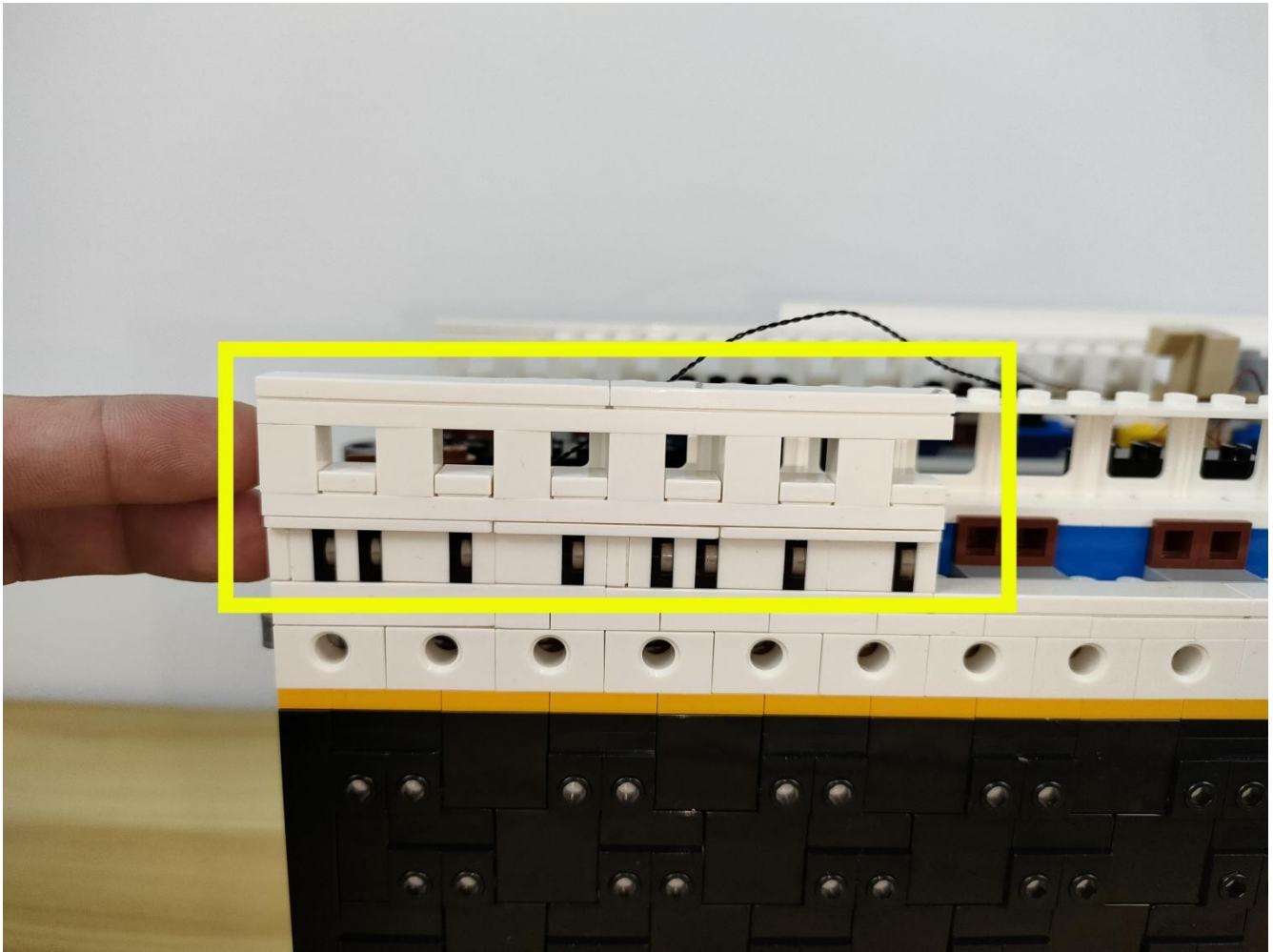

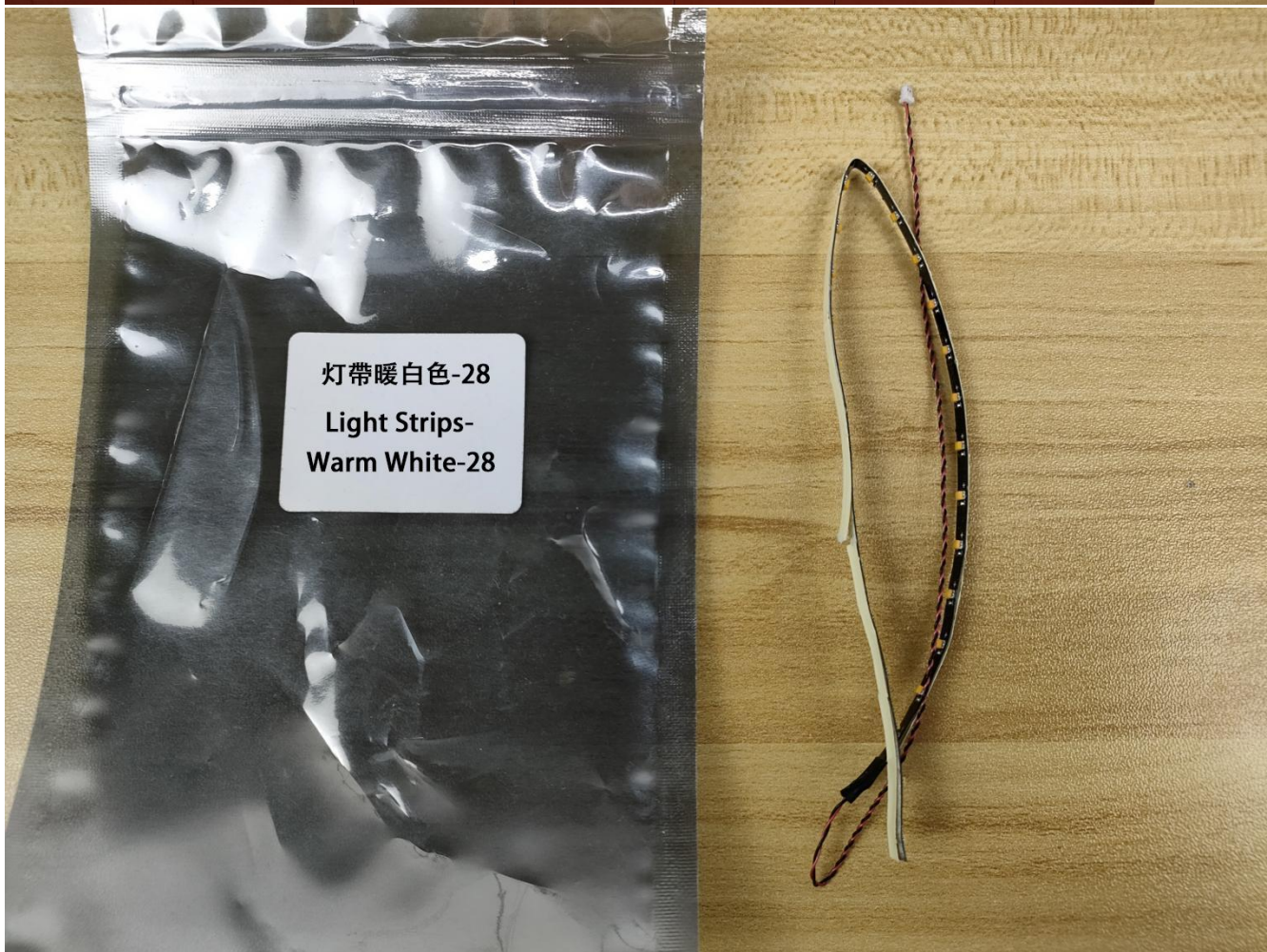
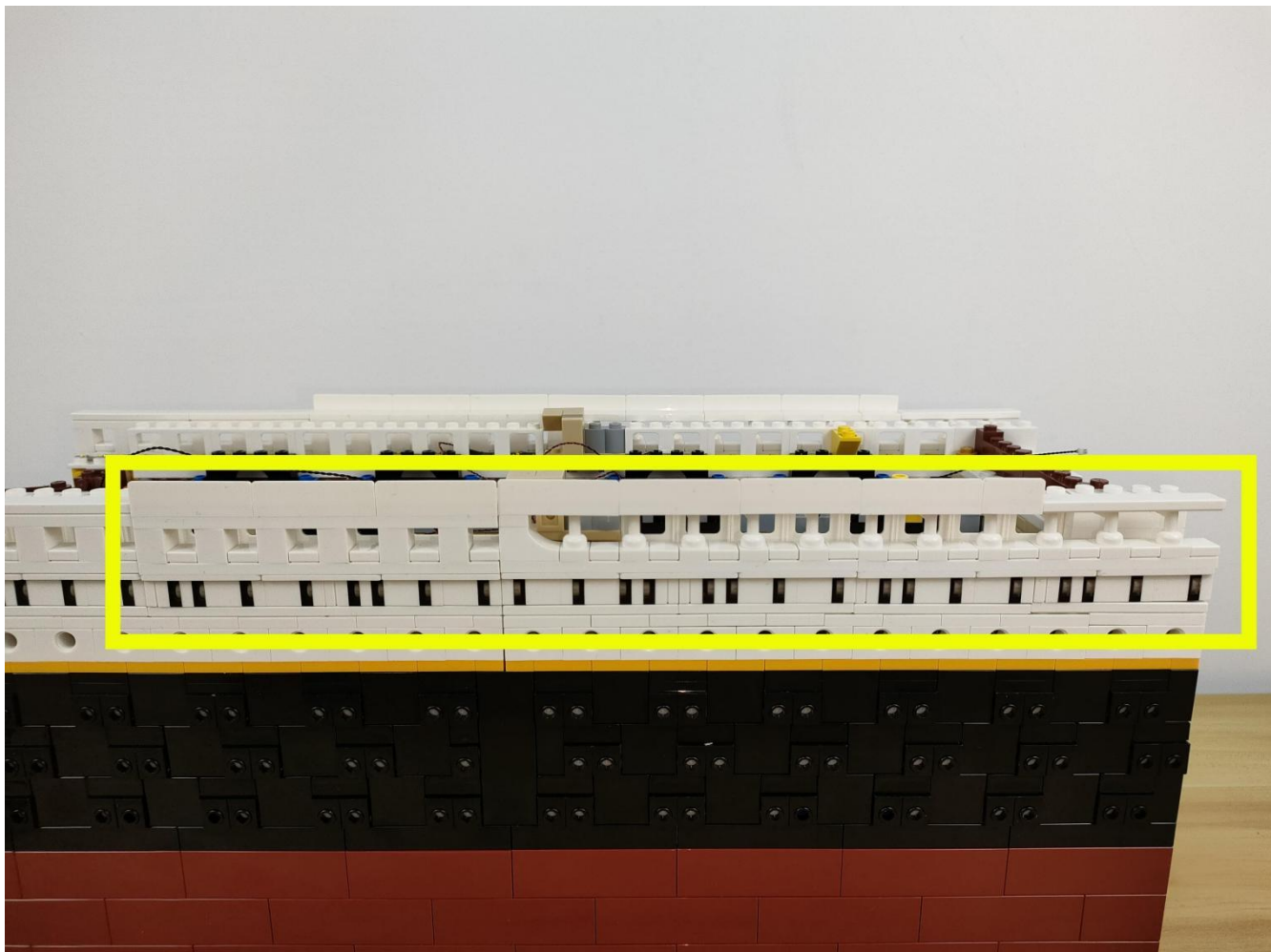

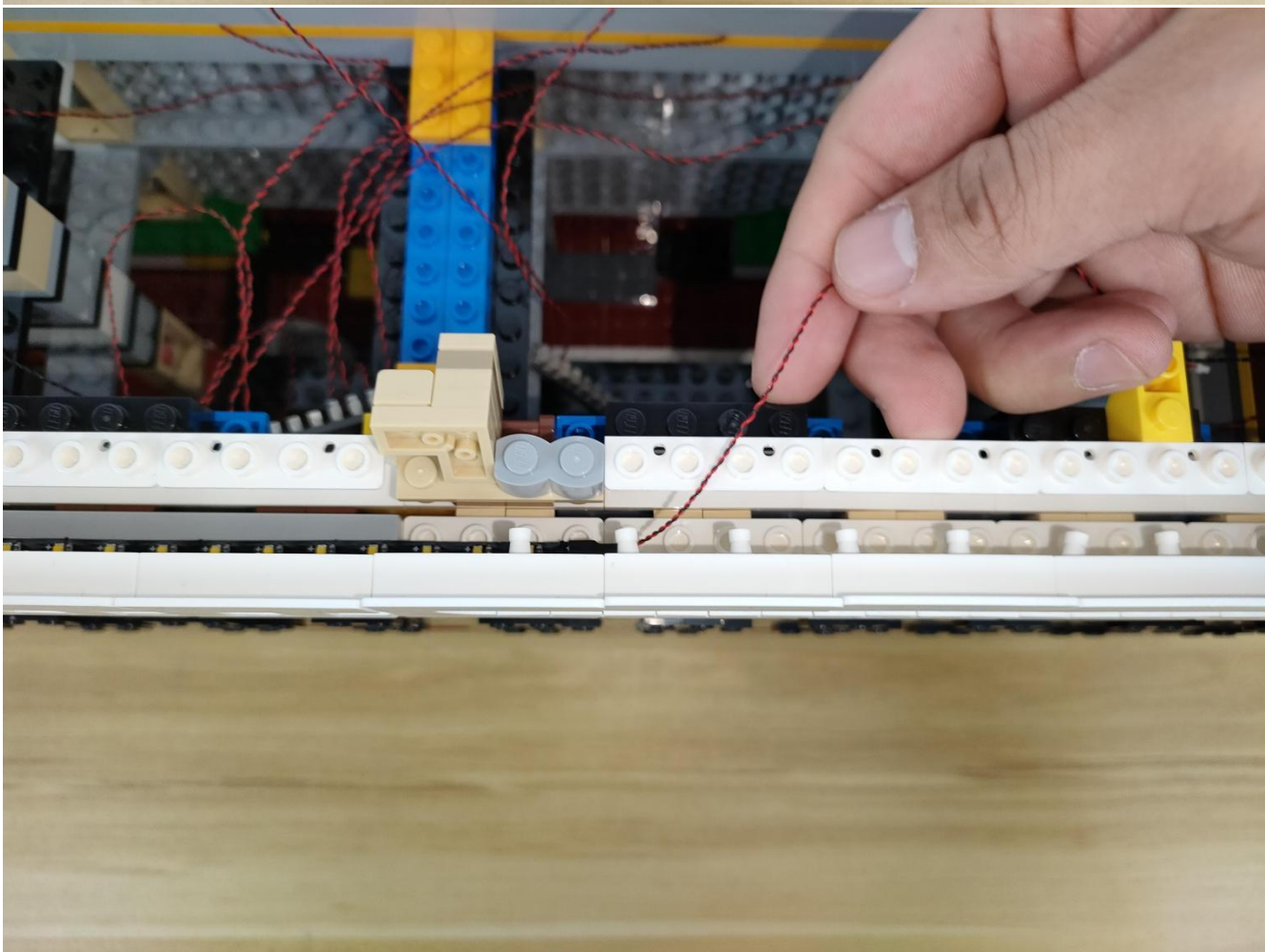
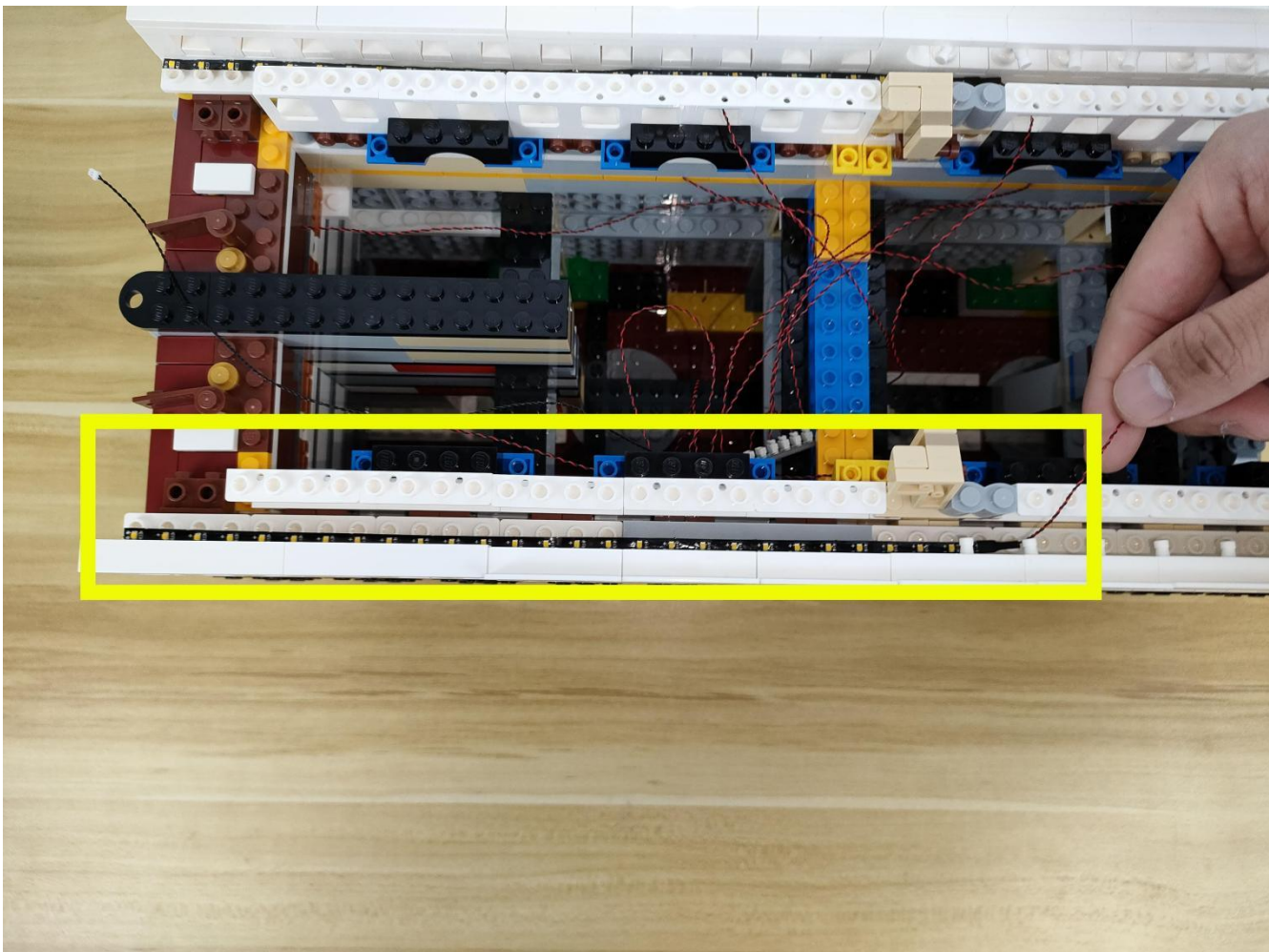

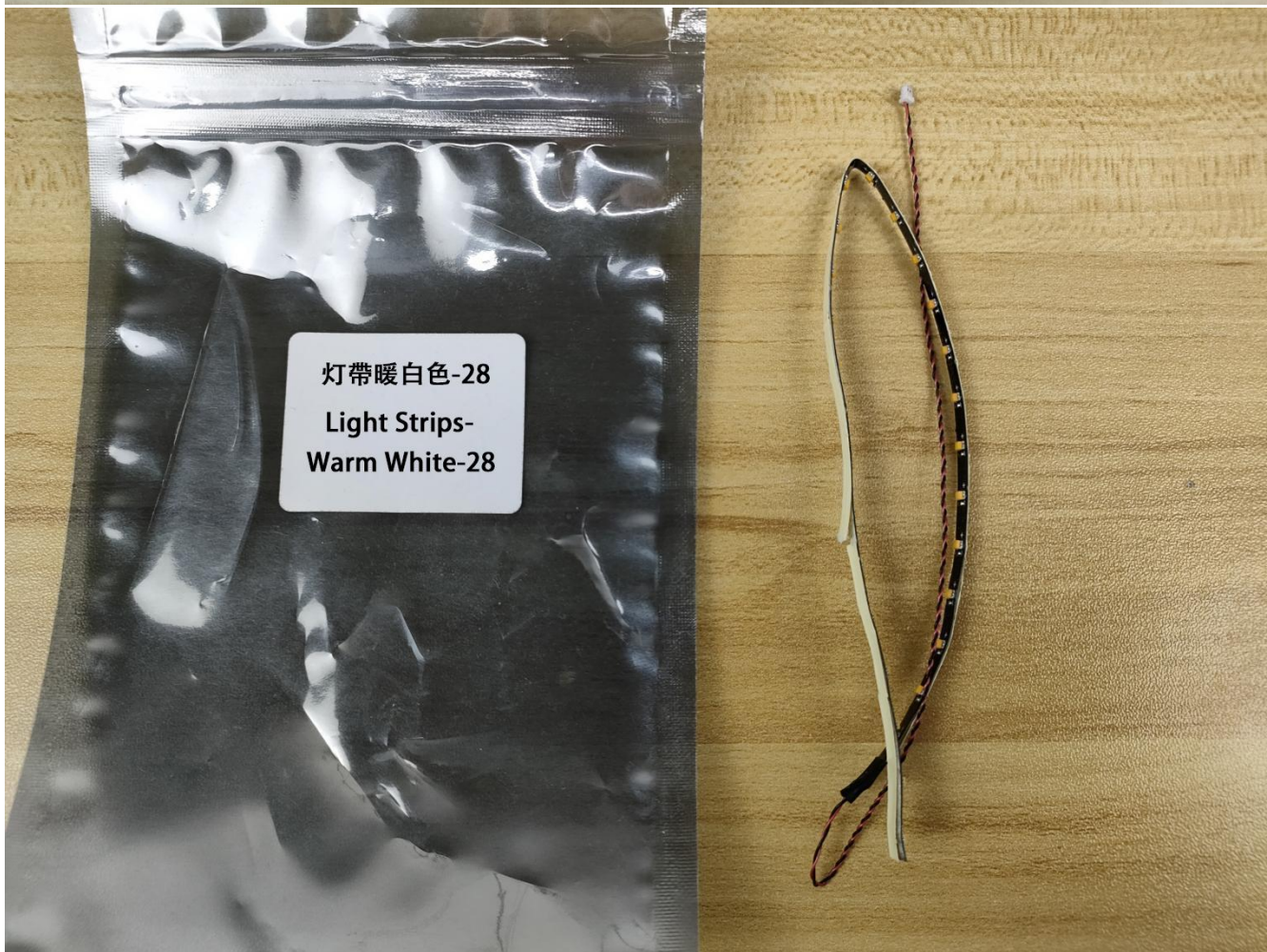
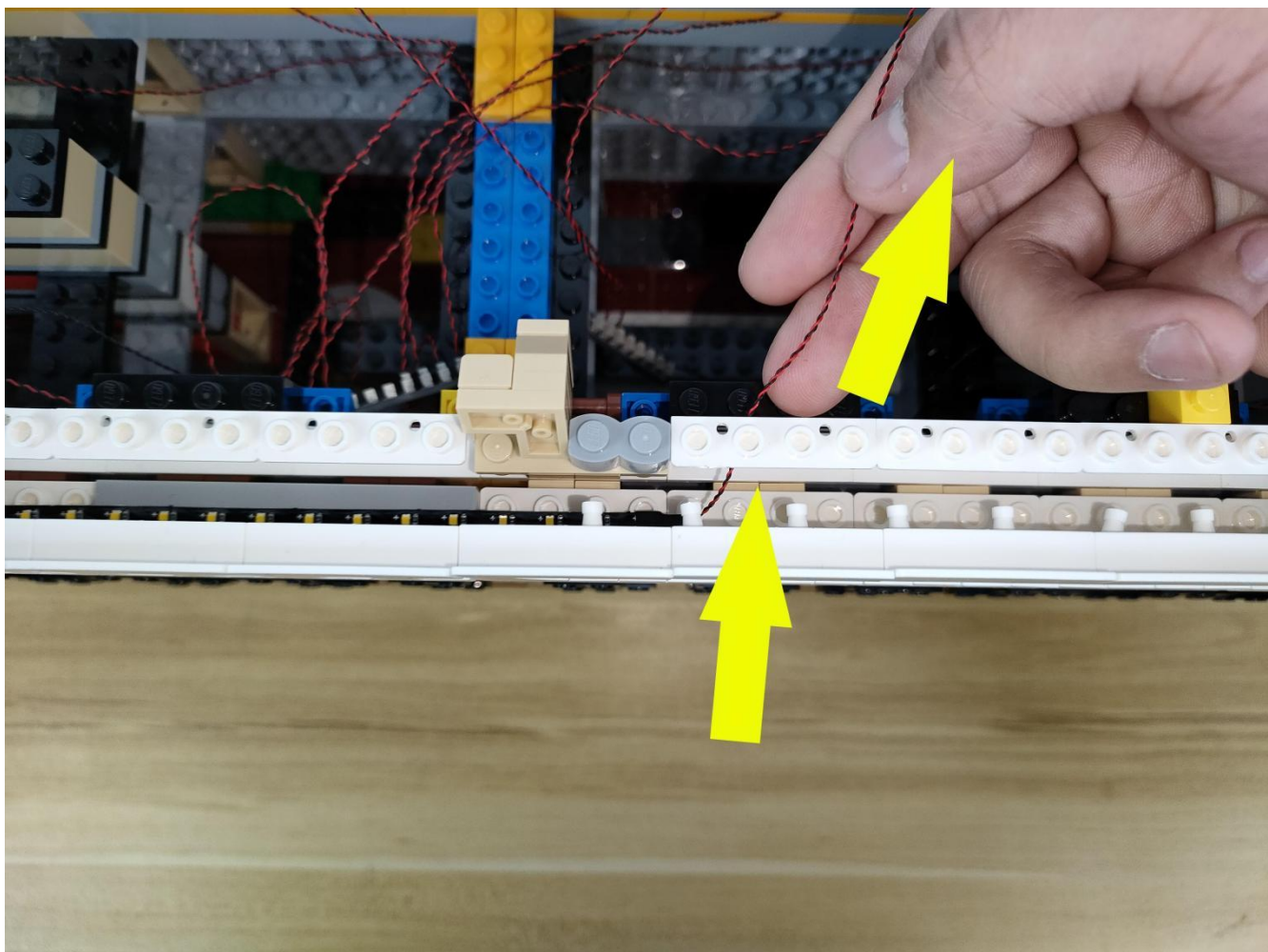

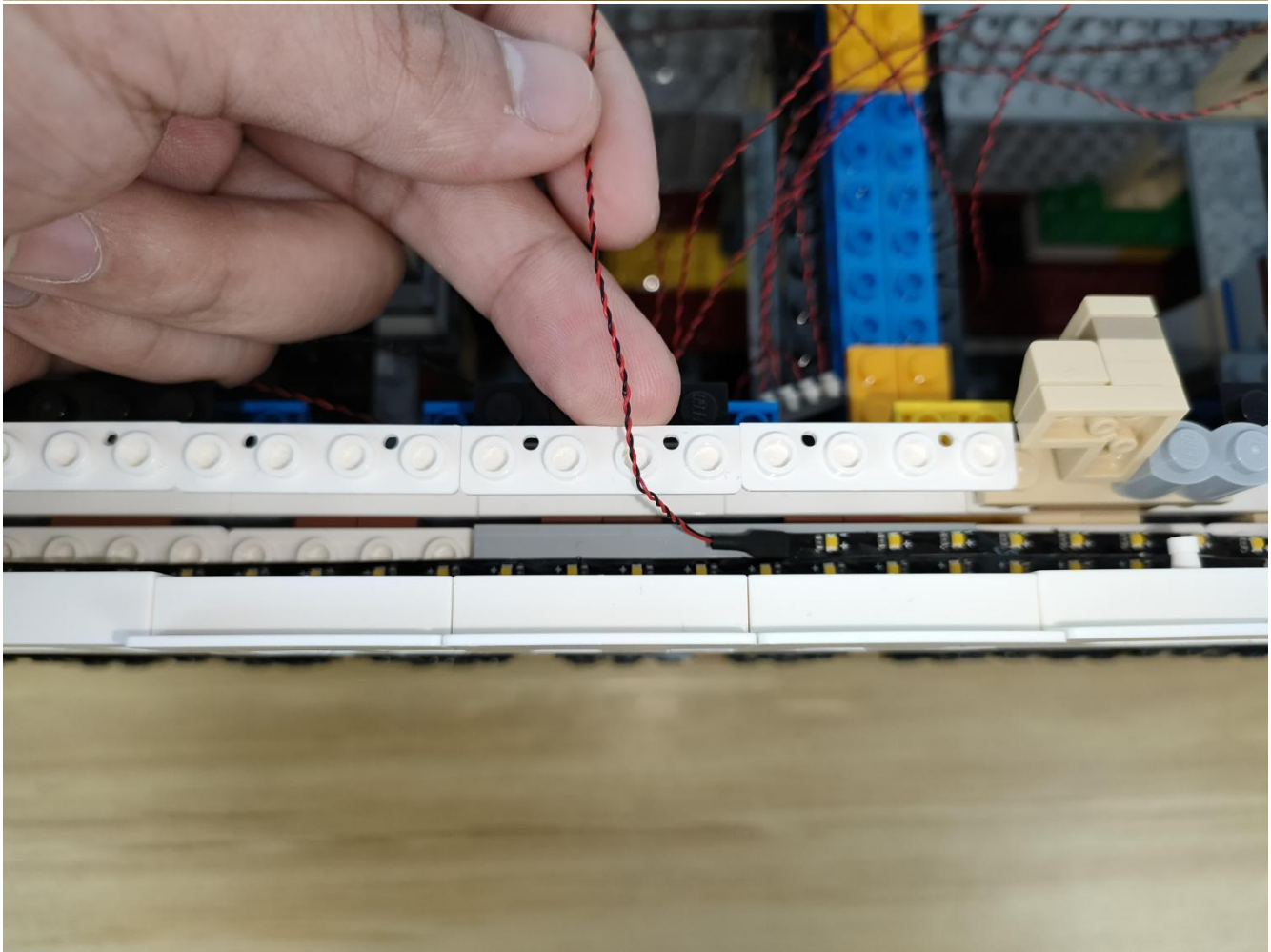
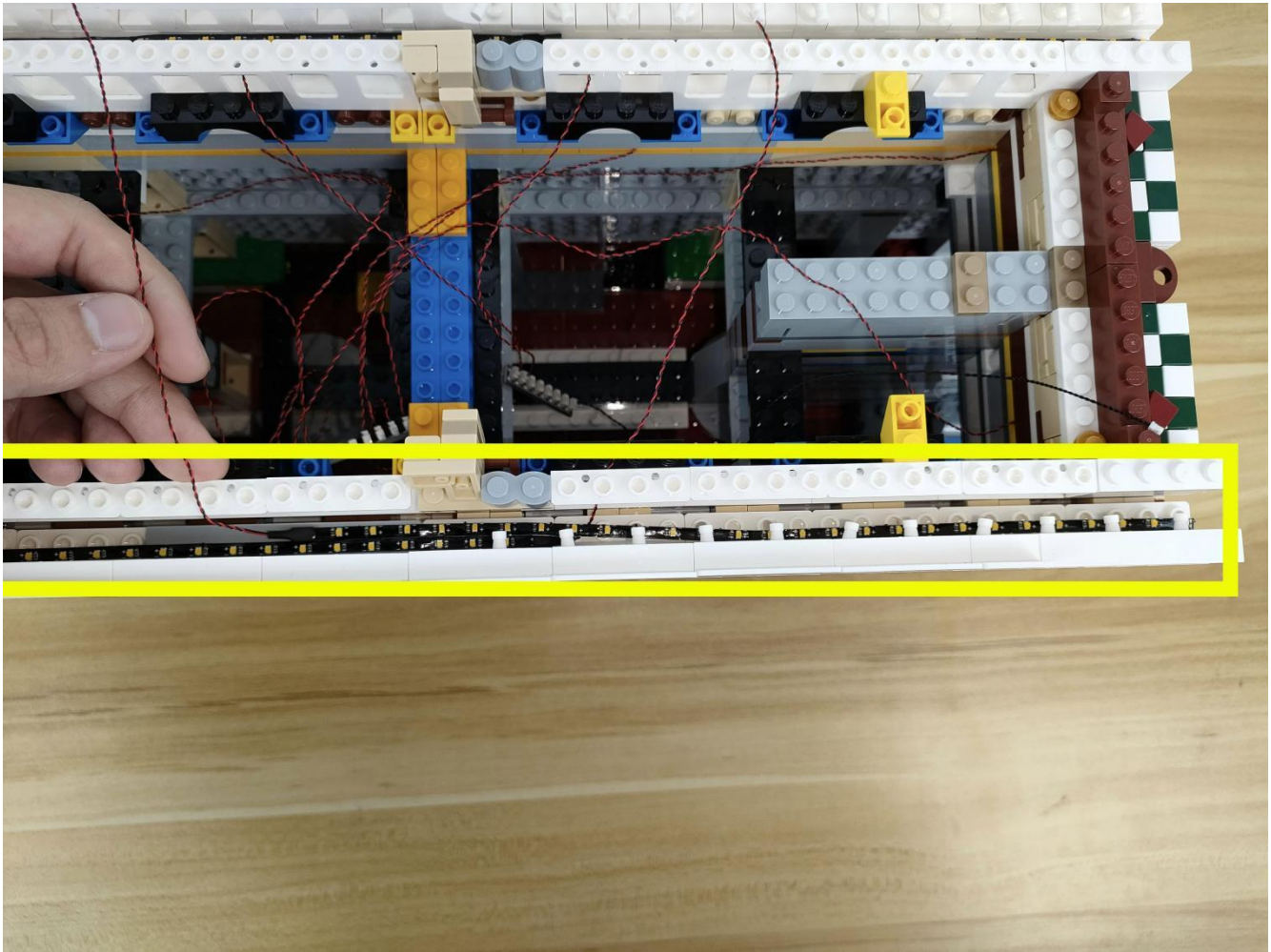

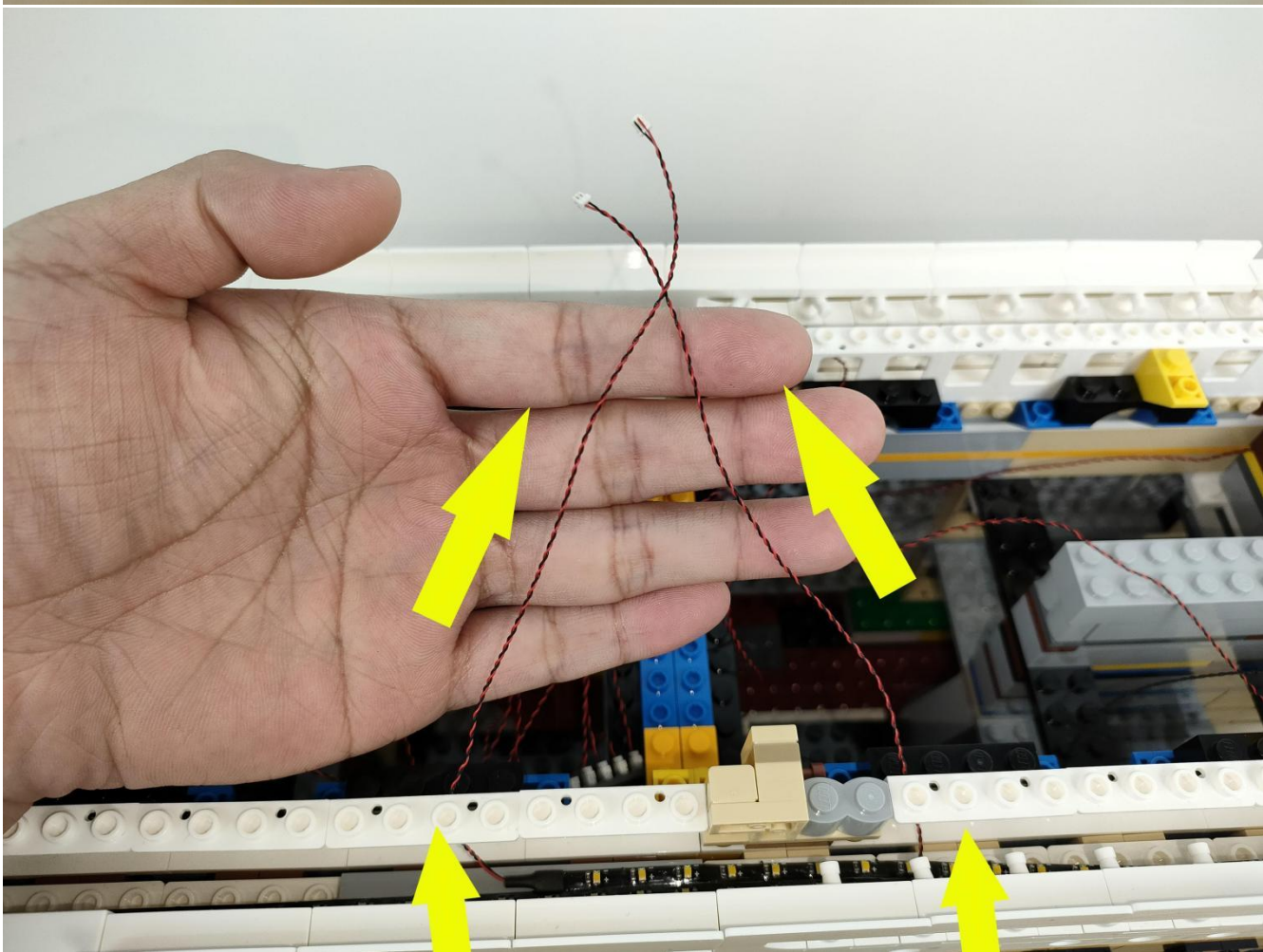
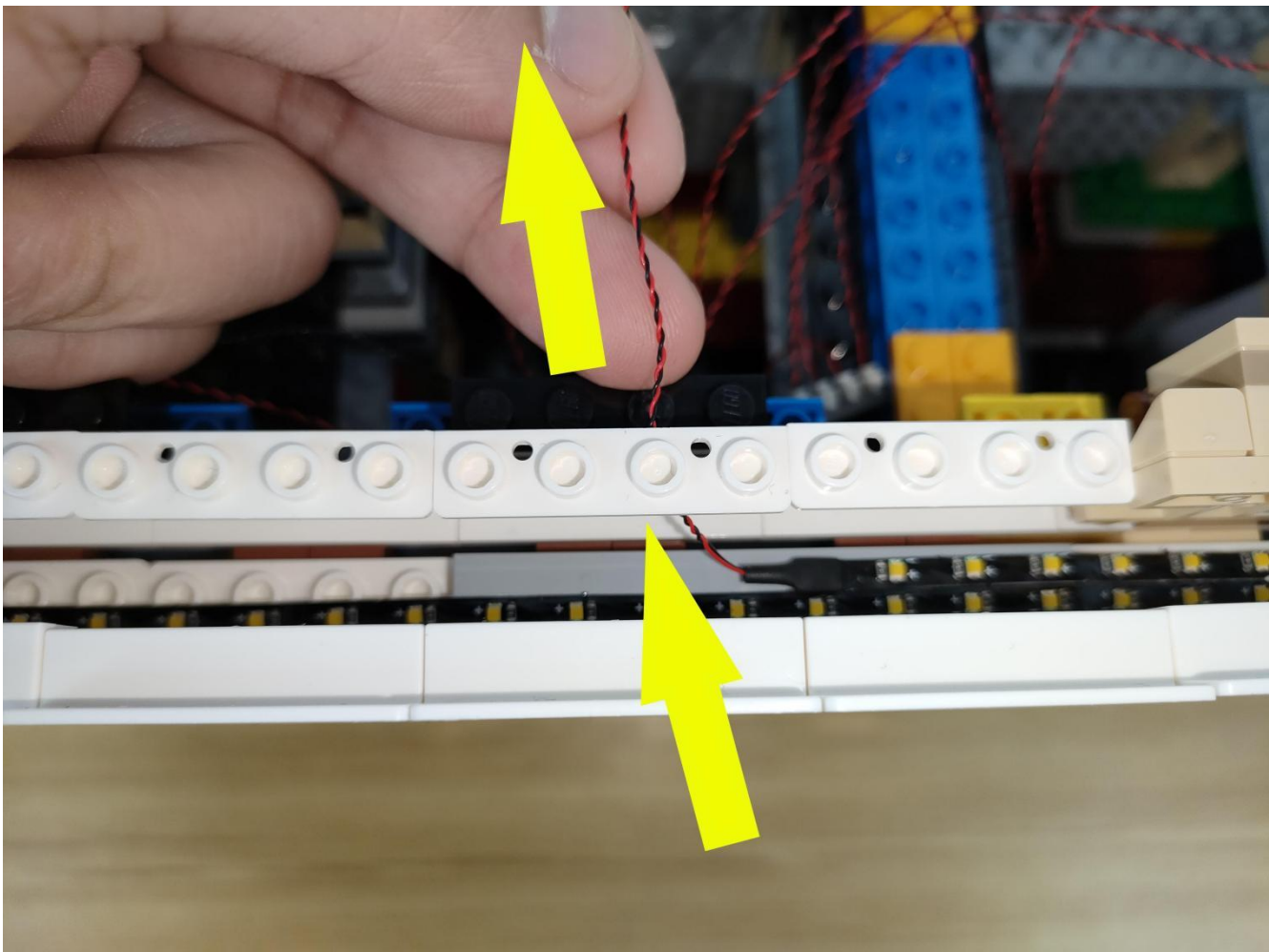

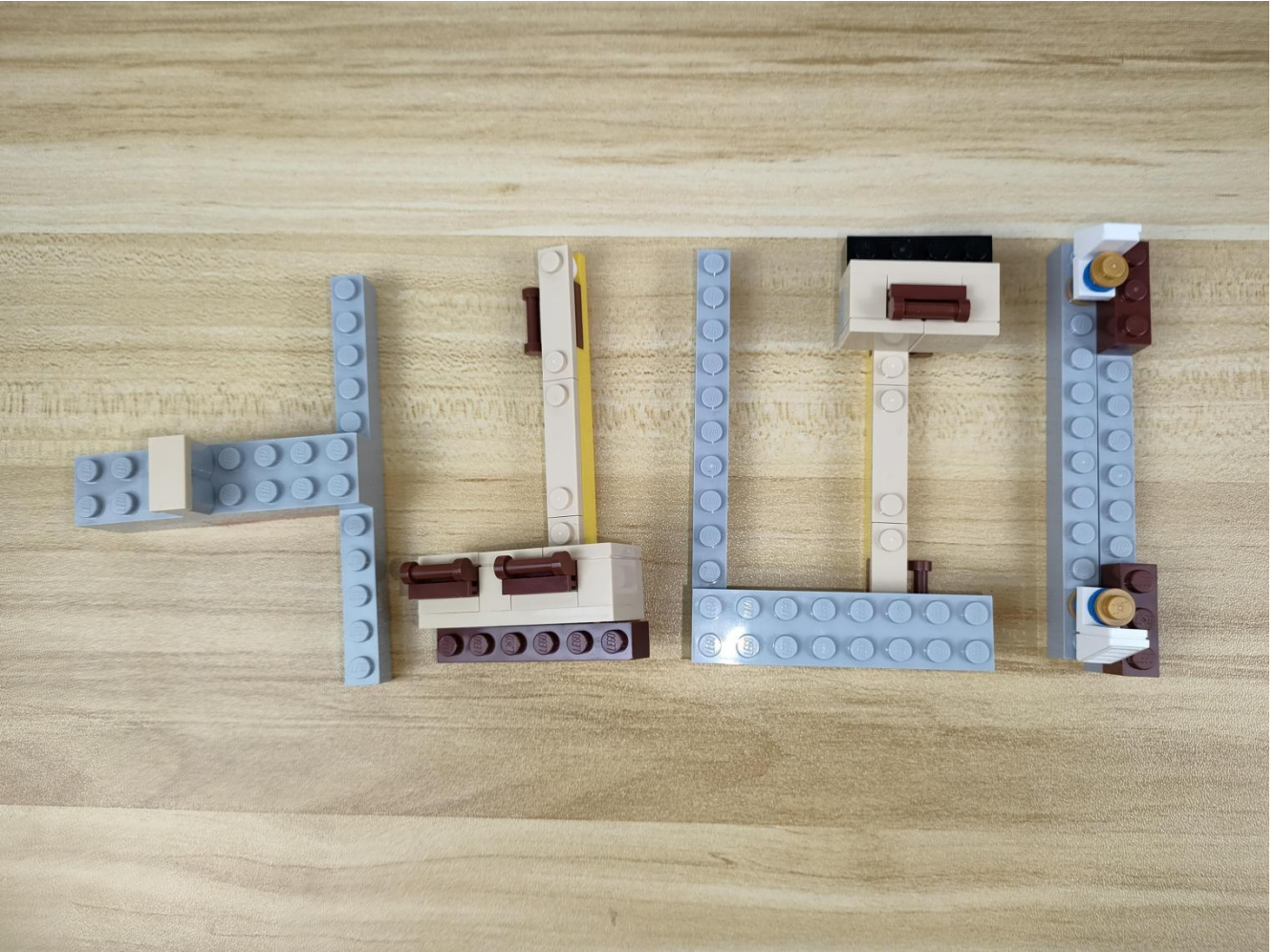
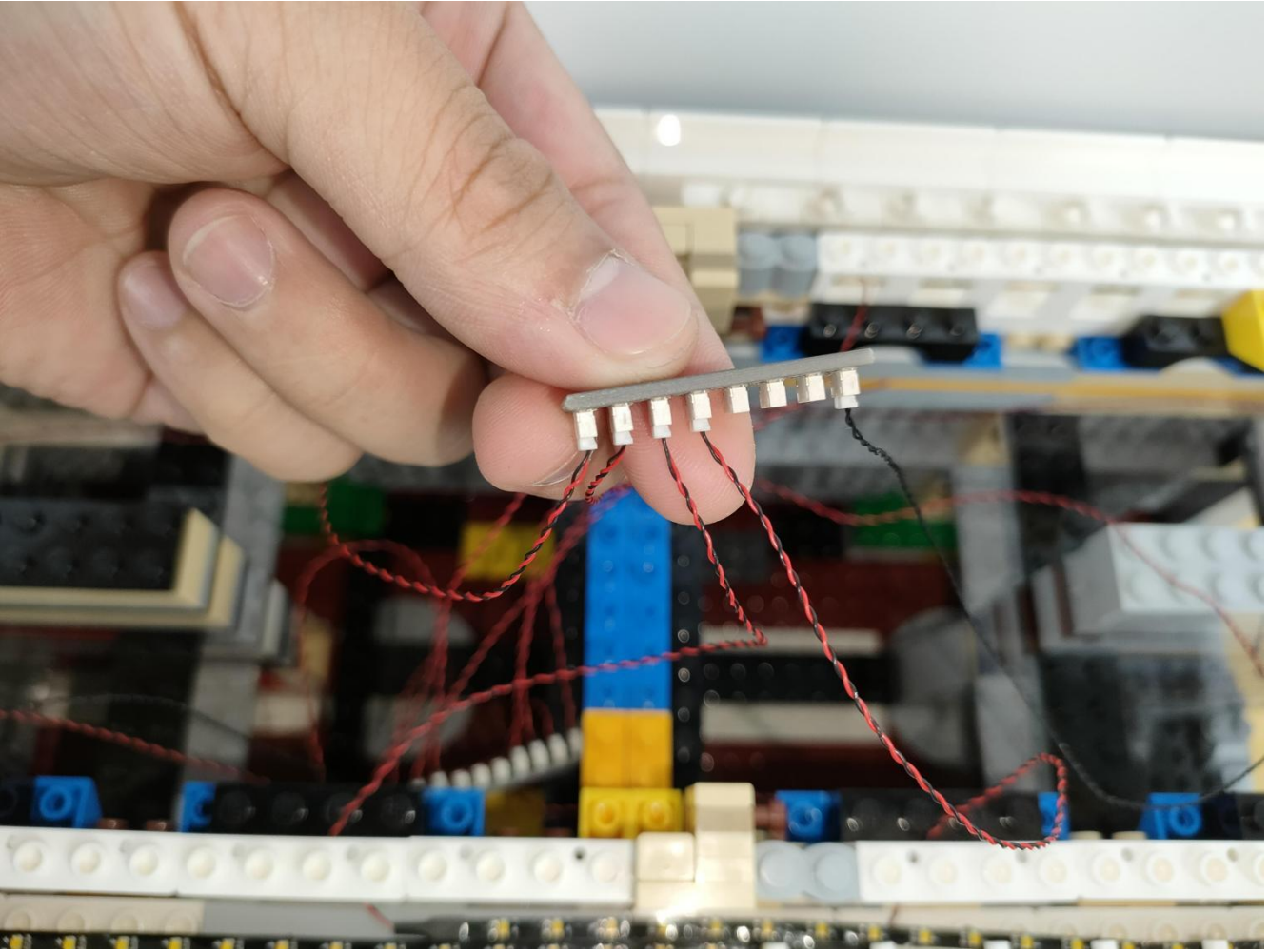

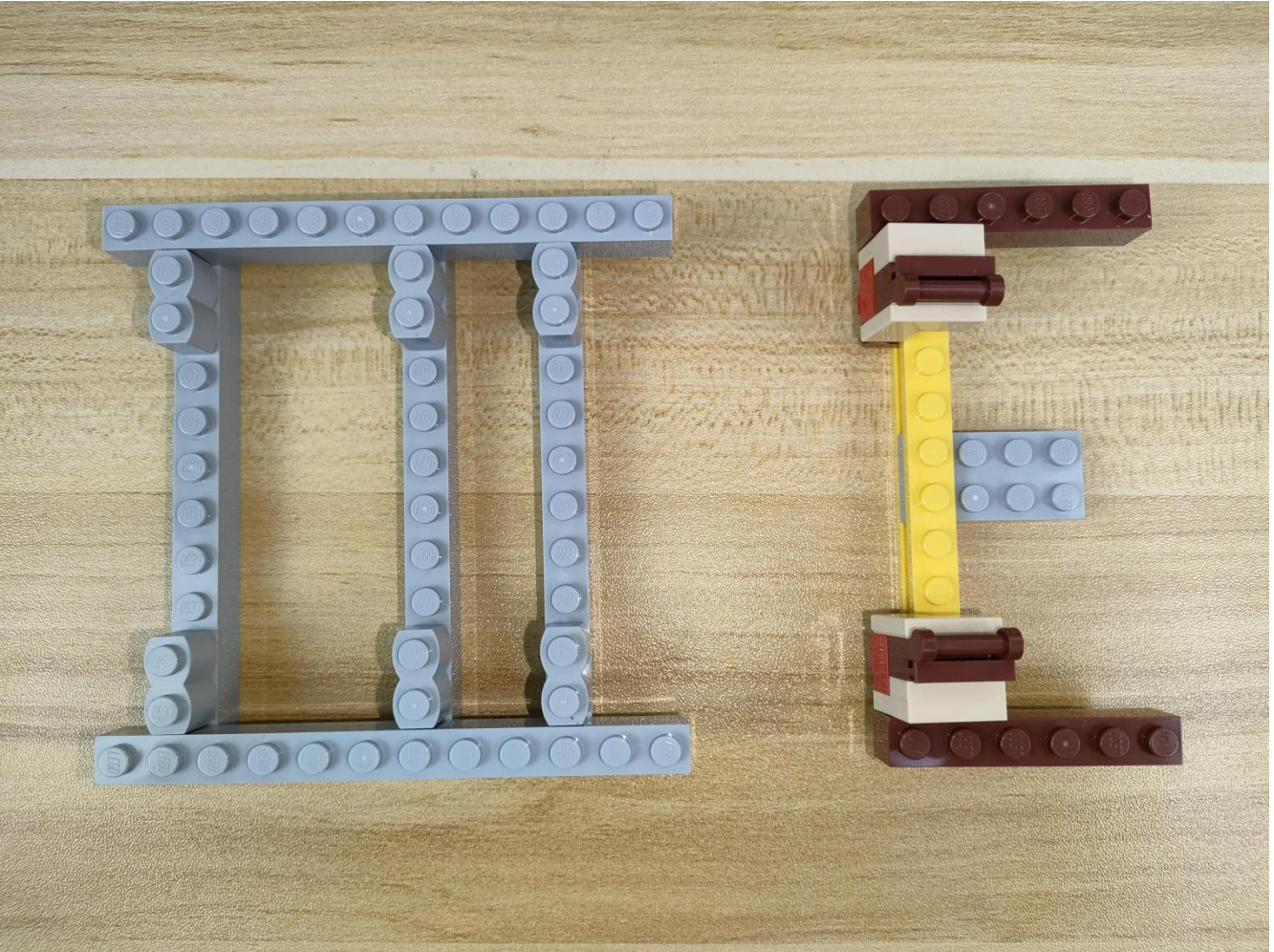

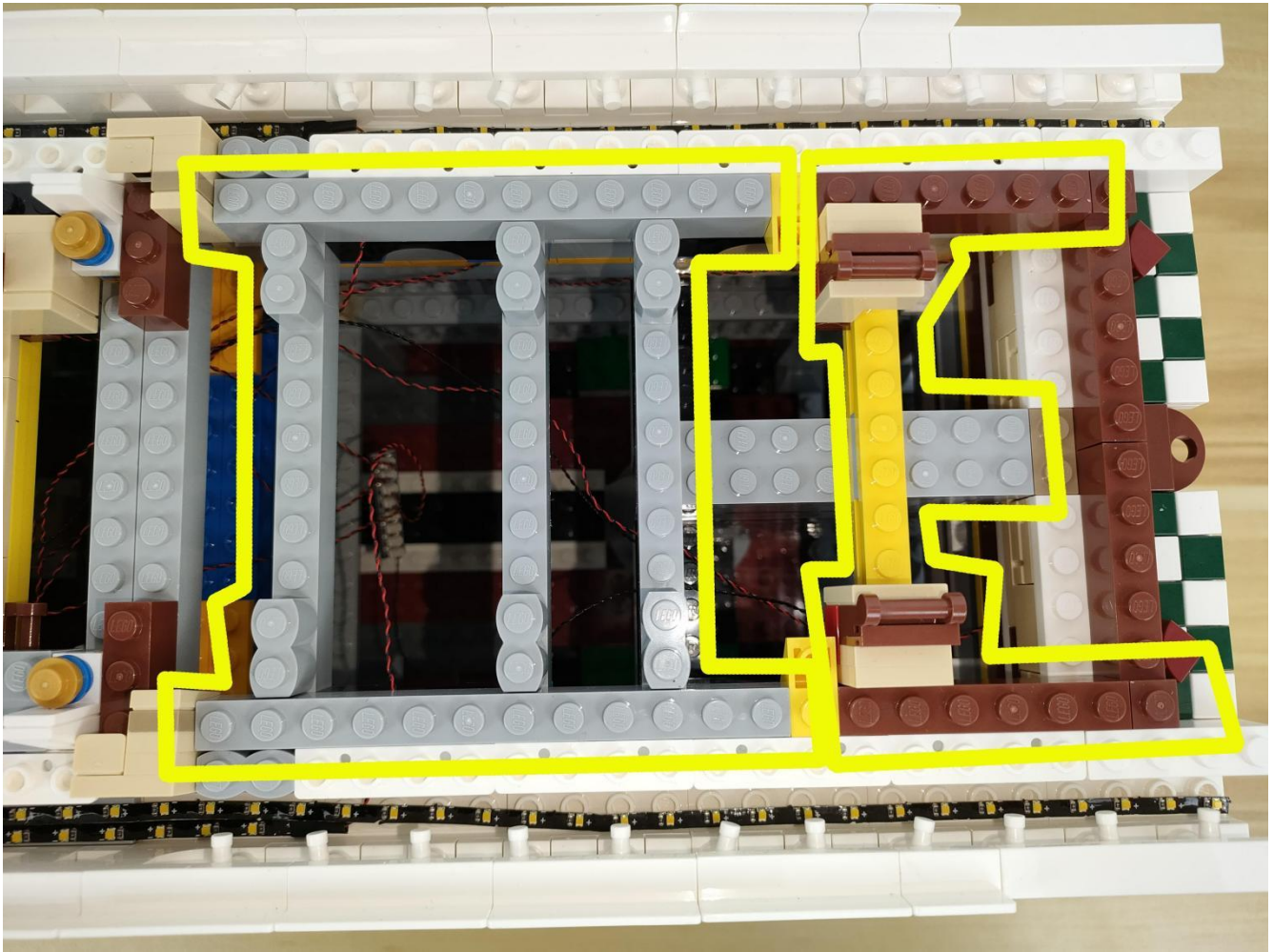



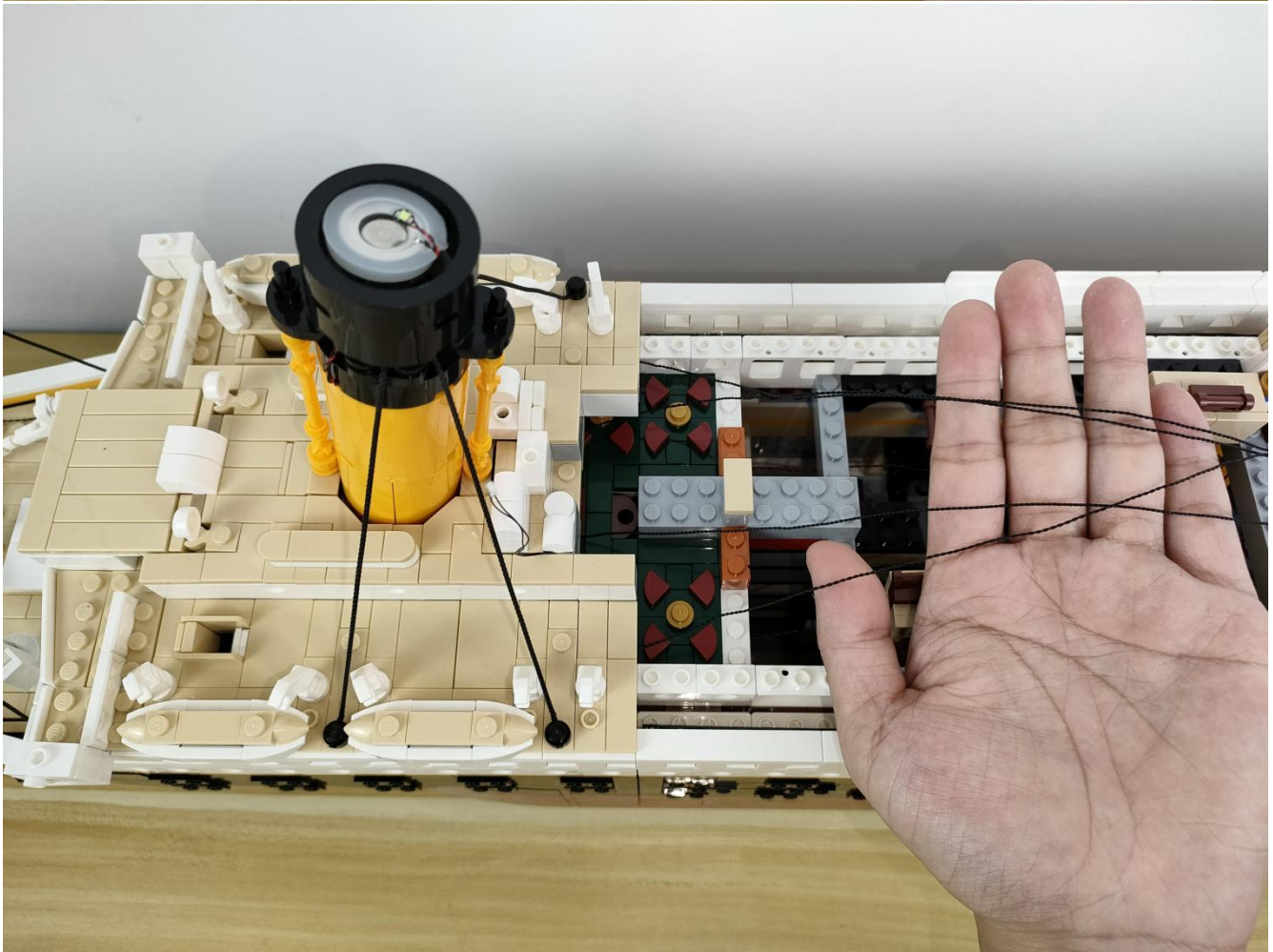
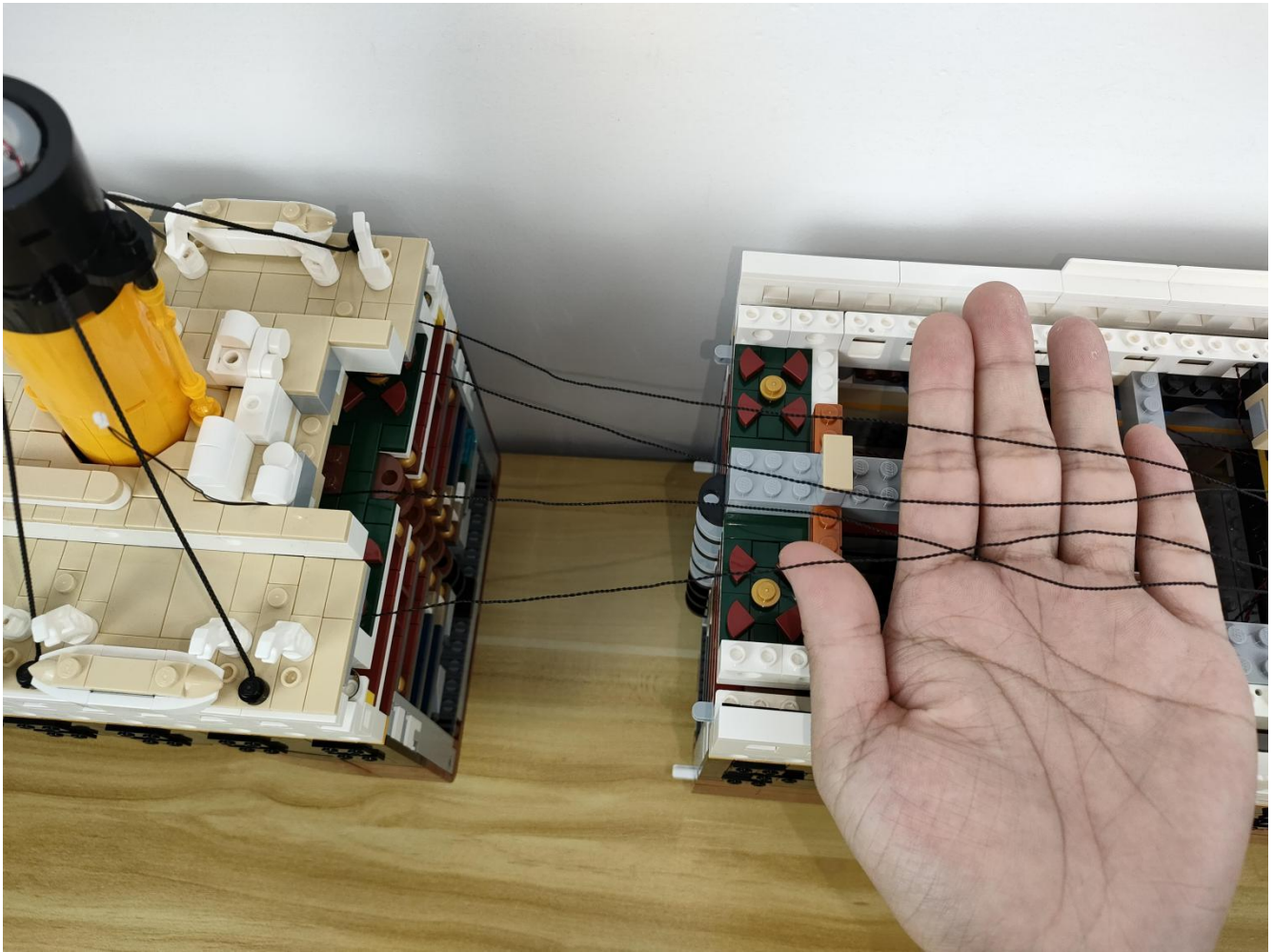

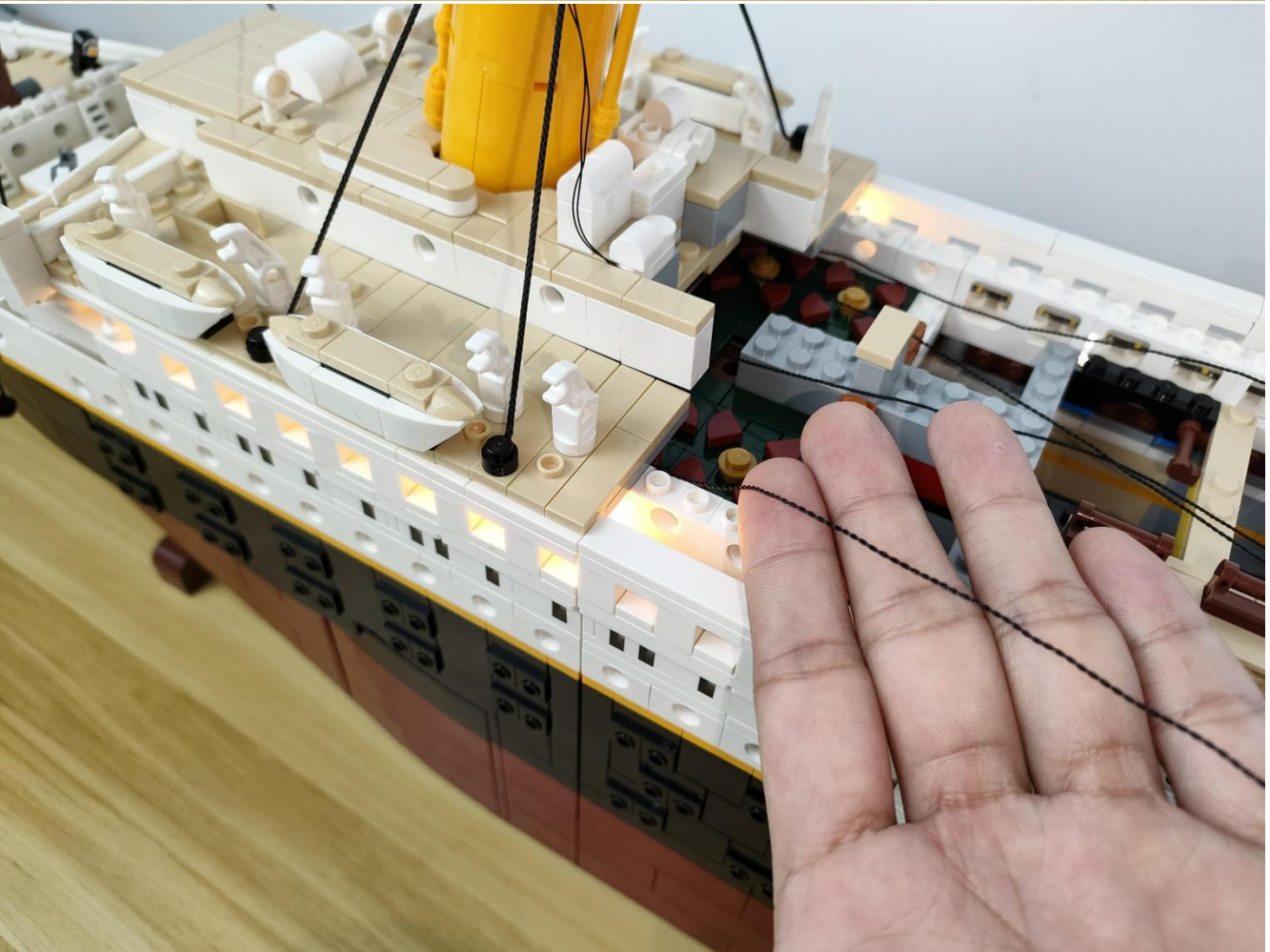

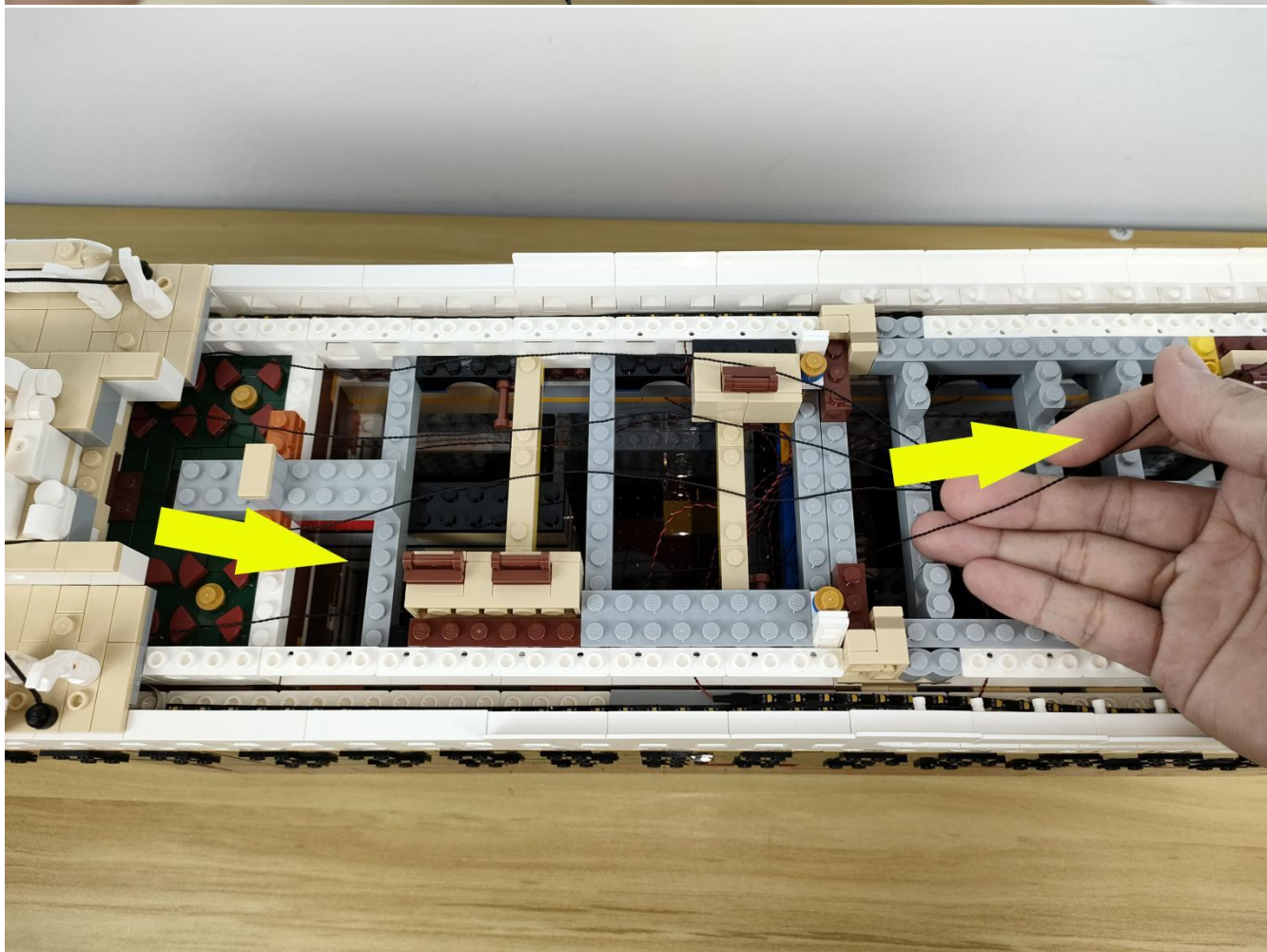
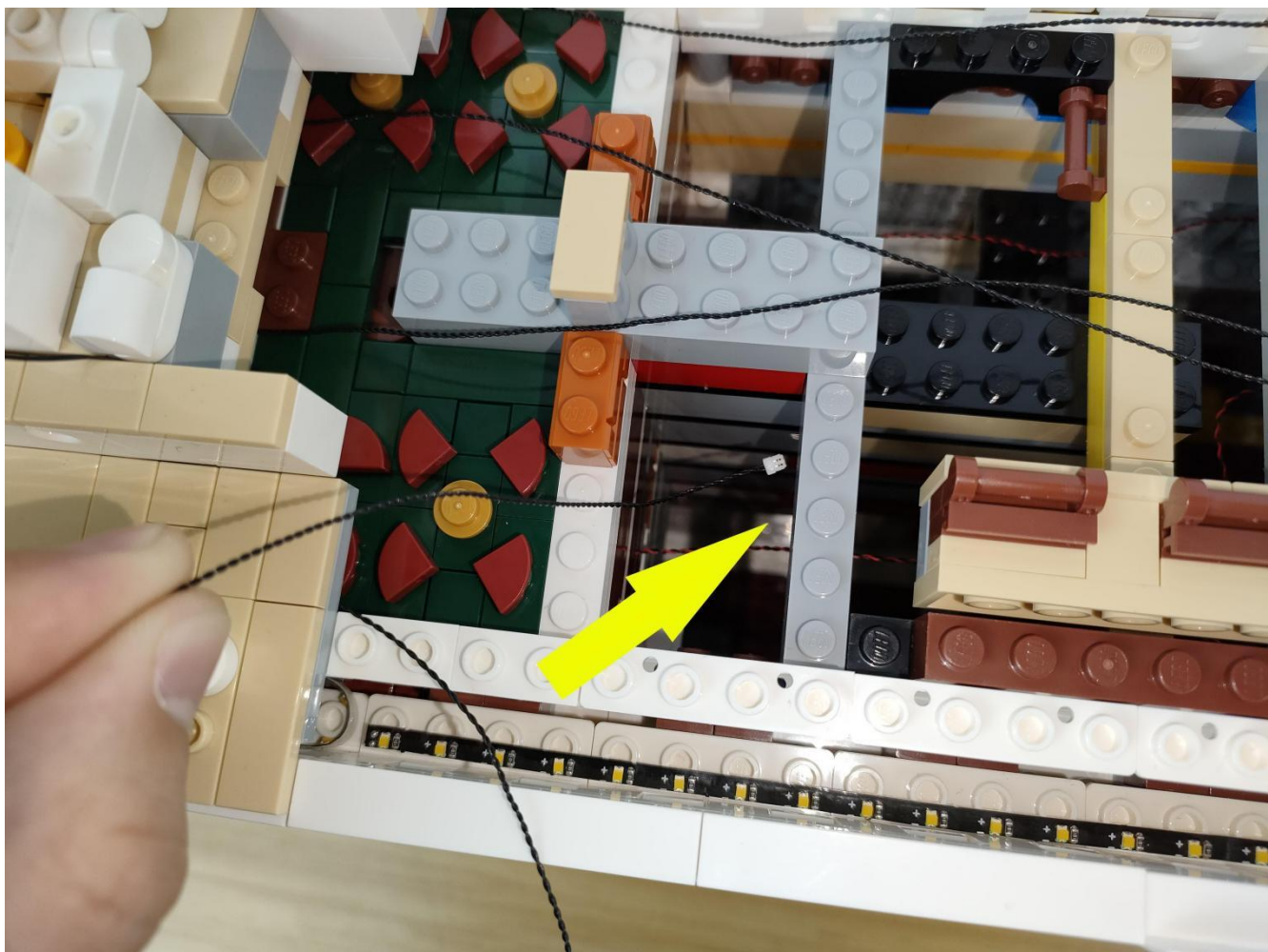

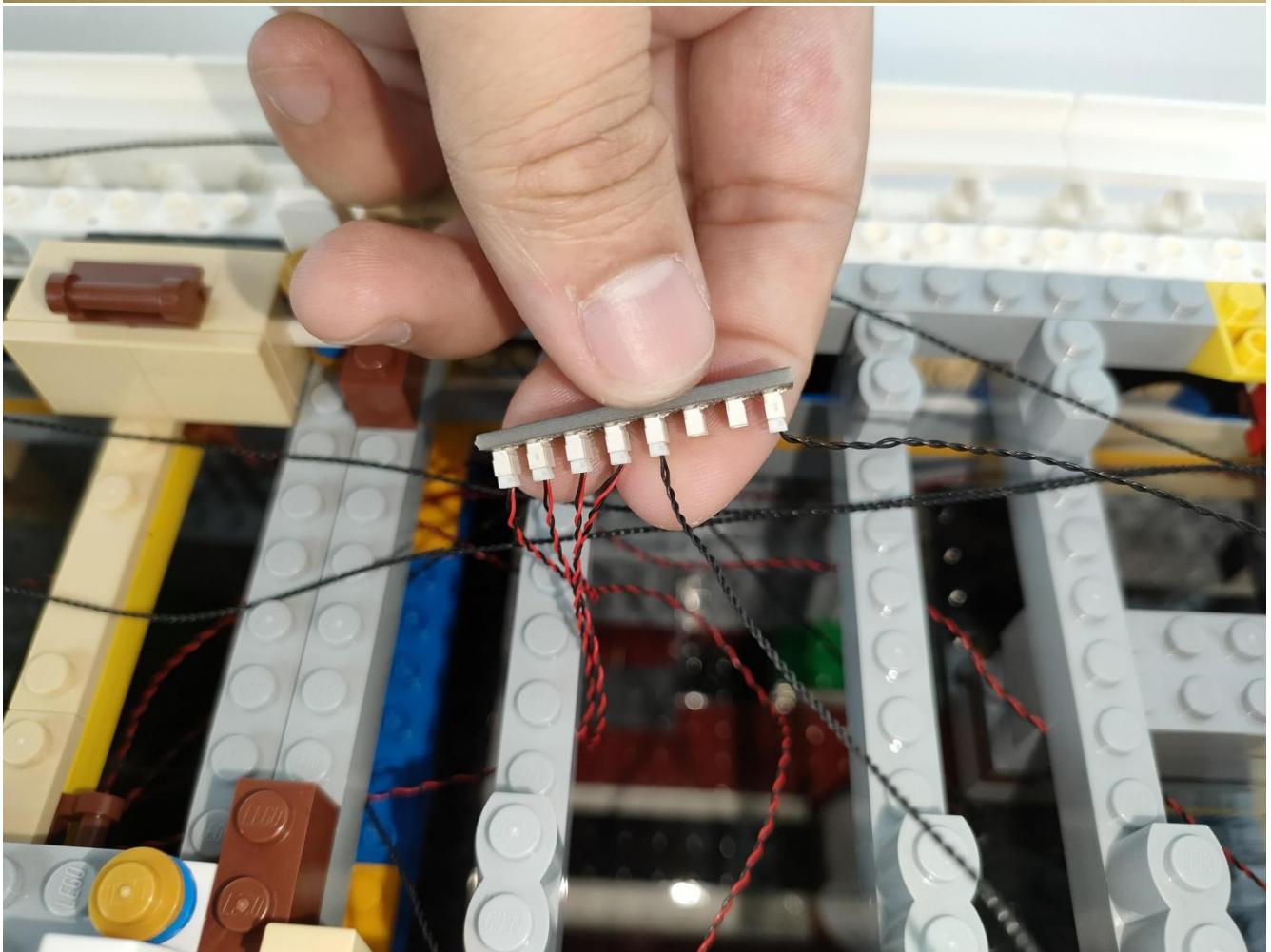
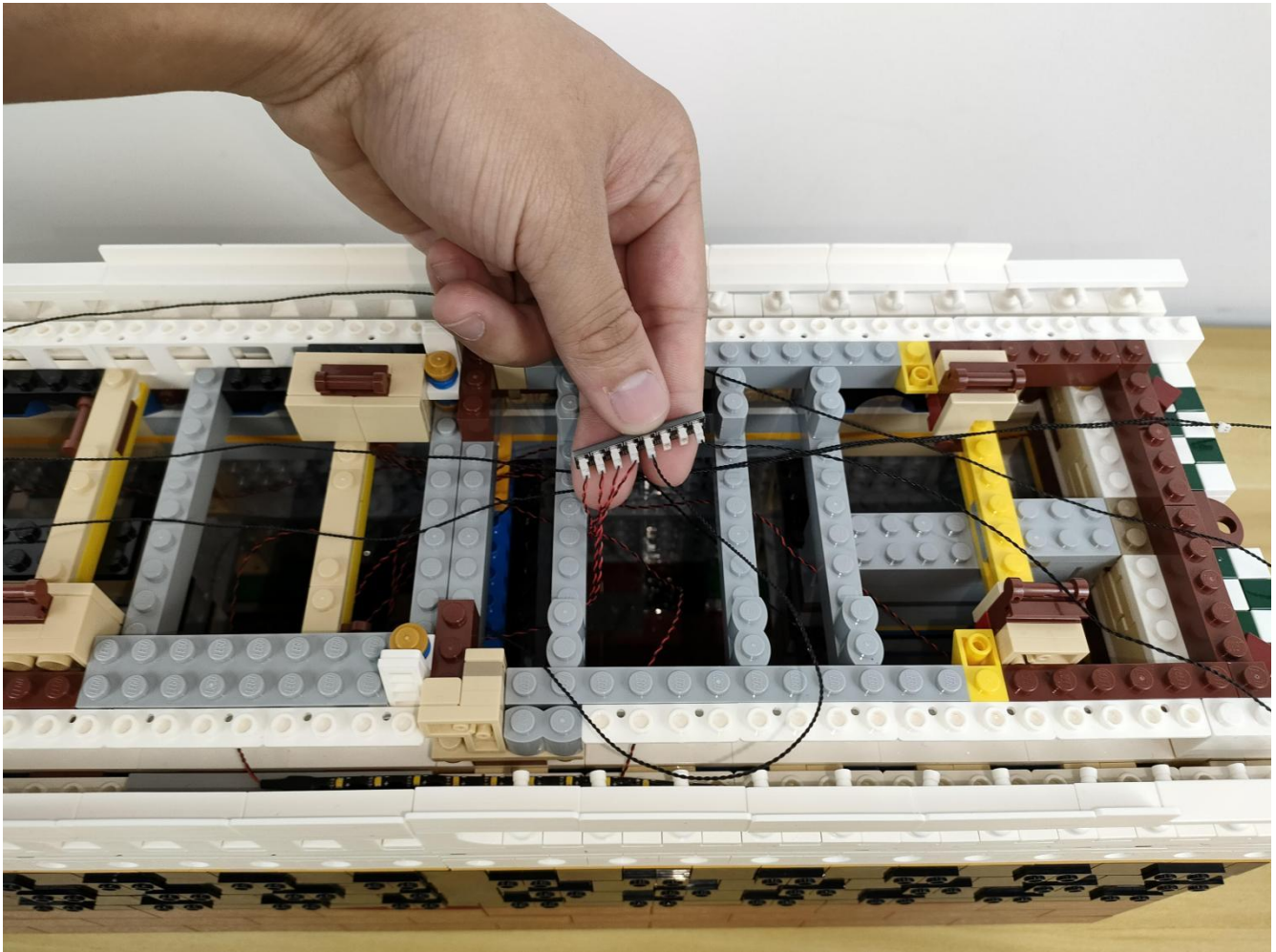



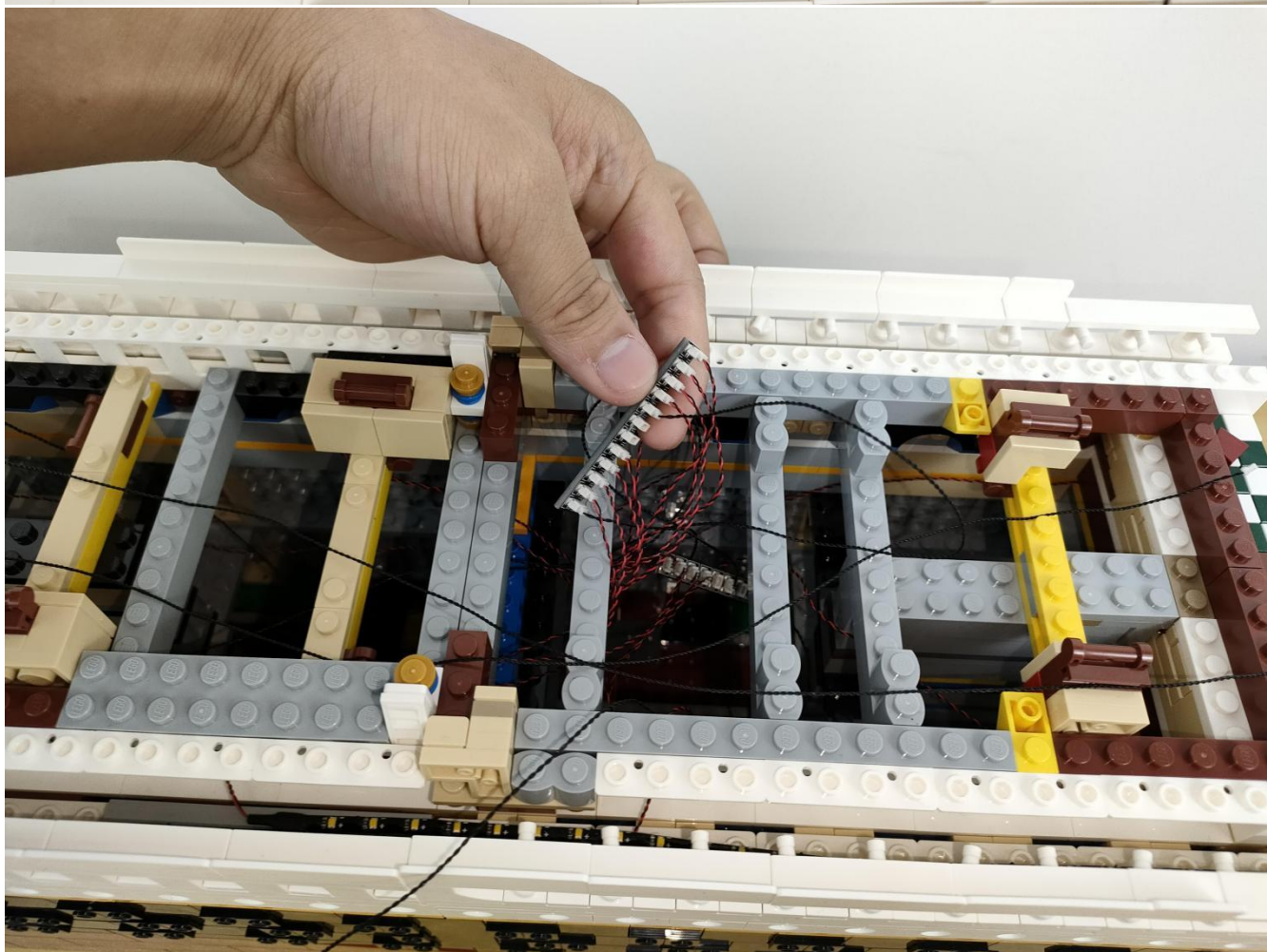
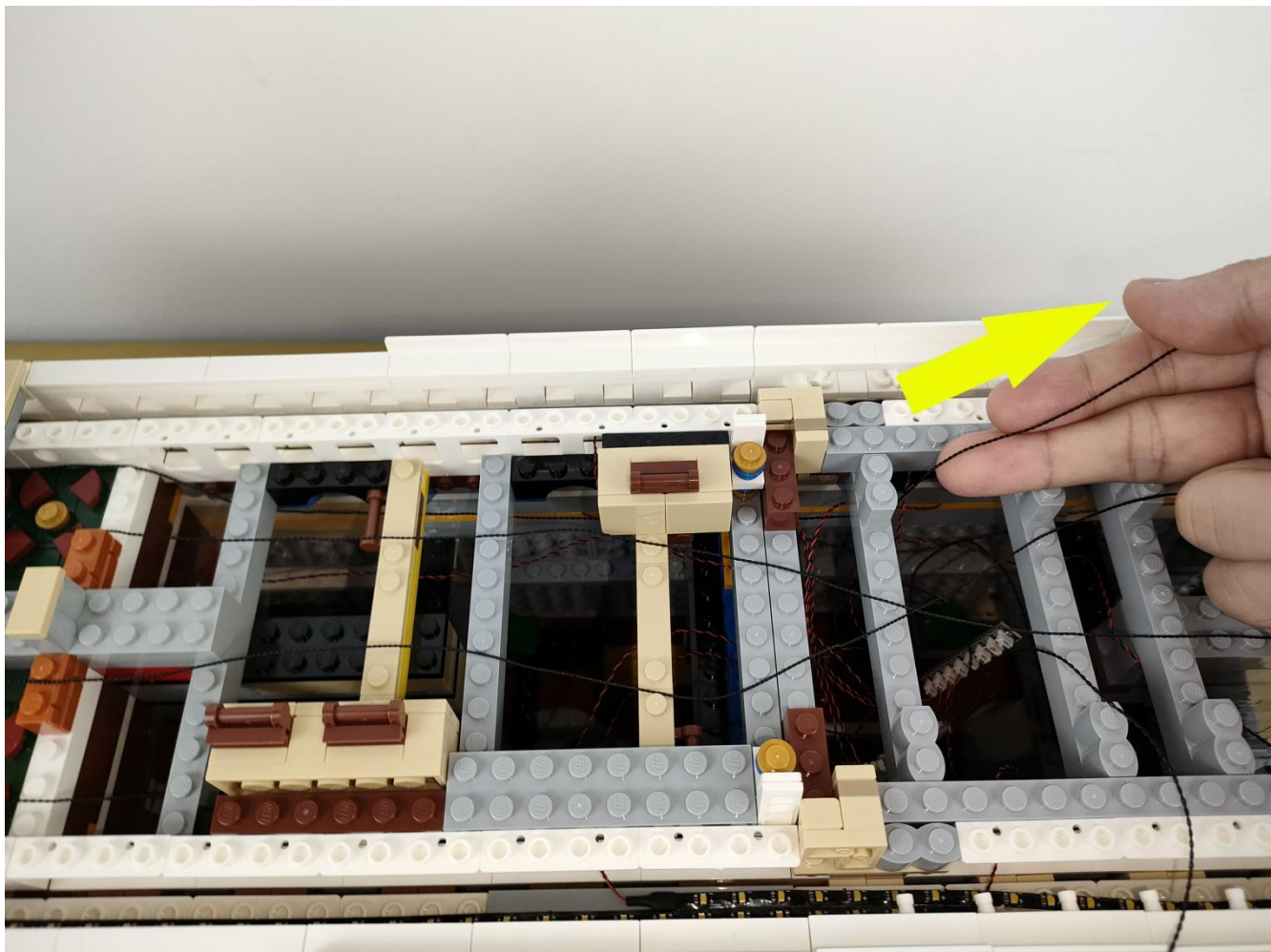

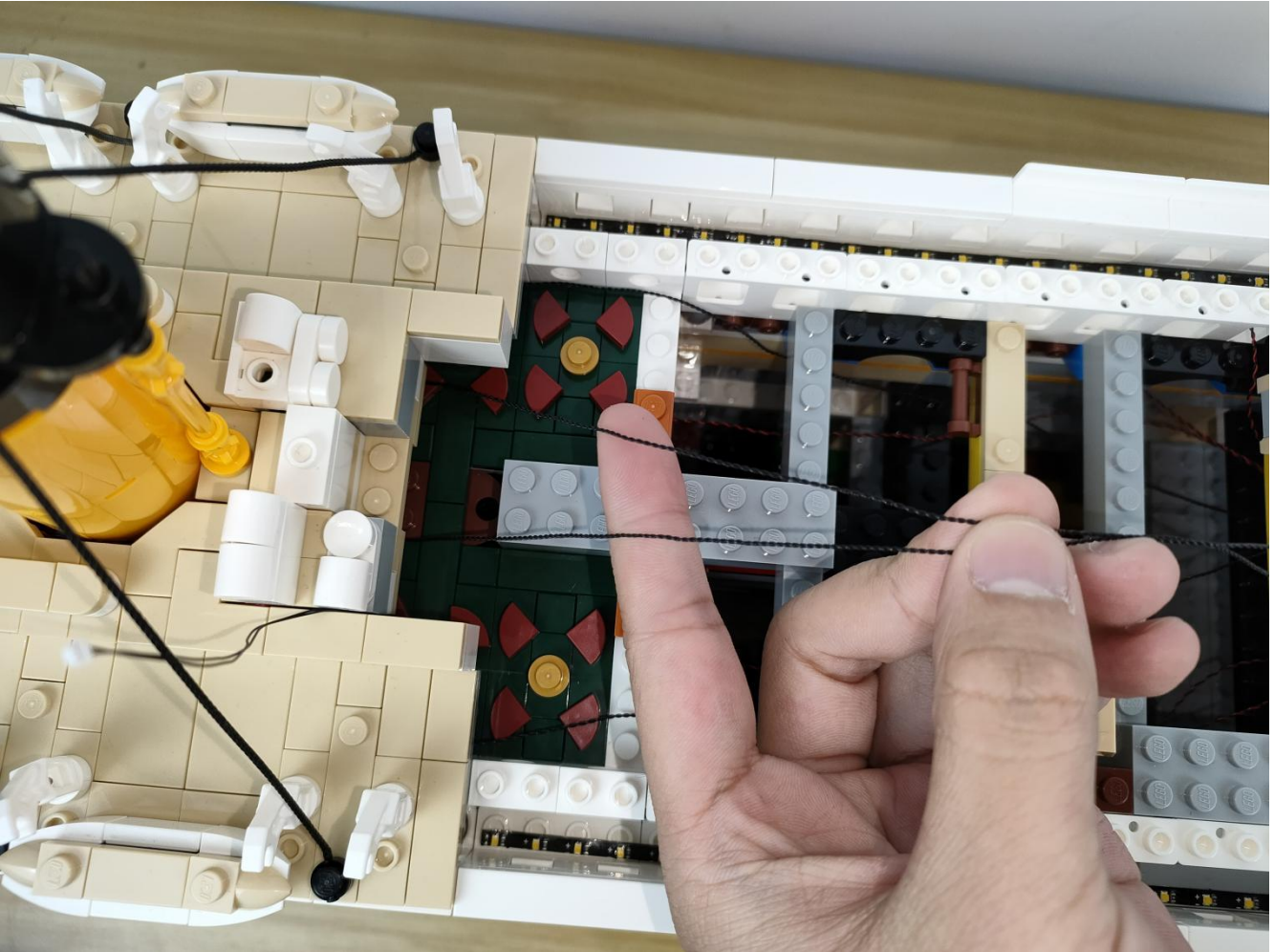
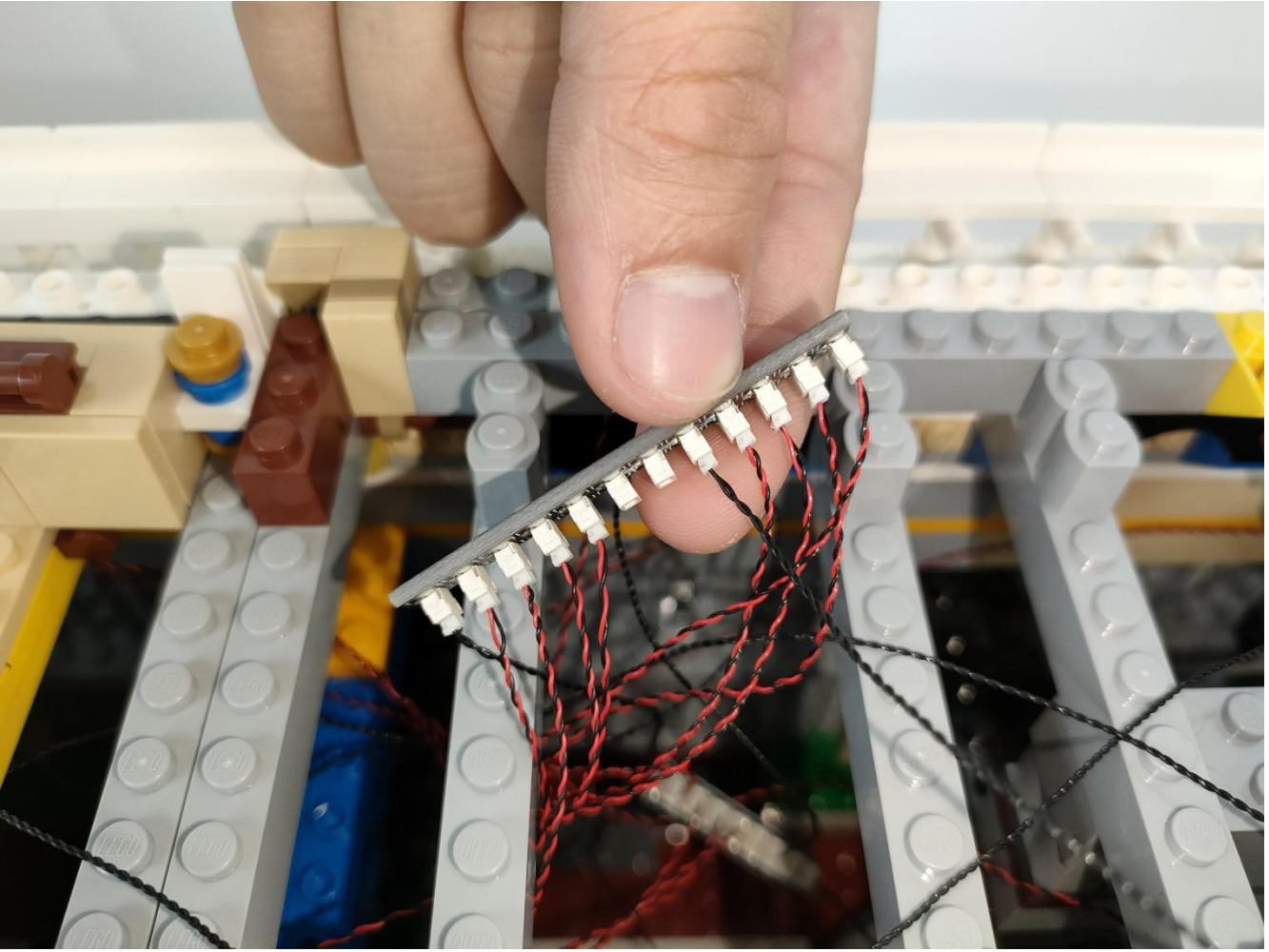

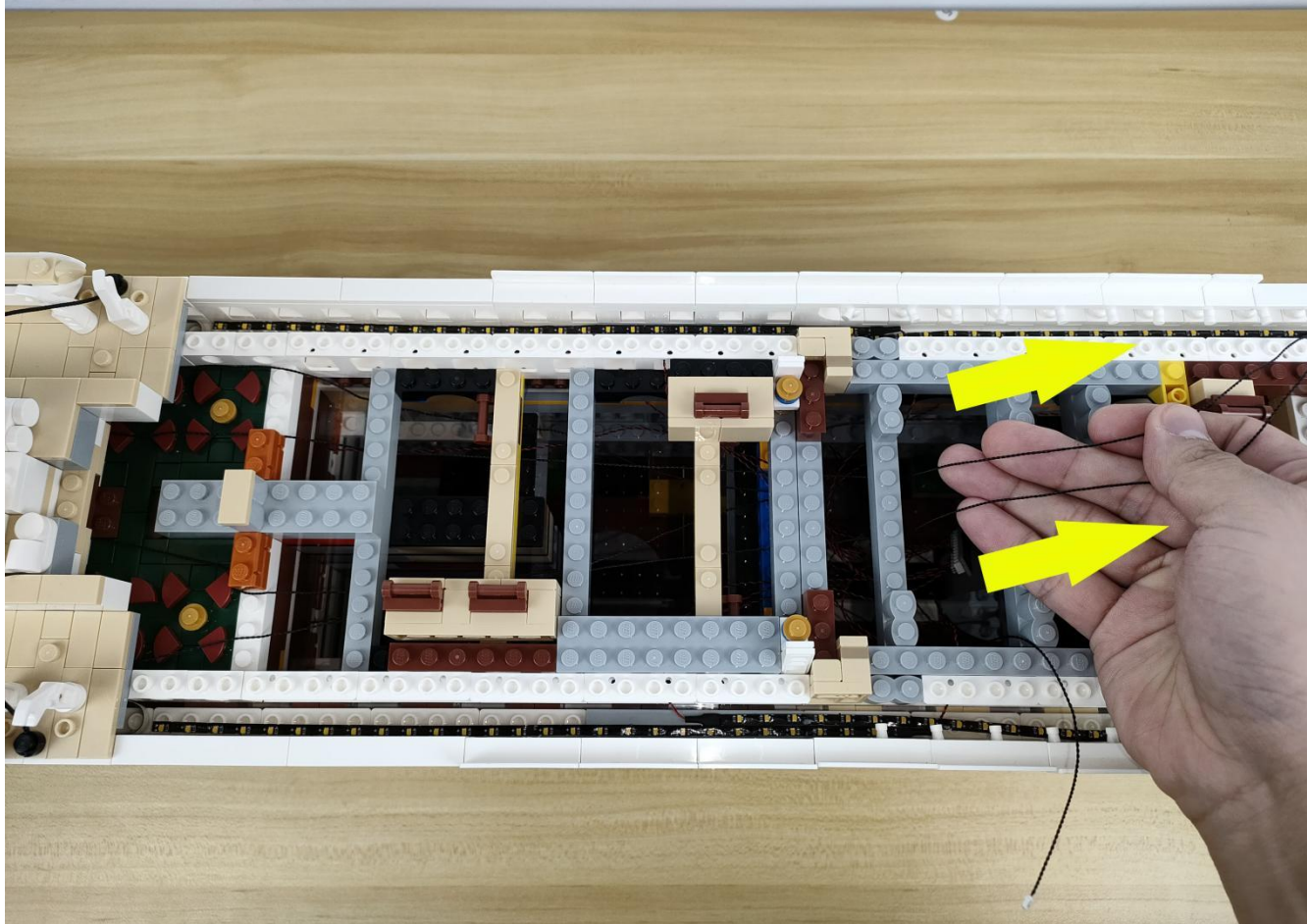
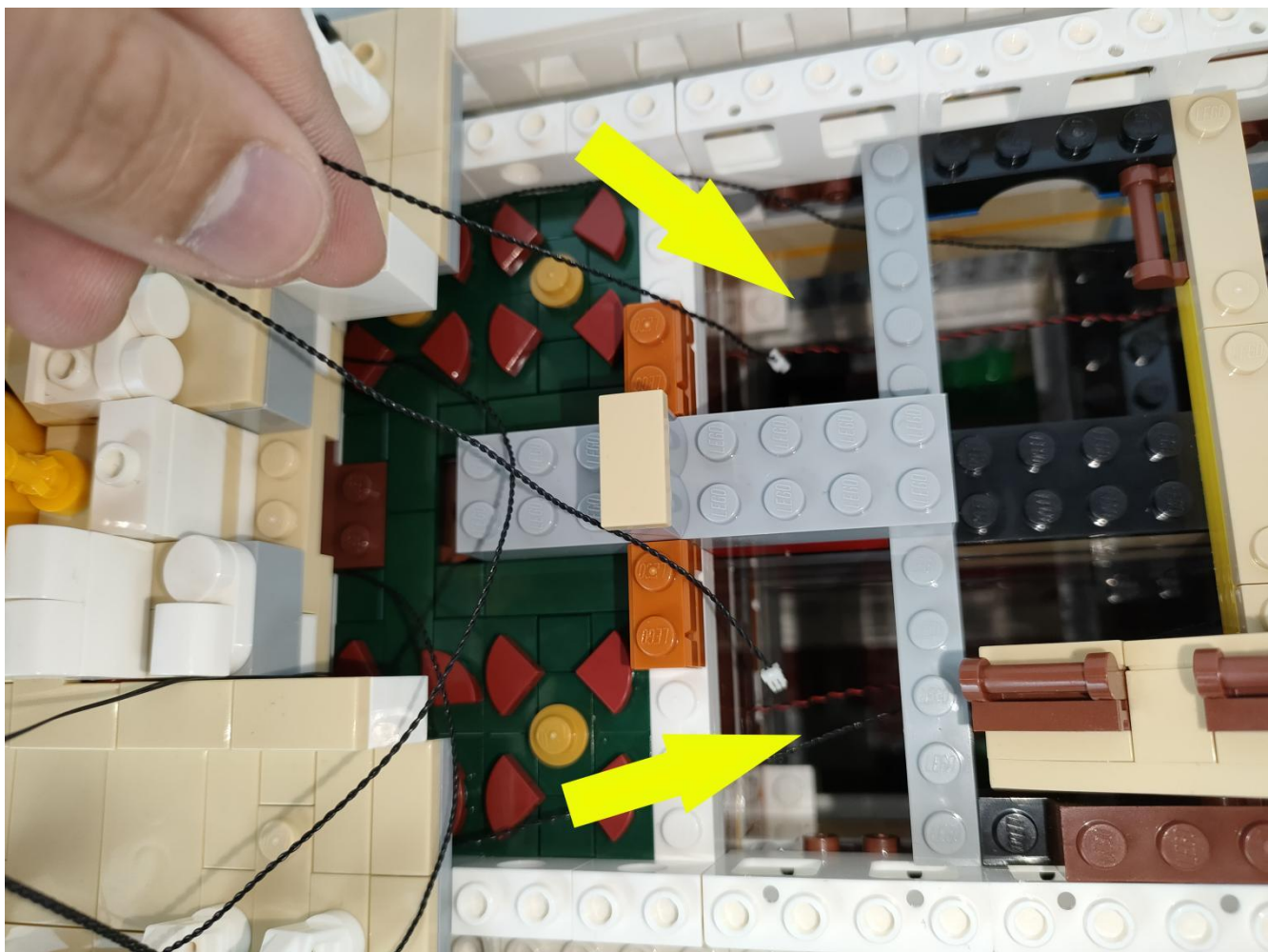

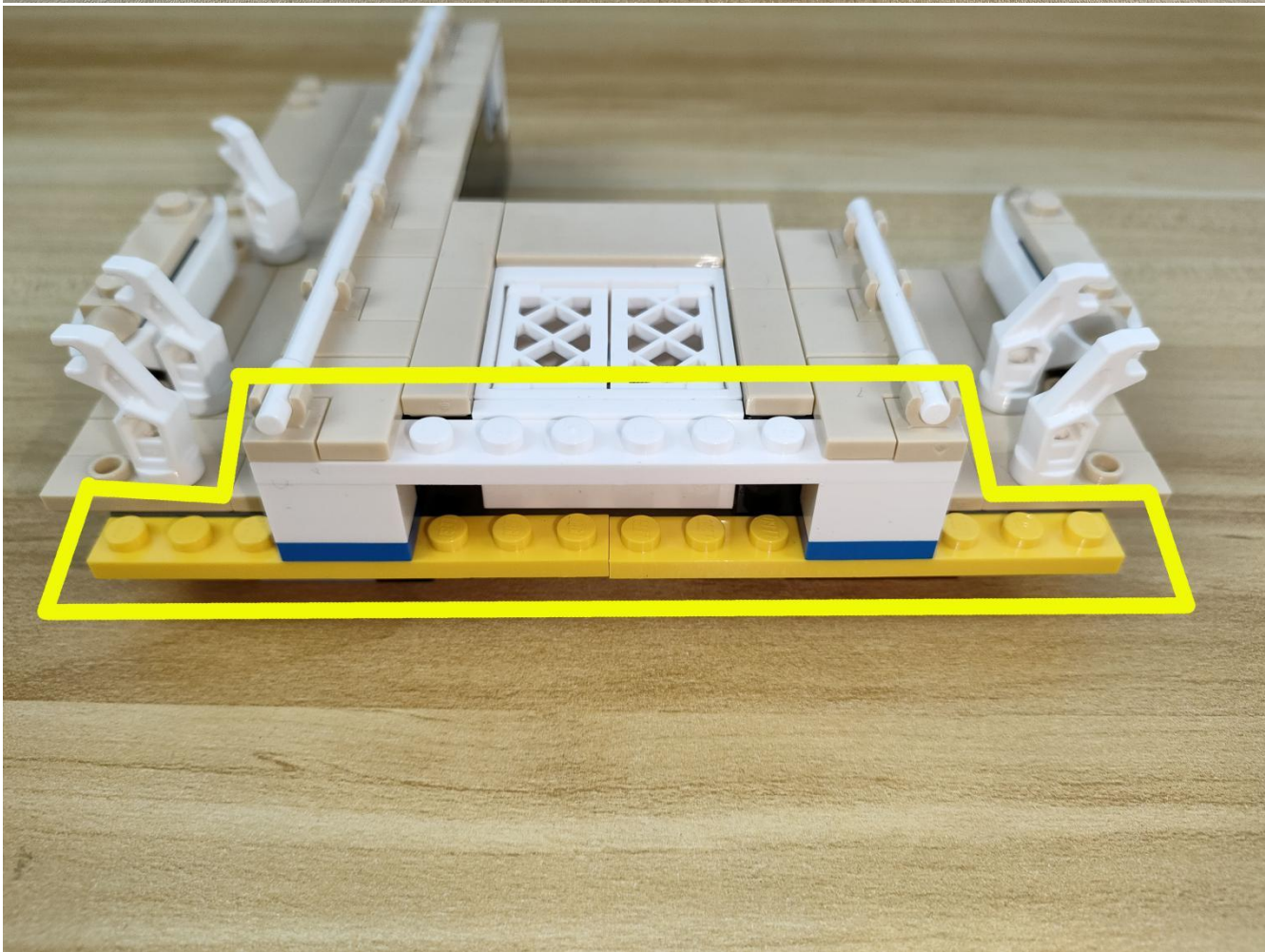
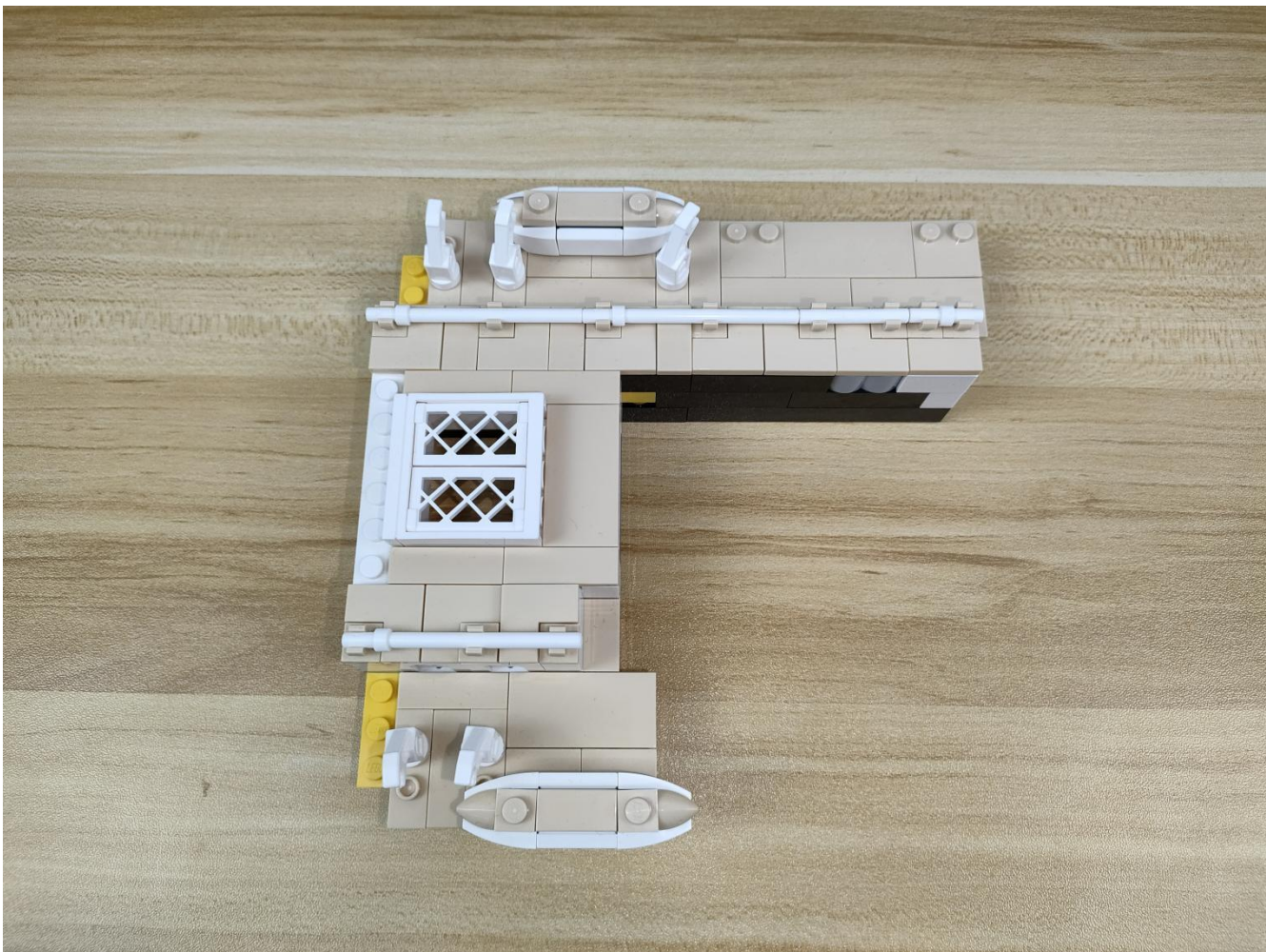

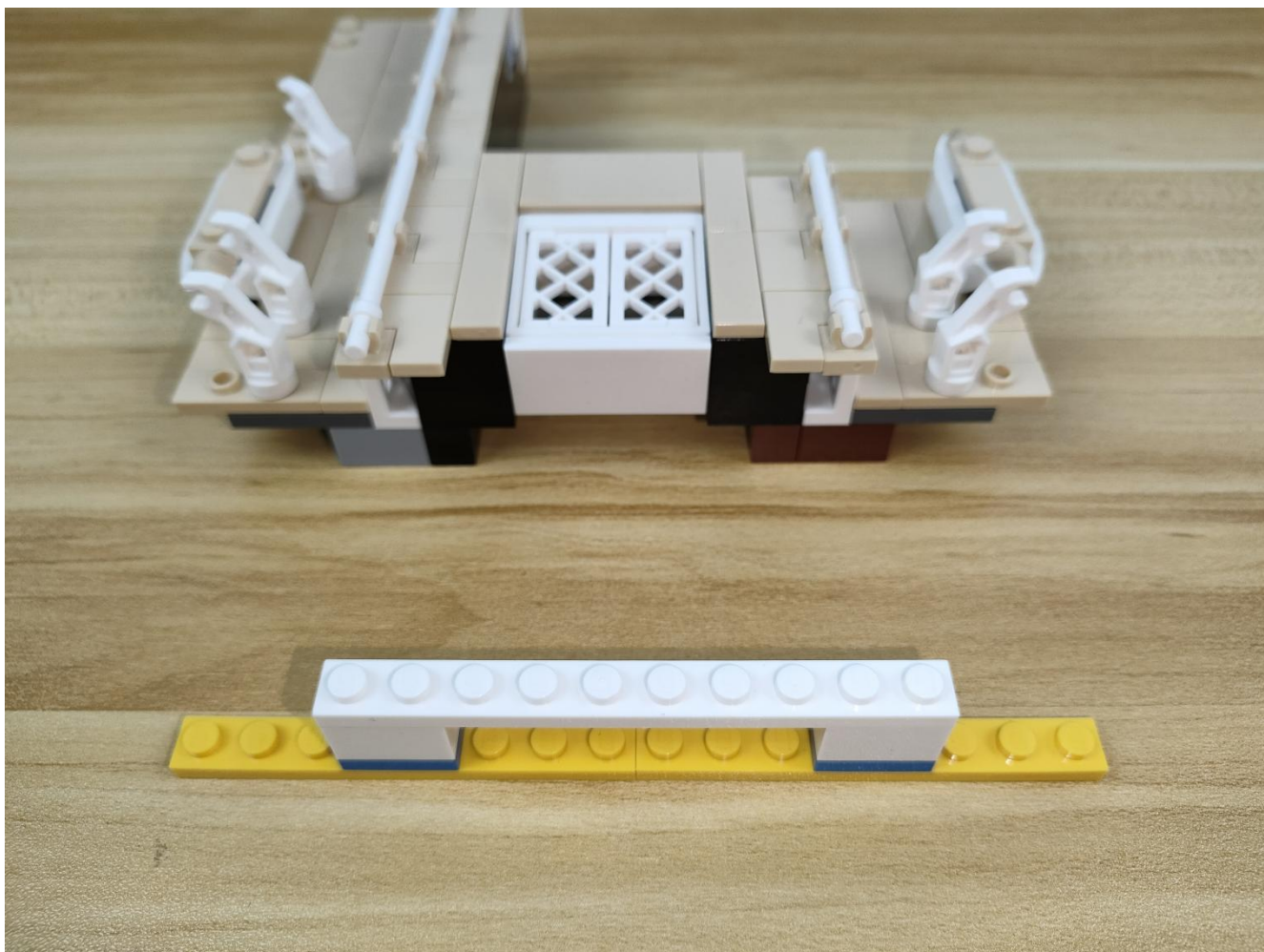

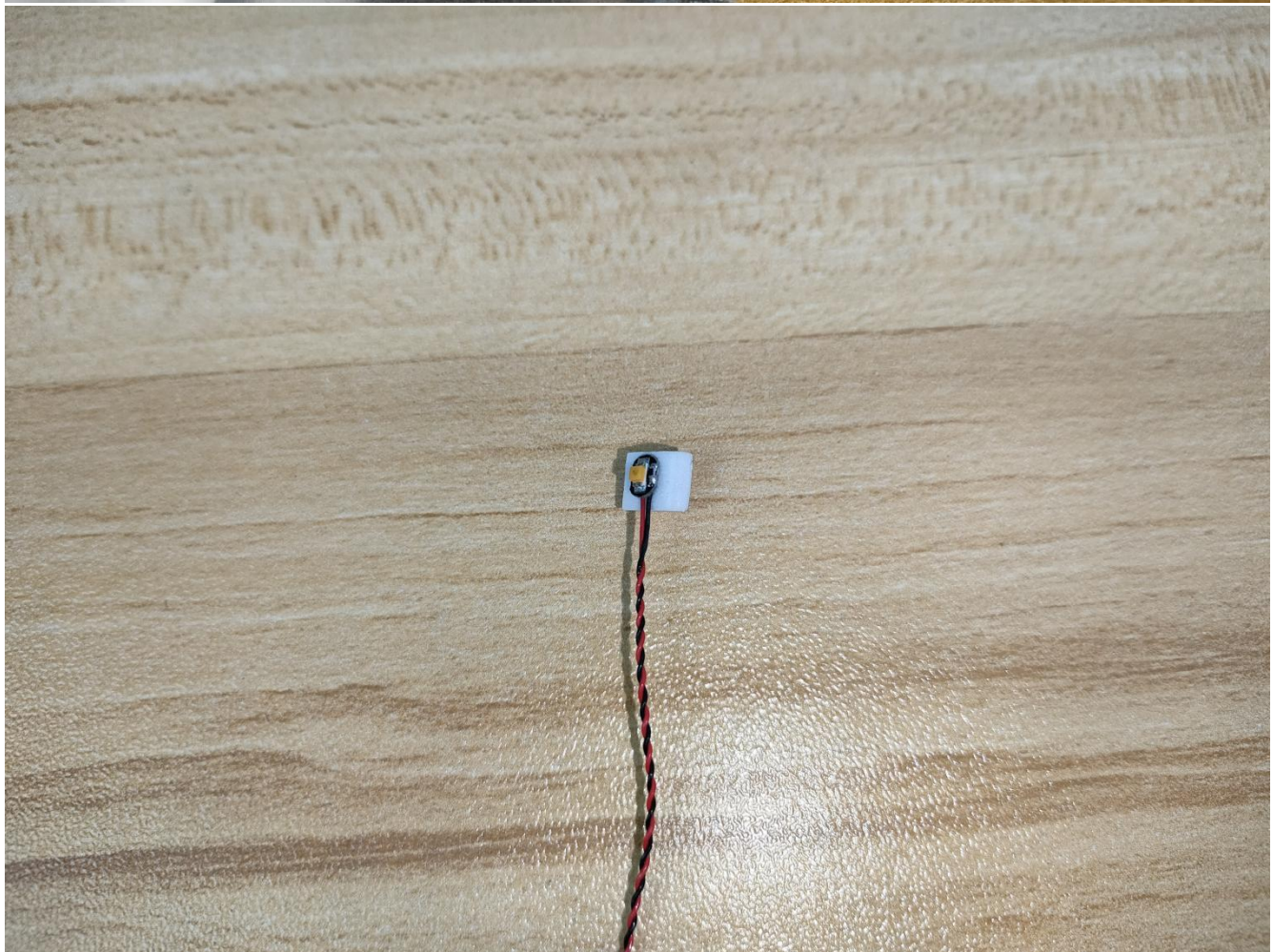

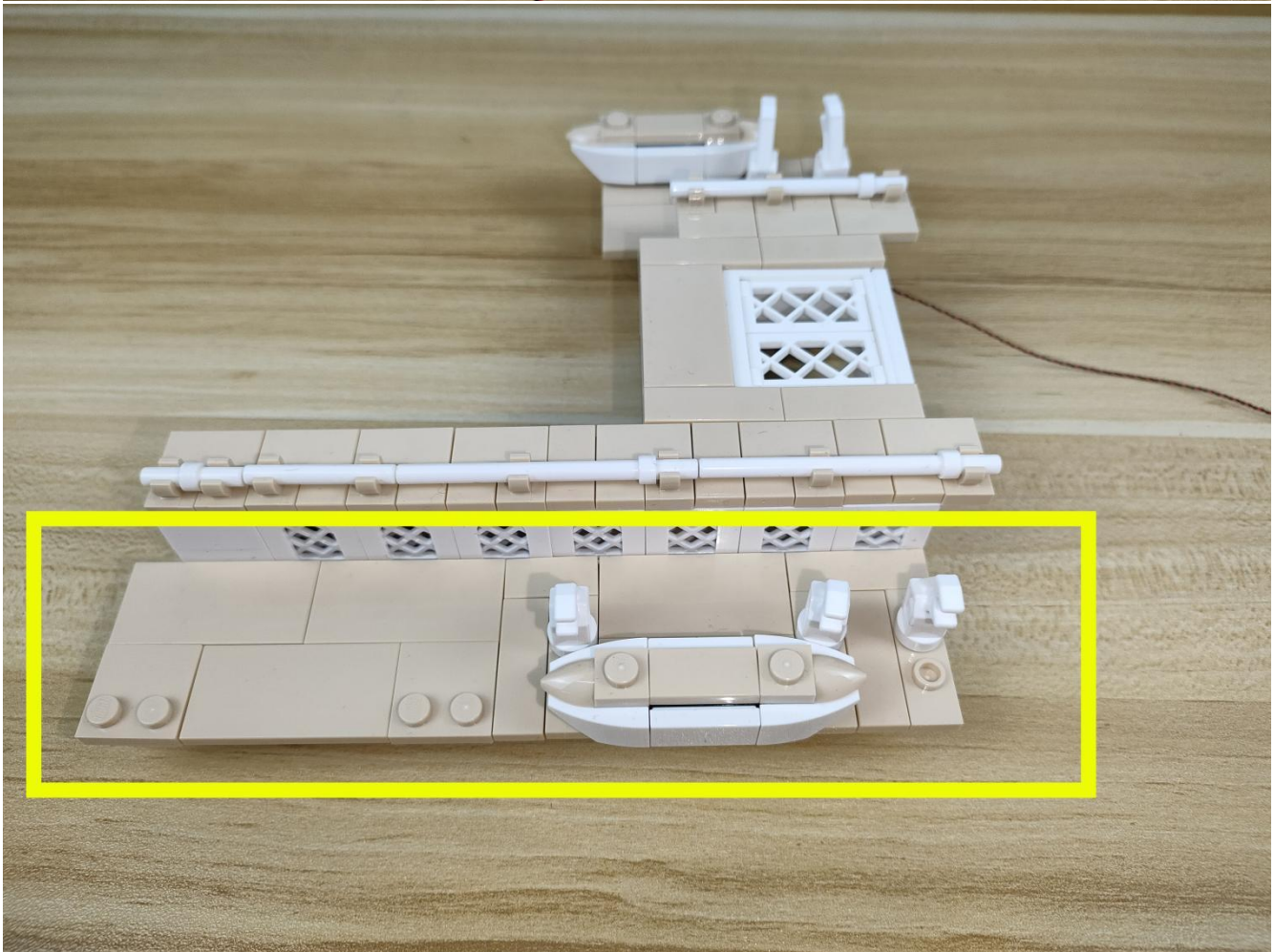
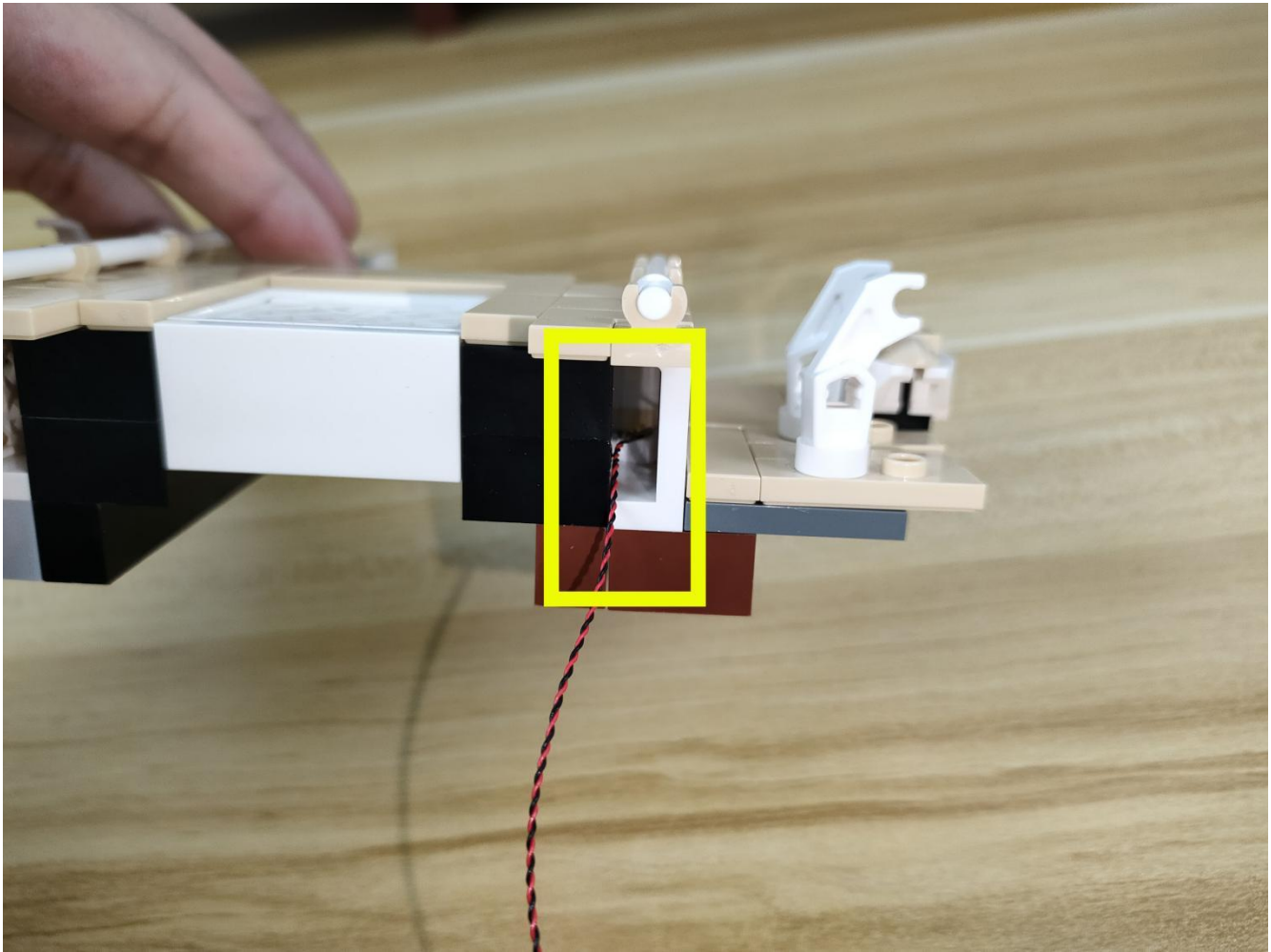

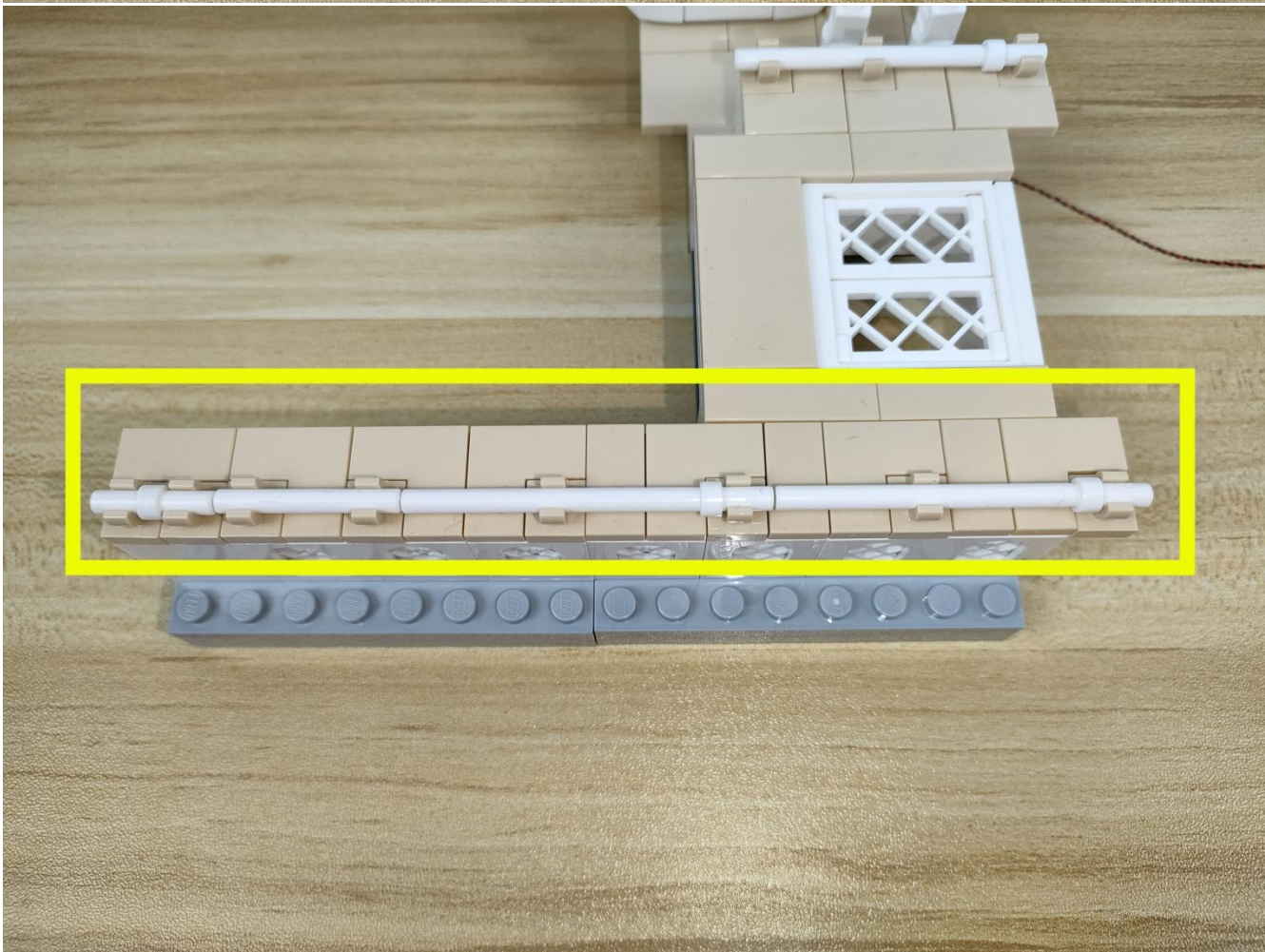
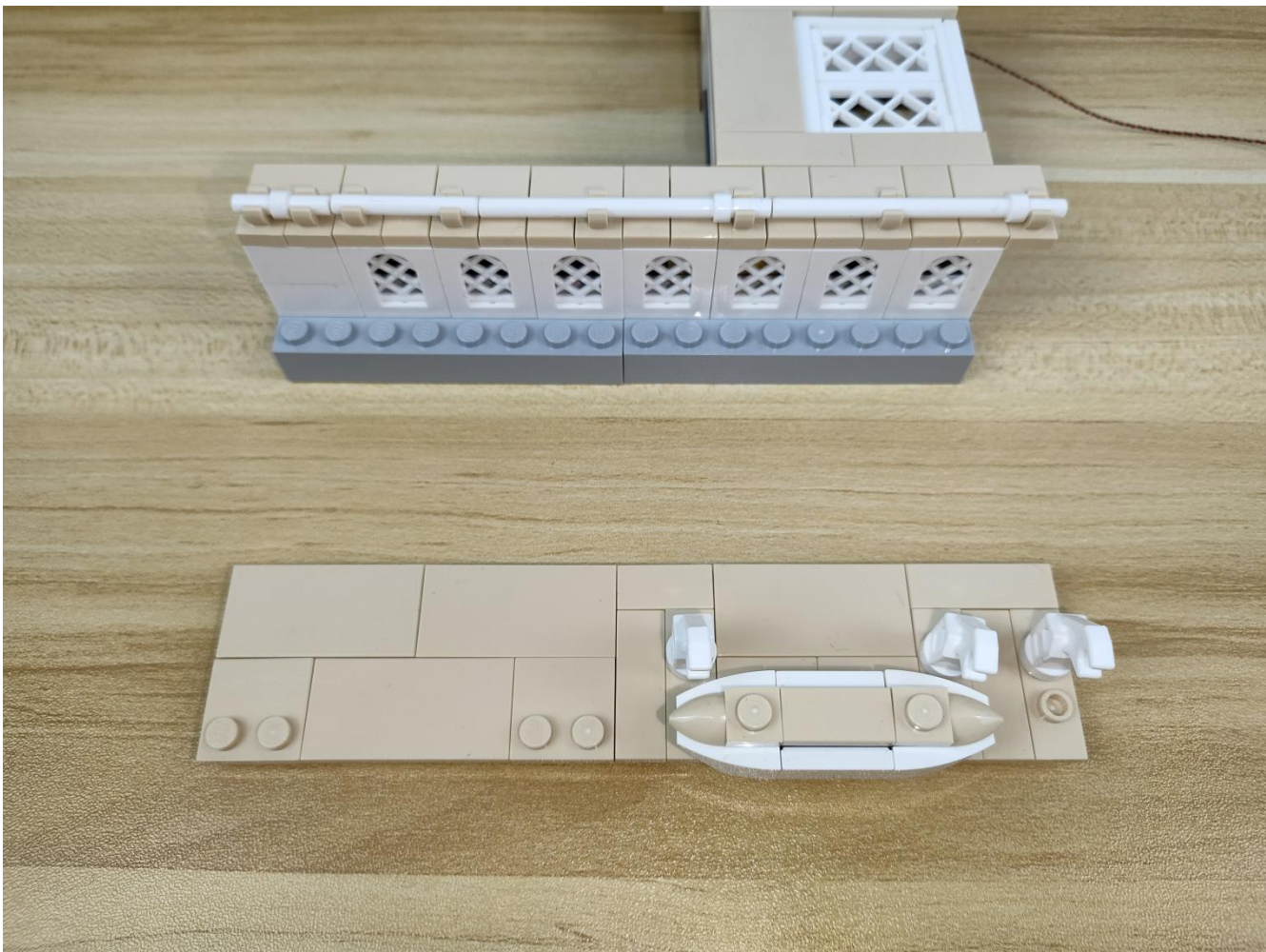

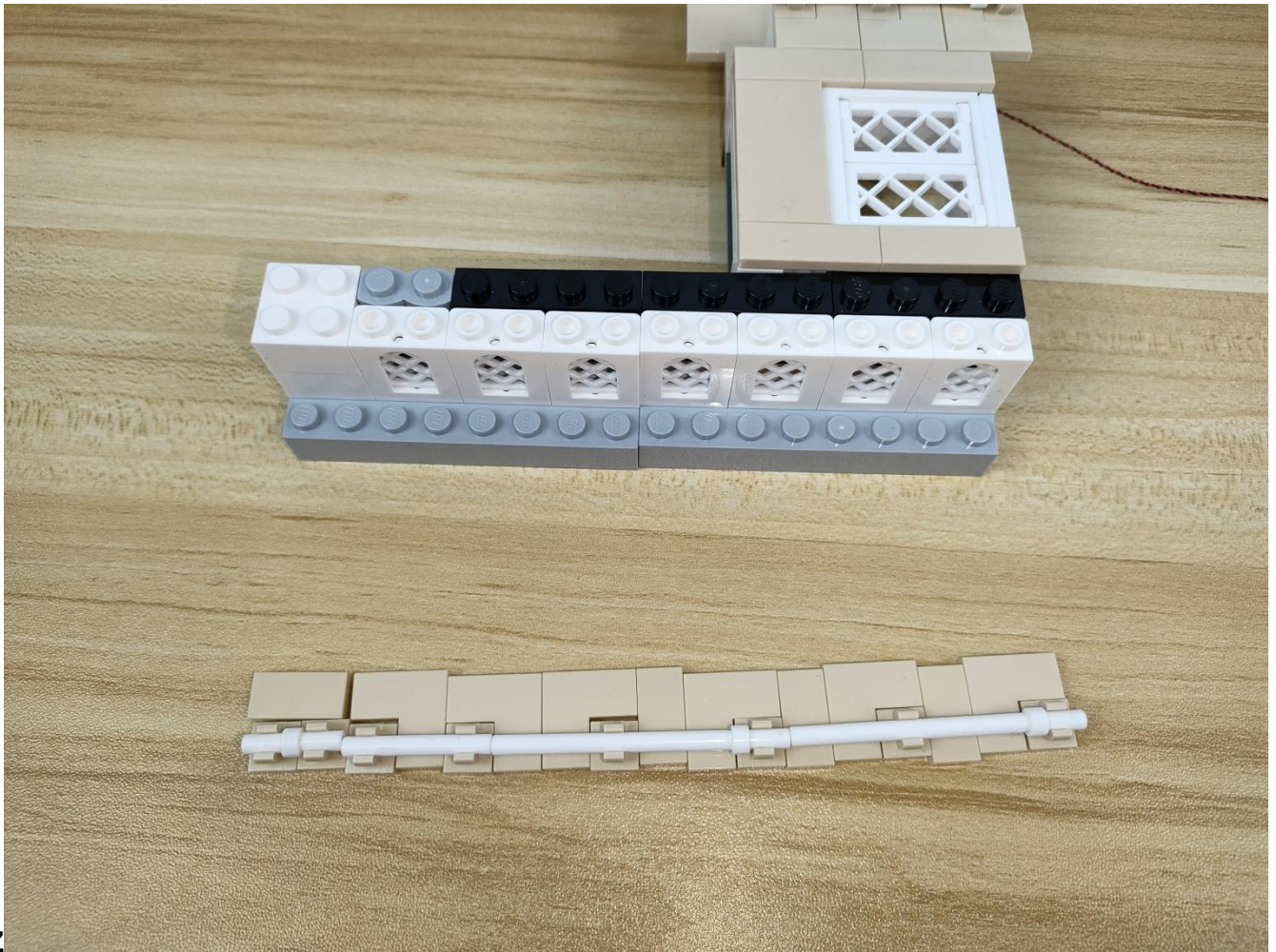

Z

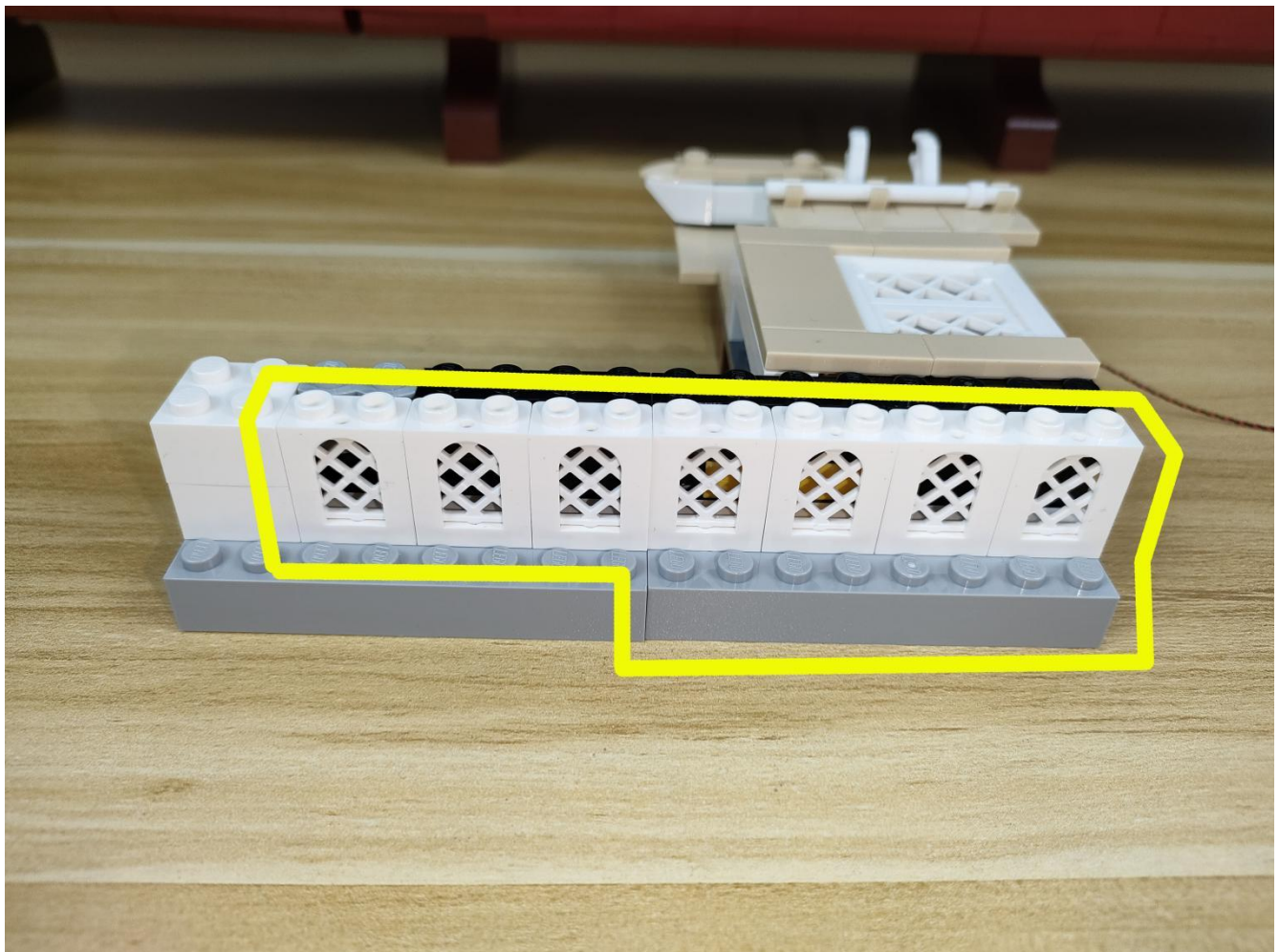

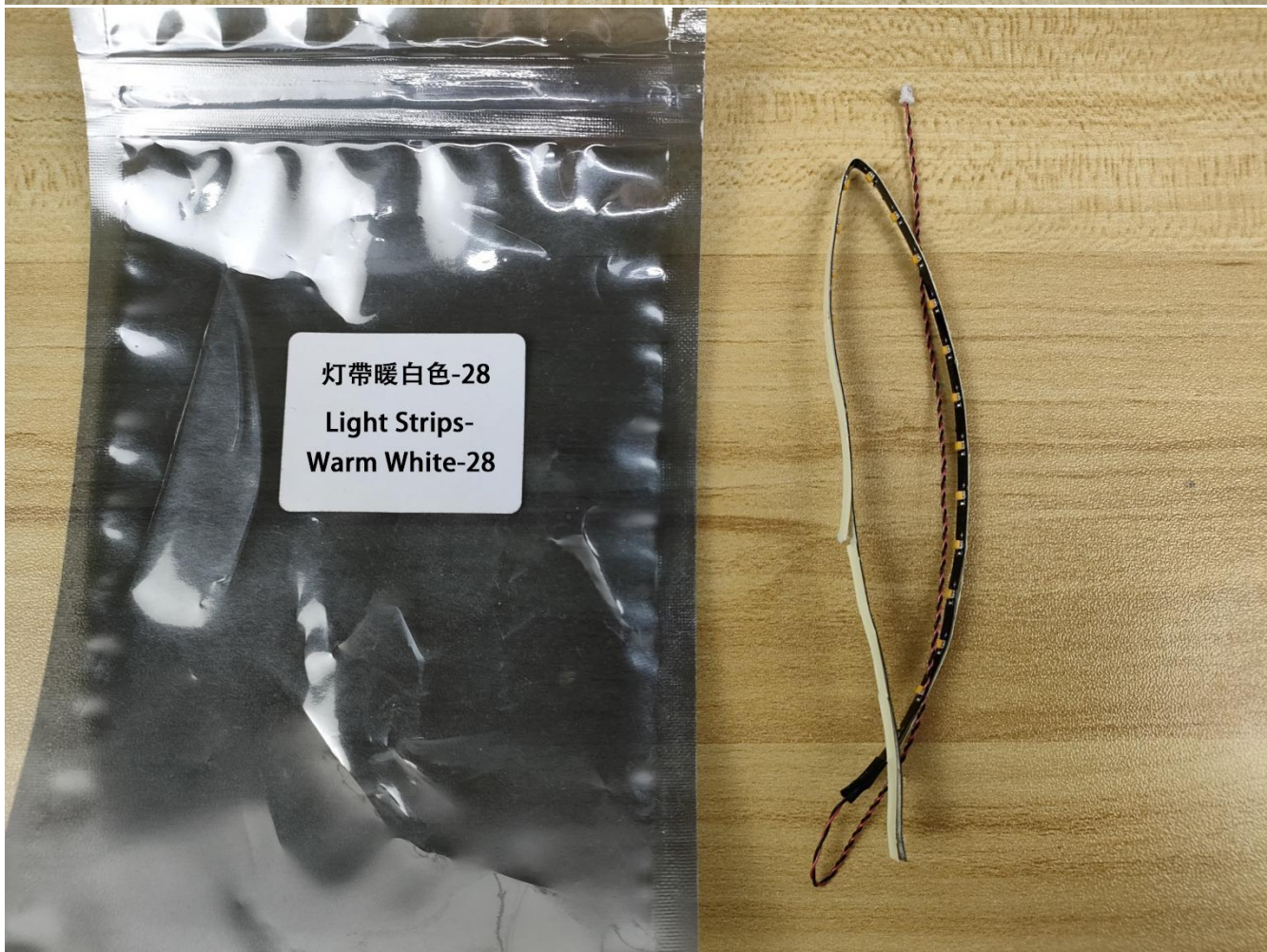
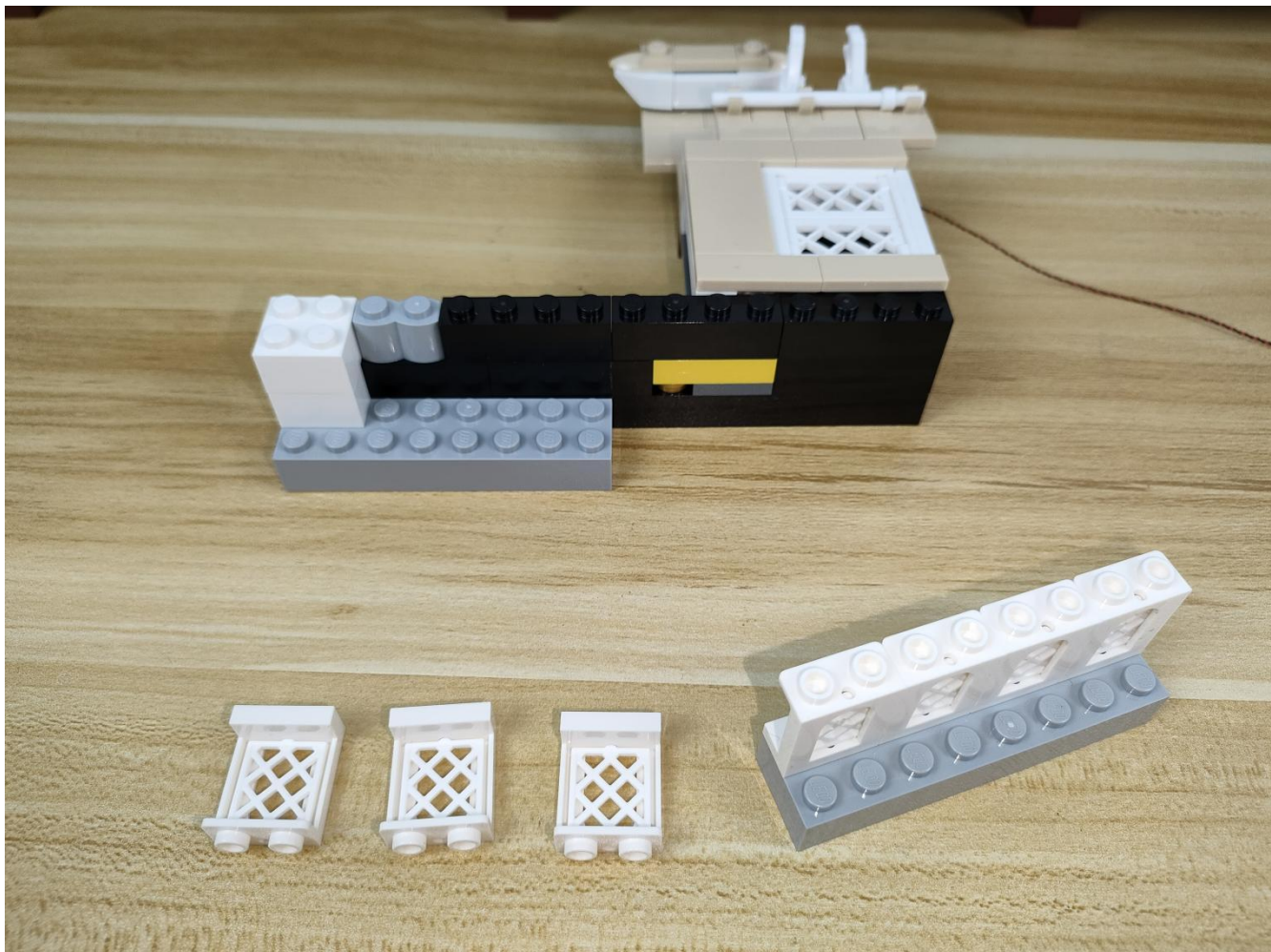

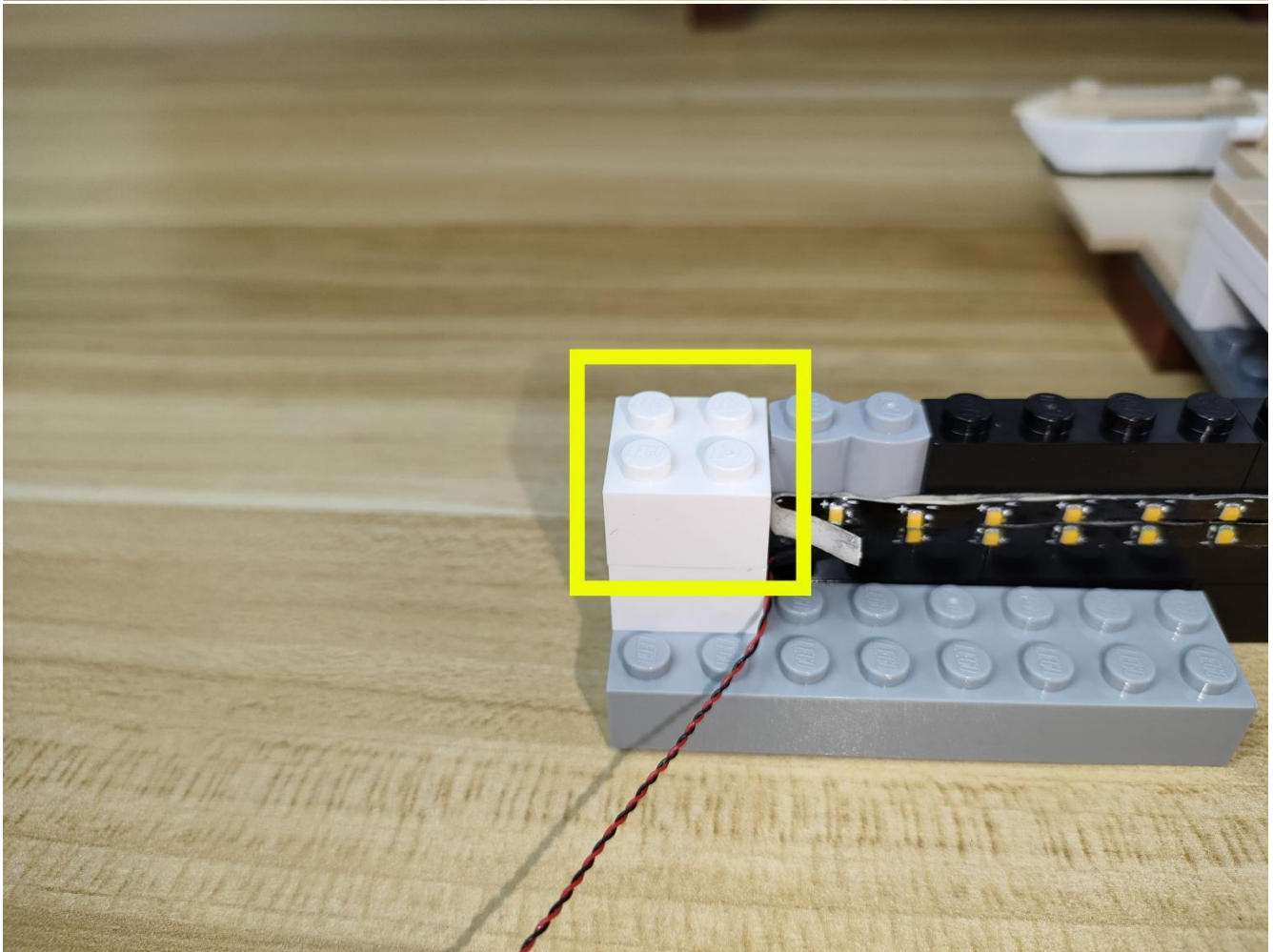

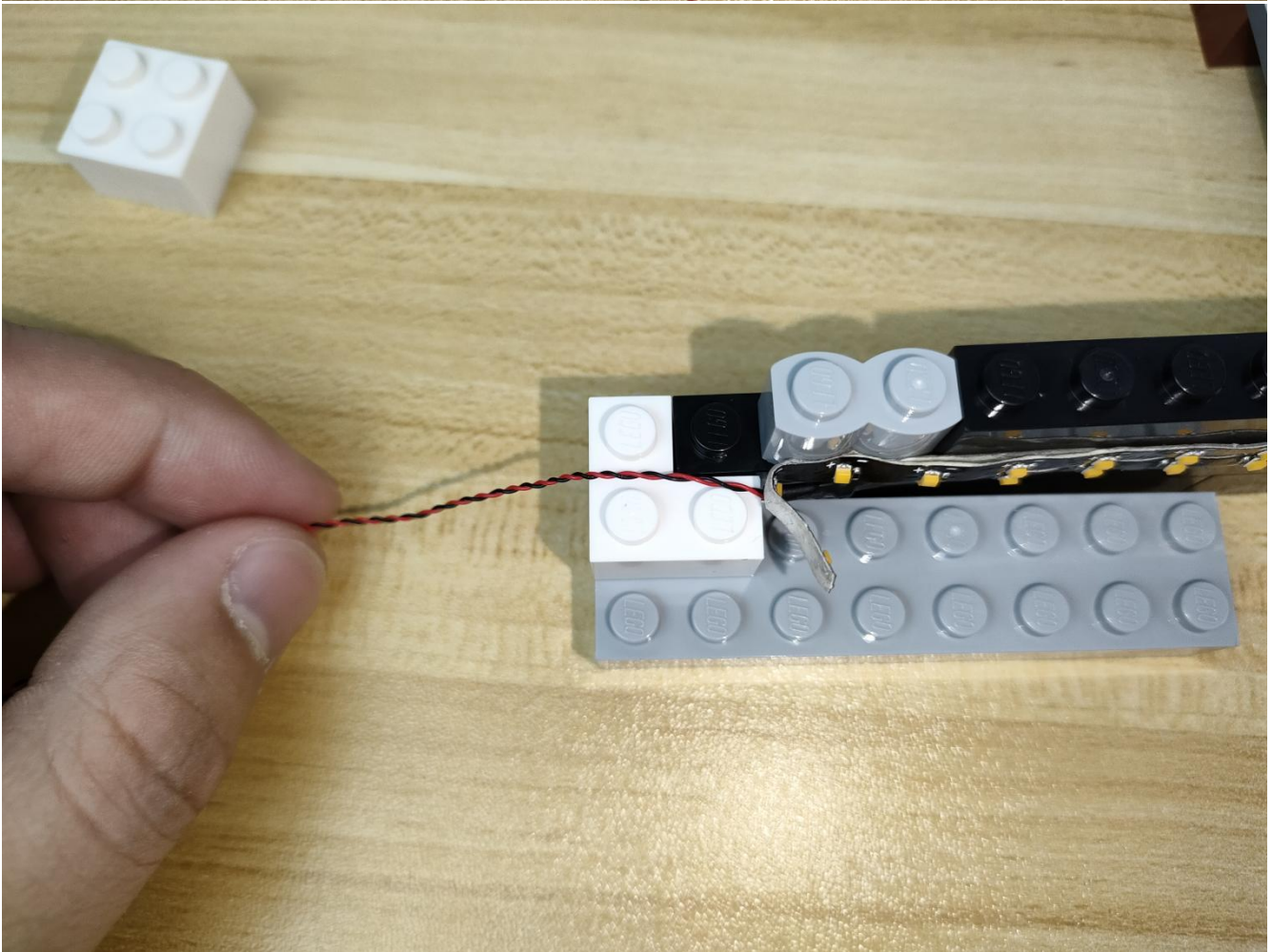
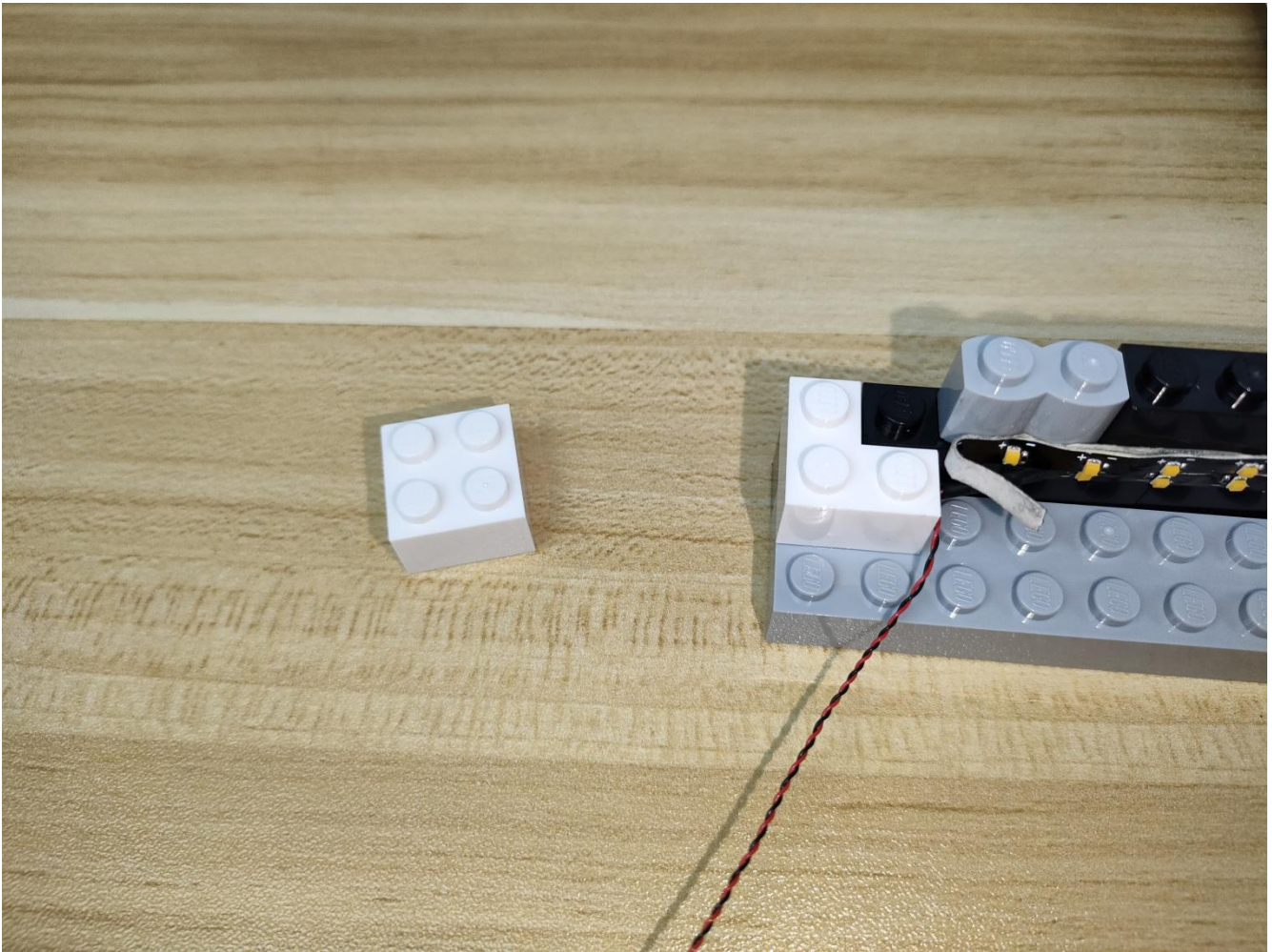

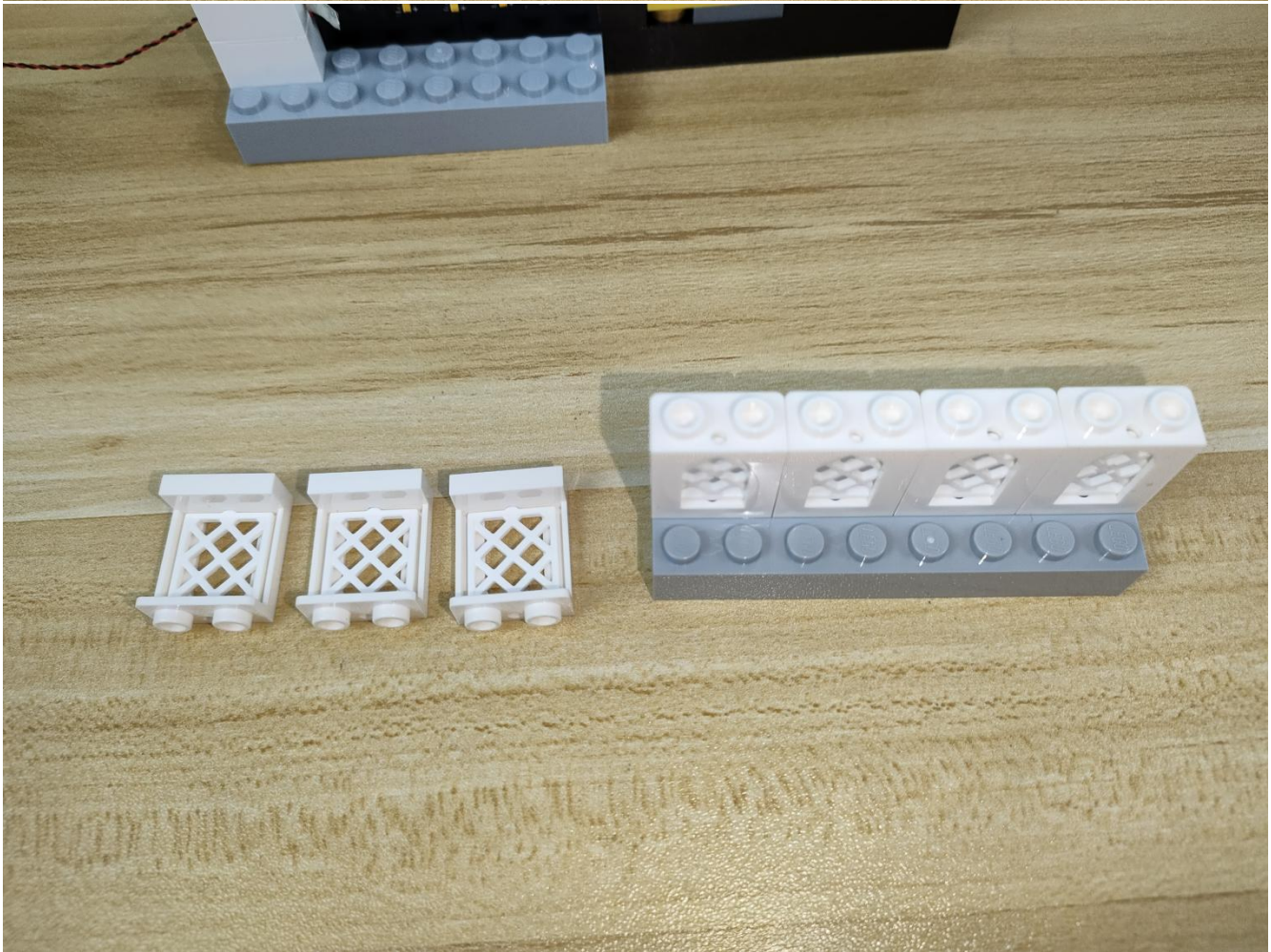
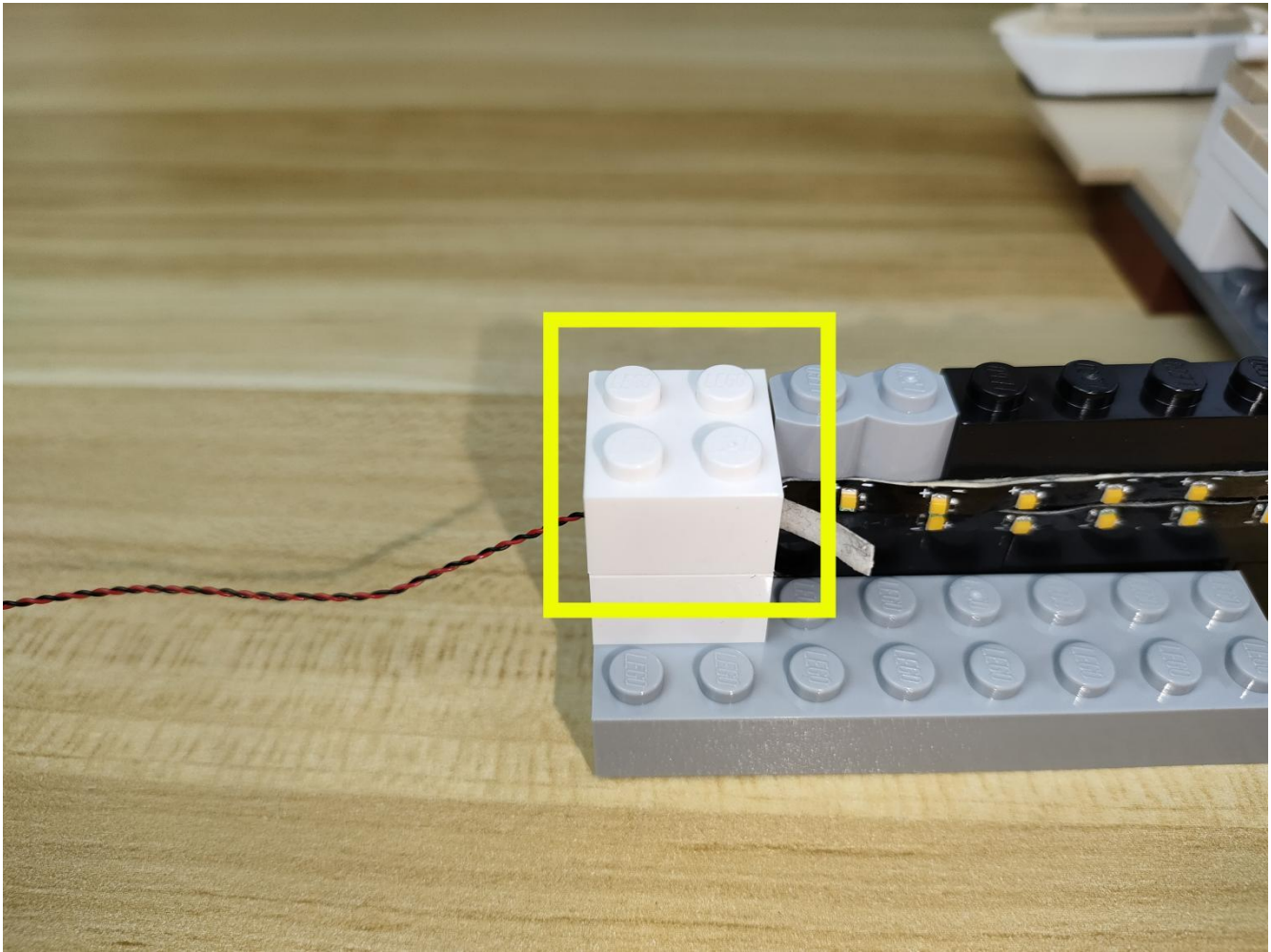

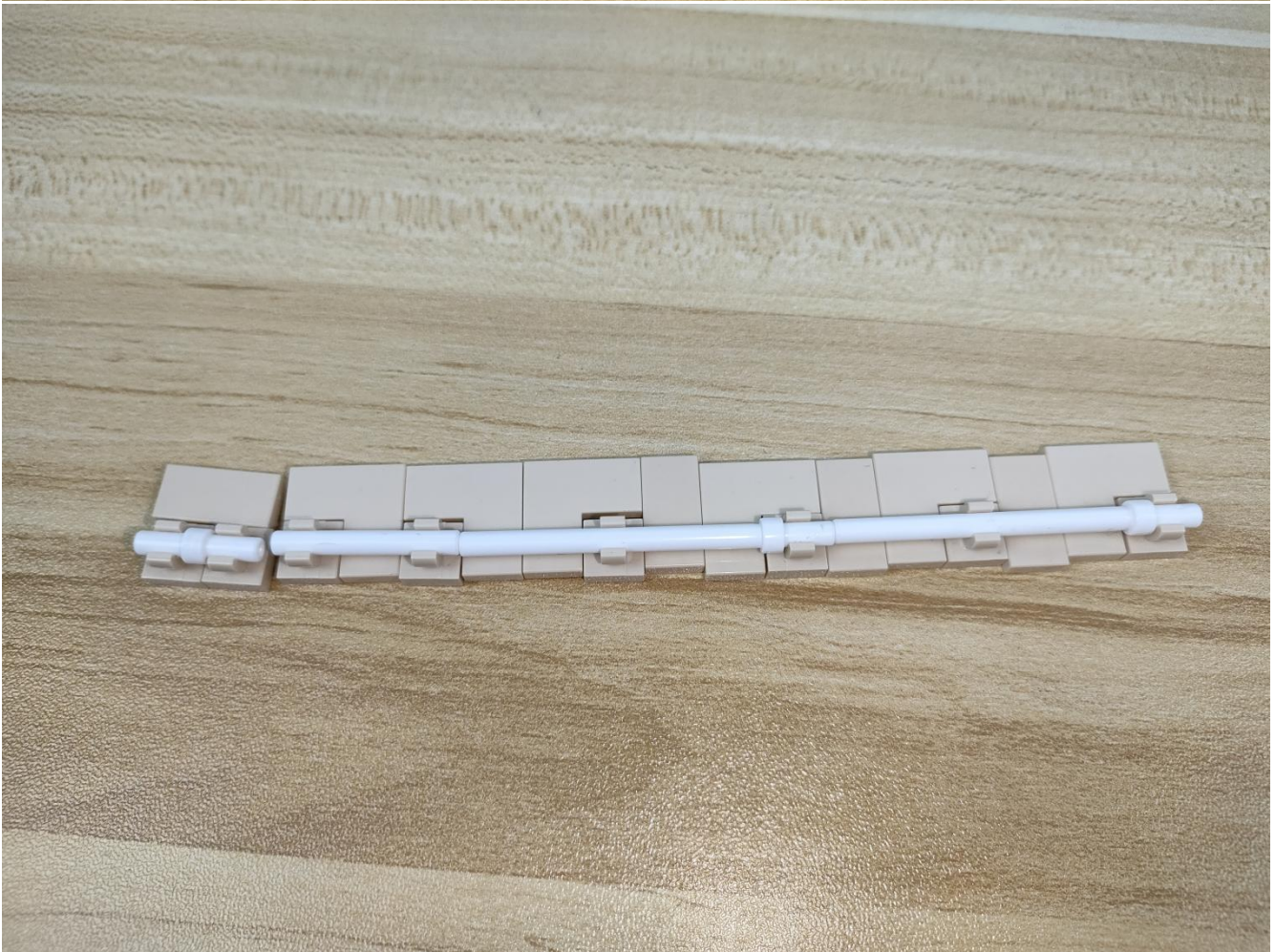
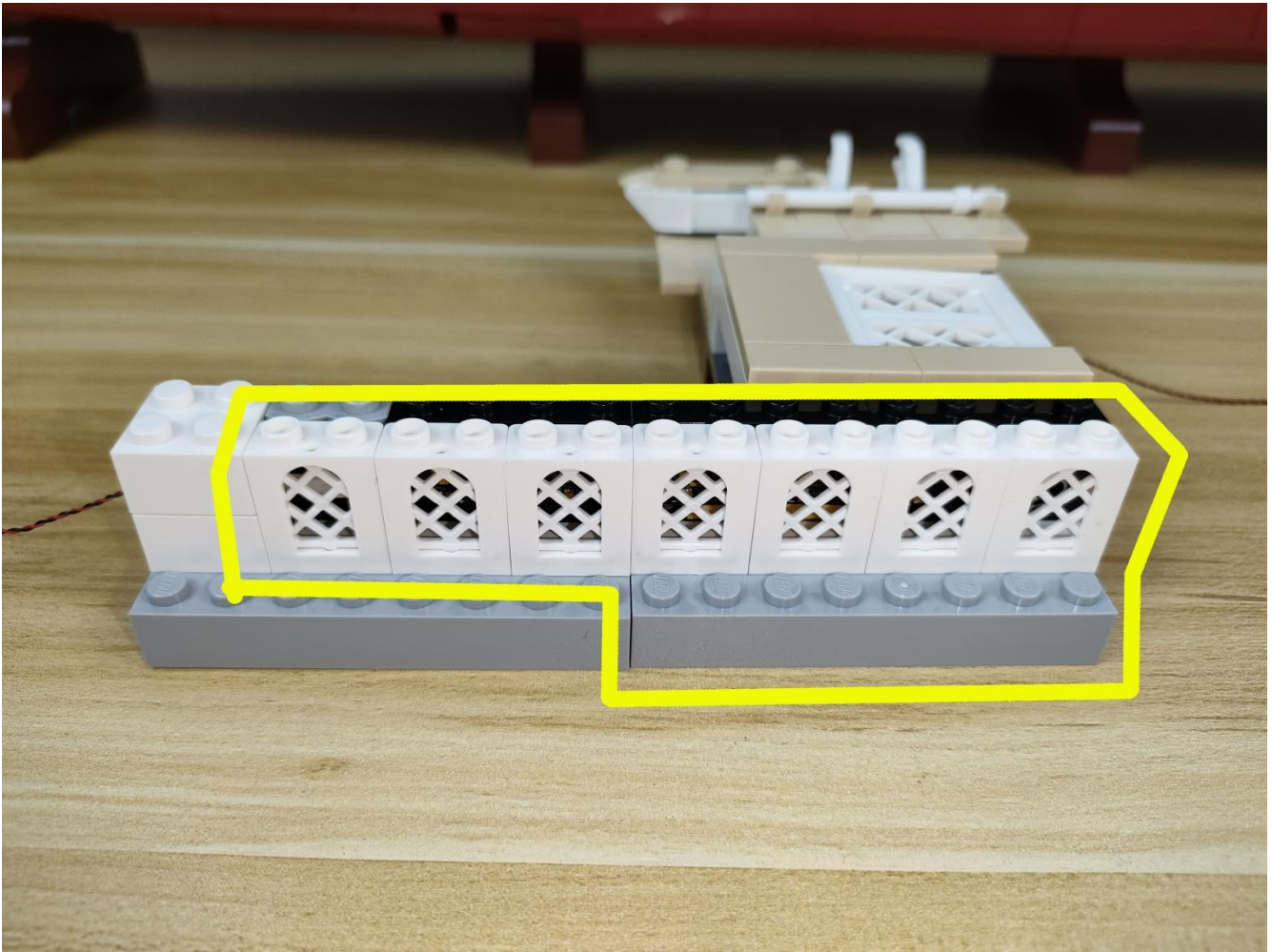

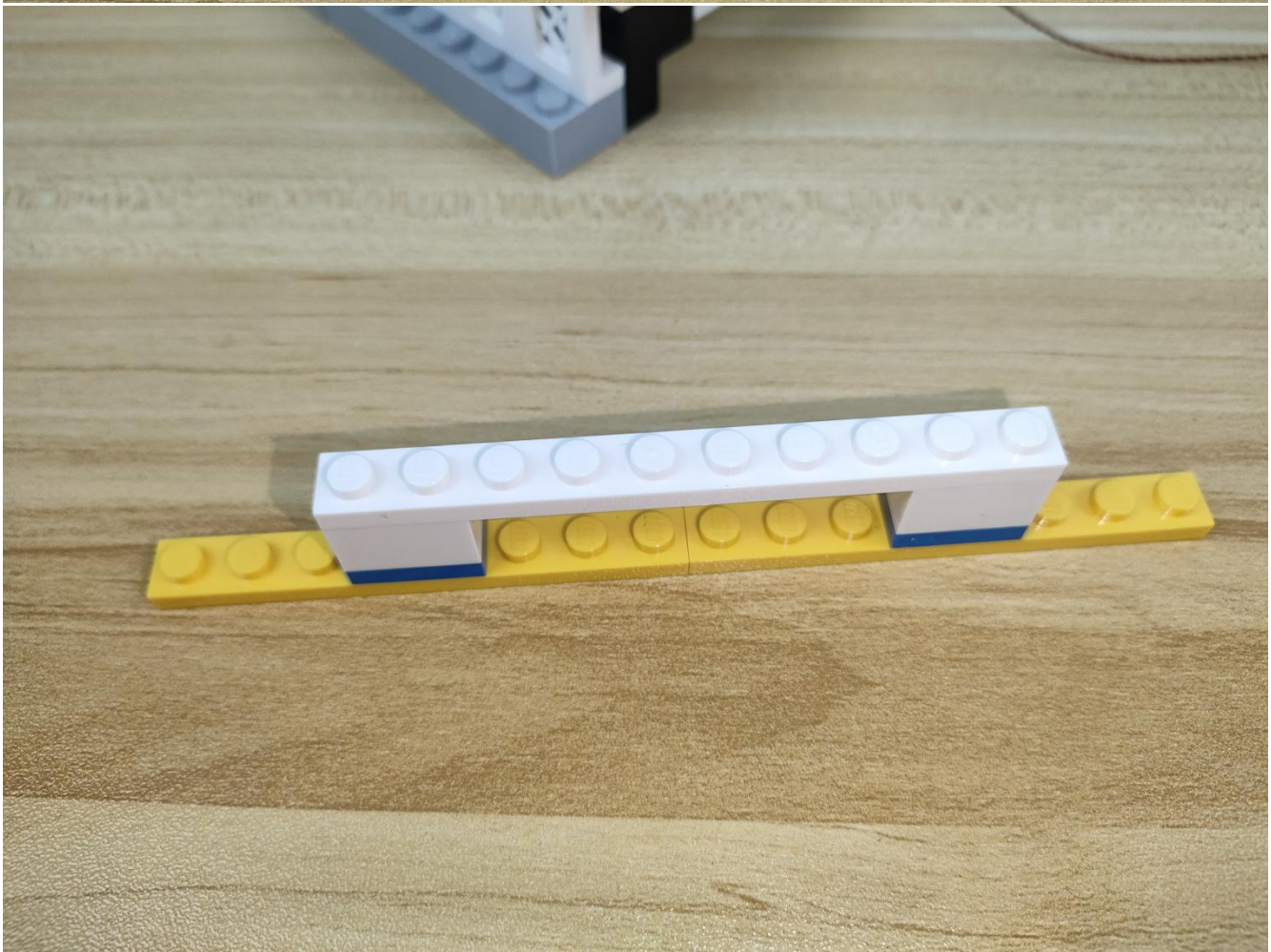
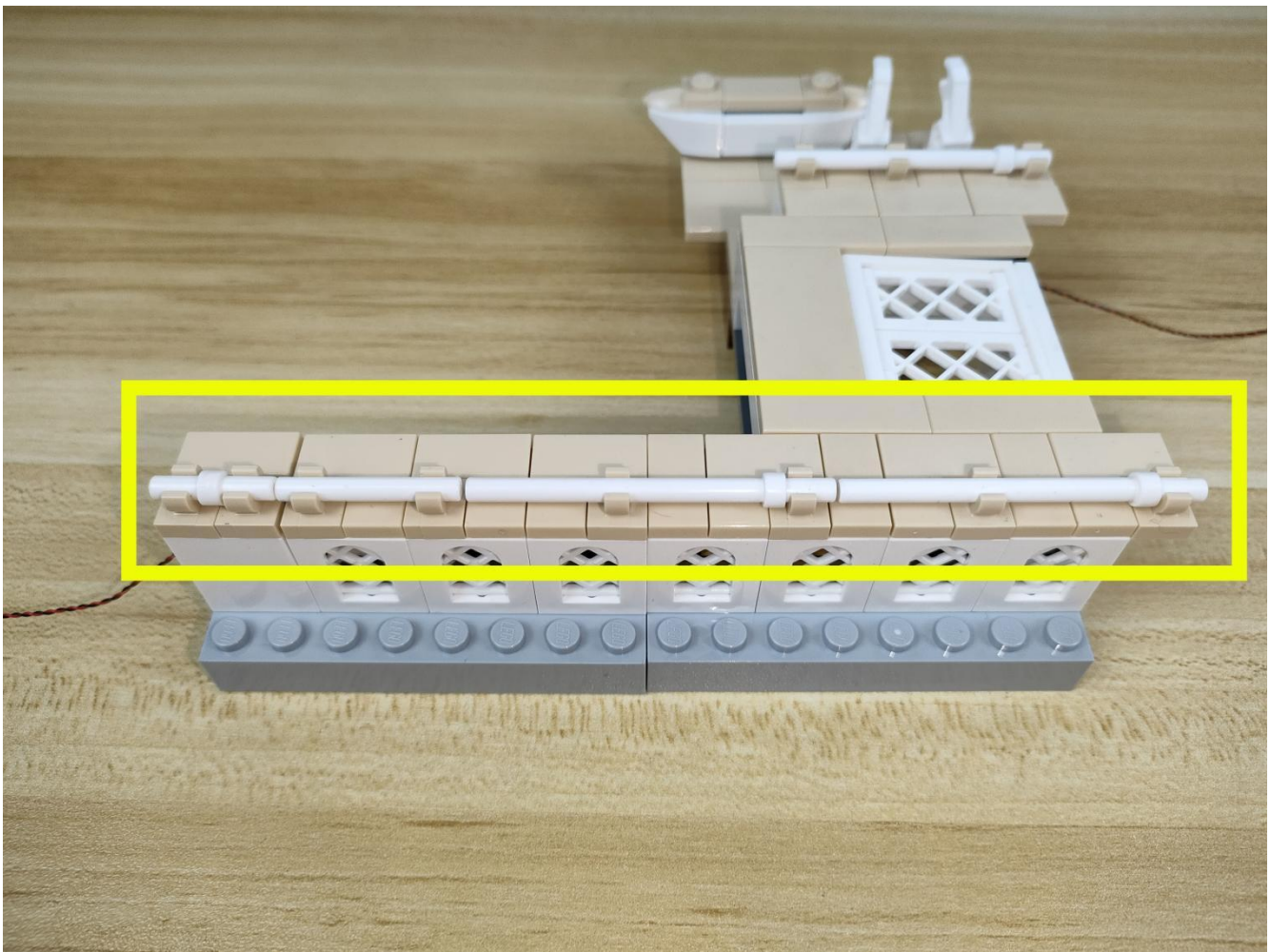

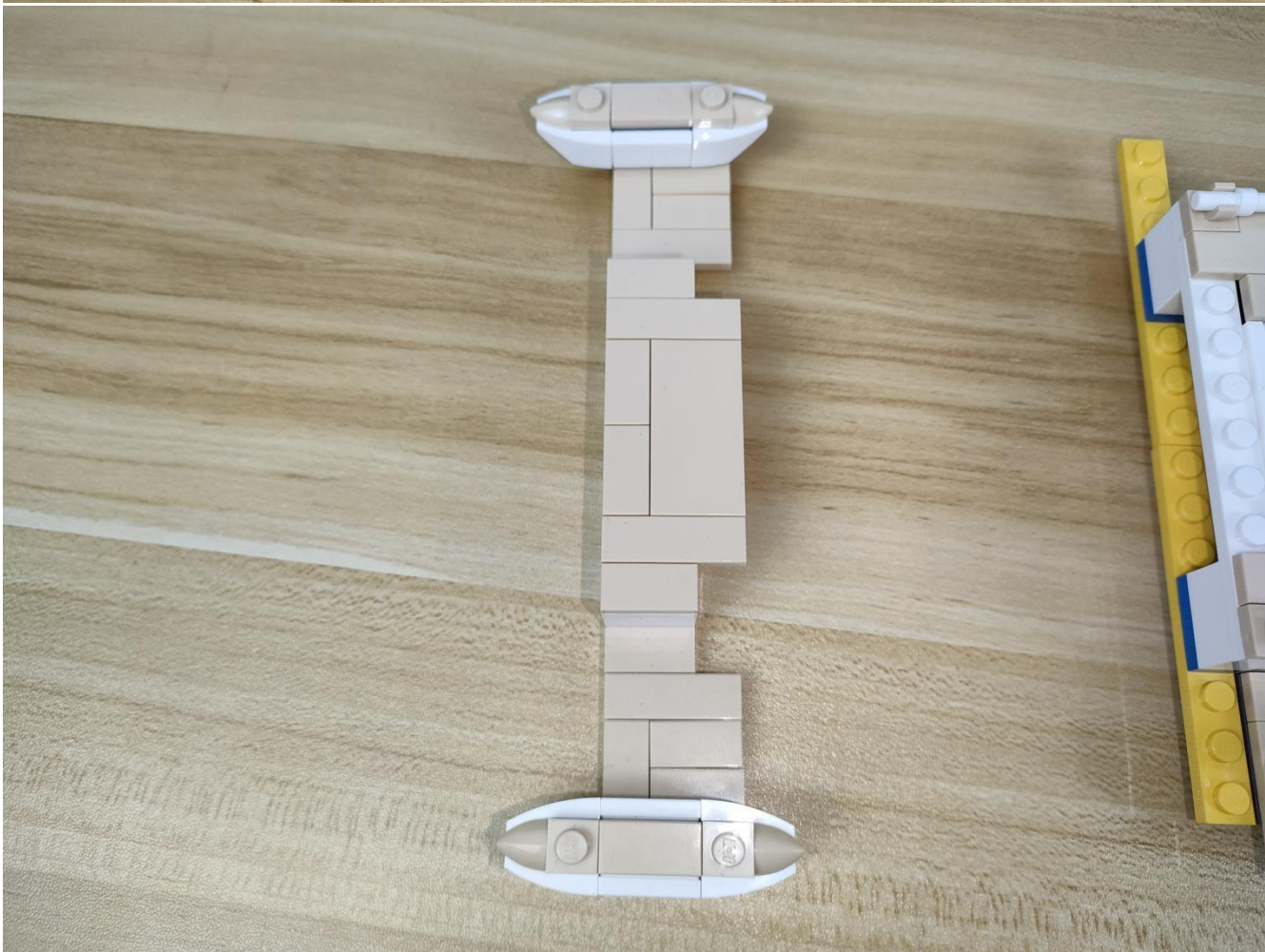
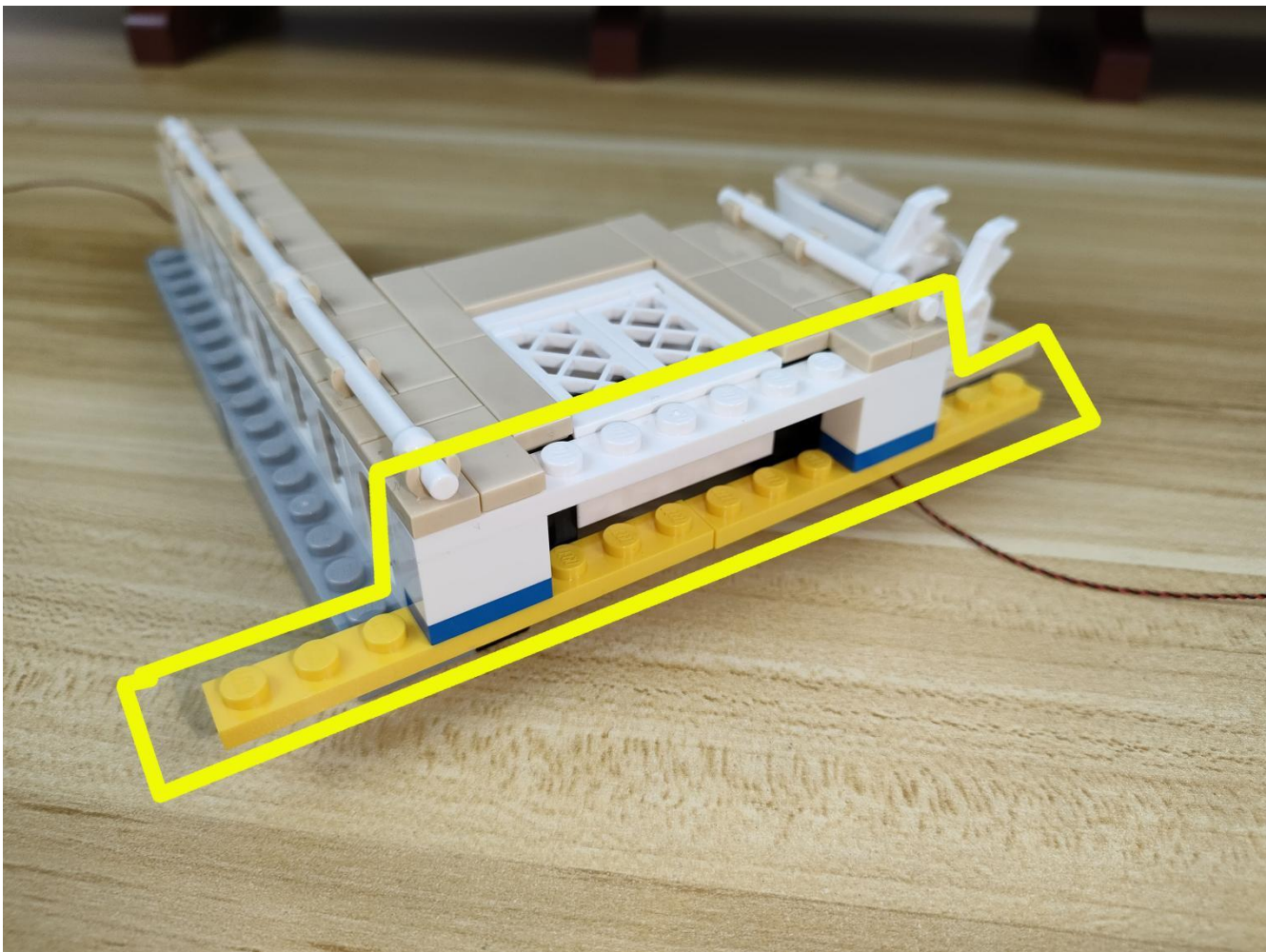

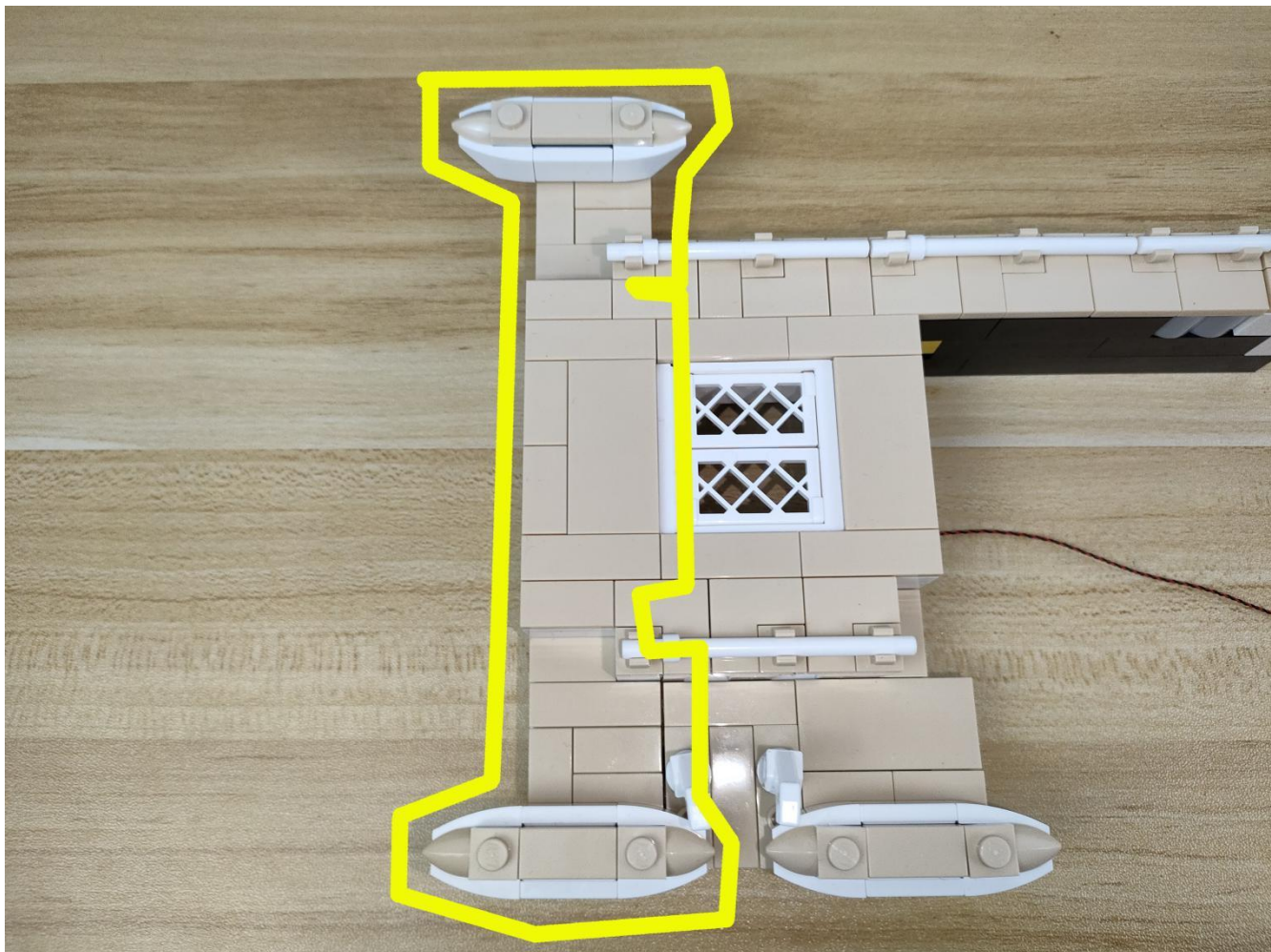

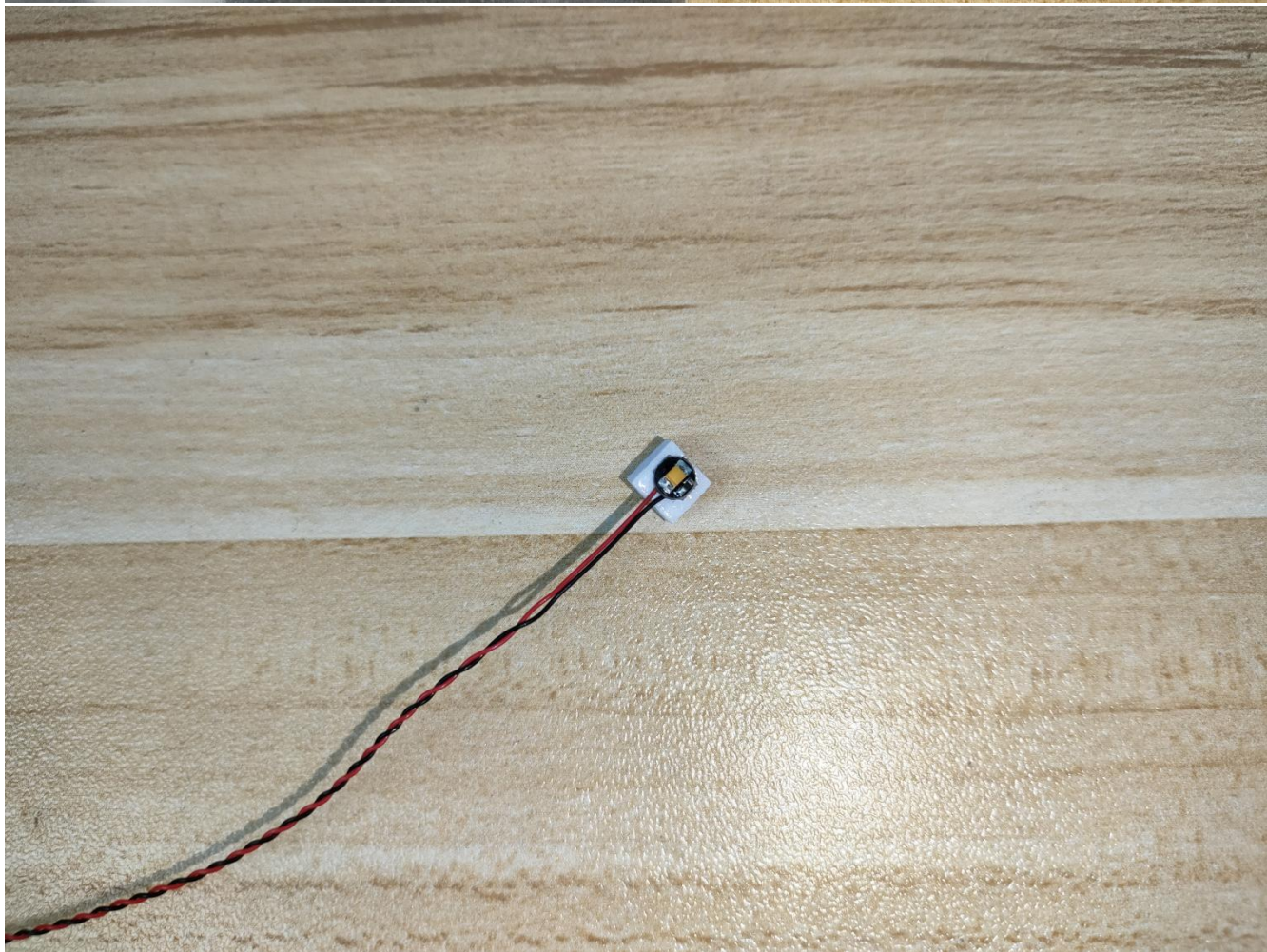
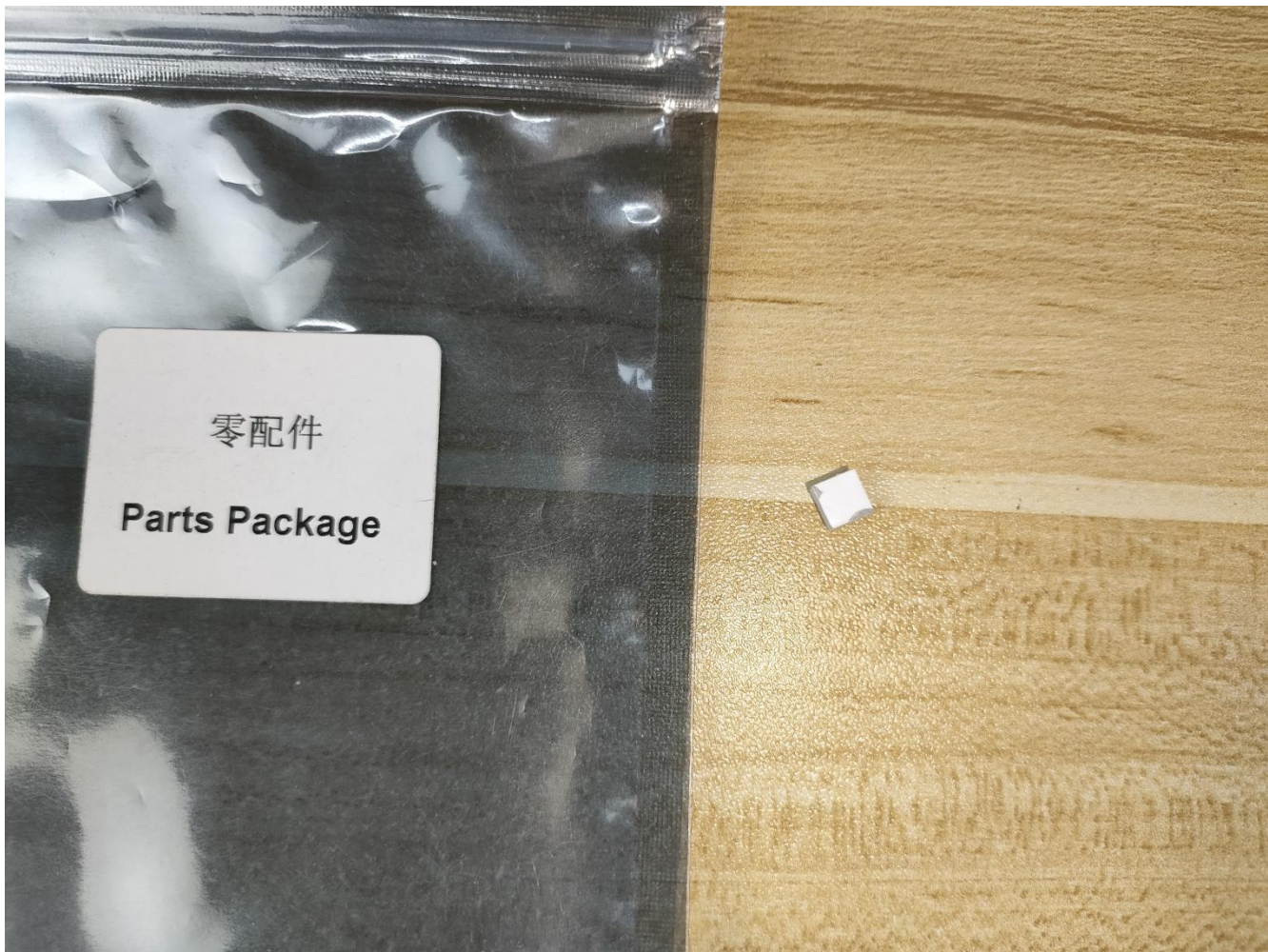

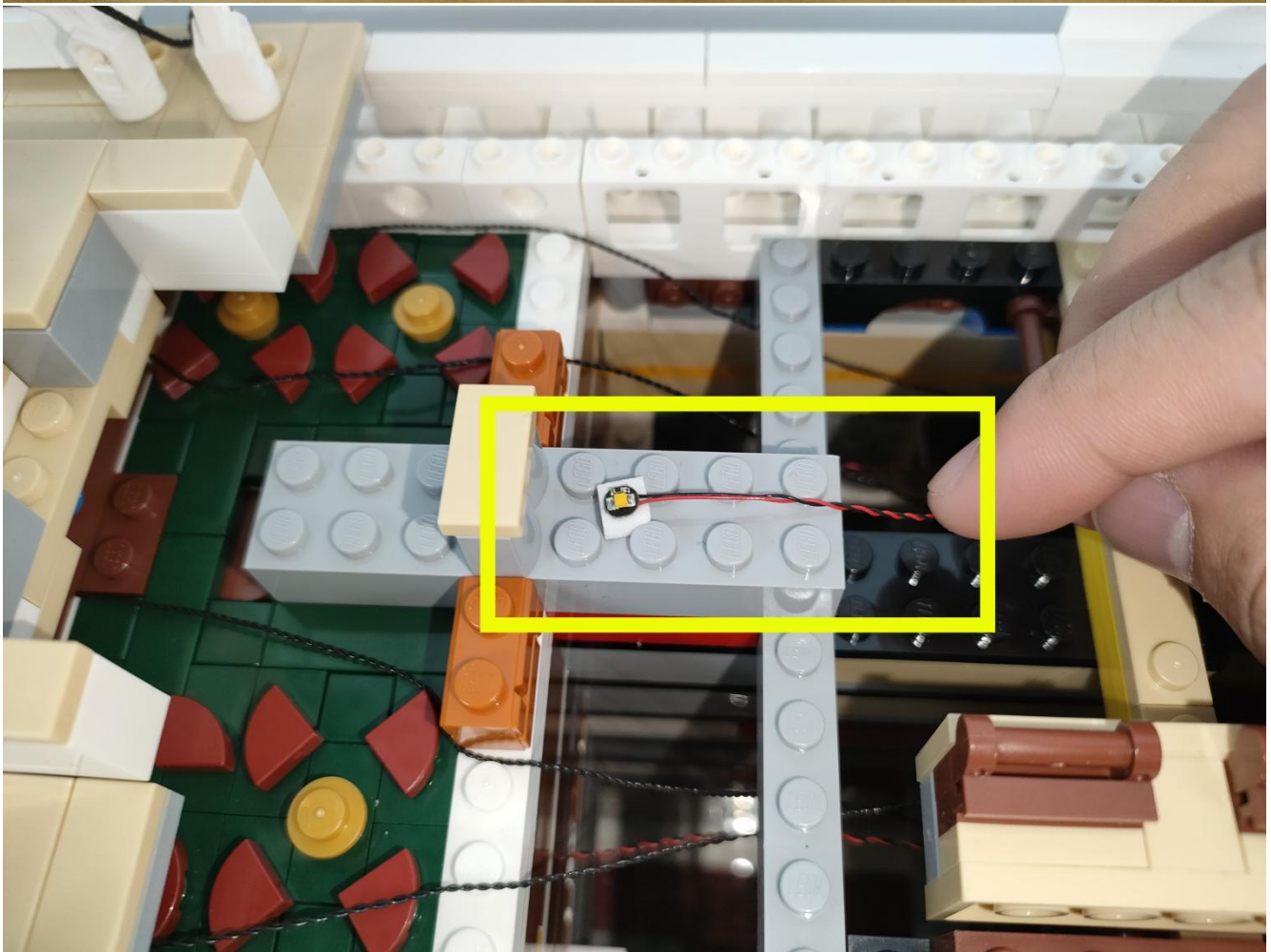
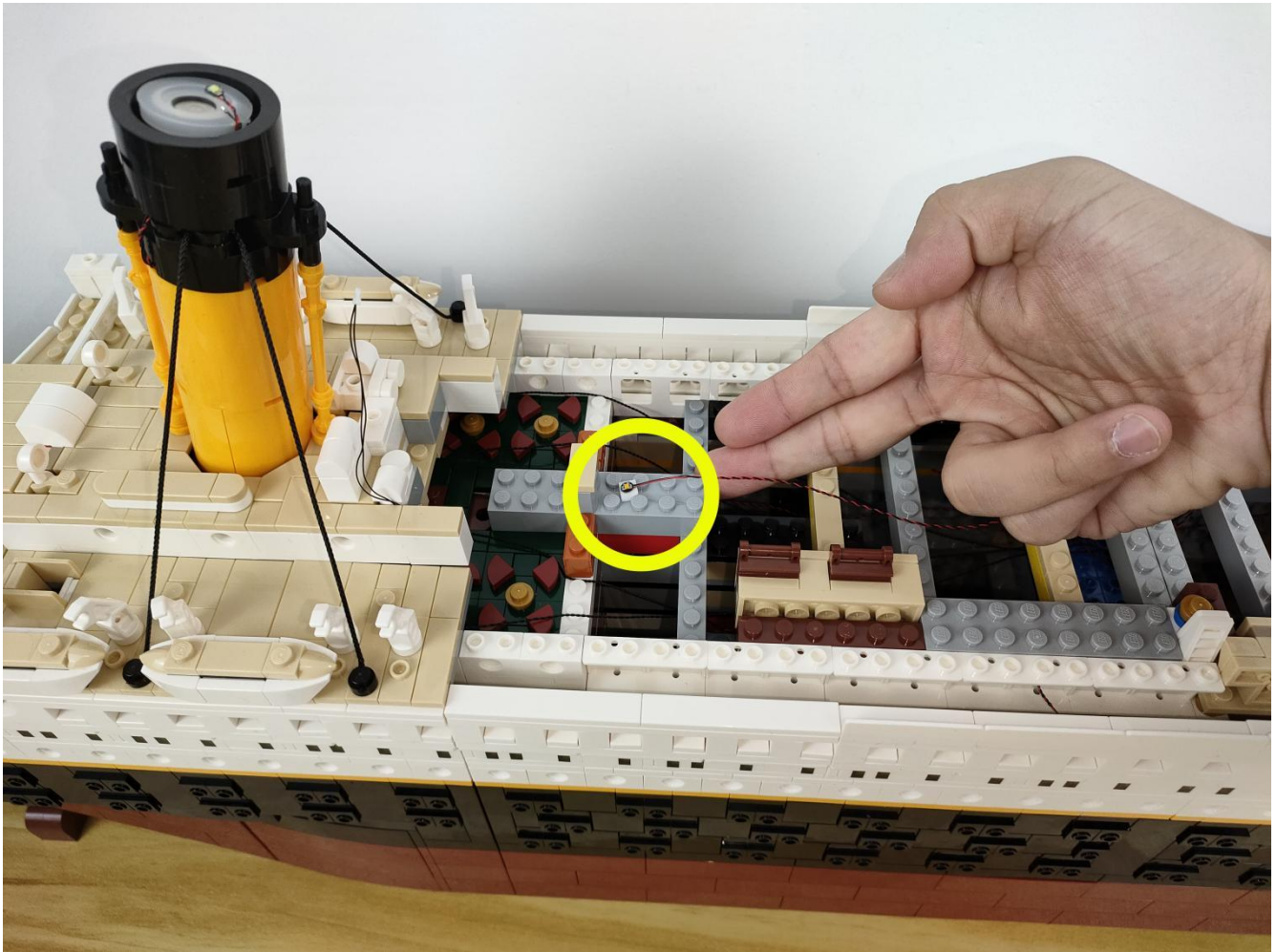

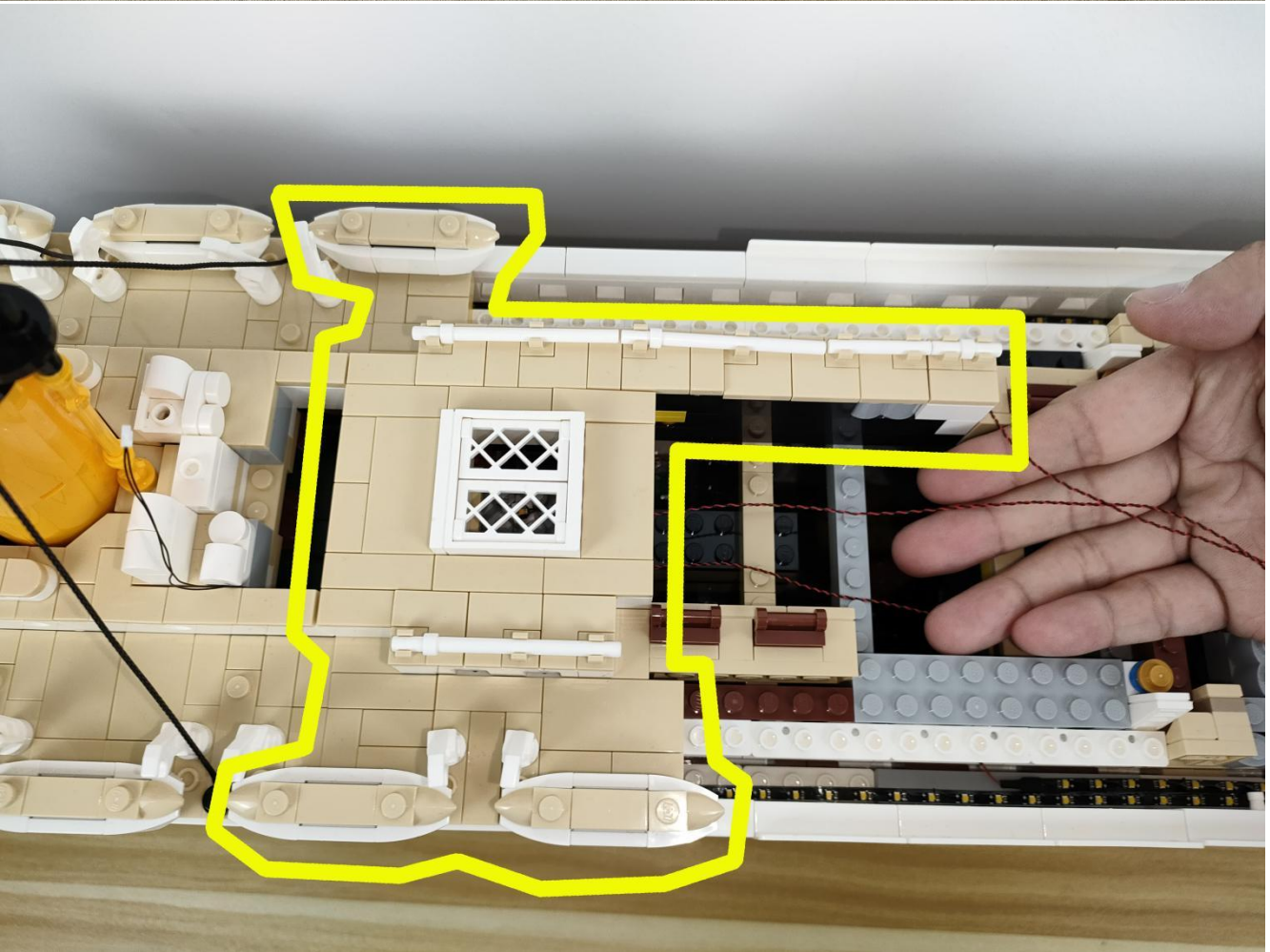
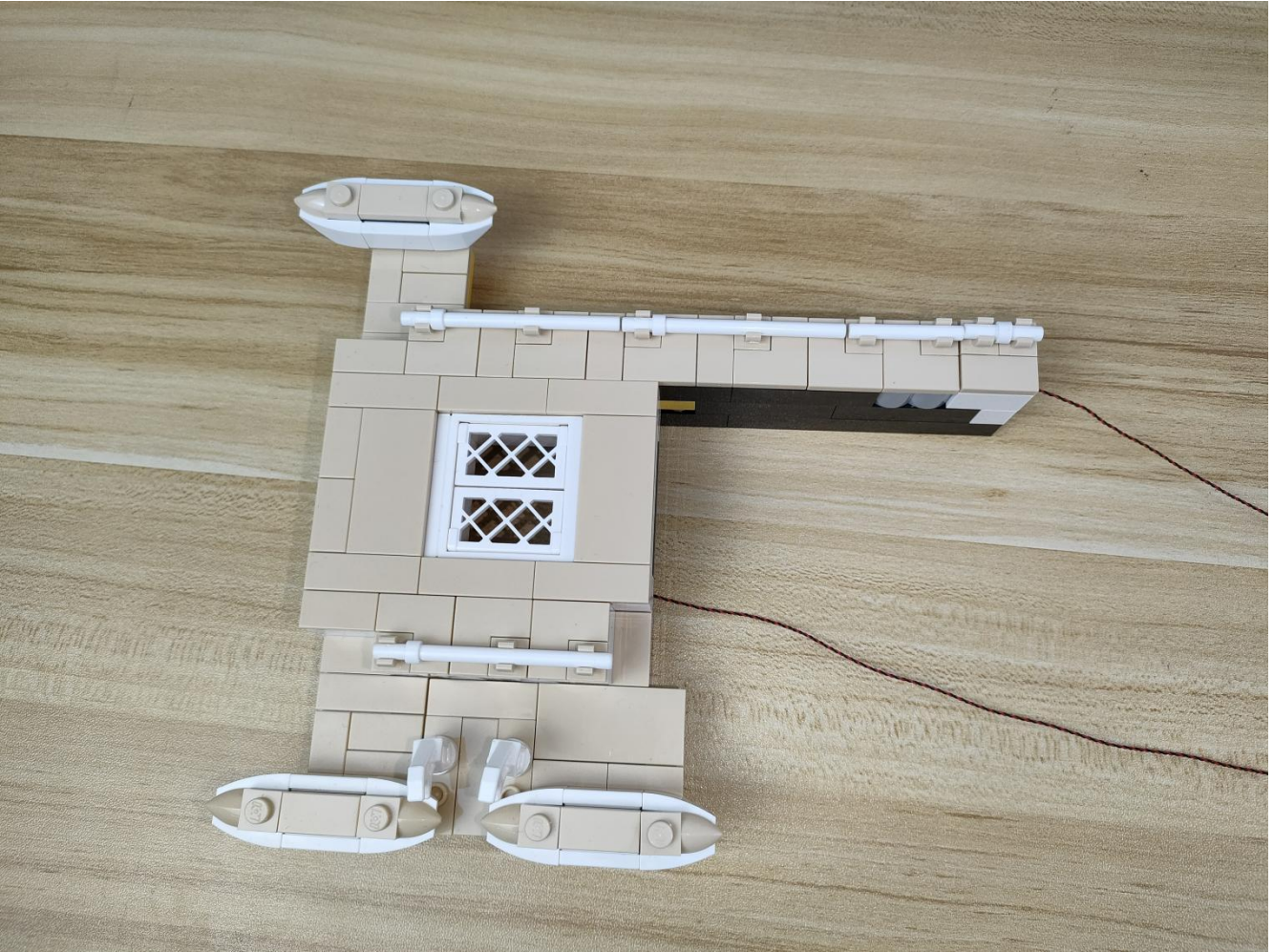

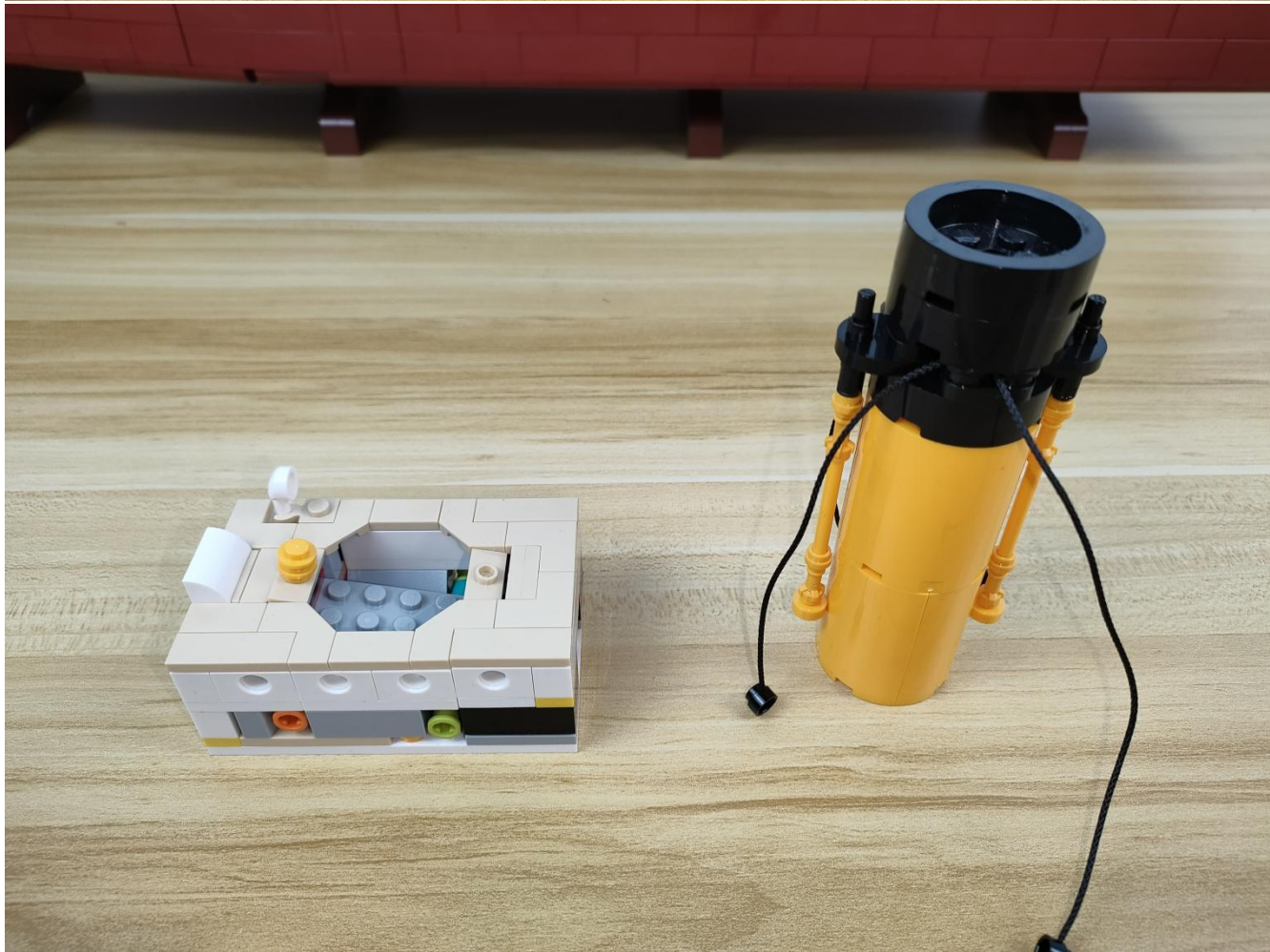
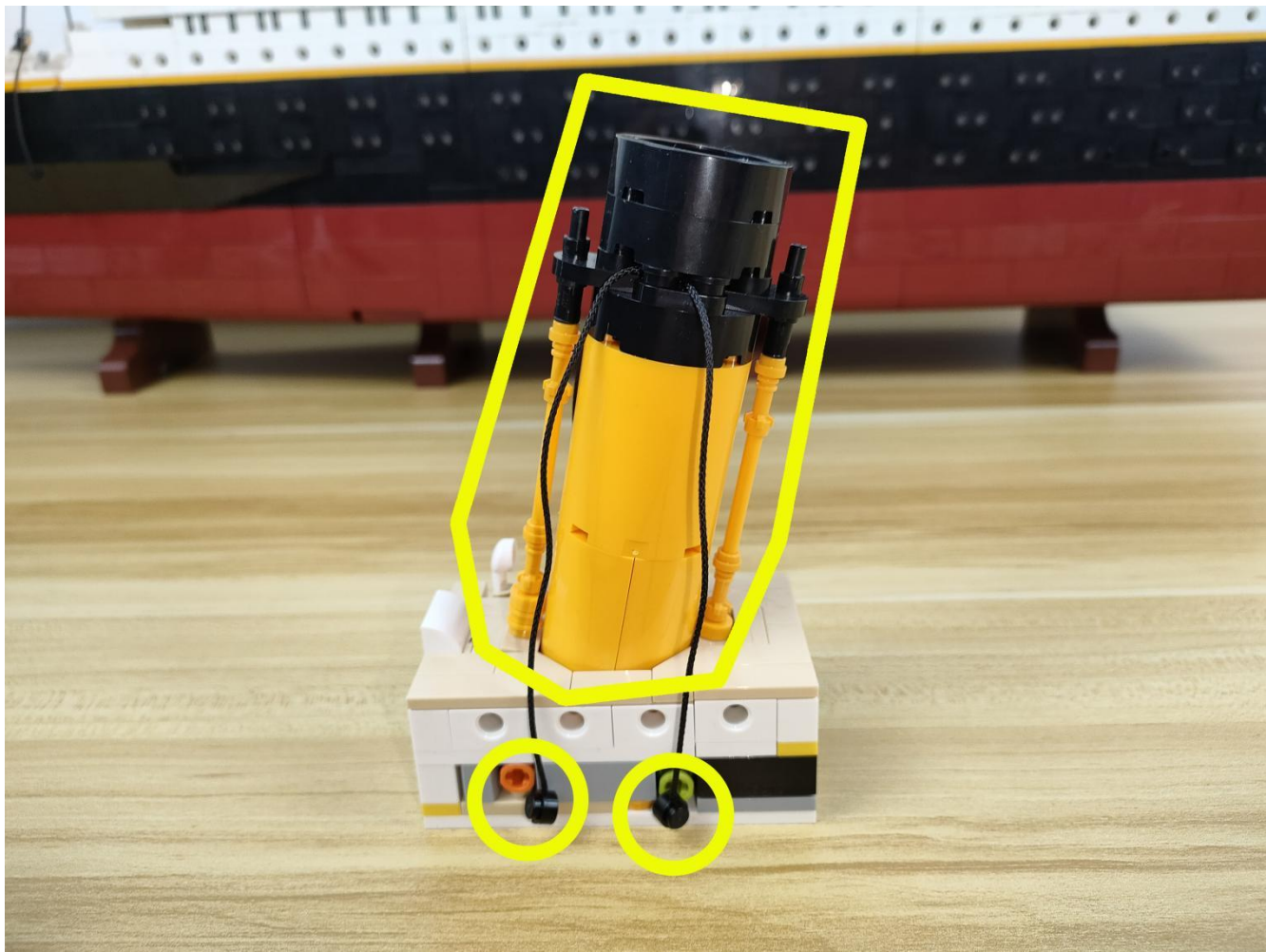

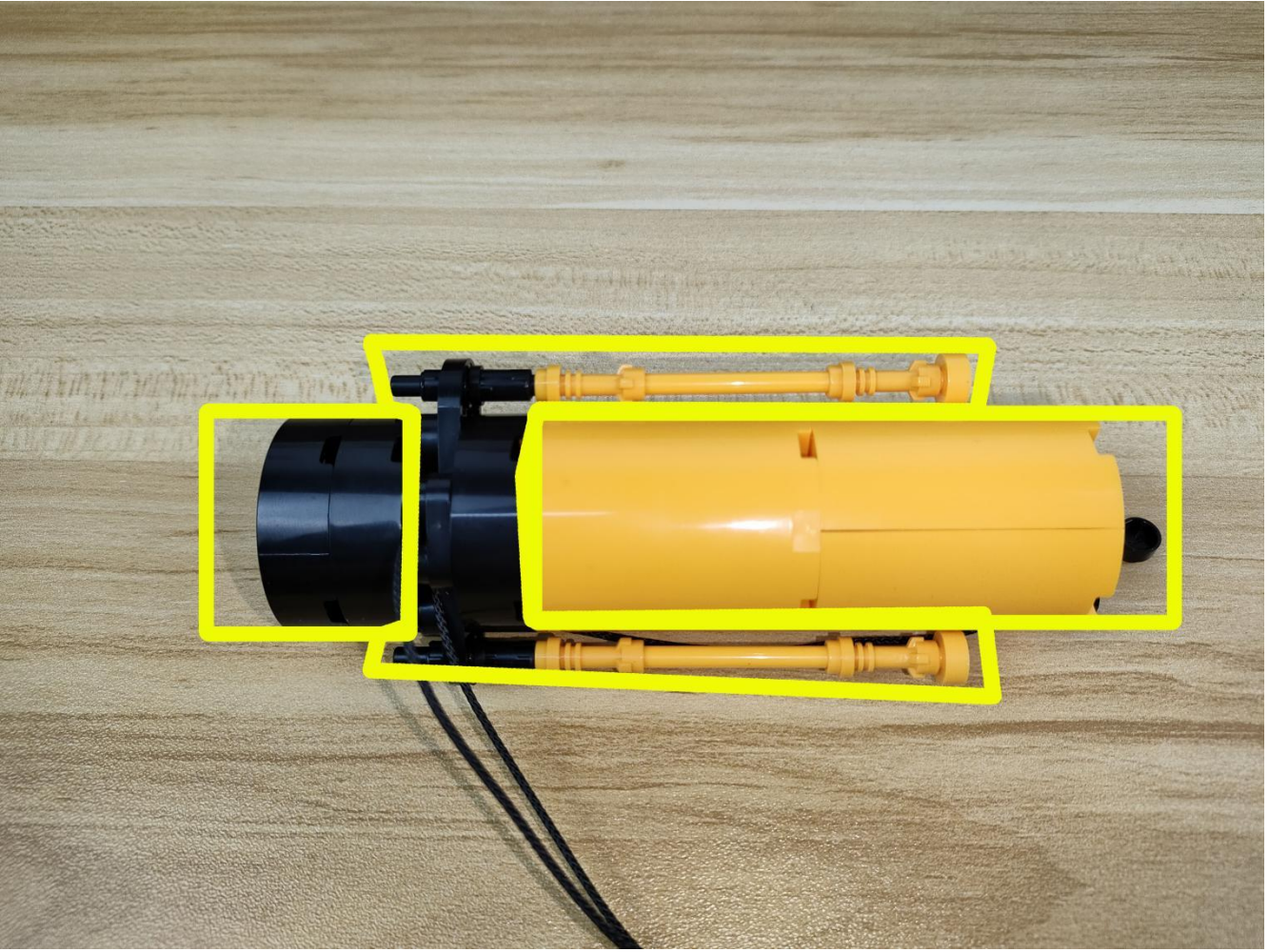

喷雾模块
Spray Module



白色普通燈粒30CM
Bit Lights-30CM
White



Fix the lamp pellet to the position selected in the figure, with the solder joints of the spray module components facing upwards.

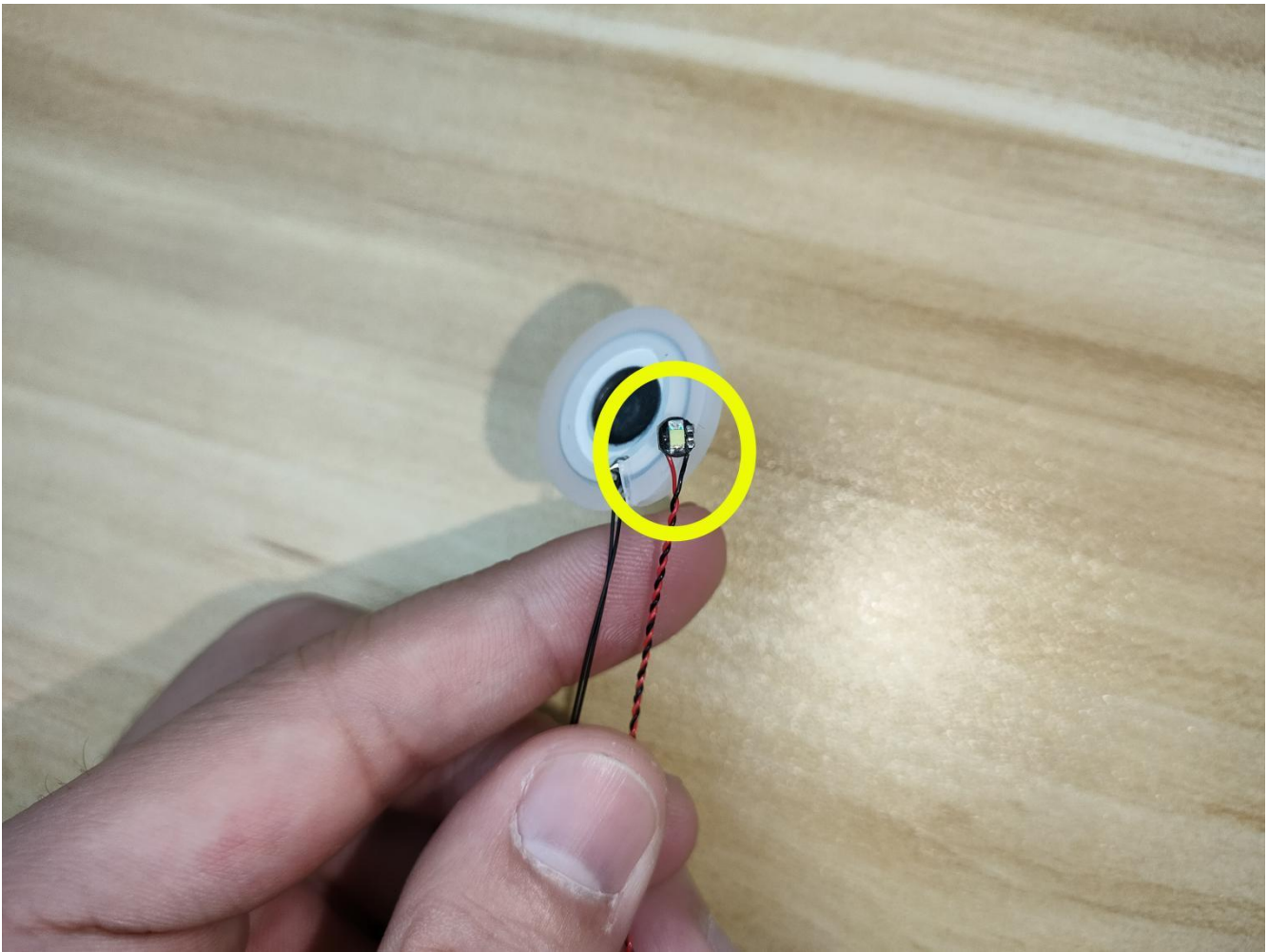

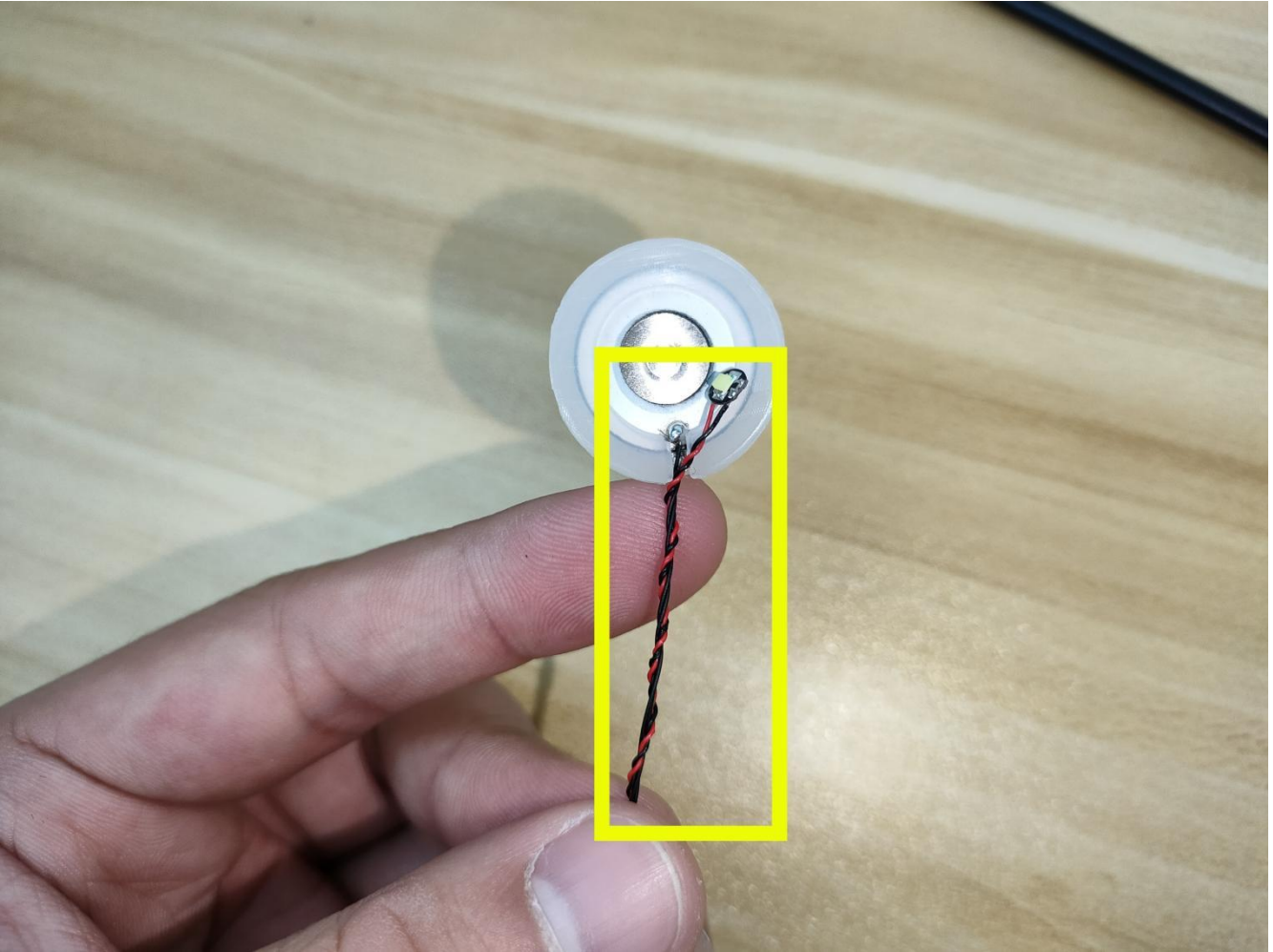

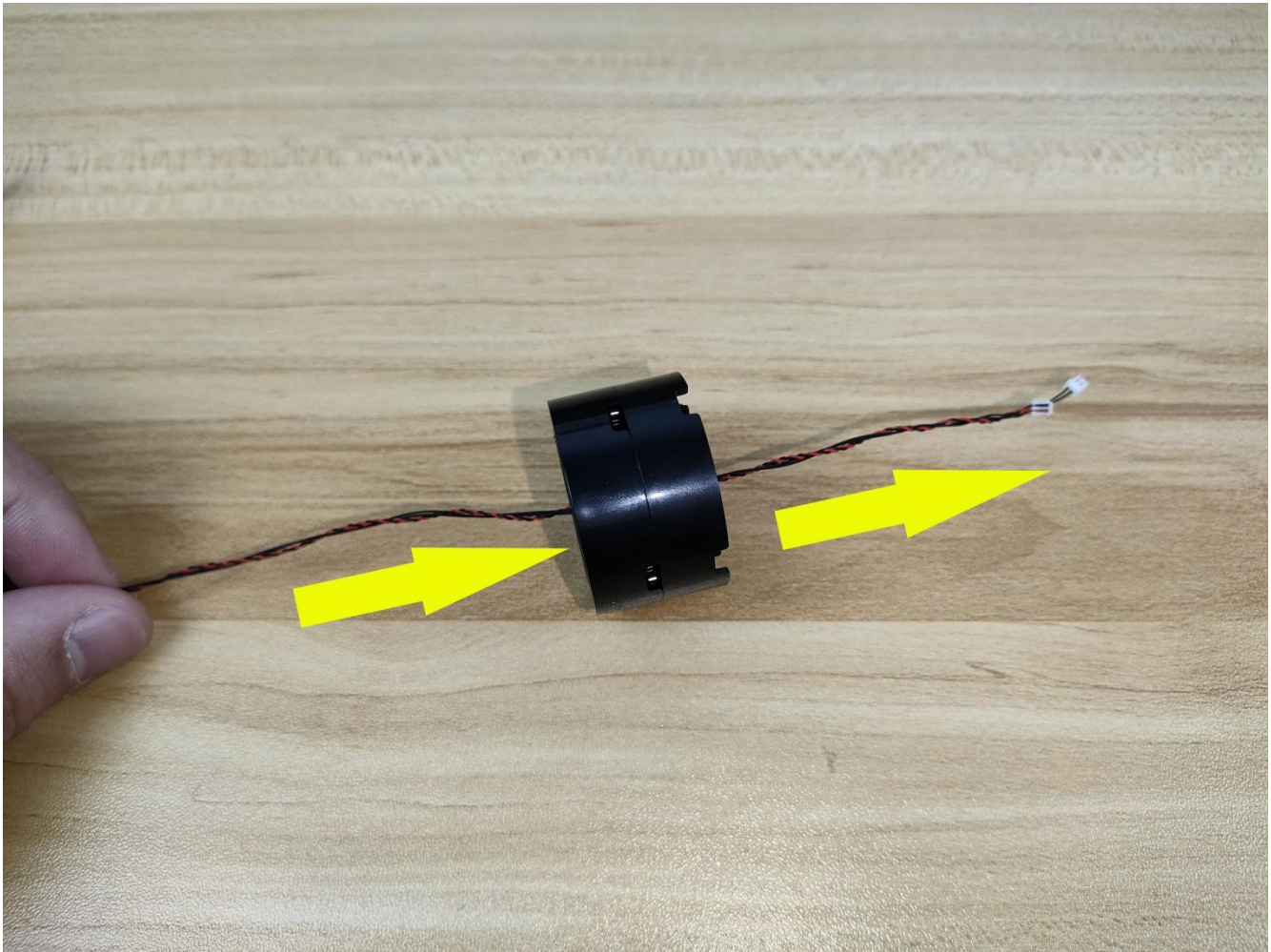

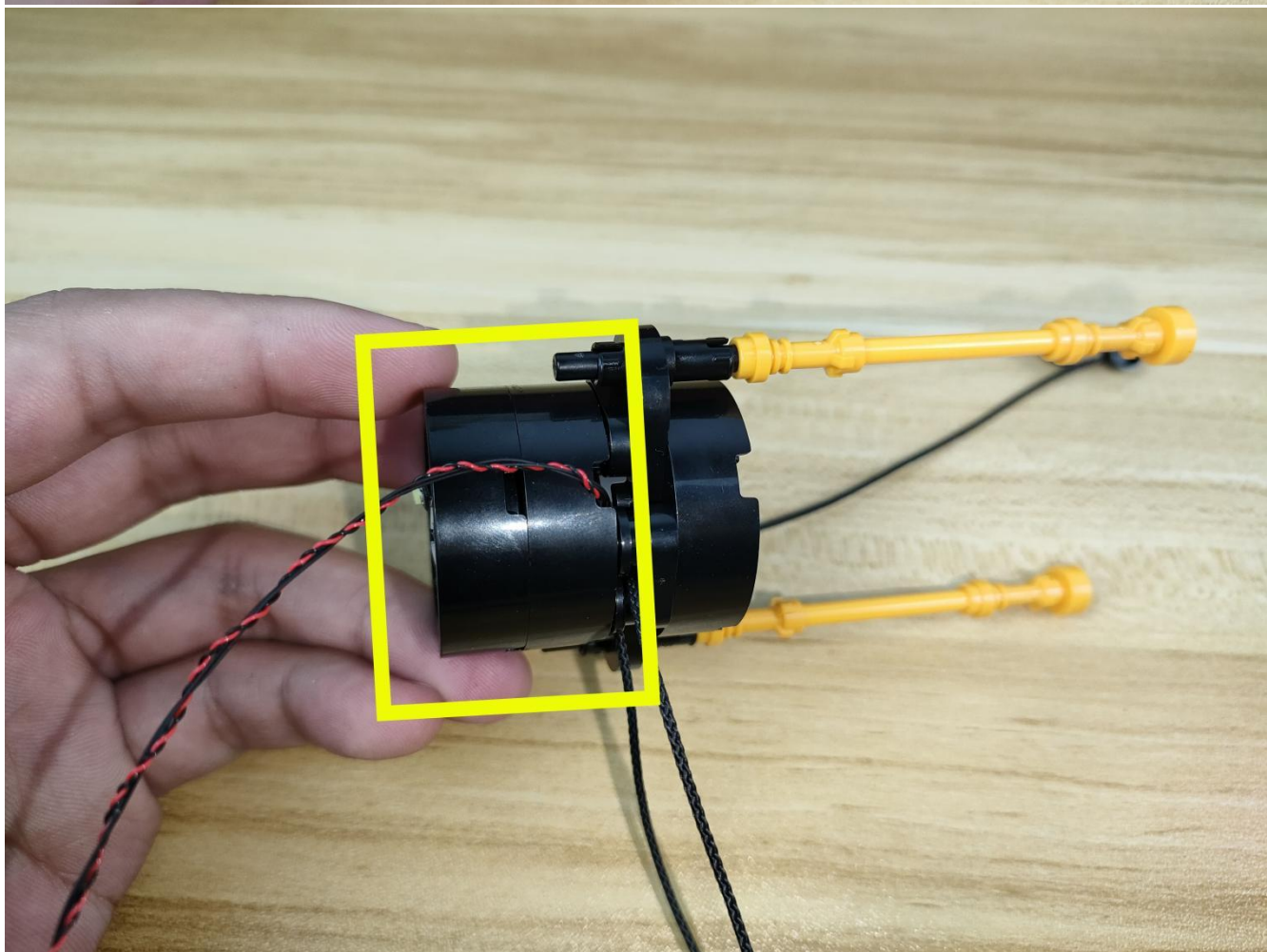
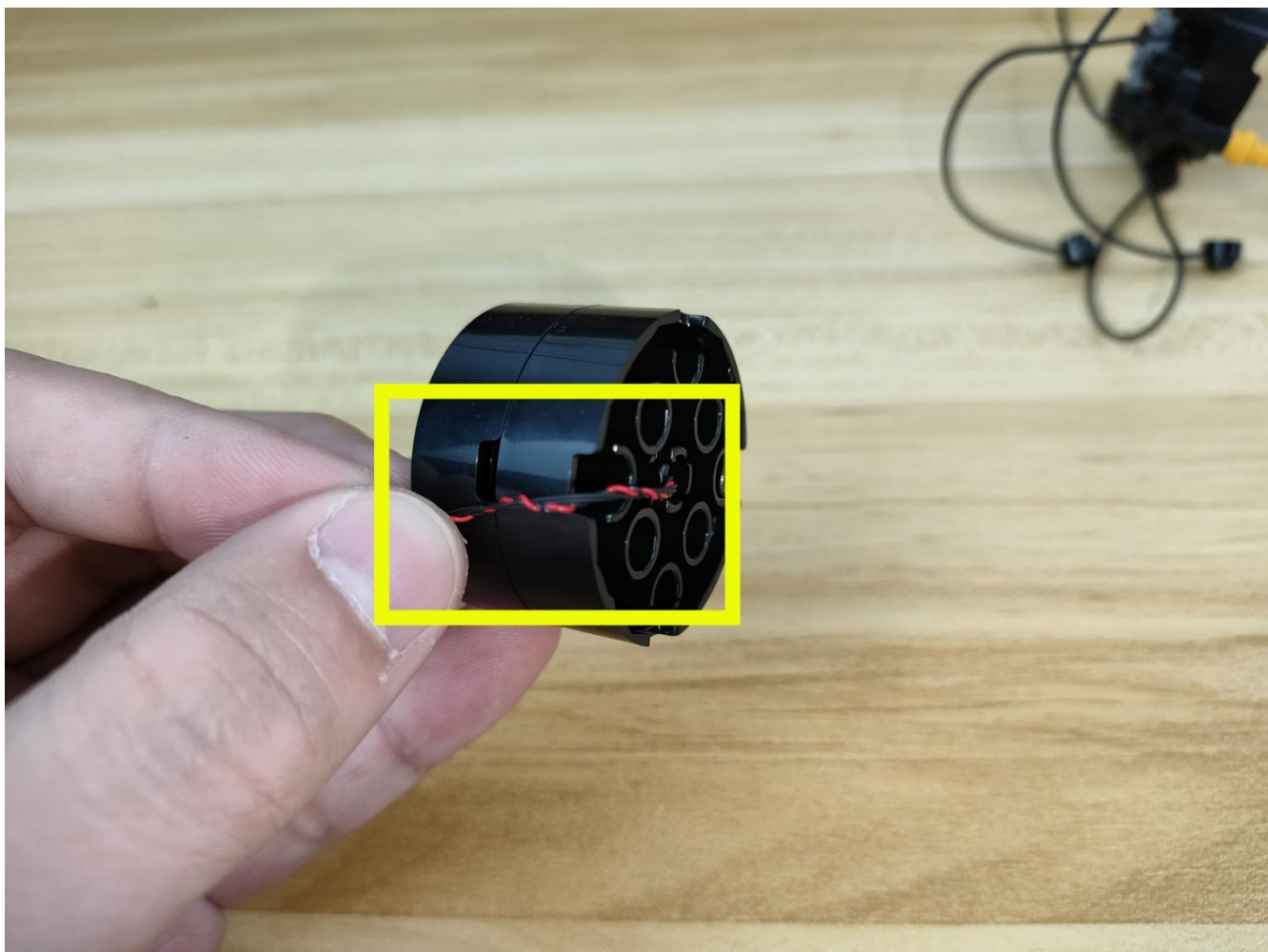

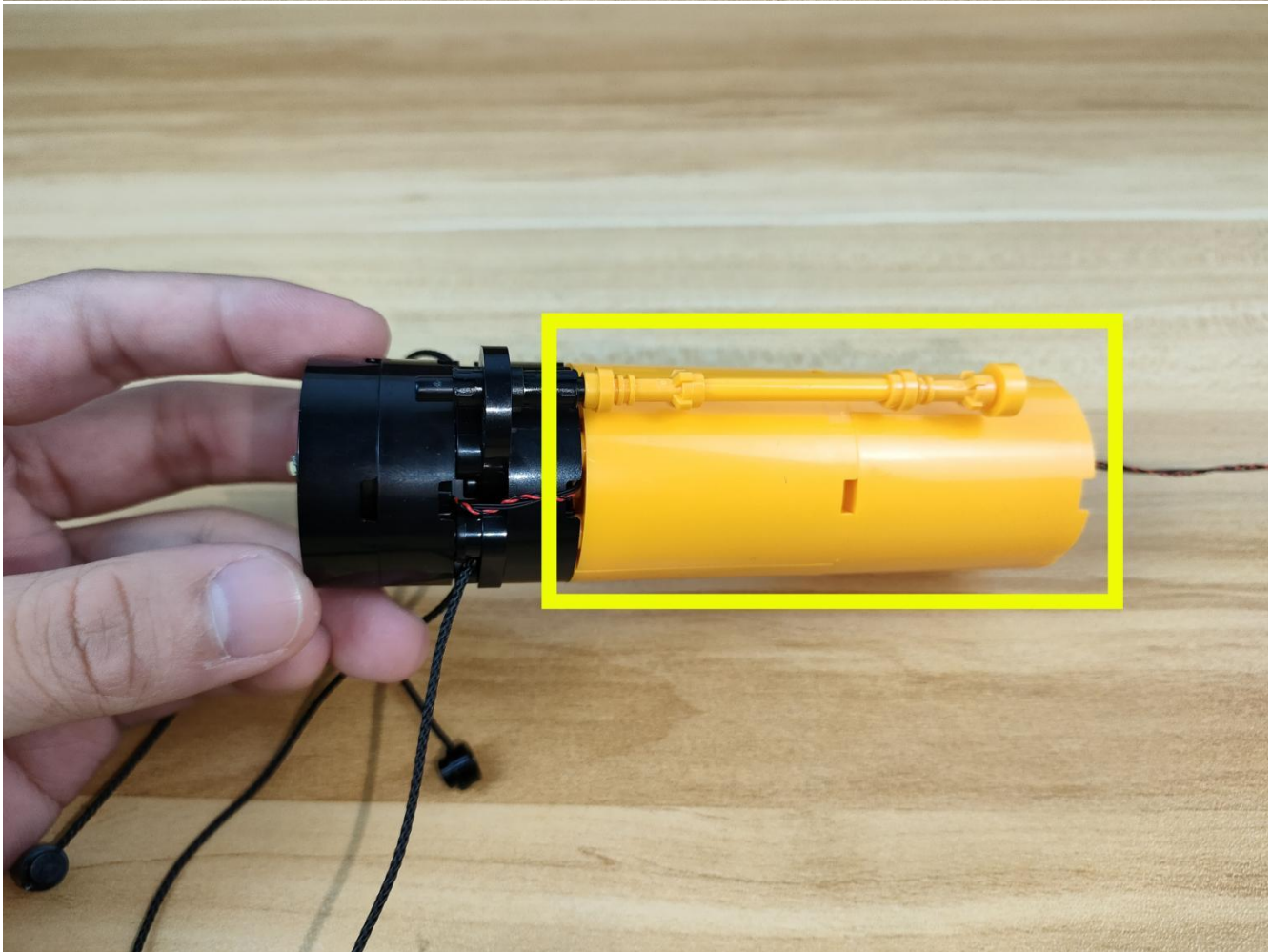
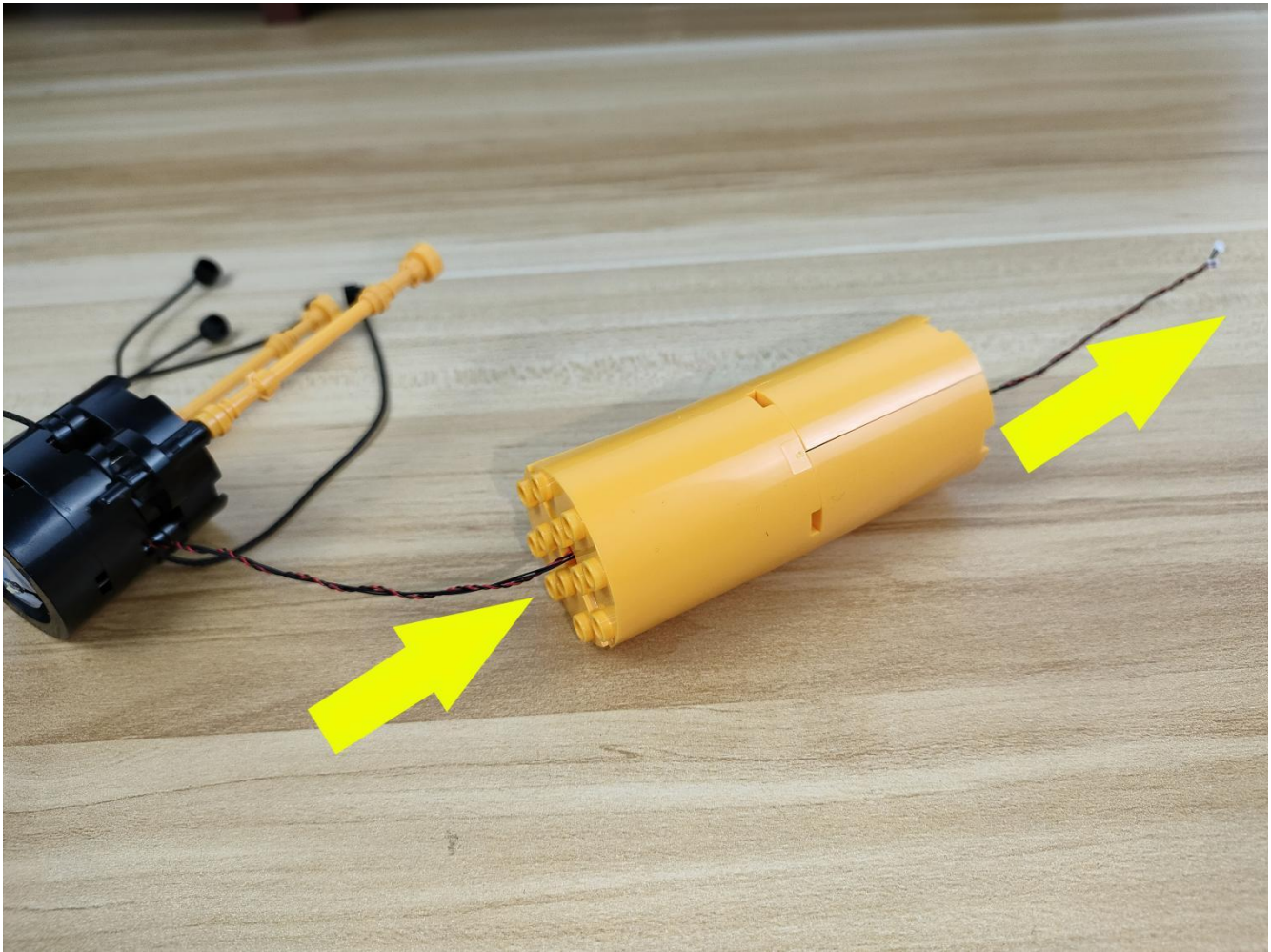

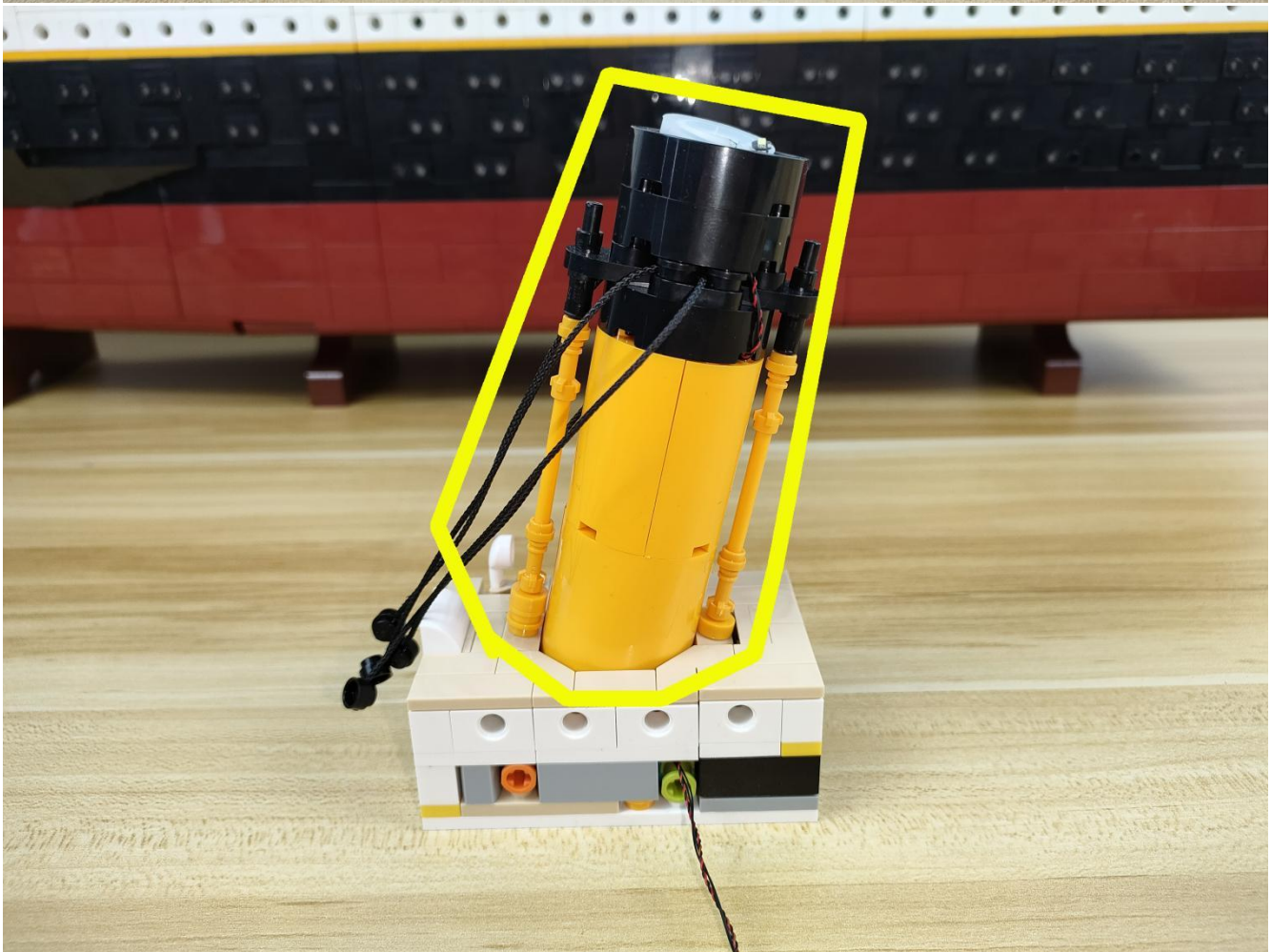
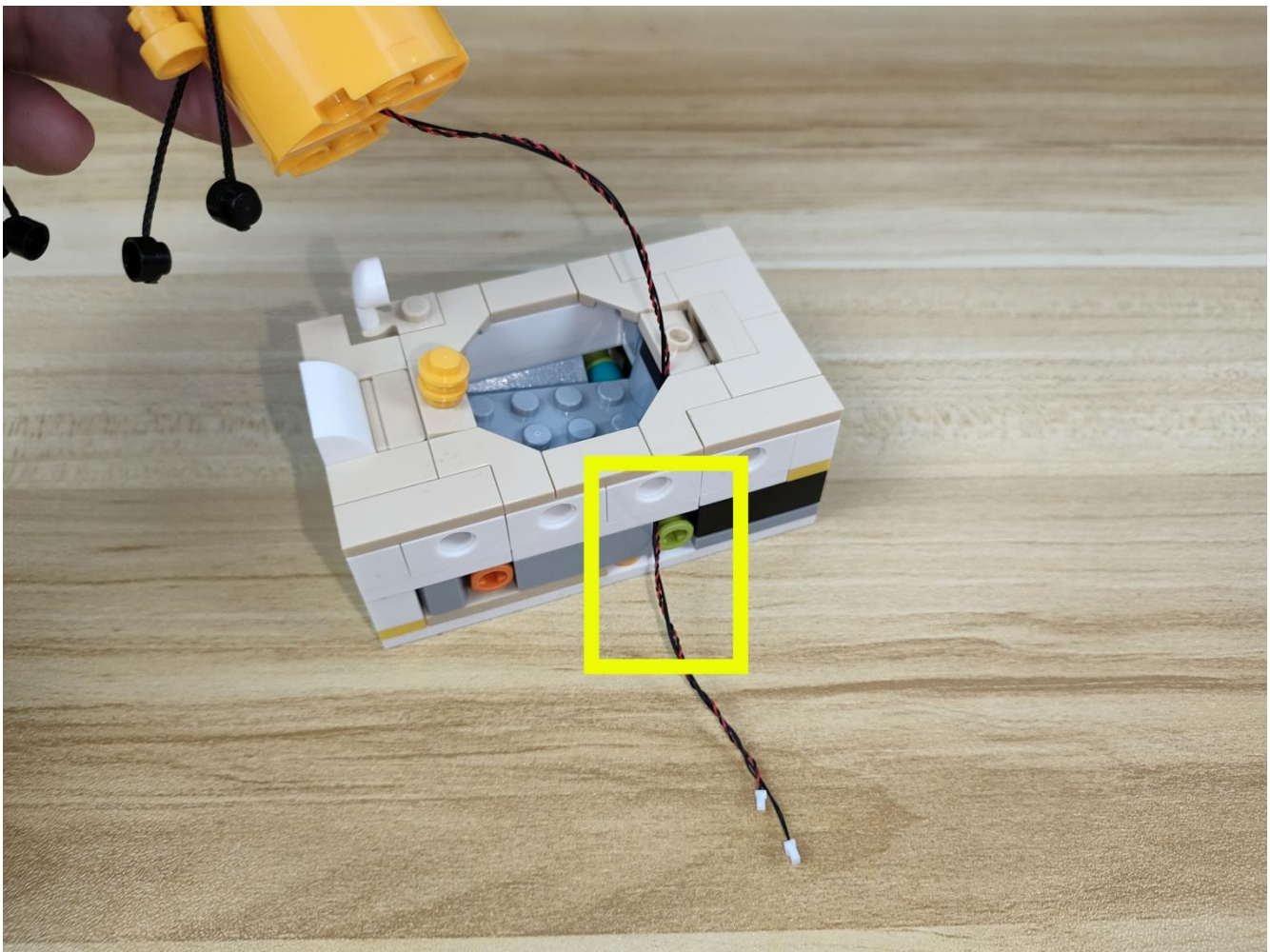

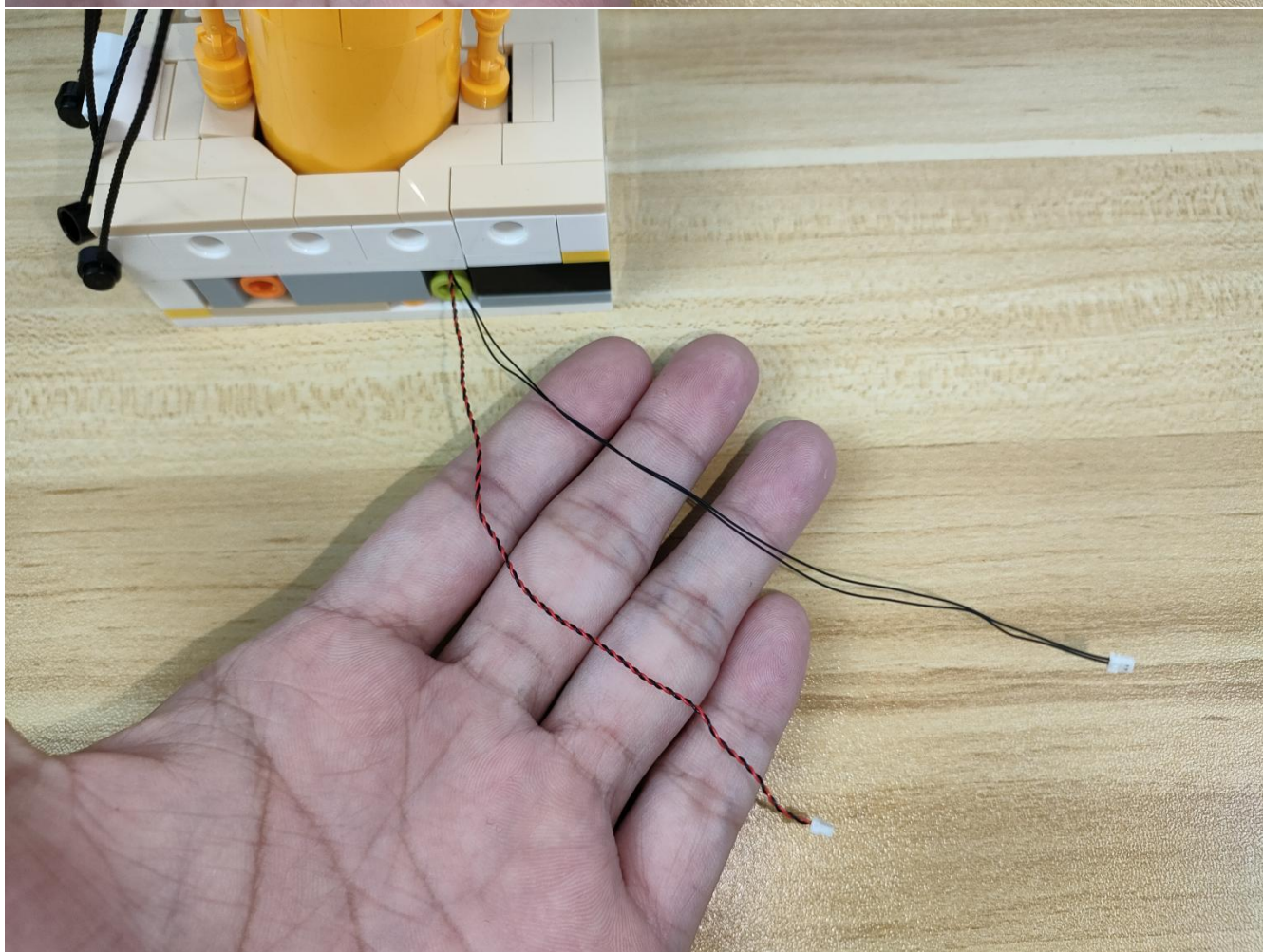
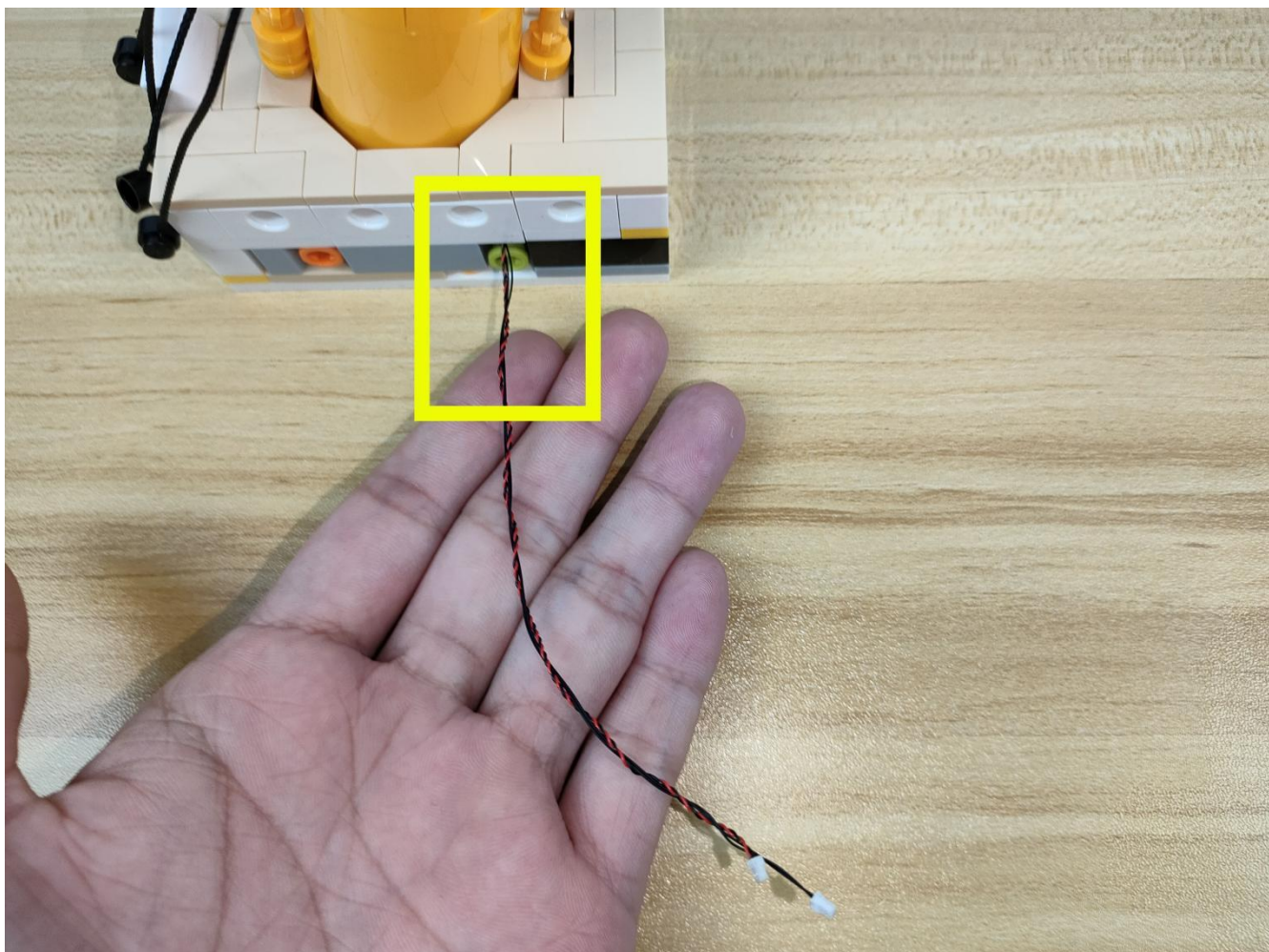

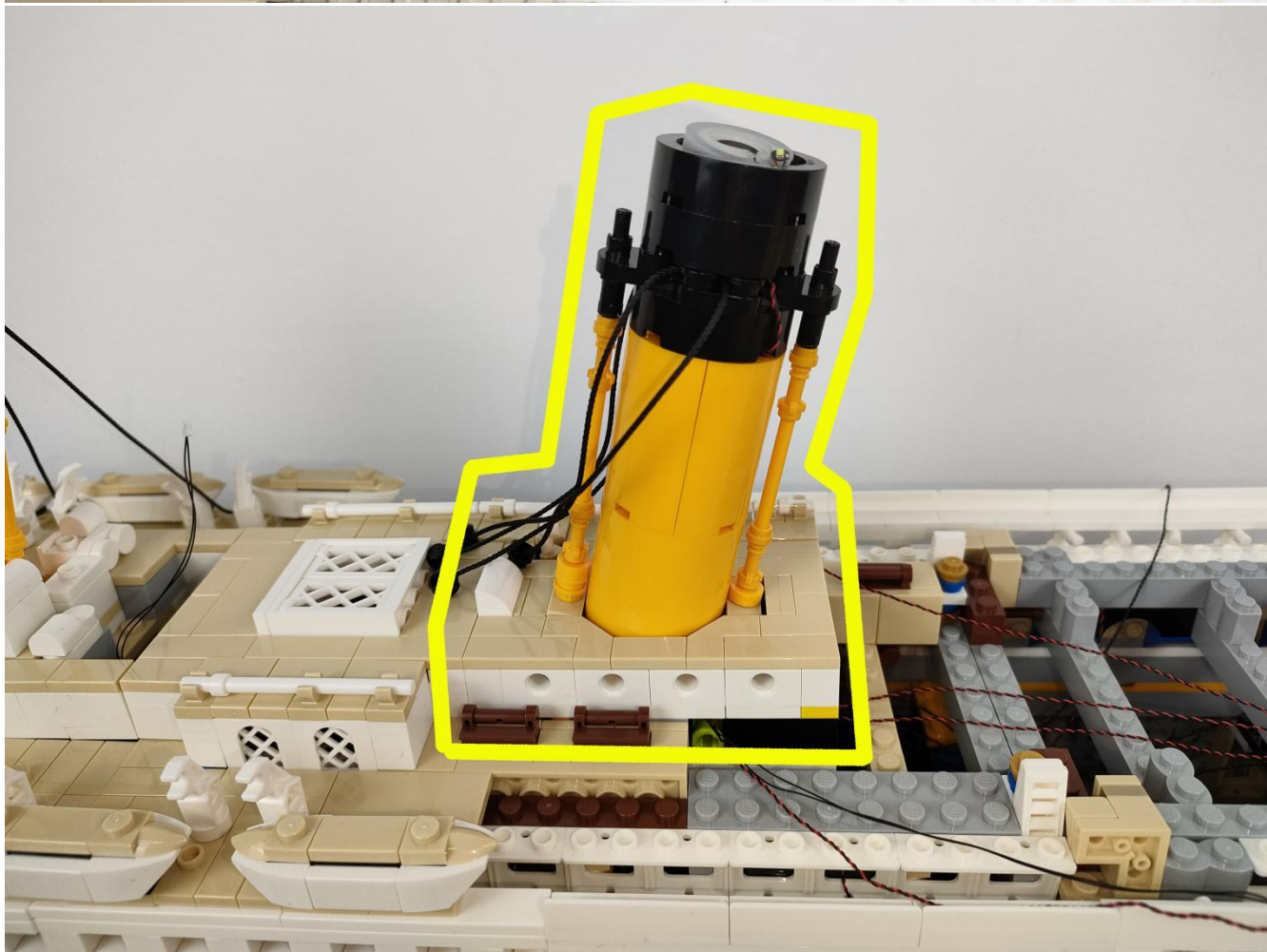
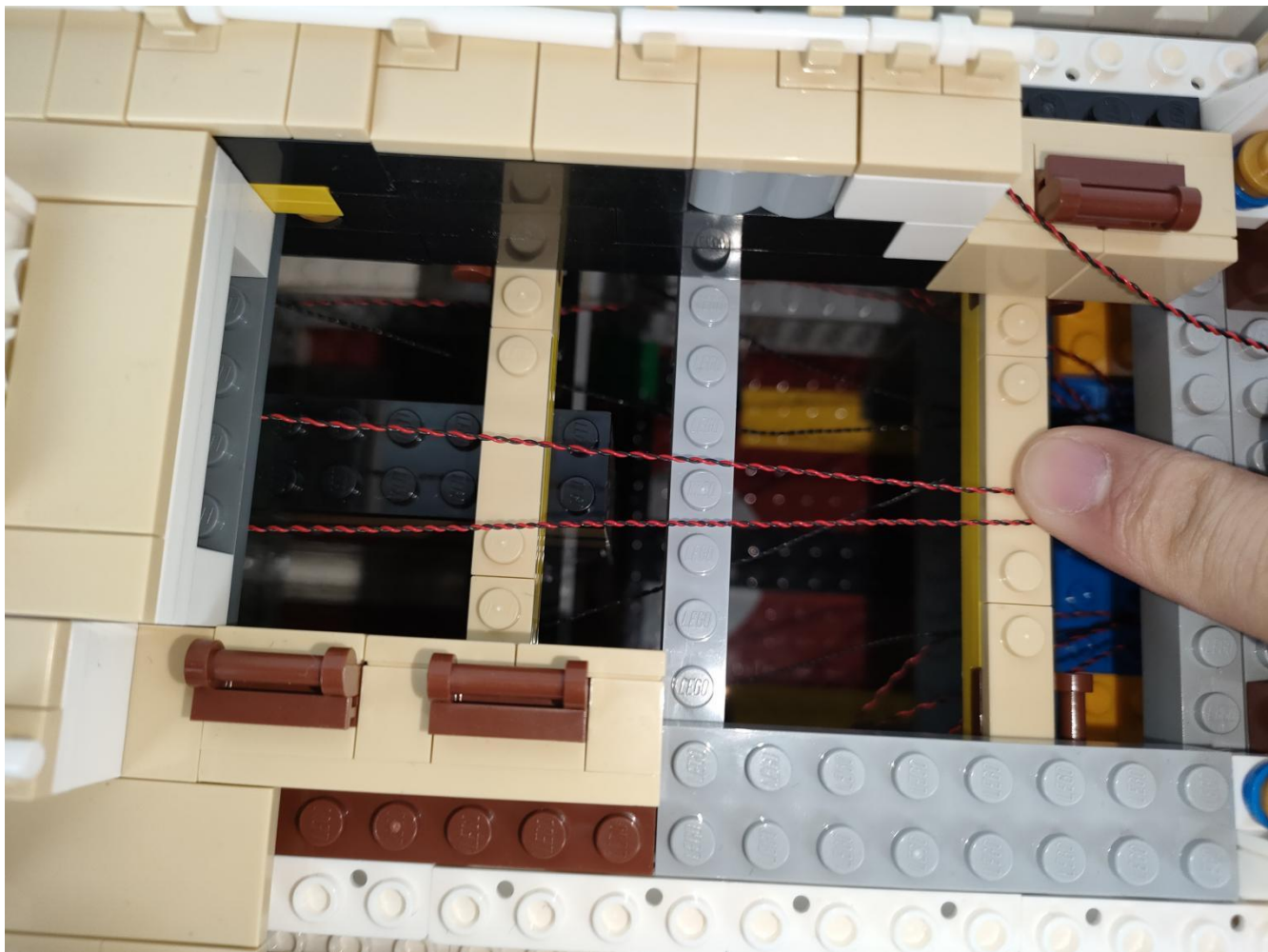

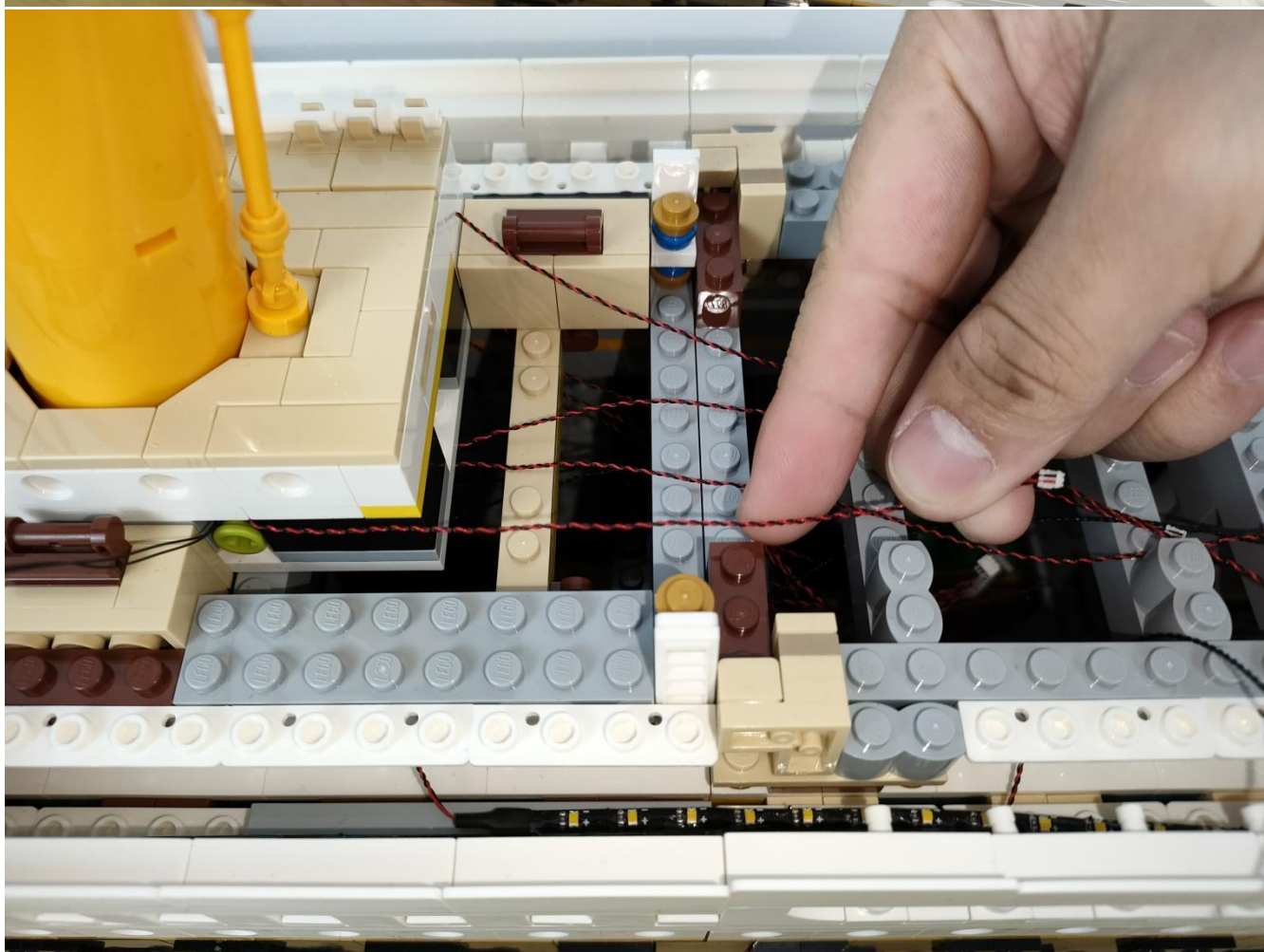
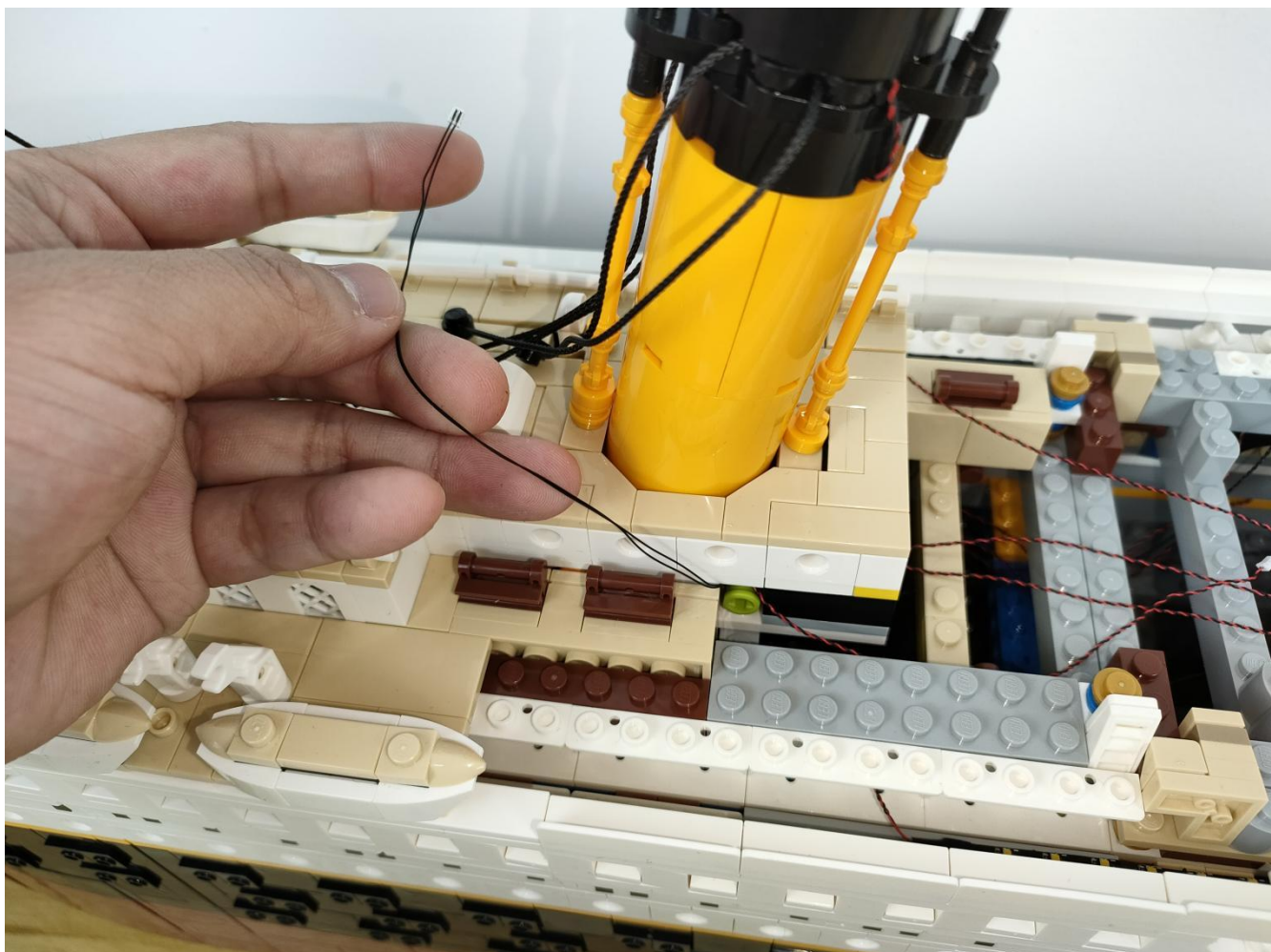



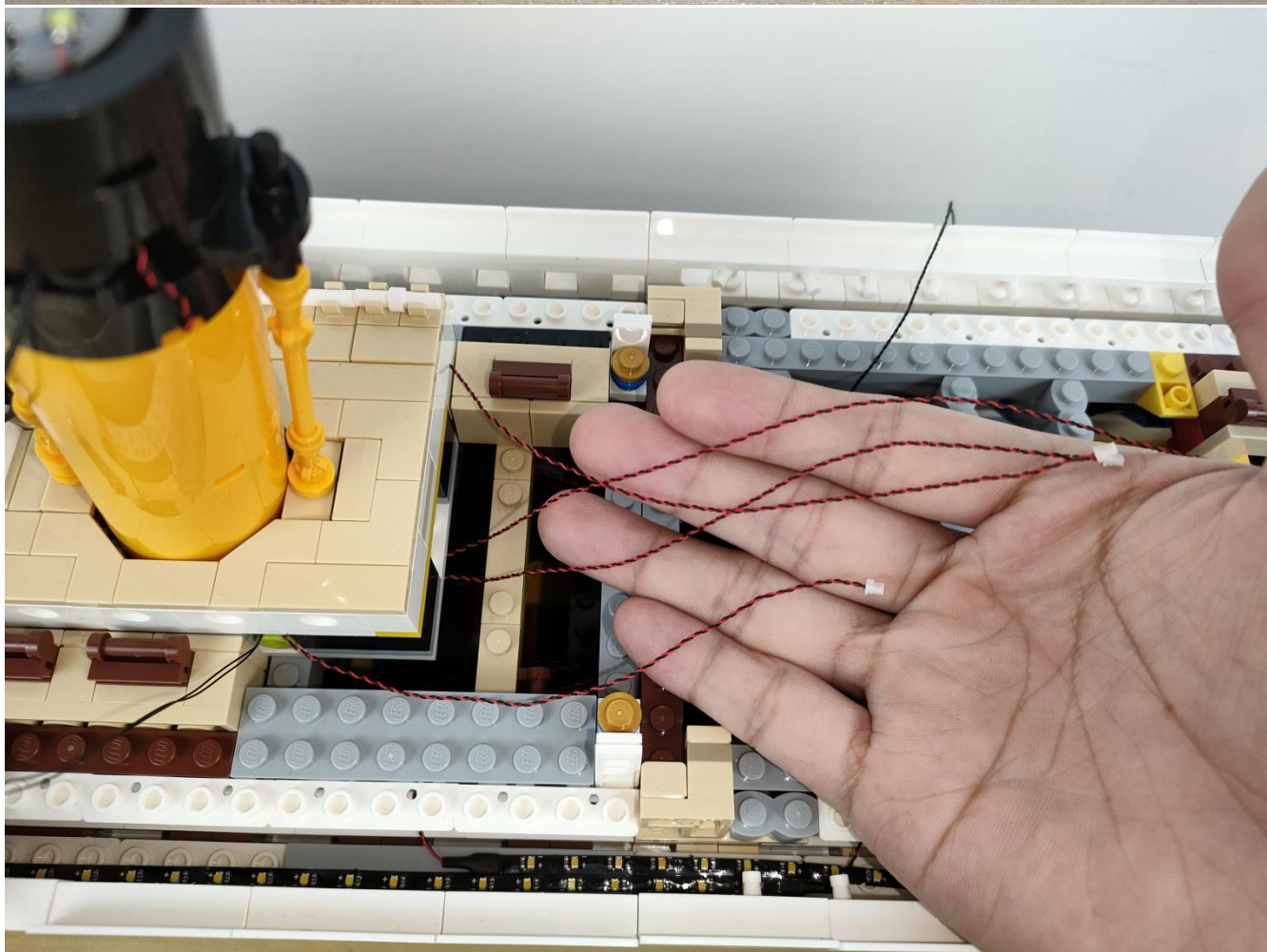

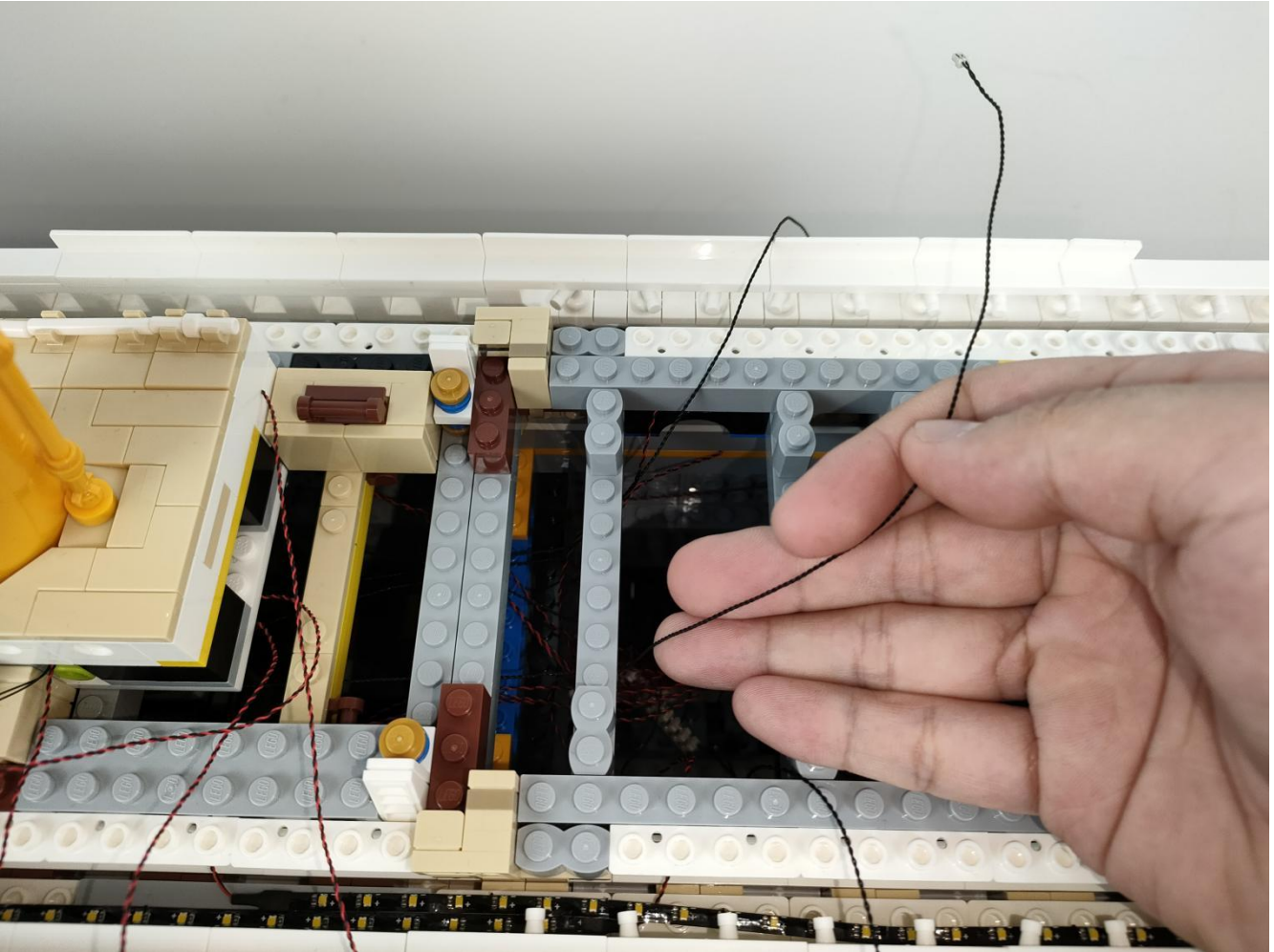
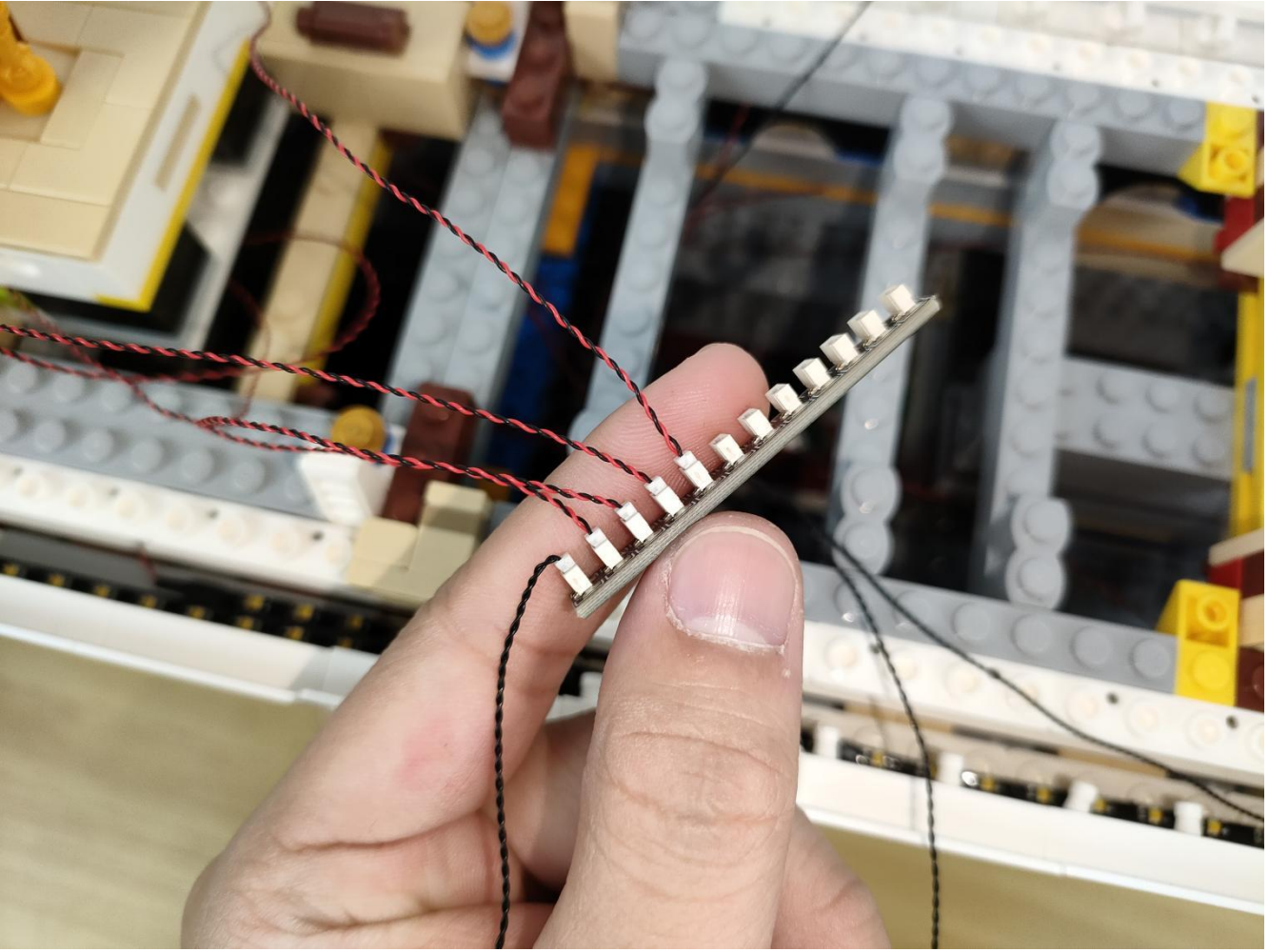

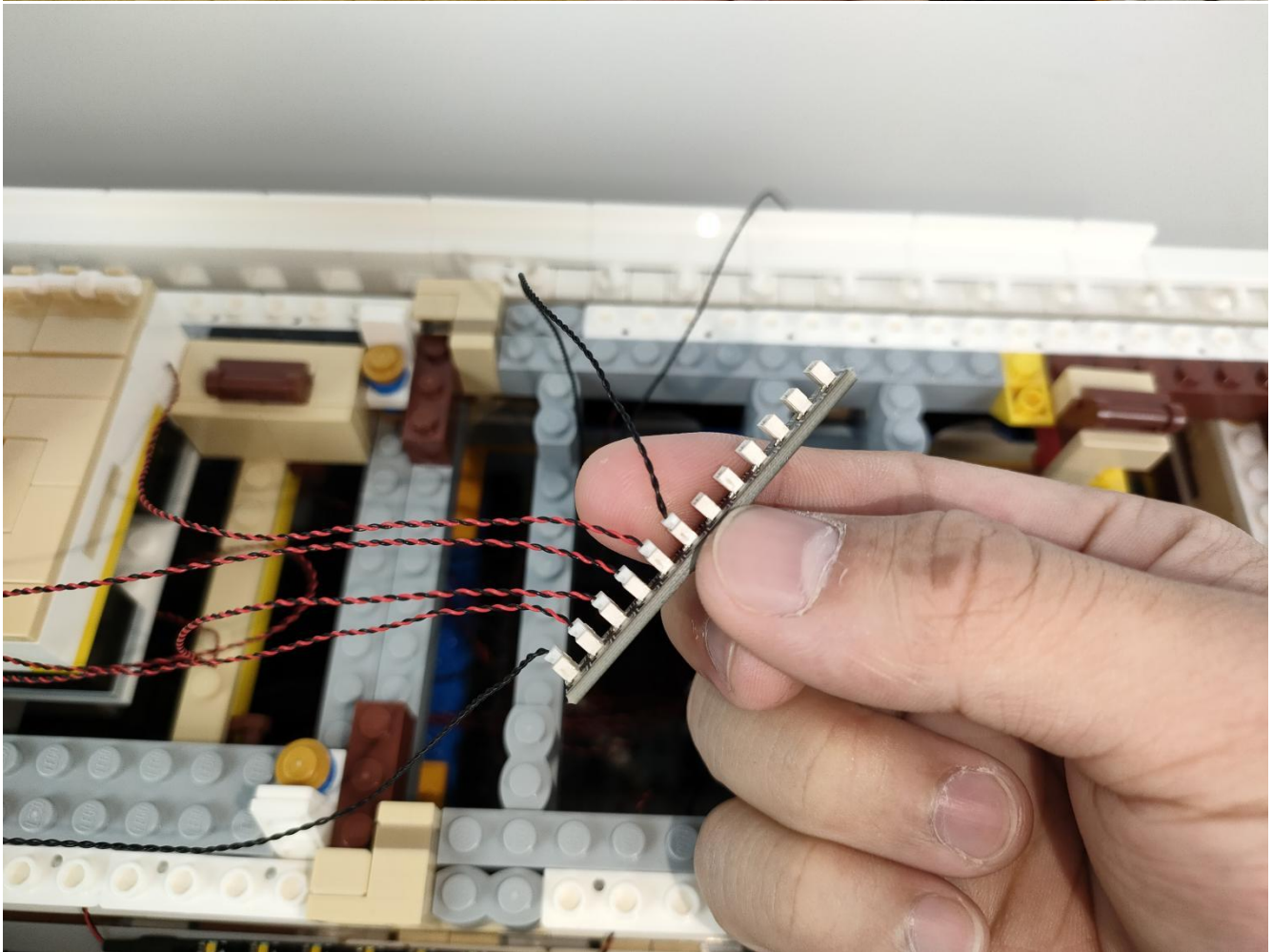

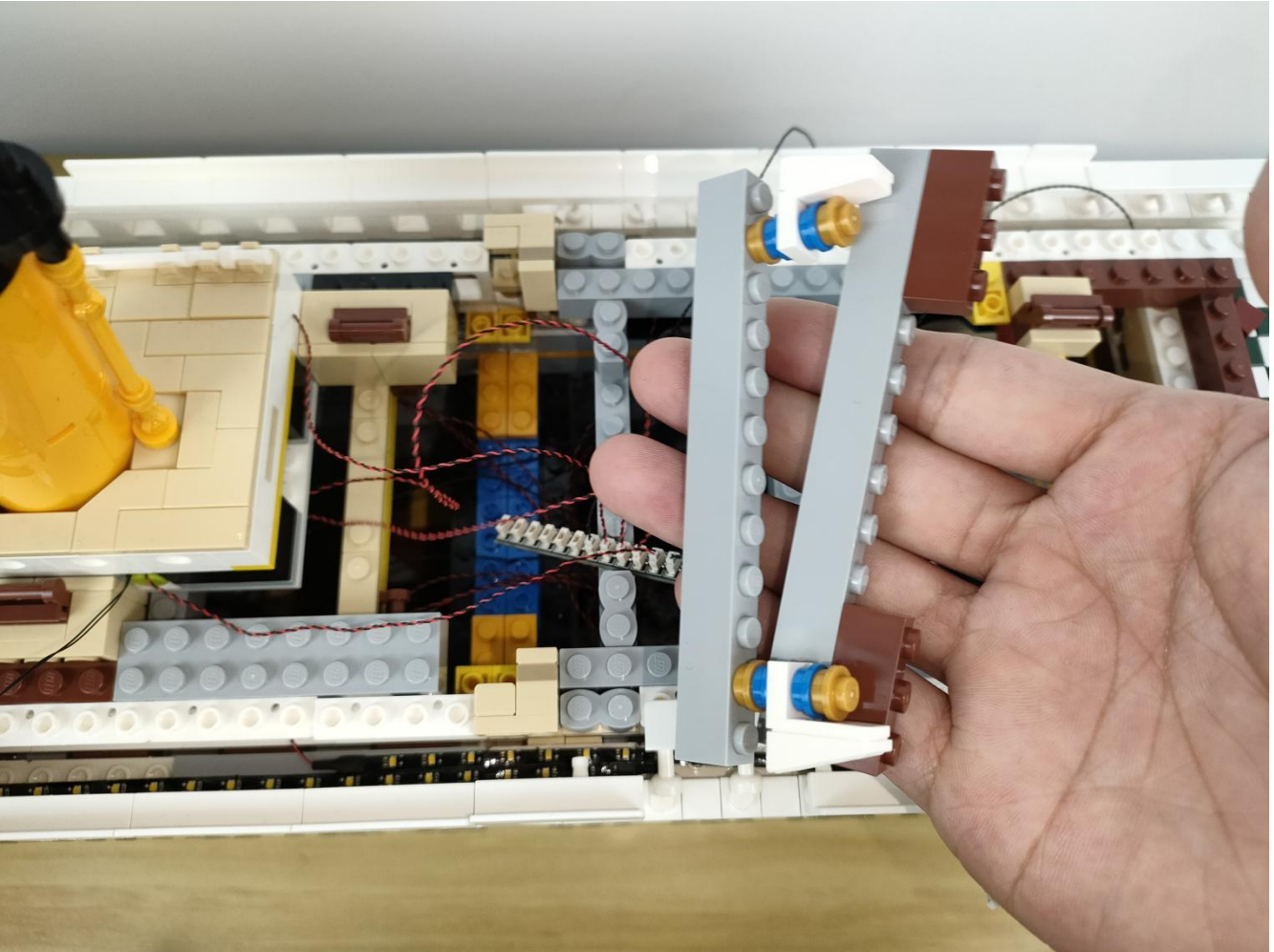
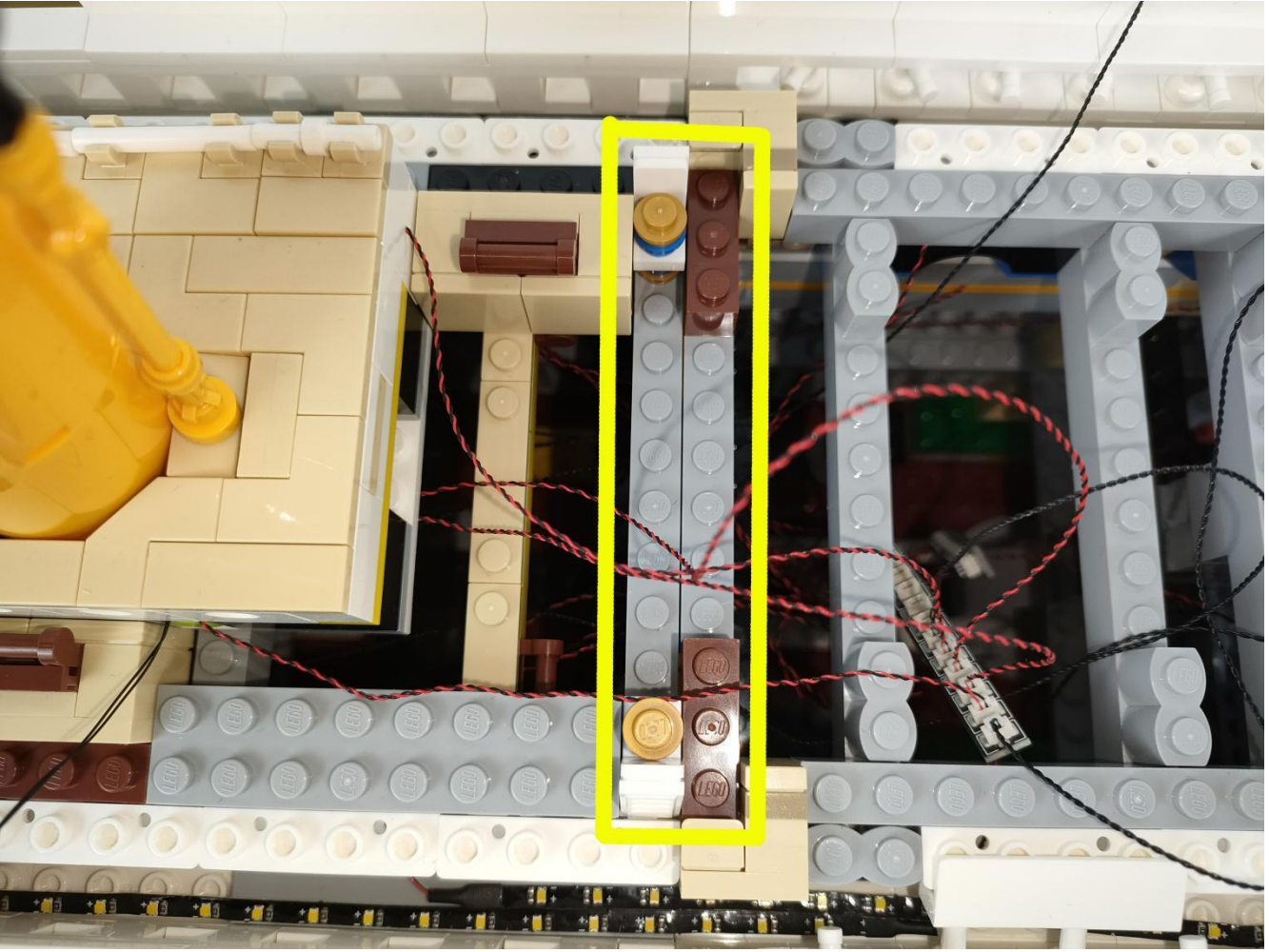

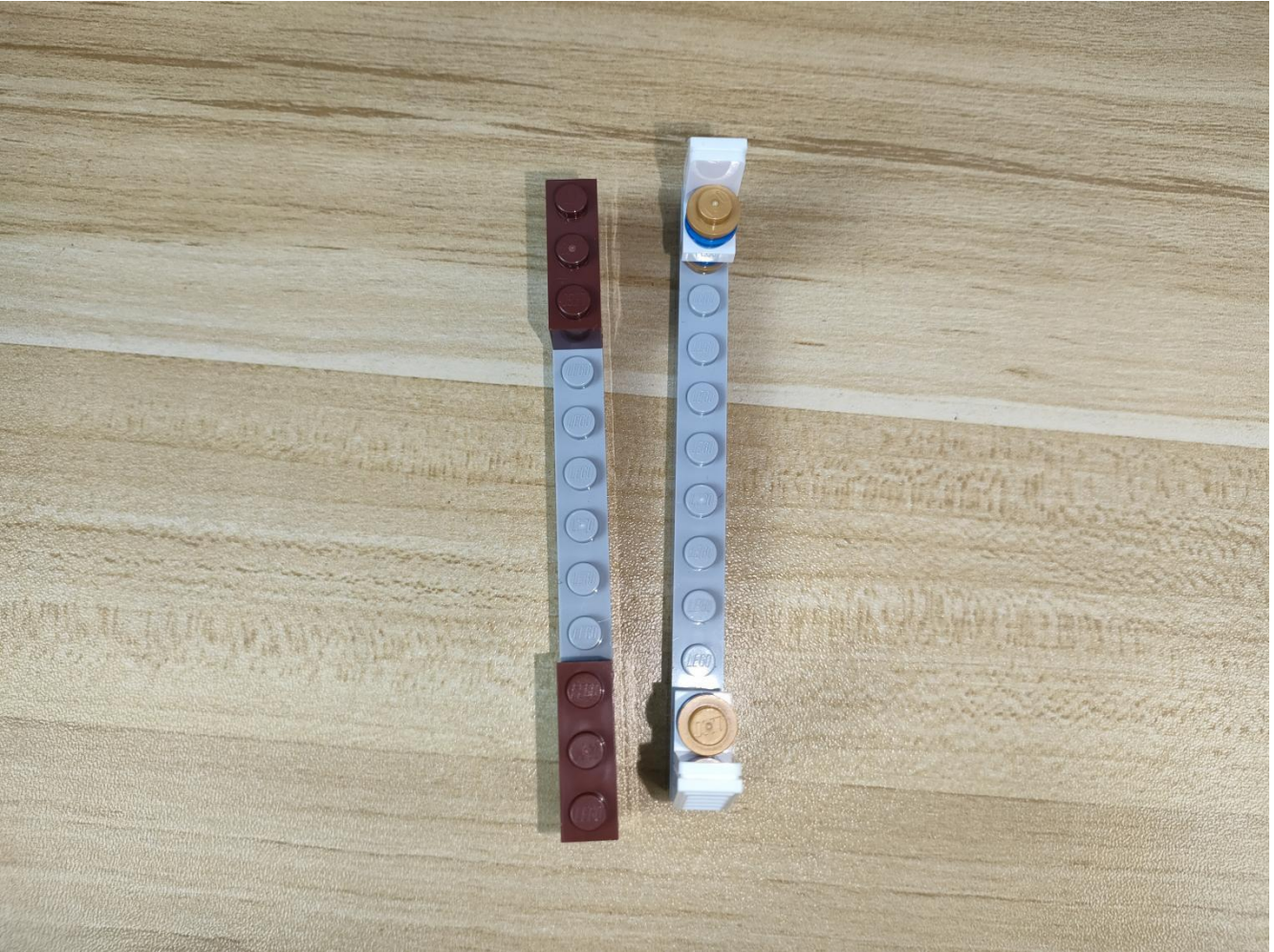
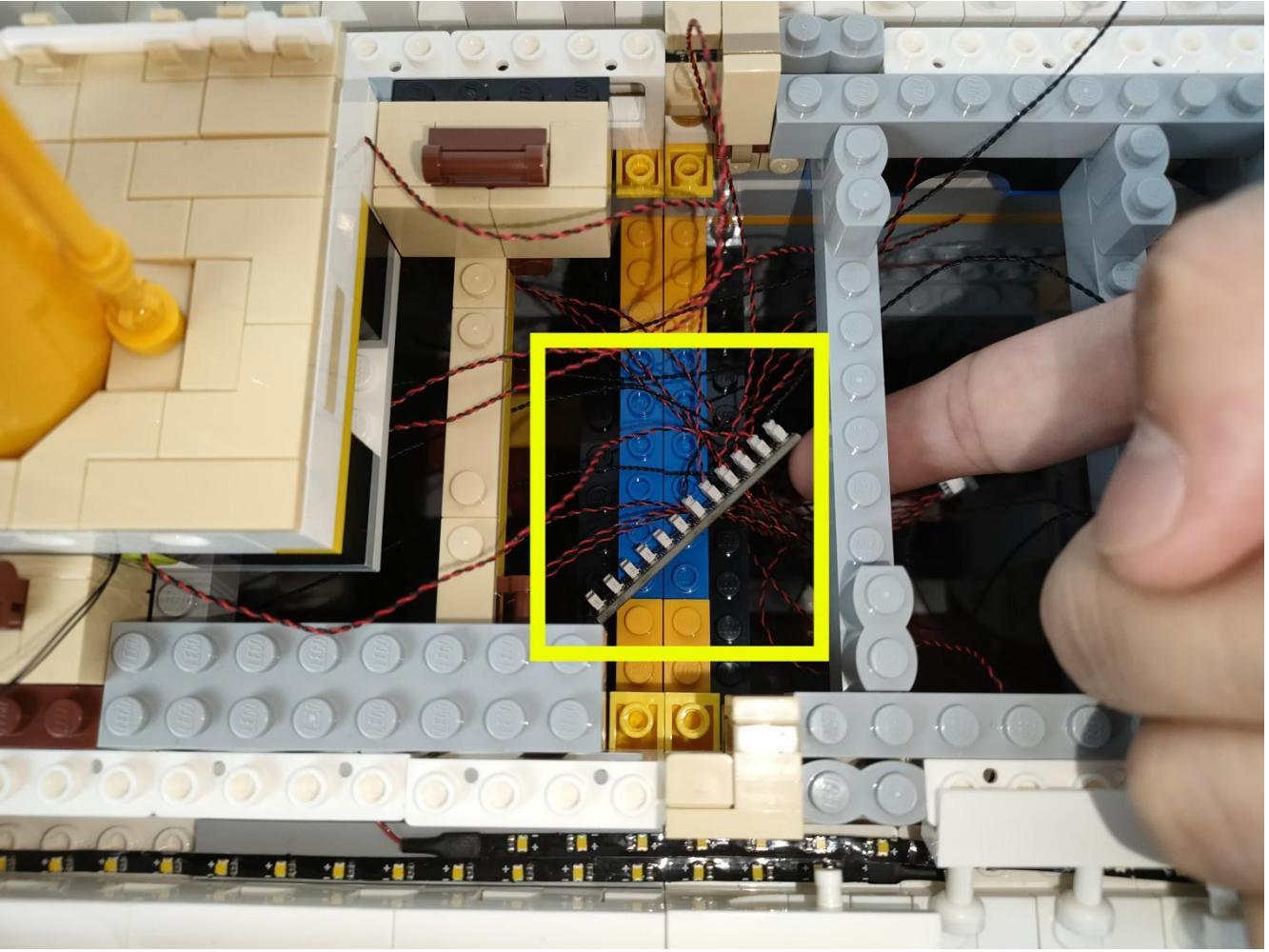

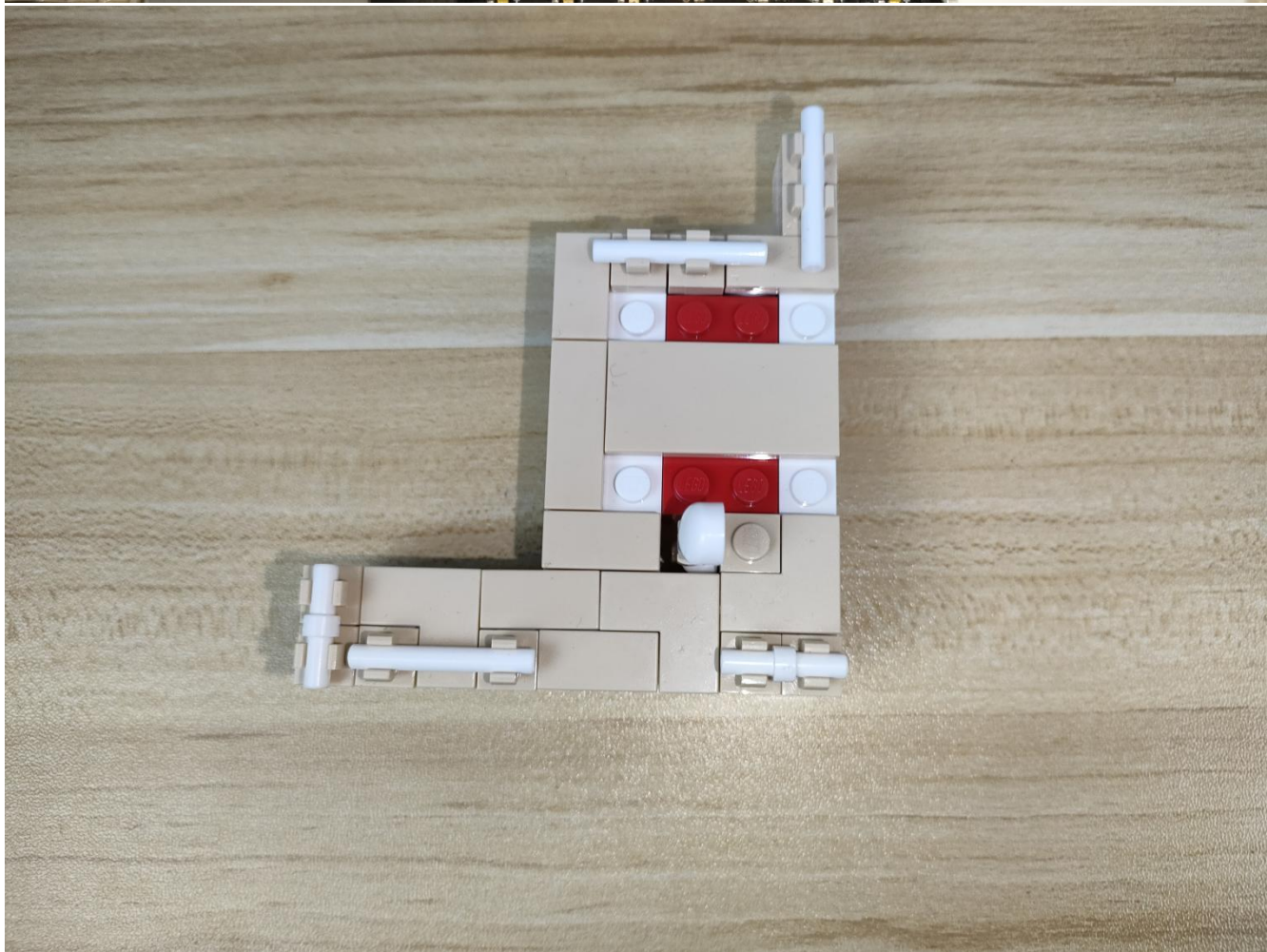
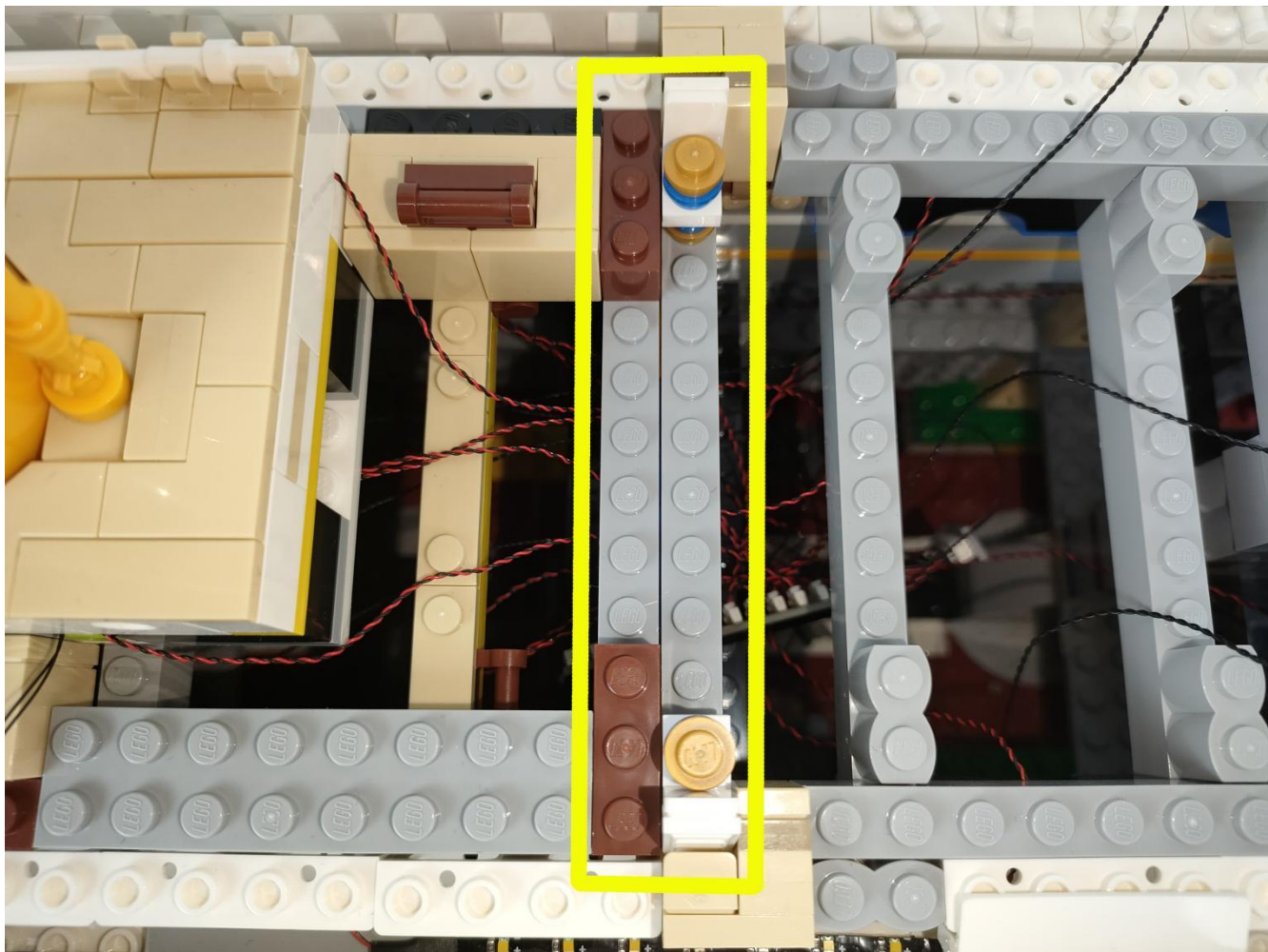

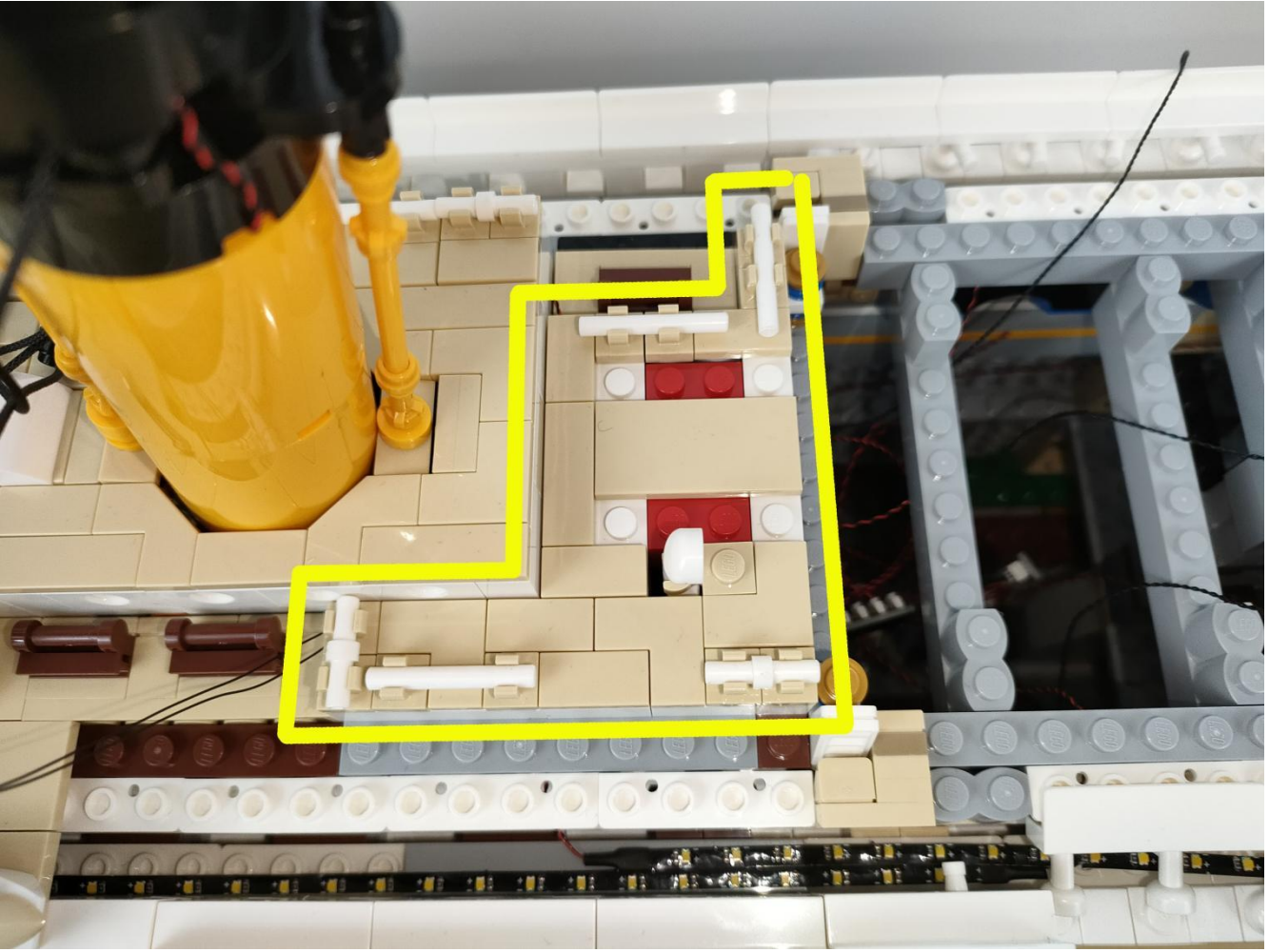

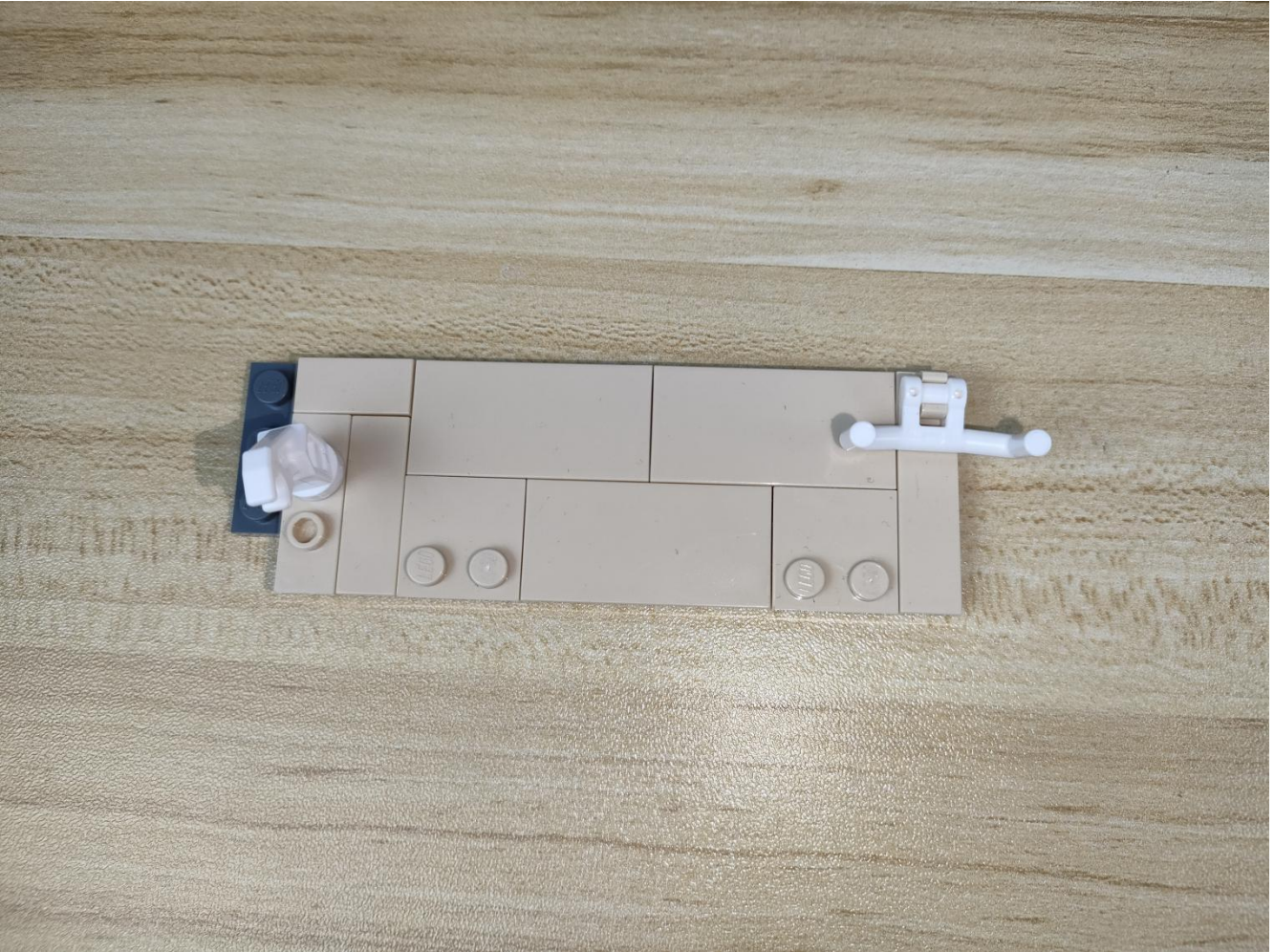
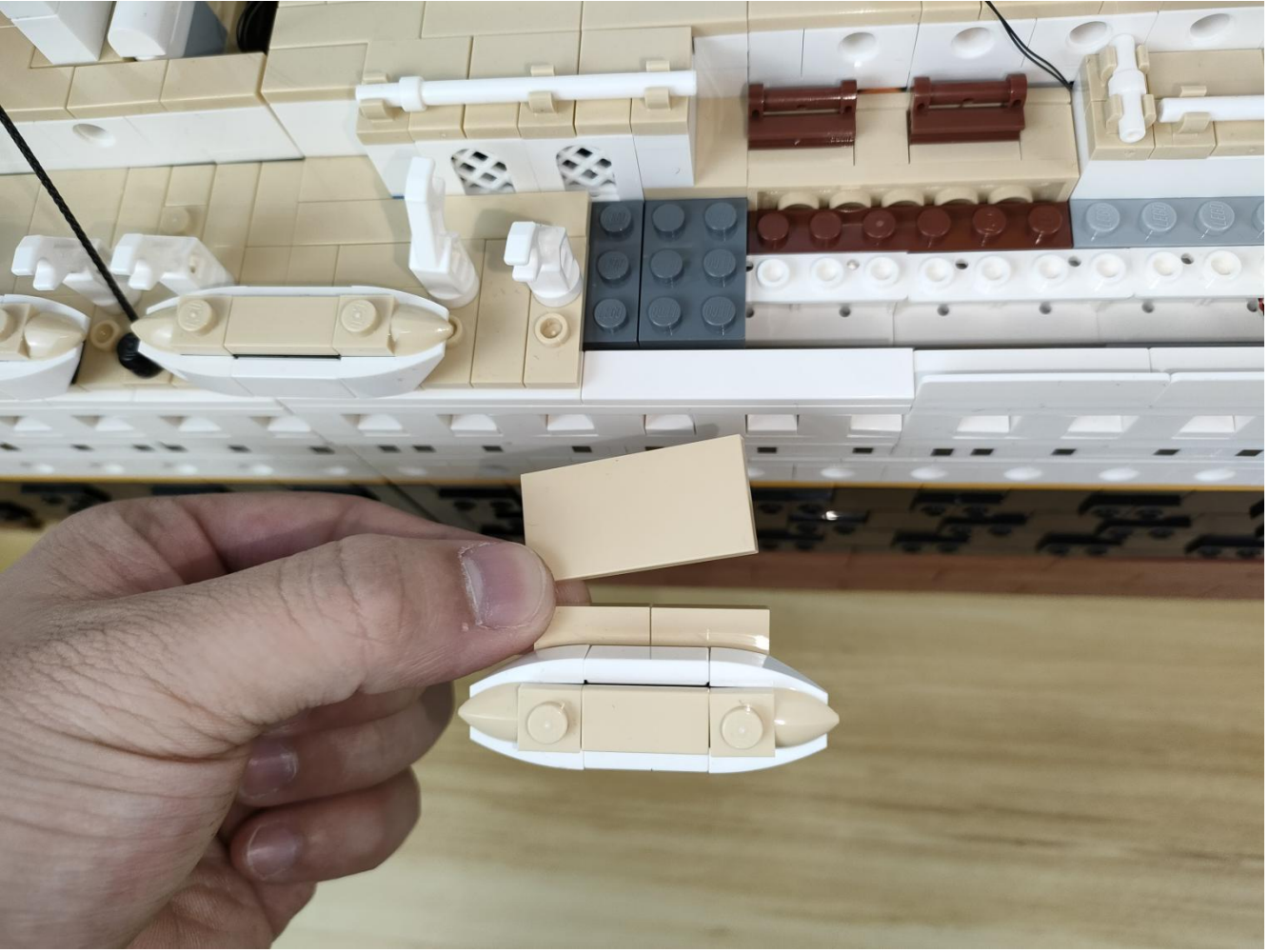

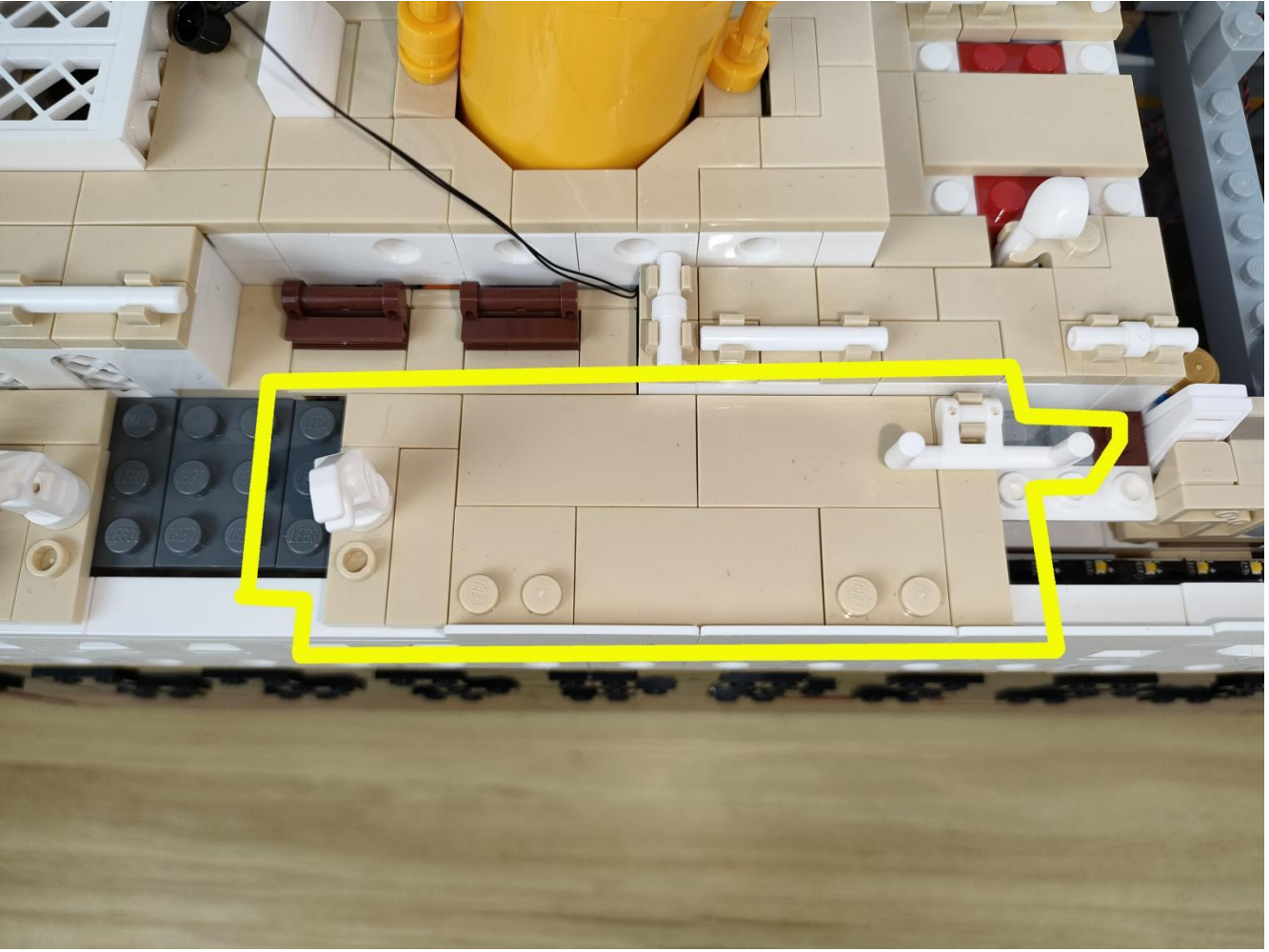

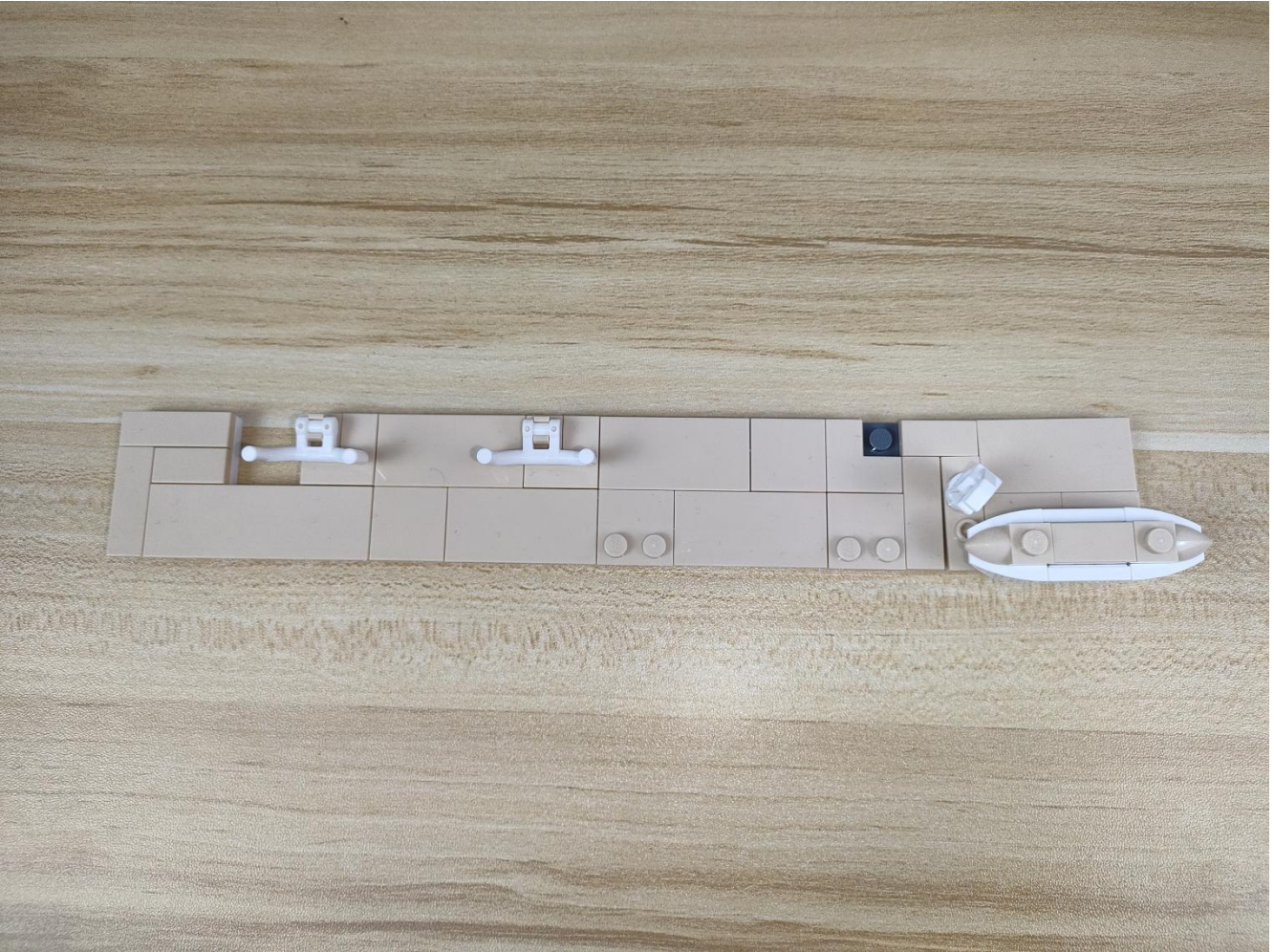
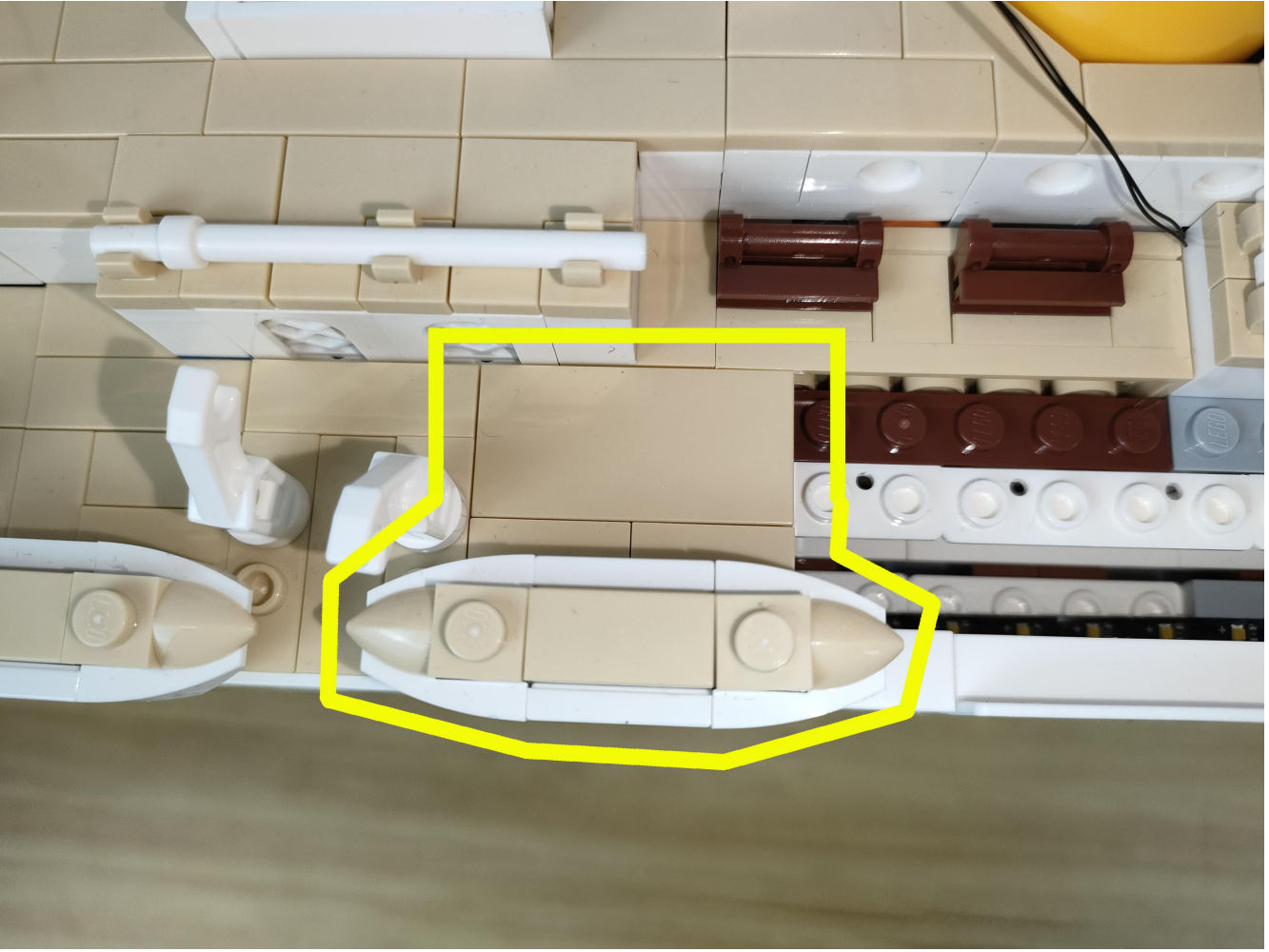

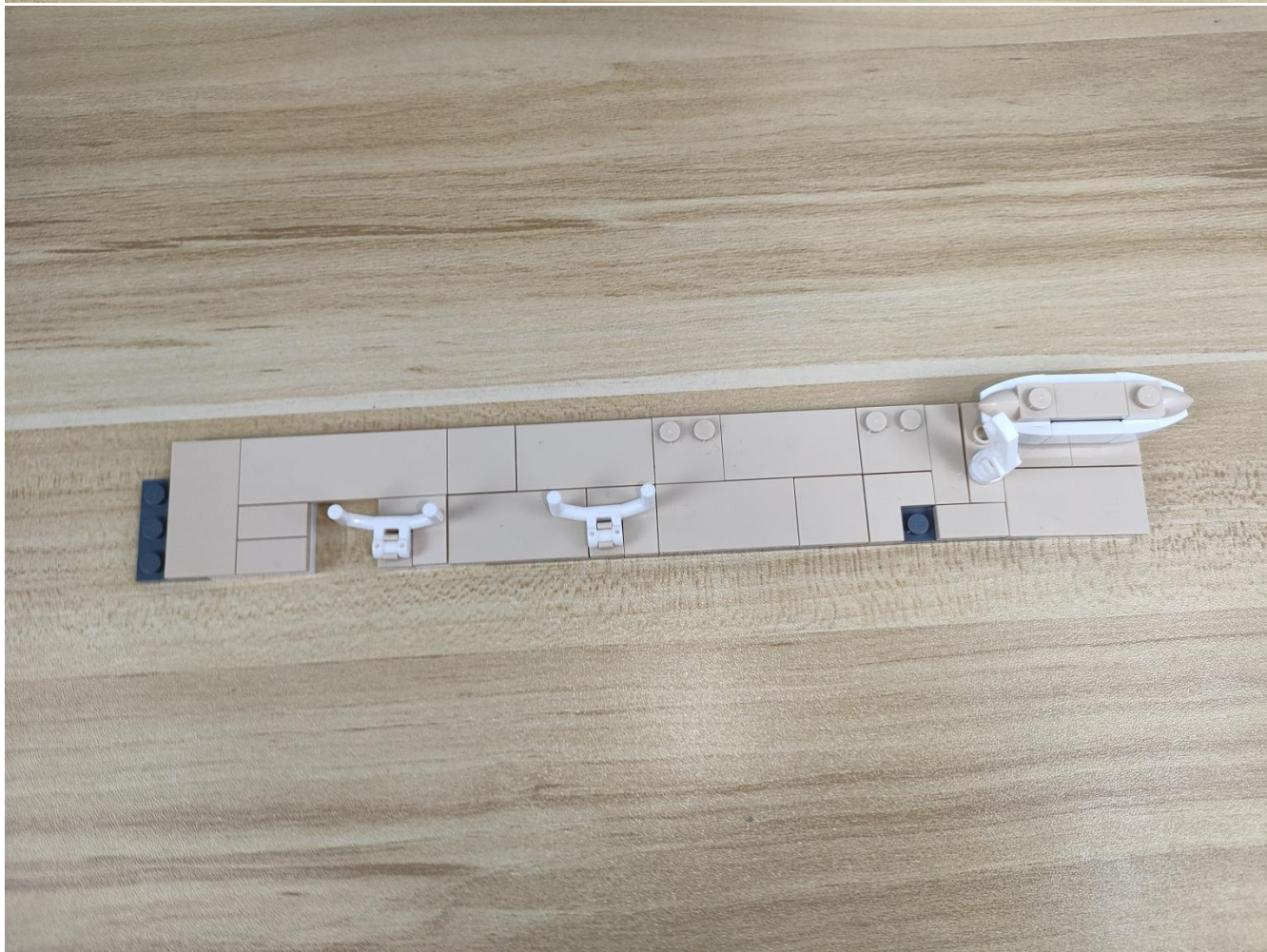
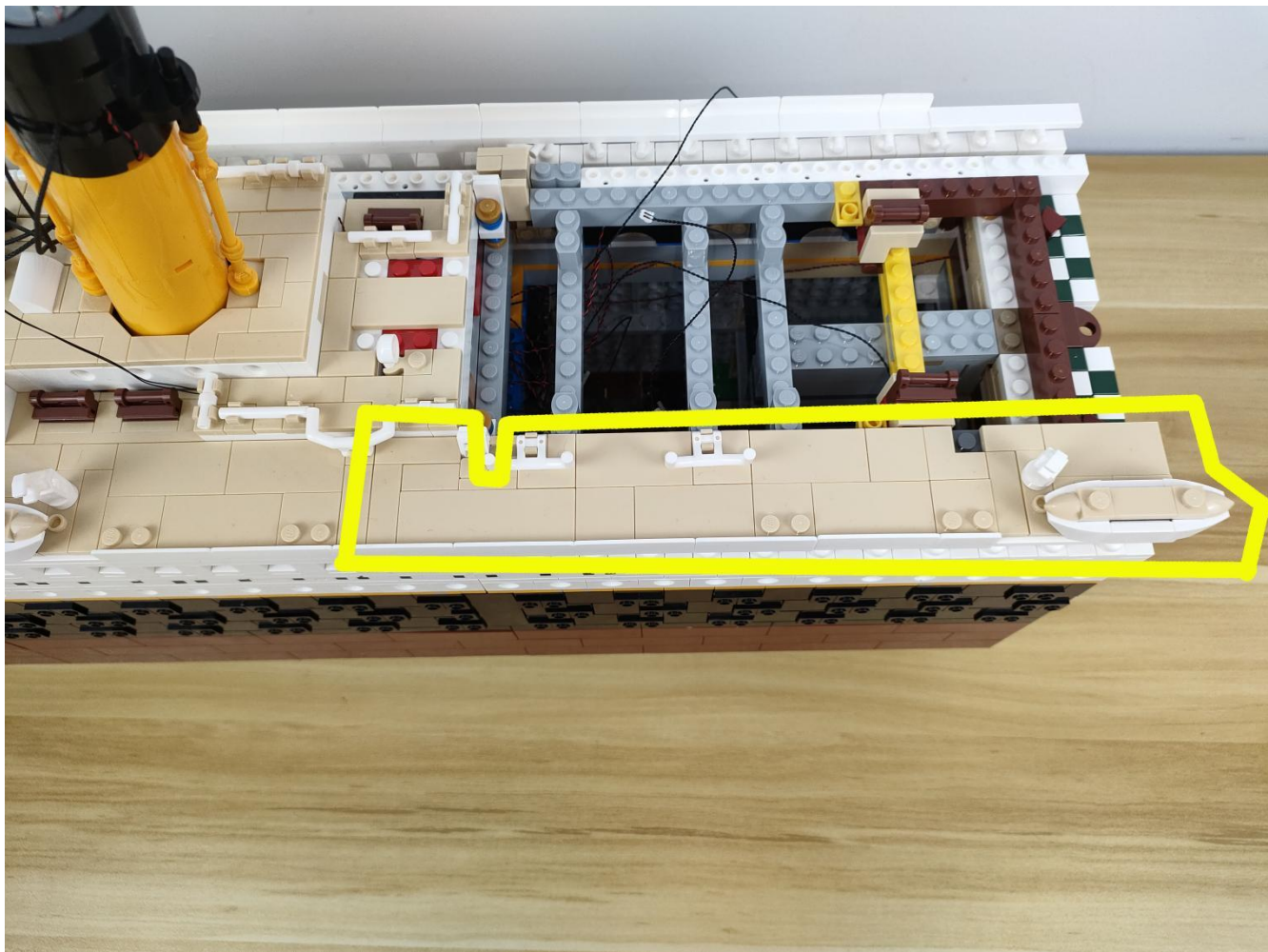

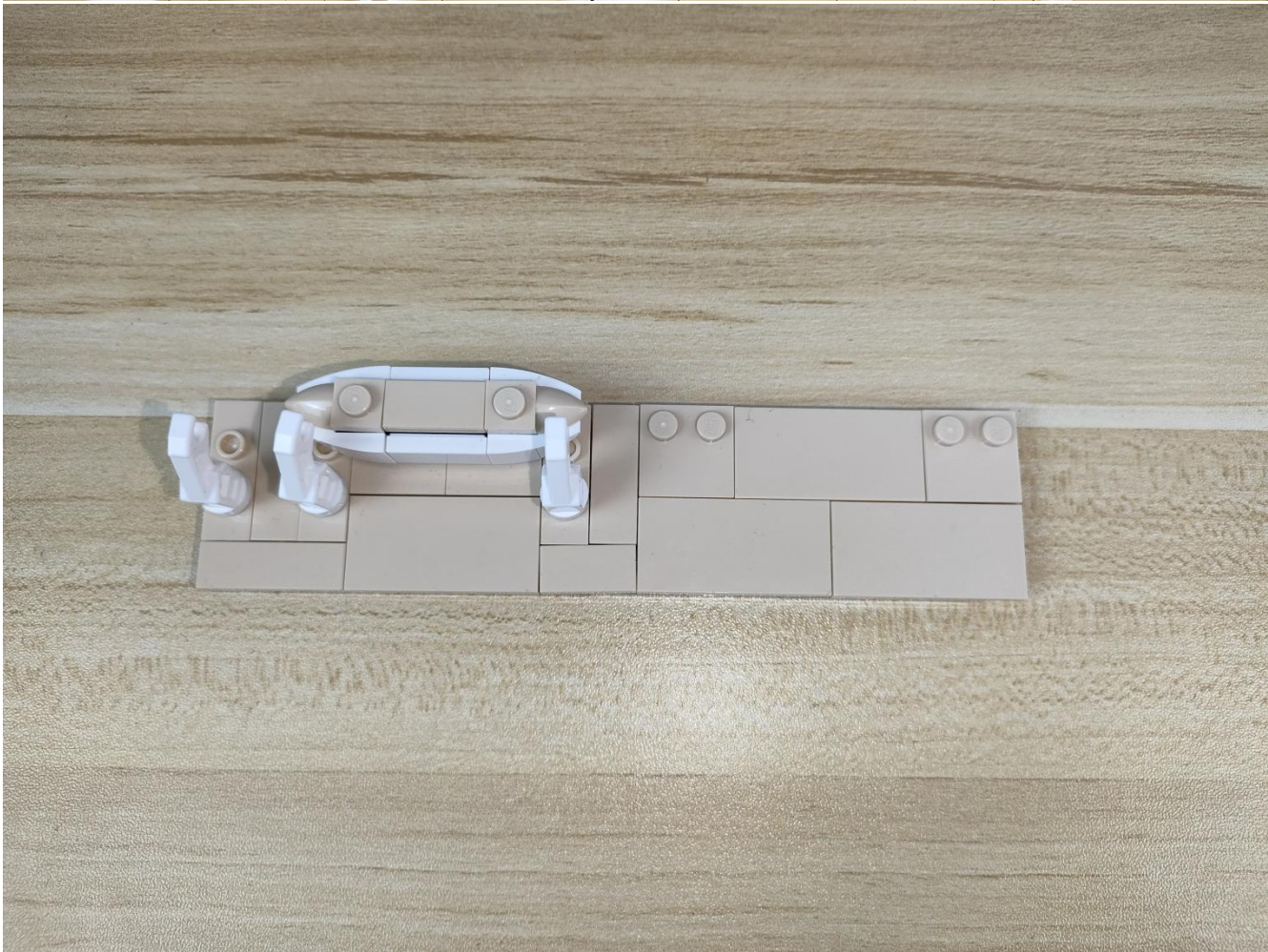
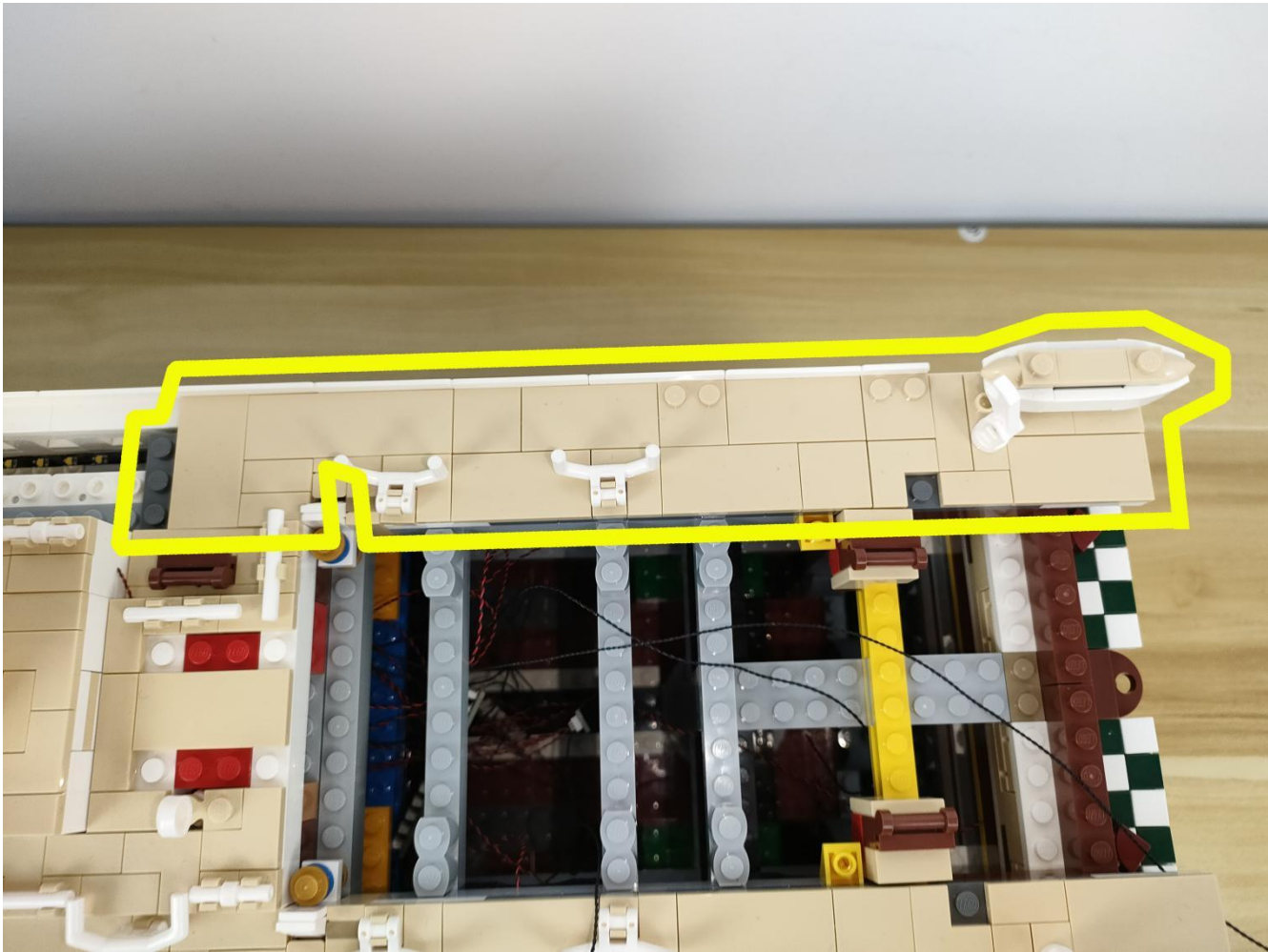

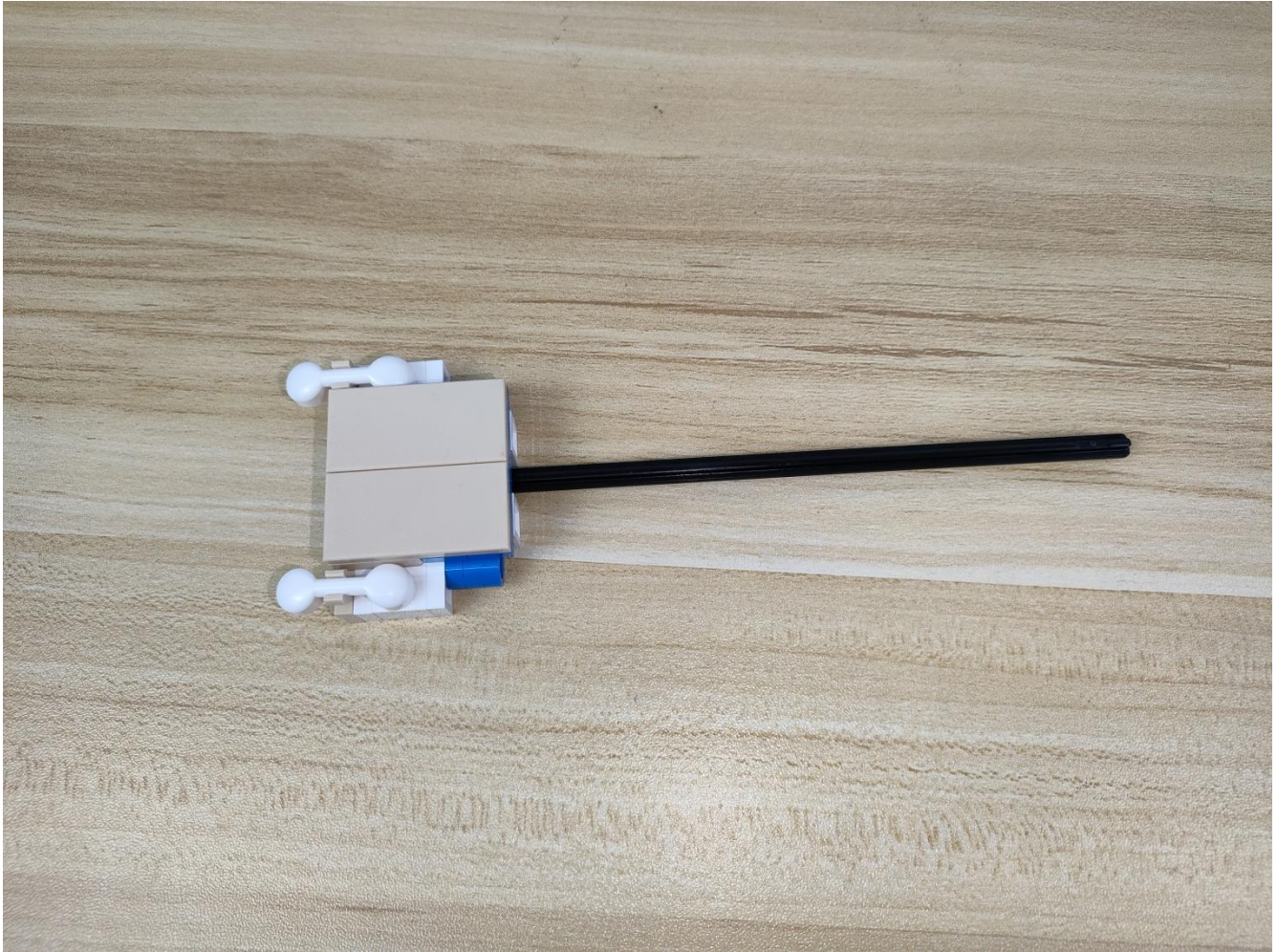

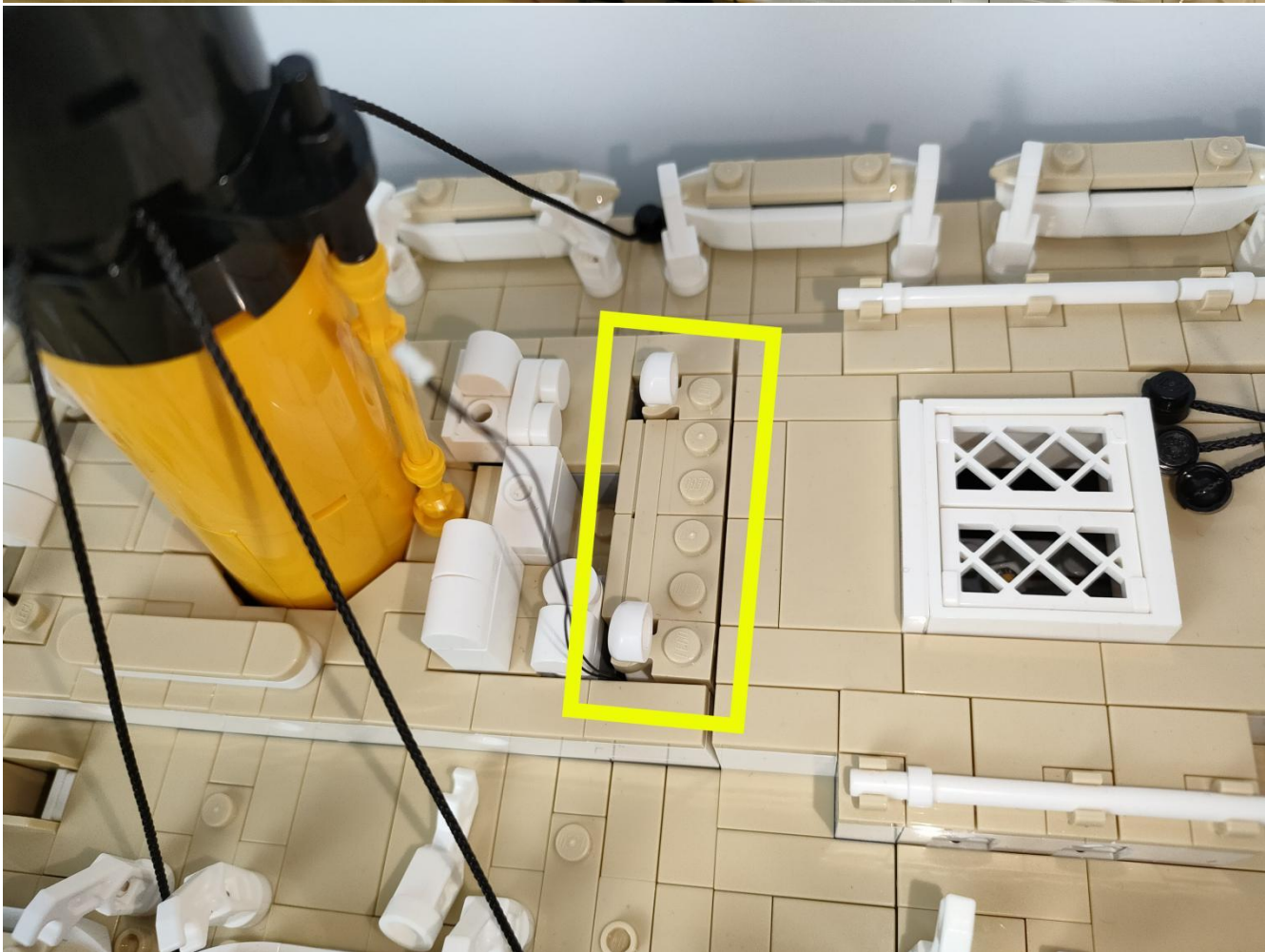
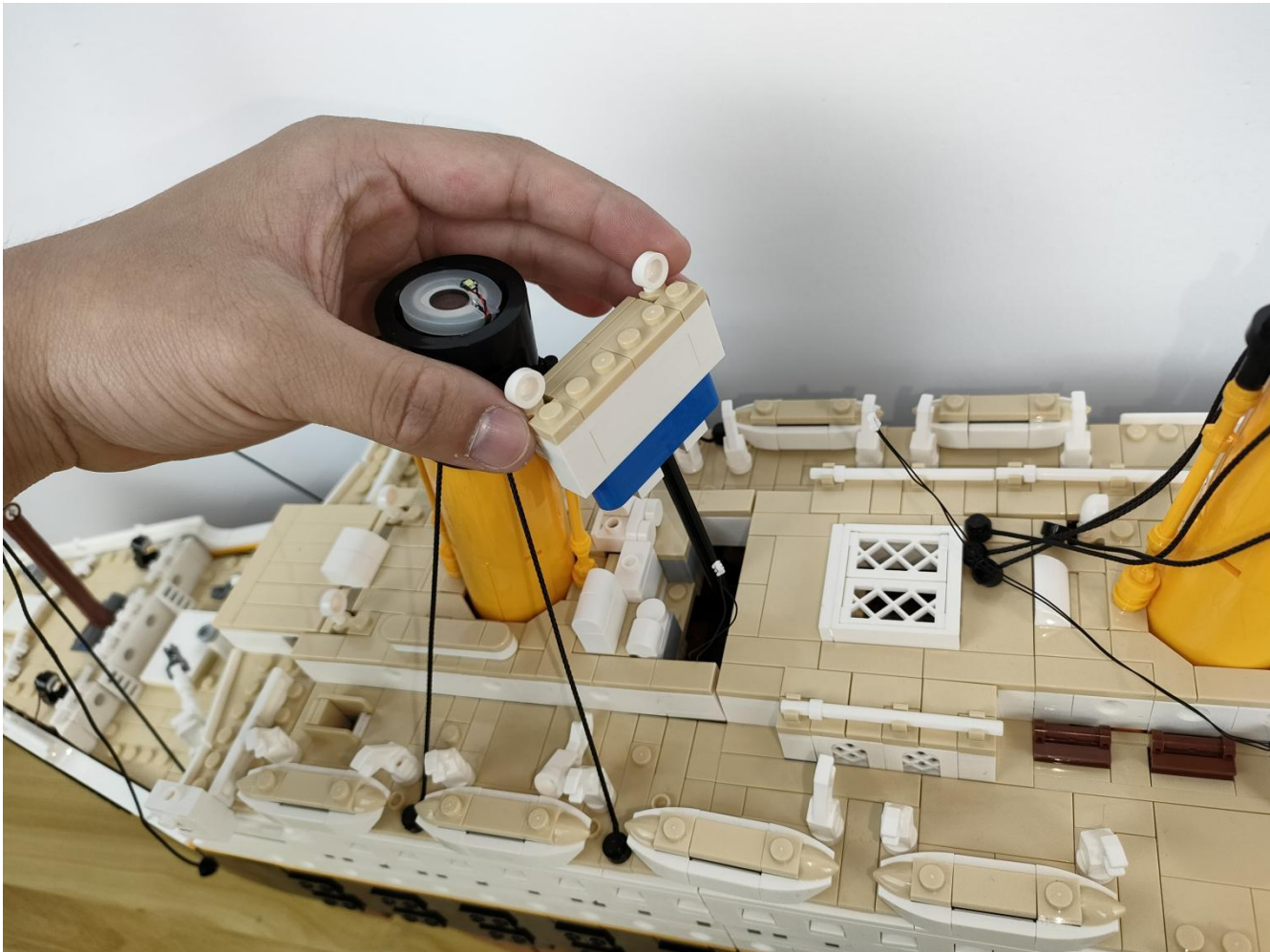

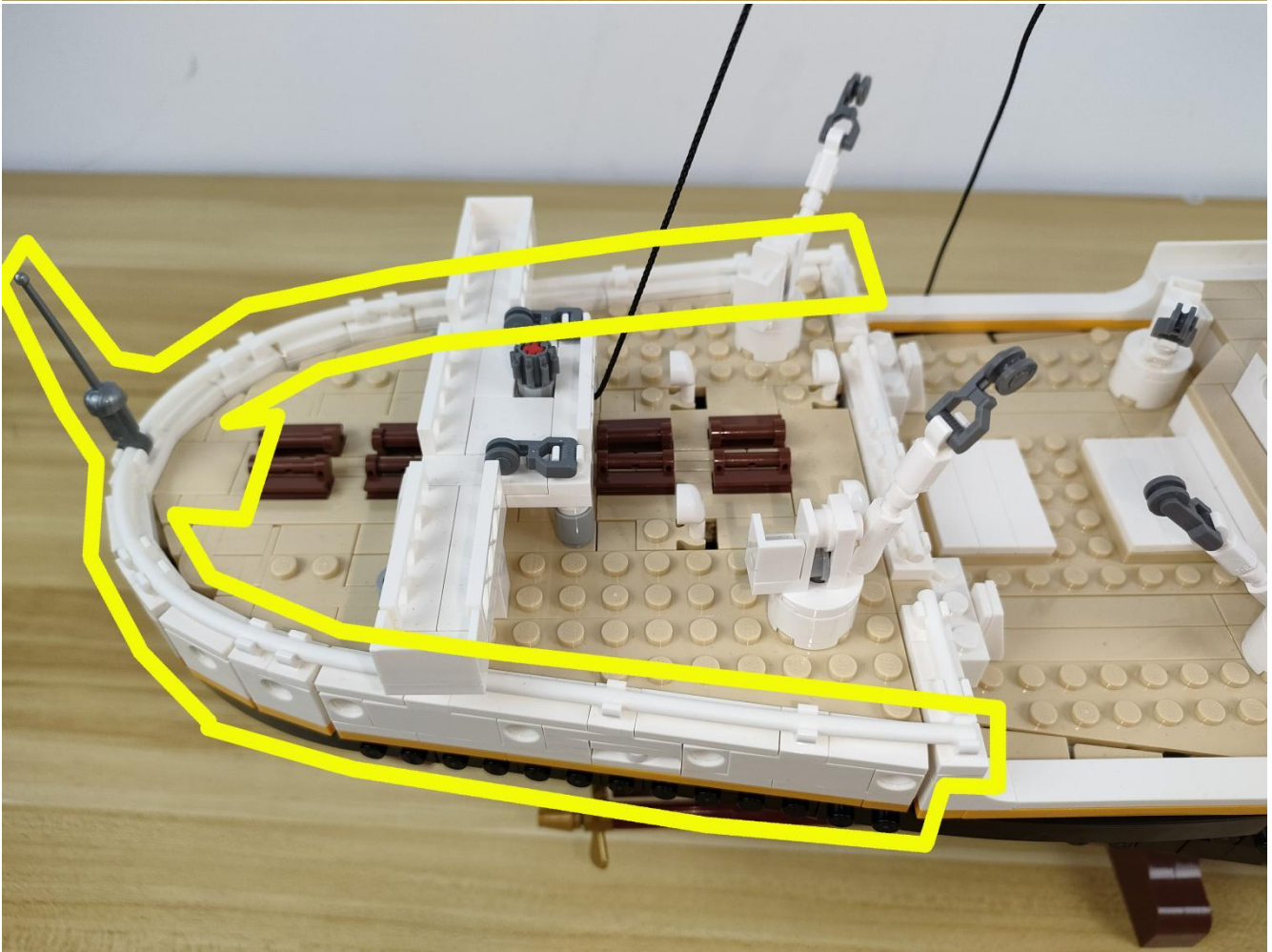

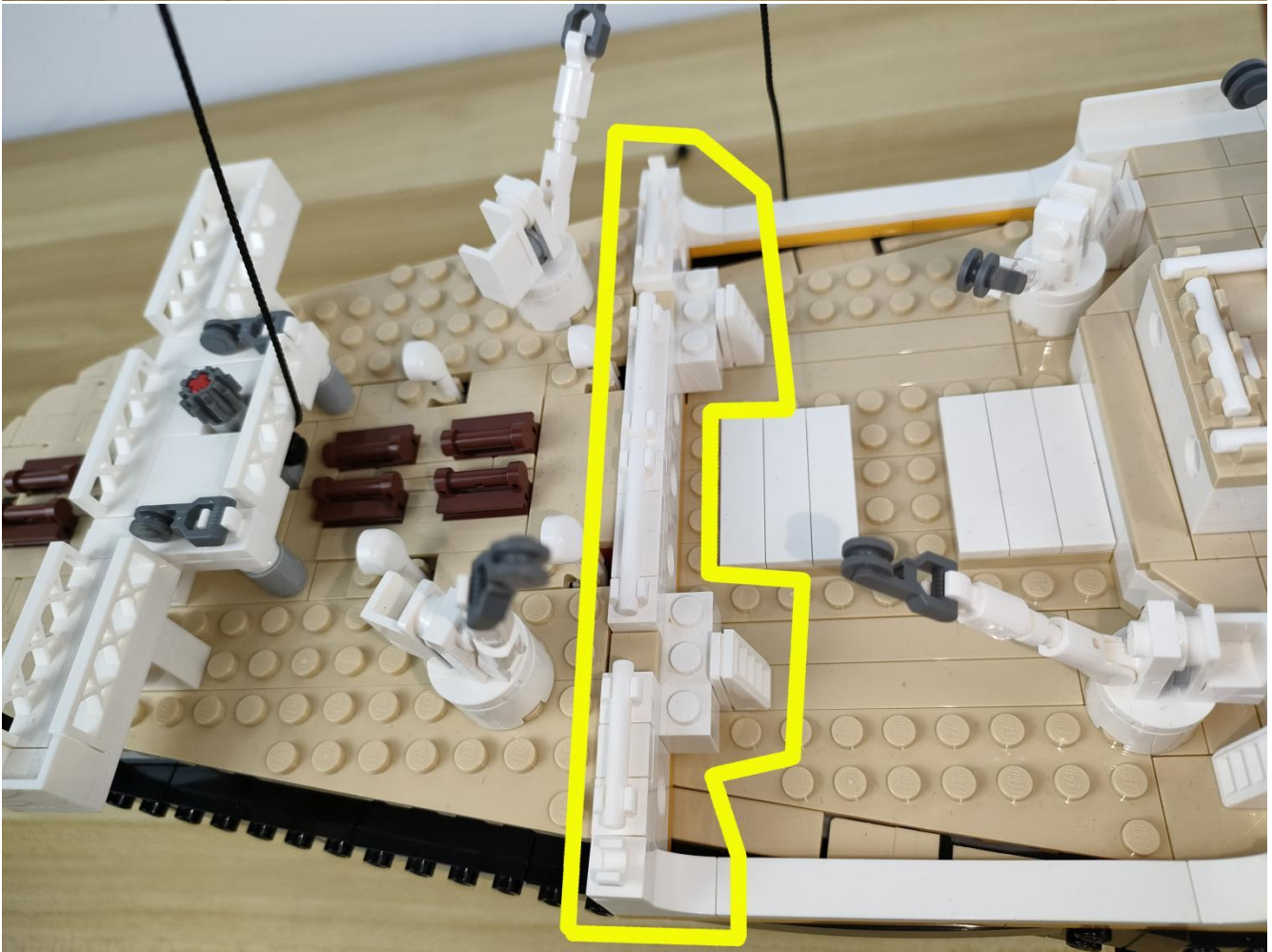
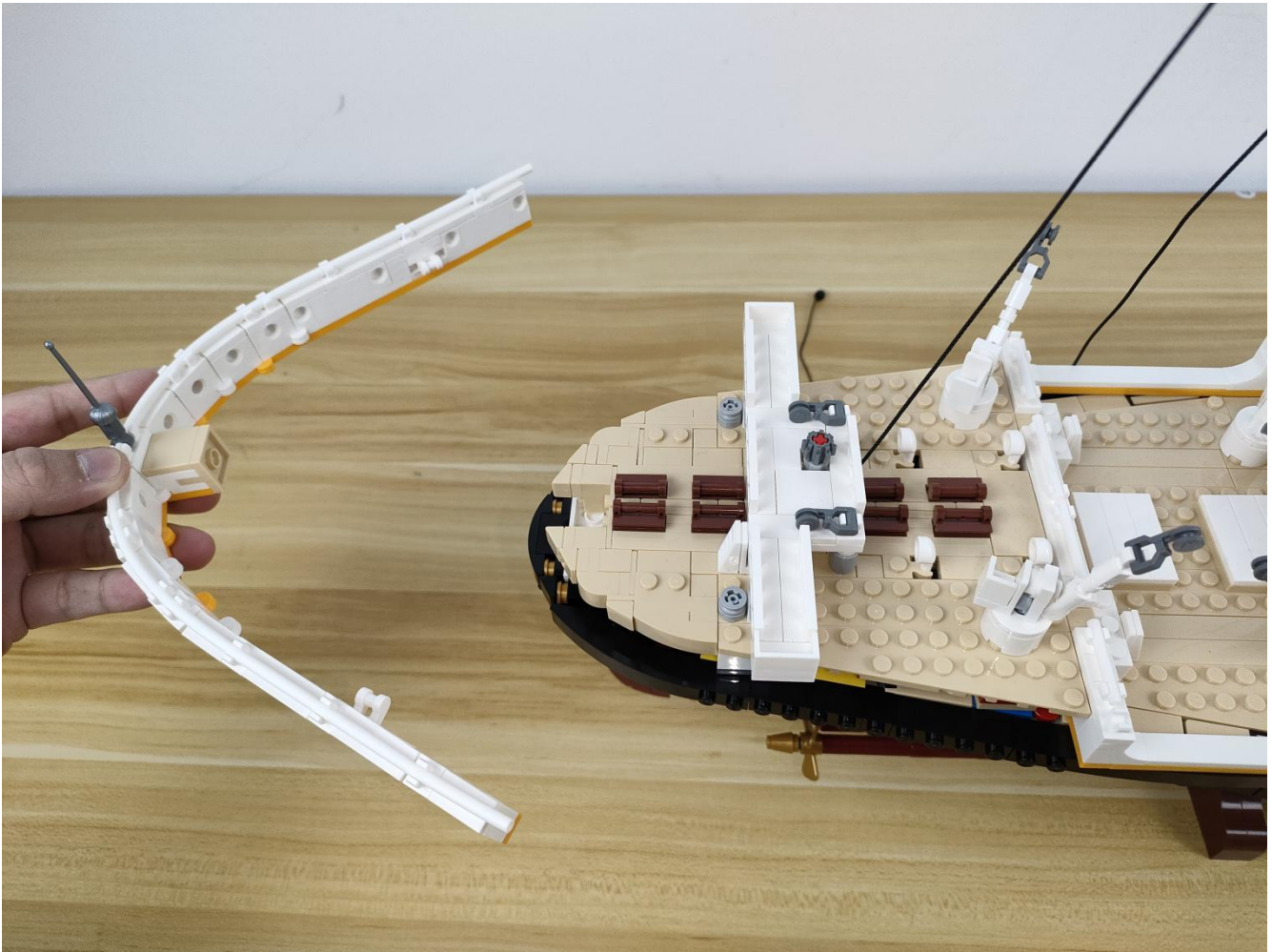

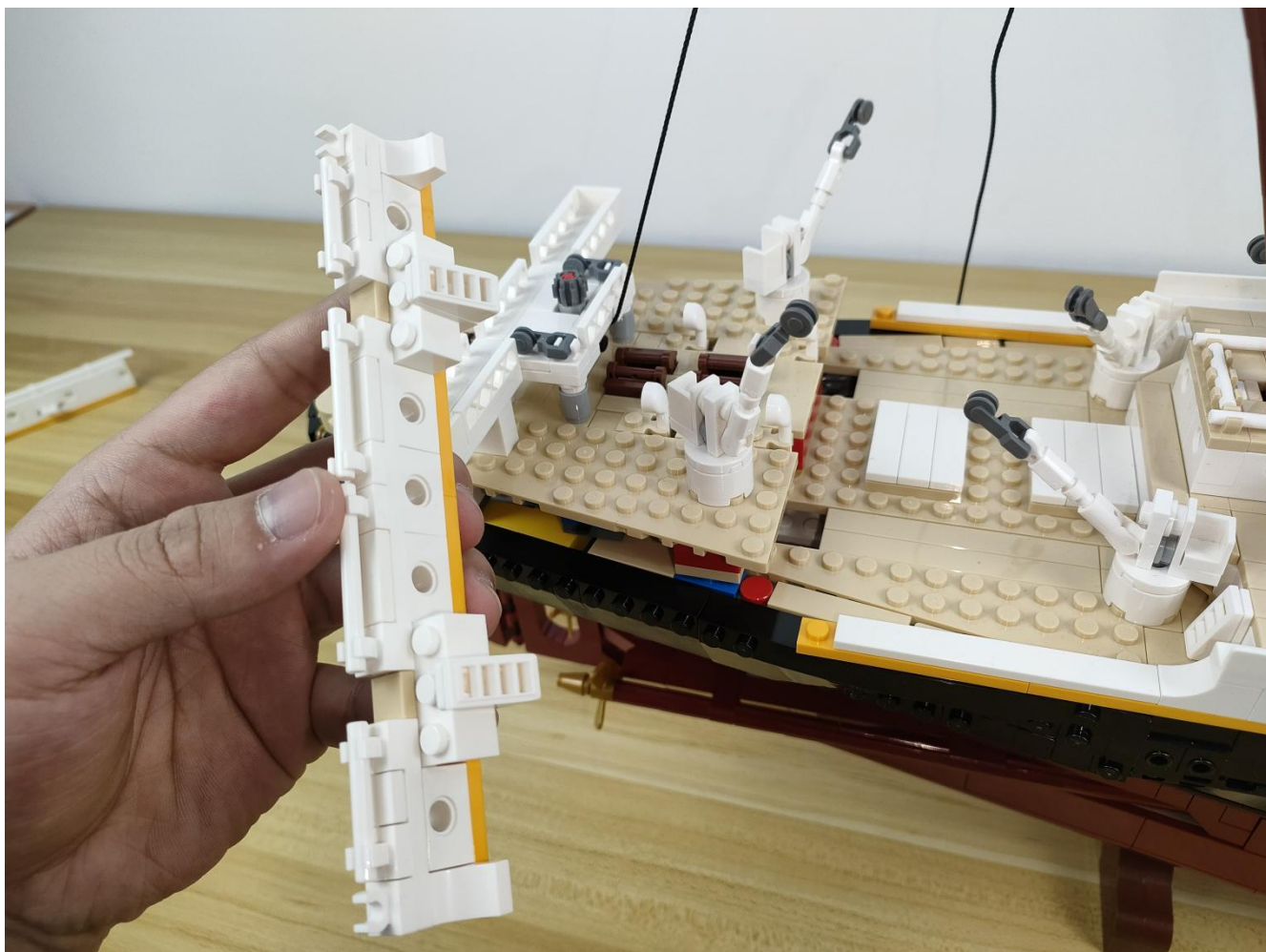

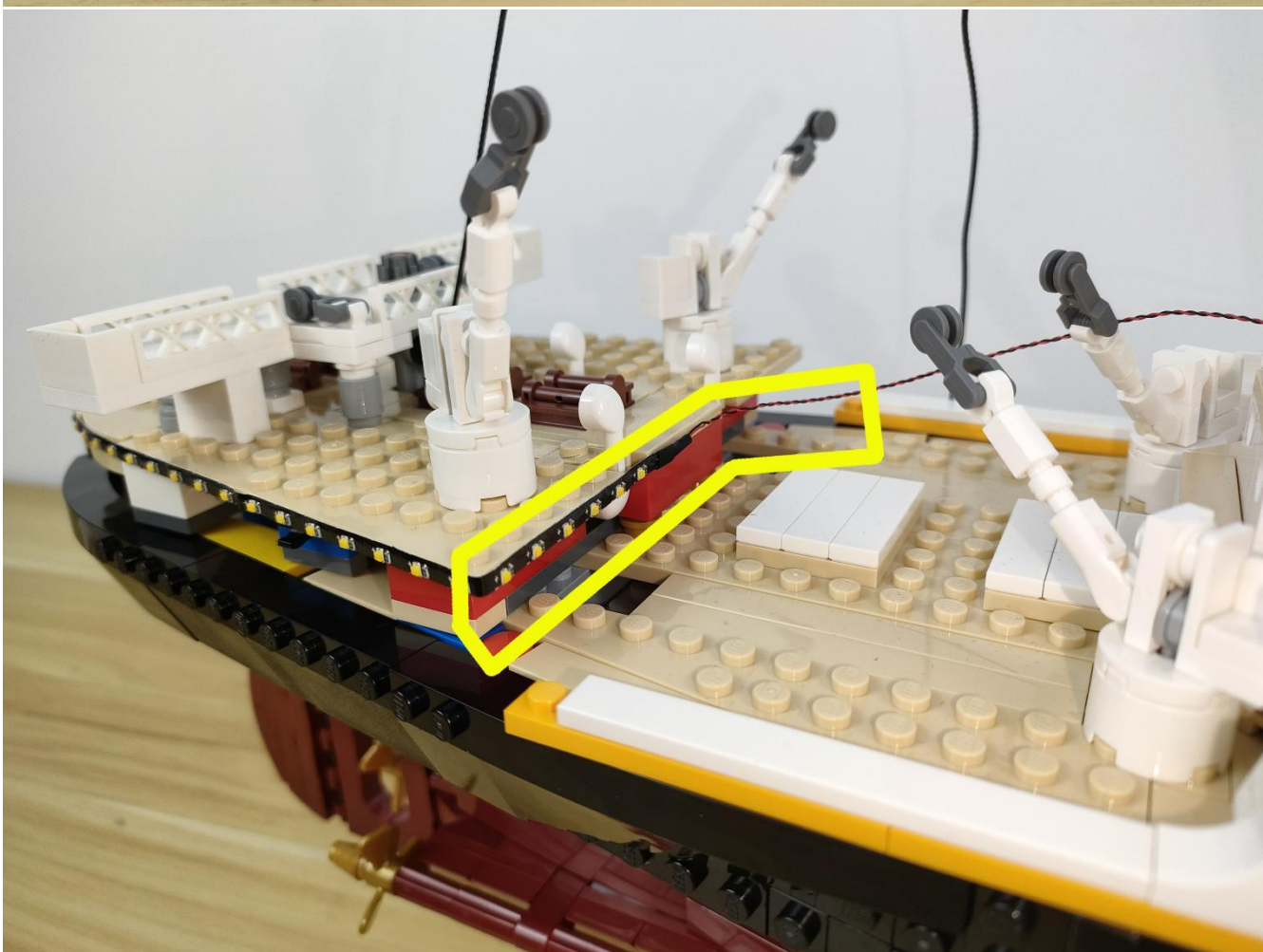



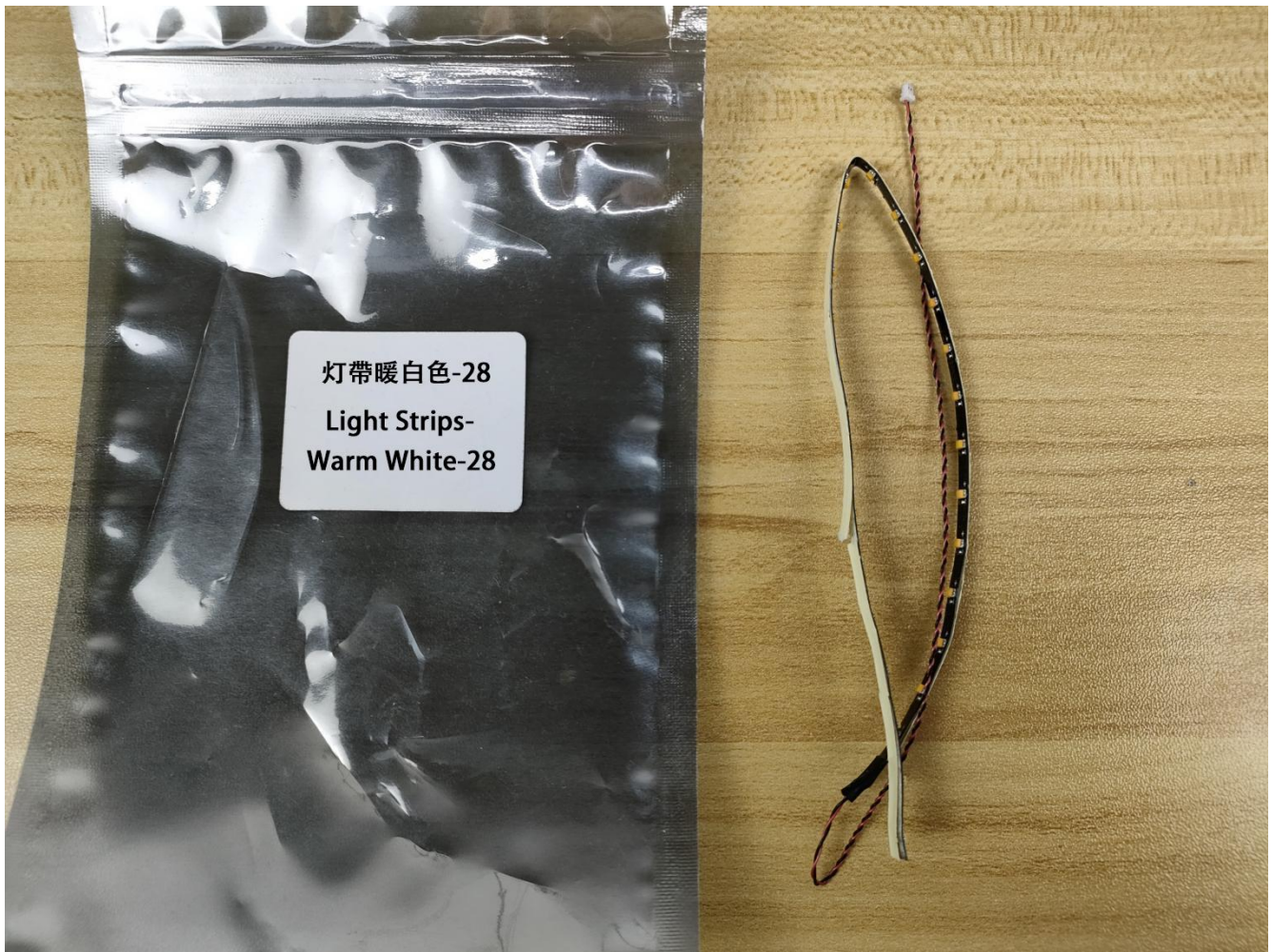

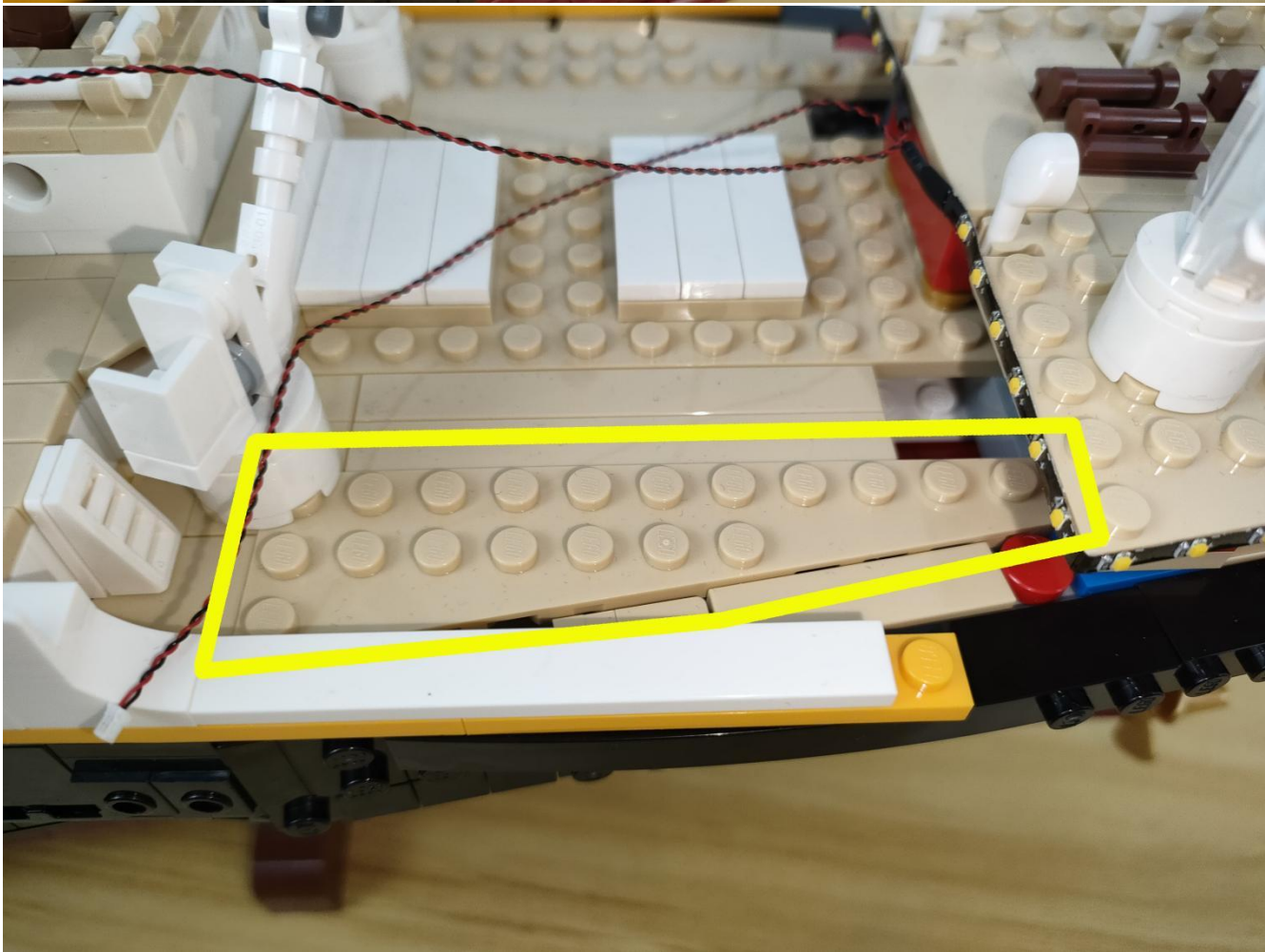
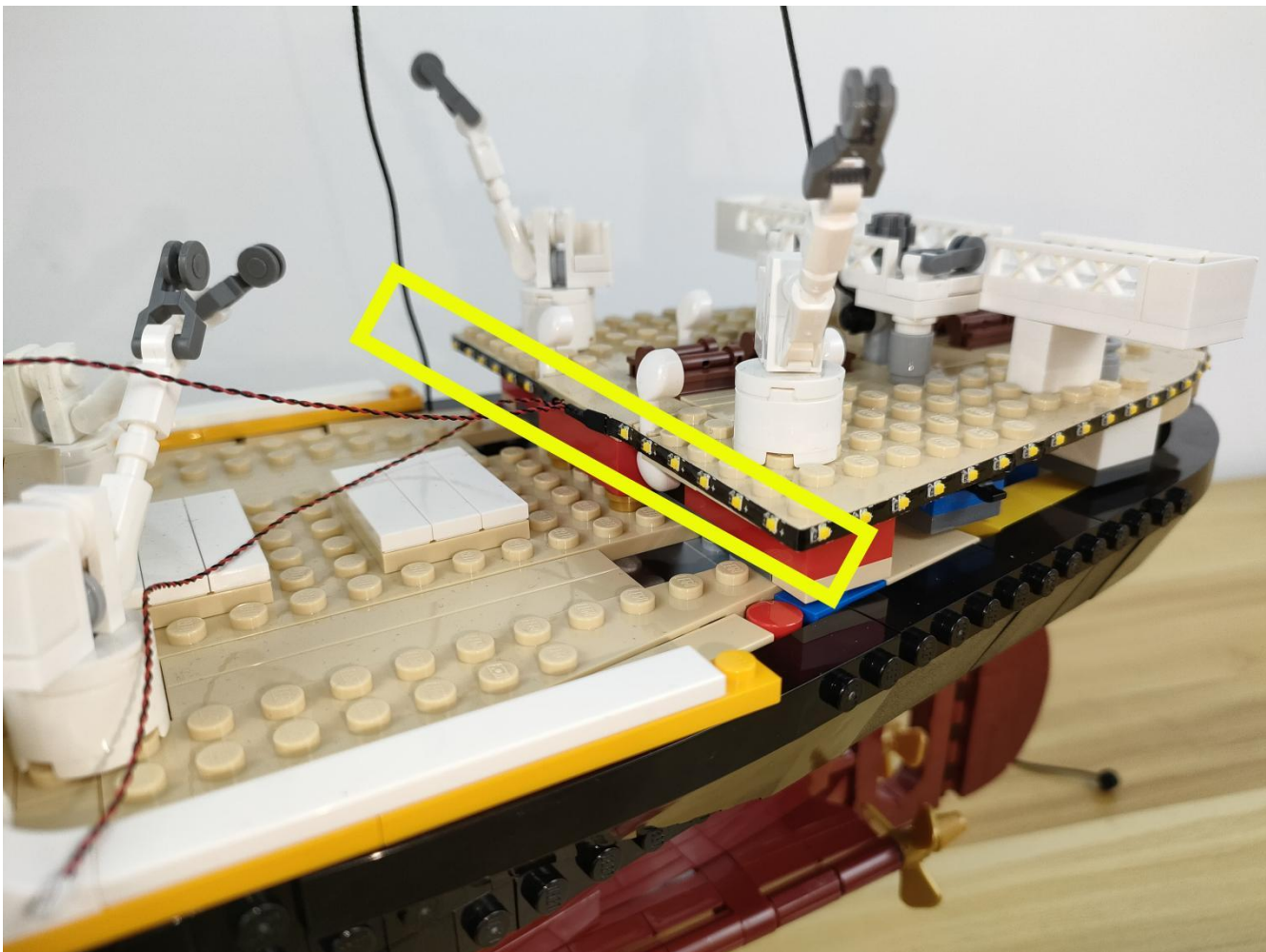

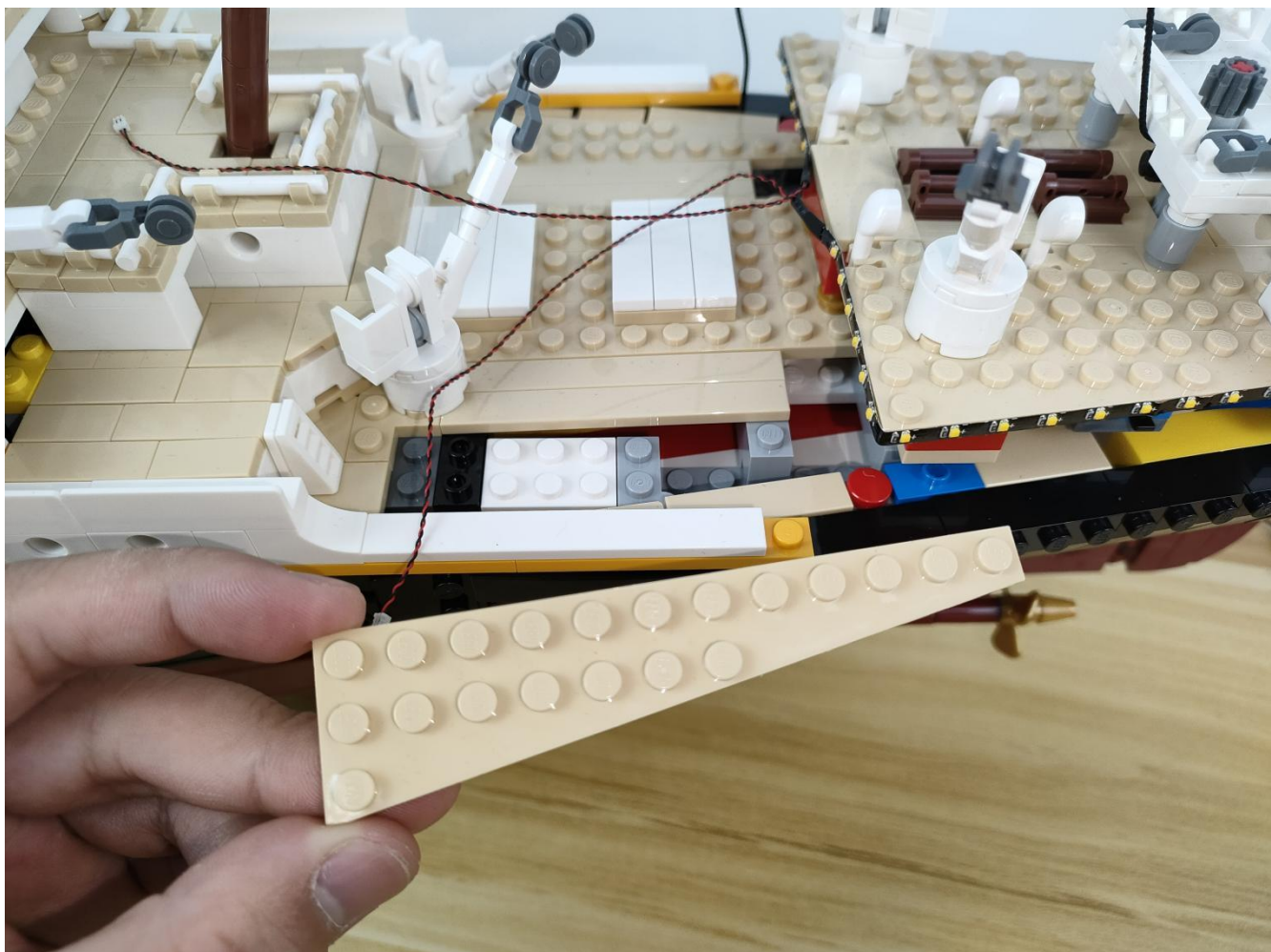

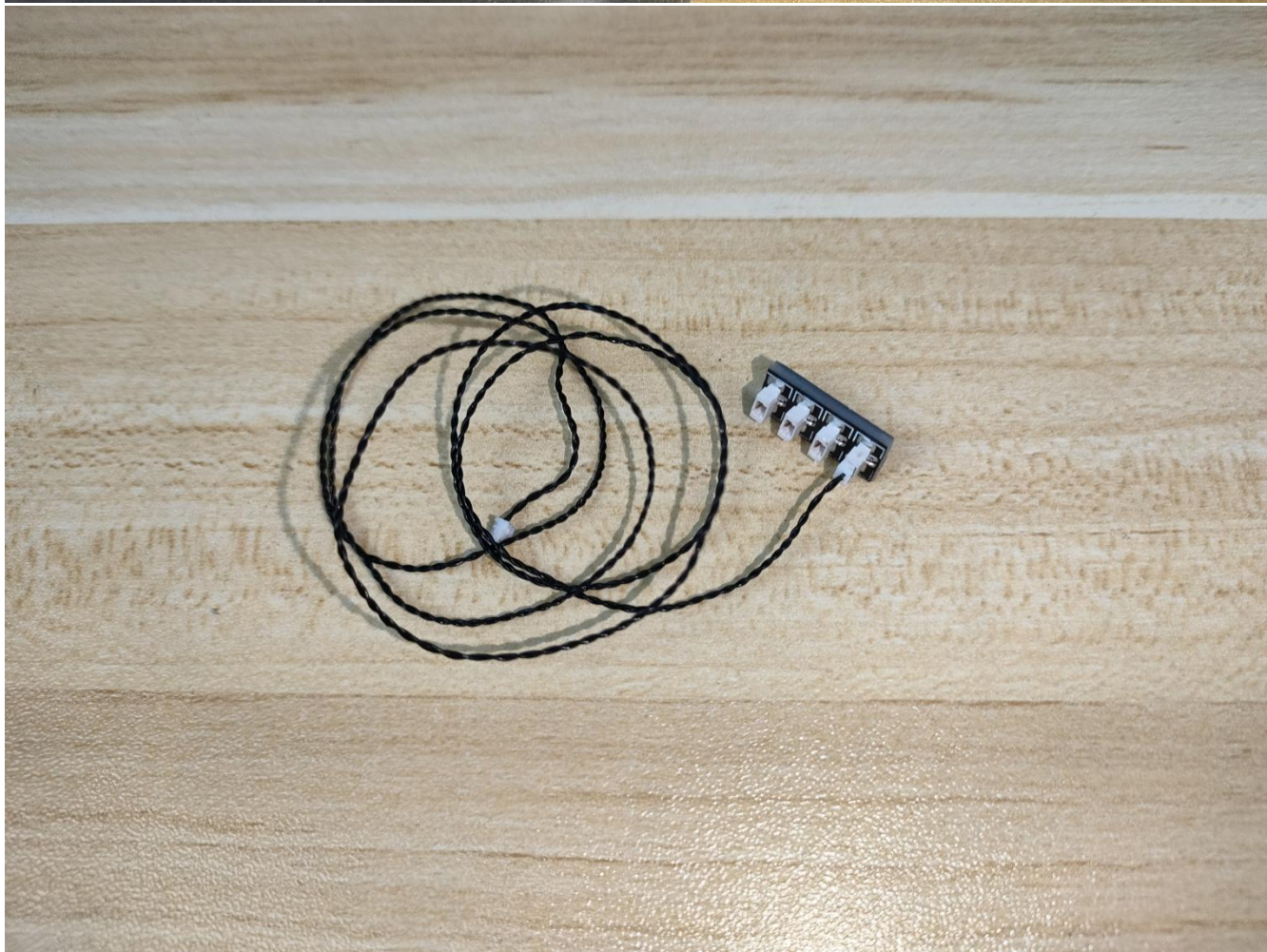

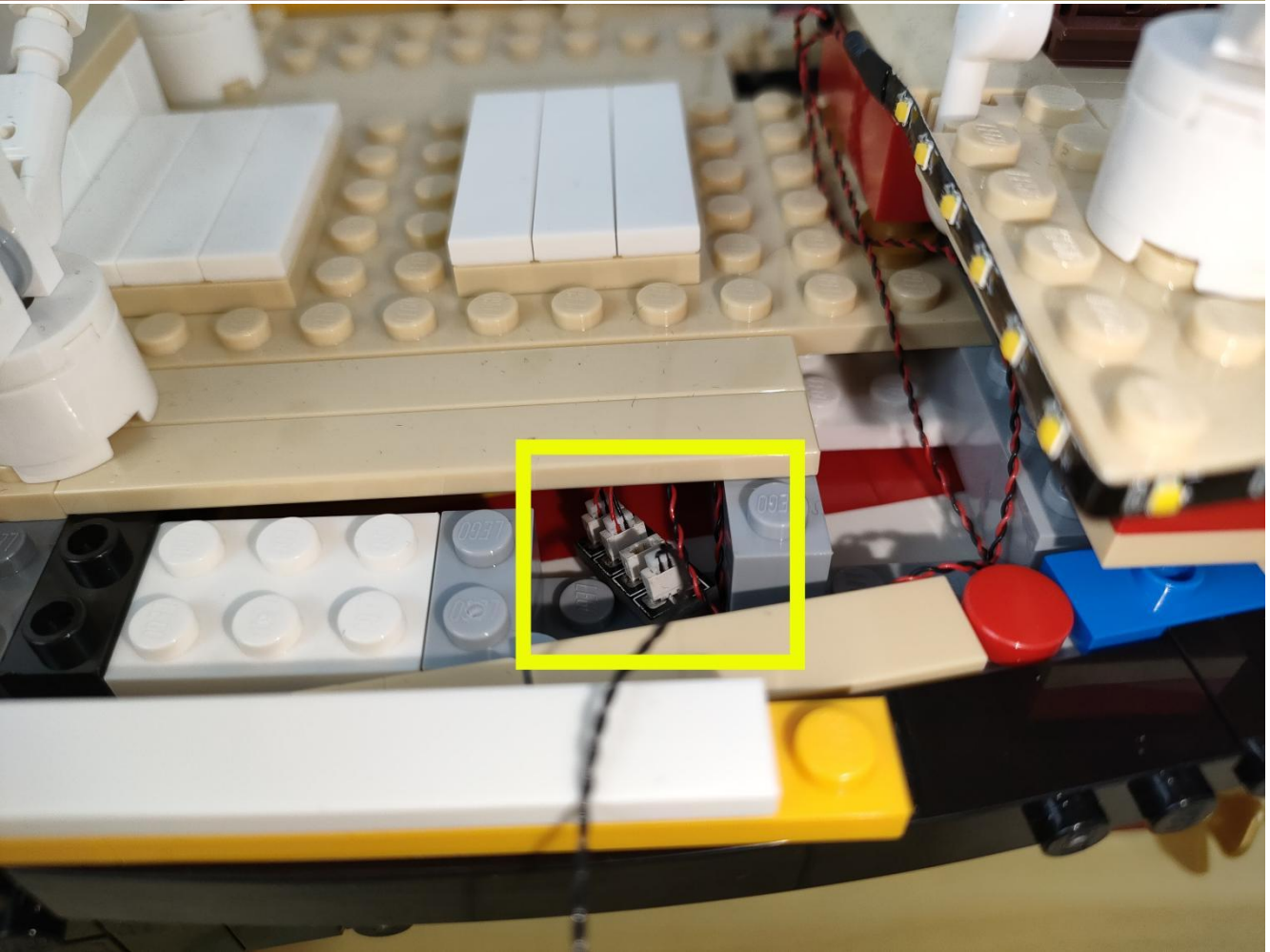
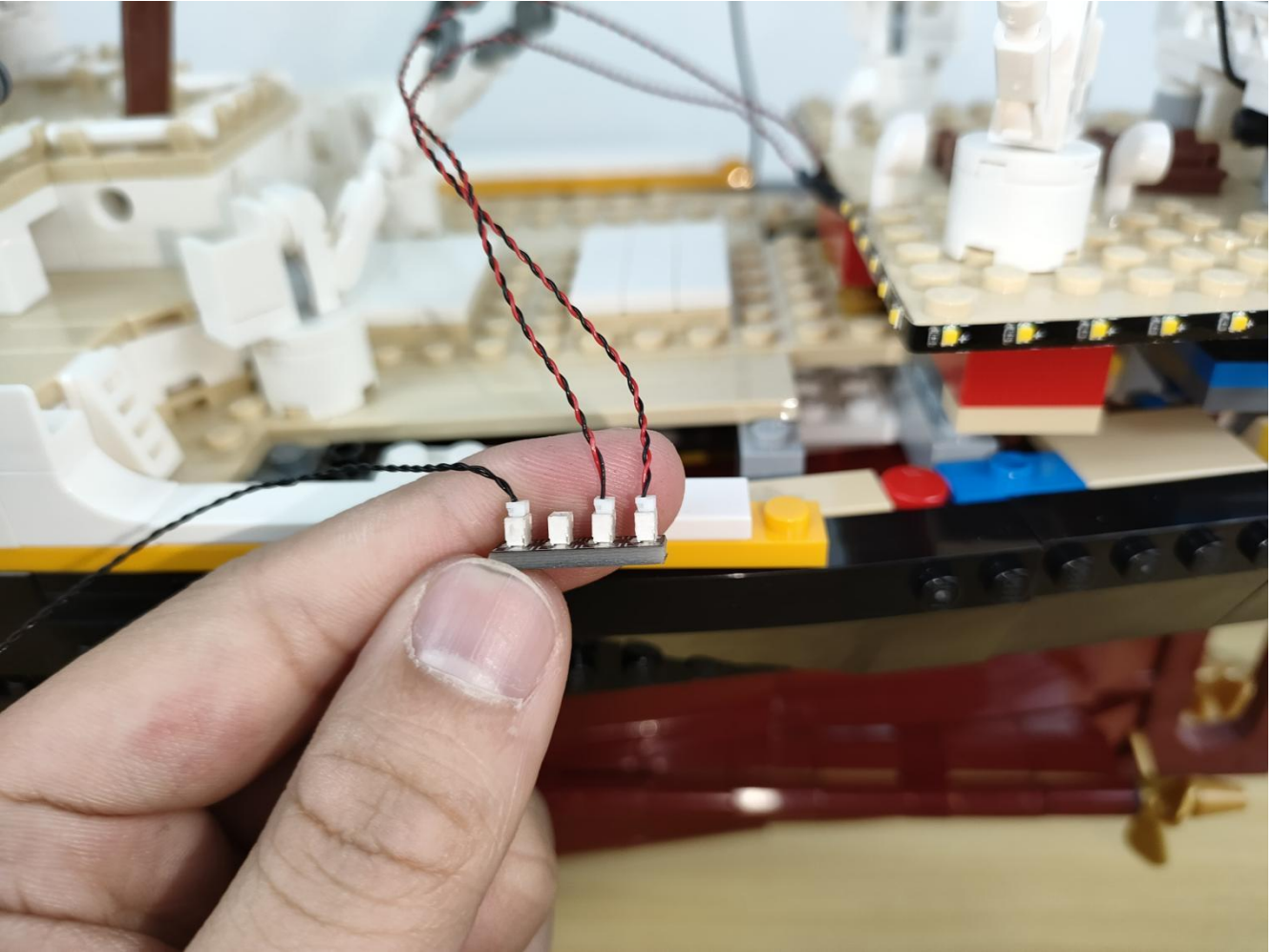

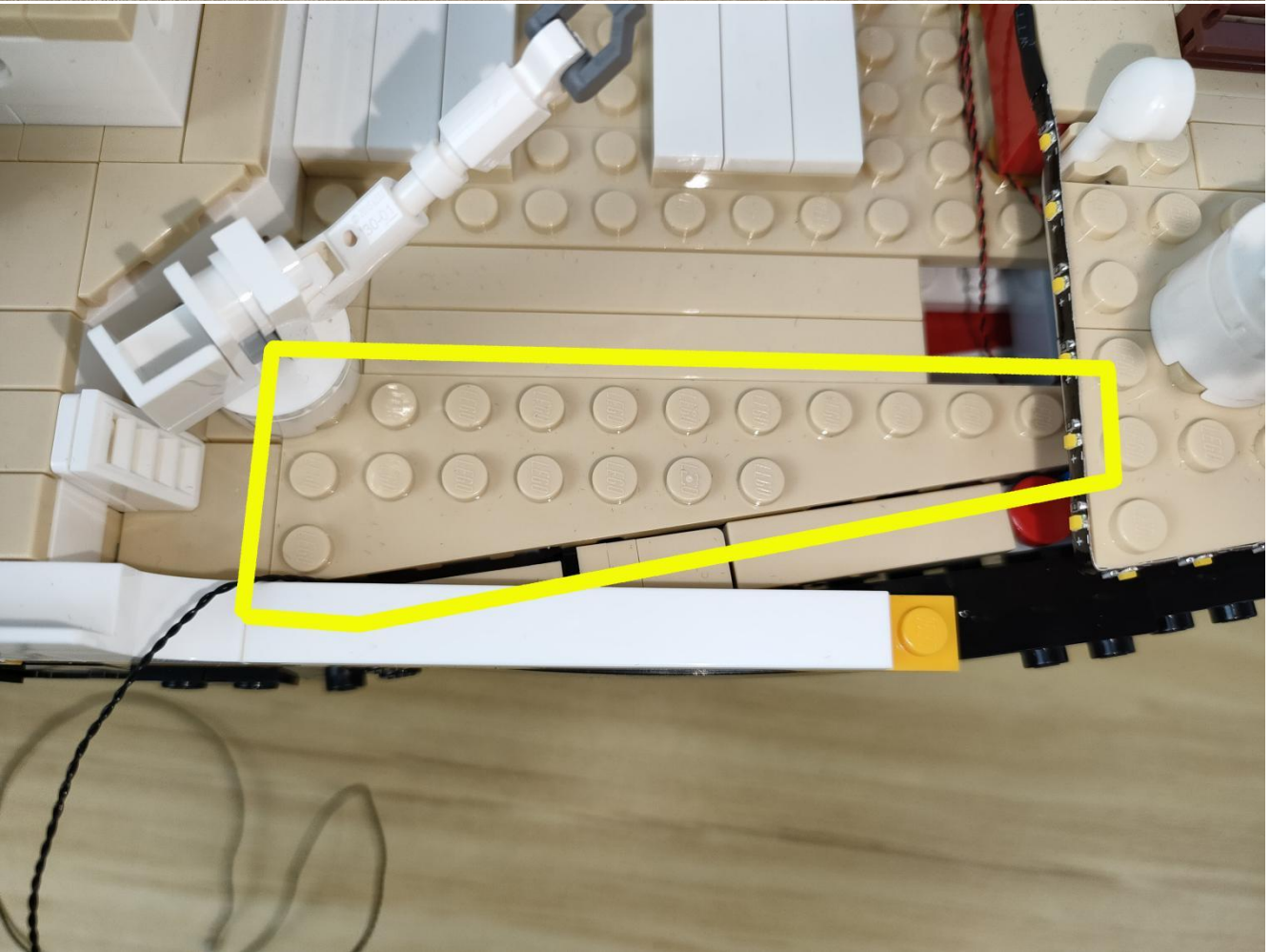

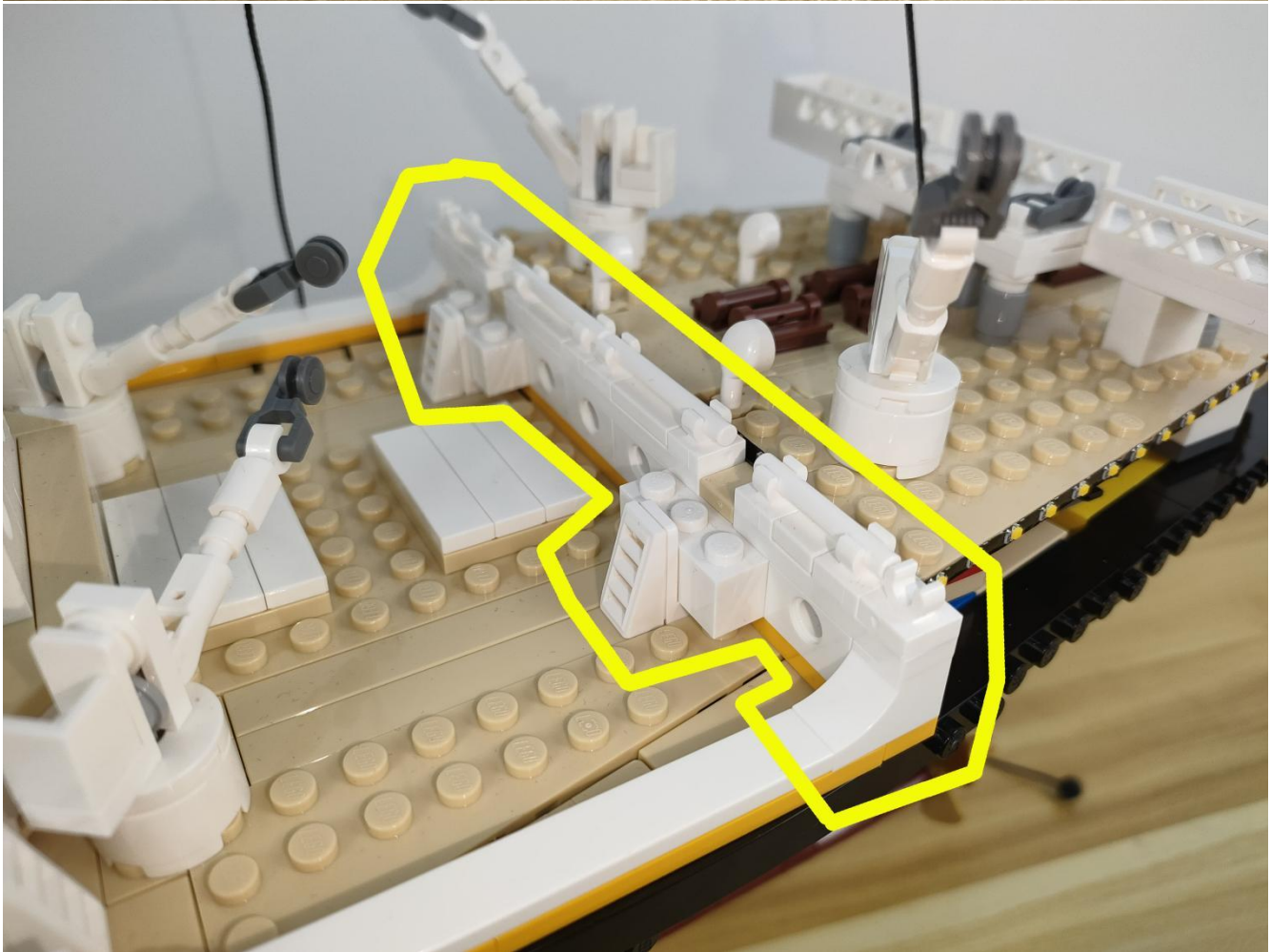
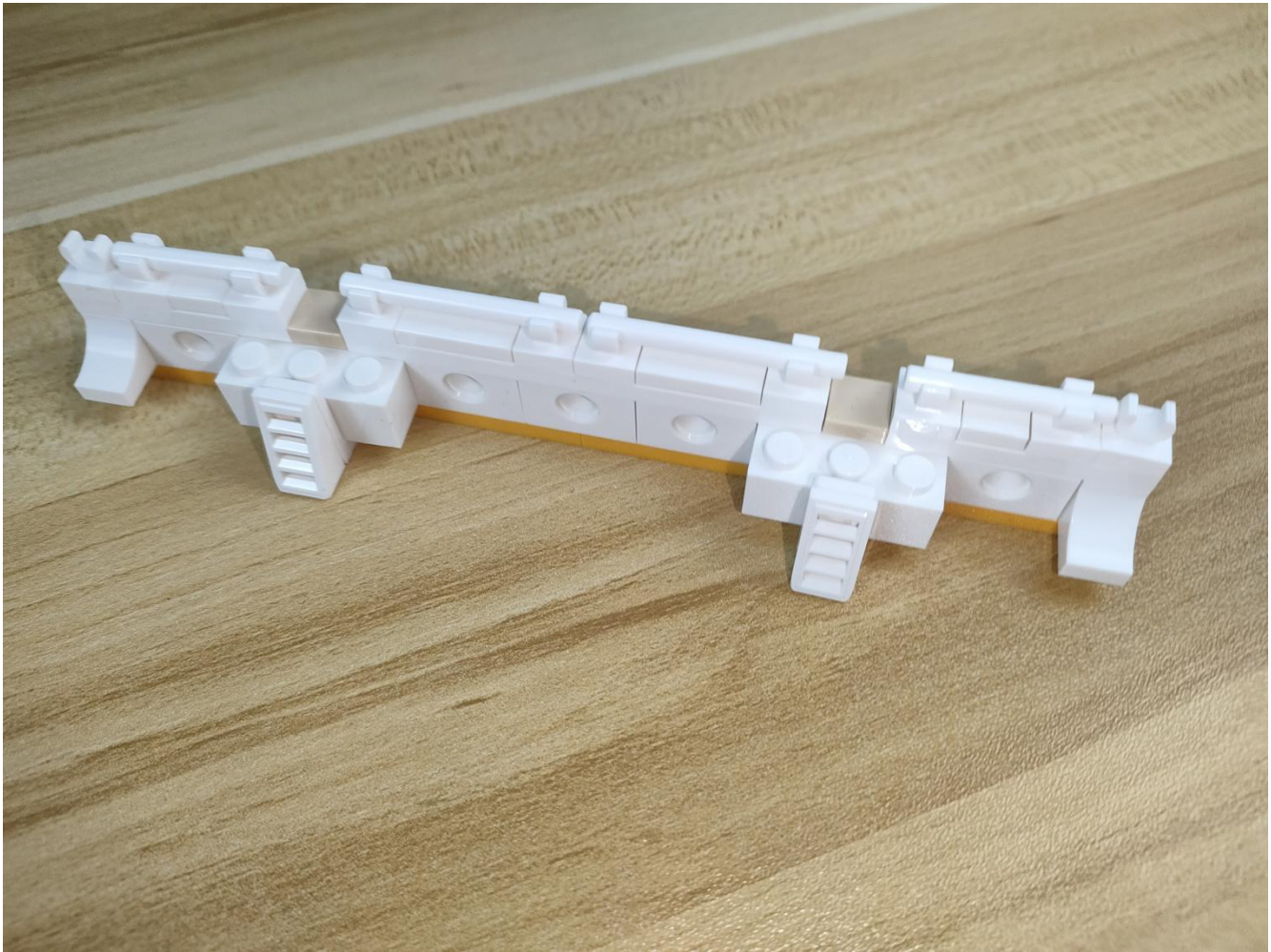

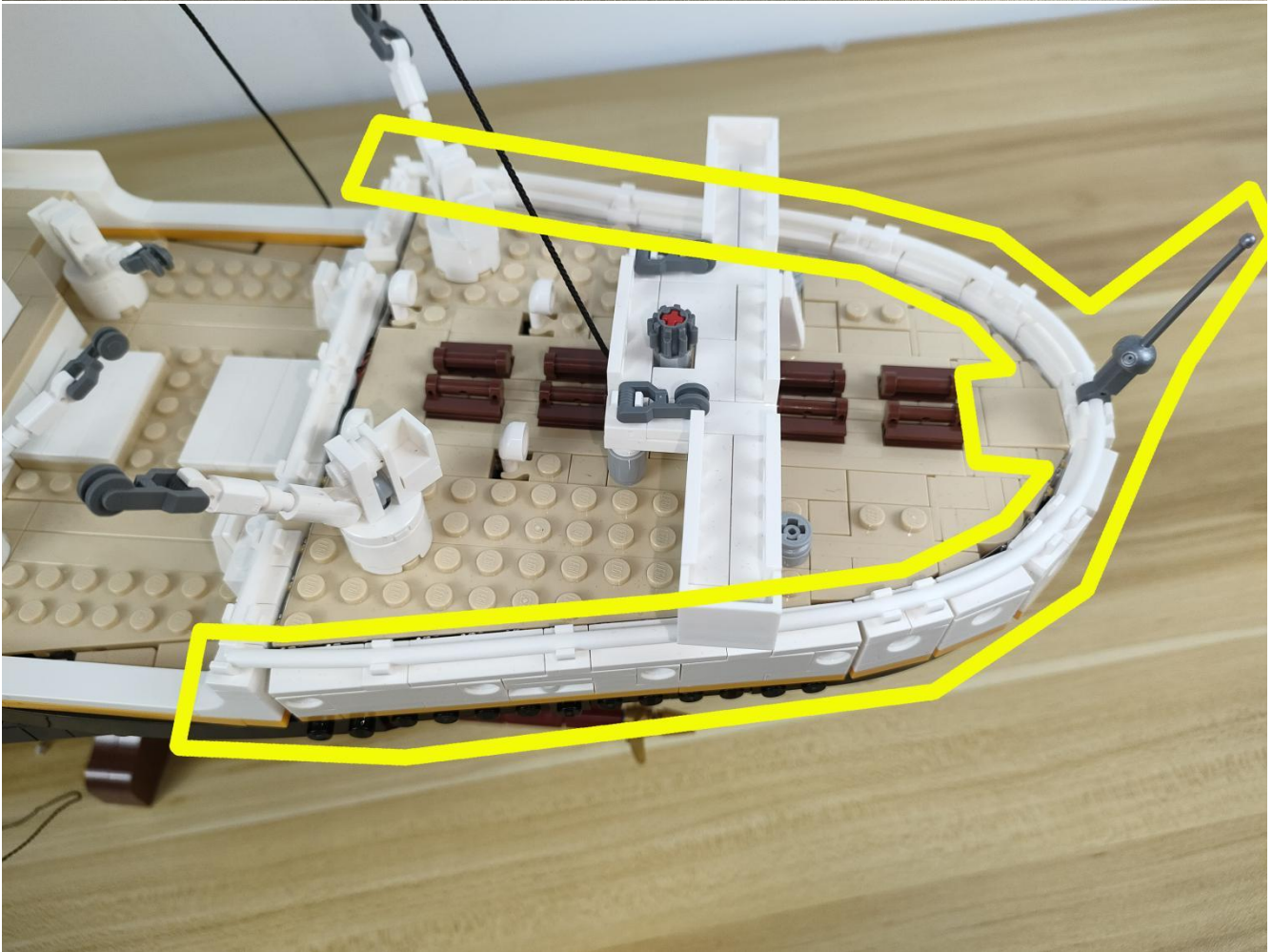
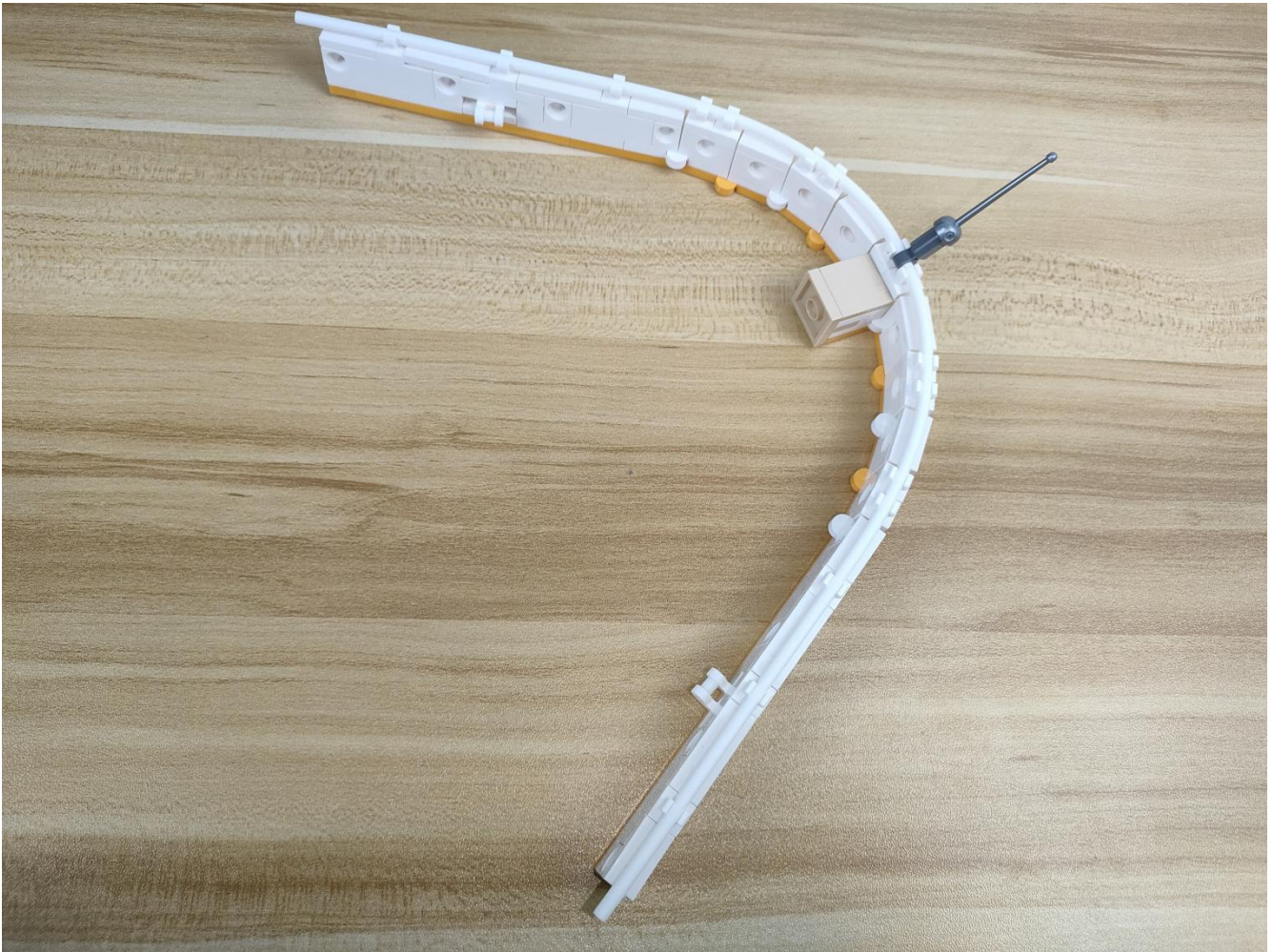

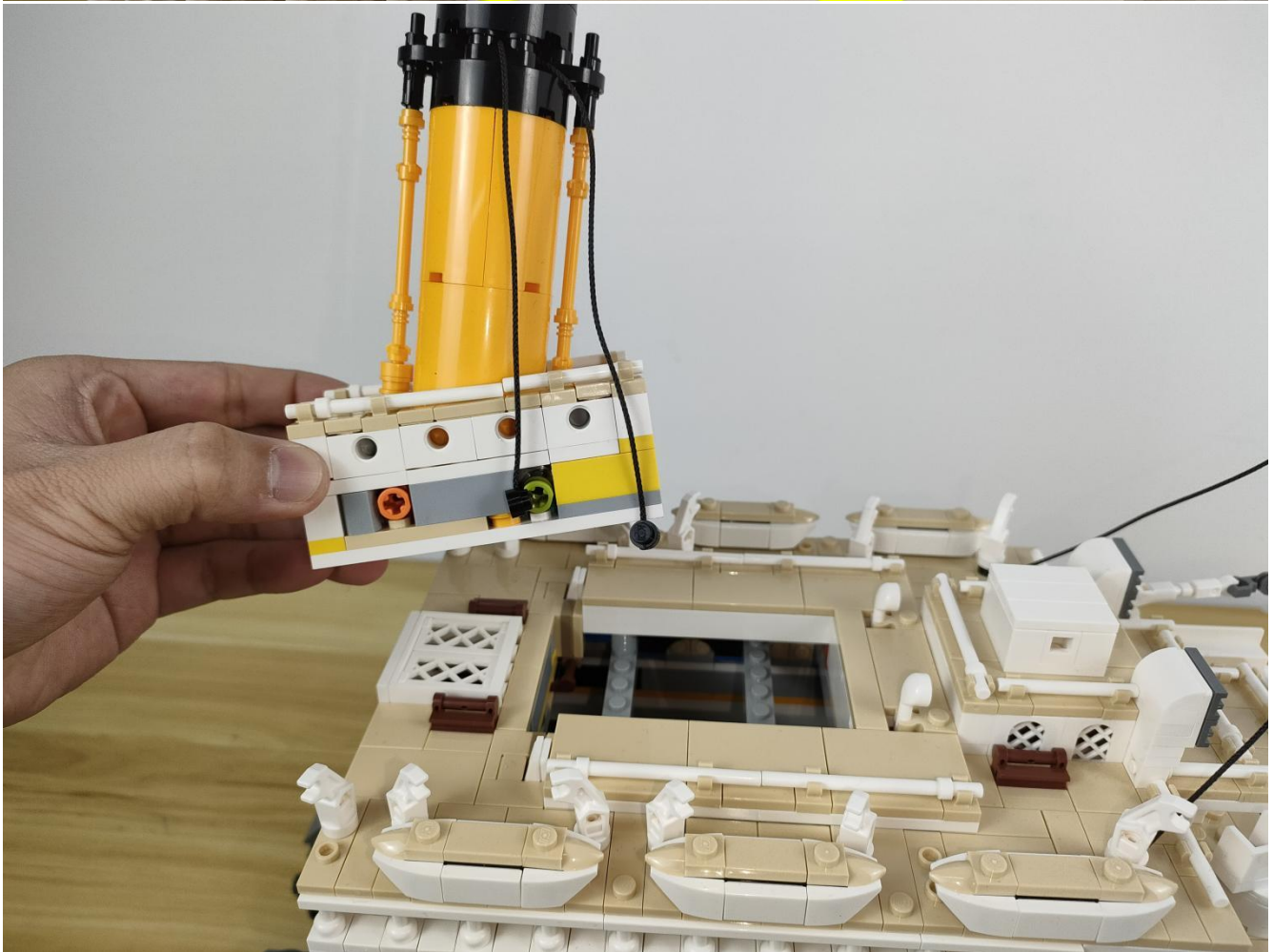
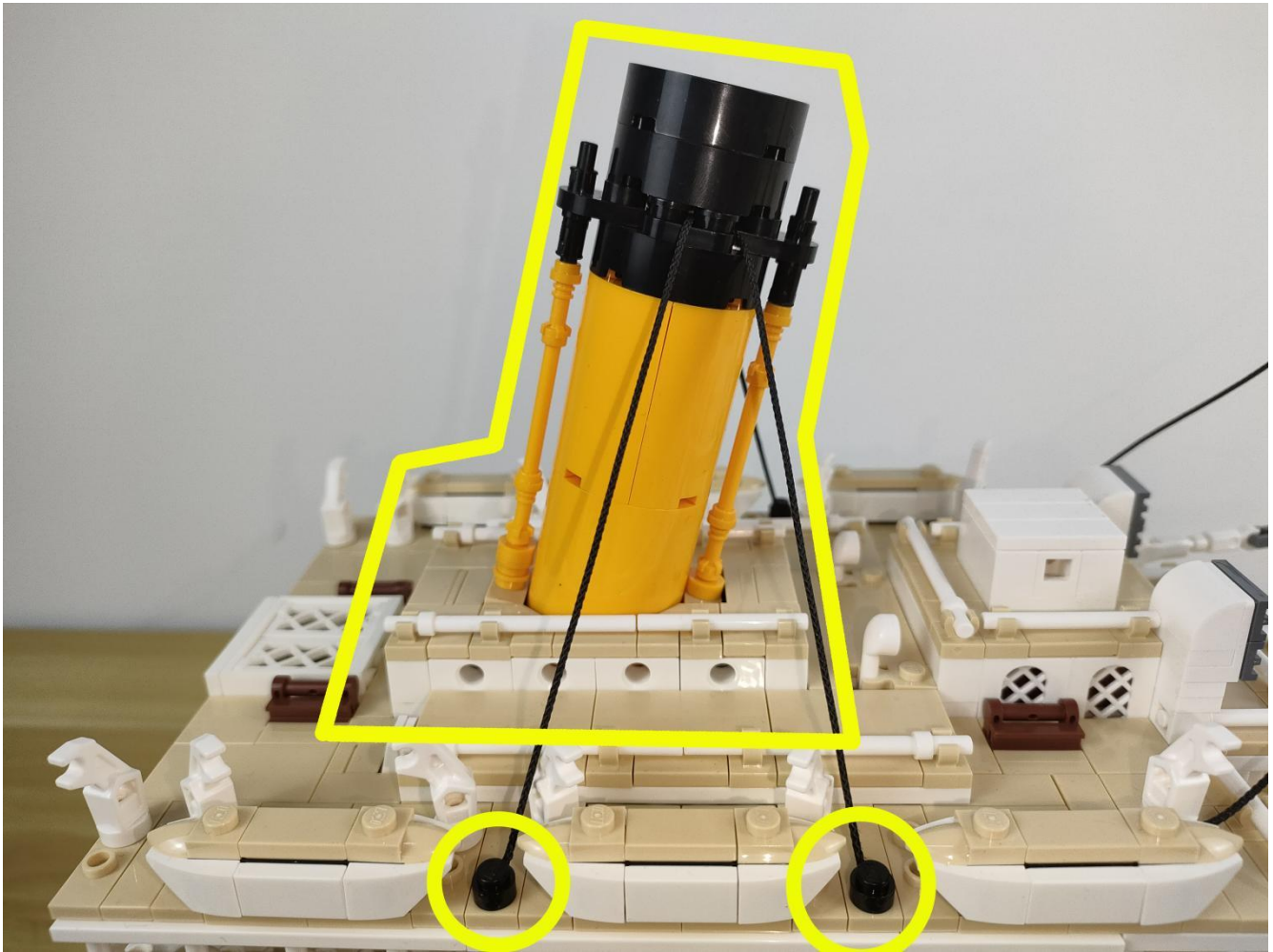

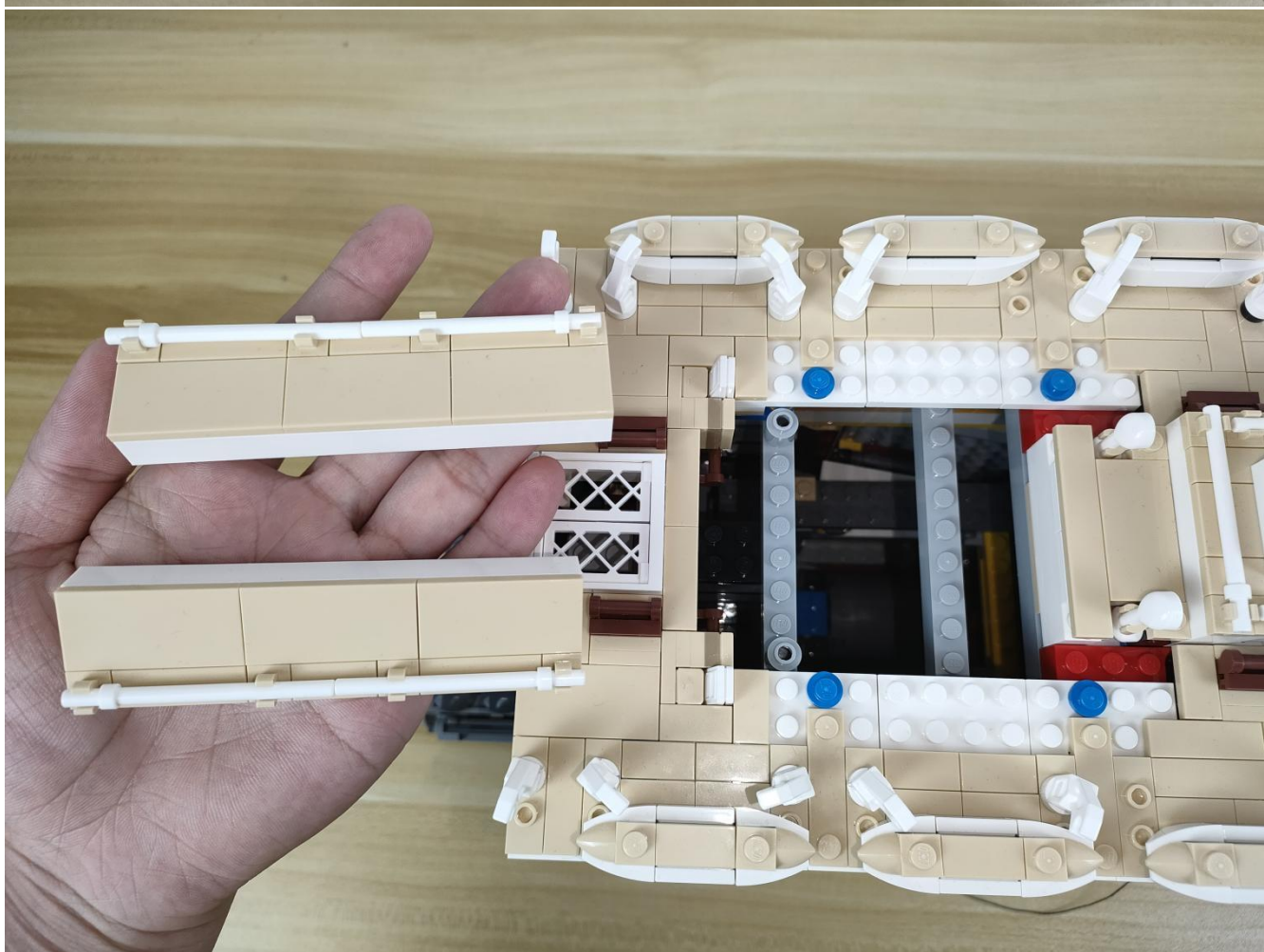
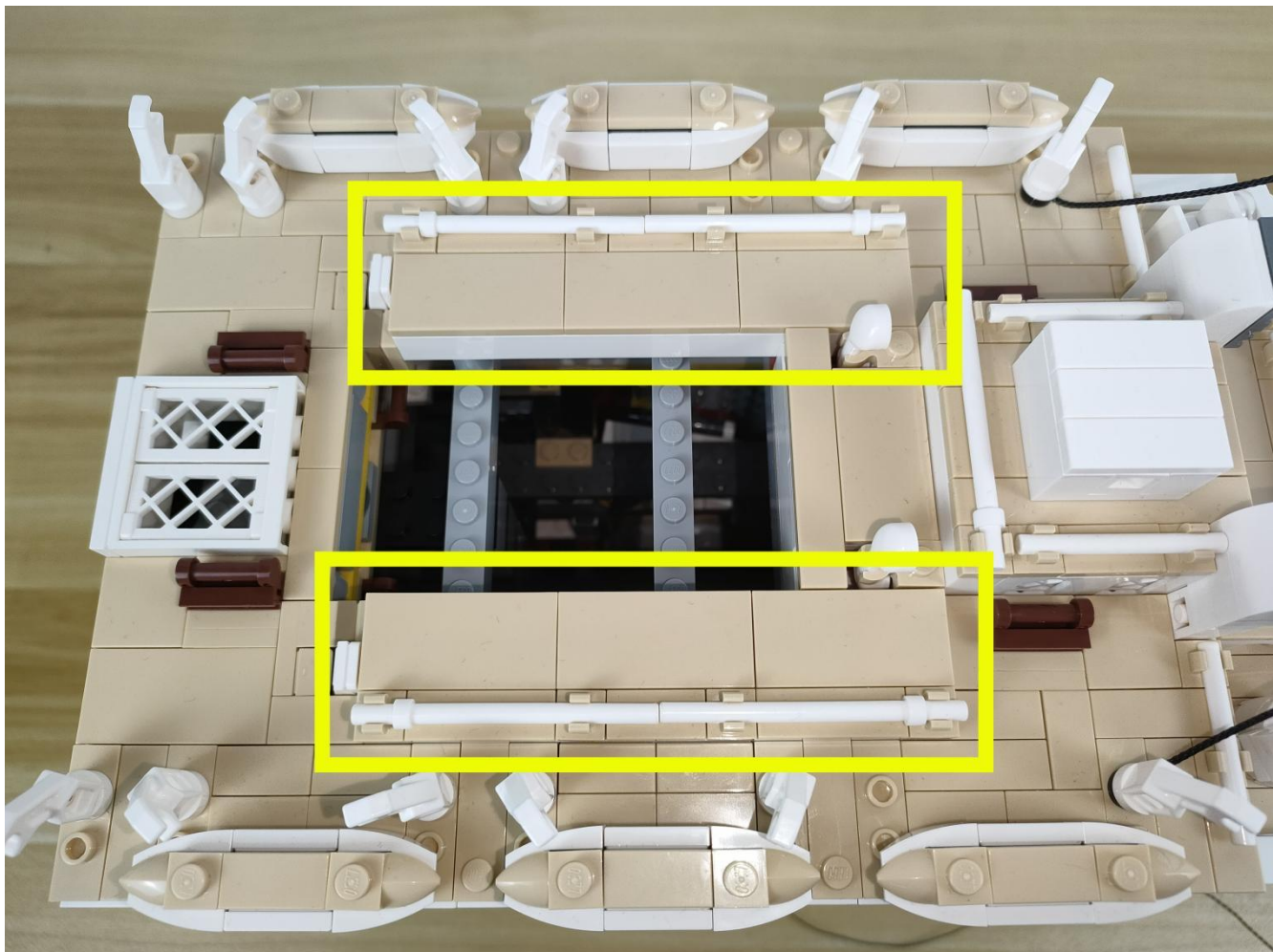

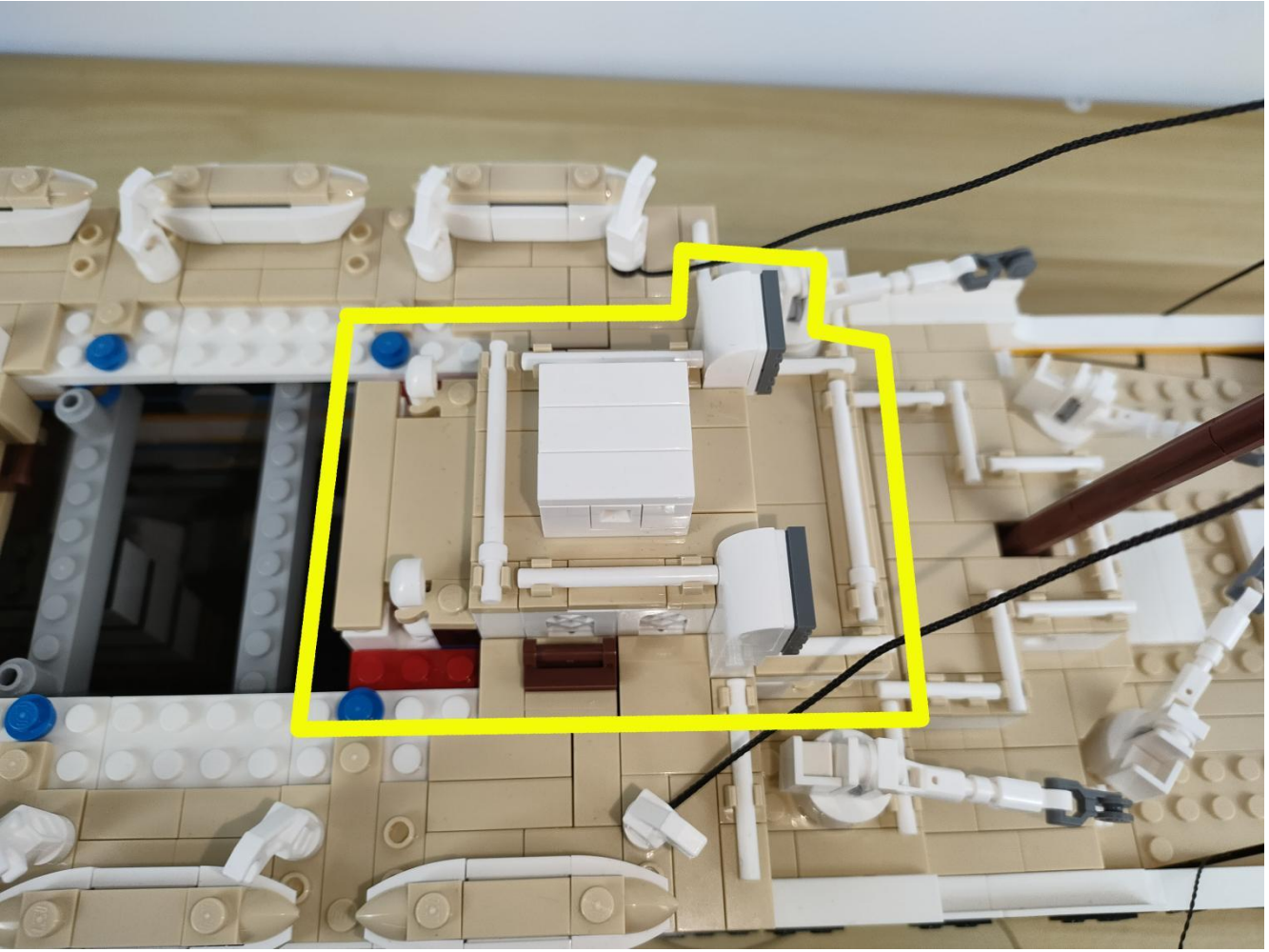

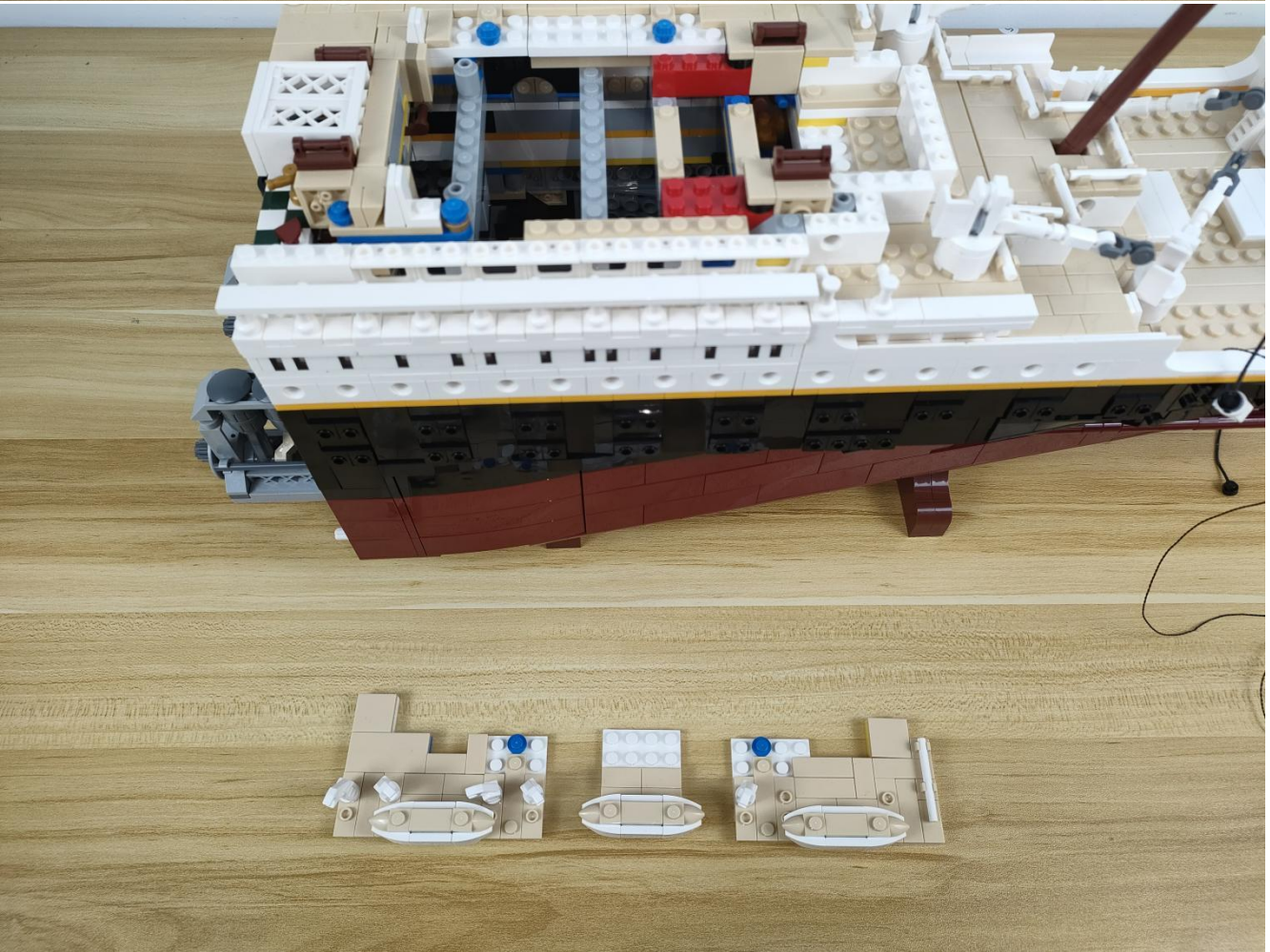
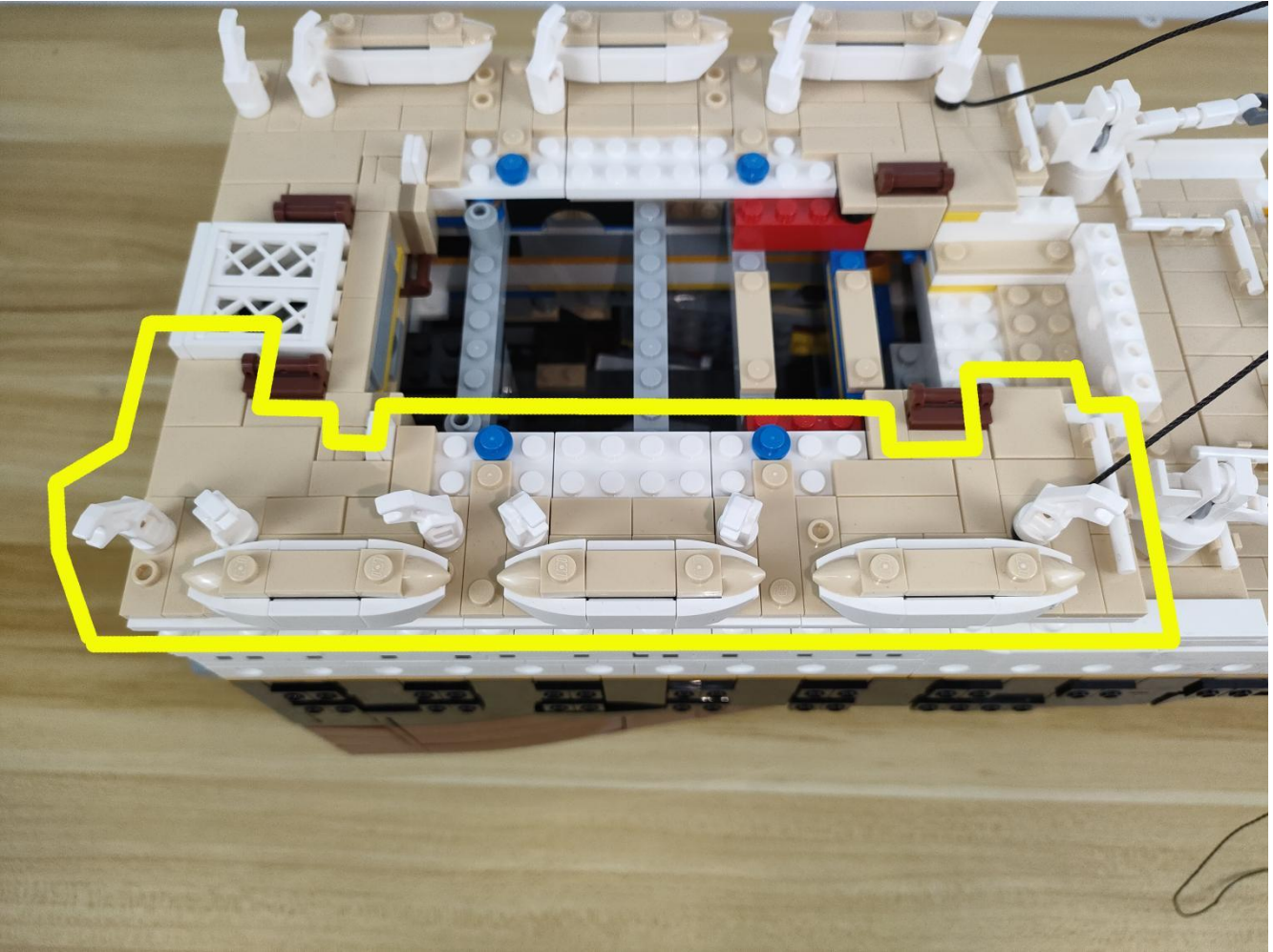

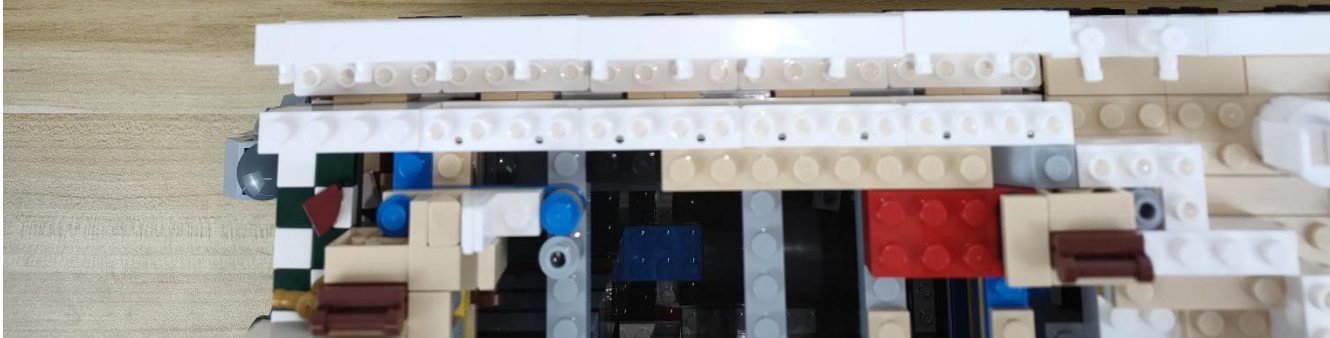
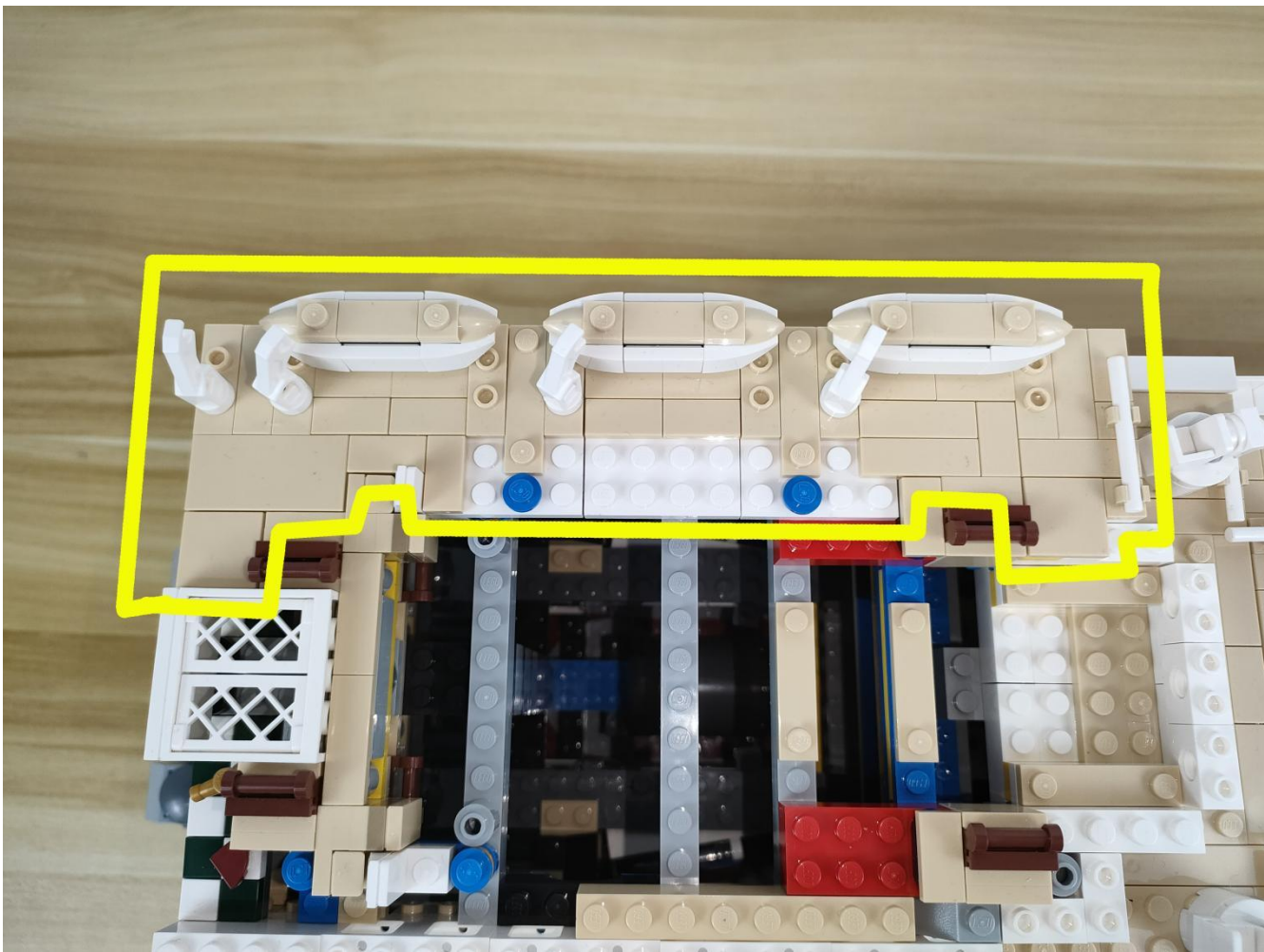

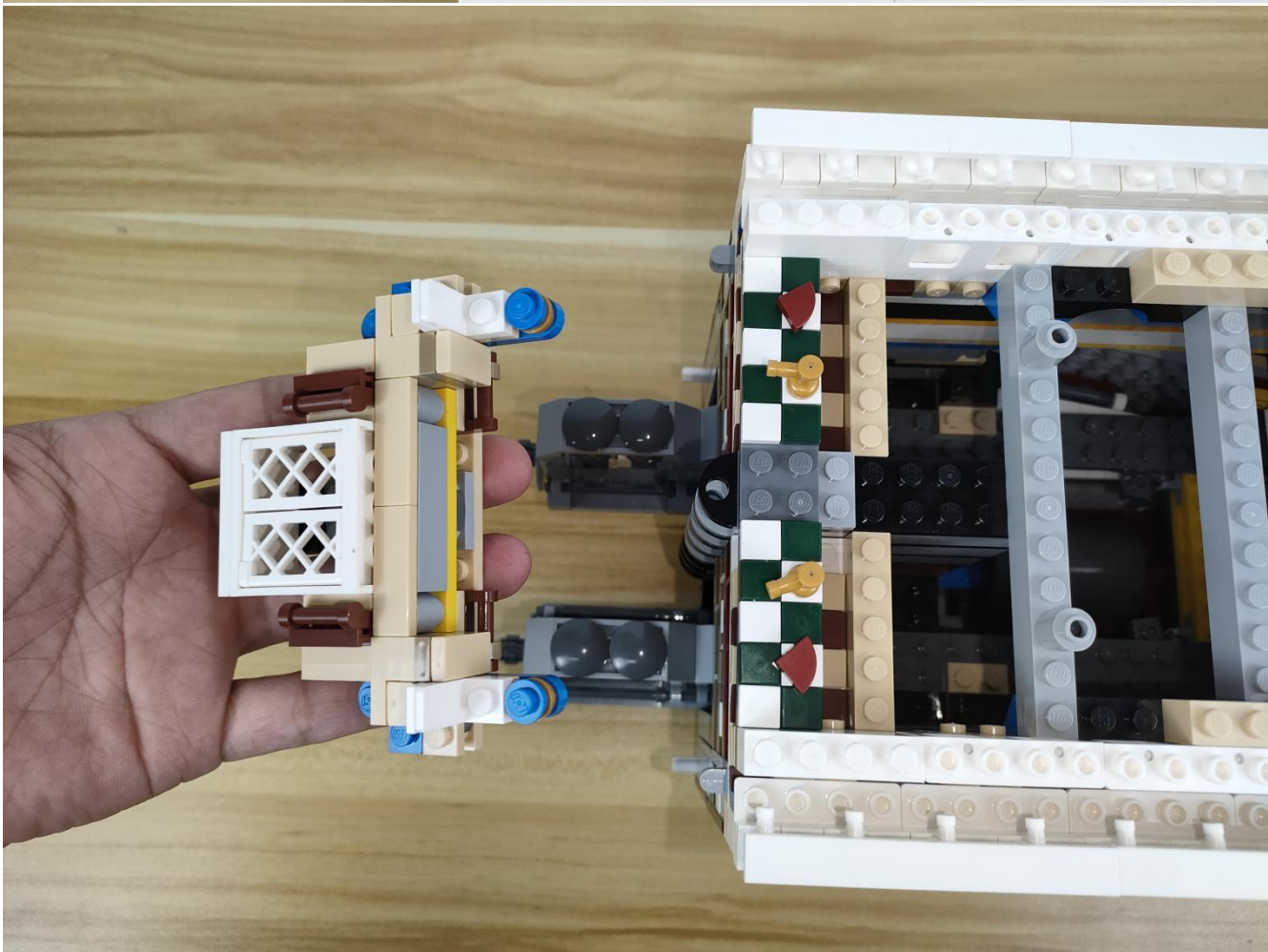
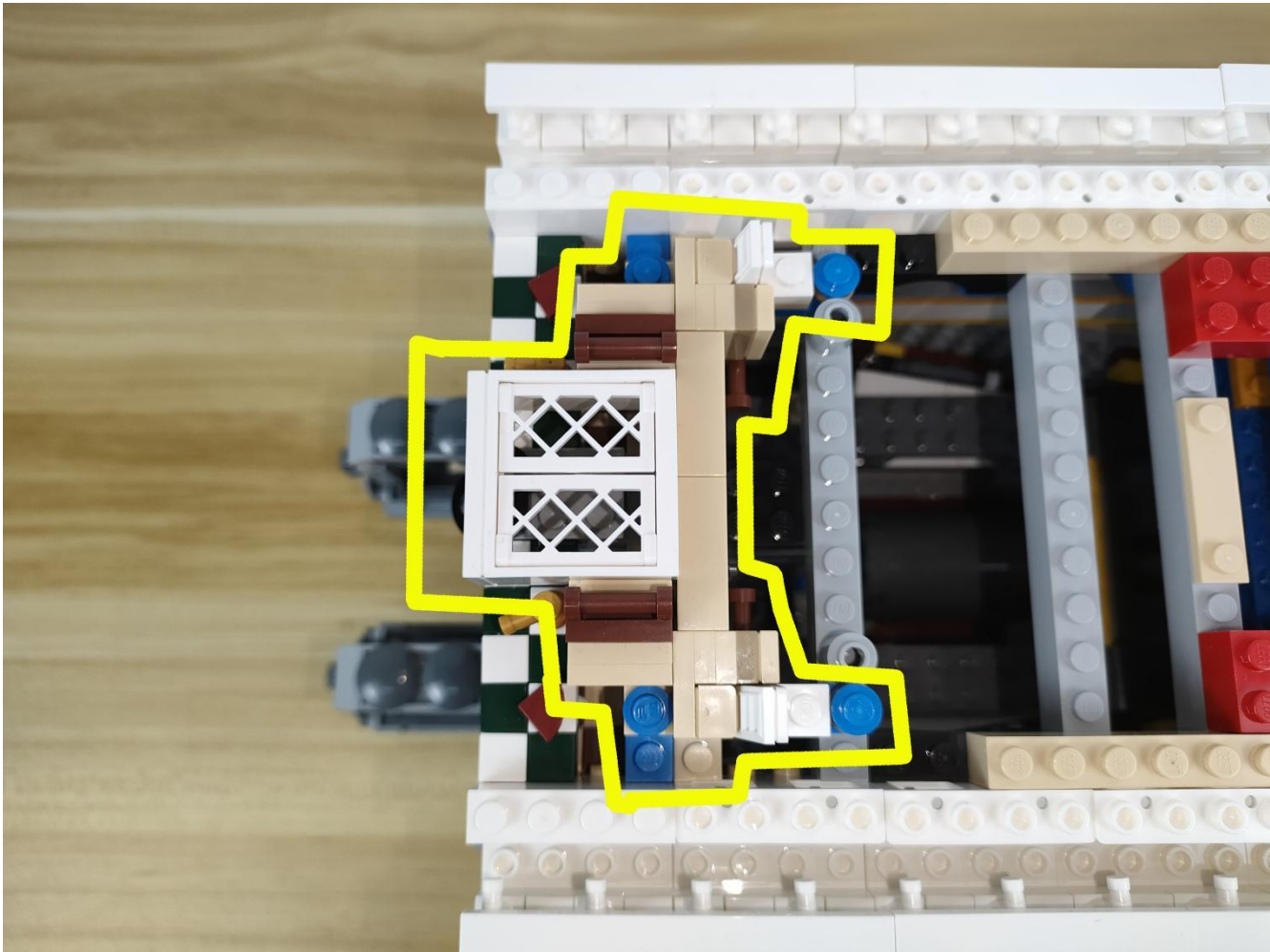

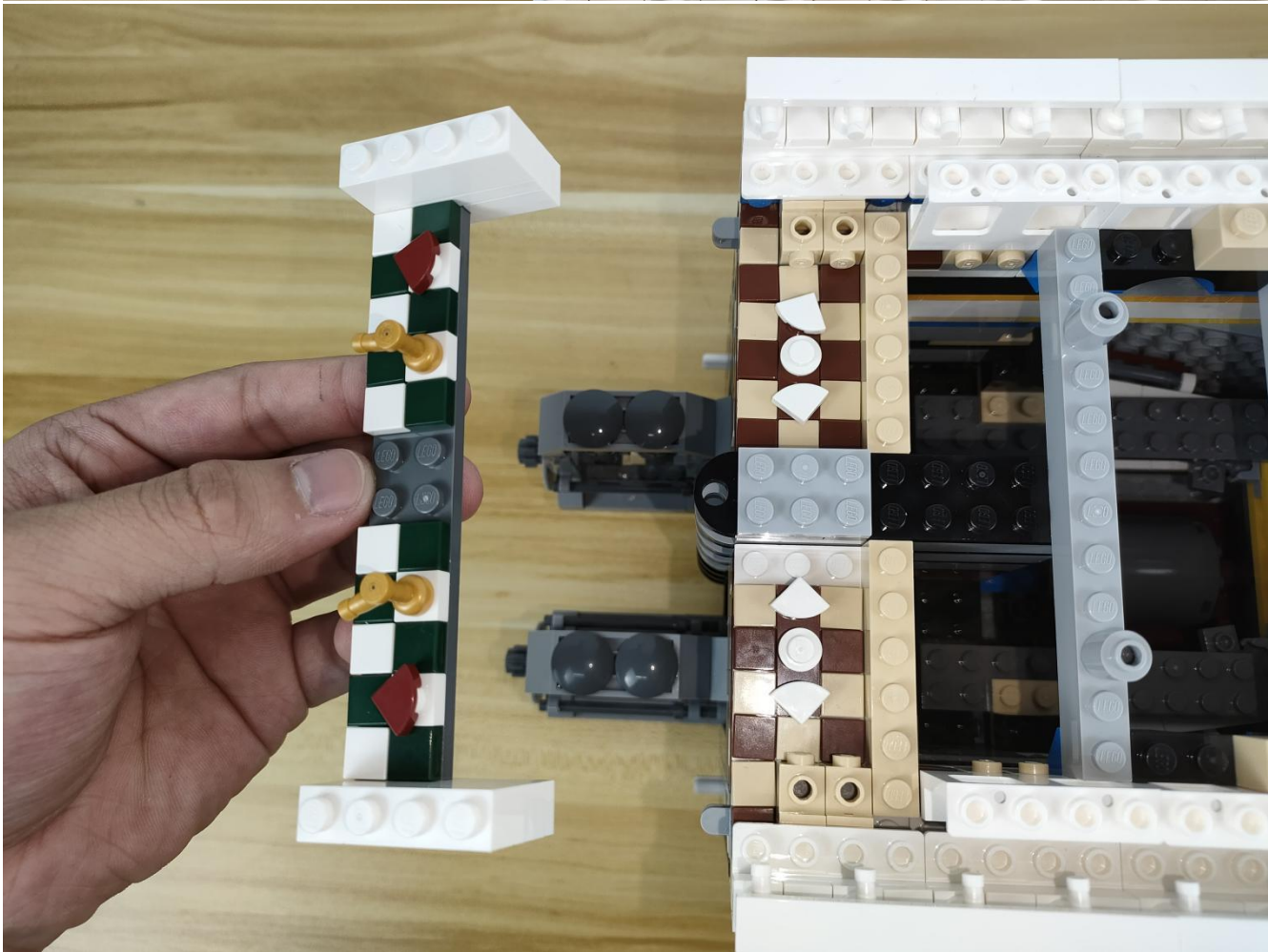
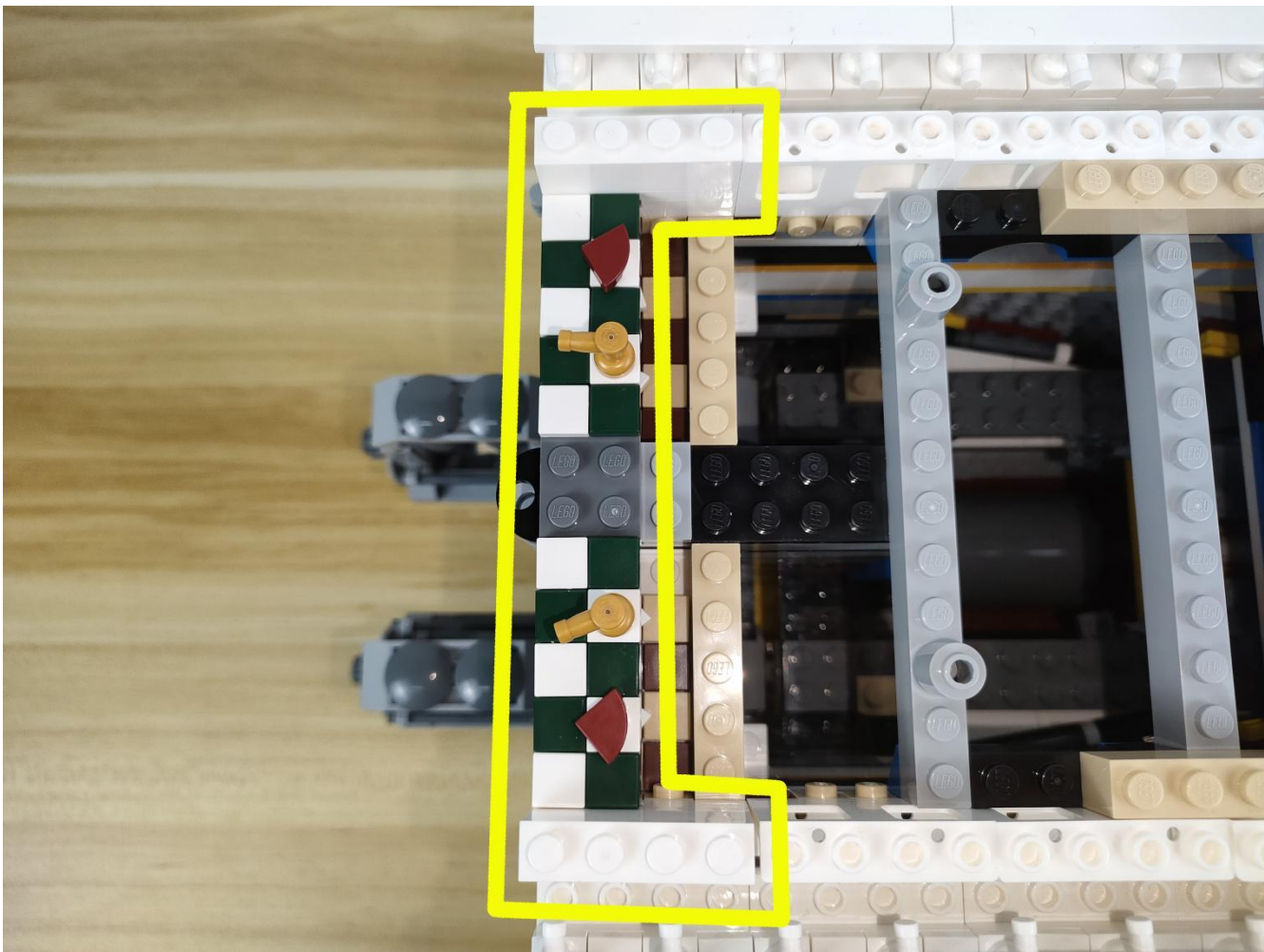

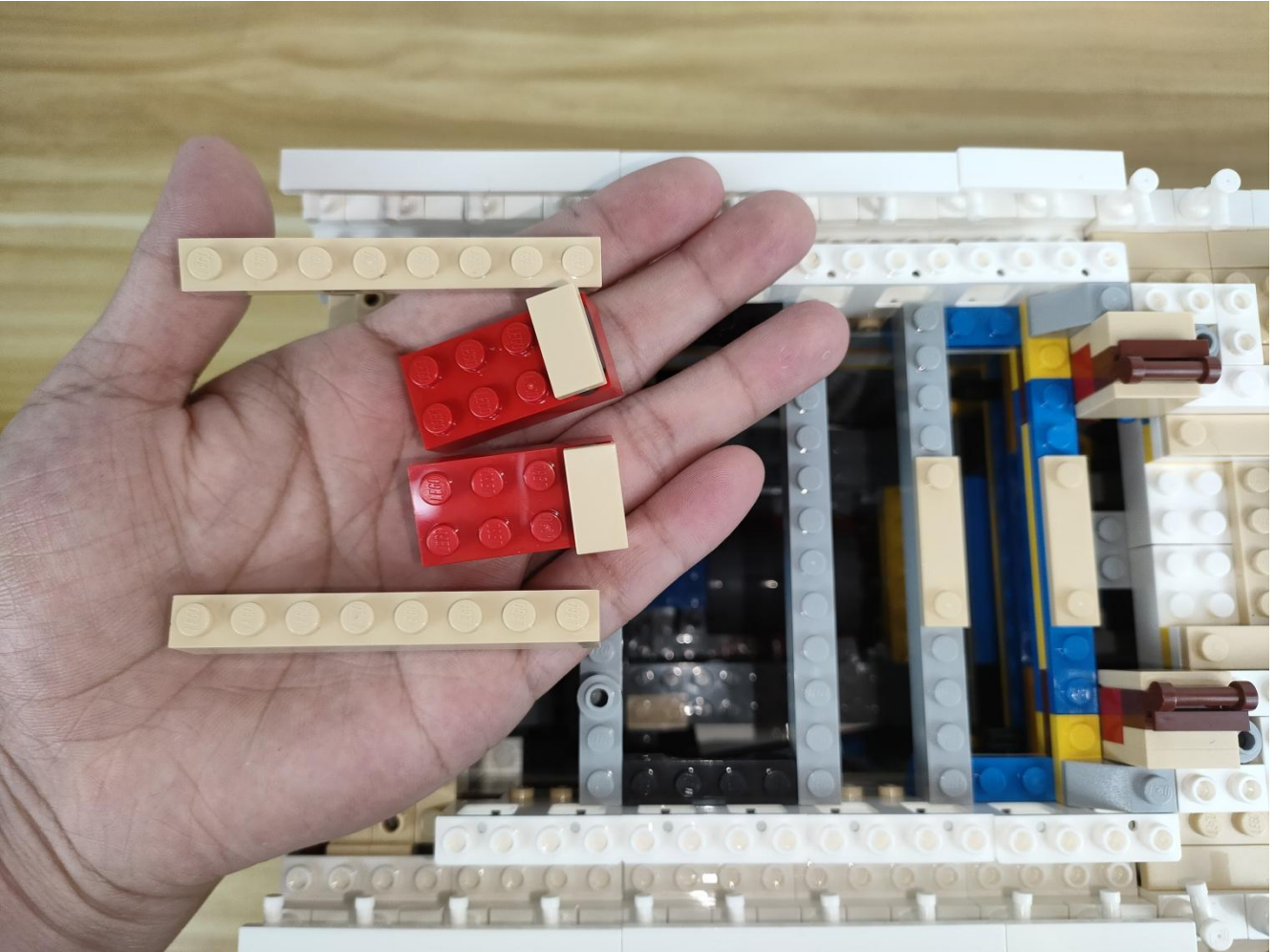
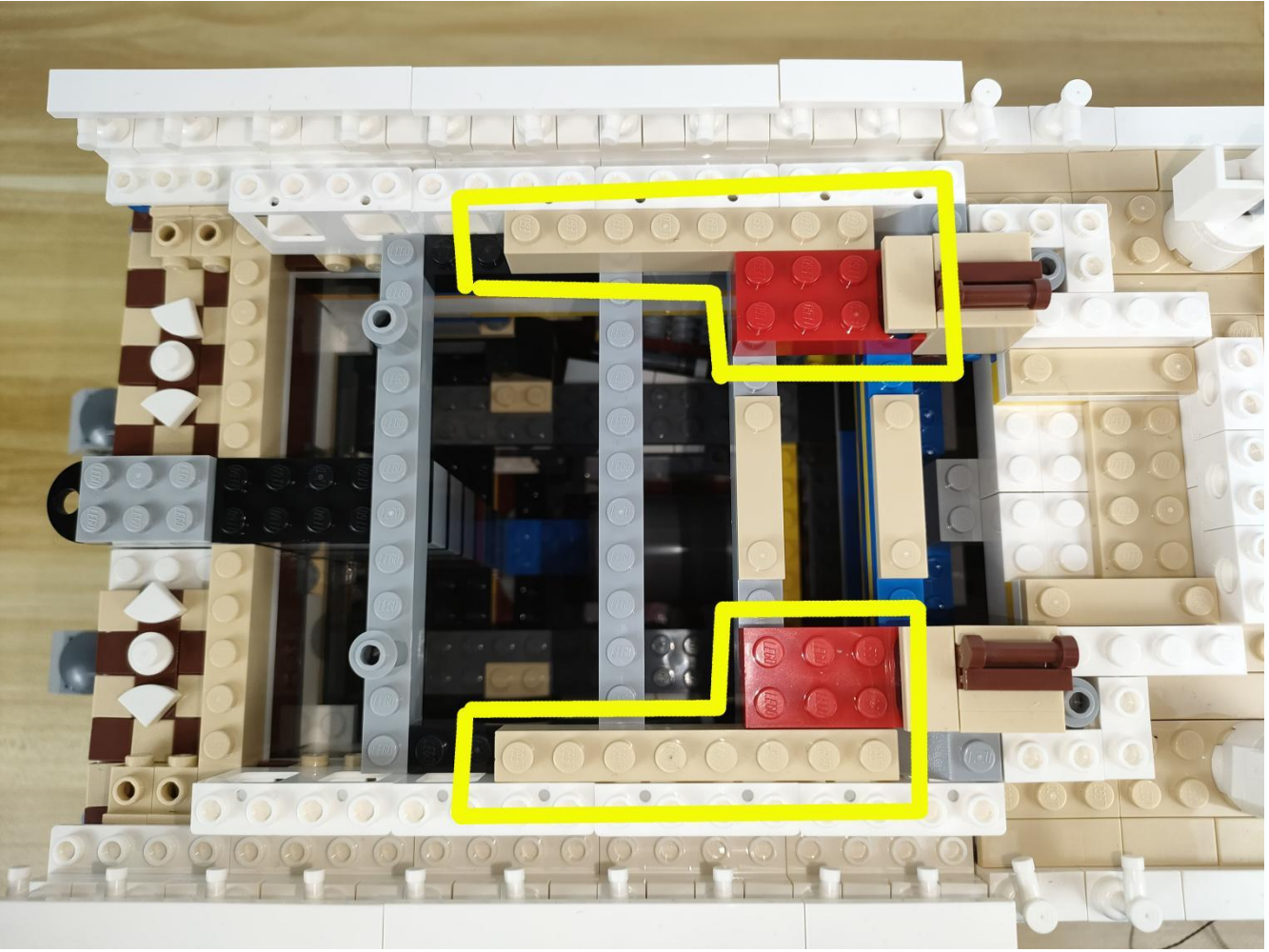

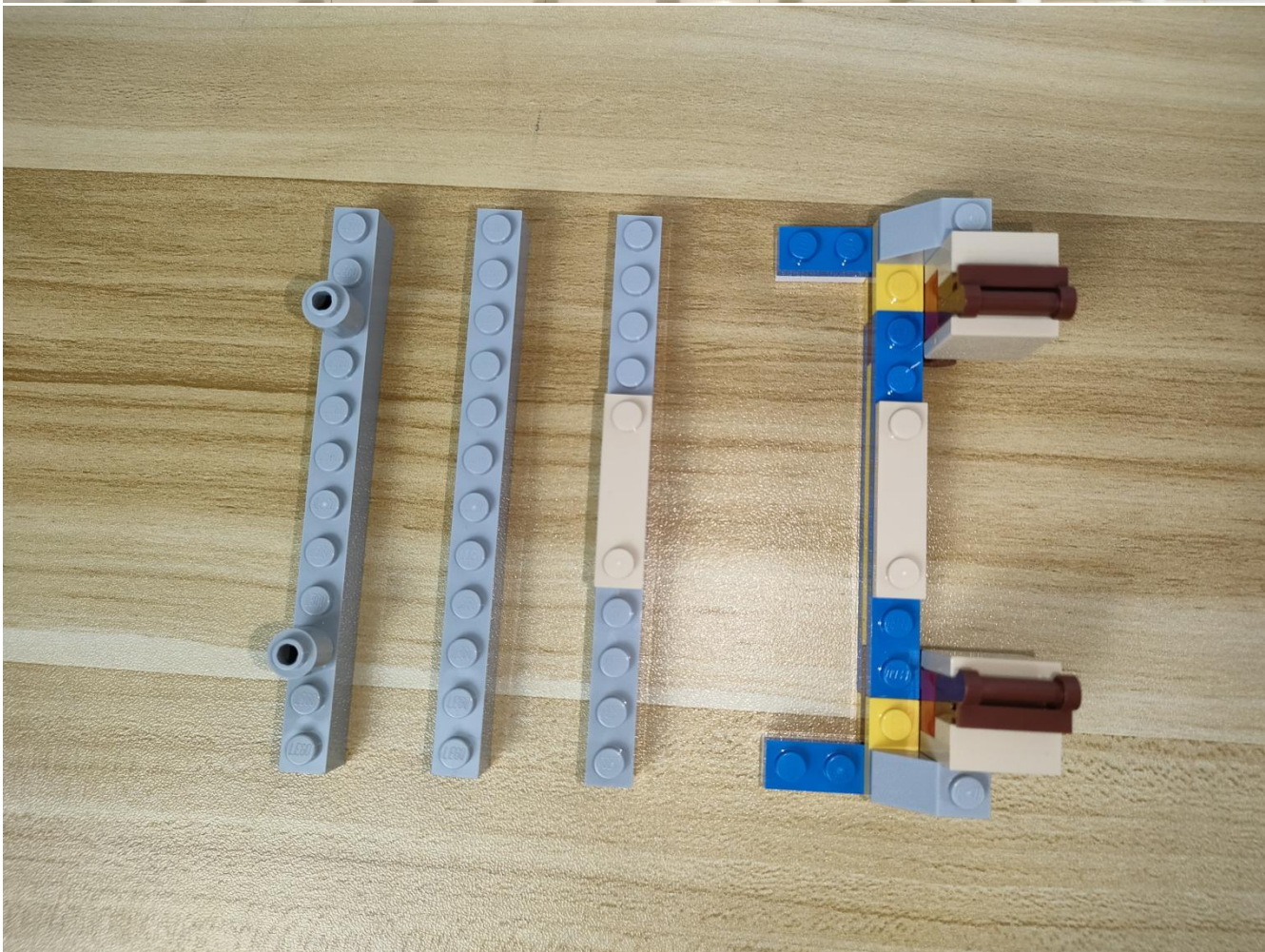
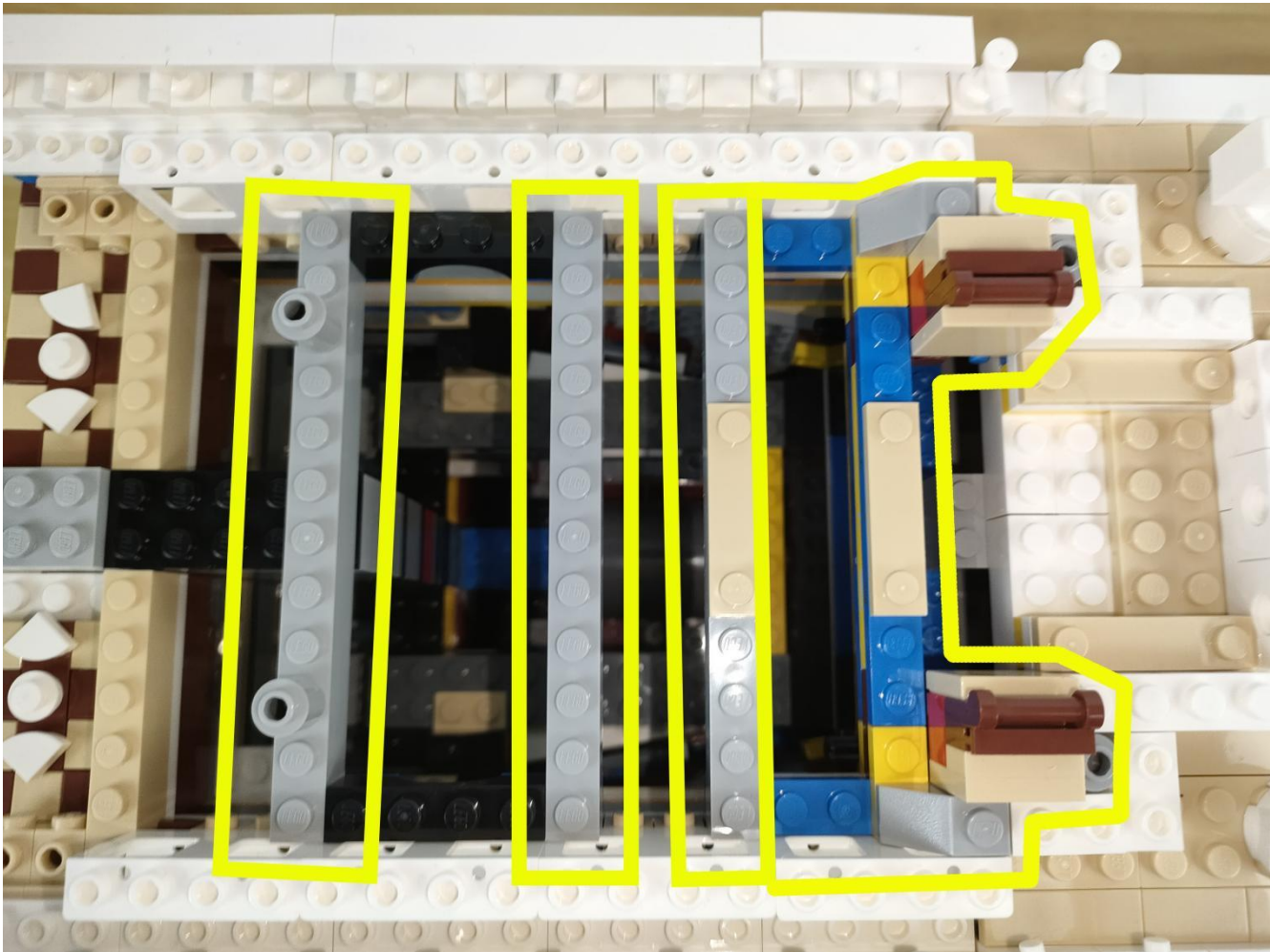

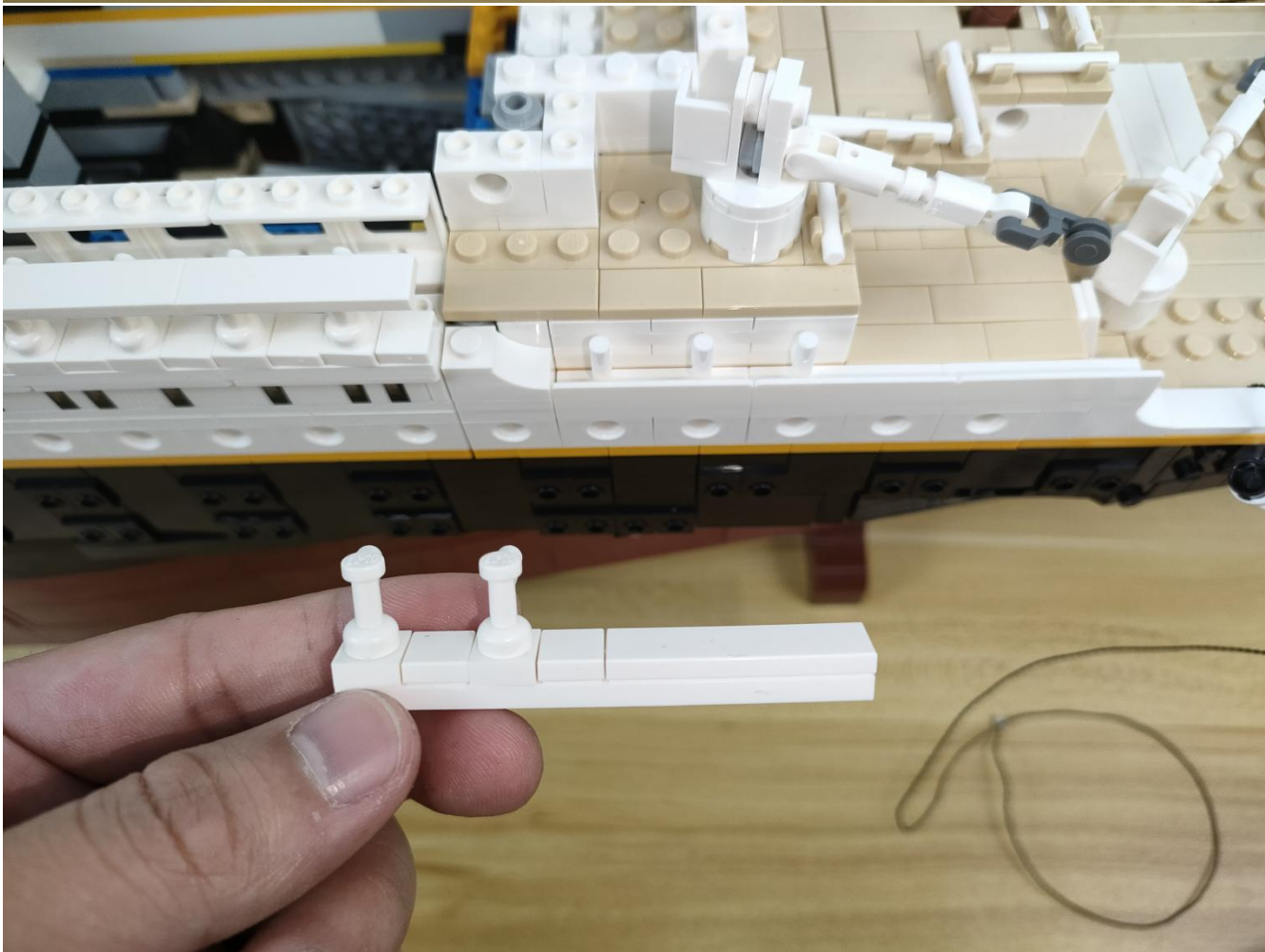
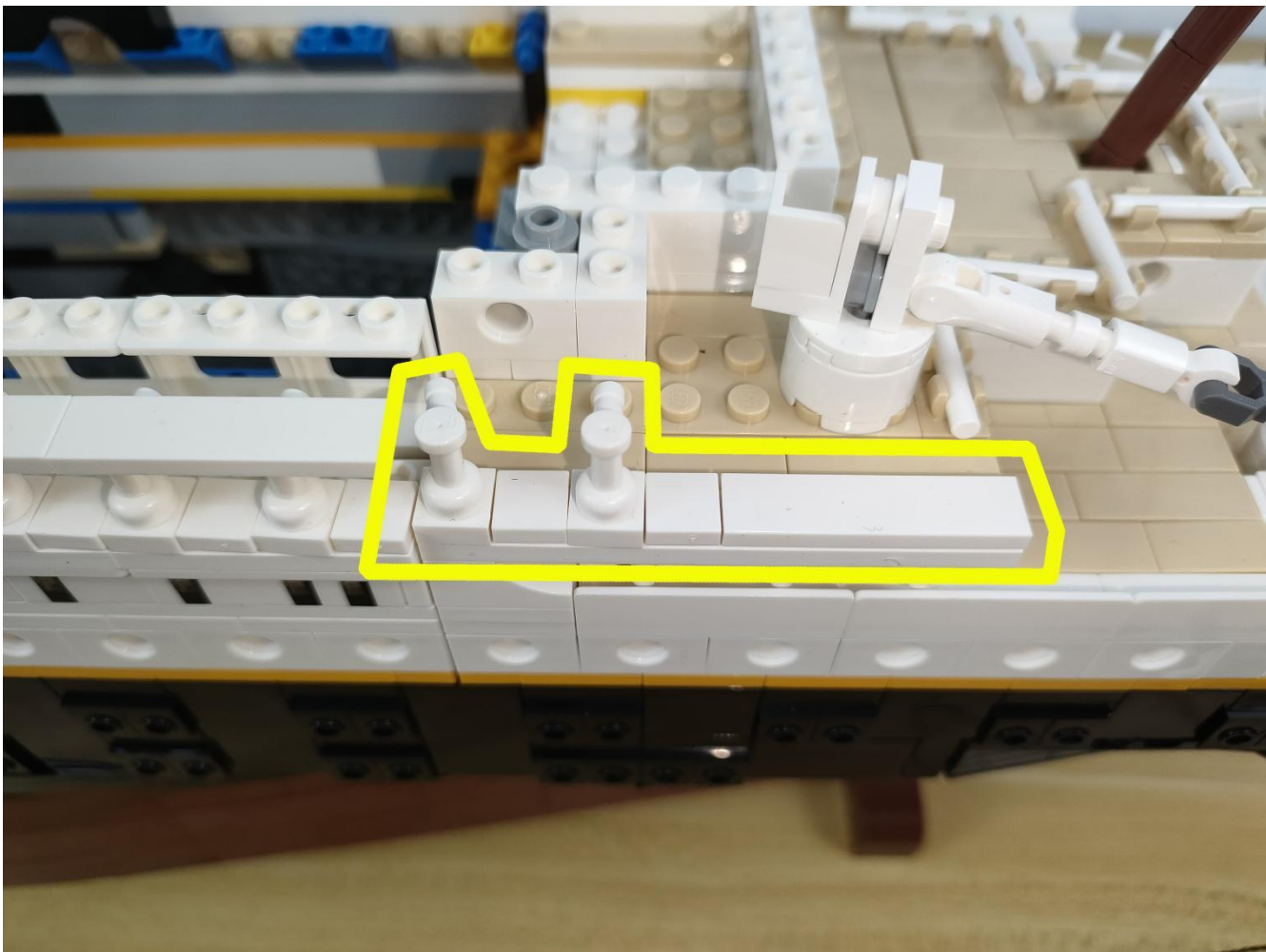

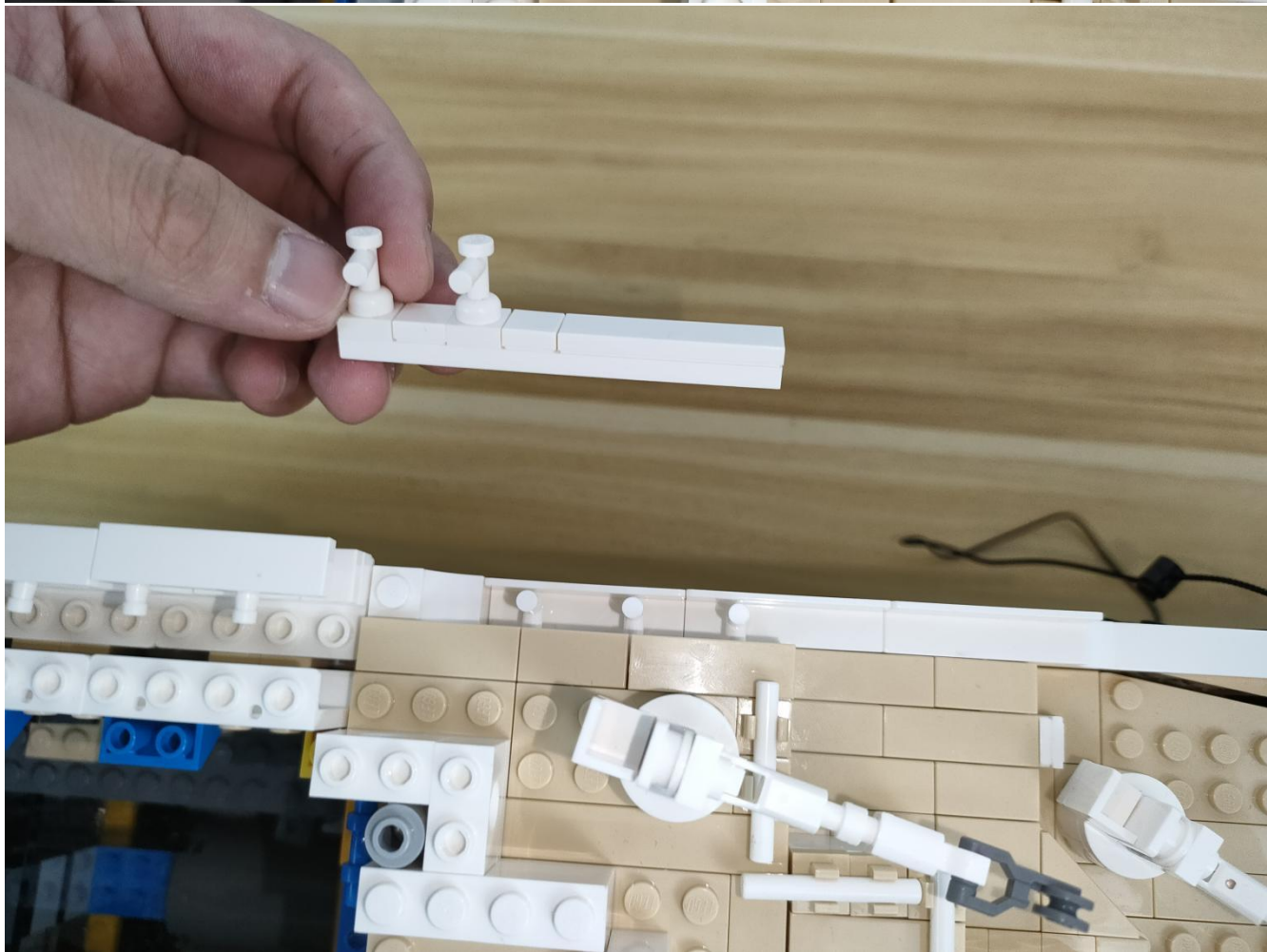
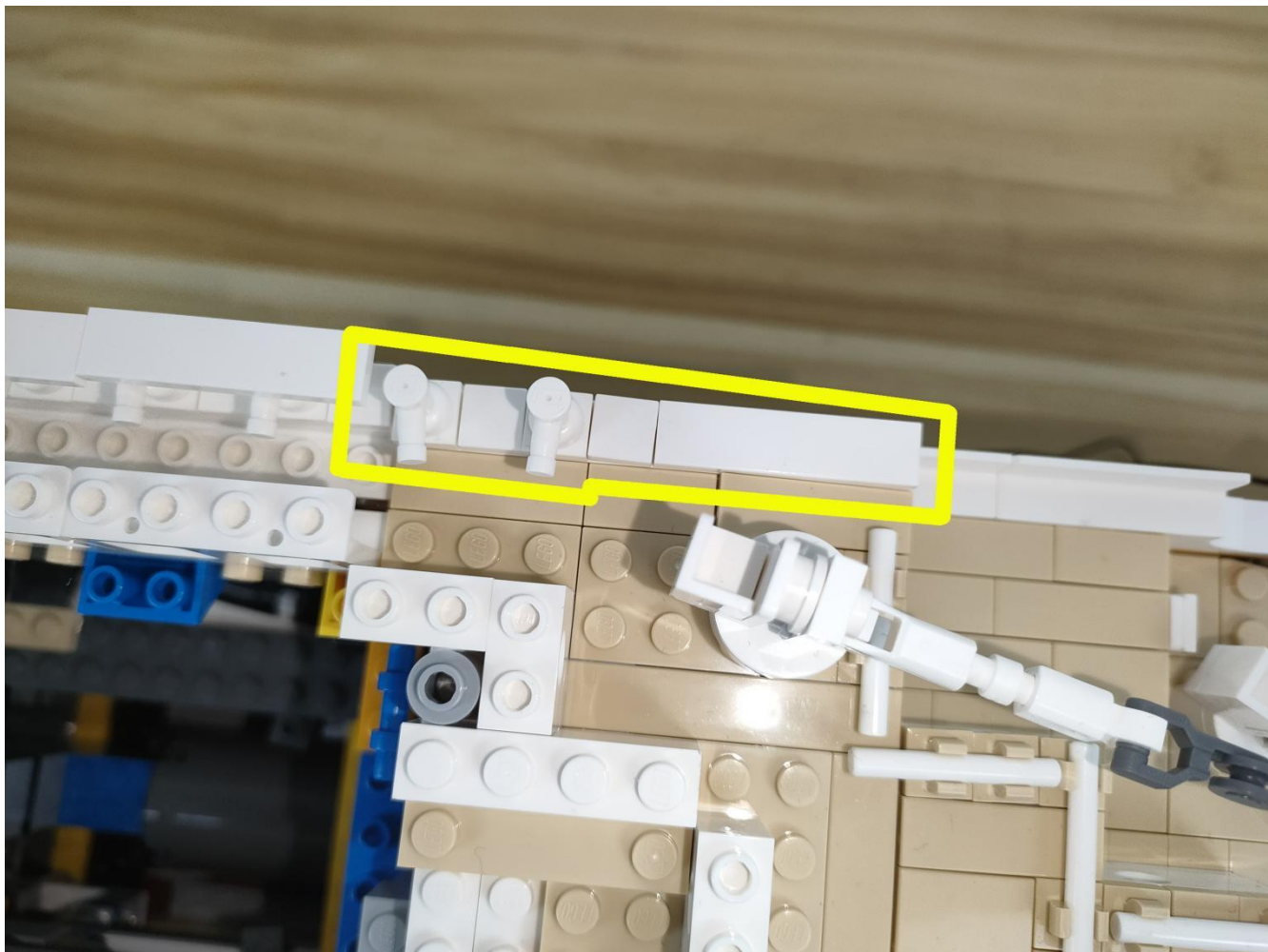

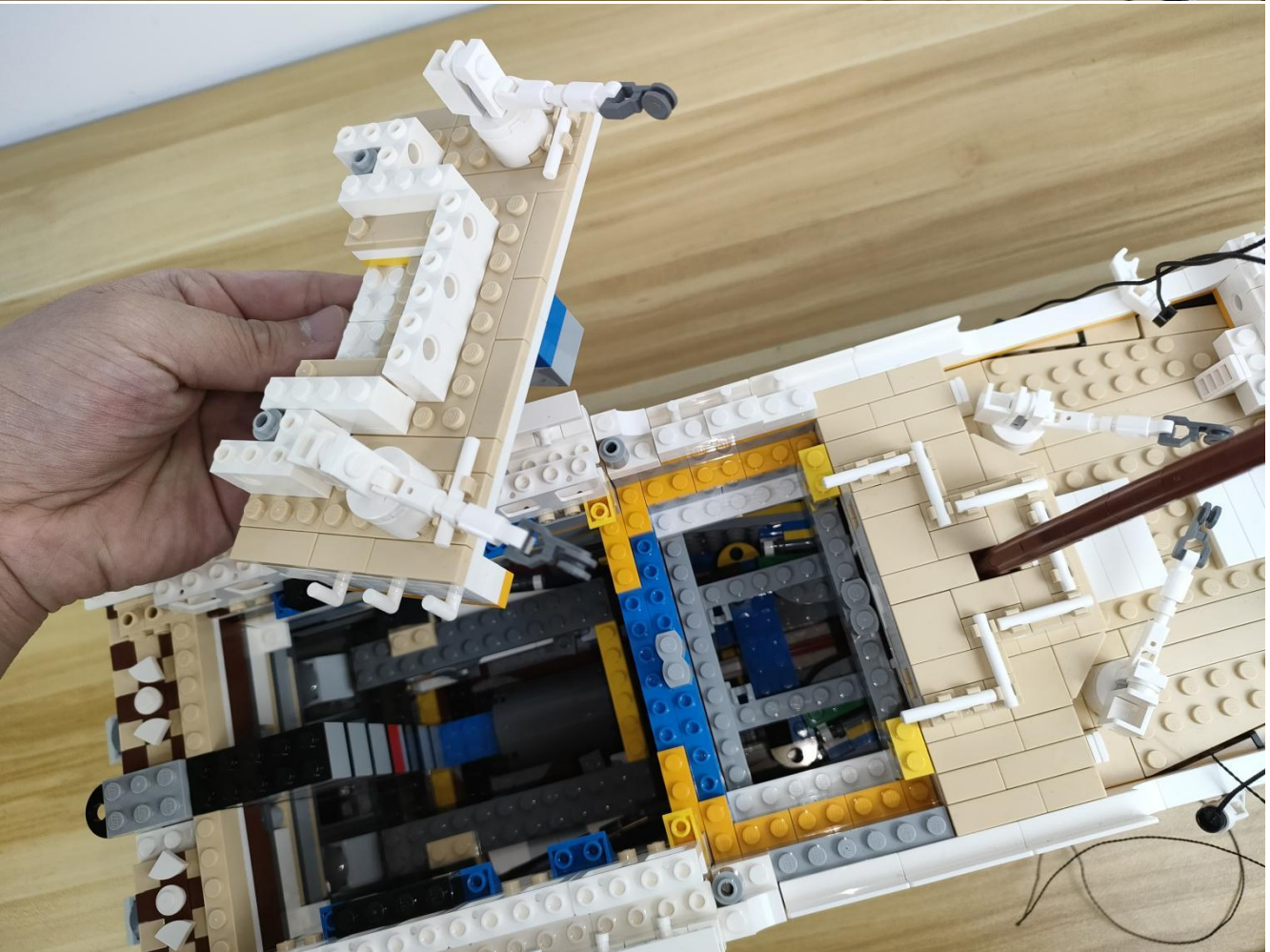
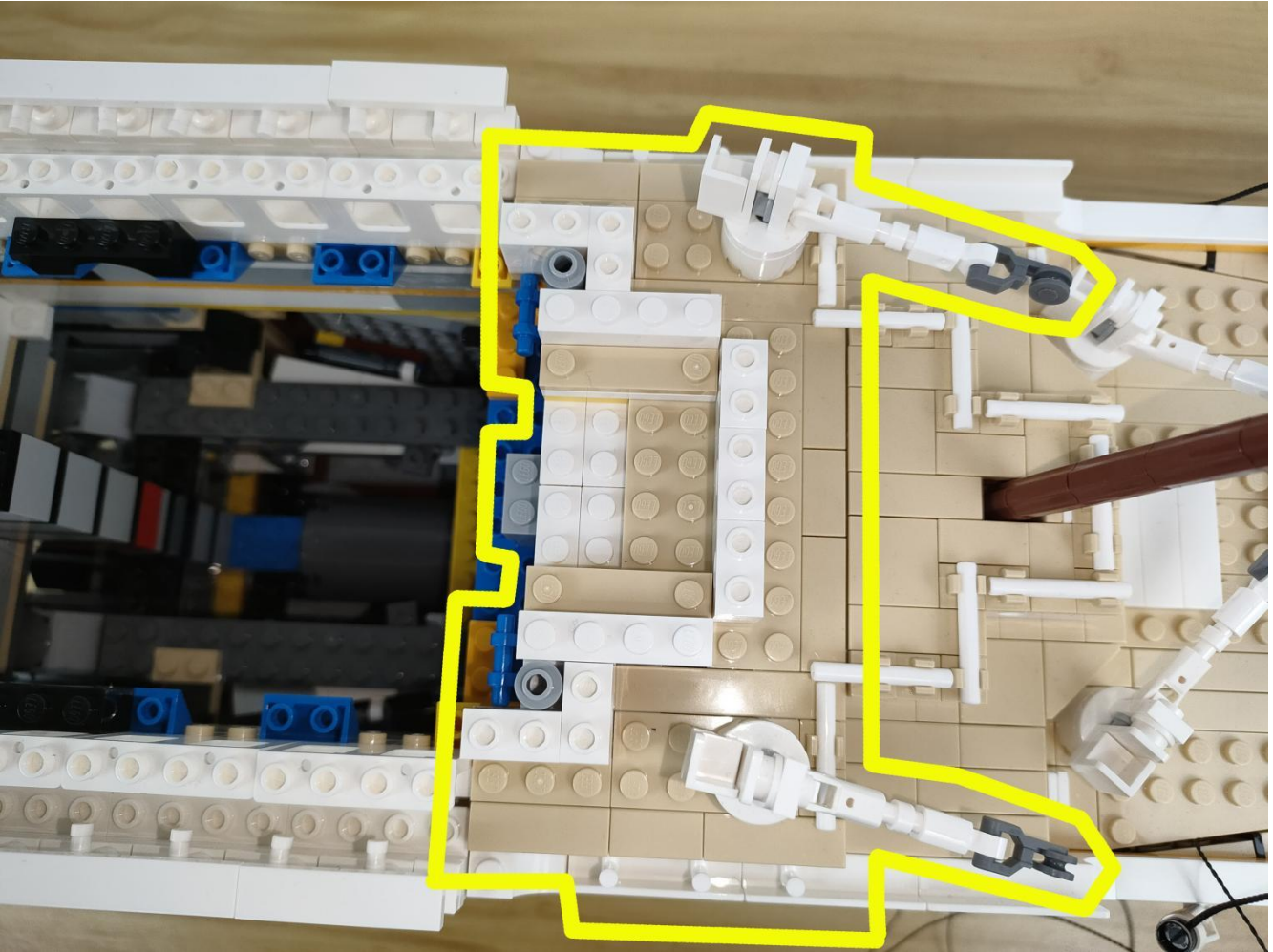

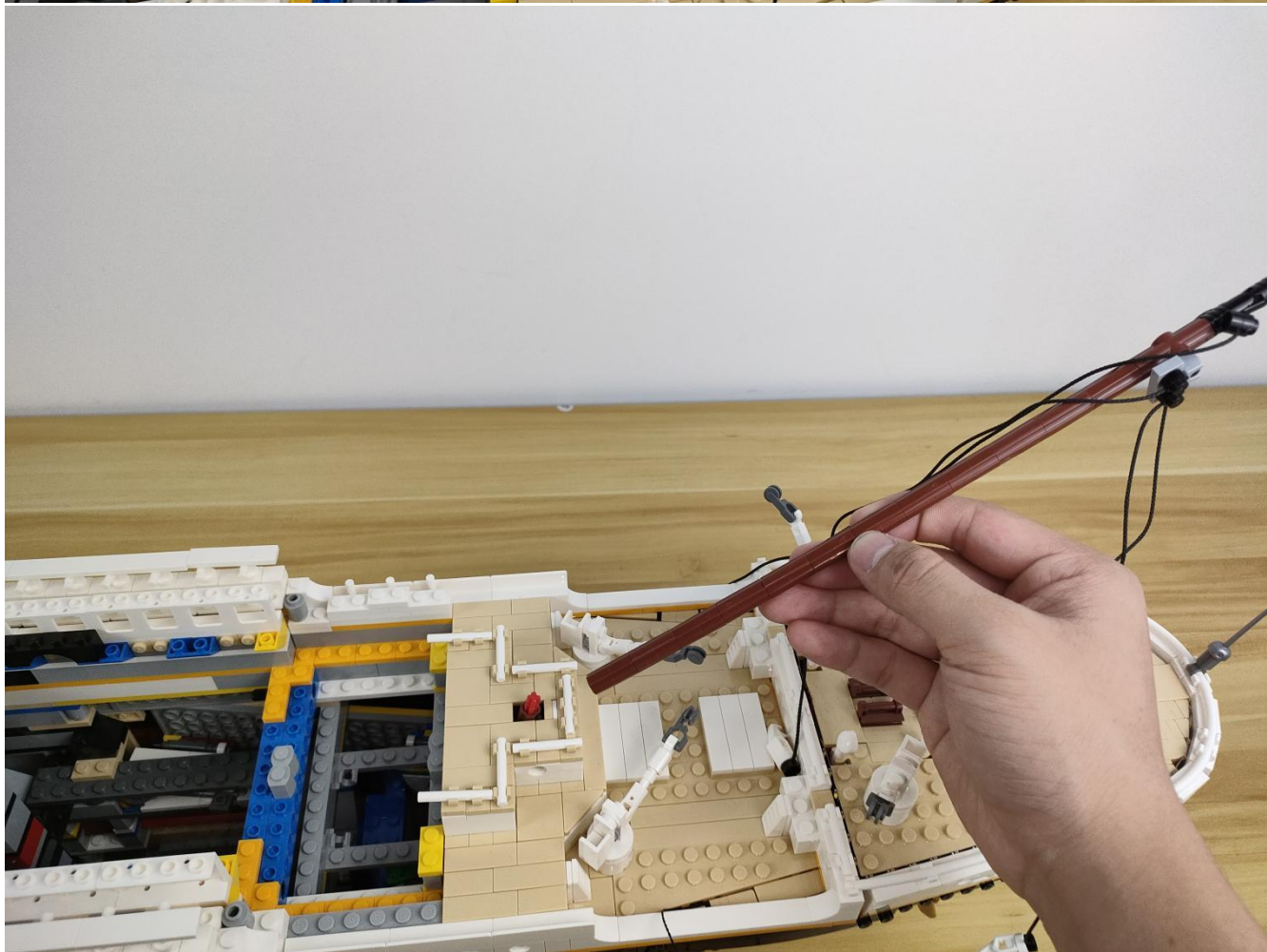
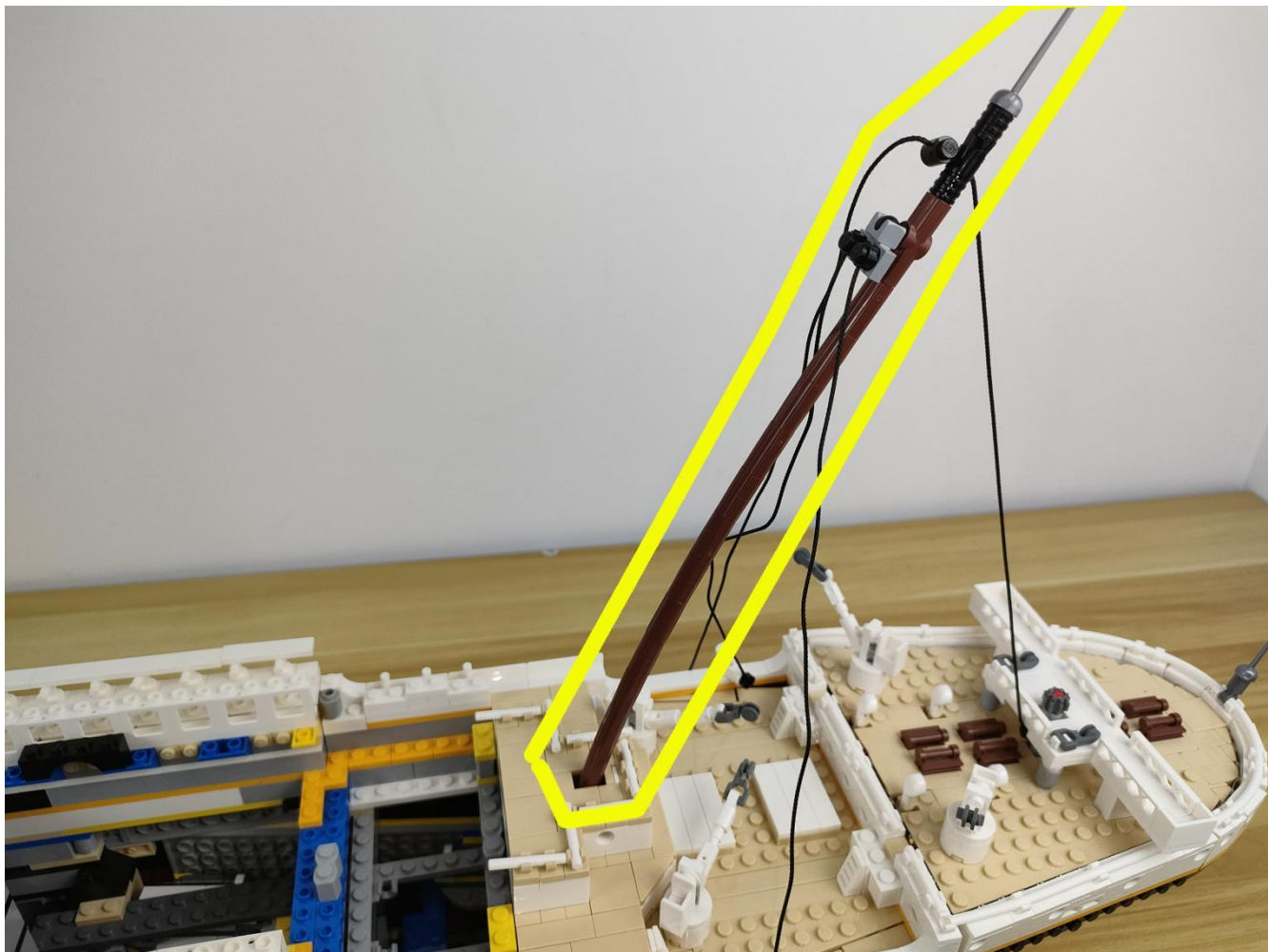



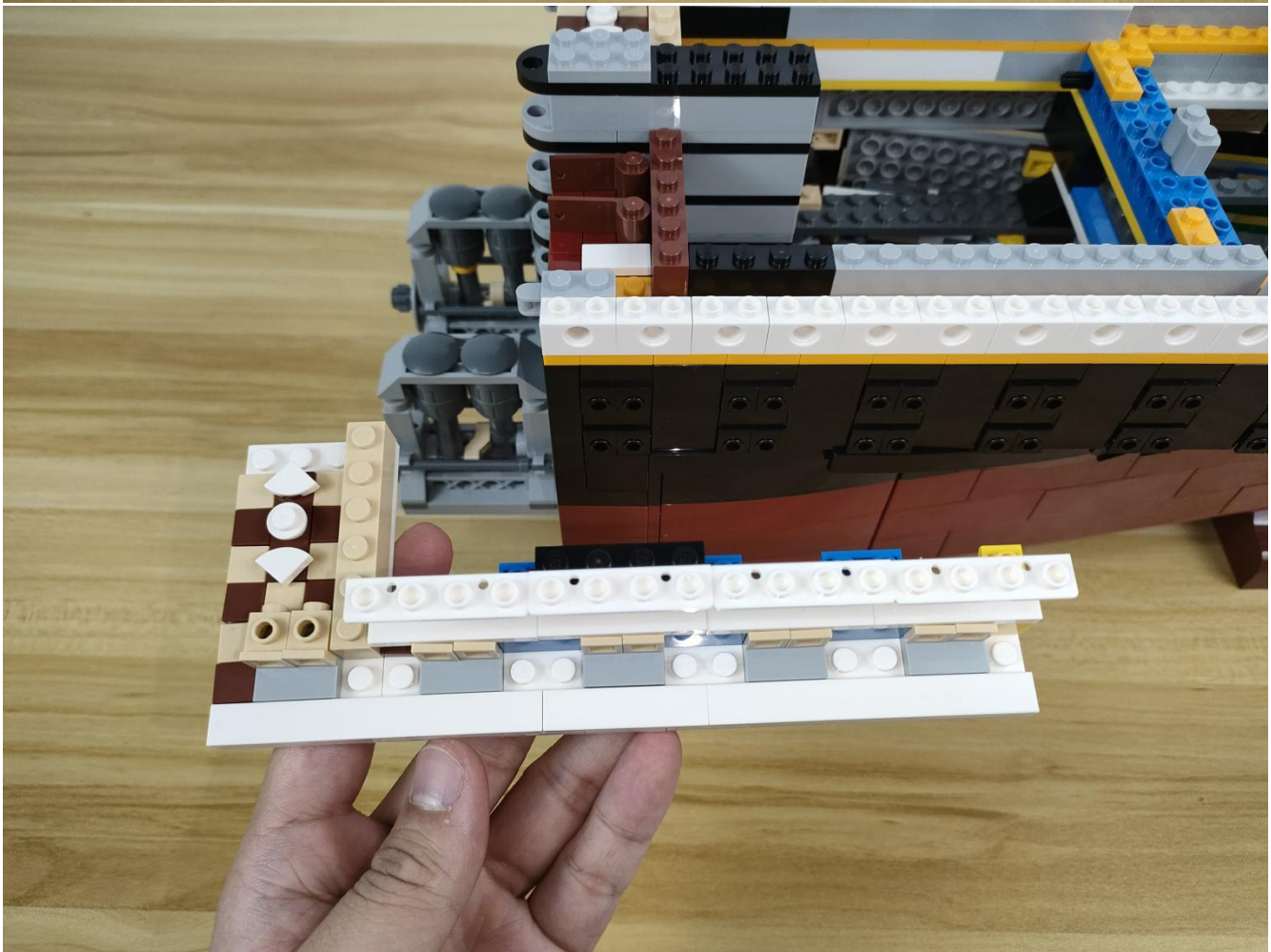
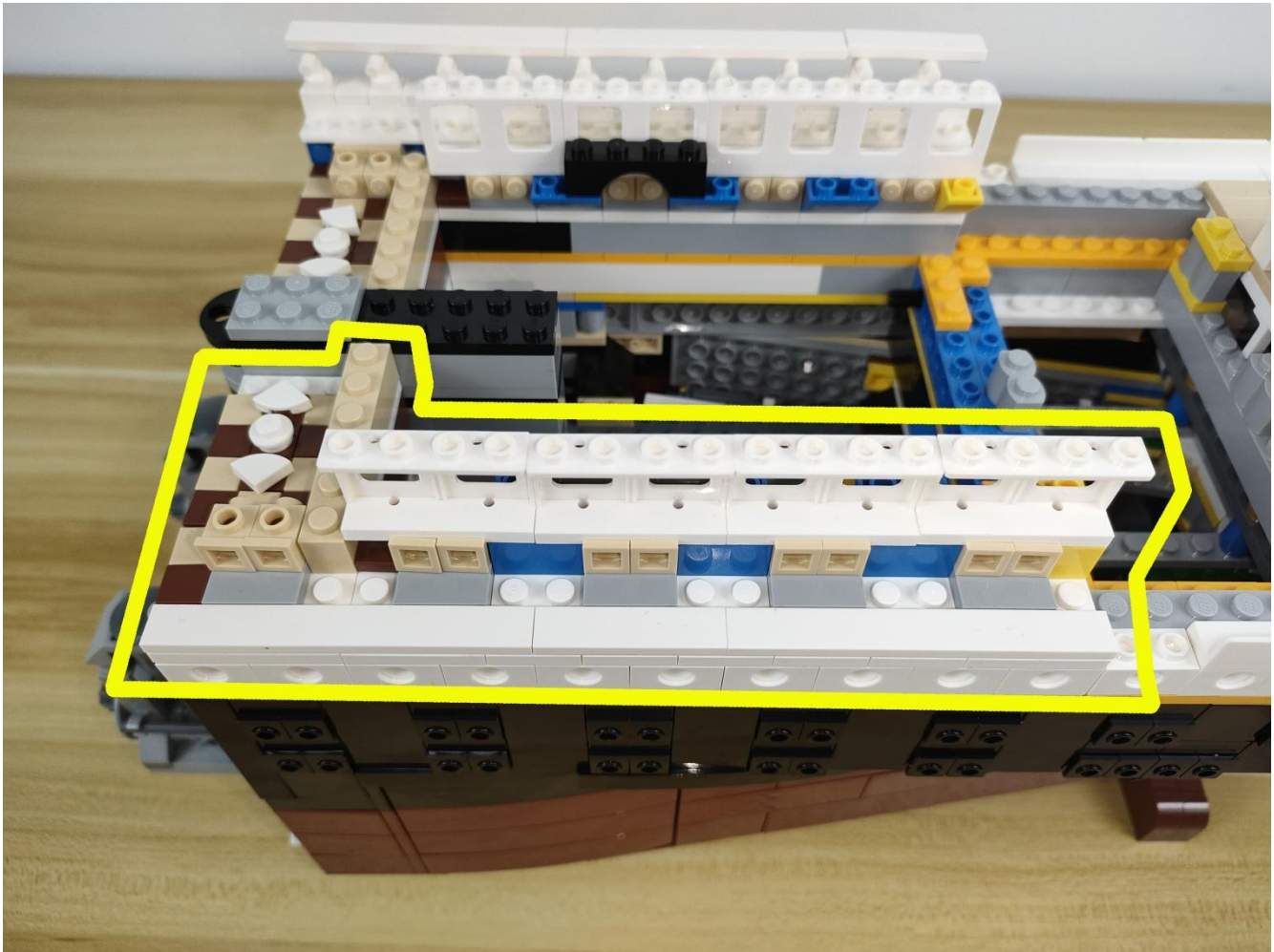

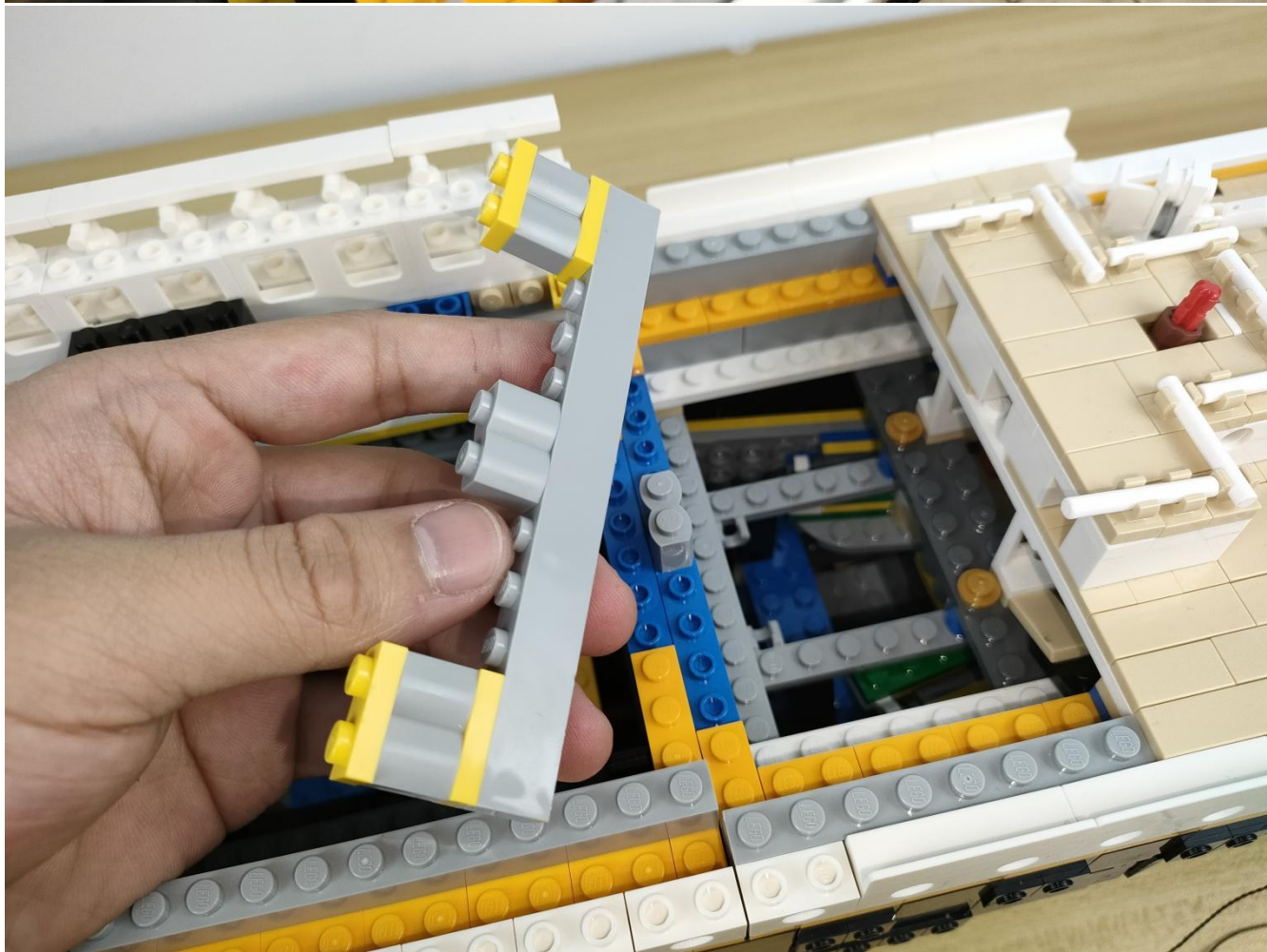
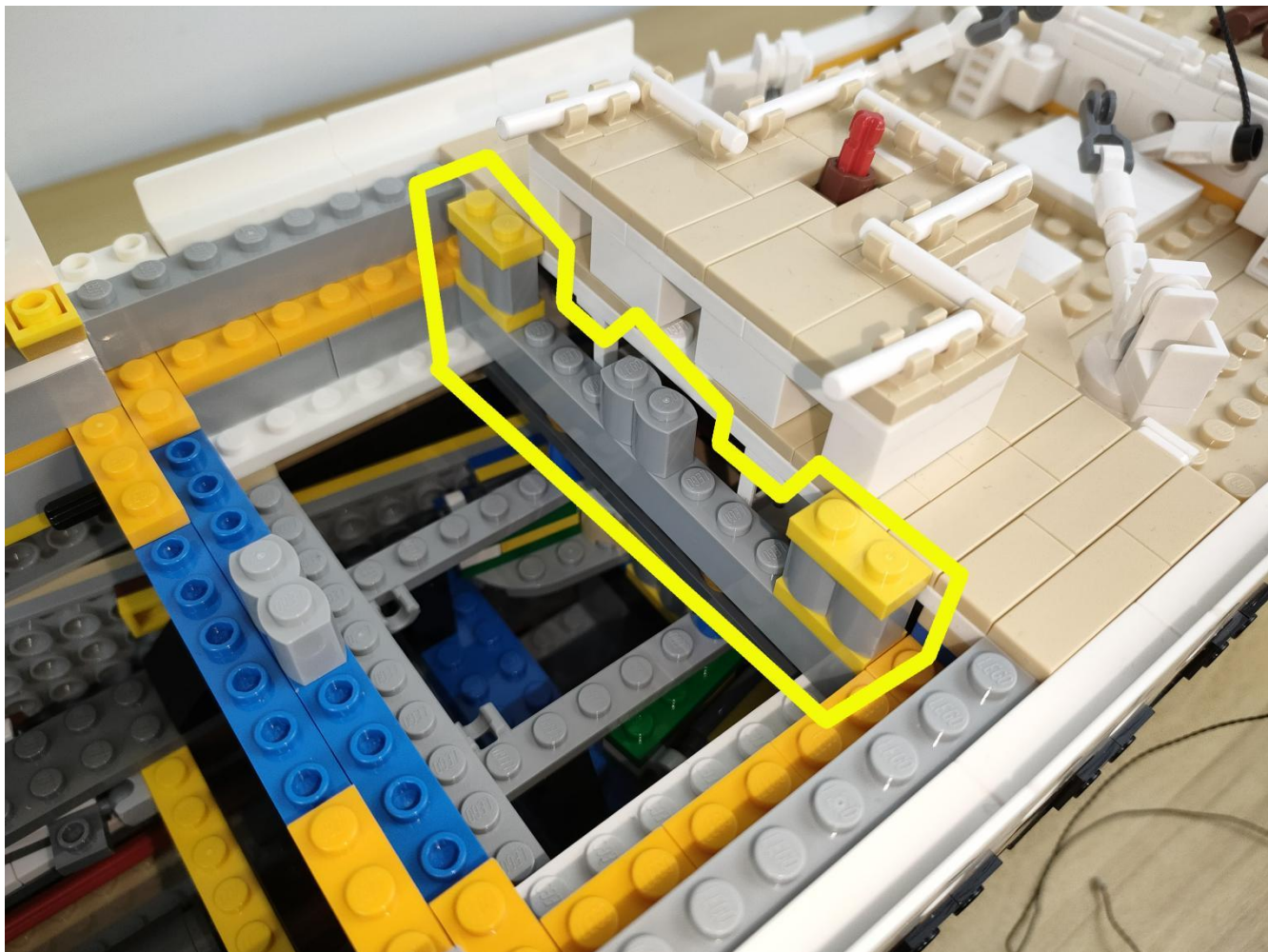

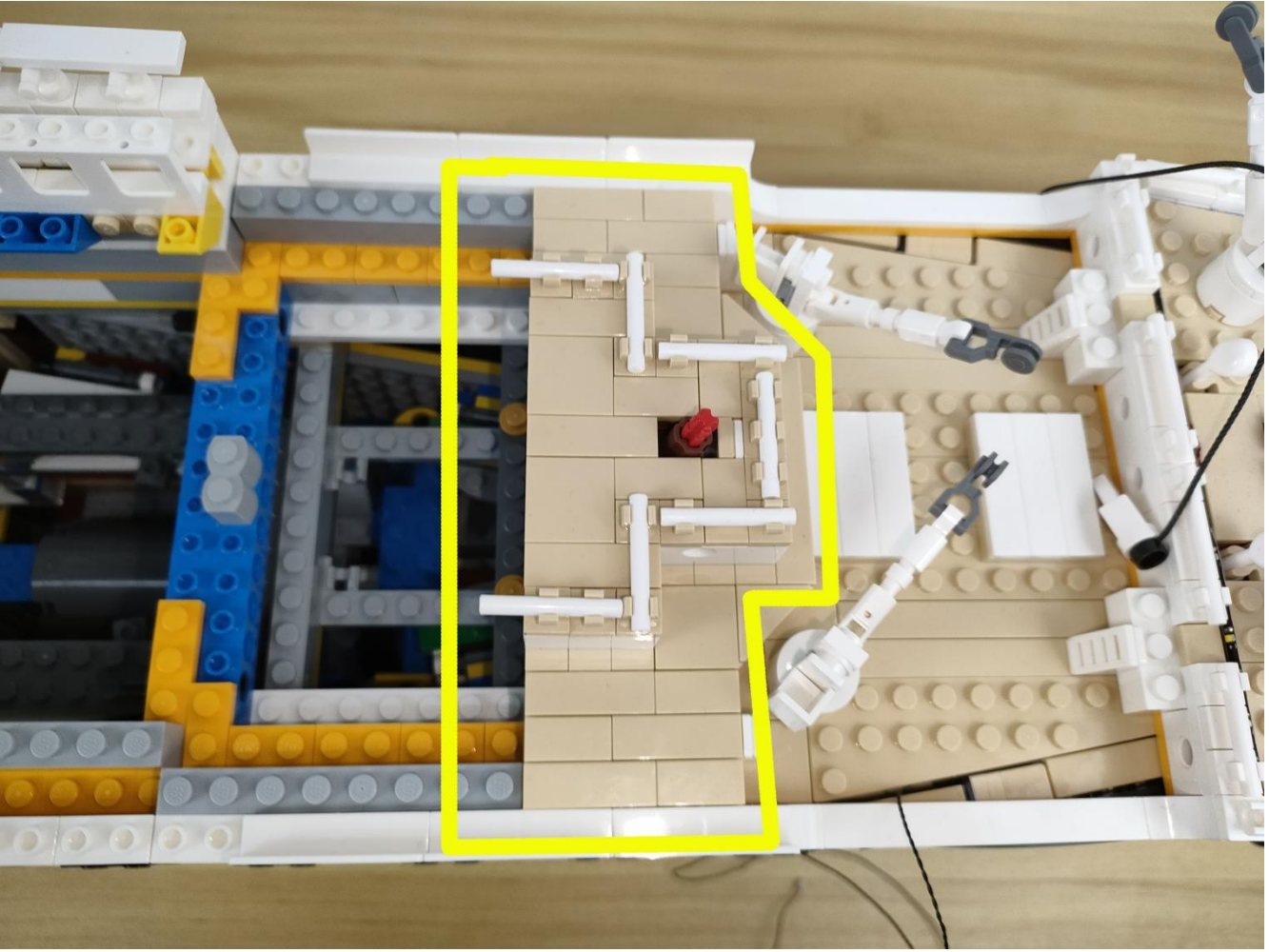

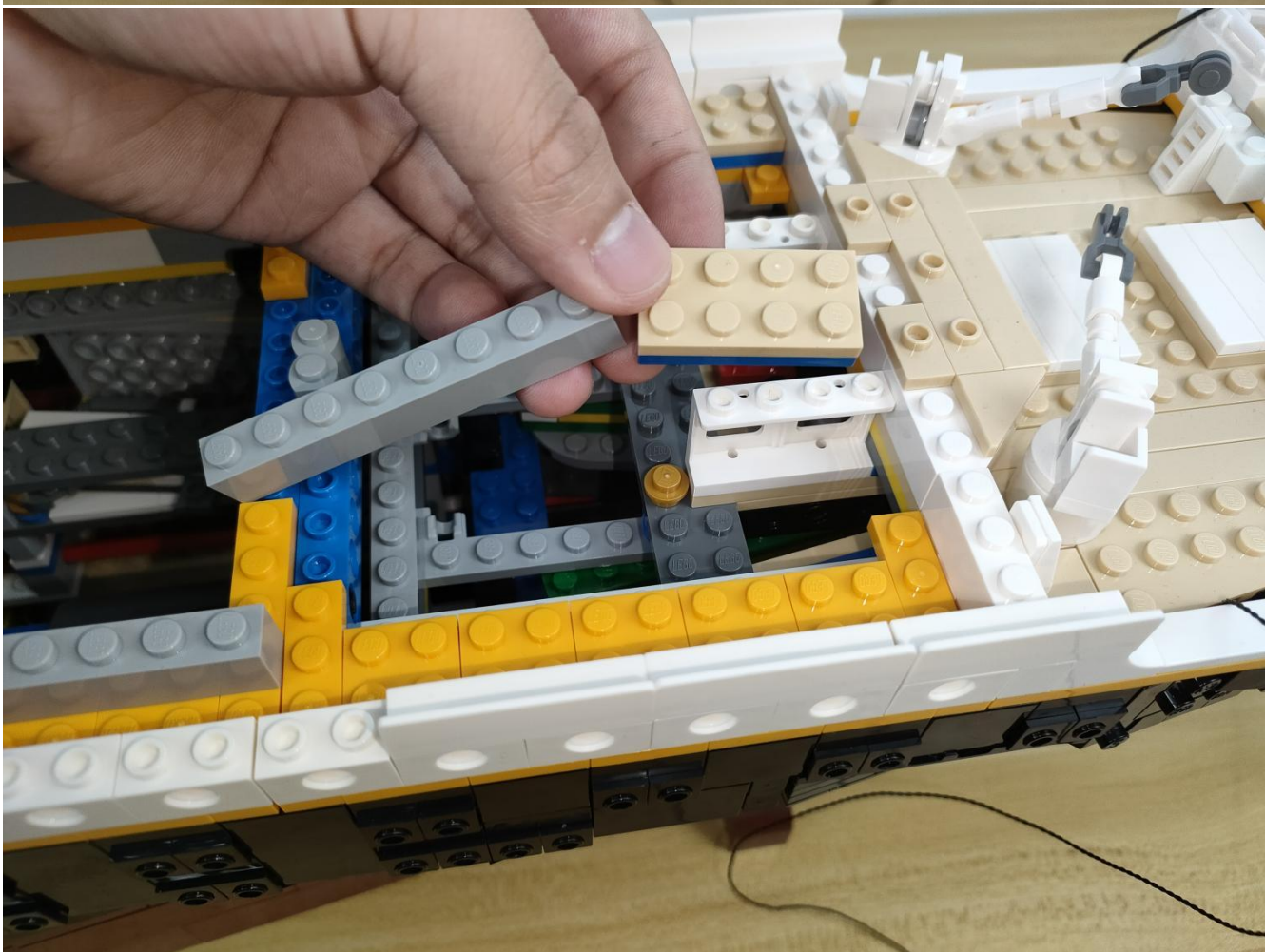
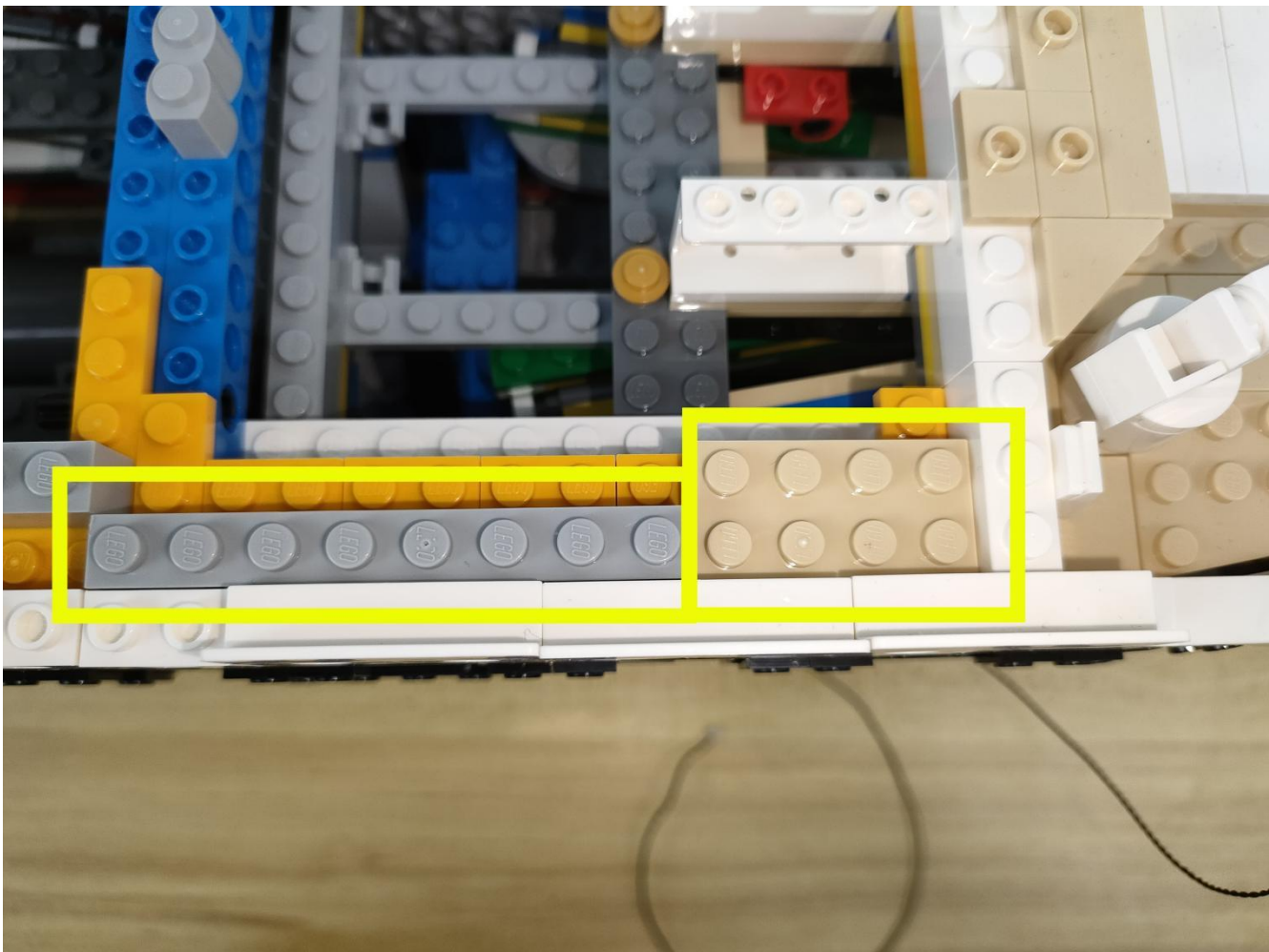

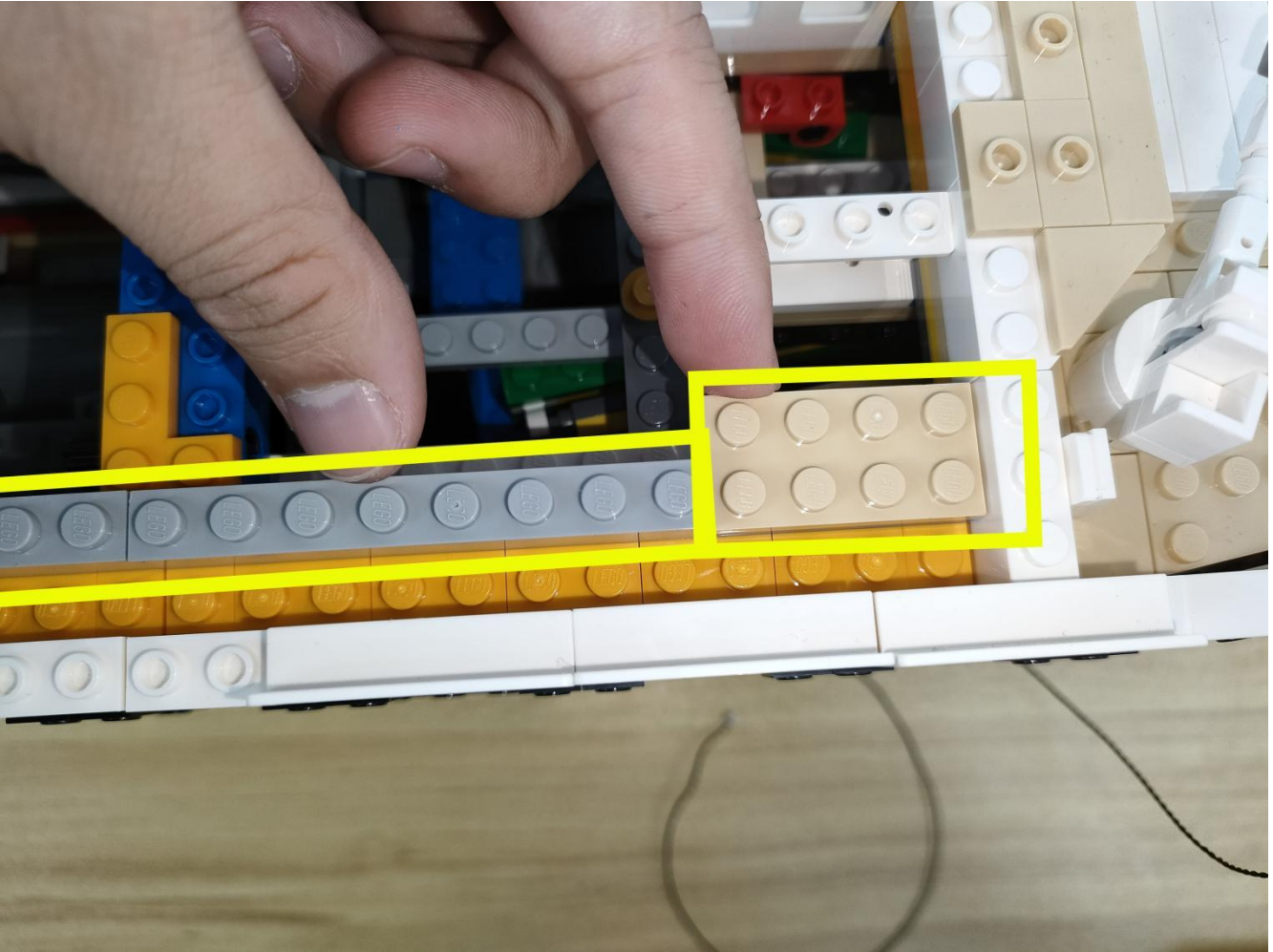

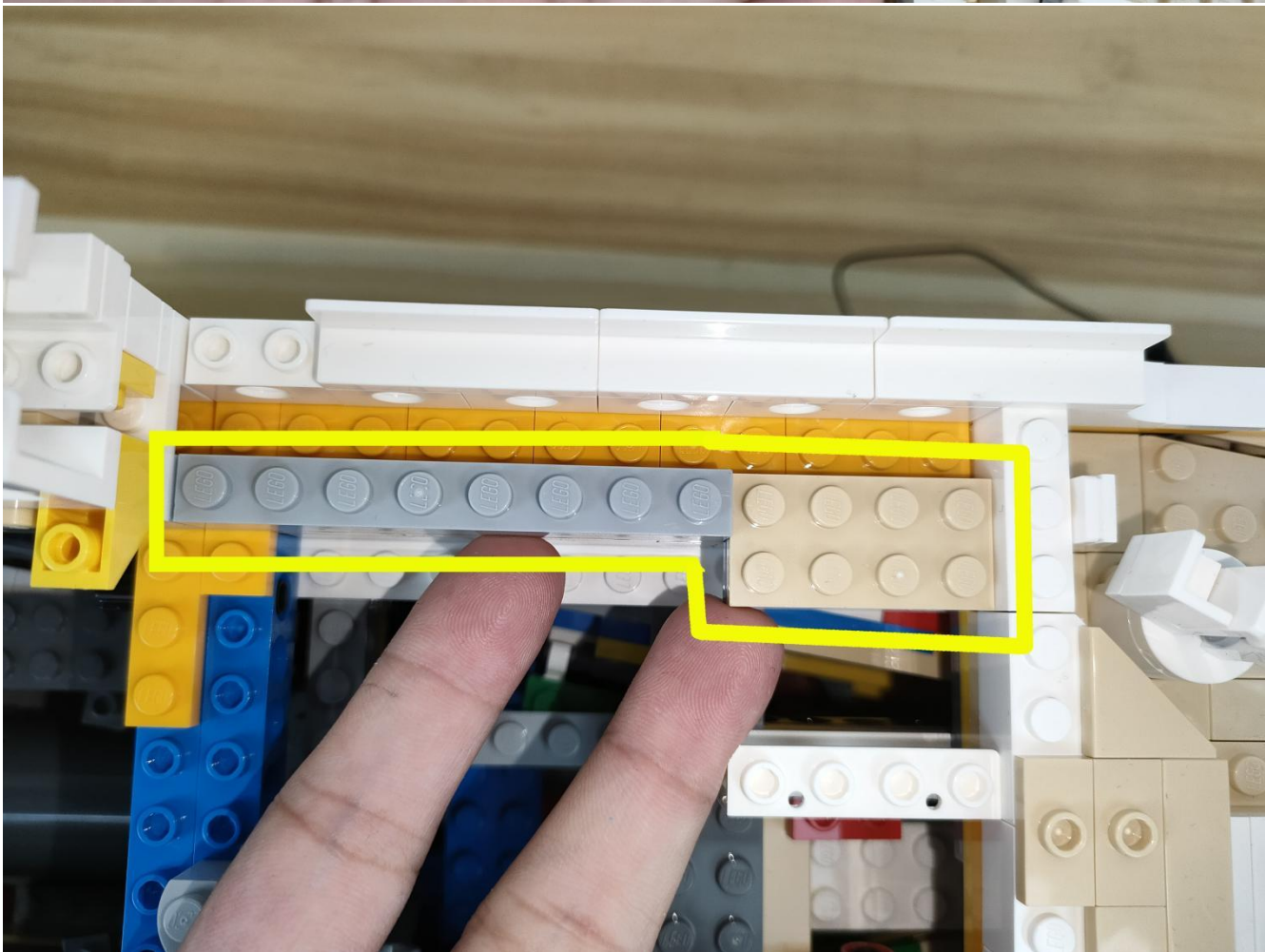
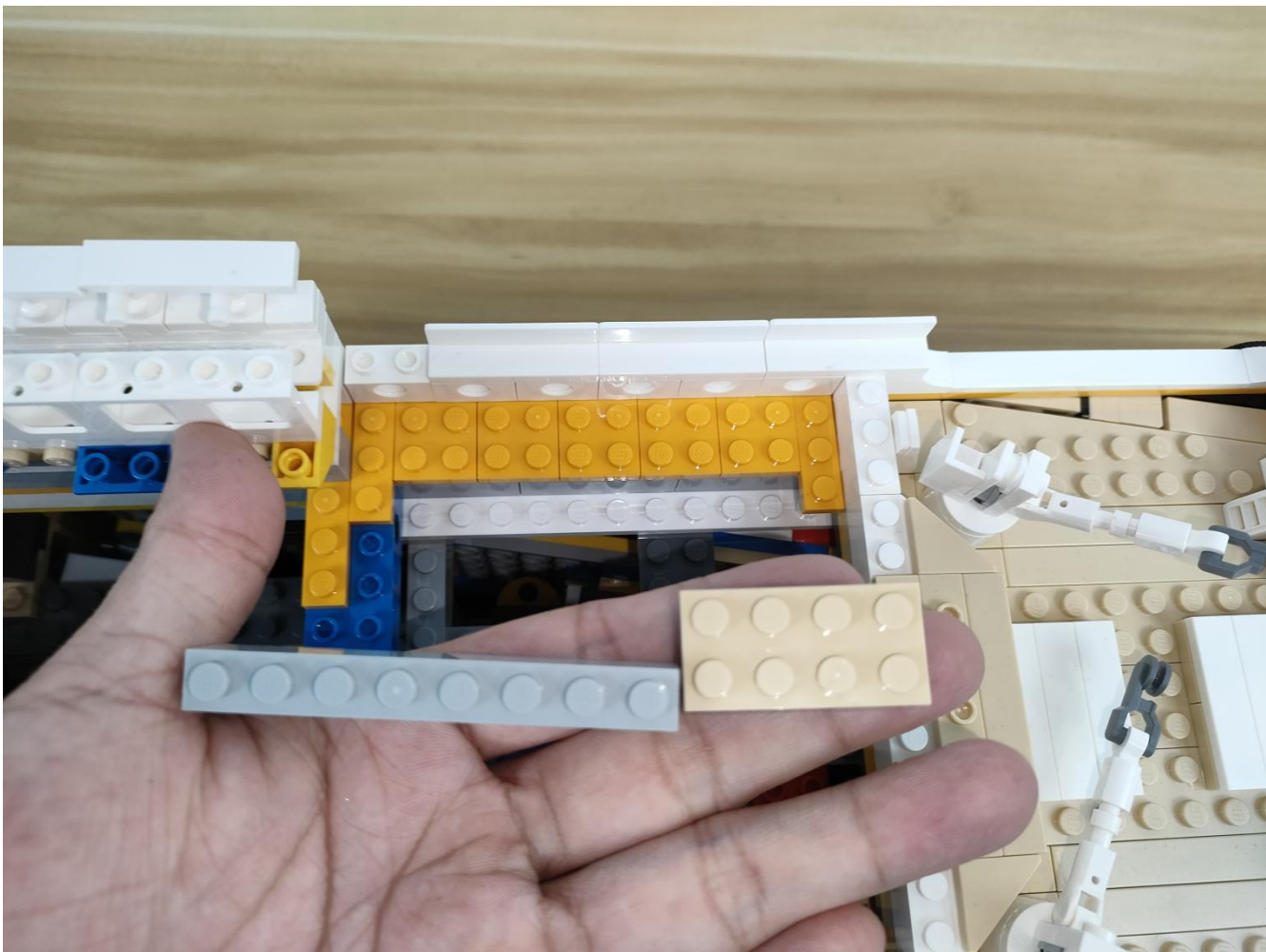

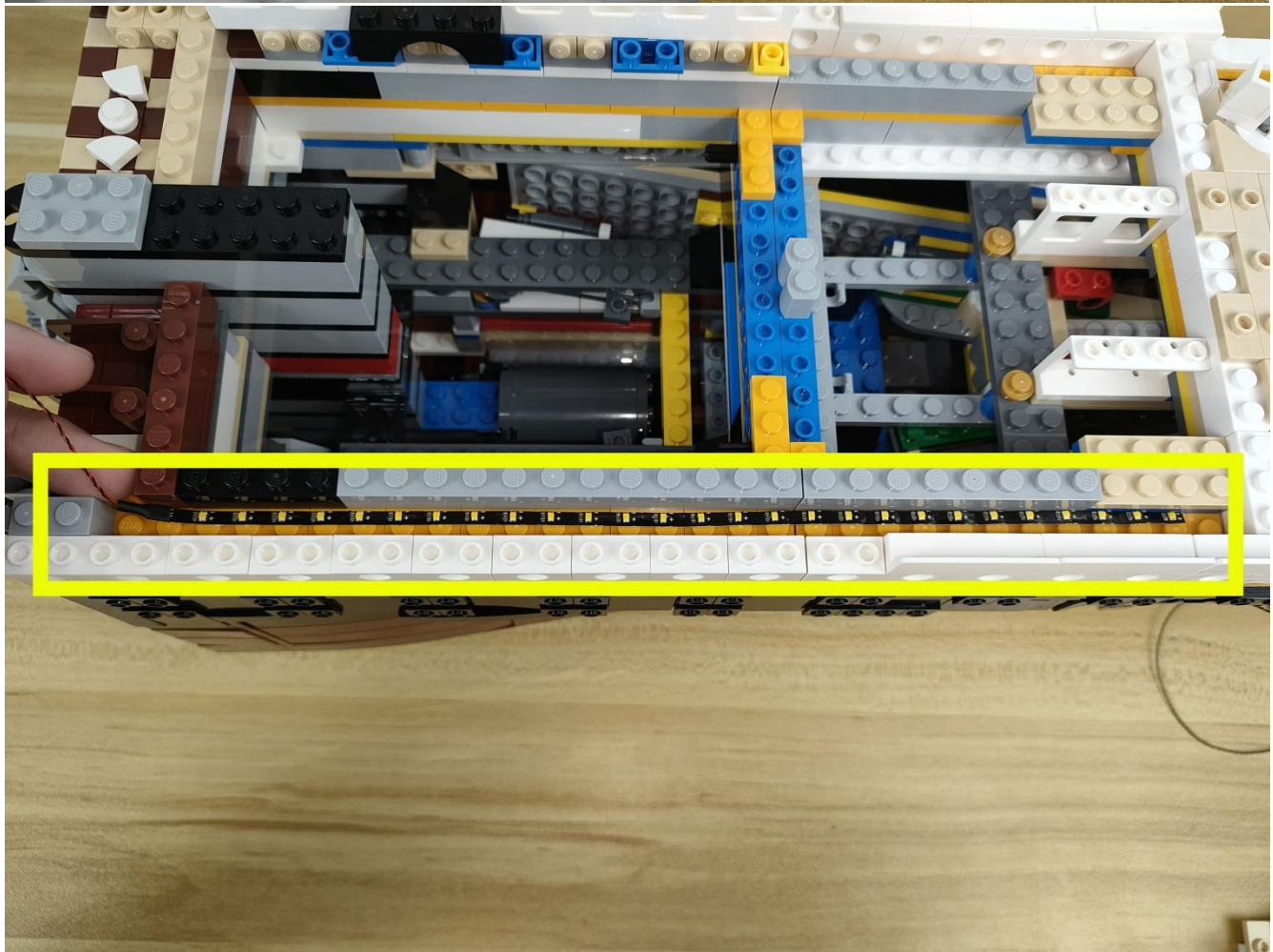
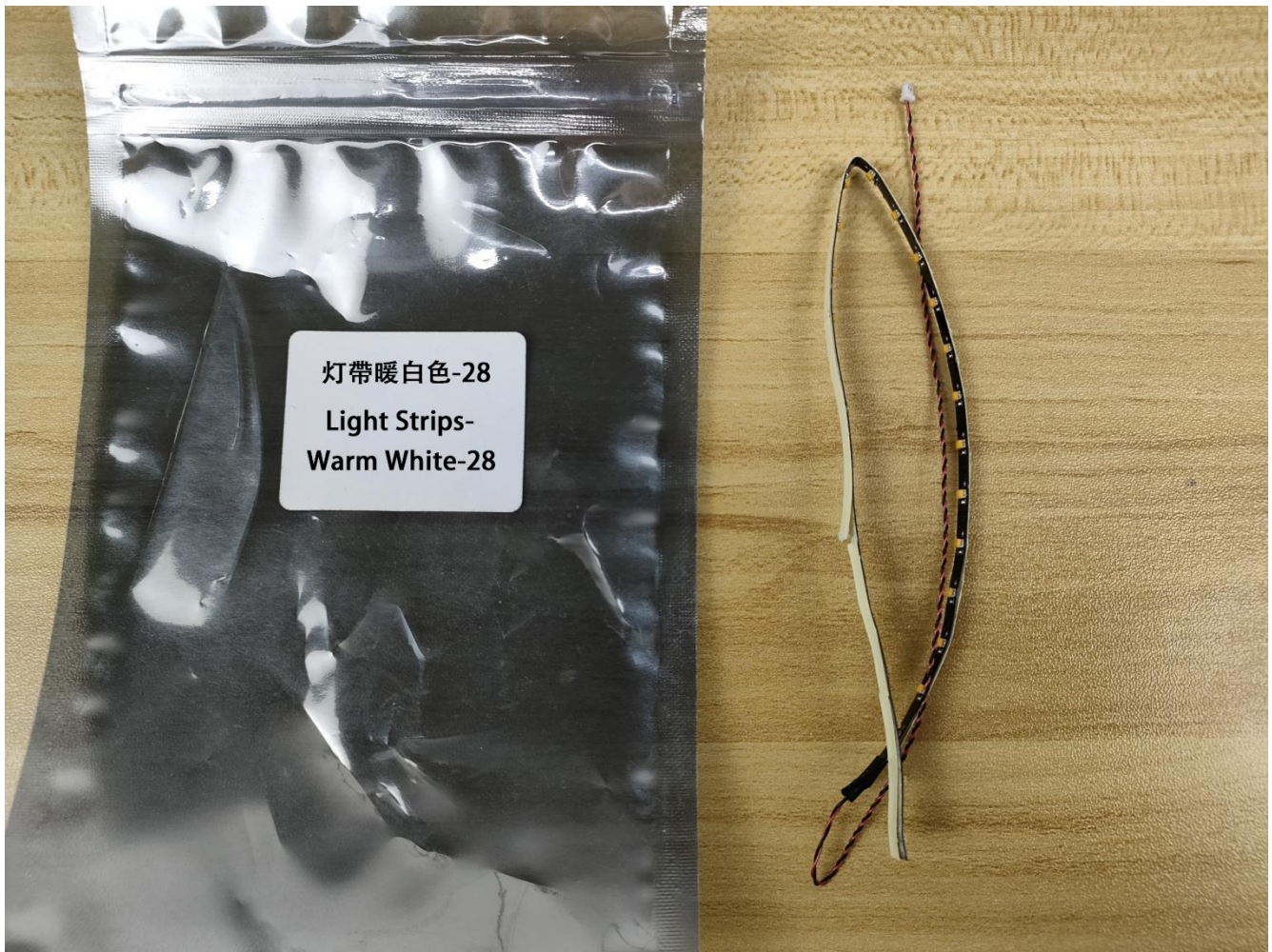

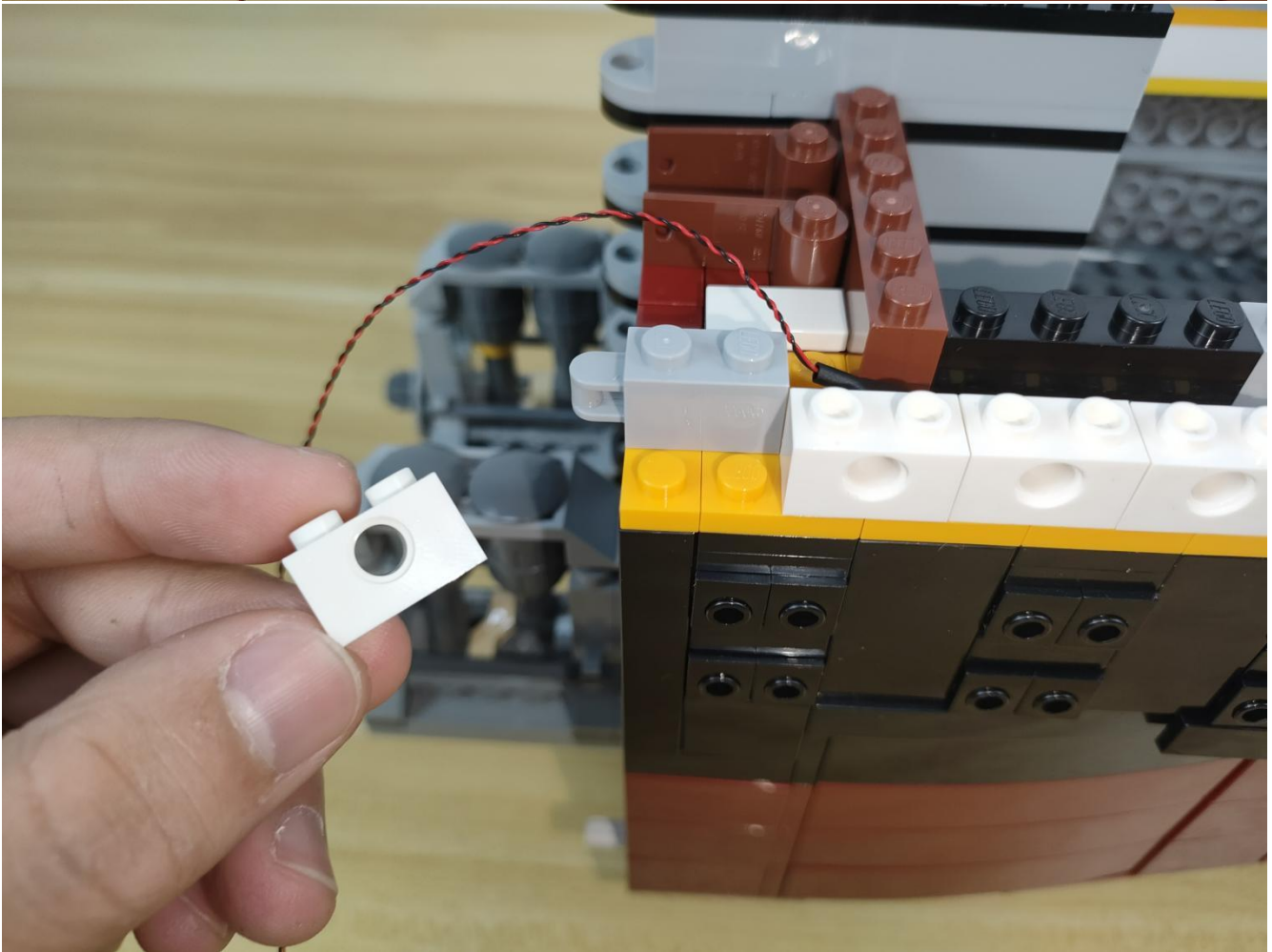
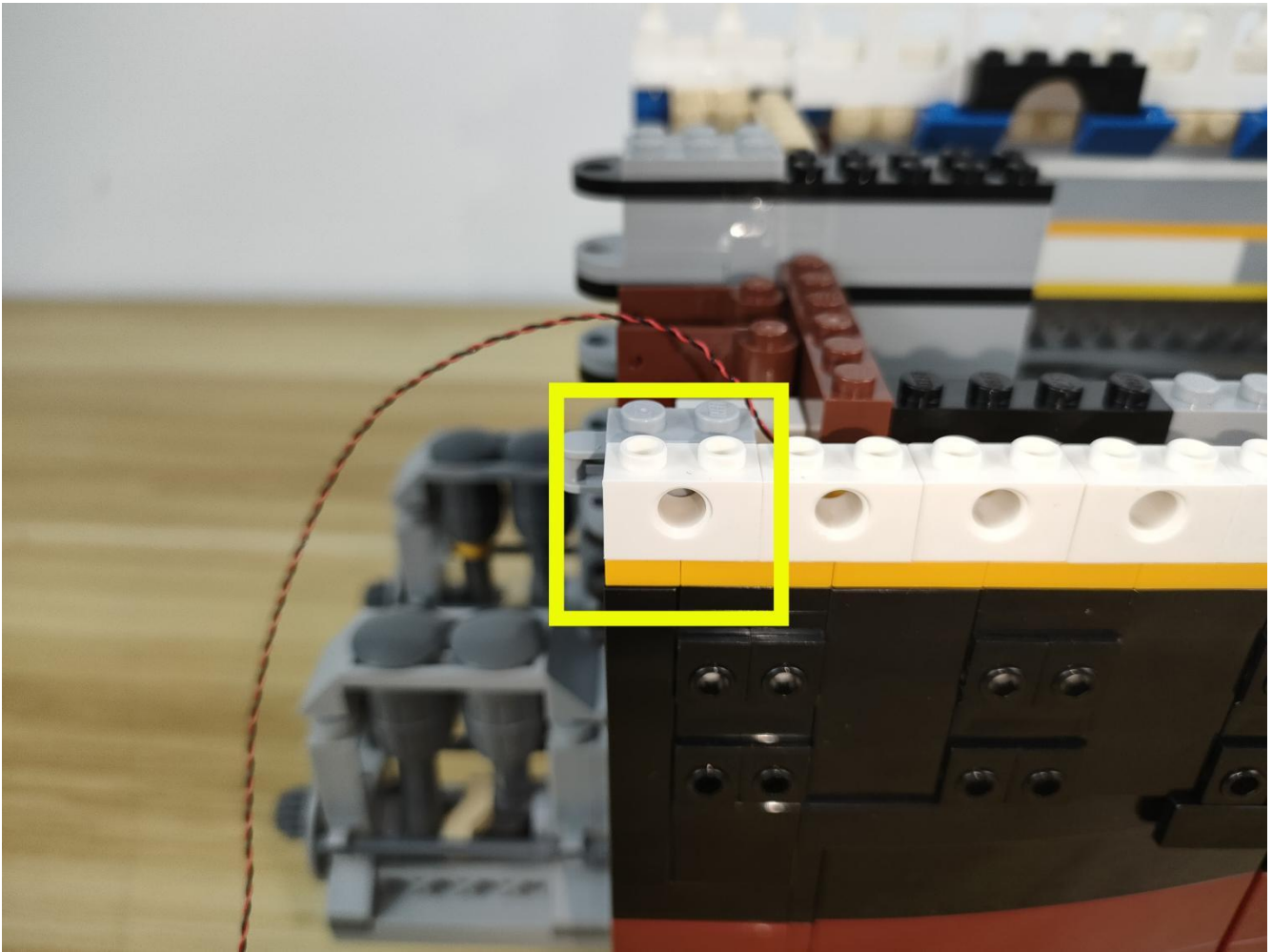

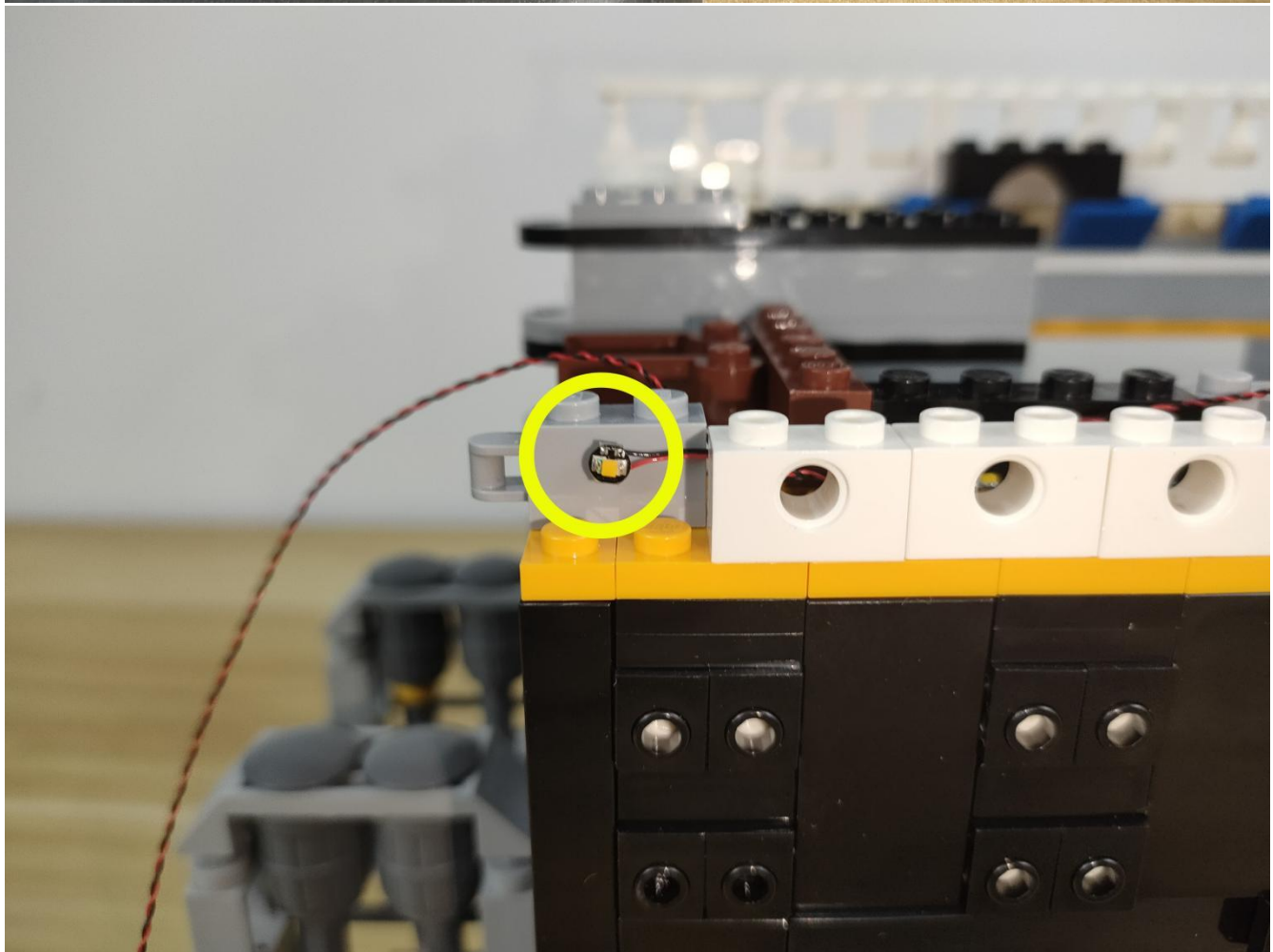

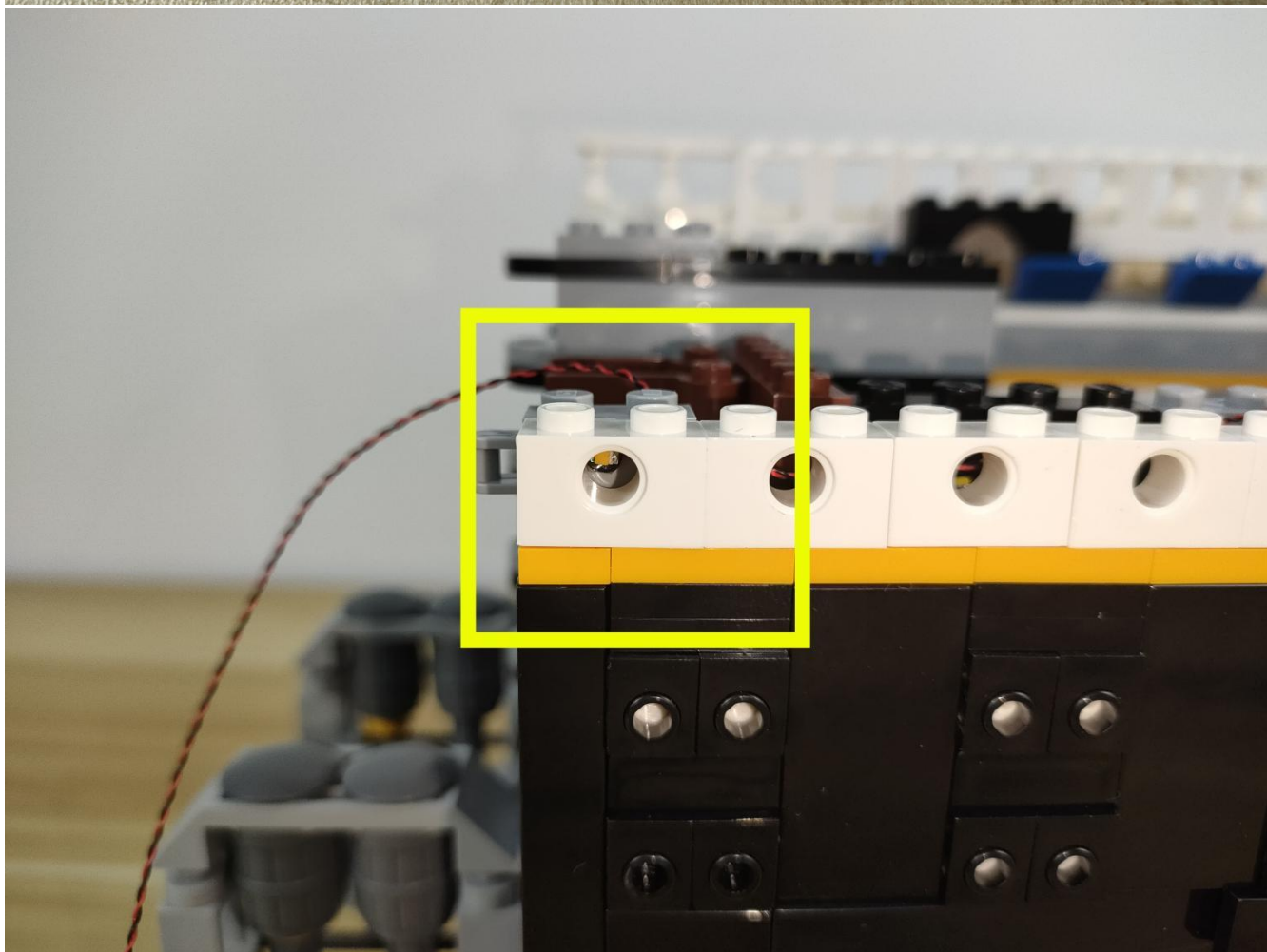
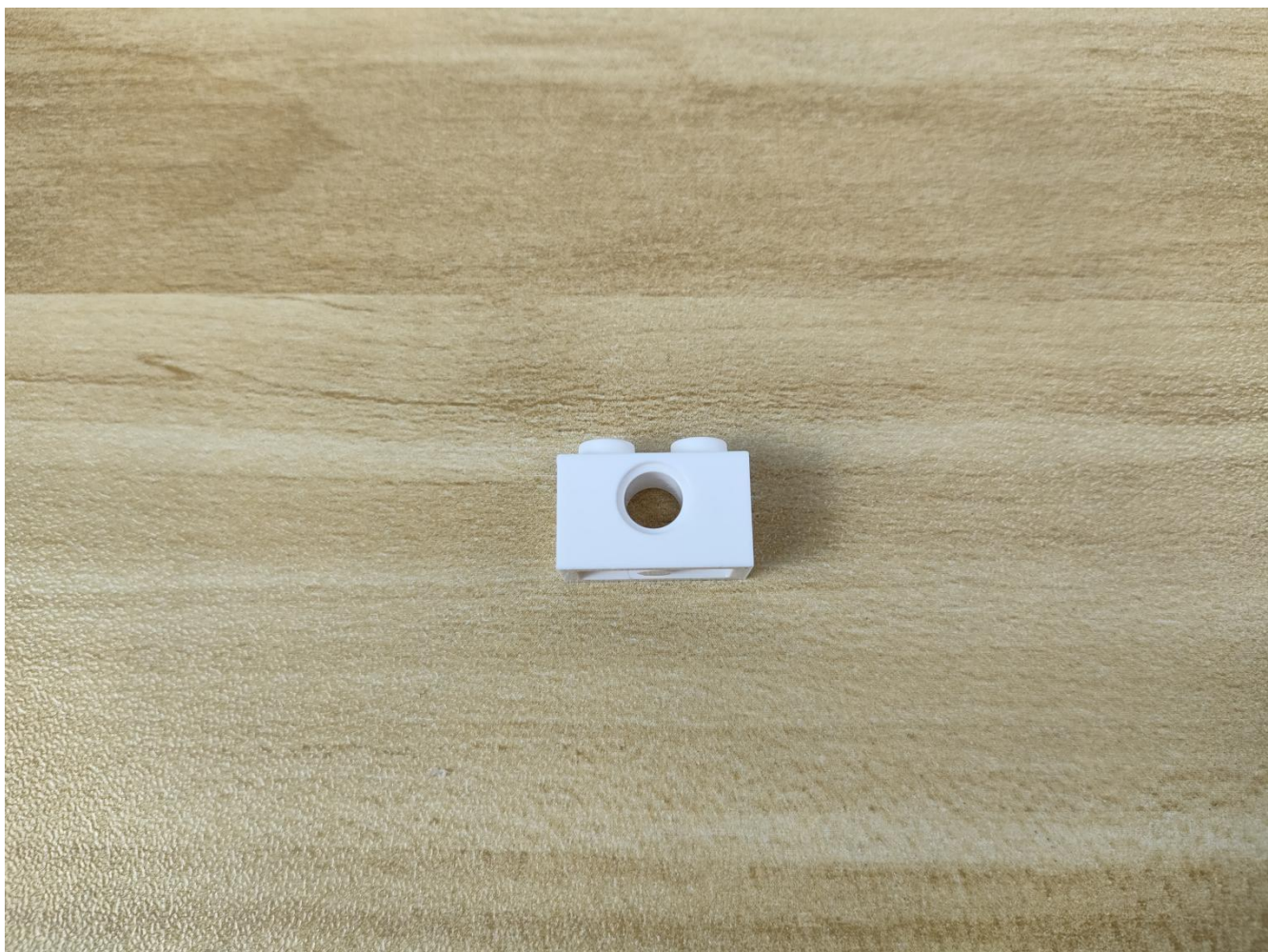

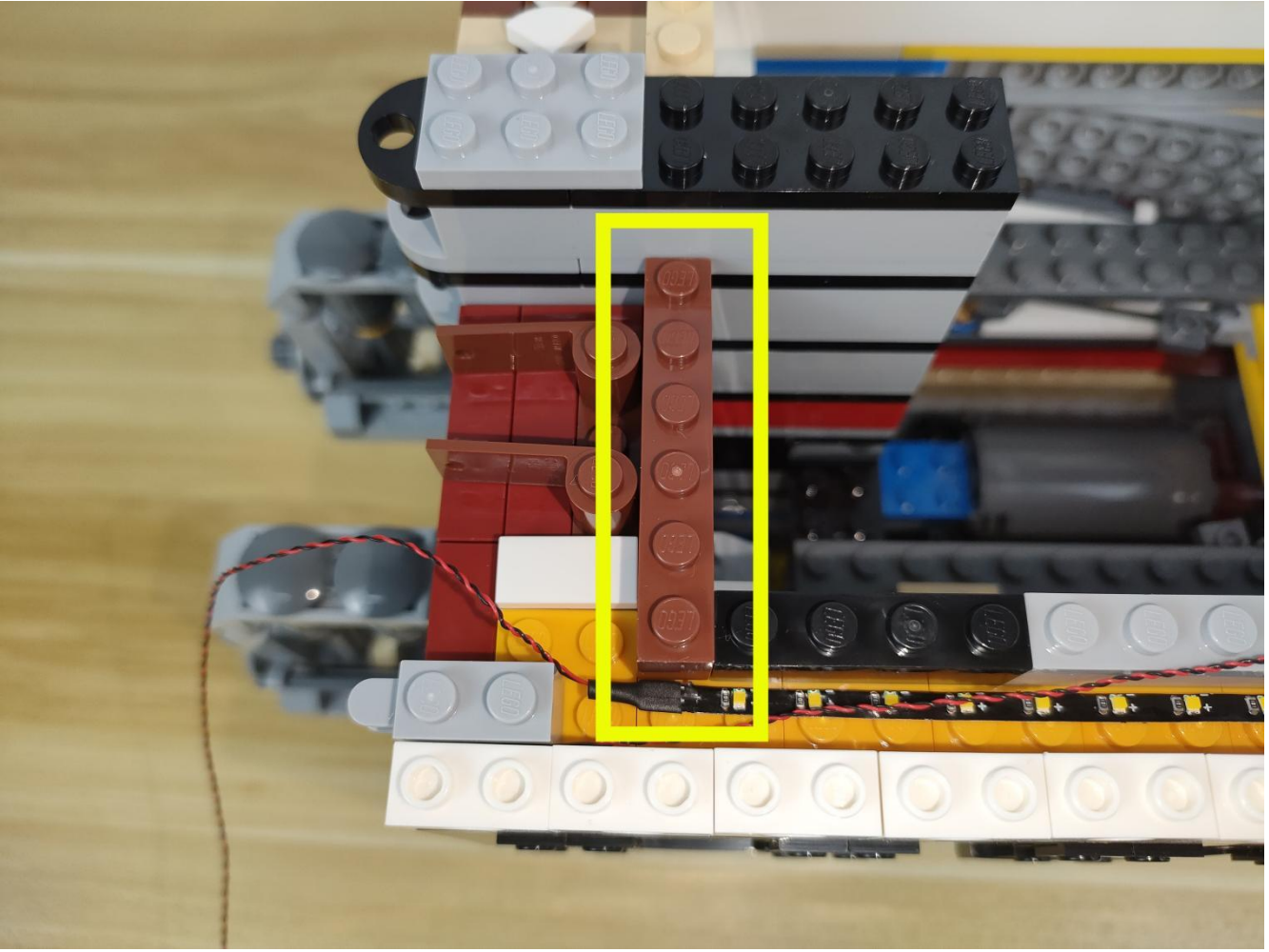

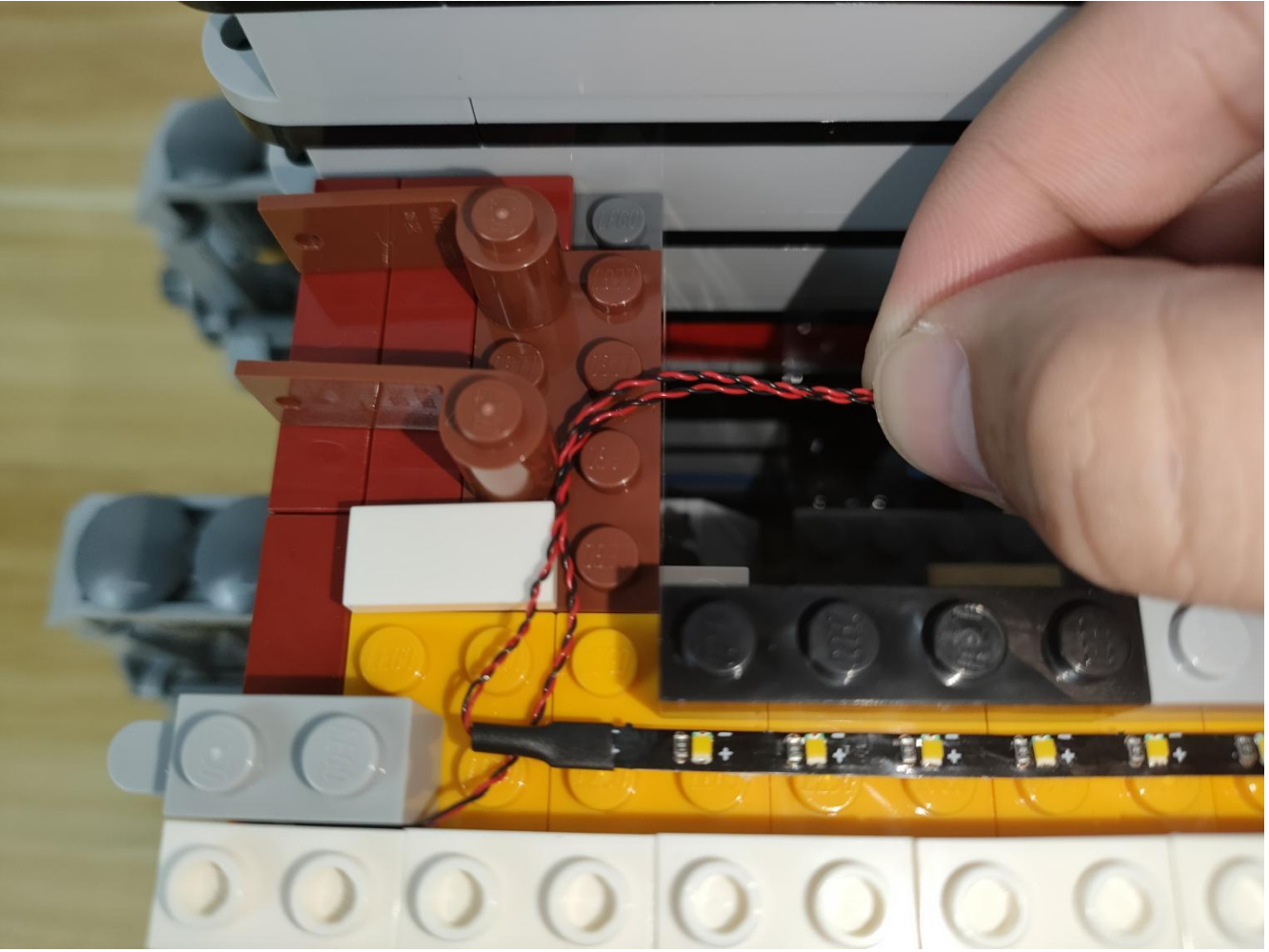

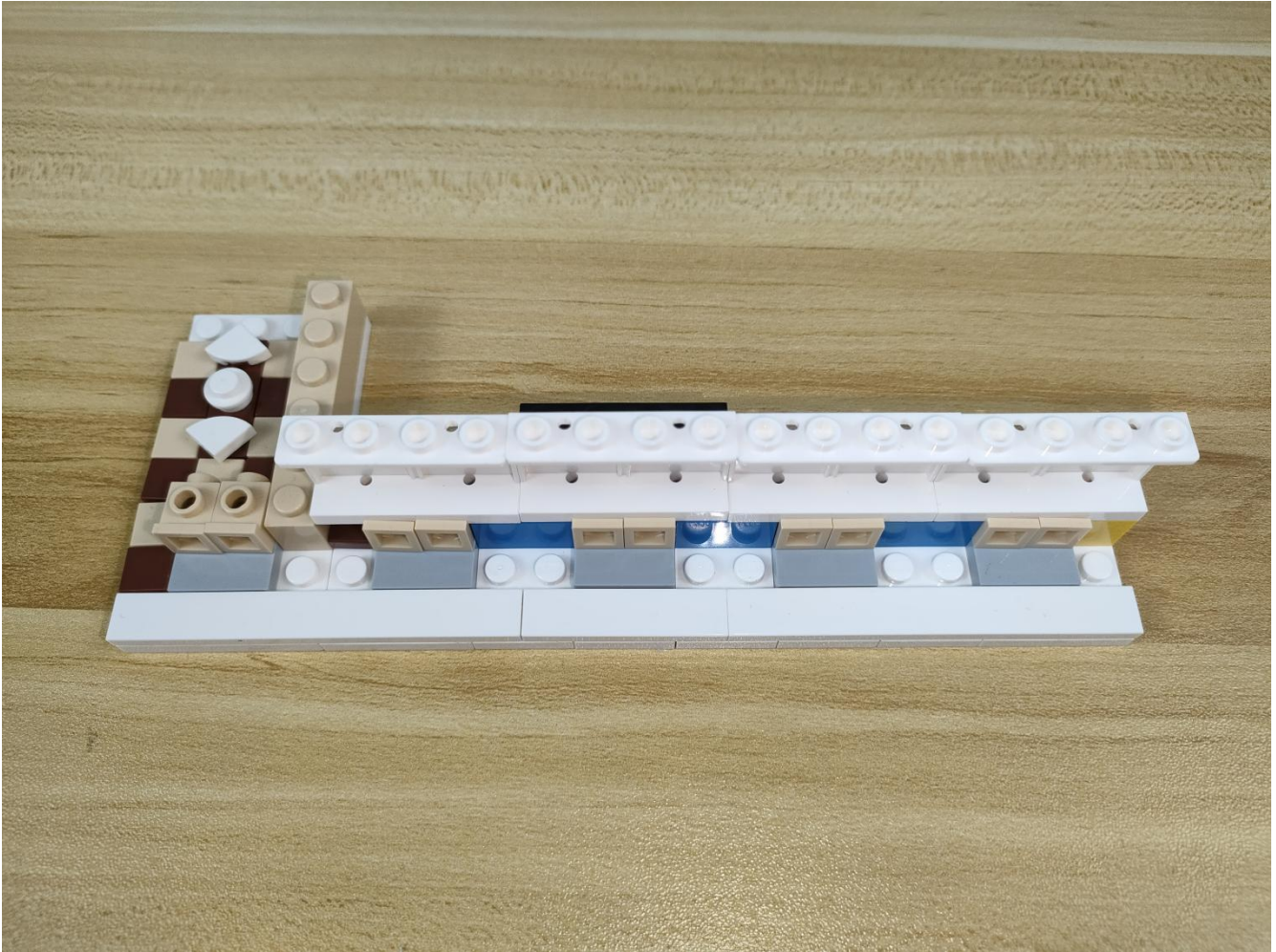
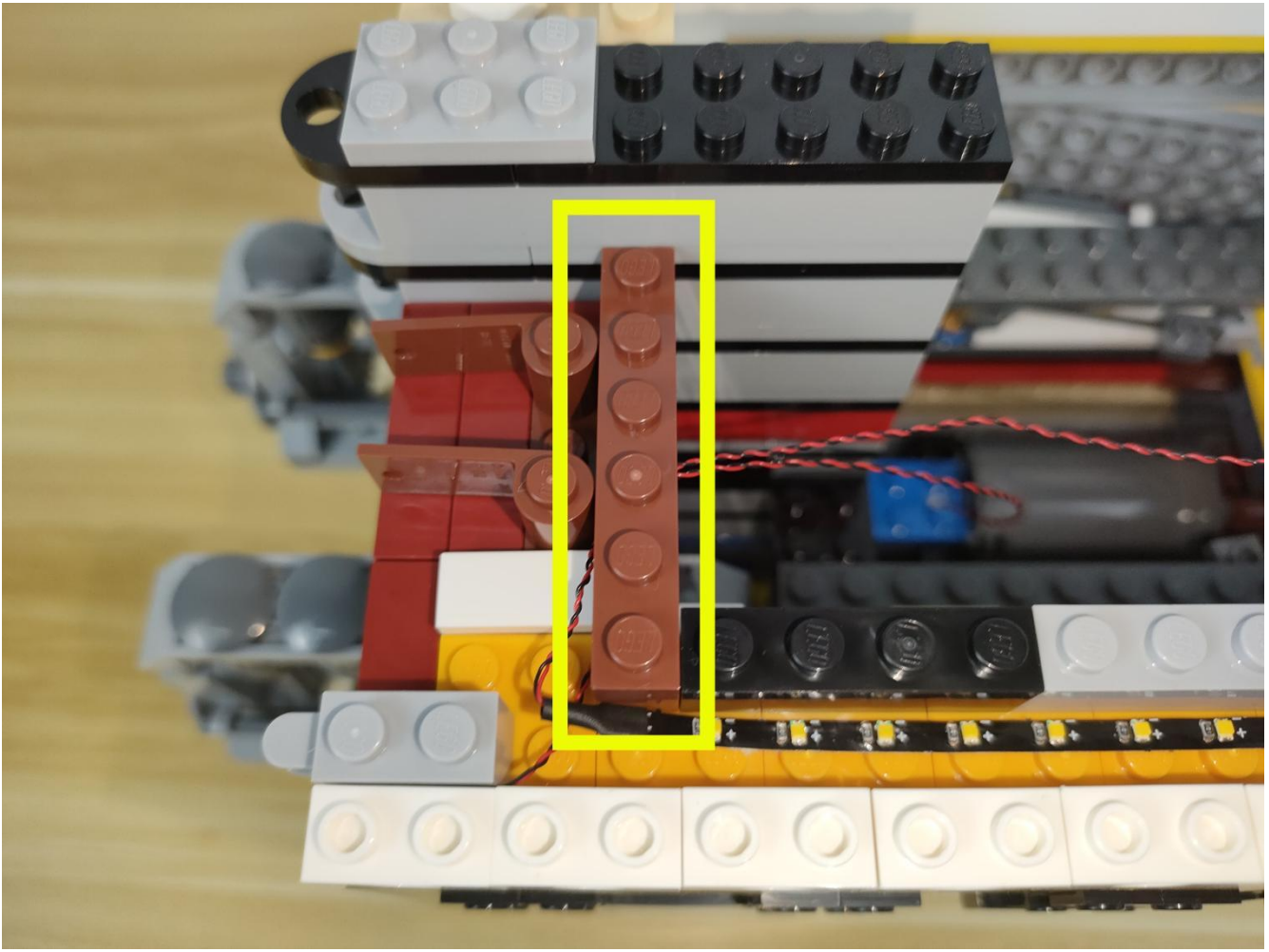

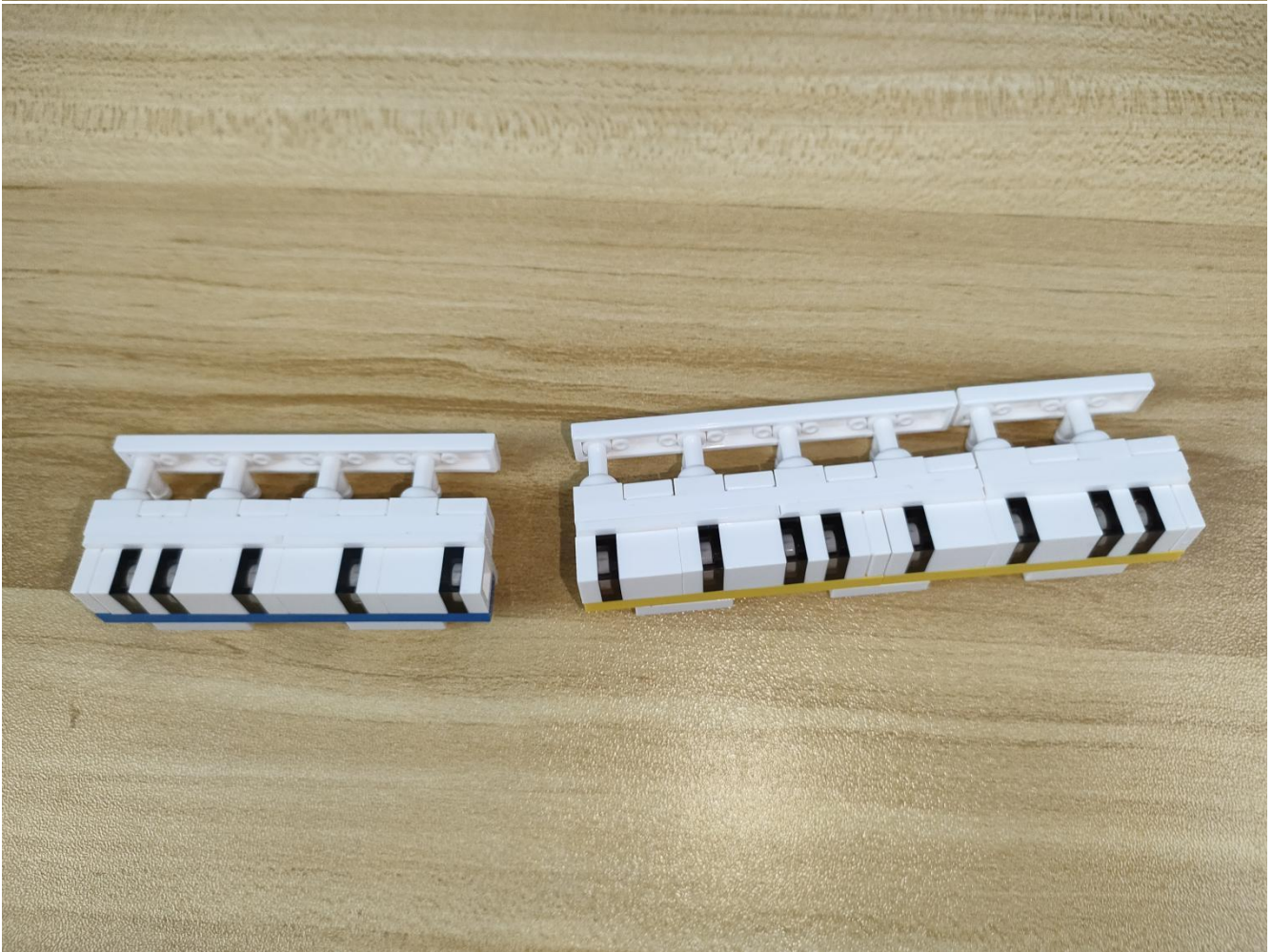
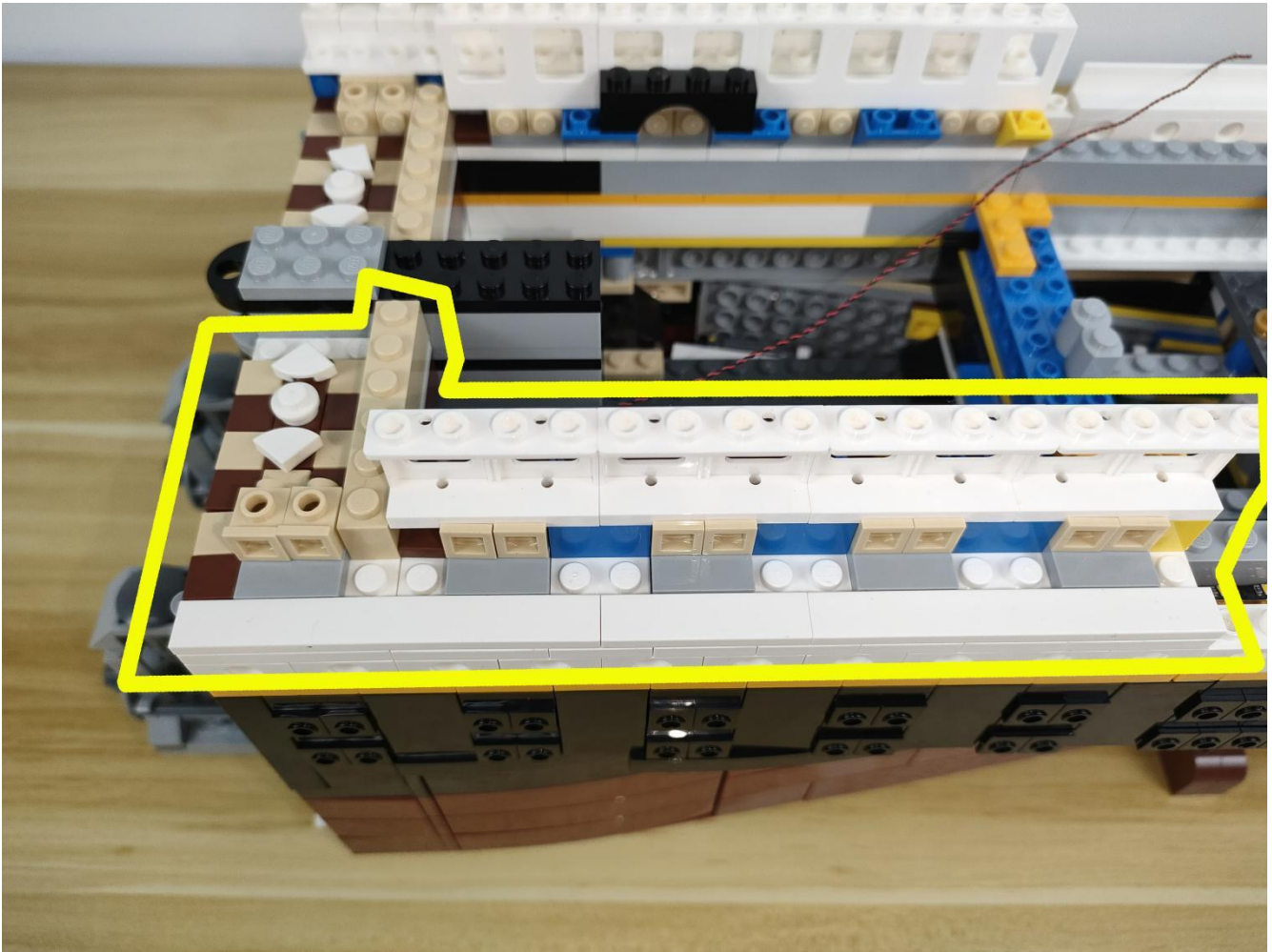

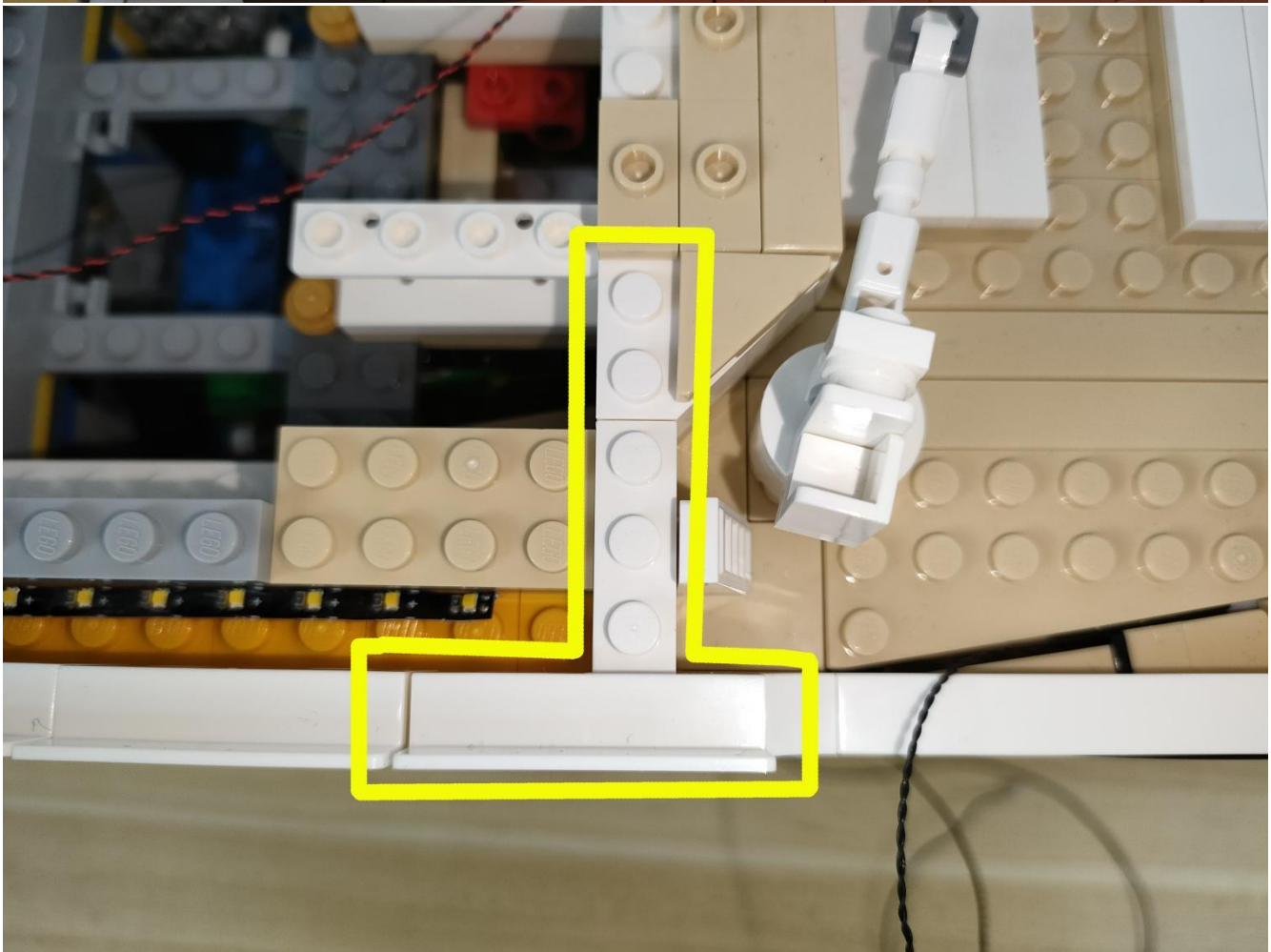

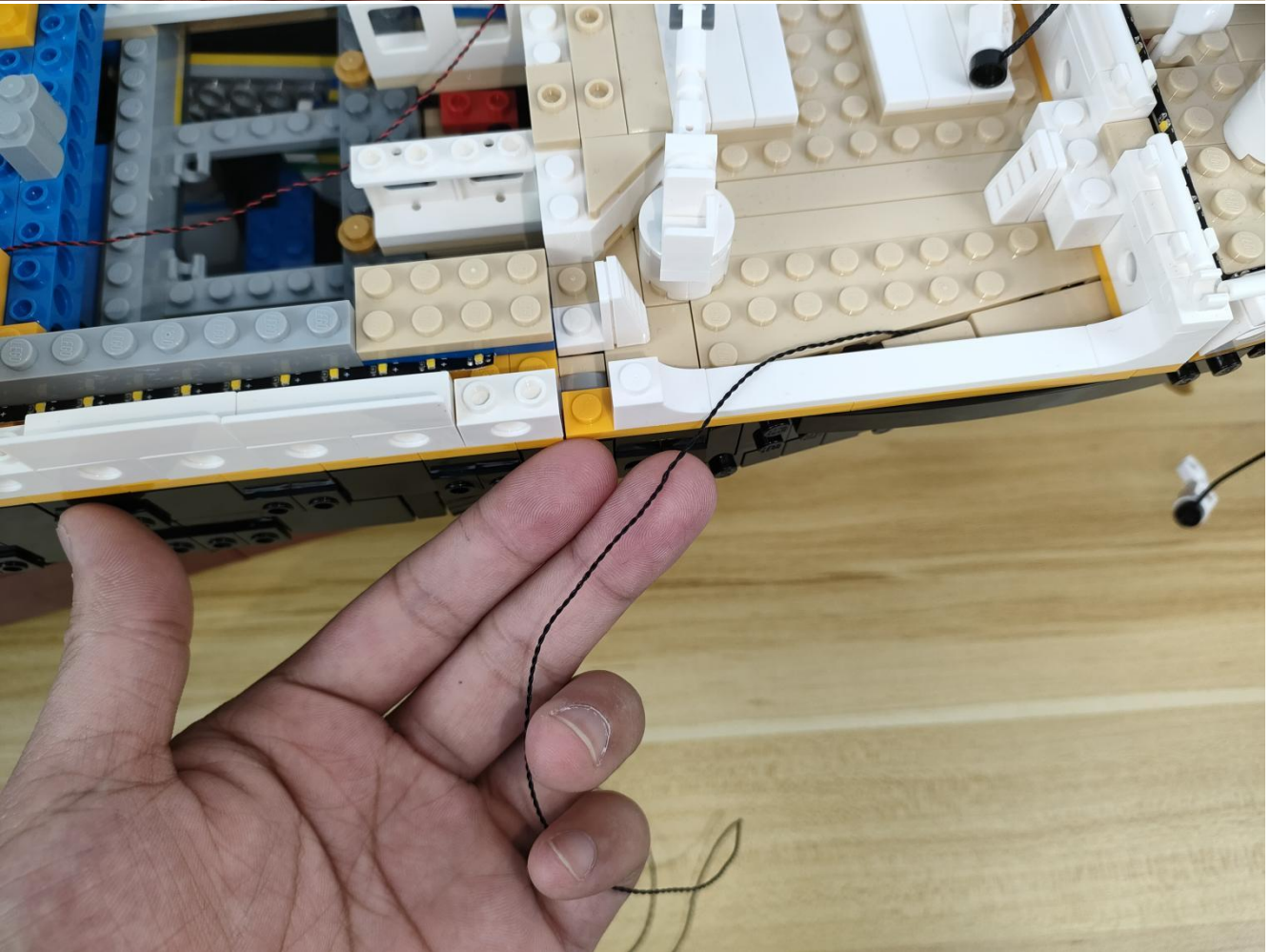
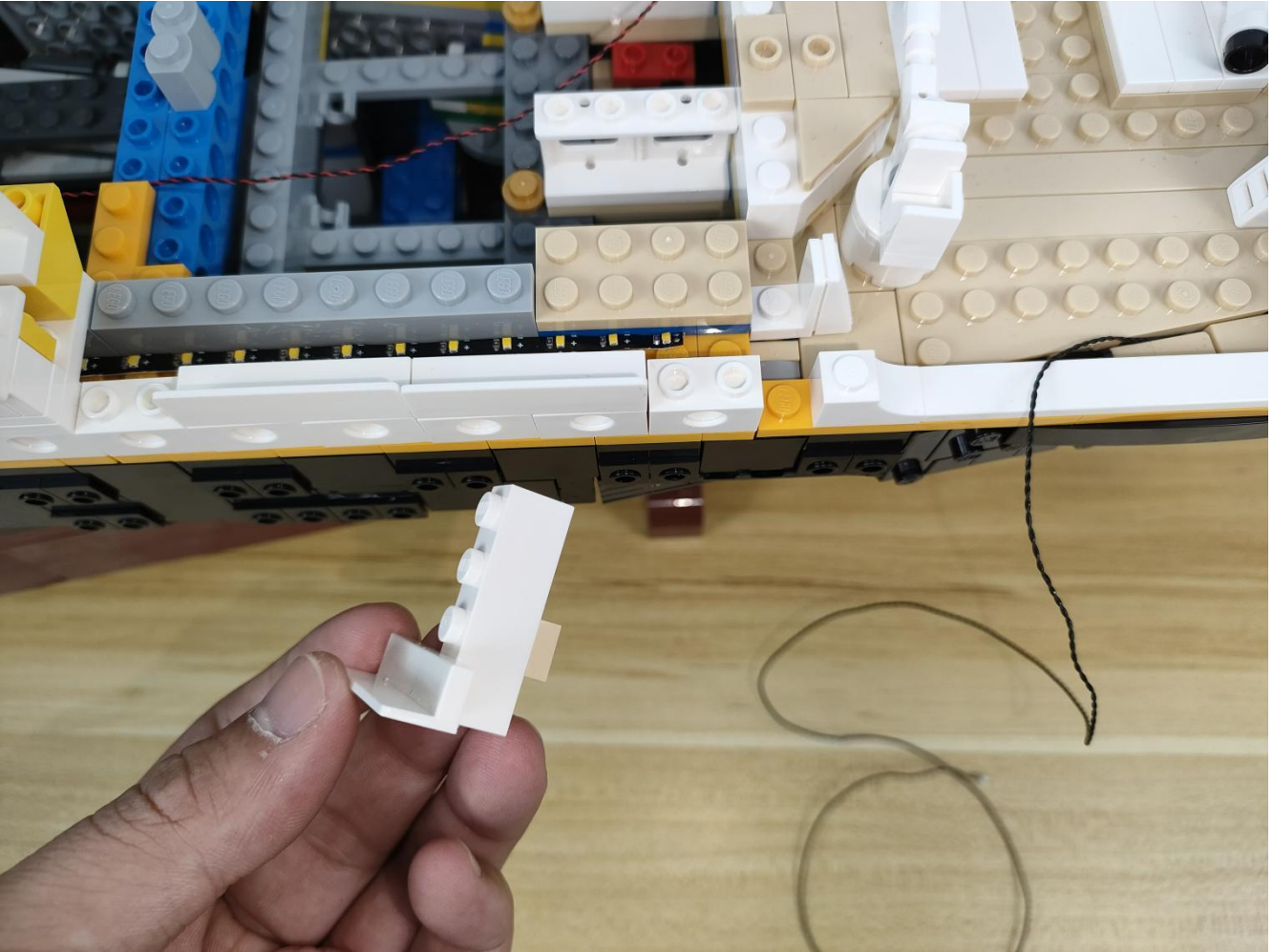

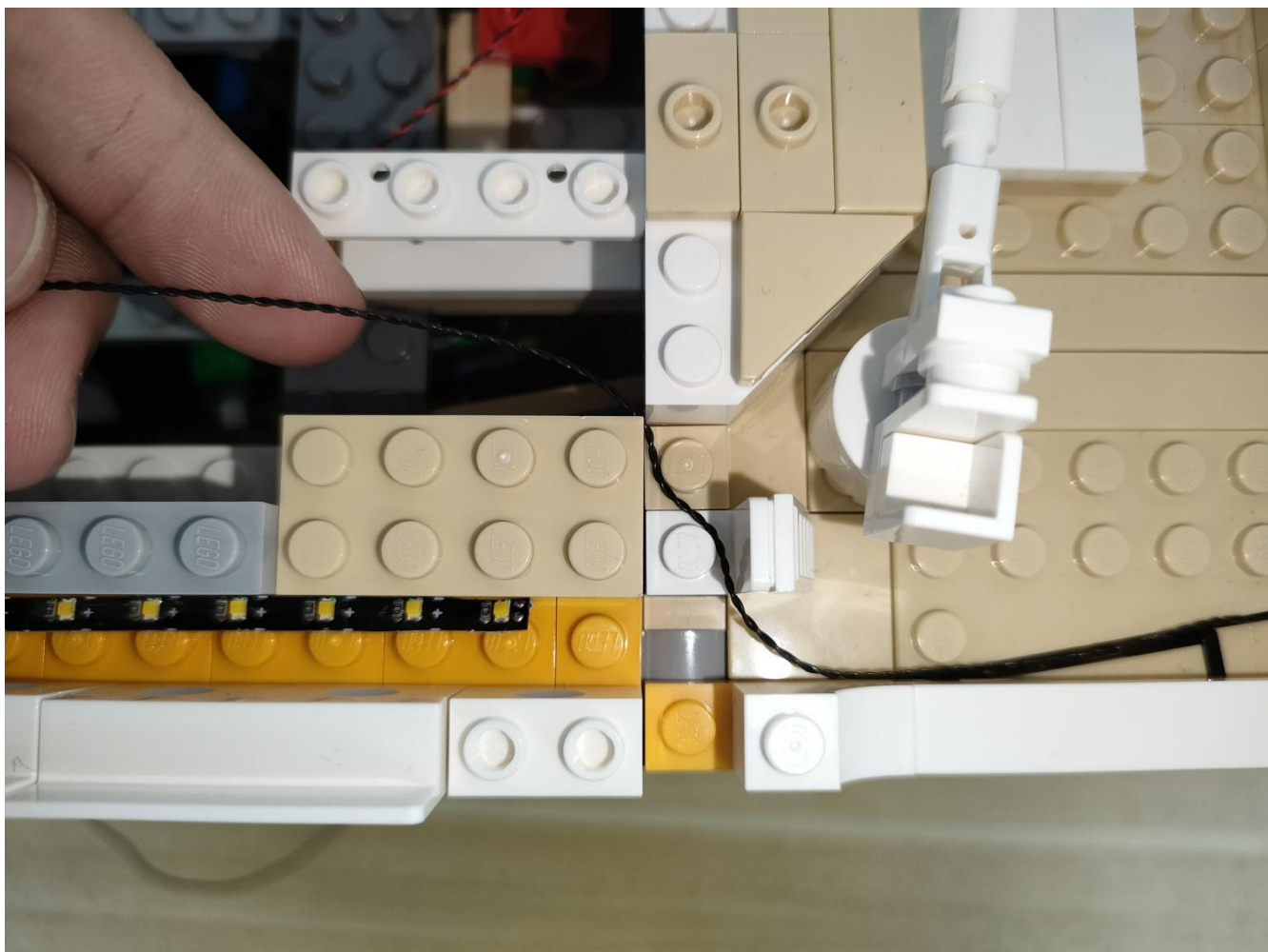

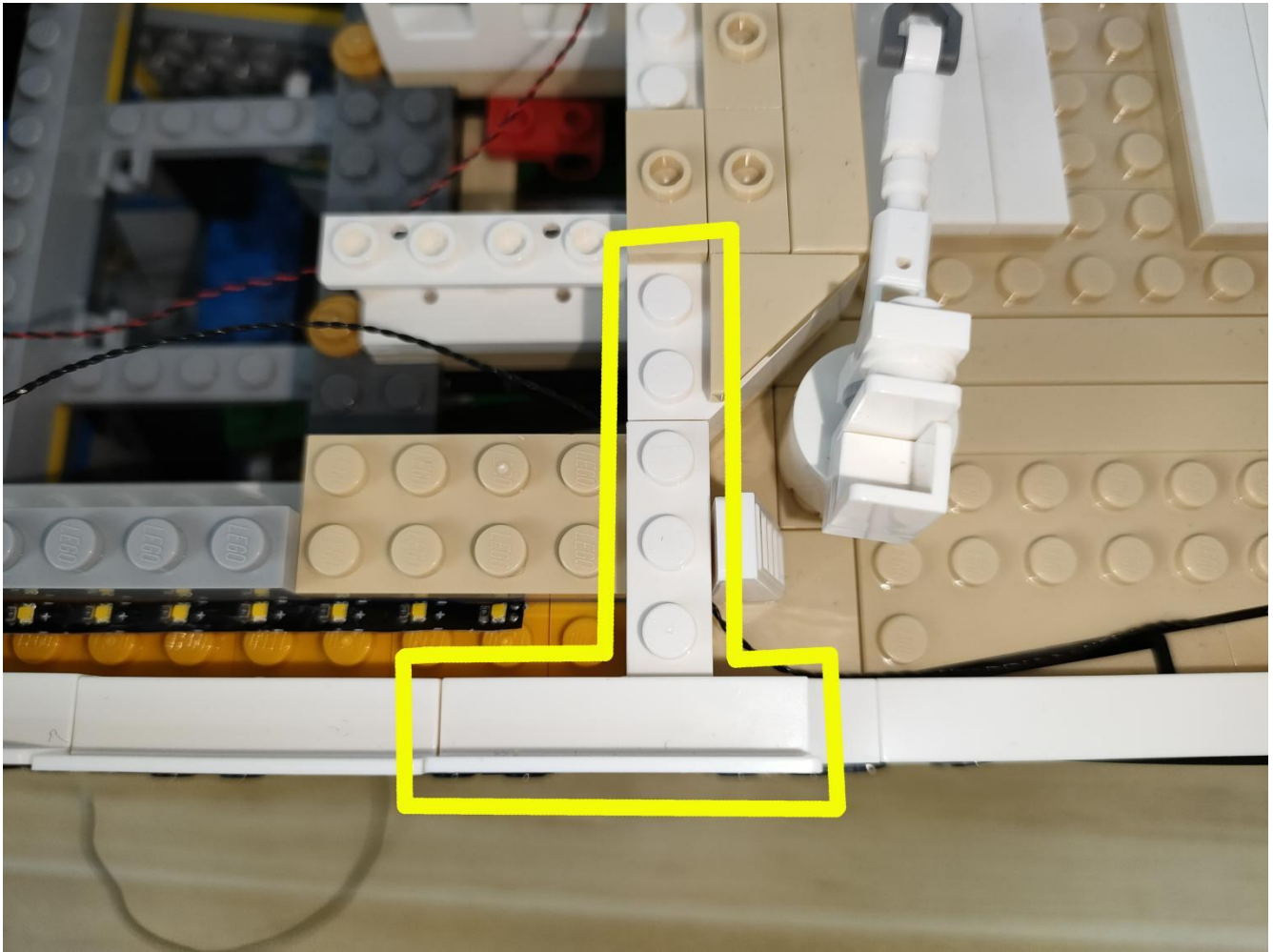

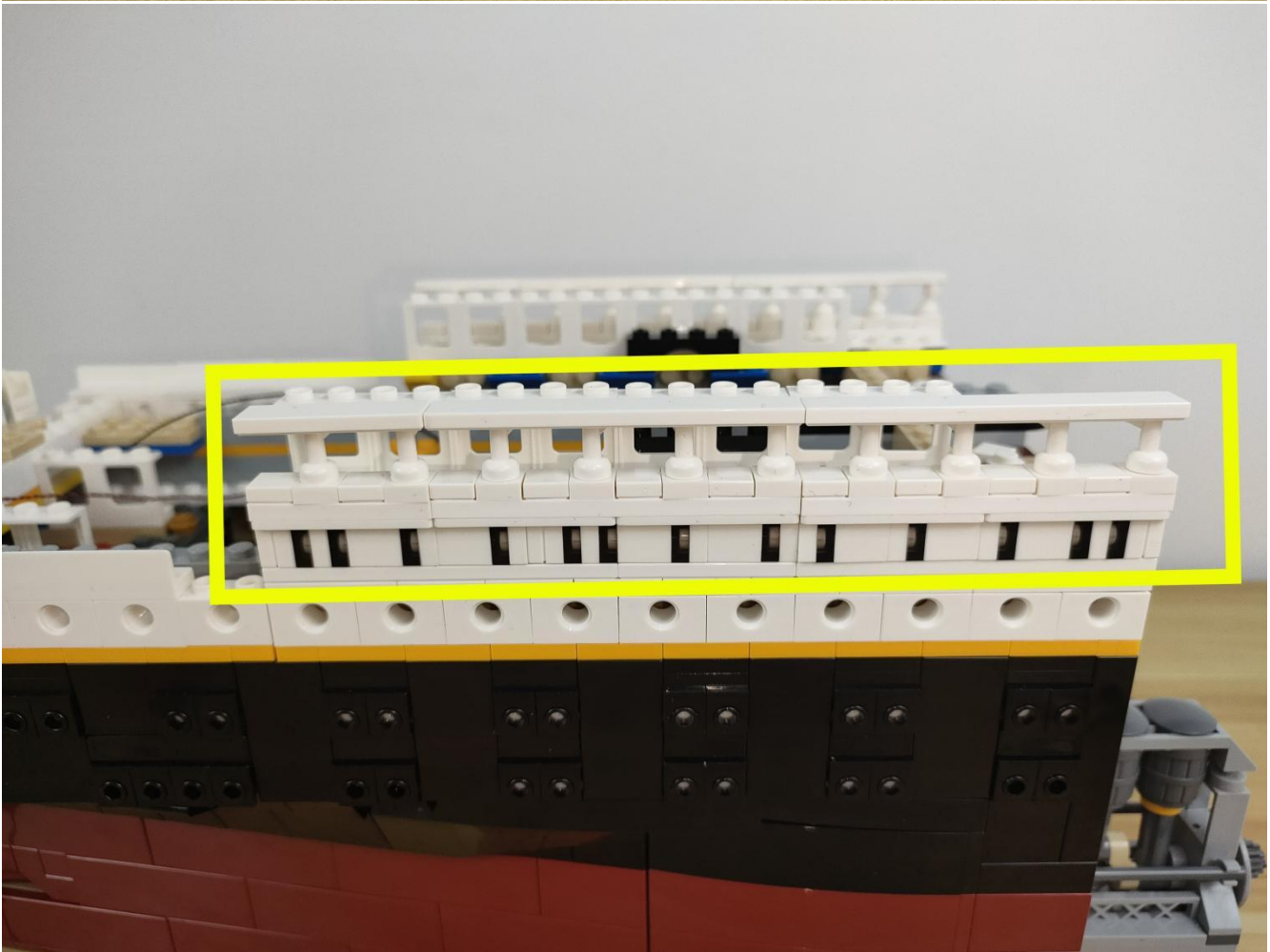



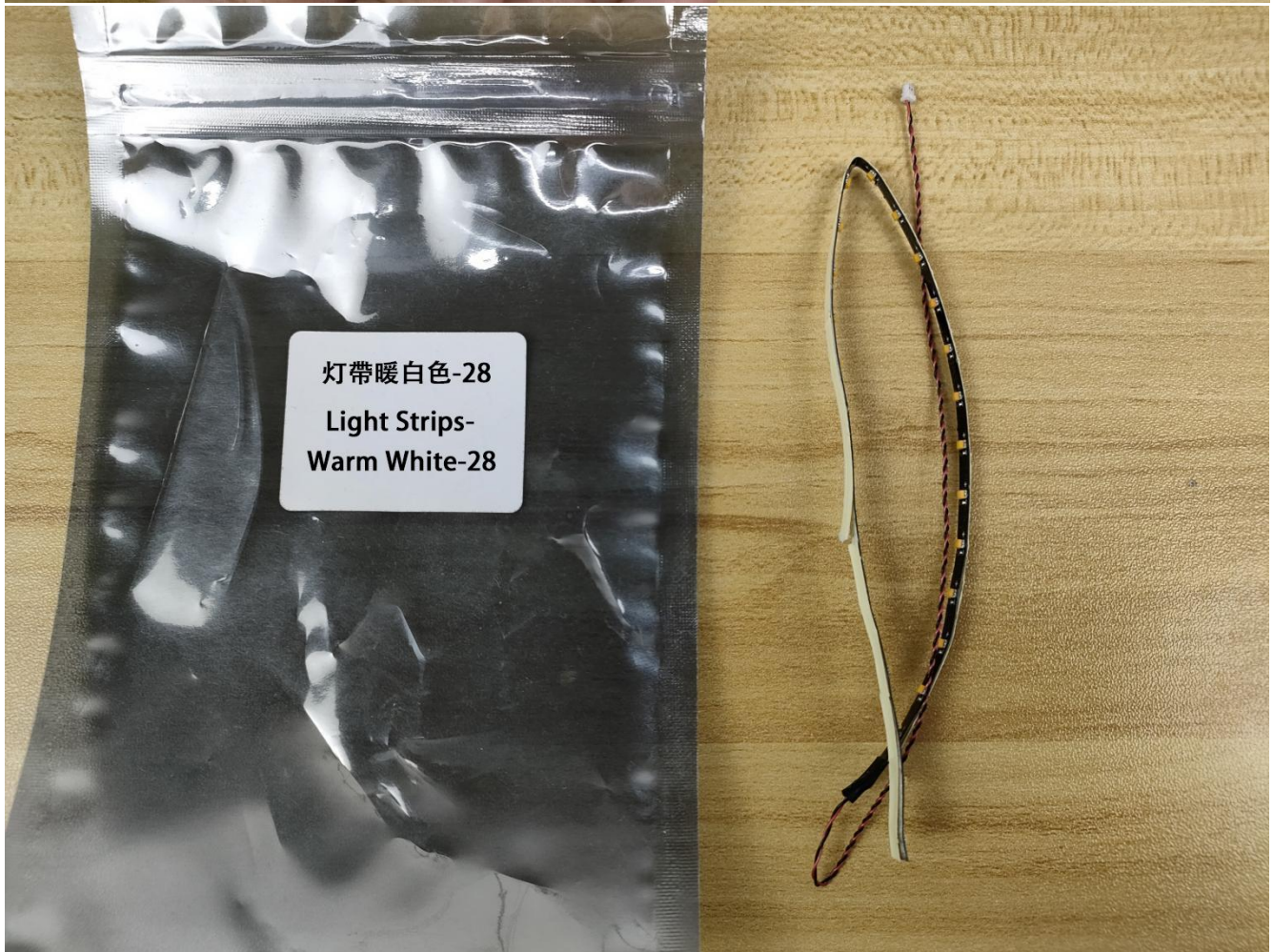
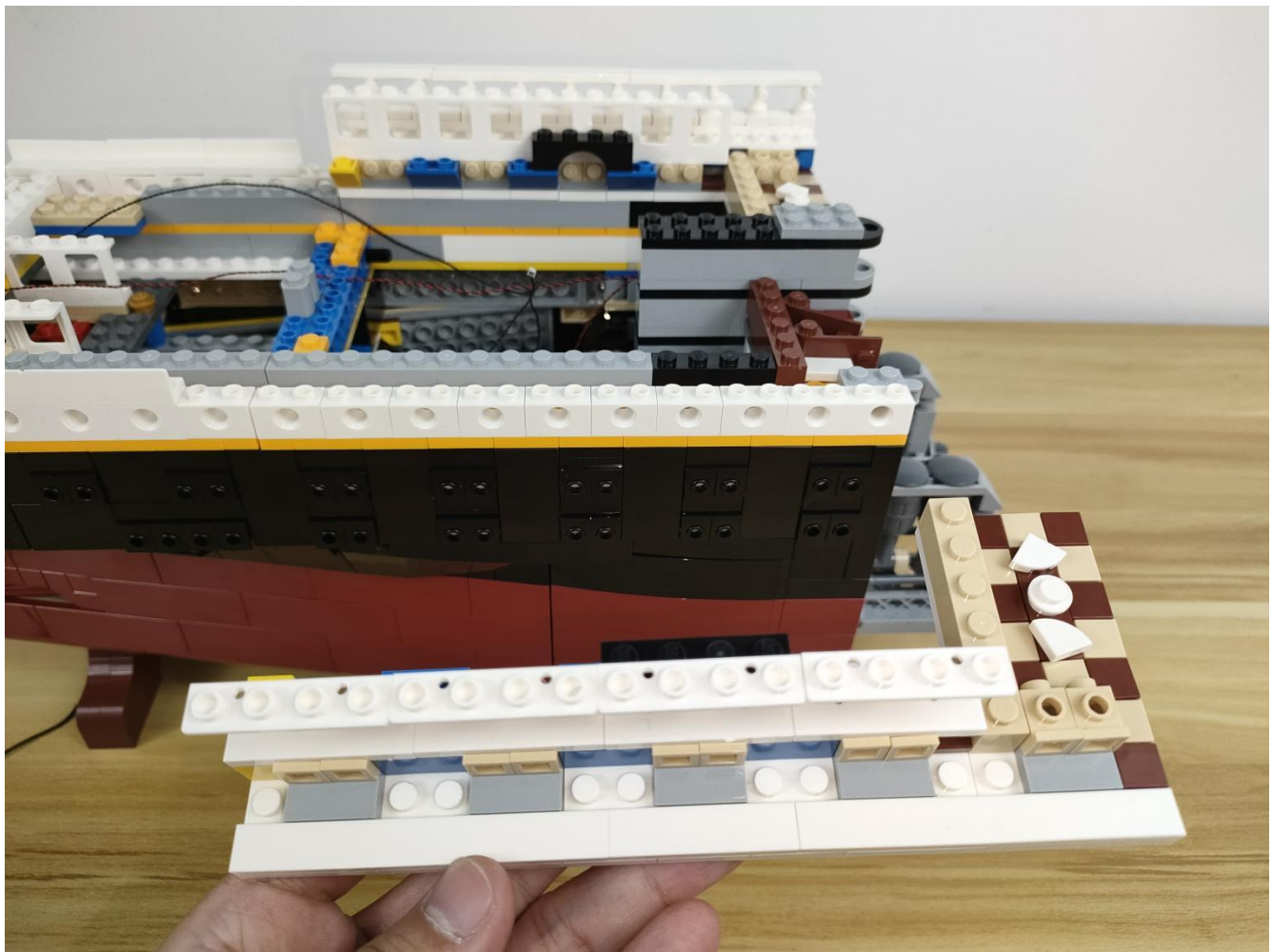

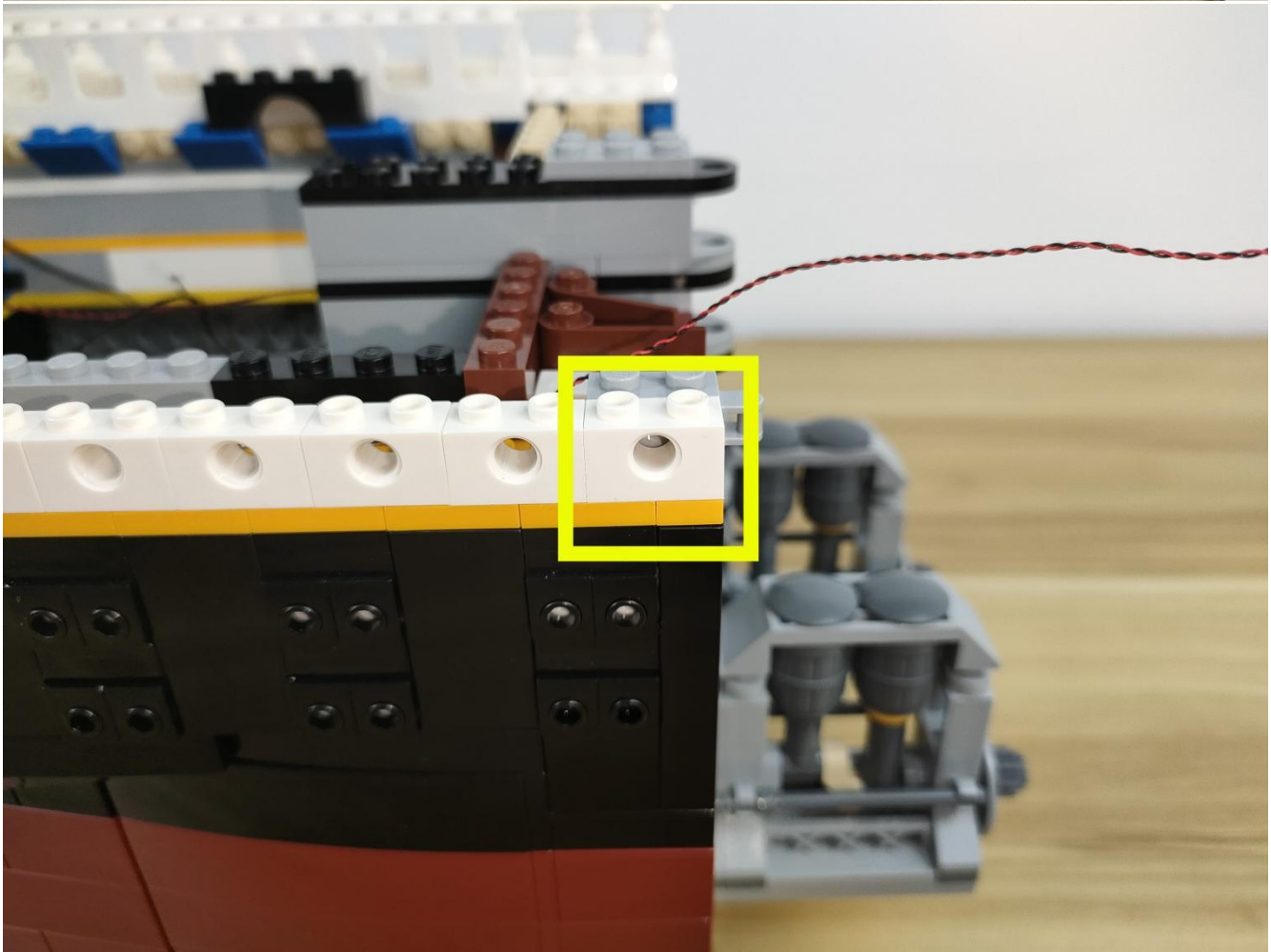
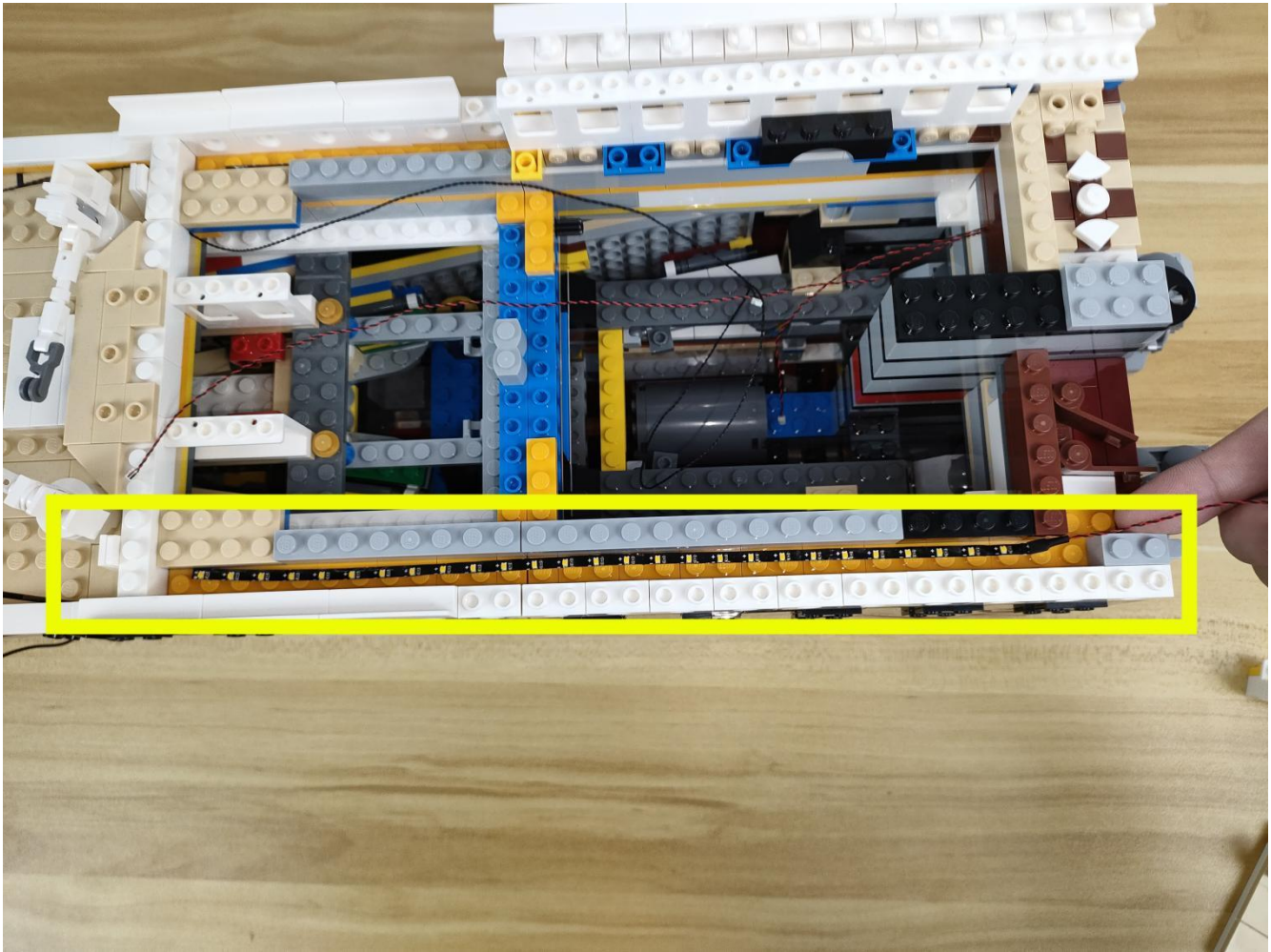

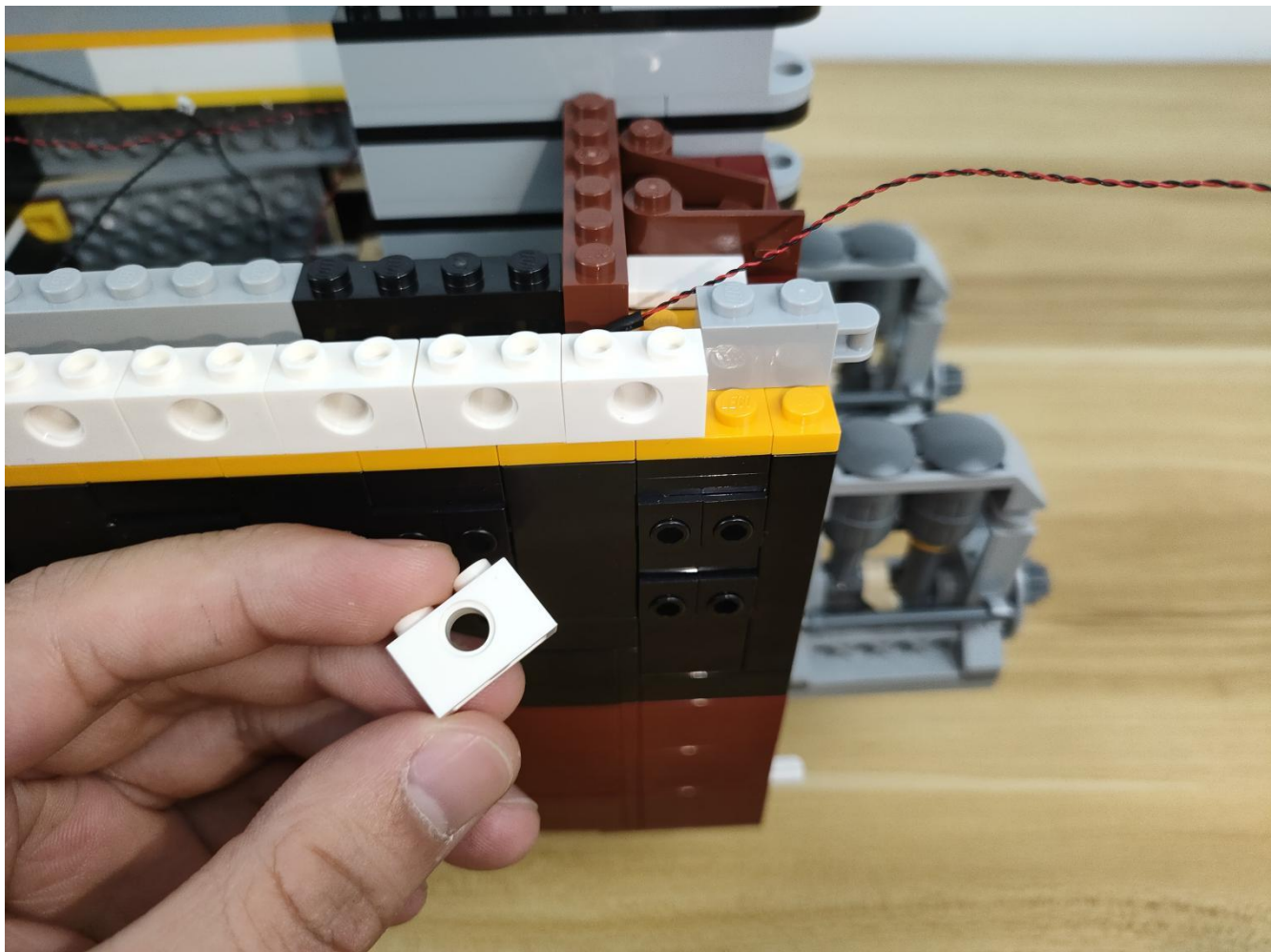

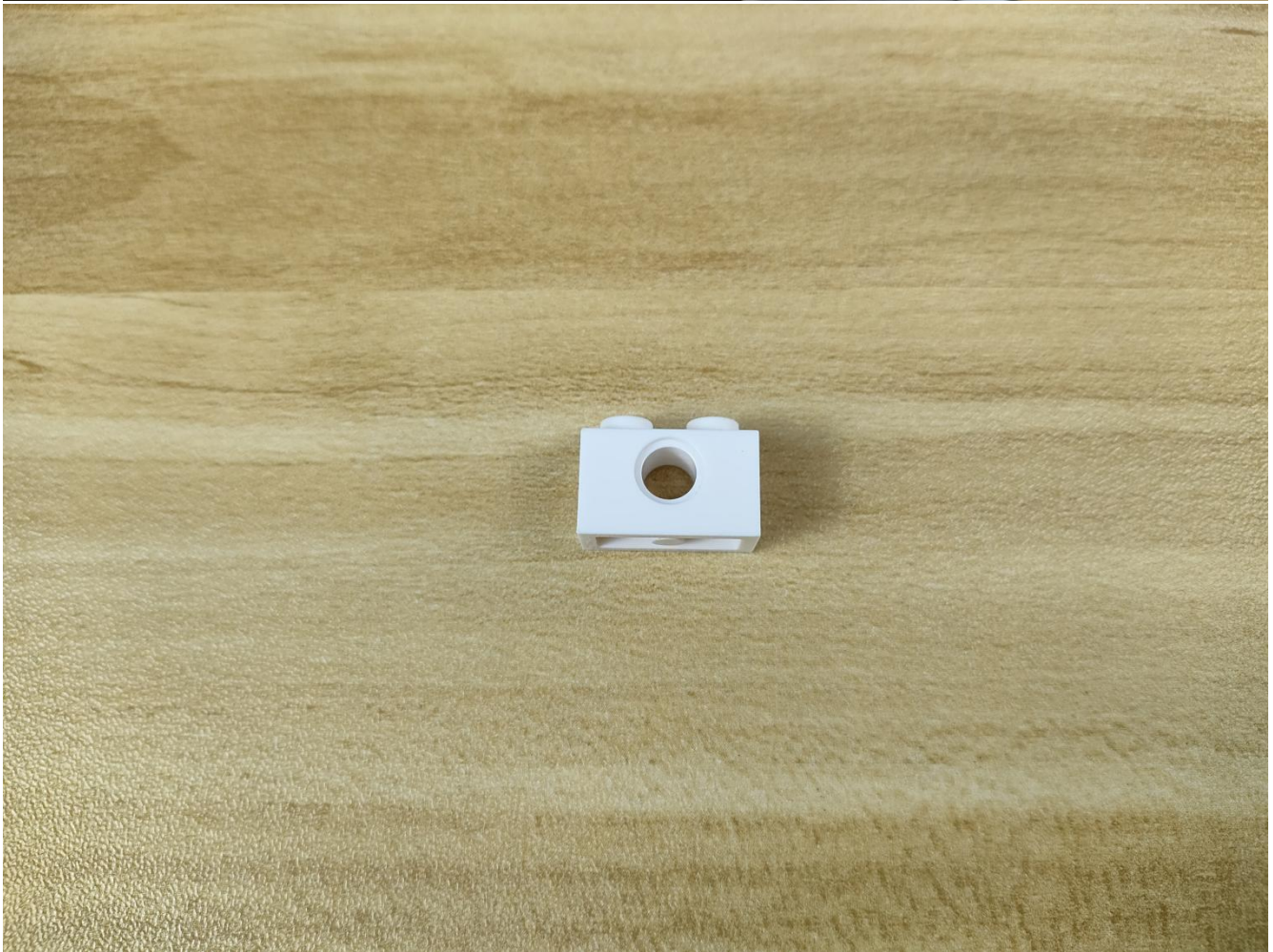
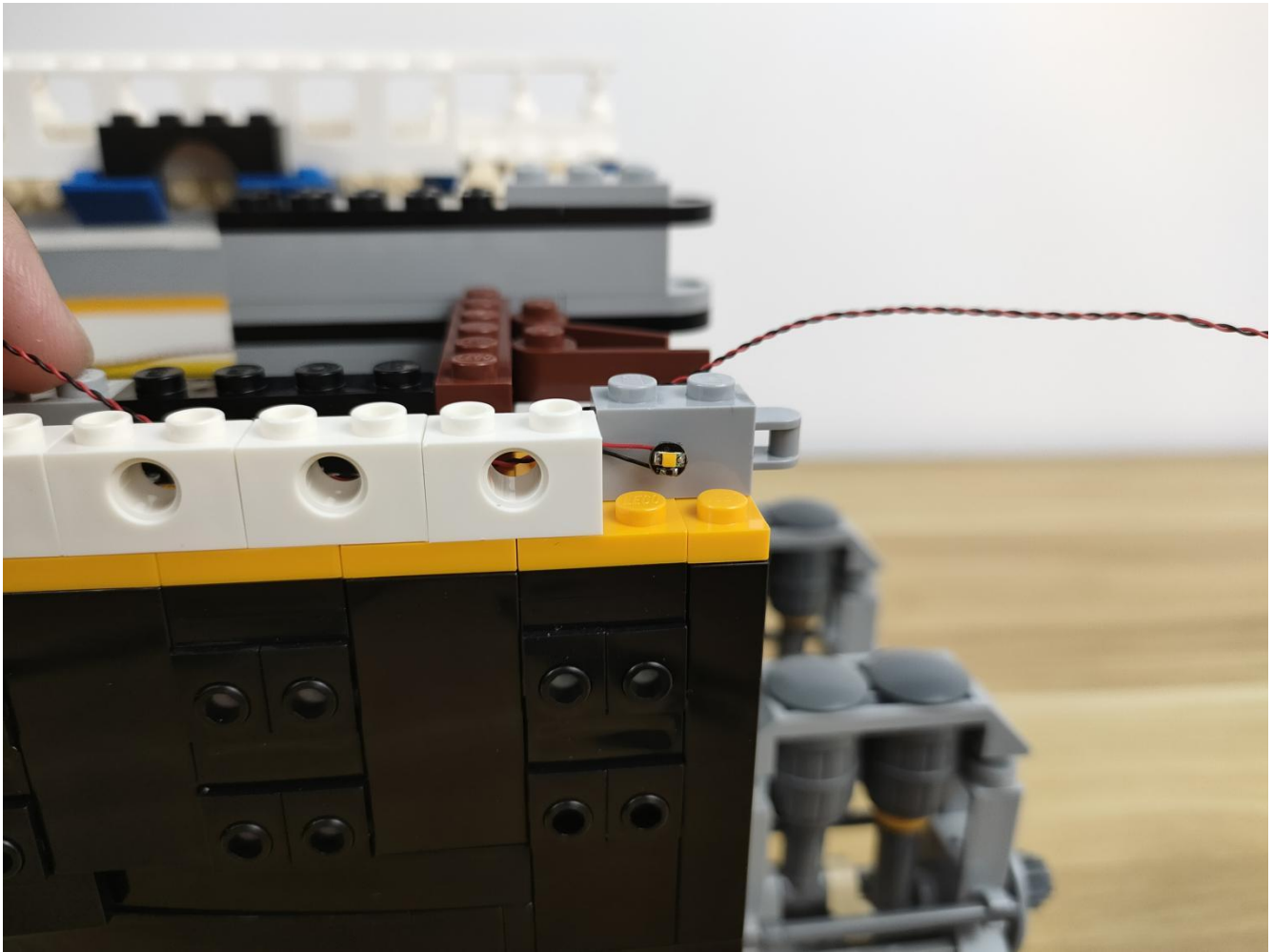

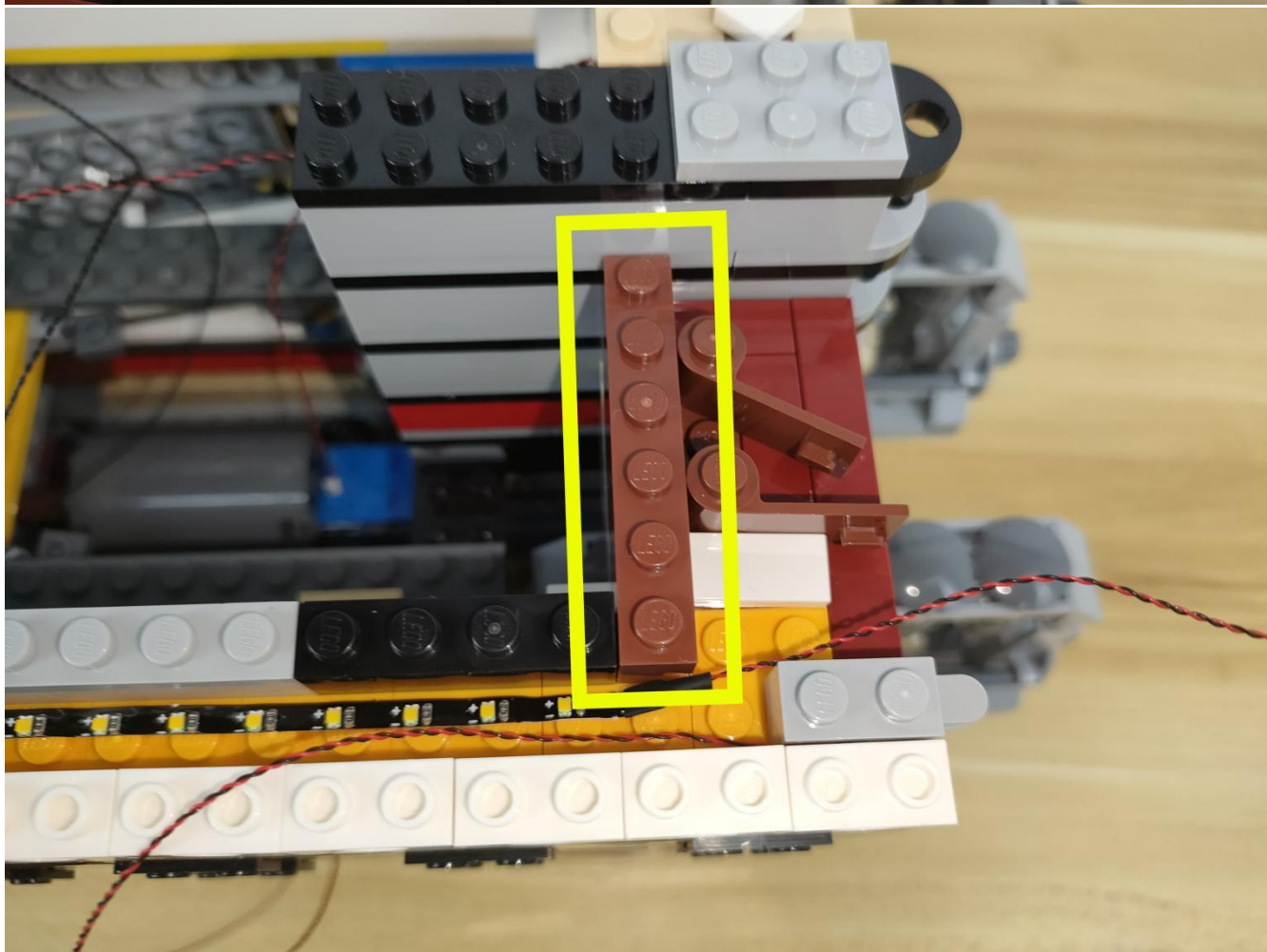
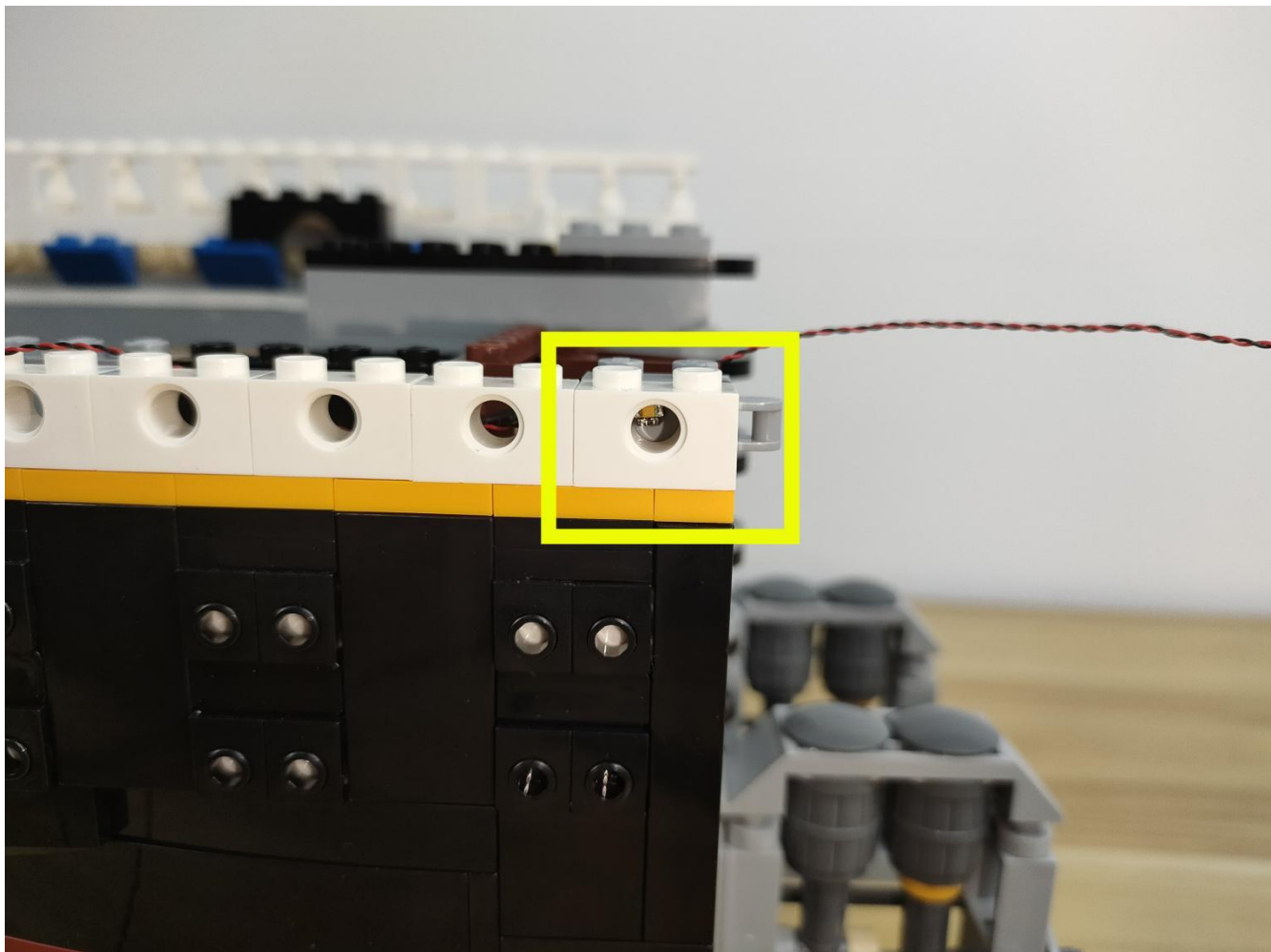

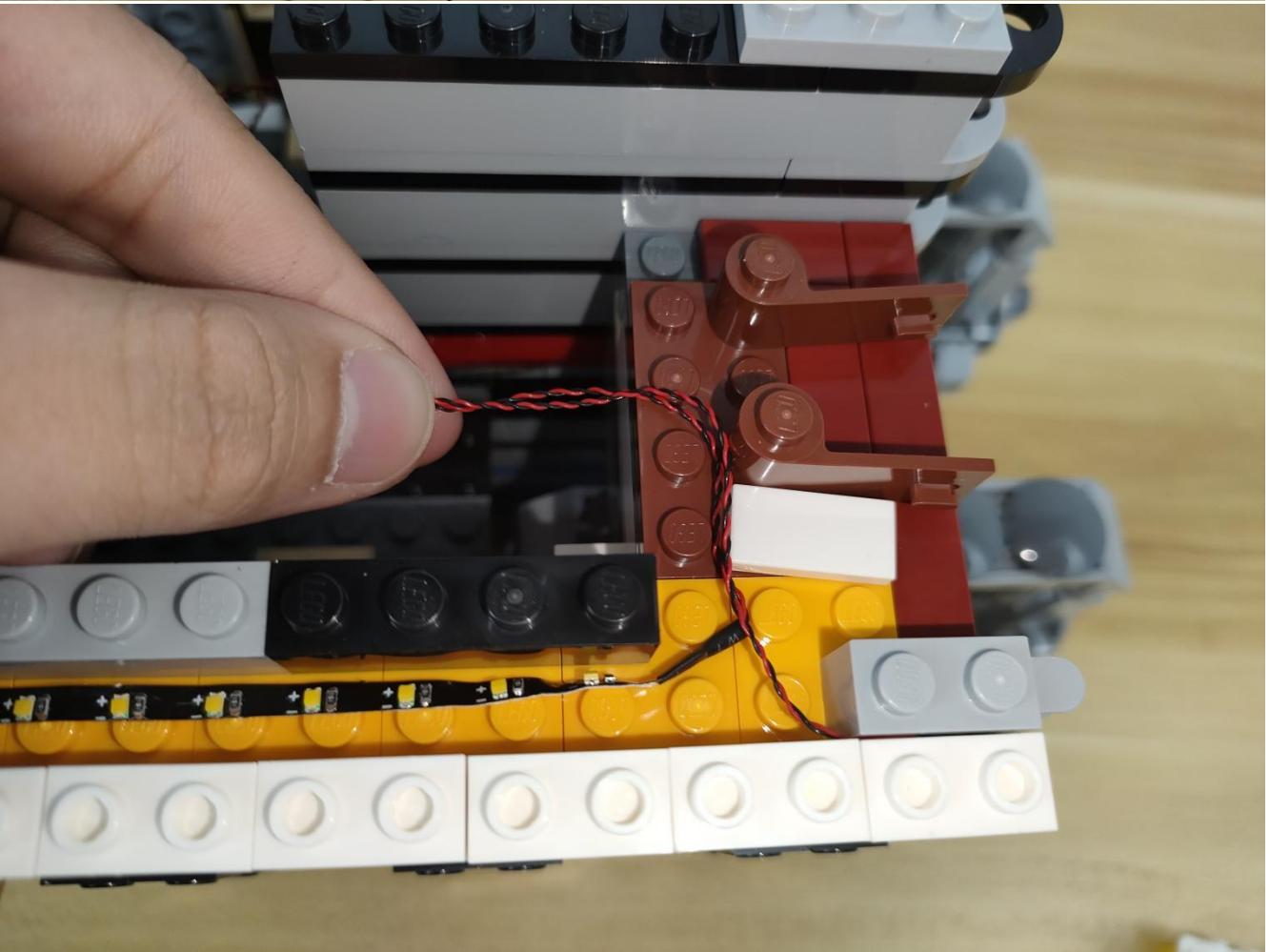
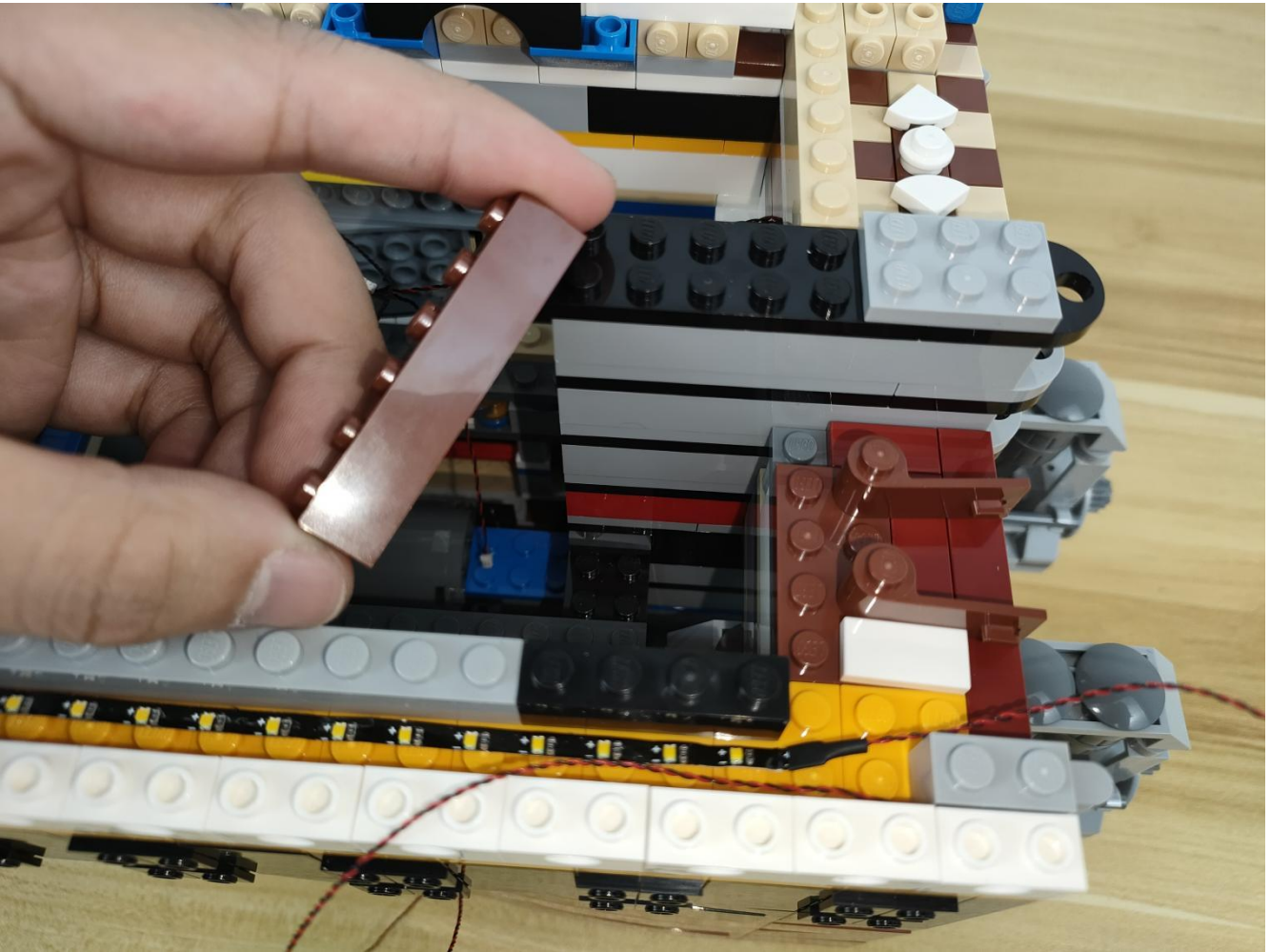

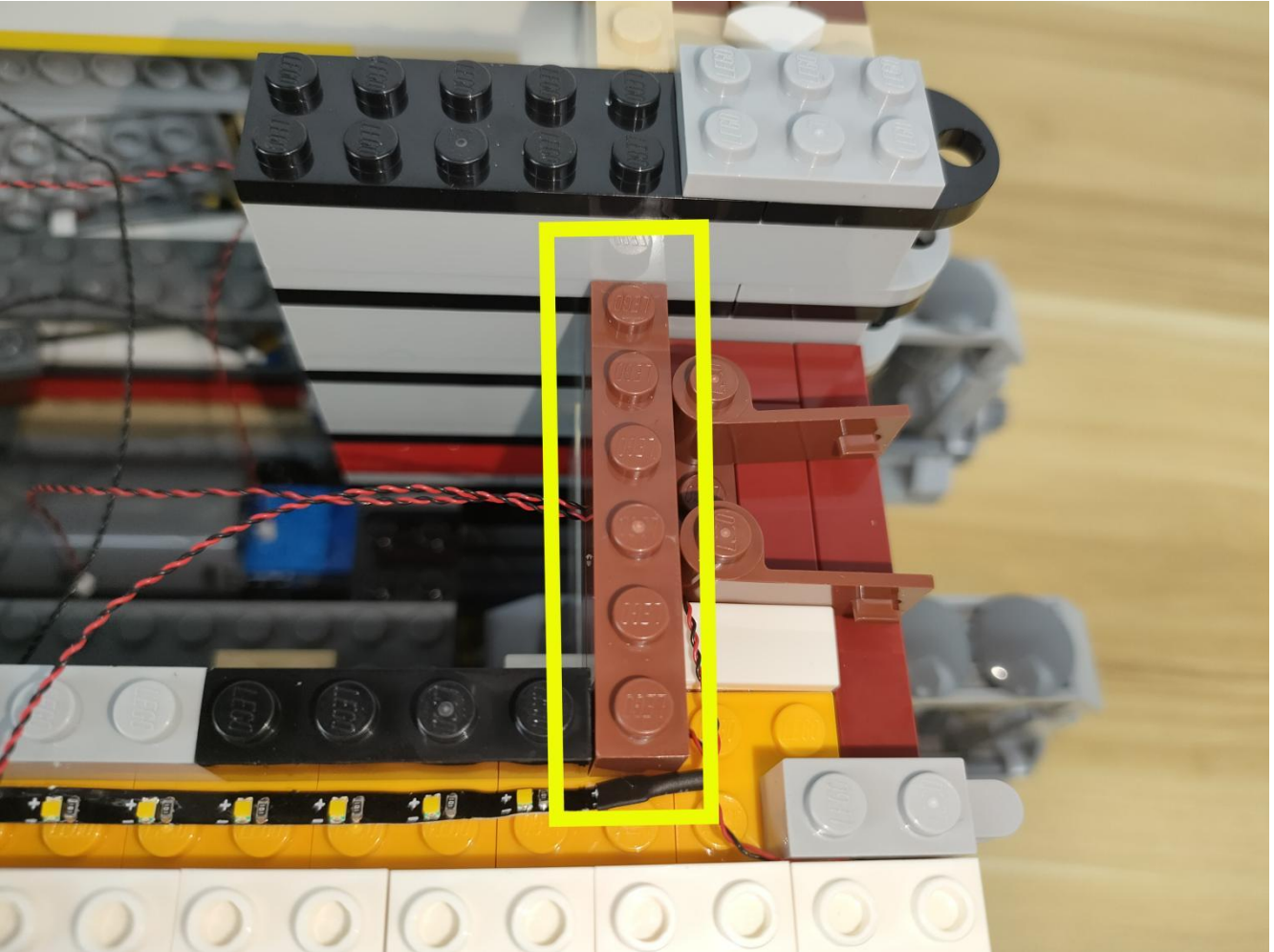



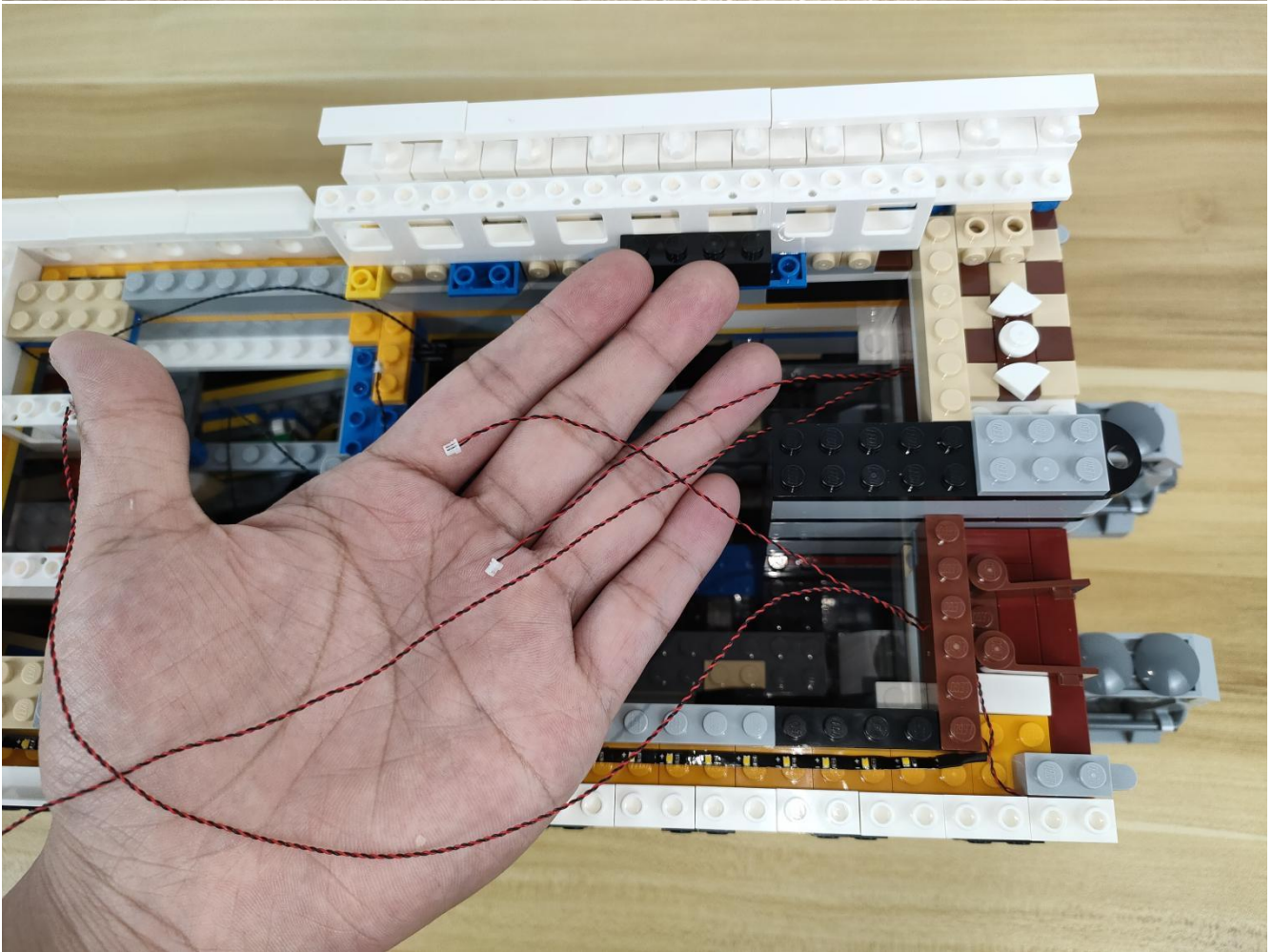
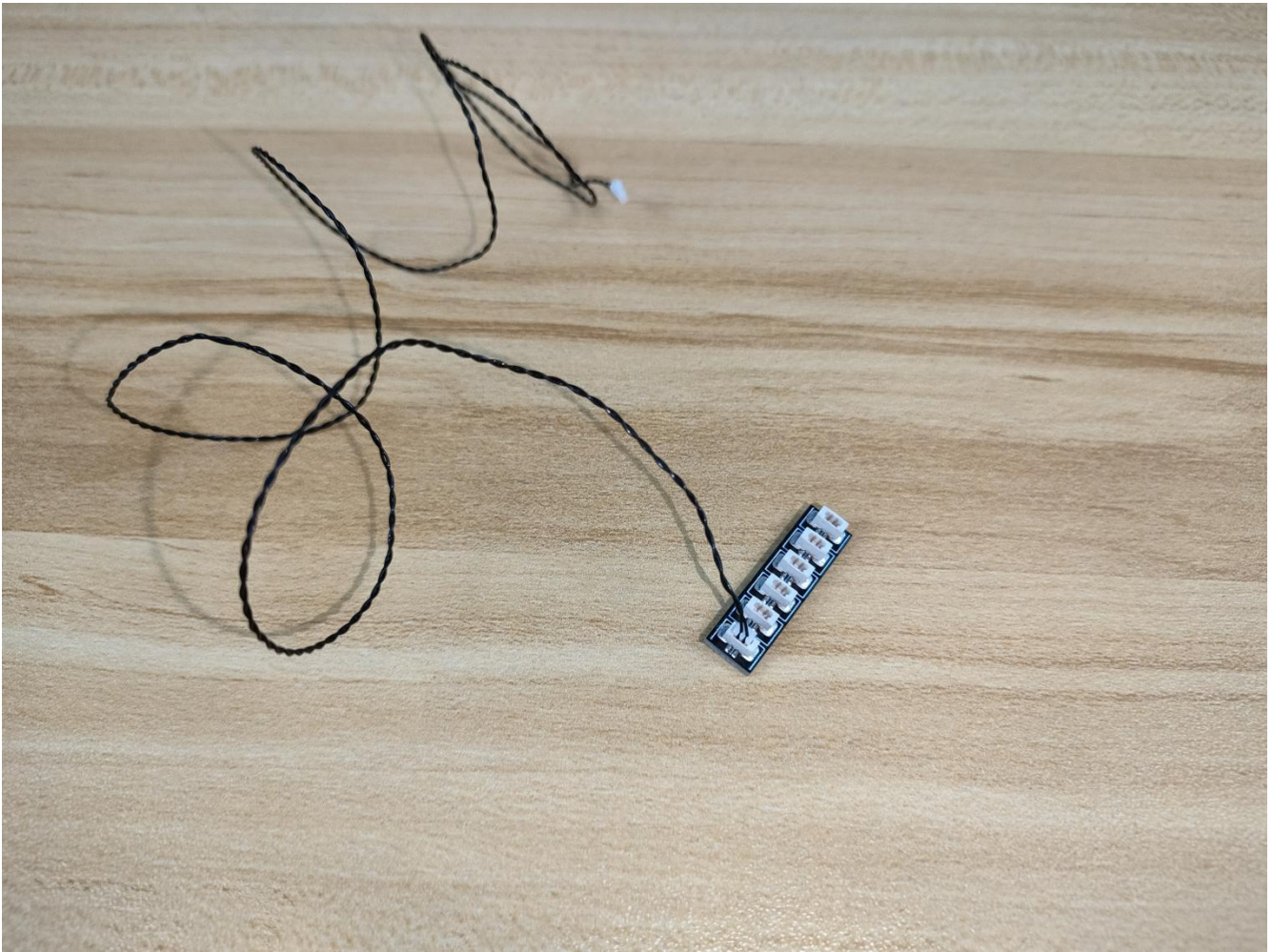

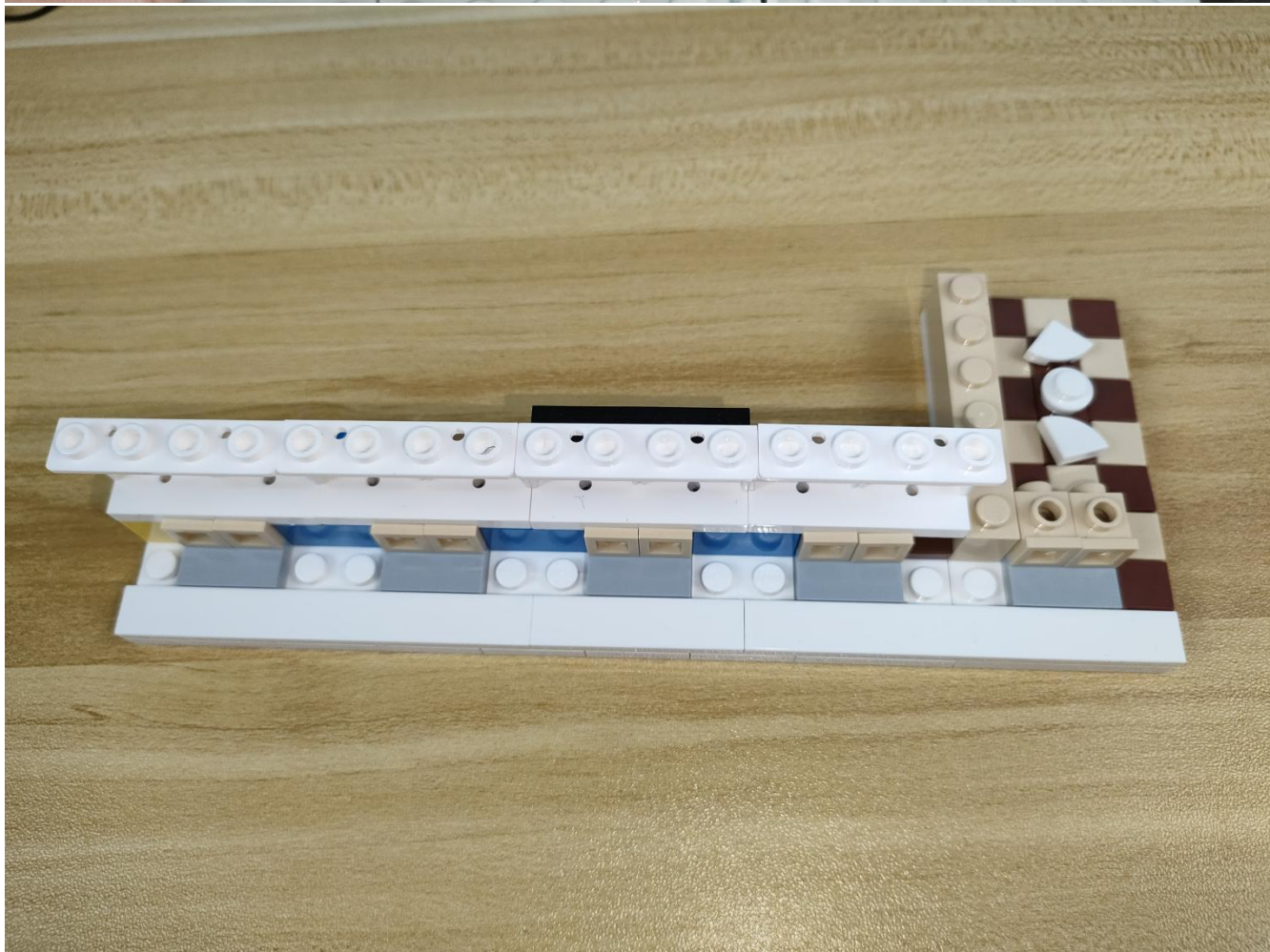
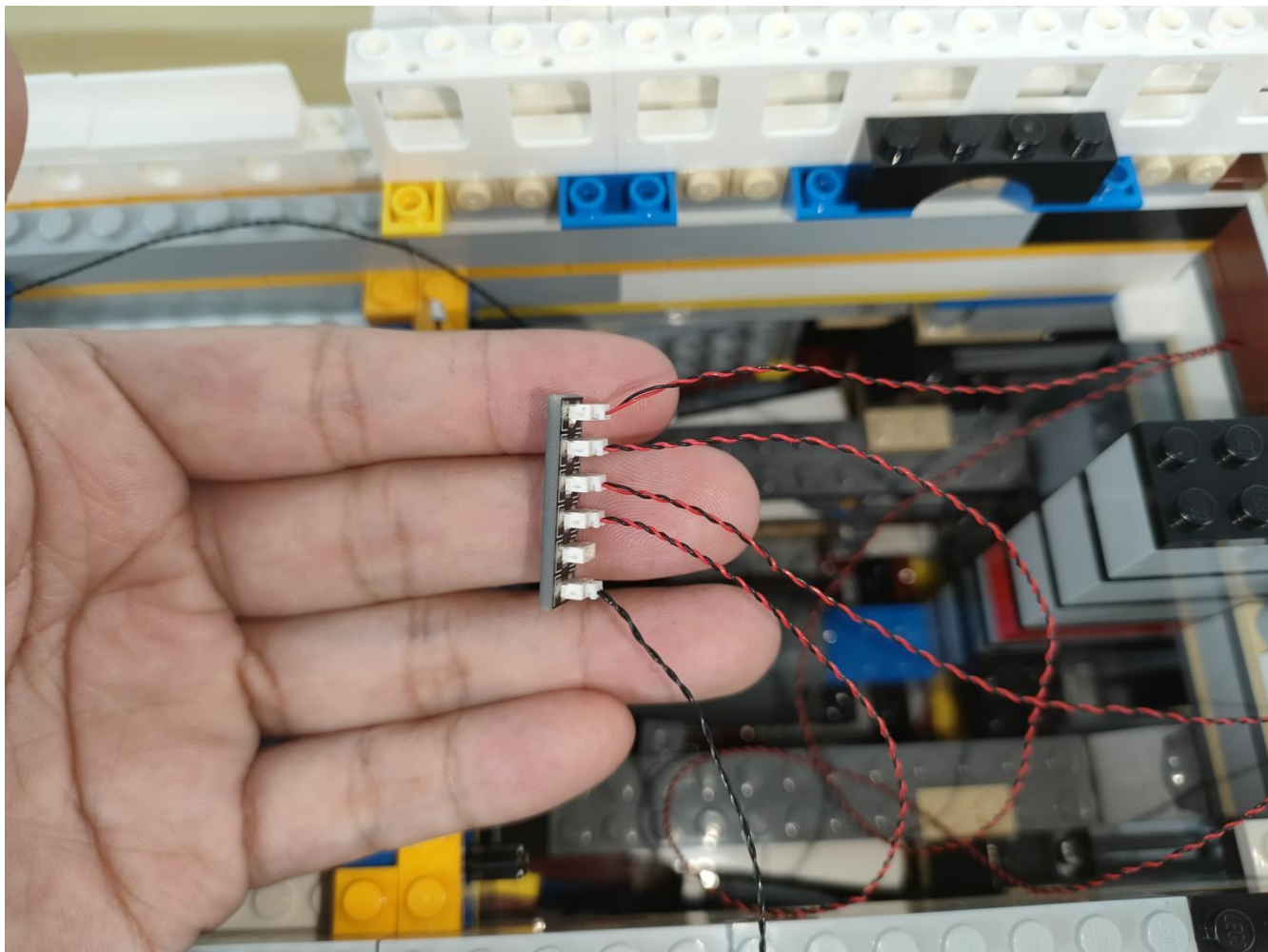

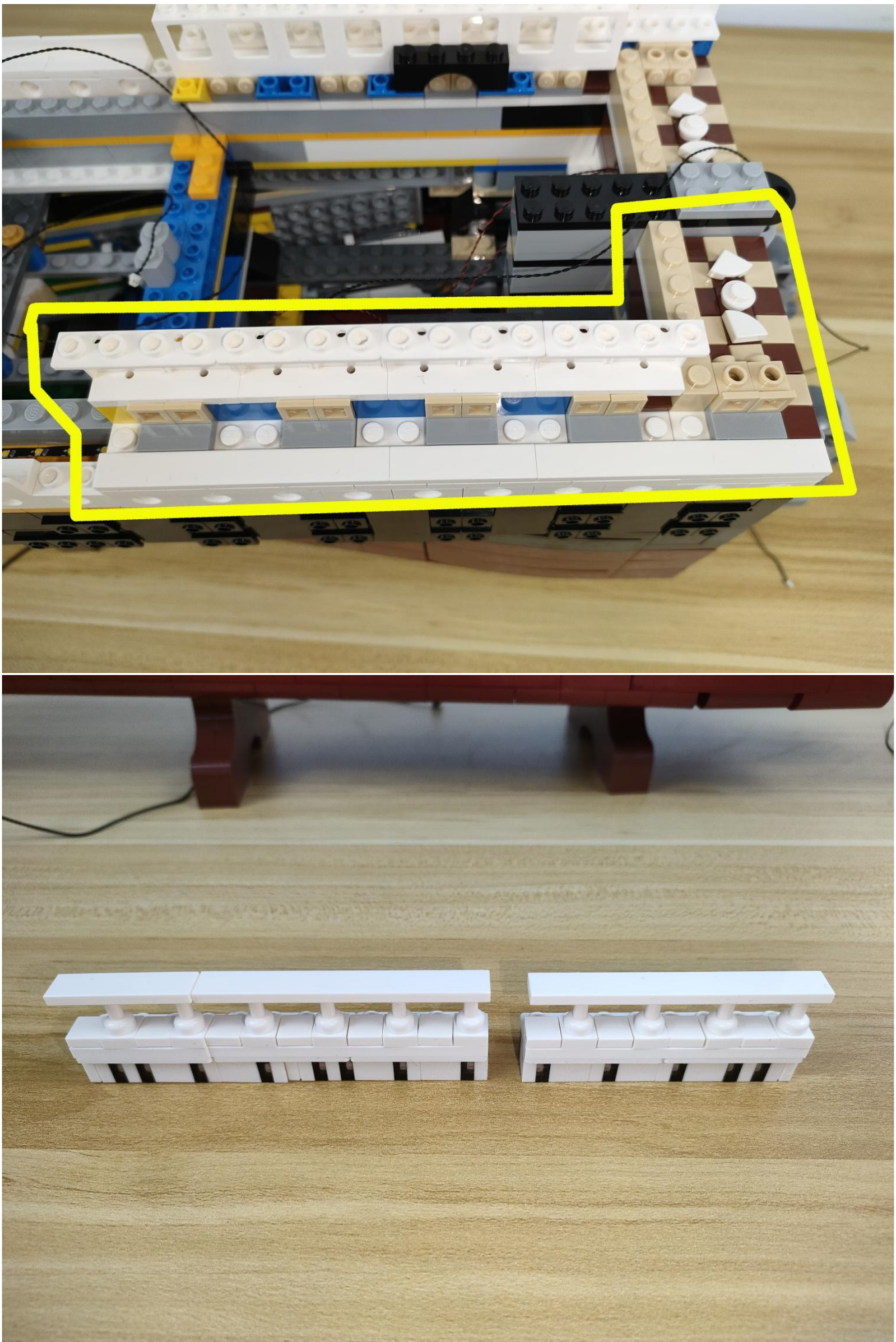

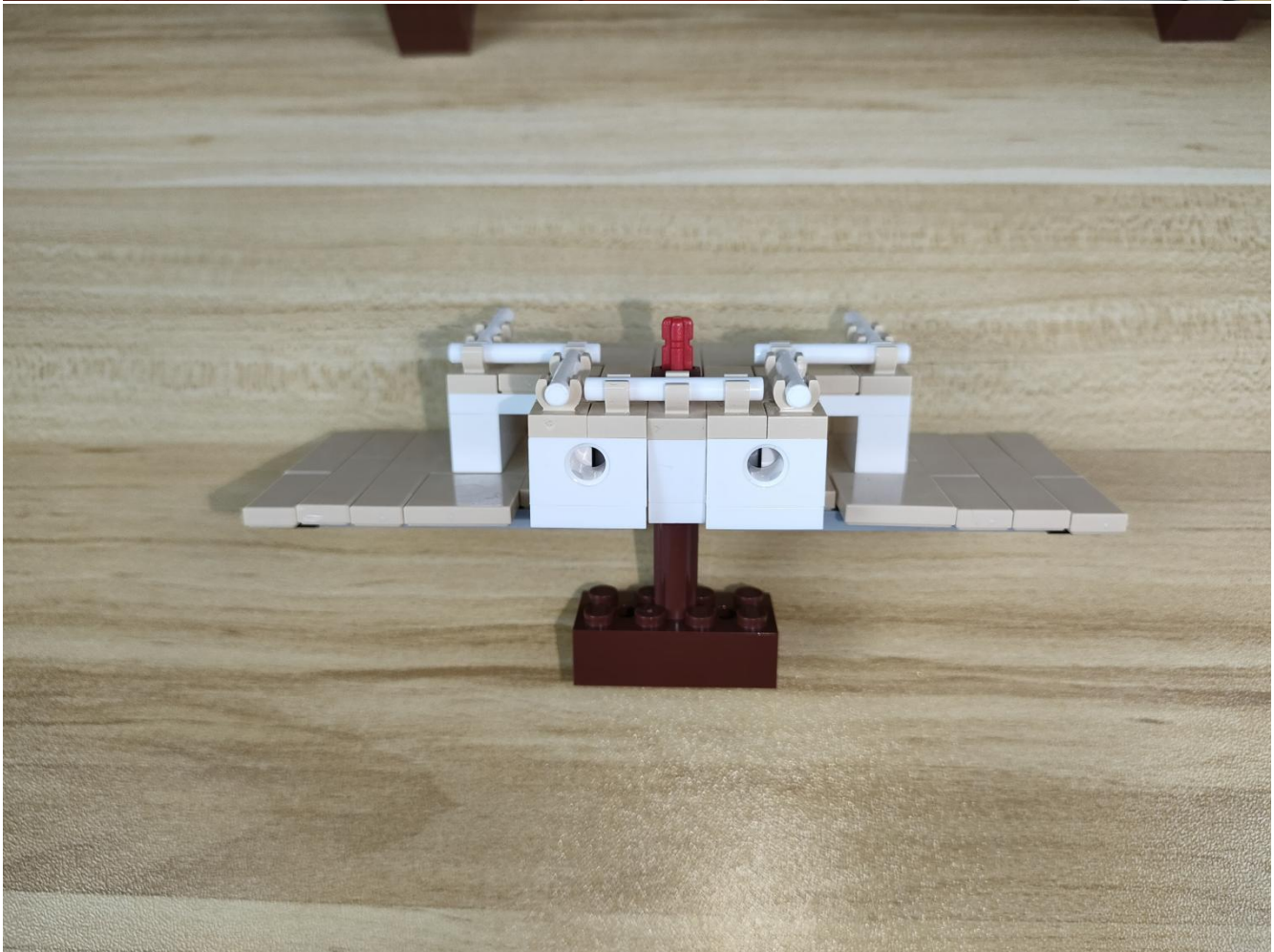

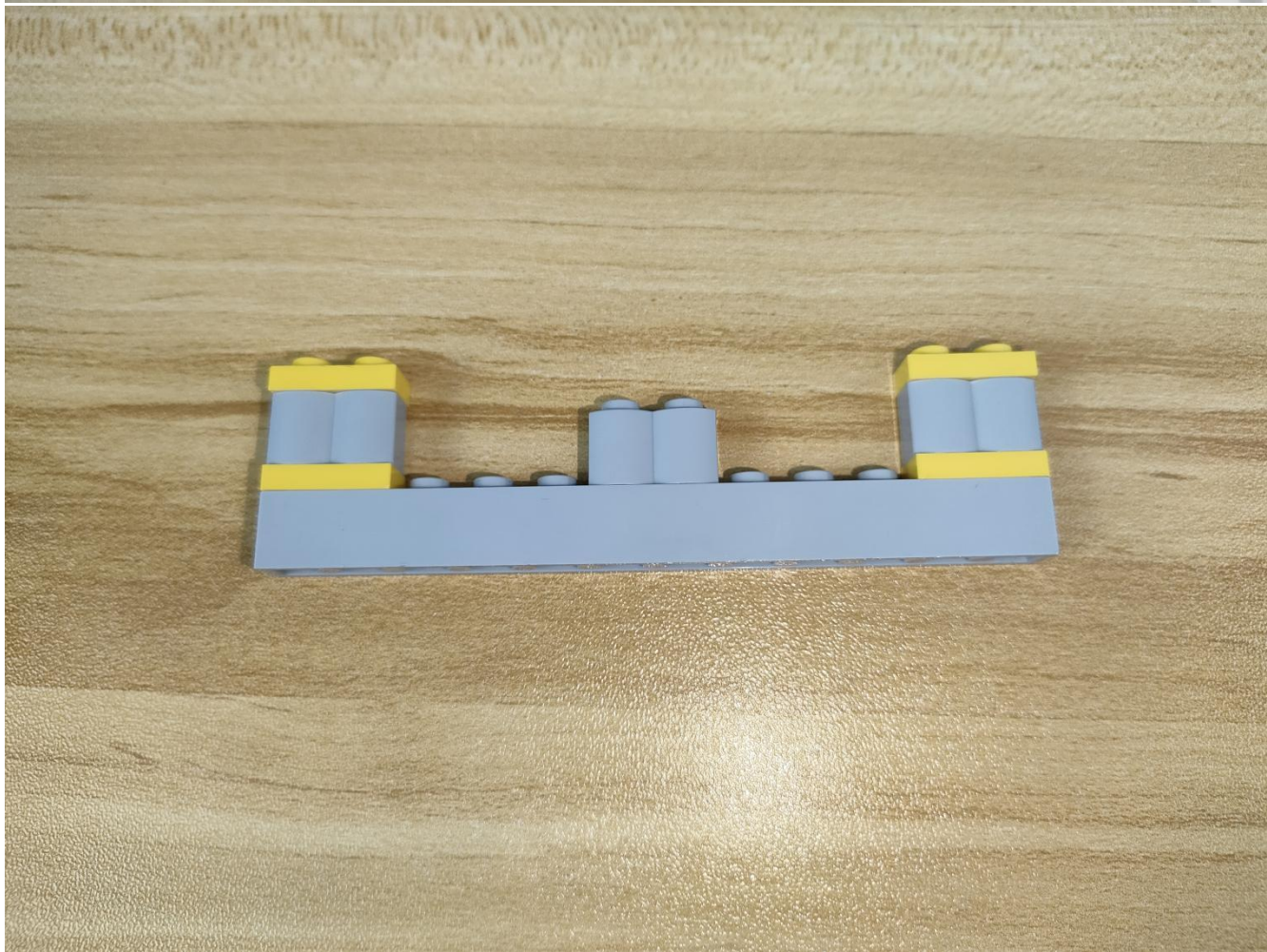
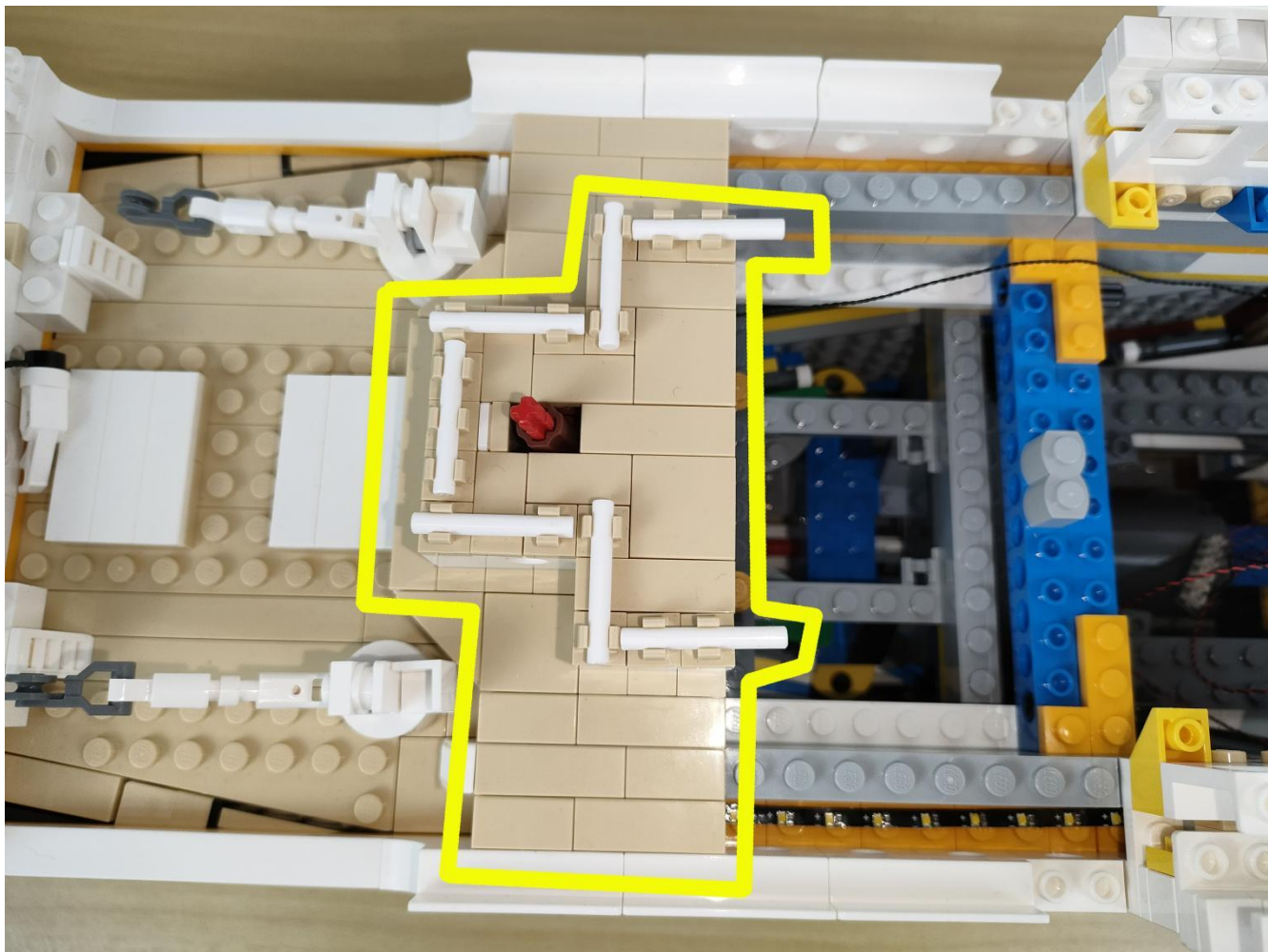

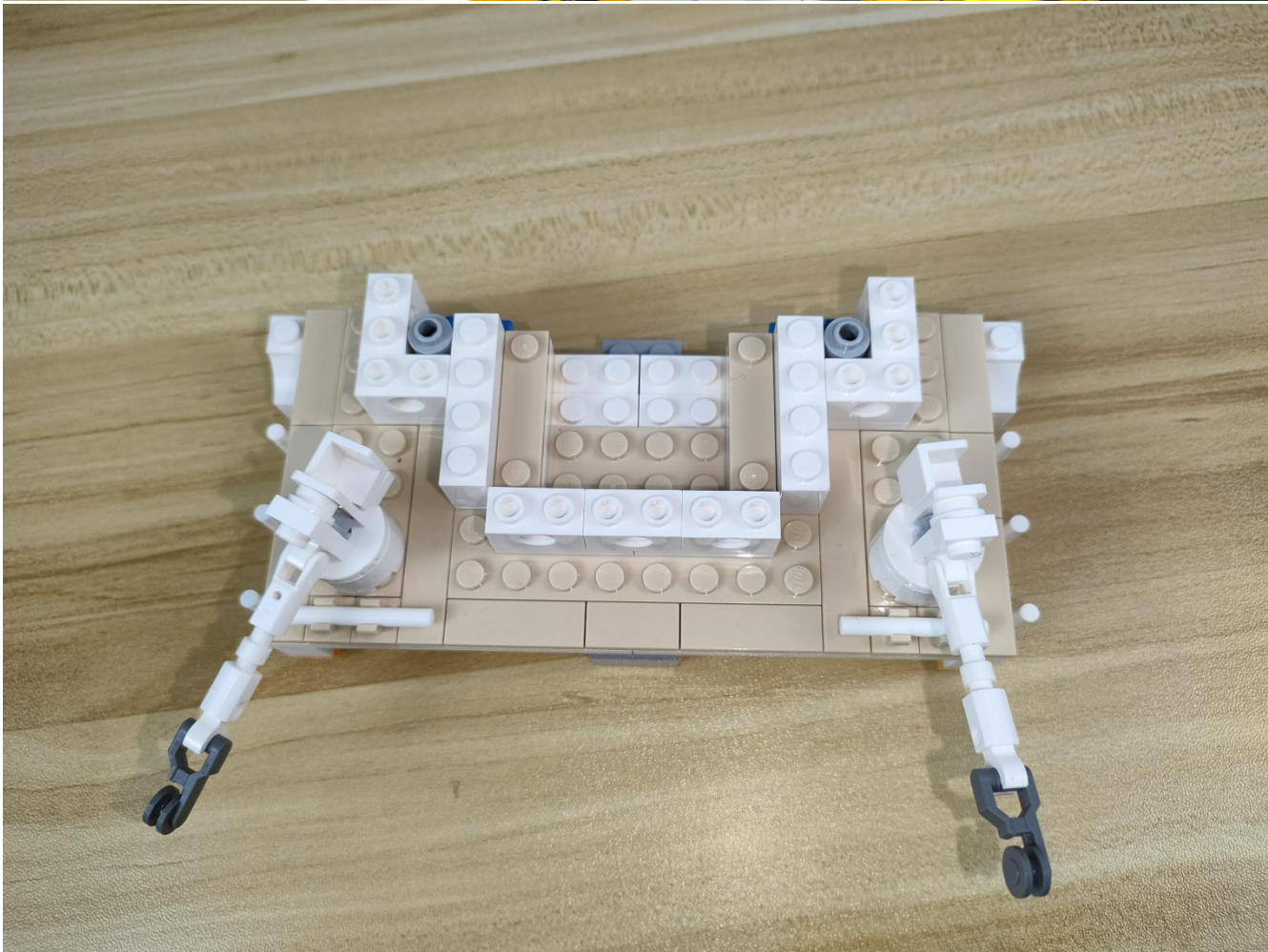
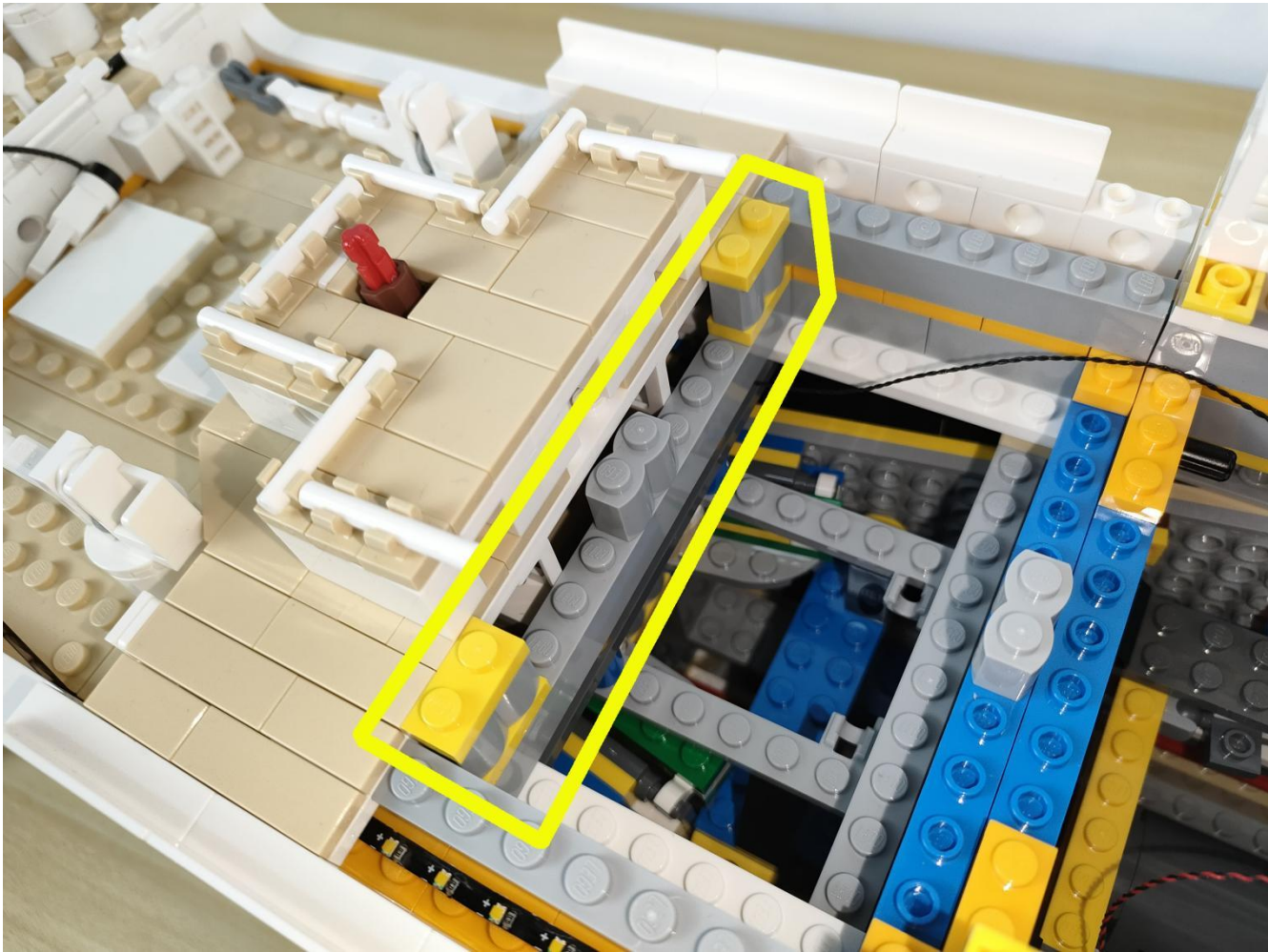

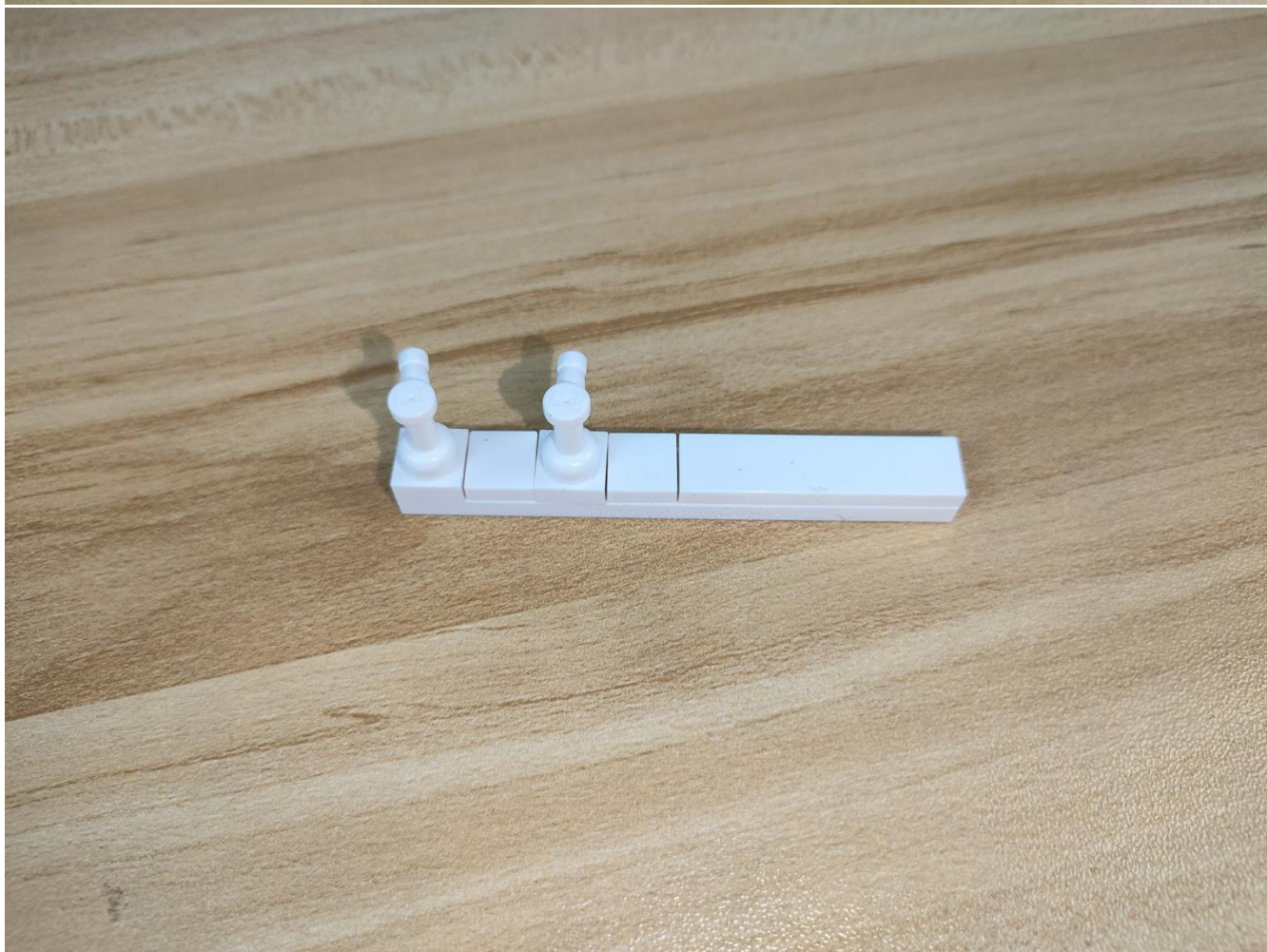
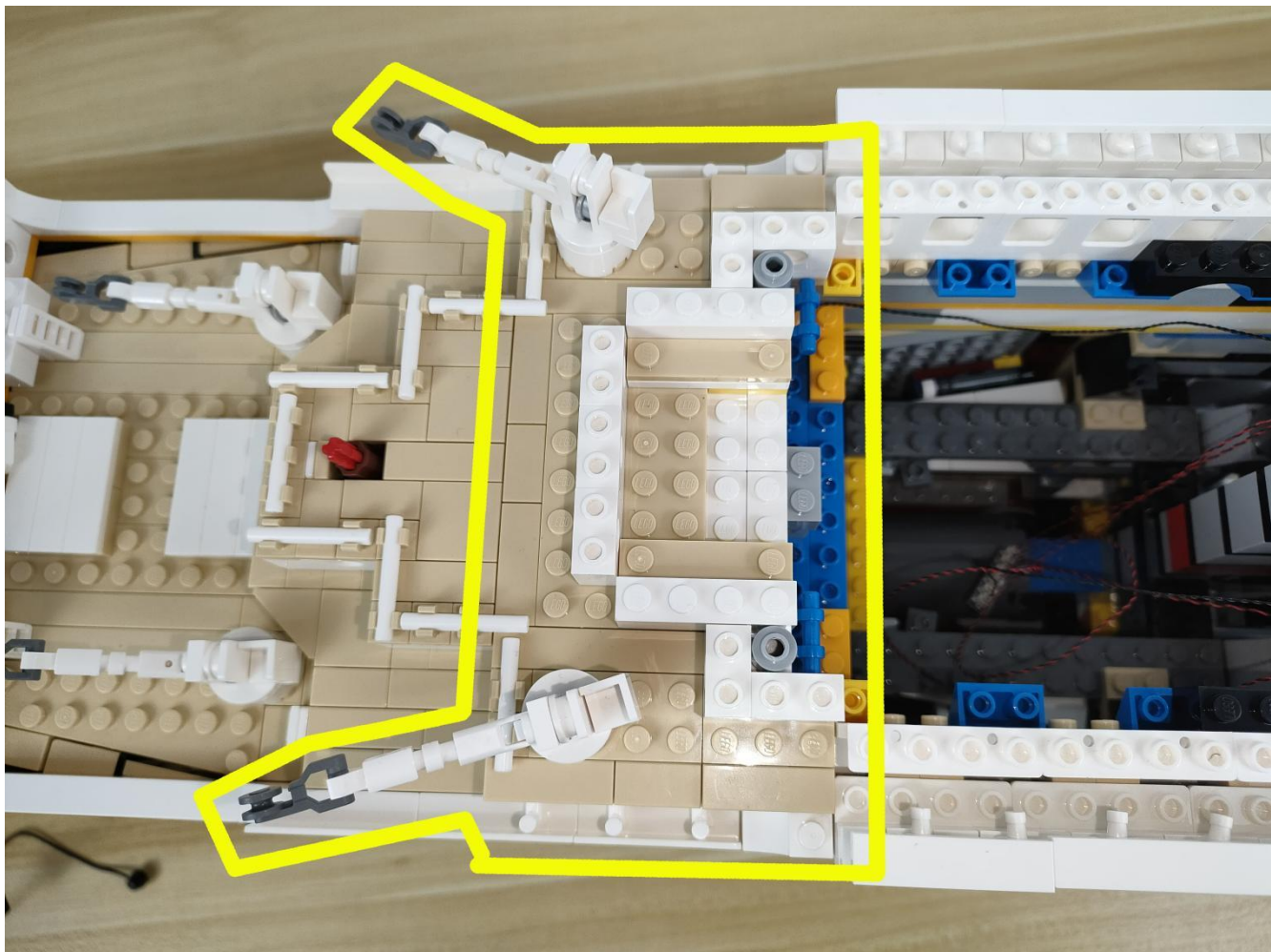

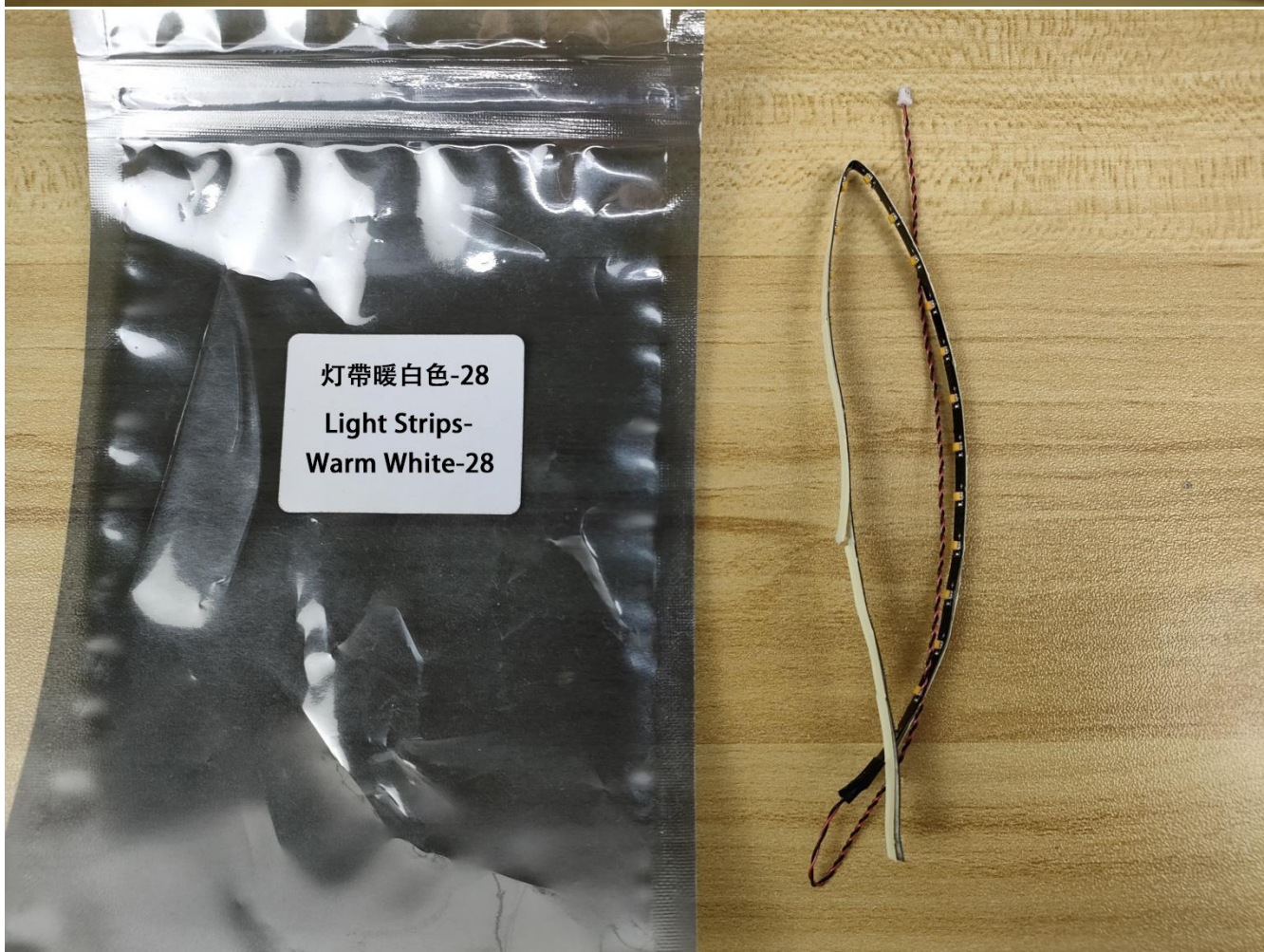
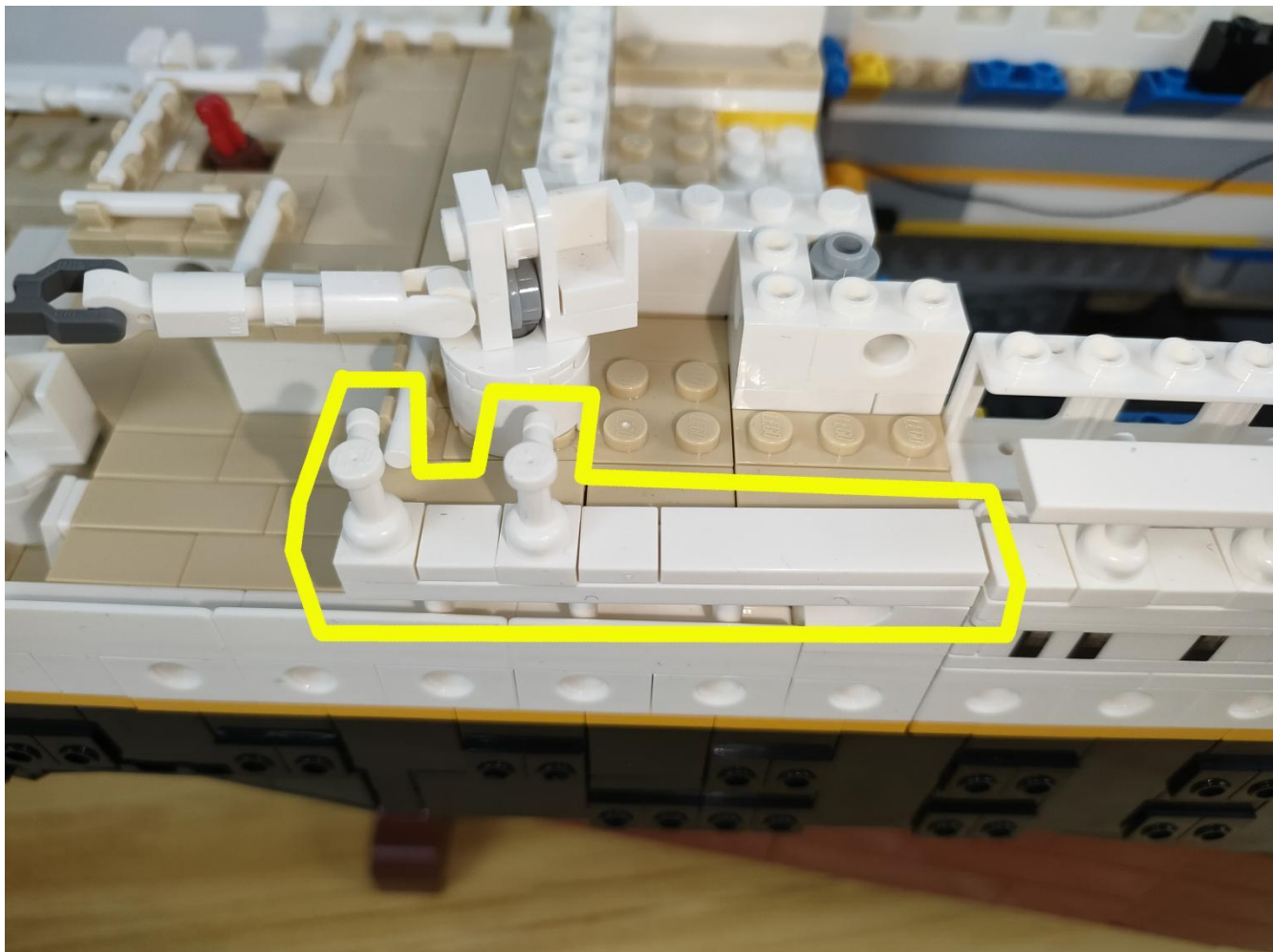

灯带暖白色-28
Light Strips-
Warm White-28

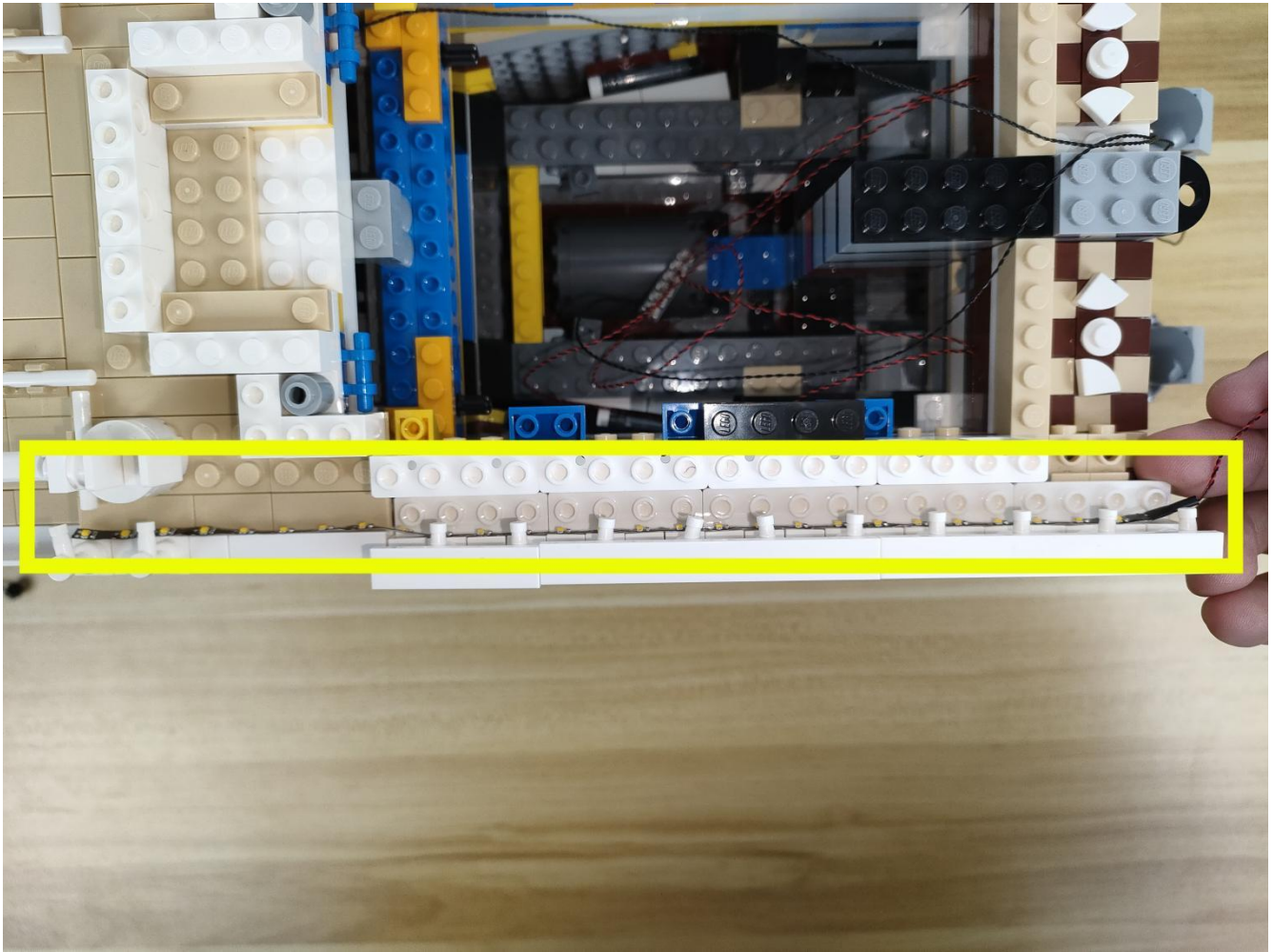

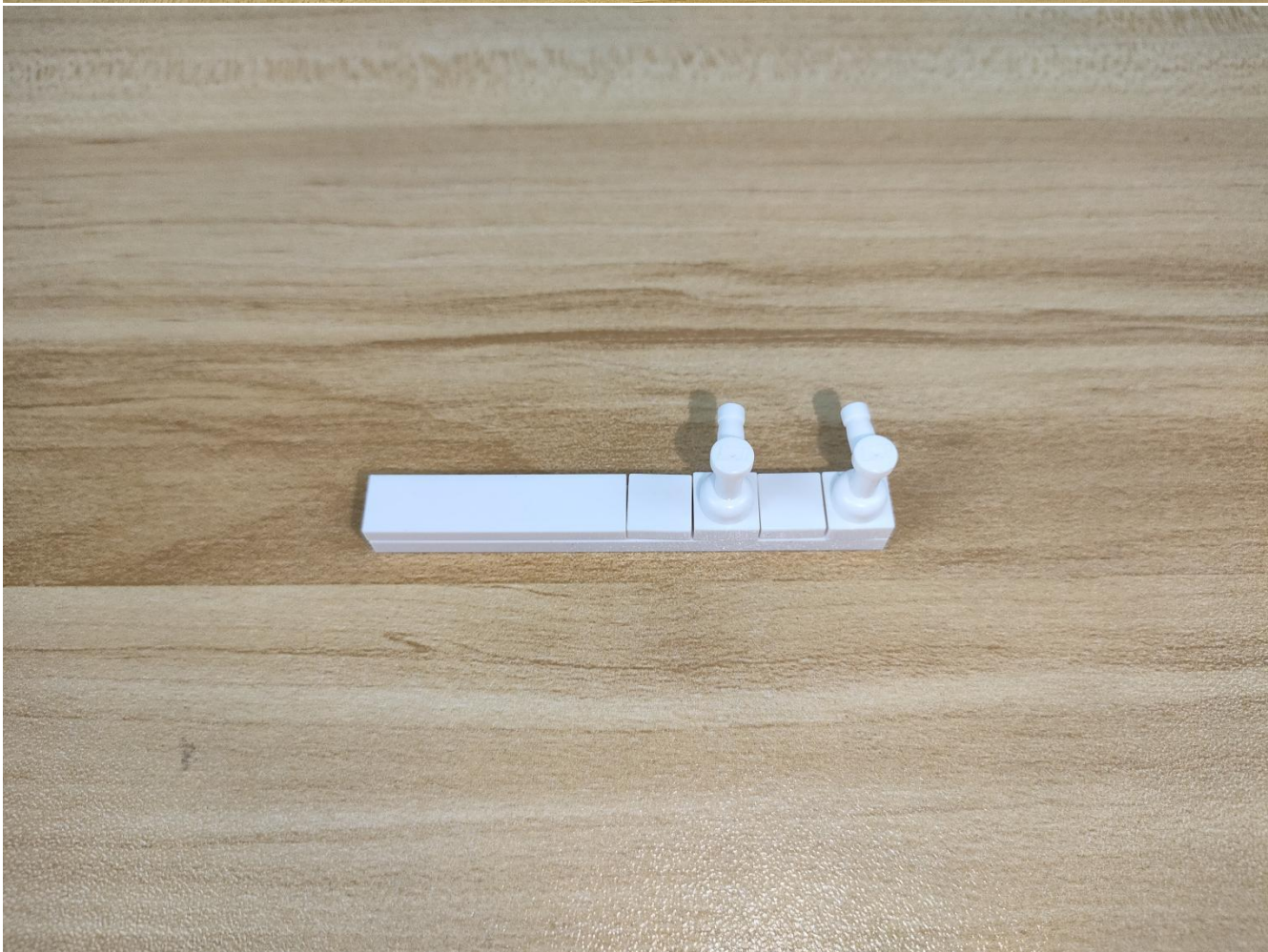

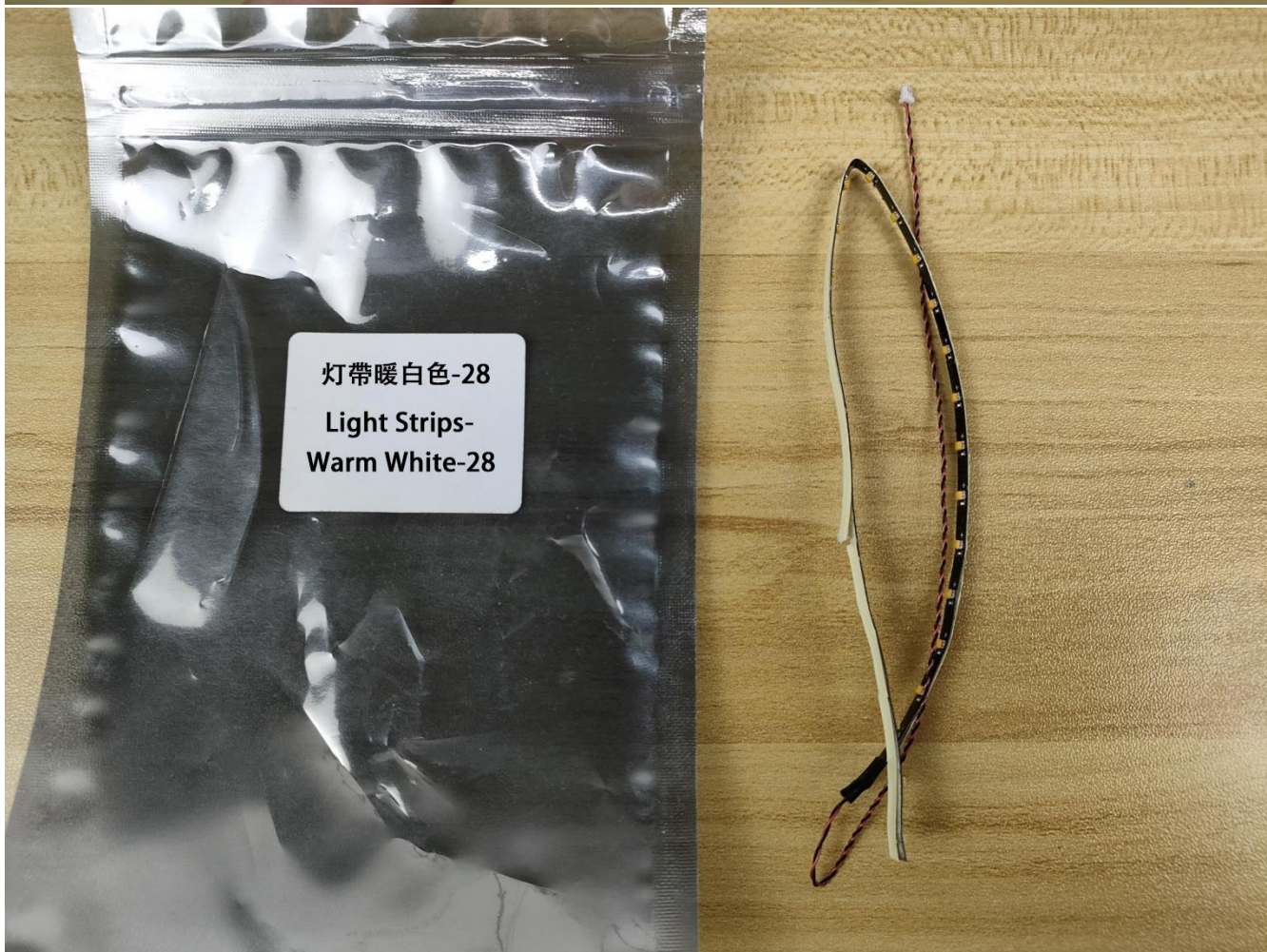
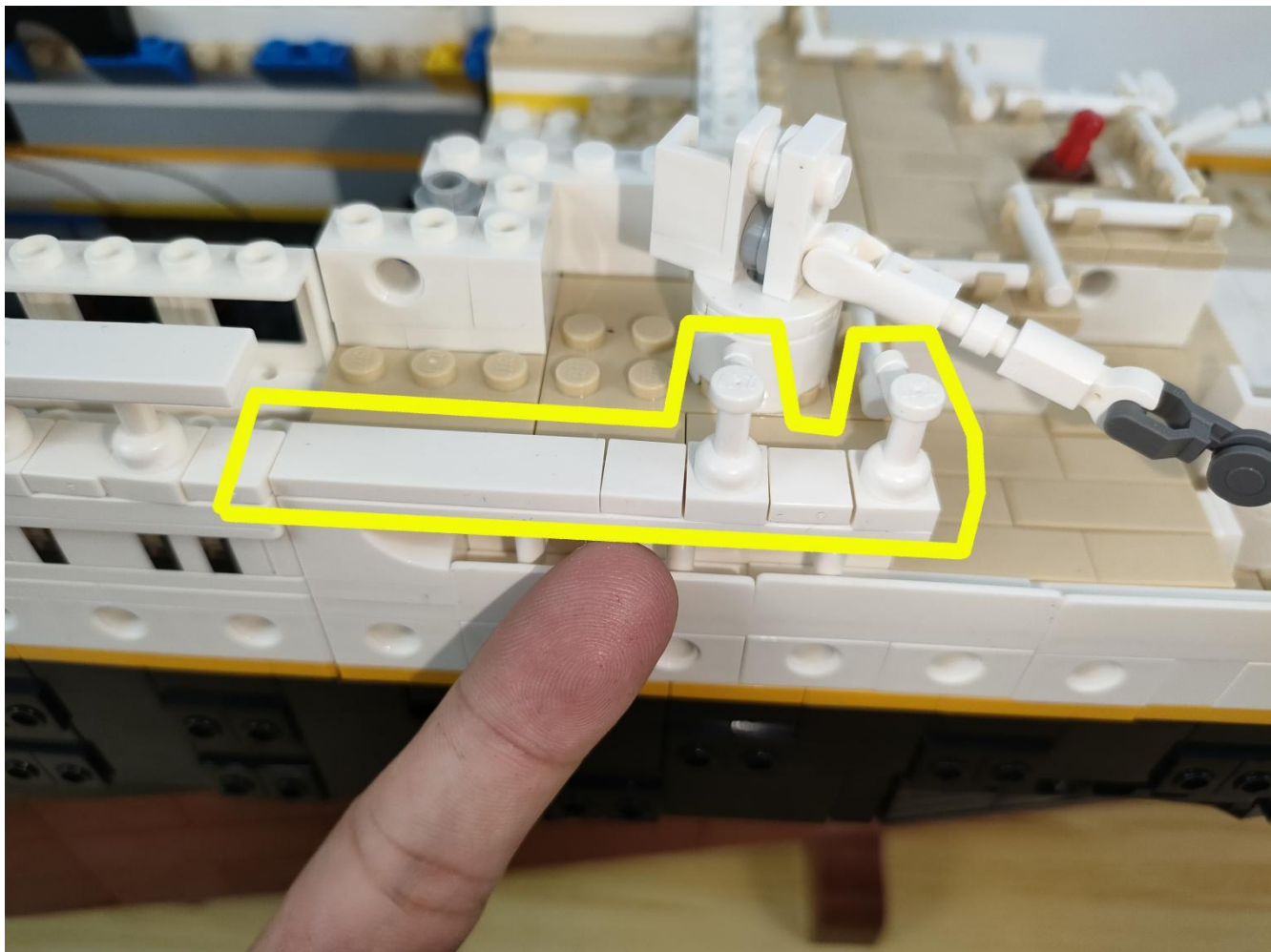

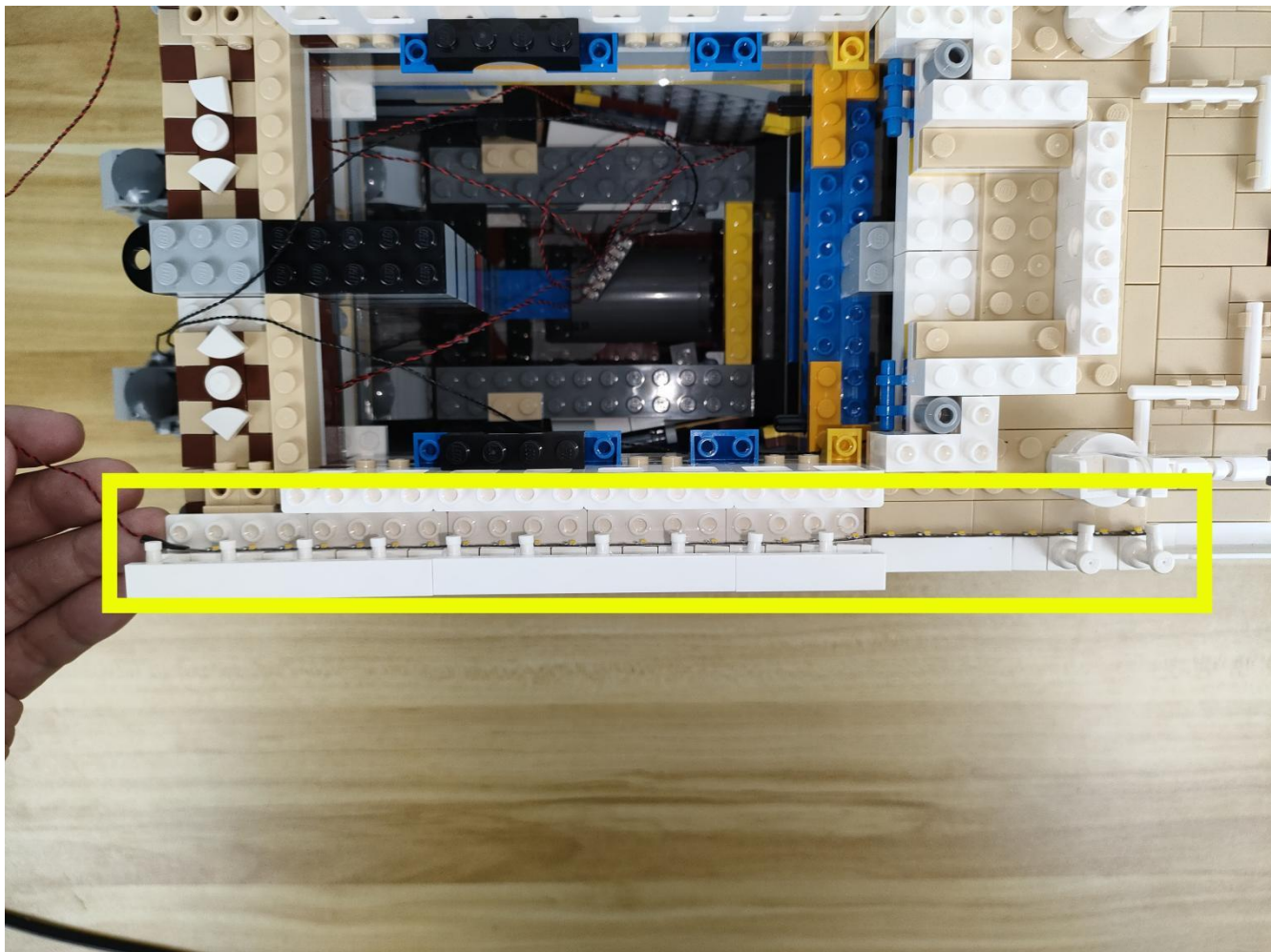

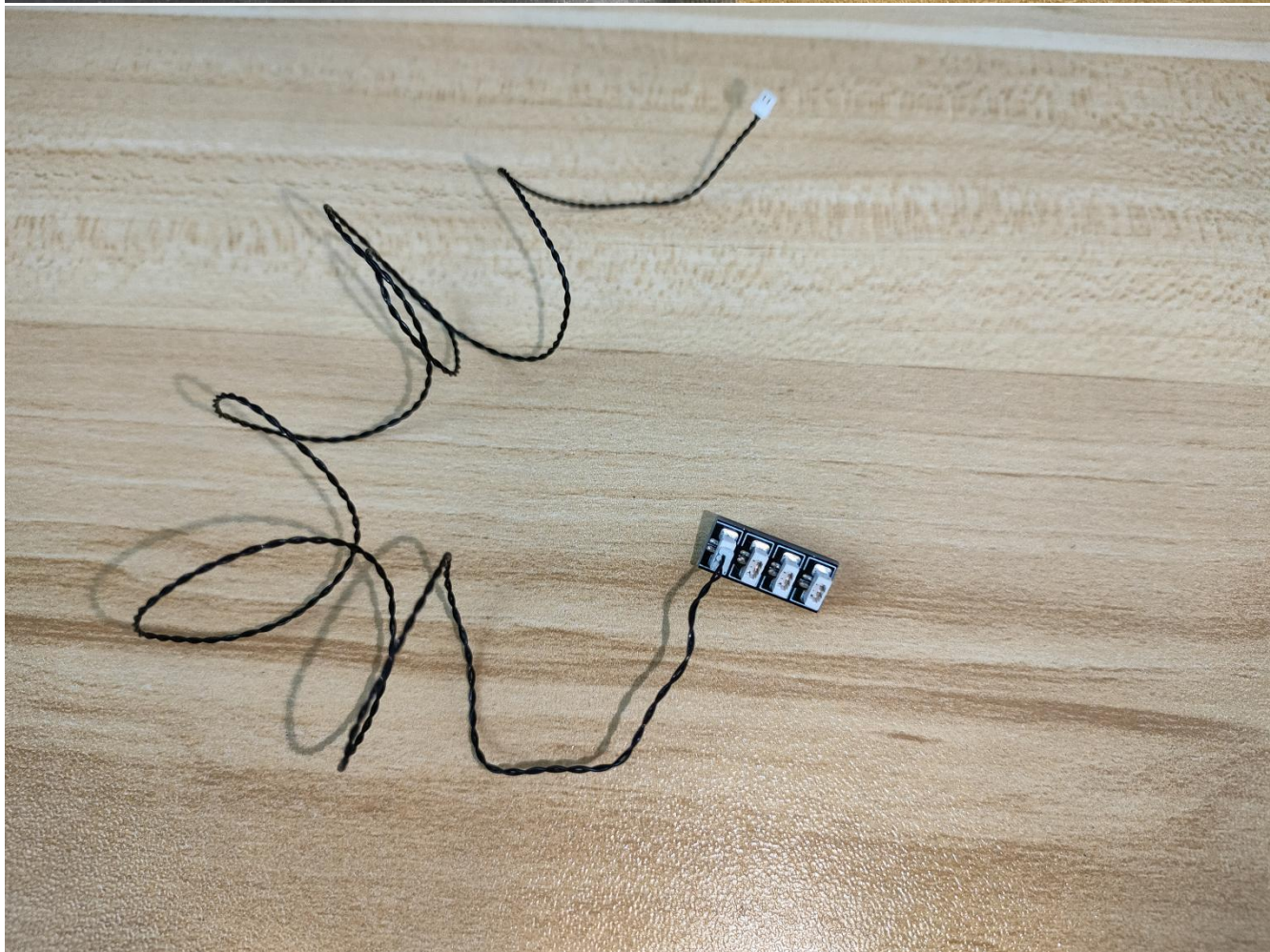

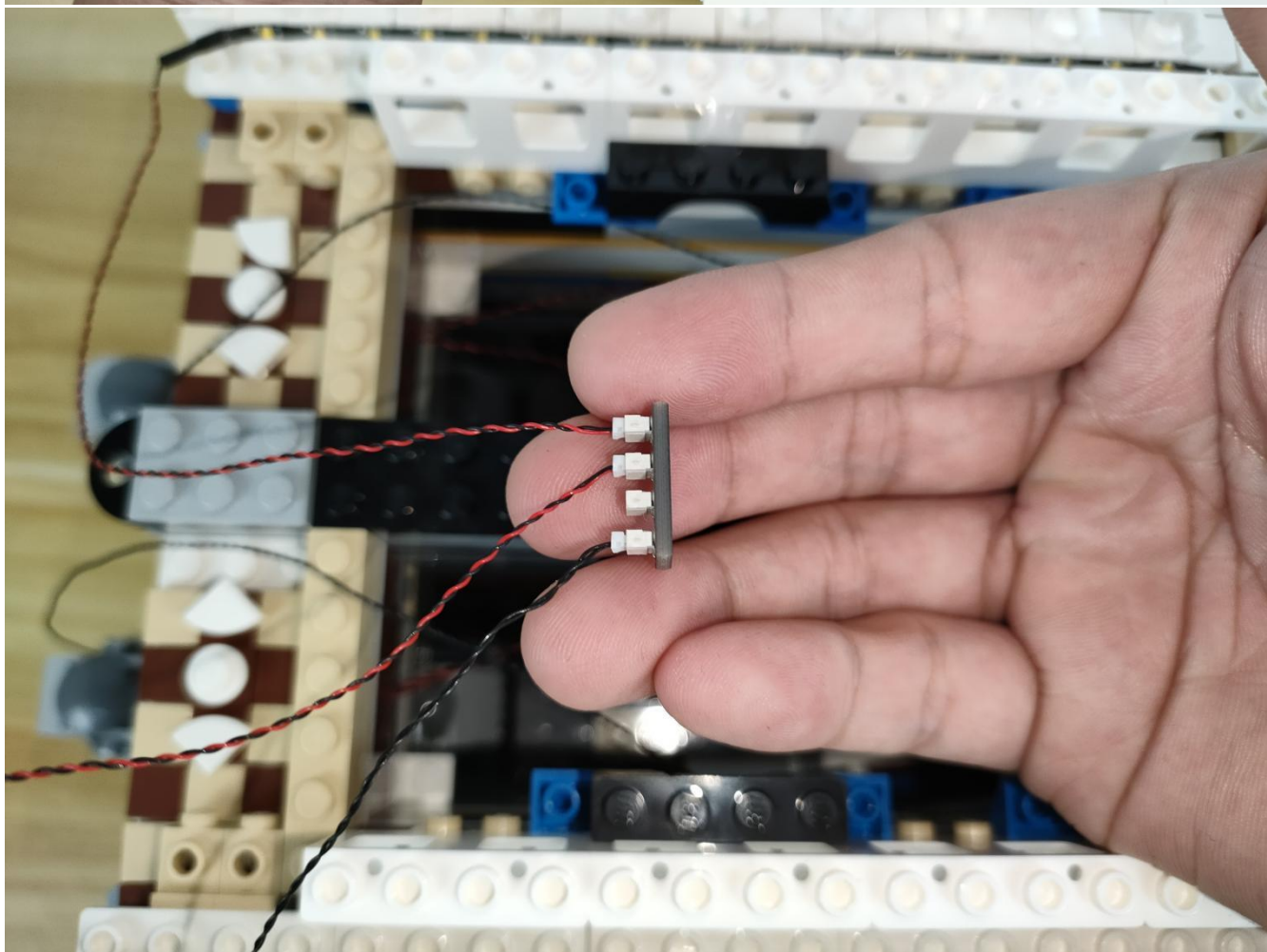
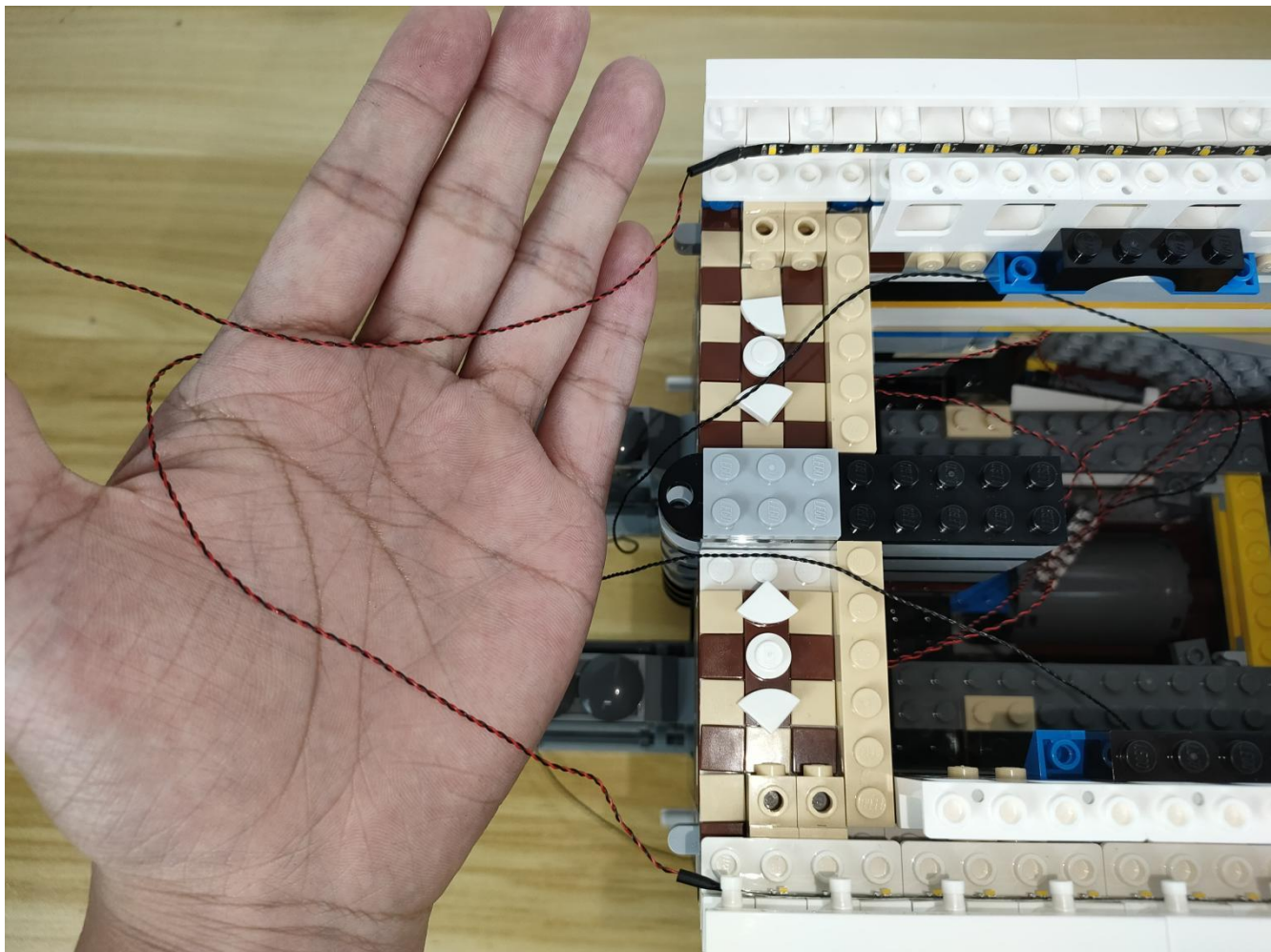

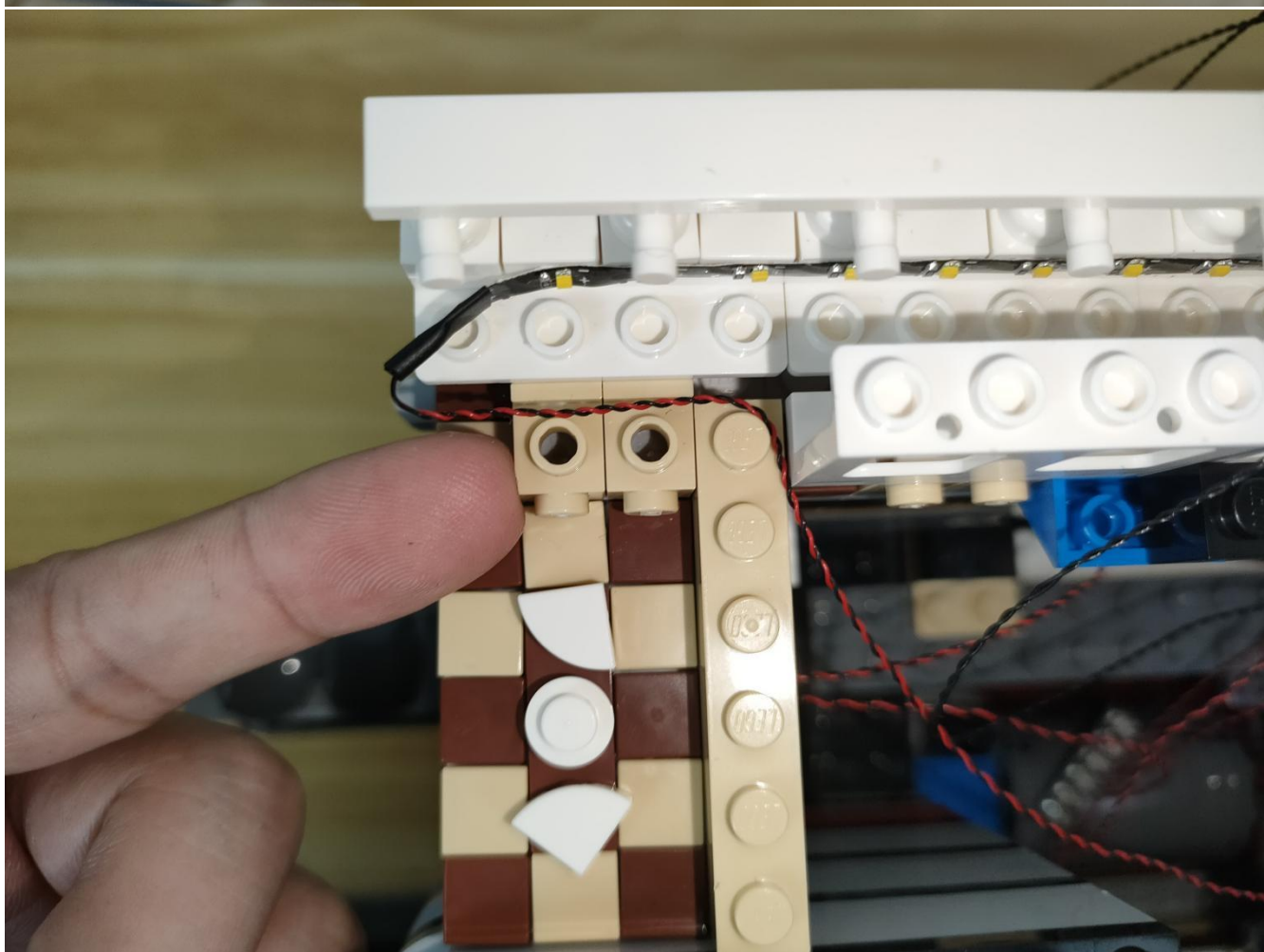
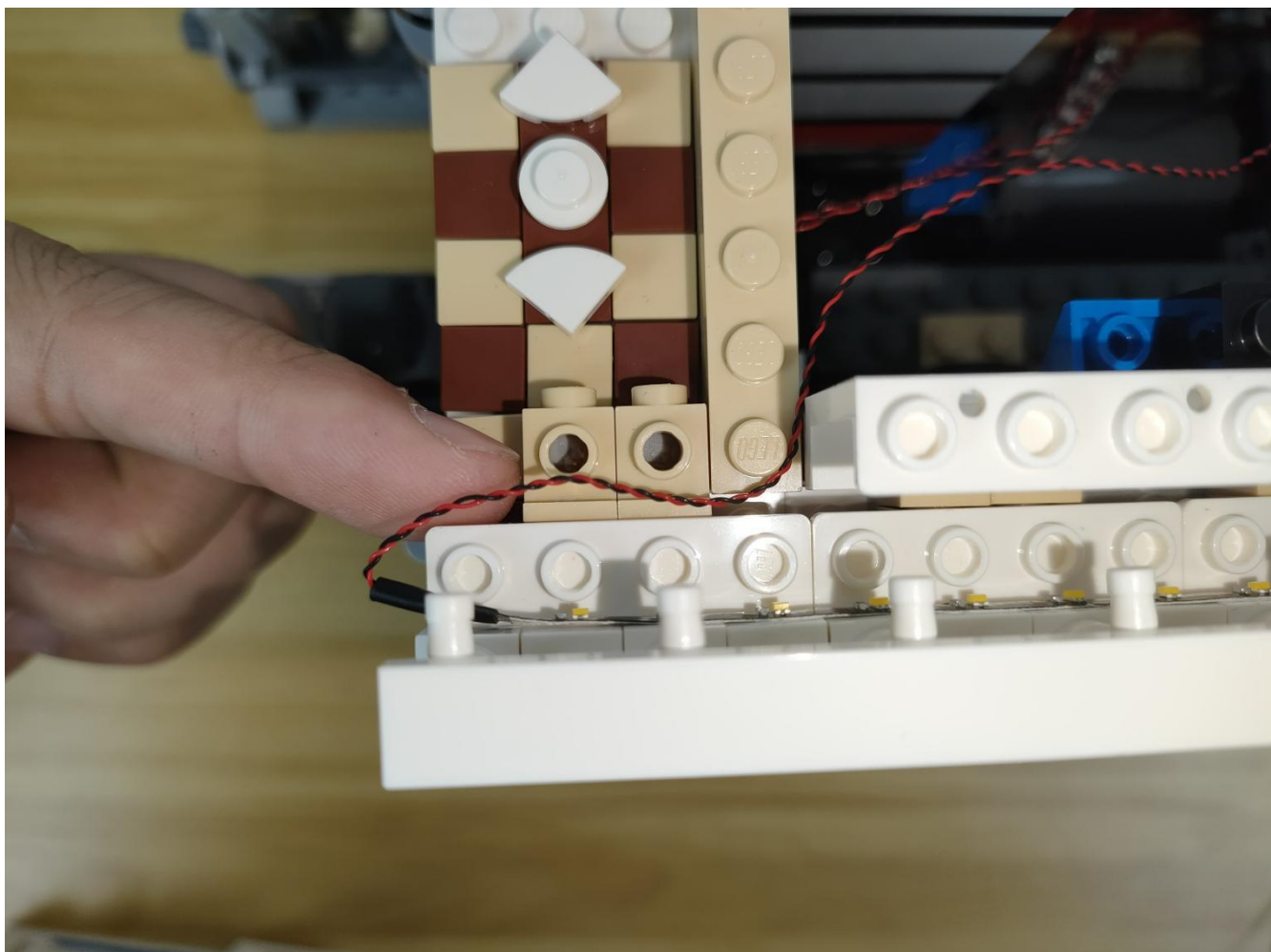

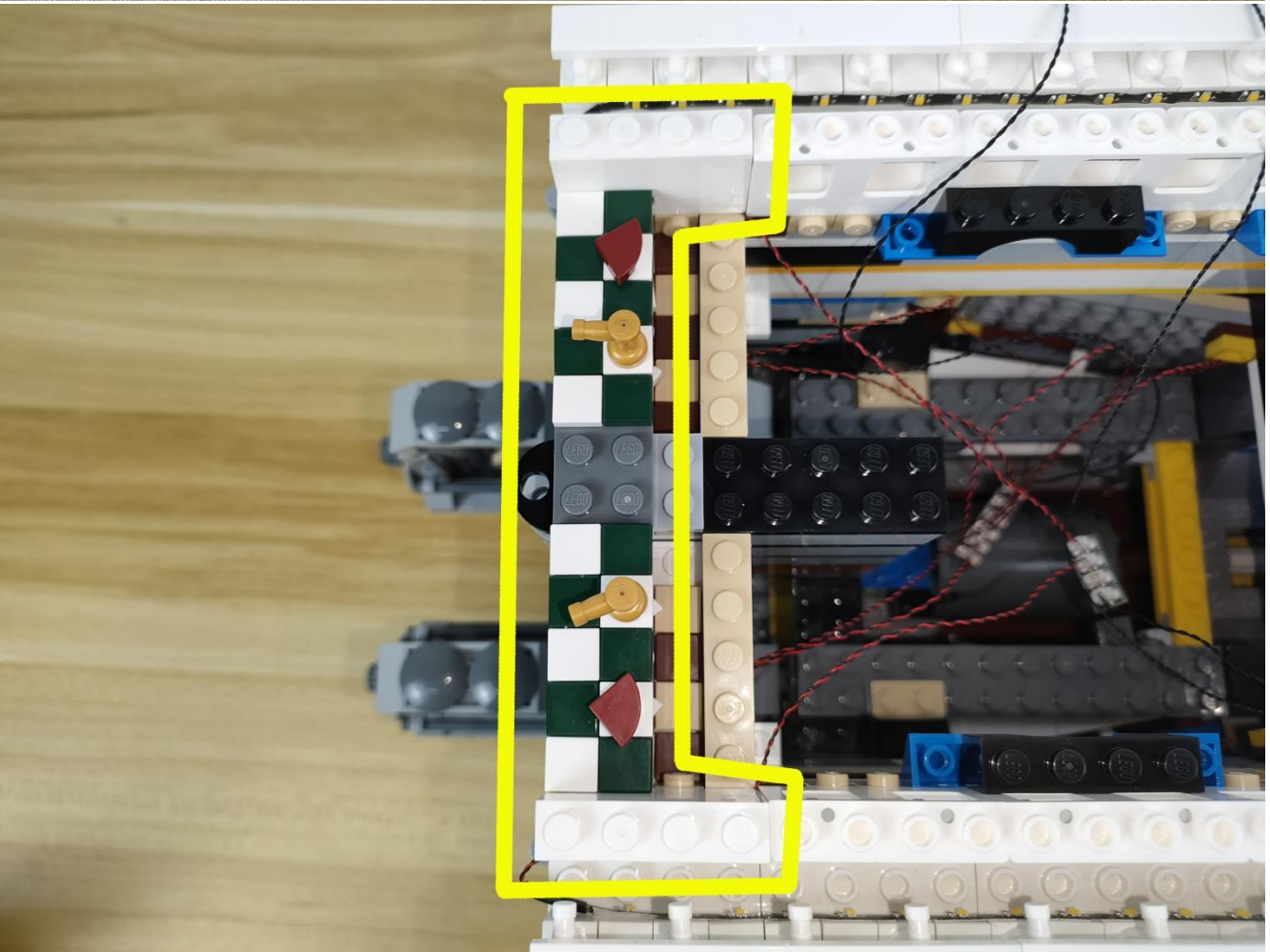
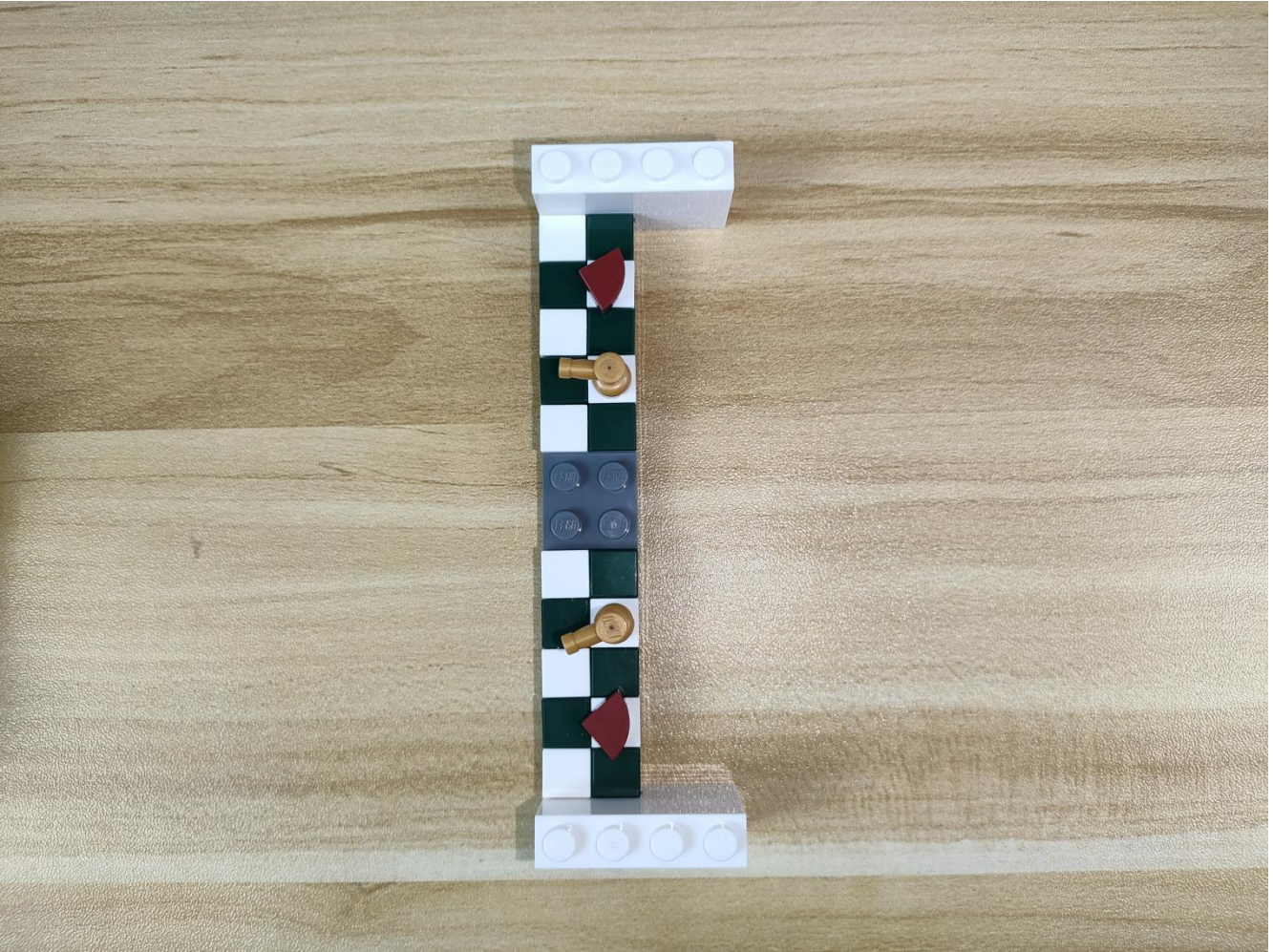

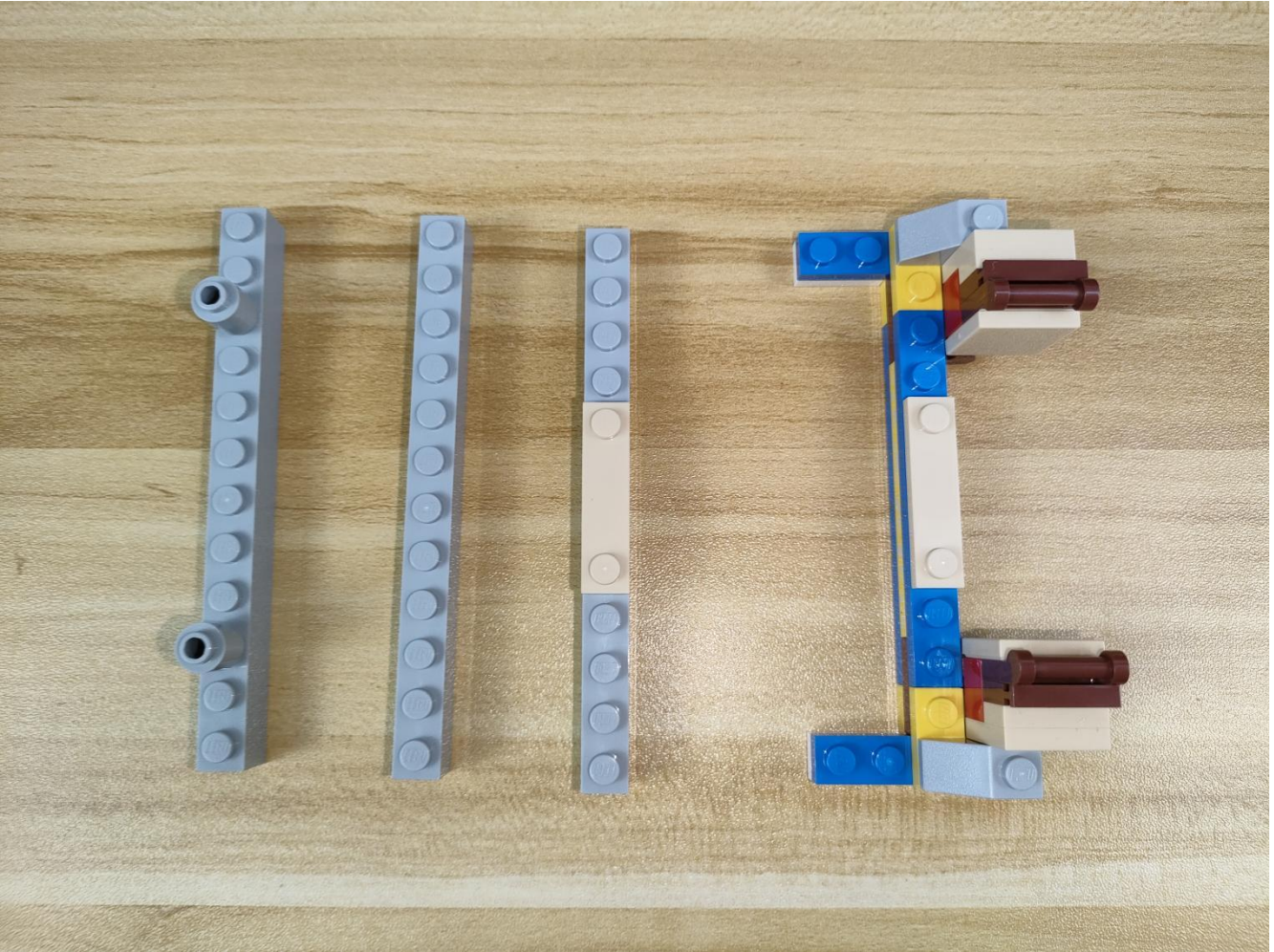
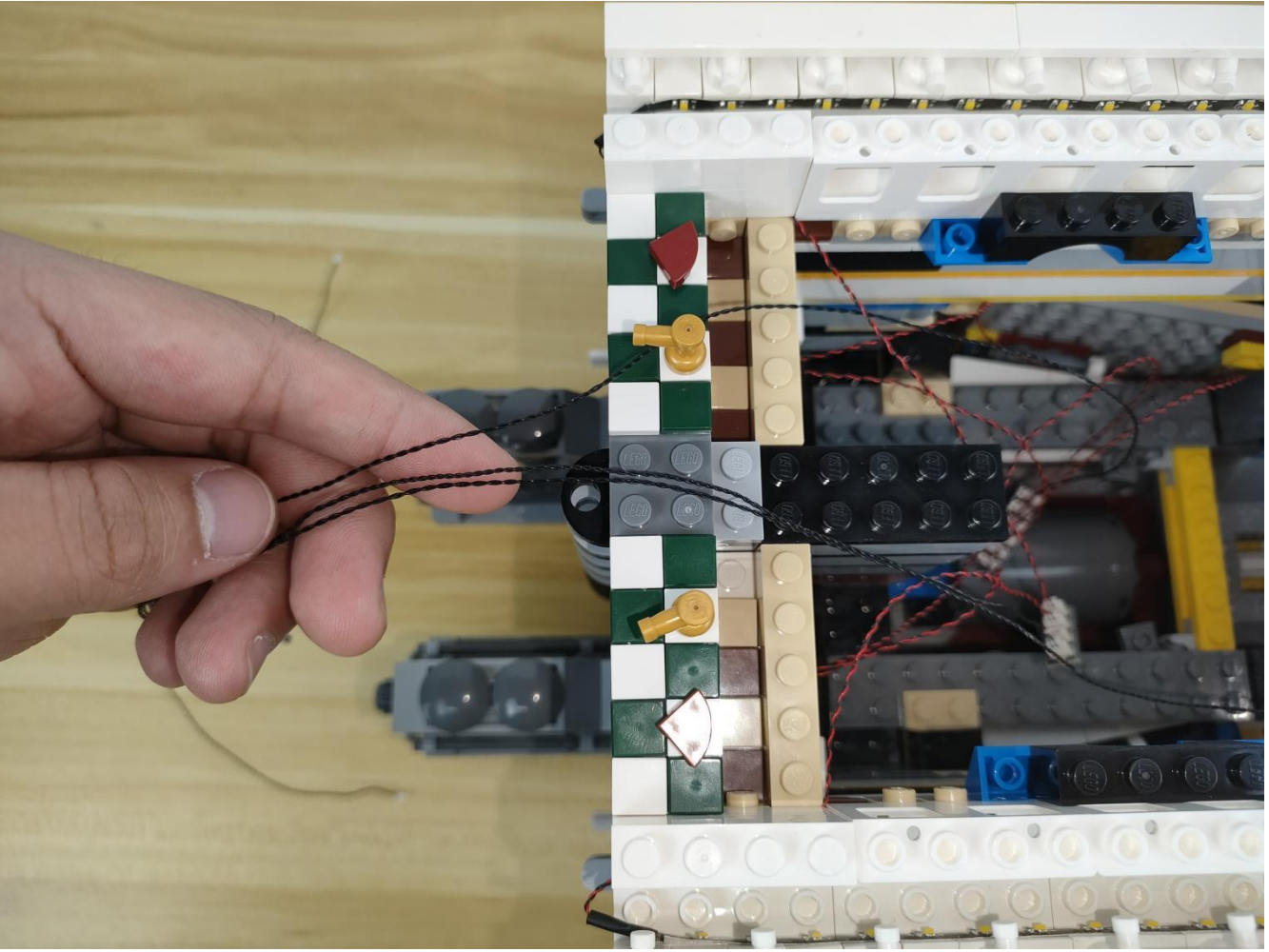

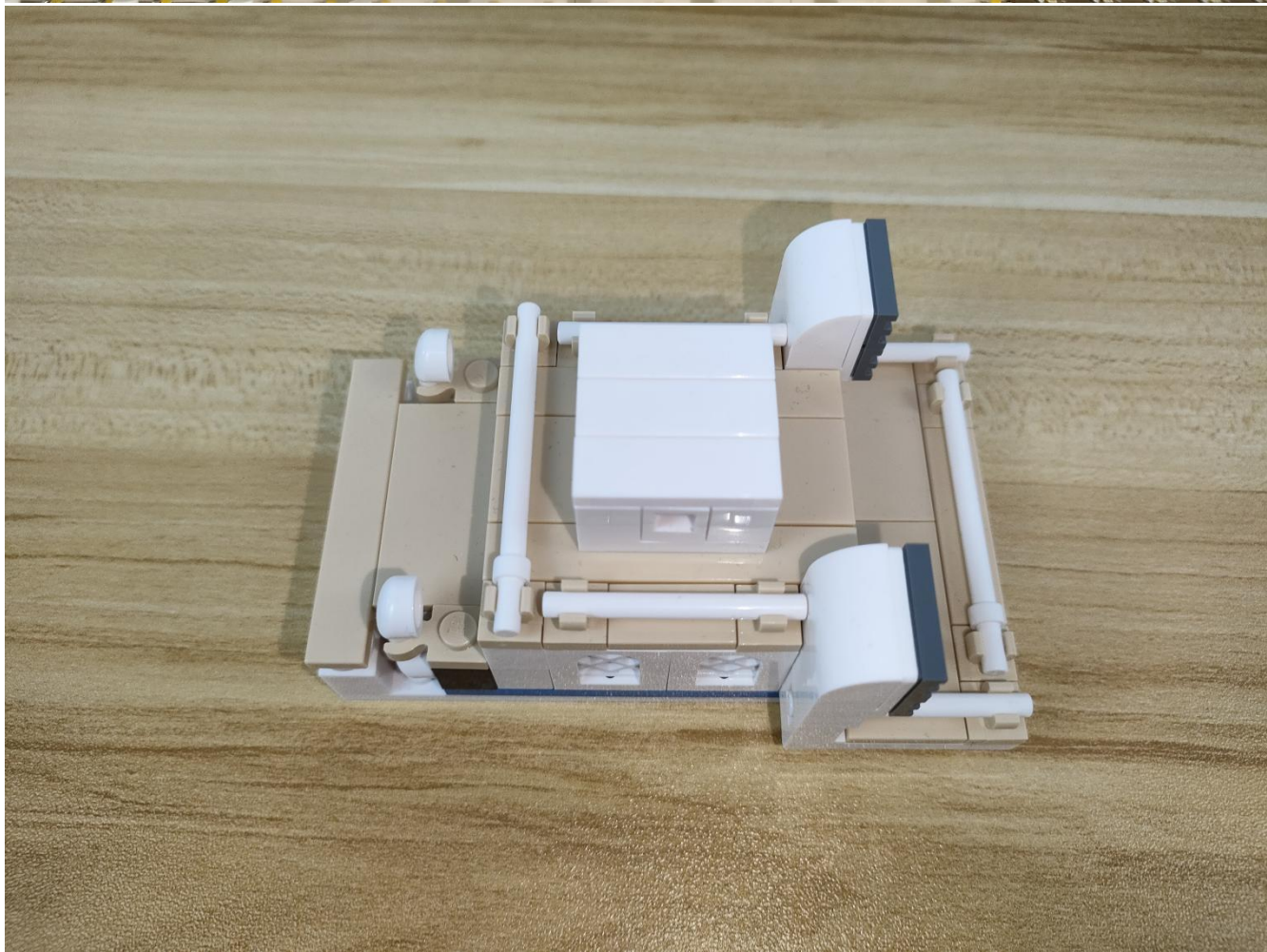
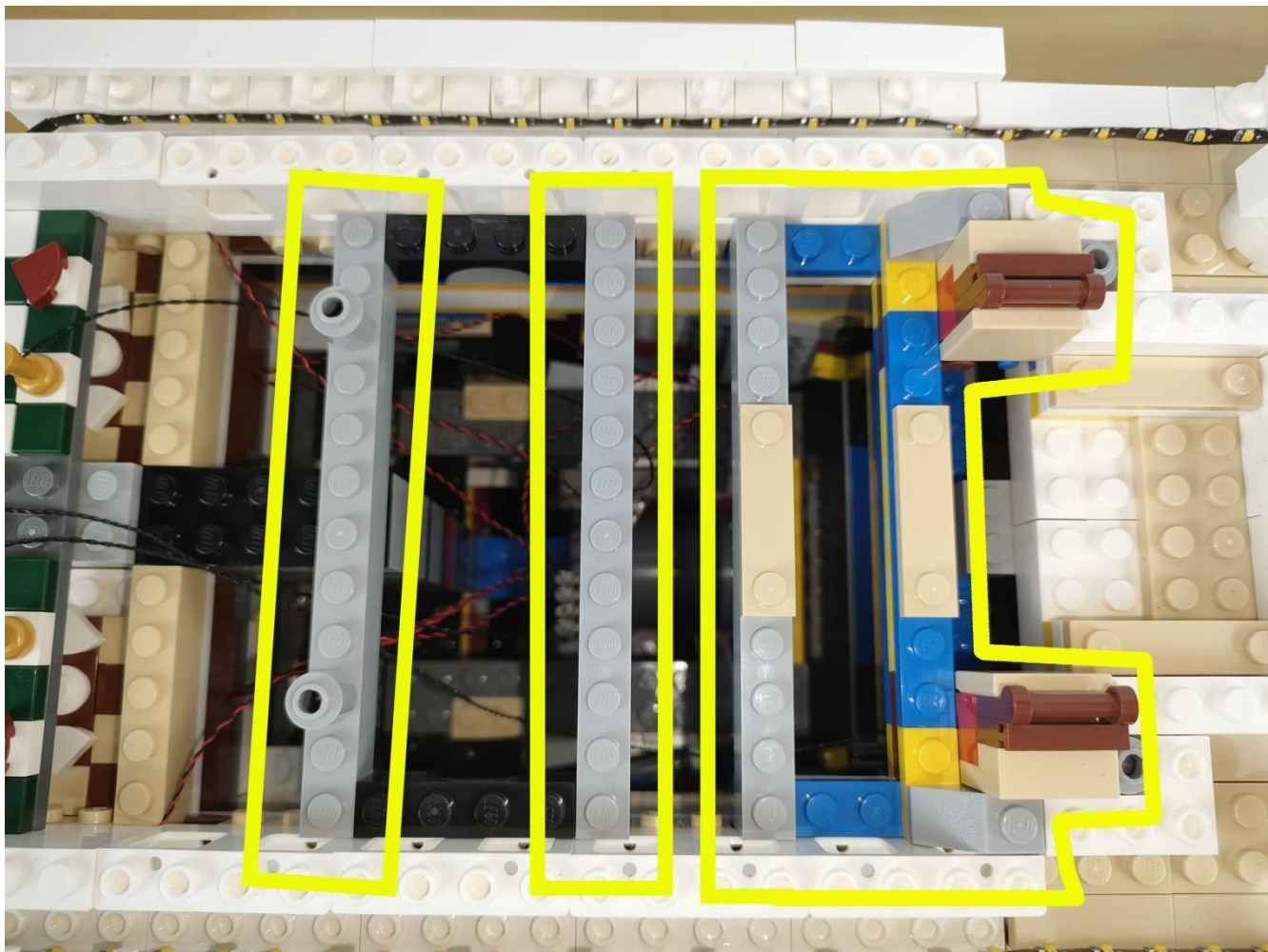

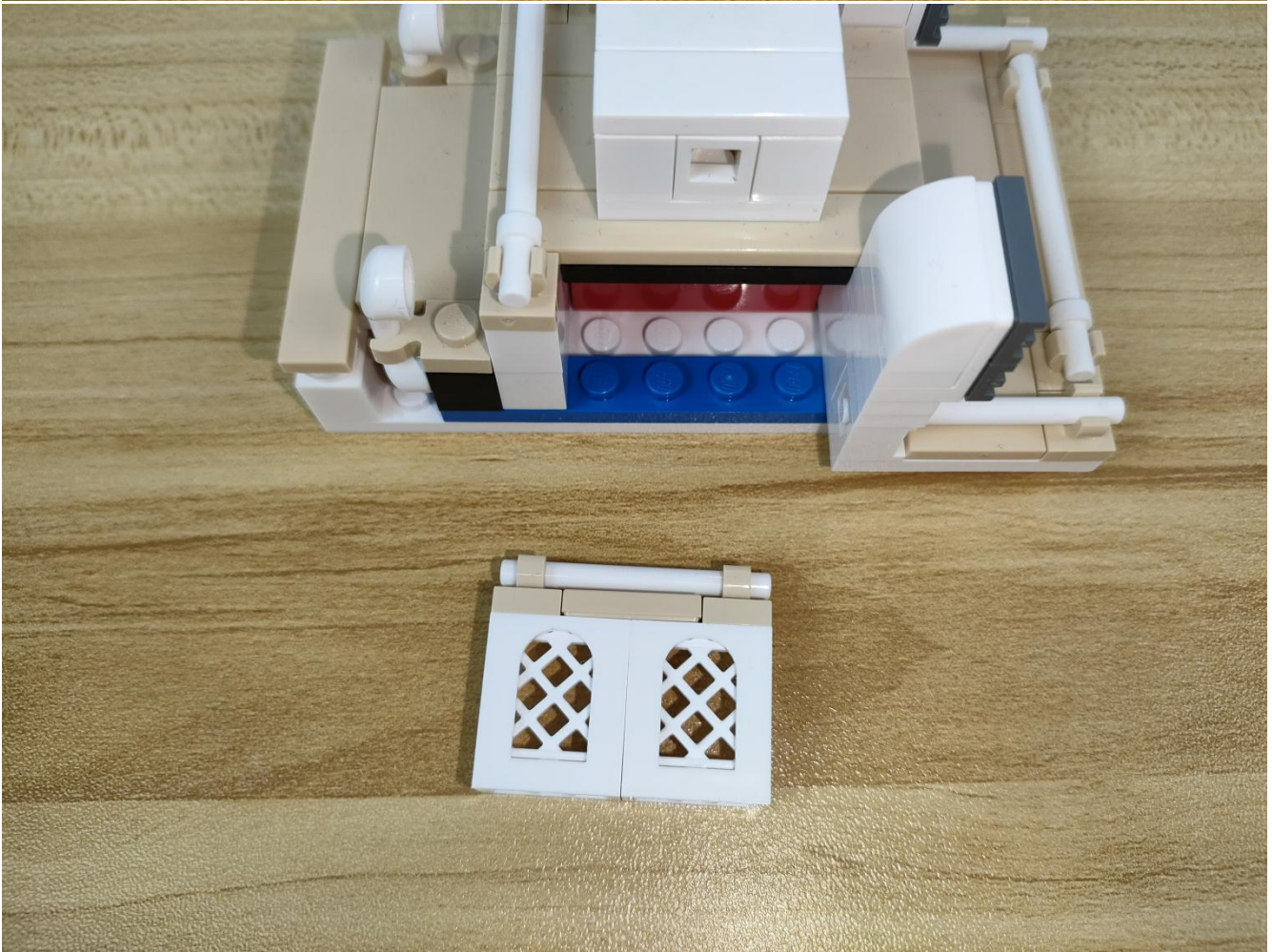
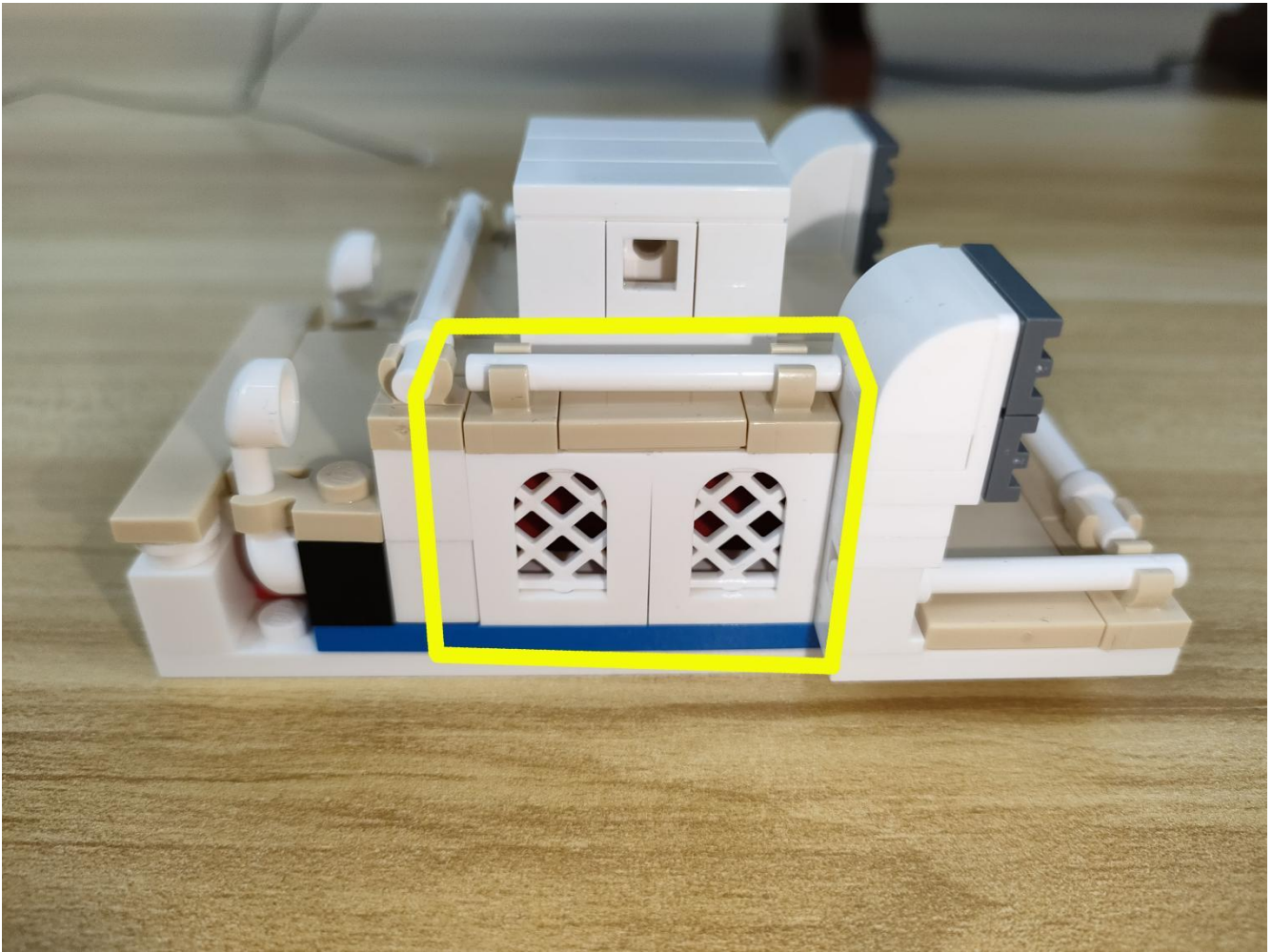



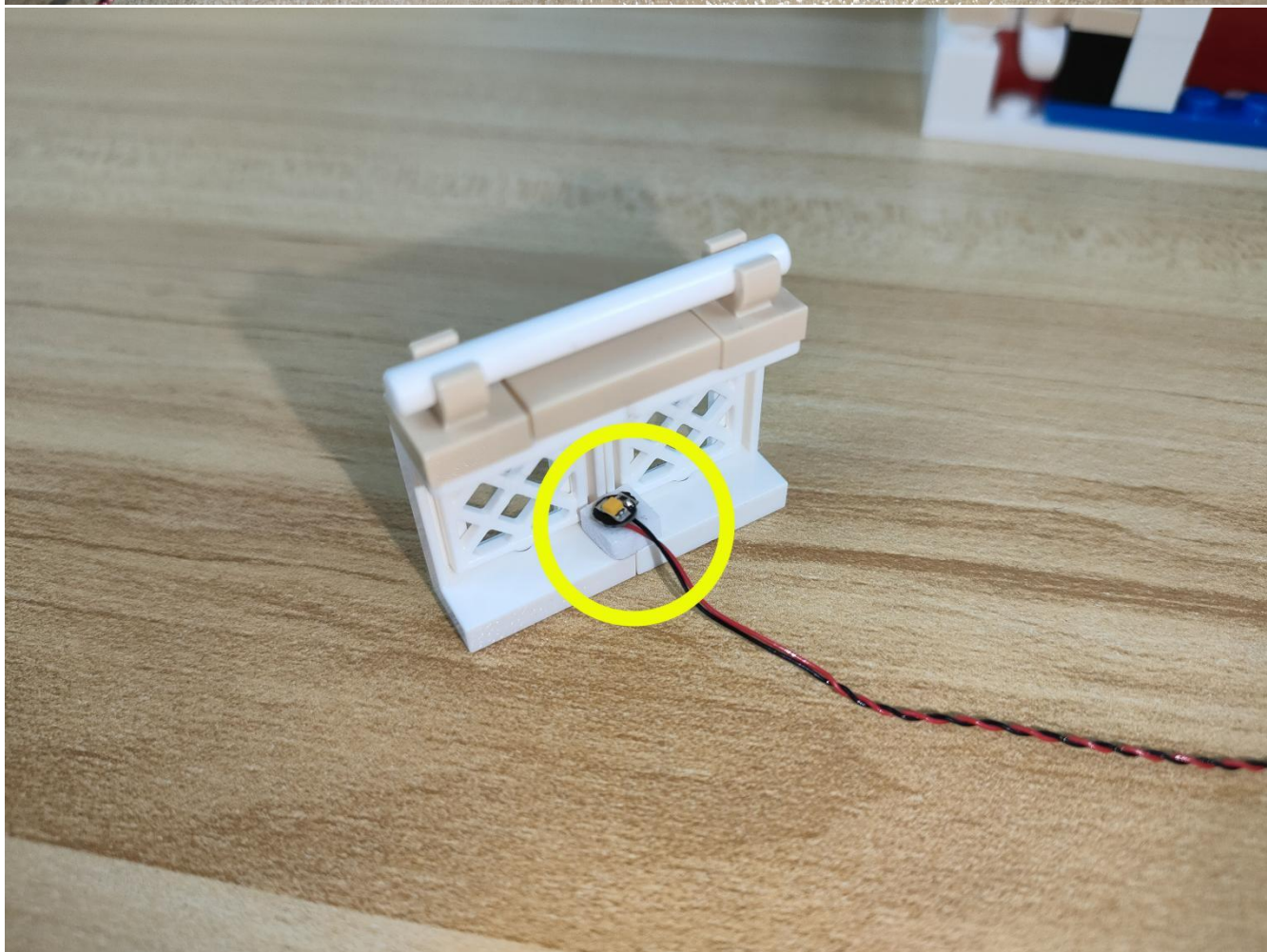
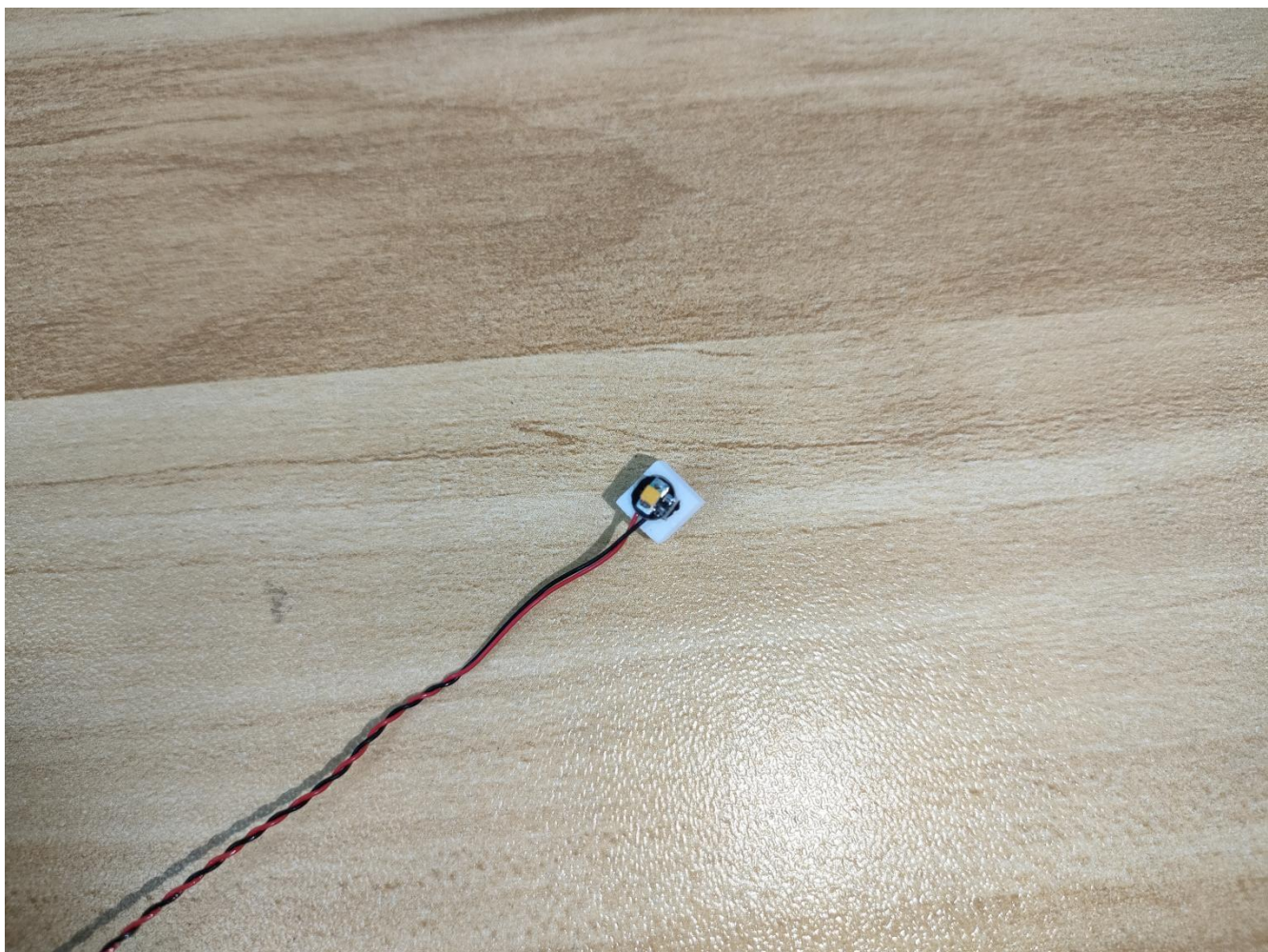

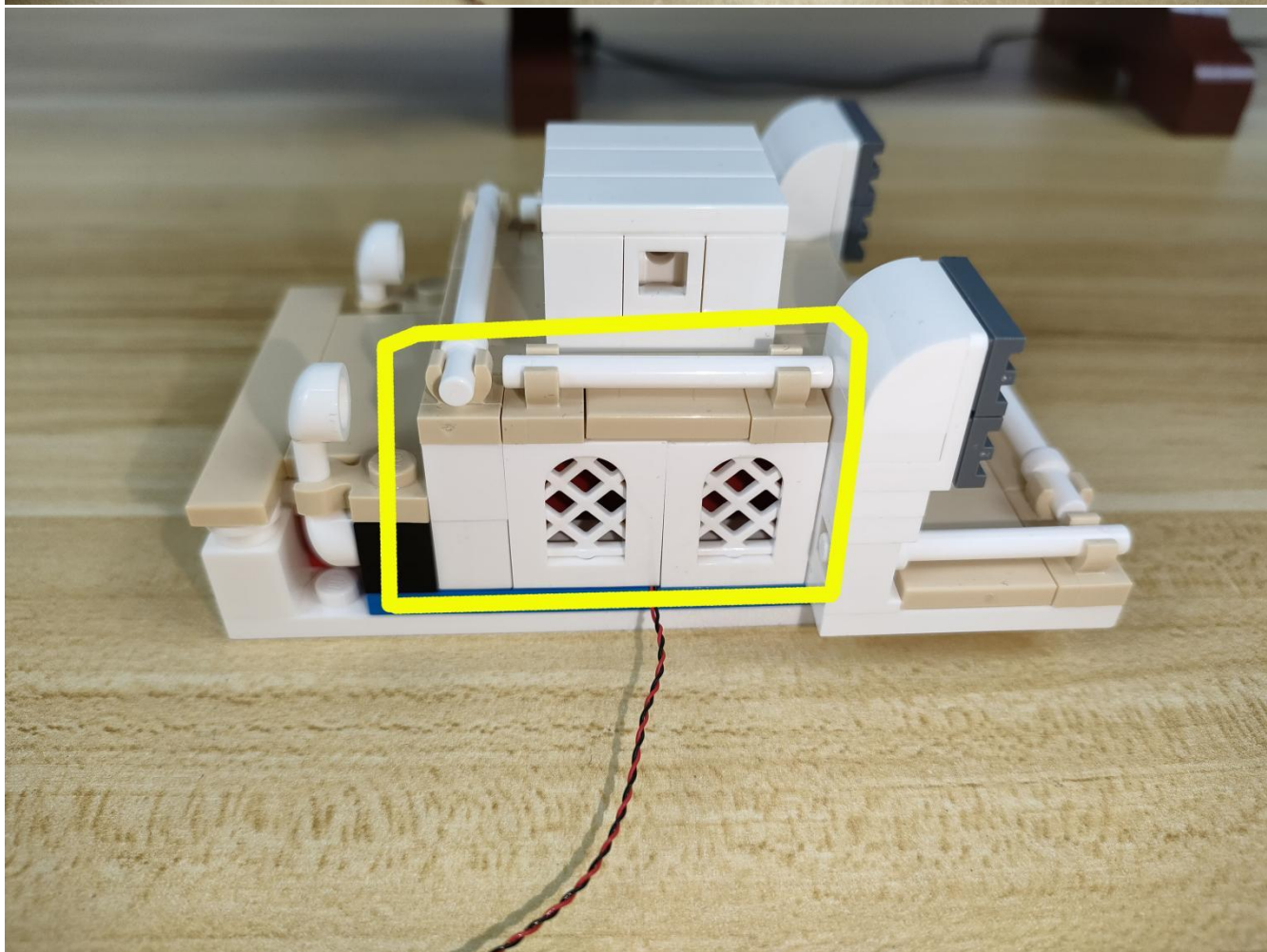
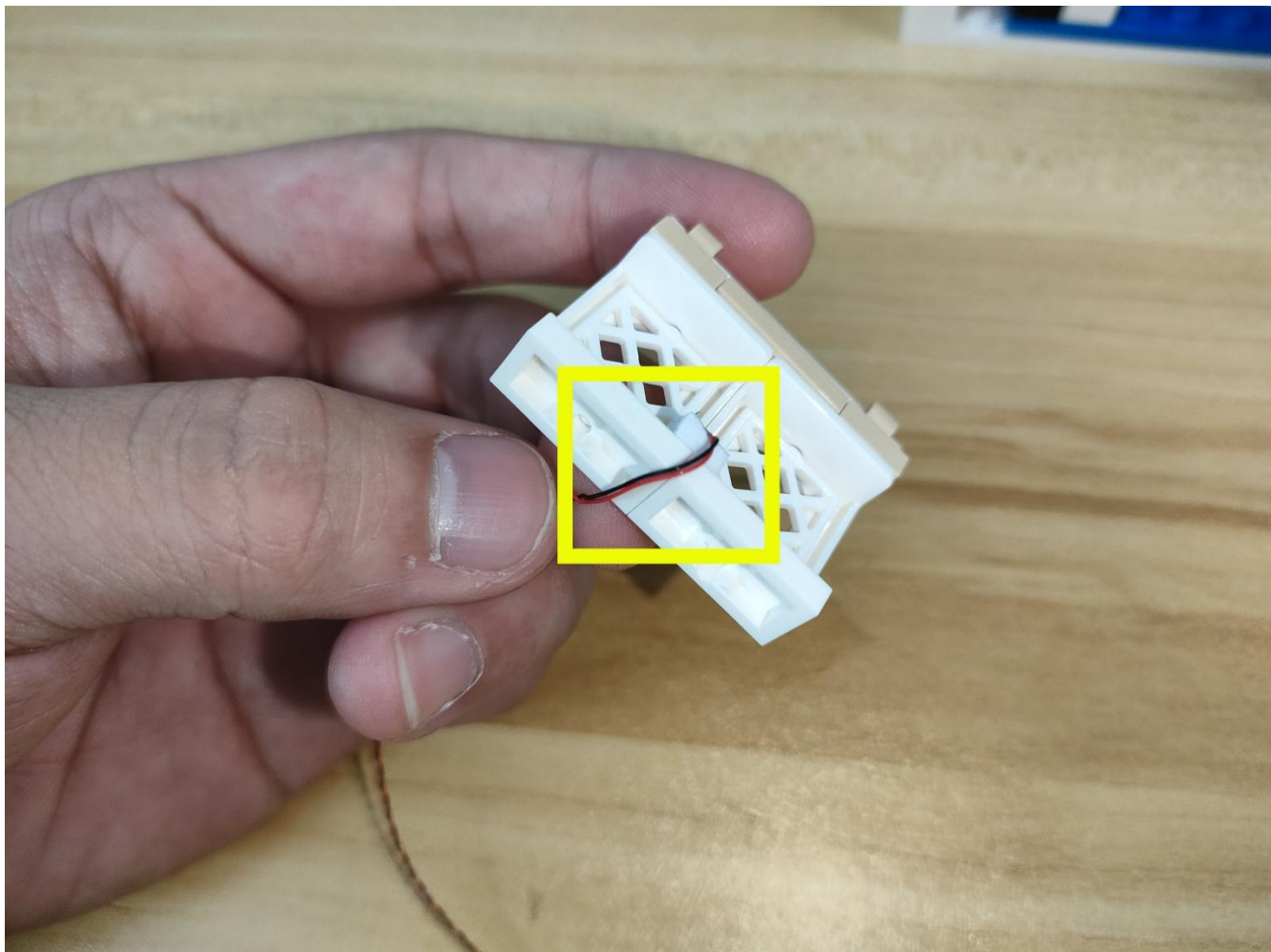

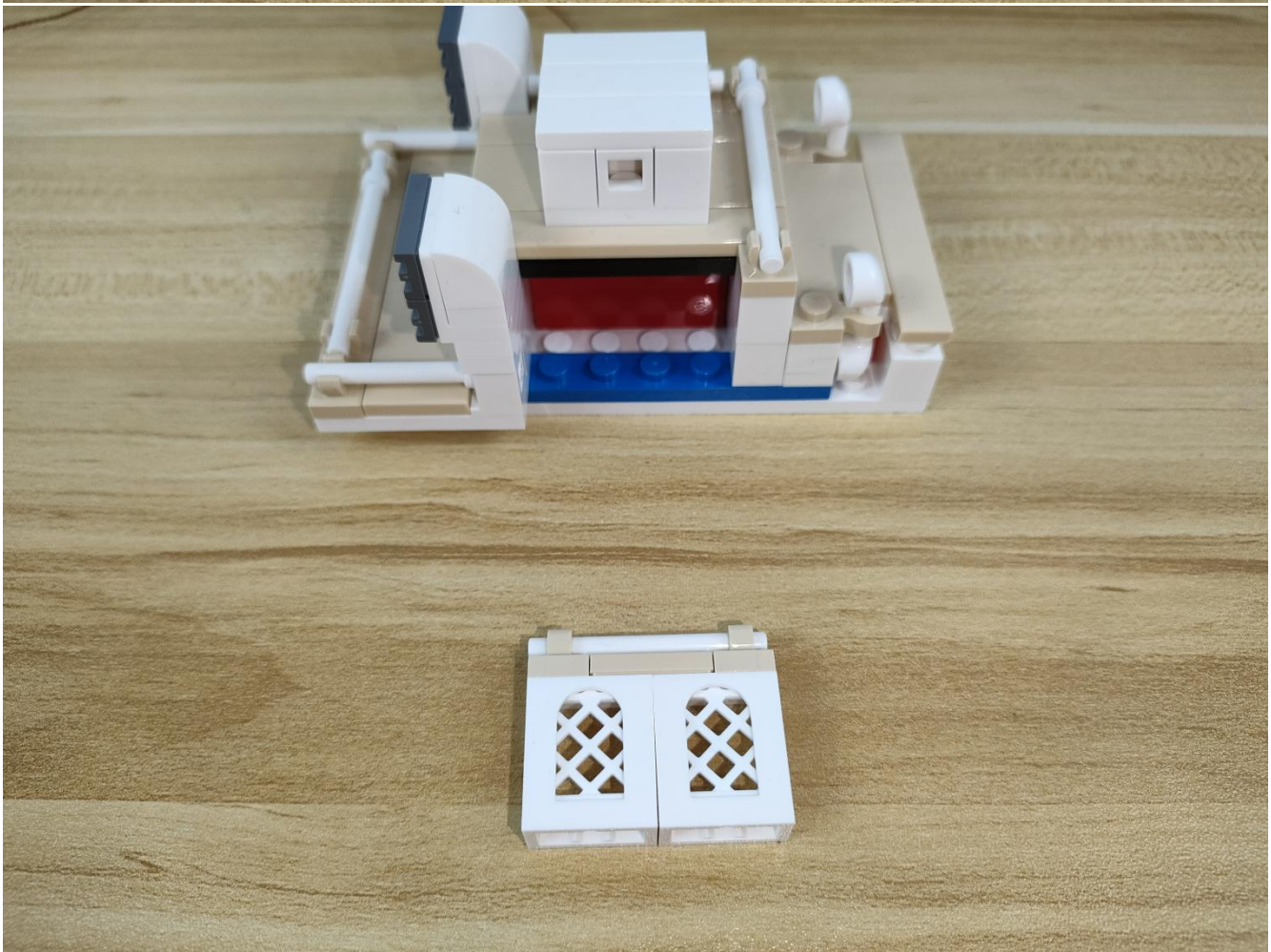
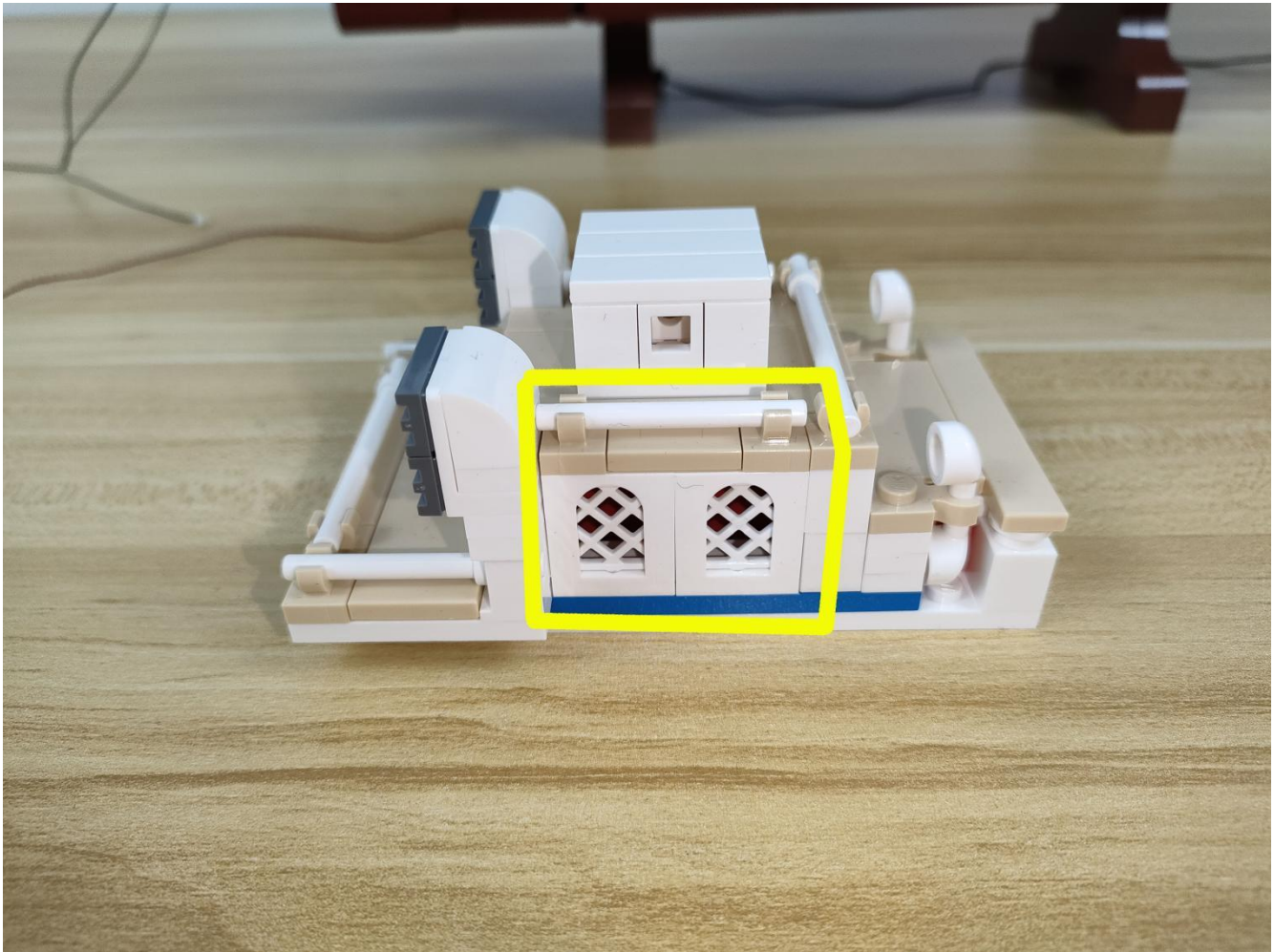

暖白普通燈粒30CM

Bit Lights-30CM

Warm White



零配件

Parts Package



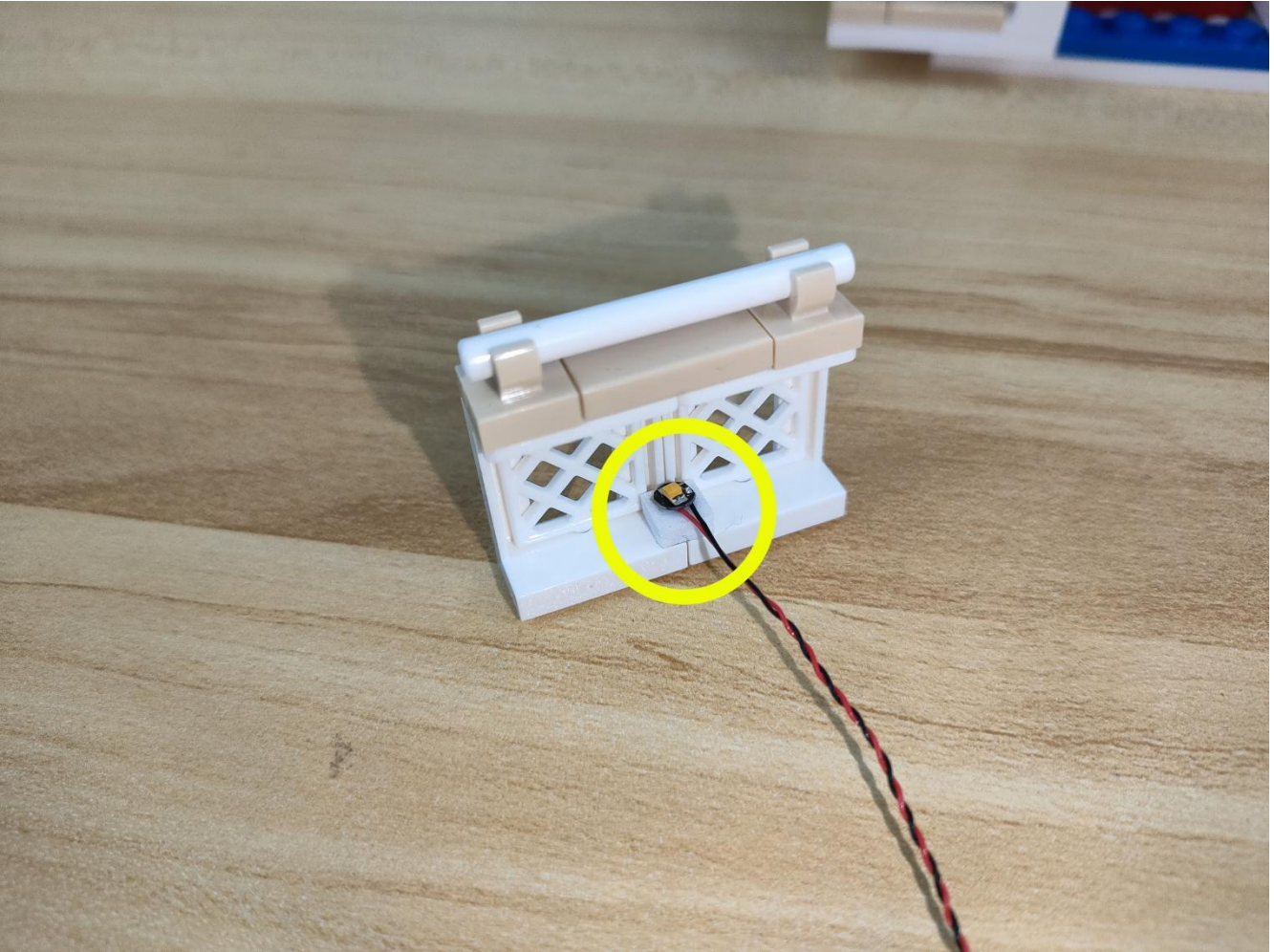
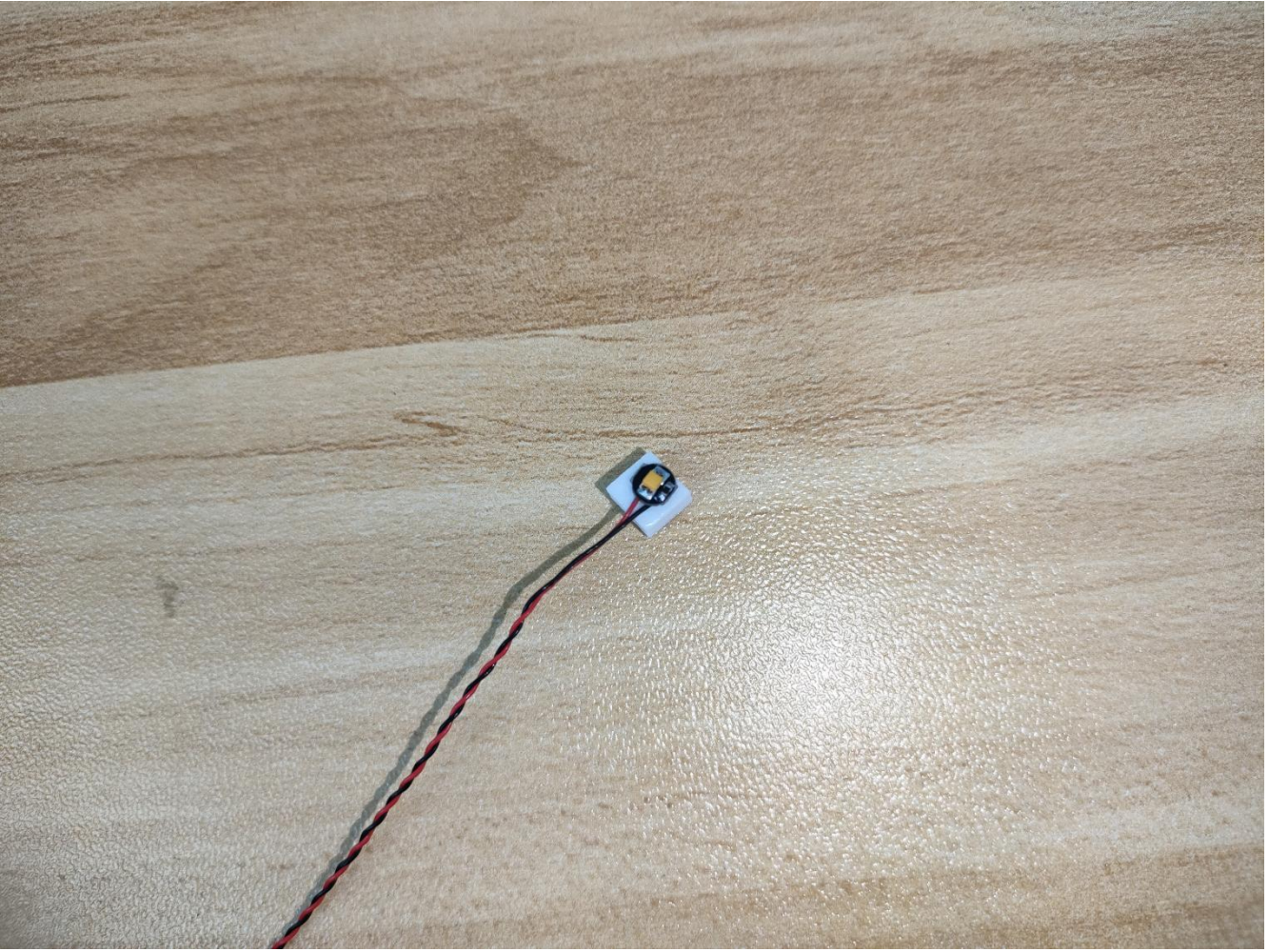

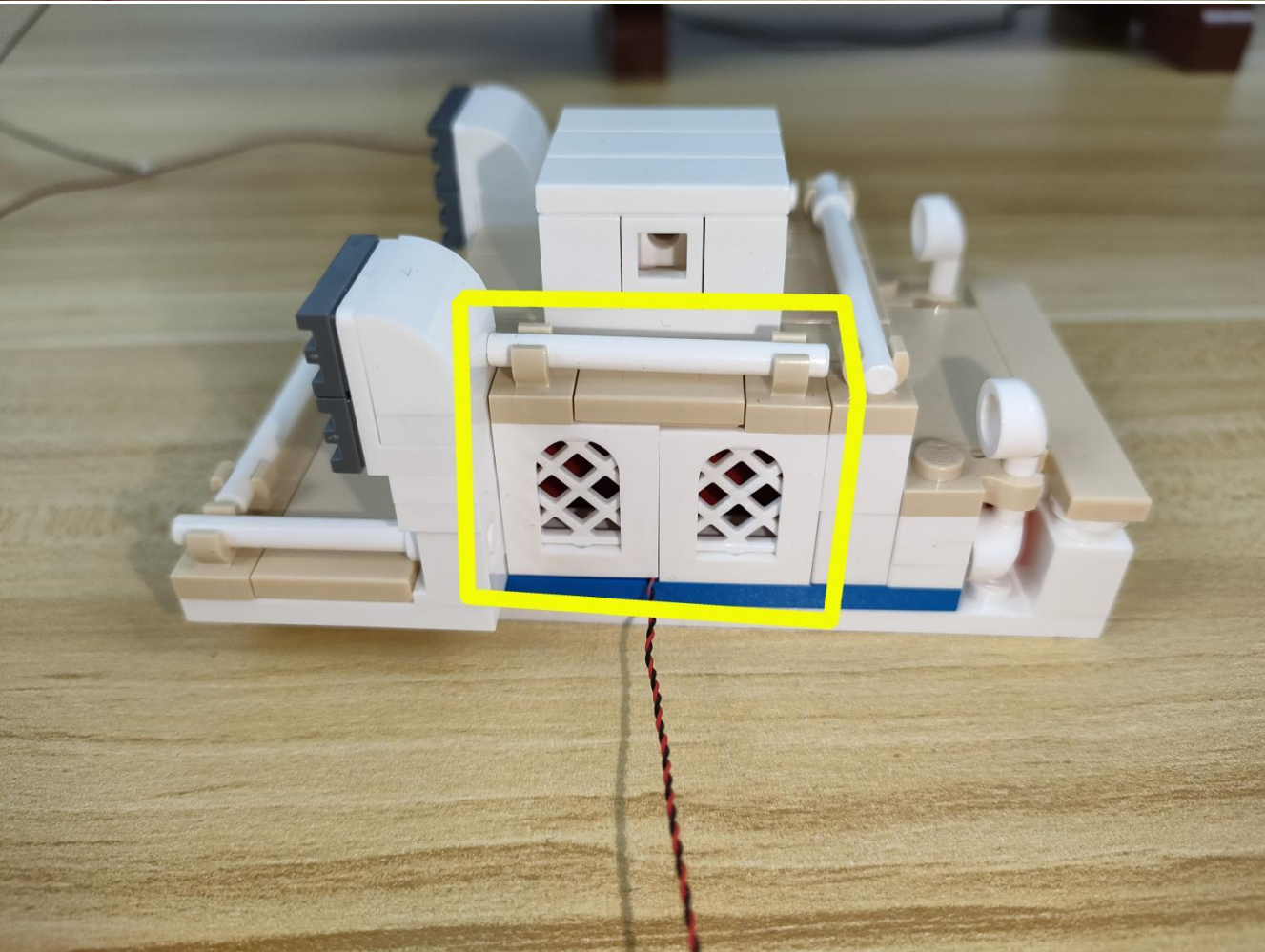
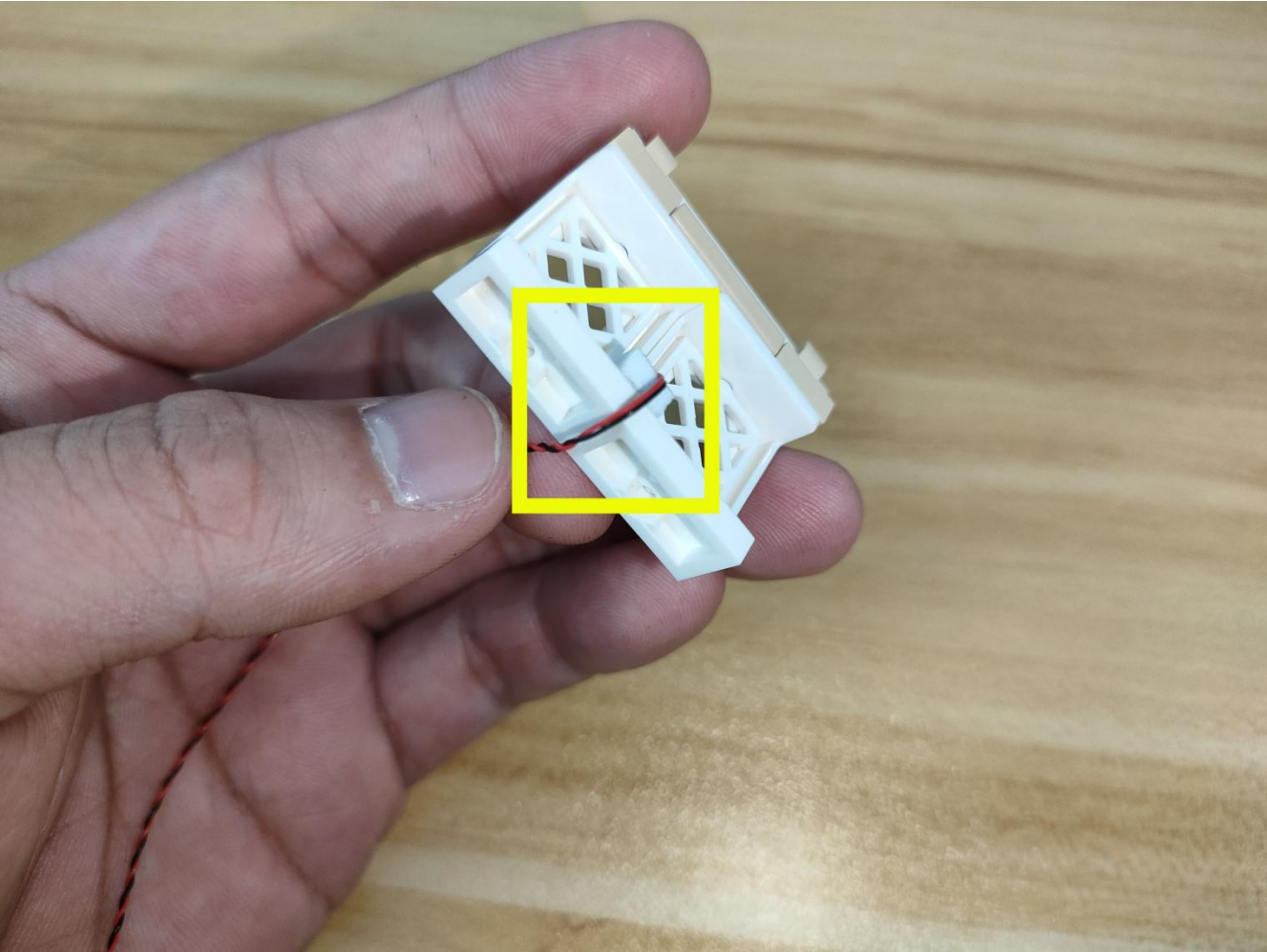

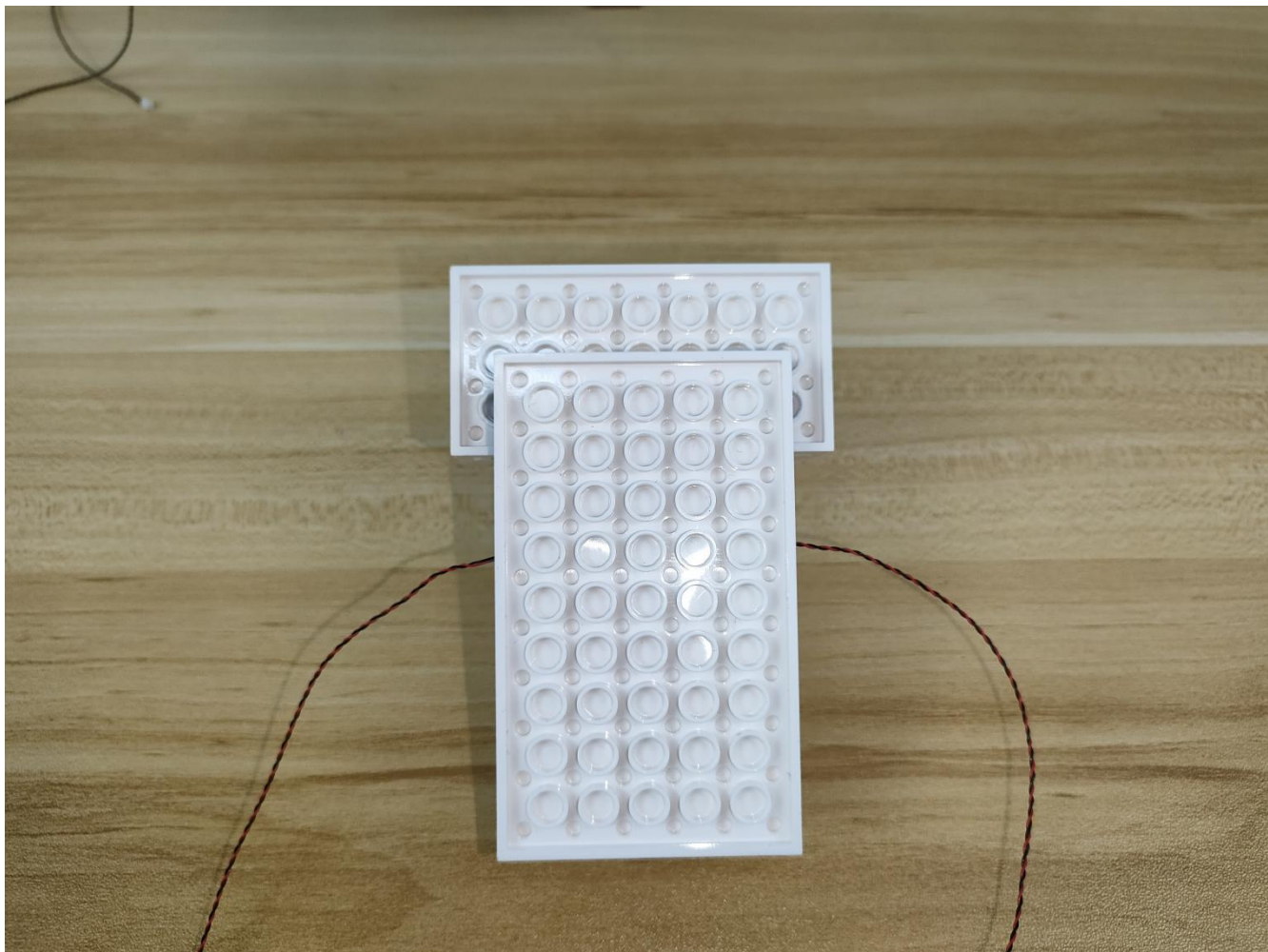

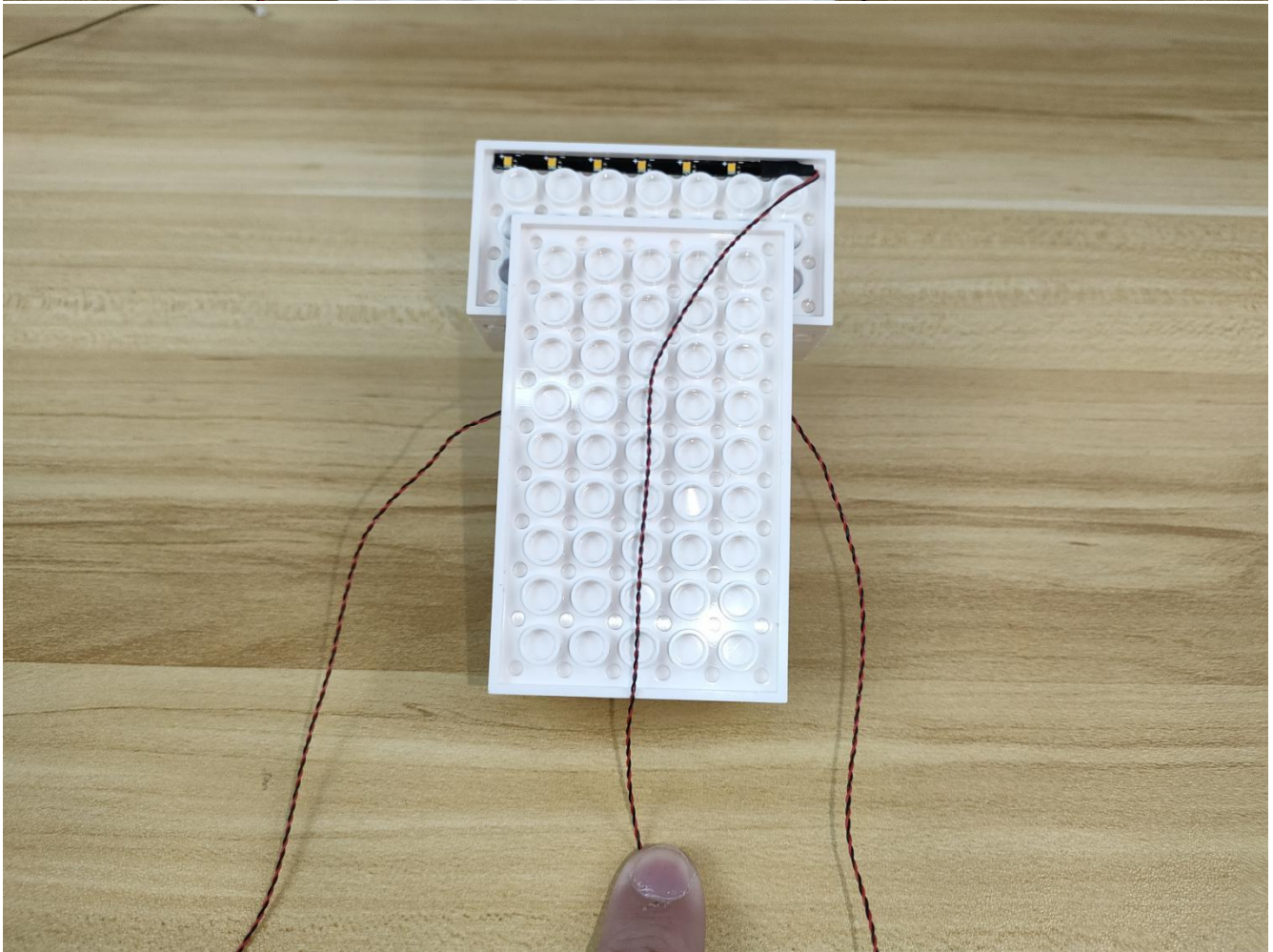
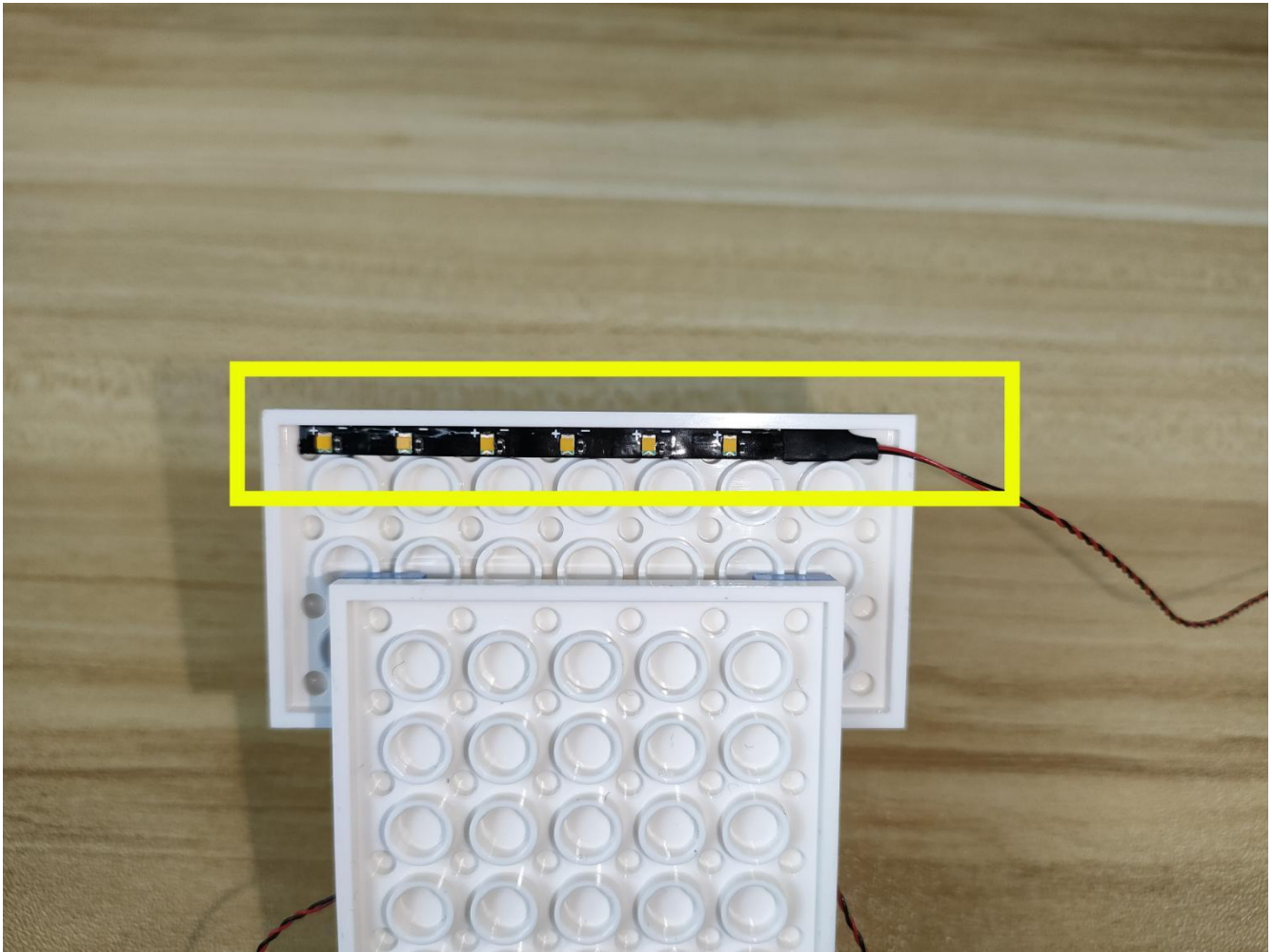

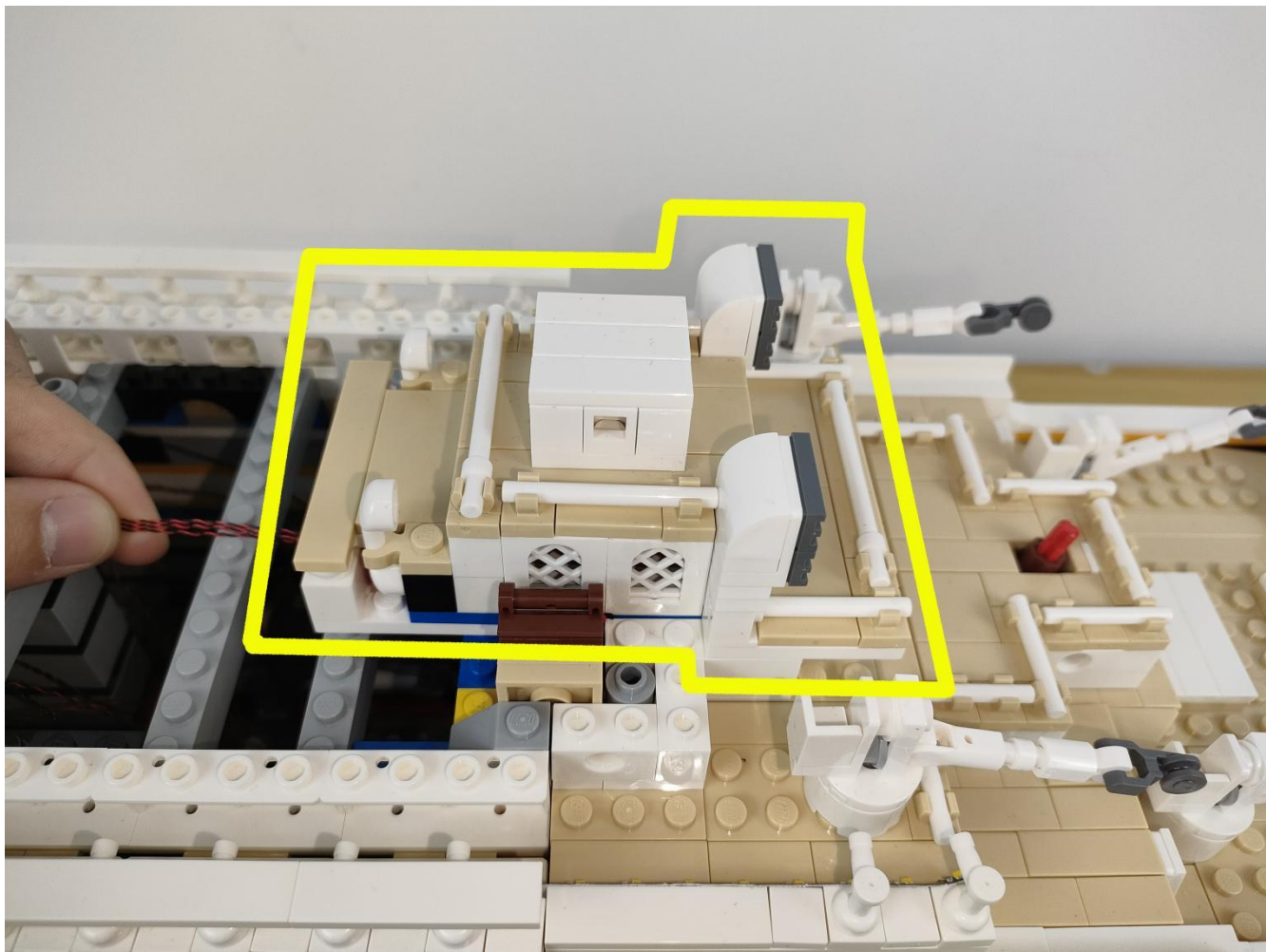

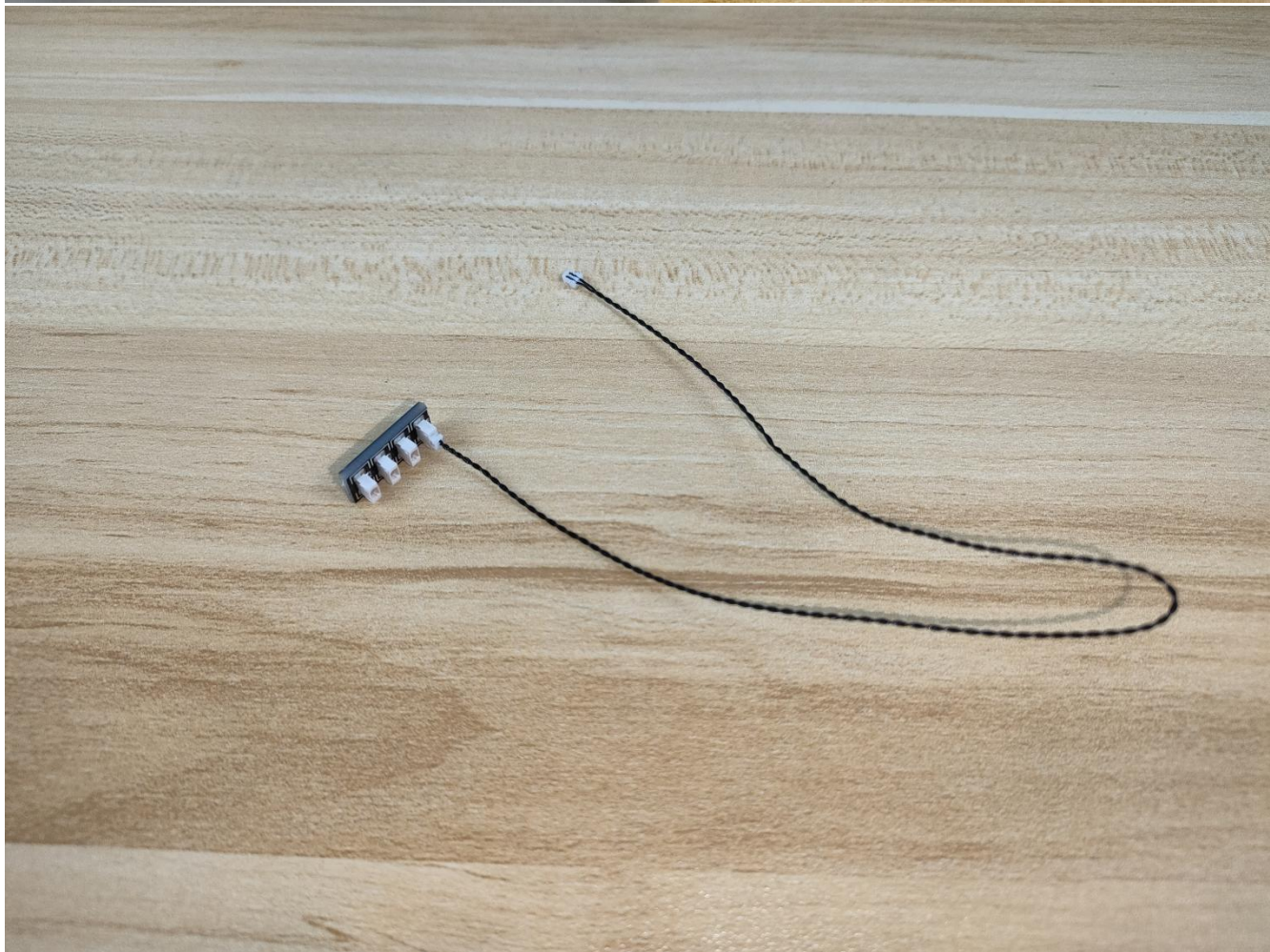

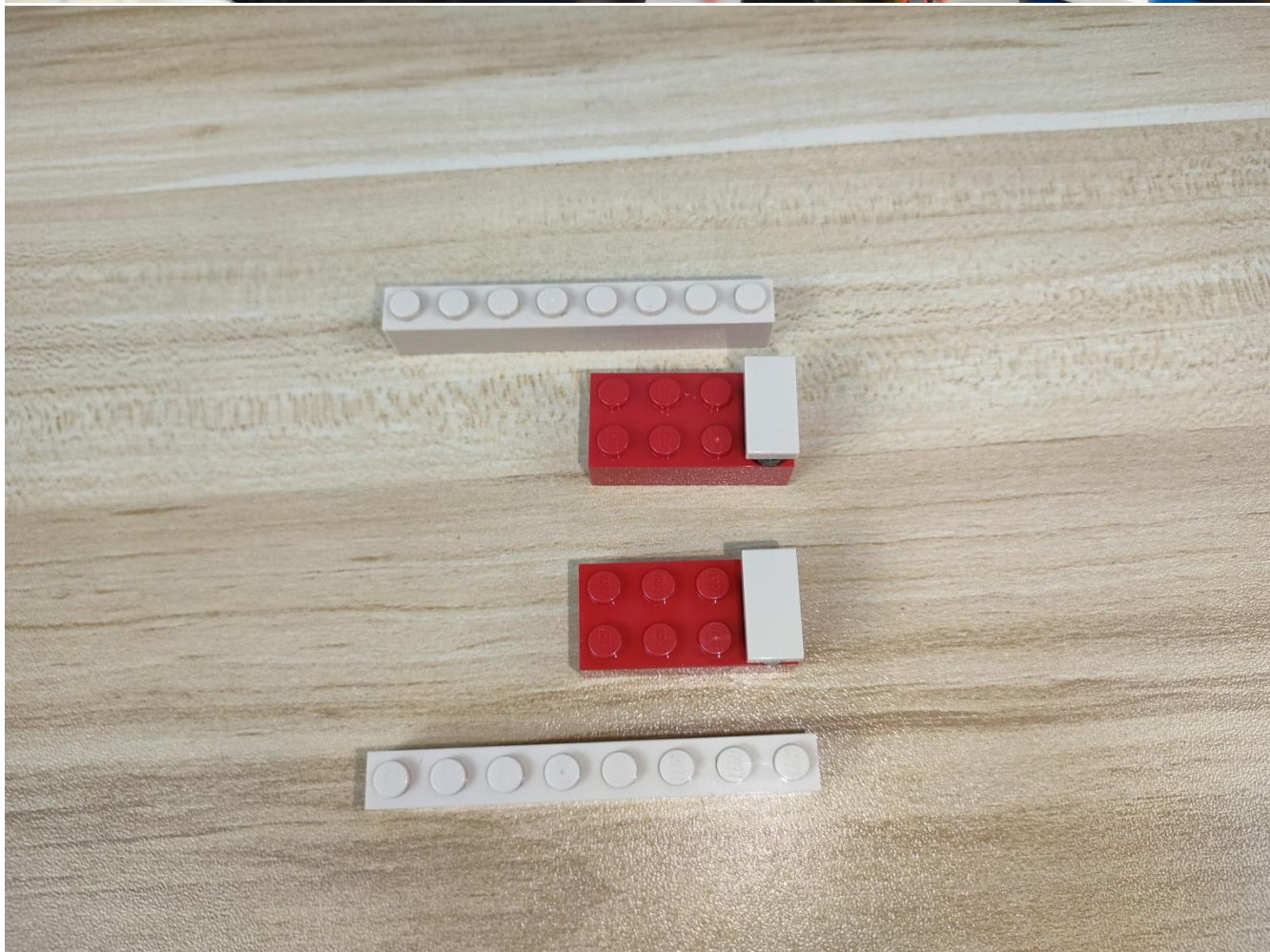
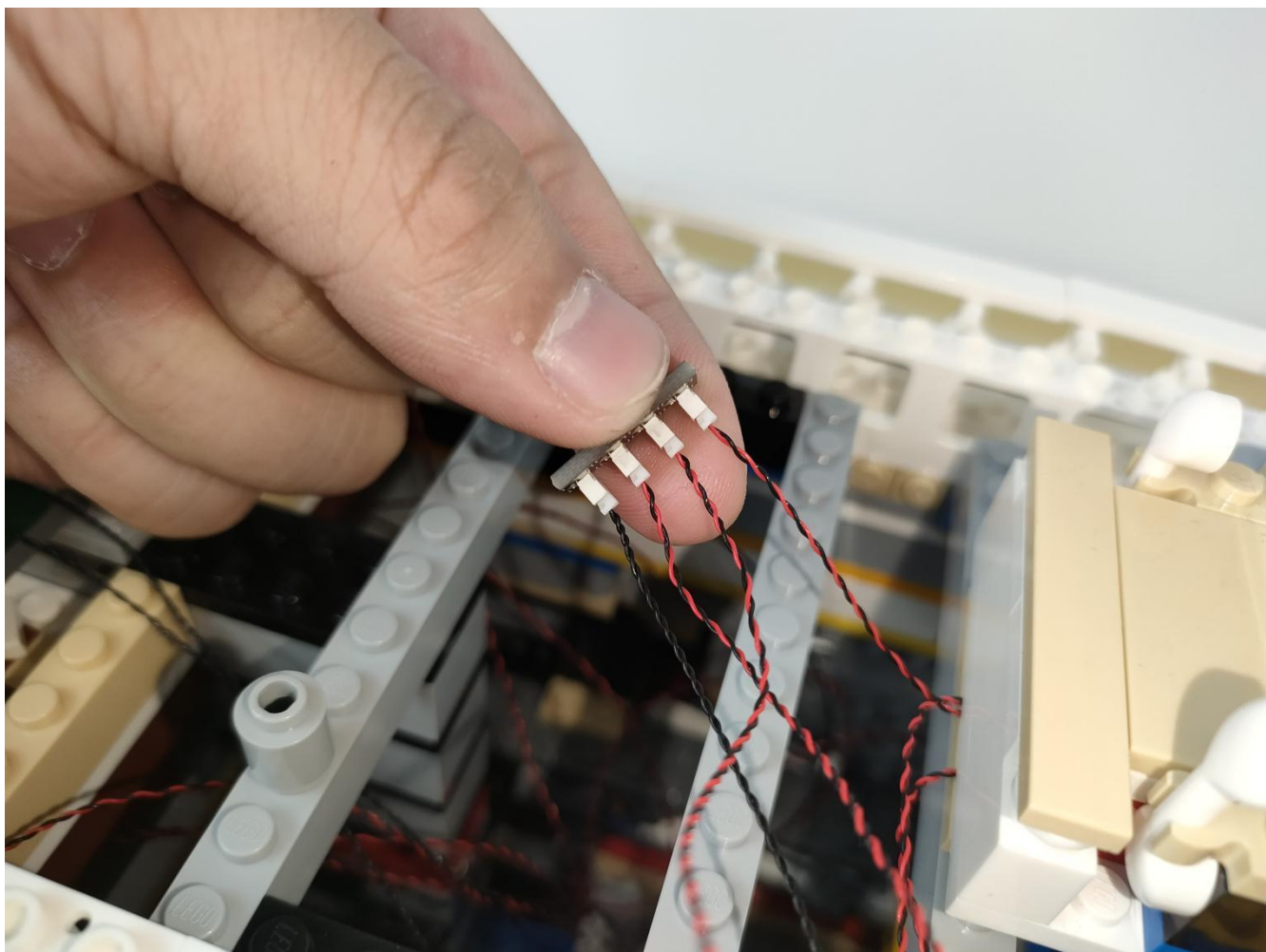

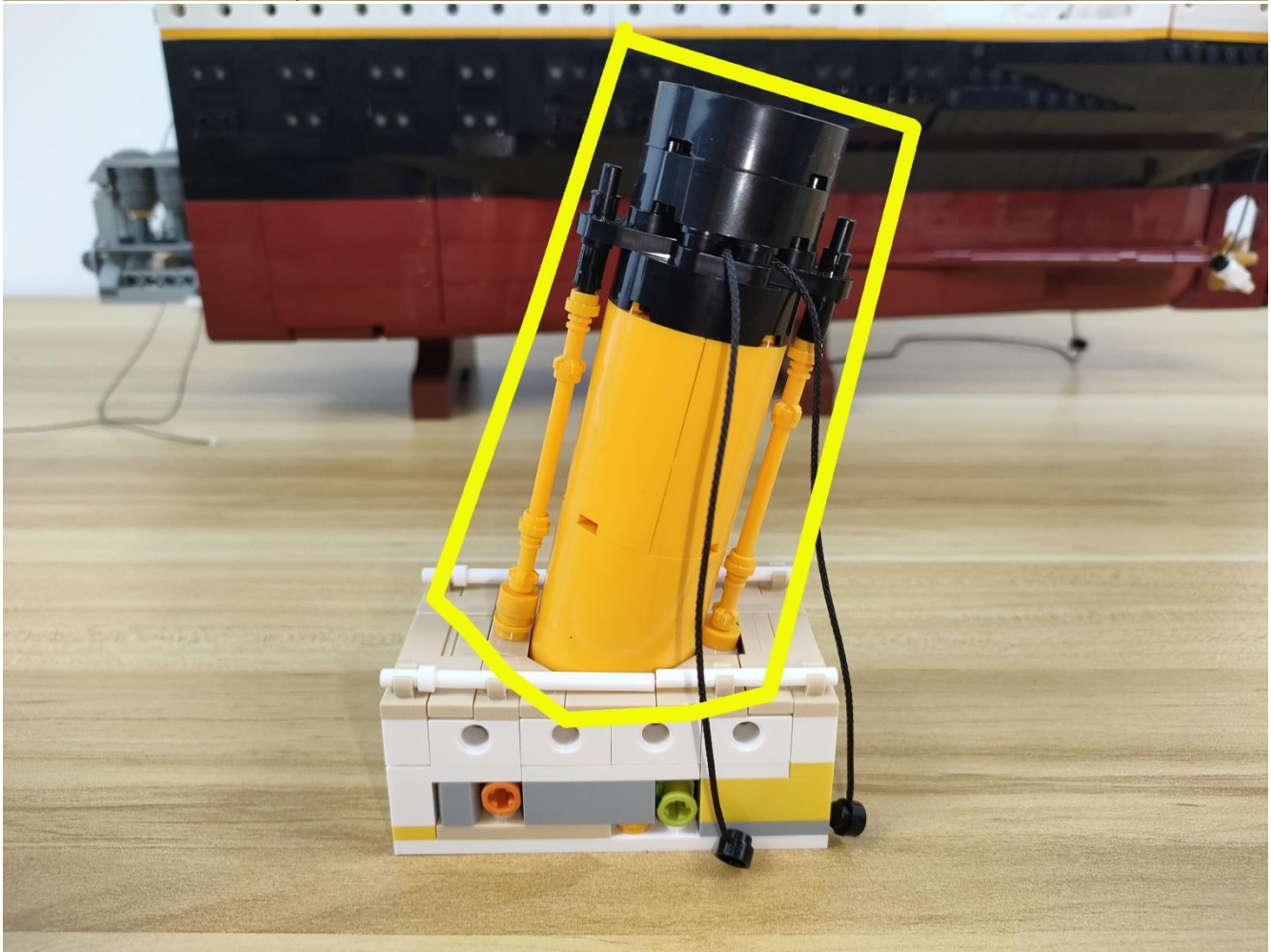
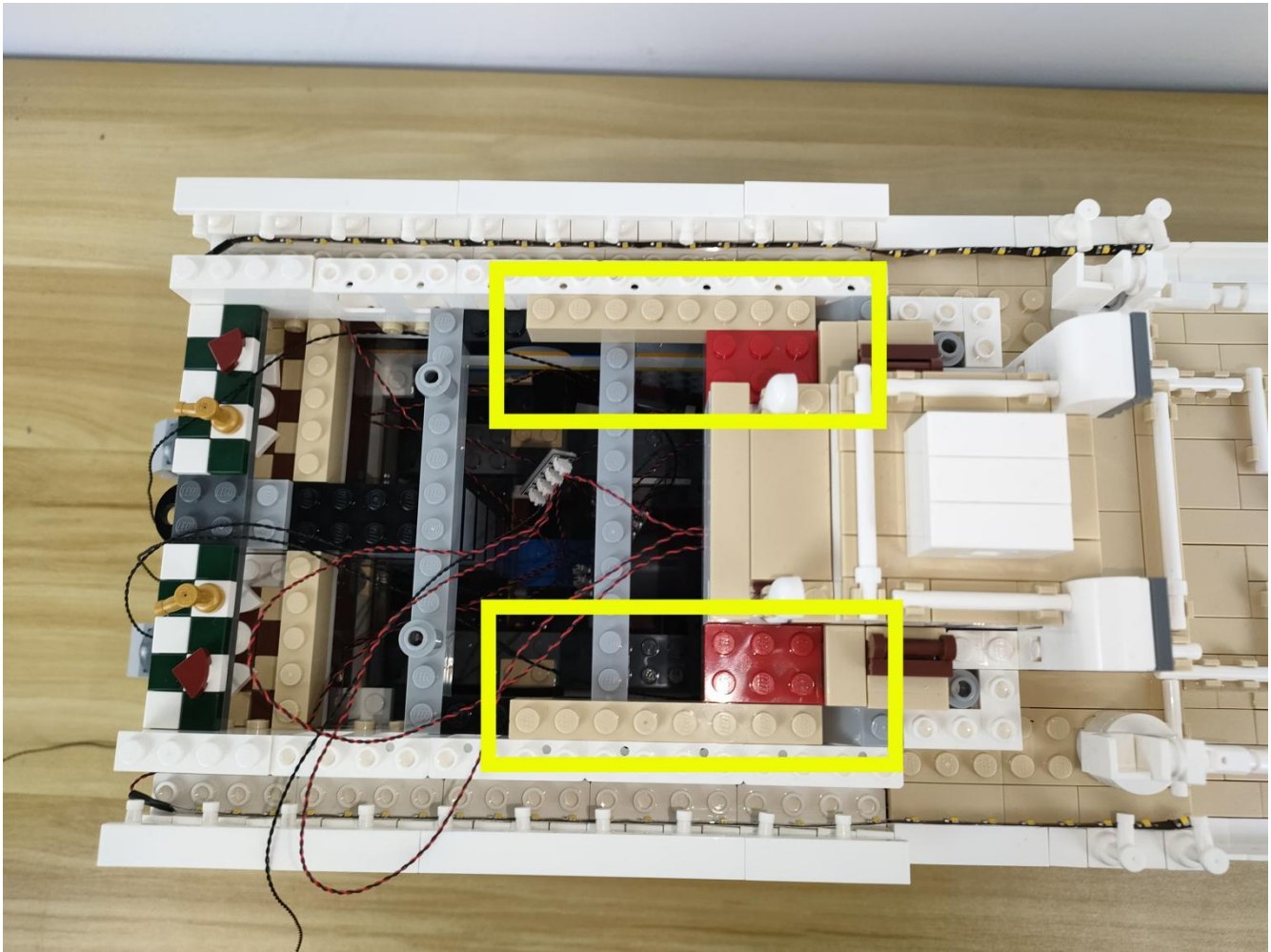

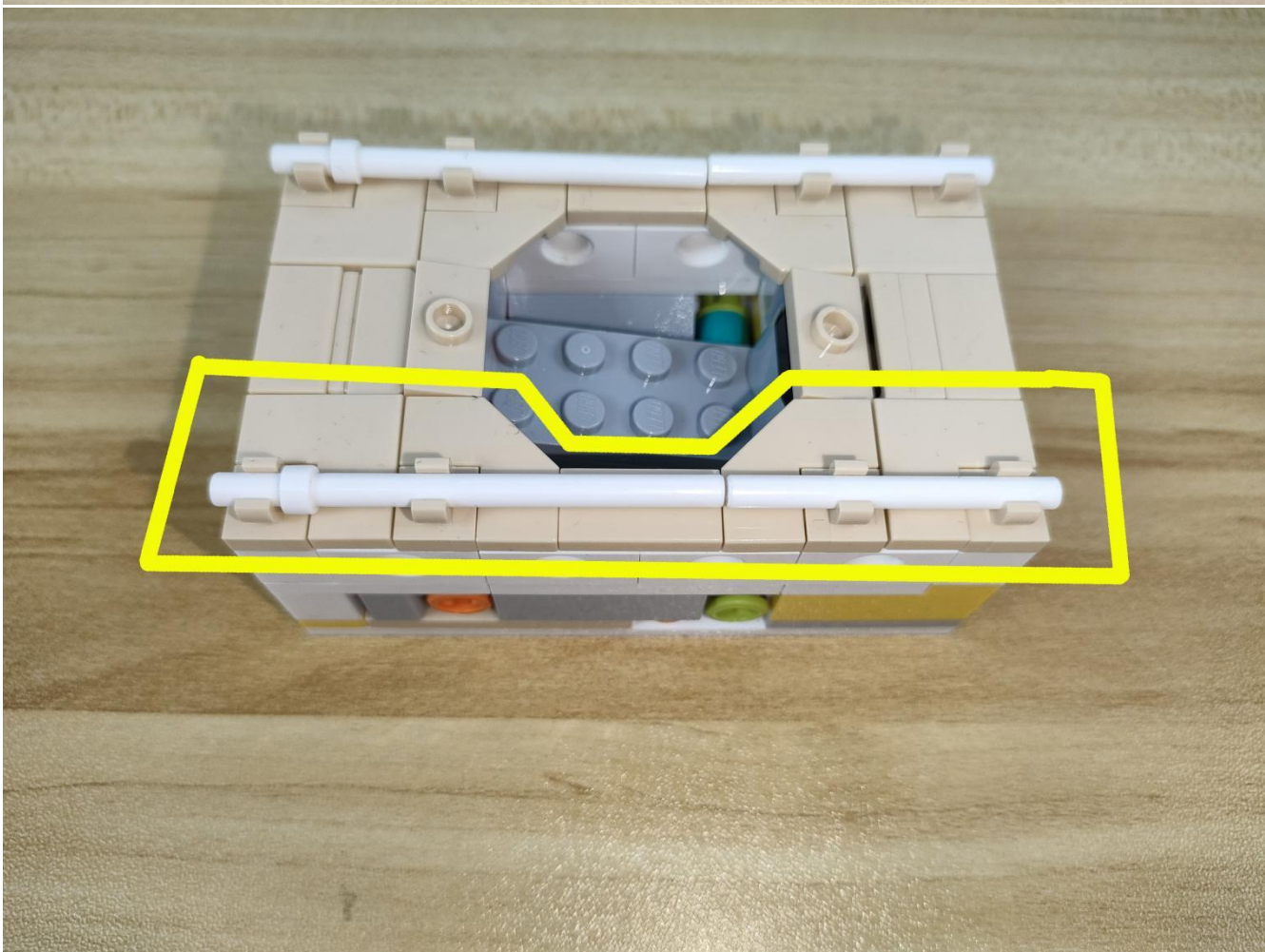

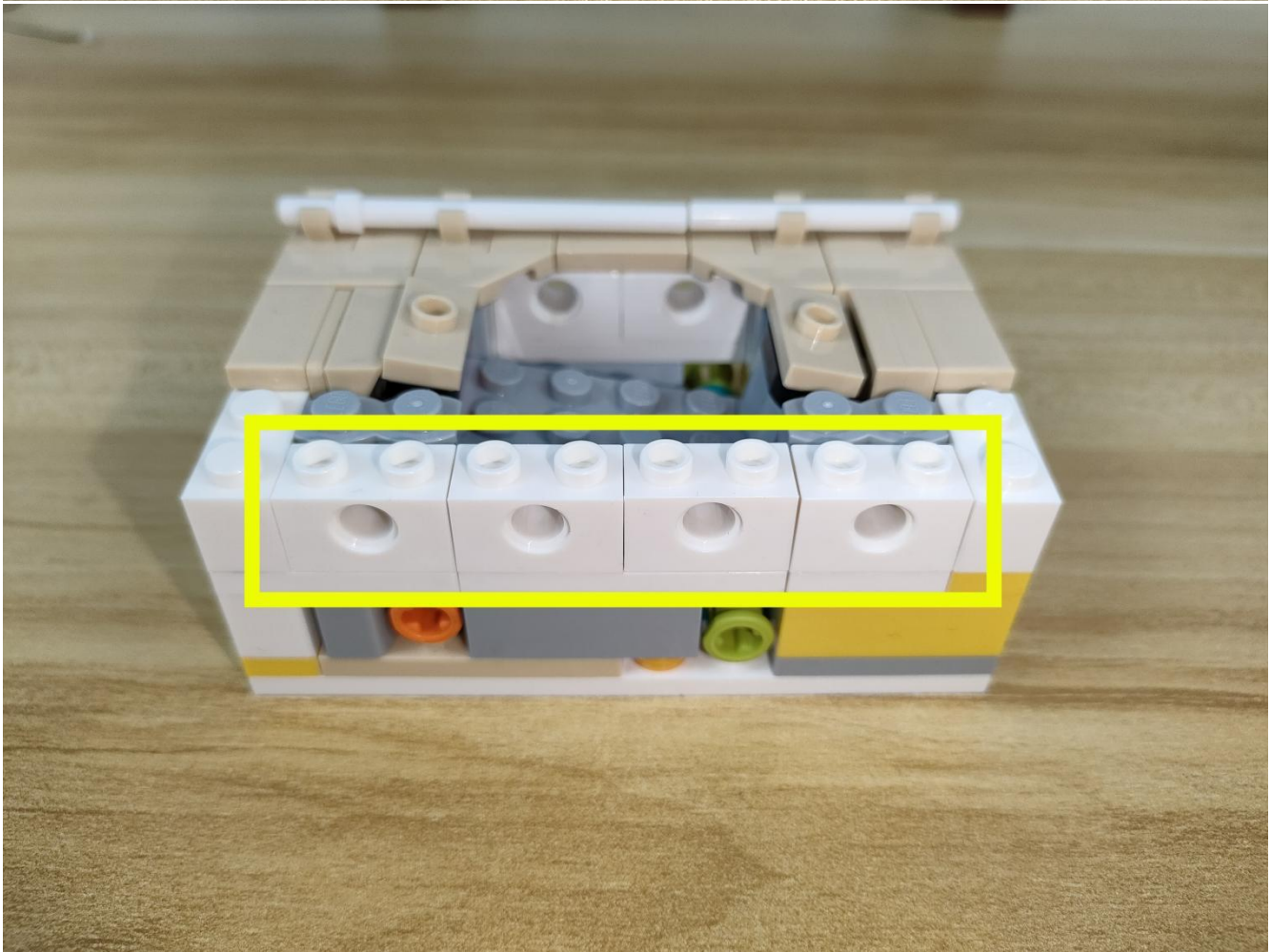
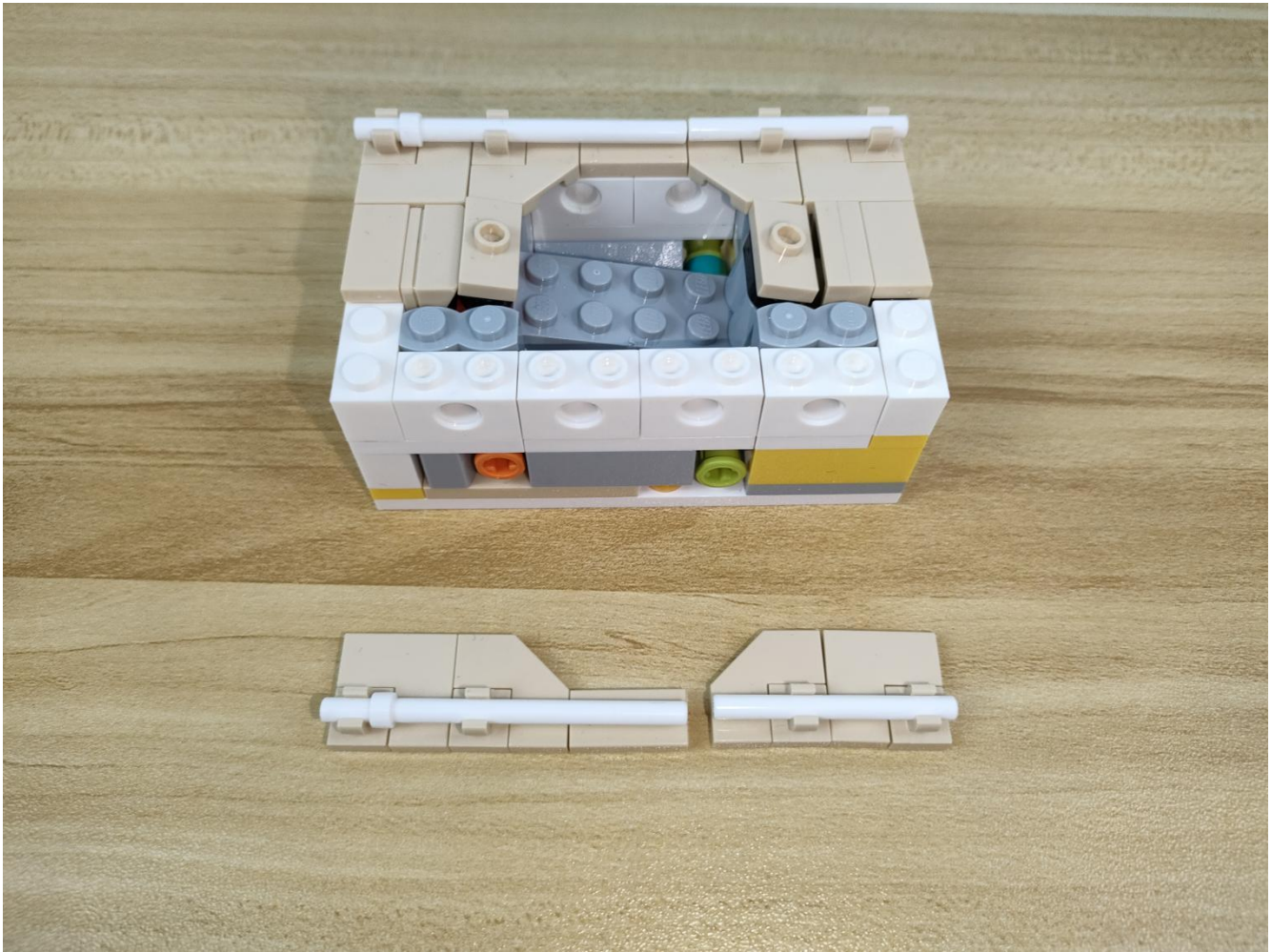

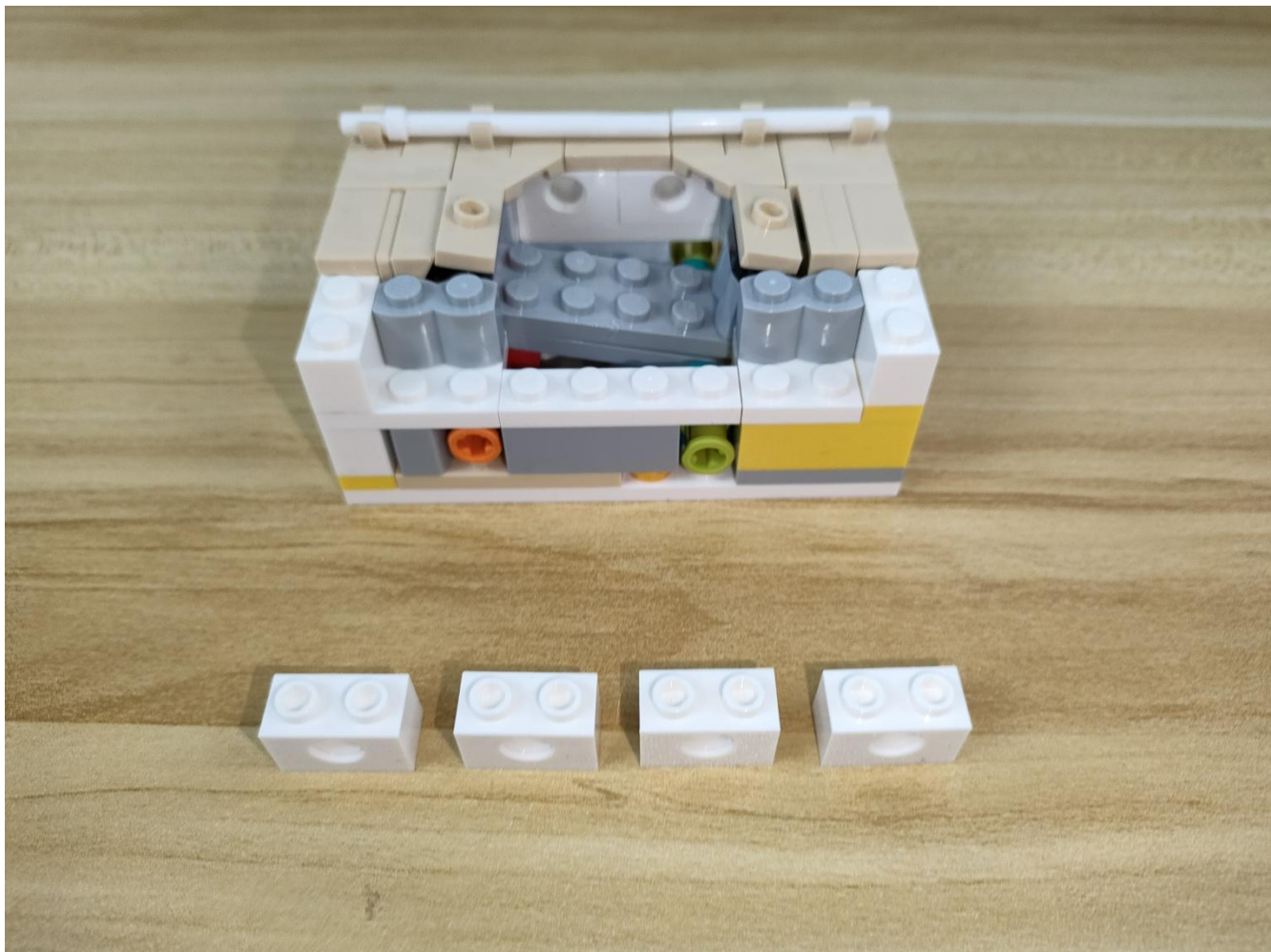

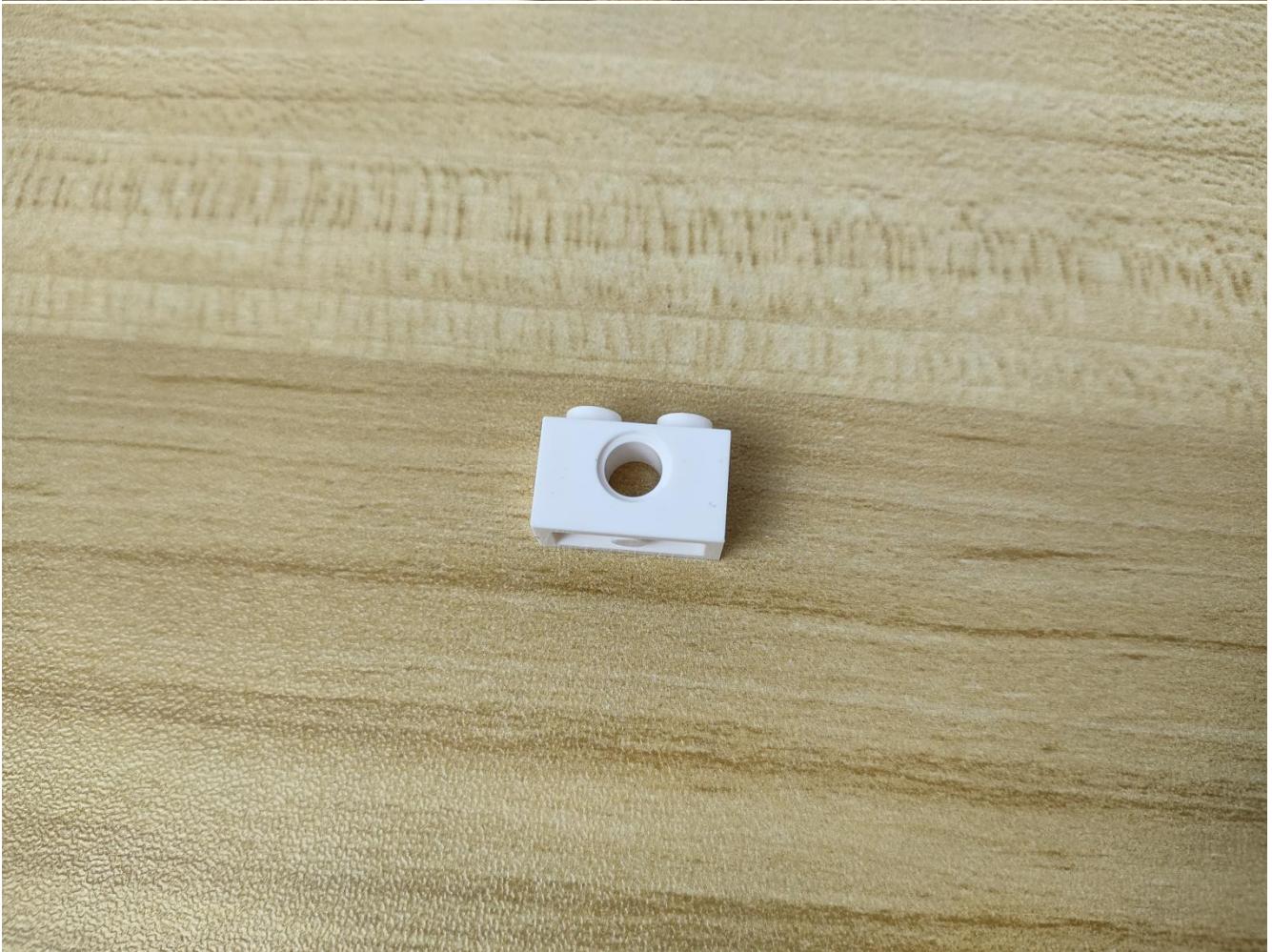
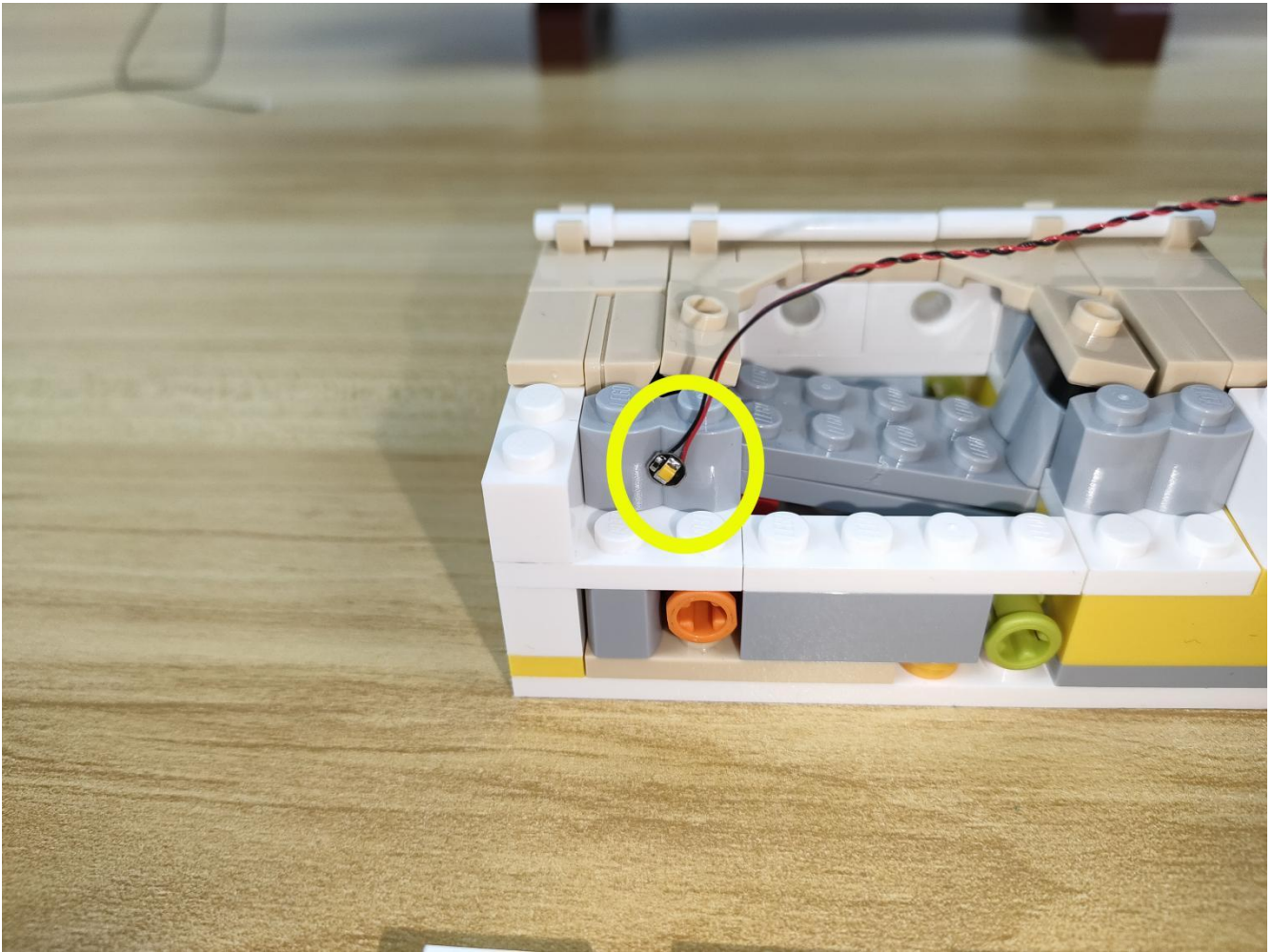

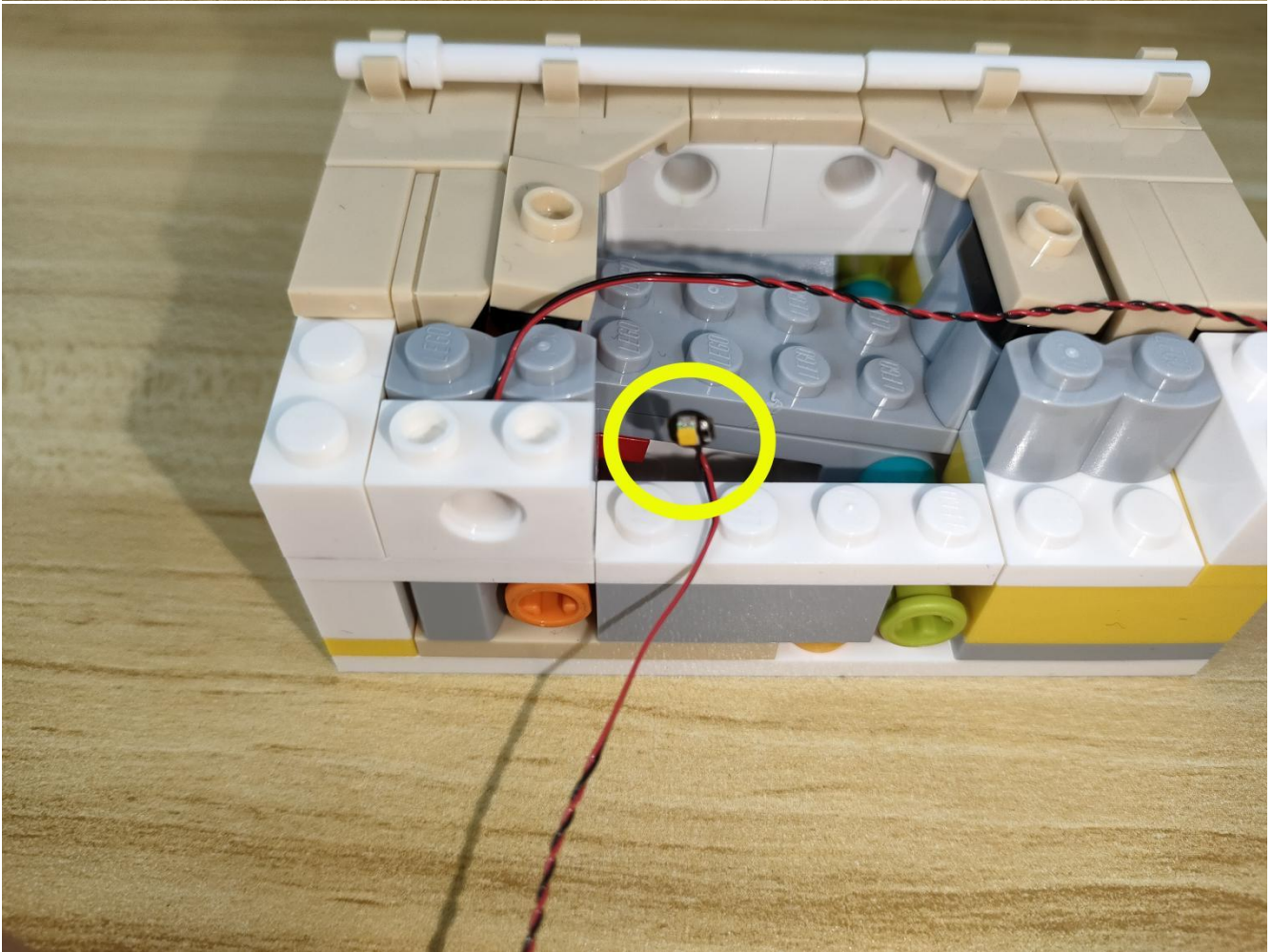
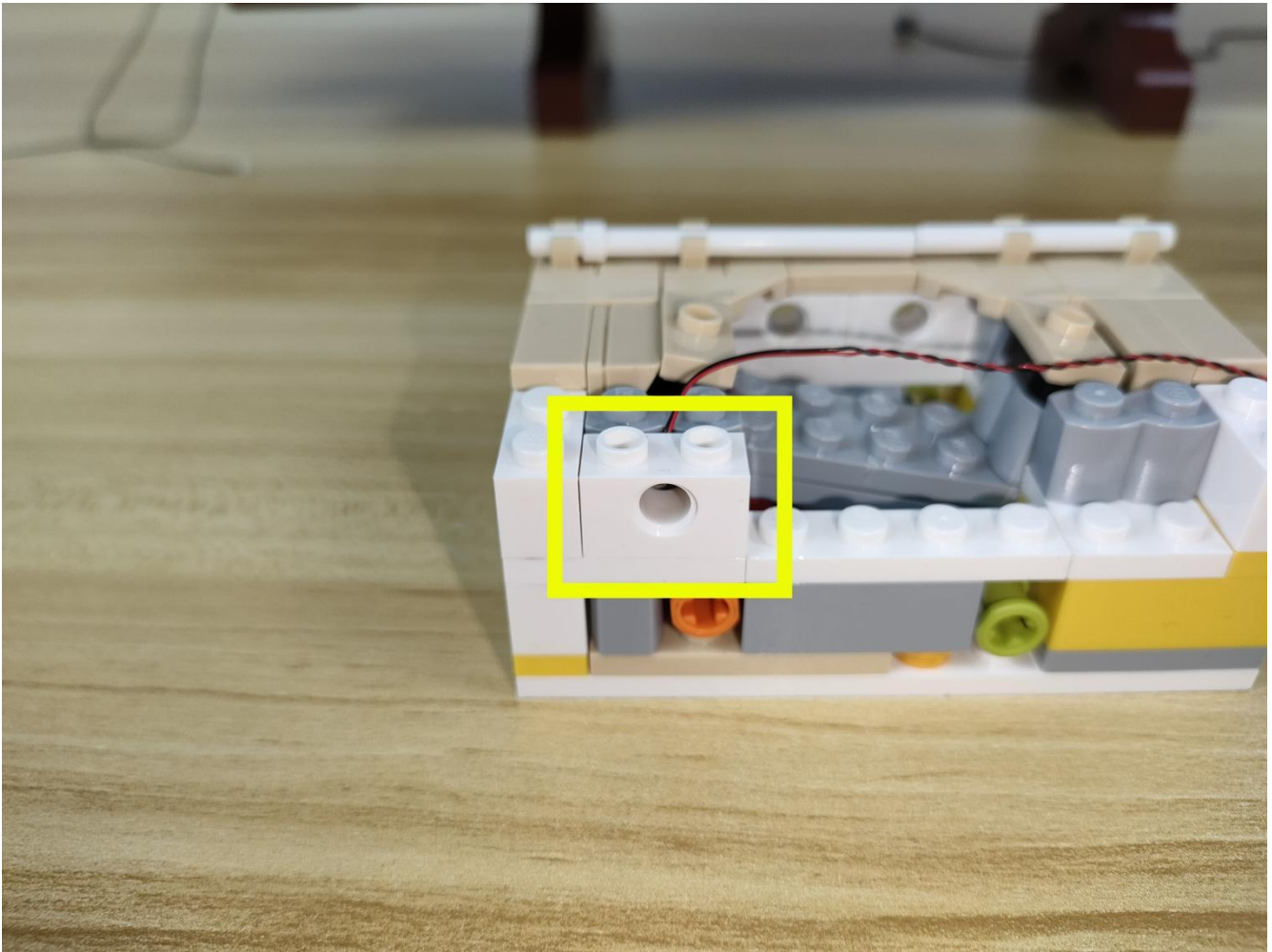

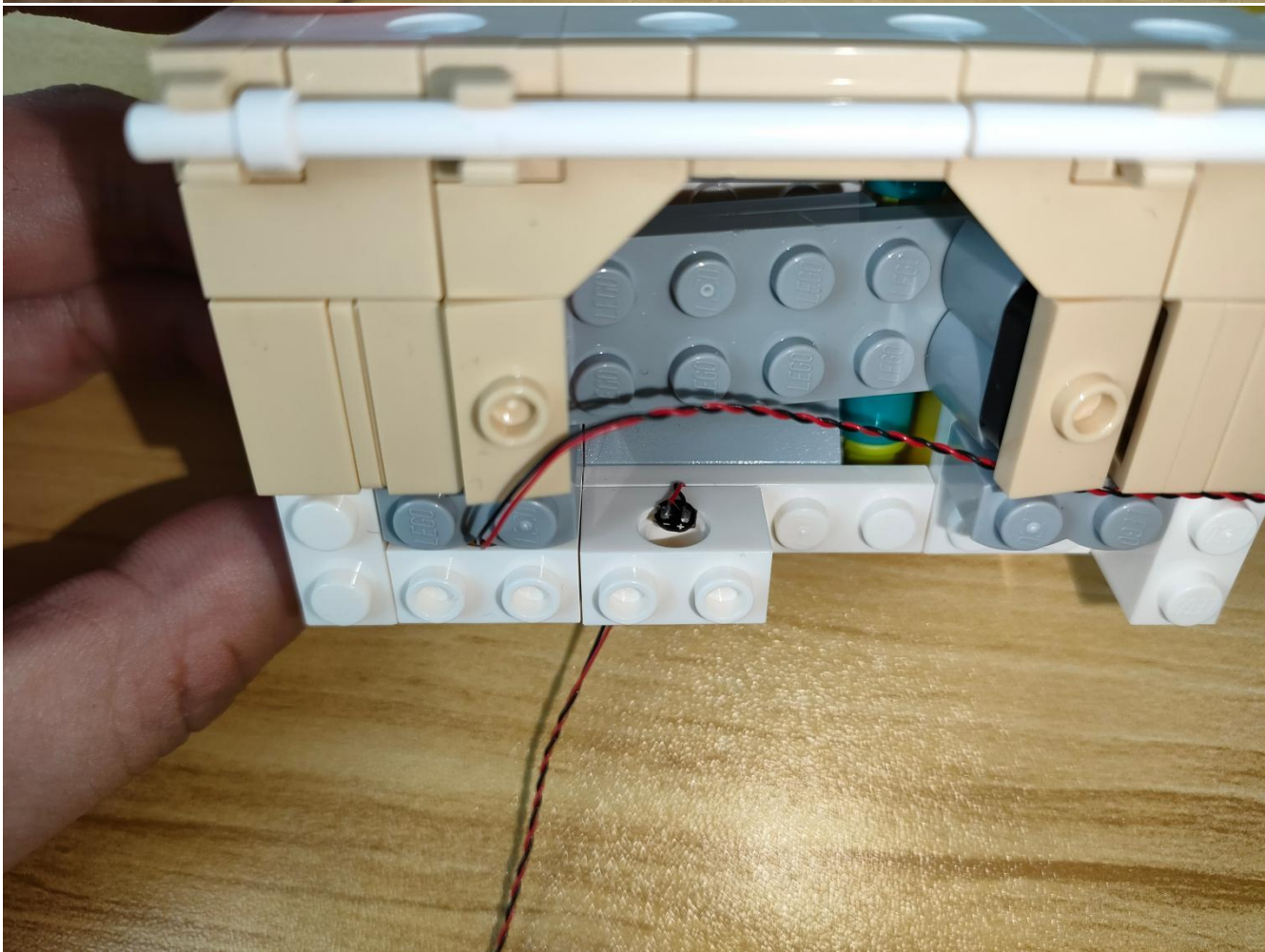
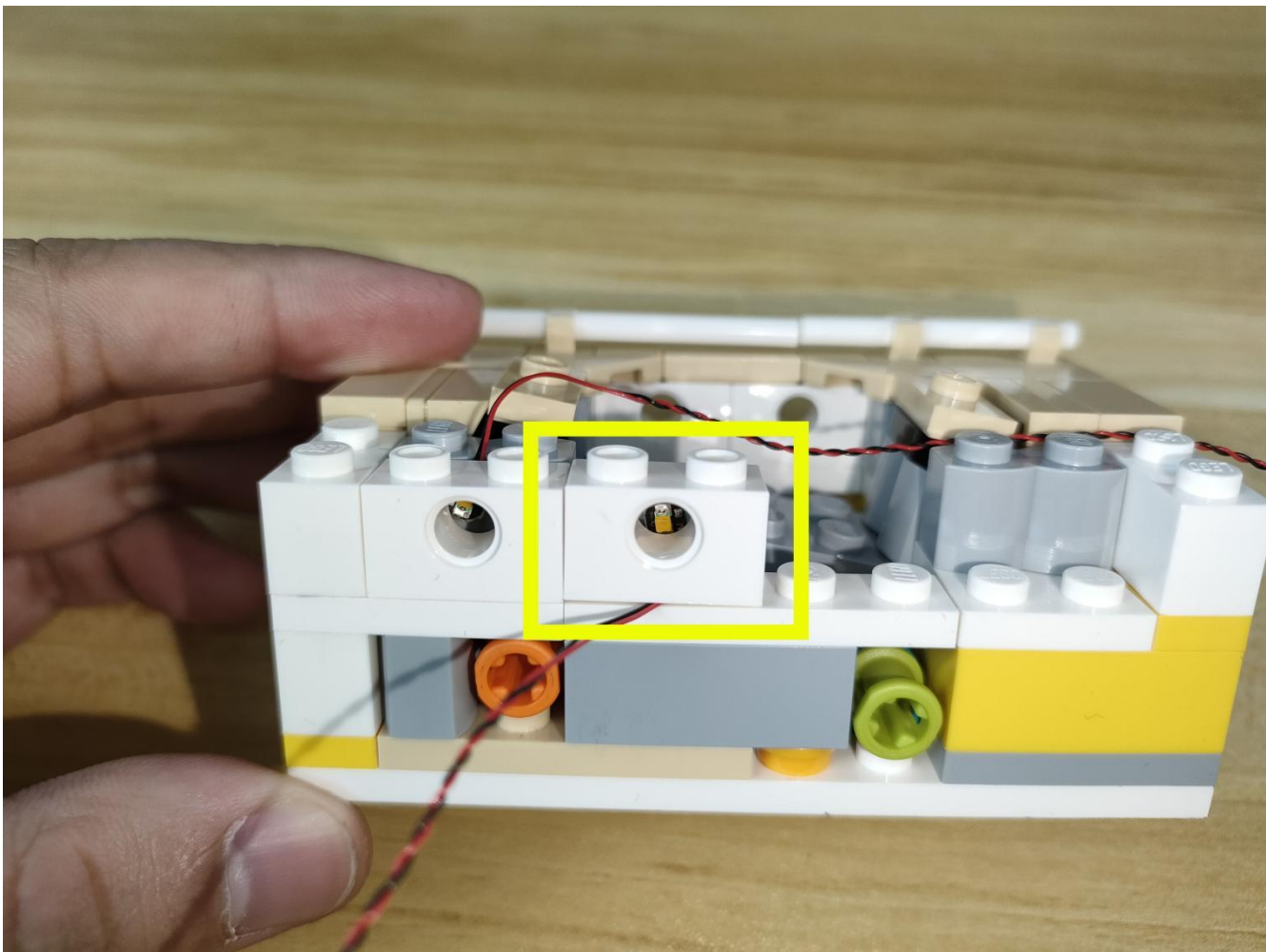

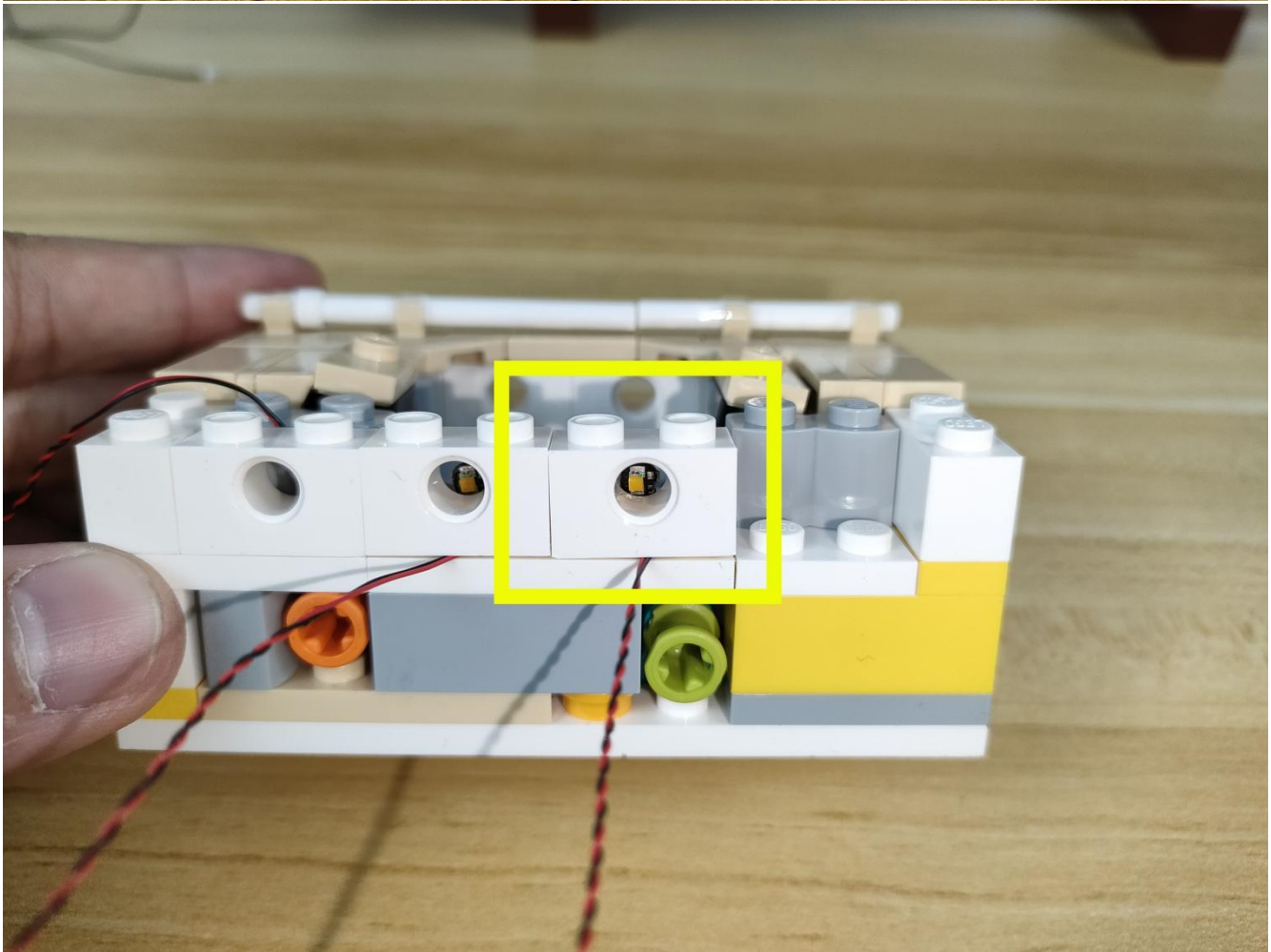
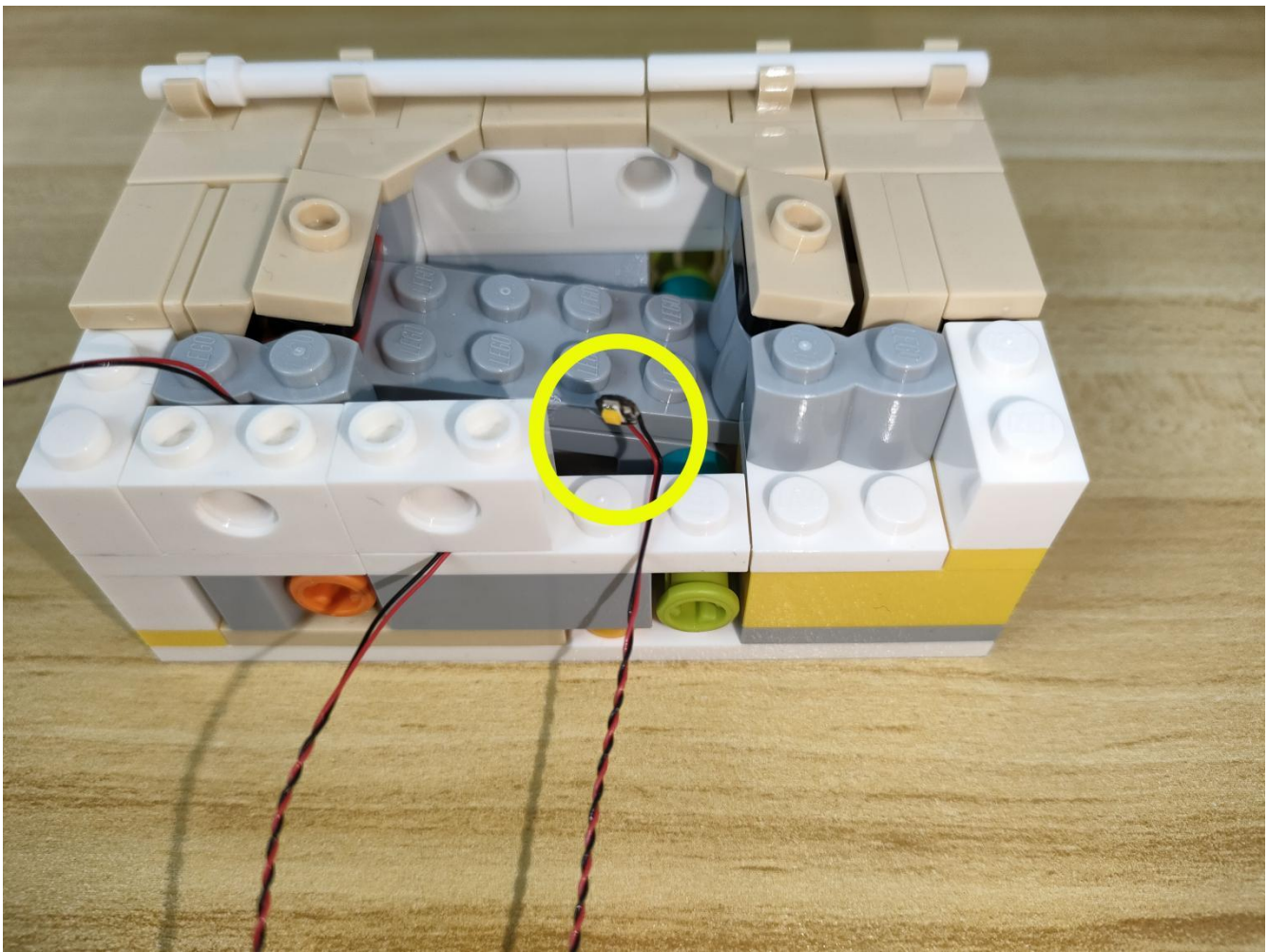

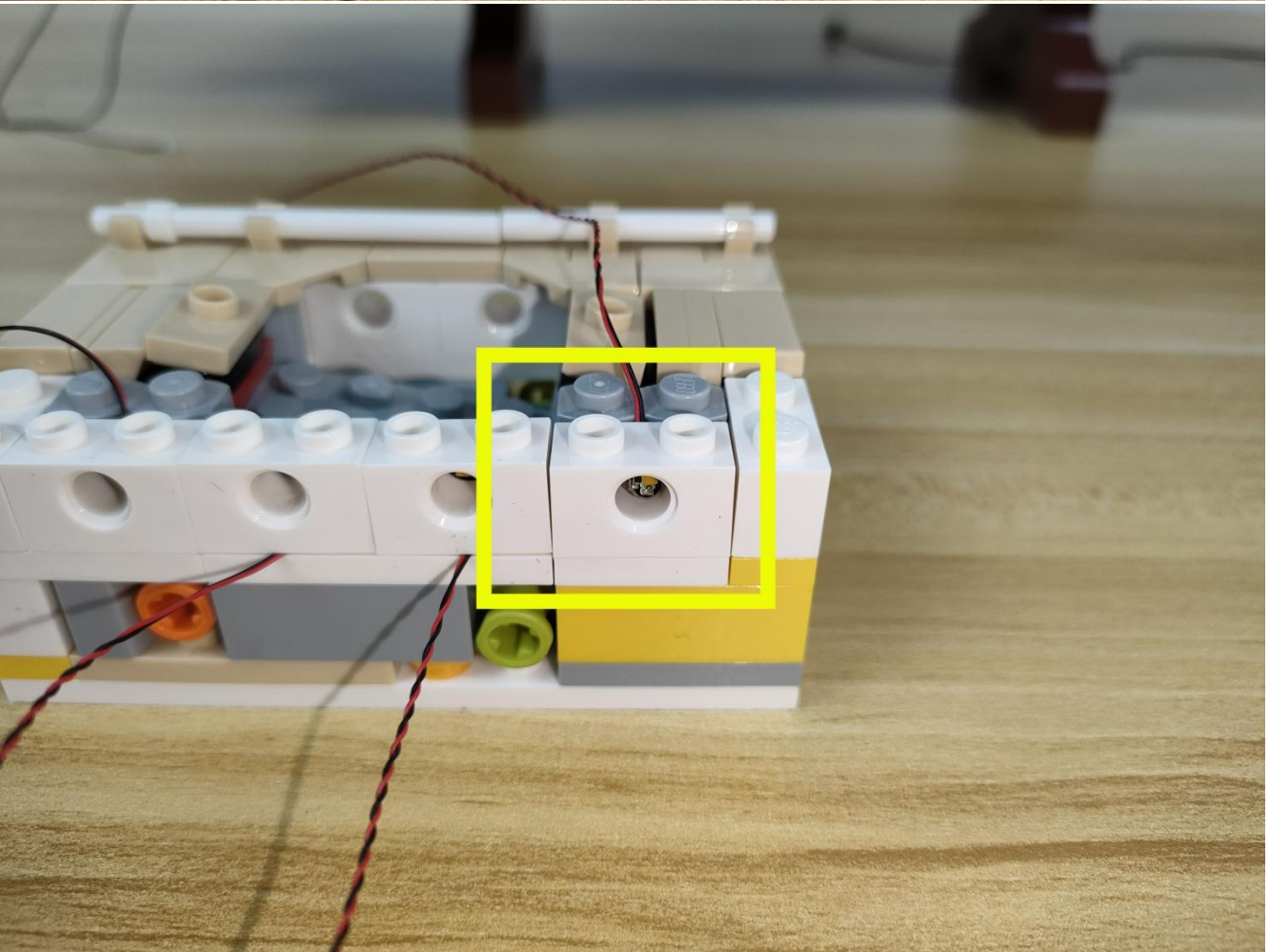
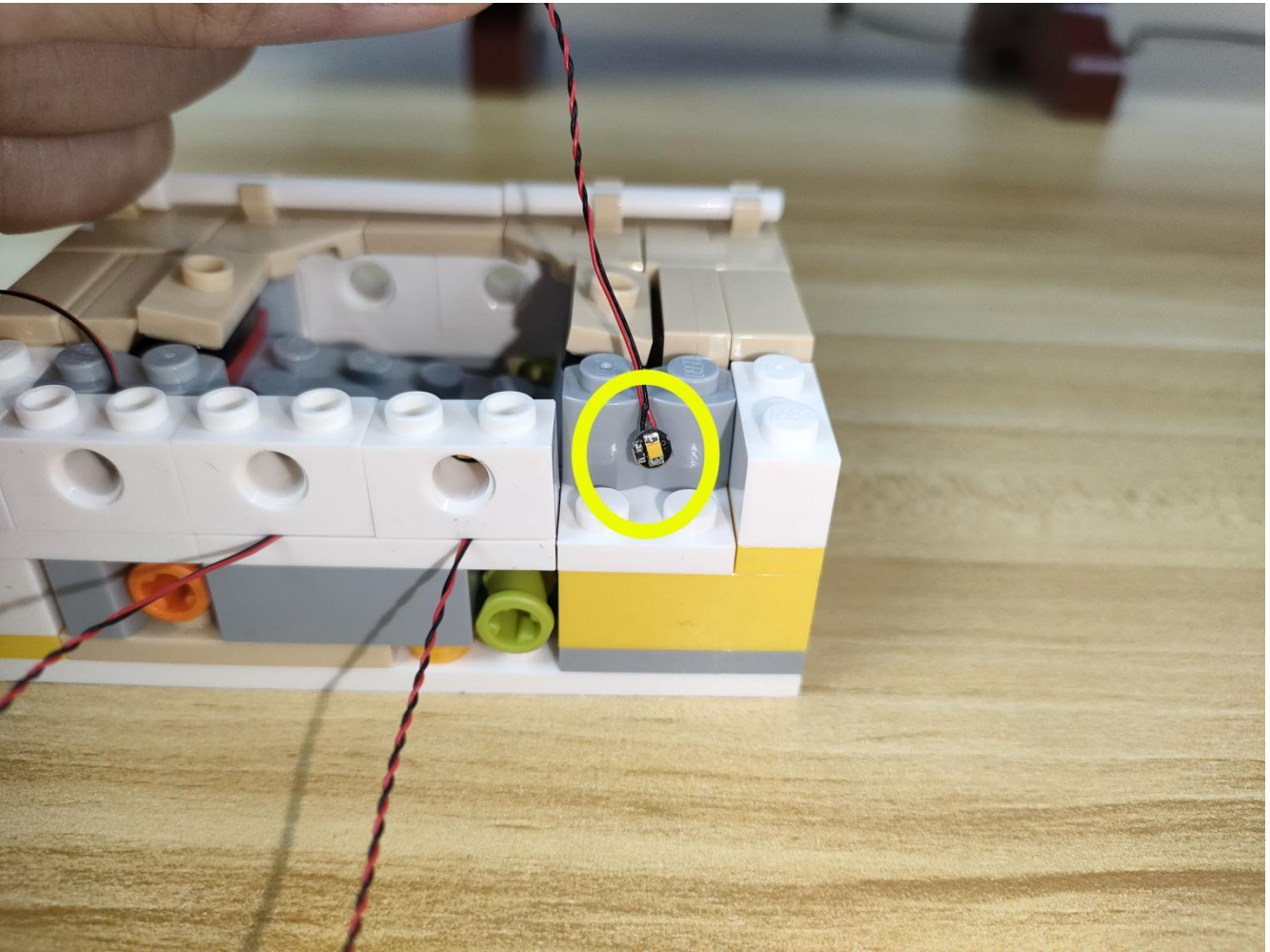

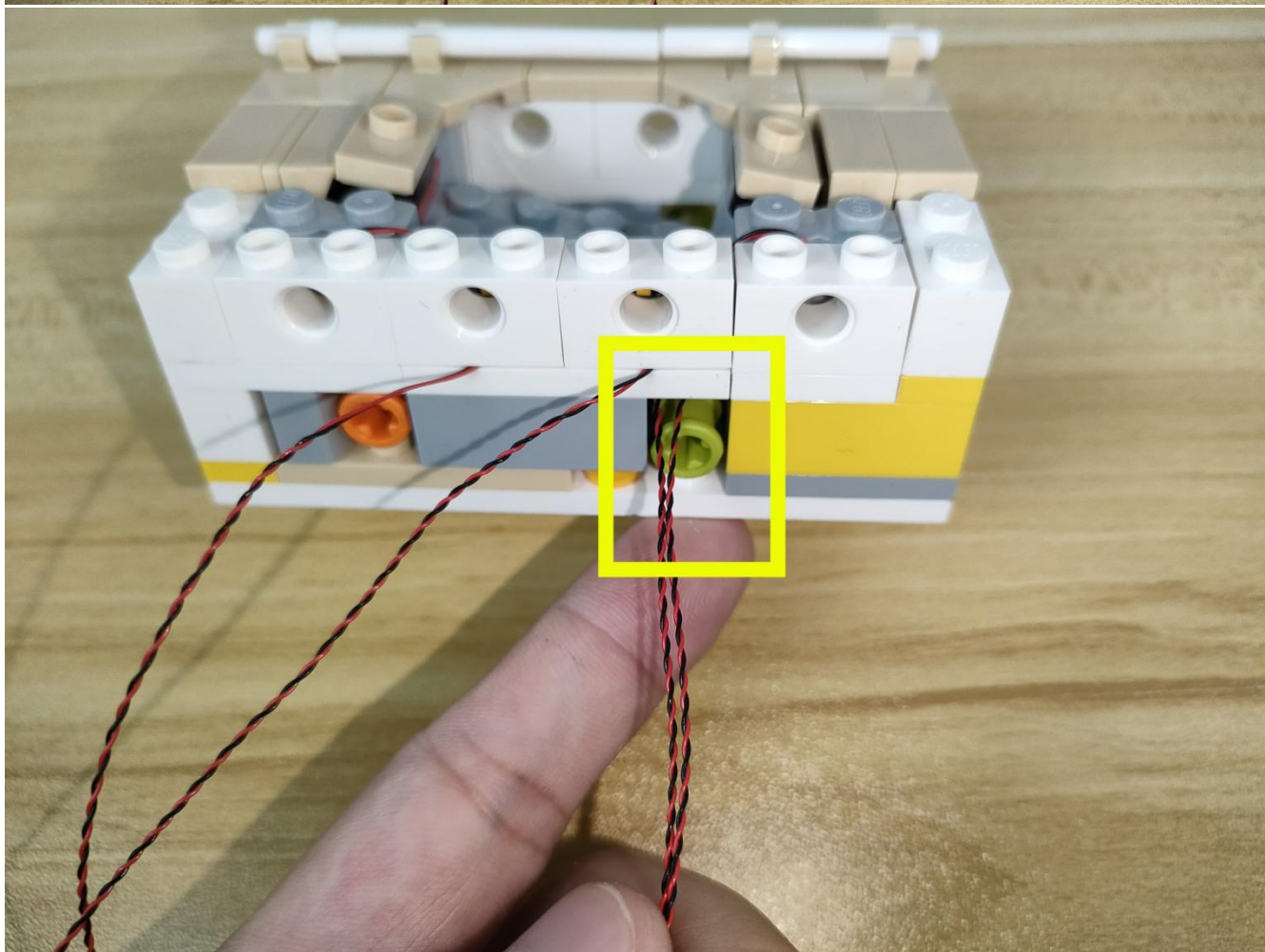
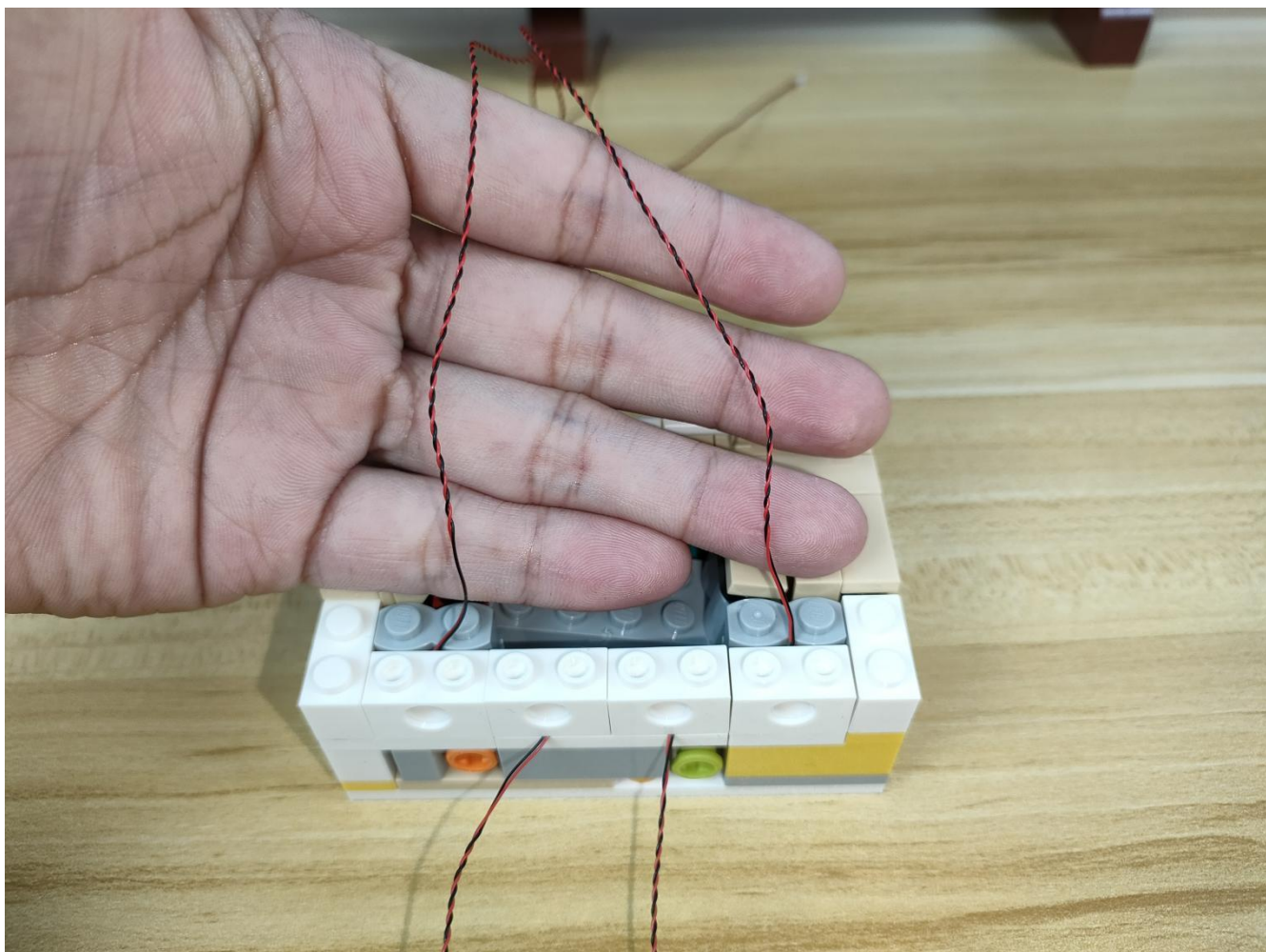

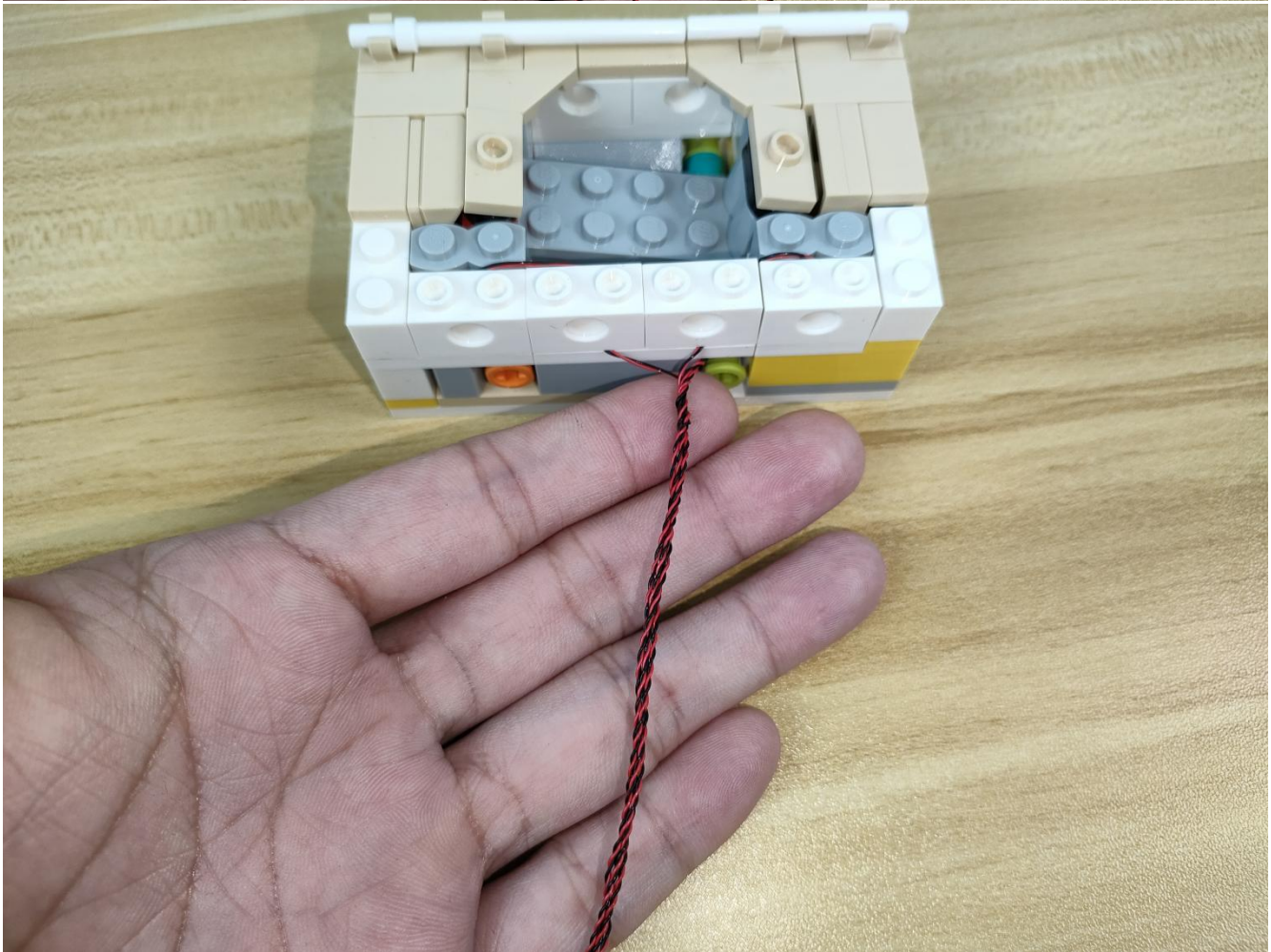
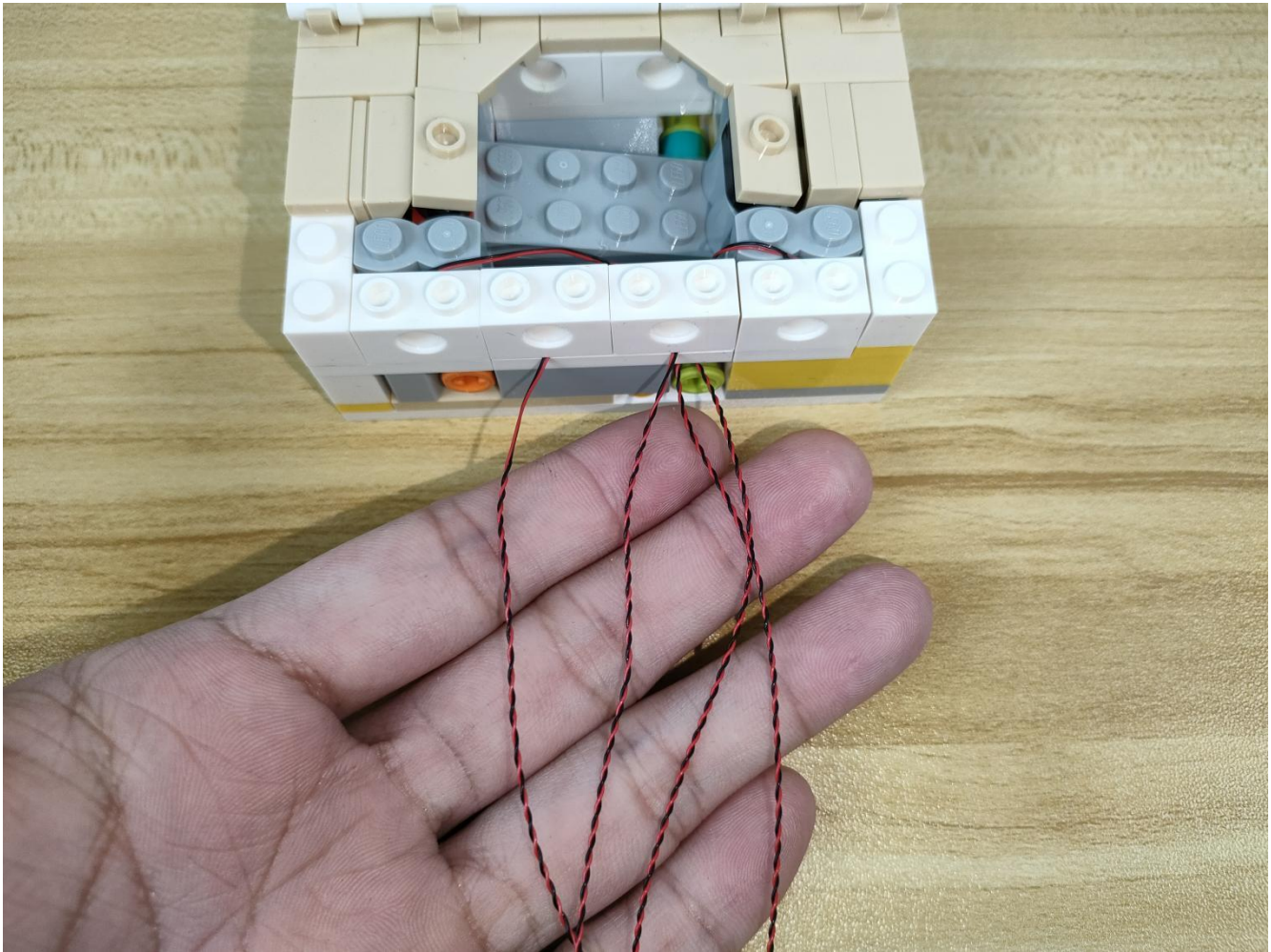

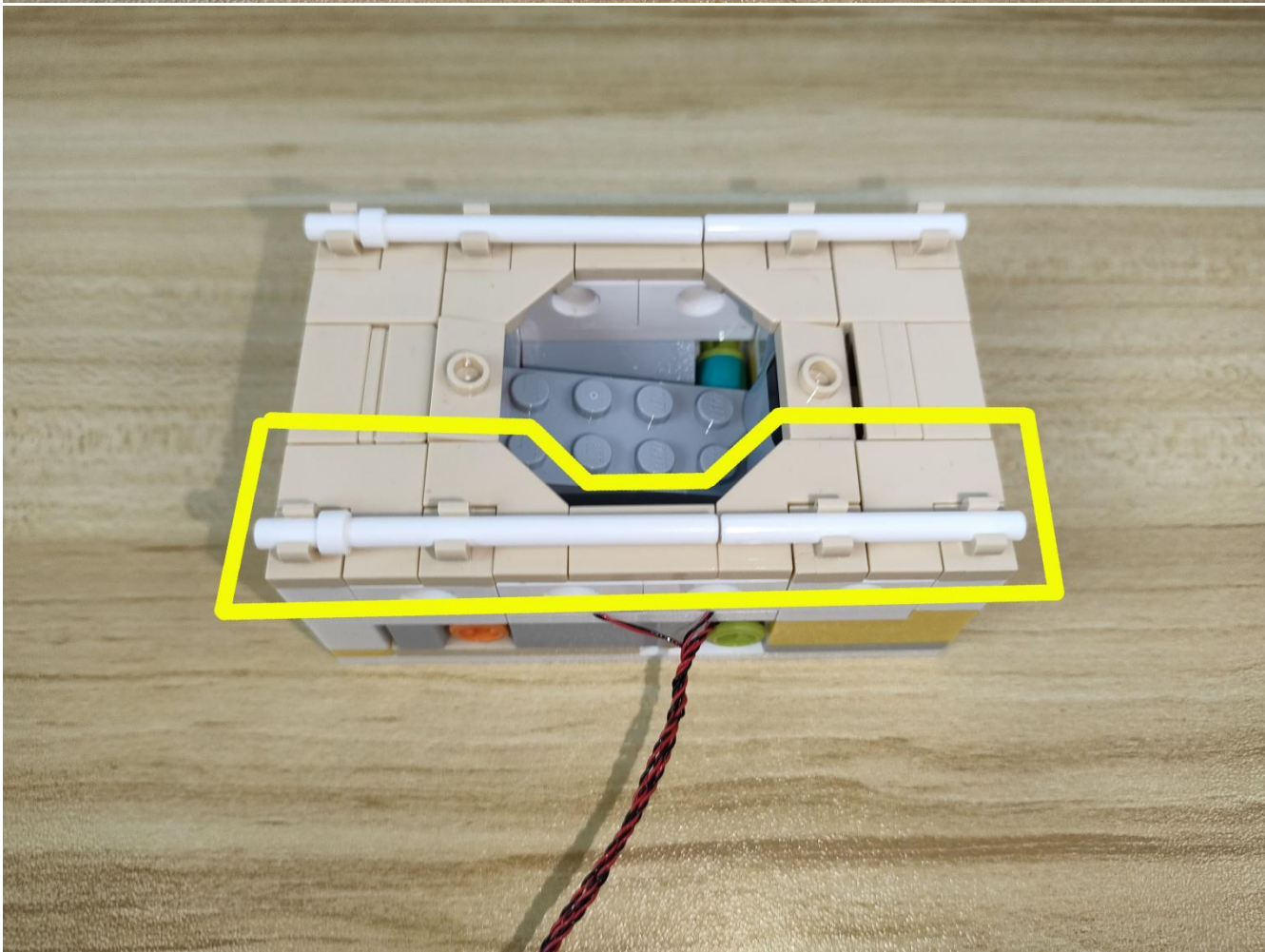
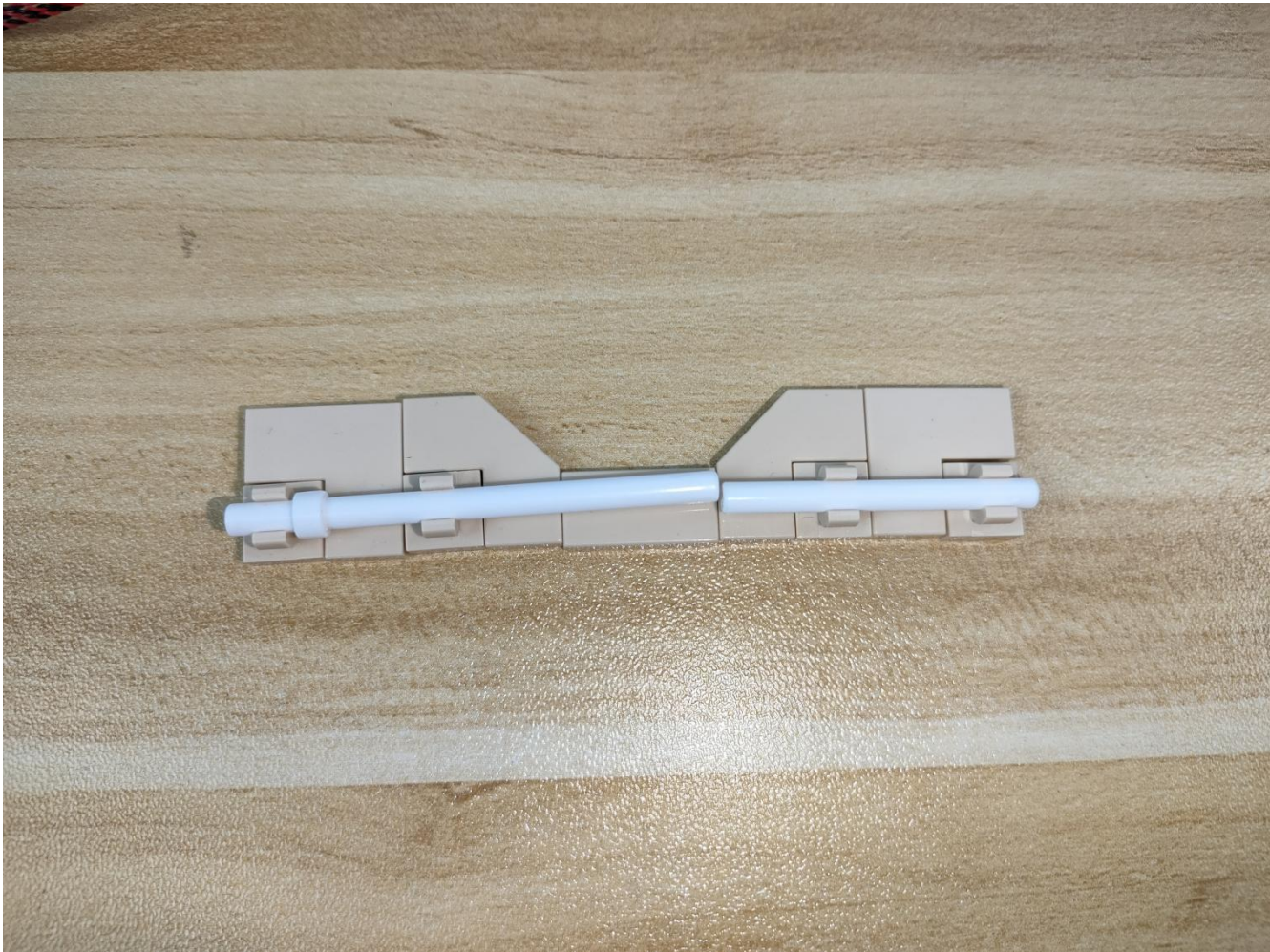

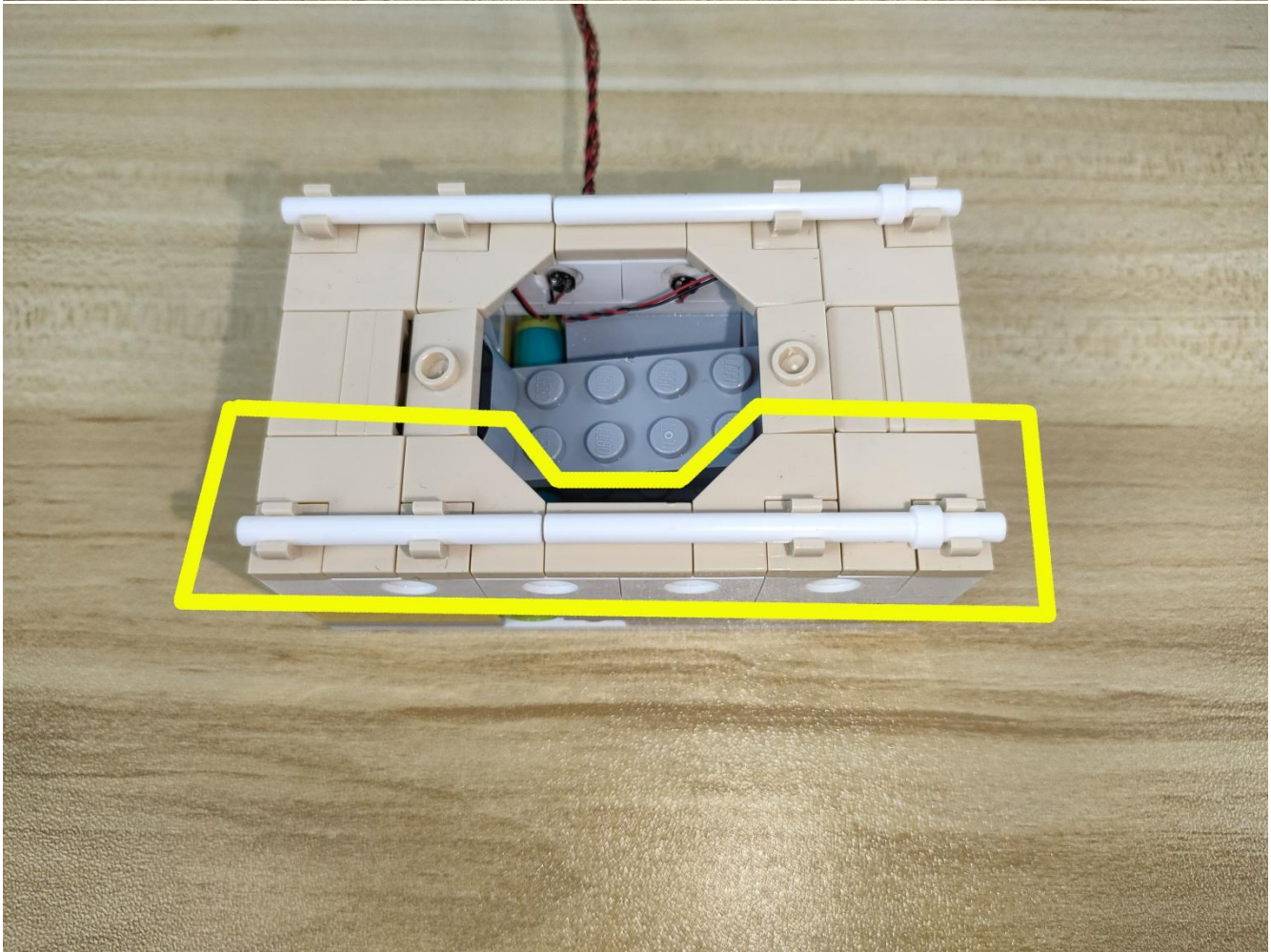
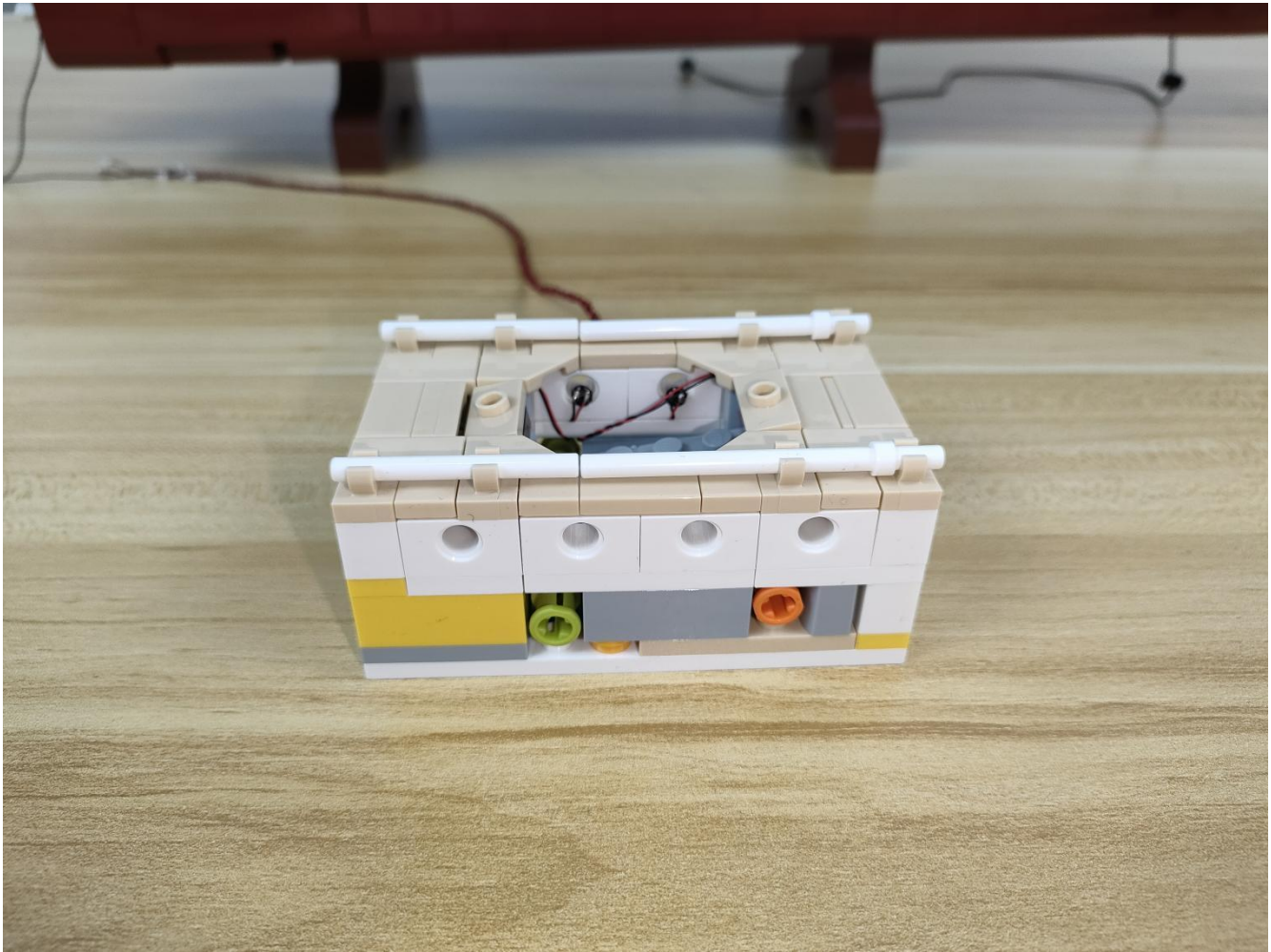

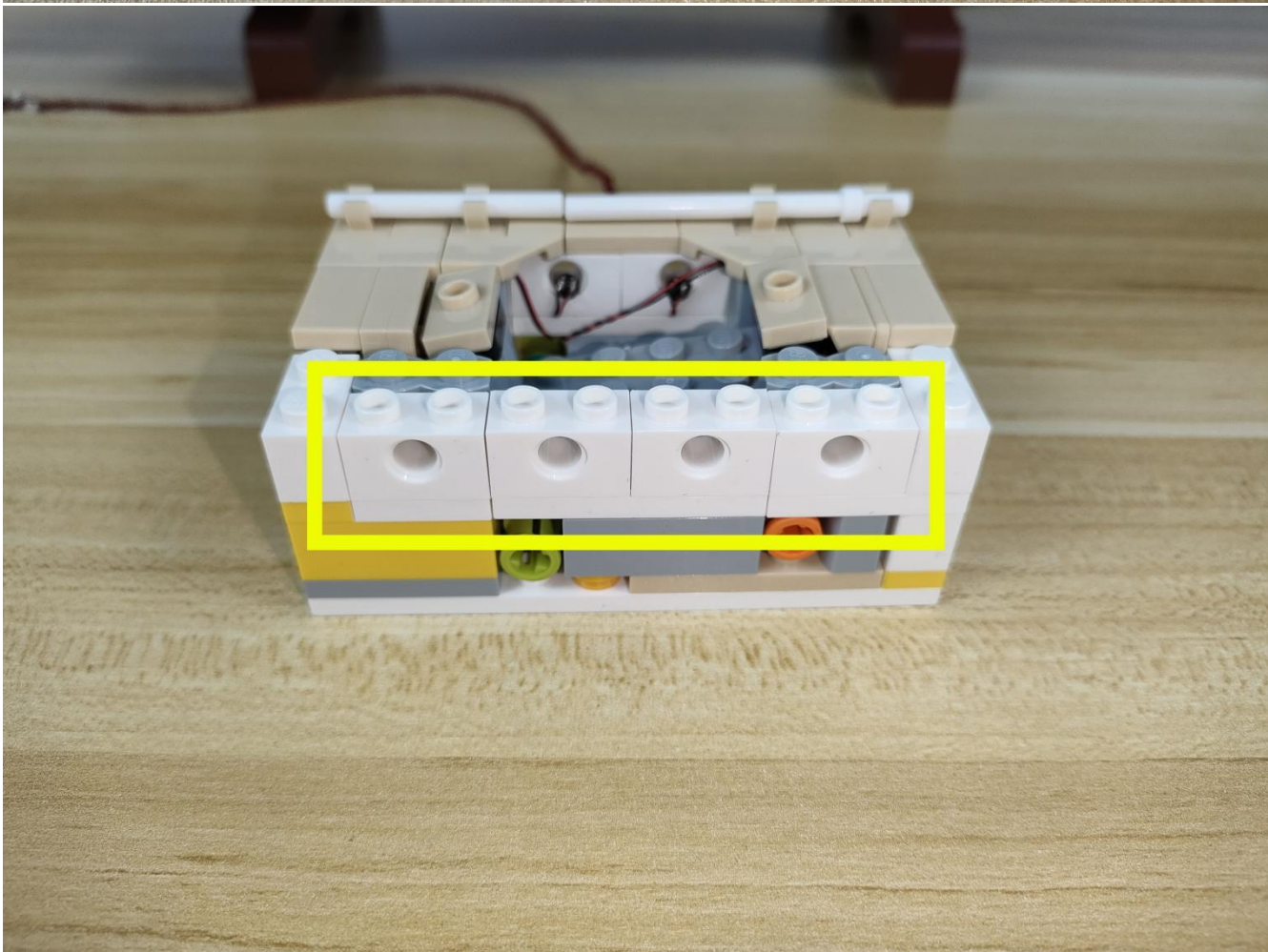
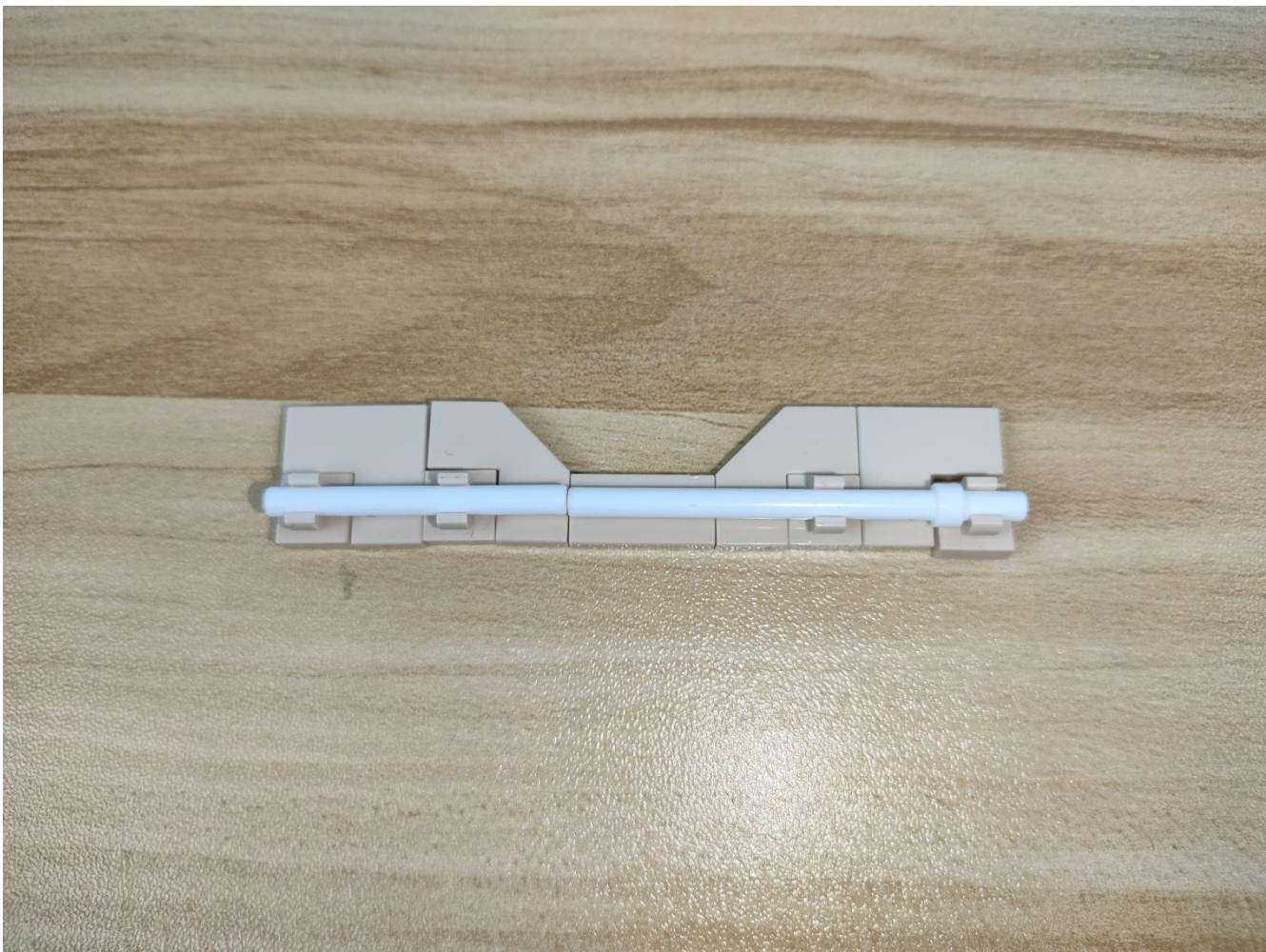

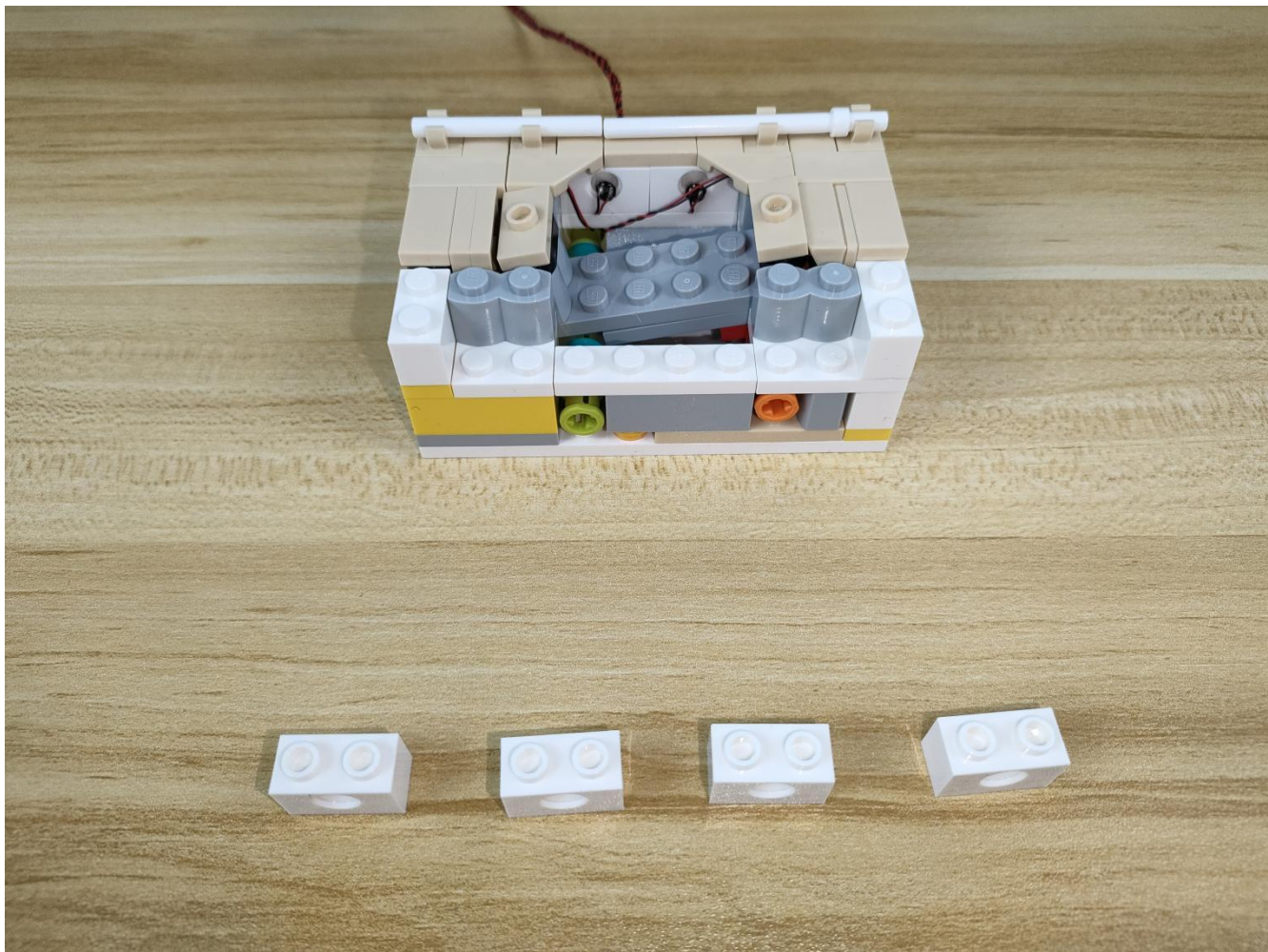

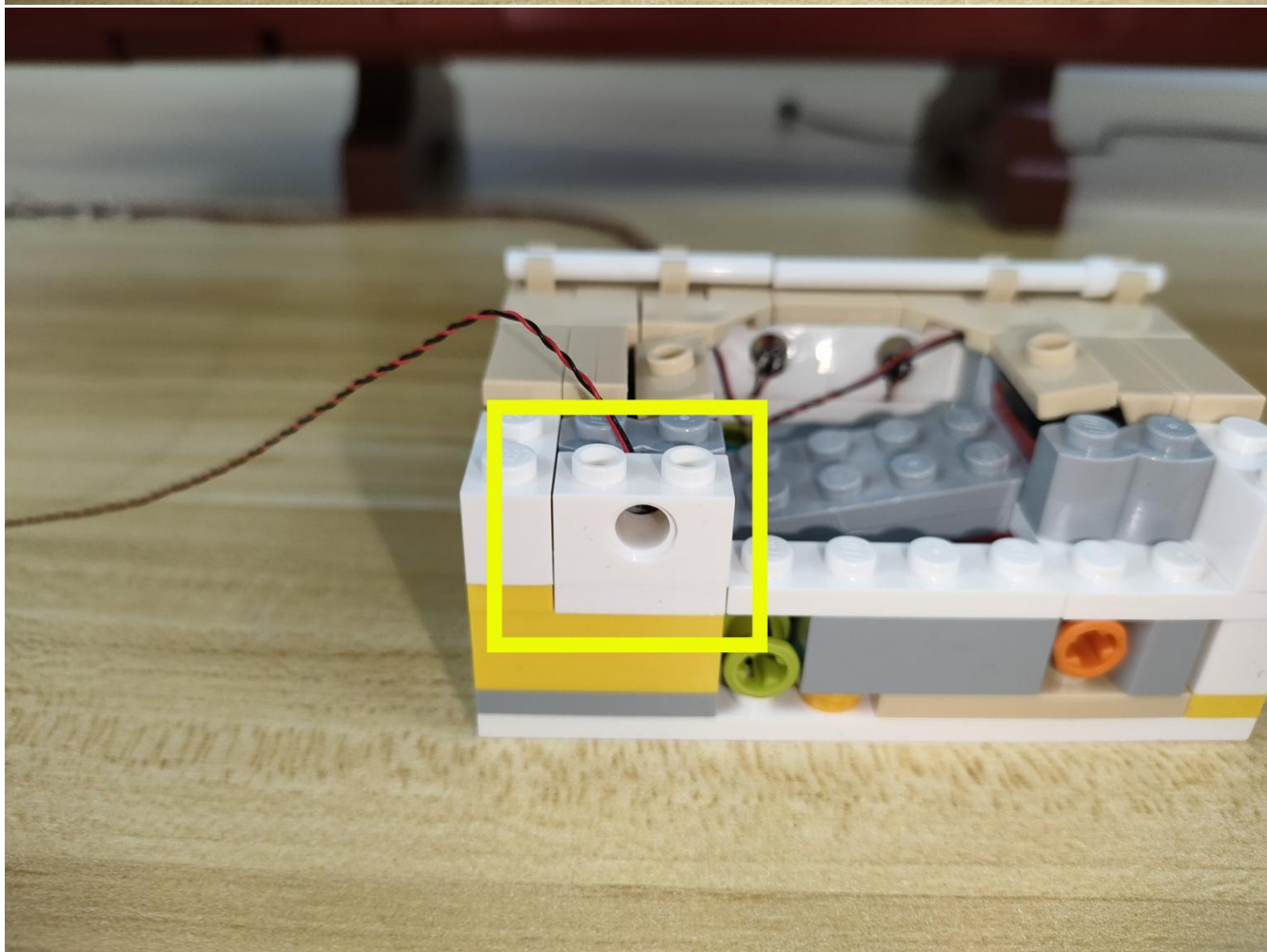
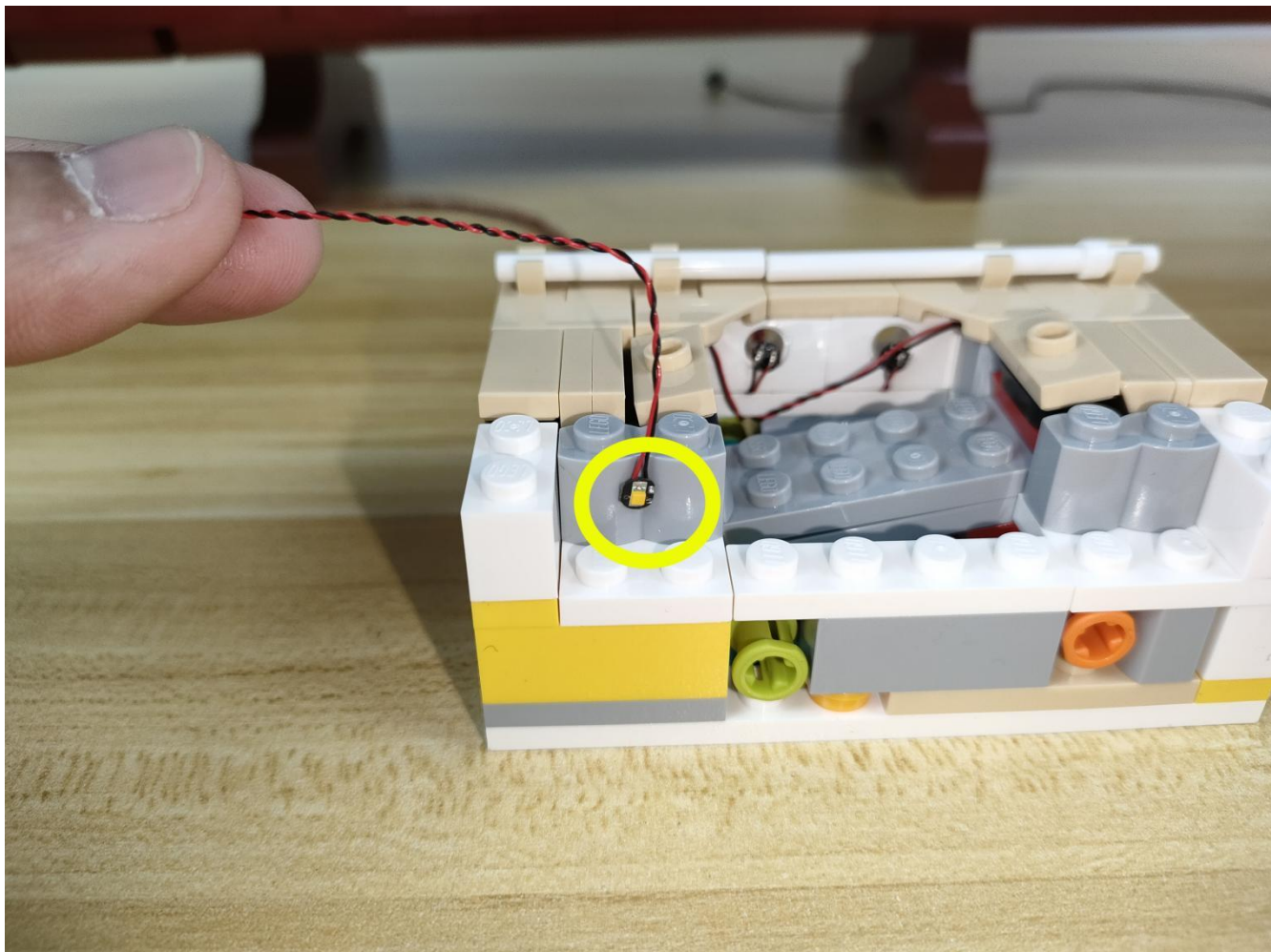

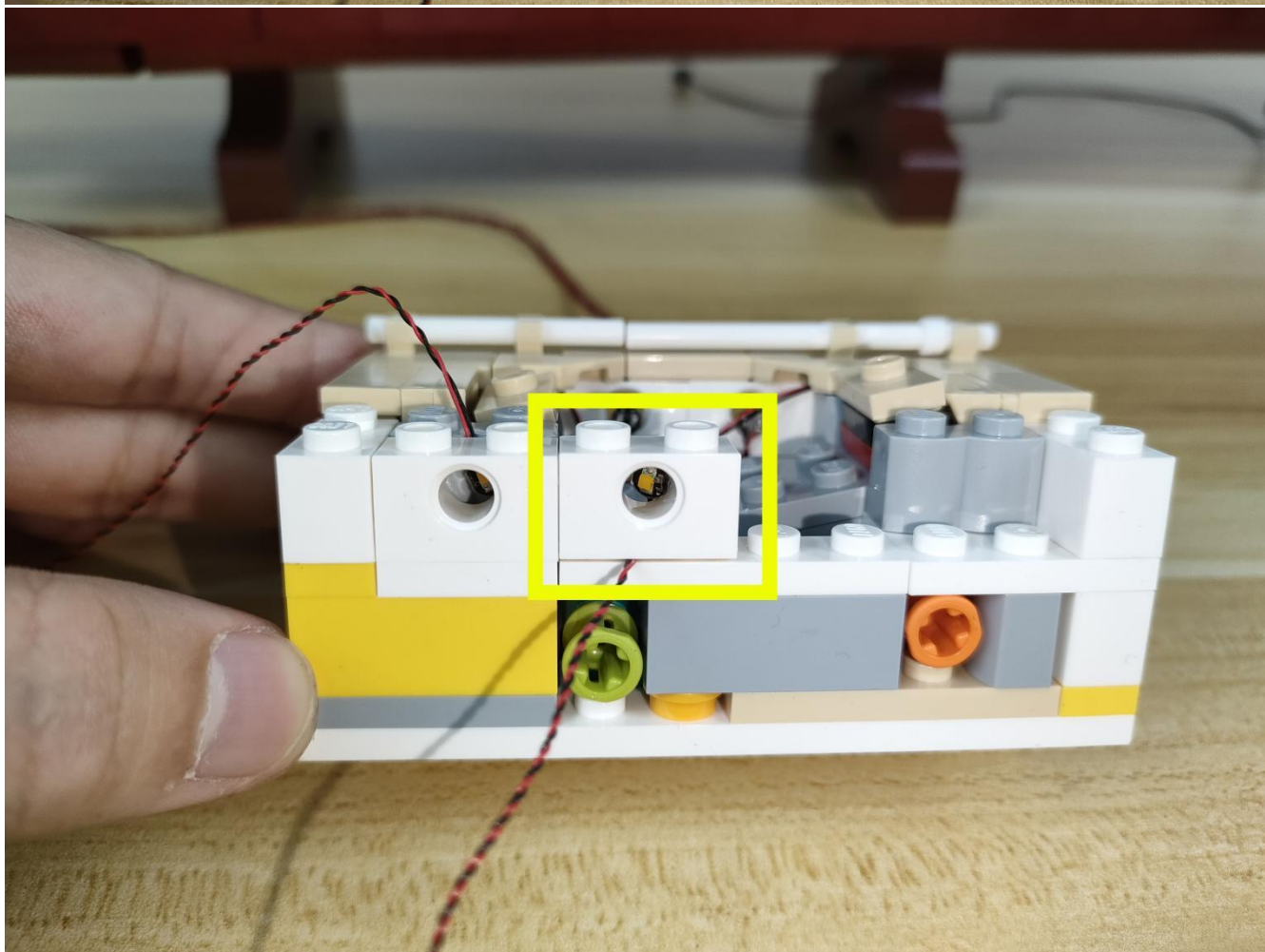
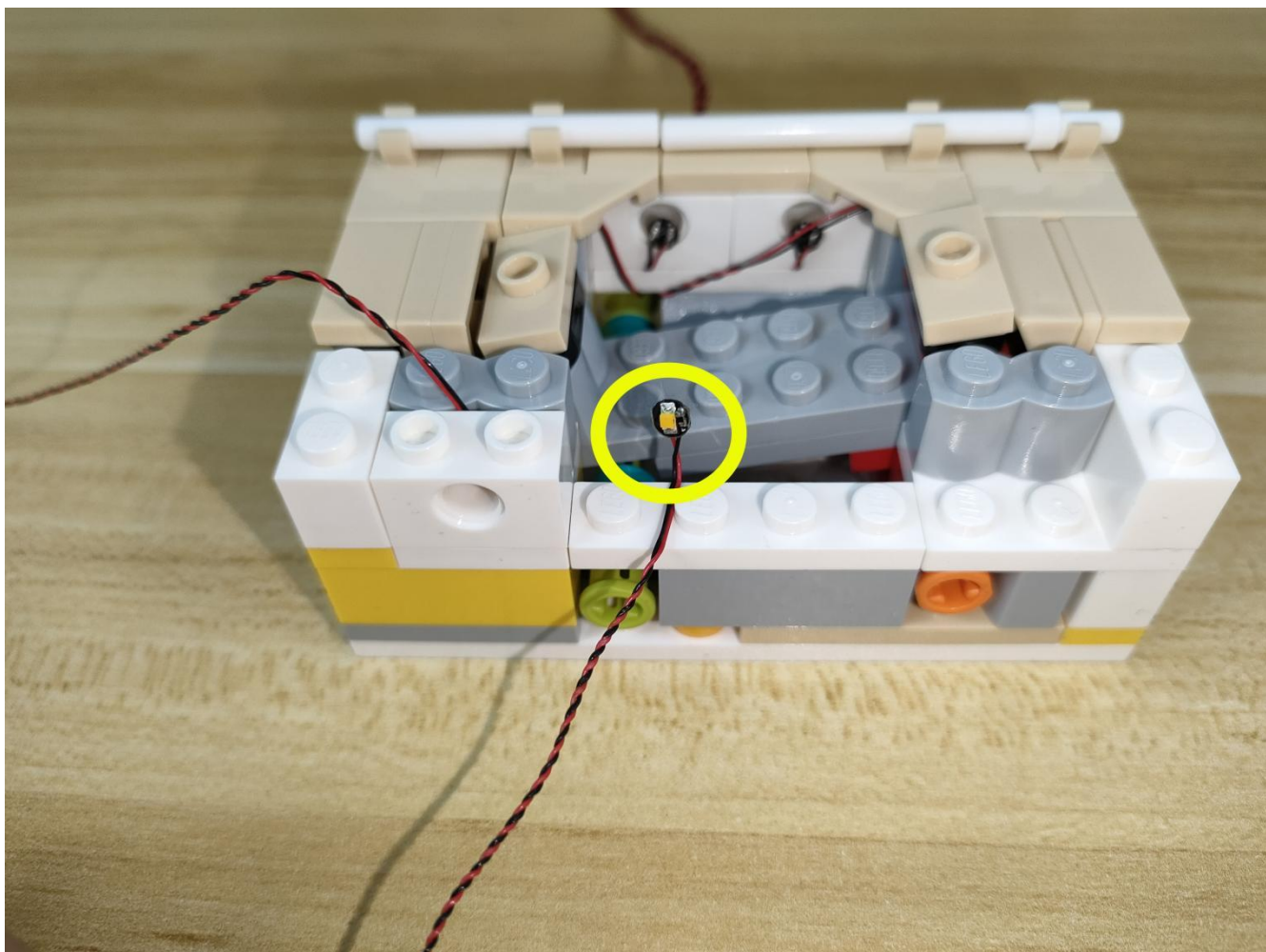

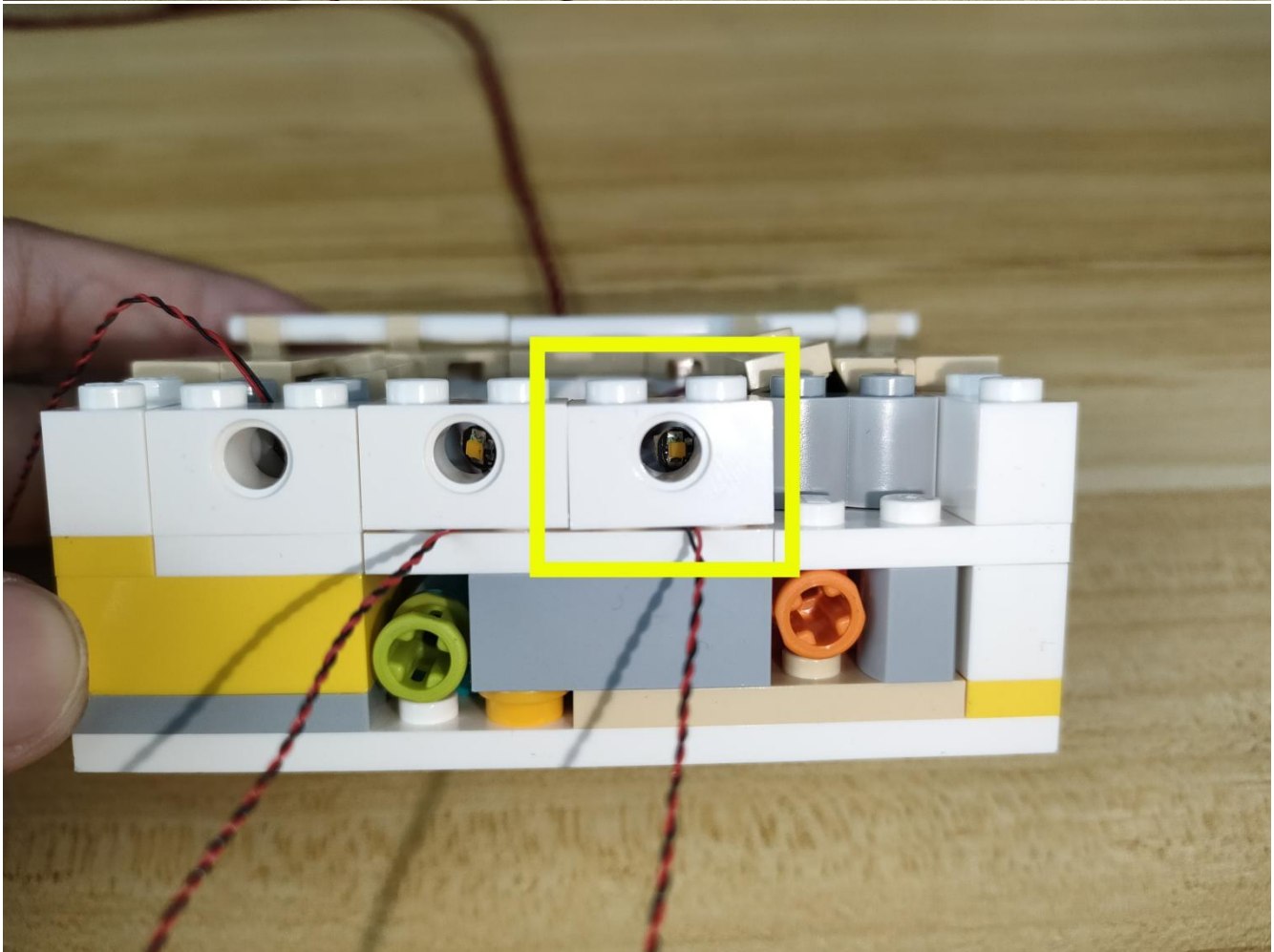
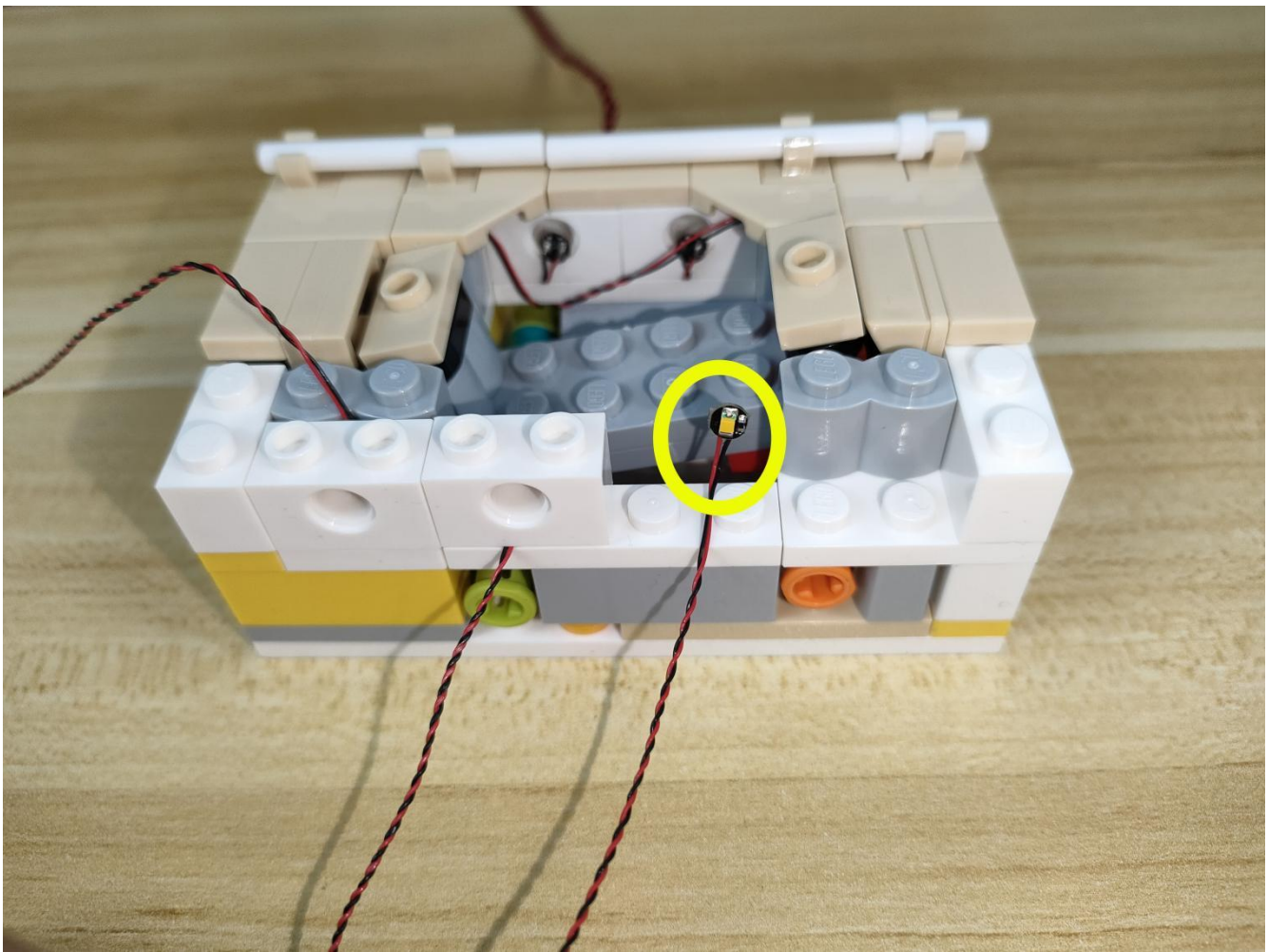

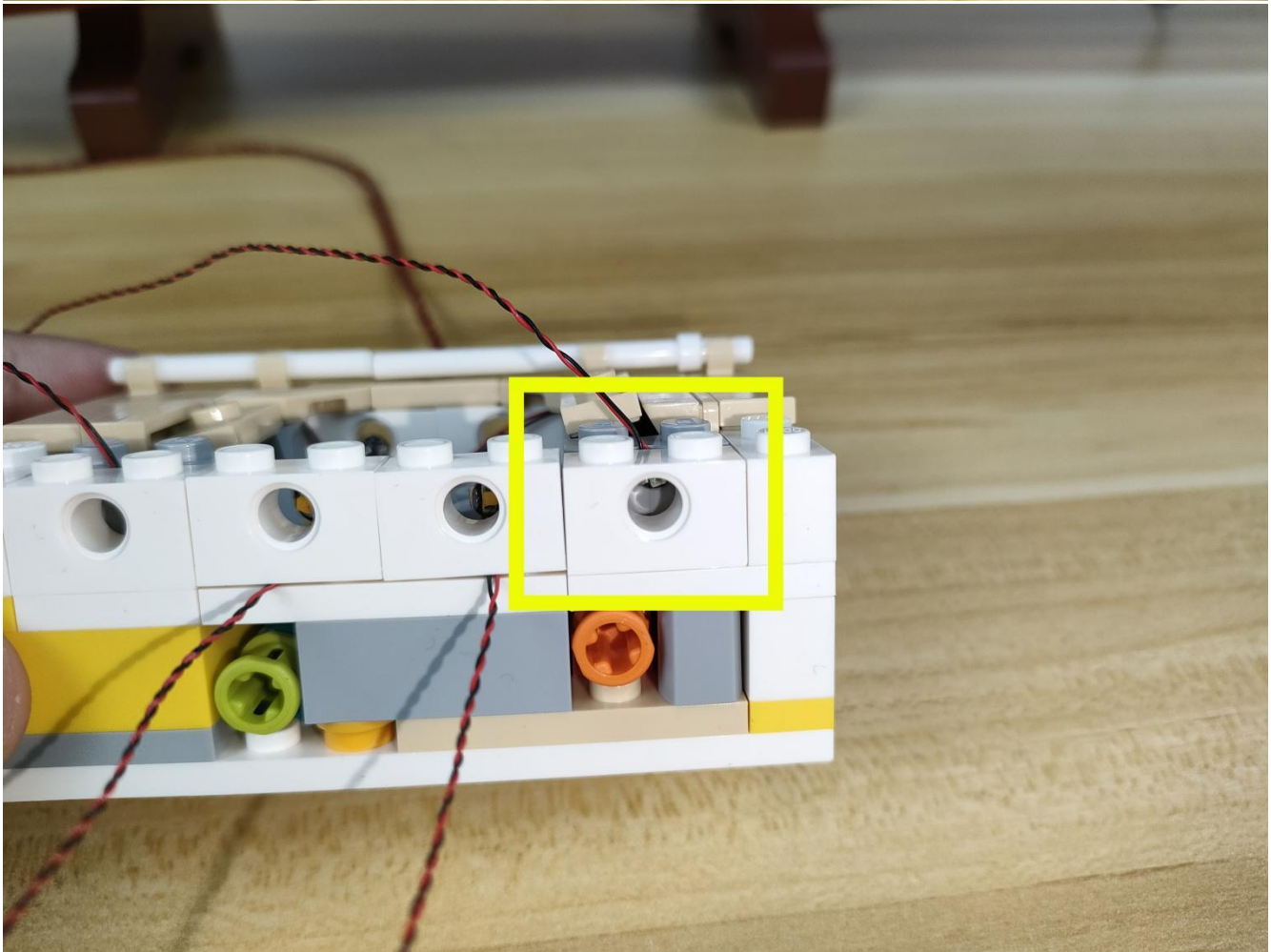
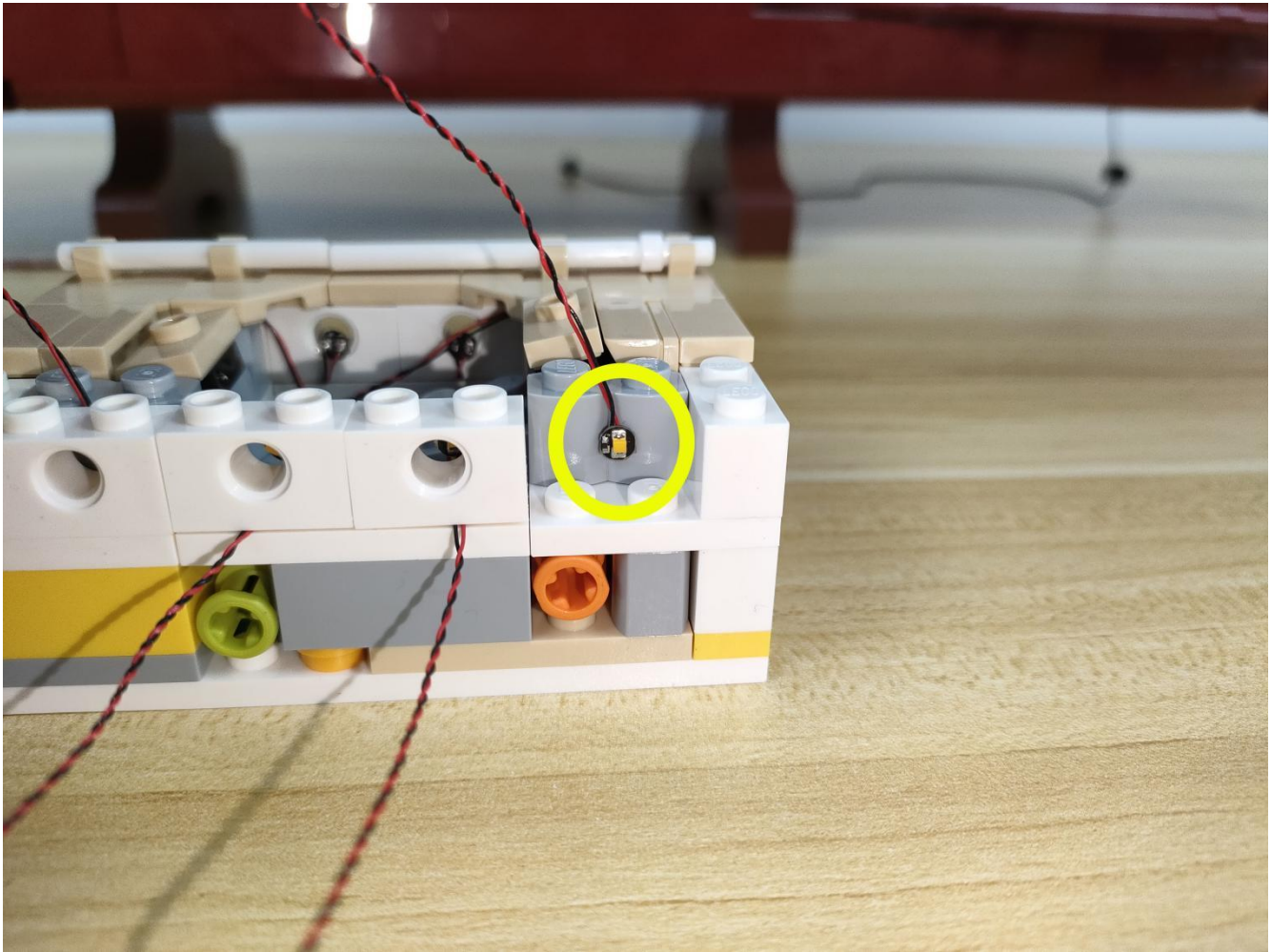

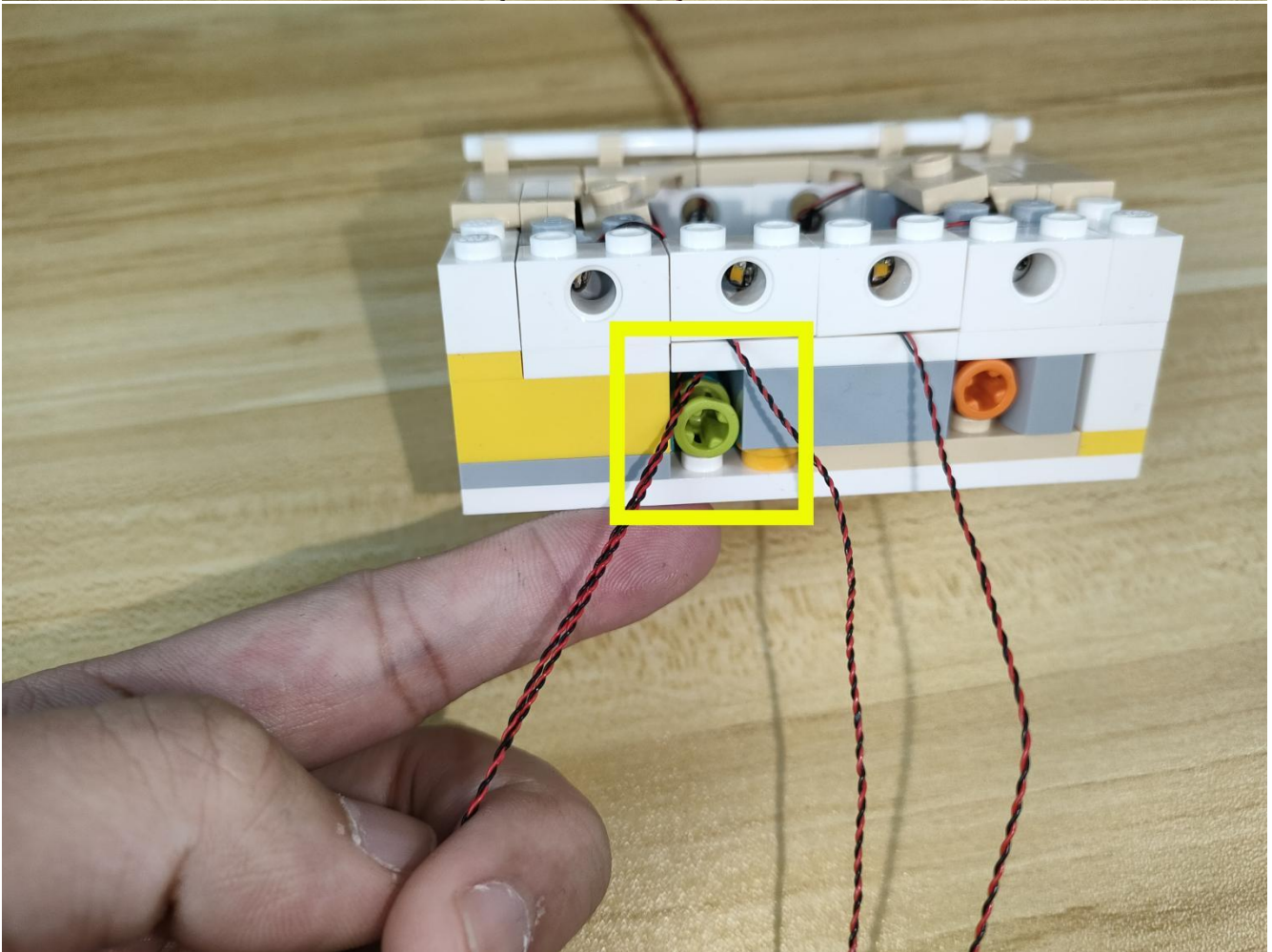
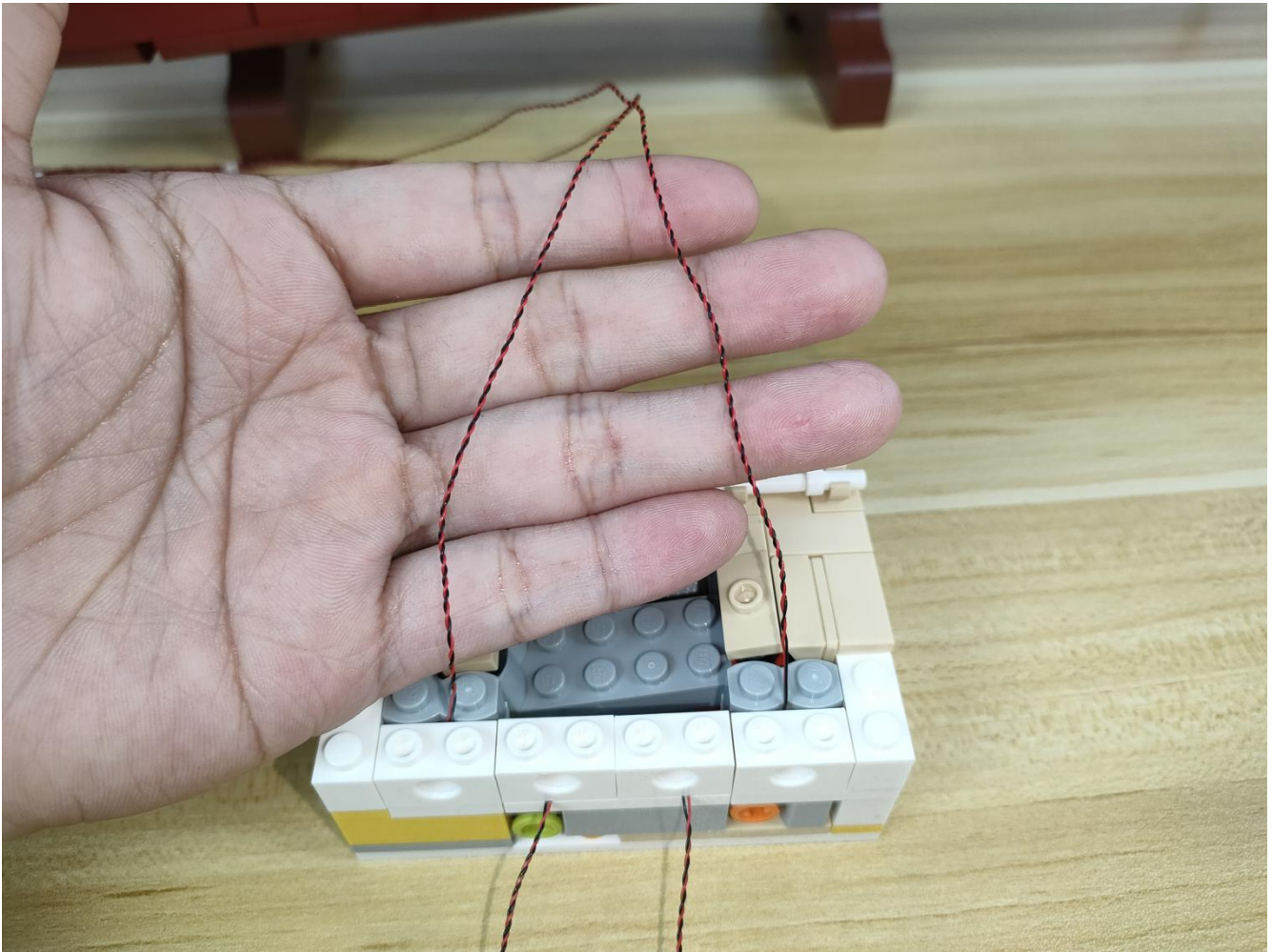

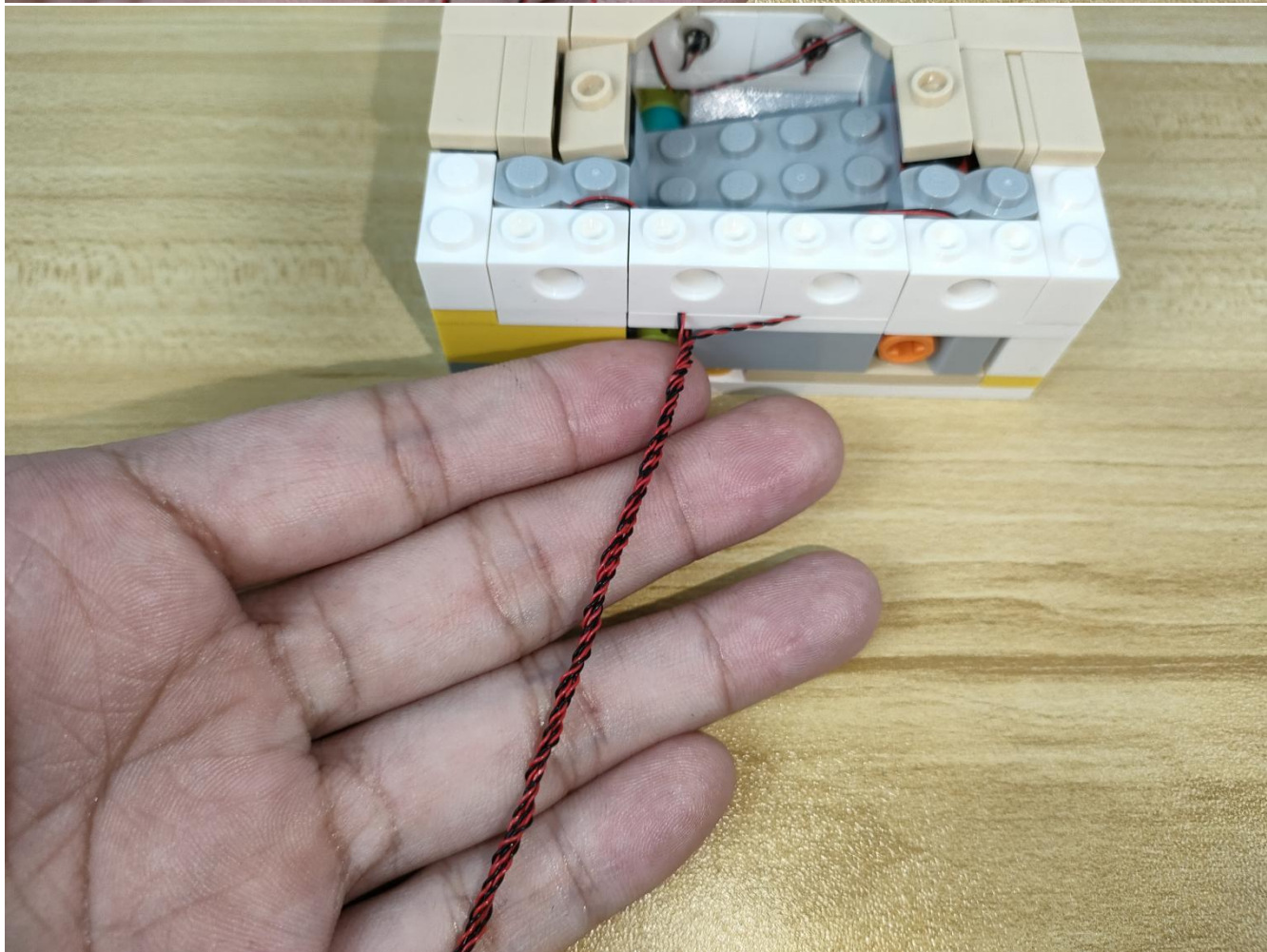
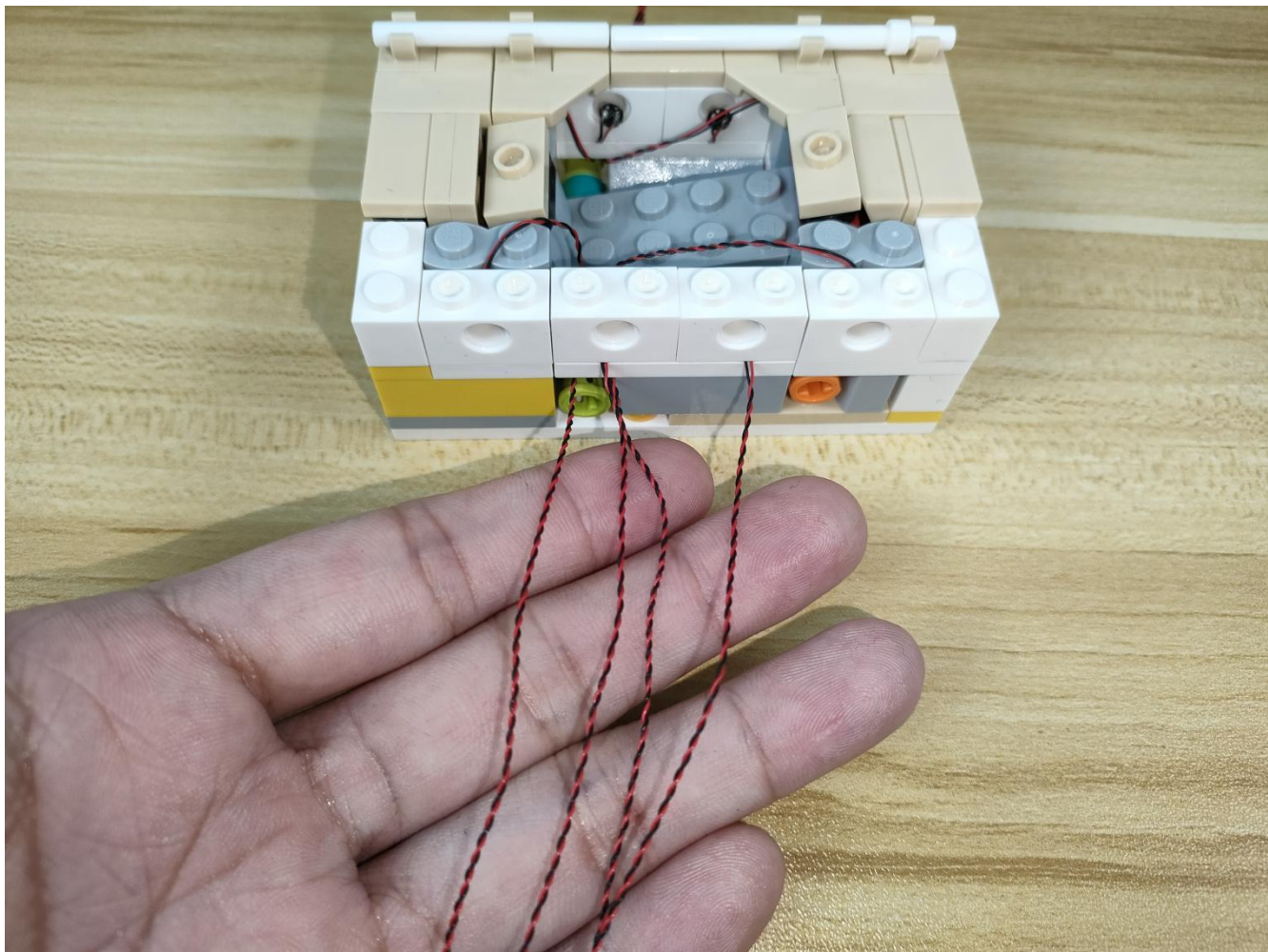

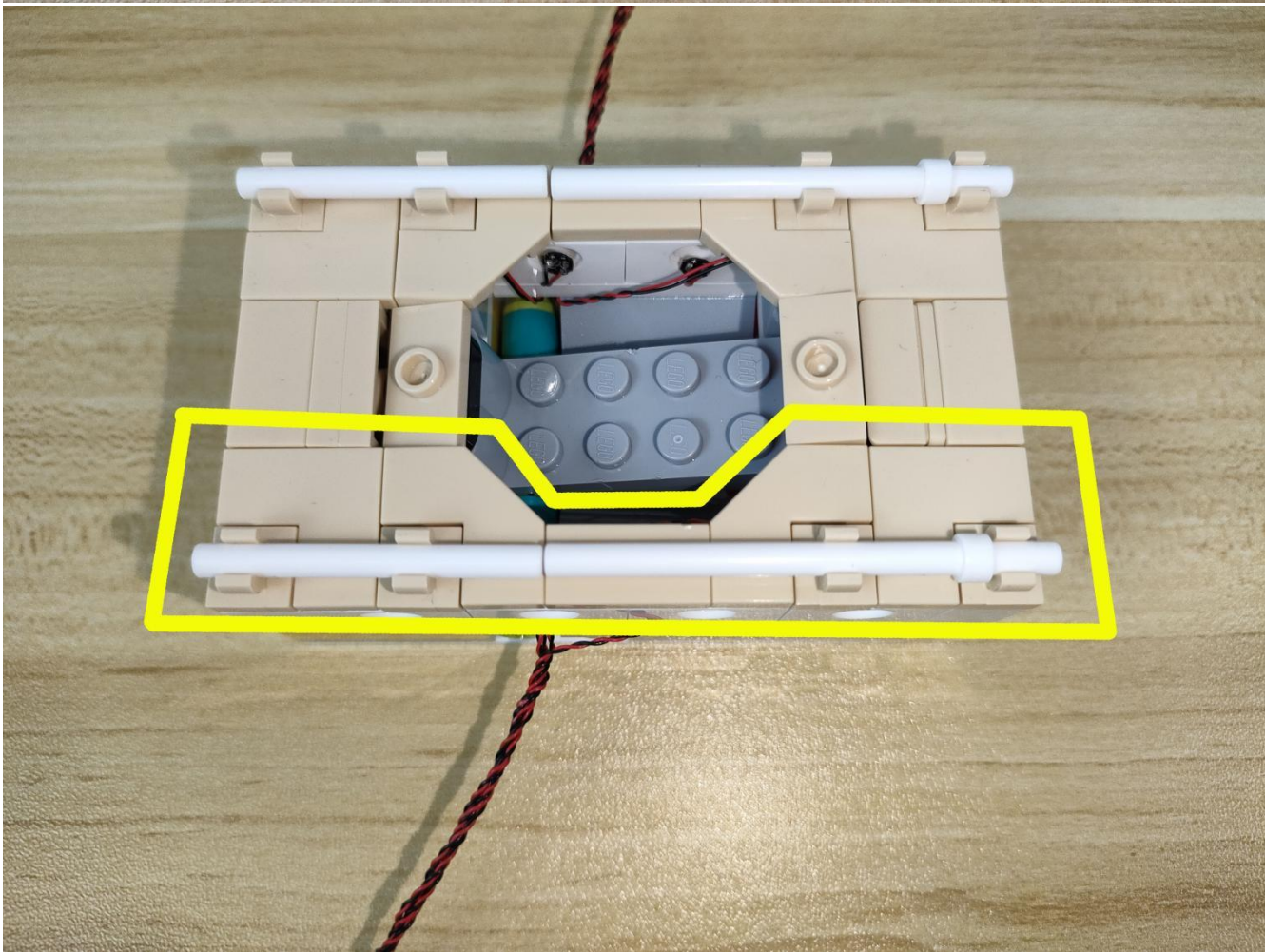
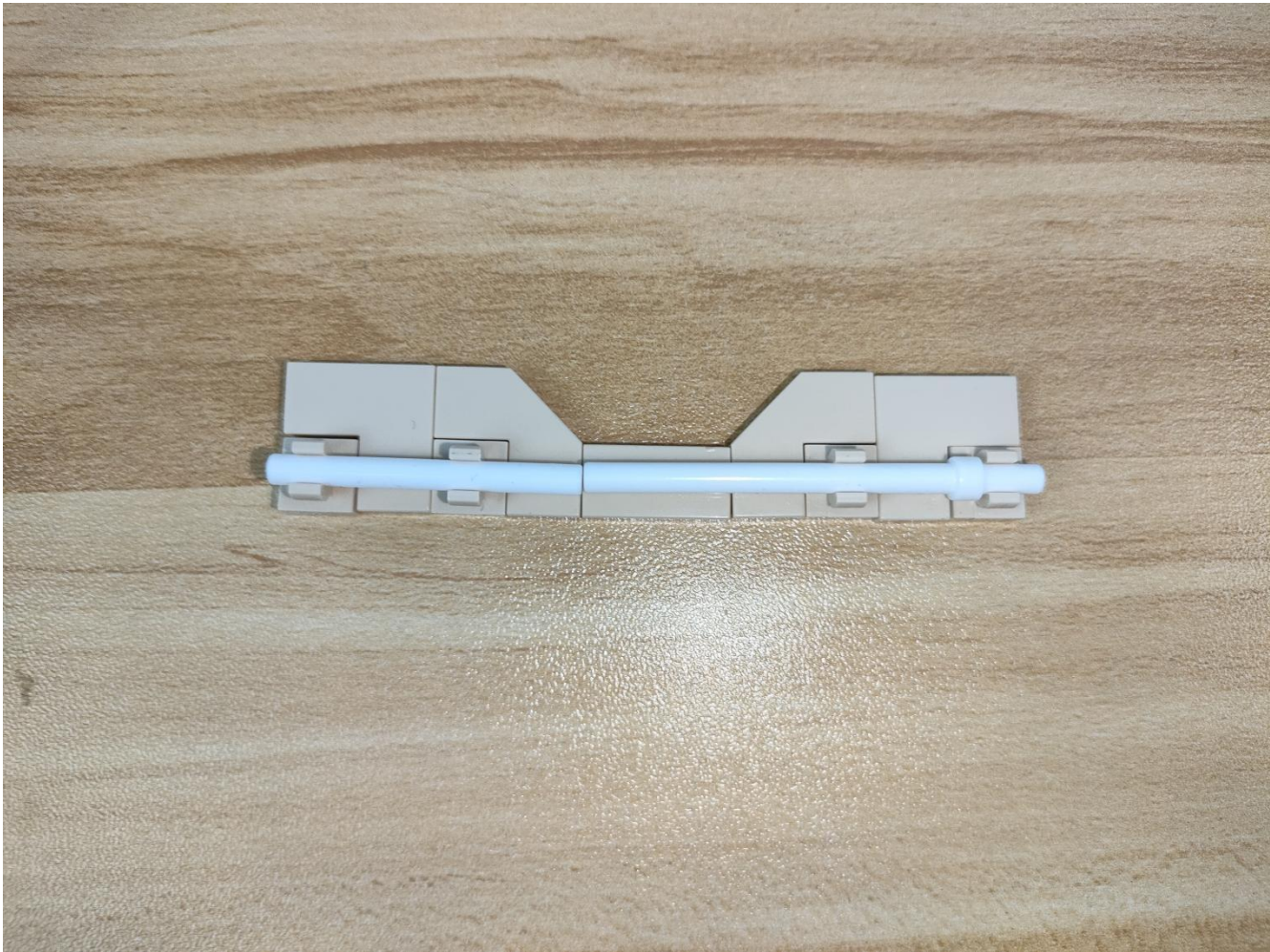

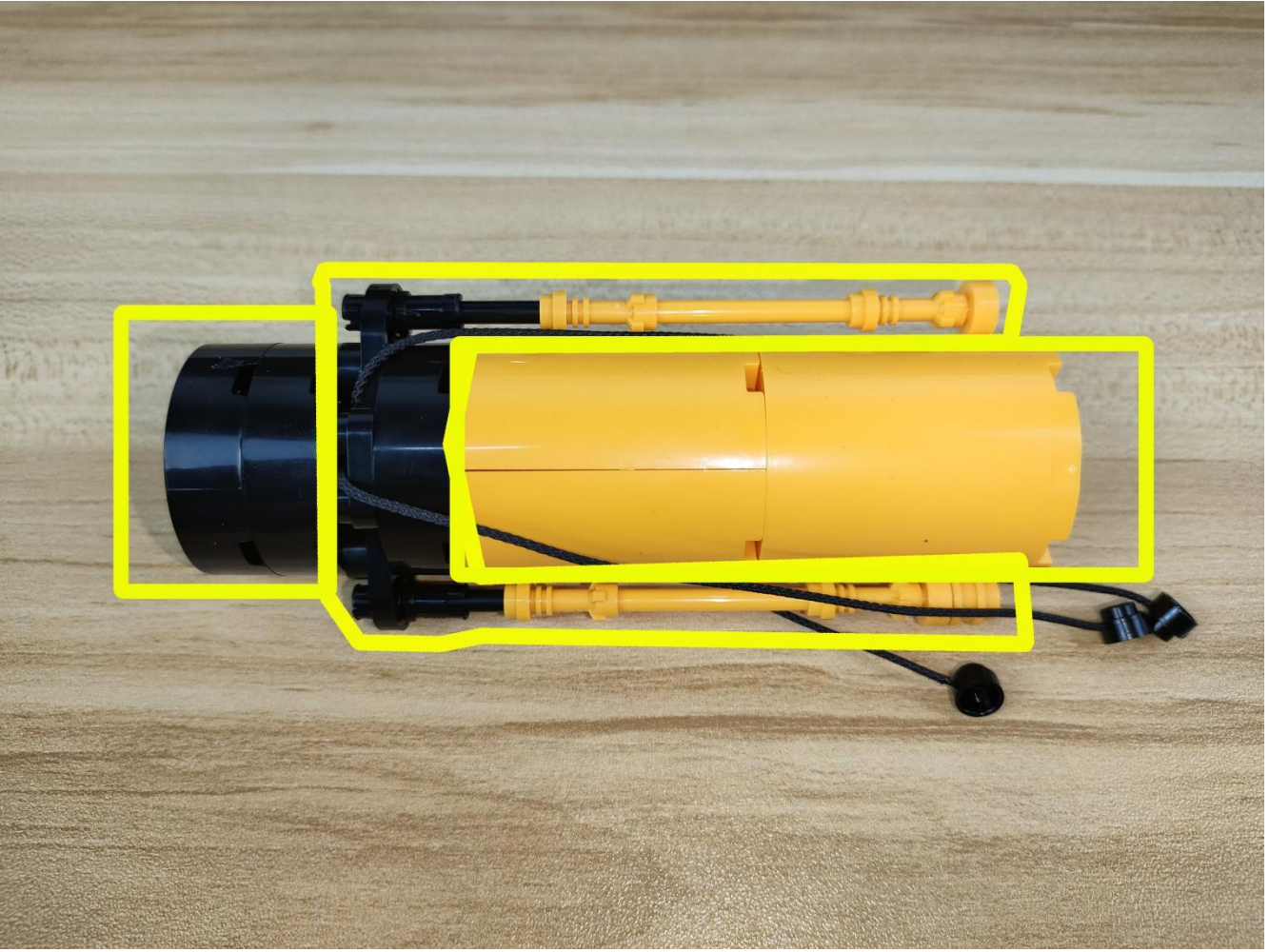

喷雾模块
Spray Module



白色普通燈粒30CM
Bit Lights-30CM
White



Fix the lamp pellet to the position selected in the figure, with the solder joints of the spray module components facing upwards.



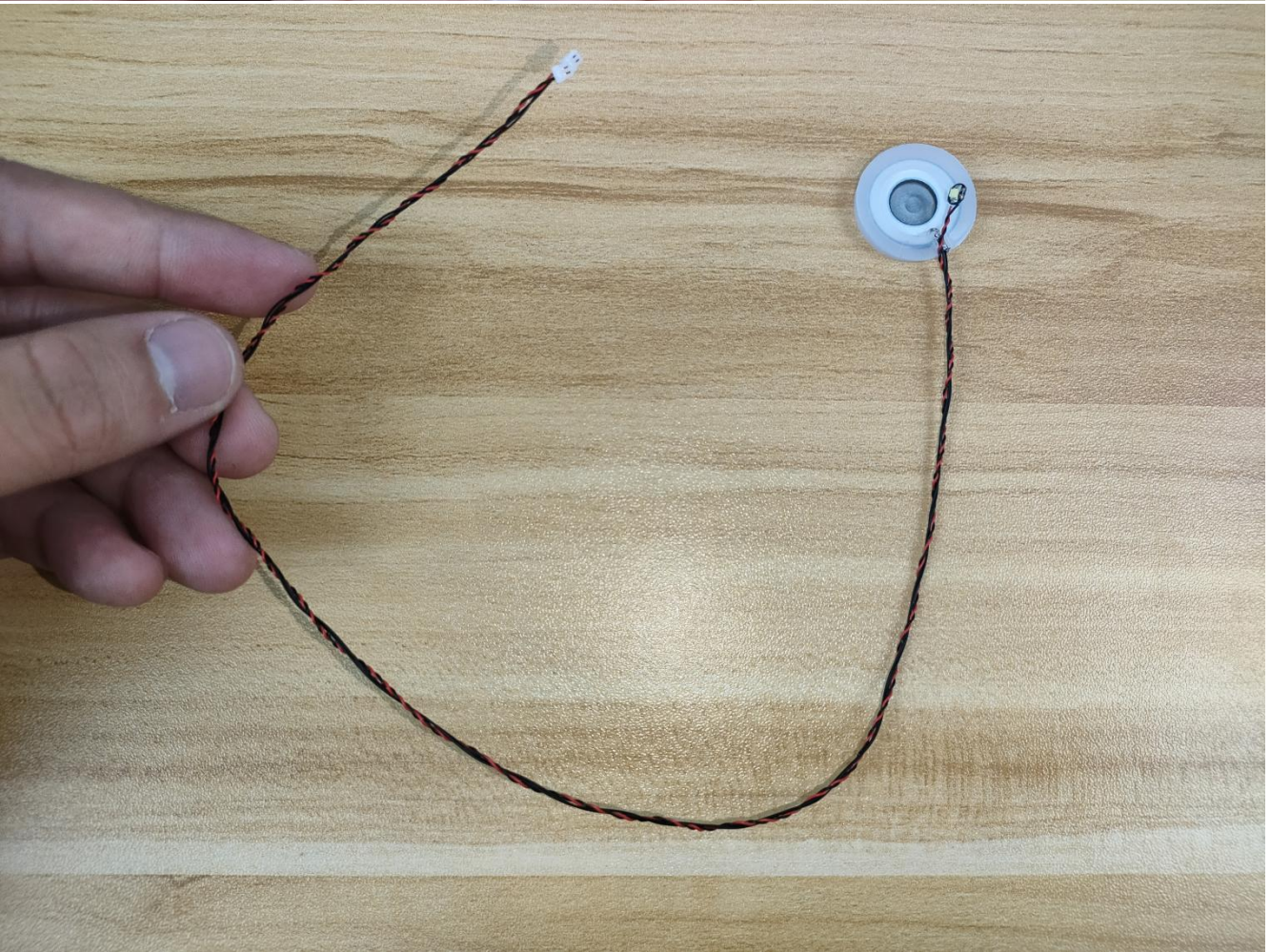

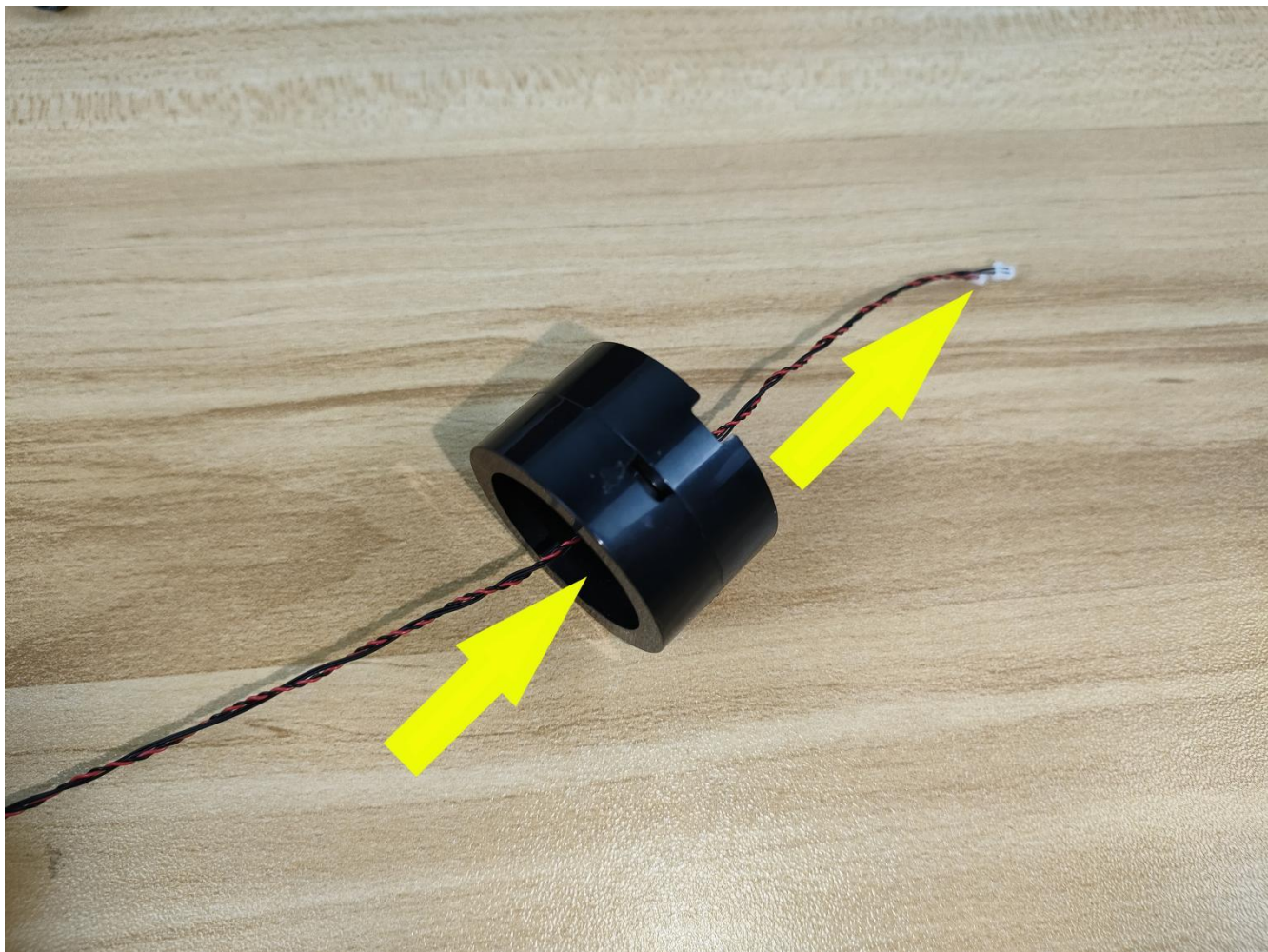

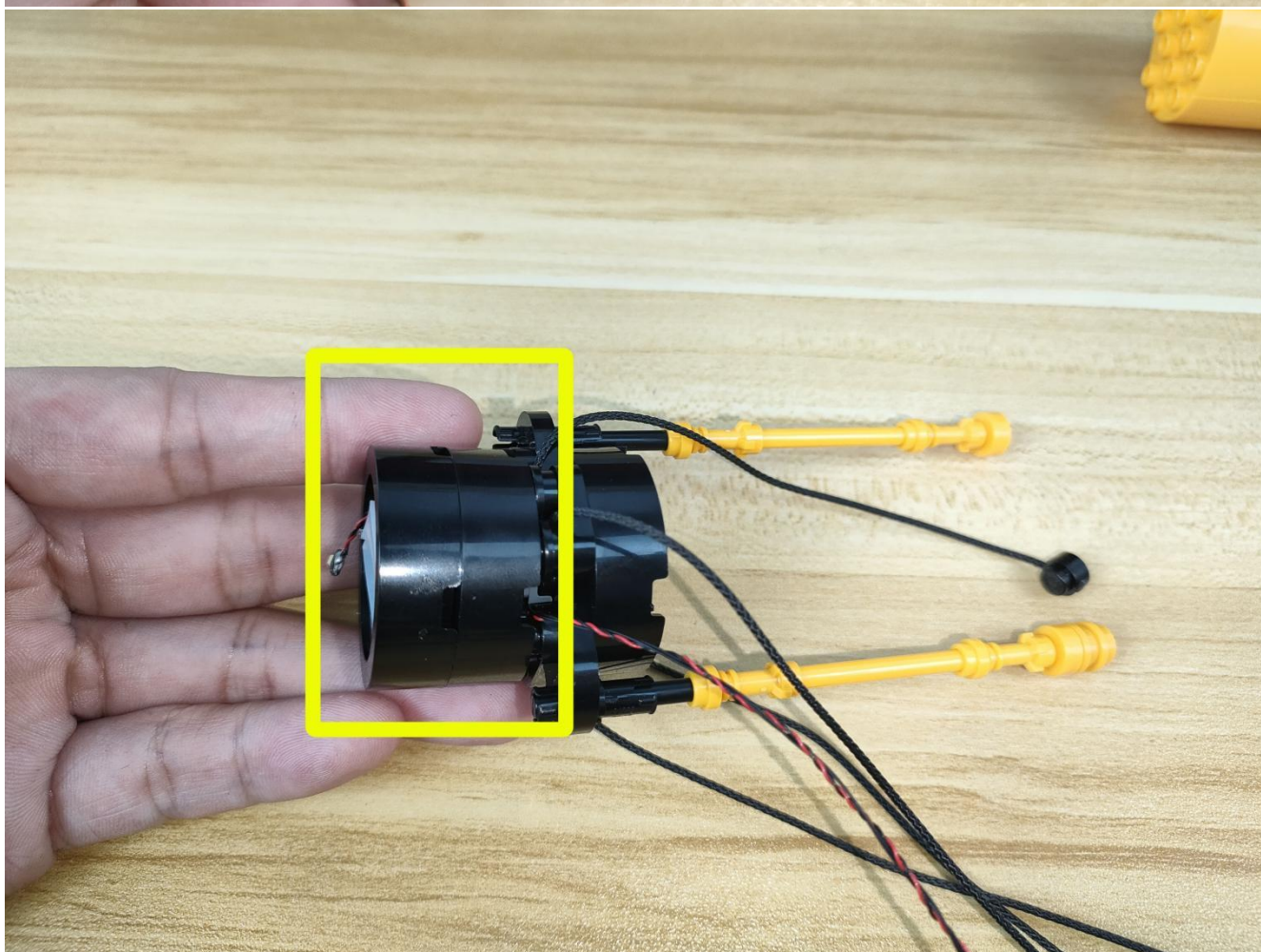
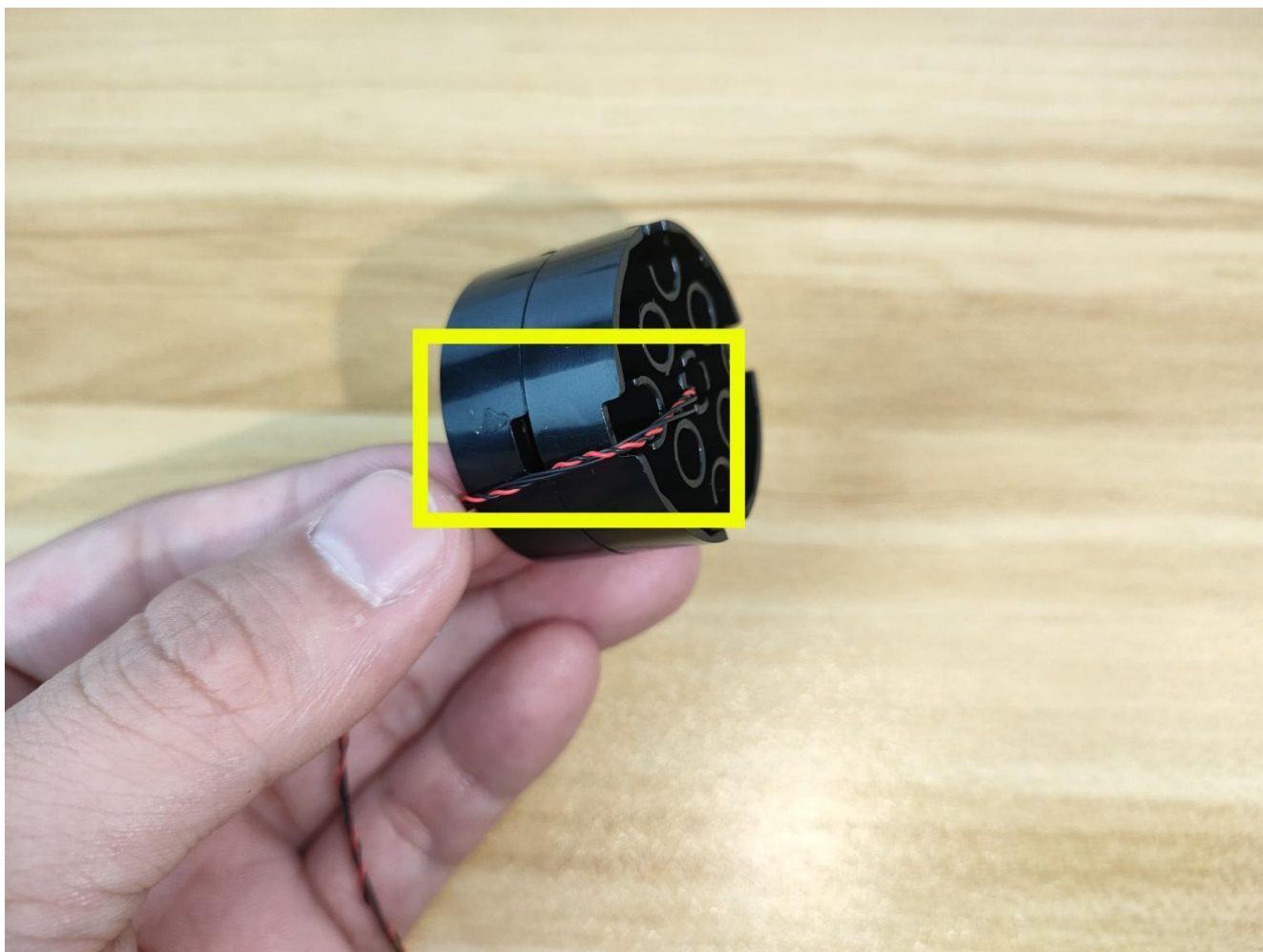

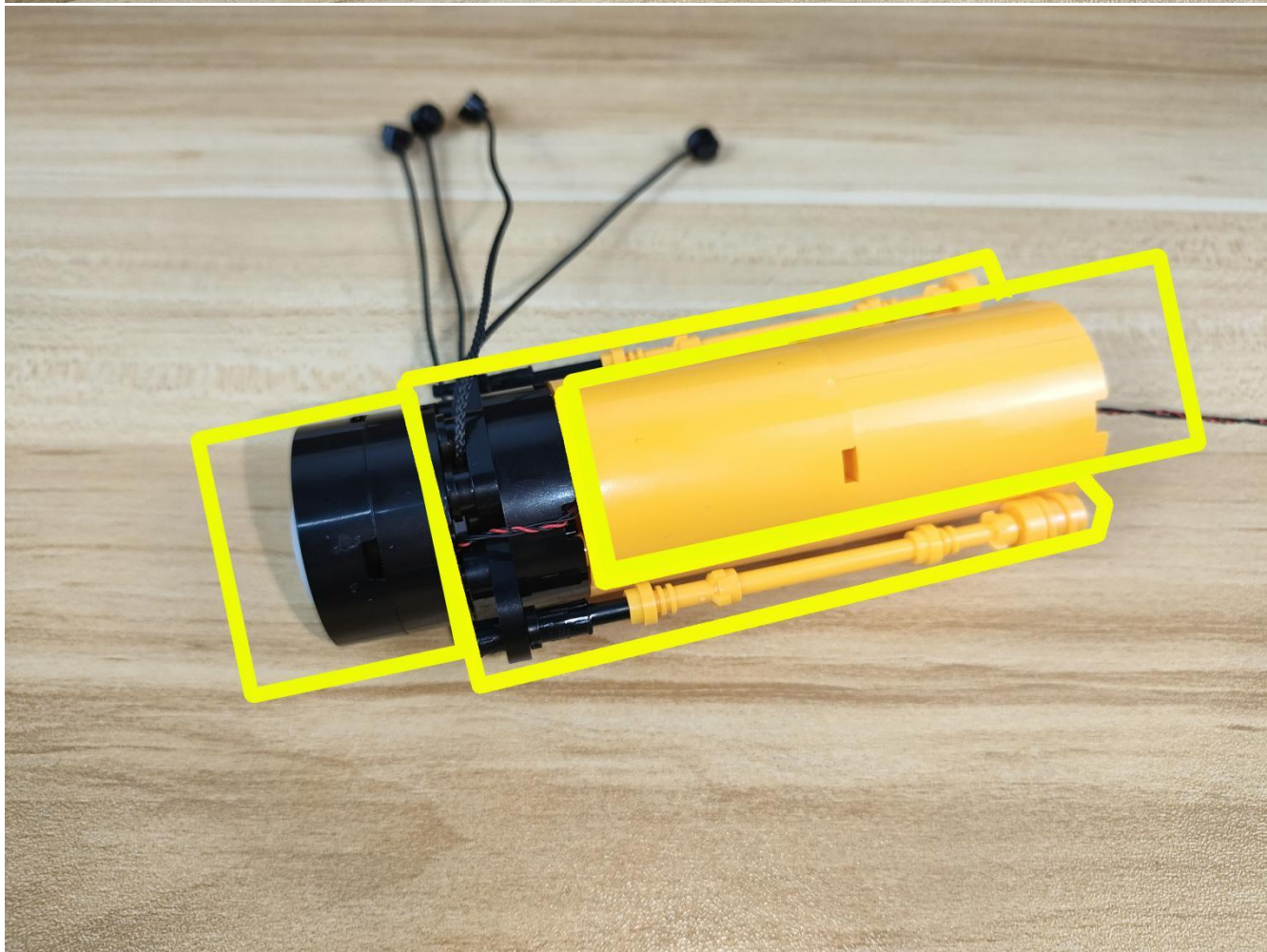
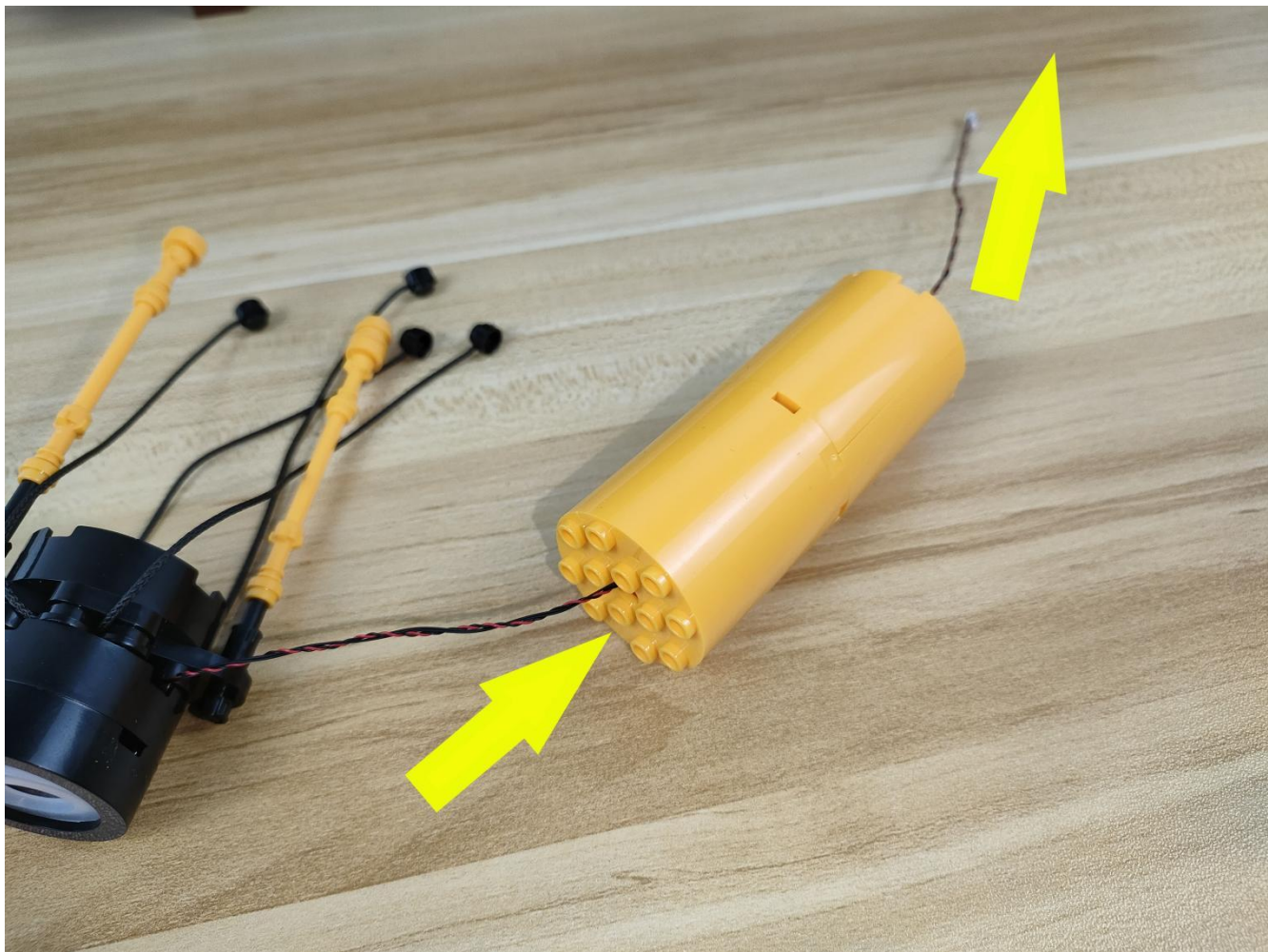

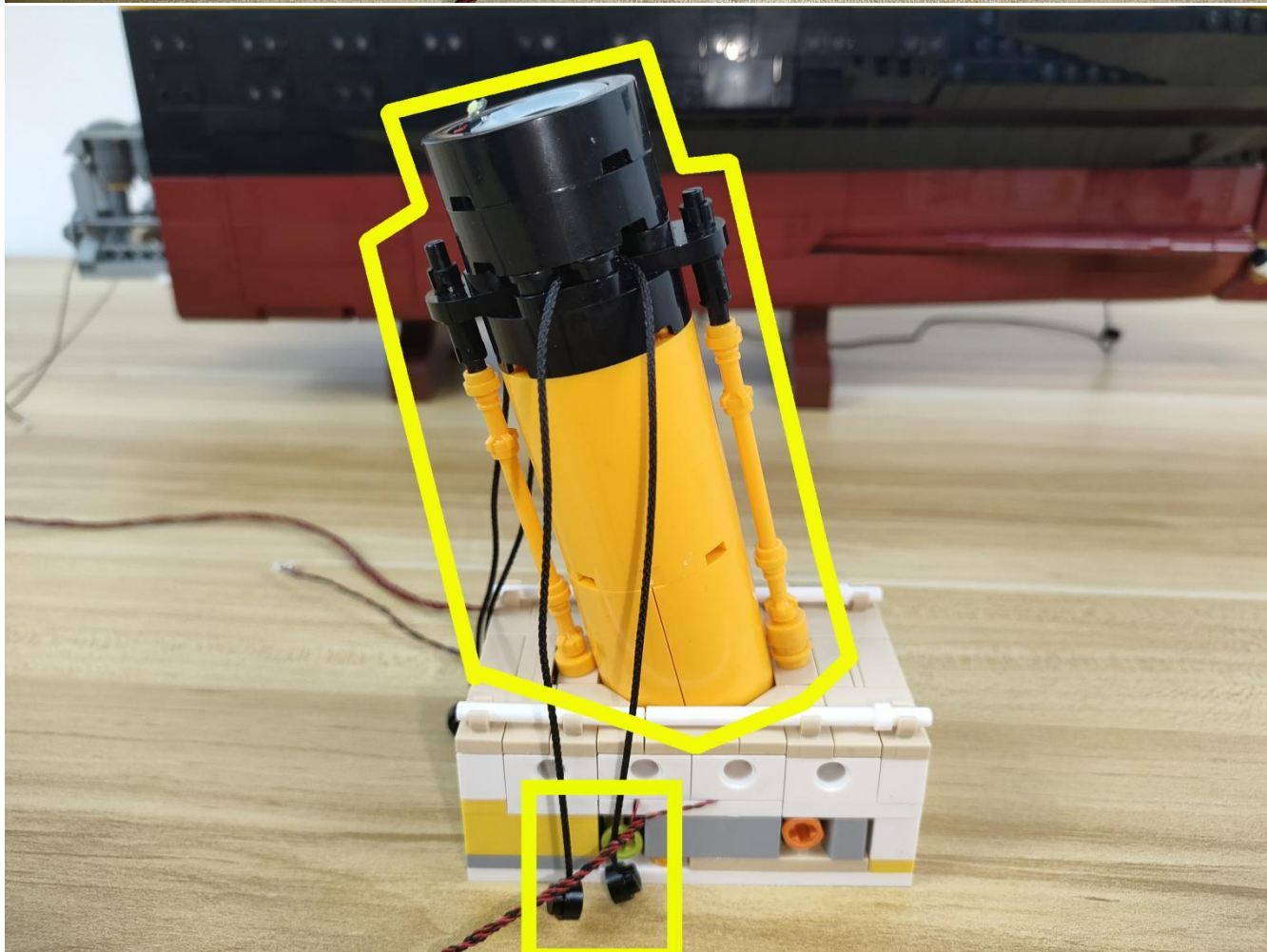
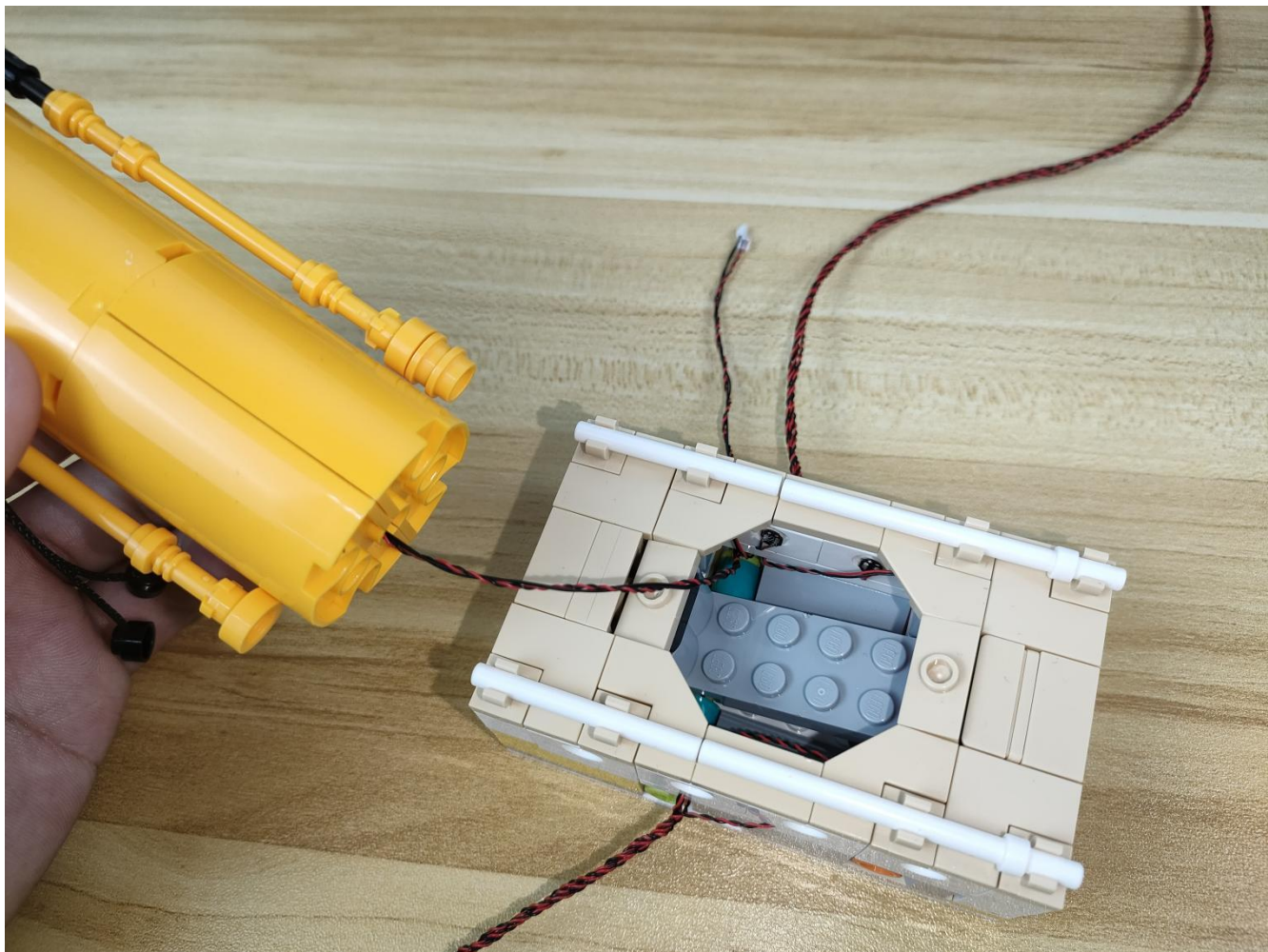

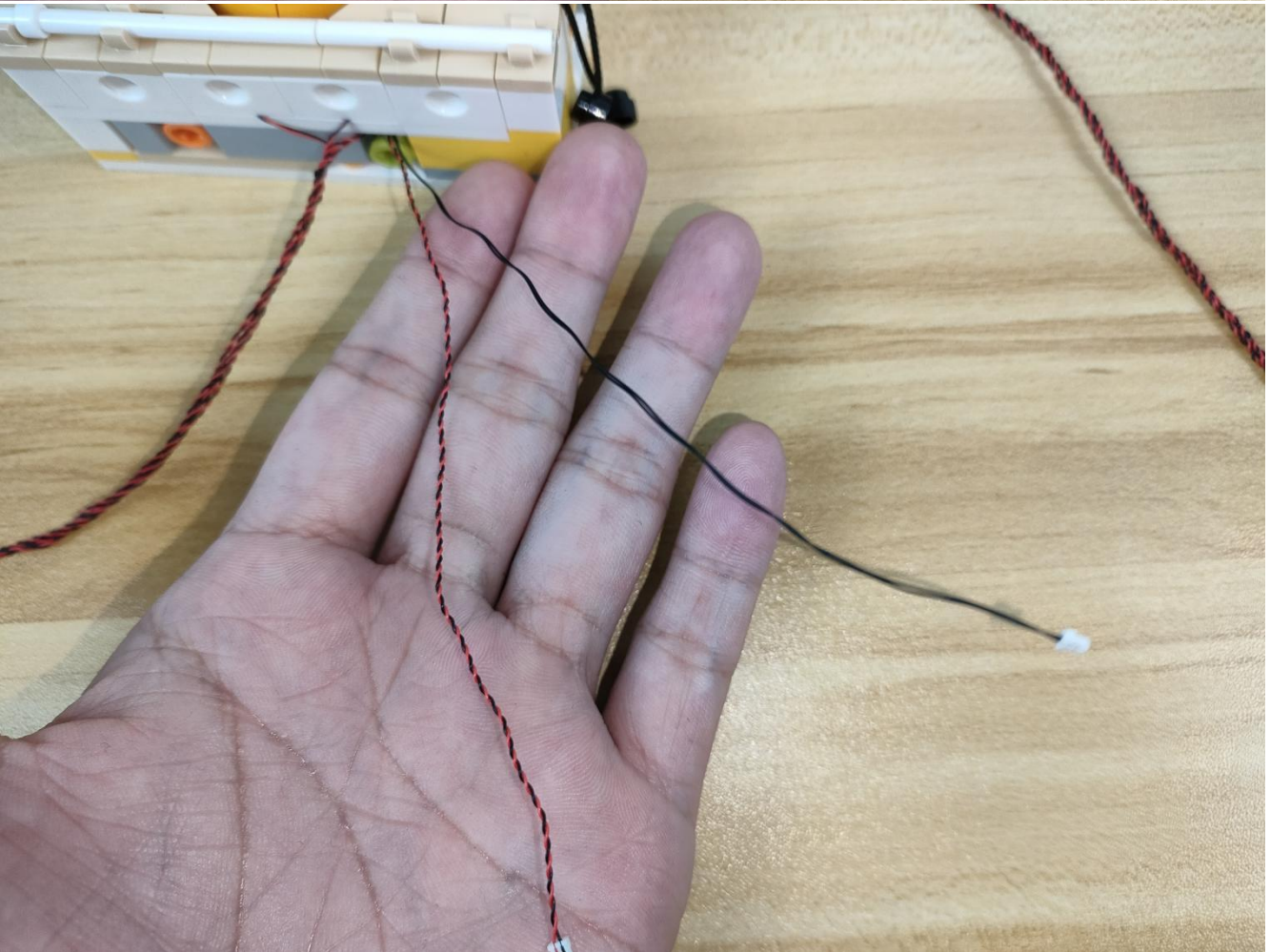
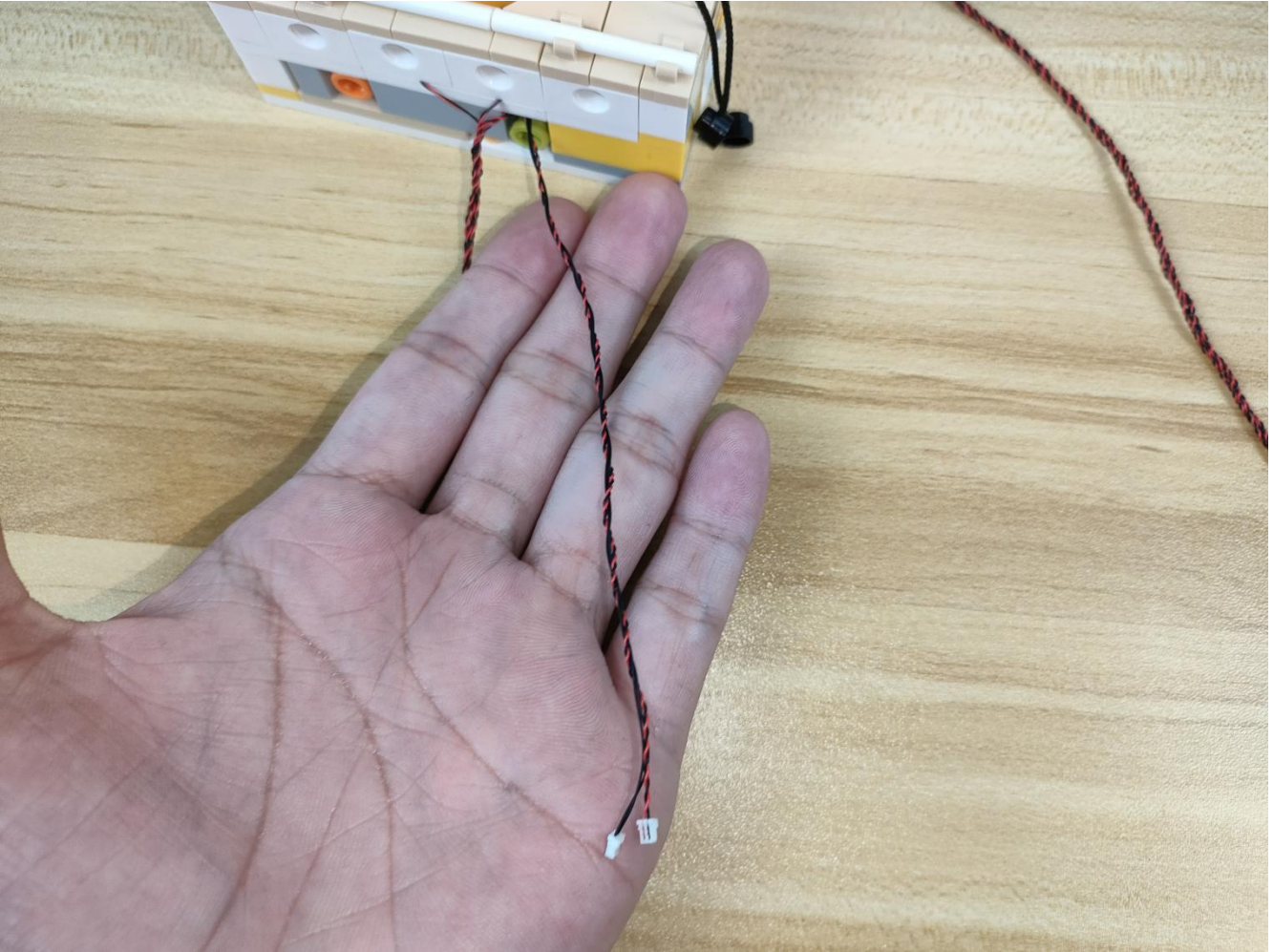

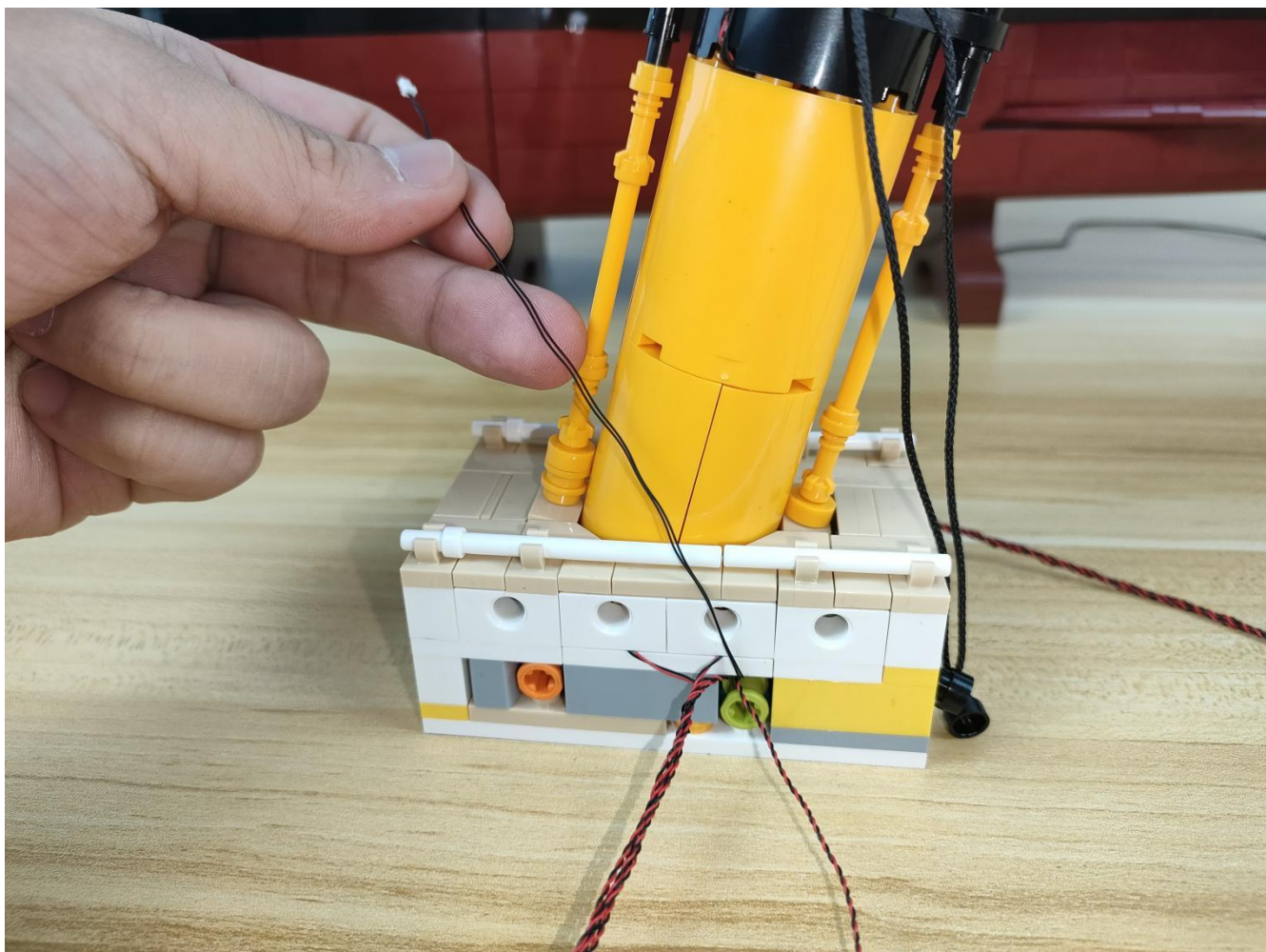



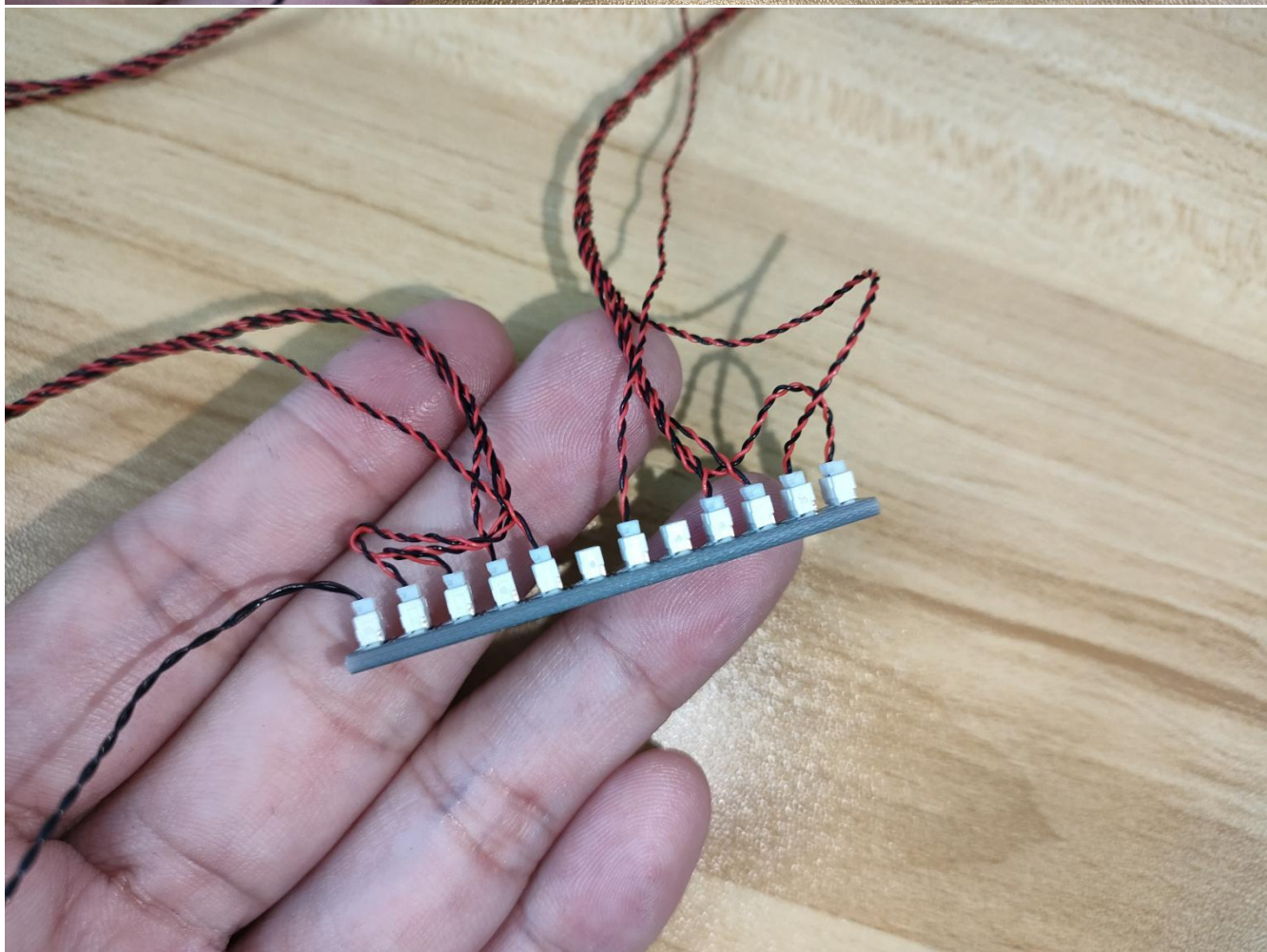
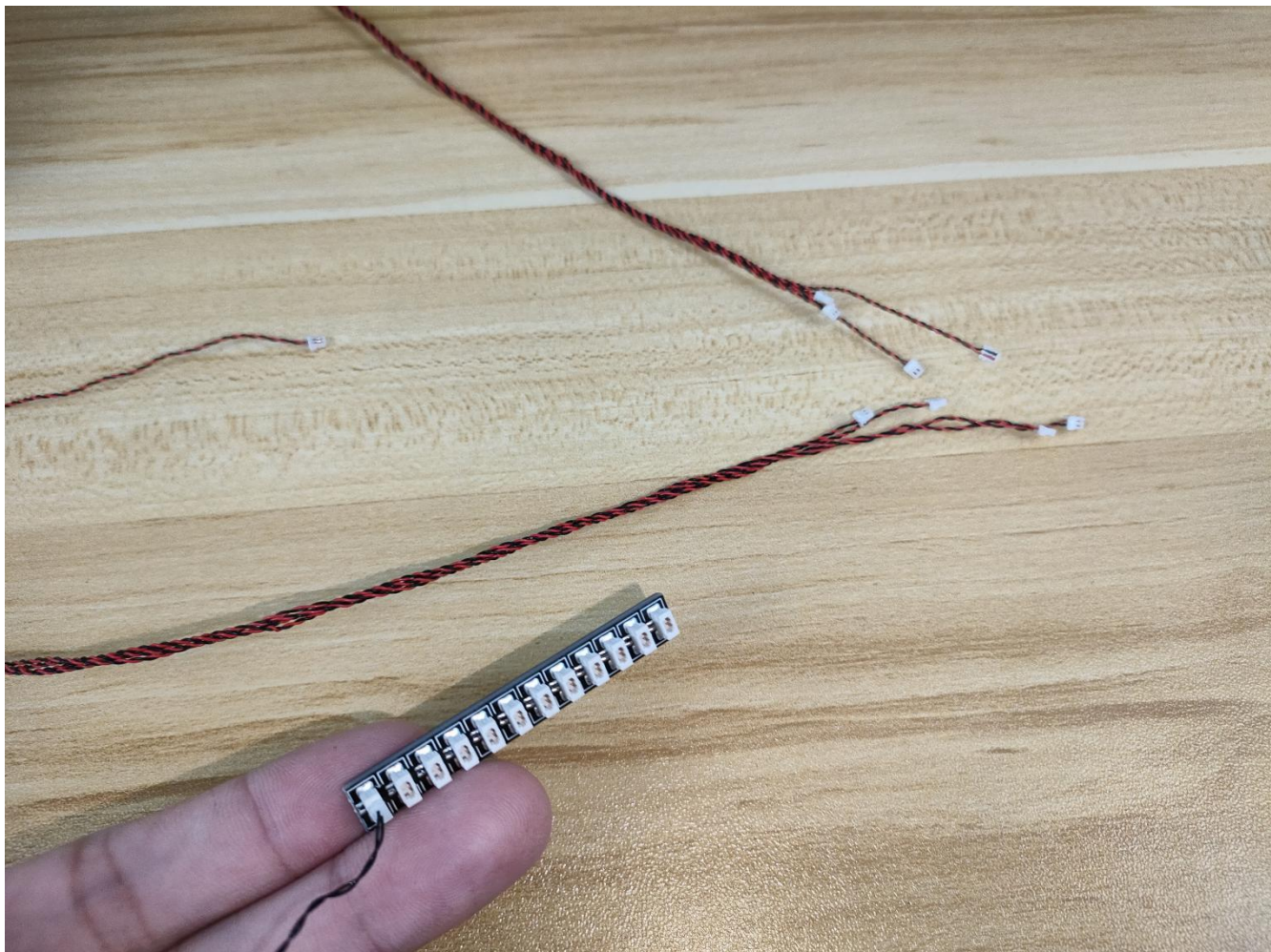

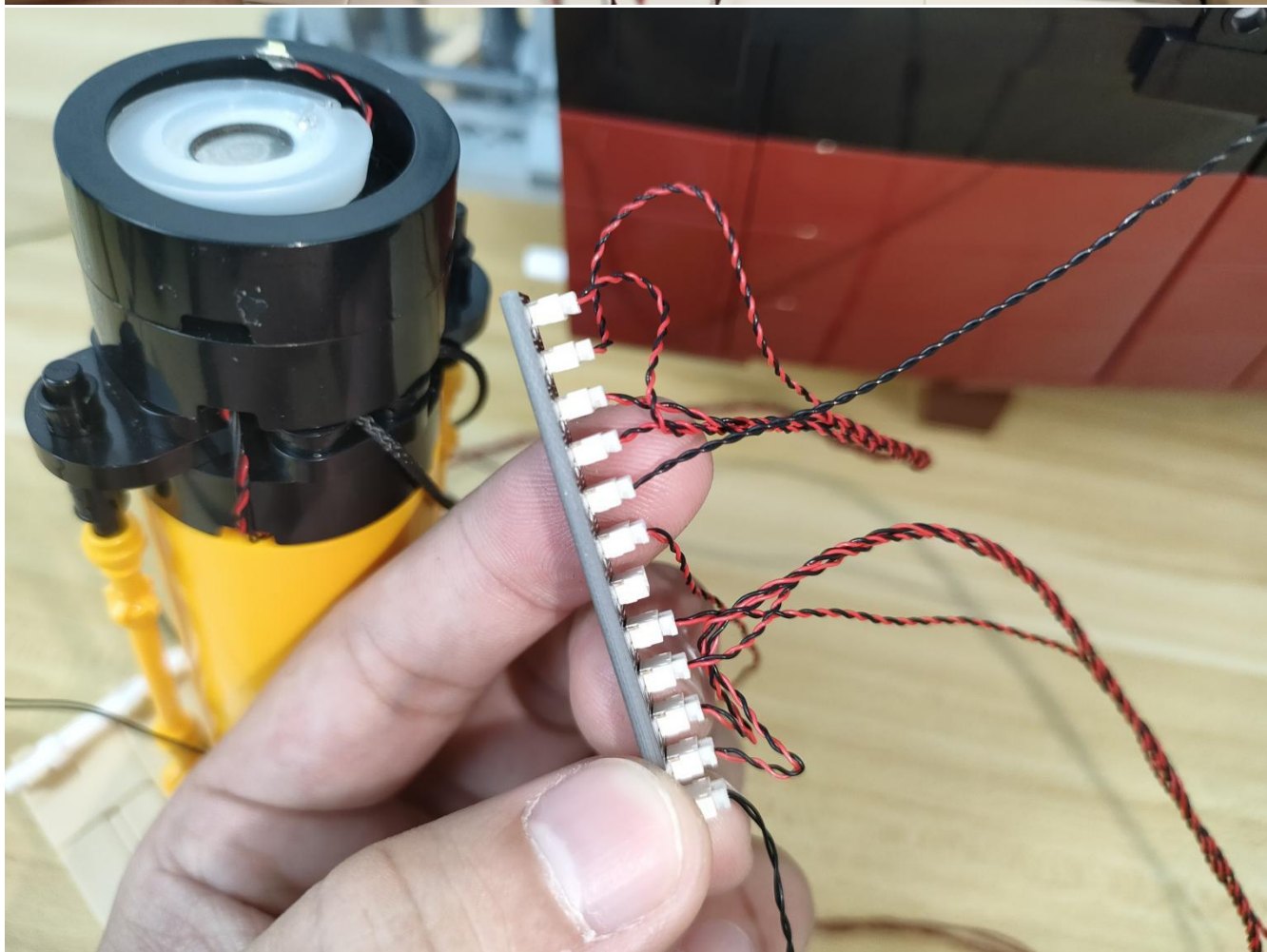
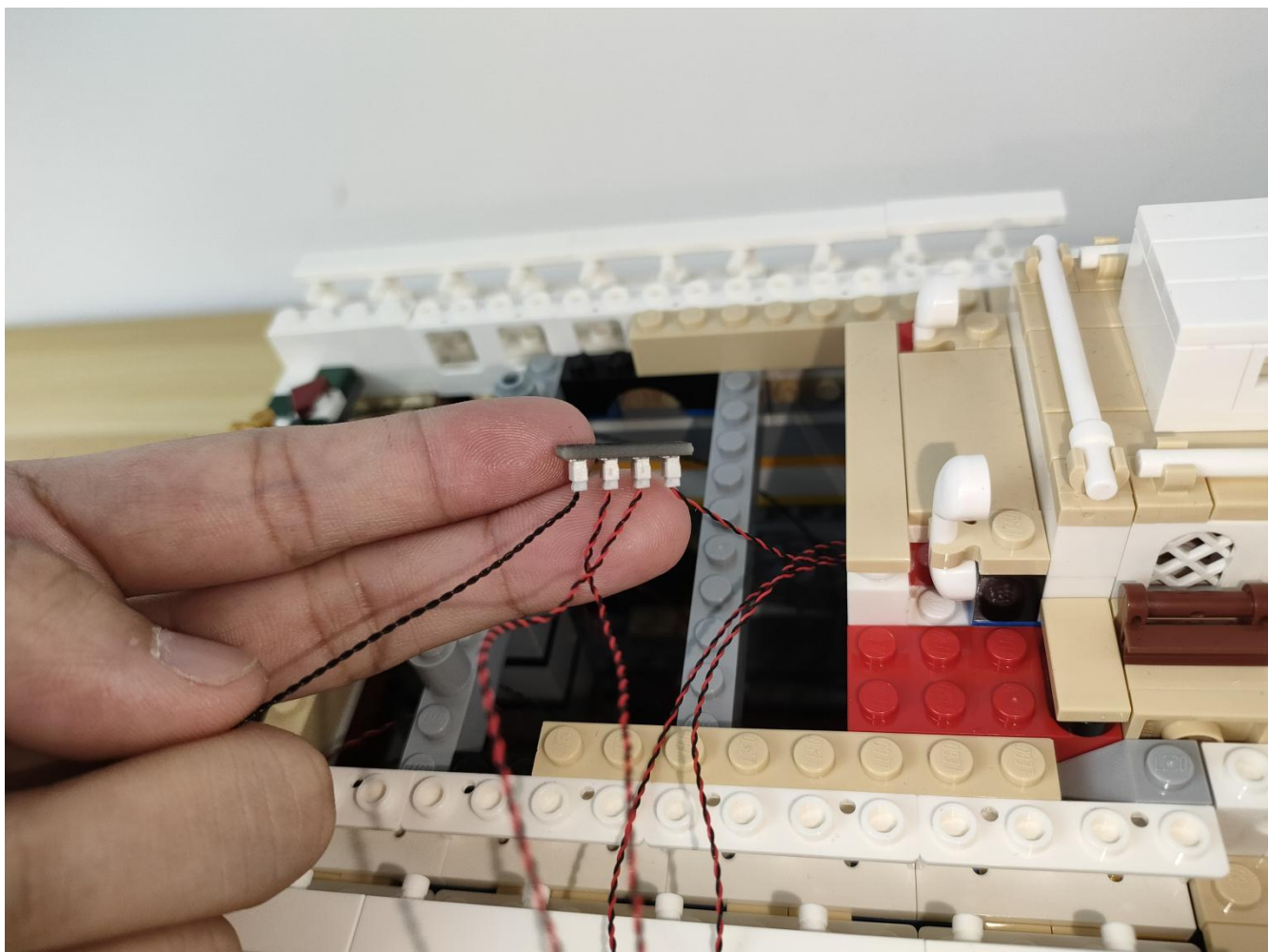

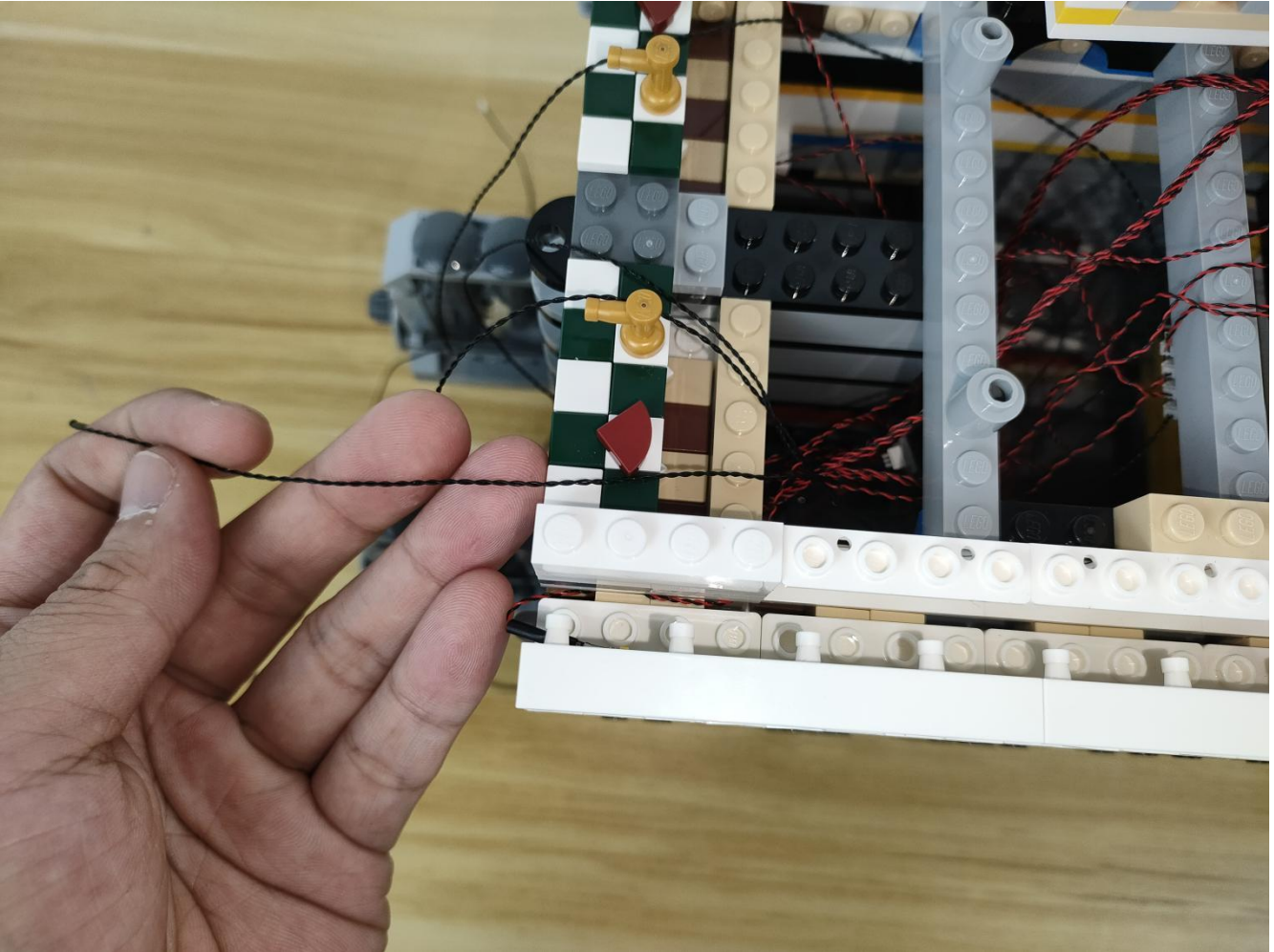
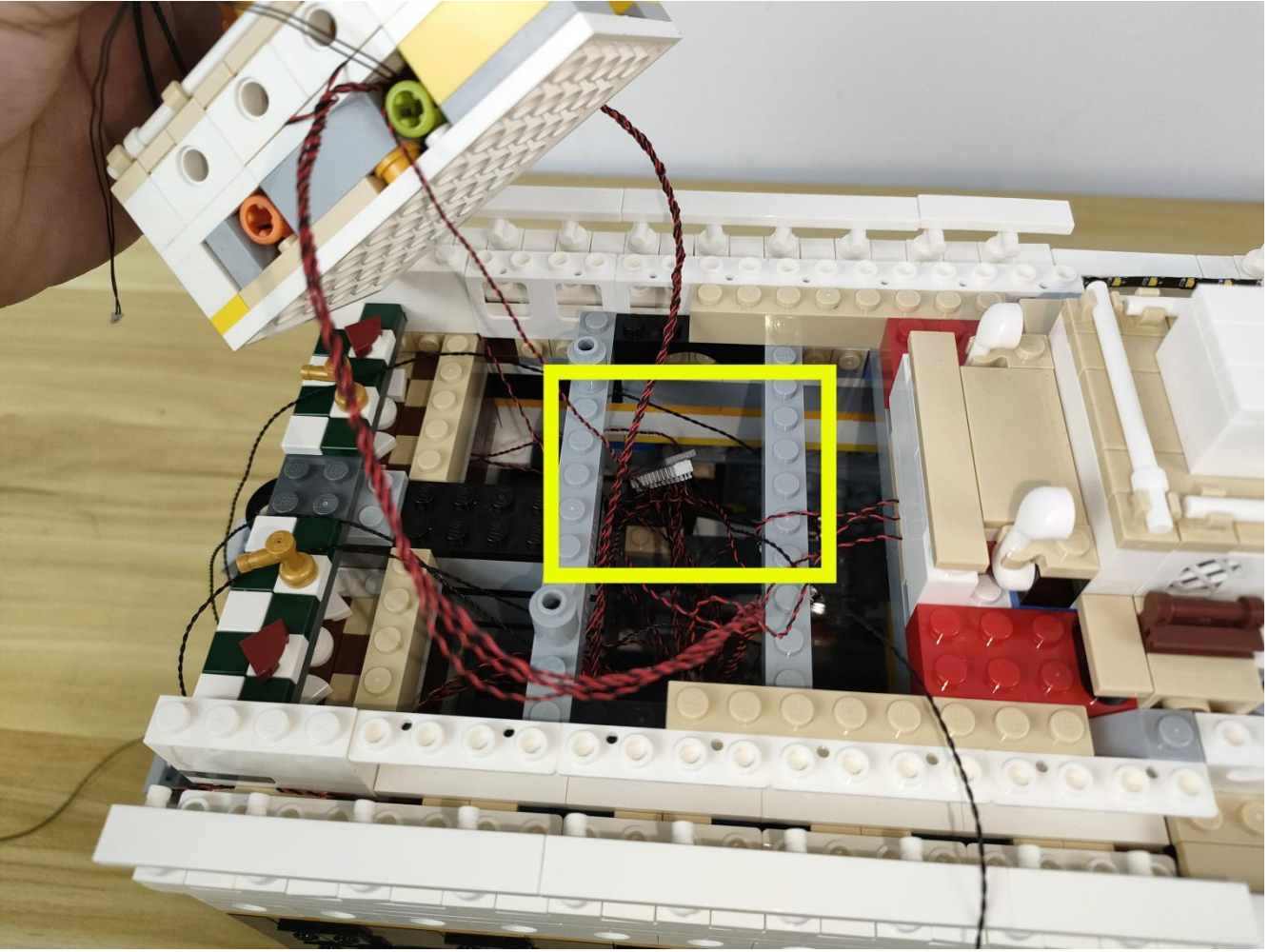

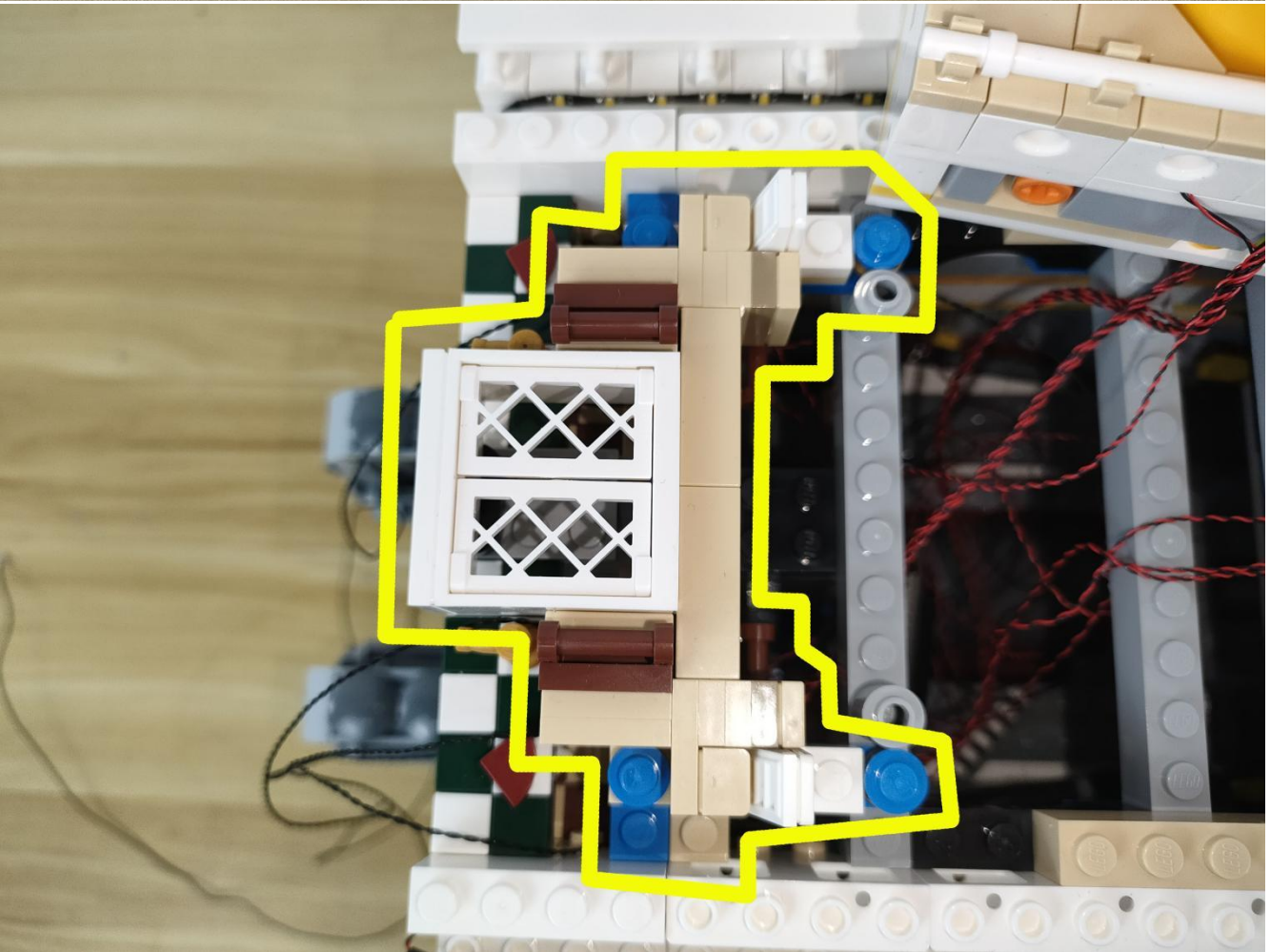
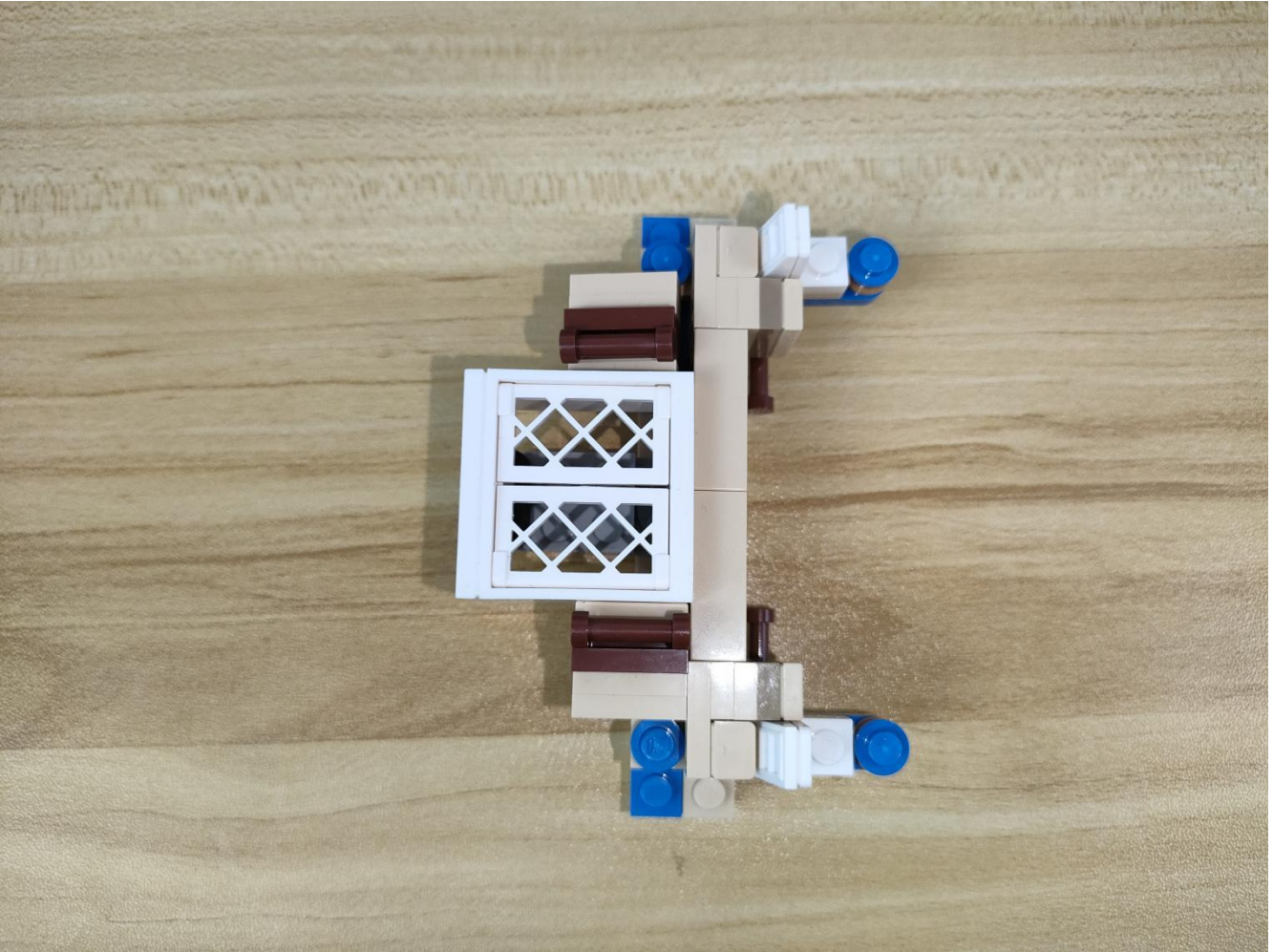

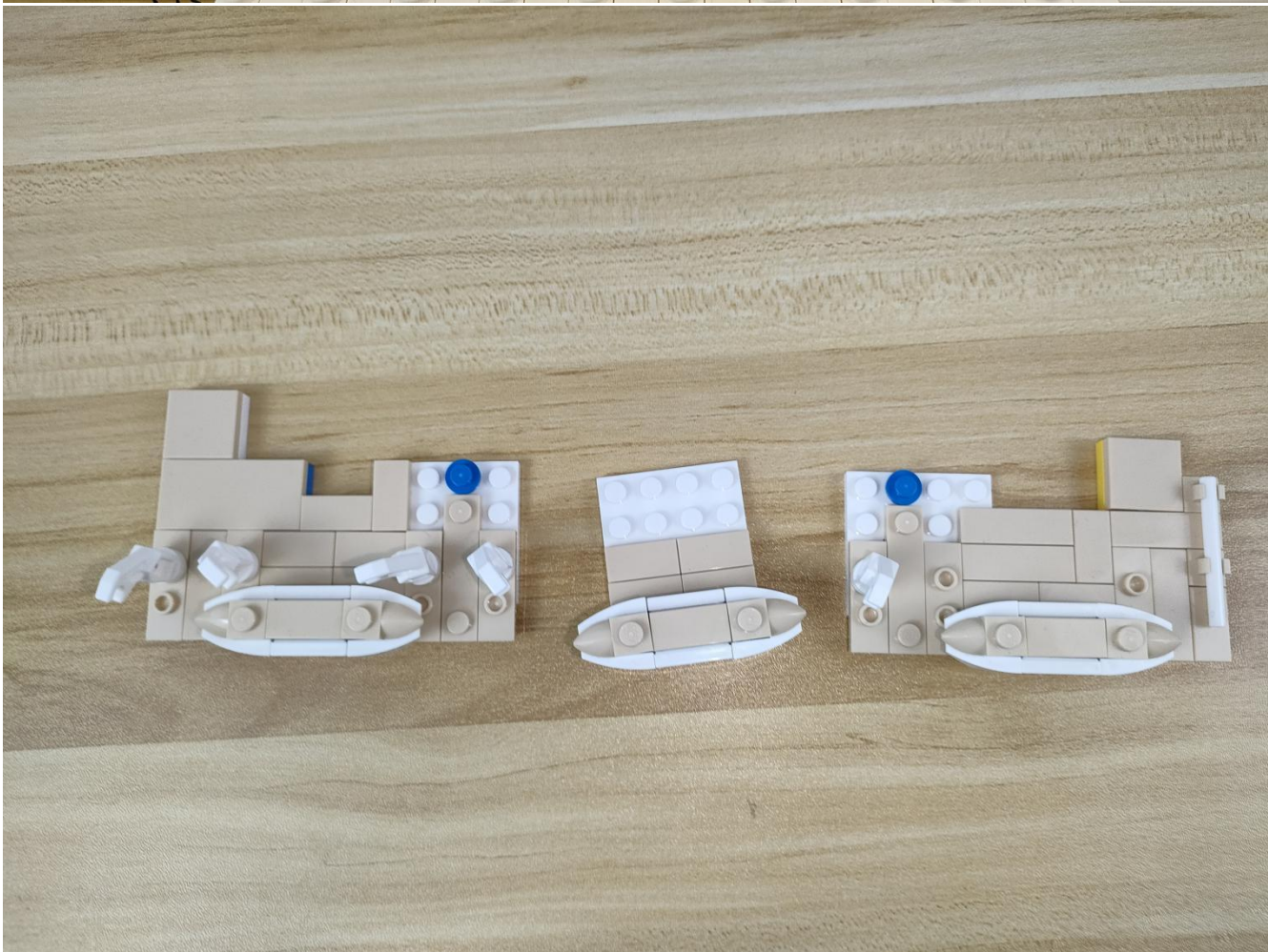
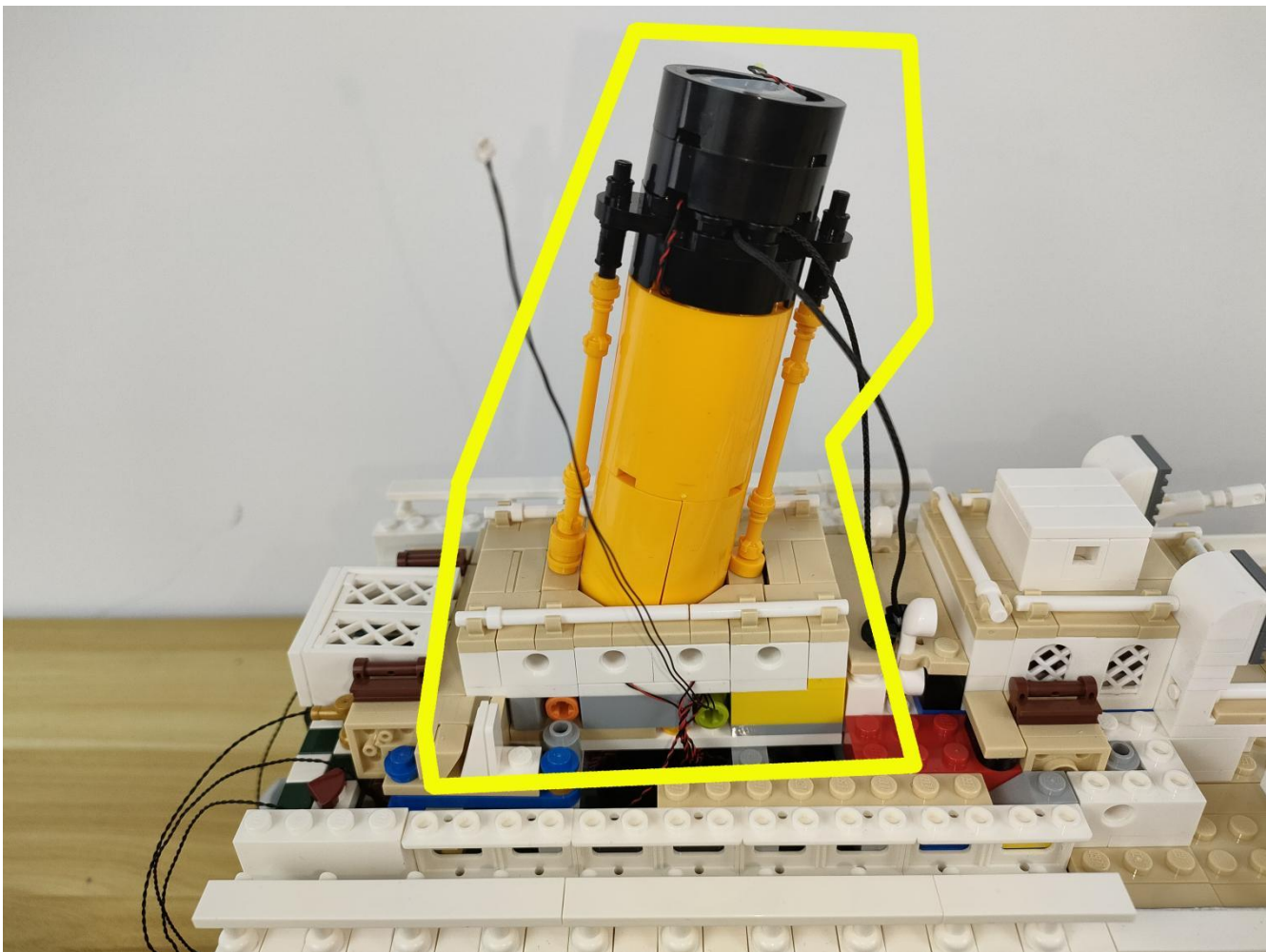

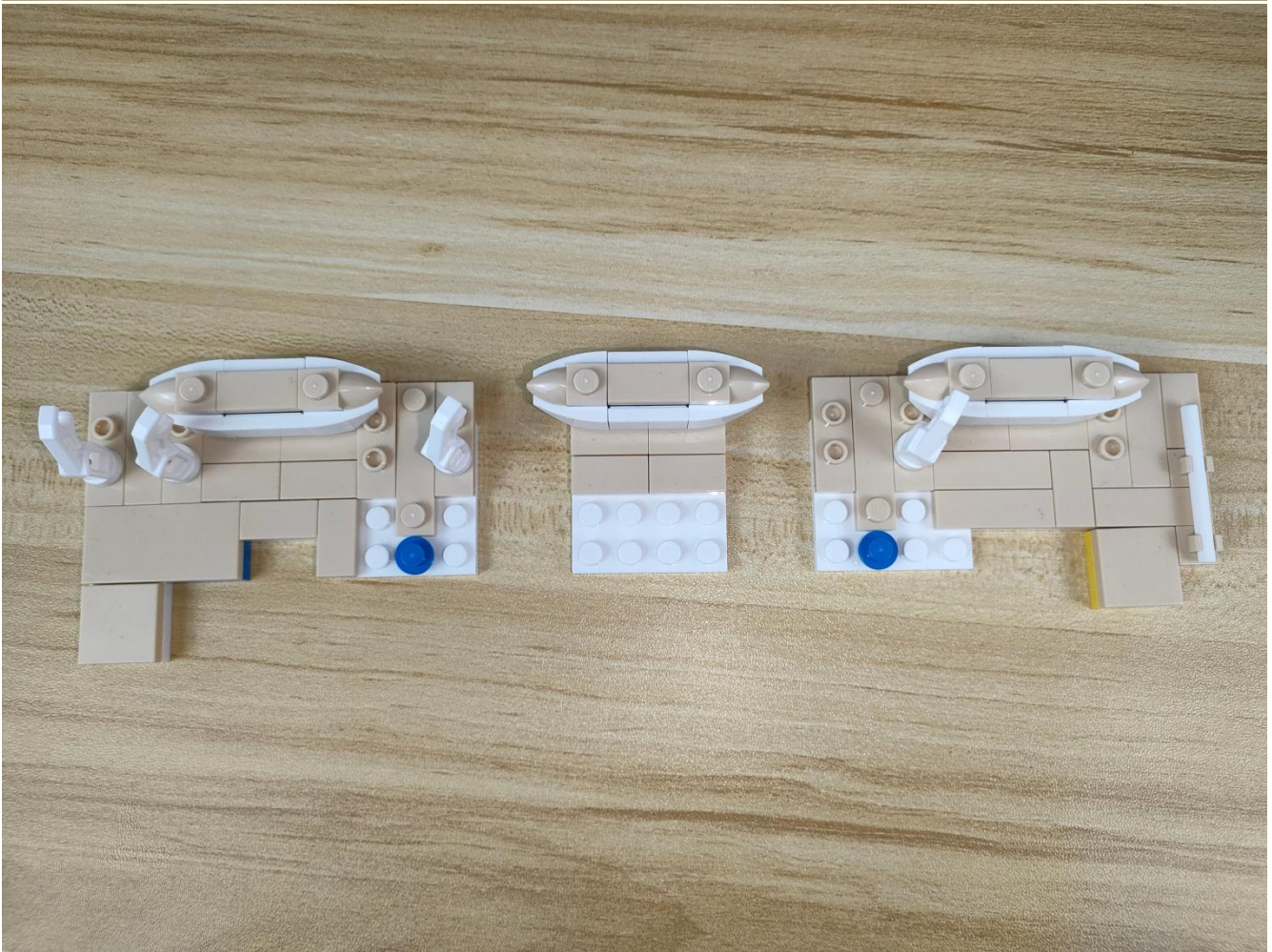
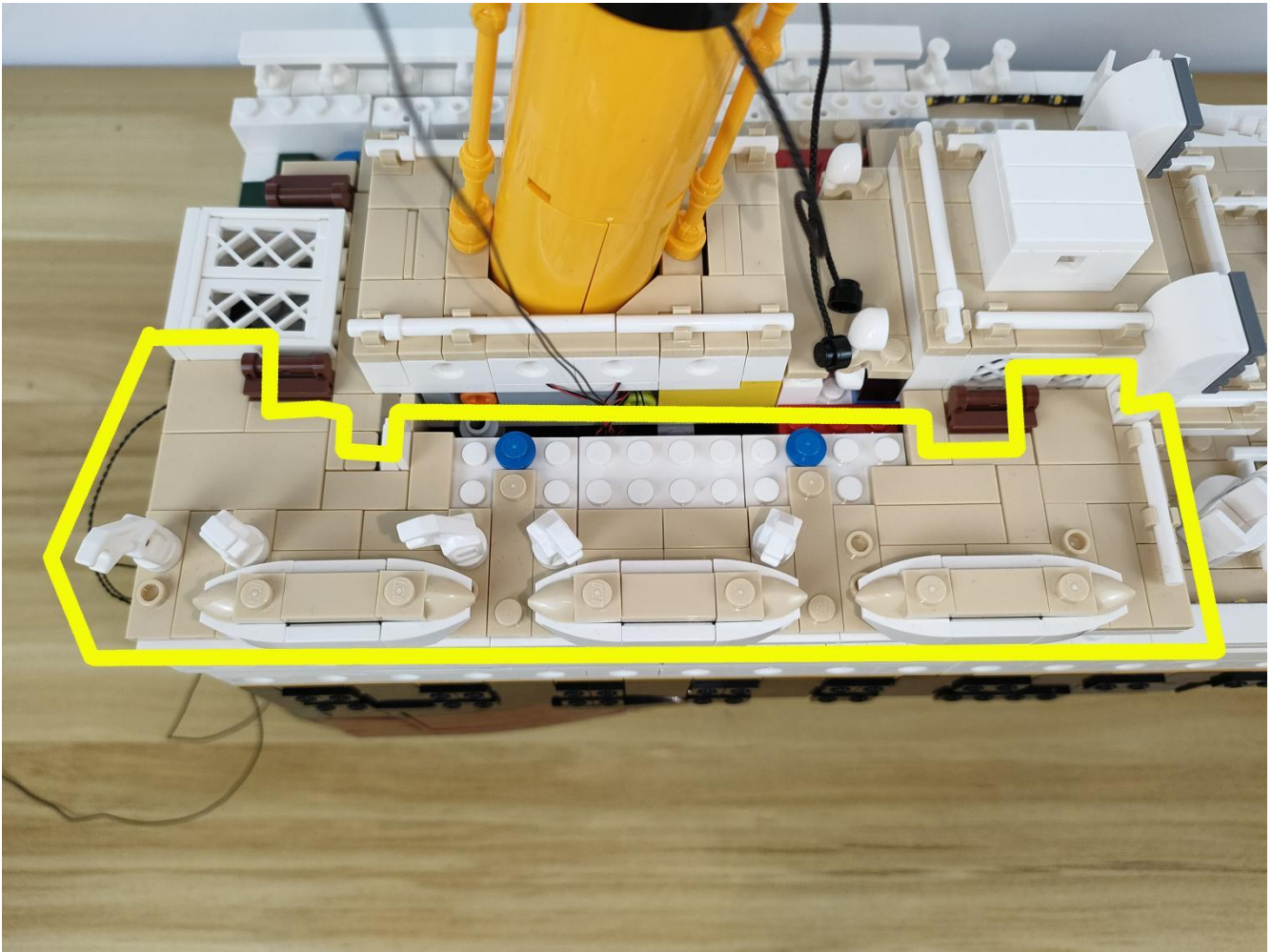

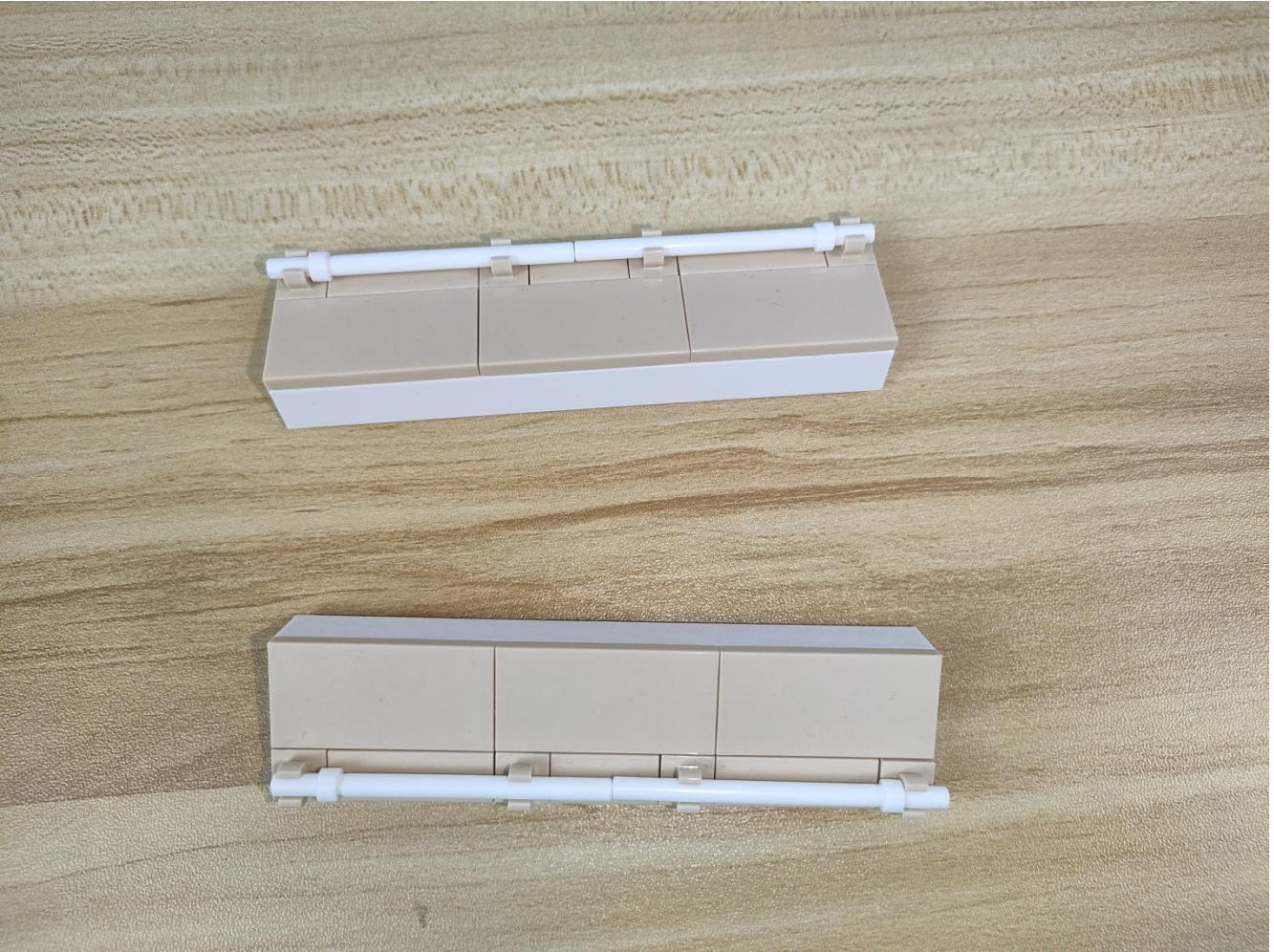
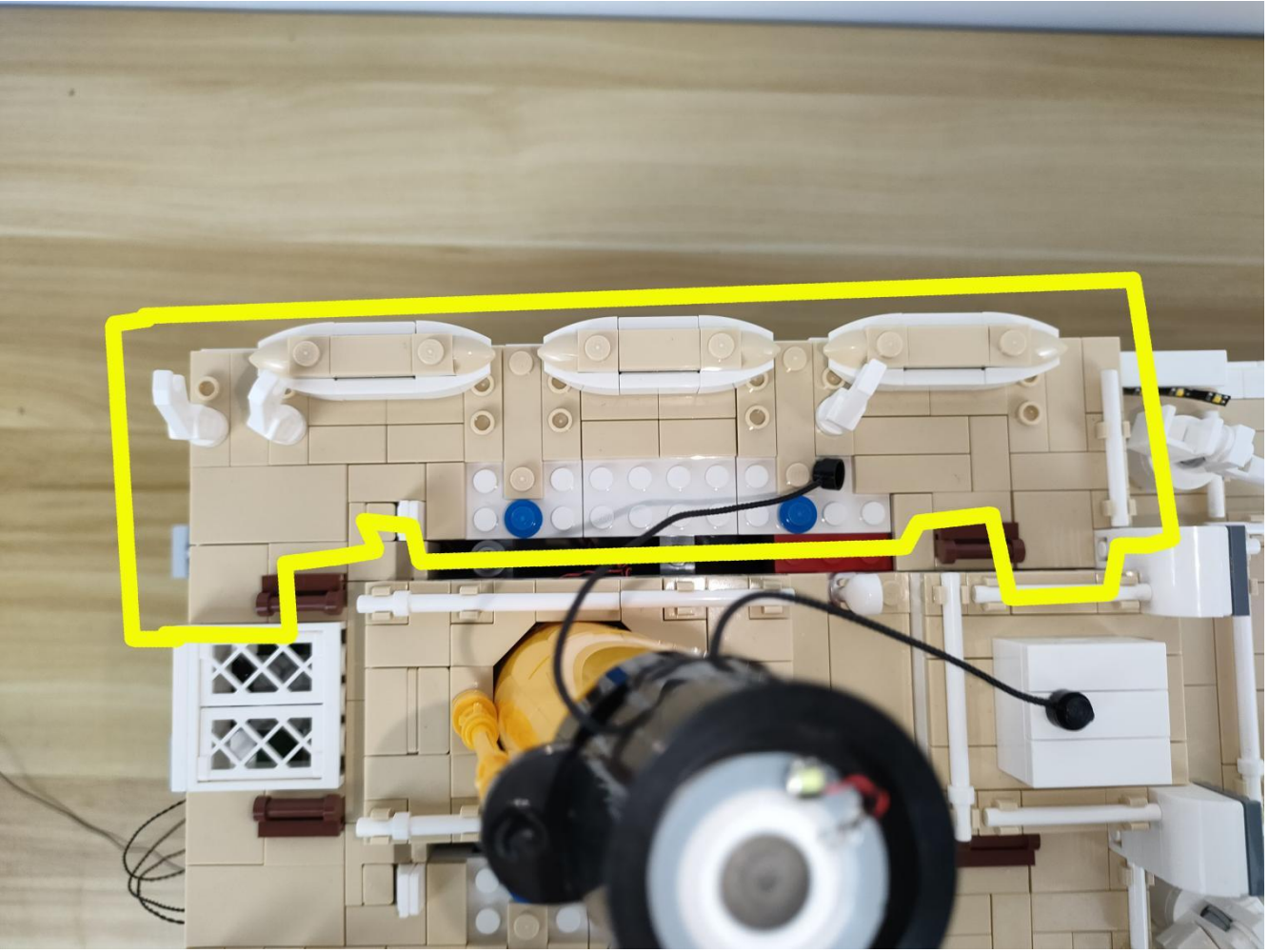

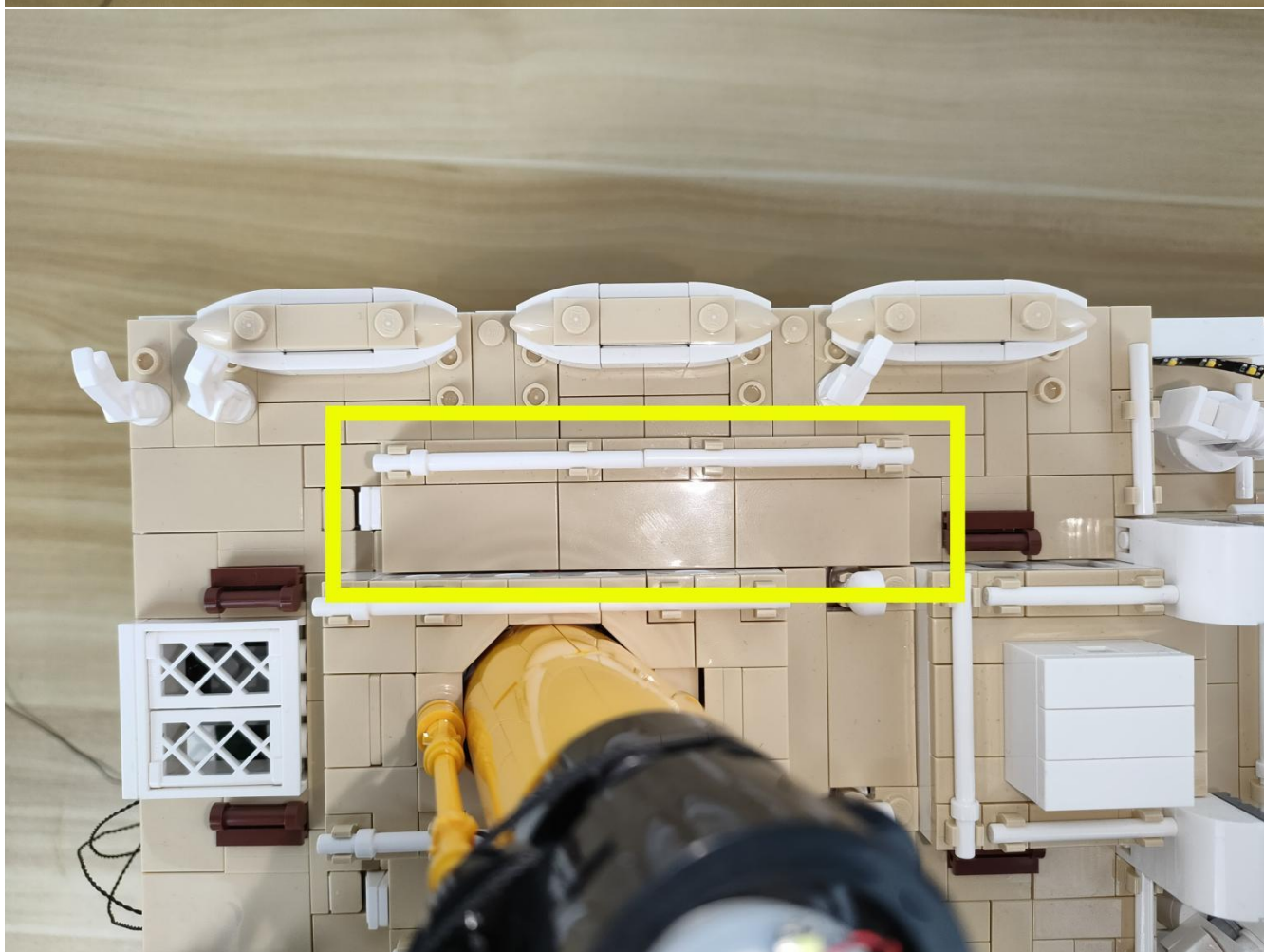
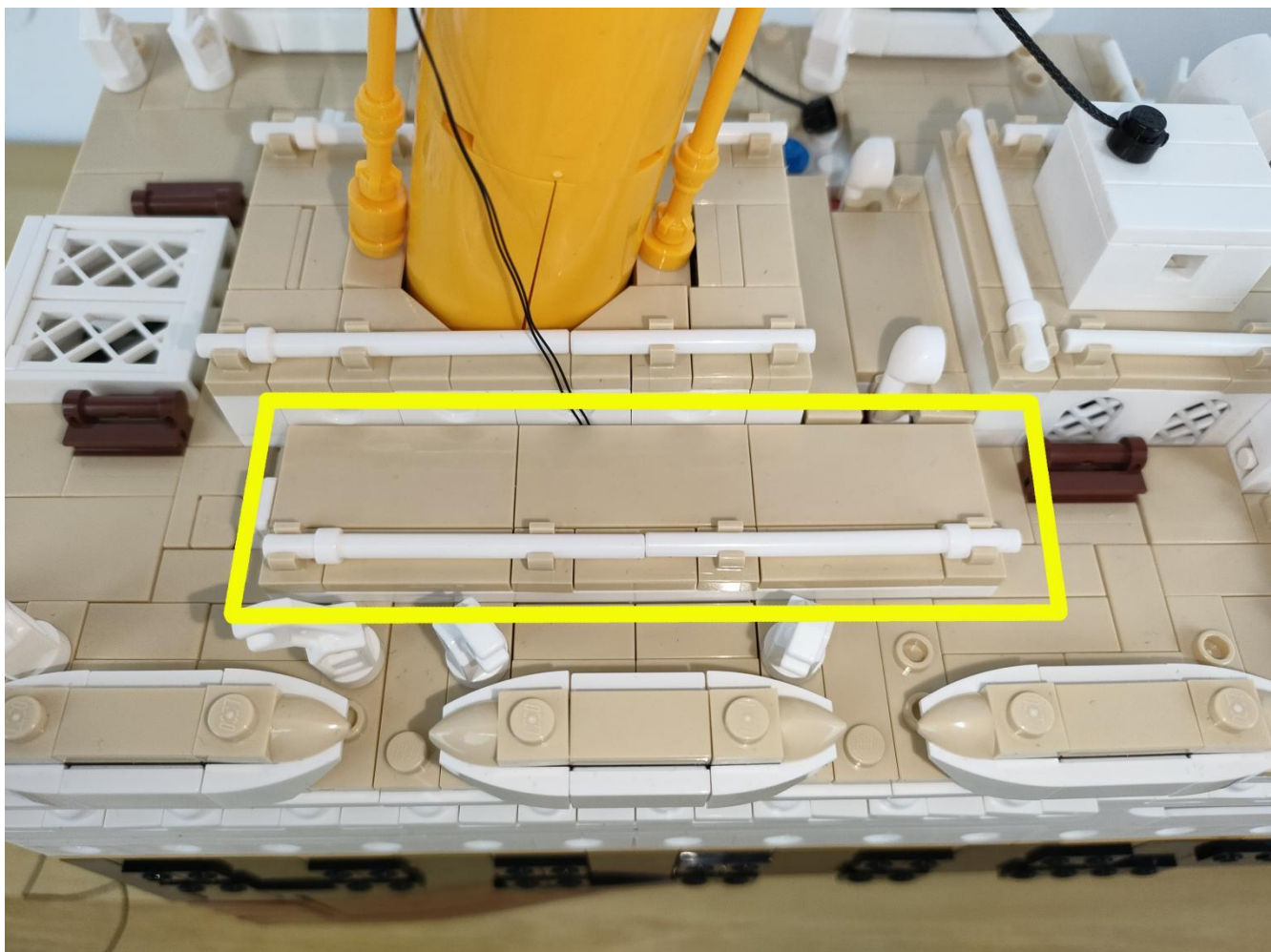

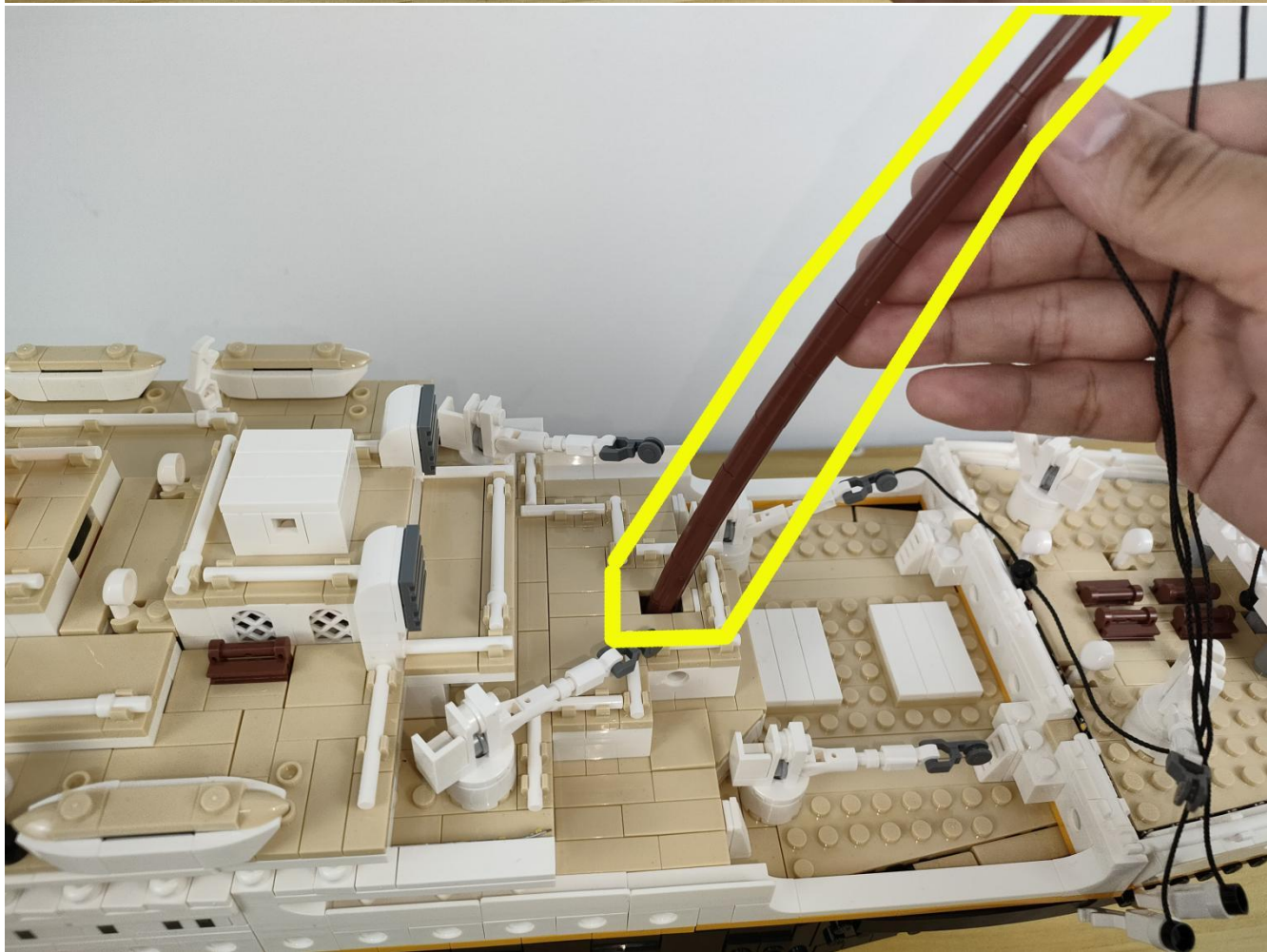
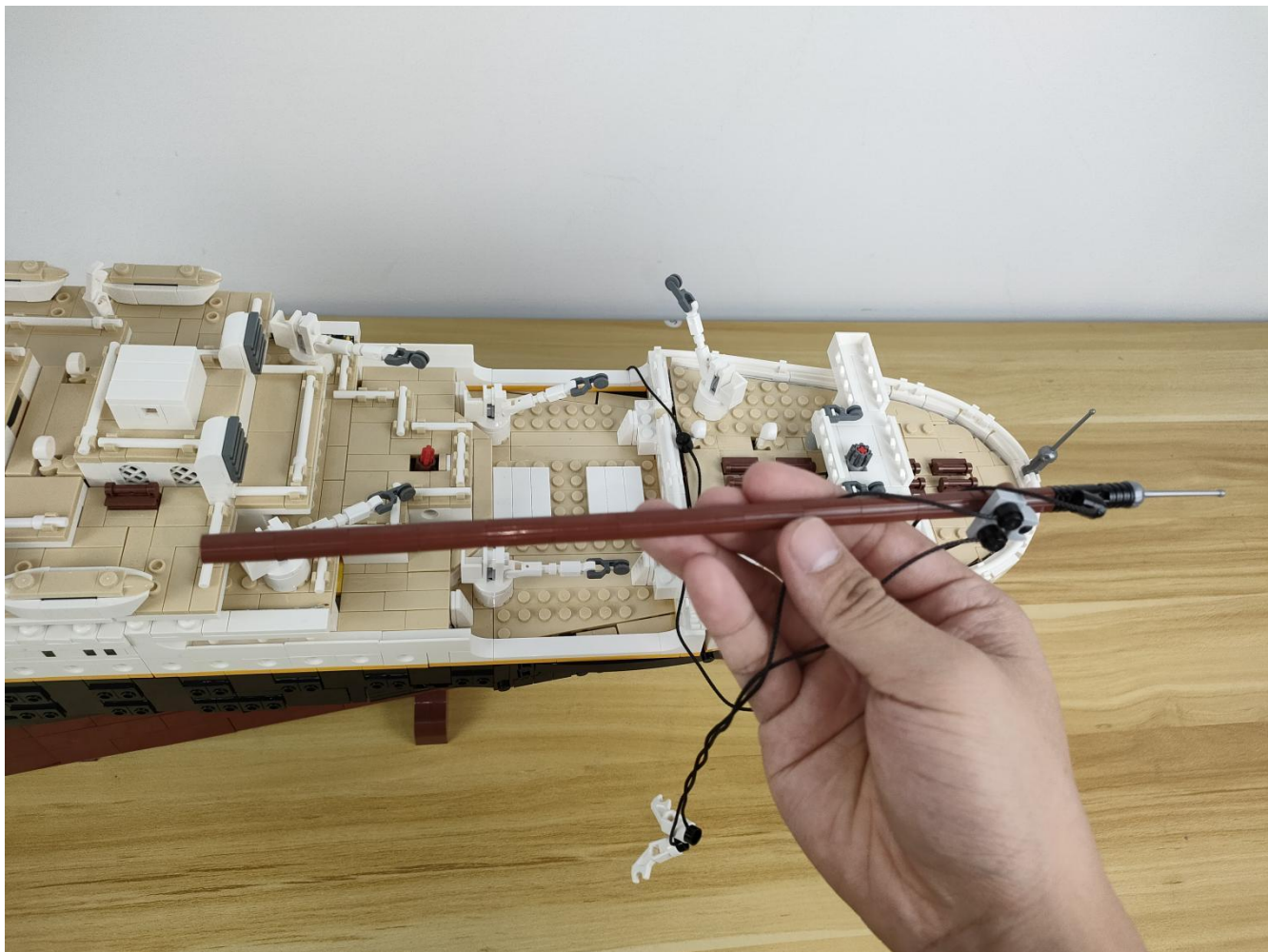

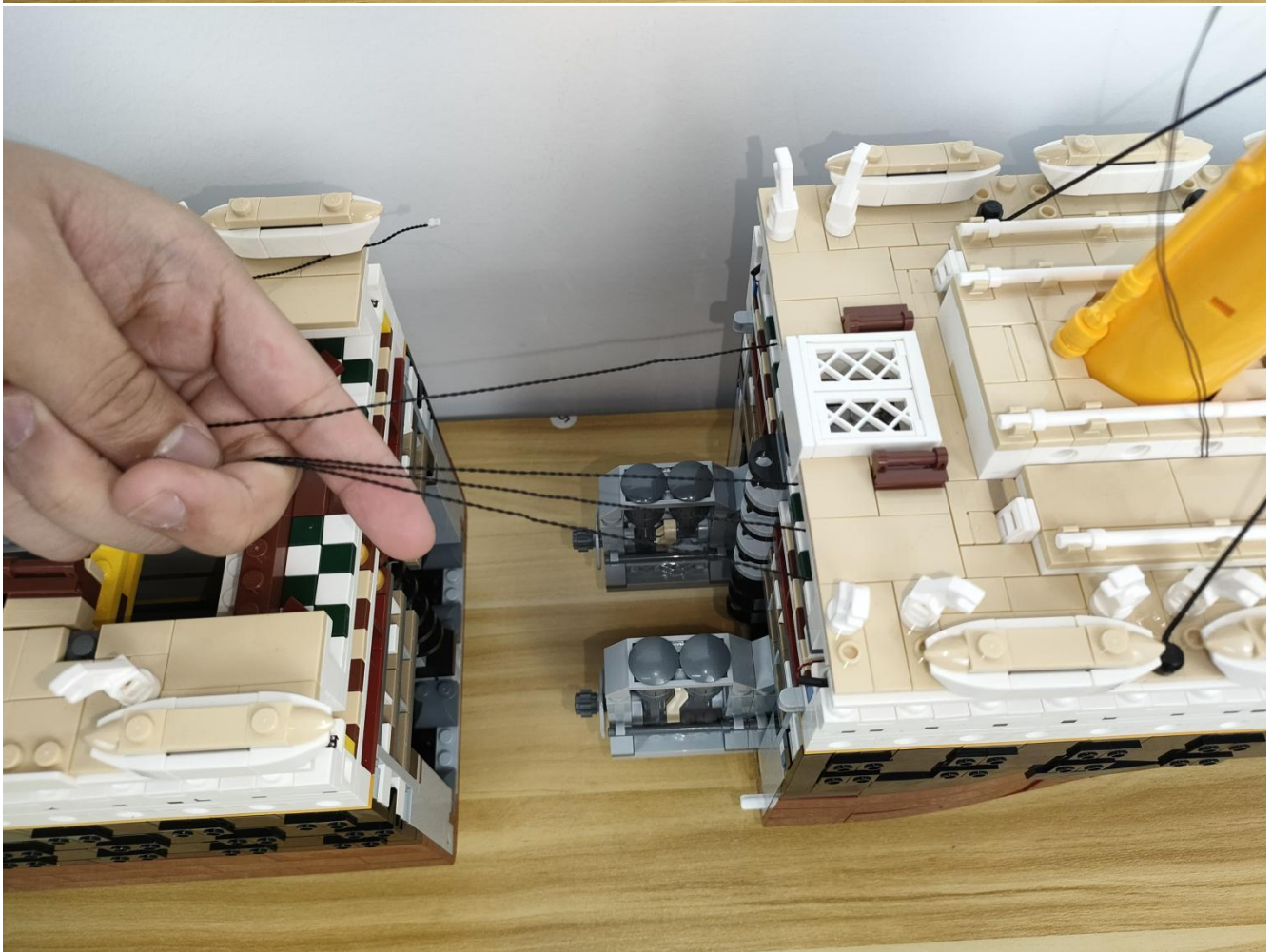

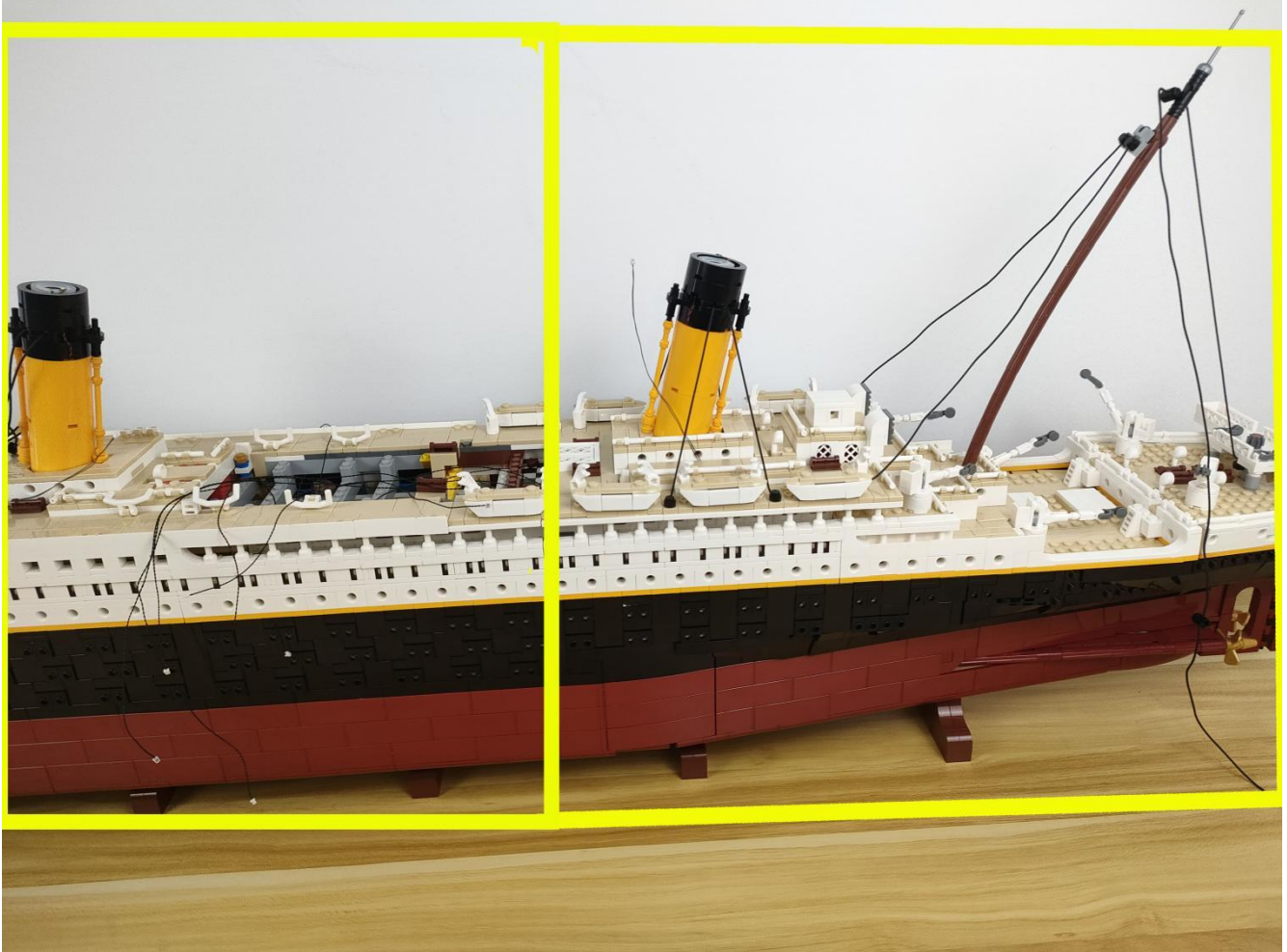
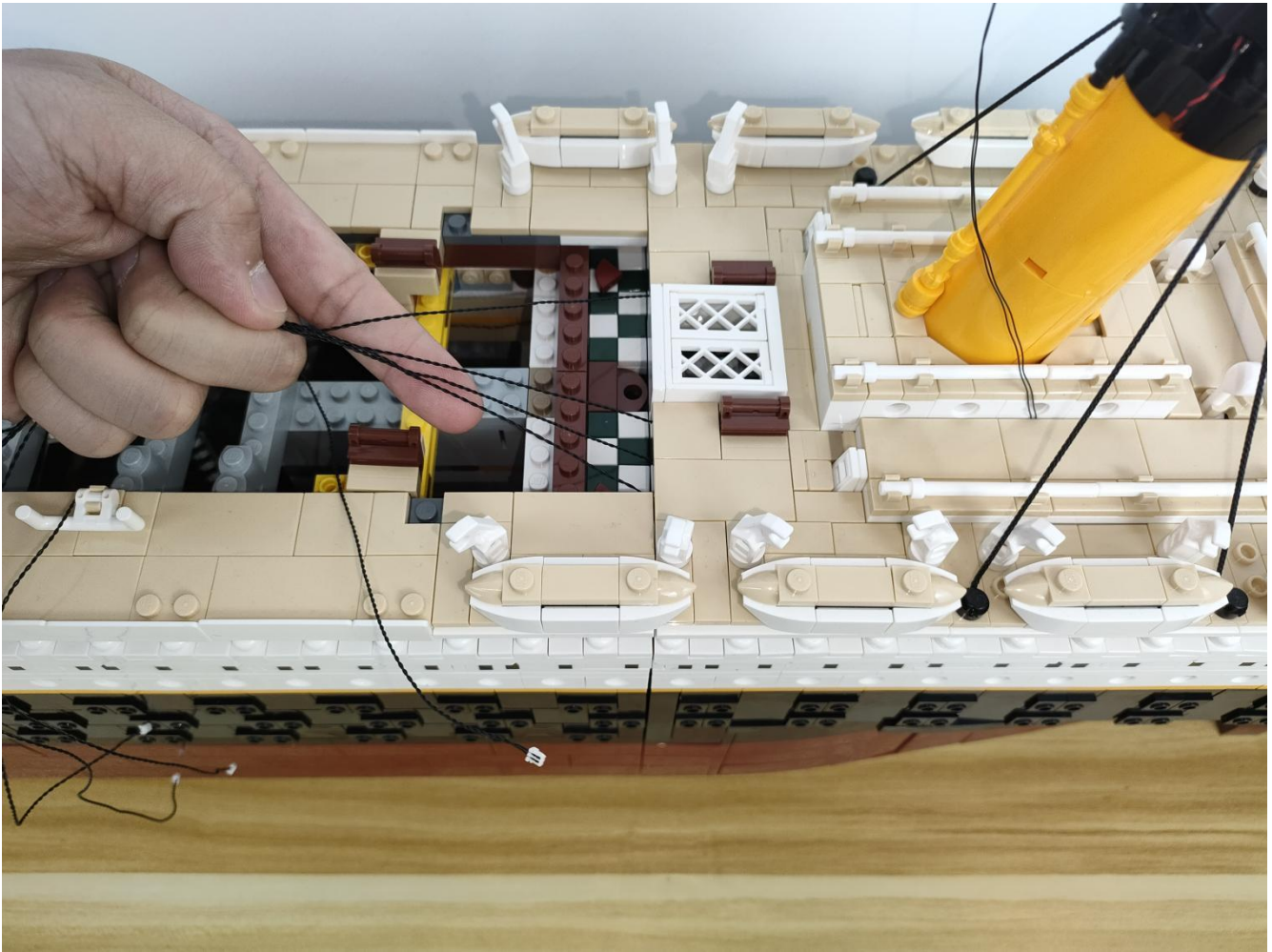

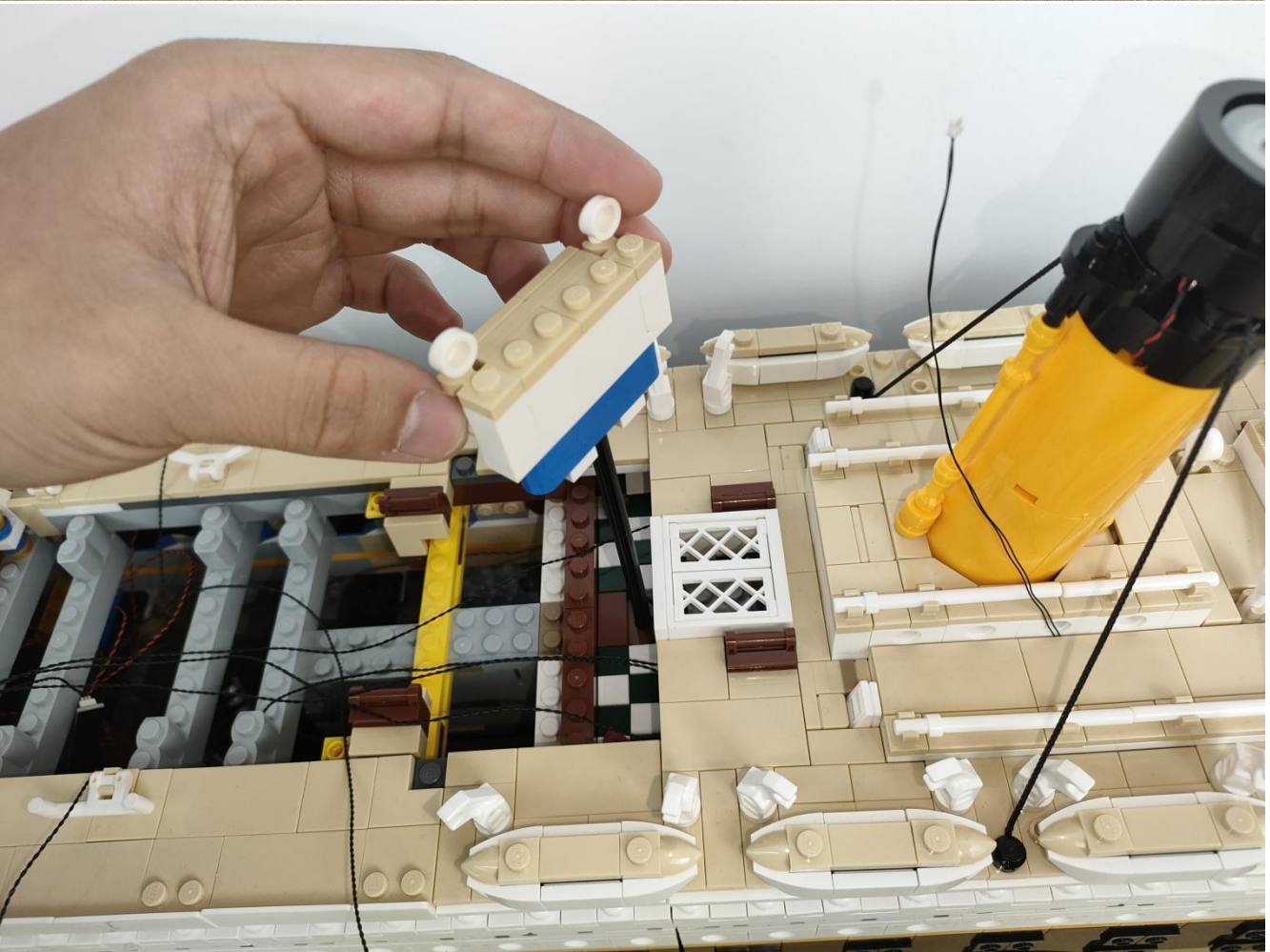
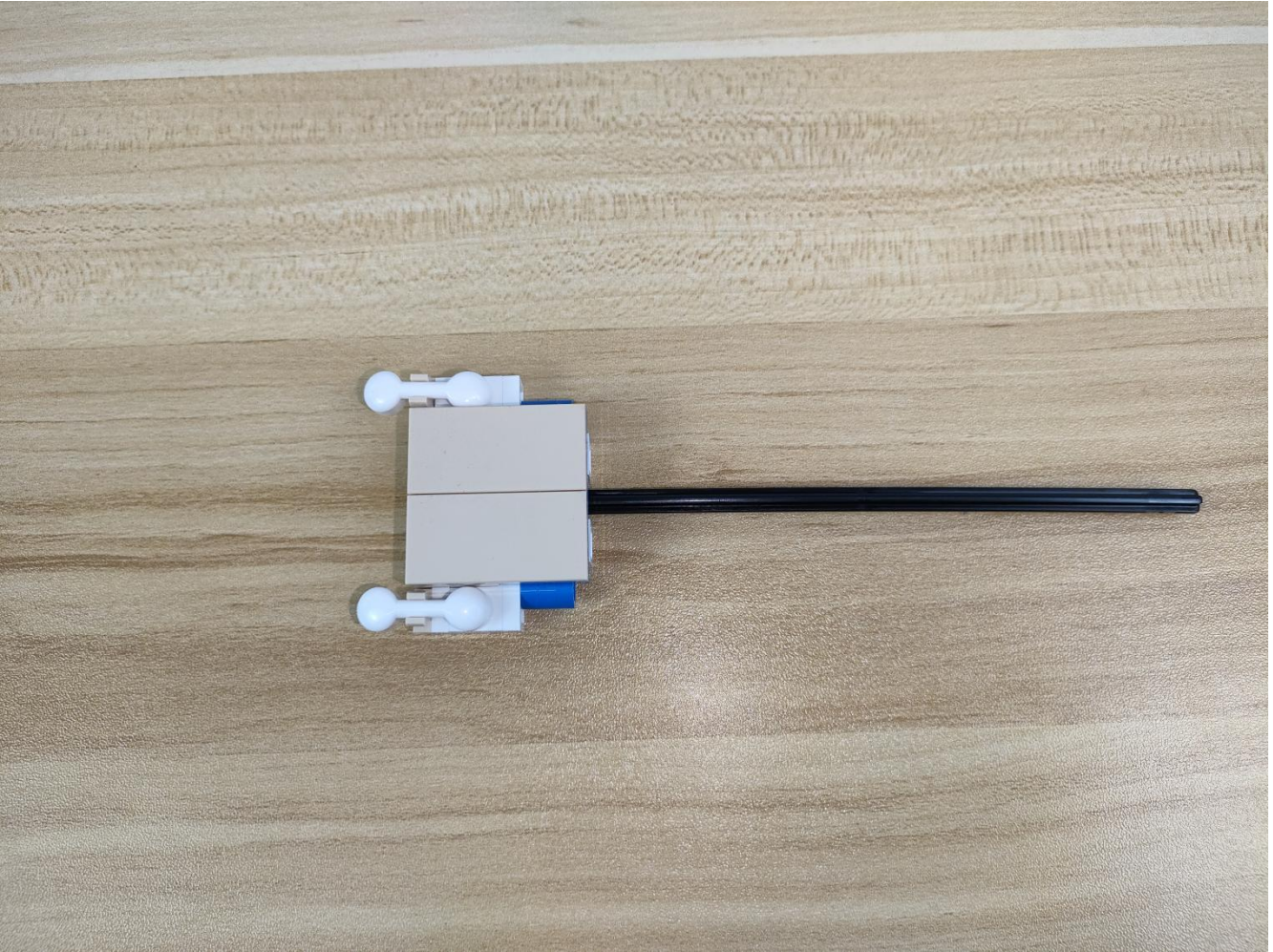

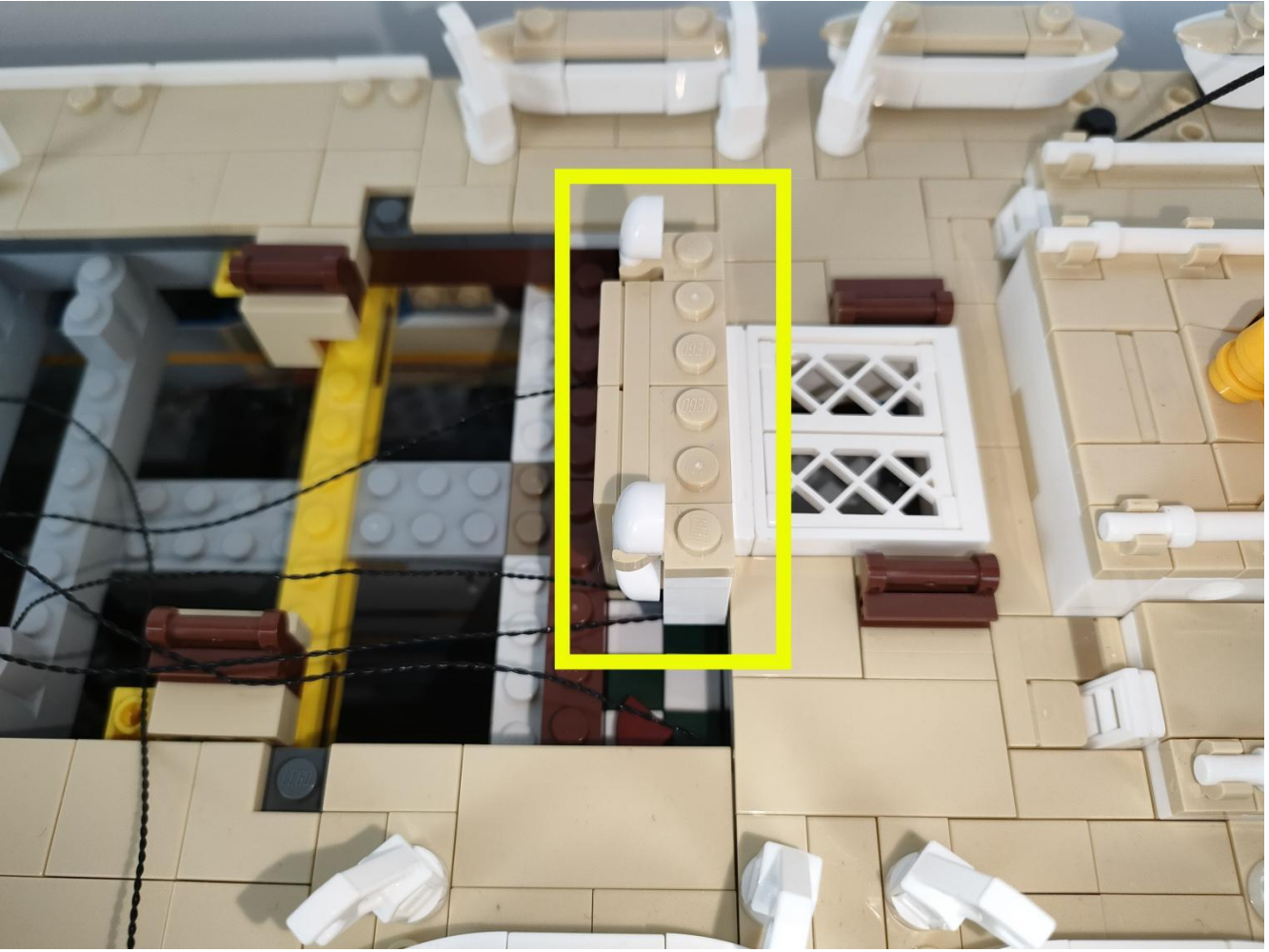

After restoring as shown in the figure, place the packing box in the middle of the hull.



Place the model diagonally against the mounting box.





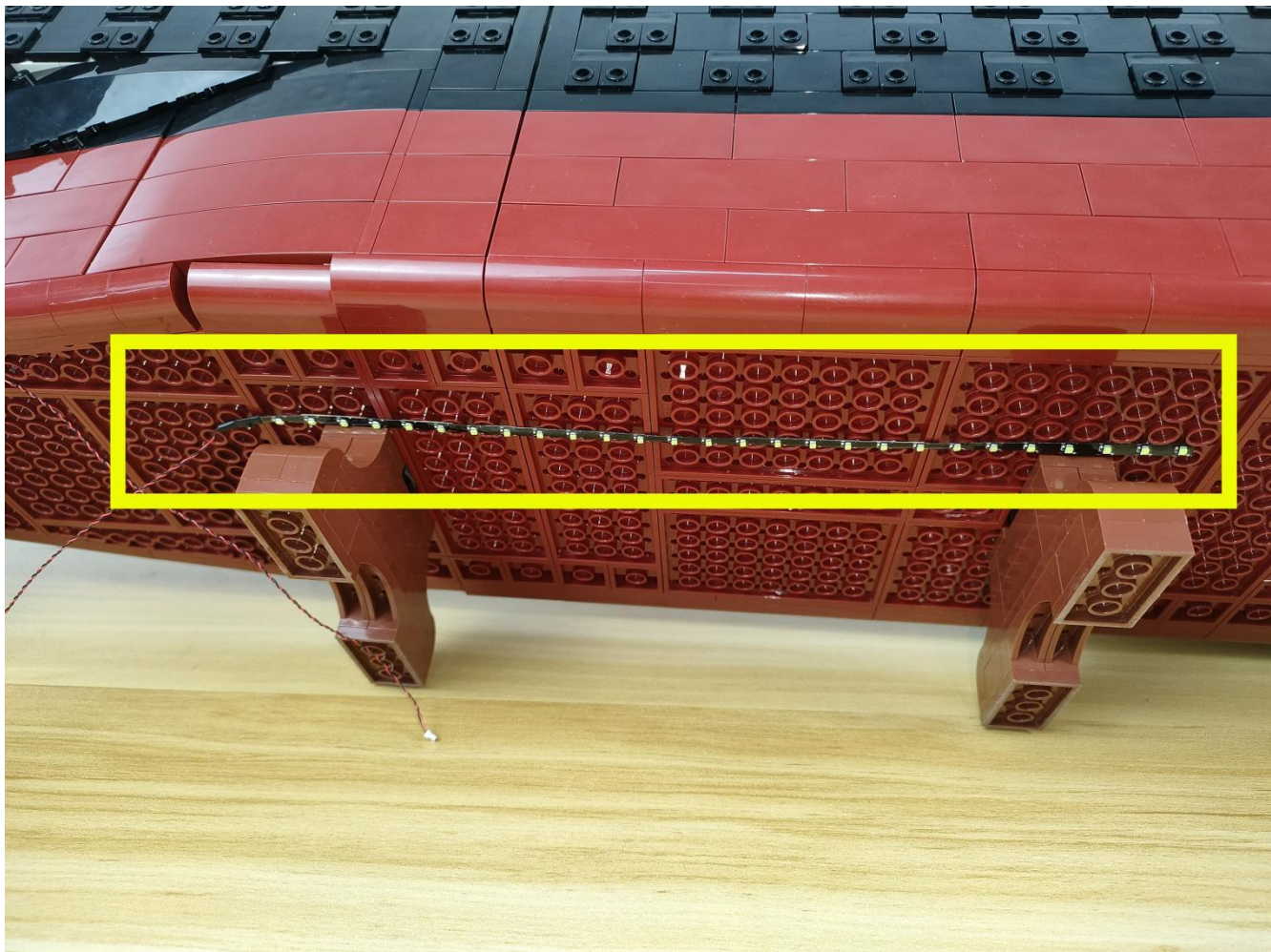



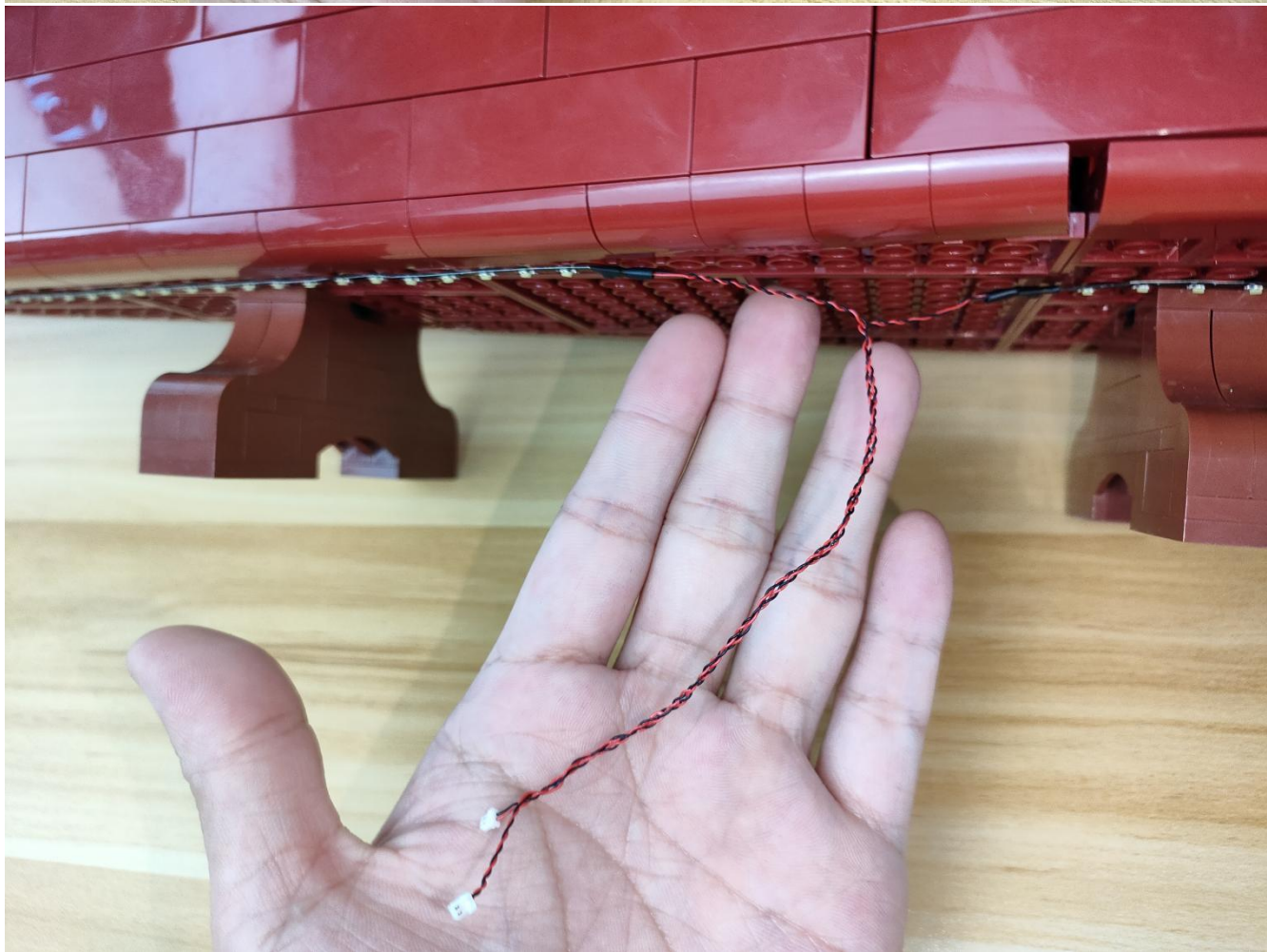
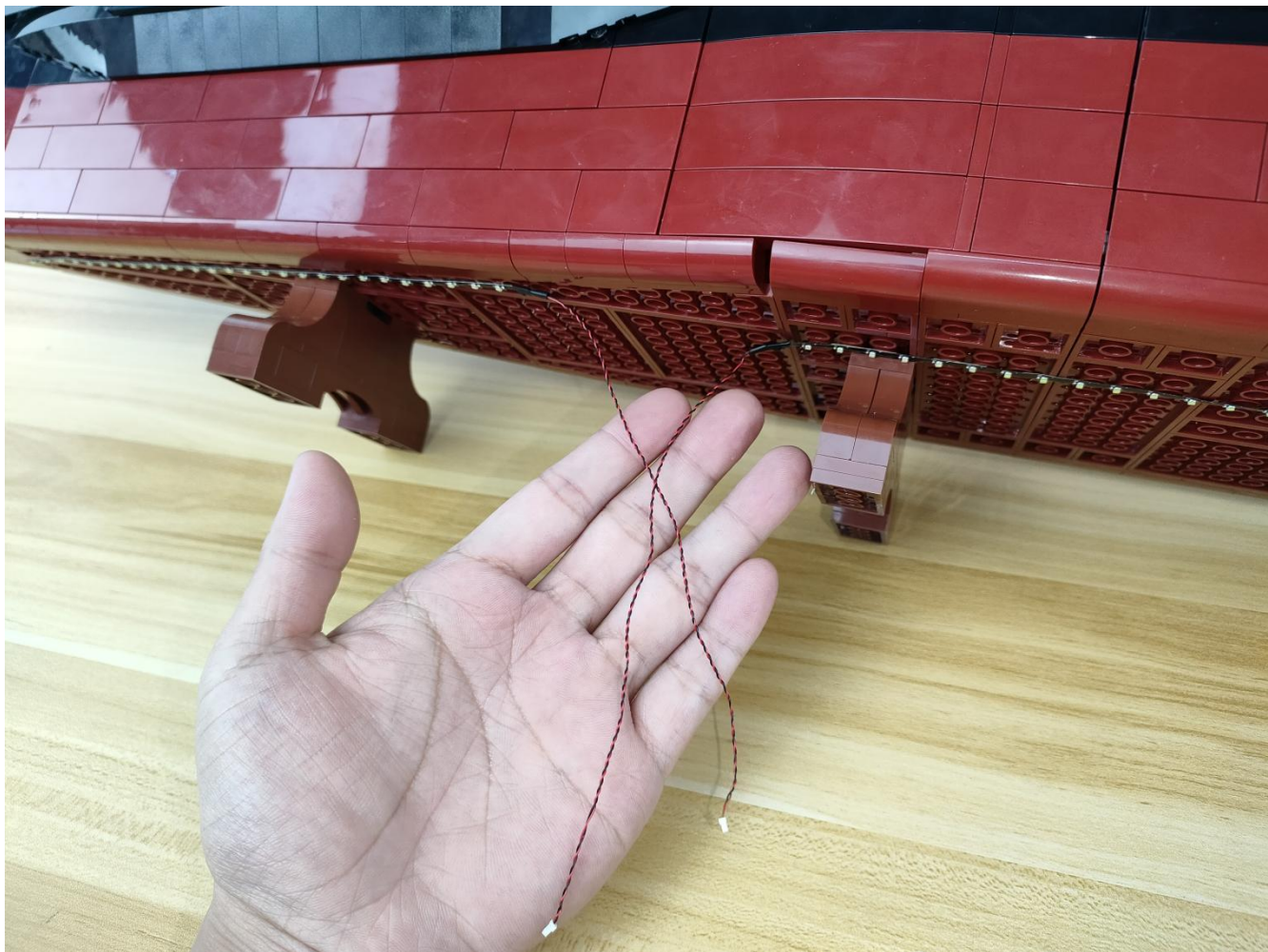

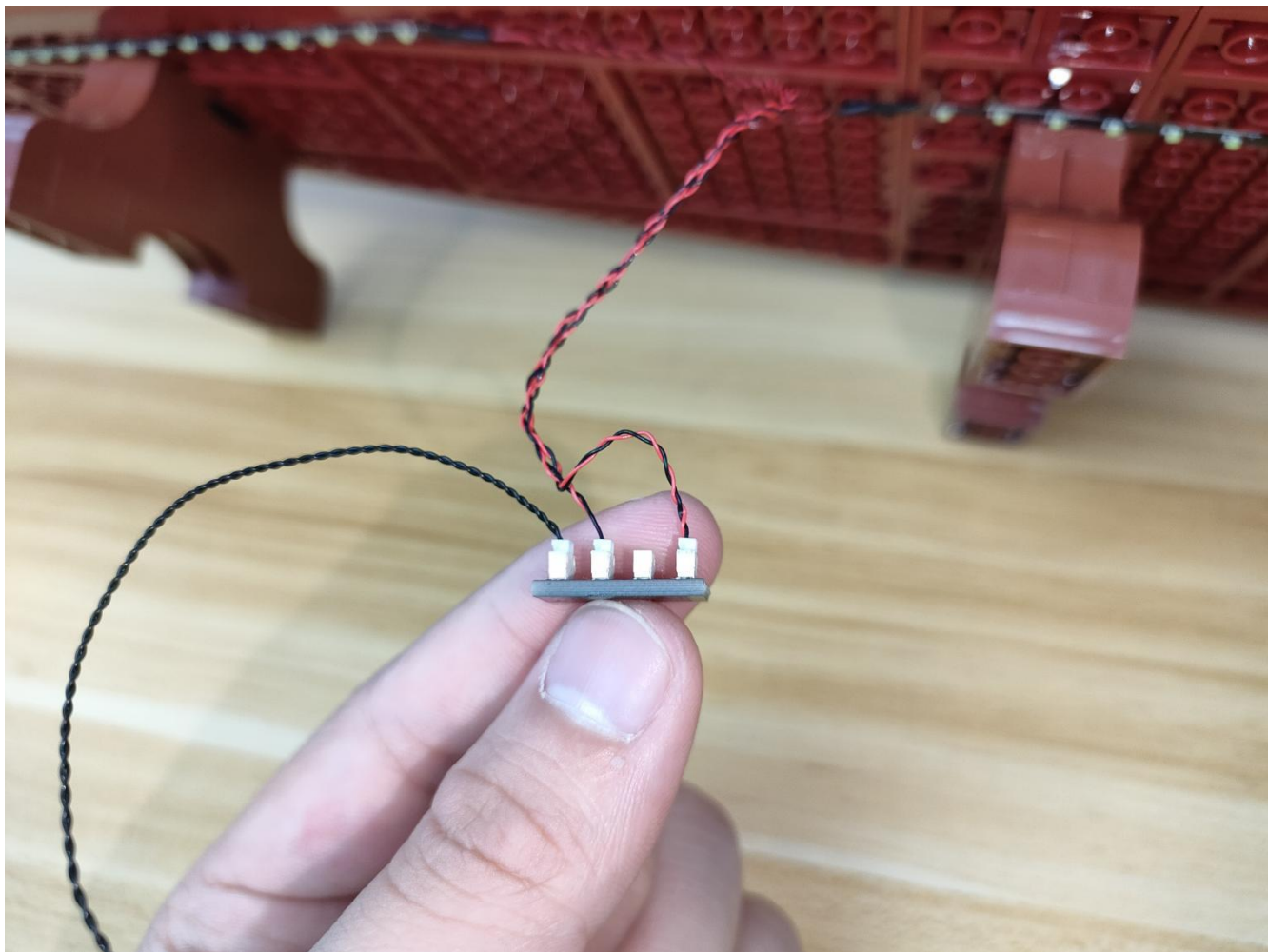

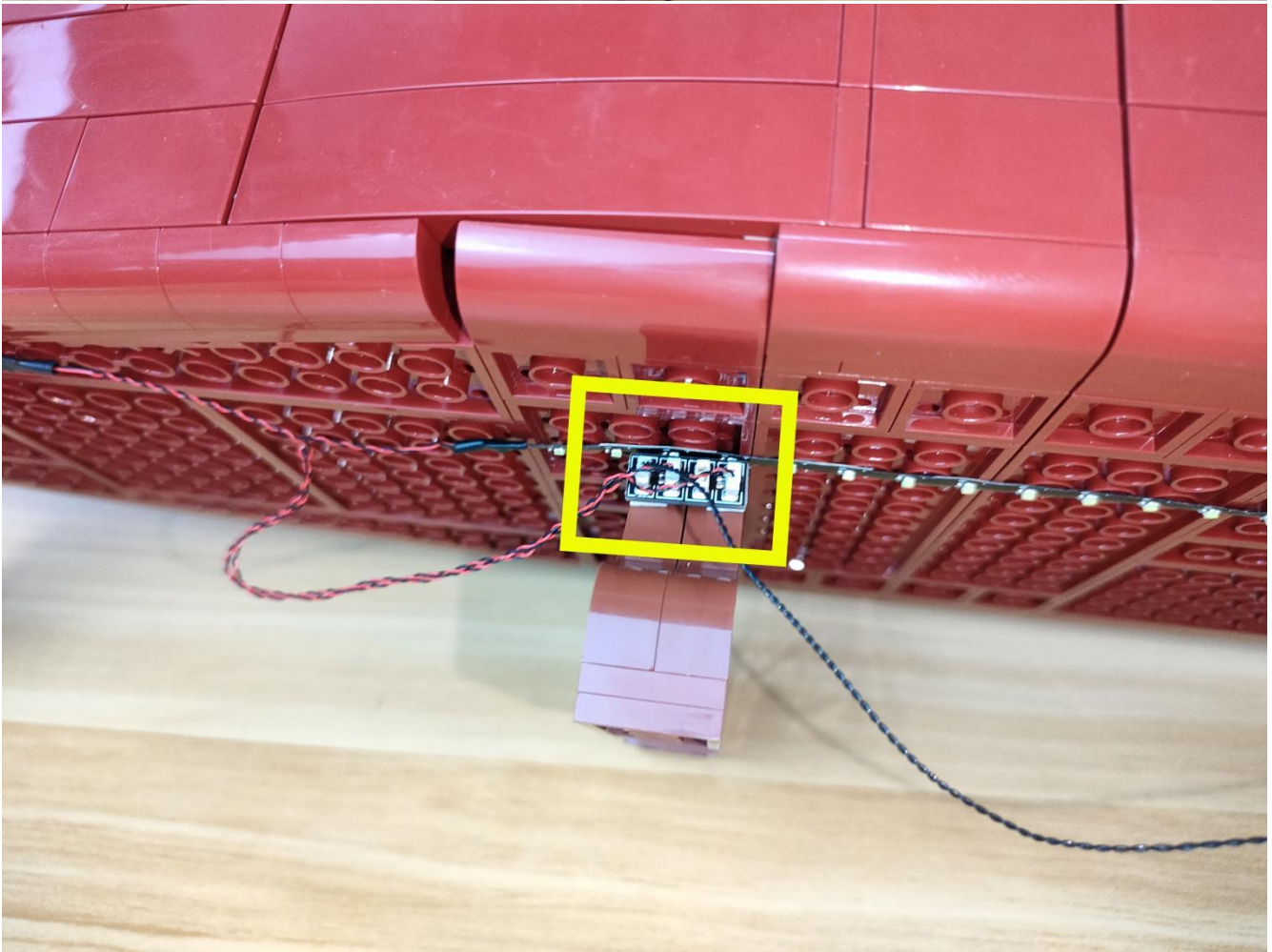
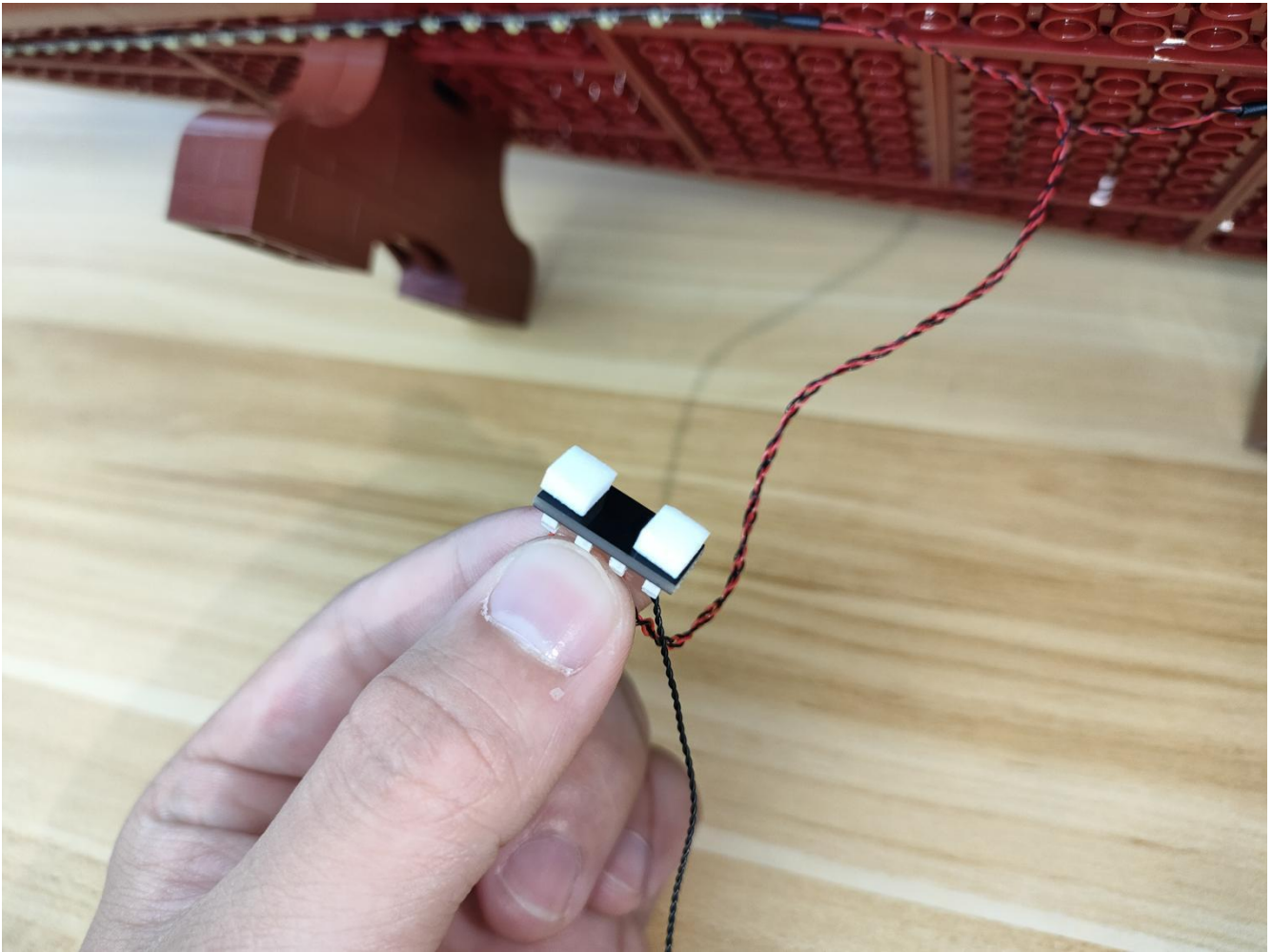

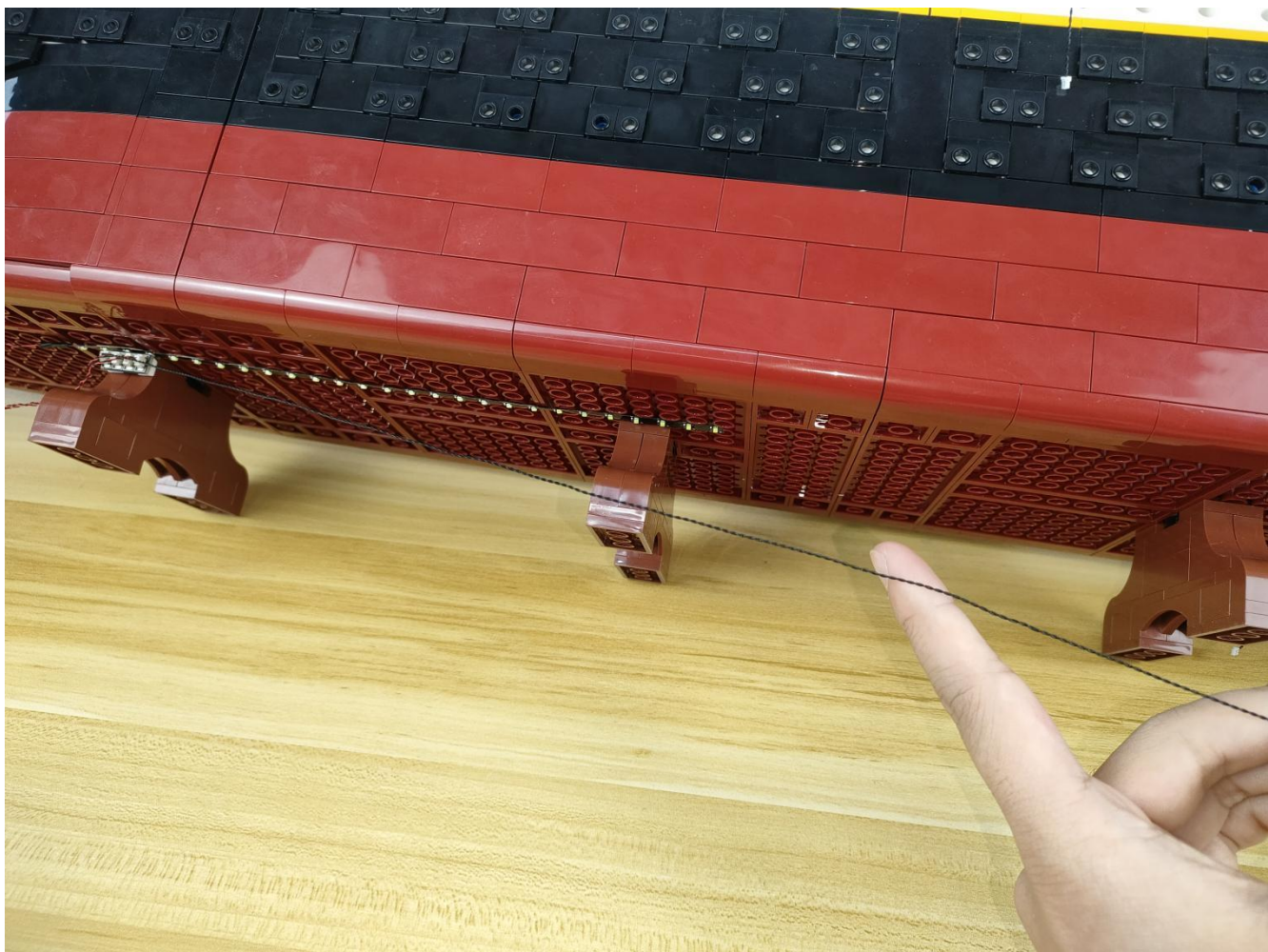

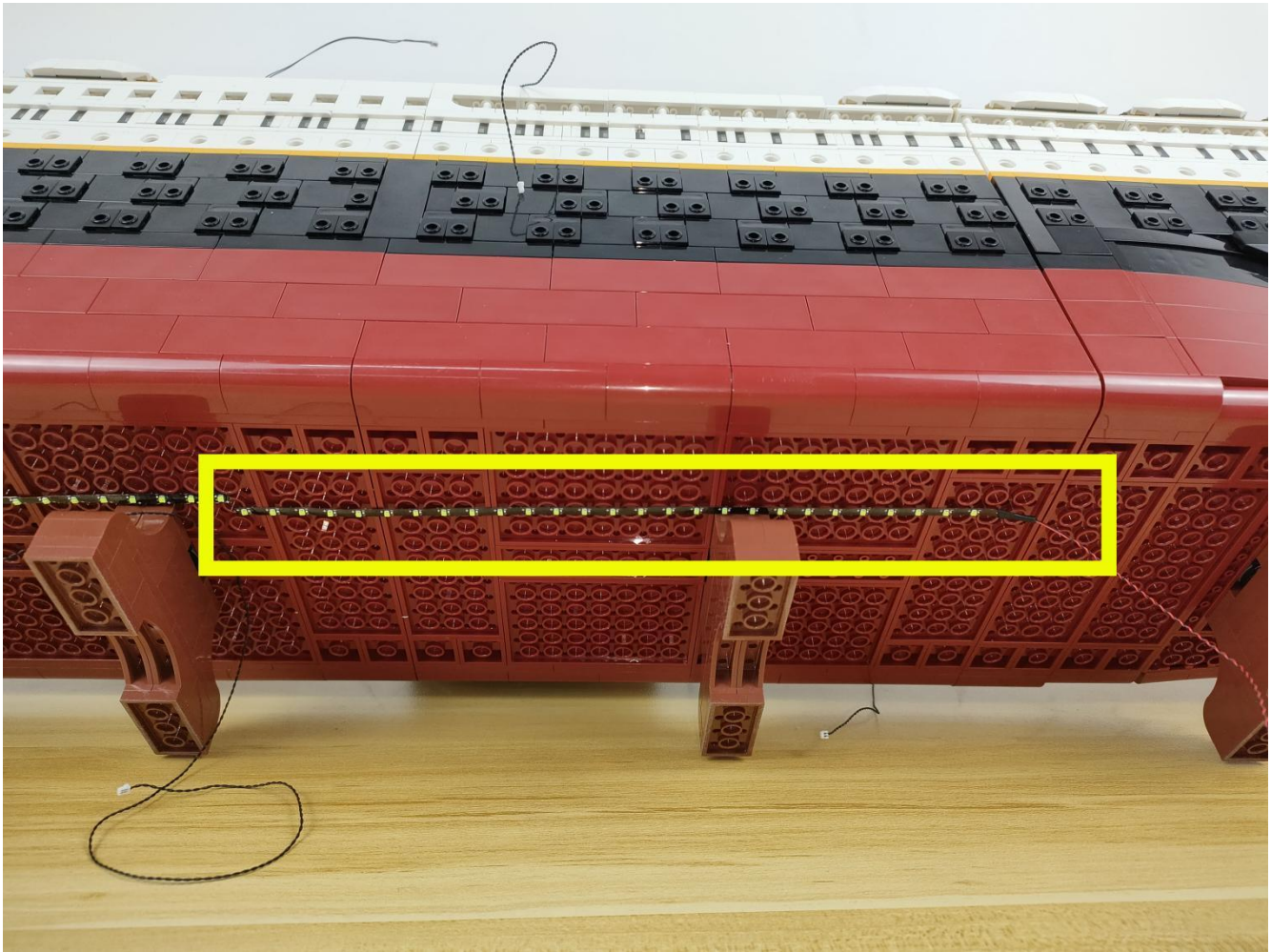



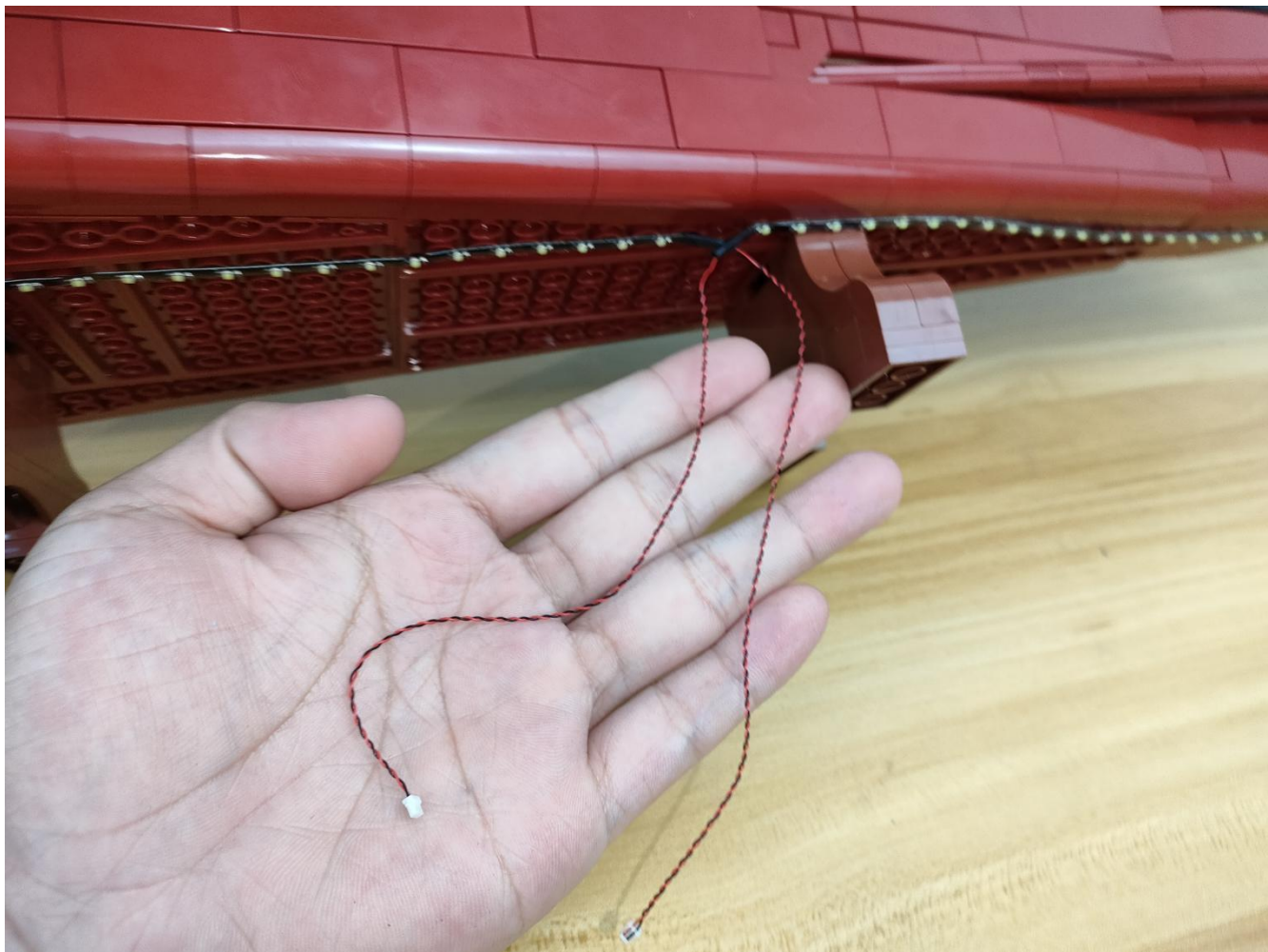



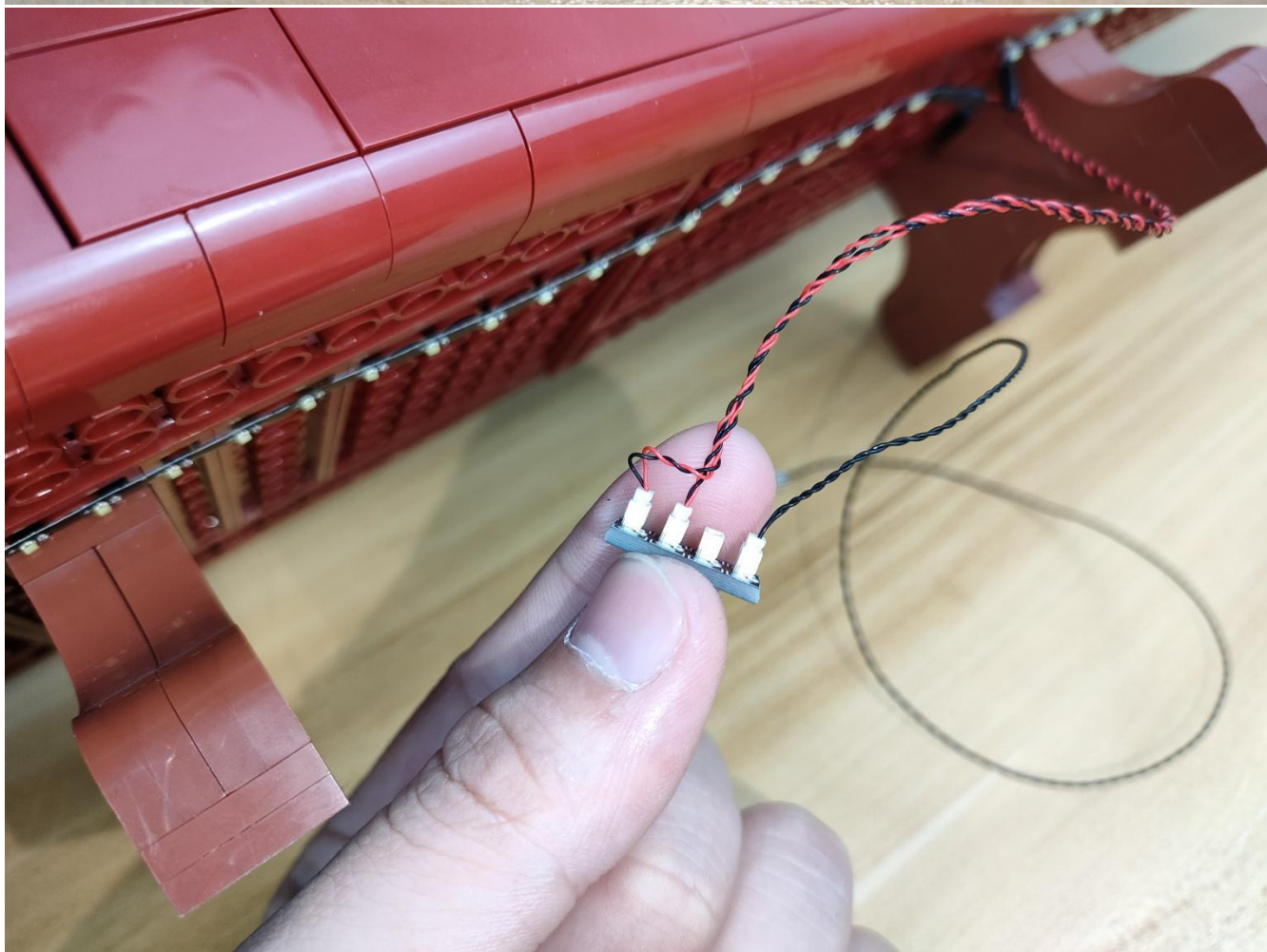

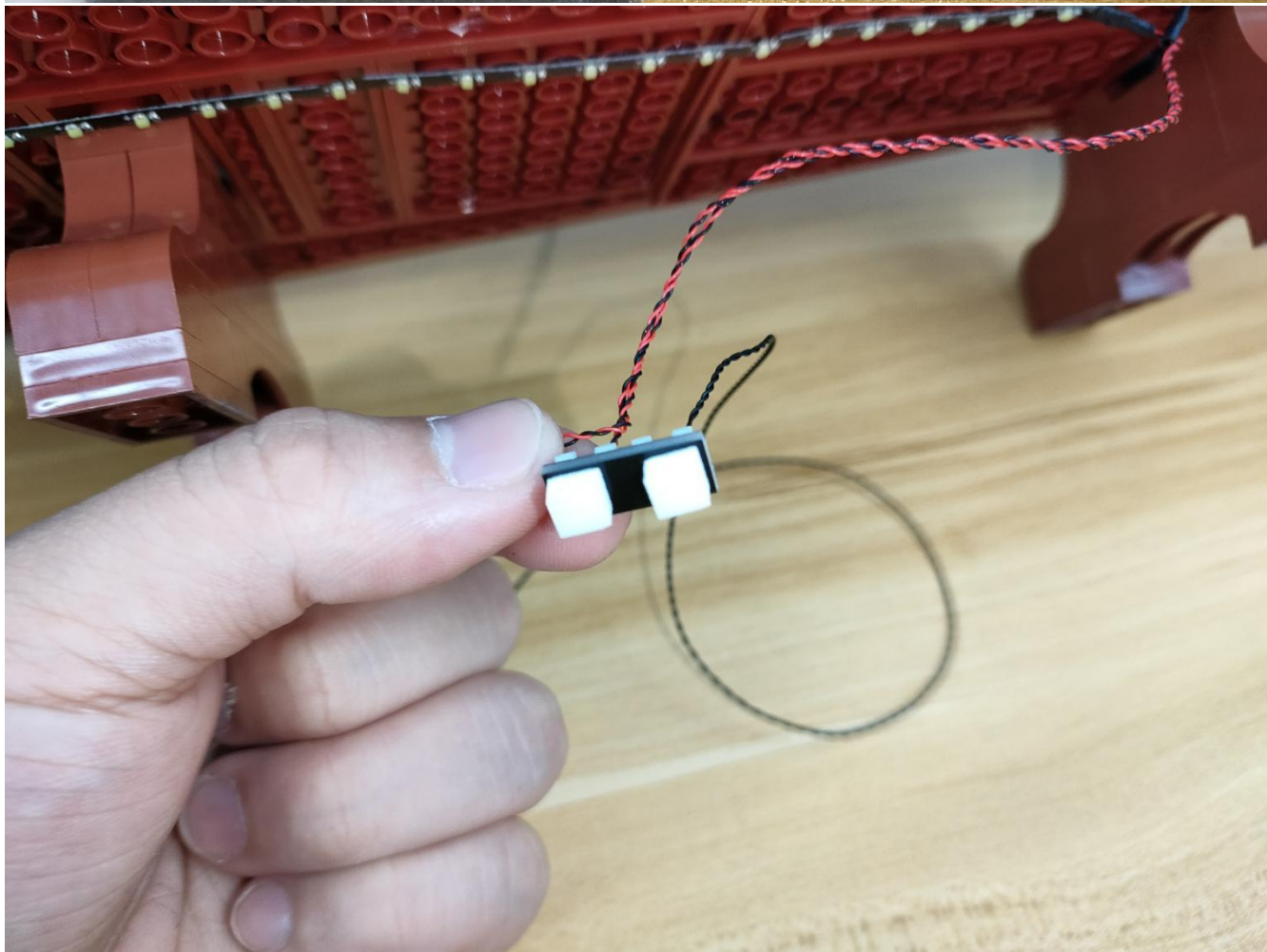

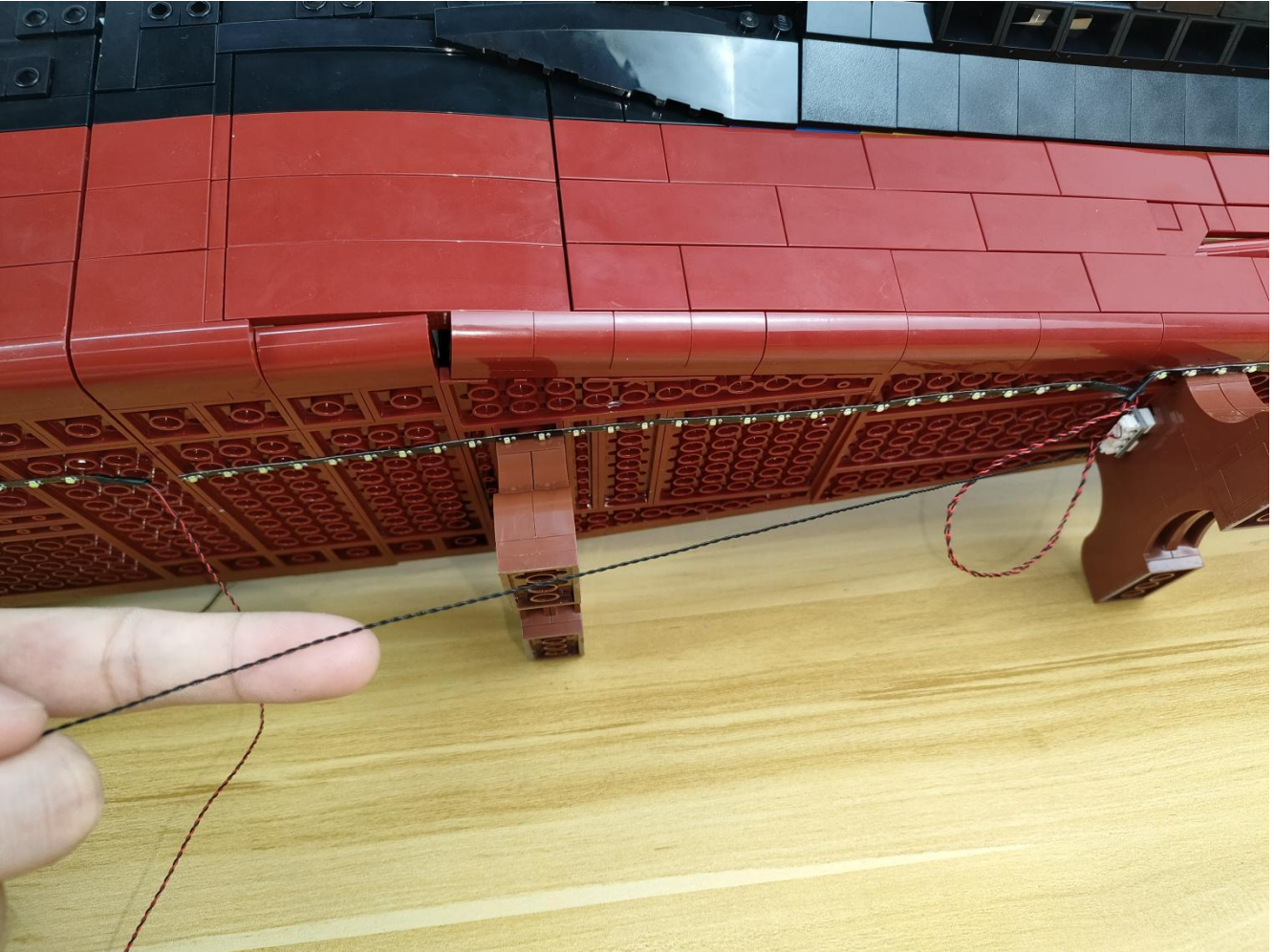
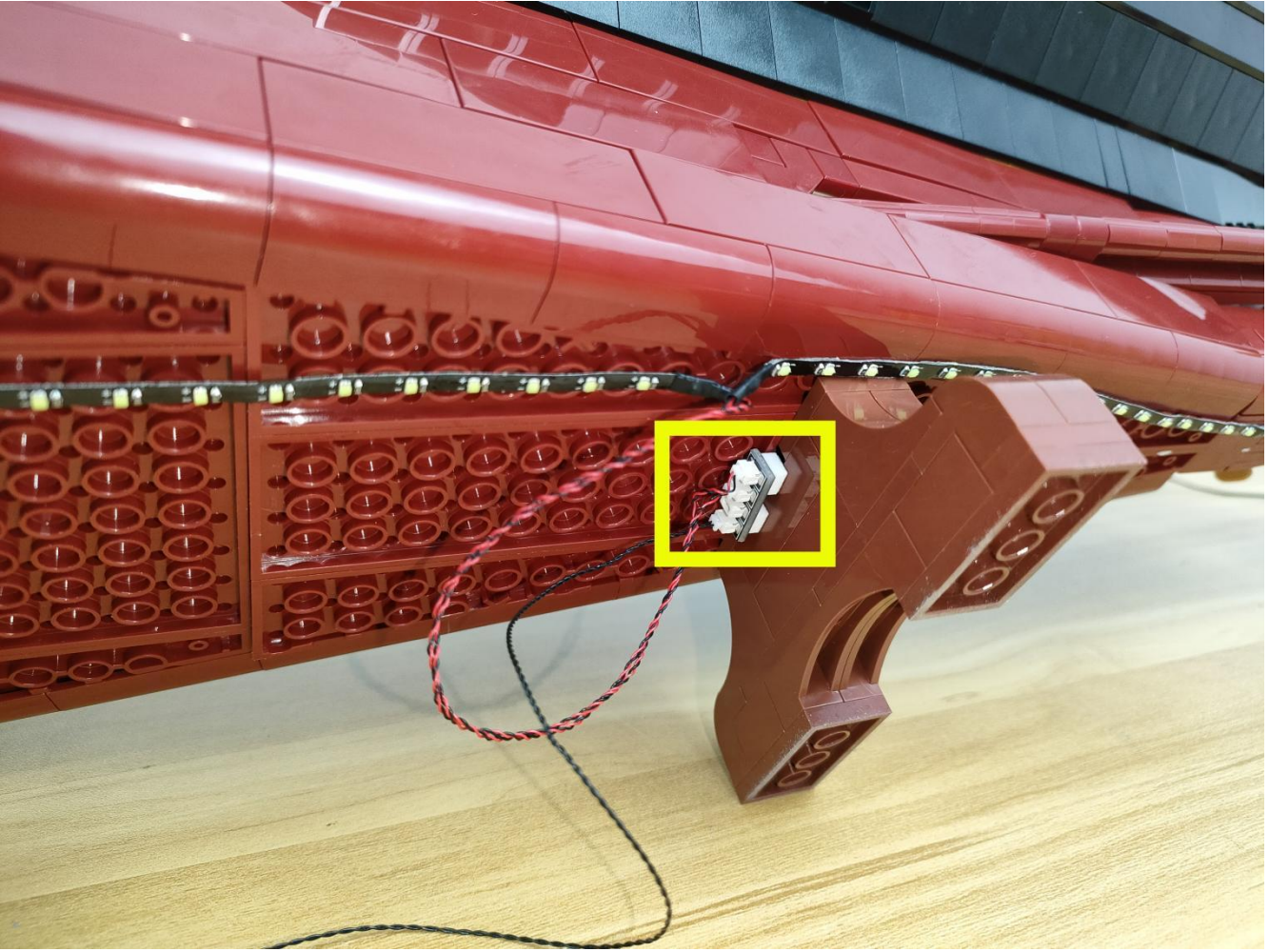



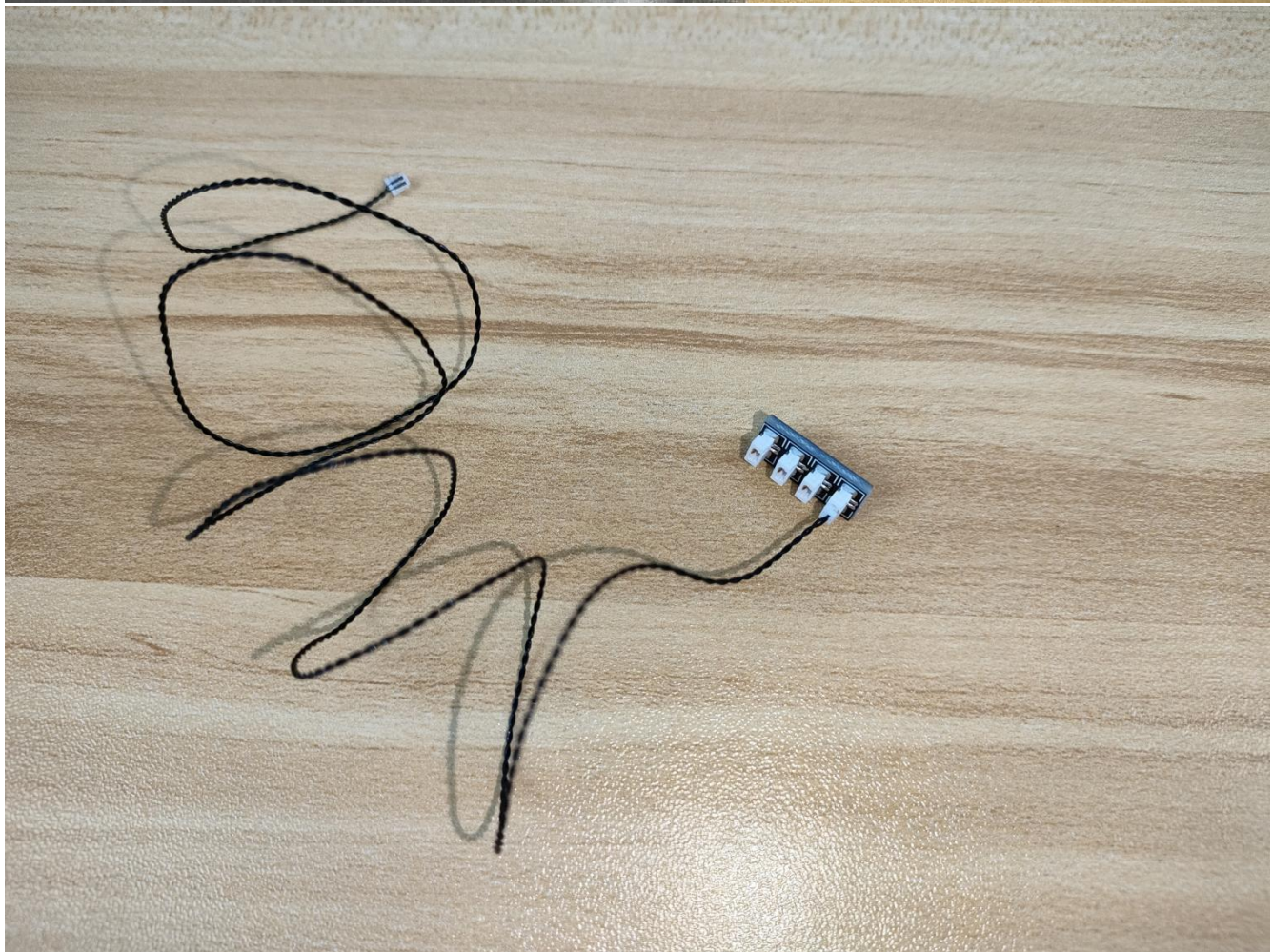

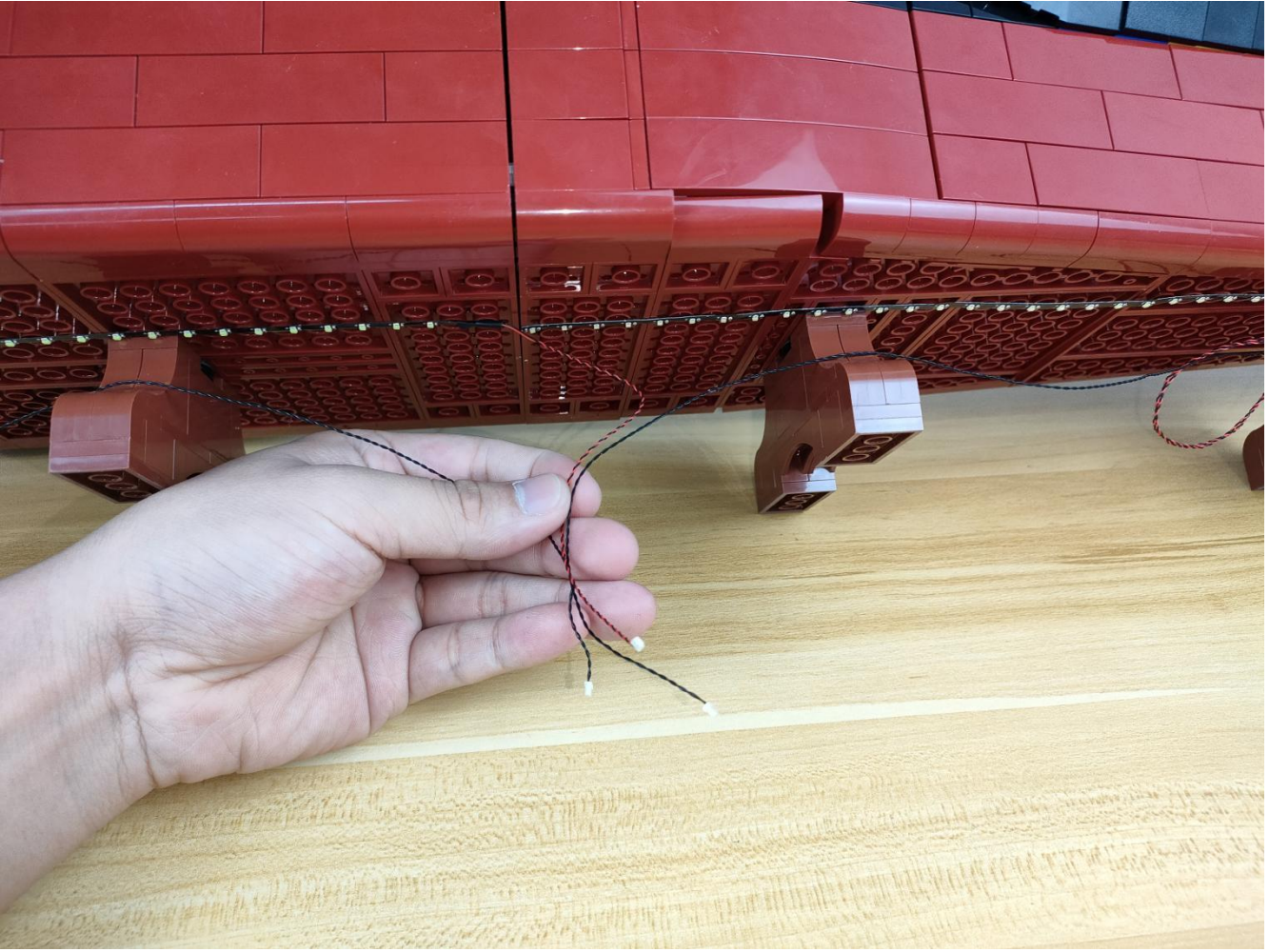



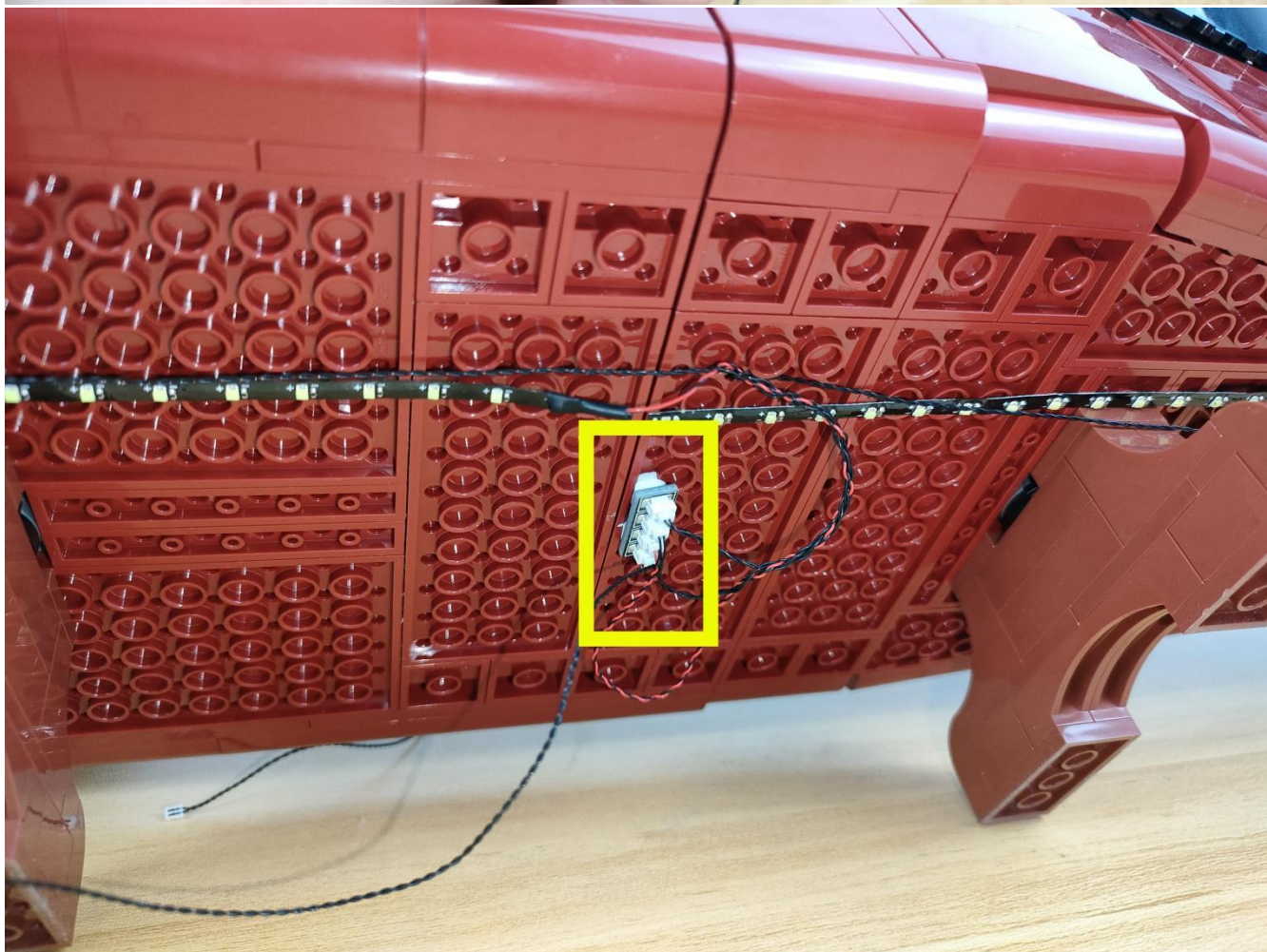
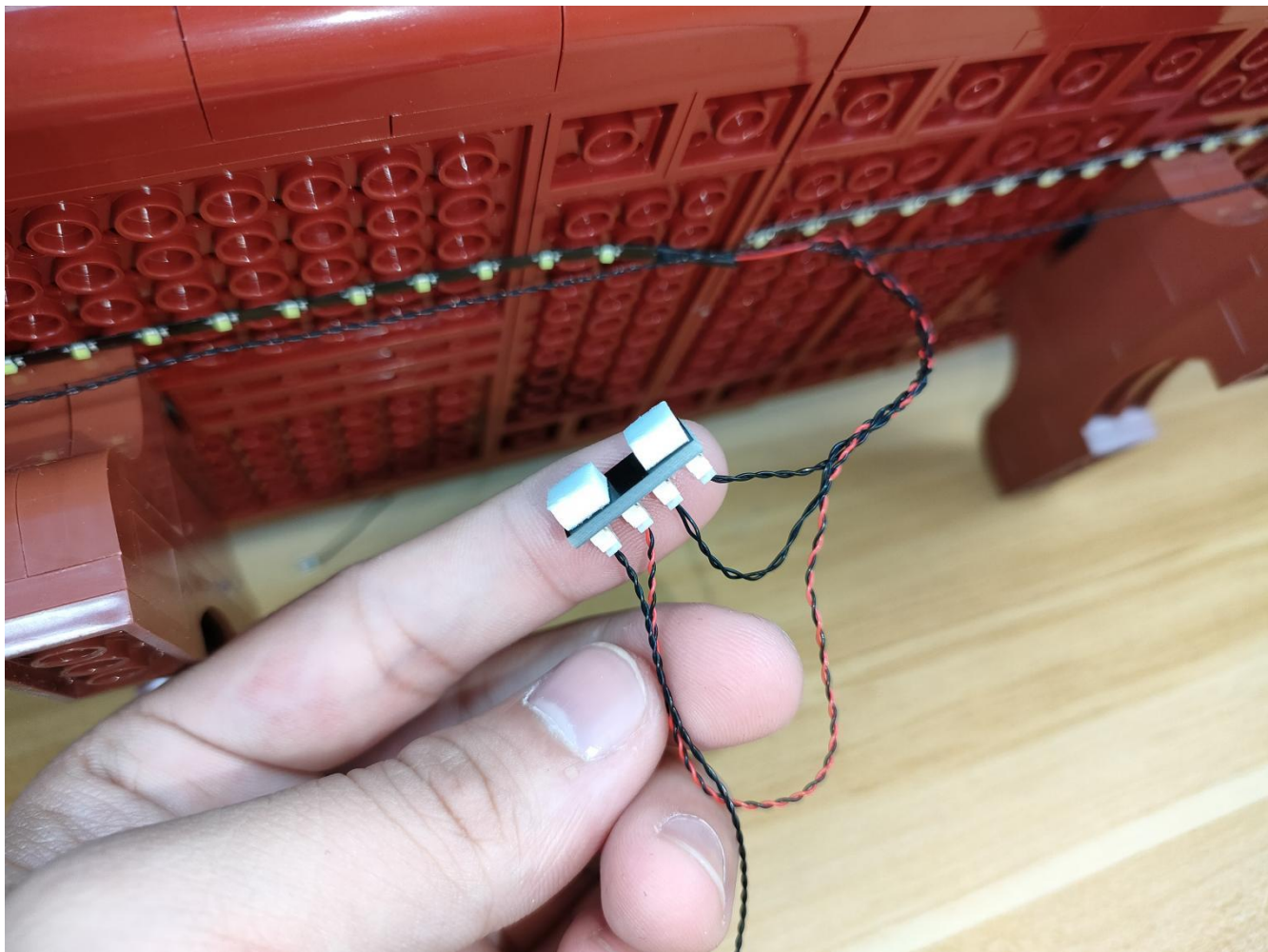

Place the connecting line in the picture in the gap between the blocks and pull the connecting line to the top.

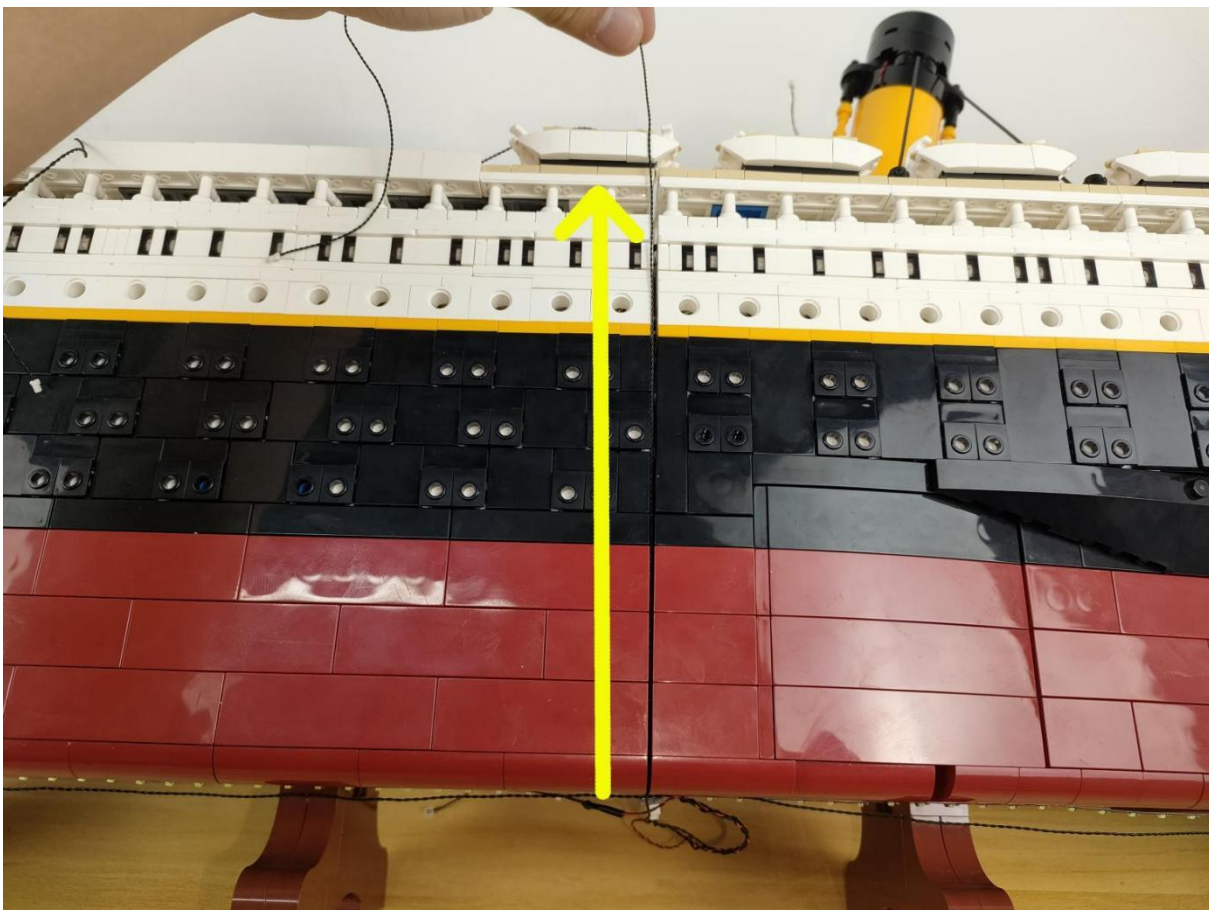
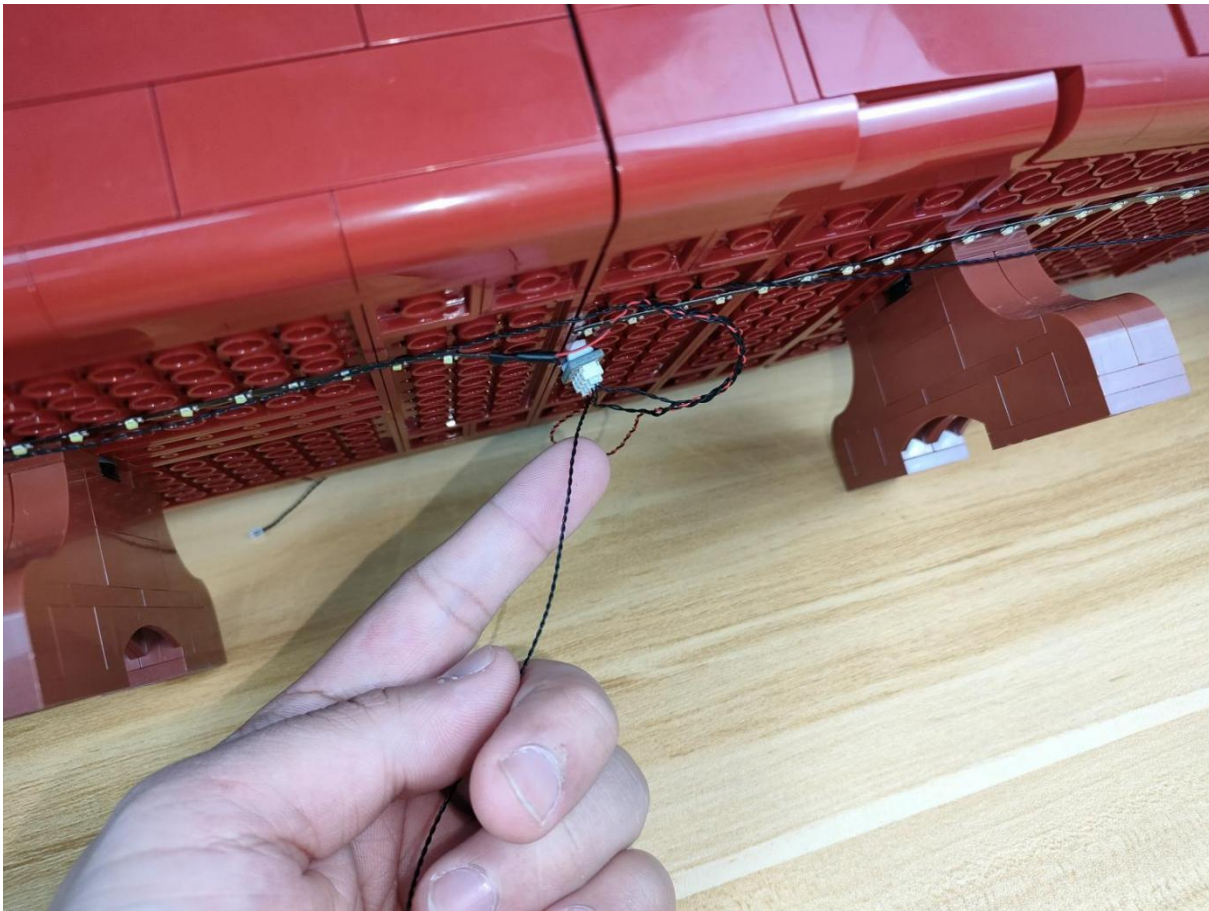





Connect the cable to the expansion board.



Take out the previously tested mobile power supply and USB power cord and an 8-seater expansion board.

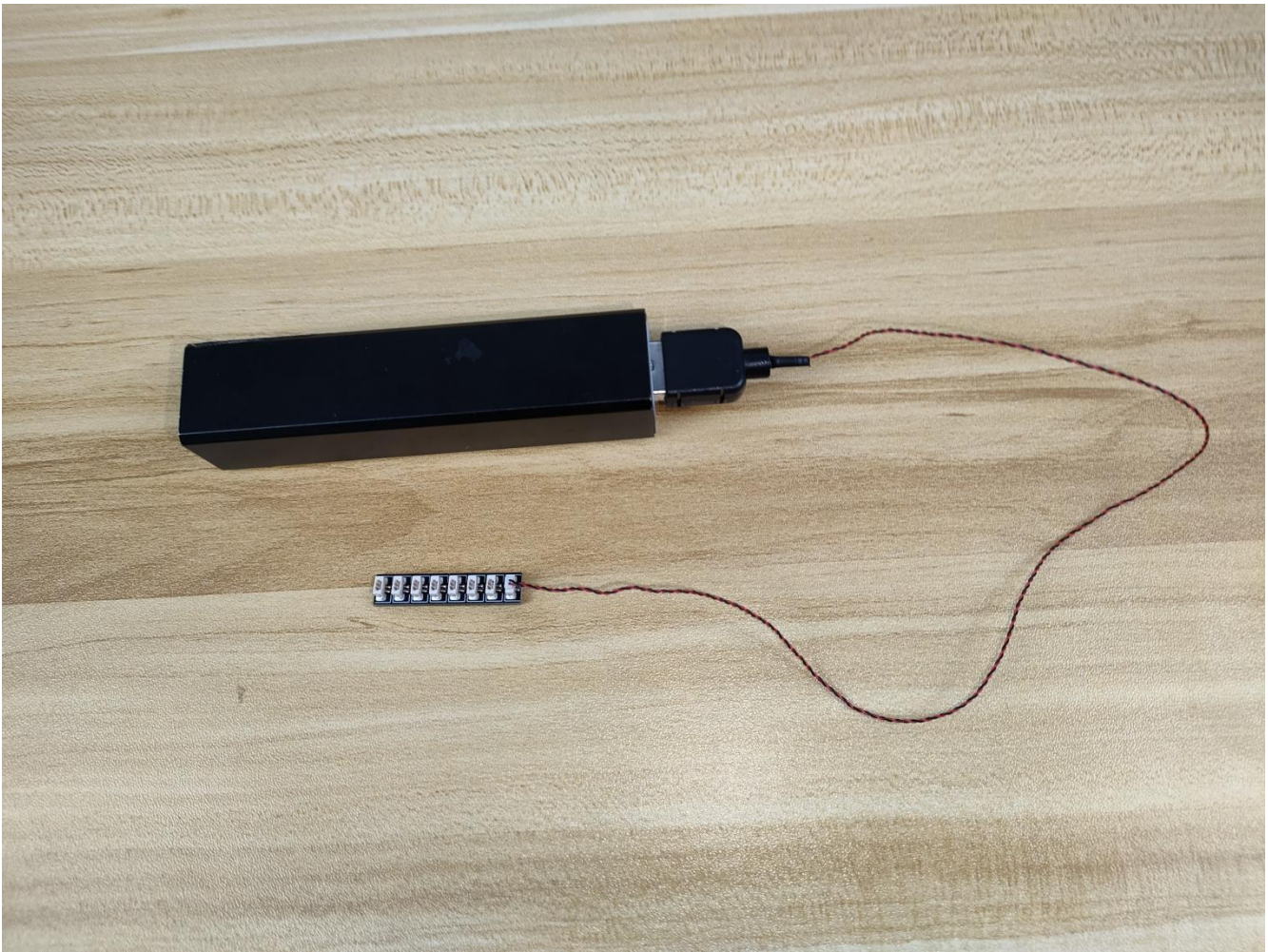

Find out the connection line of the ship's headlights.

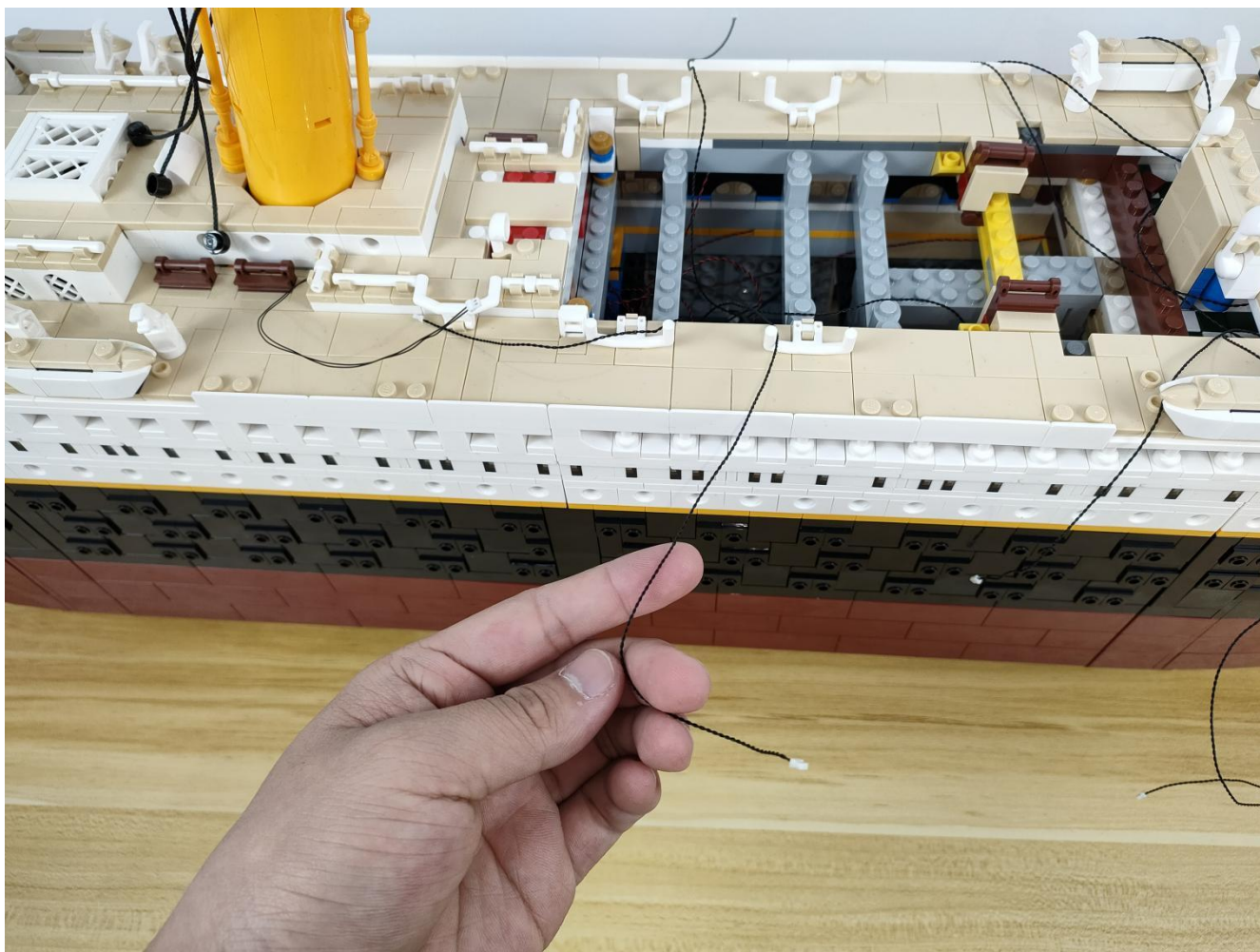

Connect the ship's headlight cable to the power source and see if the ship's headlight is lit.

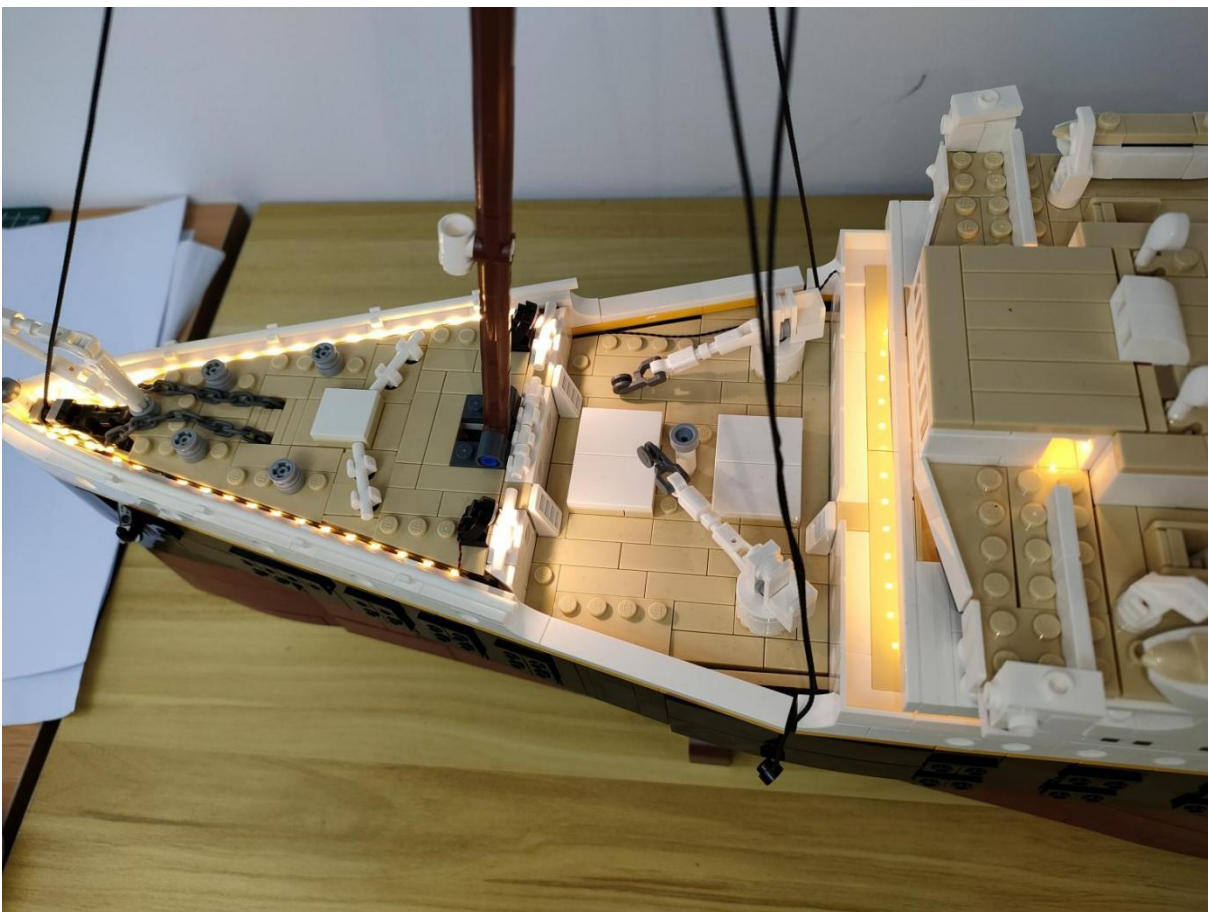
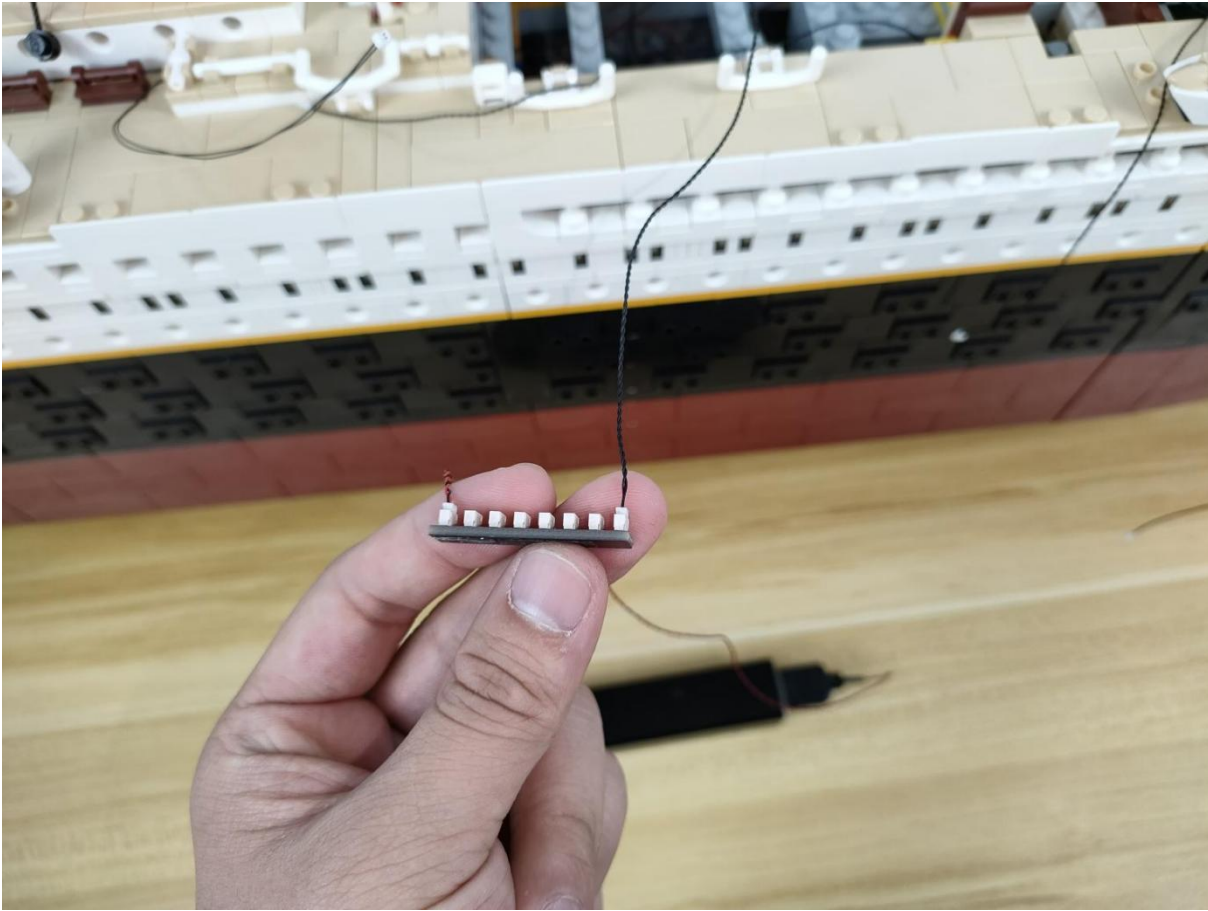

Then take off the ship's headlight cable and connect it to the 4-seater expansion board just taken out.

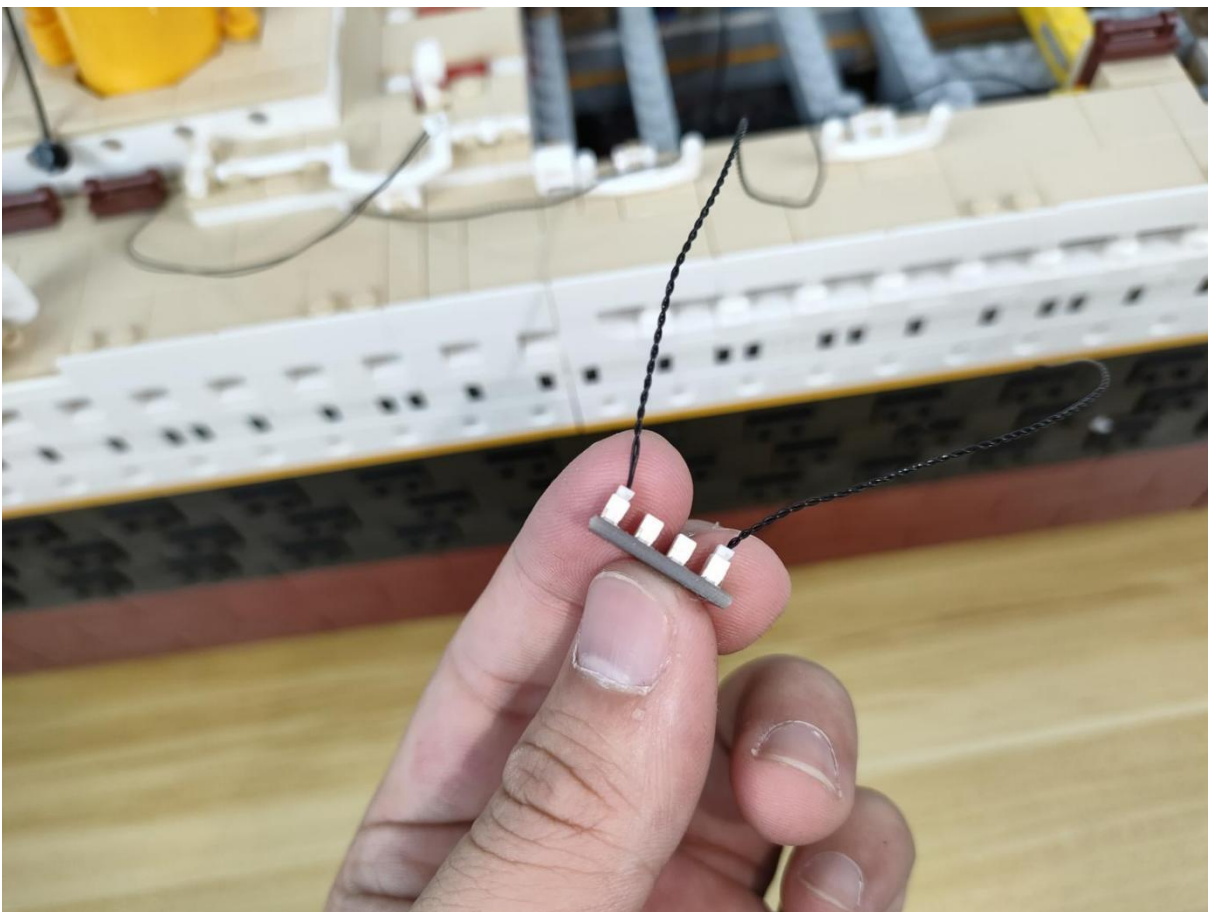

Find the connection line of the stern light.

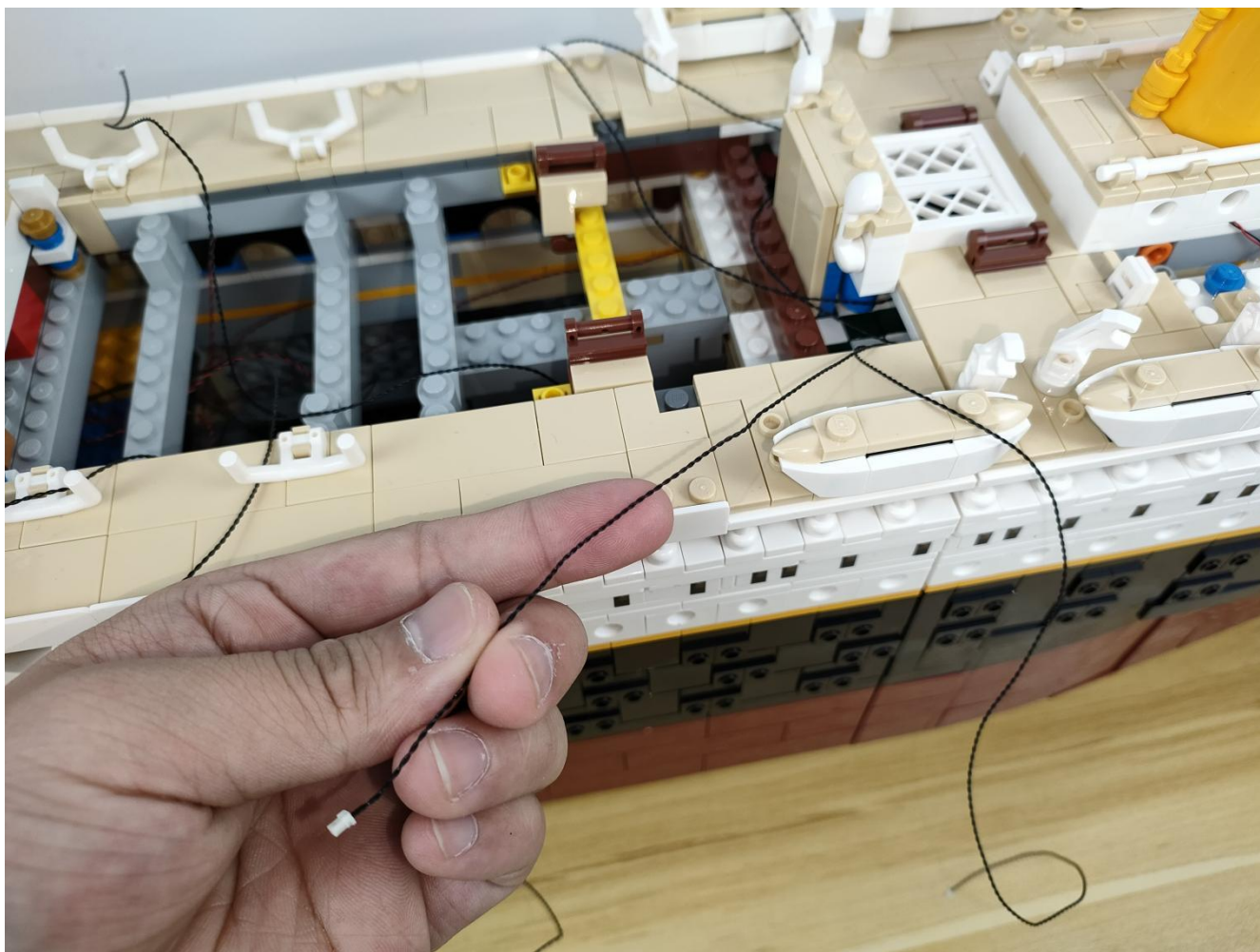

Connect the stern light cable to the power supply and see if the stern light is lit.

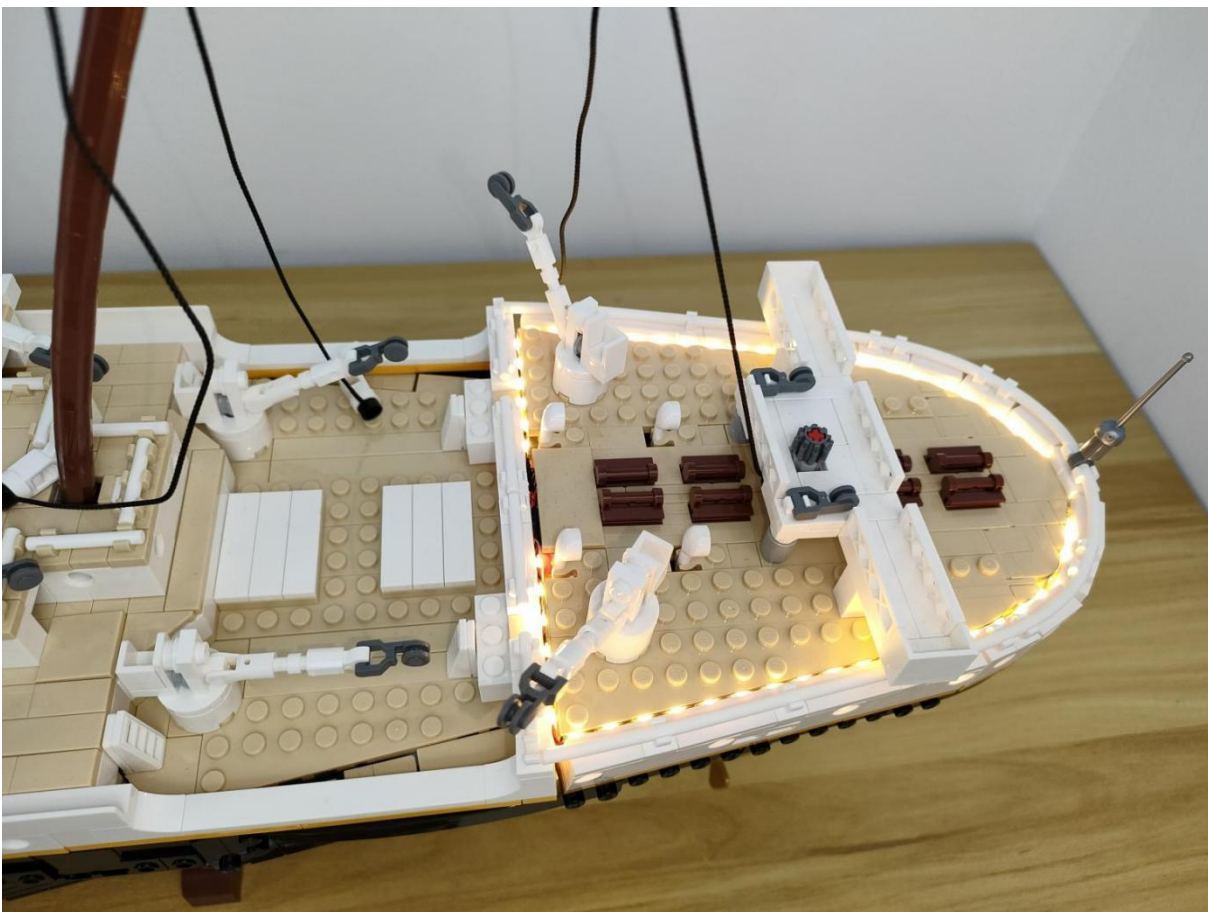
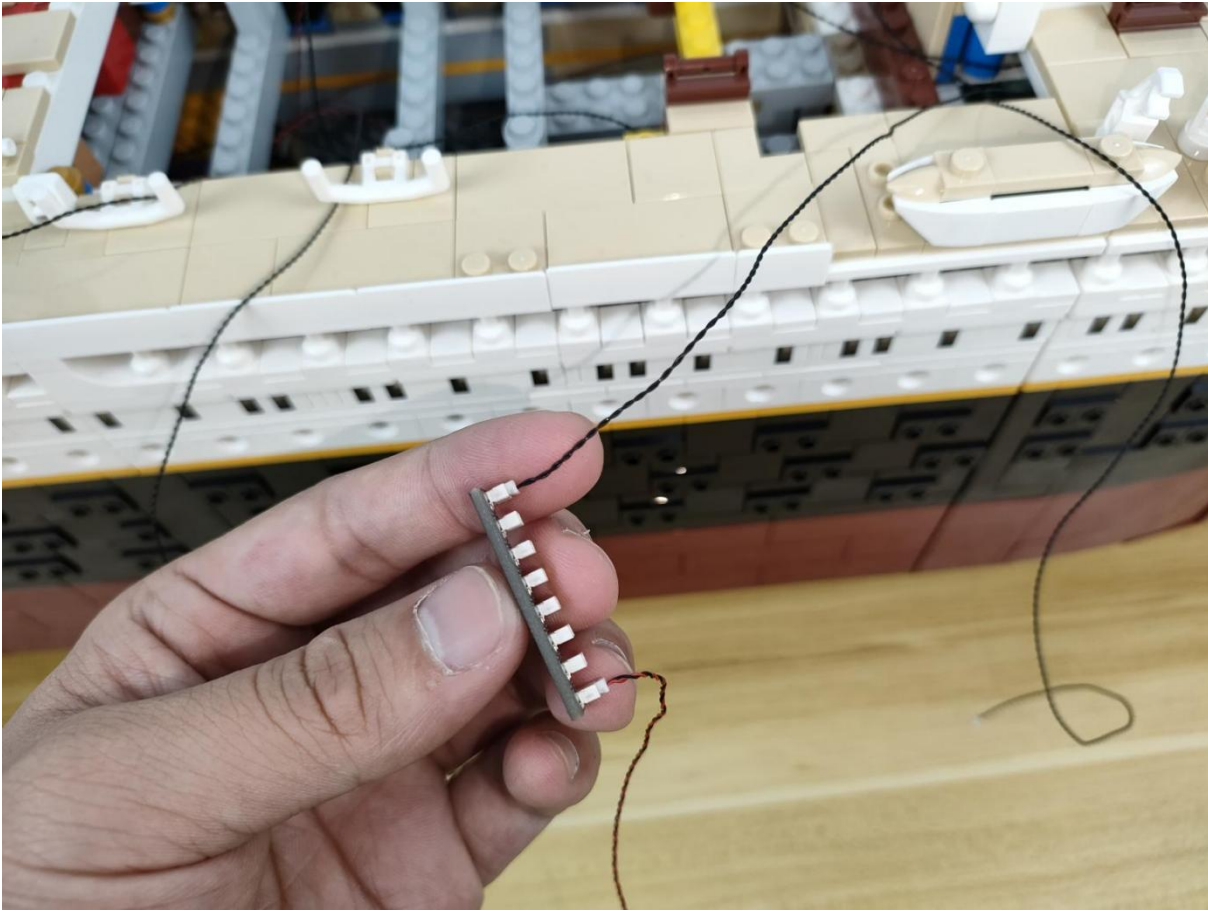

Take off the stern light cable and connect it to the 4-seater expansion board.

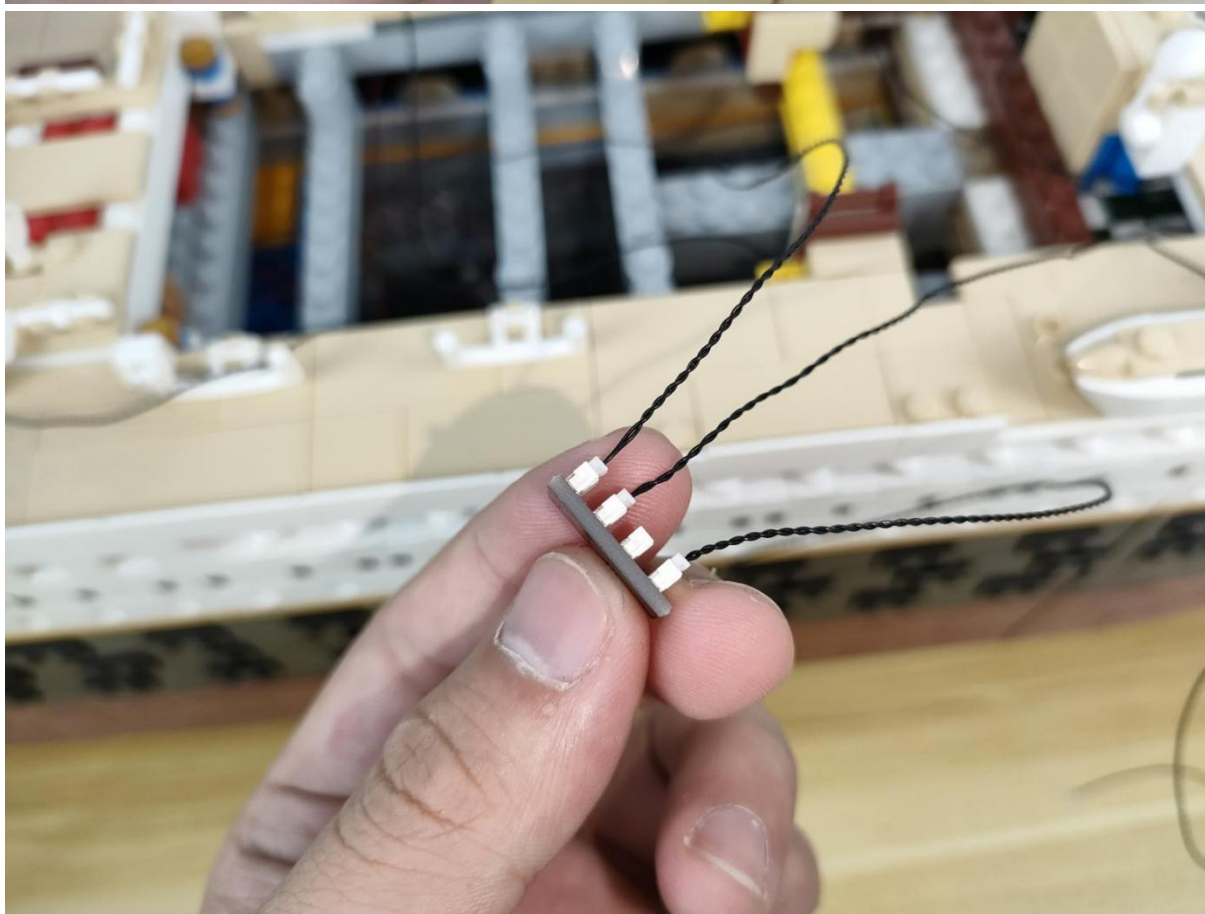
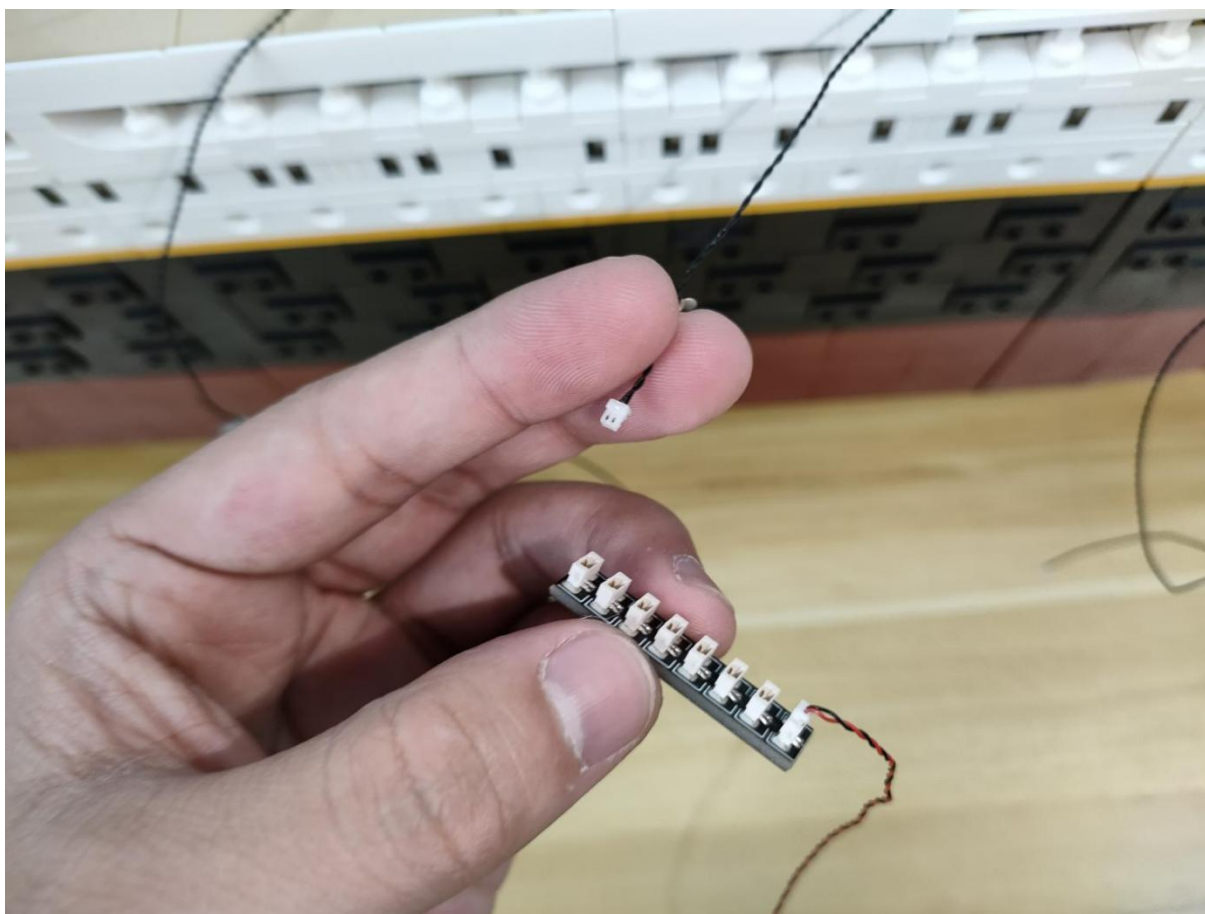

Find the connection line of the atmosphere light at the bottom of the hull.

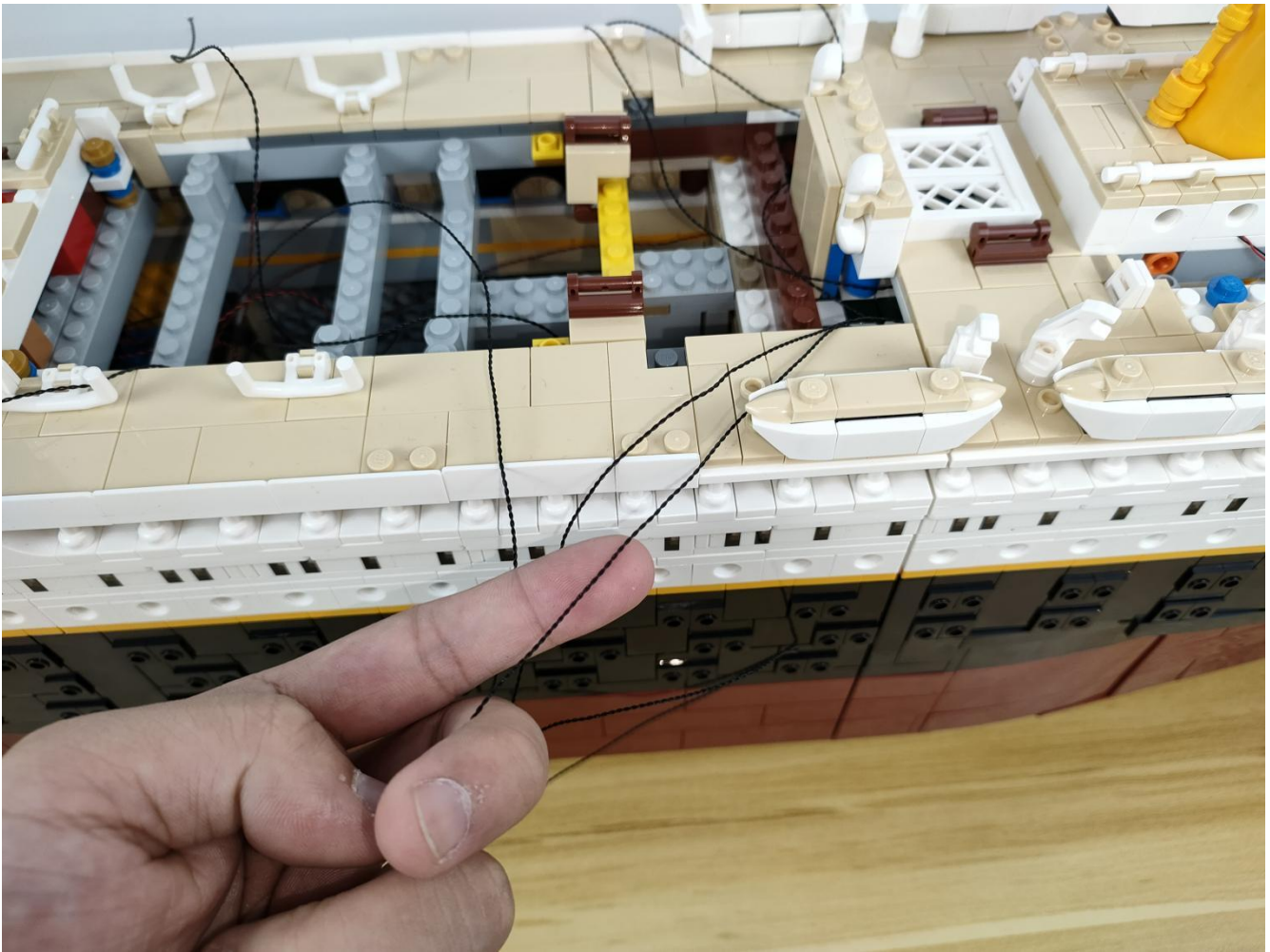

Connect the ambient light at the bottom of the hull to the power source and see if the stern light is lit.

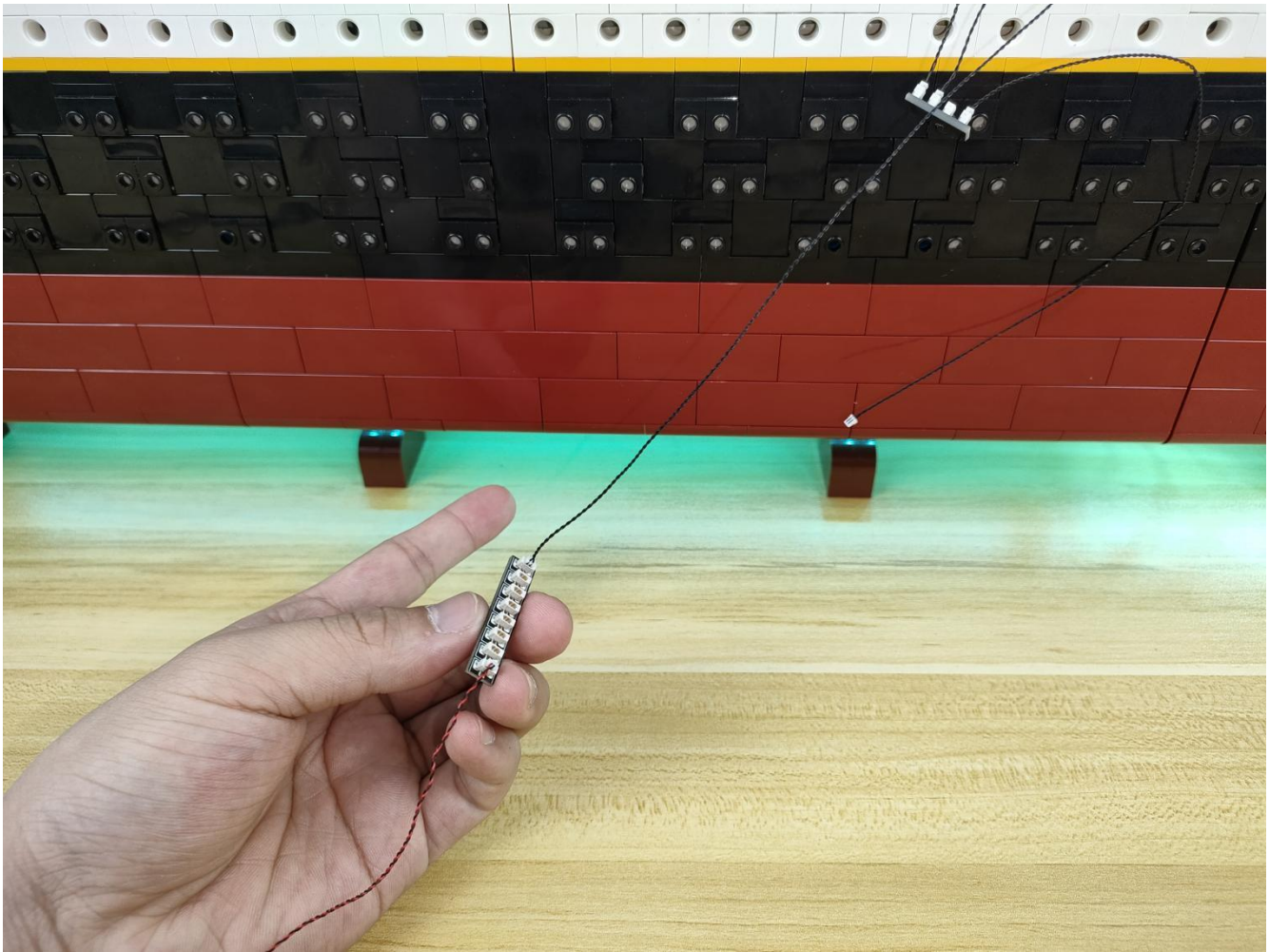

Then remove the connecting wire of the atmosphere light at the bottom of the hull and connect it to the four expansion board.

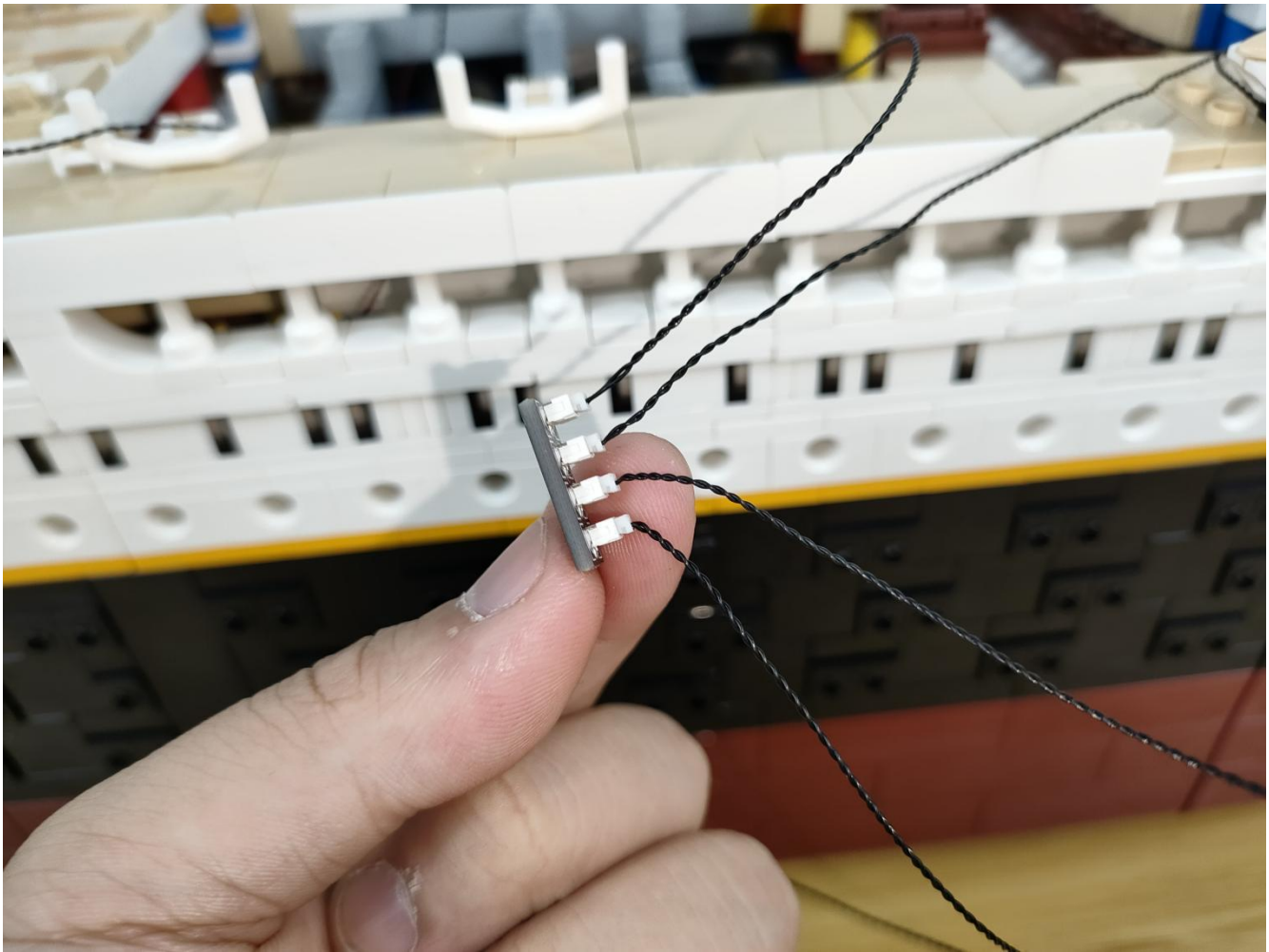

Find the connection line of the lights on the first floor of the hull.

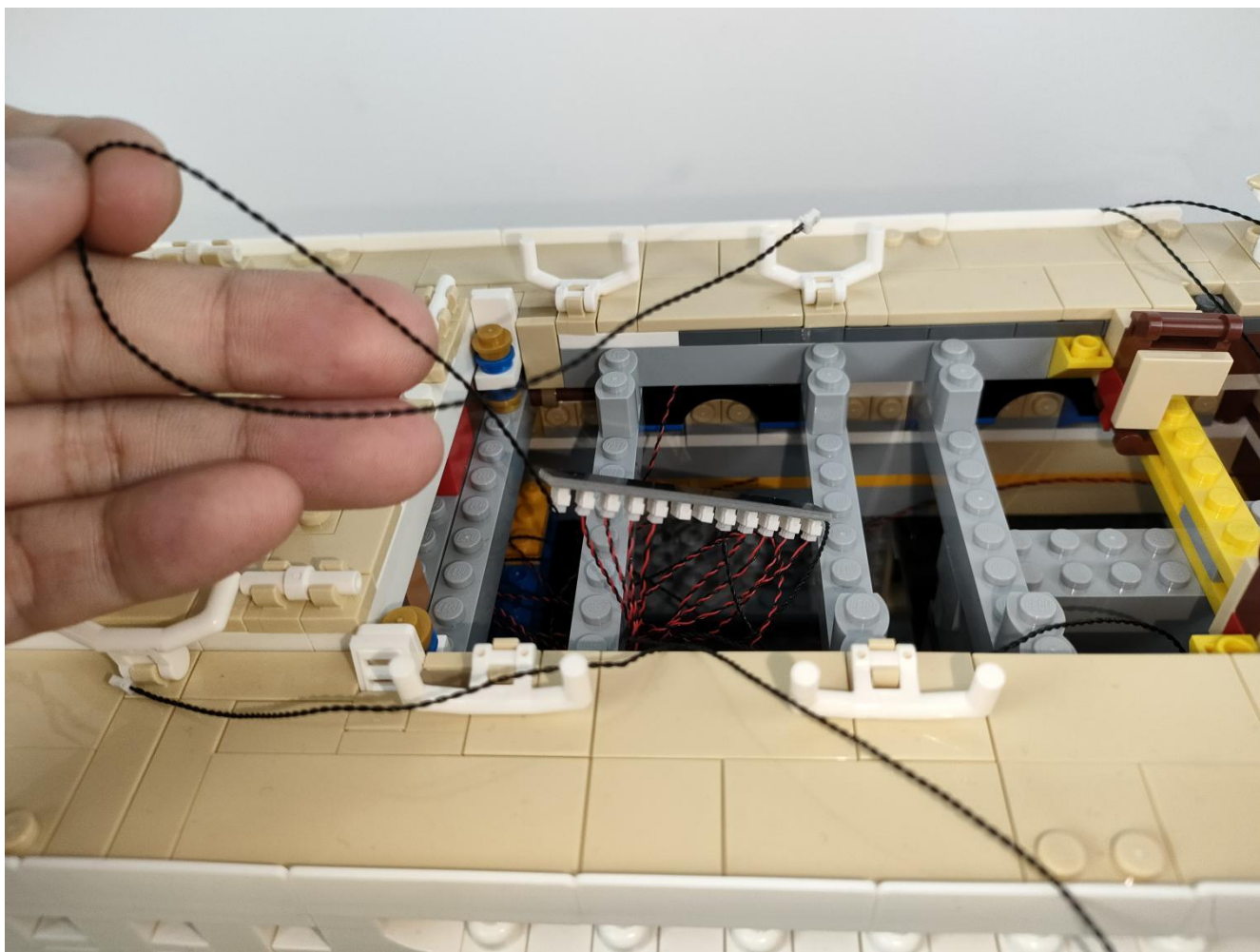

Connect the connecting line of the light on the first floor of the hull to the power source and see if the light on the first floor of the hull is lit.

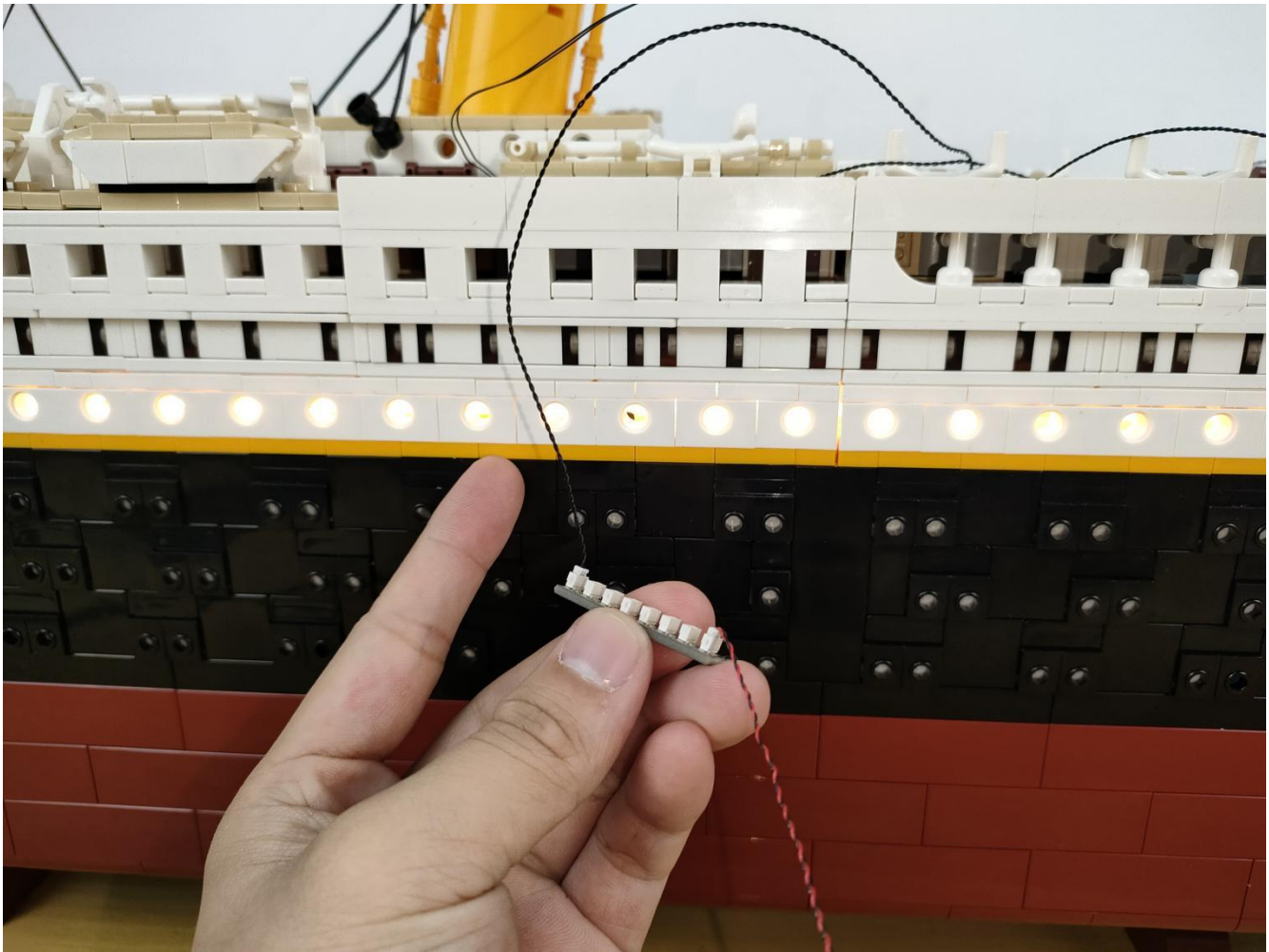

Find another connection line for the lights on the first floor of the hull.

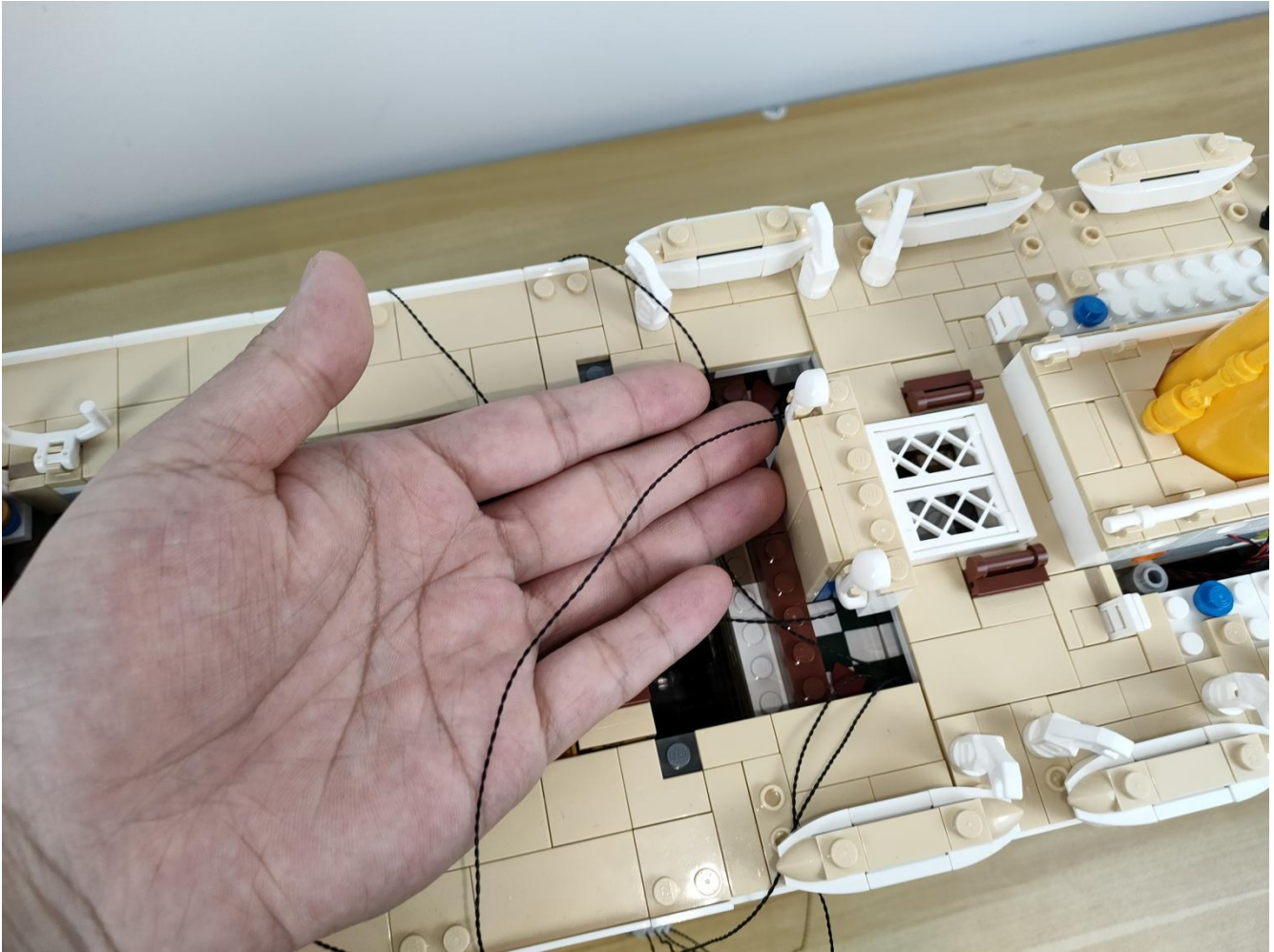

Connect the connecting line of the light on the first floor of the hull to the power source and see if the light on the first floor of the hull is lit.



Then thread the found thread into the hull.

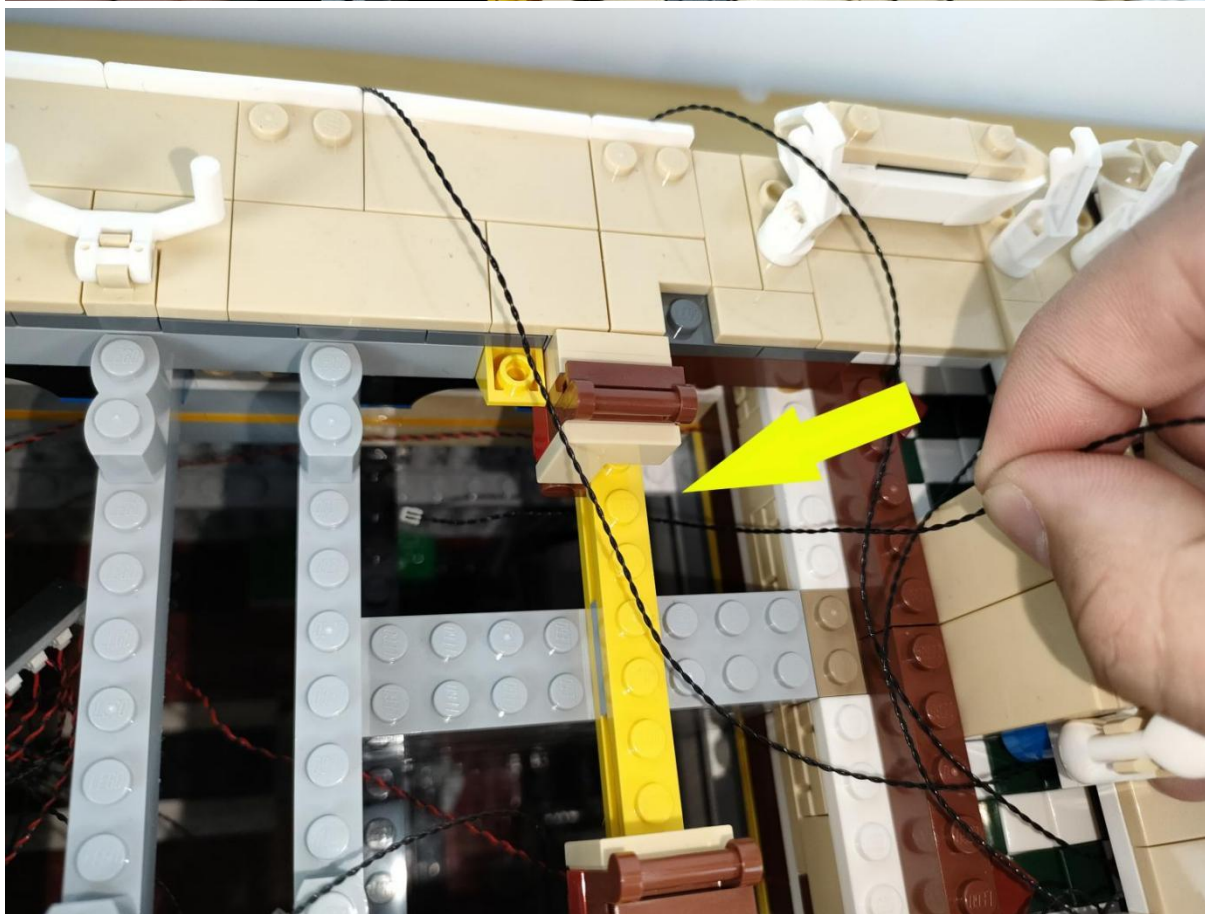
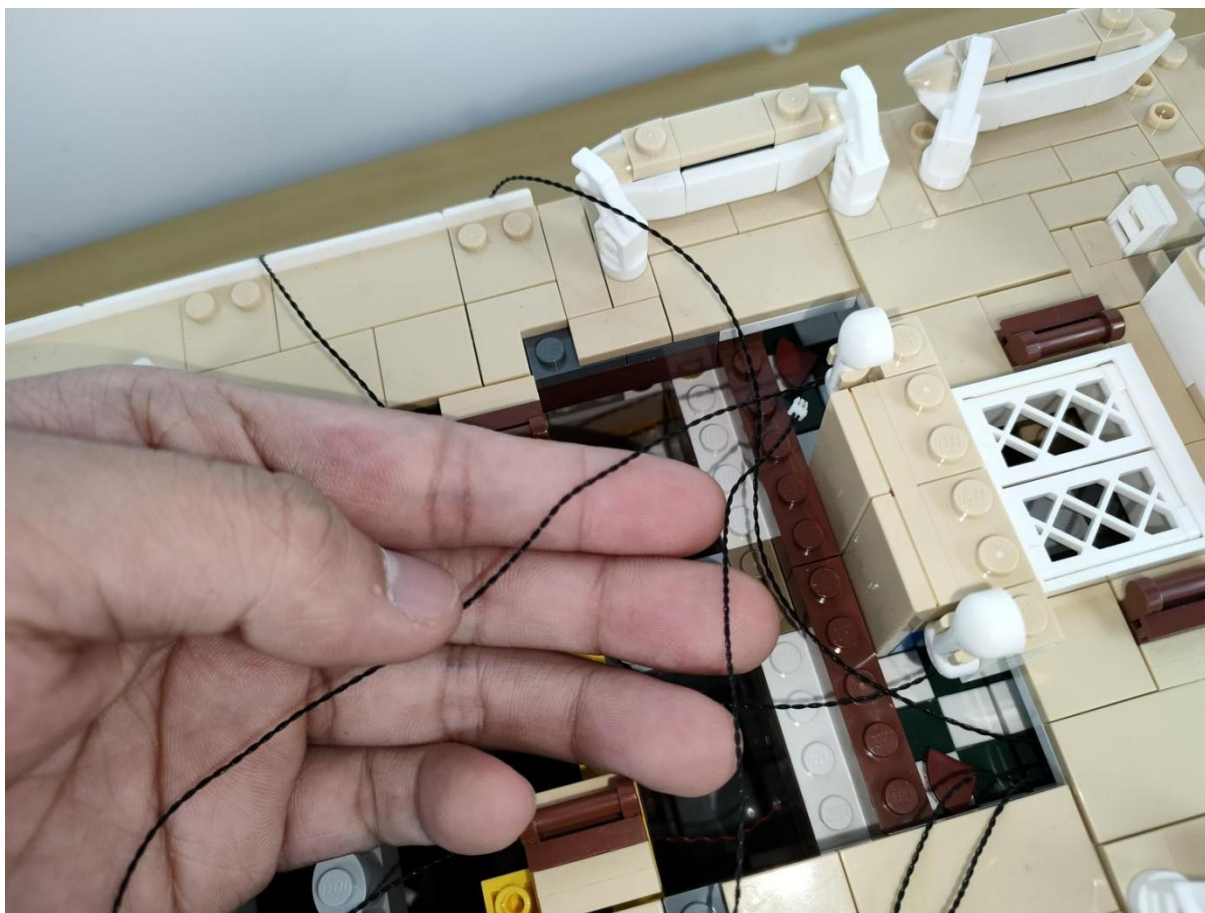

Pull it to the left, and then connect it to the expansion board.

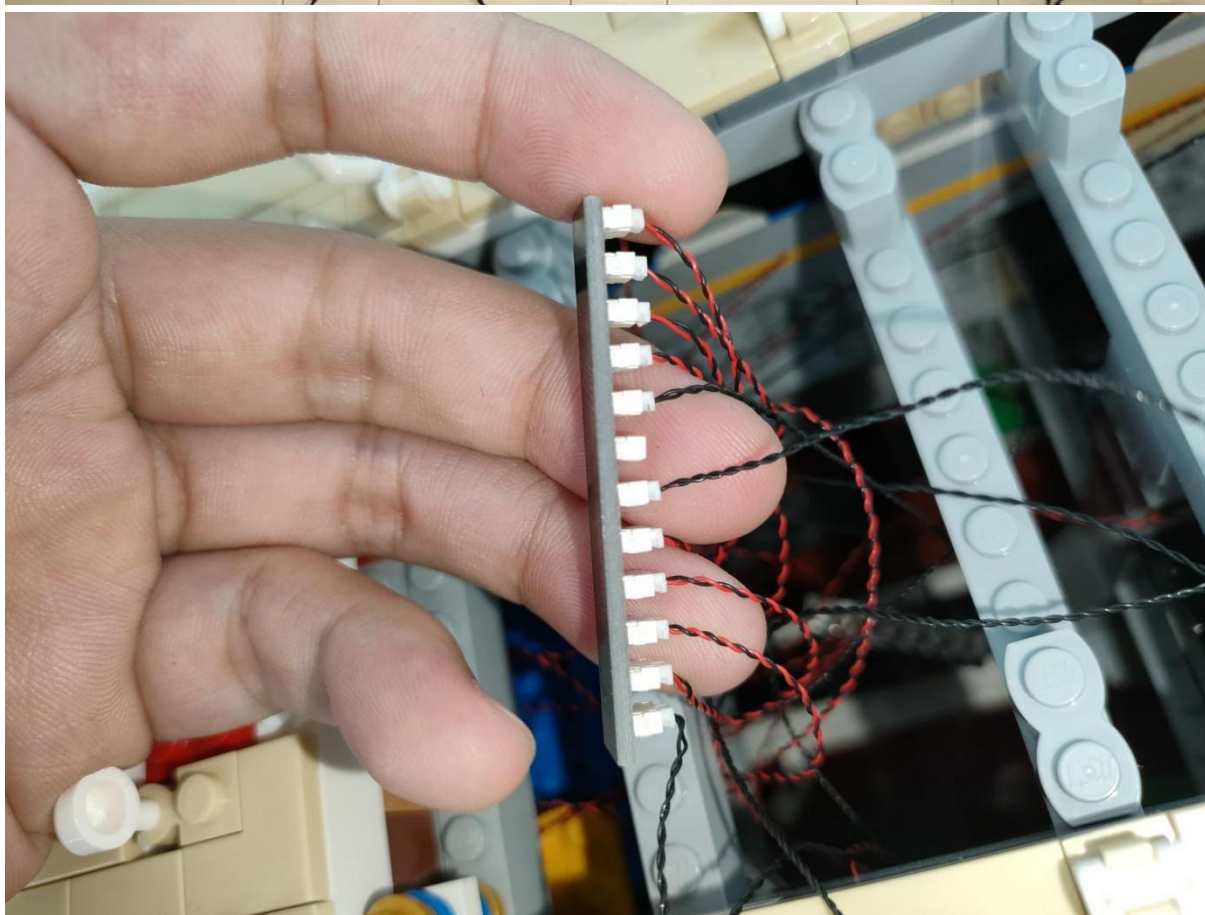
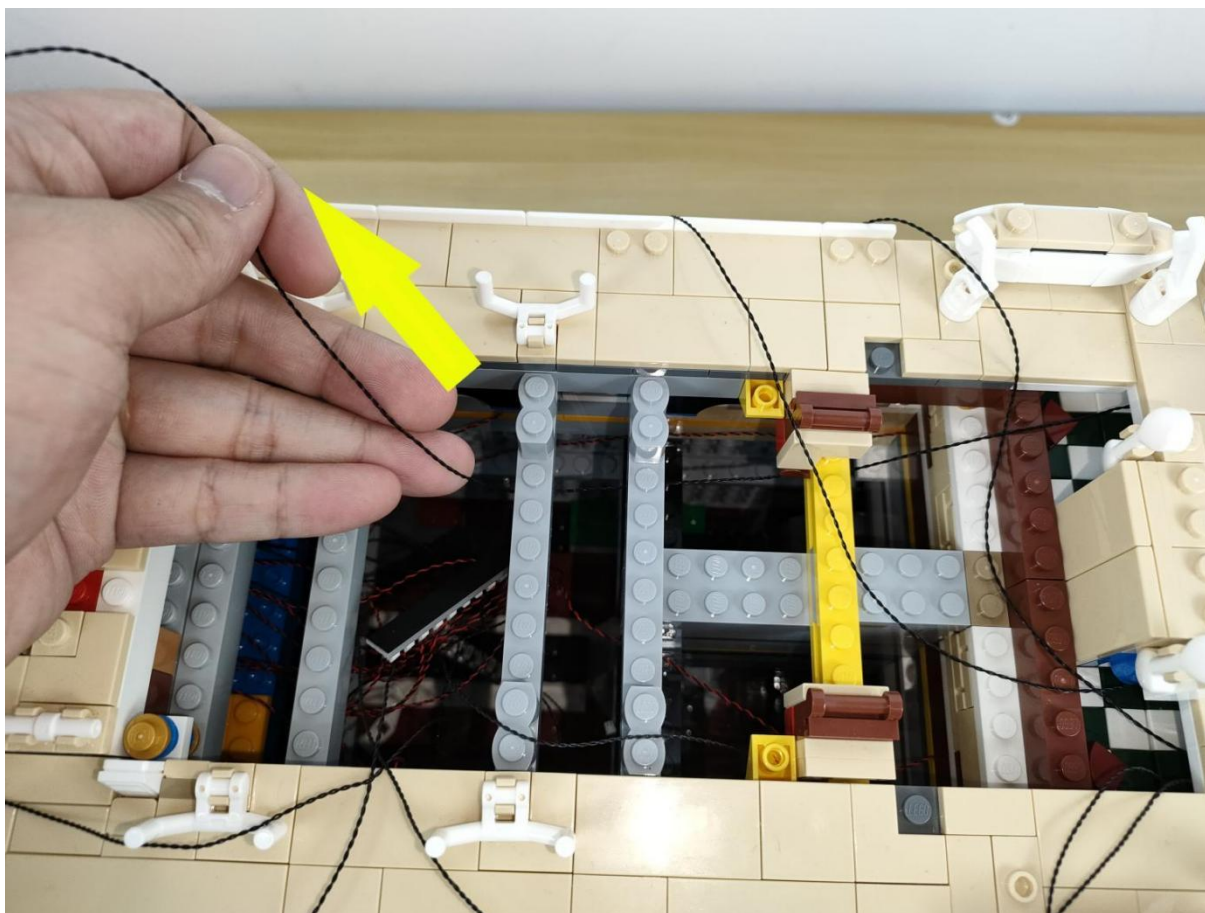

Unplug the 20cm cable on the 12 expansion board from the power supply and place it at the position shown in the figure.

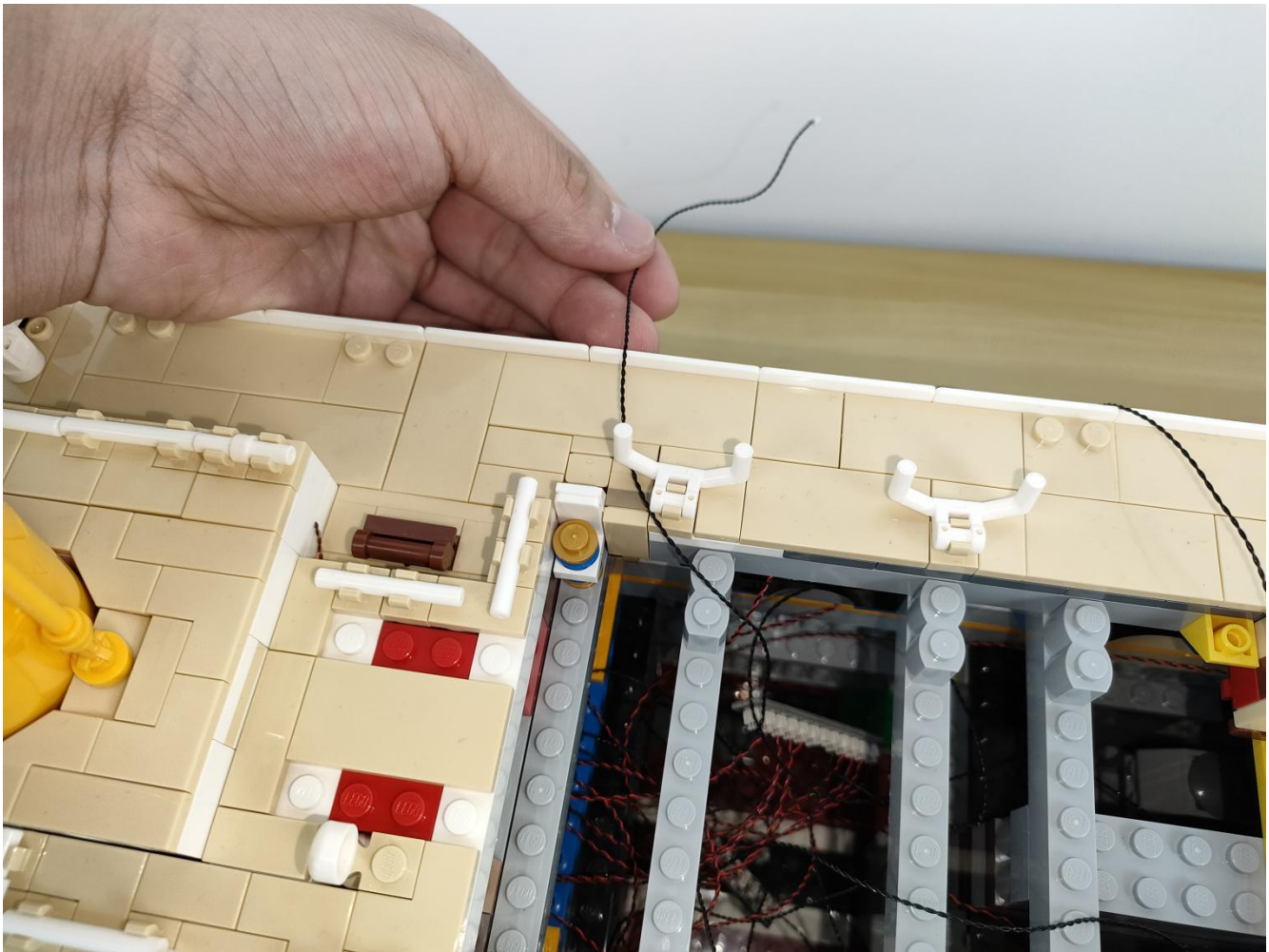

Locate the light connection line on the second floor of the hull.

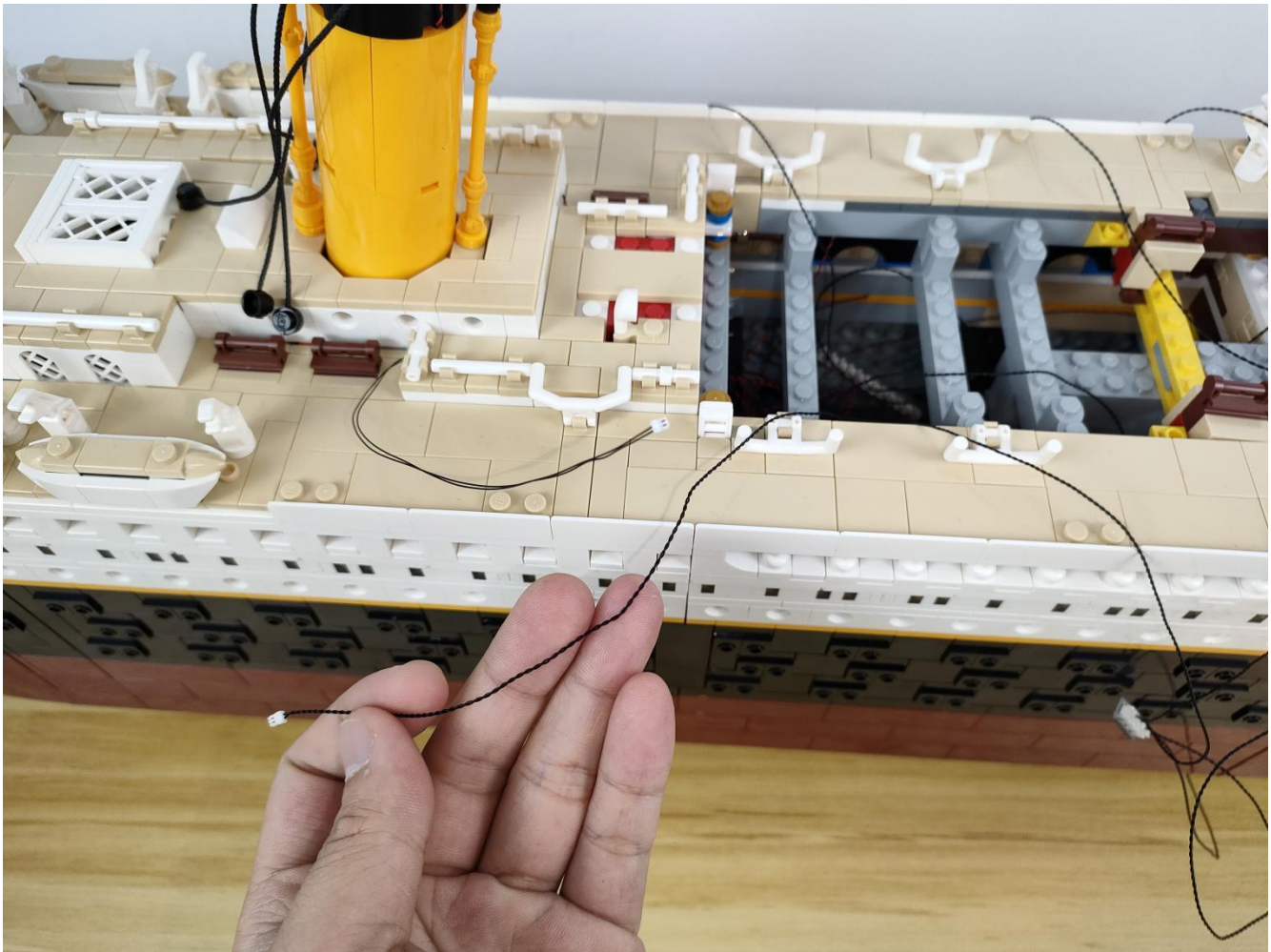

Connect the connecting line of the lamp on the second floor of the hull to the power source and see if the lamp on the second floor of the hull is lit.

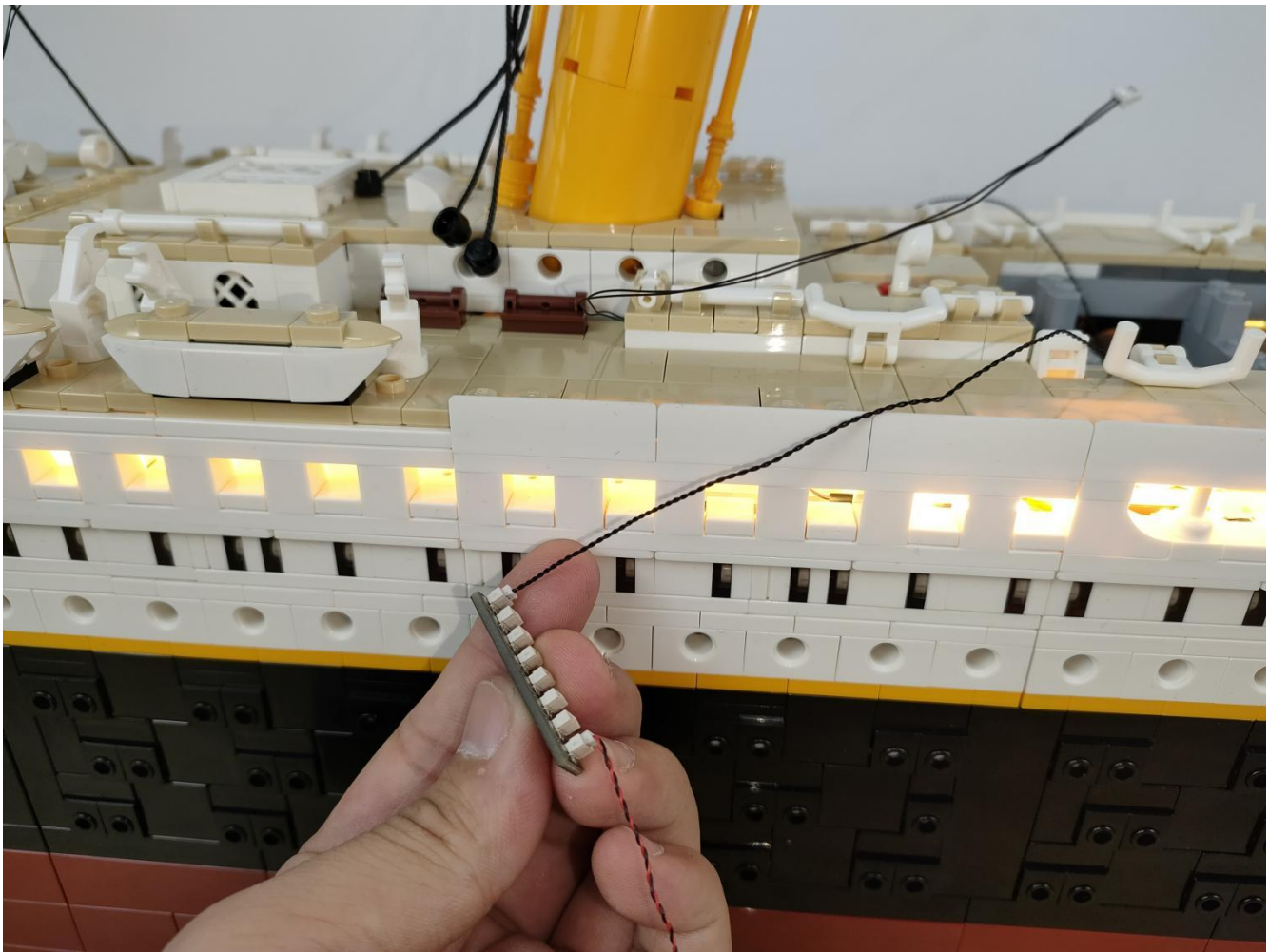

Find another second floor lamp connection line.

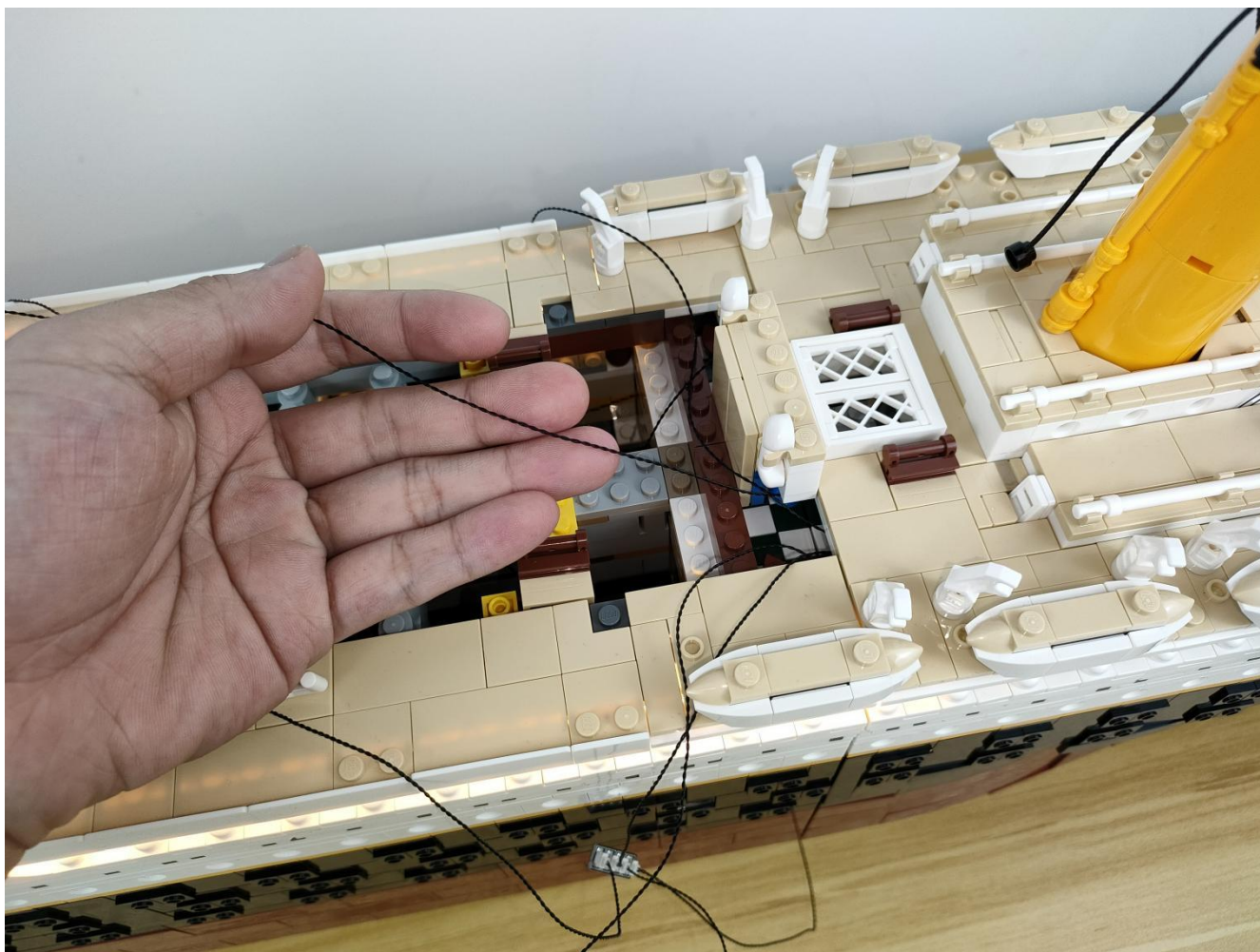

Connect the connecting line of the lamp on the second floor of the hull to the power source and see if the lamp on the second floor of the hull is lit.

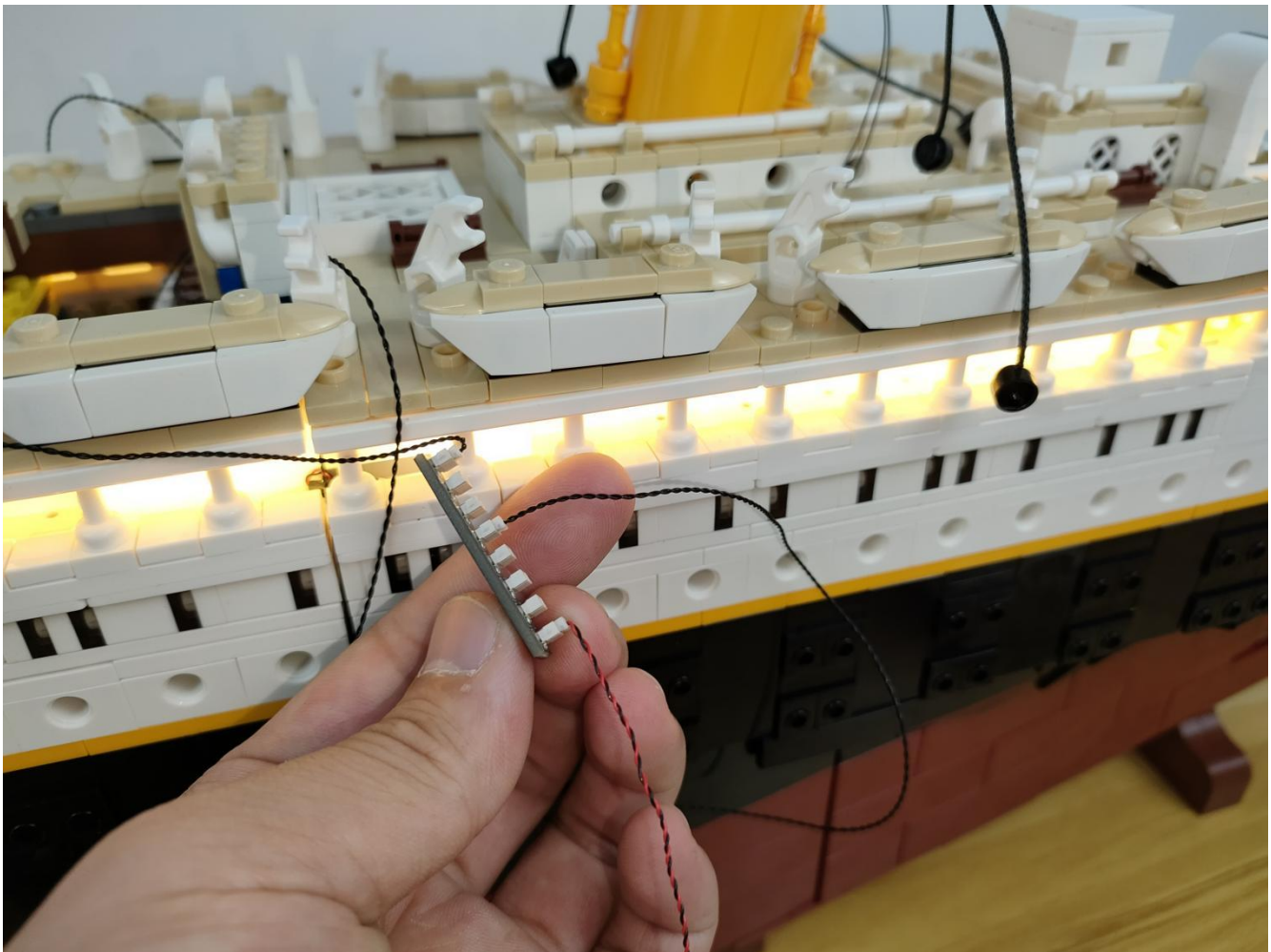

Take off the connection line of the lamp on the second floor of the hull from the power supply.

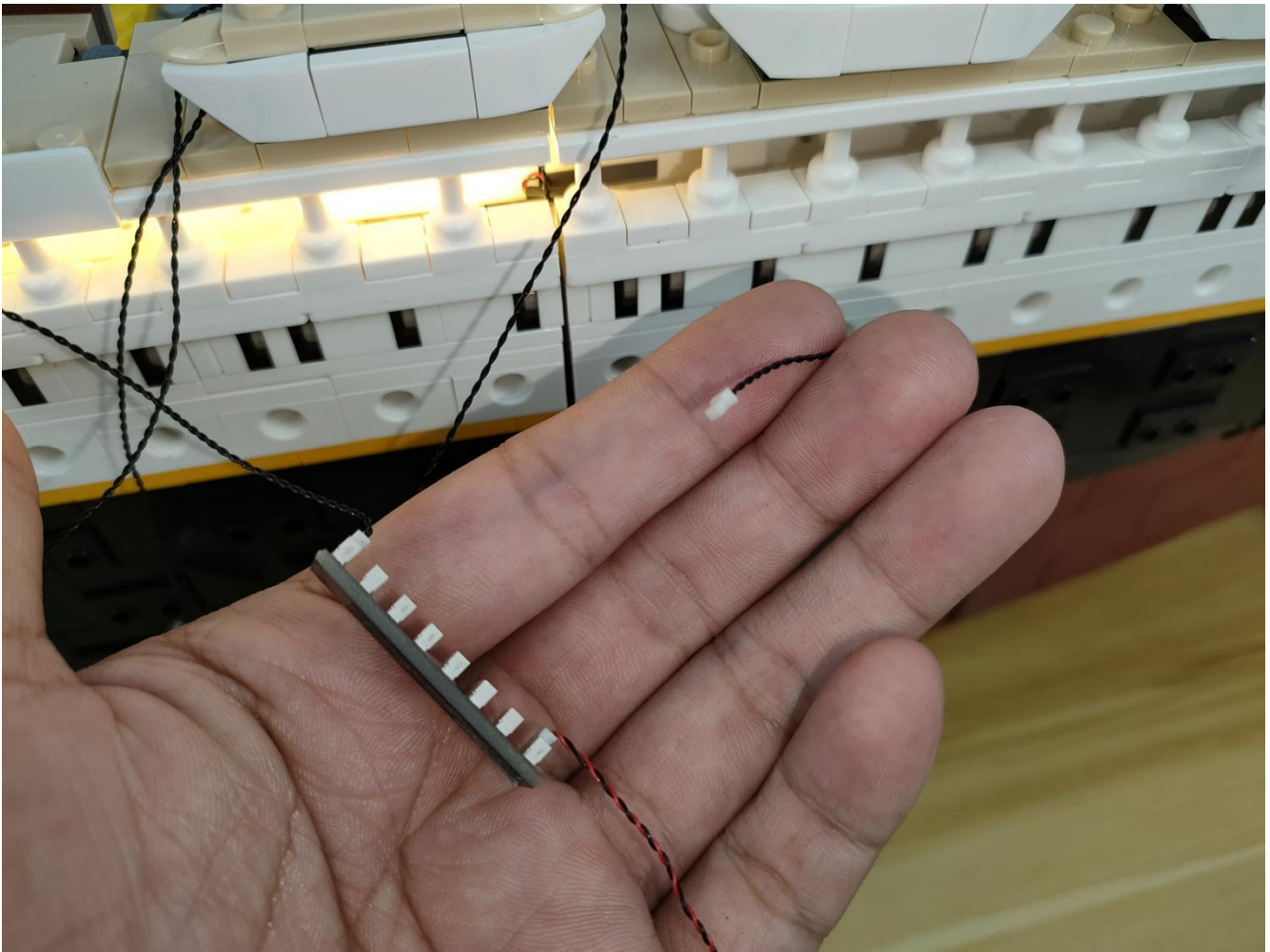

Pass the connecting line of the lamp on the second floor of the hull through the building block at the bottom and pull it to the left.

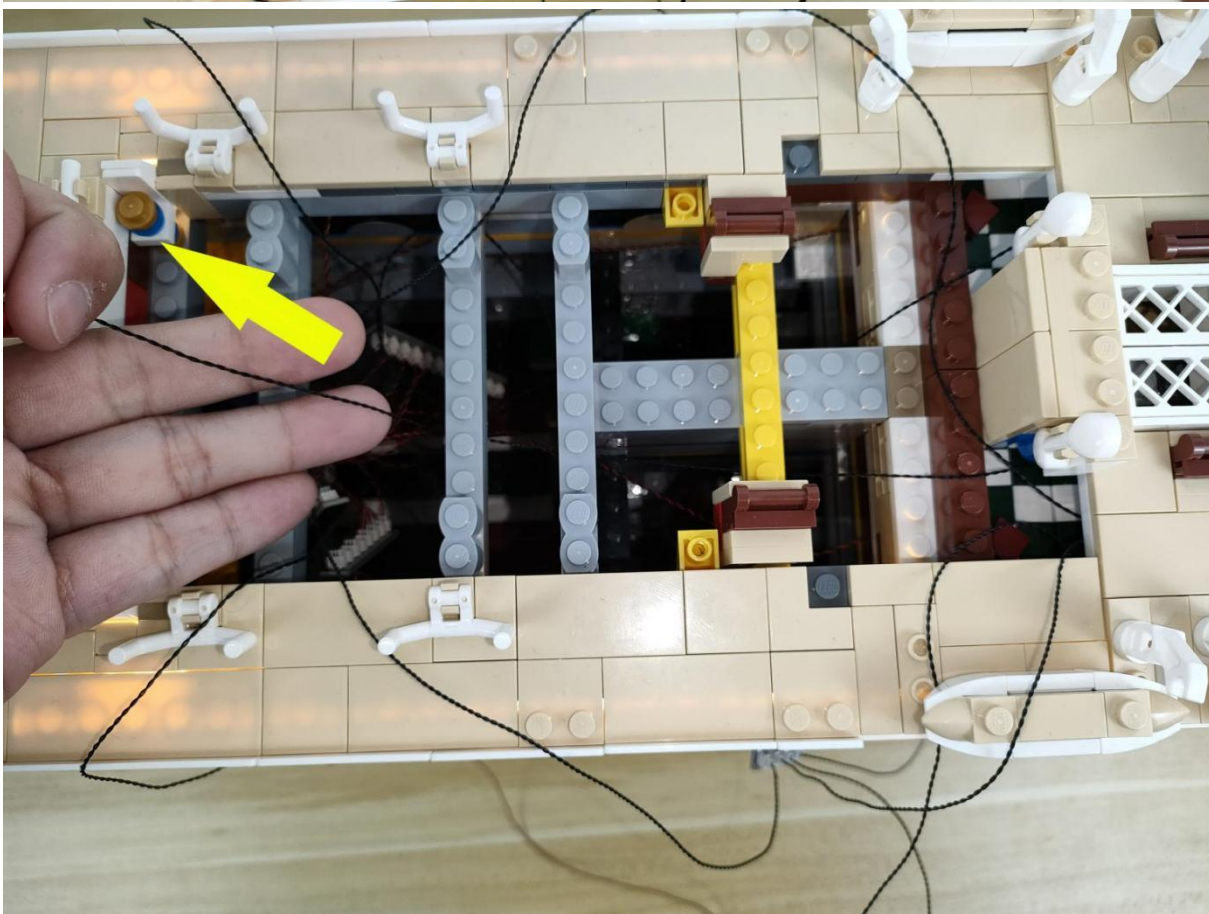
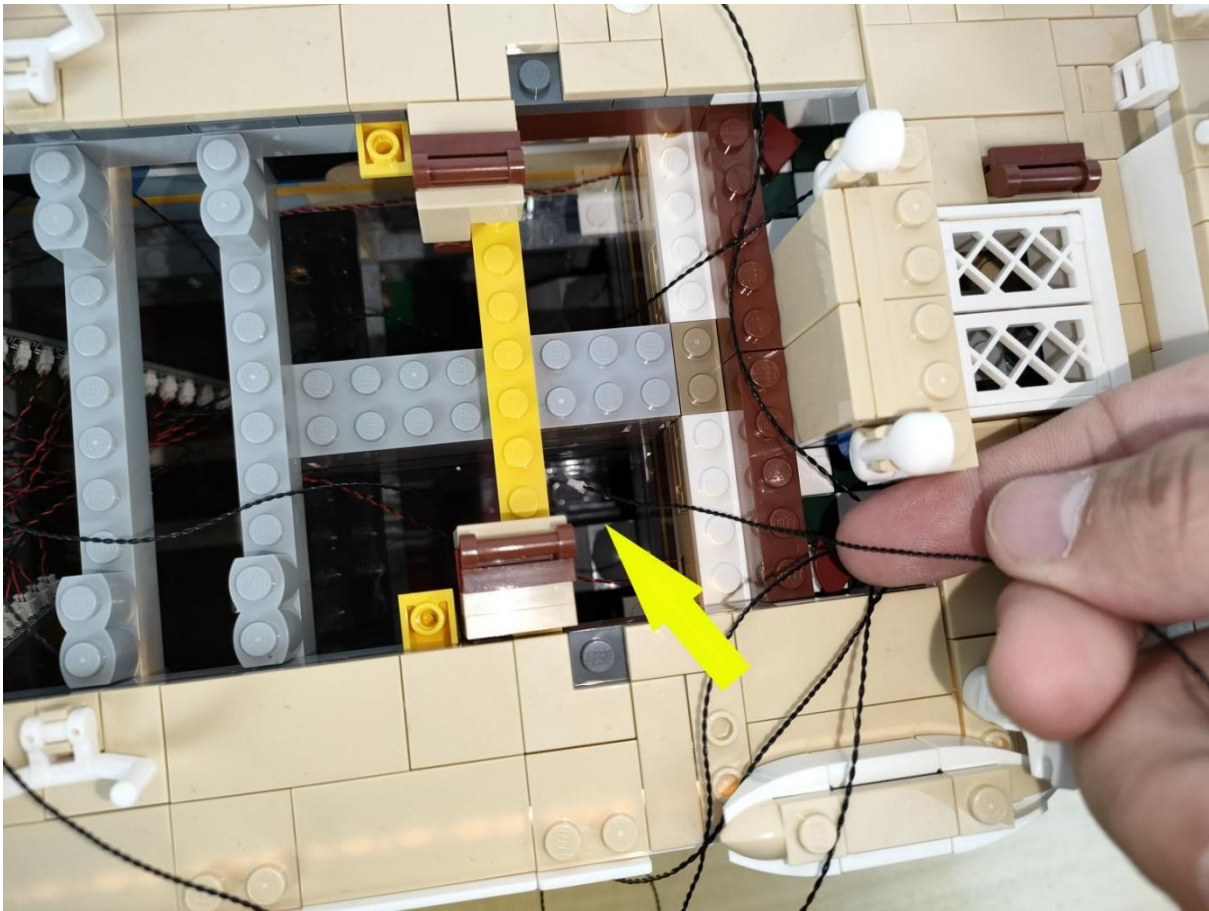

Connect the cable just pulled over to the 8-seat expansion board in the picture.

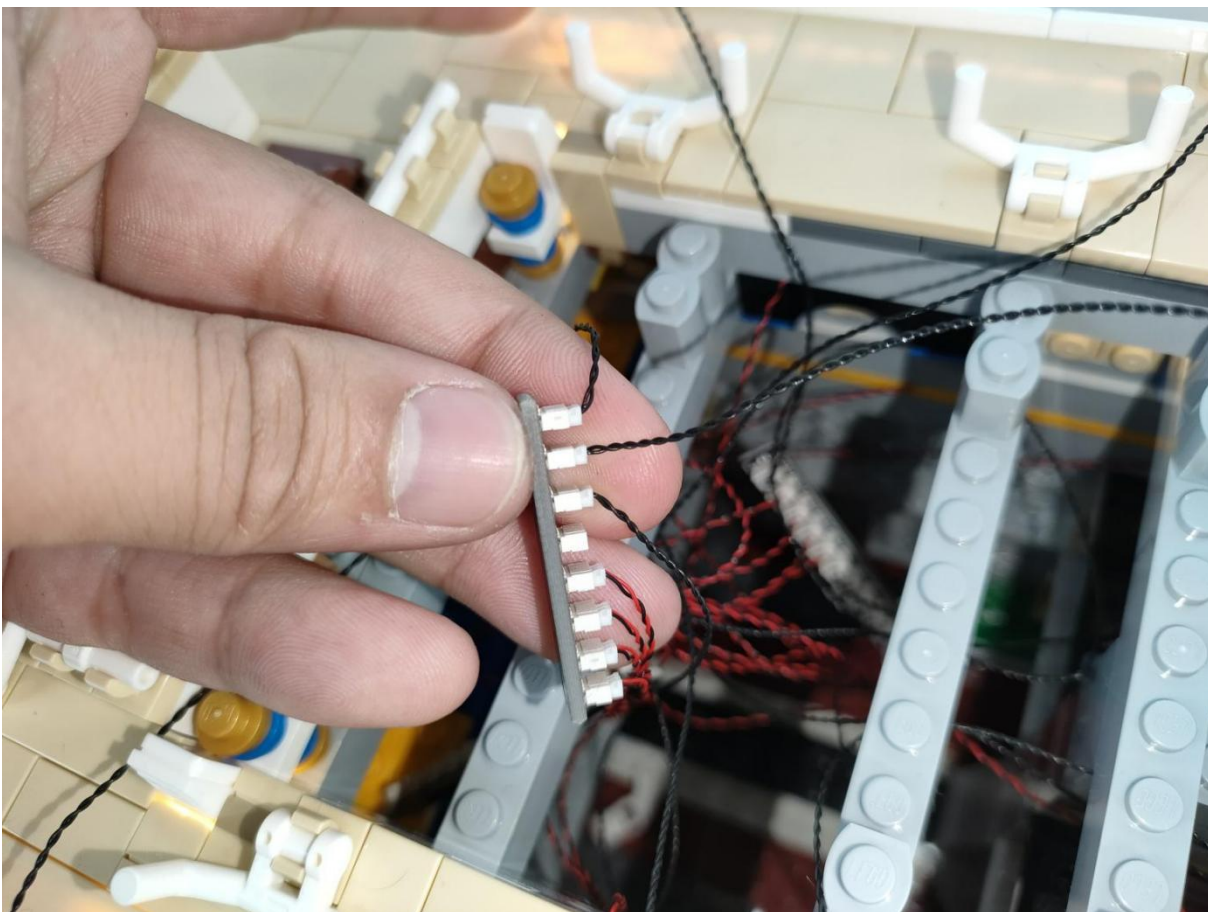
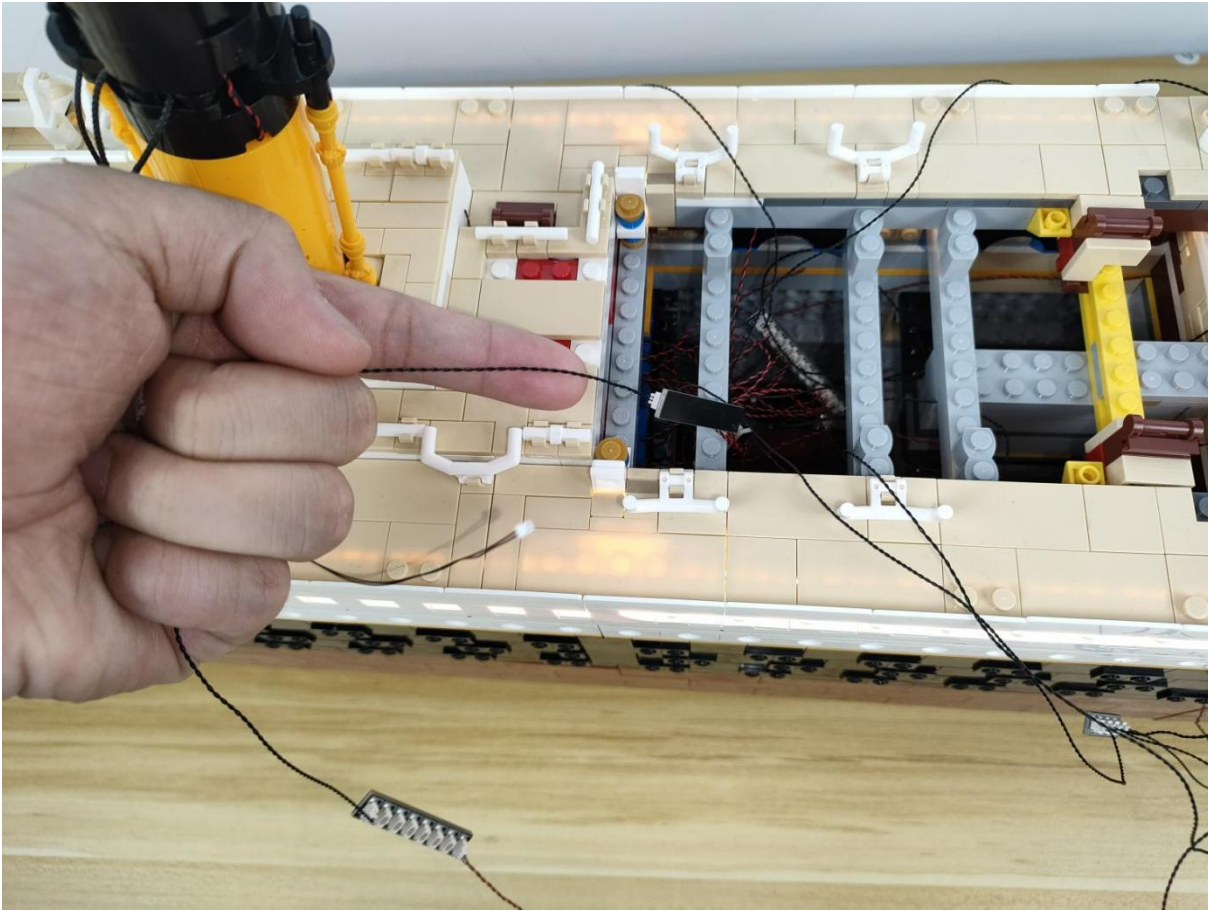

Unplug the 20cm cable on the 8-seater expansion board from the power supply.

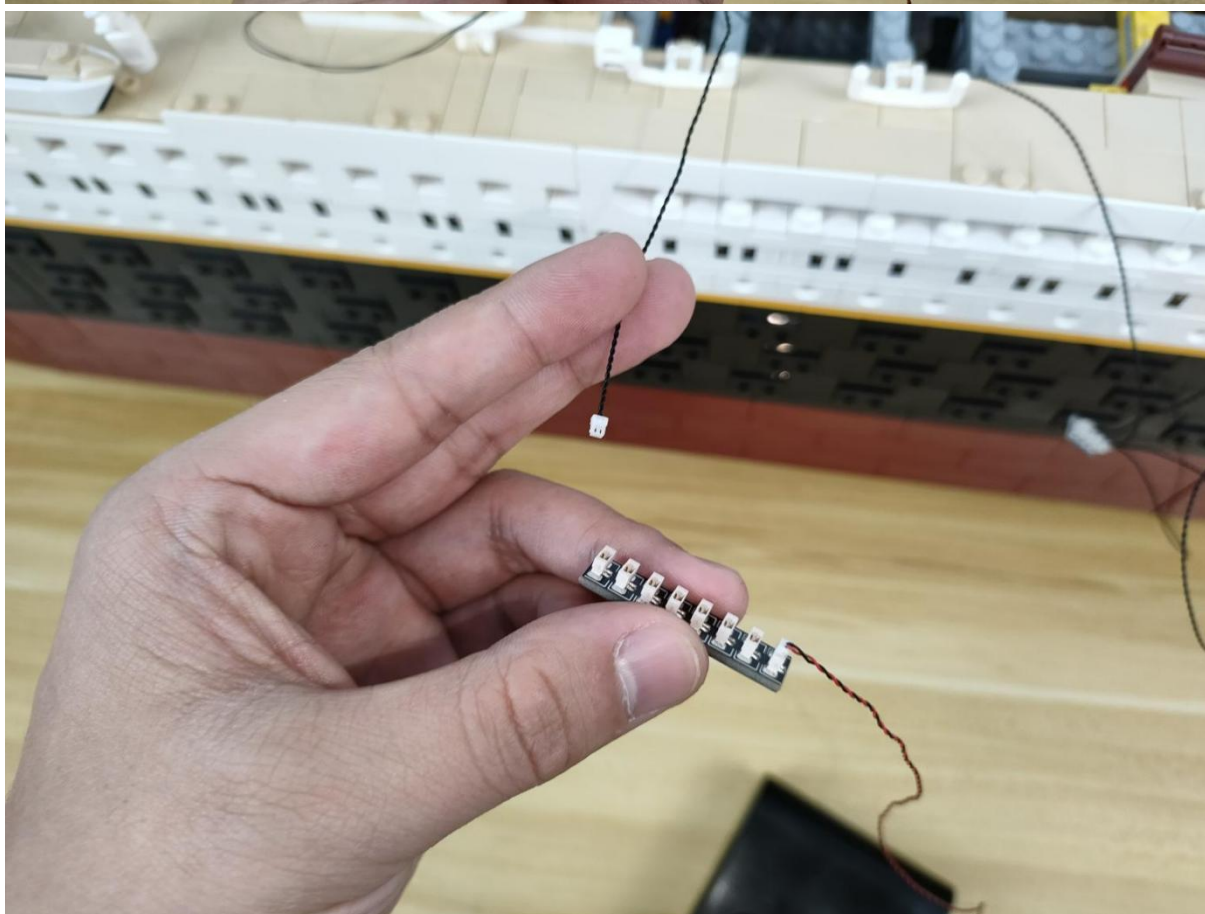
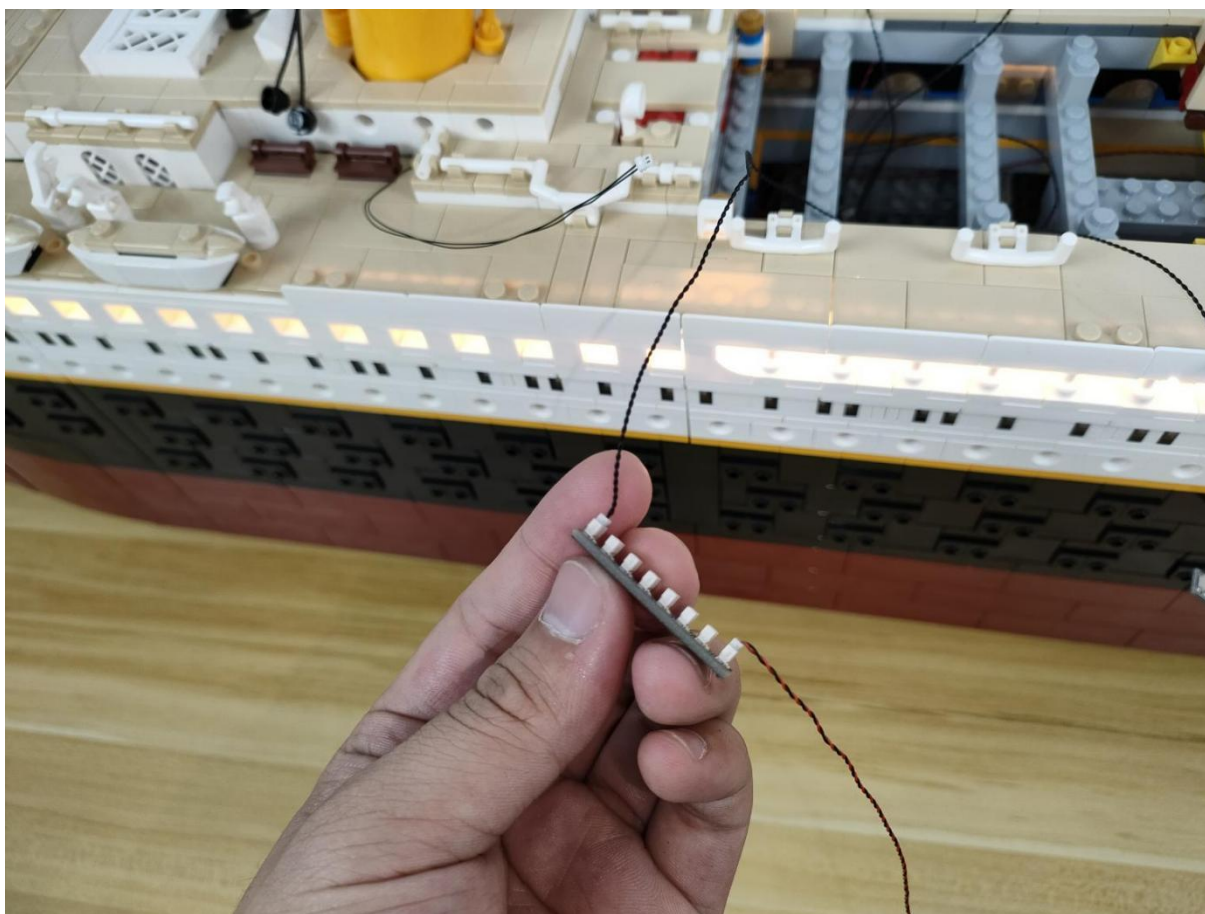

Then place it in the position in the picture.

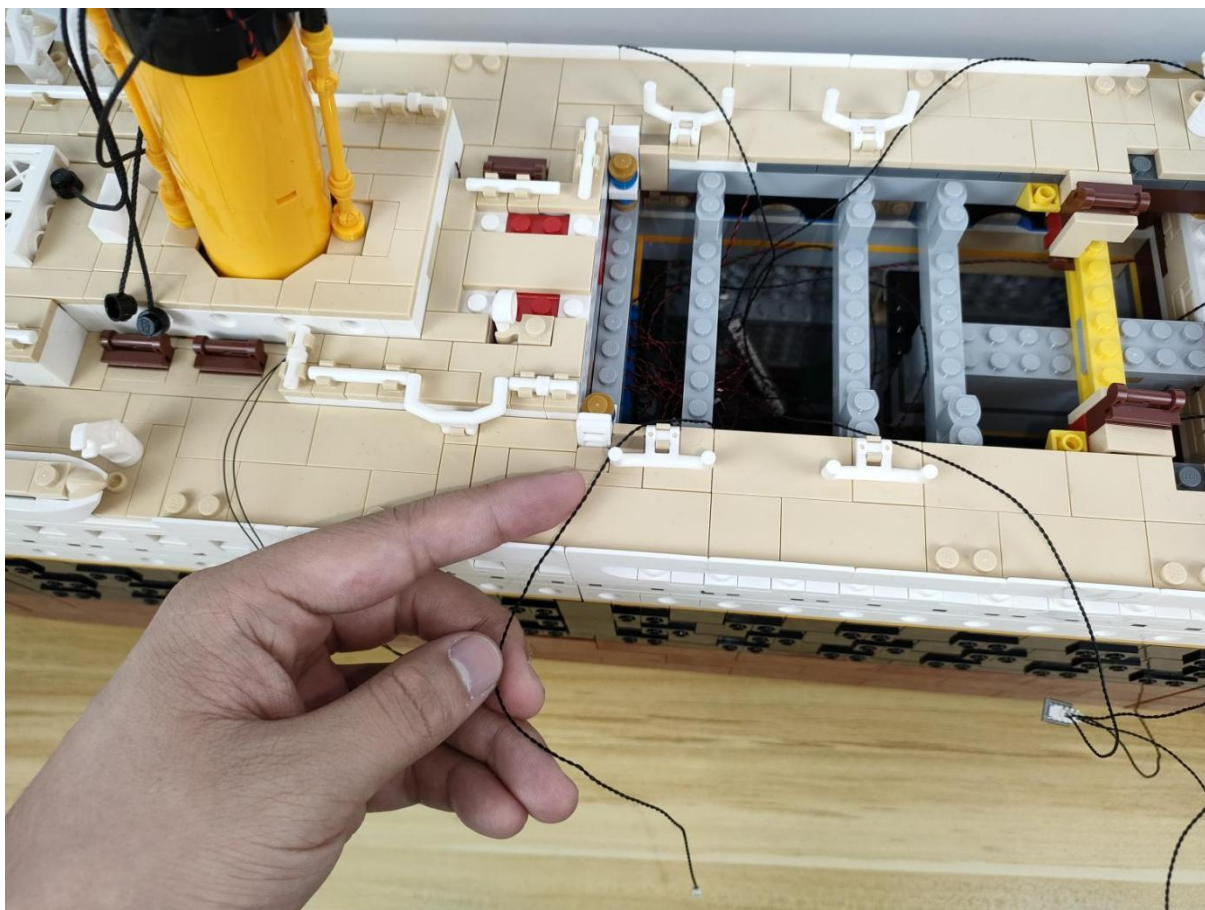

Find out the connecting wire of the deck light.

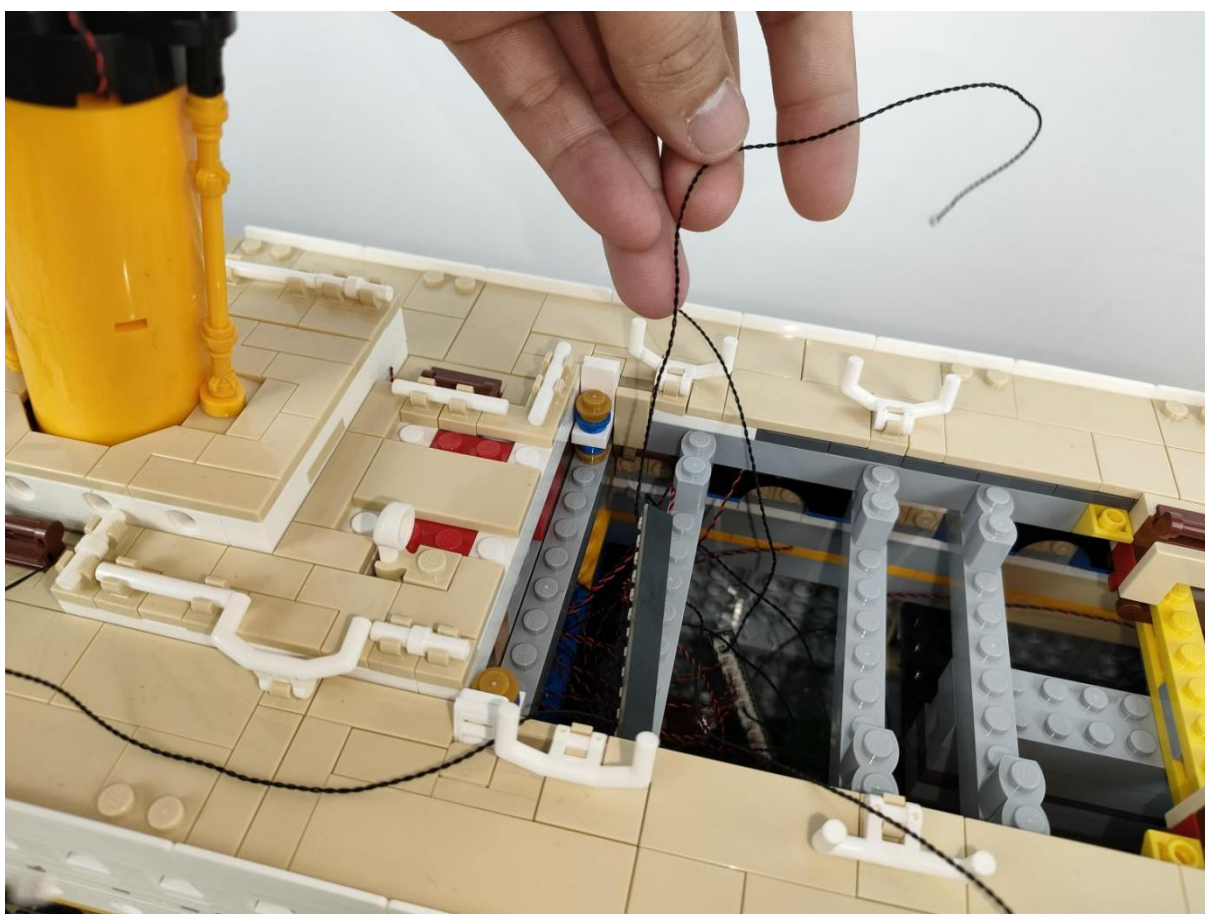

Connect the deck light cable to the power source and see if the lights on the deck are lit.



Find the connection line of another deck light.

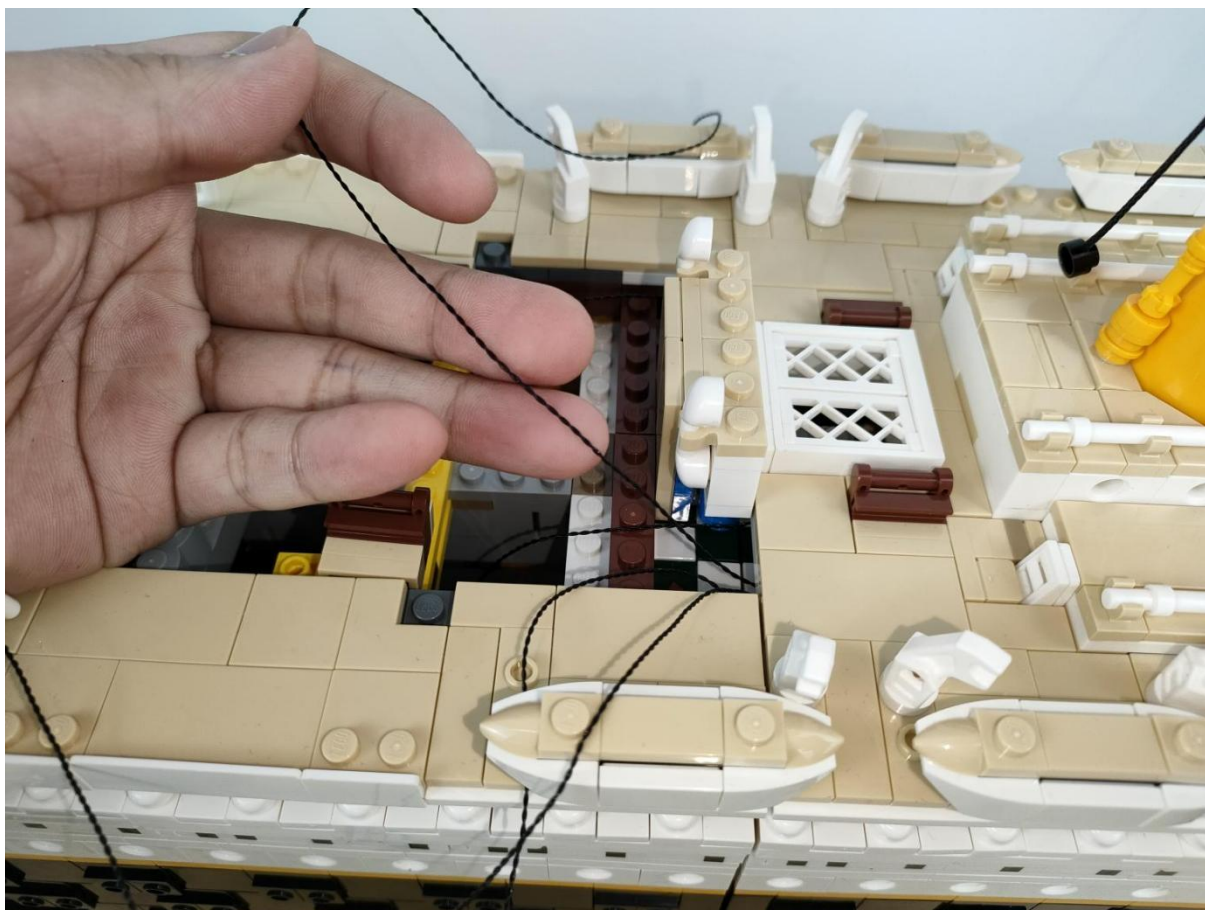

Connect the power supply to see if it is lit.

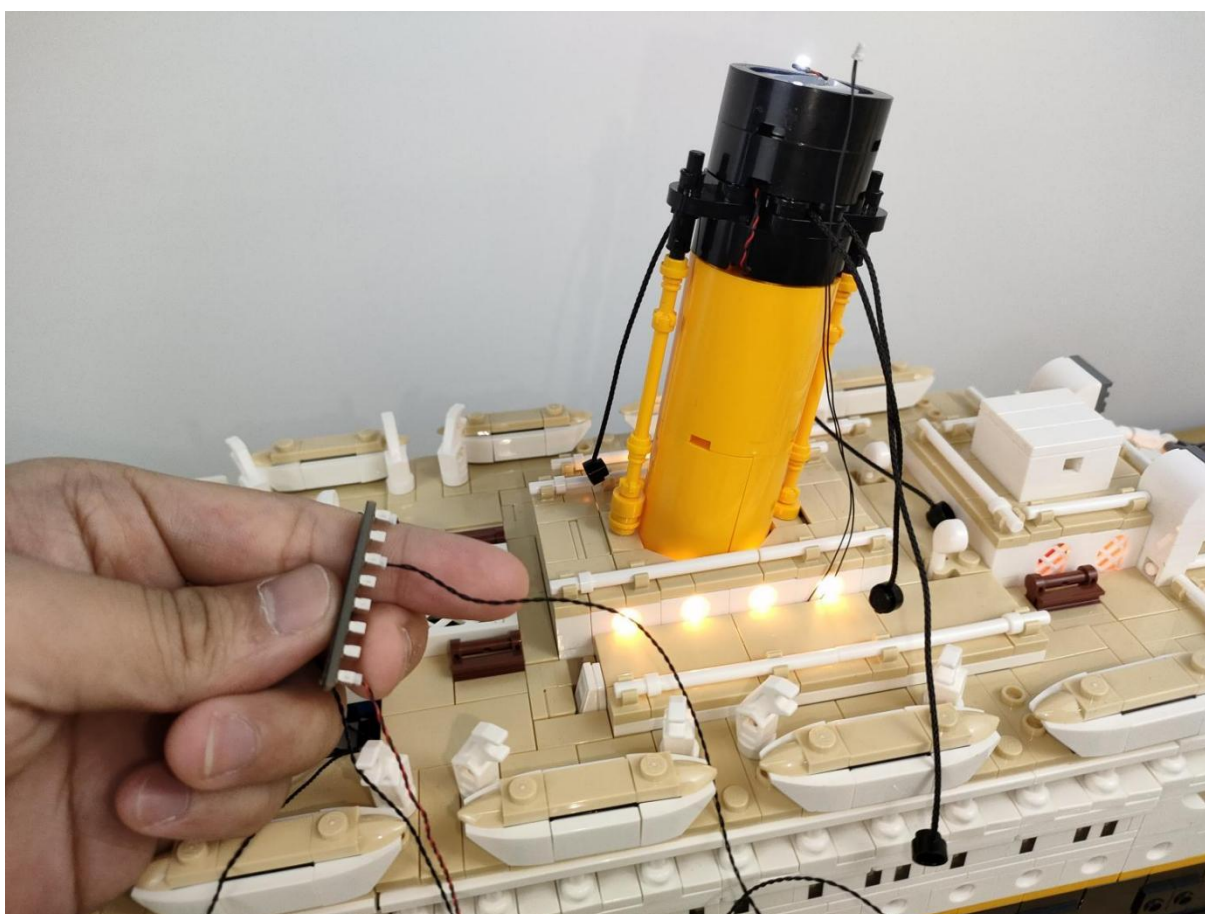

After confirmation, remove the deck light cable from the power supply.

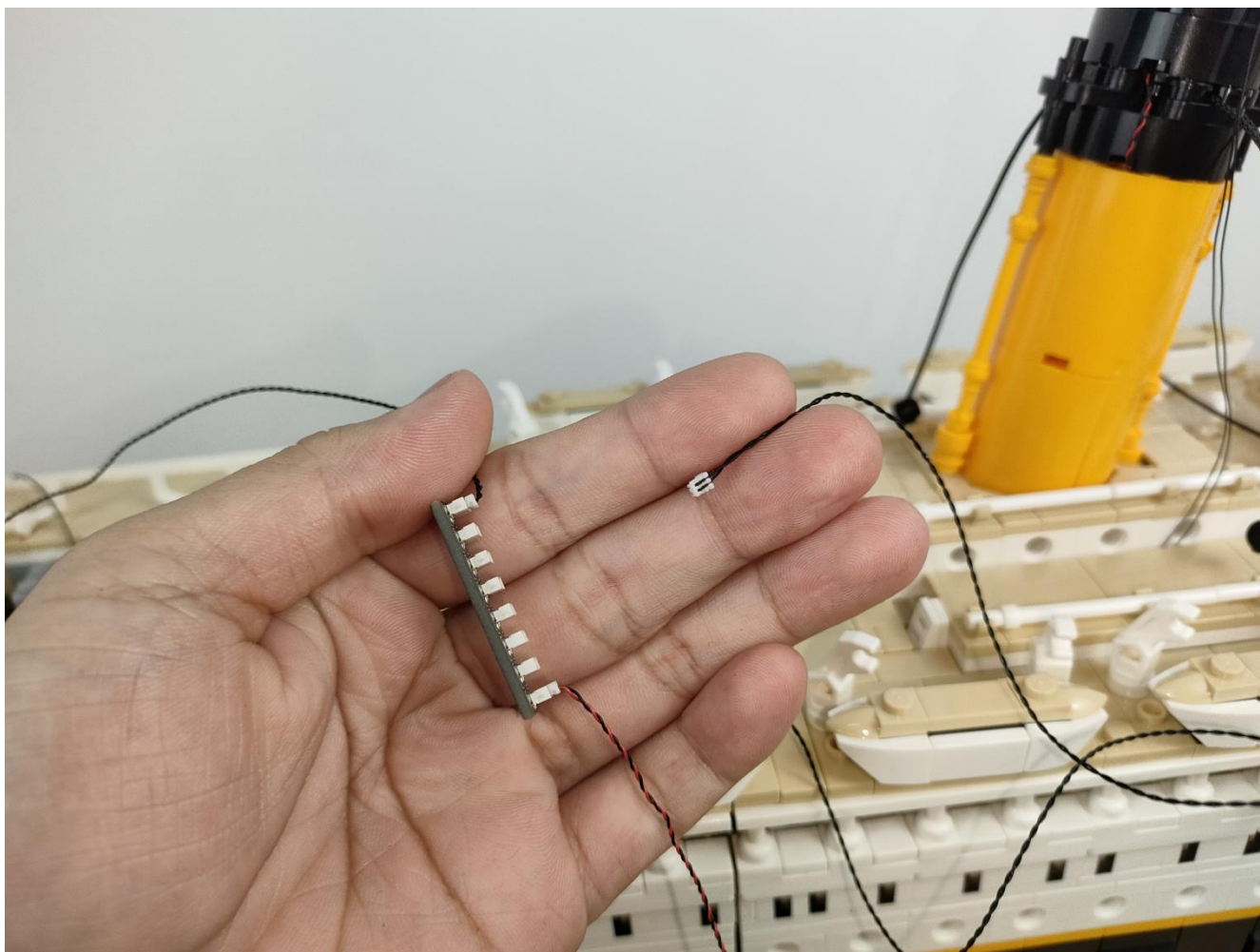

Pass the deck light connection line through the bottom block part and pull it to the left.

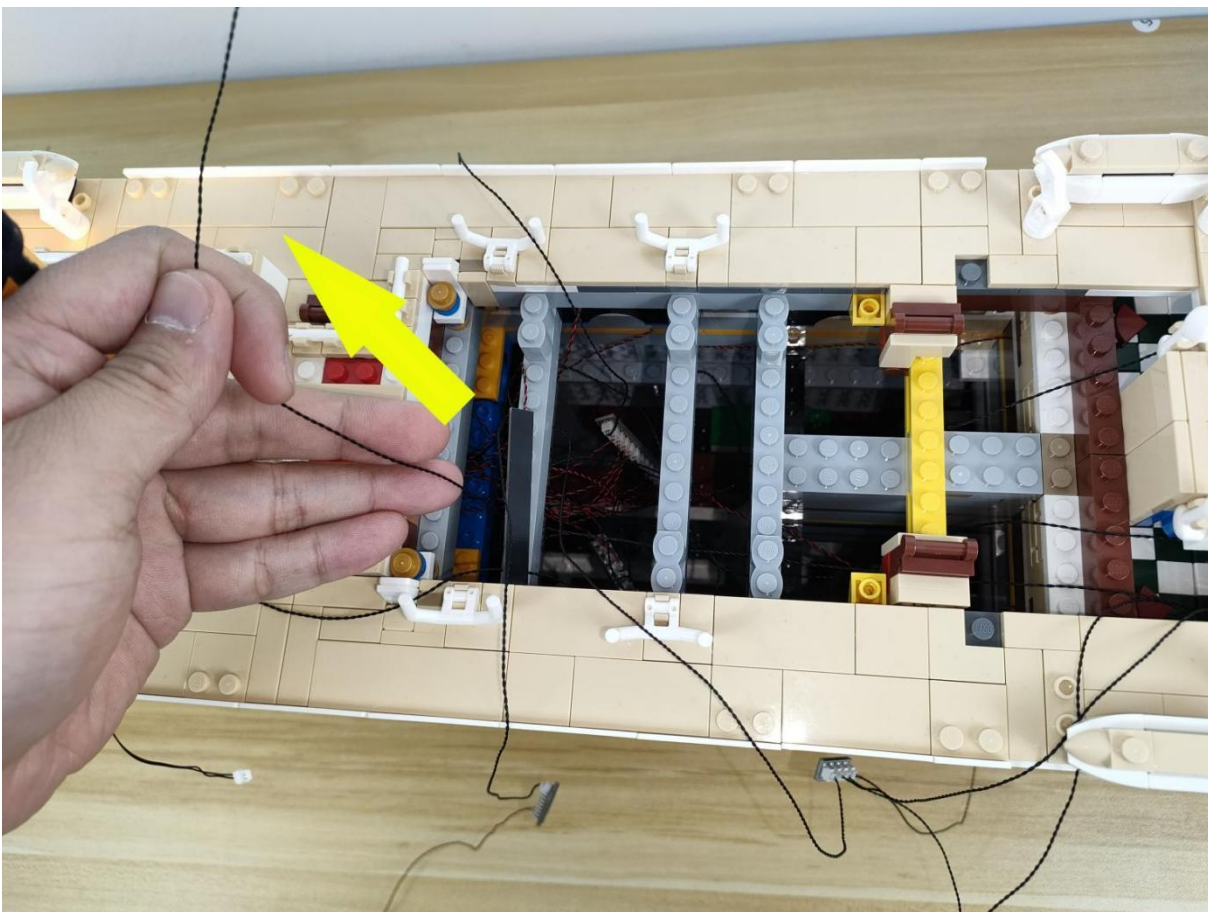
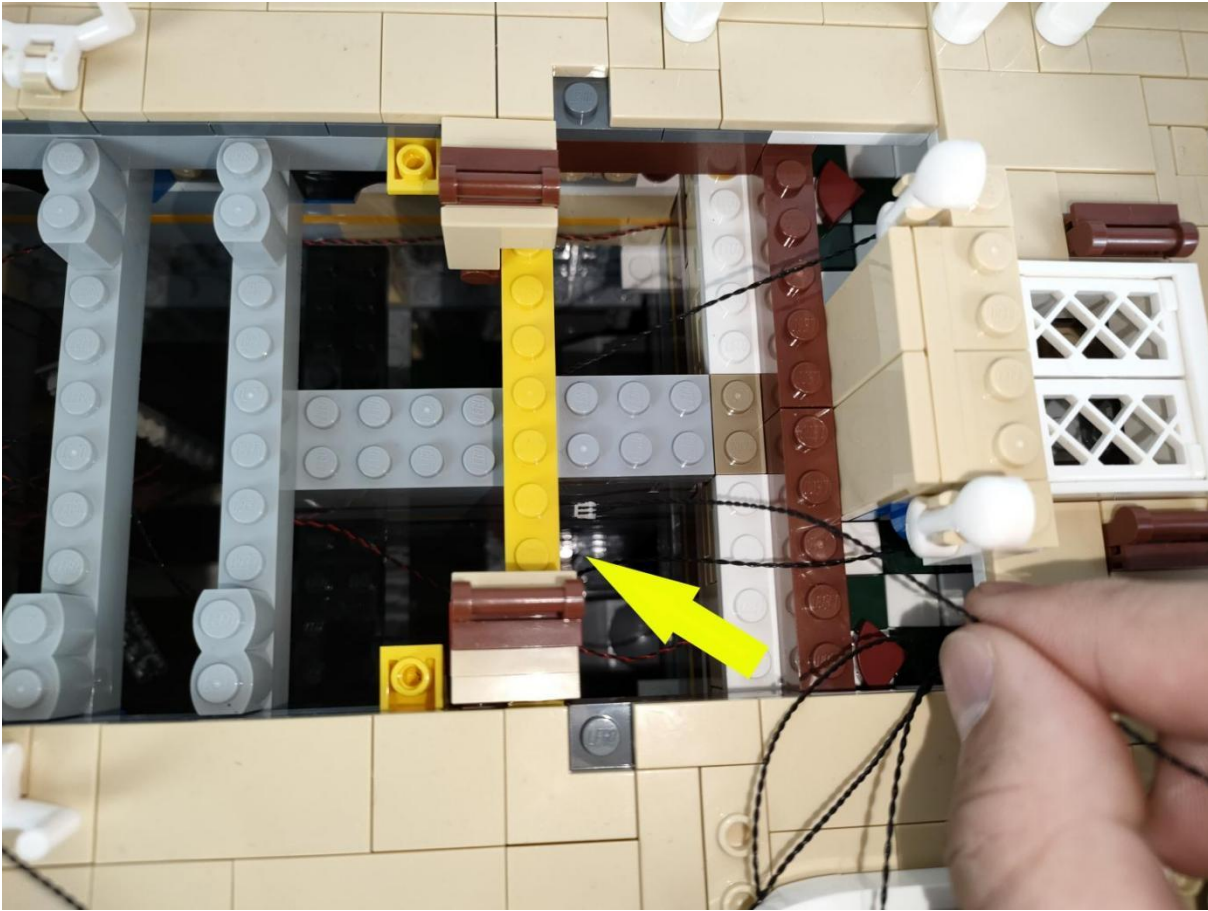

Connect the connecting wires that pass through to the 12 expansion boards in the picture.

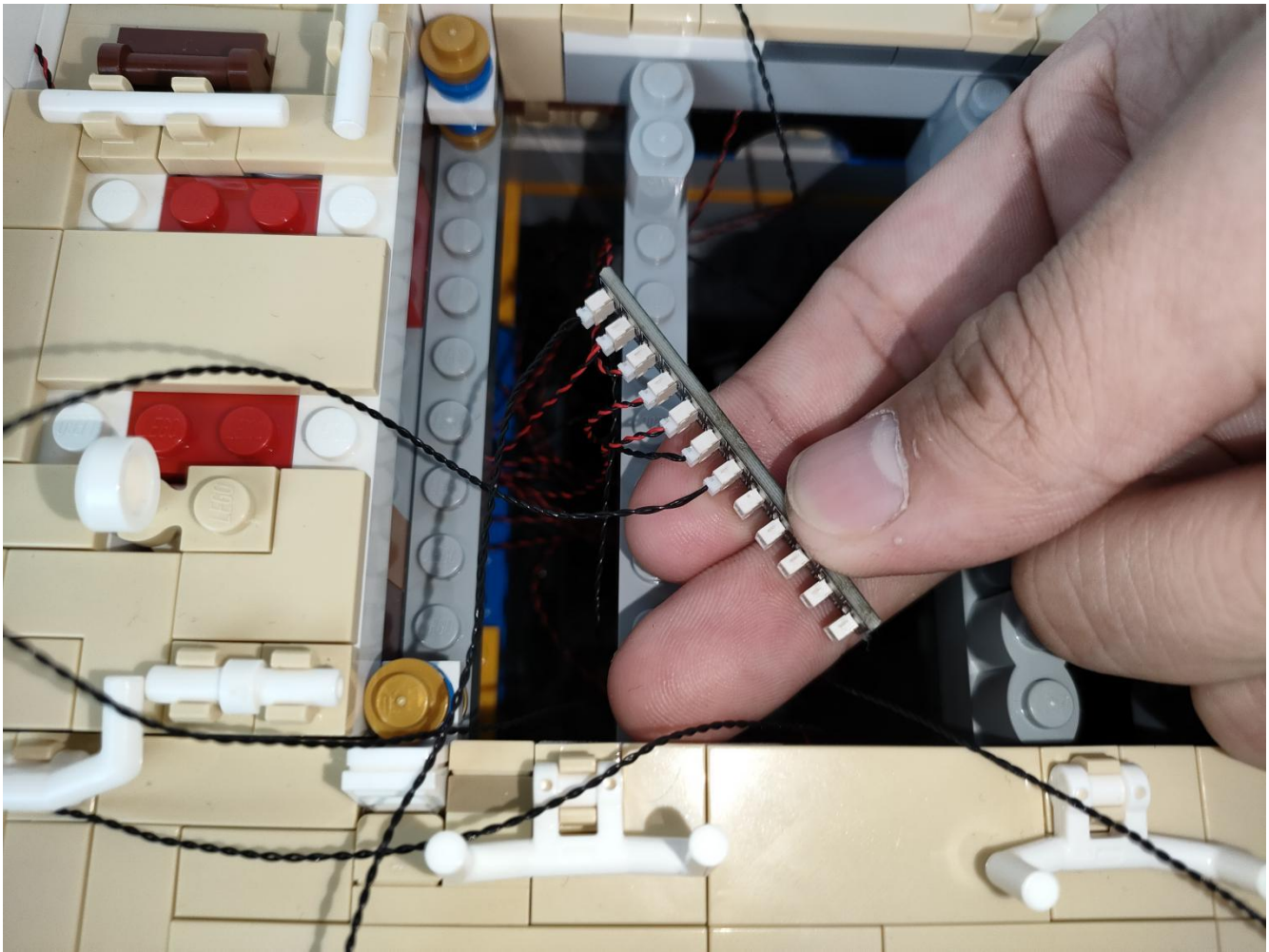

Then unplug the 20cm cable on the 12 expansion board from the power supply.

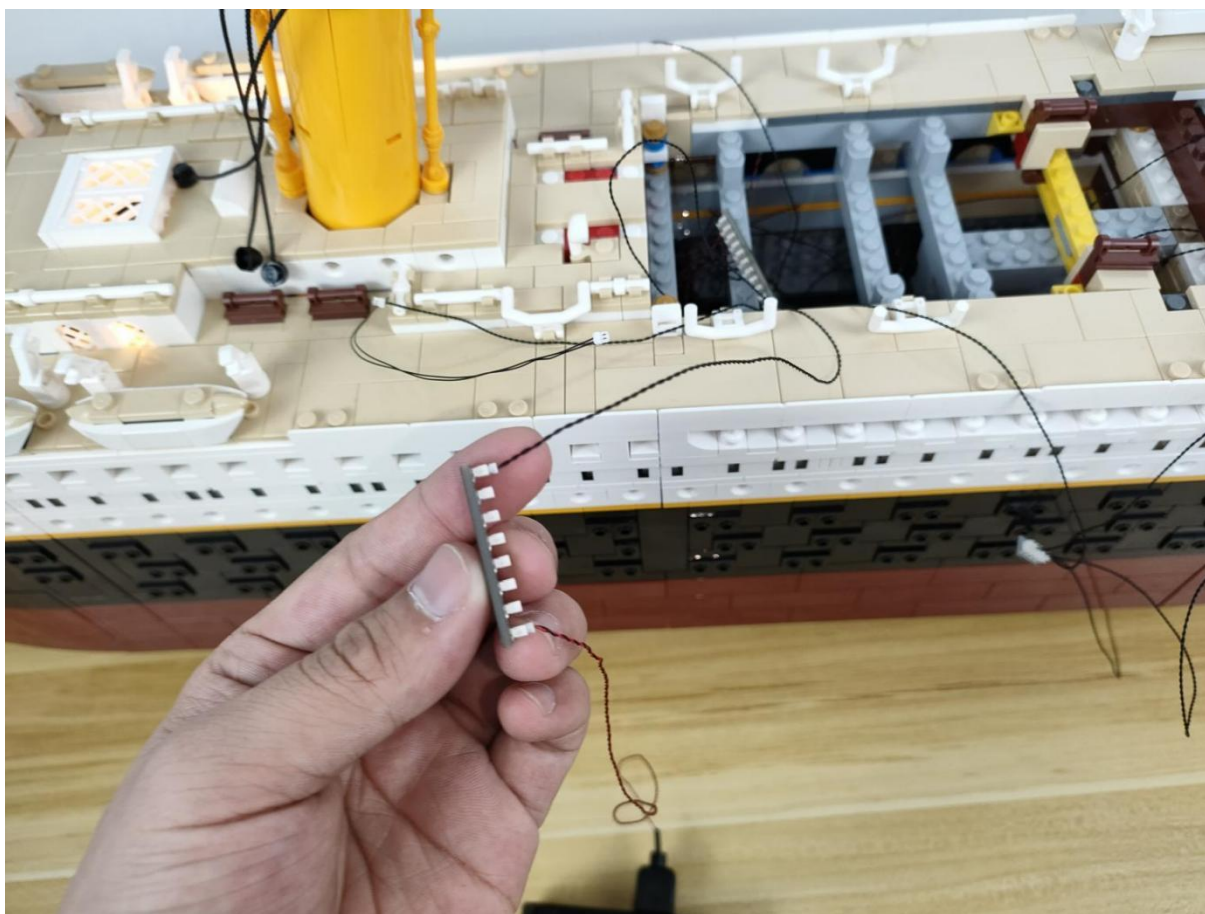

Place it in the position in the figure.

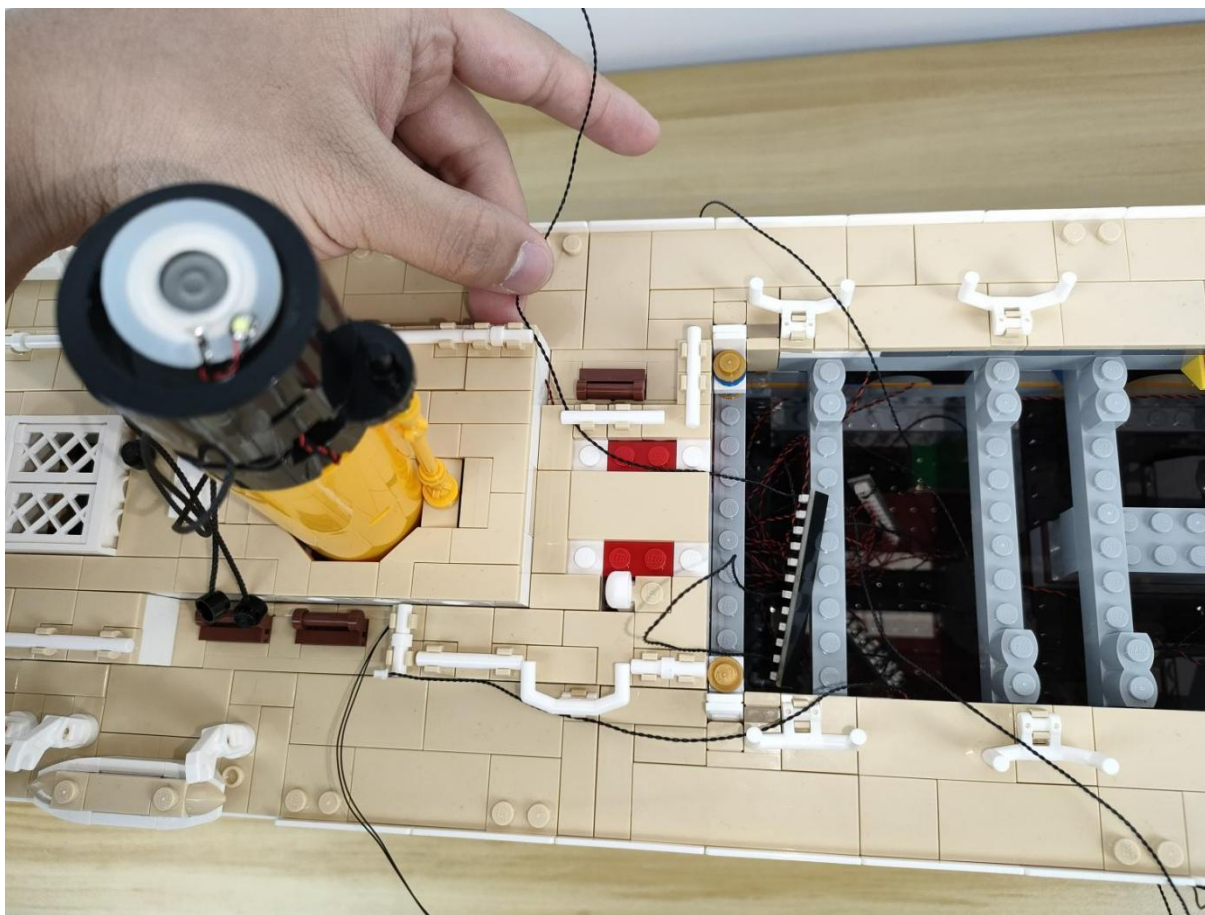

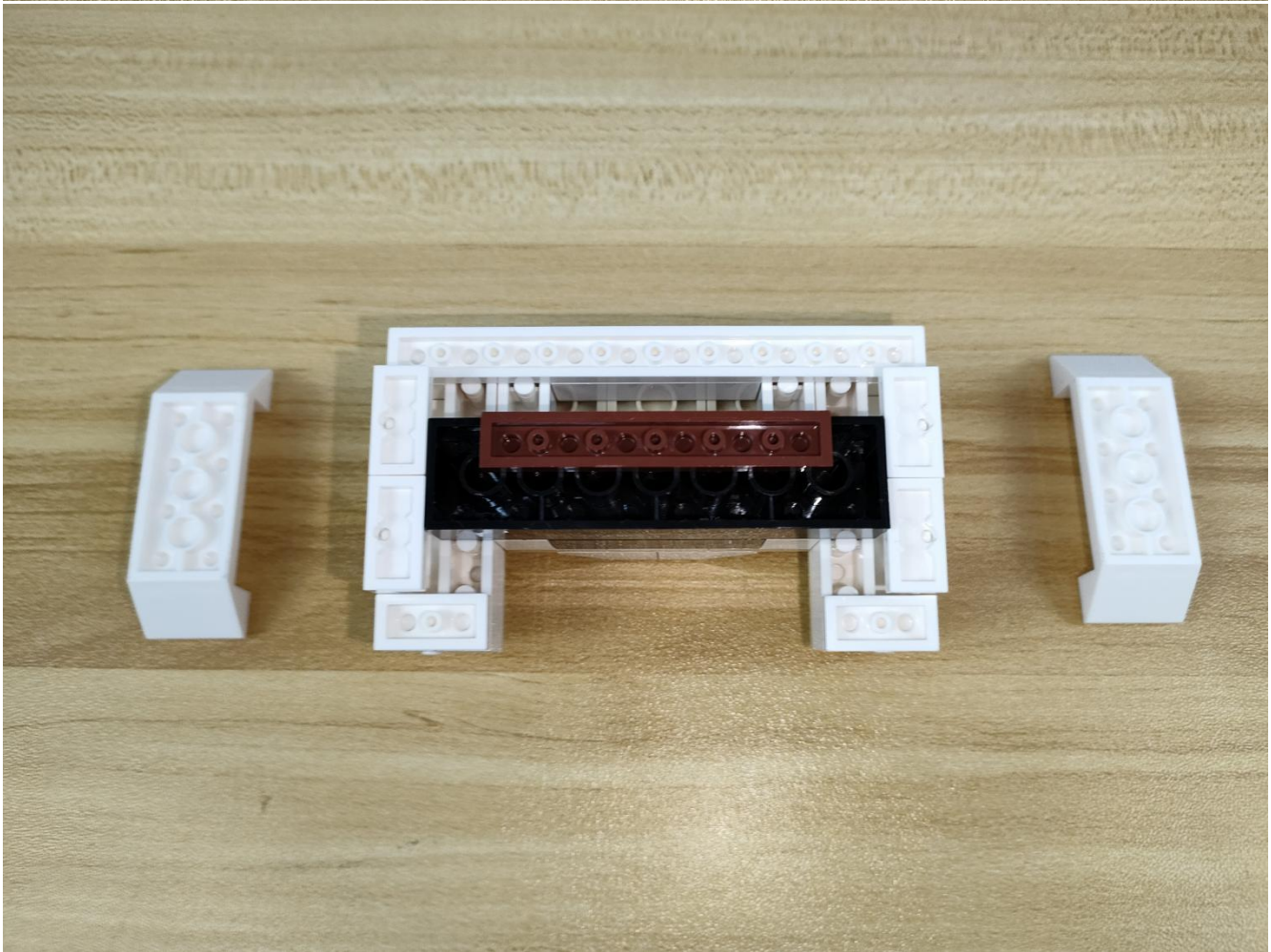
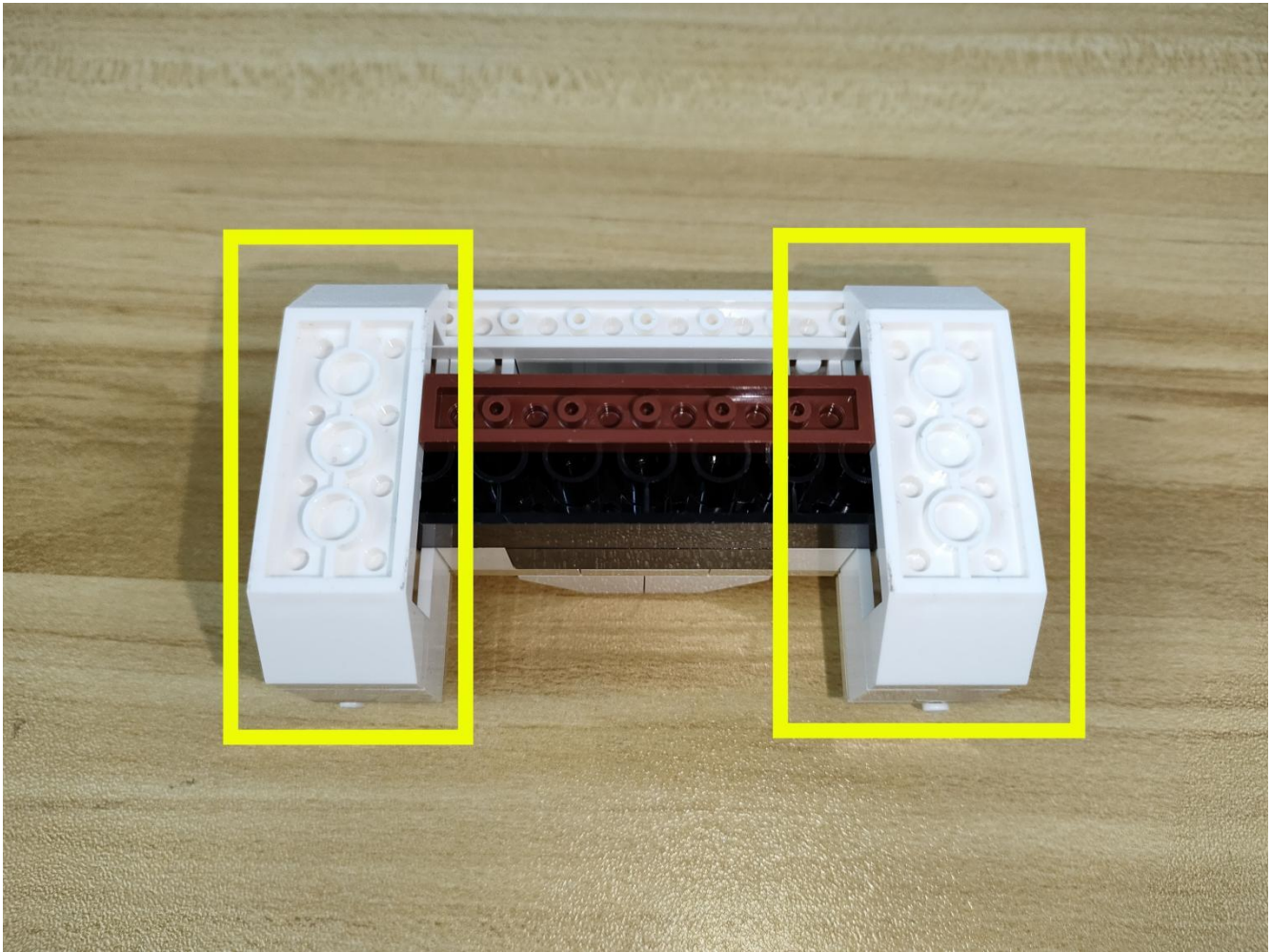

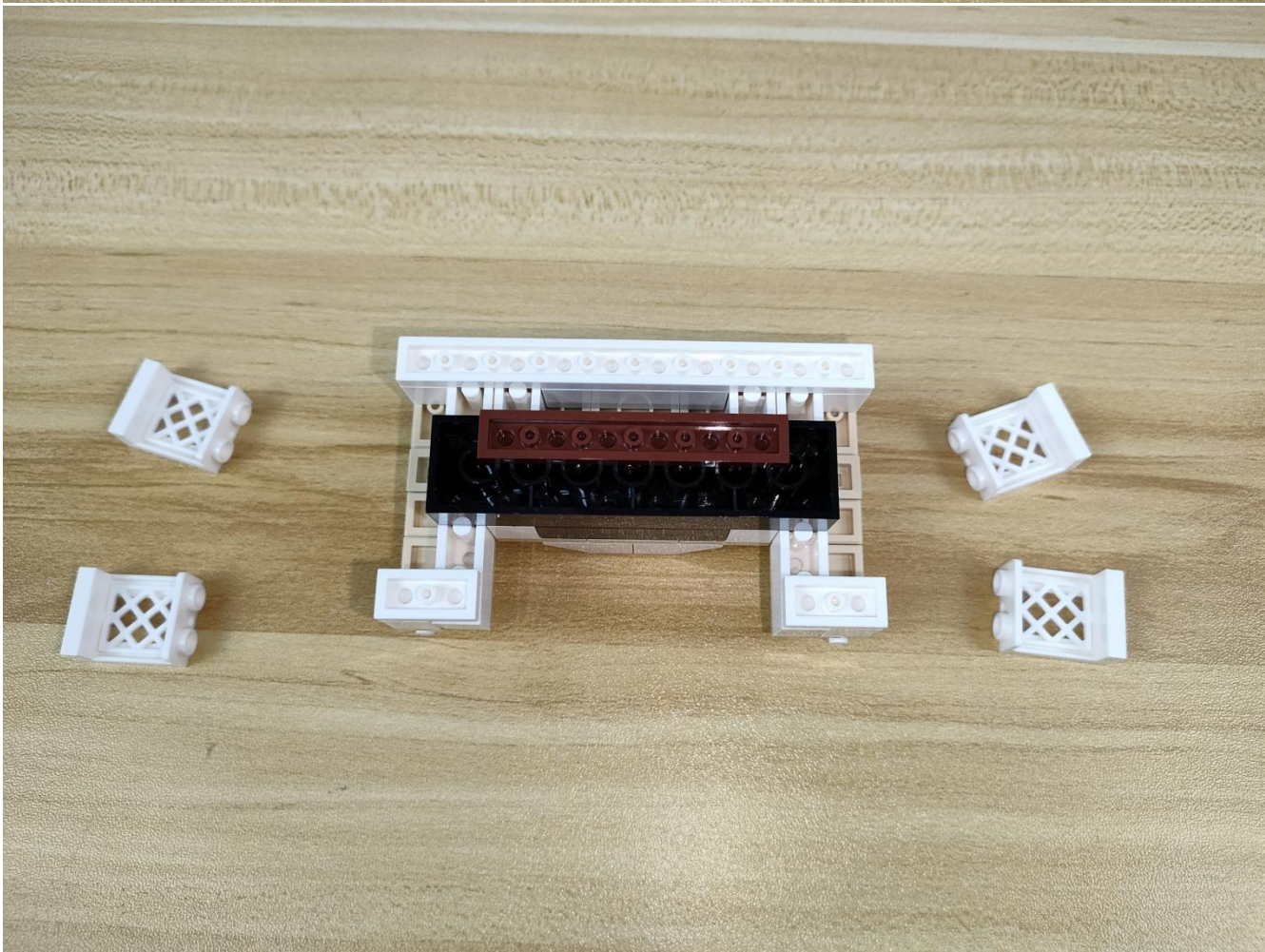
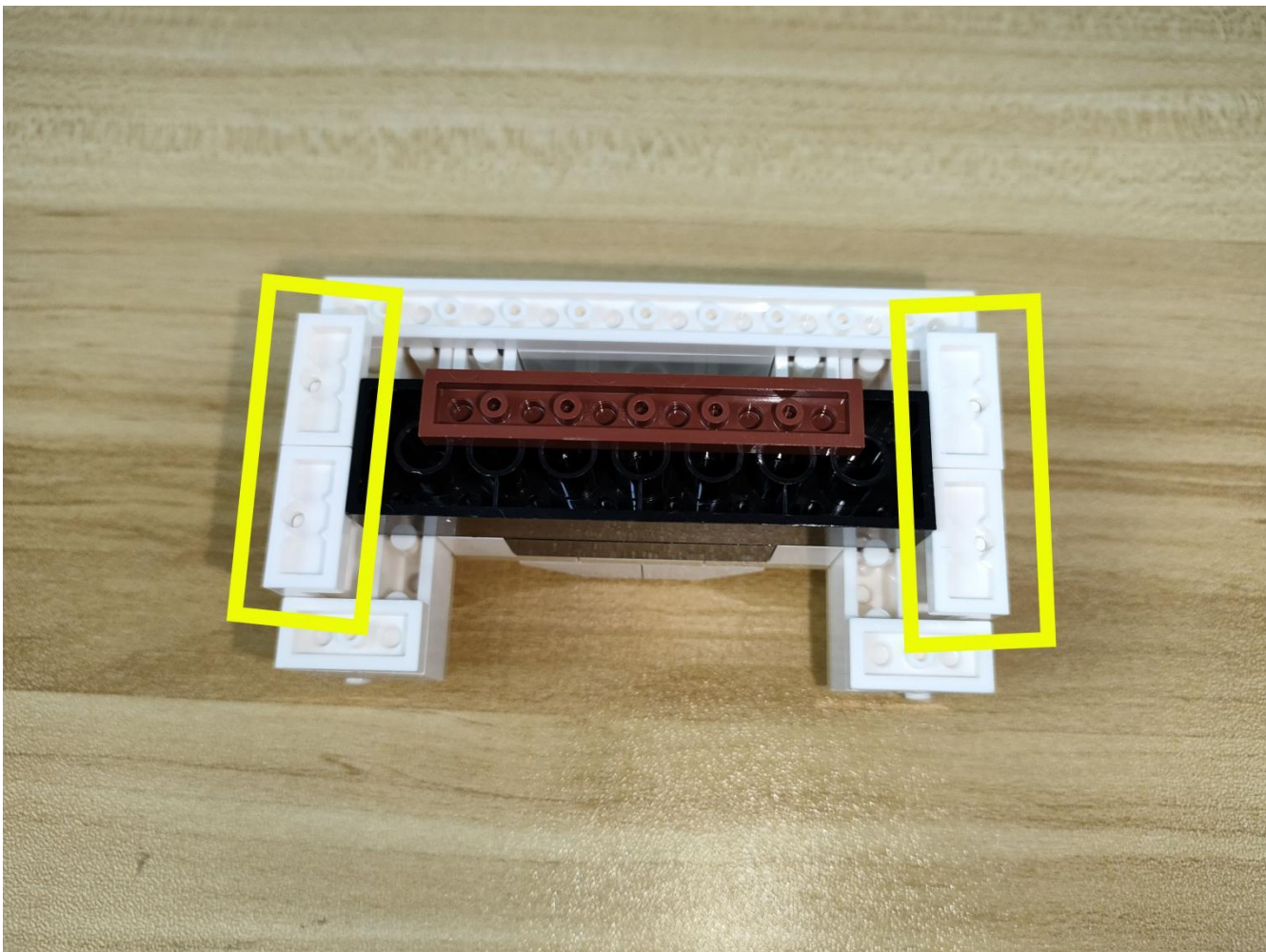



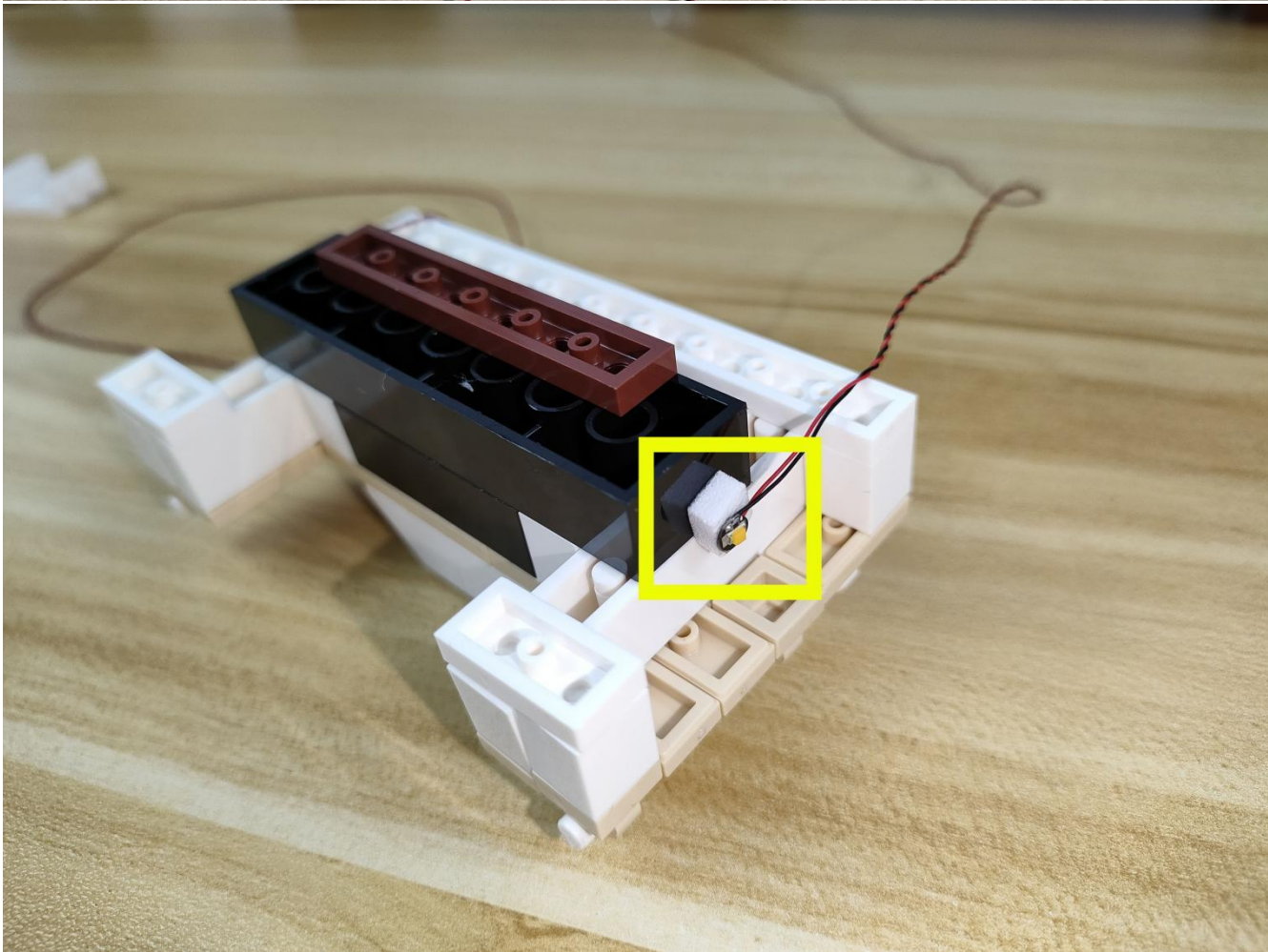

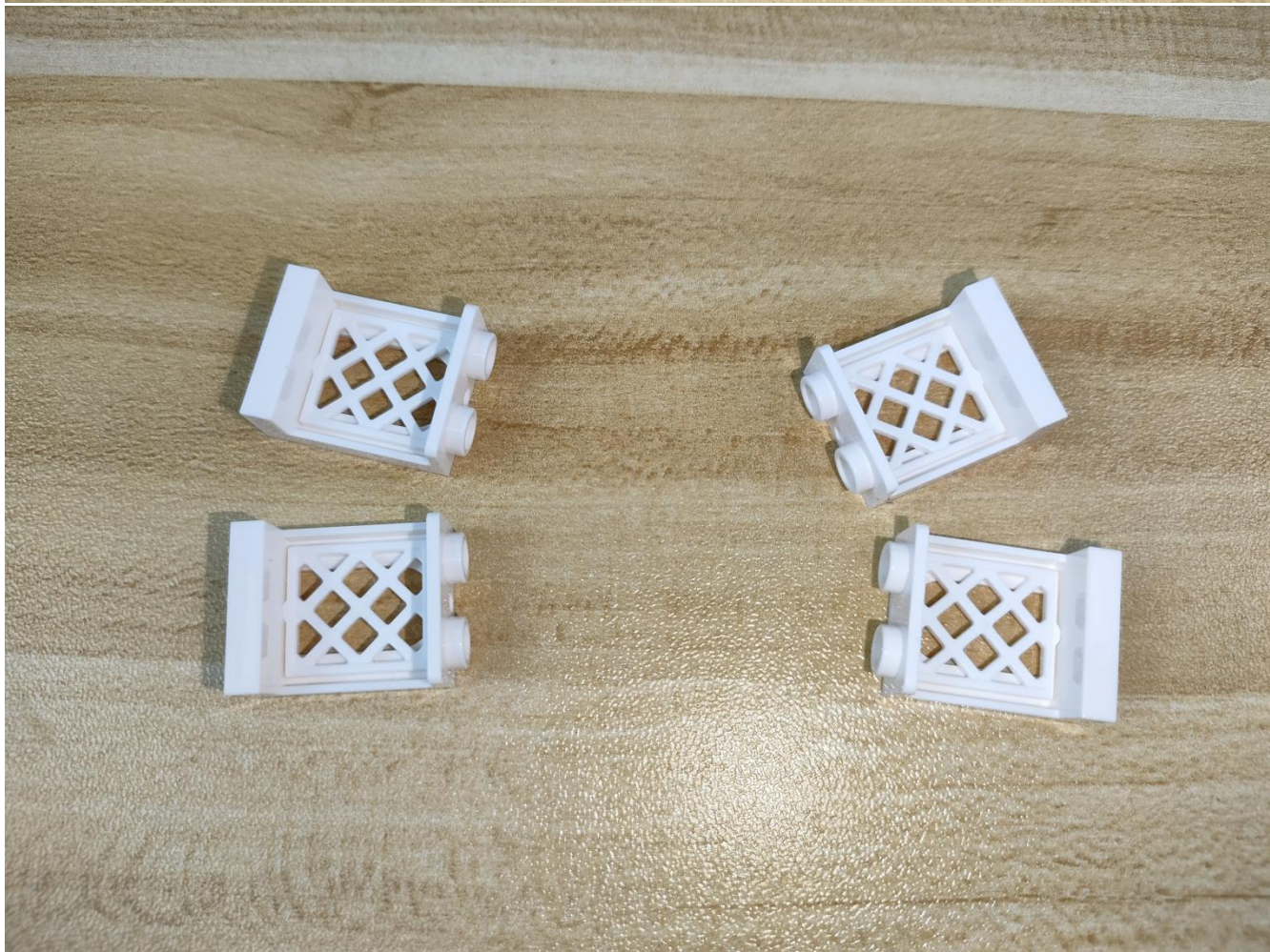
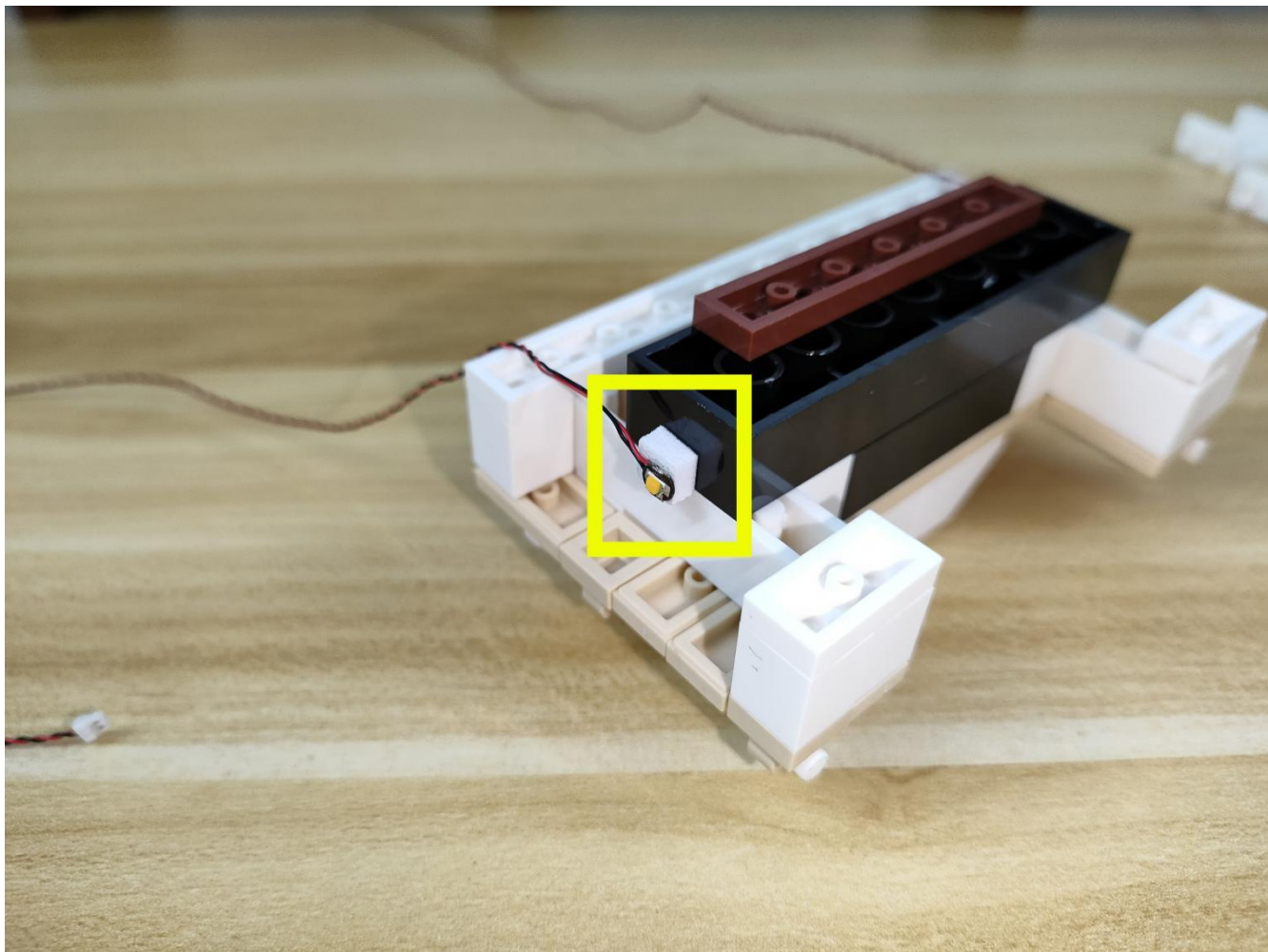

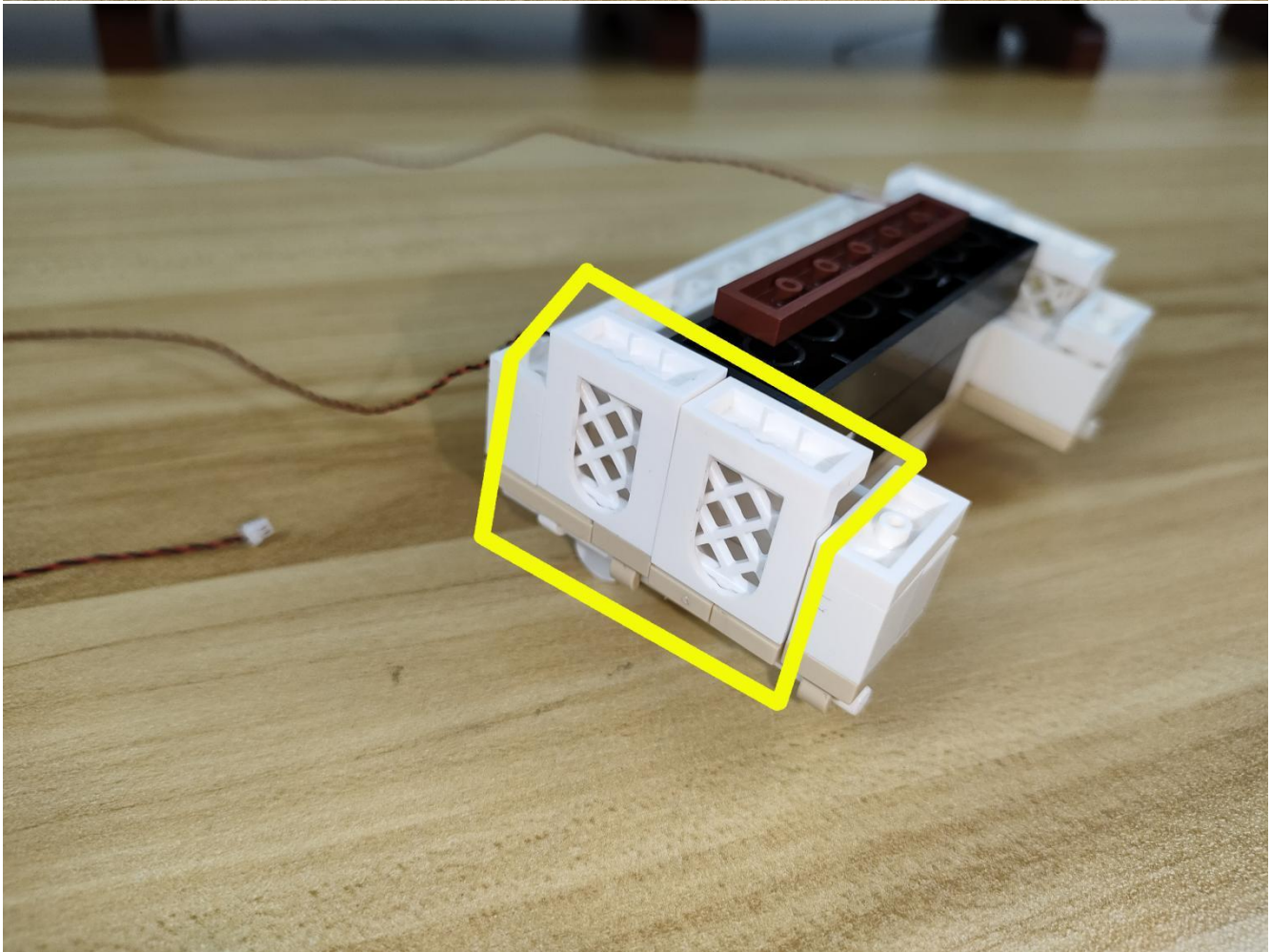
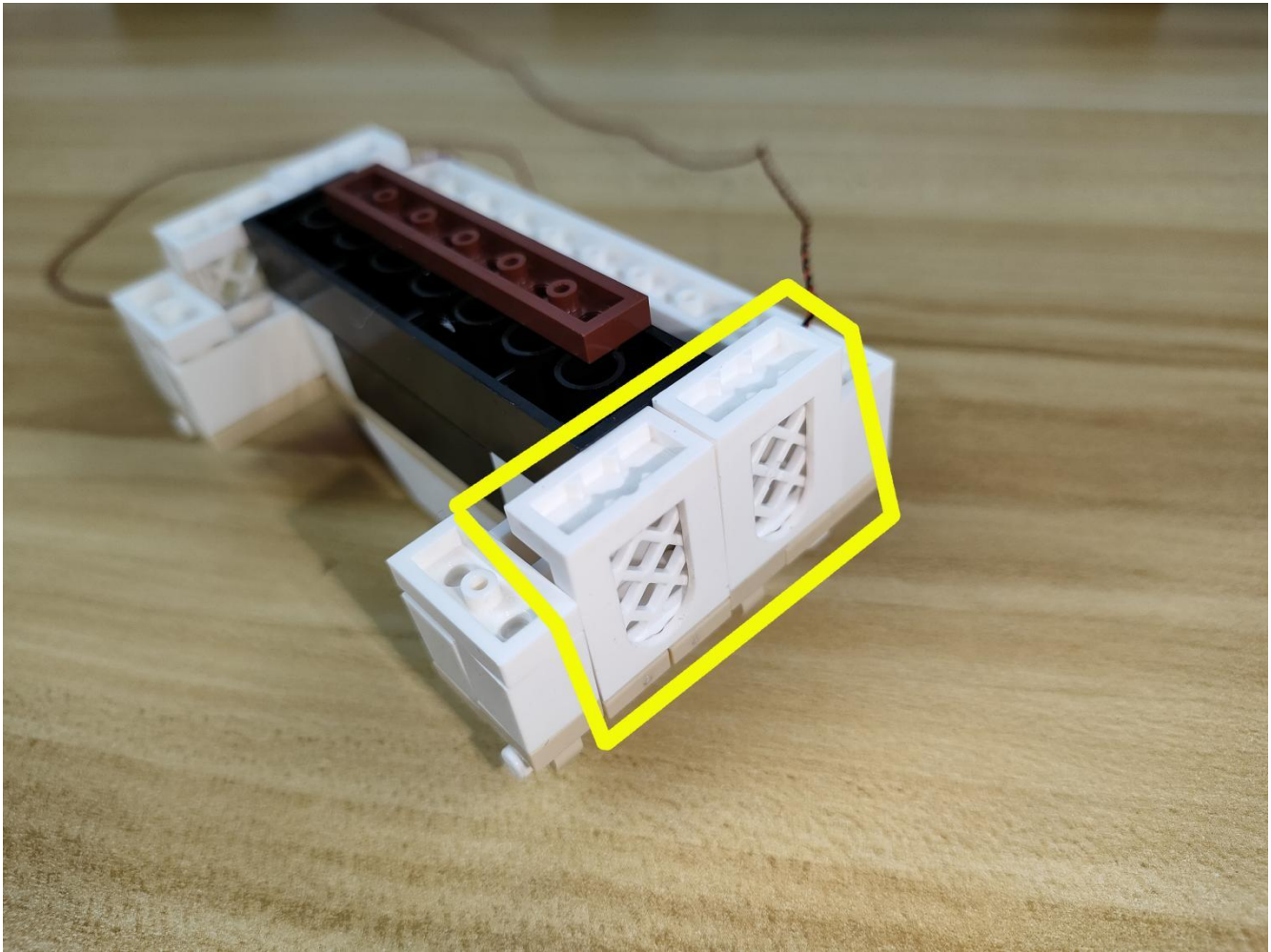

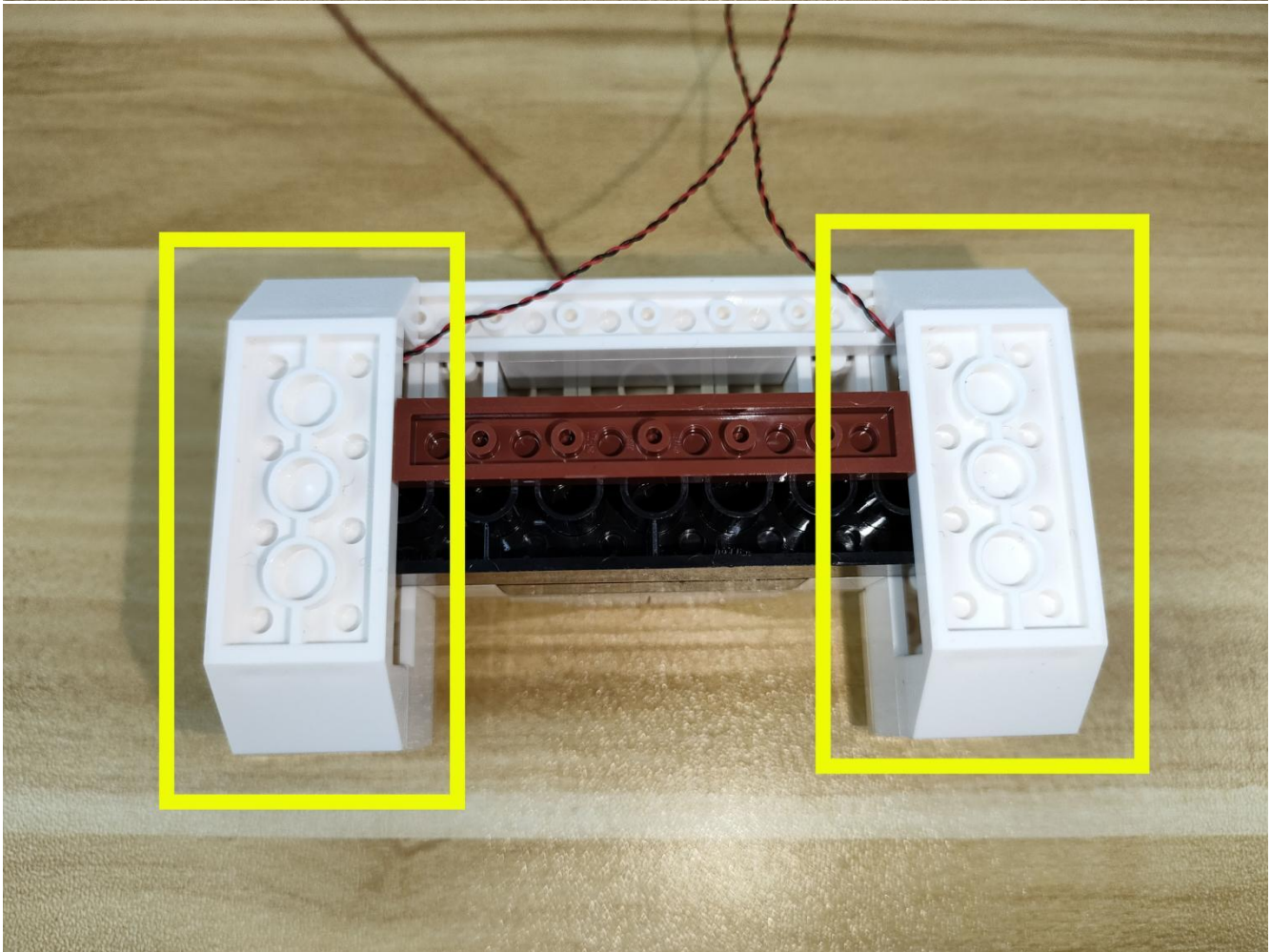

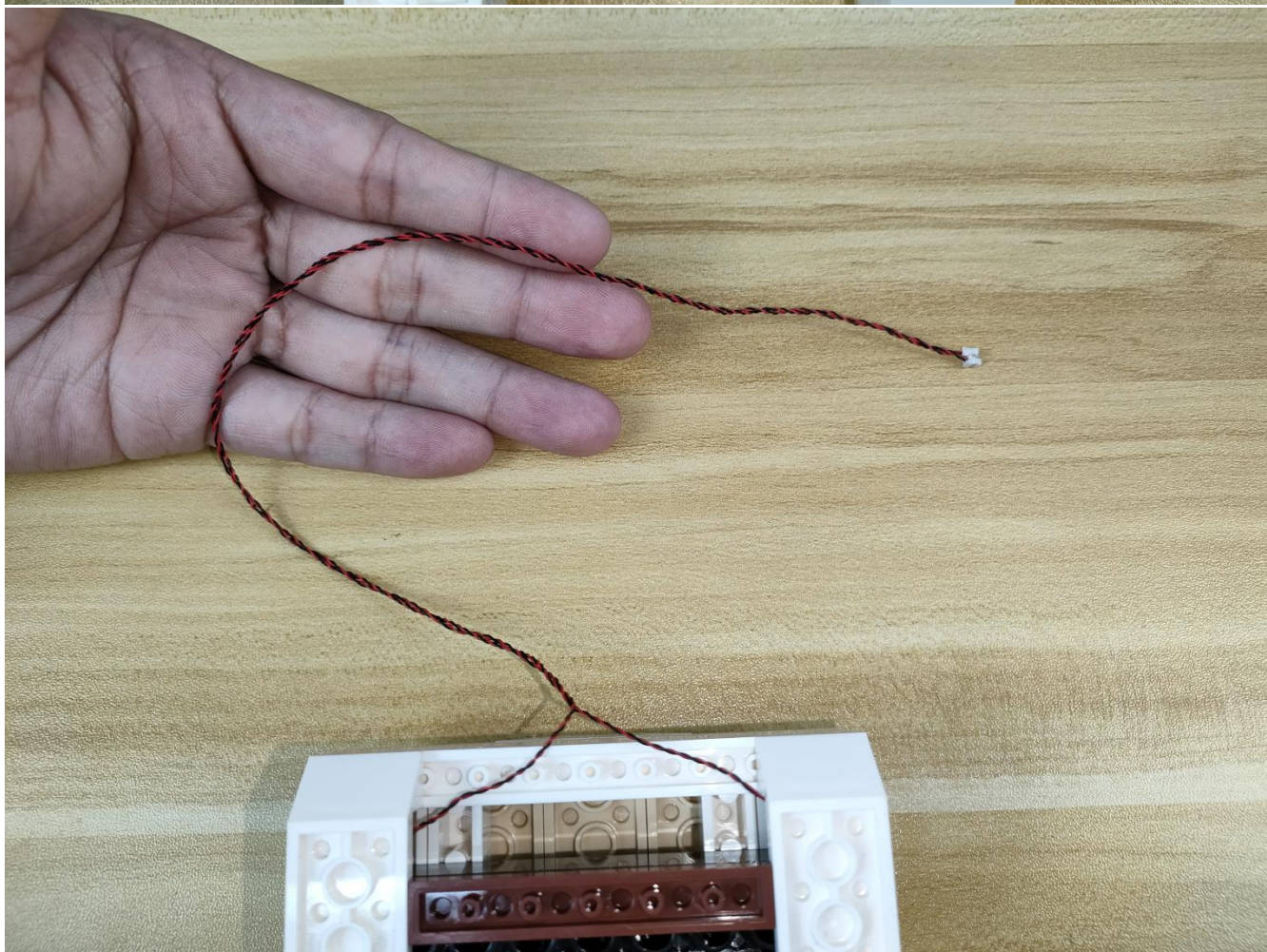
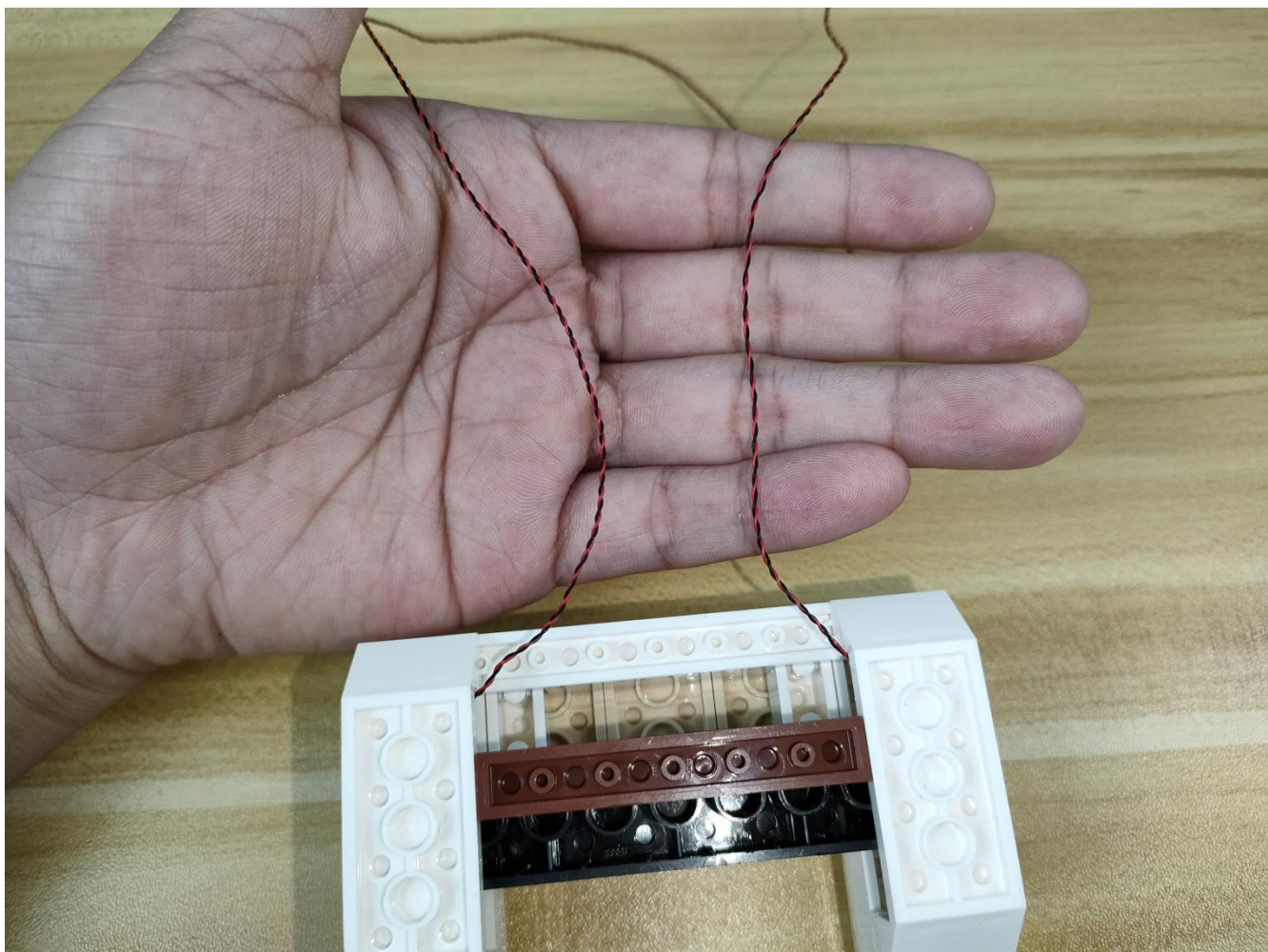

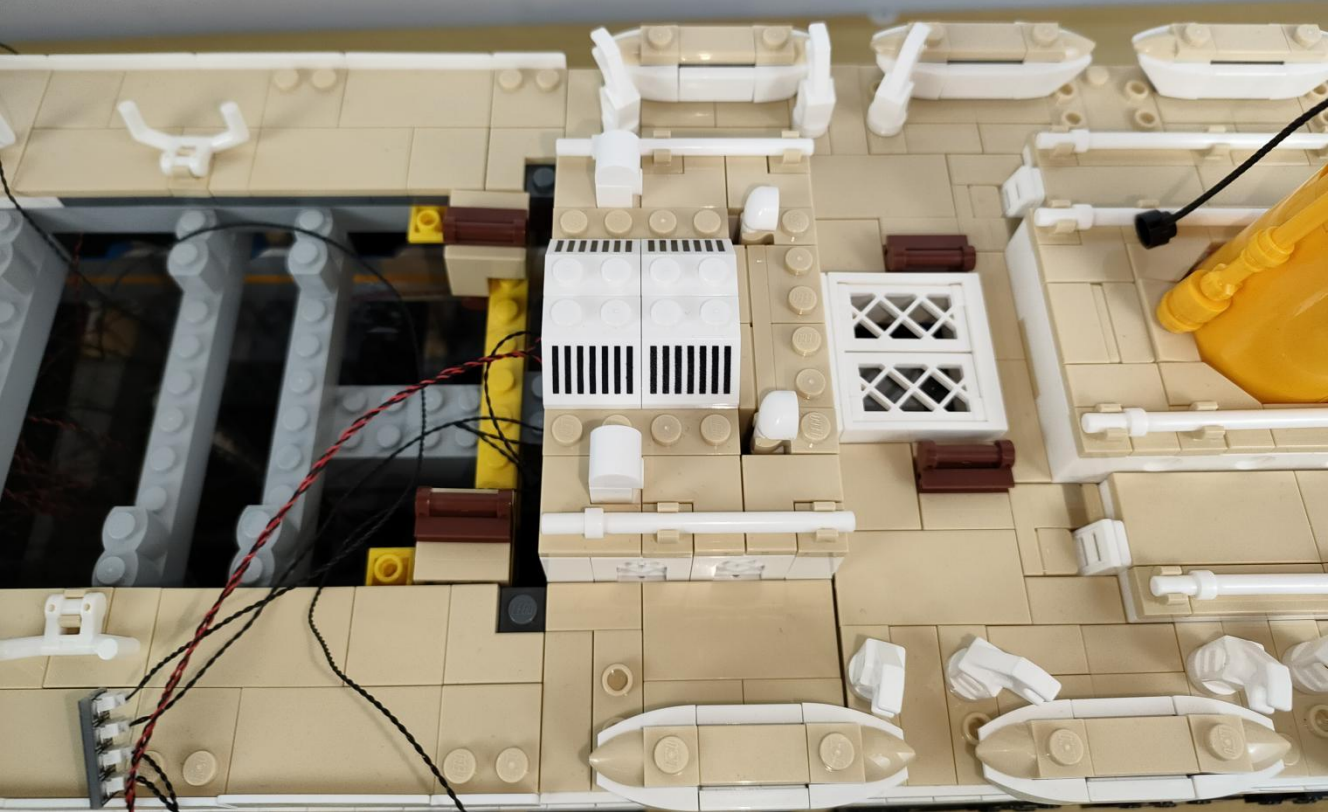
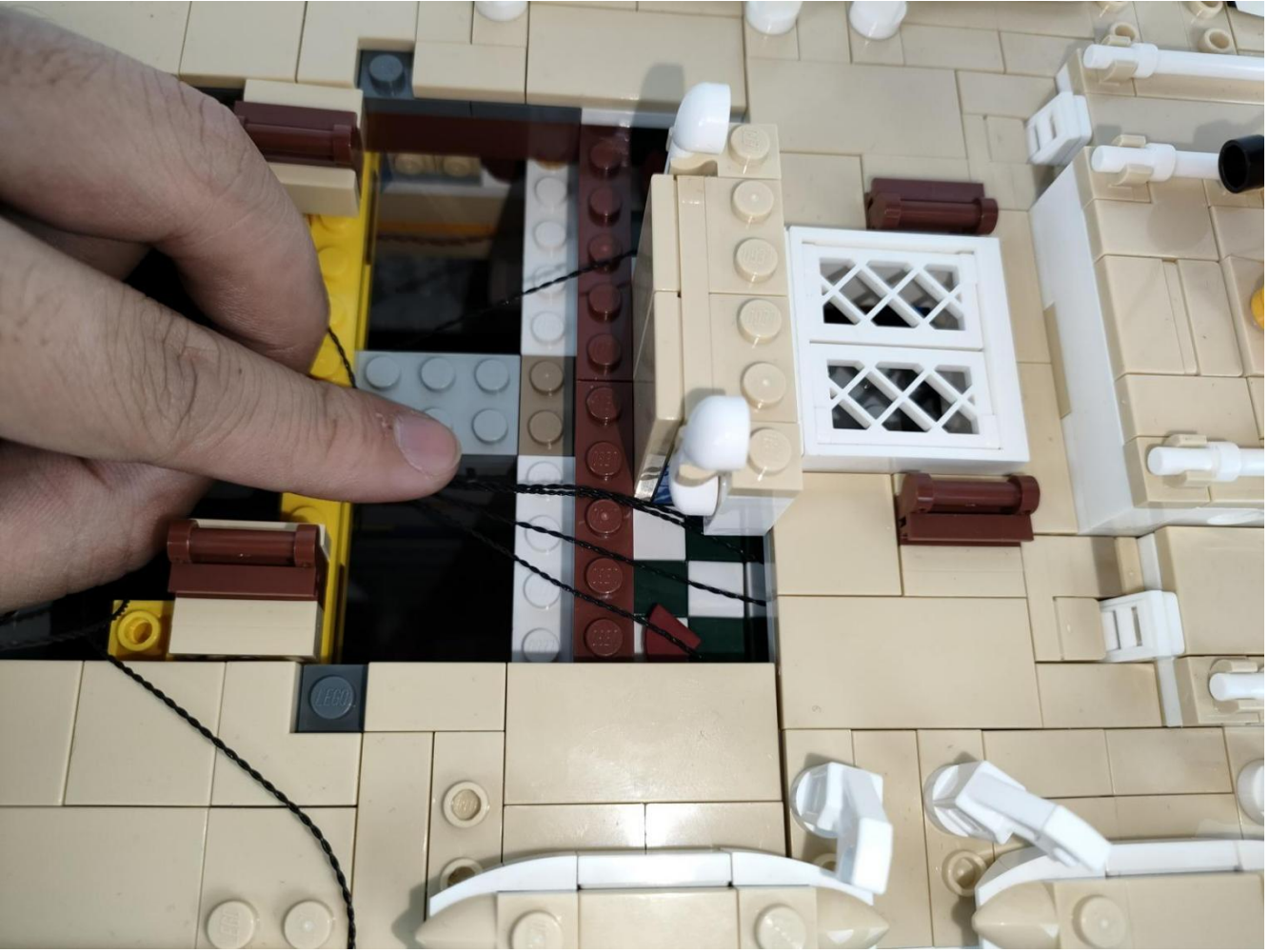

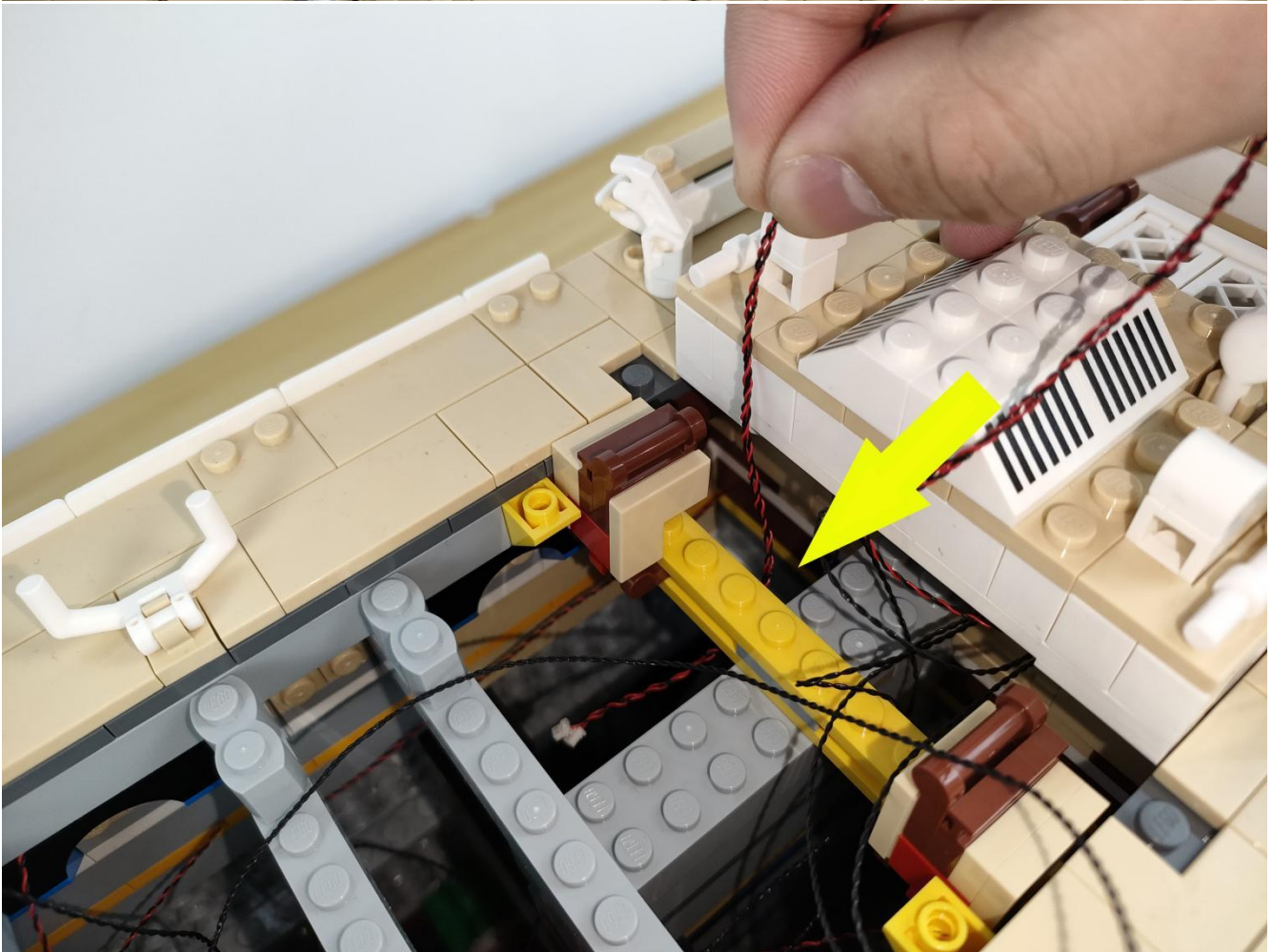
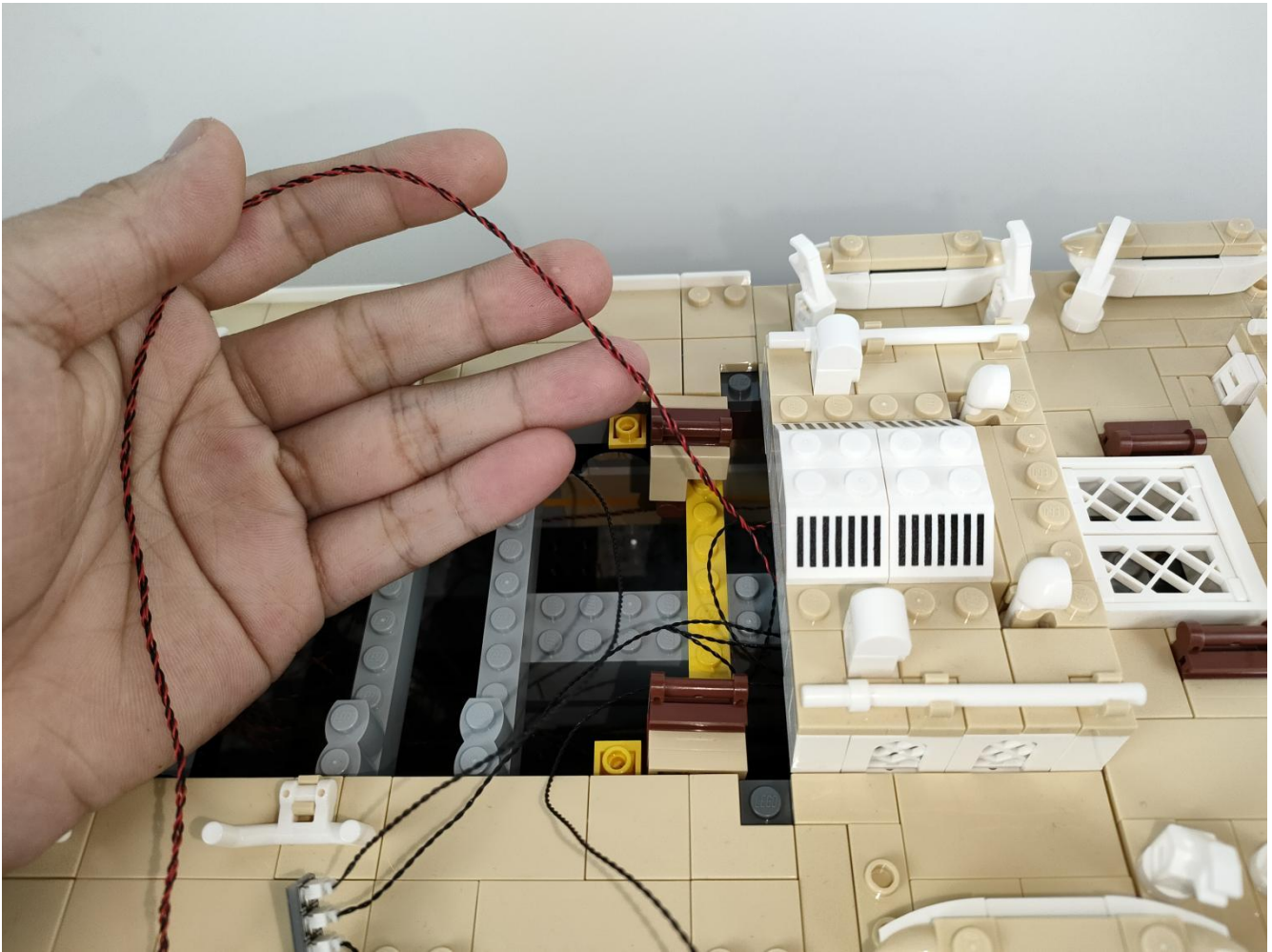

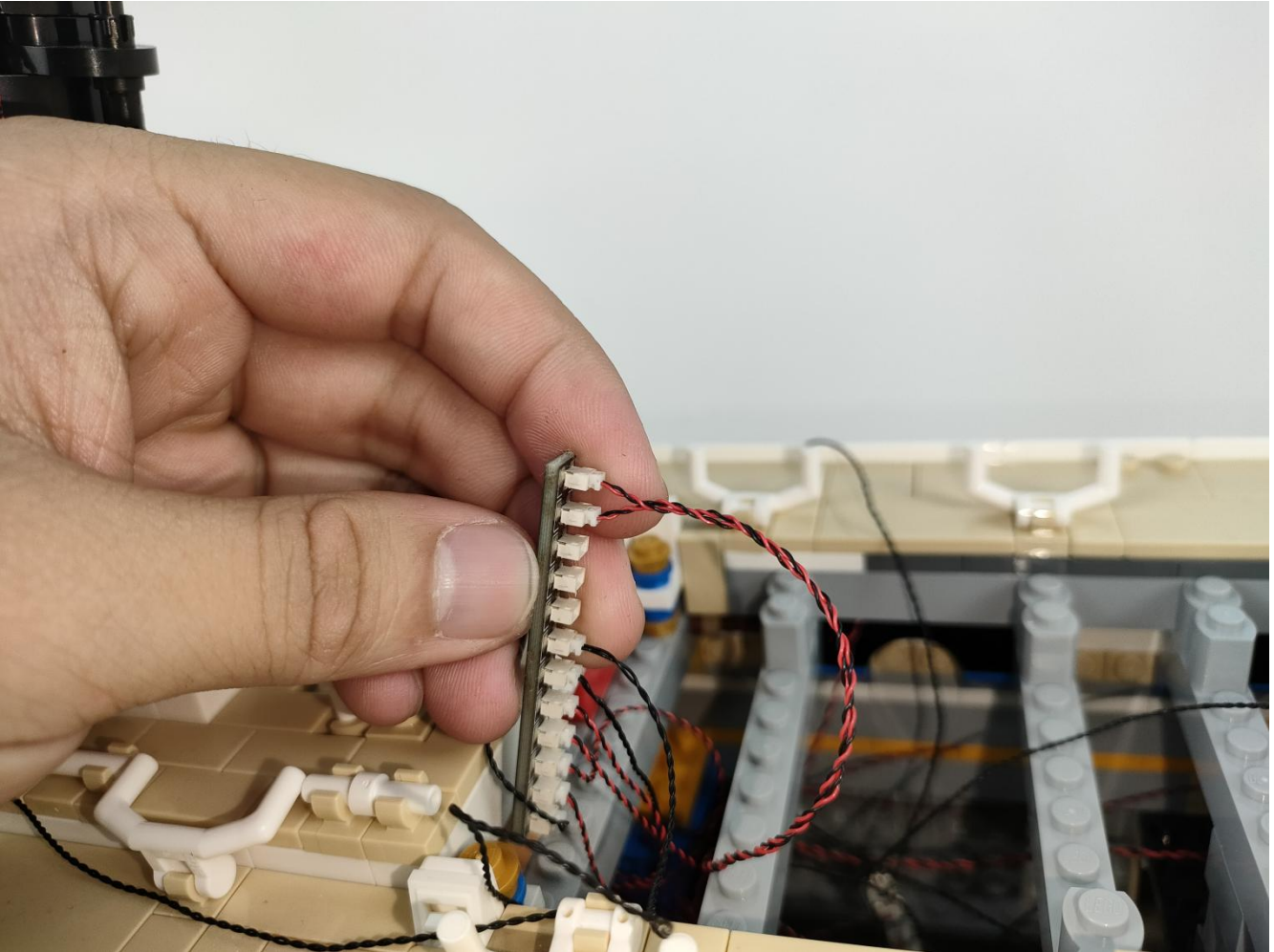
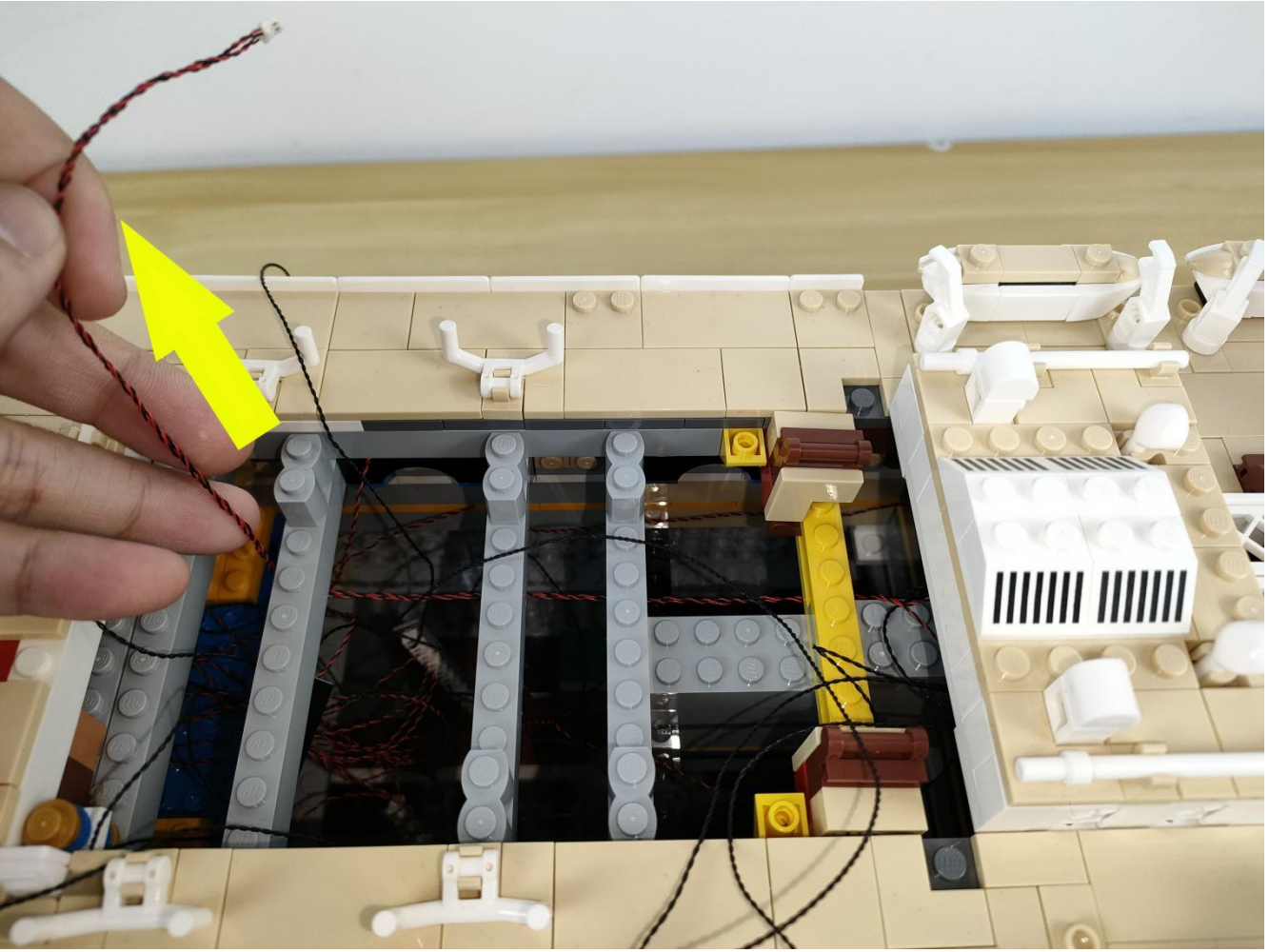

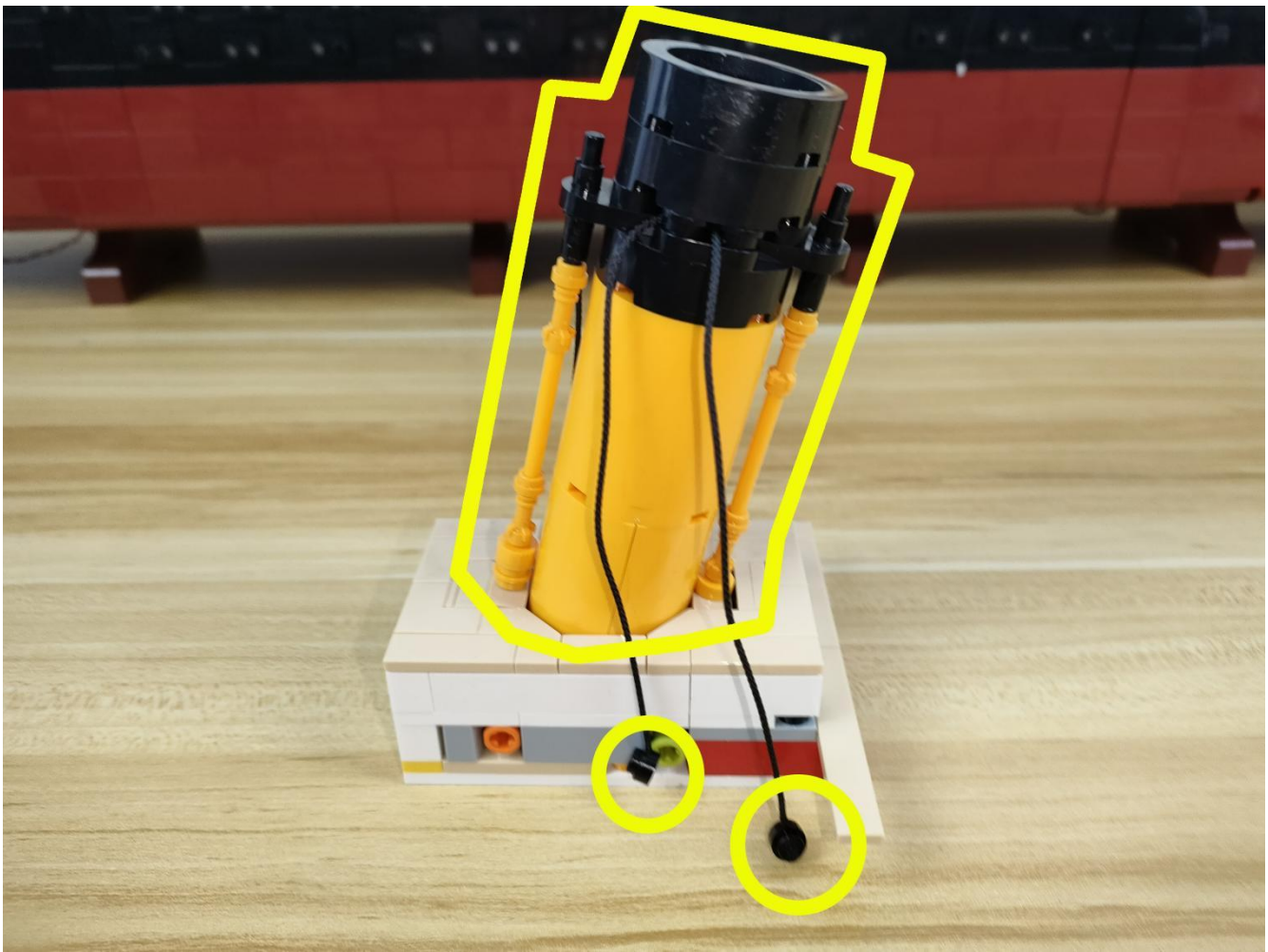

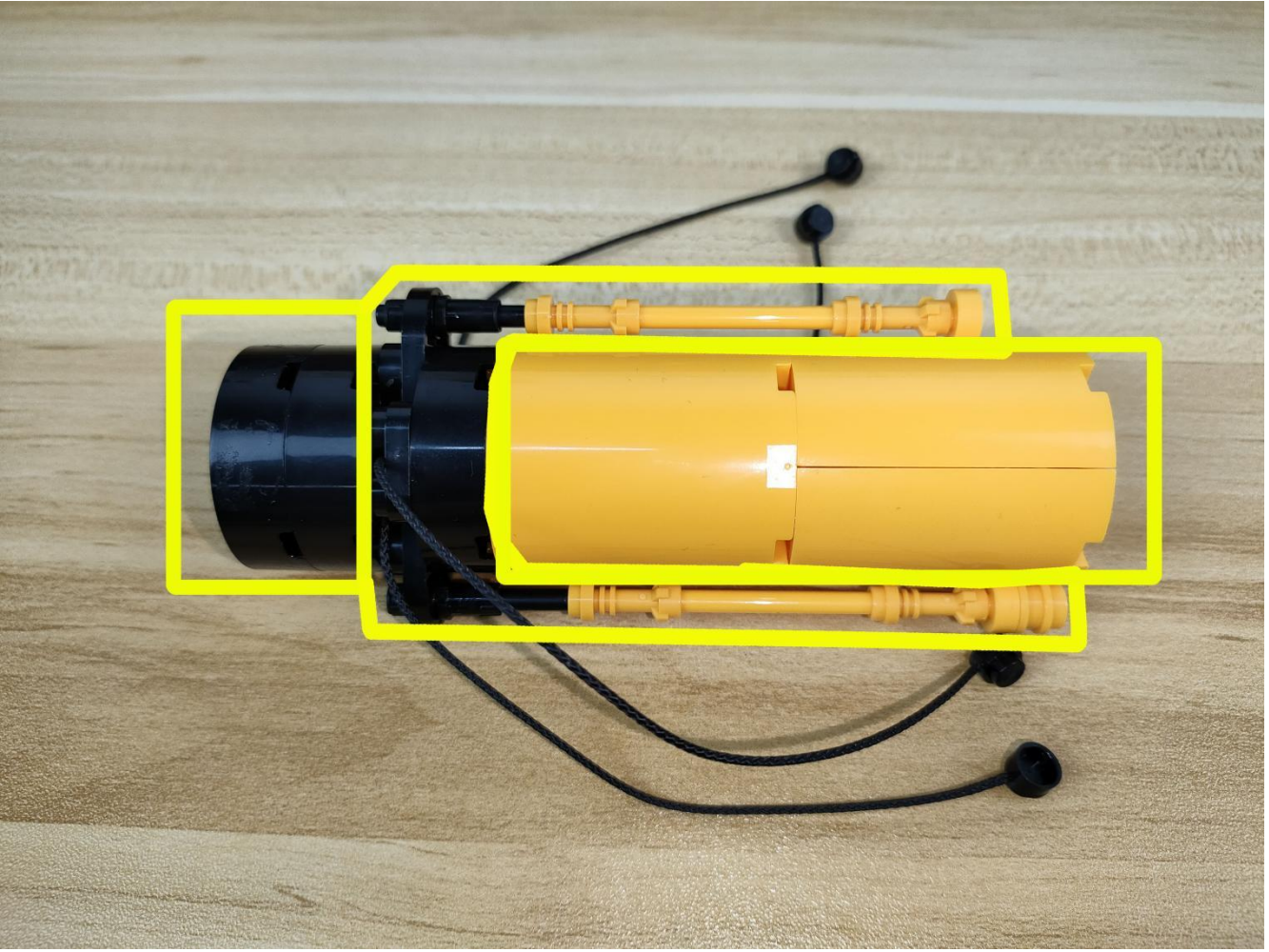

白色普通燈粒30CM

Bit Lights-30CM

White



噴霧模块
Spray Module



Fix the lamp pellet at the position selected by the frame in the figure, with the solder joints of the spray module components facing upwards.

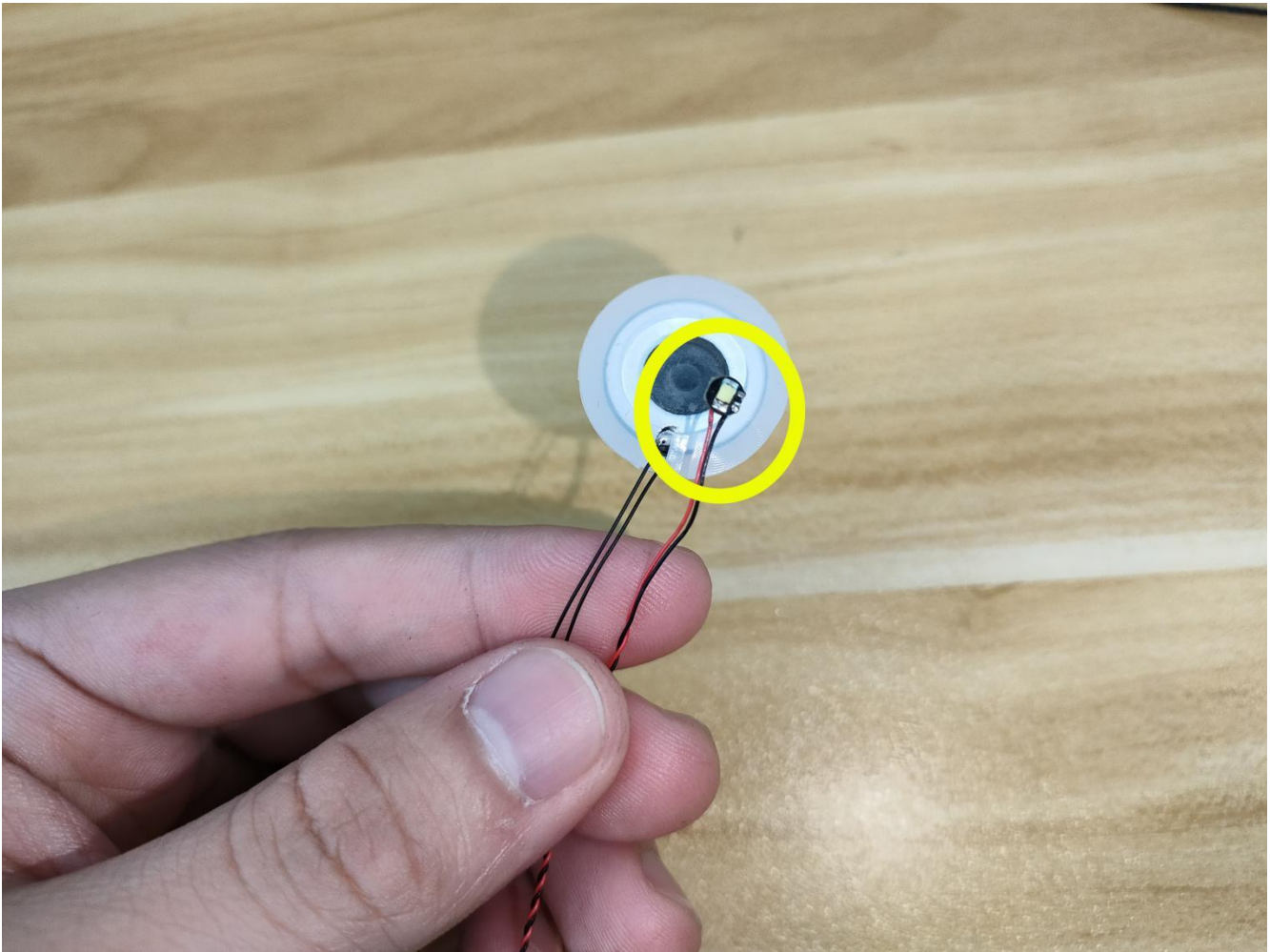

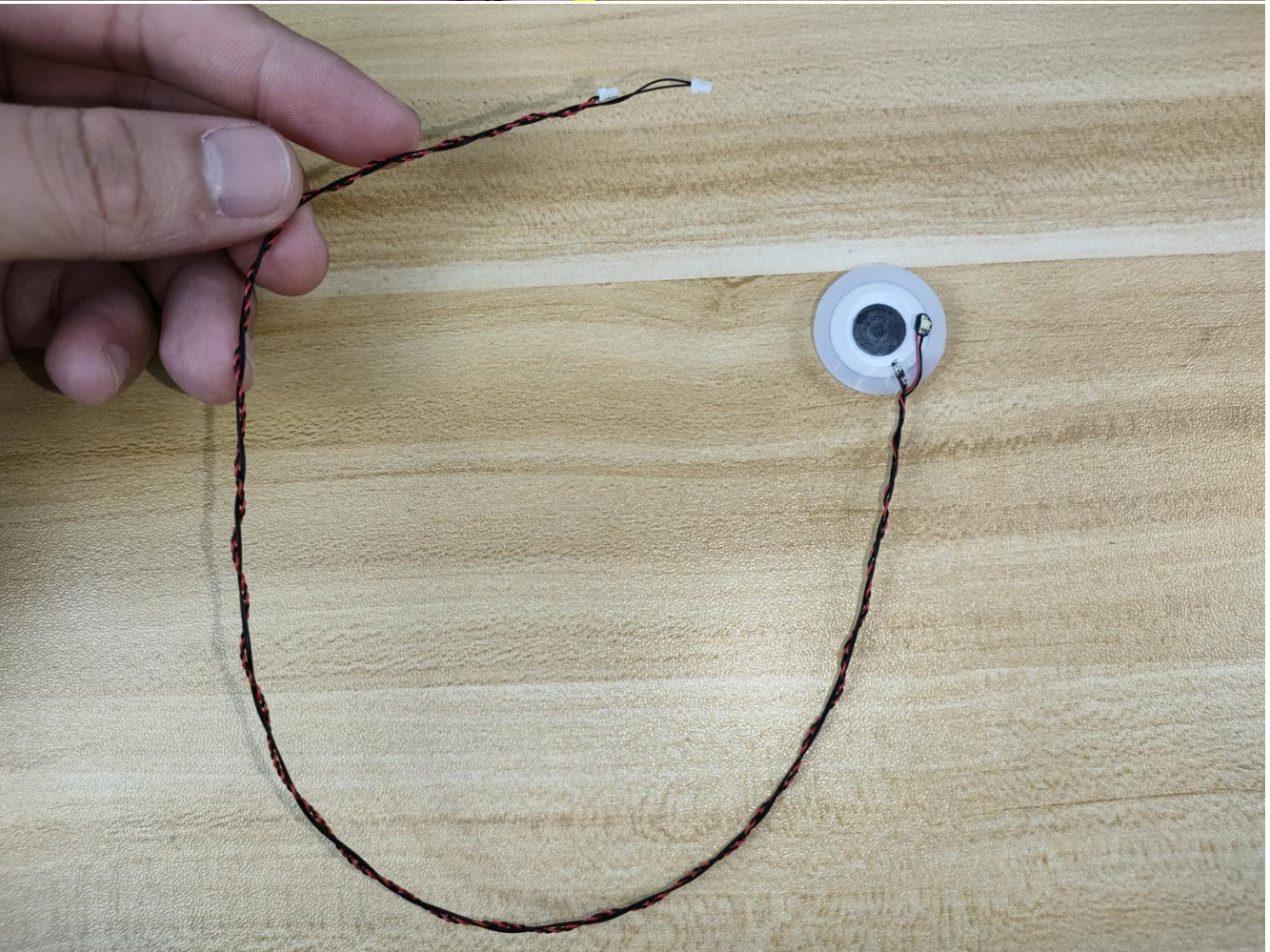

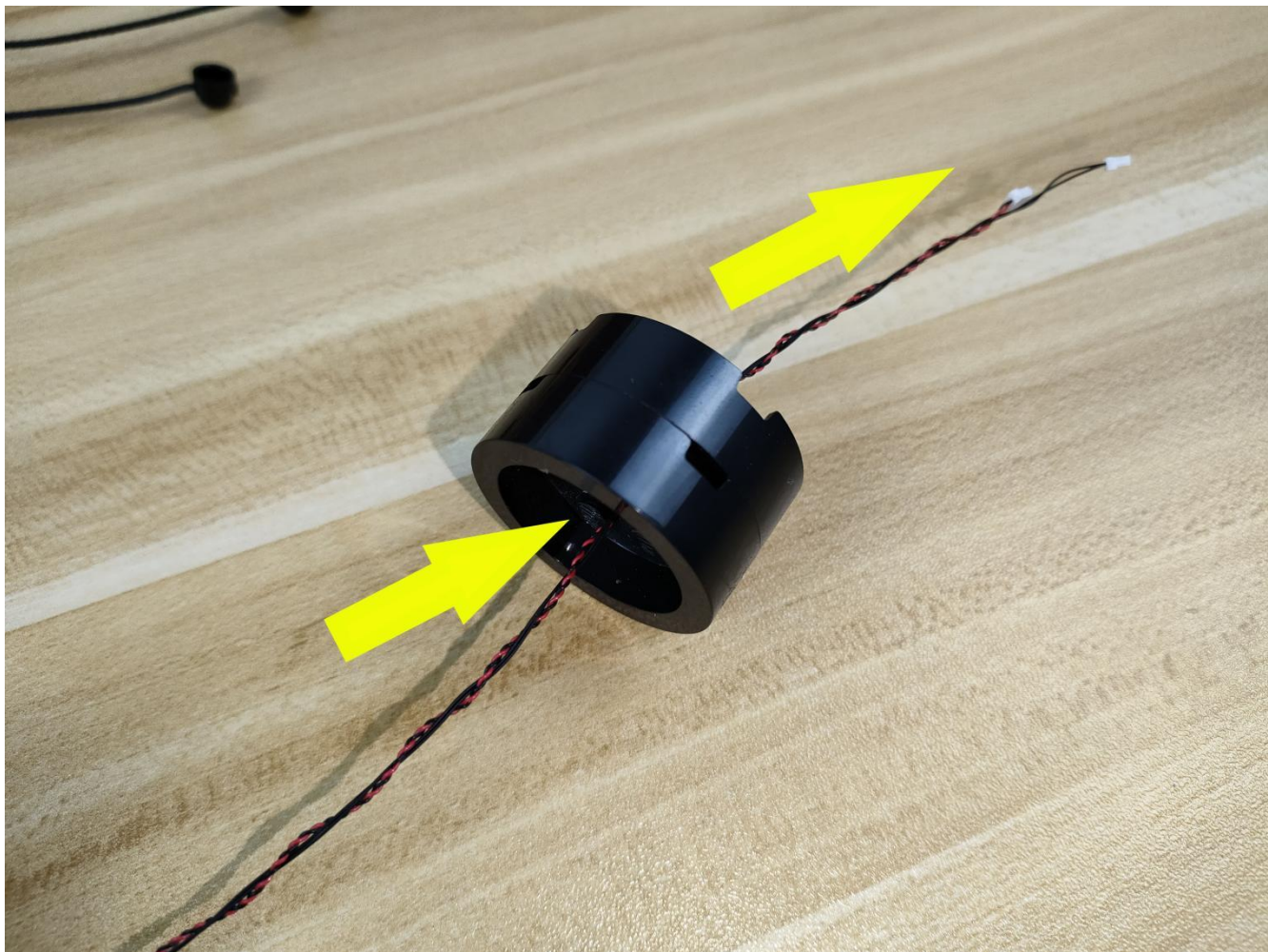

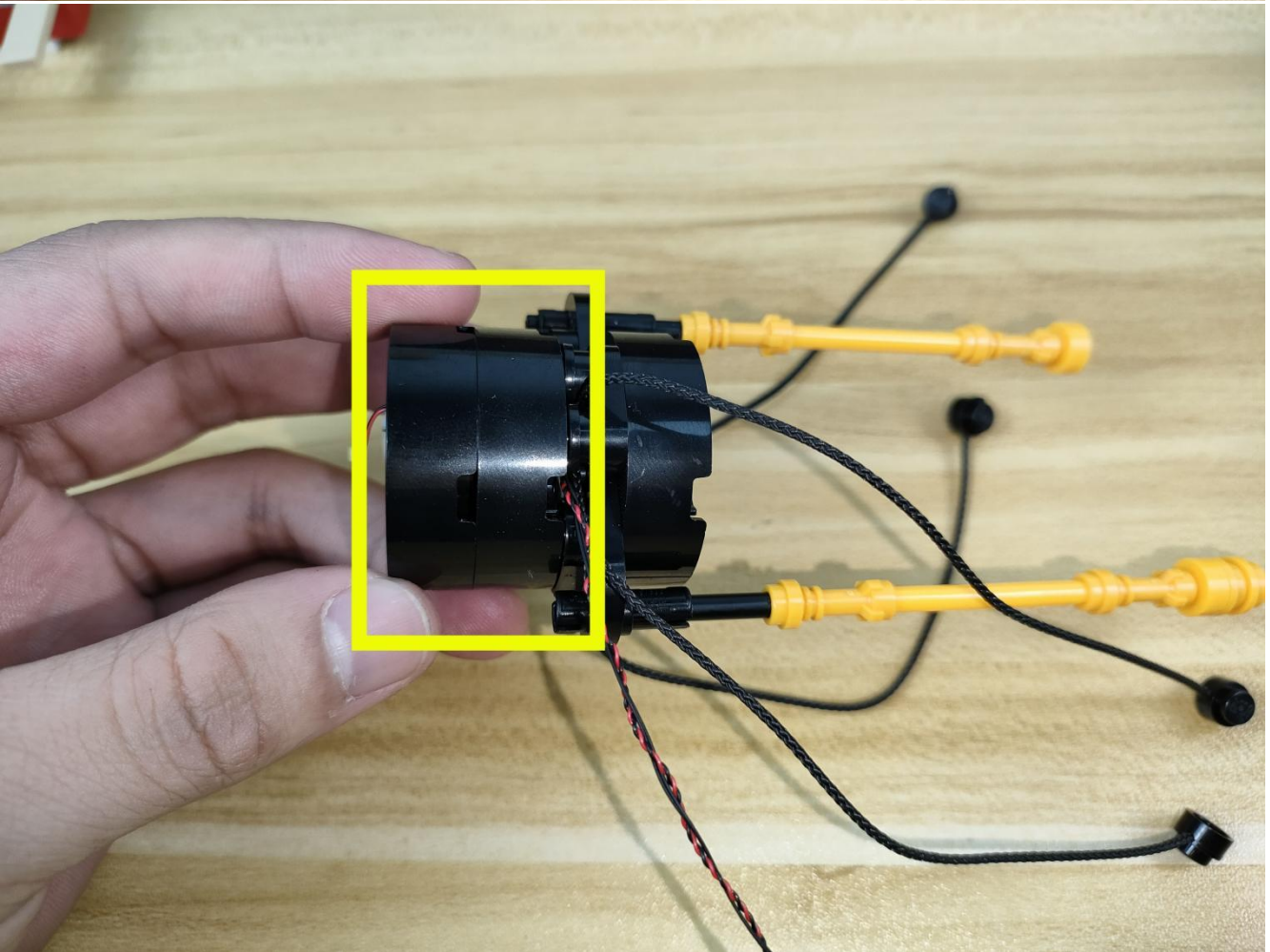

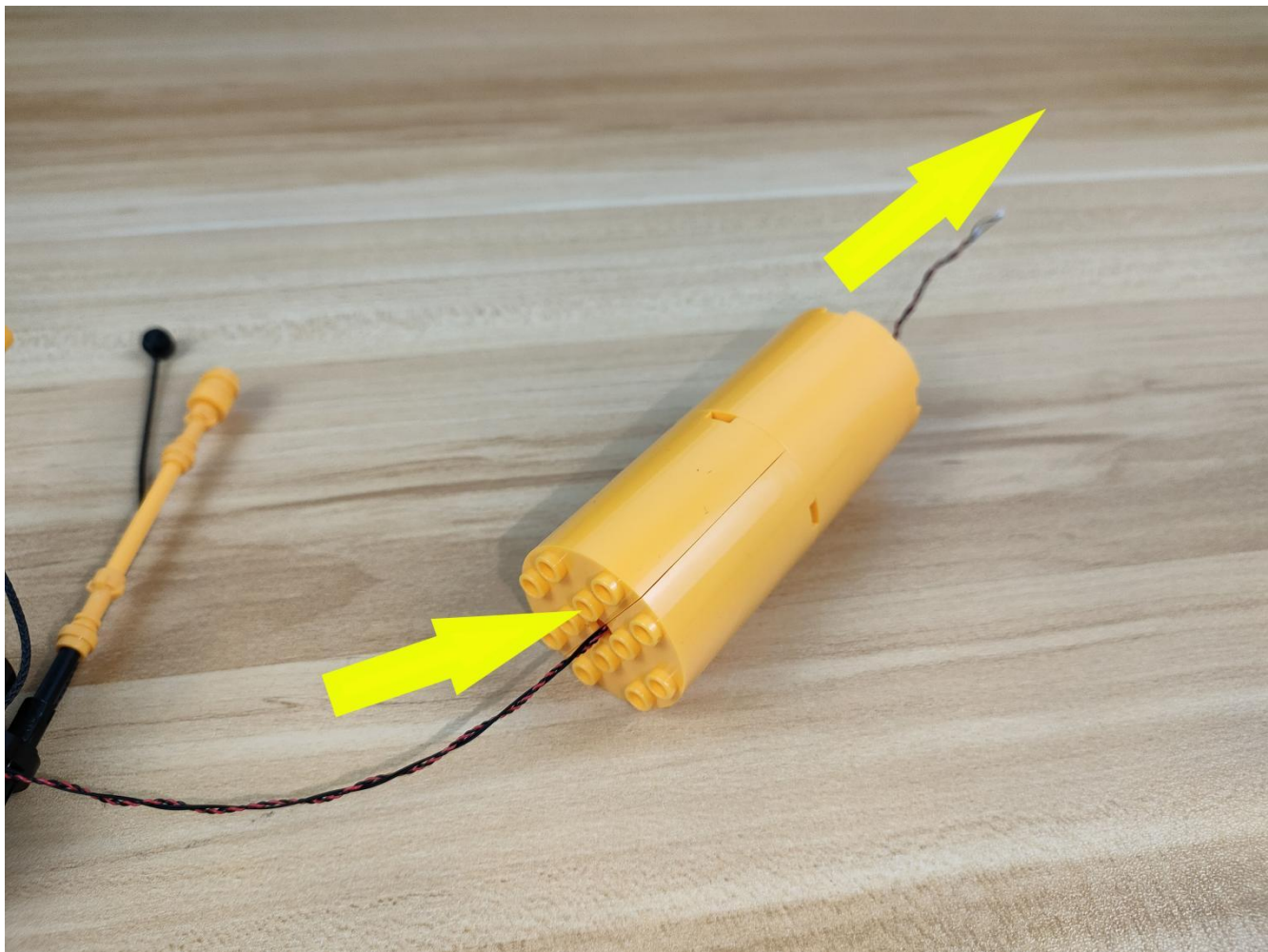

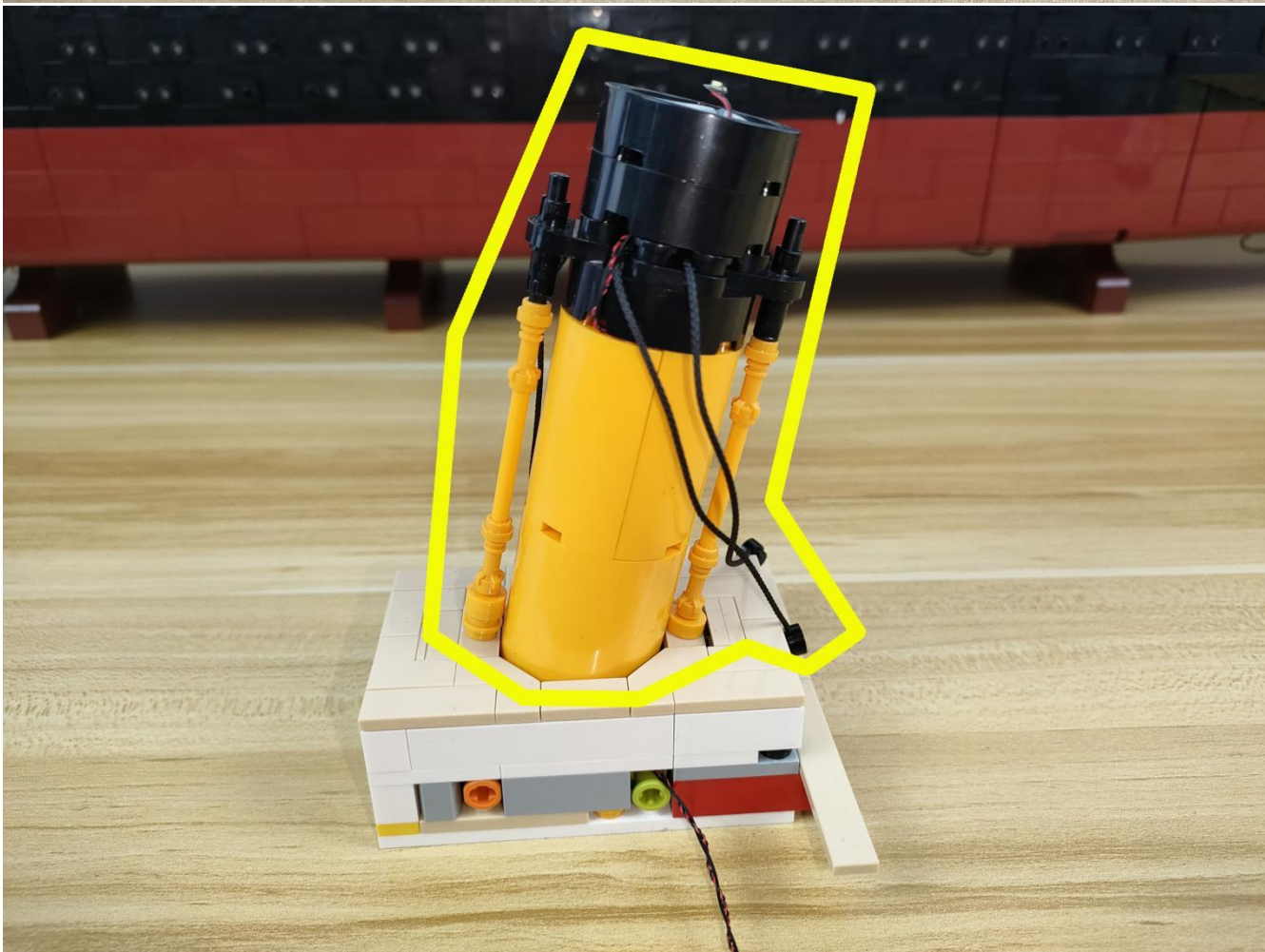
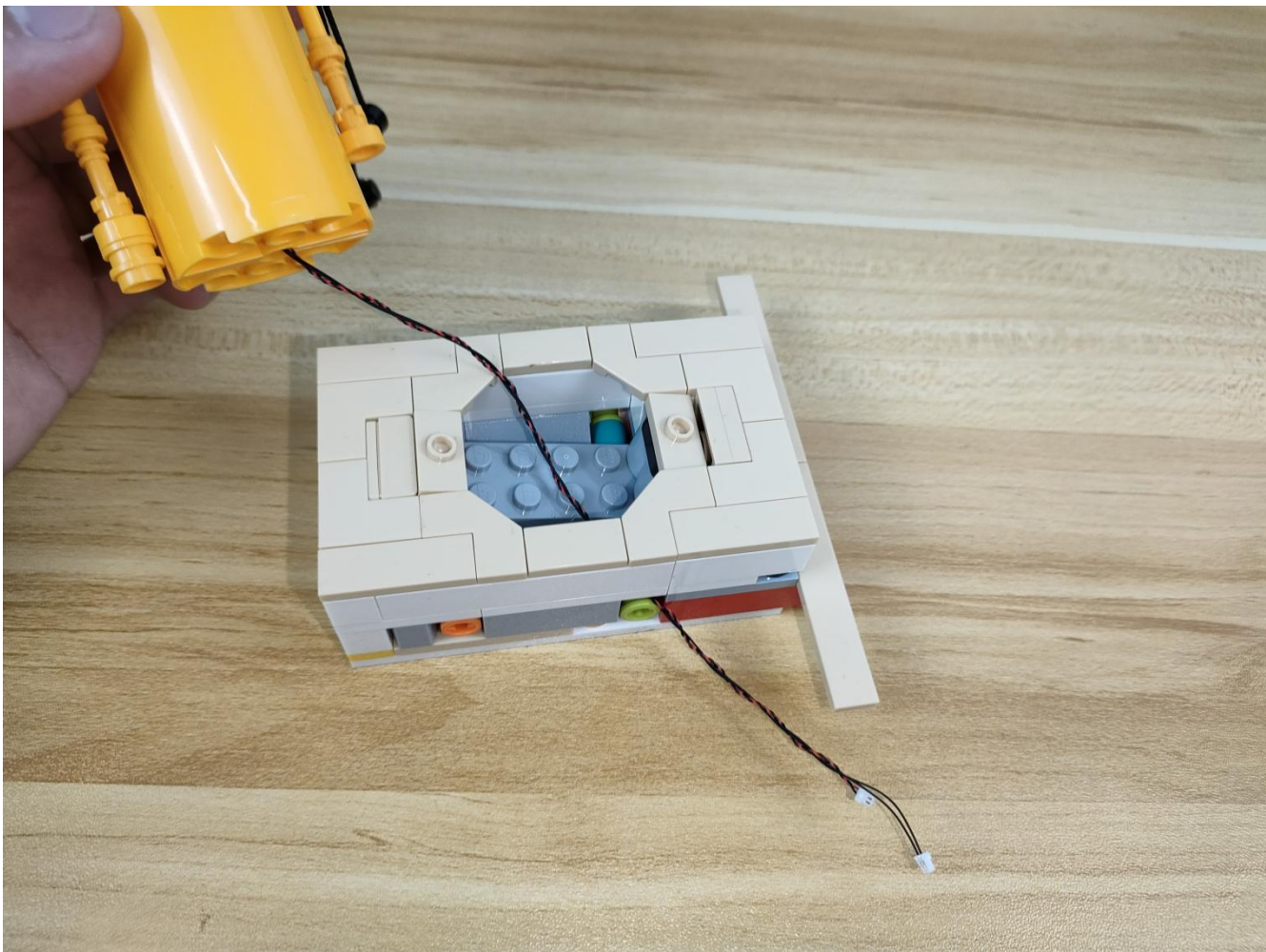

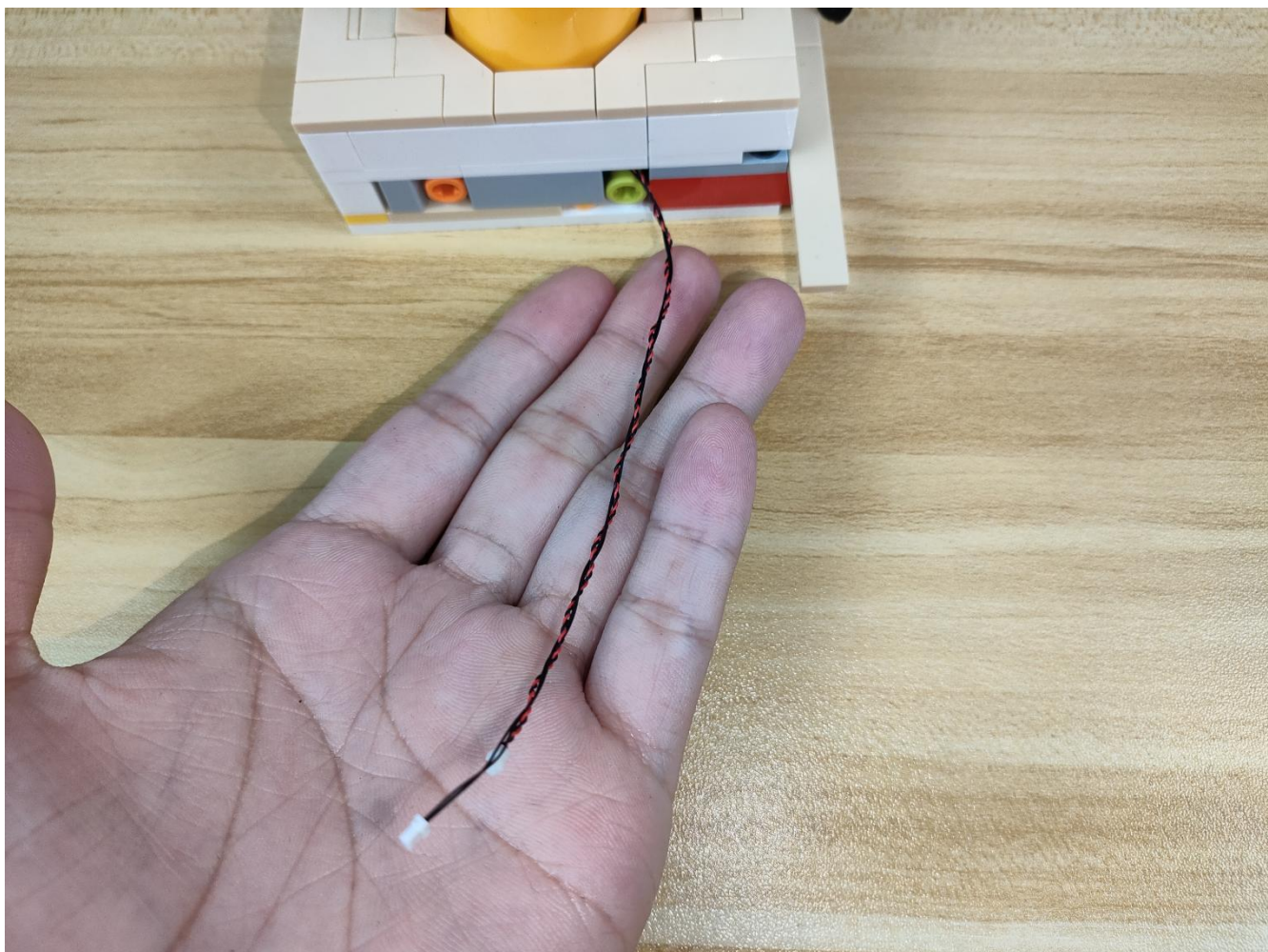

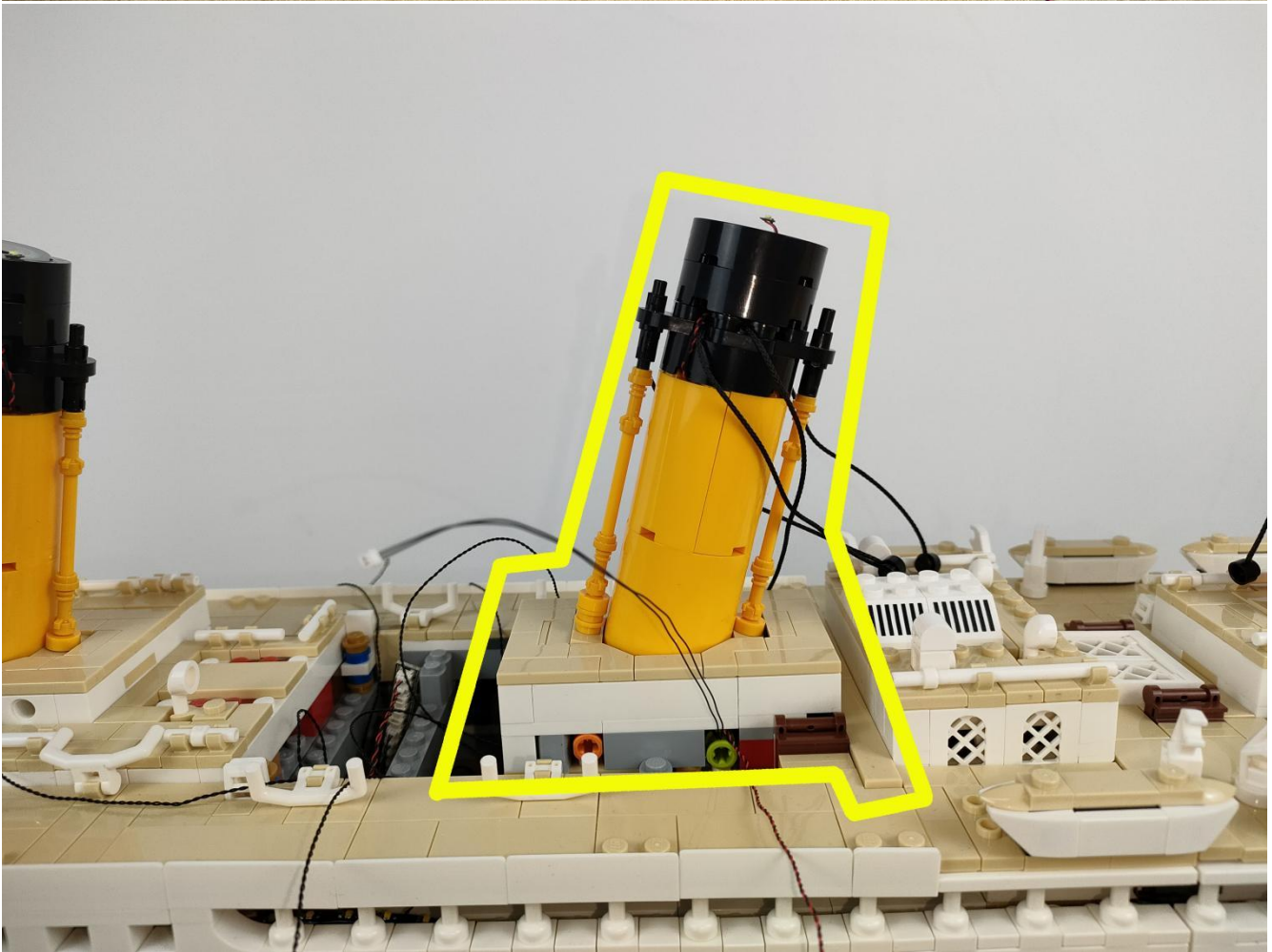
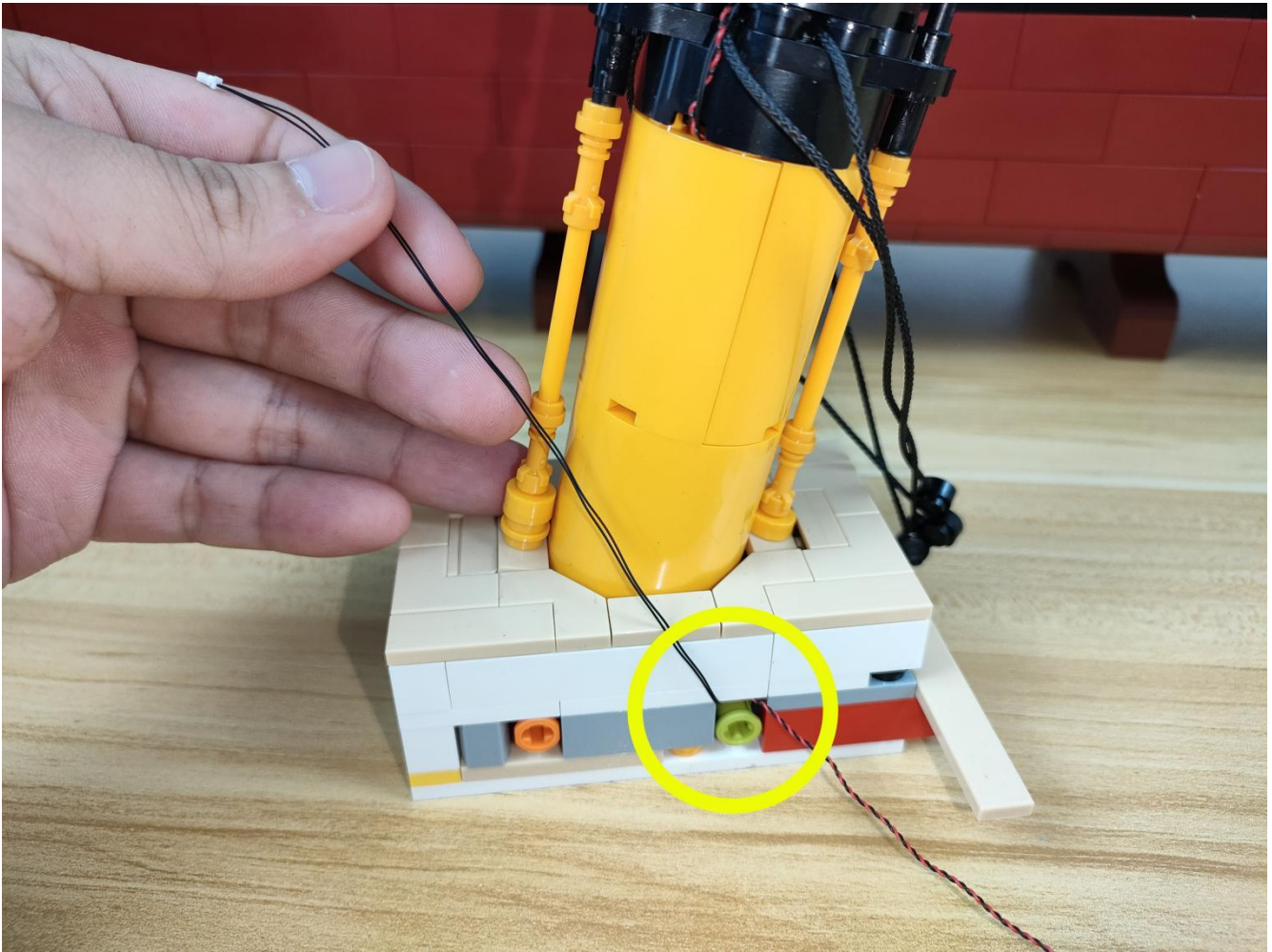

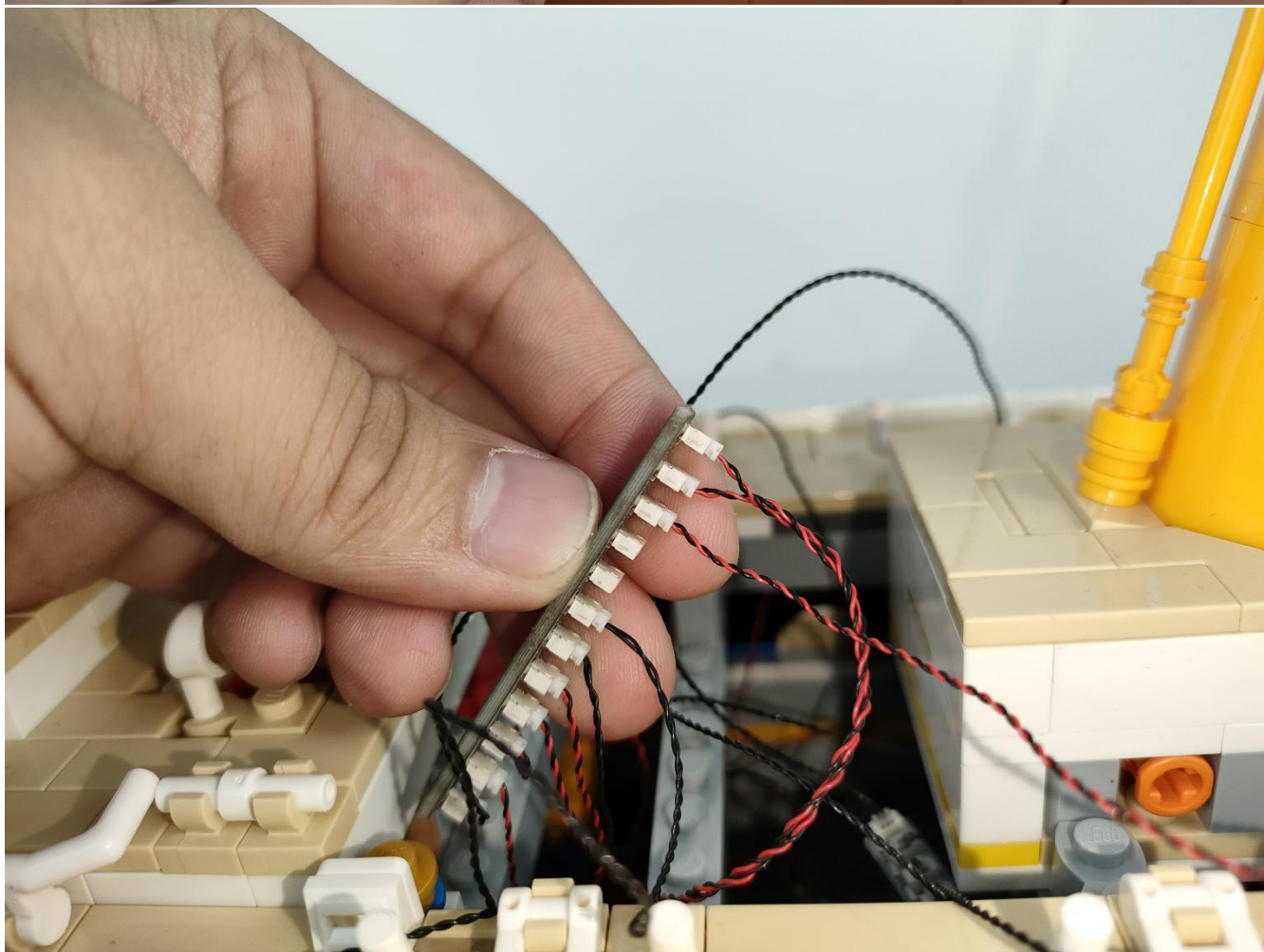
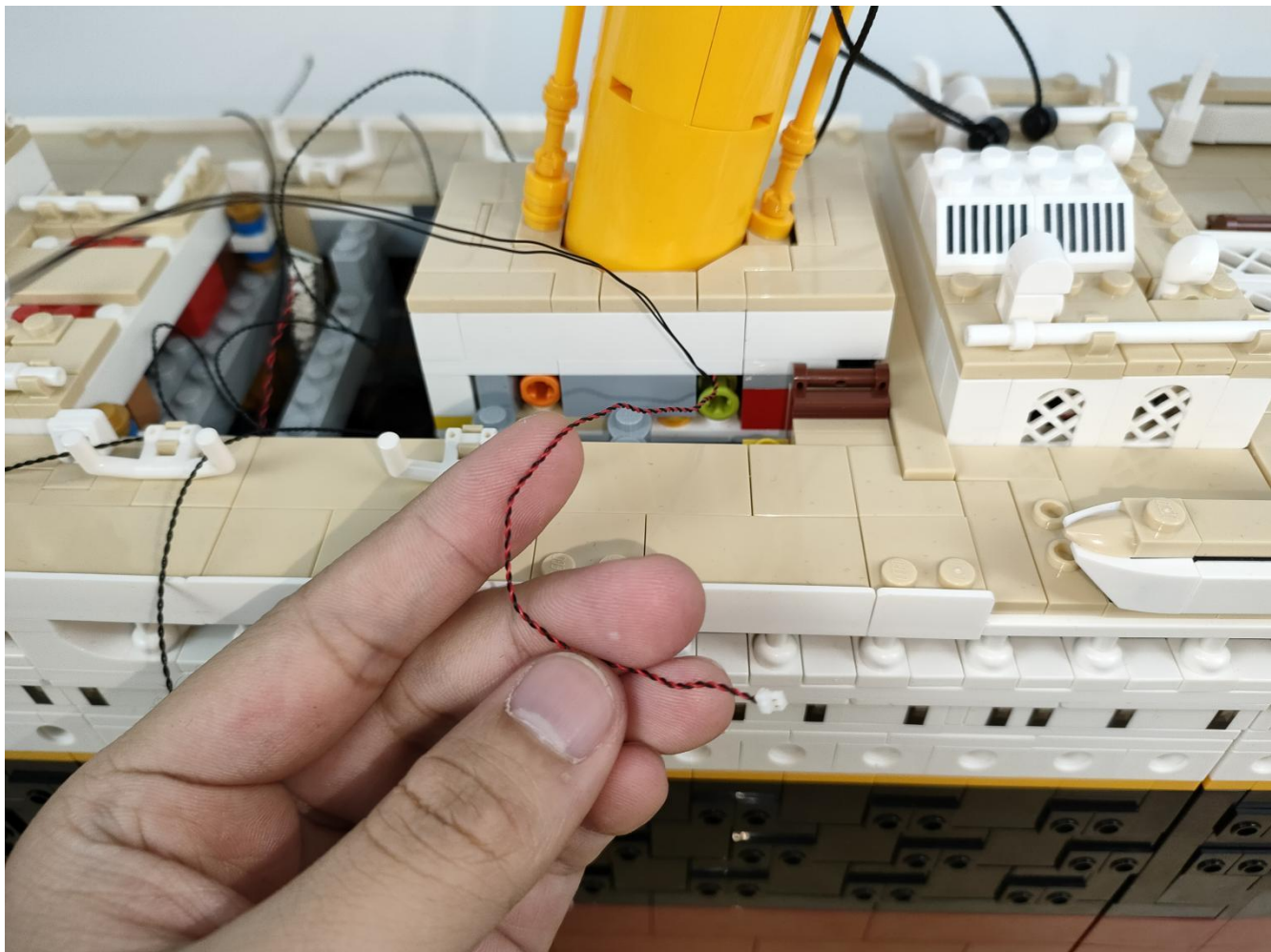



Remote control function description



ON: All branches are opened

OFF: all branches are closed

A: open/close A road

B: open/close B road

C: open/close C road

D: open/close D road

FS: Turn on blinking for the last open channel

BLN: Start breathing for the last opened path

↑: Increase blinking/breathing rate

↓: Increase blinking/breathing rate

Brightness+: Increase brightness

Brightness -: Reduce brightness



Pay attention to the connection method of the cable.

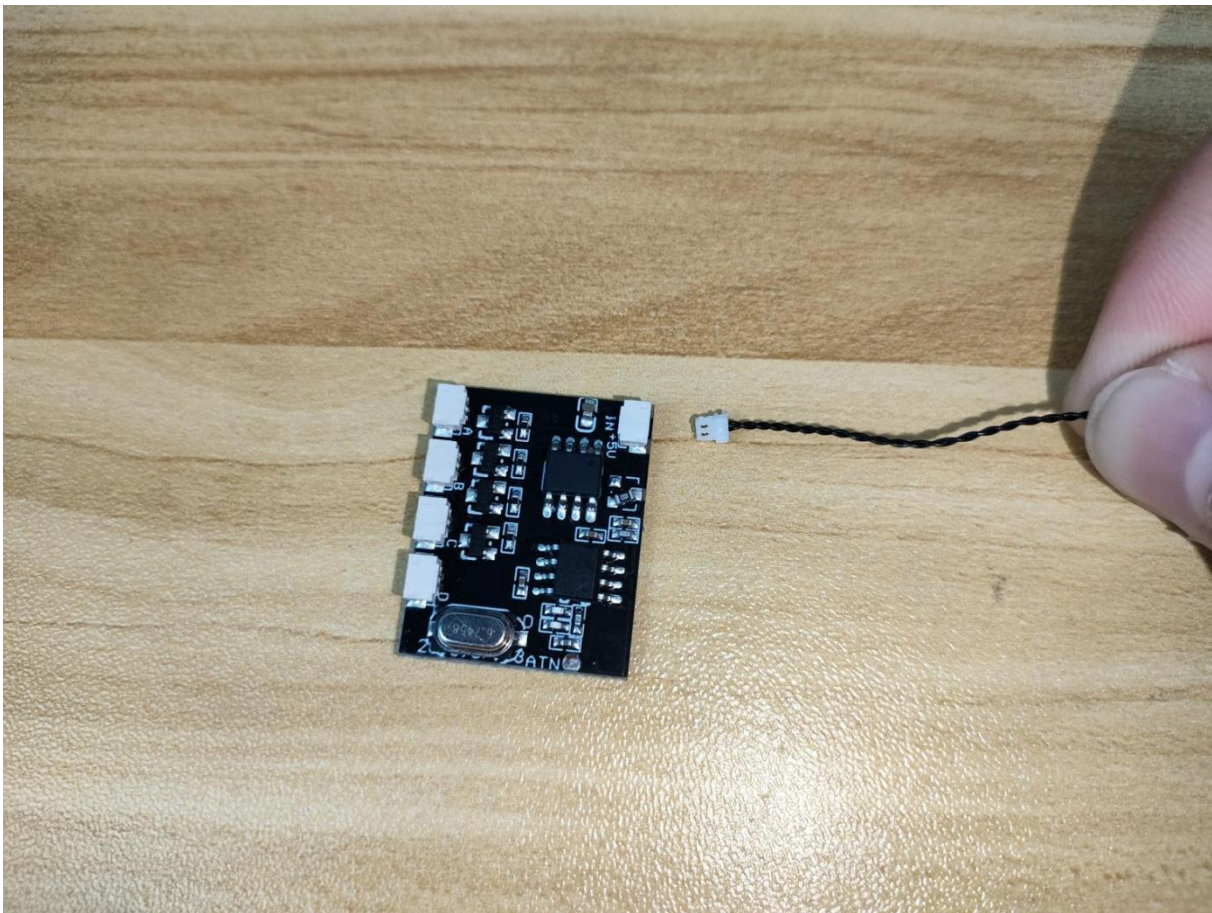

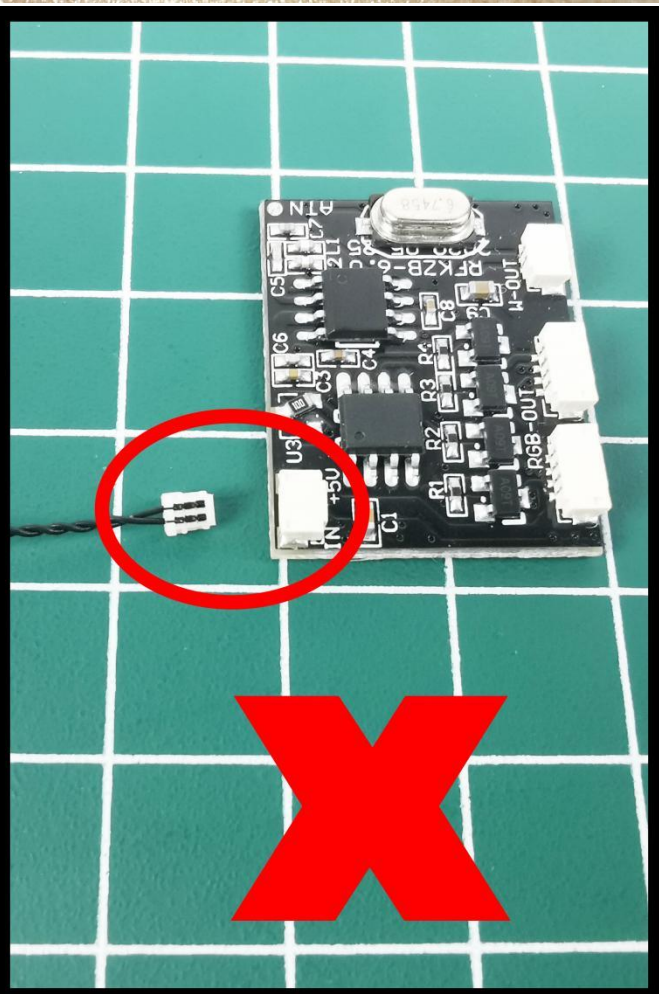
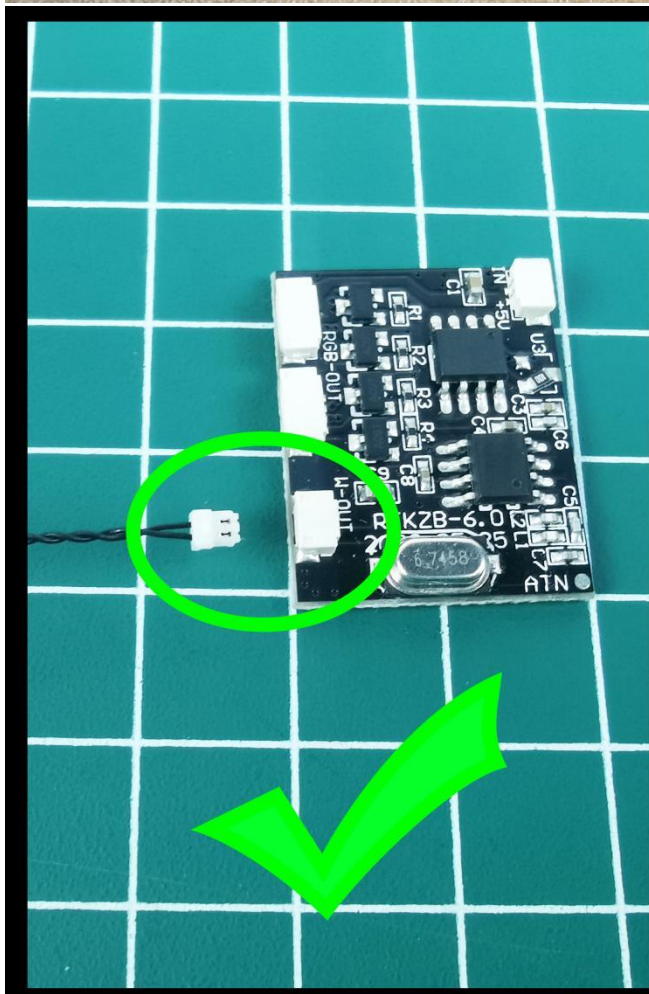
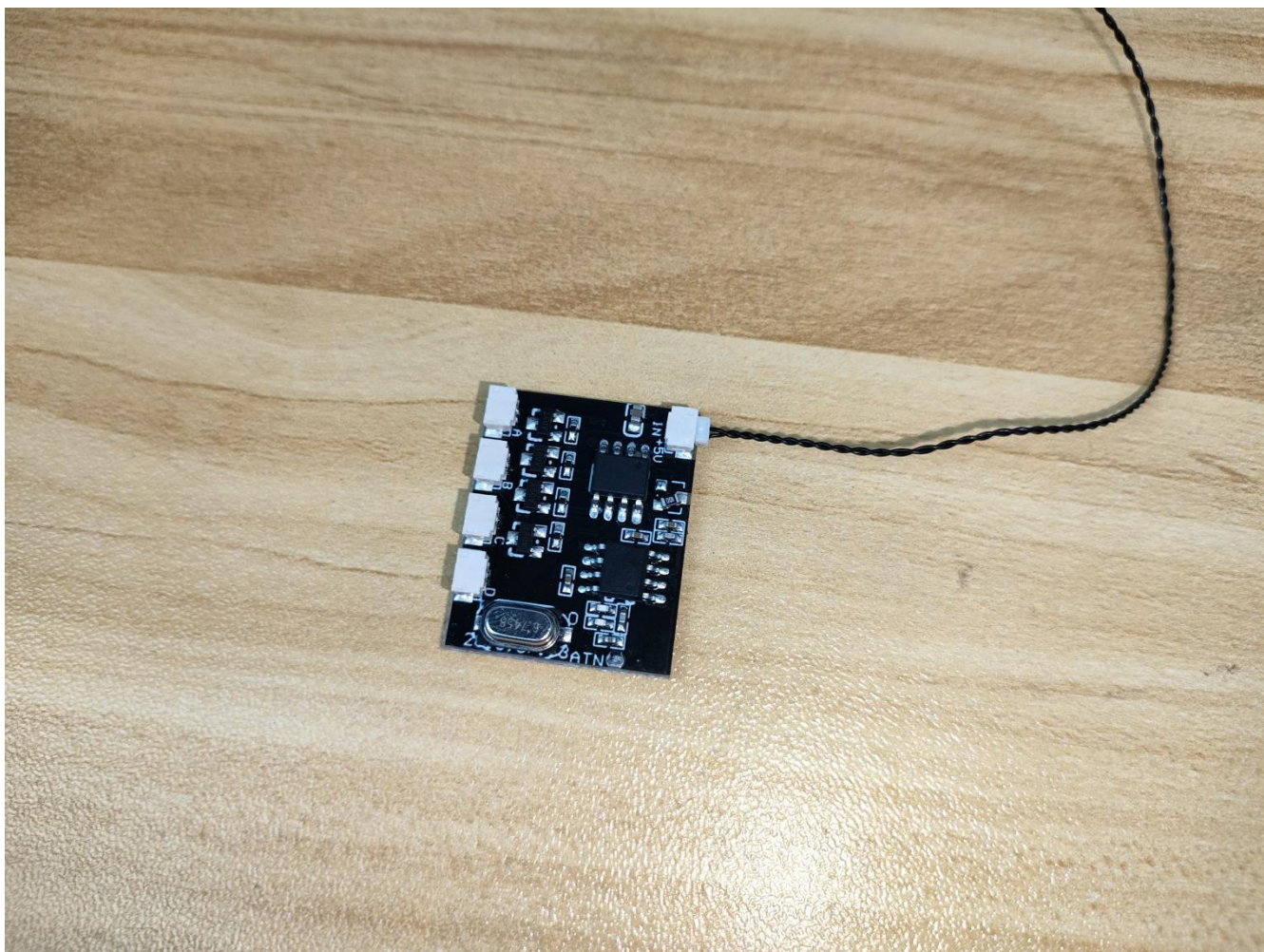

Connect the connecting wire of the bow in the picture to the remote control module.

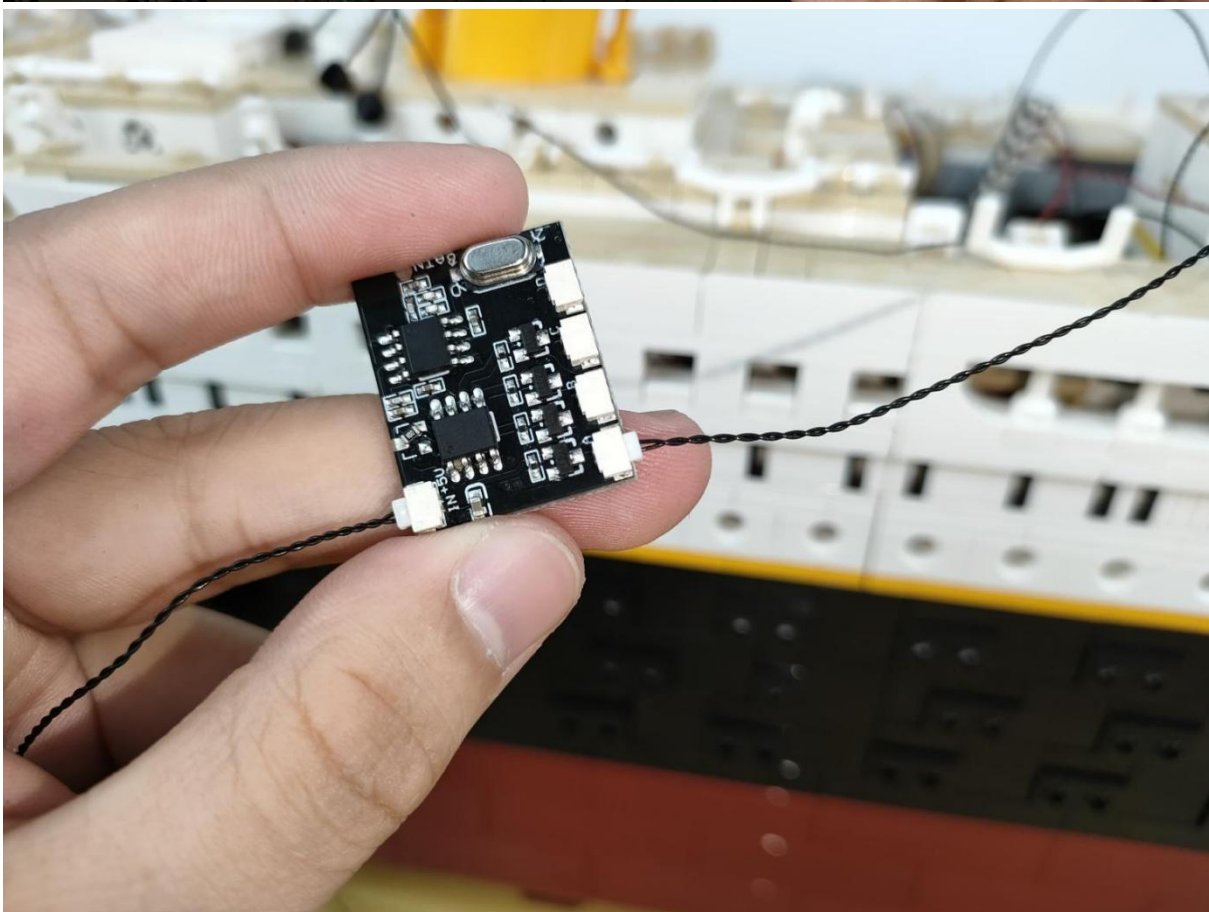
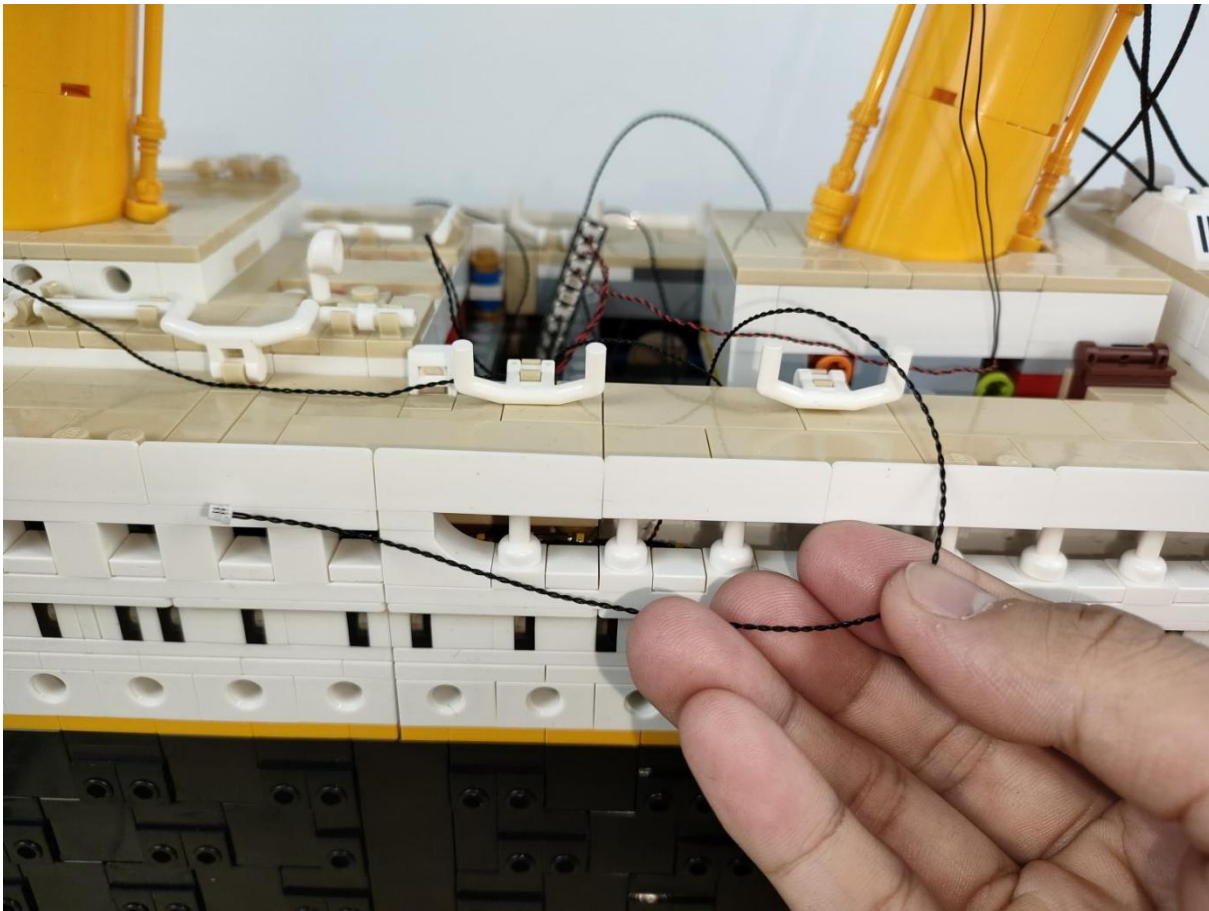

Connect the connecting wire on the first floor in the picture to the remote control module.

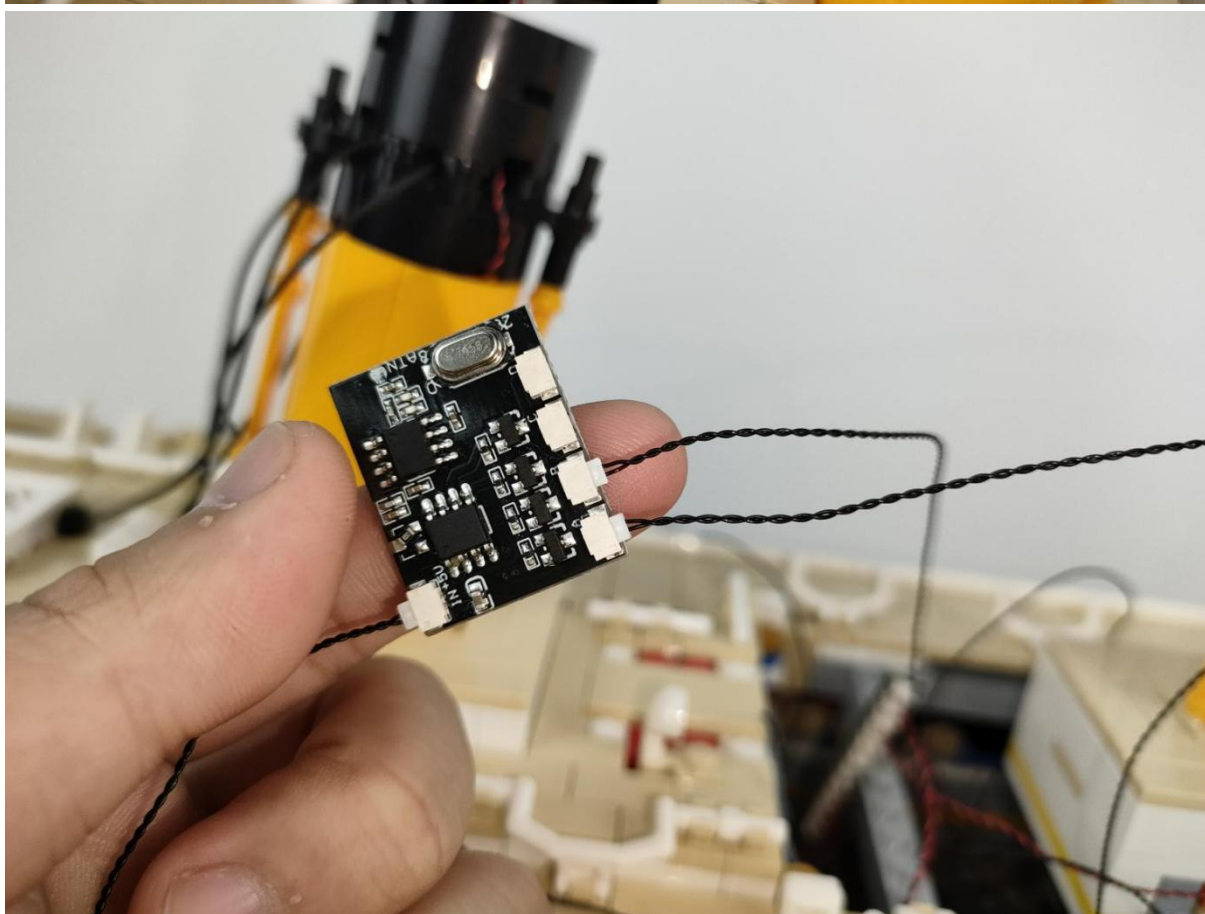
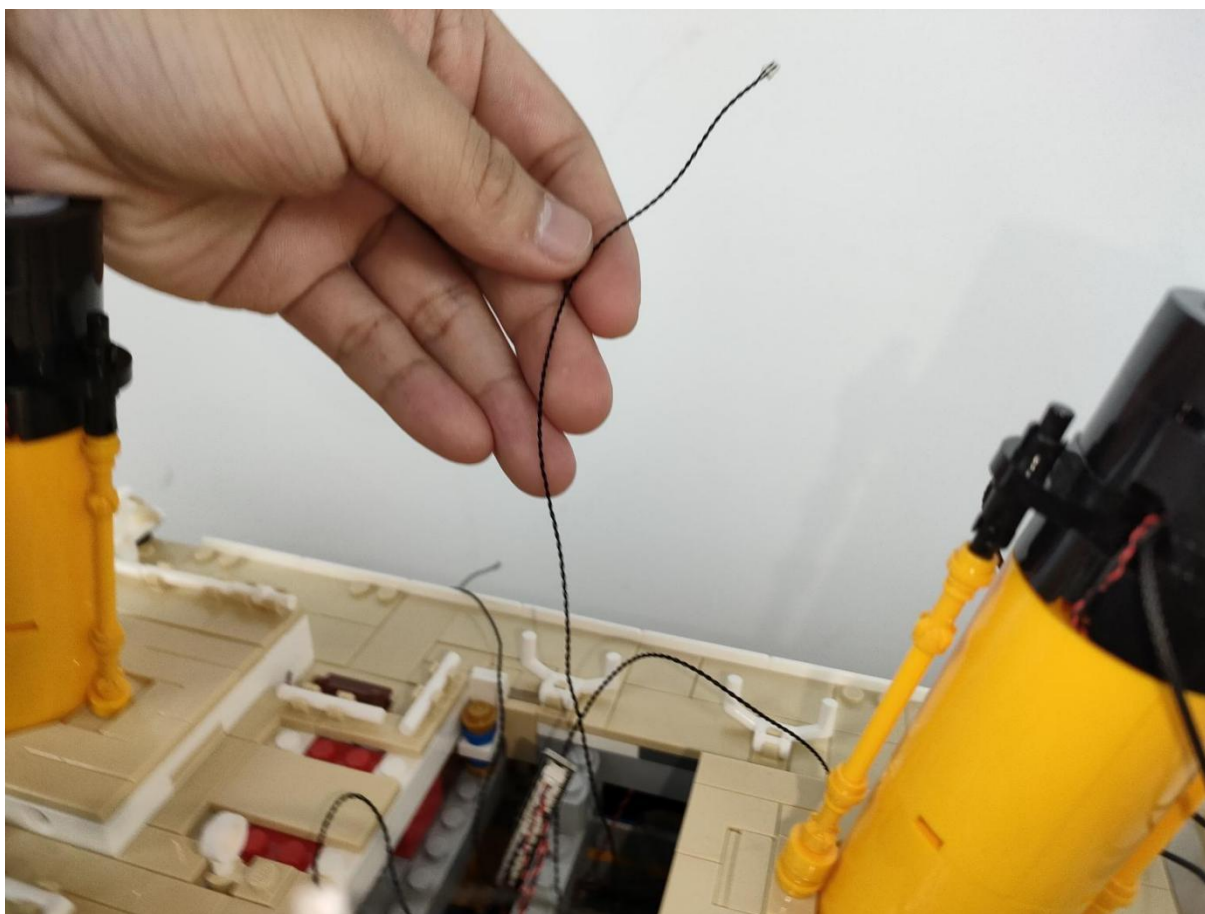

Continue to connect the cable on the 2nd floor in the picture to the remote control module.

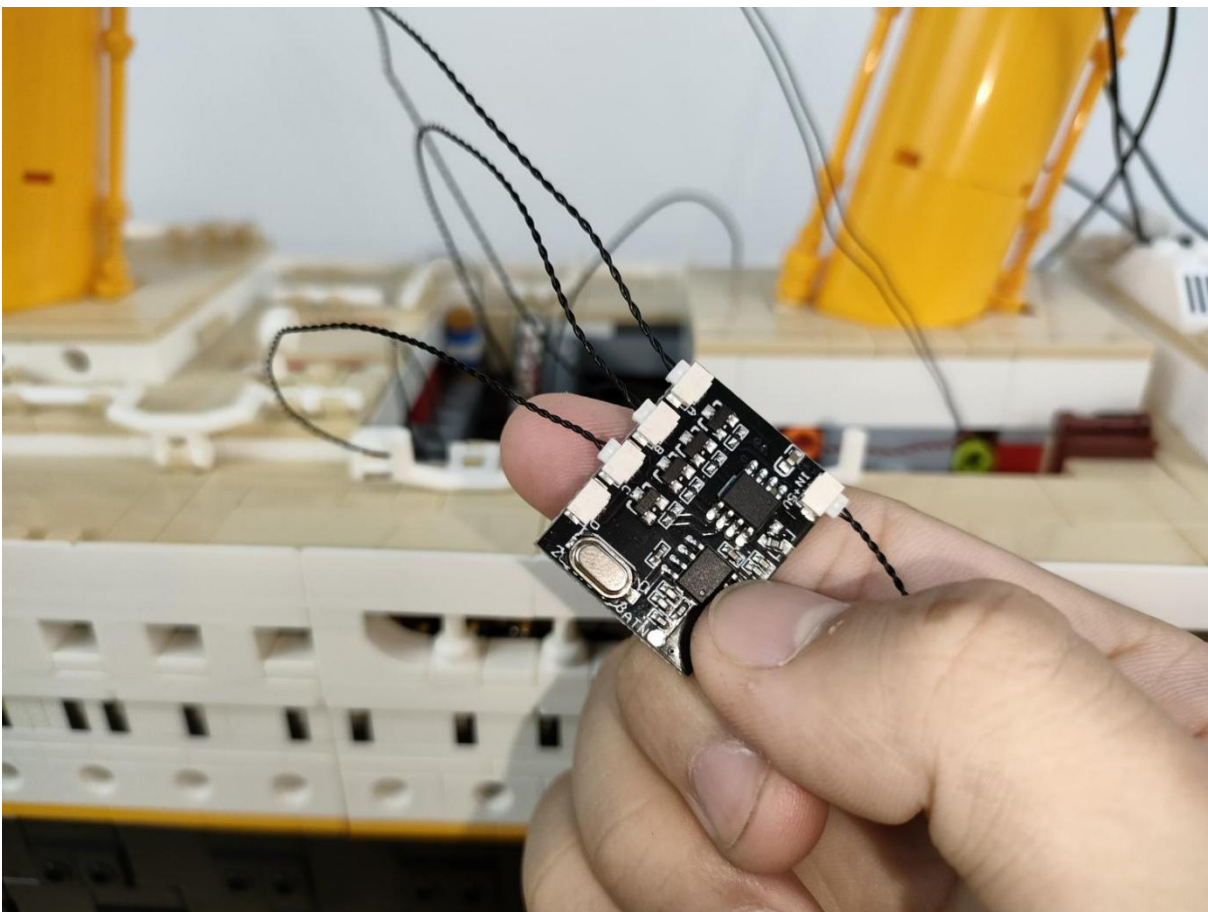
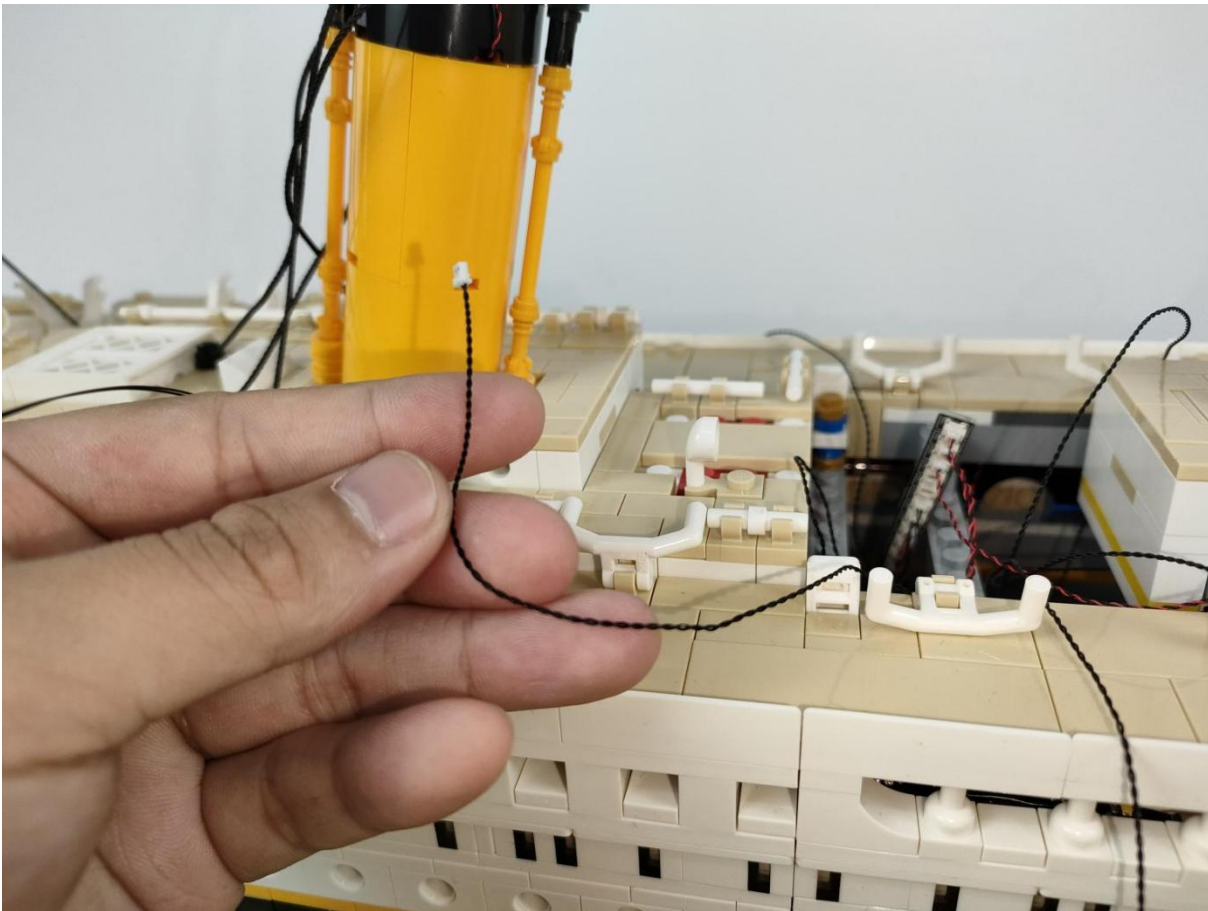

Connect the connecting wire of the deck in the picture to the remote control module.

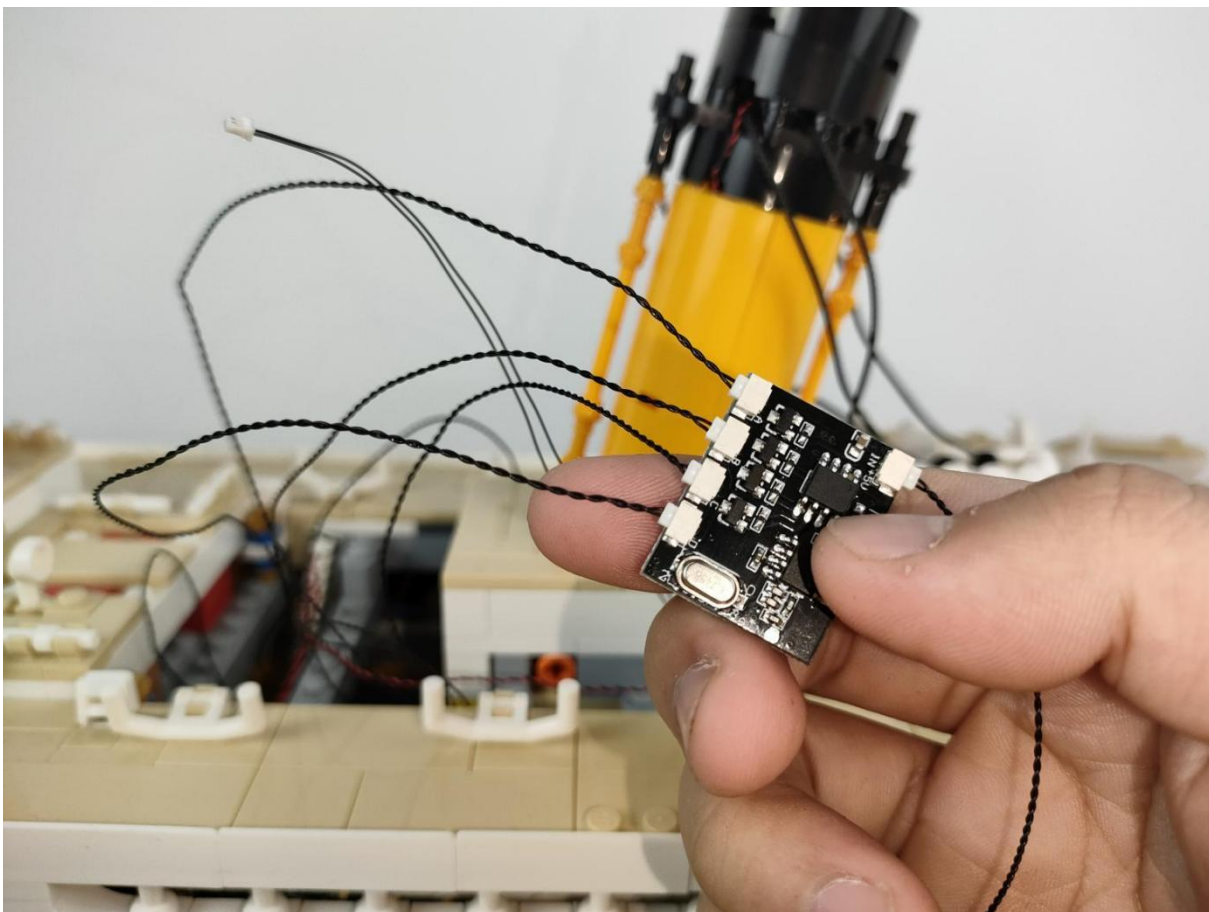
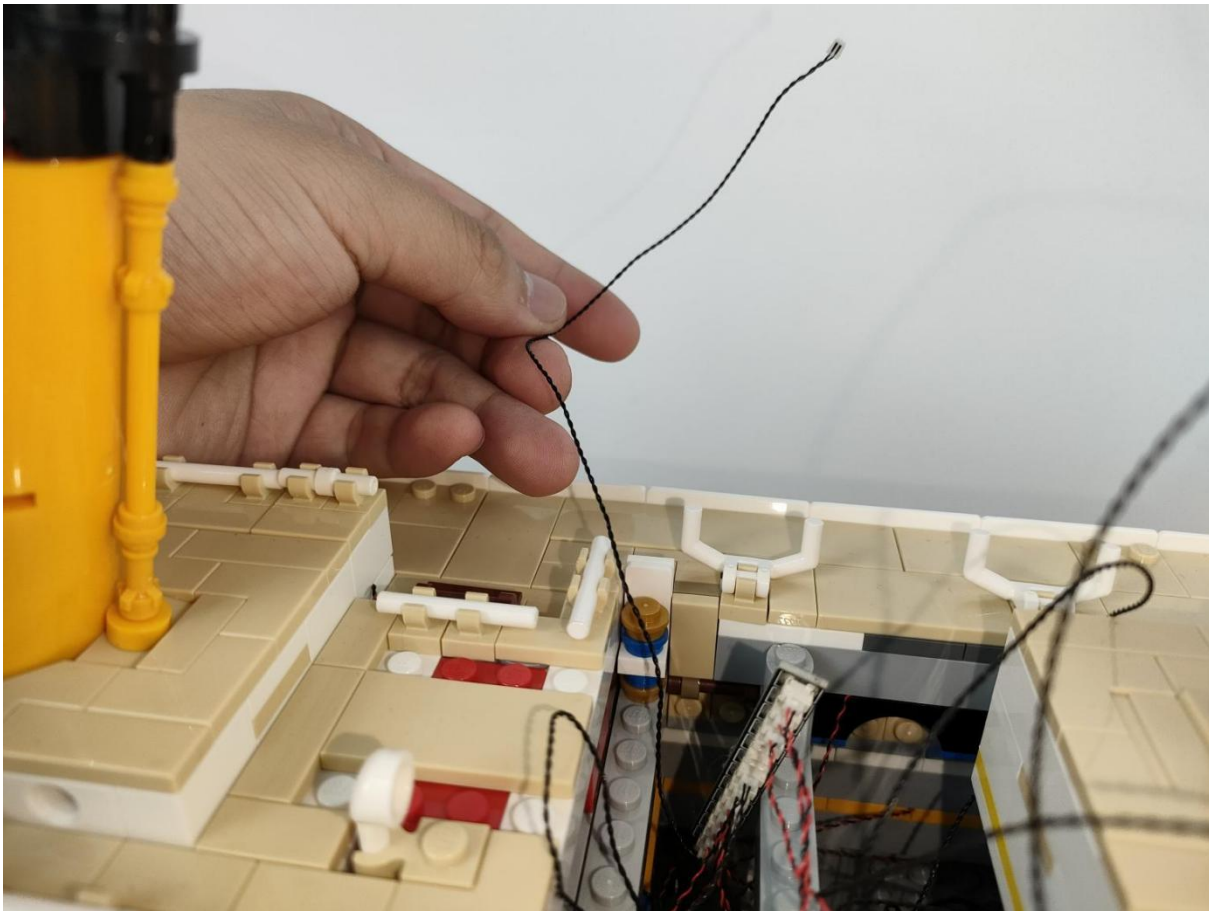

Place the remote control module on the position shown in the figure.

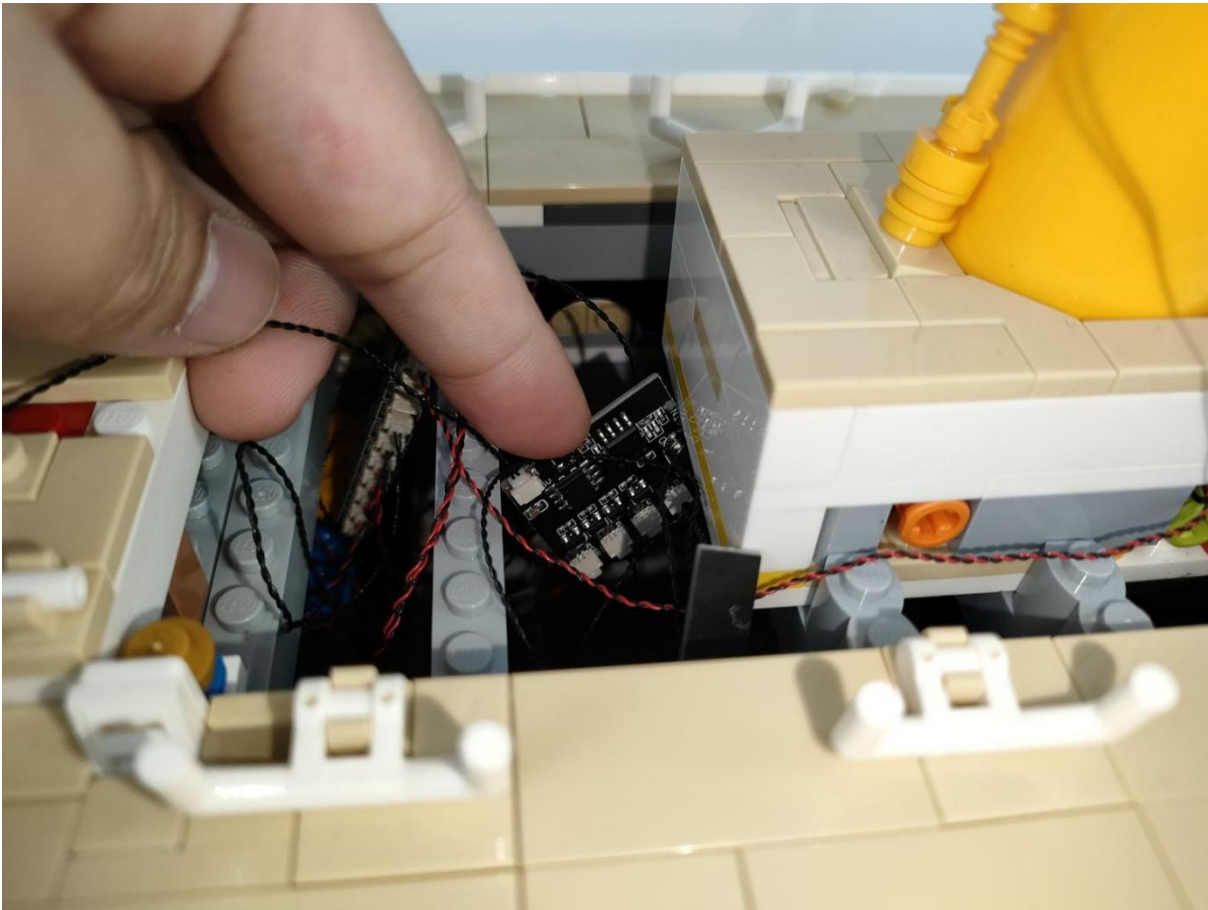

Find the 50CM connection line in the picture.

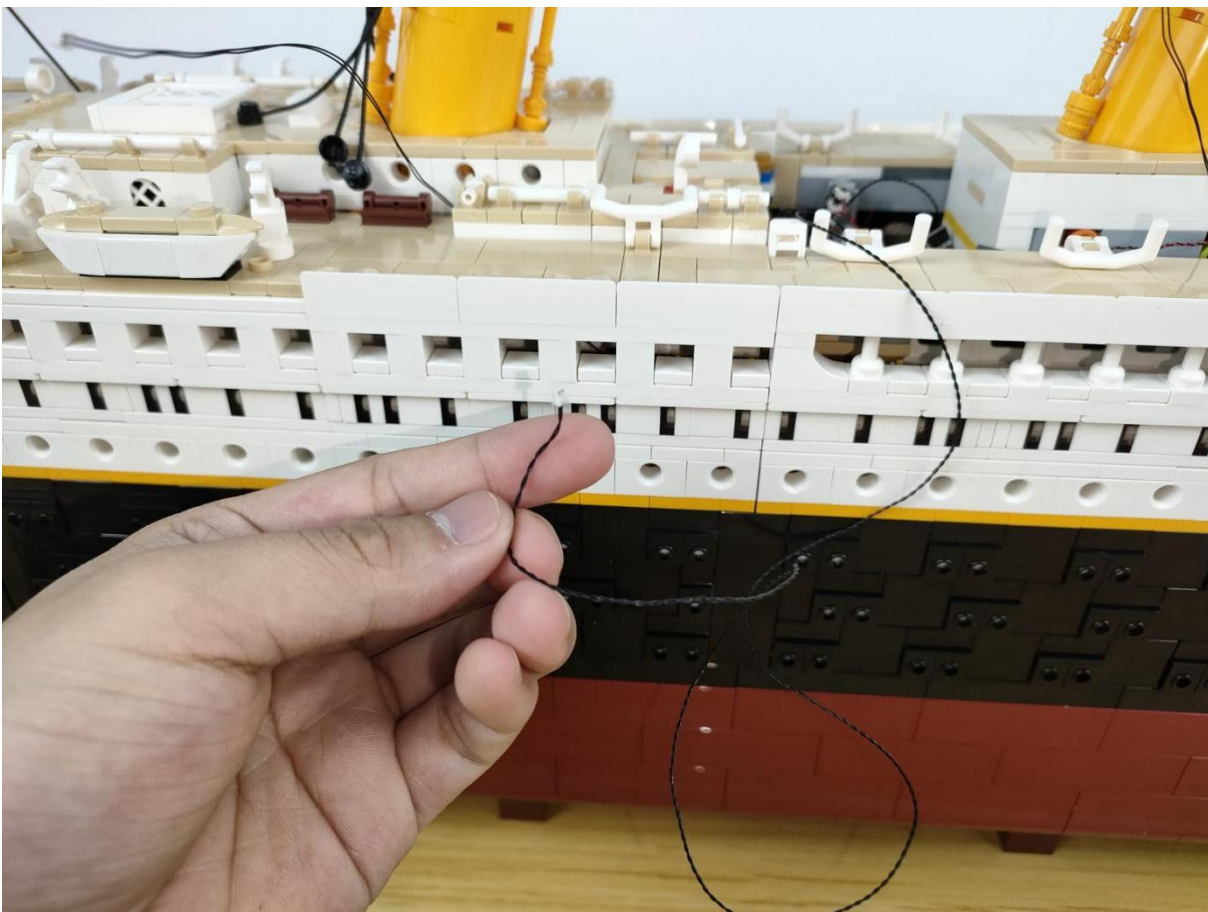



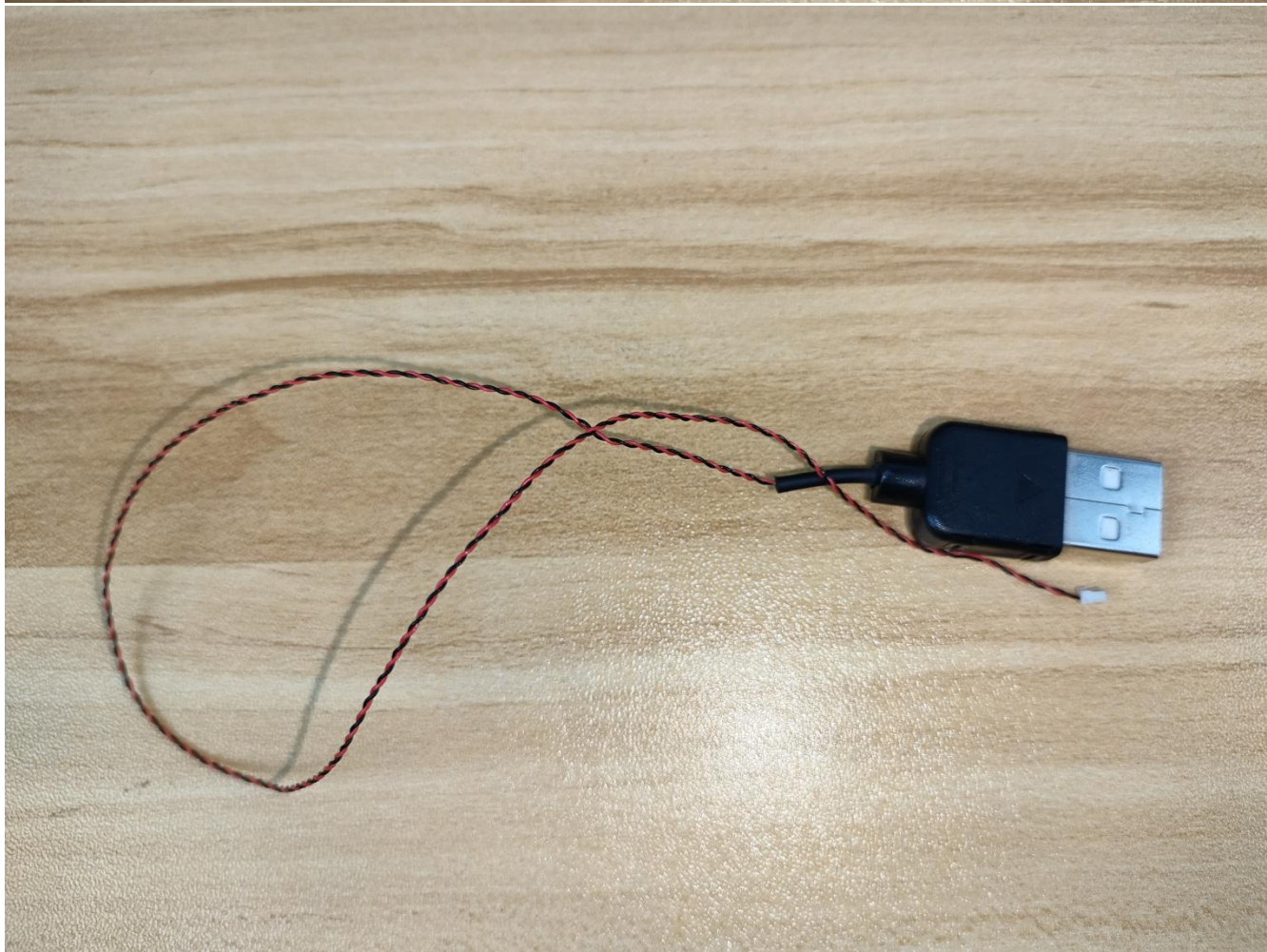
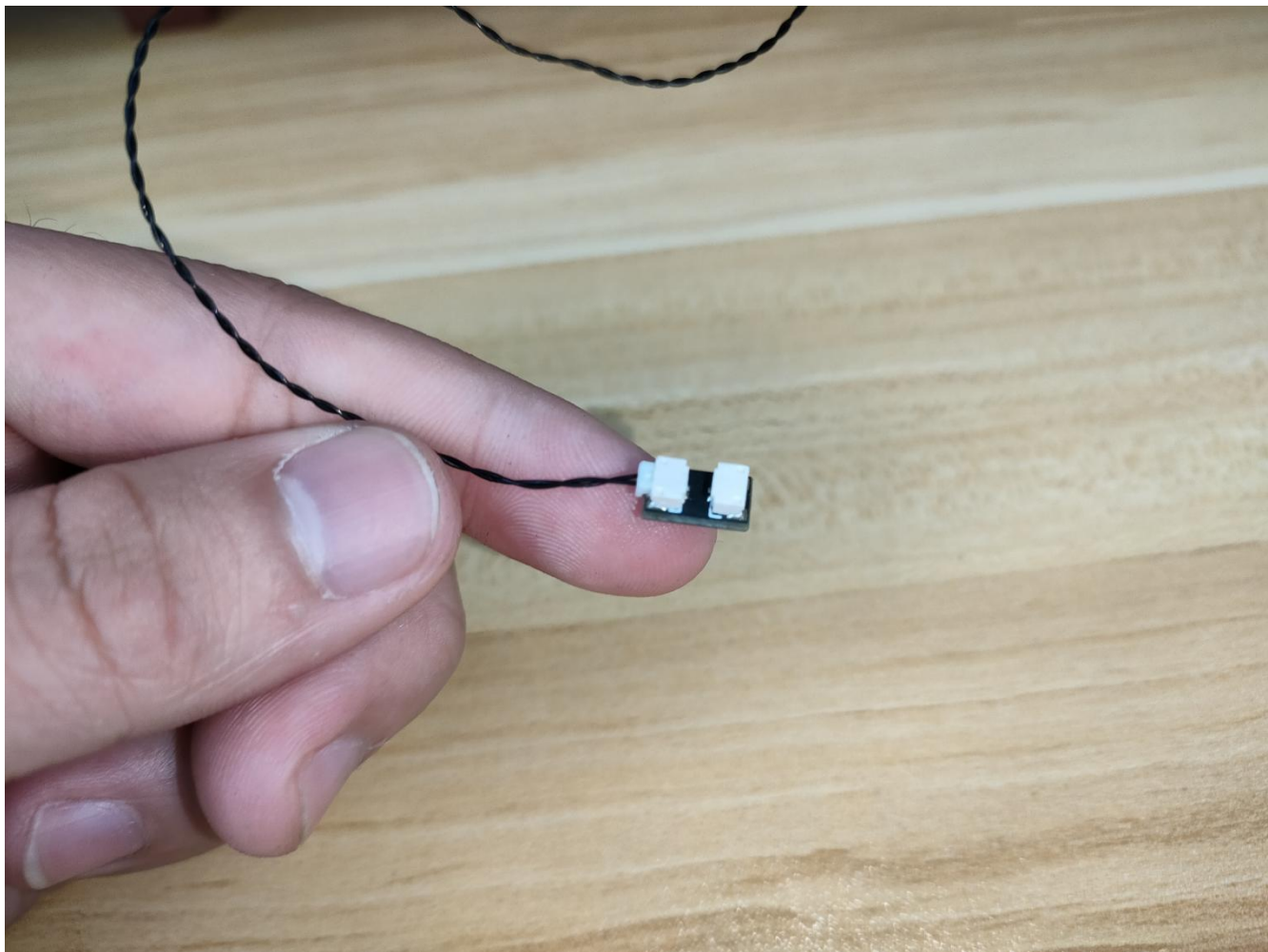

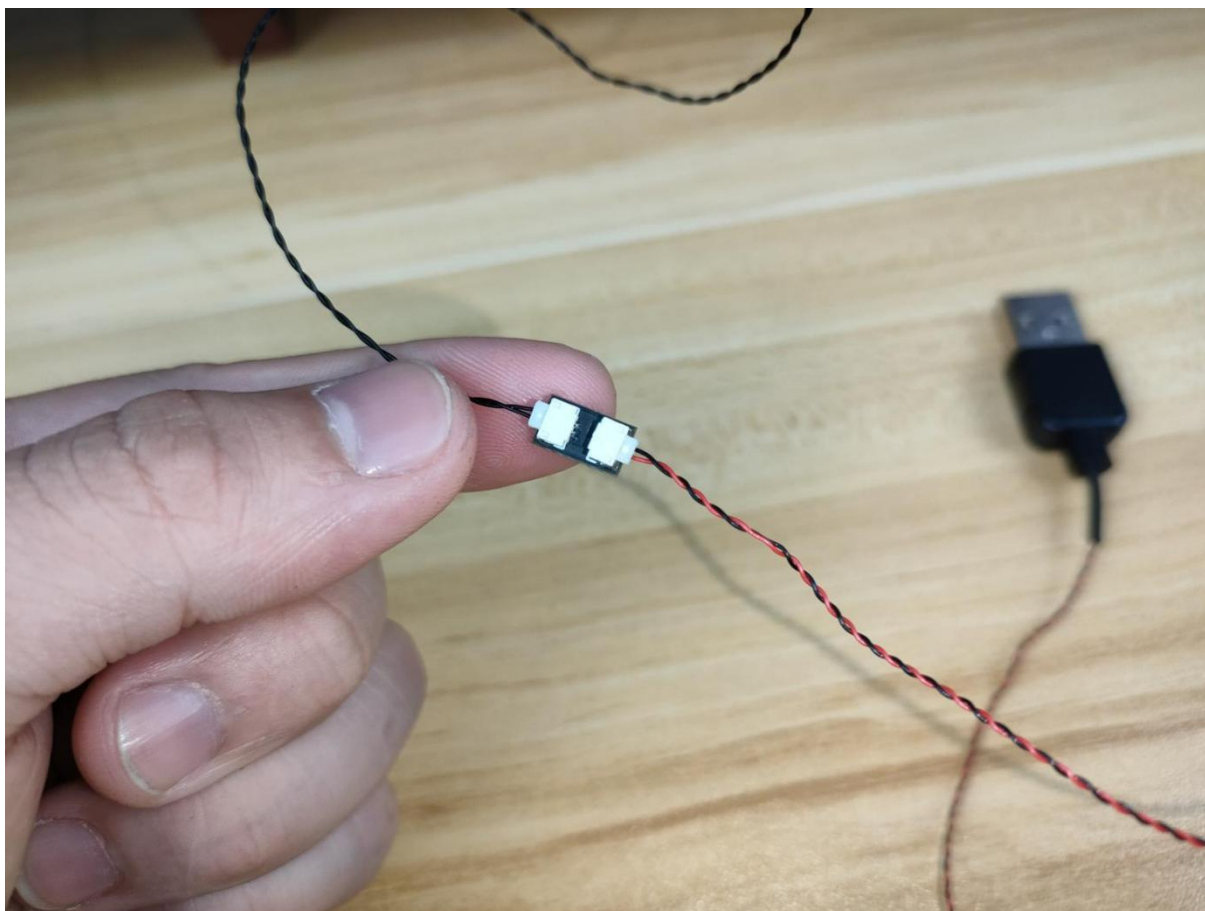

Take out the insulating film of the remote control, the remote control can be used normally.



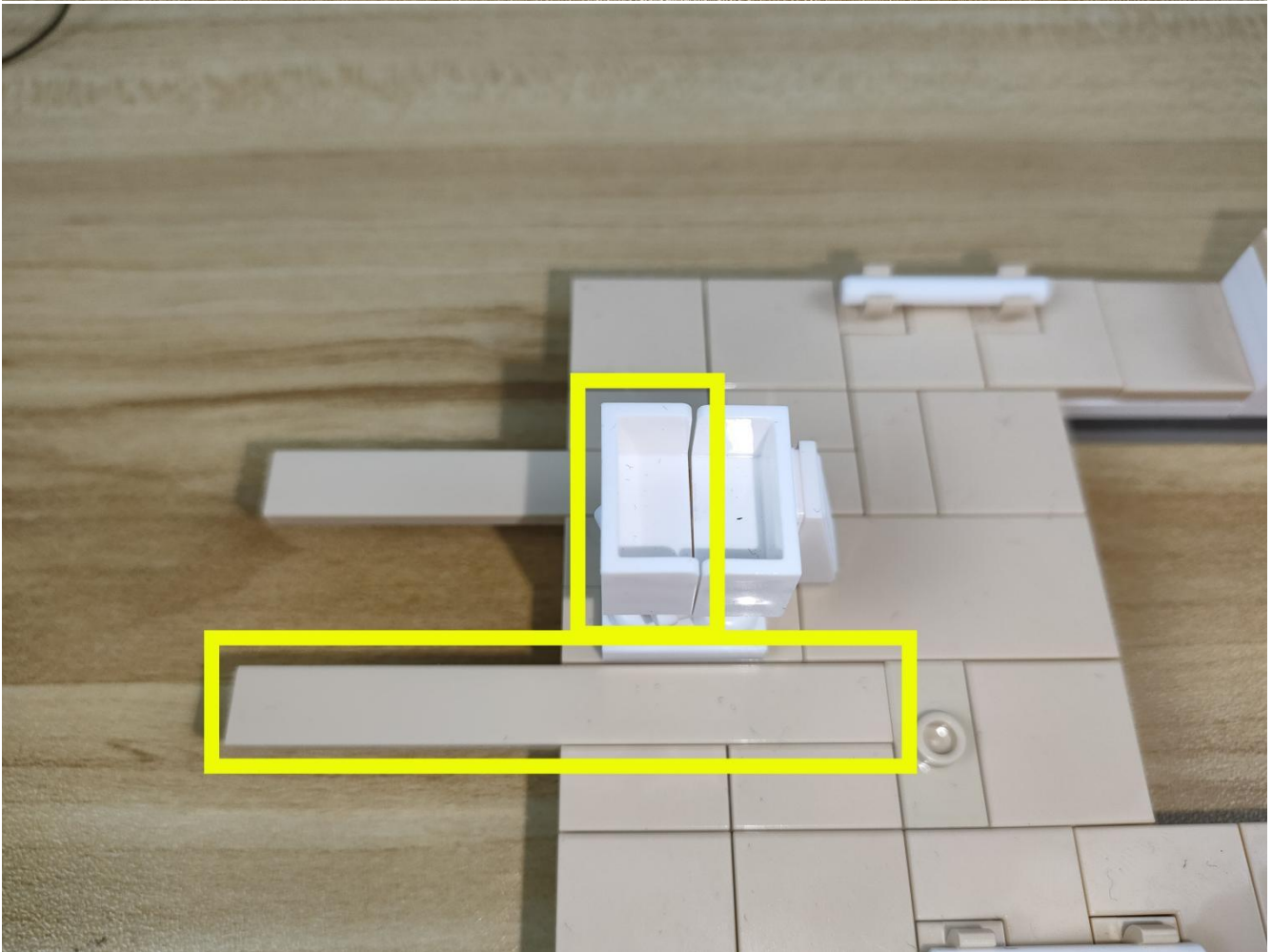
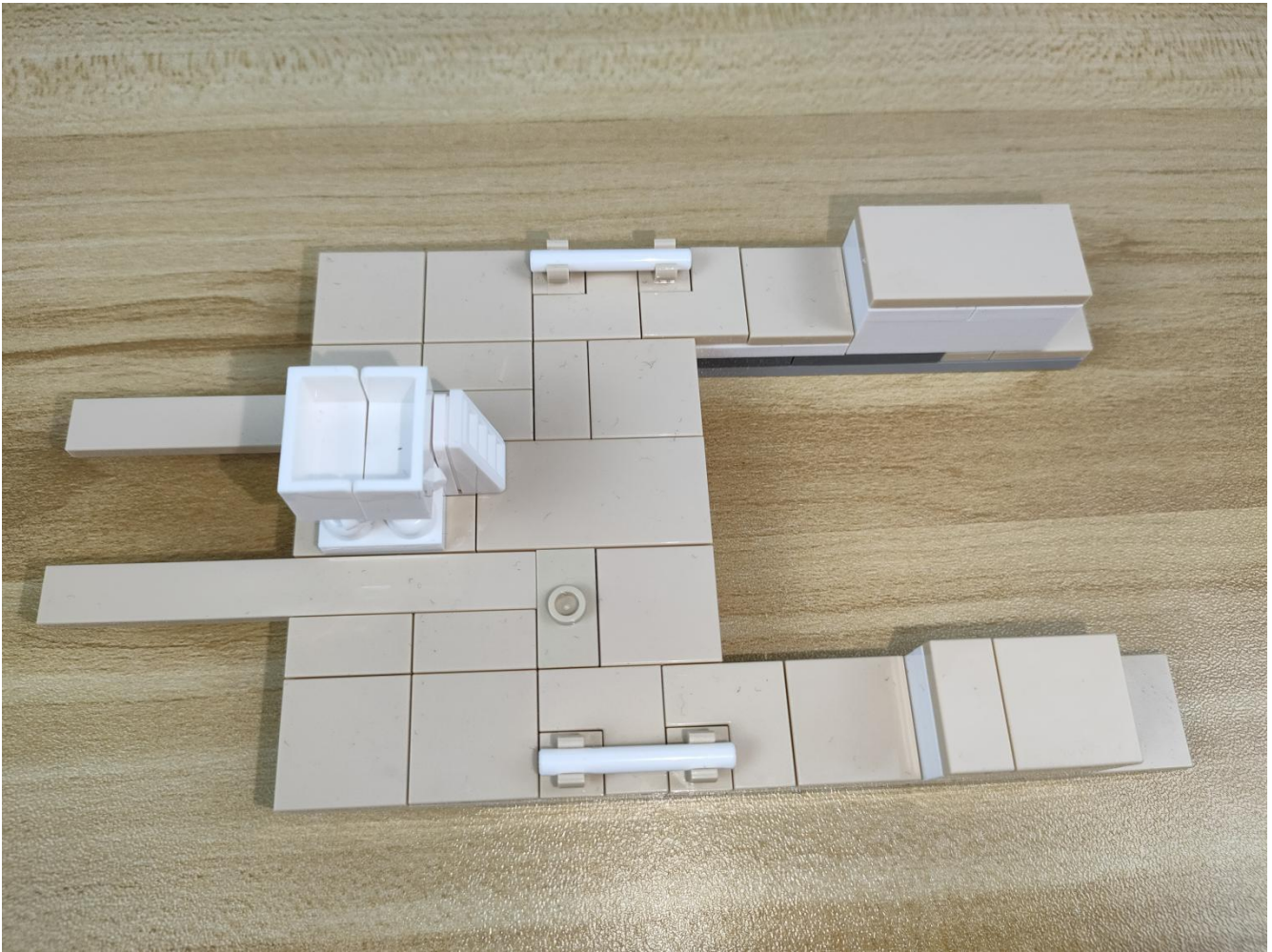

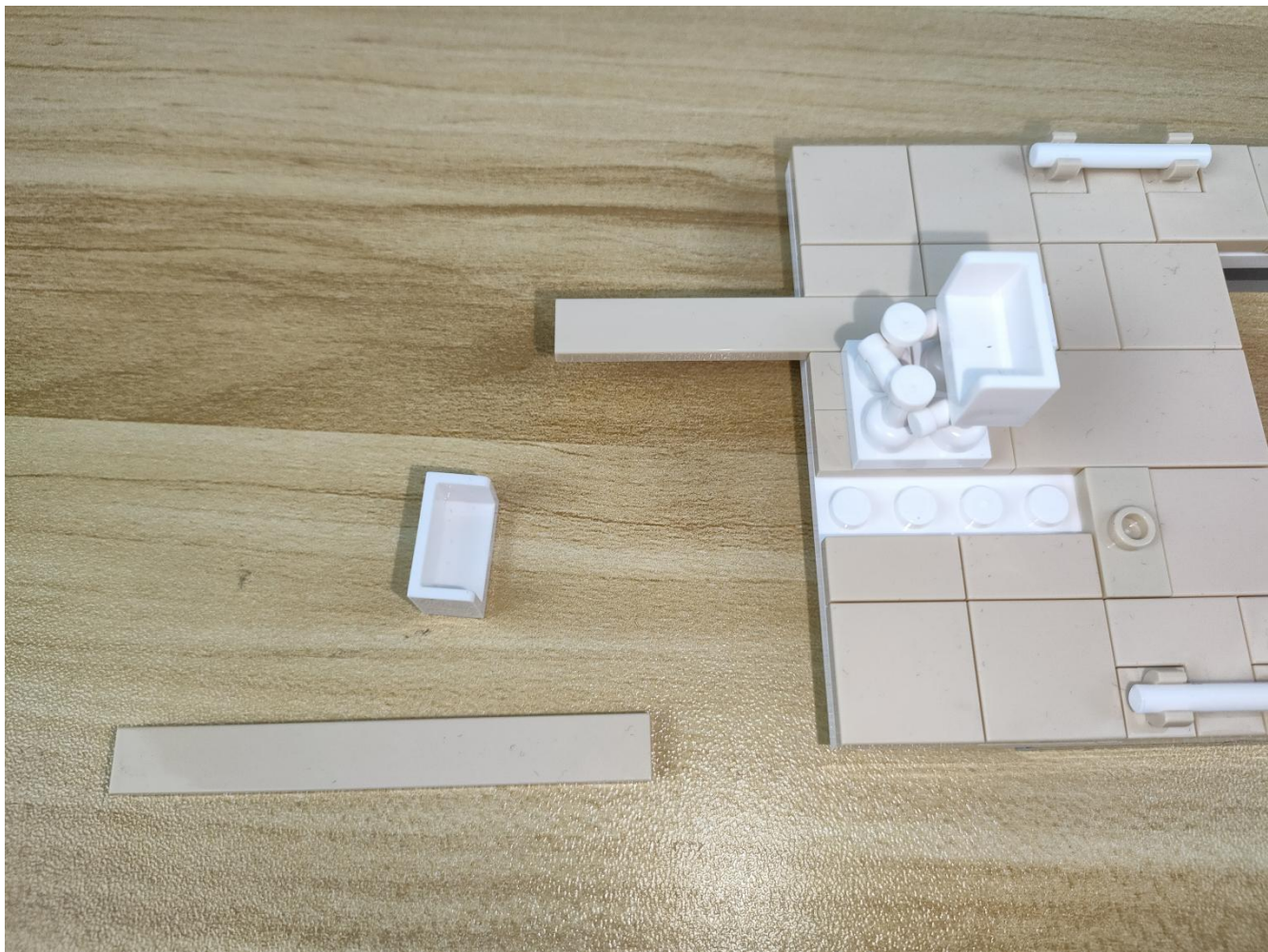

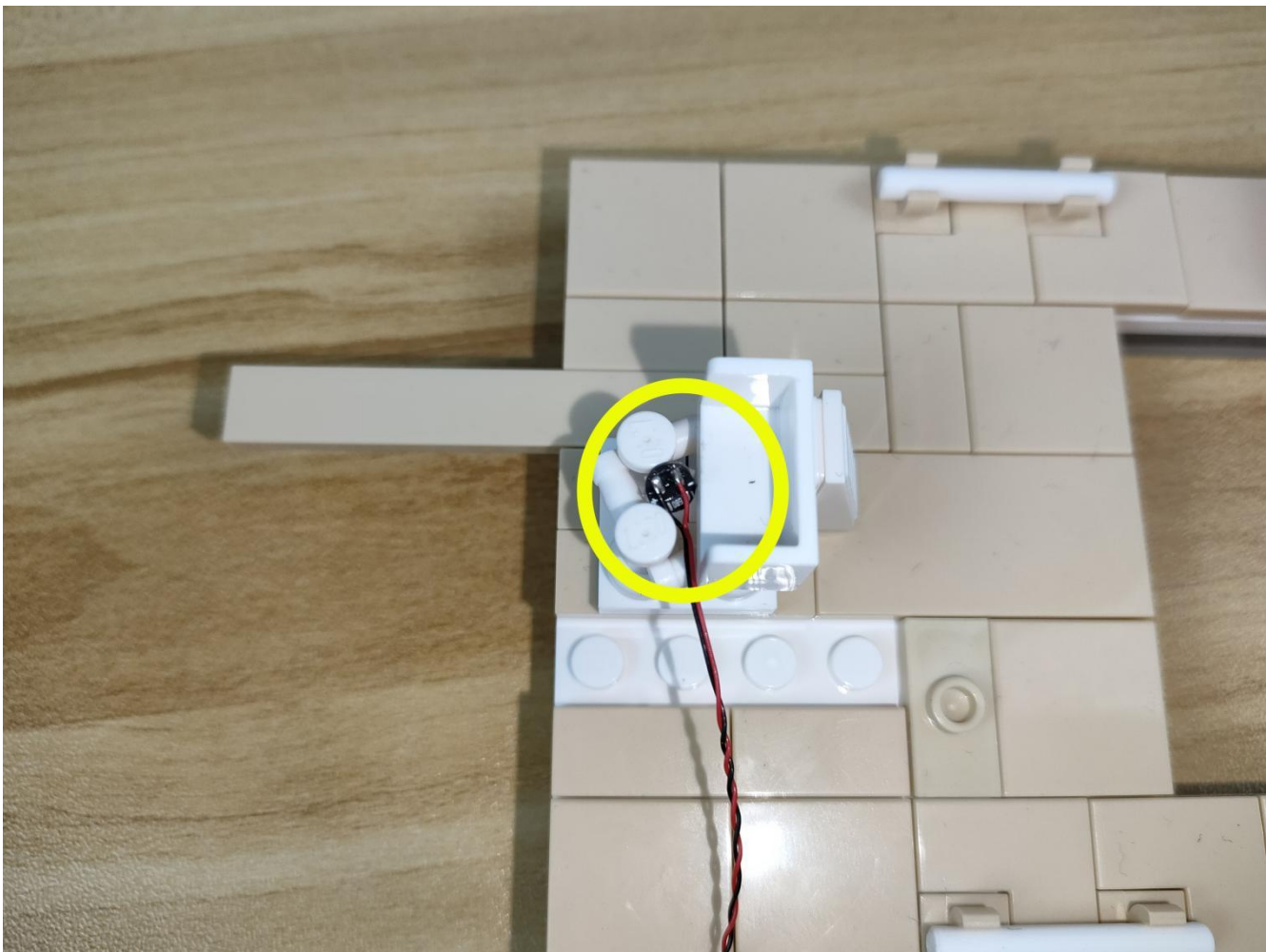

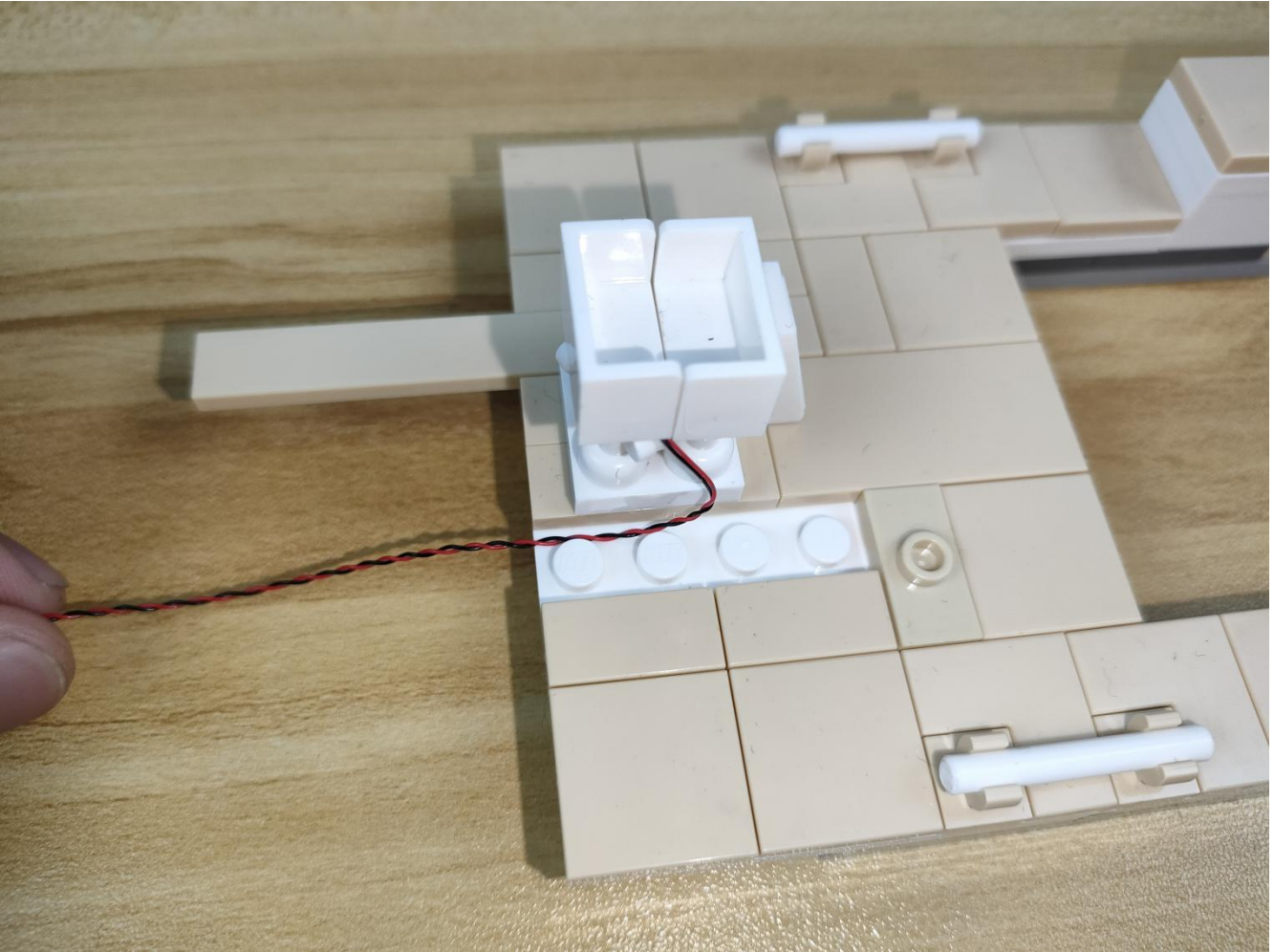
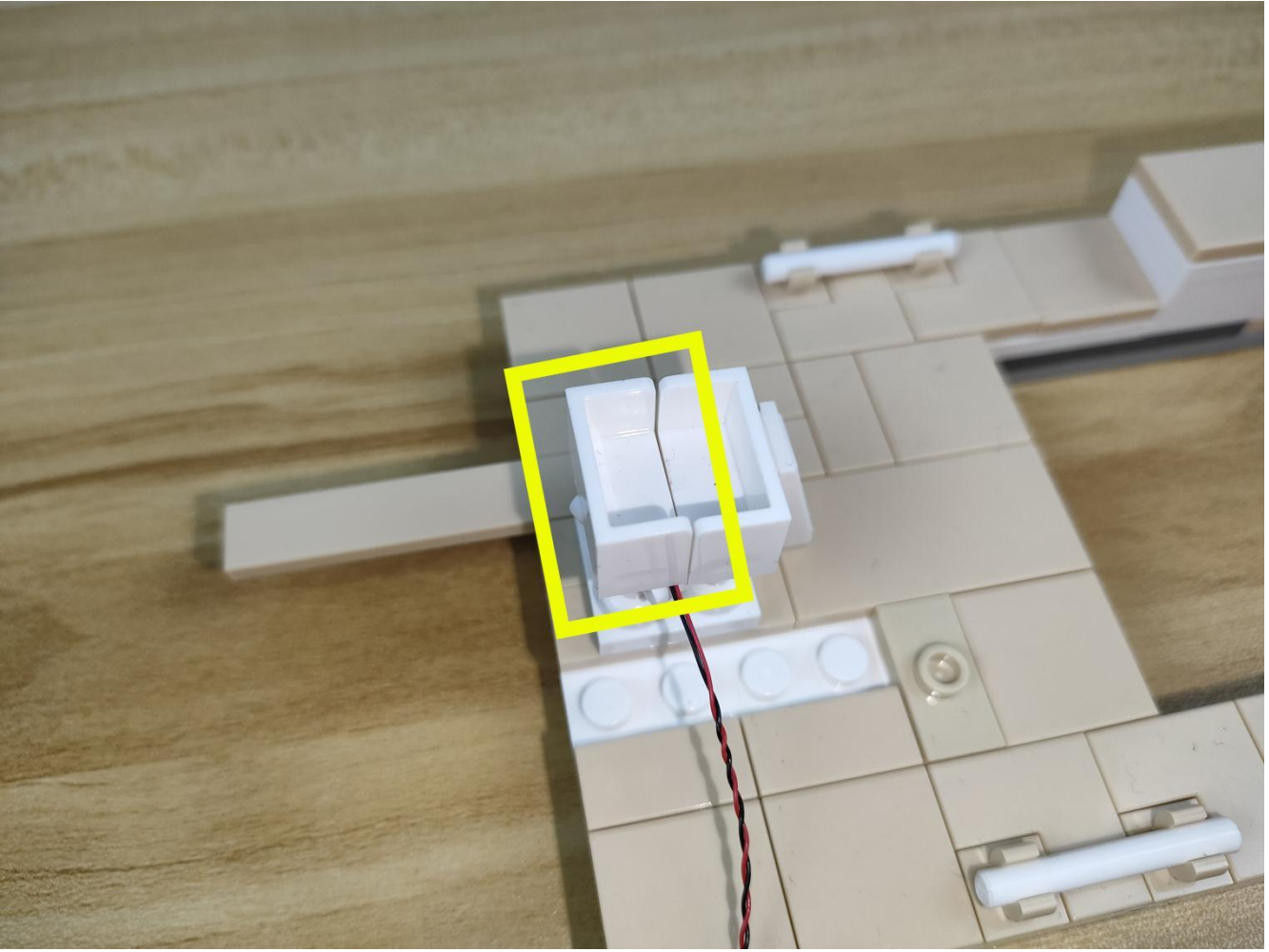

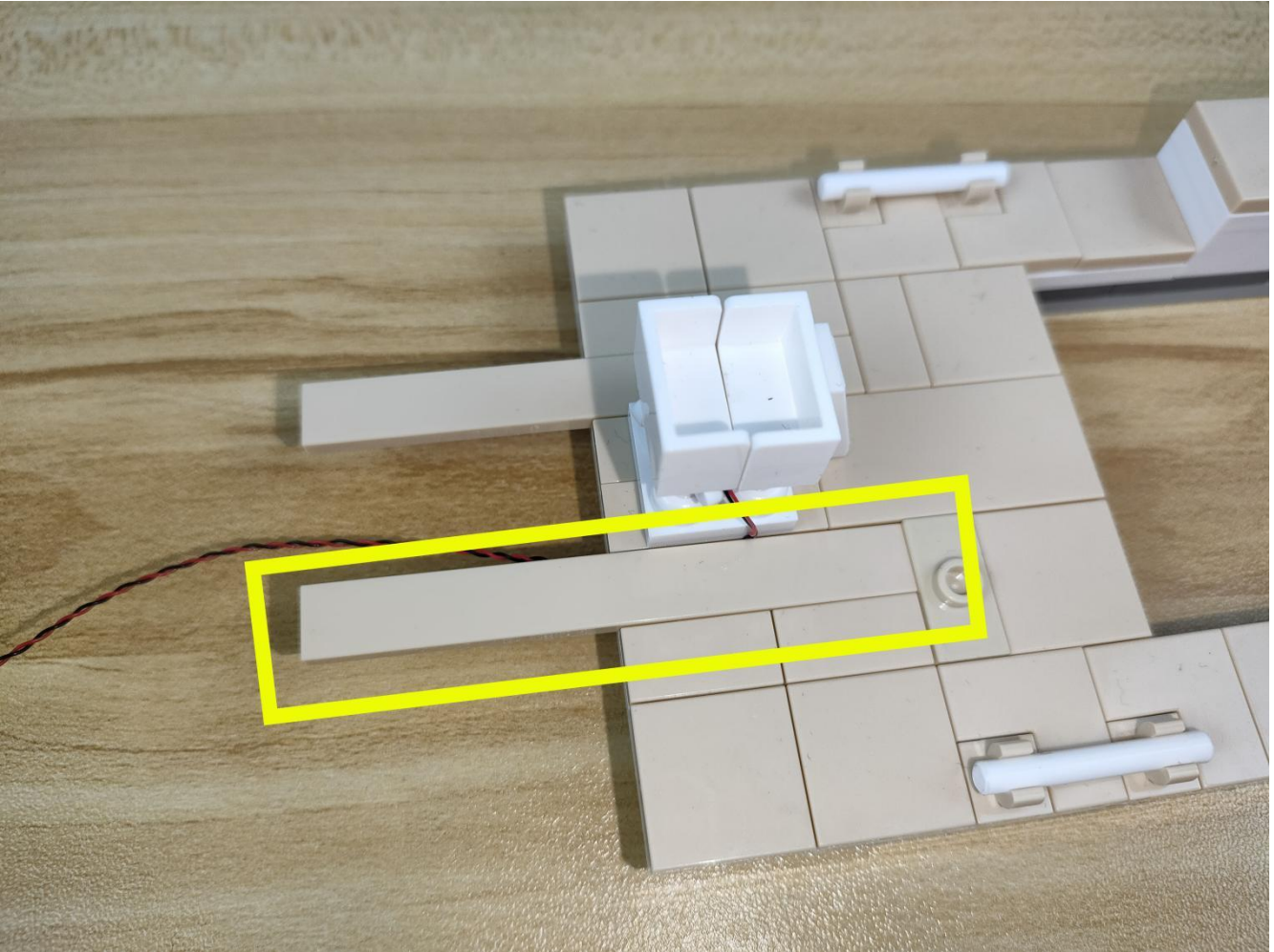

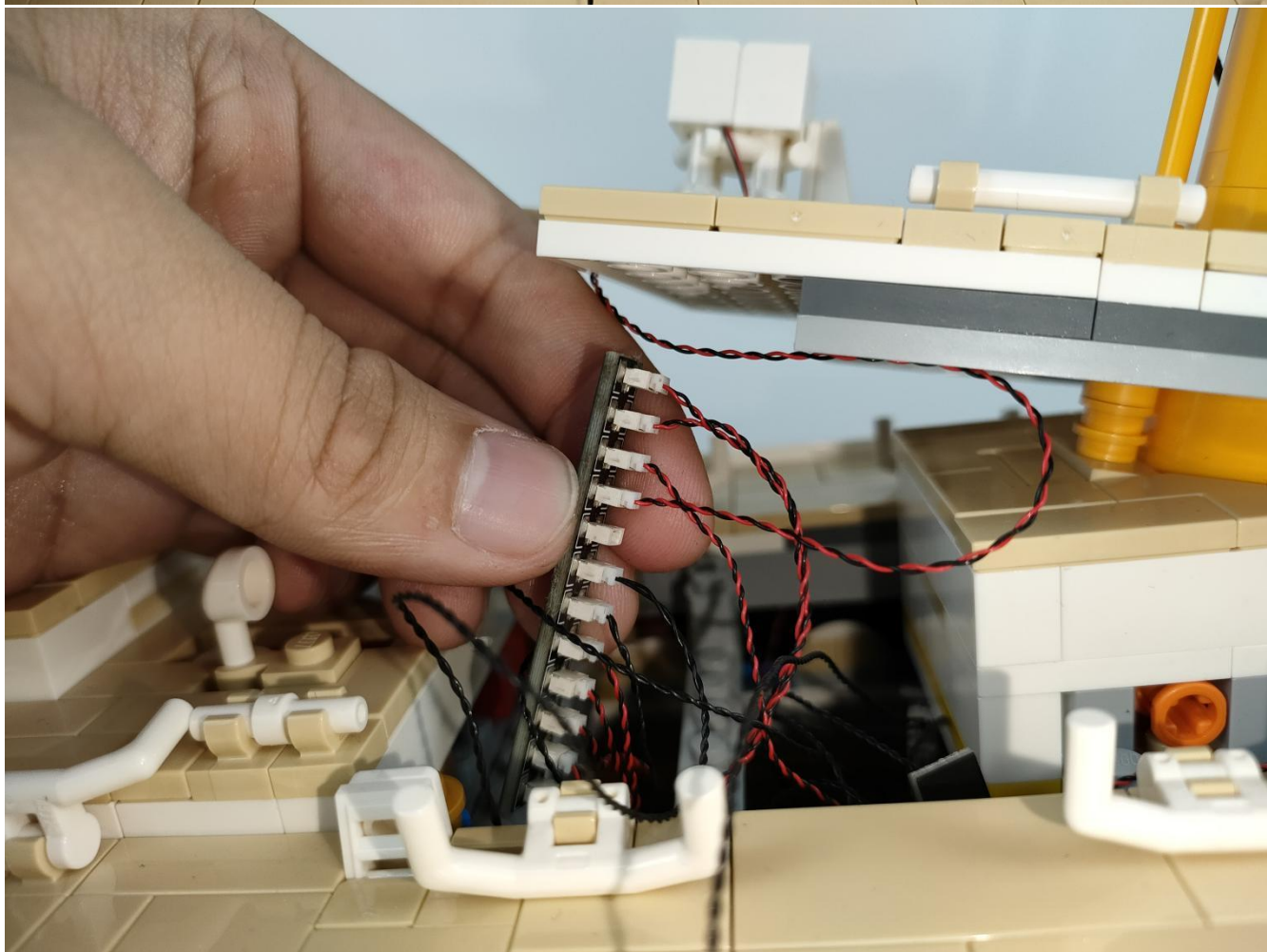
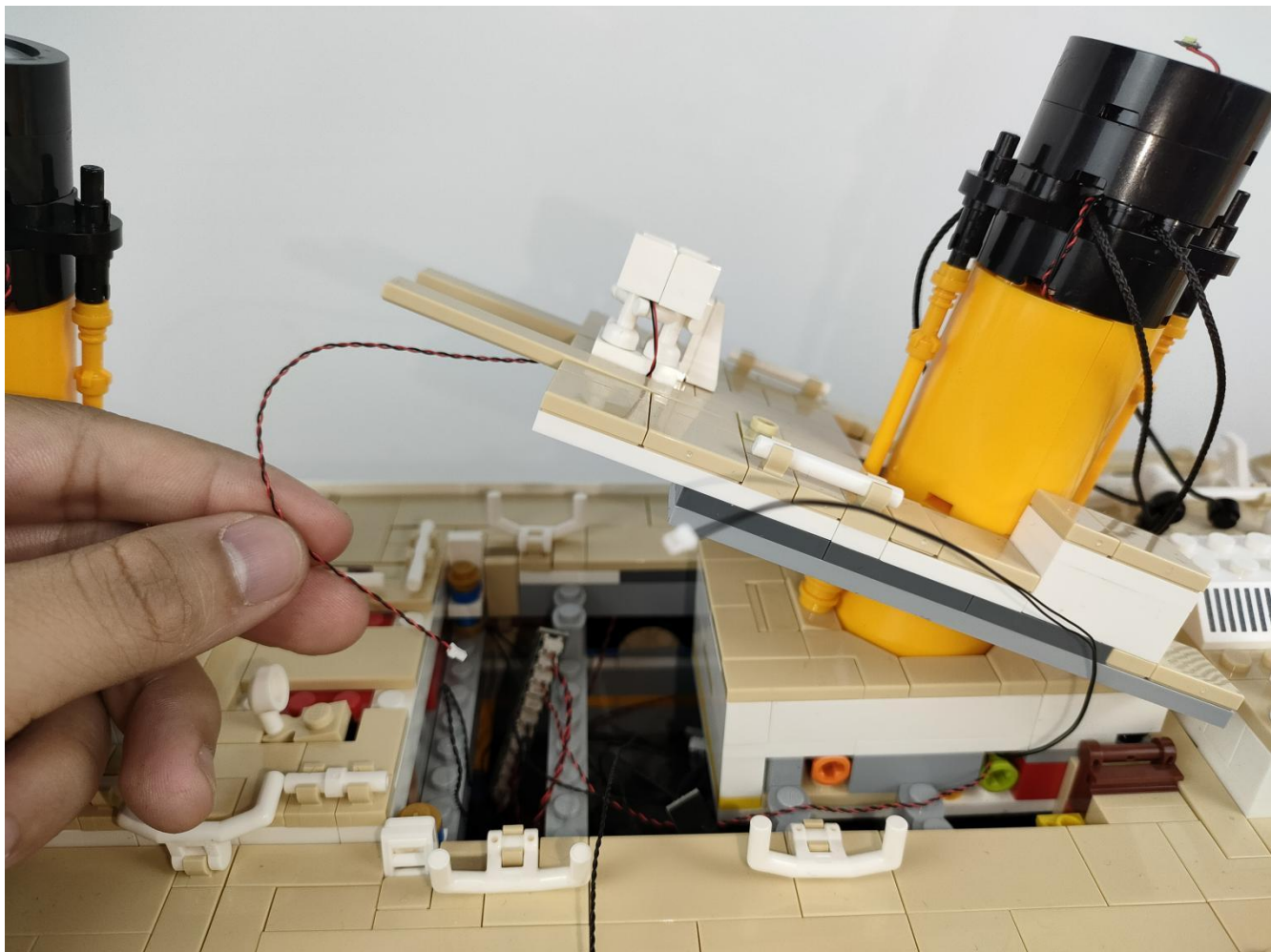

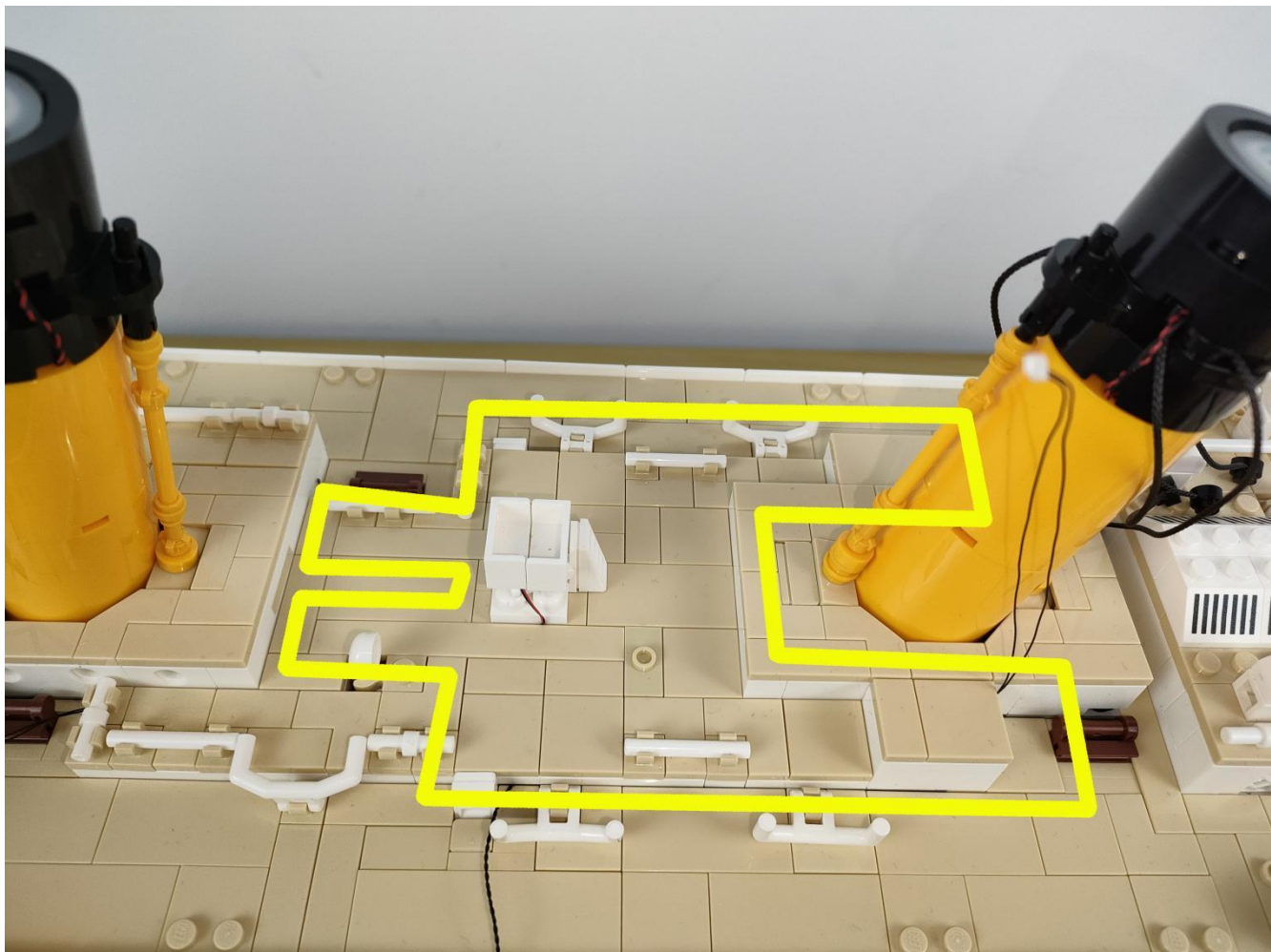

Older modules

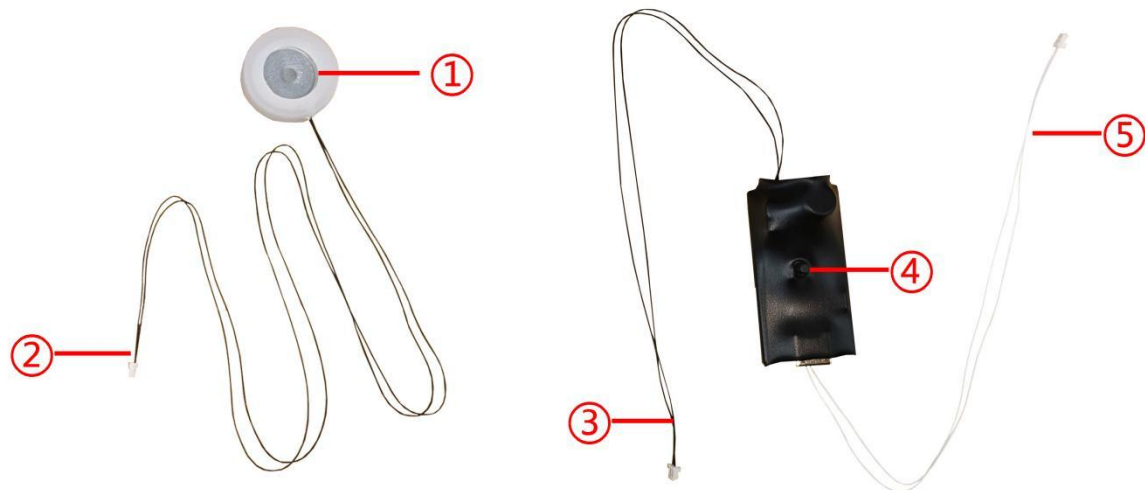

① : When using the spray generator, you can see one side of the solder joint is facing up, and the other side is in contact with water.

②: Power interface, connected with ③ when in use.

③: Power interface, connected with ② when in use.

④: The module' s power switch , click to use after power on.

⑤: The module' s power input interface , voltage is 5V.

Modules have been updated to the new generation. When installing, please take out the Connecting Cables-15CM first and connect it to both ends of the module.

Spray Module

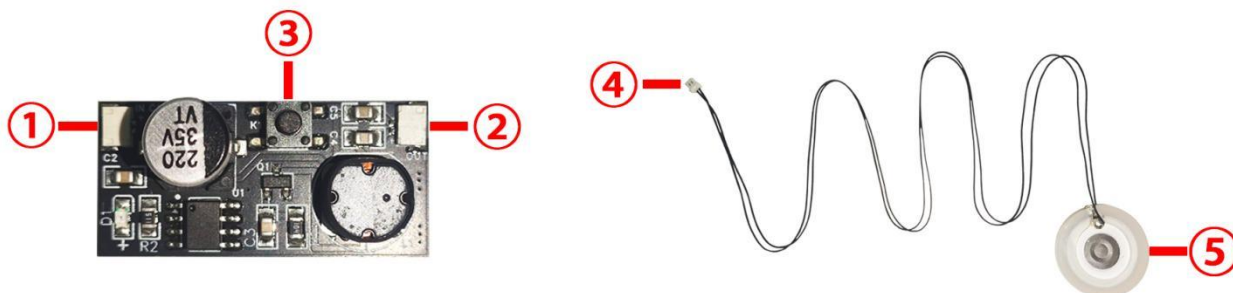

- ①: (IN) Power input port, input DC voltage 5V.
- ②: (OUT) Power output port, connected to ④.
- ③: Switch, click once to activate the module and the indicator lights up. Double click again to turn off the module.
- ④: Connected to ②.
- ⑤: Atomizer with solder joints(silver-white raised spots) positioned facing up and the other side in contact with water.

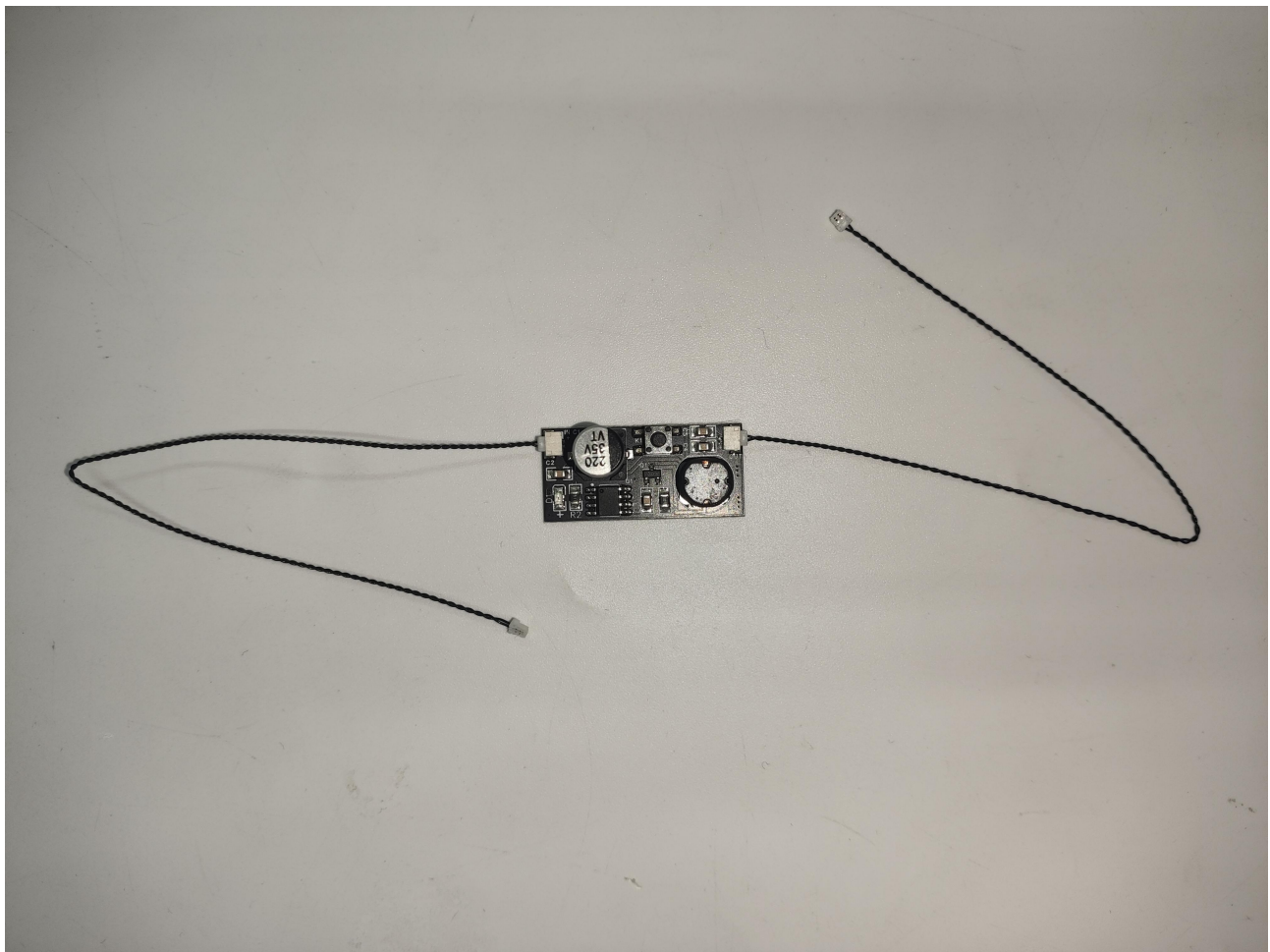

Replace the latter with the same. Please follow the introduction diagram above to distinguish the module's power connector. Several other modules are replaced in the same way.

Tip: Make sure there is enough water when the module is working. Avoid burning the module without water.

The position selected by the frame in the figure is the switch of the spray module (after the module is powered on, press the switch to use).

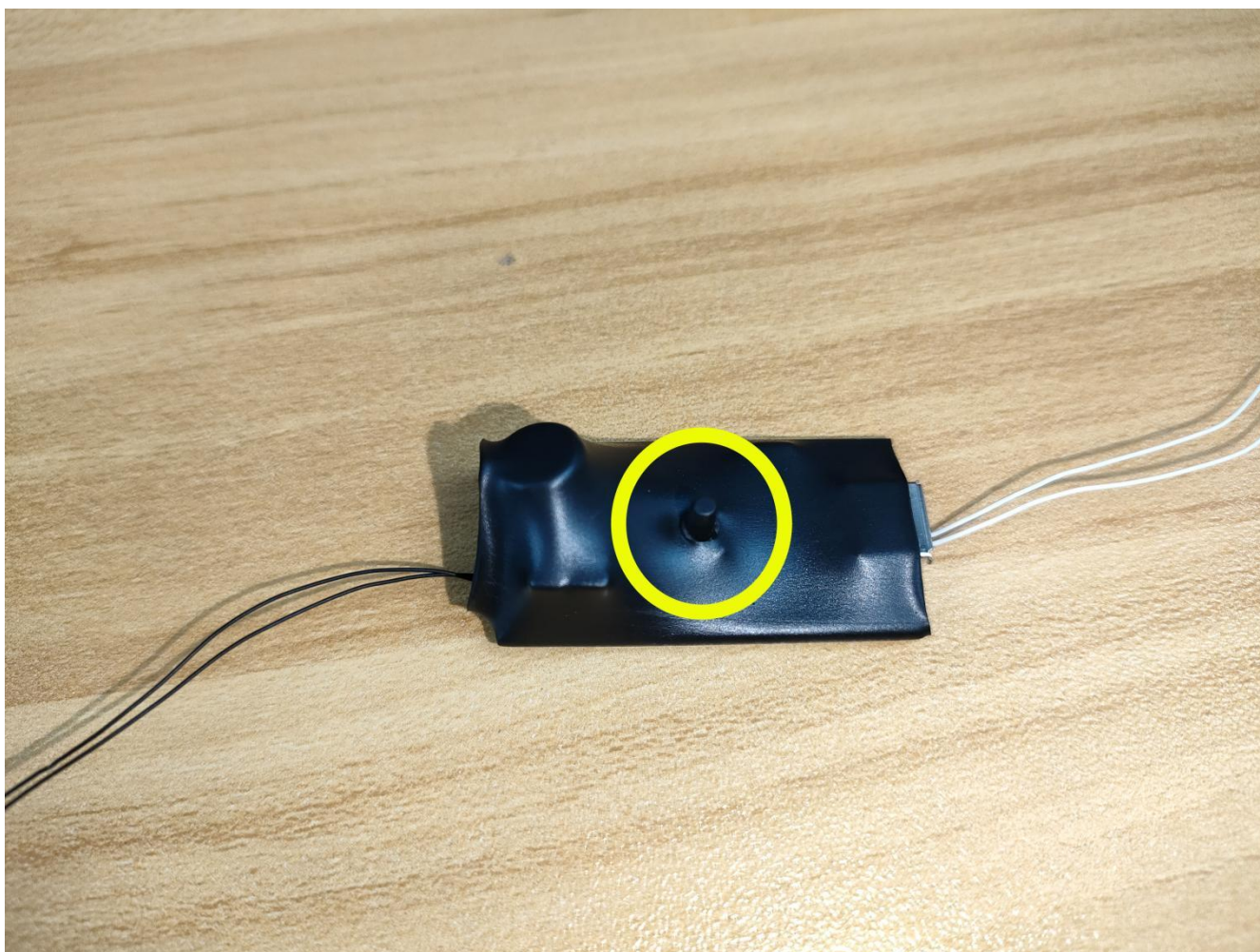

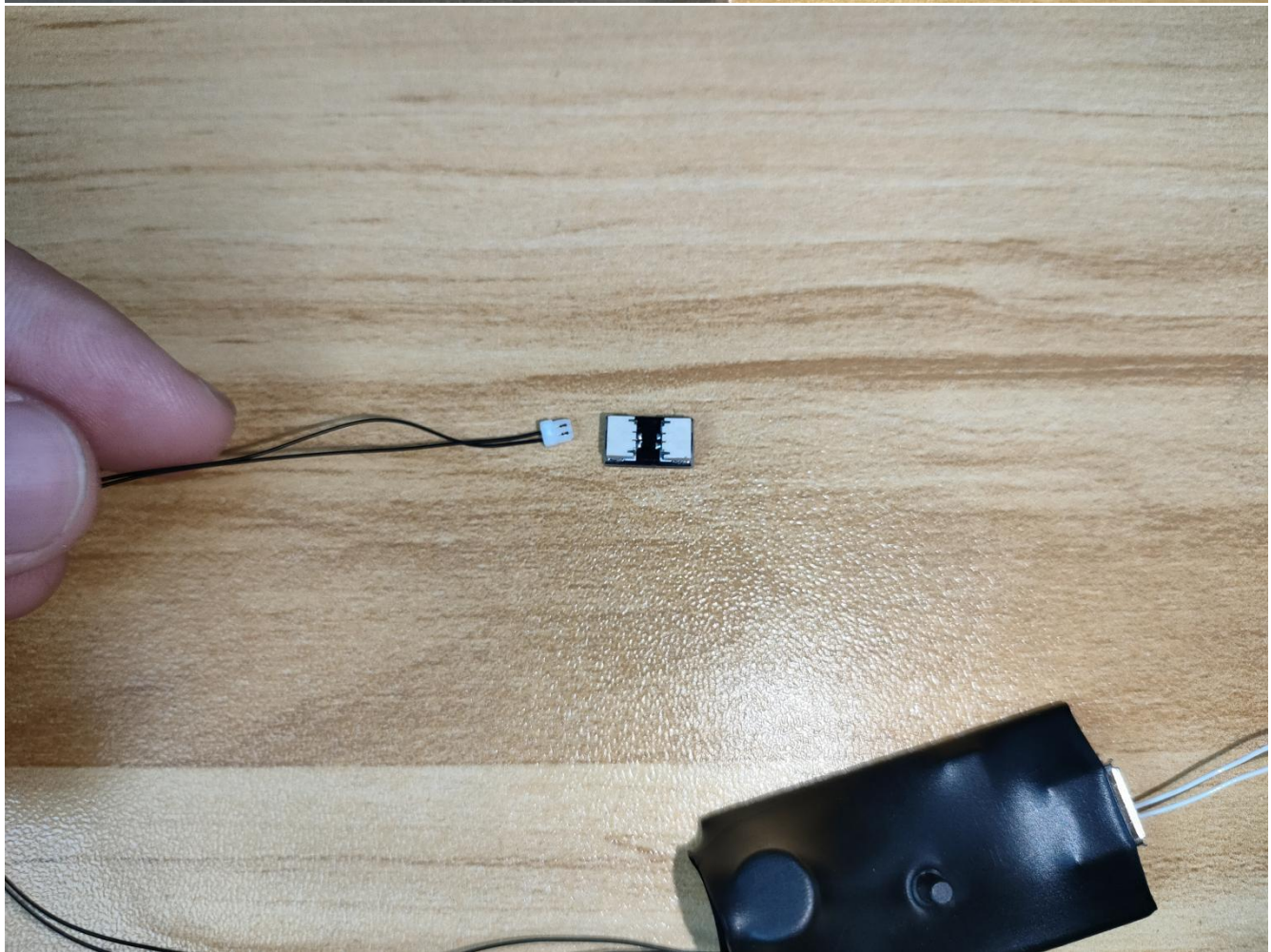

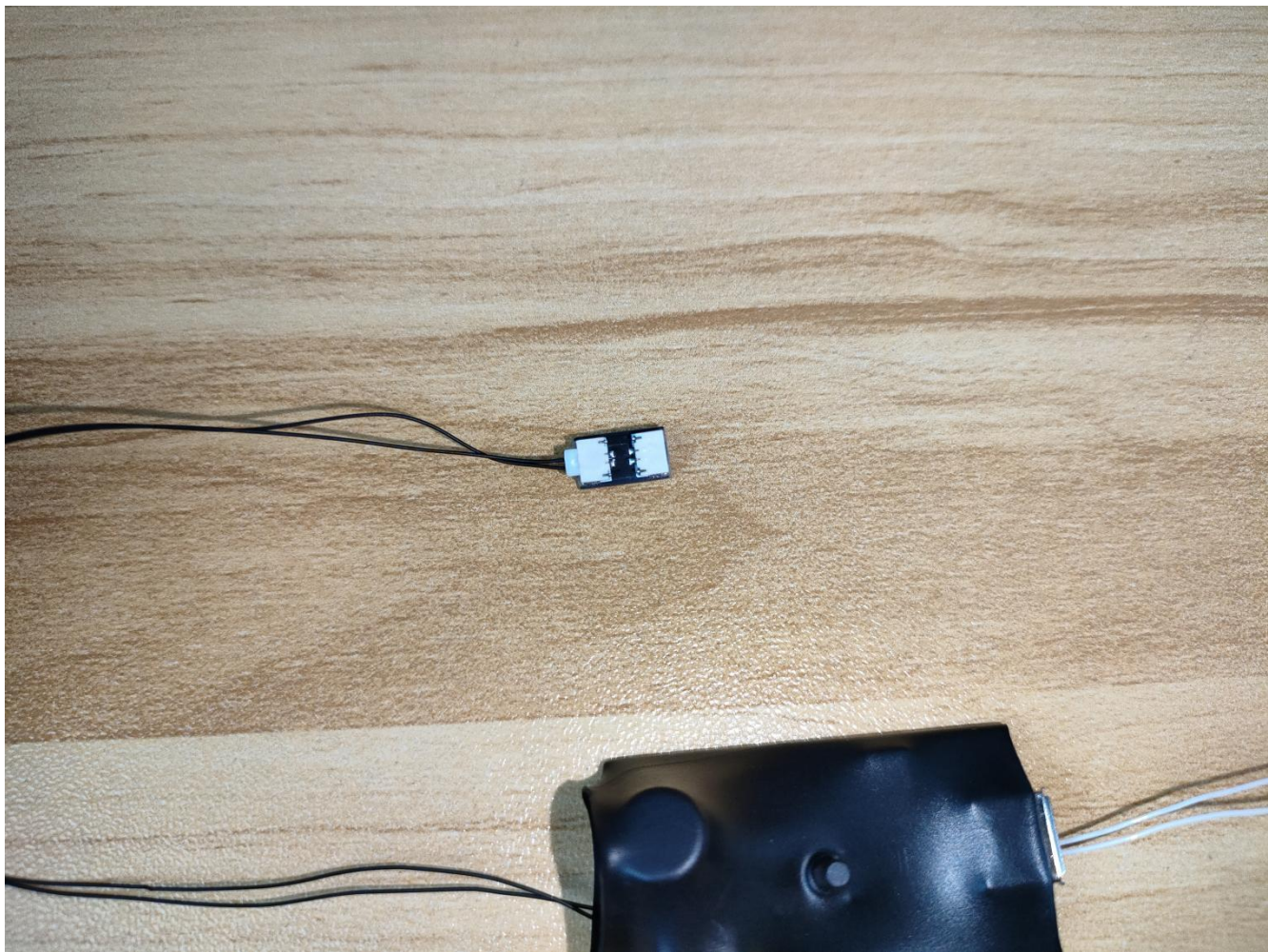

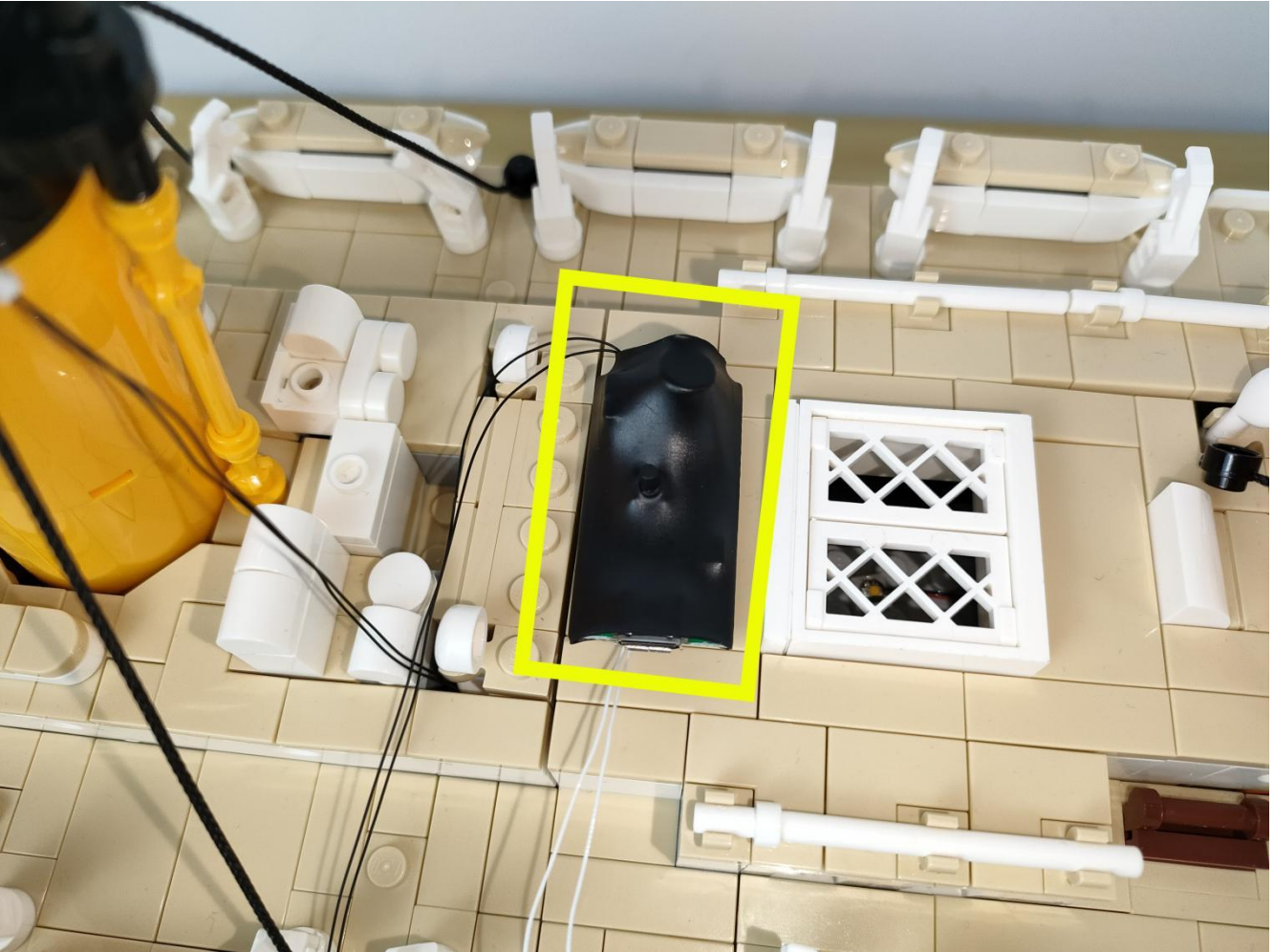
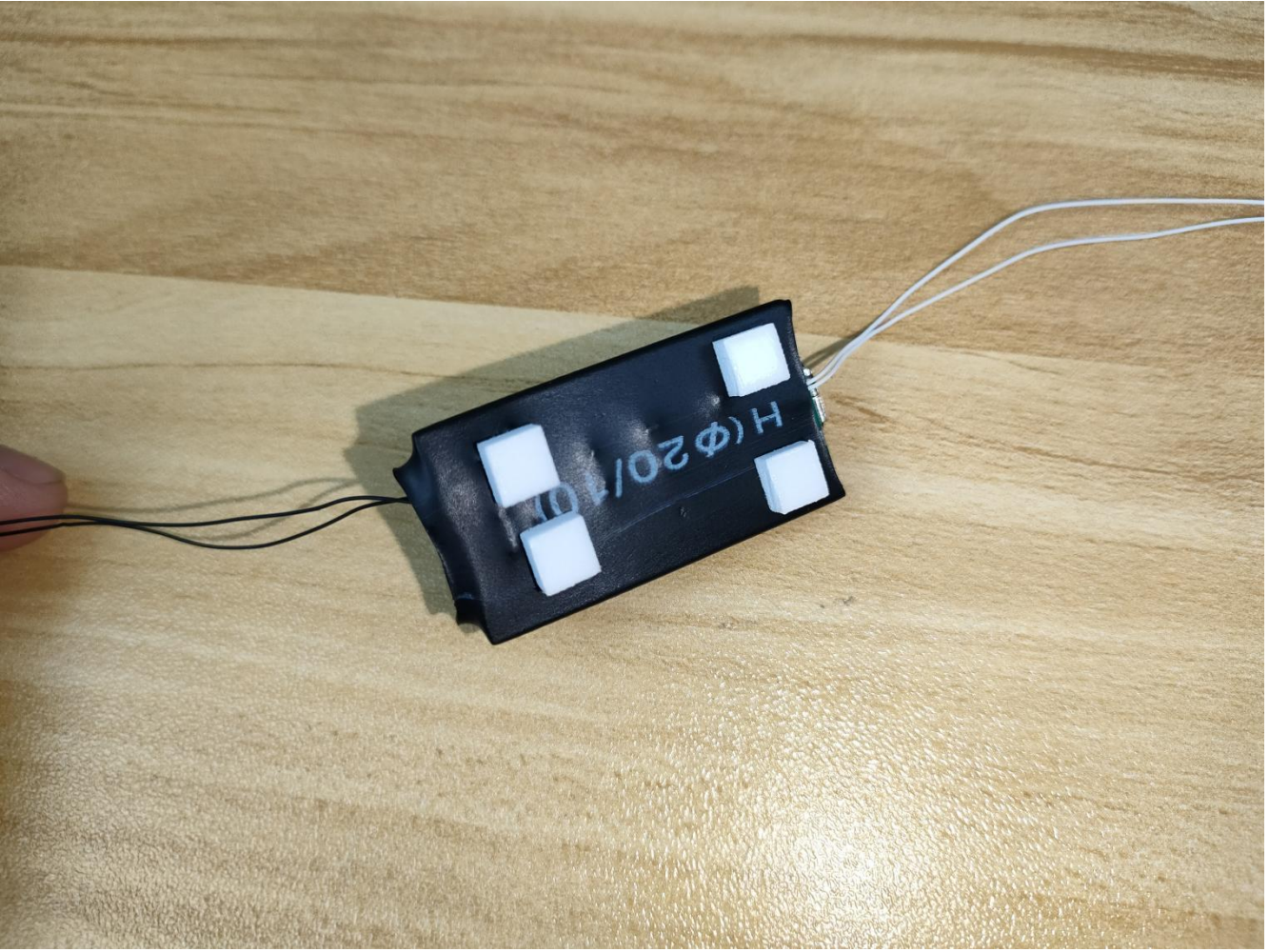

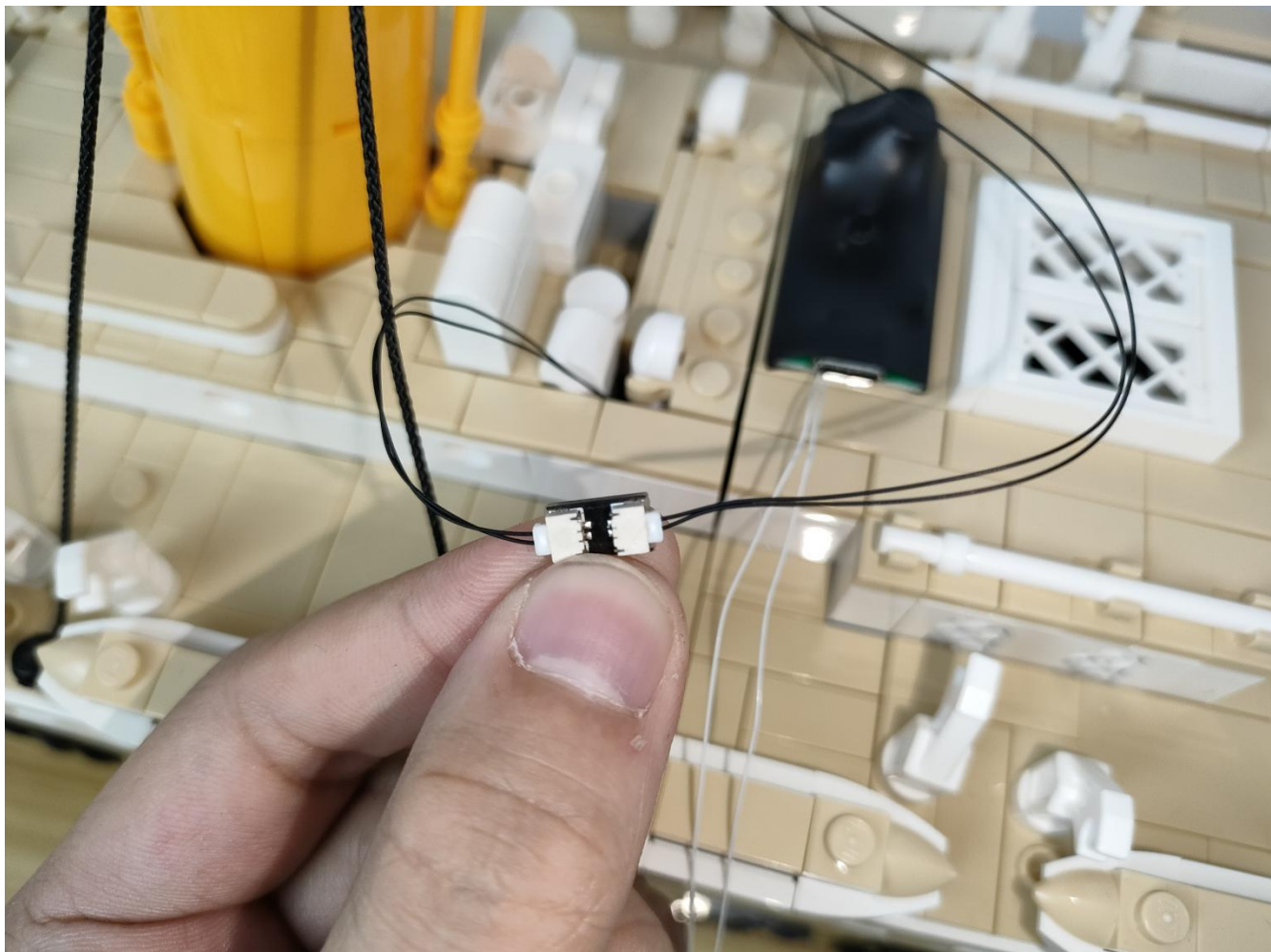





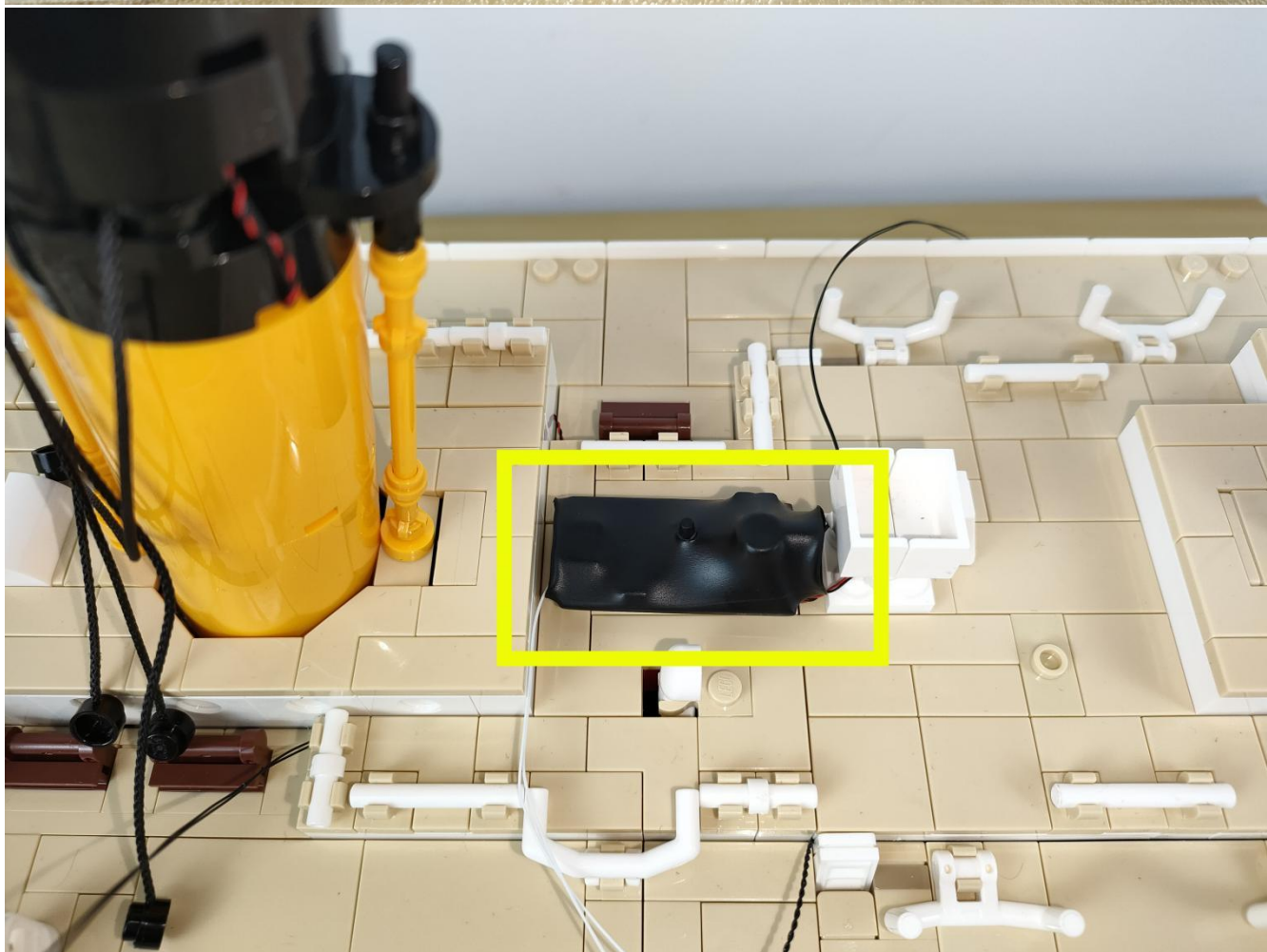
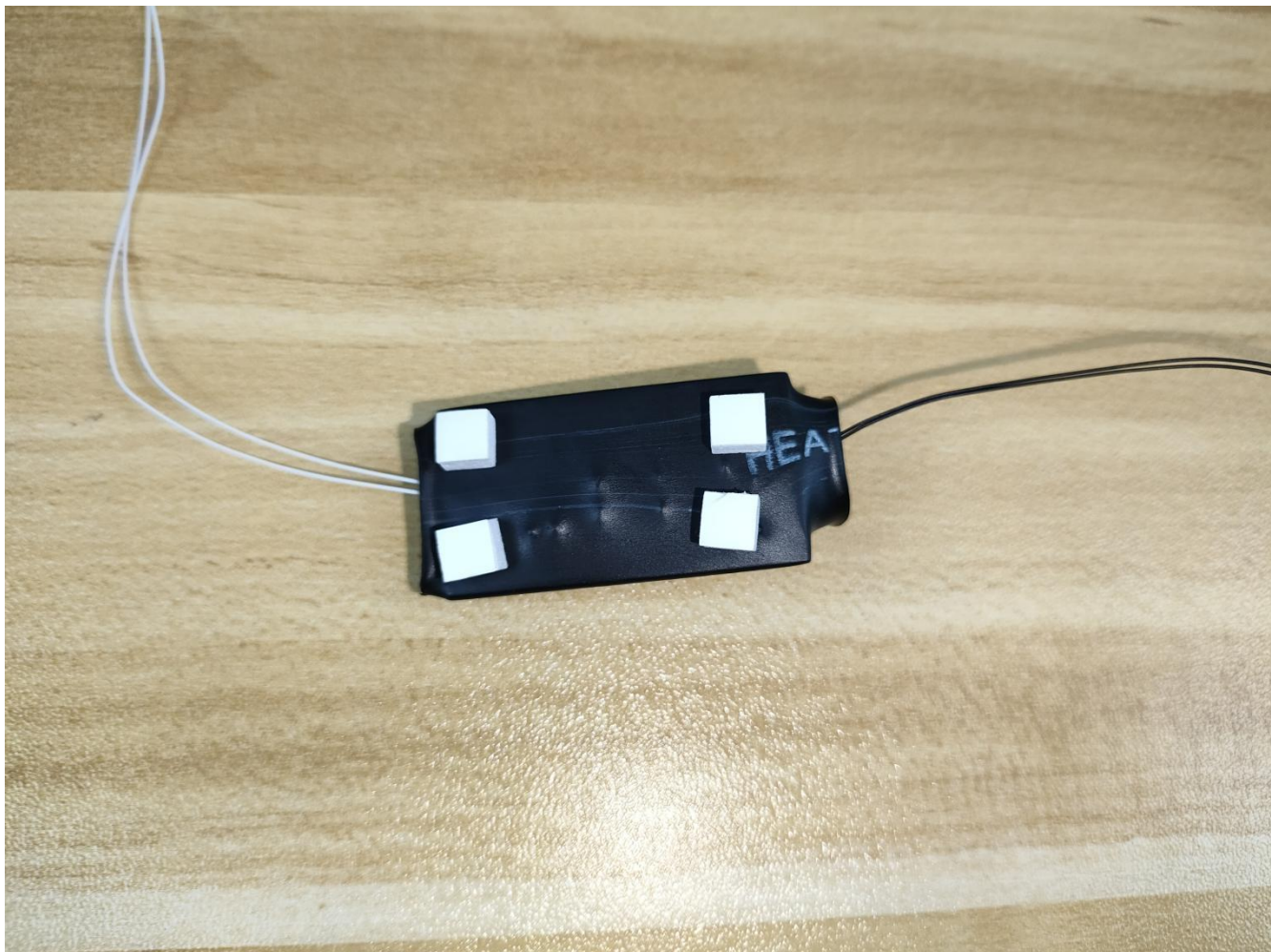

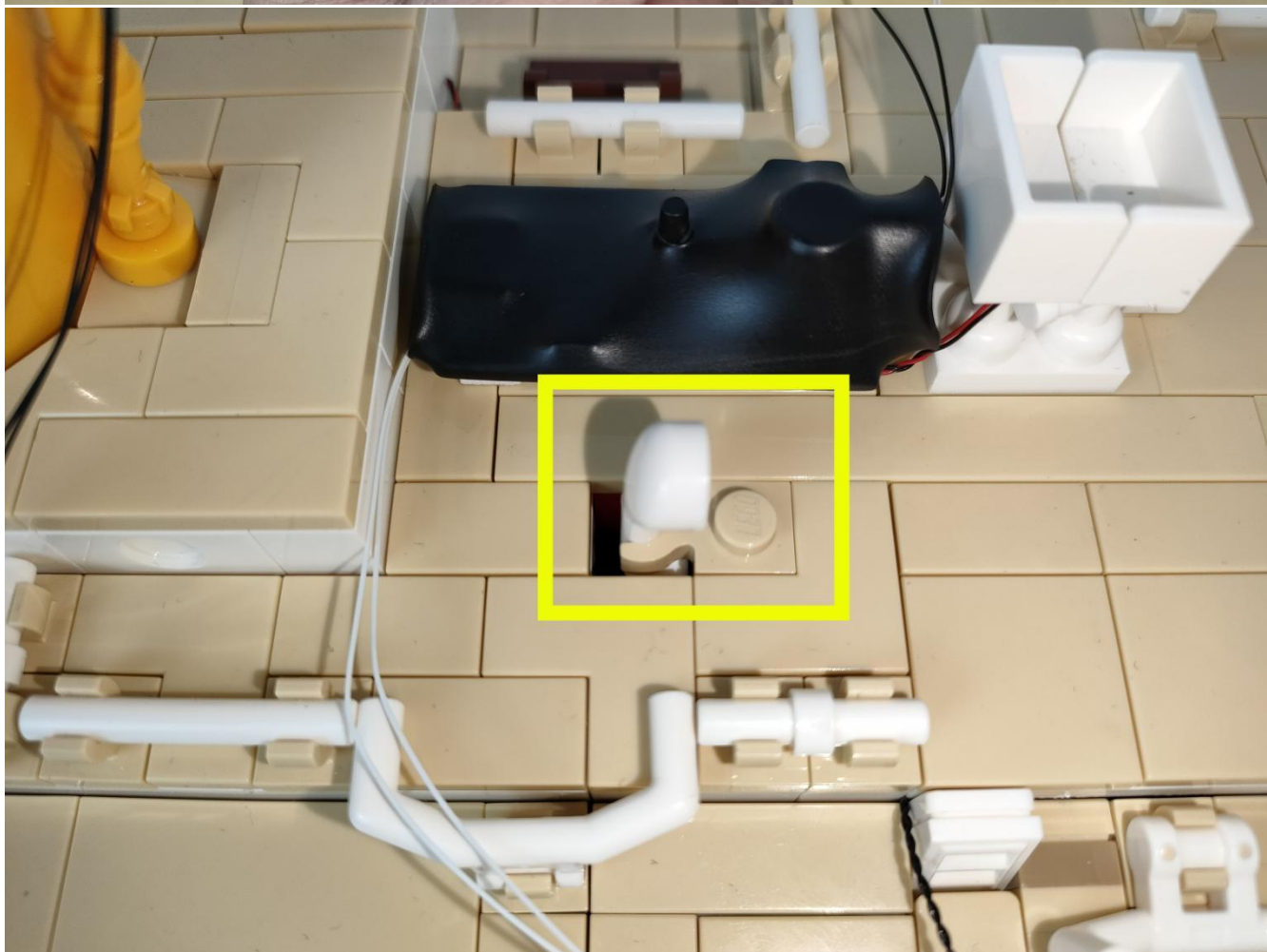
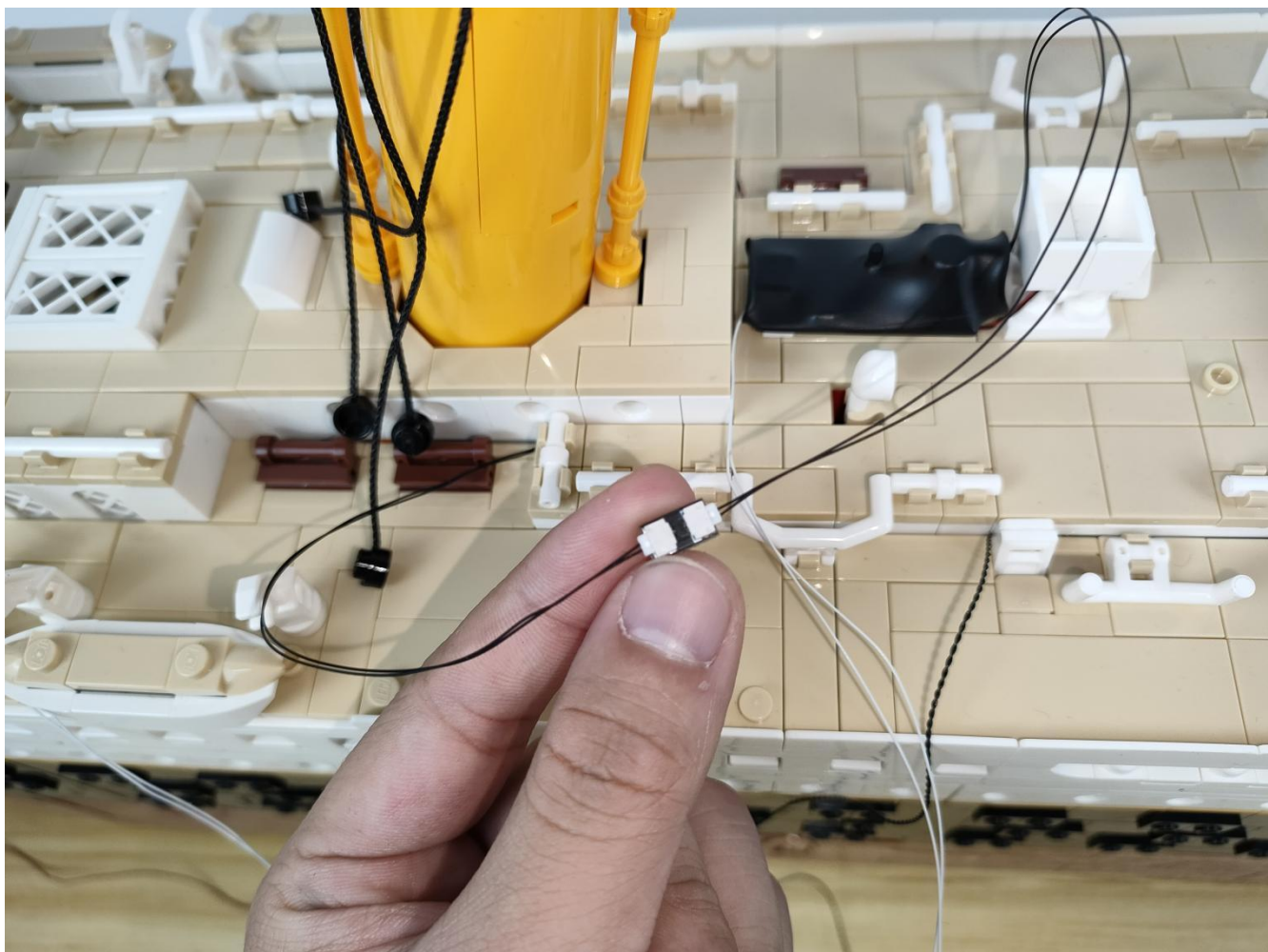

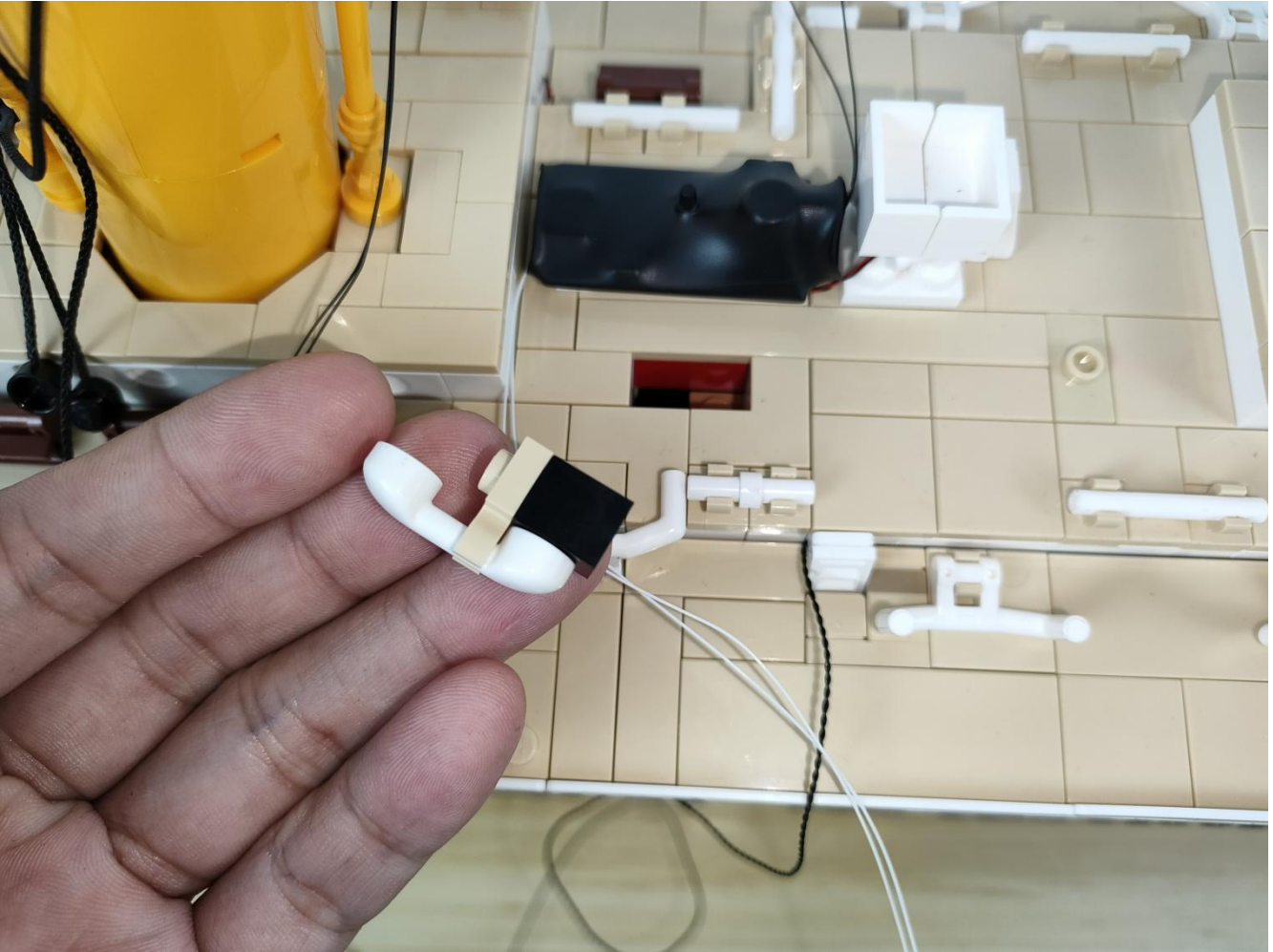

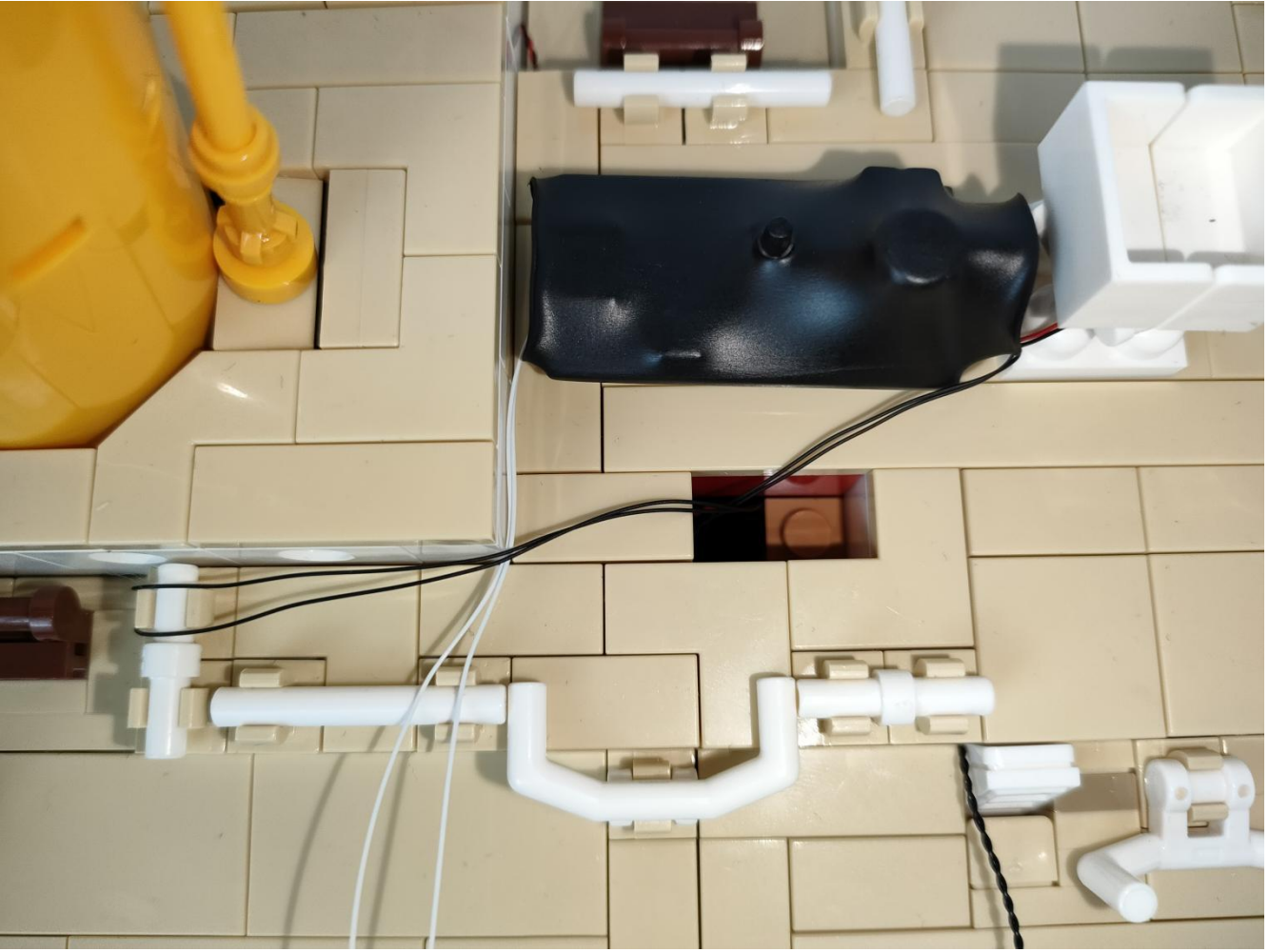

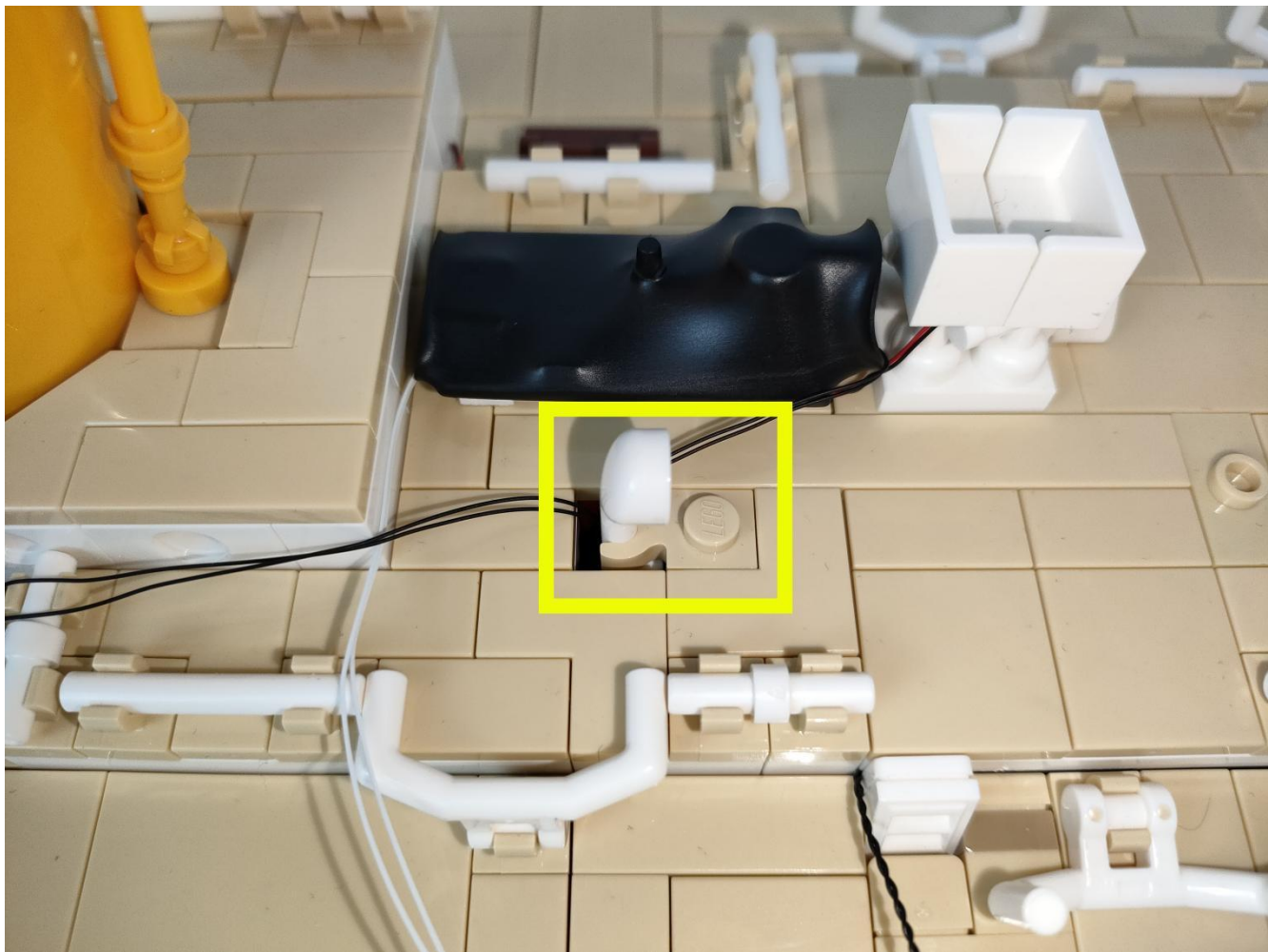

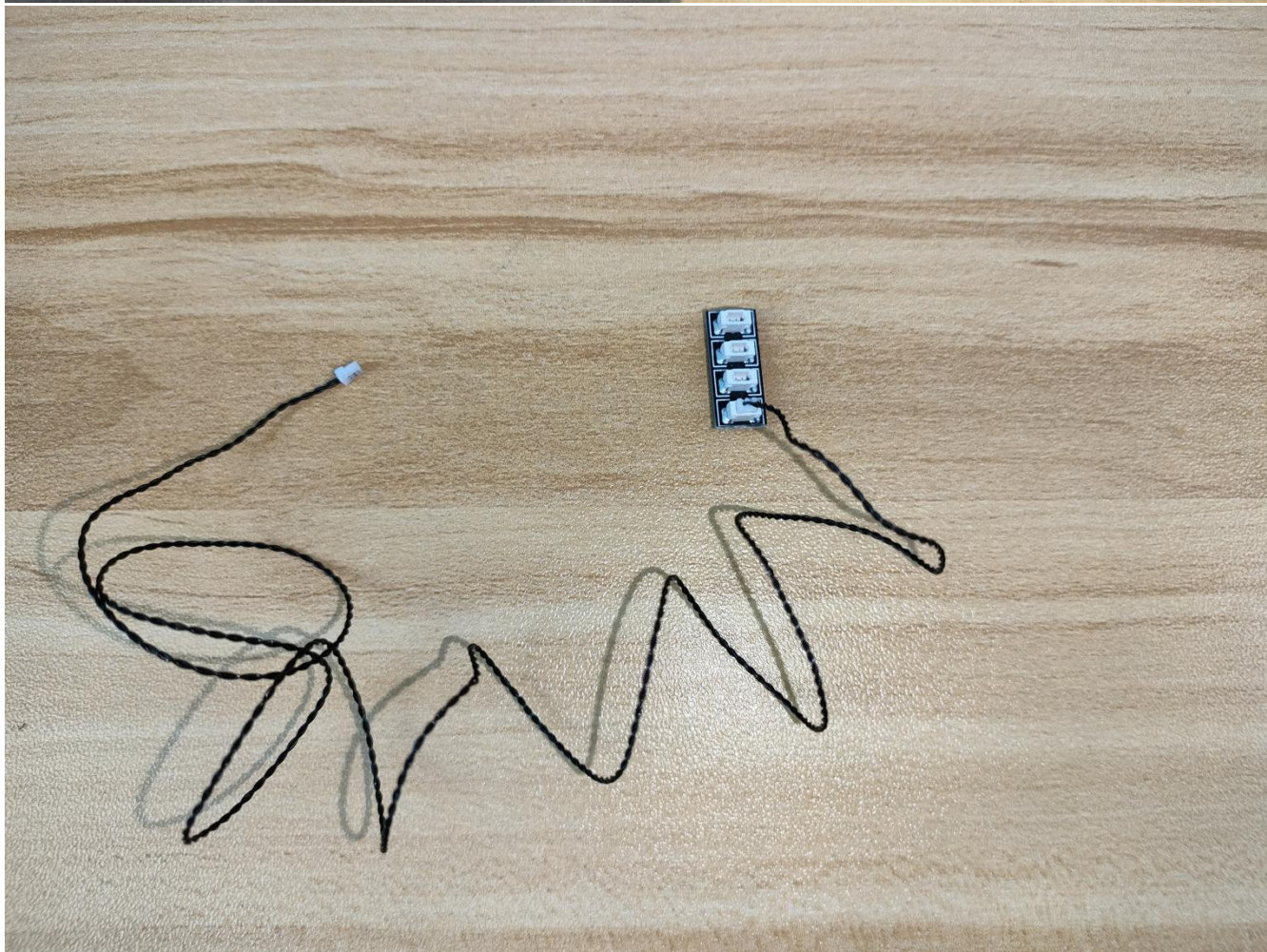

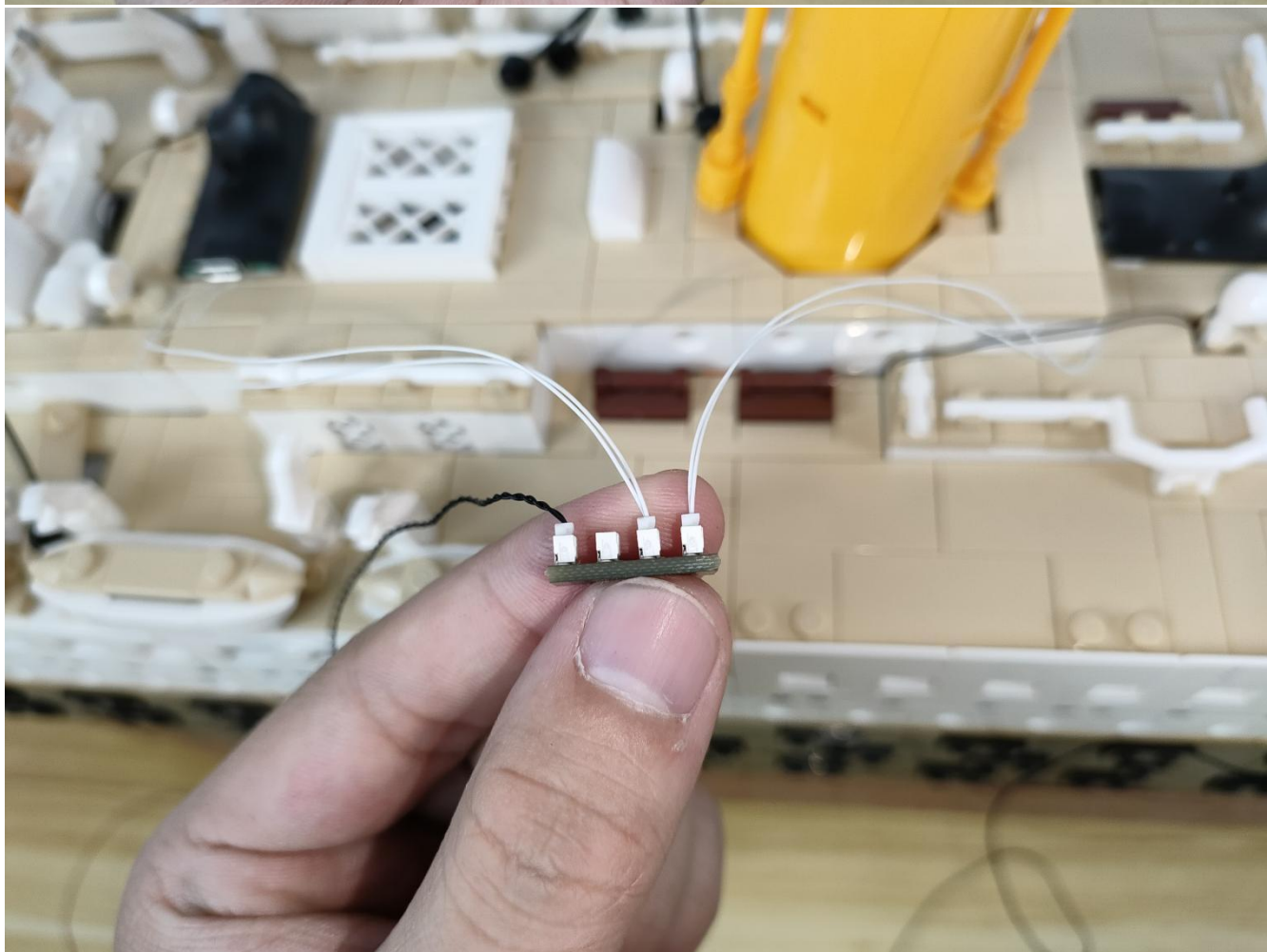

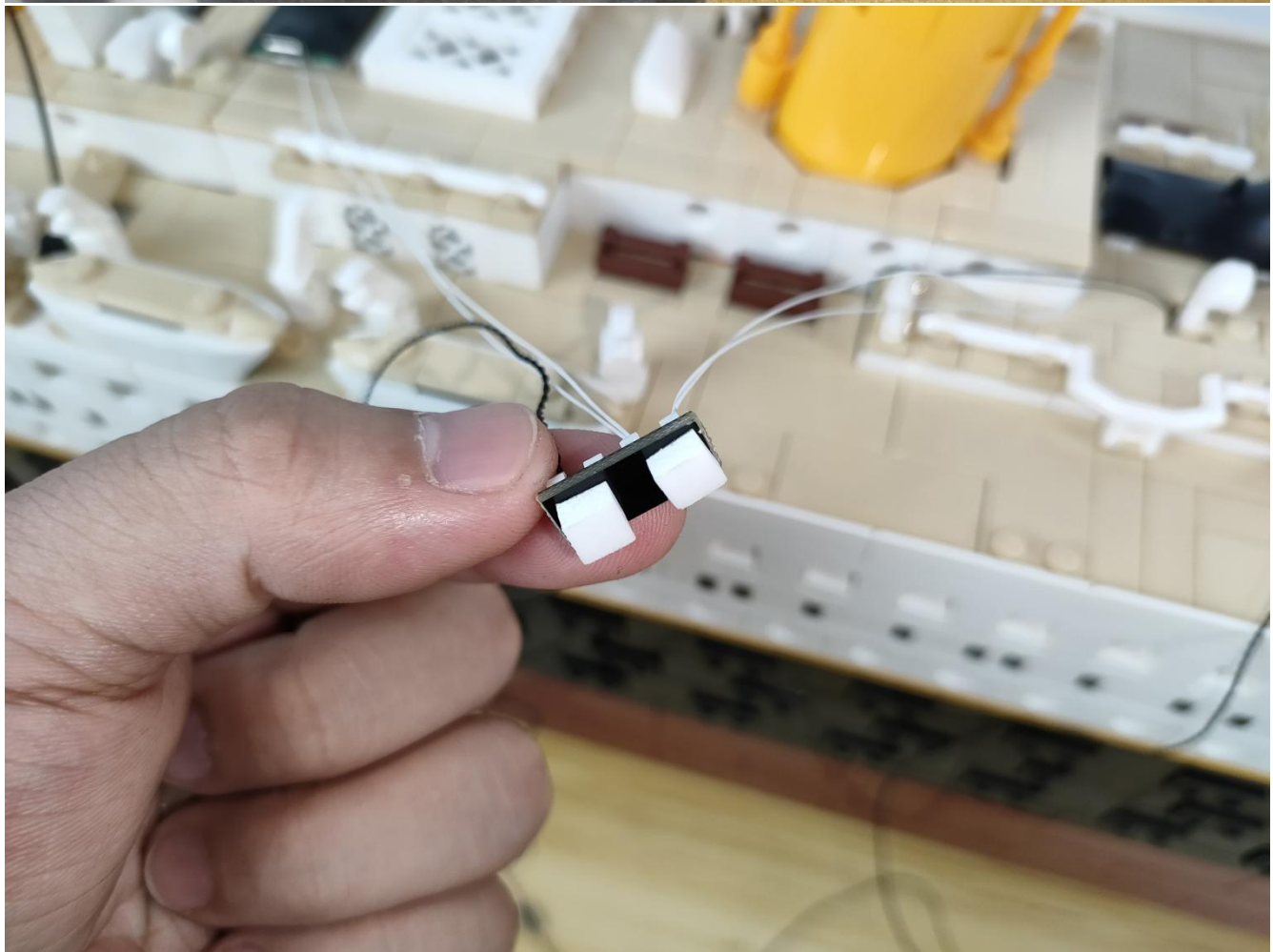

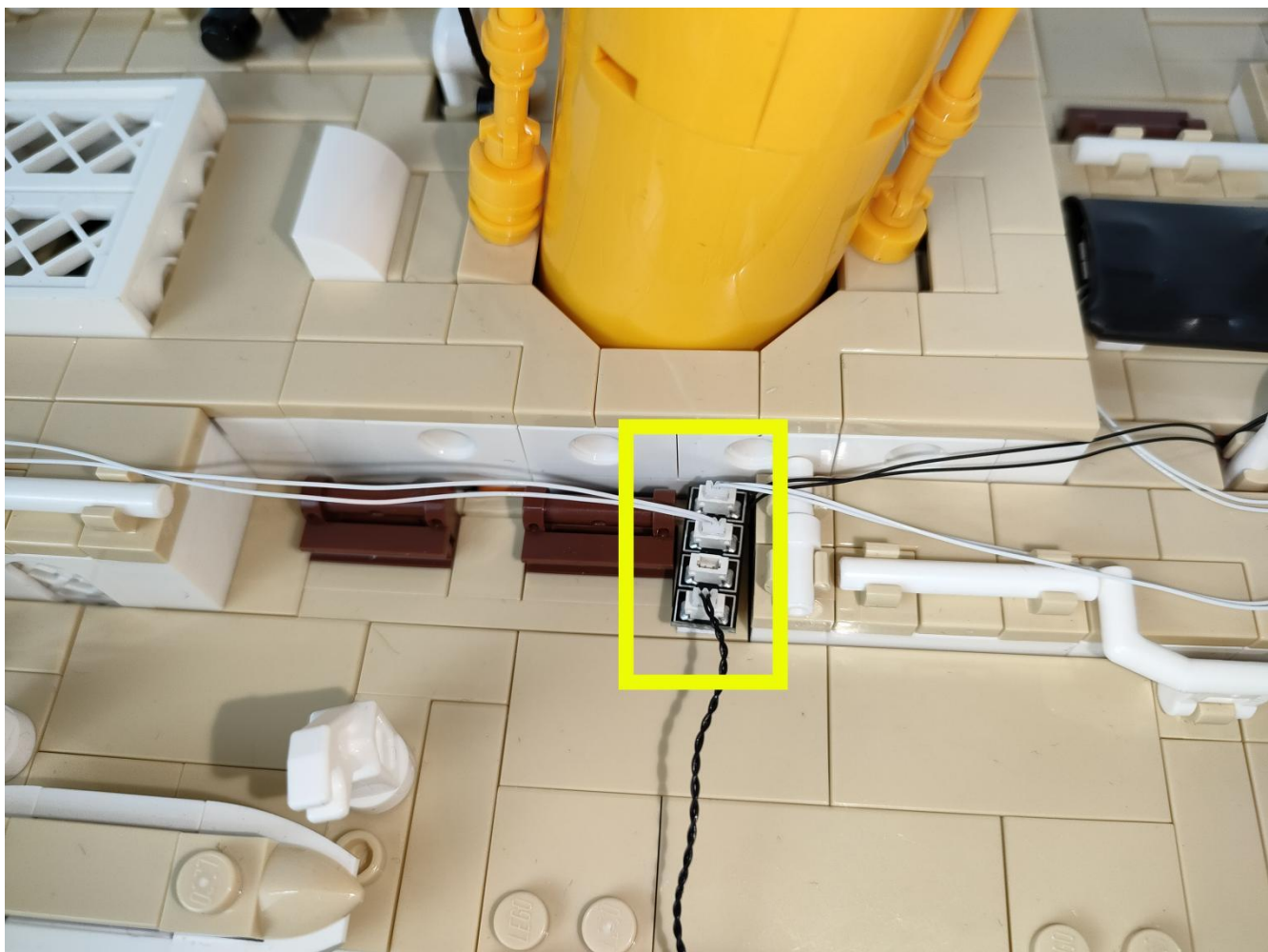

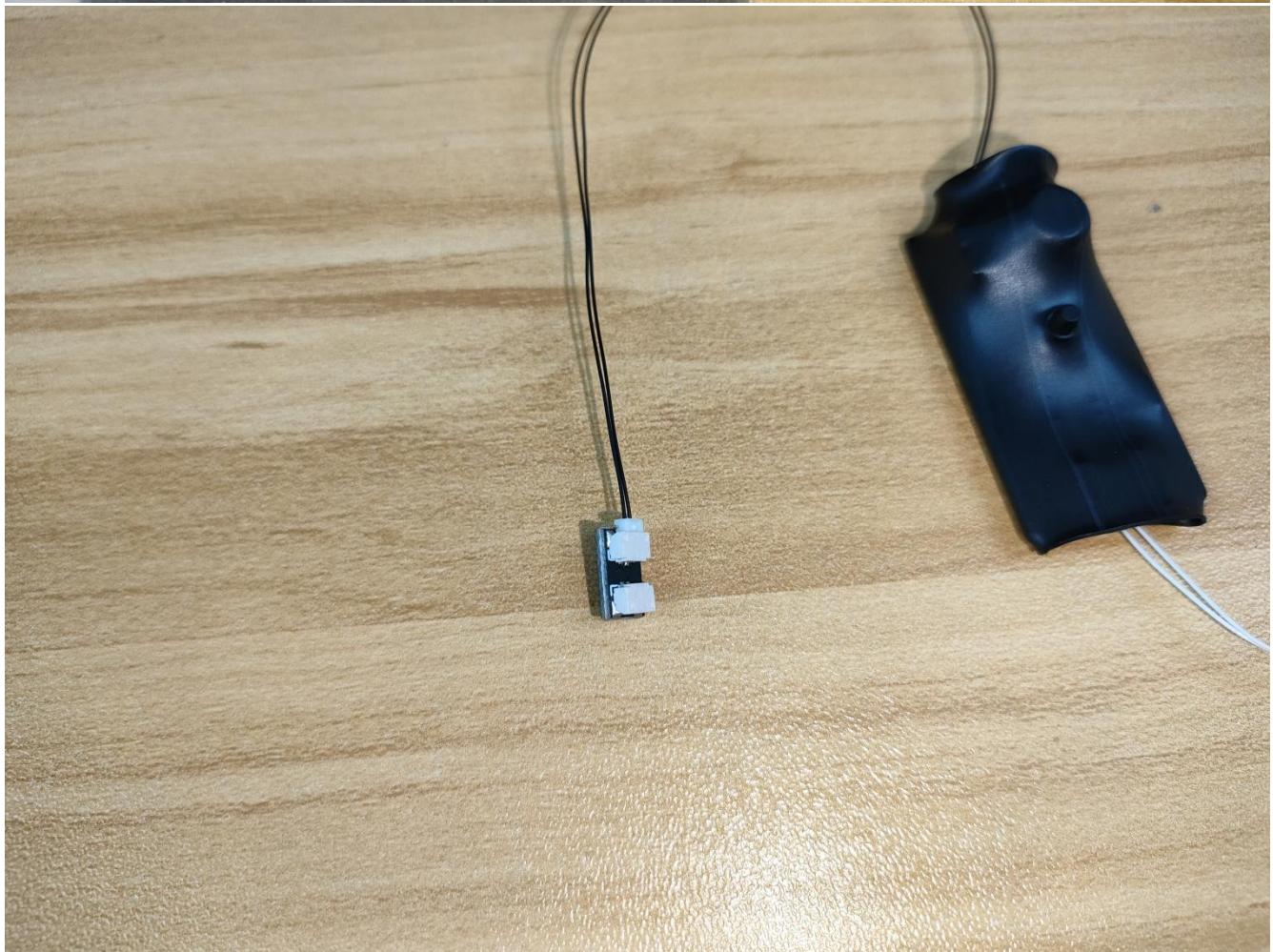

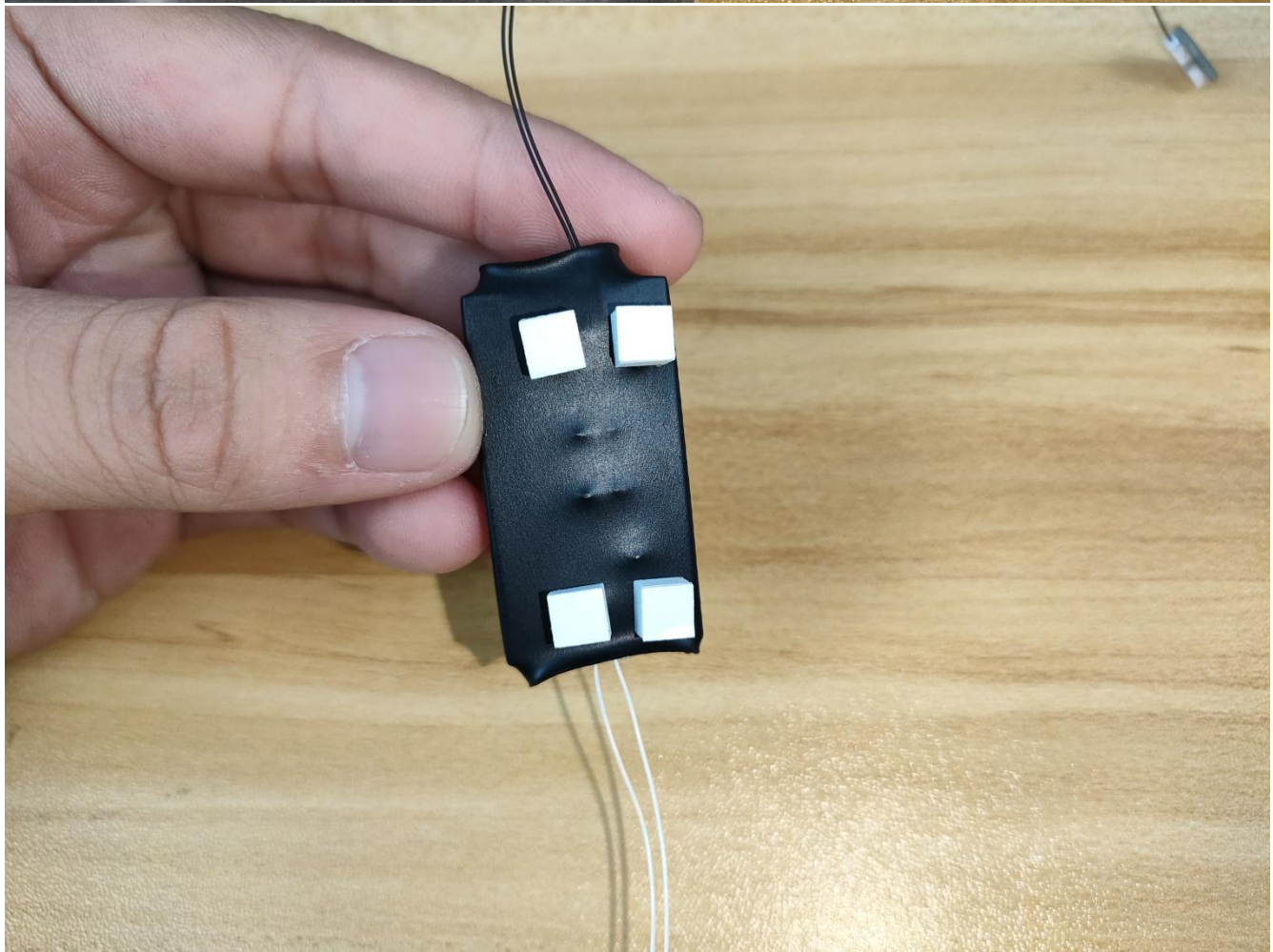
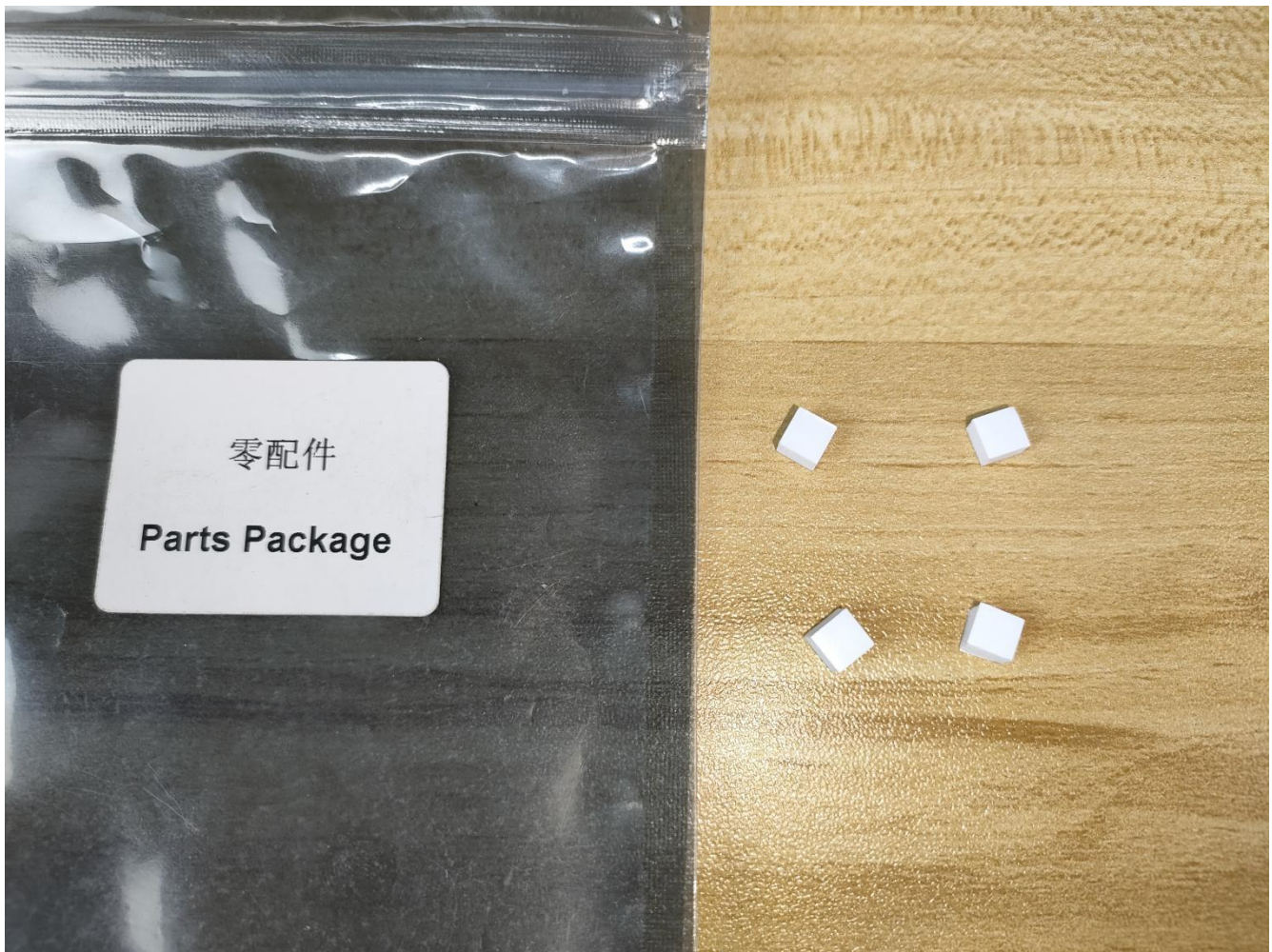

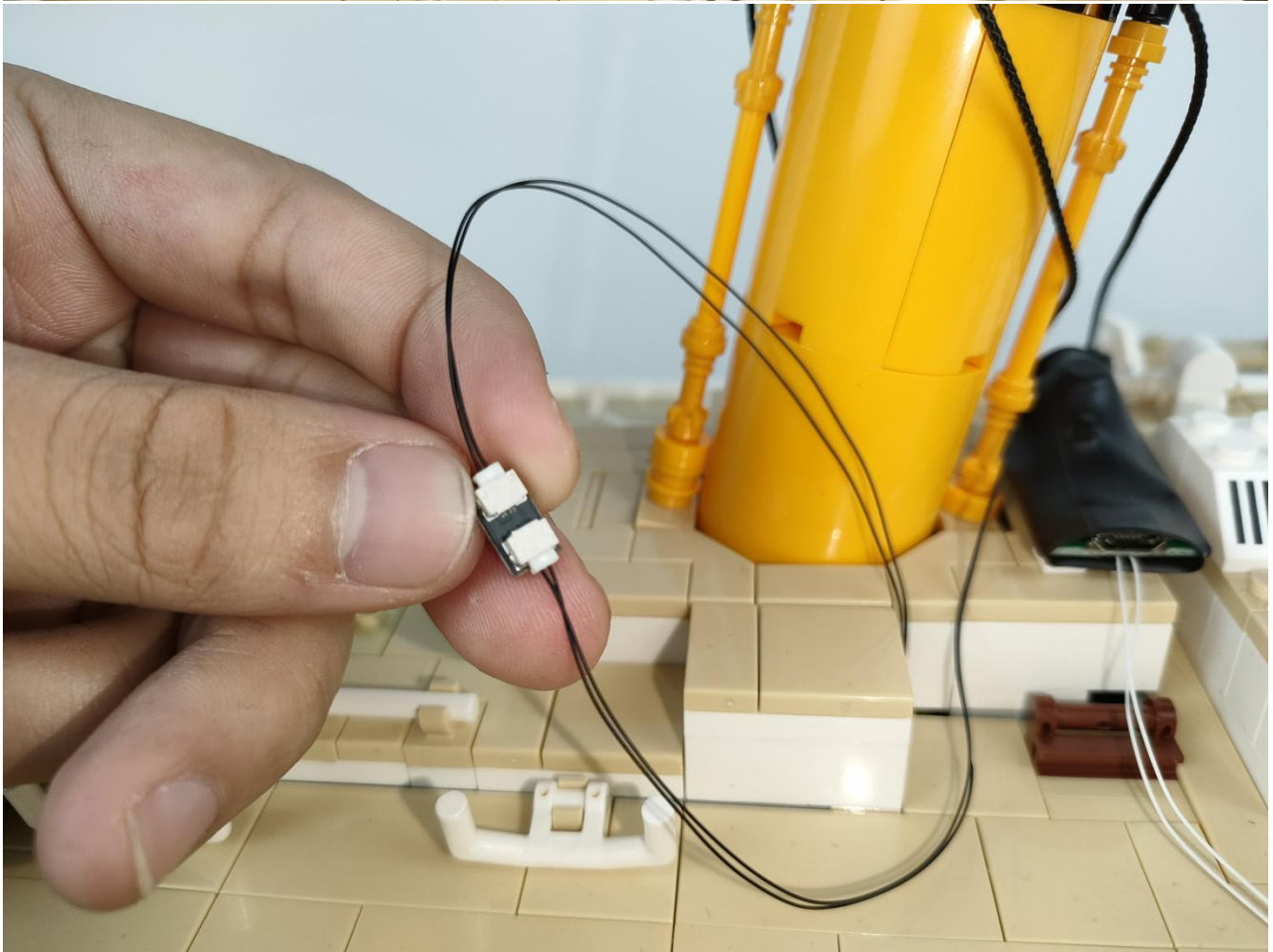

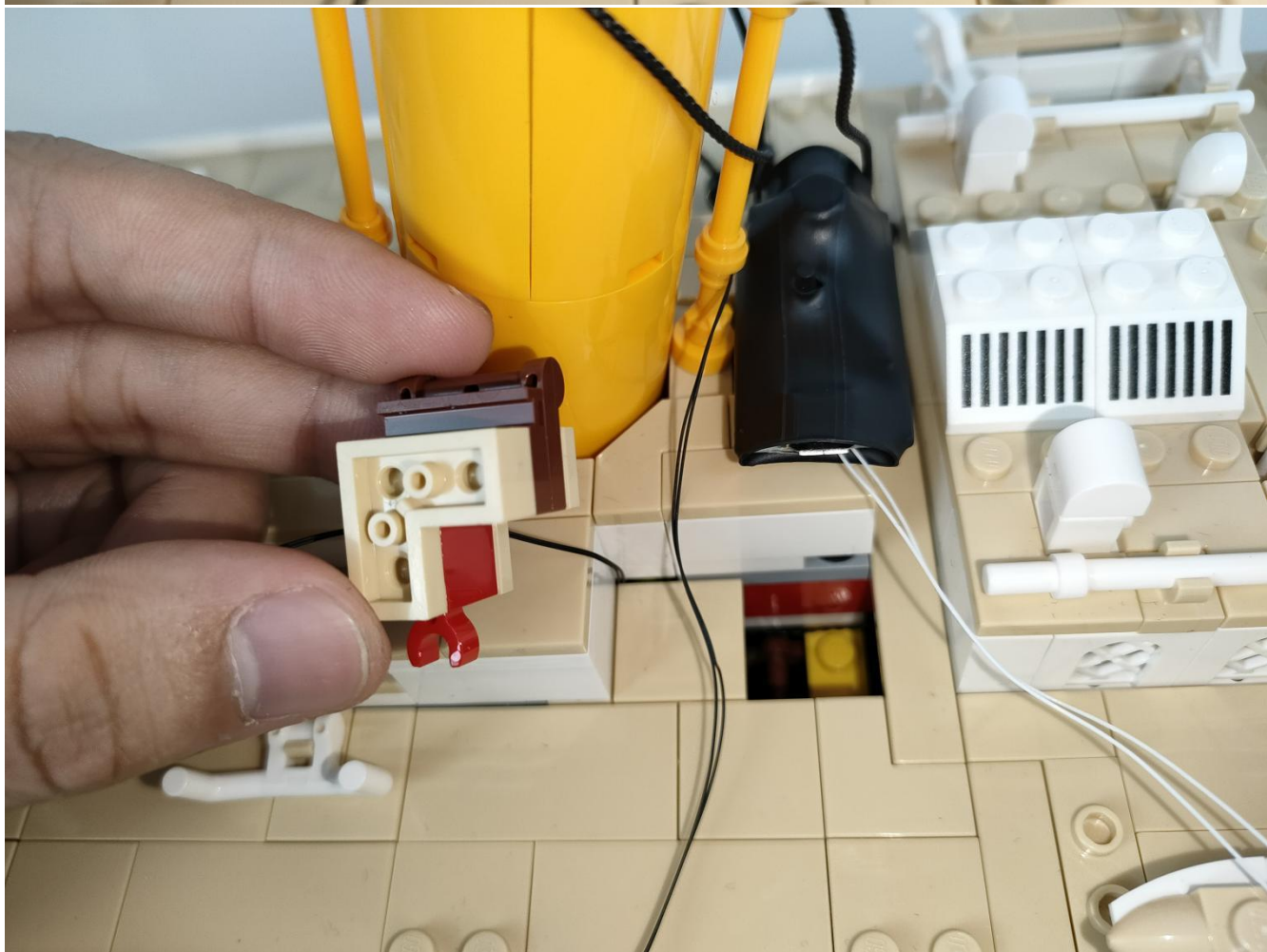
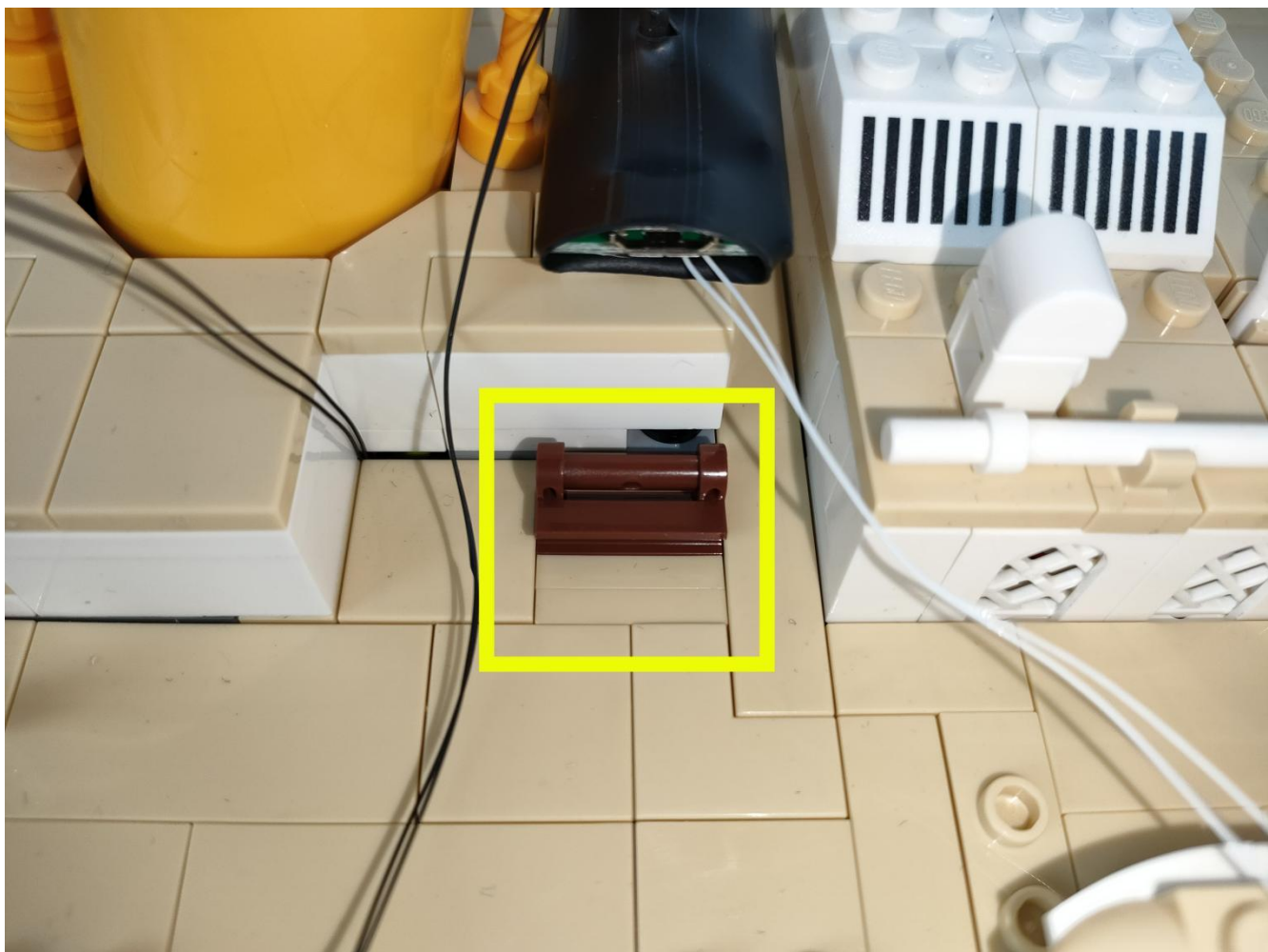

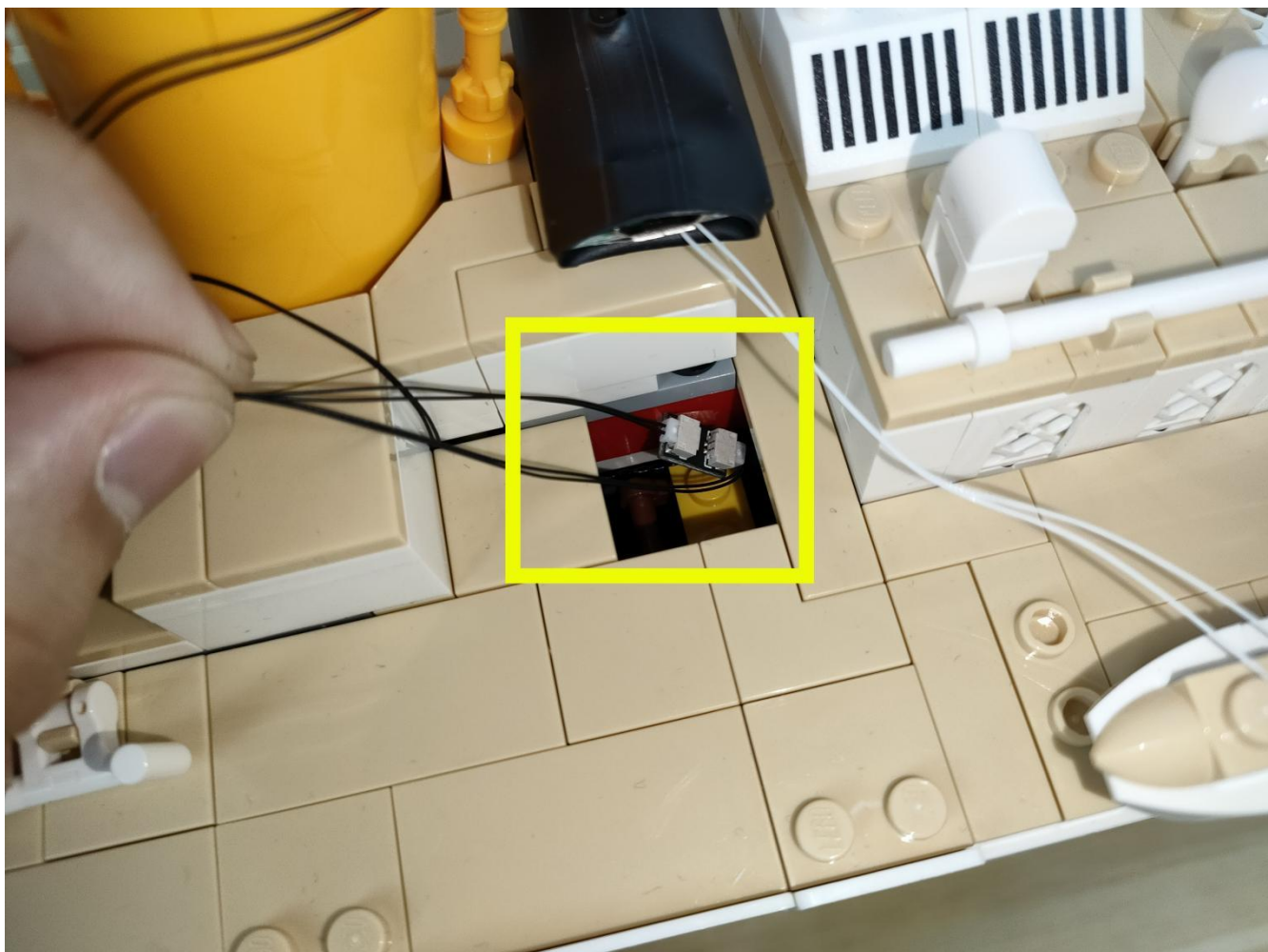

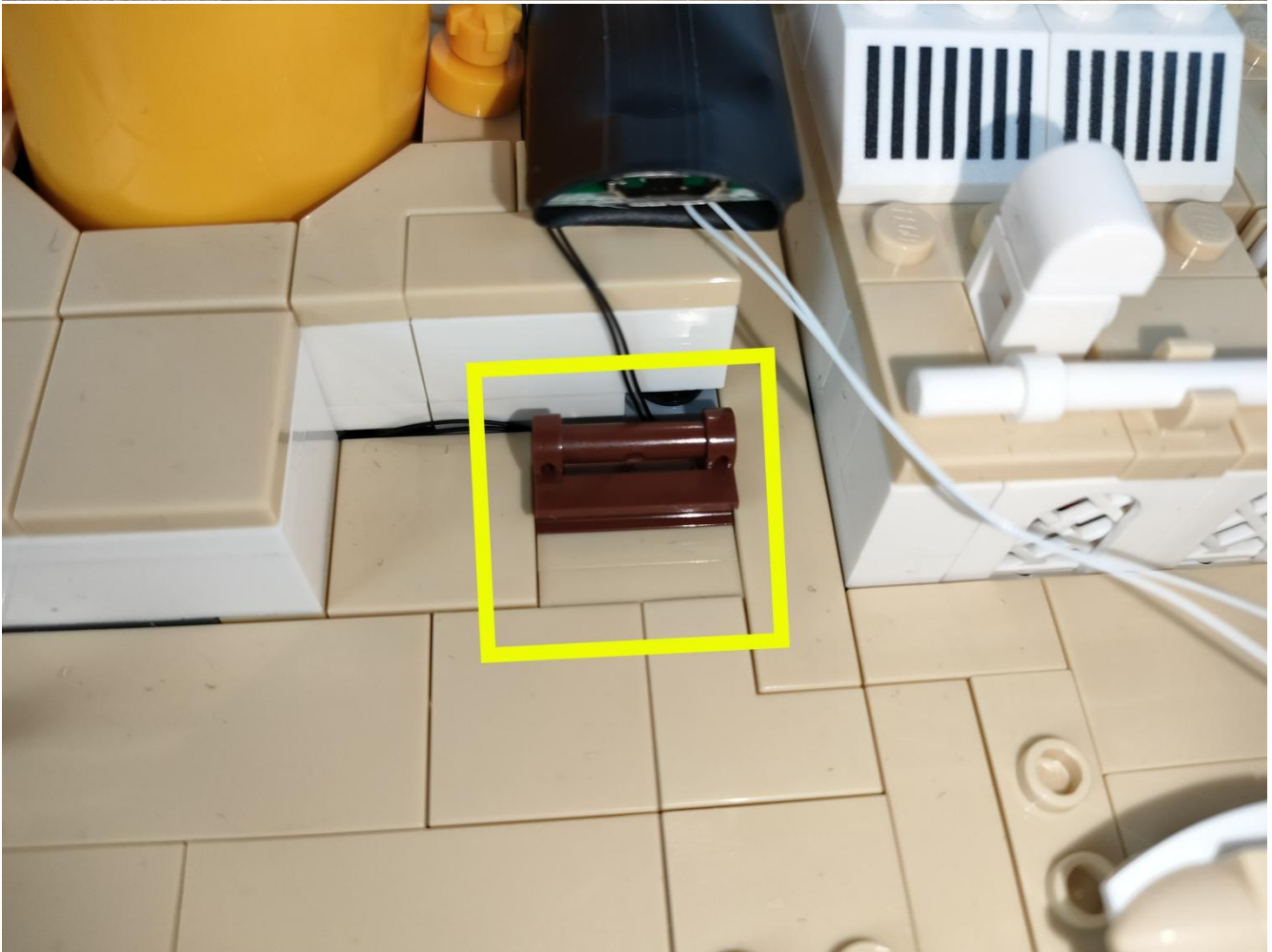
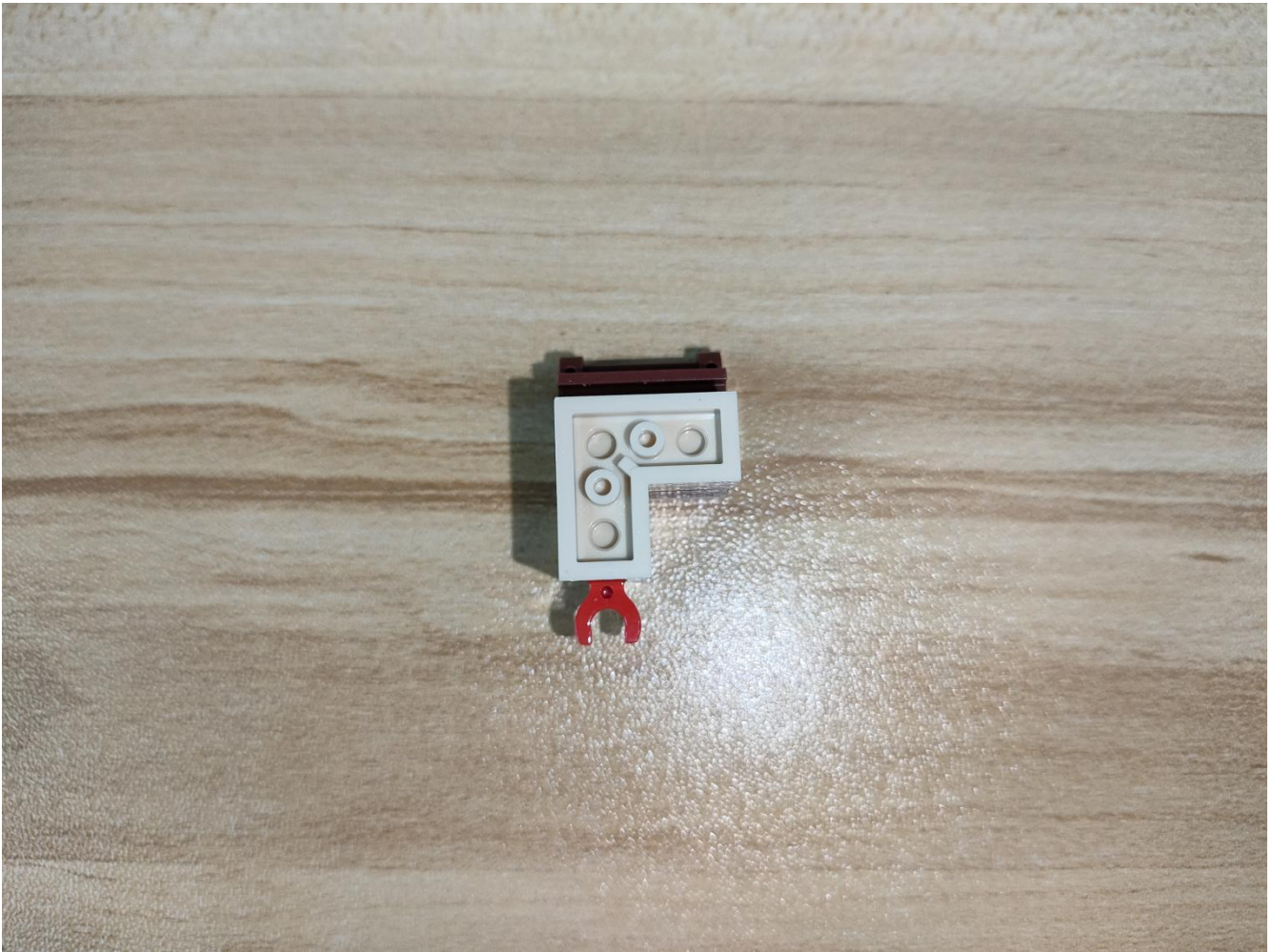





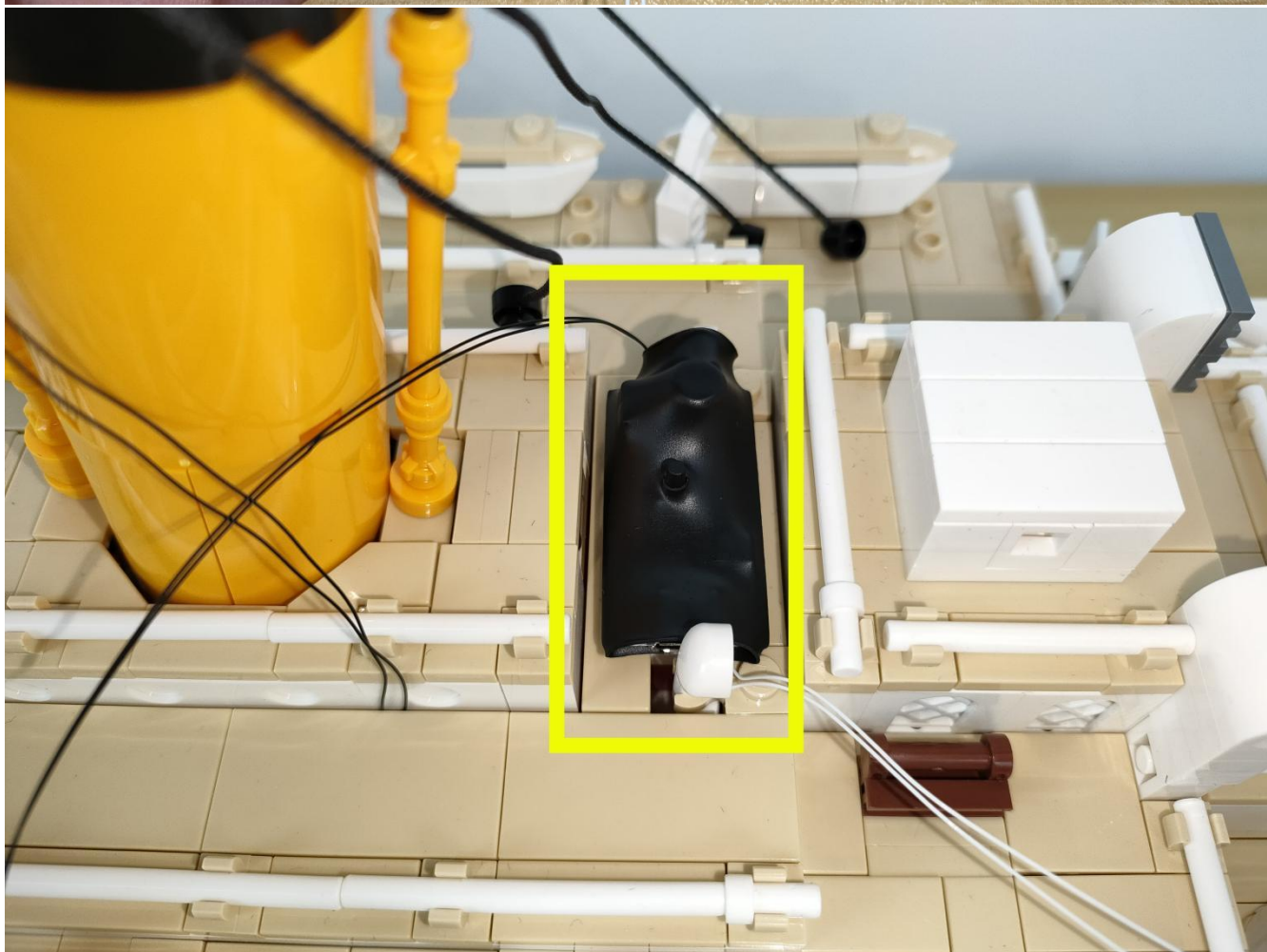
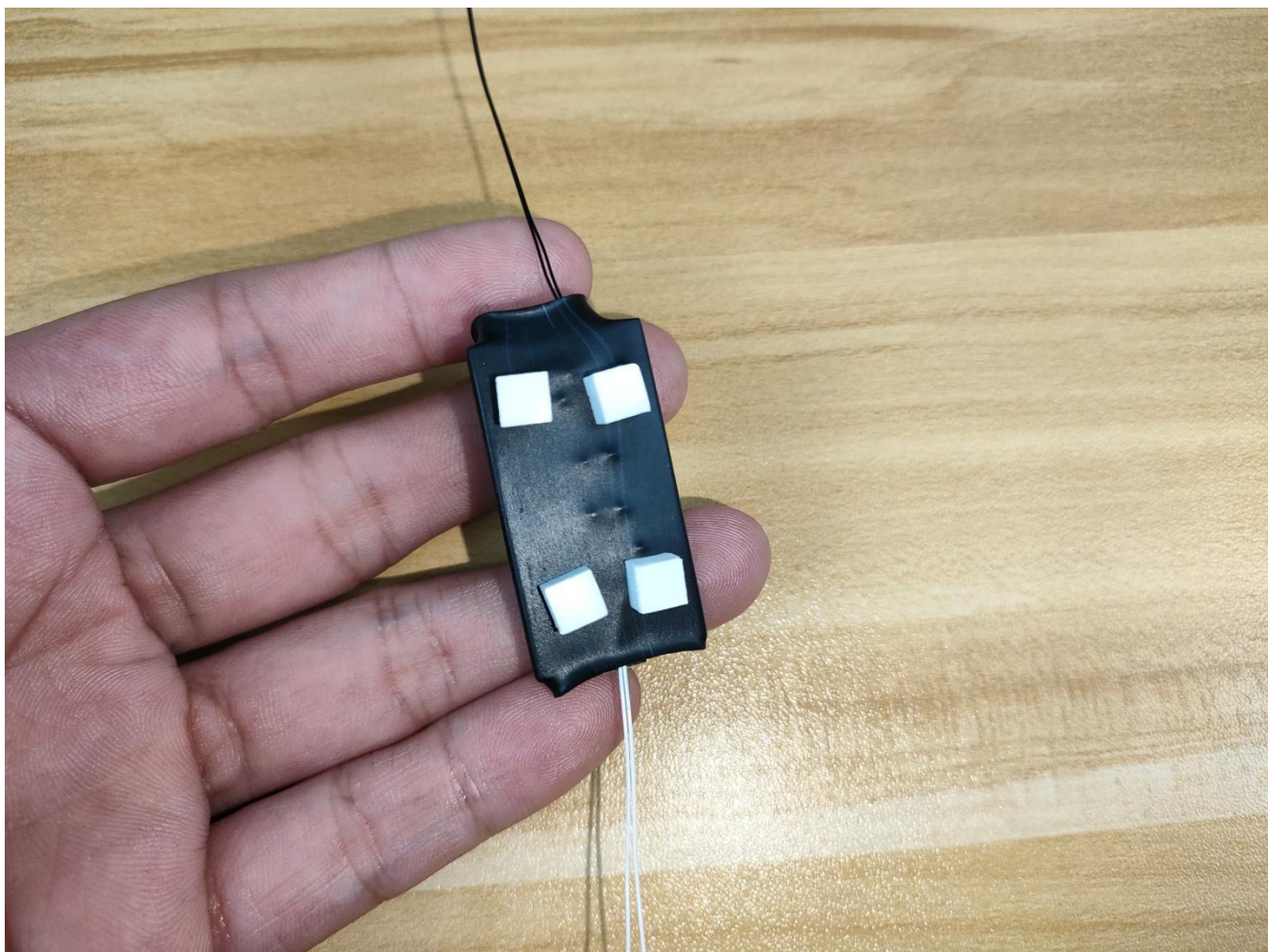

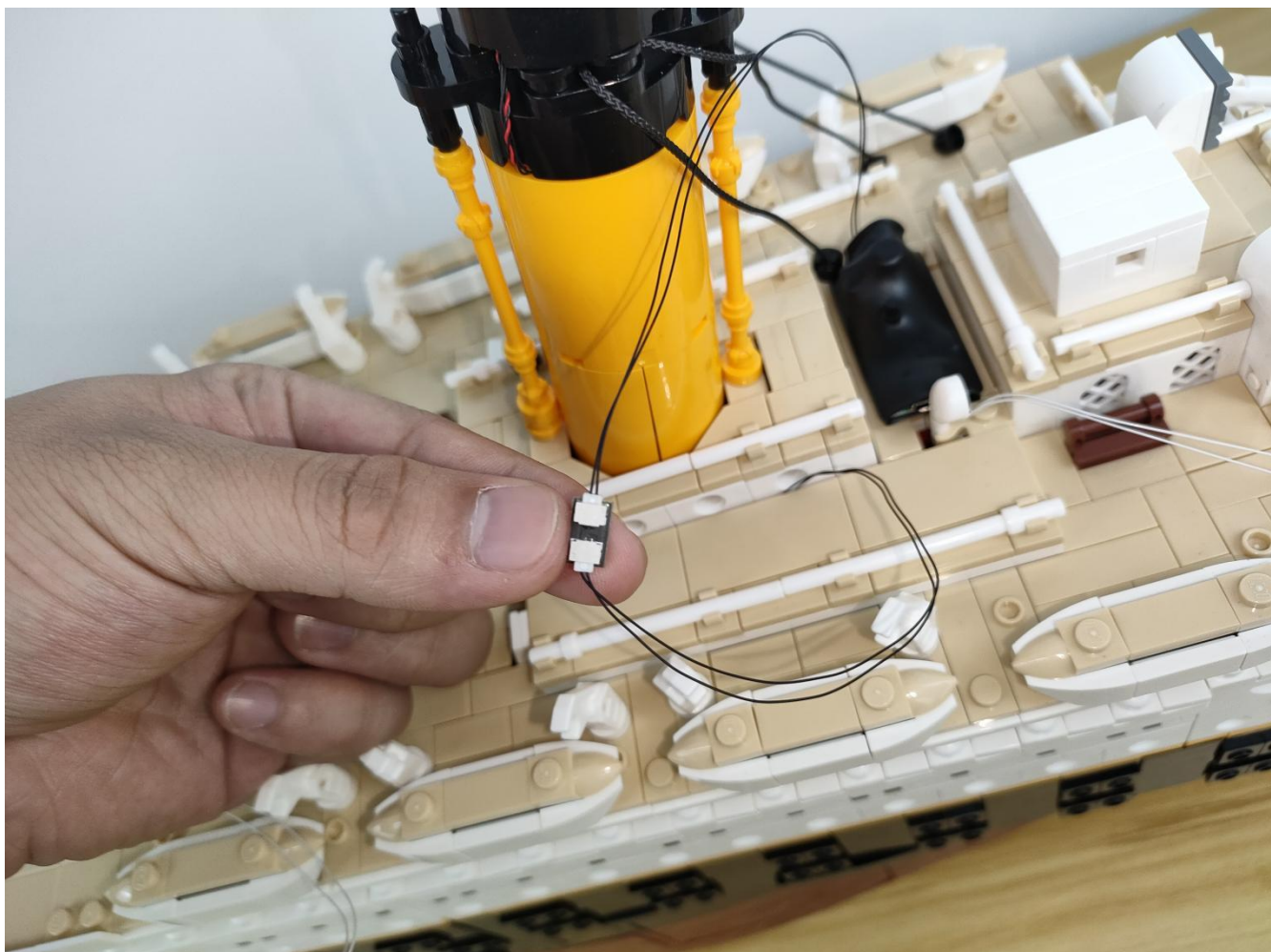

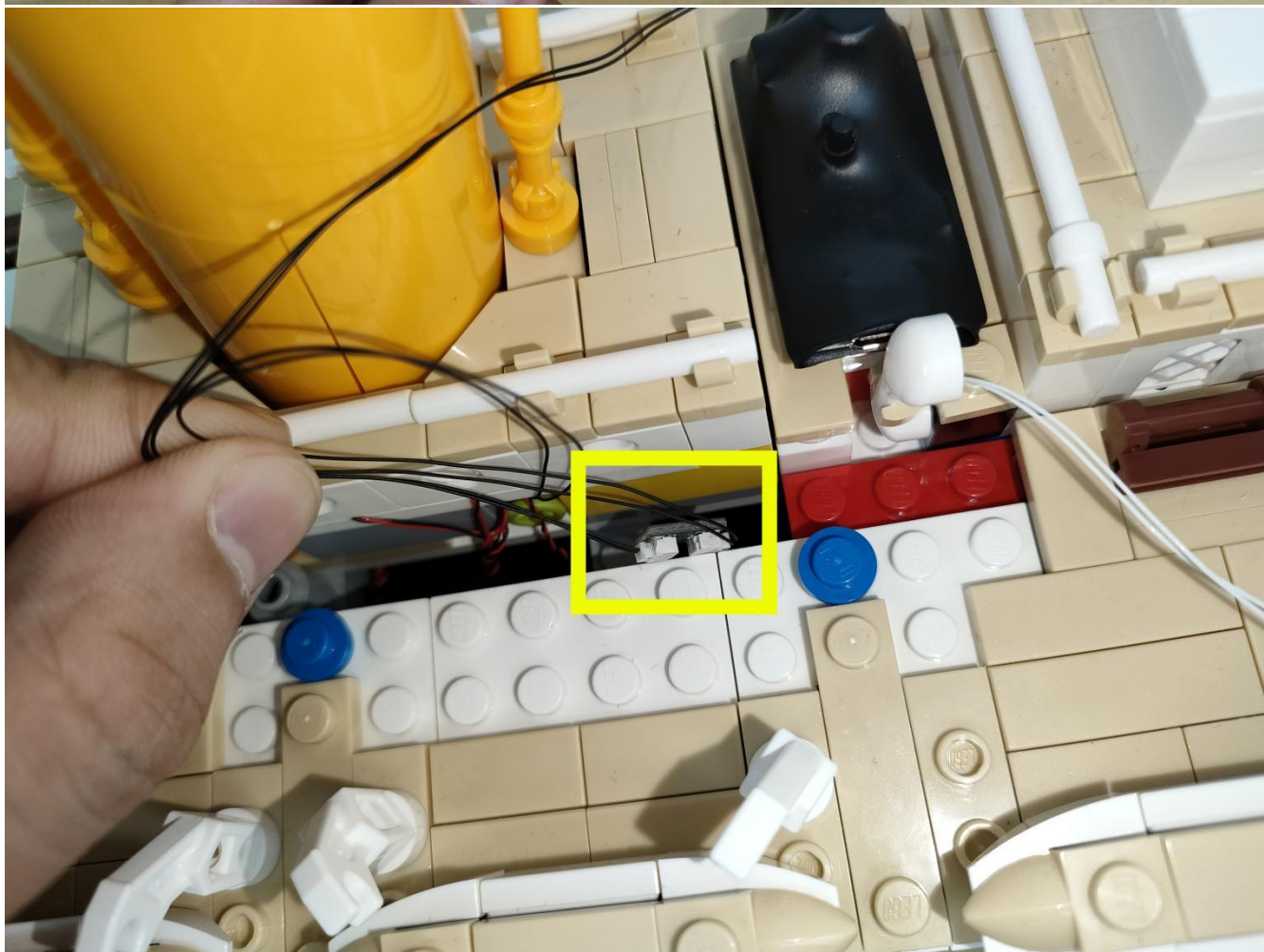
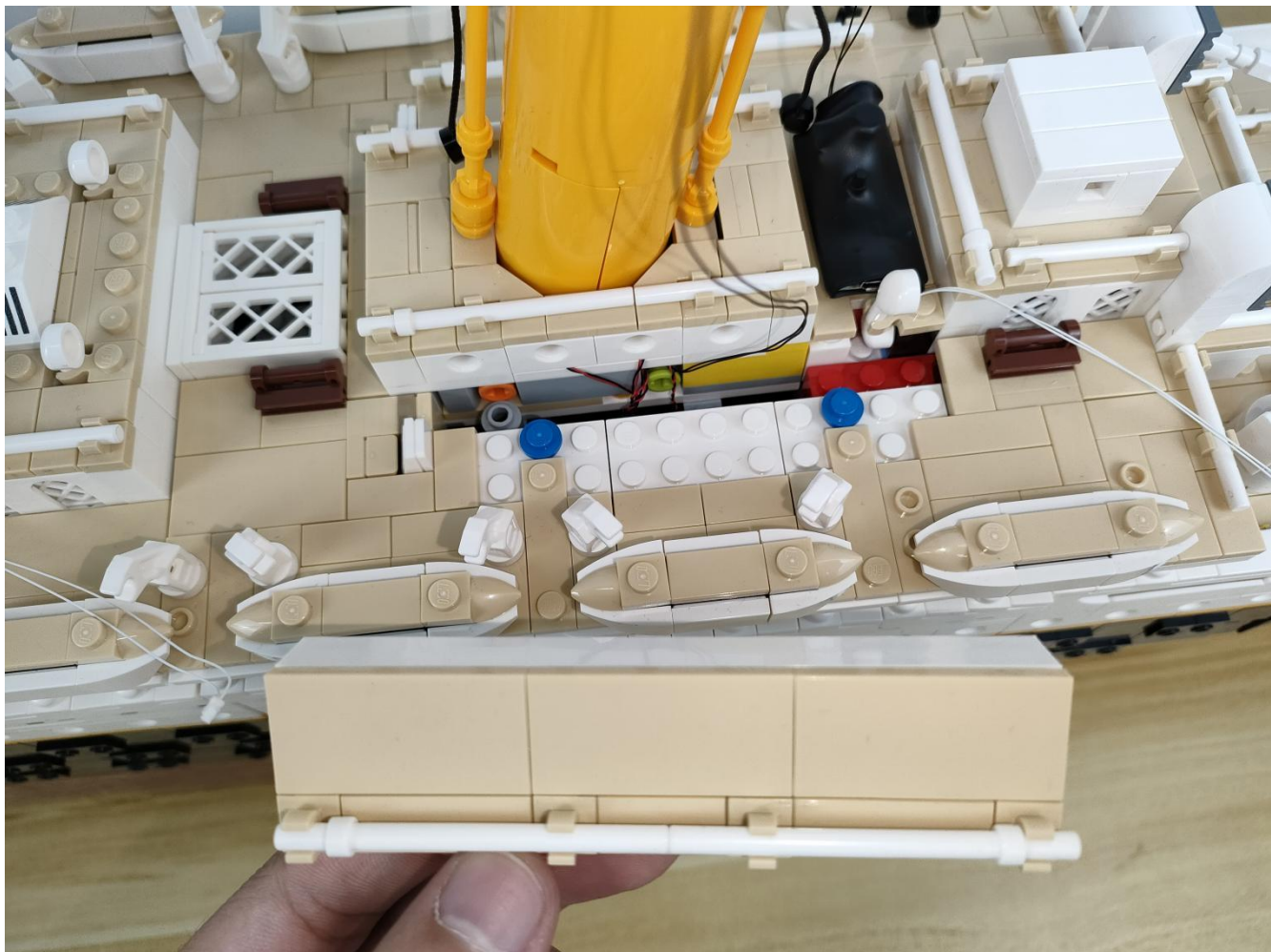

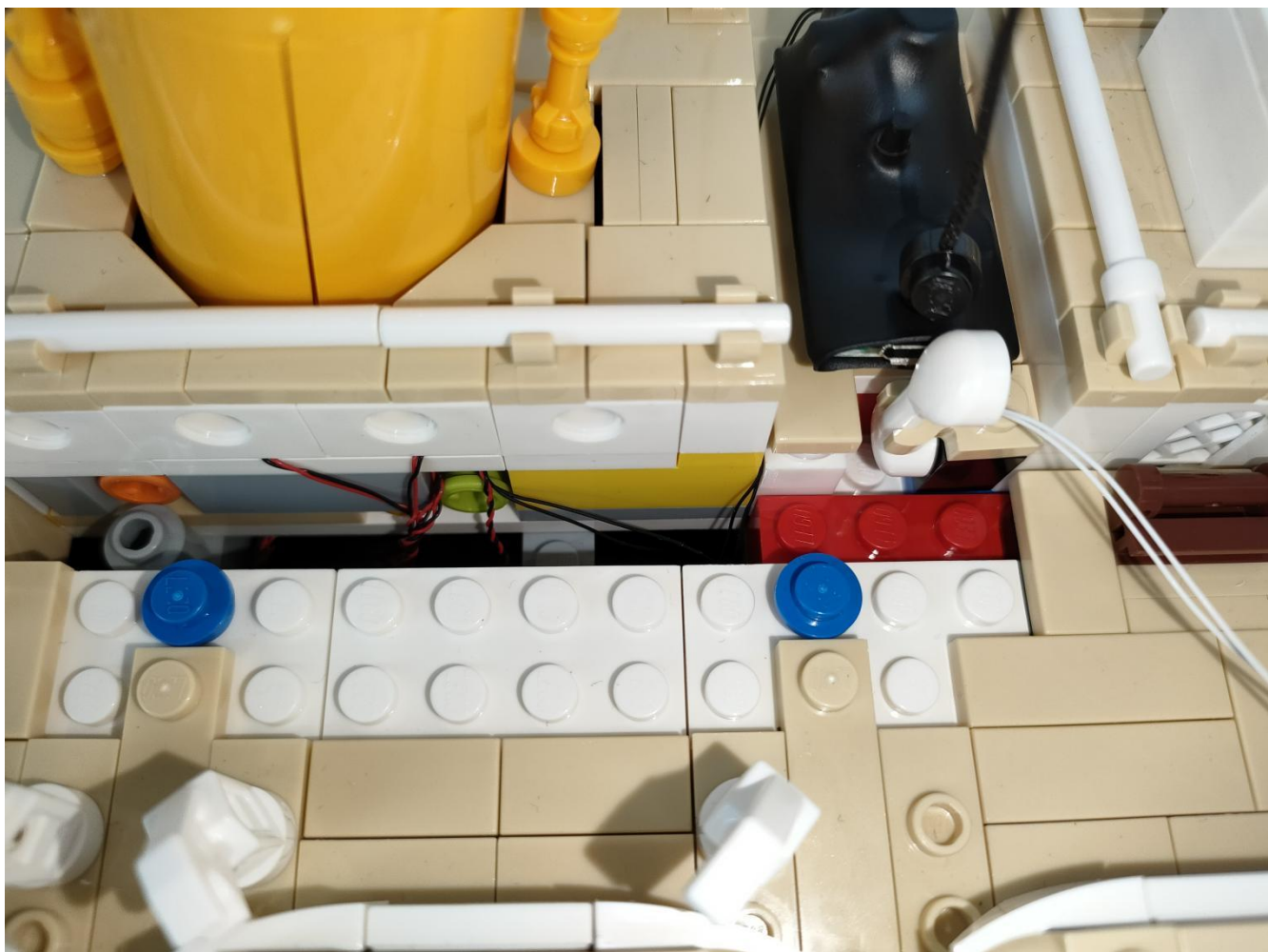

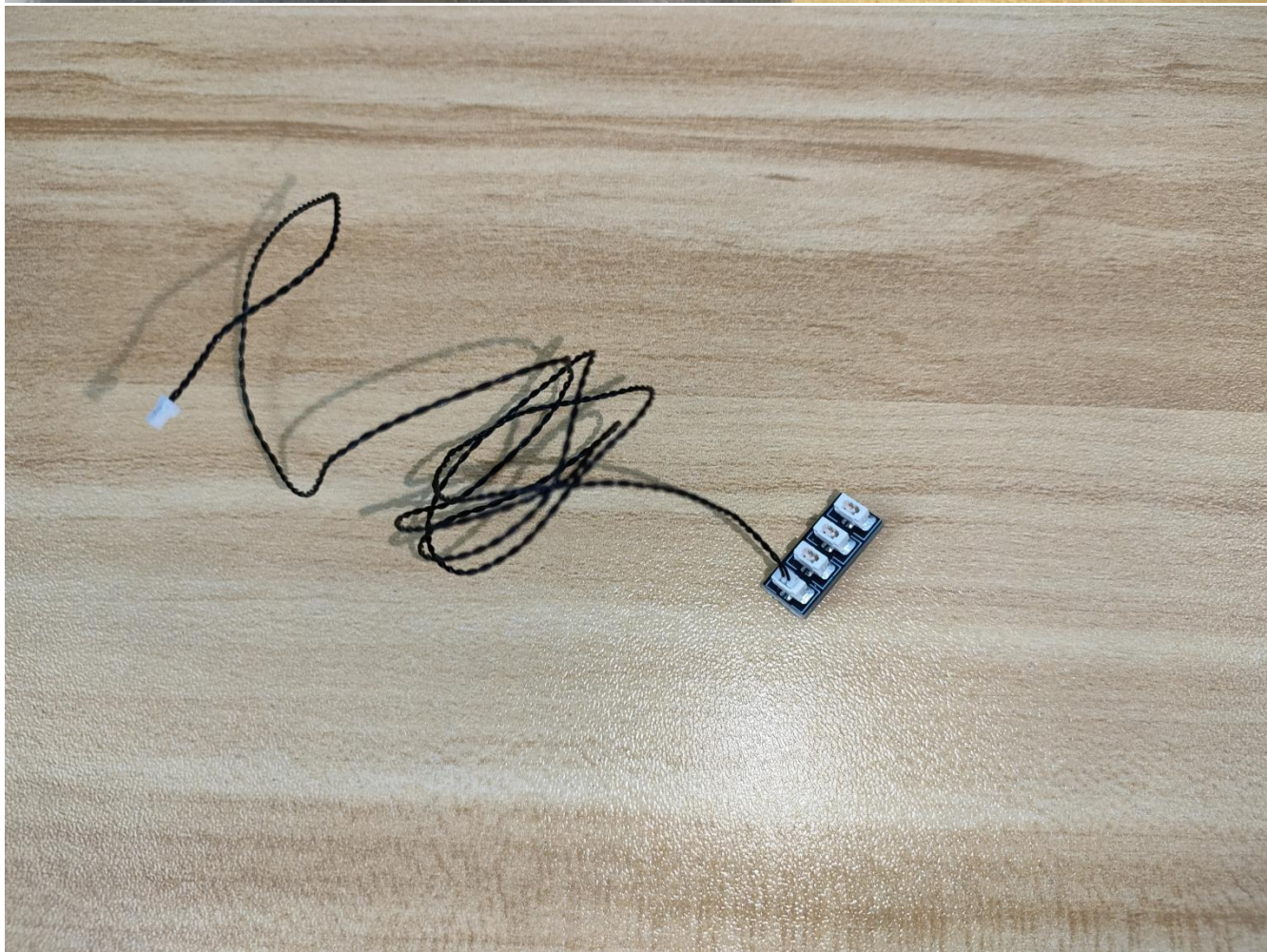

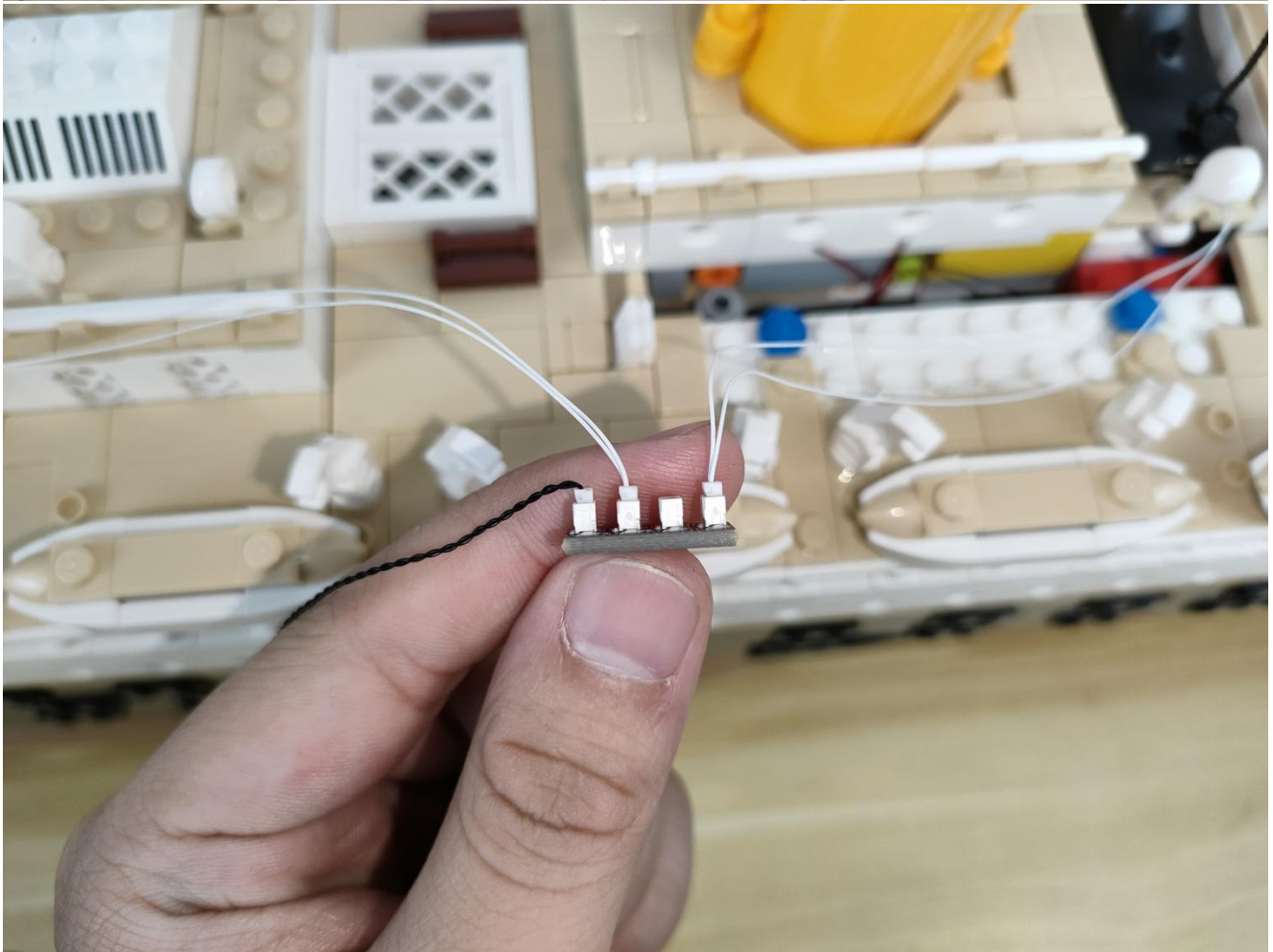
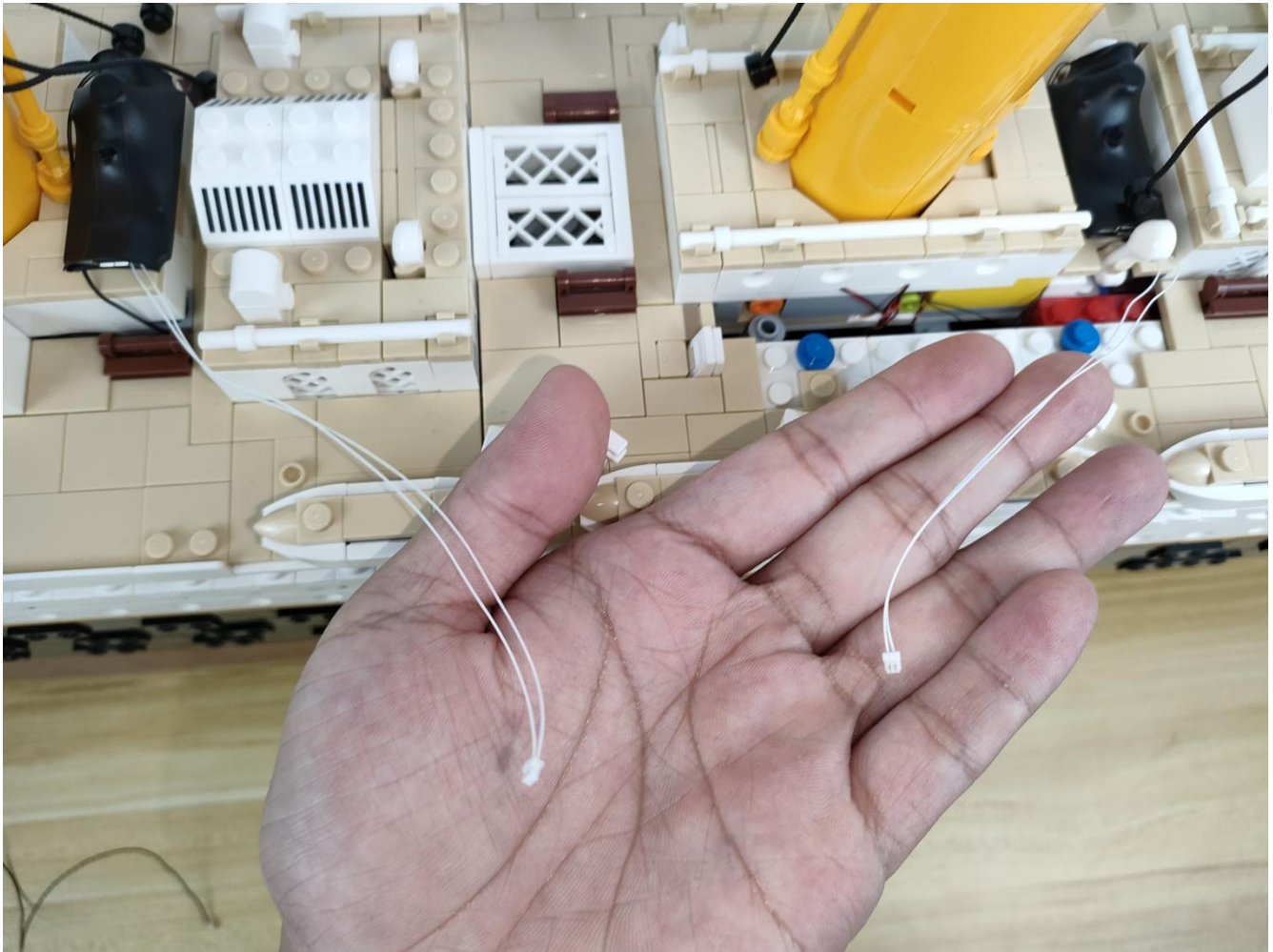

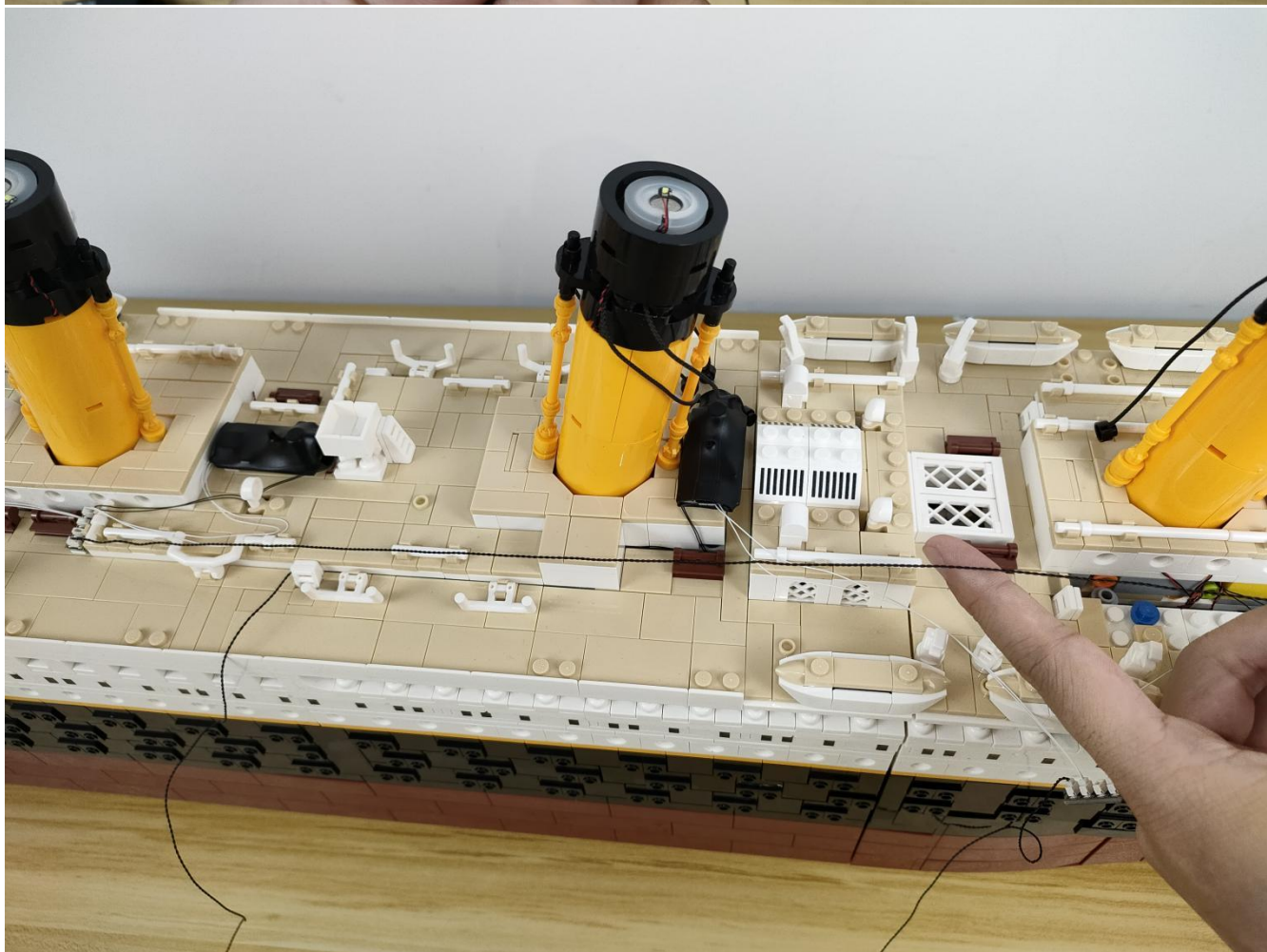
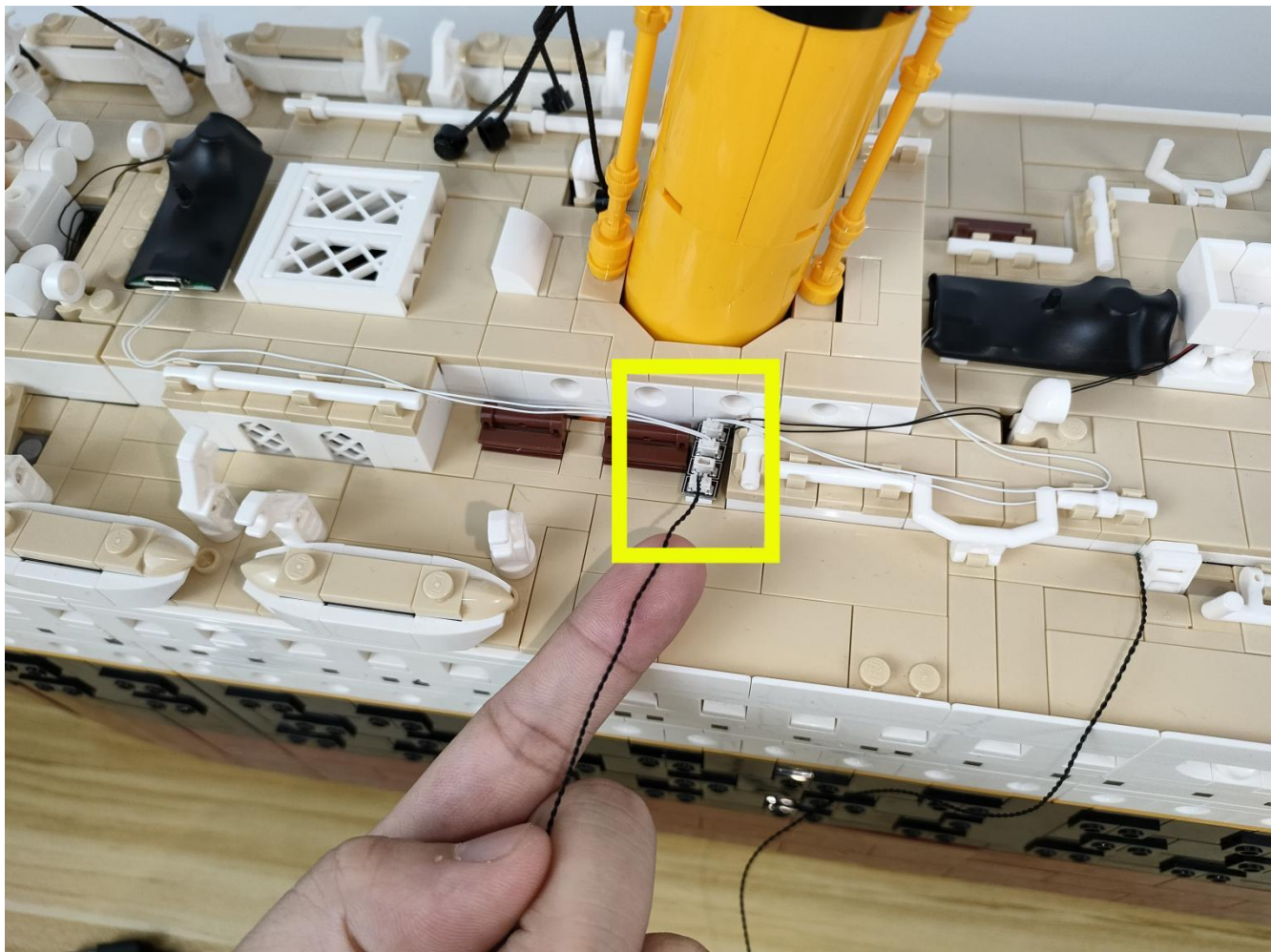

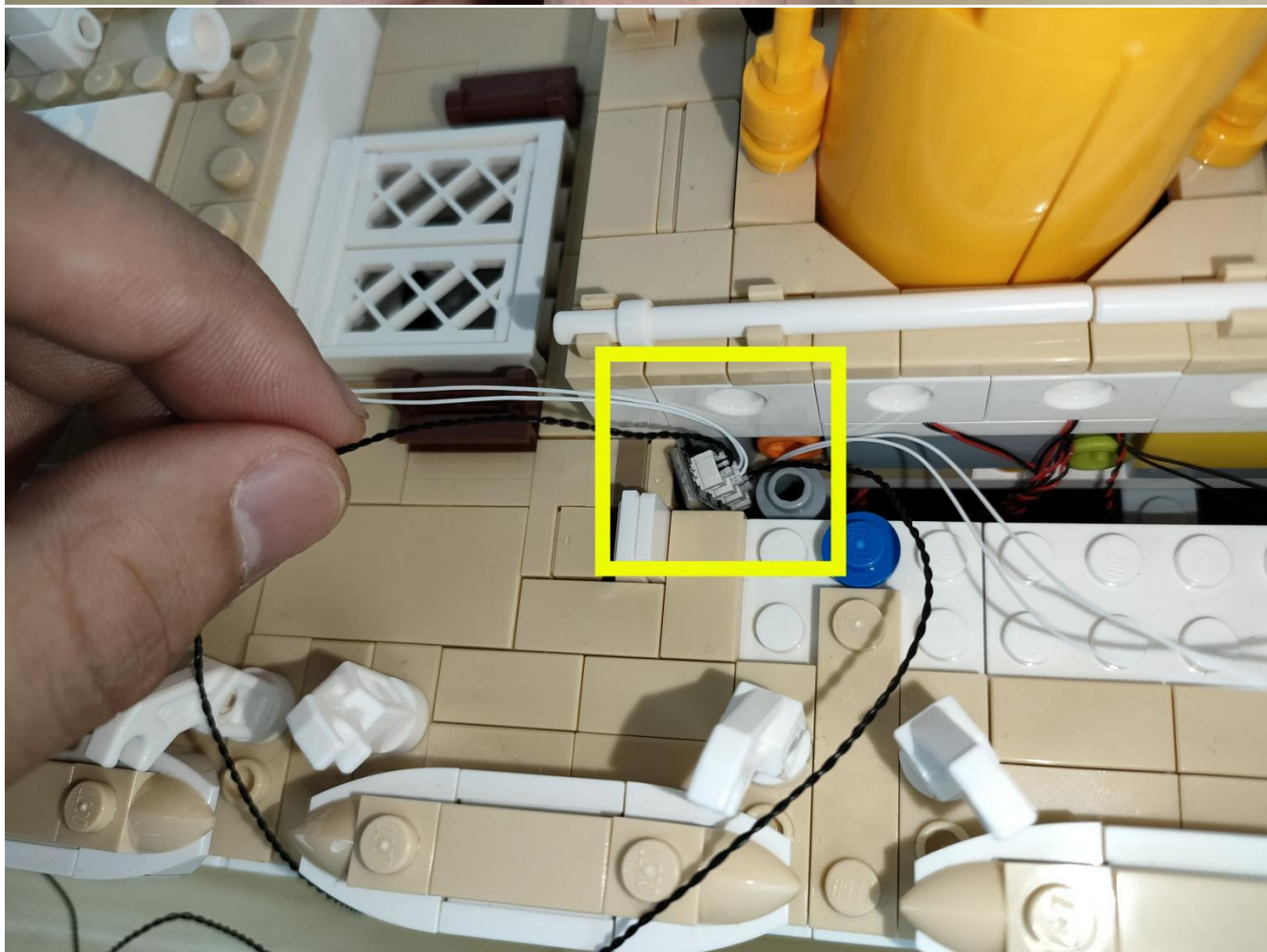
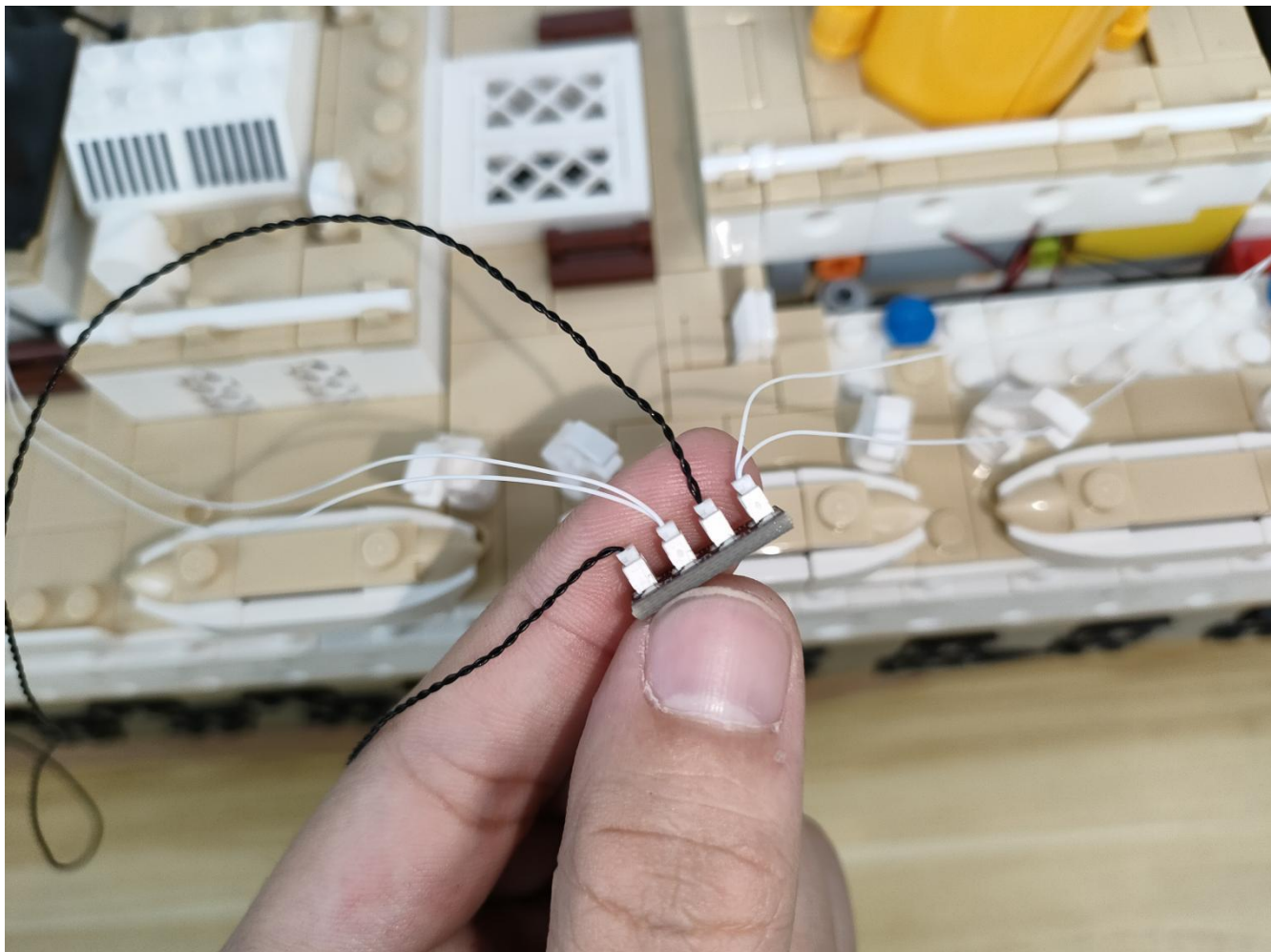

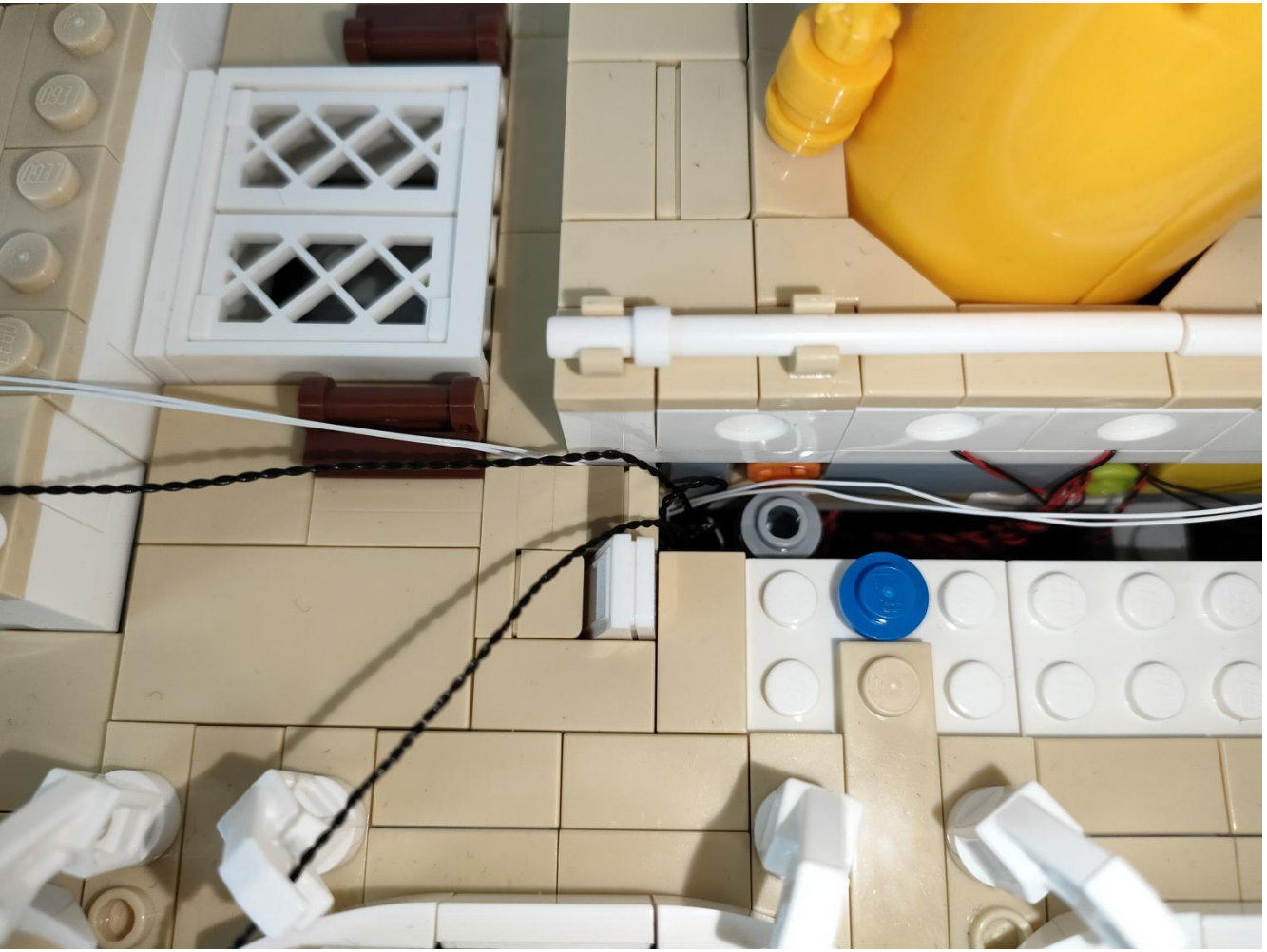

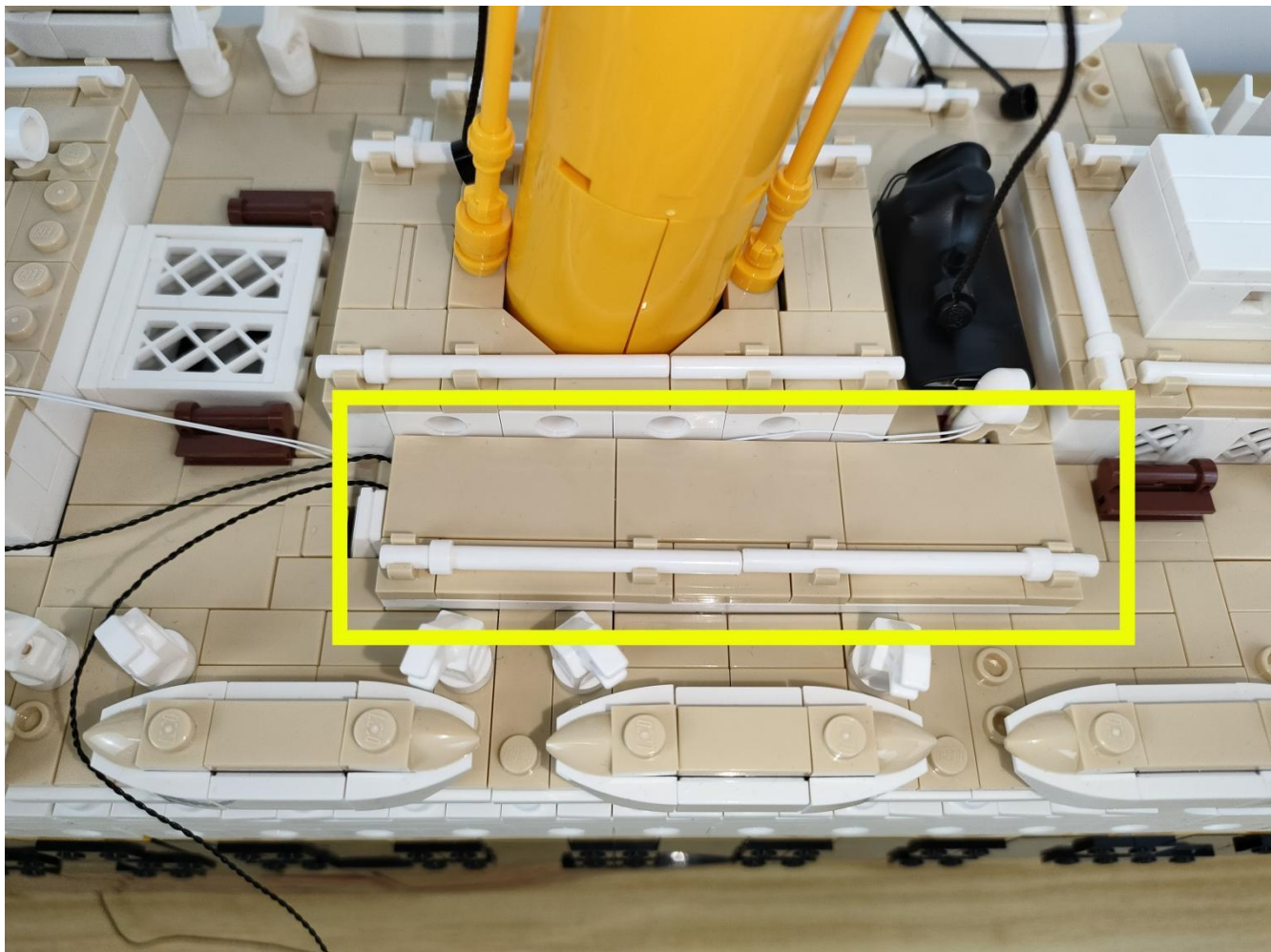

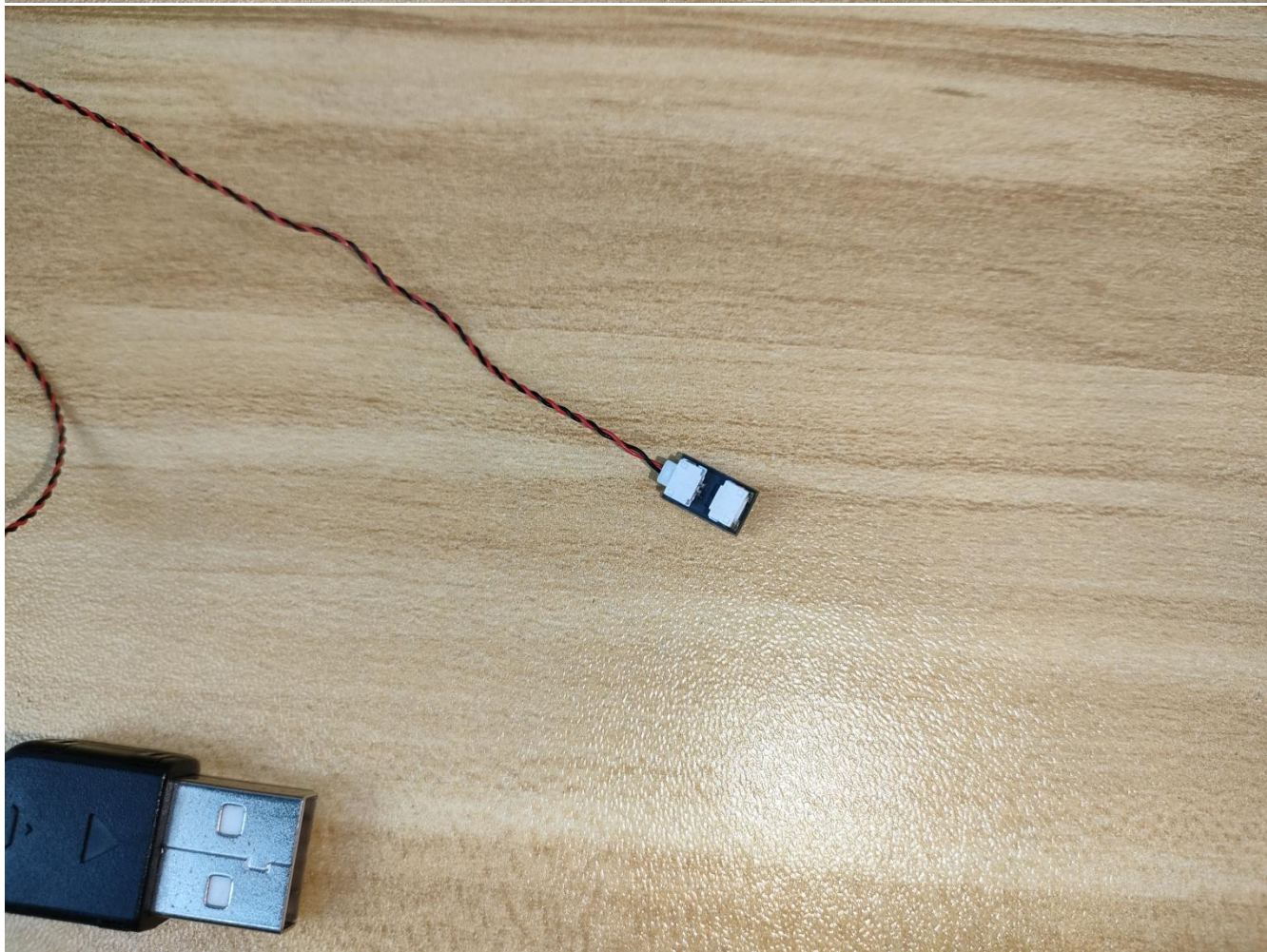
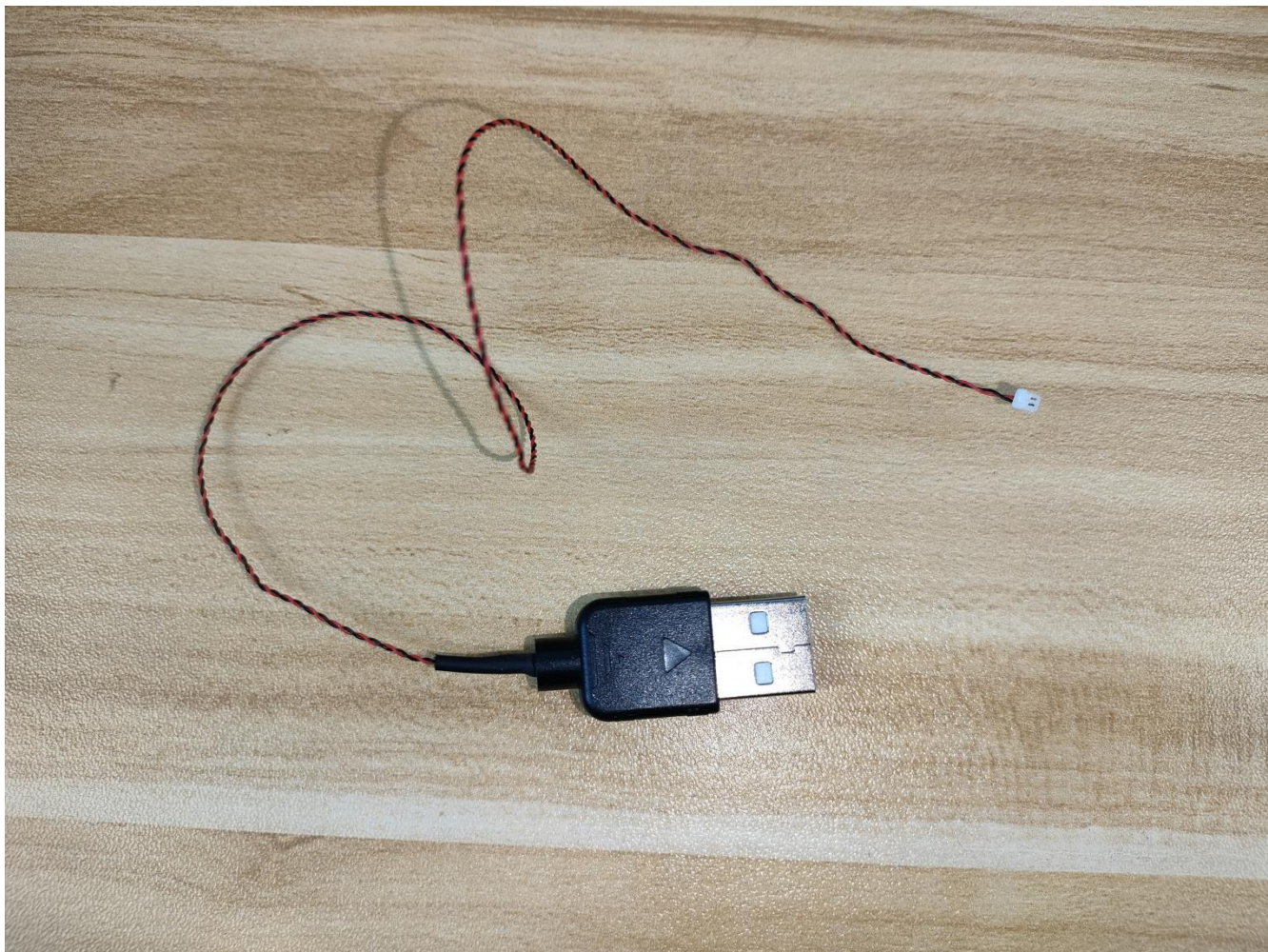

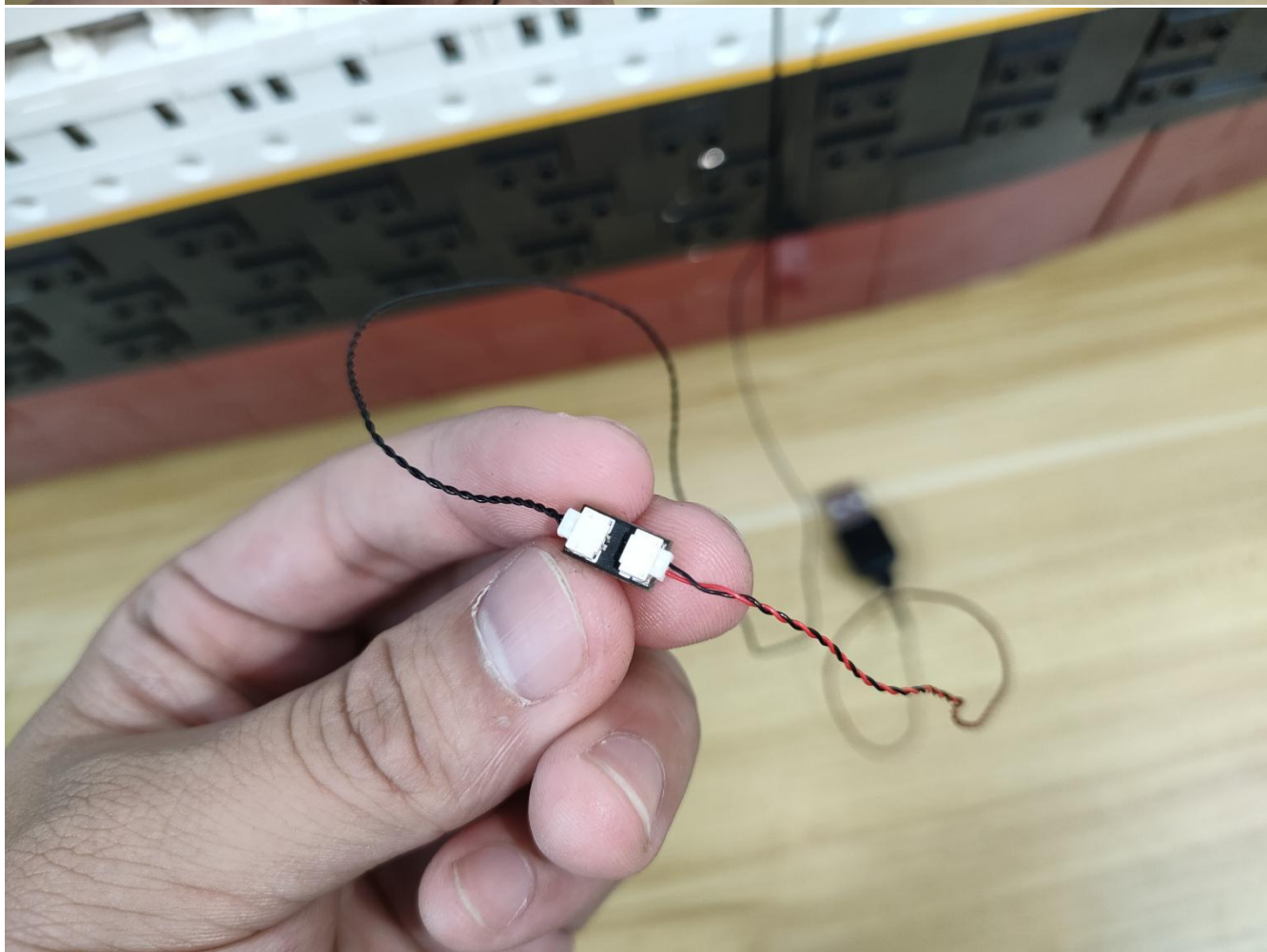
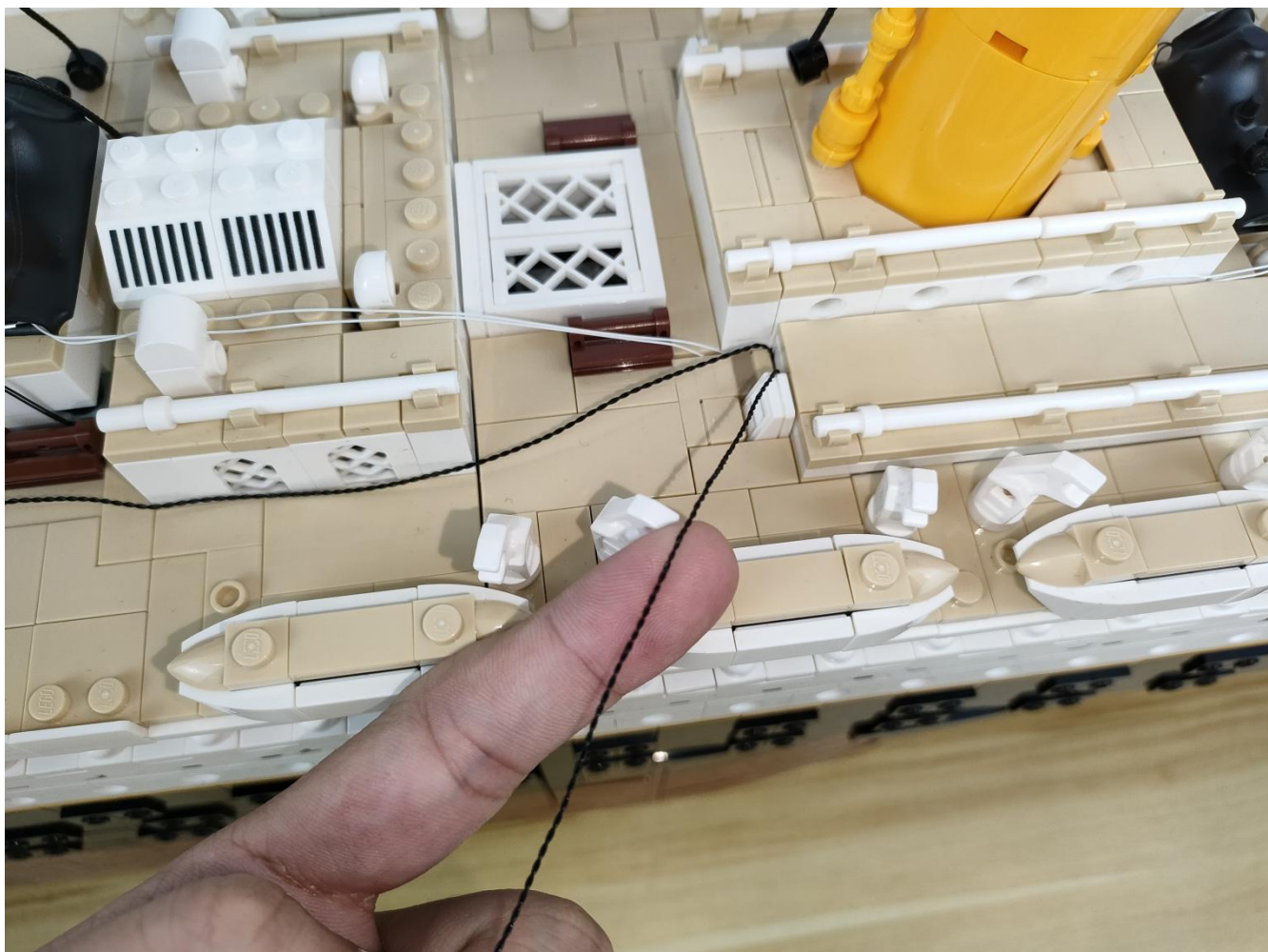



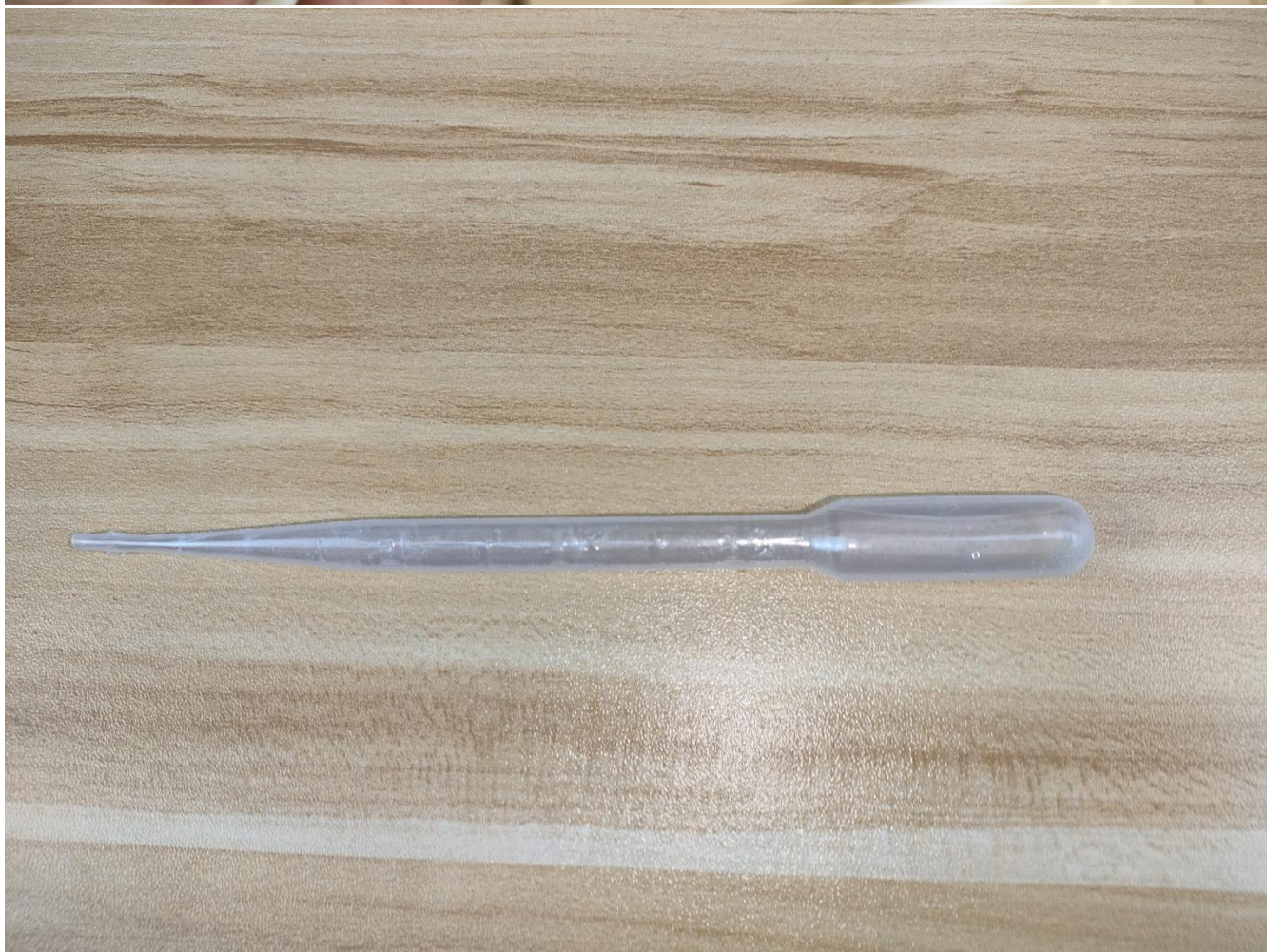



Press the dropper, and use the dropper to pour water into the cotton ball (the other three places are also operated in the same way).

**Tip: Make sure there is enough water when the module is working.
Avoid burning the module without water.**



Because there are many lights, it is recommended to use plug-in power supply directly.

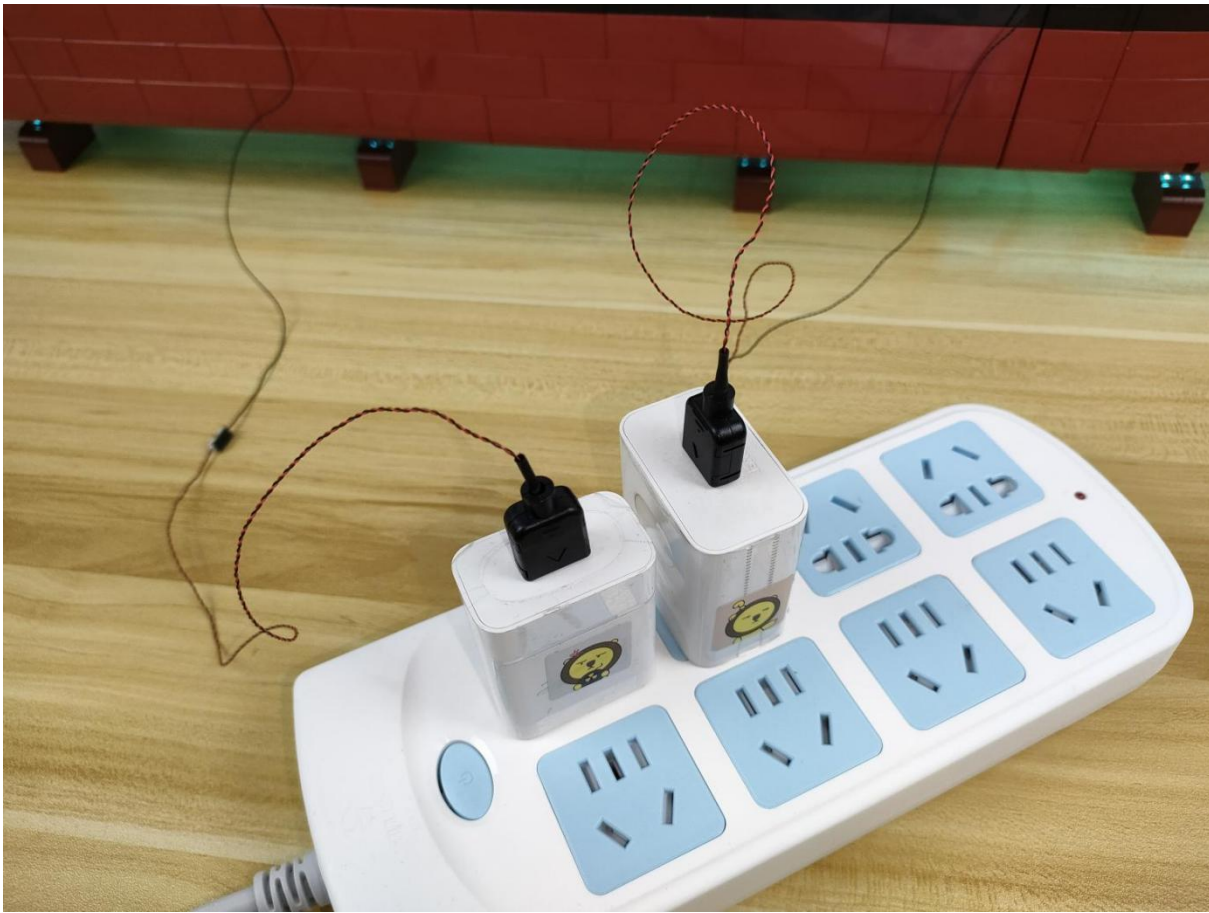

The installation is complete.



The above are ideas and instructions provided by our designers. Please move on:

- 1: Do you have any suggestions about the material and quality of our products?
- 2: Do you have any suggestions on the installation instructions and the degree of difficulty of the installation?
- 3: If you have better installation method and ideas, please contact us in time.