

# LEGO 42129 4x4 Mercedes-Benz Zetros Trial Truck LED lighting Kit (Deluxe Version)

## P26603

Thank you for choosing our lighting products. We are committed to LEGO product study and lighting development, we're always trying our best to provide LEGO fans with the best products and the best installation ideas. Must be careful observation, imagination can be infinite. We provide basic parts to support your imagination.

DO IT YOURSELF .that's what LEGO is .

As always, Lego has been adhering to the DIY philosophy from product selection, research and development to sales. Consumers buy the parts, you will assemble them by yourself, and you can experience every step from picking up the first piece to installing the last one. Besides, LEGO has different answers for the installation form and method of each part. Vonado lighting also does not want to kill your unlimited creativity, we will try our best to make products with high variability, high play ability and unlimited play. If you have any dissatisfaction or your own ideas on the parts such as the color of the lights, the length of the cables, the installation position of the product, and the final effects of each module, you can make your own arrangement, and we will cooperate with you to replace or repurchase.

LETS MOVE!

### Package contents:

- 4 x 15cm Bit Lights-15CM-White
- 2 x Bit Lights-30CM-Red
- 2 x Bit Lights-15CM-Orange
- 2 x Flashing Bit Lights-15CM-Orange
- 2 x Bit Lights-30CM-Orange
- 1 x LED Strip Lights-White
- 2 x 12-Port Expansion Boards
- 2 x Light Strips-Blue-28
- 2 x Headlights-30CM-White
- 1 x Headlights-30CM-Blue
- 1 x AAA Battery Pack
- 1 x USB Power Cable
- 1 x Connecting Cables-15CM
- 1 x Connecting Cables-30CM
- Parts Package



First step:

Test every lamp pellet.

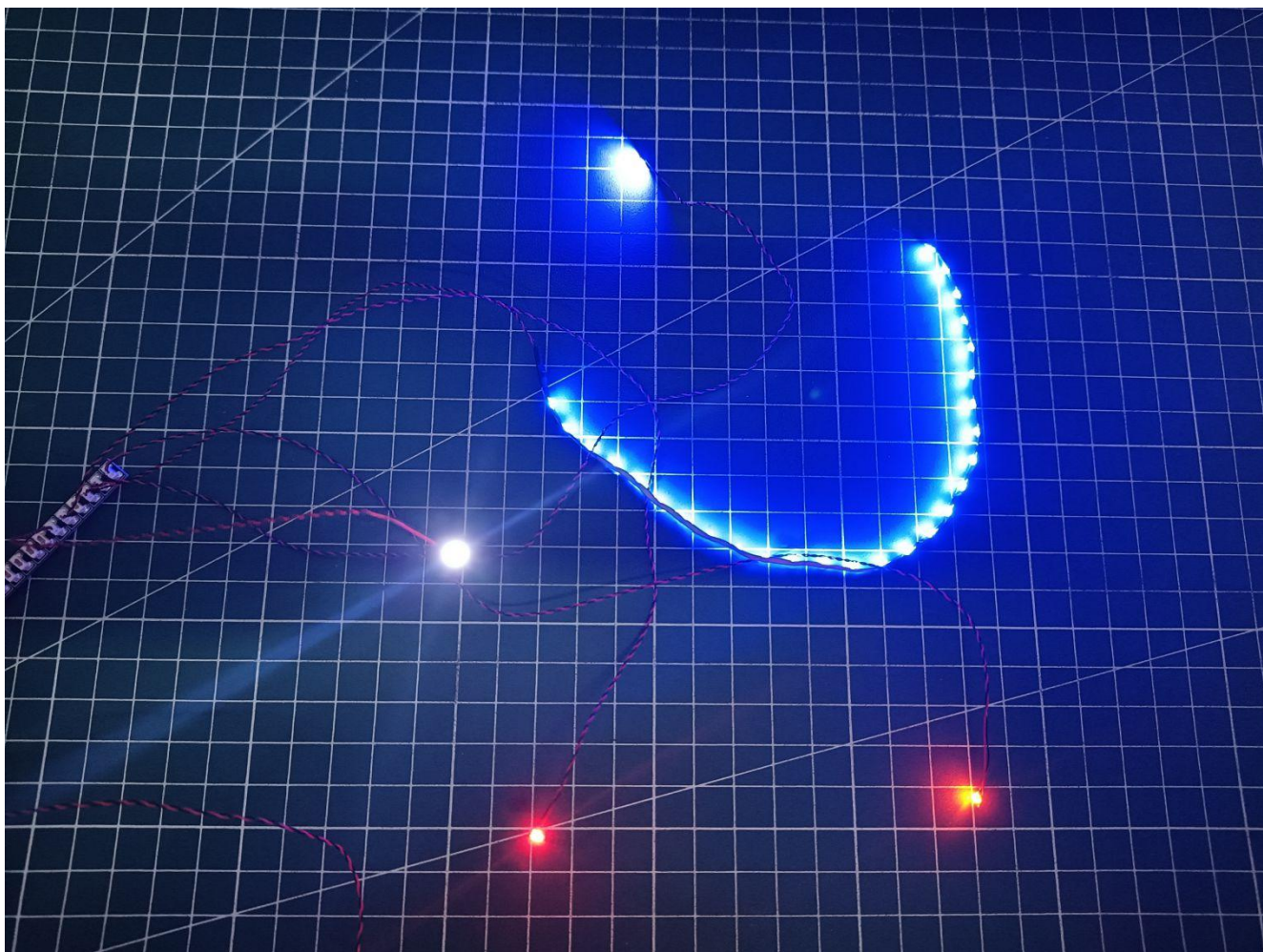

Second step:

Instructions



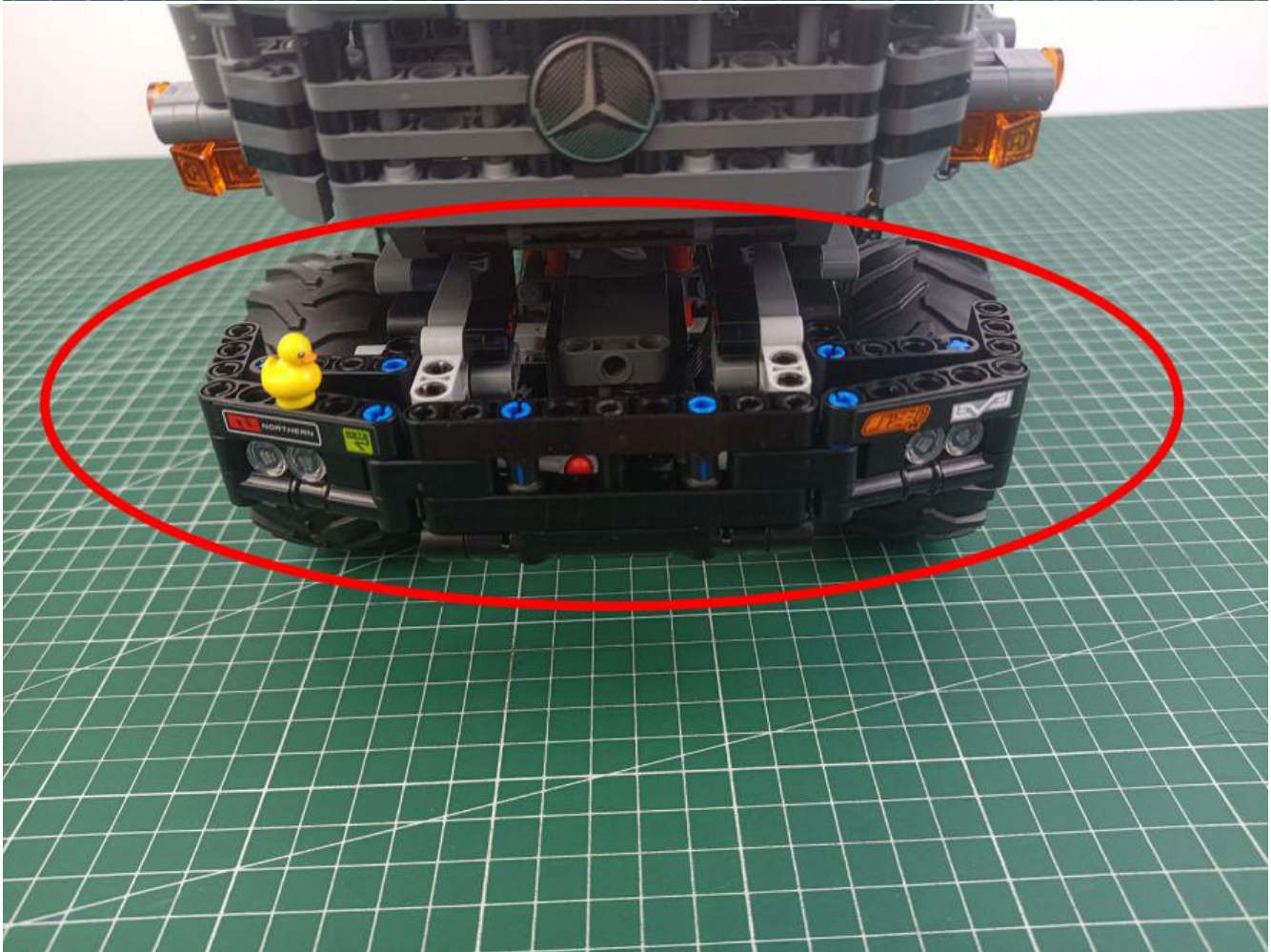
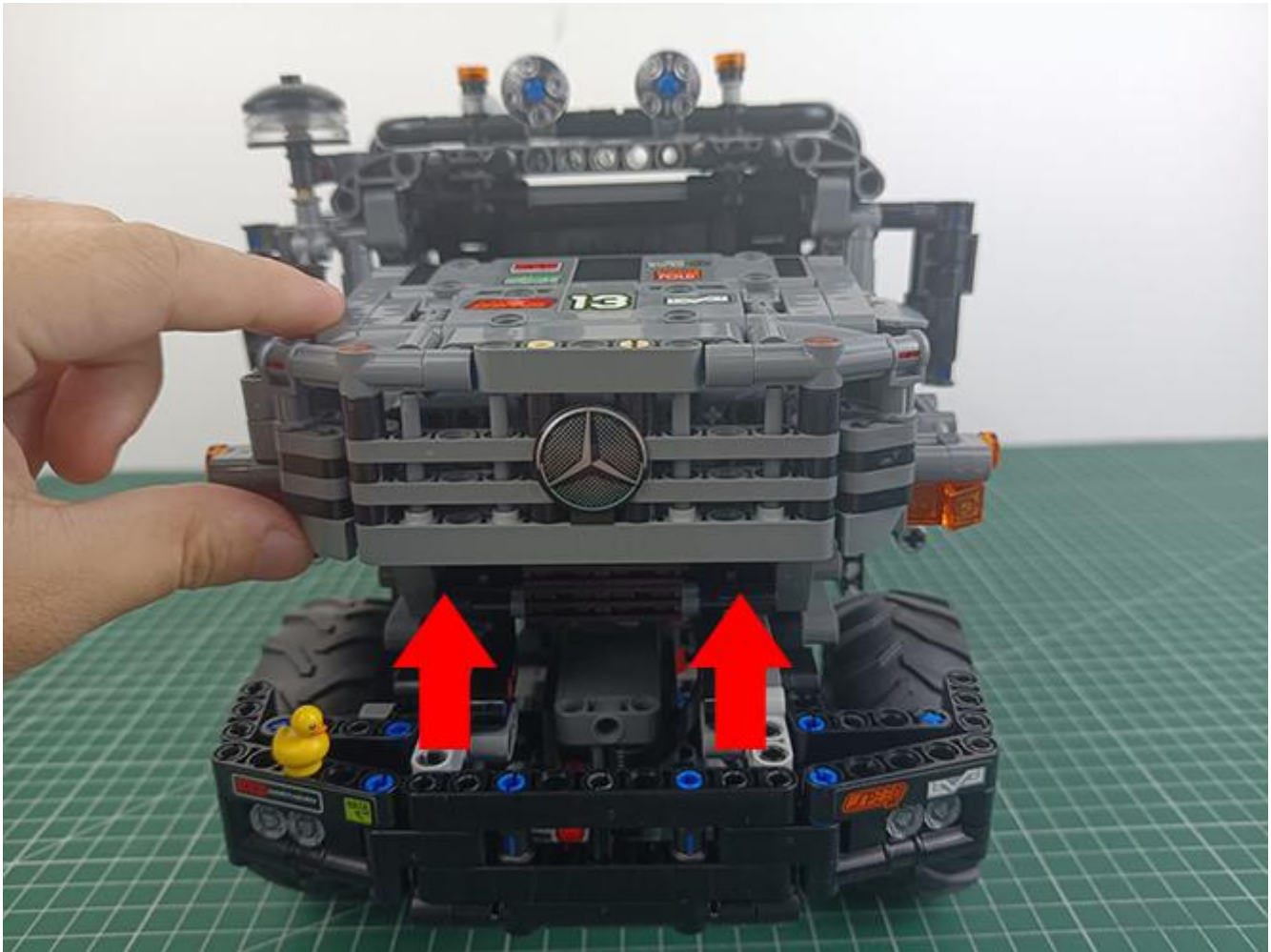

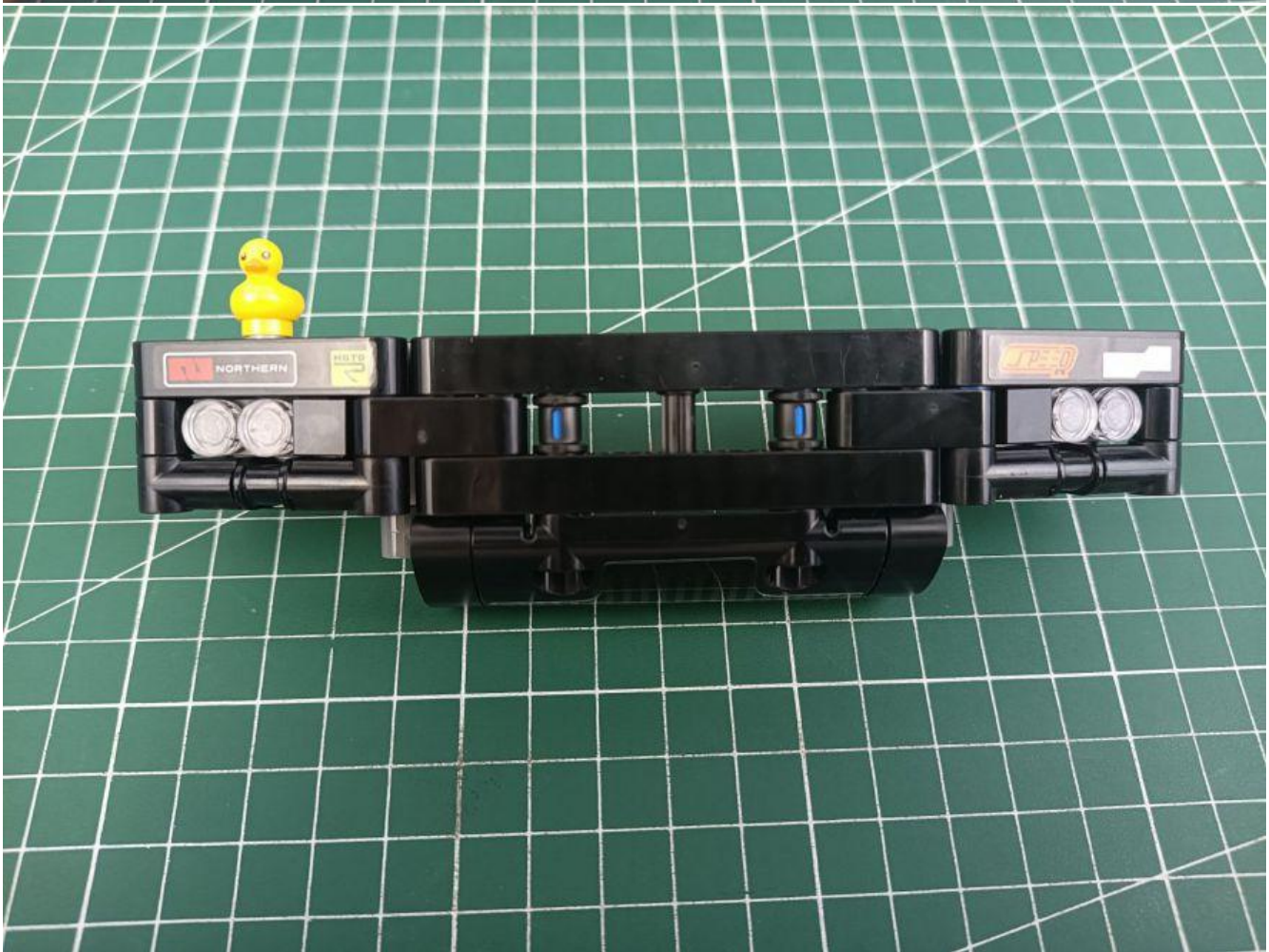
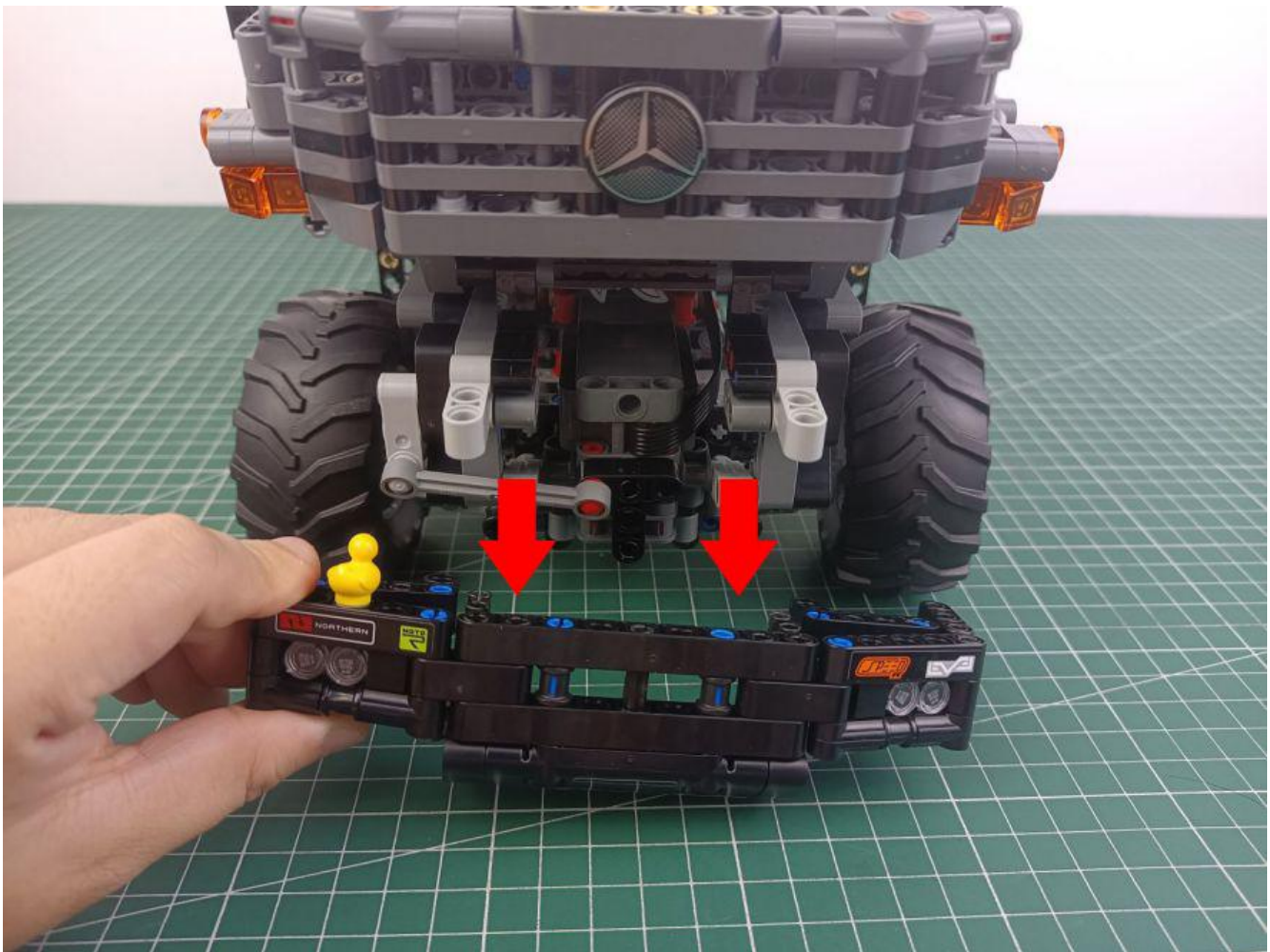

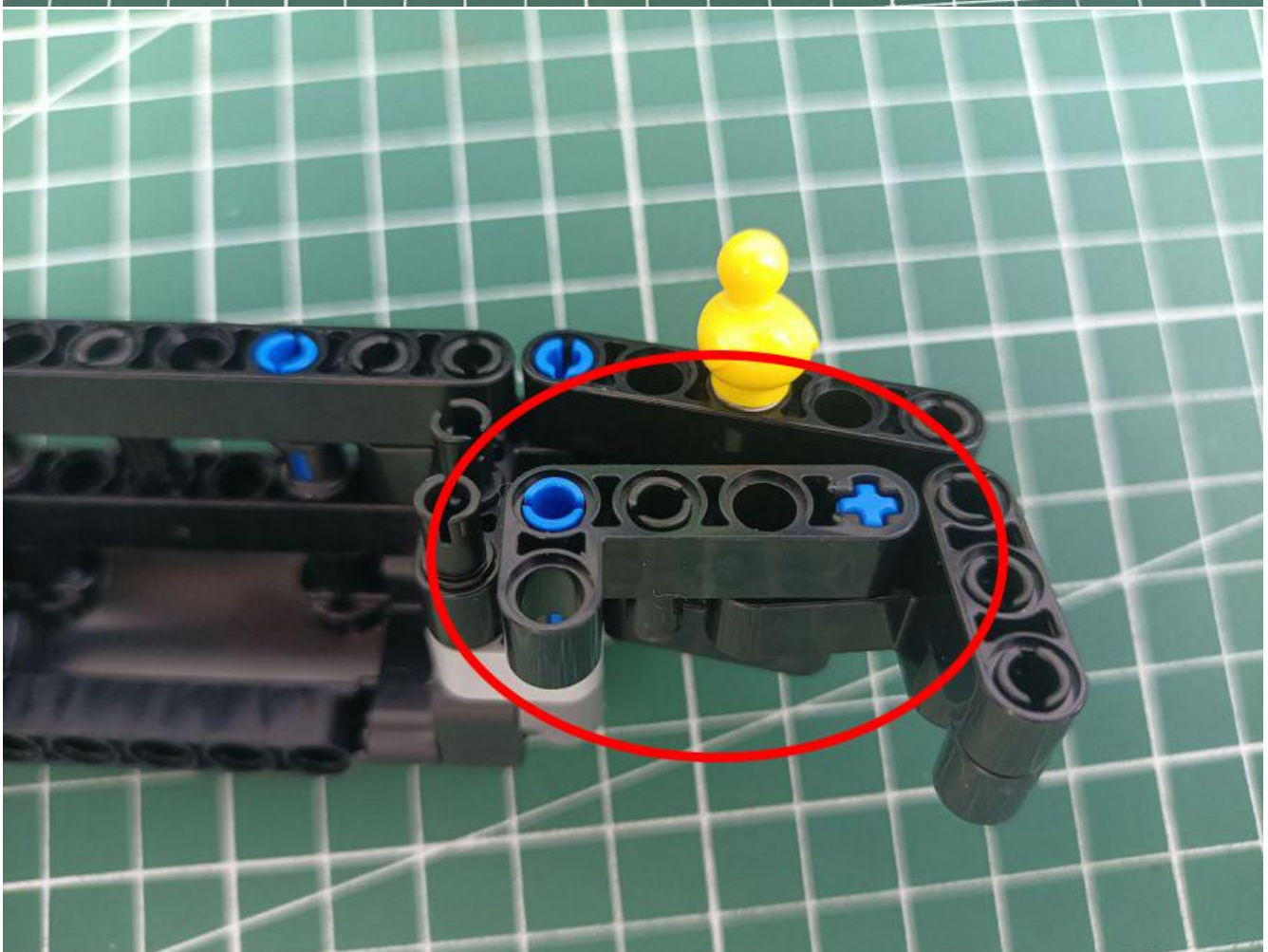
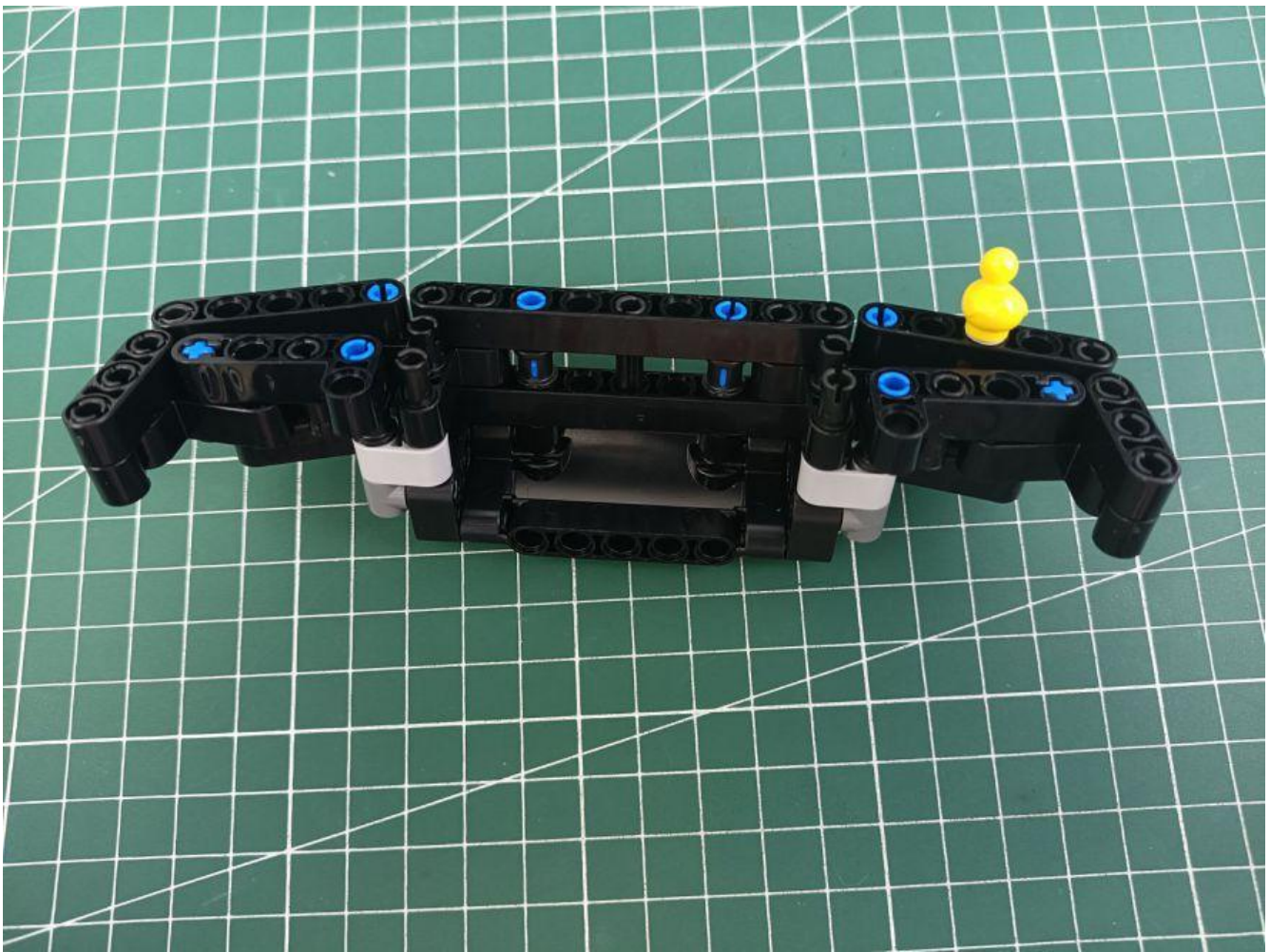

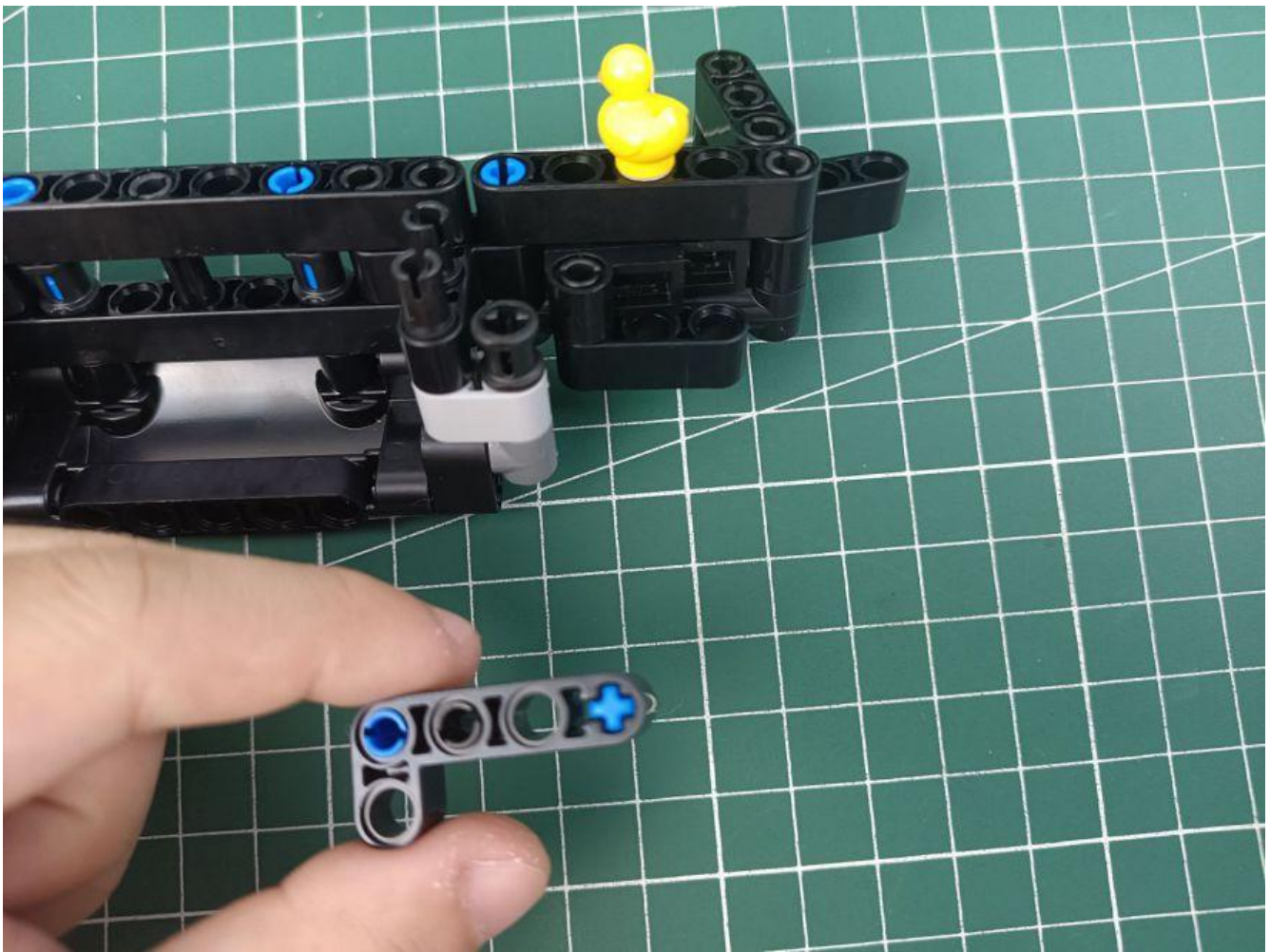



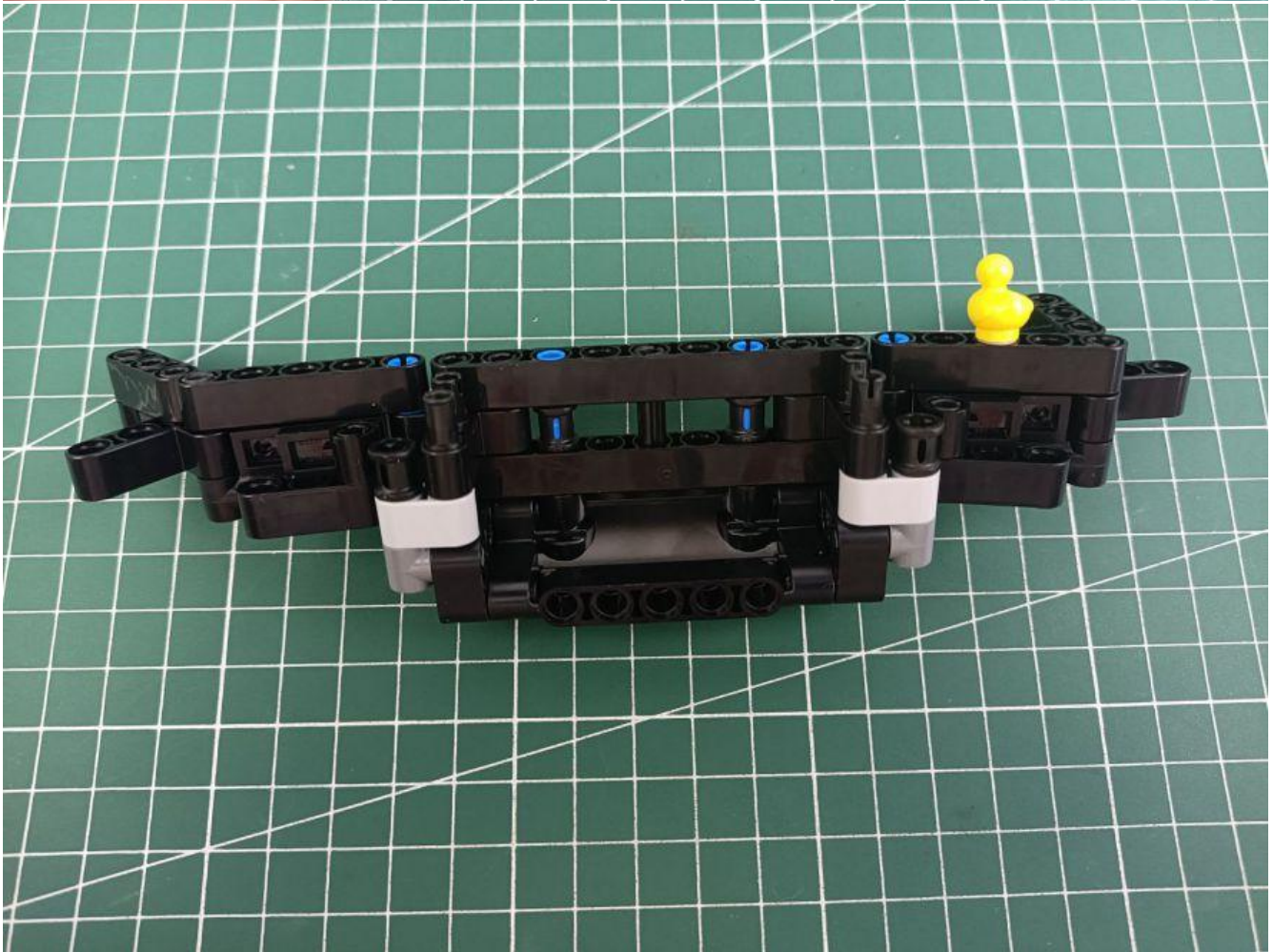
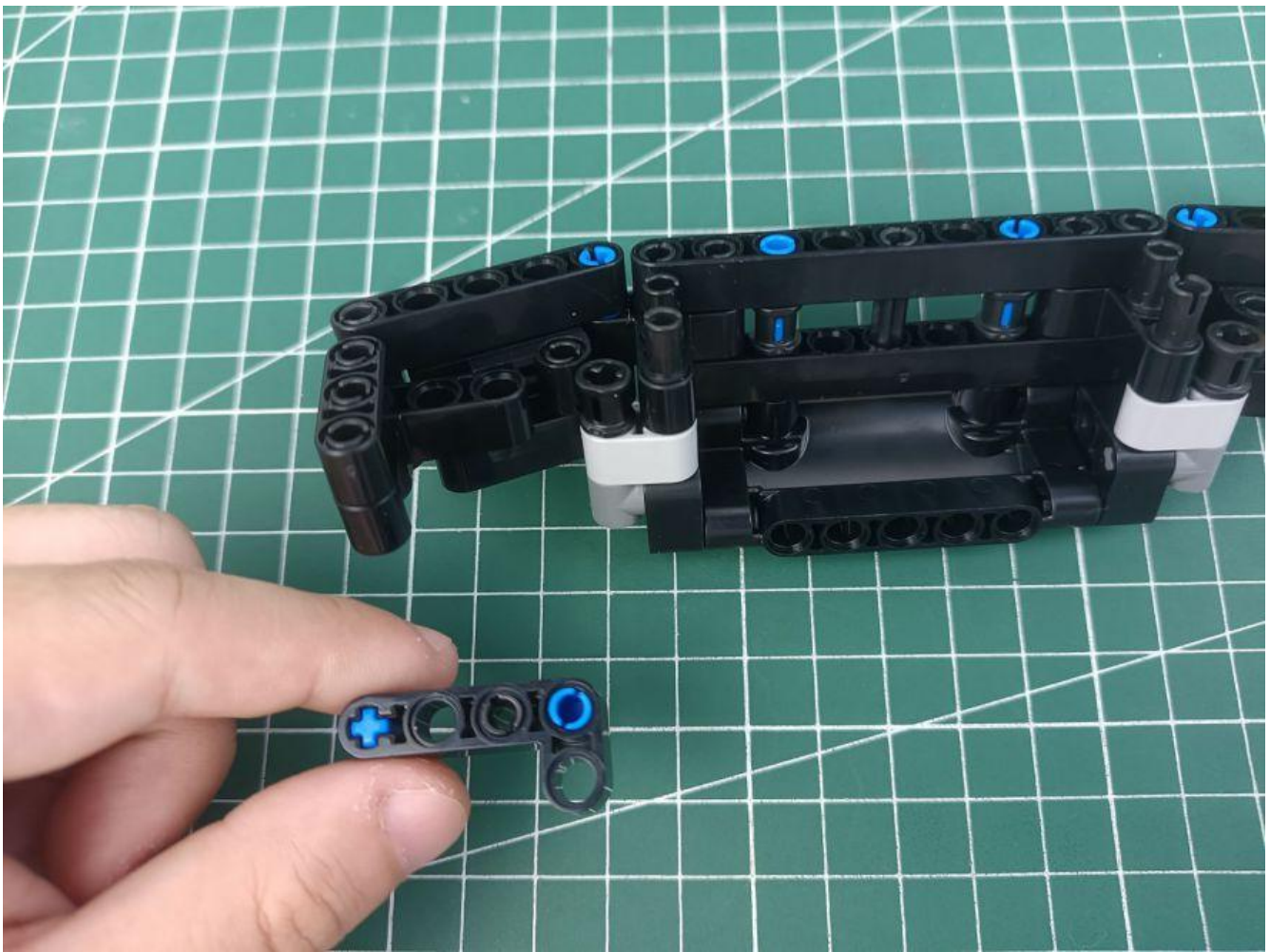

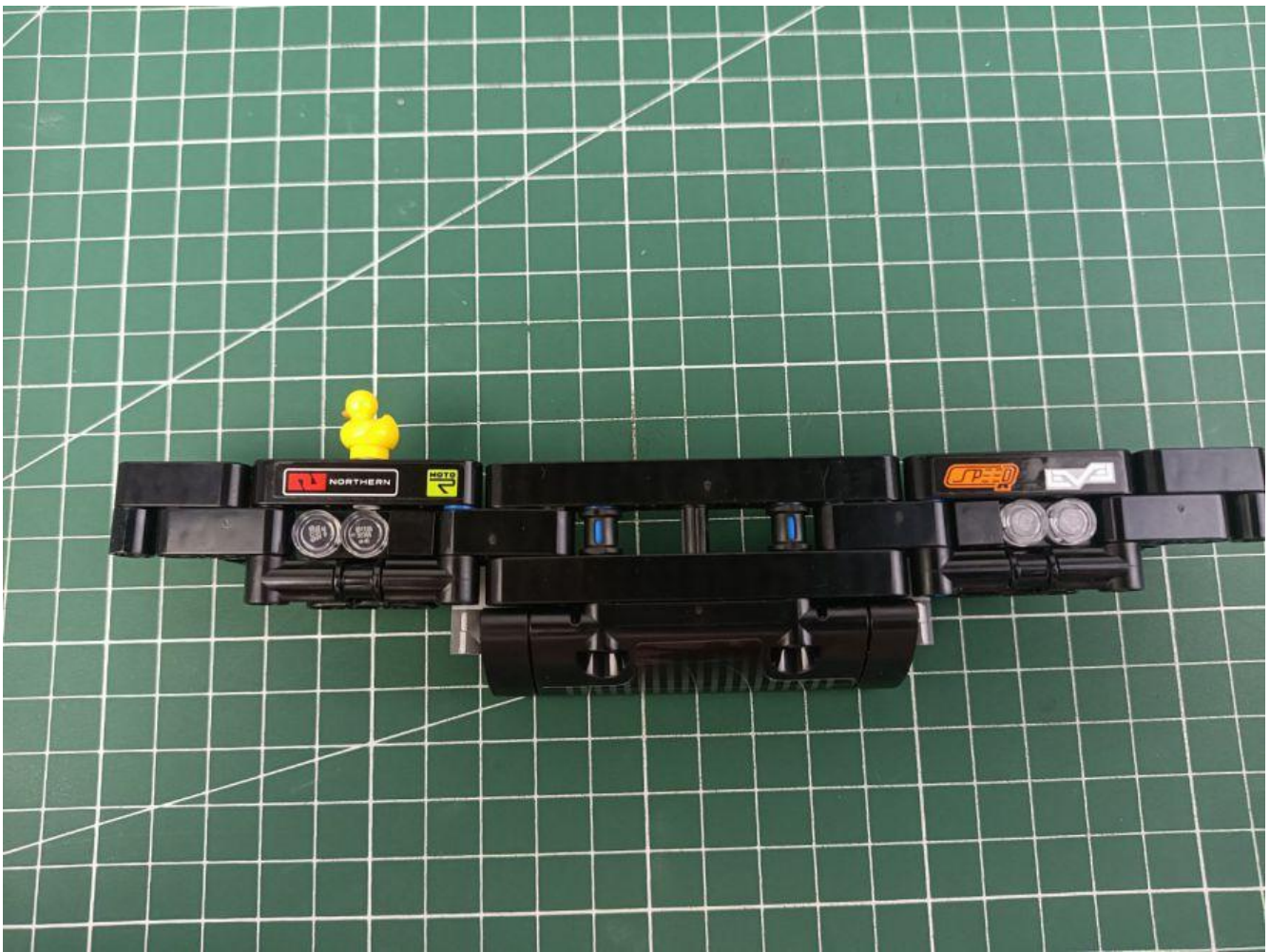

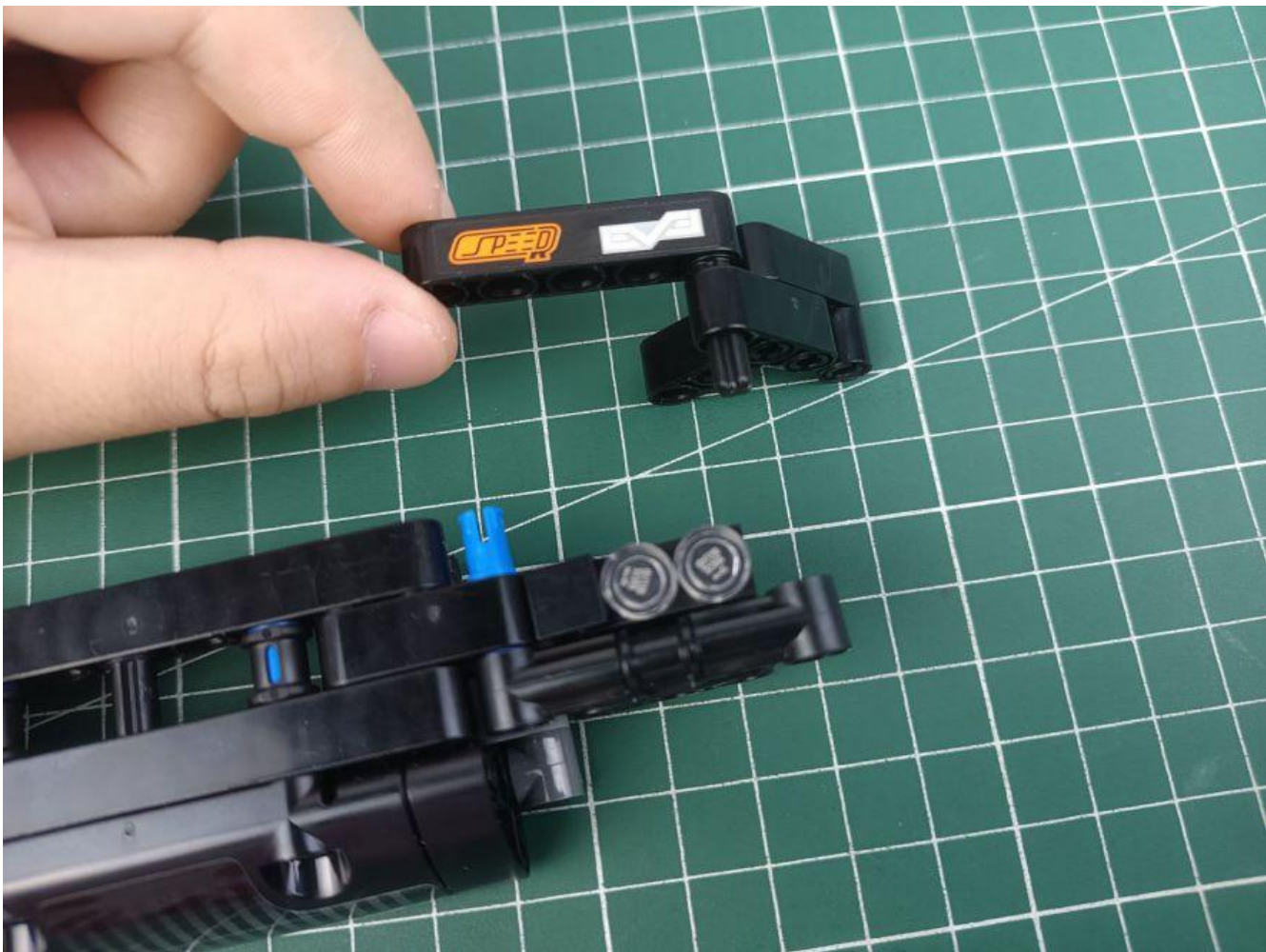

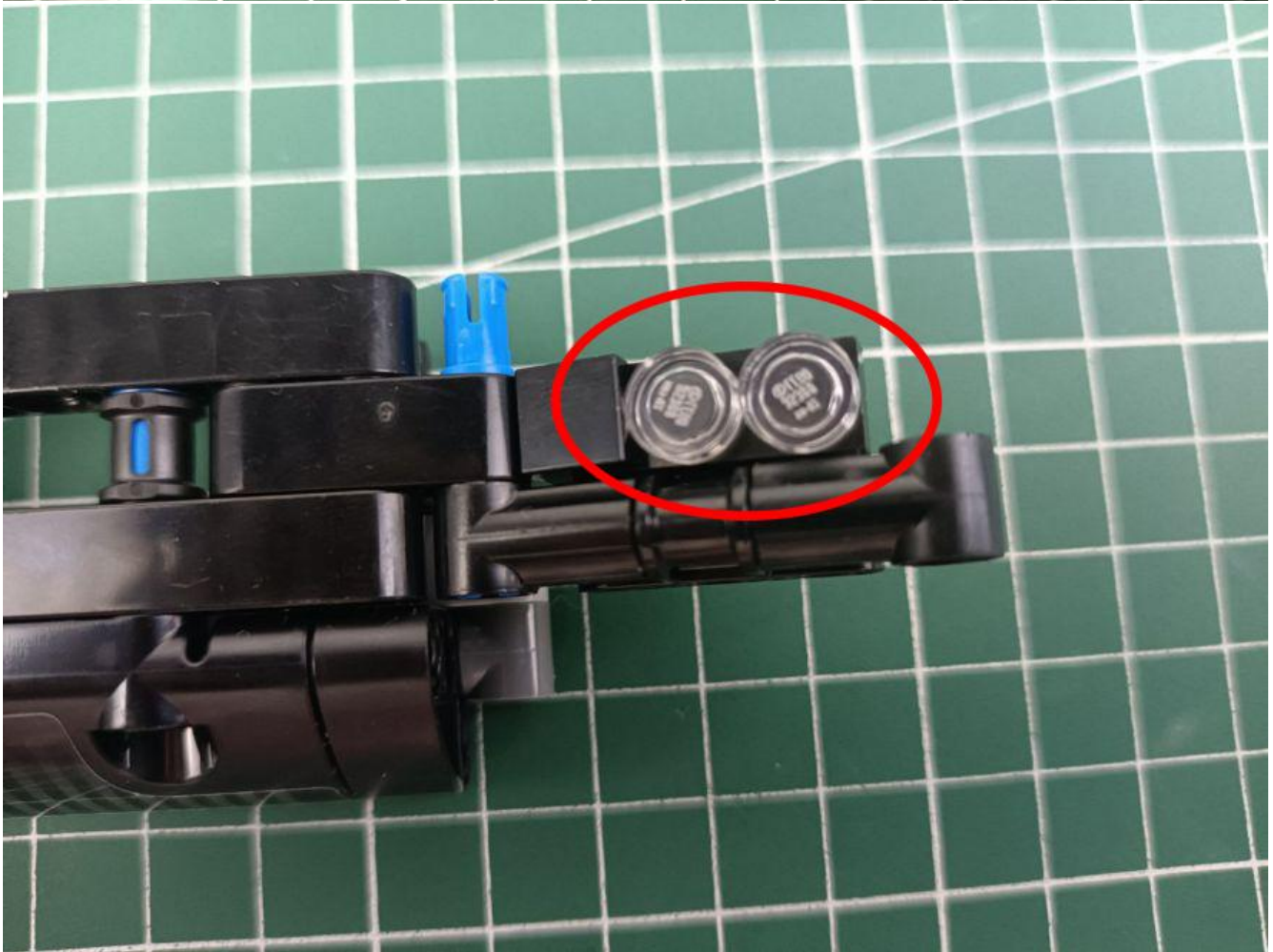
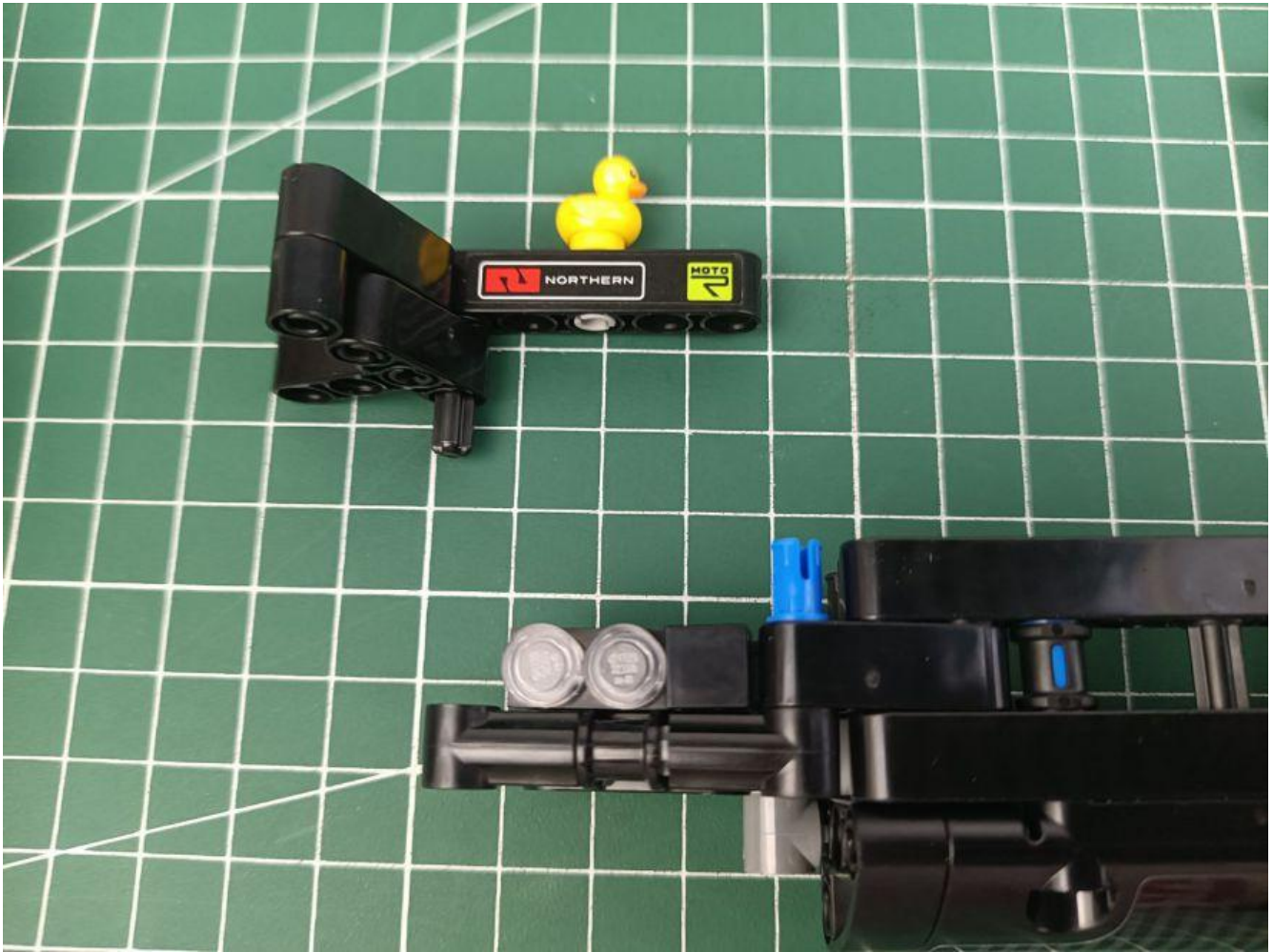

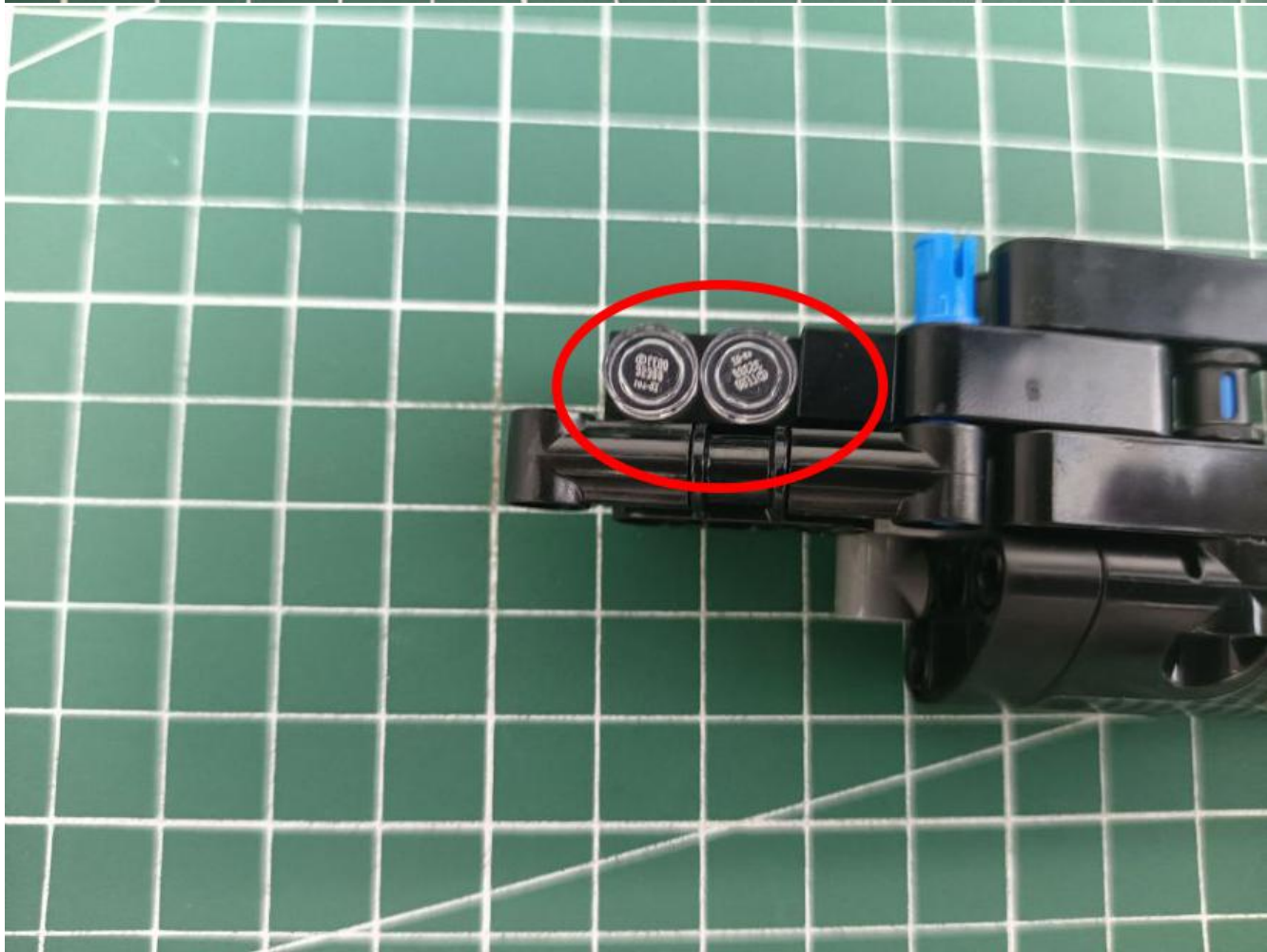
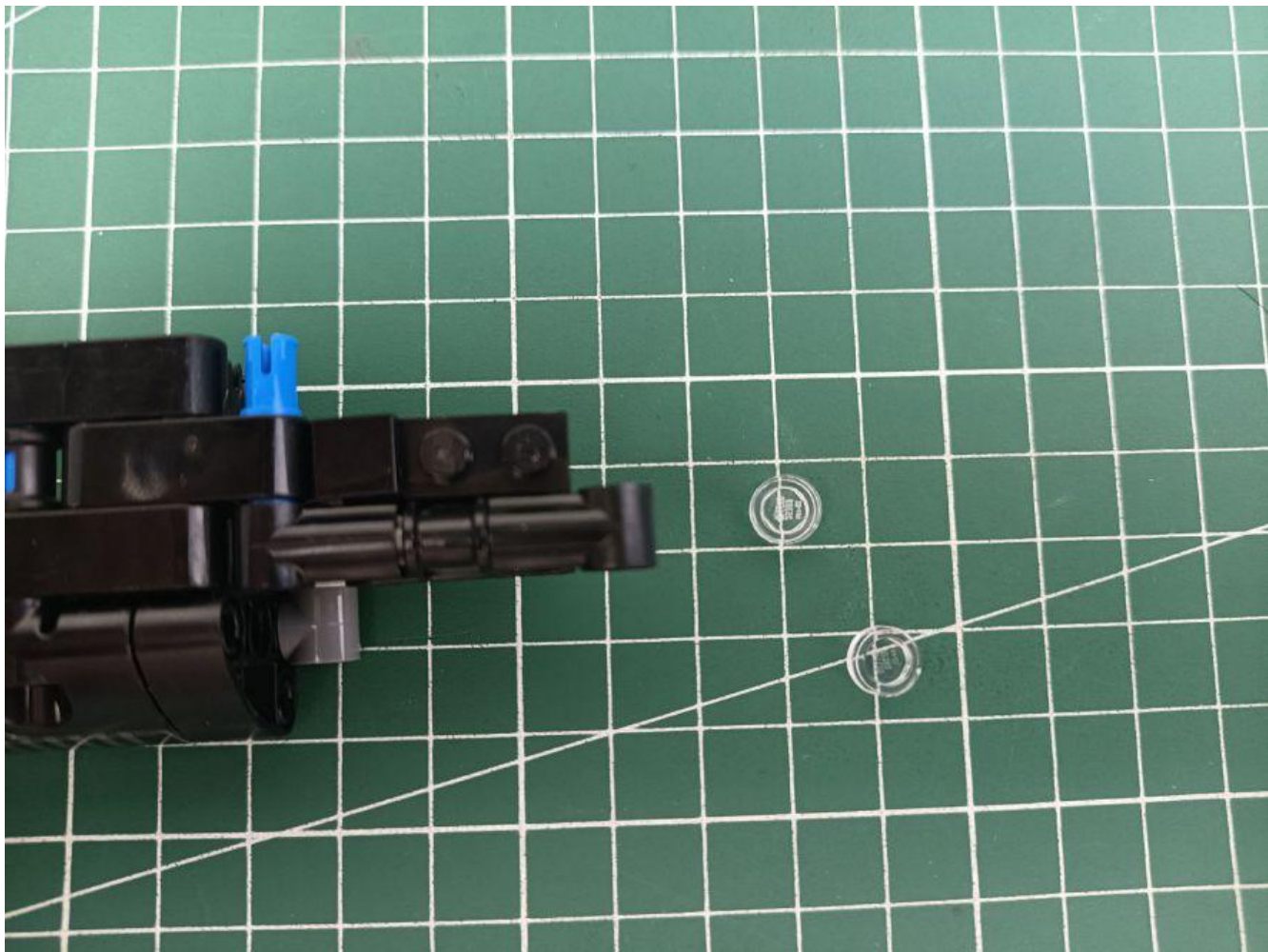





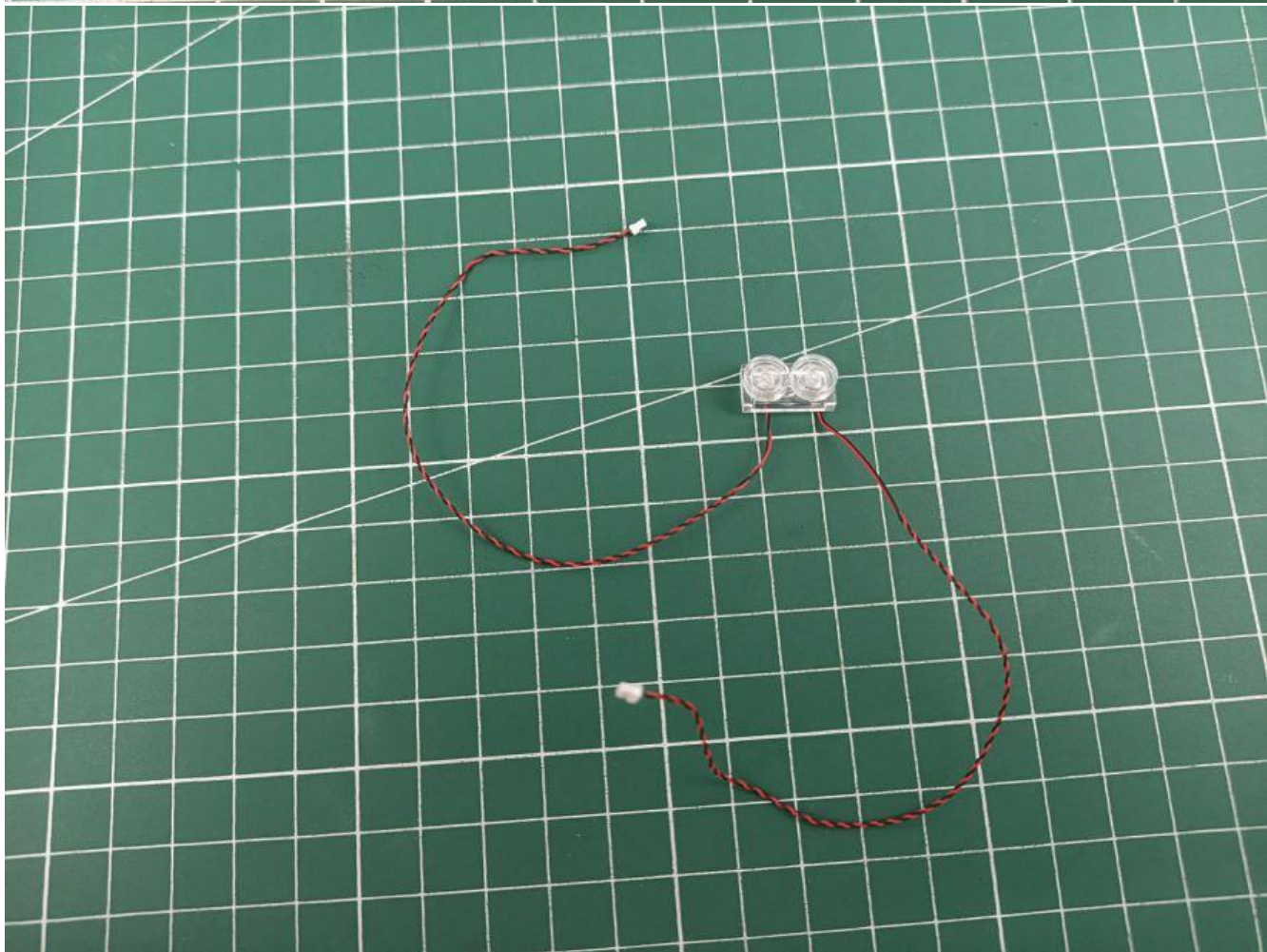
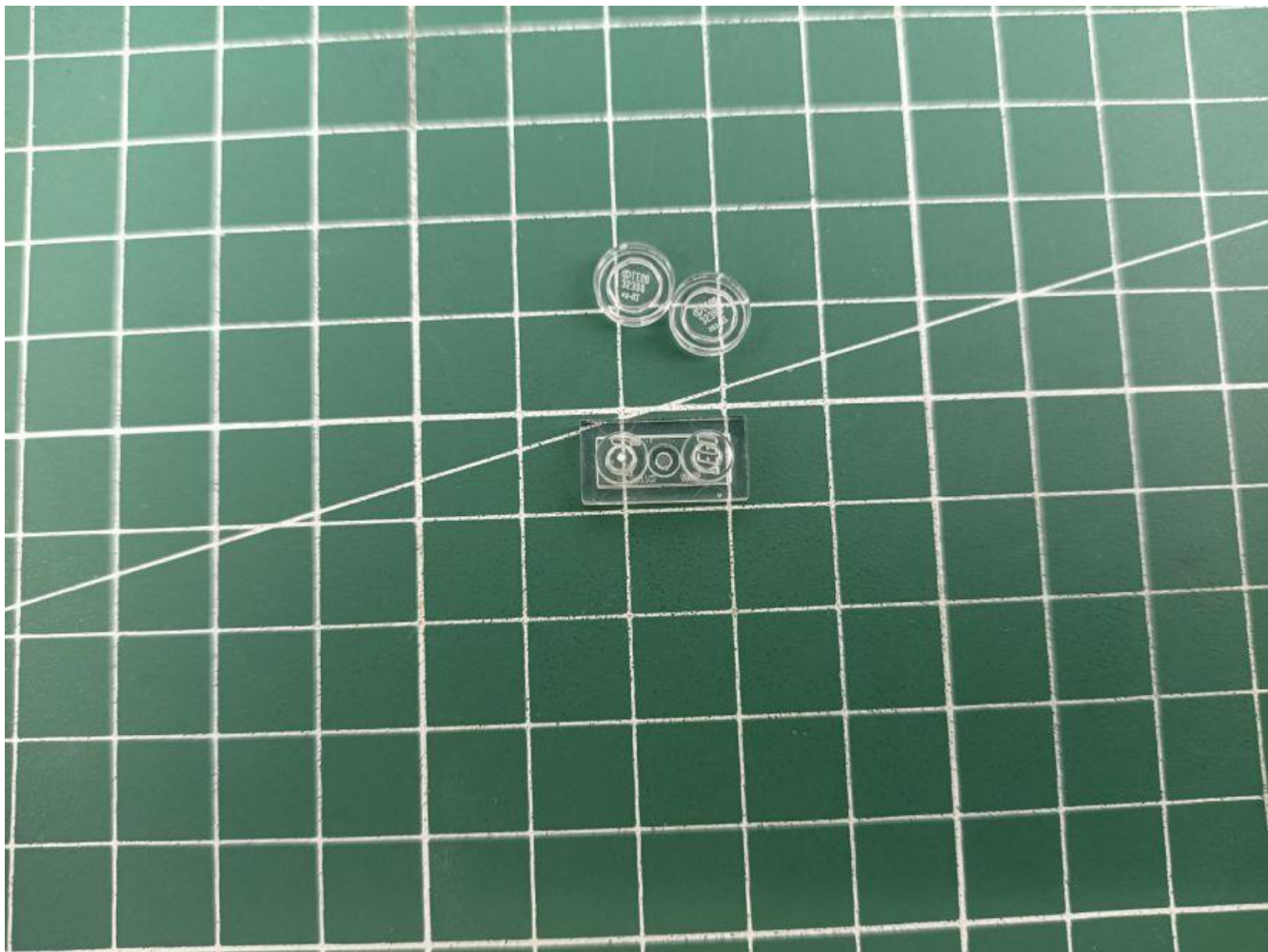



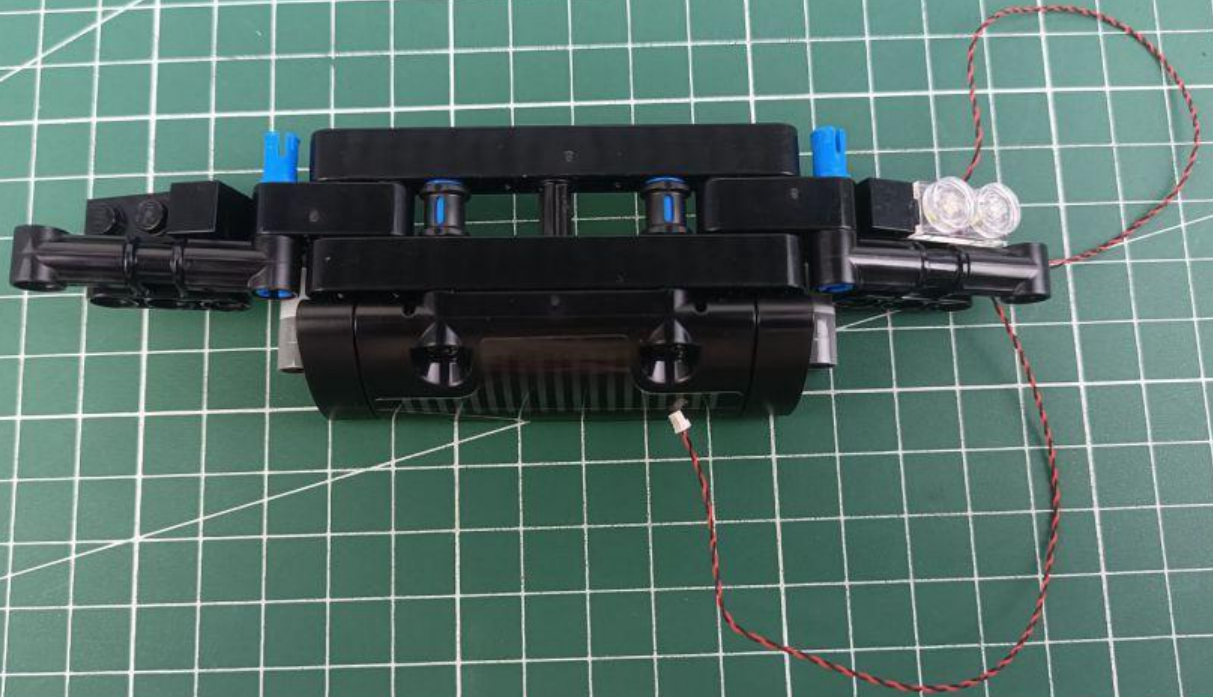

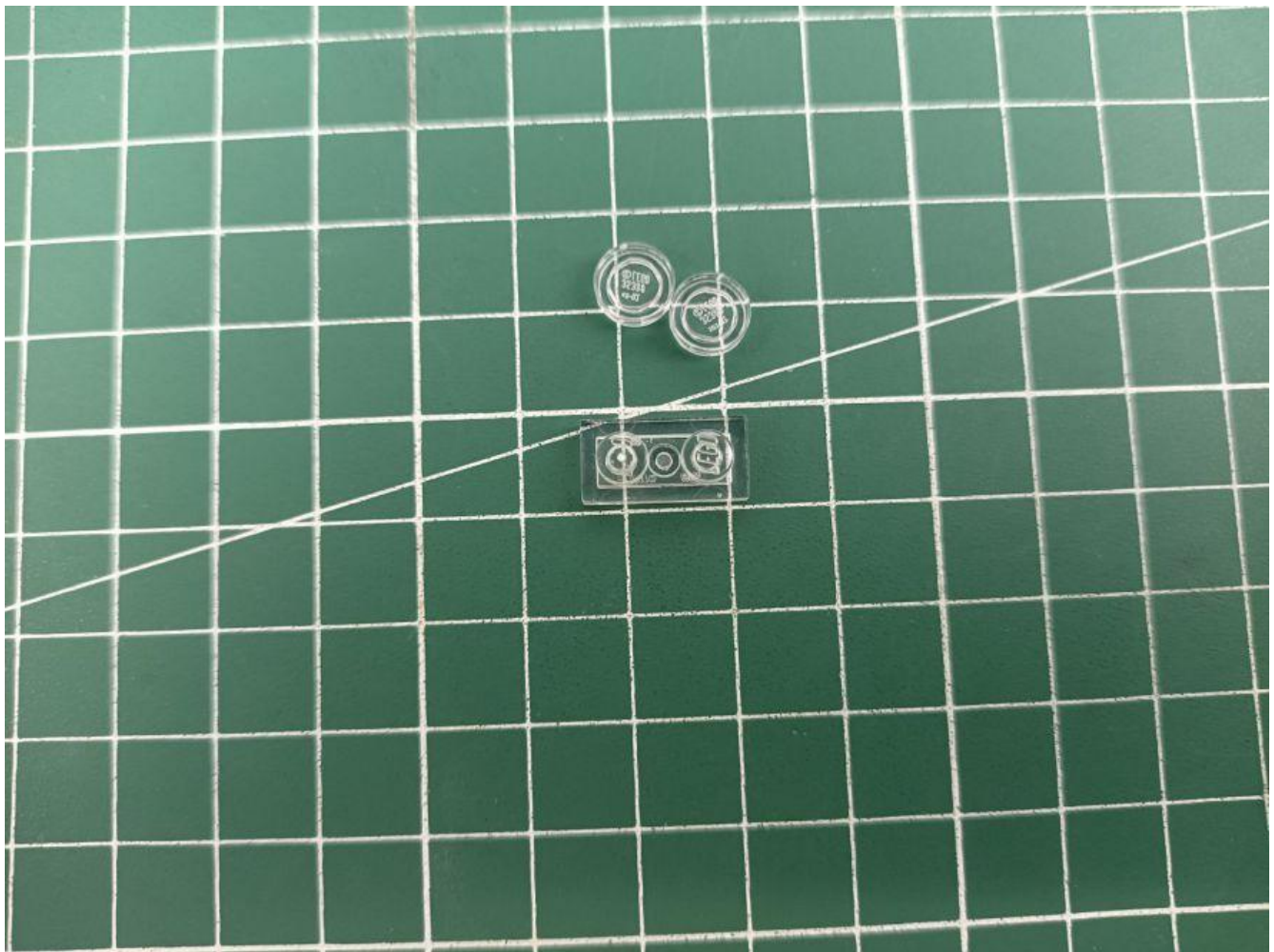

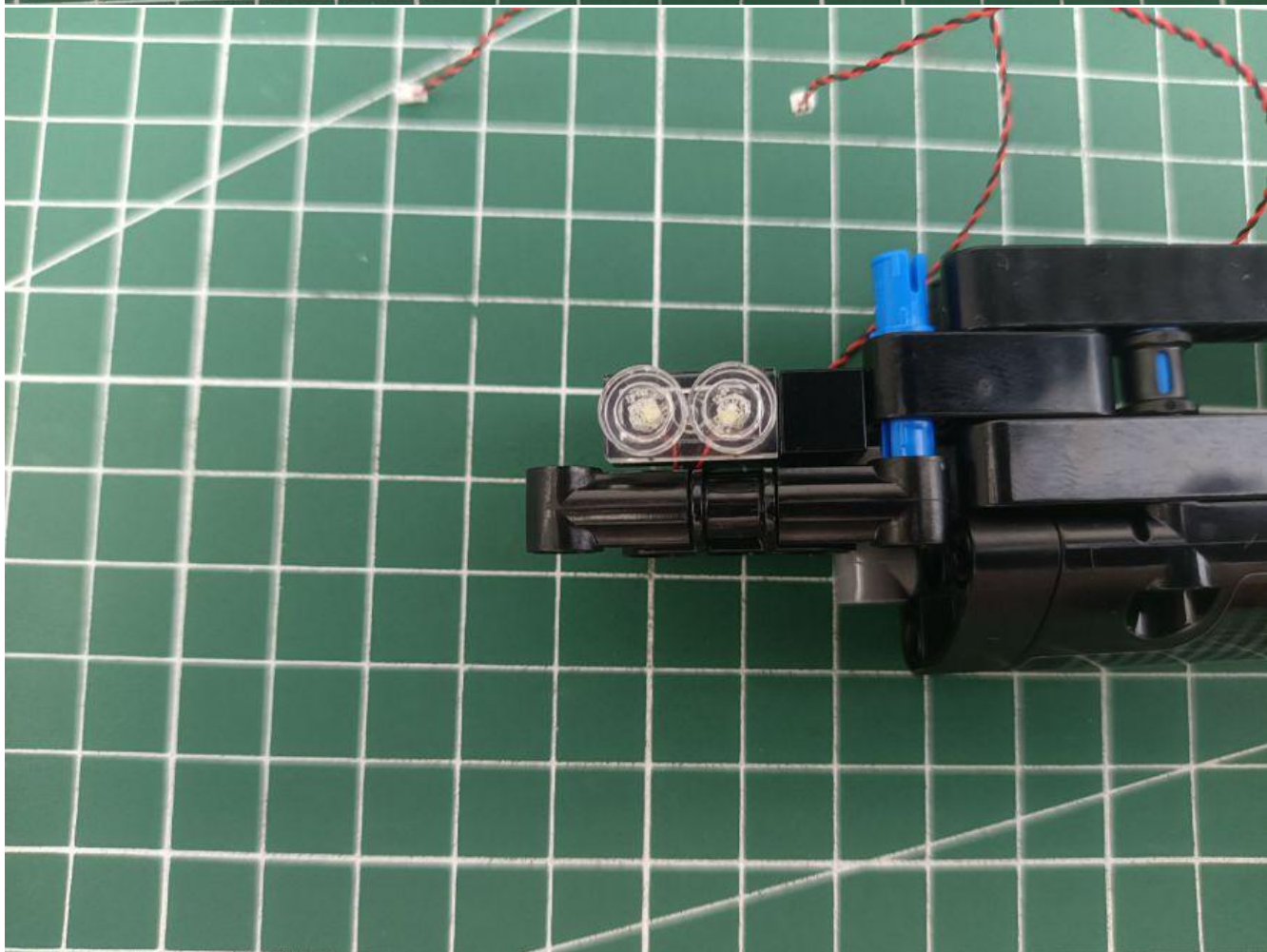
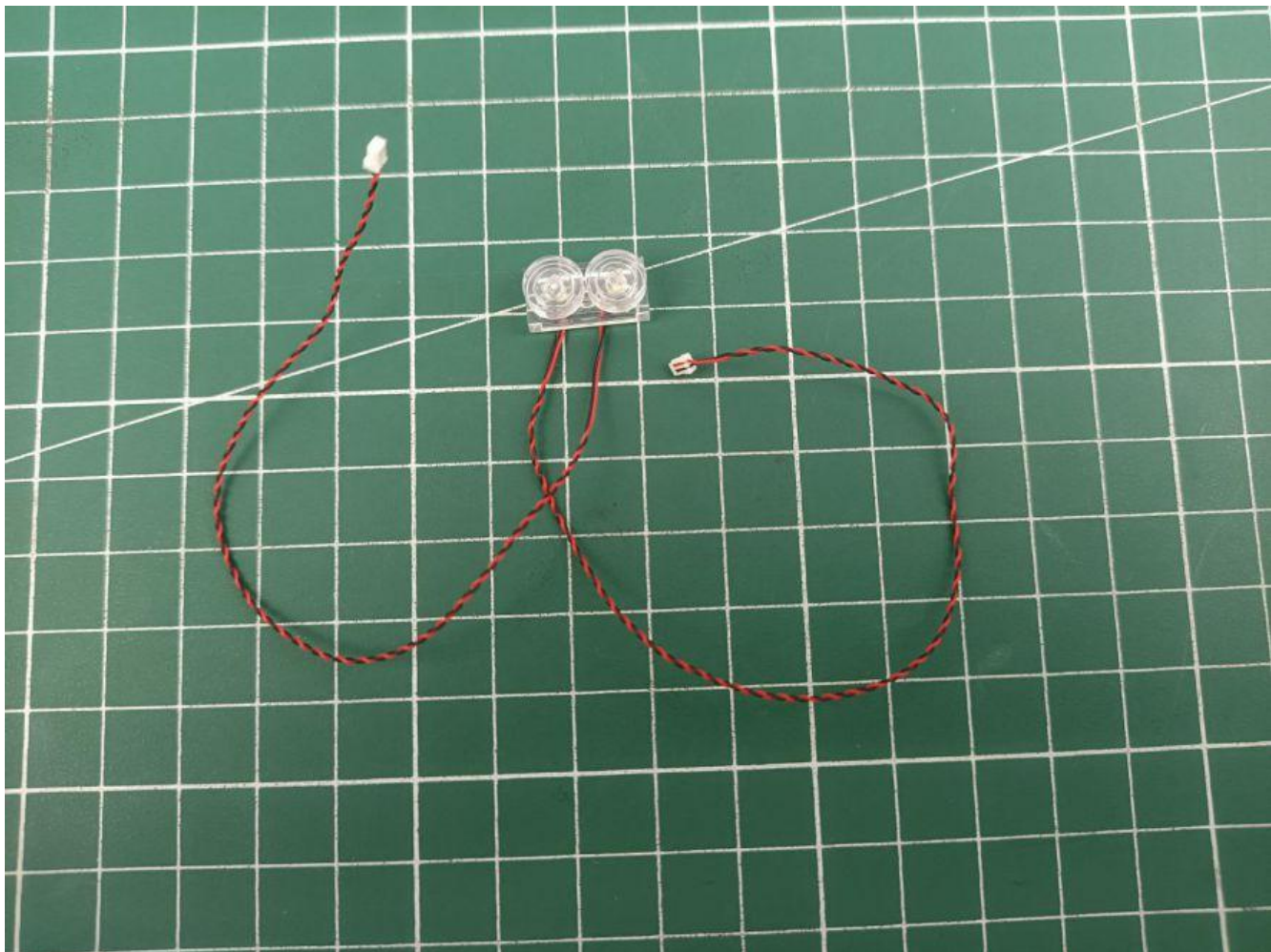

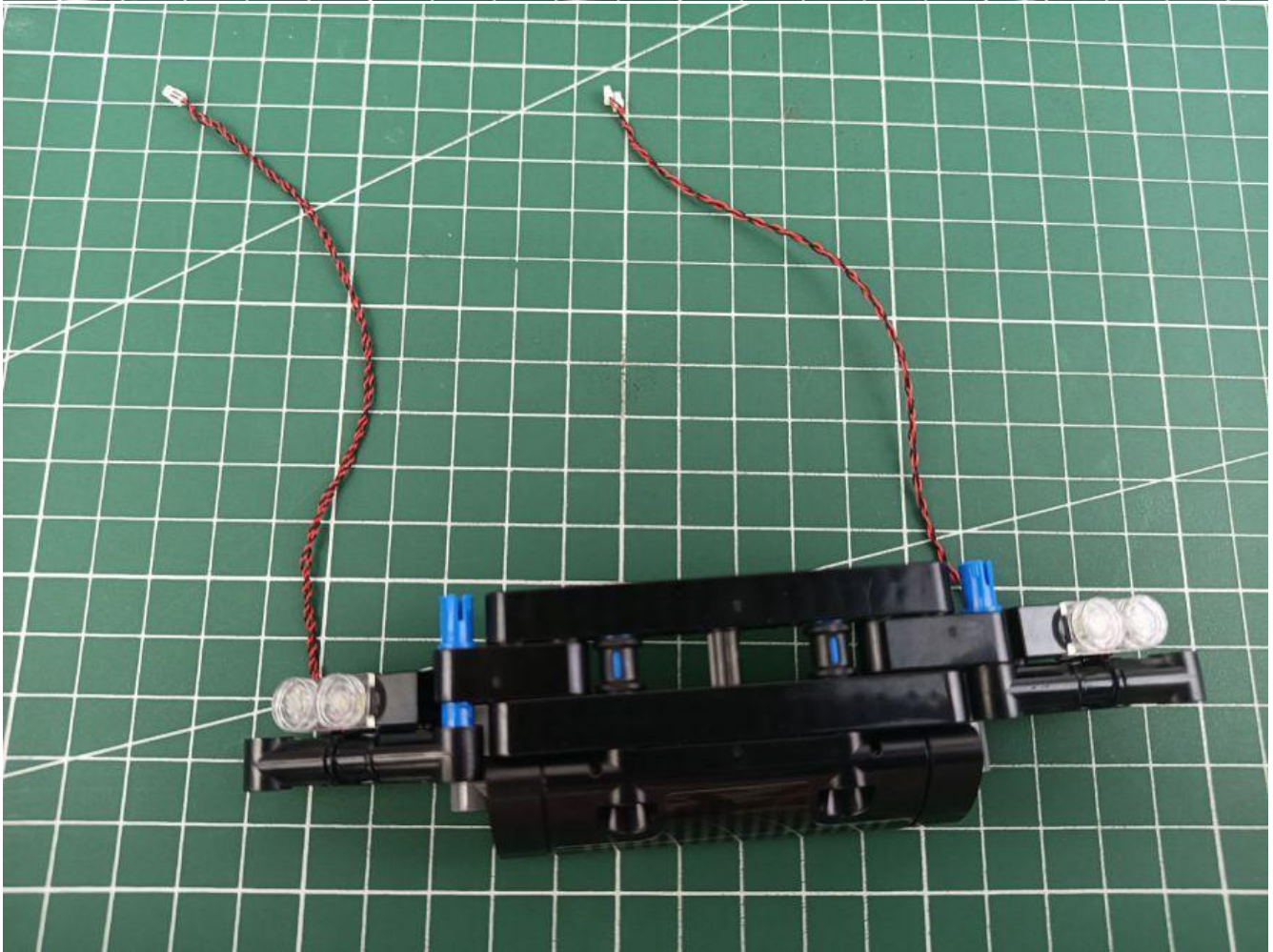
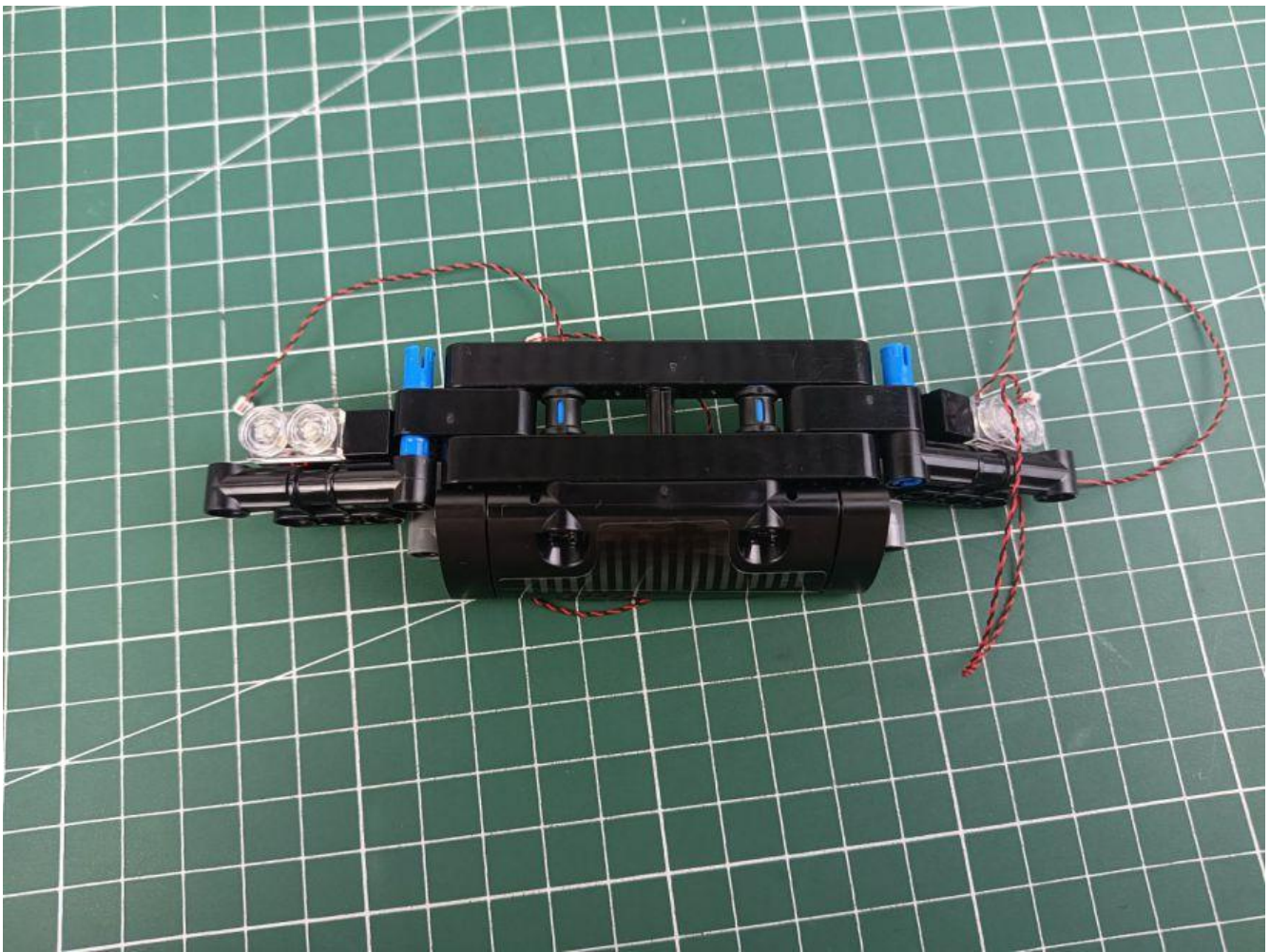

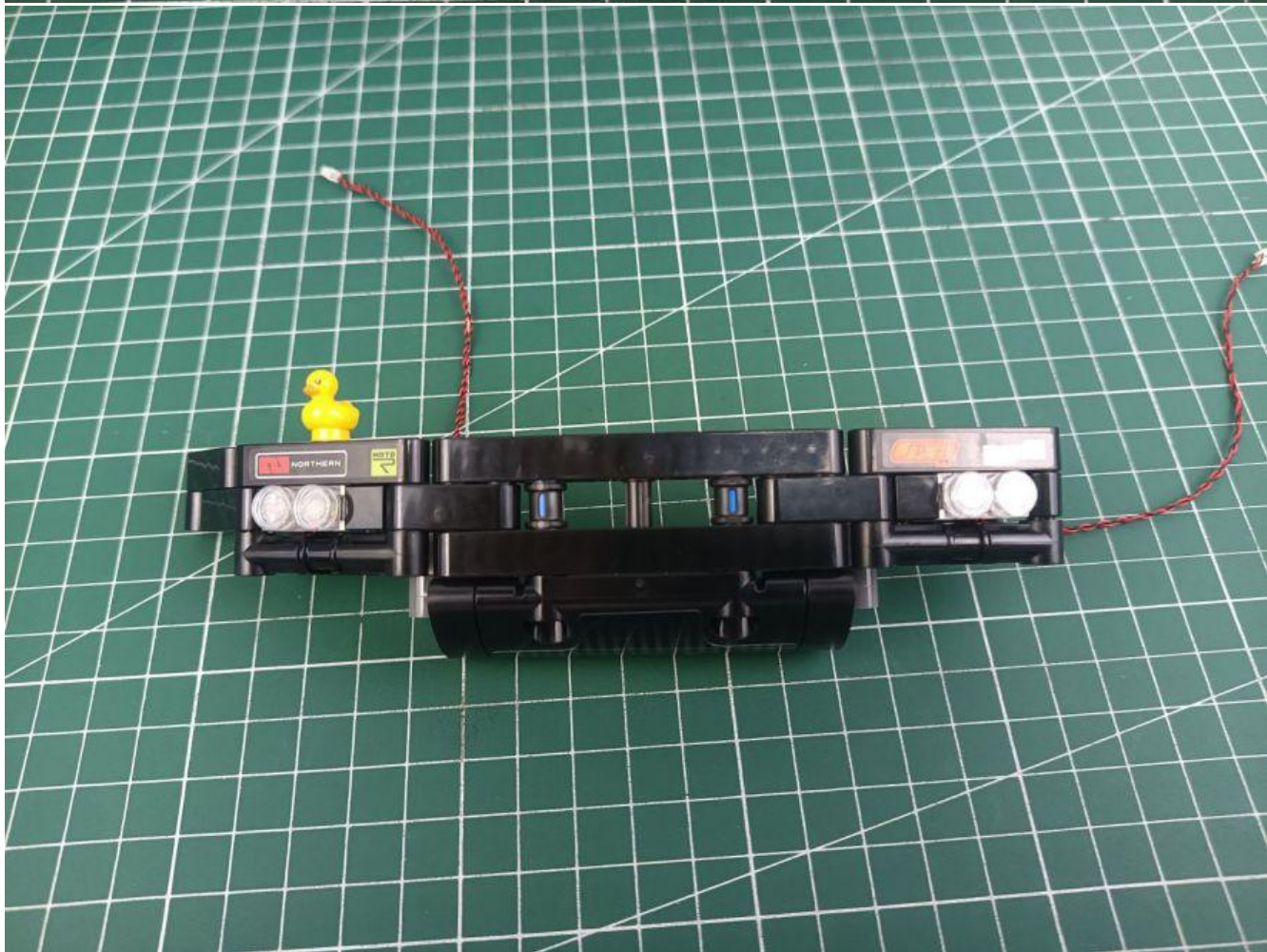
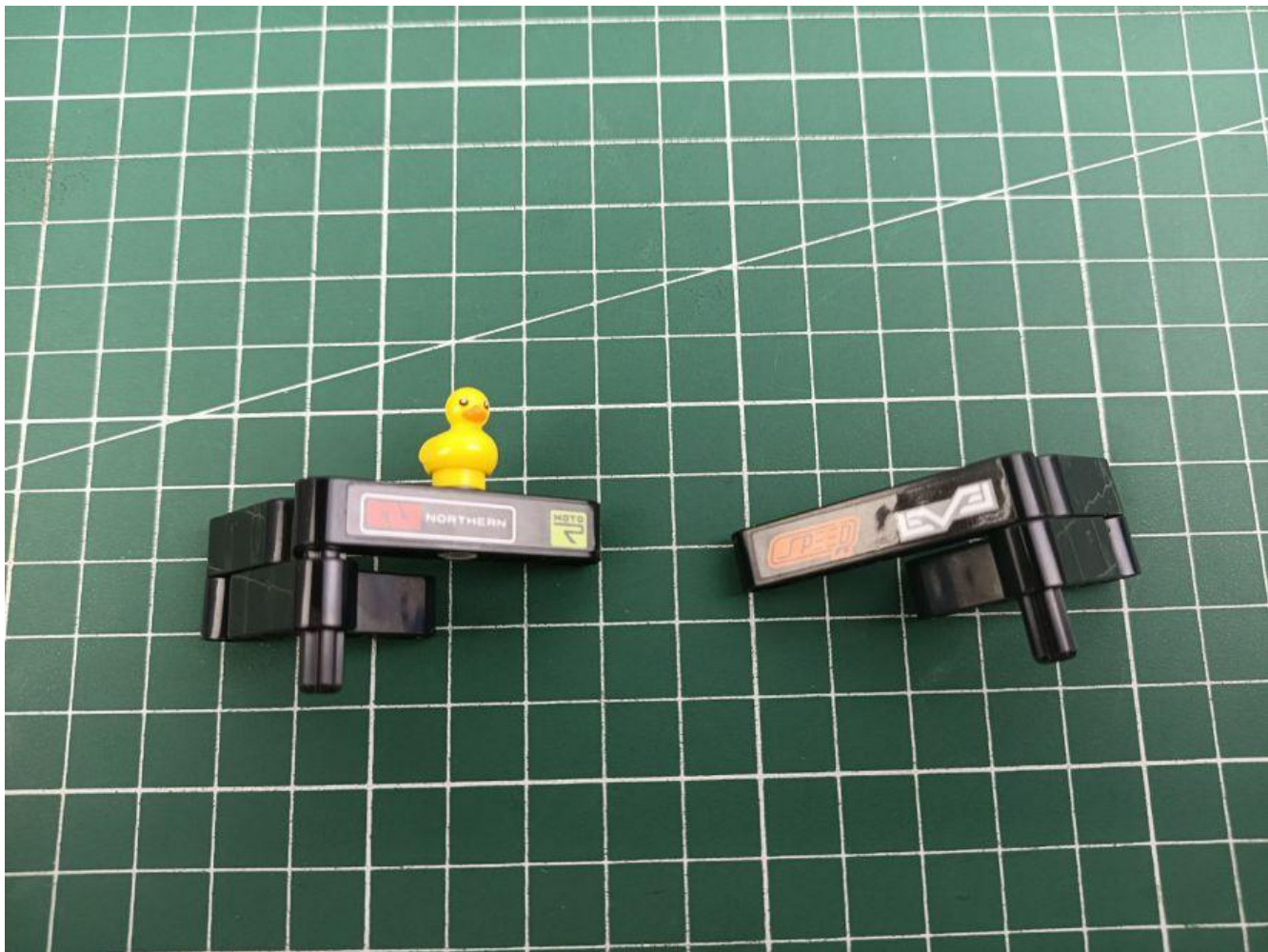

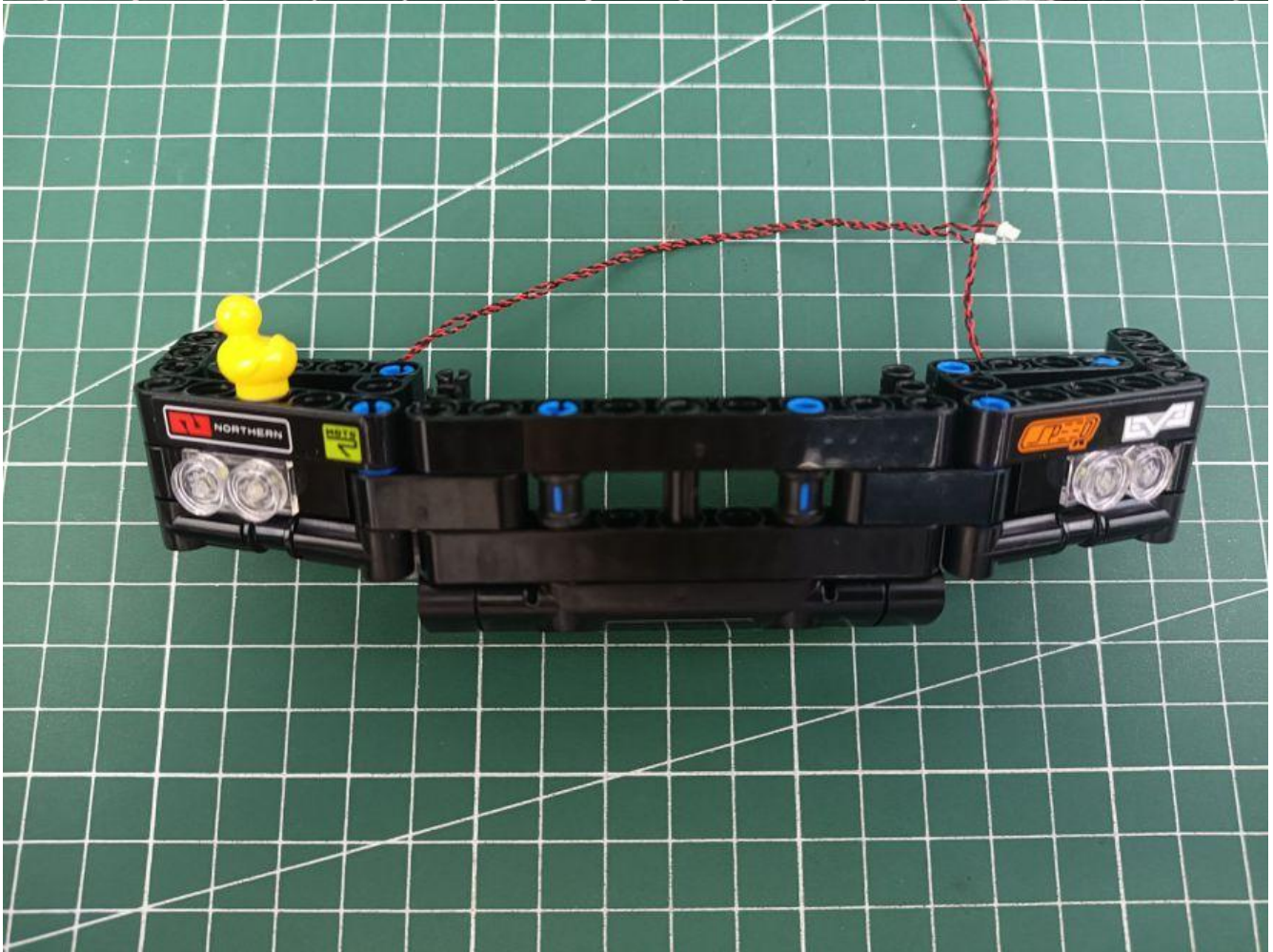

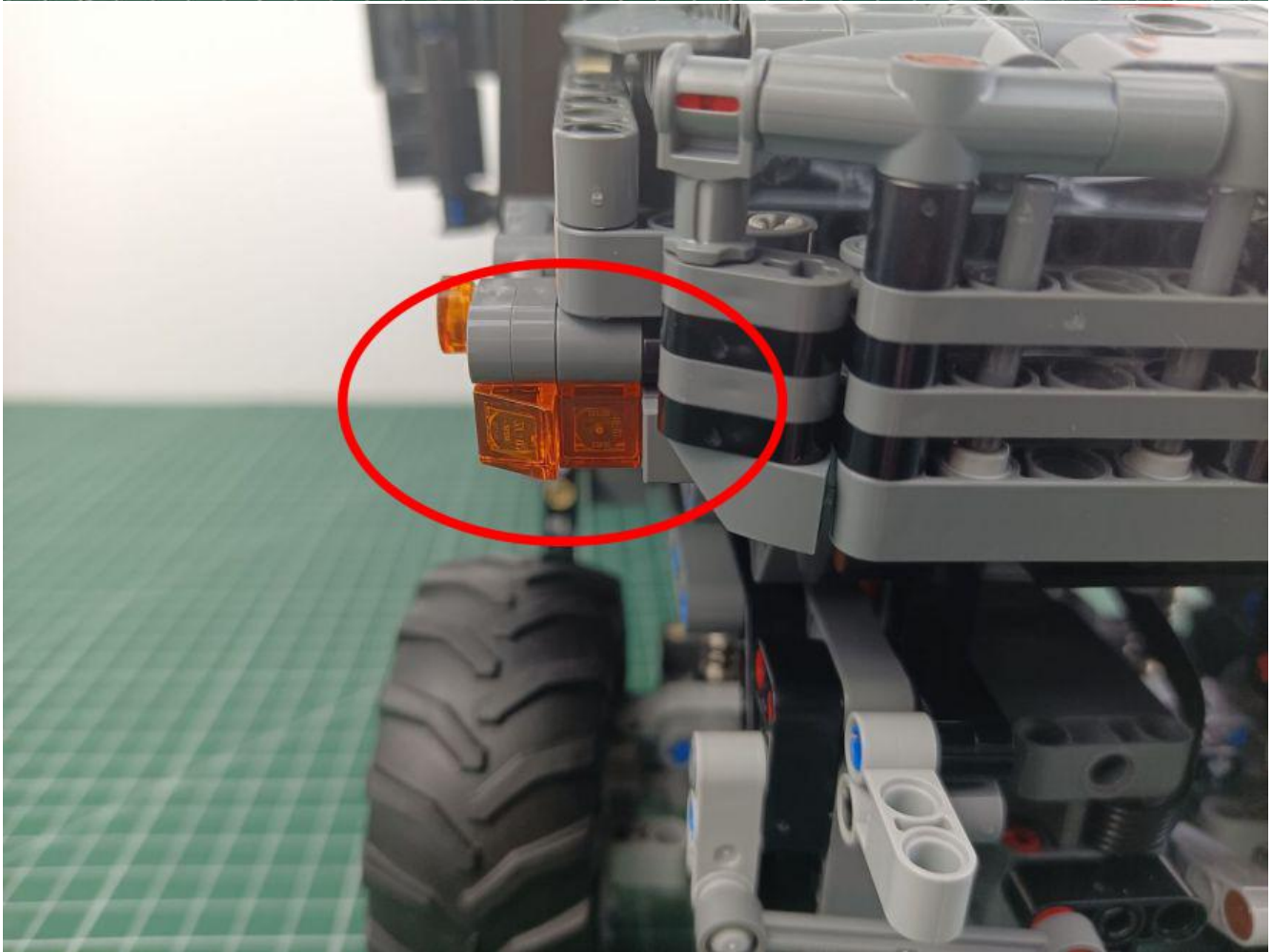

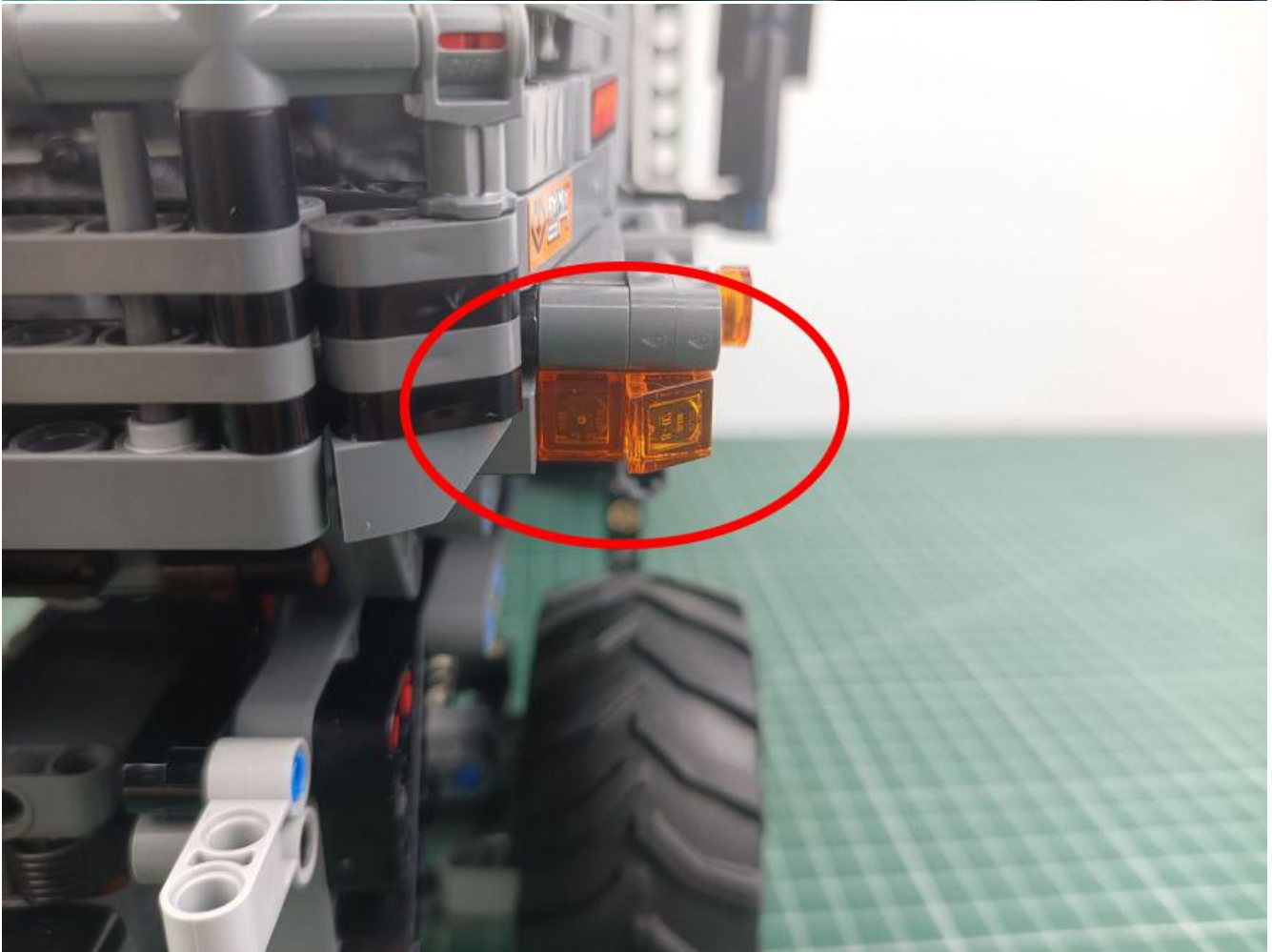
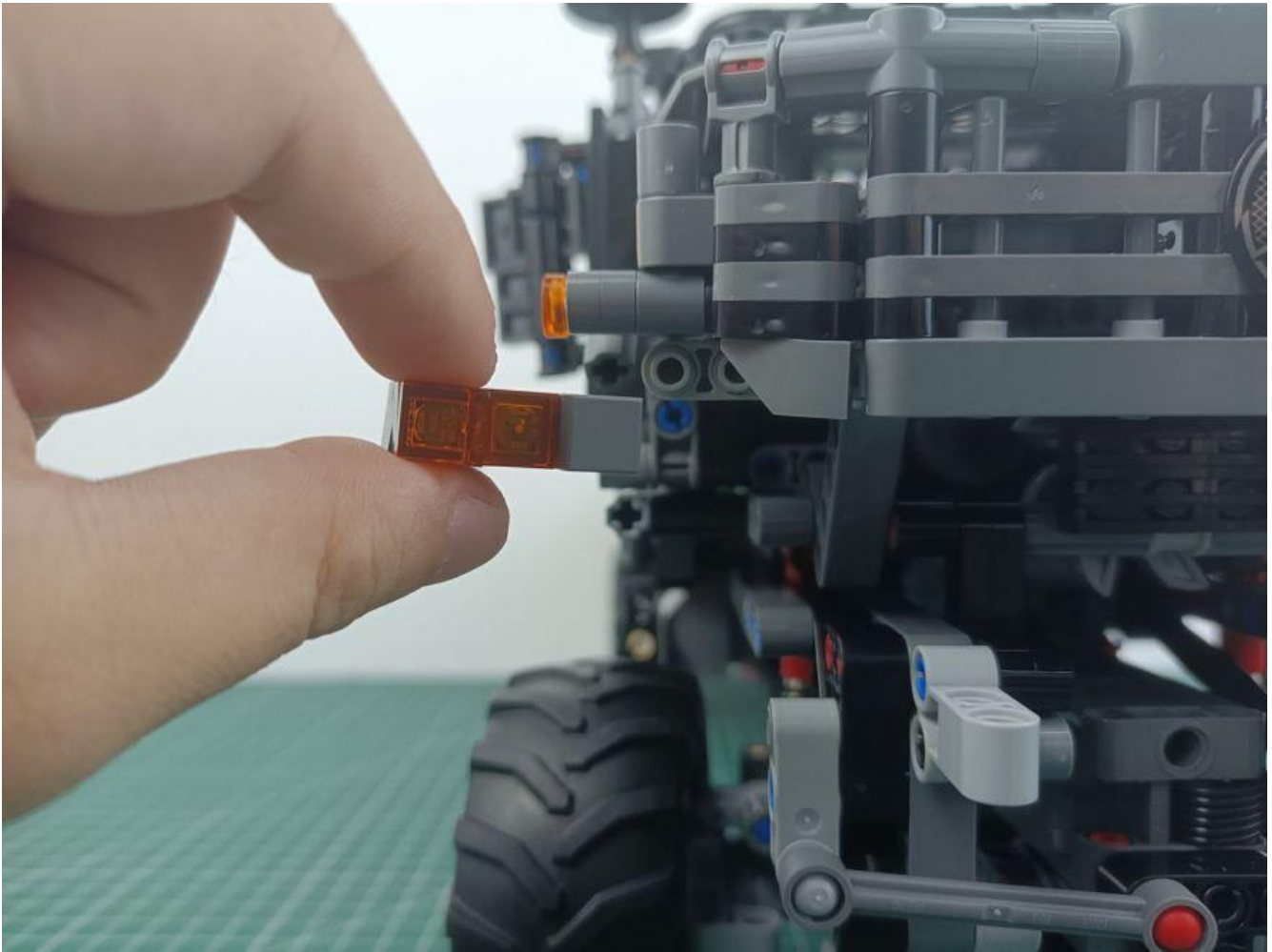



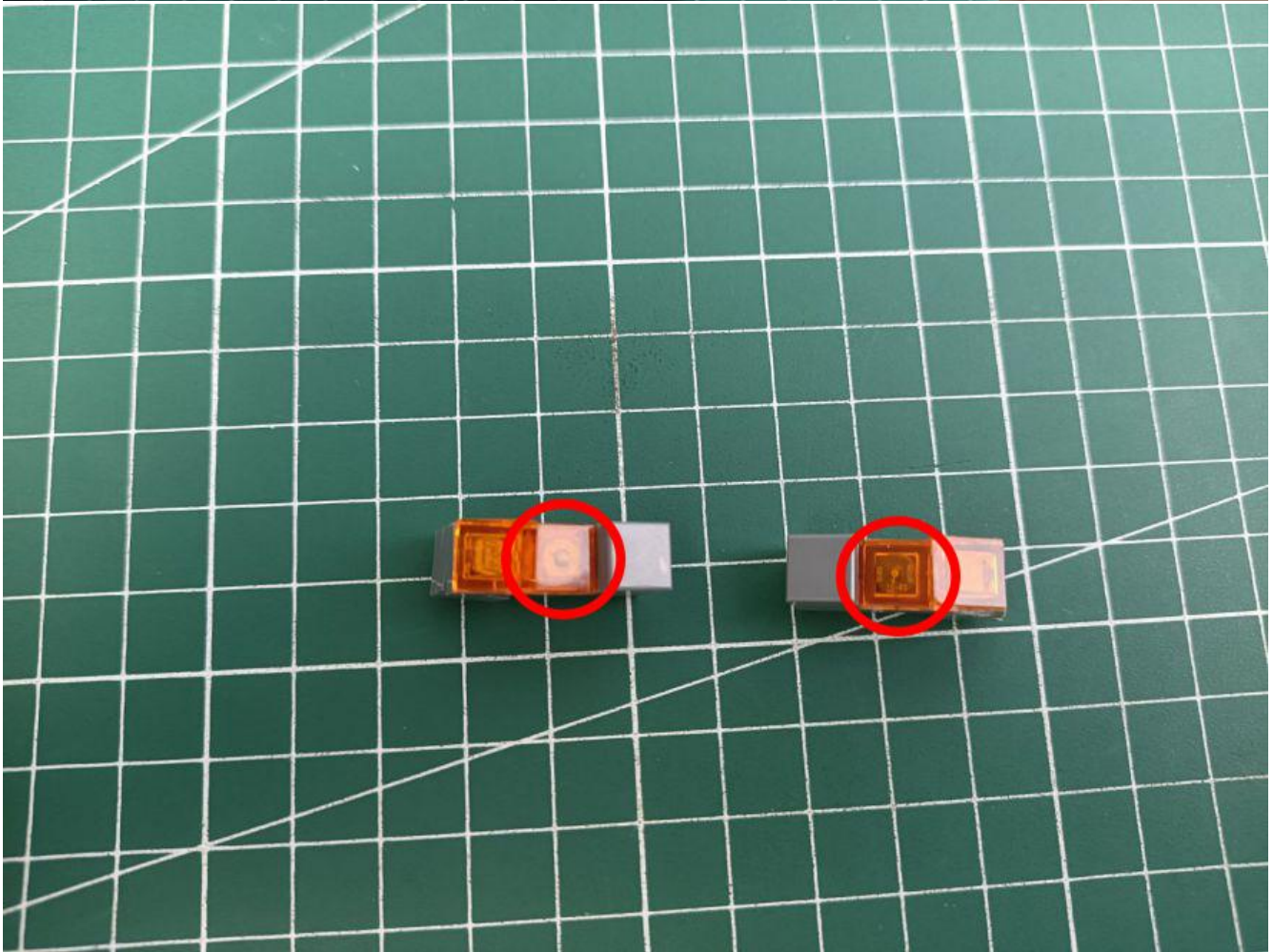
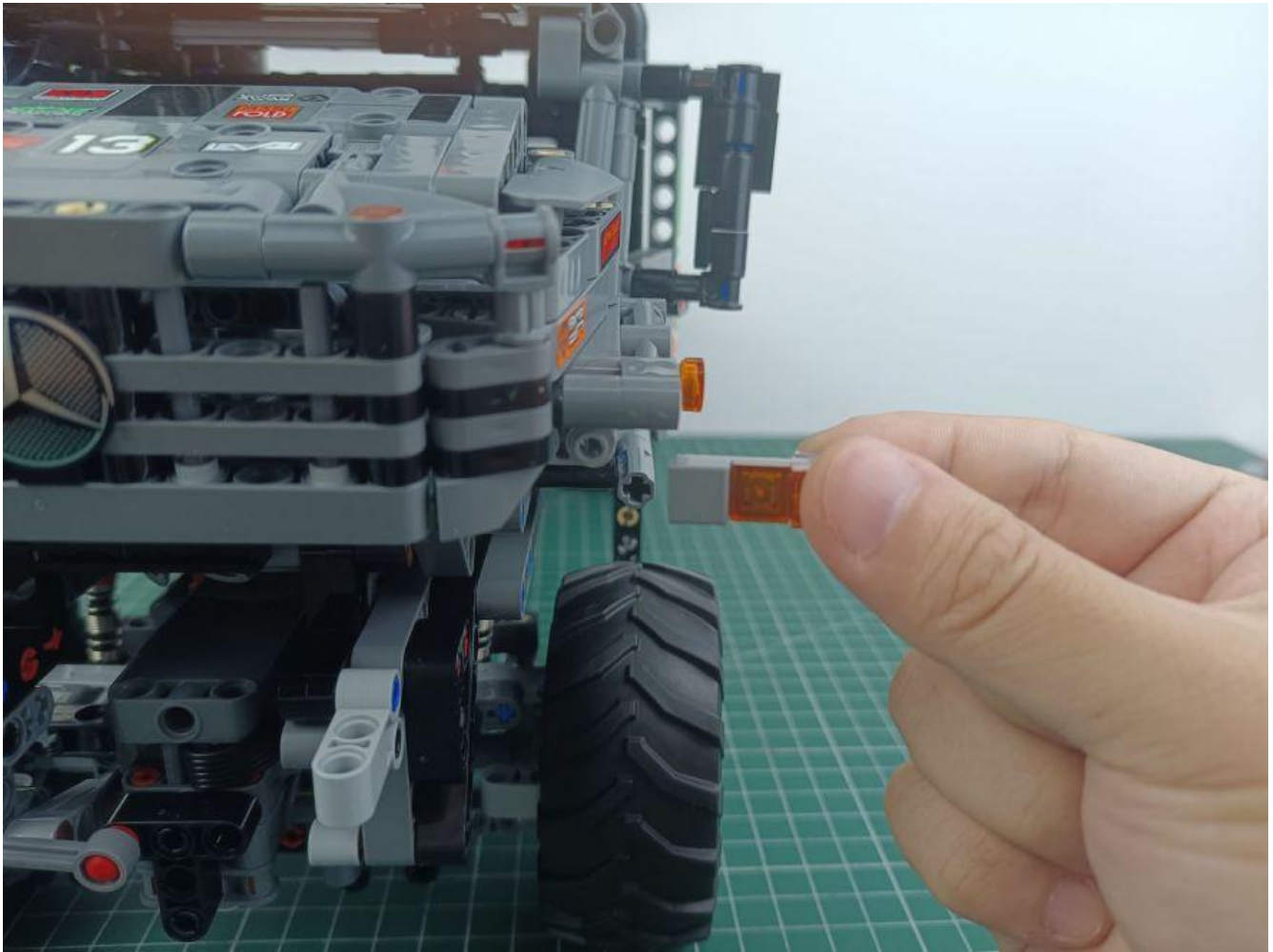

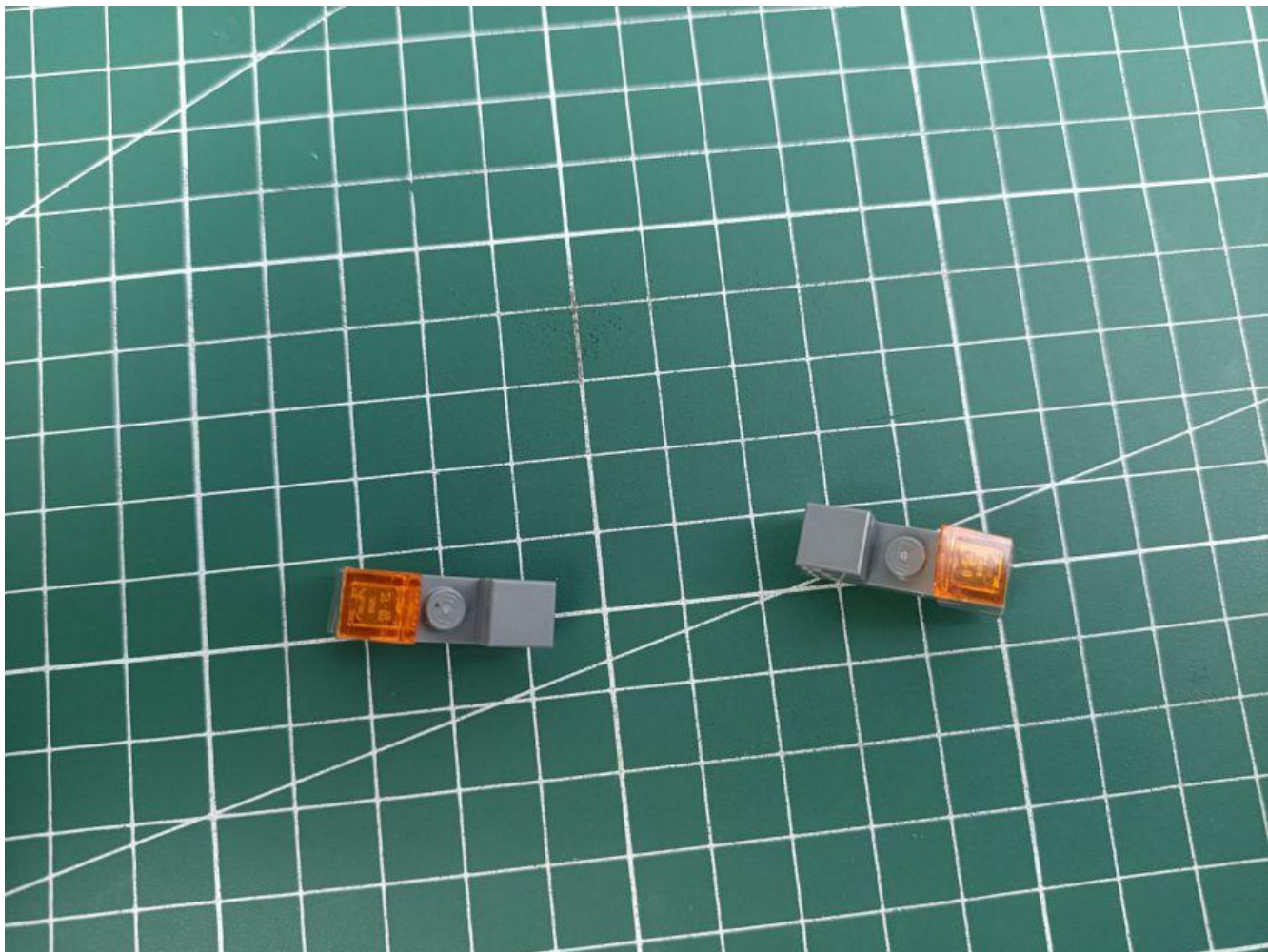

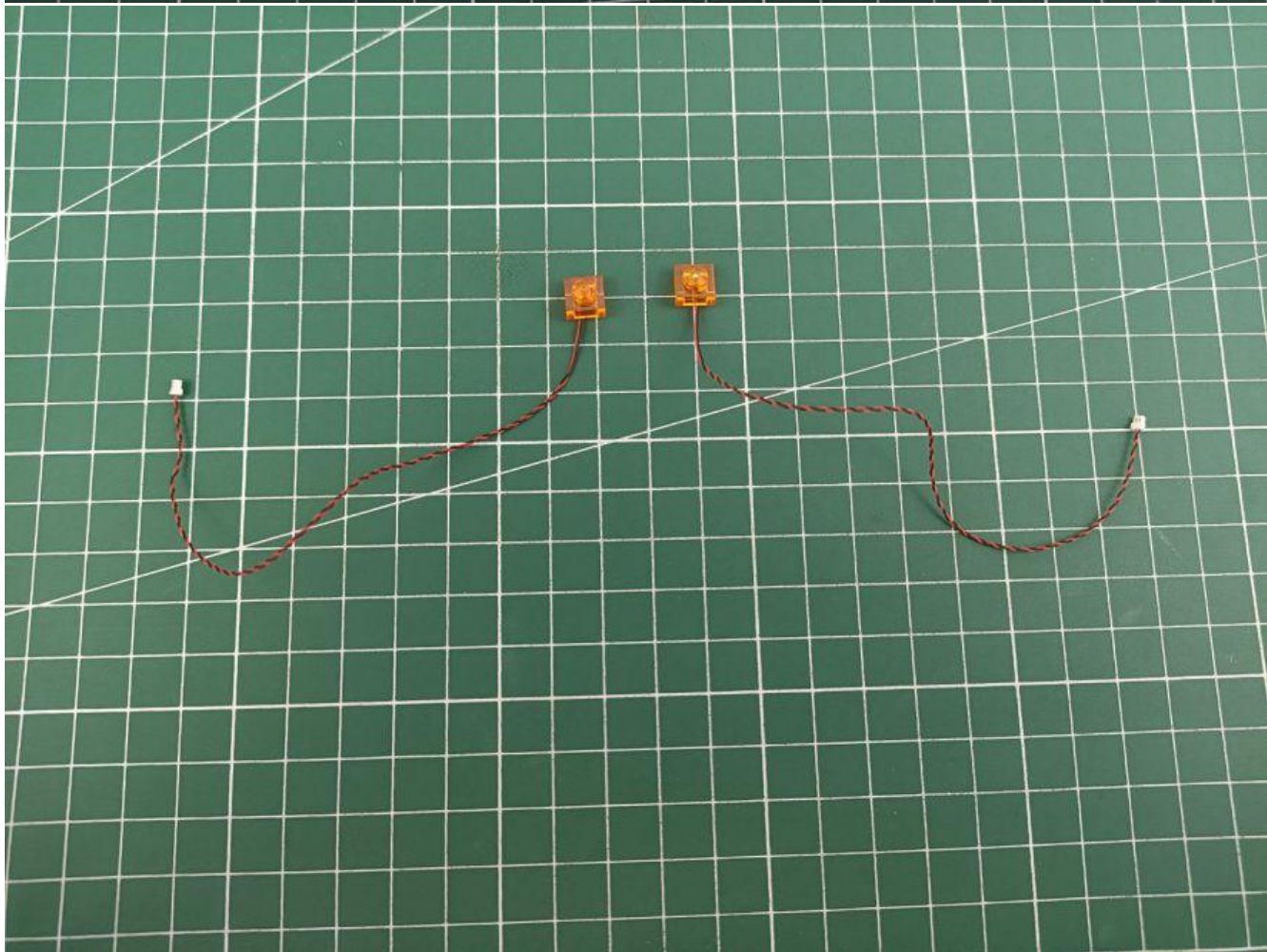

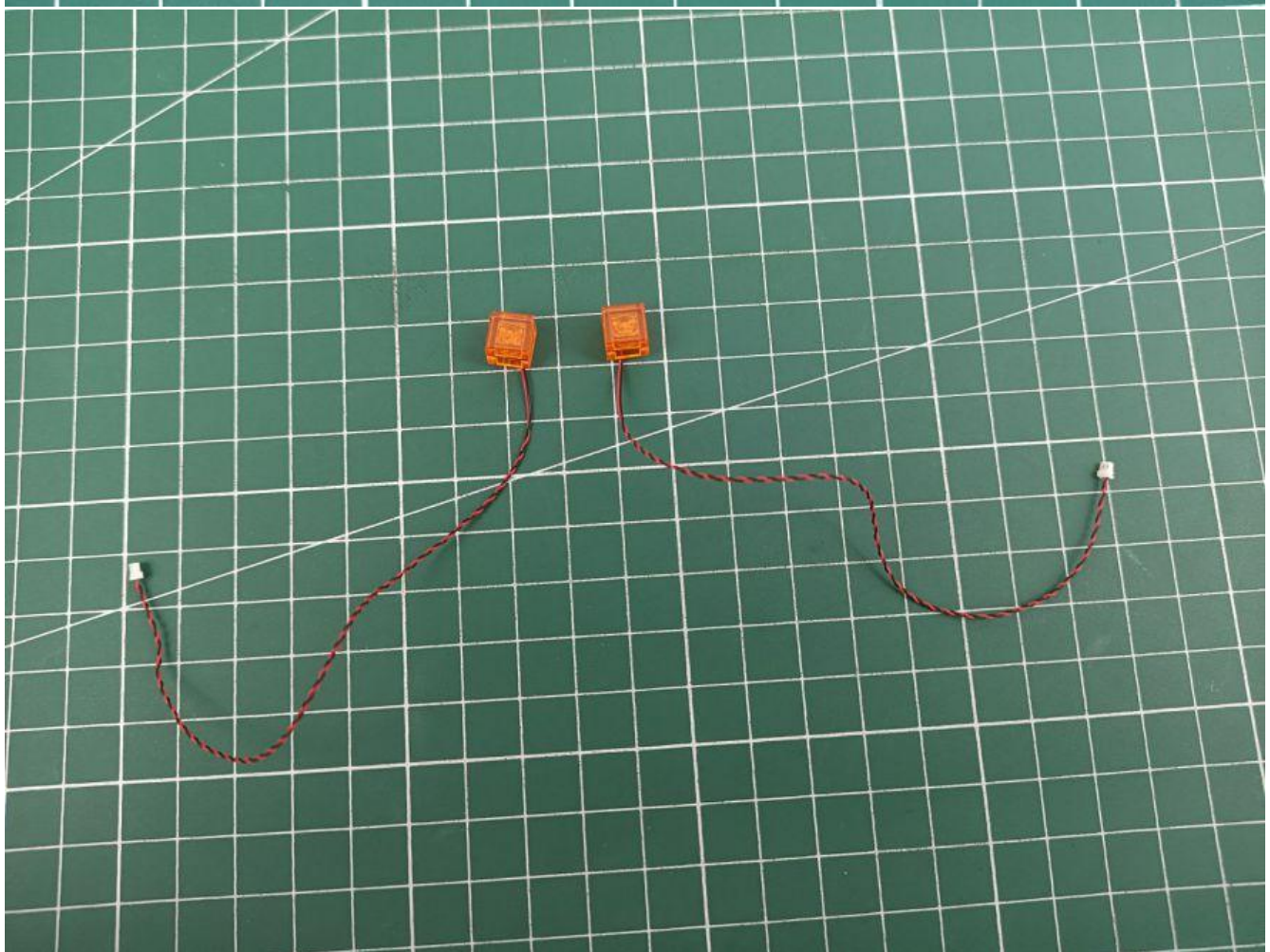
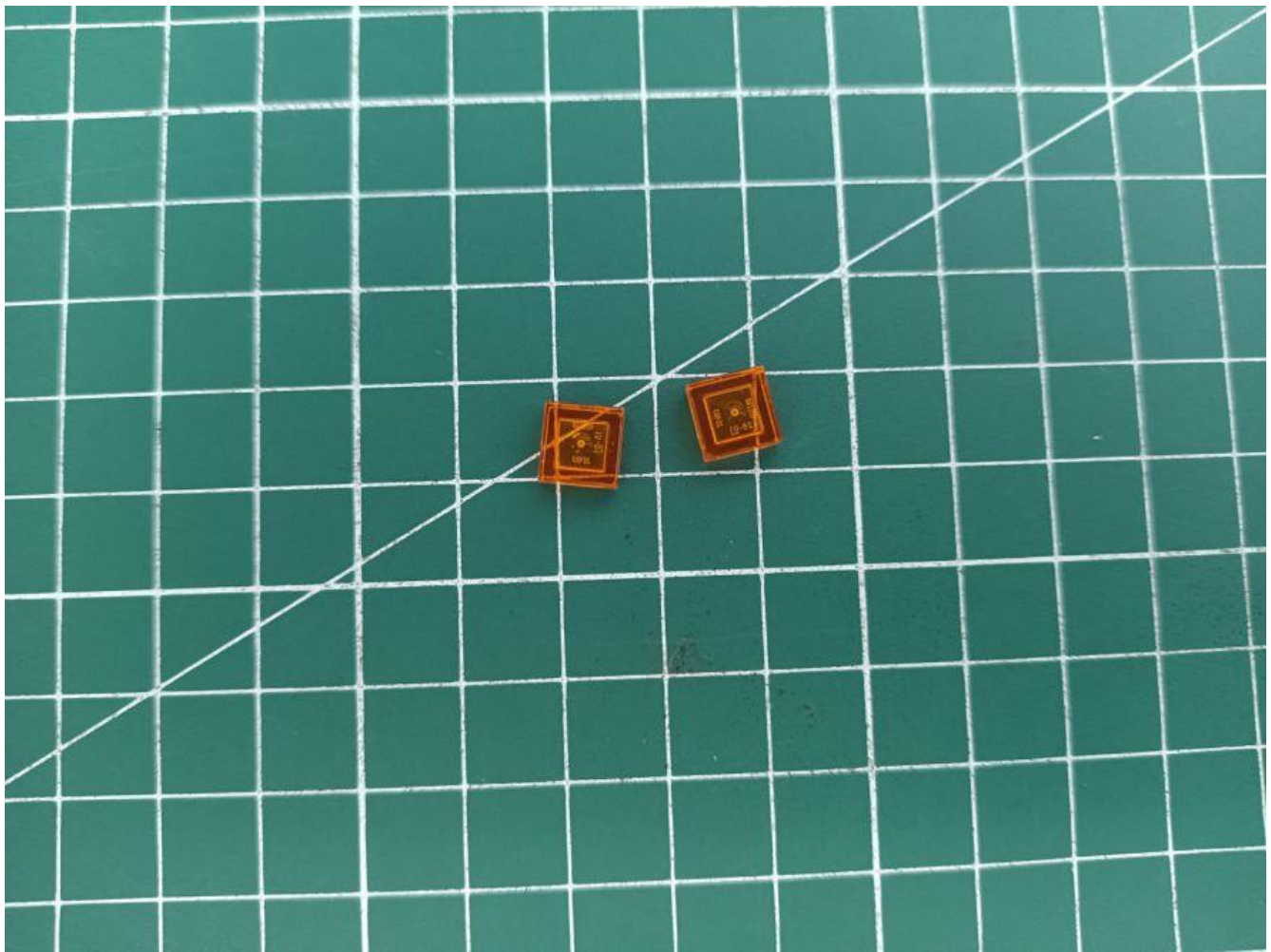

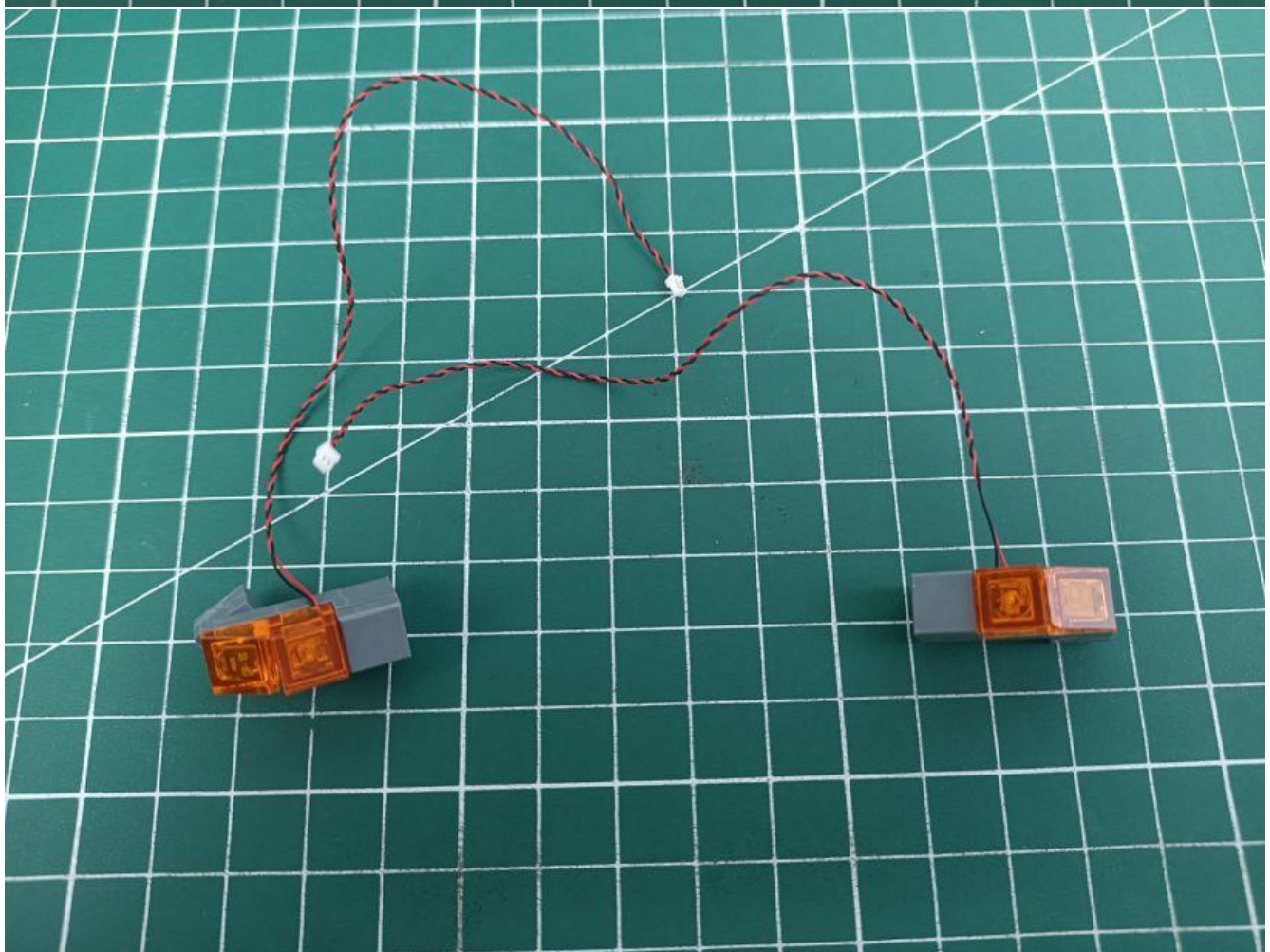
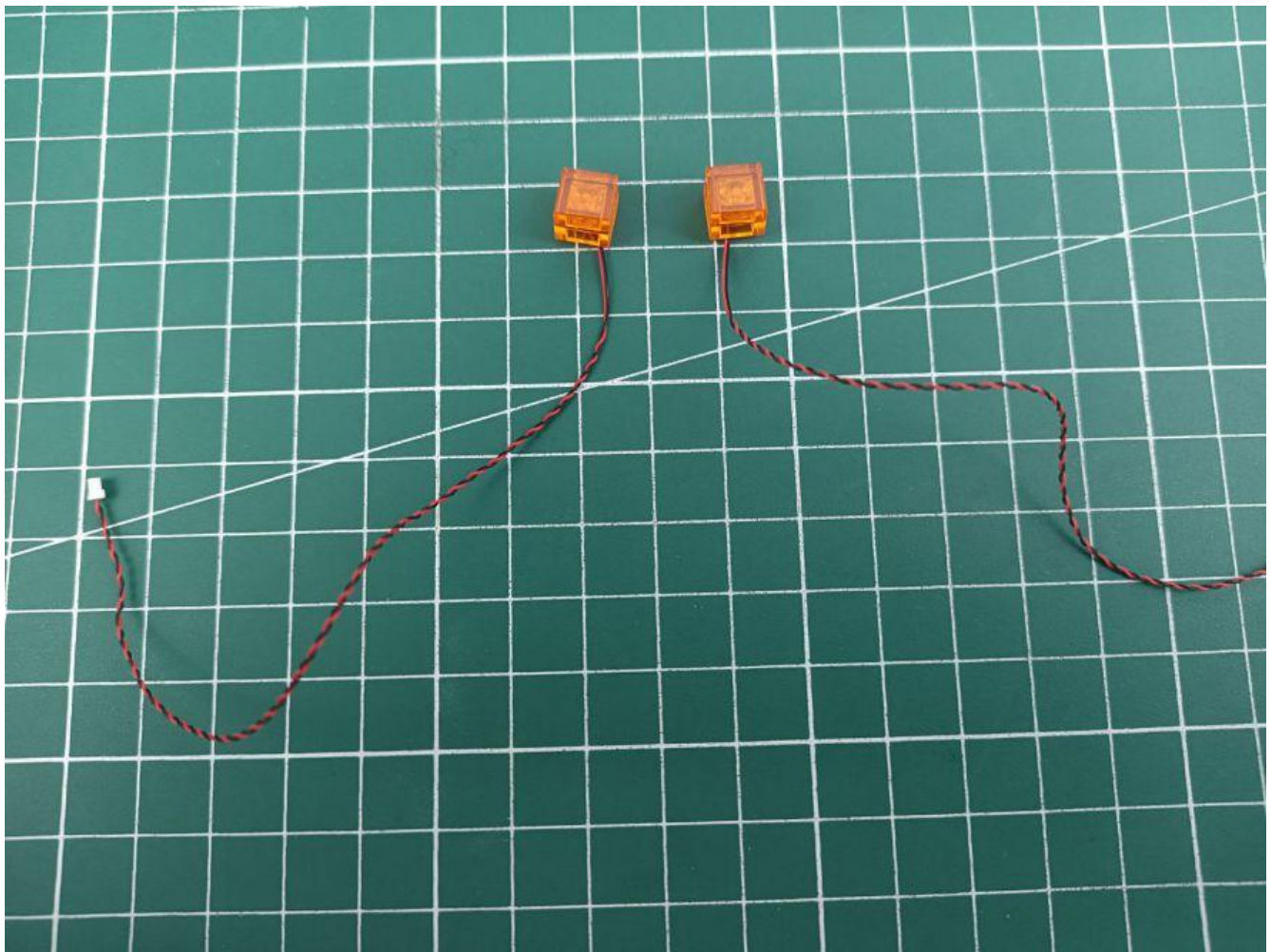



# Friendly tips

The small round pellets in the parts package are designed with openings. After manual processing, the cut-out gap is about 1mm wide and 2mm deep.

No opening:



Opening pieces:



**Need to install the lamp thread through the gap on the building block.**

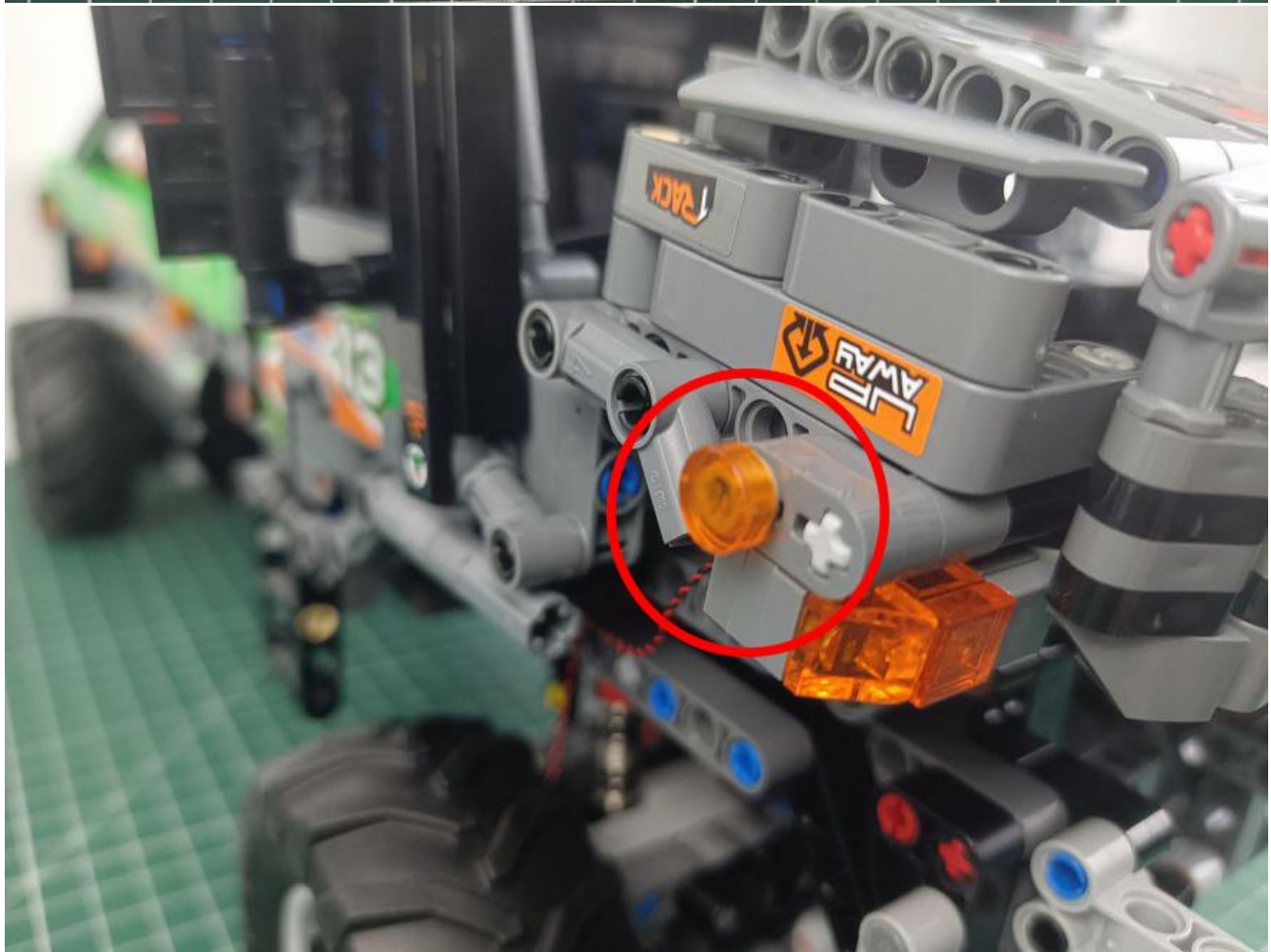



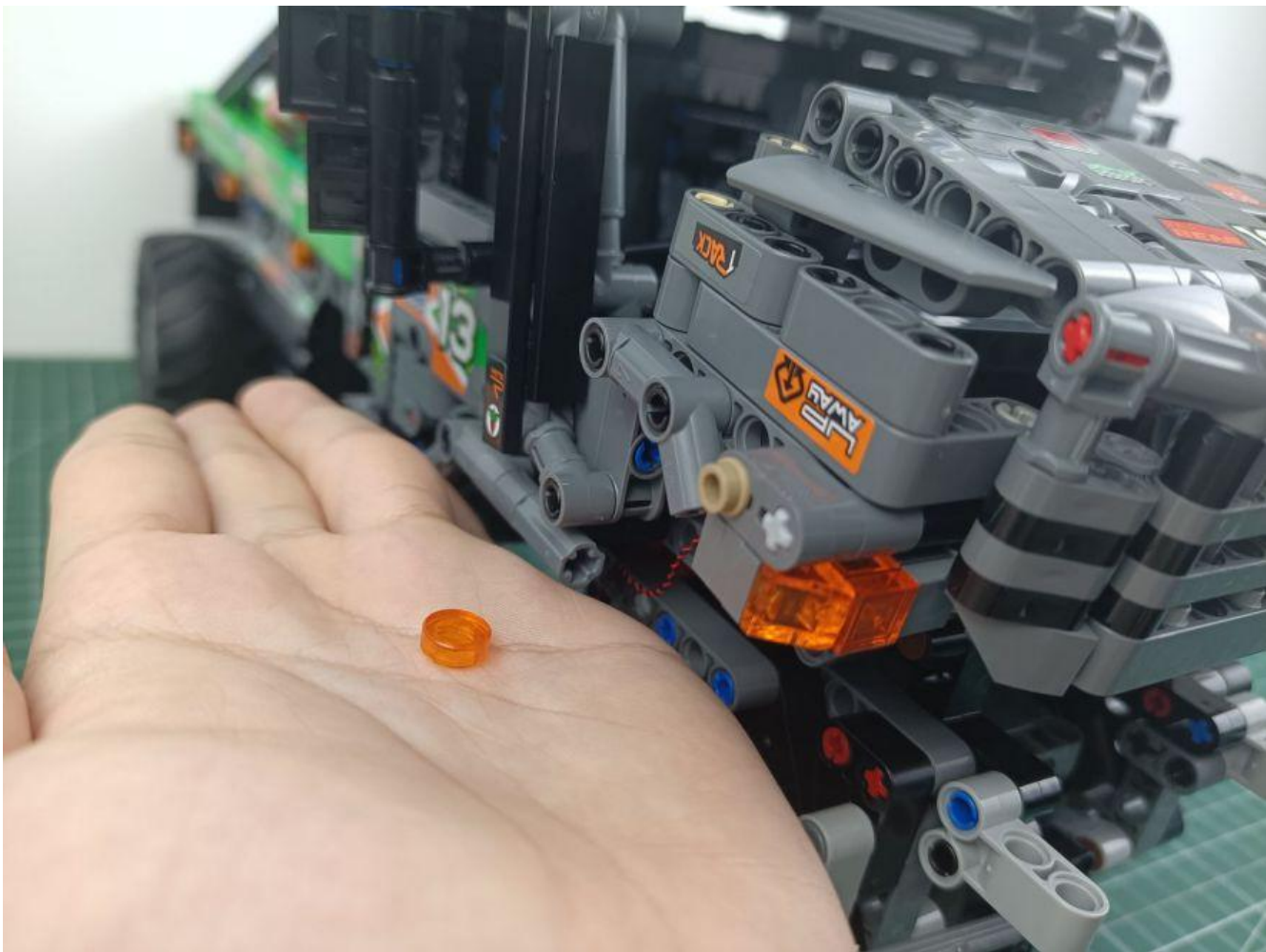

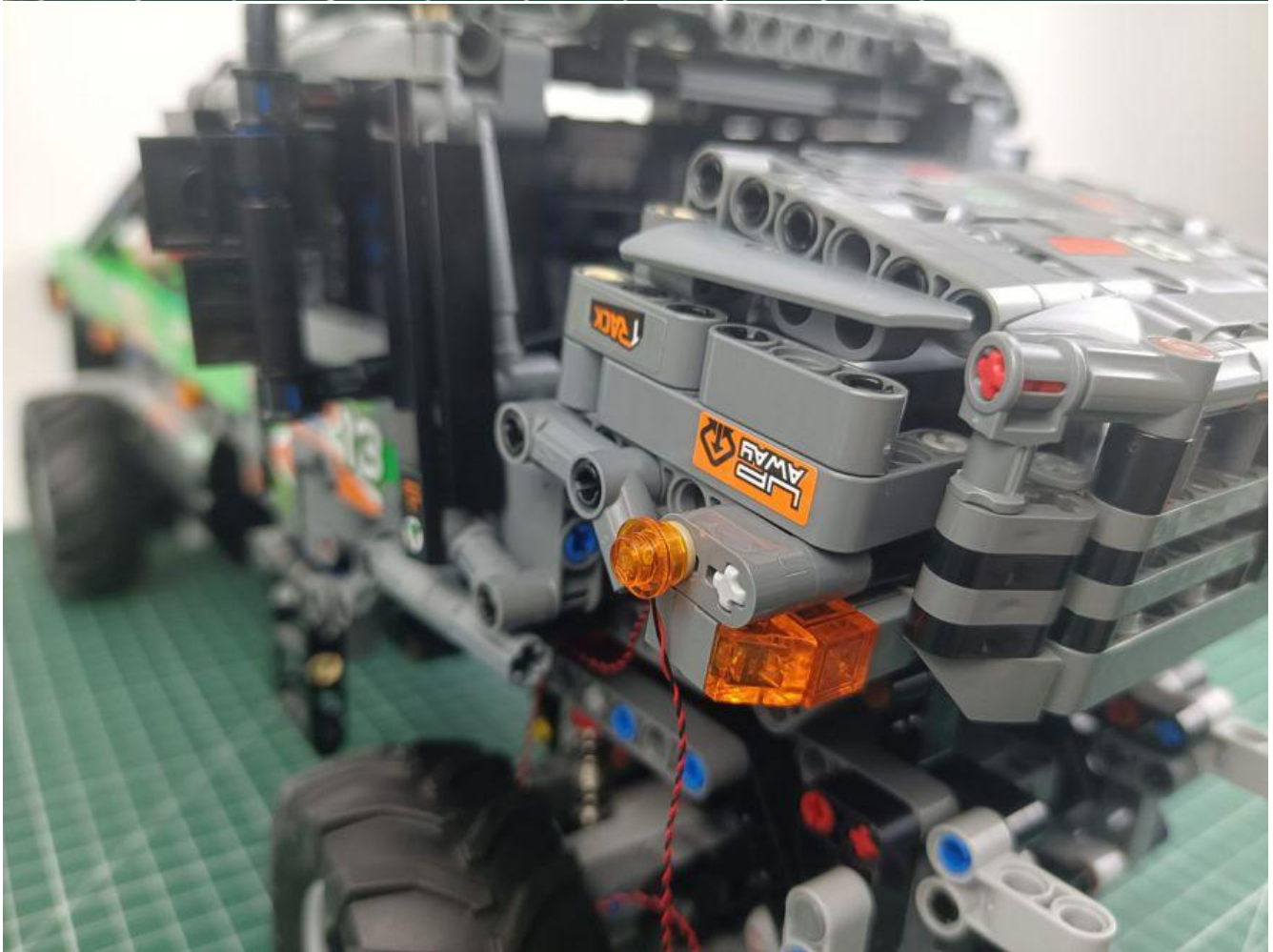
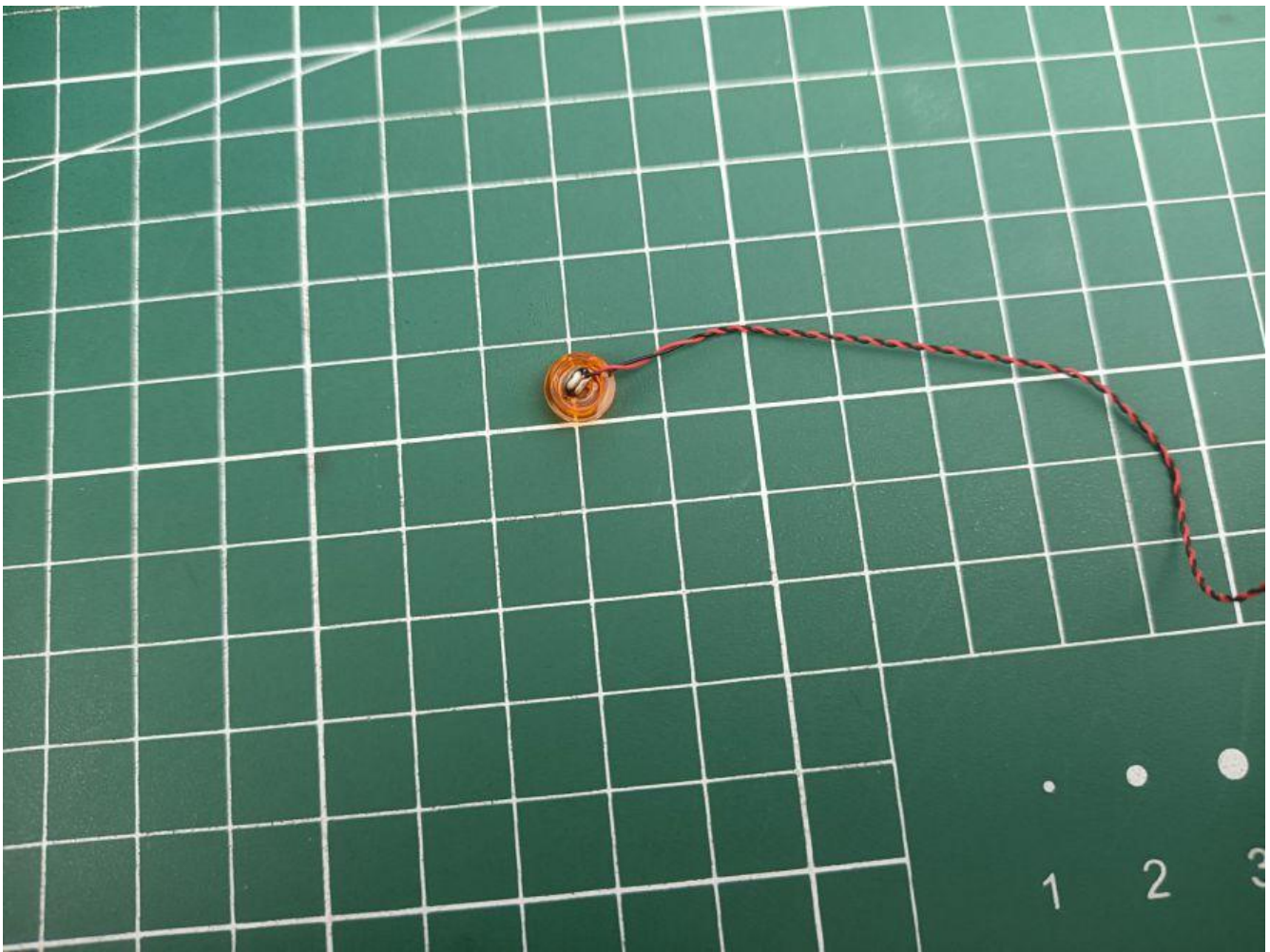







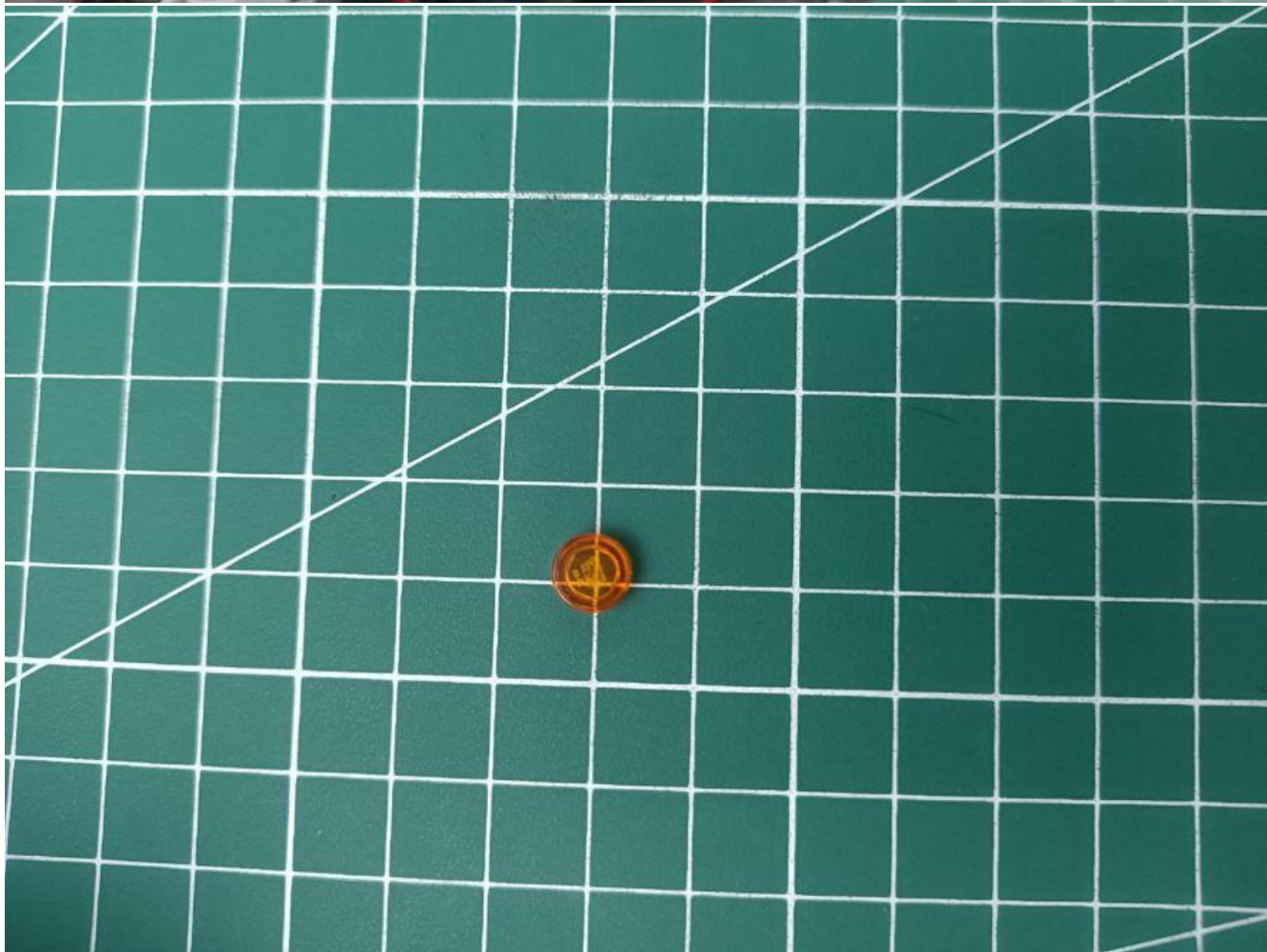
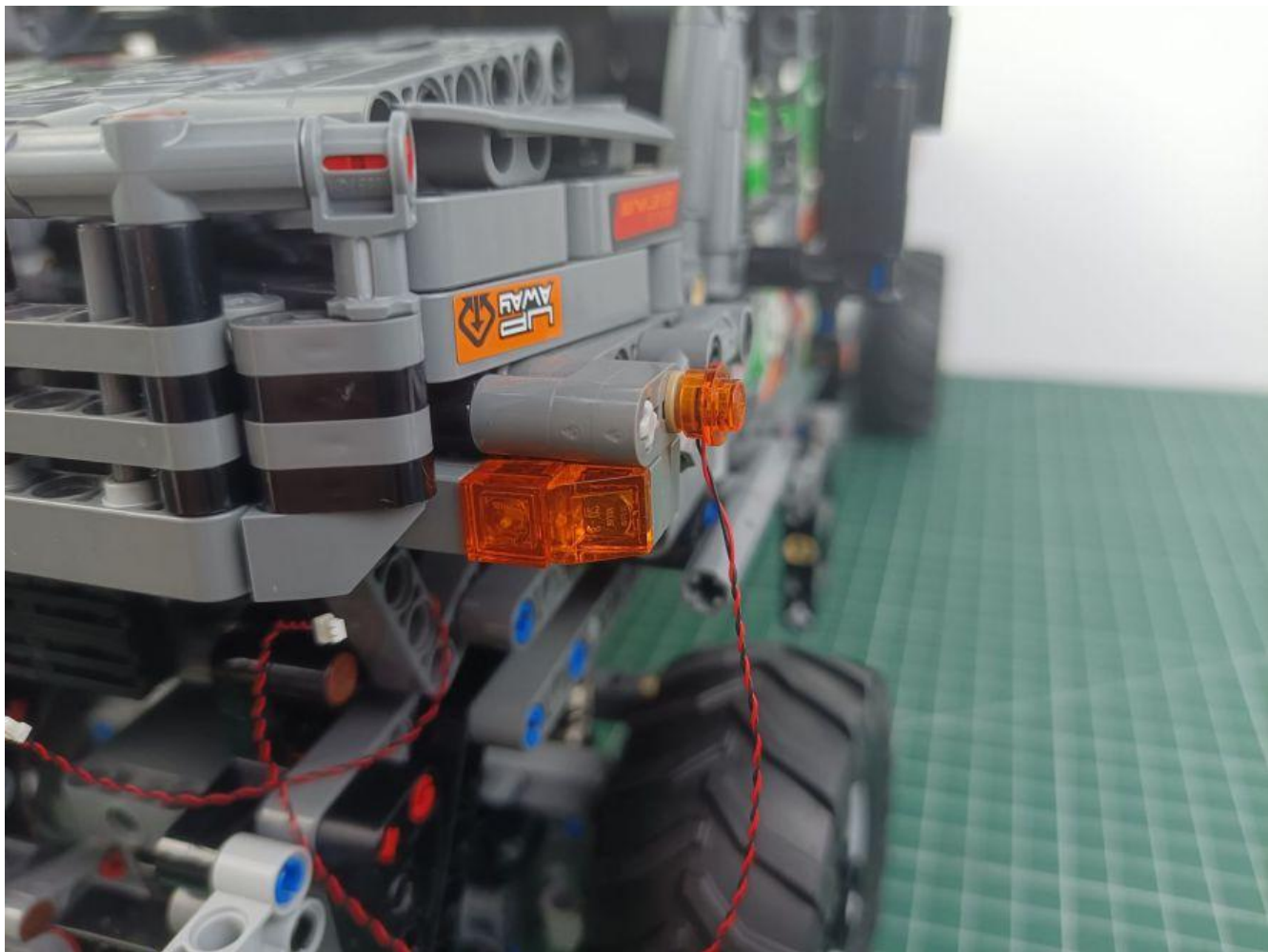

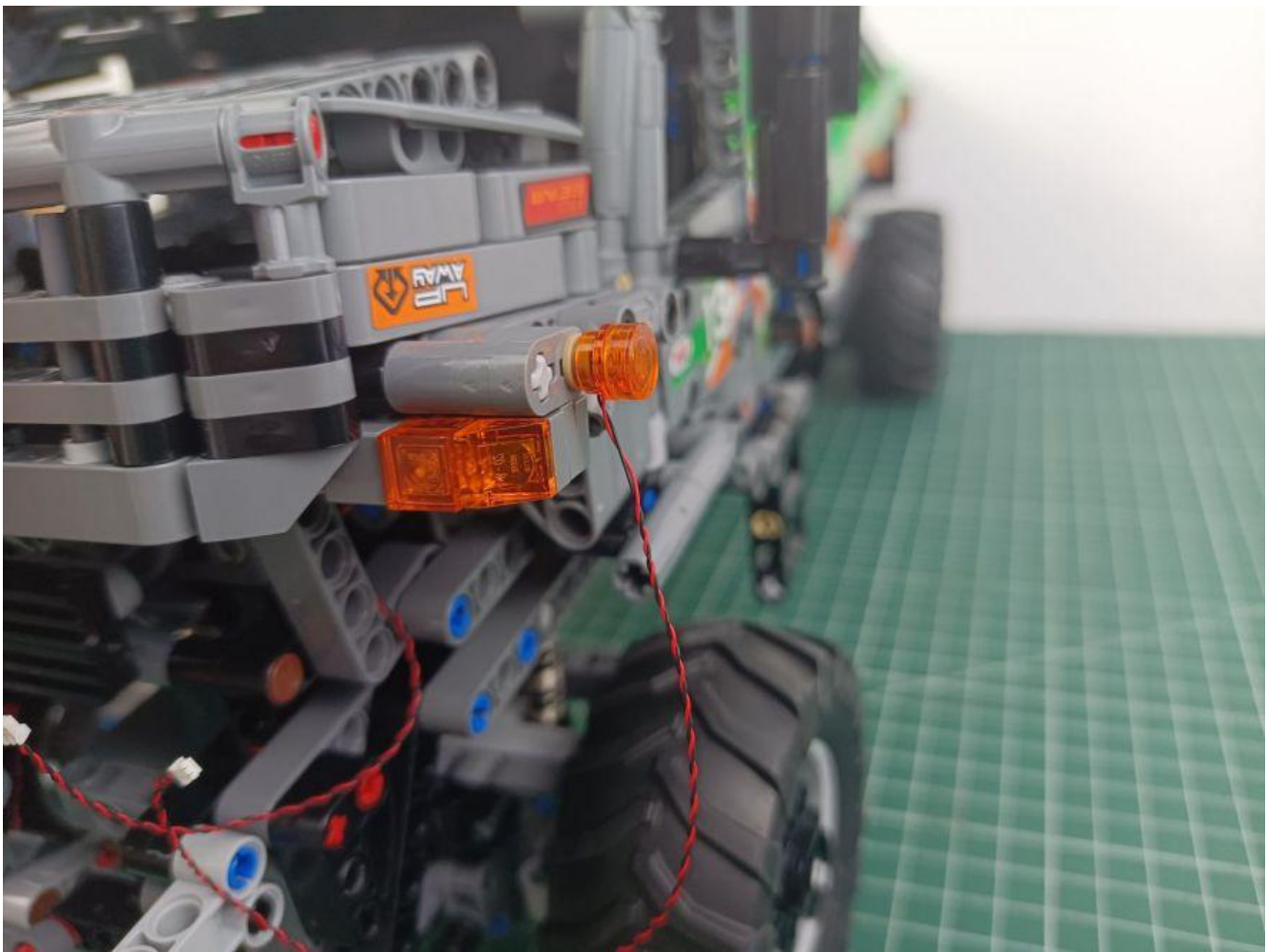

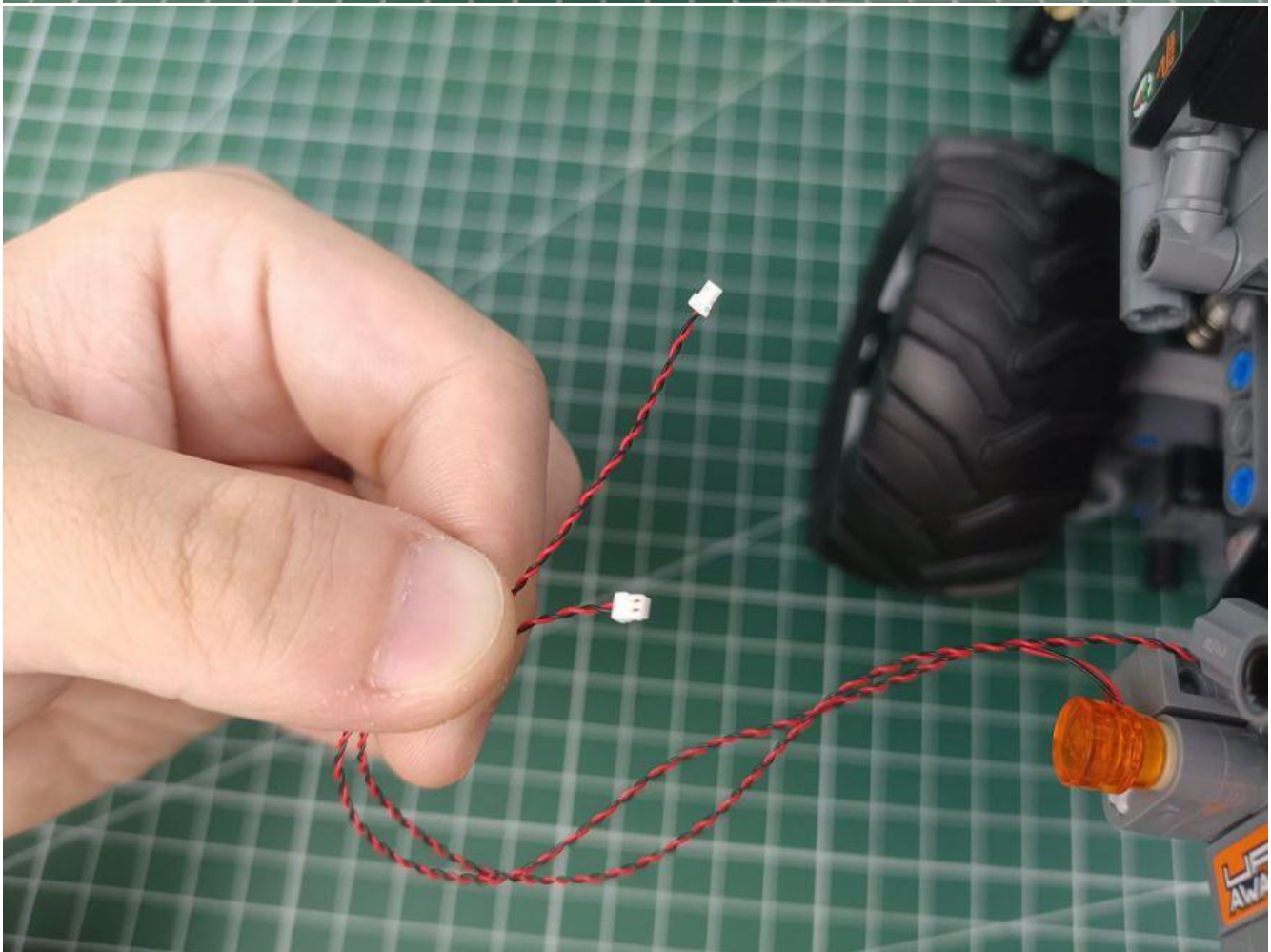



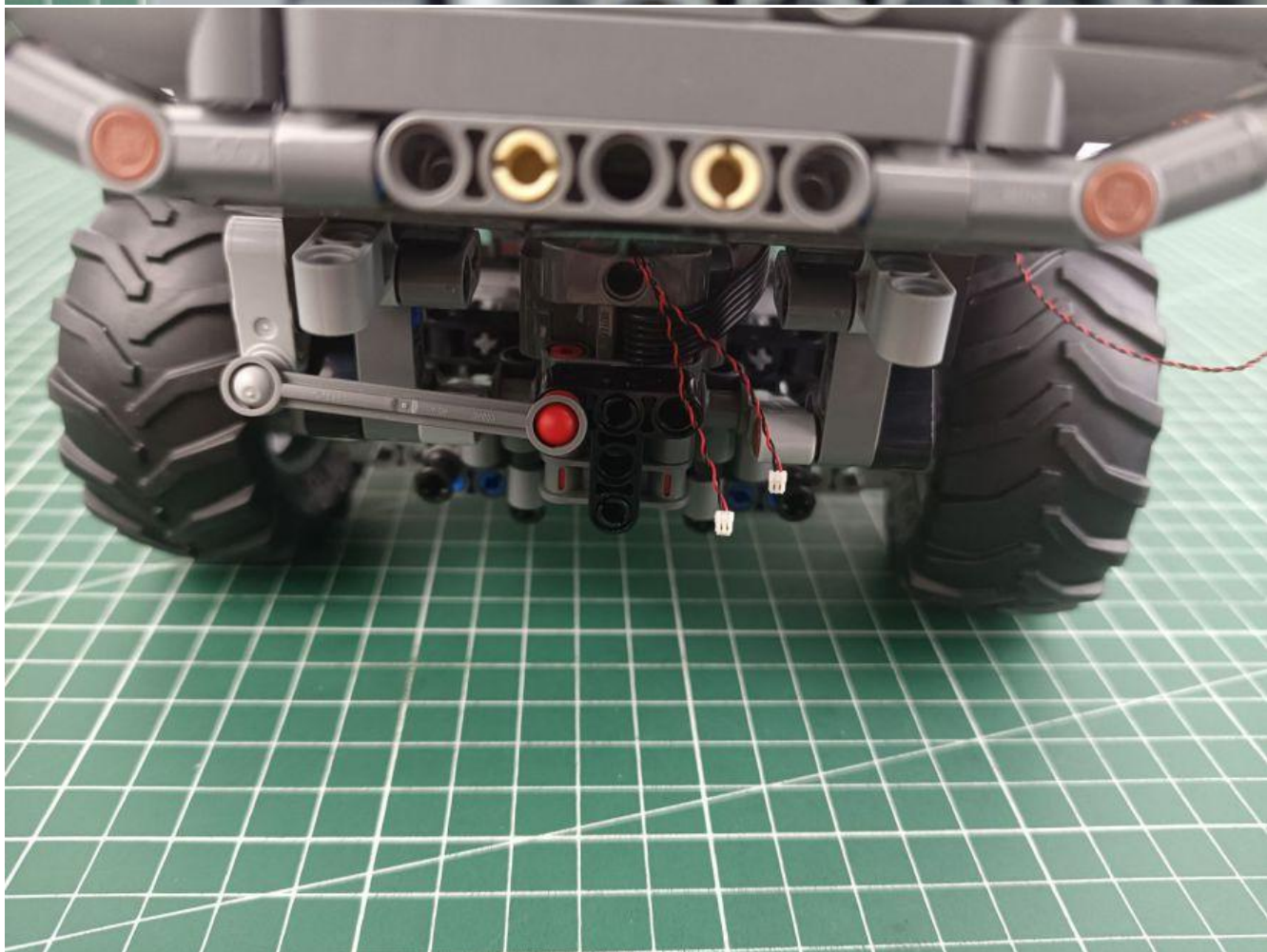
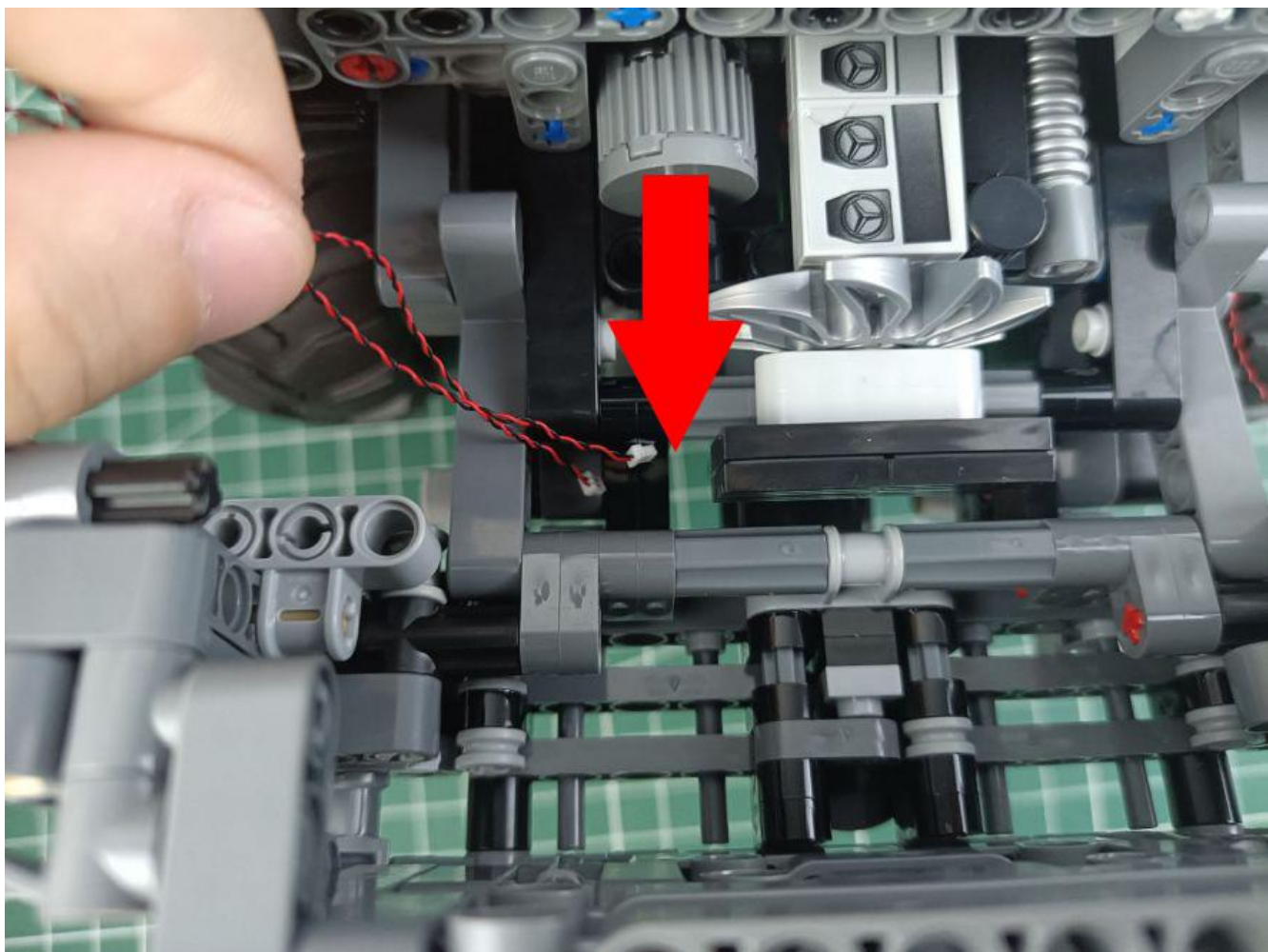

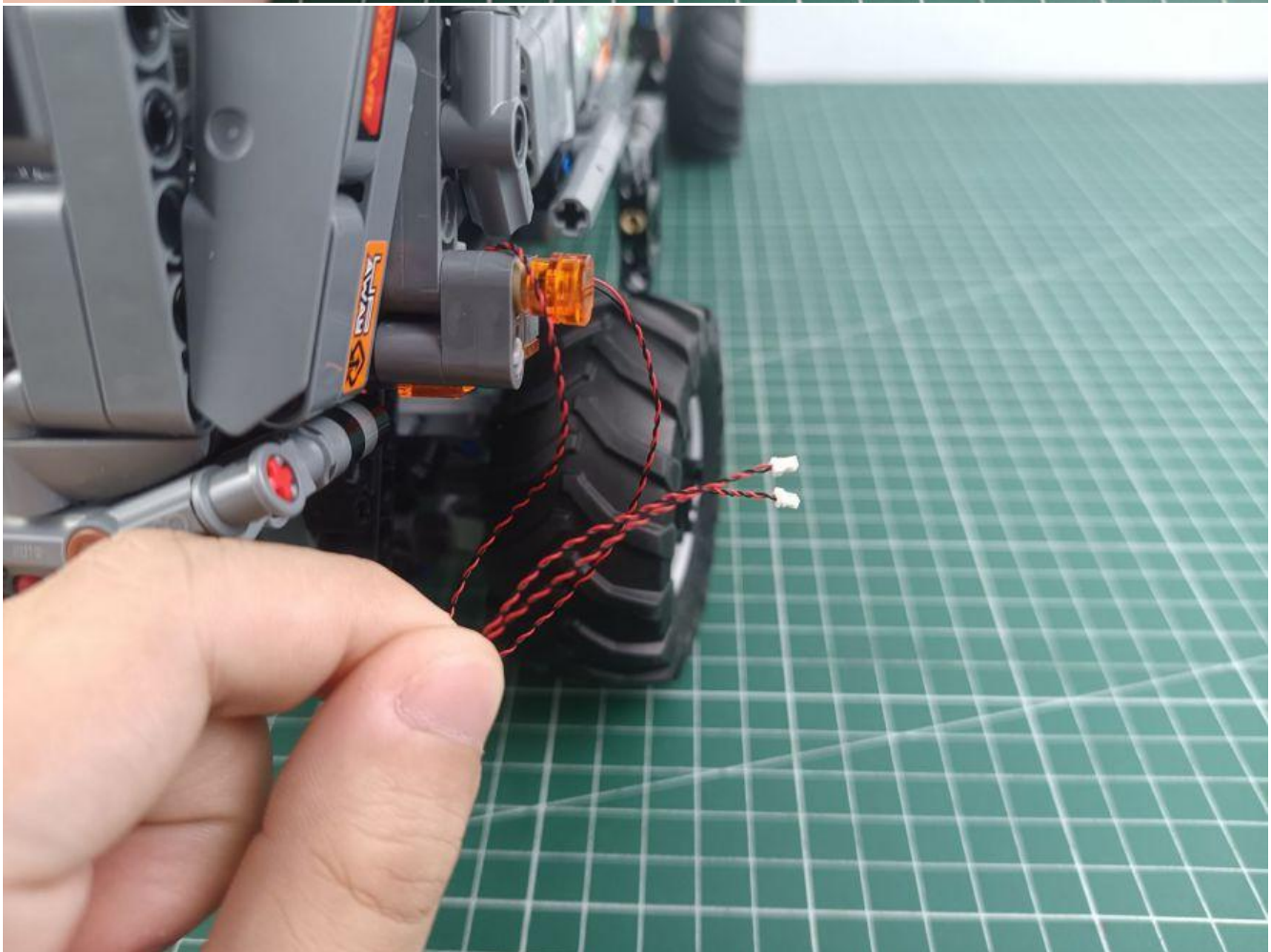
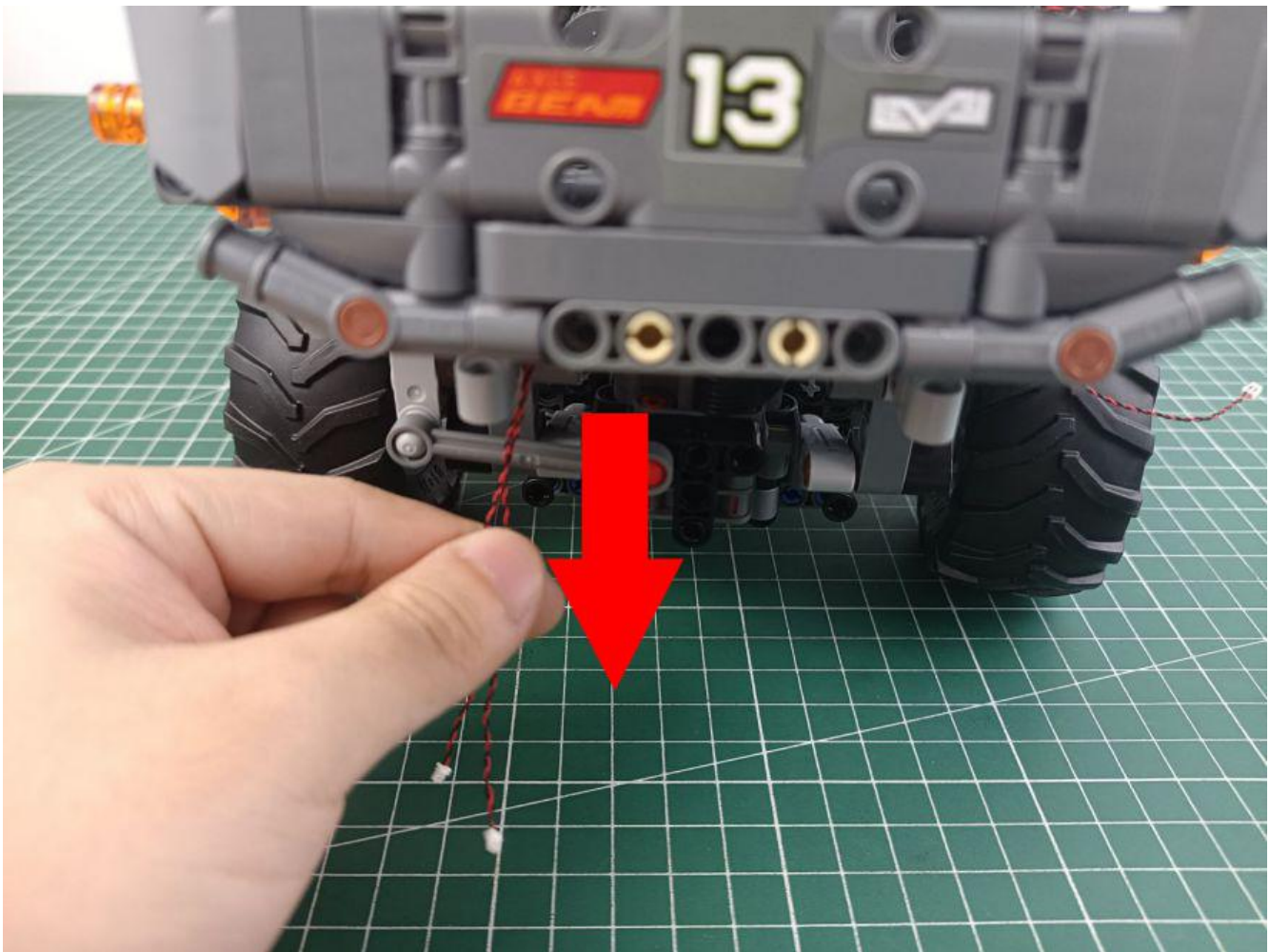

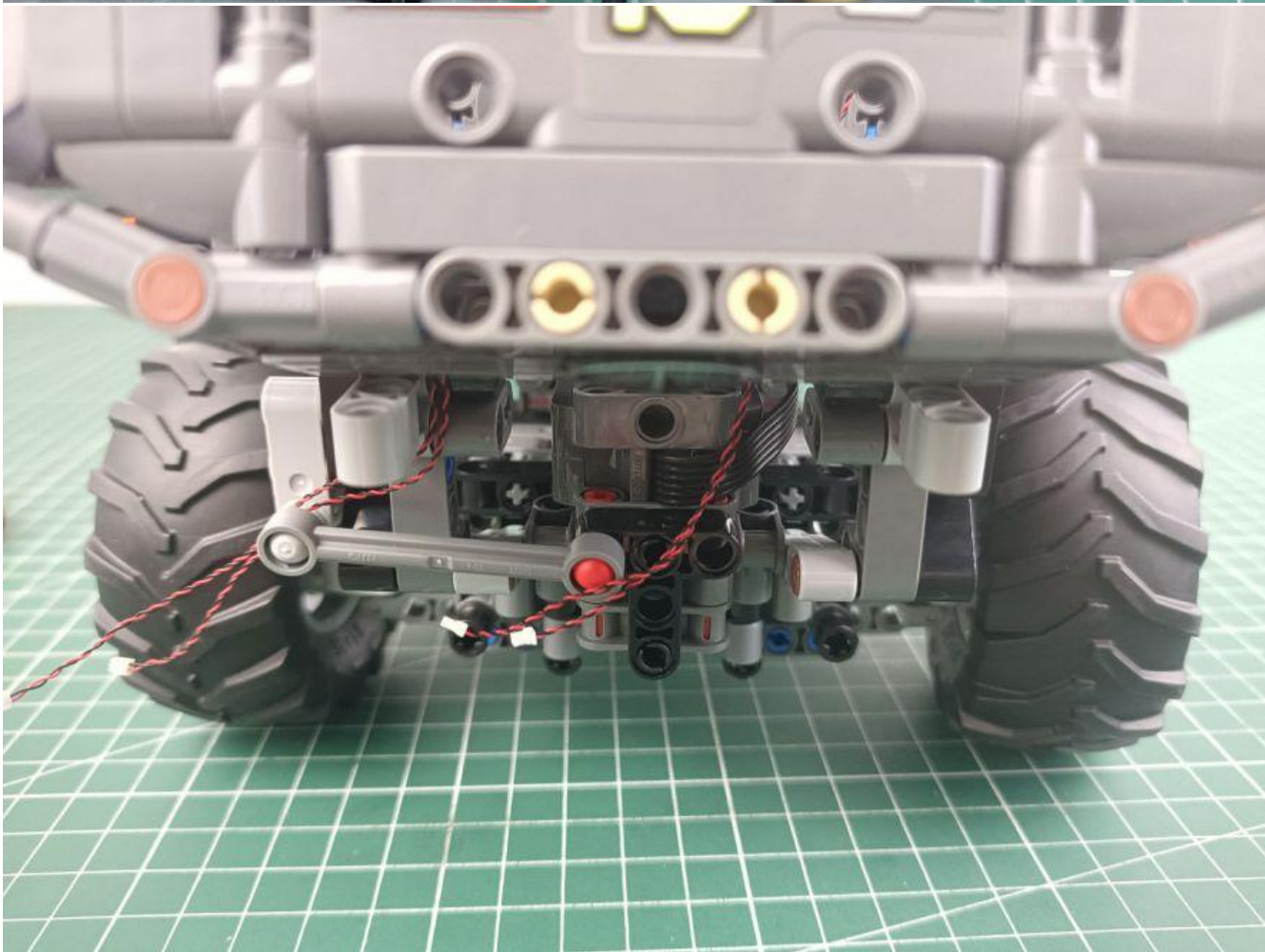
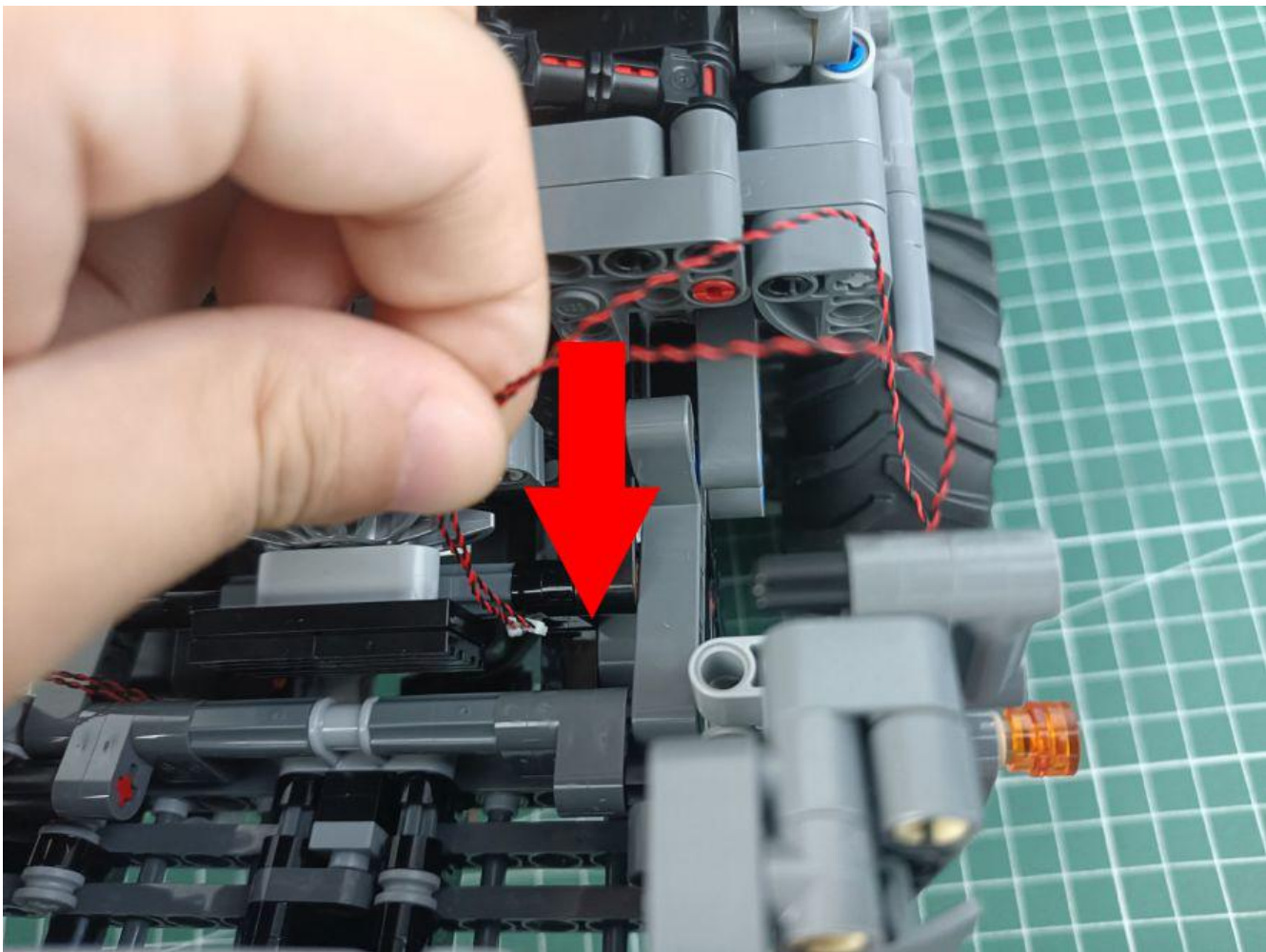



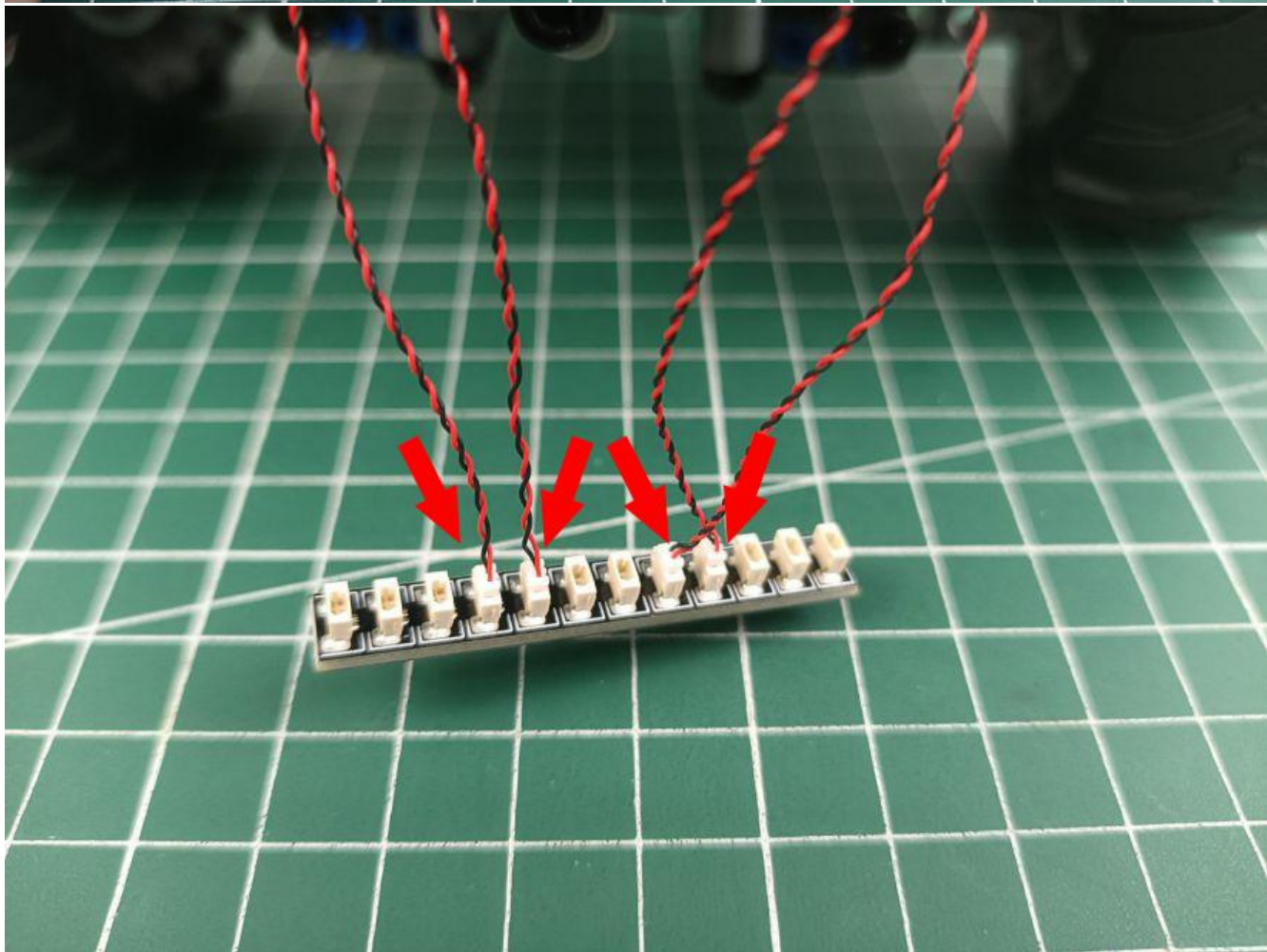
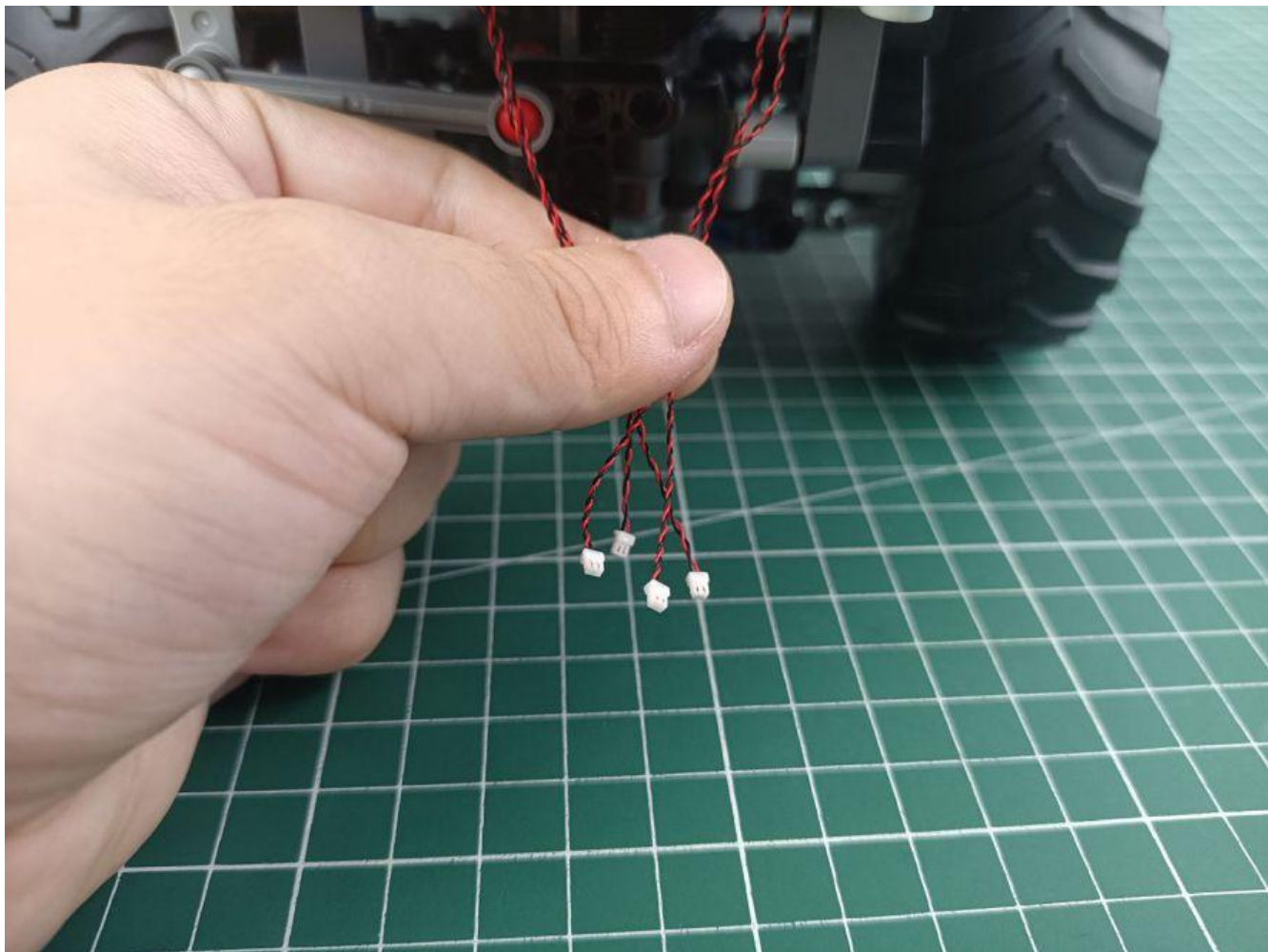

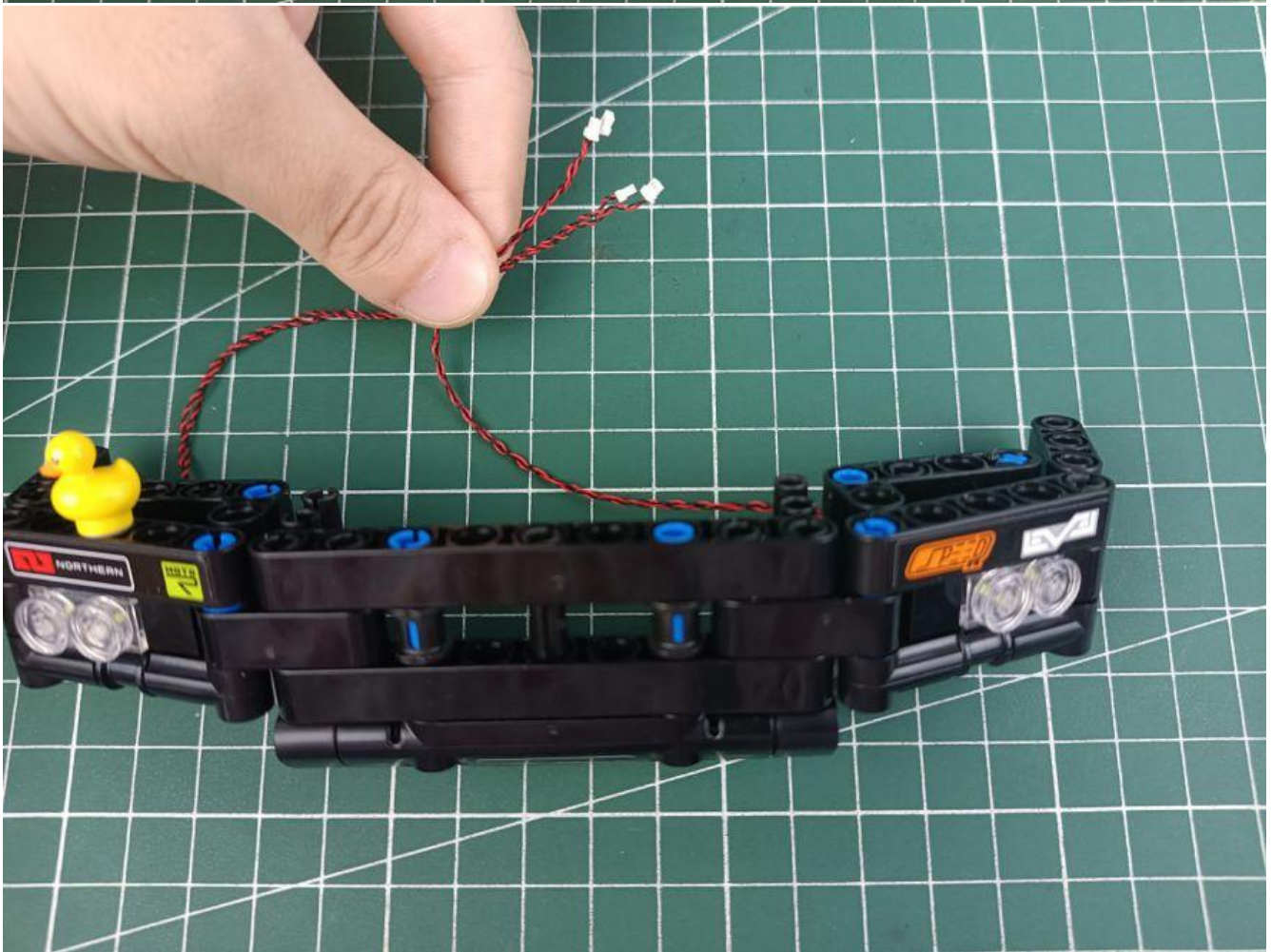
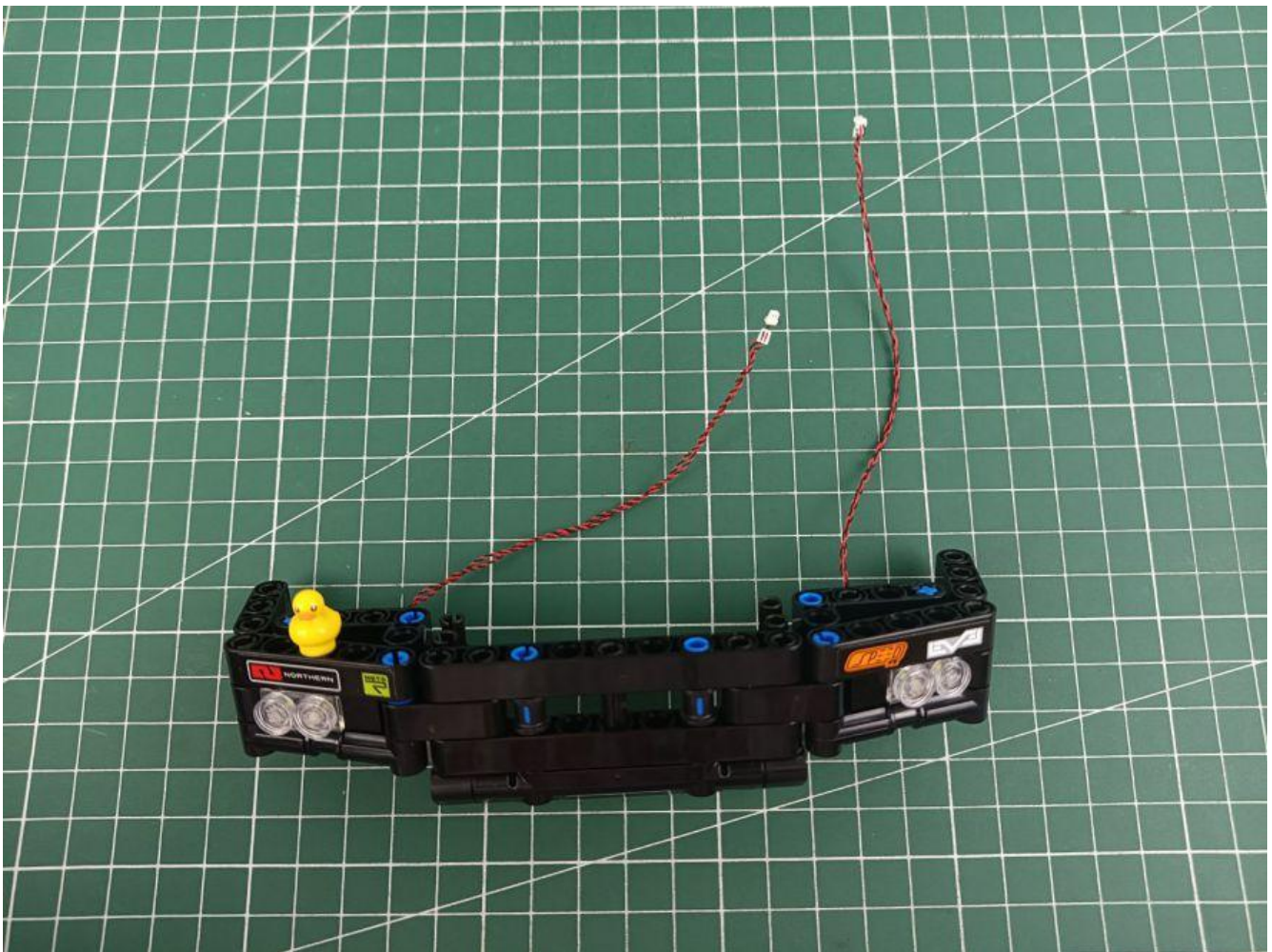

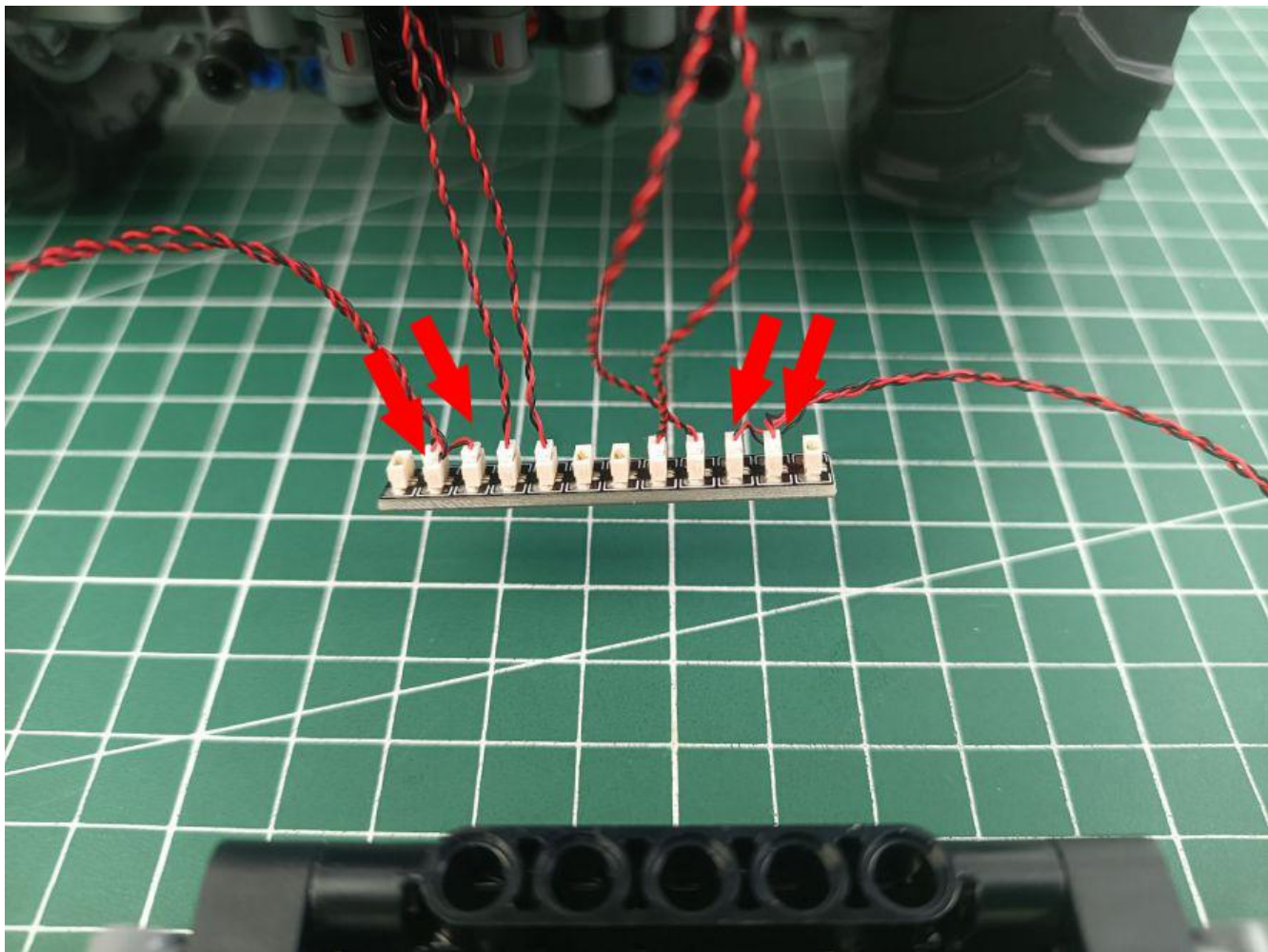

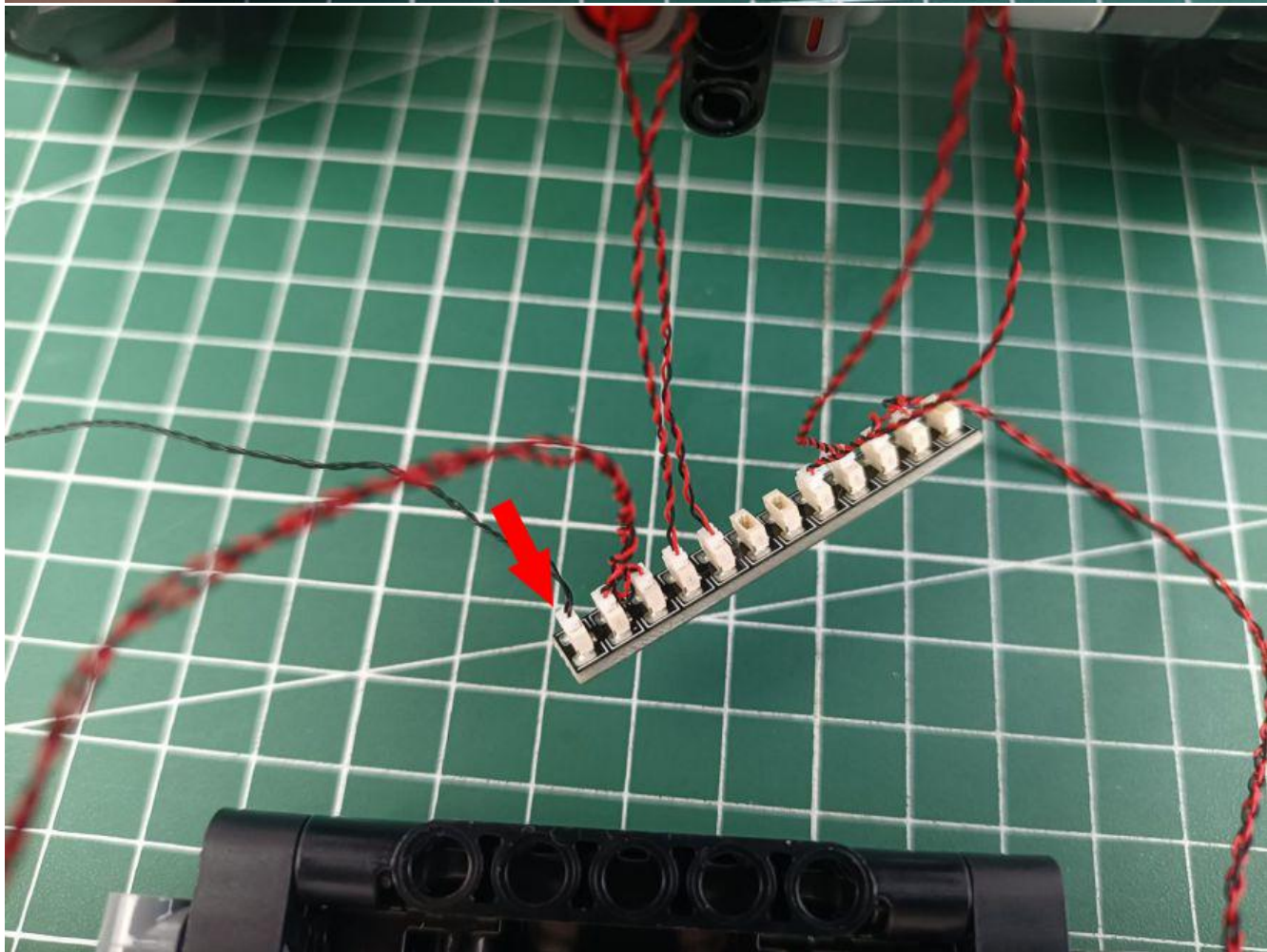
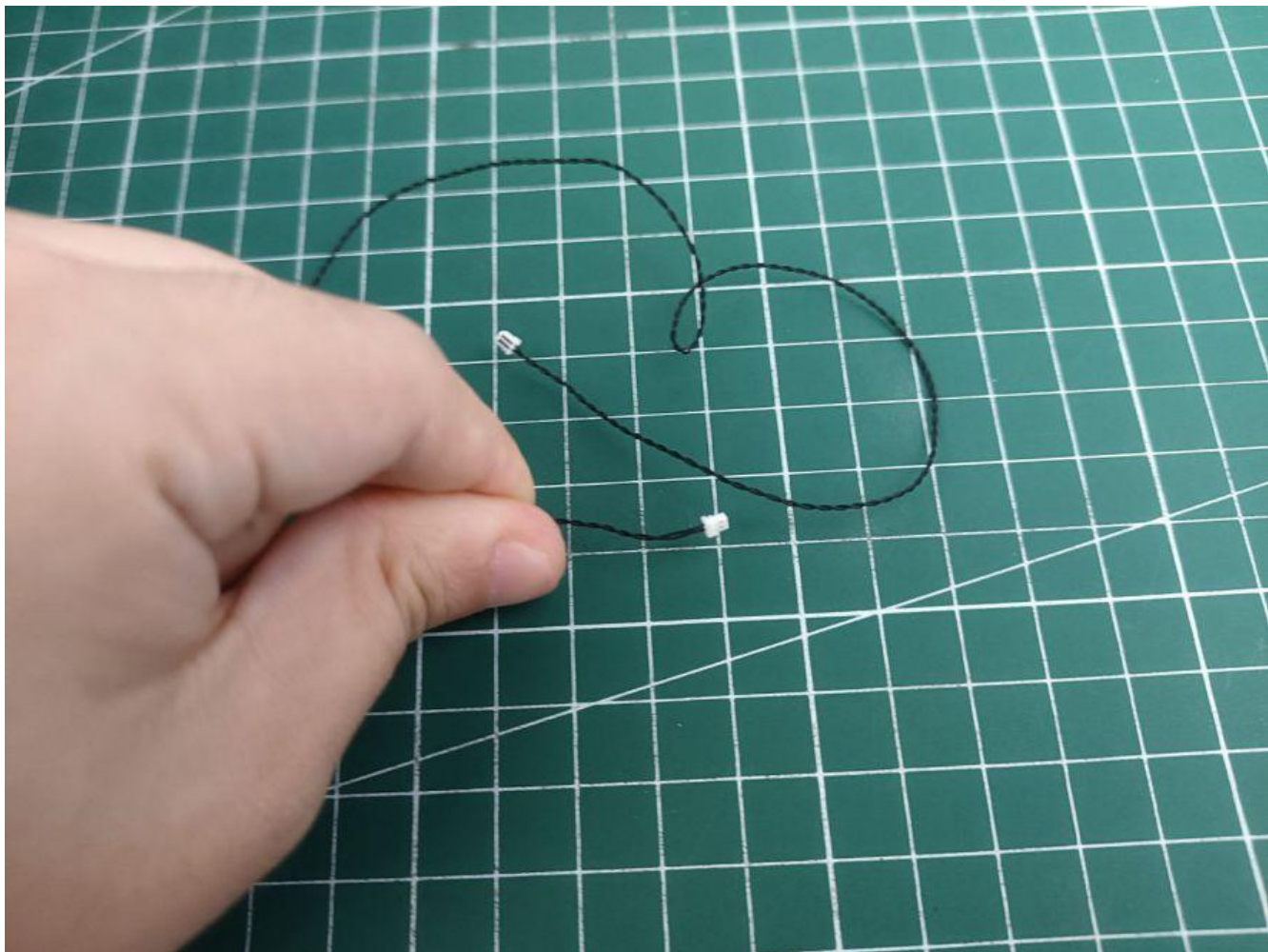



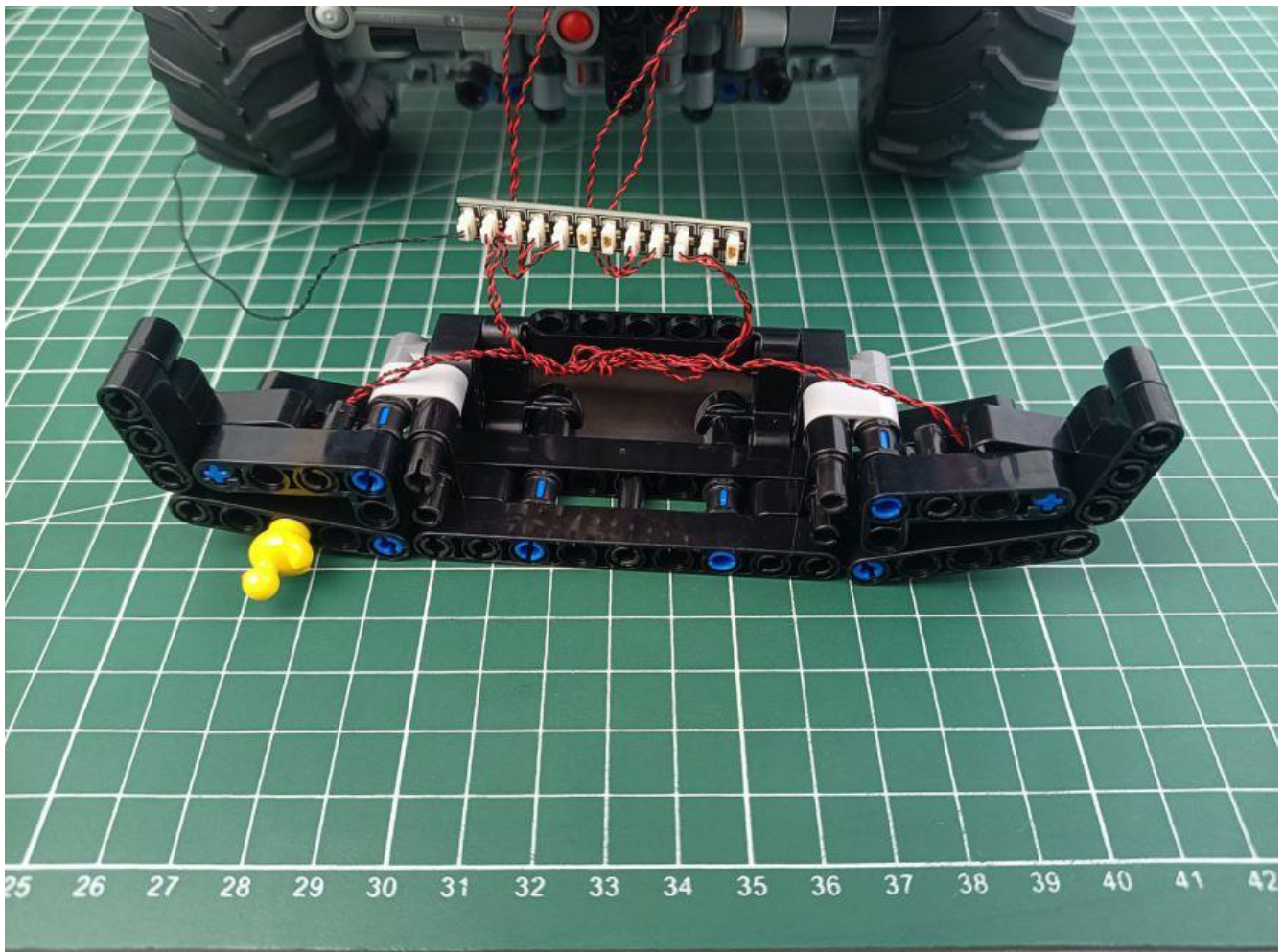



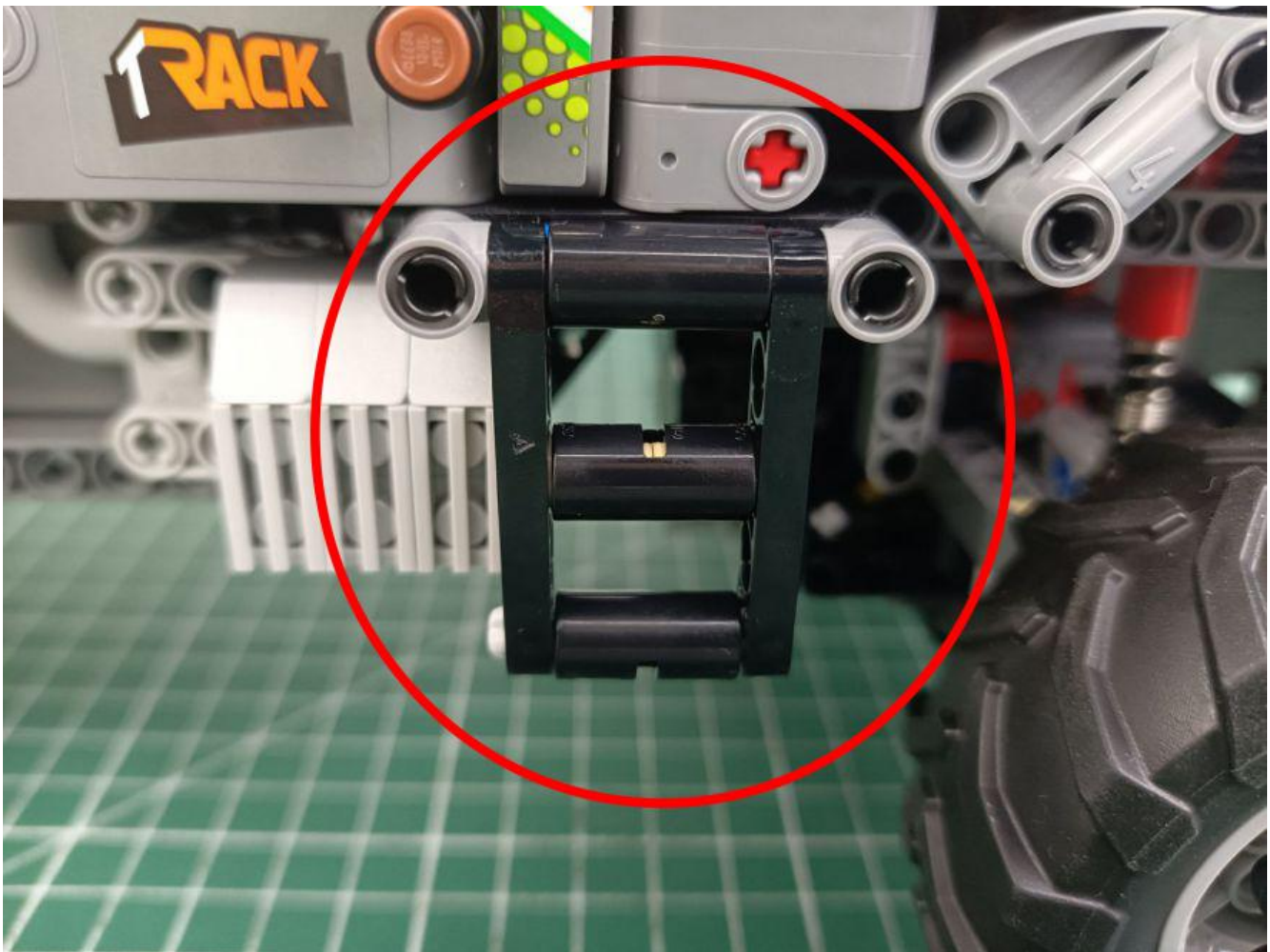



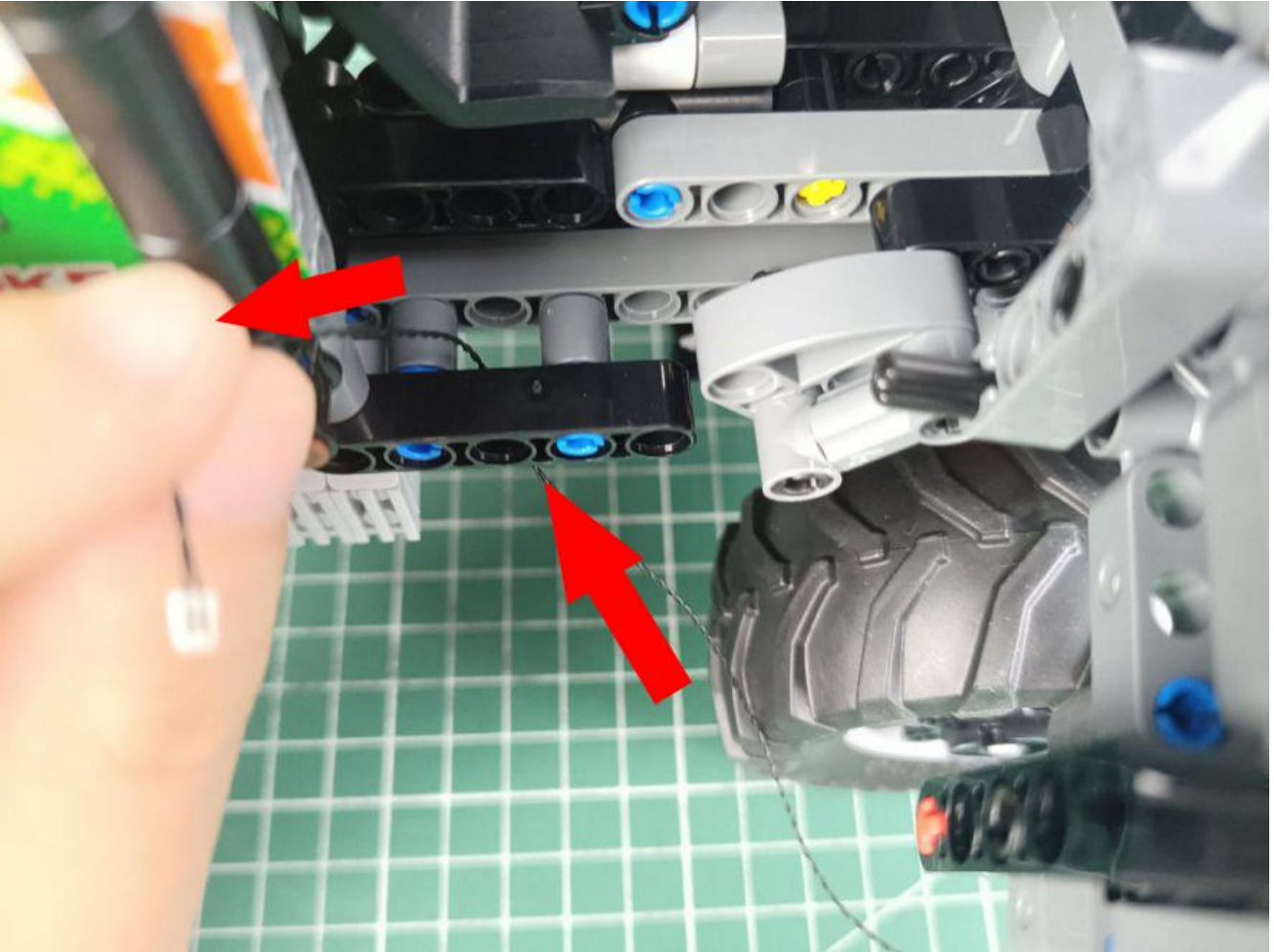

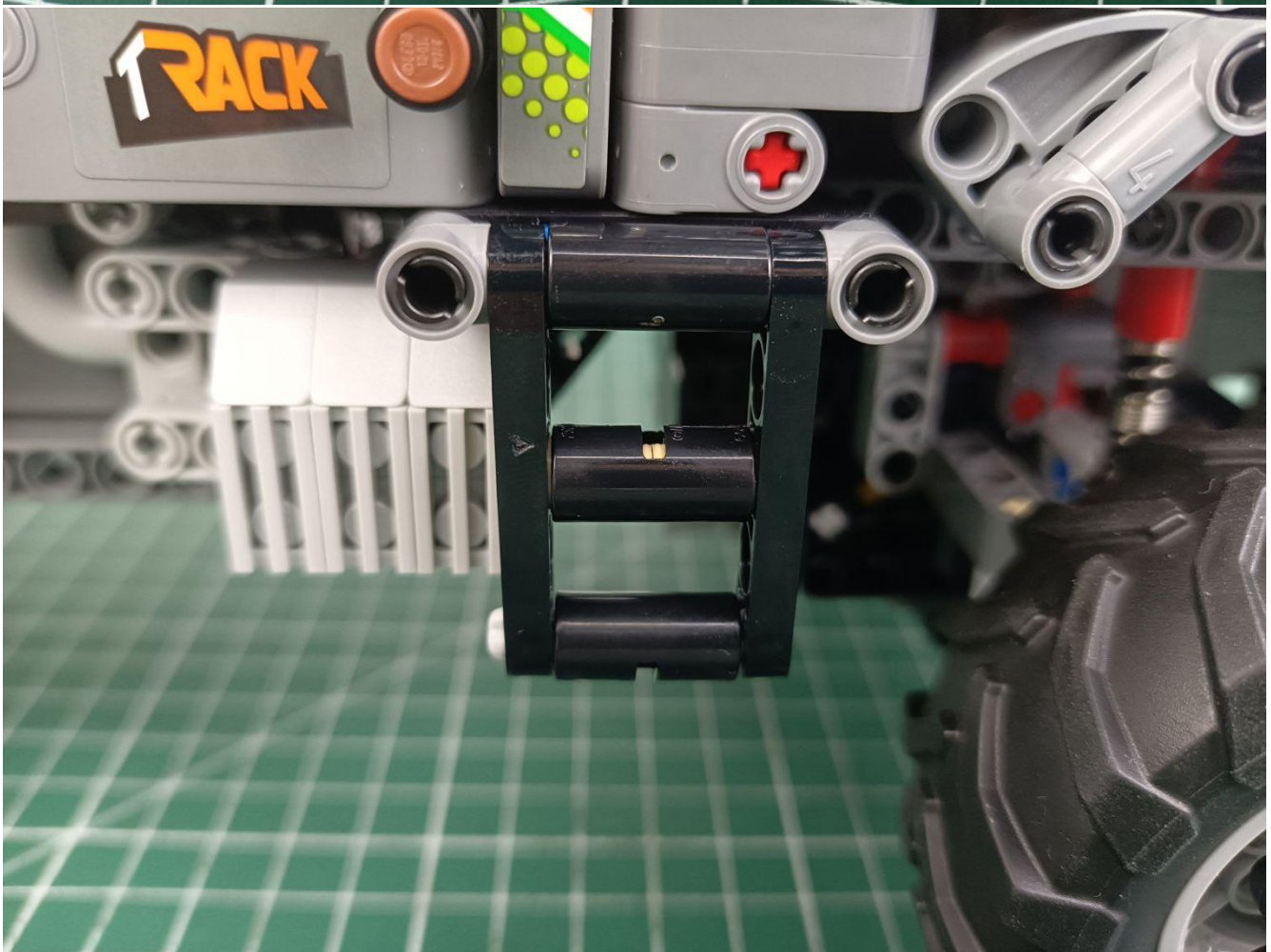







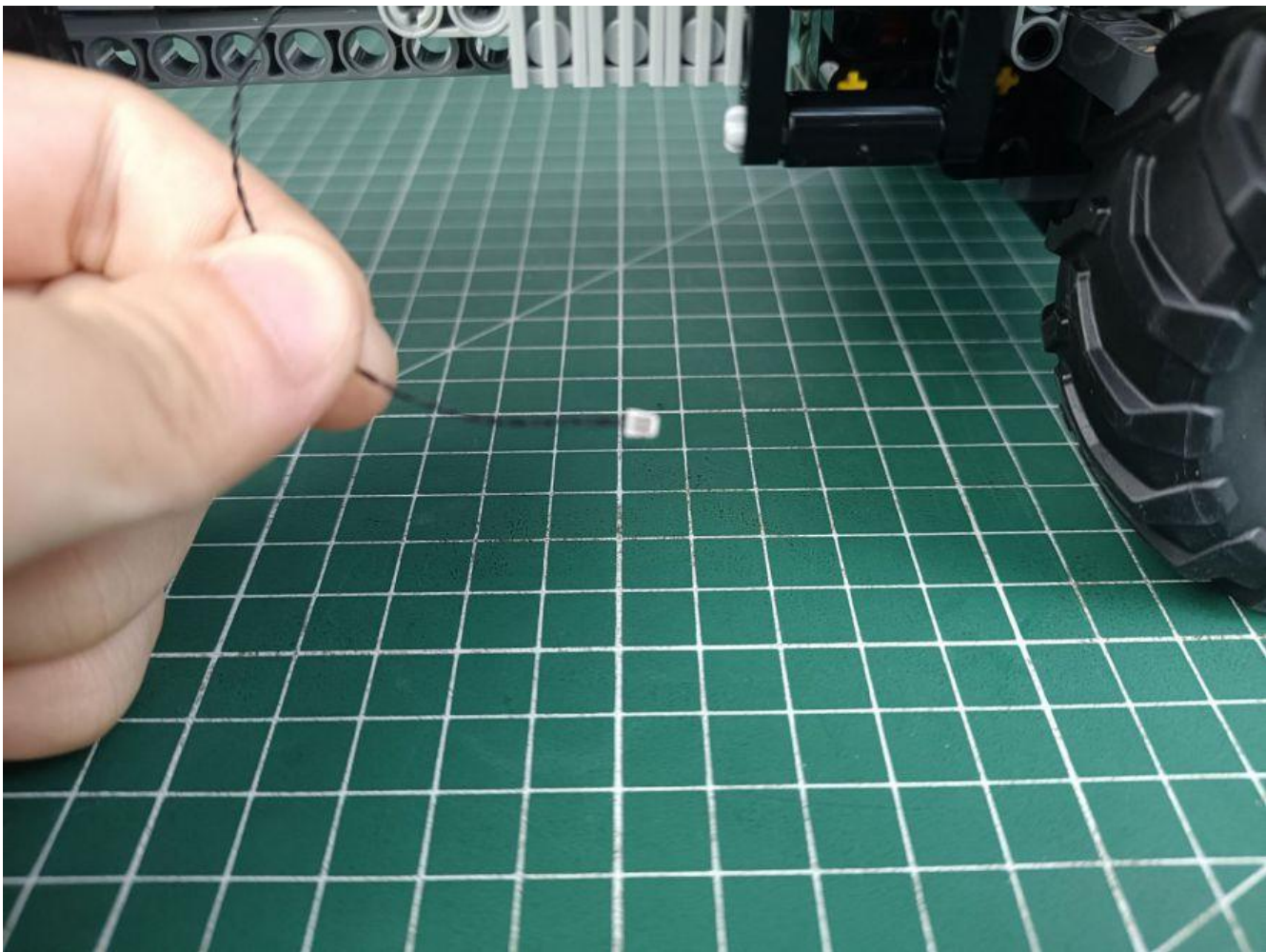









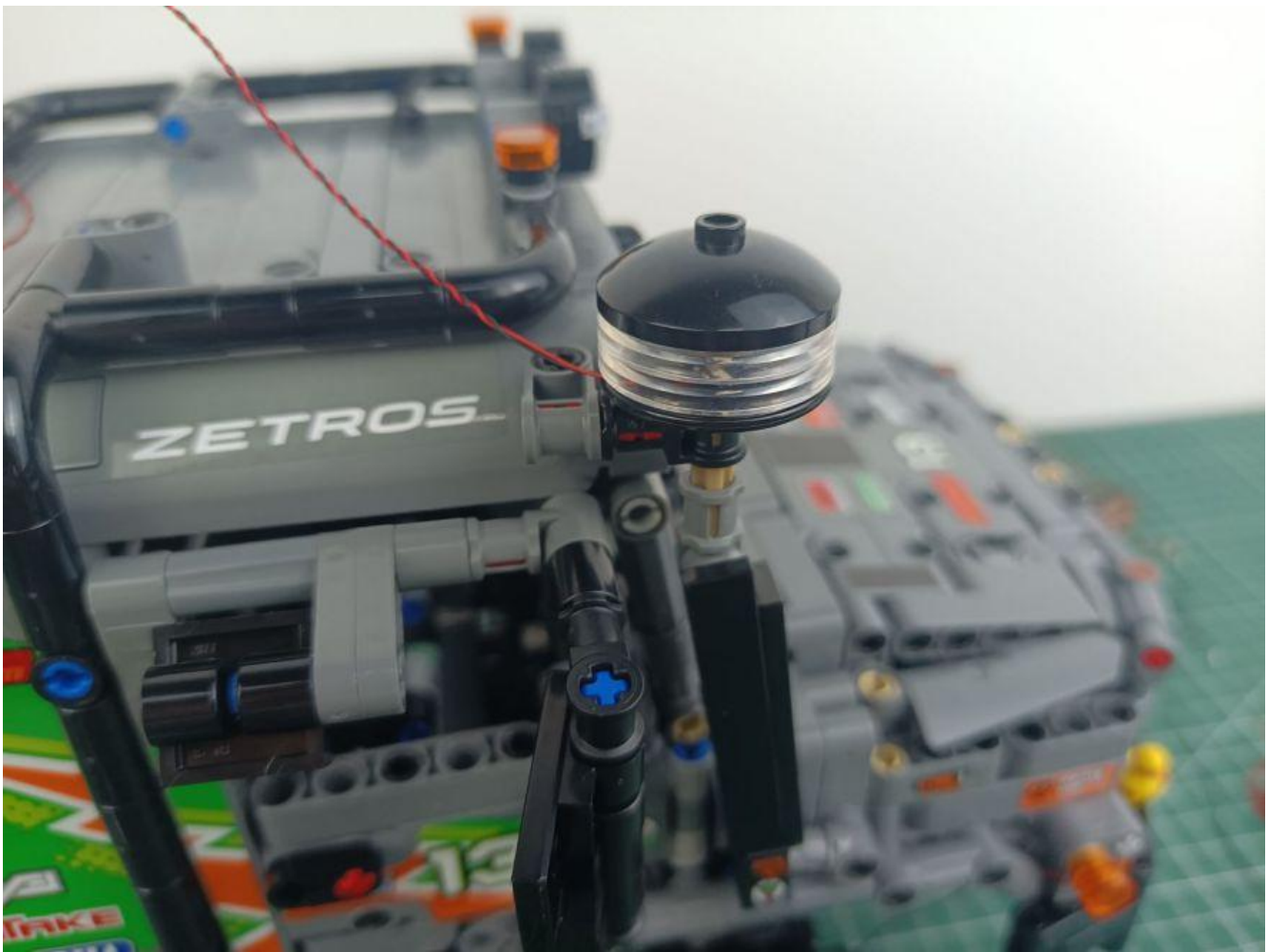

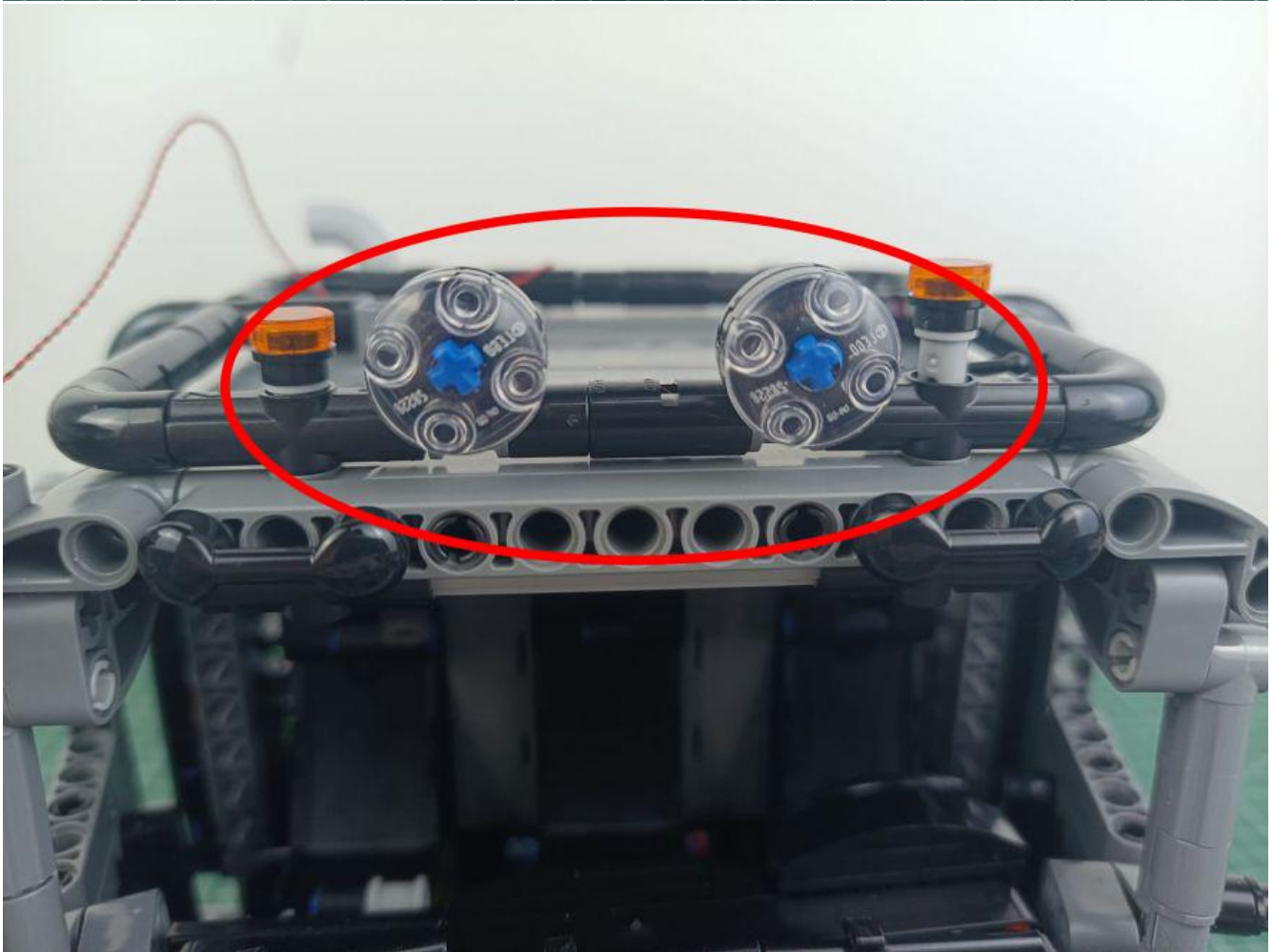







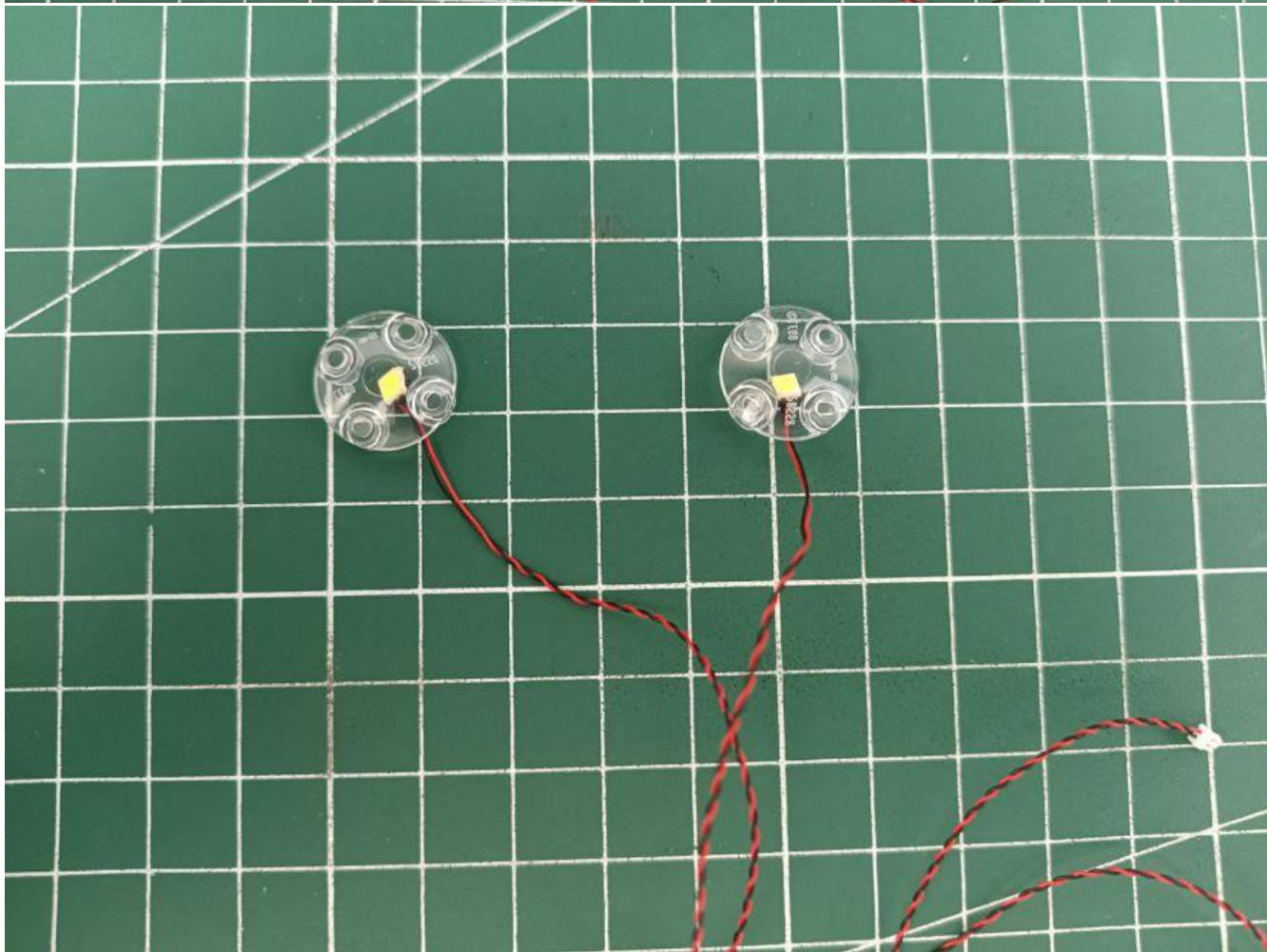
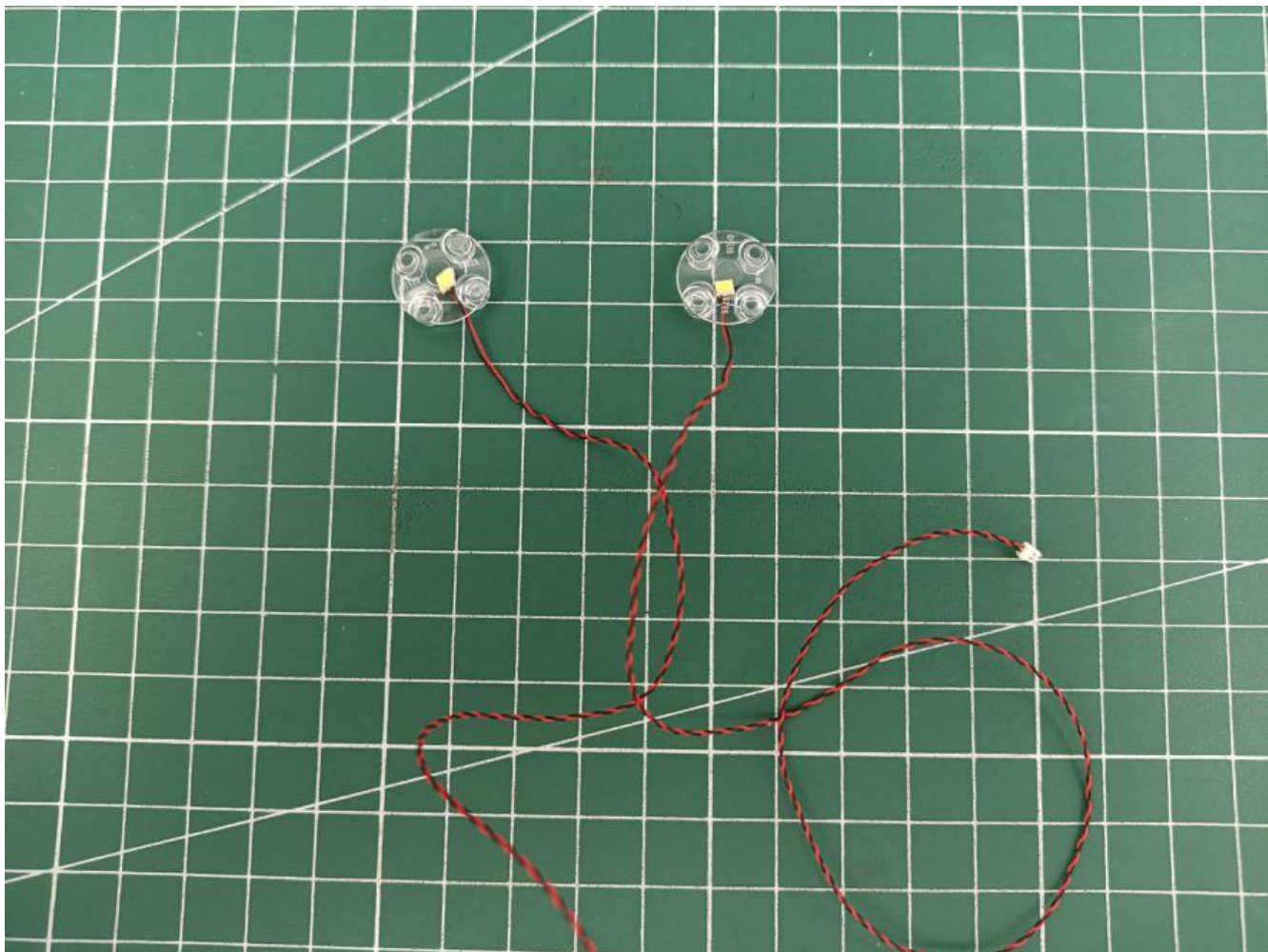

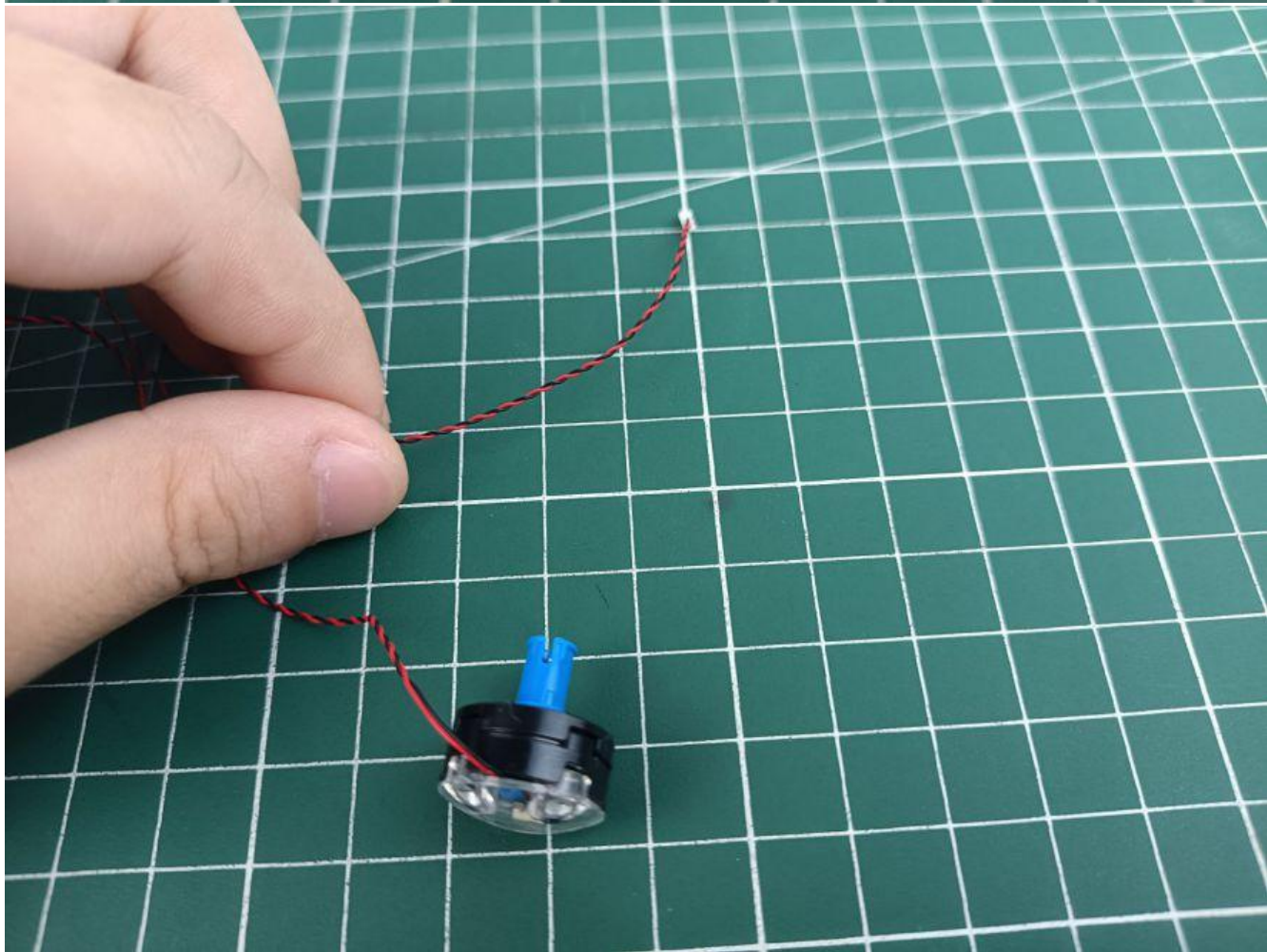
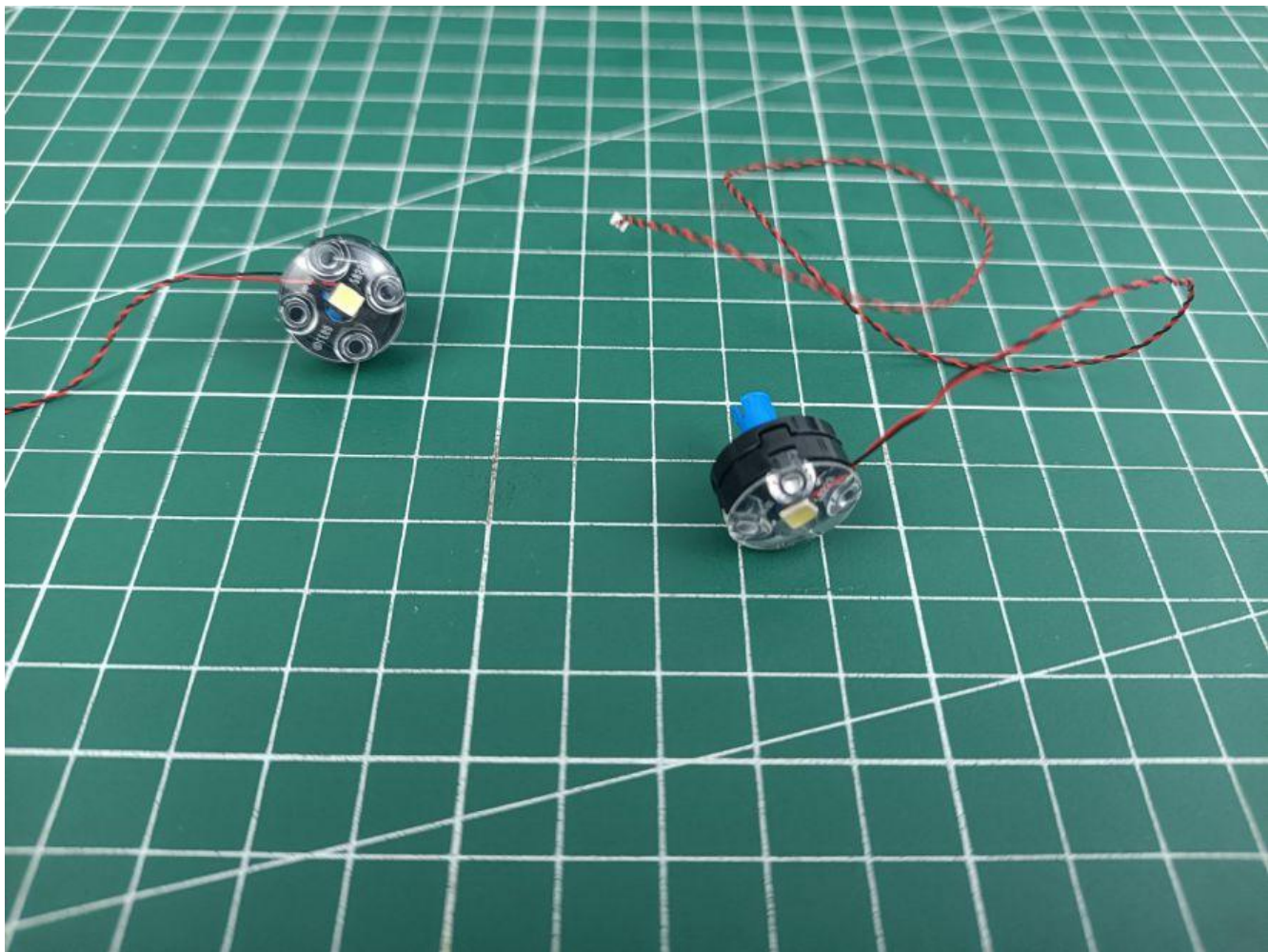

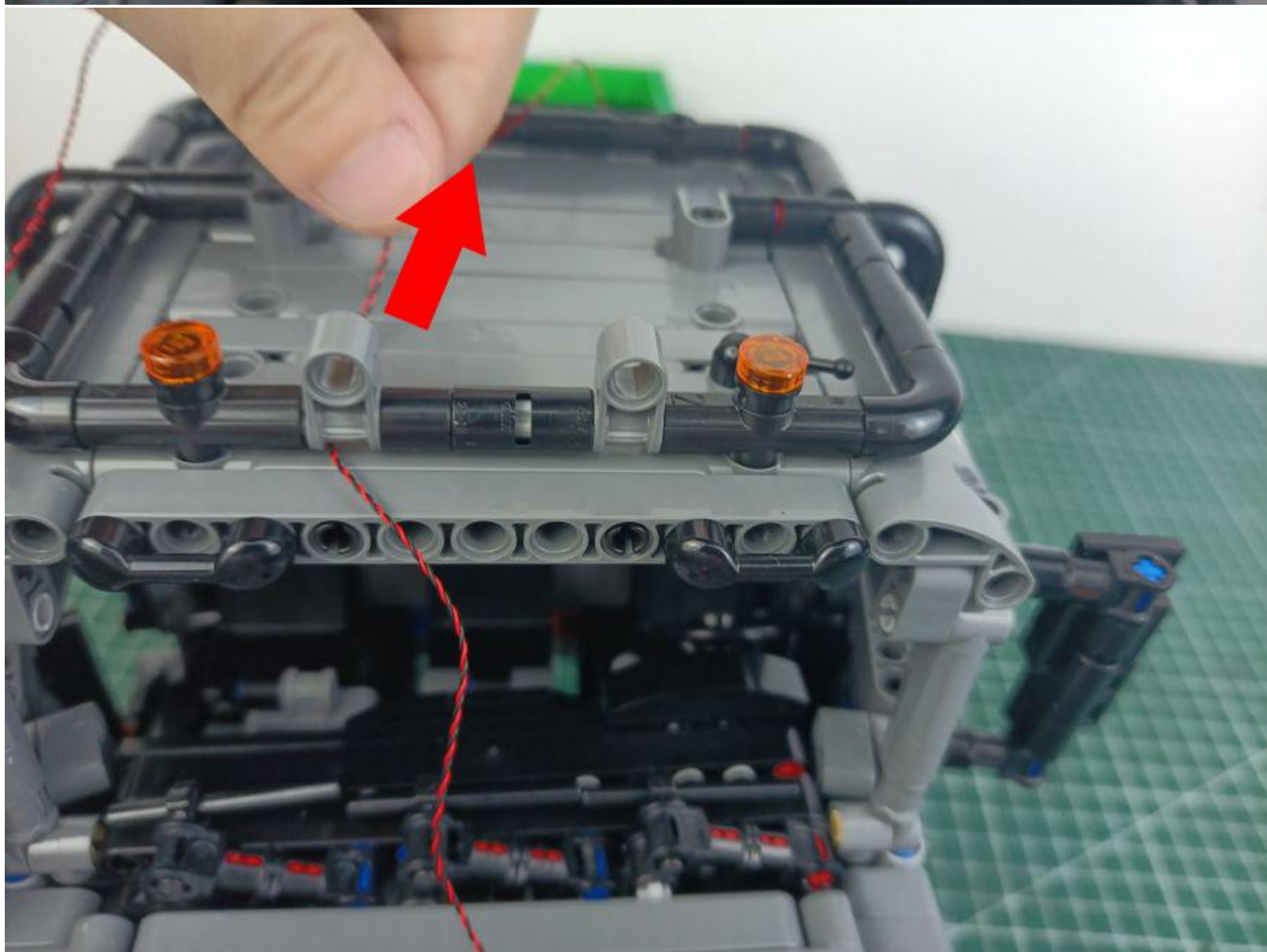
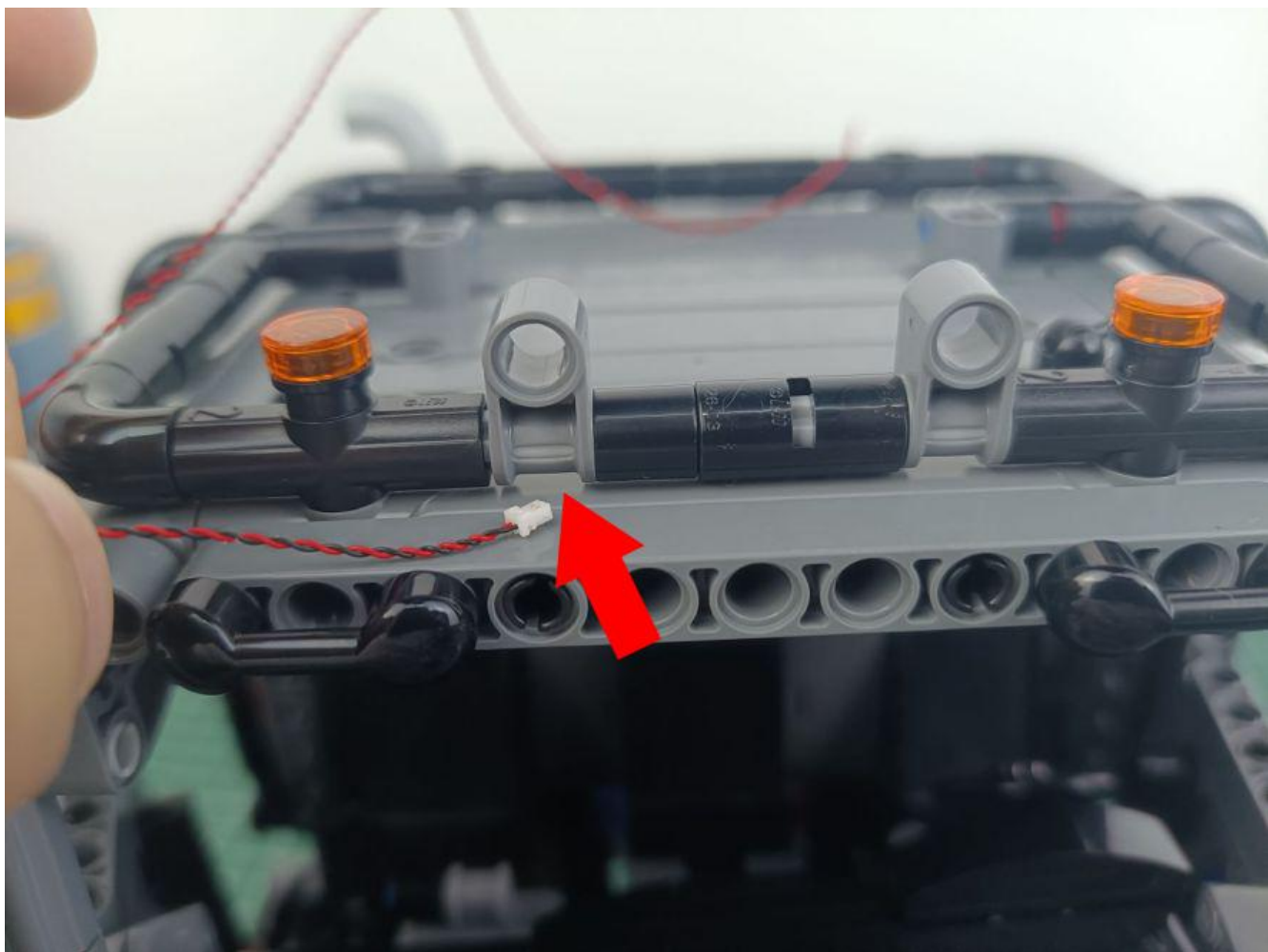

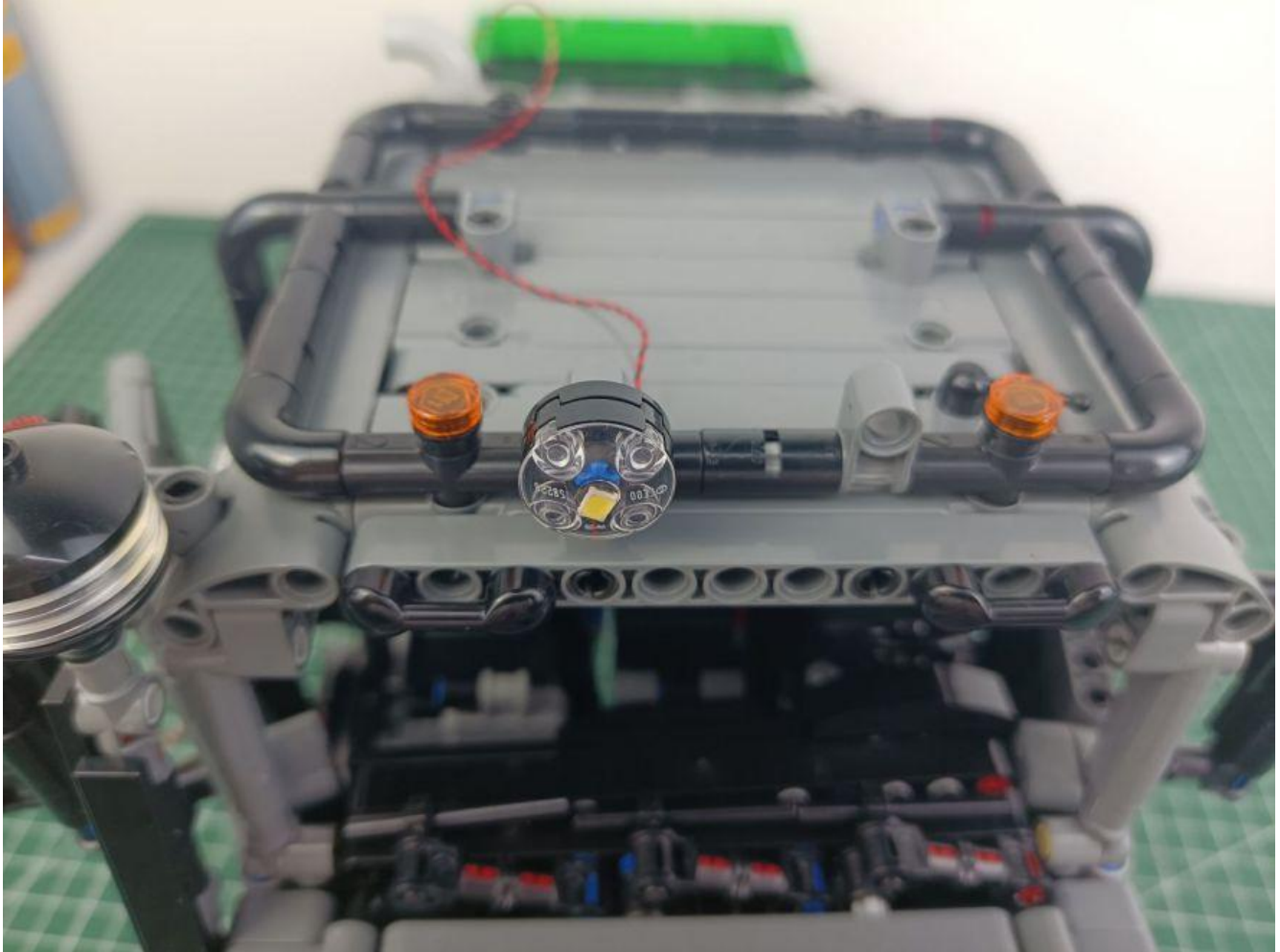
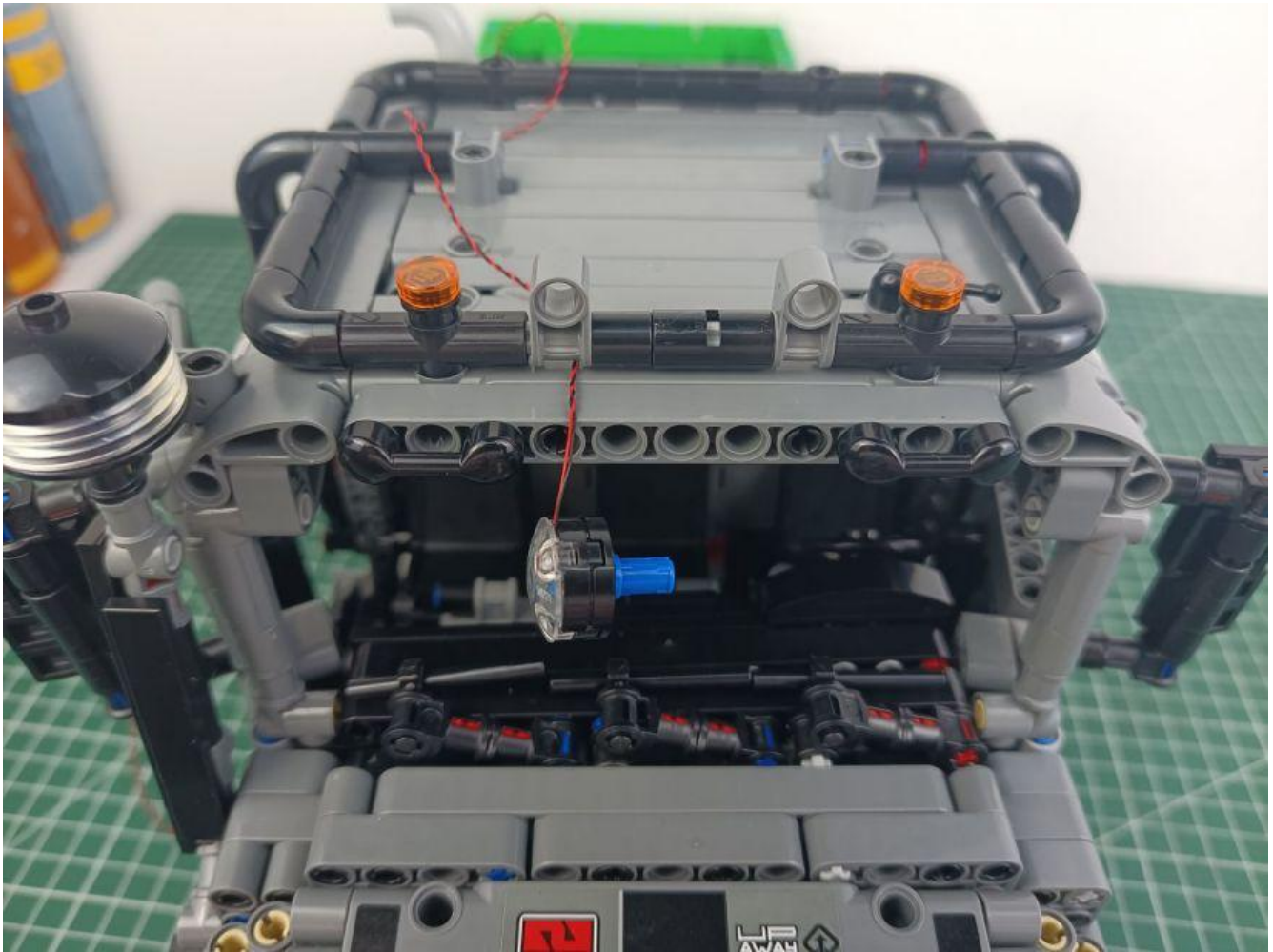

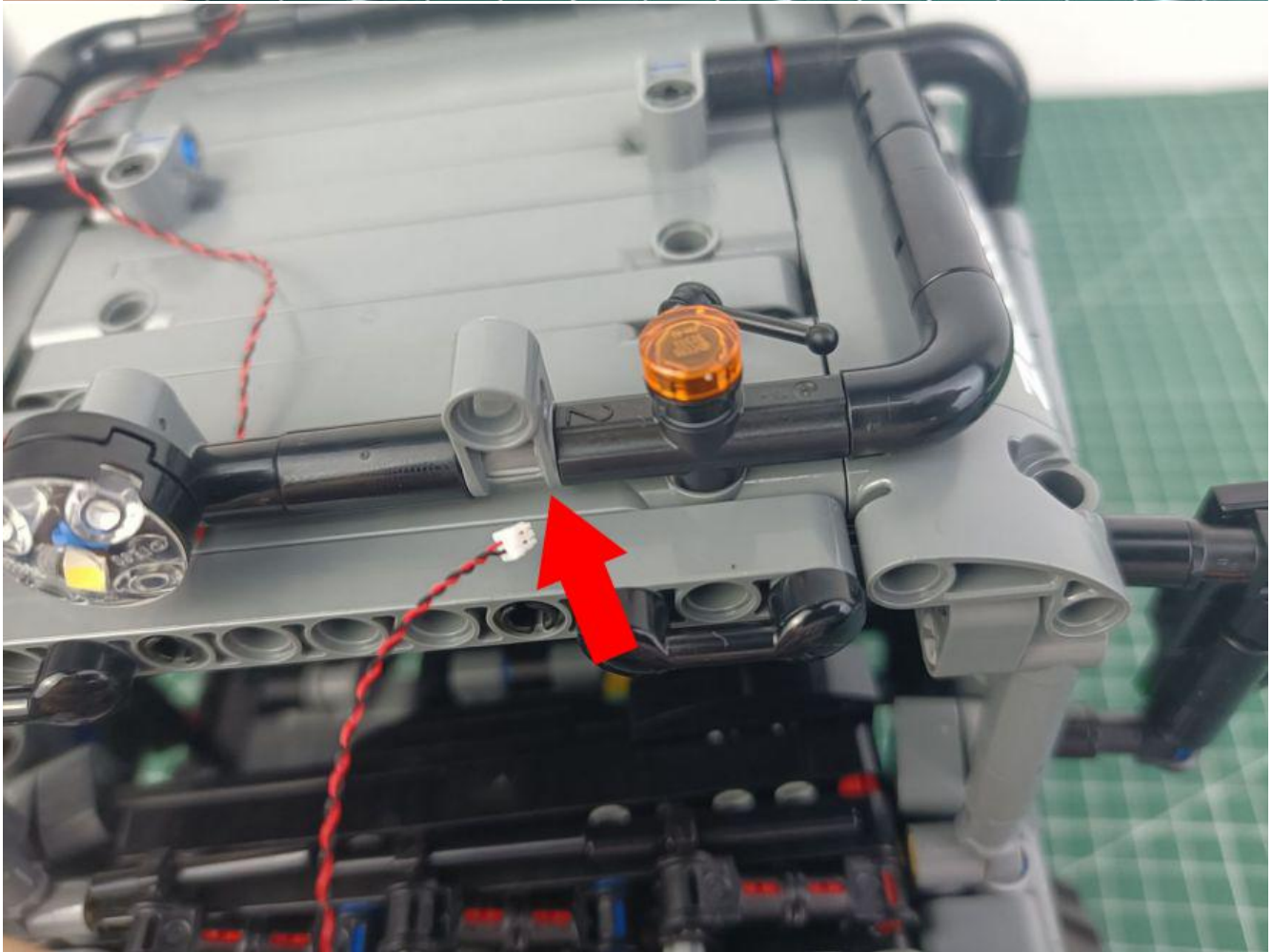
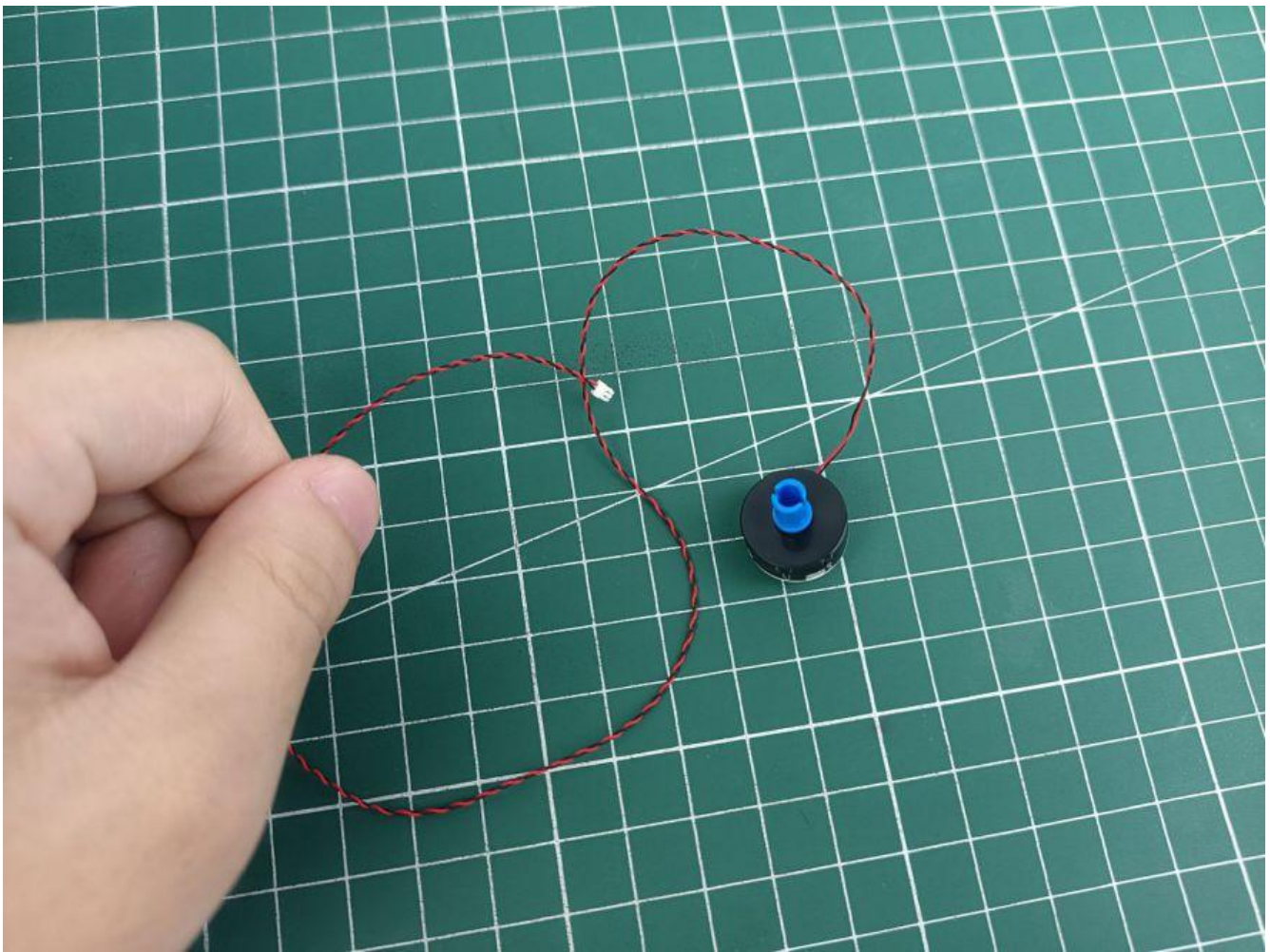

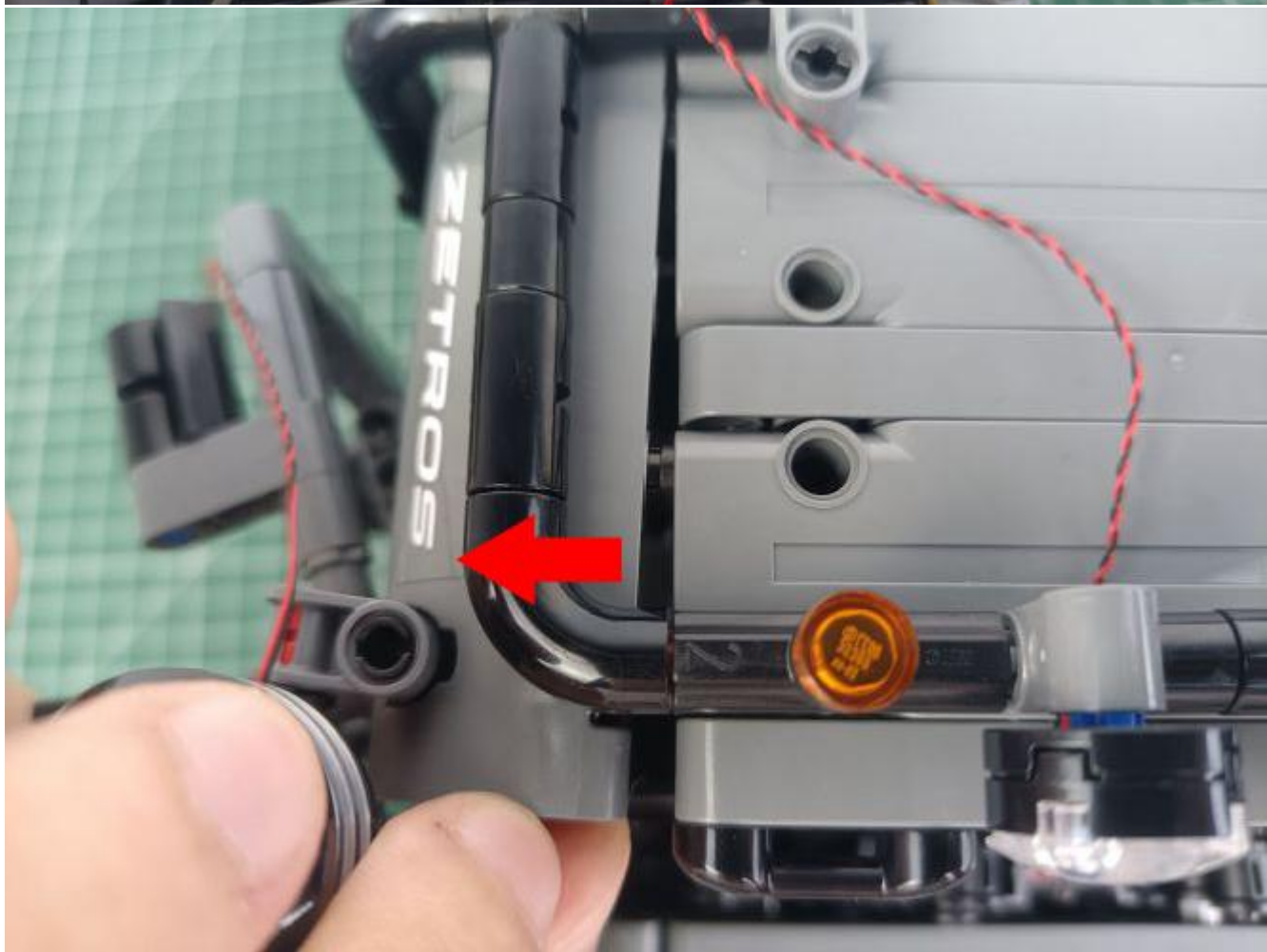
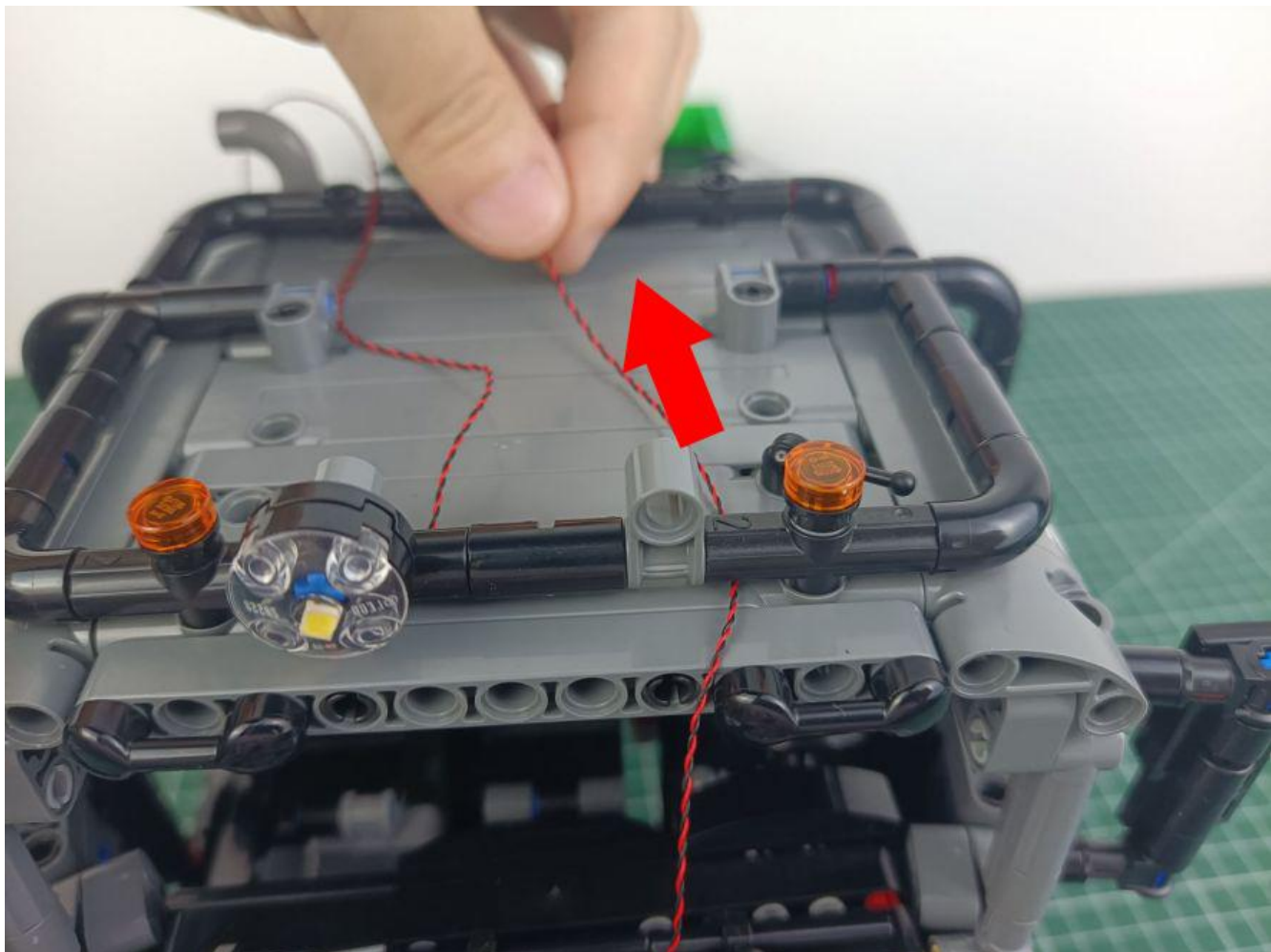

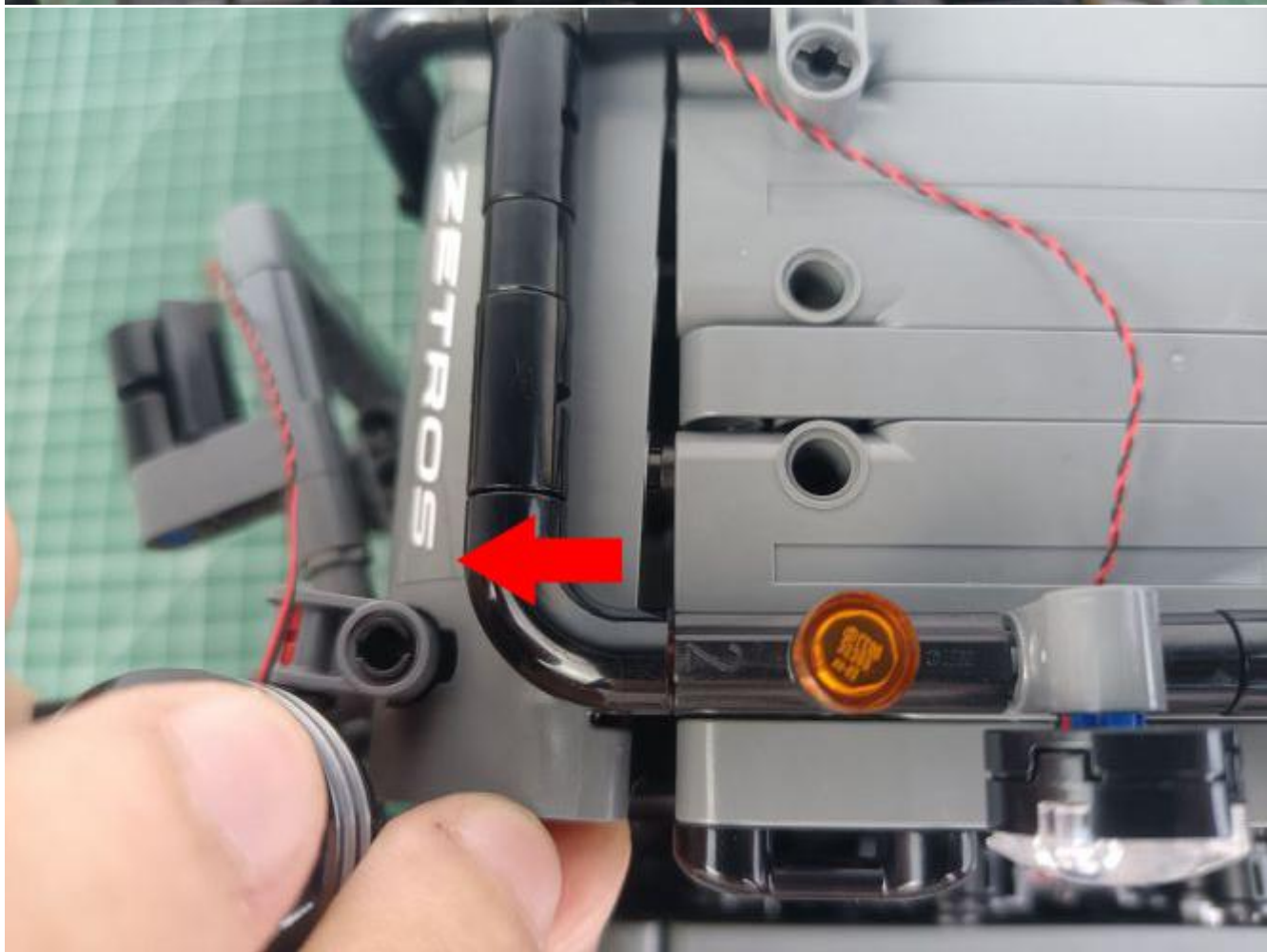
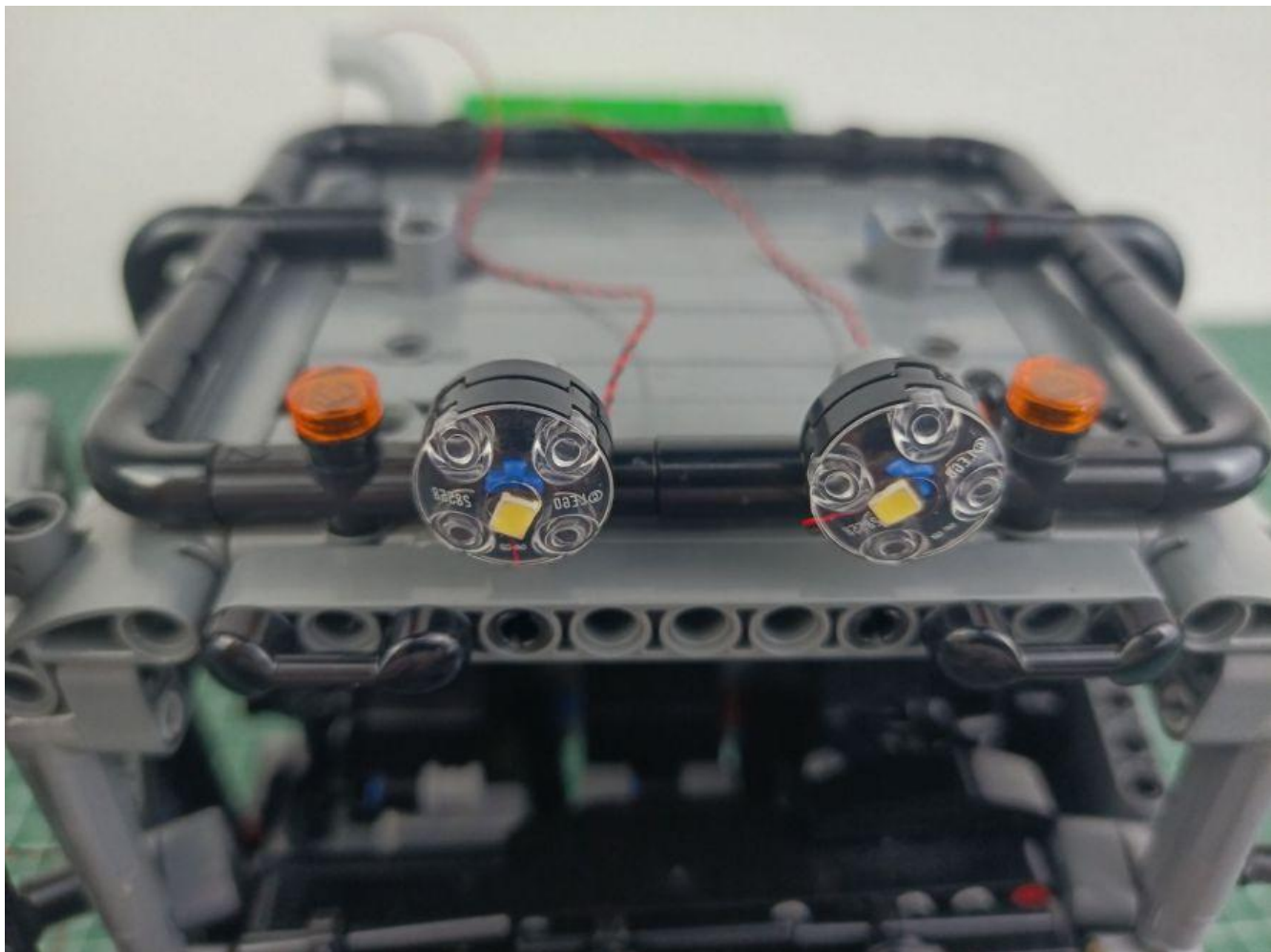



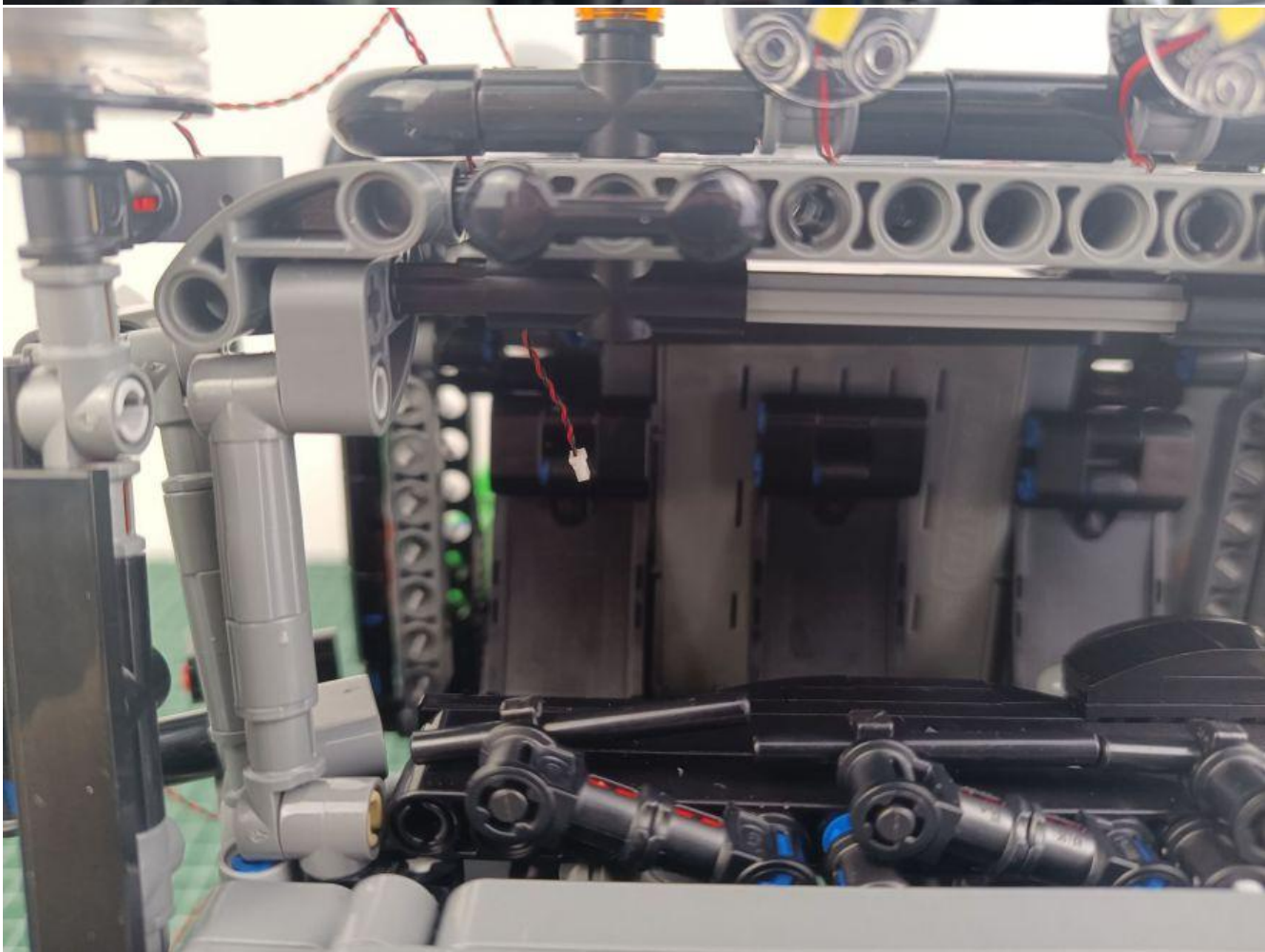
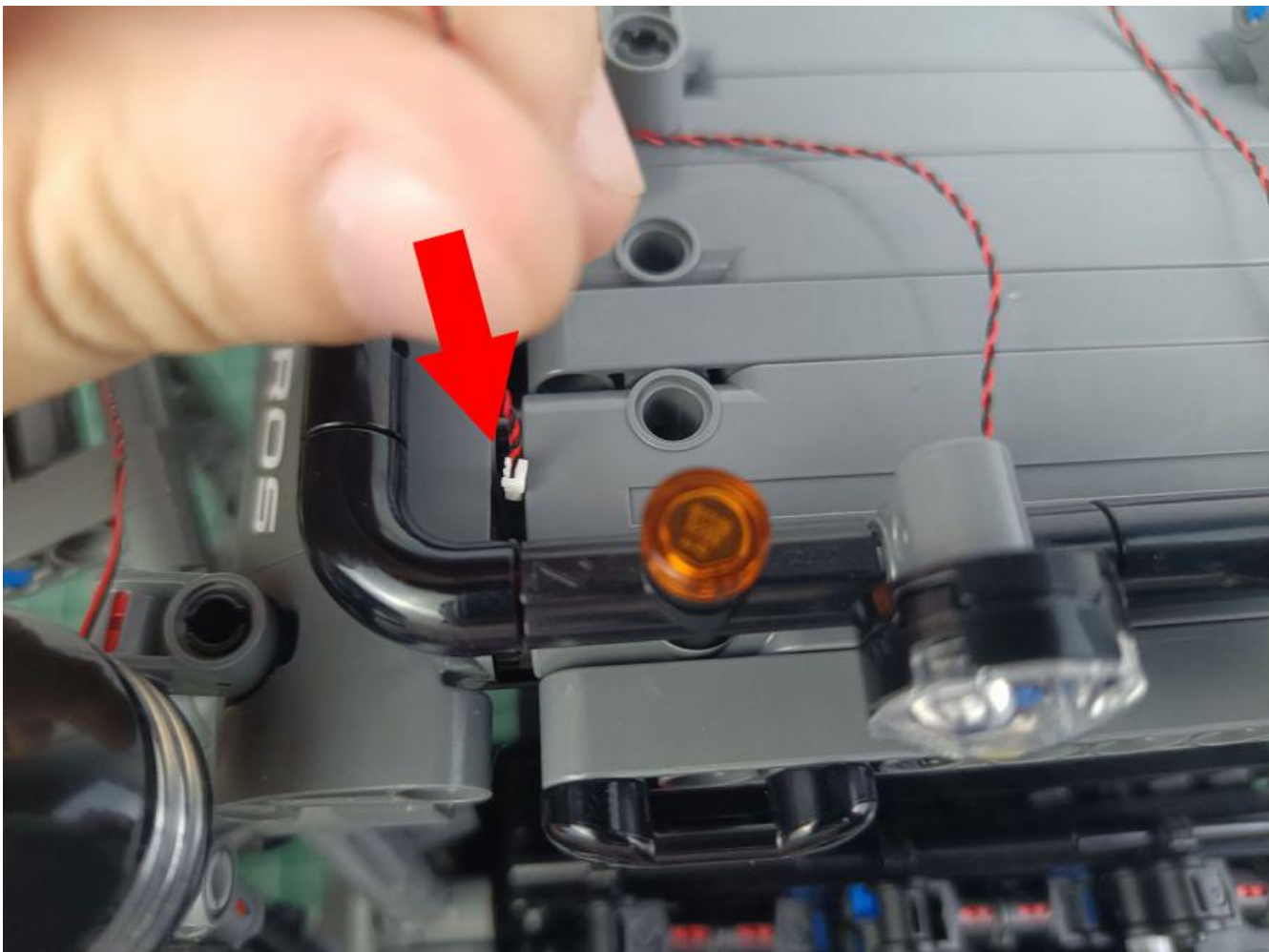

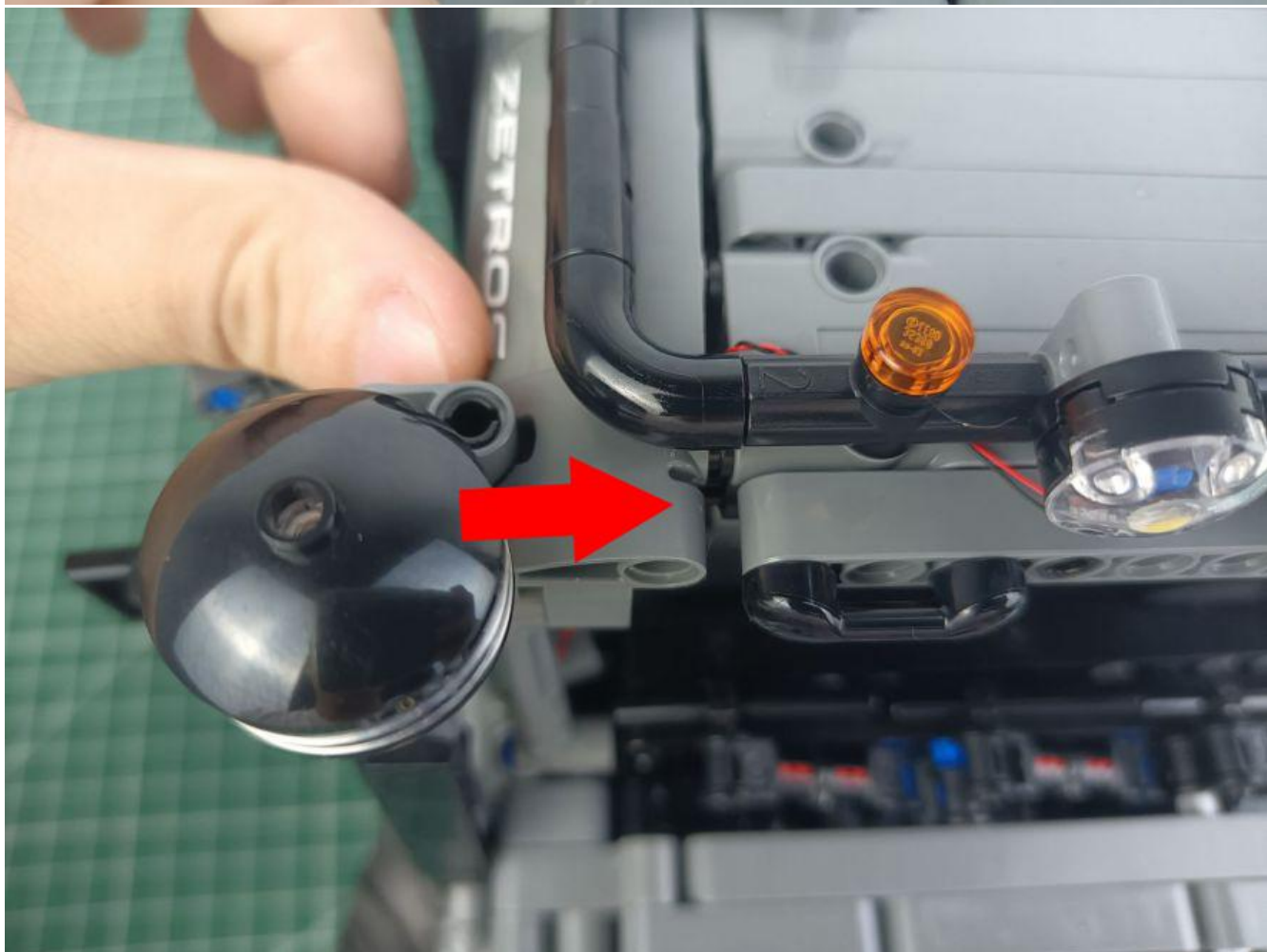
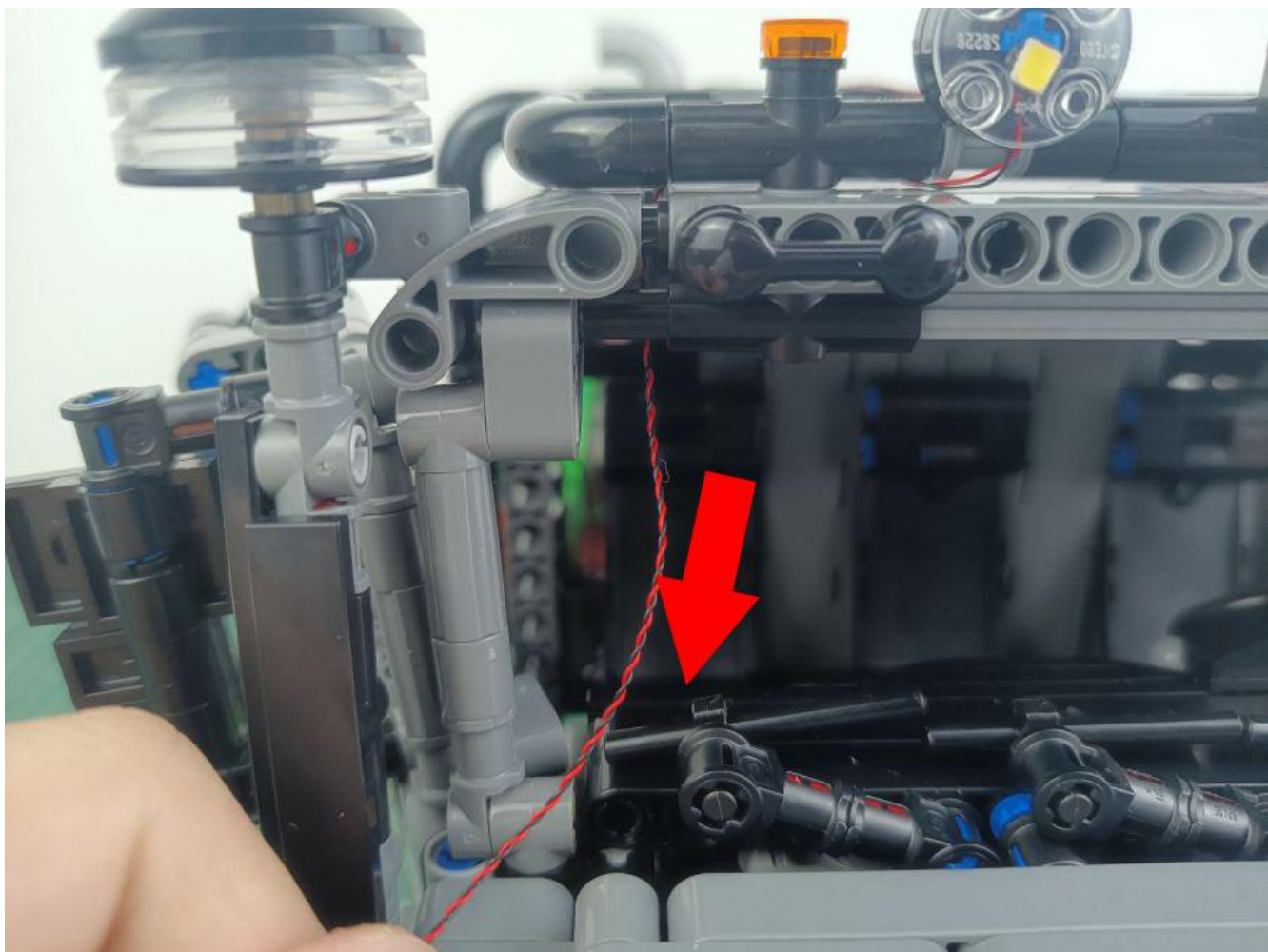

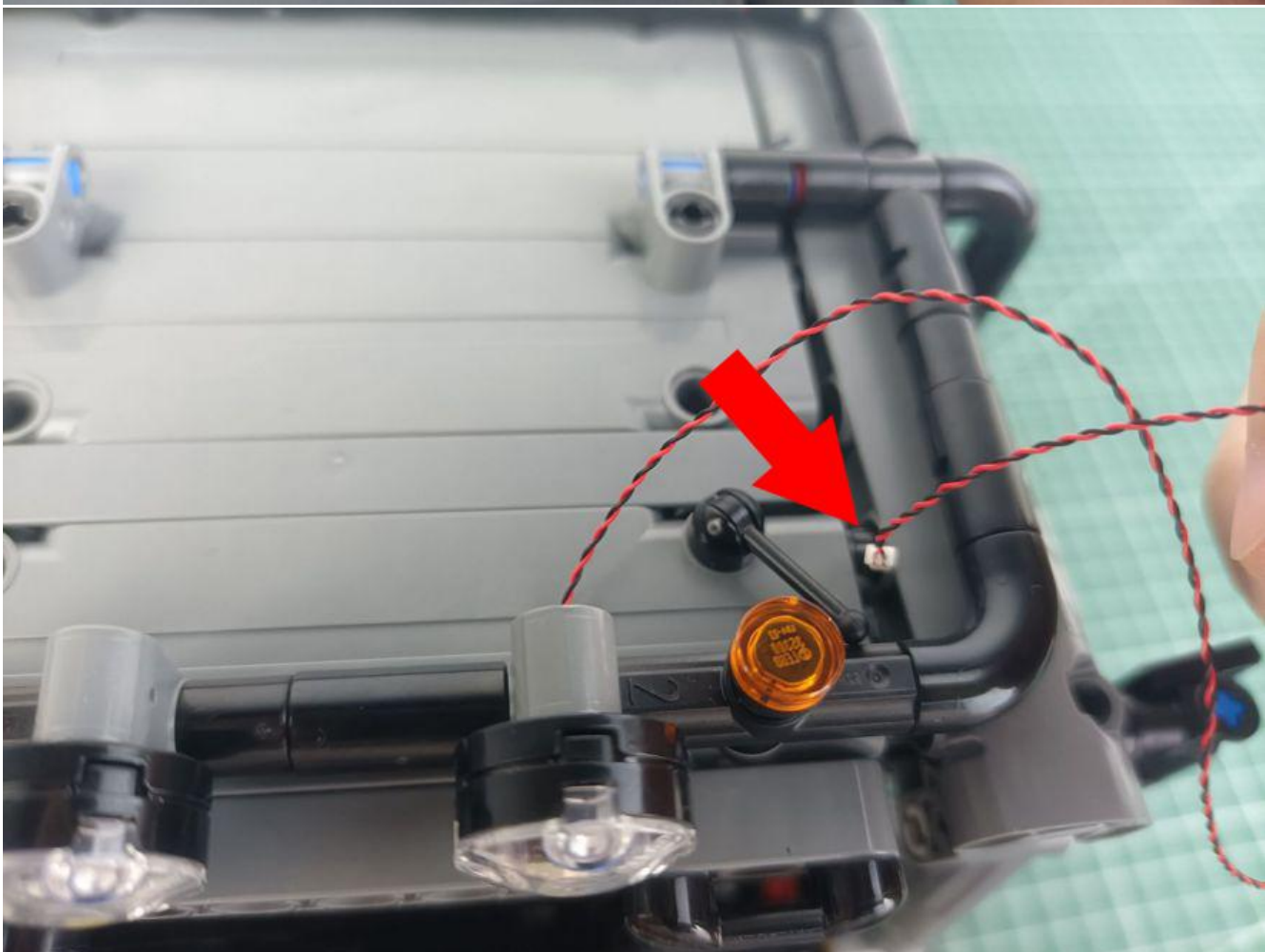
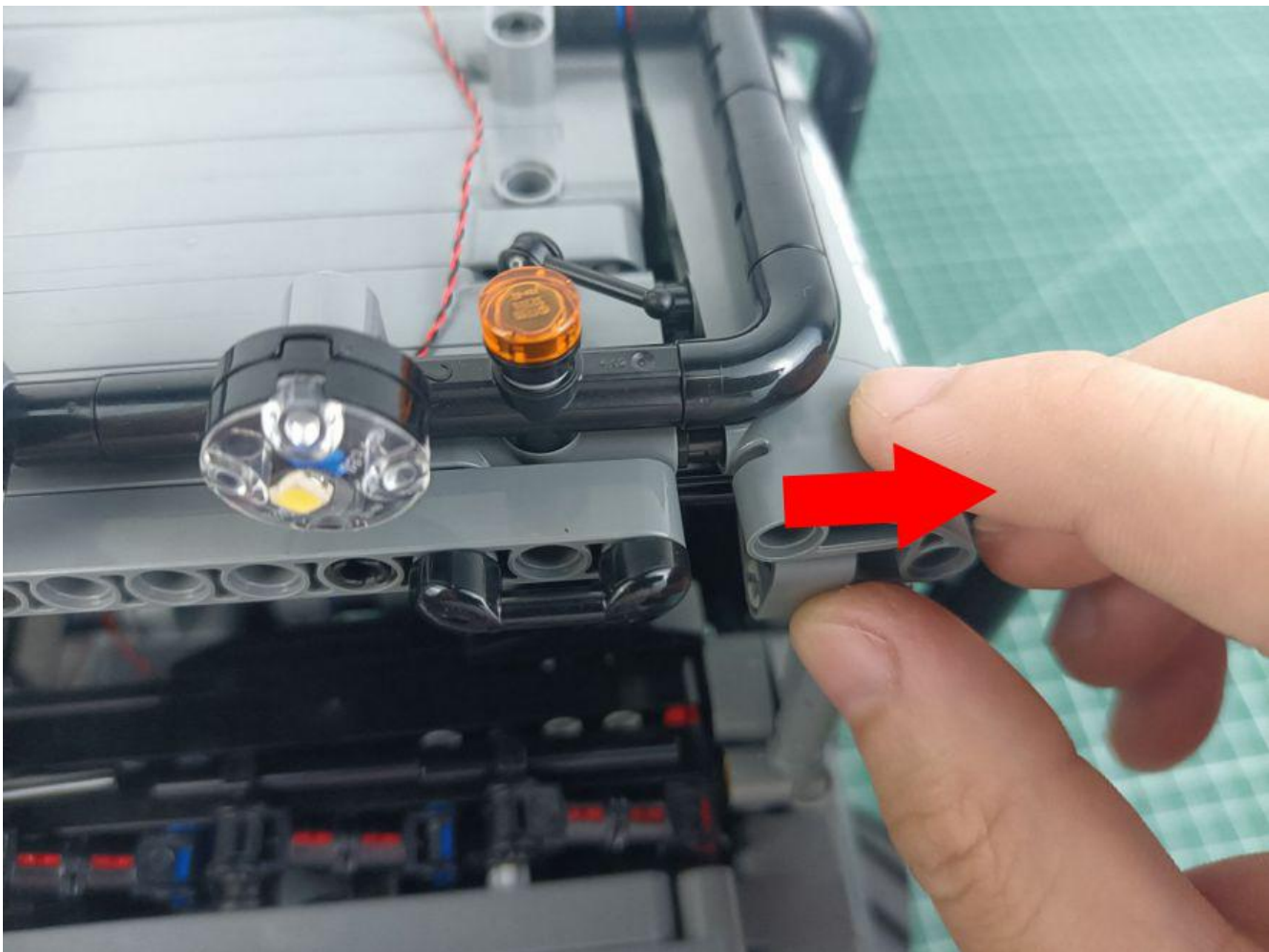

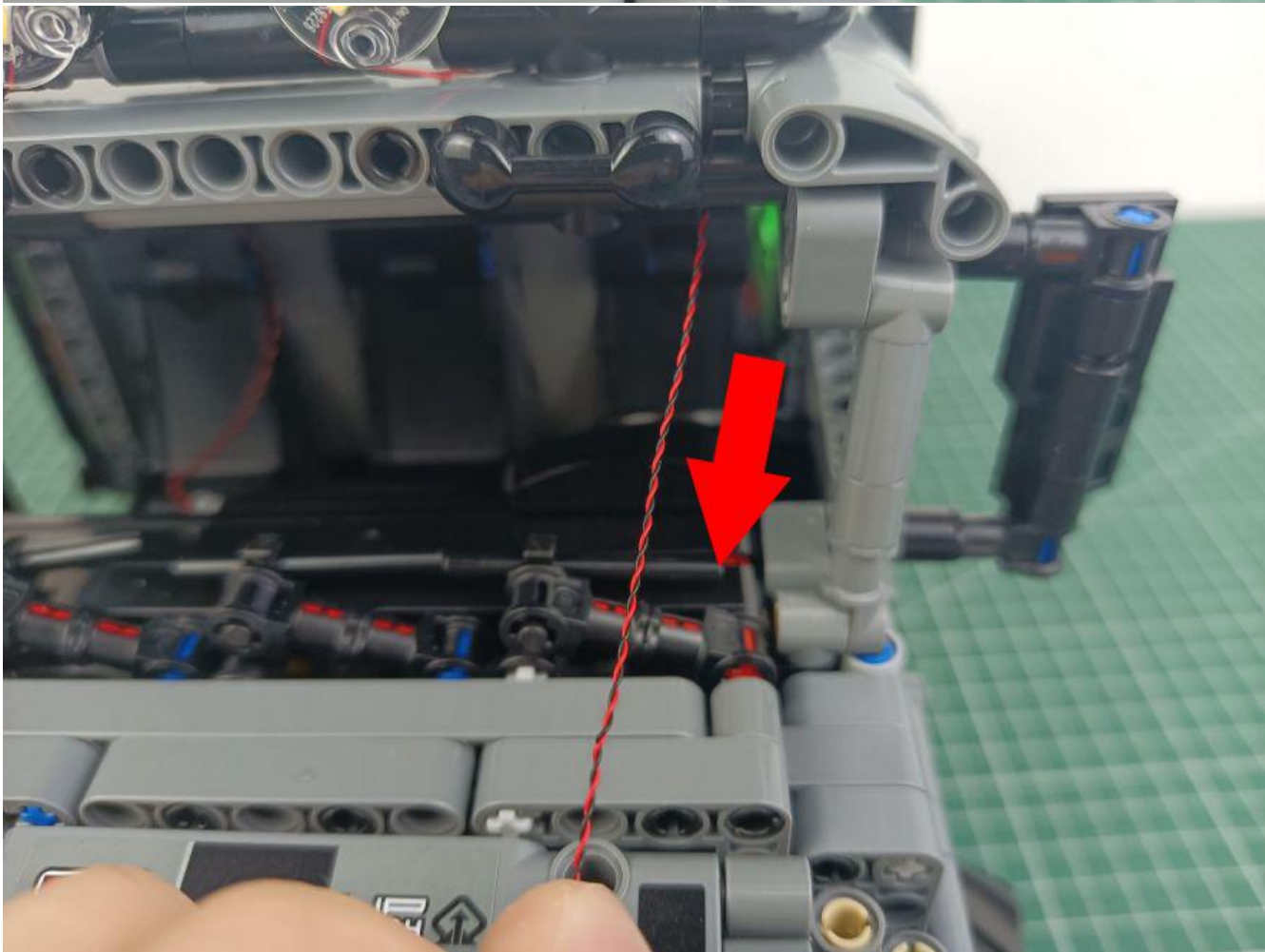
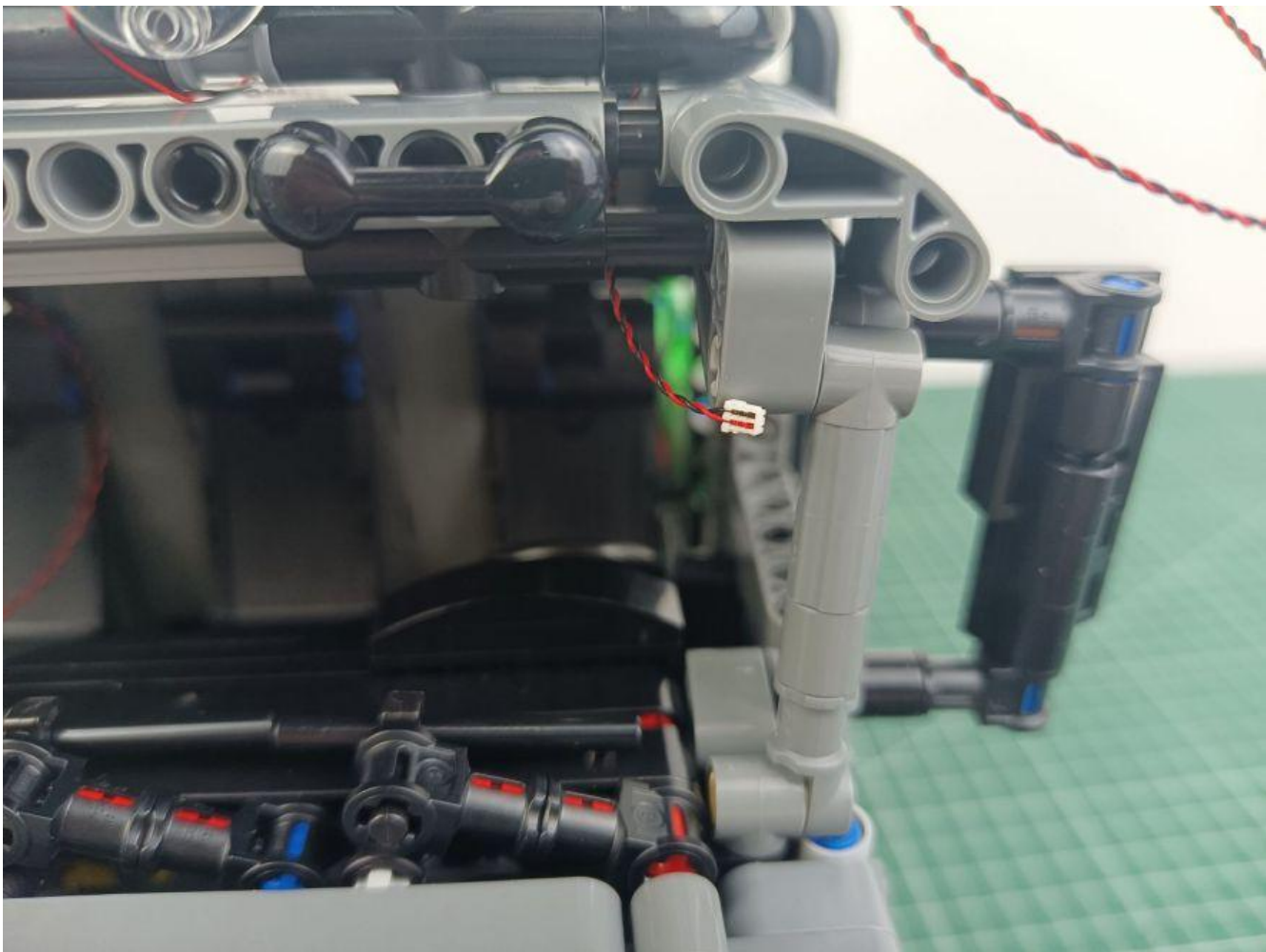

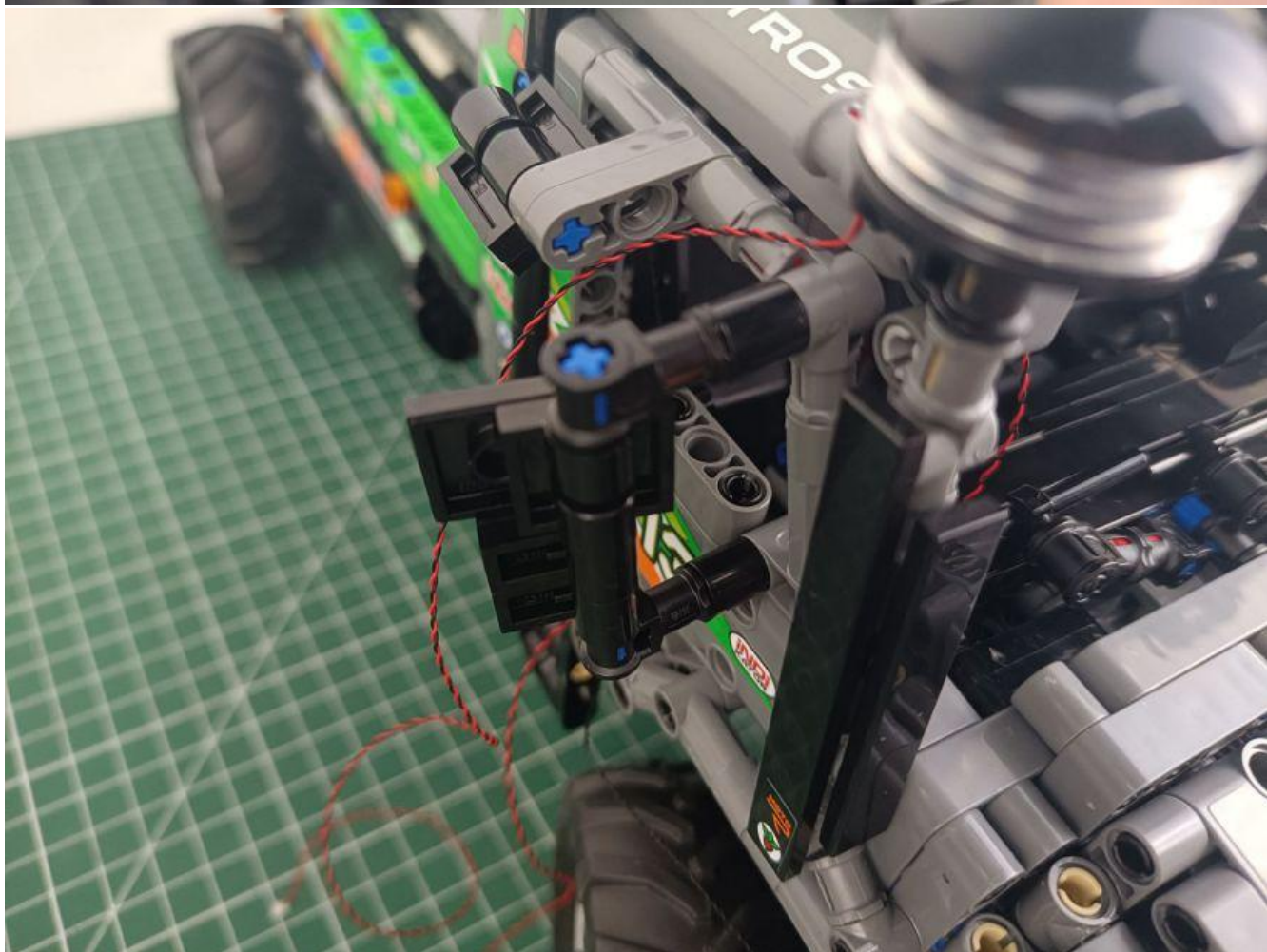
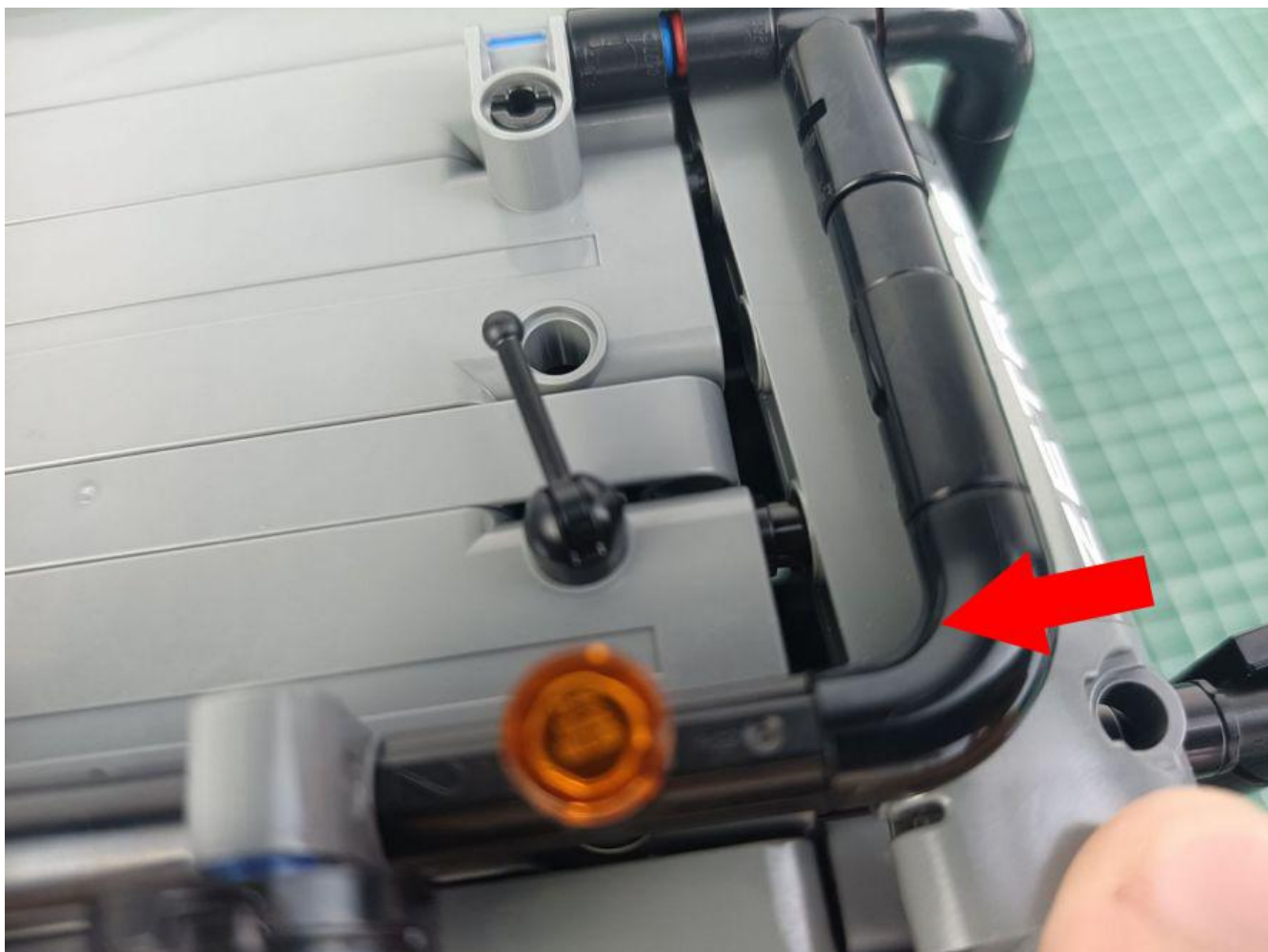

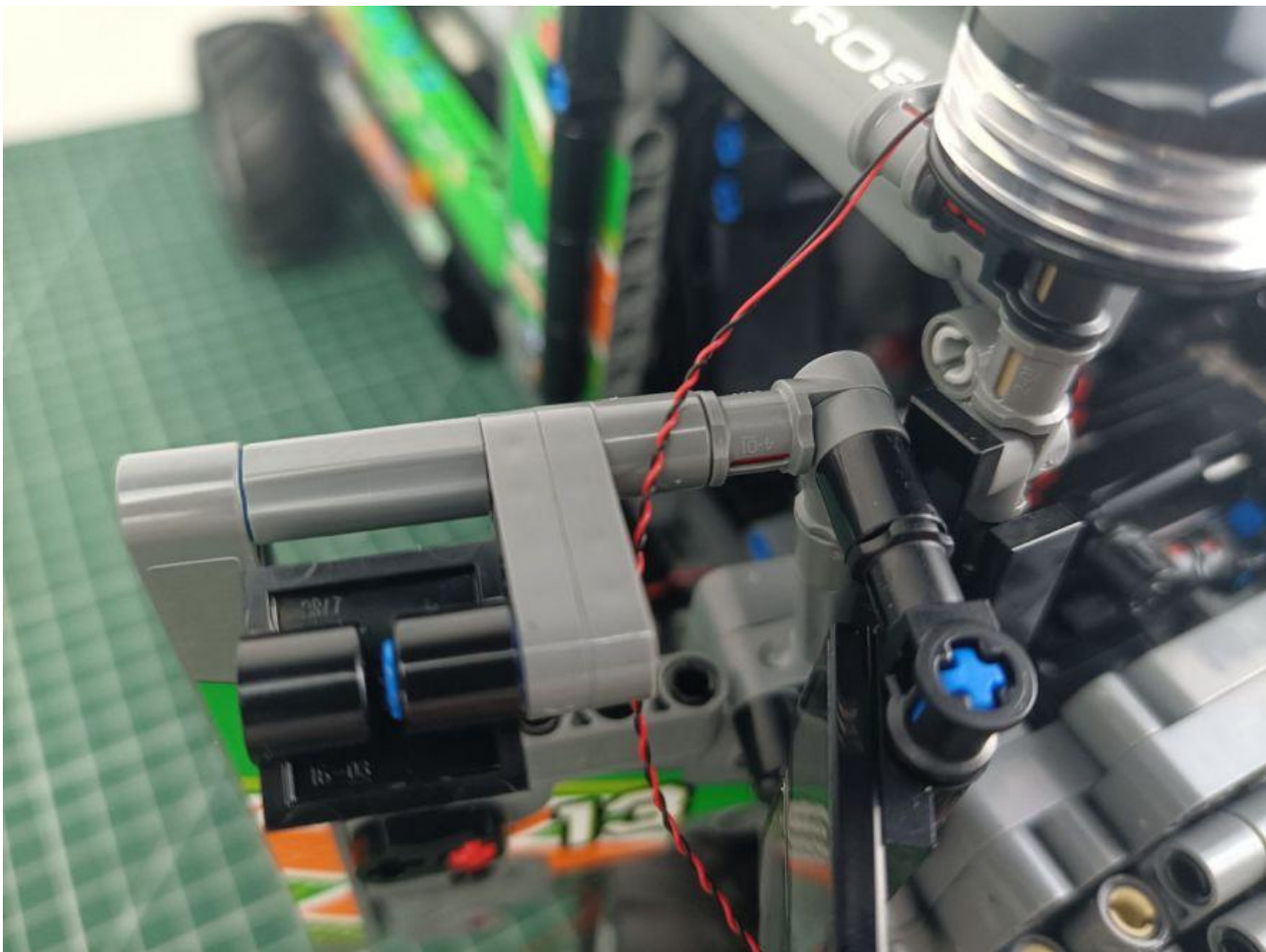

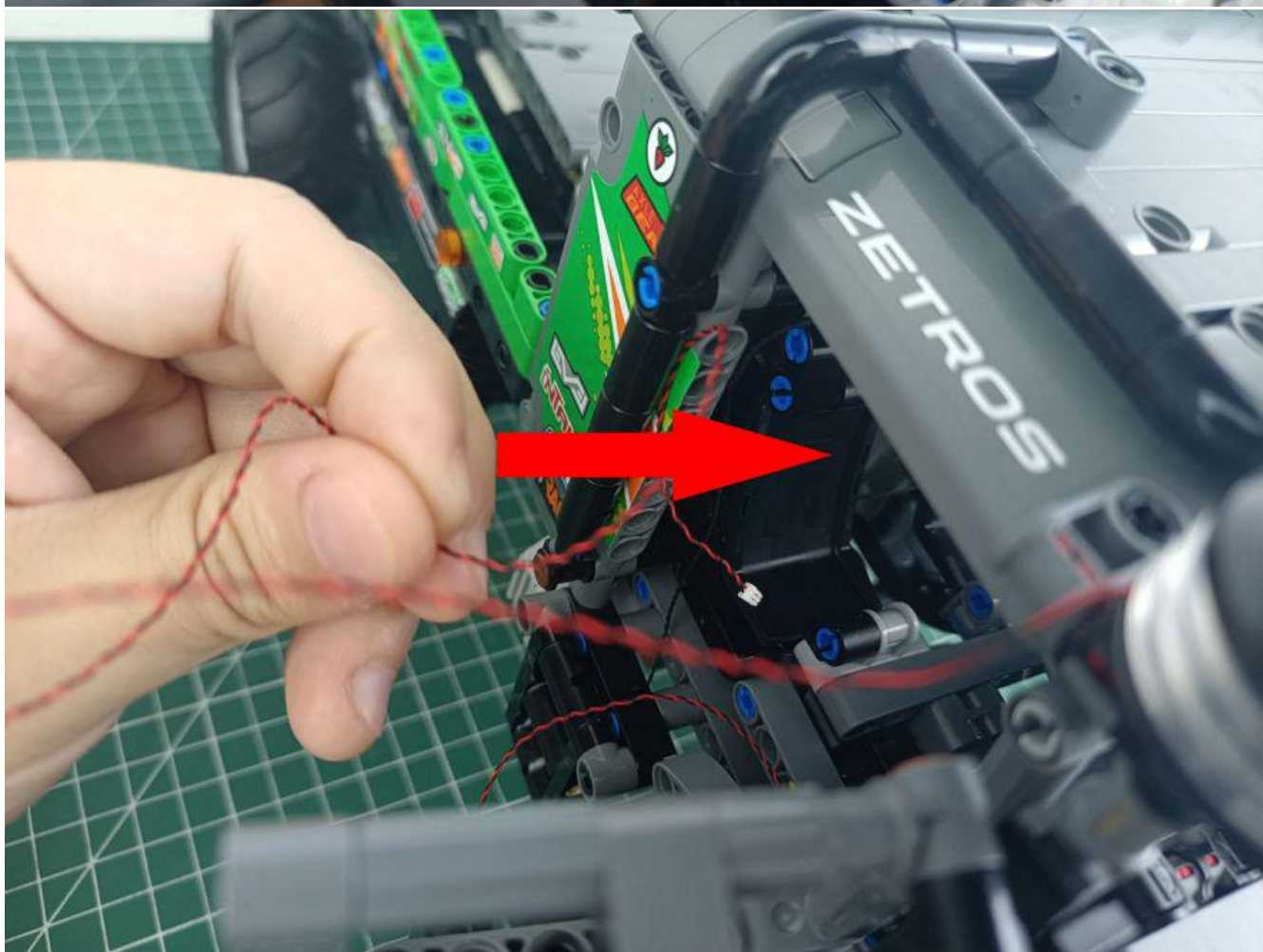

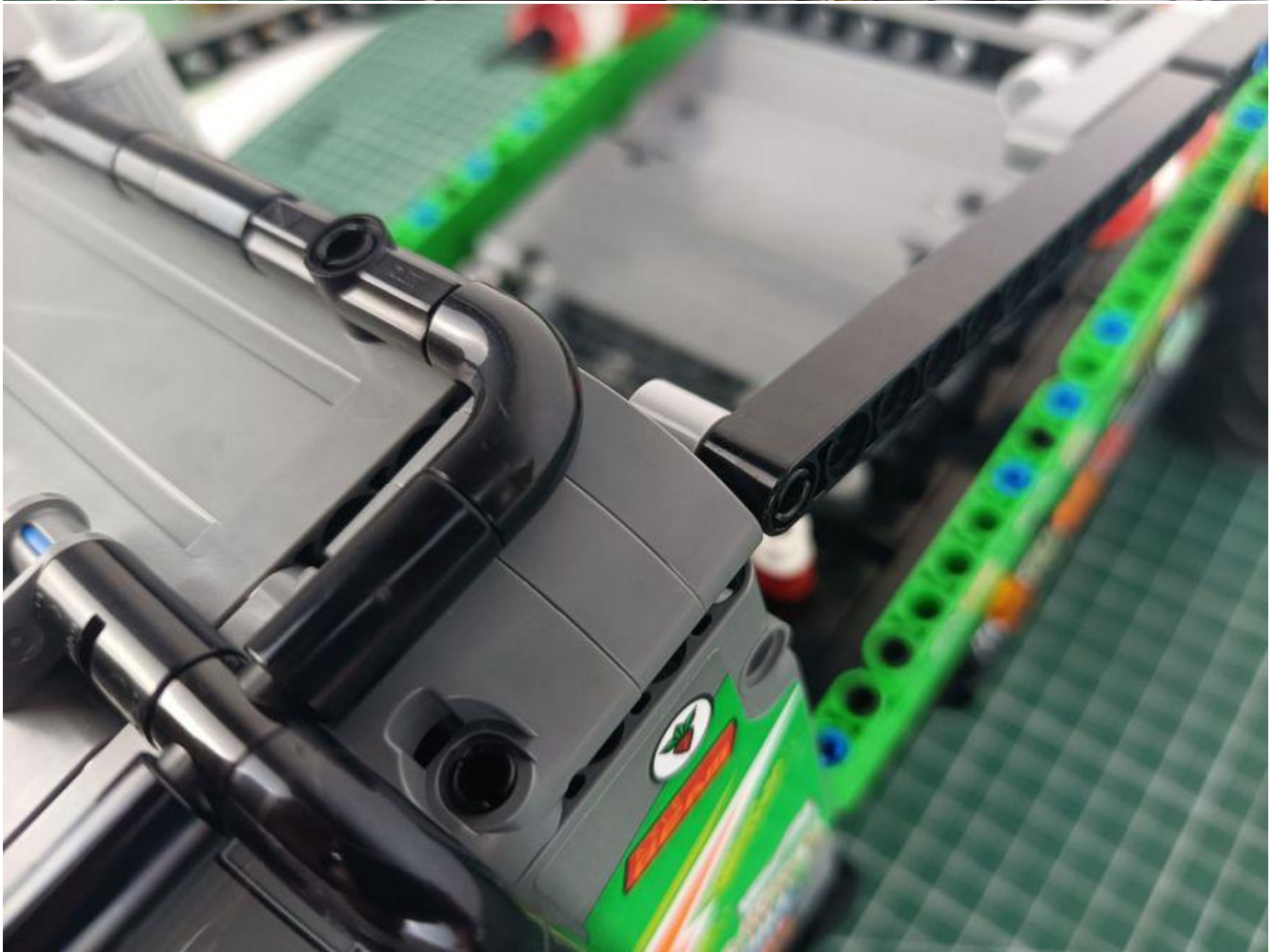
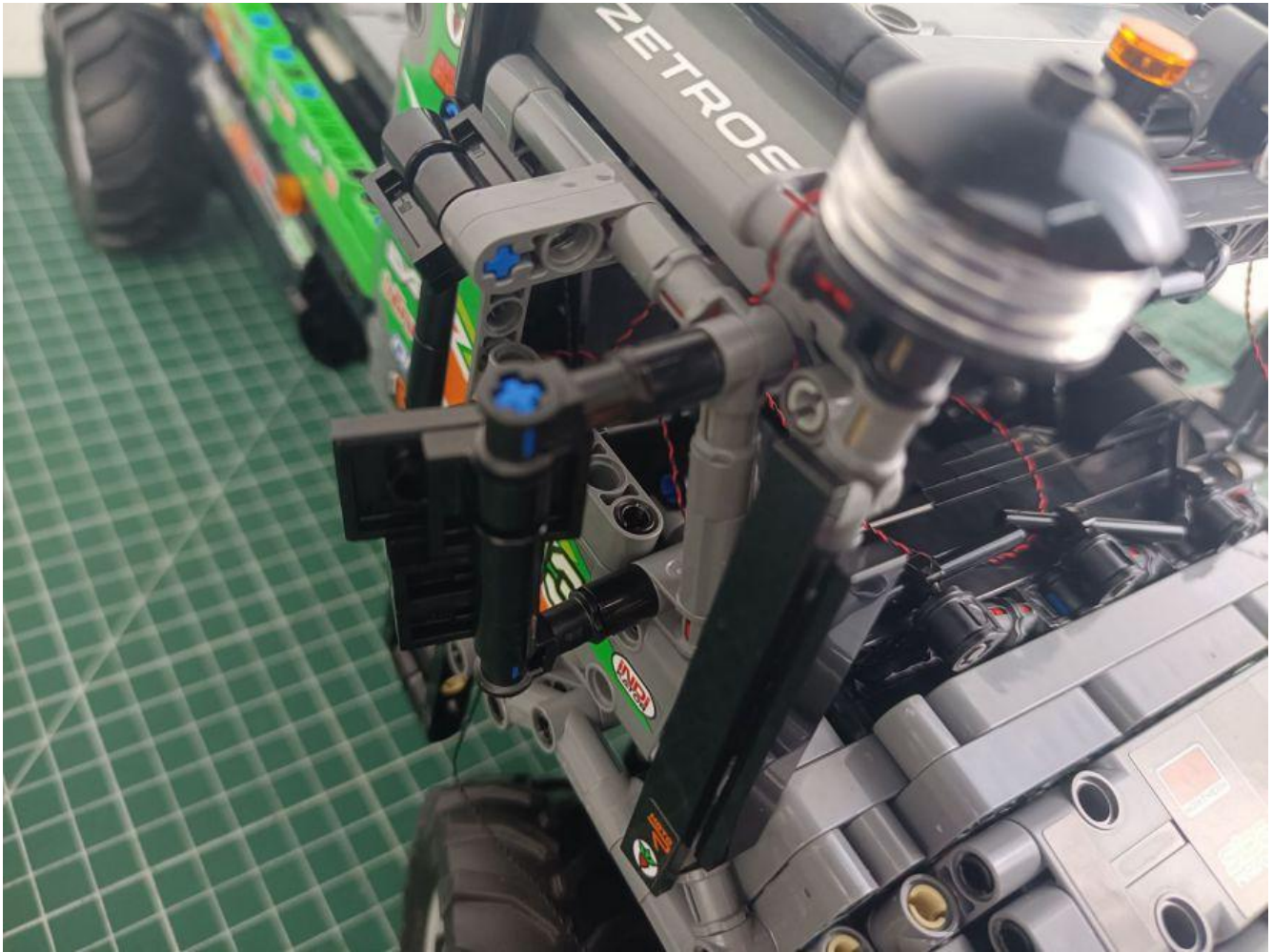





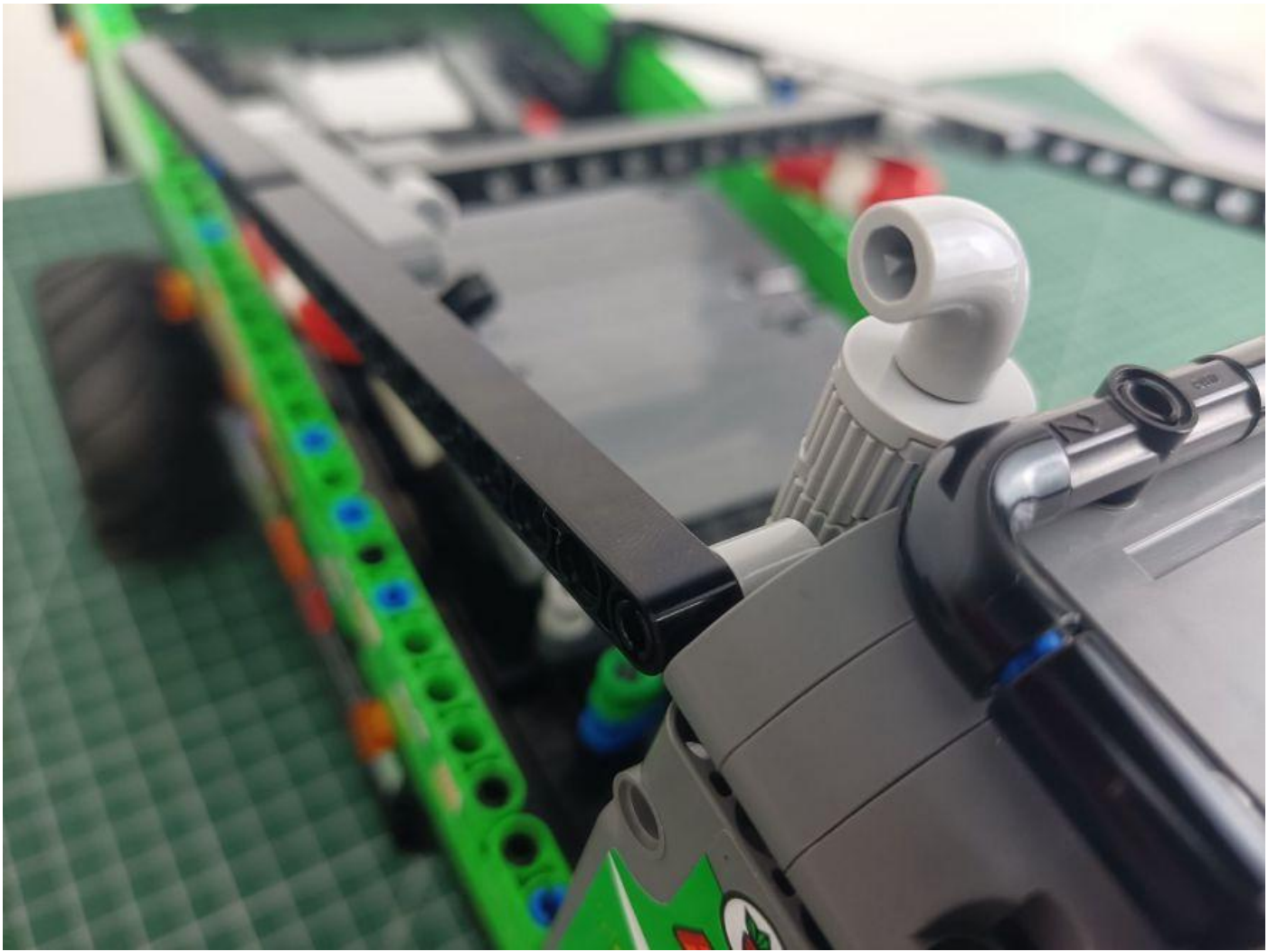

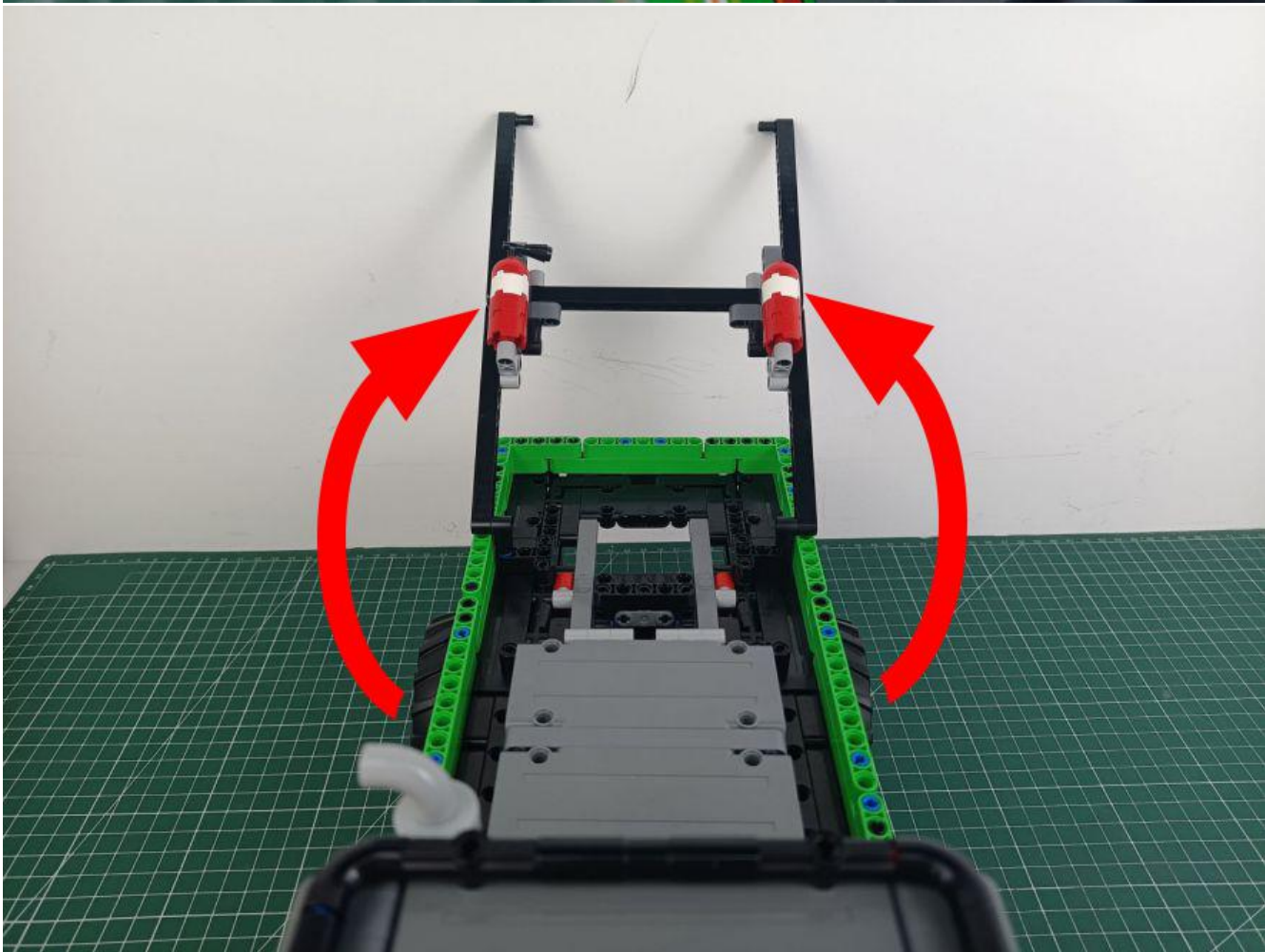
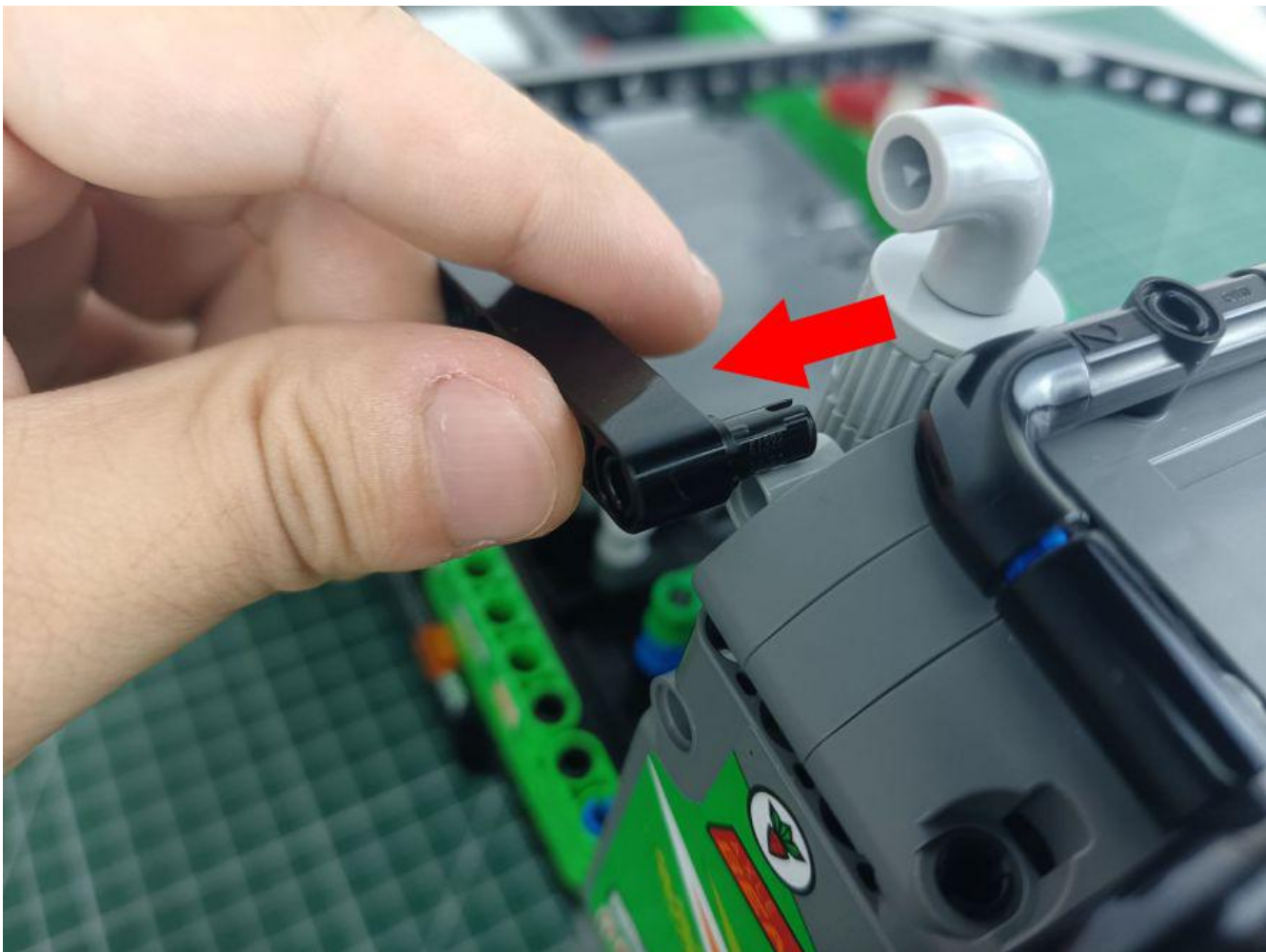





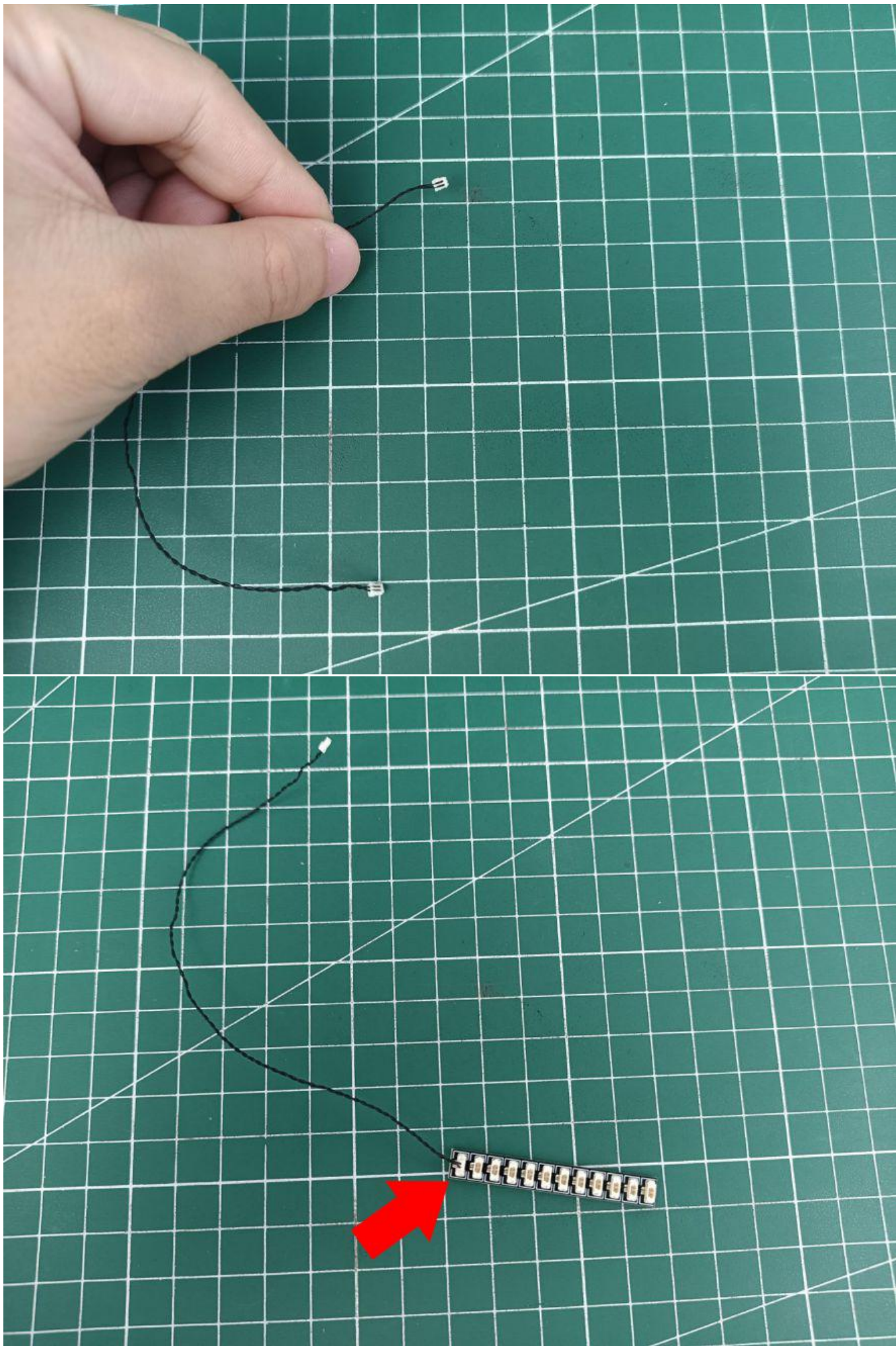



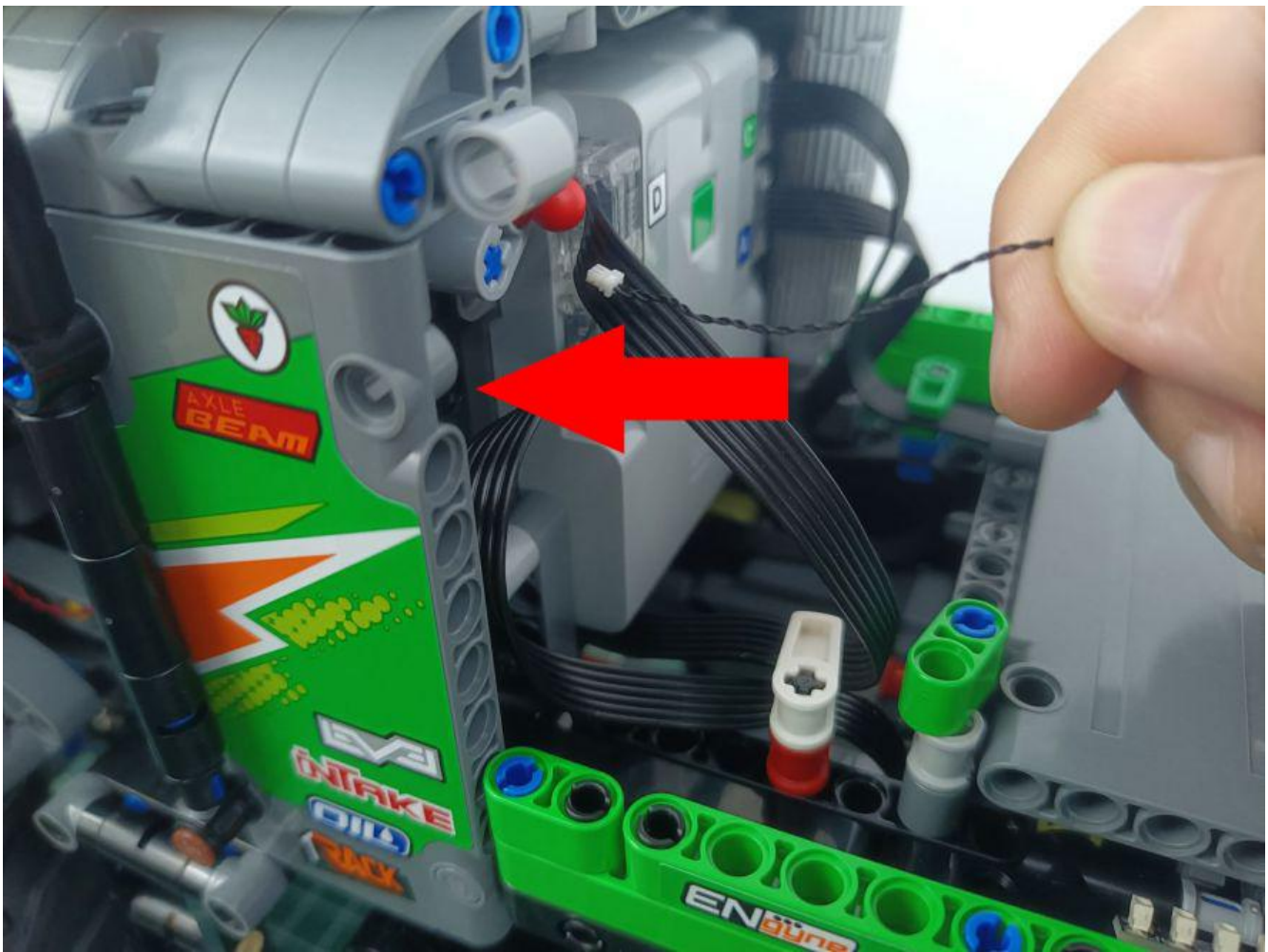



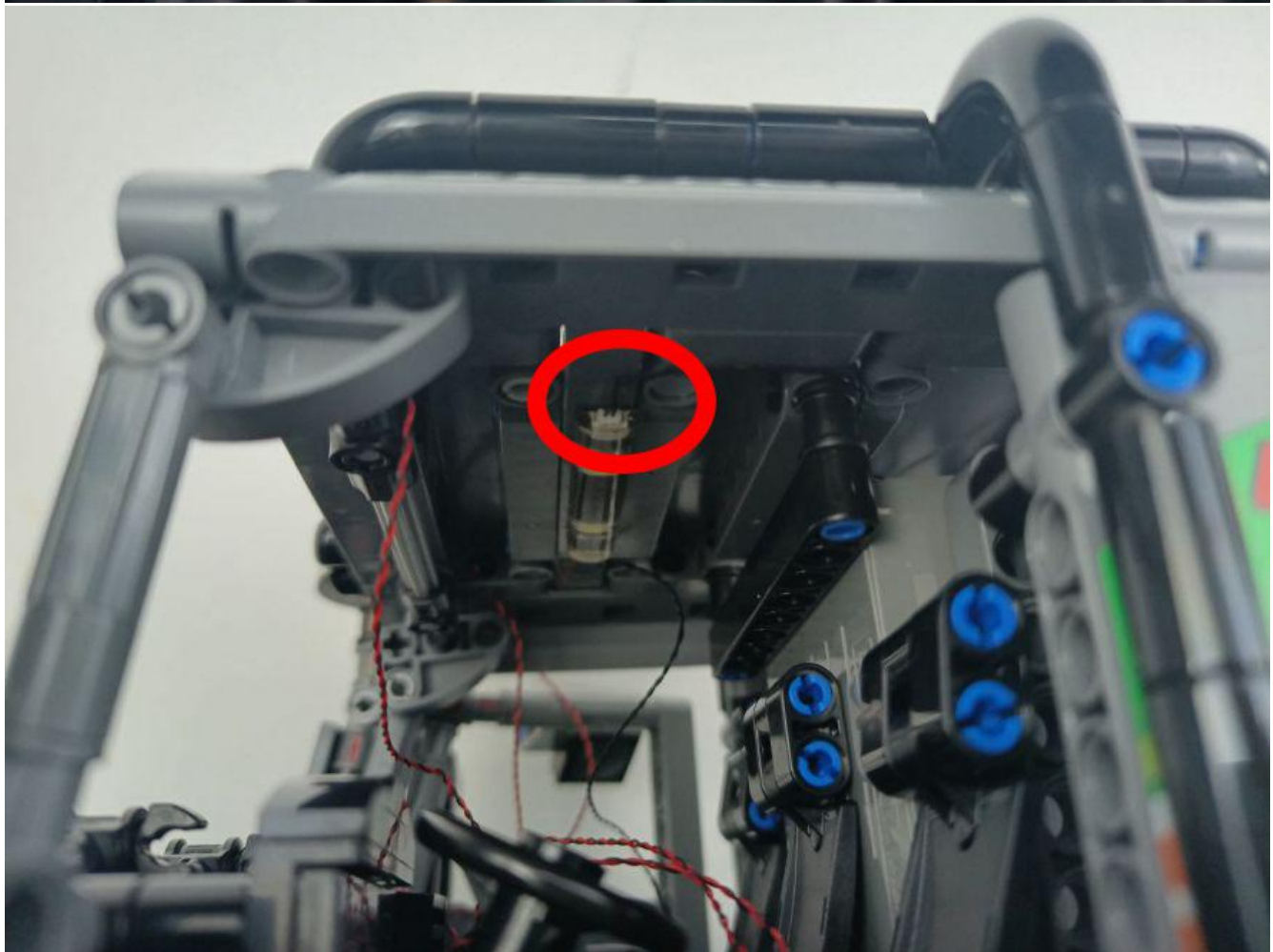
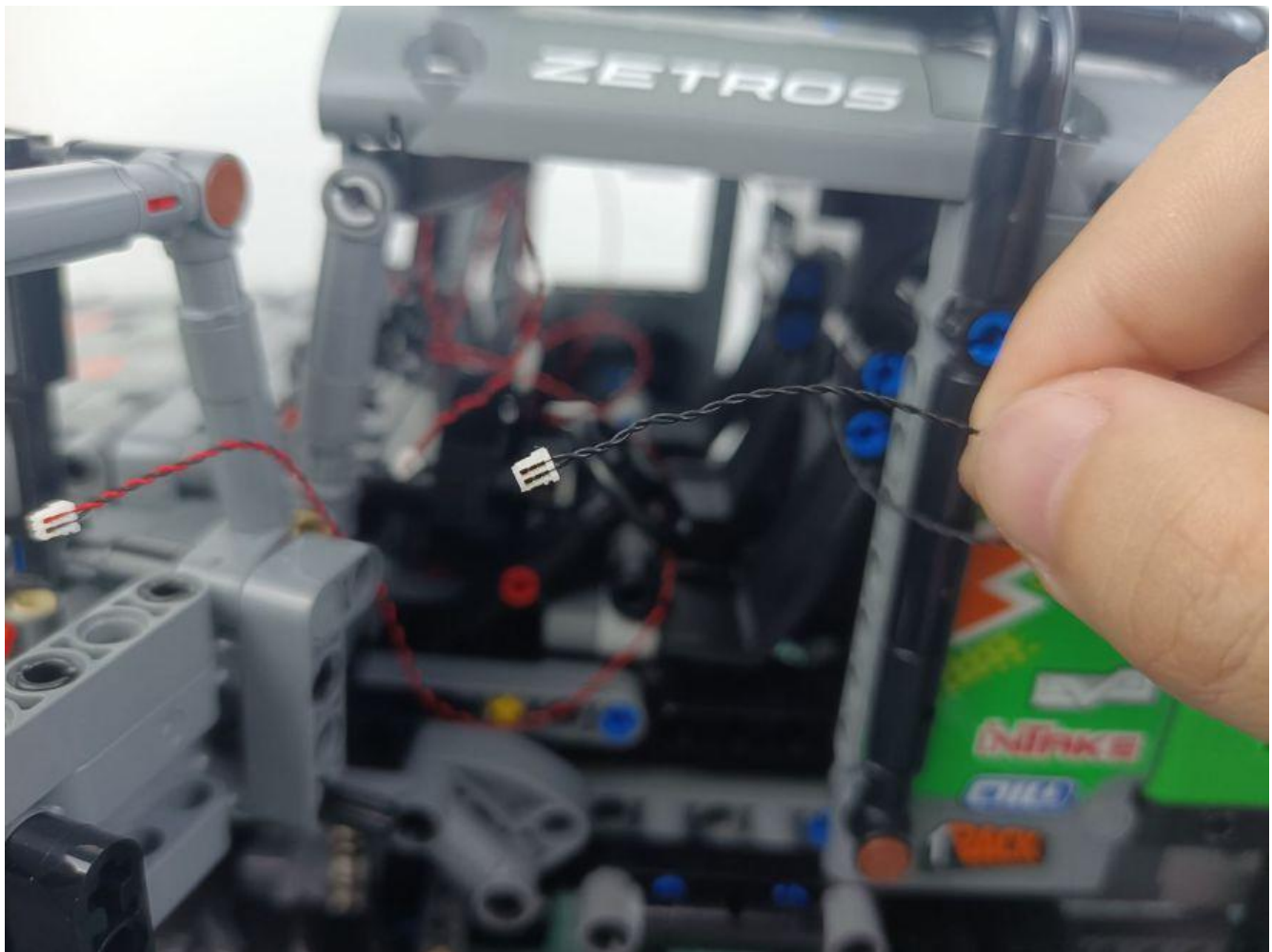

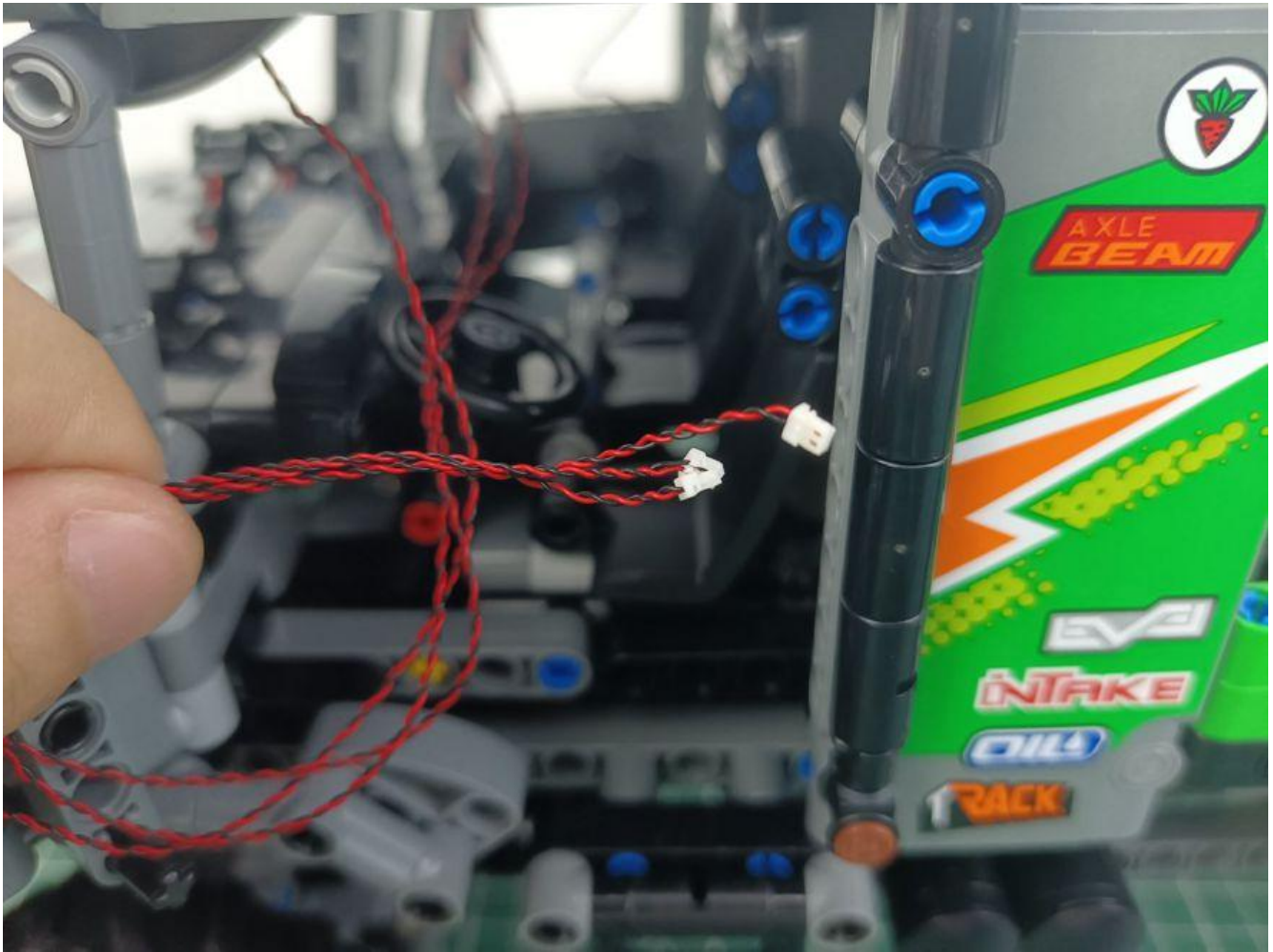

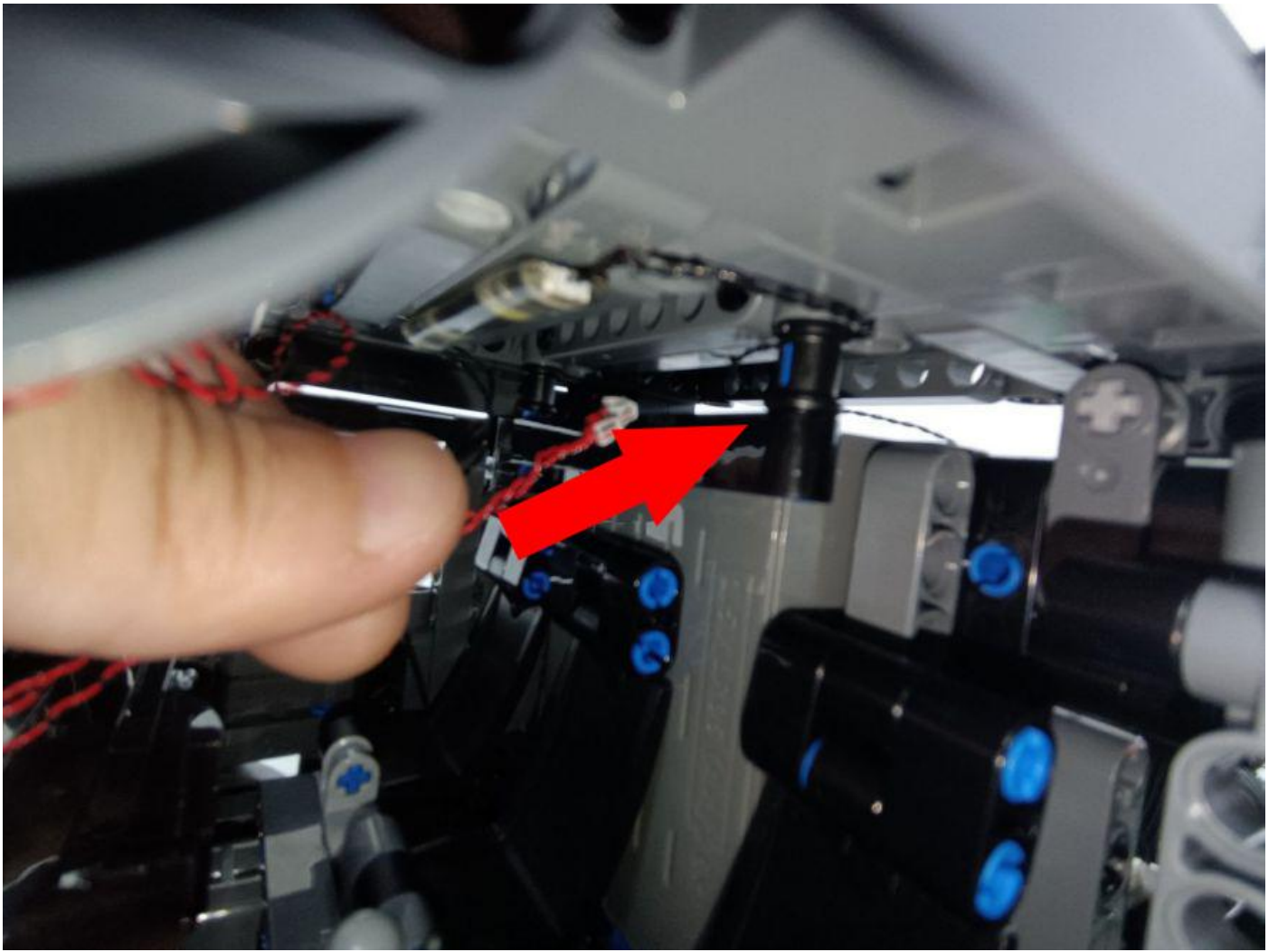

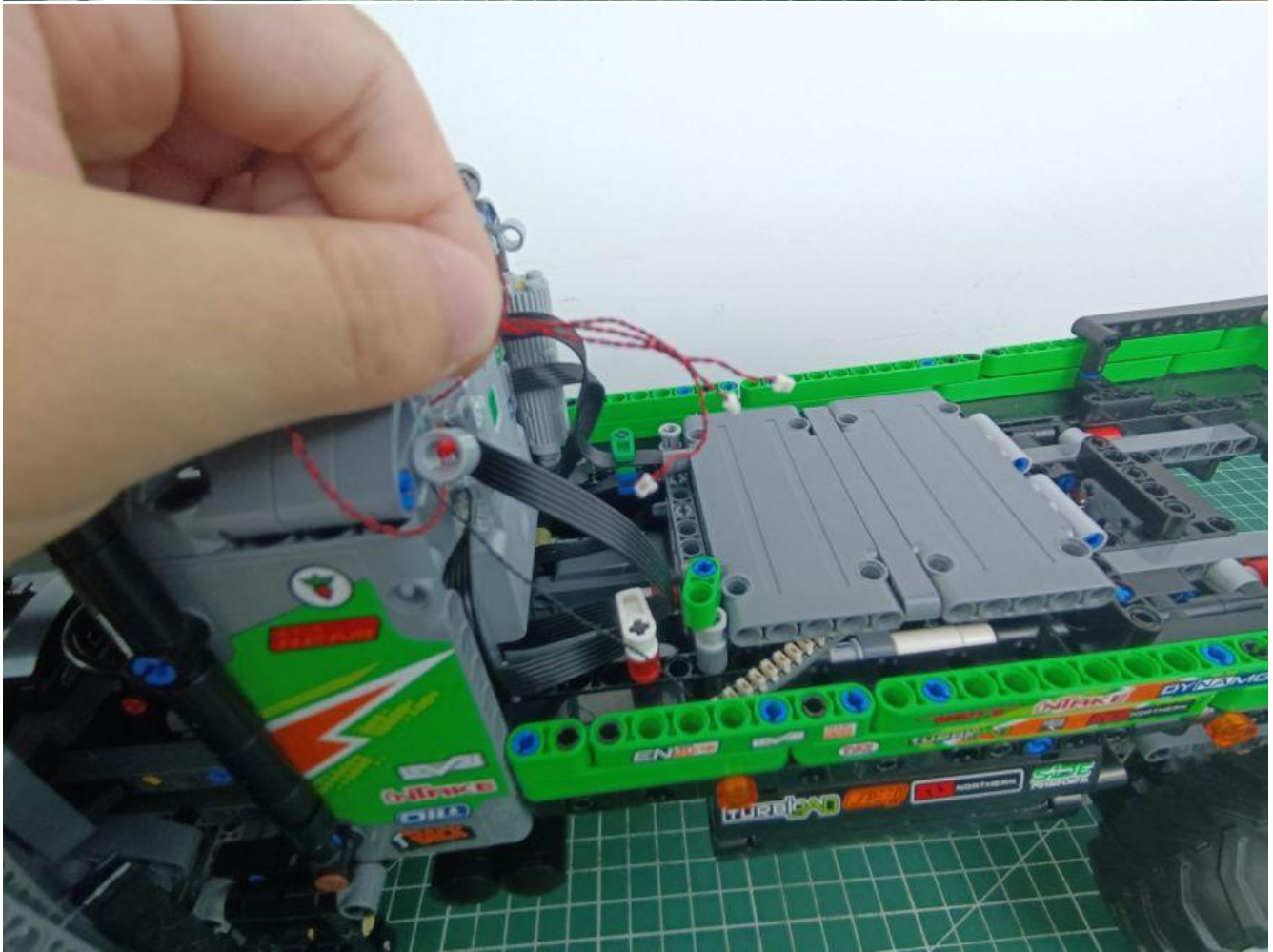
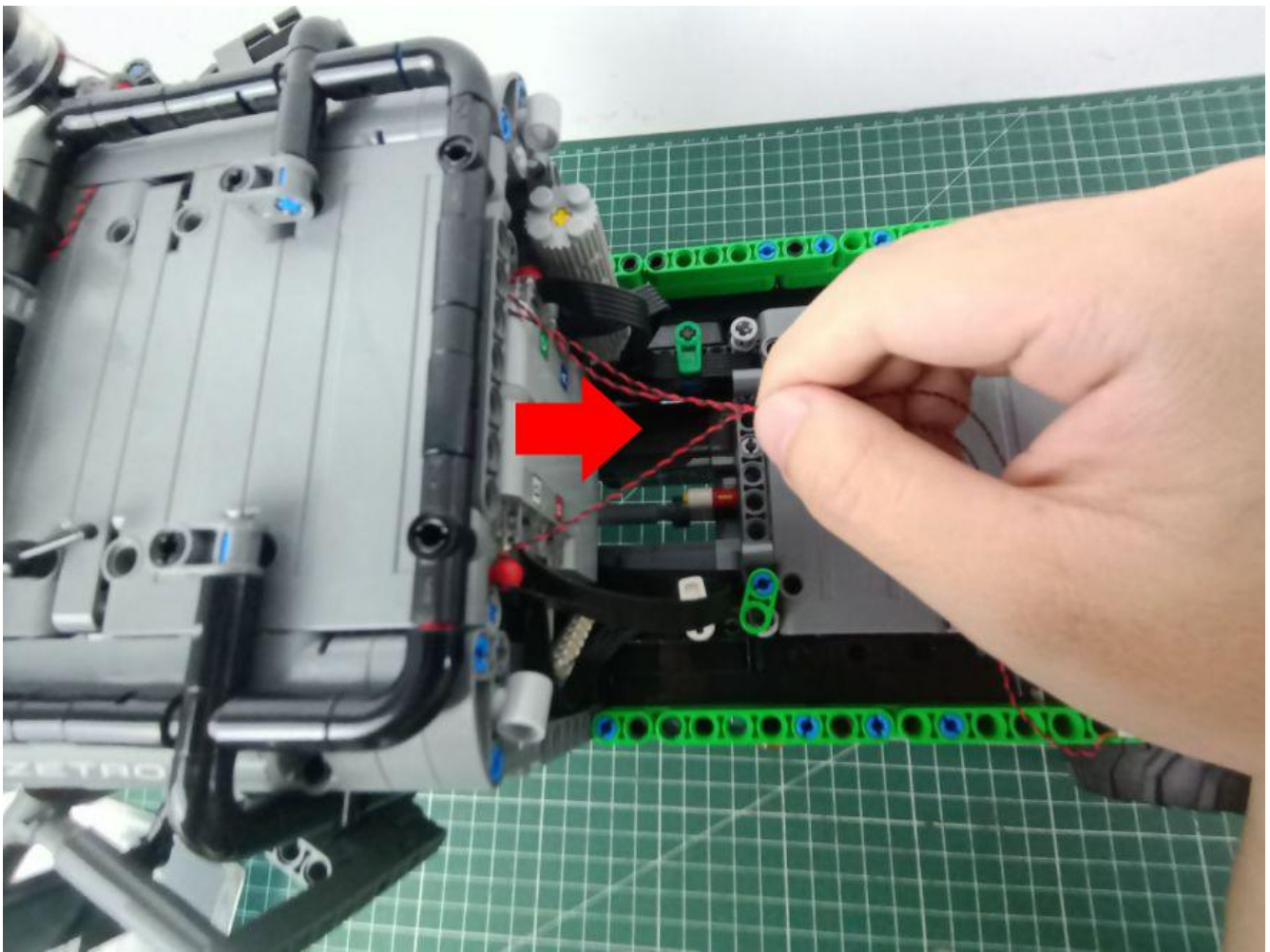

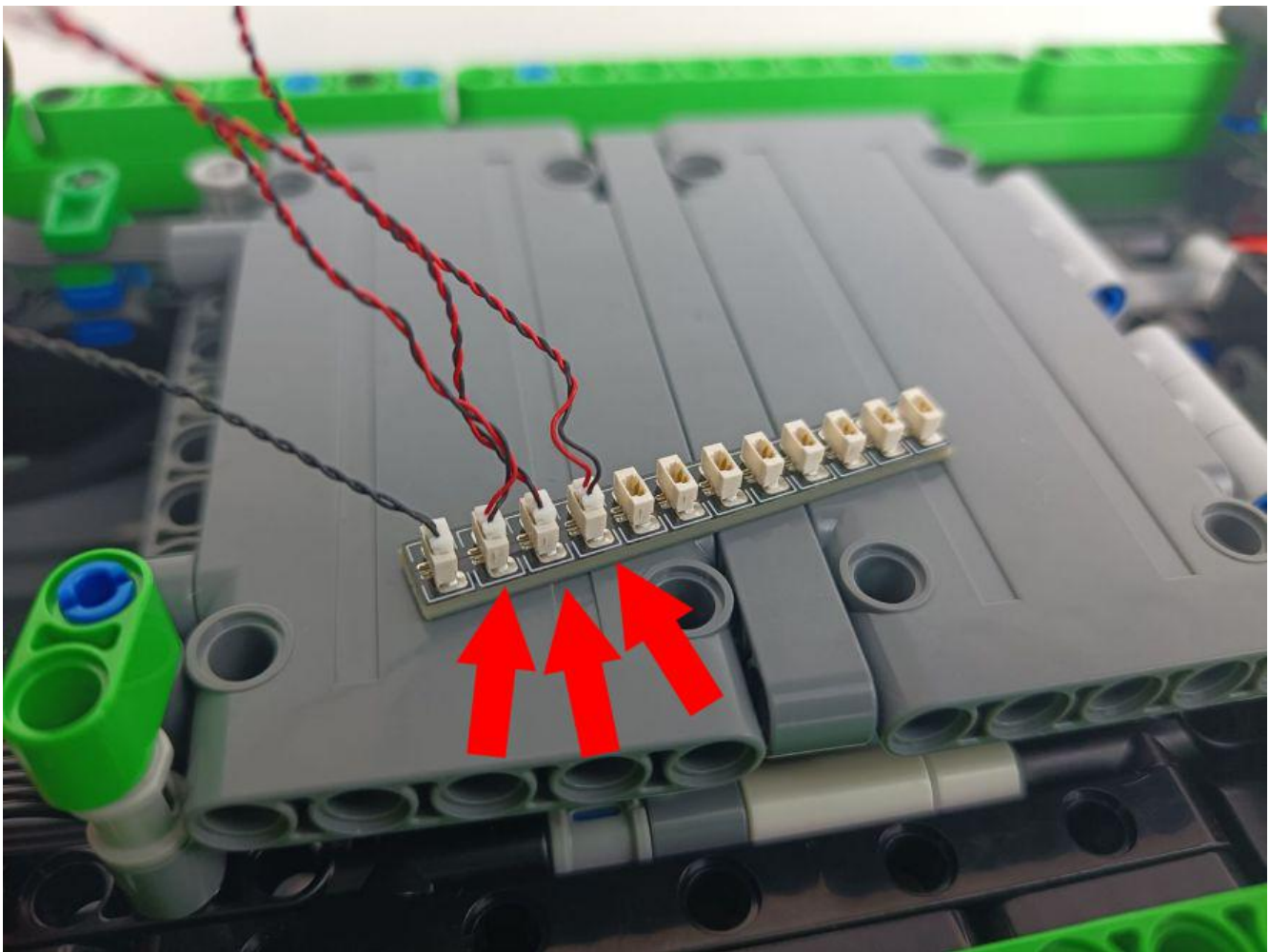

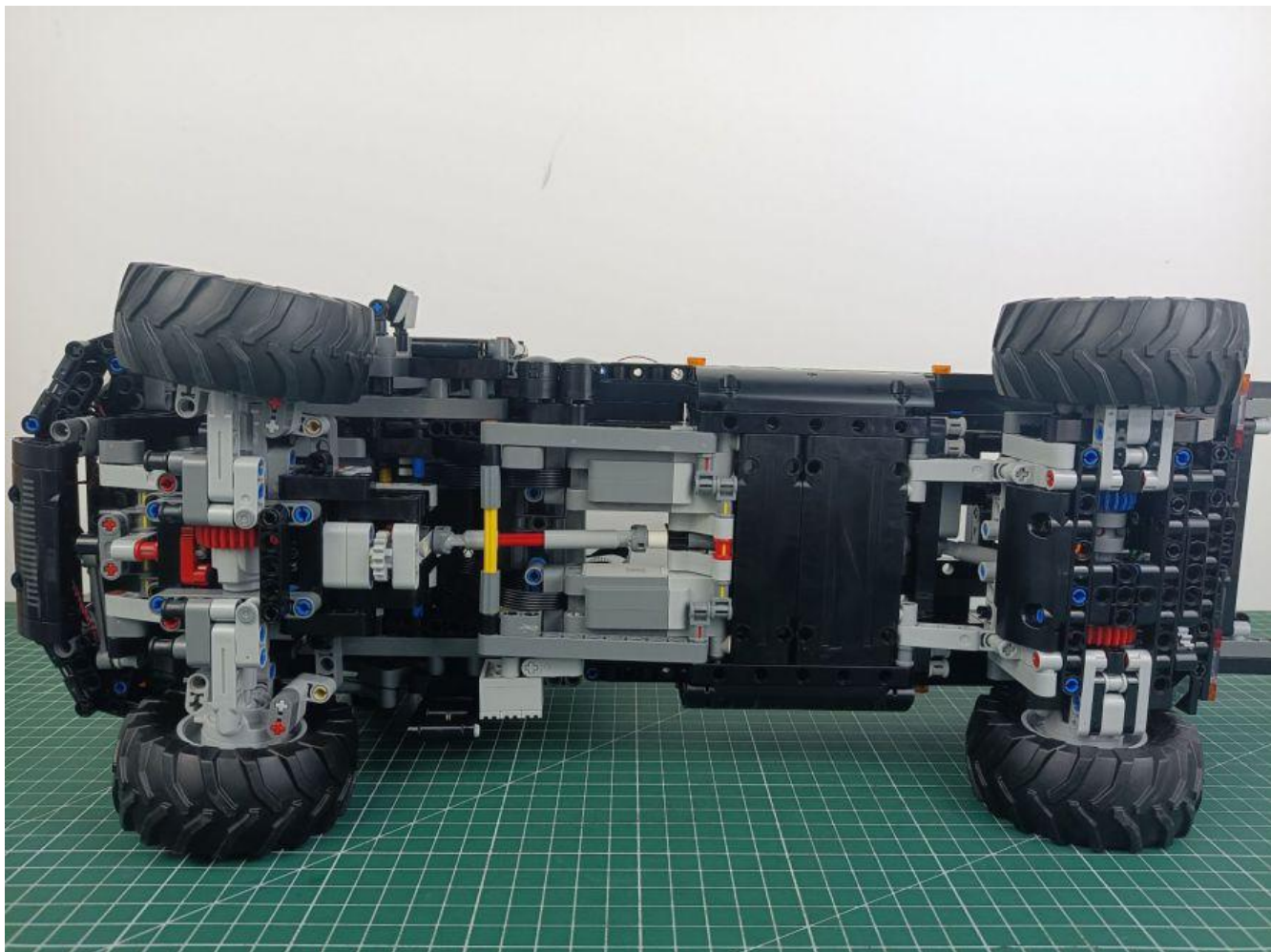

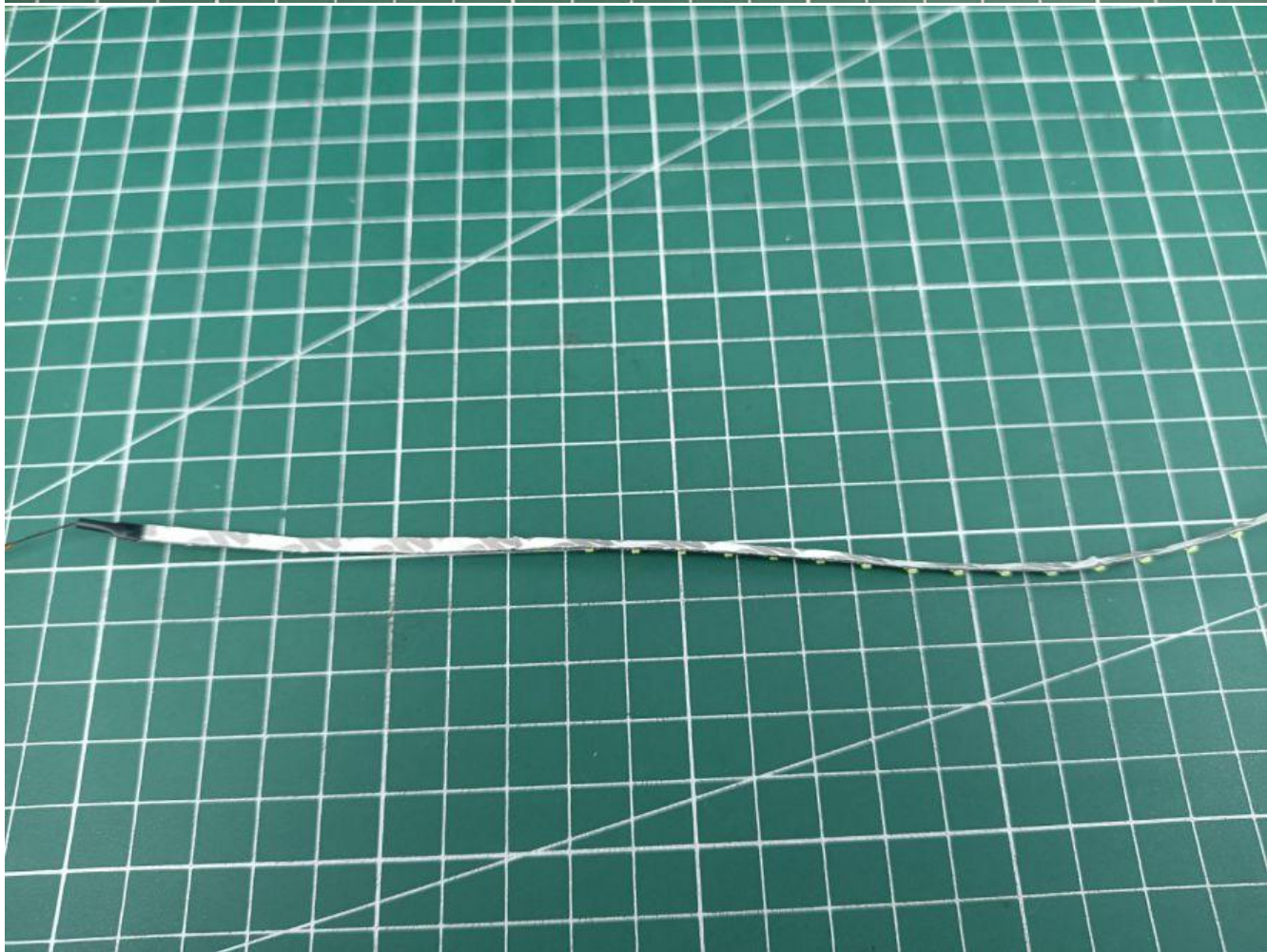
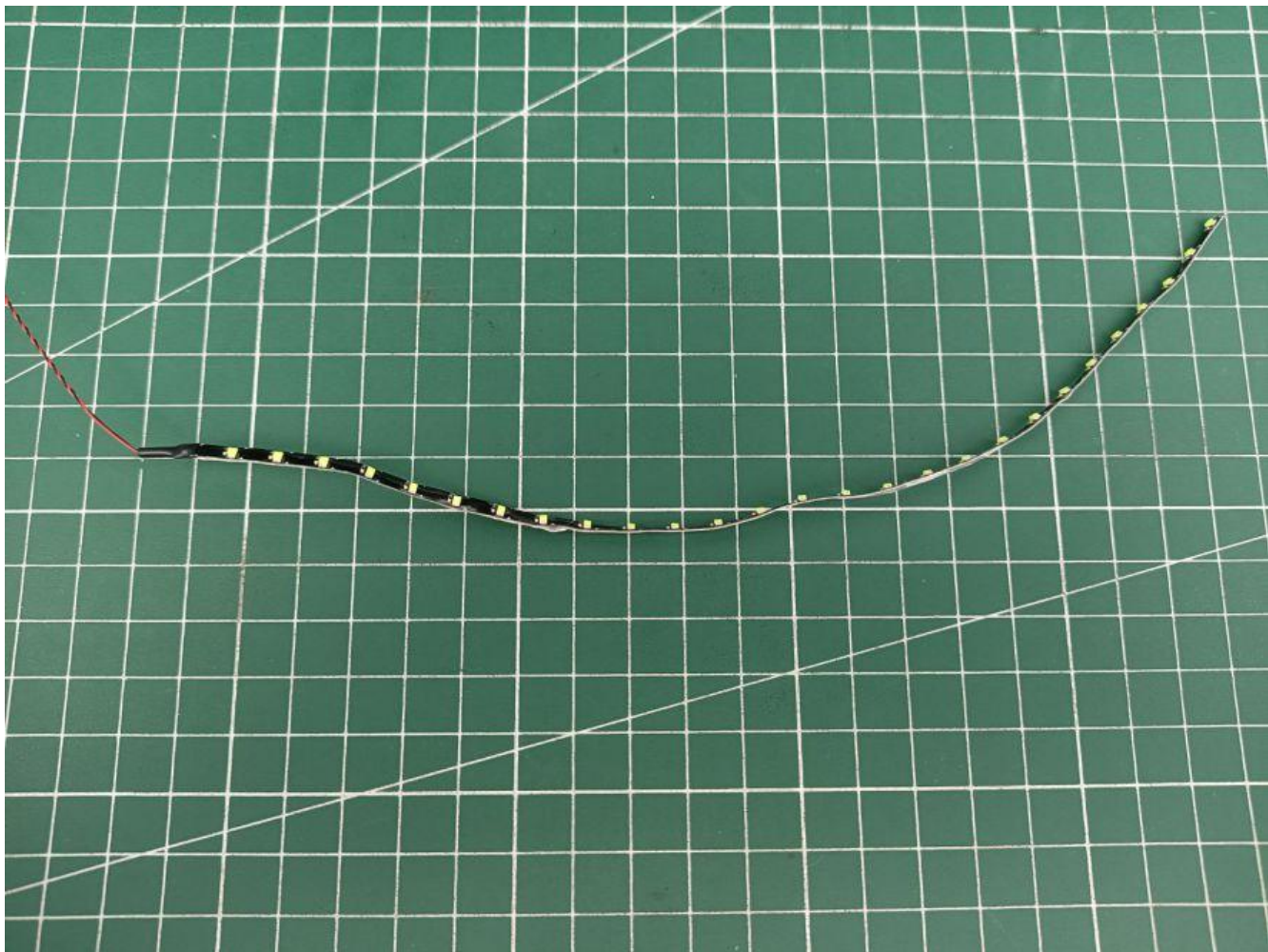

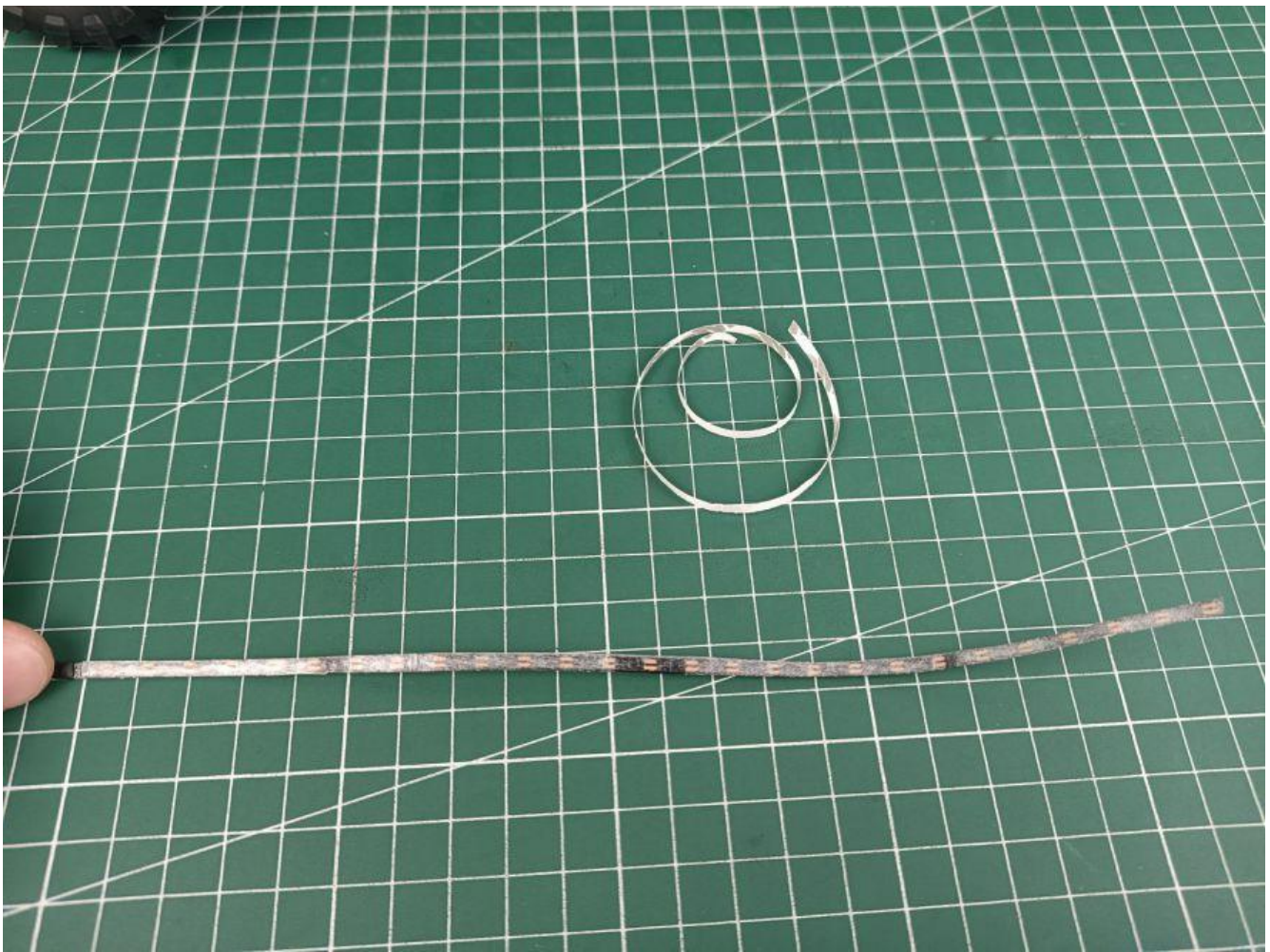



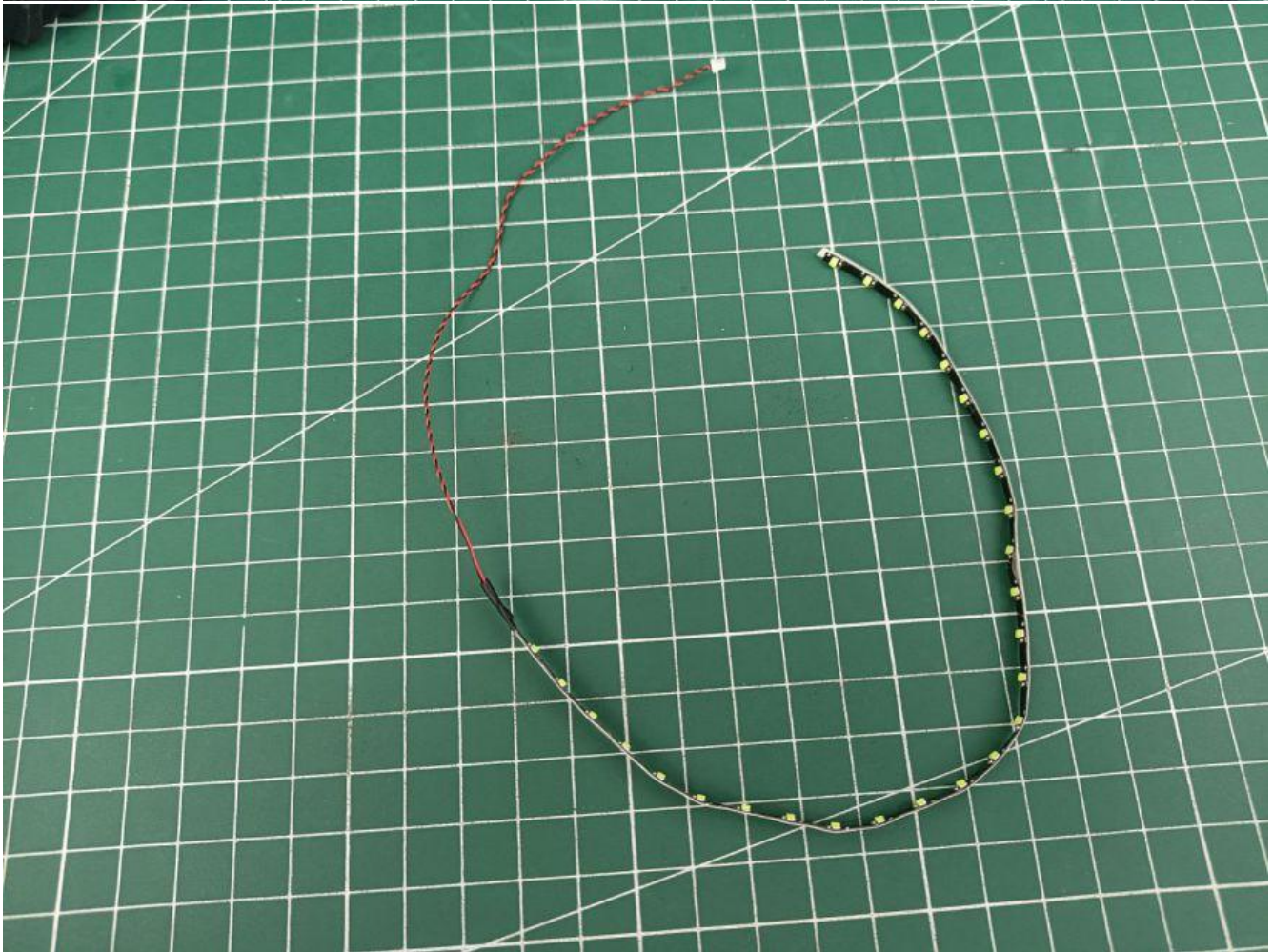
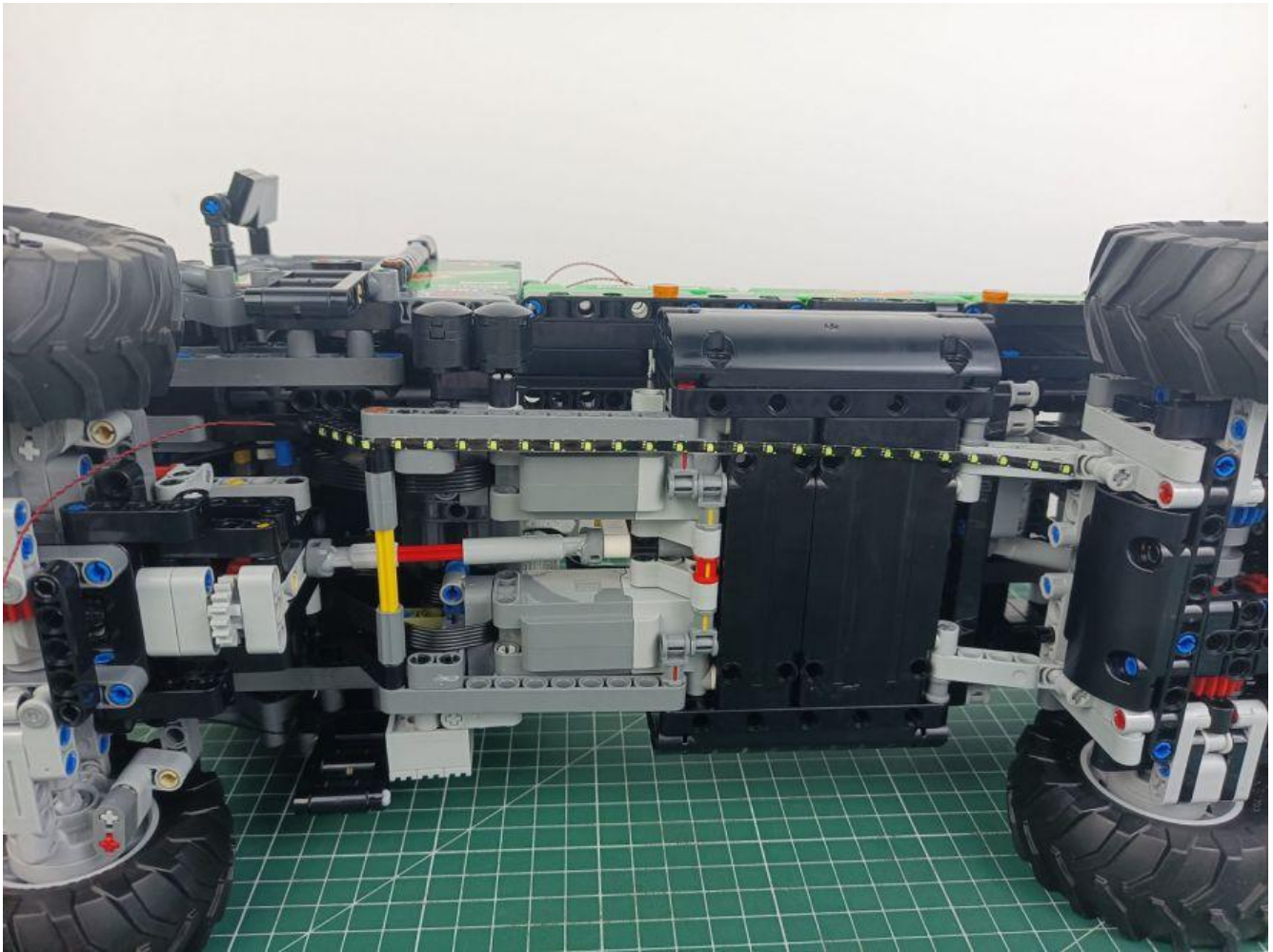

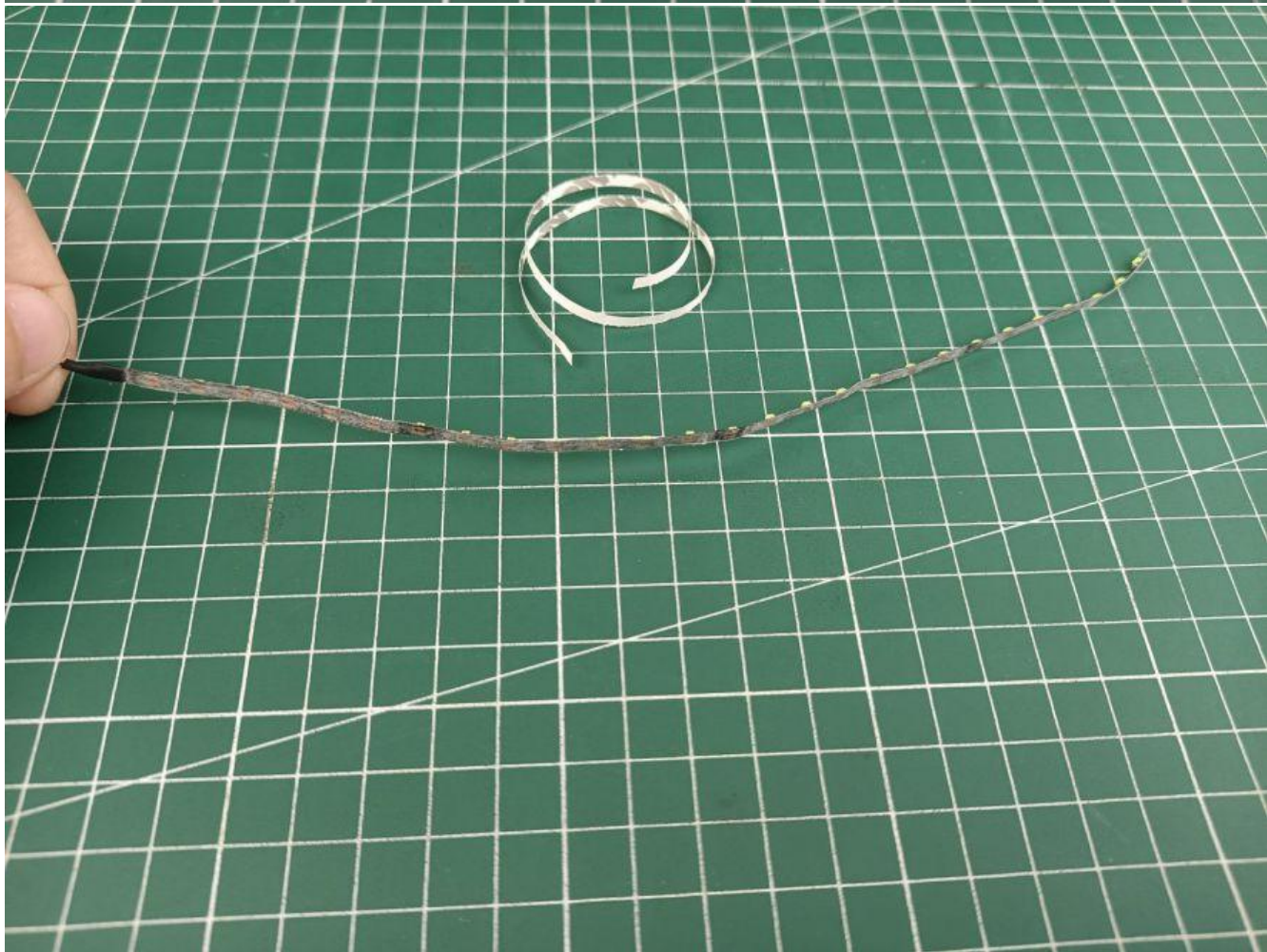
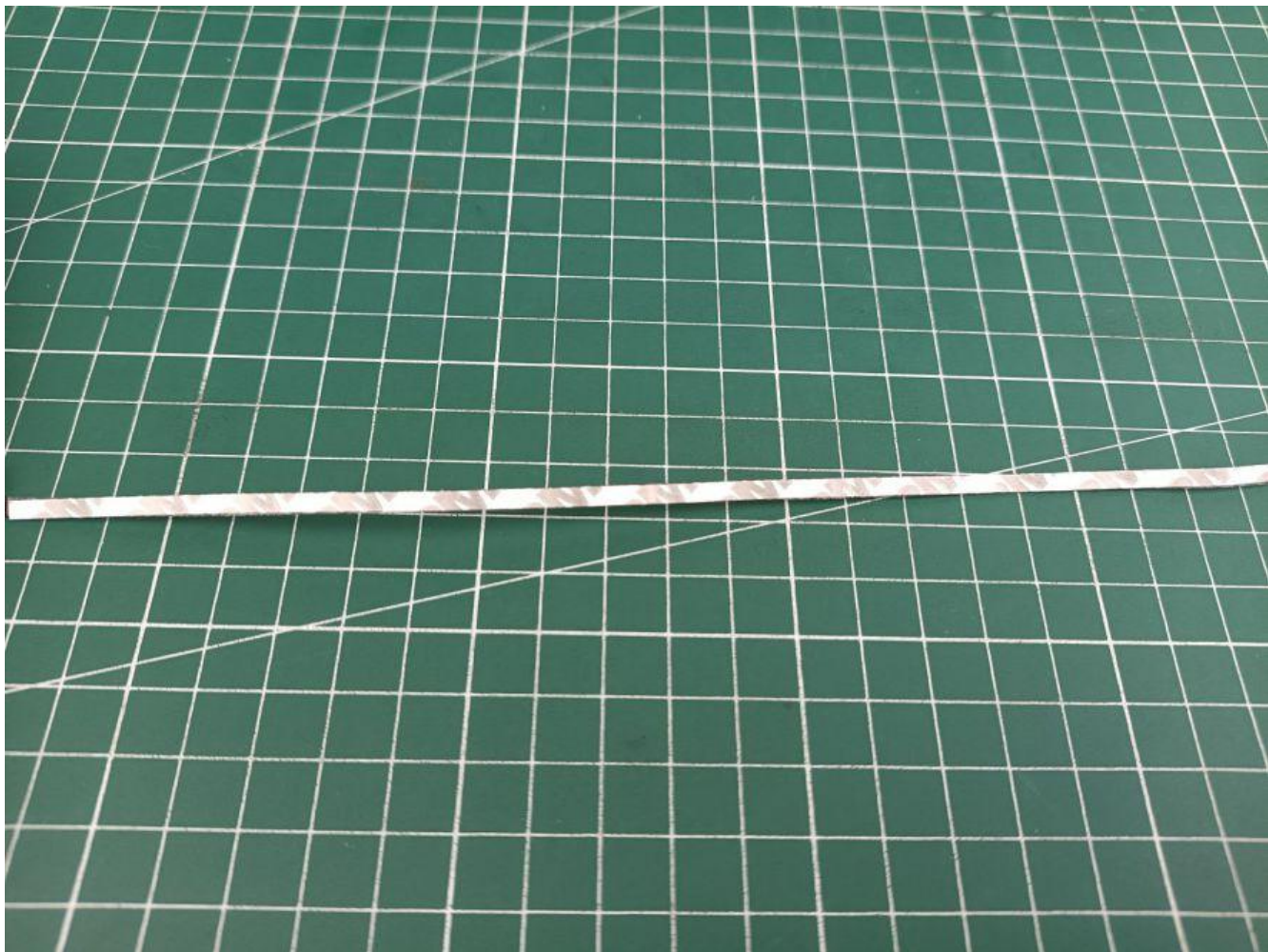

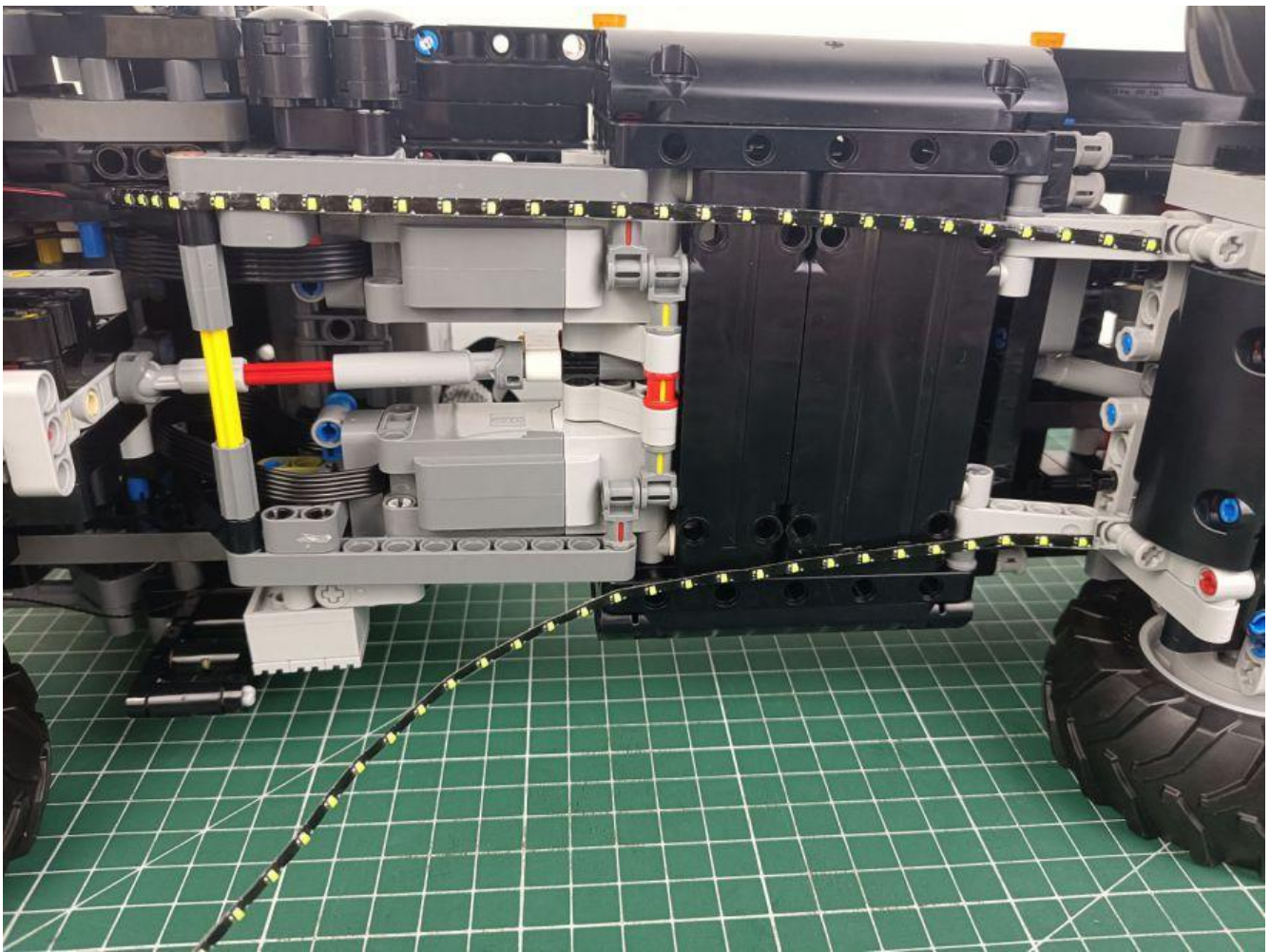

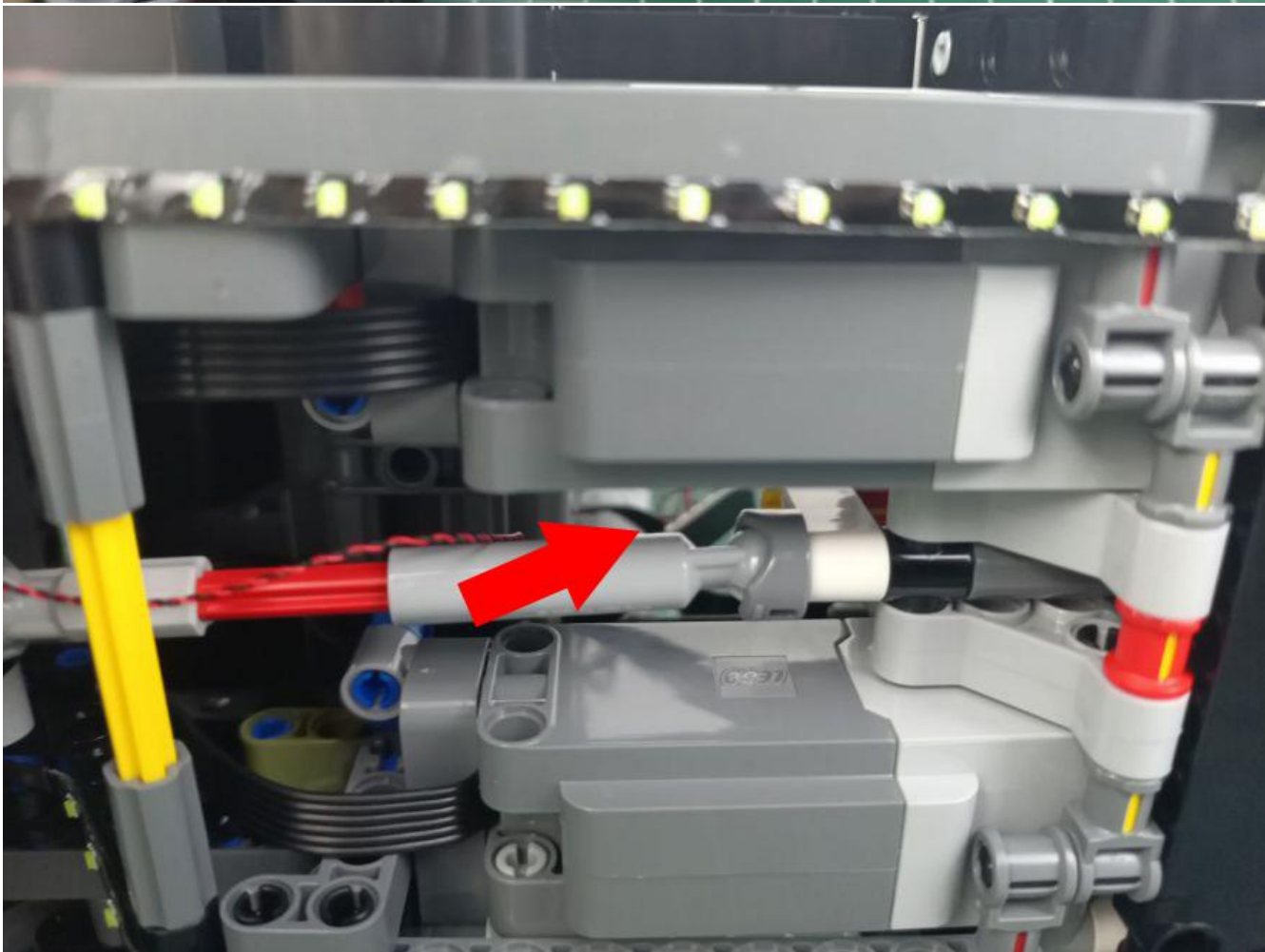
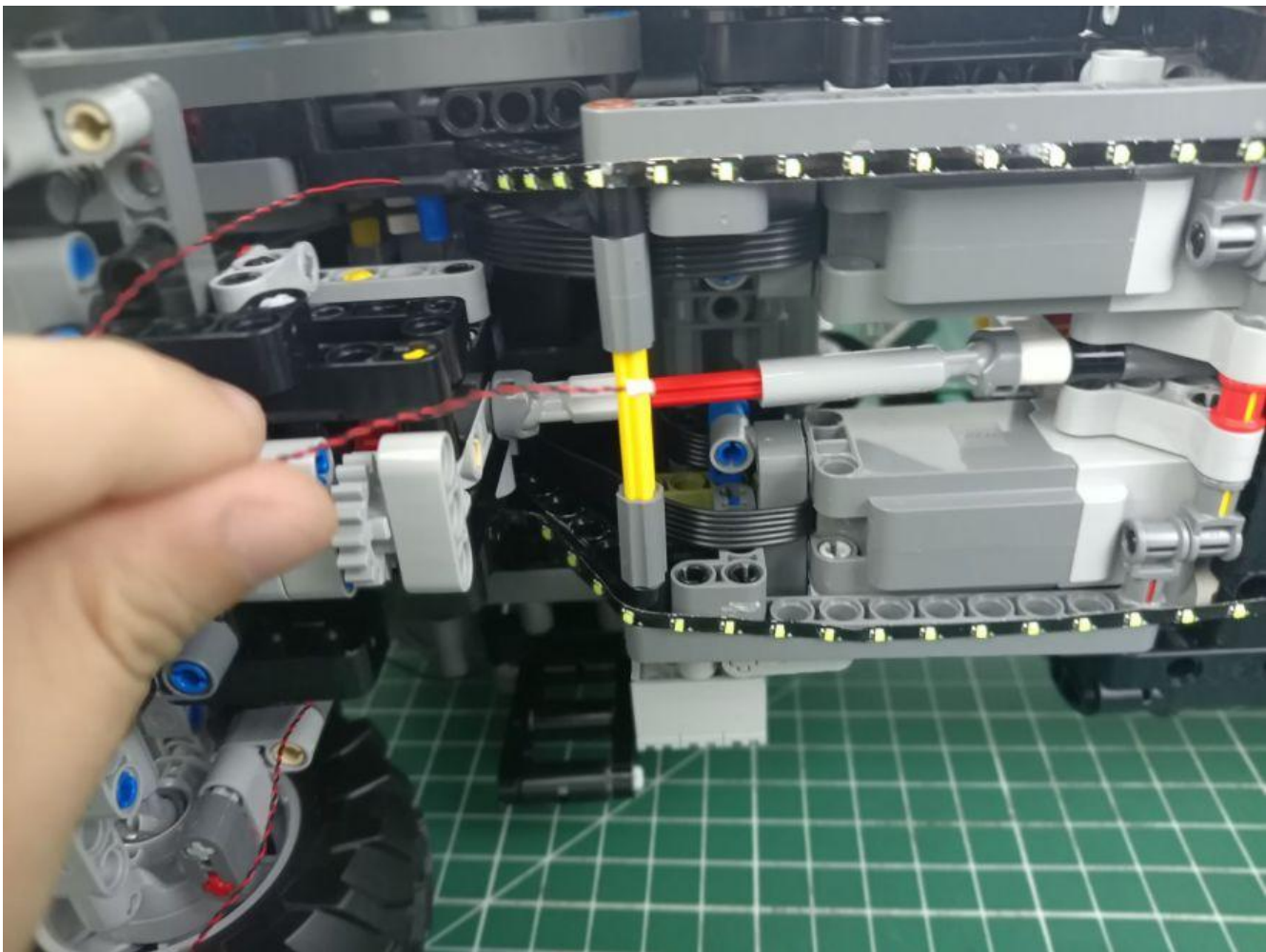

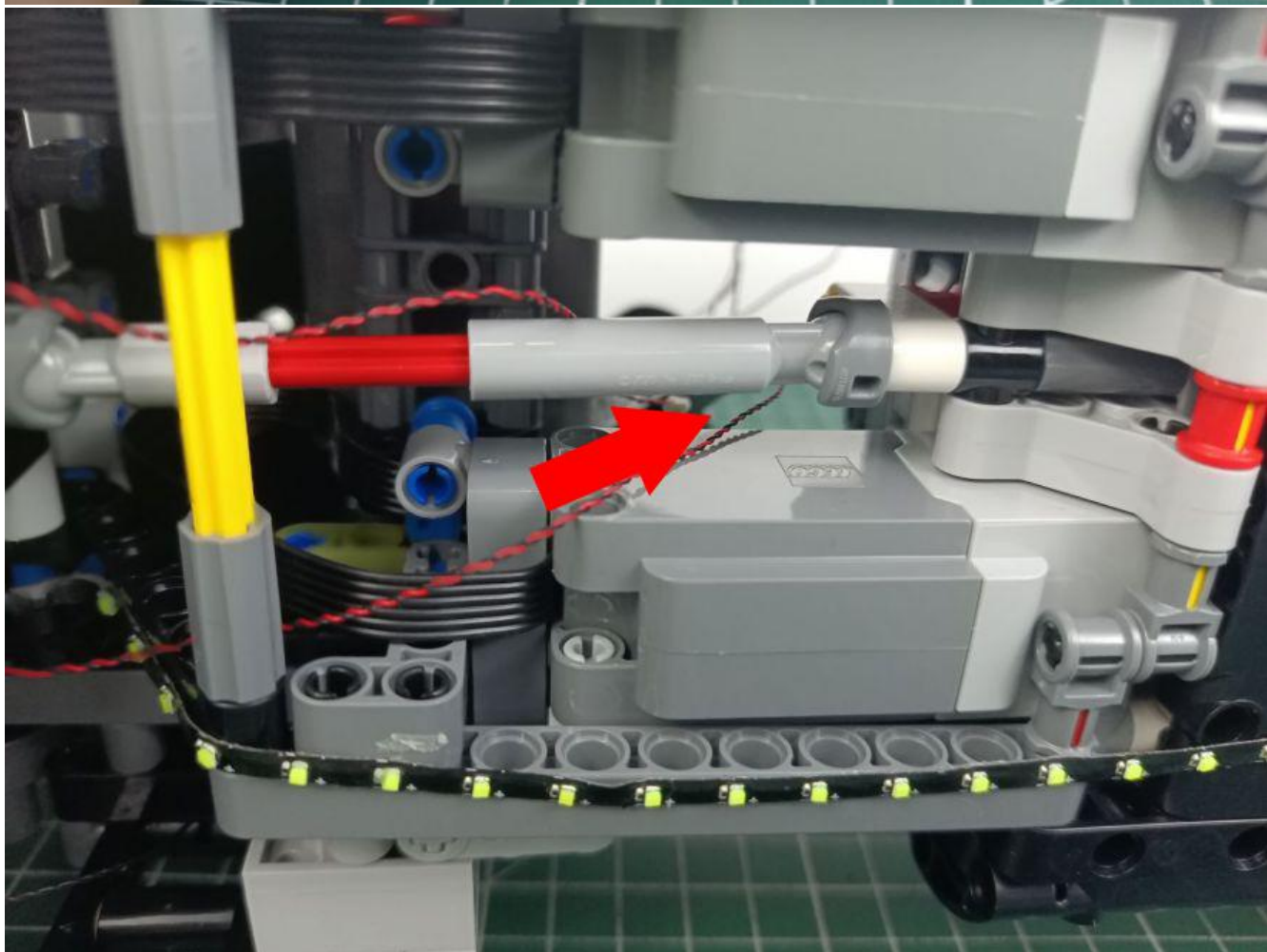
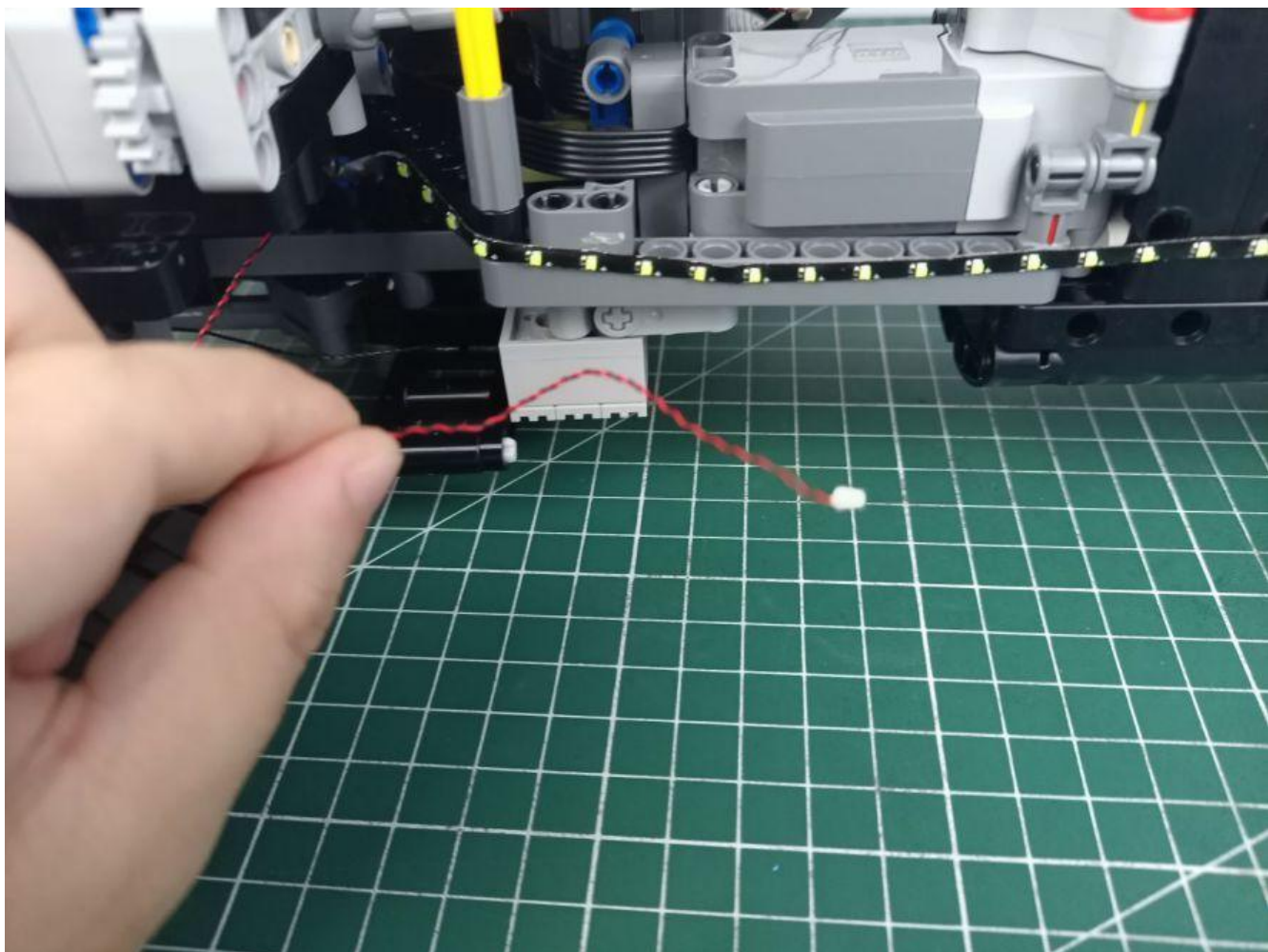



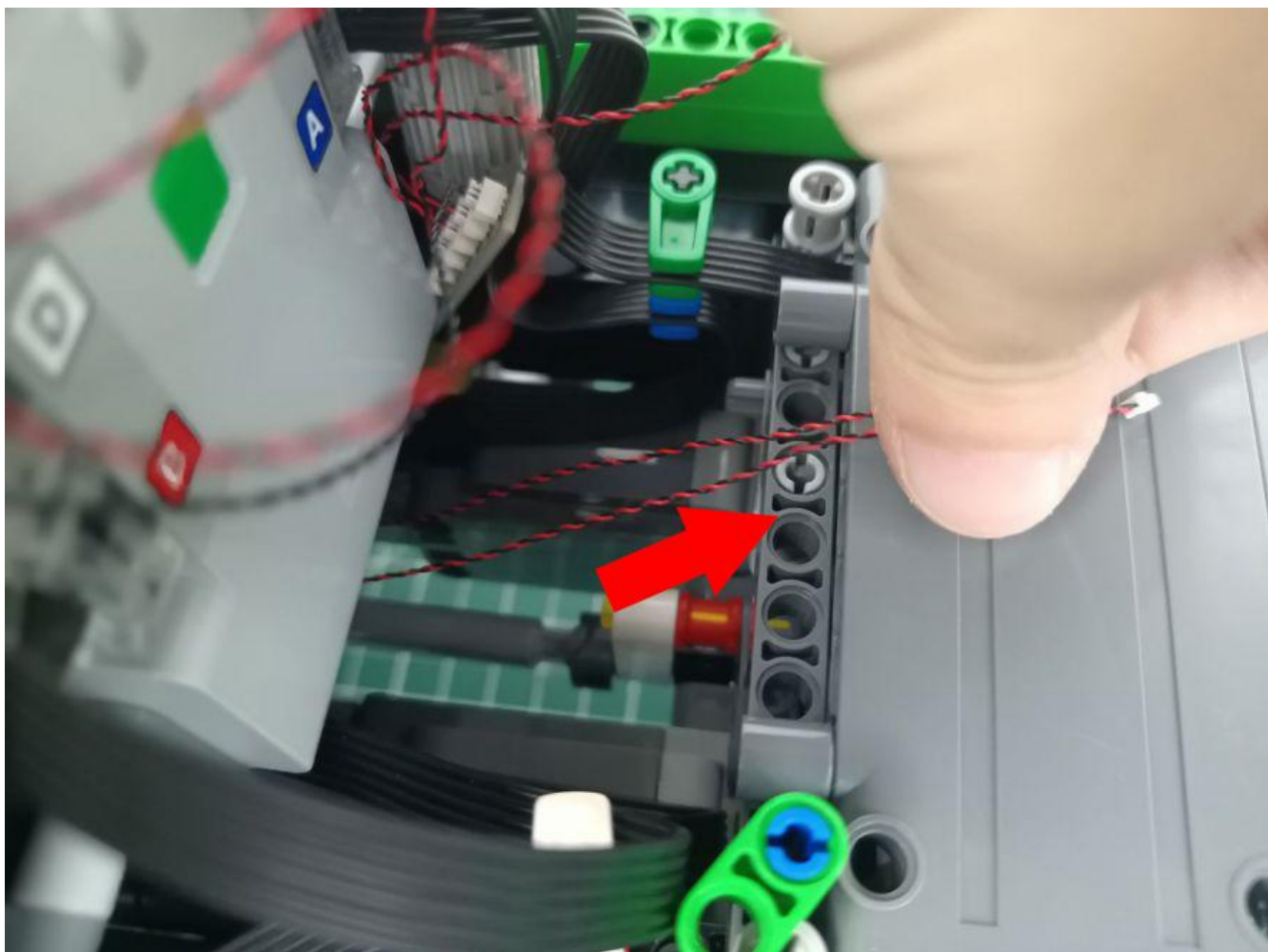

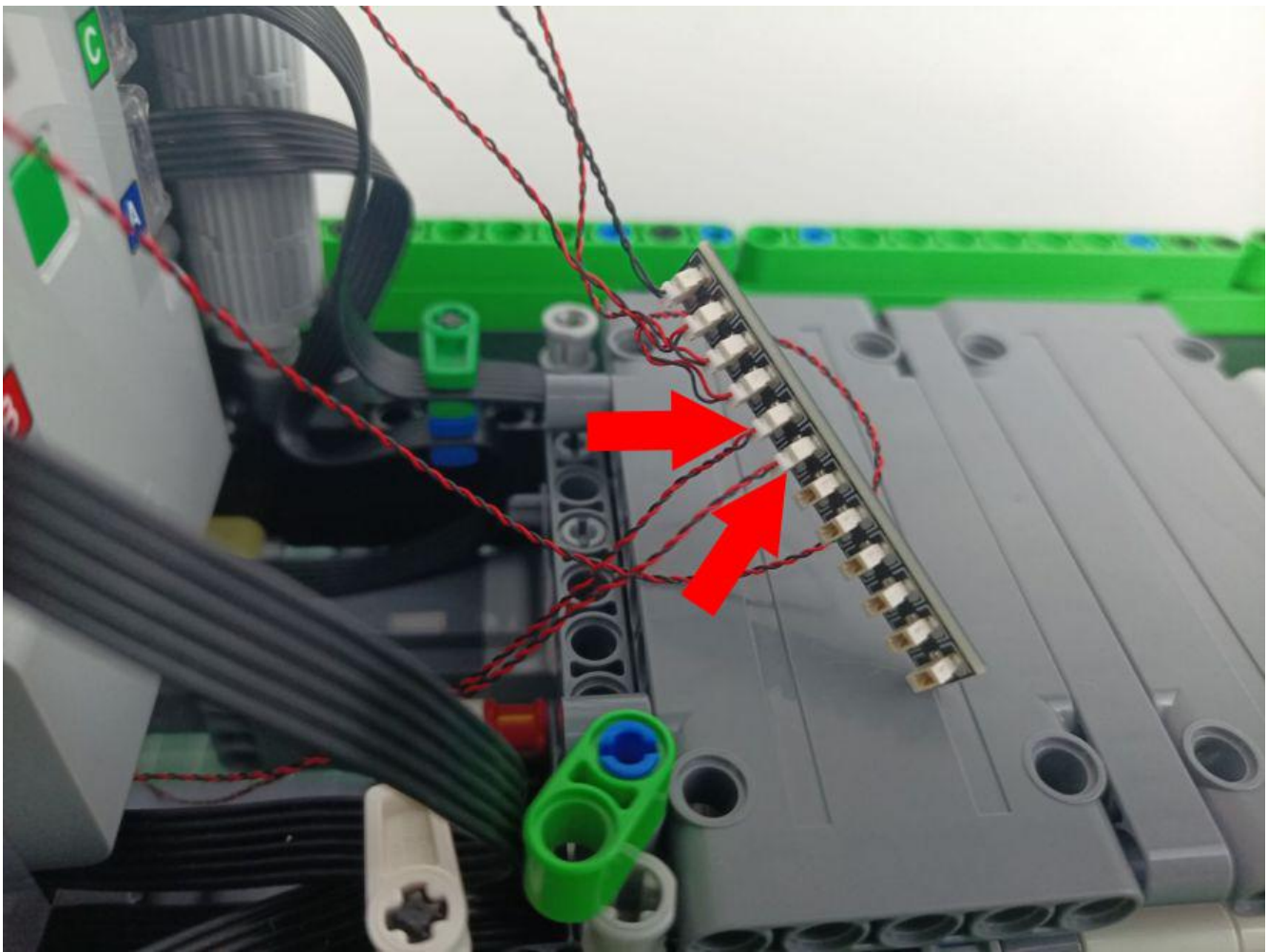





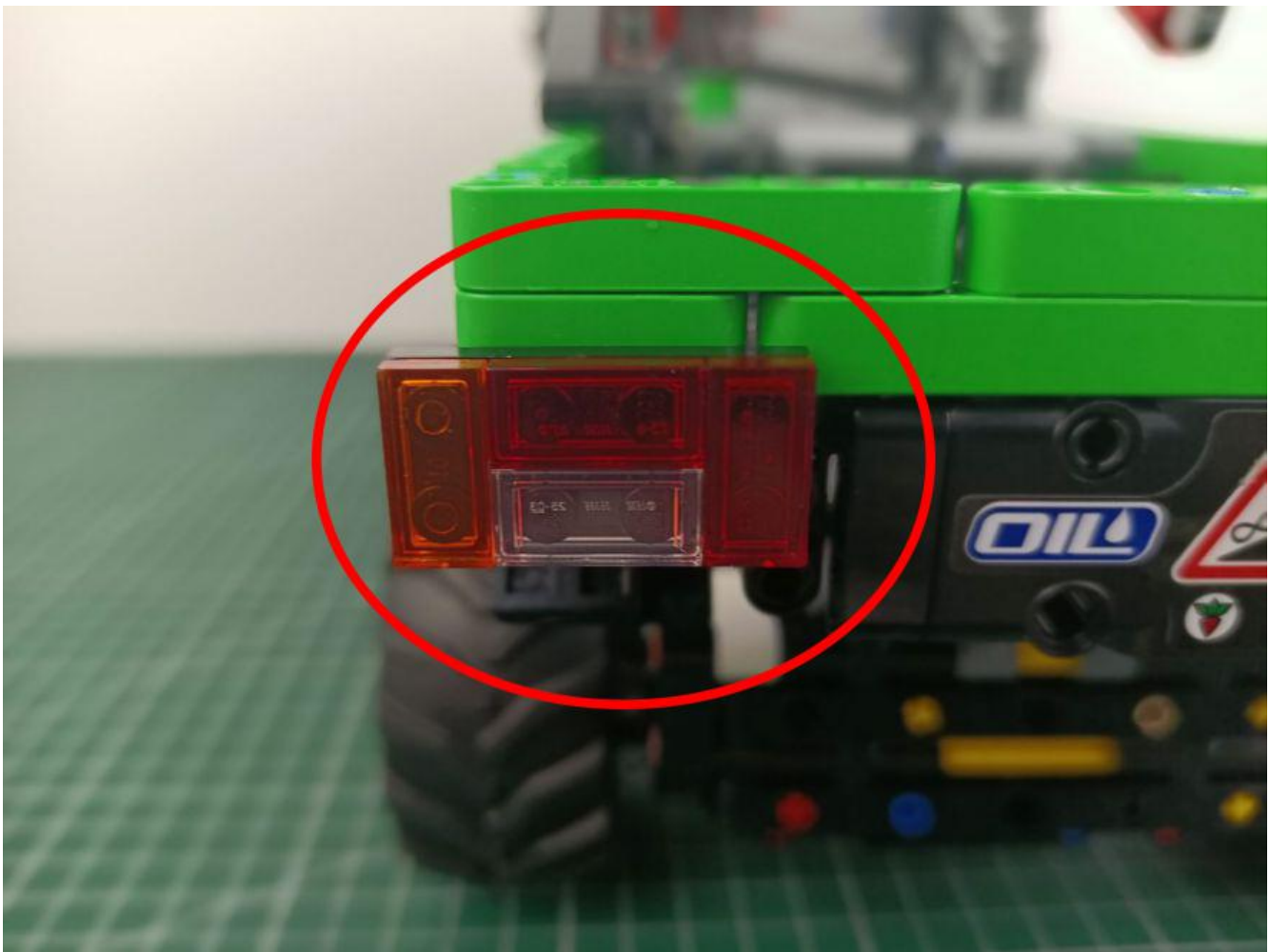

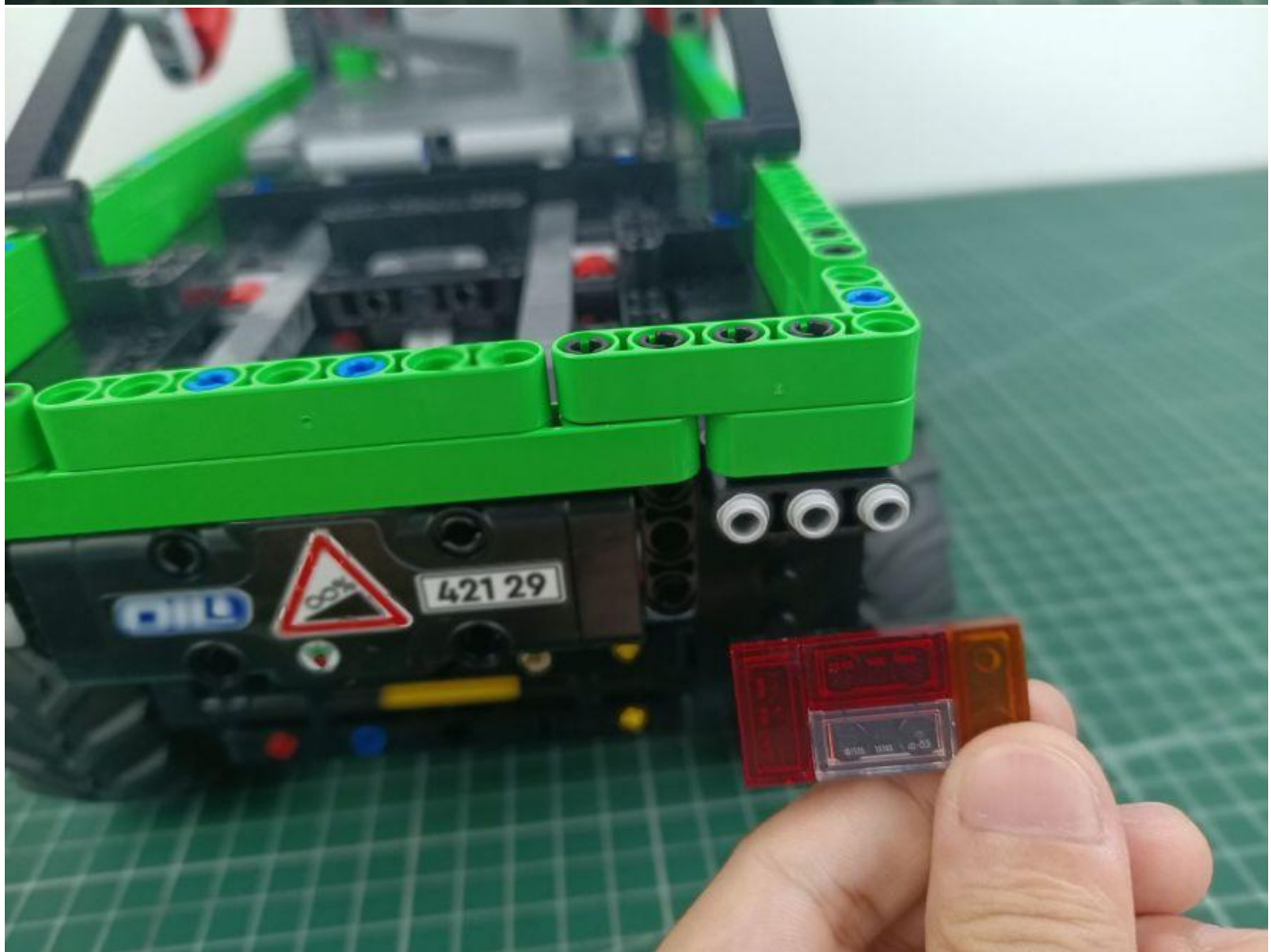
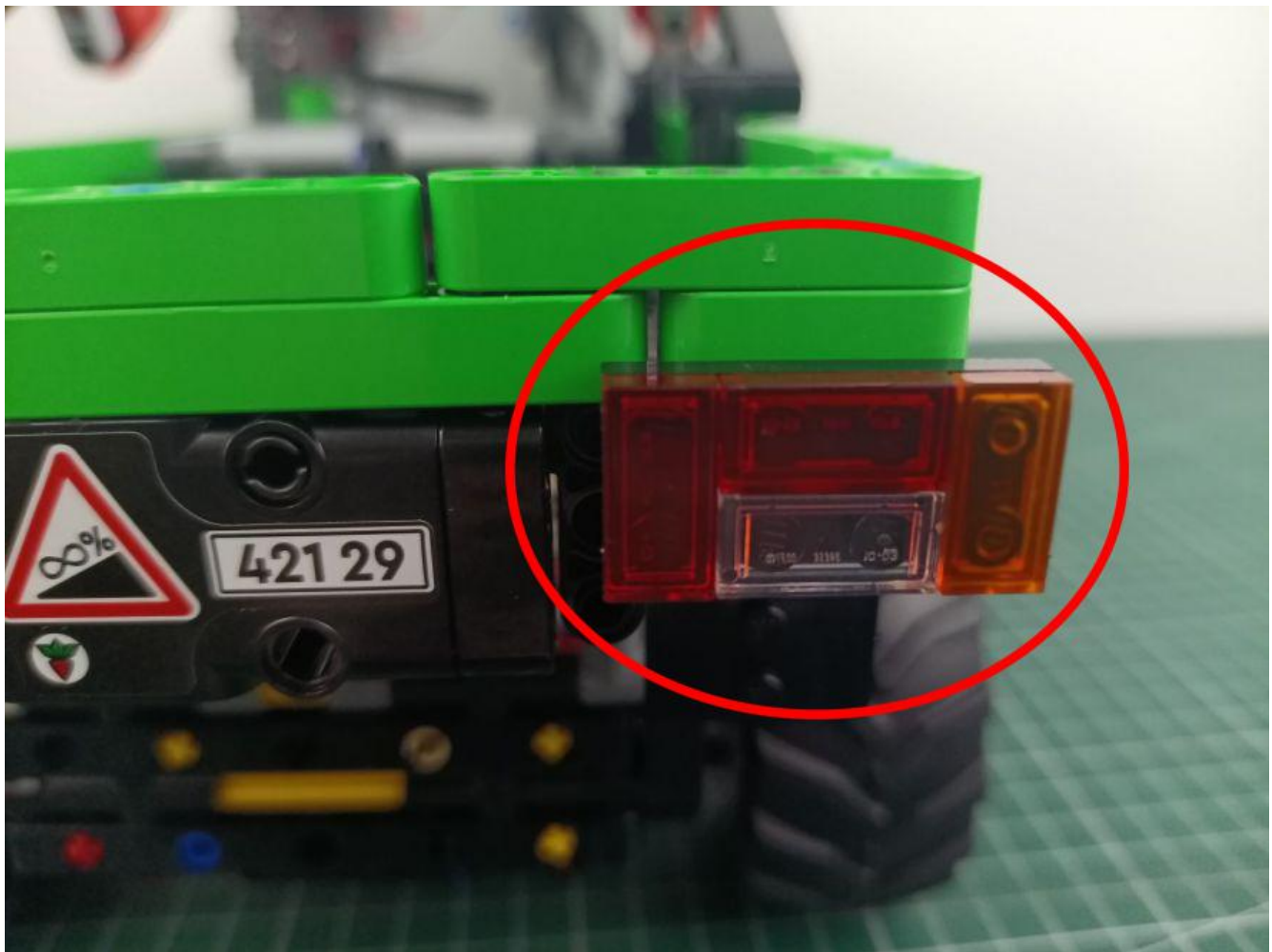

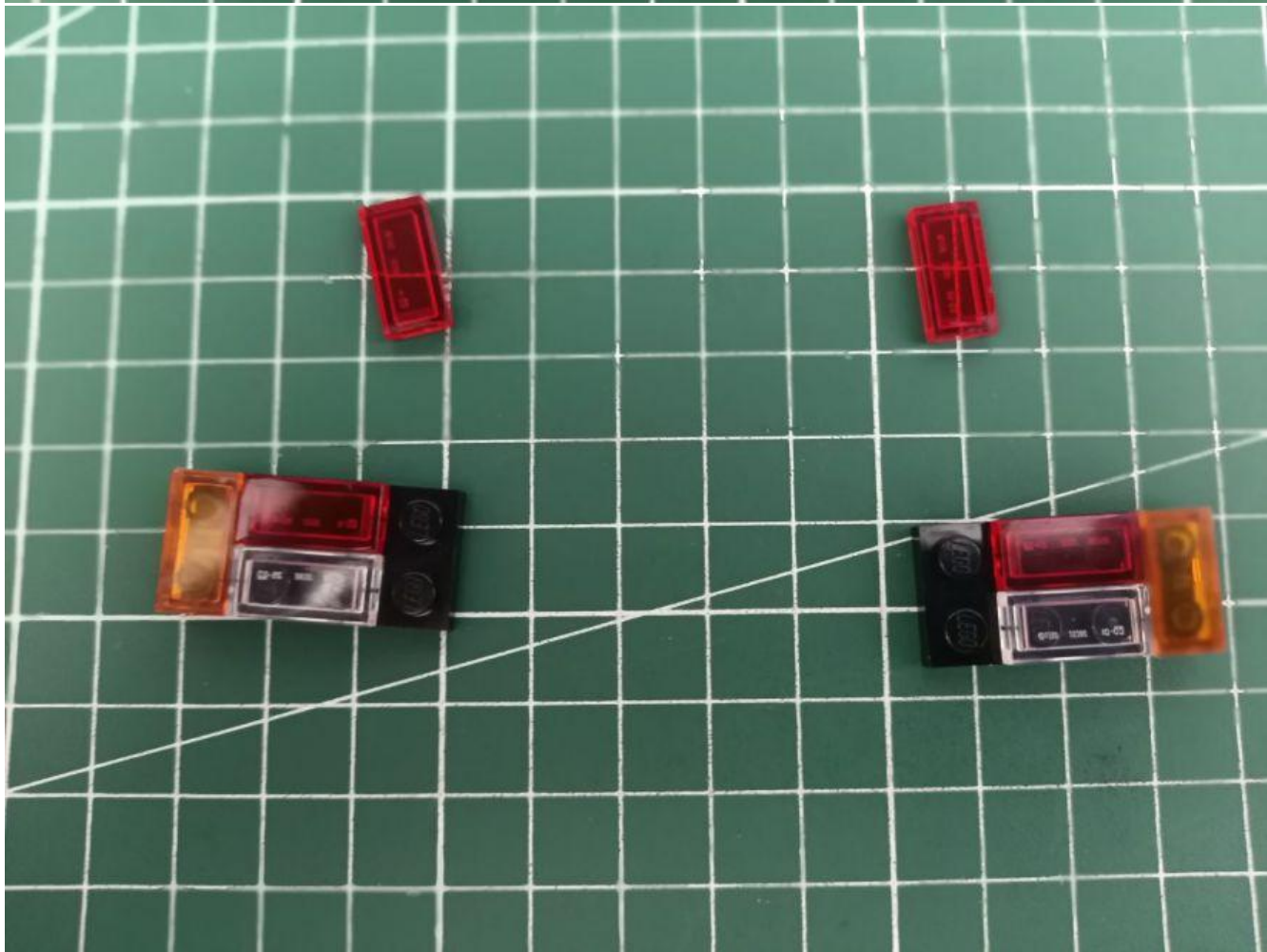
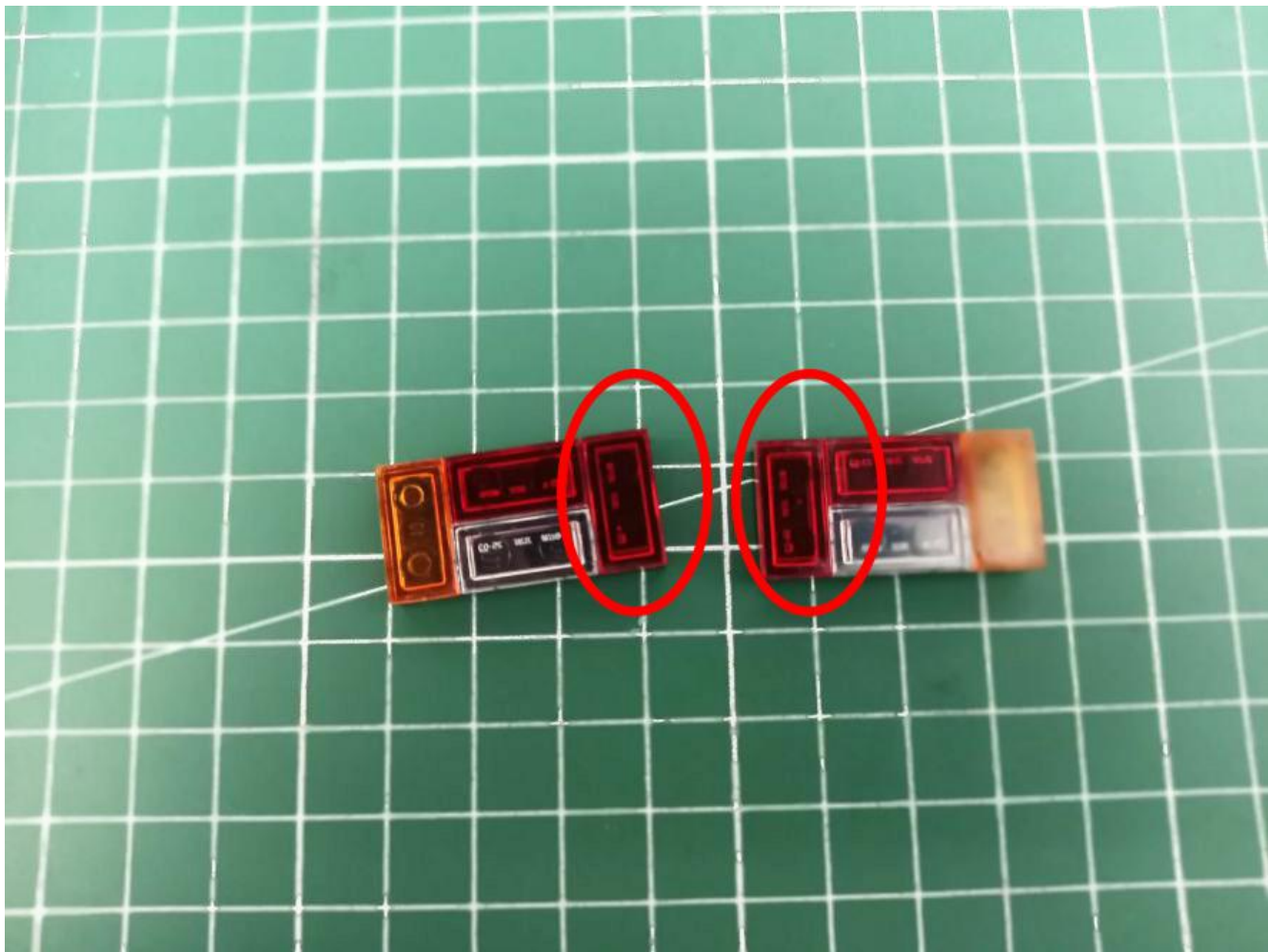

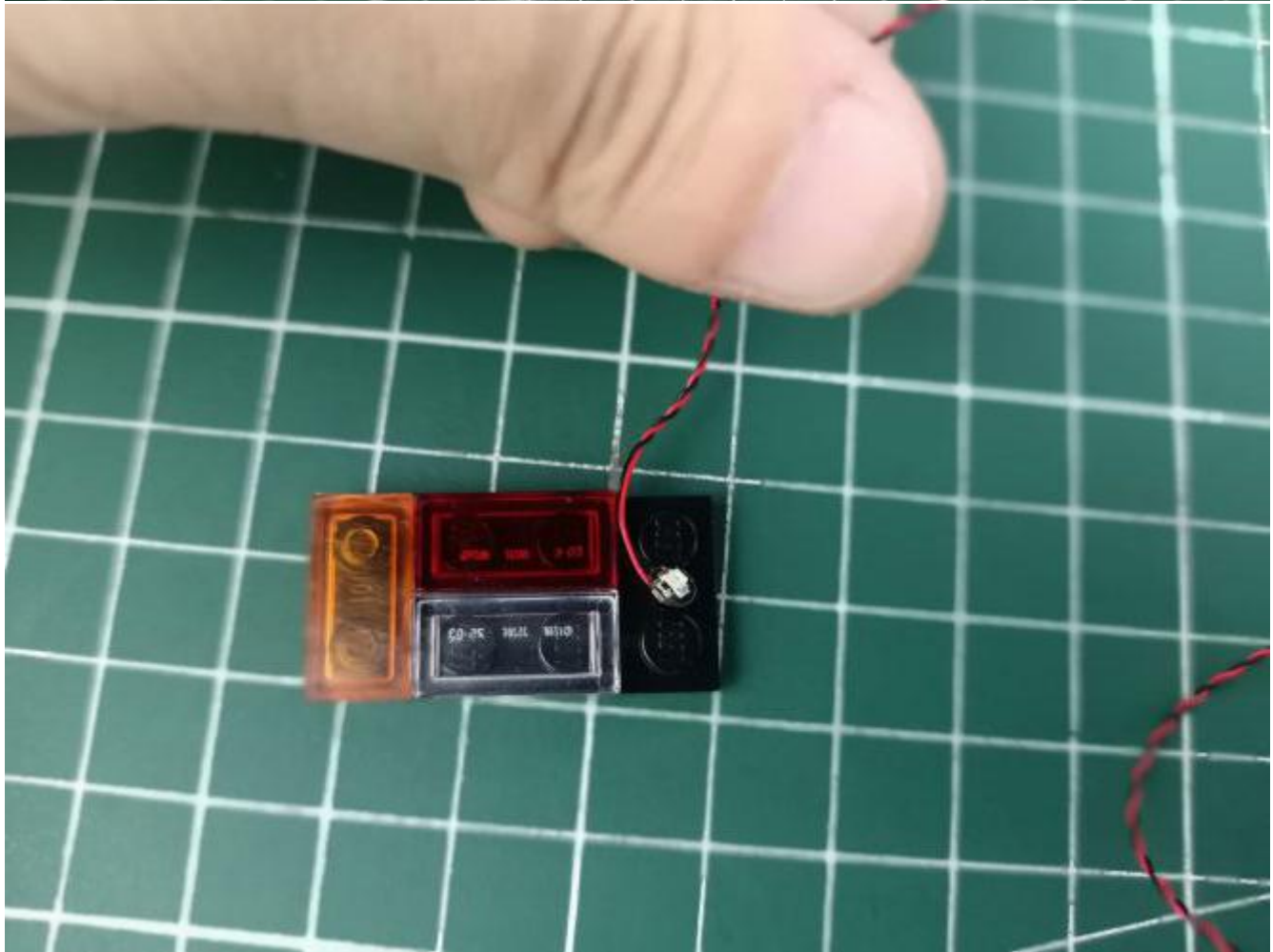

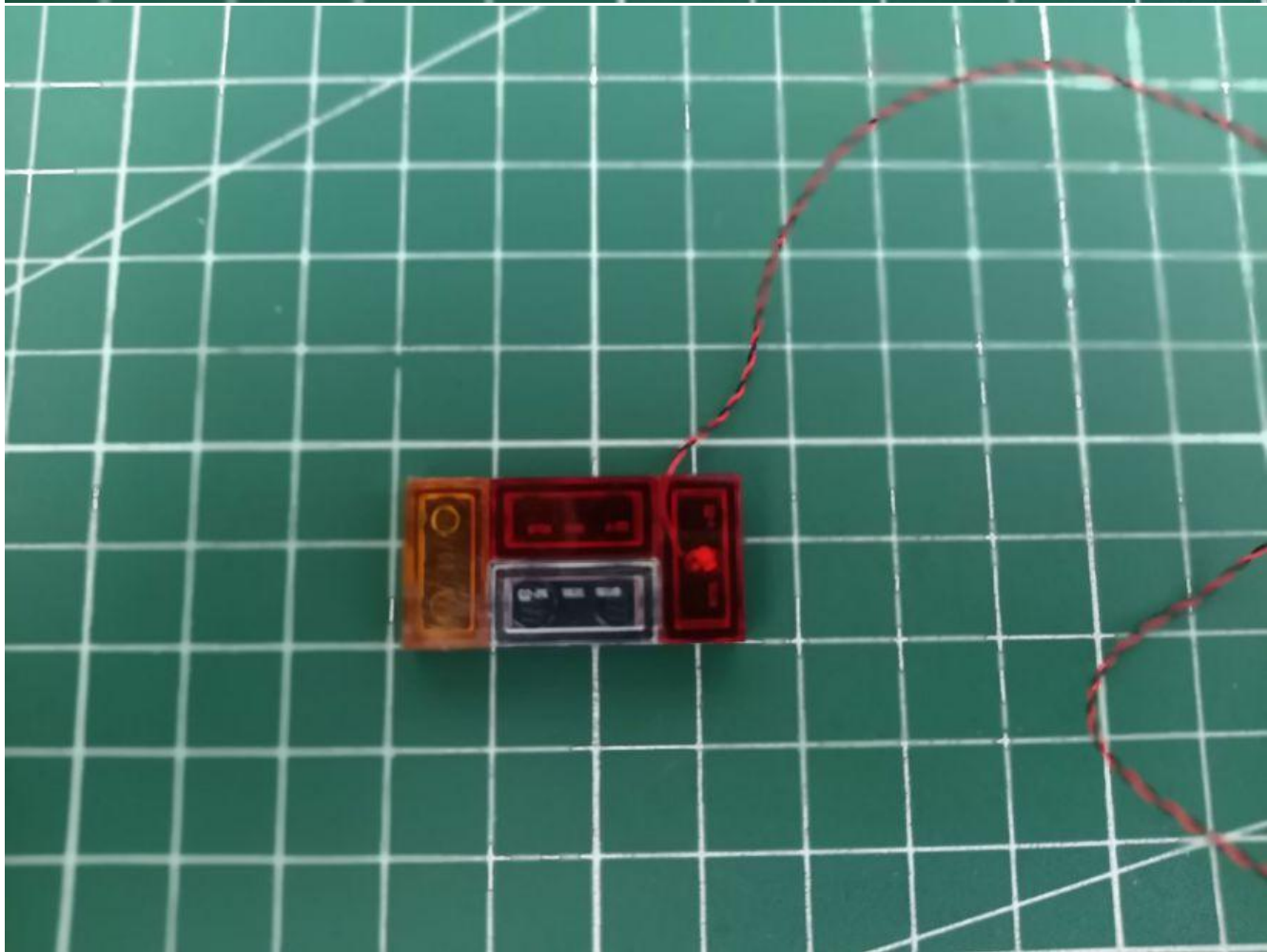
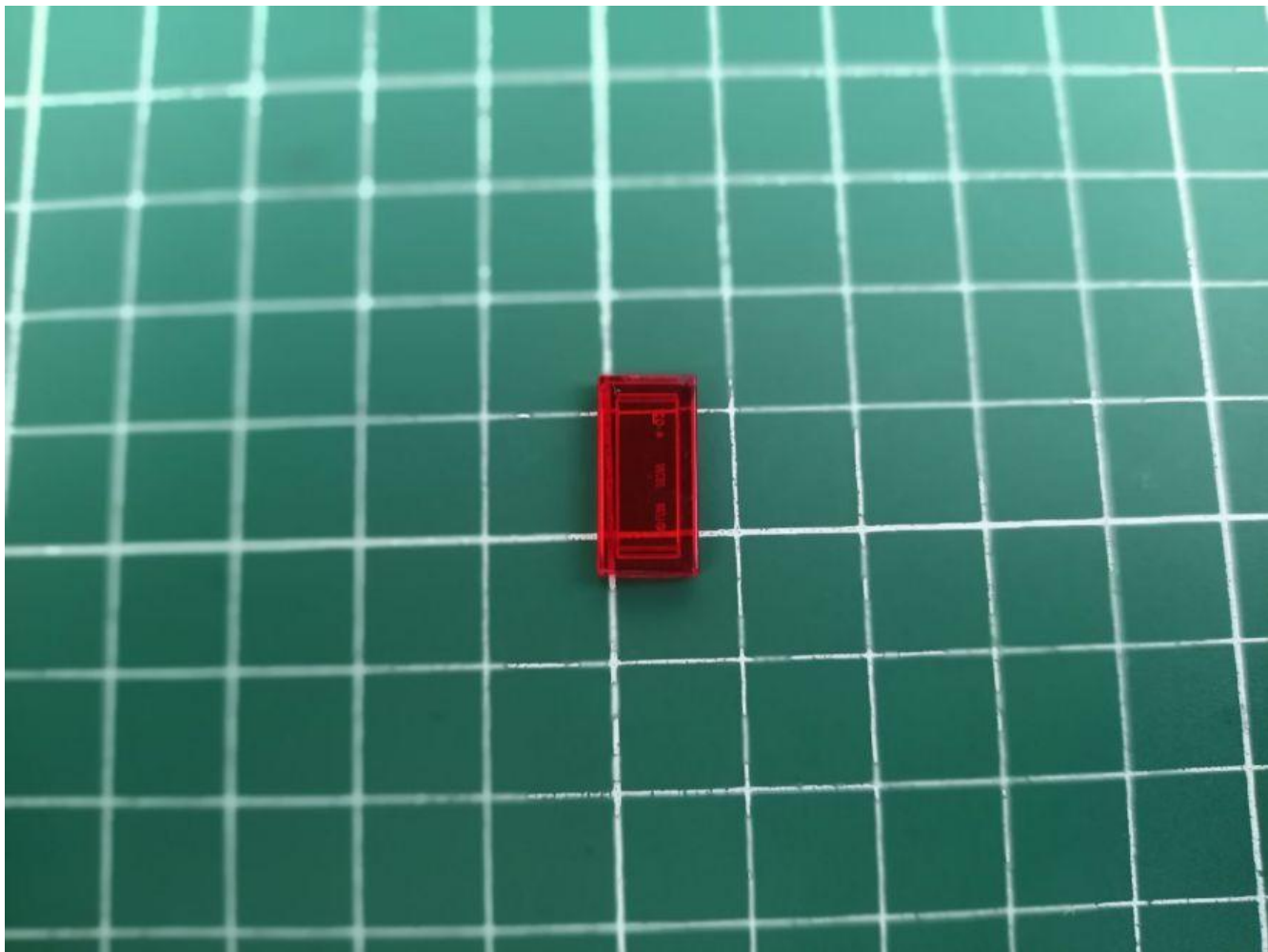

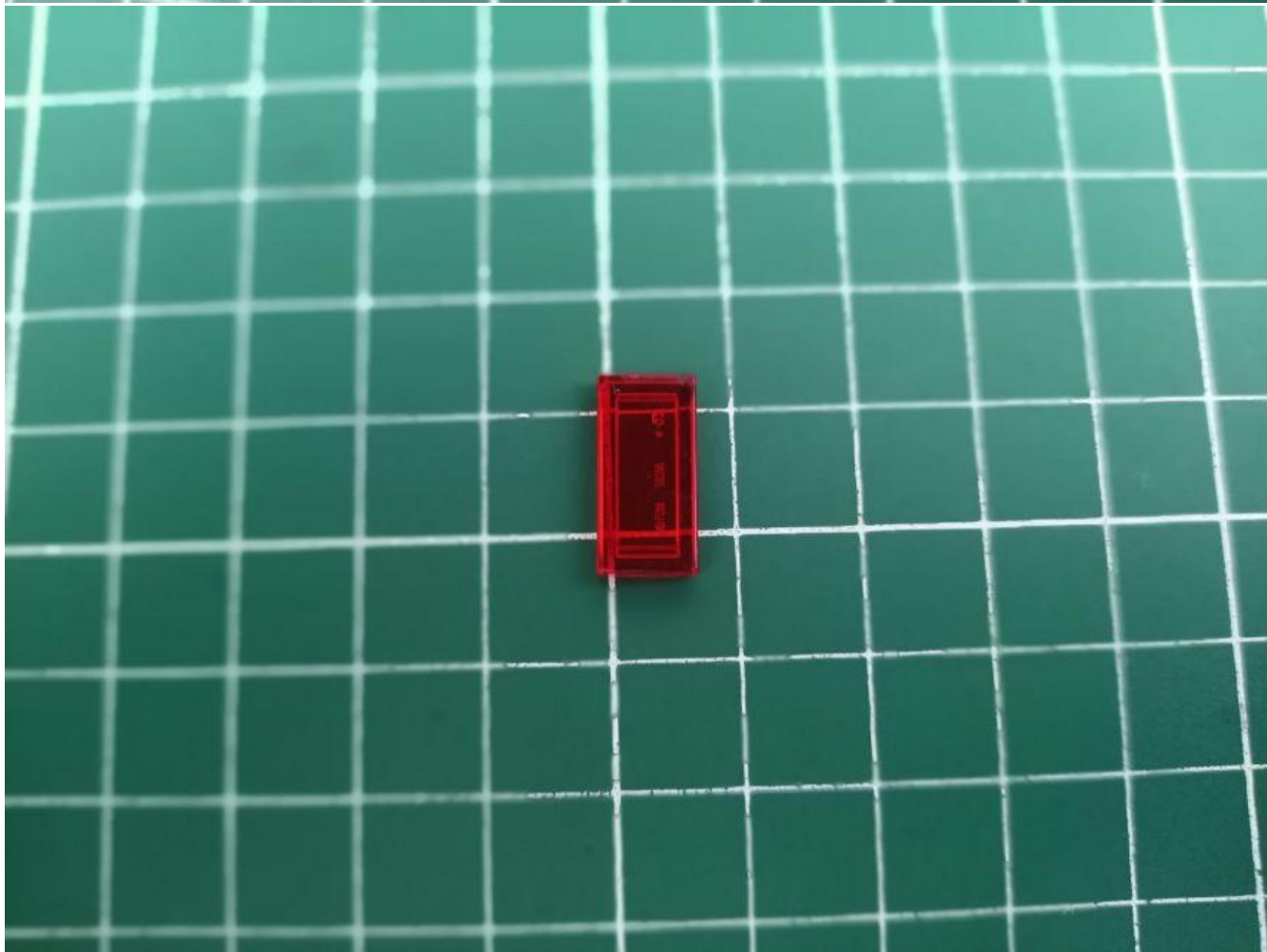
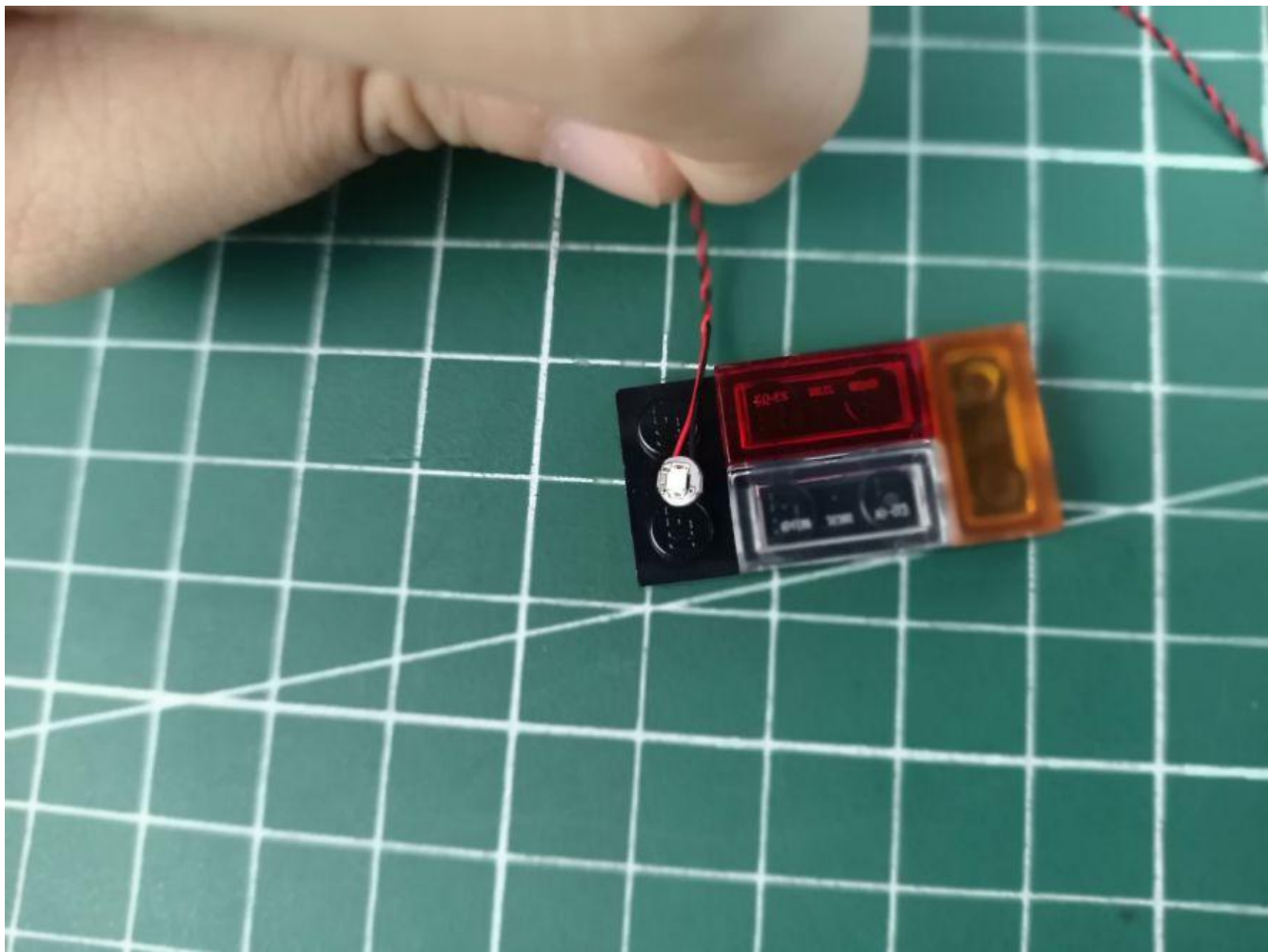

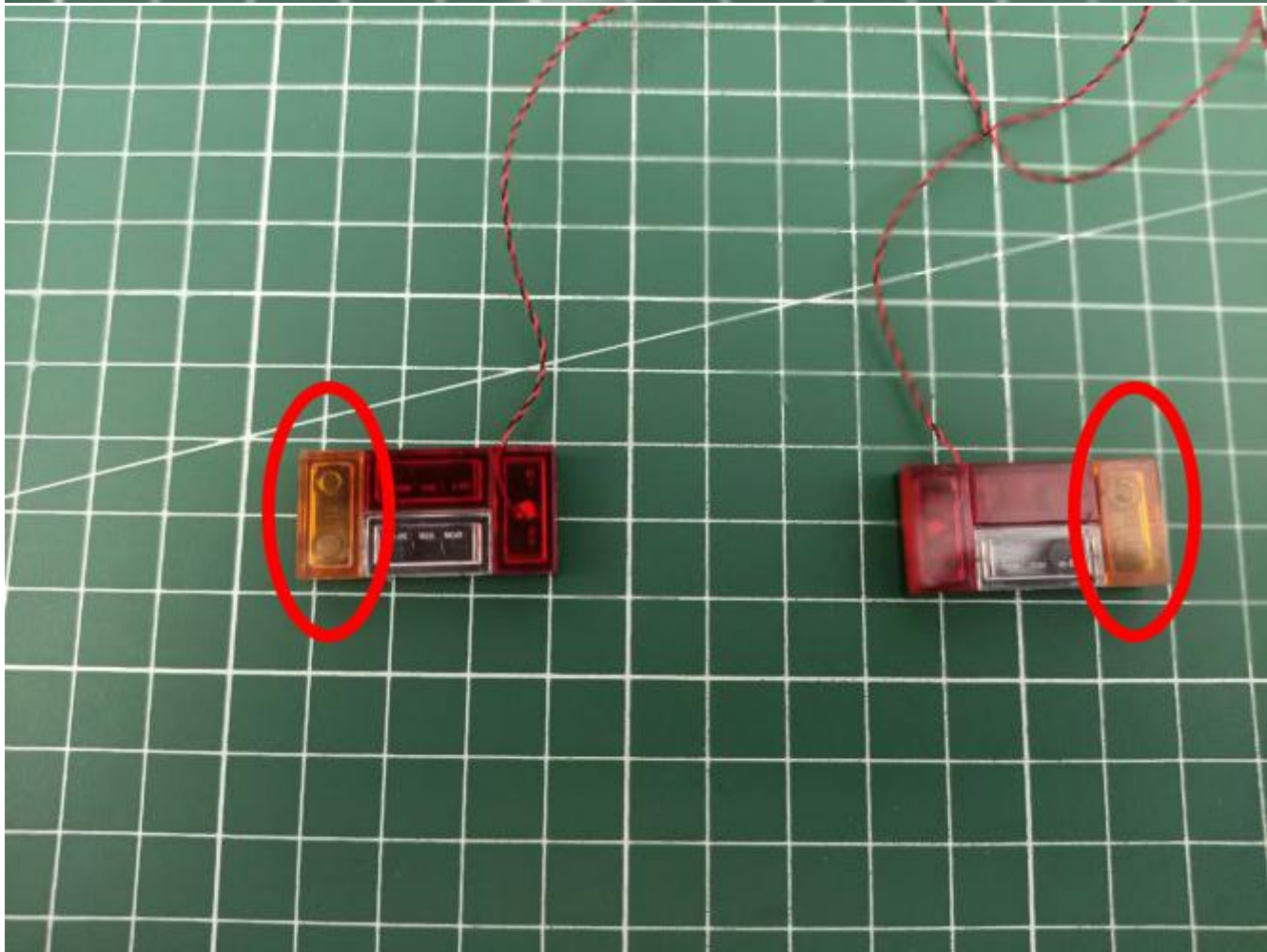
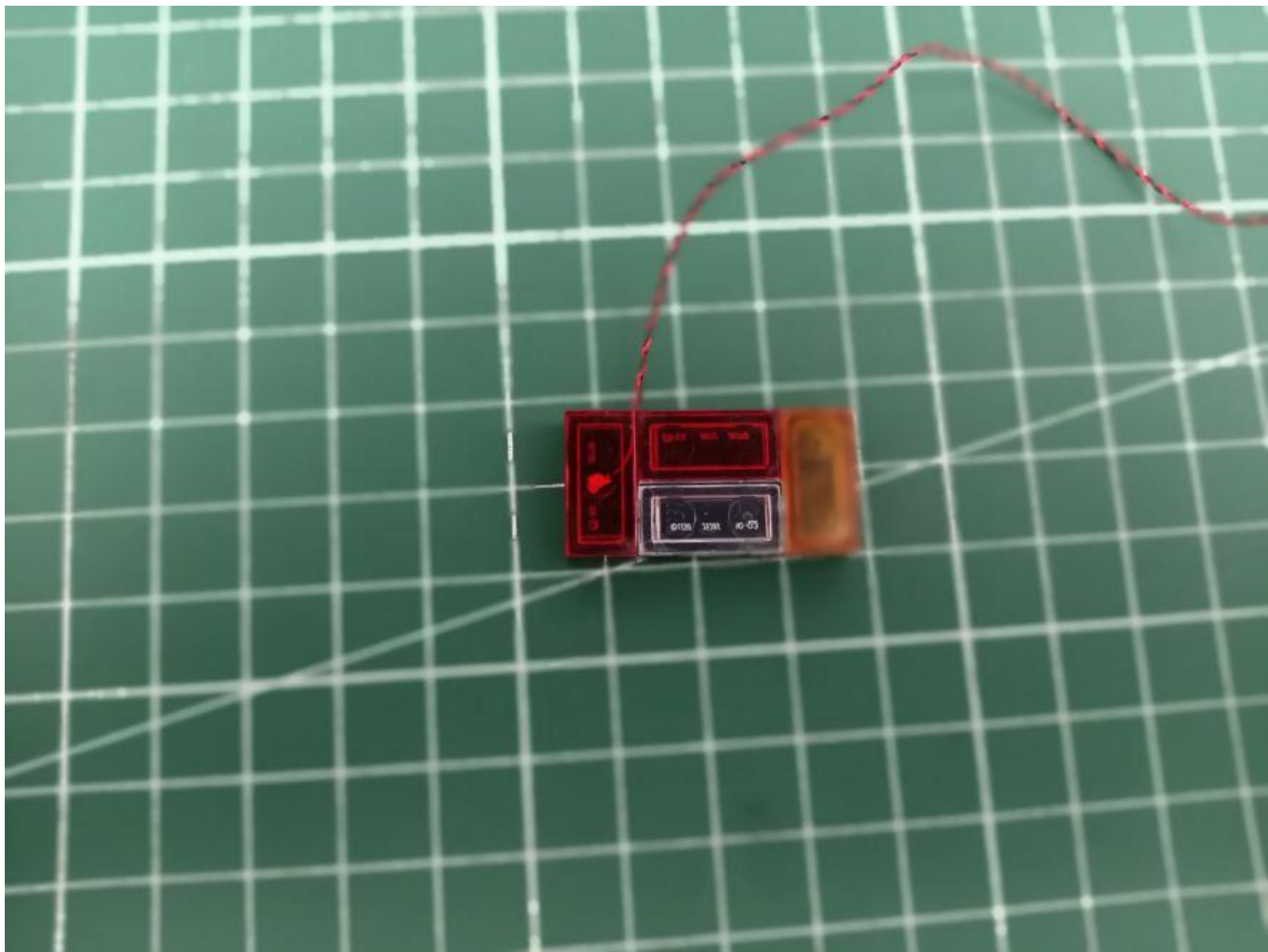



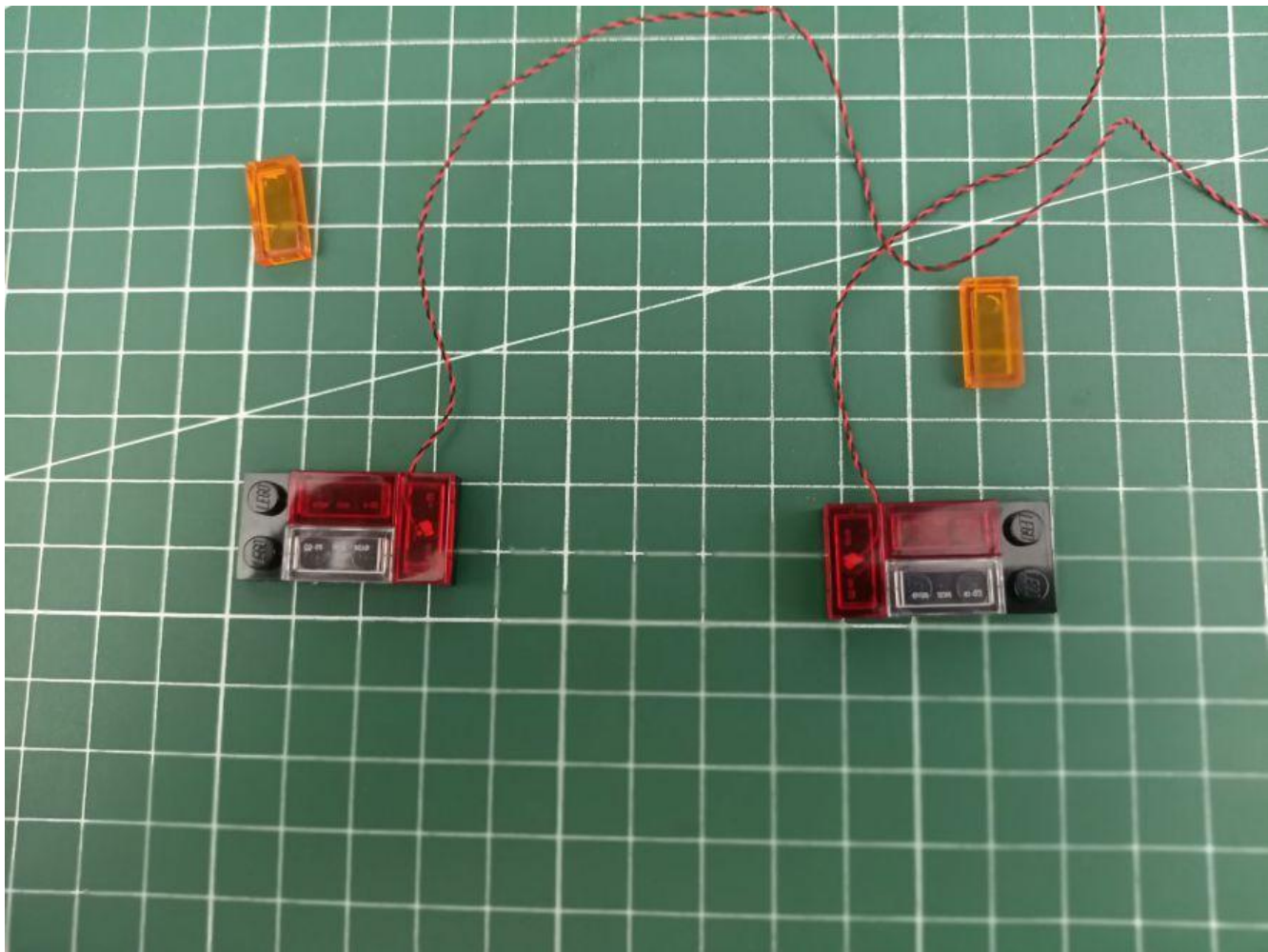

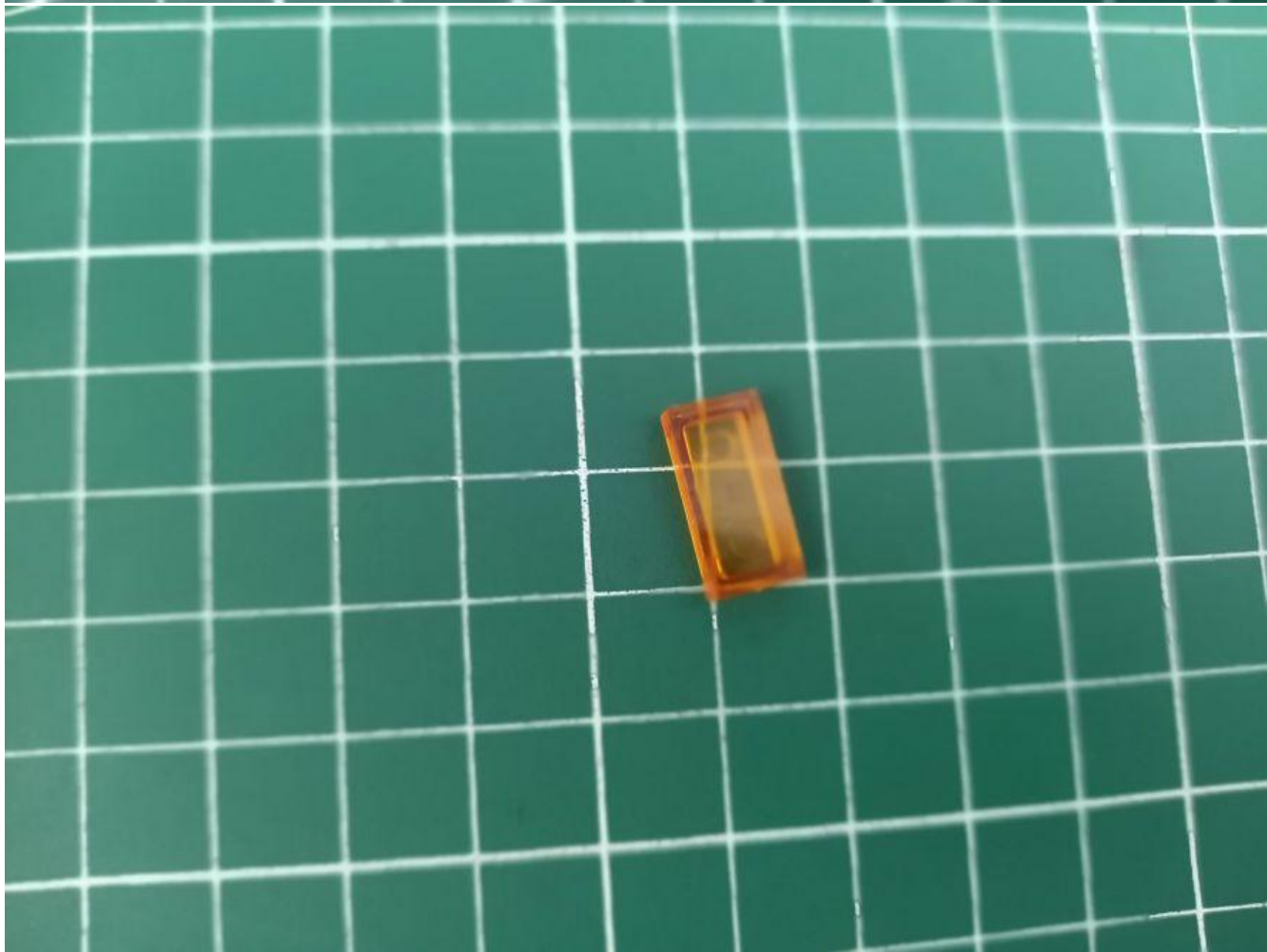
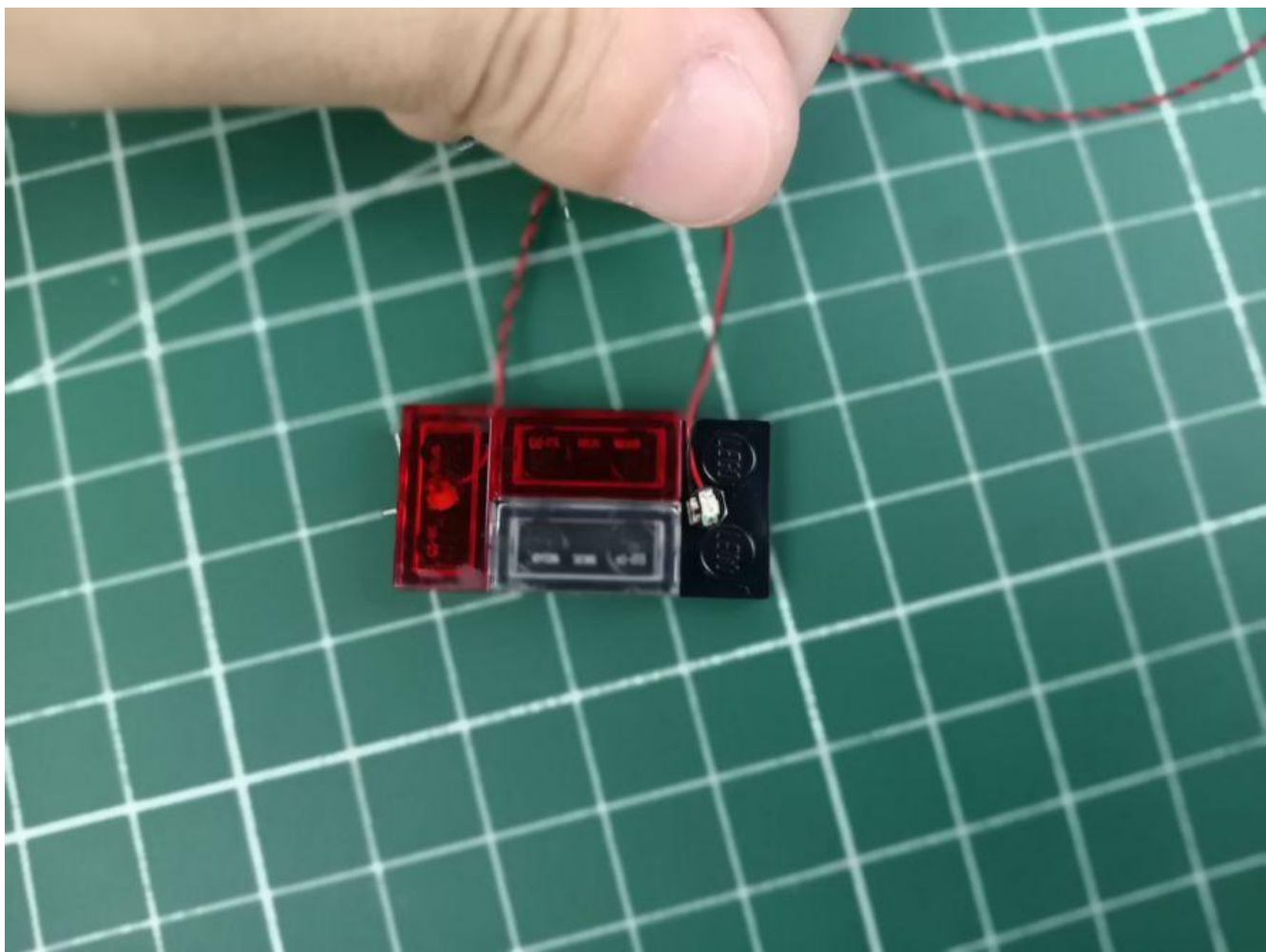

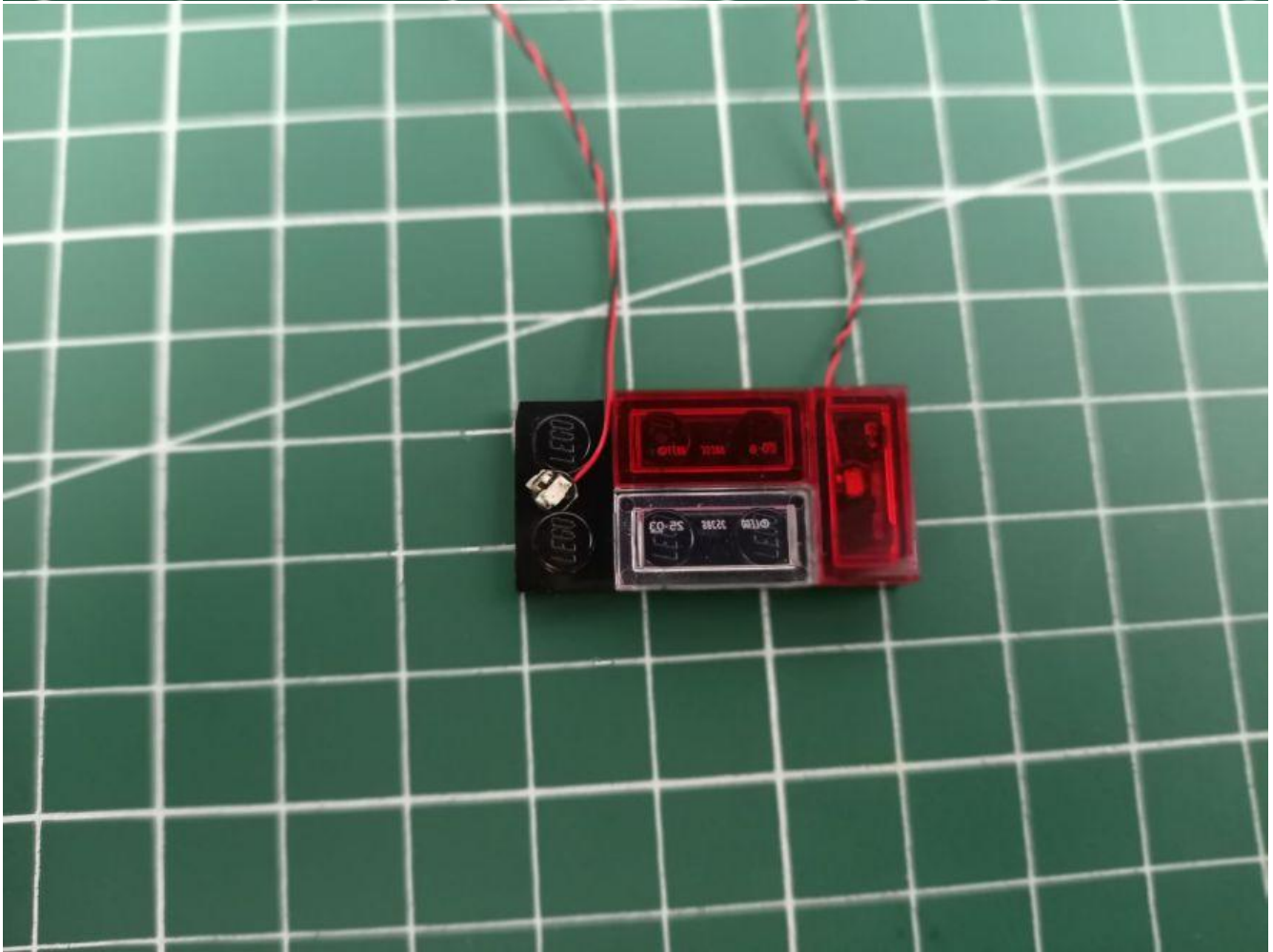

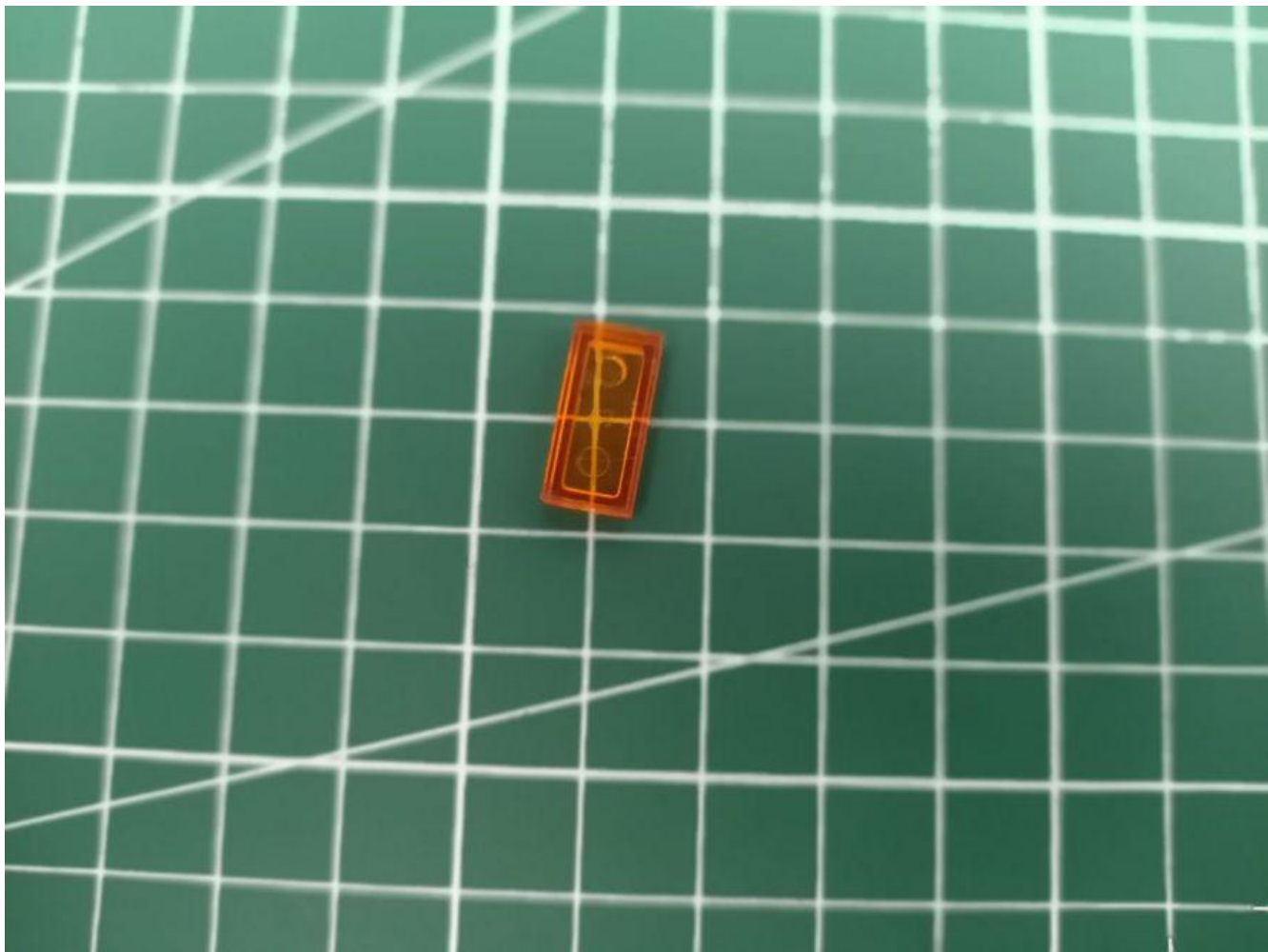

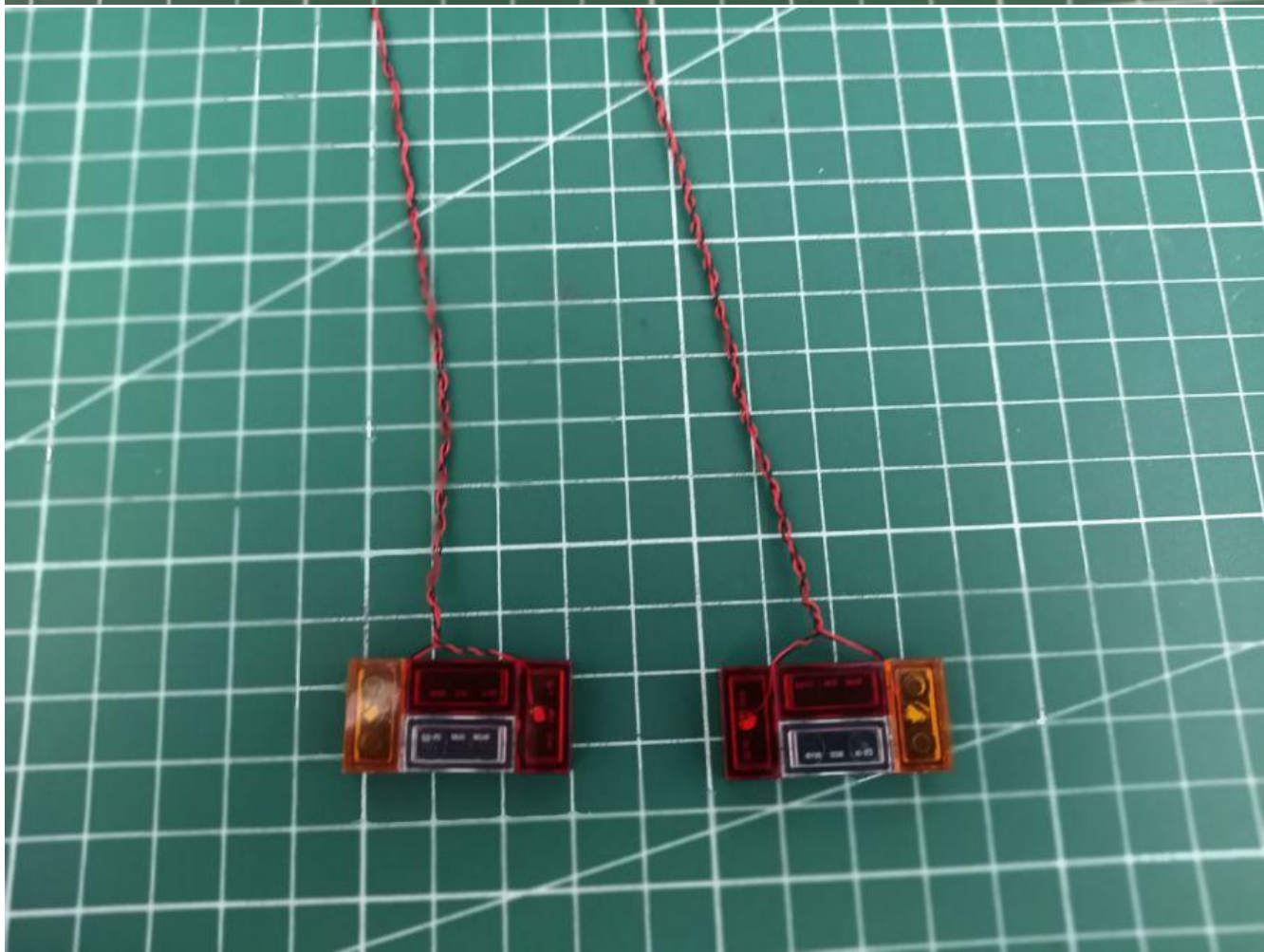
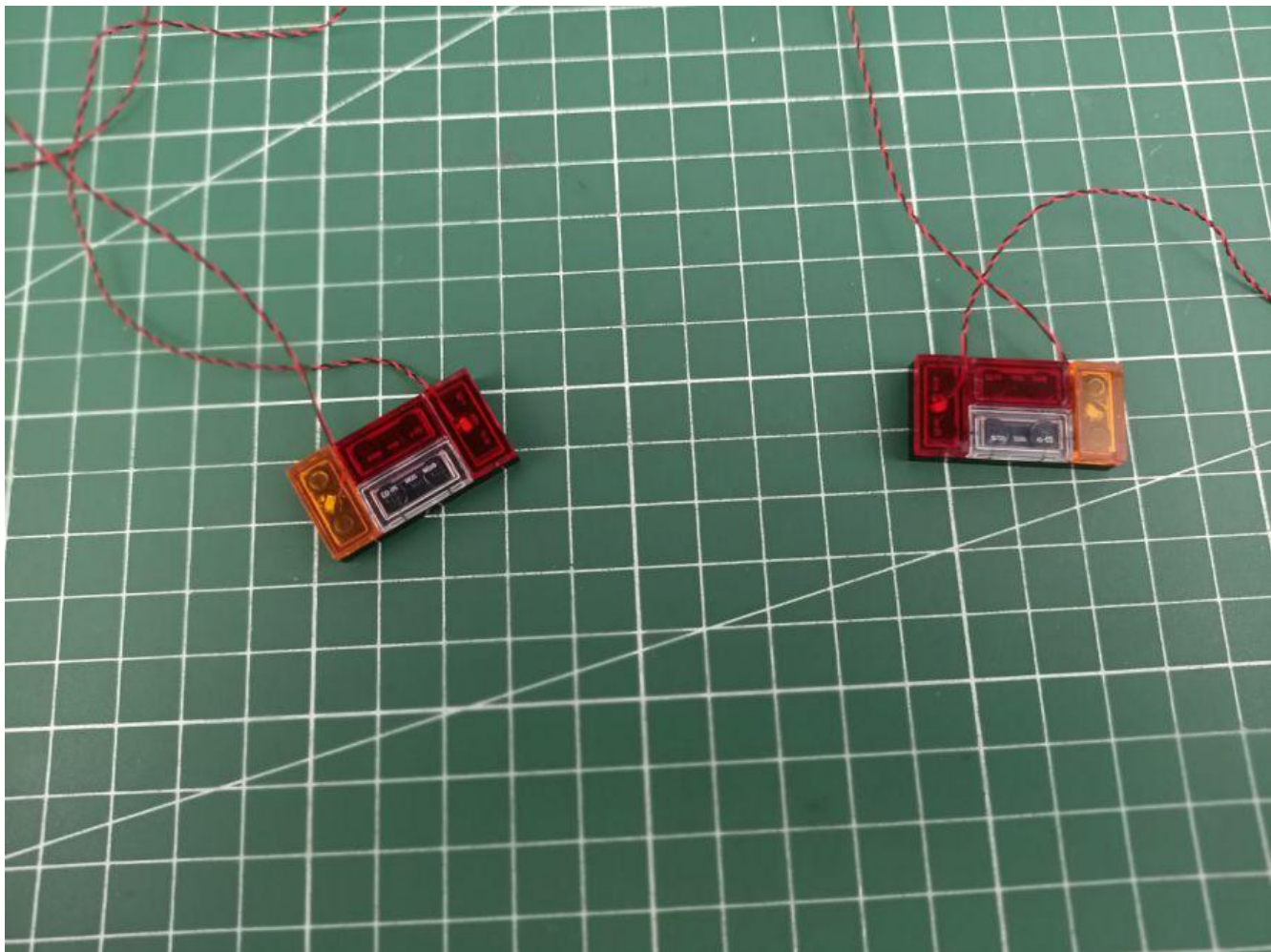

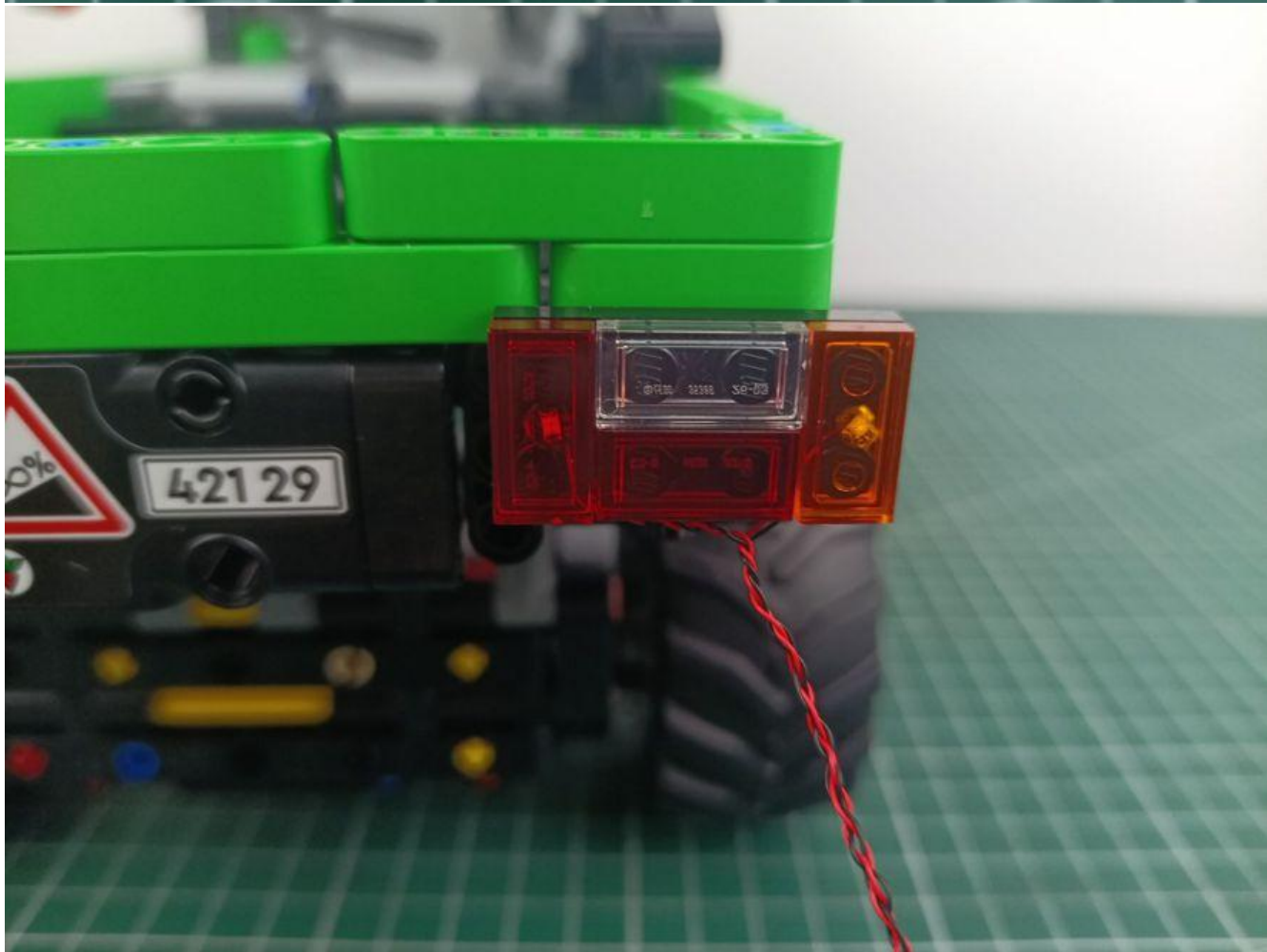
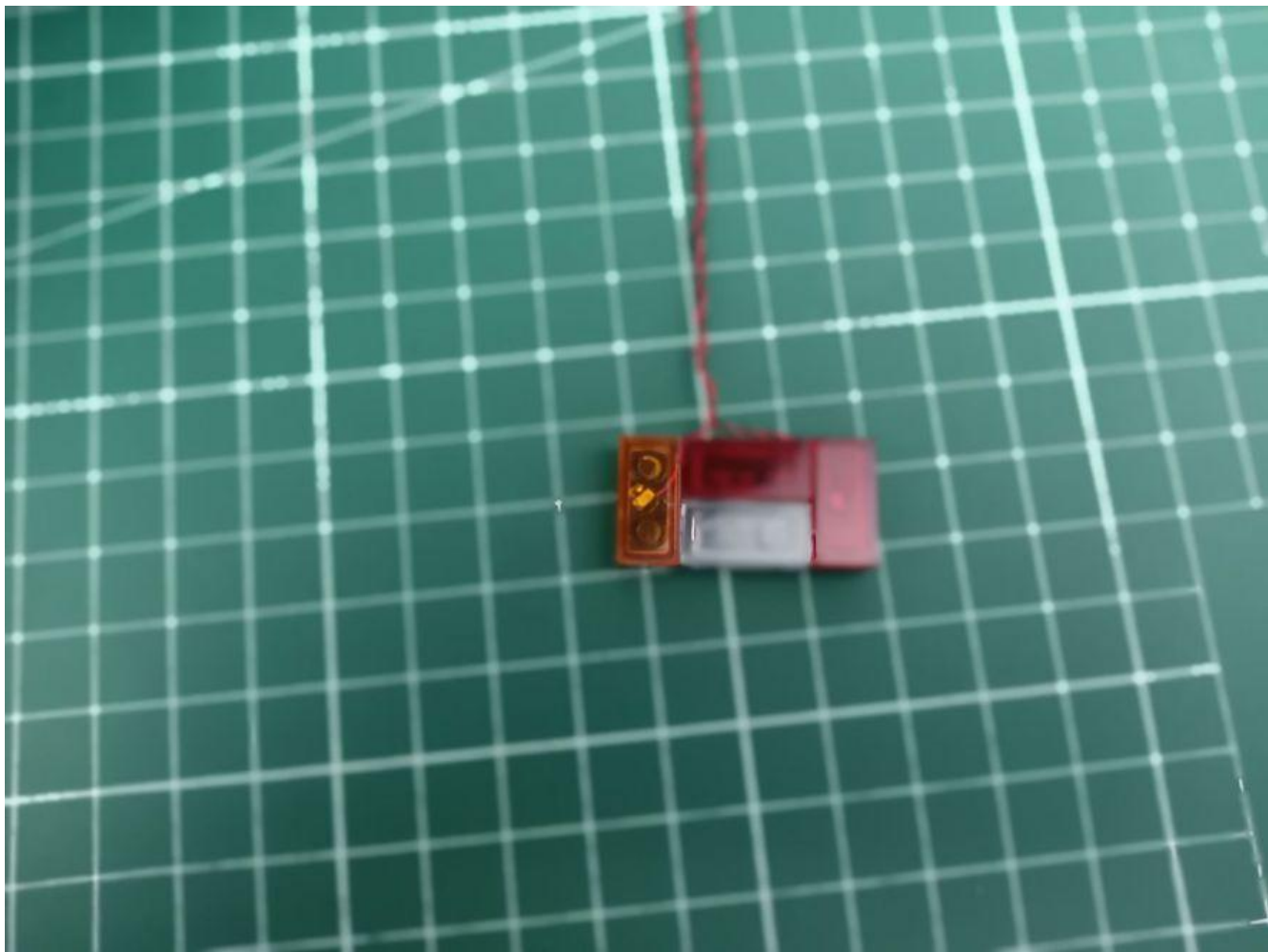

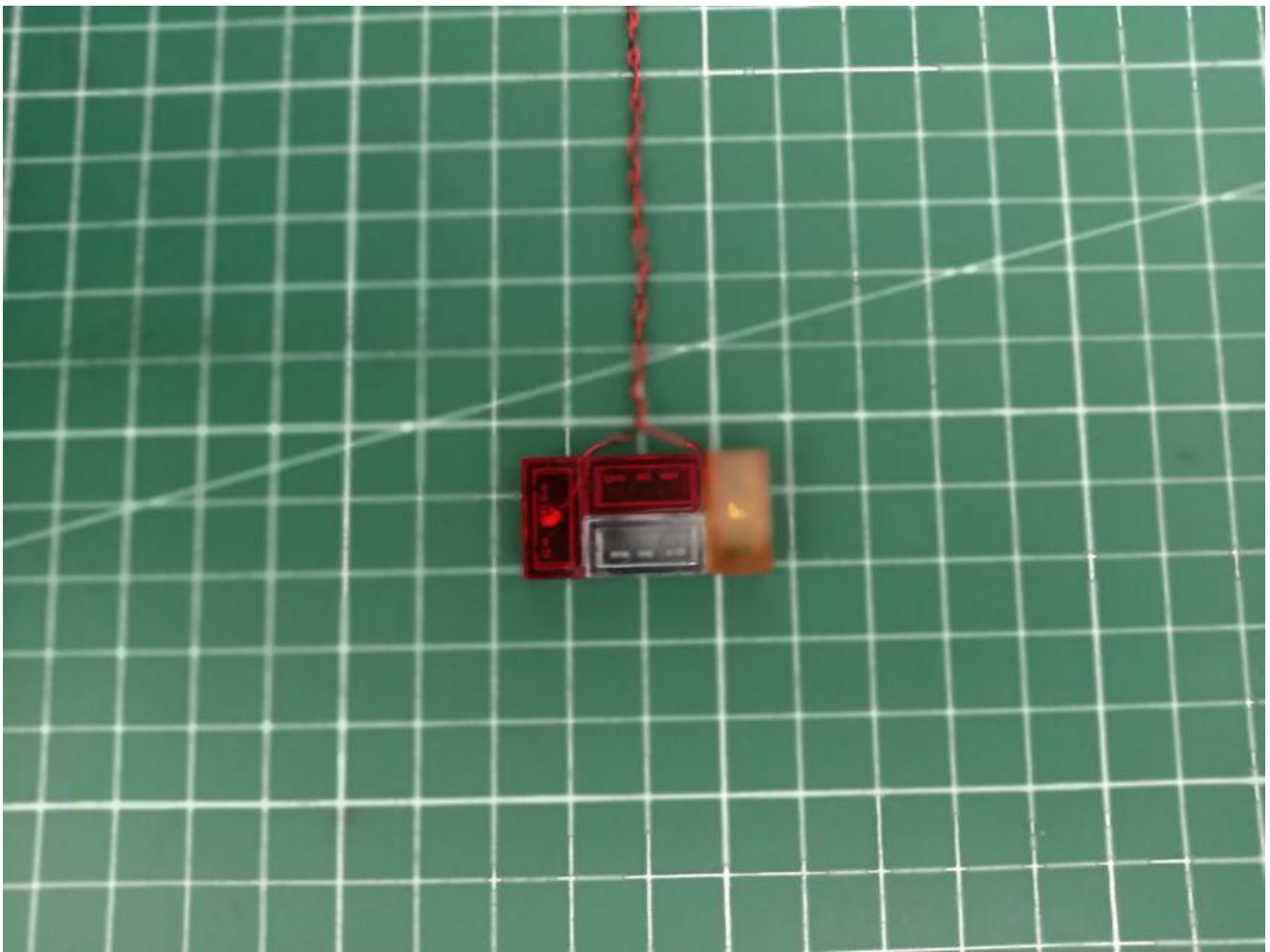





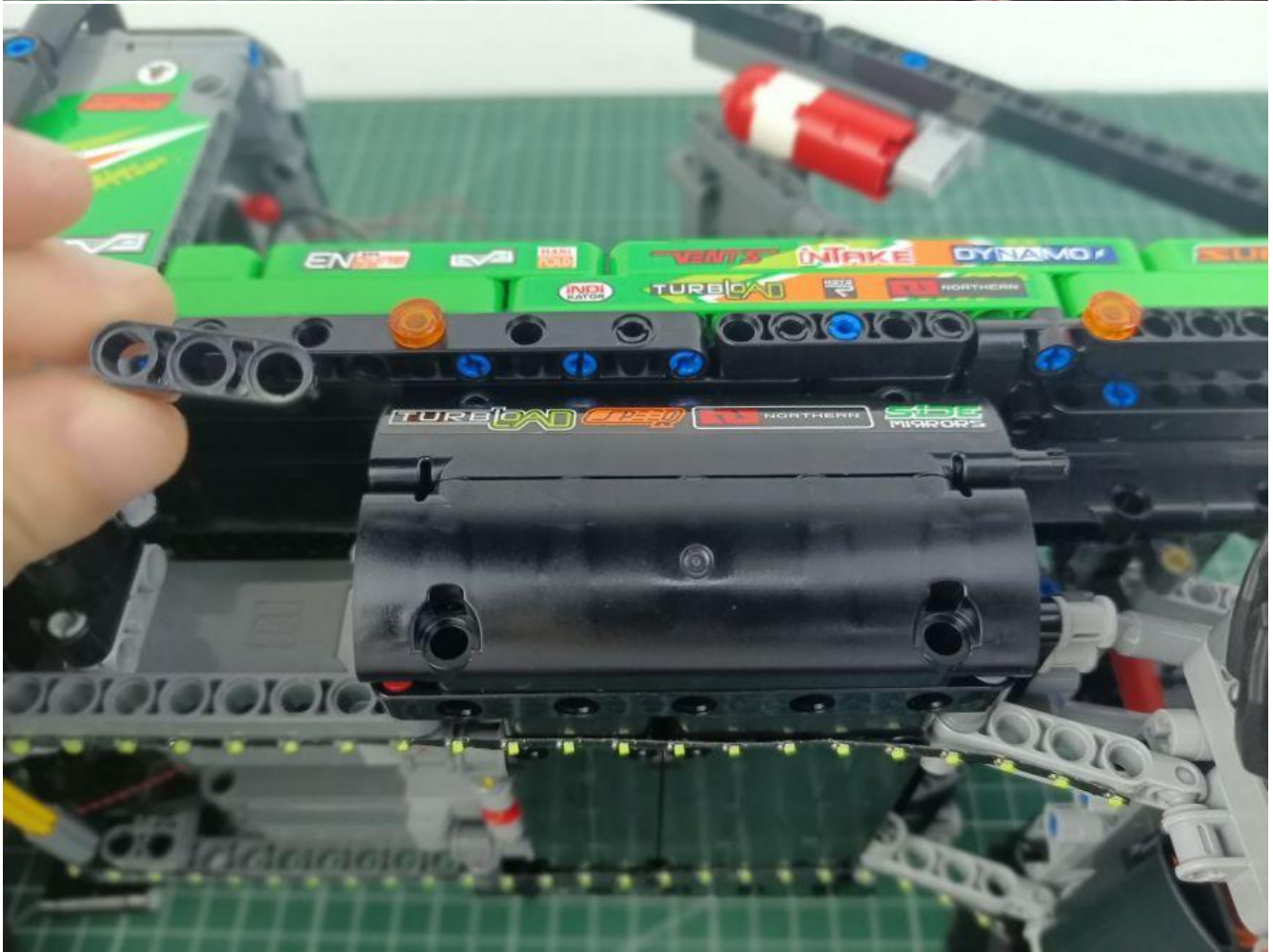
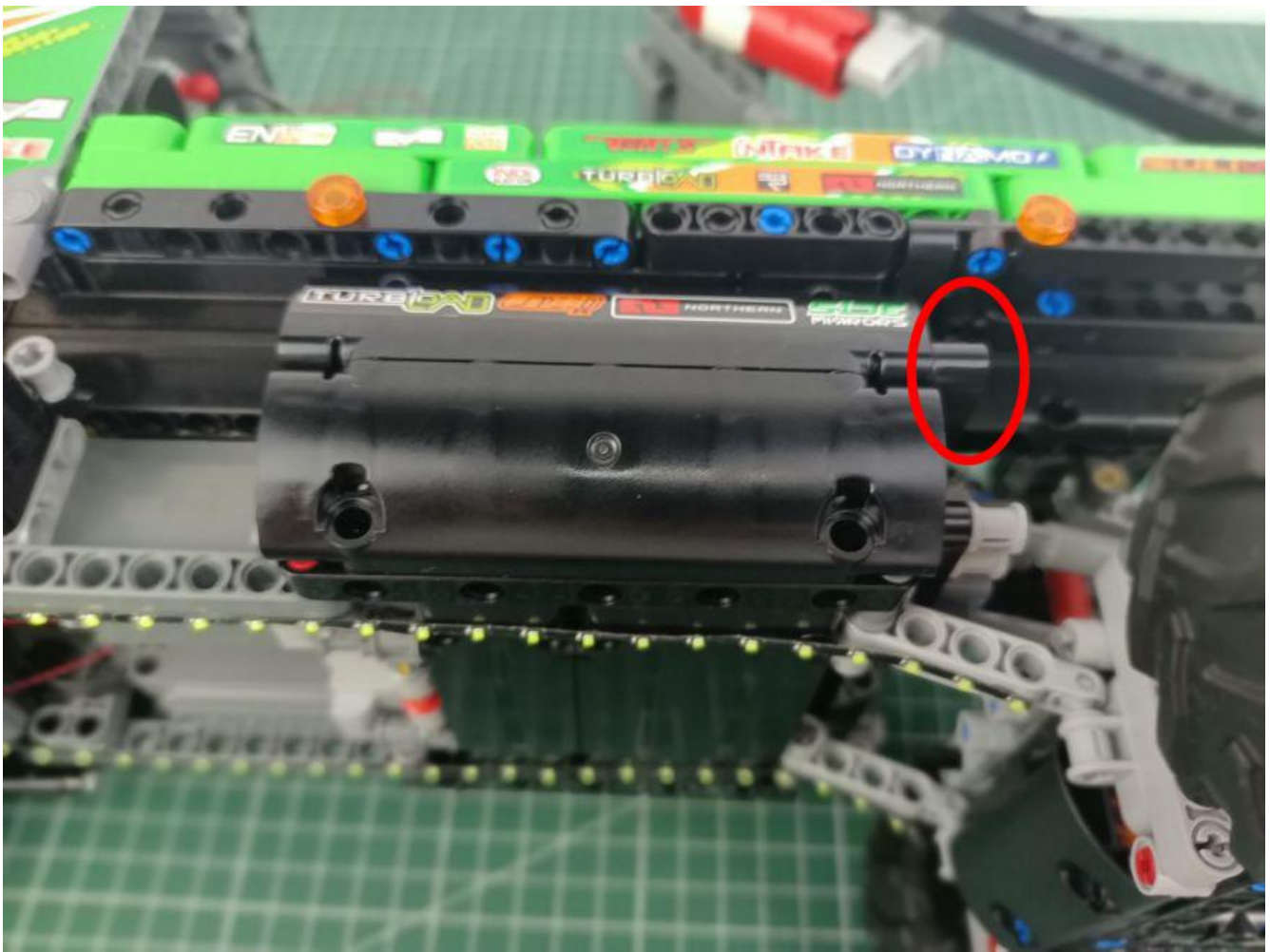



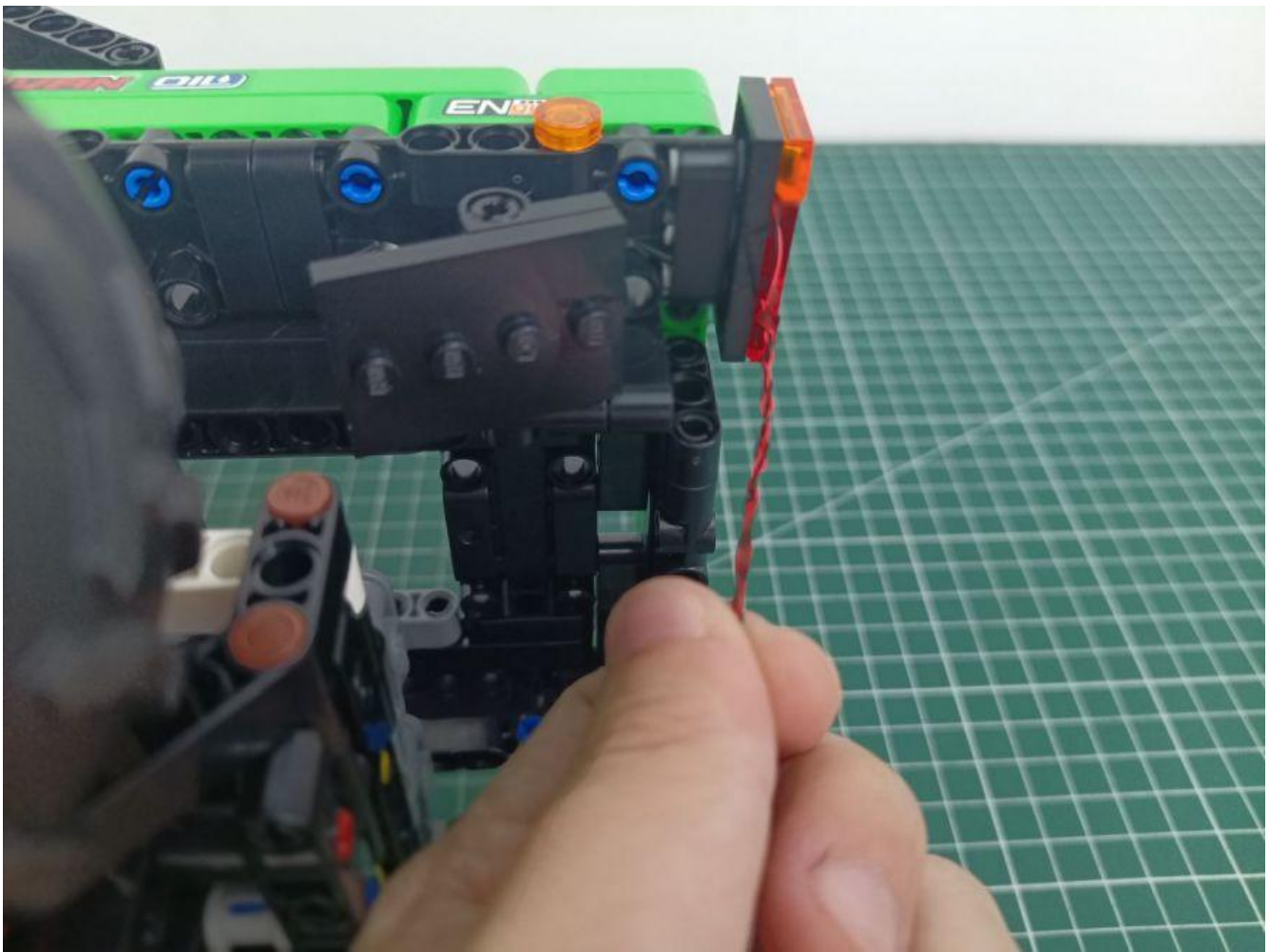

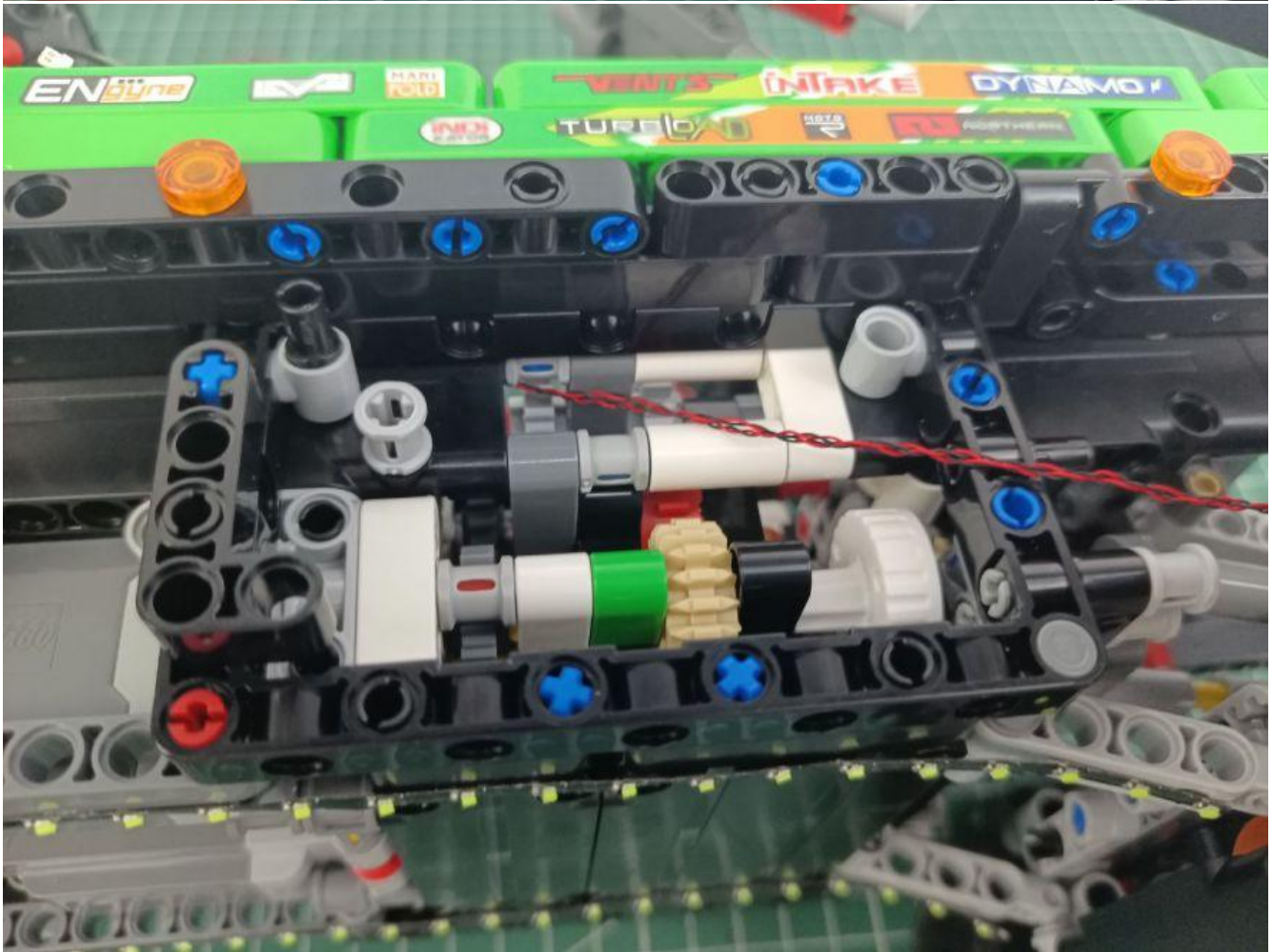
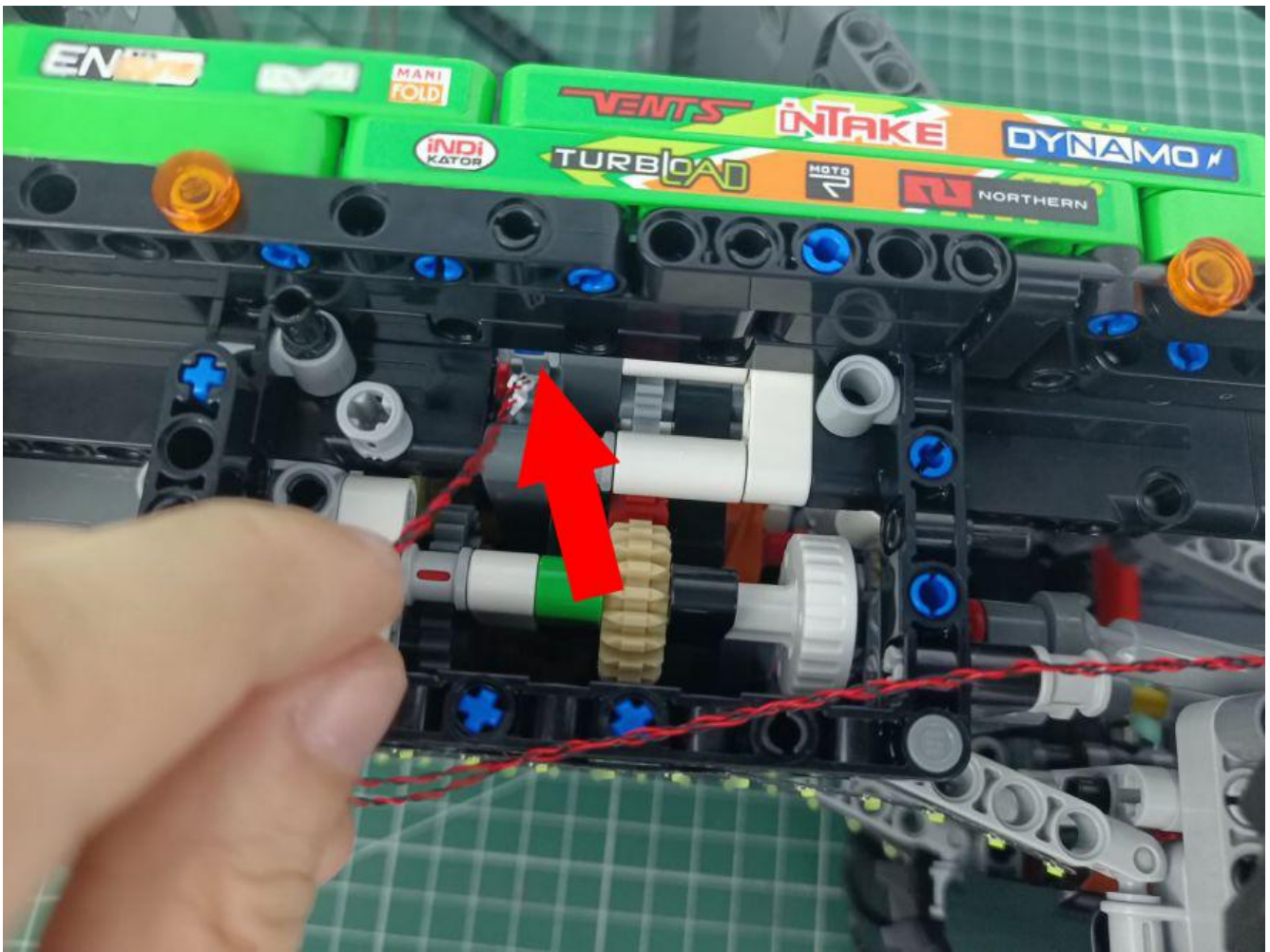

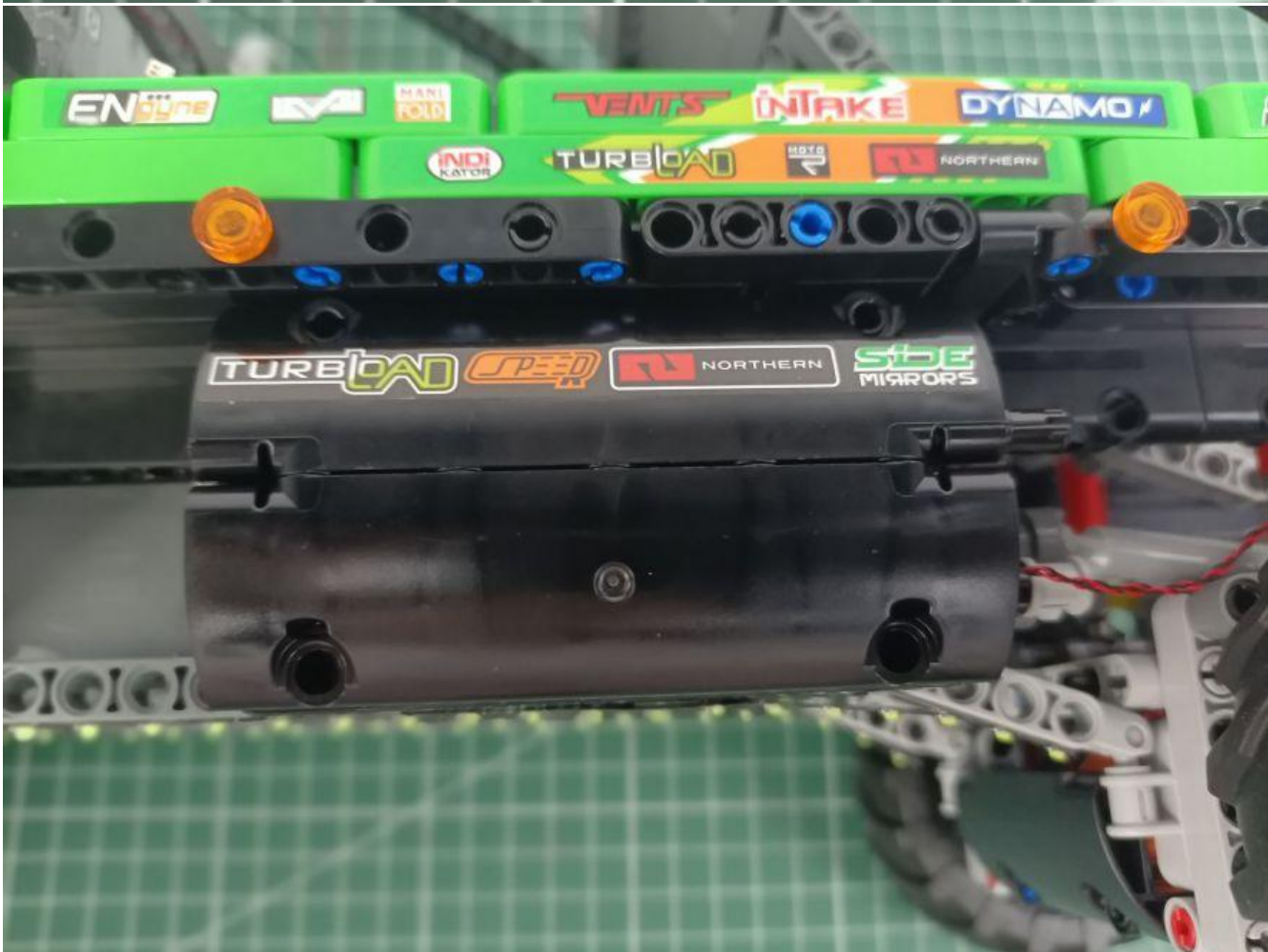

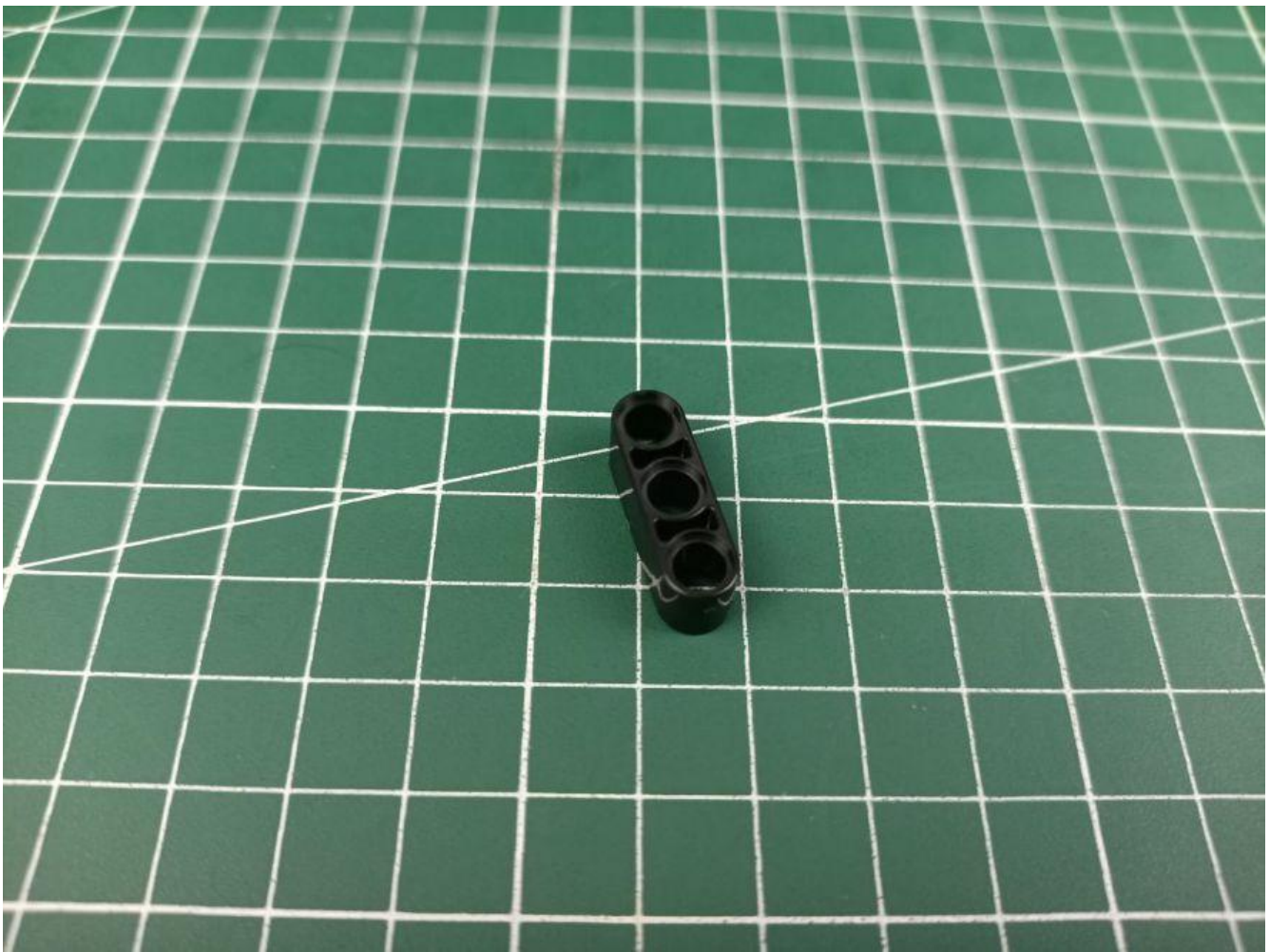

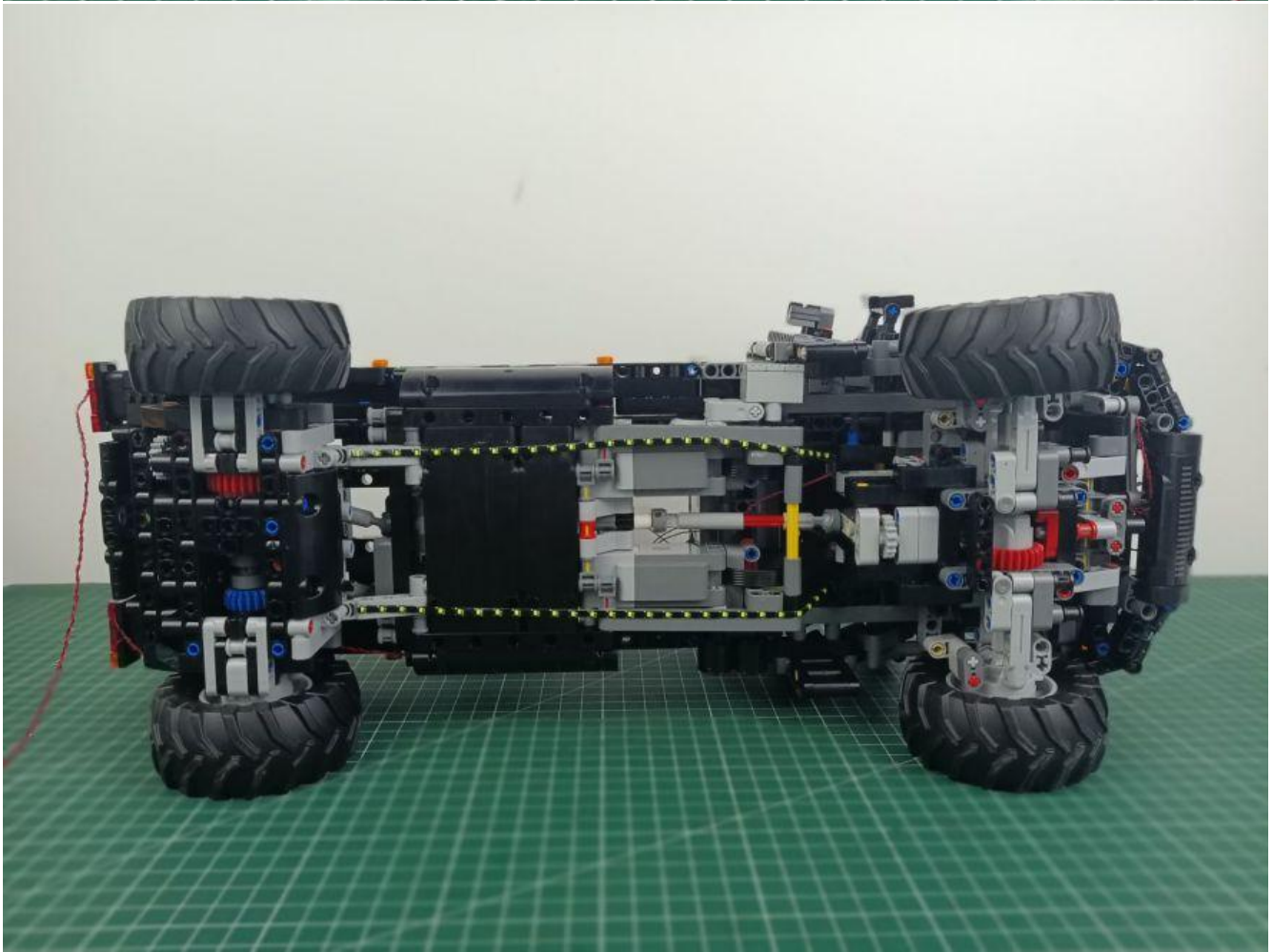
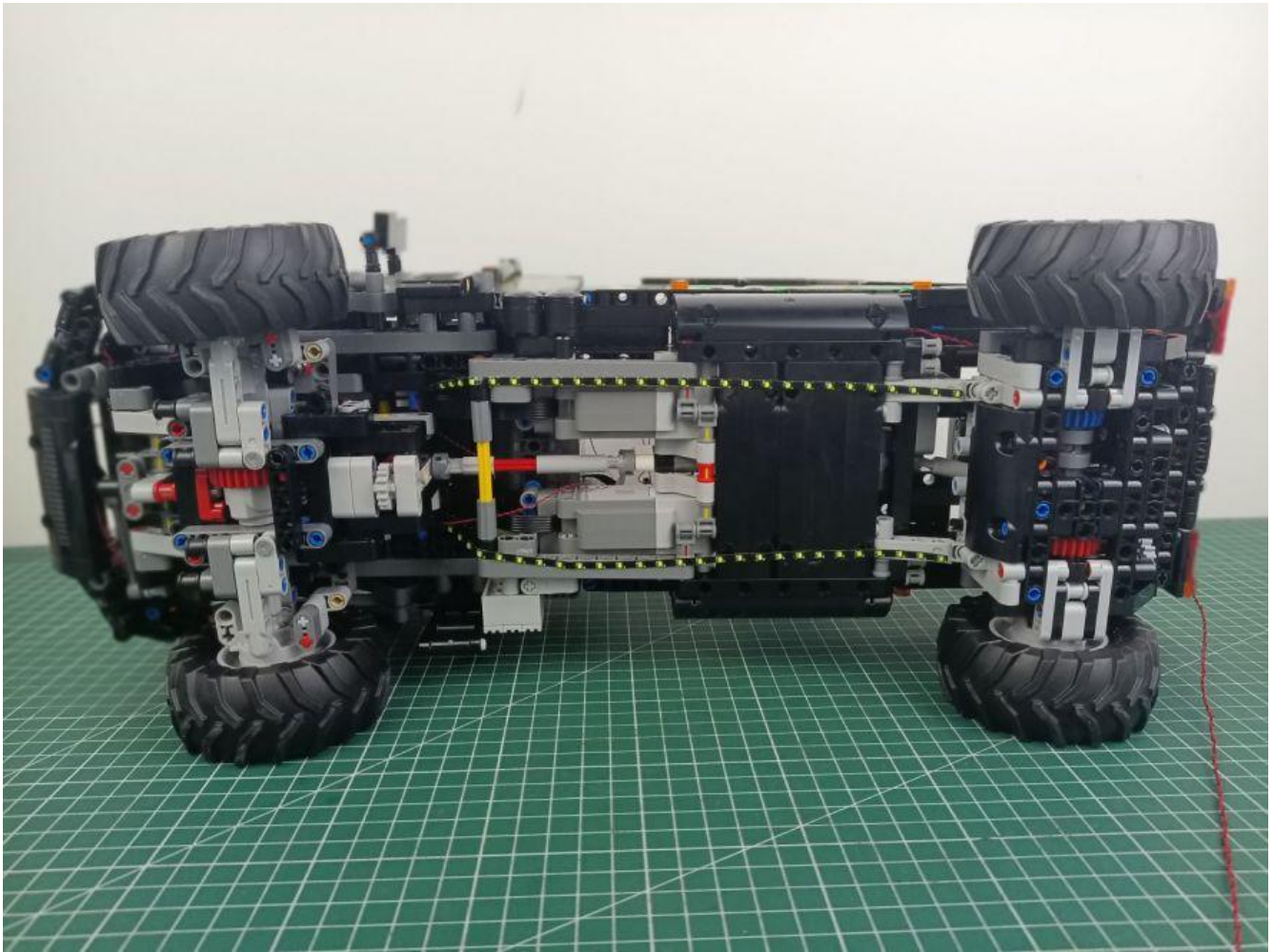

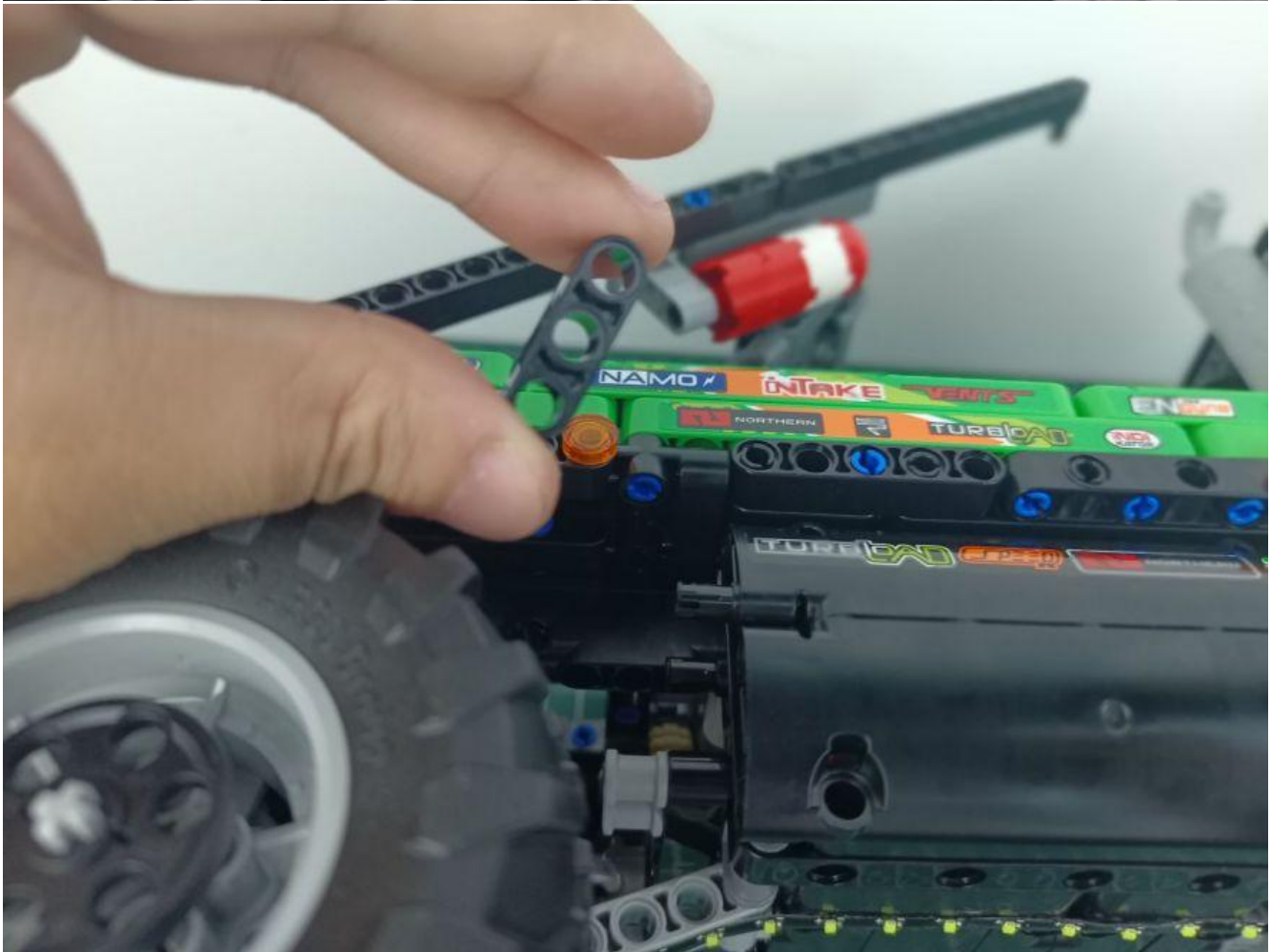



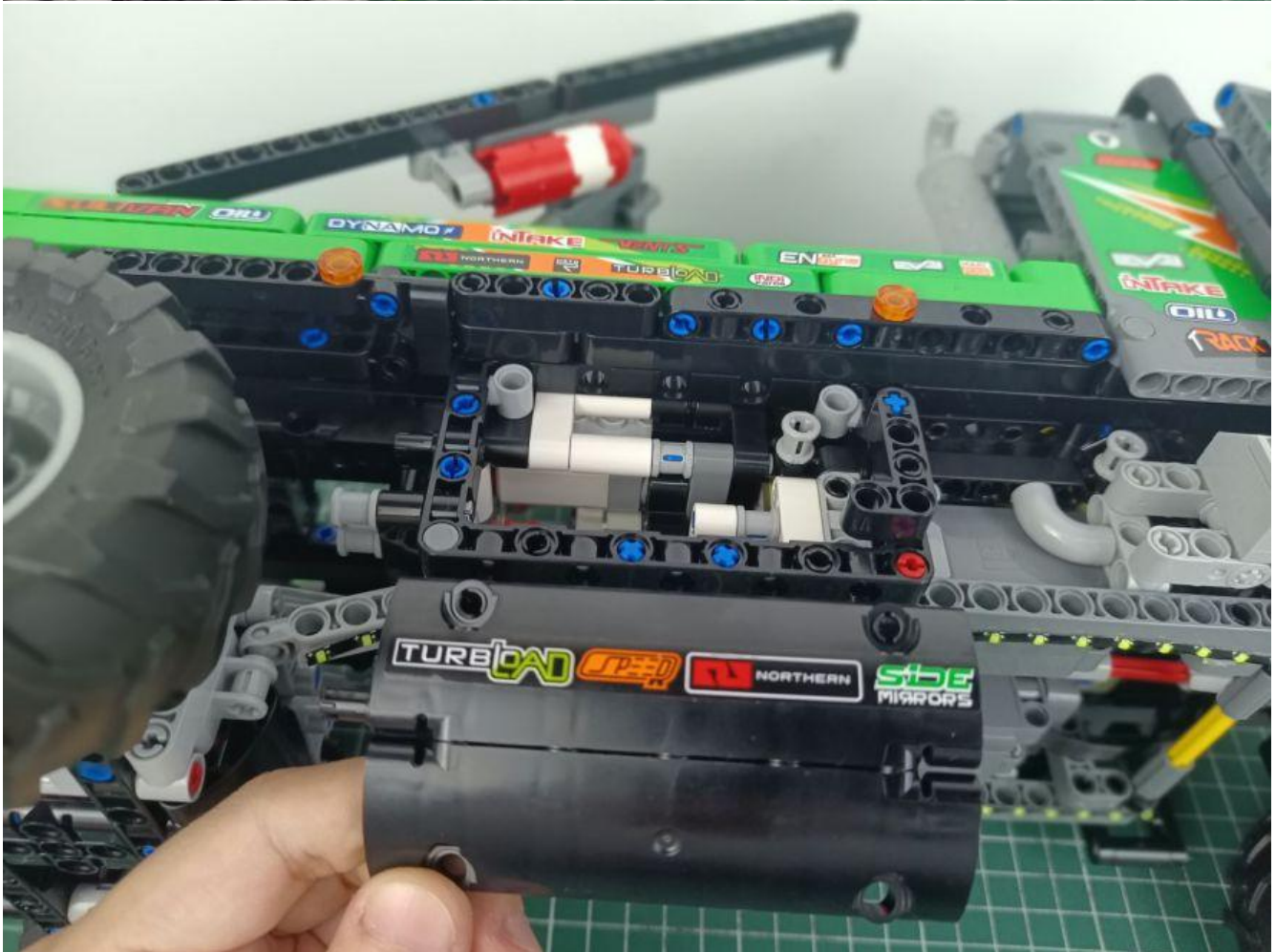

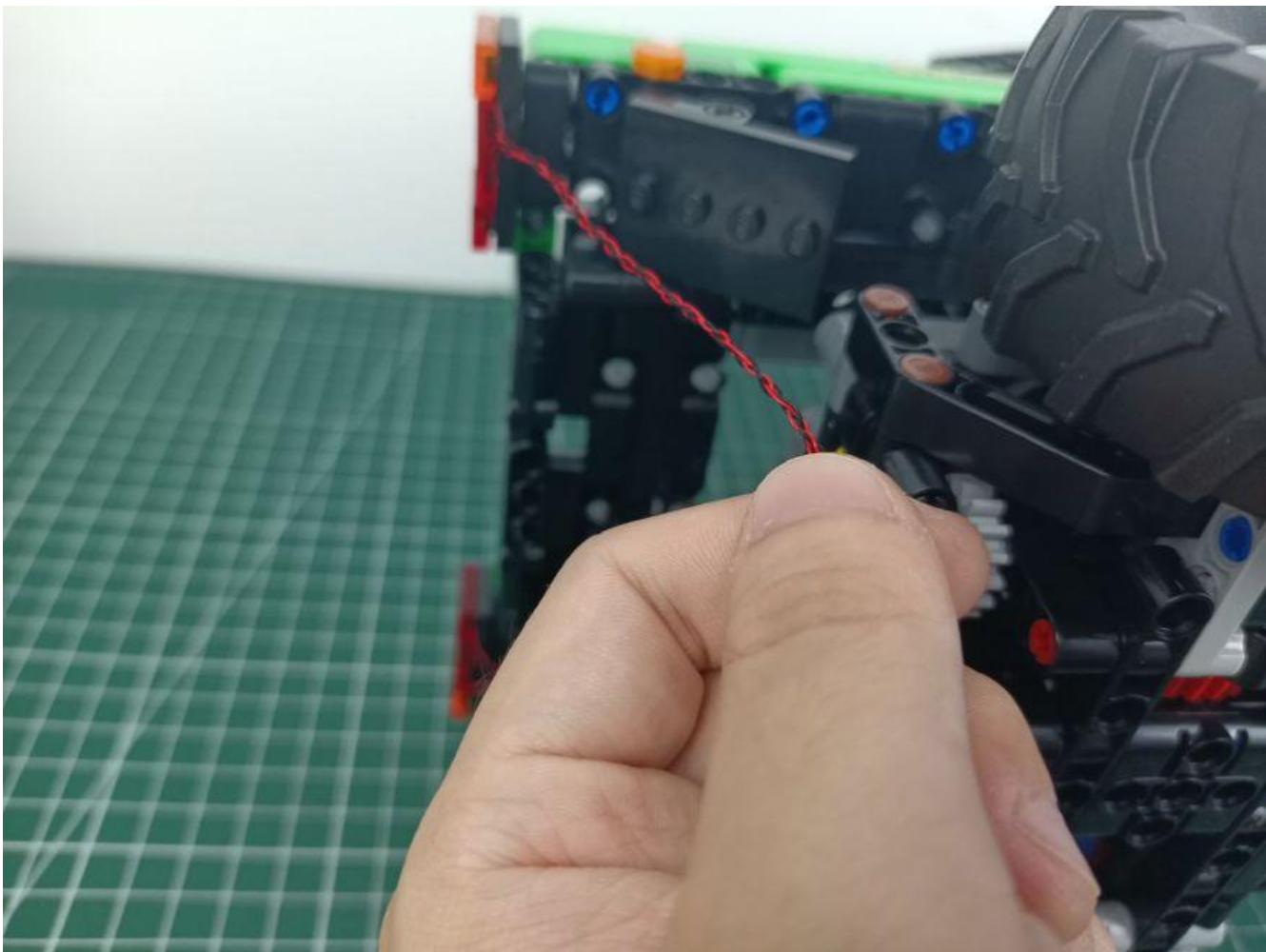

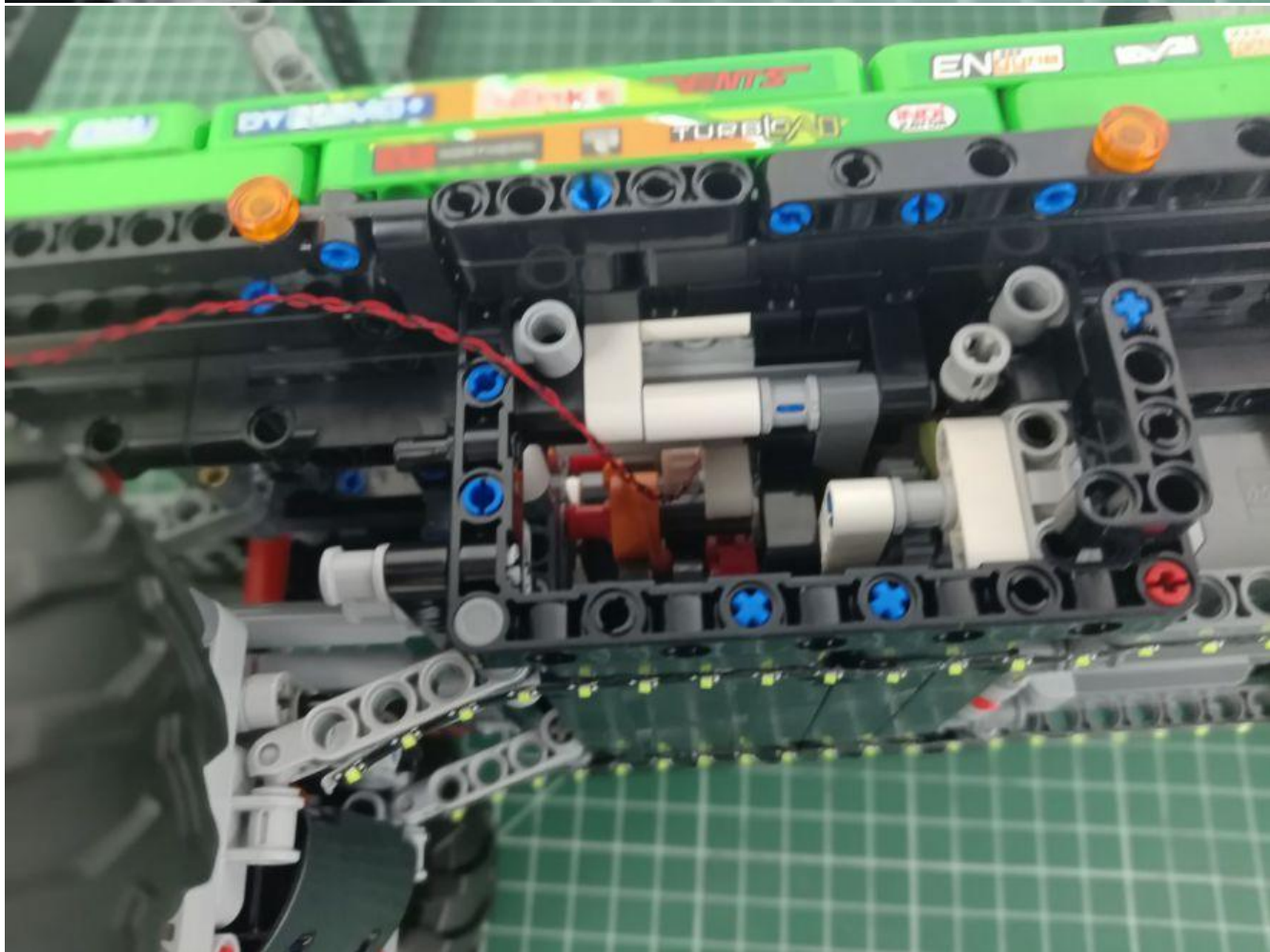
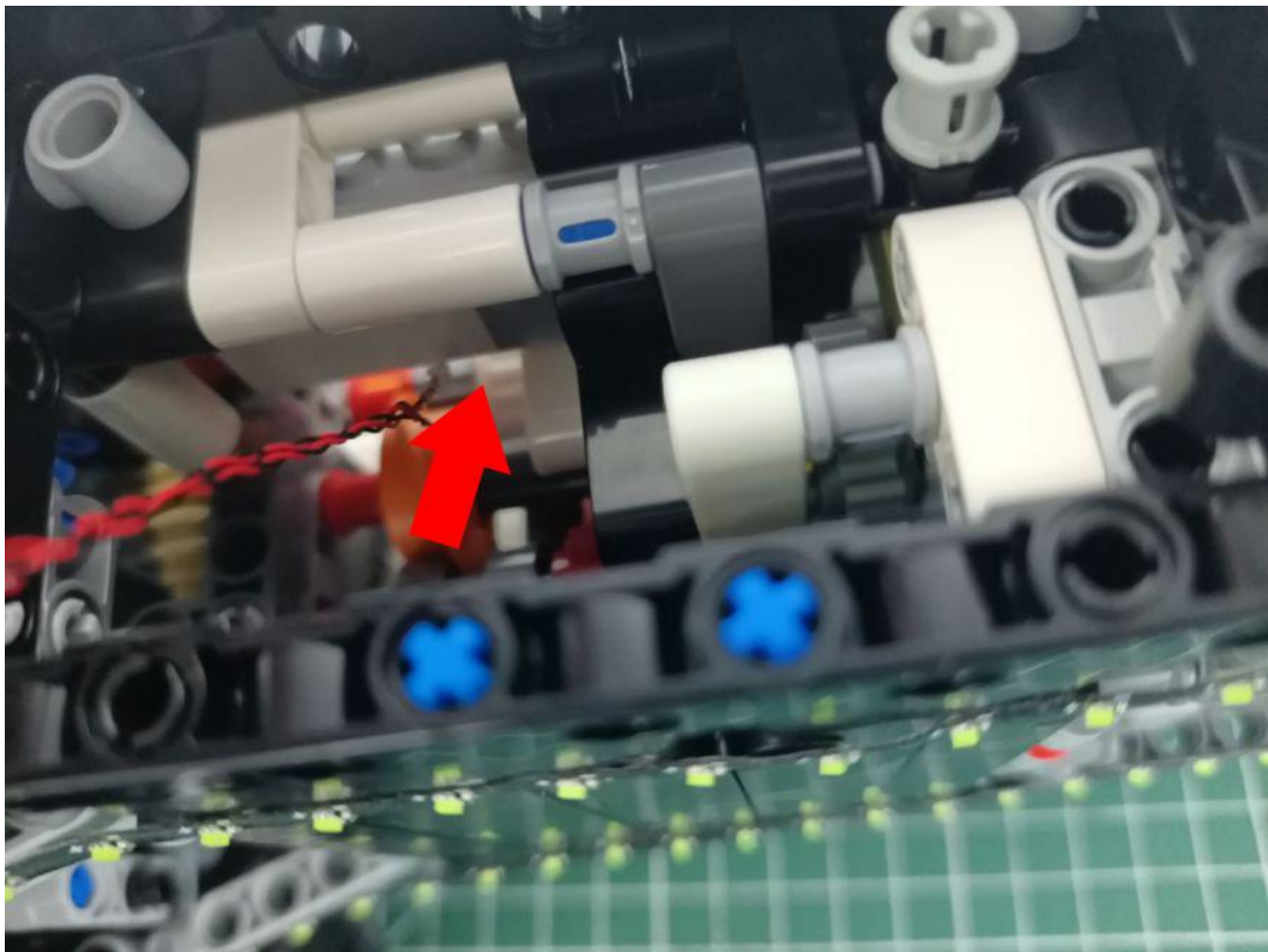









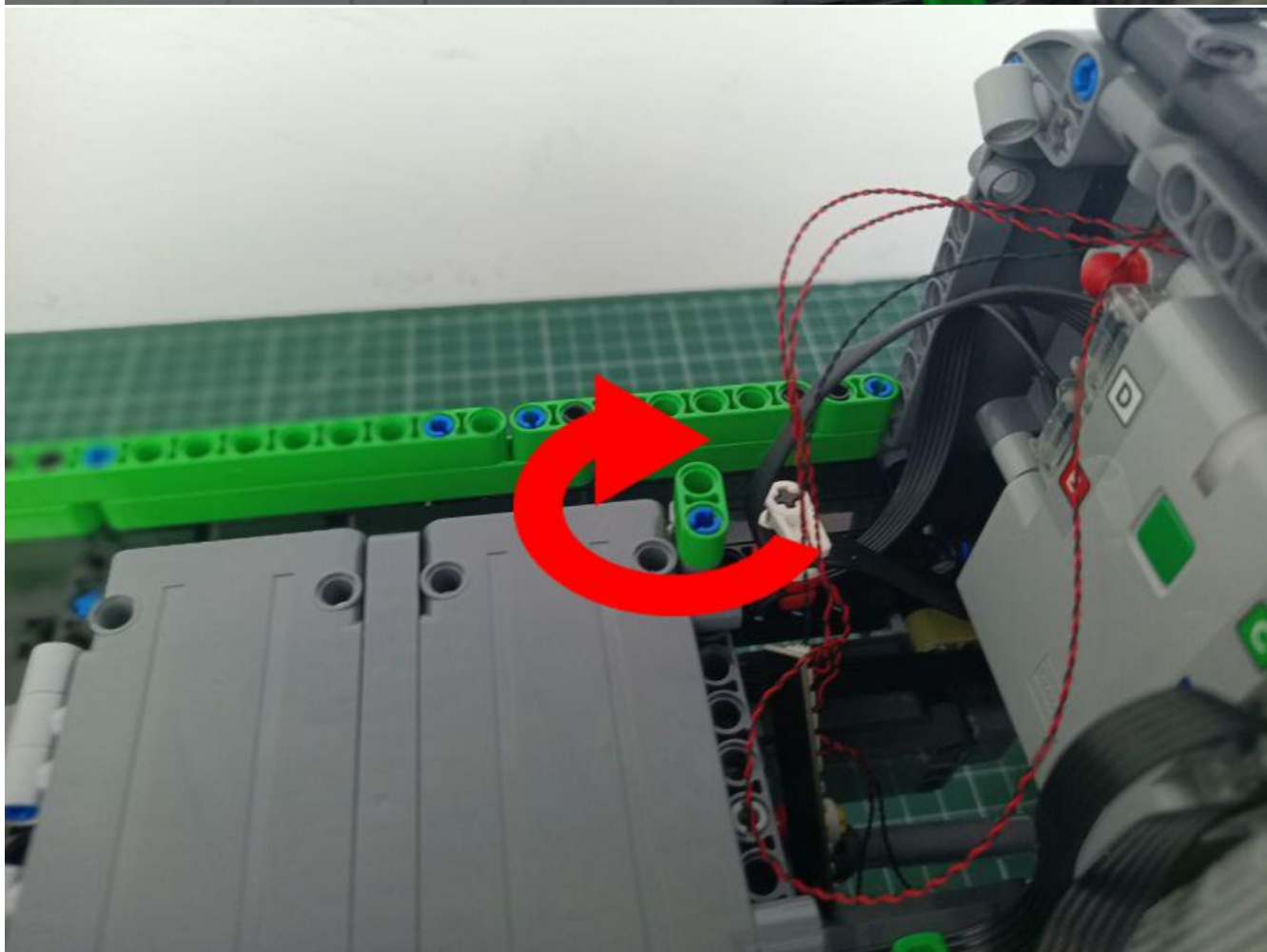
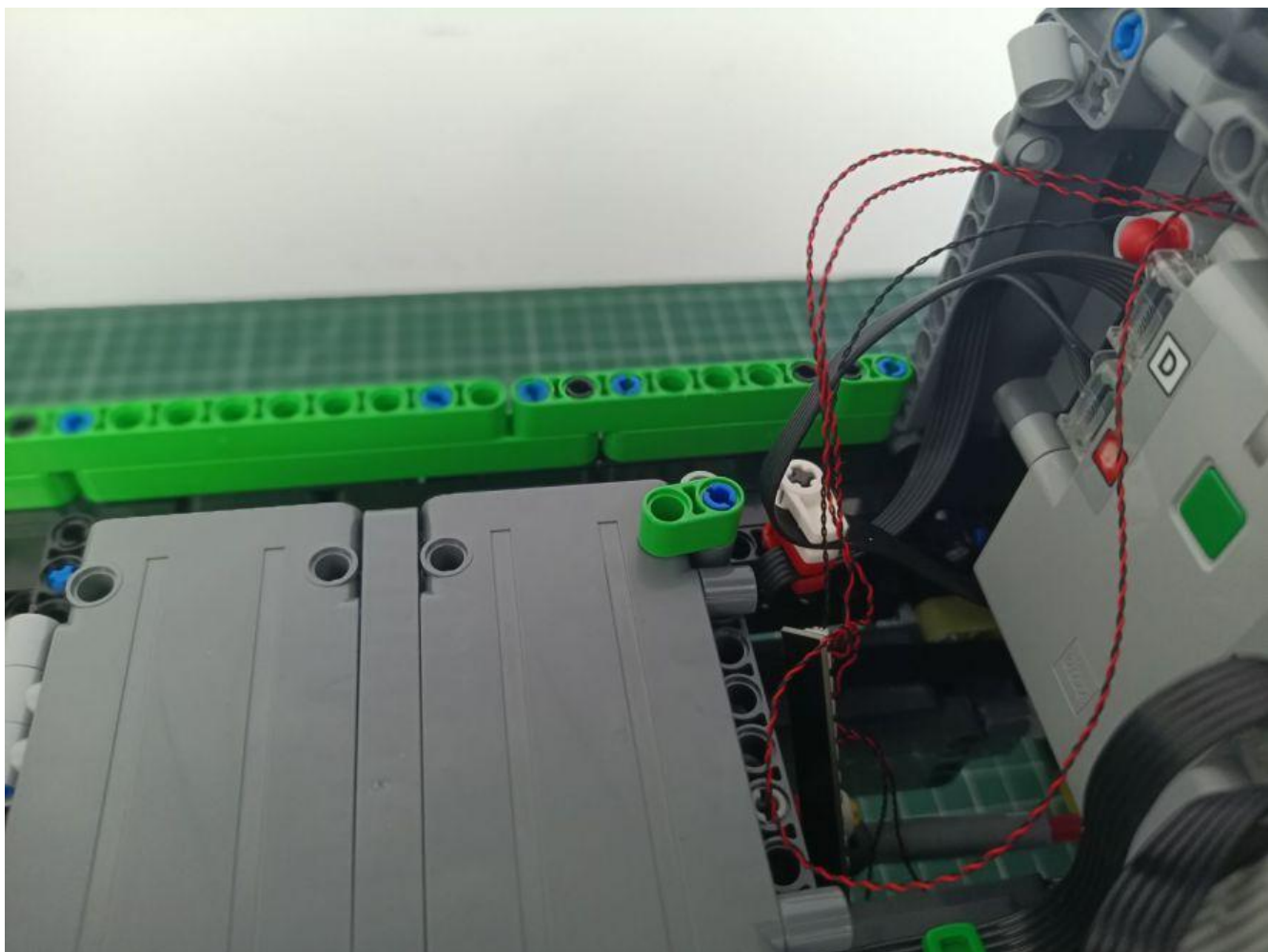



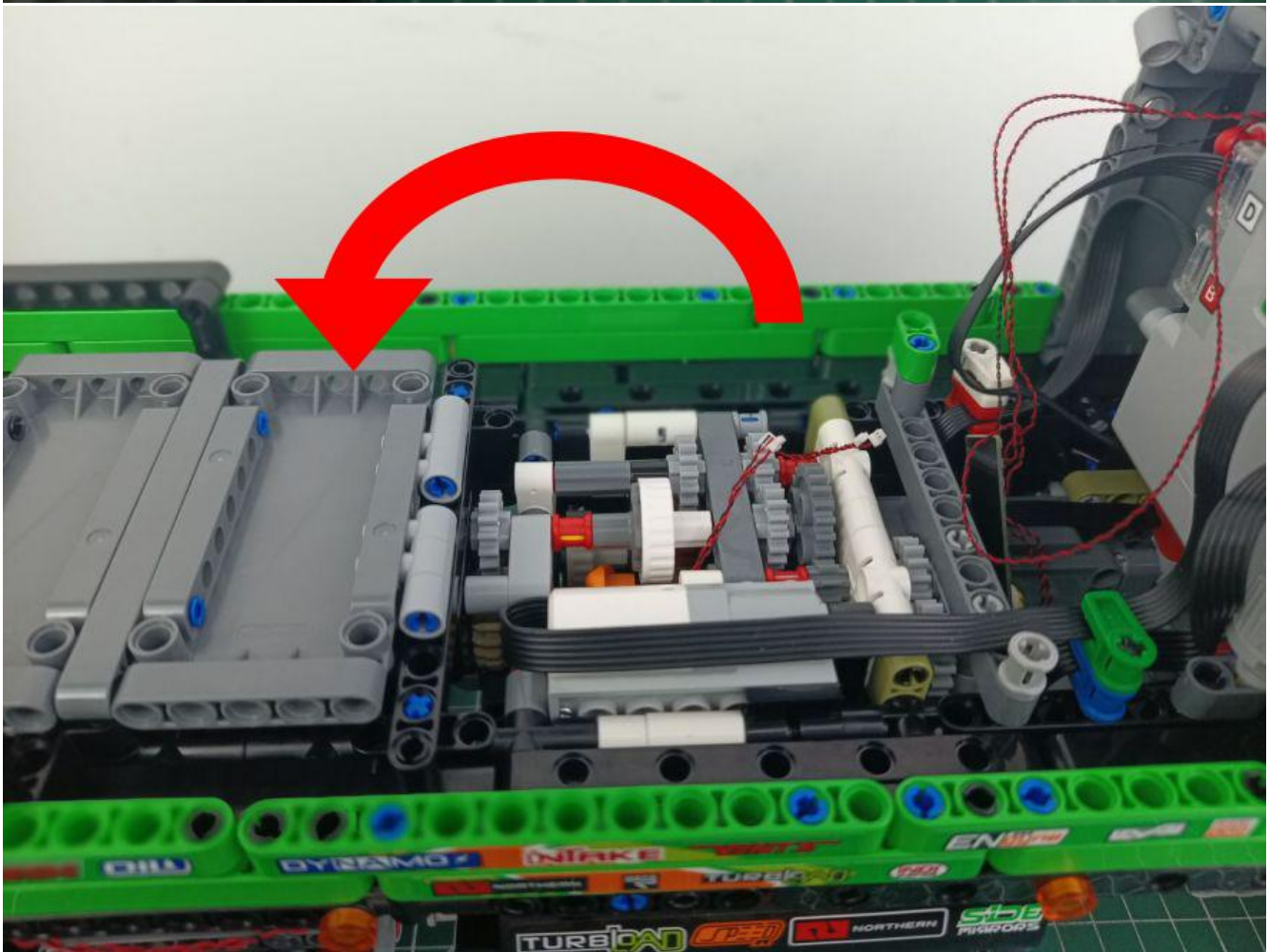
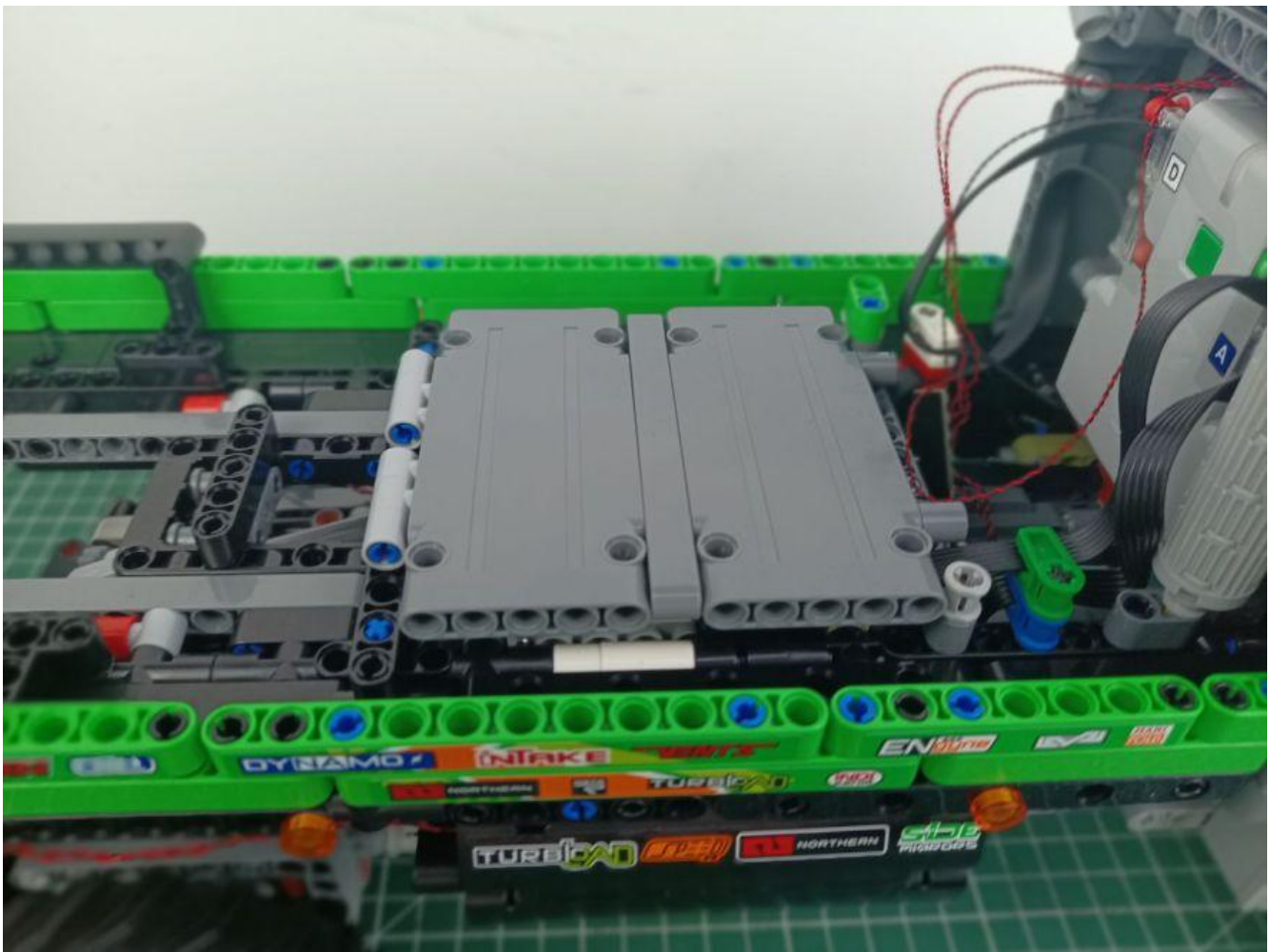

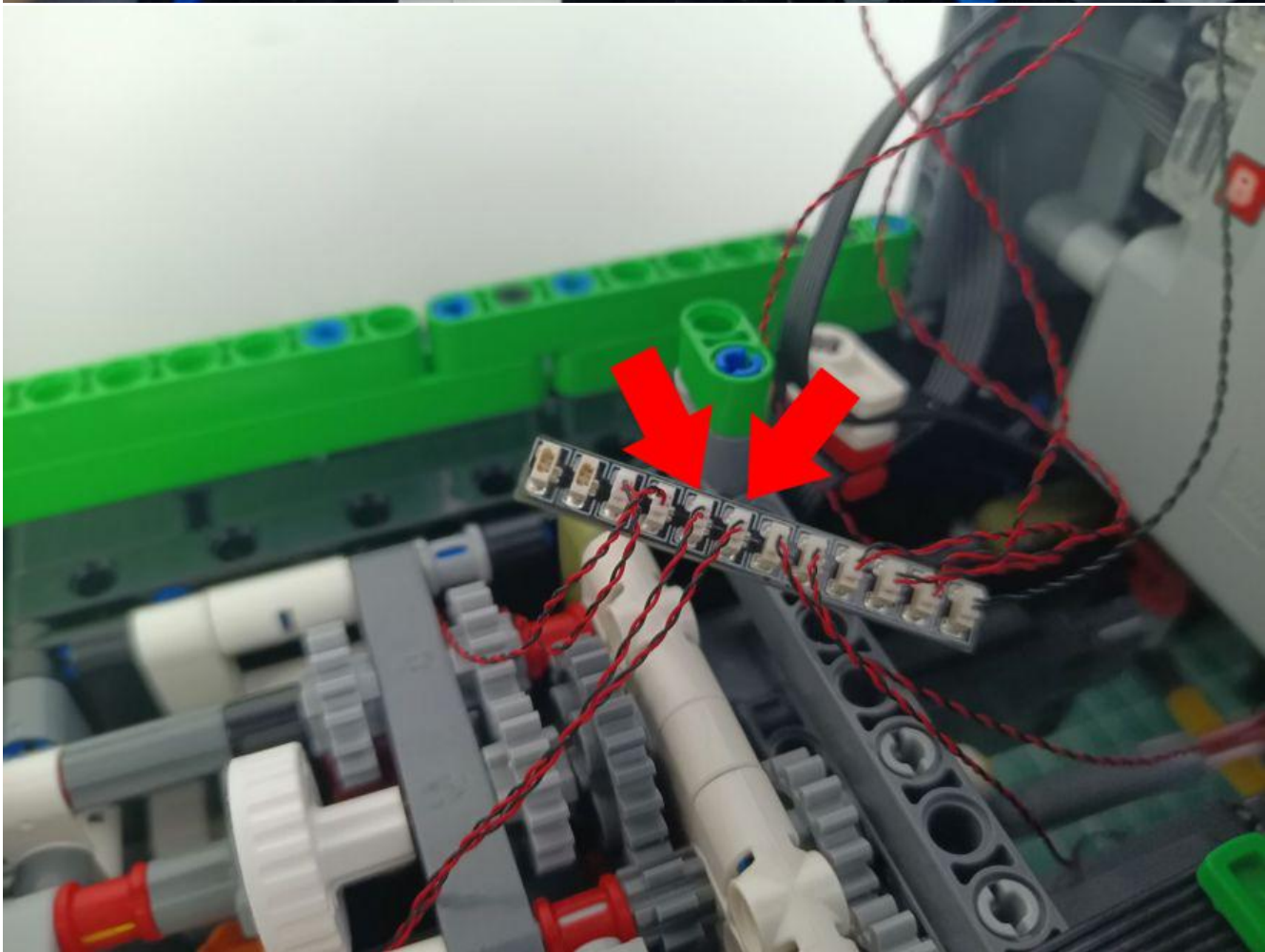
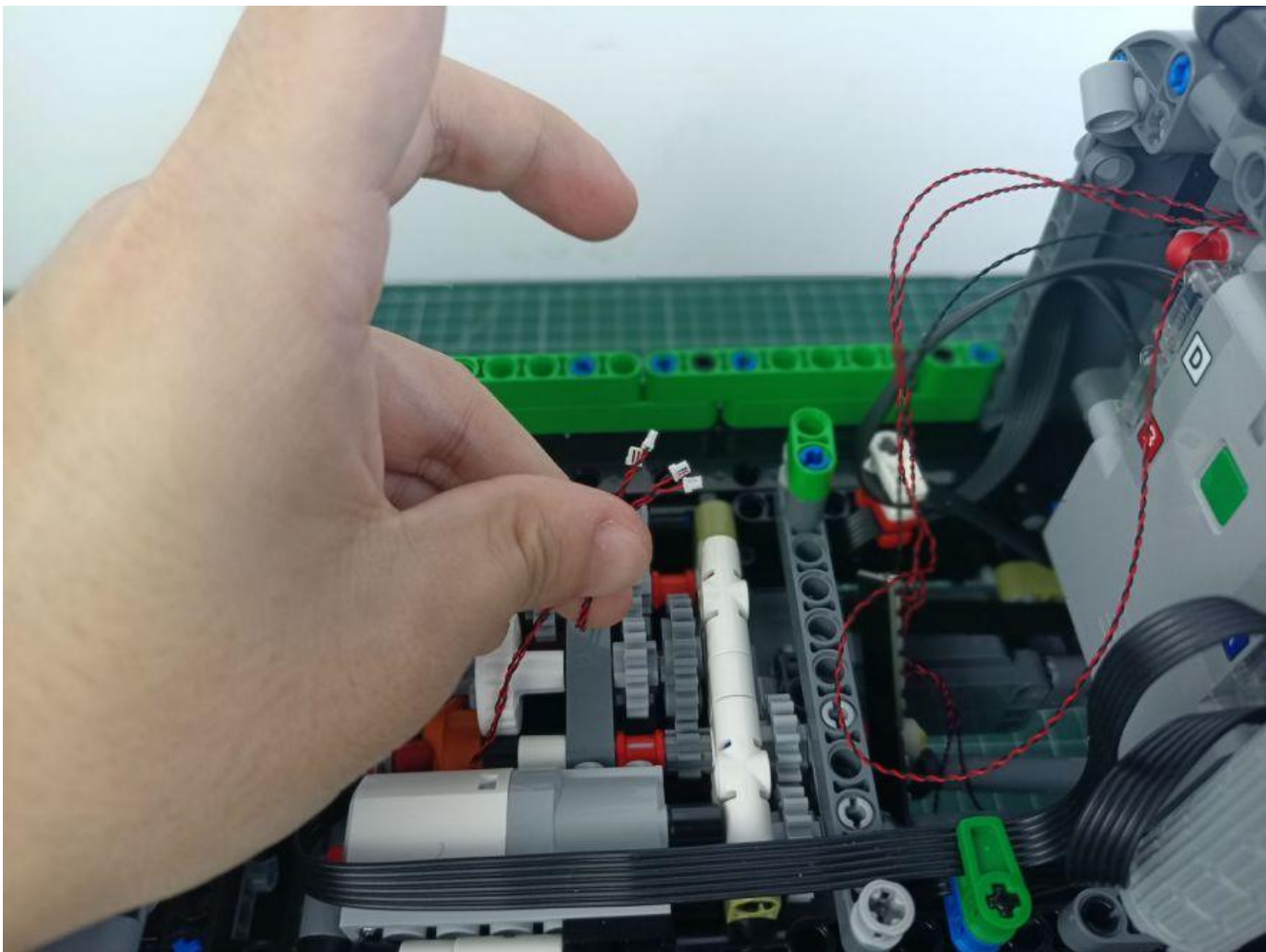

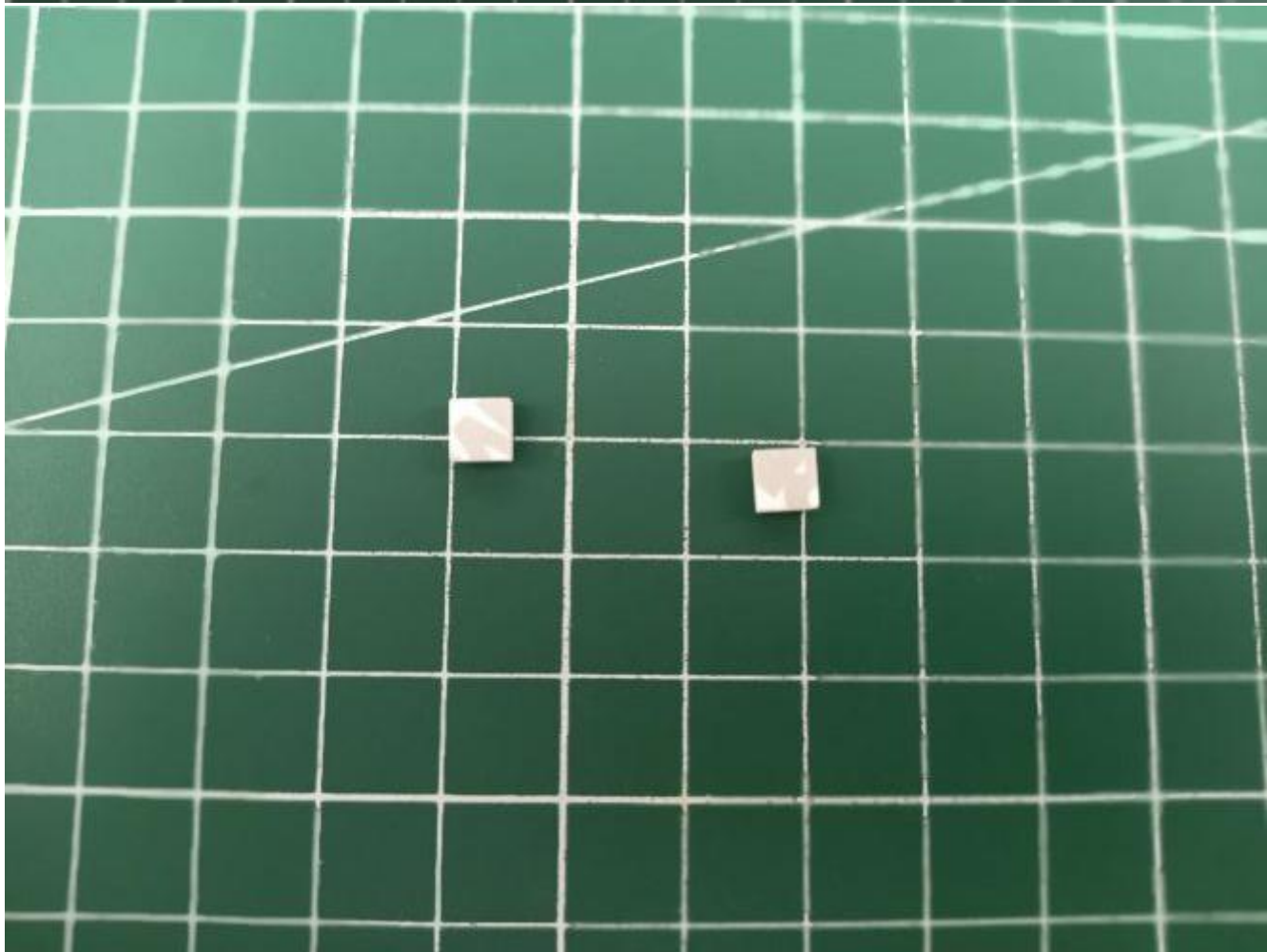

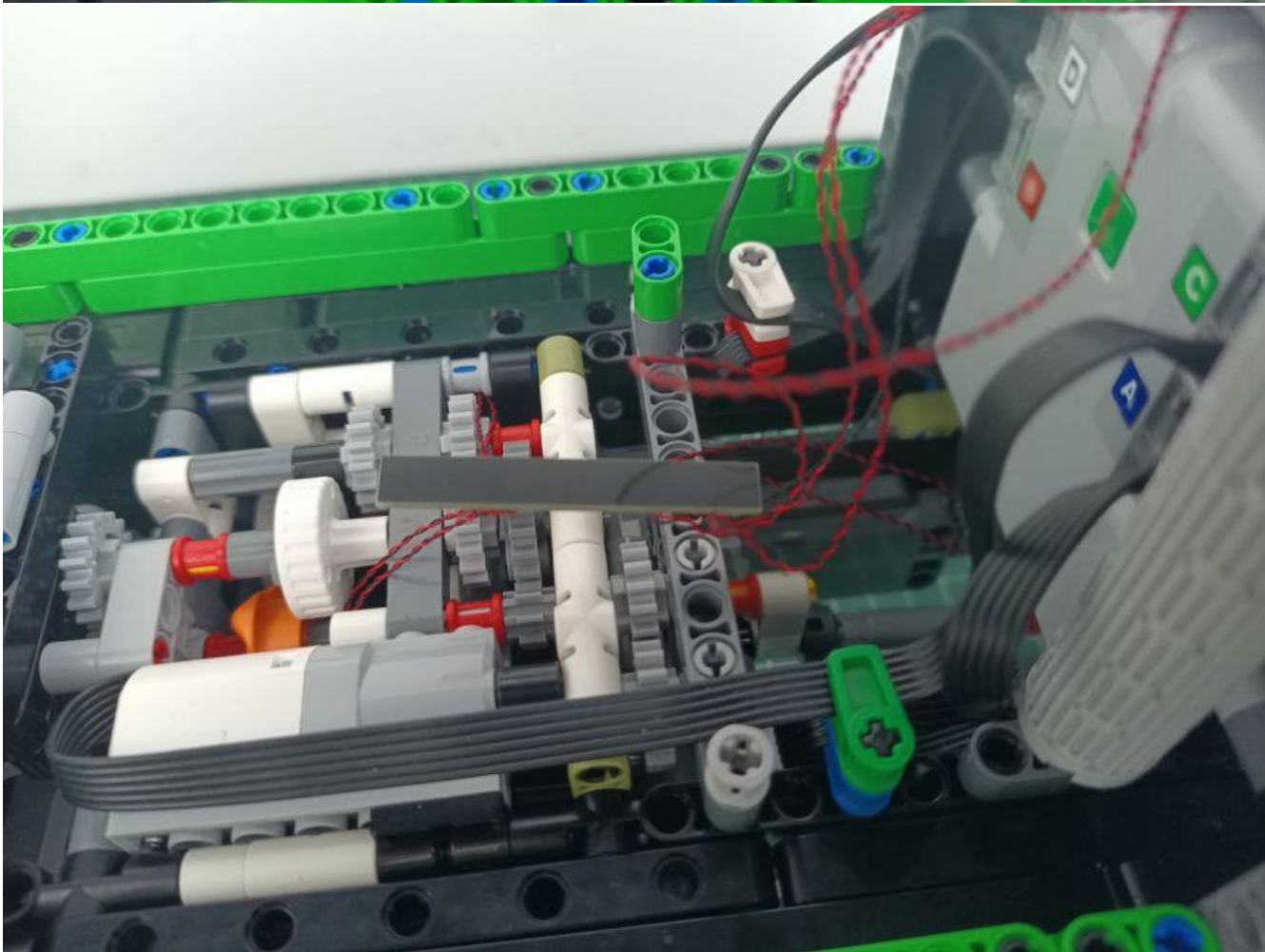
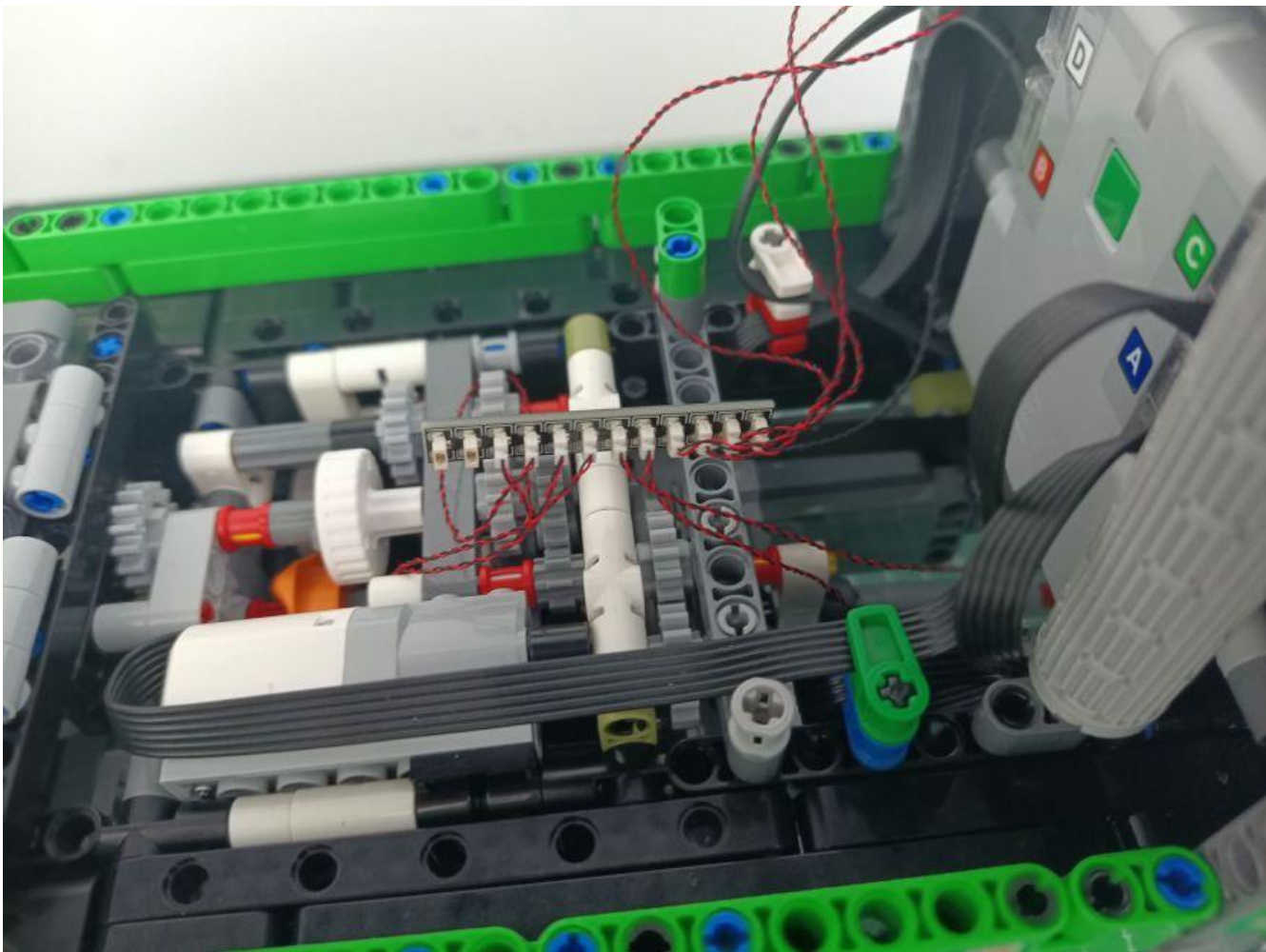

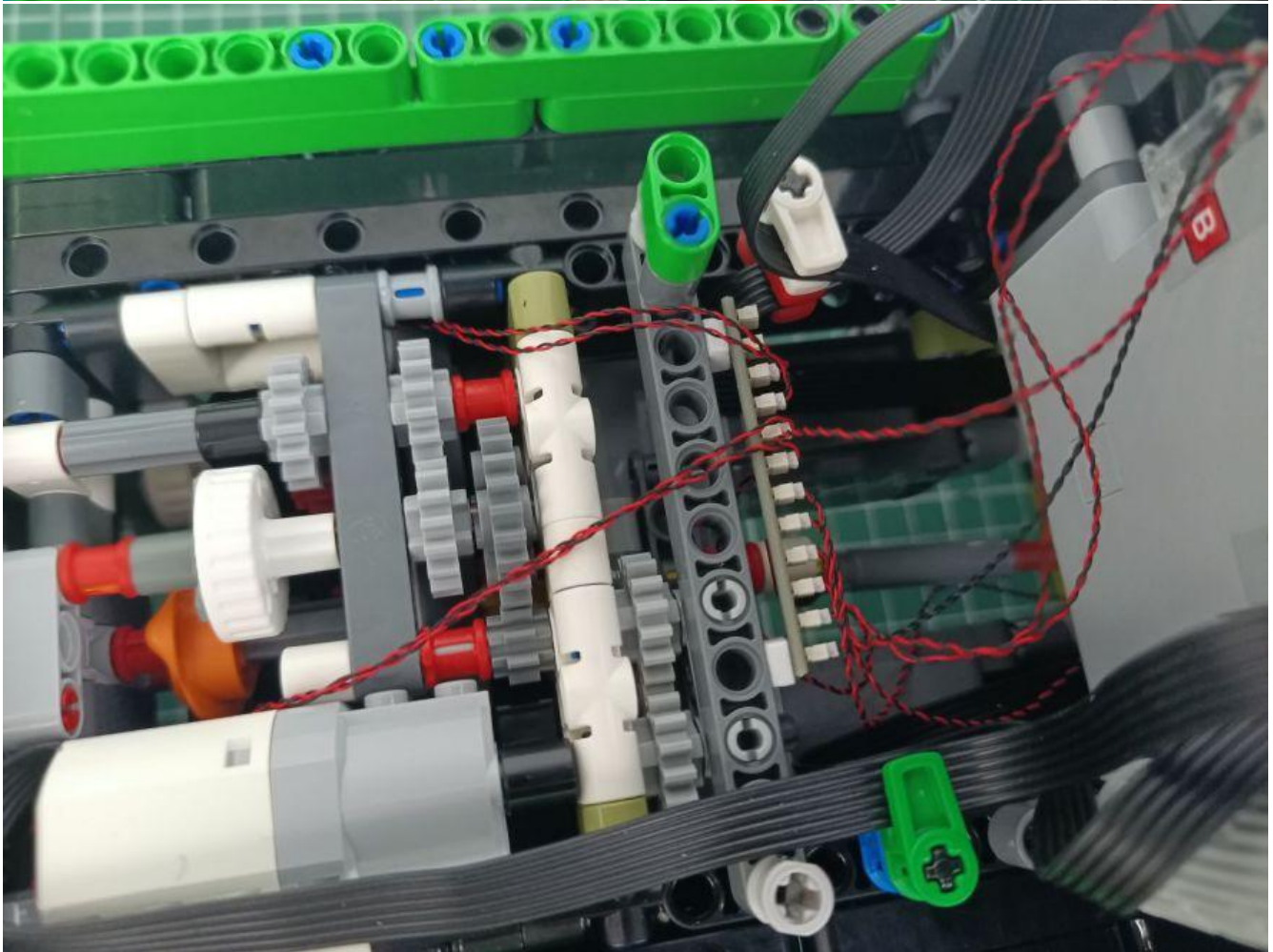
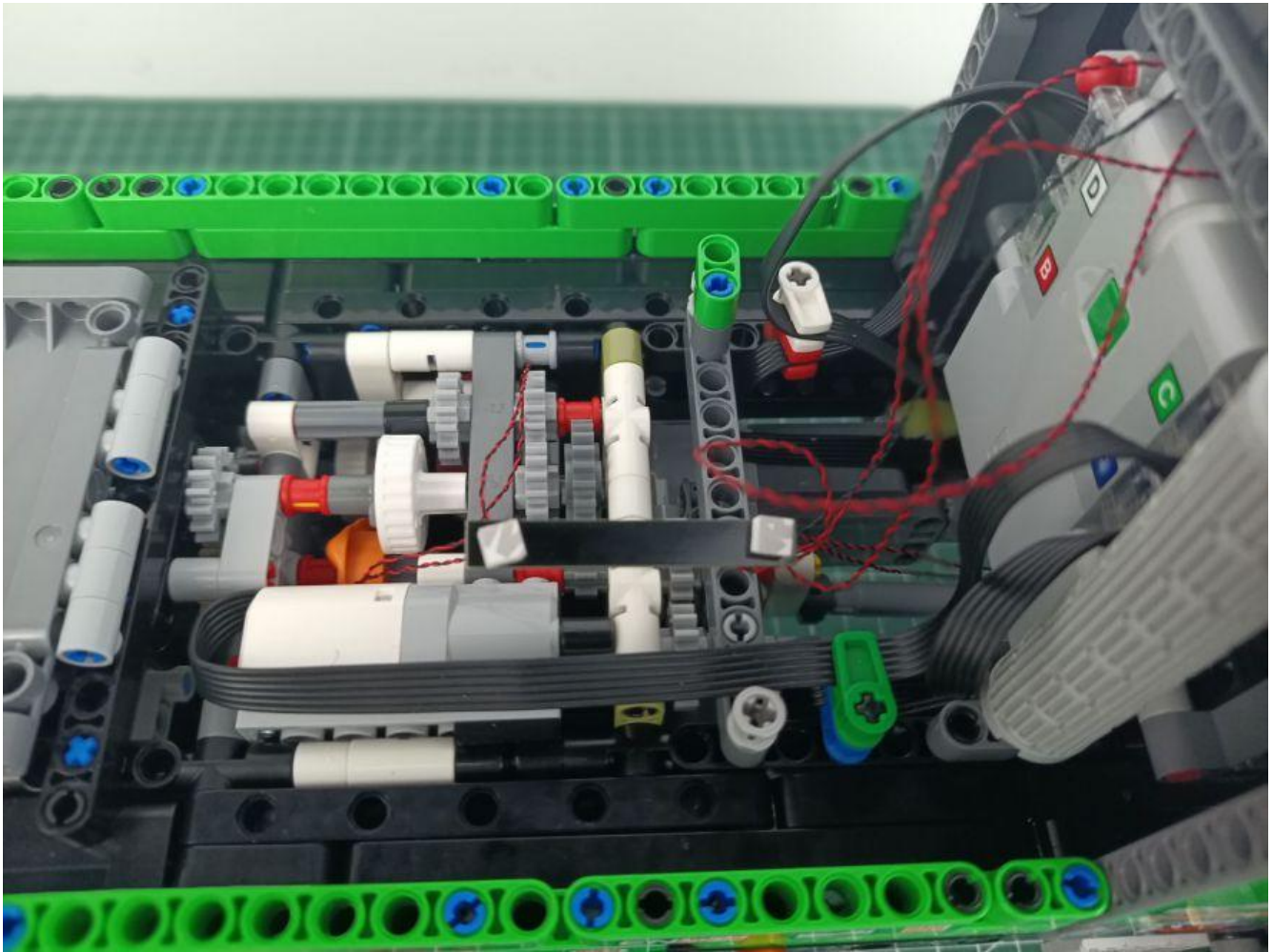

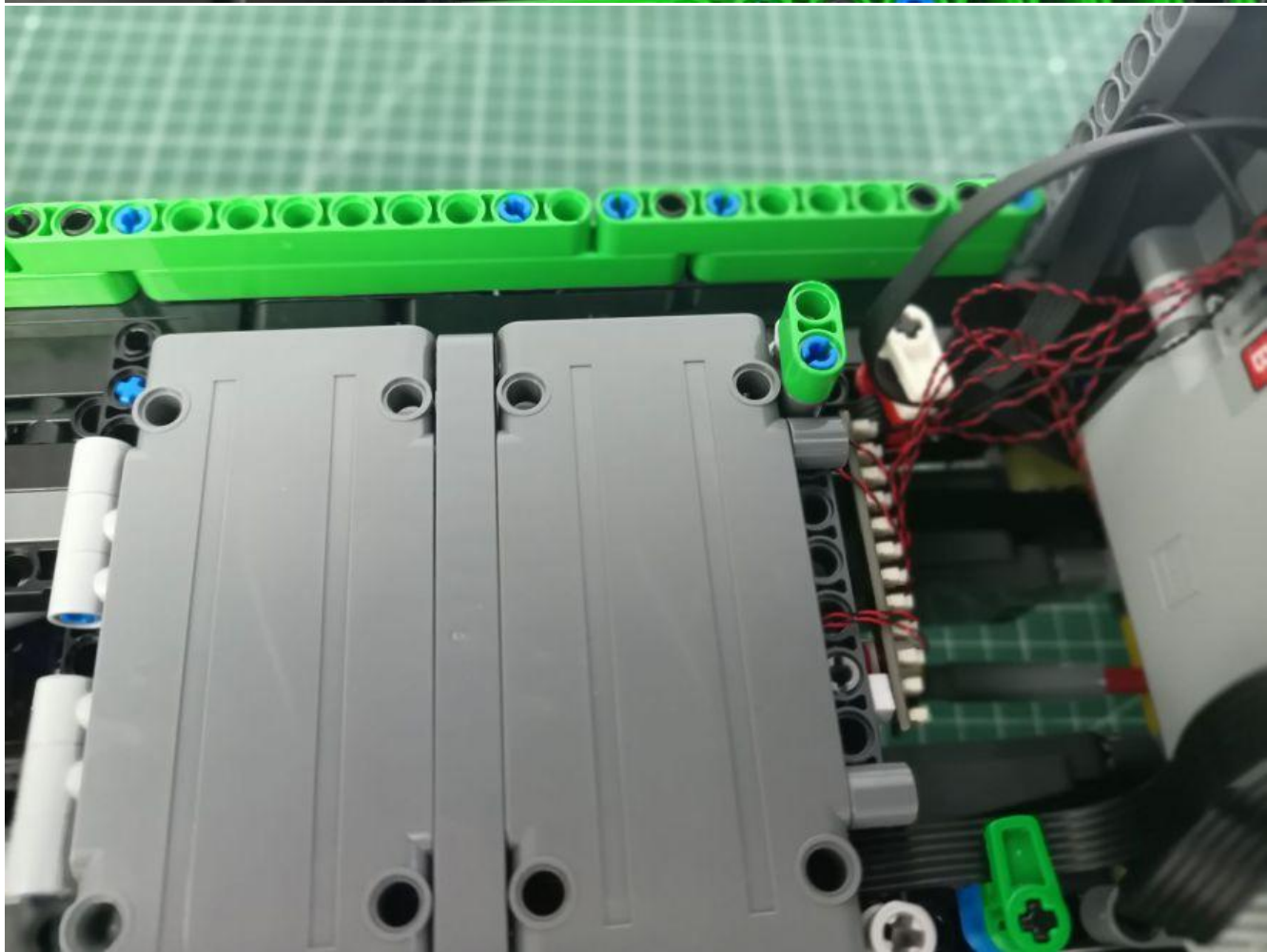
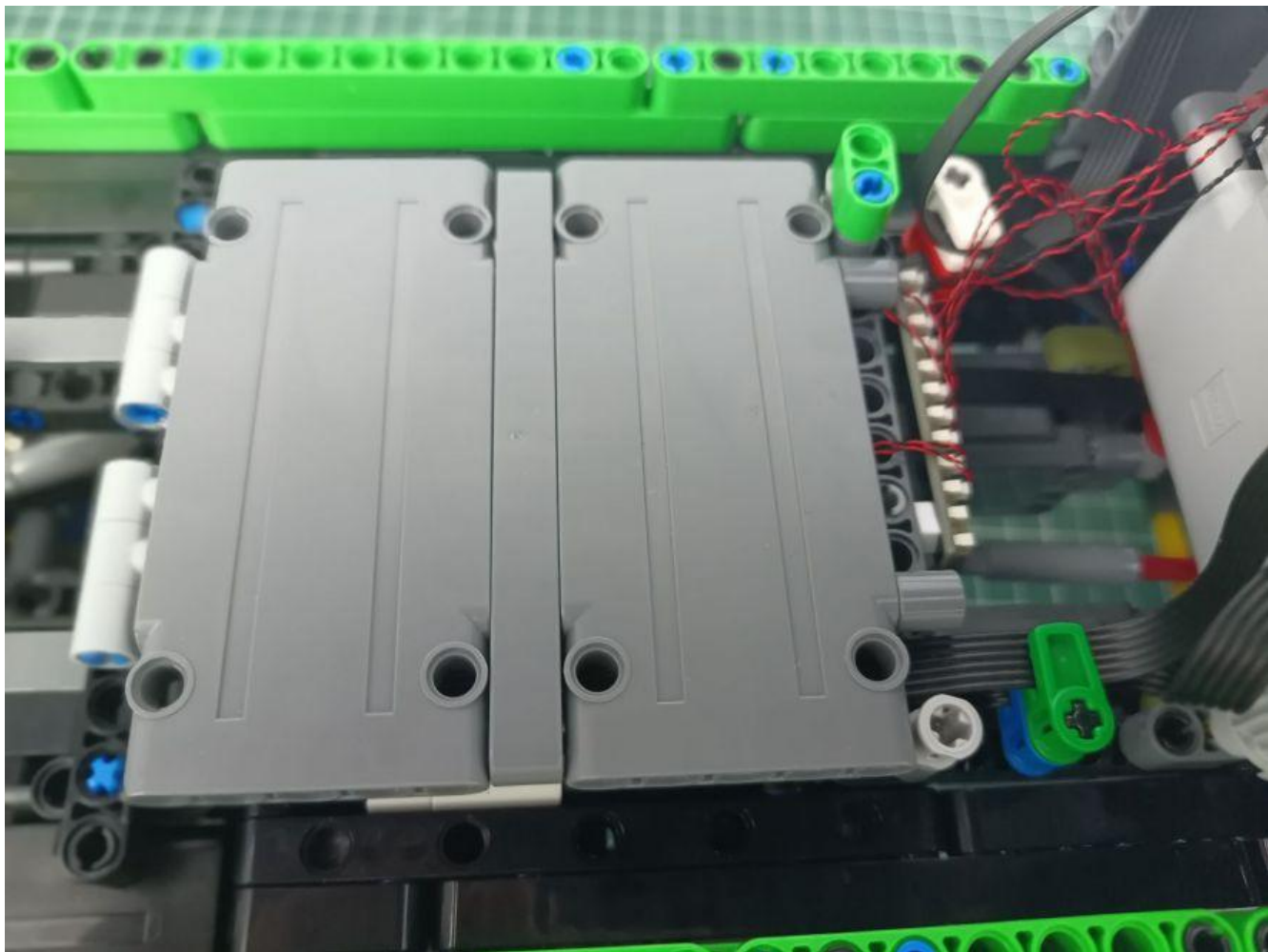

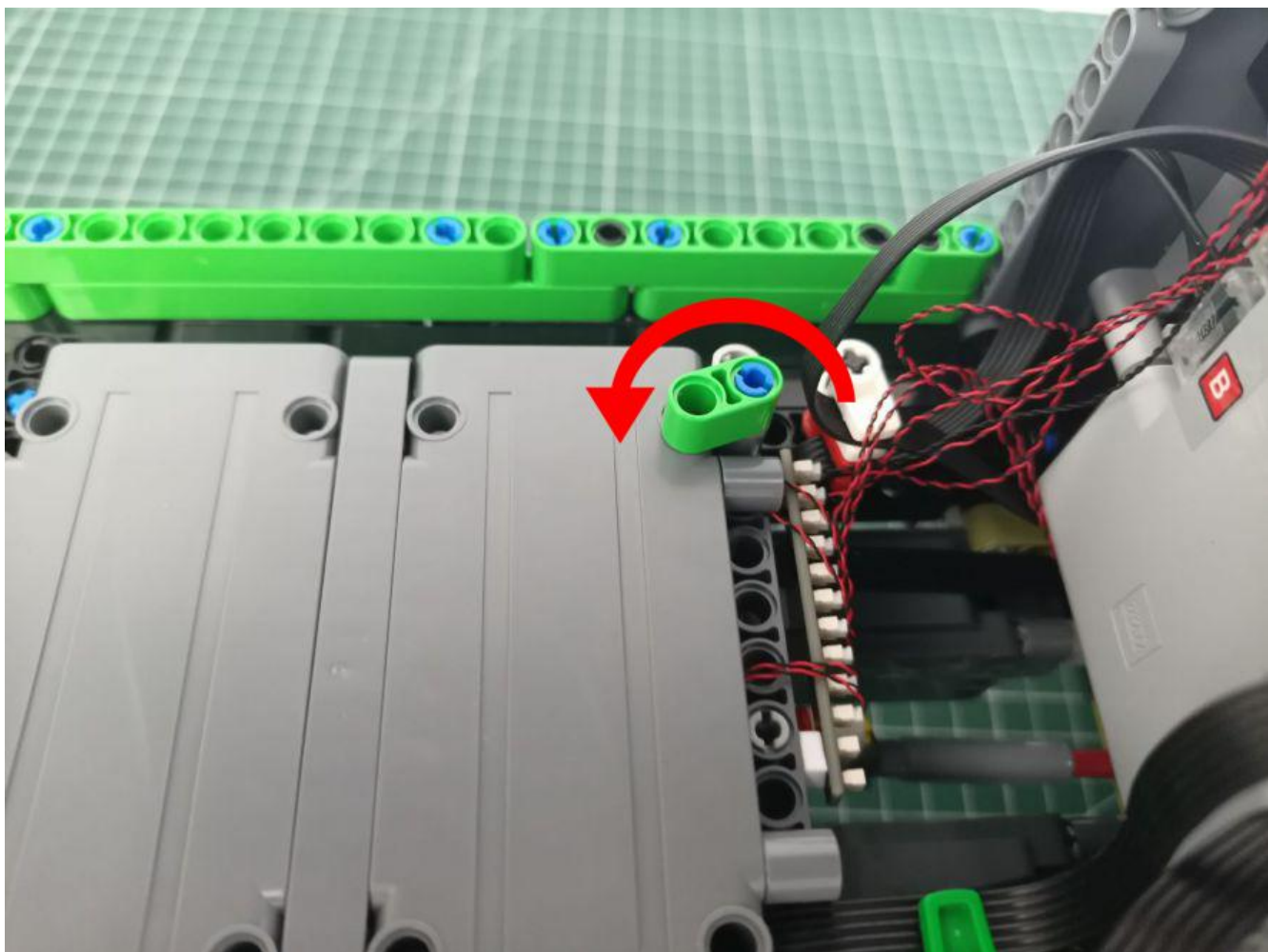

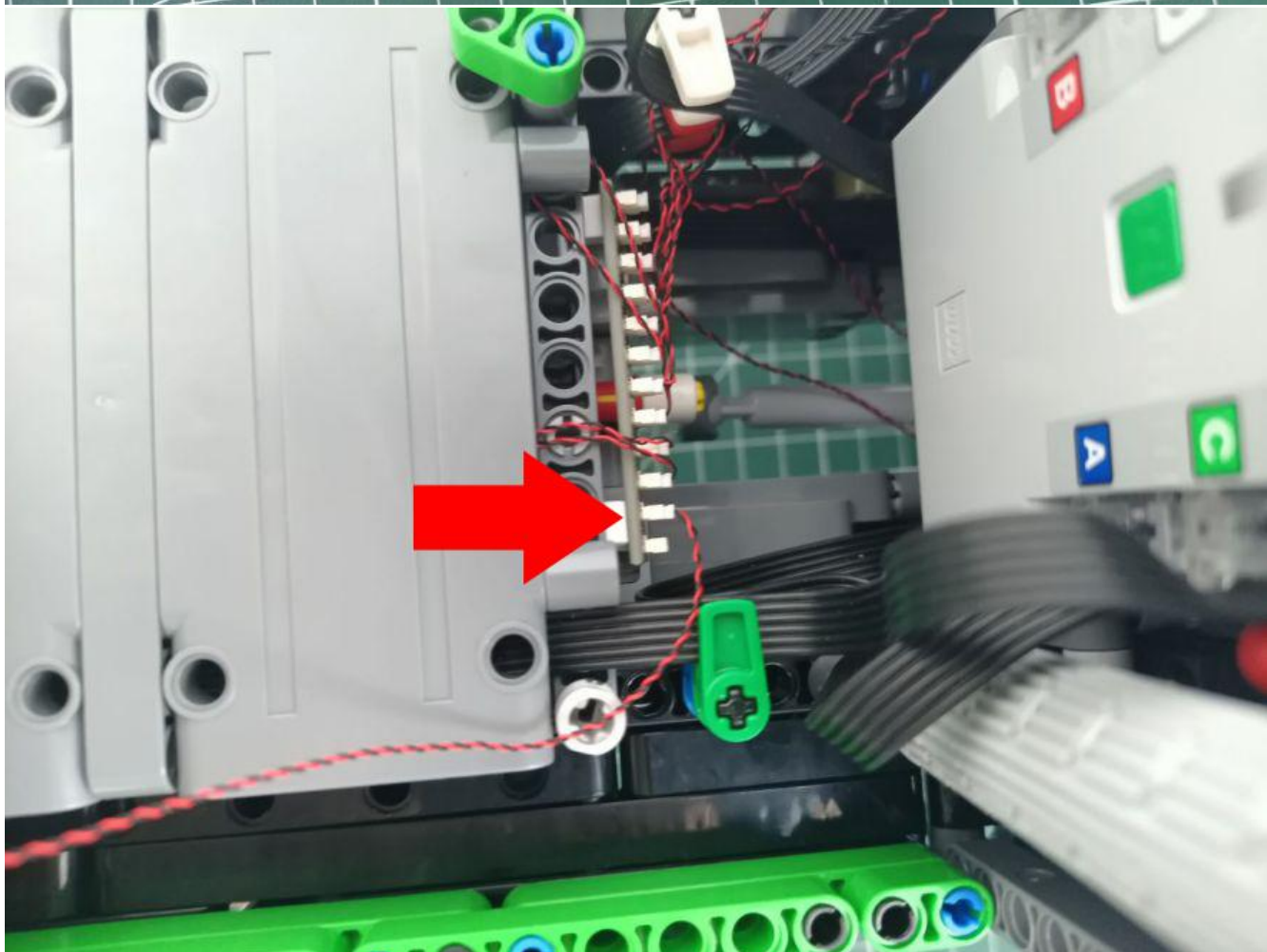
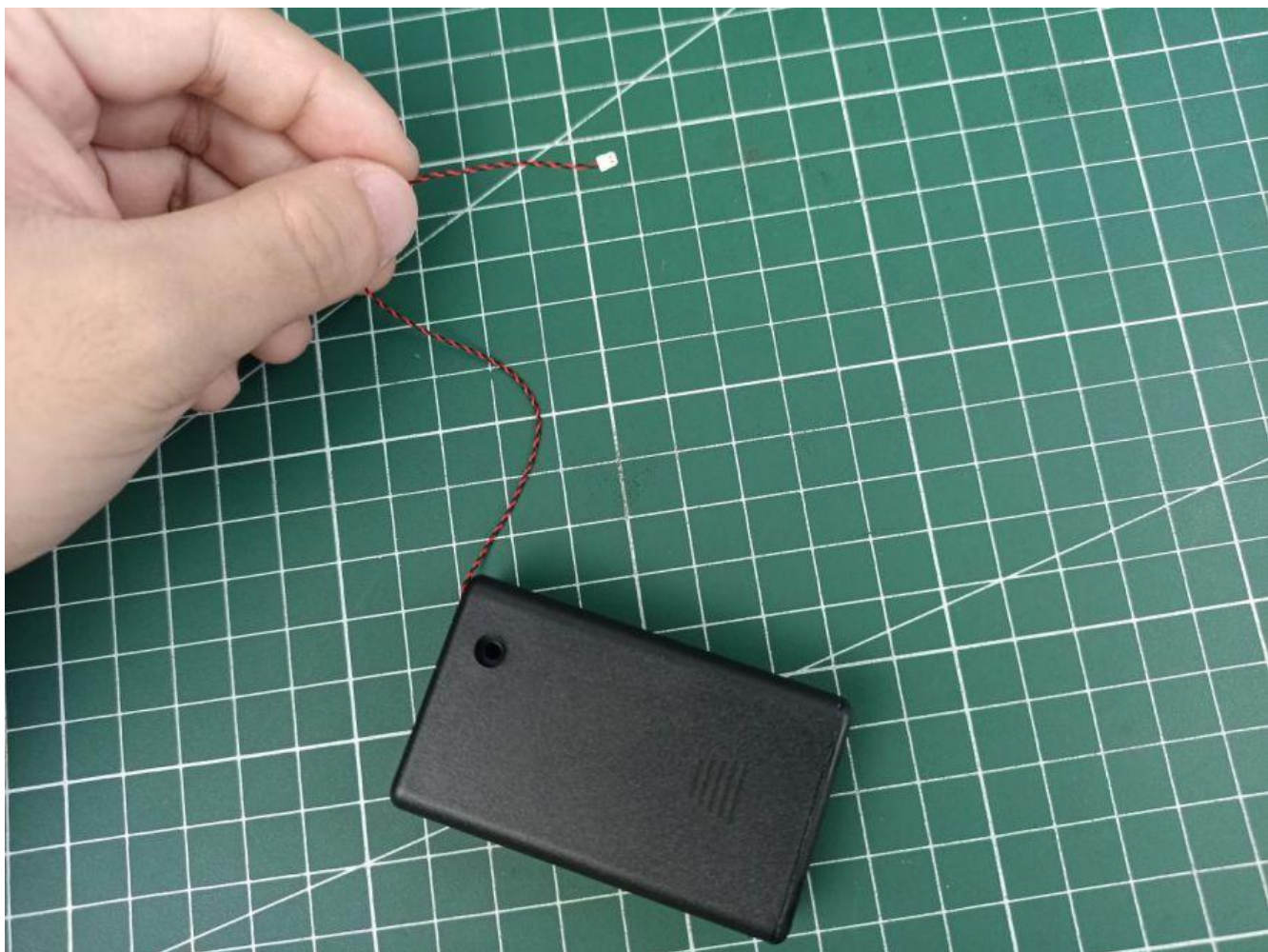



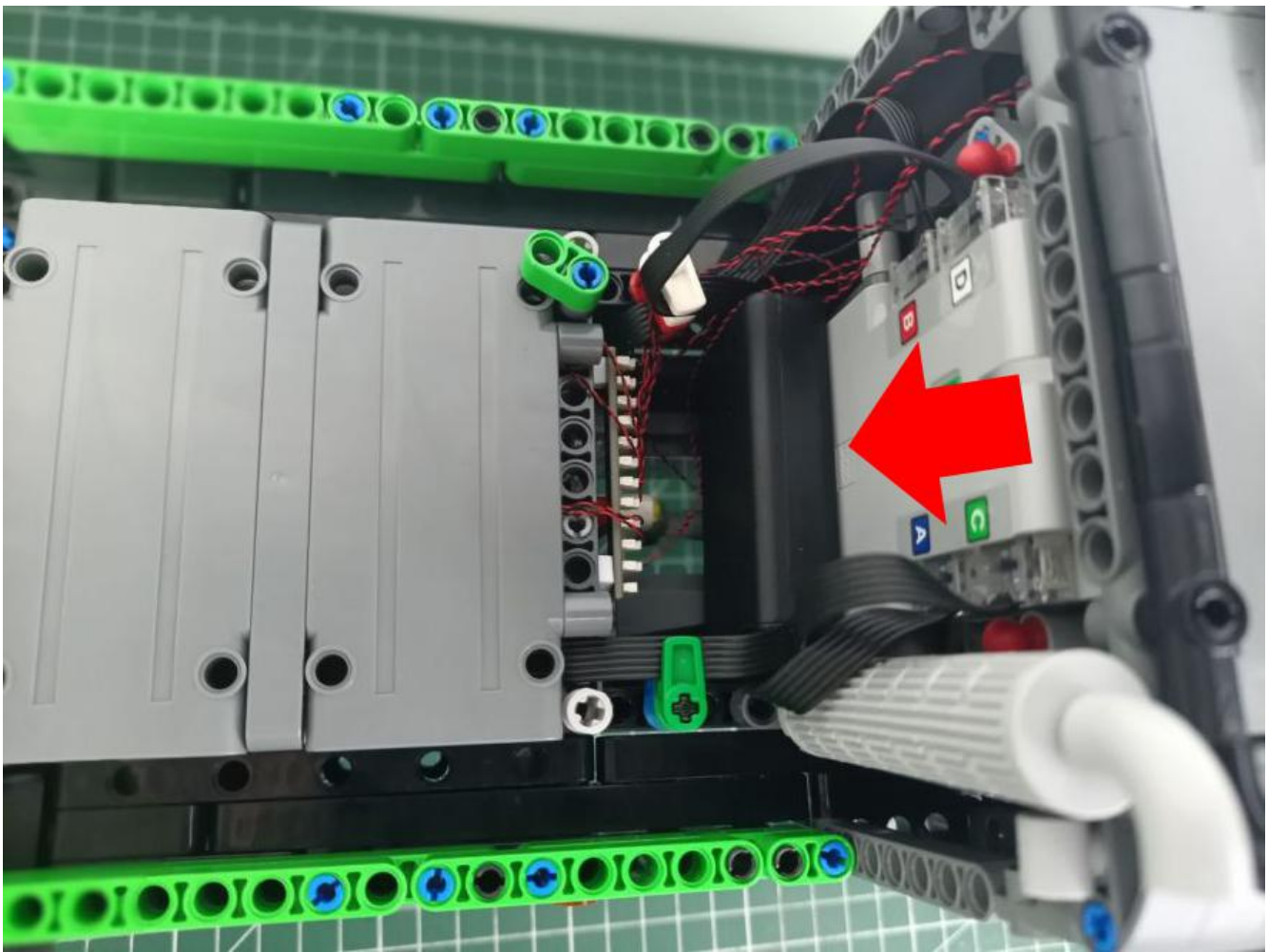



for installing this kit.



# USB connectors to connect devices

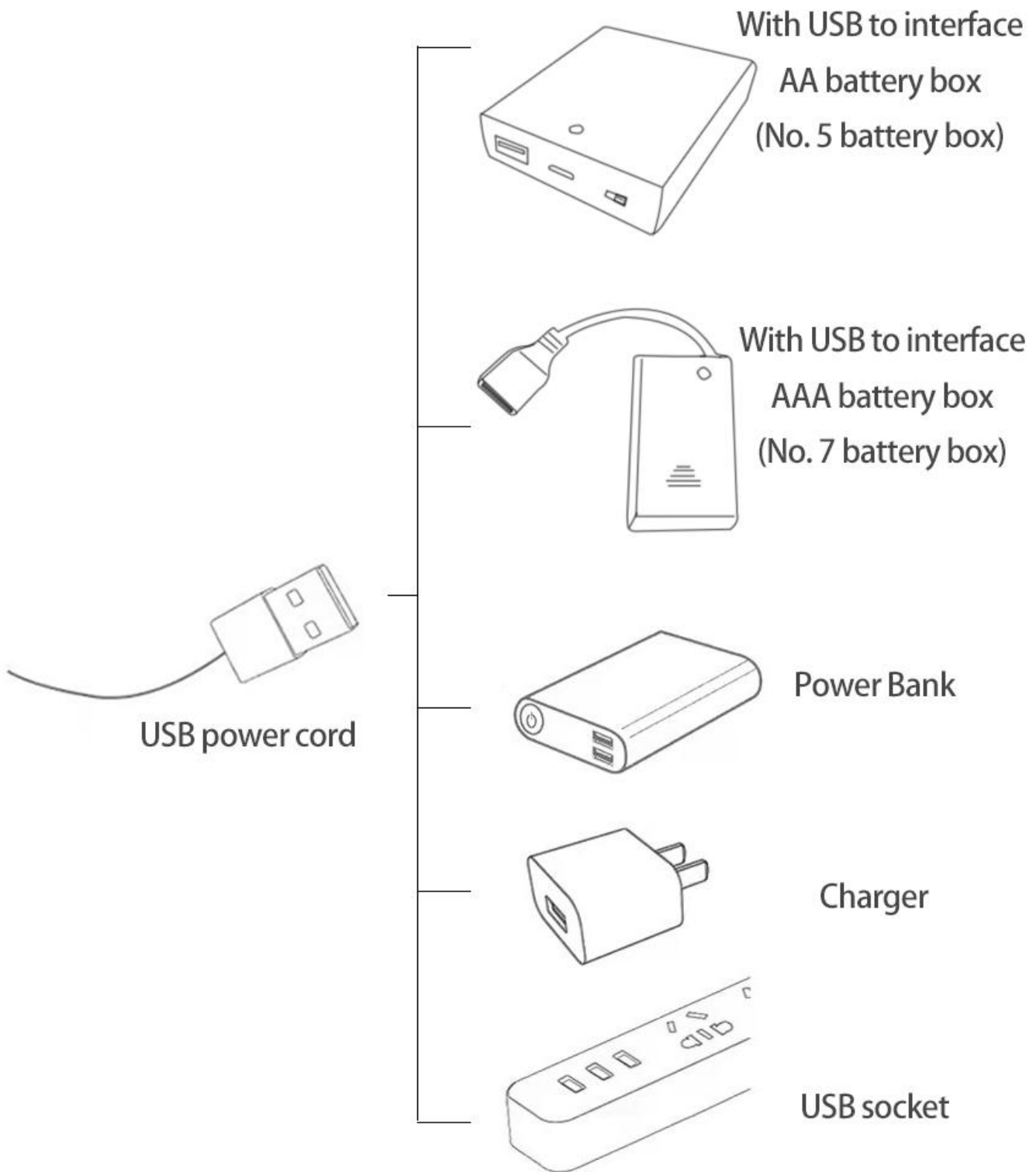

The above are ideas and instructions provided by our designers. Please move on:

1: Do you have any suggestions about the material and quality of our products?

2: Do you have any suggestions on the installation instructions and the degree of difficulty of the installation?

3: If you have better installation method and ideas, please contact us in time.