

42129 4x4 Mercedes-Benz Zetros Trial Truck P26602

- P26602 is the unique code of lighting set, we use this to accurately identify the product you purchased and the corresponding manuals and services you need to obtain. Please make sure your product code is the same as the label on the back of the box shown “42129 P26602”.
- Installation requires a lot of patience and great observation that your LEGO bricks will come alive when you get this finished. The bricks with lighting as below, so make sure you're ready and let's get started.



Strategies for the Installation

This instruction divides three sections to complete the installation of the lighting set.

Section A: Check the type and quantity of components.

The quantity and type of components of each products are different and it needs to be carefully checked to make sure there do have enough material. The type of components is indicated by the label on the bag.

Section B: Test that each components is working properly.

Each components is made individually so it is necessary to test that each components is working properly to avoid the situation that the lighting does not work .

Section C: laying out components following the instruction.

Our material is very small but not fragile, just be reminded that don't to pull the wires too hard. For different people, there may be some installation steps that you can't understand. Please look at the previous and later installation step

Section A: Check the type and quantity of components.

There are 17 bags in this set. The name and quantities of specific components are as shown , please check carefully.

Label	Content	Quantity
Bit Lights-15CM-White	Bit Lights-15CM-White	4
Bit Lights-30CM-Red	Bit Lights-30CM-Red	2
Bit Lights-15CM-Orange	Bit Lights-15CM-Orange	2
Flashing Bit Lights-15CM-Orange	Flashing Bit Lights-15CM-Orange	2
Bit Lights-30CM-Orange	Bit Lights-30CM-Orange	2
LED Strip Lights-White	LED Strip Lights-White	1
Expansion Board	6 Socket Expansion Board	1
	12 Socket Expansion Board	1
	4 Socket Expansion Board	2
USB Power Cable	USB Power Cable-30CM	1
AAA Battery Box	AAA Battery Box	1
Connecting Cables-5CM	Connecting Cables-5CM	3
Connecting Cables-15CM	Connecting Cables-15CM	1
Connecting Cables-30CM	Connecting Cables-30CM	1
Light Strips-Cyan-28	Light Strips-Cyan-28	2
Remote Control Board	Remote Control Board	1
Headlights-30CM-White	Headlights-30CM-White	2
Headlights-30CM-Blue	Headlights-30CM-Blue	1
Parts package		

Please contact us immediately if there have any missing components.

Section B: Test that each components is working properly.

We need a structure to test all lights, so take out the bag with label “AAA Battery Box” and “Expansion Boards” as follows.



The AAA Battery Box does not contain batteries, please buy three AAA batteries in the nearest store and install it in the AAA Battery Box.



It is worth reminding that our products are all customized. They have a unique way of connecting. The white plug on wire and the socket of the expansion board need to be connected together to transmit power.

Note that on one side of the white plug you can see two very small golden wires that should be connected to the two golden needles in socket of the expansion board. shown as blow.

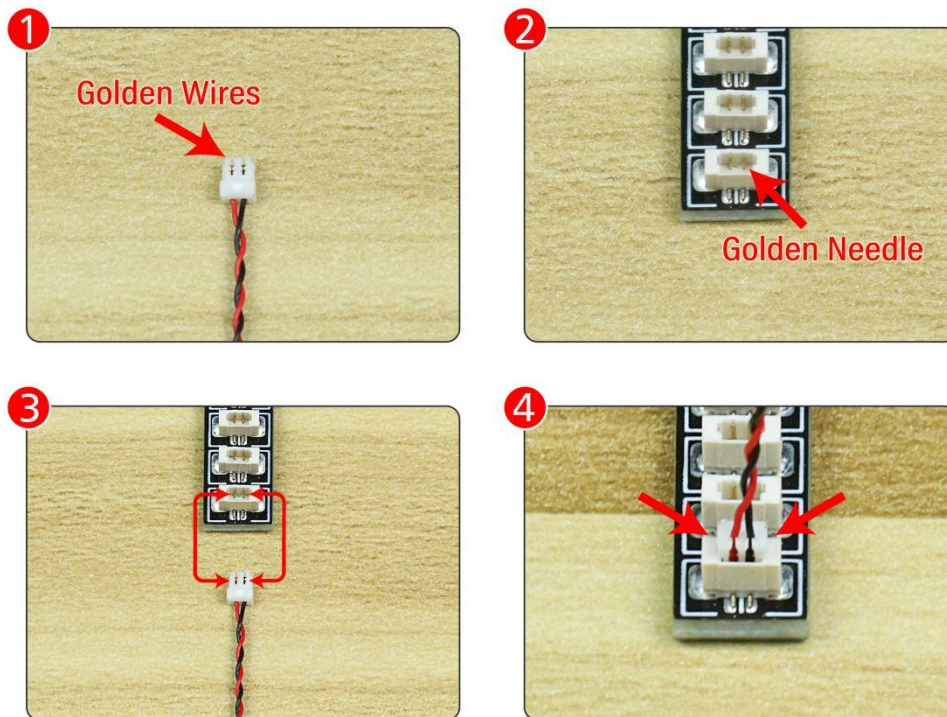

All our connections between plug and socket are all the same as shown above. So for any such structure with plug and socket, please pay attention to the golden wire of the plug and the golden needle of the socket, they must be touched together.

The connection method between the AAA Battery Box and Expansion Boards is as follows:

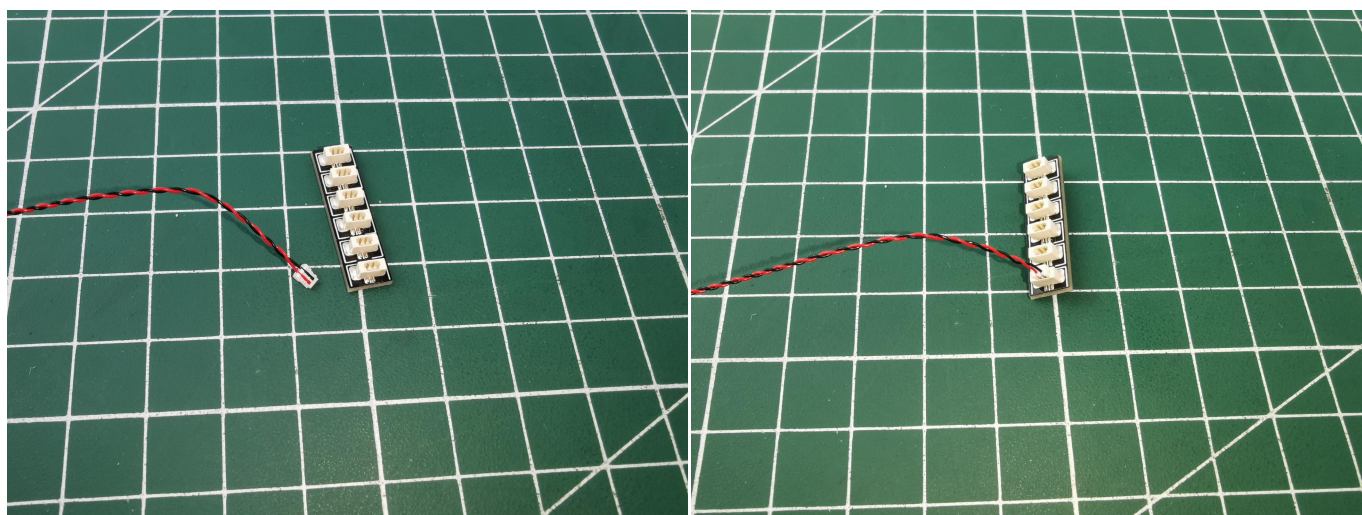

when we test "Bit Lights-15CM-White" particles,Take out the bag labelled "Bit Lights-15CM-White".Take out one of the light and connect it to the socket. Turn on the battery box, the light will turn on normally as shown below.

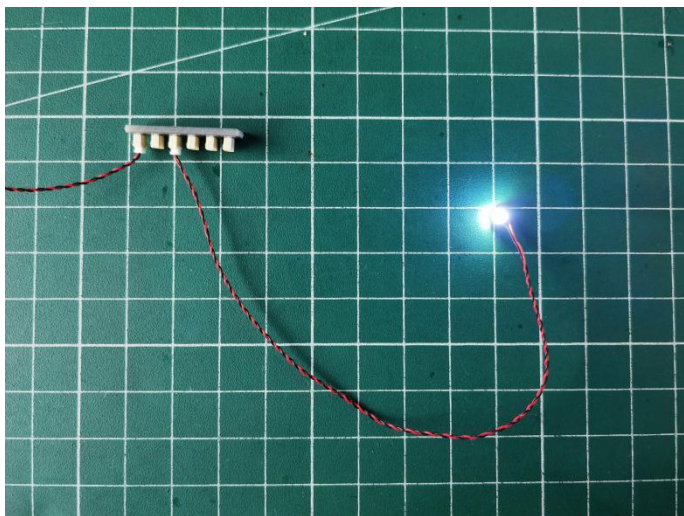

Test each lamp according to this method. It should be noted that after the test, the lamp must be returned to the corresponding bag to avoid confusion of types.



The components needs to be tested in this set is 3*Bit Lights-15CM-White,2*Bit Lights-30CM-Red,2*Bit Lights-15CM-Orange,2*Flashing Bit Lights-15CM-Orange,2*Bit Lights-30CM-Orange,1*LED Strip Lights-White,2*Light Strips-Cyan-28,2*Headlights-30CM-White,1*Headlights-30CM-Blue.

Please contact us immediately if any components don't work.

Section C: laying out components following the instruction.

1



2

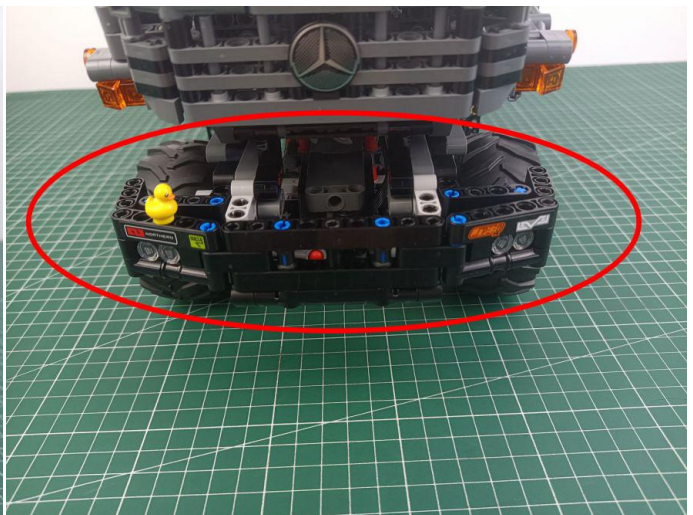
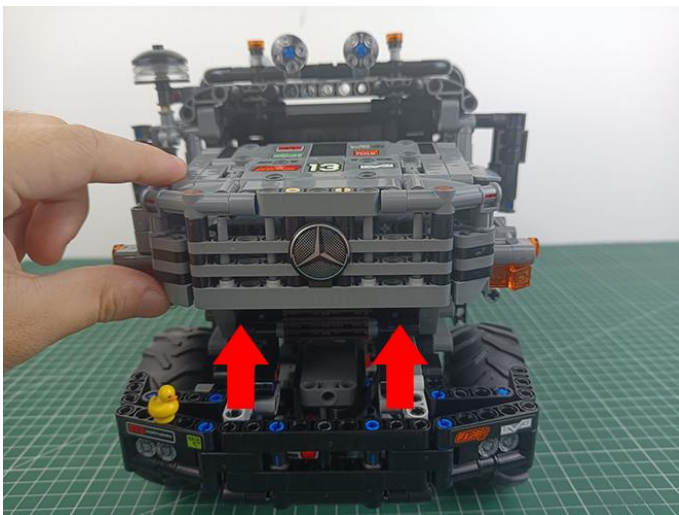

3

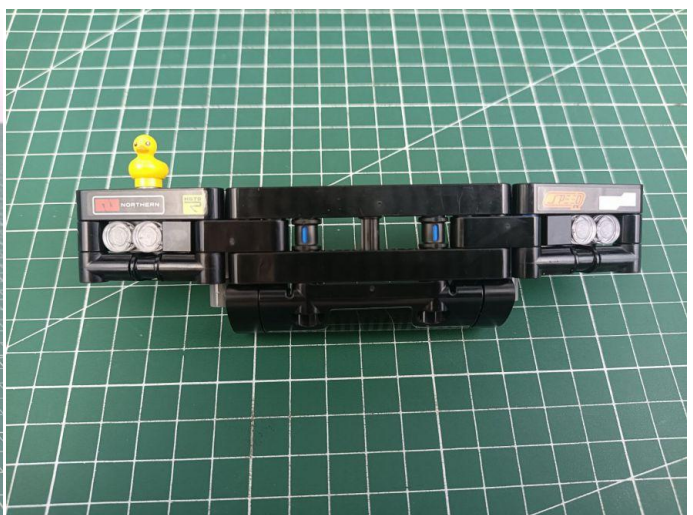
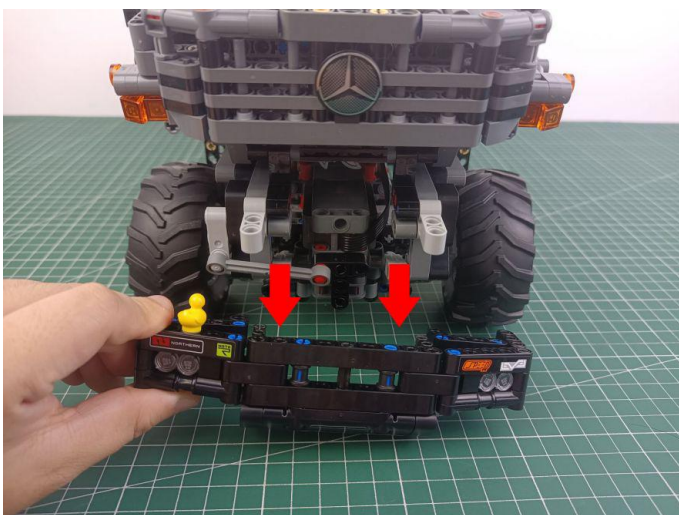

4

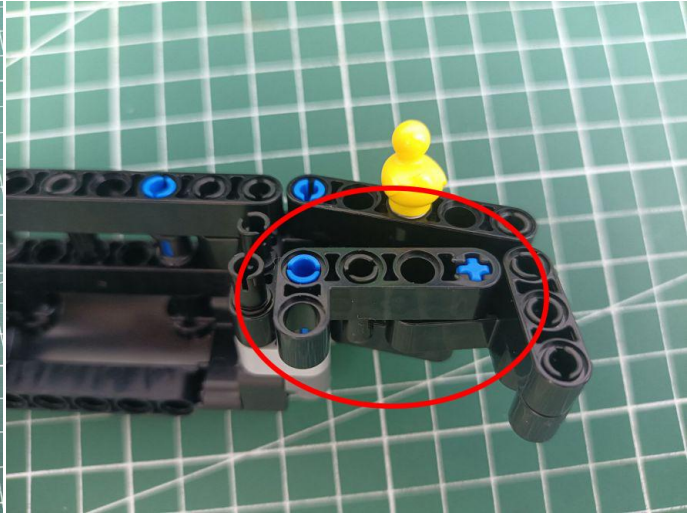
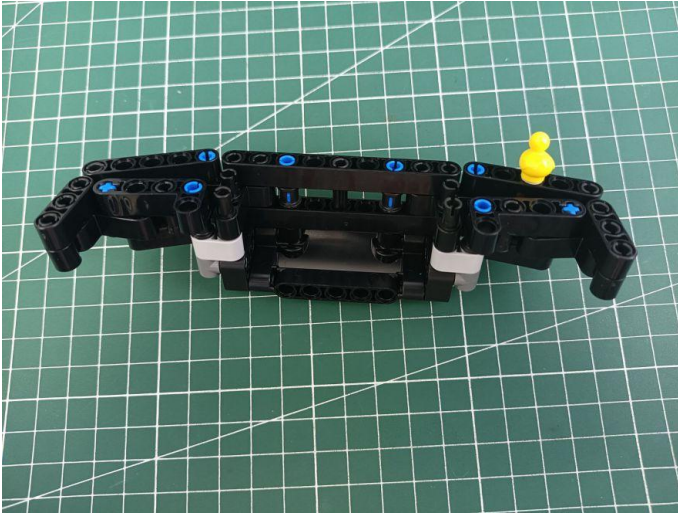

5

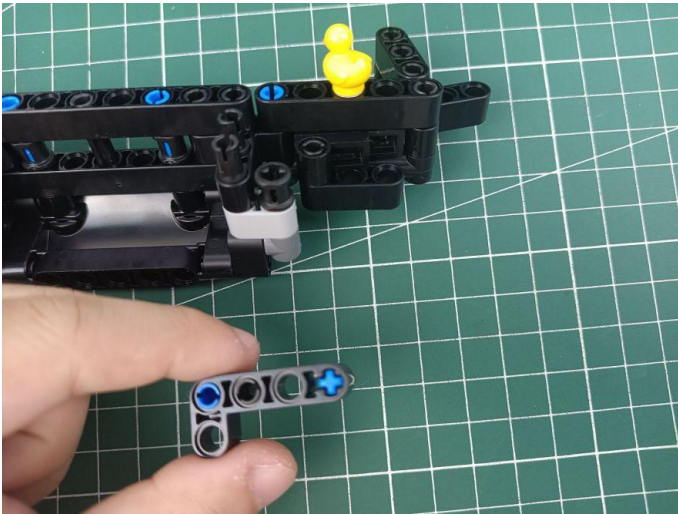

6

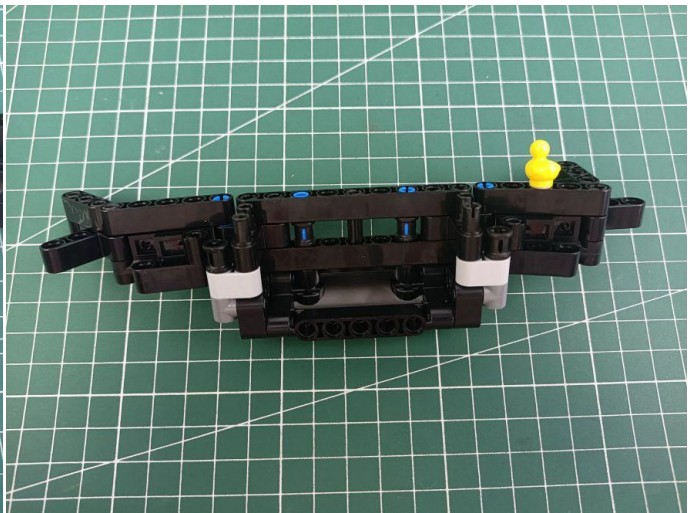
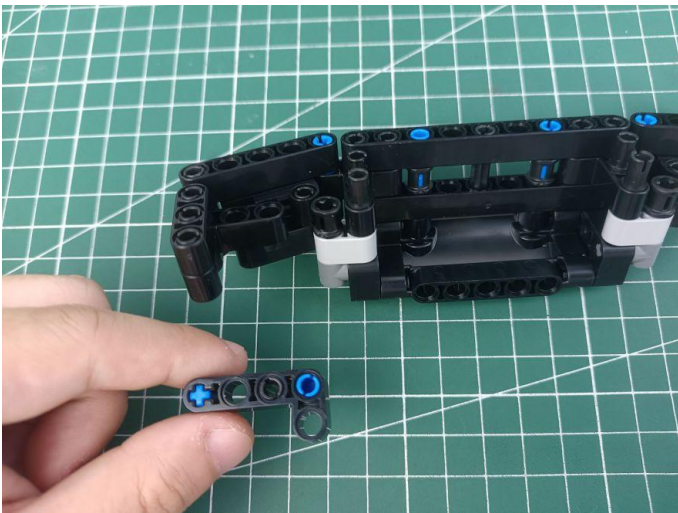

7

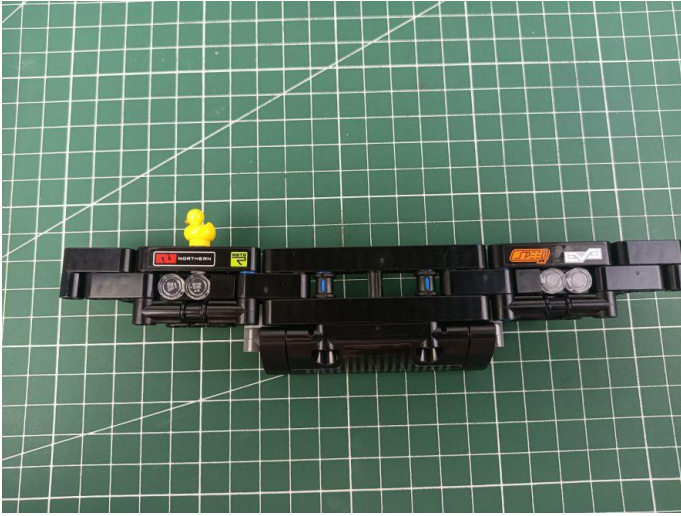

8

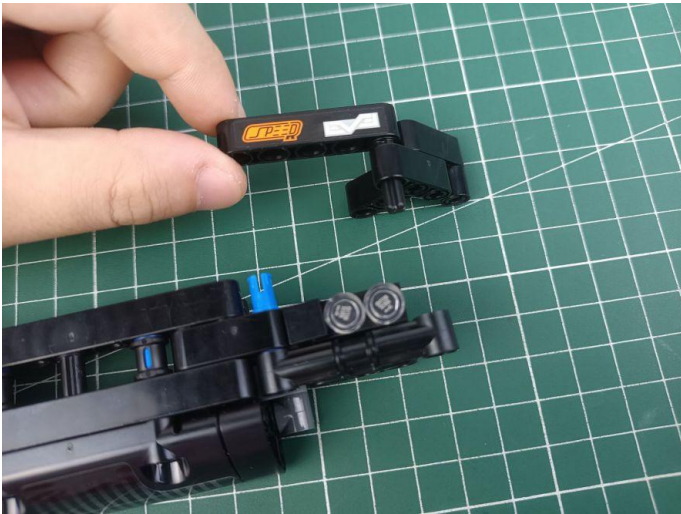

9

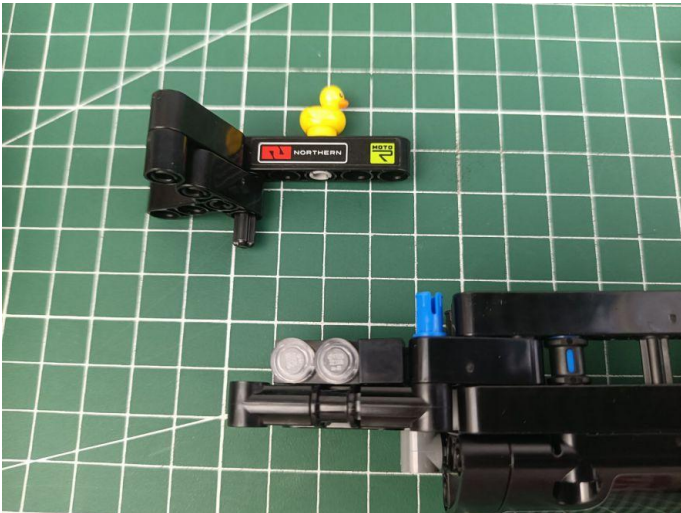

10

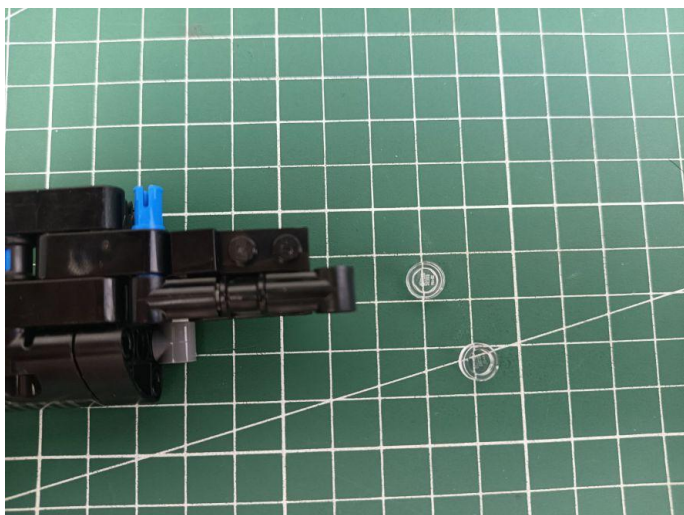

11



12



13

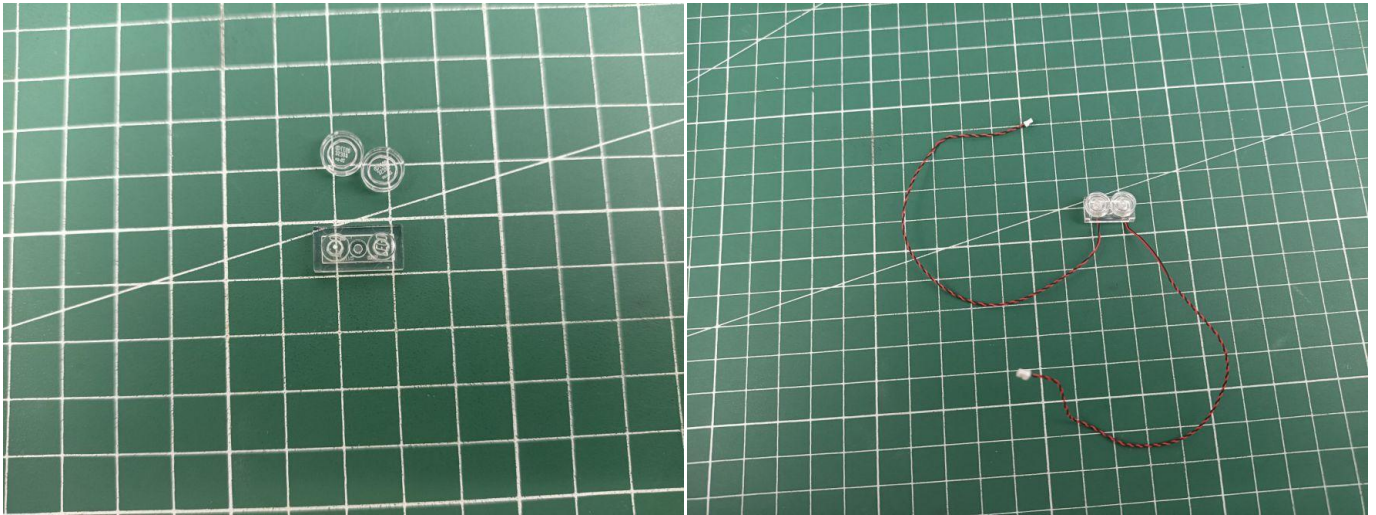

14

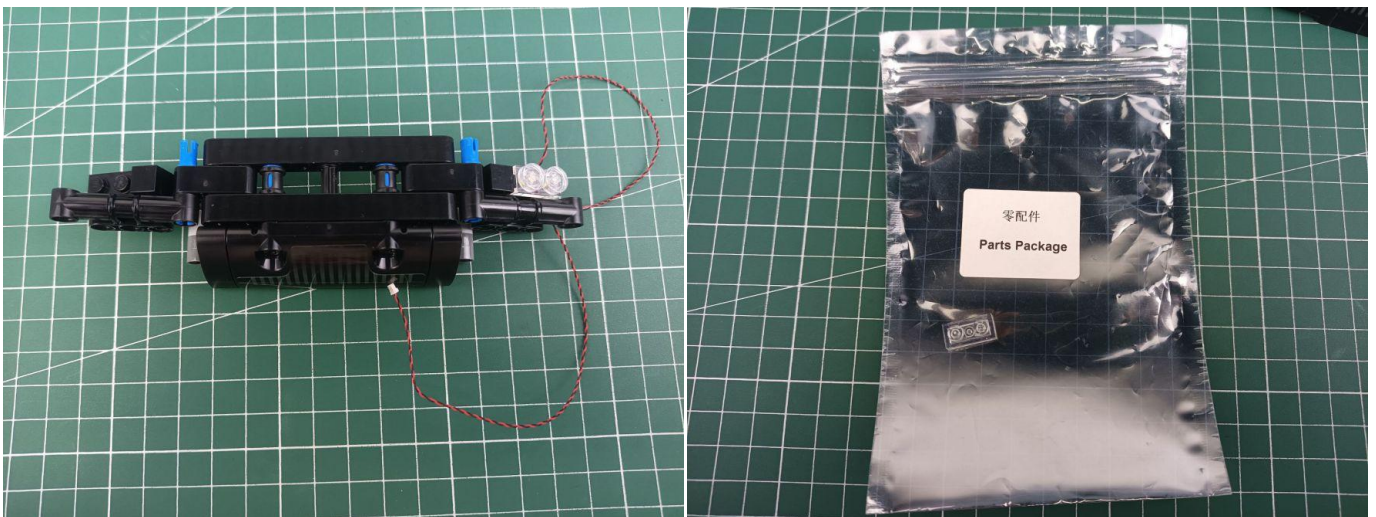

15

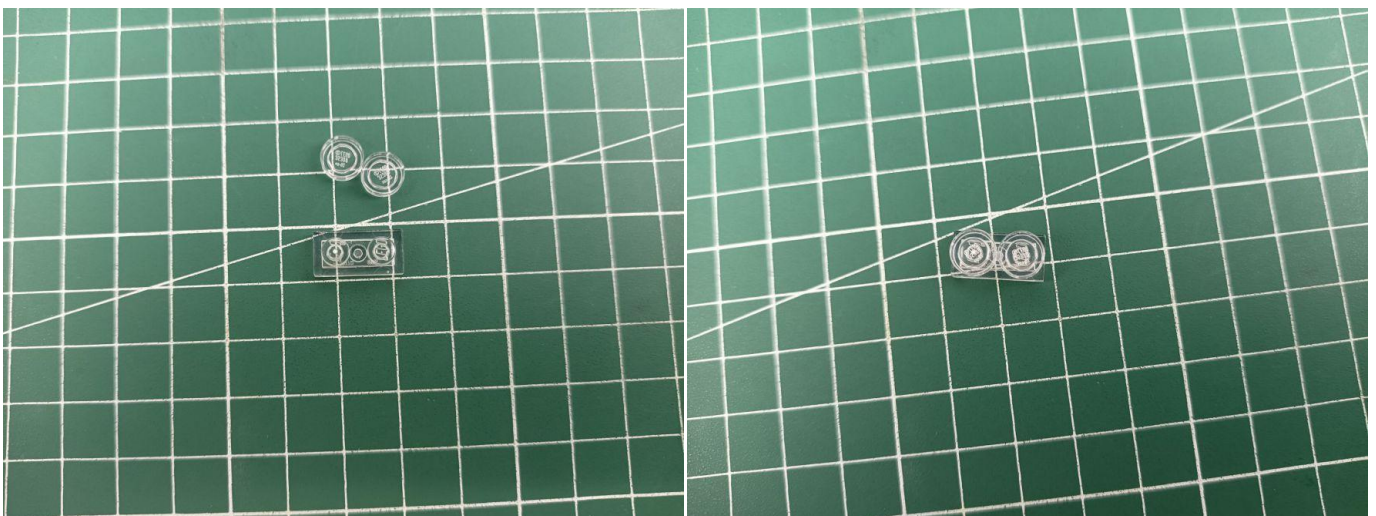

16

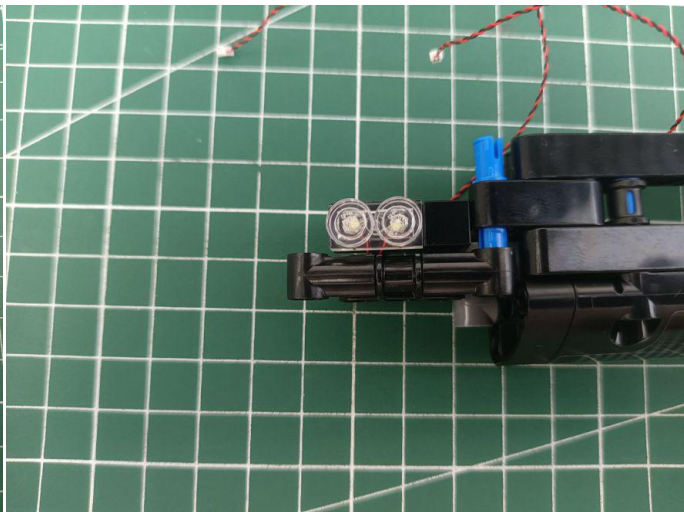
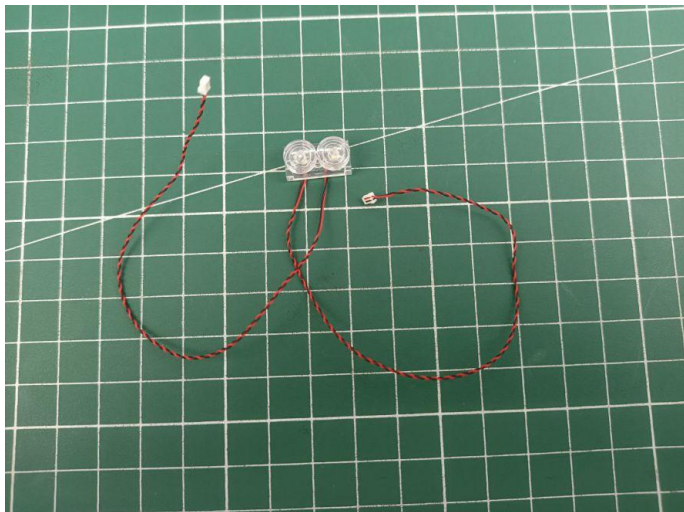

17

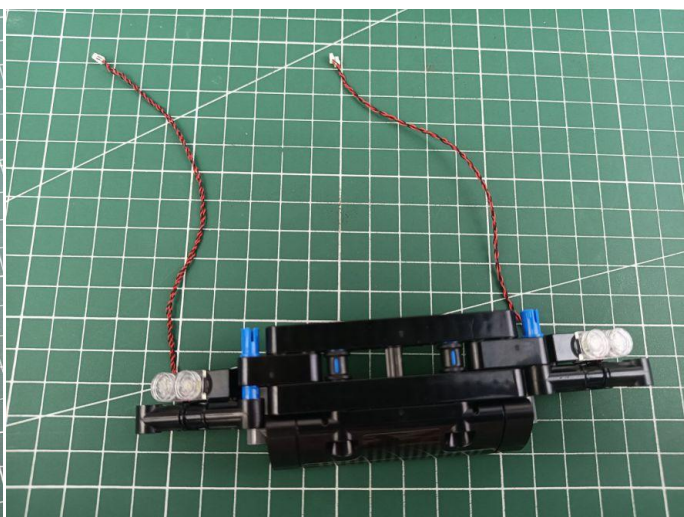
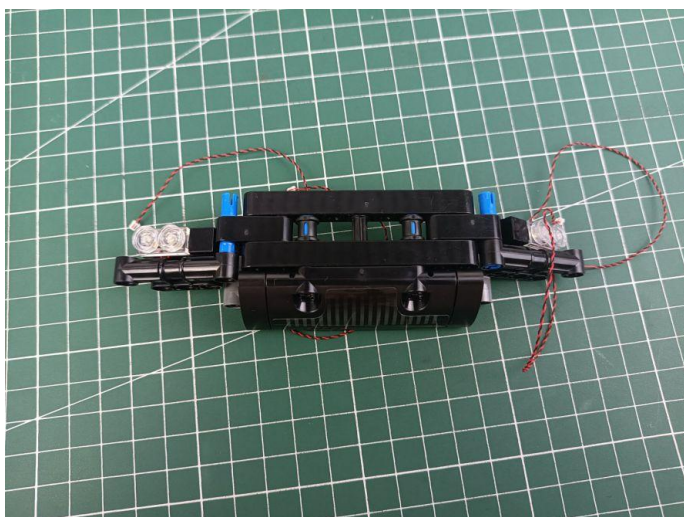

18

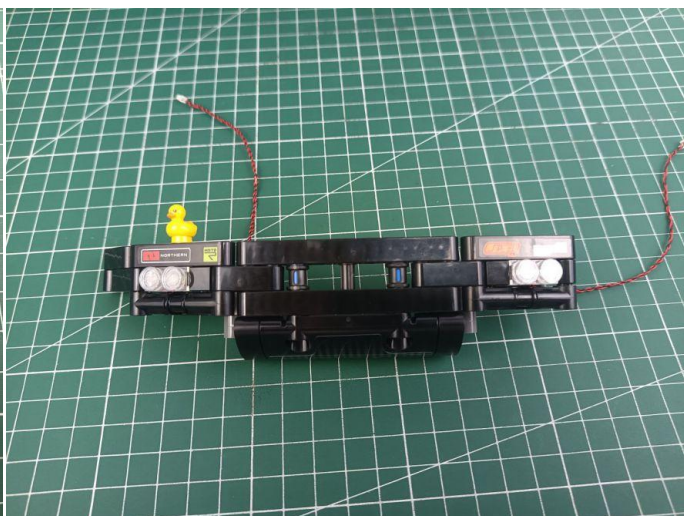
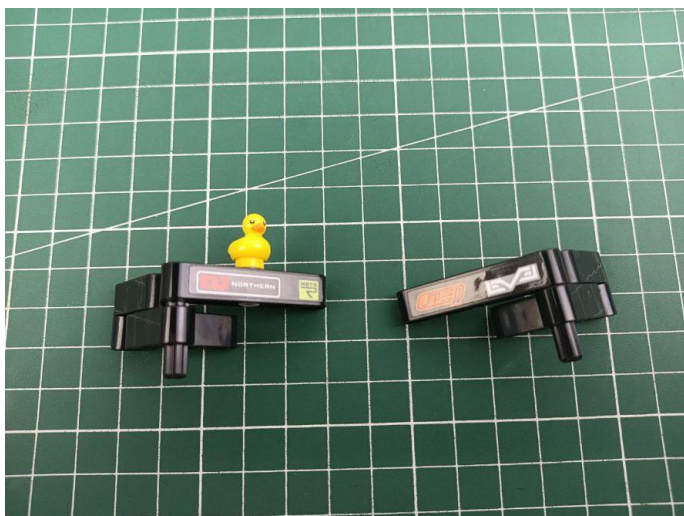

19

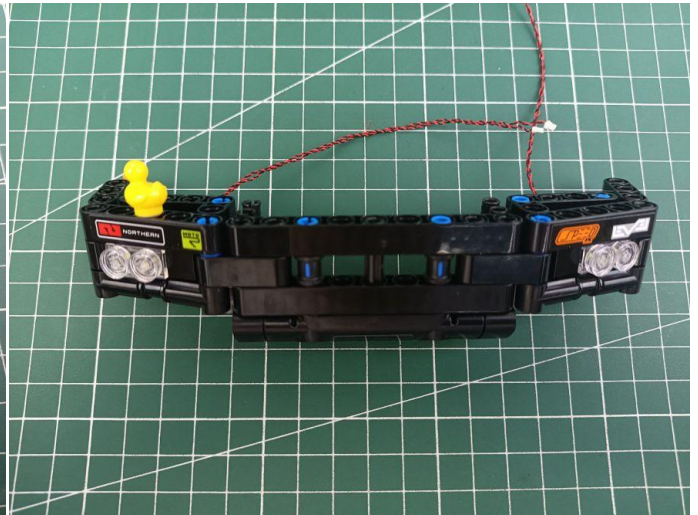
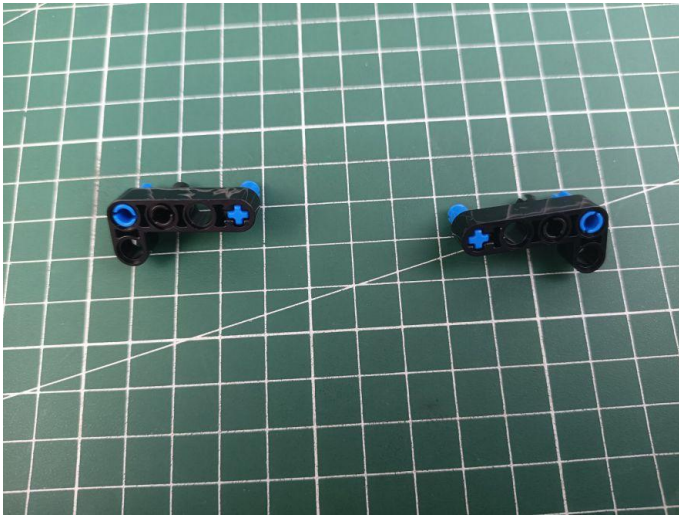

20

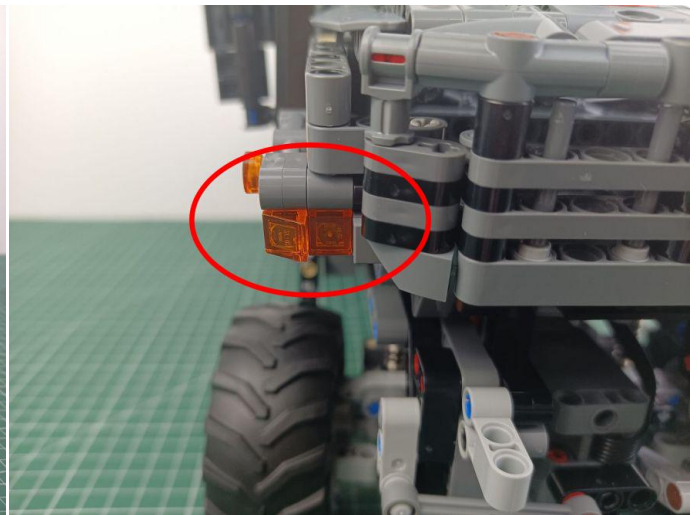

21

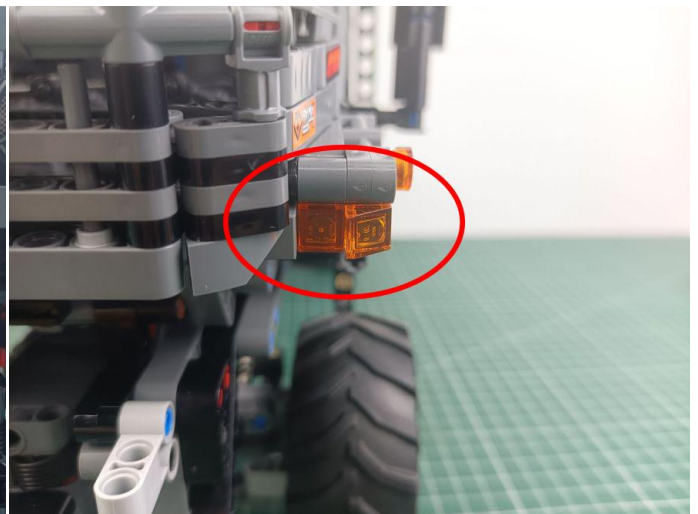
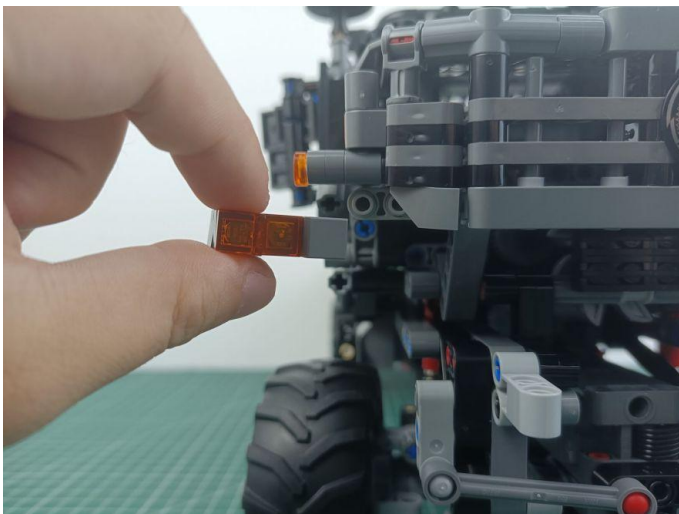

22

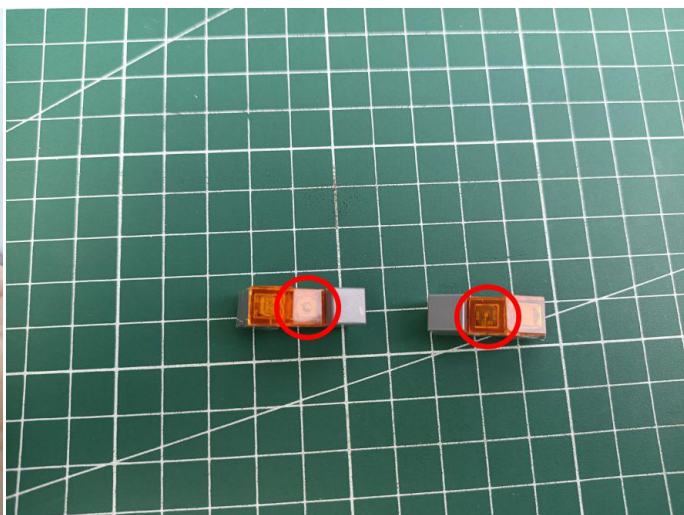
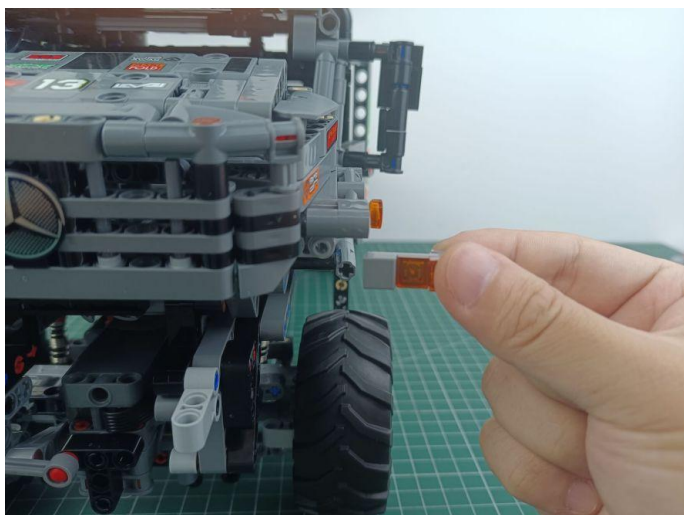

23

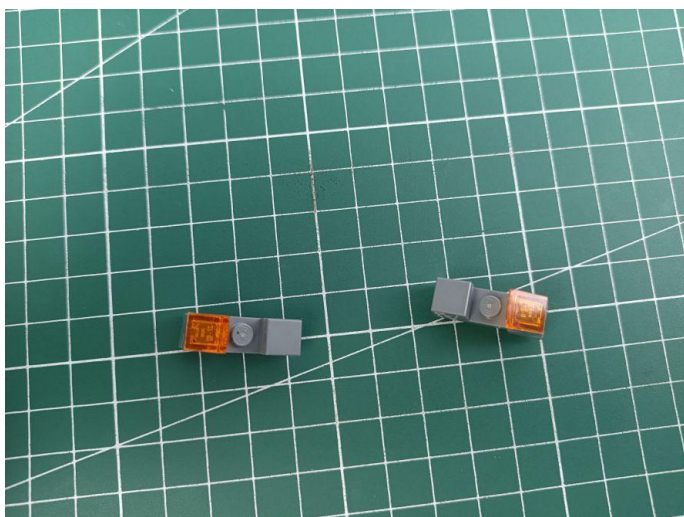

24

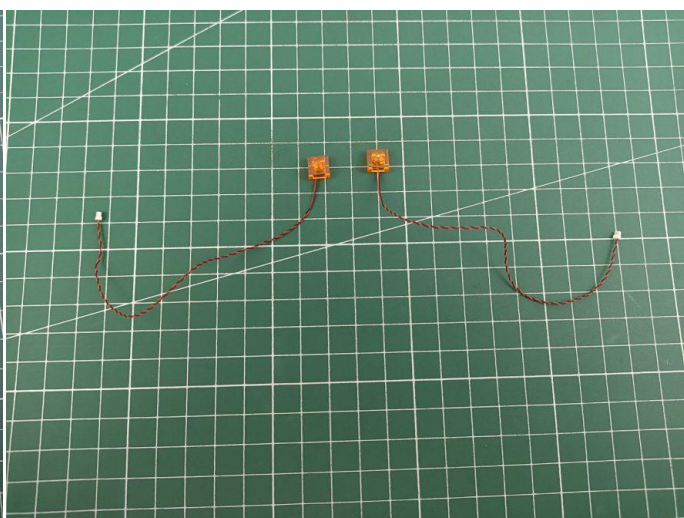

25

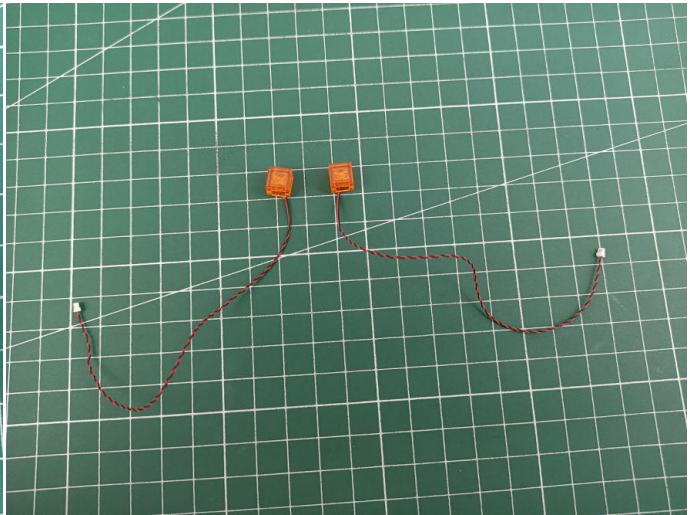
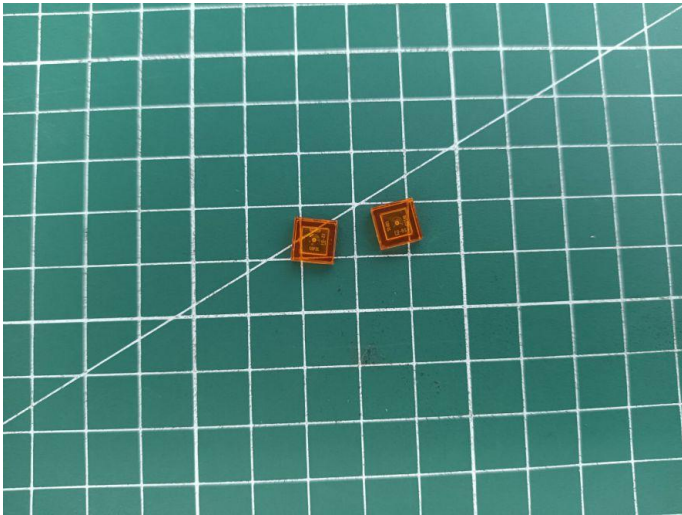

26

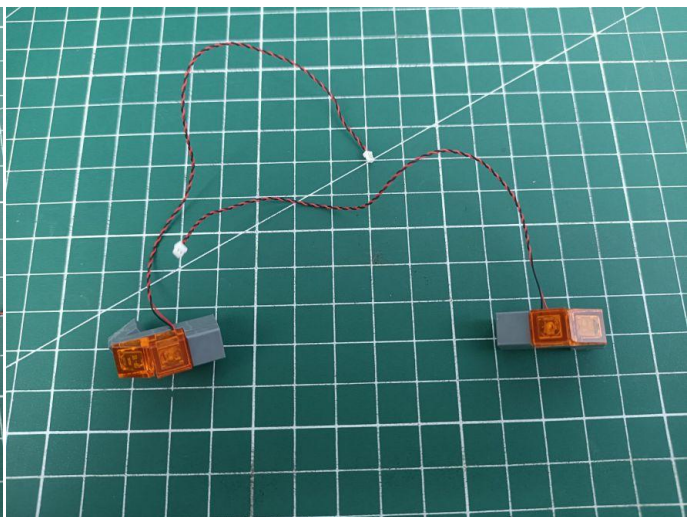
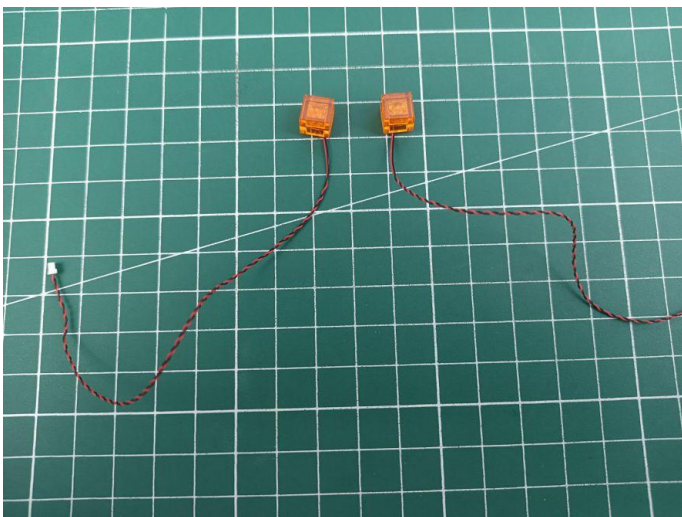

27



28

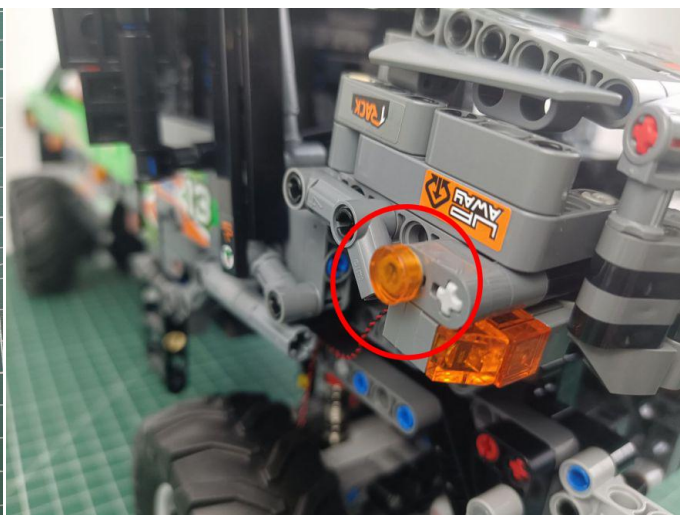

29

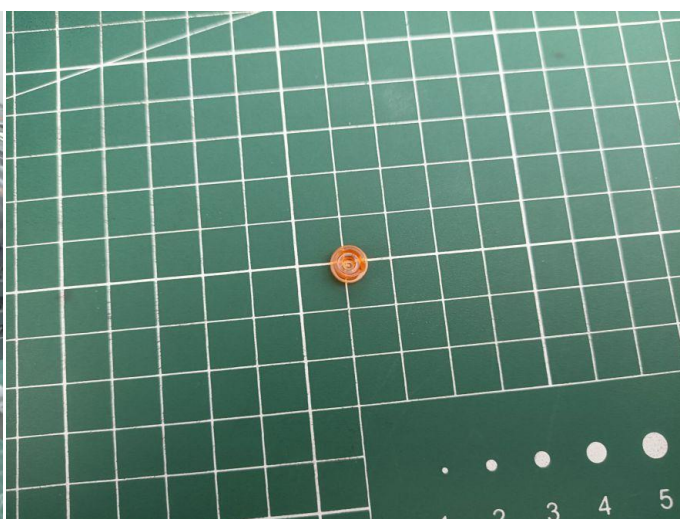
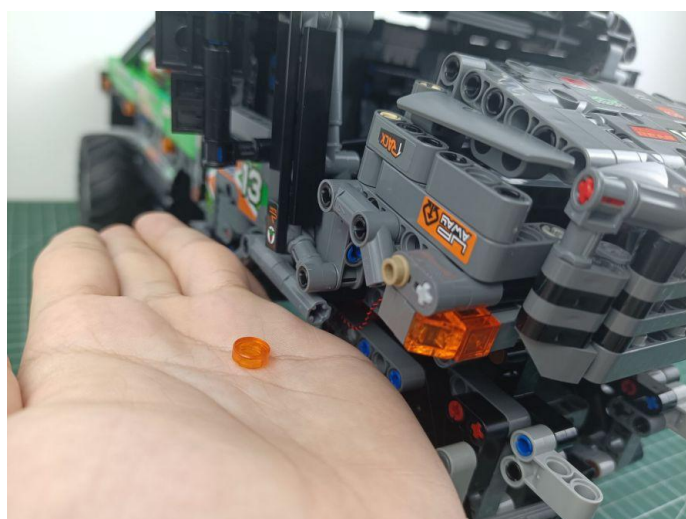

30

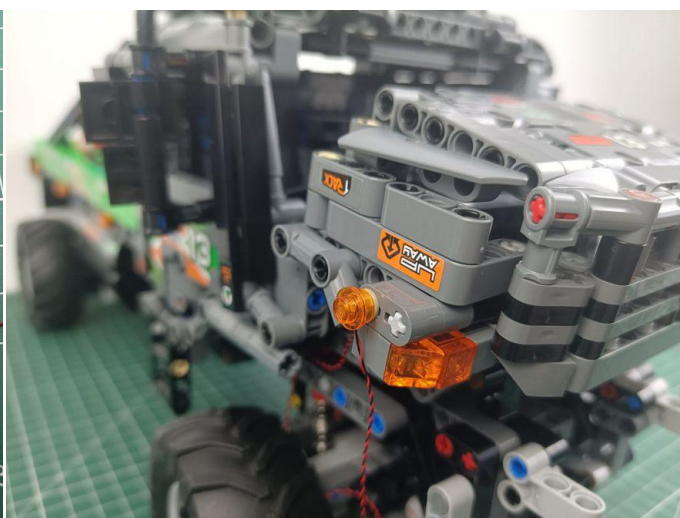
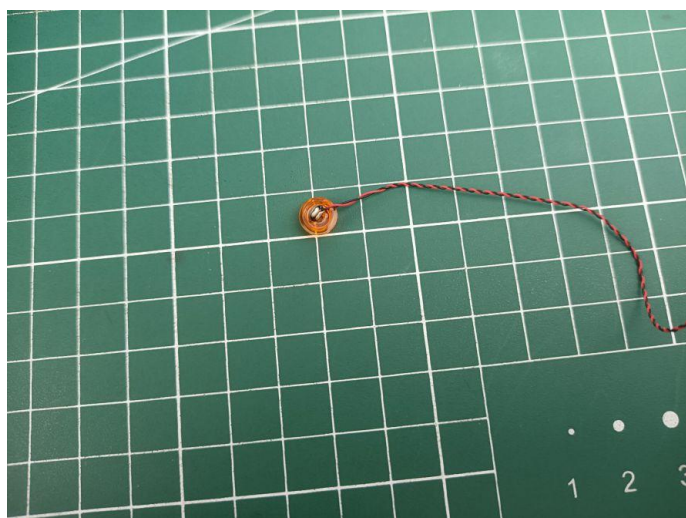

31



32

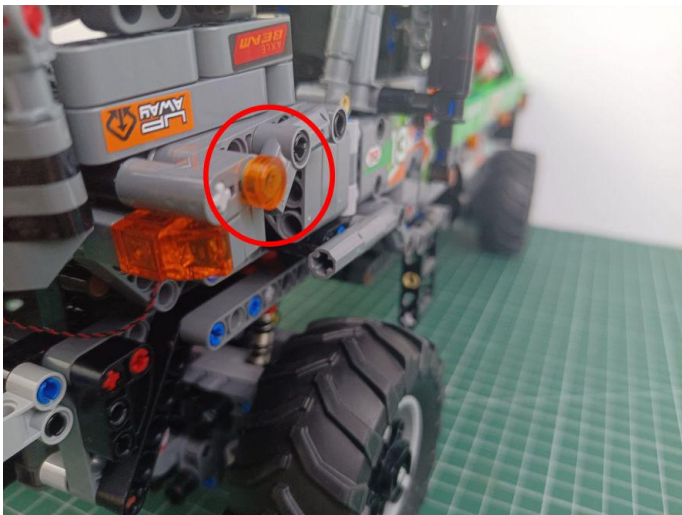

33

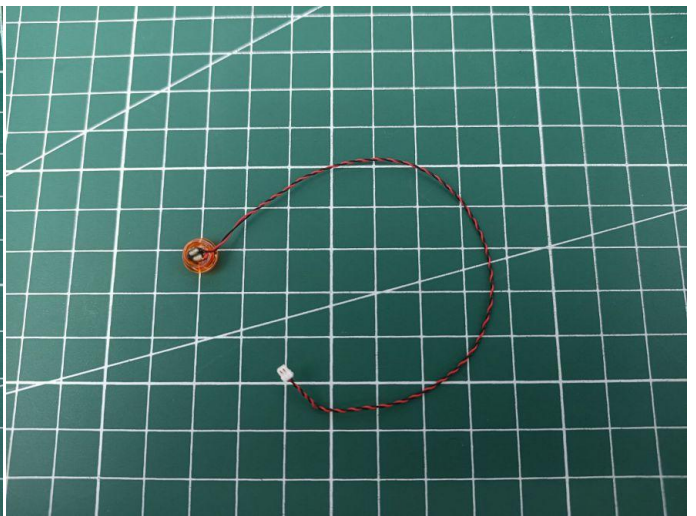
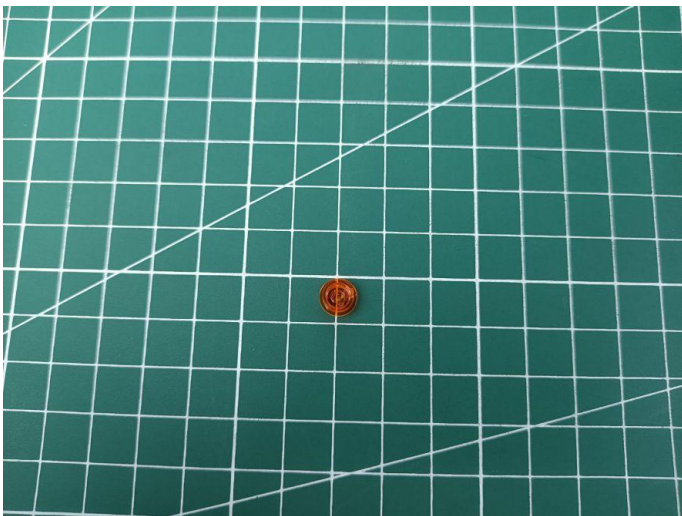

34

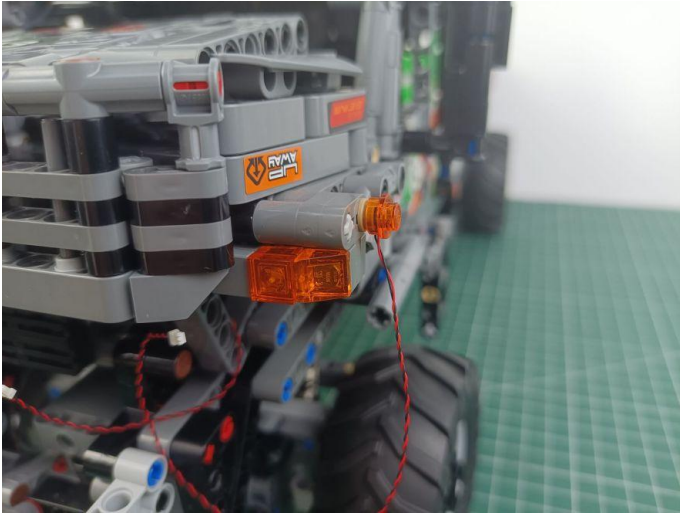

35

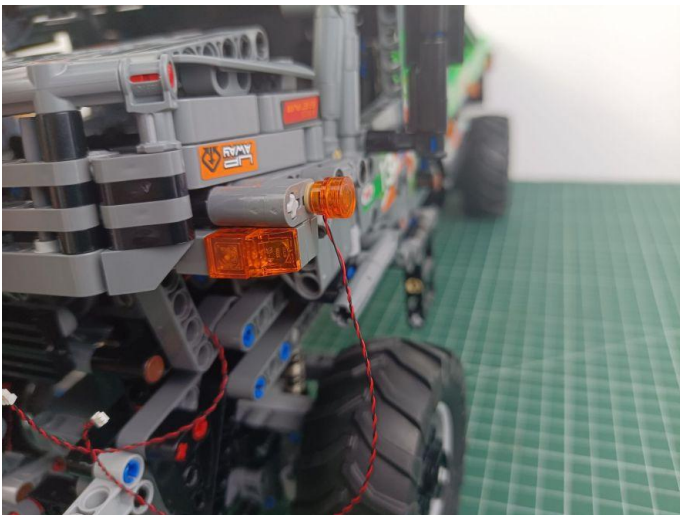

36

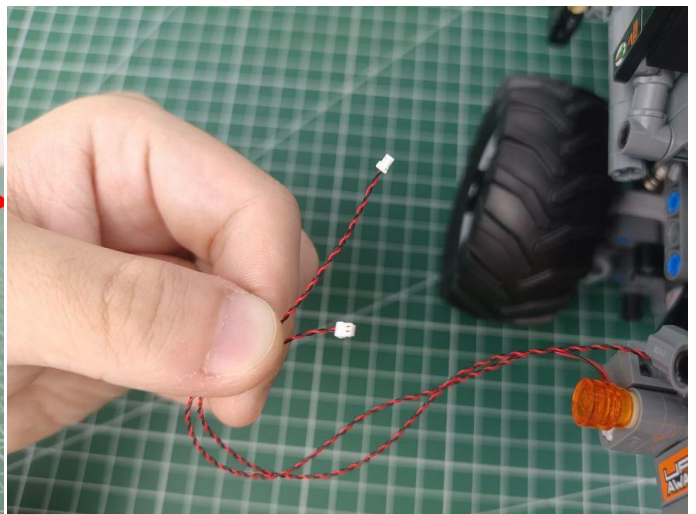

37

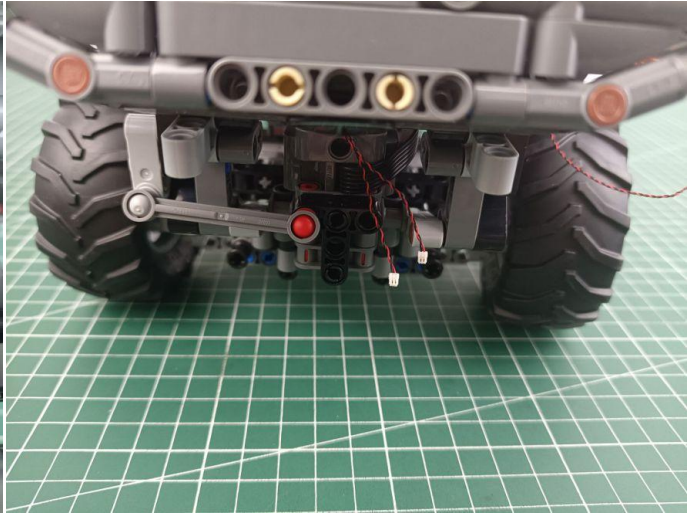
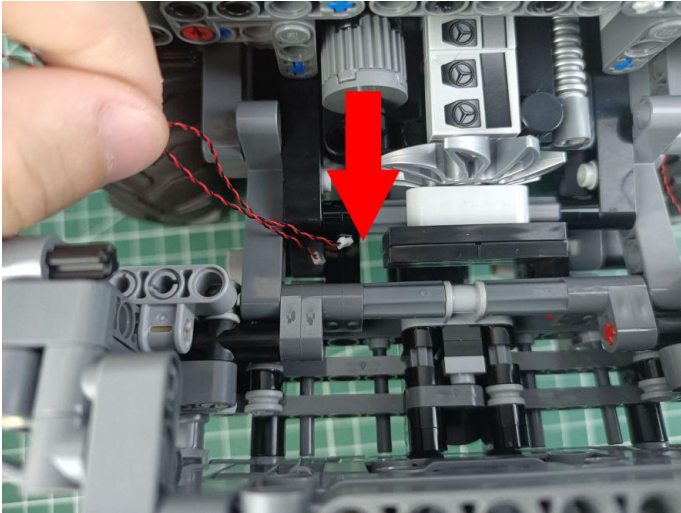

38

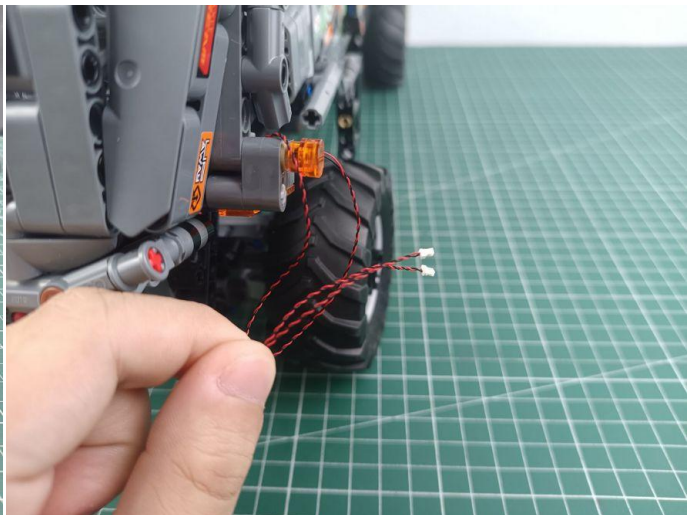

39

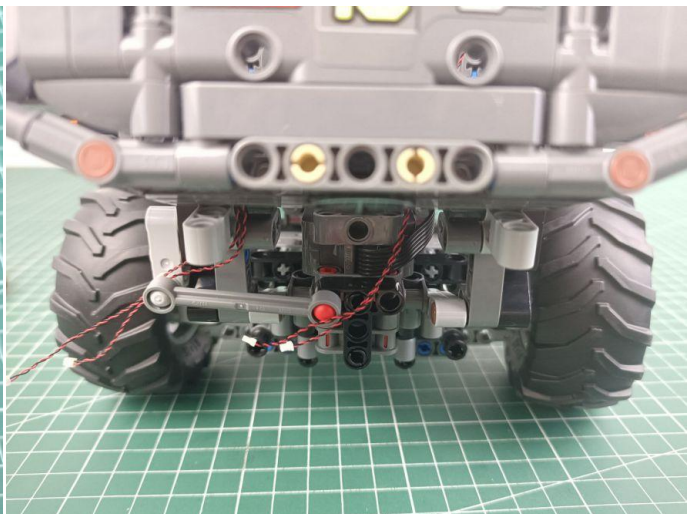
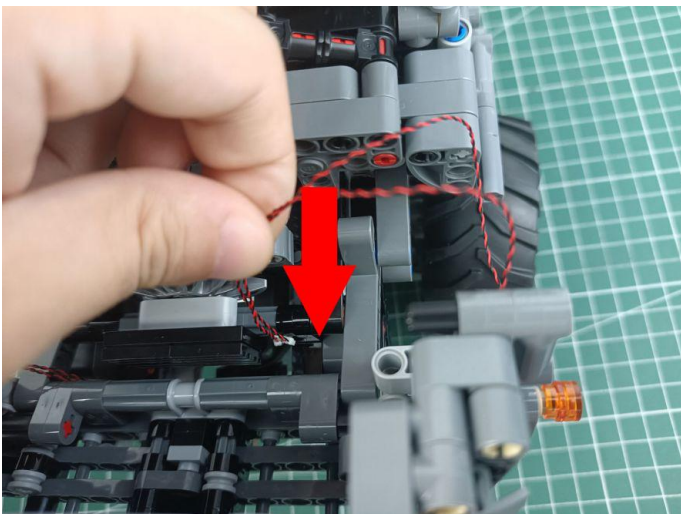

40



41

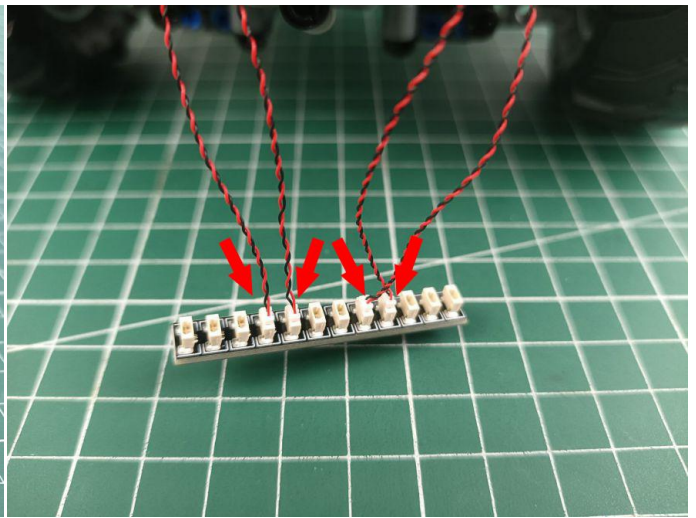
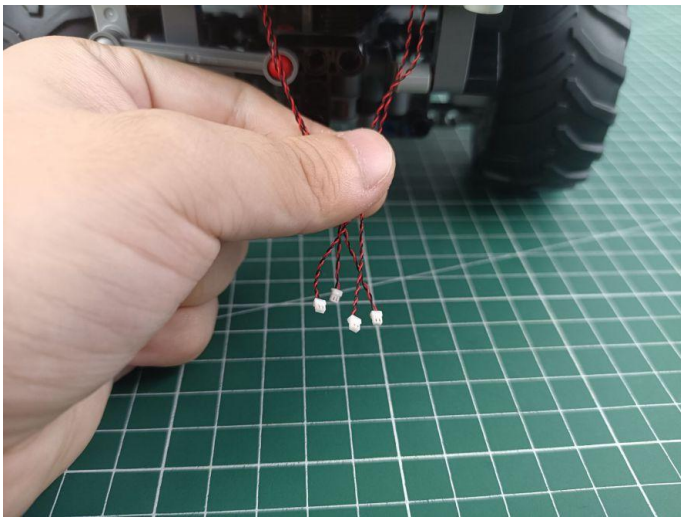

42

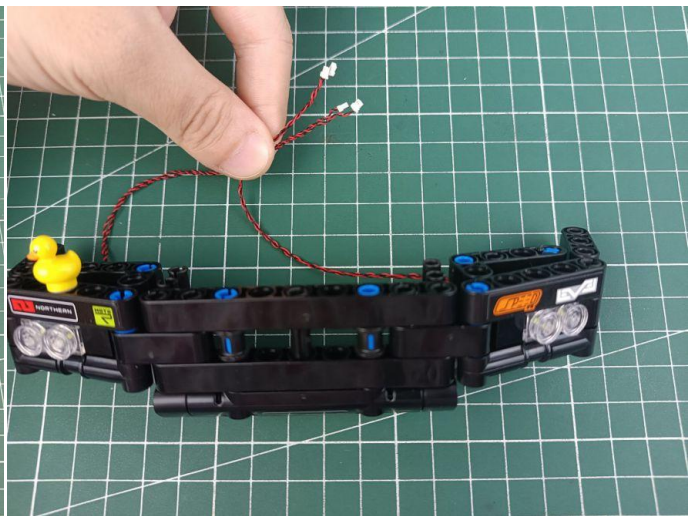
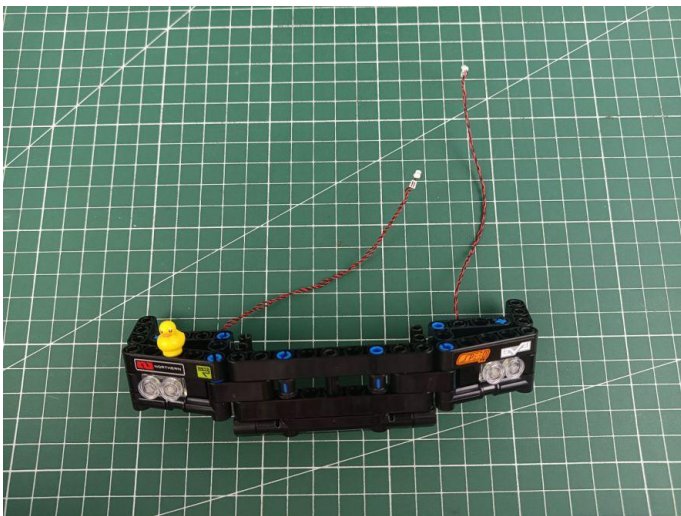

43

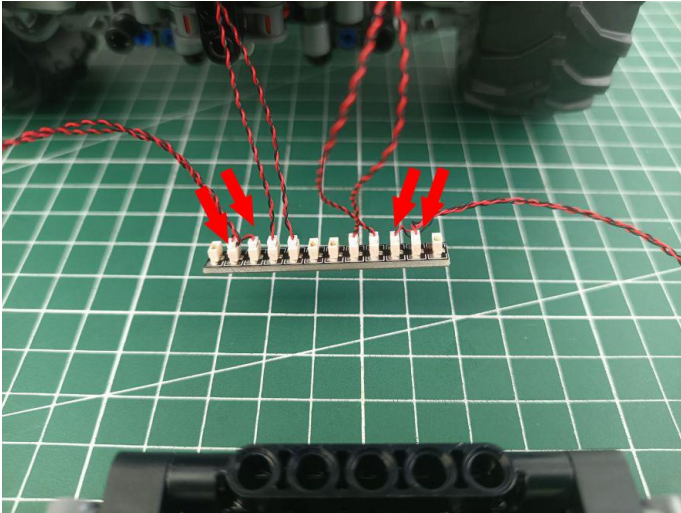

44

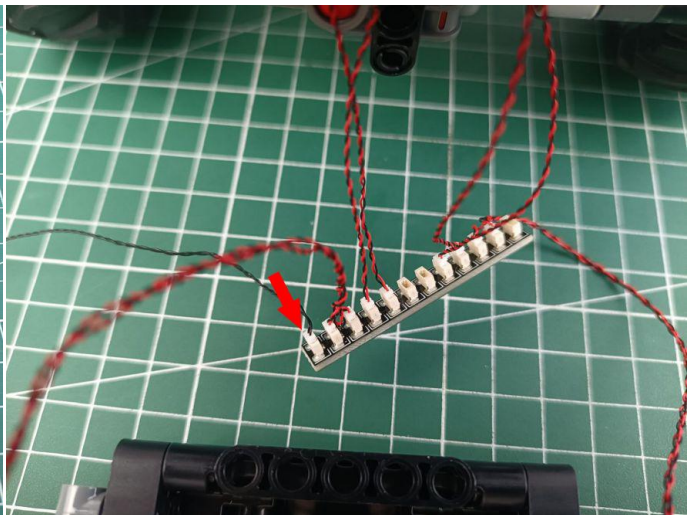
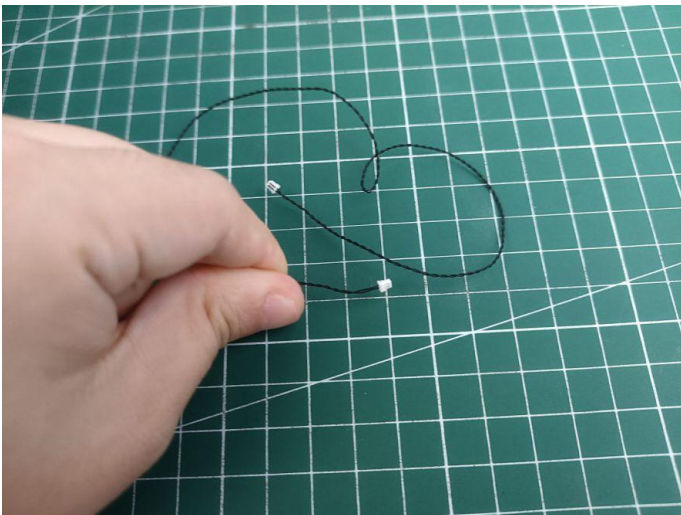

45

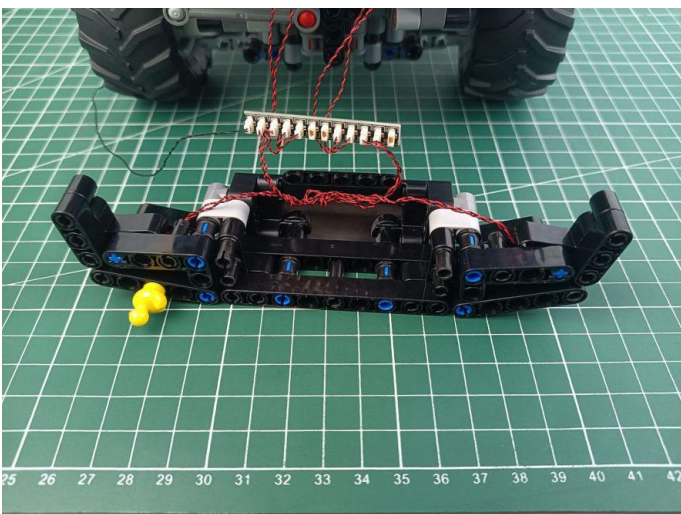

46



47

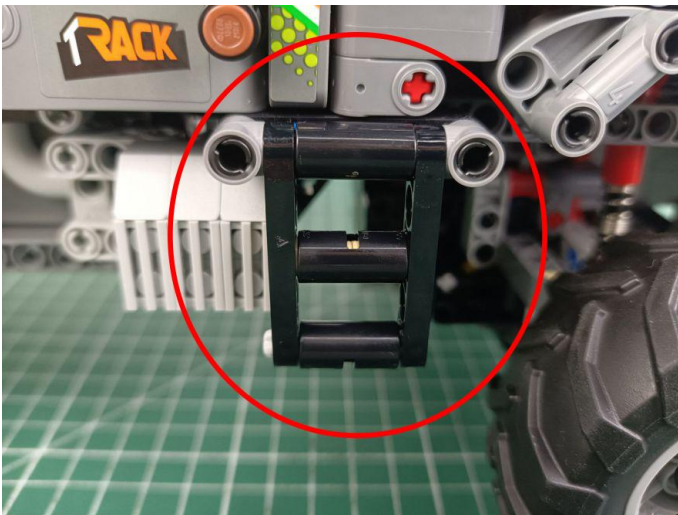

48



49

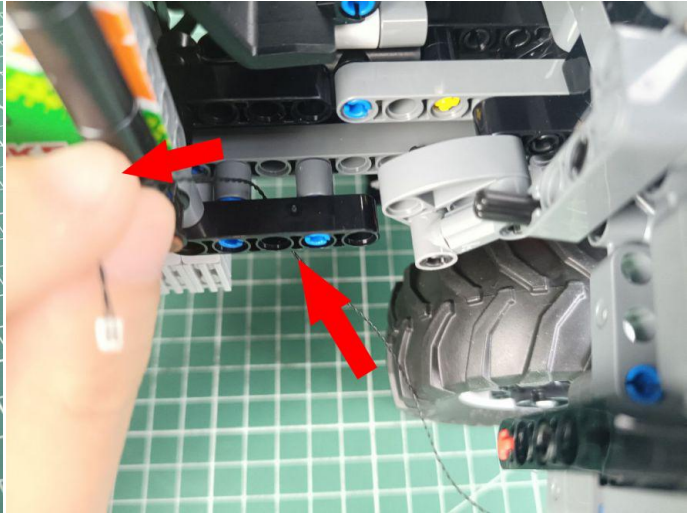

50

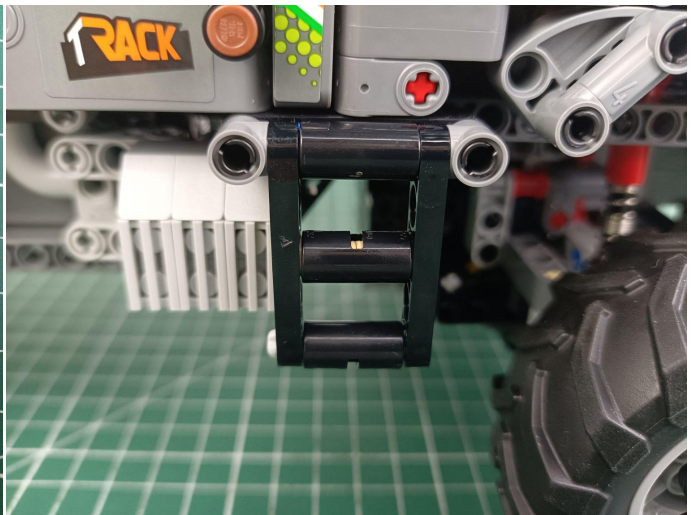

51



52



53

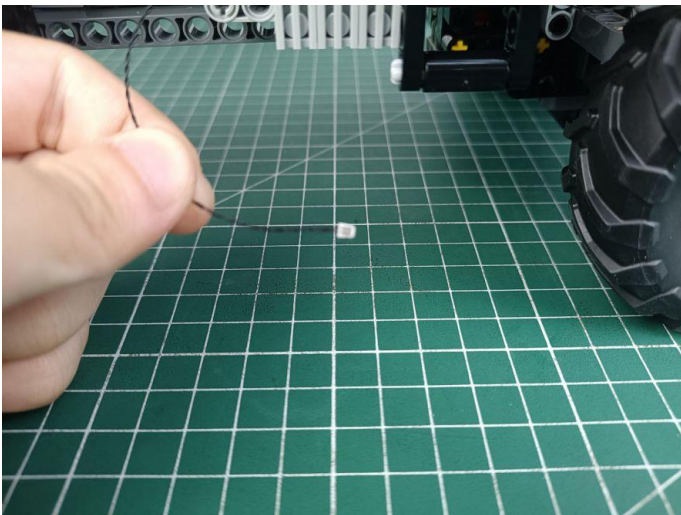

54



55



56



57



58

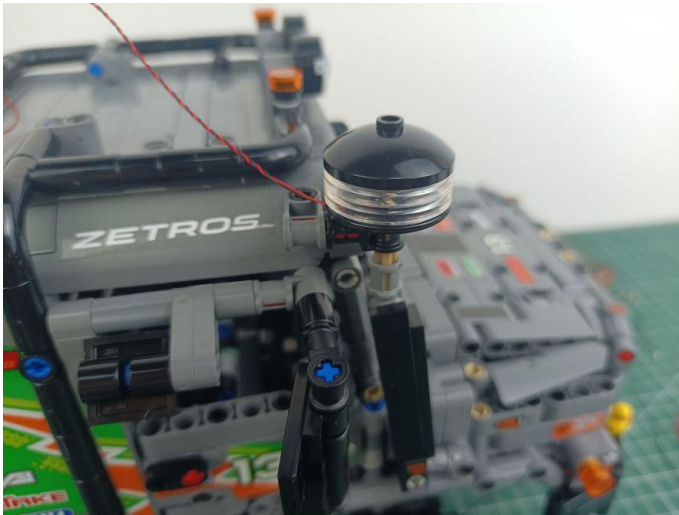

59

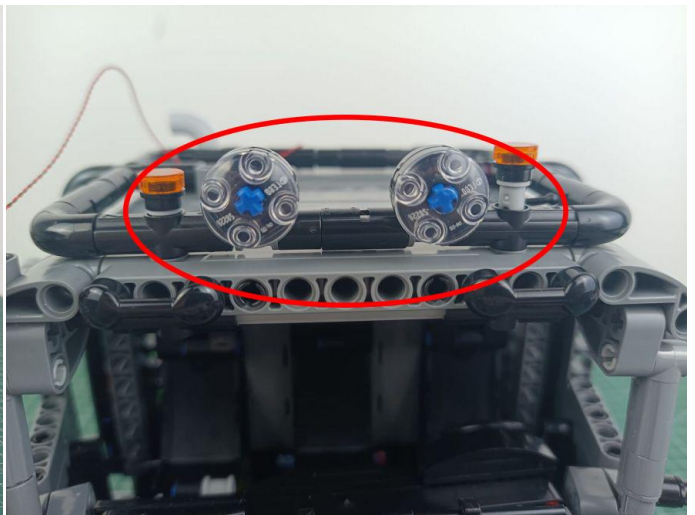

60



61

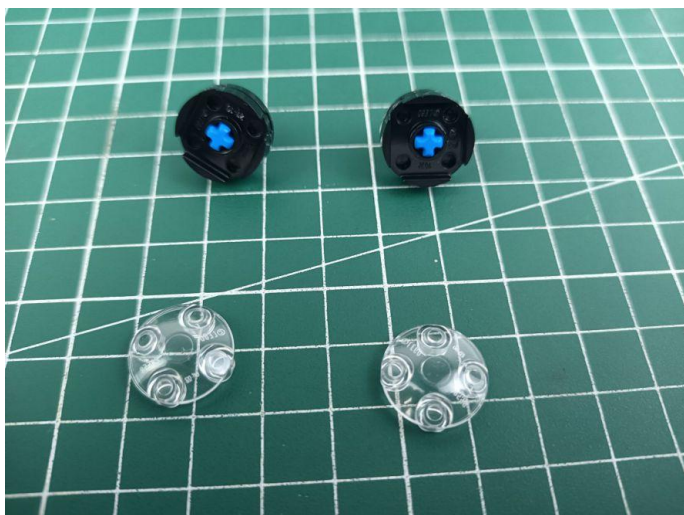

62

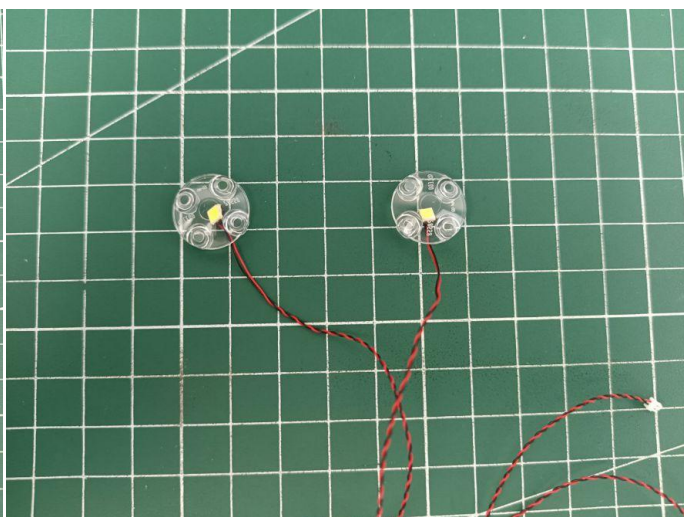
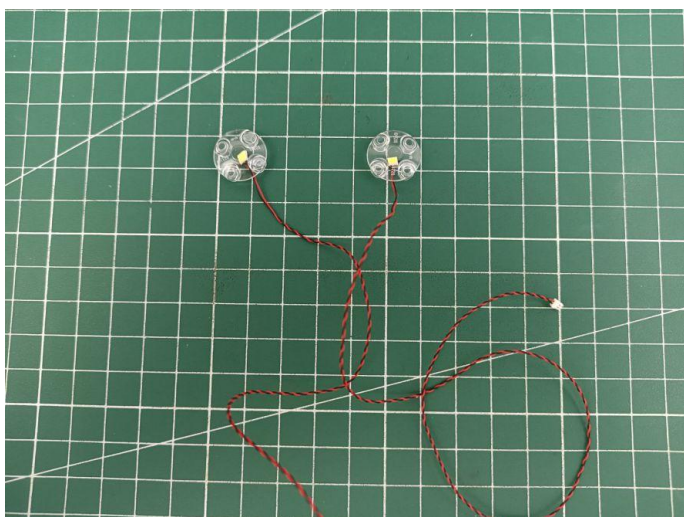

63

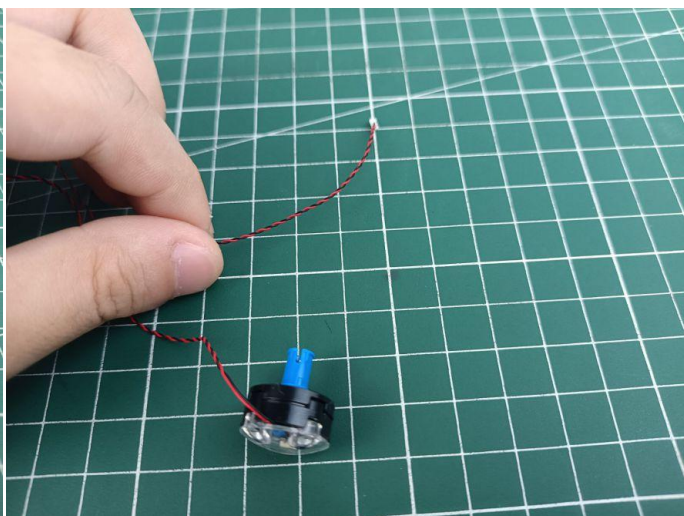
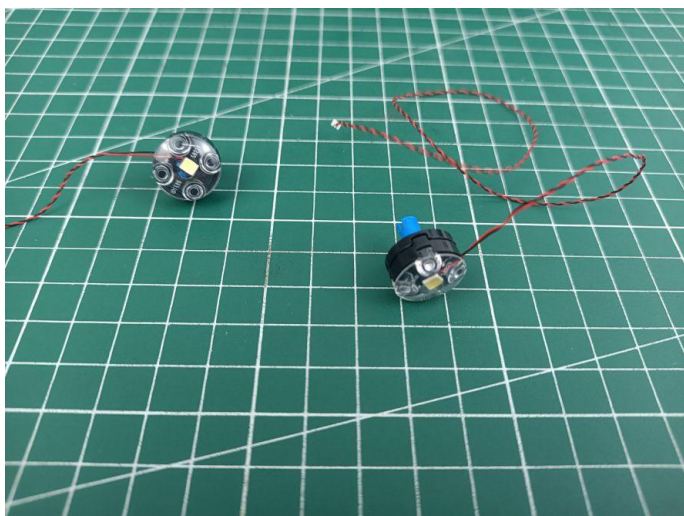

64

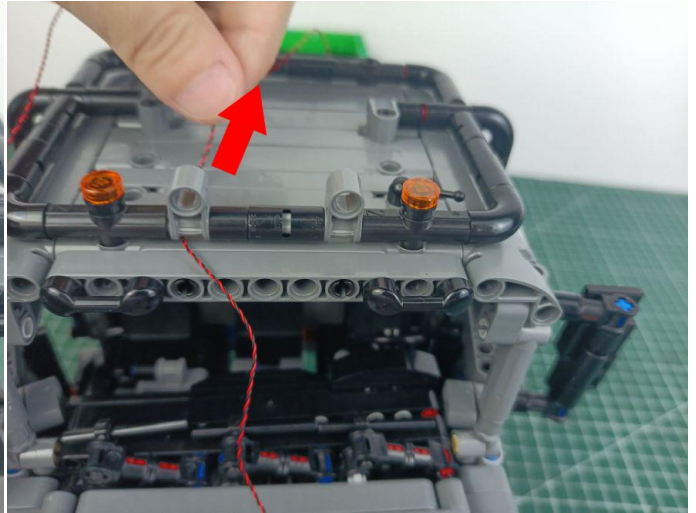
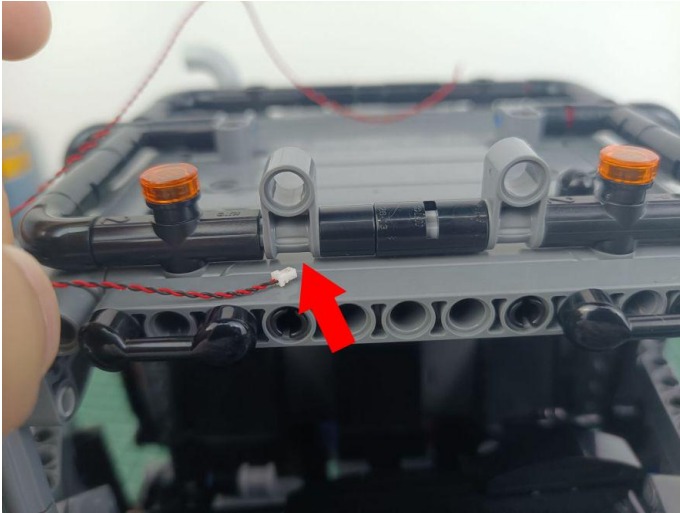

65

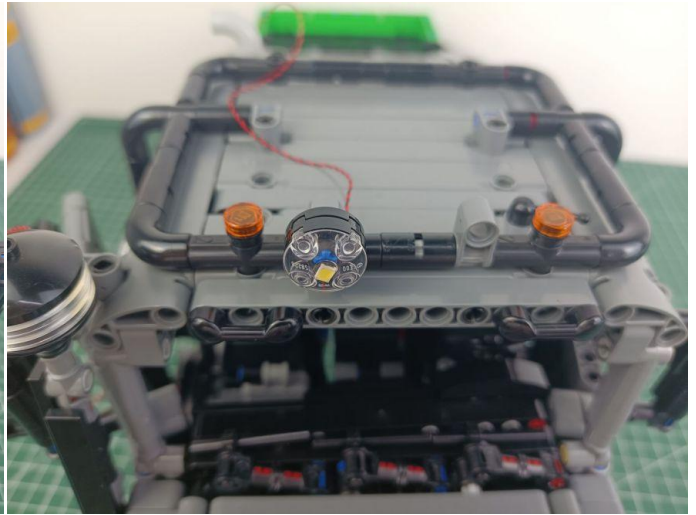
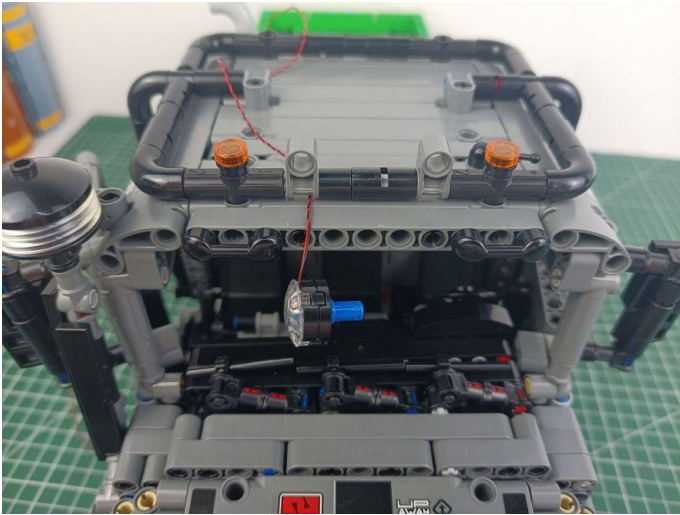

66

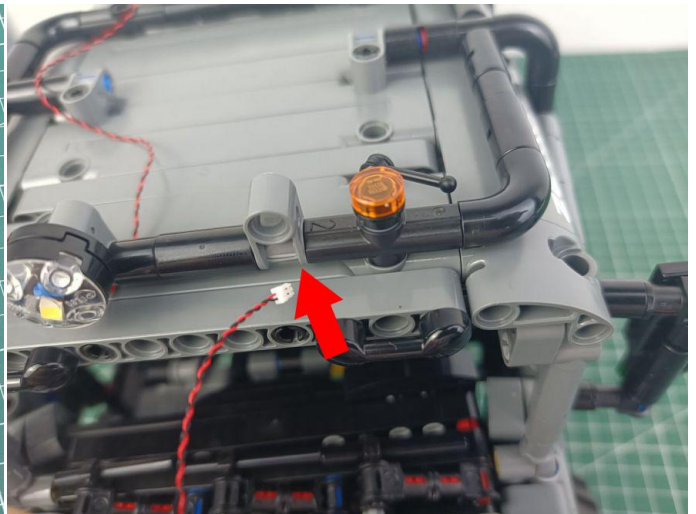
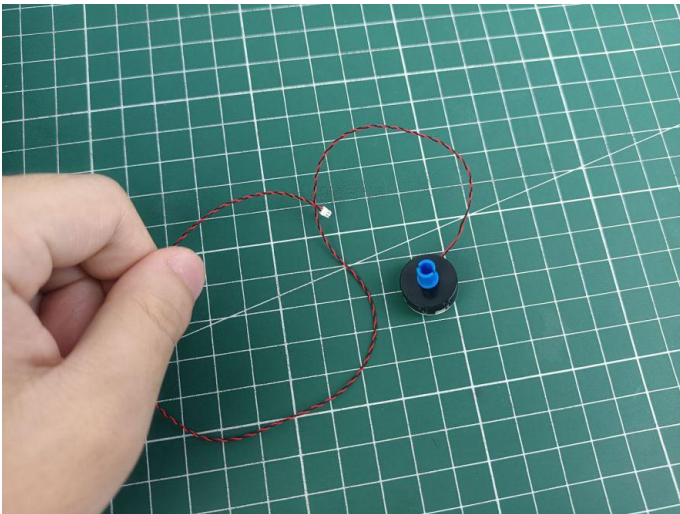

67

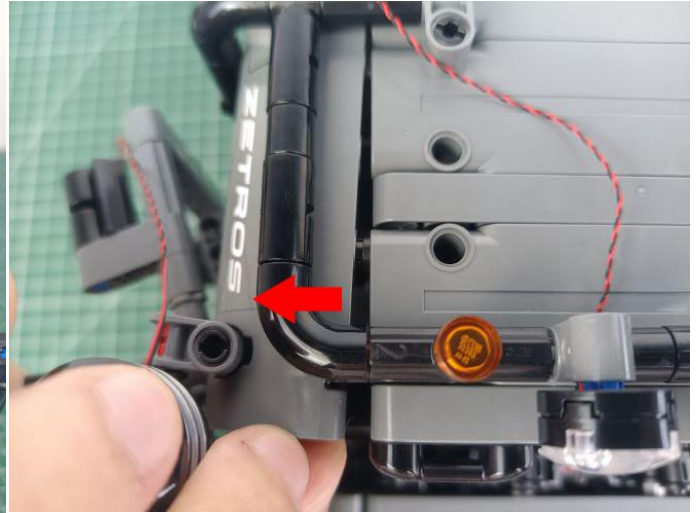
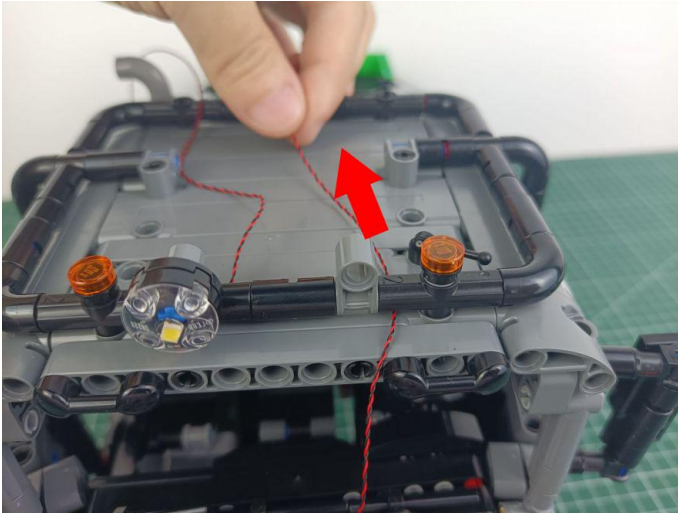

68

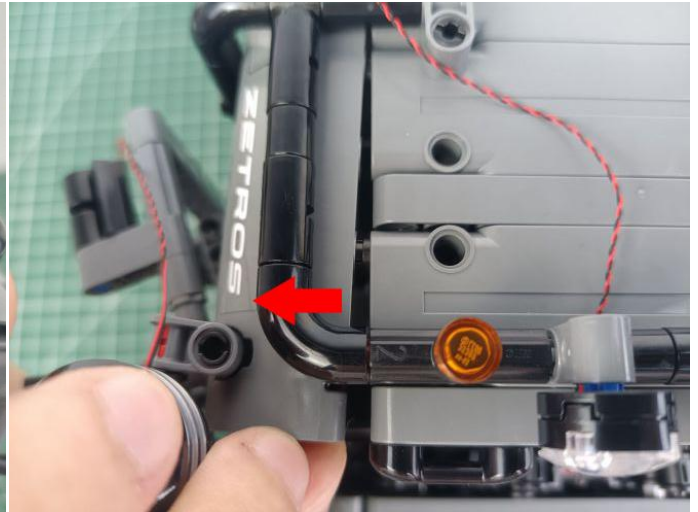
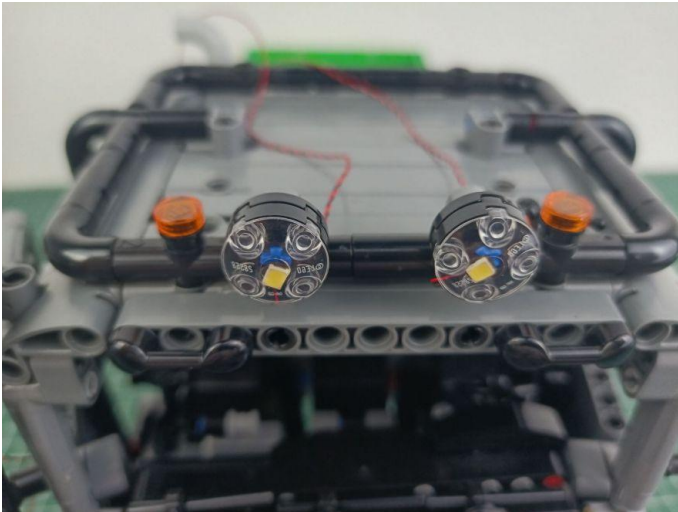

69

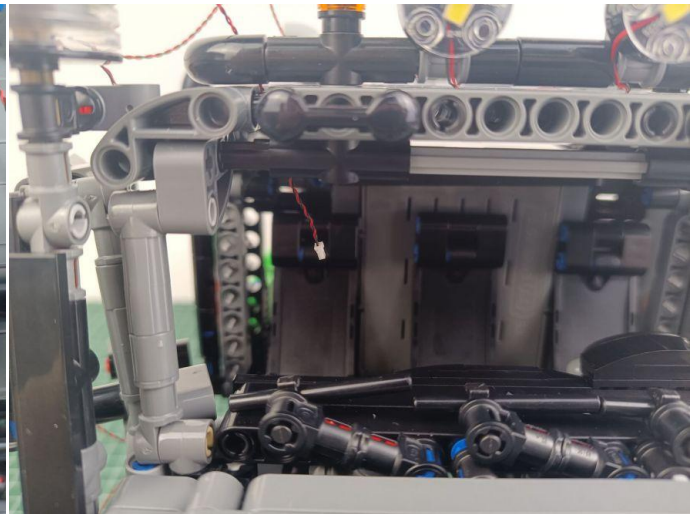
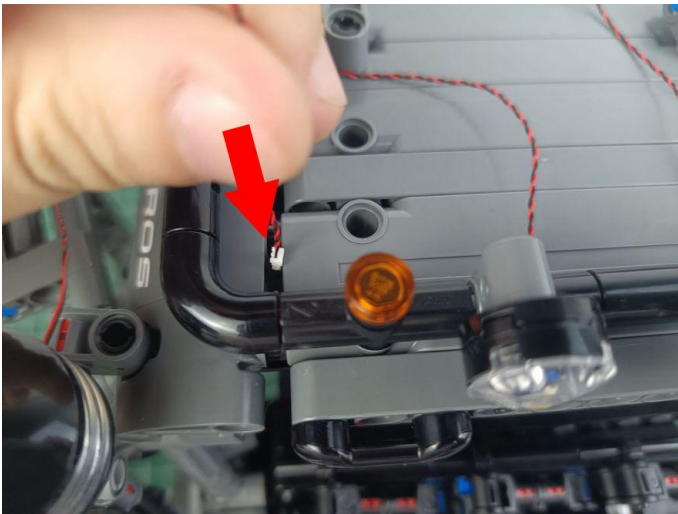

70

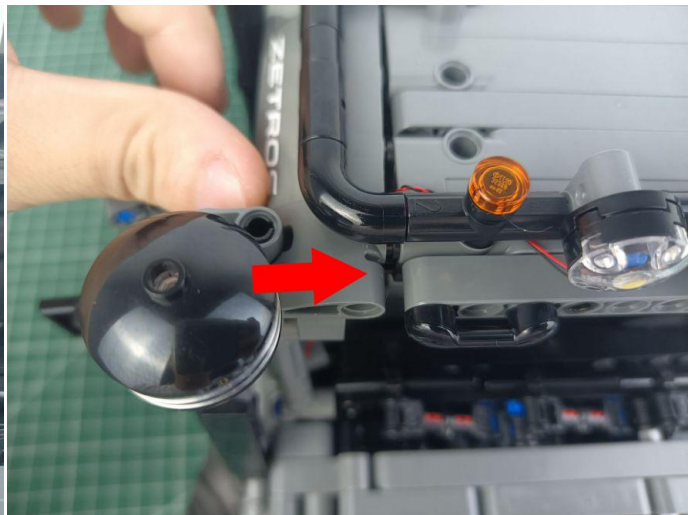
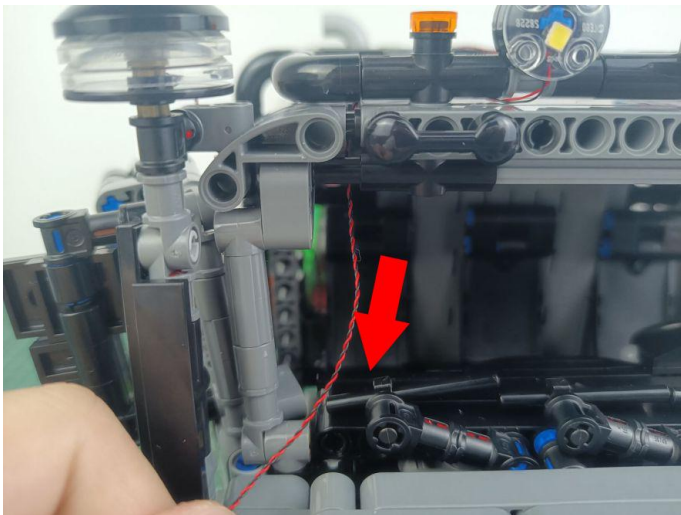

71

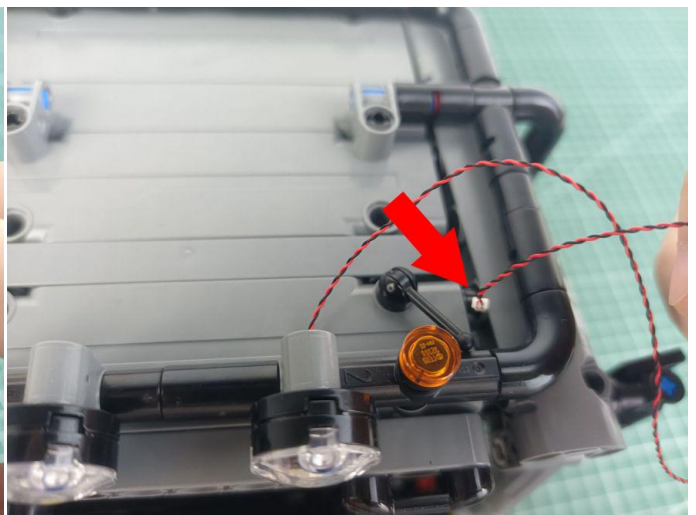
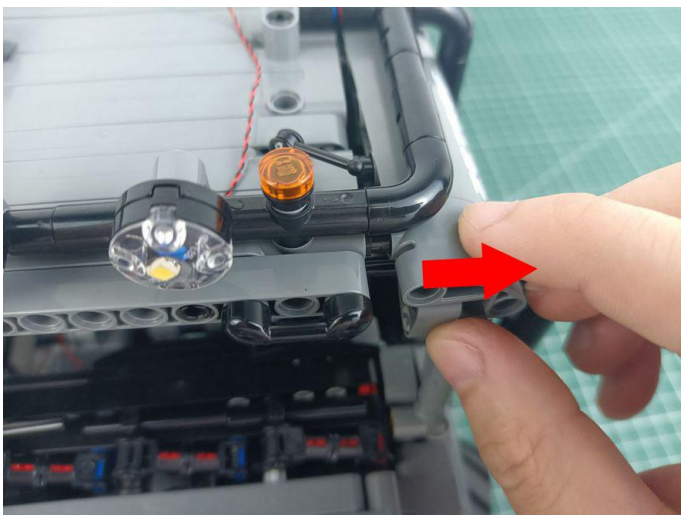

72

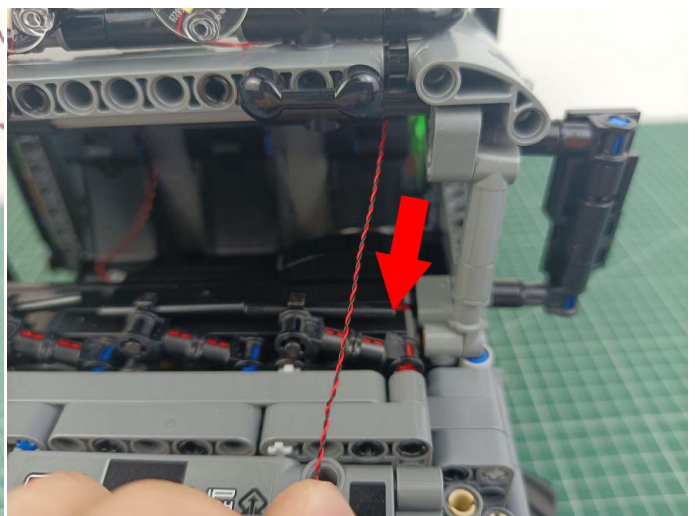
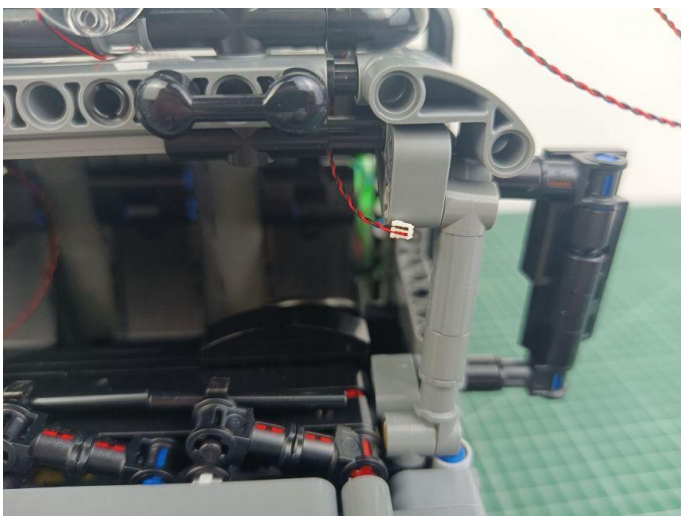

73

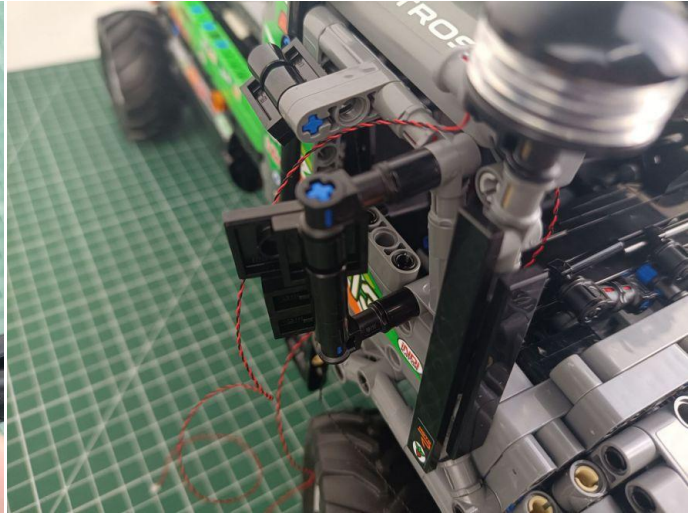

74

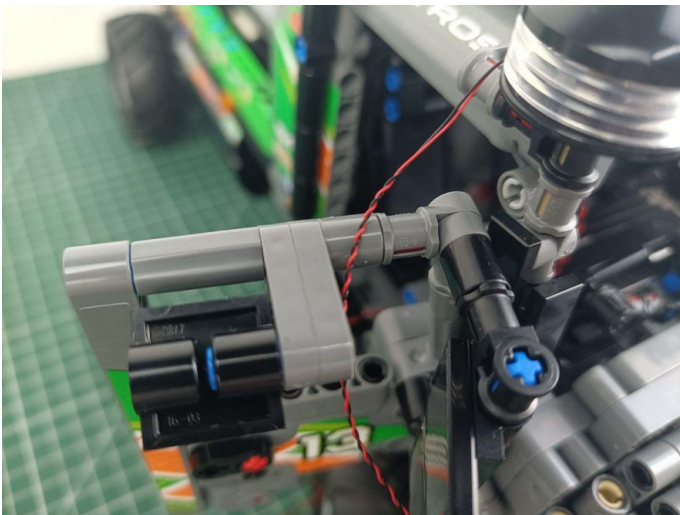

75

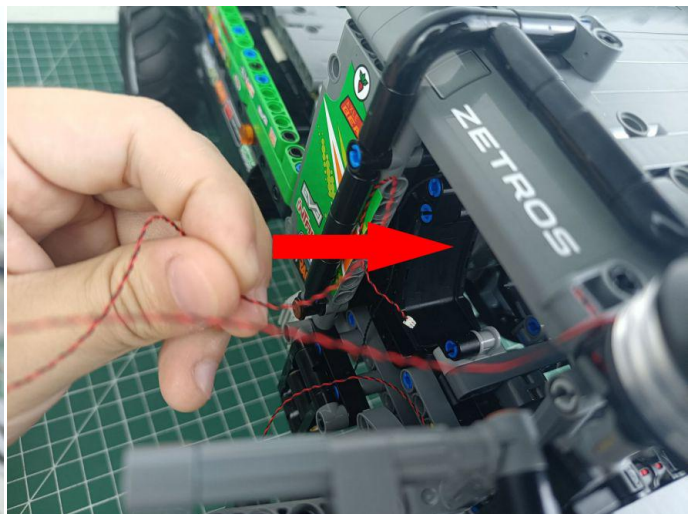

76

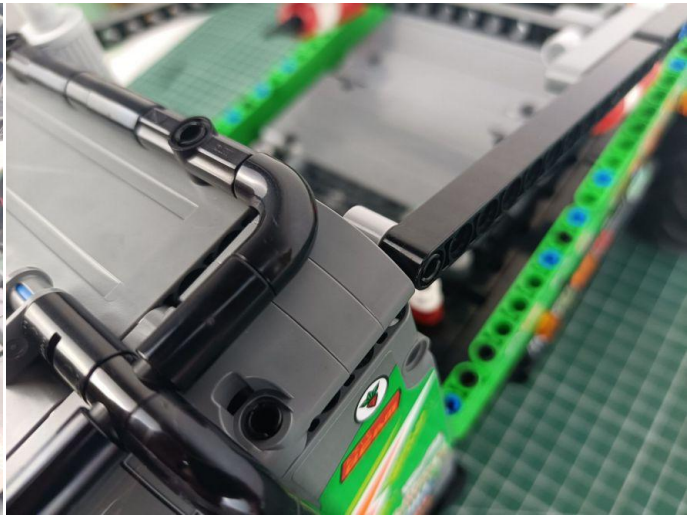
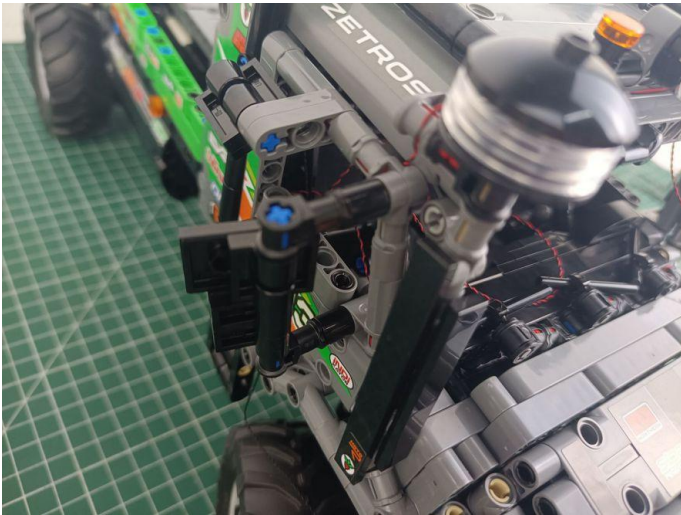

77

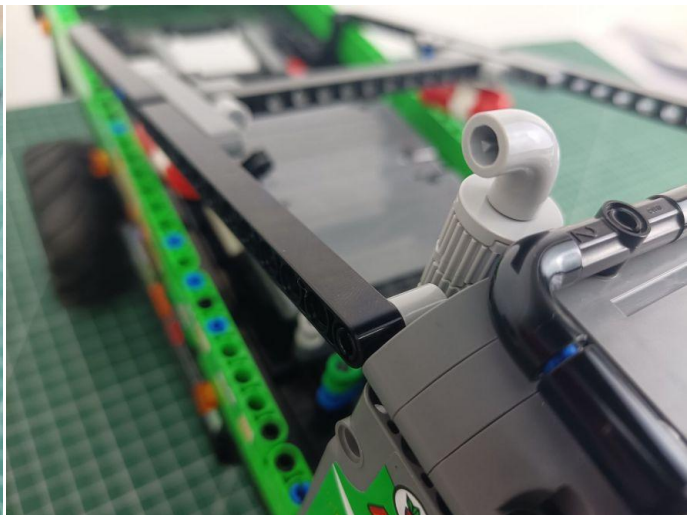

78

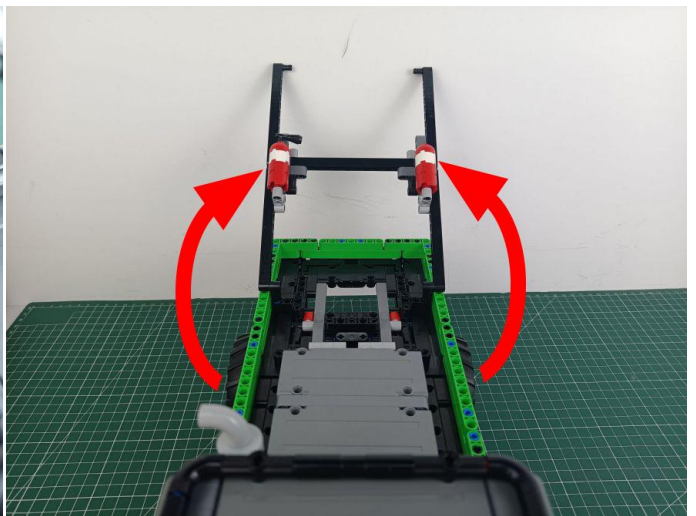
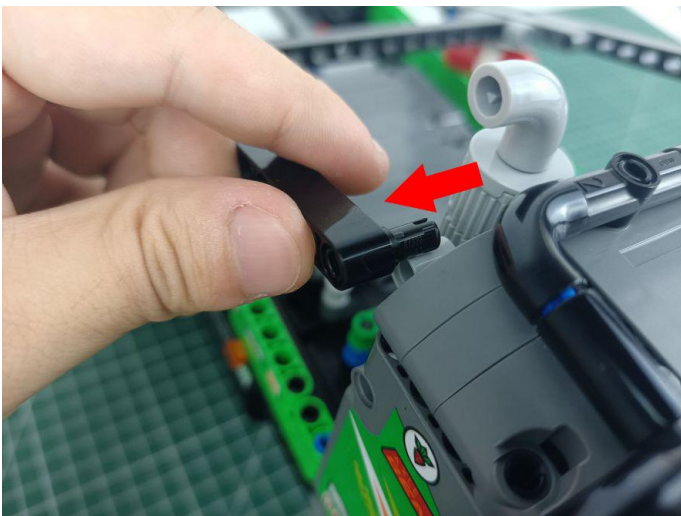

79



80

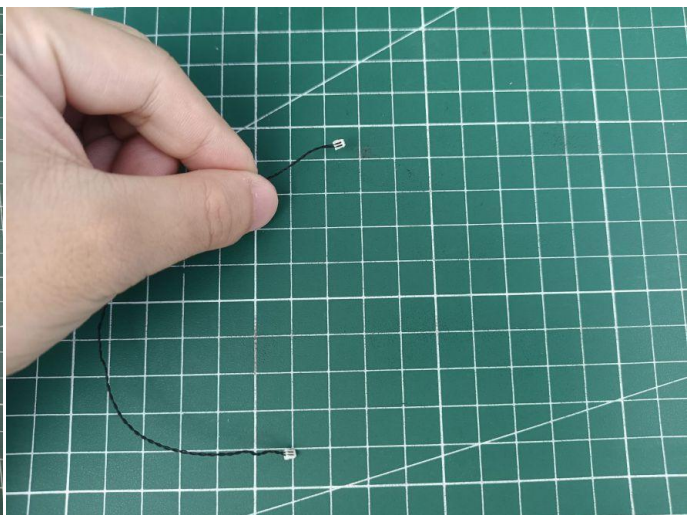

81



82

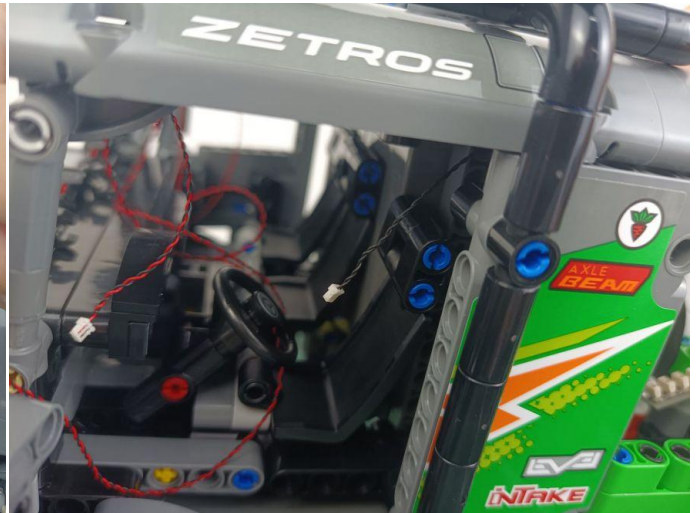
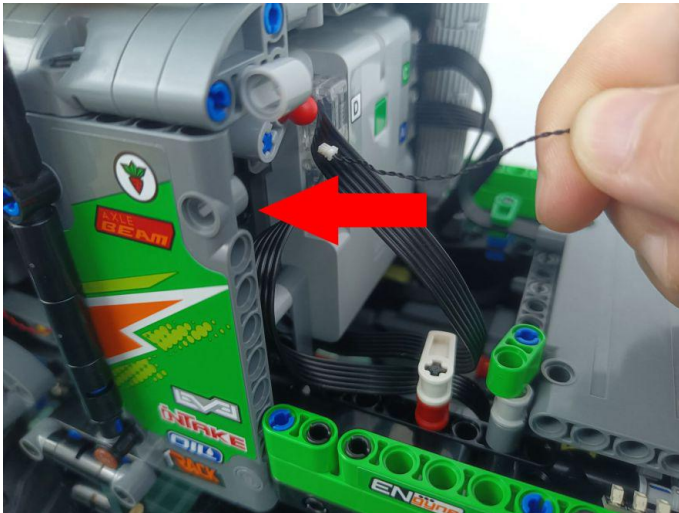

83

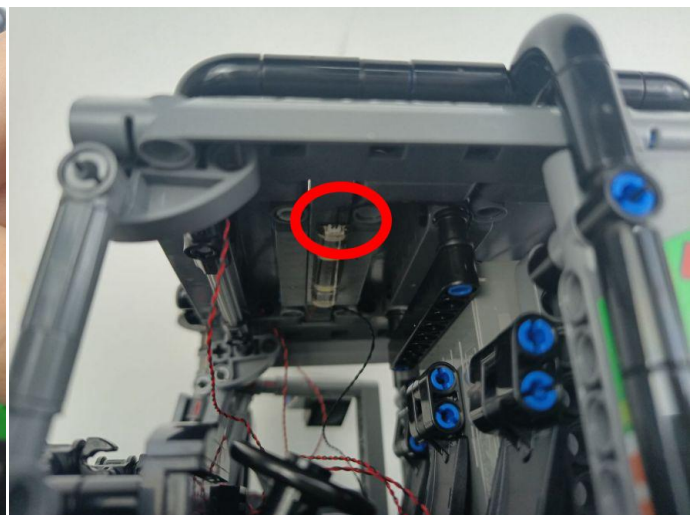
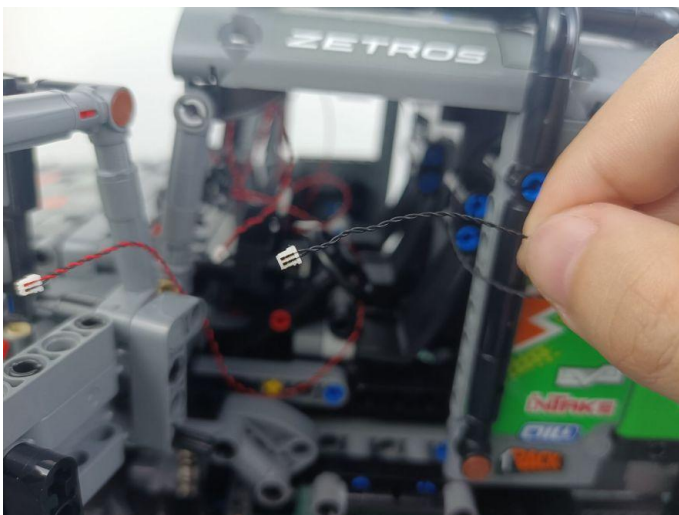

84

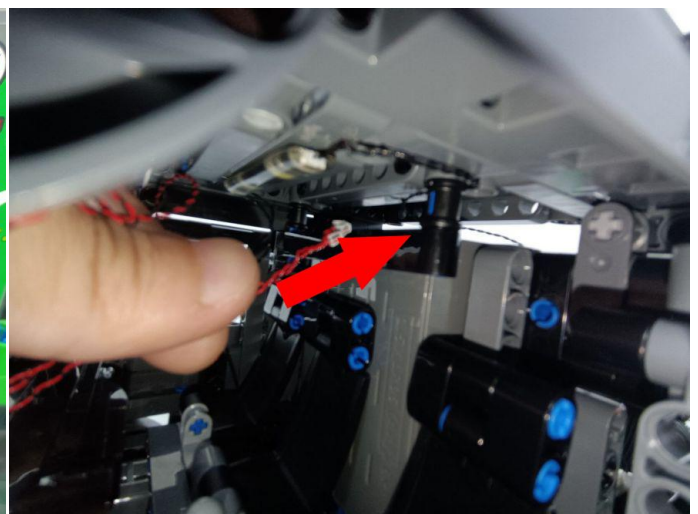
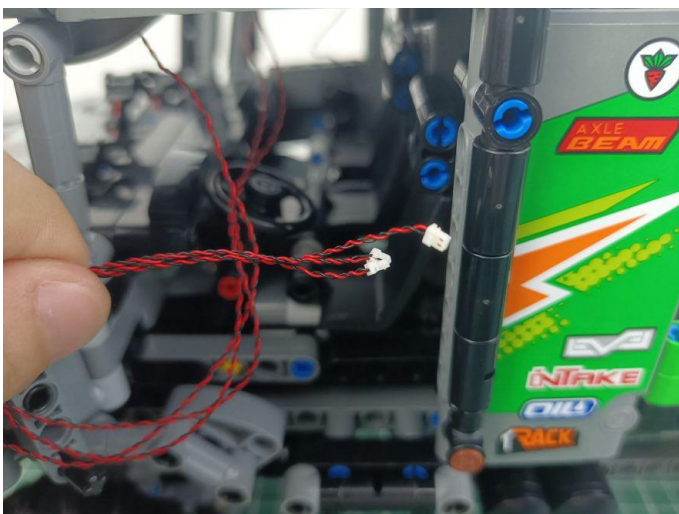

85

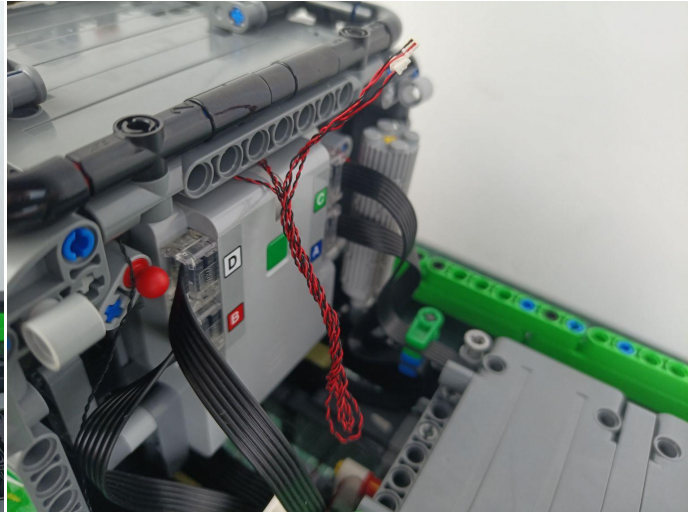
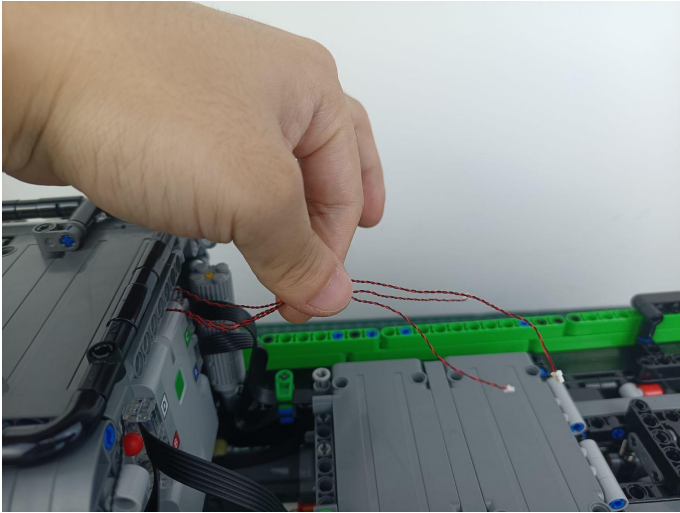

86

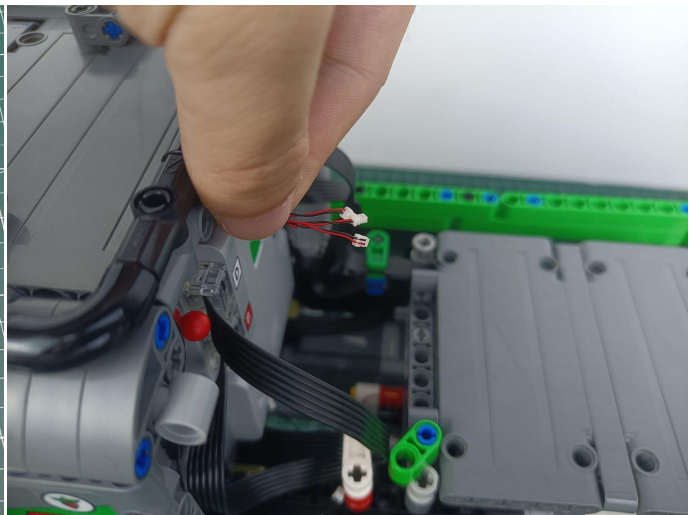

87

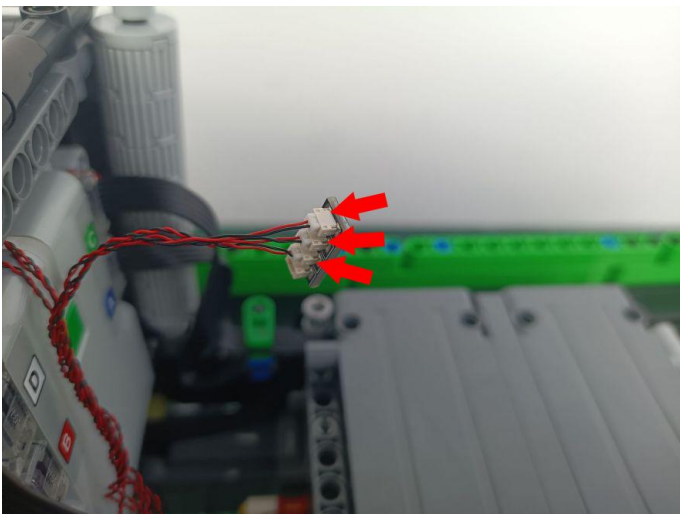

88

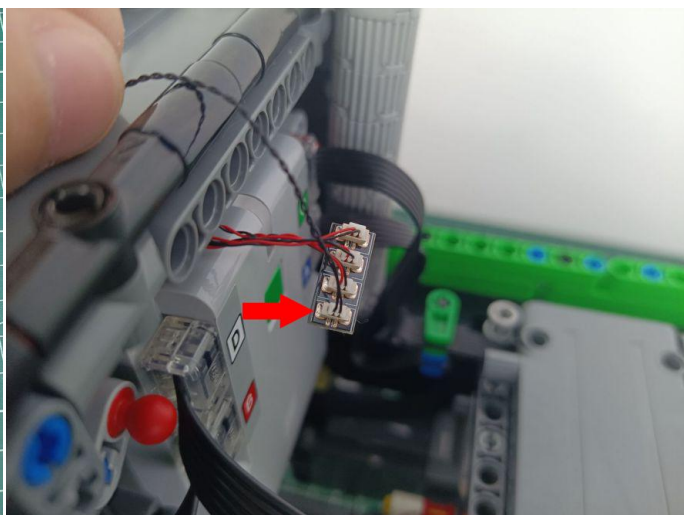
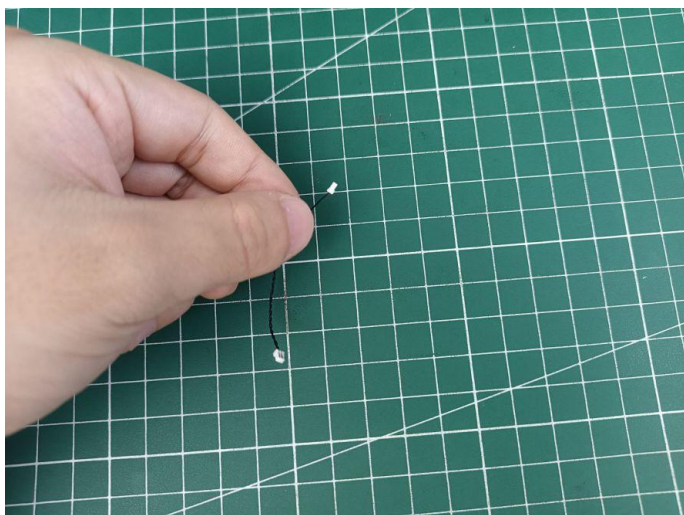

89



Remote control function description



ON: All branches are opened

OFF: all branches are closed

A: open/close A road

B: open/close B road

C: open/close C road

D: open/close D road

FS: Turn on blinking for the last open channel

BLN: Start breathing for the last opened path

↑: Increase blinking/breathing rate

↓: Increase blinking/breathing rate

Brightness+: Increase brightness

Brightness -: Reduce brightness

The remote control does not contain batteries, please buy a CR2025 or CR2032 button battery in the nearest store and install it in the remote control.



90

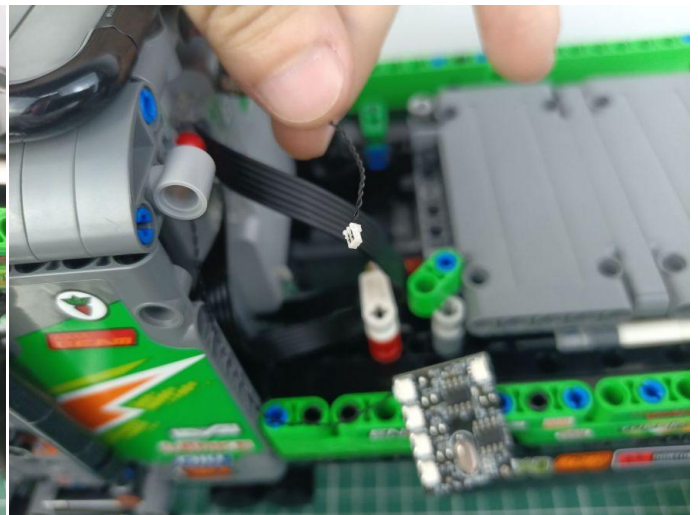
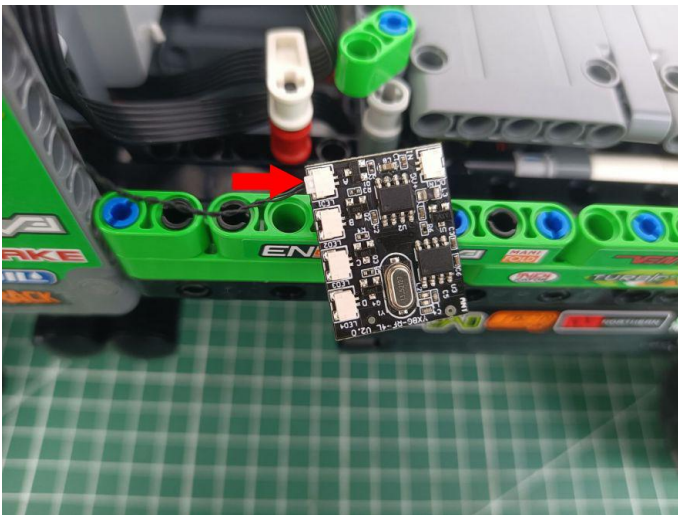

91

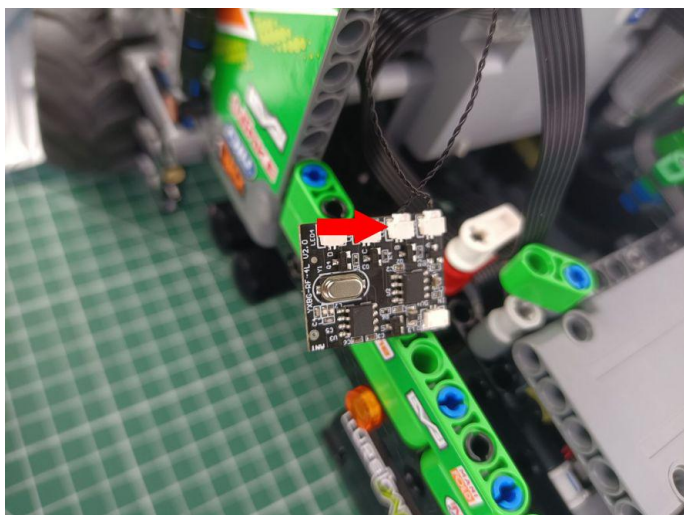

92



93

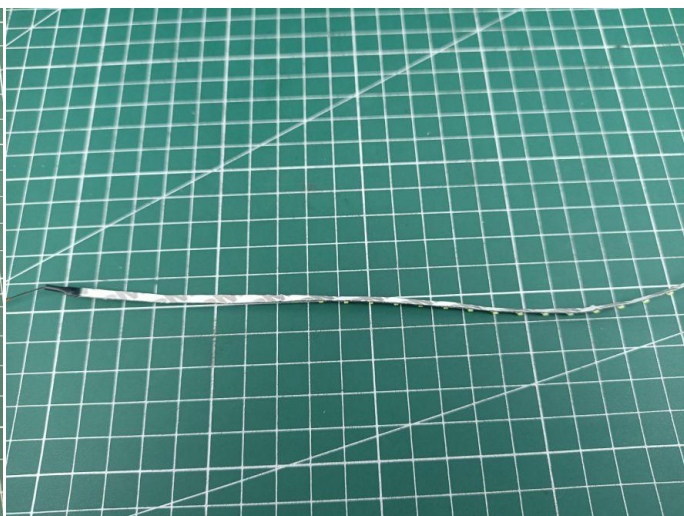
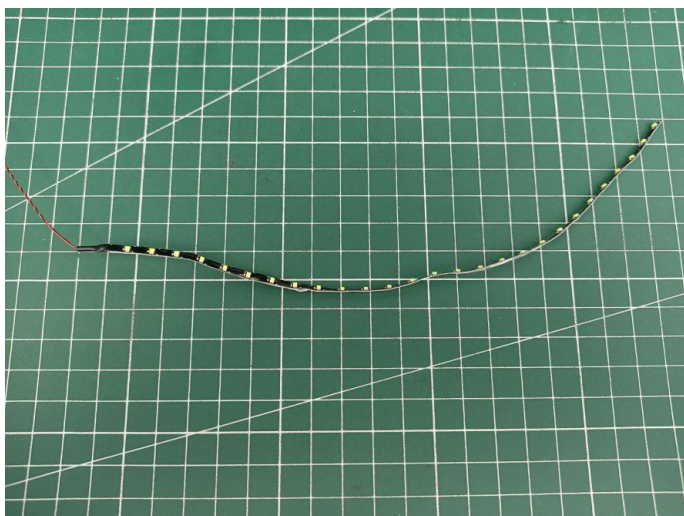

94

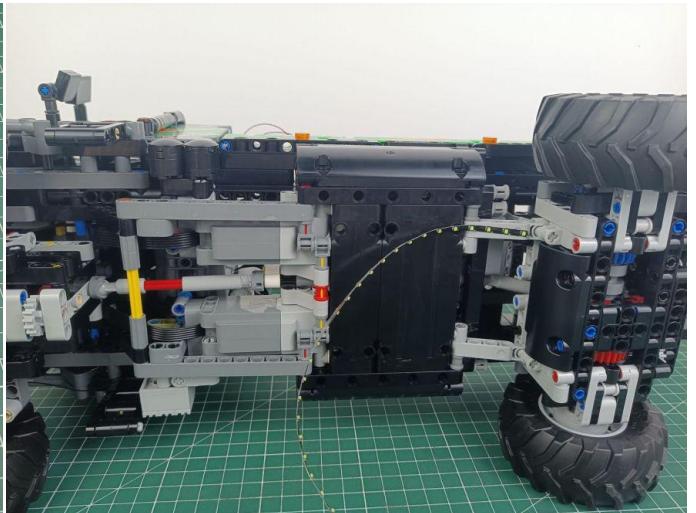
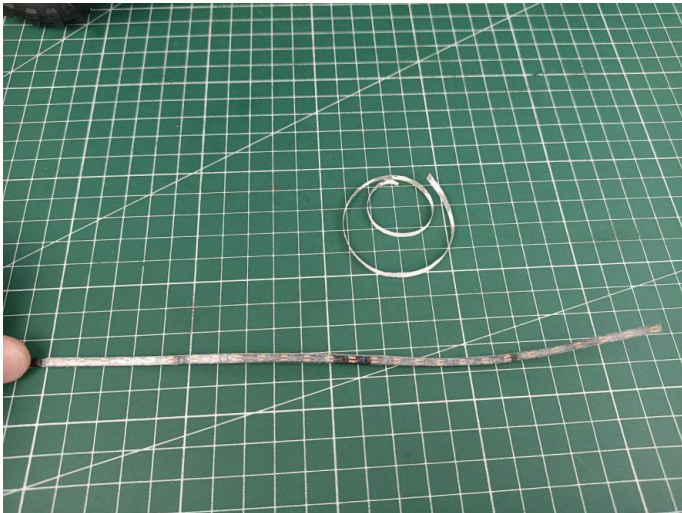

95

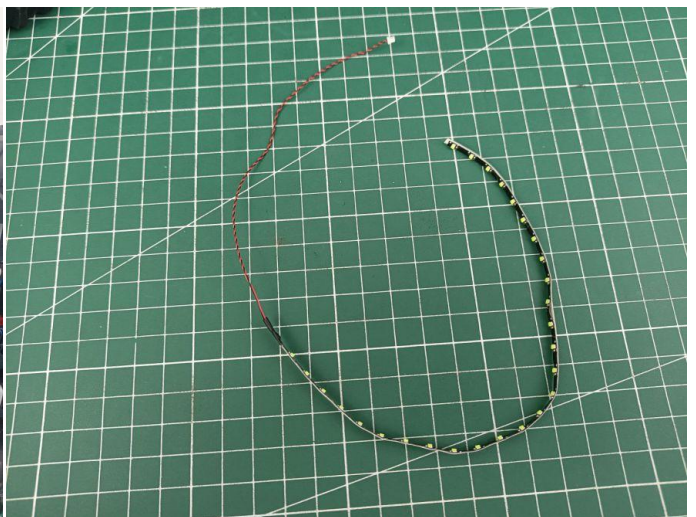
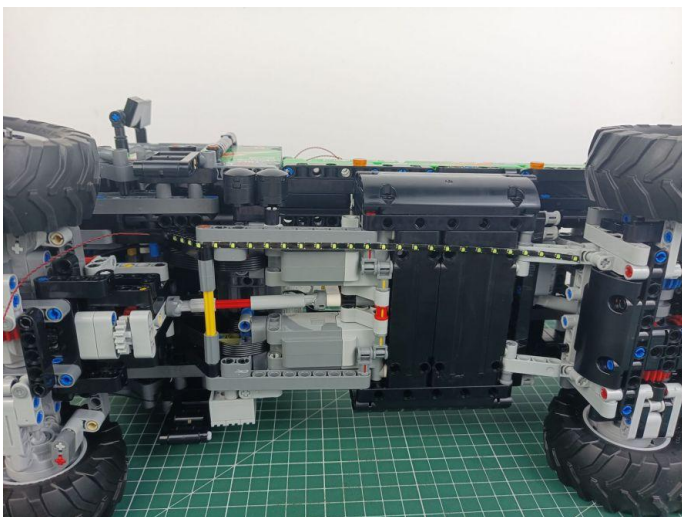

96

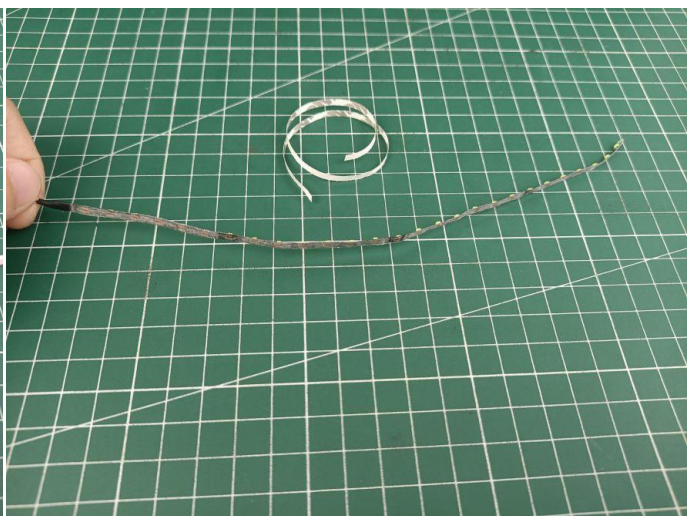
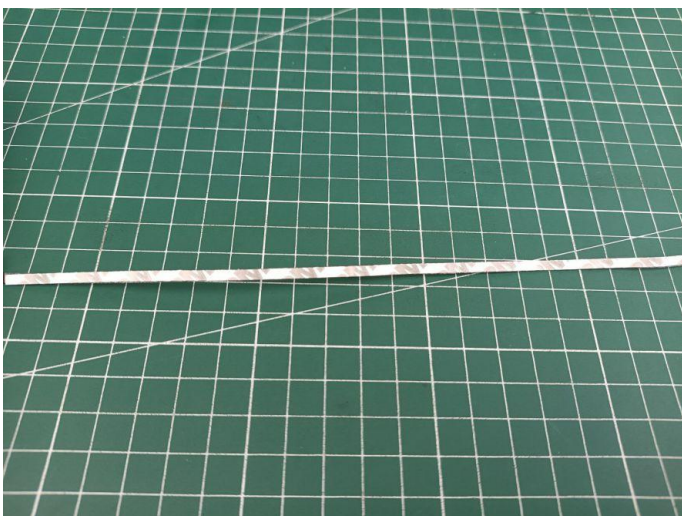

97

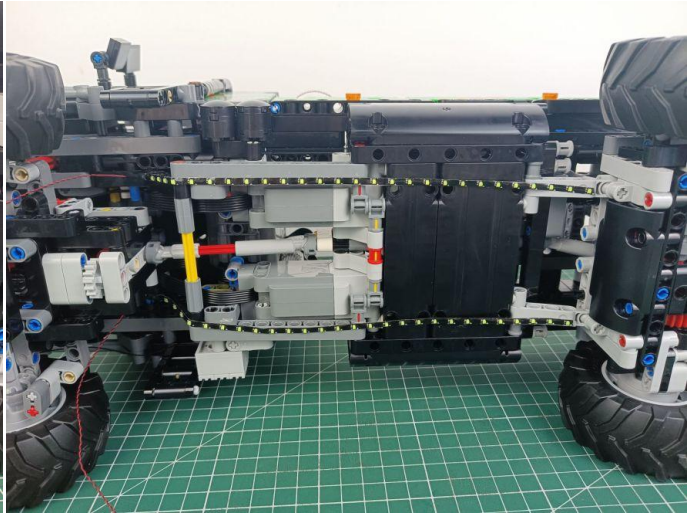
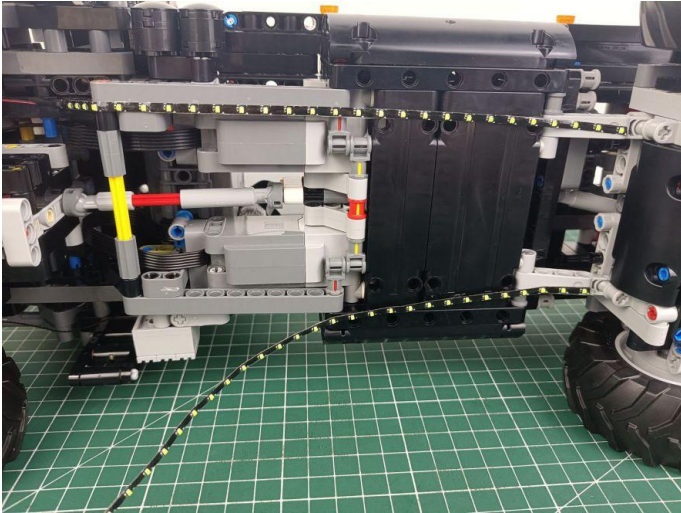

98

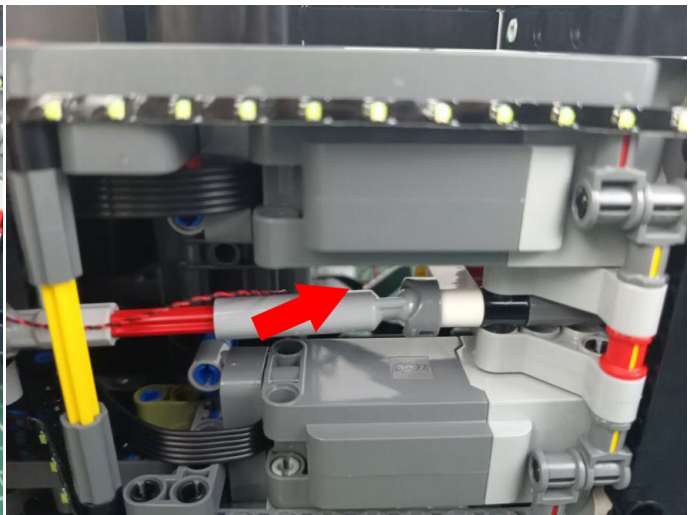
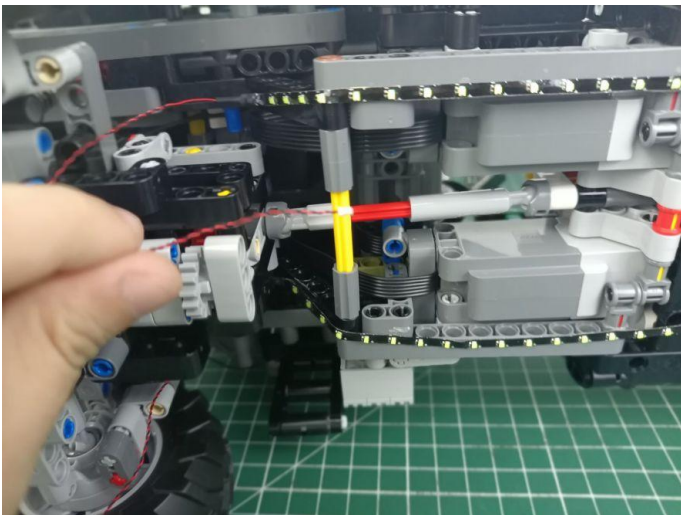

99

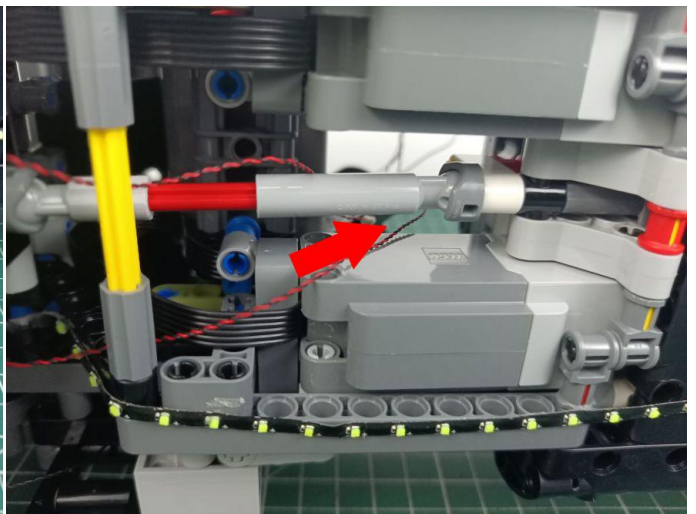
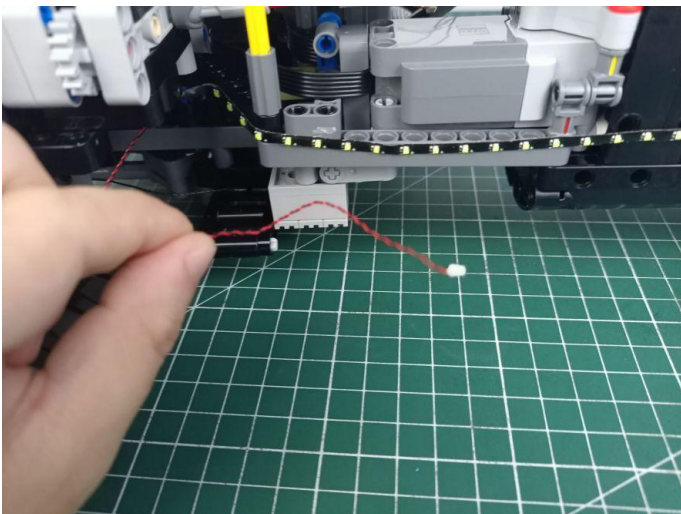

100



101

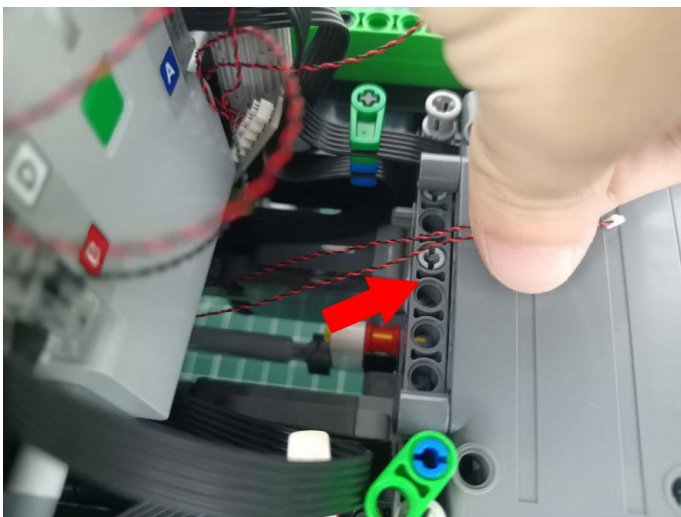

102

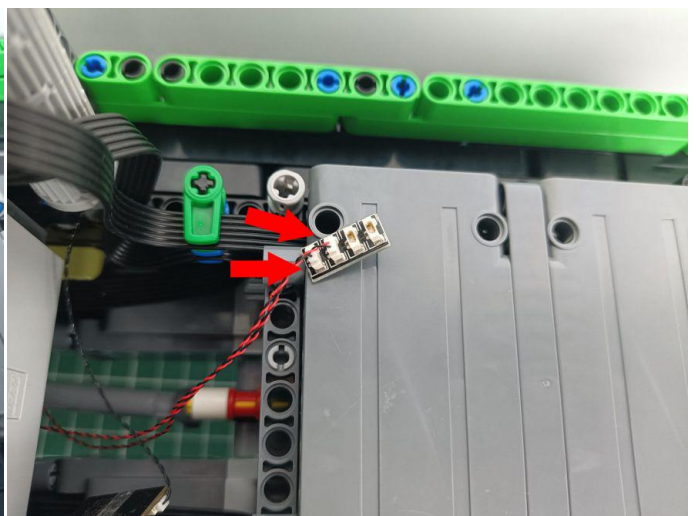

103

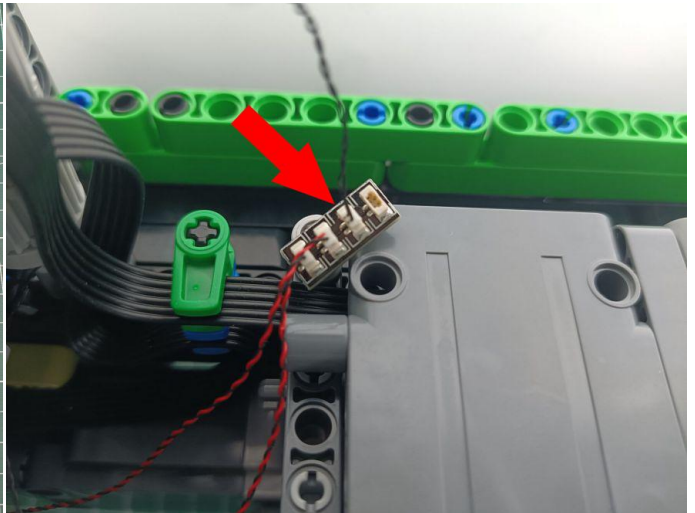

104

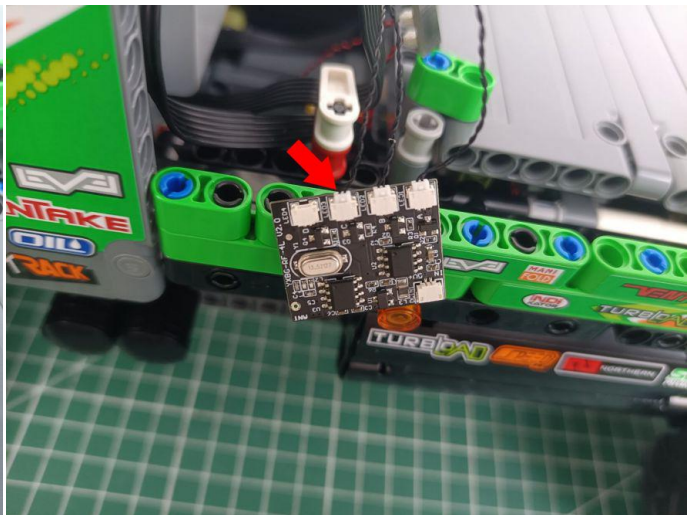
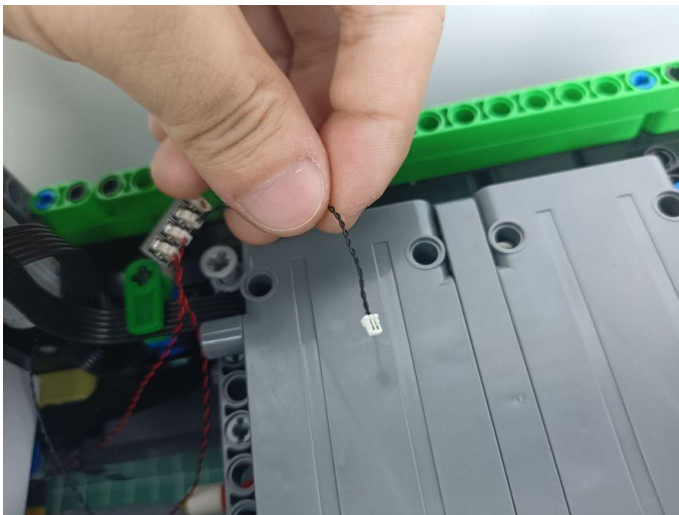

105



106



107

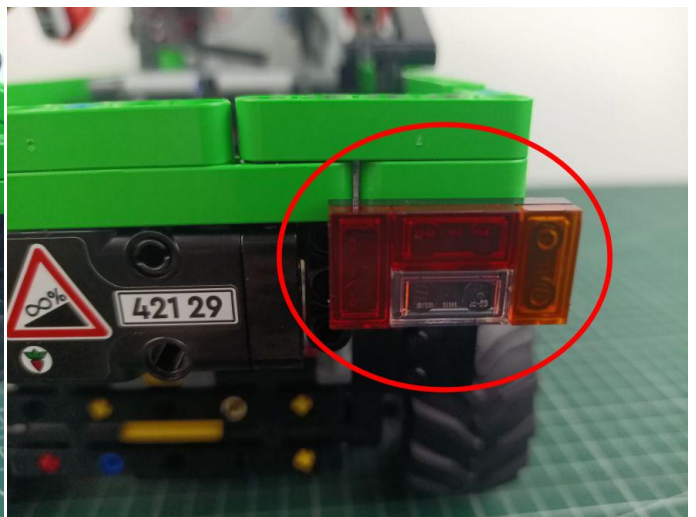

108

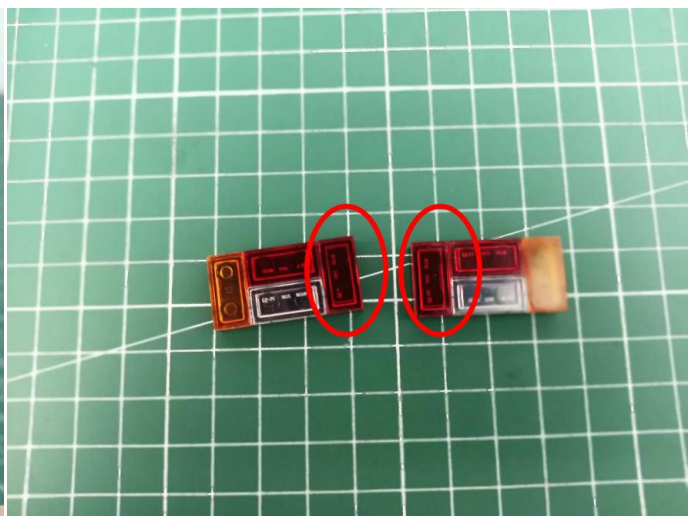
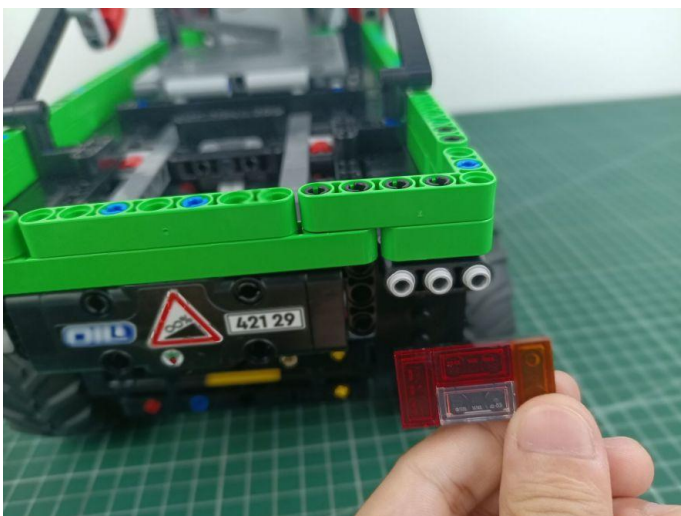

109

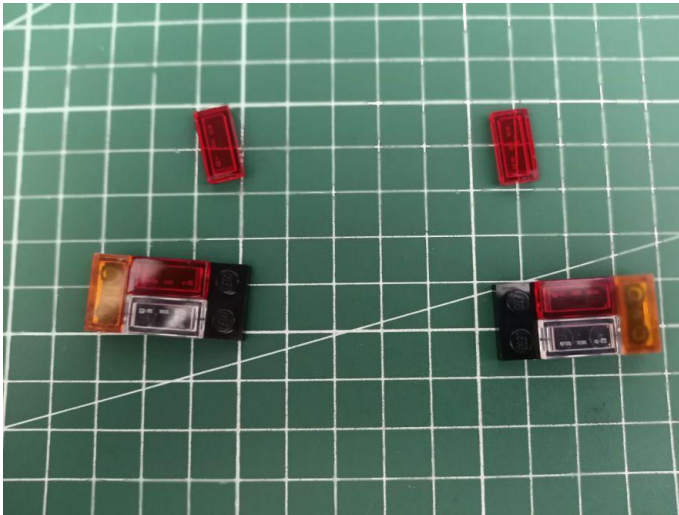

110

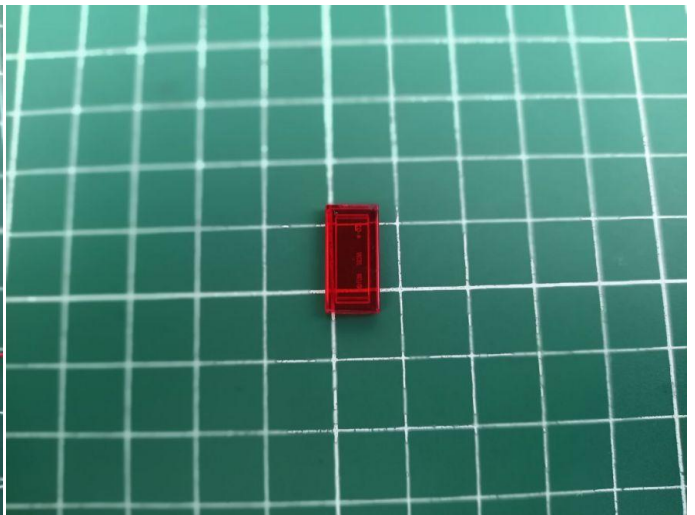
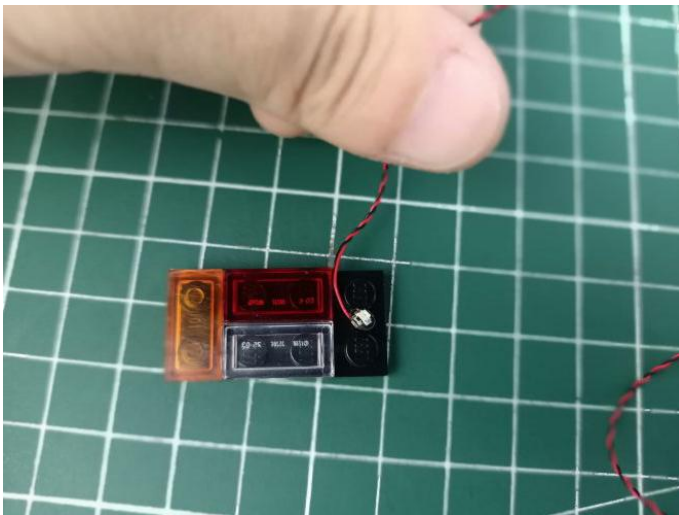

111

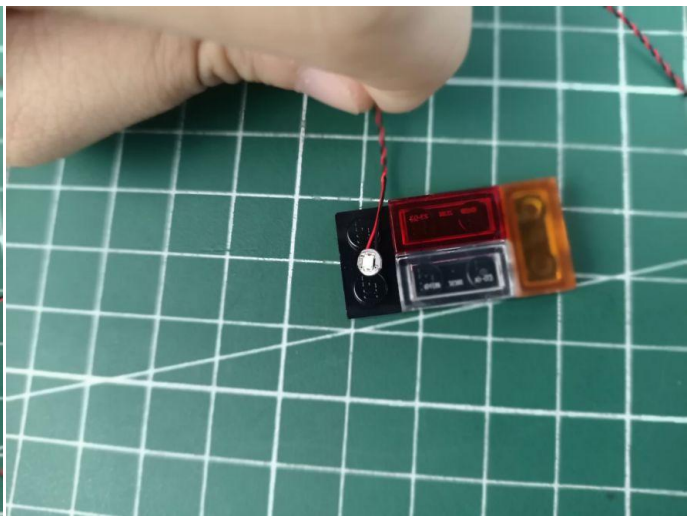
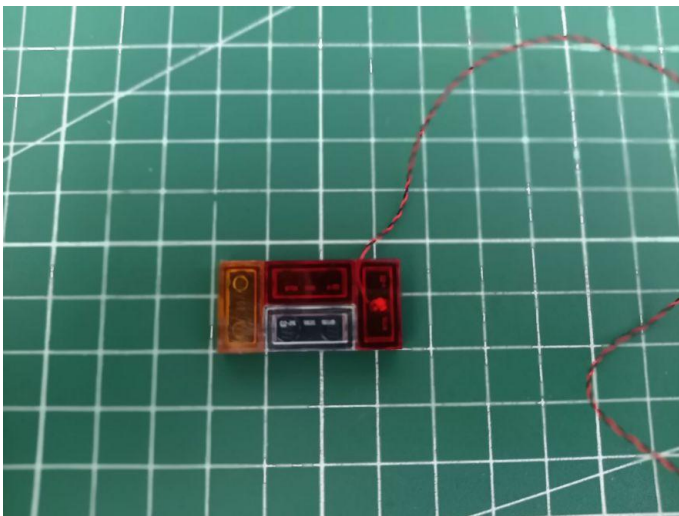

112

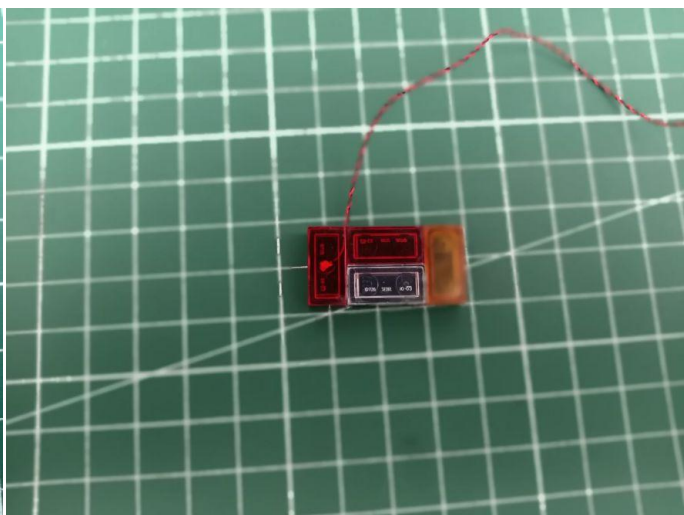
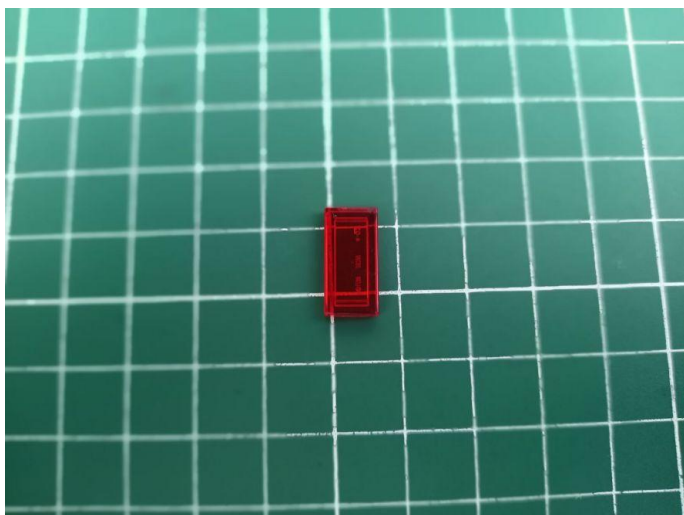

113

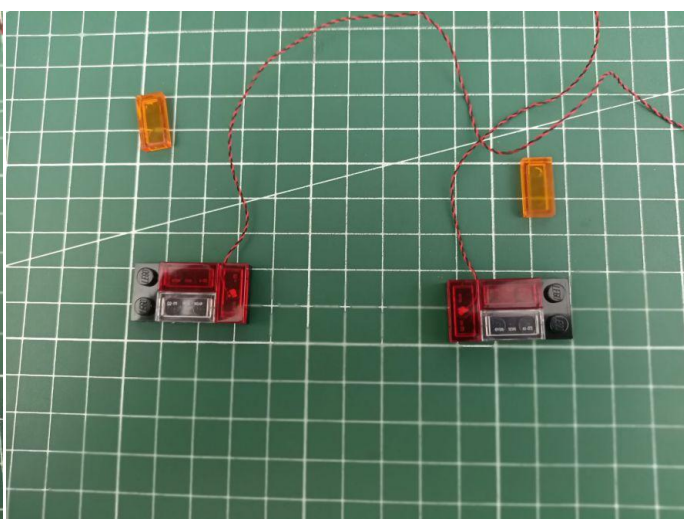
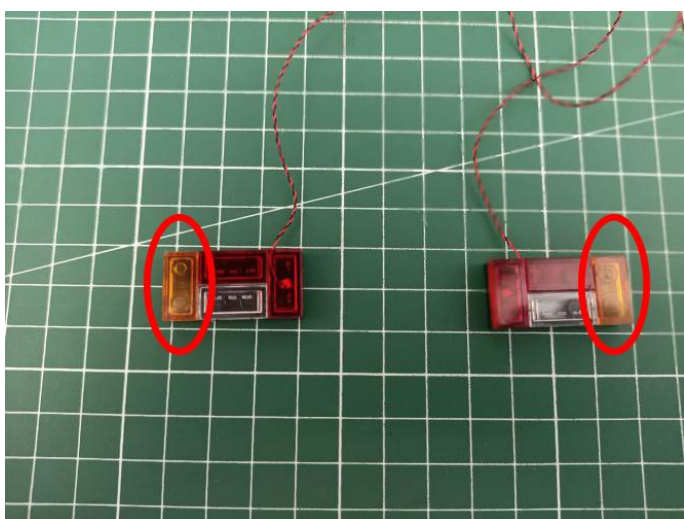

114

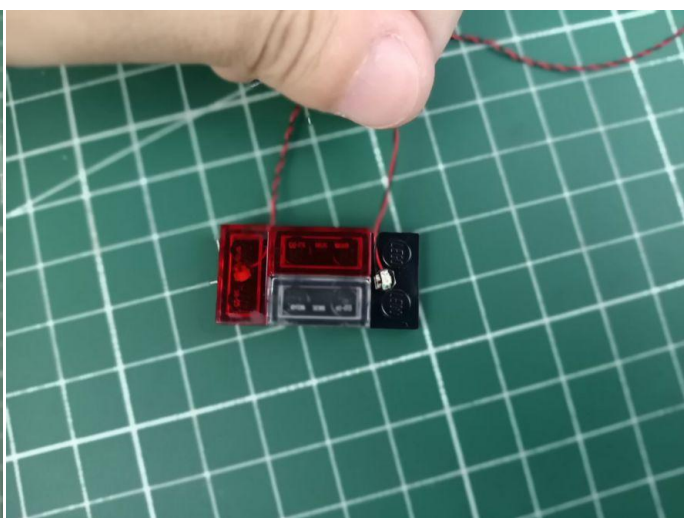

115

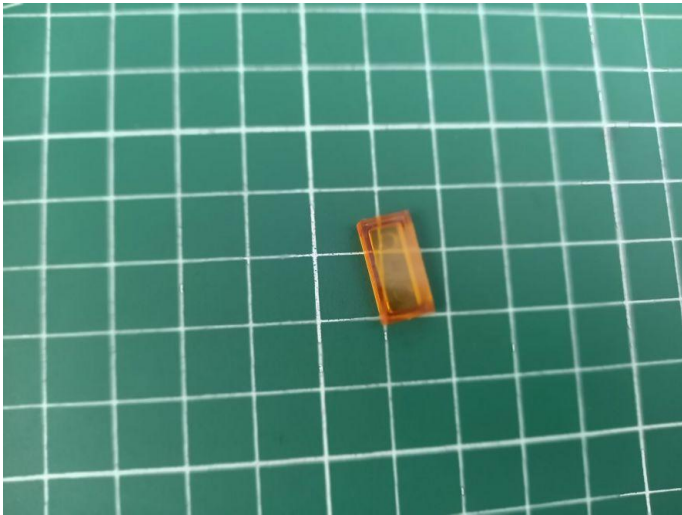

116

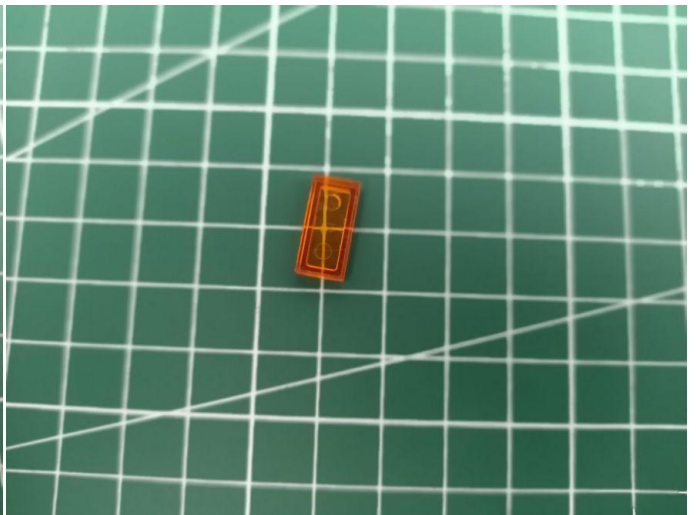
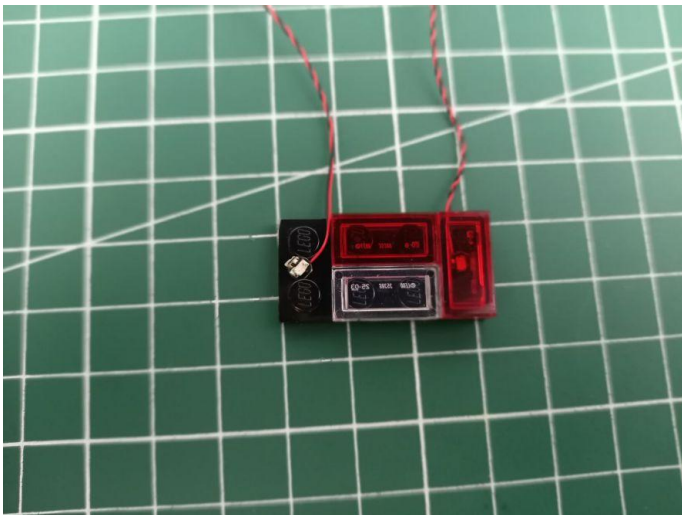

117

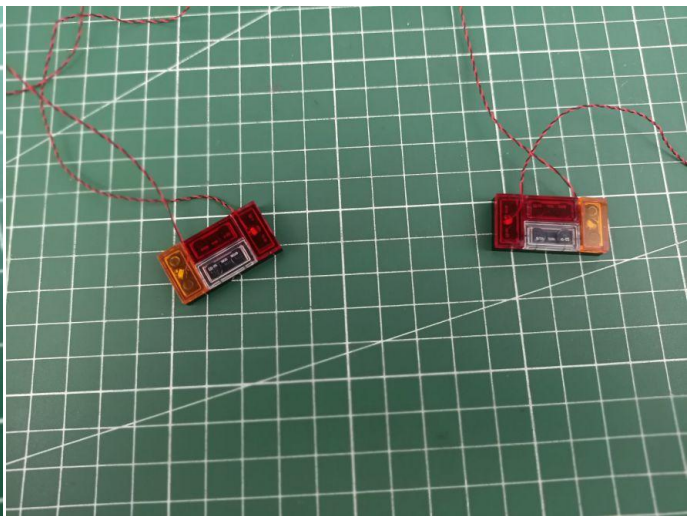

118

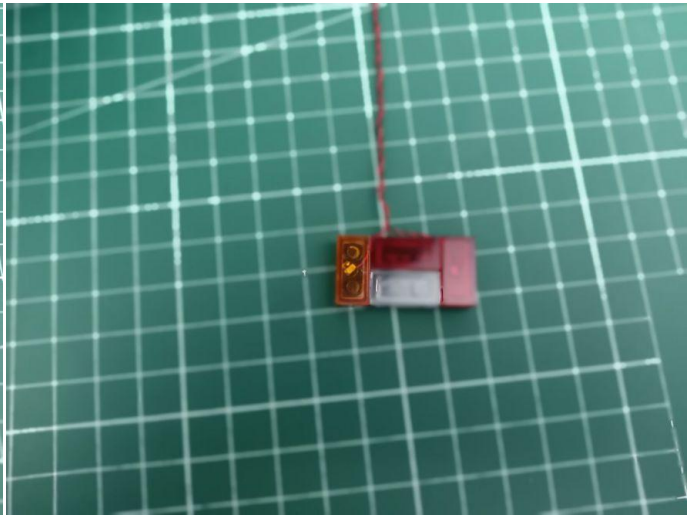
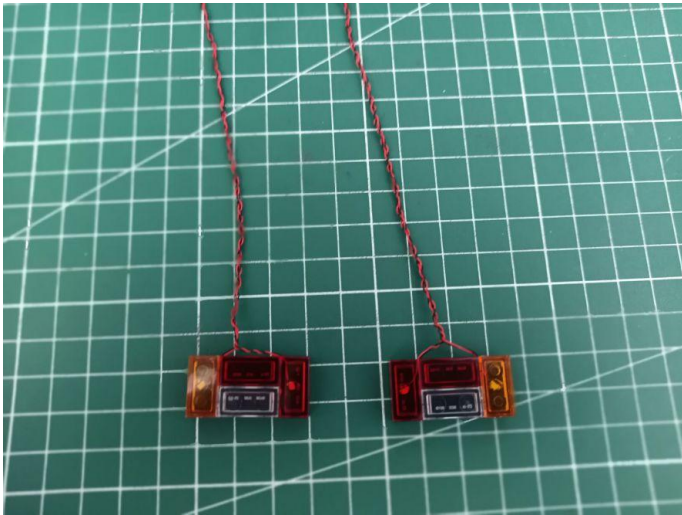

119

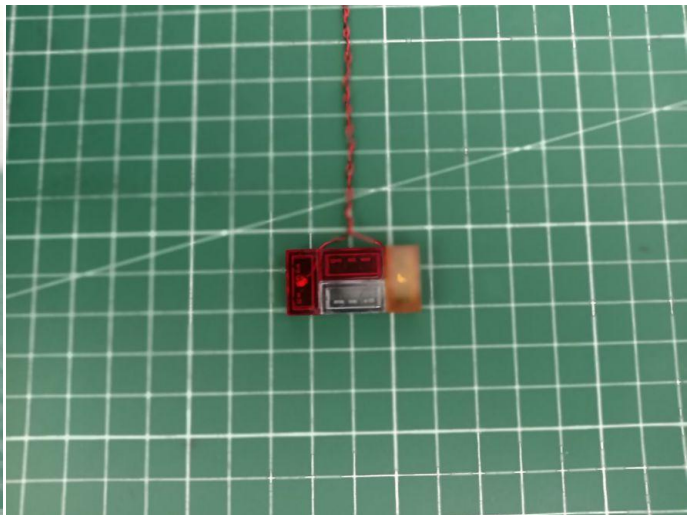
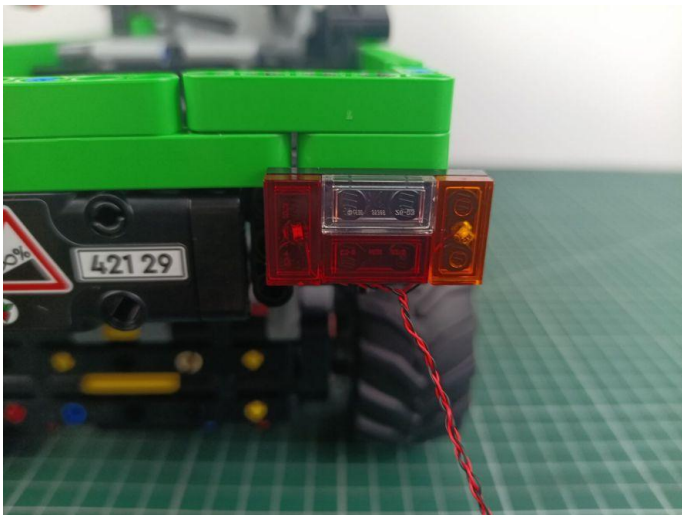

120



121

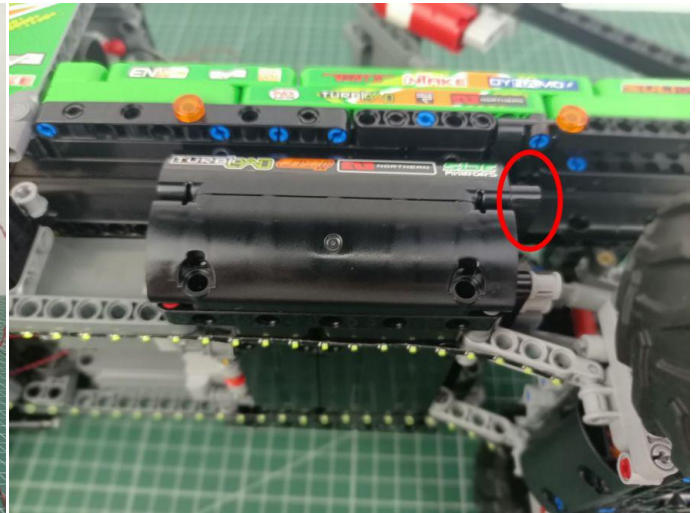

122

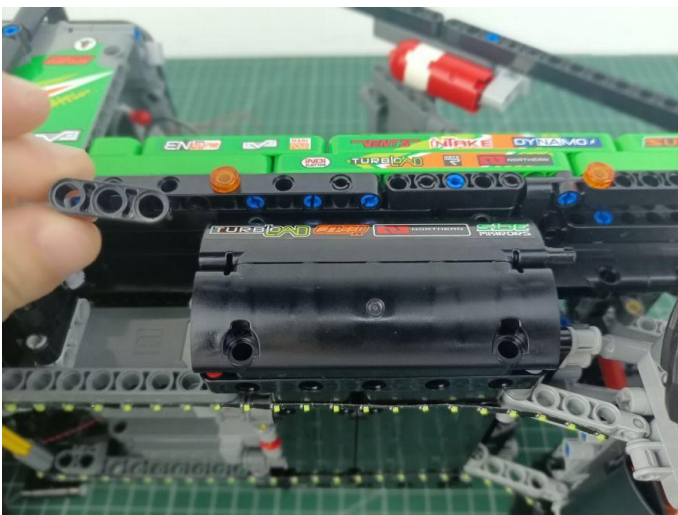

123

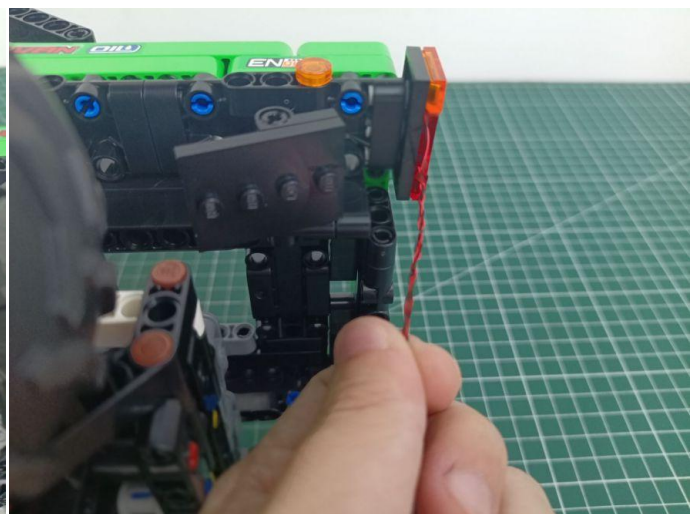

124

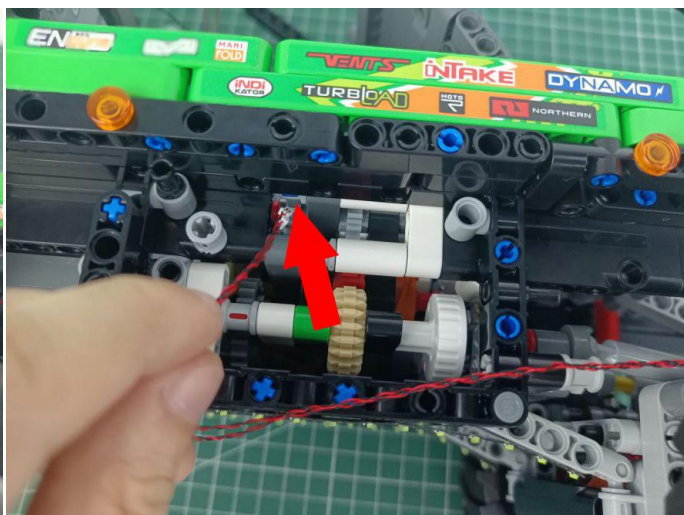

125

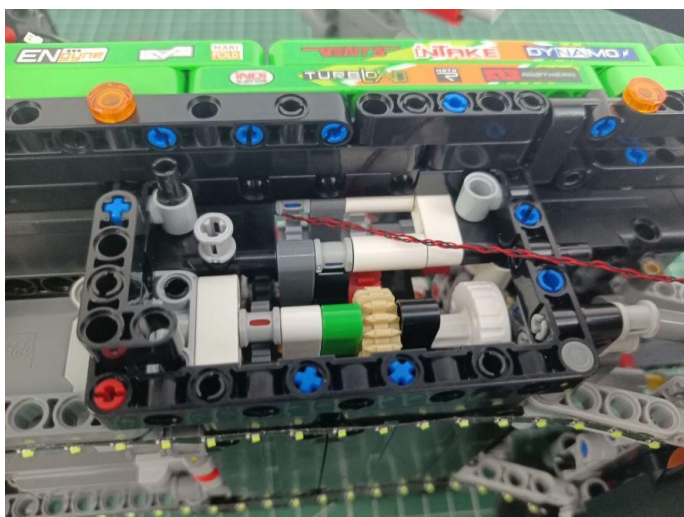

126

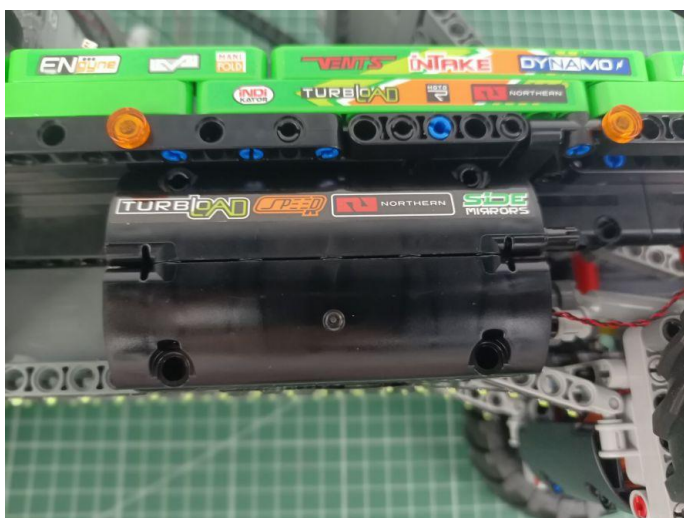

127

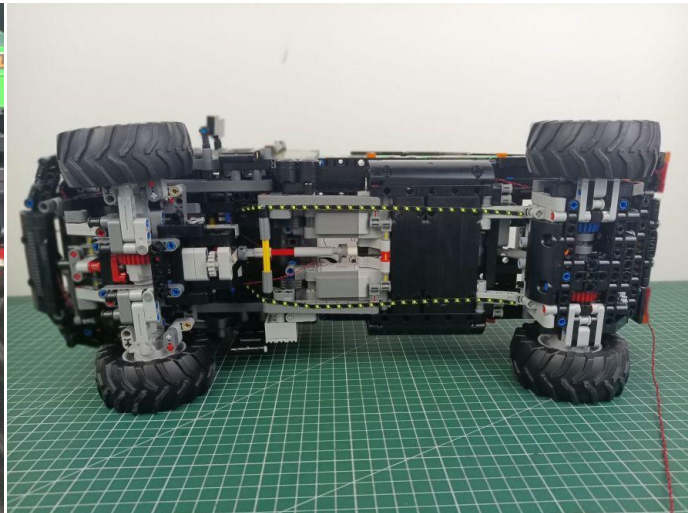

128

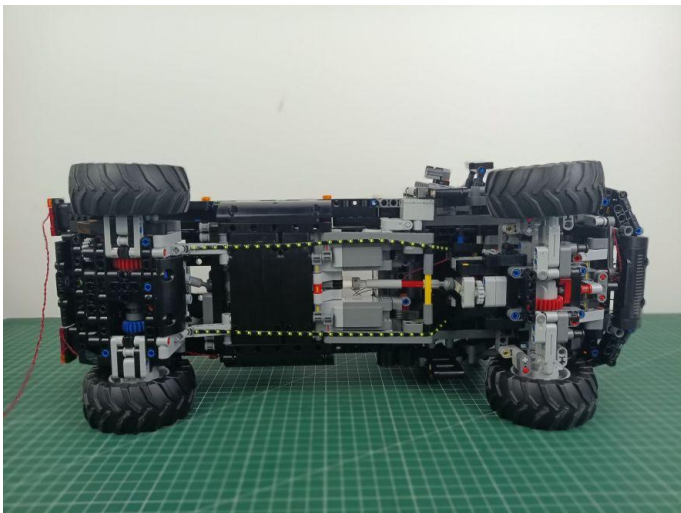

129

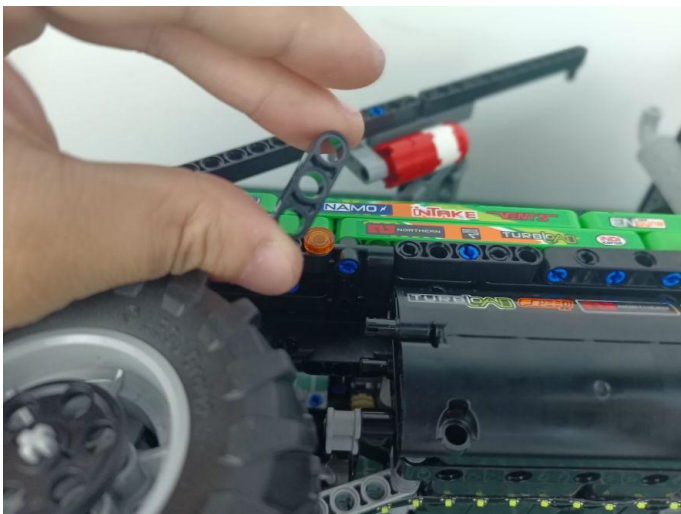

130

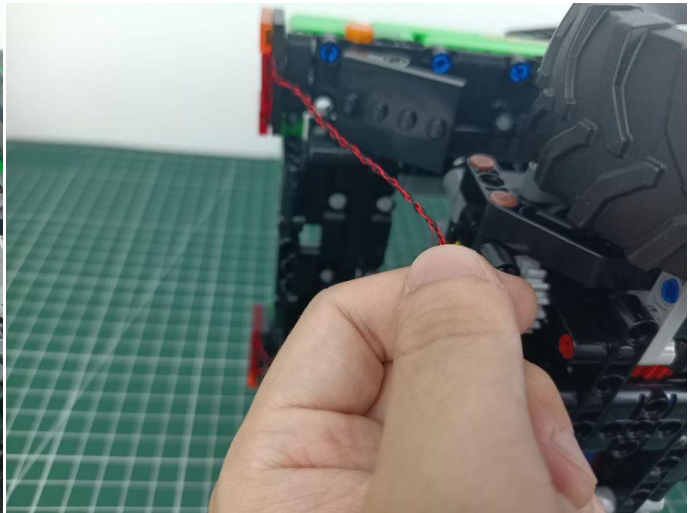
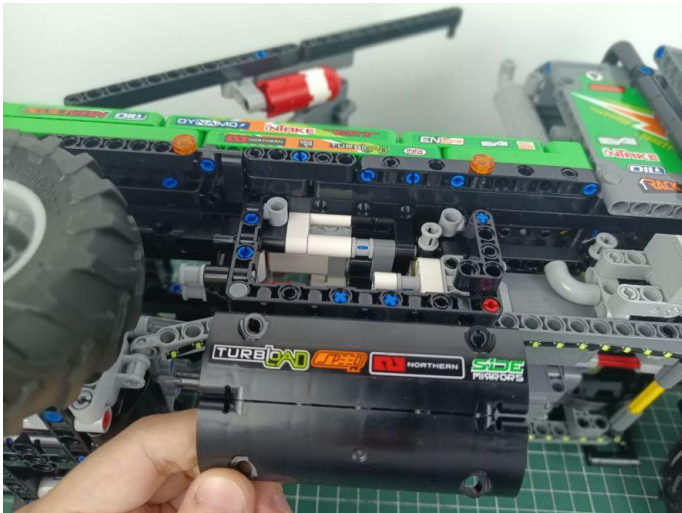

131

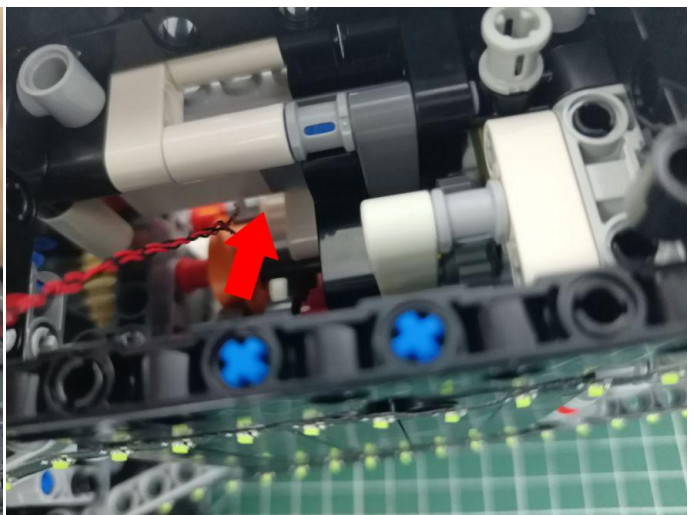

132

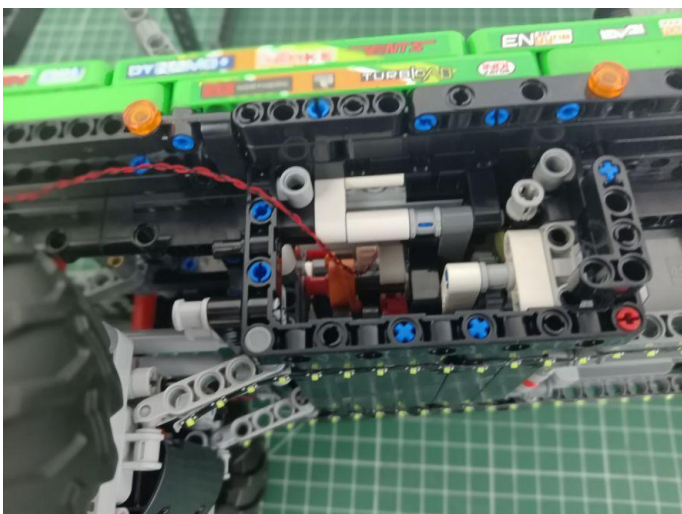

133

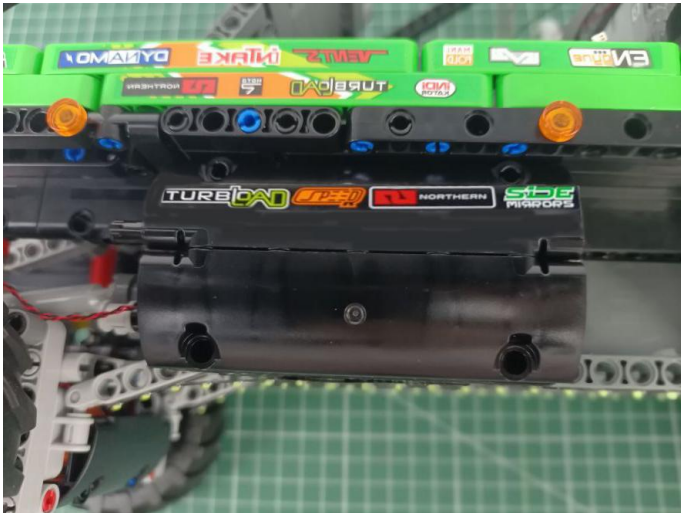

134

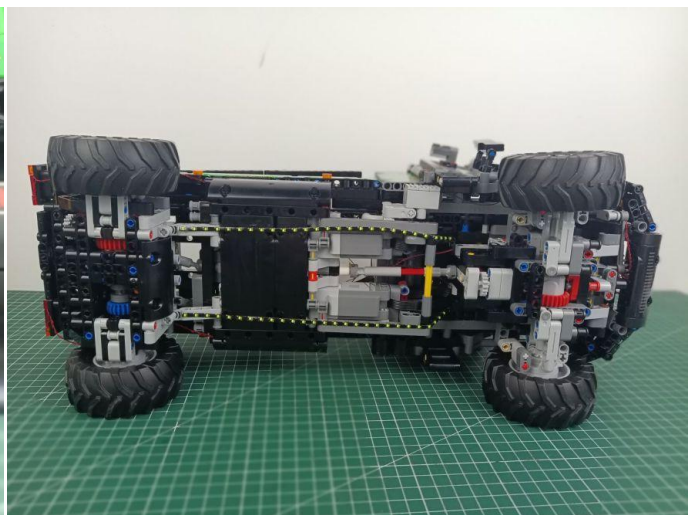

135



136

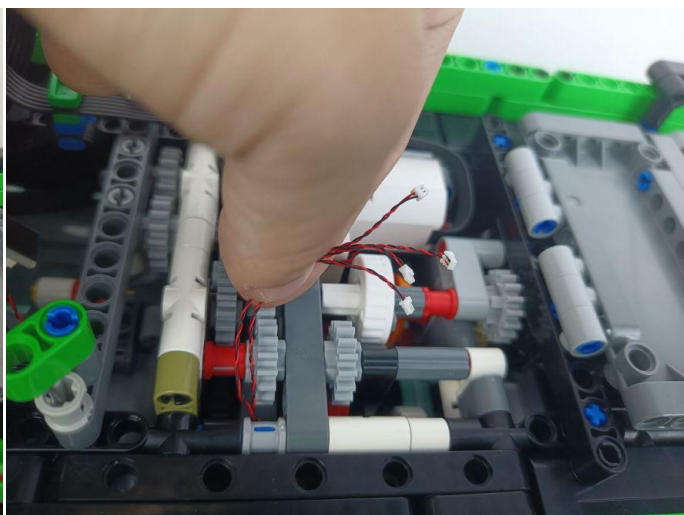
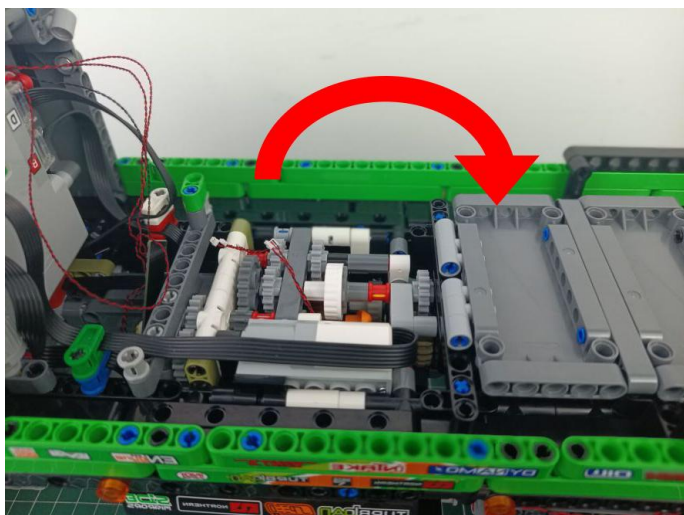

137

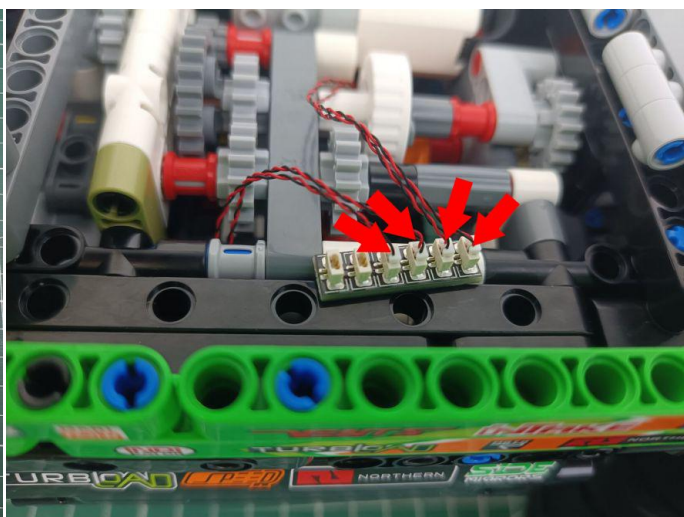

138

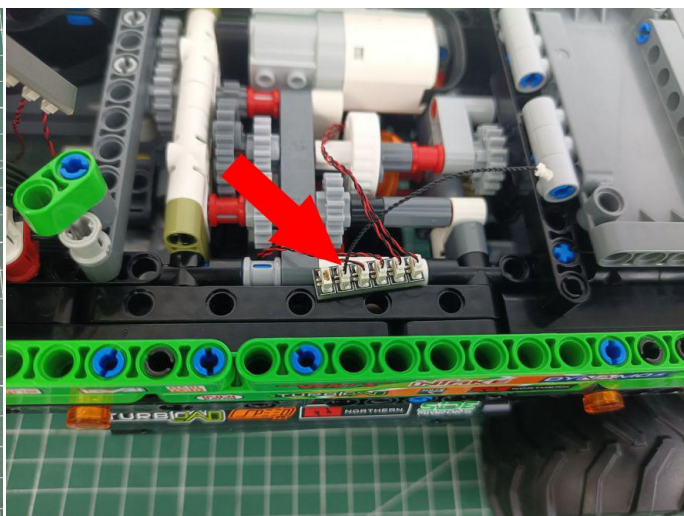

139

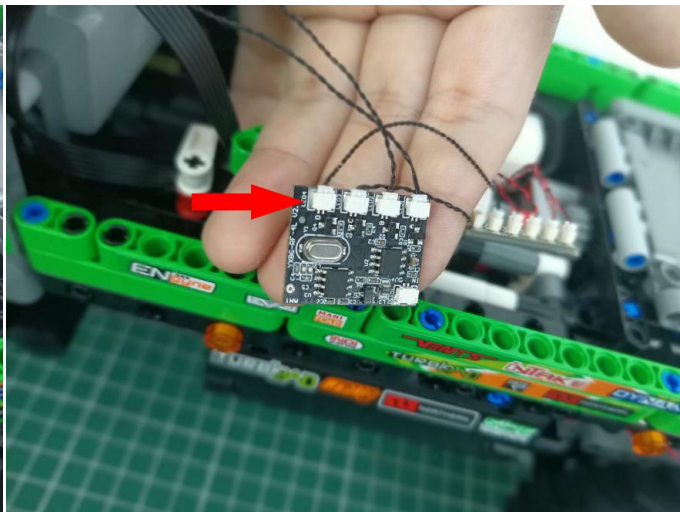
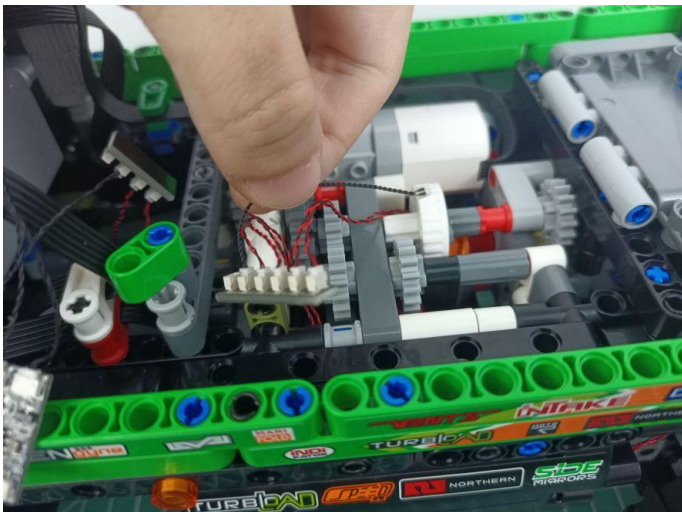

140



141

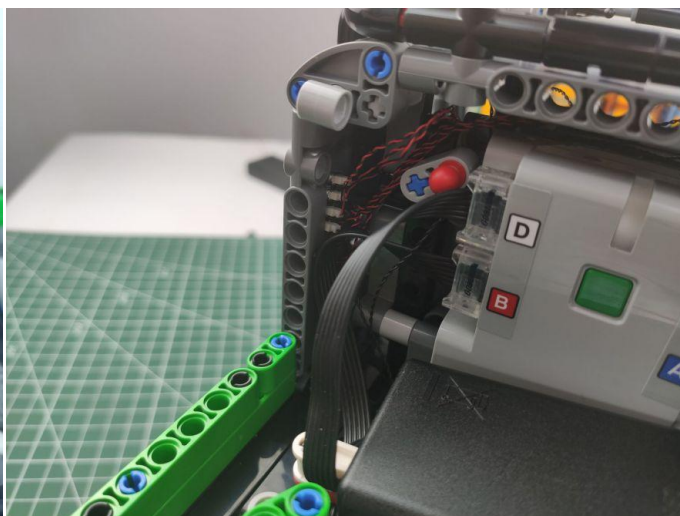
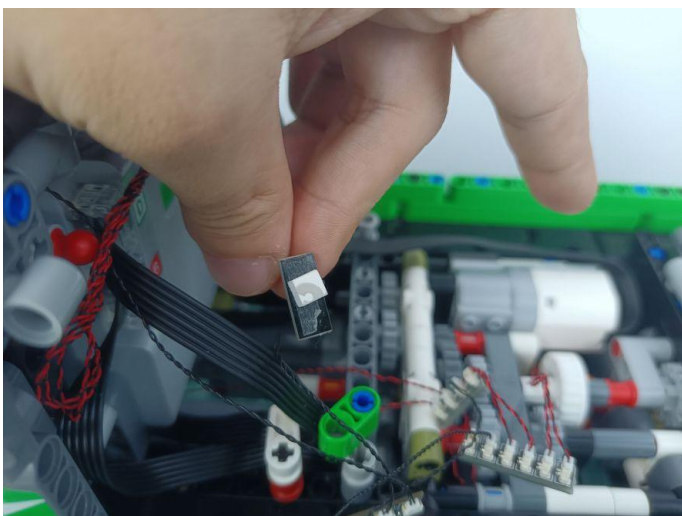

142

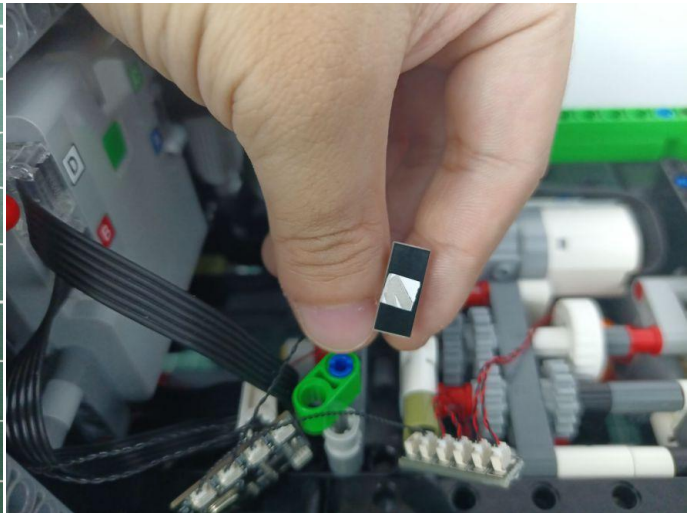
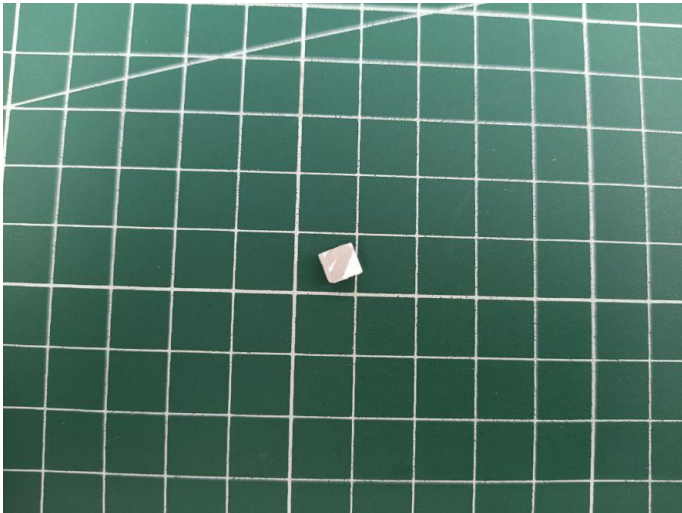

143

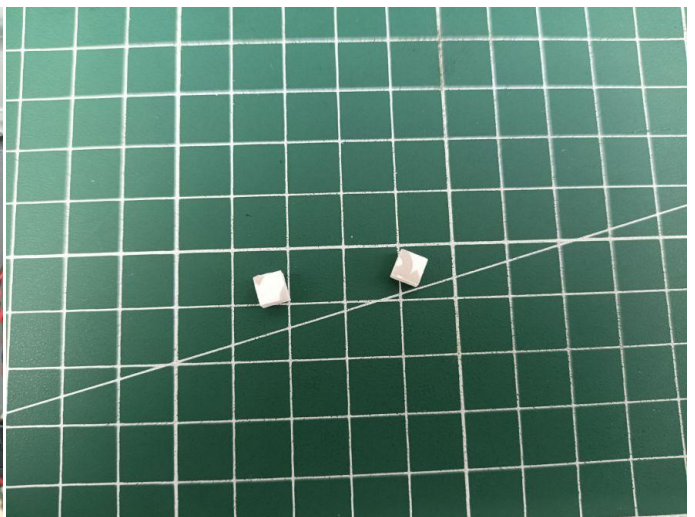
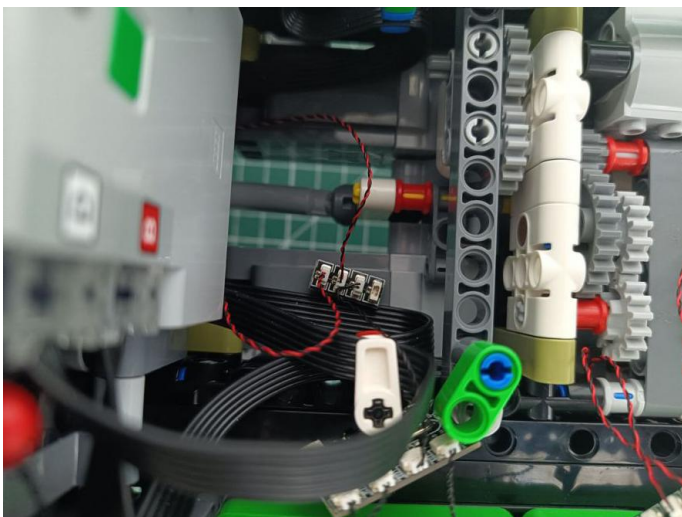

144

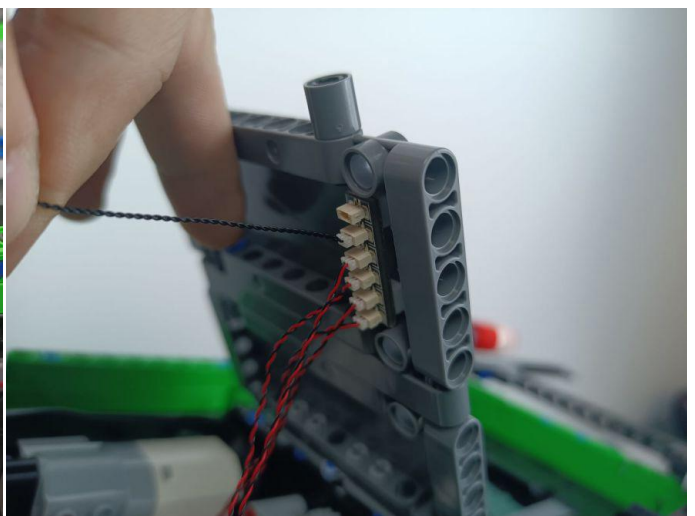

145

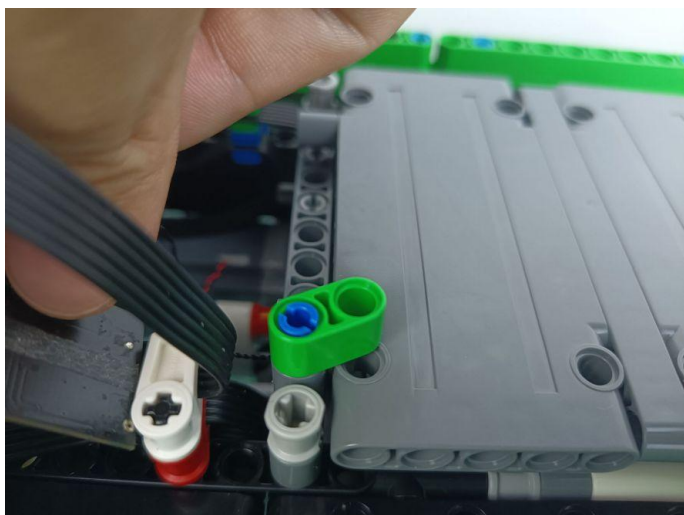

146

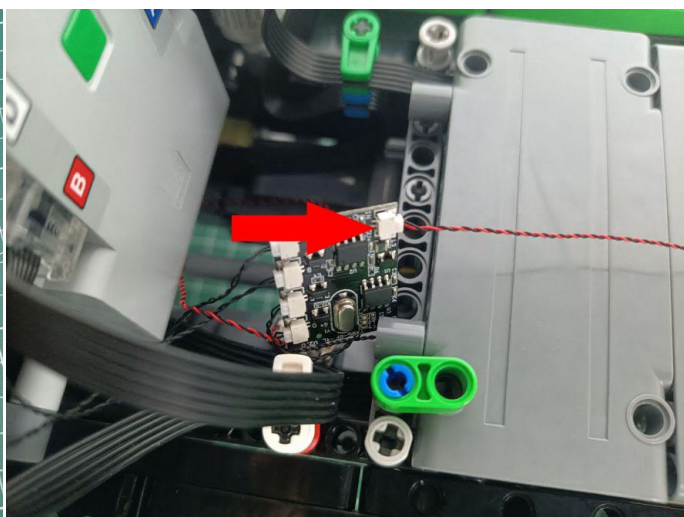

147

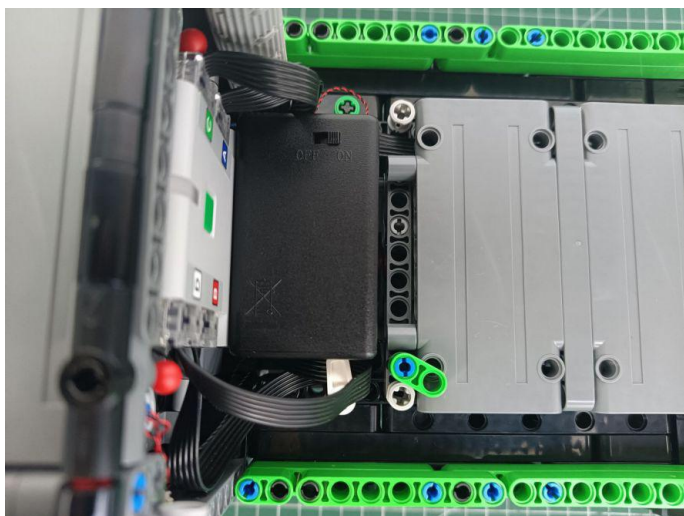

148



Good job, you've done all the installation steps, power it up and enjoy your work.

