

75315 Imperial Light Cruiser P26402

- P26402 is the unique code of lighting set, we use this to accurately identify the product you purchased and the corresponding manuals and services you need to obtain. Please make sure your product code is the same as the label on the back of the box shown “75315 P26402”.
- Installation requires a lot of patience and great observation that your LEGO bricks will come alive when you get this finished. The bricks with lighting as below, so make sure you're ready and let's get started.

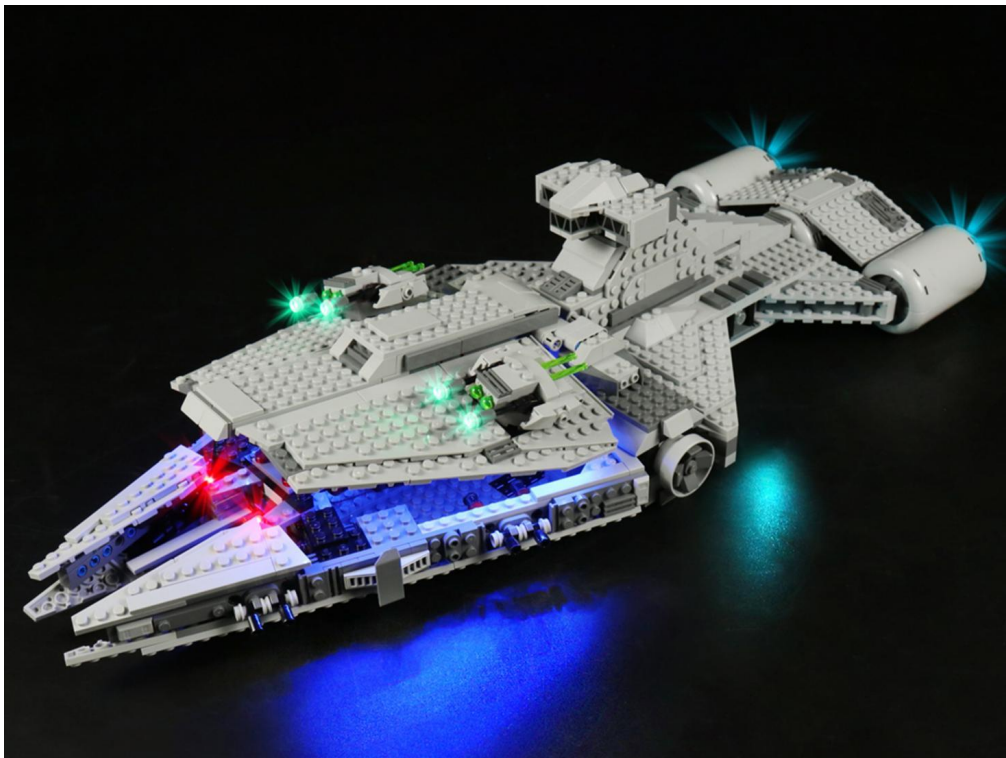

Strategies for the Installation

This instruction divides three sections to complete the installation of the lighting set.

Section A: Check the type and quantity of components.

The quantity and type of components of each products are different and it needs to be carefully checked to make sure there do have enough material. The type of components is indicated by the label on the bag.

Section B: Test that each components is working properly.

Each components is made individually so it is necessary to test that each components is working properly to avoid the situation that the lighting does not work .

Section C: laying out components following the instruction.

Our material is very small but not fragile, just be reminded that don't to pull the wires too hard. For different people, there may be some installation steps that you can't understand. Please look at the previous and later installation step

Section A: Check the type and quantity of components.

There are 15 bags in this set. The name and quantities of specific components are as shown , please check carefully.

Label	Content	Quantity
Bit Lights-15CM-Red	Bit Lights-15CM-Red	2
Bit Lights-15CM-Cyan	Bit Lights-15CM-Cyan	2
Expansion Board	6 Socket Expansion Board	1
	4 Socket Expansion Board	3
AA Battery Box	AA Battery Box	1
USB Power Cable	USB Power Cable-50CM	1
Connecting Cables-5CM	Connecting Cables-5CM	1
Connecting Cables-30CM	Connecting Cables-30CM	1
Connecting Cables-20CM	Connecting Cables-20CM	3
Flashing Bit Lights-30CM-Green	Flashing Bit Lights-30CM-Green	4
Flicker-Effects Board	Flicker-Effects Board	1
Light Strips-Blue-21	Light Strips-Blue-21	2
Light Strips-Cyan-14	Light Strips-Cyan-14	3
Voice Control Module	Voice Control Module	1
Headlights-15CM-Red	Headlights-15CM-Red	1
Parts package		

Please contact us immediately if there have any missing components.

Section B: Test that each components is working properly.

We need a structure to test all lights, so take out the bag with label “USB Power Cord”and “Expansion Boards”as follows.



It is worth reminding that our products are all customized. They have a unique way of connecting. The white plug on wire and the socket of the expansion board need to be connected together to transmit power.

Note that on one side of the white plug you can see two very small golden wires that should be connected to the two golden needles in socket of the expansion board.shown as blow.



All our connections between plug and socket are all the same as shown above. So for any such structure with plug and socket, please pay attention to the golden wire of the plug and the golden needle of the socket, they must be touched together.

The connection method between the USB Power Cord and Expansion Boards is as follows:

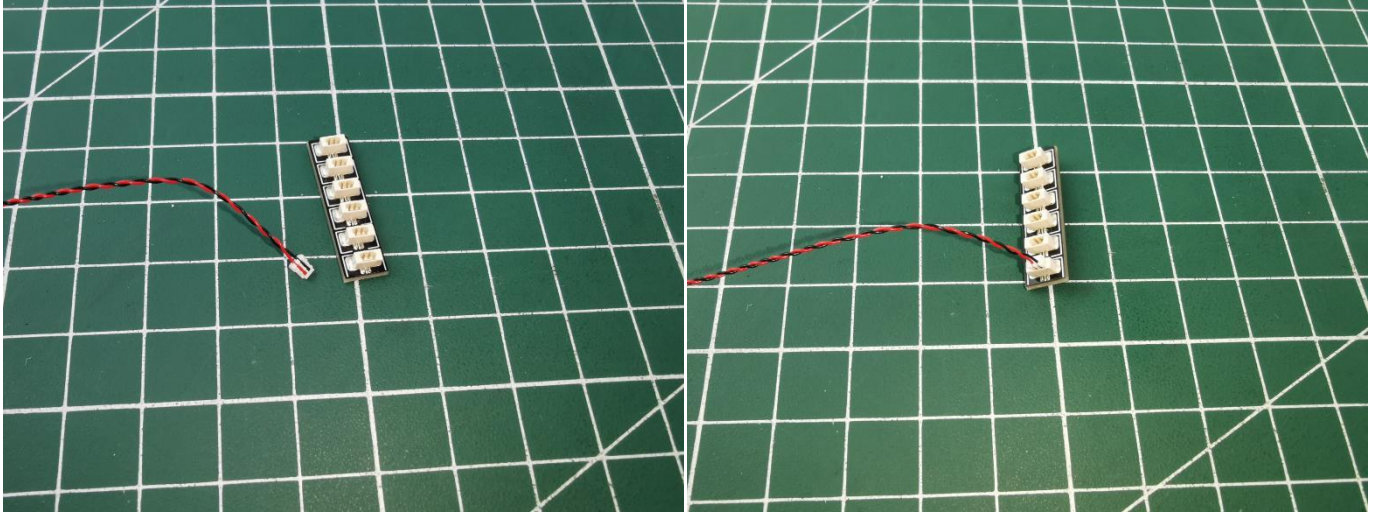

The USB Power Cord can be powered by phone chargers, power banks, etc.

USB connectors to connect devices

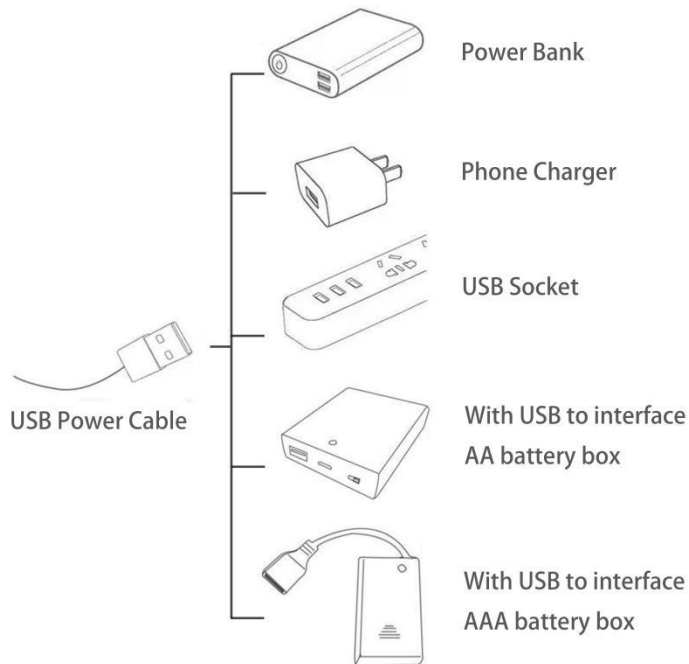

This instruction will use the power bank as power supply . The test structure is shown as follow. All lamp in this set will be tested by this structure.



when we test "Bit Lights-15CM-Red" particles,Take out the bag labelled "Bit Lights-15CM-Red".Take out one of the light and connect it to the socket. Turn on the power bank, the light will turn on normally as shown below.

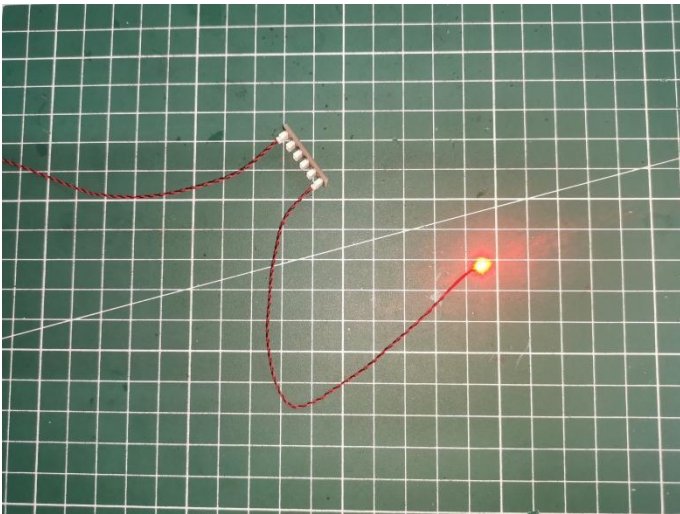

Test each lamp according to this method. It should be noted that after the test, the lamp must be returned to the corresponding bag to avoid confusion of types



The components needs to be tested in this set is 1*Bit Lights-15CM-Red,2*Bit Lights-15CM-Cyan,4*Flashing Bit Lights-30CM-Green,2*Light Strips-Blue-21,3*Light Strips-Cyan-14,1*Headlights-15CM-Red.

Please contact us immediately if any components don't work.

Section C: laying out components following the instruction.

1



2

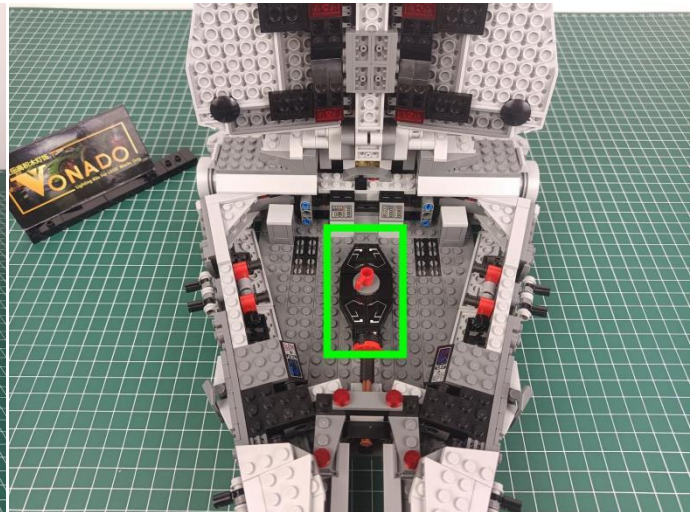

3

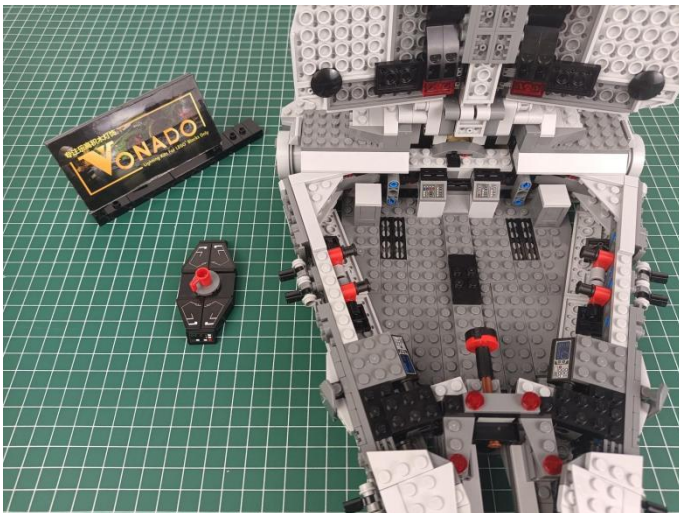

4



5



6



7

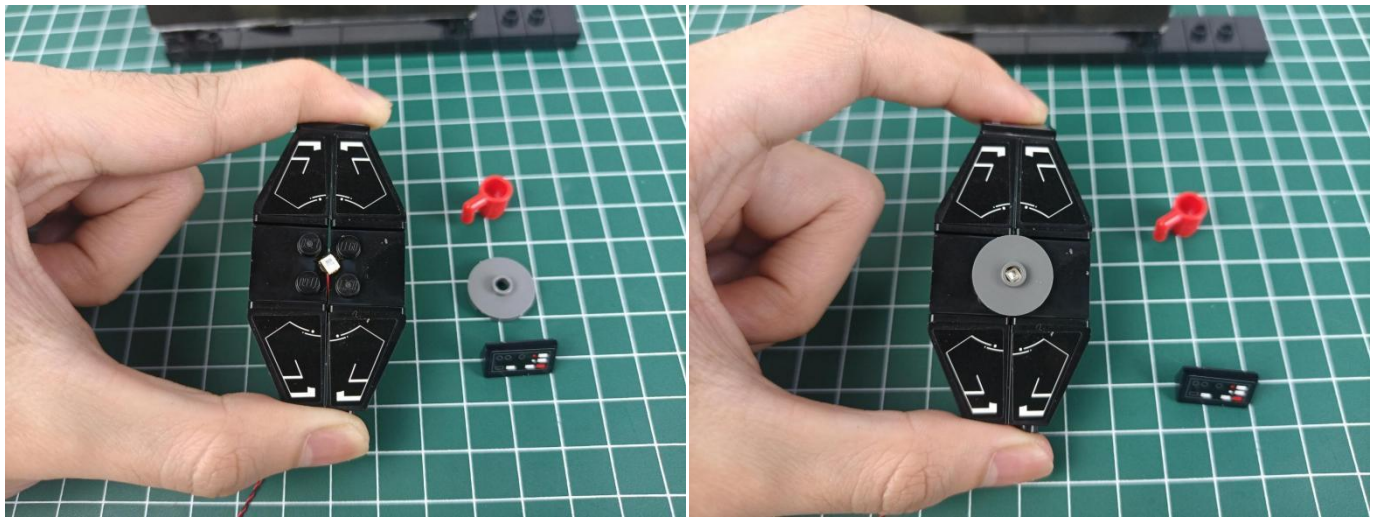

8

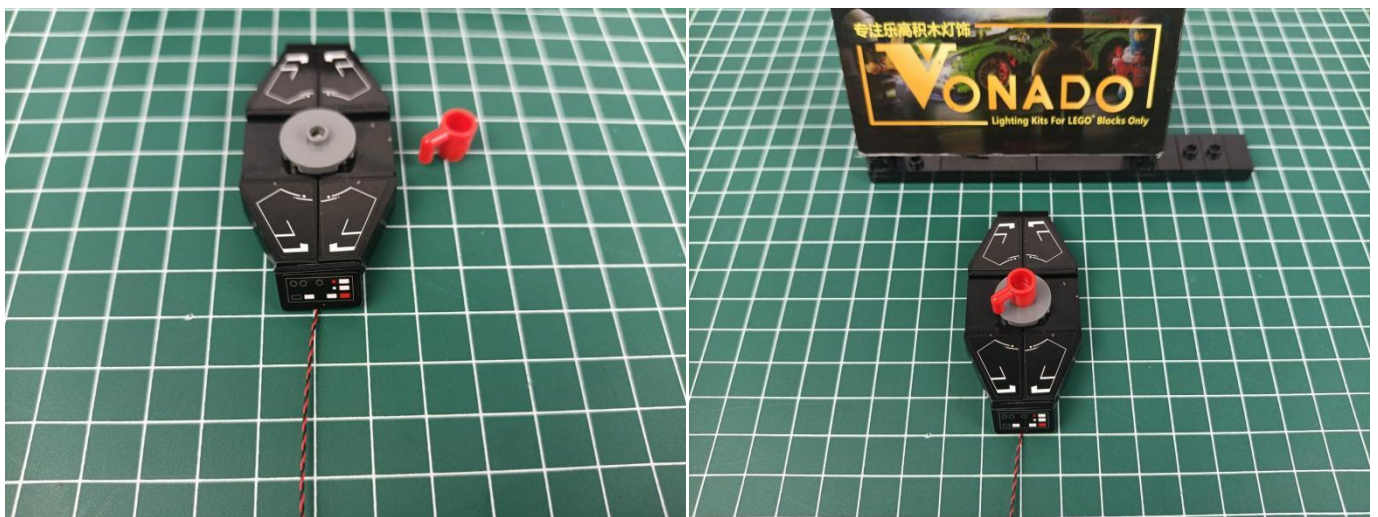

9



10



11



12

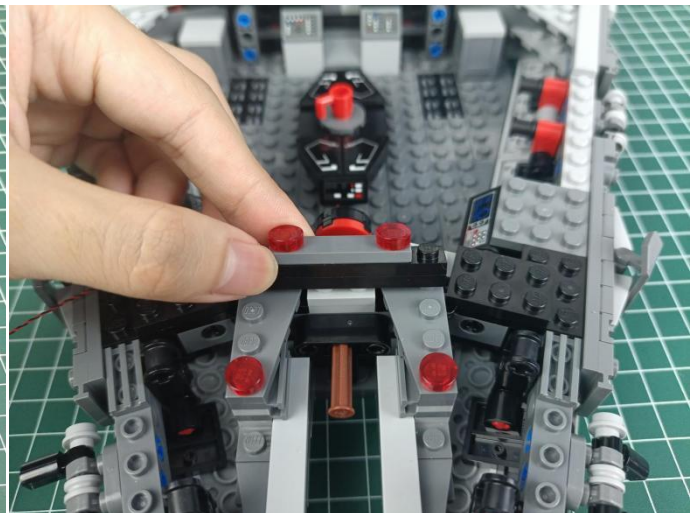
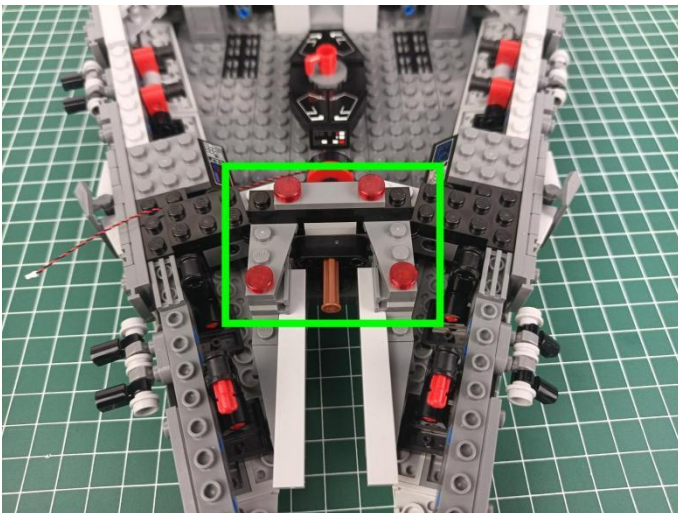

13

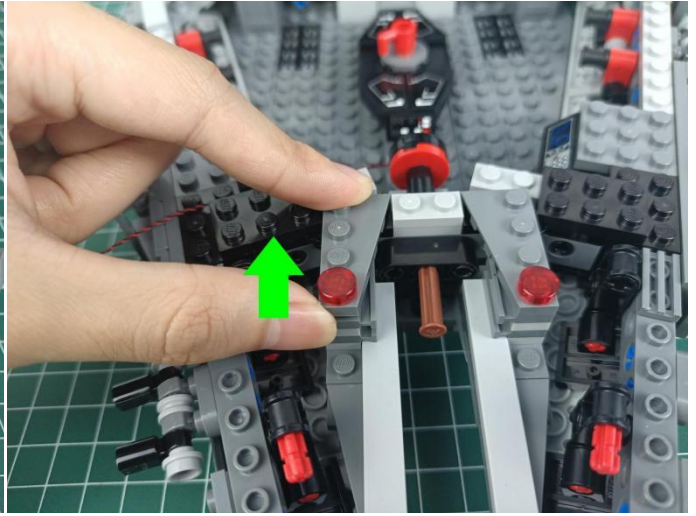
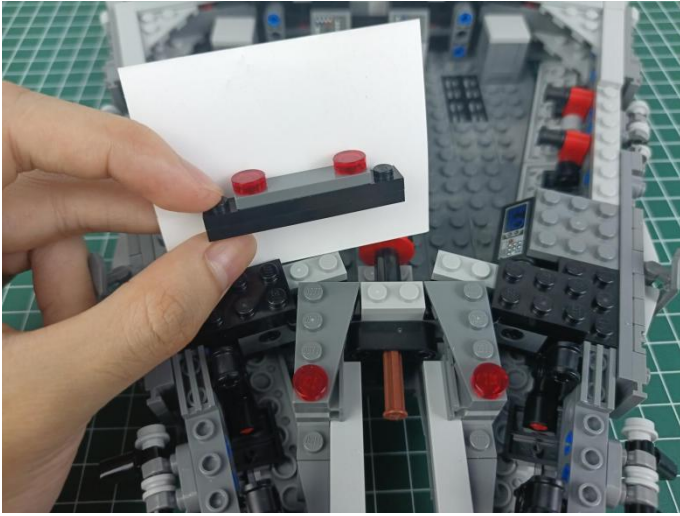

14

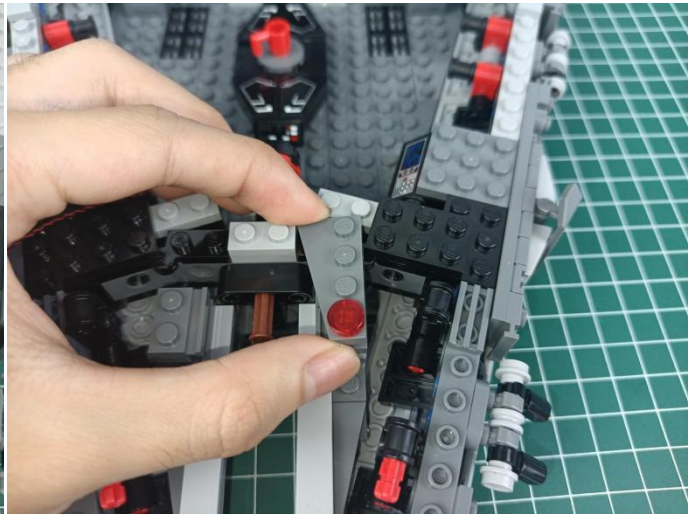
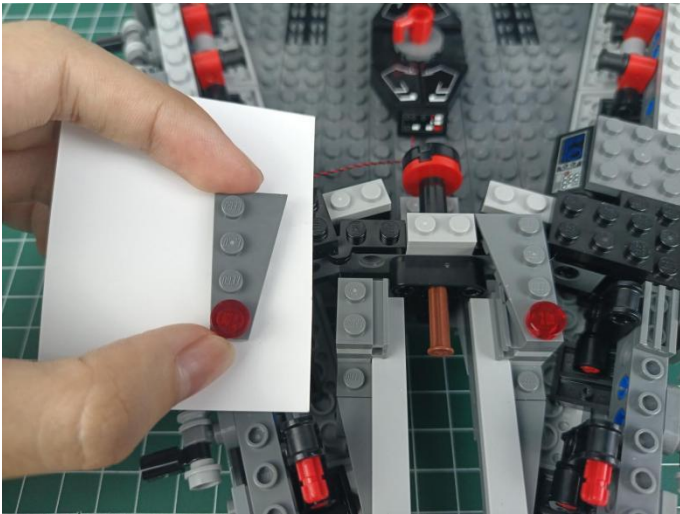

15

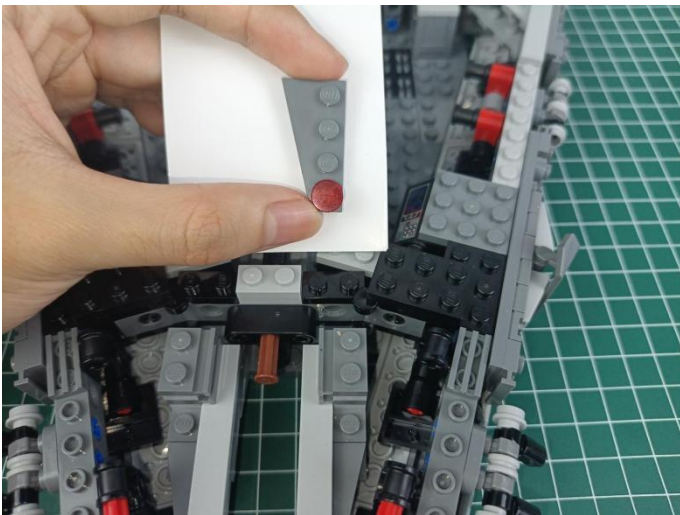

16



17



Tips

The plate without slit:

The plate without slit:

The squeeze causes the protective layer of the wire to be torn apart, the positive and negative wires touch together, and the set is short-circuited, and the hot or wire is crushed, the wire to be disconnected and don't work.



The plate with slit:

The plate with slit:

The wire has enough space to avoid being squeezed endowed with longer service life and more stable effect.

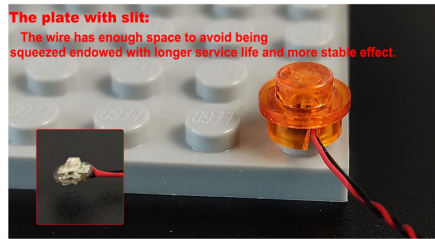

The slit on the the plate round 1X1 are hand-made to avoid squeeze the wire and cause short circuit and abnormal heat during installation.

18

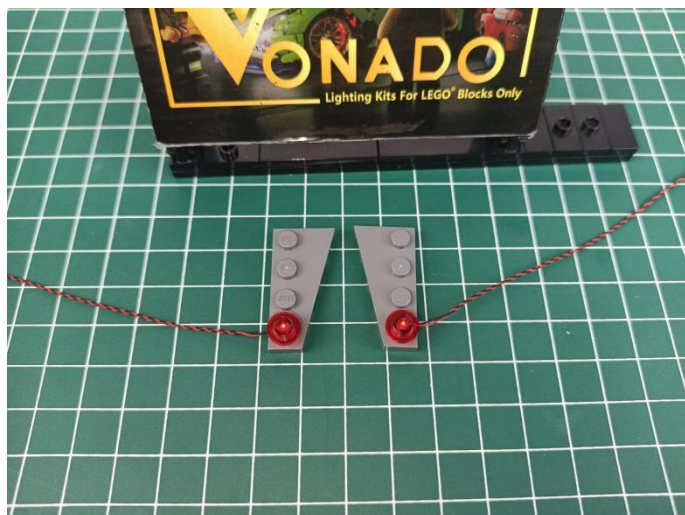

19

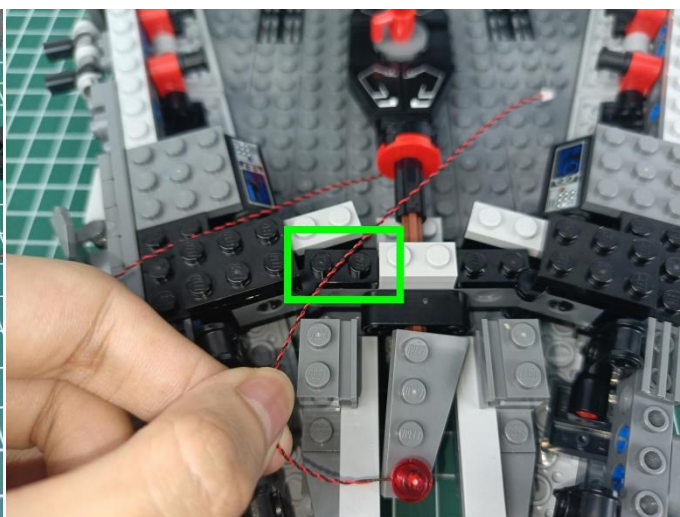

20

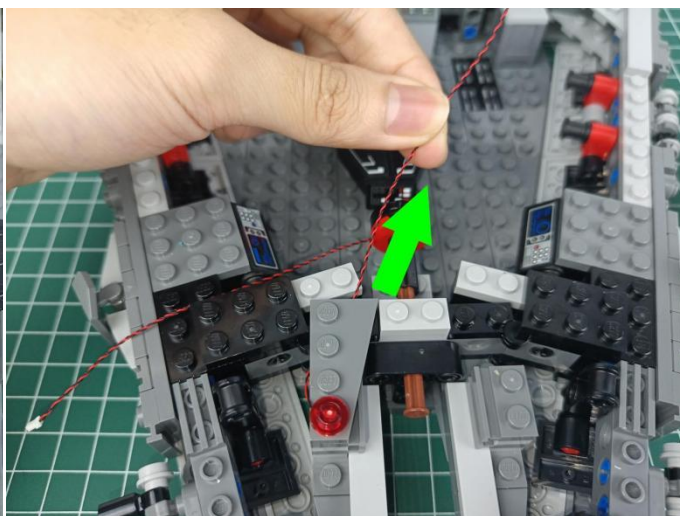
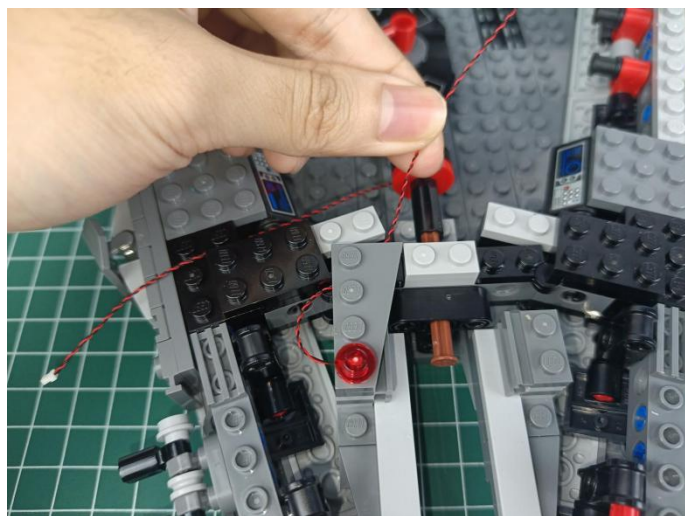

21

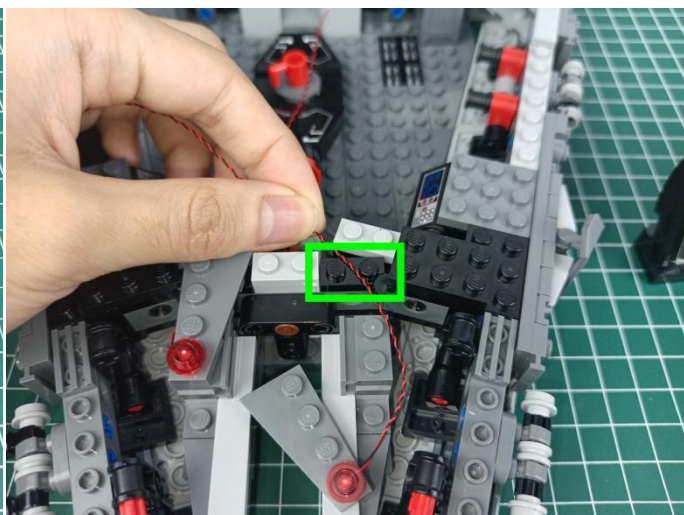

22

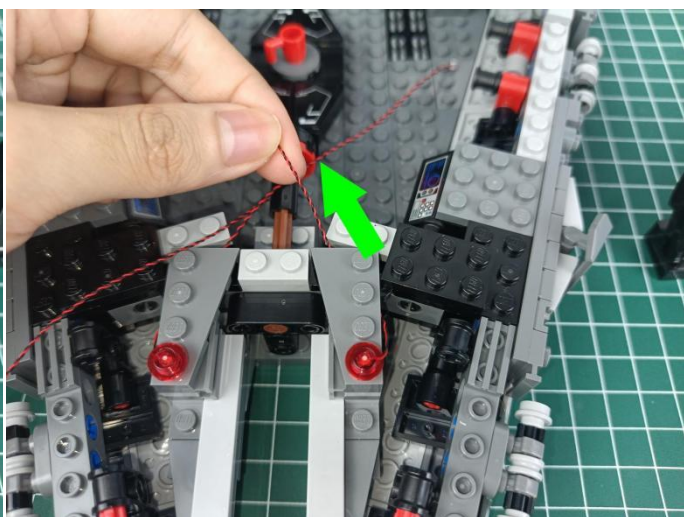
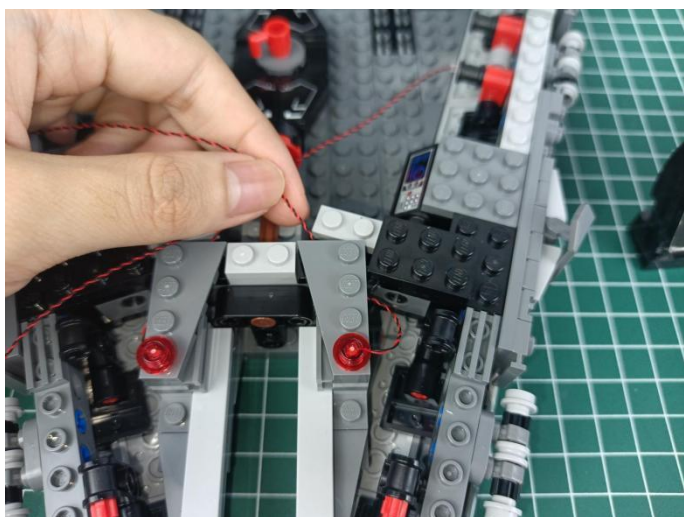

23

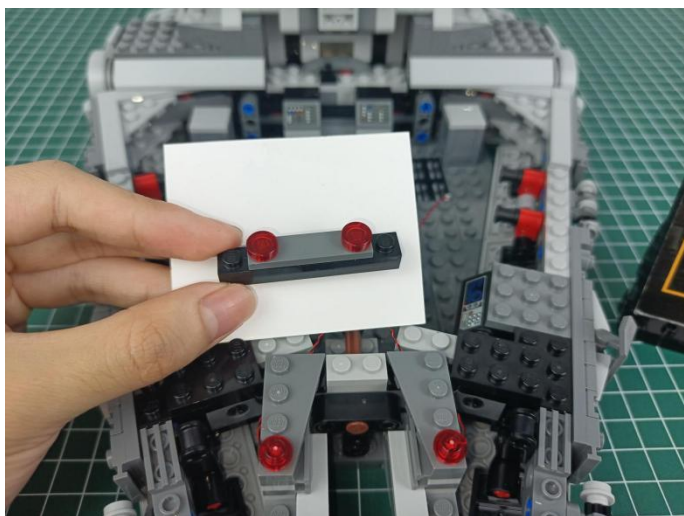

24



25



26

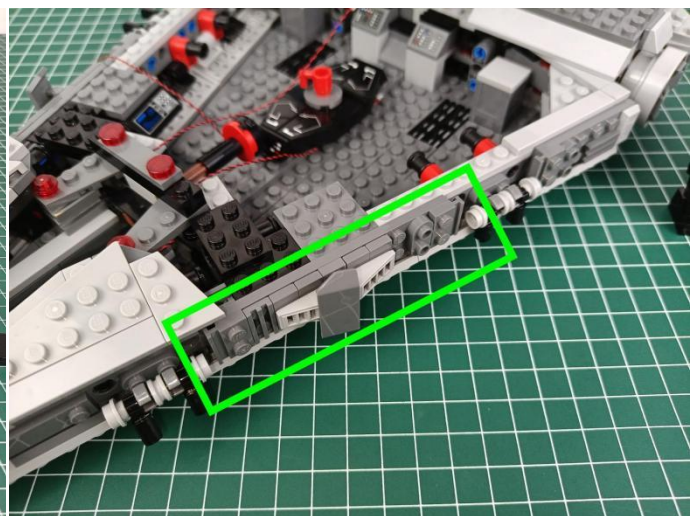

27

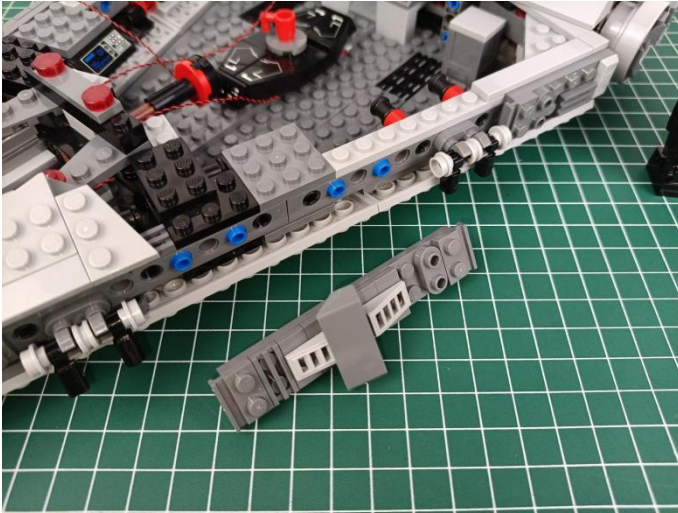

28



29

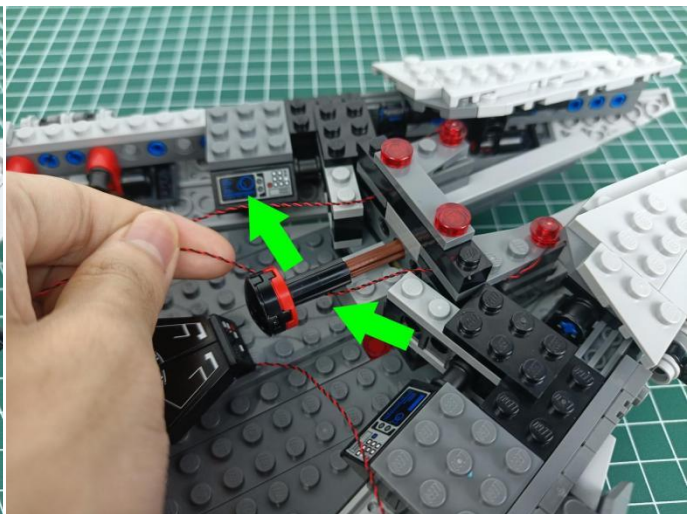
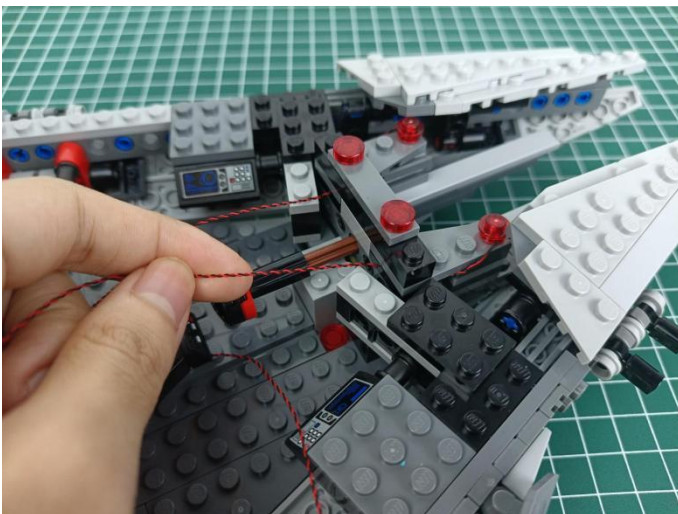

30

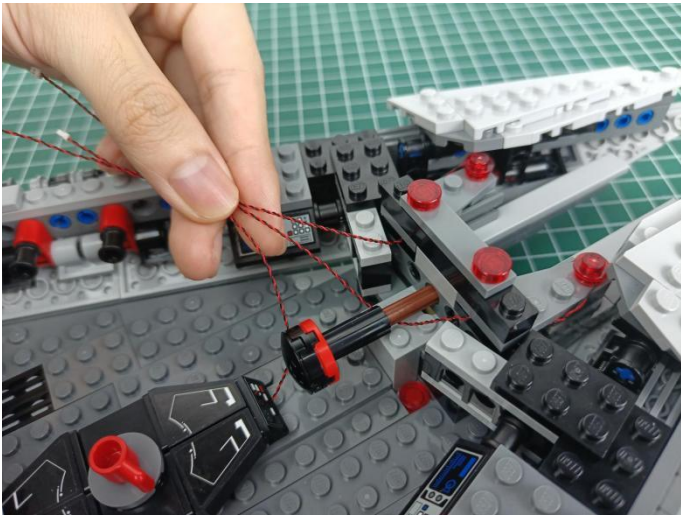

31



32

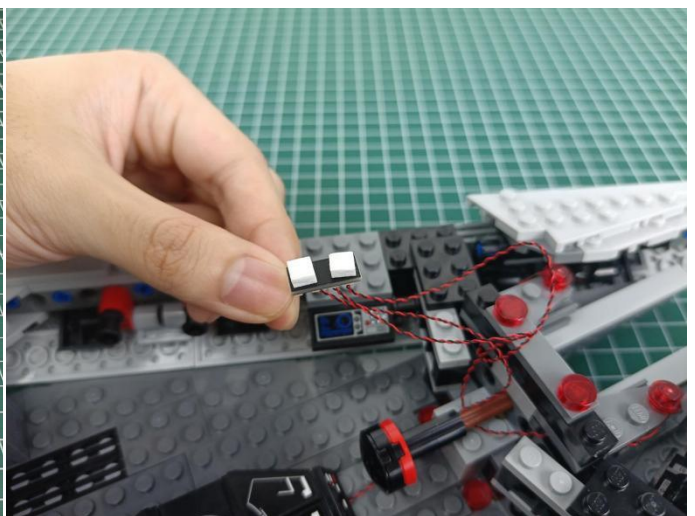

33

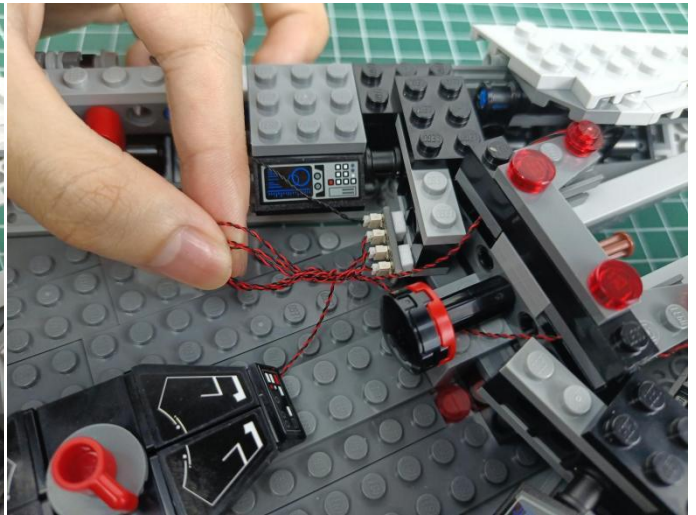
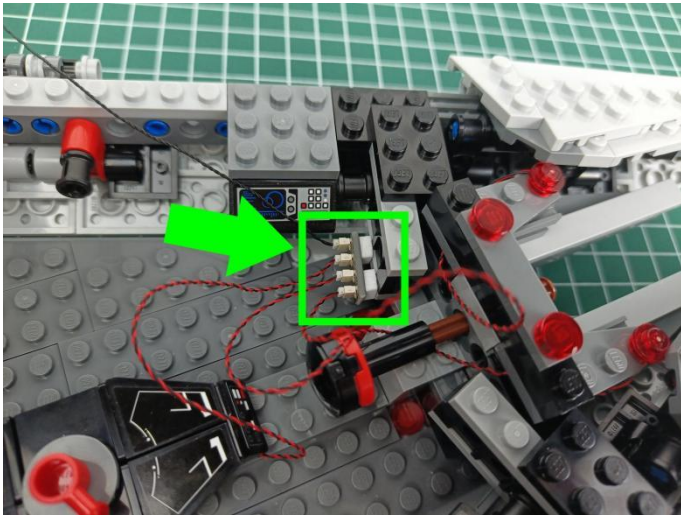

34

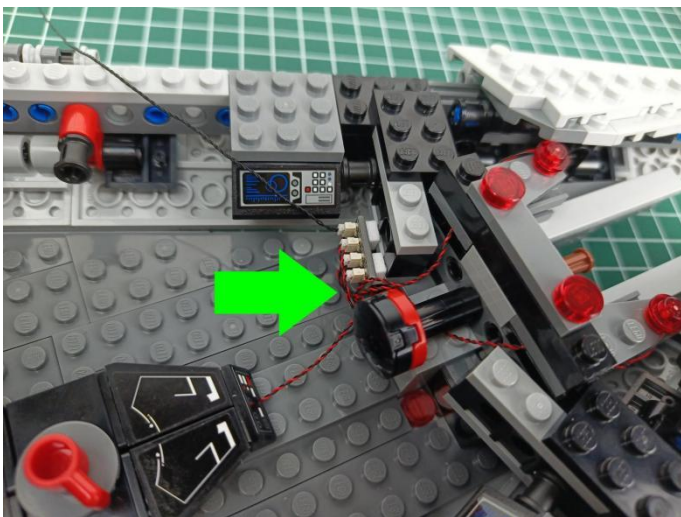

35

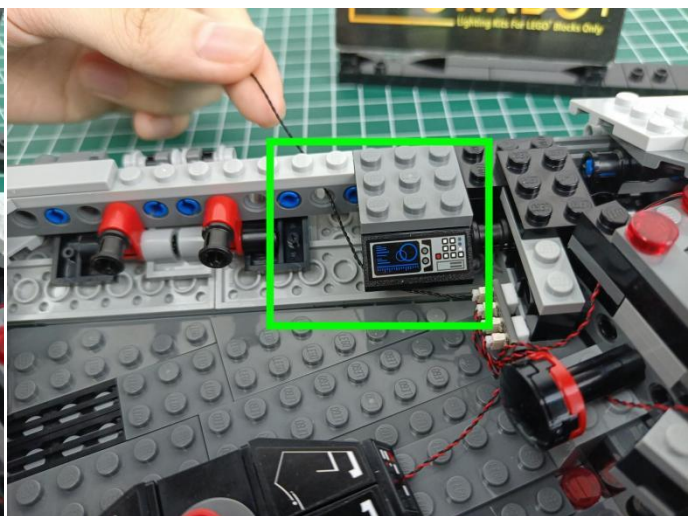
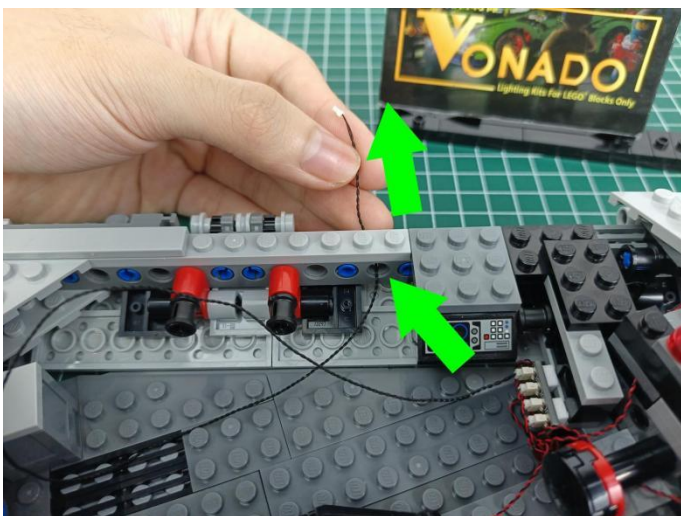

36



37

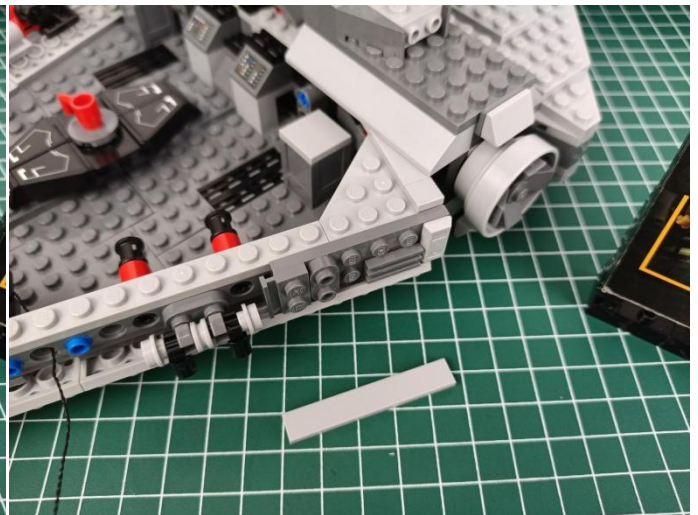
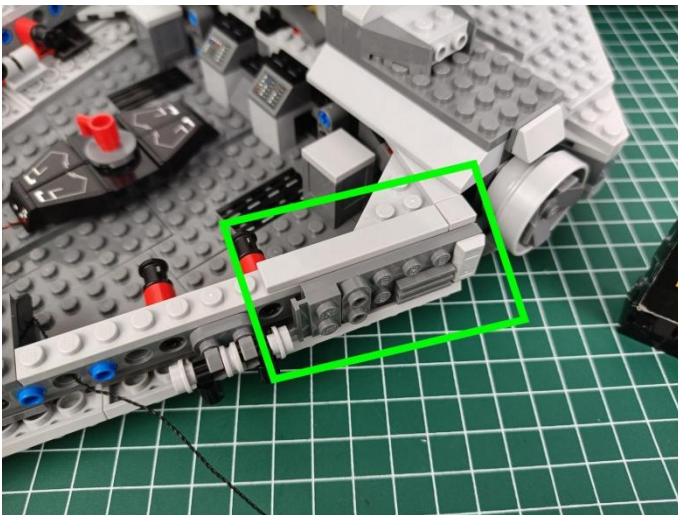

38

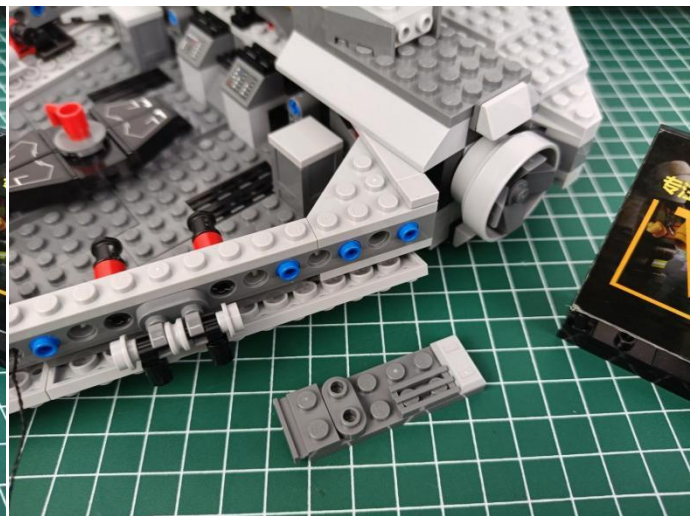

39

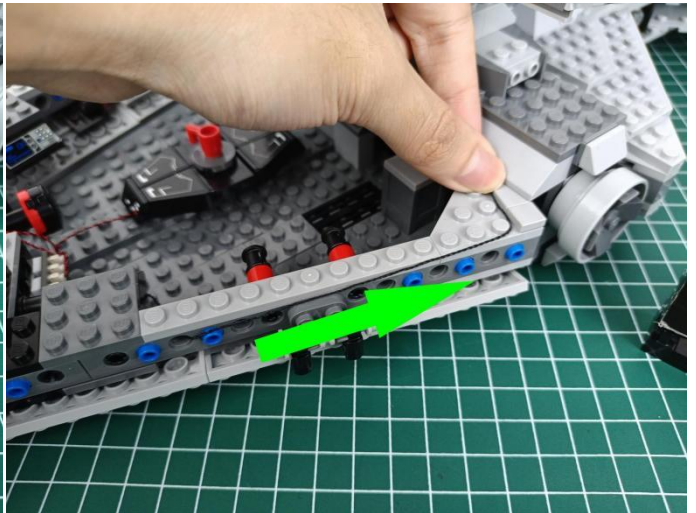
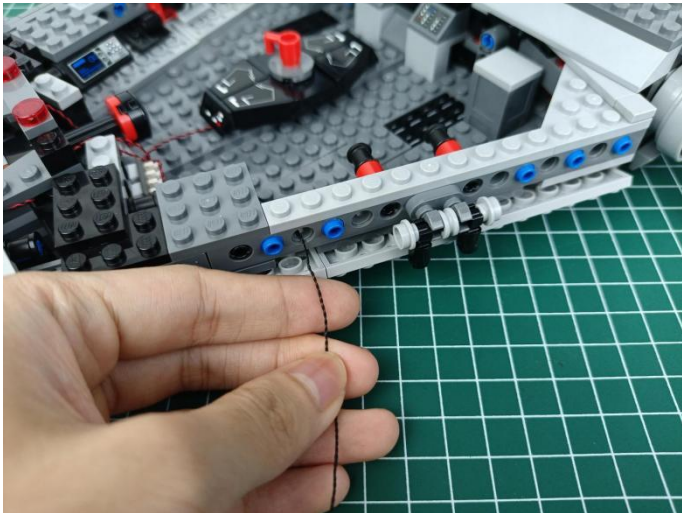

40

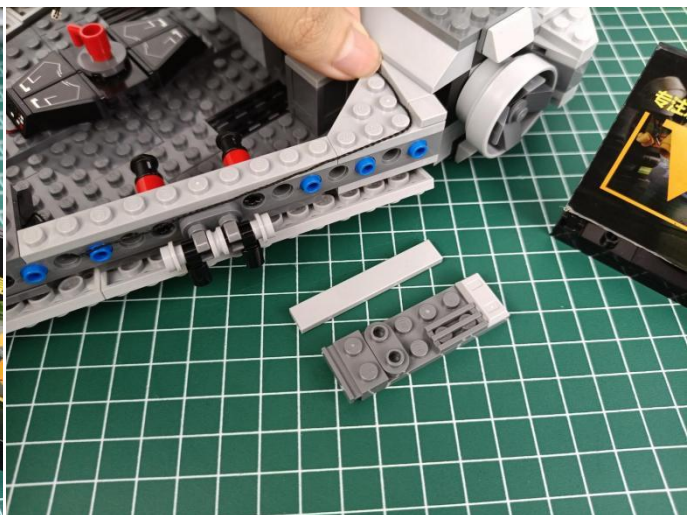
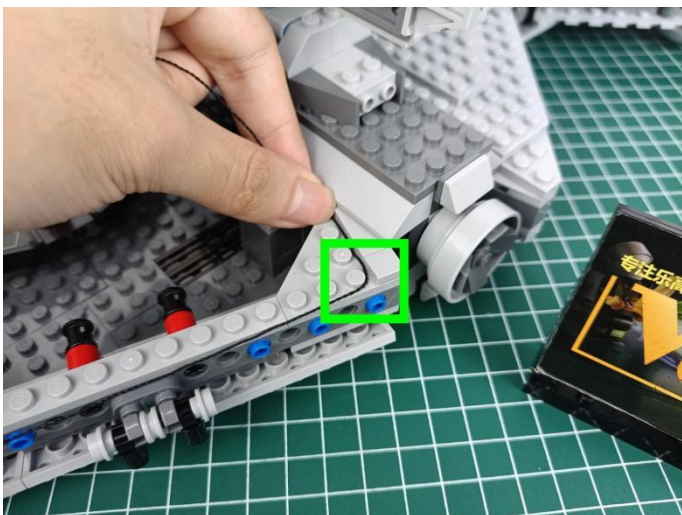

41

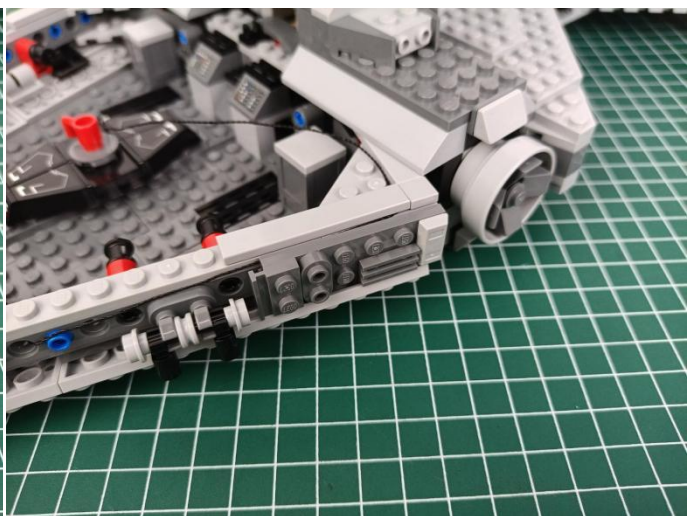
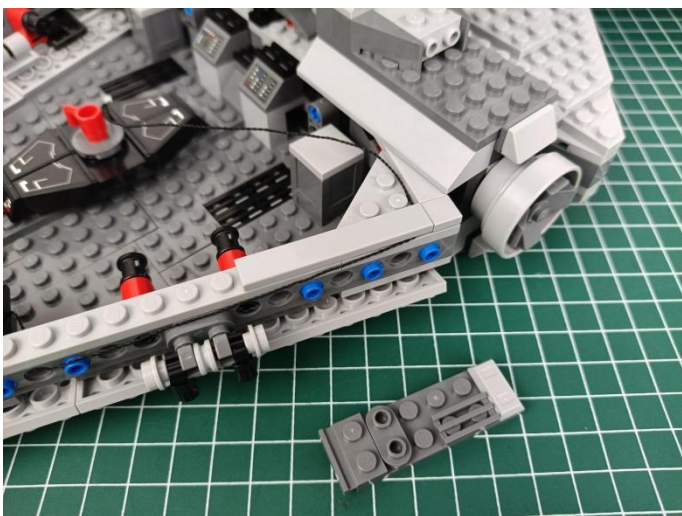

42

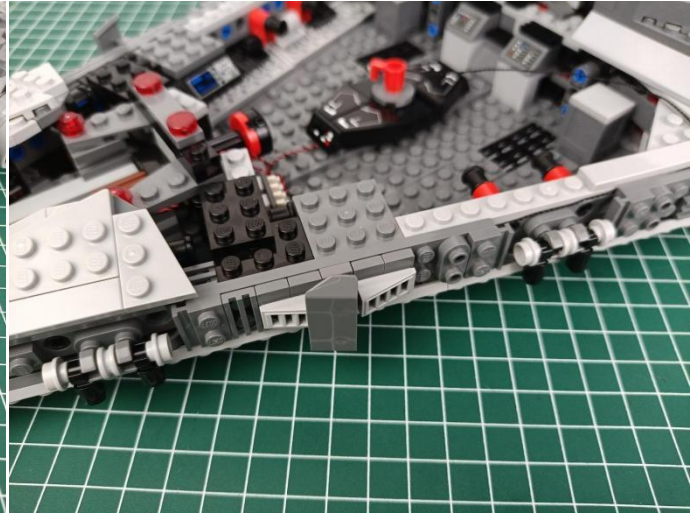
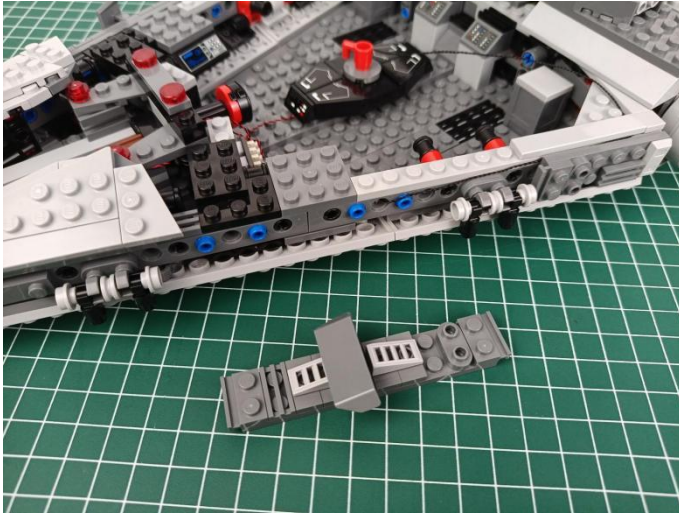

43

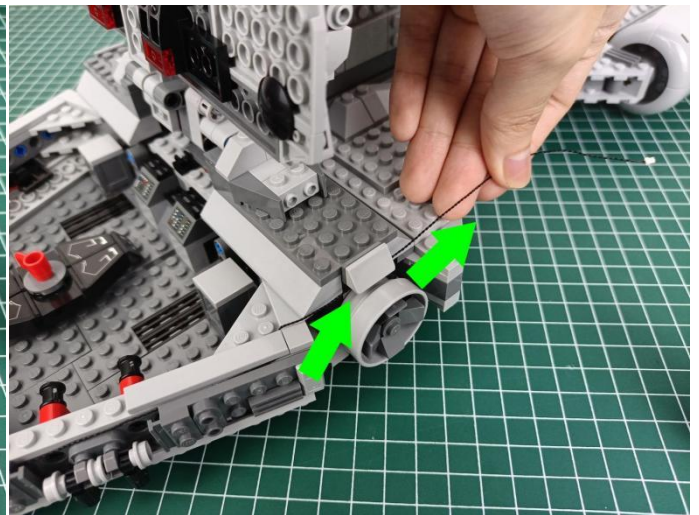
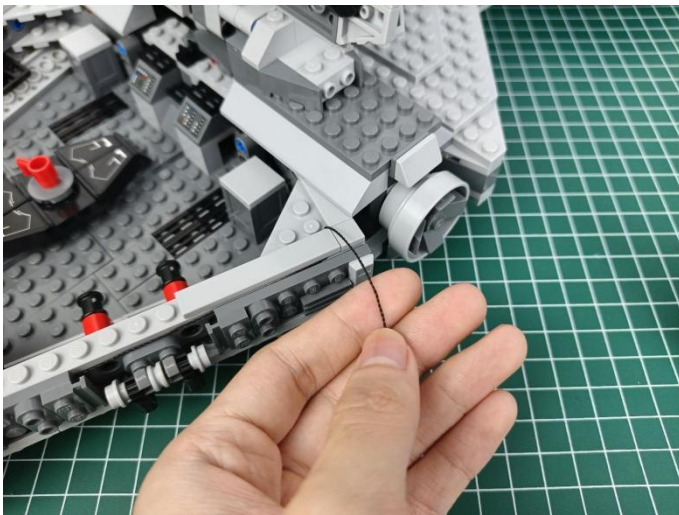

44



45



46



47



48

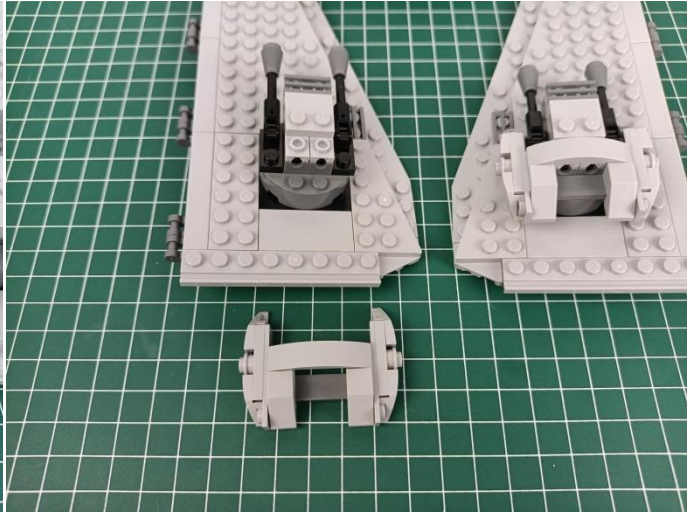
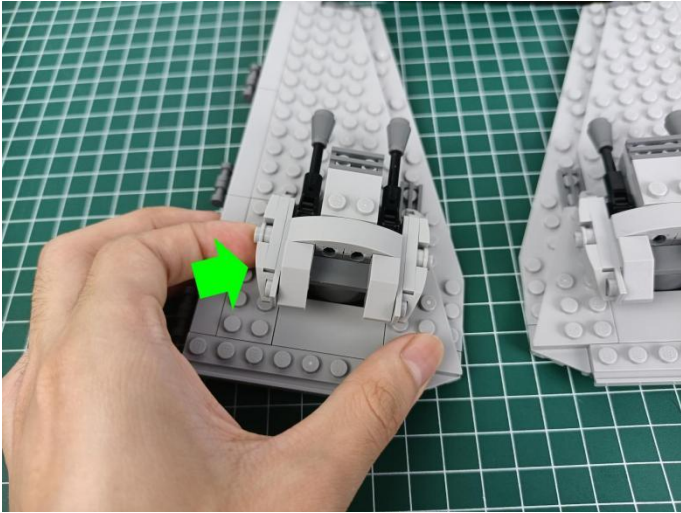

49

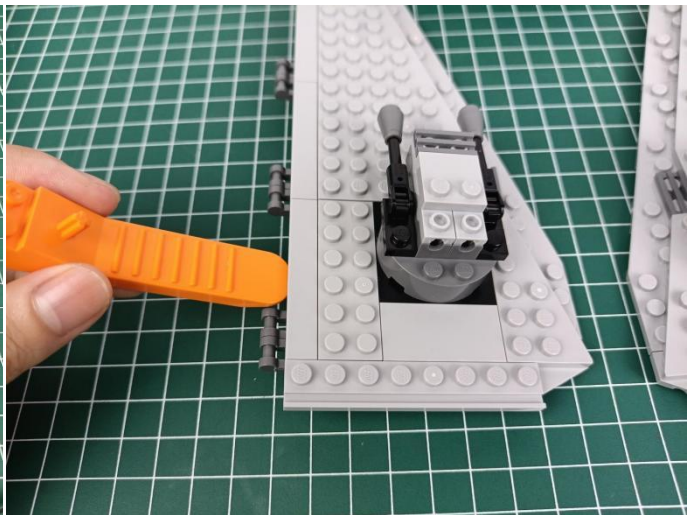
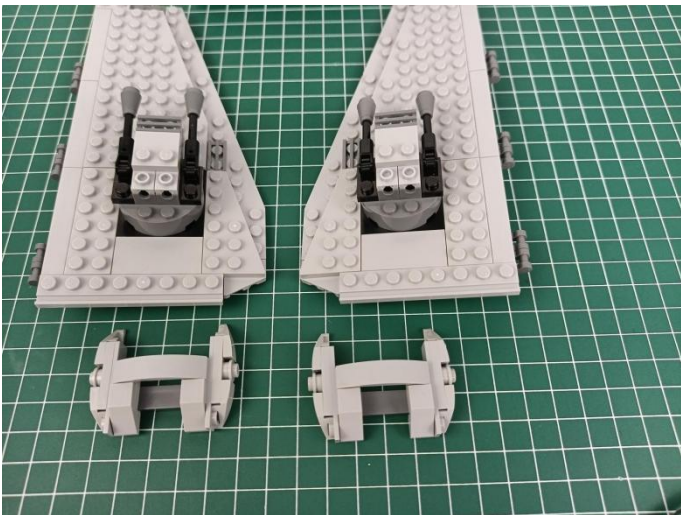

50

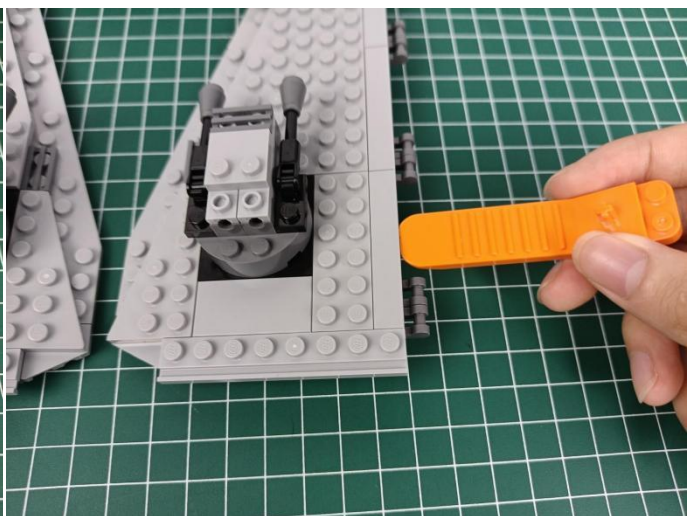
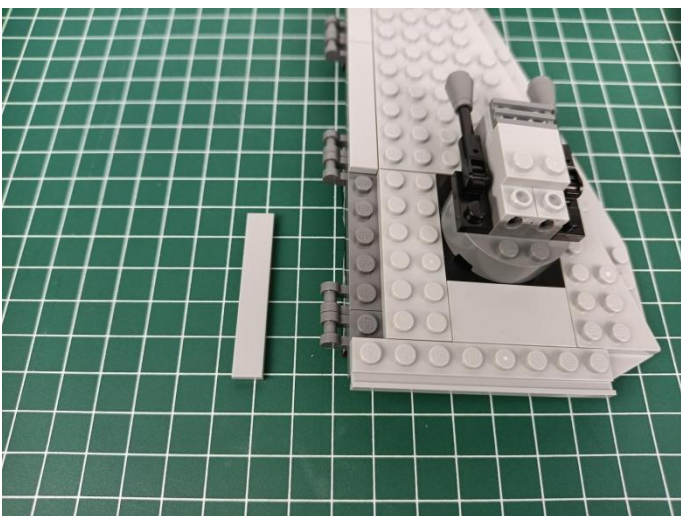

51

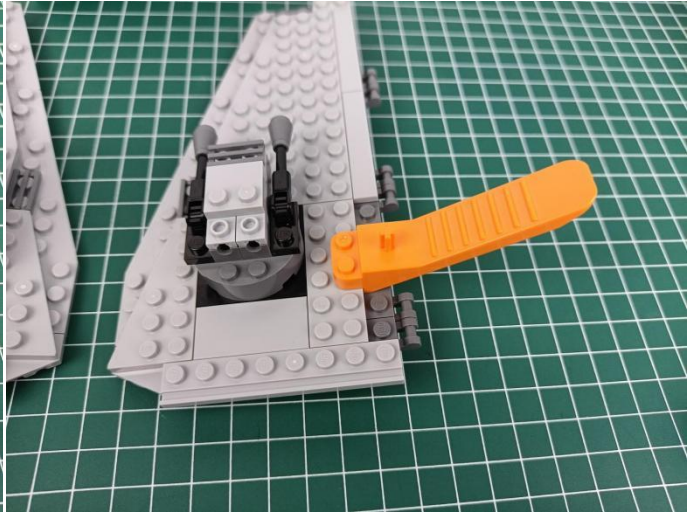
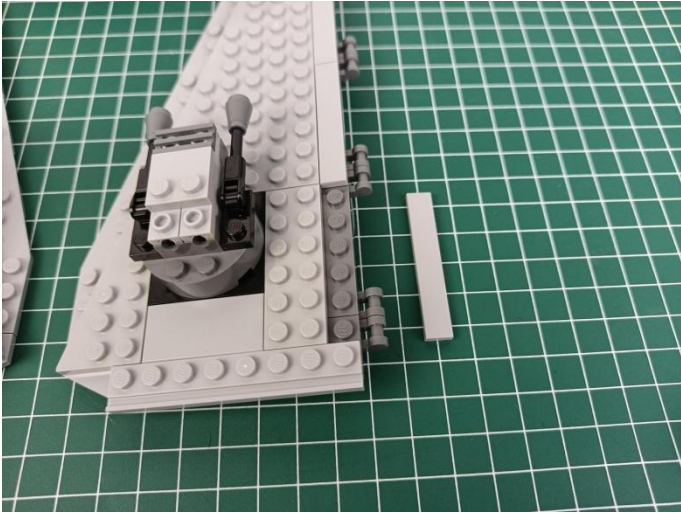

52

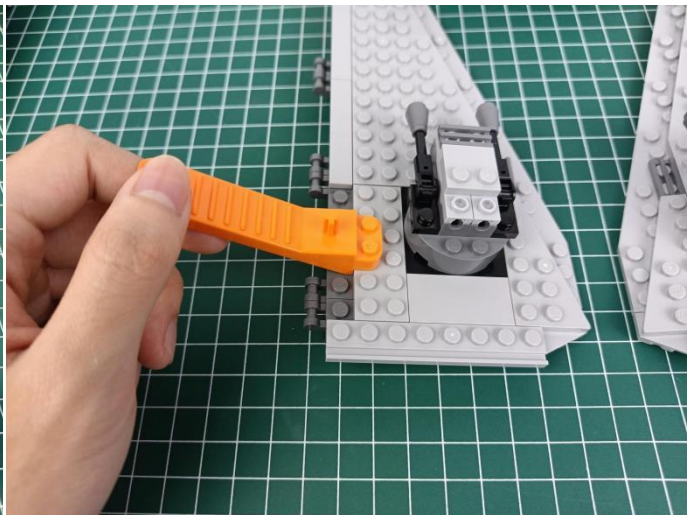
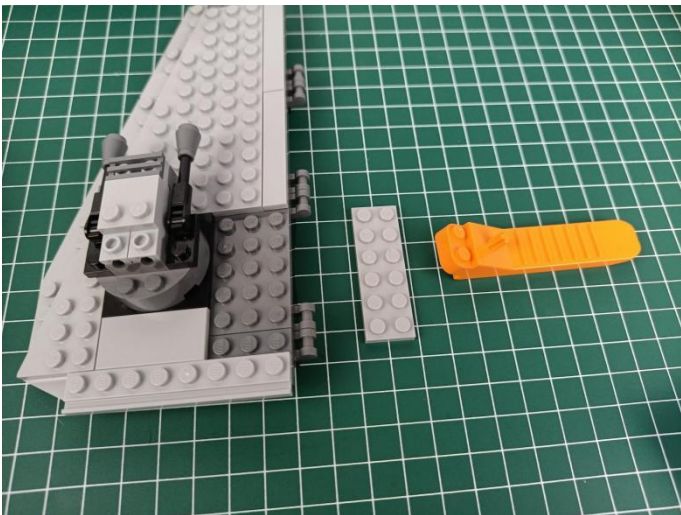

53

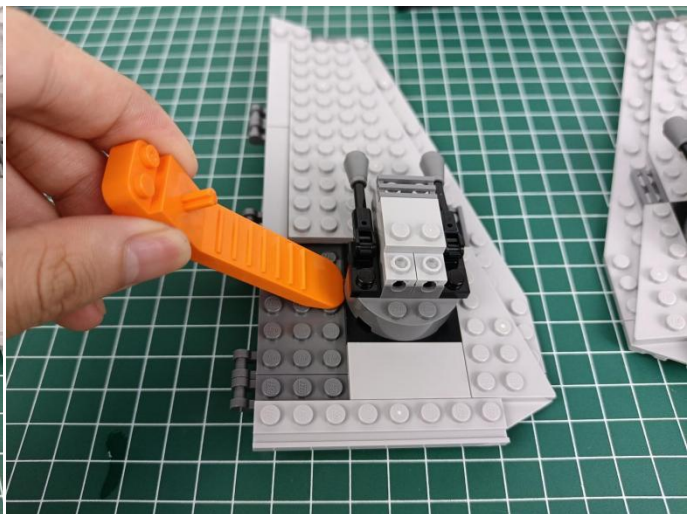
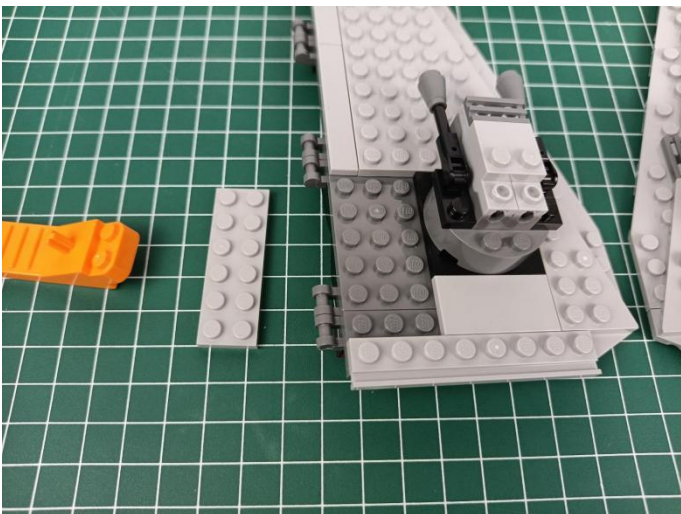

54

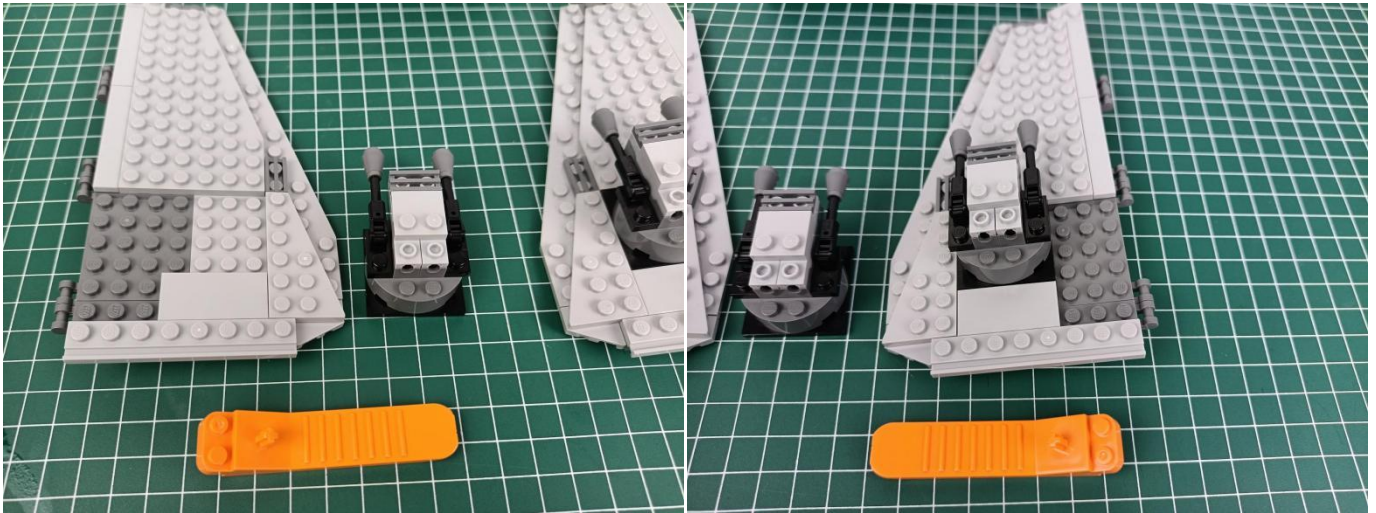

55



56

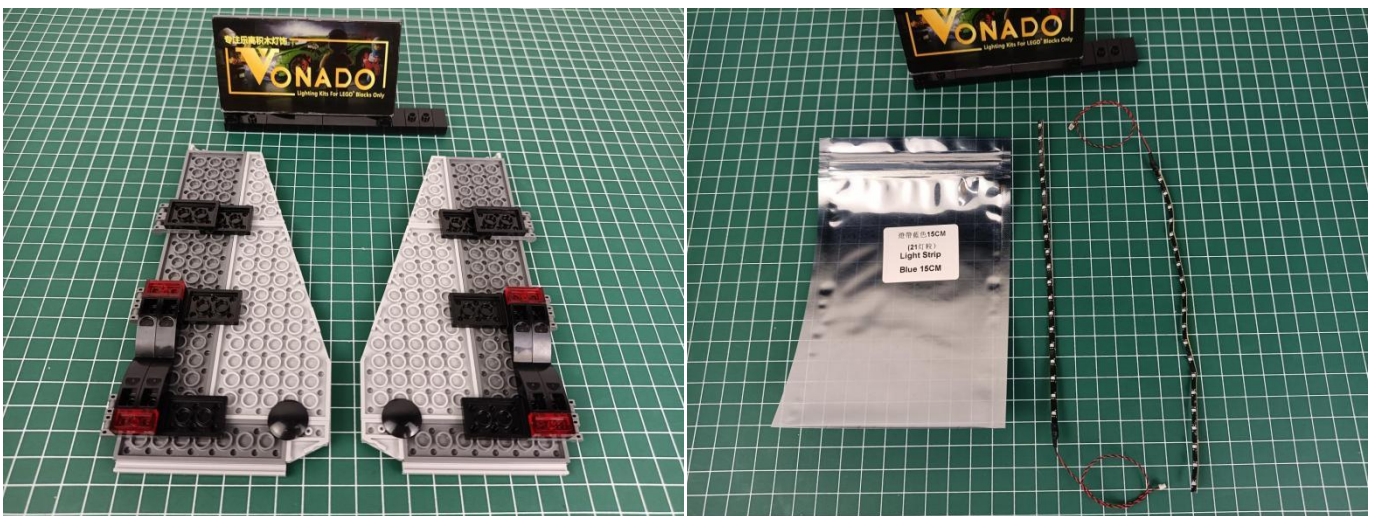

57



58

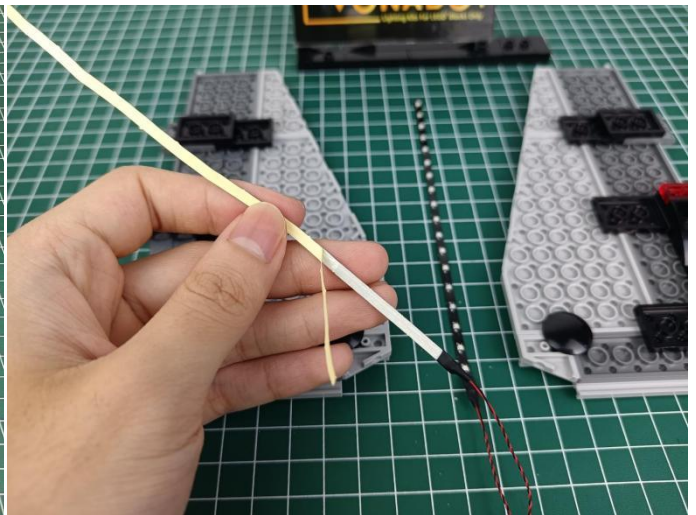
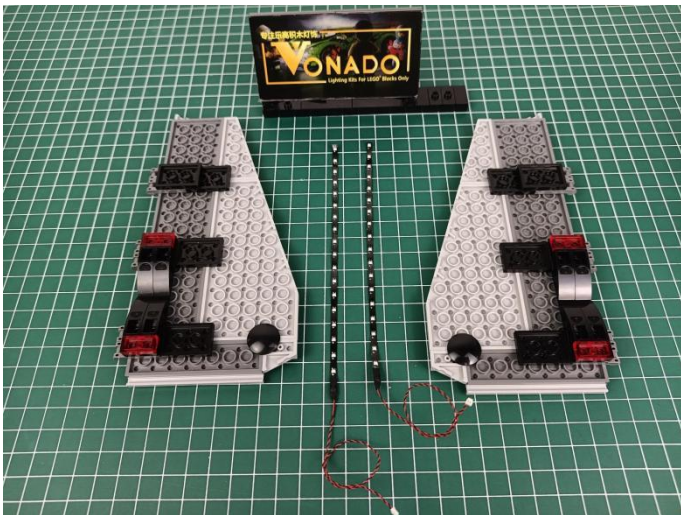

59

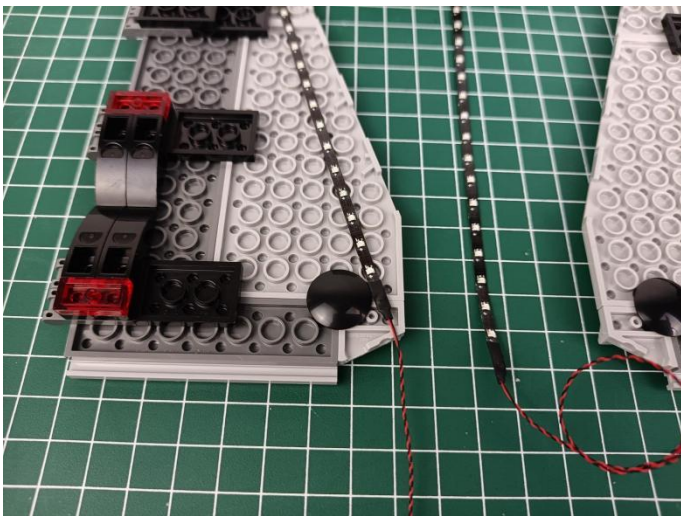

60

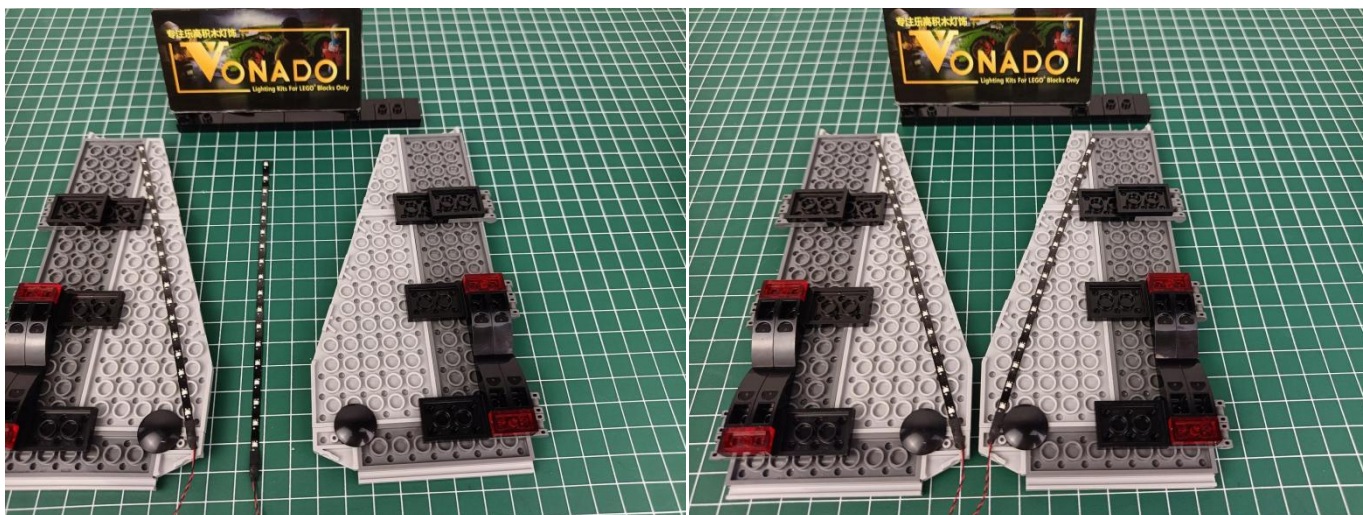

61

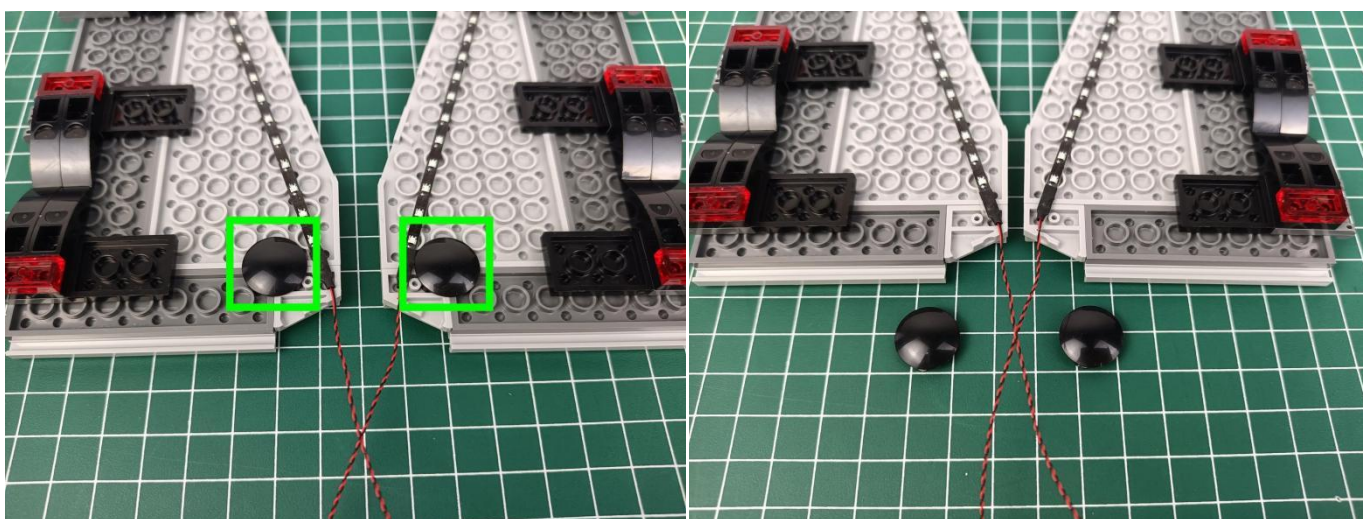

62

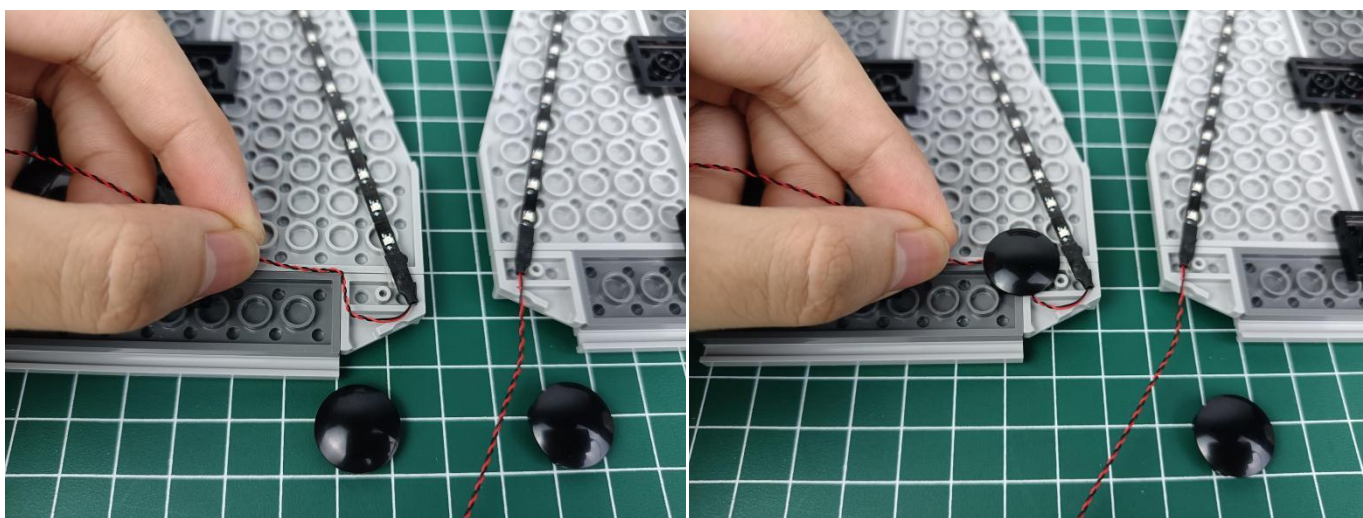

63

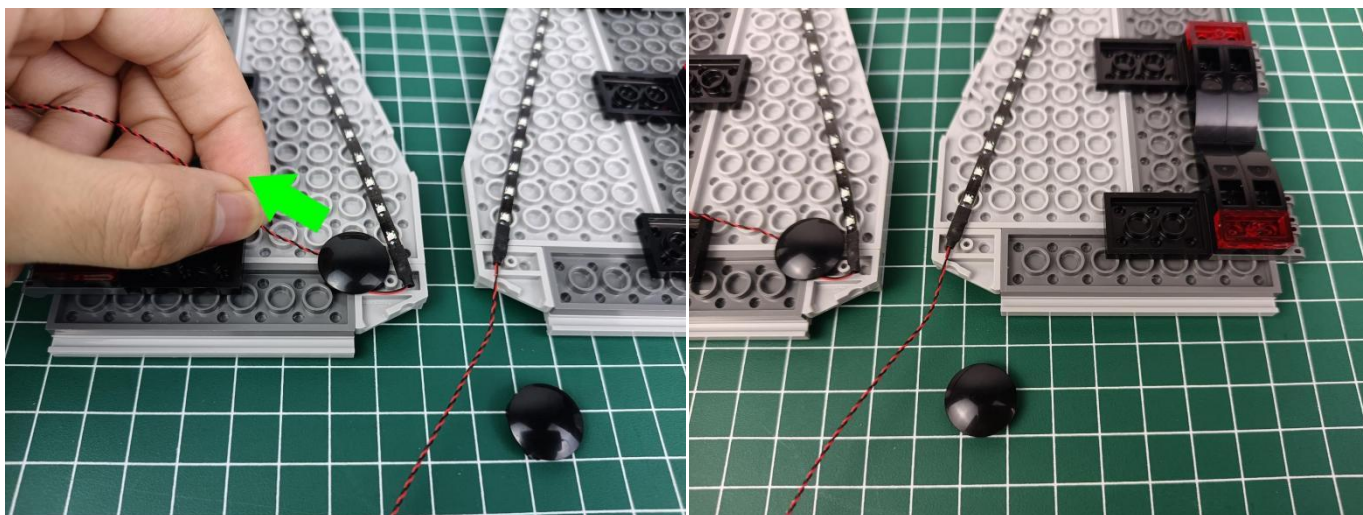

64

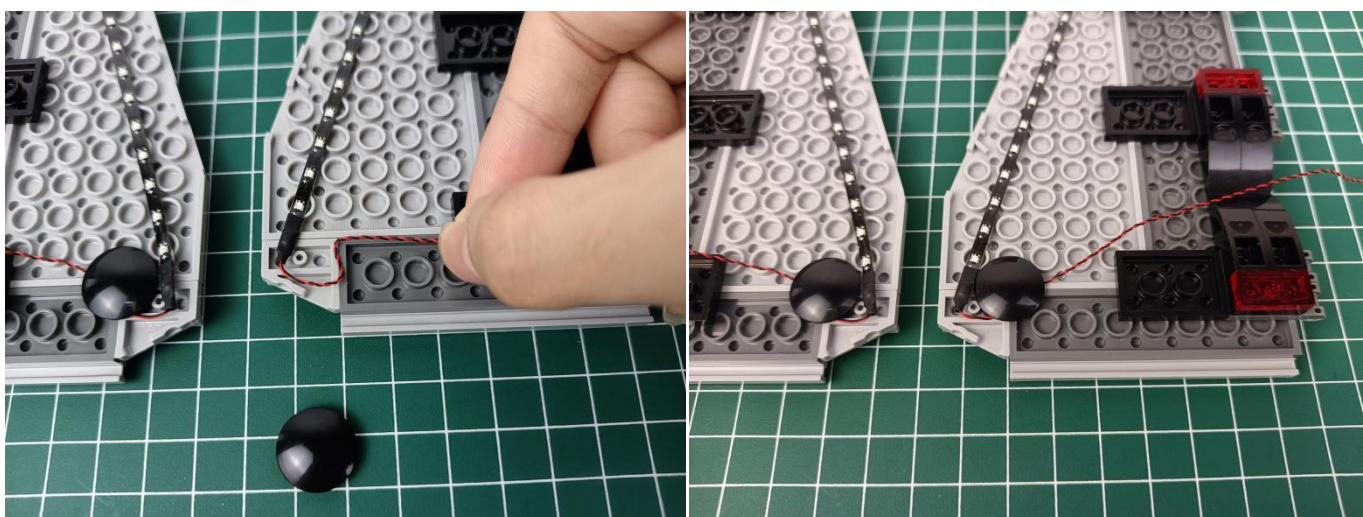

65

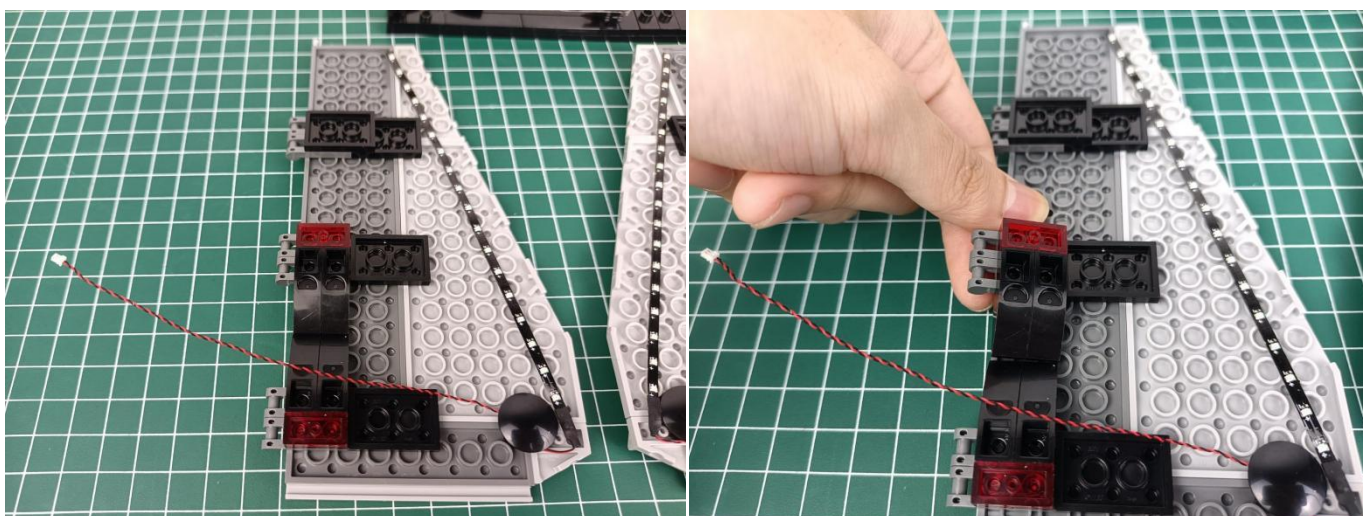

66

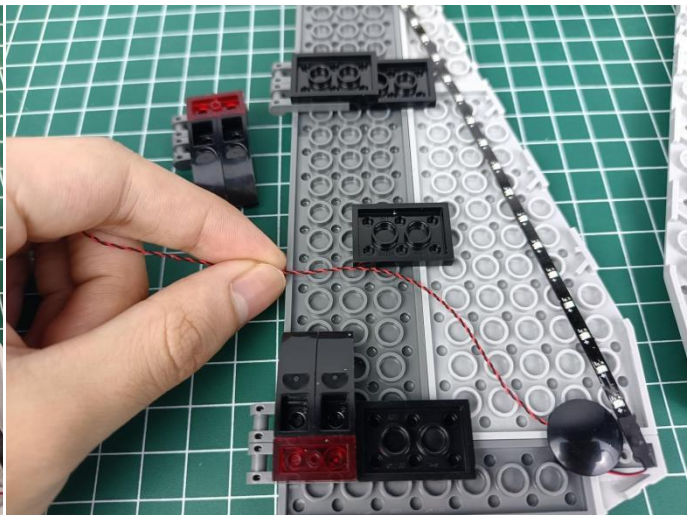
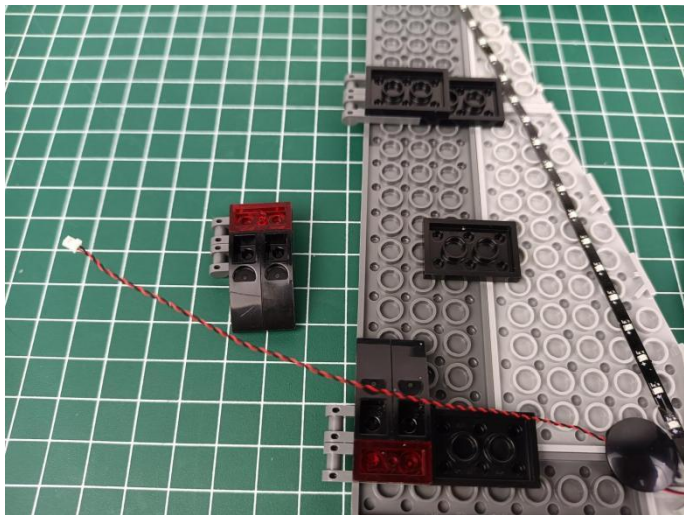

67

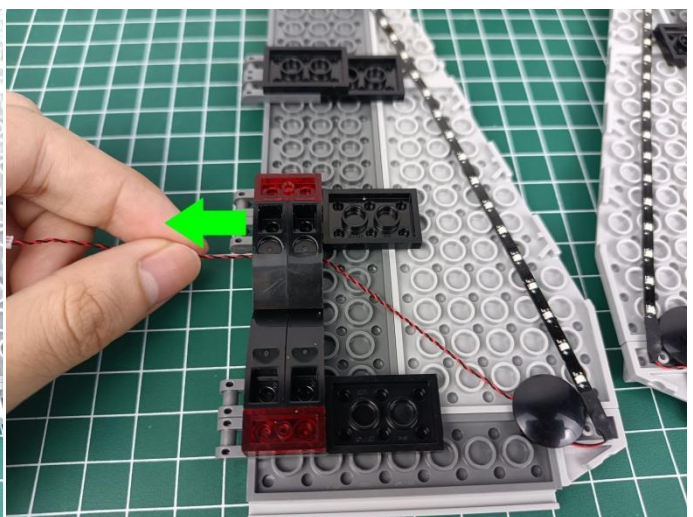
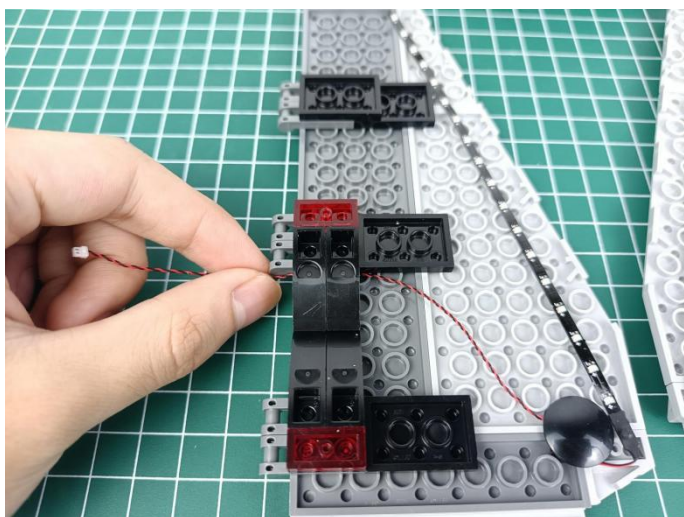

68

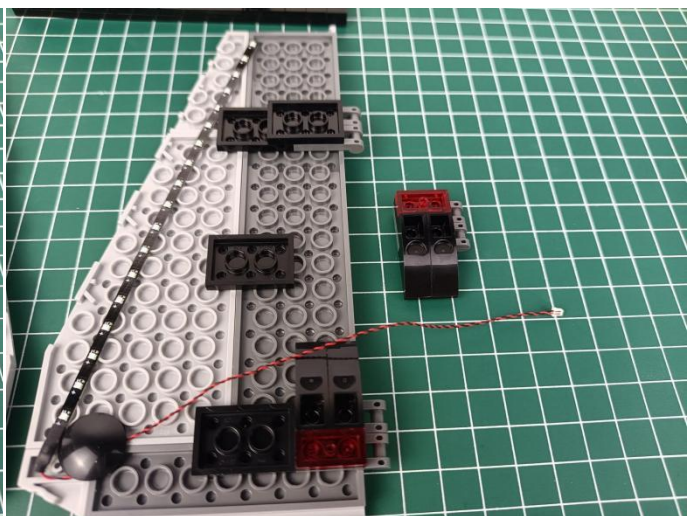
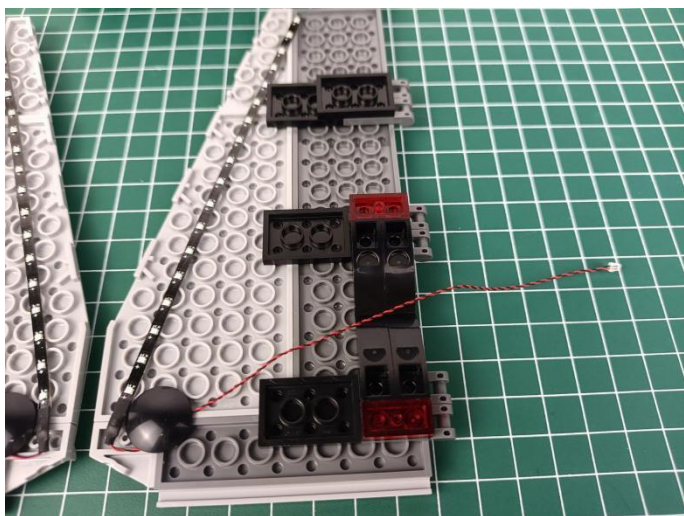

69

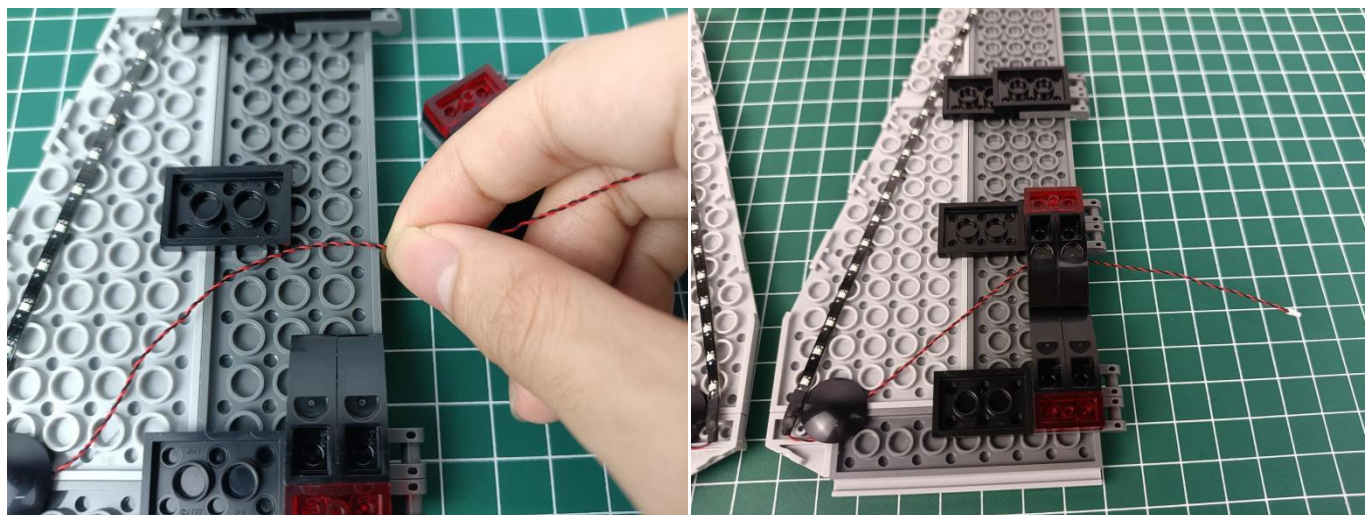

70

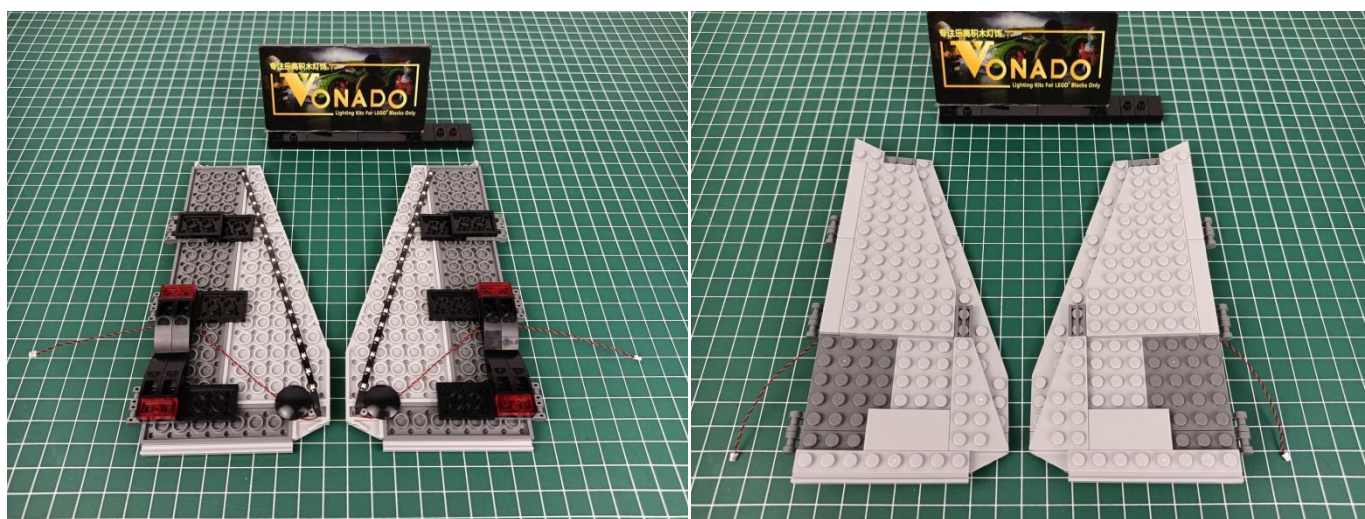

71



72



73



74

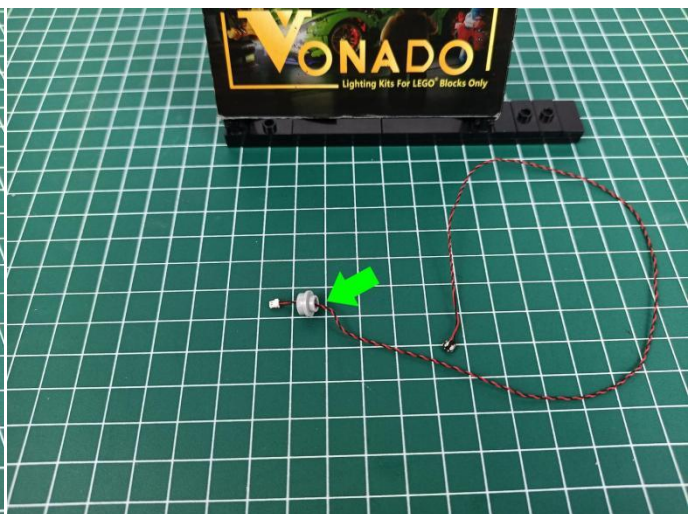

75

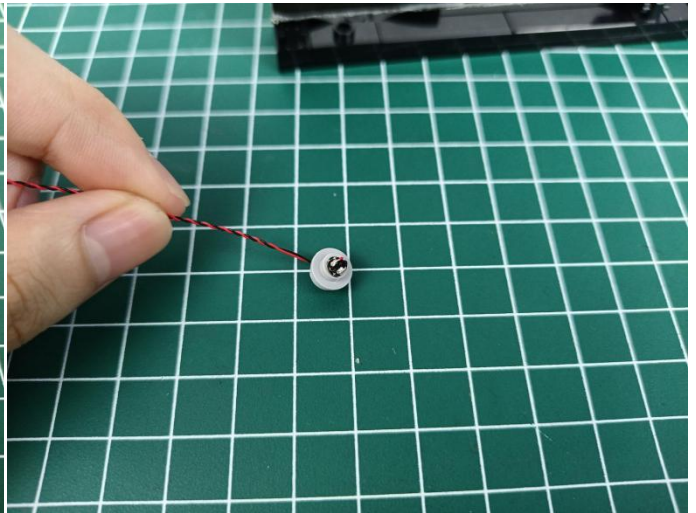
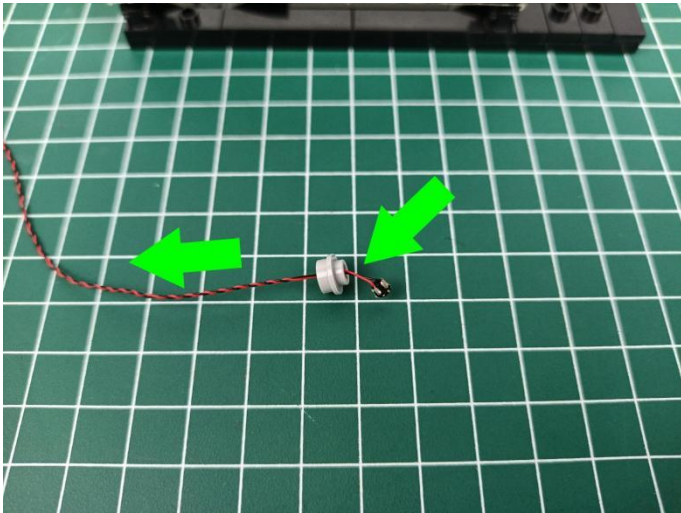

76



77



78

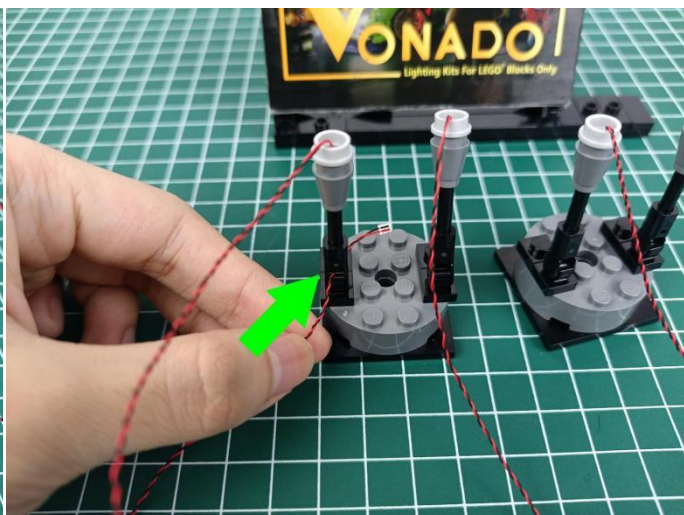

79



80



81

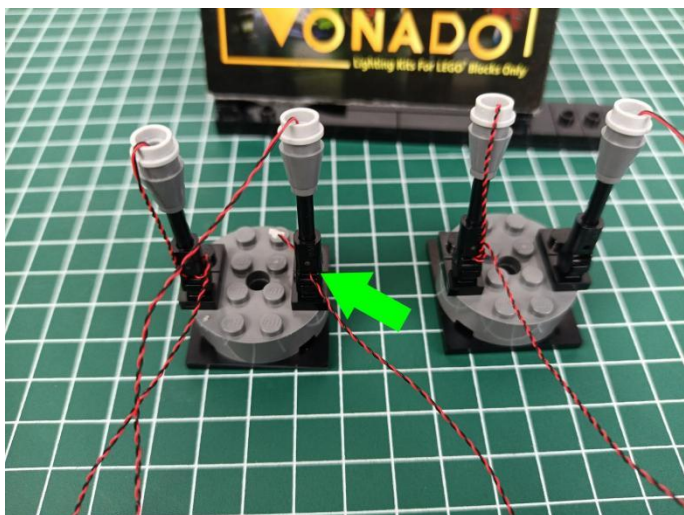

82

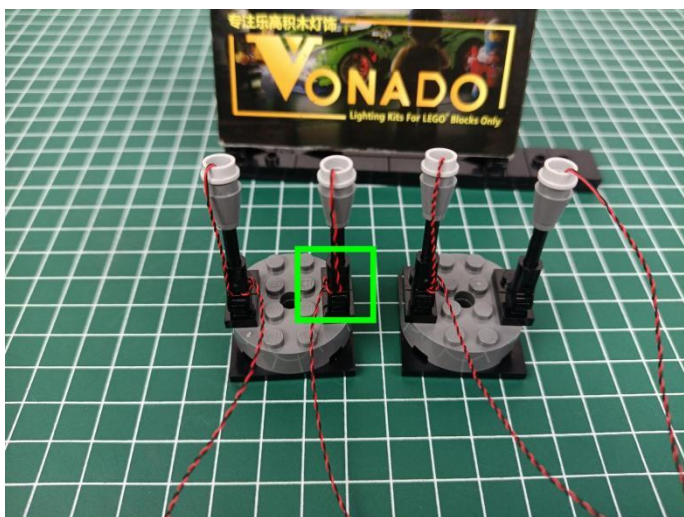

83



84

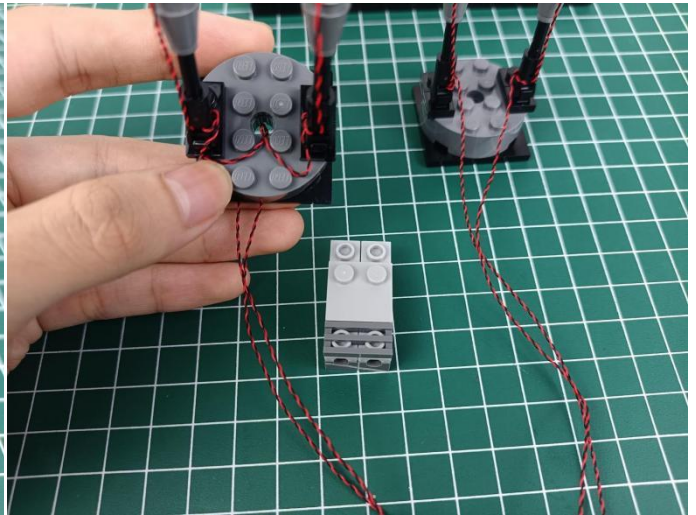

85

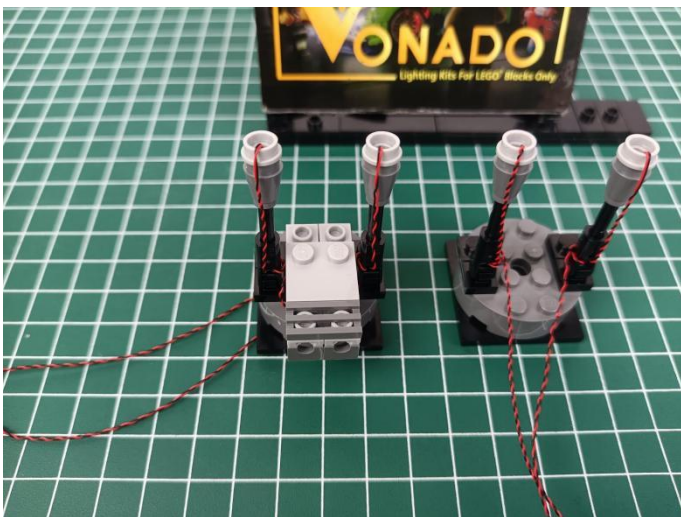

86



87



88

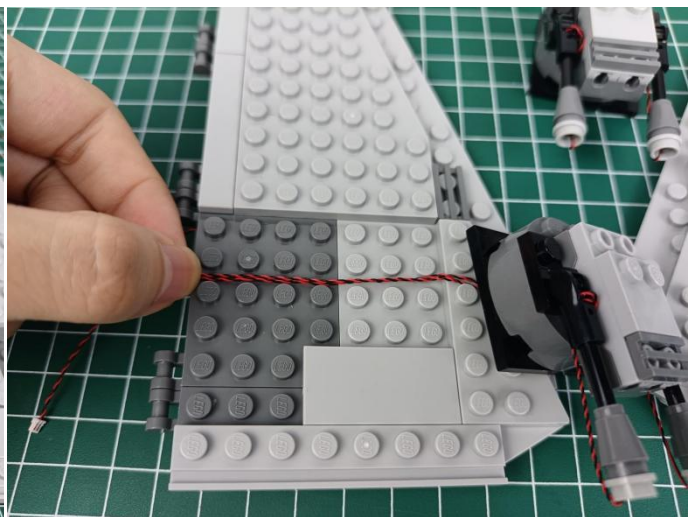
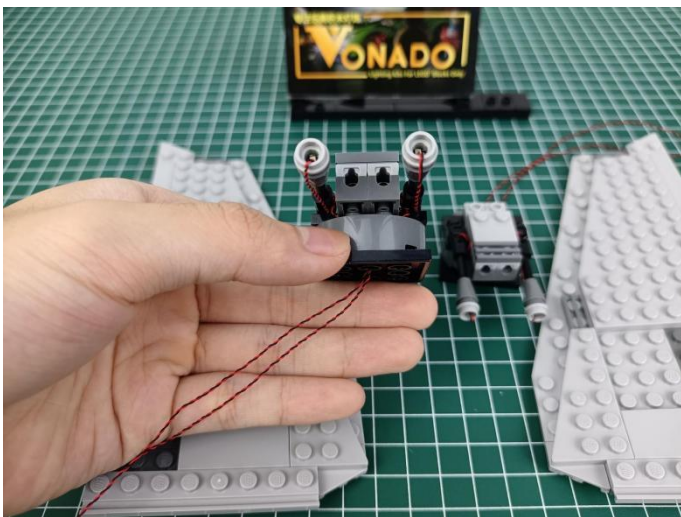

89

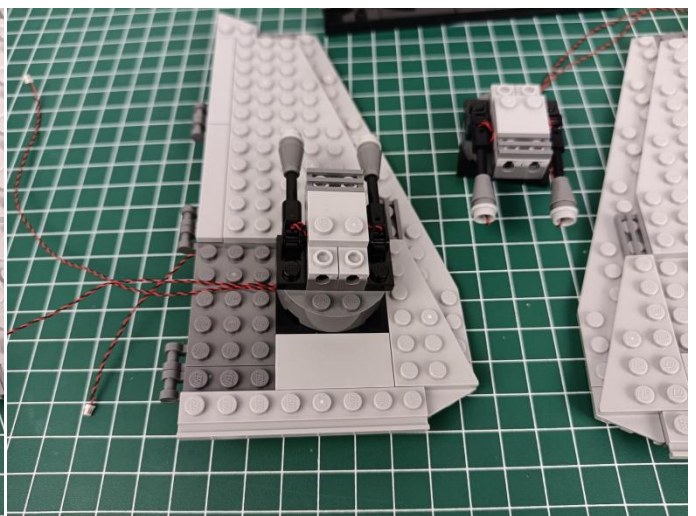
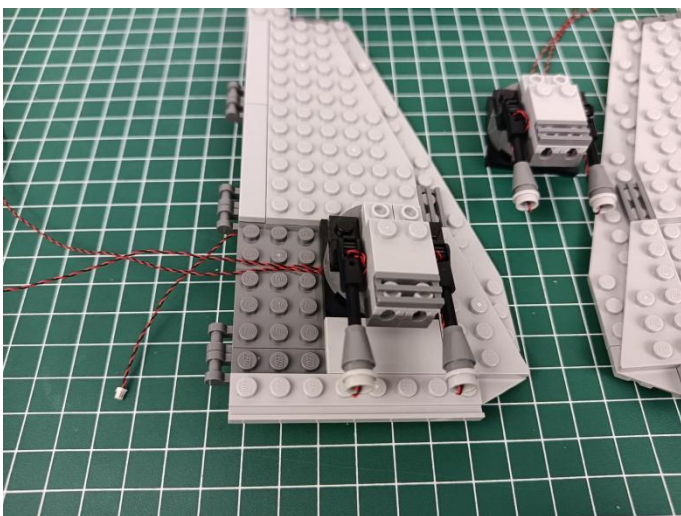

90

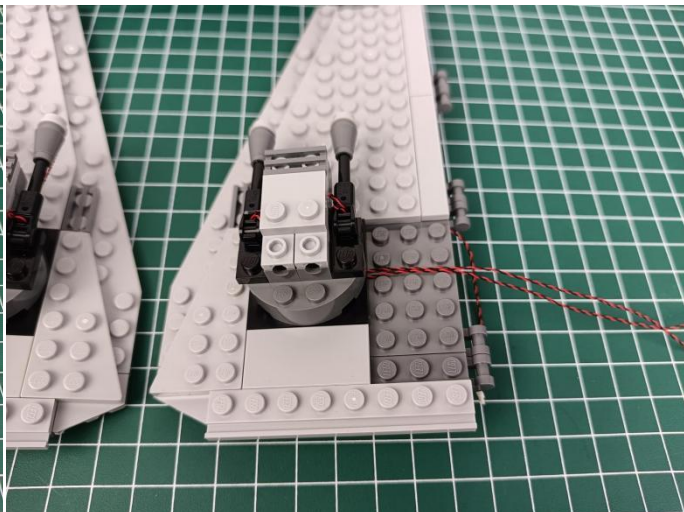
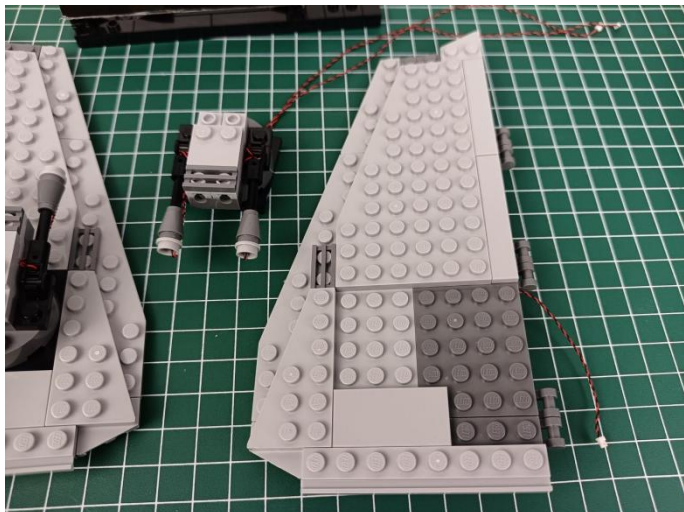

91

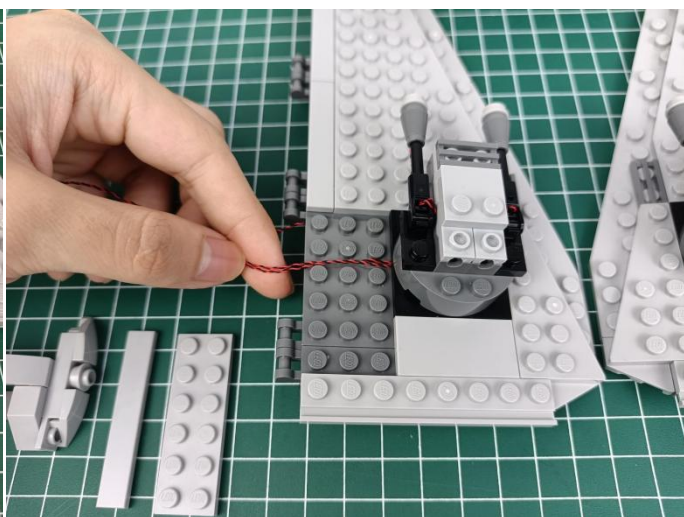
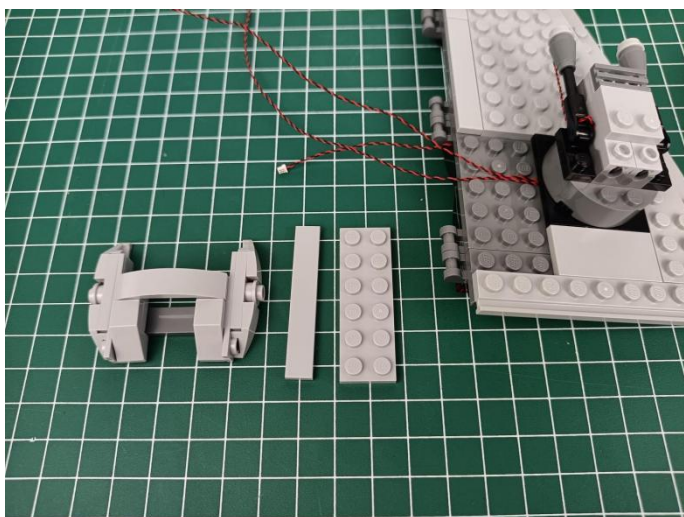

92

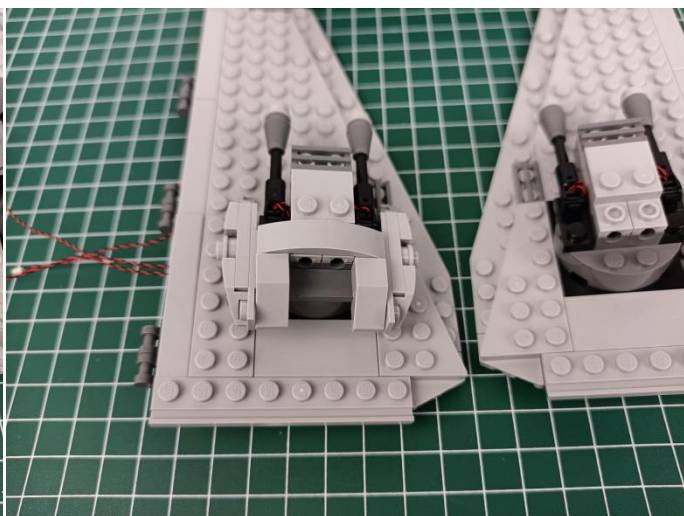
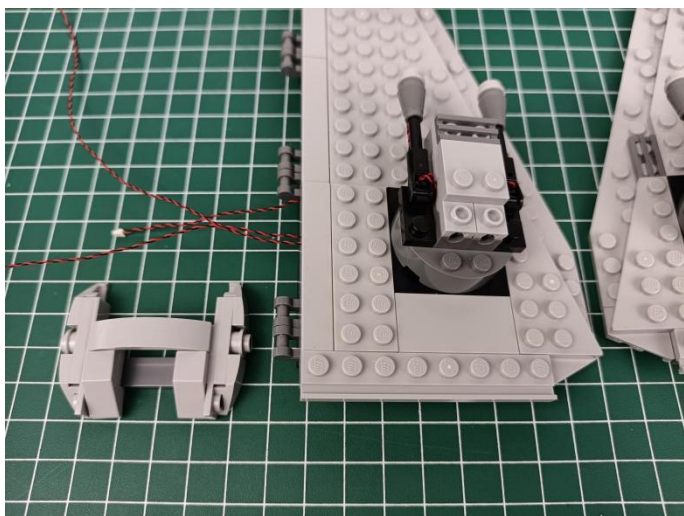

93

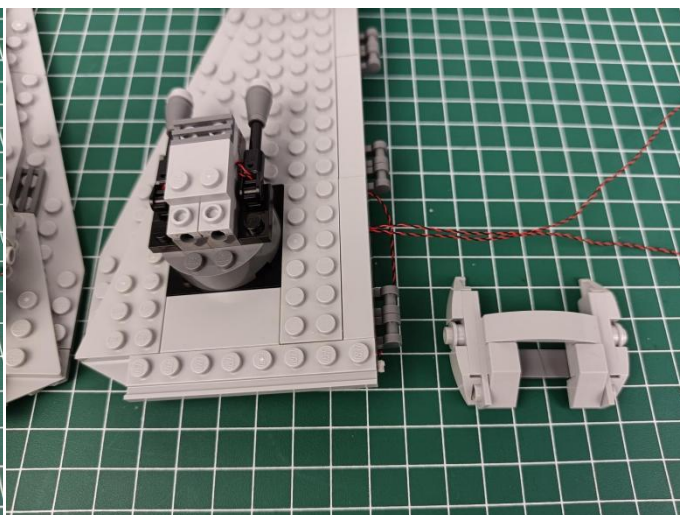
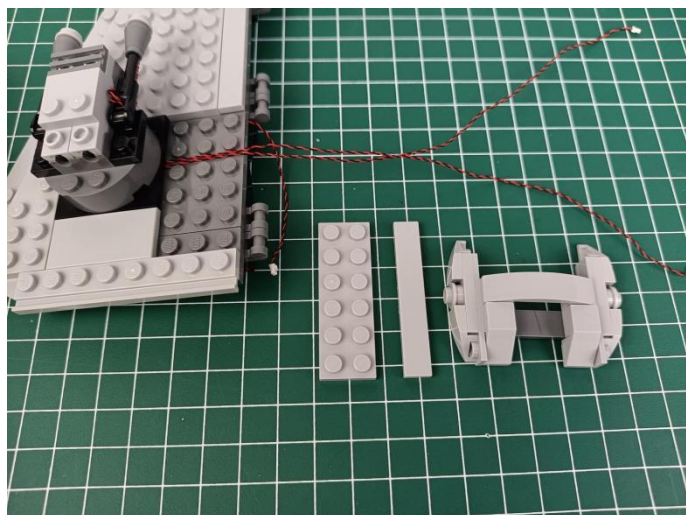

94

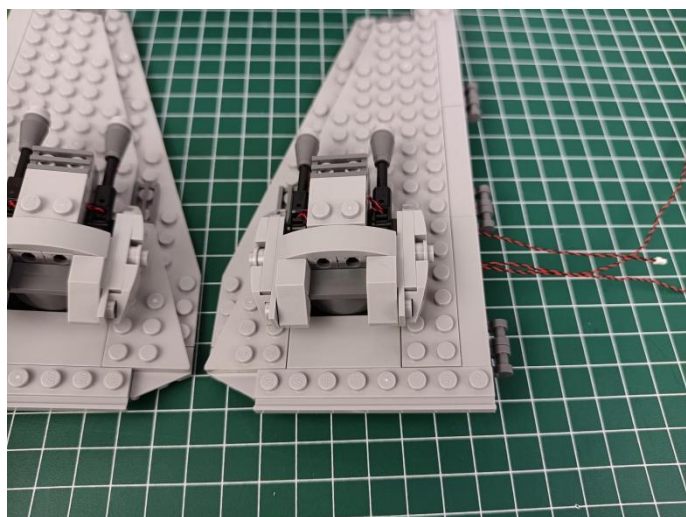

95



96

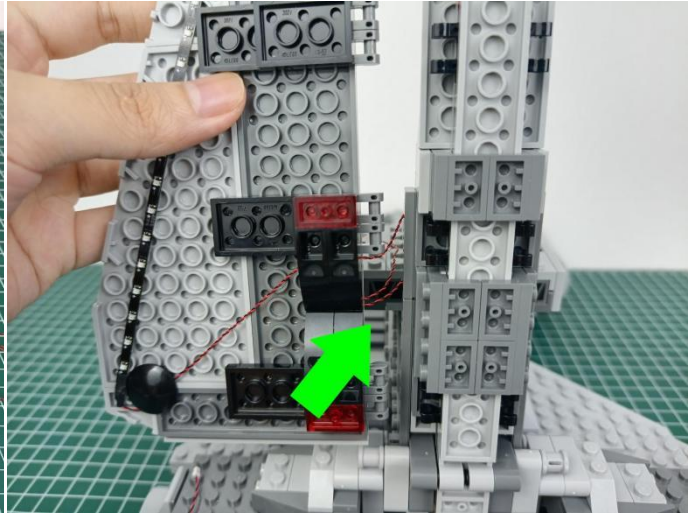
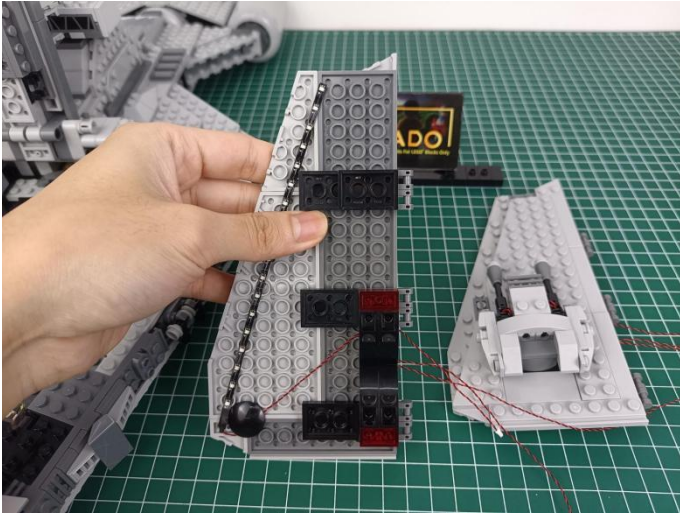

97

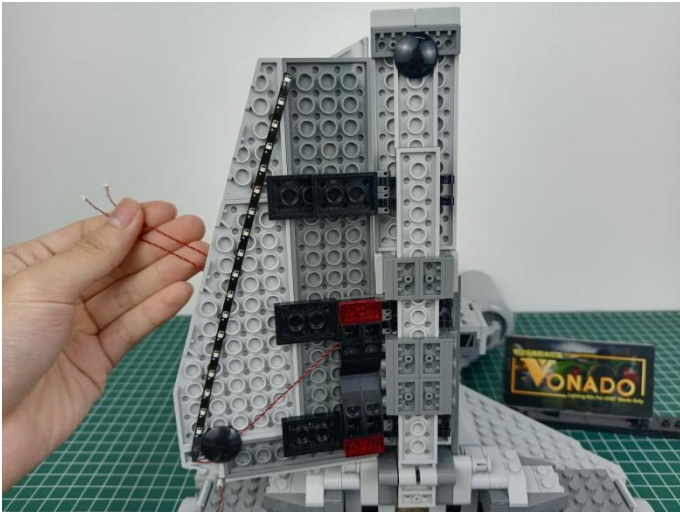

98

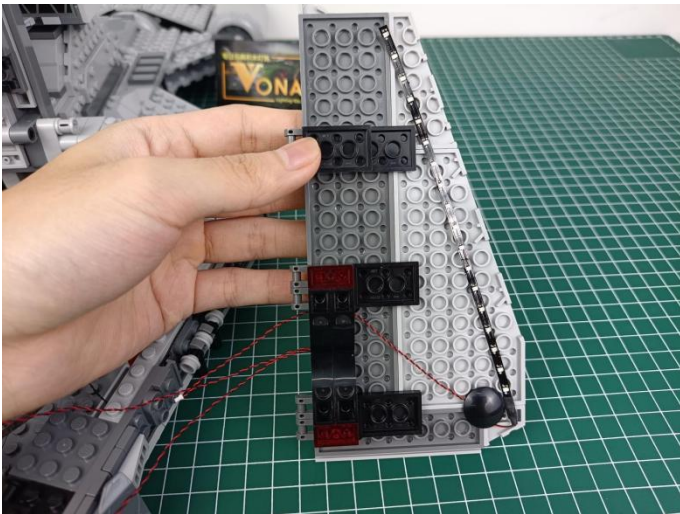

99

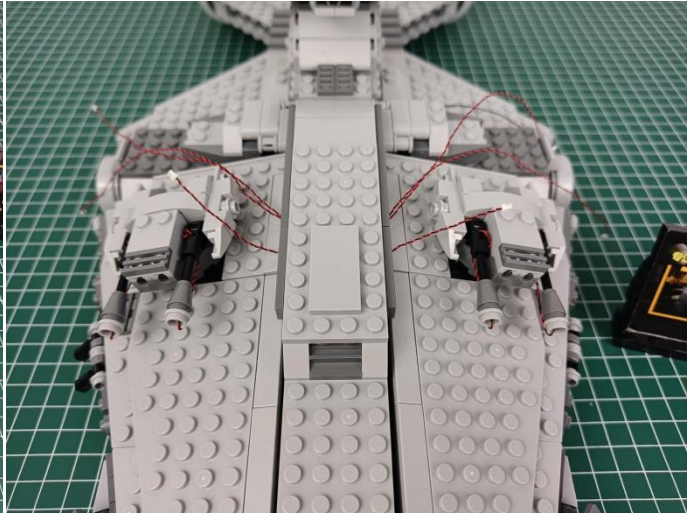

100

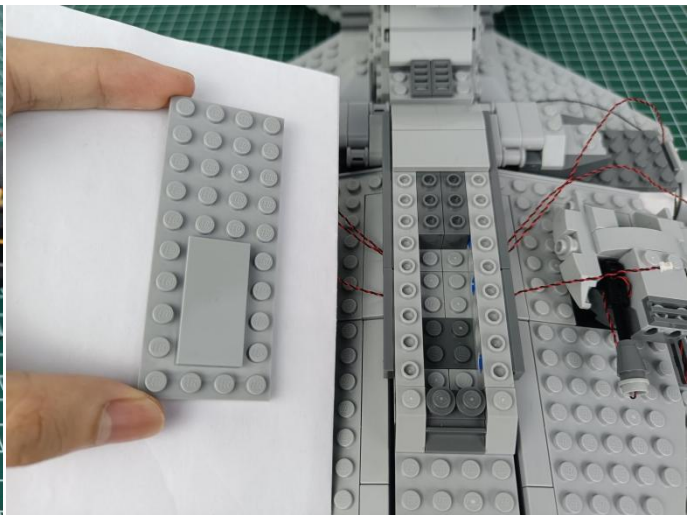
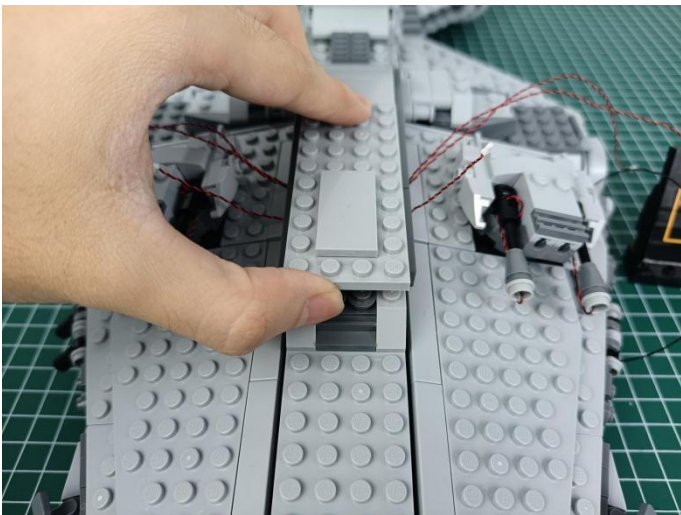

101

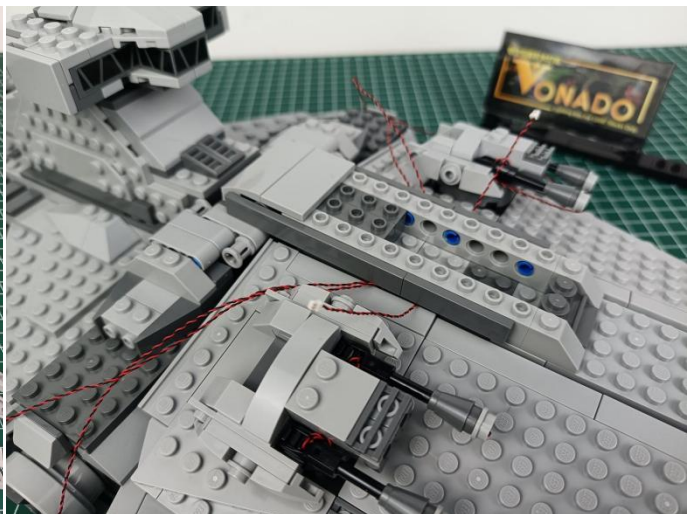

102

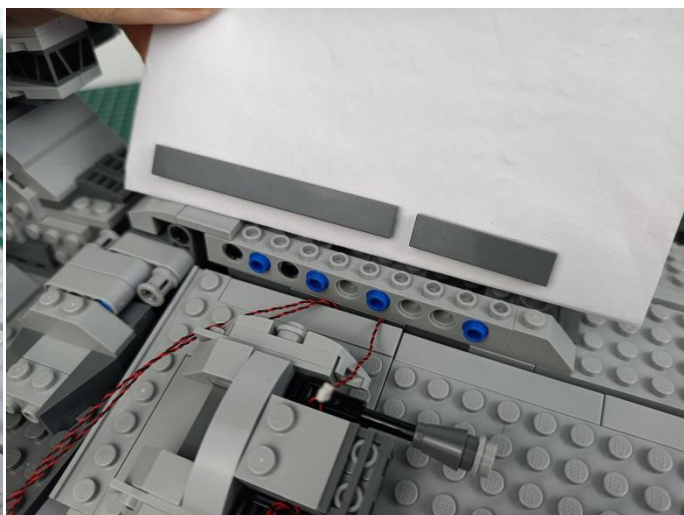
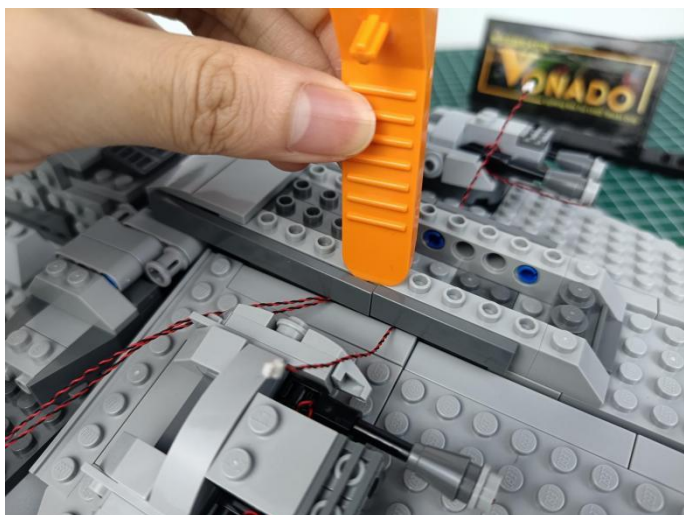

103

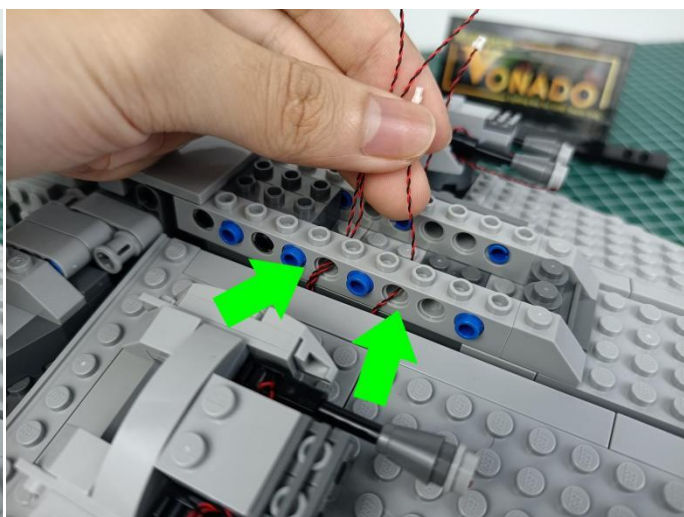
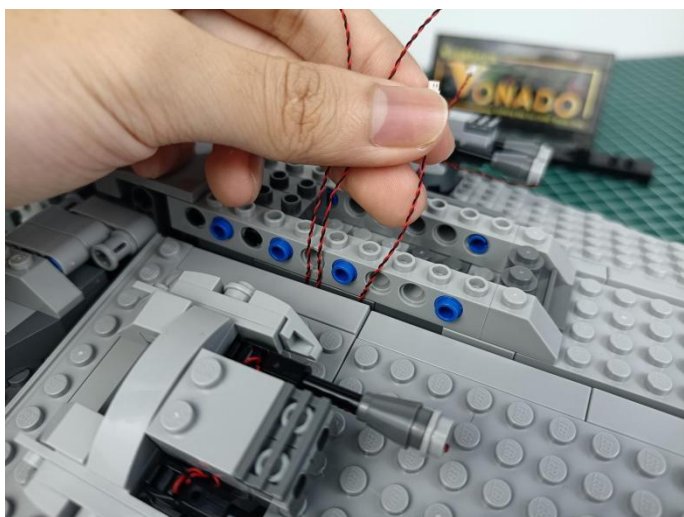

104

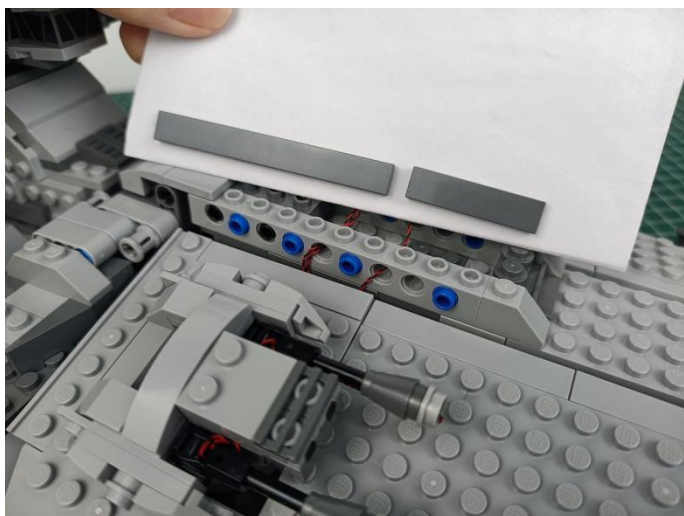

105

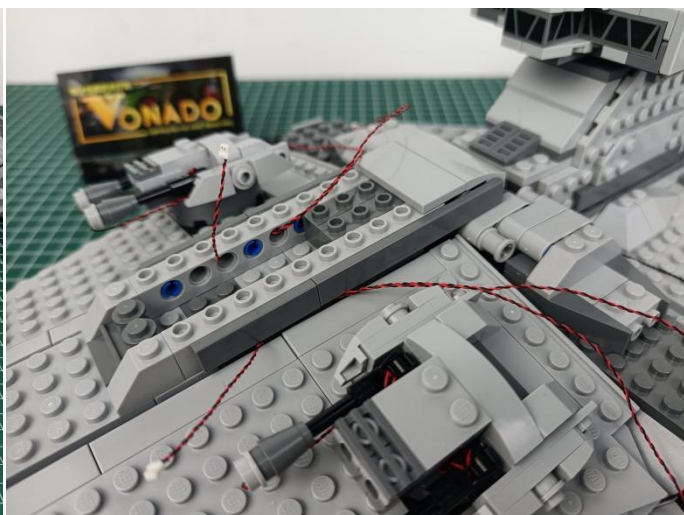

106

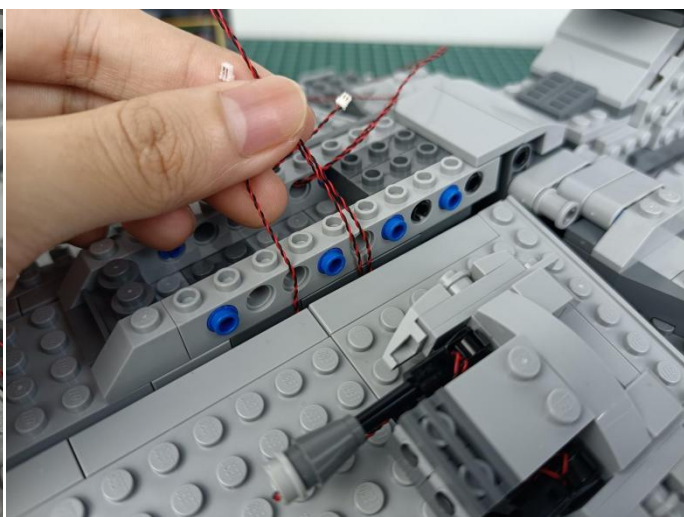
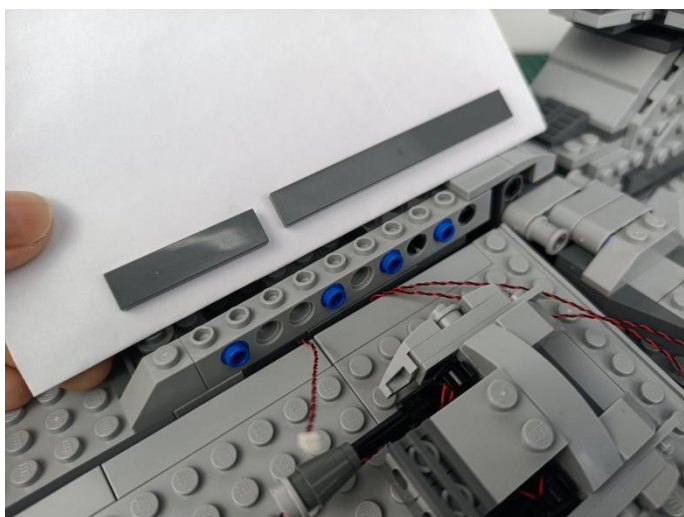

107

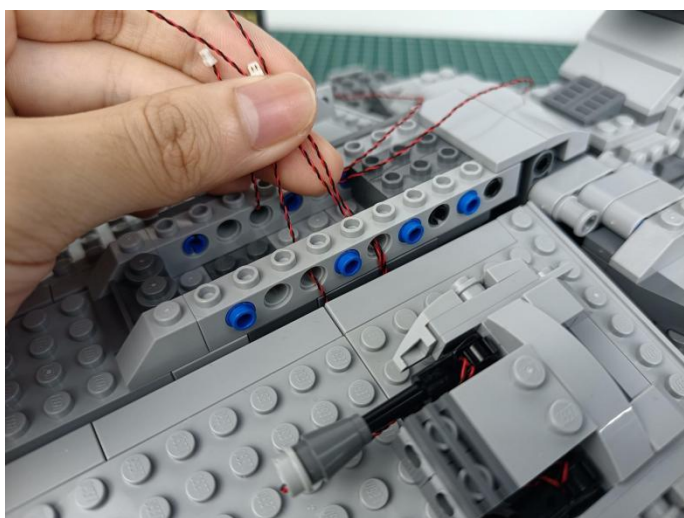

108

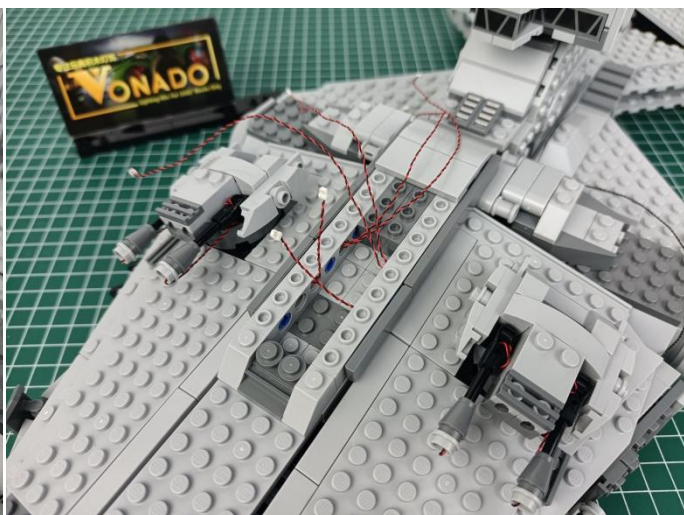

109

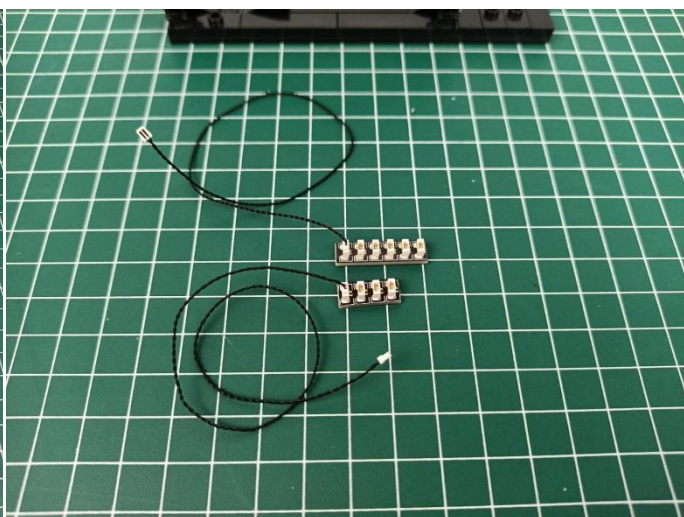

110

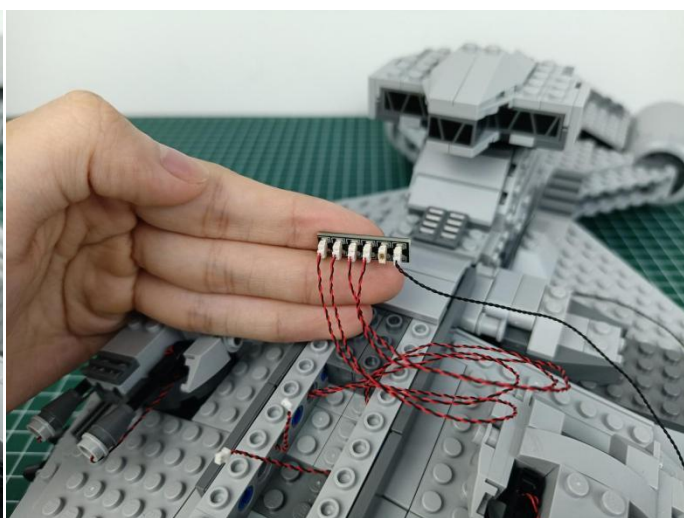
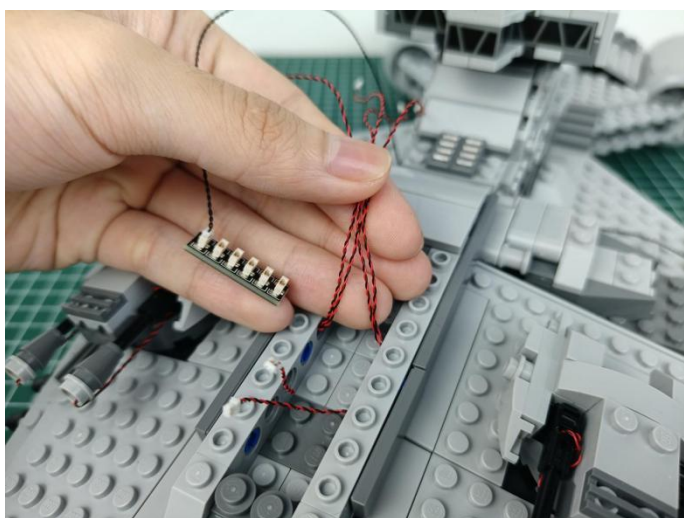

111

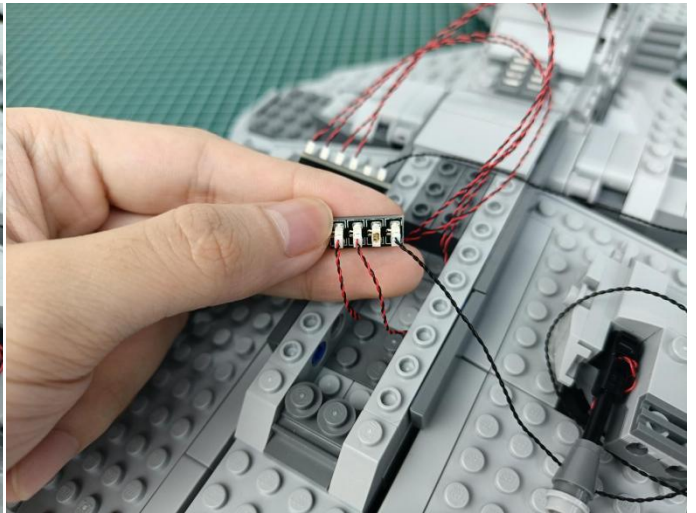
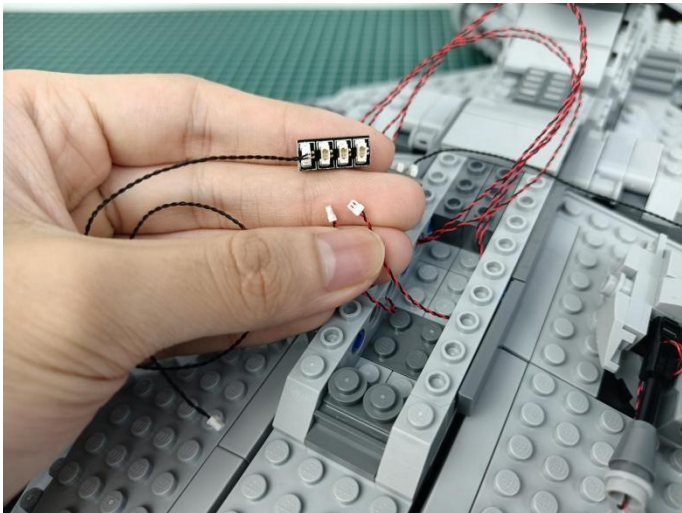

112

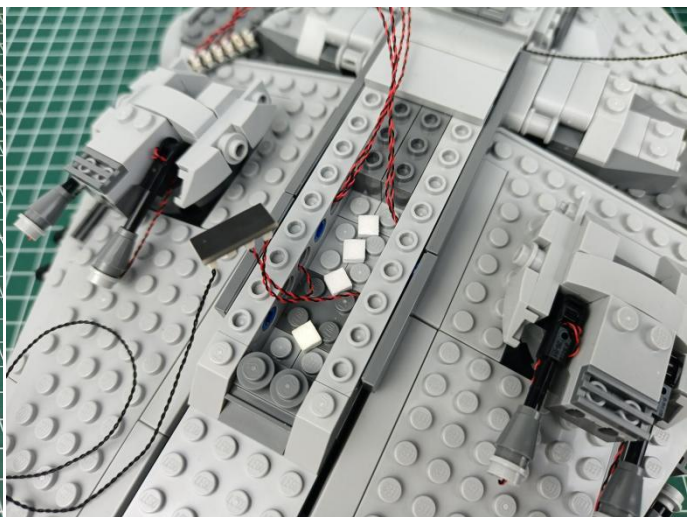

113

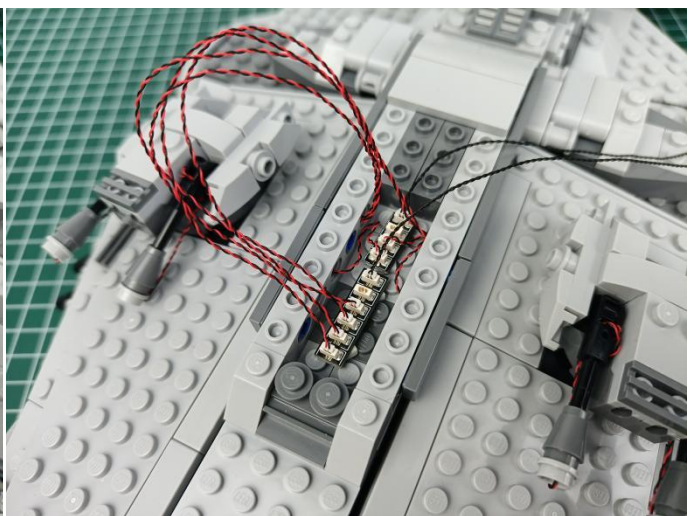
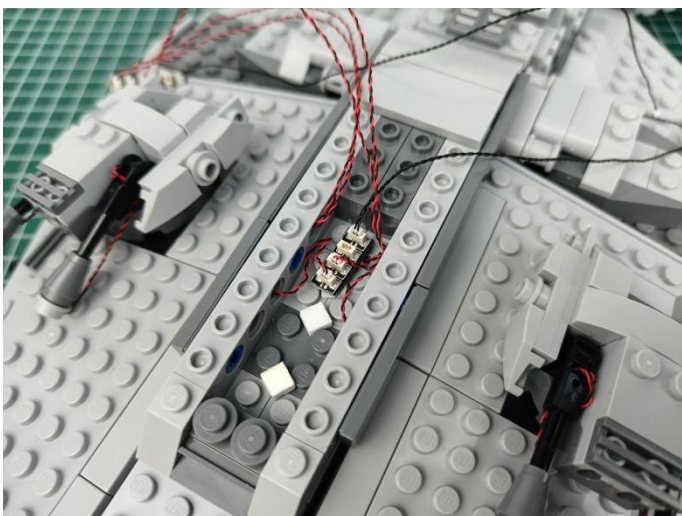

114

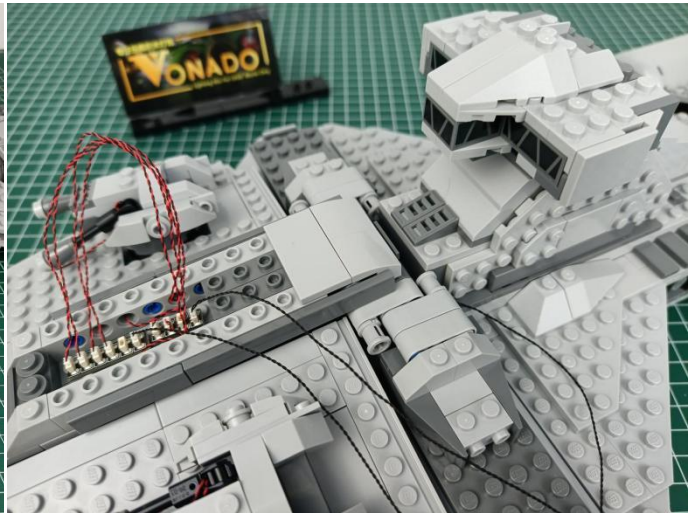

115

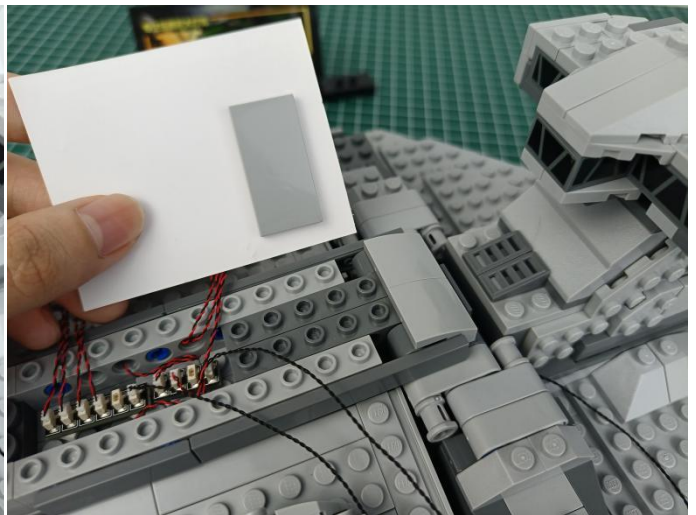

116

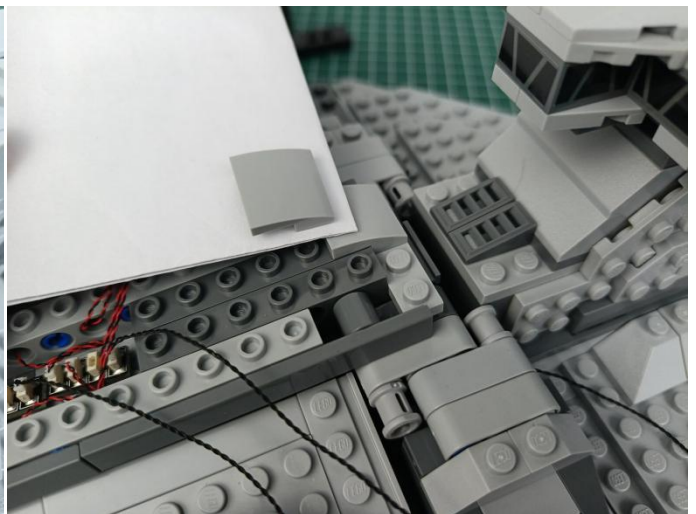

117

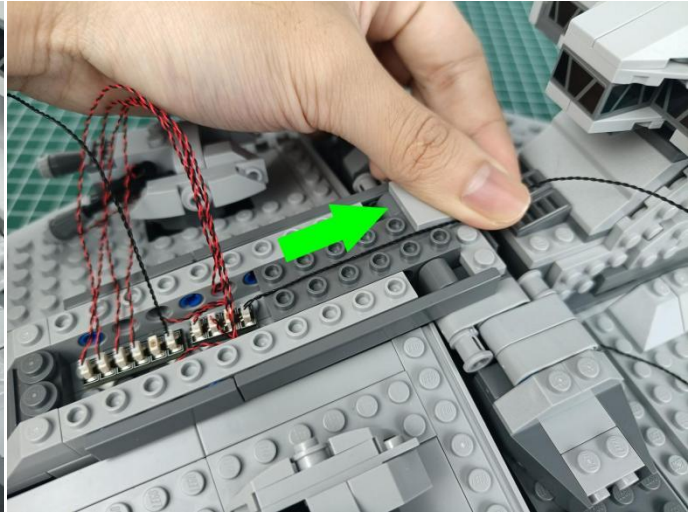
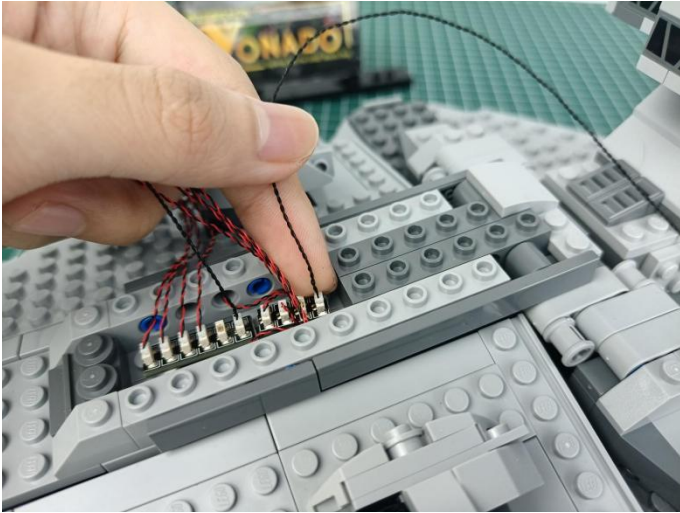

118

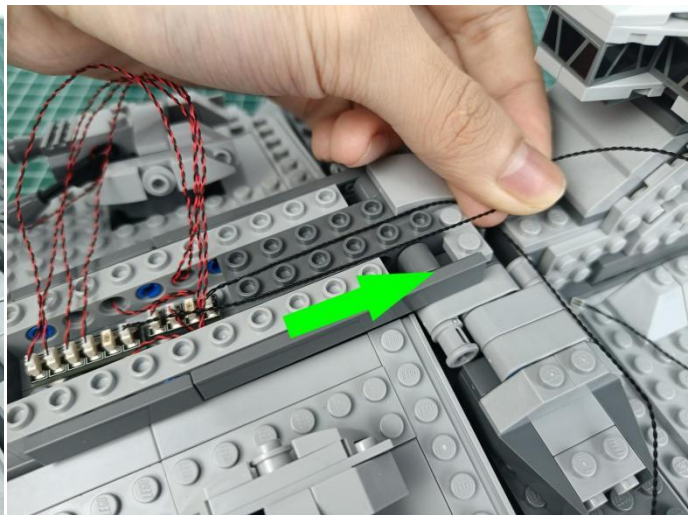
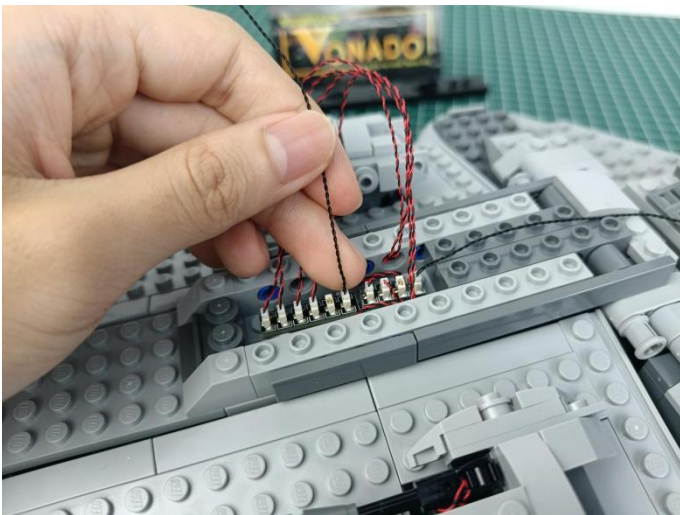

119

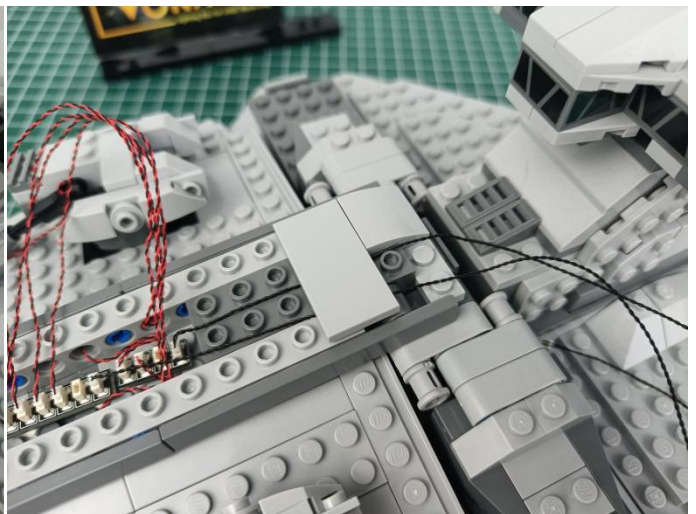
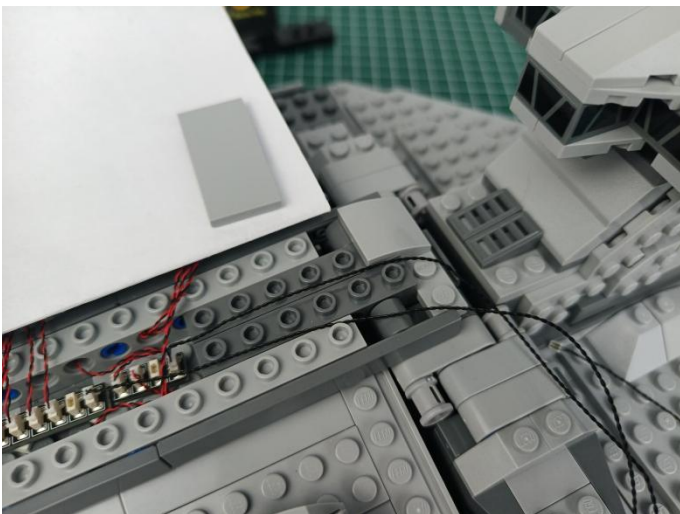

120



121

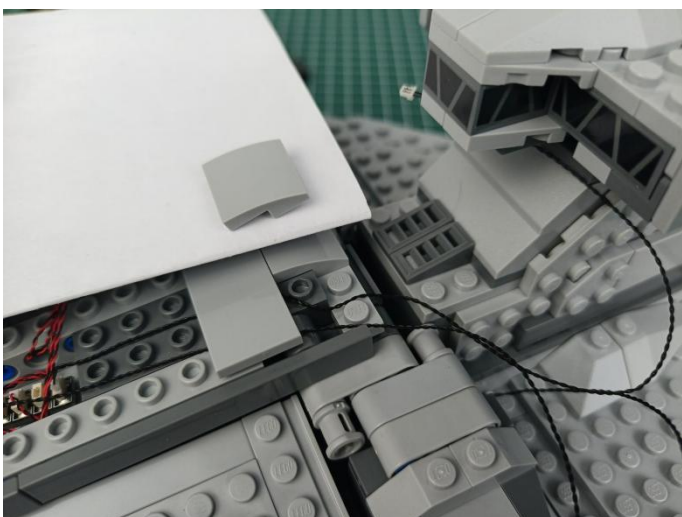

122

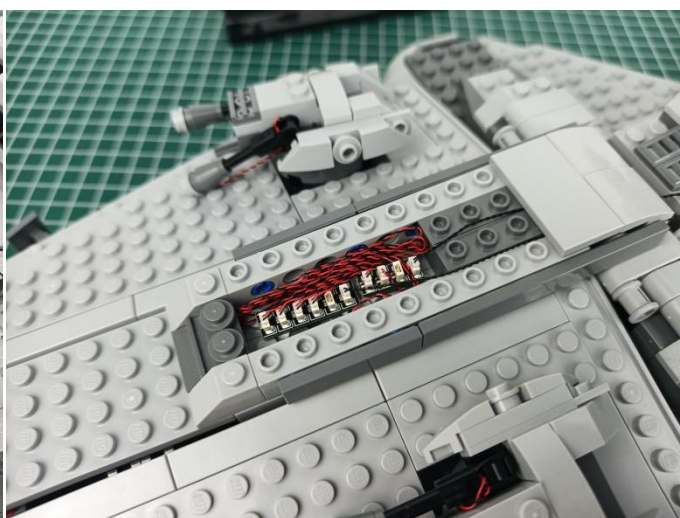
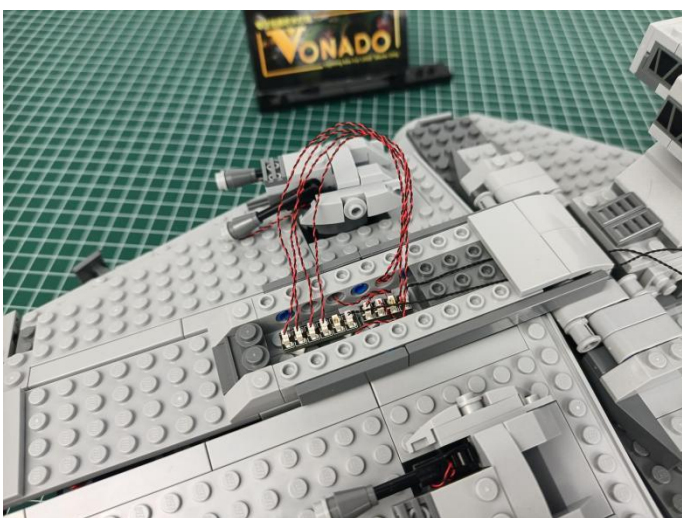

123

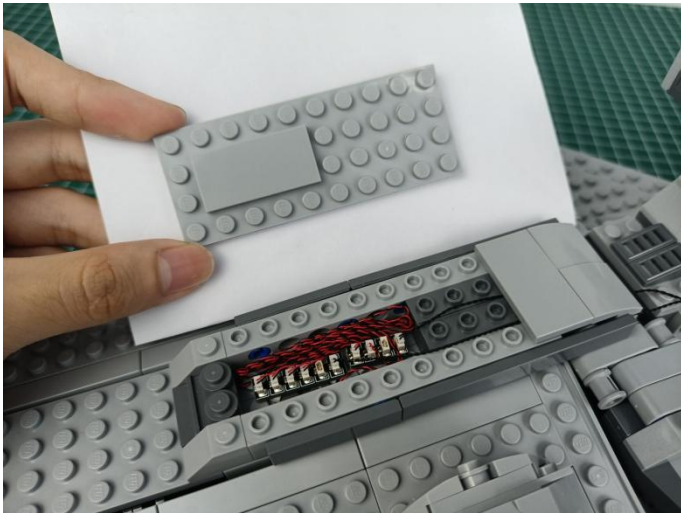

124



125



126



127

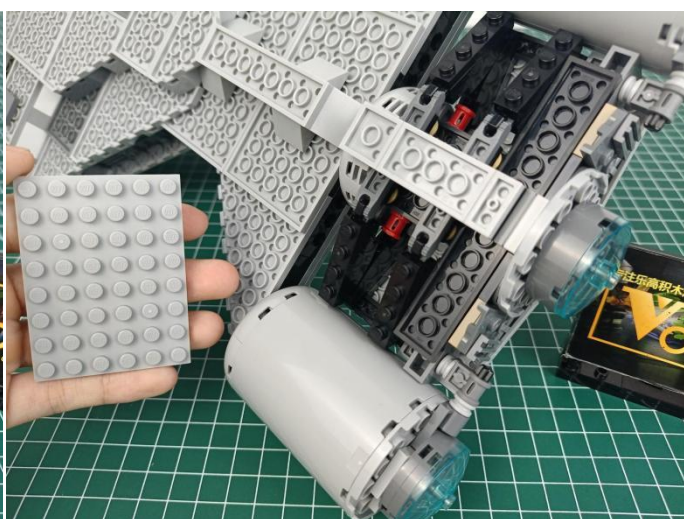

128

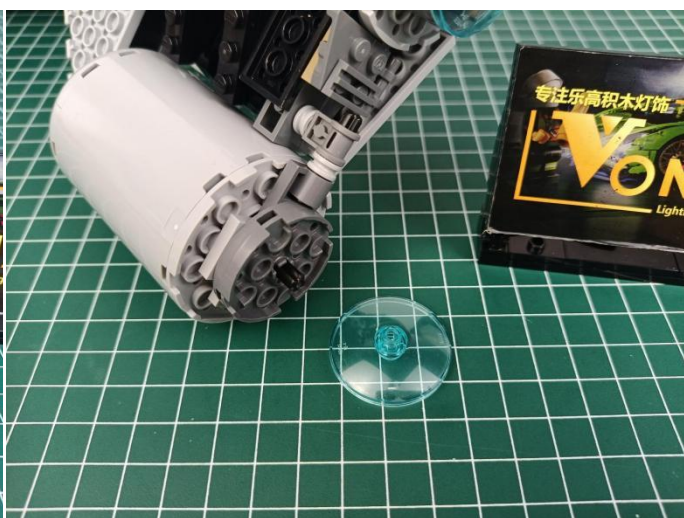

129

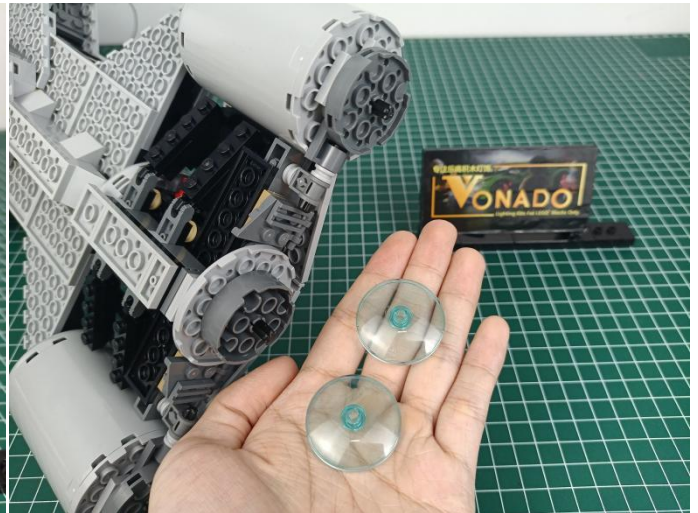
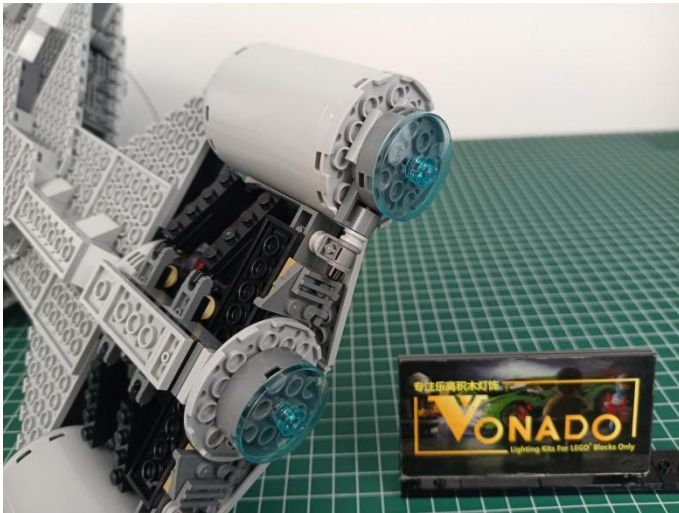

130



131

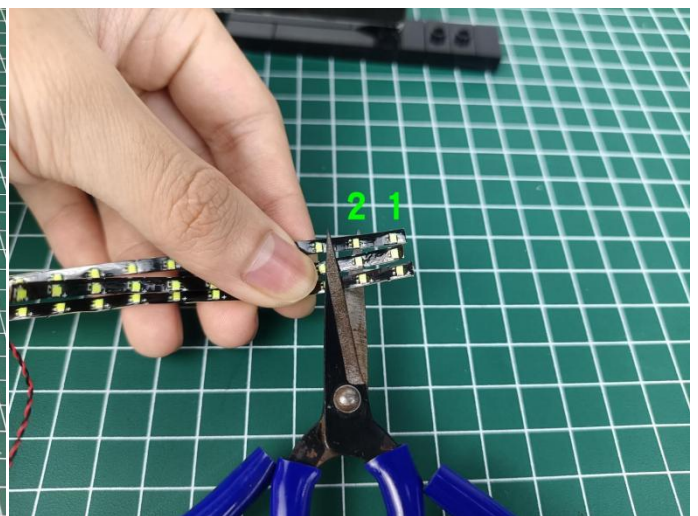

132

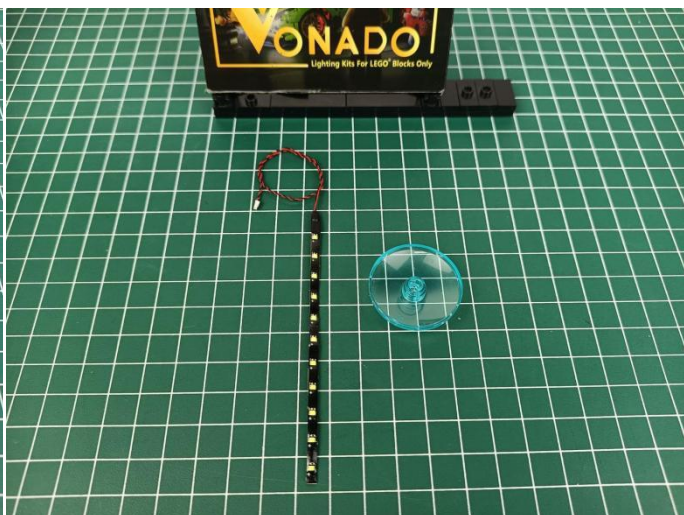

133



134



135

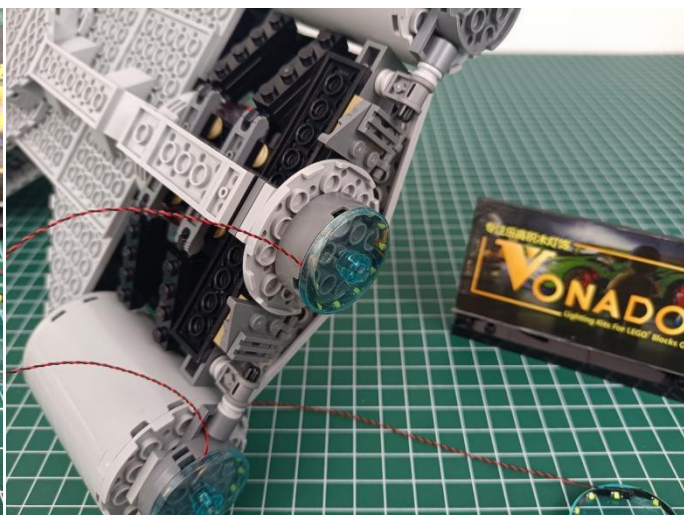
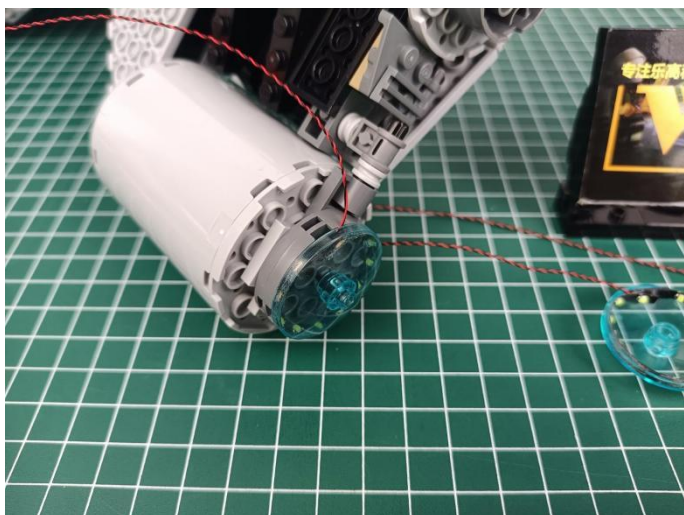

136

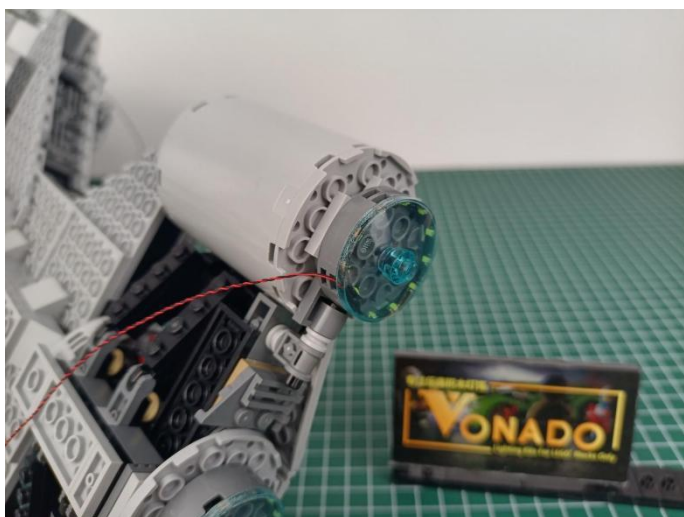

137

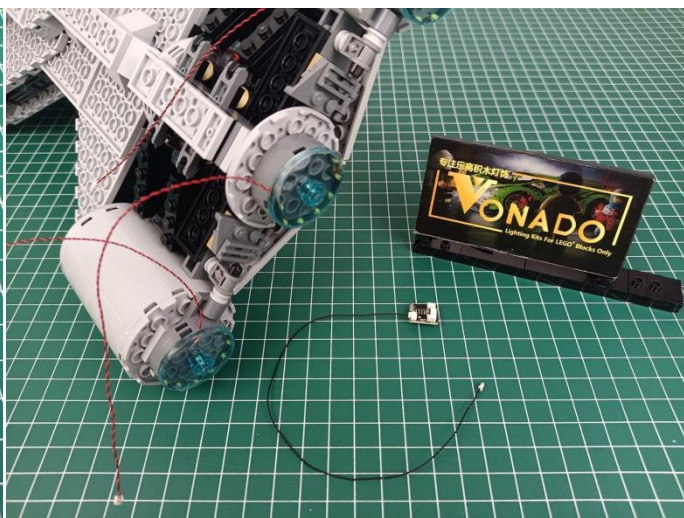

138

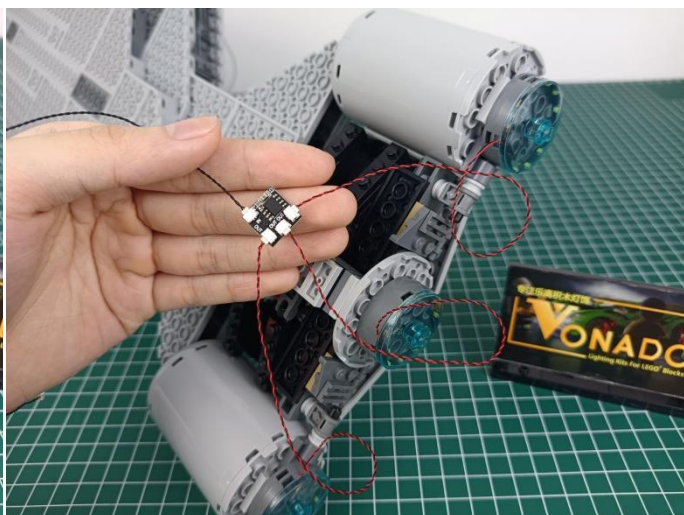
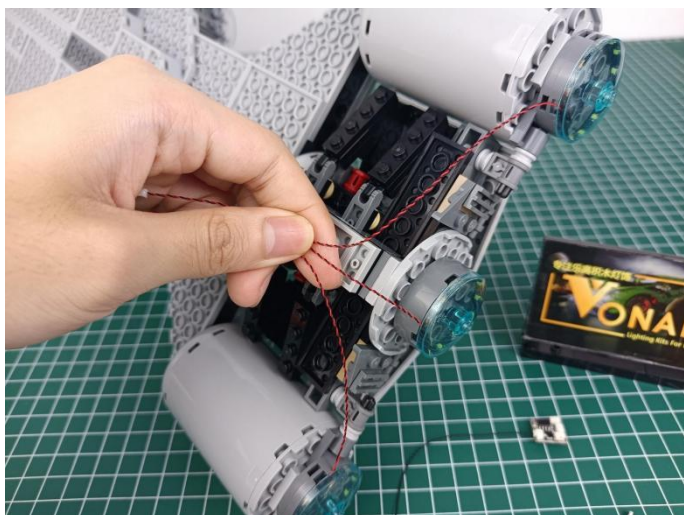

139

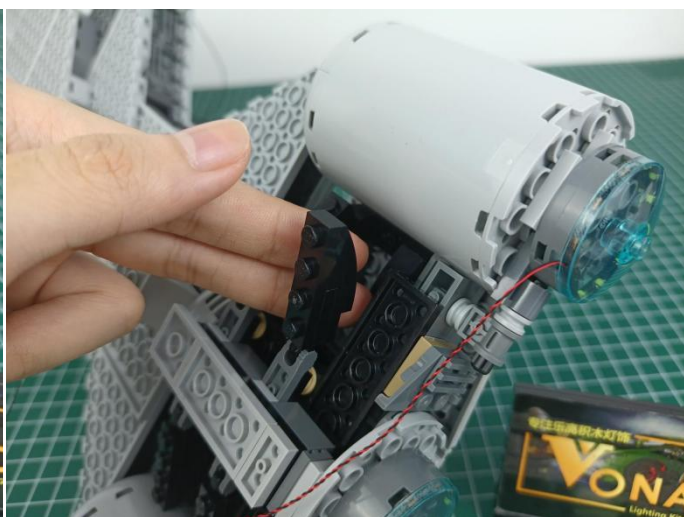
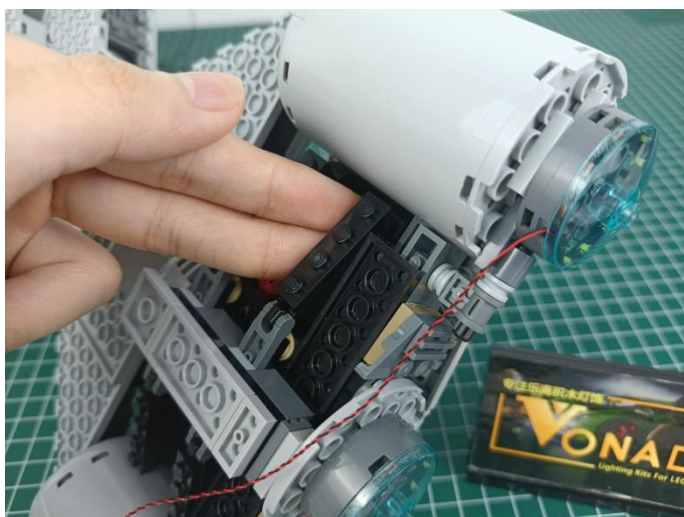

140

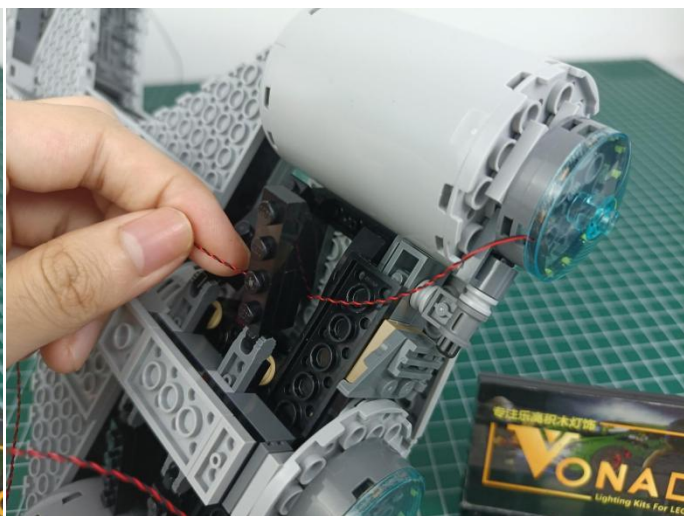
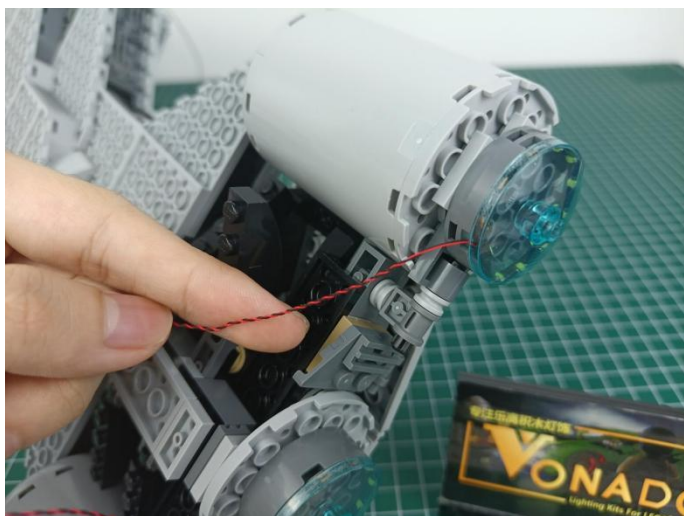

141

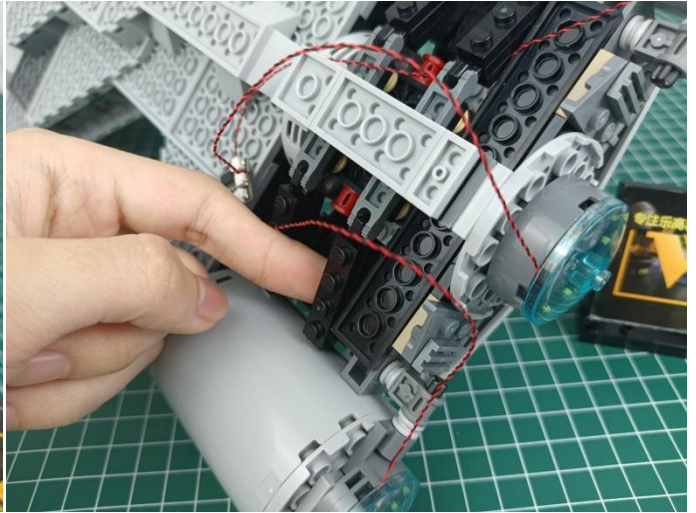
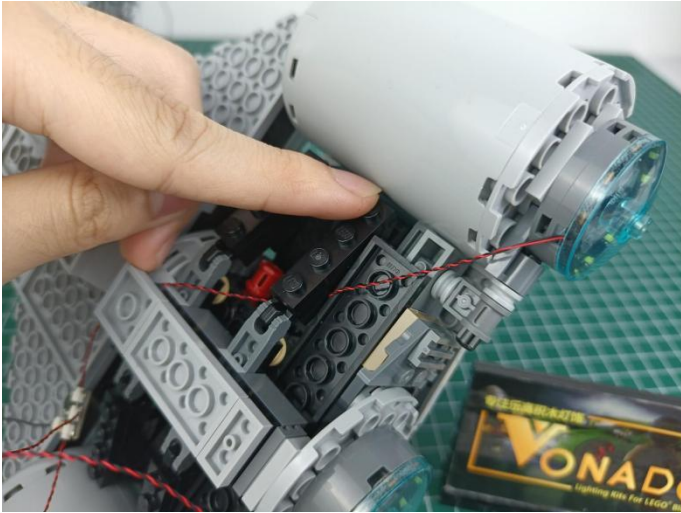

142

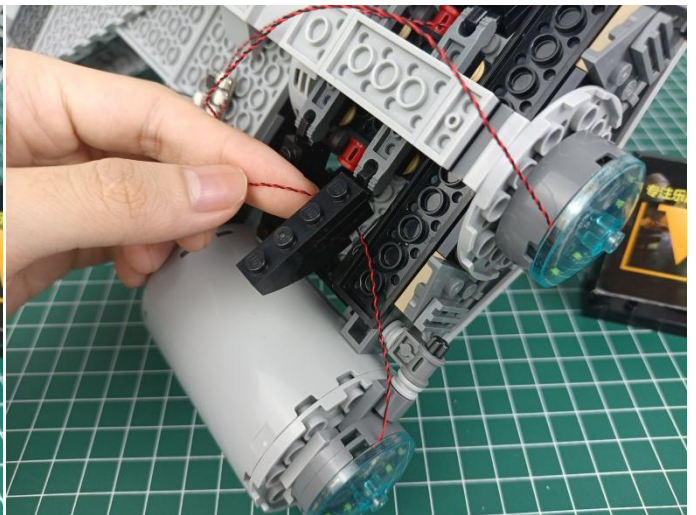
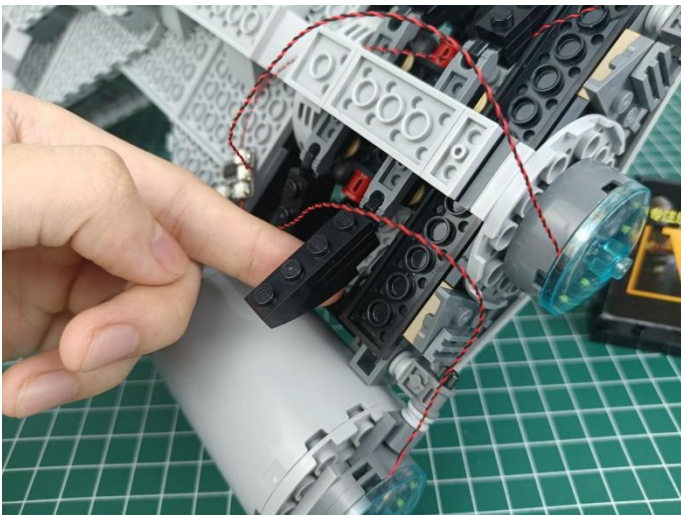

143

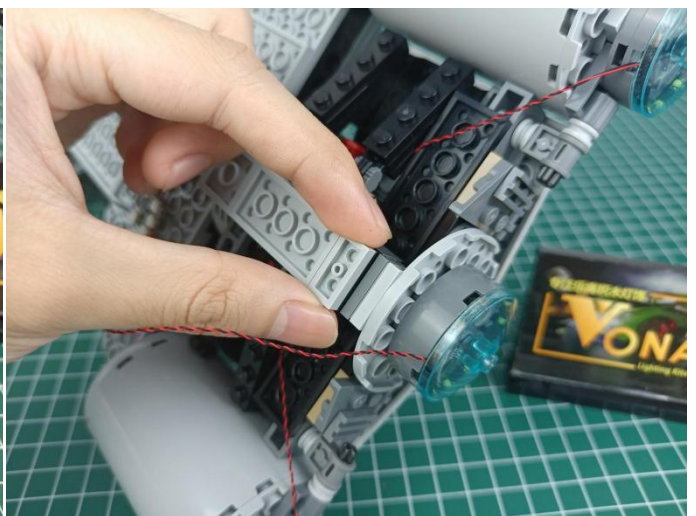
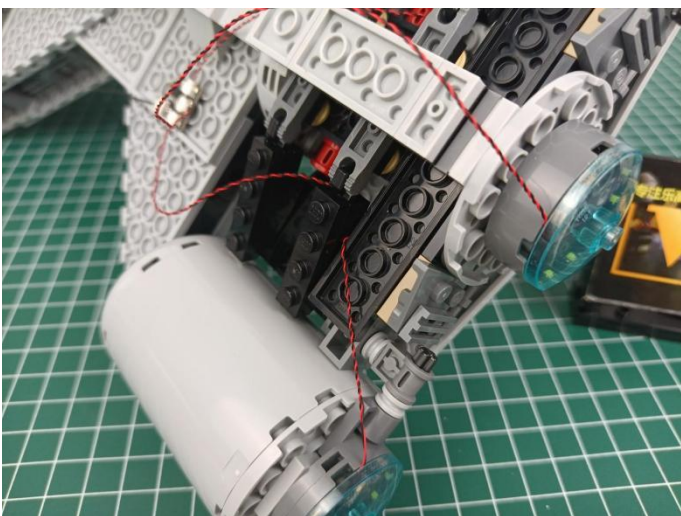

144

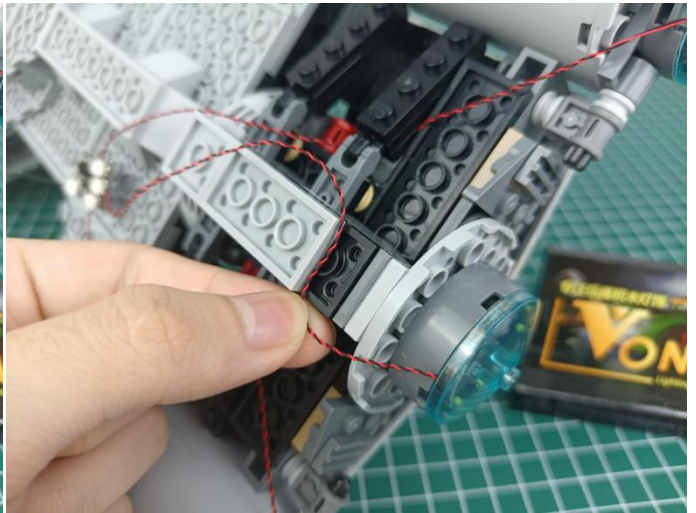
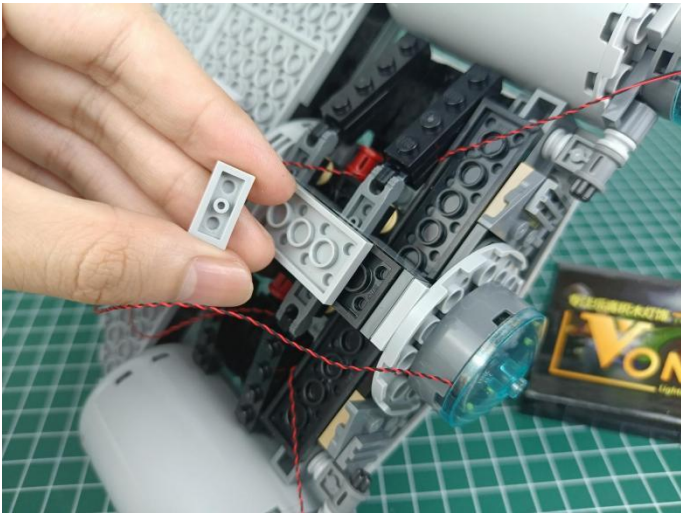

145

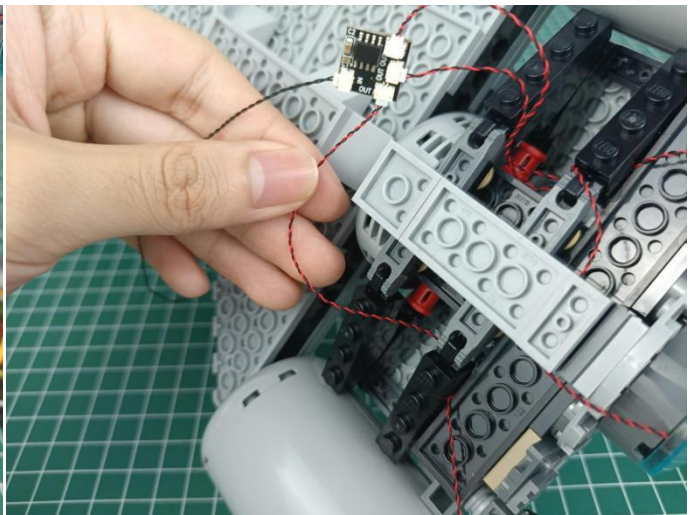
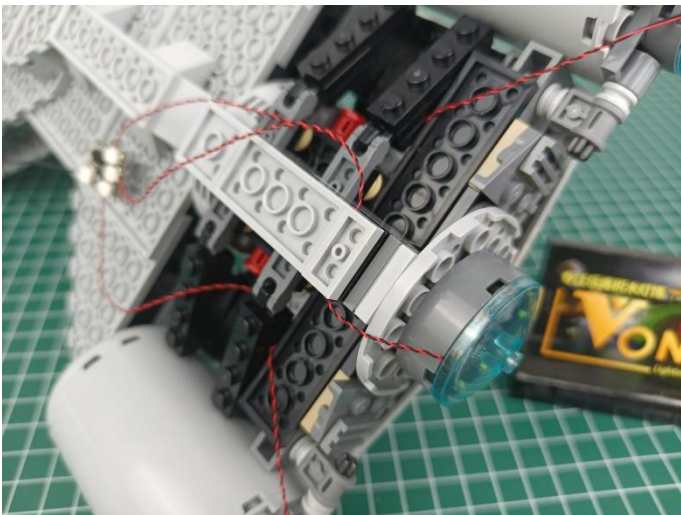

146

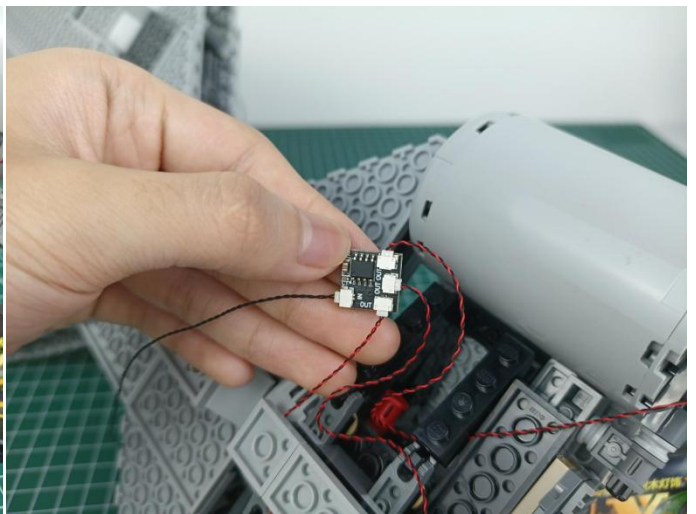
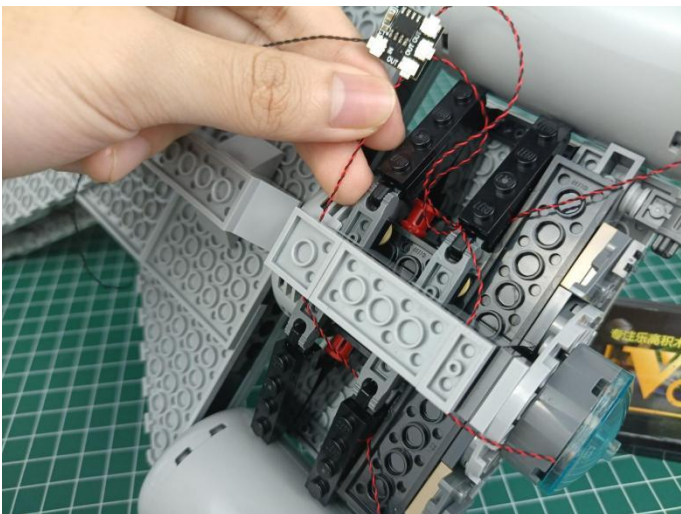

147

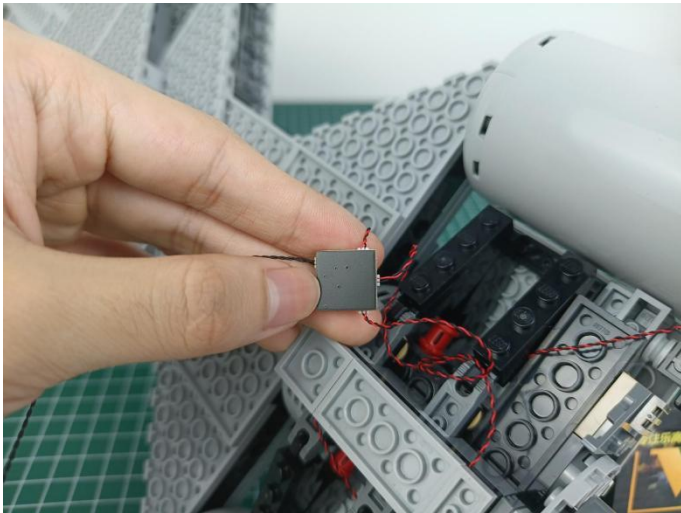

148

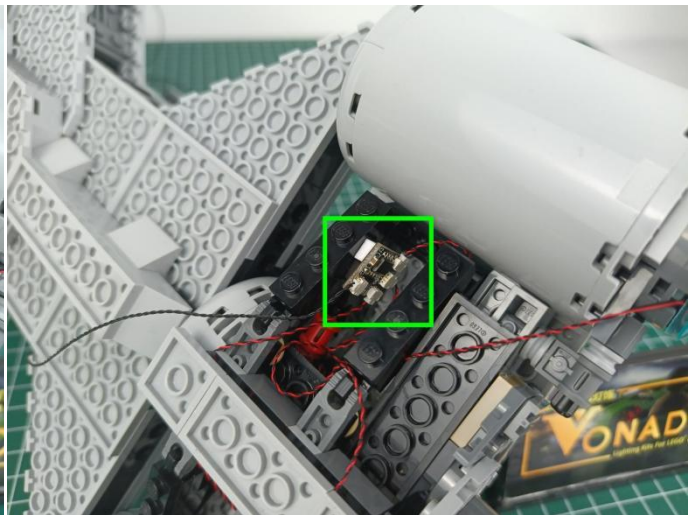
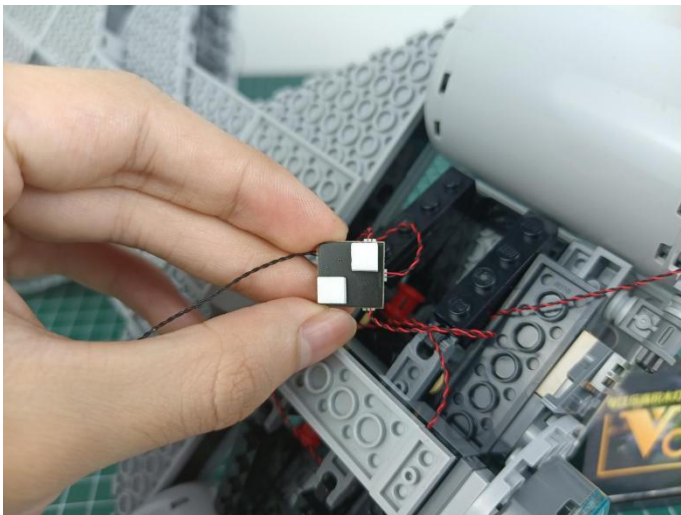

149

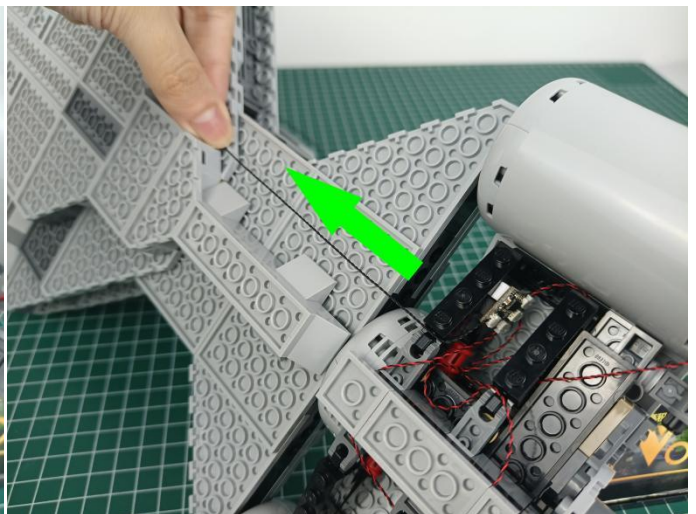
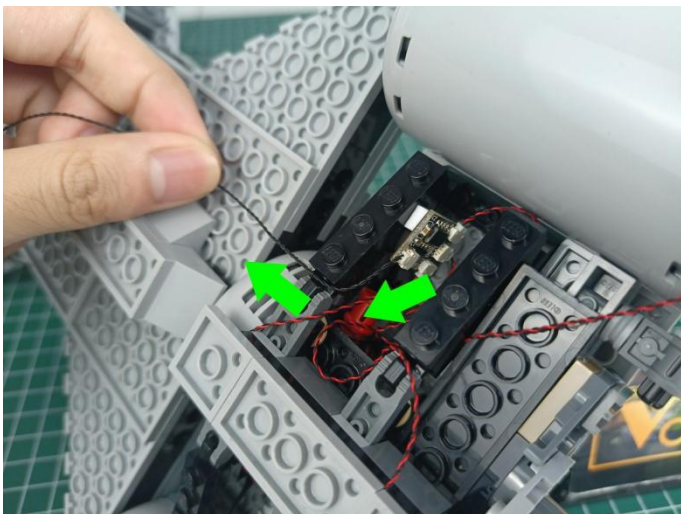

150

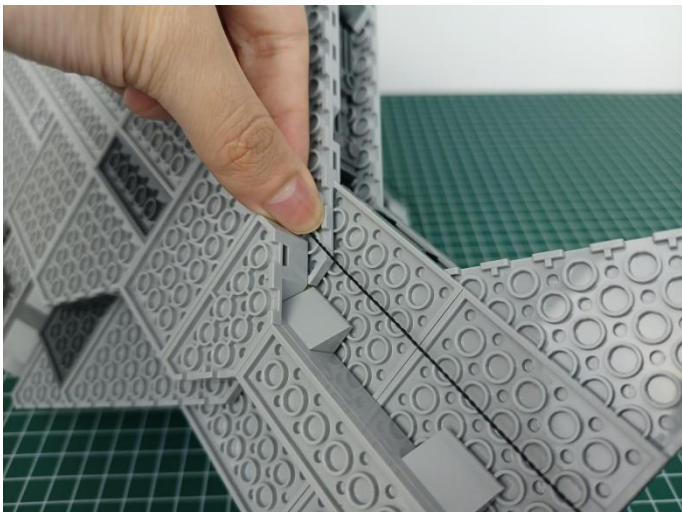

151

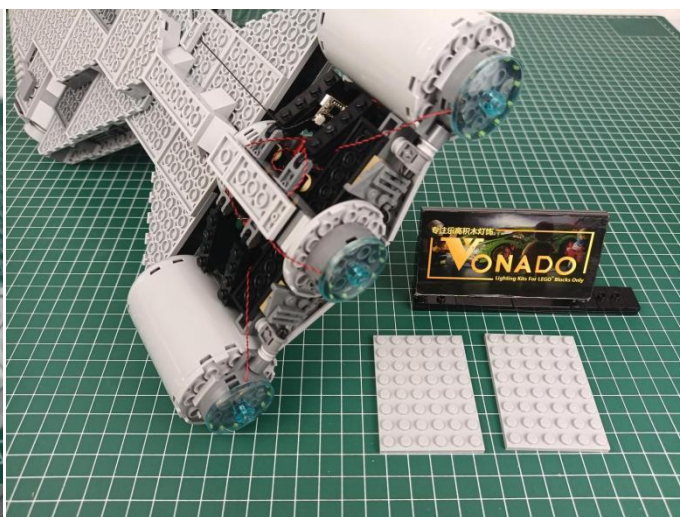

152

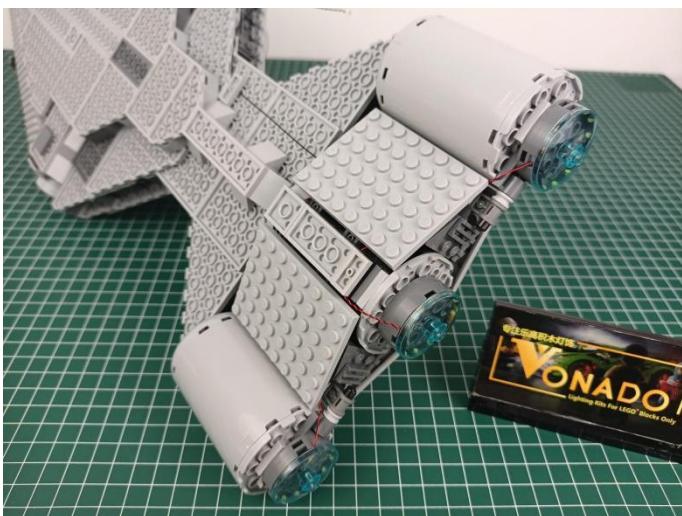

153

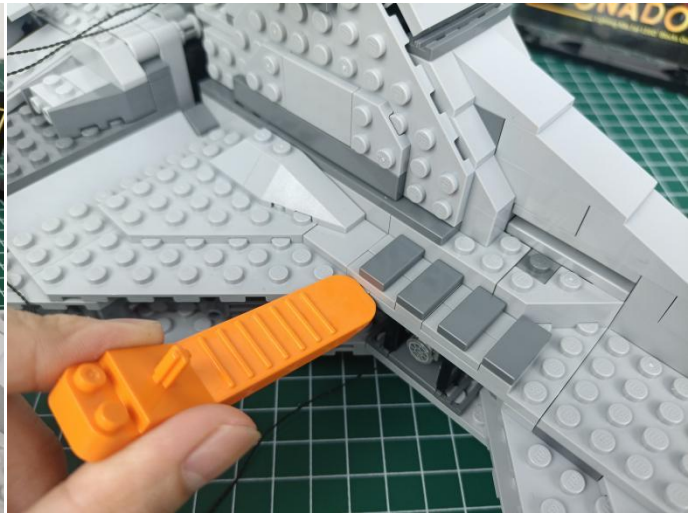

154

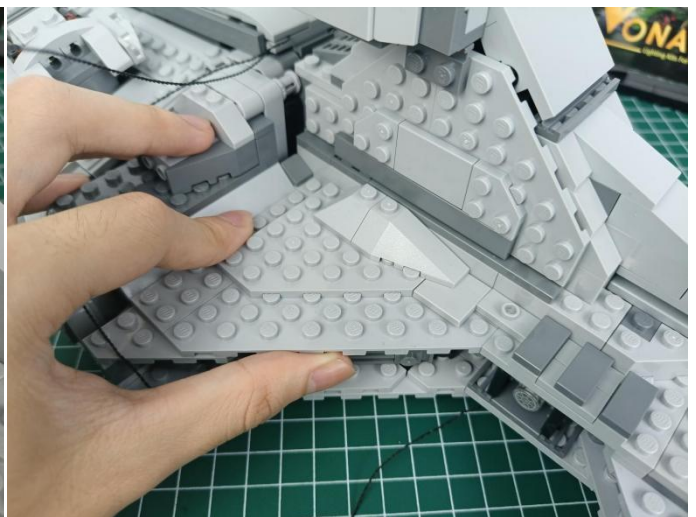
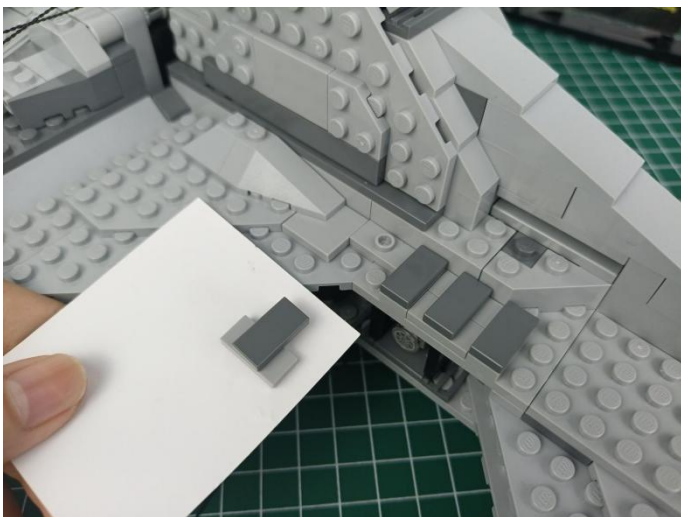

155

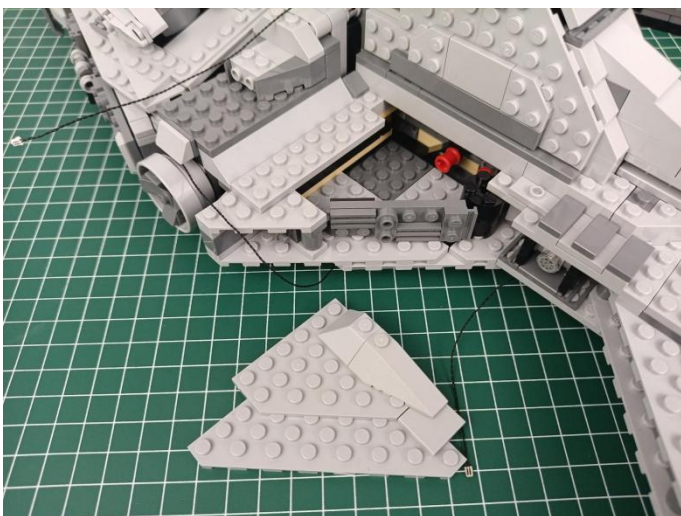

156

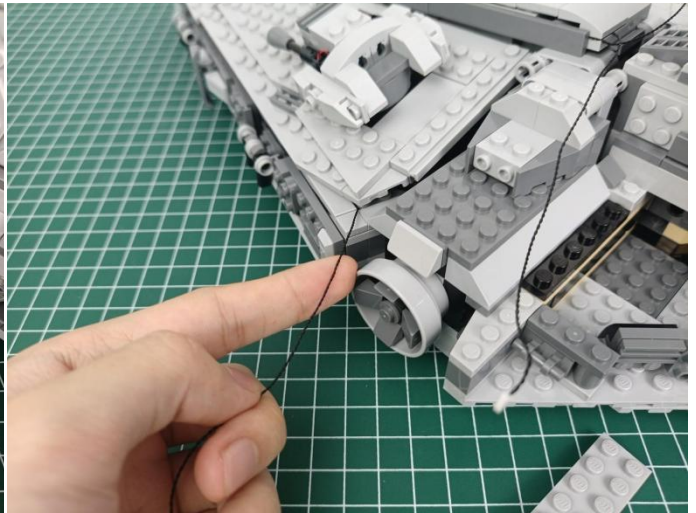

157

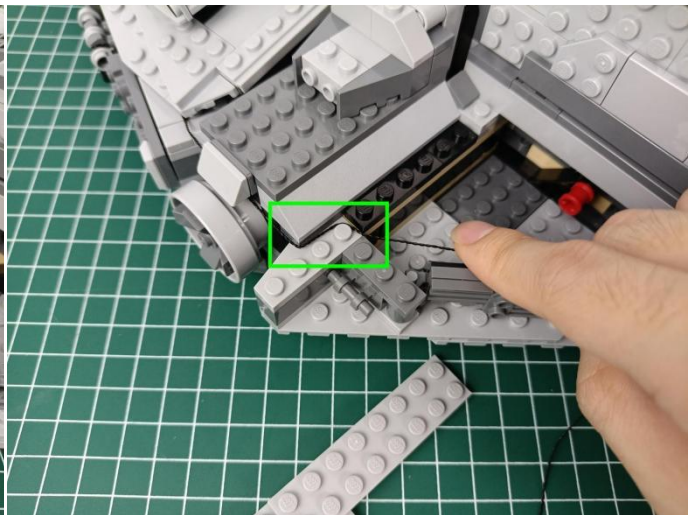

158

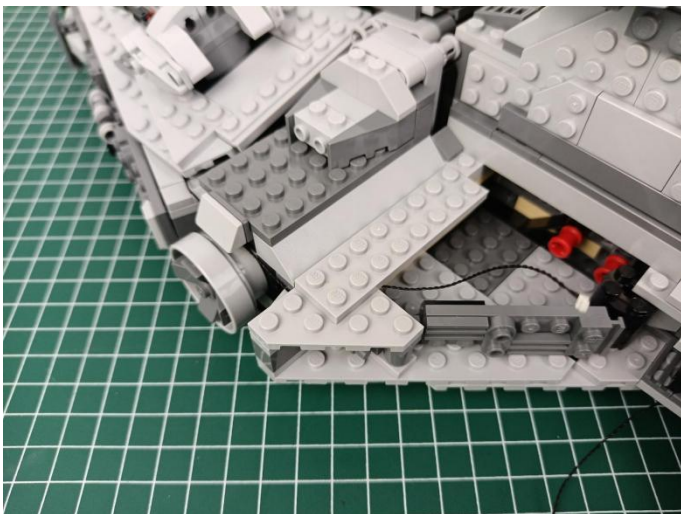

159



160



161

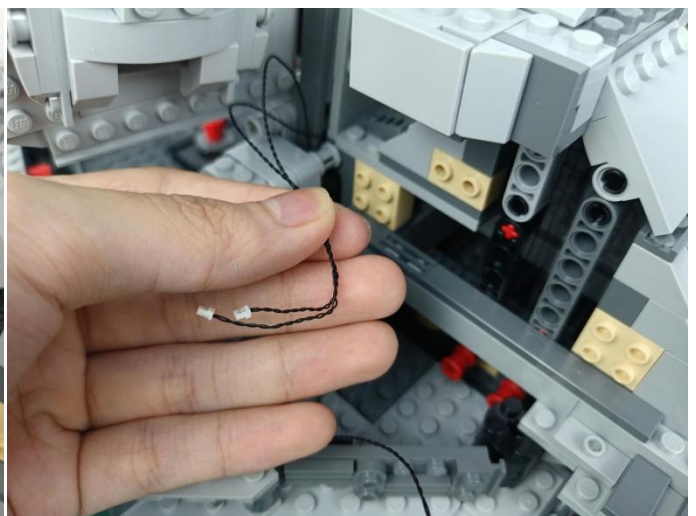
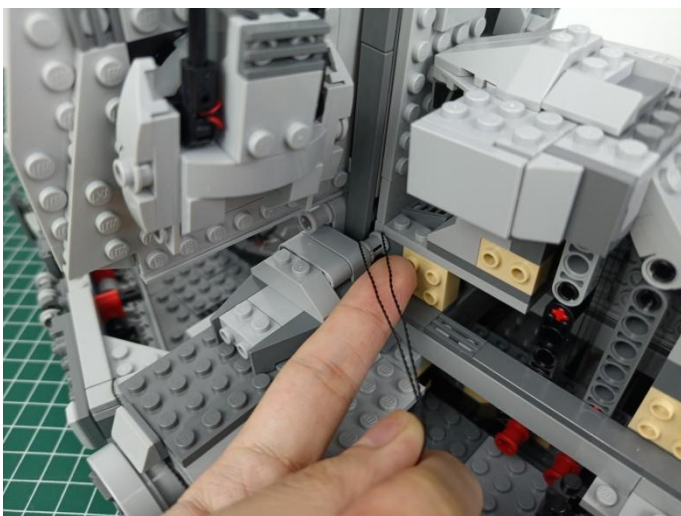

162

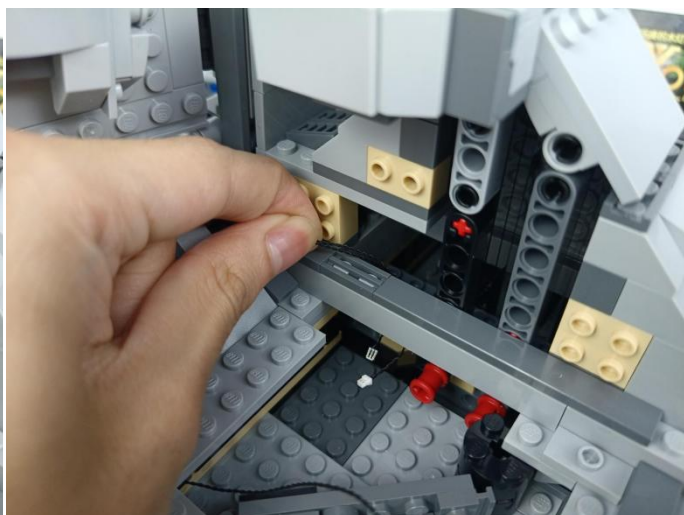

163



164



165

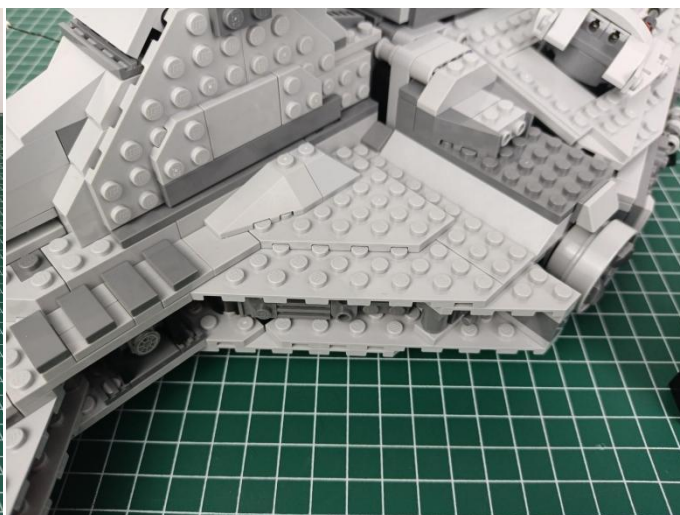

166

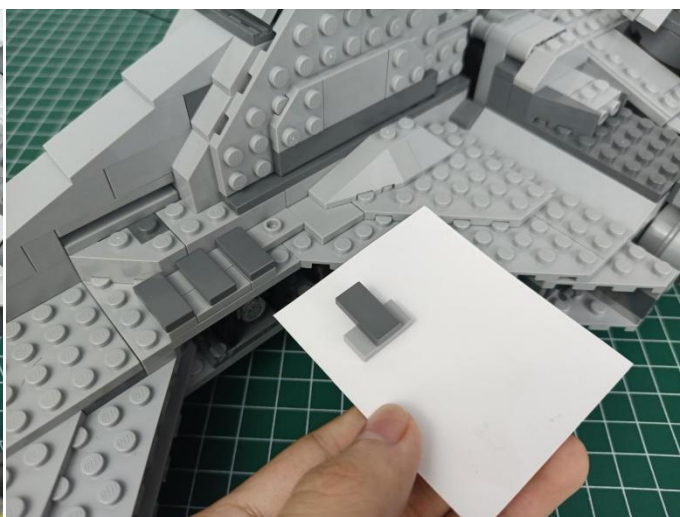
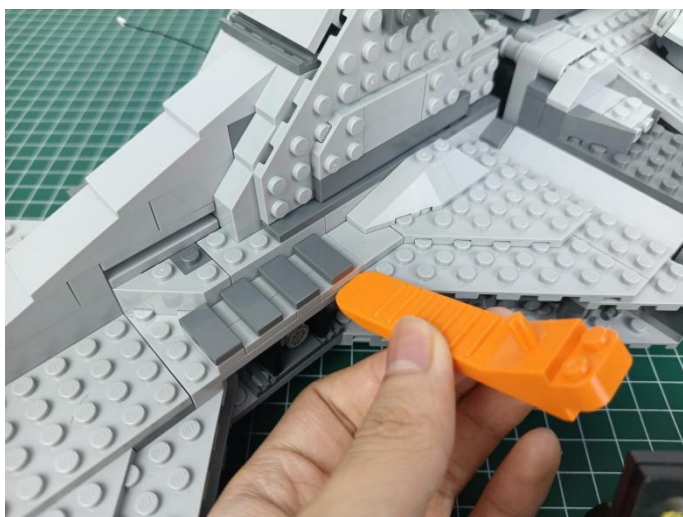

167

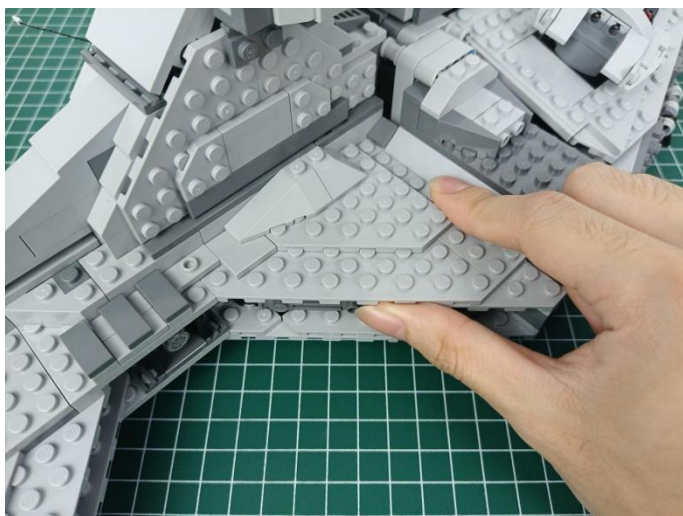

168

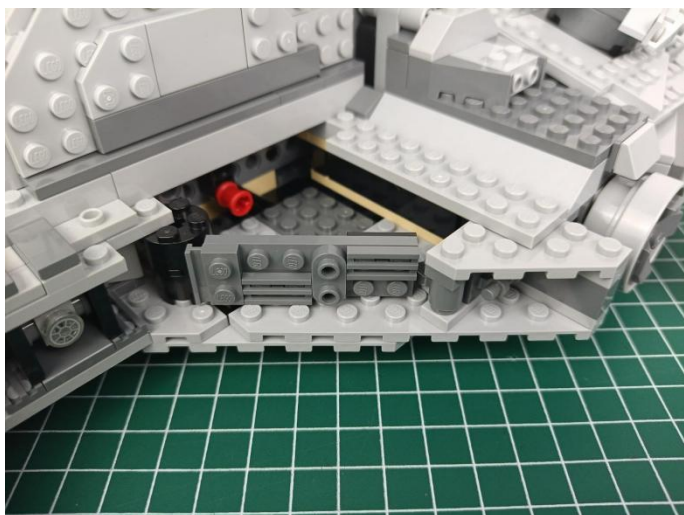

169

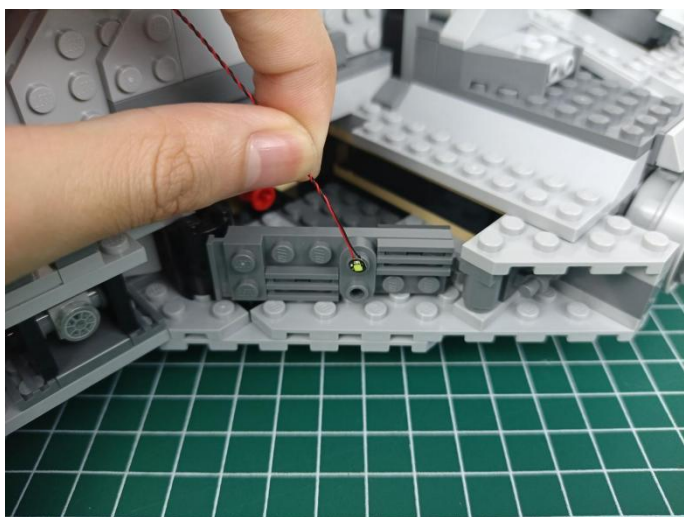

Tips

The plate without slit:

The plate without slit:

The squeeze causes the protective layer of the wire to be torn apart, the positive and negative wires touch together, and the set is short-circuited and the hot or wire is crushed, the wire to be disconnected and don't work.



The plate with slit:

The plate with slit:

The wire has enough space to avoid being squeezed endowed with longer service life and more stable effect.



The slit on the the plate round 1X1 are hand-made to avoid squeeze the wire and cause short circuit and abnormal heat during installation.

170

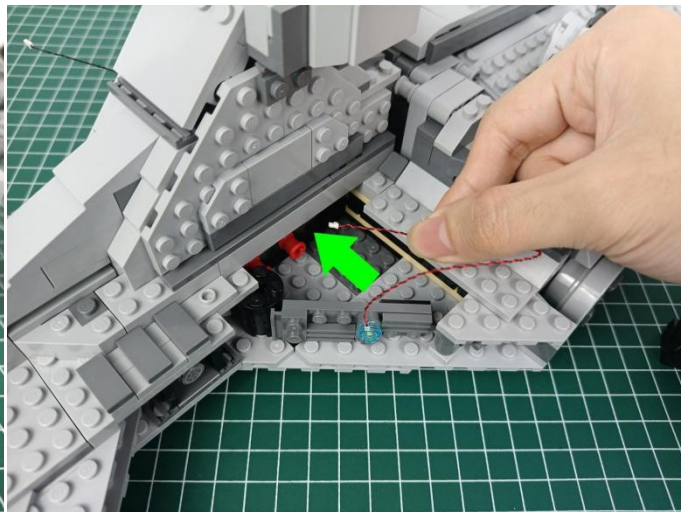
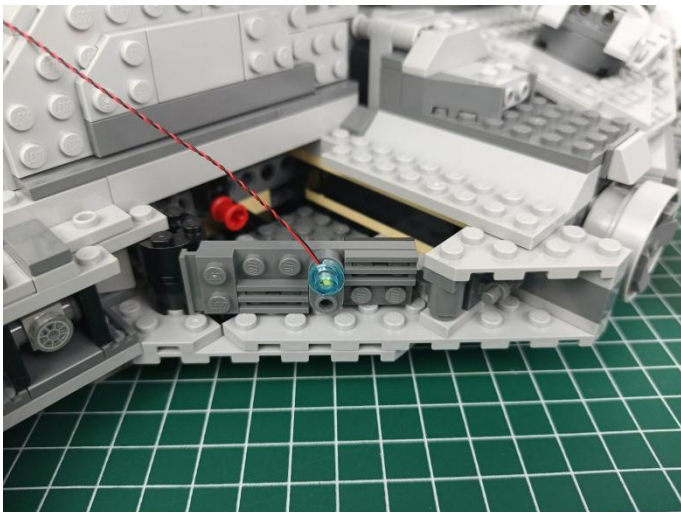

171

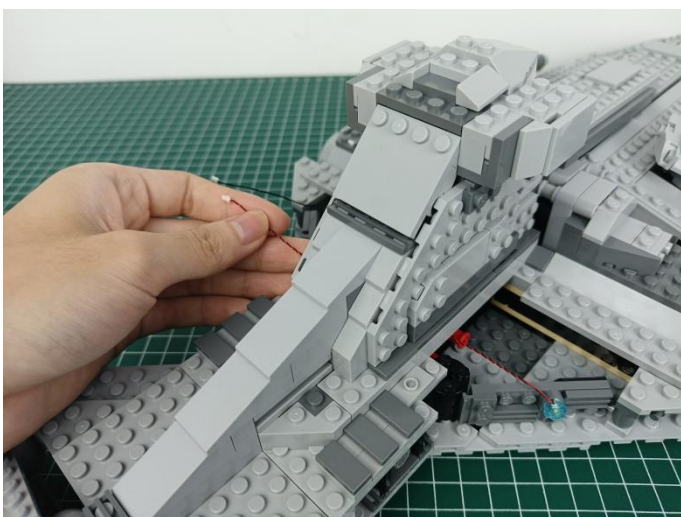

172

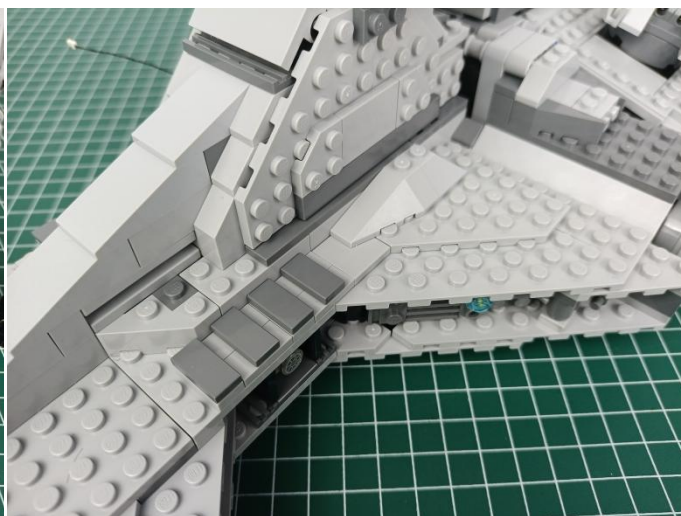
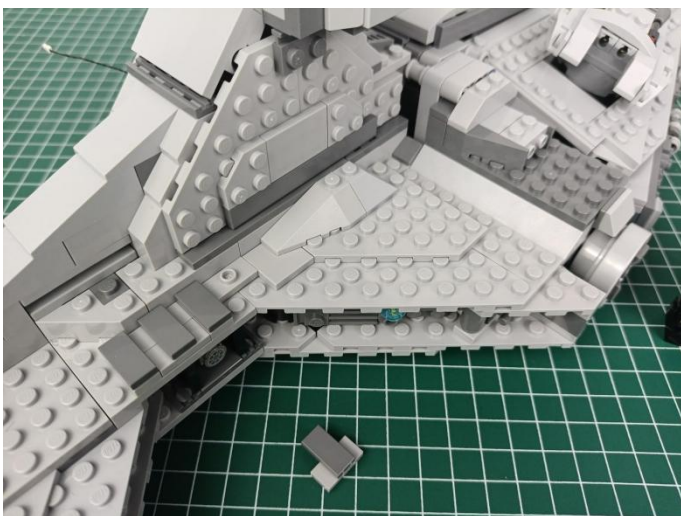

173

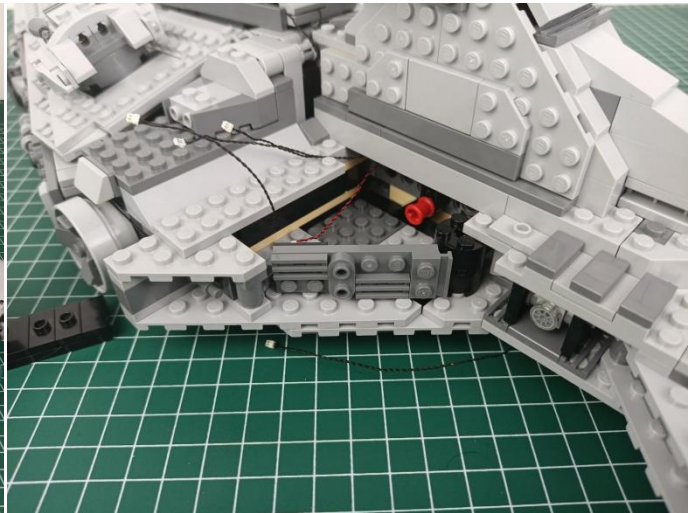

174

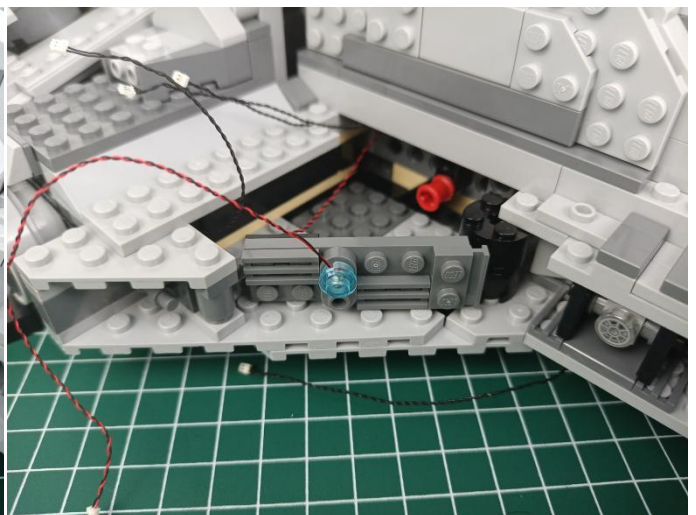
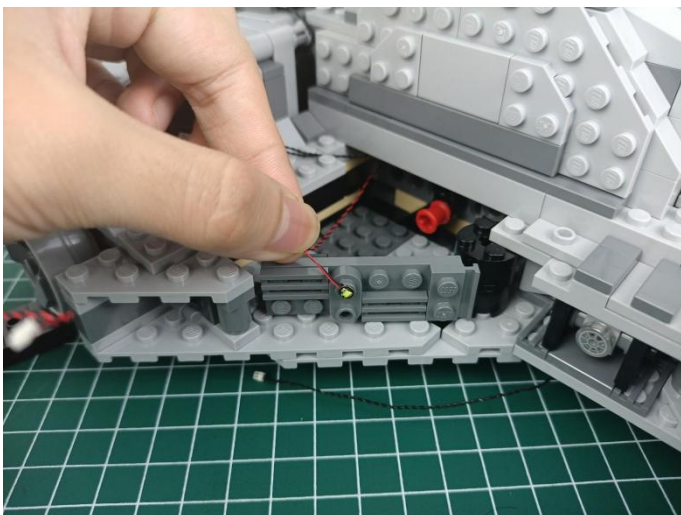

175

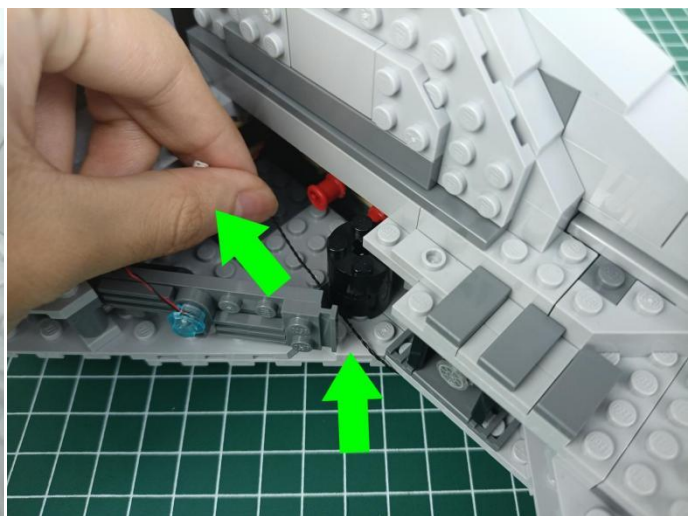
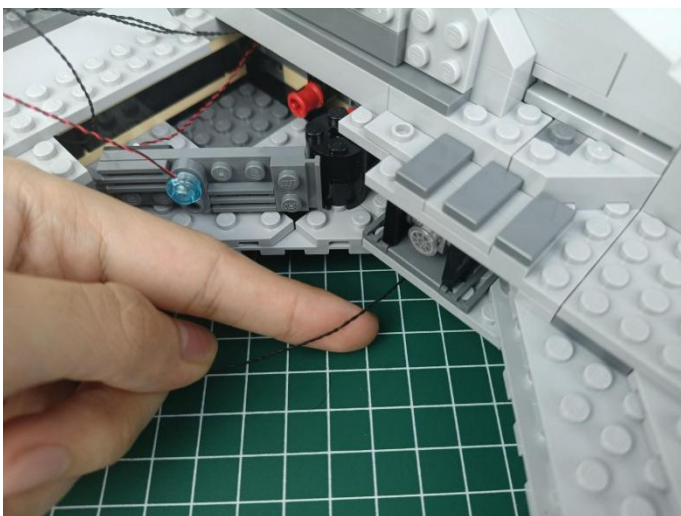

176

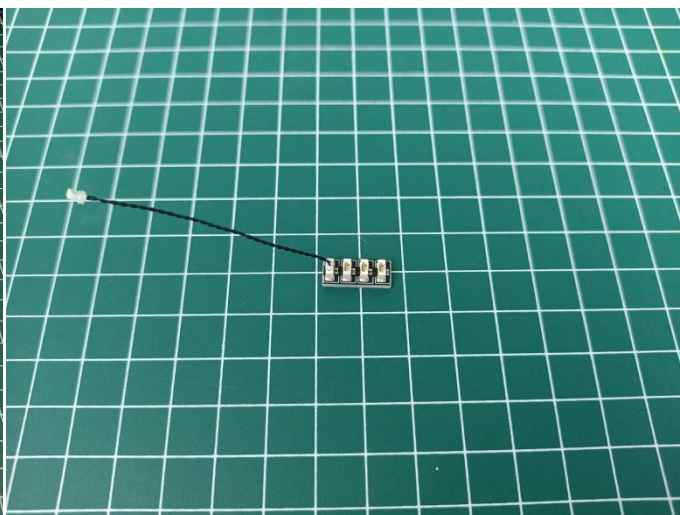

177

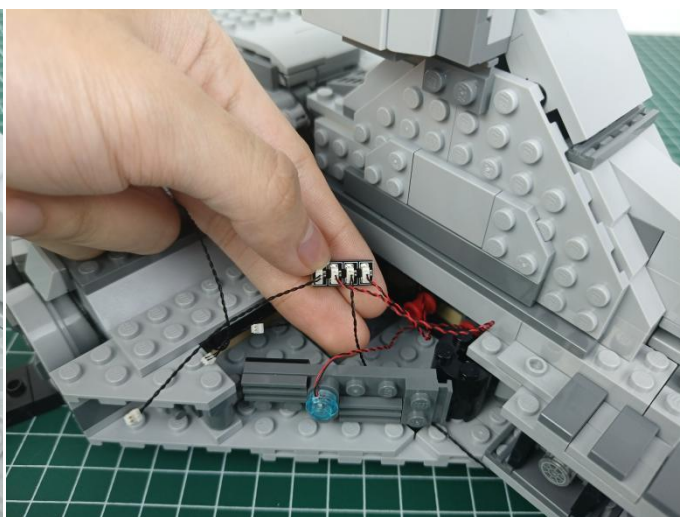
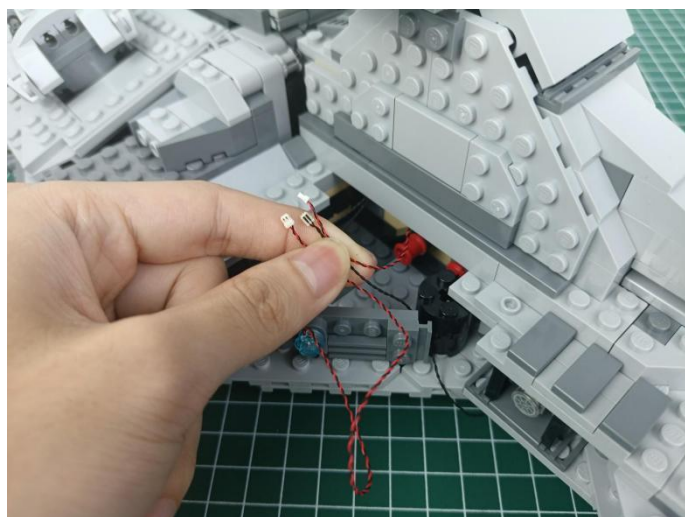

178

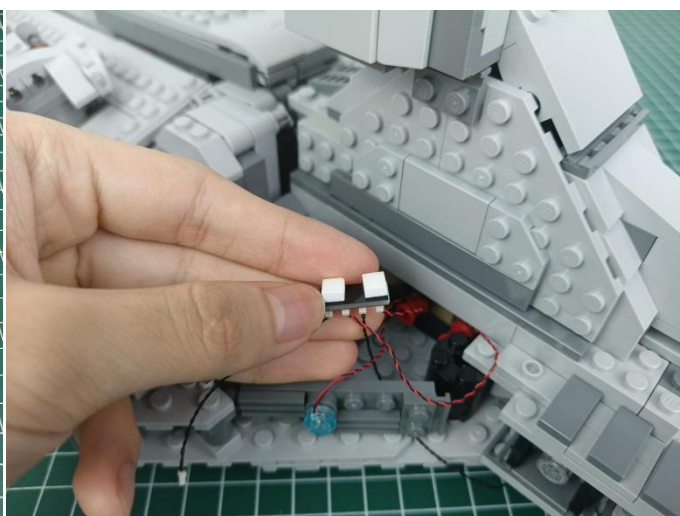

179

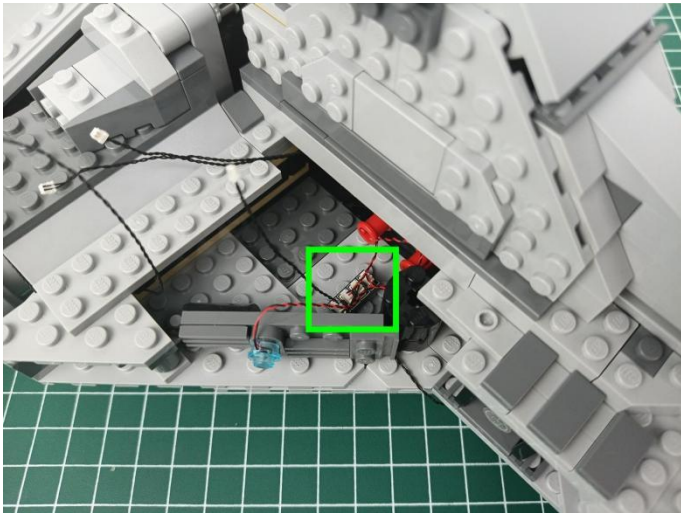

180

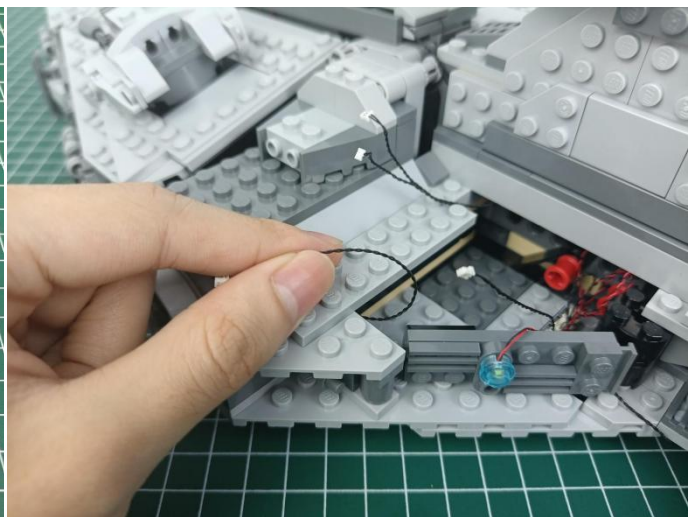

181

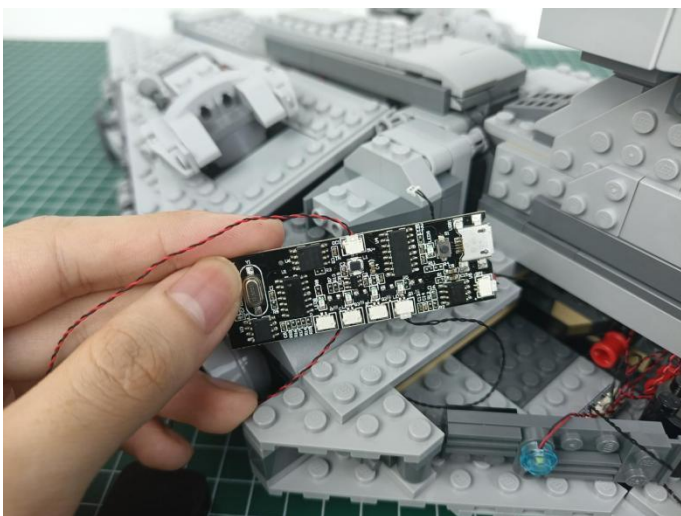

182

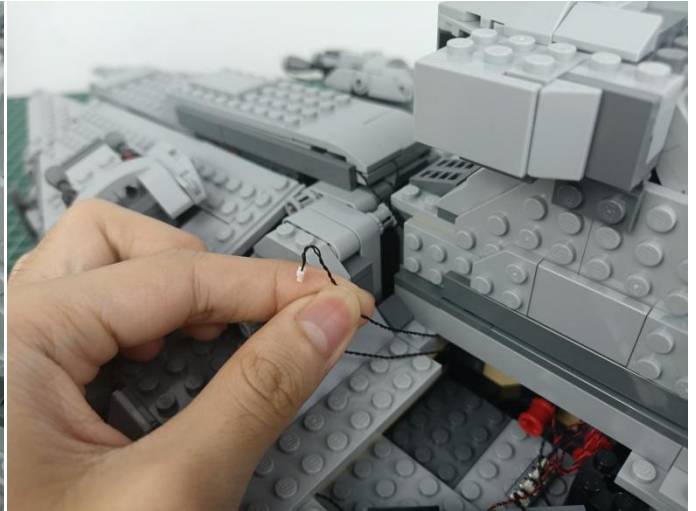
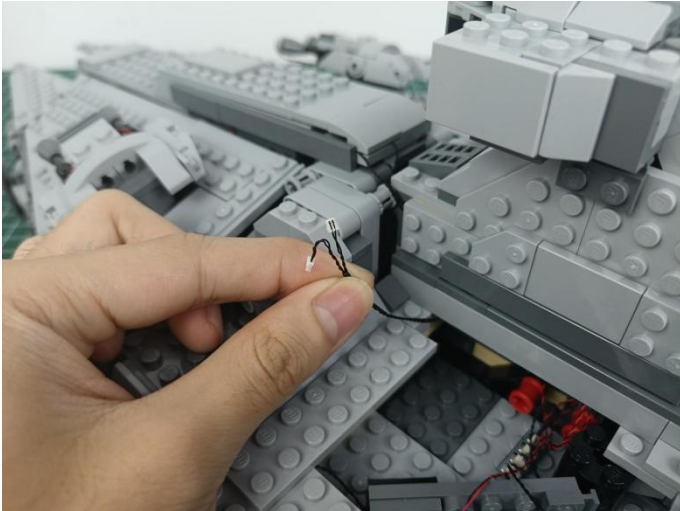

183

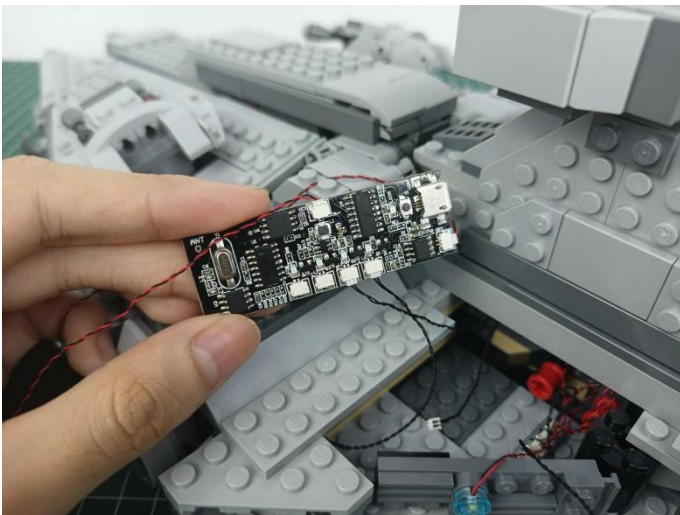

184



185

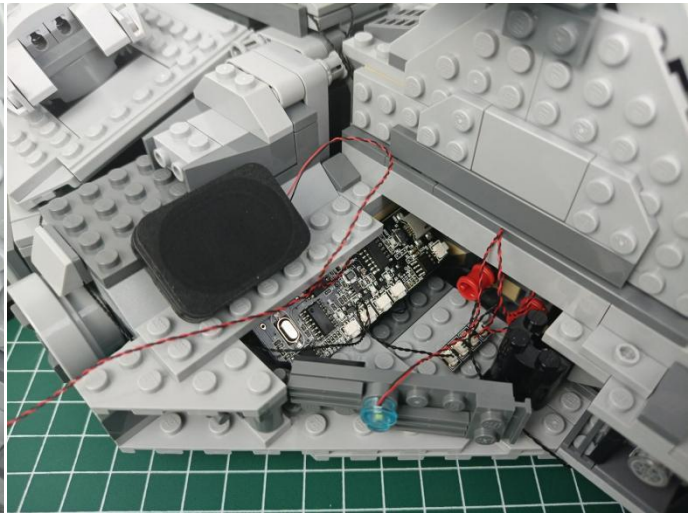
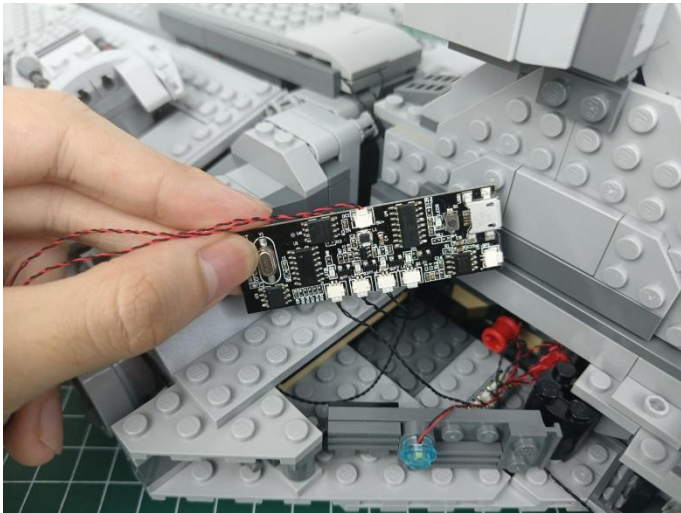

186

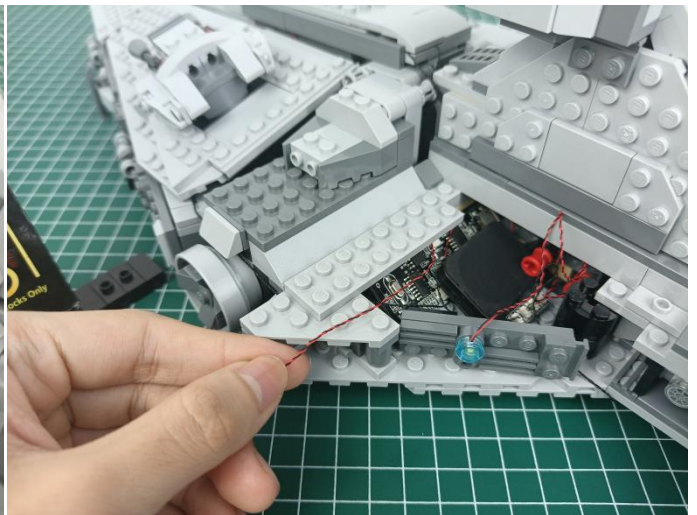
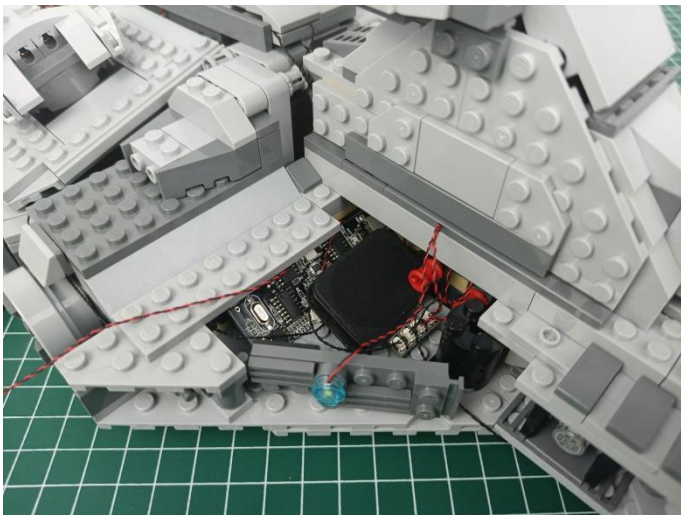

187

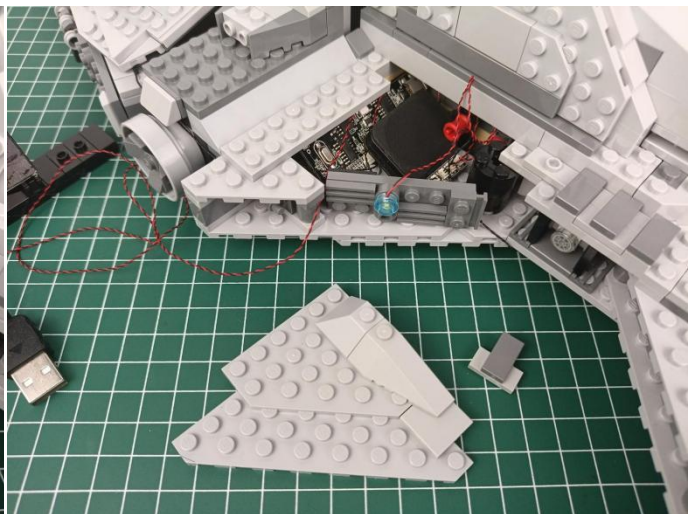
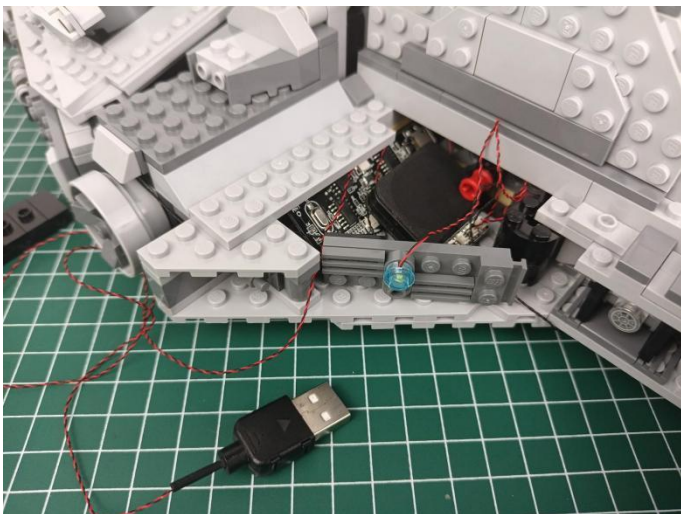

188

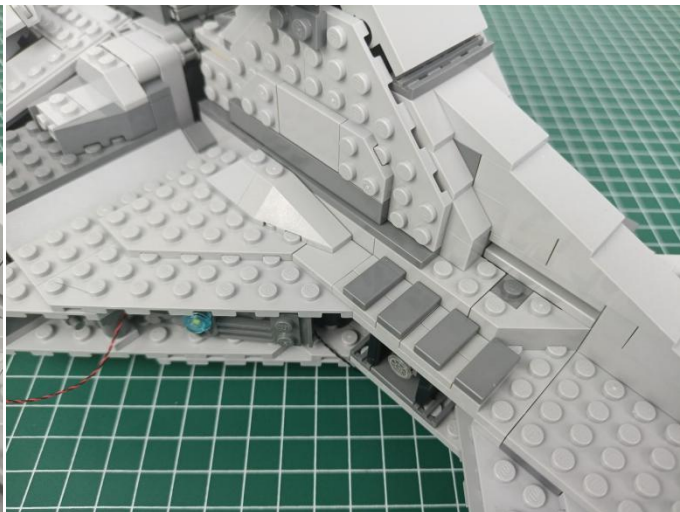
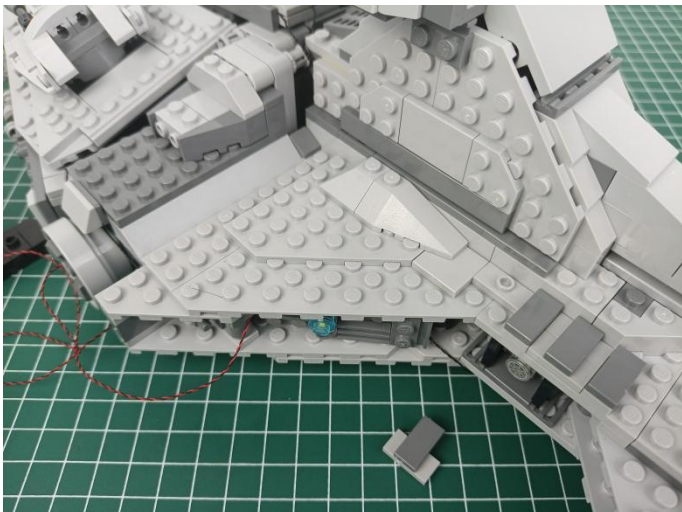

189



190

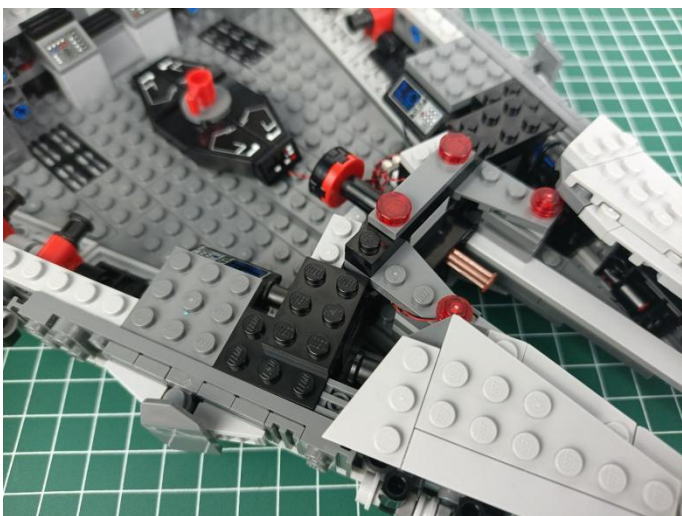

191

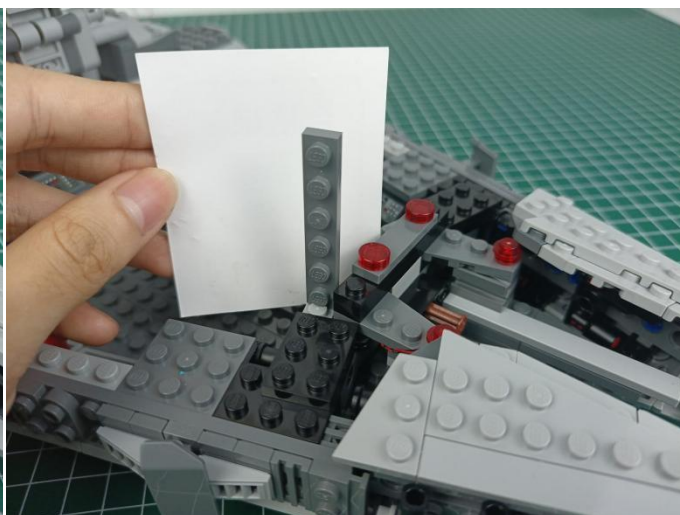
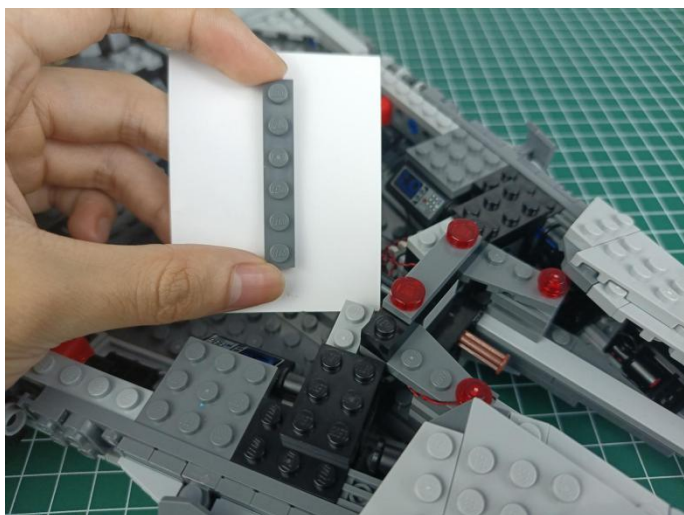

192



Good job, you've done all the installation steps, power it up and enjoy your work.

