

21044 Paris P23901

- **P23901 is the unique code of lighting set, we use this to accurately identify the product you purchased and the corresponding manuals and services you need to obtain. Please make sure your product code is the same as the label on the back of the box shown “21044 P23901”.**
- **Installation requires a lot of patience and great observation that your LEGO bricks will come alive when you get this finished. The bricks with lighting as below, so make sure you're ready and let's get started.**



Strategies for the Installation

This instruction divides three sections to complete the installation of the lighting set.

Section A: Check the type and quantity of components.

The quantity and type of components of each products are different and it needs to be carefully checked to make sure there do have enough material.

The type of components is indicated by the label on the bag.

Section B: Test that each components is working properly.

Each components is made individually so it is necessary to test that each components is working properly to avoid the situation that the lighting does not work .

Section C: laying out components following the instruction.

Our material is very small but not fragile, just be reminded that don't to pull the wires too hard. For different people, there may be some installation steps that you can't understand. Please look at the previous and later installation step

Section A: Check the type and quantity of components.

There are 15 bags in this set. The name and quantities of specific components are as shown , please check carefully.

Label	Content	Quantity
Bit Lights-15CM-Warm White	Bit Lights-15CM-Warm White	4
Bit Lights-15CM-Red	Bit Lights-15CM-Red	1
Bit Lights-15CM-Green	Bit Lights-15CM-Green	2
Bit Lights-15CM-Blue	Bit Lights-15CM-Blue	2
Bit Lights-30CM-Red	Bit Lights-30CM-Red	1
Bit Lights-30CM-Pink	Bit Lights-30CM-Pink	1
Multi-Colour Lights 30CM	Multi-Colour Lights 30CM	1
Multi-Colour Lights 15CM	Multi-Colour Lights 15CM	1
Headlights-15CM-Warm White	Headlights-15CM-Warm White	1
Expansion Board	8 Socket Expansion Board	1
	12 Socket Expansion Board	1
USB Power Cable	USB Power Cable-30CM	1
AAA Battery Box	AAA Battery Box	1
Connecting Cables-15CM	Connecting Cables-15CM	1
Light Strips-Warm White-28	Light Strips-Warm White-28	1
Parts package		

Please contact us immediately if there have any missing components.

Section B: Test that each components is working properly.

We need a structure to test all lights, so take out the bag with label “USB Power Cord”and “Expansion Boards”as follows.



It is worth reminding that our products are all customized. They have a unique way of connecting. The white plug on wire and the socket of the expansion board need to be connected together to transmit power.

Note that on one side of the white plug you can see two very small golden wires that should be connected to the two golden needles in socket of the expansion board.shown as blow.

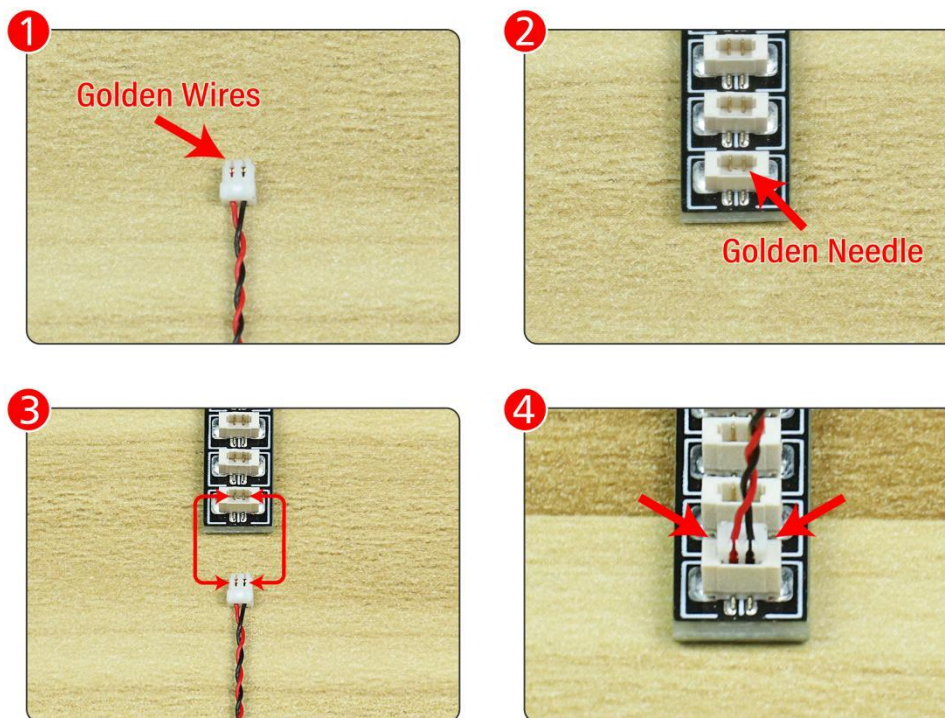

All our connections between plug and socket are all the same as shown above. So for any such structure with plug and socket, please pay attention to the golden wire of the plug and the golden needle of the socket, they must be touched together.

The connection method between the USB Power Cord and Expansion Boards is as follows:

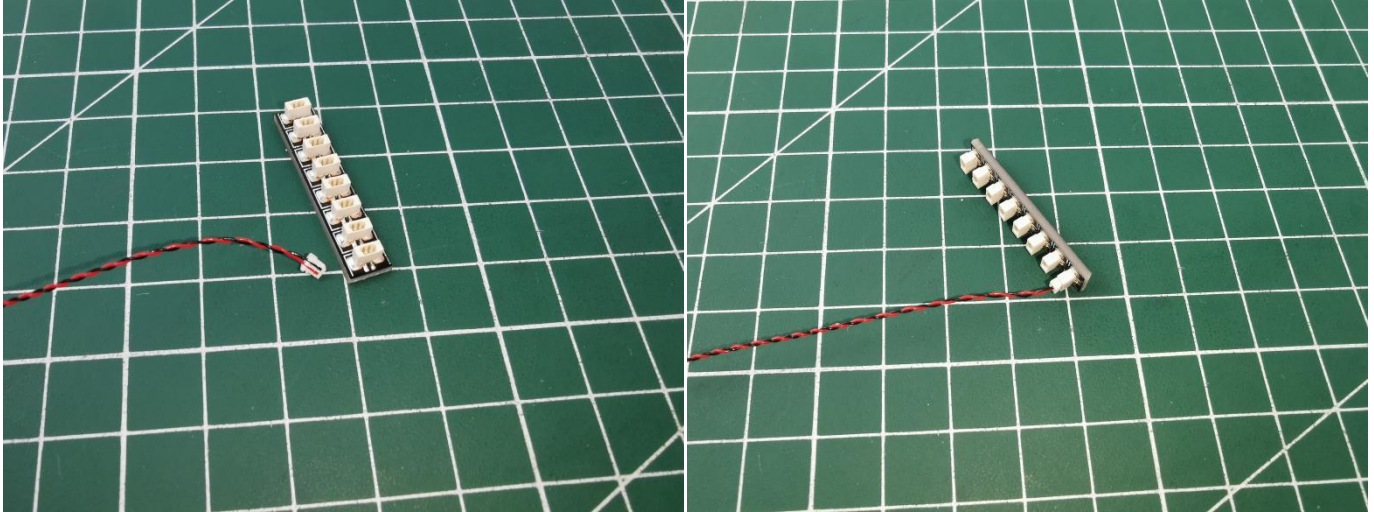

The USB Power Cord can be powered by phone chargers, power banks, etc.

USB connectors to connect devices

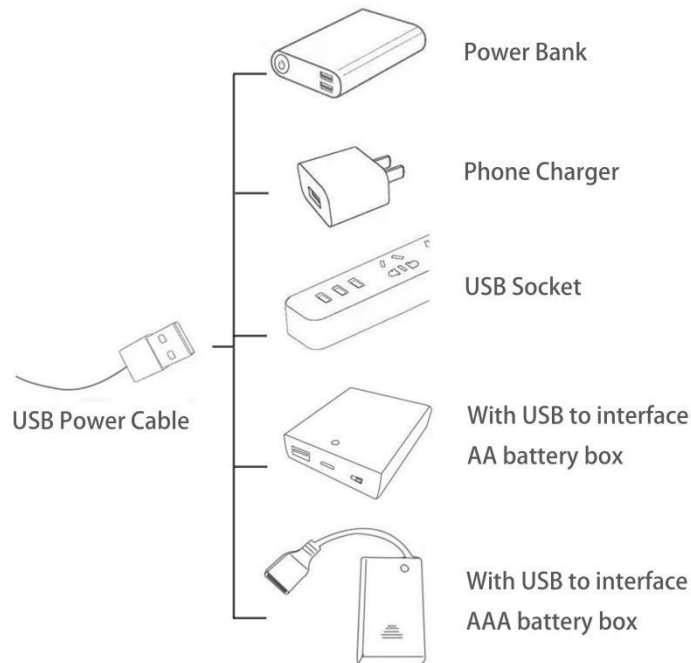

This instruction will use the power bank as power supply . The test structure is shown as follow. All lamp in this set will be tested by this structure.



when we test "Bit Lights-15CM-Warm White" particles,Take out the bag labelled "Bit Lights-15CM-Warm White".Take out one of the light and connect it to the socket. Turn on the power bank, the light will turn on normally as shown below.

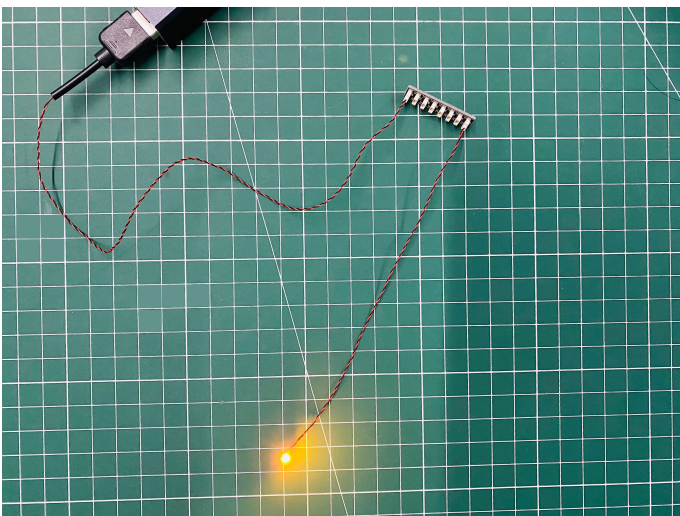

Test each lamp according to this method. It should be noted that after the test, the lamp must be returned to the corresponding bag to avoid confusion of types.



The components needs to be tested in this set is 4*Bit Lights-15CM-Warm White,1*Bit Lights-15CM-Red,2*Bit Lights-15CM-Green,2*Bit Lights-15CM-Blue,1*Bit Lights-30CM-Red,1*Bit Lights-30CM-Pink,1*Multi-Colour Lights 30CM,1*Multi-Colour Lights 15CM,1*Headlights-15CM-Warm White,1*Light Strips-Warm White-28.

Please contact us immediately if any components don't work.

Section C: laying out components following the instruction.

1

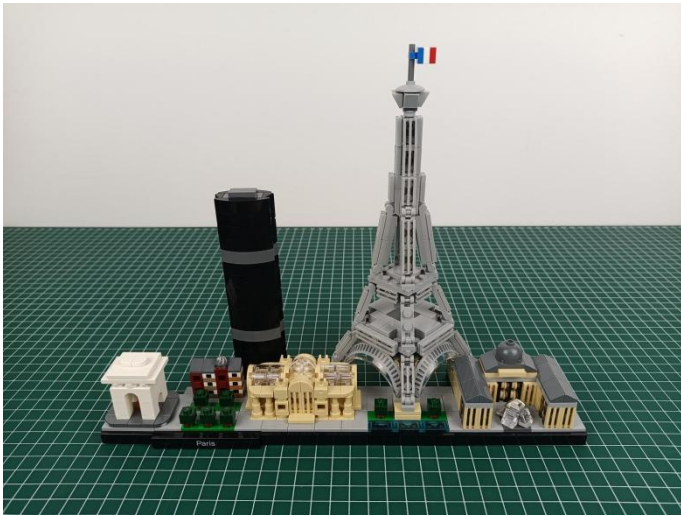

2

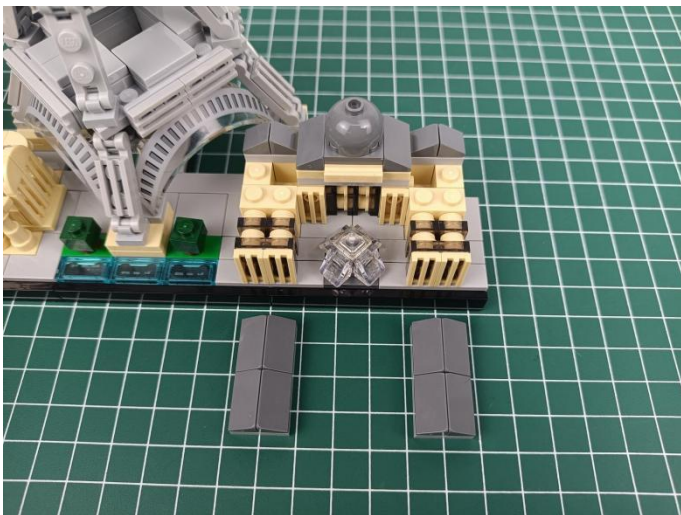

3



4



5

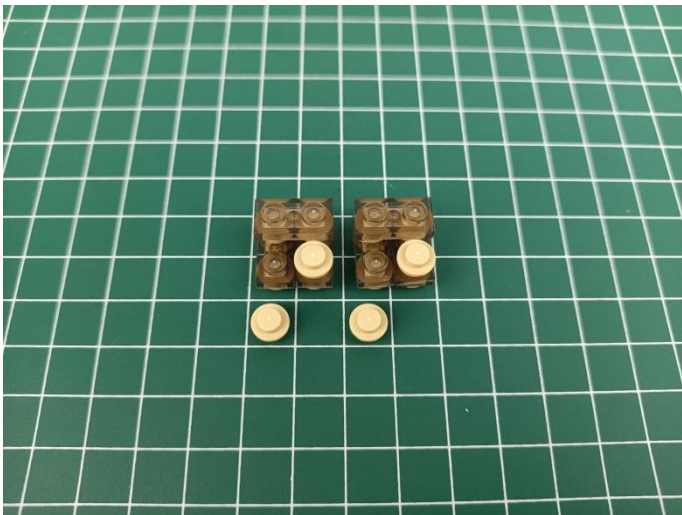

6

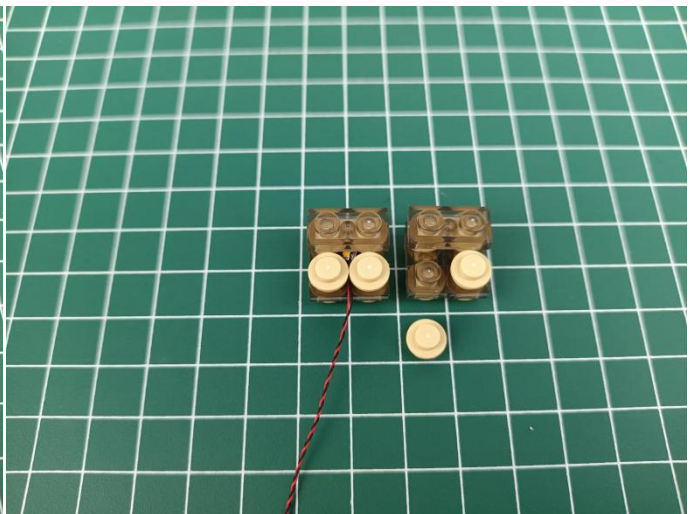
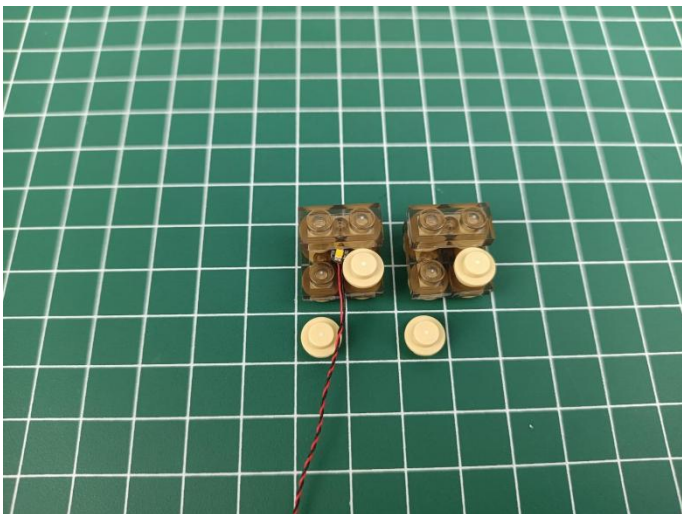

7

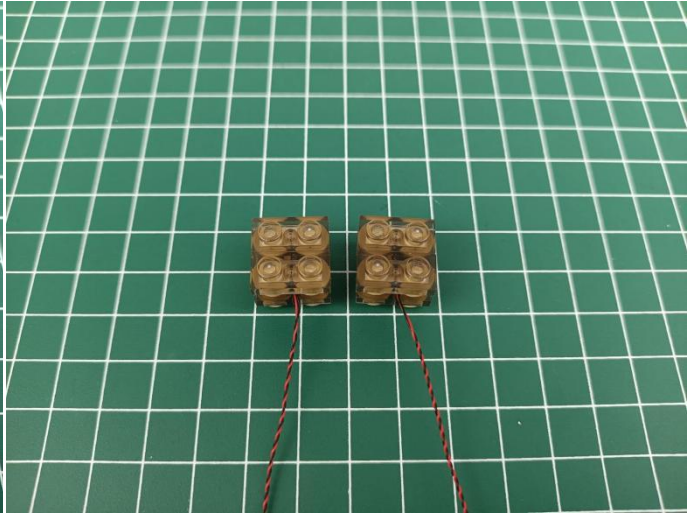
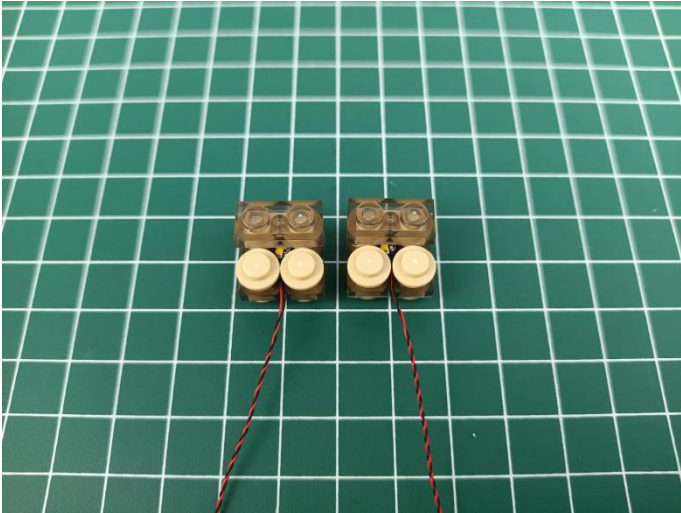

8

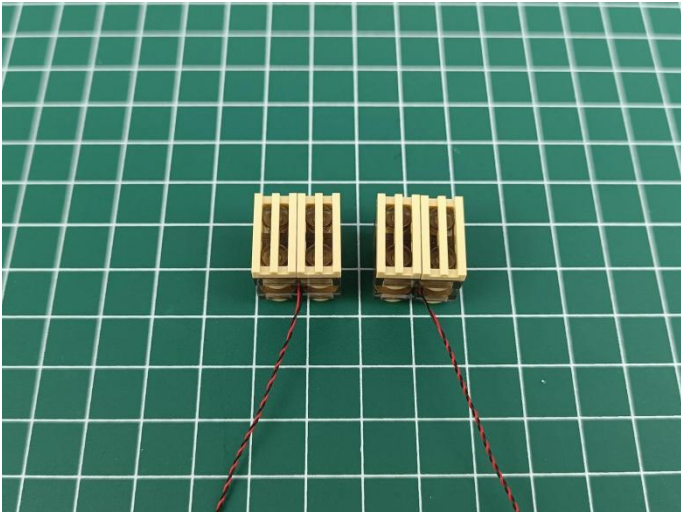

9

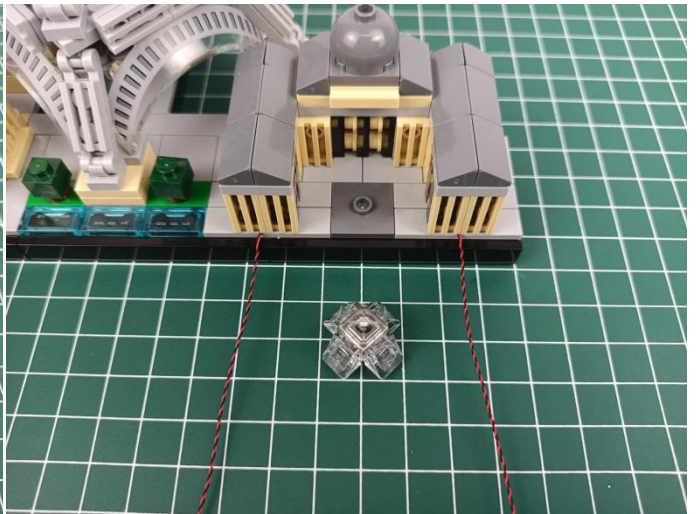

10

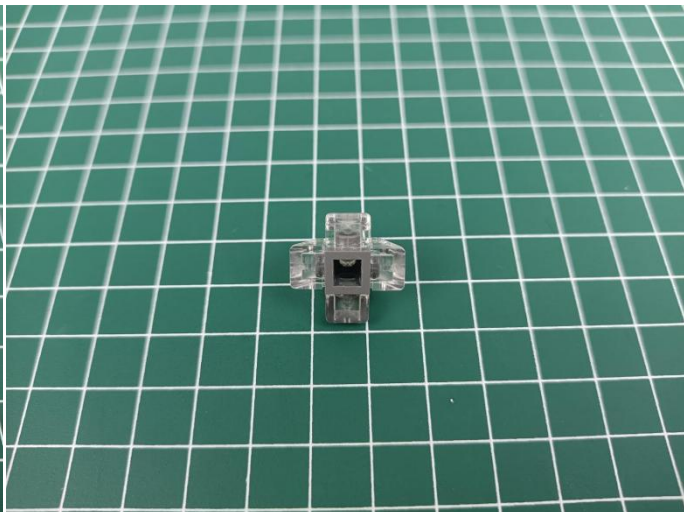

11

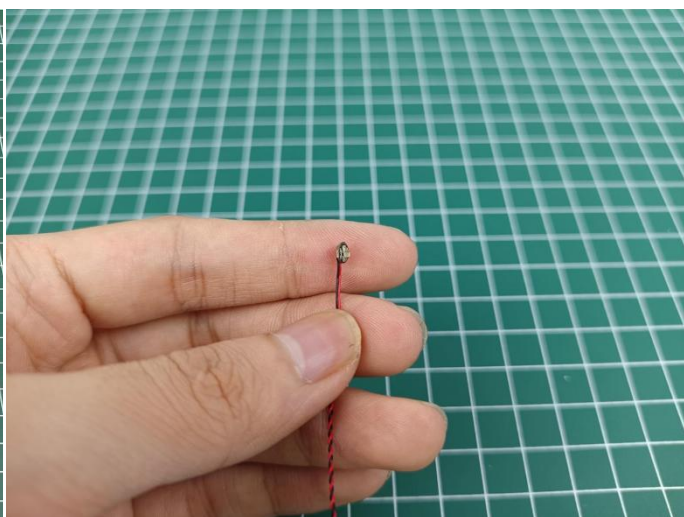

12

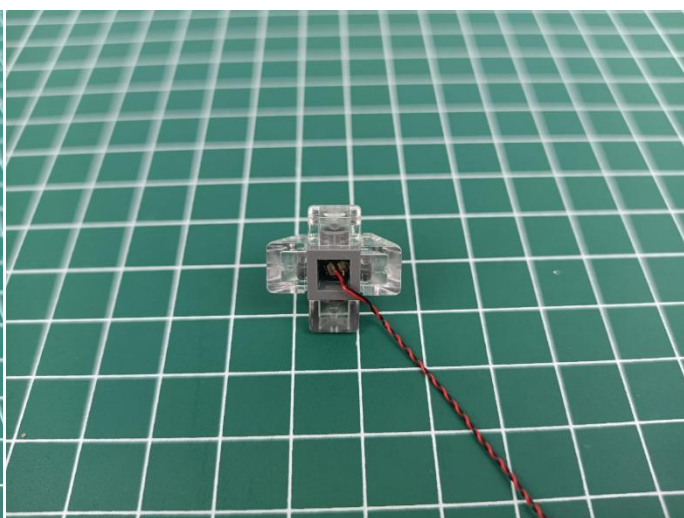
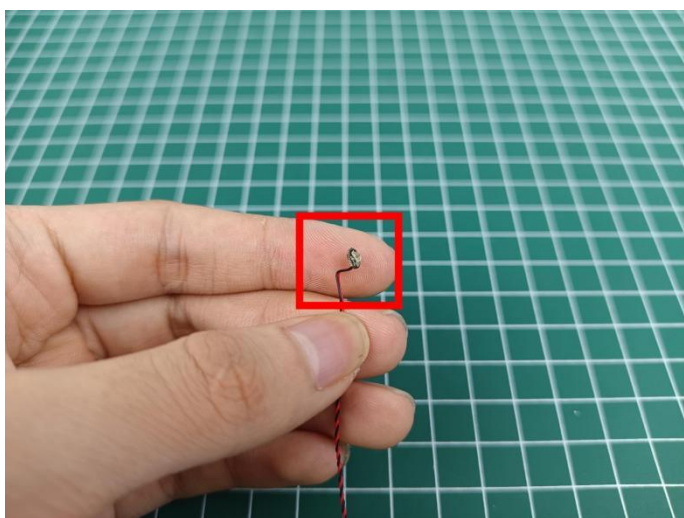

13

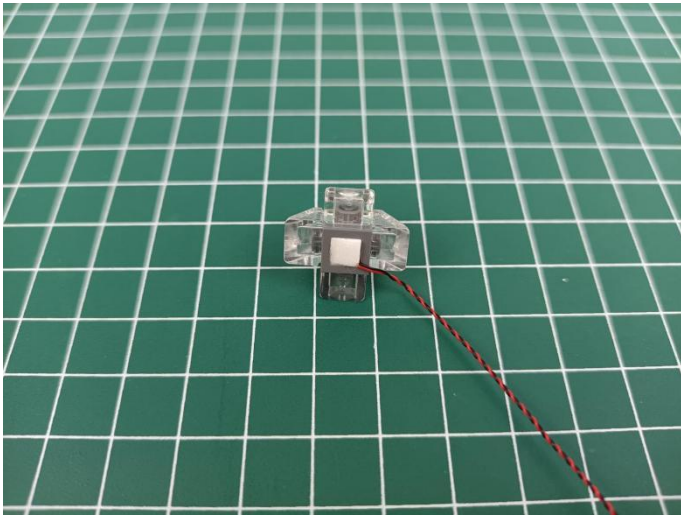

14

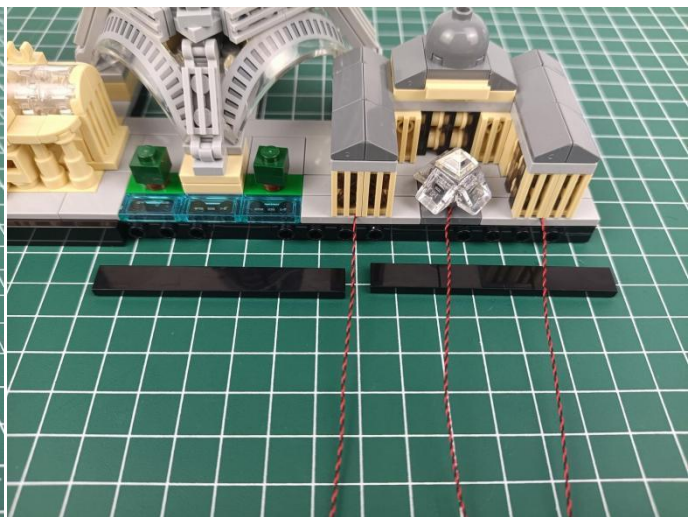
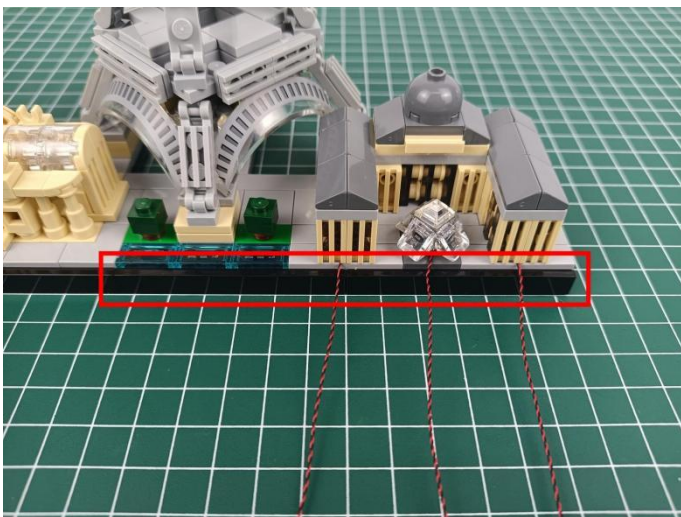

15

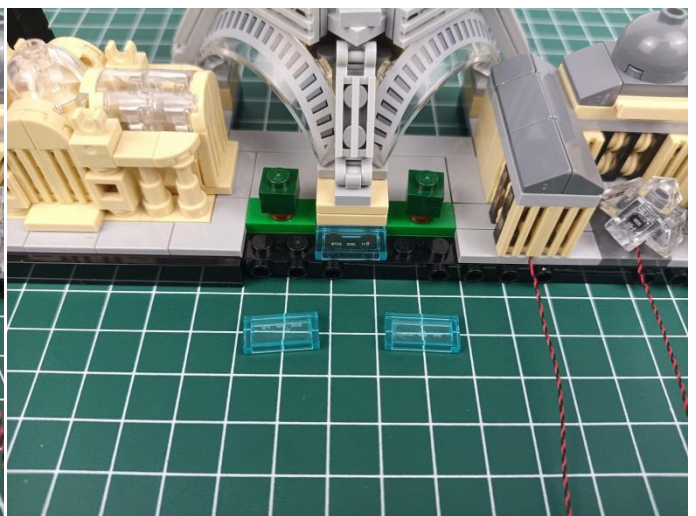
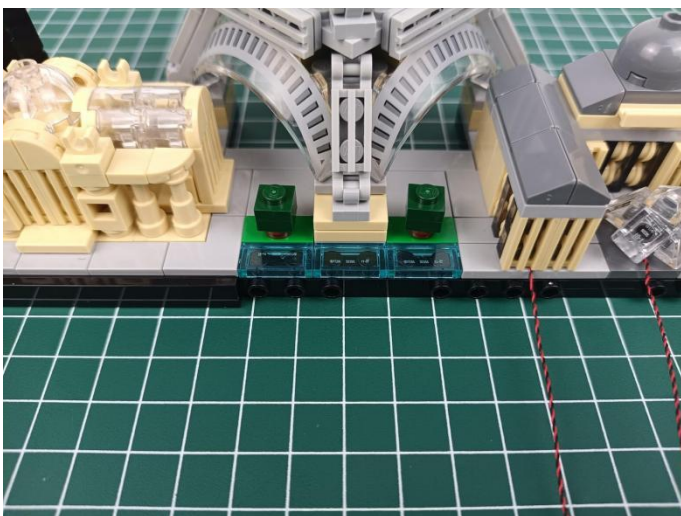

16

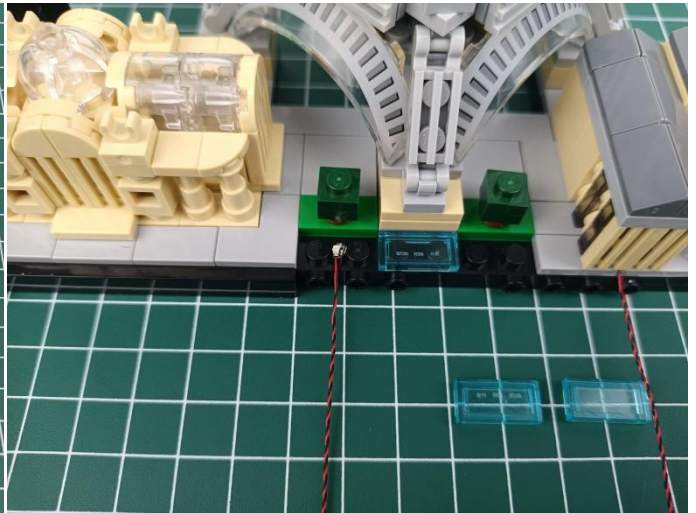

17

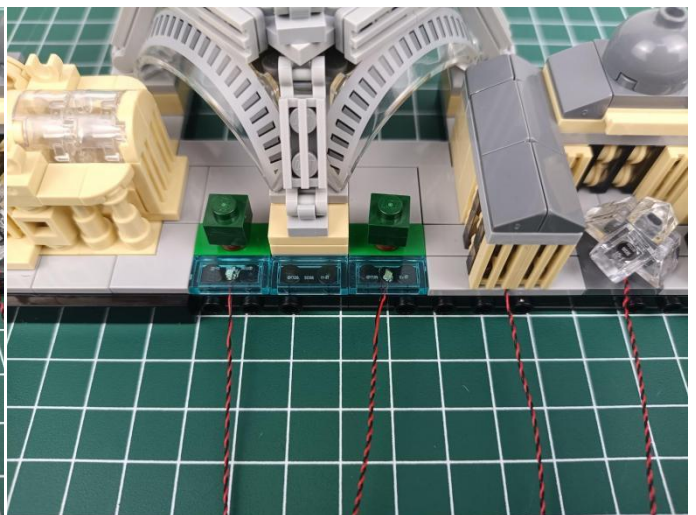

18

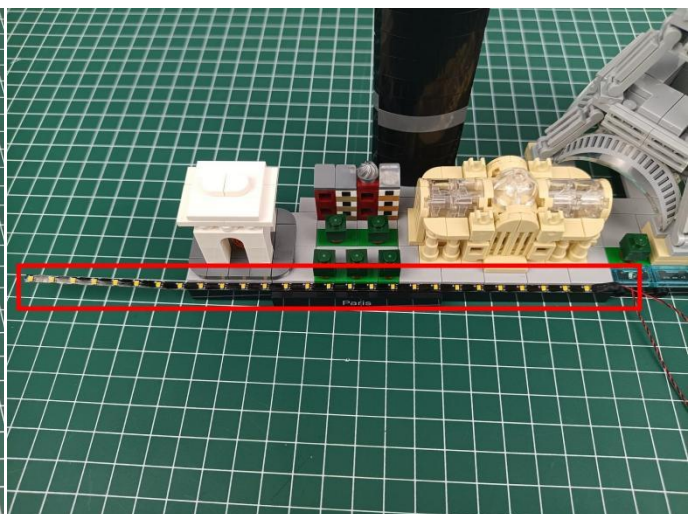

19

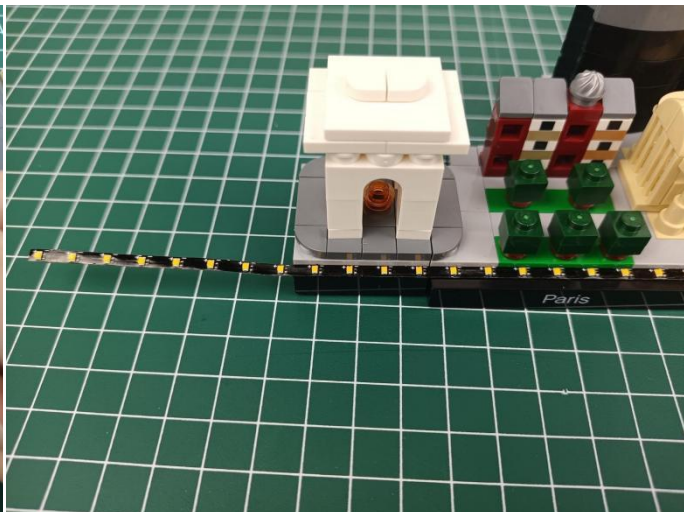
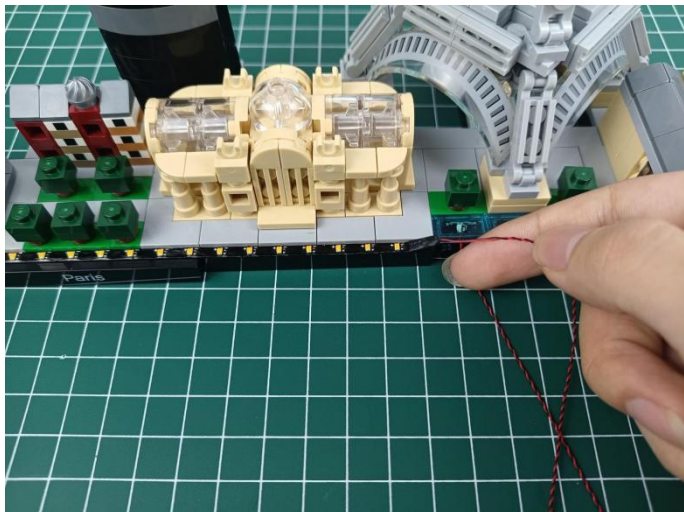

20

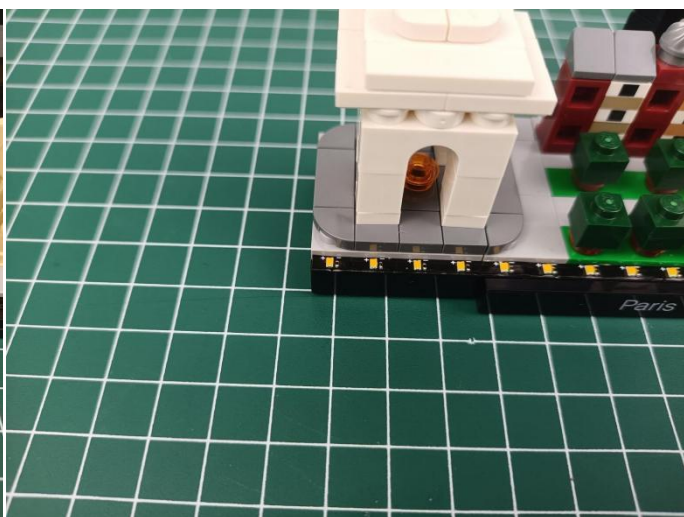
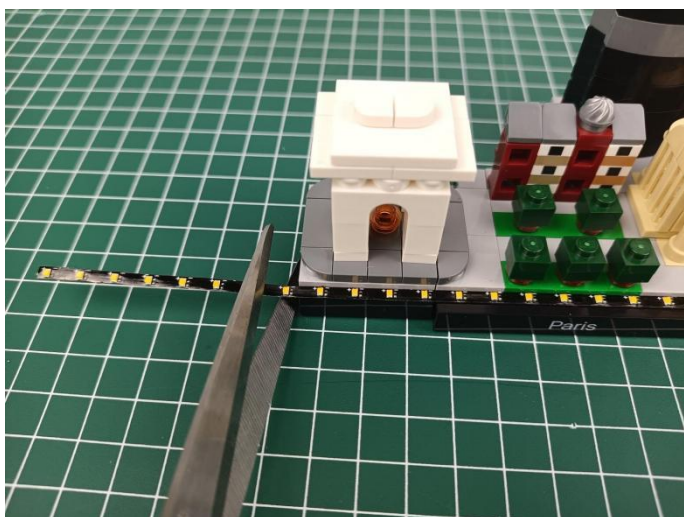

21

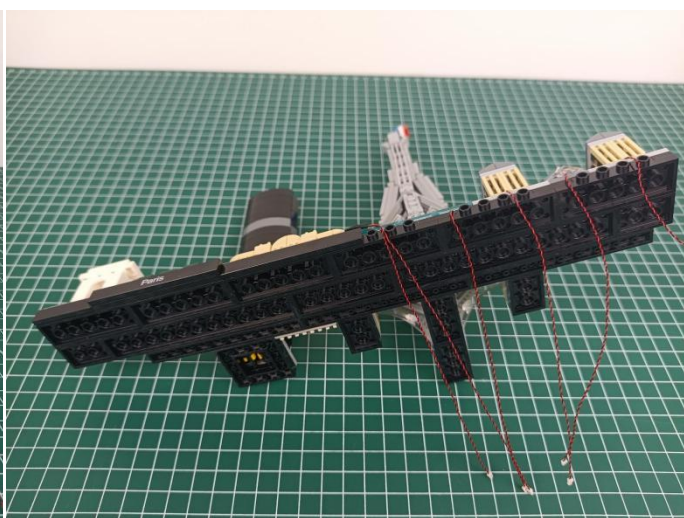

22

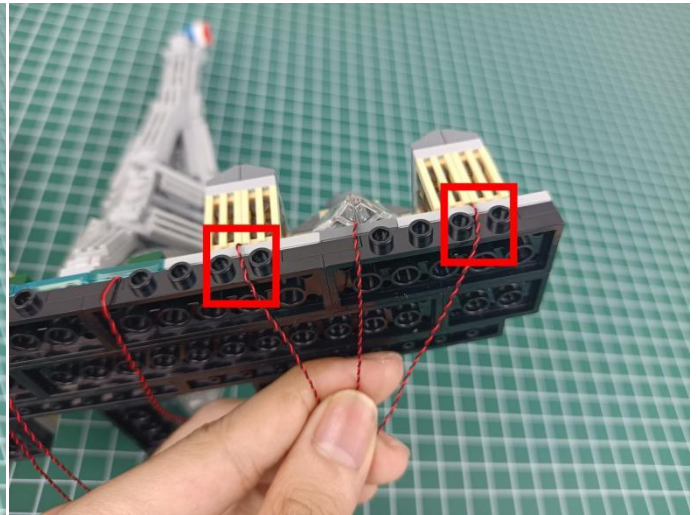
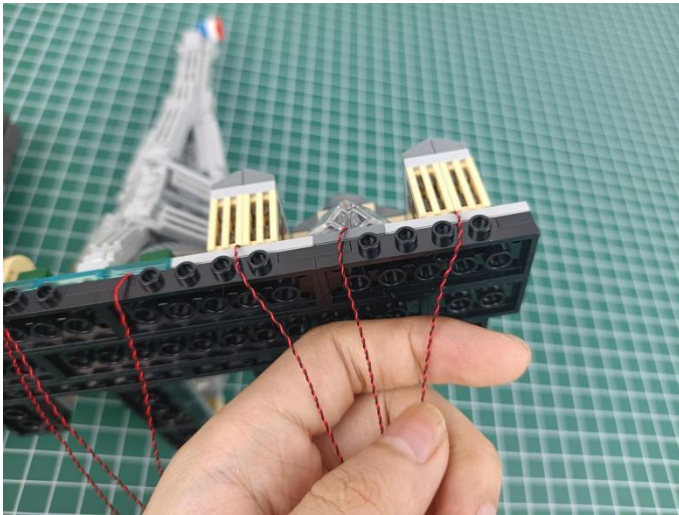

23

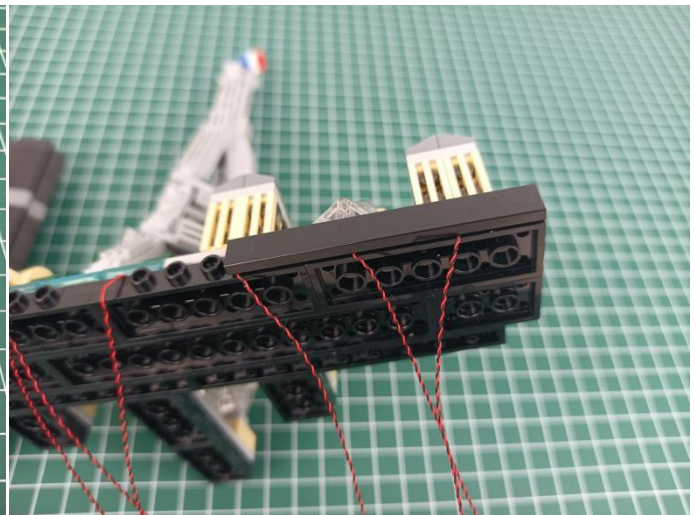

24

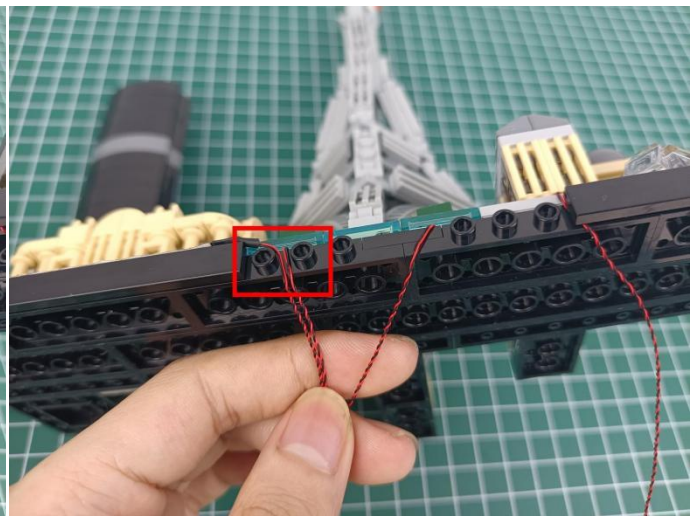
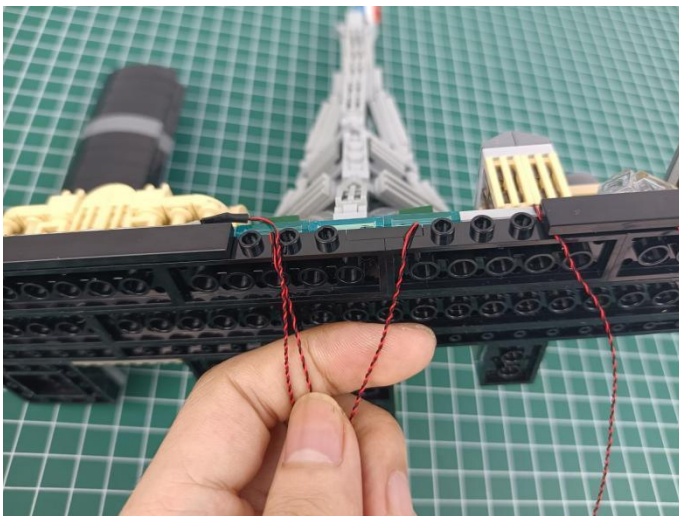

25

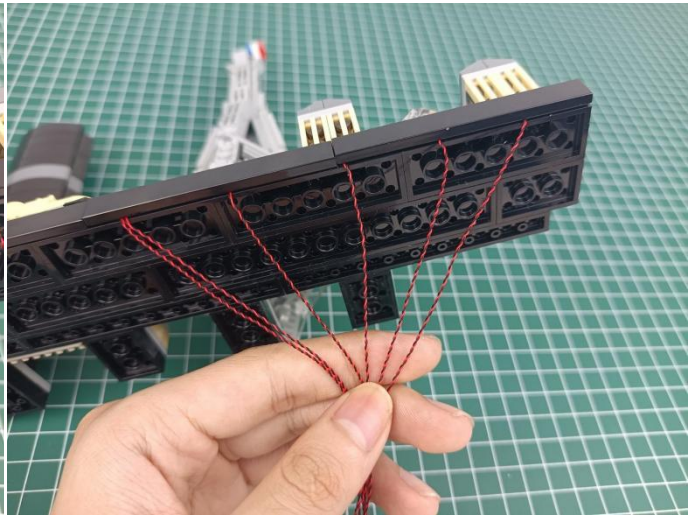
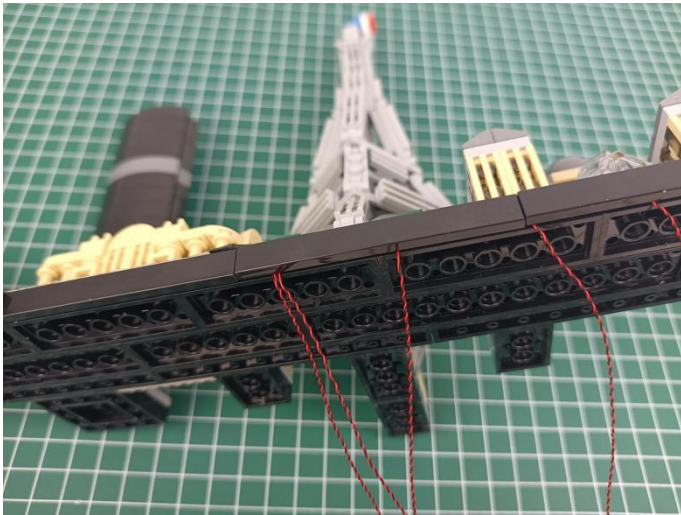

26

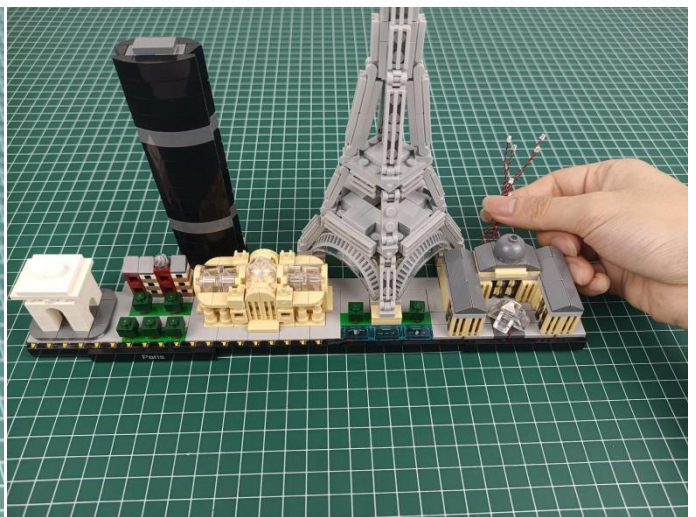
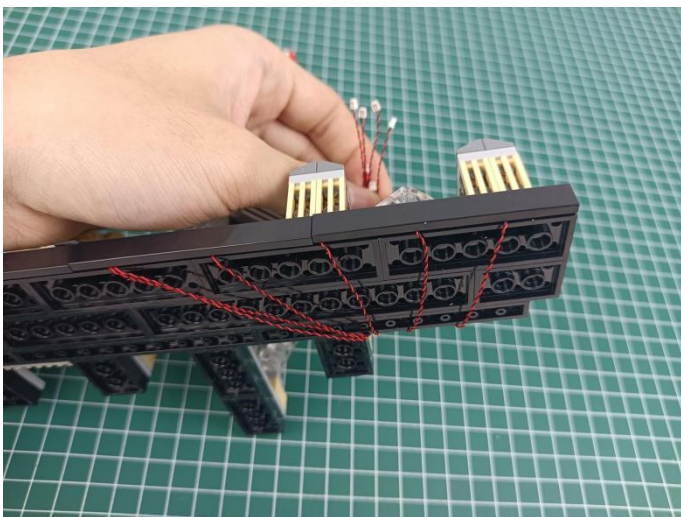

27

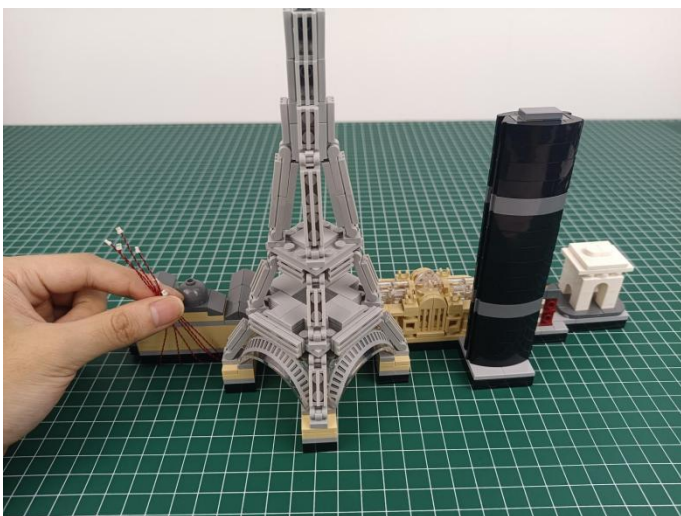

28

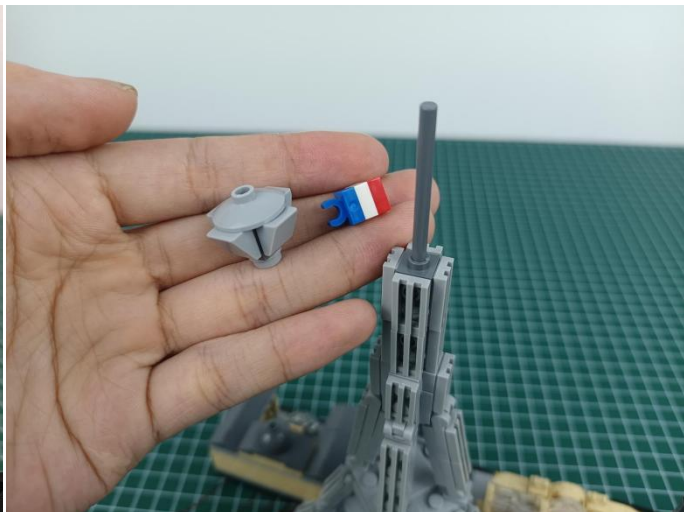
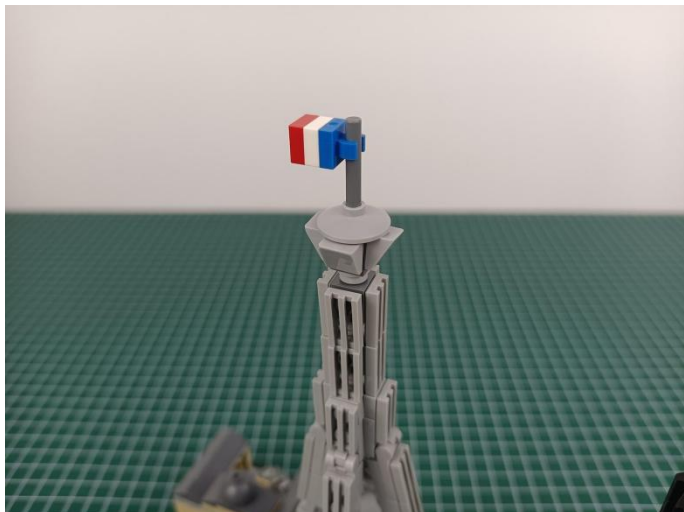

29

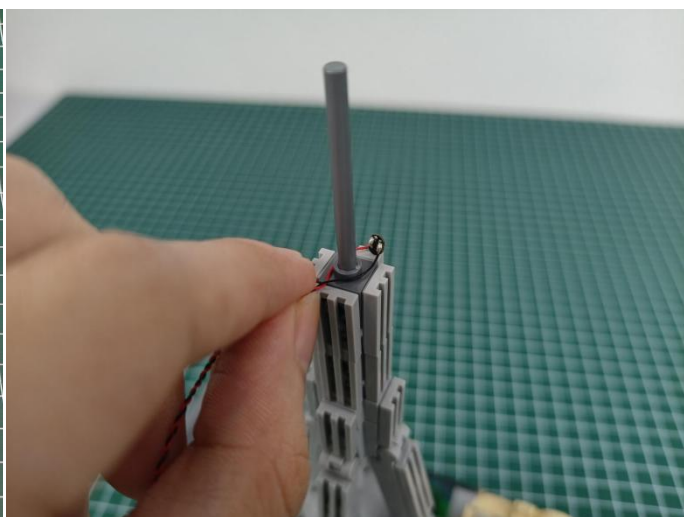

30

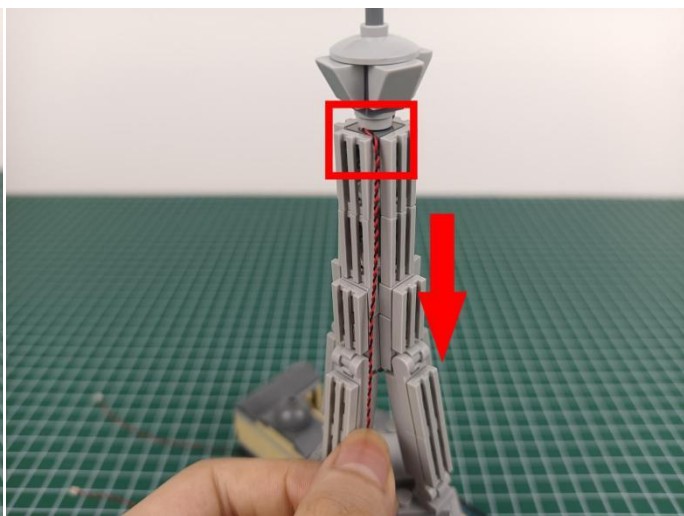
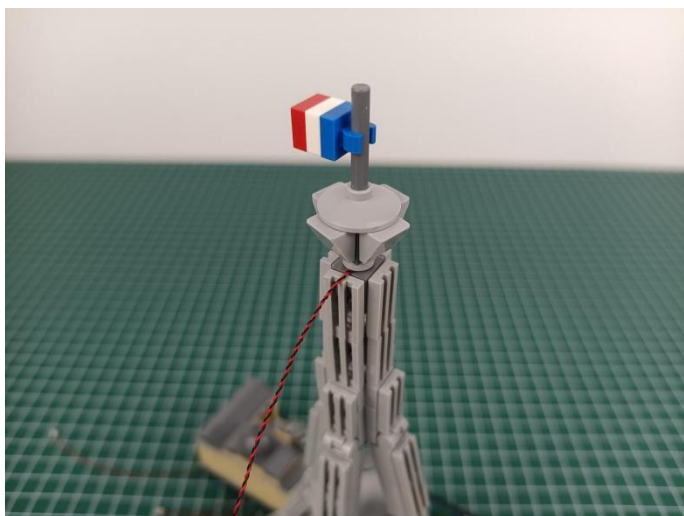

31

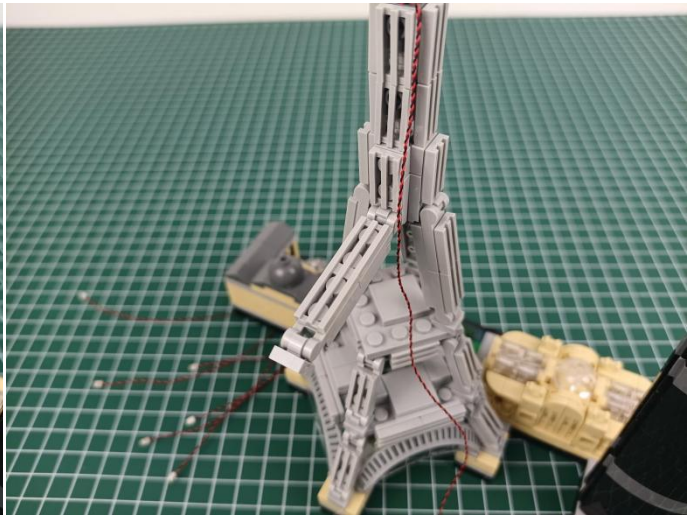
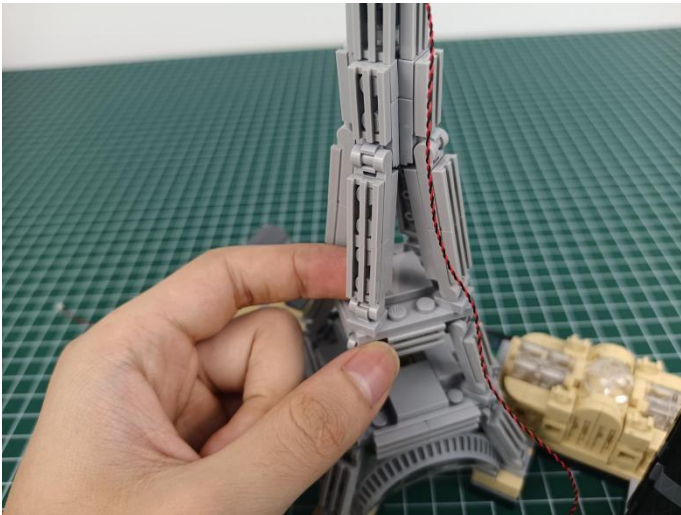

32

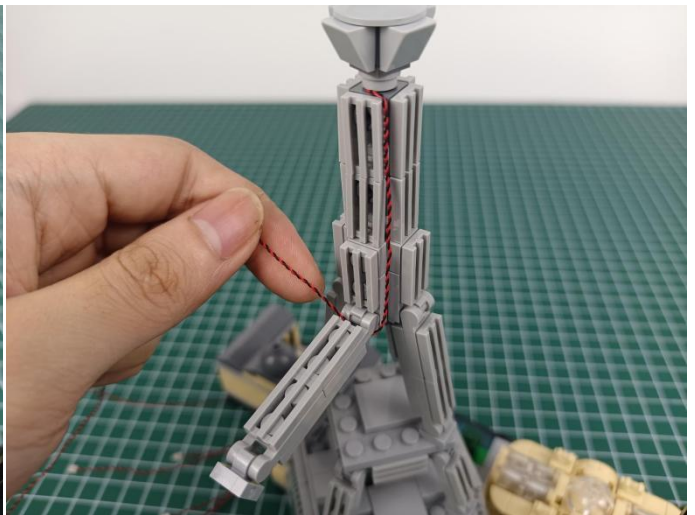
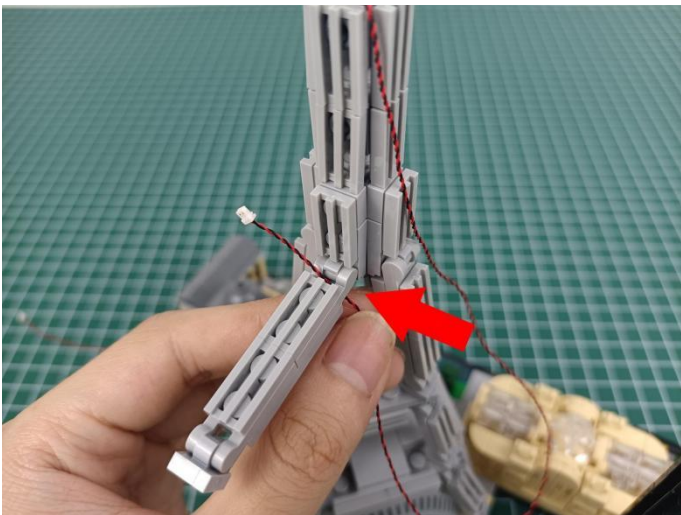

33

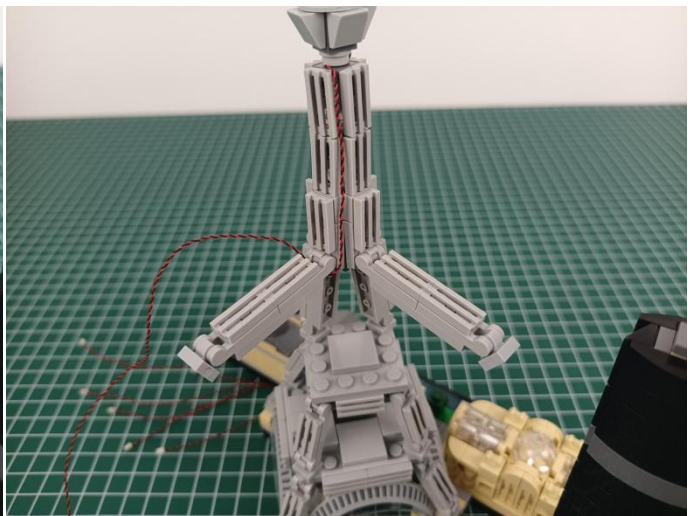
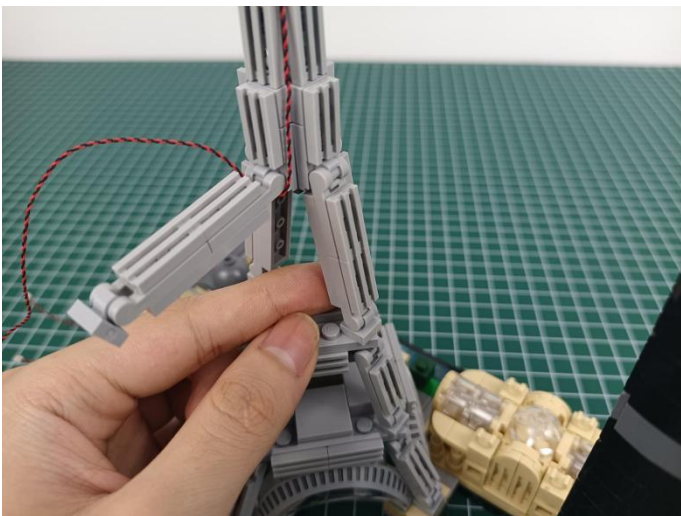

34

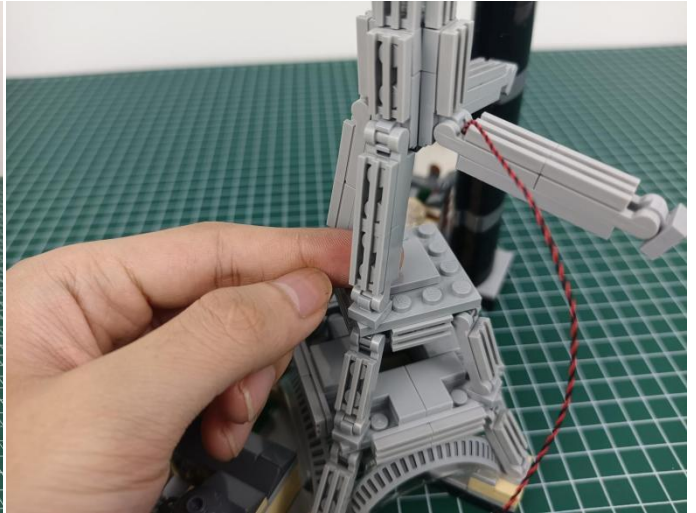
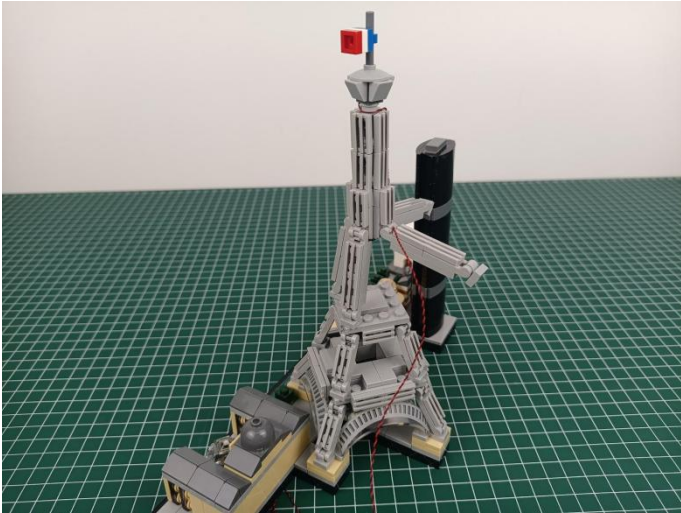

35

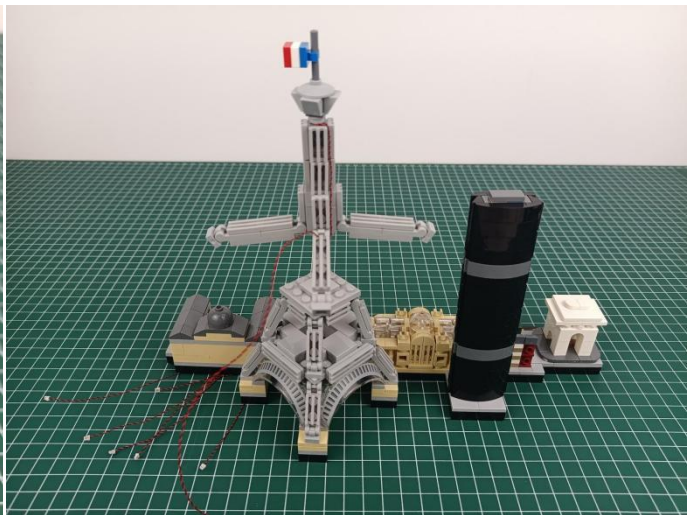
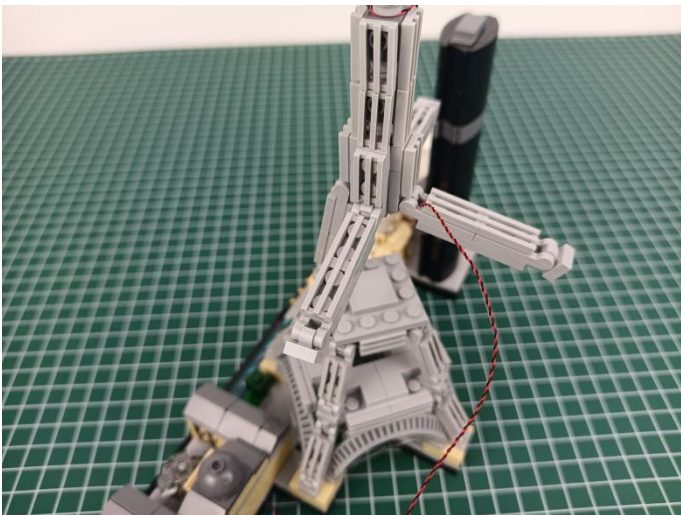

36

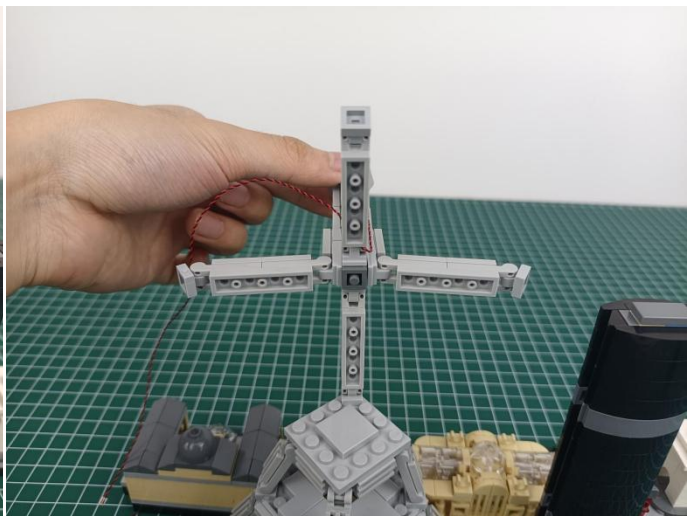
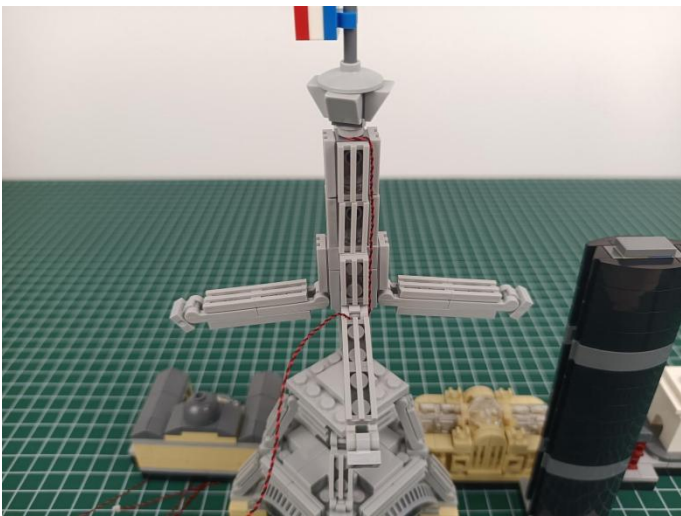

37

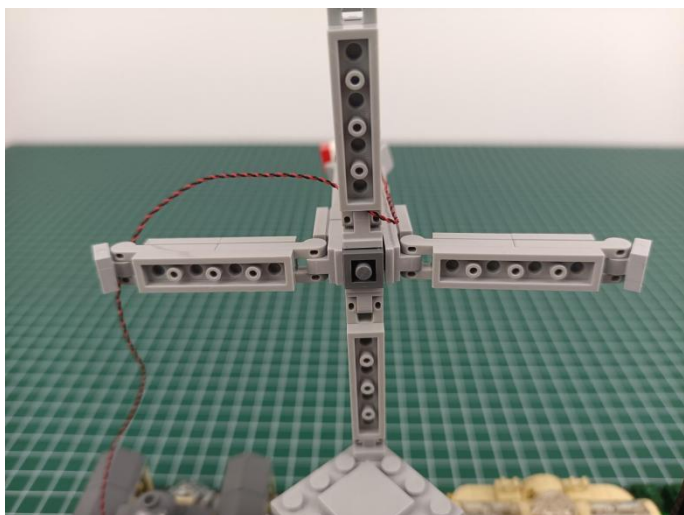

38

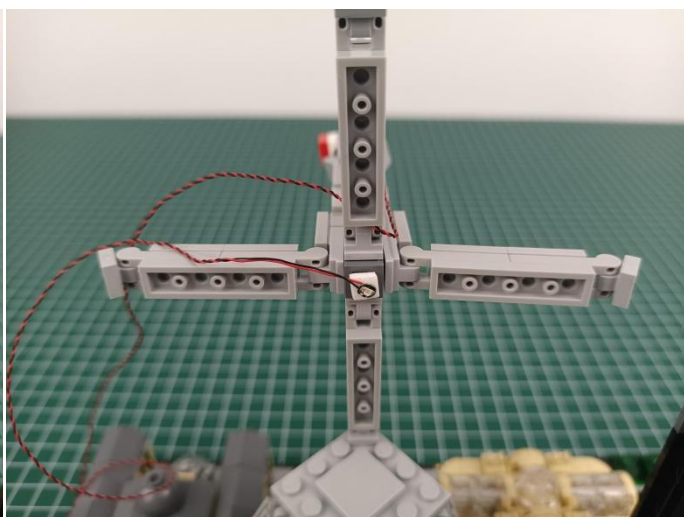
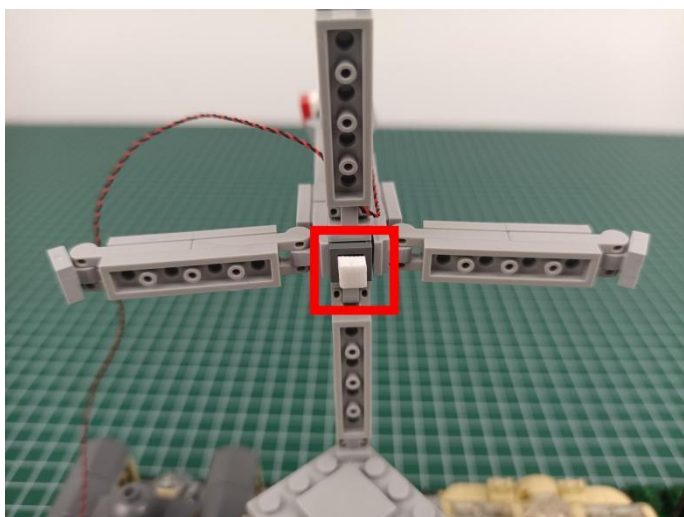

39



40

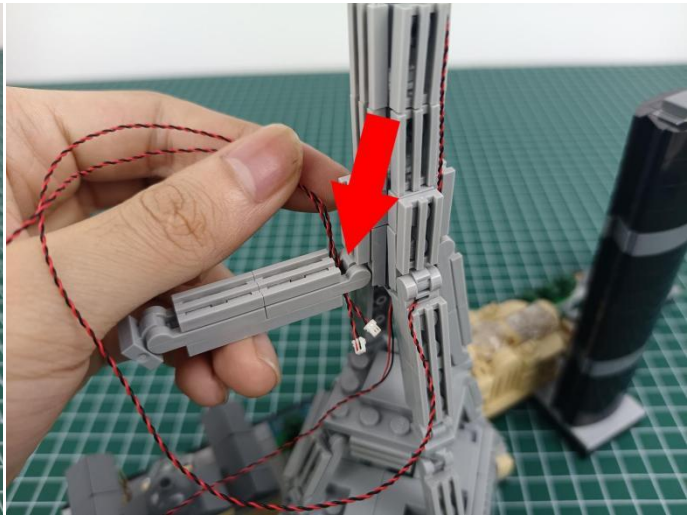
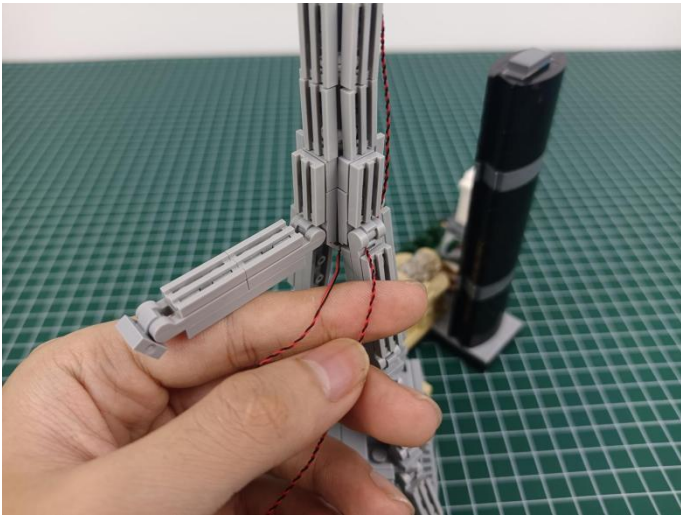

41

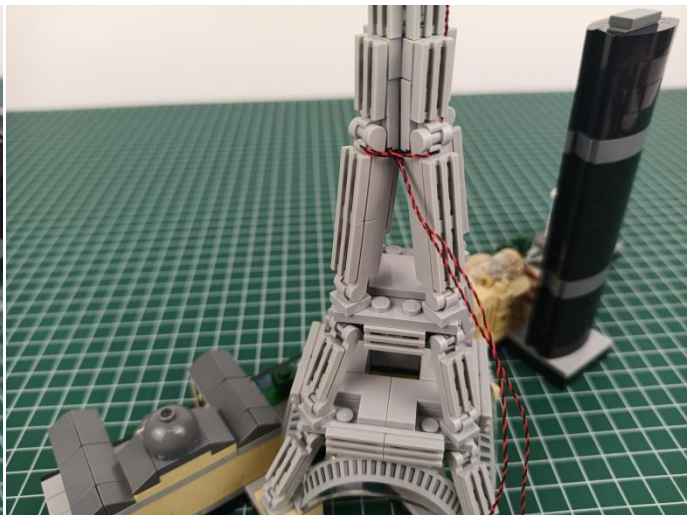
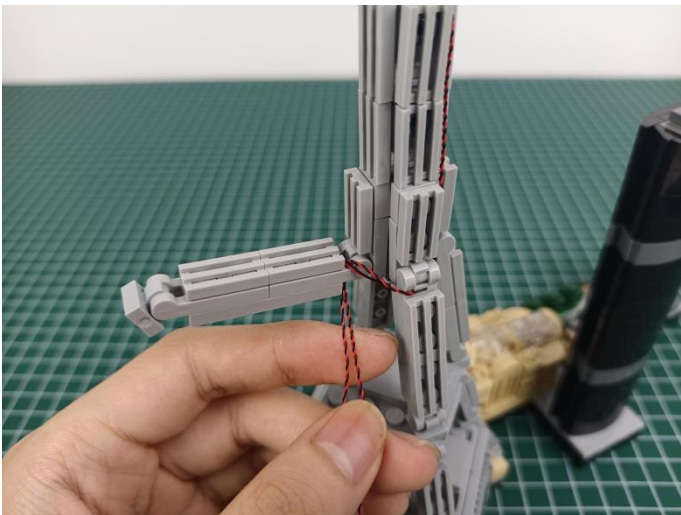

42

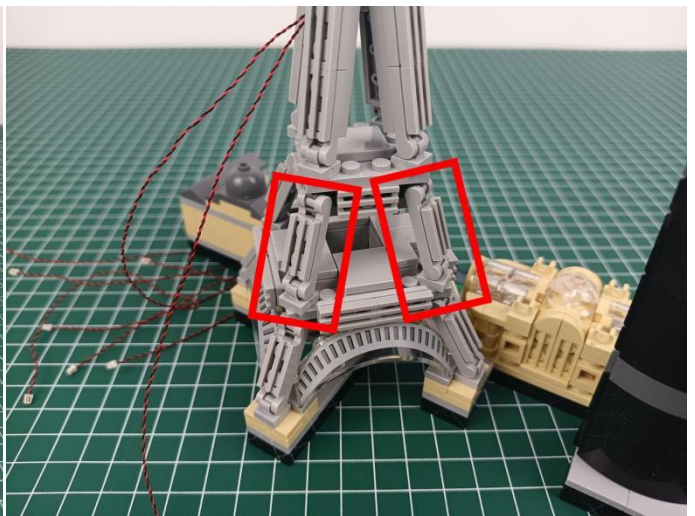

43

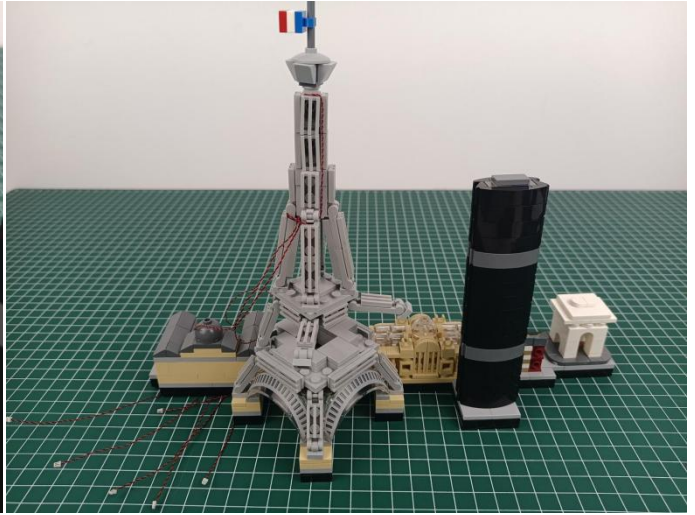
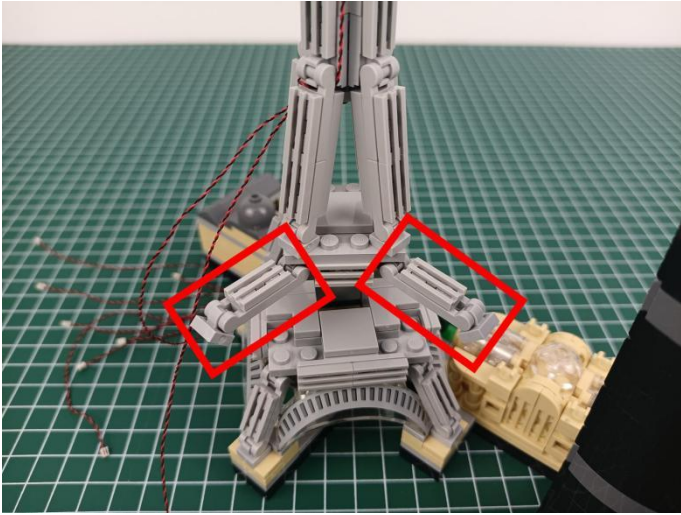

44

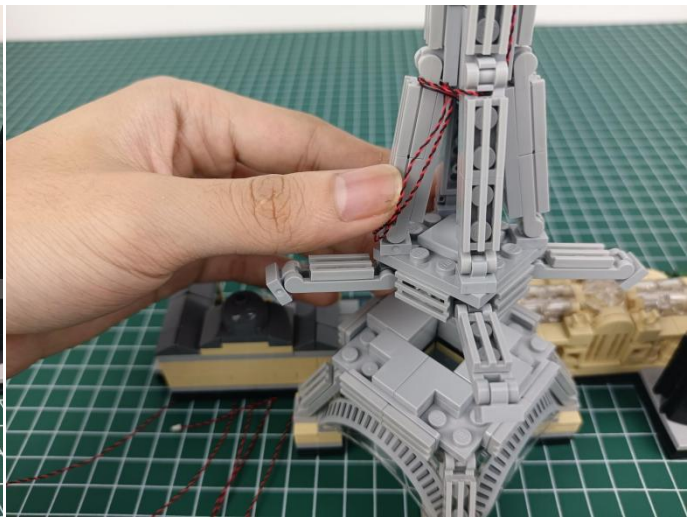
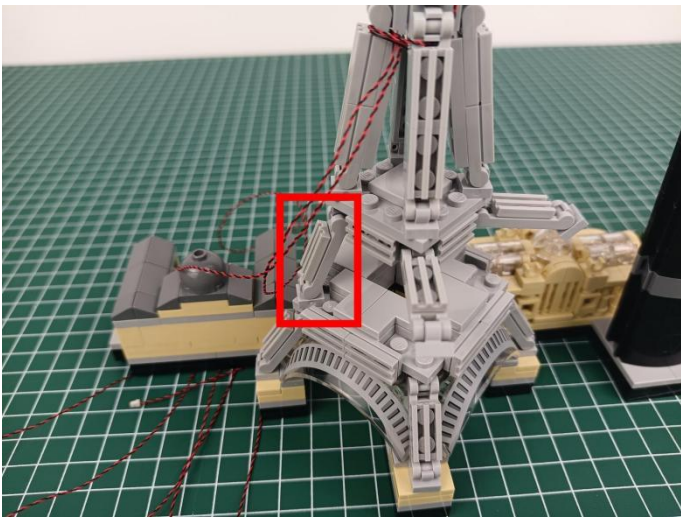

45

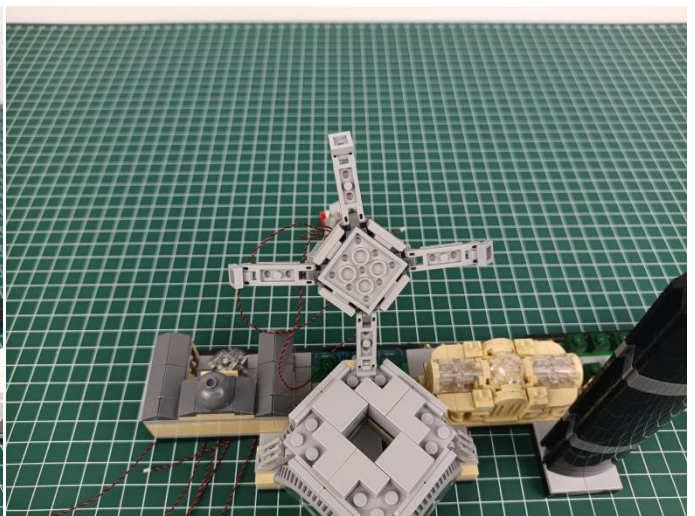
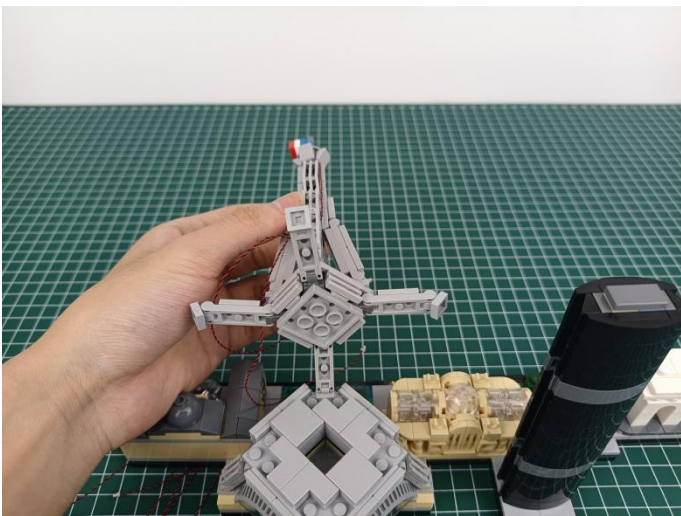

46

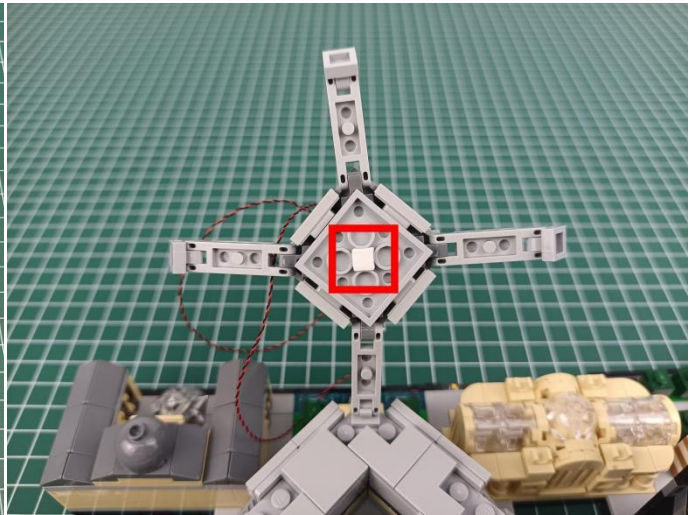

47

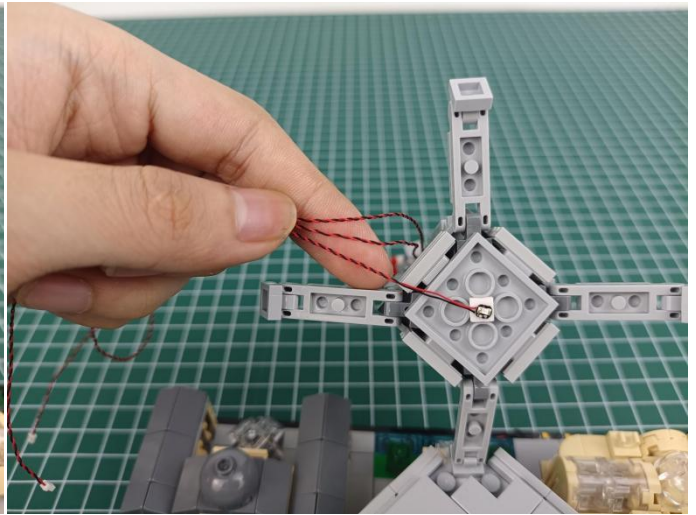
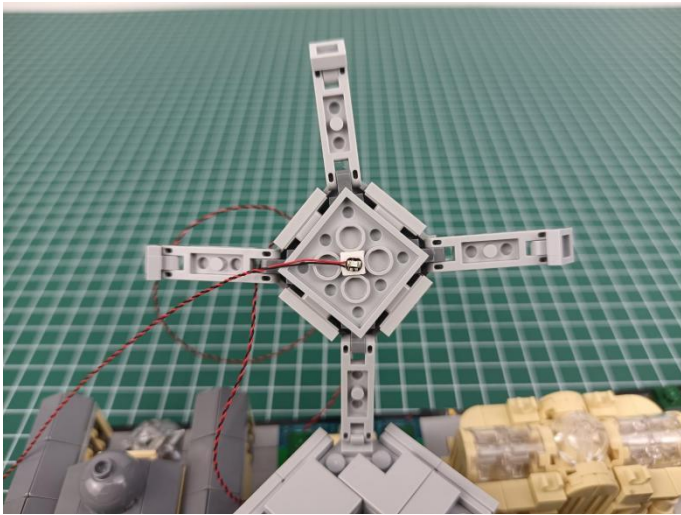

48

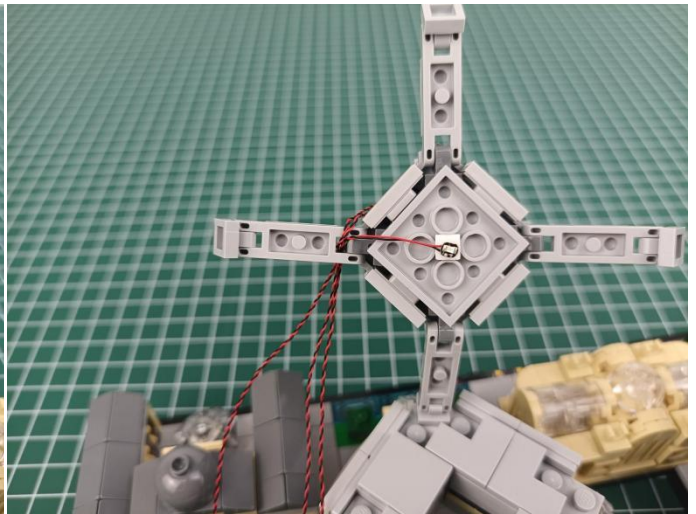
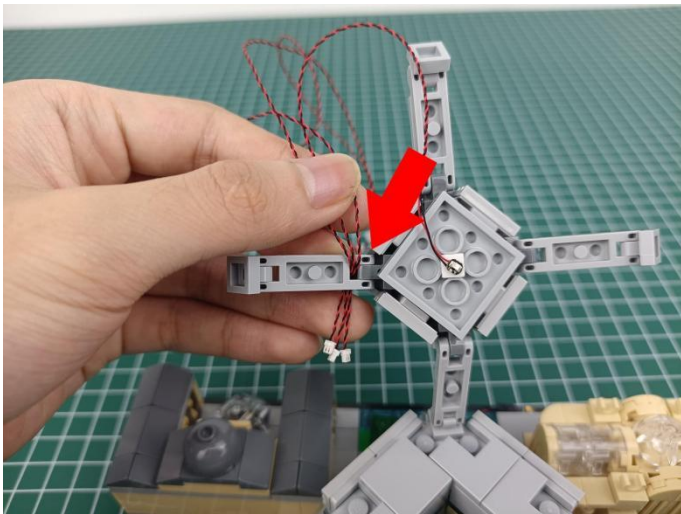

49

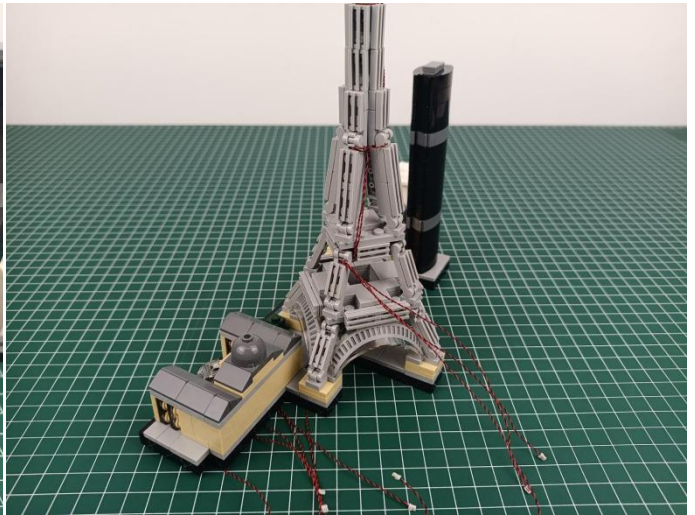
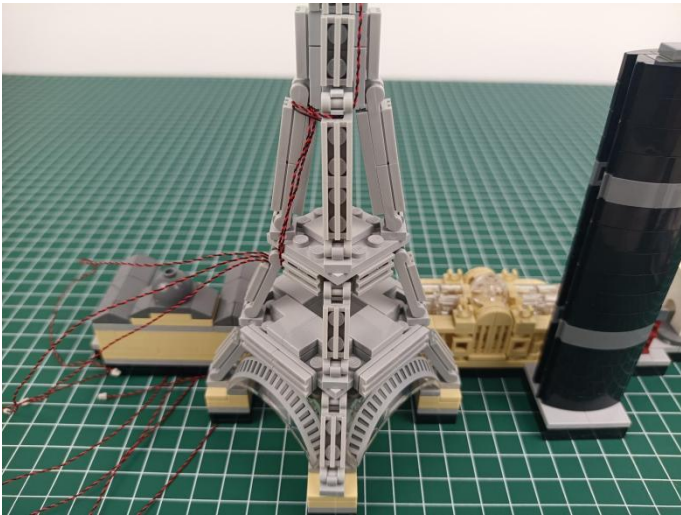

50

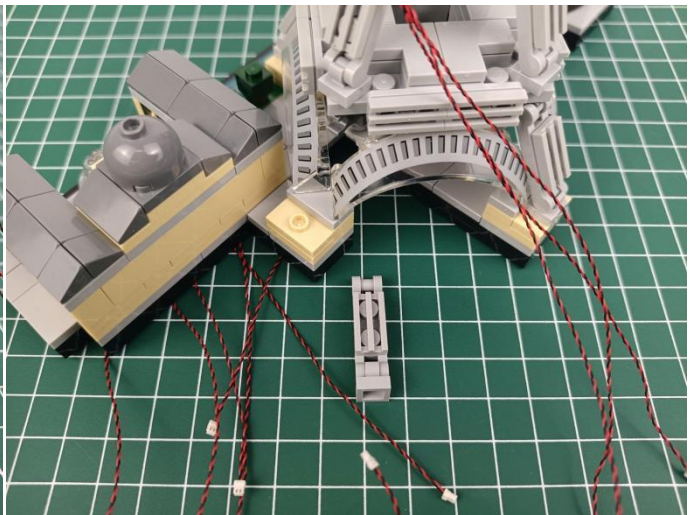
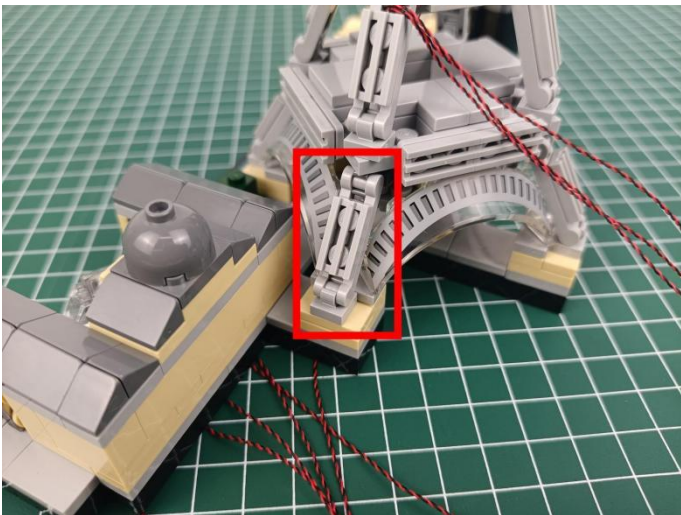

51

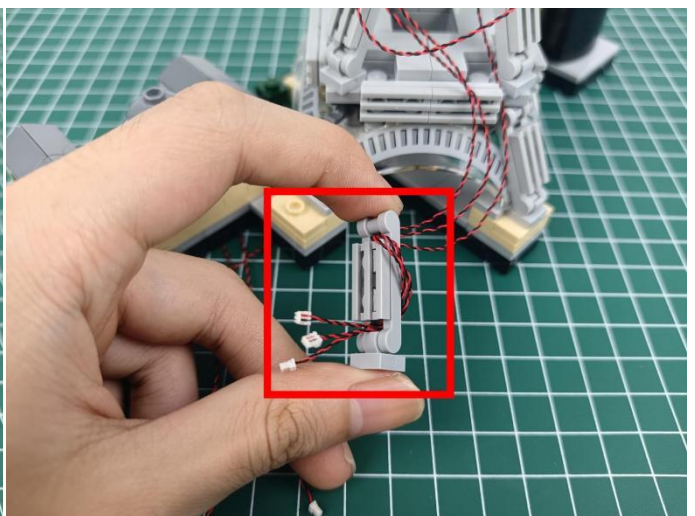
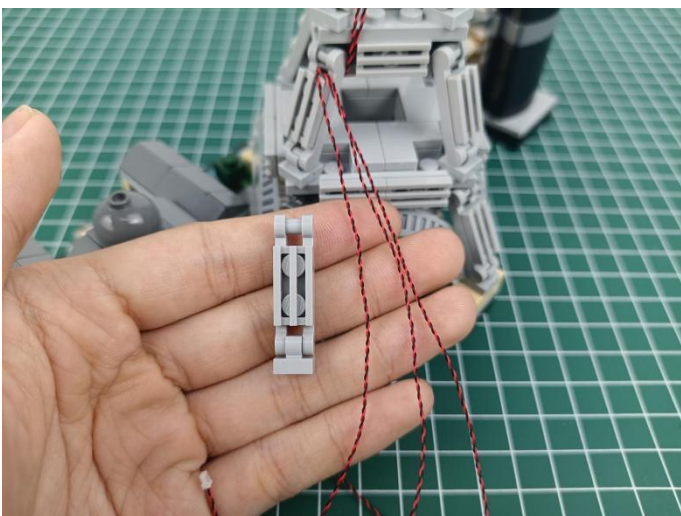

52

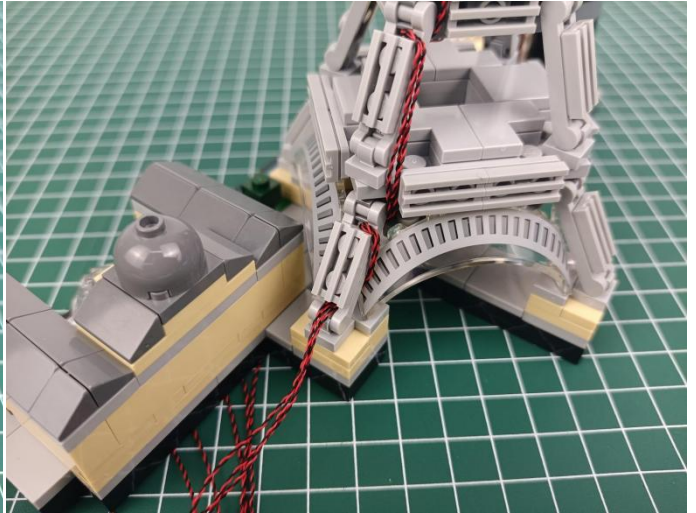
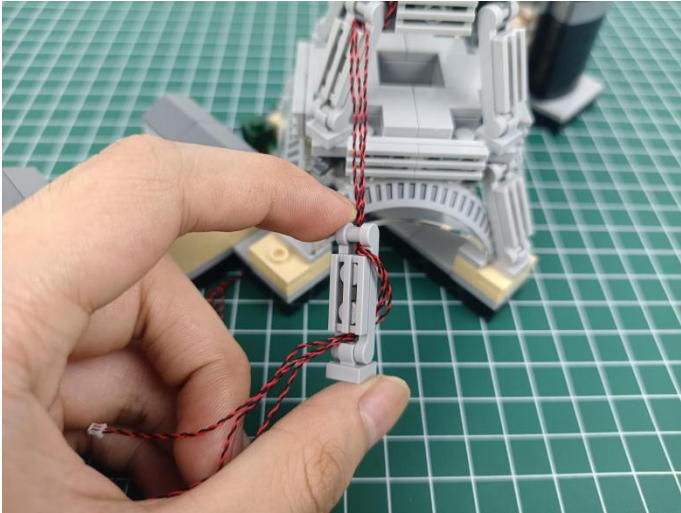

53

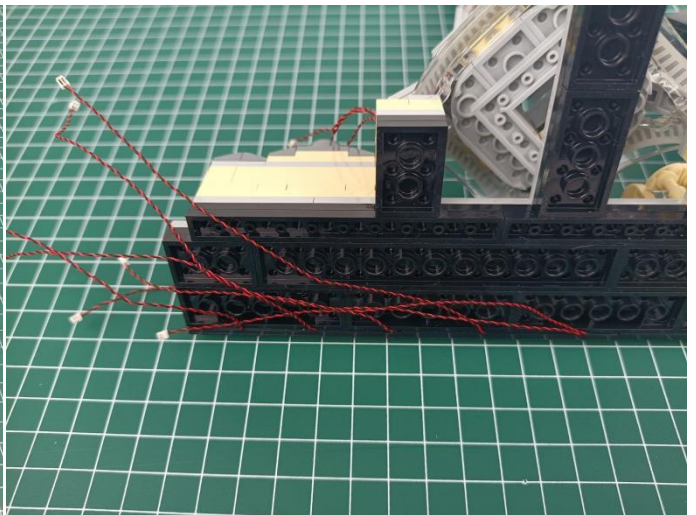
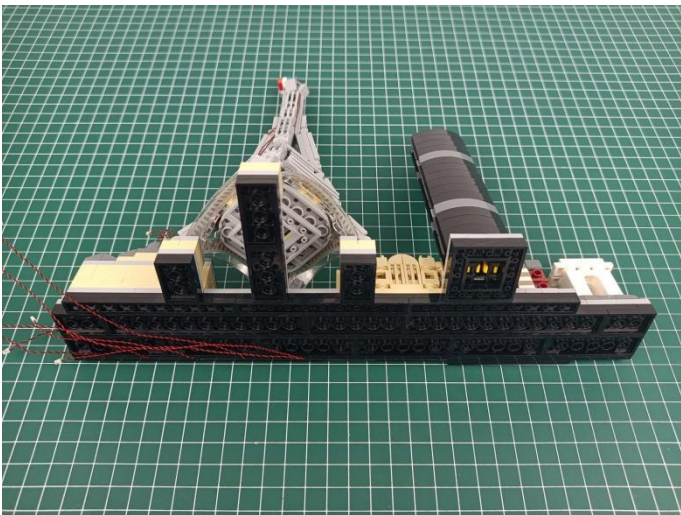

54

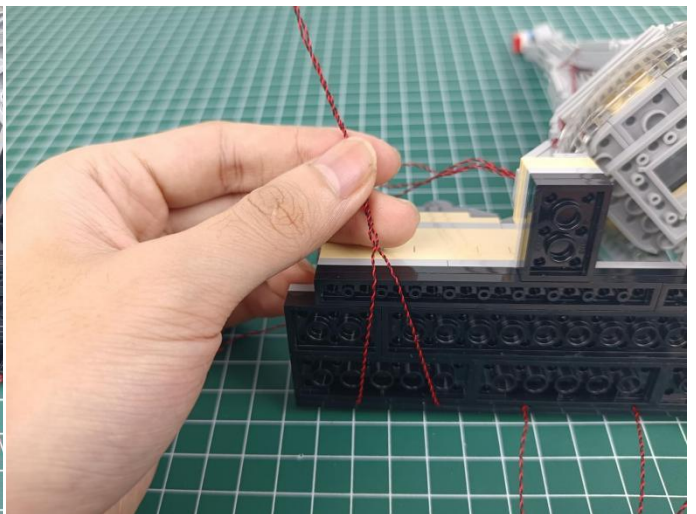
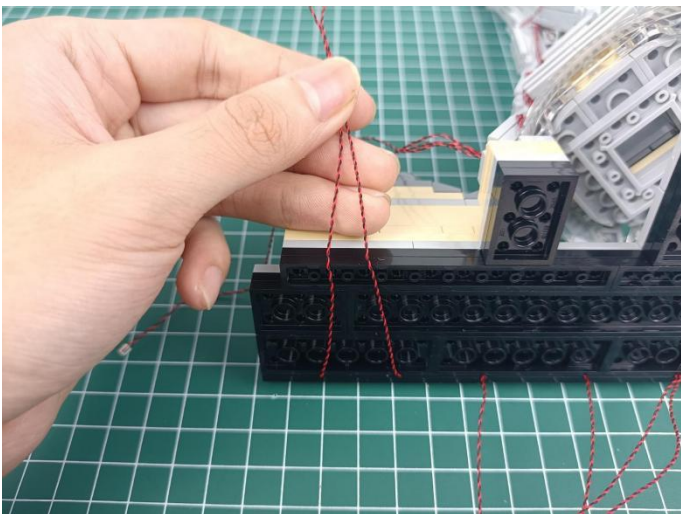

55

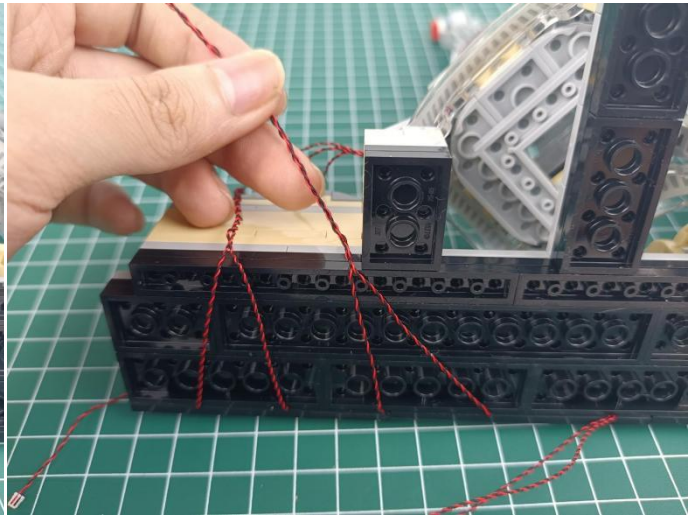
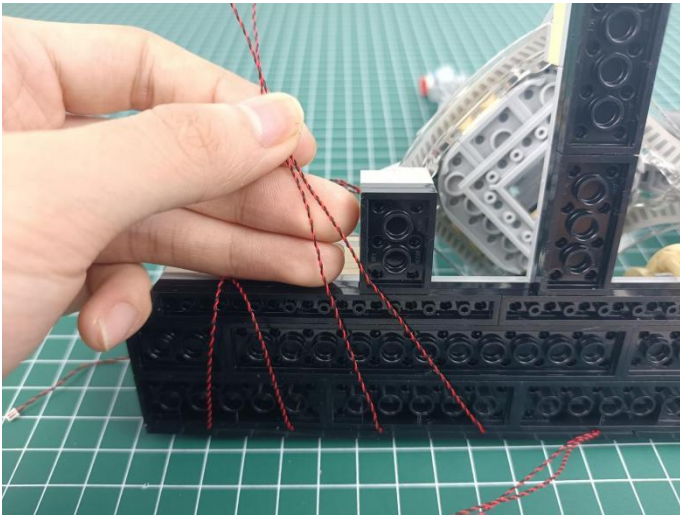

56

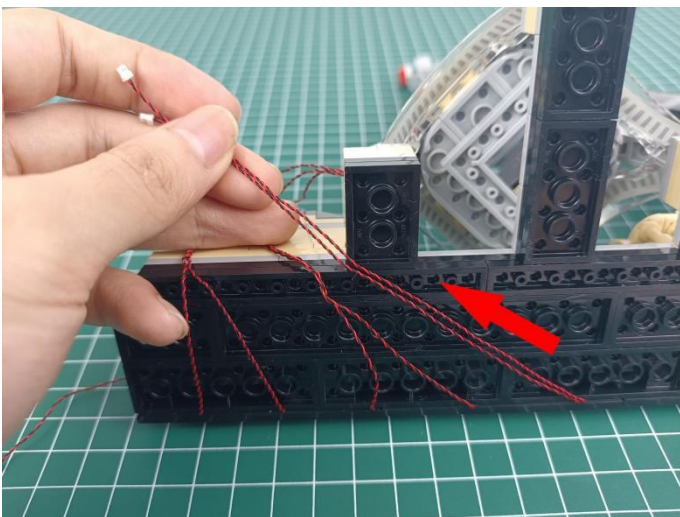

57

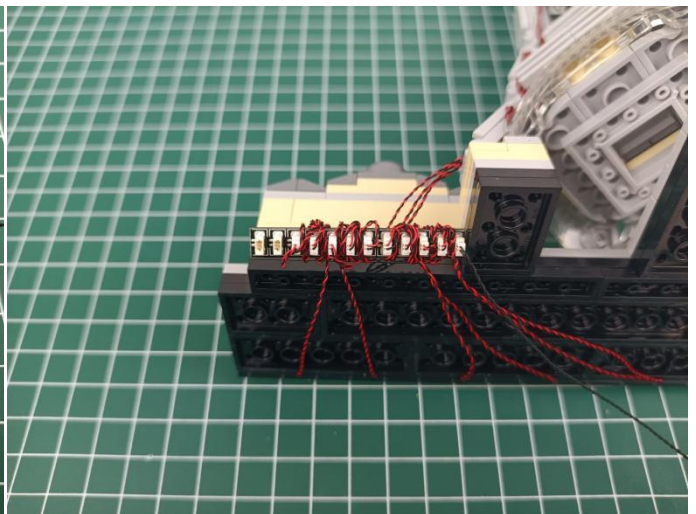
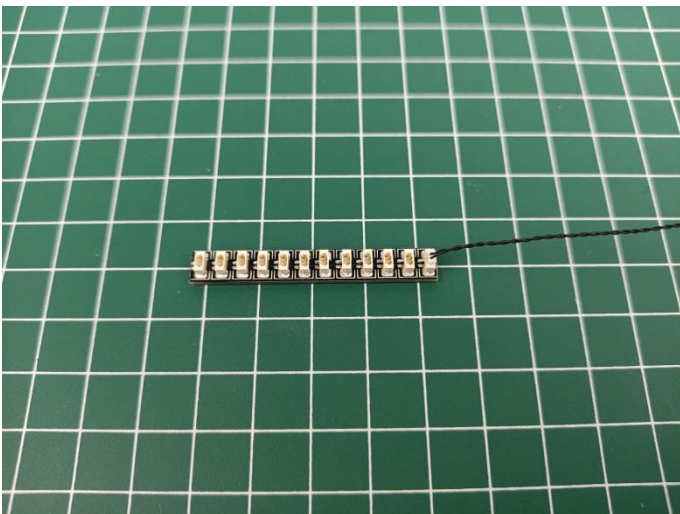

58

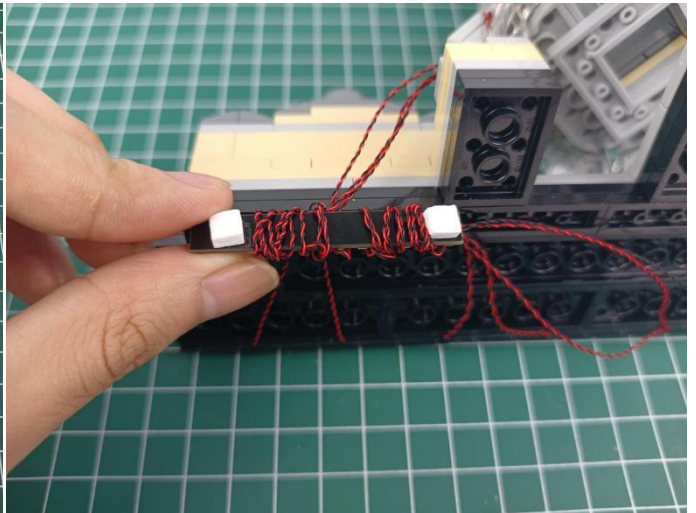

59

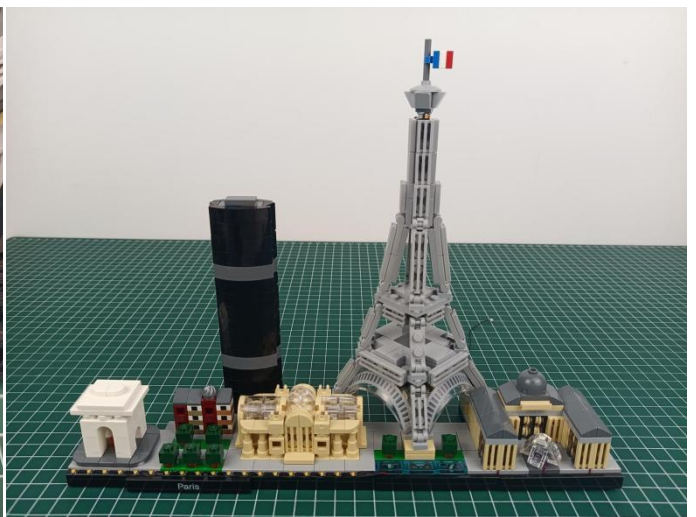
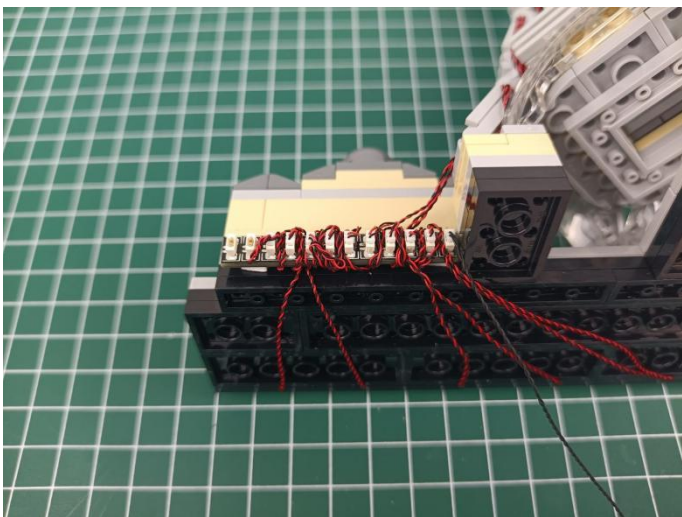

60

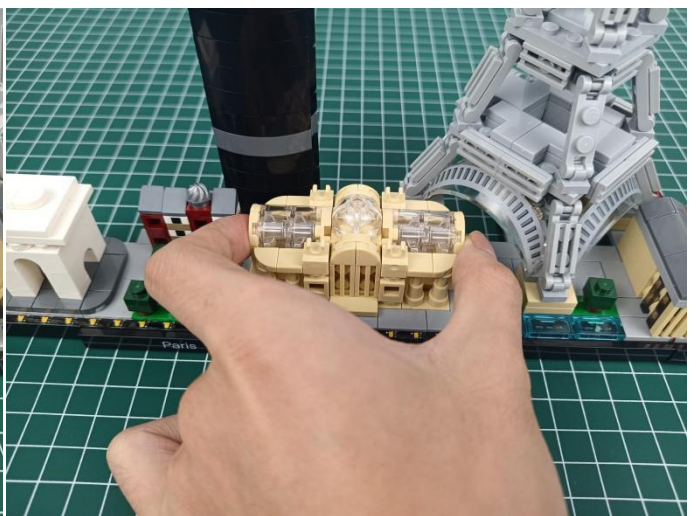

61

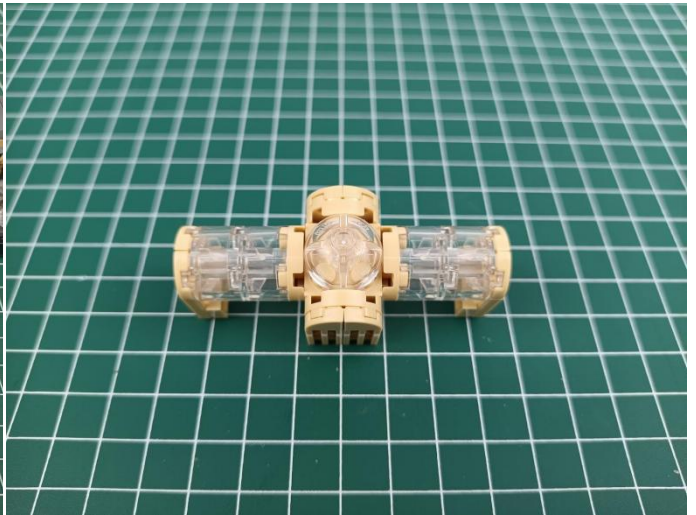
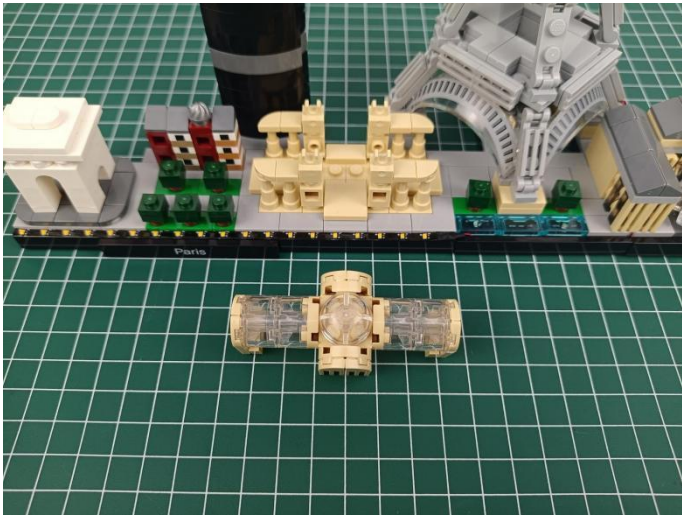

62

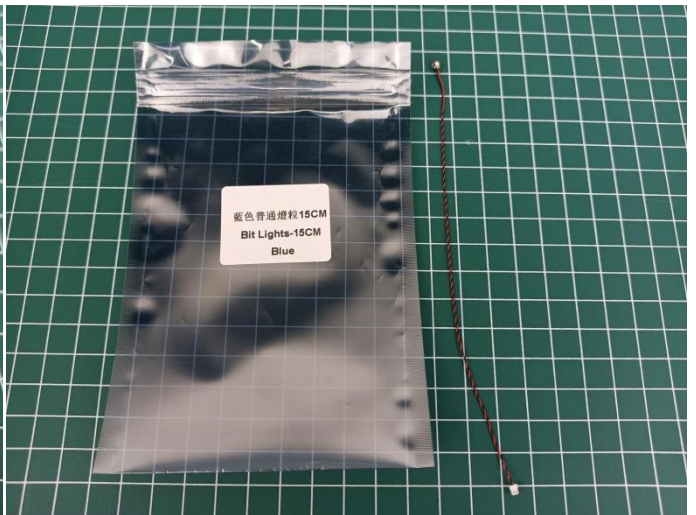
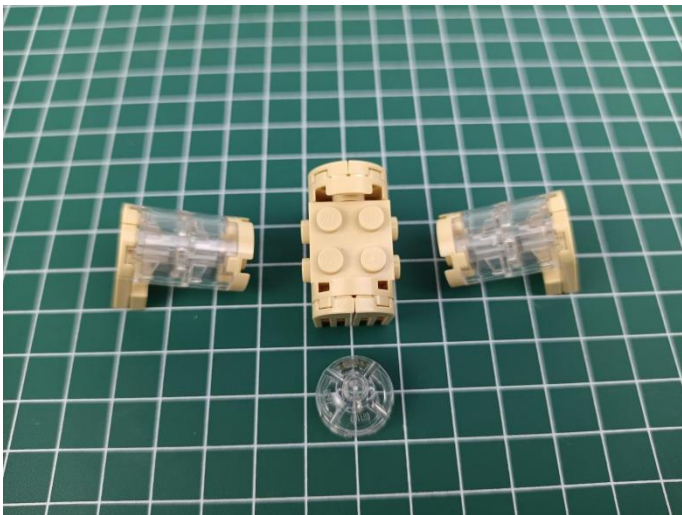

63

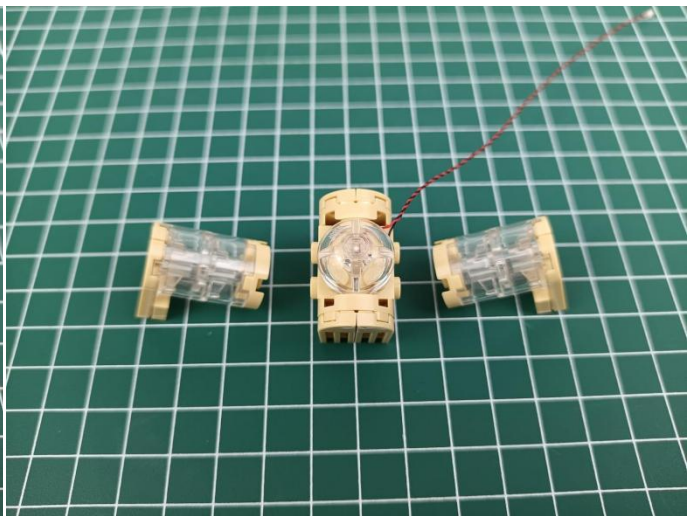
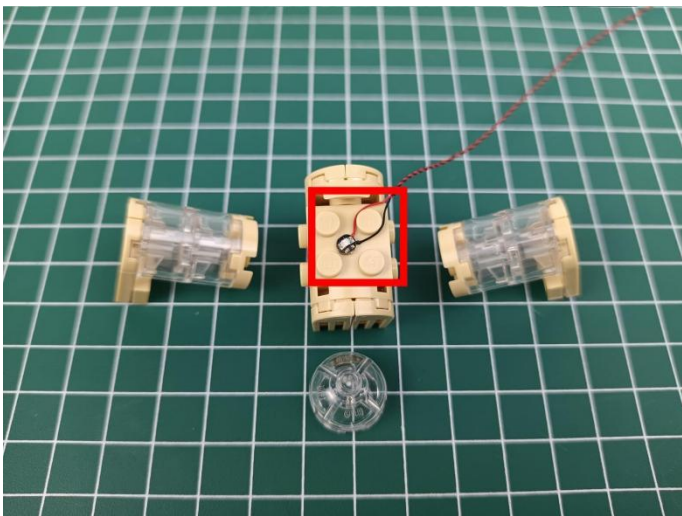

64



65



66

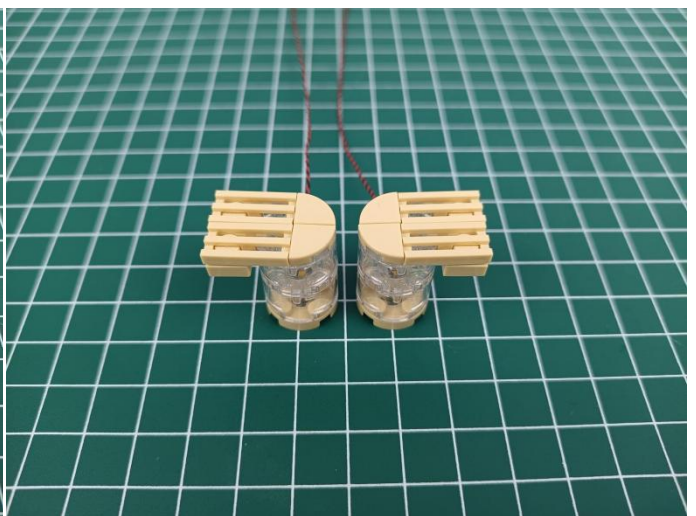
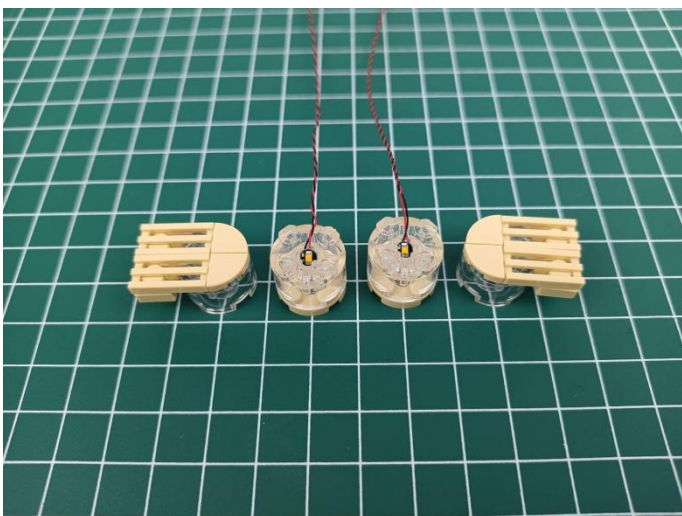

67

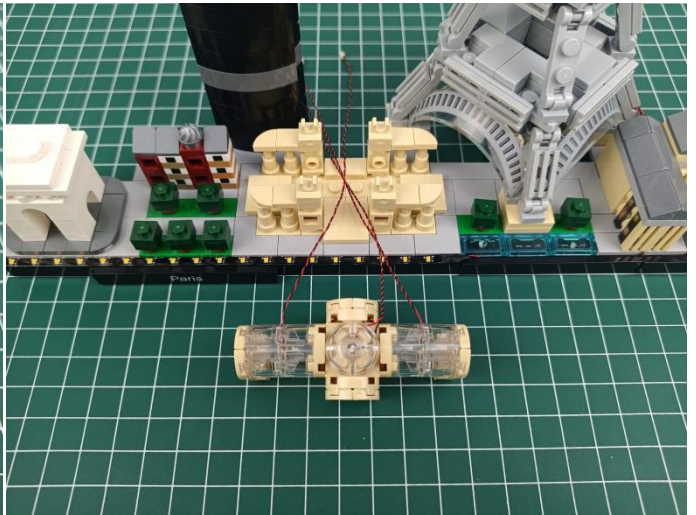
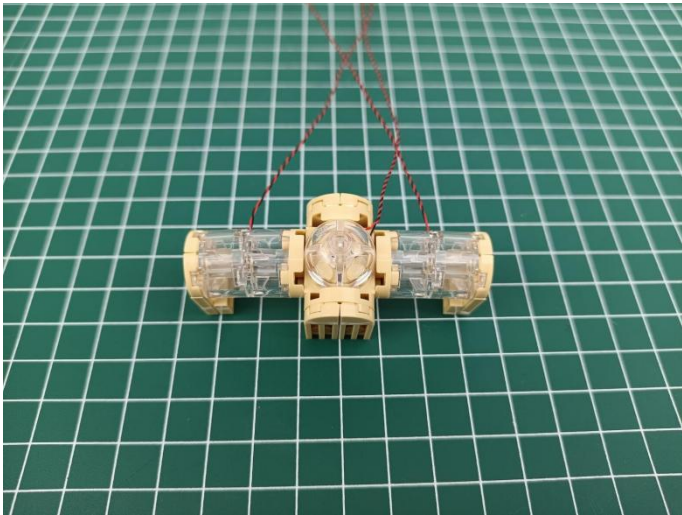

68

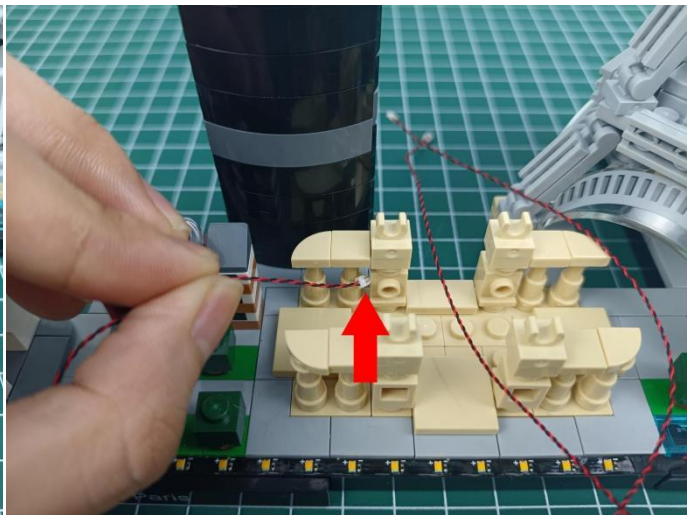
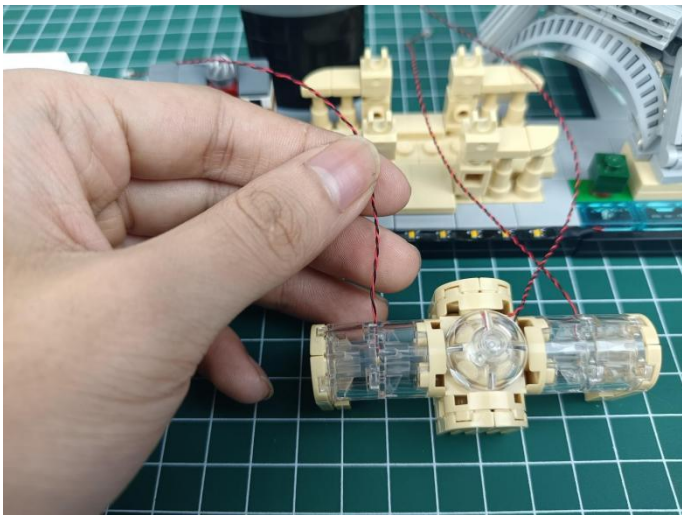

69

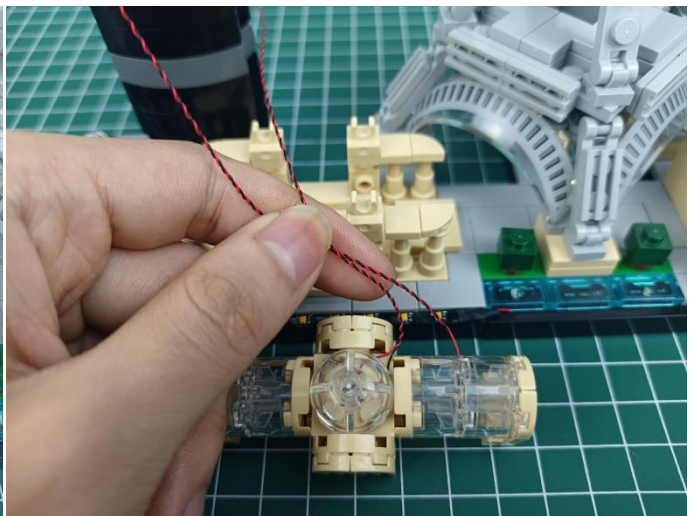
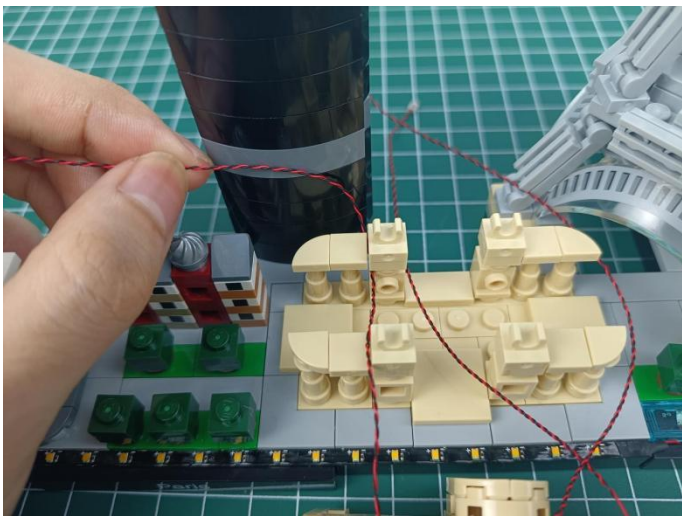

70

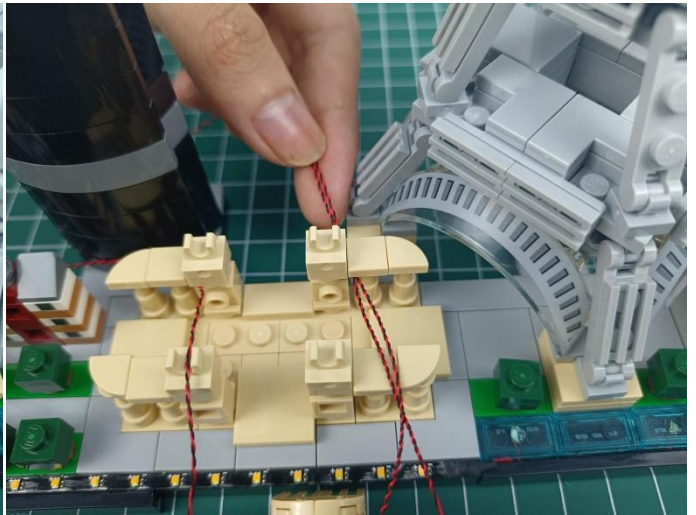
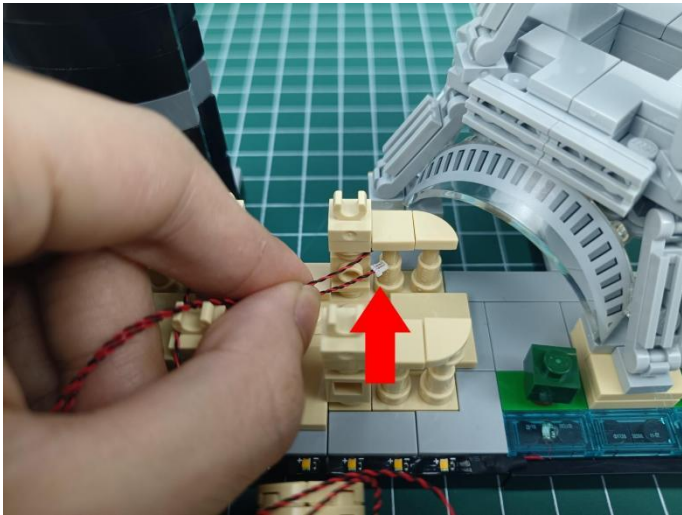

71

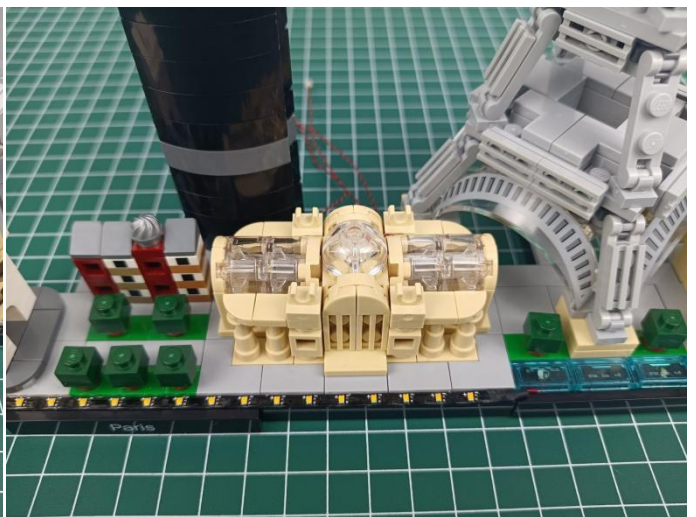
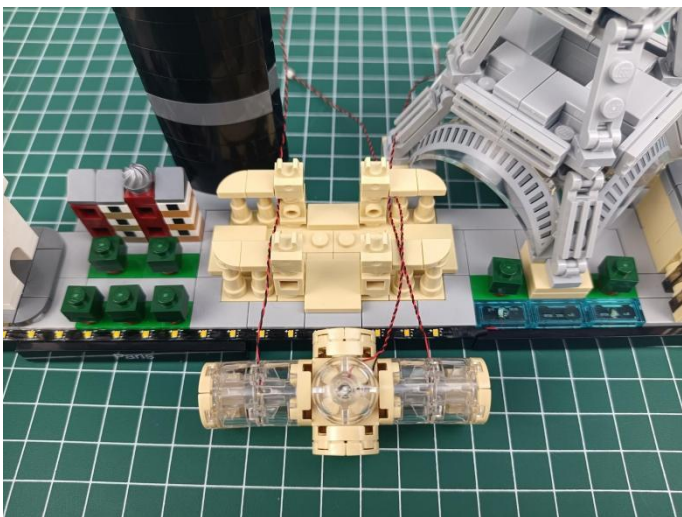

72

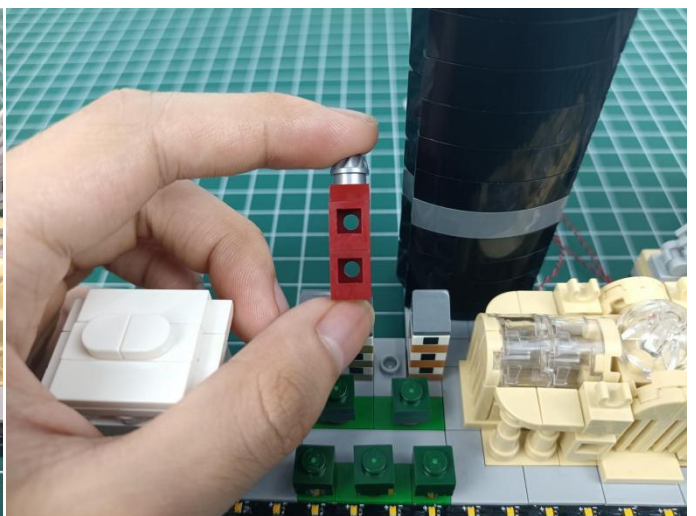
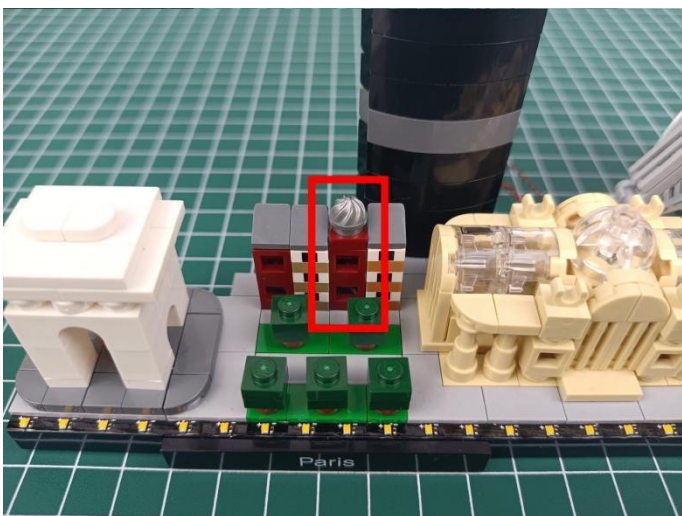

73

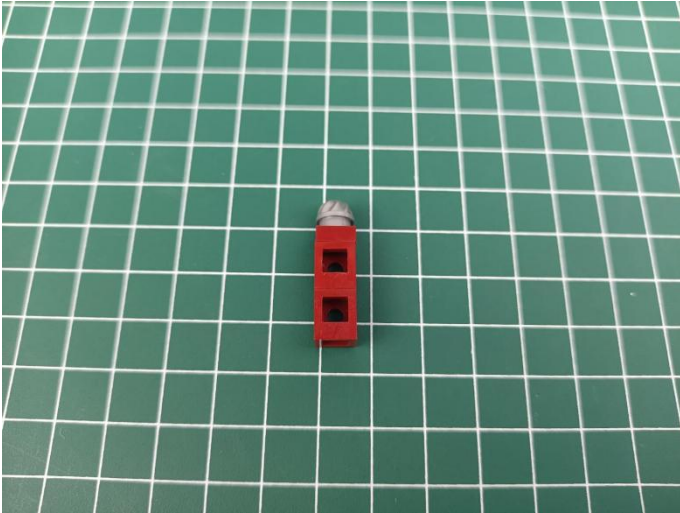

74

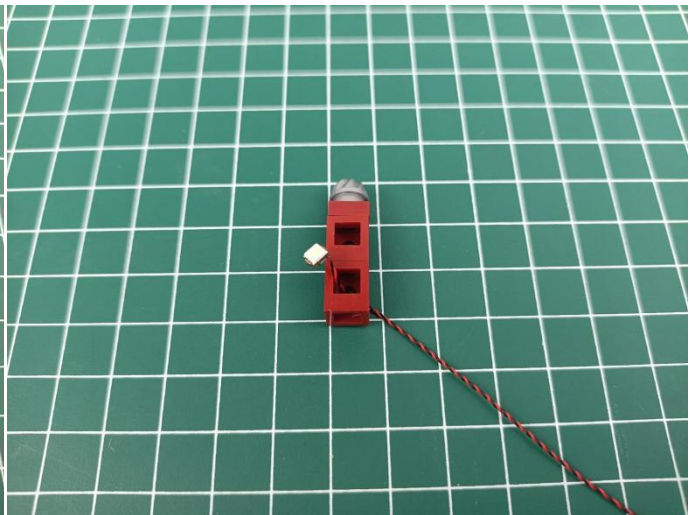
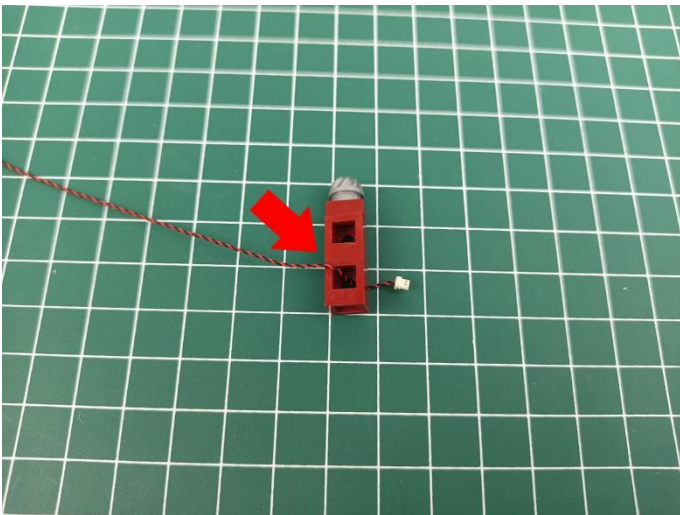

75



76

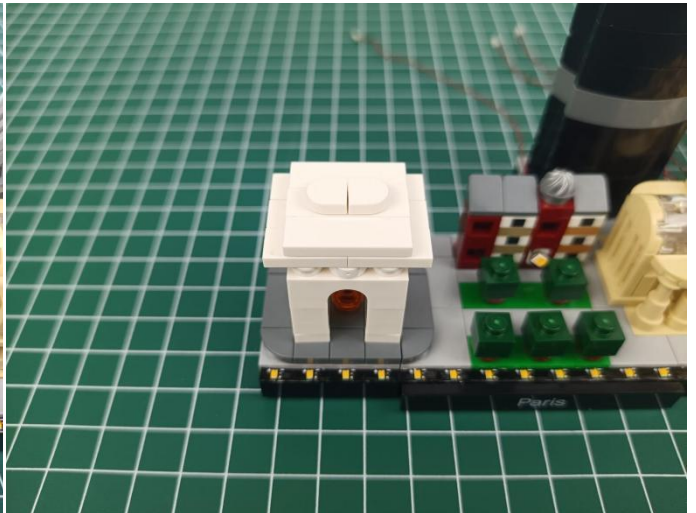
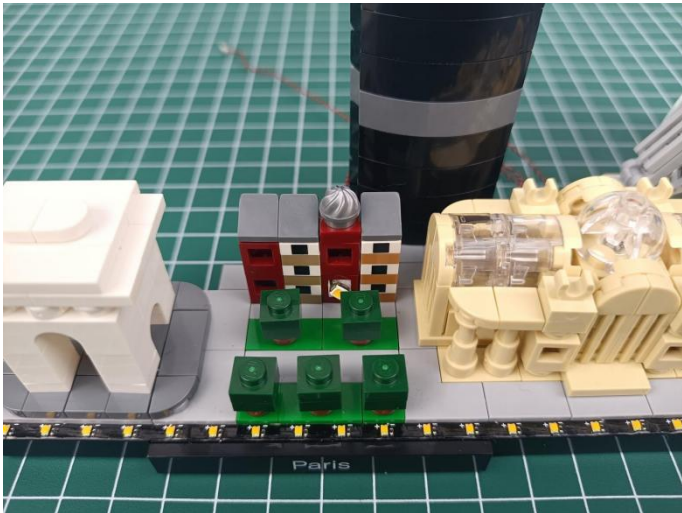

77

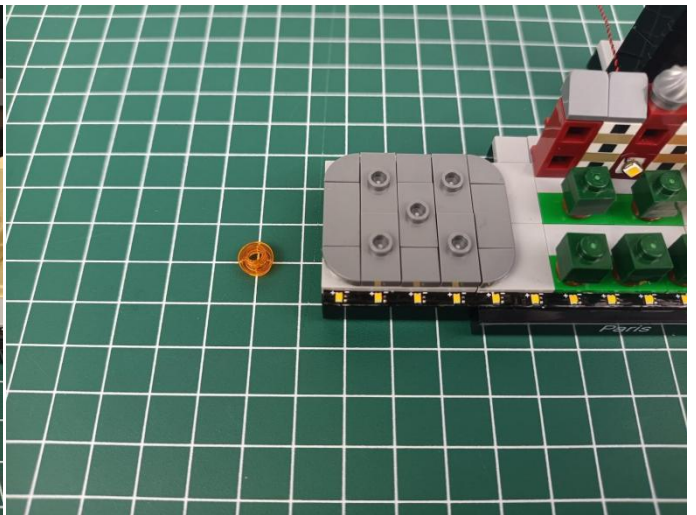
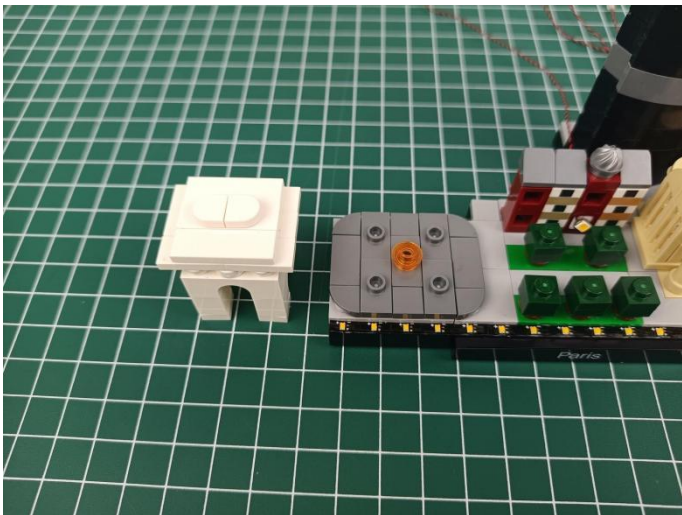

78

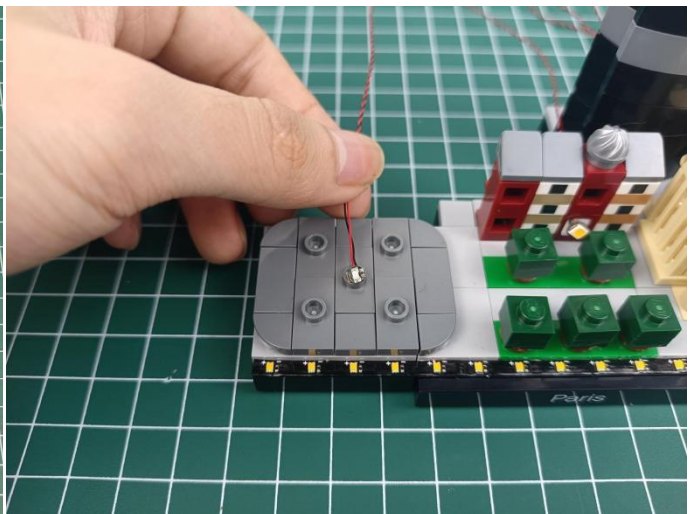

79

Tips

The plate without slit:

The plate without slit:

The squeeze causes the protective layer of the wire to be torn apart, the positive and negative wires touch together, and the set is short-circuited and the hot or wire is crushed, the wire to be disconnected and don't work.



The plate with slit:

The plate with slit:

The wire has enough space to avoid being squeezed and avoid with longer service life and more stable effect.



The slit on the the plate round 1X1 are hand-made to avoid squeeze the wire and cause short circuit and abnormal heat during installation.

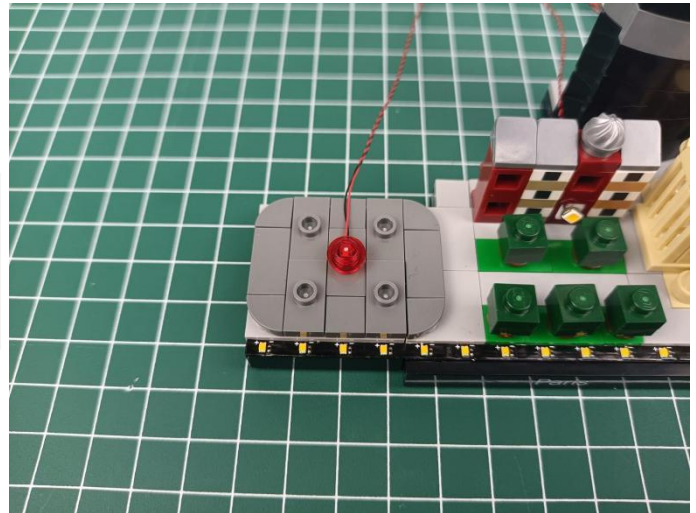

80

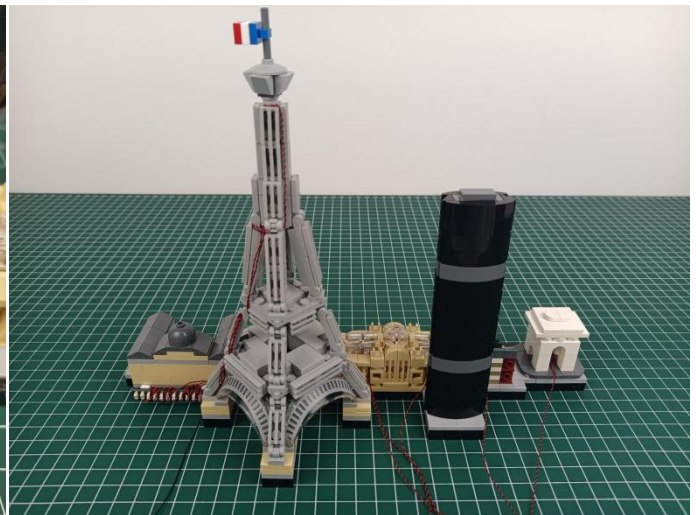
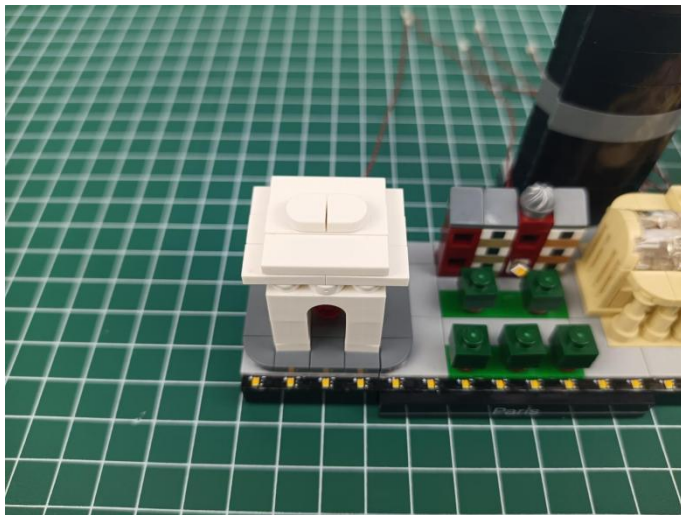

81

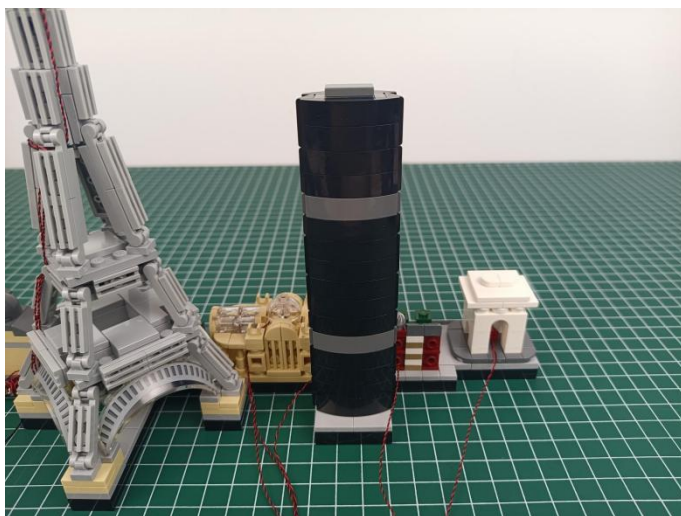

85

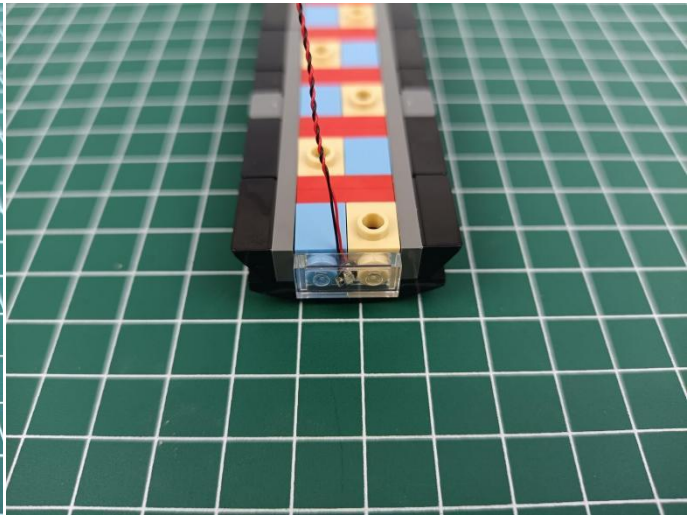
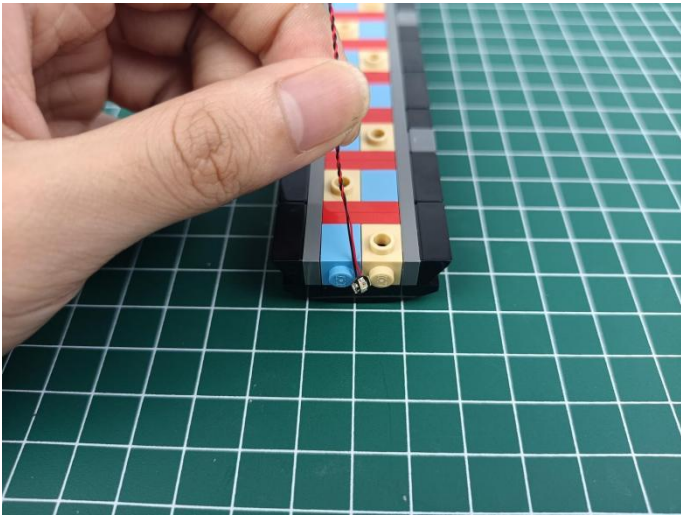

86

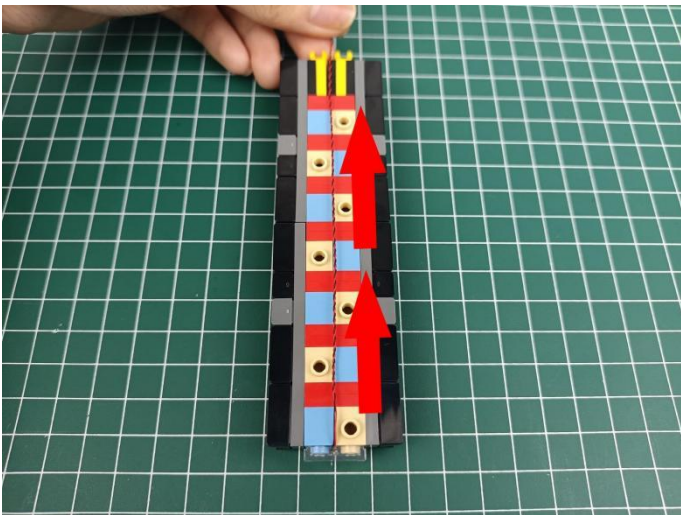

87

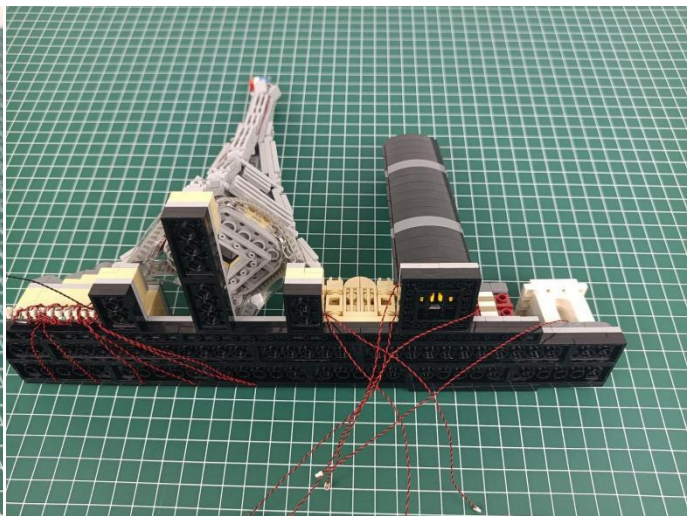
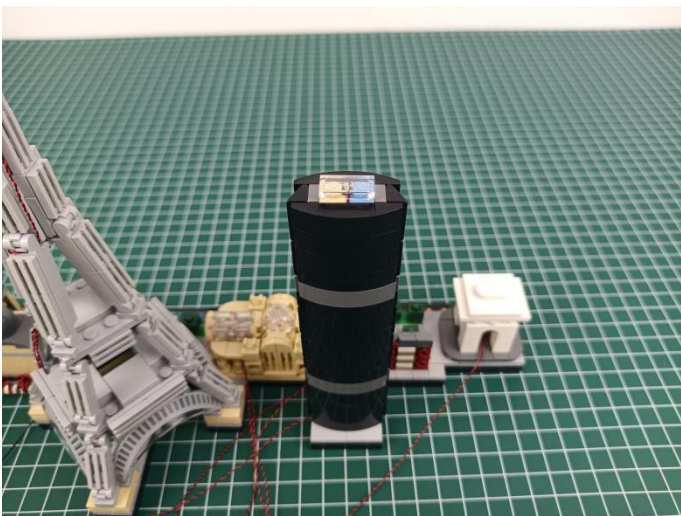

88

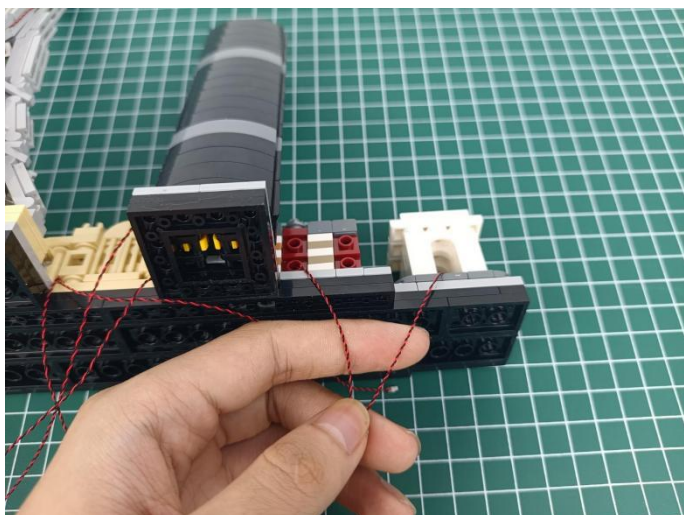

89

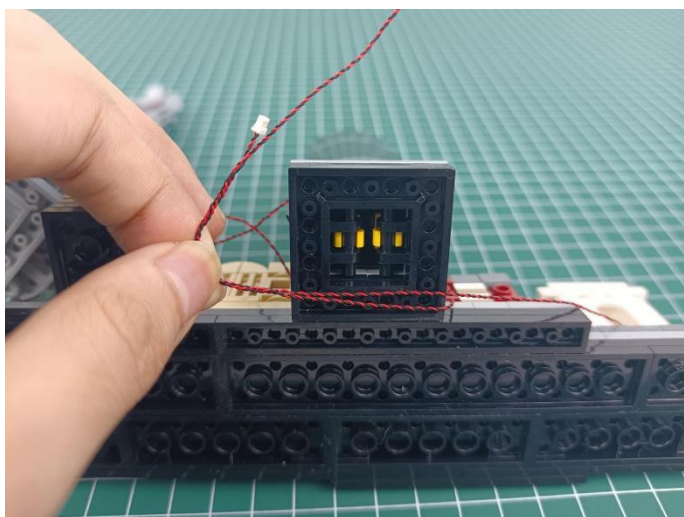

90

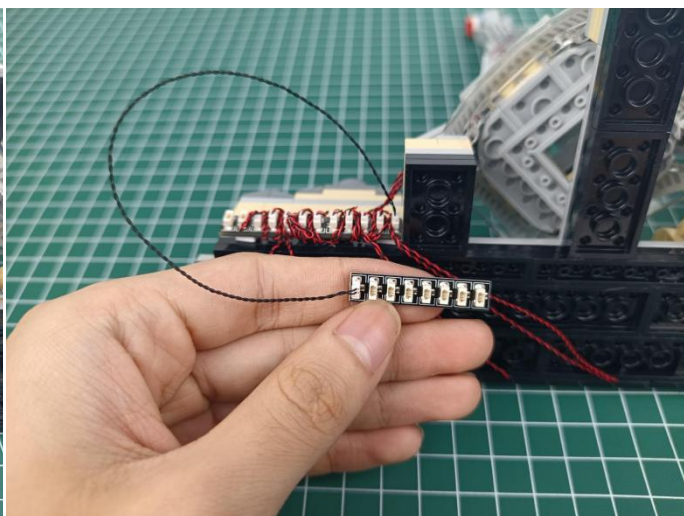
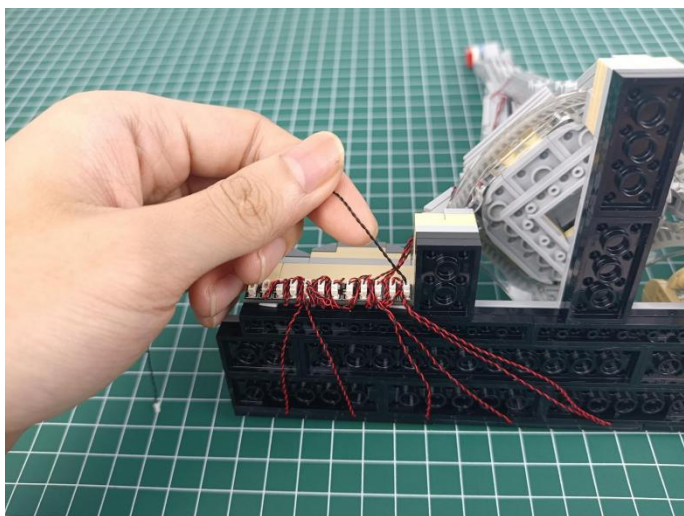

91

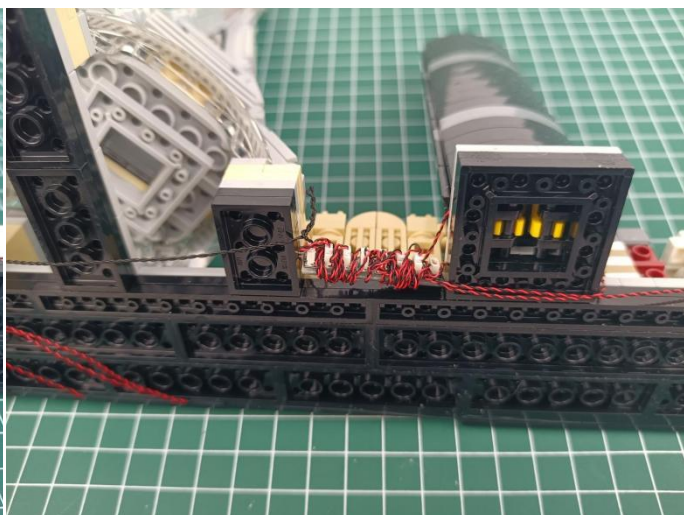
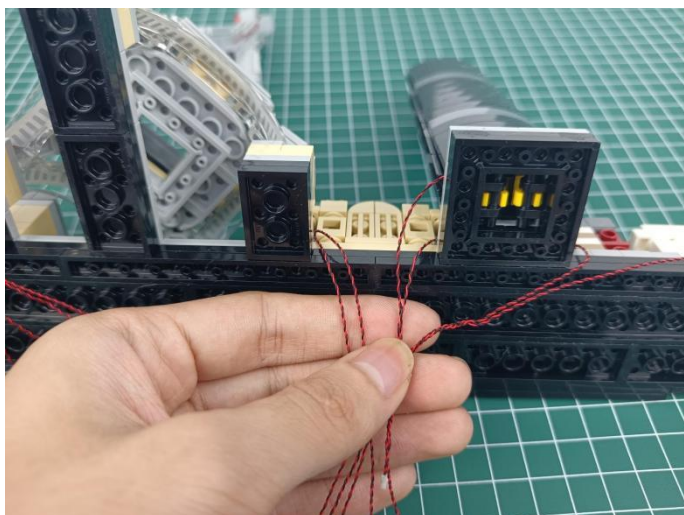

92

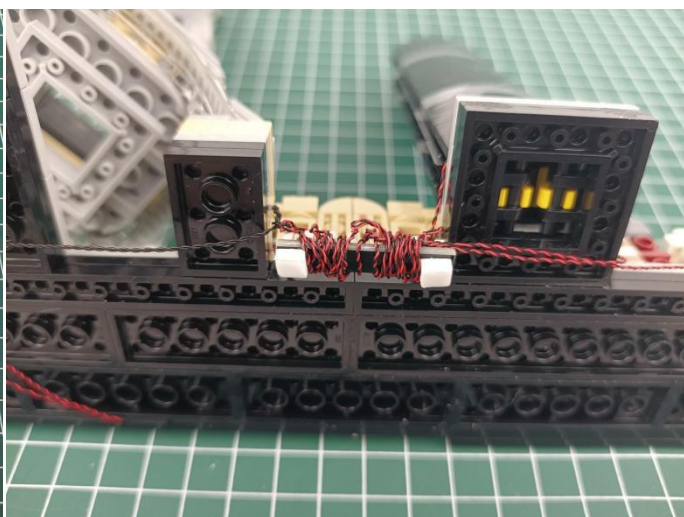

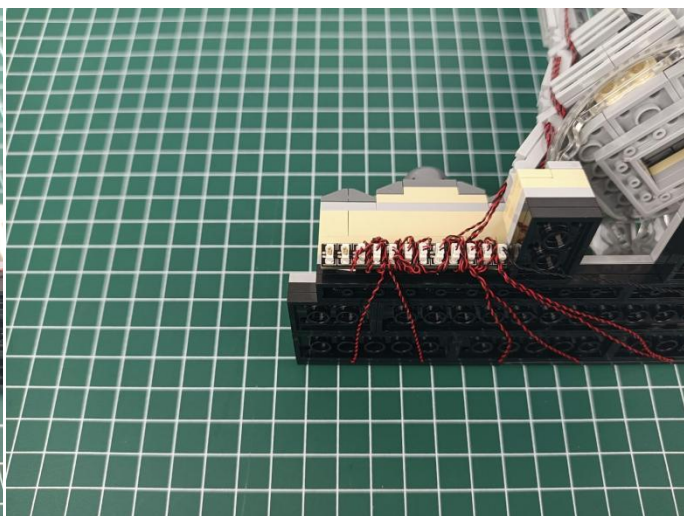

93



Install Power Supply Mode:

There are two power supply modes: A and B. You can only choose one of the two.
The advantages and disadvantages are as follows:

Image	Power Supply	Name	Advantage	Disadvantage
	Power Supply Mode A	USB Powered	1.Sufficient power 2.Relatively high brightness 3.Reusable	1.The use scene is relatively fixed 2.Poor stealth effect
	Power Supply Mode B	Battery Pack Powered	1.Sufficient power 2.Relatively high brightness 3.Reusable	1.The use scene is relatively fixed 2.Poor stealth effect

Power Supply Mode A:

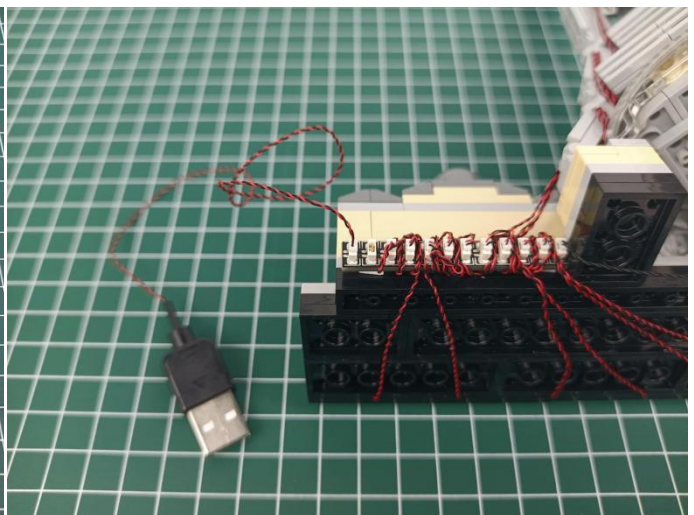

Power Supply Mode B:

Please bring your own battery.

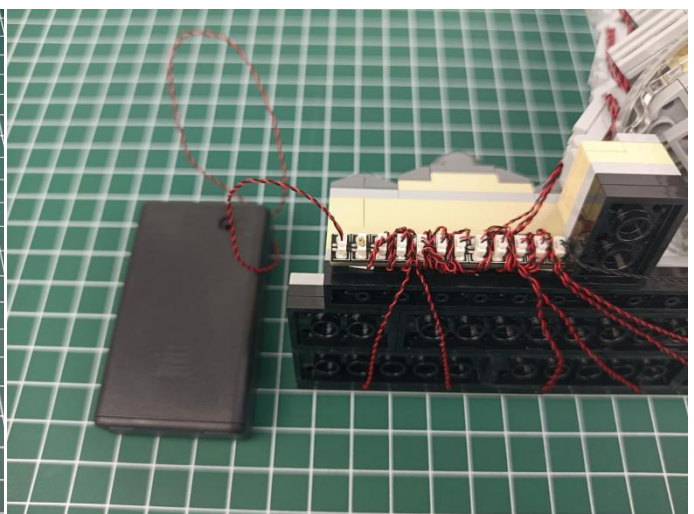

Good job, you've done all the installation steps, power it up and enjoy your work.



The battery box can also power the set. If it is necessary to change the power supply , prepare three AAA batteries, install them in the battery box, turn on the switch on the battery box, remove the plug of the USB Power Cable from the socket of the expansion board,plug the plug of the battery box to the same socket in the expansion board to power the suit as well.

THANKS