

# 42122 Wrangler cross-country car P21501

- P21501 is the unique code of lighting set, we use this to accurately identify the product you purchased and the corresponding manuals and services you need to obtain. Please make sure your product code is the same as the label on the back of the box shown “42122 P21501”.
- Installation requires a lot of patience and great observation that your LEGO bricks will come alive when you get this finished. The bricks with lighting as below, so make sure you're ready and let's get started.



# Strategies for the Installation

This instruction divides three sections to complete the installation of the lighting set.

## **Section A:** Check the type and quantity of components.

The quantity and type of components of each products are different and it needs to be carefully checked to make sure there do have enough material.

The type of components is indicated by the label on the bag.

## **Section B:** Test that each components is working properly.

Each components is made individually so it is necessary to test that each components is working properly to avoid the situation that the lighting does not work .

## **Section C:** laying out components following the instruction.

Our material is very small but not fragile, just be reminded that don't to pull the wires too hard. For different people, there may be some installation steps that you can't understand. Please look at the previous and later installation steps.

## **Section A: Check the type and quantity of components.**

There are 9 bags in this set. The name and quantities of specific components are as shown , please check carefully.

<b>Label</b>	<b>Content</b>	<b>Quantity</b>
<b>Bit Lights-15CM-White</b>	<b>Bit Lights-15CM-White</b>	<b>4</b>
<b>Bit Lights-15CM-Red</b>	<b>Bit Lights-15CM-Red</b>	<b>4</b>
<b>Colorful flash light particles-15CM</b>	<b>Colorful flash light particles-15CM</b>	<b>2</b>
<b>Headlights-15CM-Warm White</b>	<b>Headlights-15CM-Warm White</b>	<b>1</b>
<b>Light Strips-White -7</b>	<b>Light Strips-White -7</b>	<b>1</b>
<b>Expansion Board</b>	<b>6 Socket Expansion Board</b>	<b>1</b>
	<b>12 Socket Expansion Board</b>	<b>1</b>
<b>Connecting Cables-30CM</b>	<b>Connecting Cables-30CM</b>	<b>1</b>
<b>USB Power Cable</b>	<b>USB Power Cable-30CM</b>	<b>1</b>
<b>Parts package</b>		

**Please contact us immediately if there have any missing components.**

## Section B: Test that each components is working properly.

We need a structure to test all lights, so take out the bag with label “USB Power Cord”and “Expansion Boards”as follows.



It is worth reminding that our products are all customized. They have a unique way of connecting. The white plug on wire and the socket of the expansion board need to be connected together to transmit power.

Note that on one side of the white plug you can see two very small golden wires that should be connected to the two golden needle in socket of the expansion board.shown as blow.

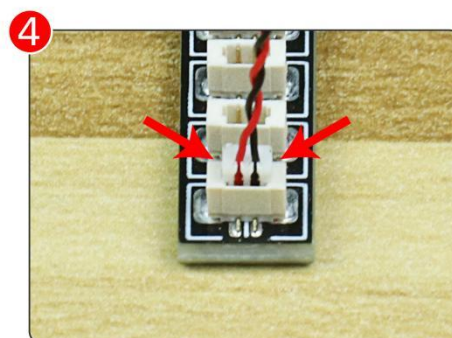
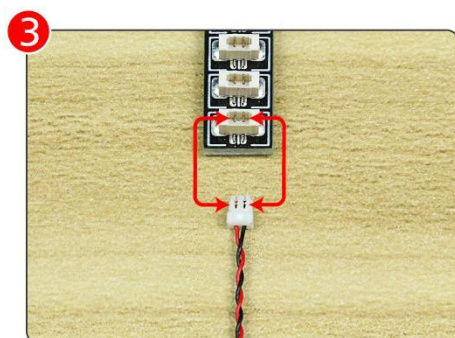
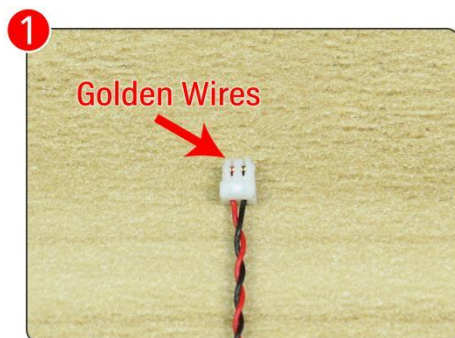



All our connections between plug and socket are all the same as shown above. So for any such structure with plug and socket, please pay attention to the golden wire of the plug and the golden needle of the socket, they must be touched together.

The connection method between the USB Power Cord and Expansion Boards is as follows:

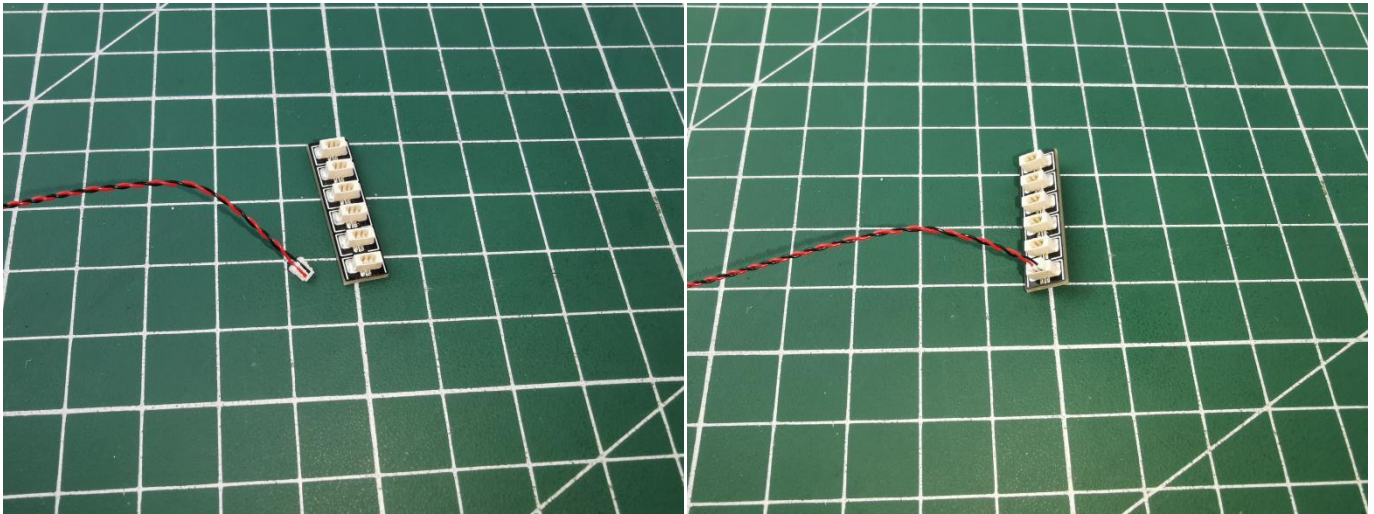

The USB Power Cord can be powered by phone chargers, power banks, etc.

USB connectors to connect devices

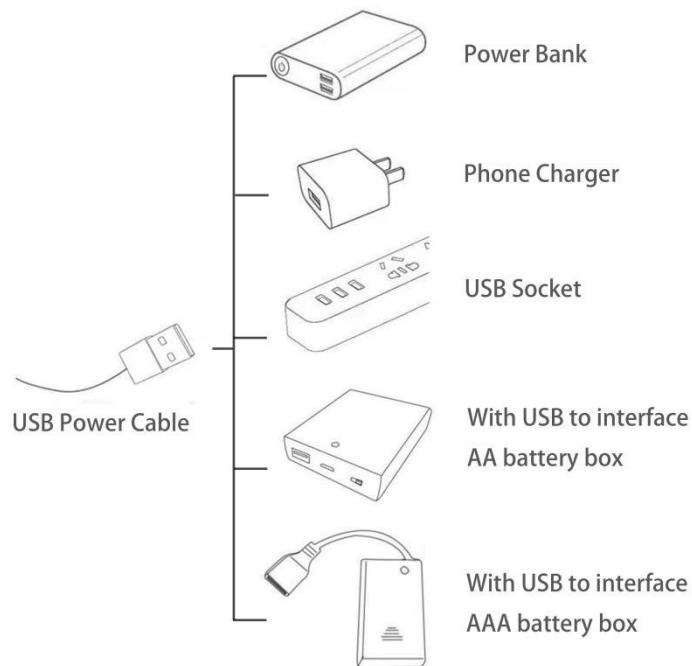

**This instruction will use the power bank as power supply . The test structure is shown as follow. All lamp in this set will be tested by this structure.**



**when we test "Headlights-15CM-Warm White" particles,Take out the bag labelled "Headlights-15CM-Warm White".Take out one of the light and connect it to the socket. Turn on the power bank, the light will turn on normally as shown below.**

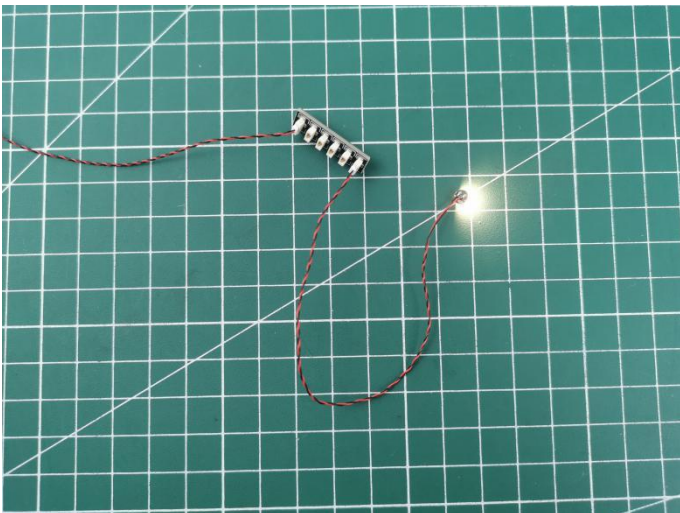

**Test each lamp according to this method. It should be noted that after the test, the lamp must be returned to the corresponding bag to avoid confusion of types.**



**The components needs to be tested in this set is 4\*Bit Lights-15CM-White,4\*Bit Lights-15CM-Red,2\*Colorful flash light particles-15CM,1\*Headlights-15CM-Warm White,1\*Light Strips-White-7 .**

**Please contact us immediately if any components don't work.**



## Section C: laying out components following the instruction.

1



2

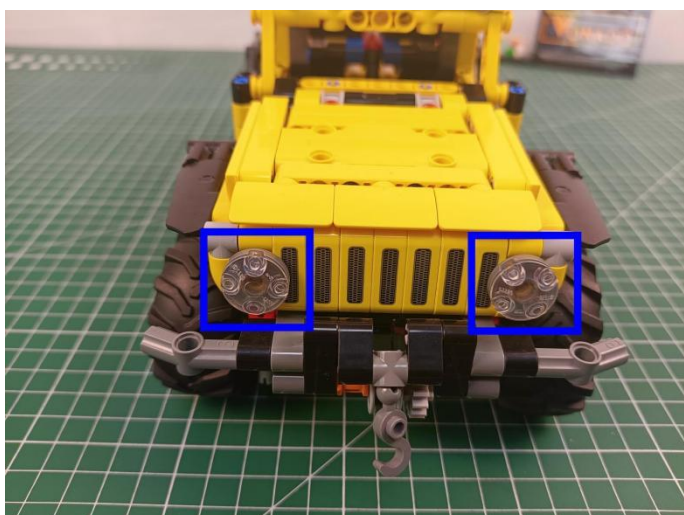

3

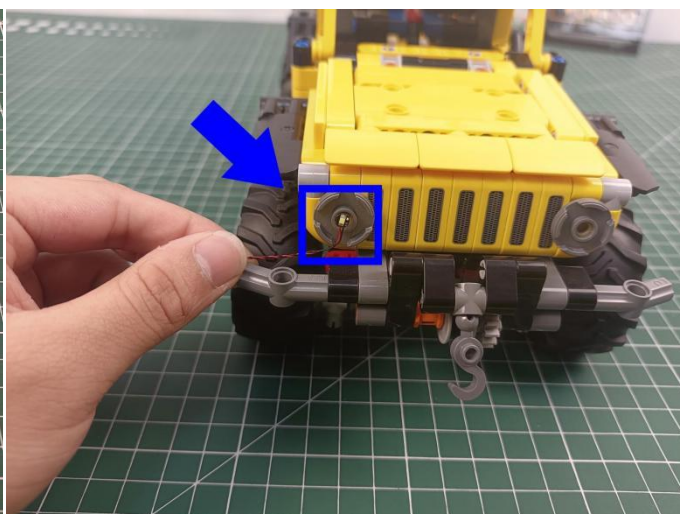



4

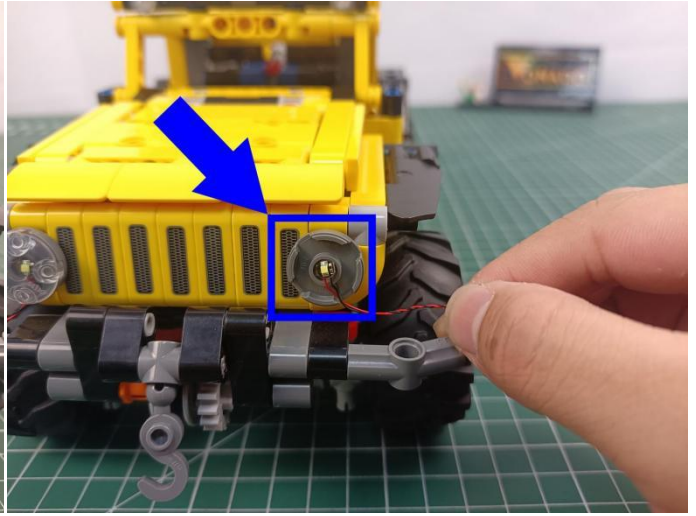
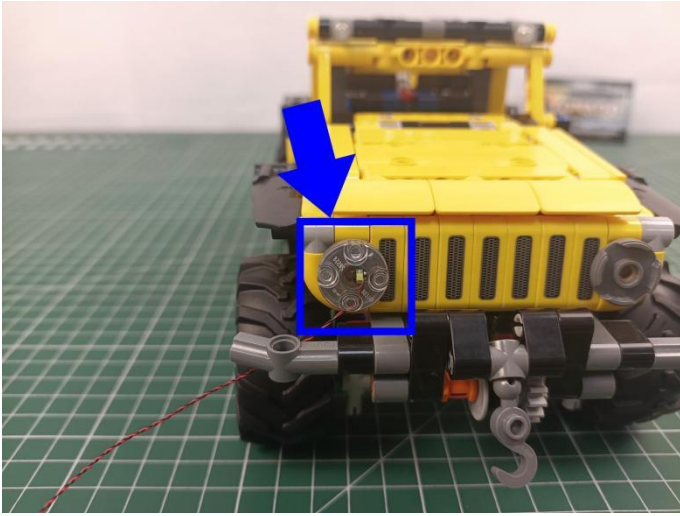

5

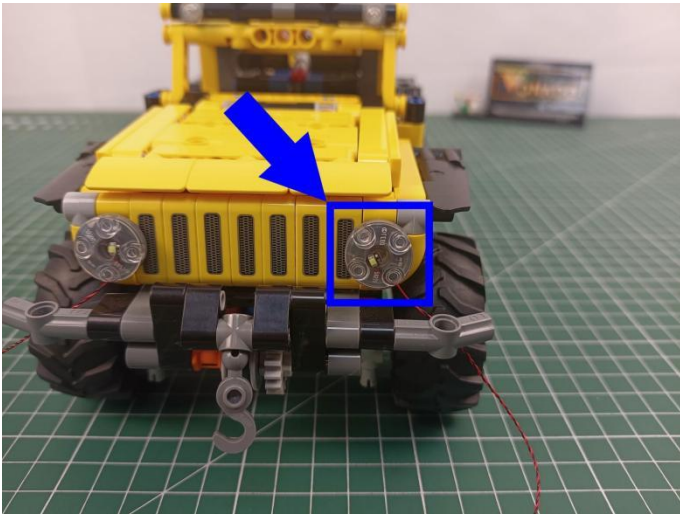

6





7

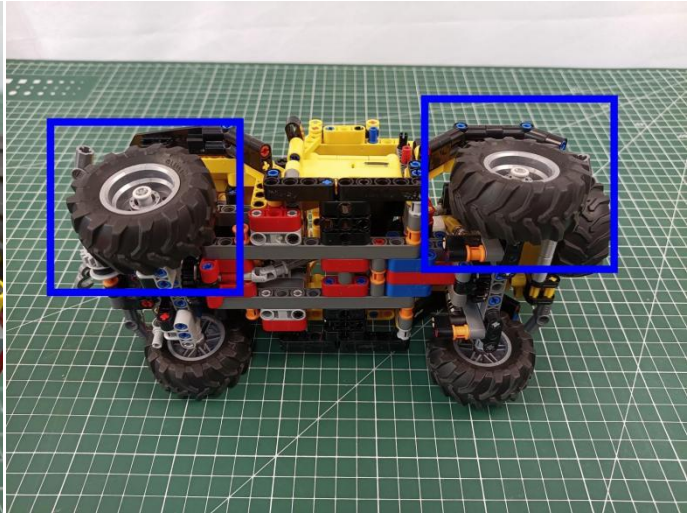
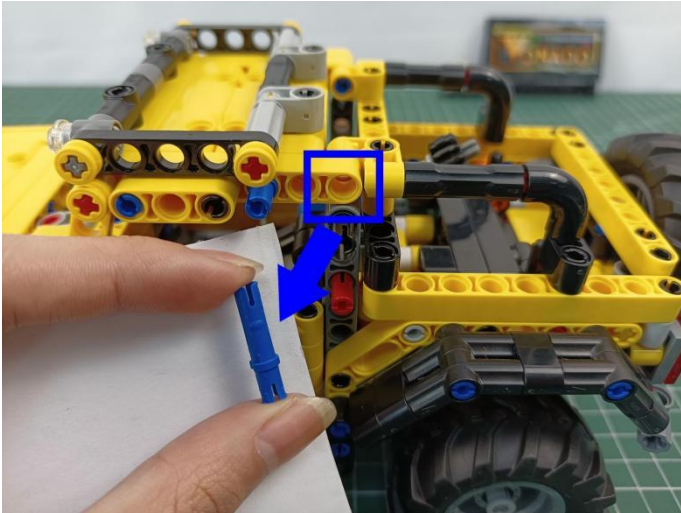

8

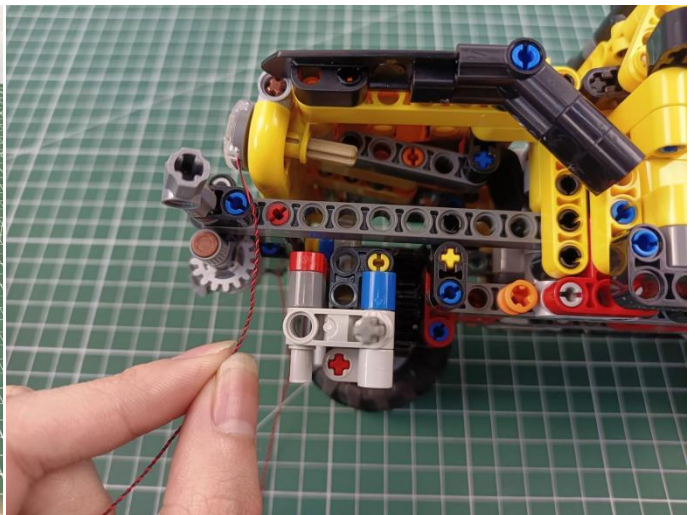

9

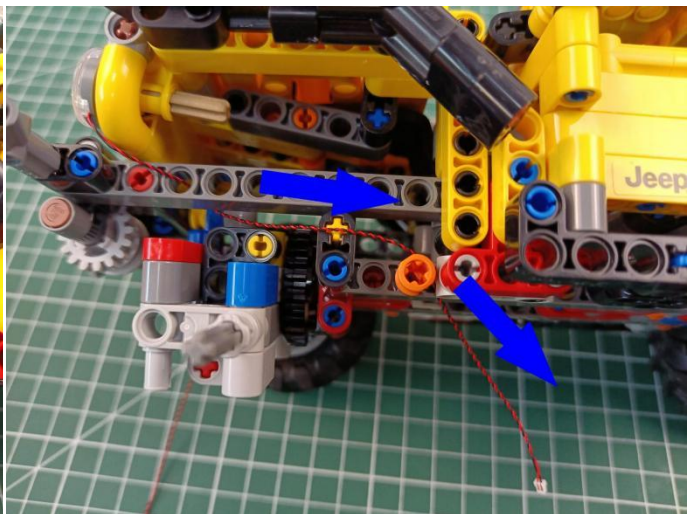
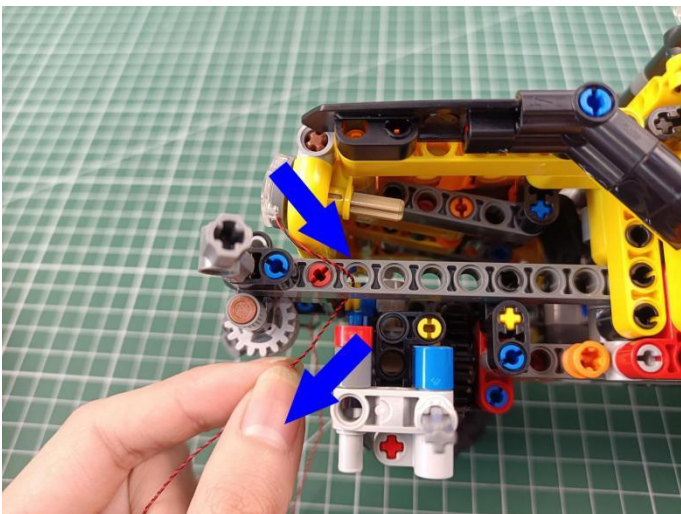



10

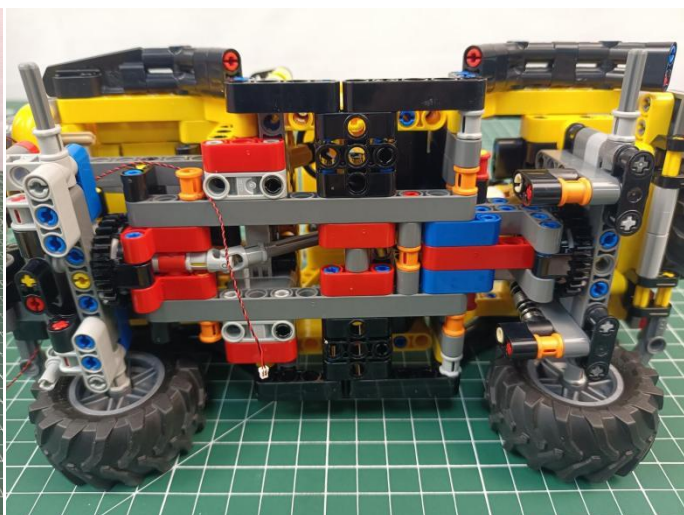
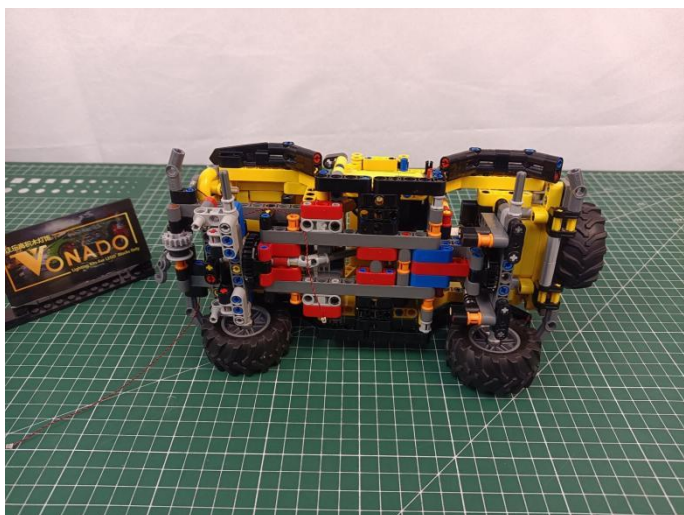

11

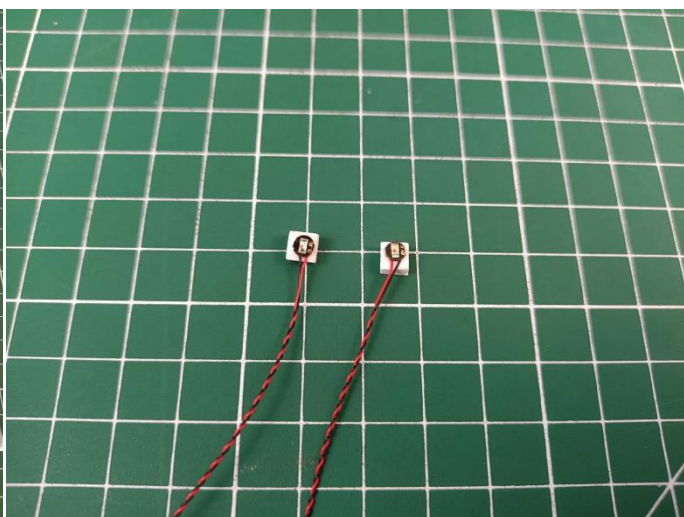

12

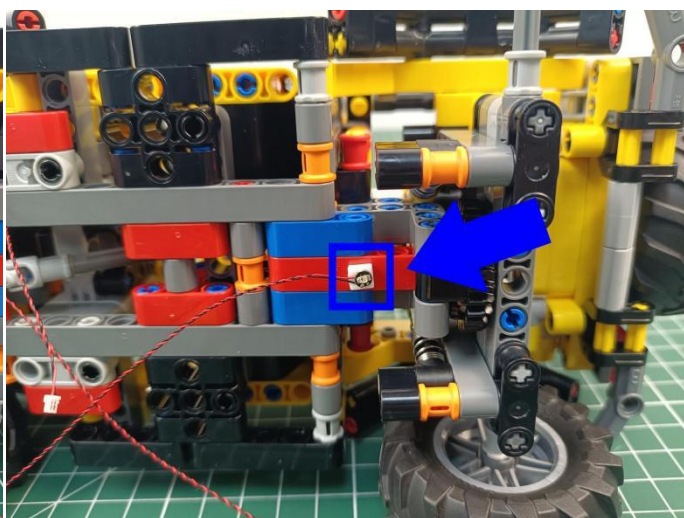
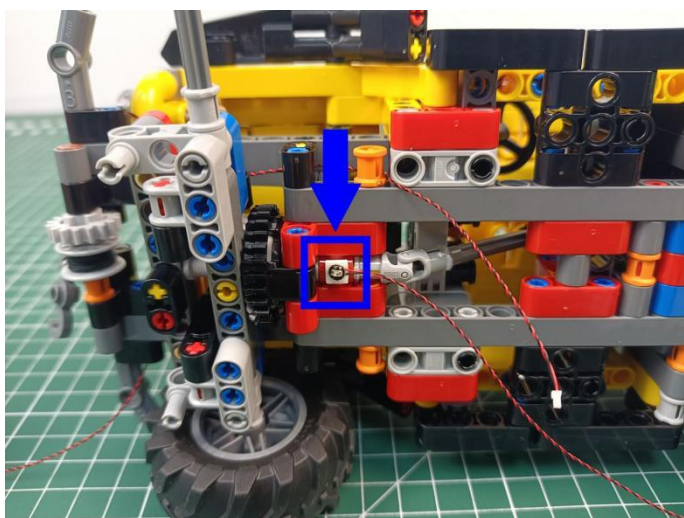



13

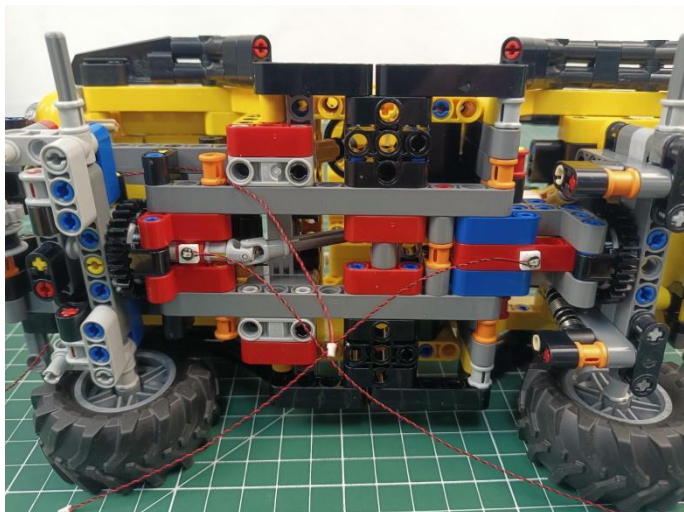

14

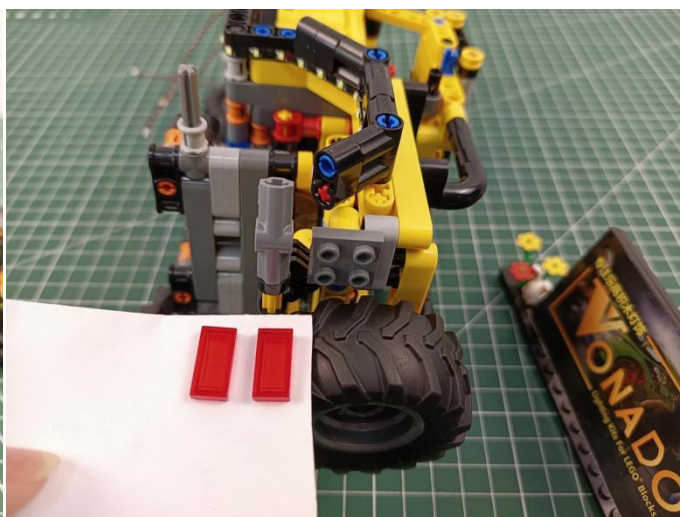
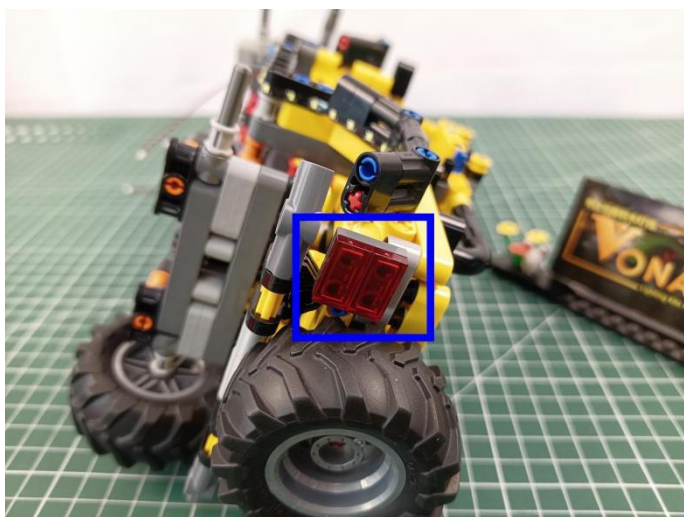

15





16

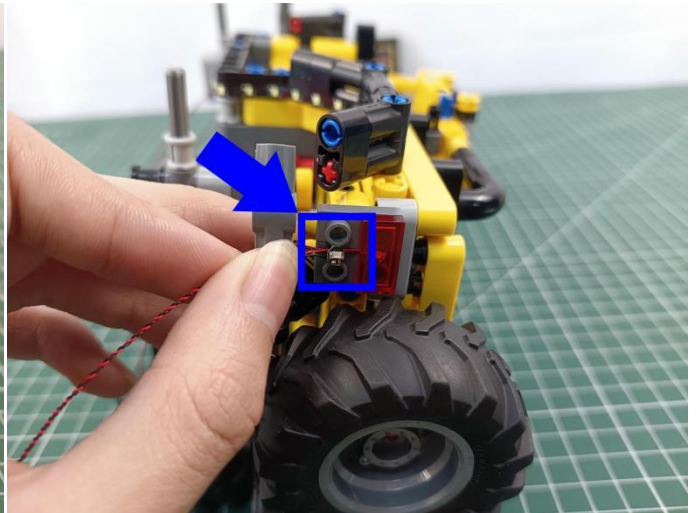
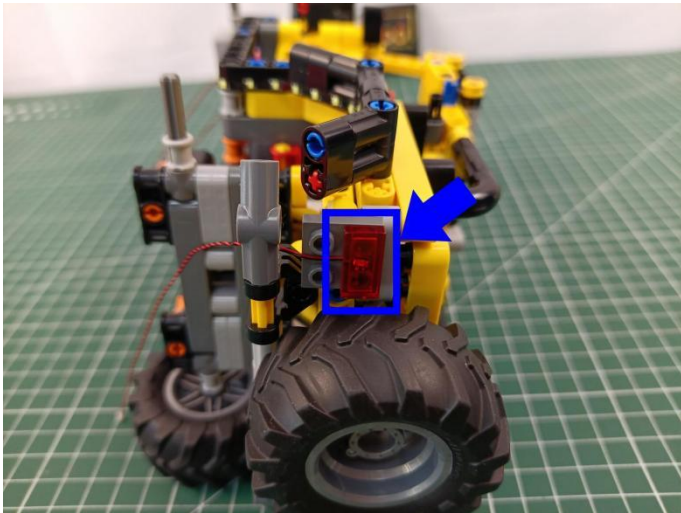

17

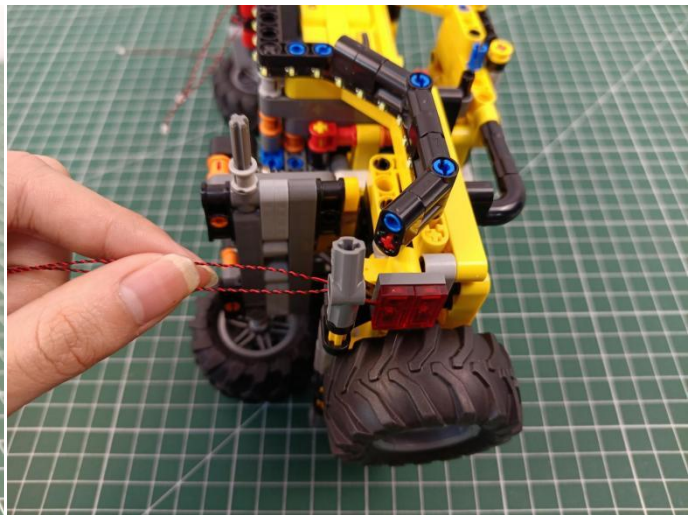
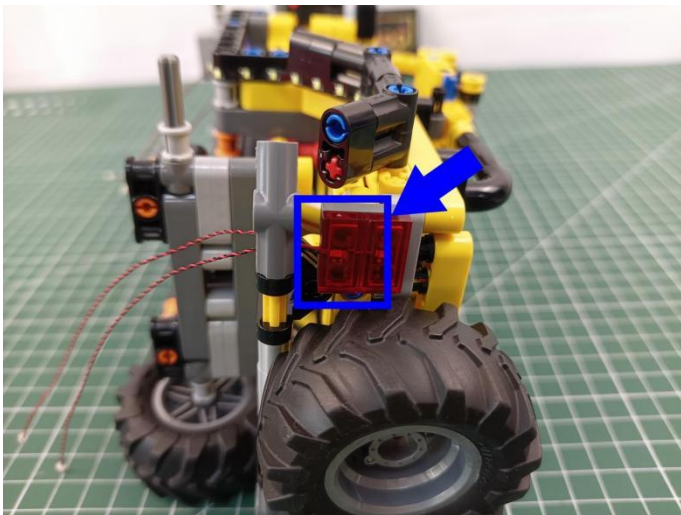

18

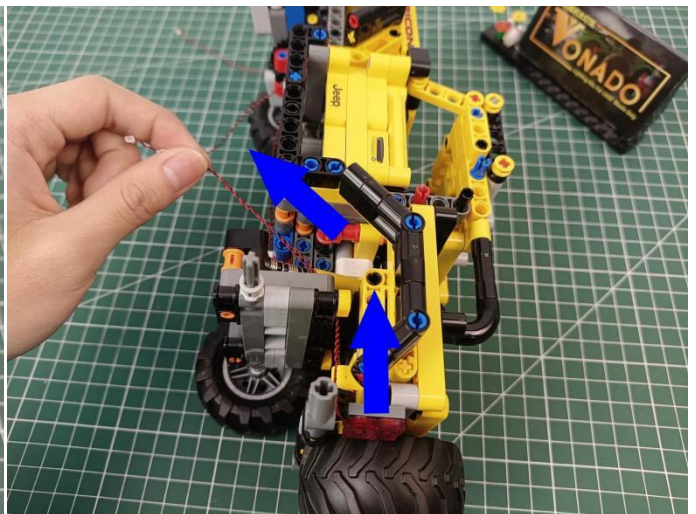
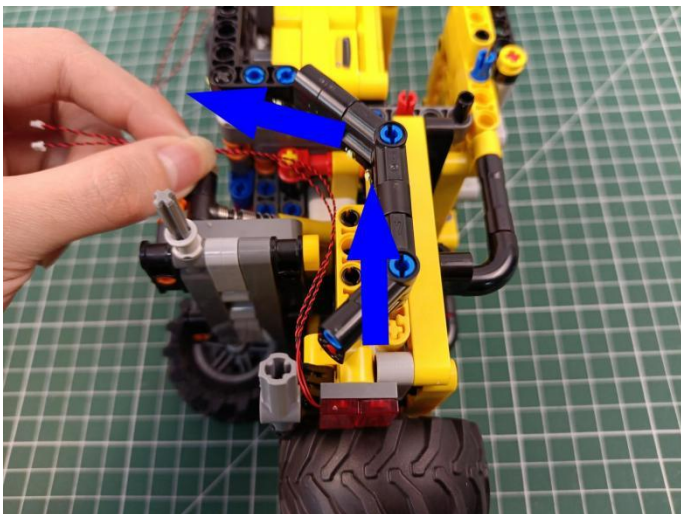



19



20

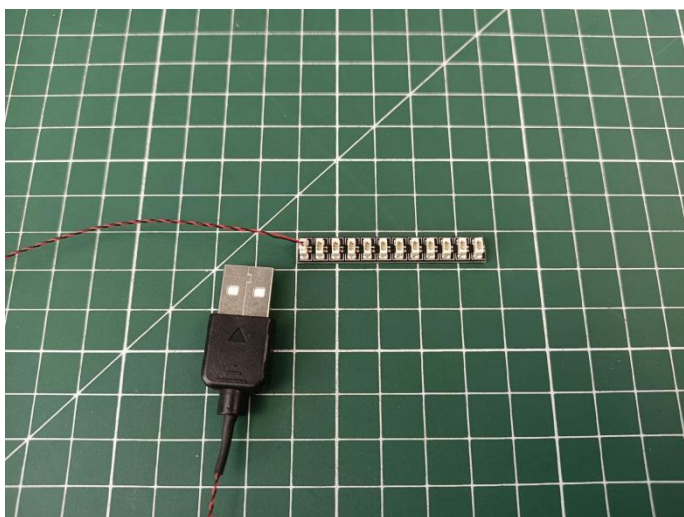

21

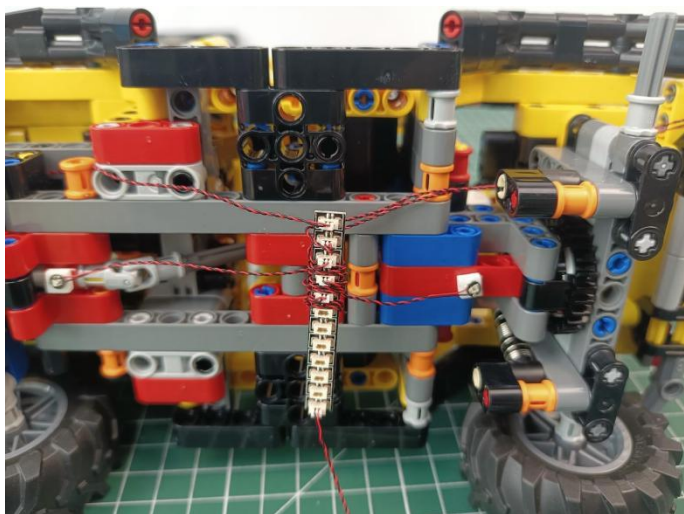



22



23

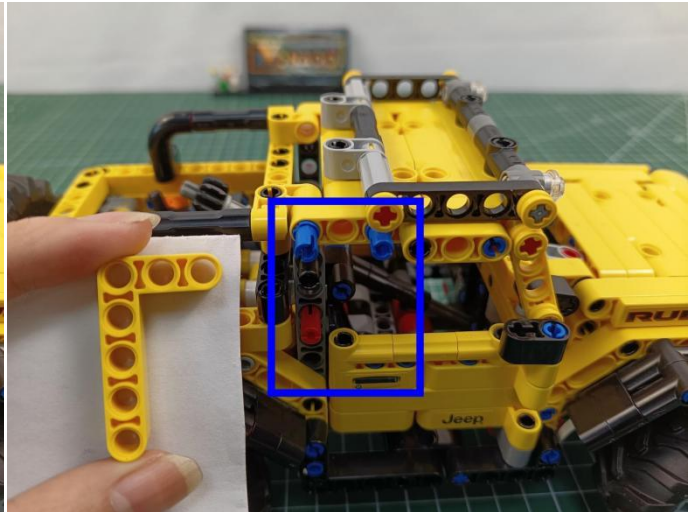
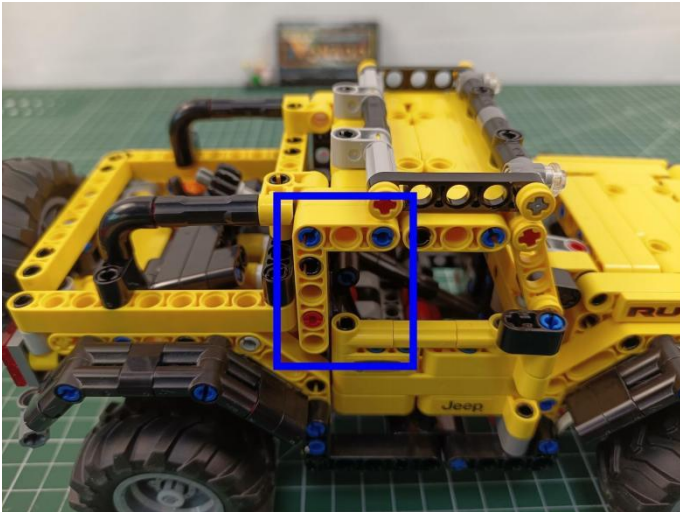

24

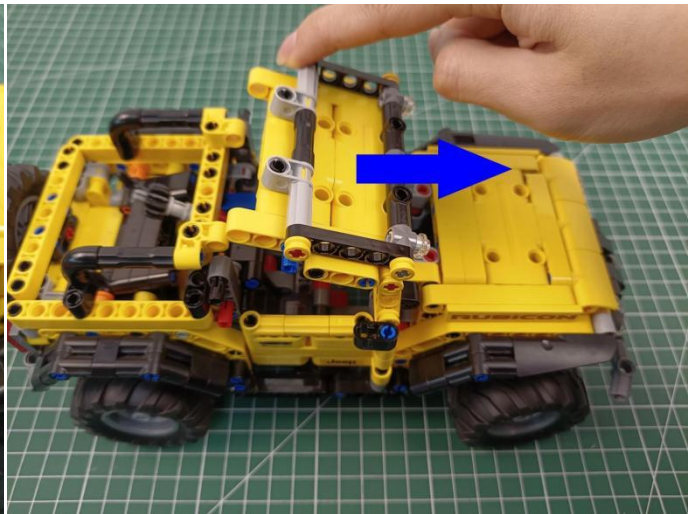
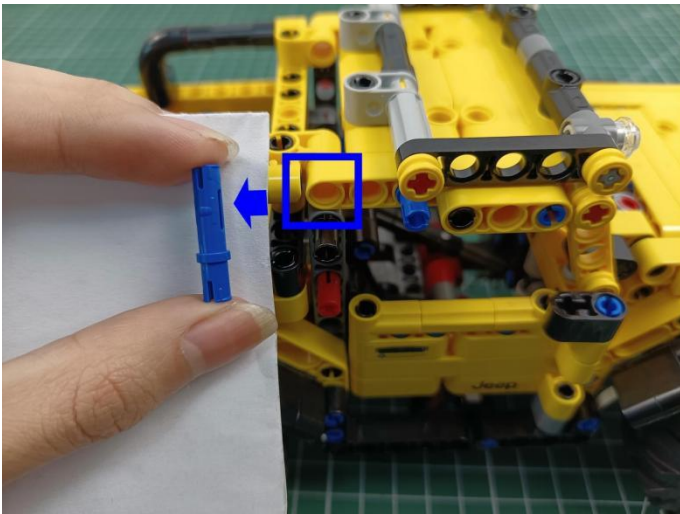



25



26

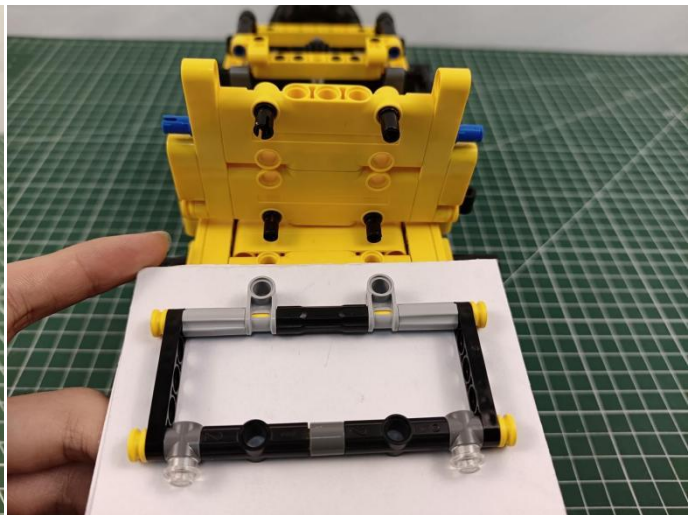
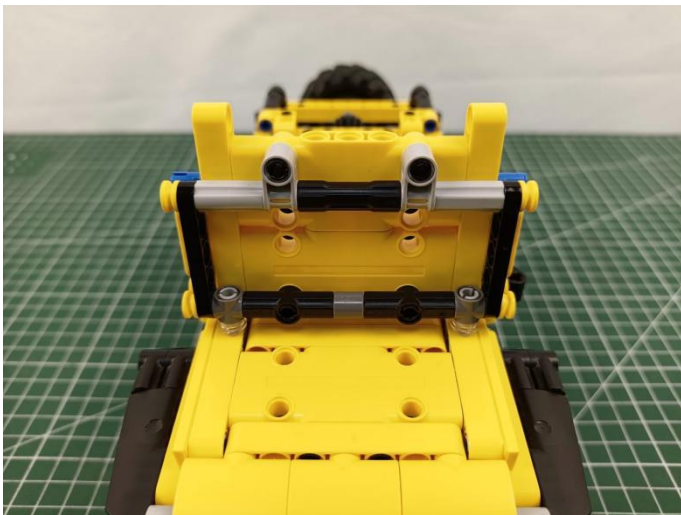

27

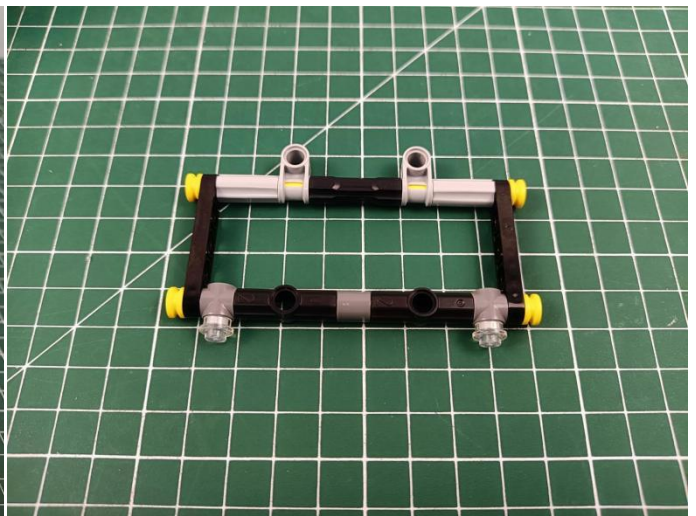
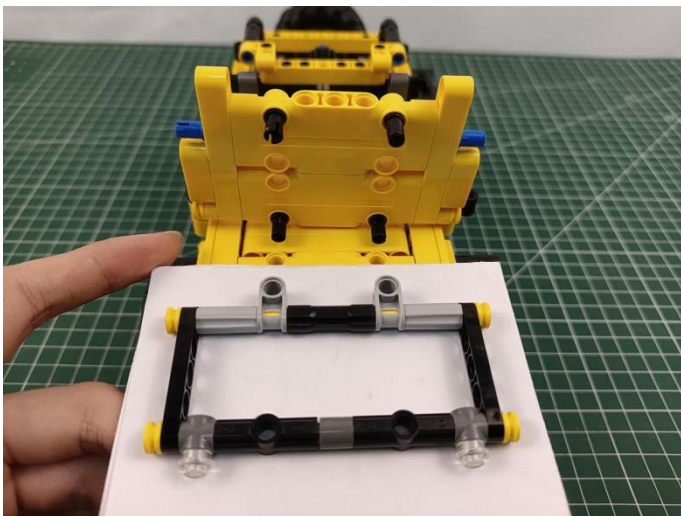



28

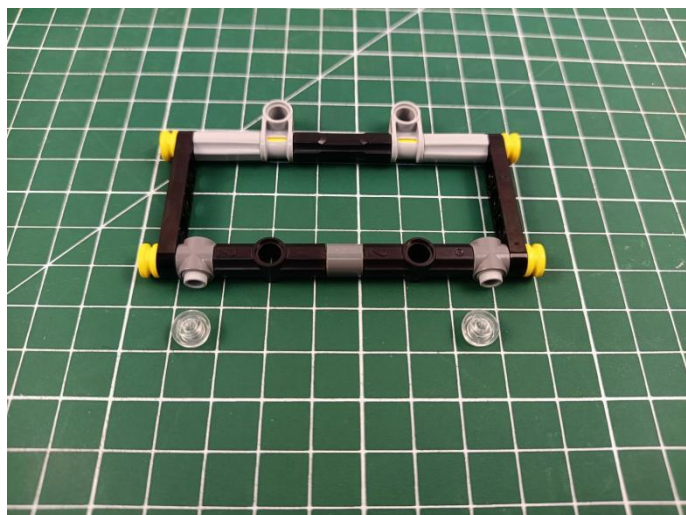

29

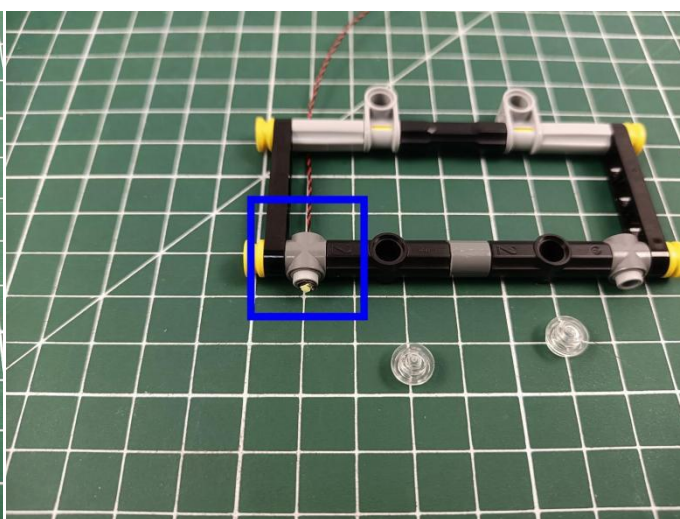
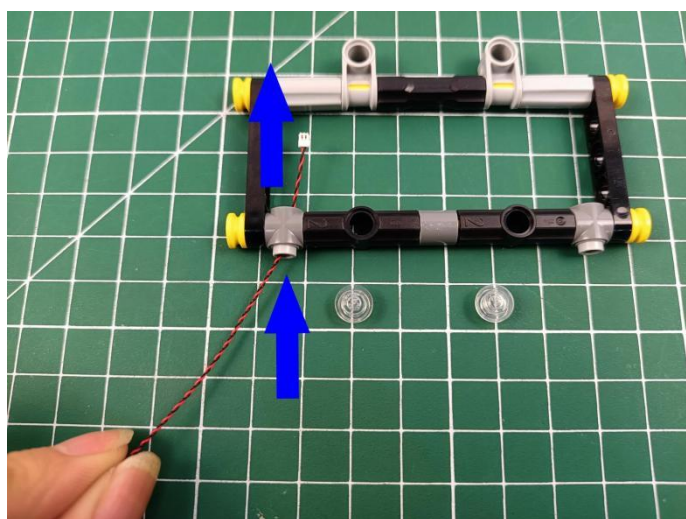

30

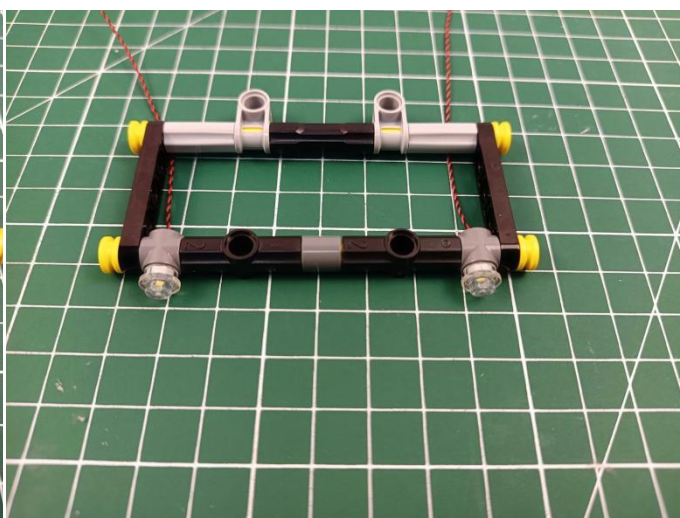
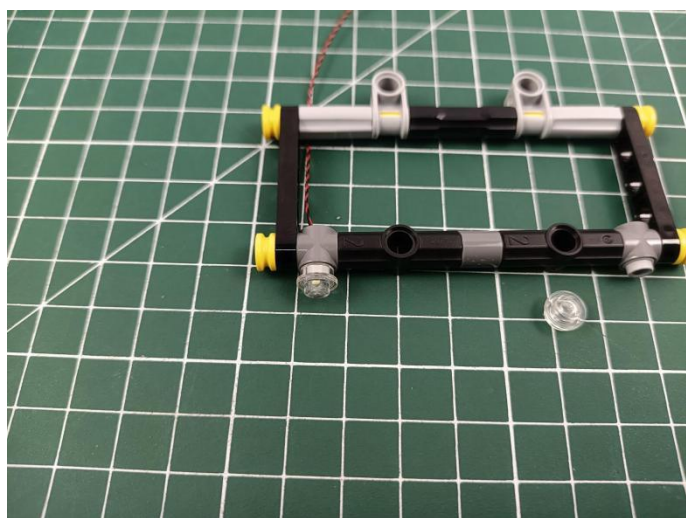



31

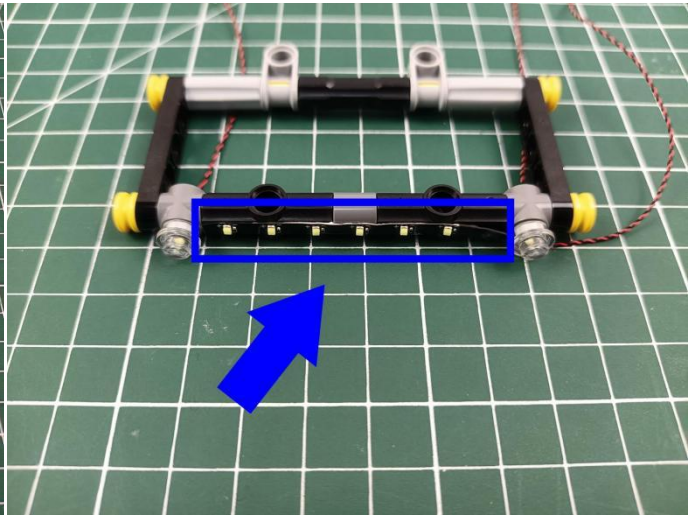

32

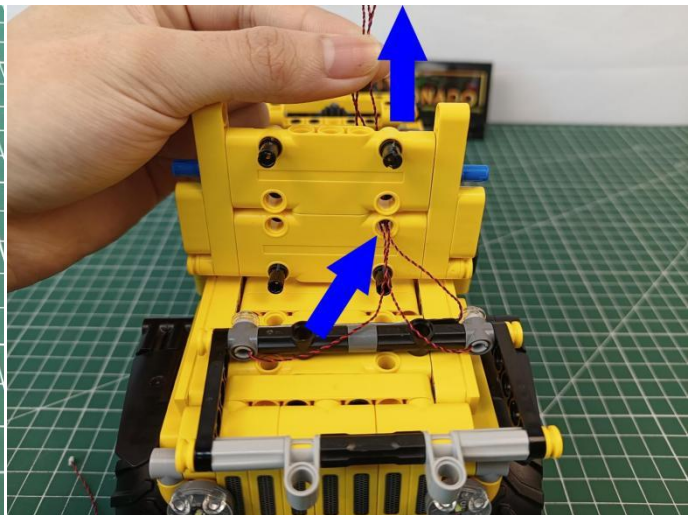
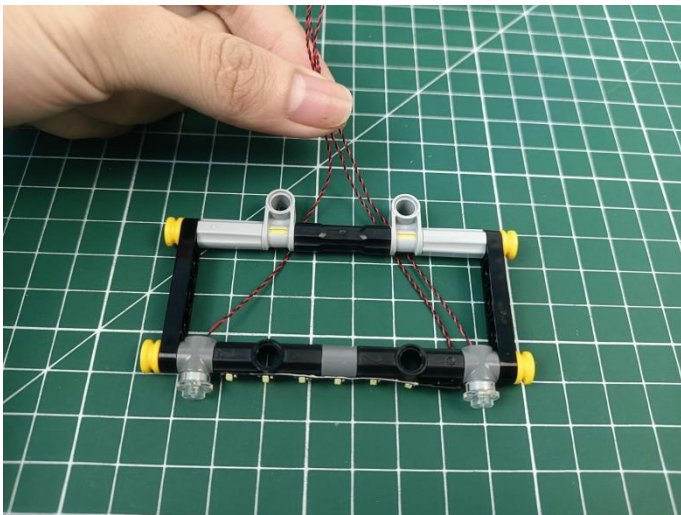

33

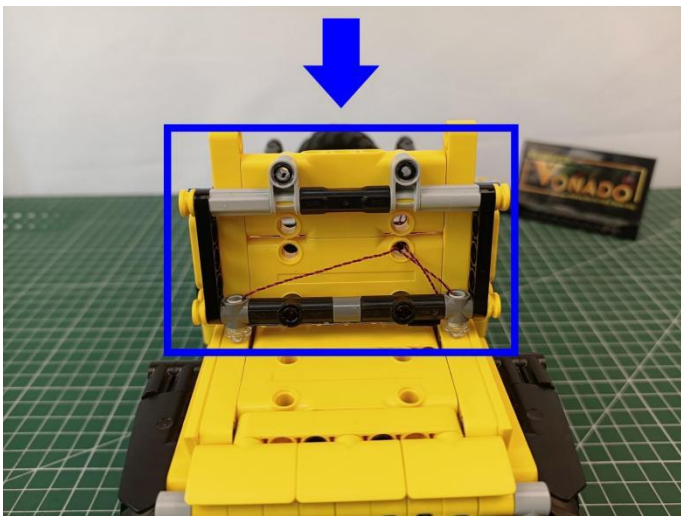



34

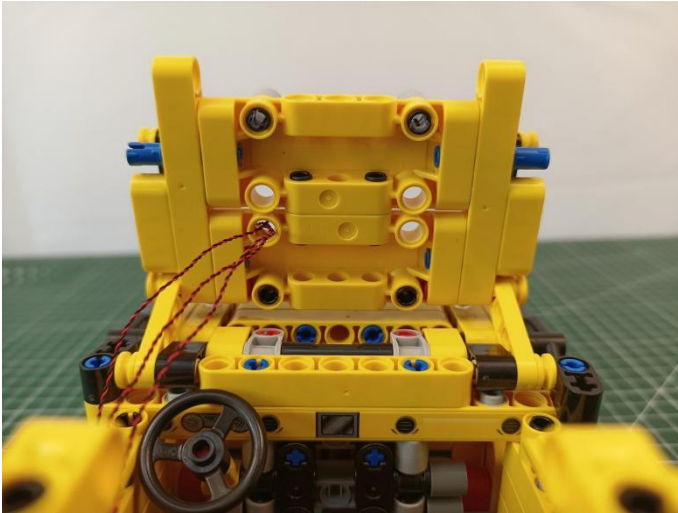

35

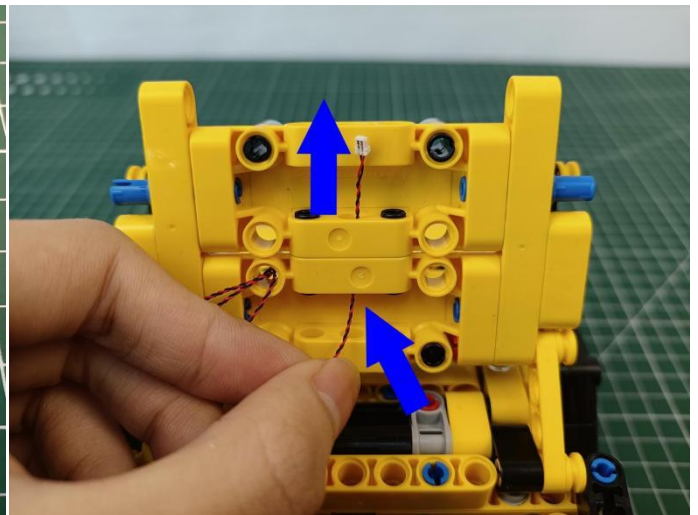
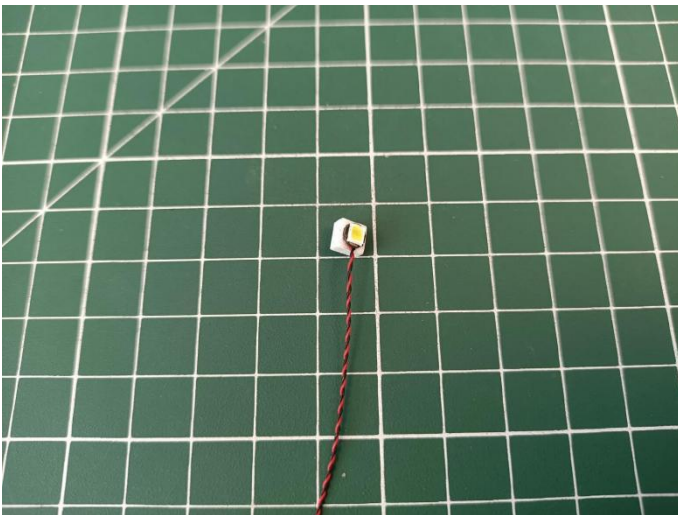

36

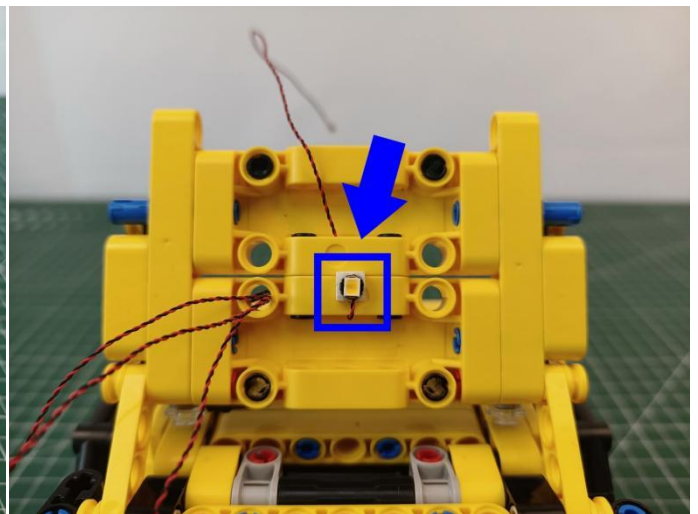
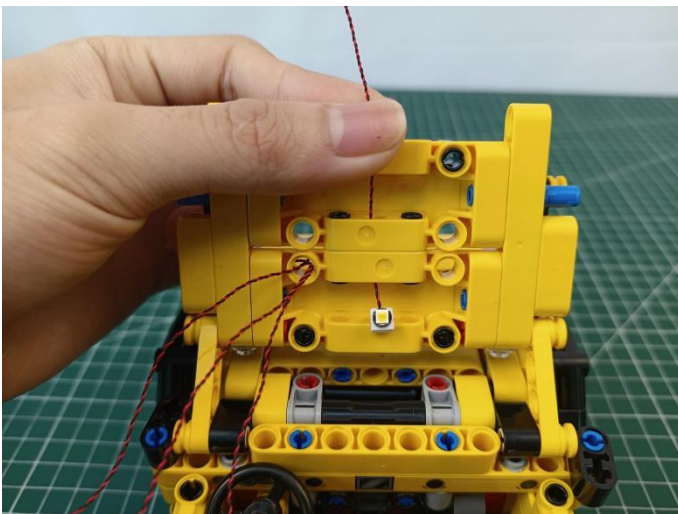



37

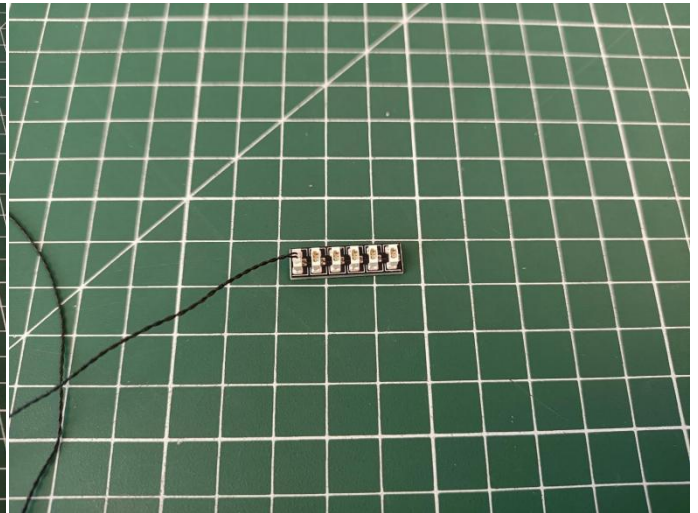

38

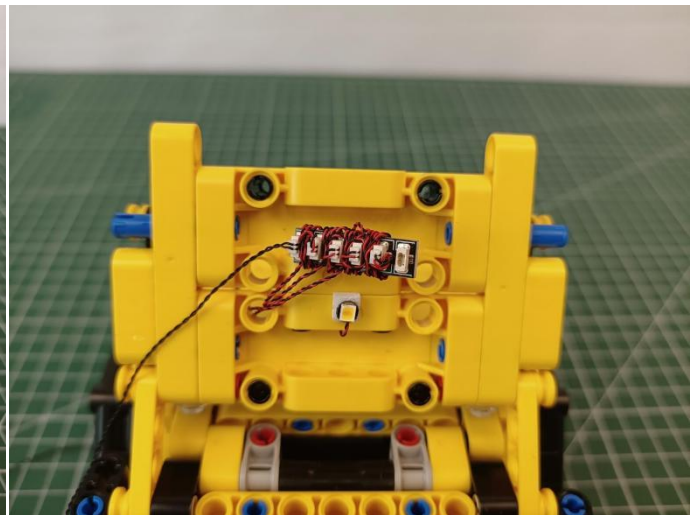
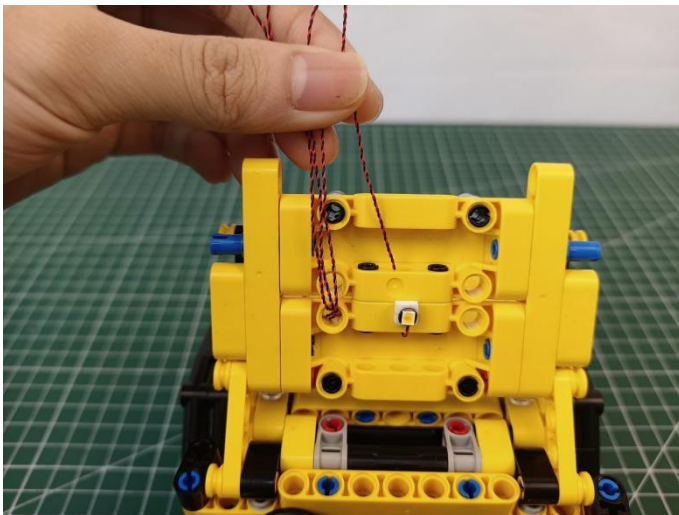

39

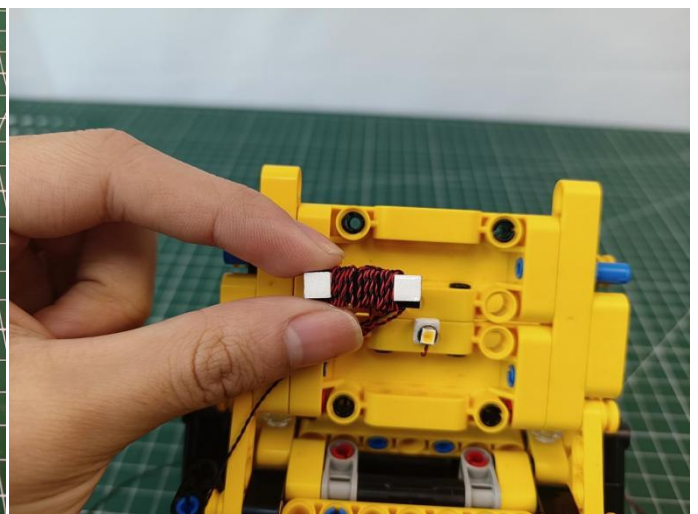



40

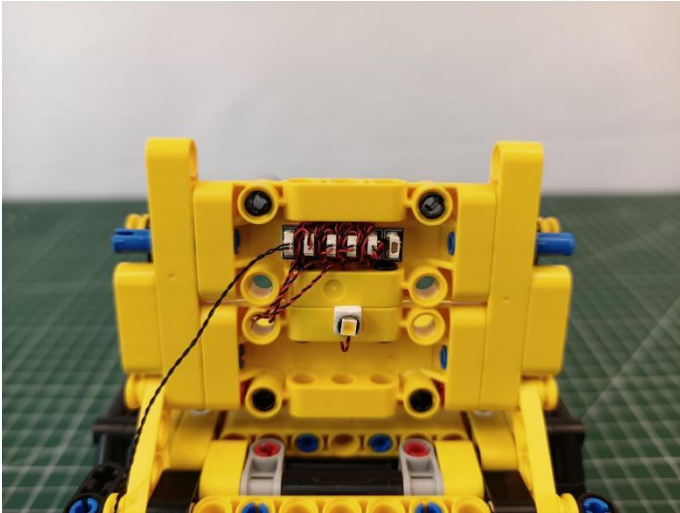

41

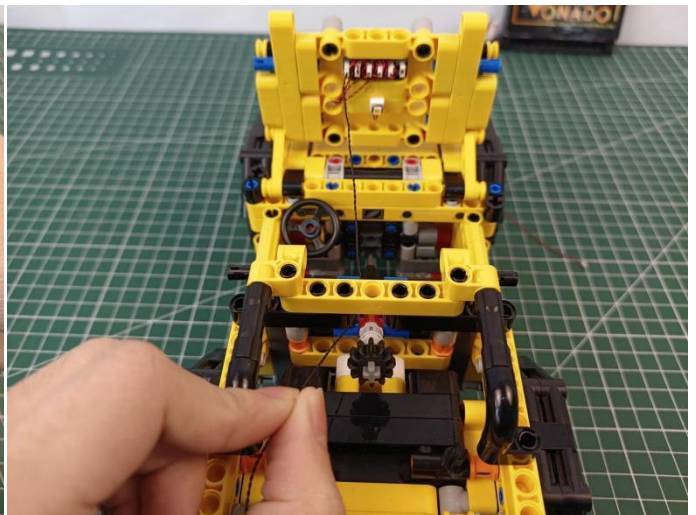
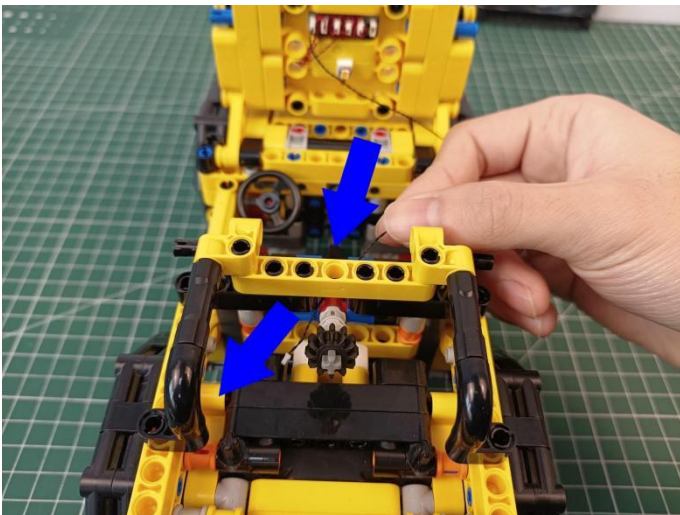

42

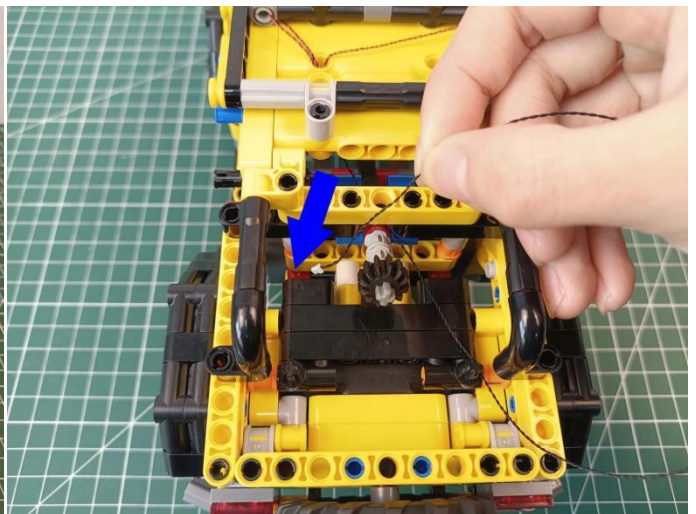



43

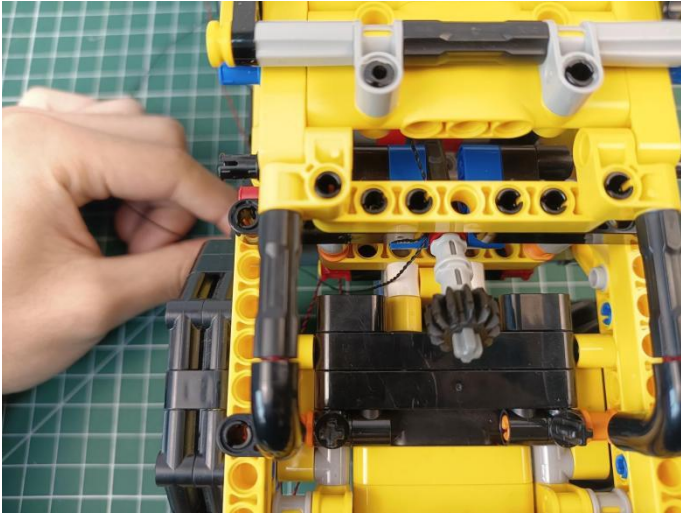

44

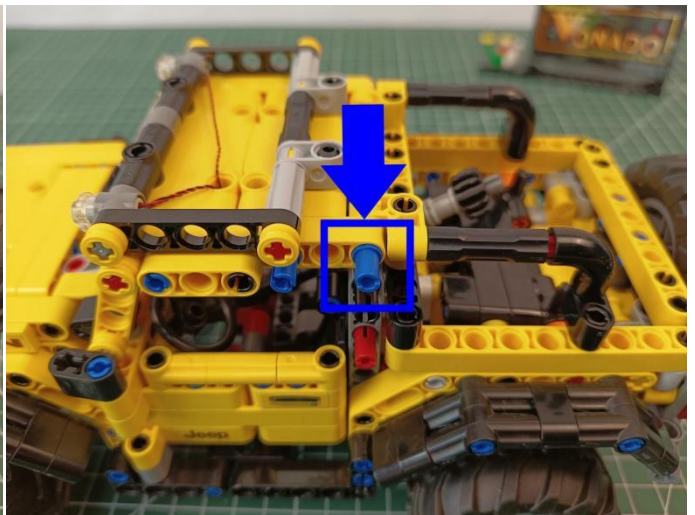

45

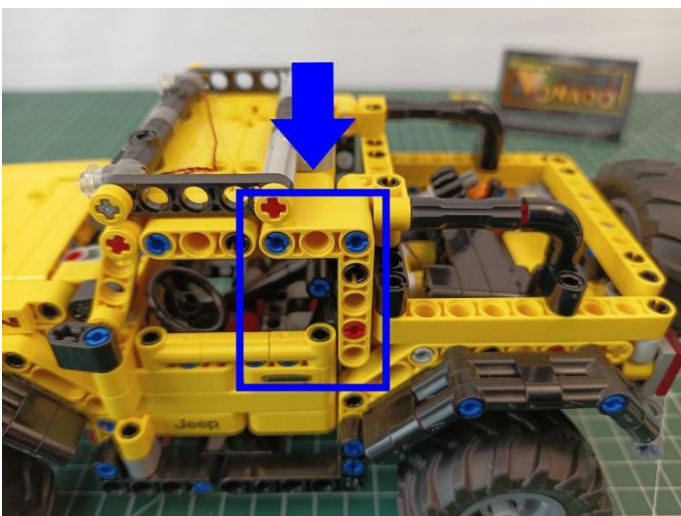



46

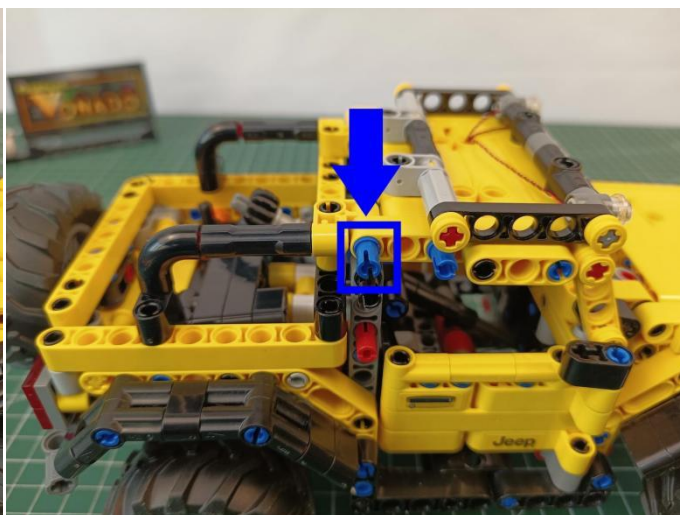

47

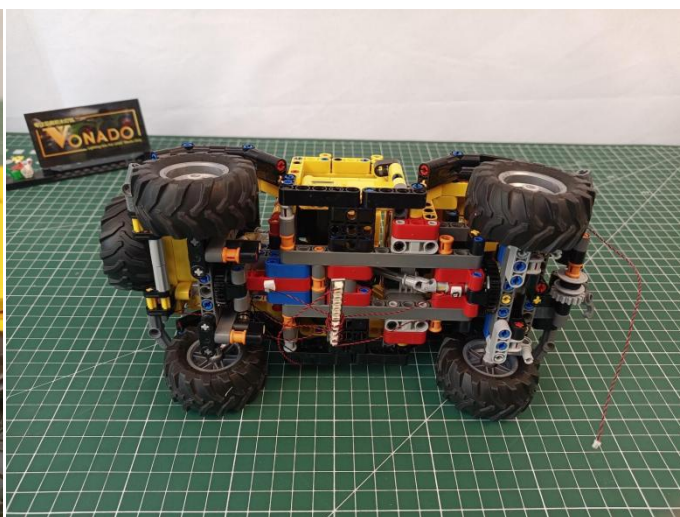
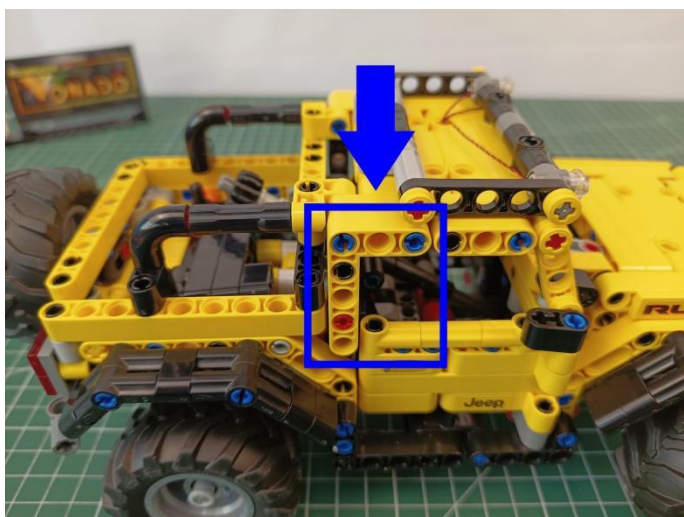

48

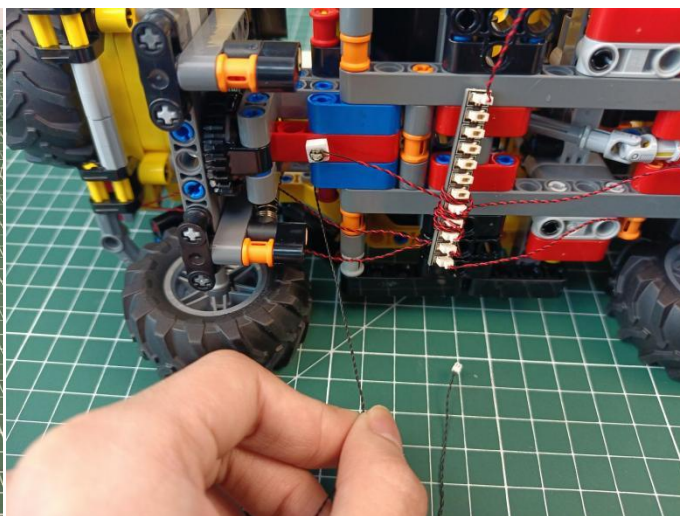



49

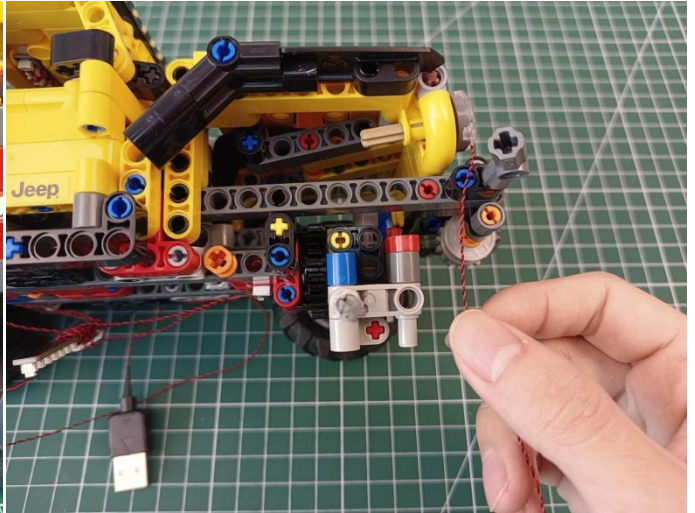
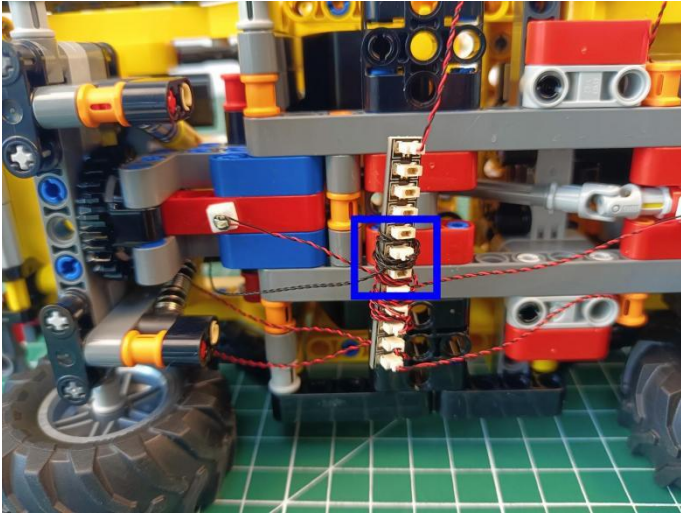

50

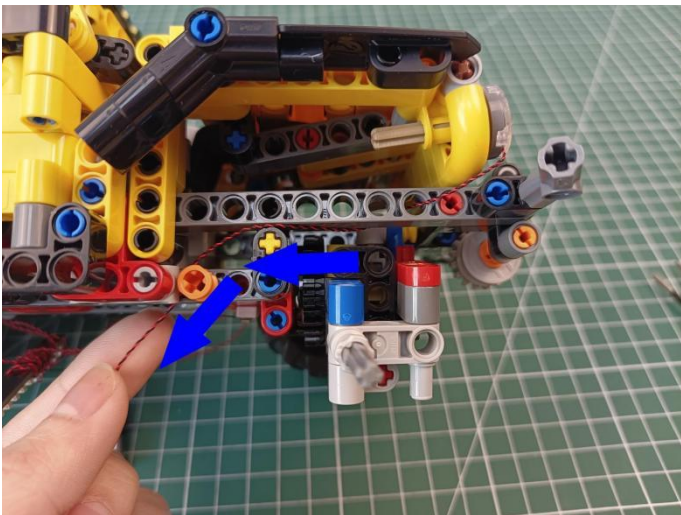

51

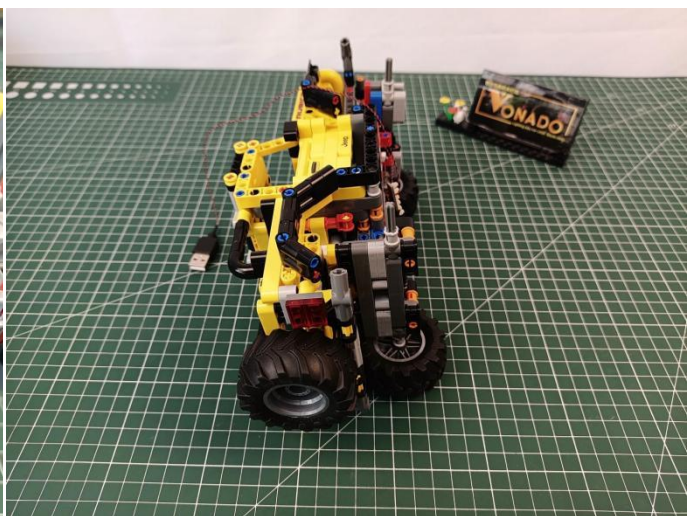
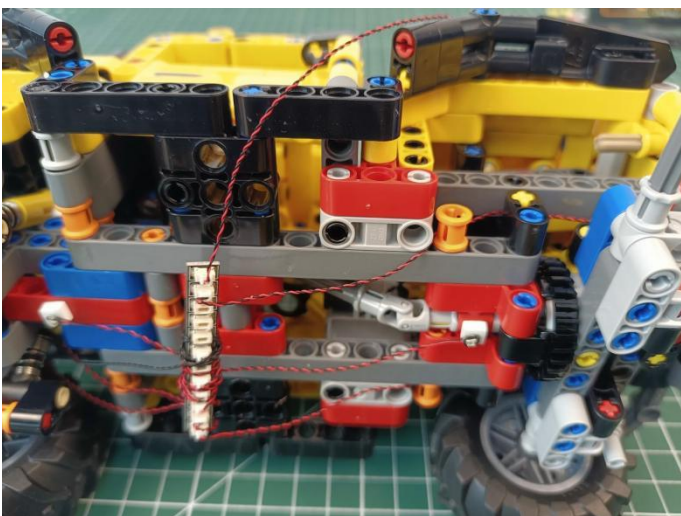



52

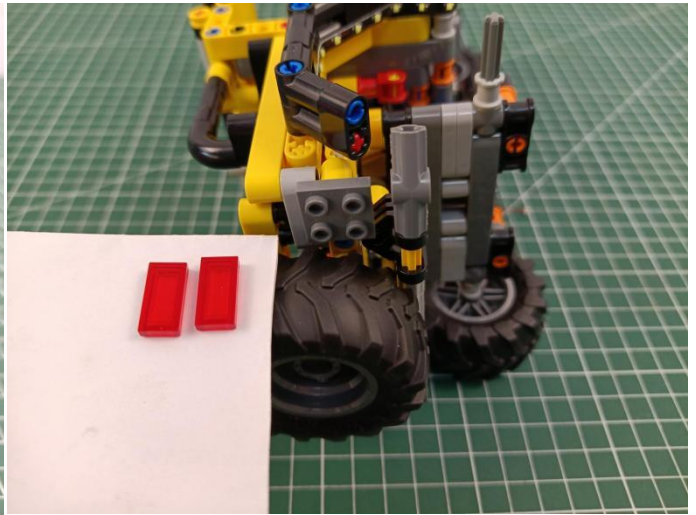
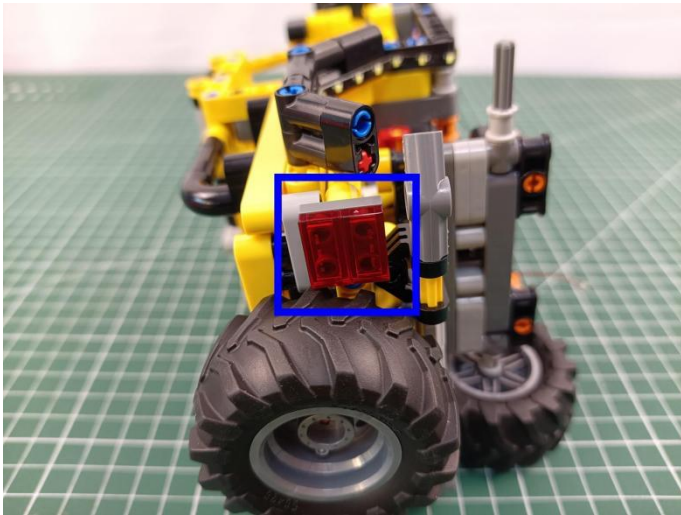

53

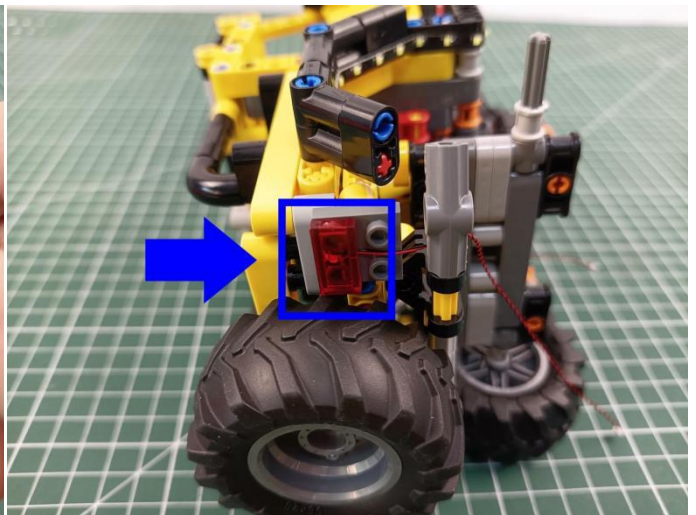
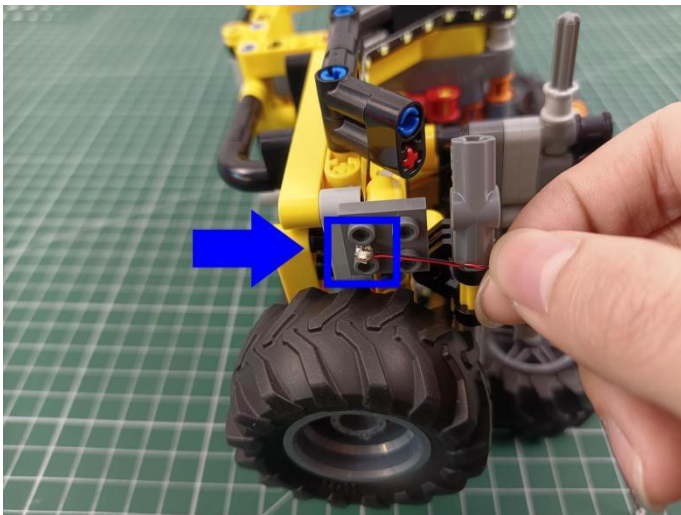

54

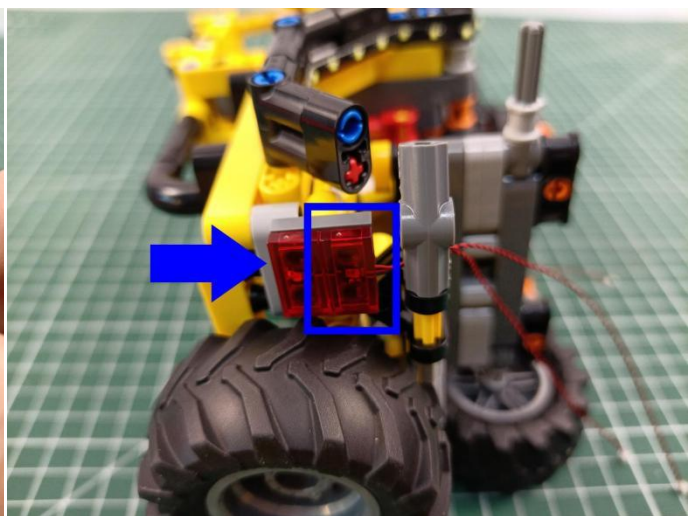
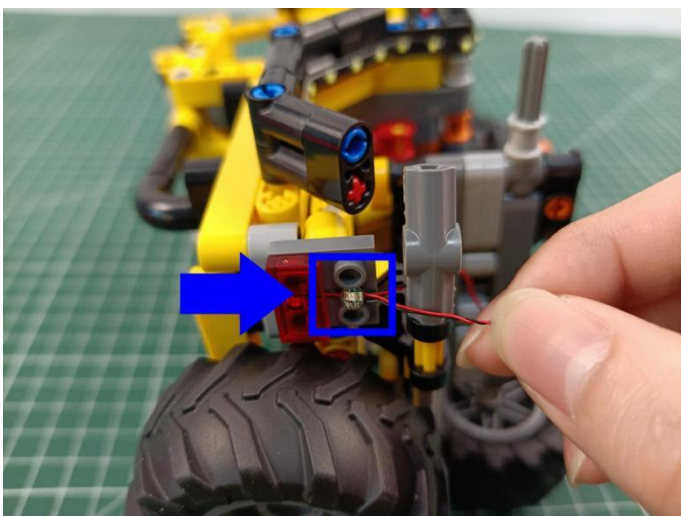



55

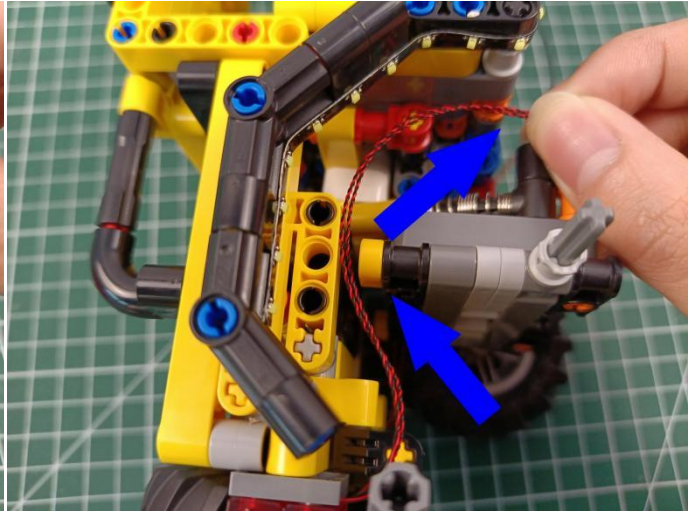
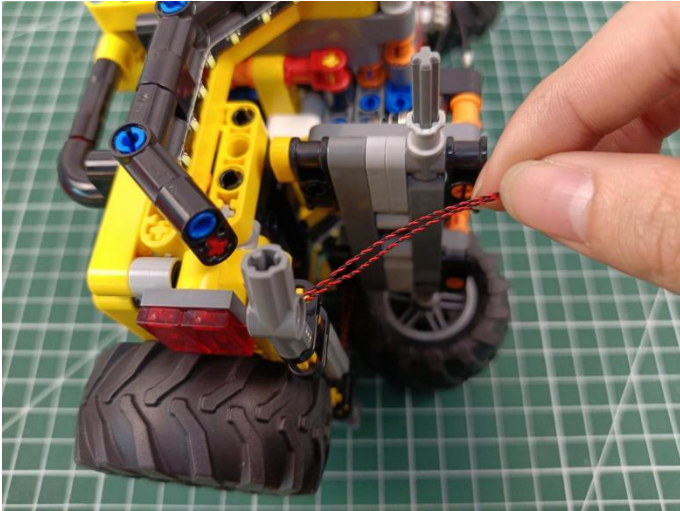

56

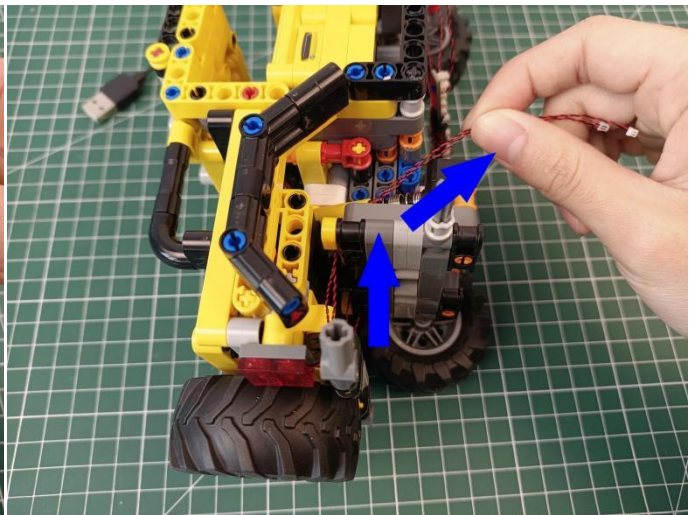
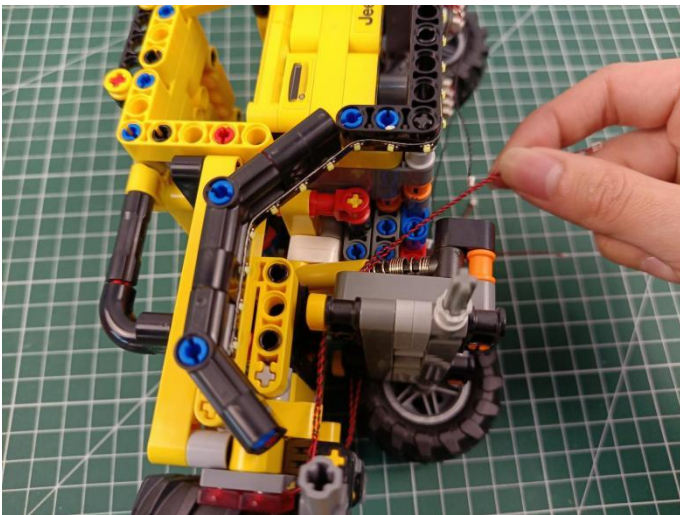

57

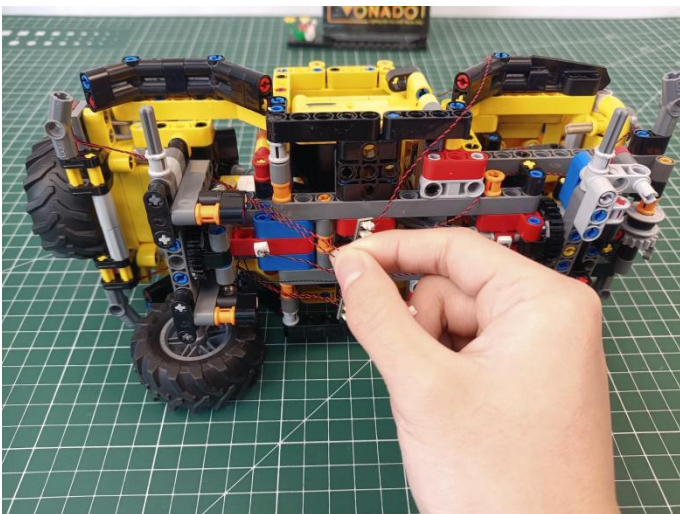



58

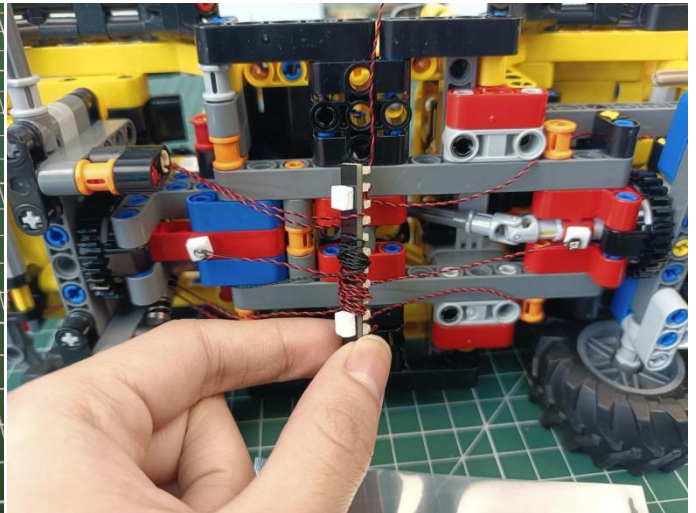

59

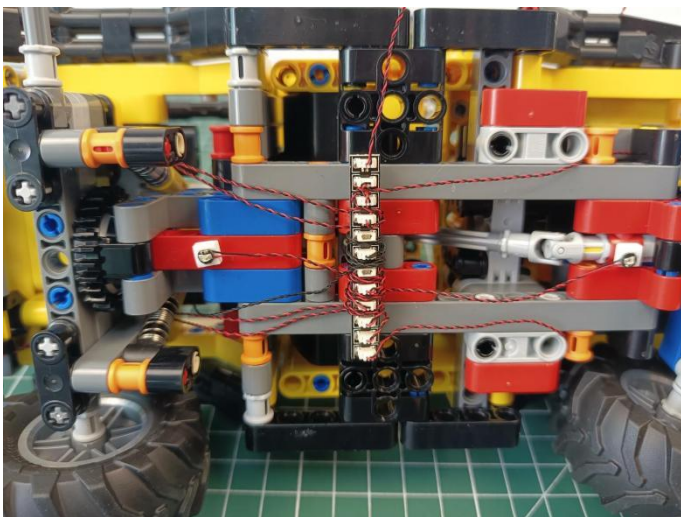

60





**Good job, you've done all the installation steps, power it up and enjoy your work.**



**If everything is as excellent as expected, we'll be appreciate if a good review can be given.**

**THANKS**