

76240 Batman Batmobile Tumbler LED lighting Kit (Standard Version) LG139/GC139

Instructions for installing this kit:



All the accessories in the manual are samples, and there may be differences between the pictures and the actual products! The installation is not affected under normal circumstances. If you cannot install it, please contact us in time! ! !

Step 1

Test:

This product has 3 bags, and the AA Battery Pack is a gift. (Without battery)



Accessories Show. (for reference only)





Take out all the accessories in the No. 3 bag.



Take out 8-Port Expansion Boards and remove the protective film.

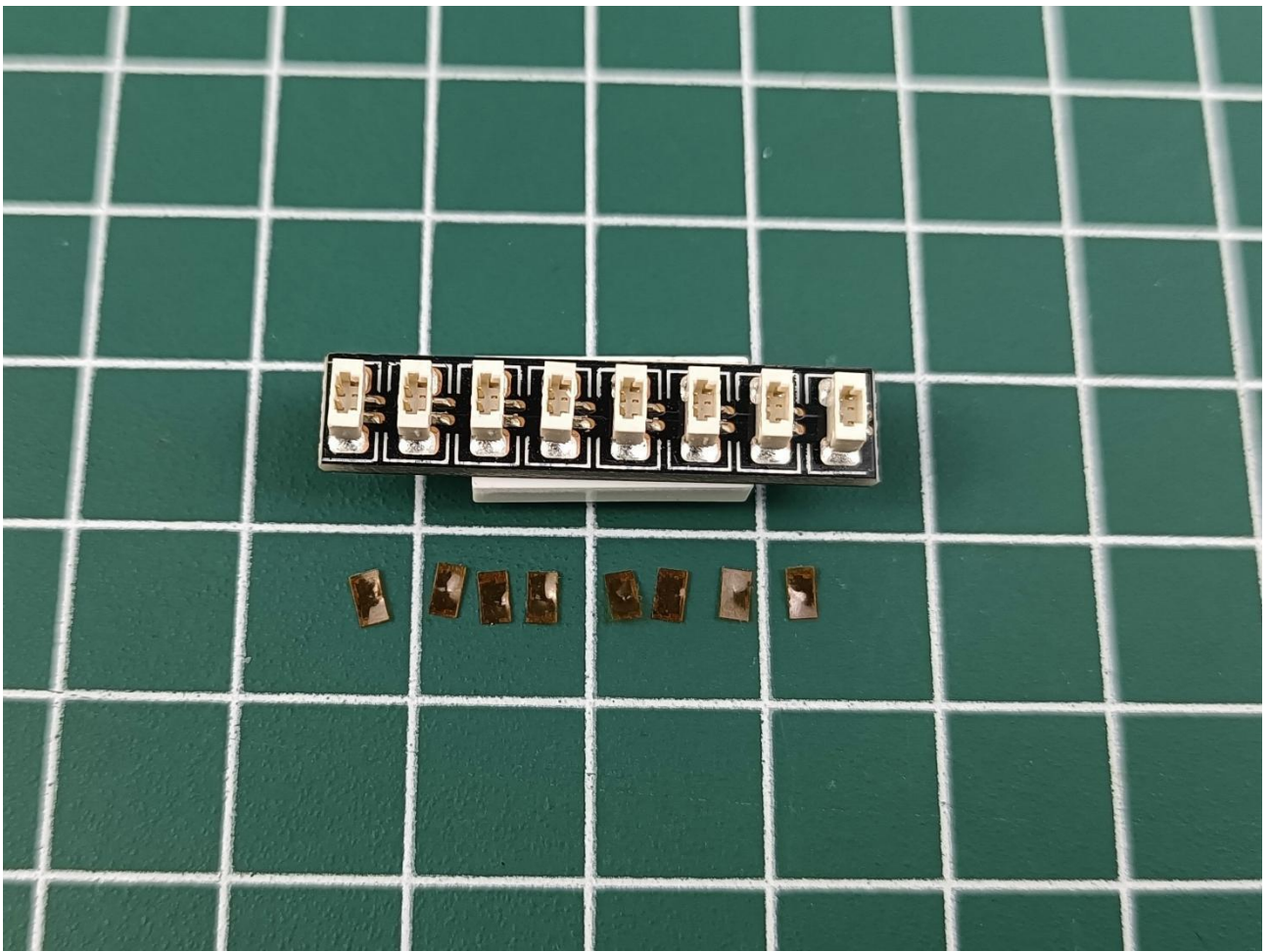
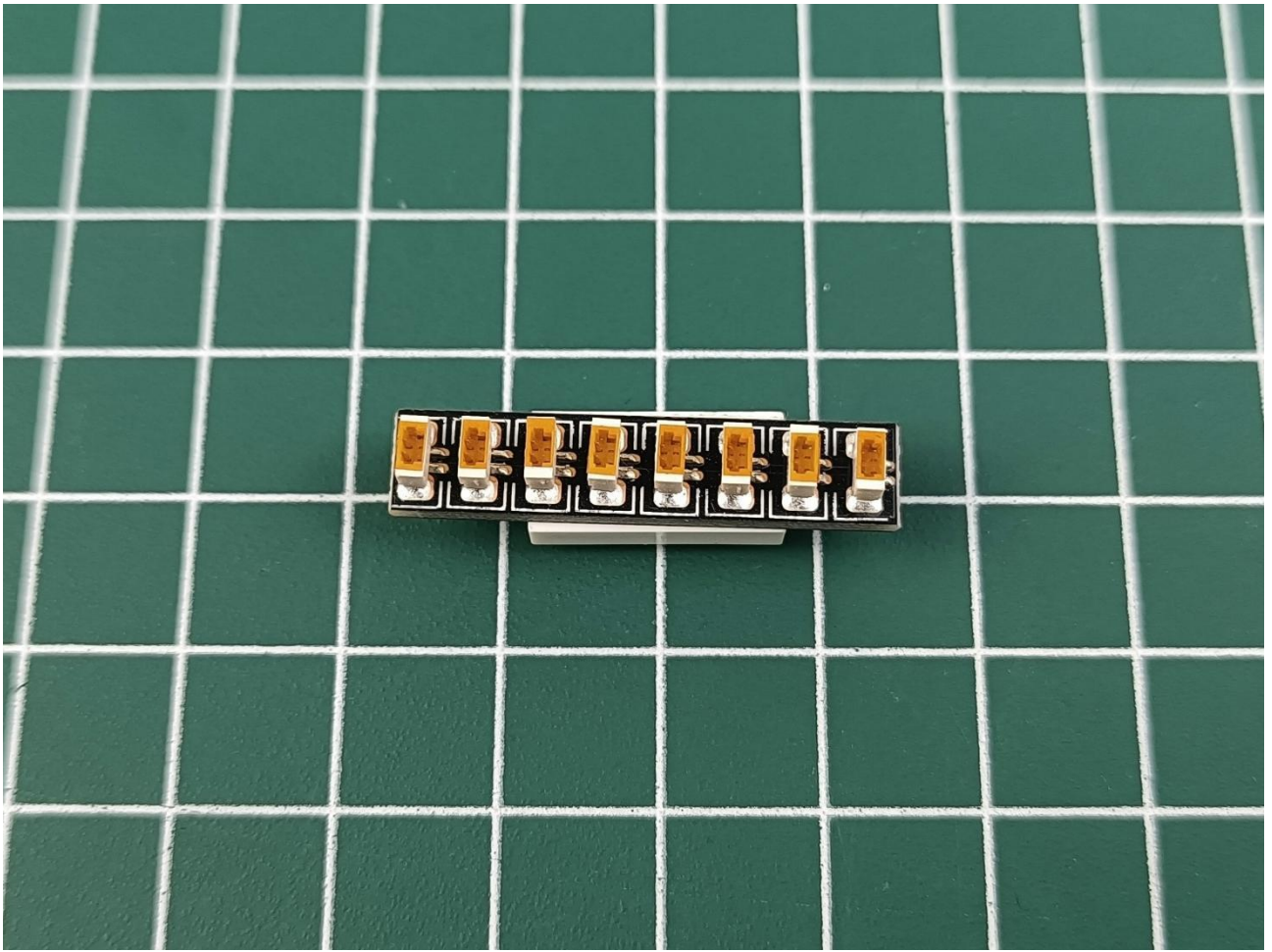

Please pay attention to the use of the interface. The interface is small. Please use it carefully: the = number of the 2P interface is aligned with the = number of the expansion board. The equal sign on the expansion board refers to the two solder joints on the outside, not the two inside the jack Metal pin.

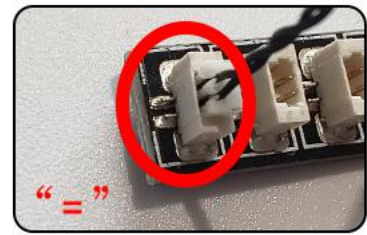
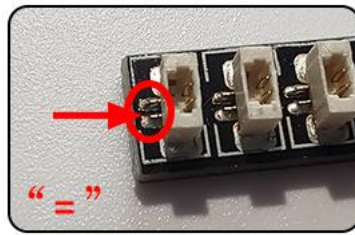
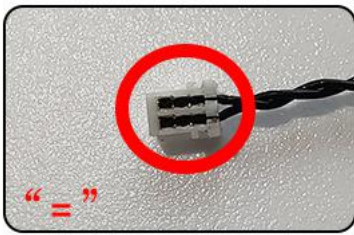

Take out the USB Power Cable and connect it to the 8-Port Expansion Boards referring to the instructions.

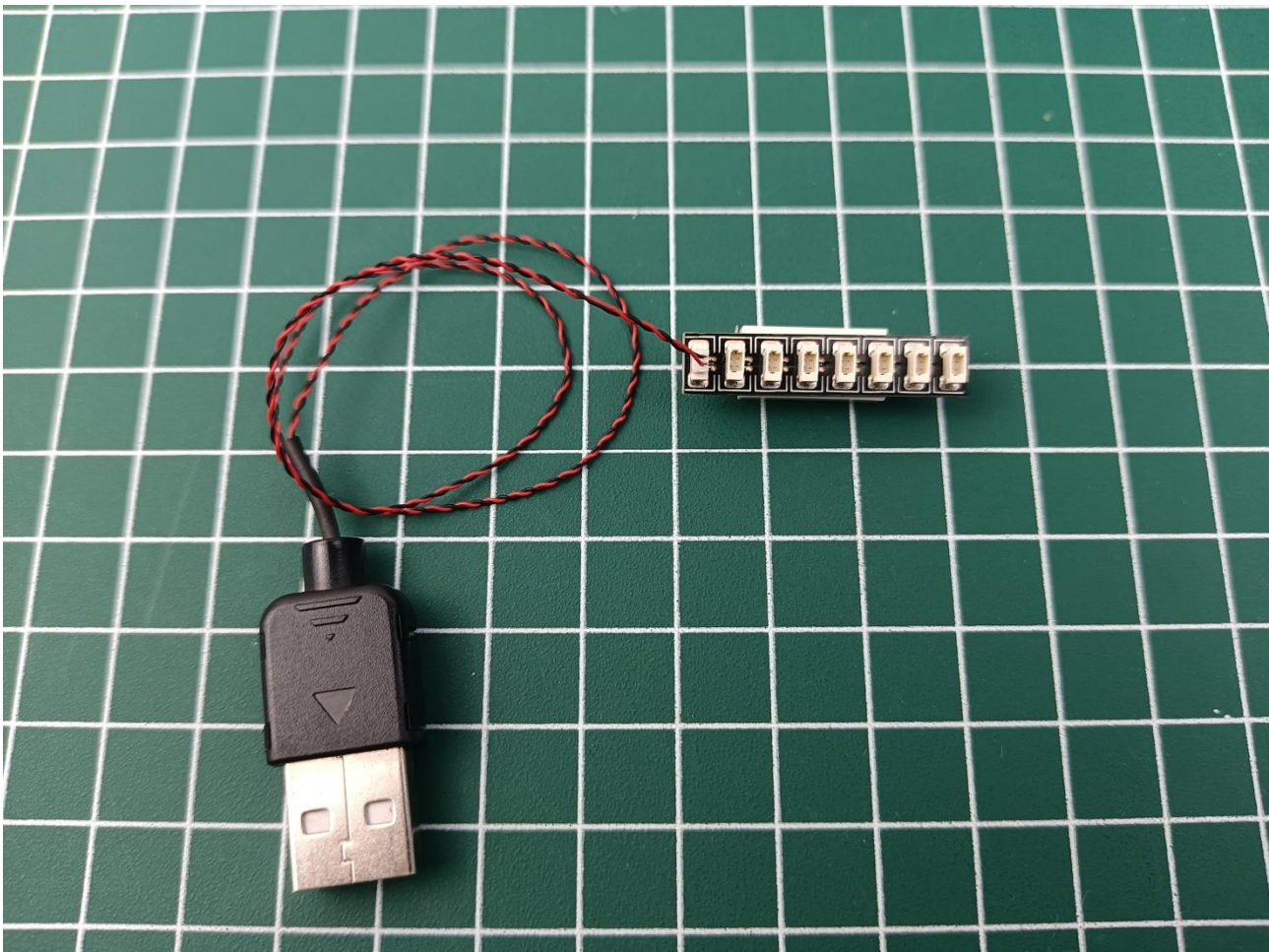

Take out the accessories from bag No. 1 and connect them to 8-Port Expansion Boards.

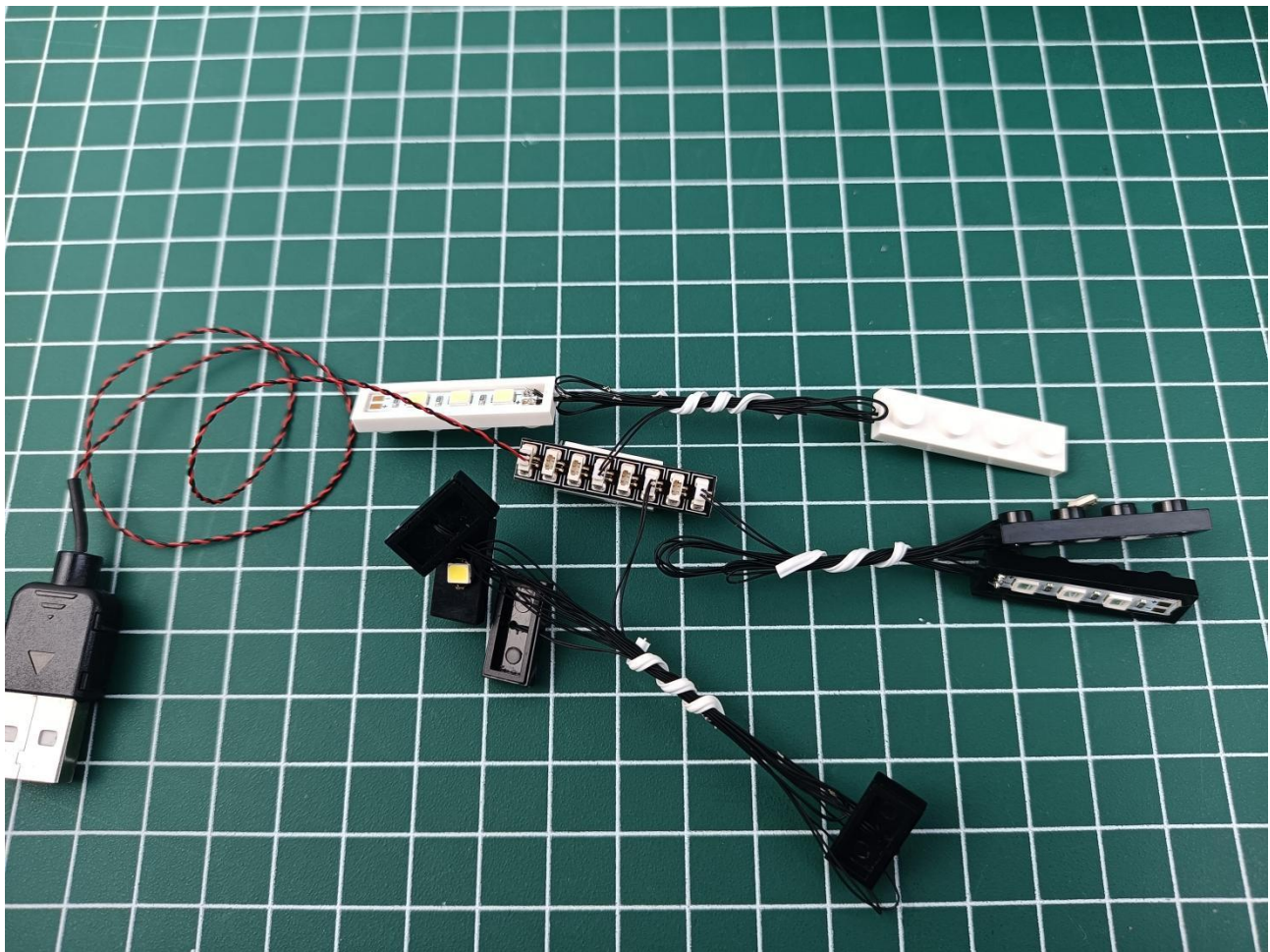

The power supplies that can be used with the USB power cord are as follows.

USB connectors to connect devices

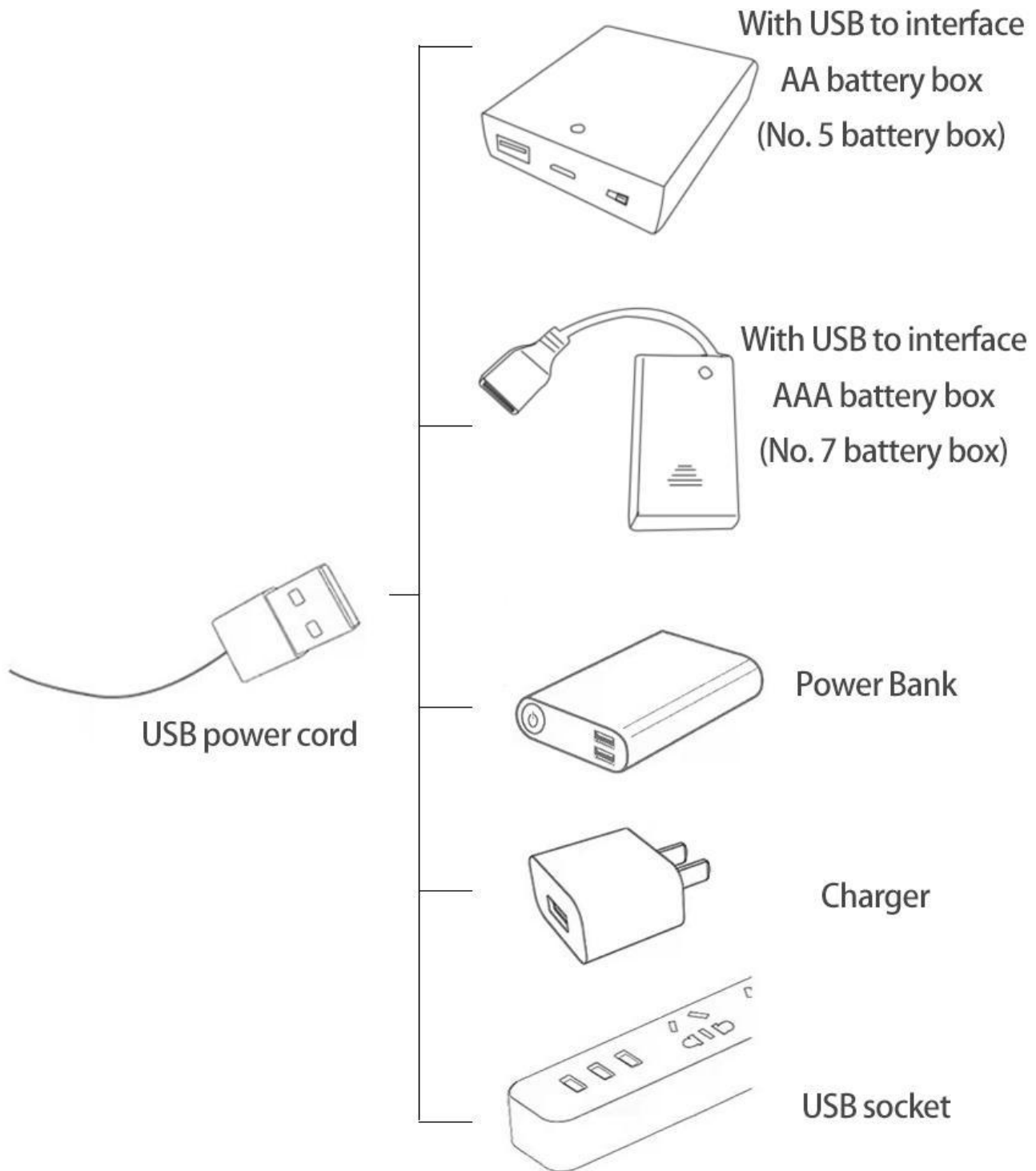

Refer to the prompt to choose the power supply method by yourself, here is an example of a power bank.

Check if the accessories are working properly.

If there is an abnormality, please contact us in time!!!

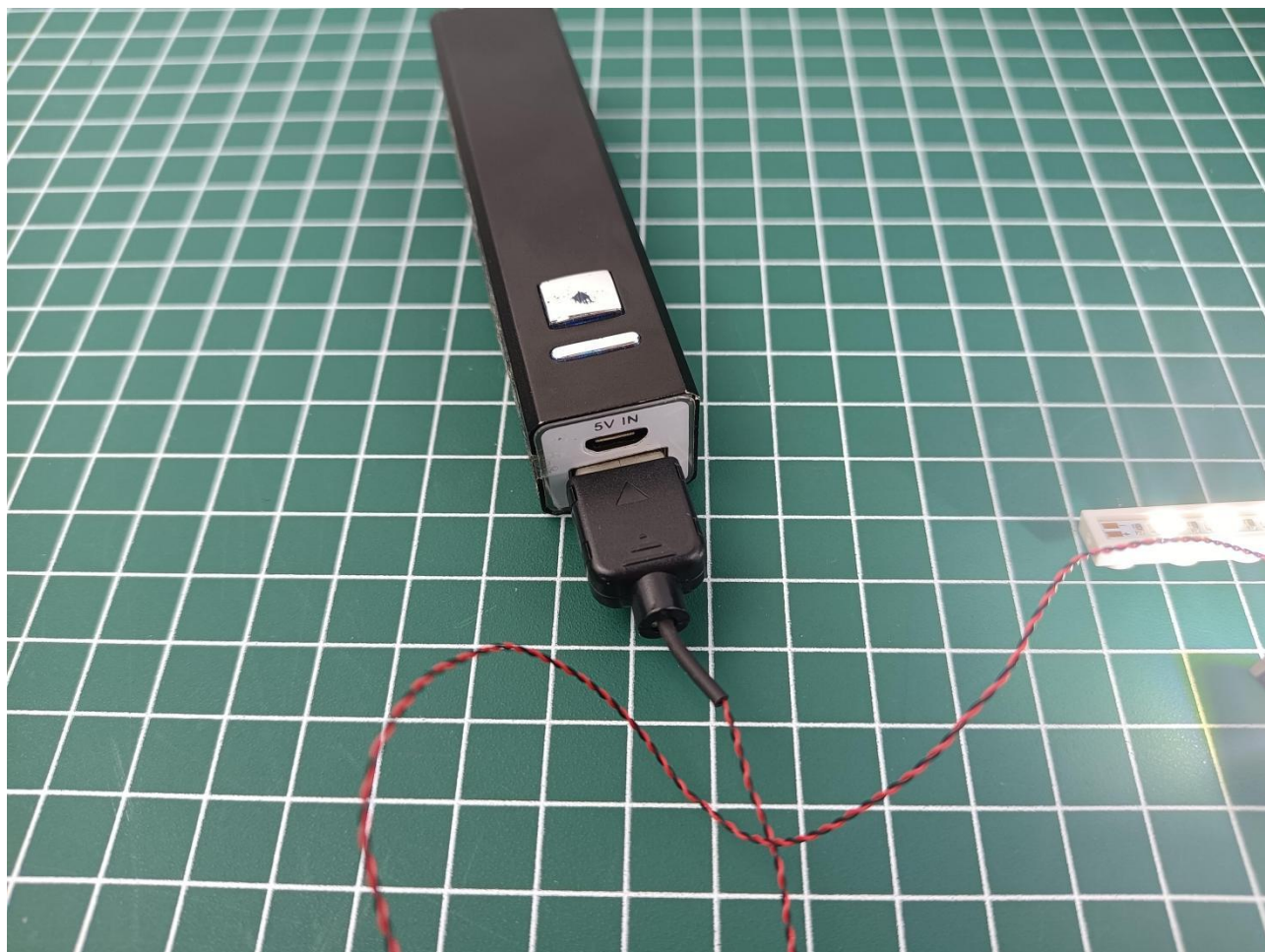

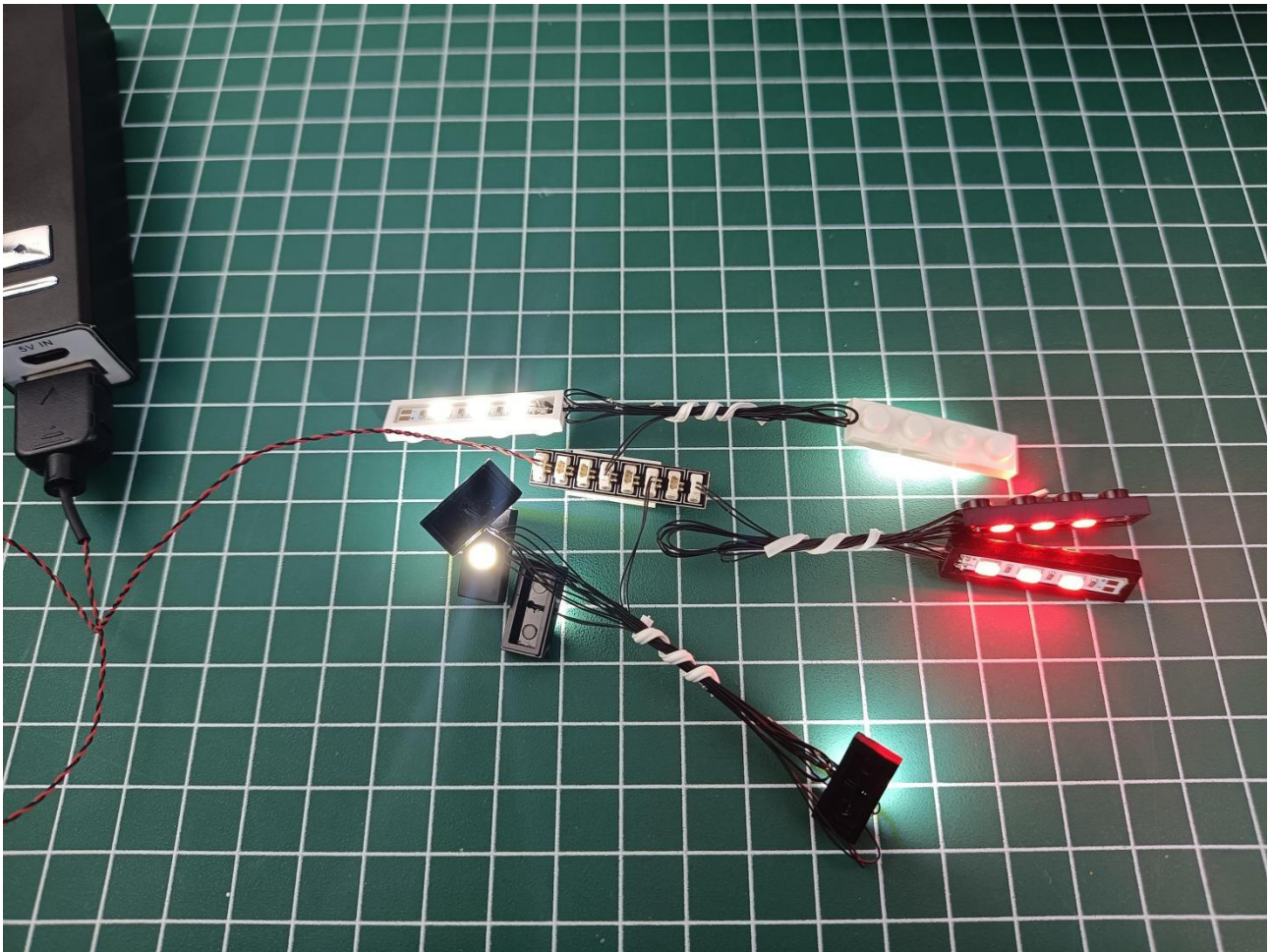

Separate the accessories from the 8-Port Expansion Boards and put them back in place.



Refer to the demo above to test the accessories in the illustrated bag. (Test one by one, beware of confusion or loss)



After testing all parts, separate the parts shown in the figure.

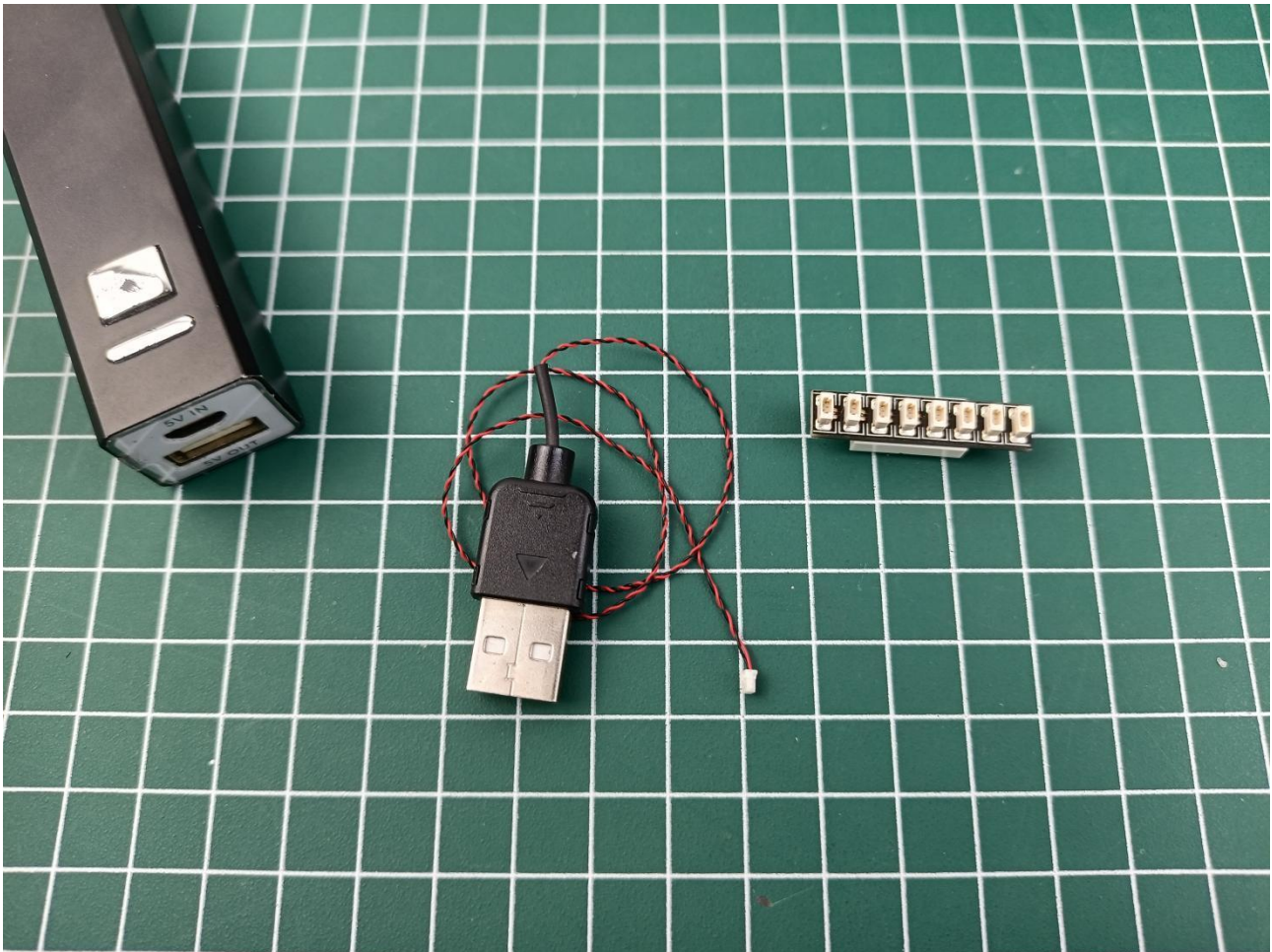

Put the accessories back in the No.3 bag.



Note:

Please be careful when installing. The lamp wire is relatively slender and cannot be pressed on the raised position of the building block. It should pass along the gap, otherwise the lamp wire will be pinched.

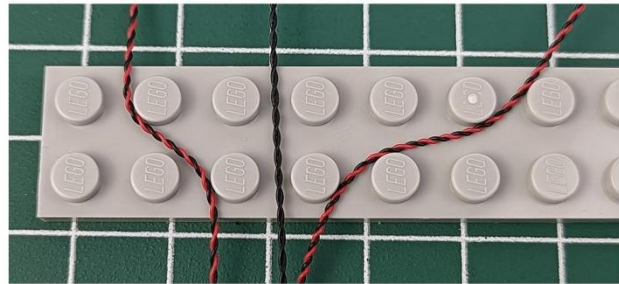
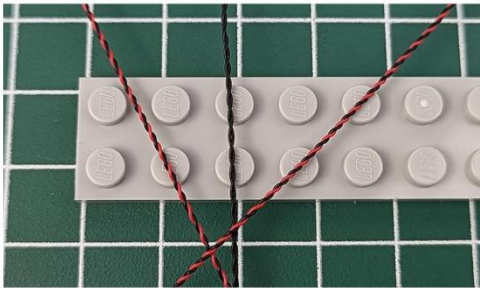

Step 2

Install:

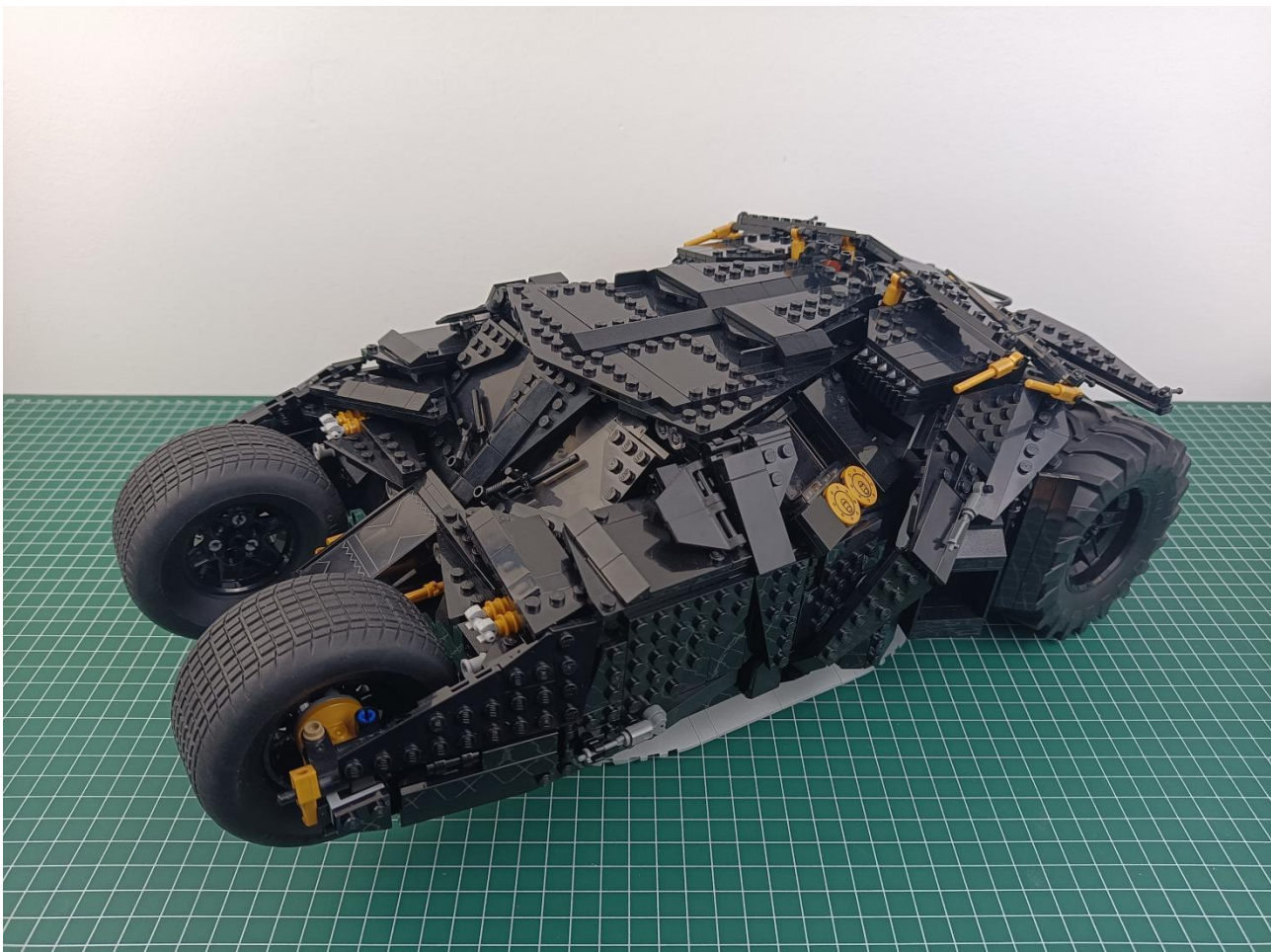

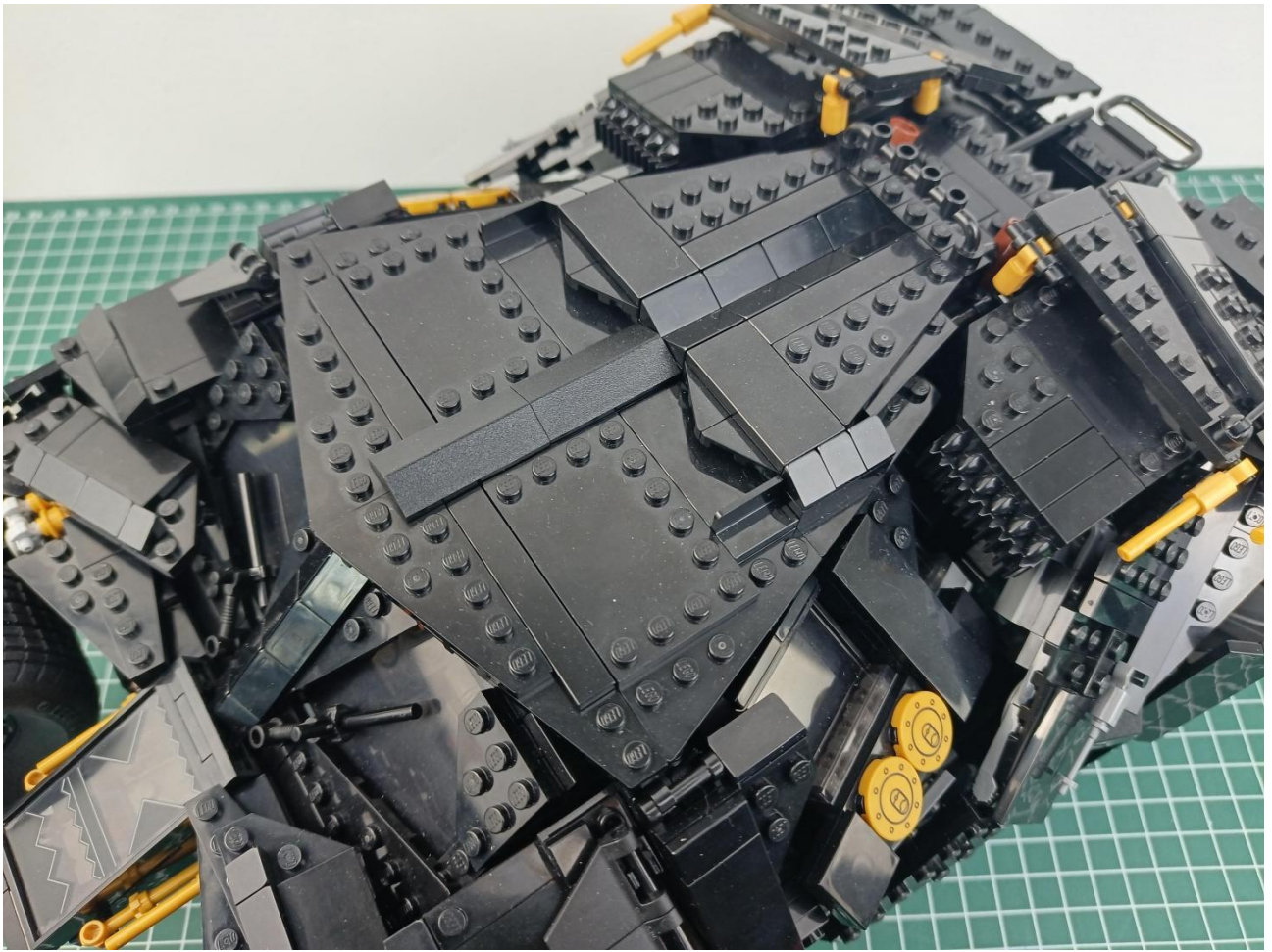

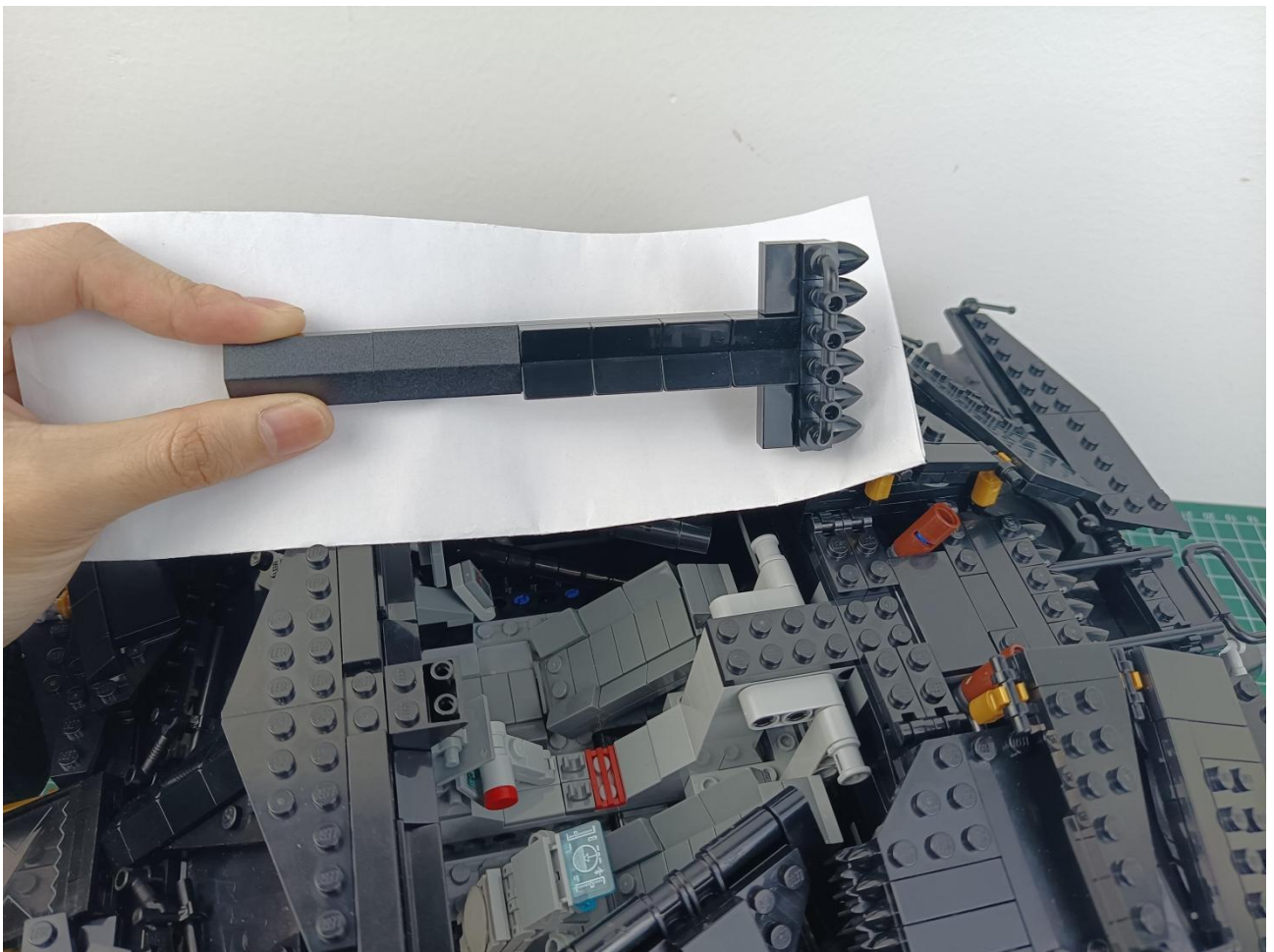
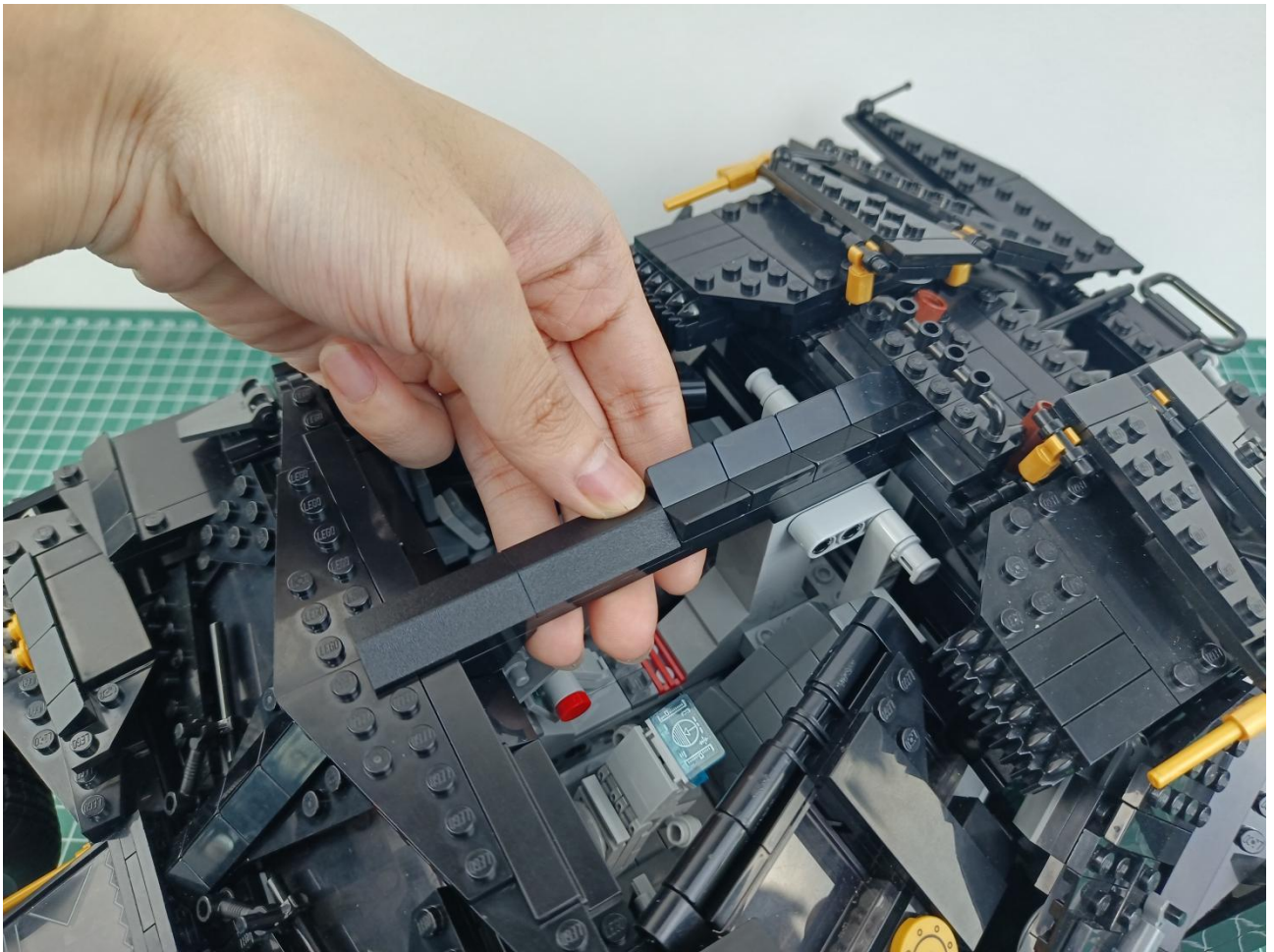

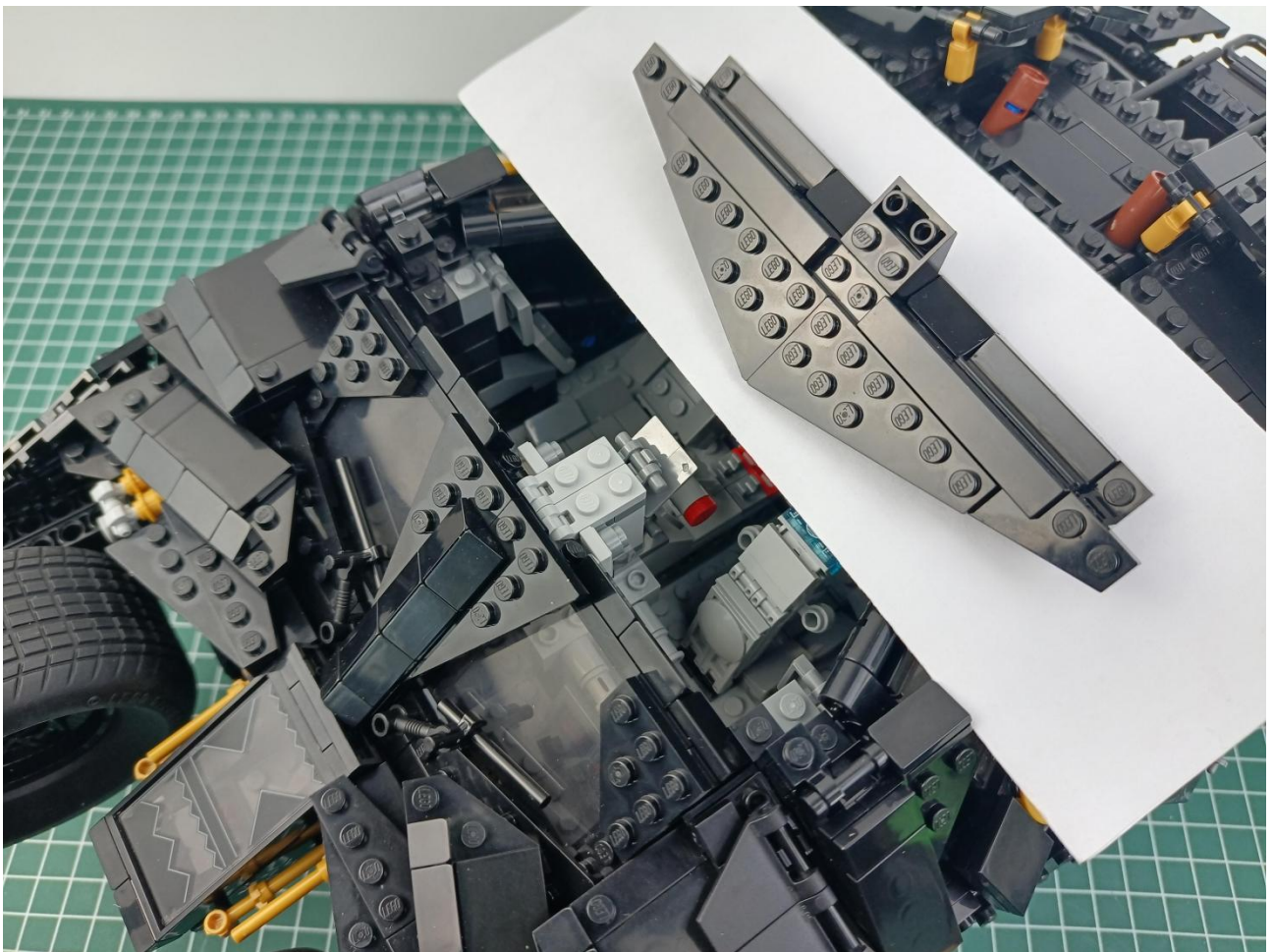
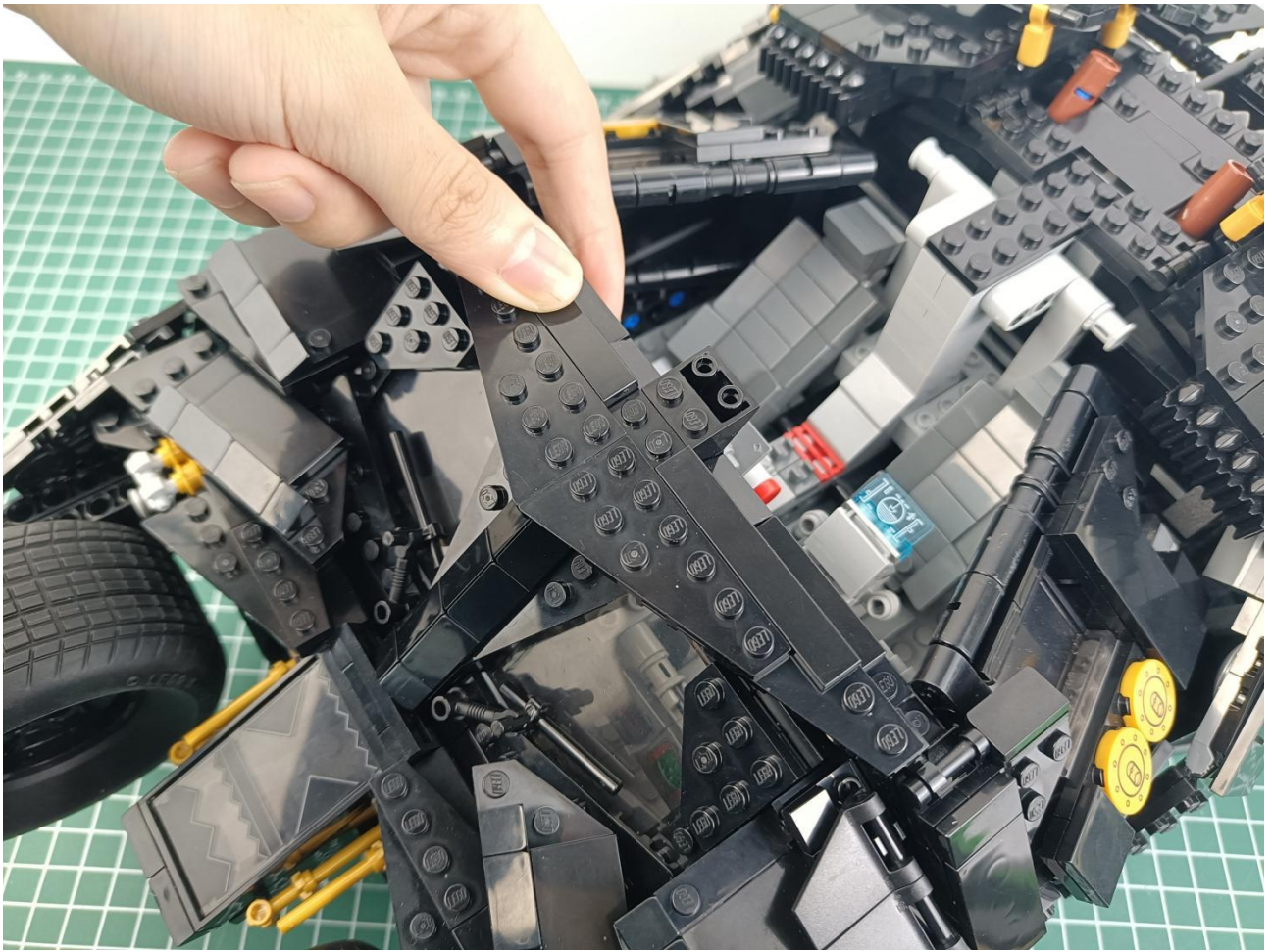

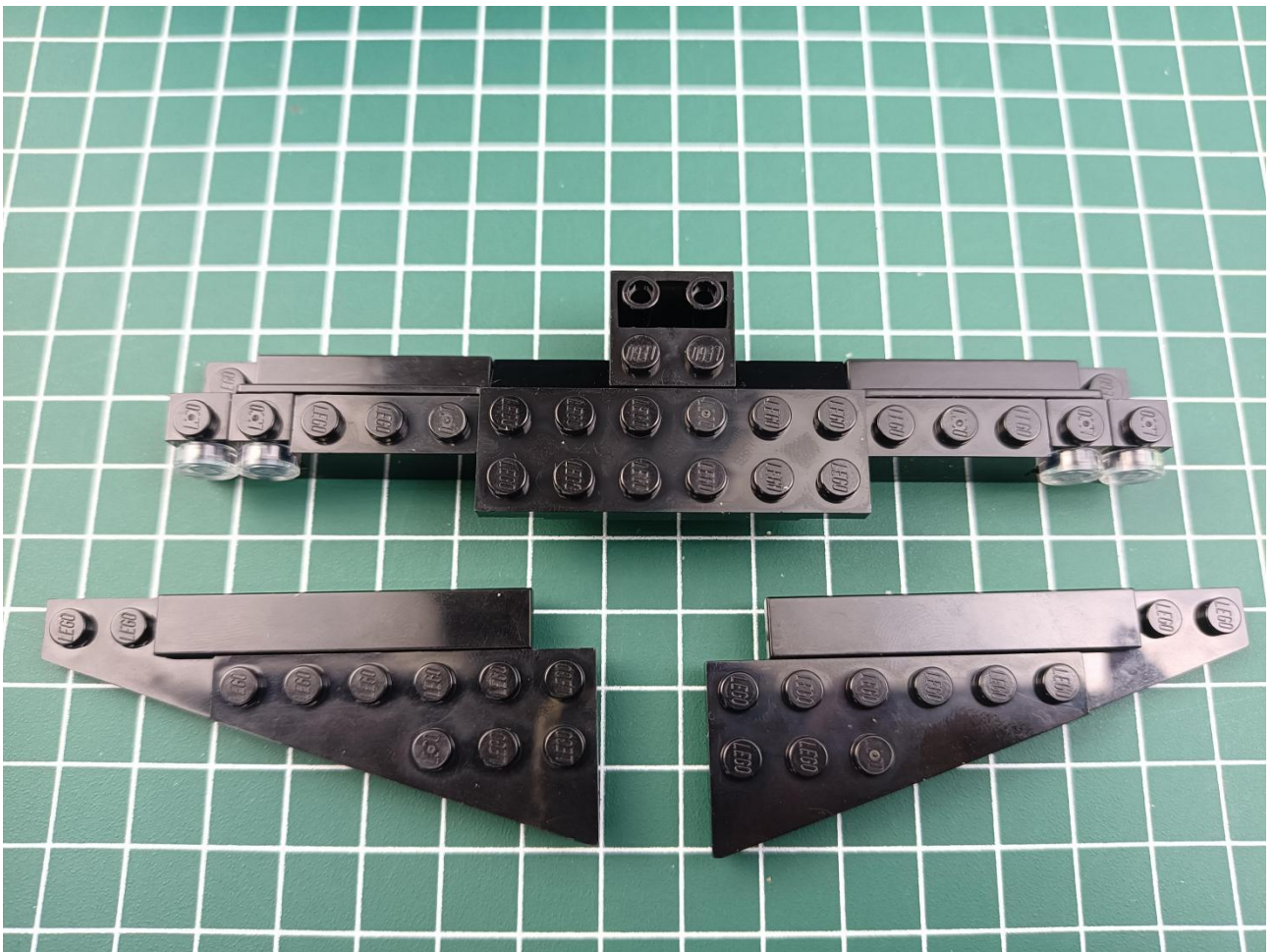
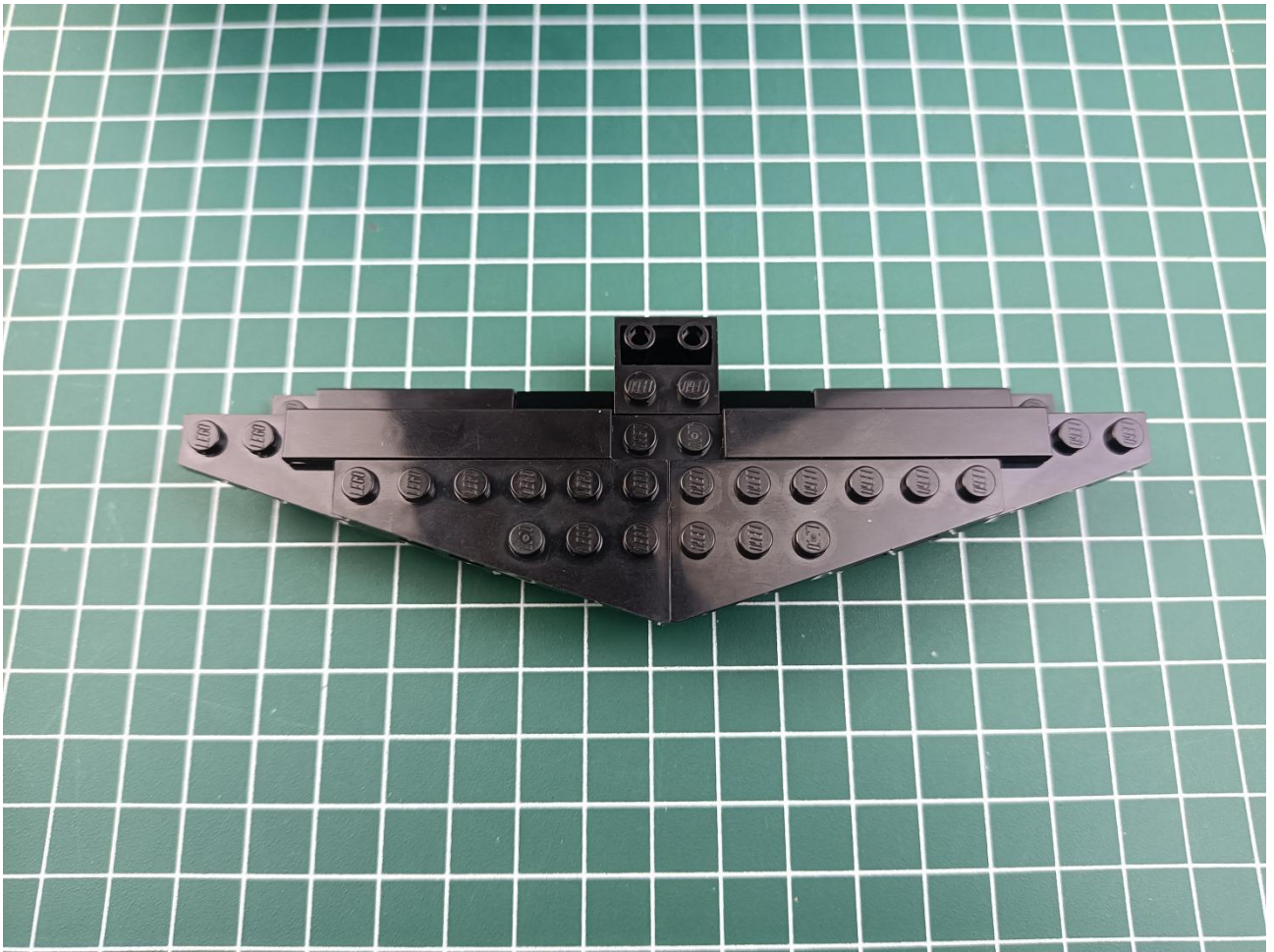

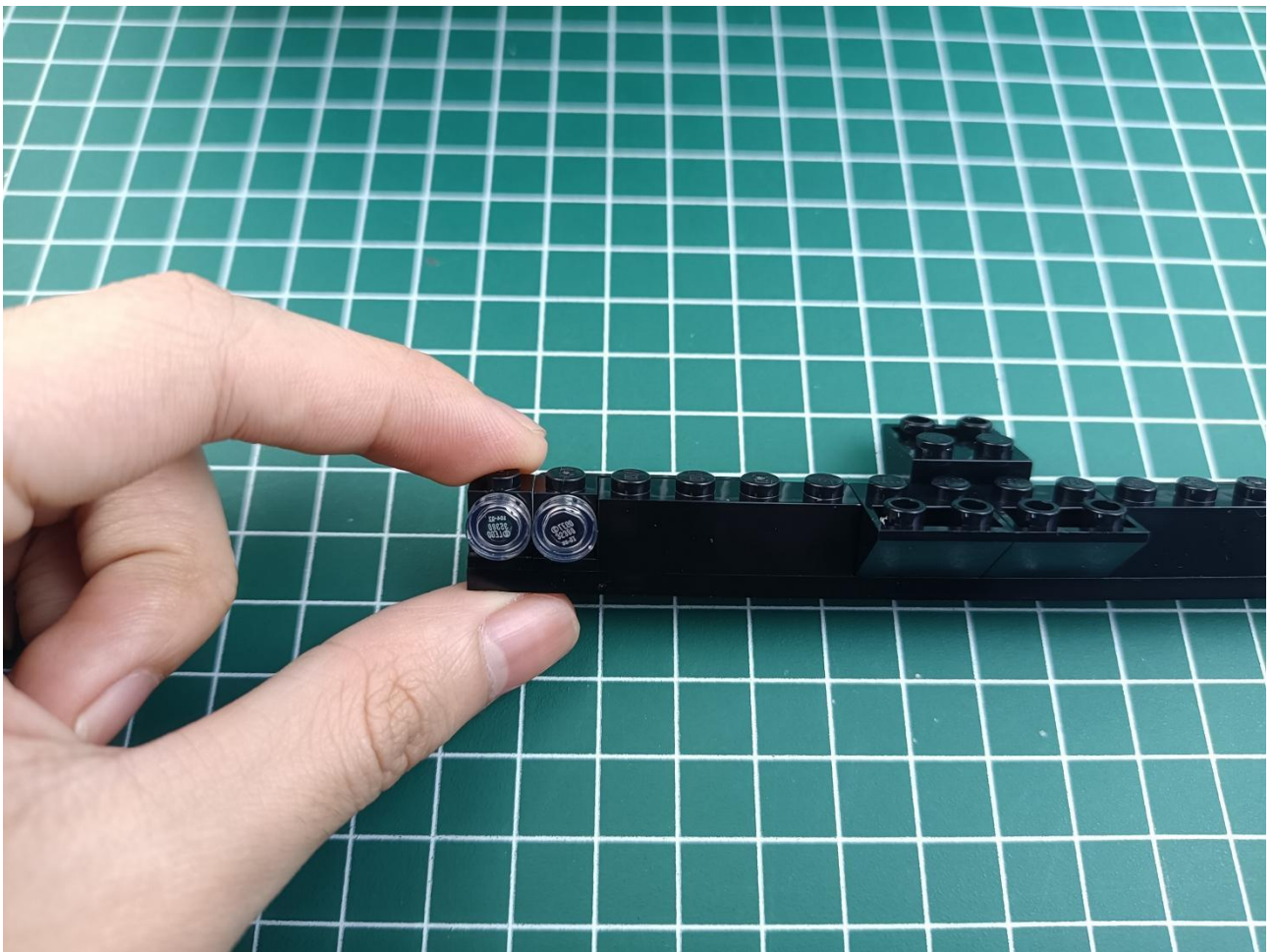
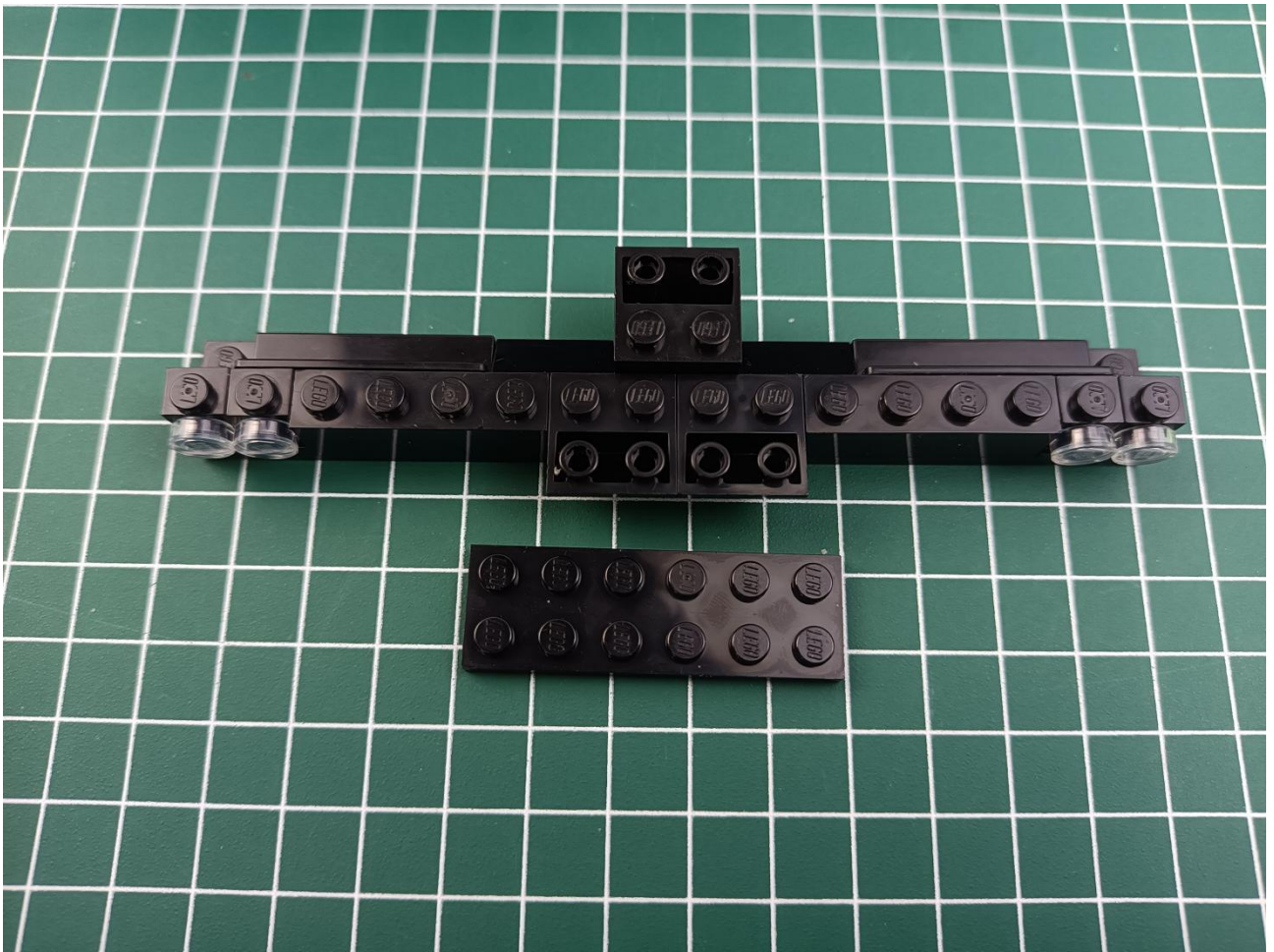

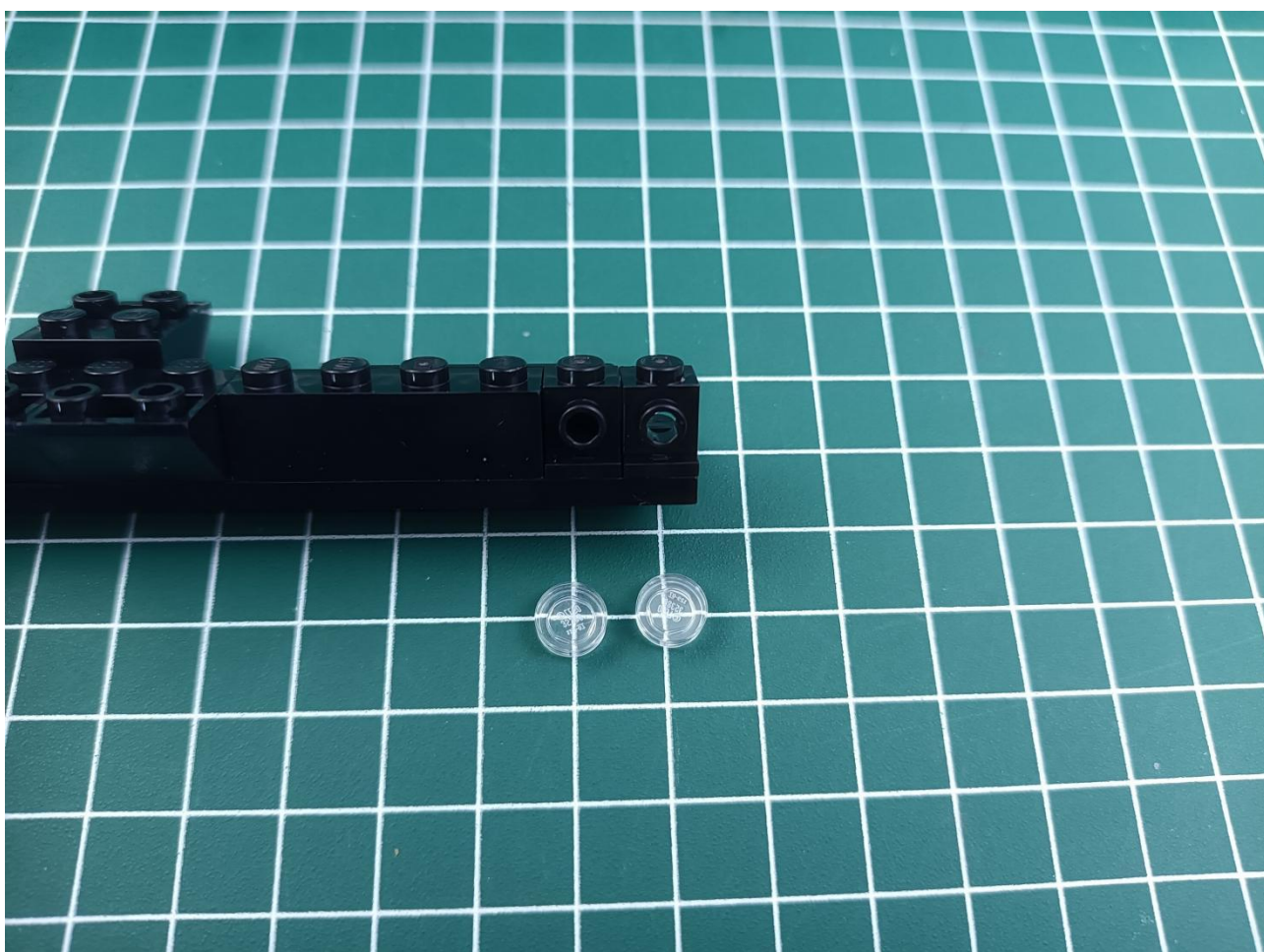

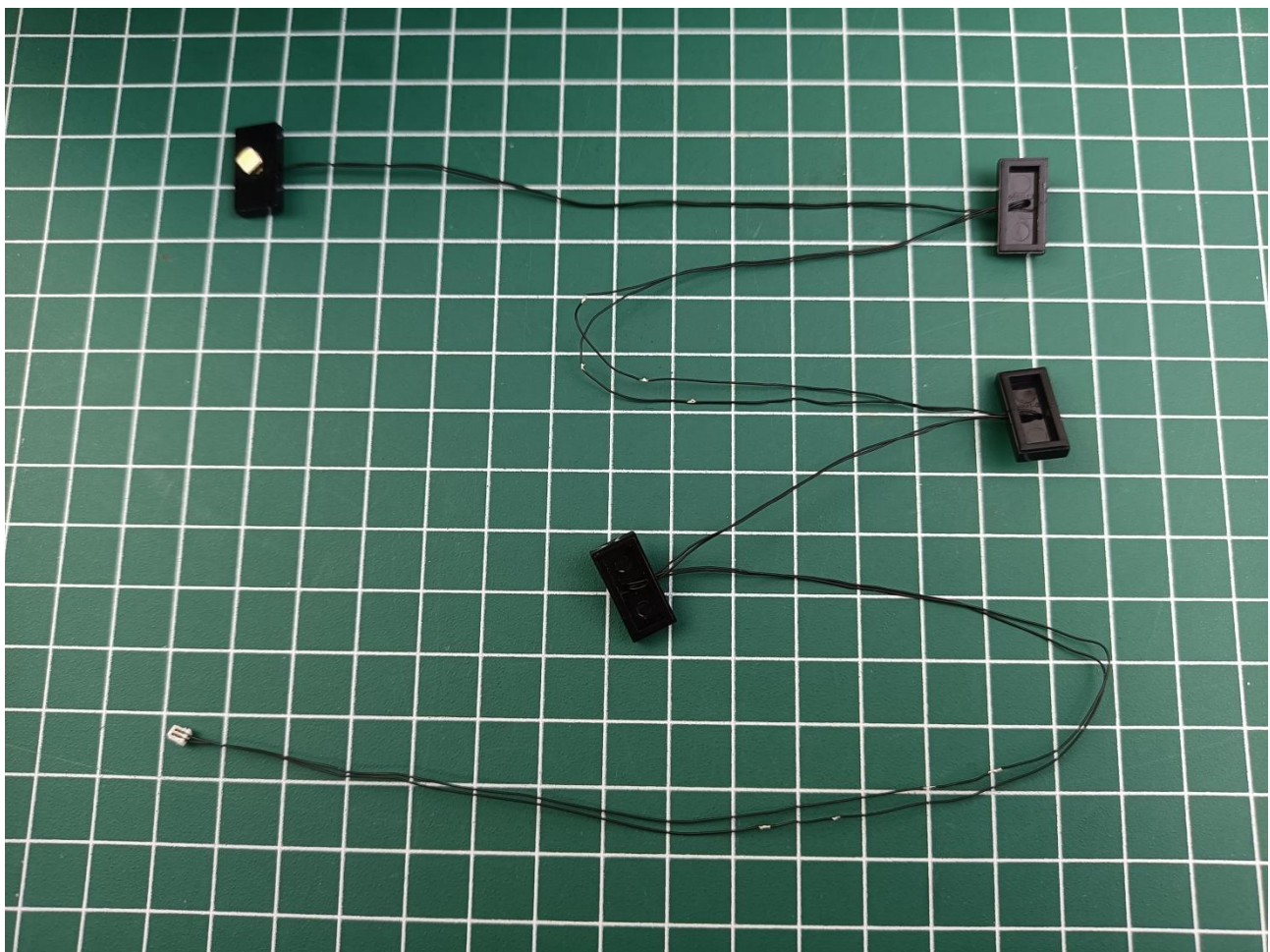

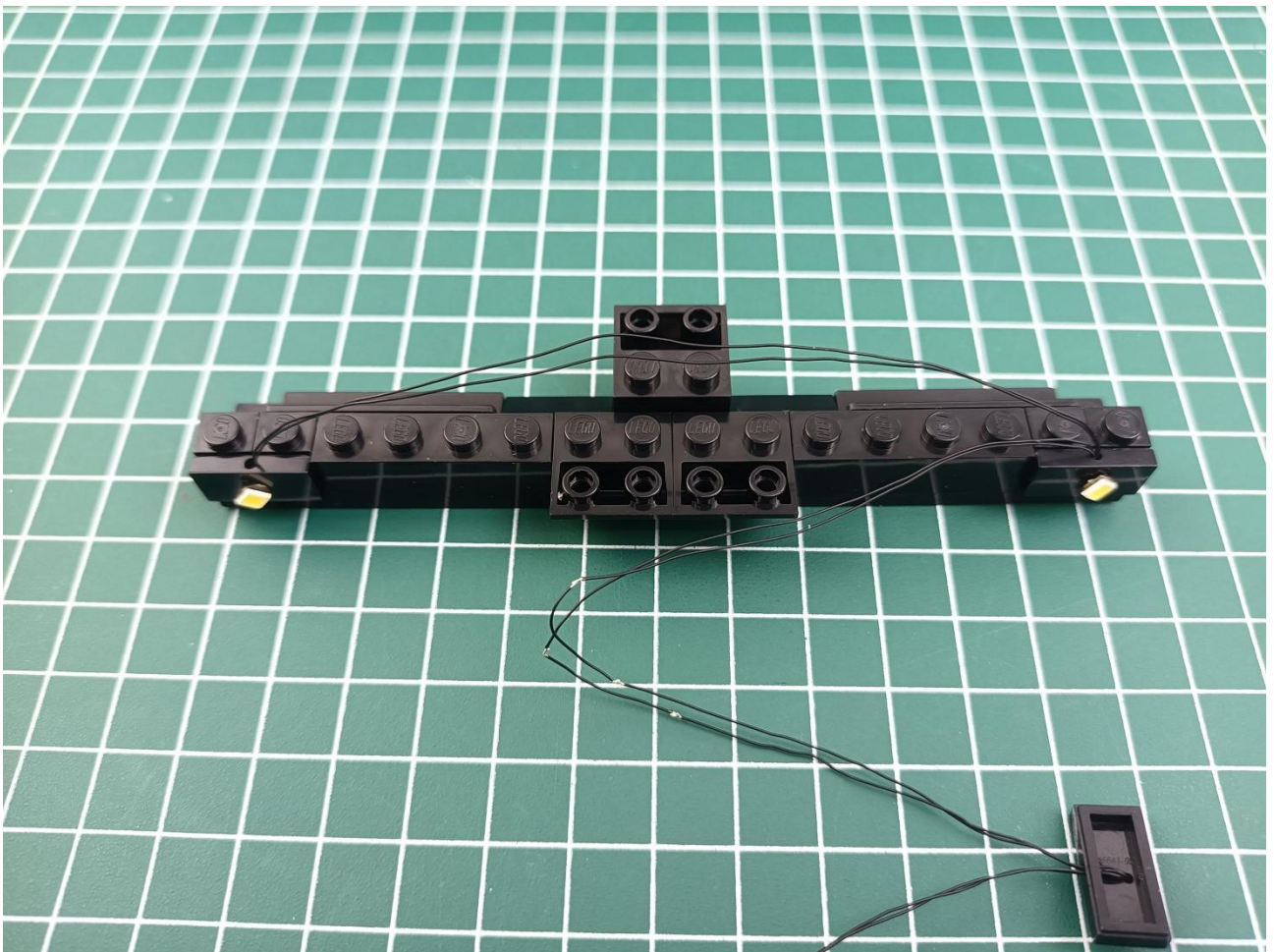
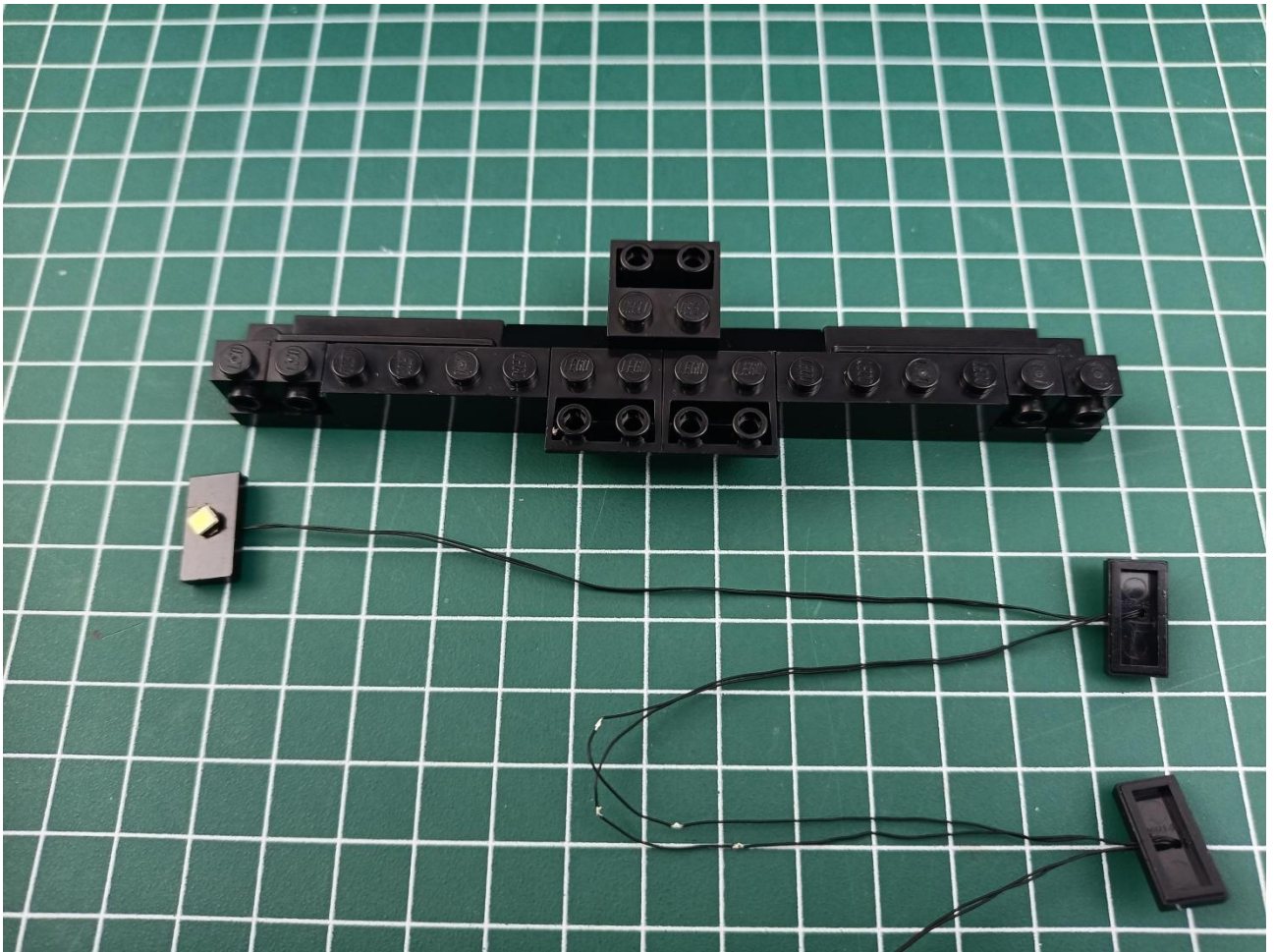

Note:

Please be careful when installing. The lamp wire is relatively slender and cannot be pressed on the raised position of the building block. It should pass along the gap, otherwise the lamp wire will be pinched.

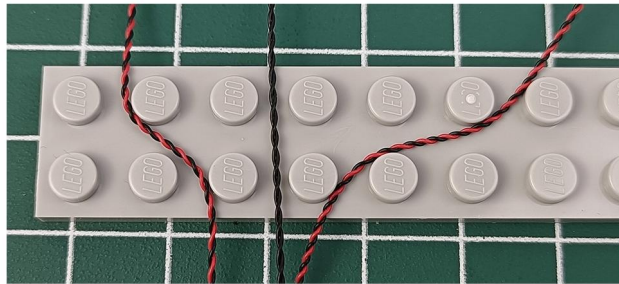
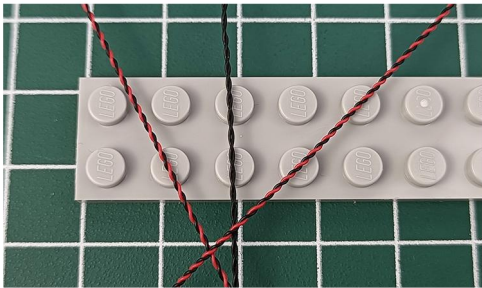

This is for reference only, please wind it according to the actual length.





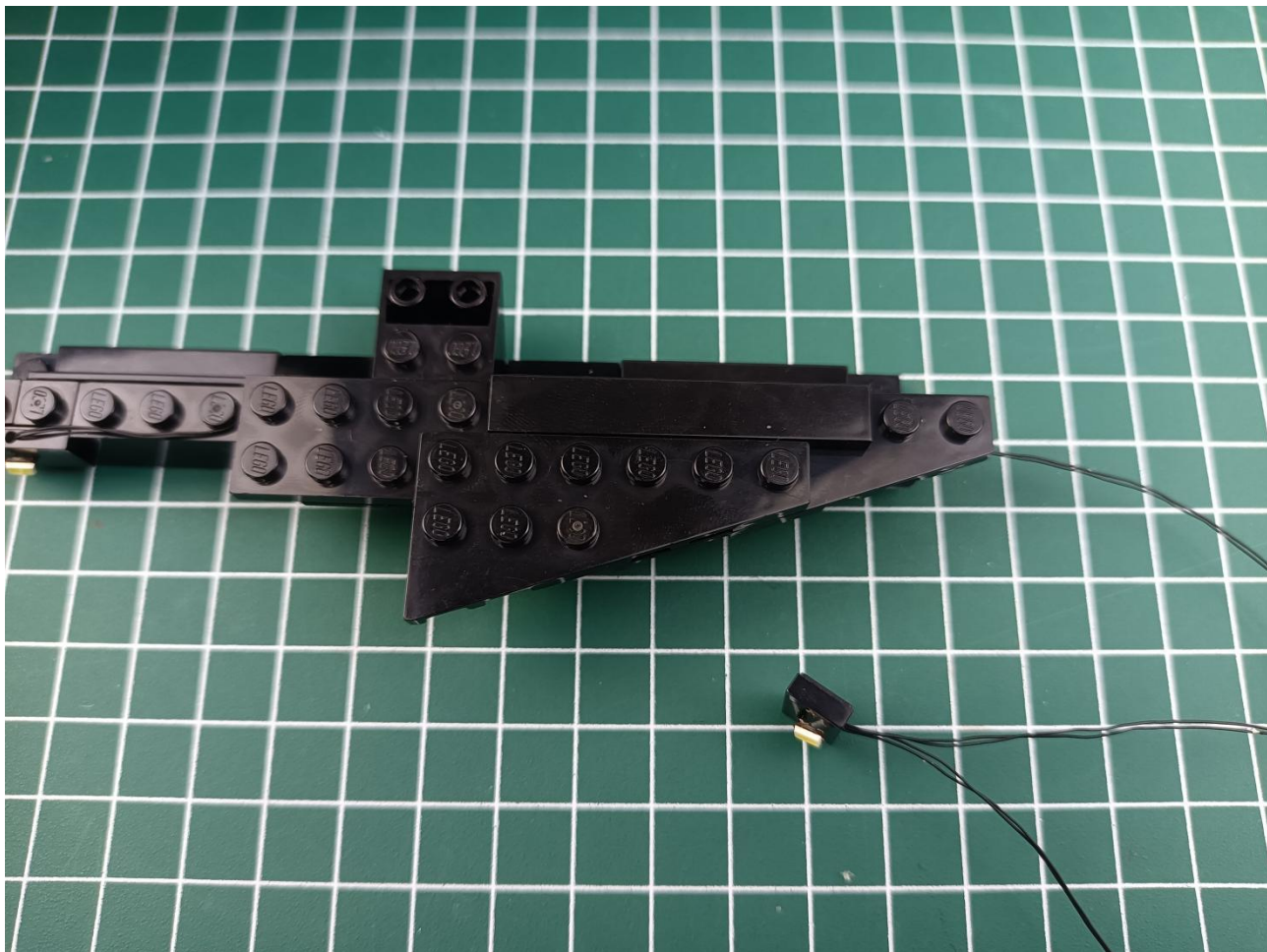

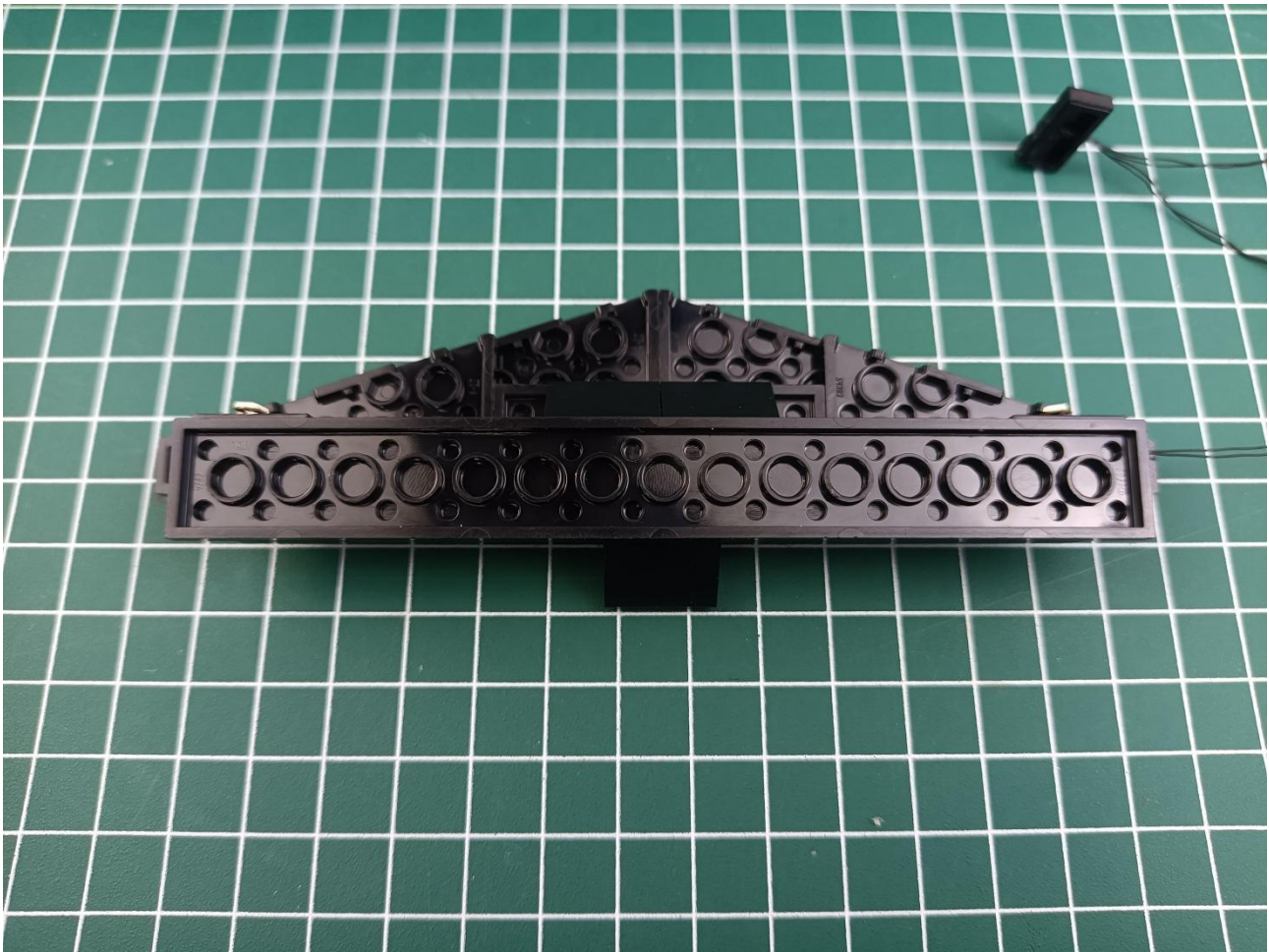

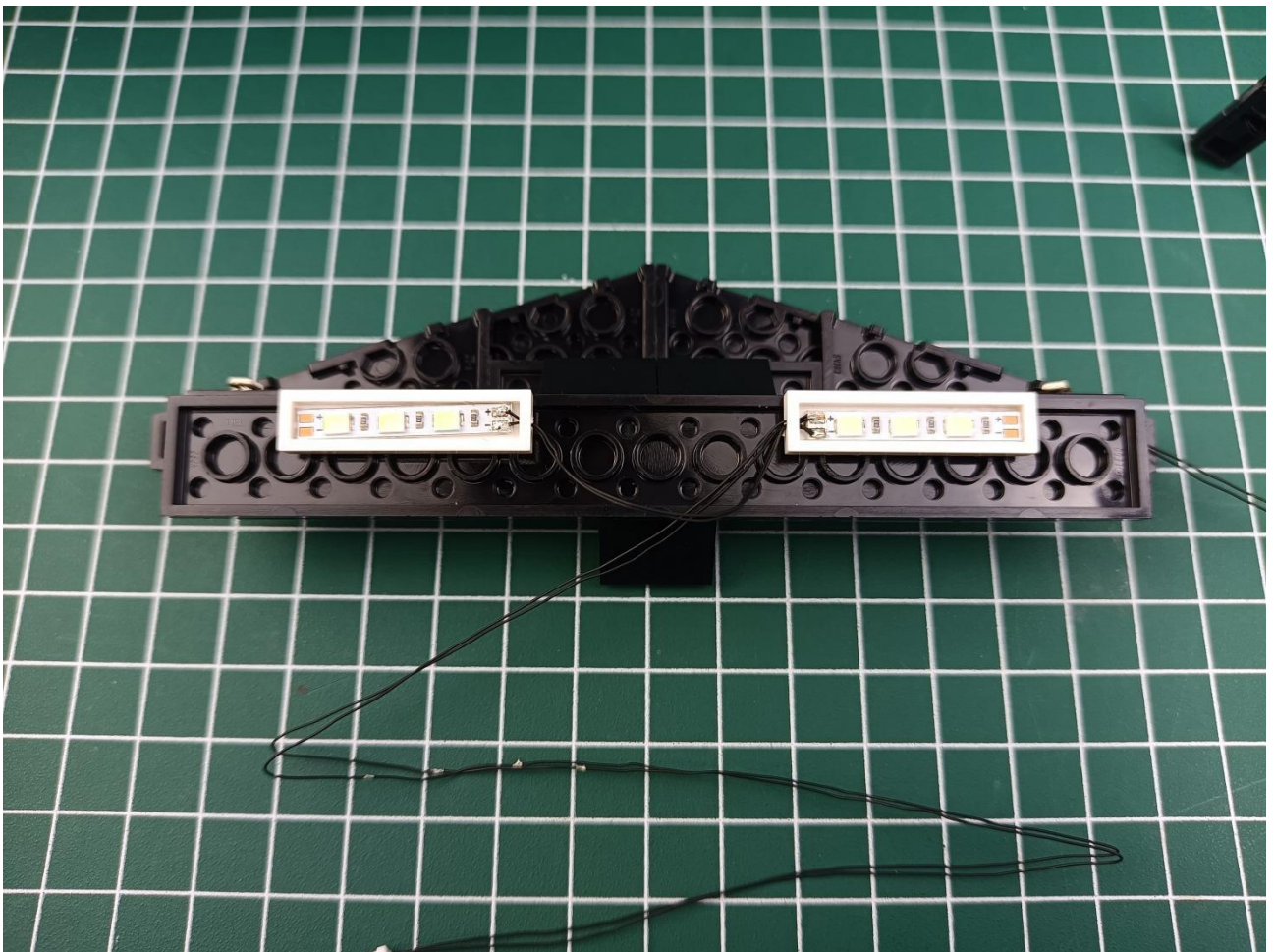
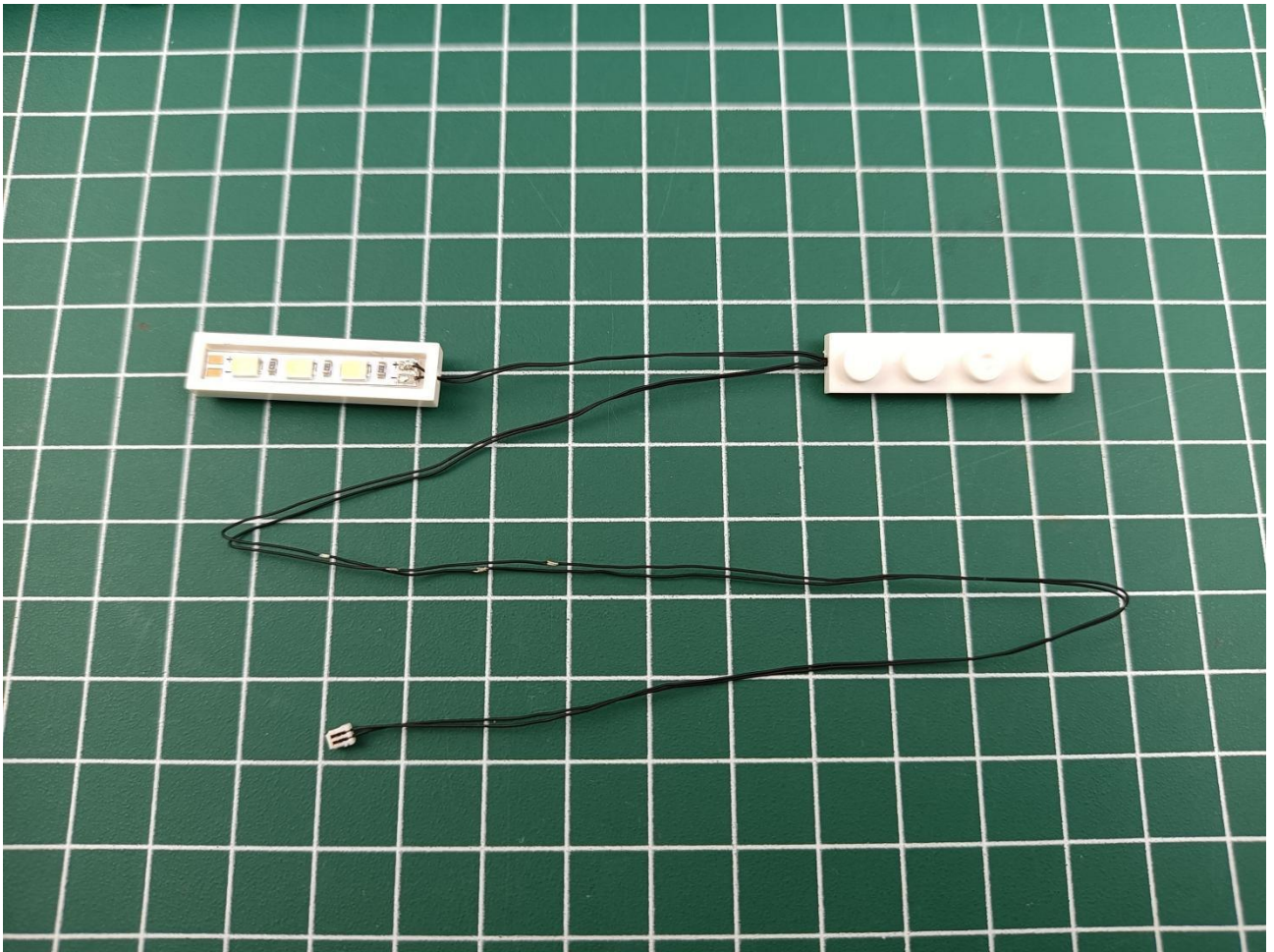

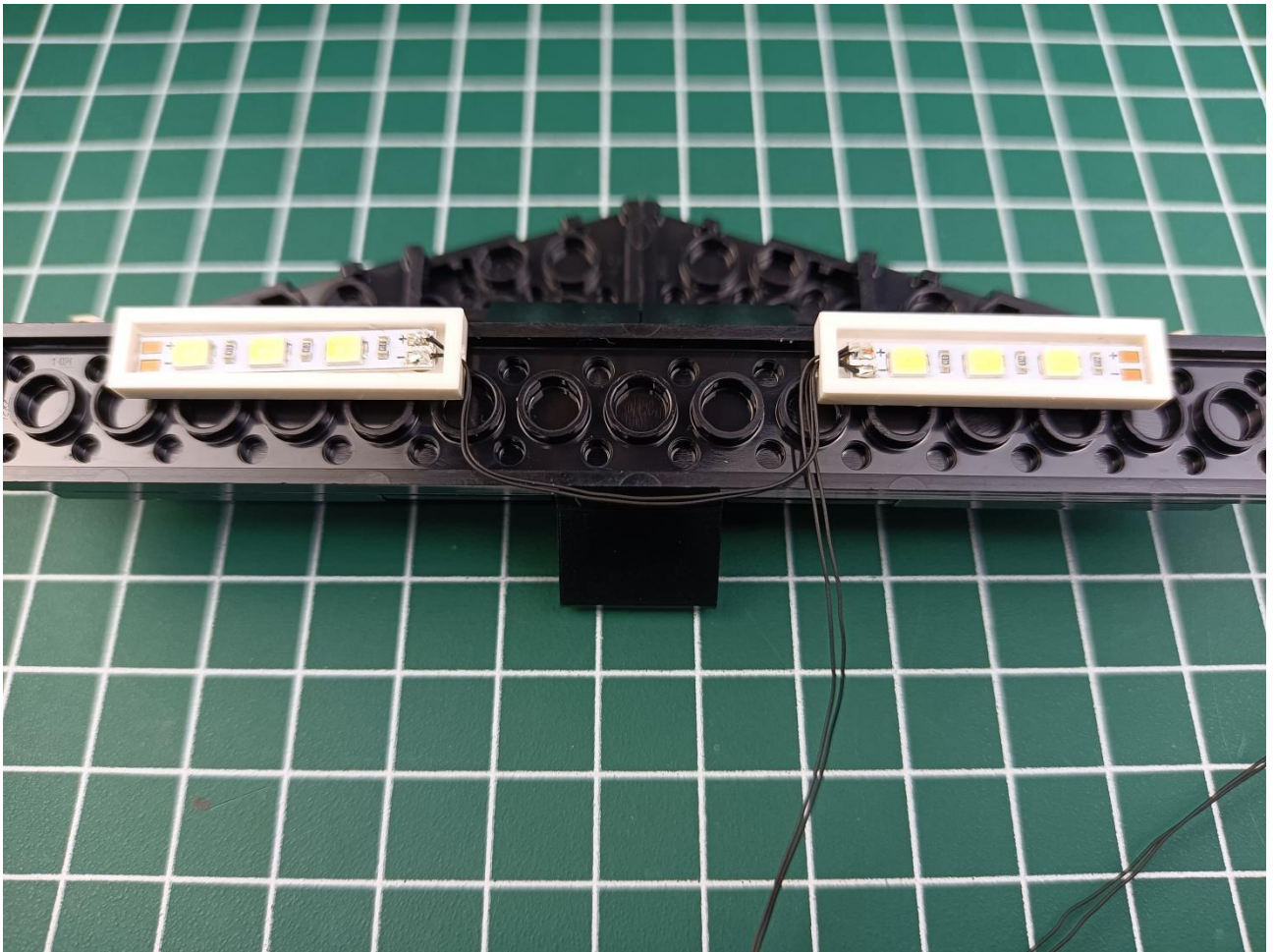

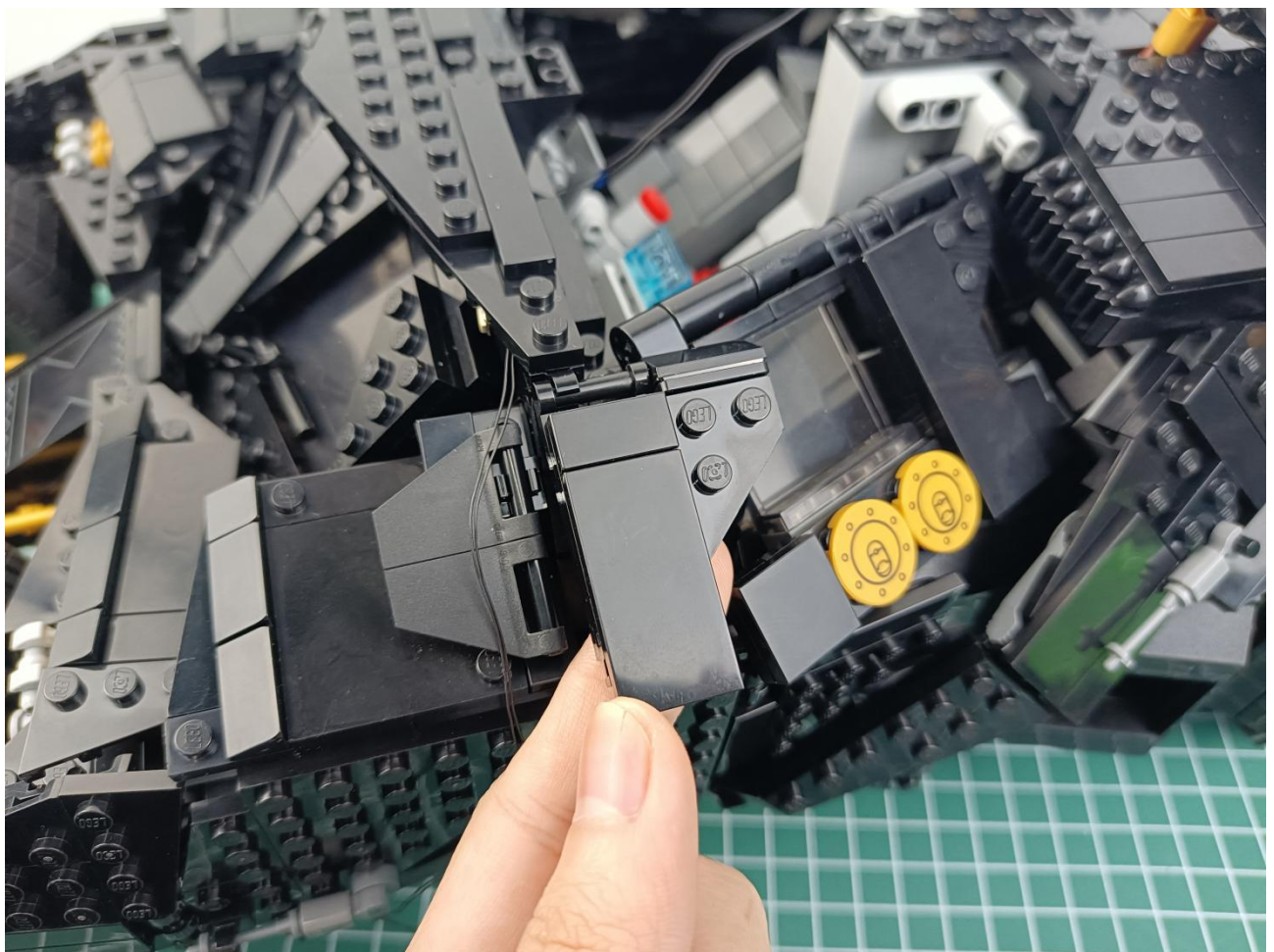

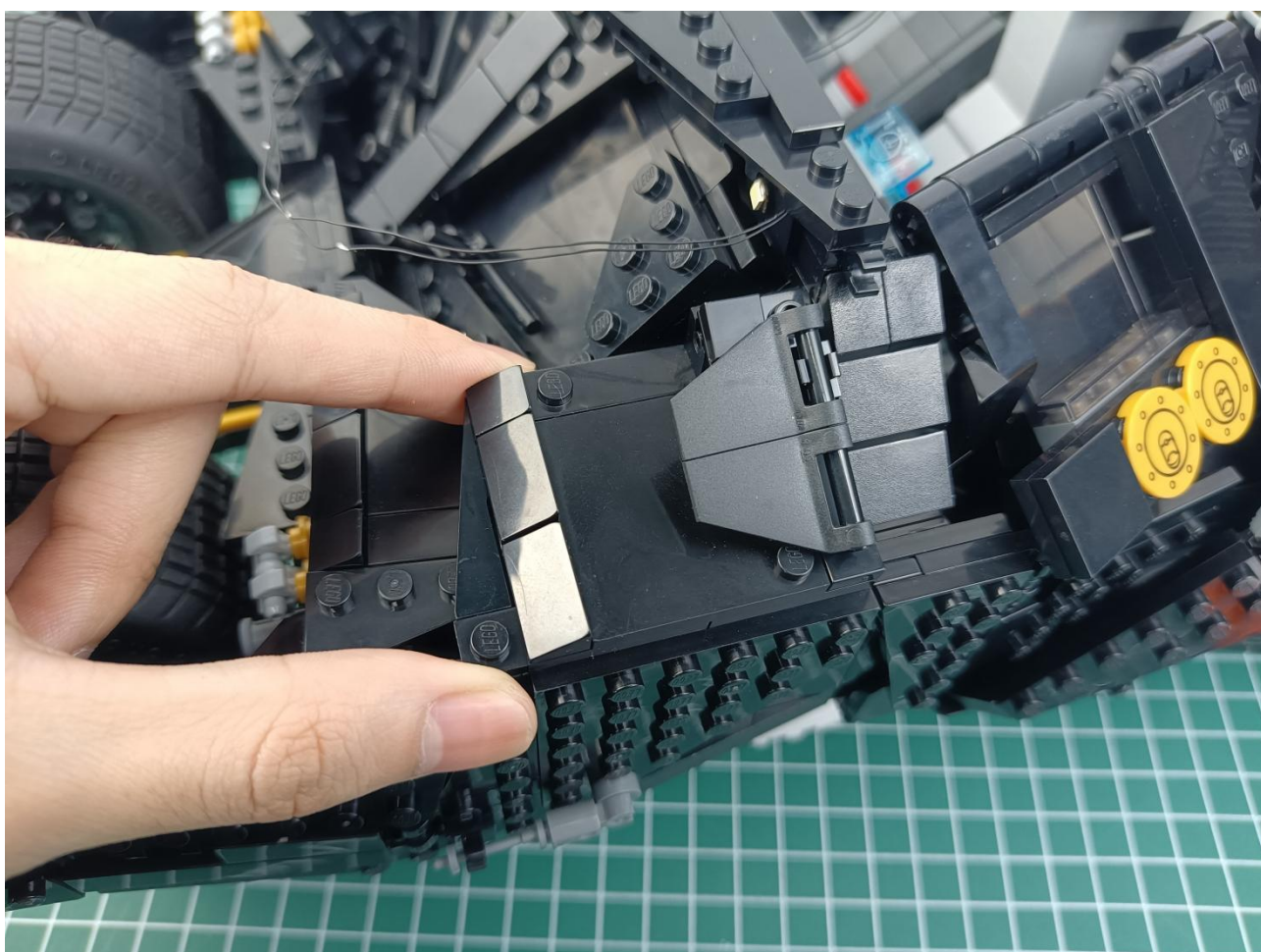
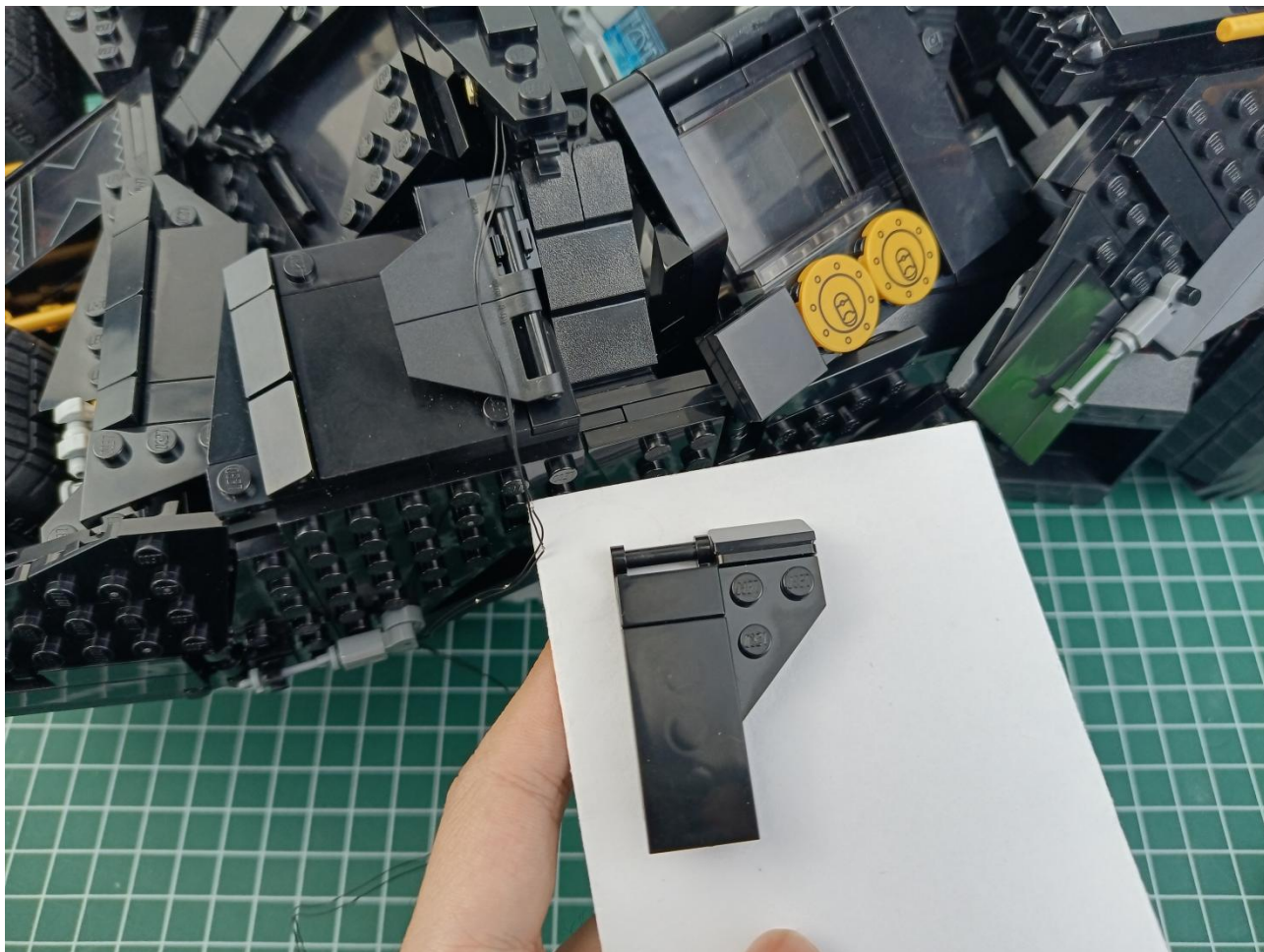

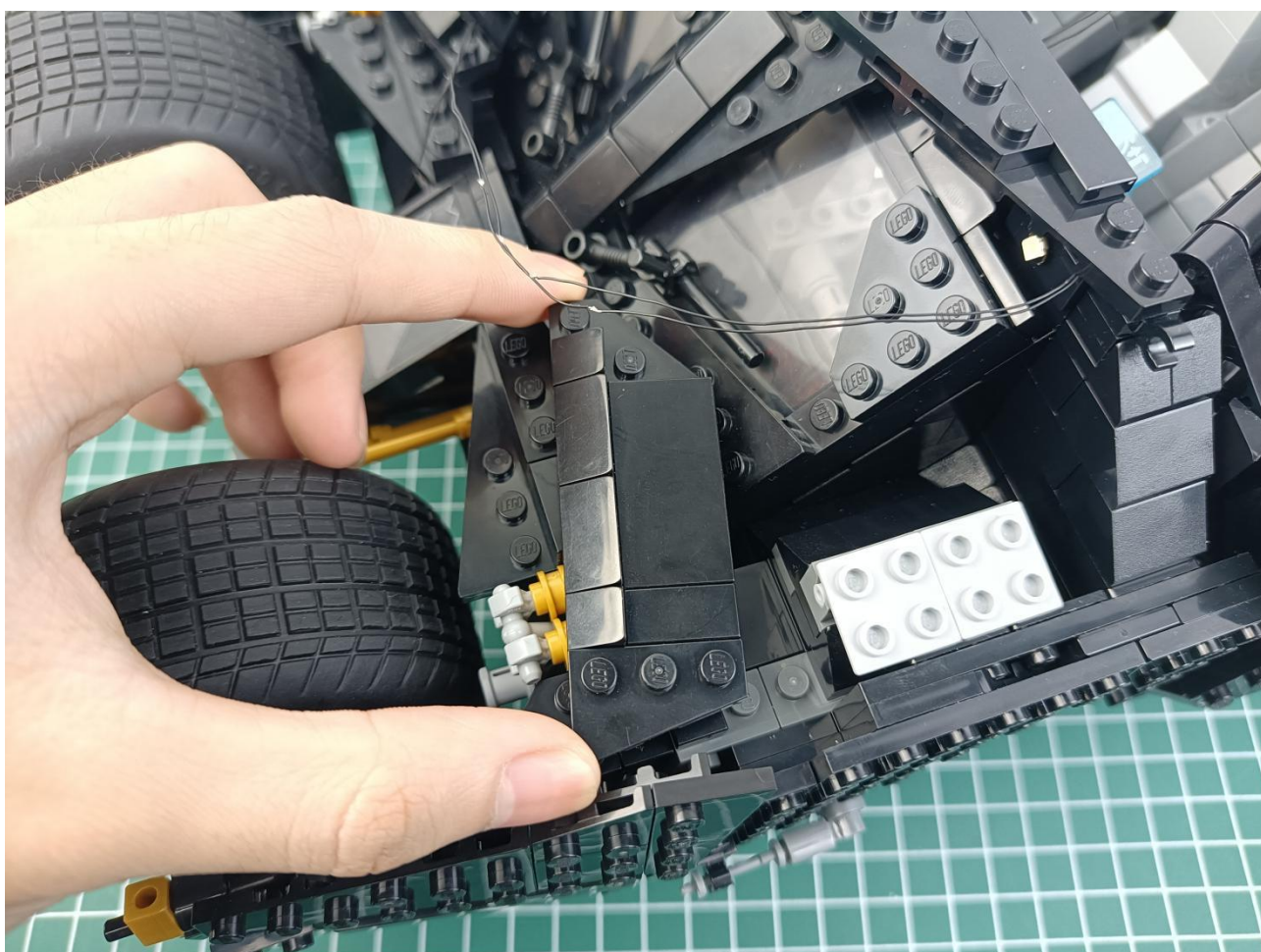
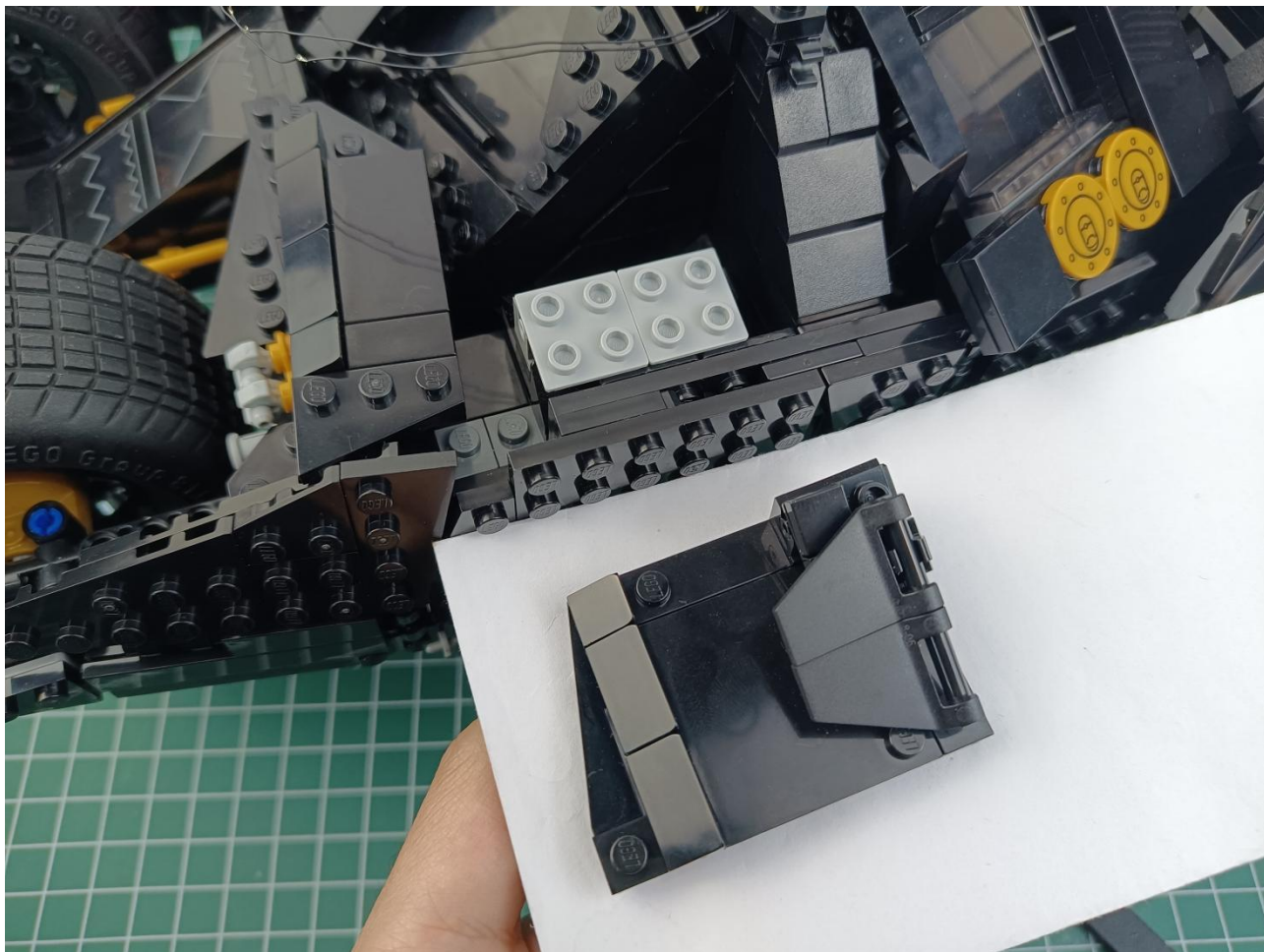

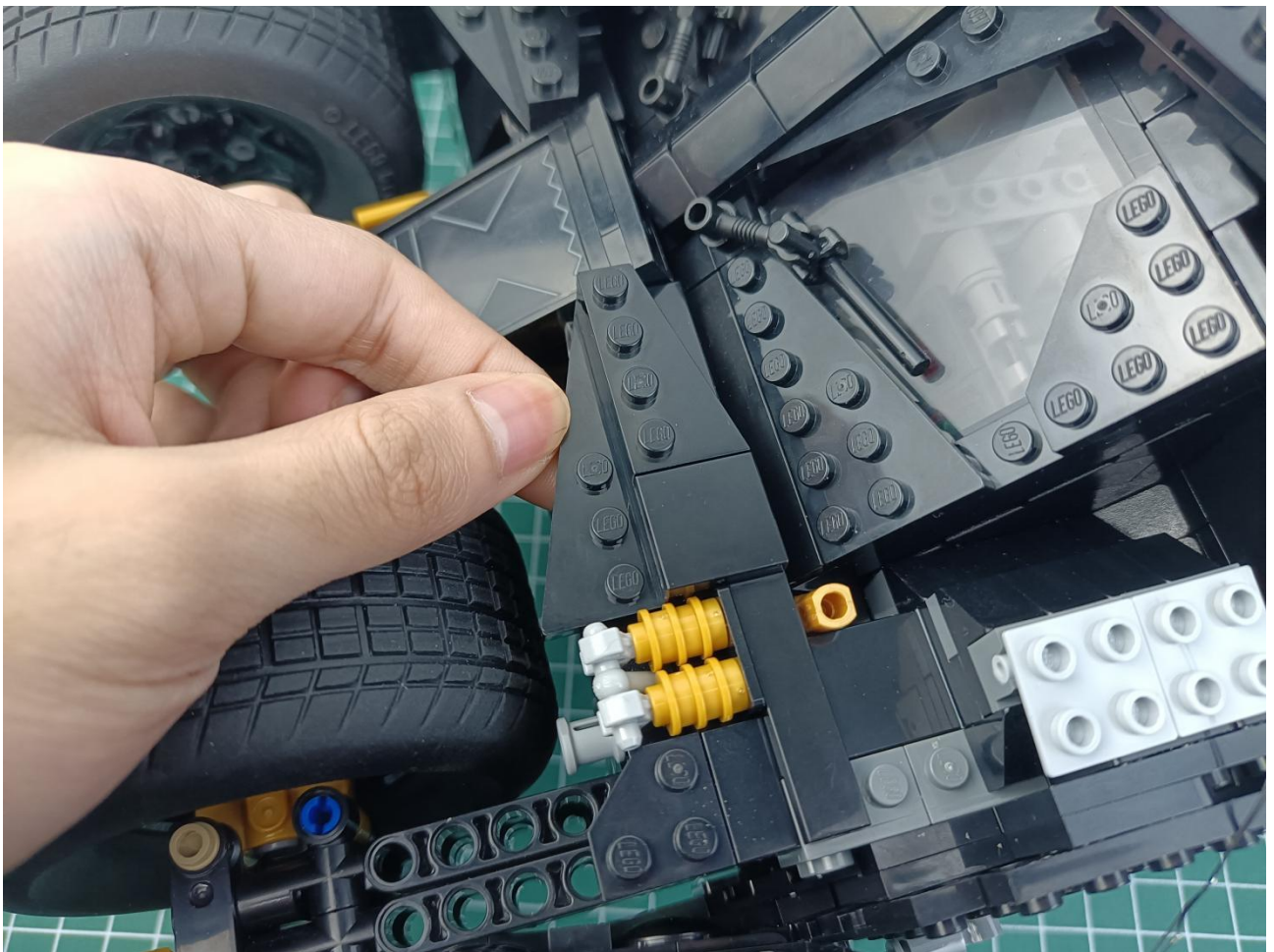
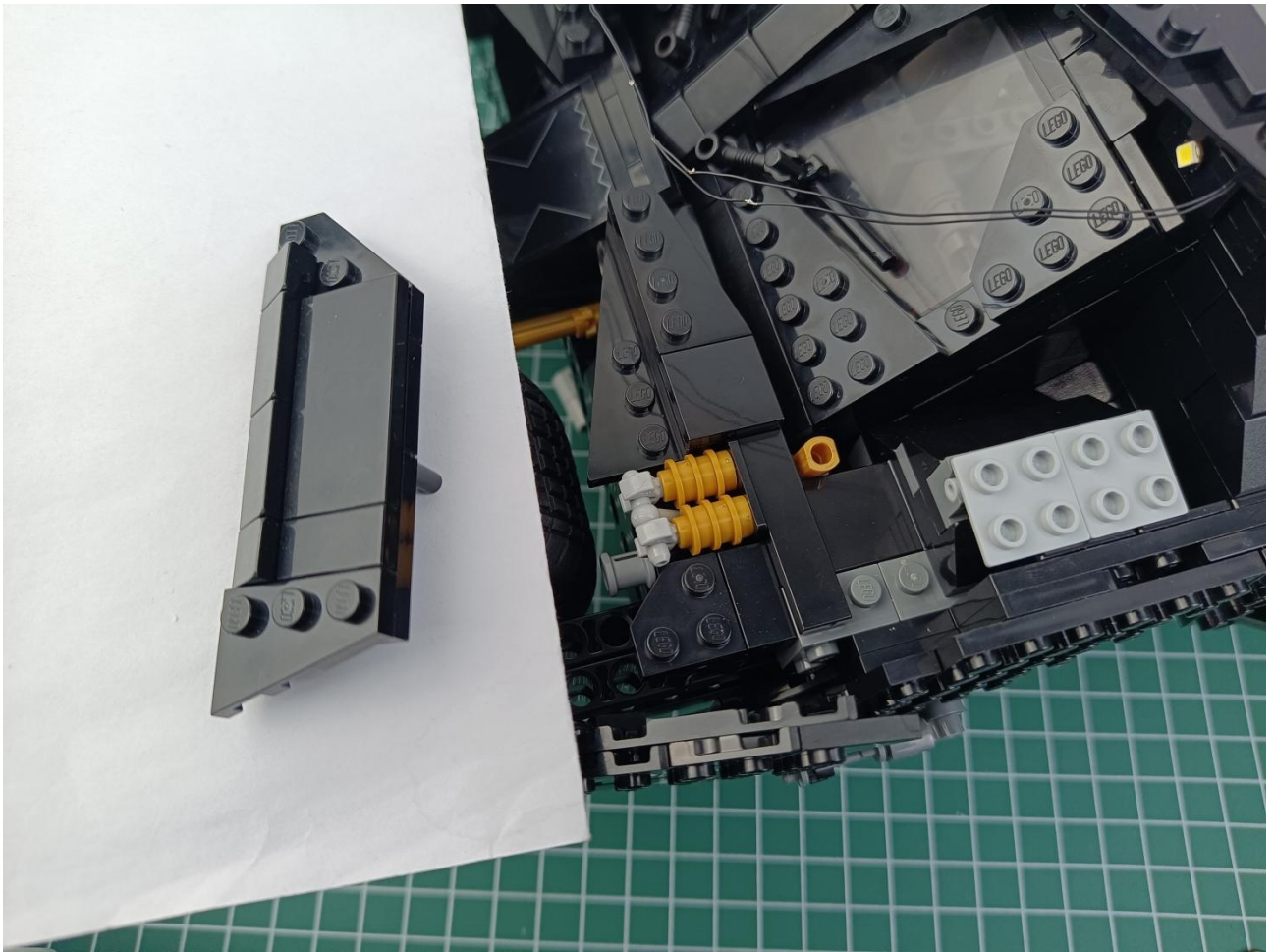

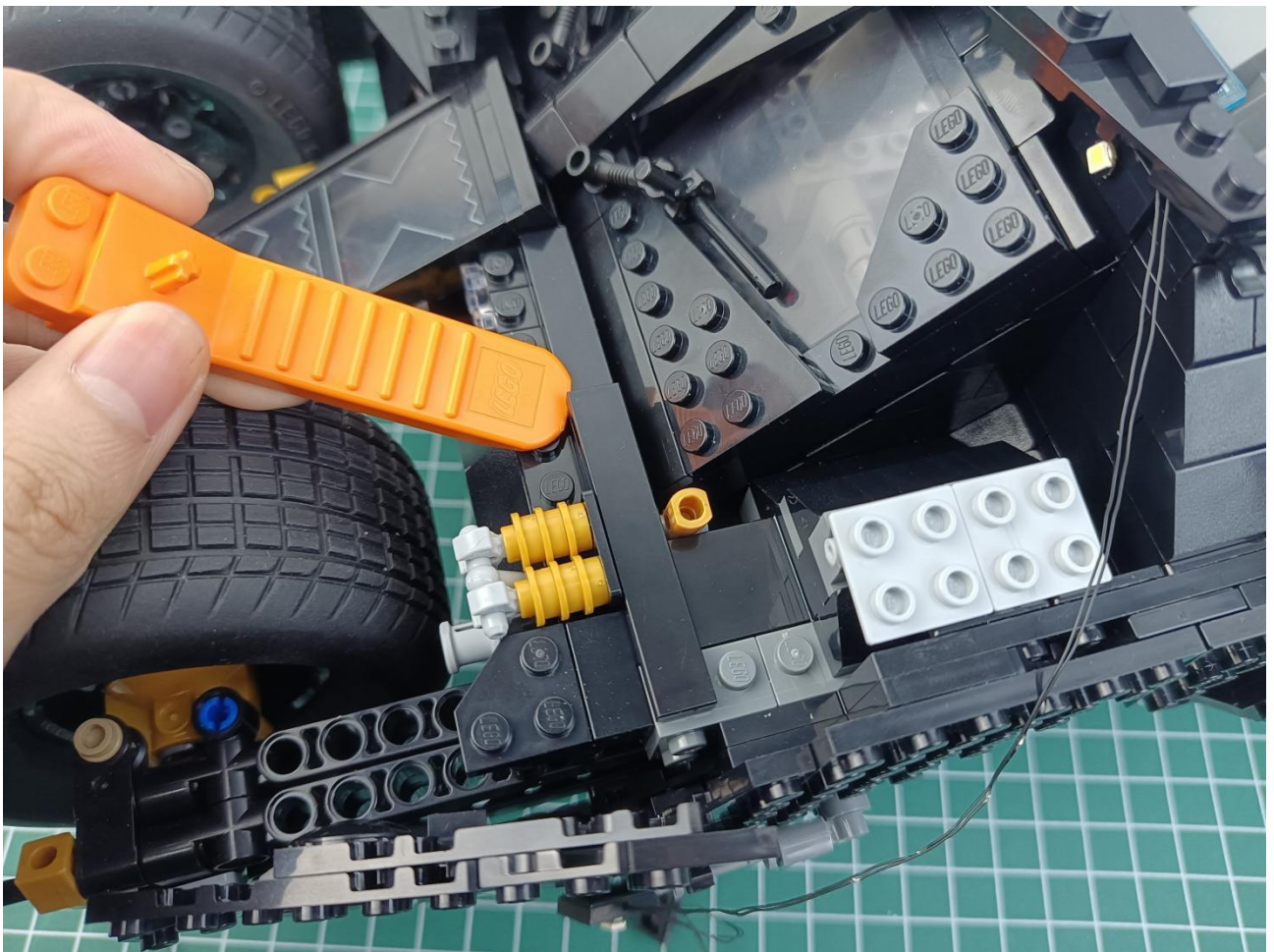
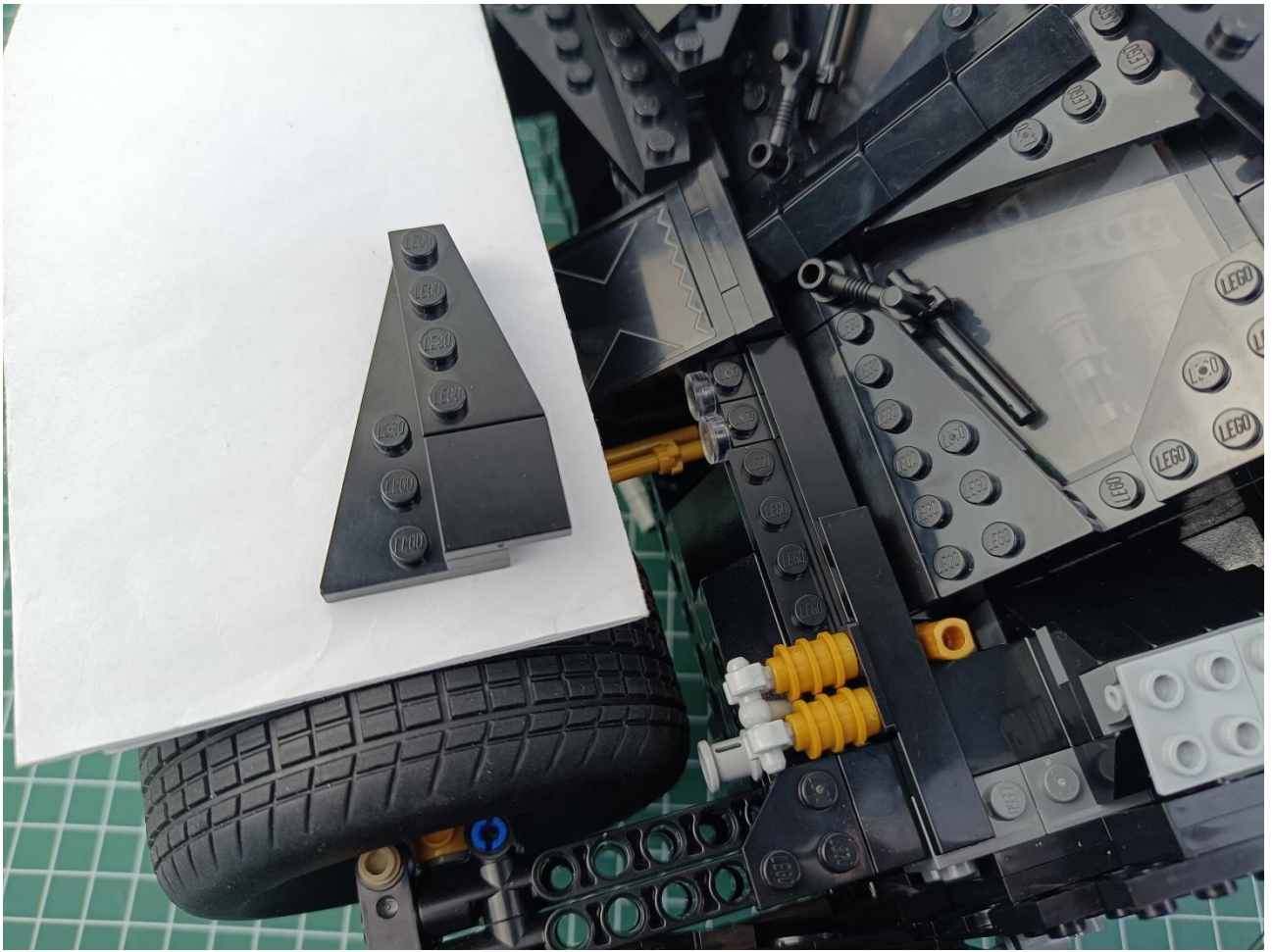

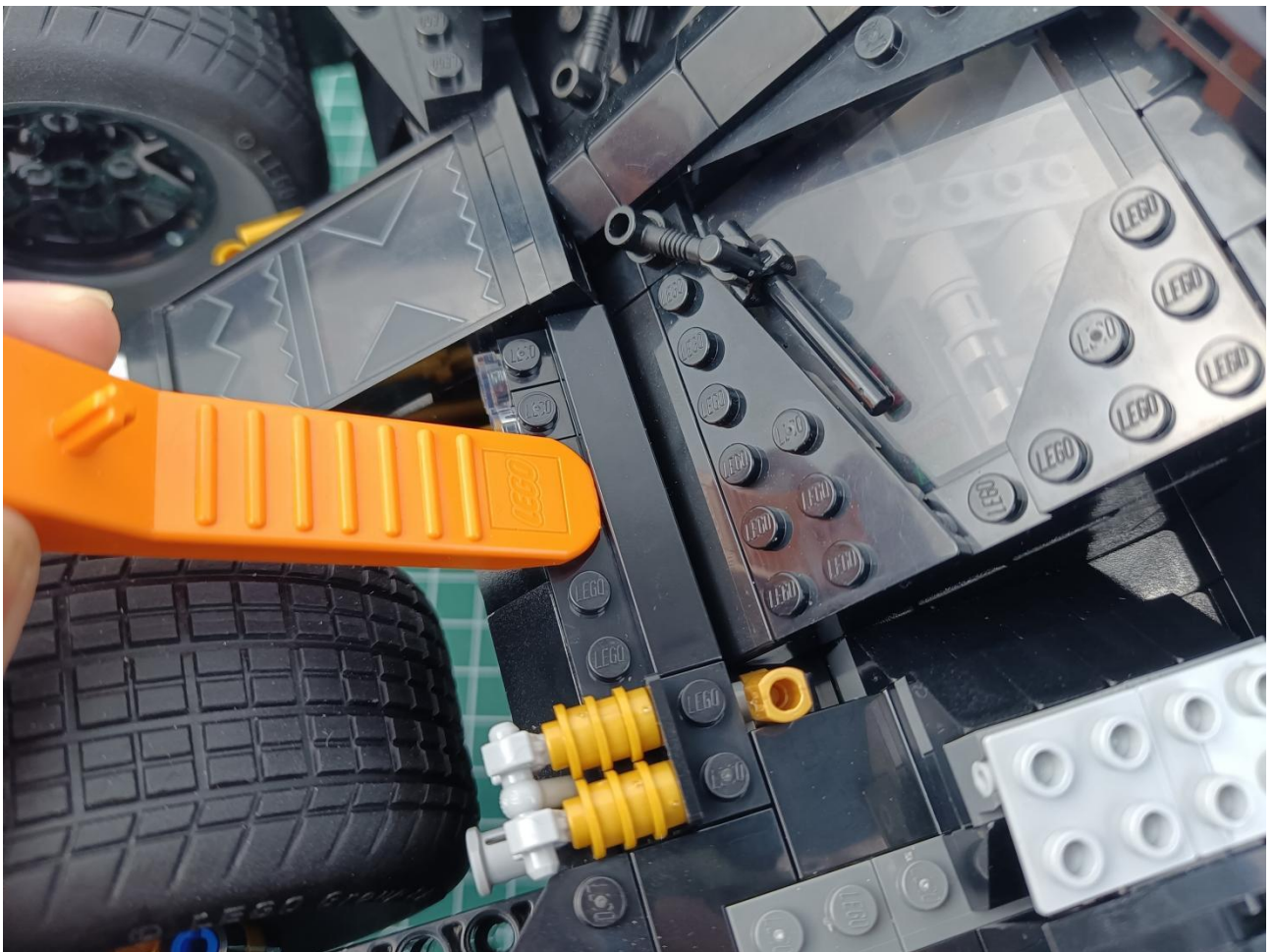
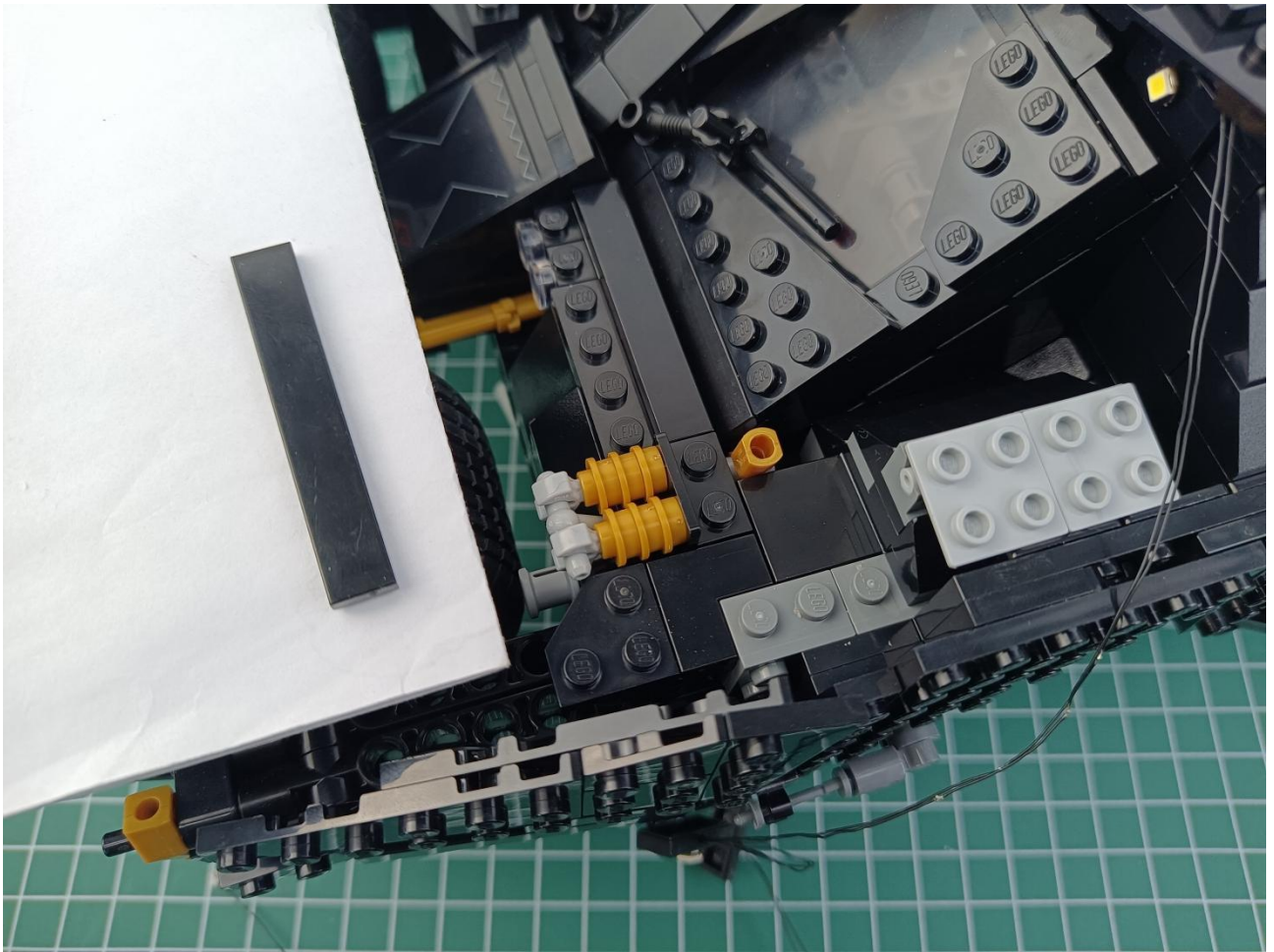

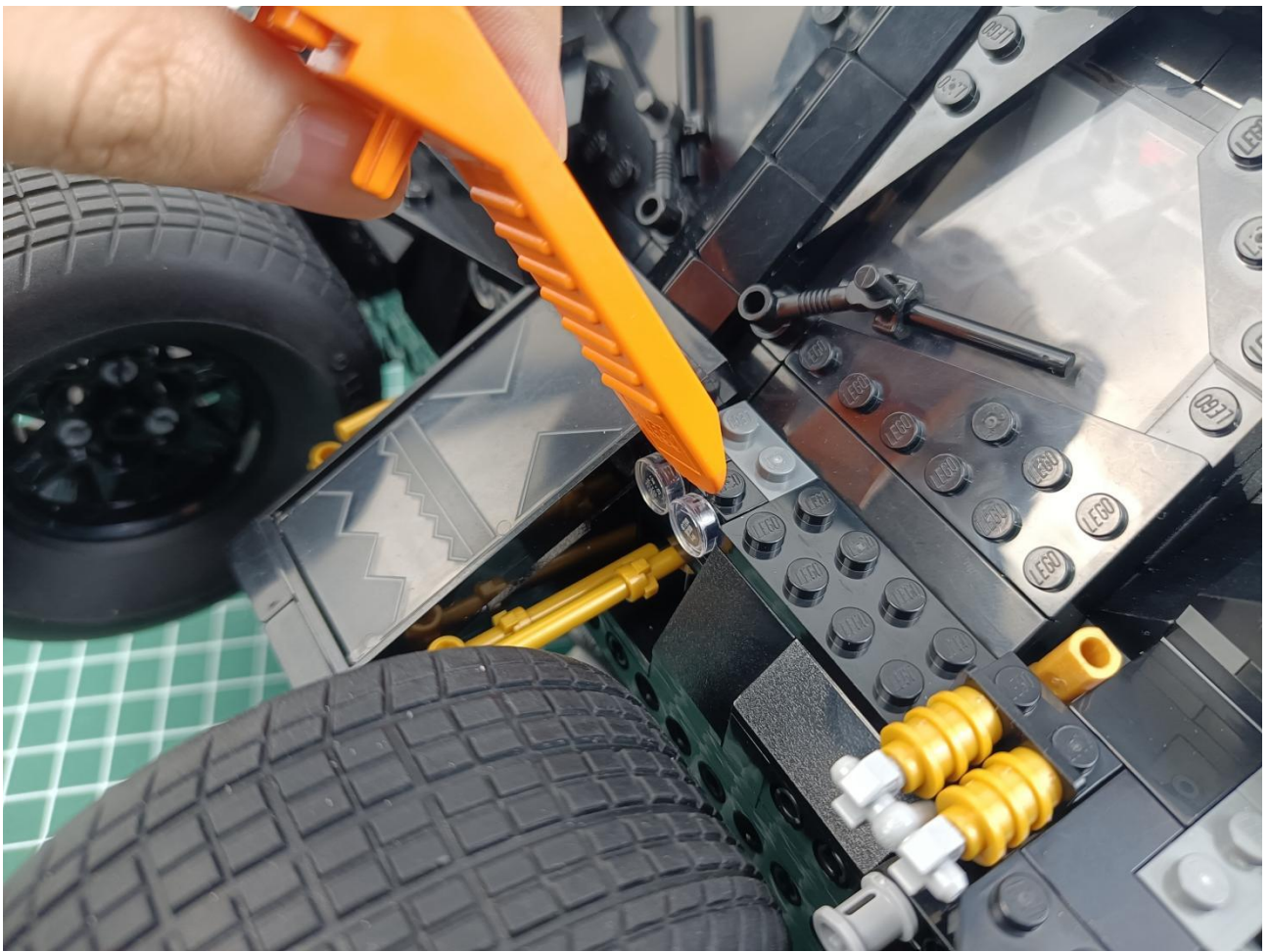
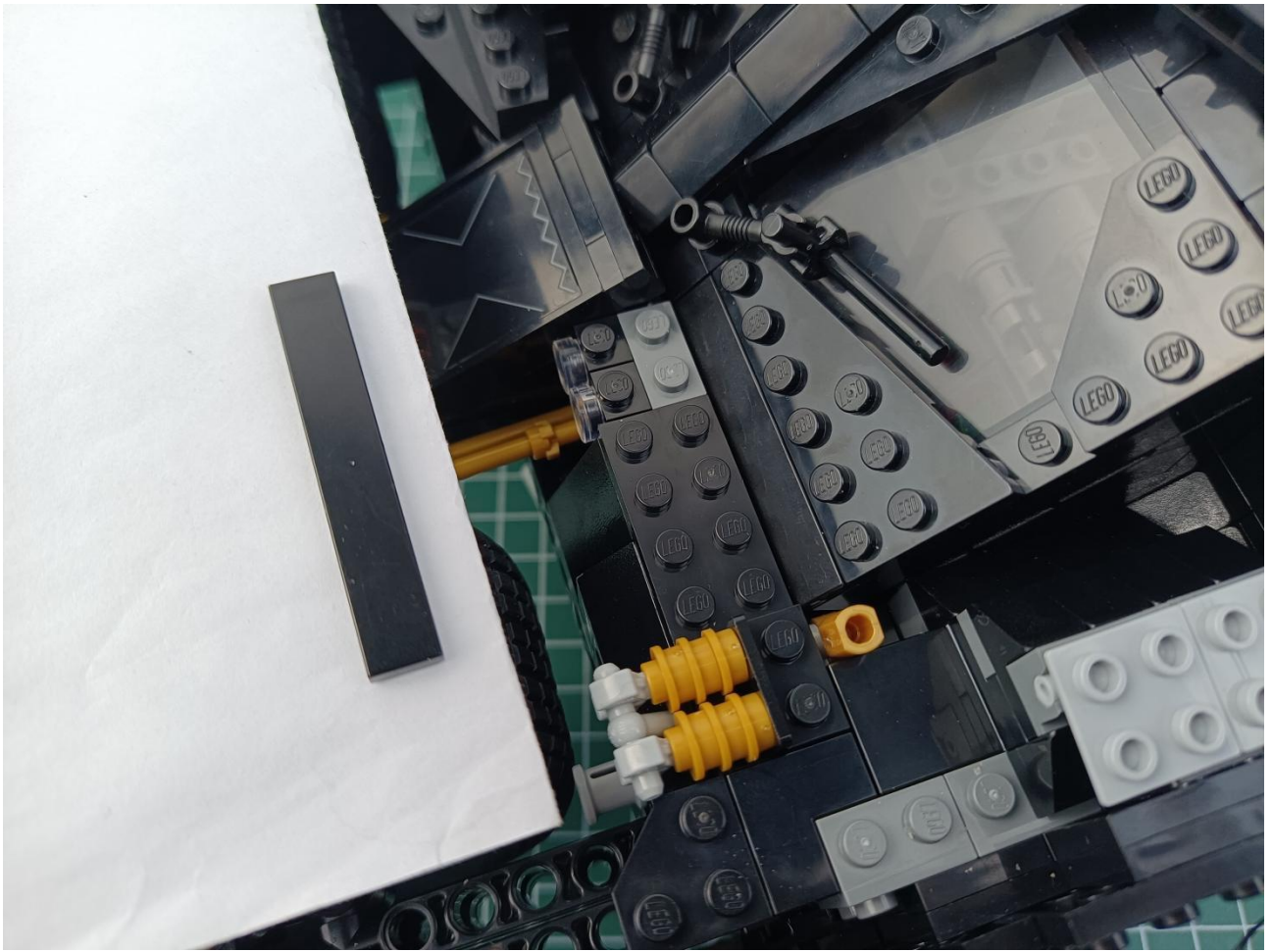

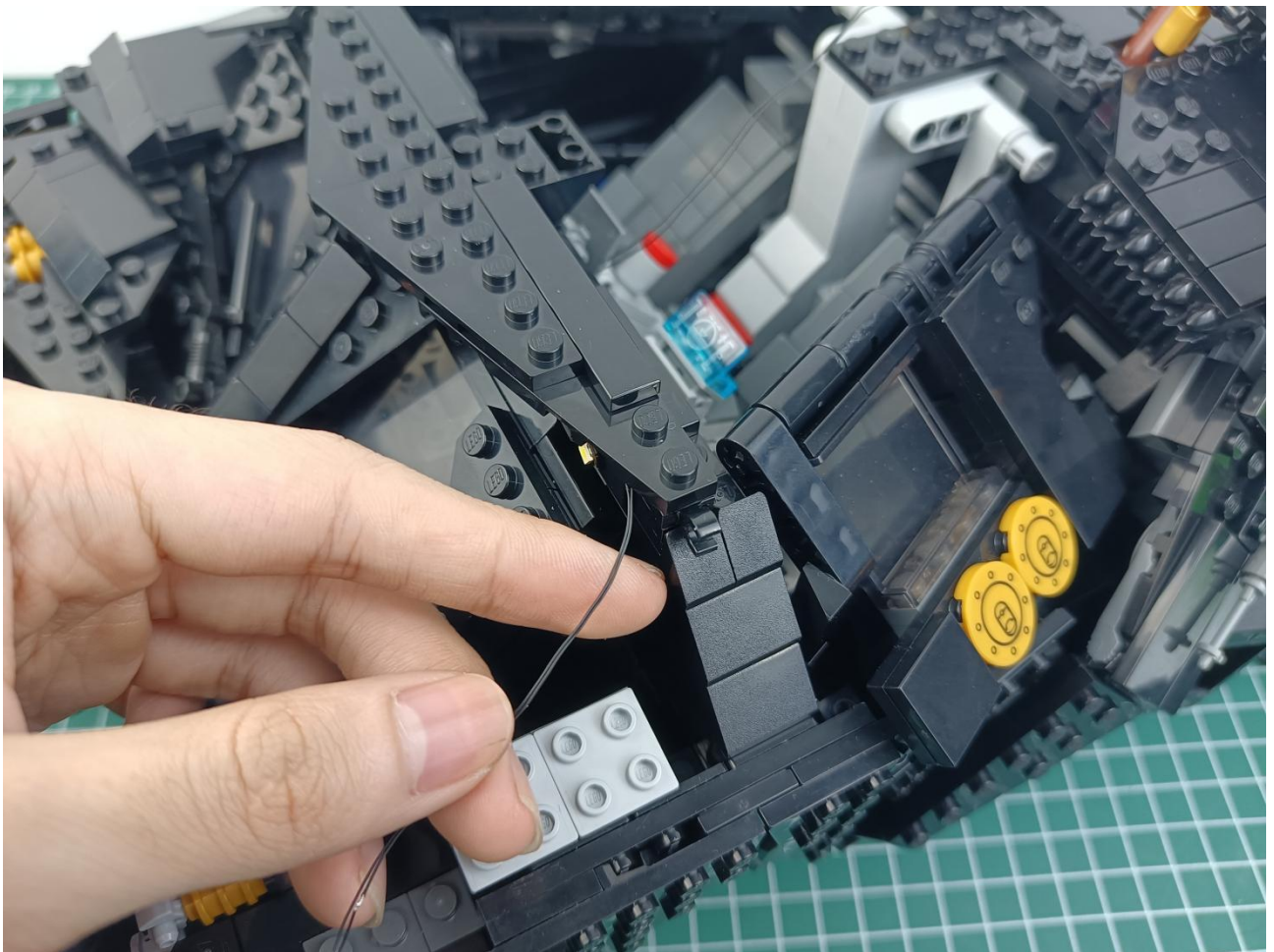
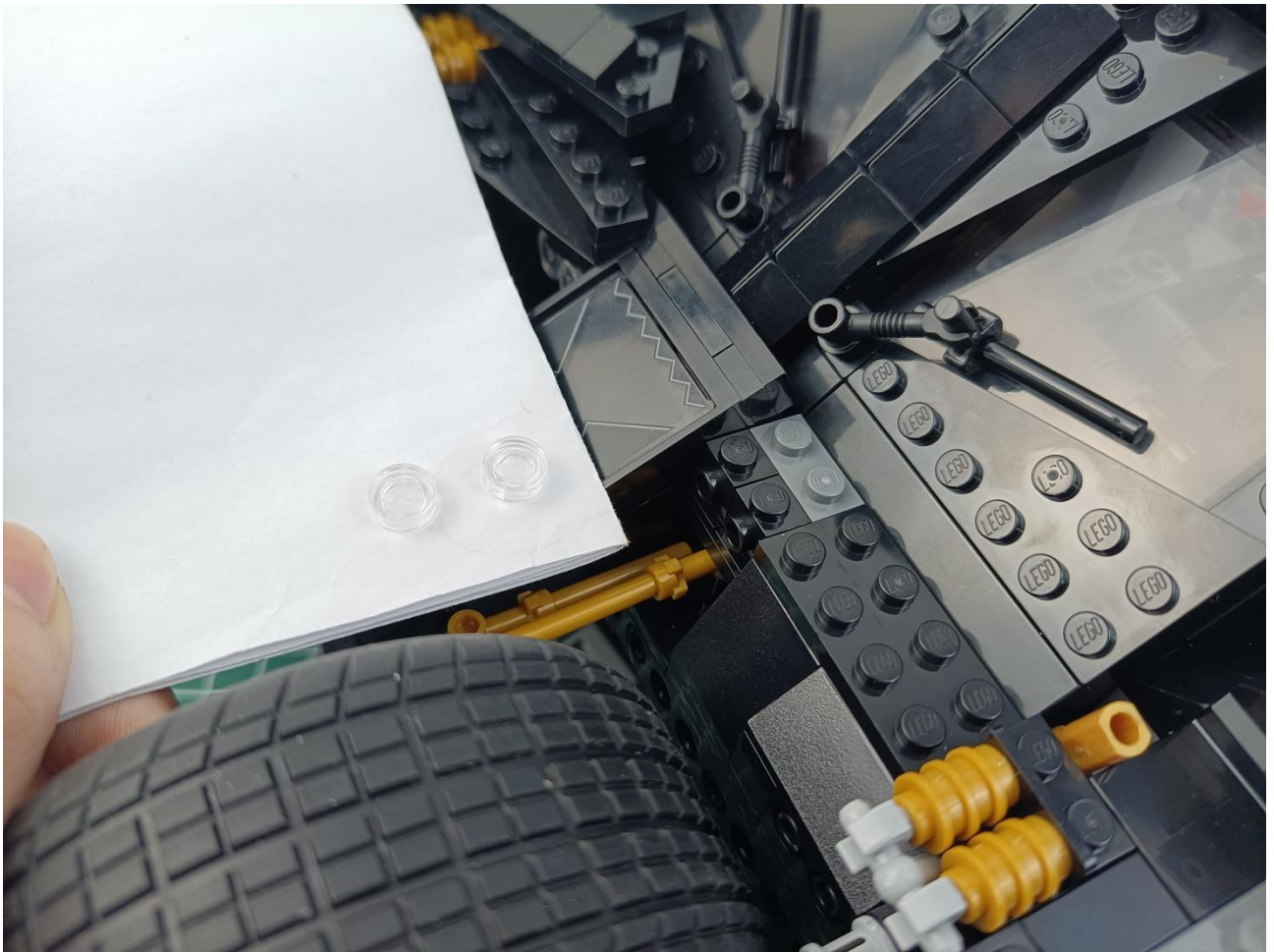

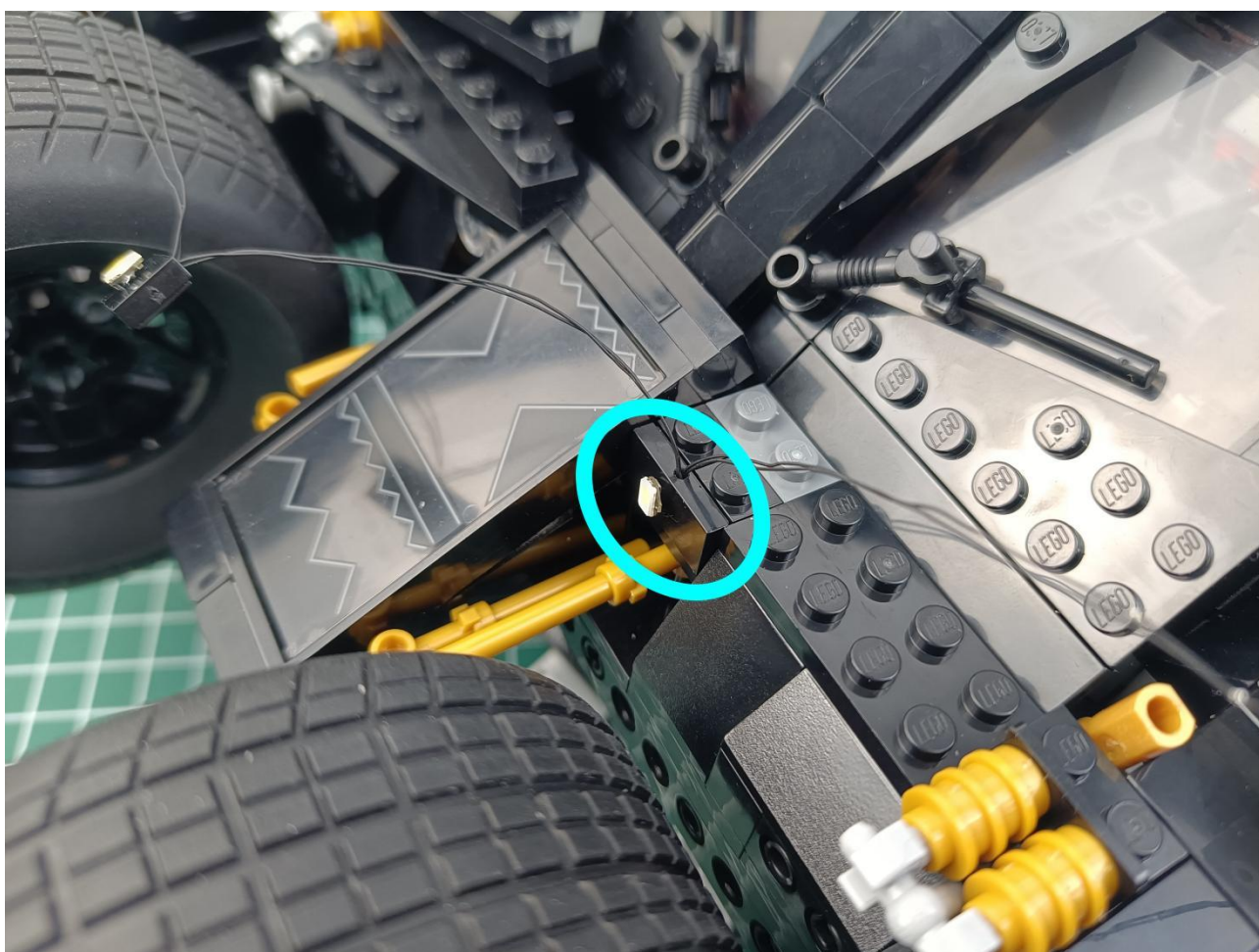
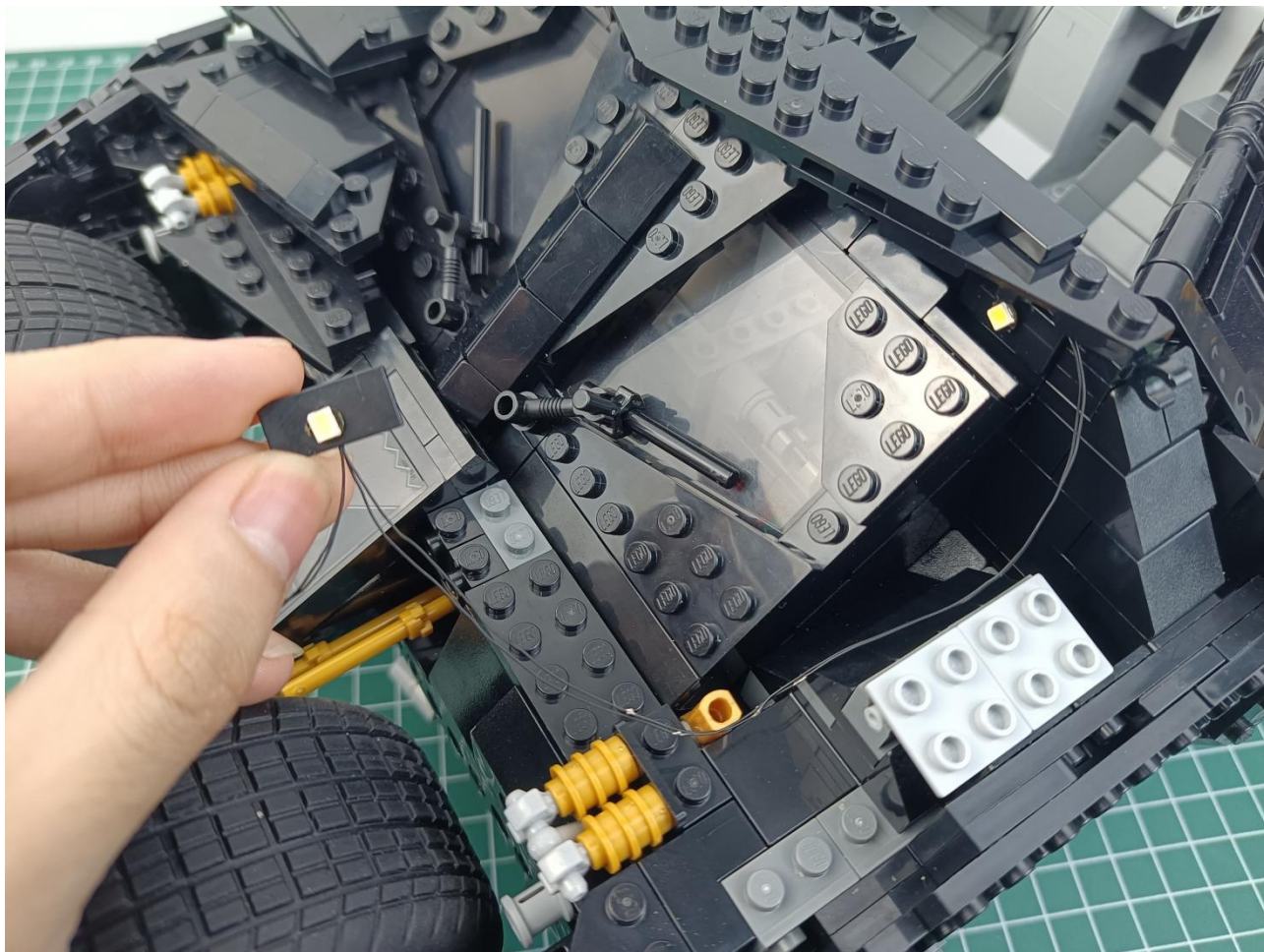

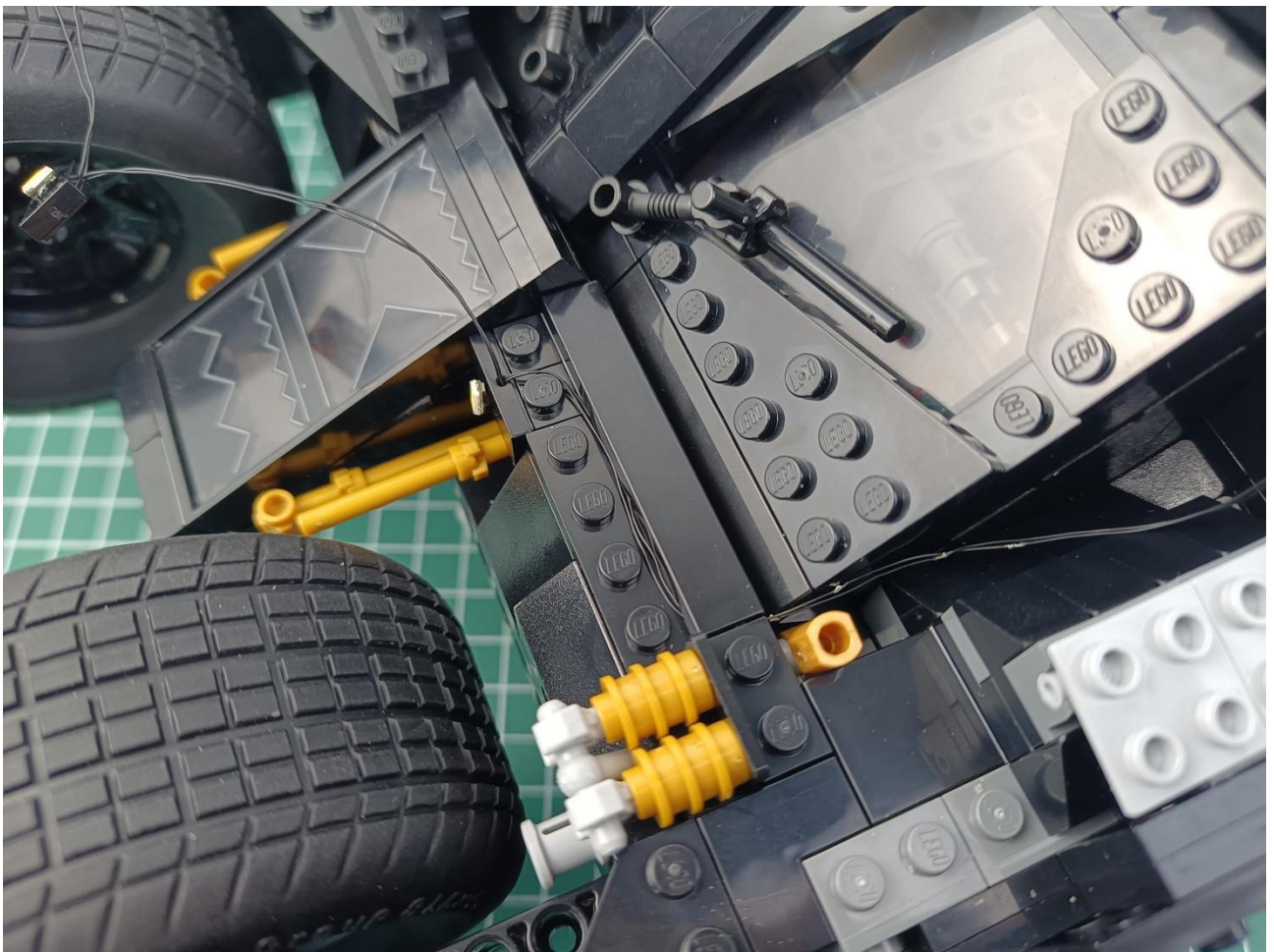
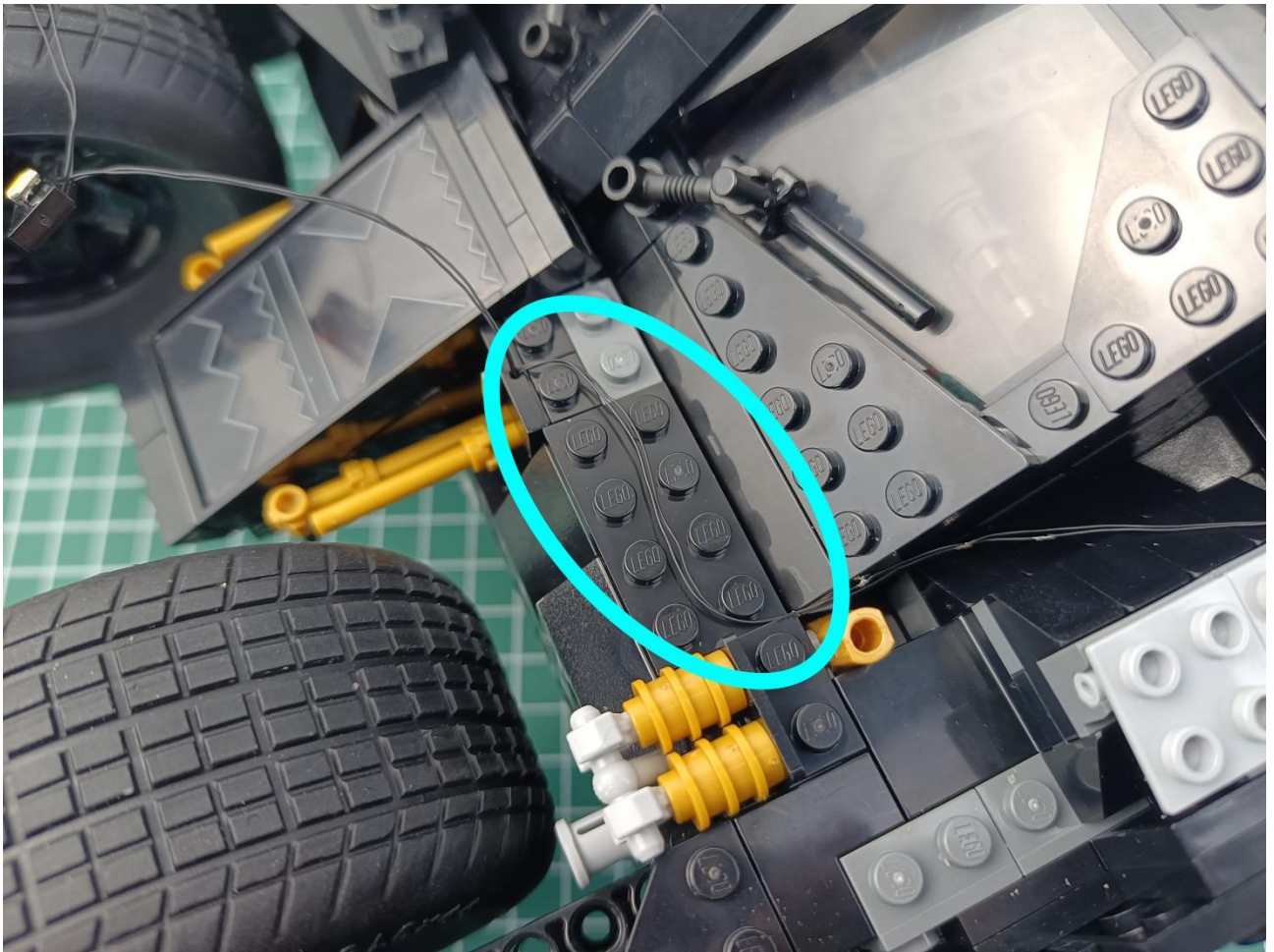

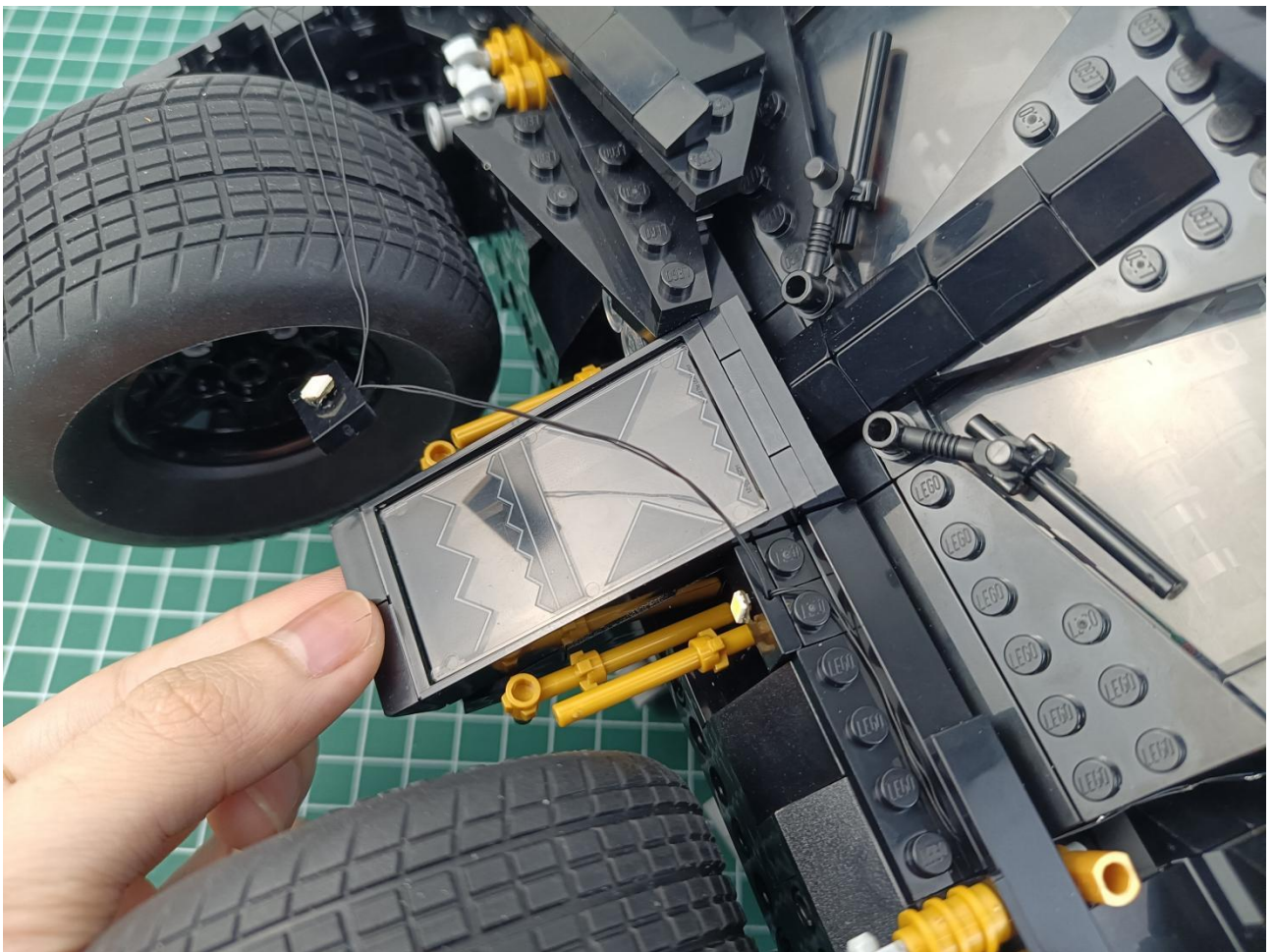
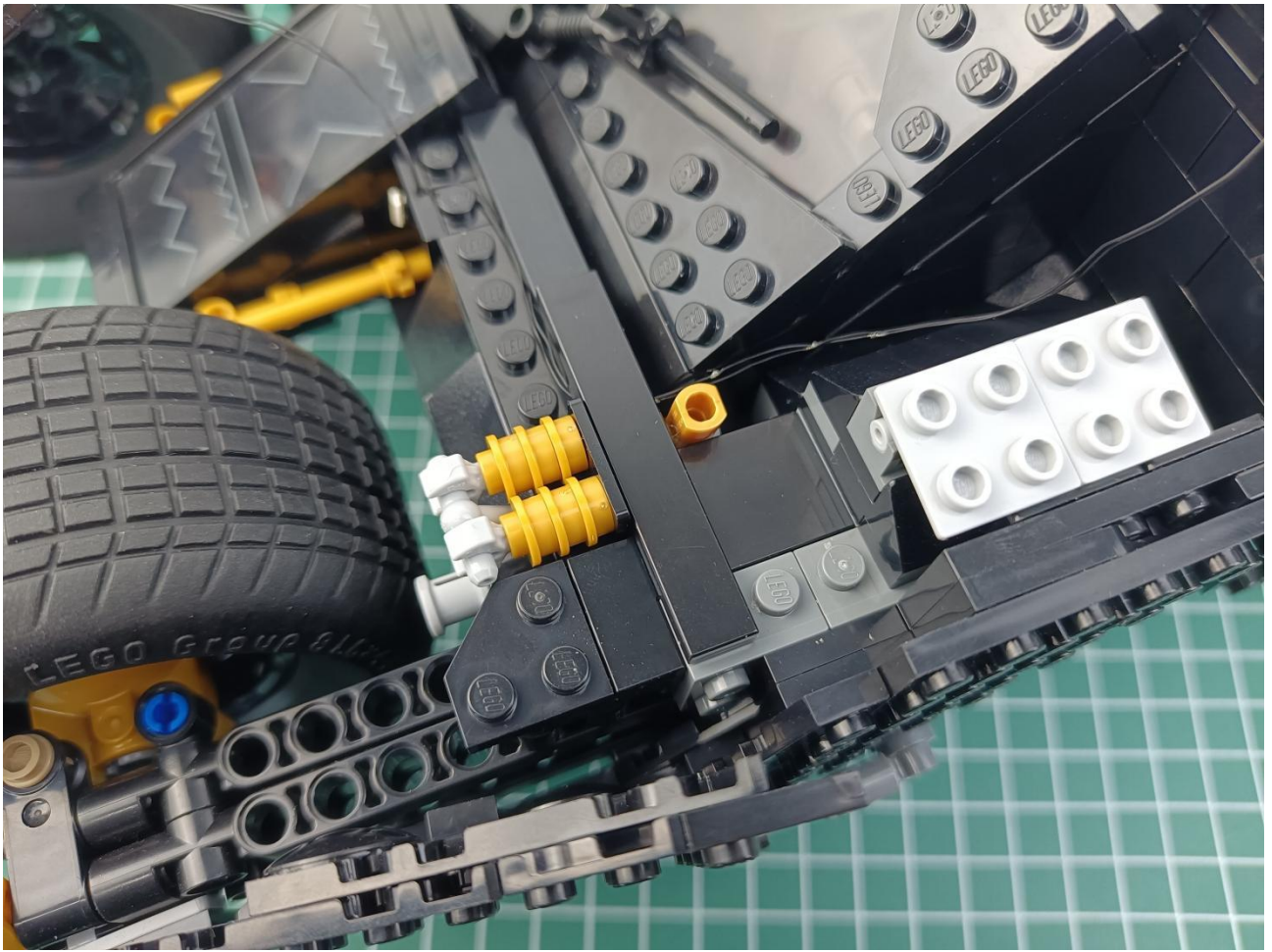

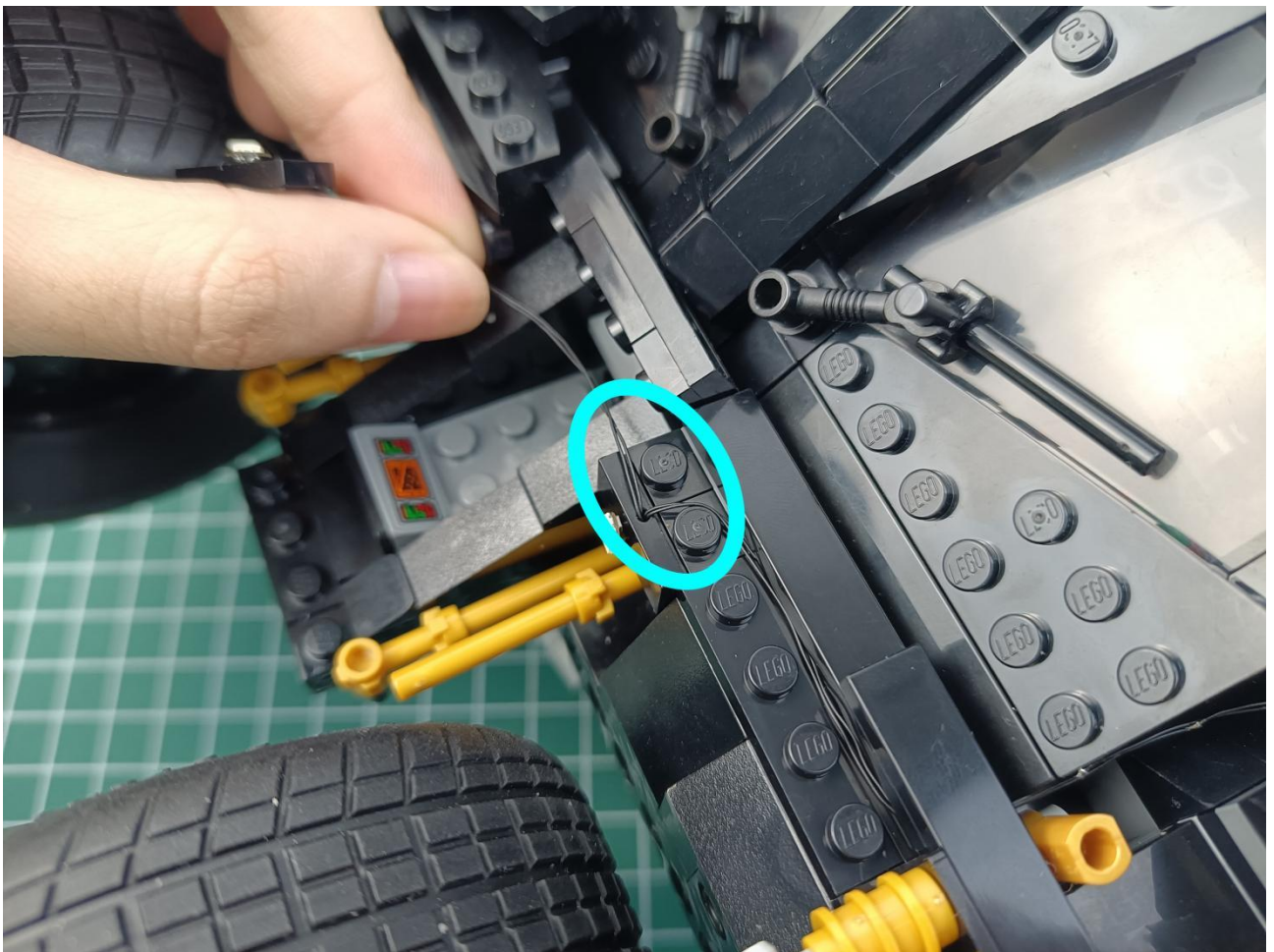
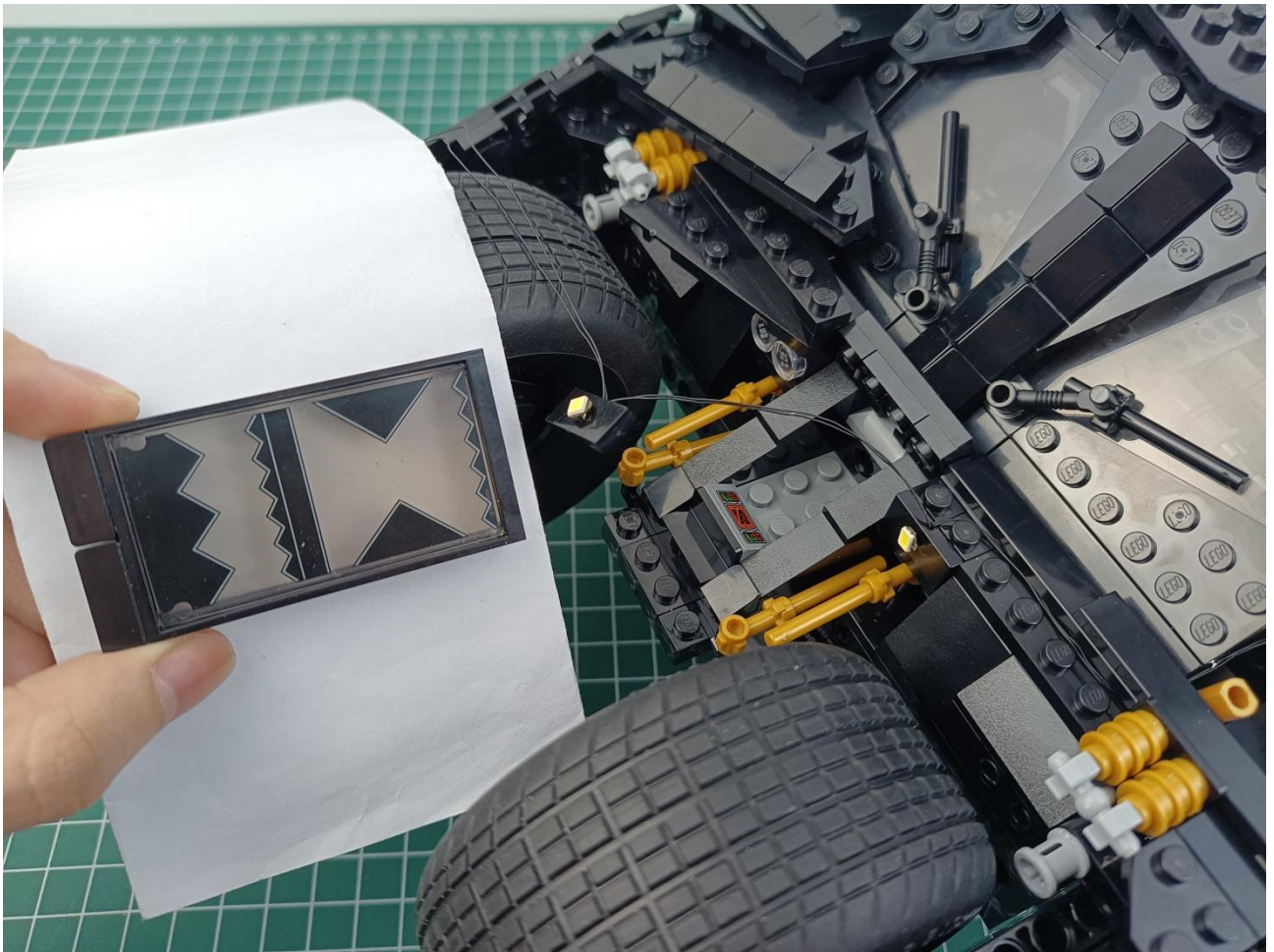

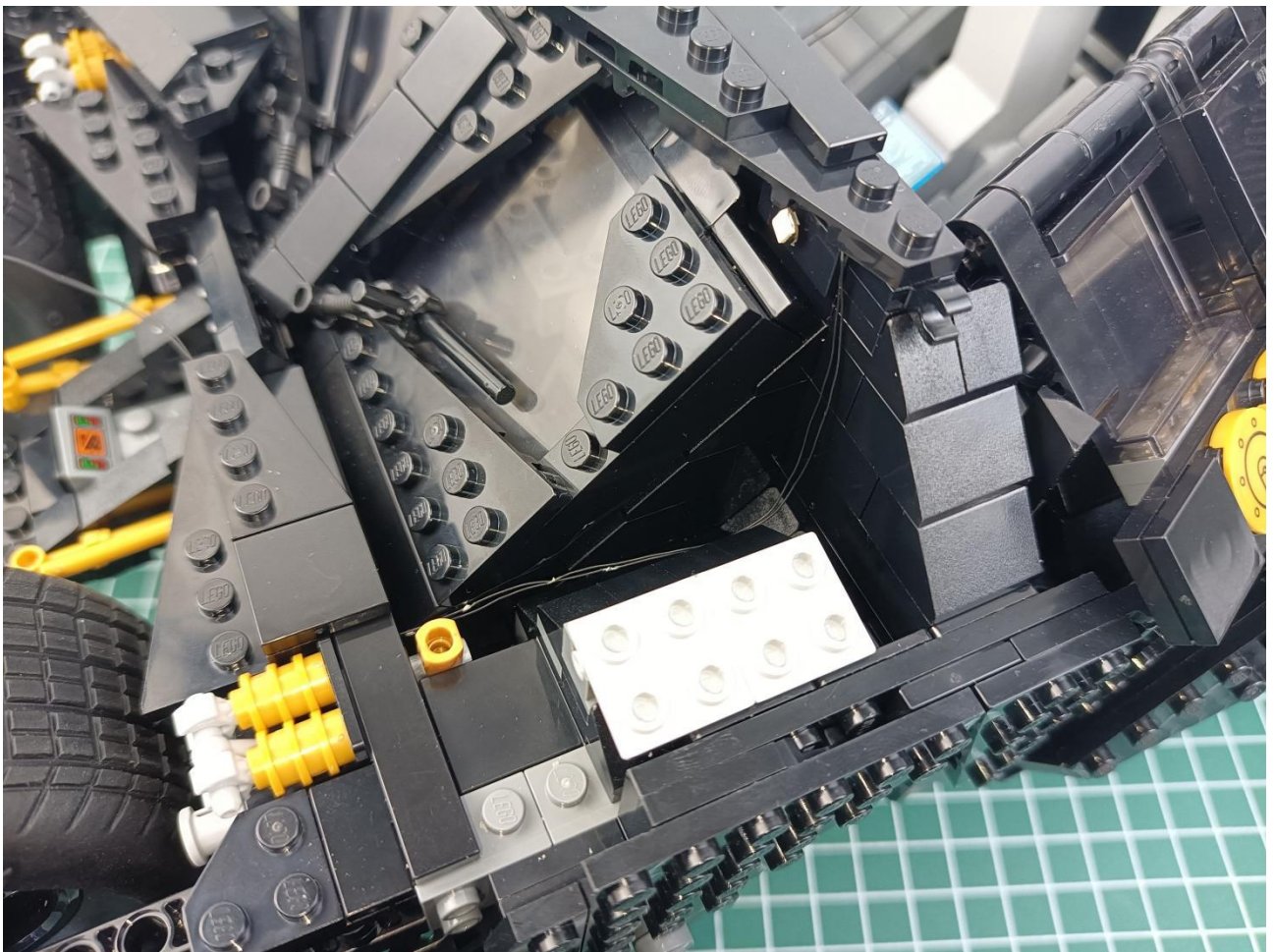
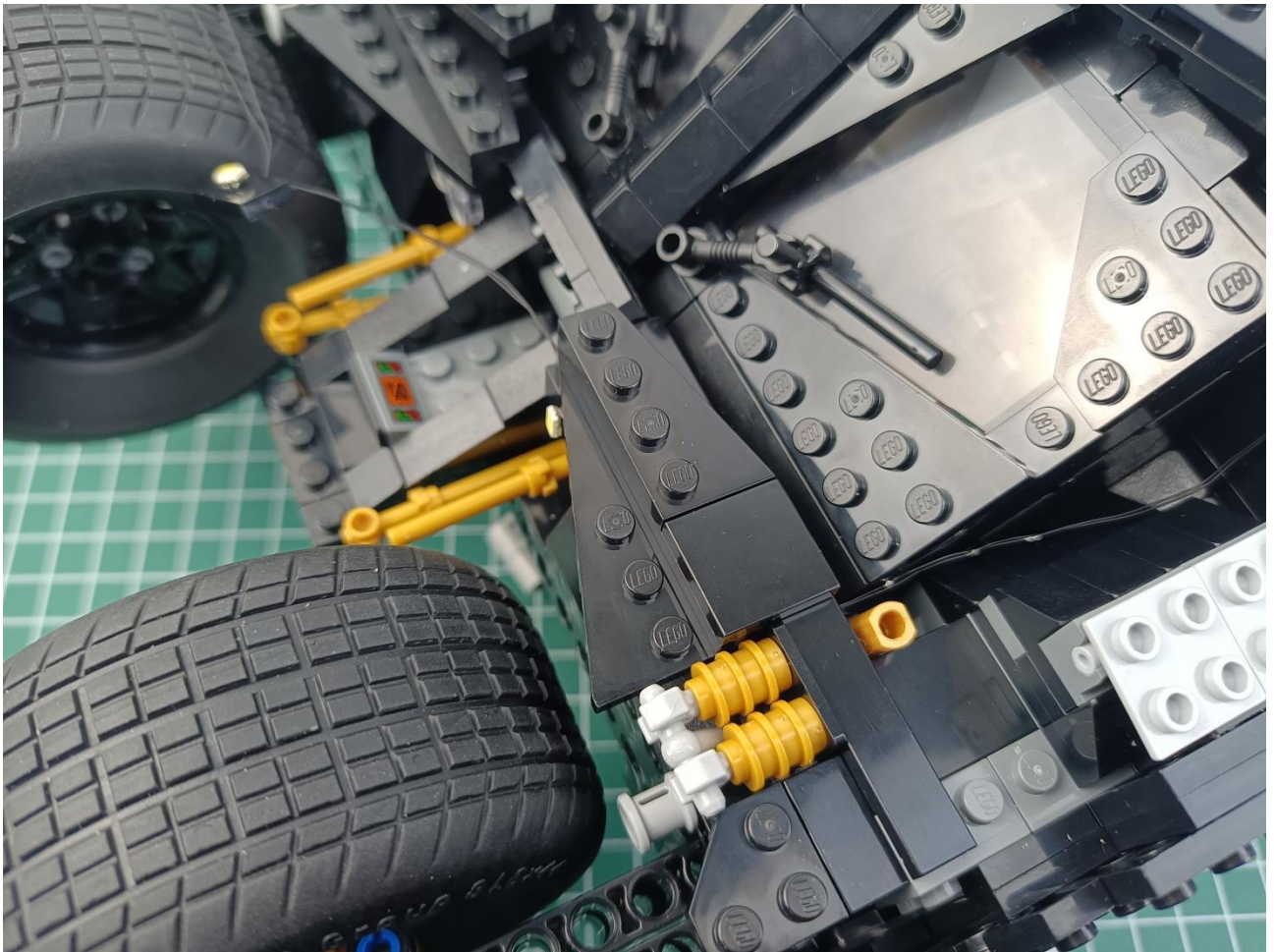

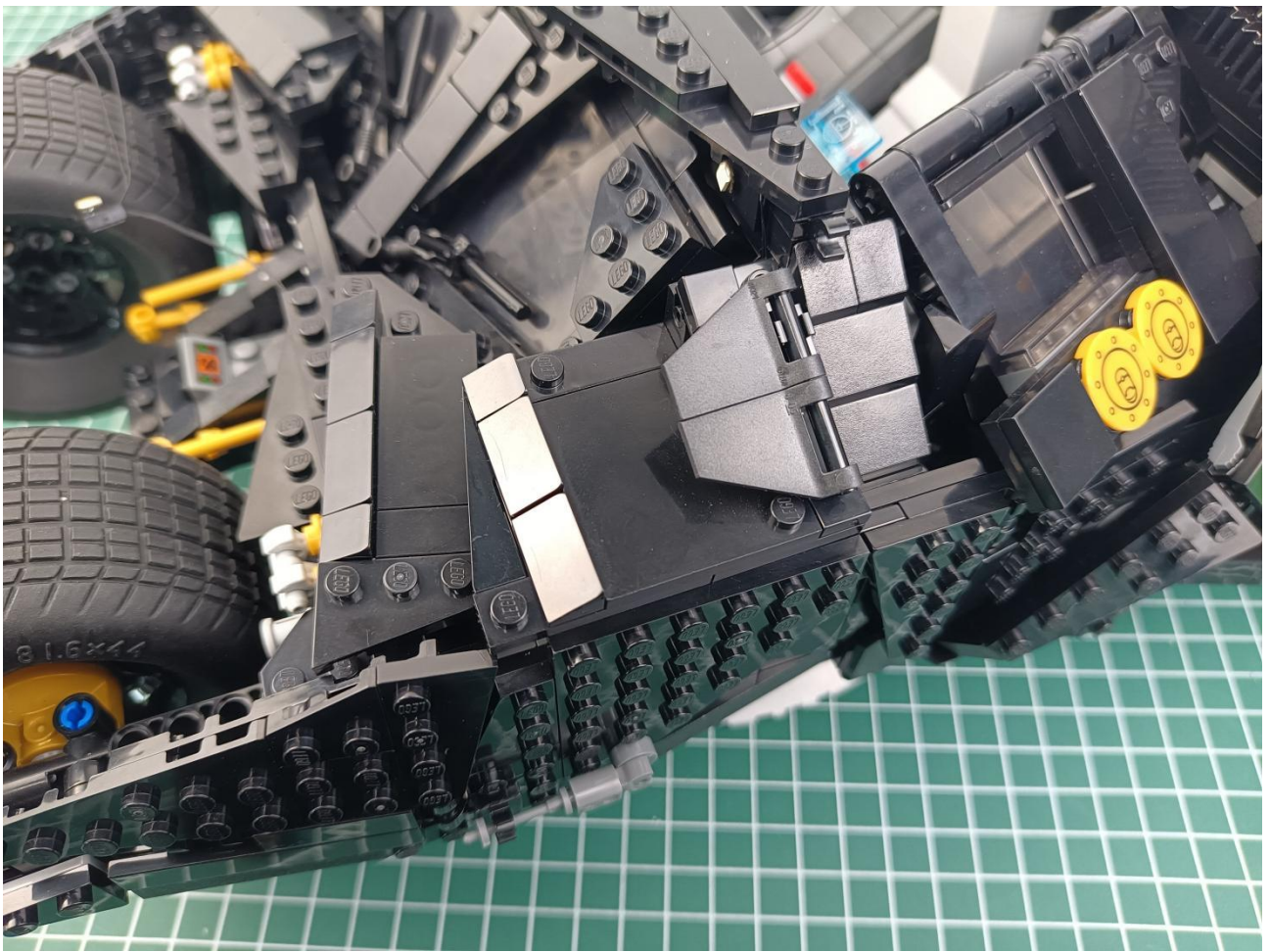
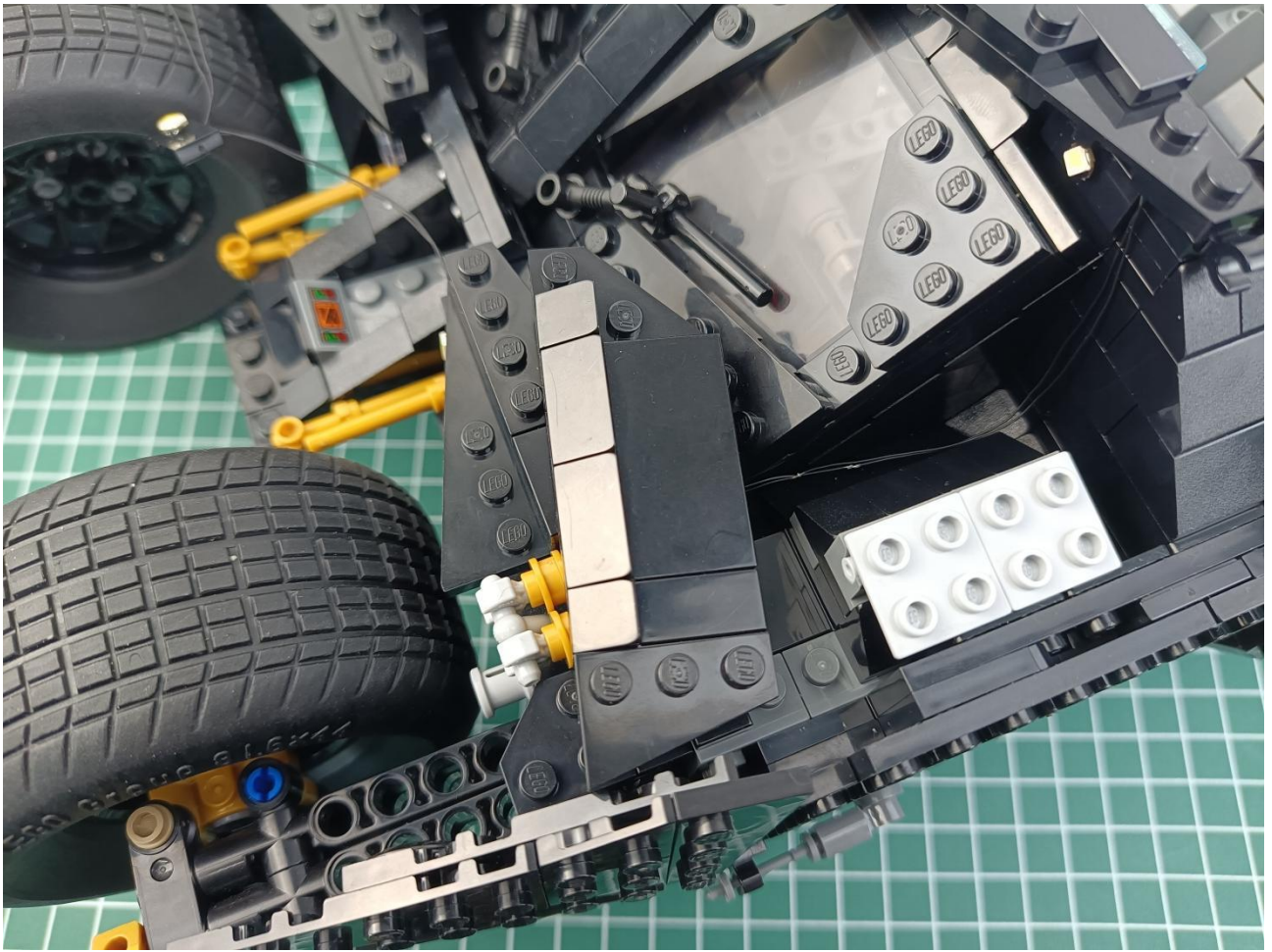

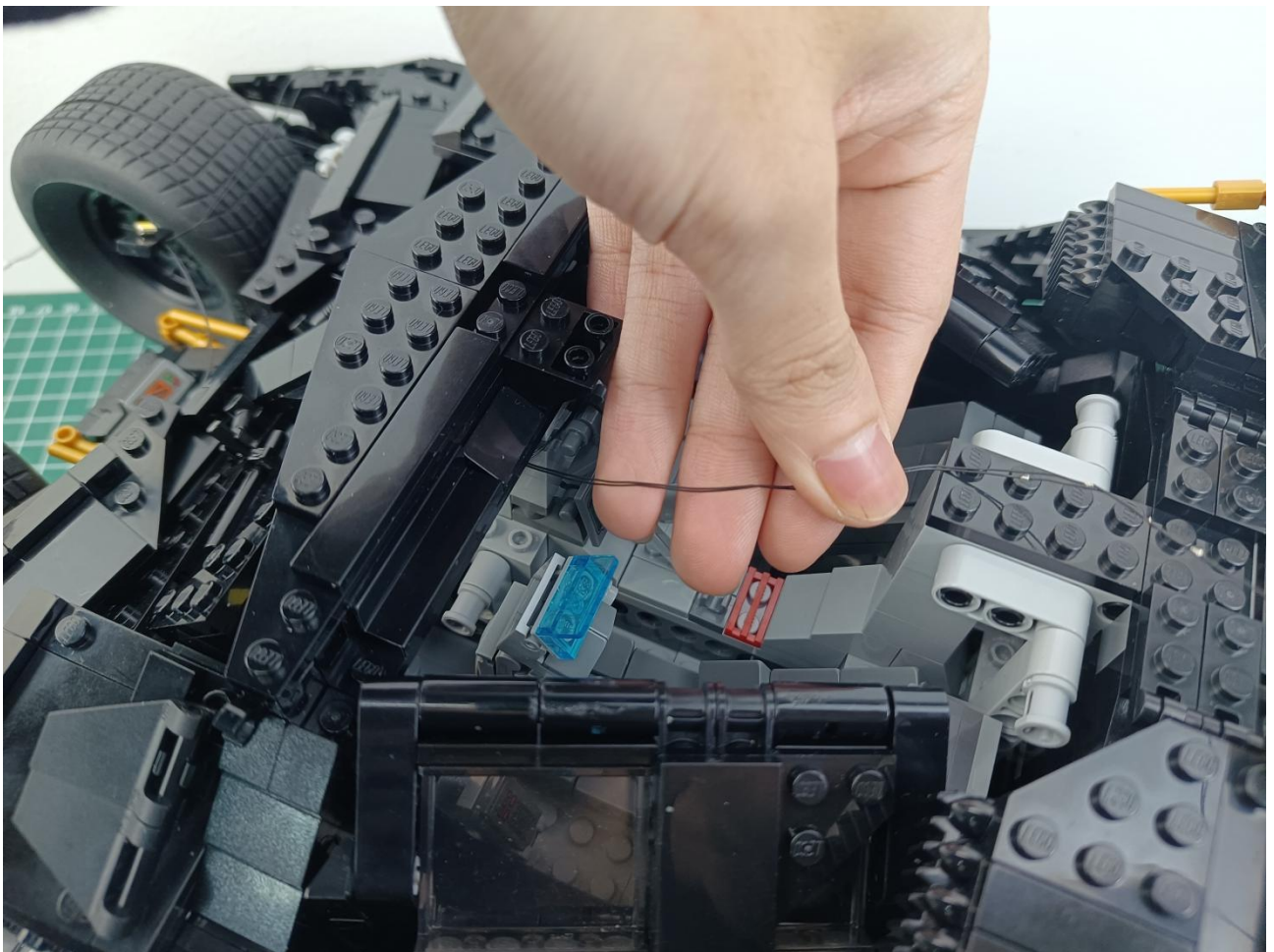
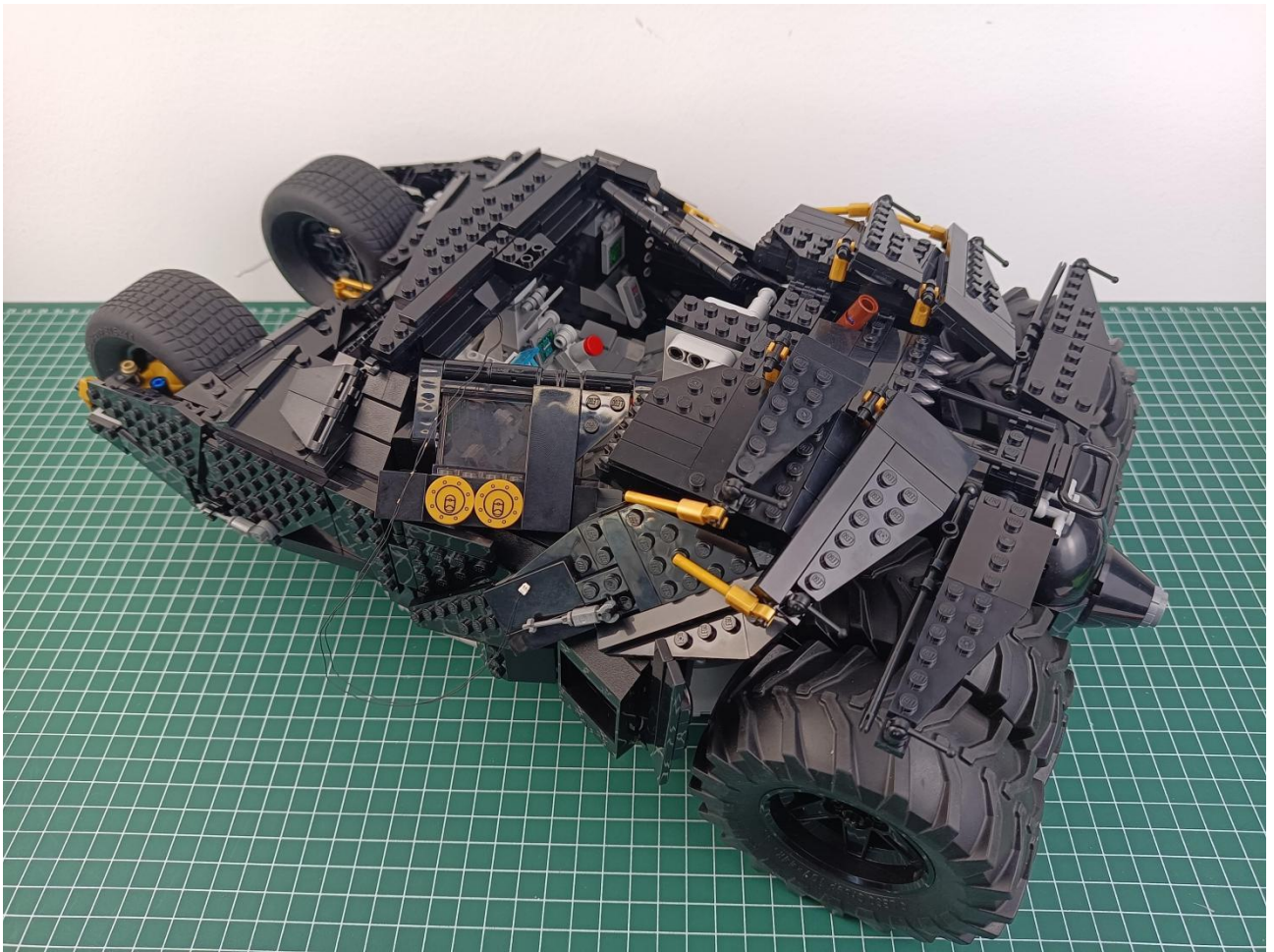

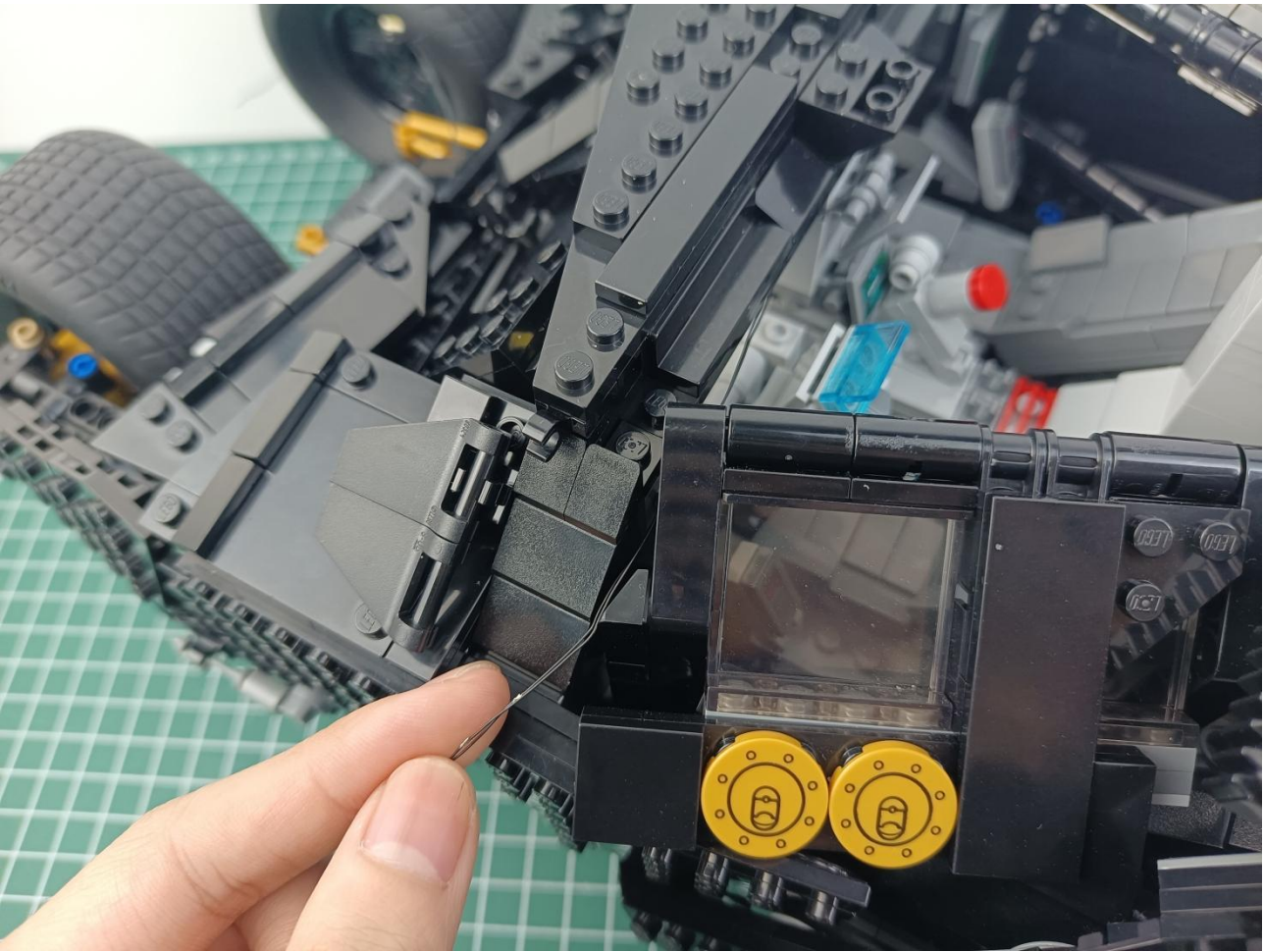
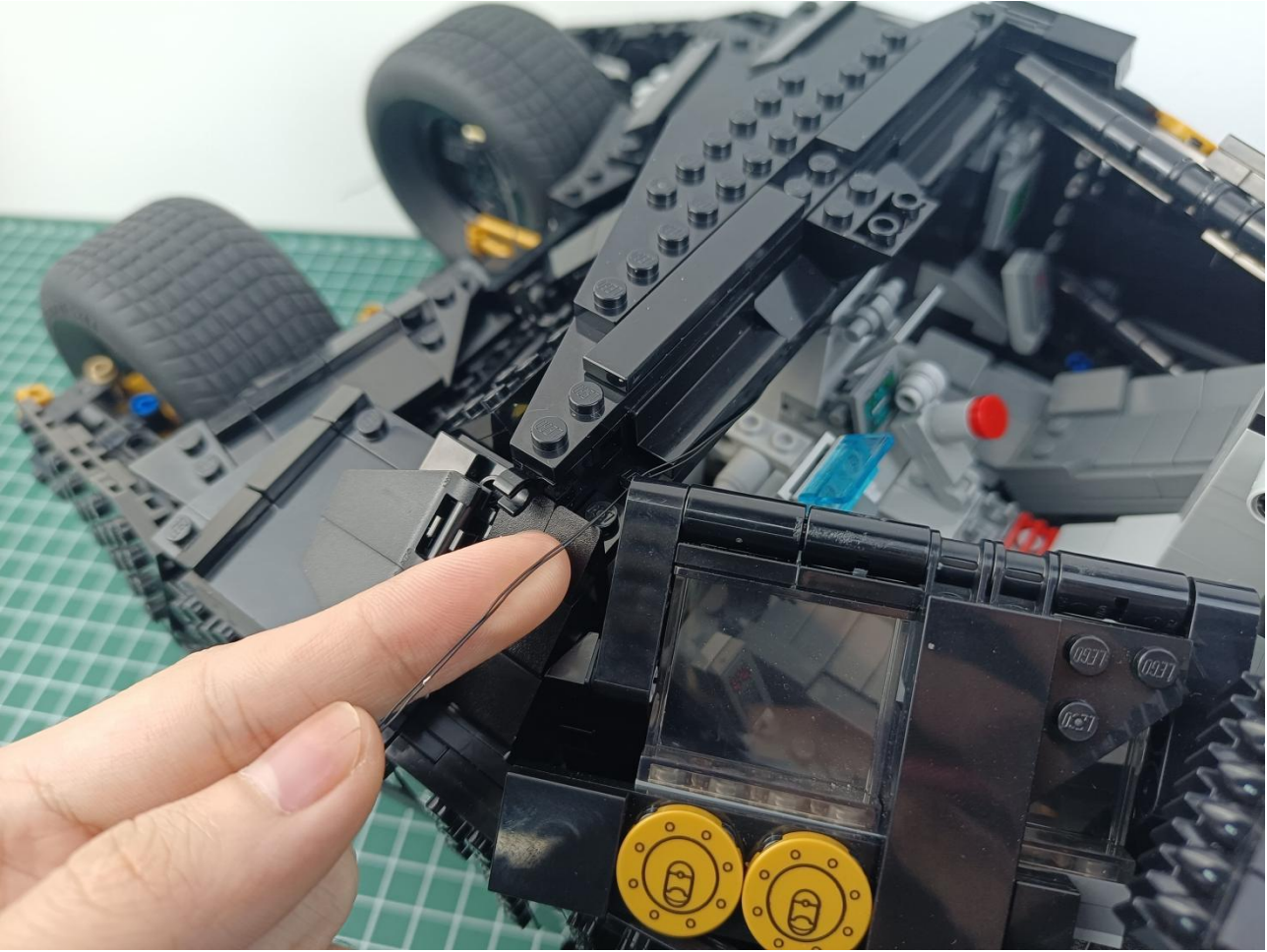

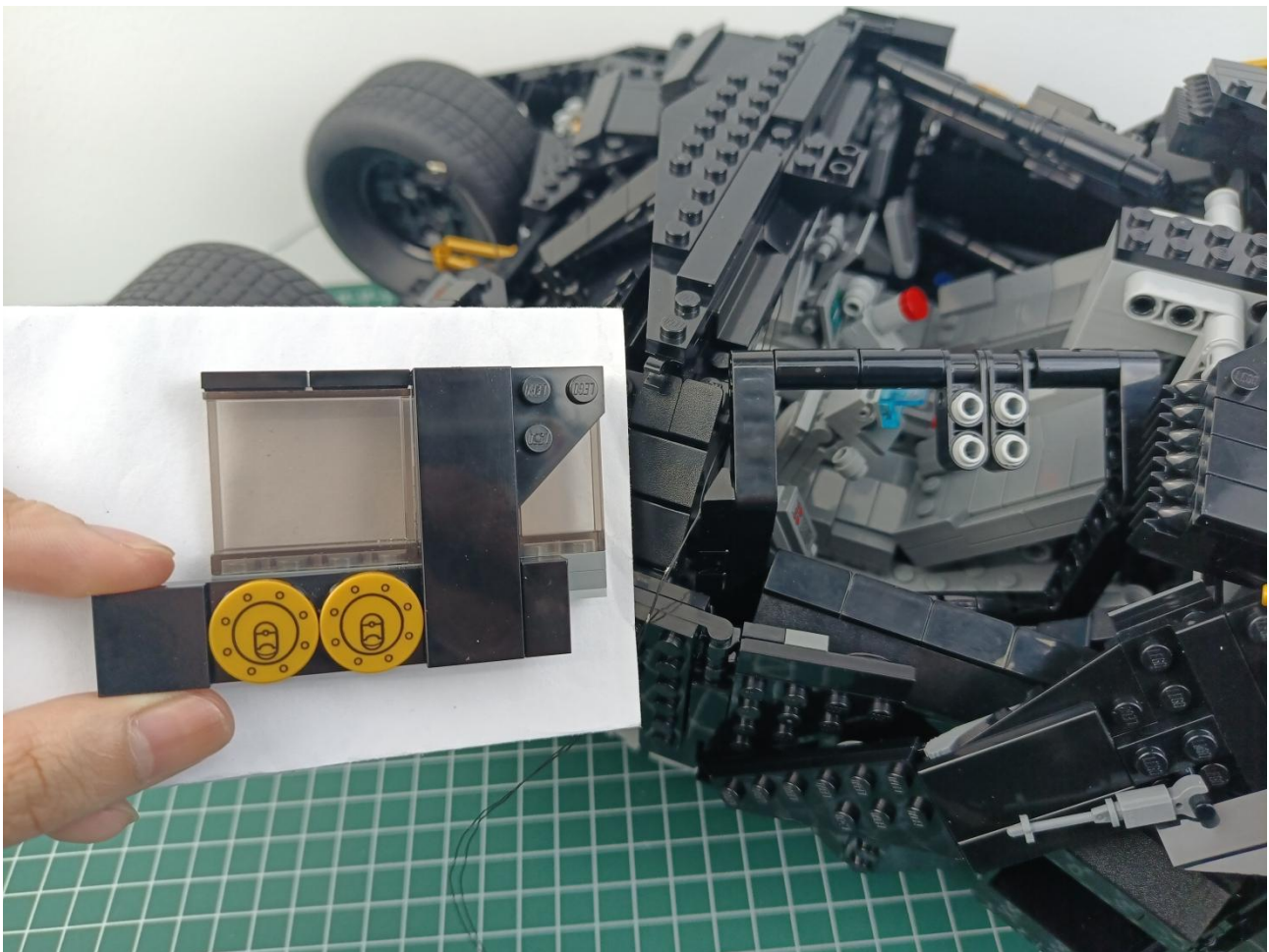
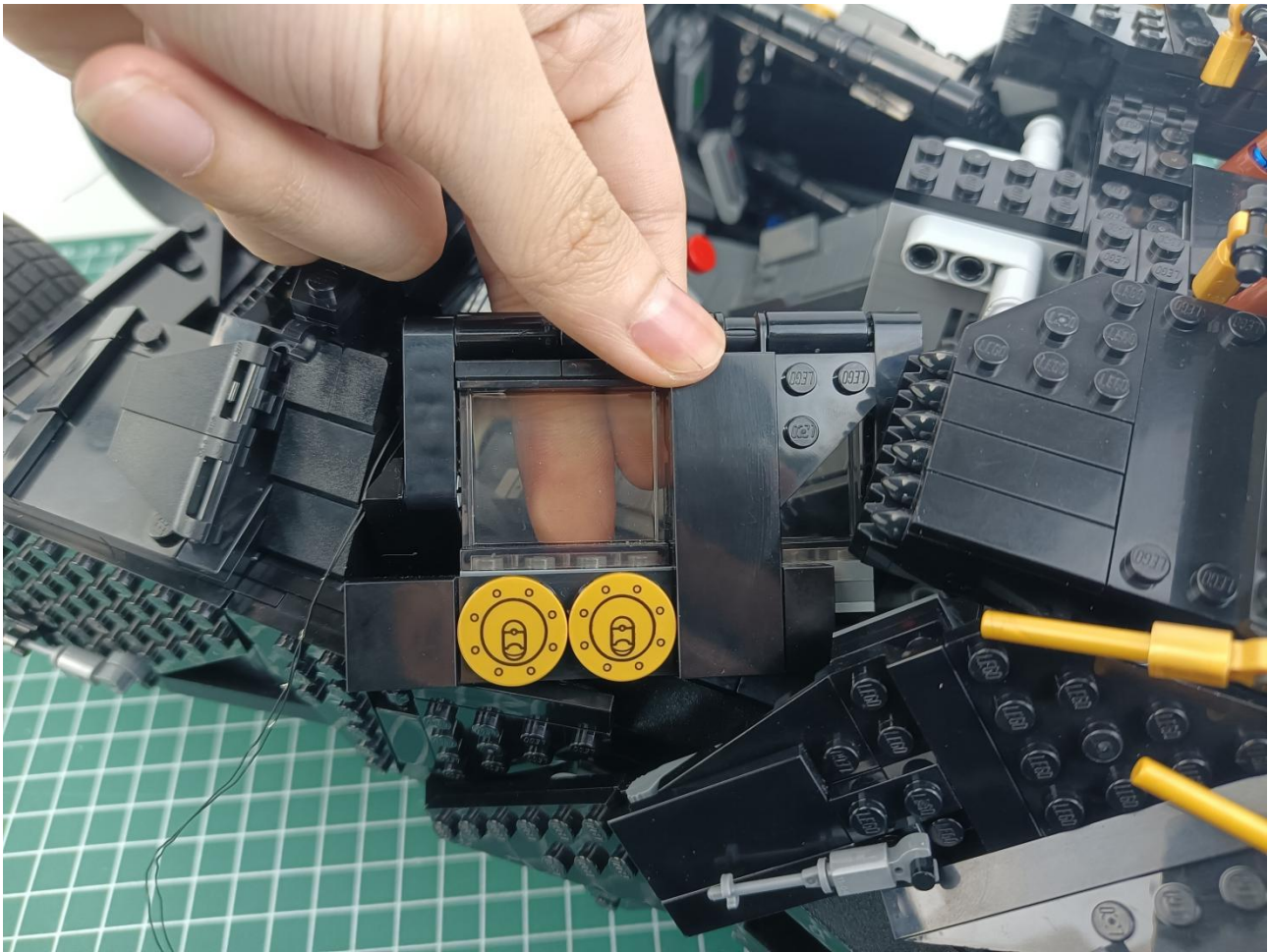

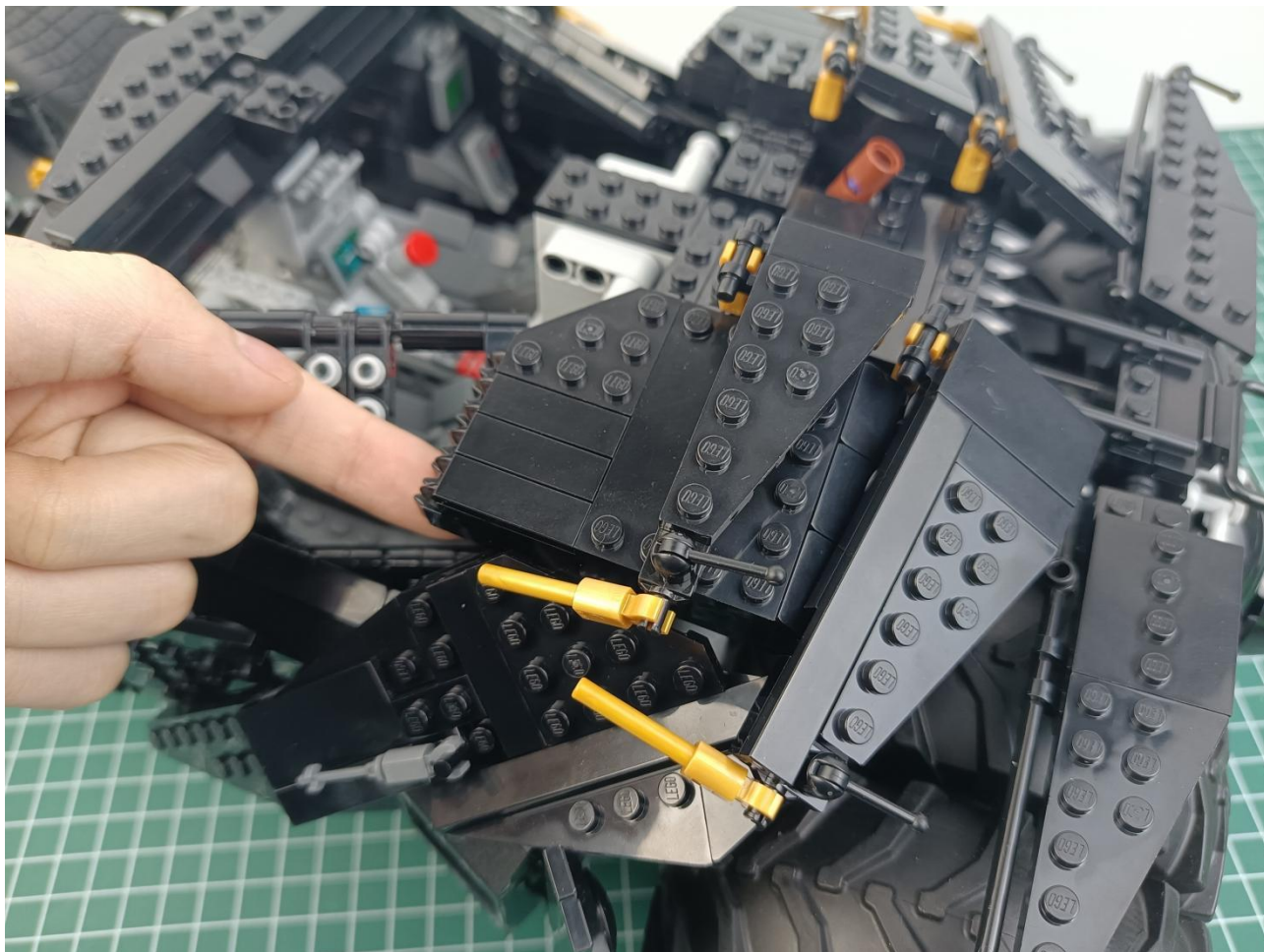

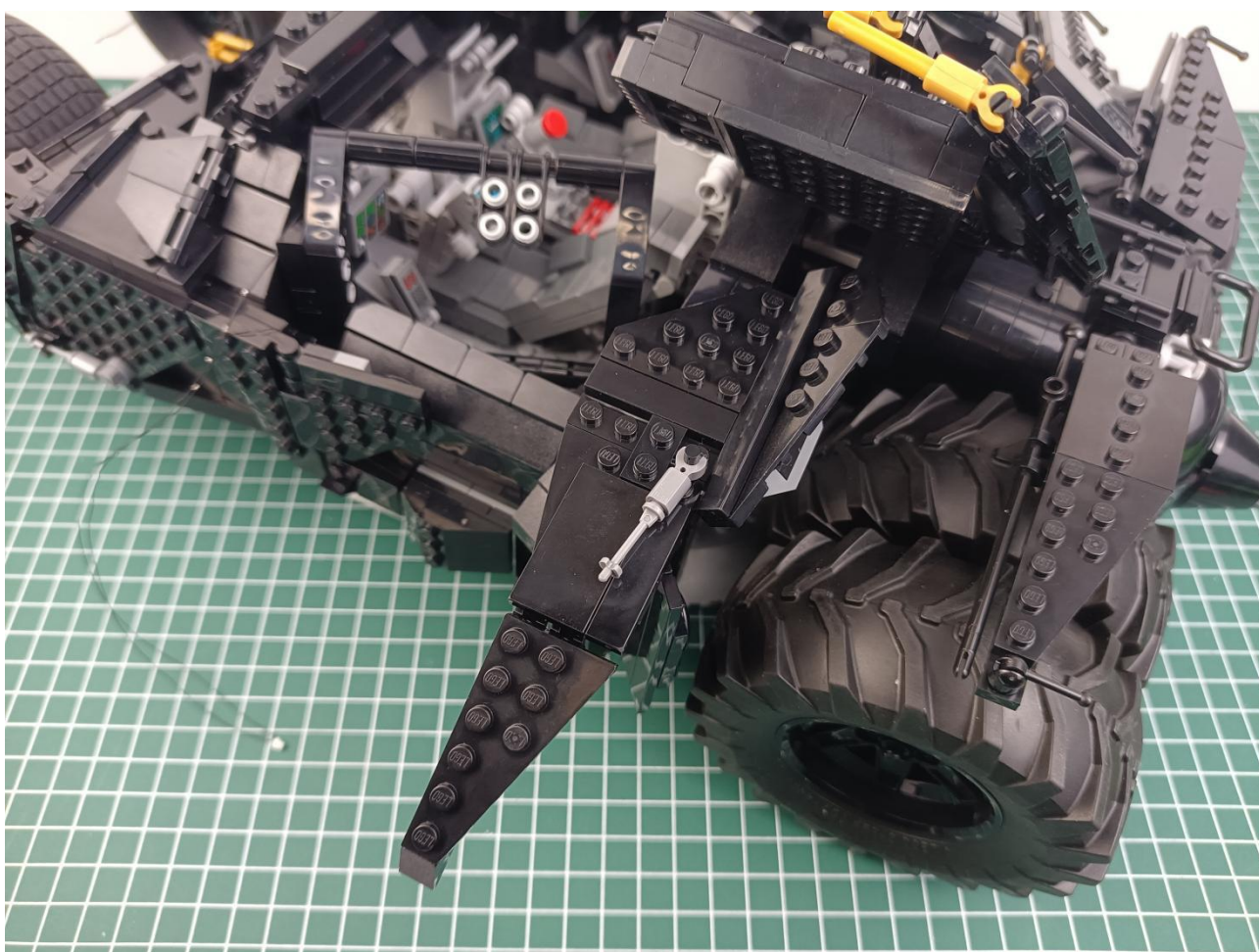
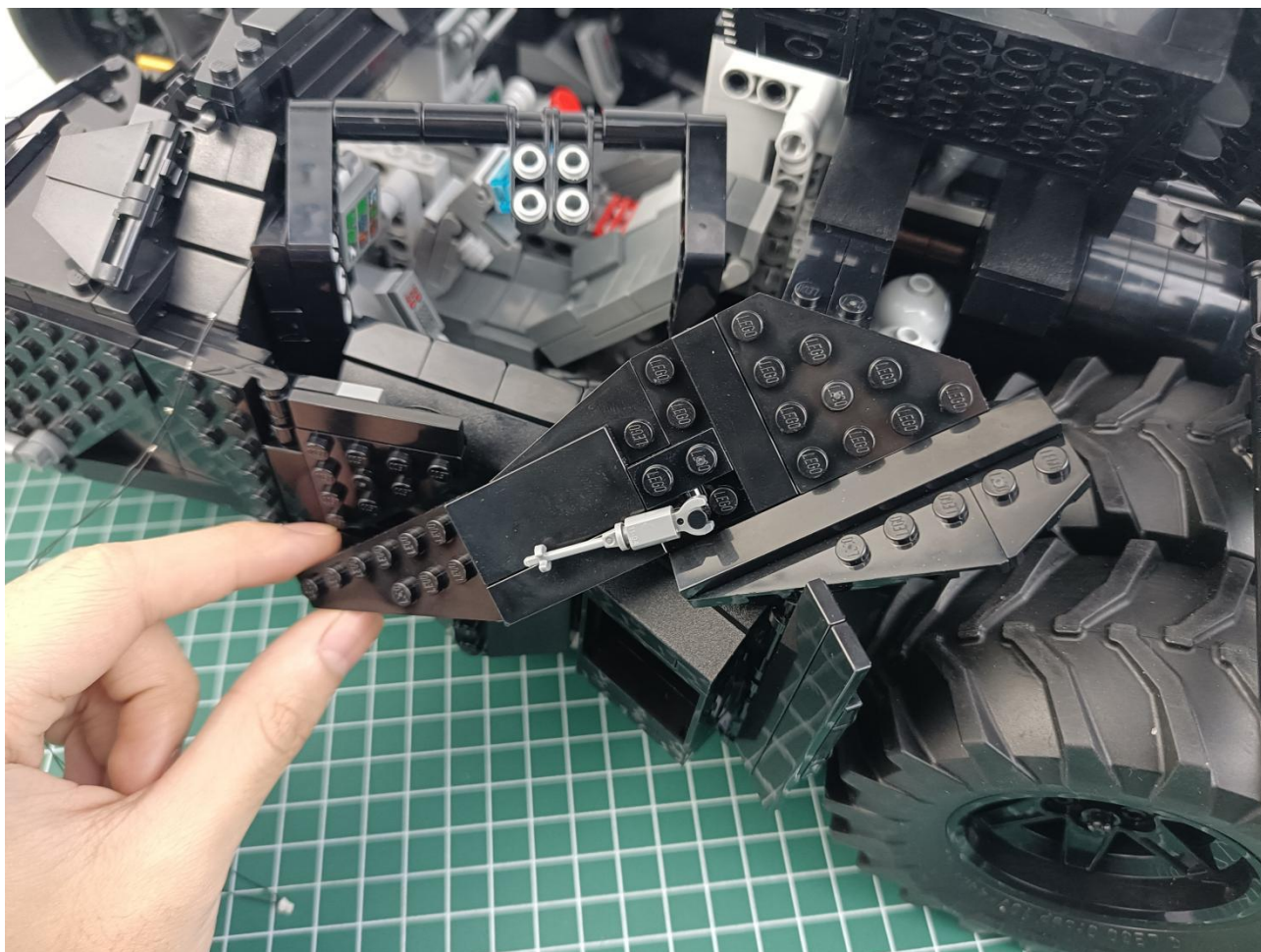

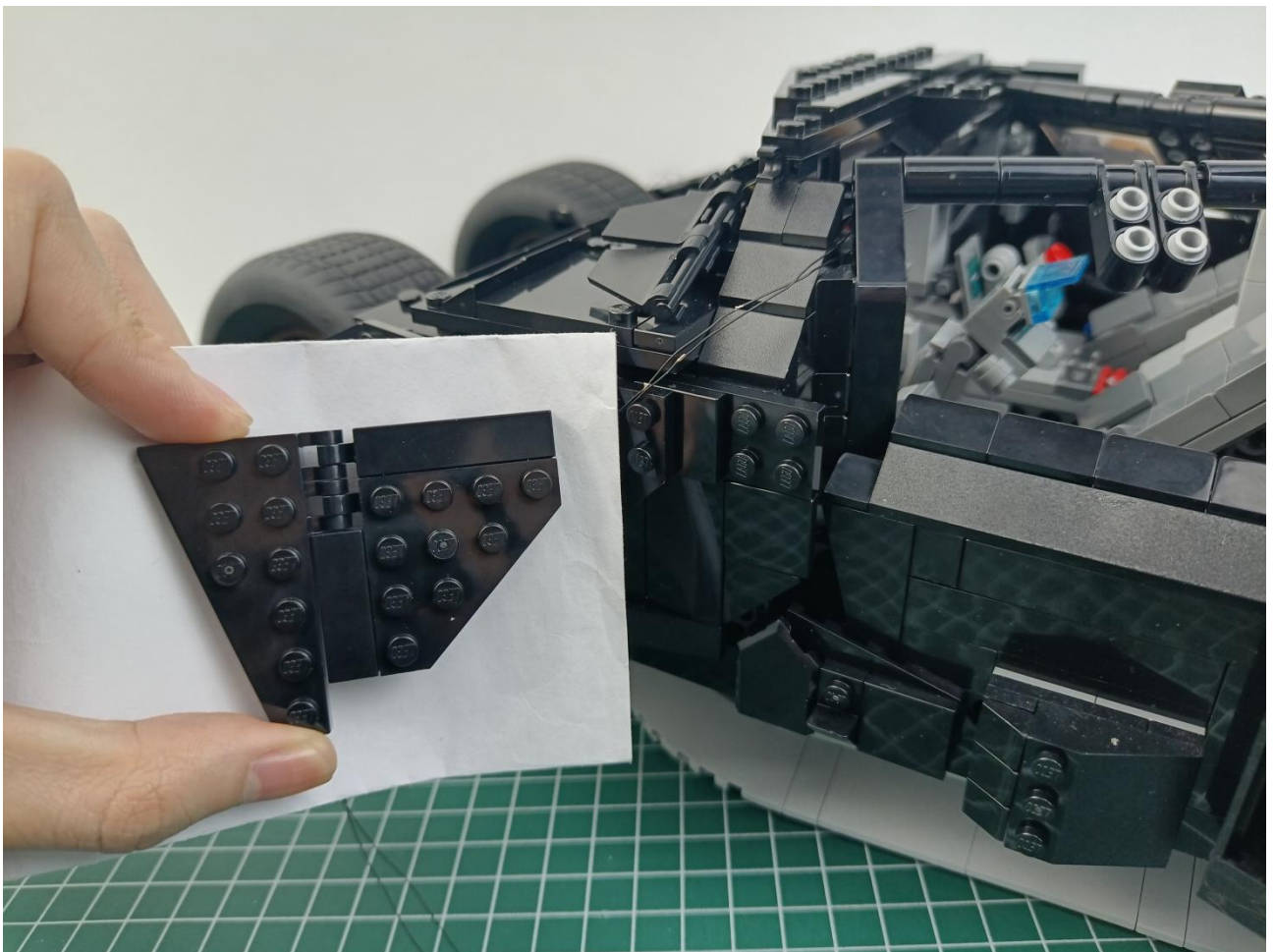
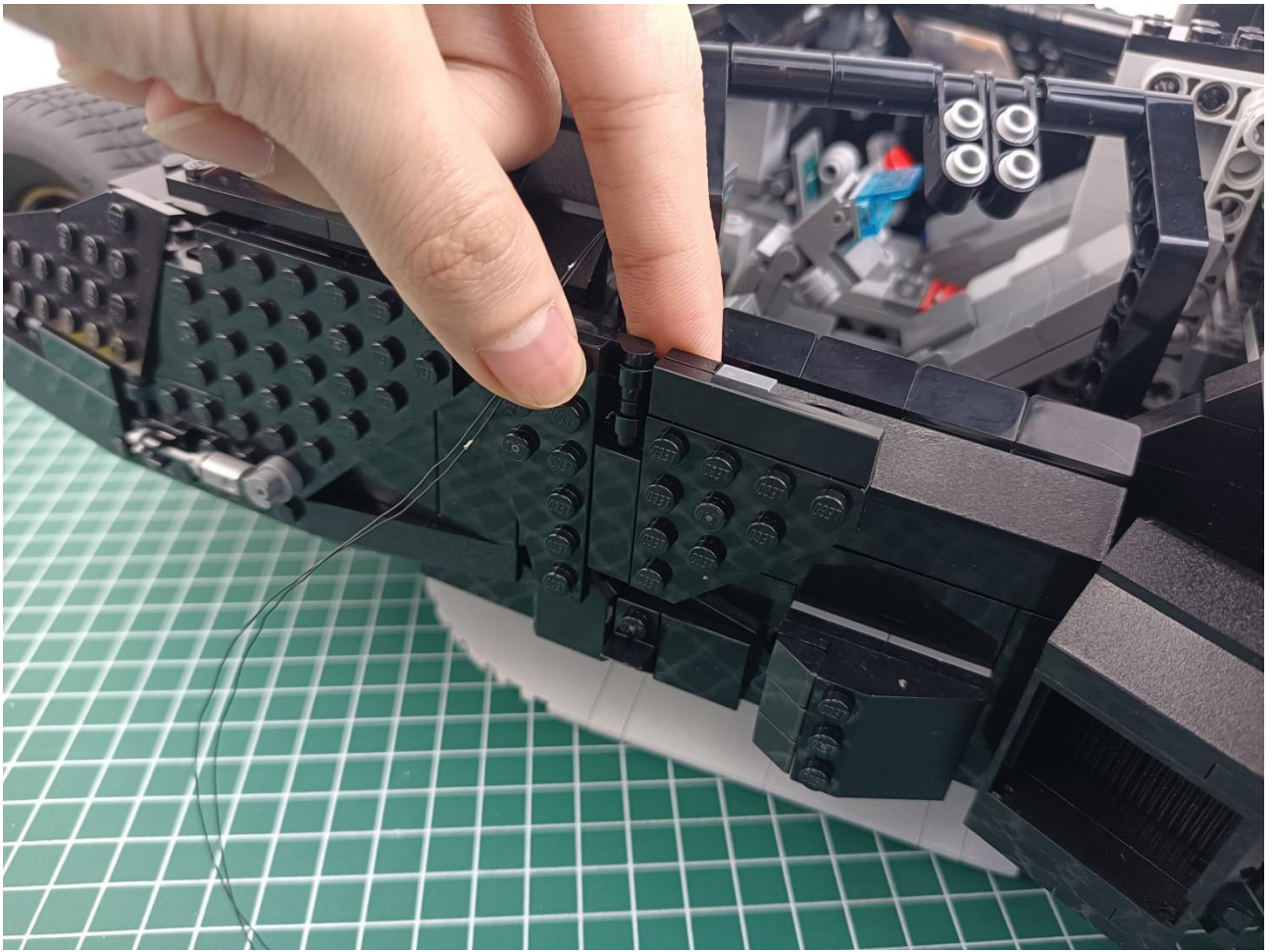

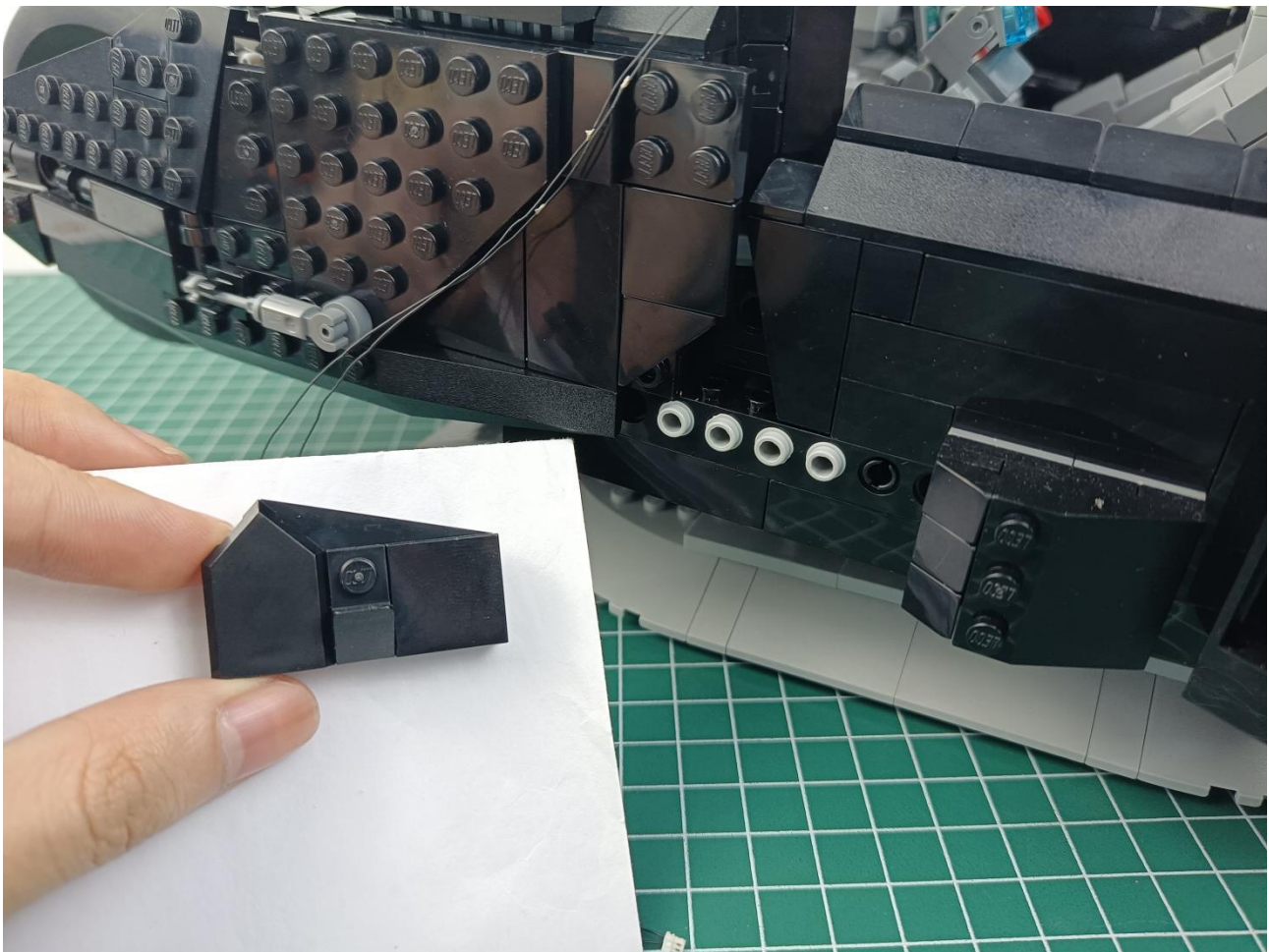

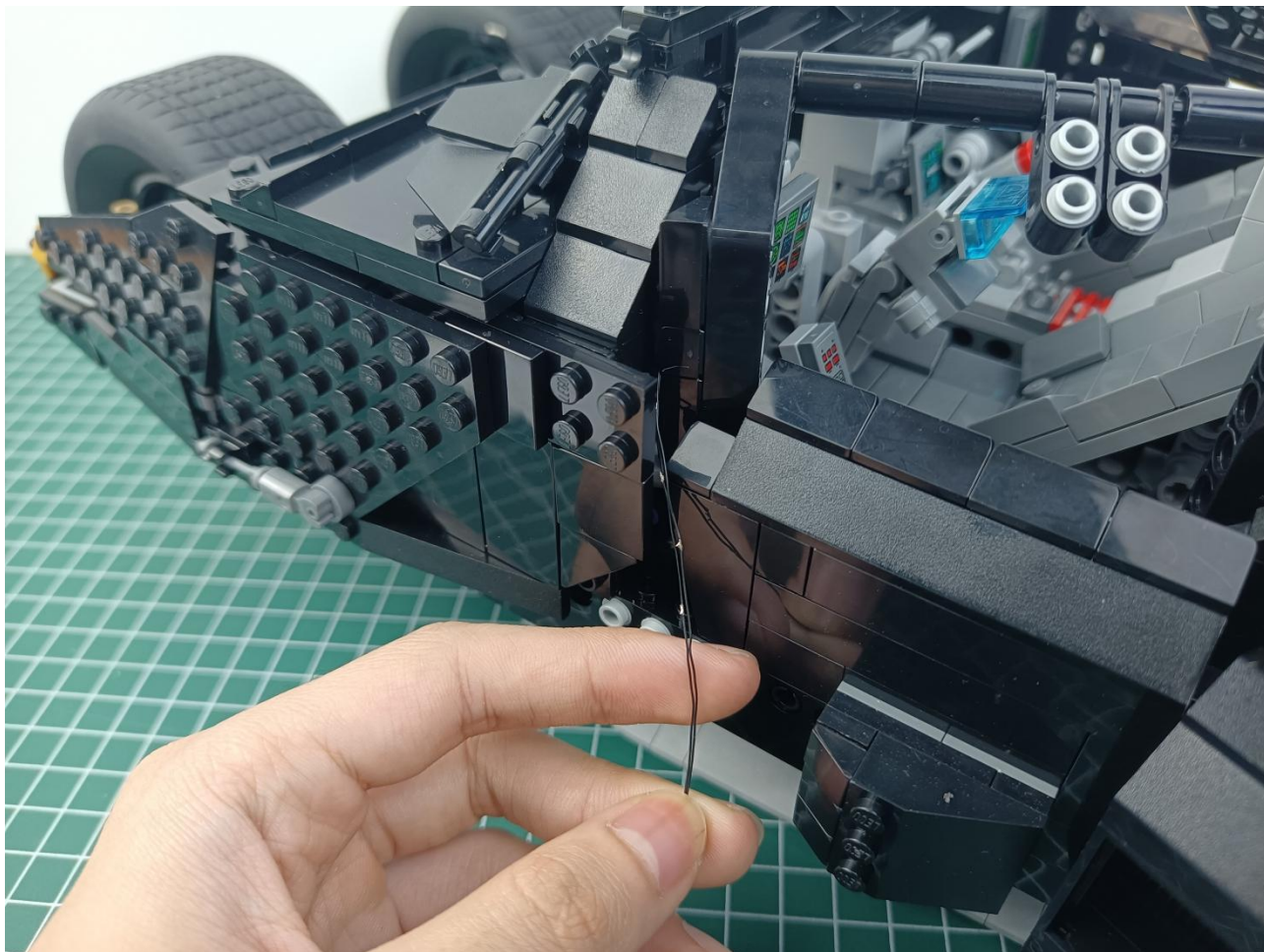

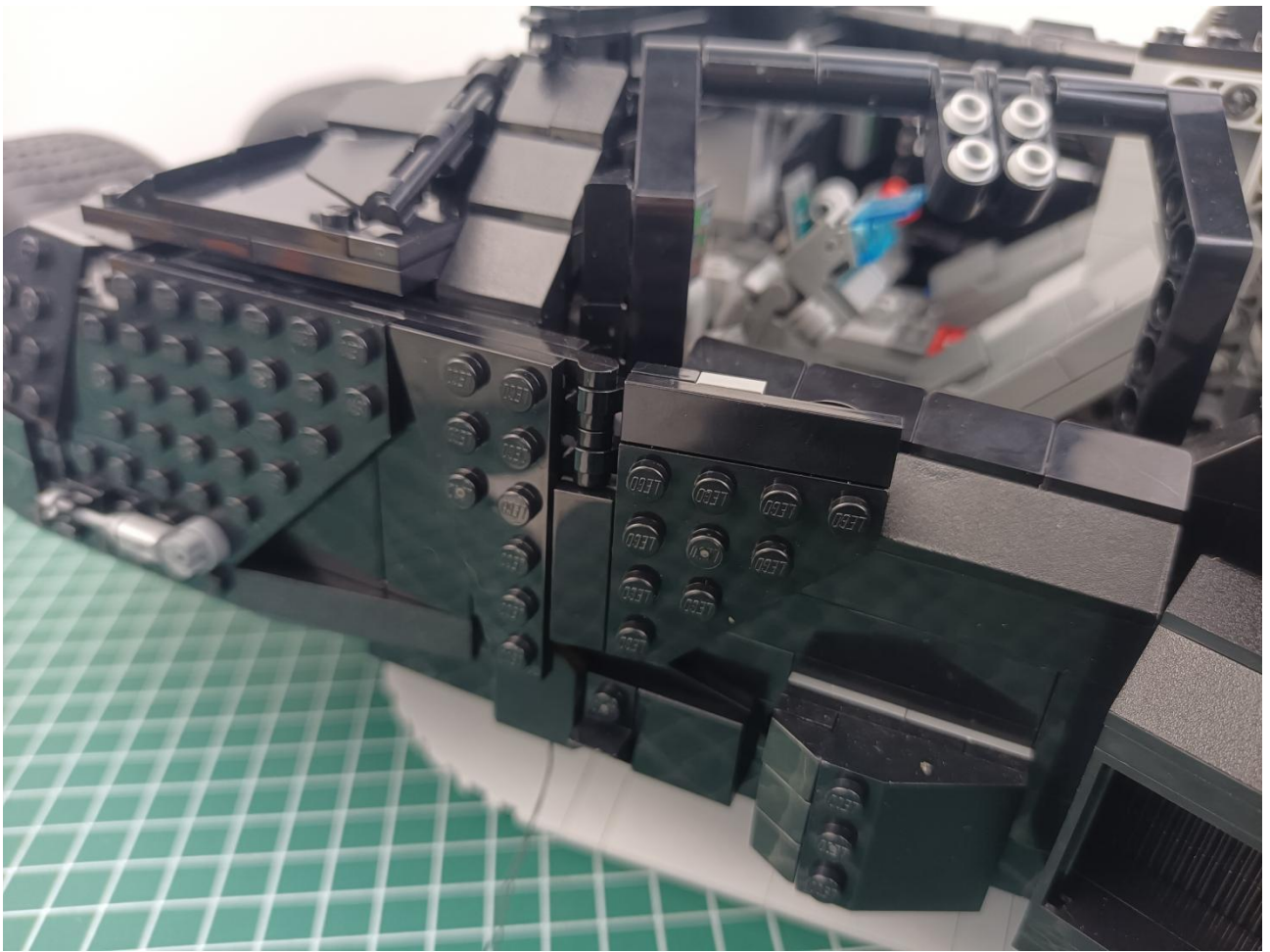
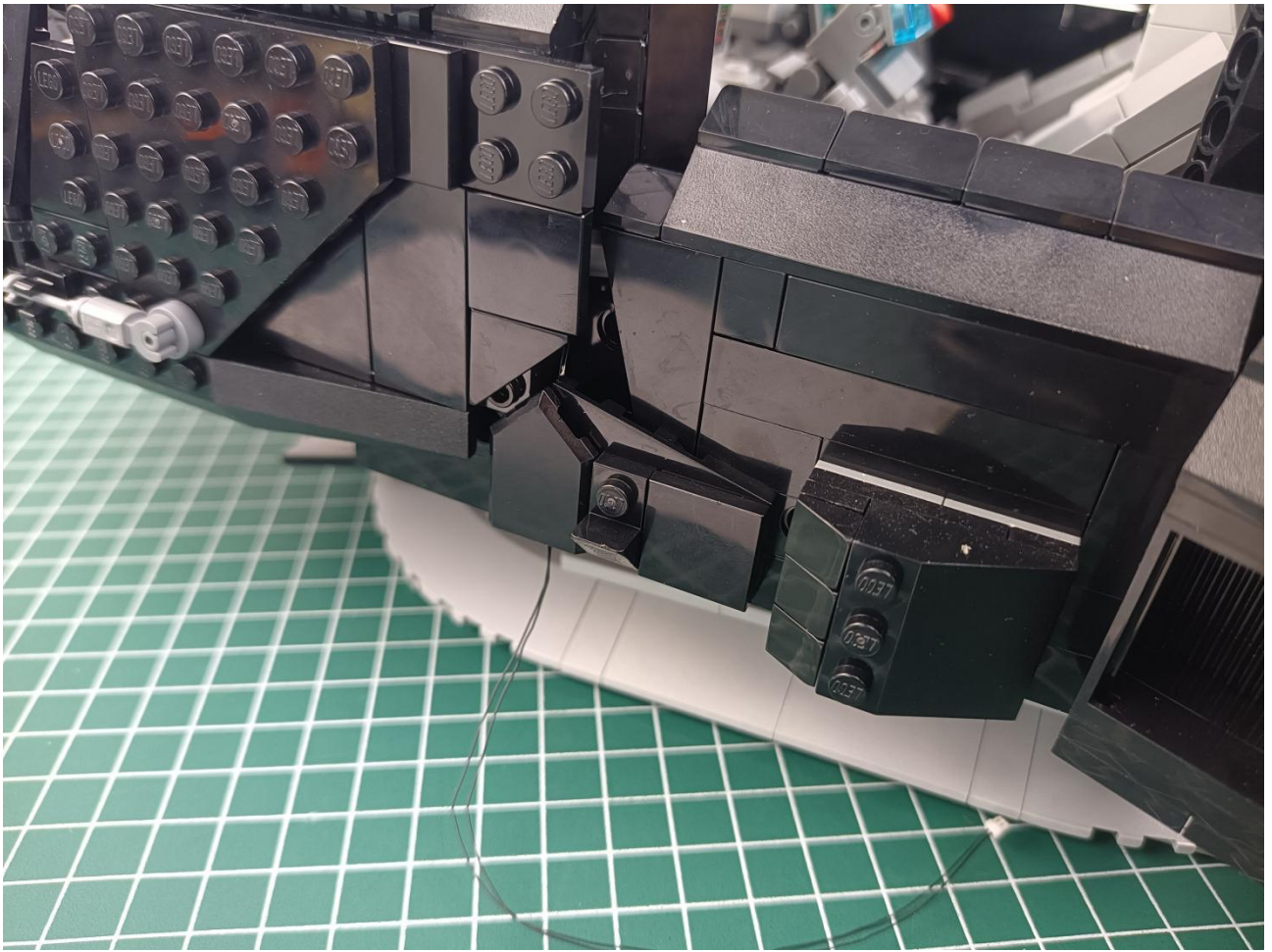

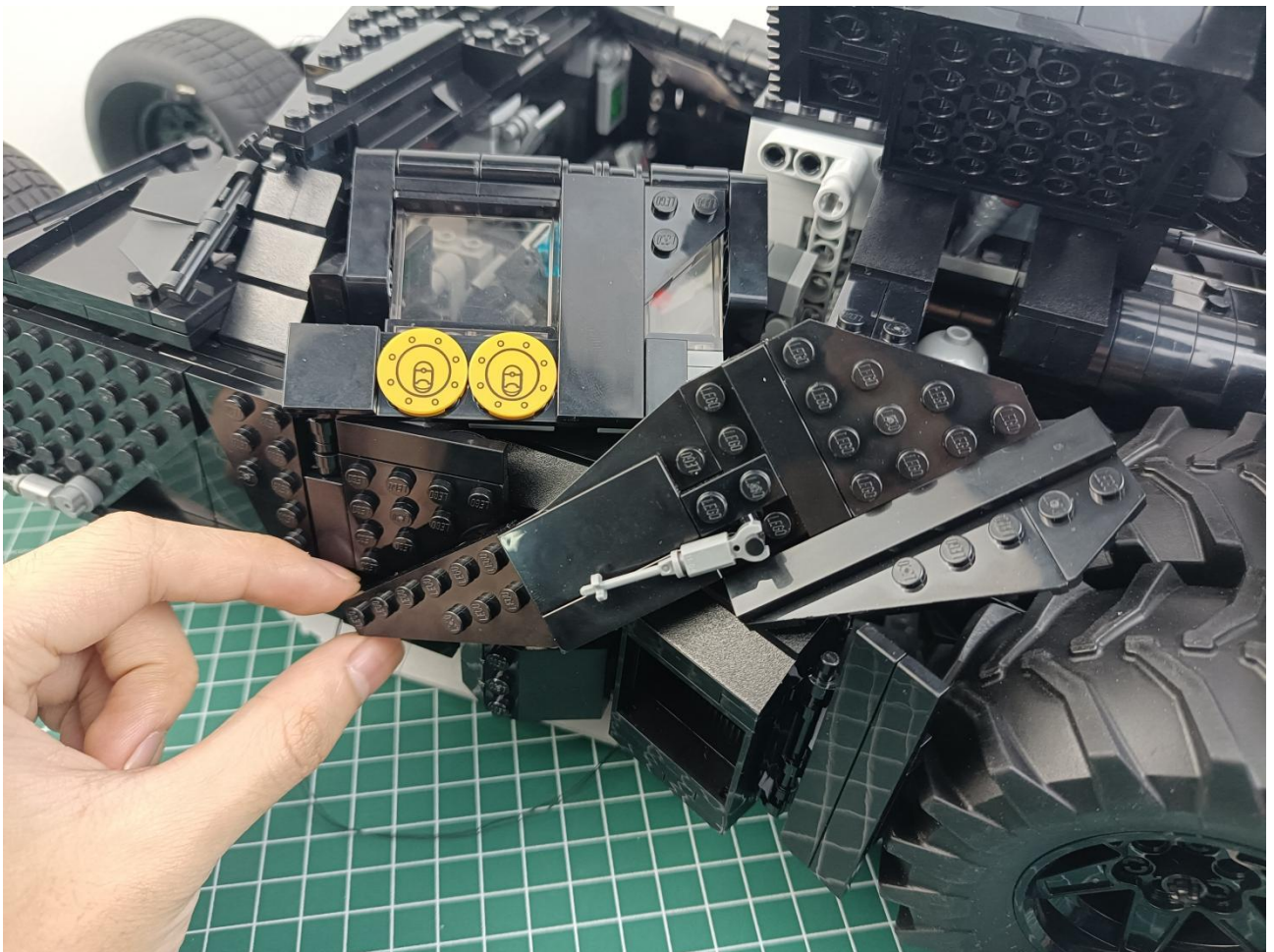
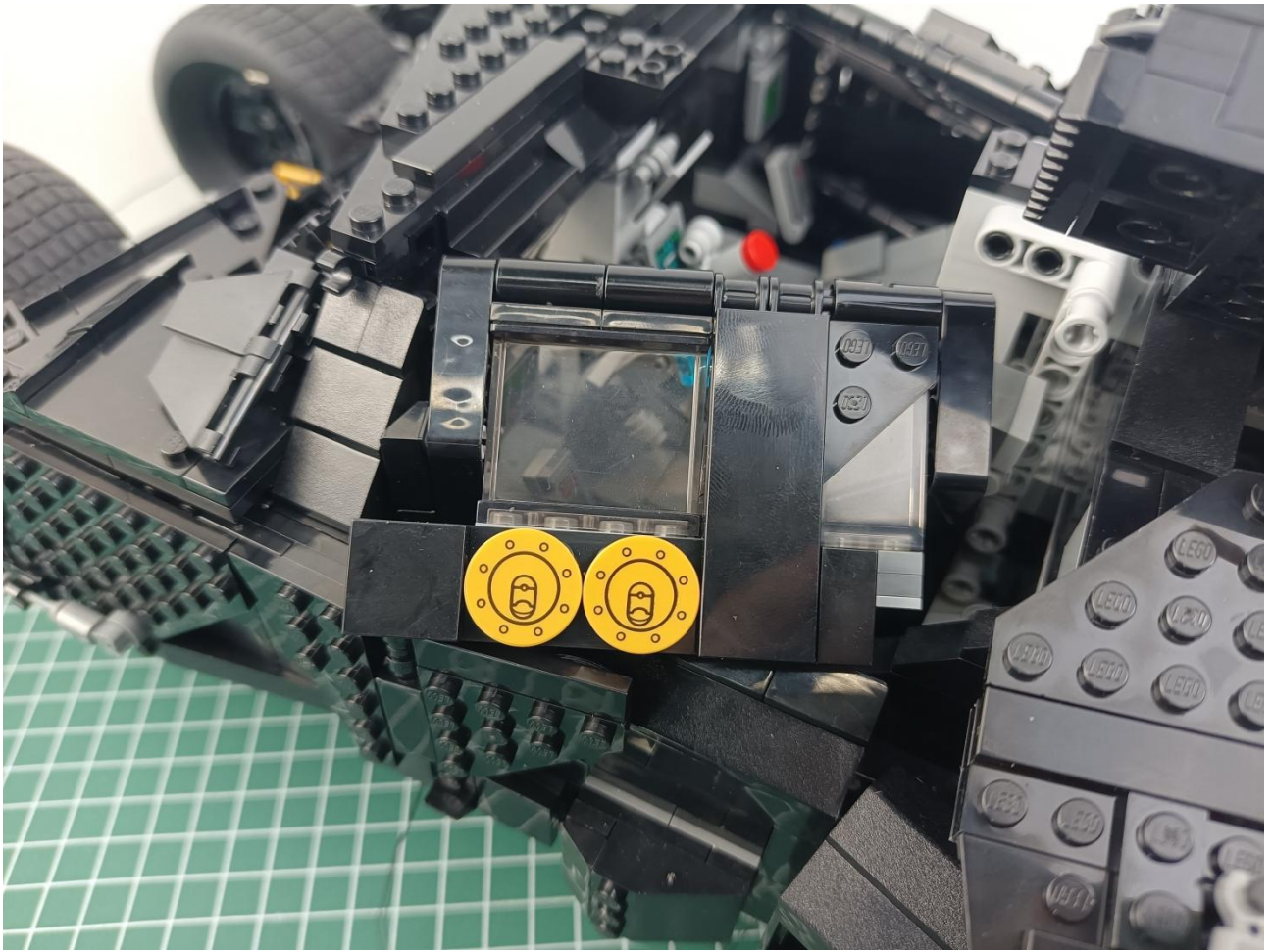

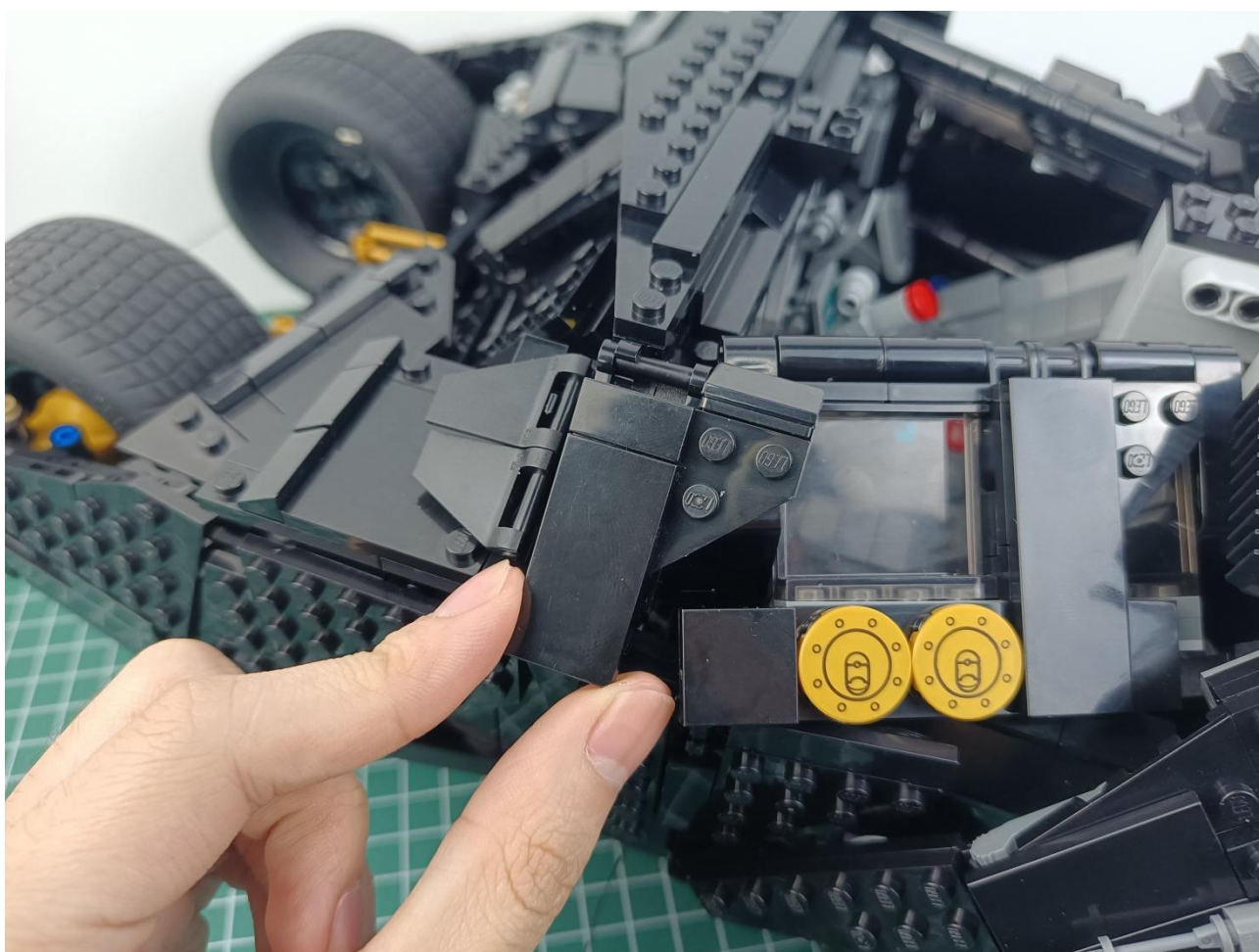
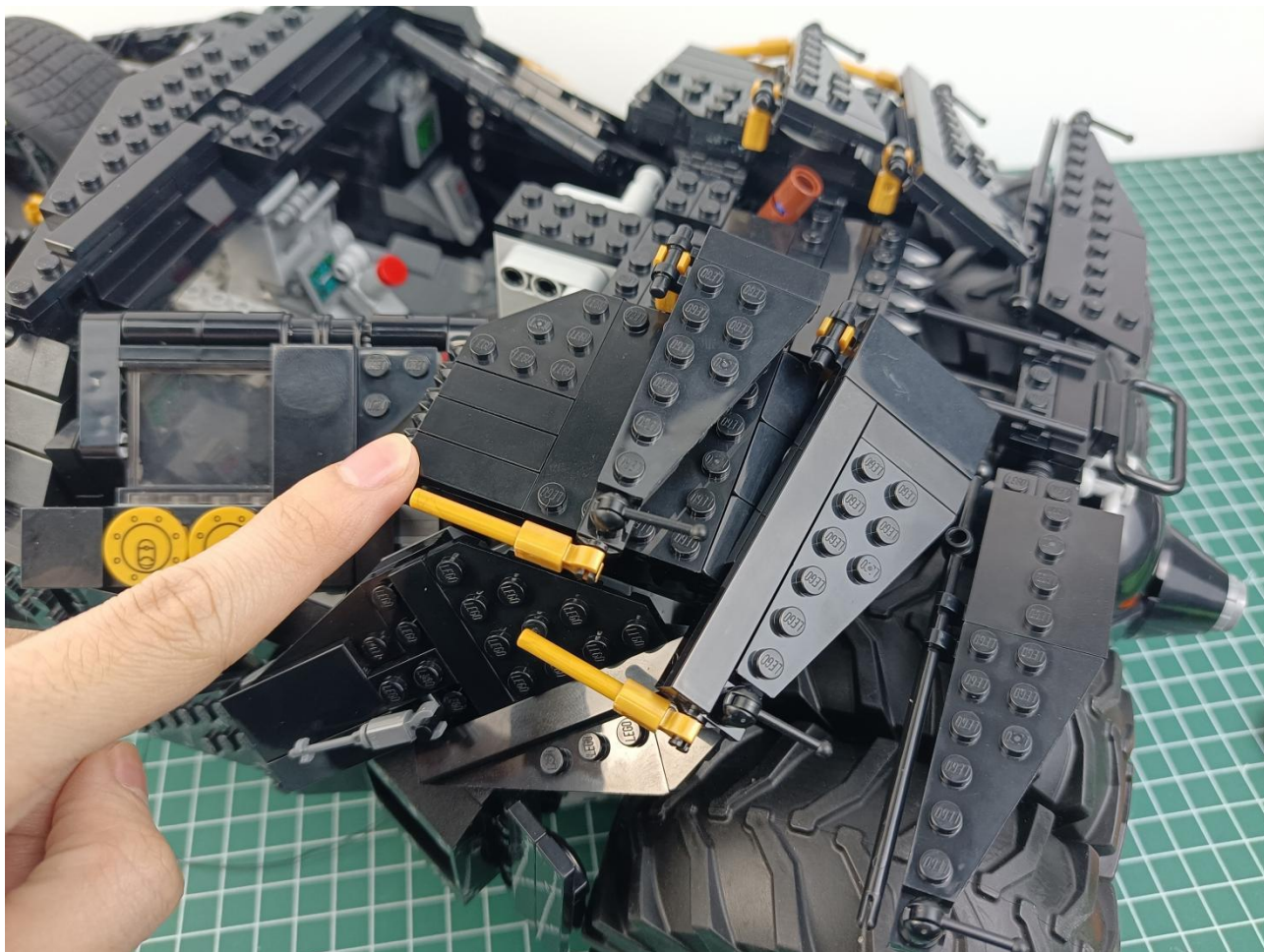

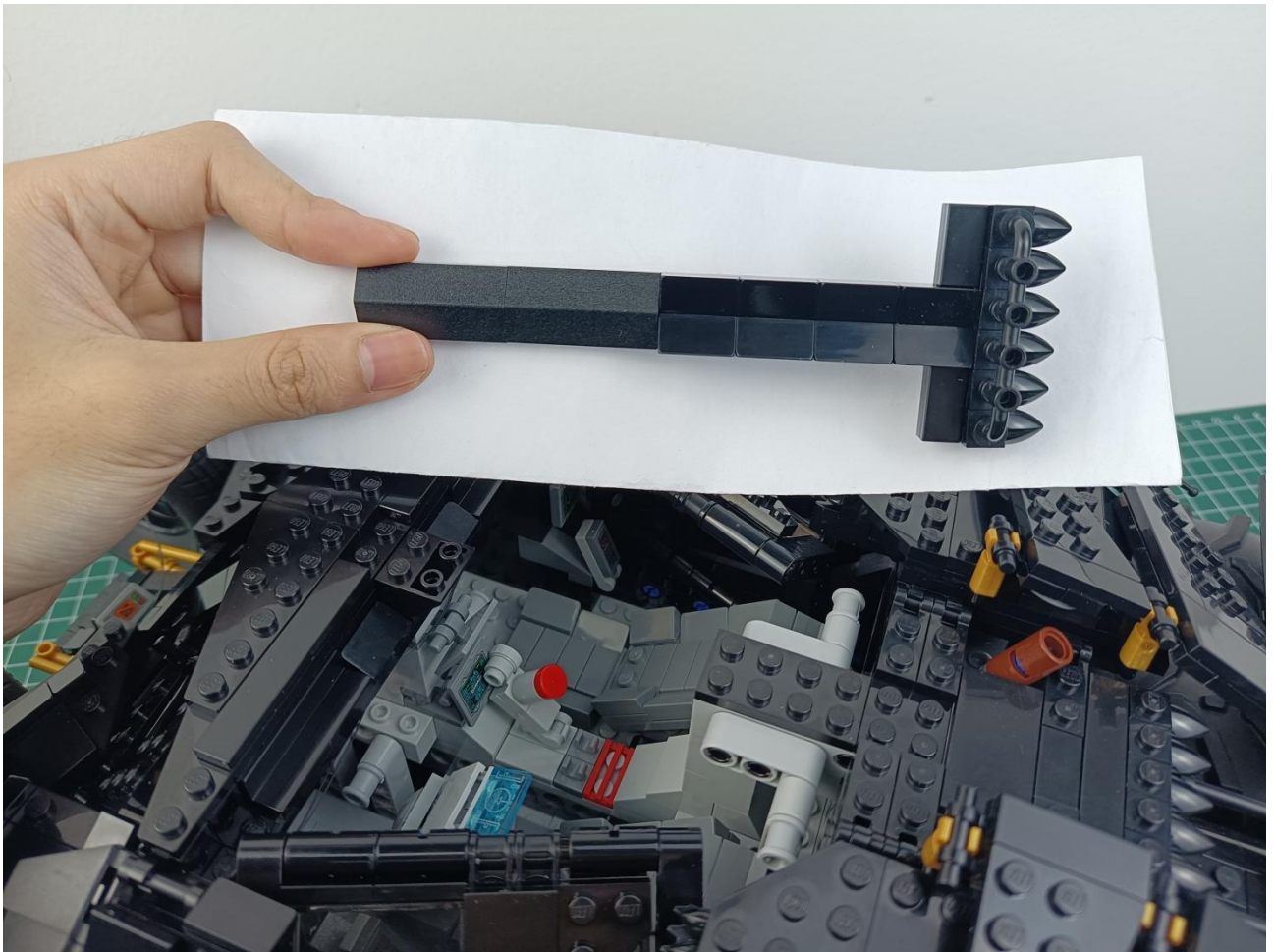

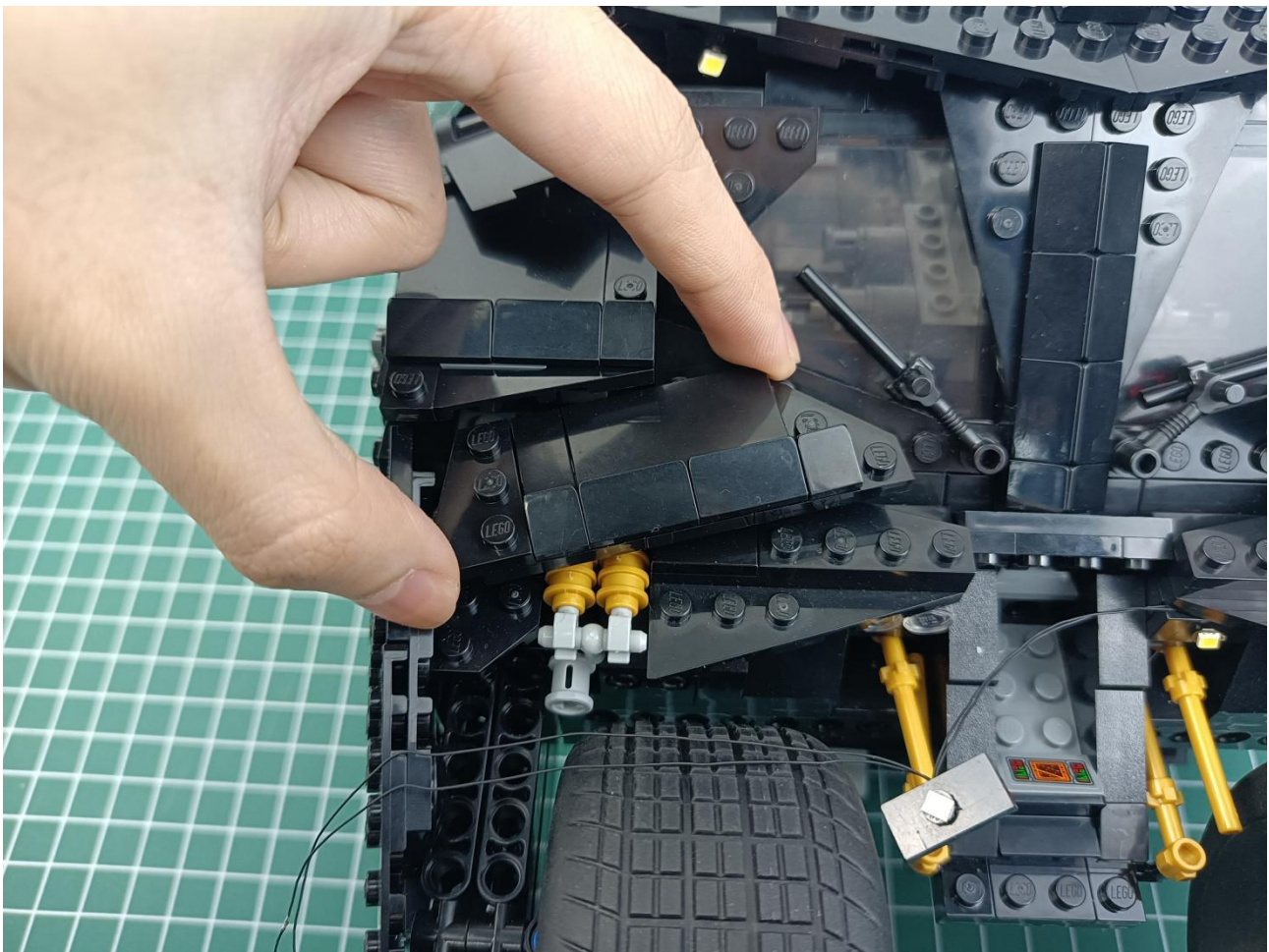
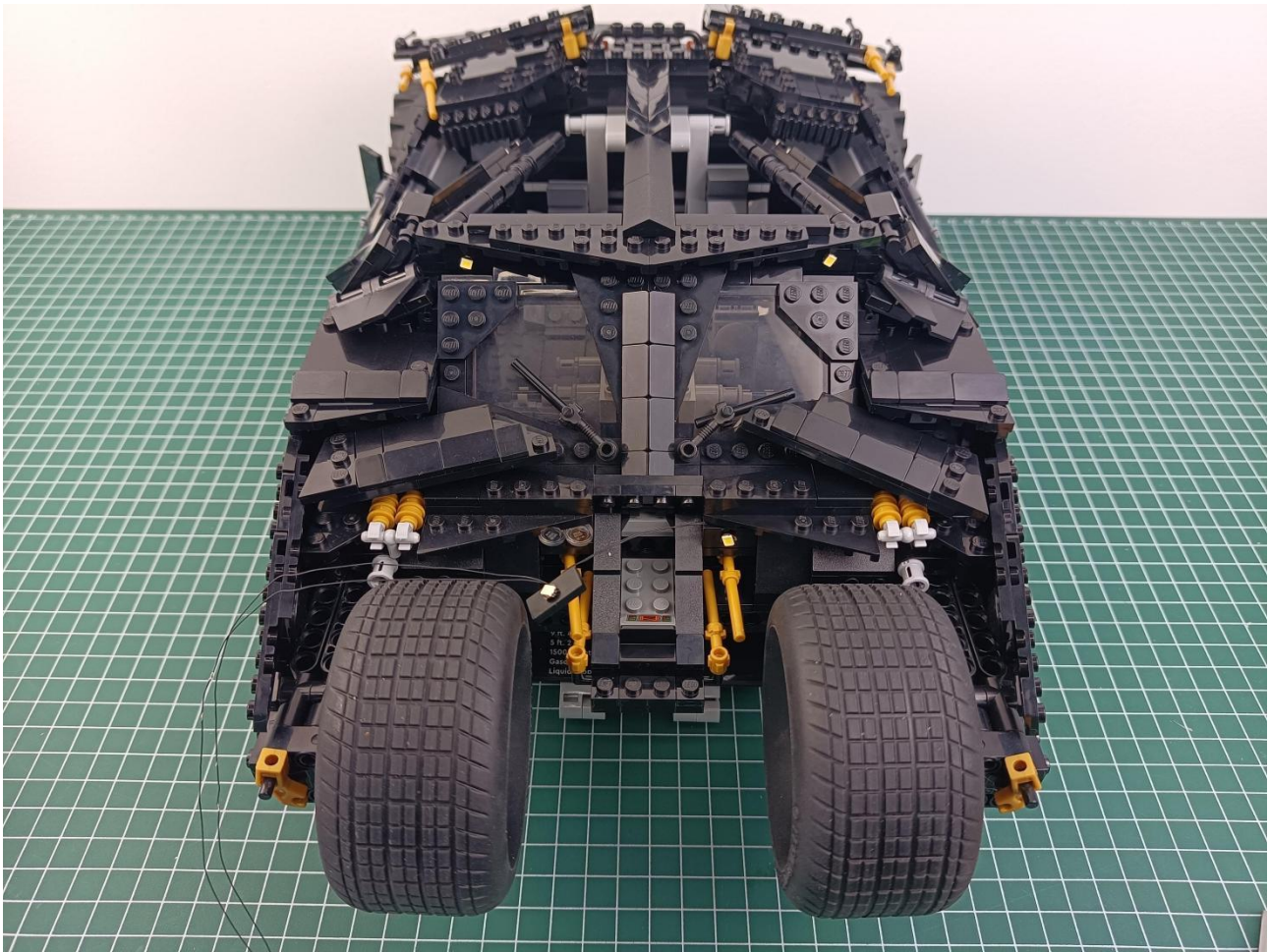

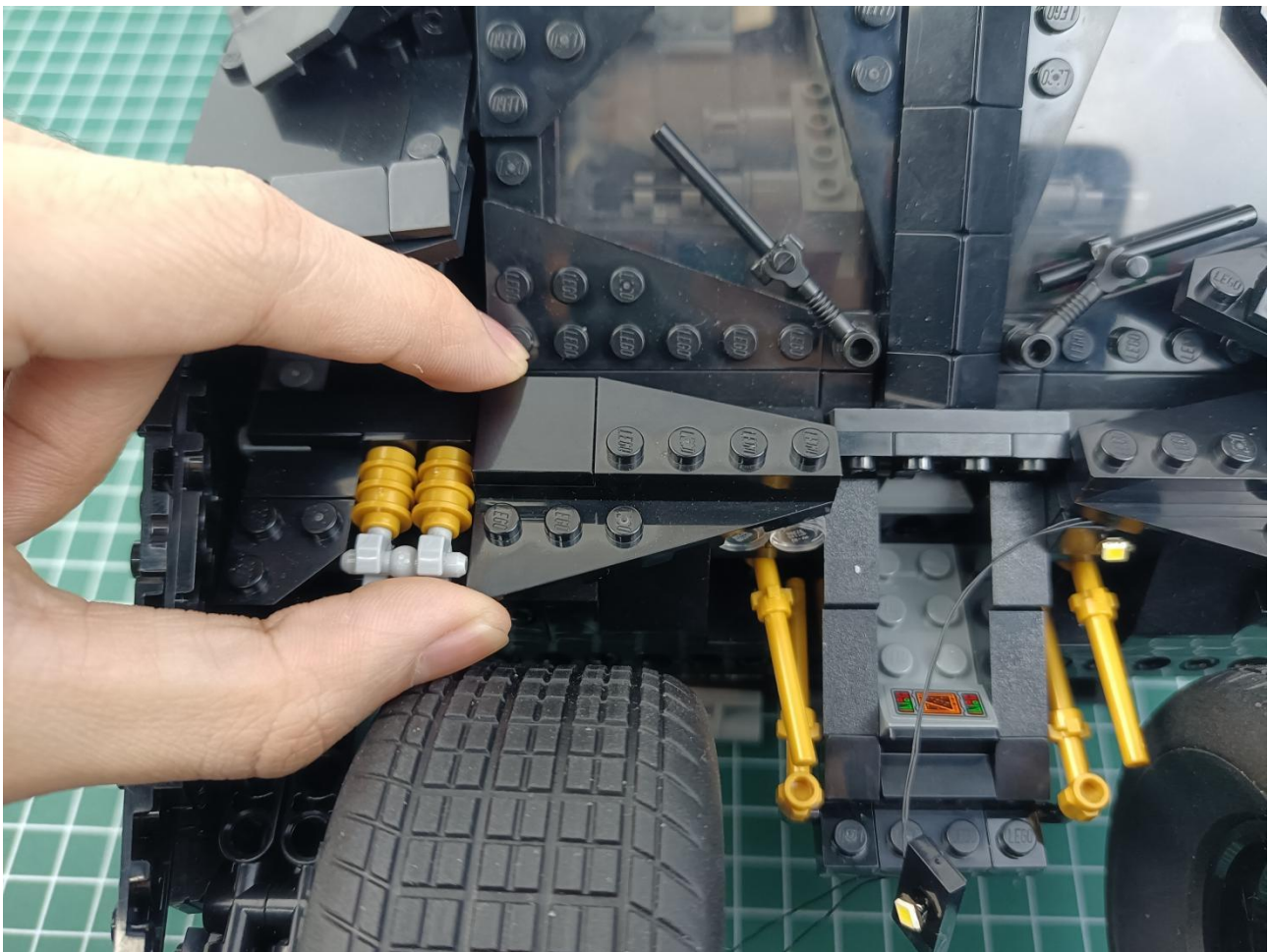
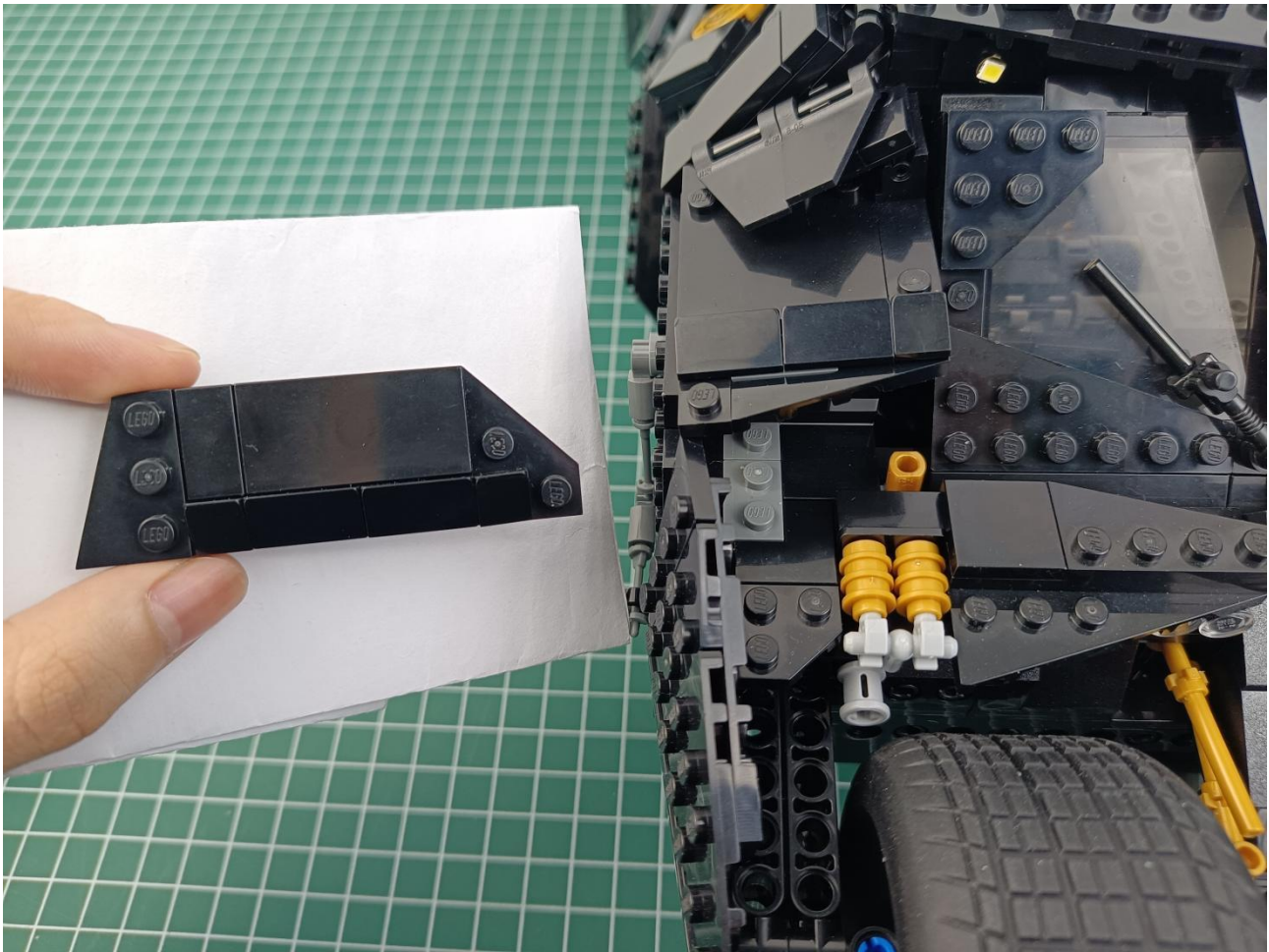

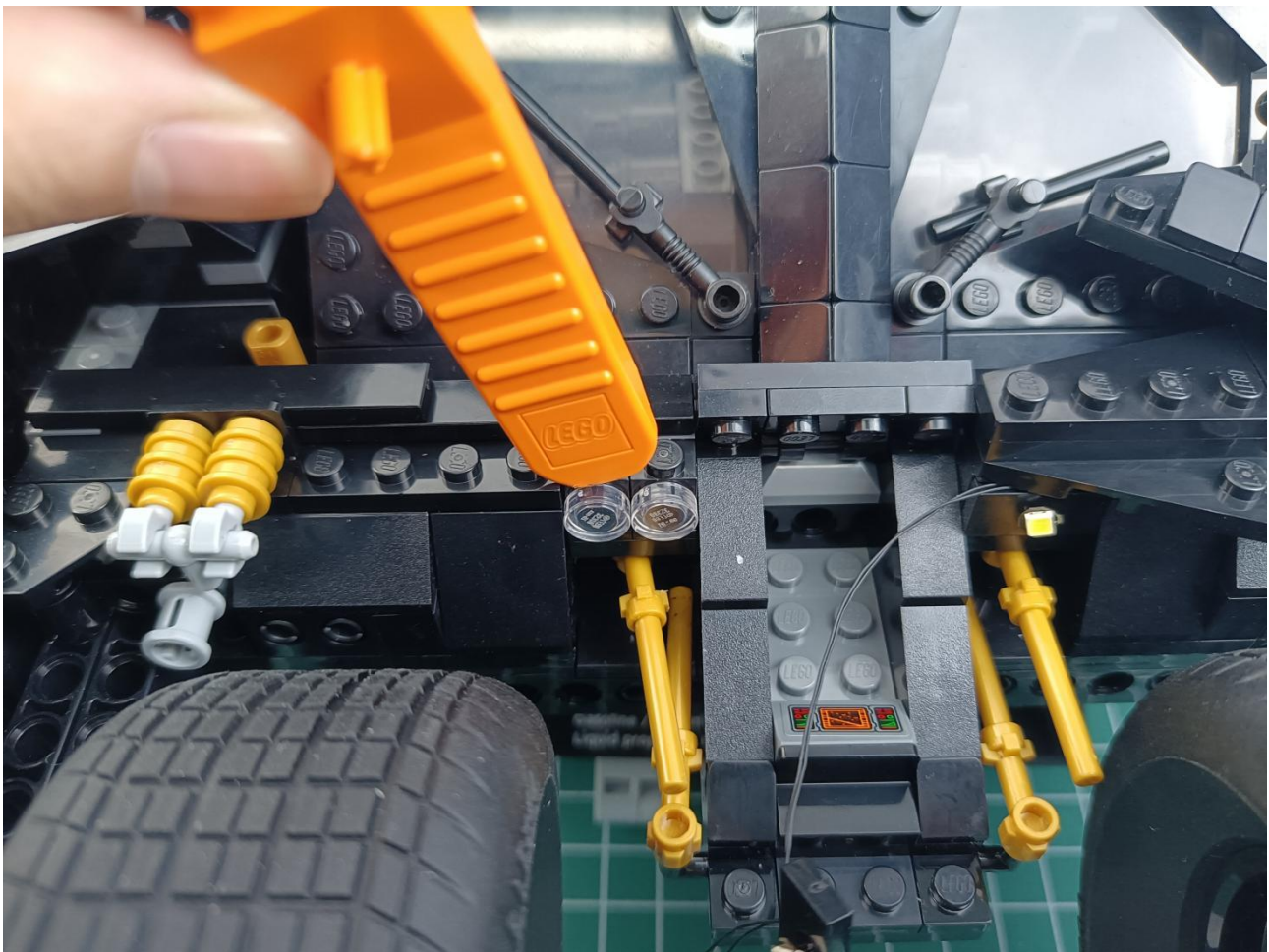
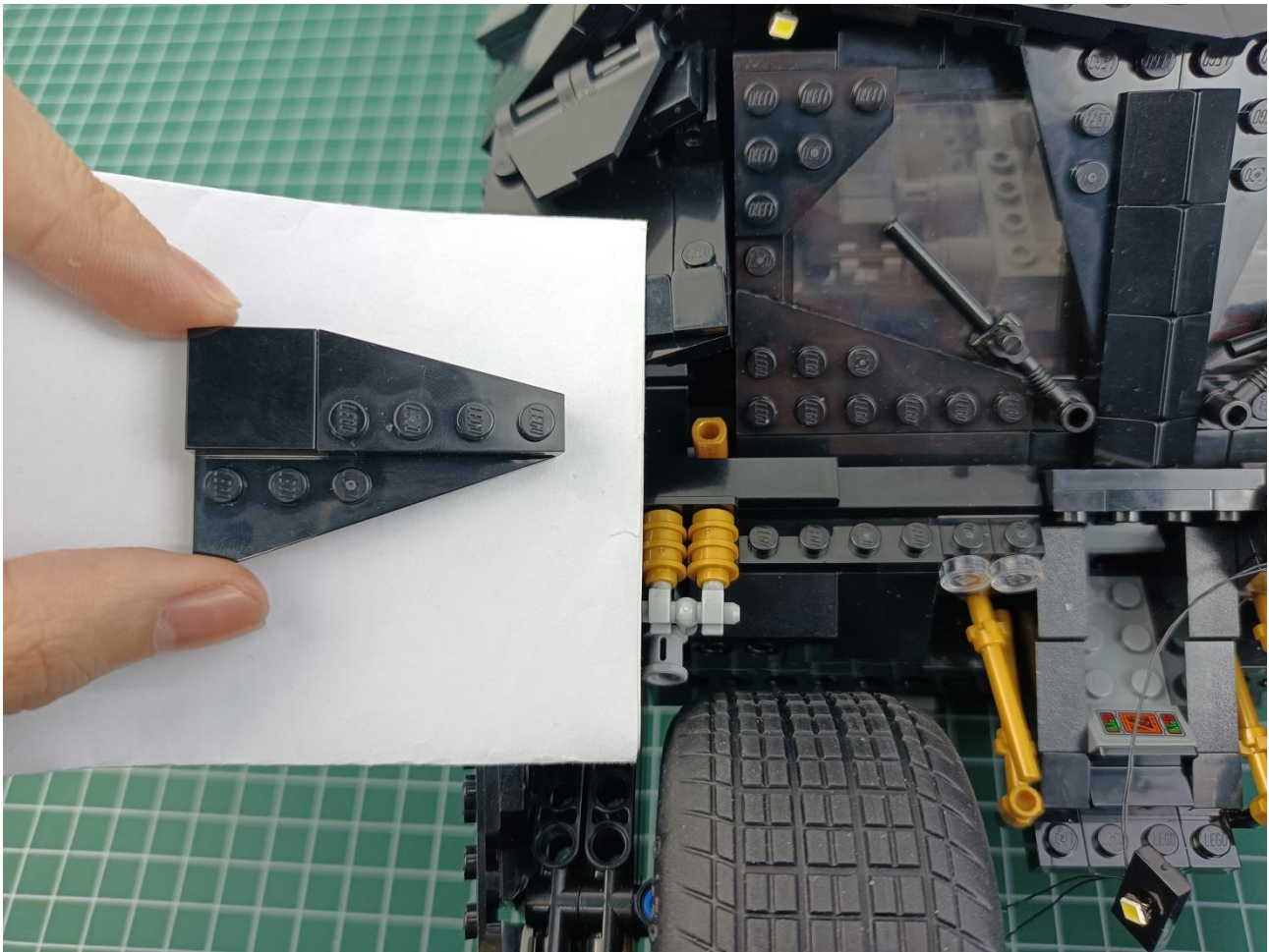

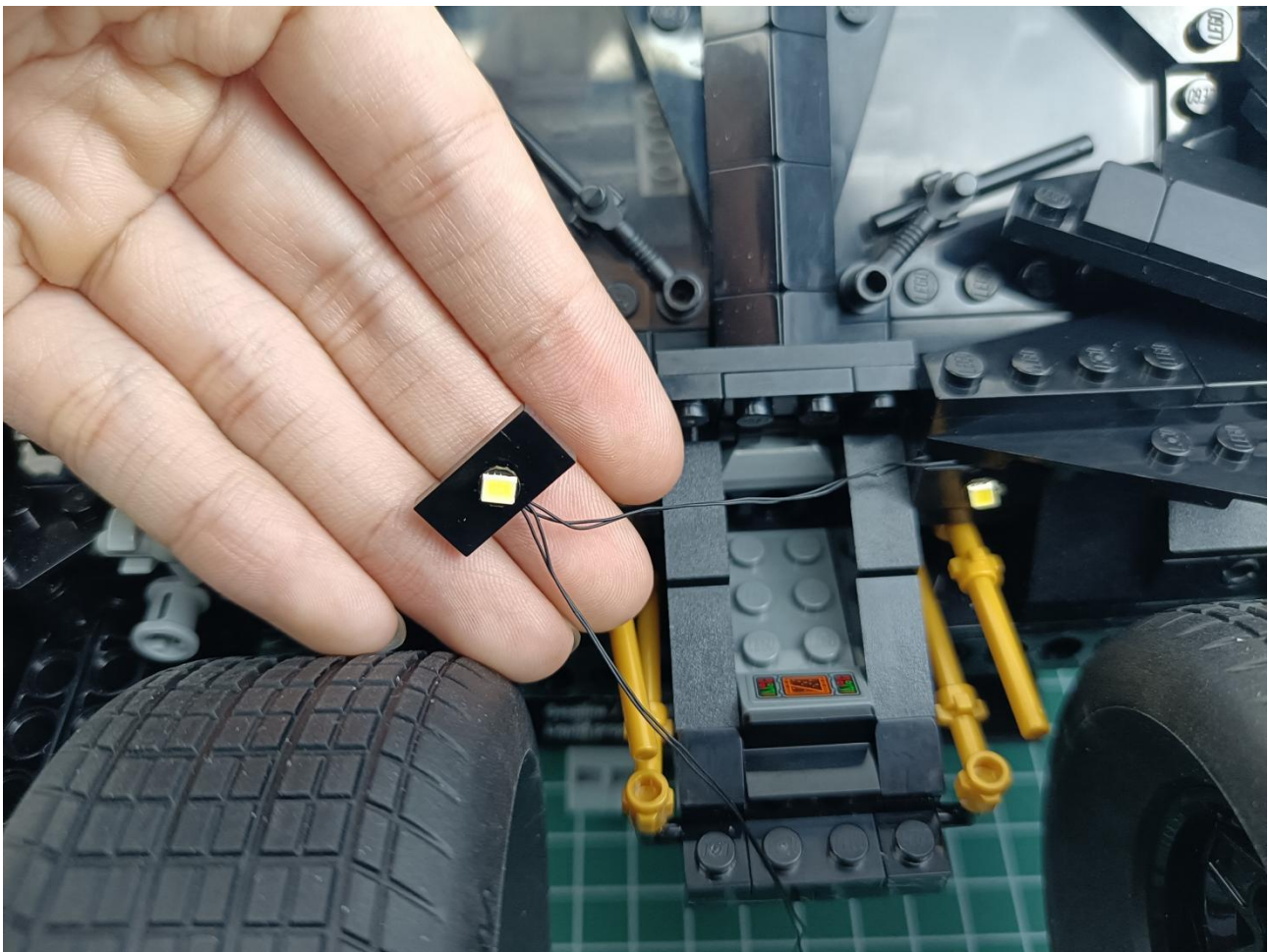
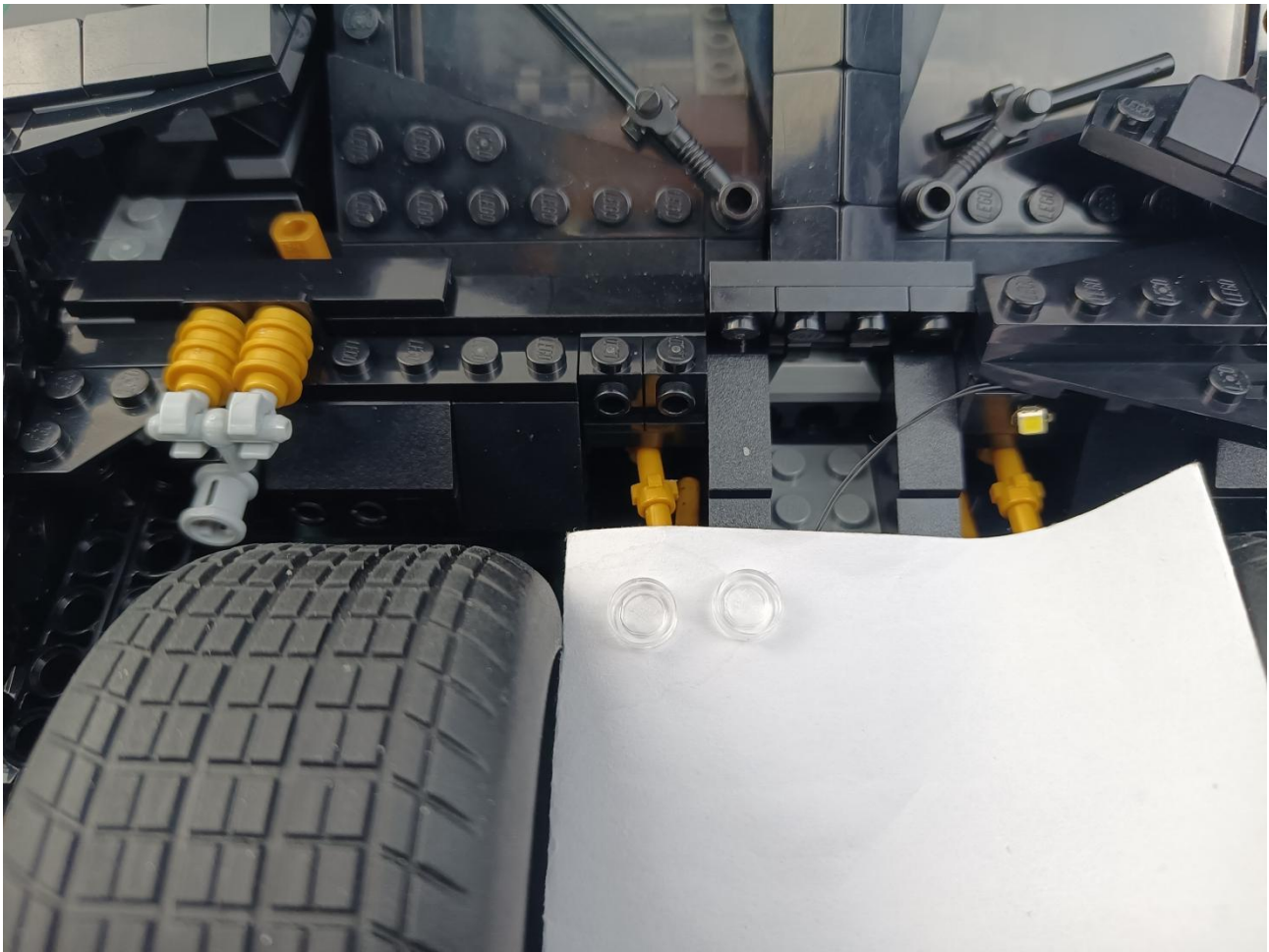

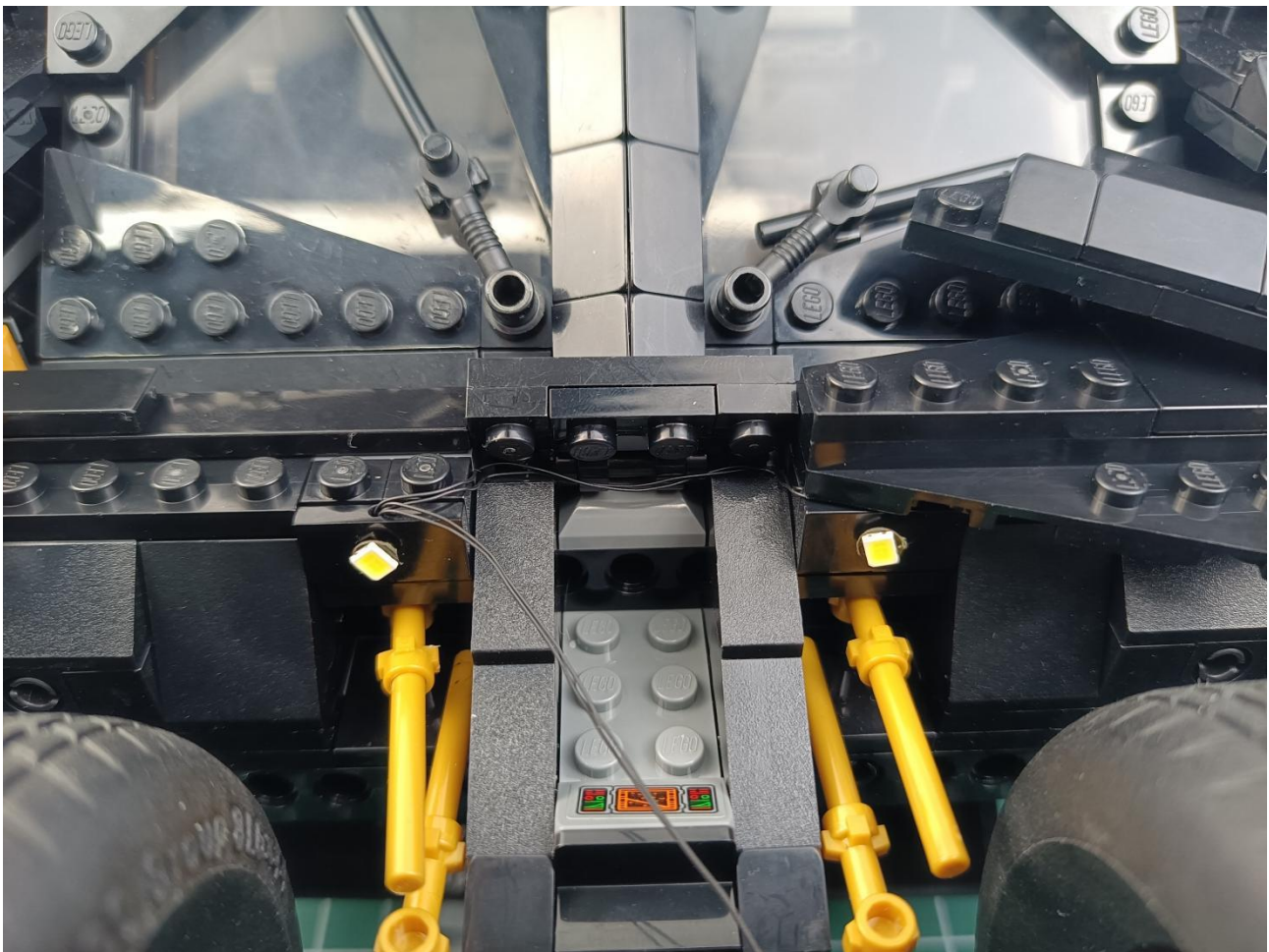
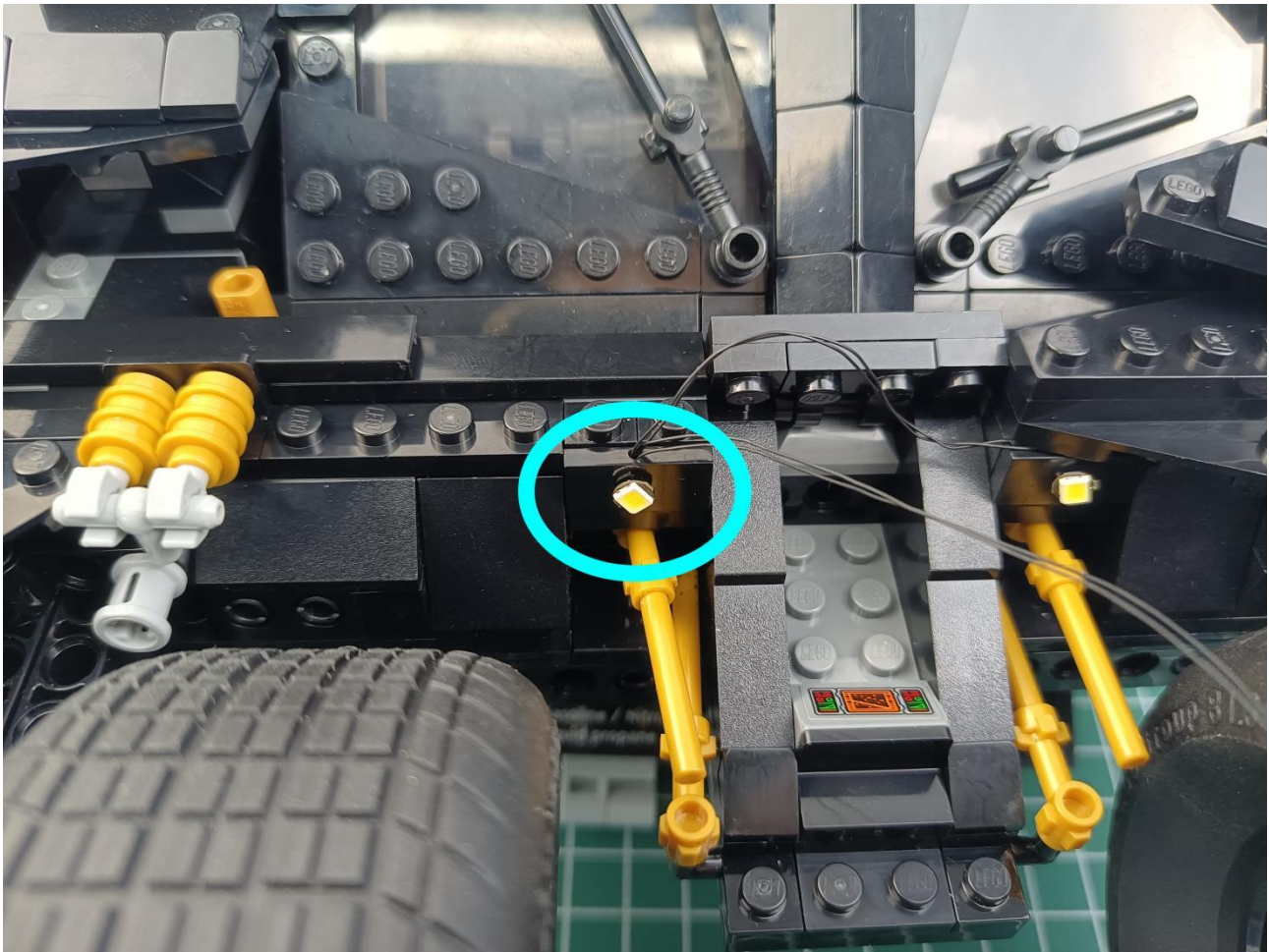

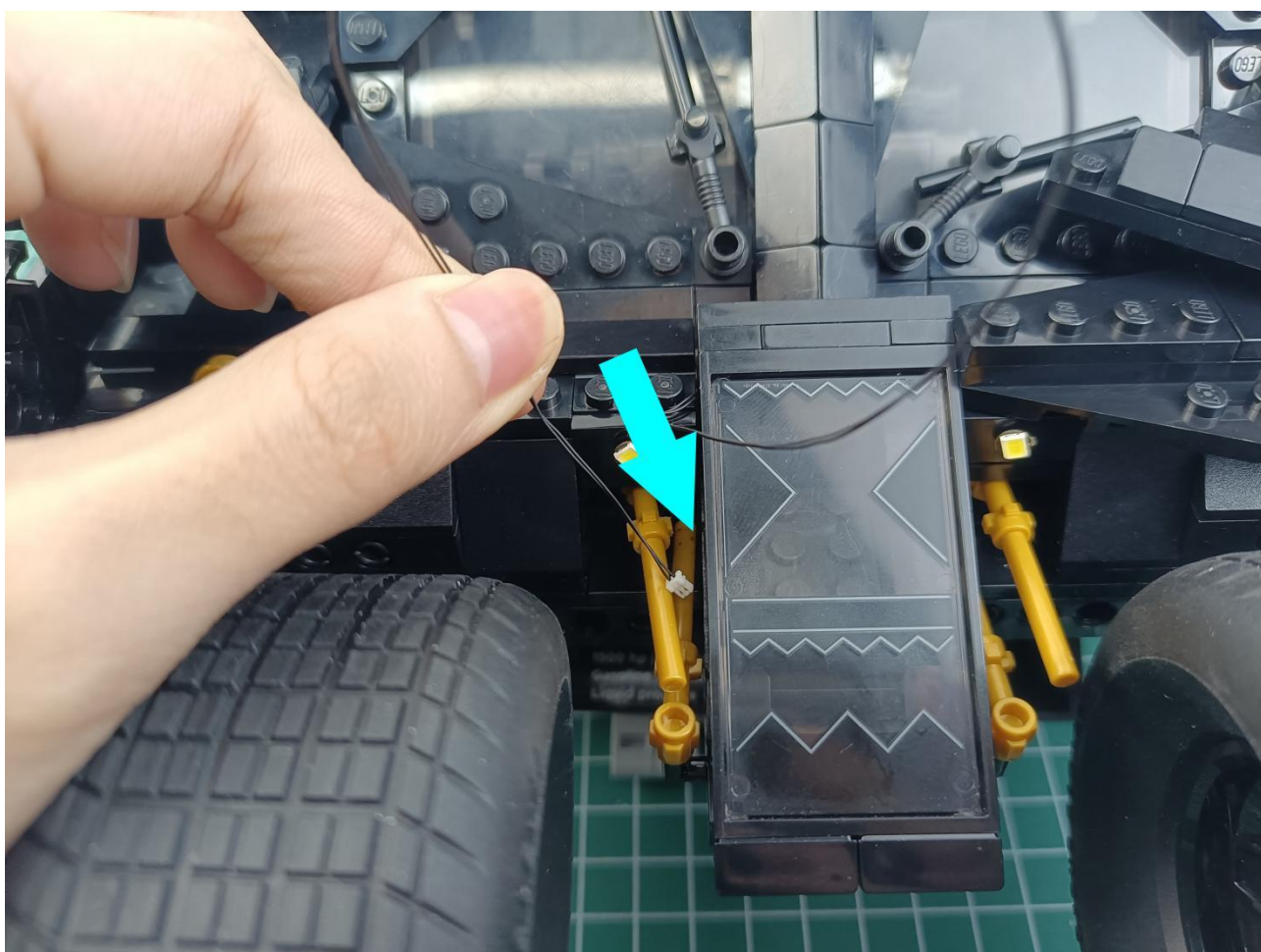
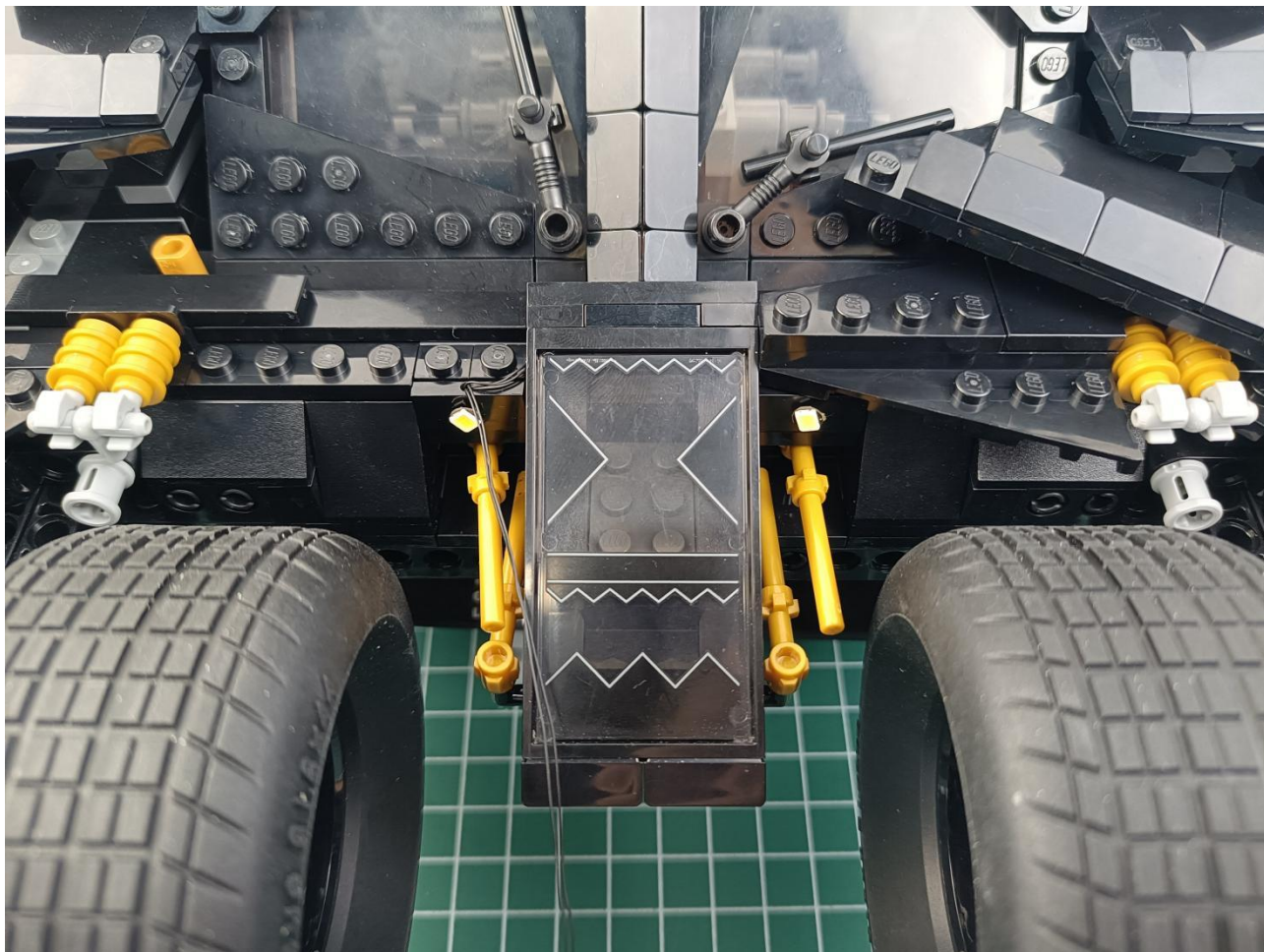

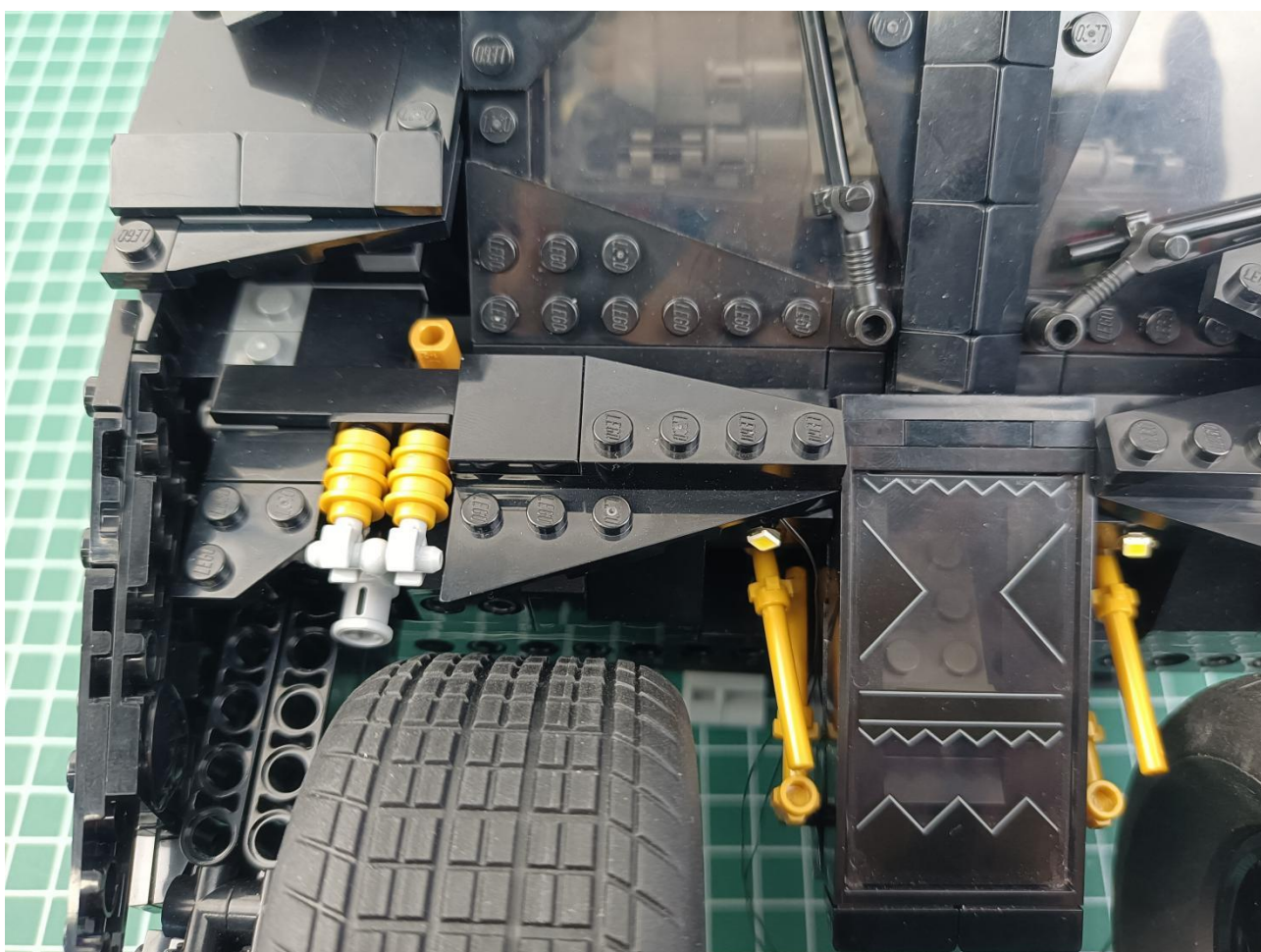
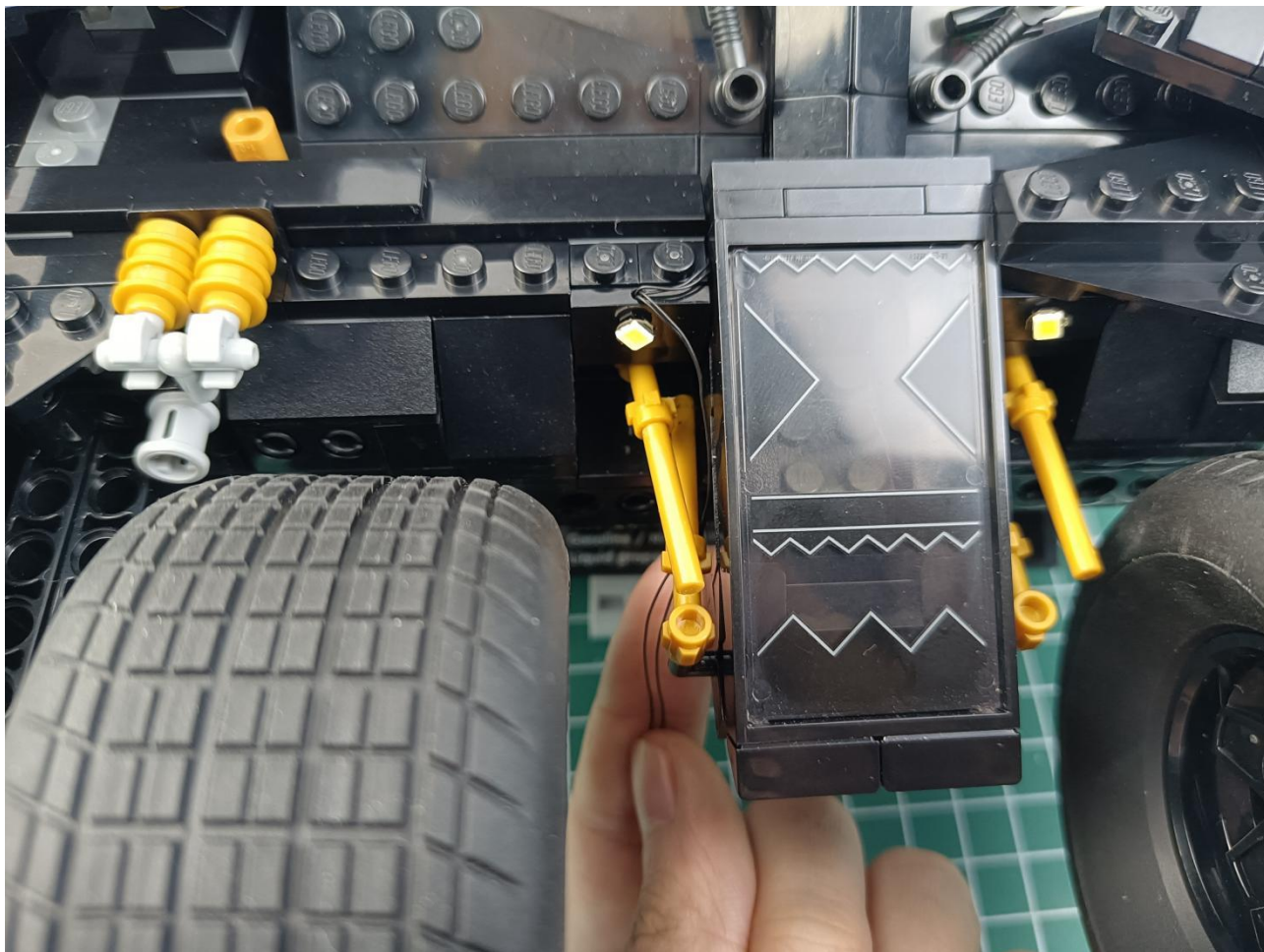

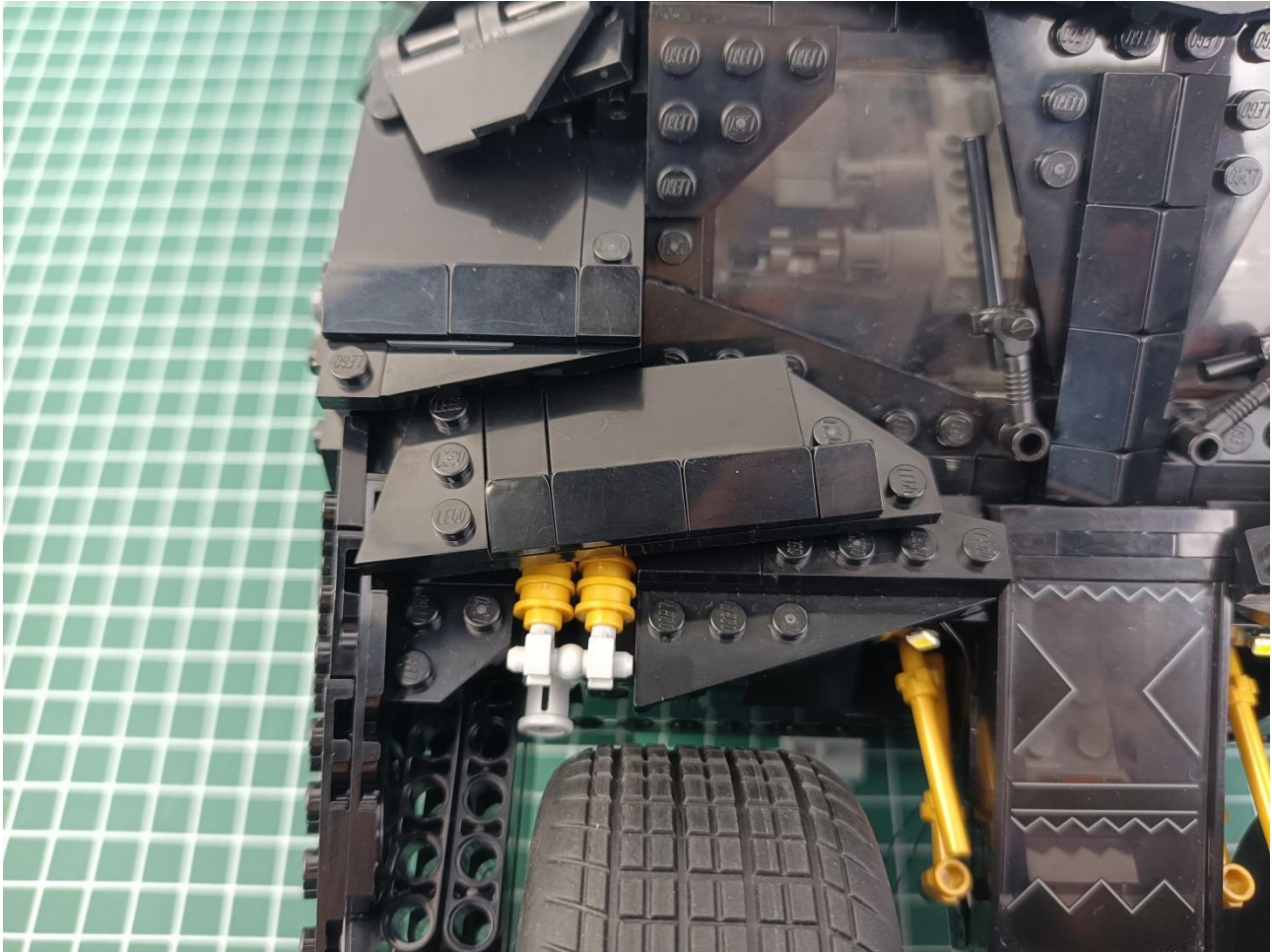

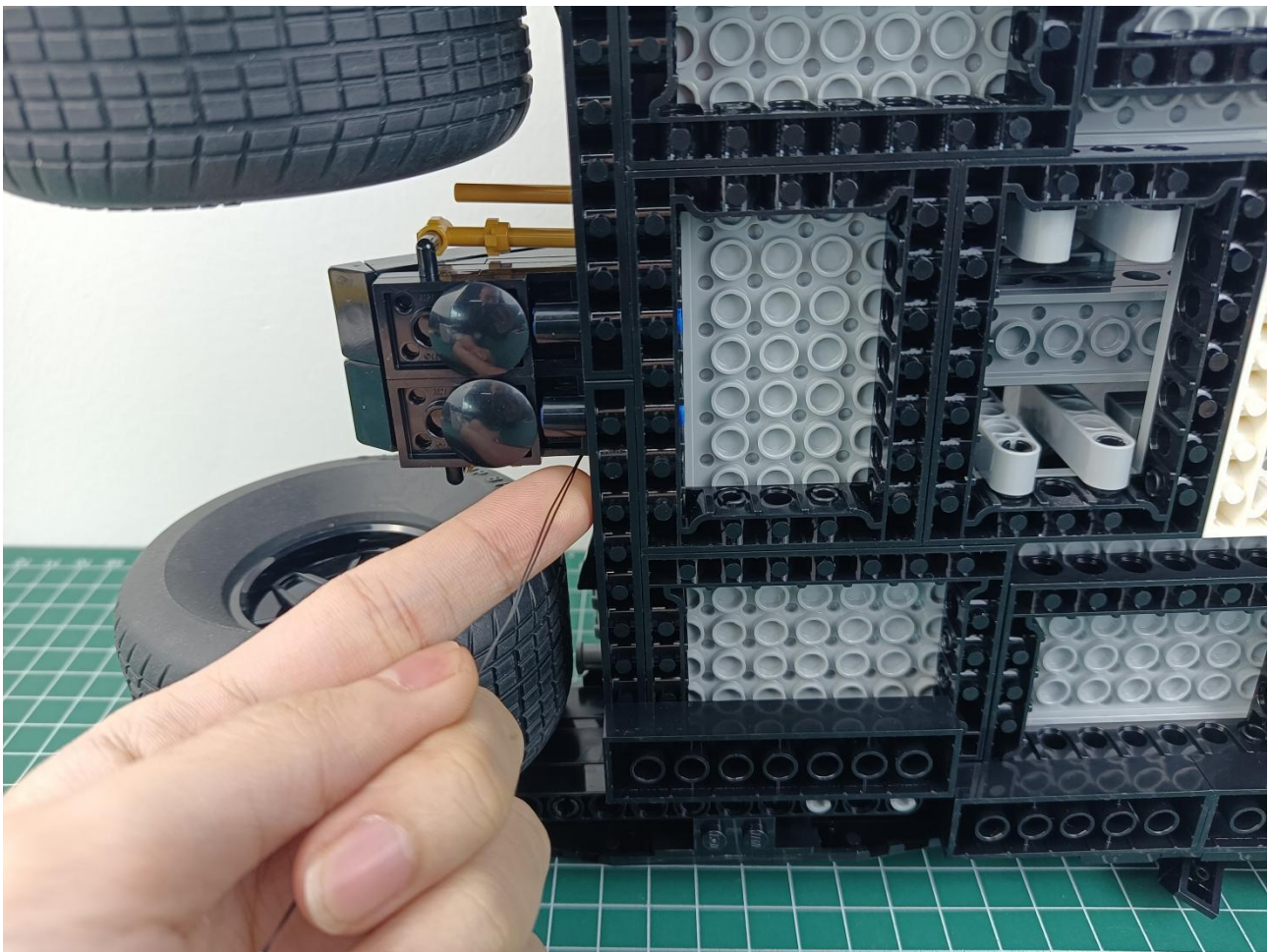
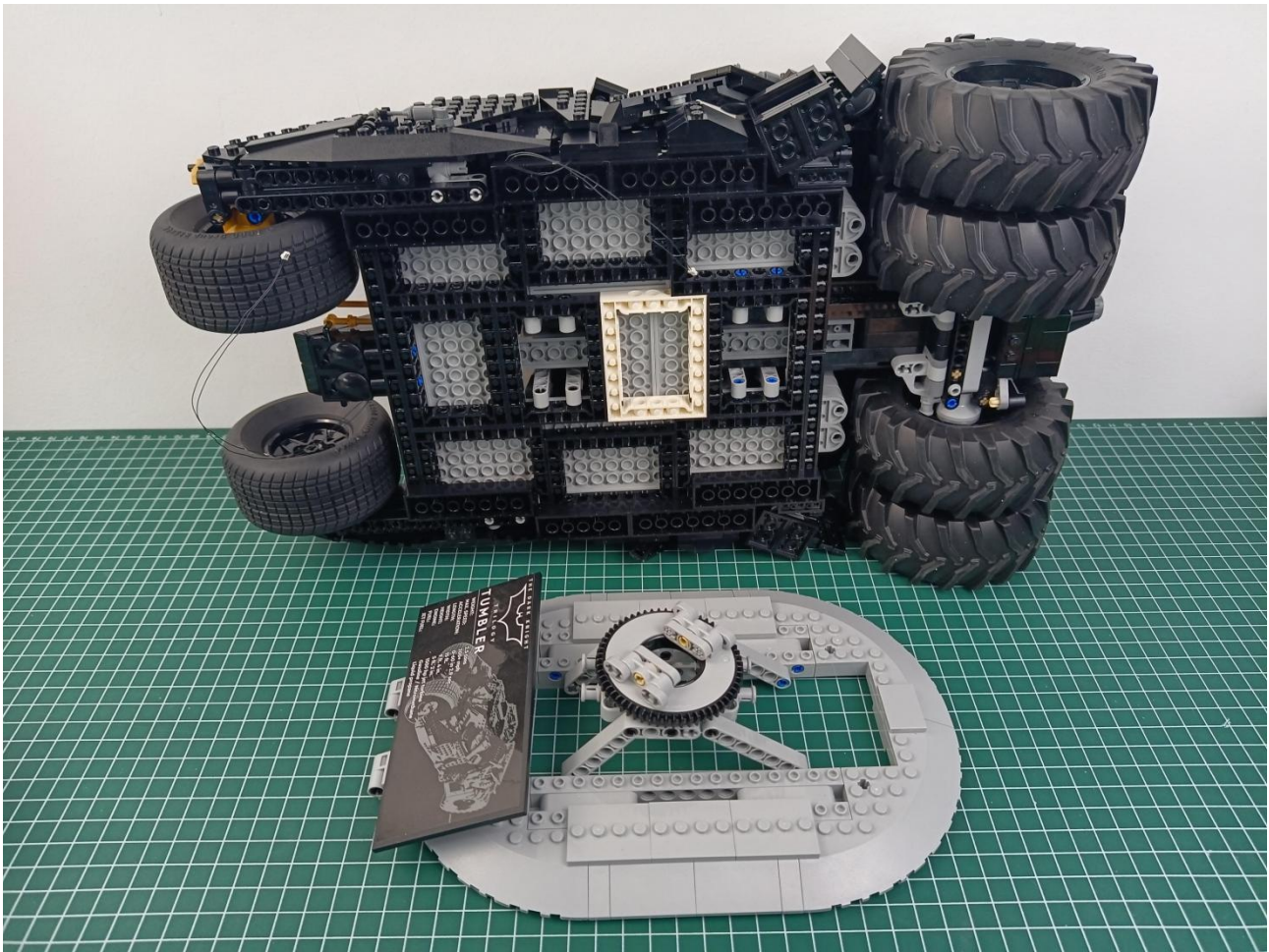

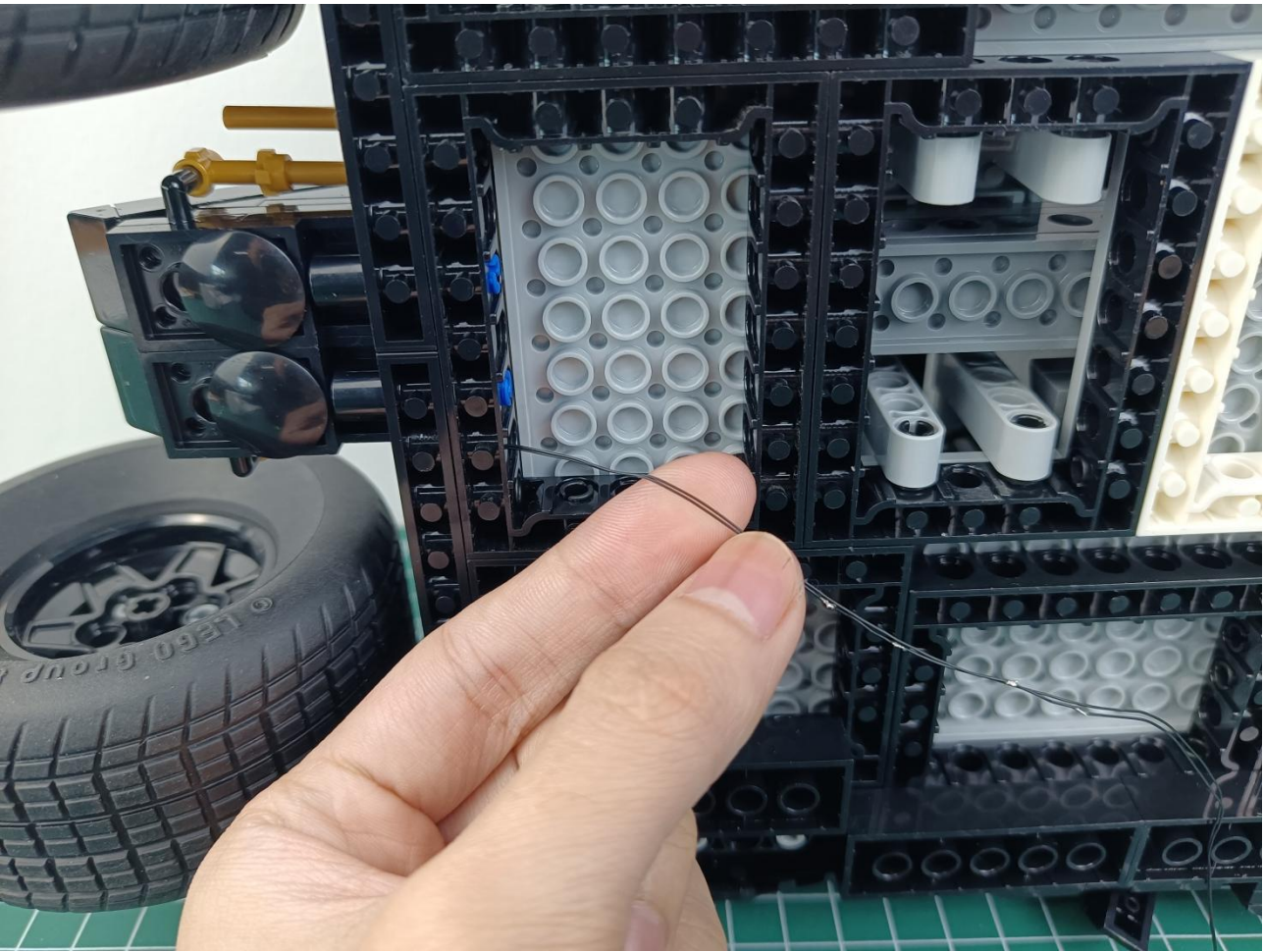
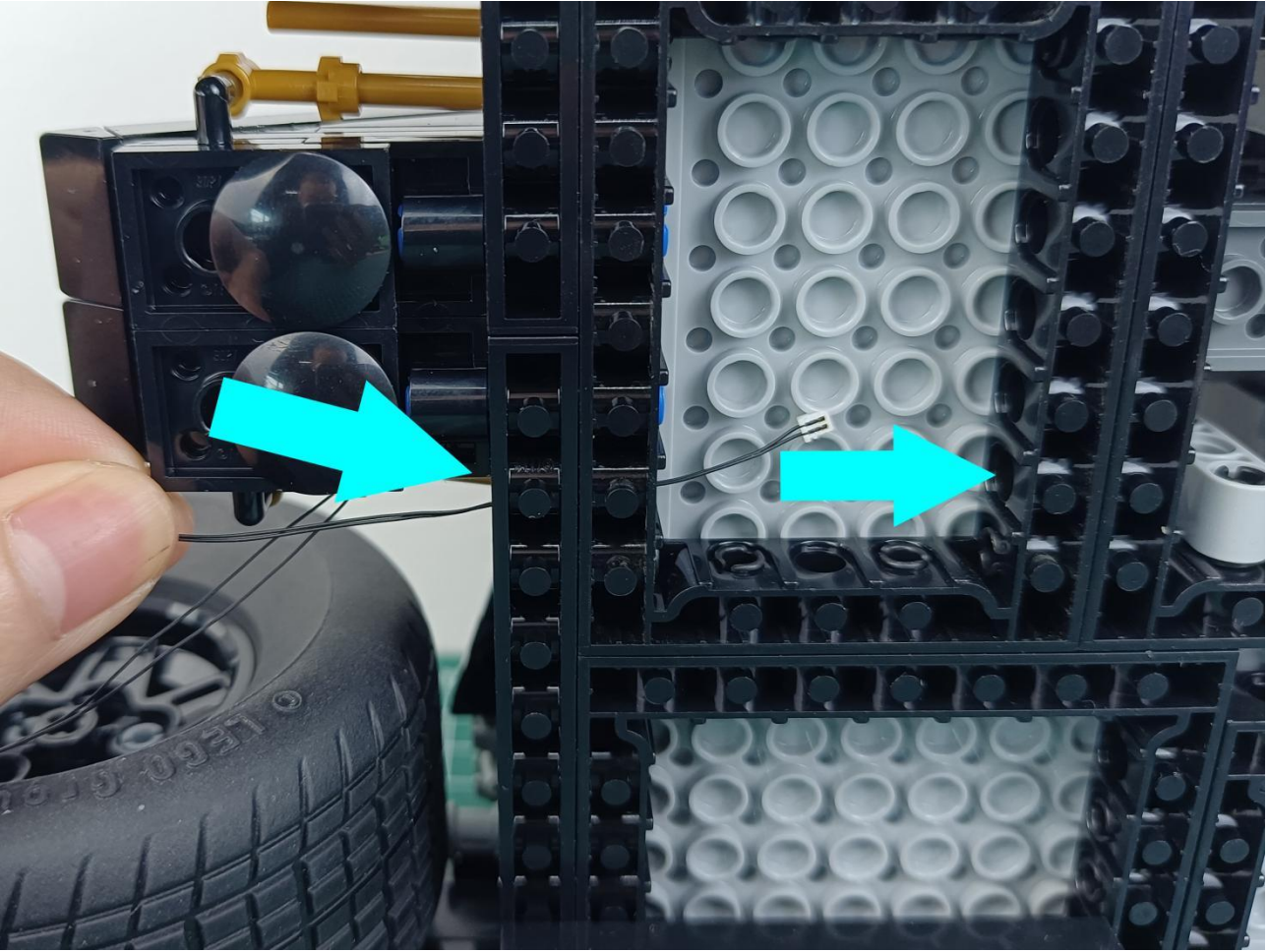

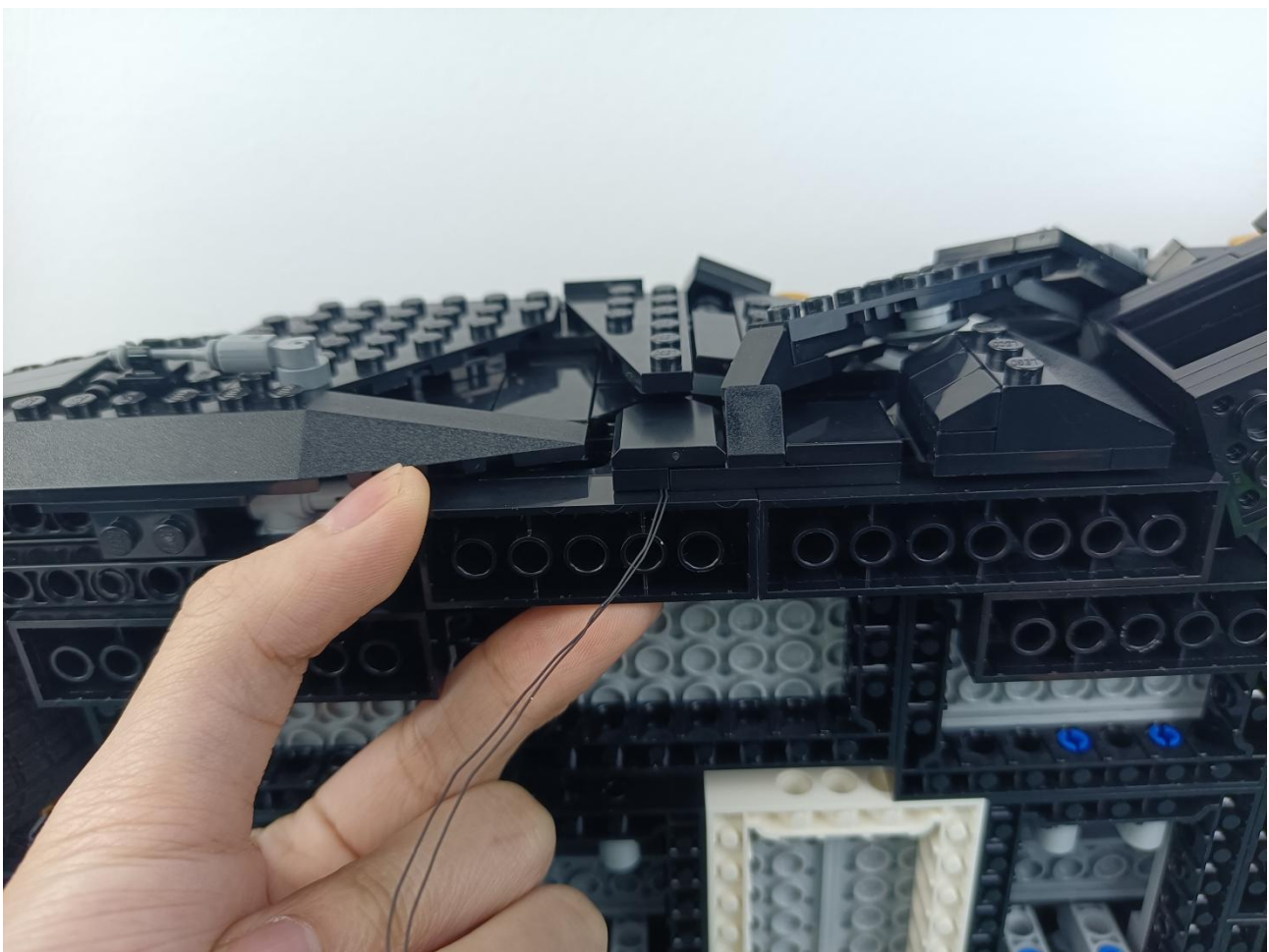
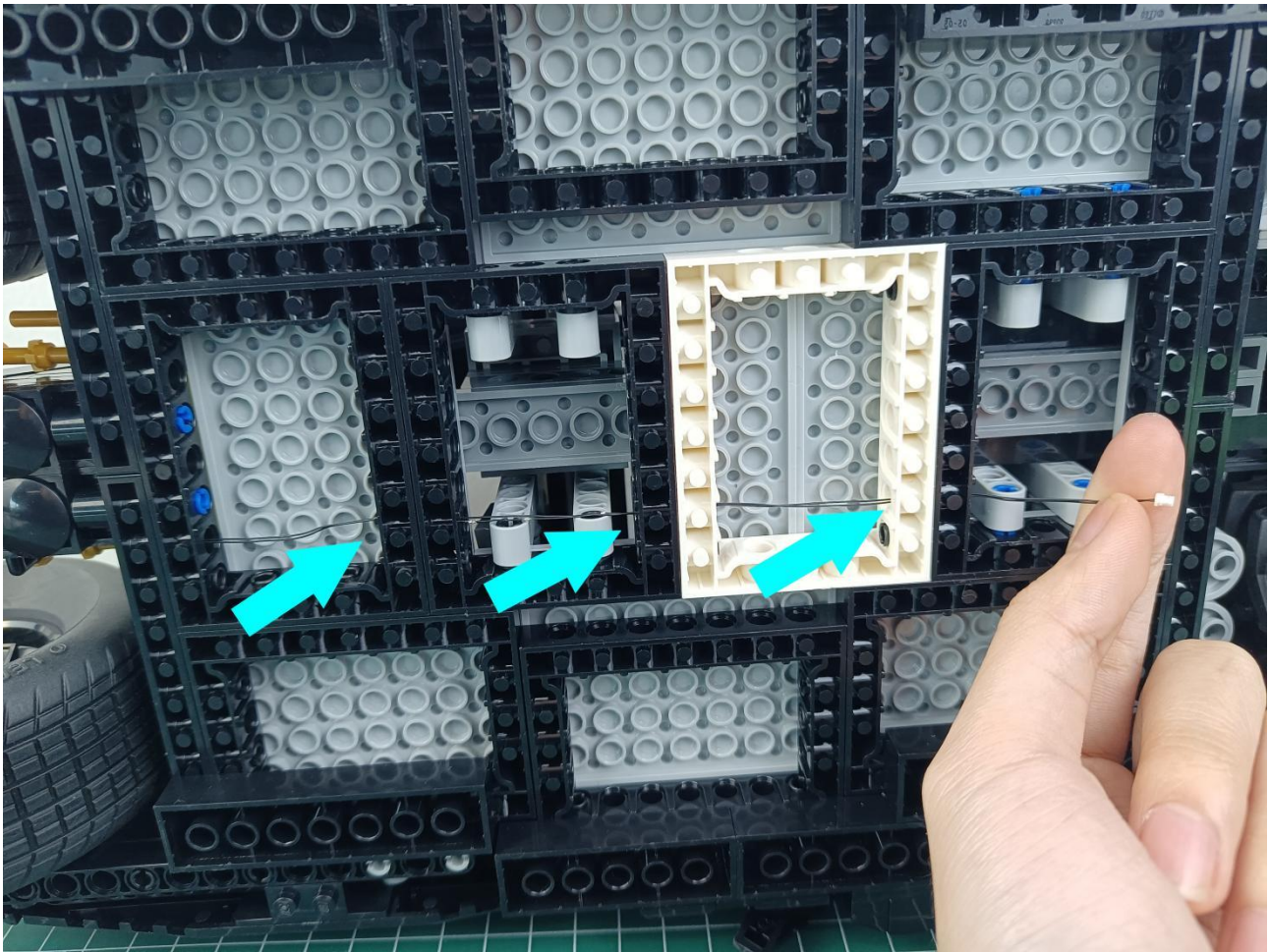

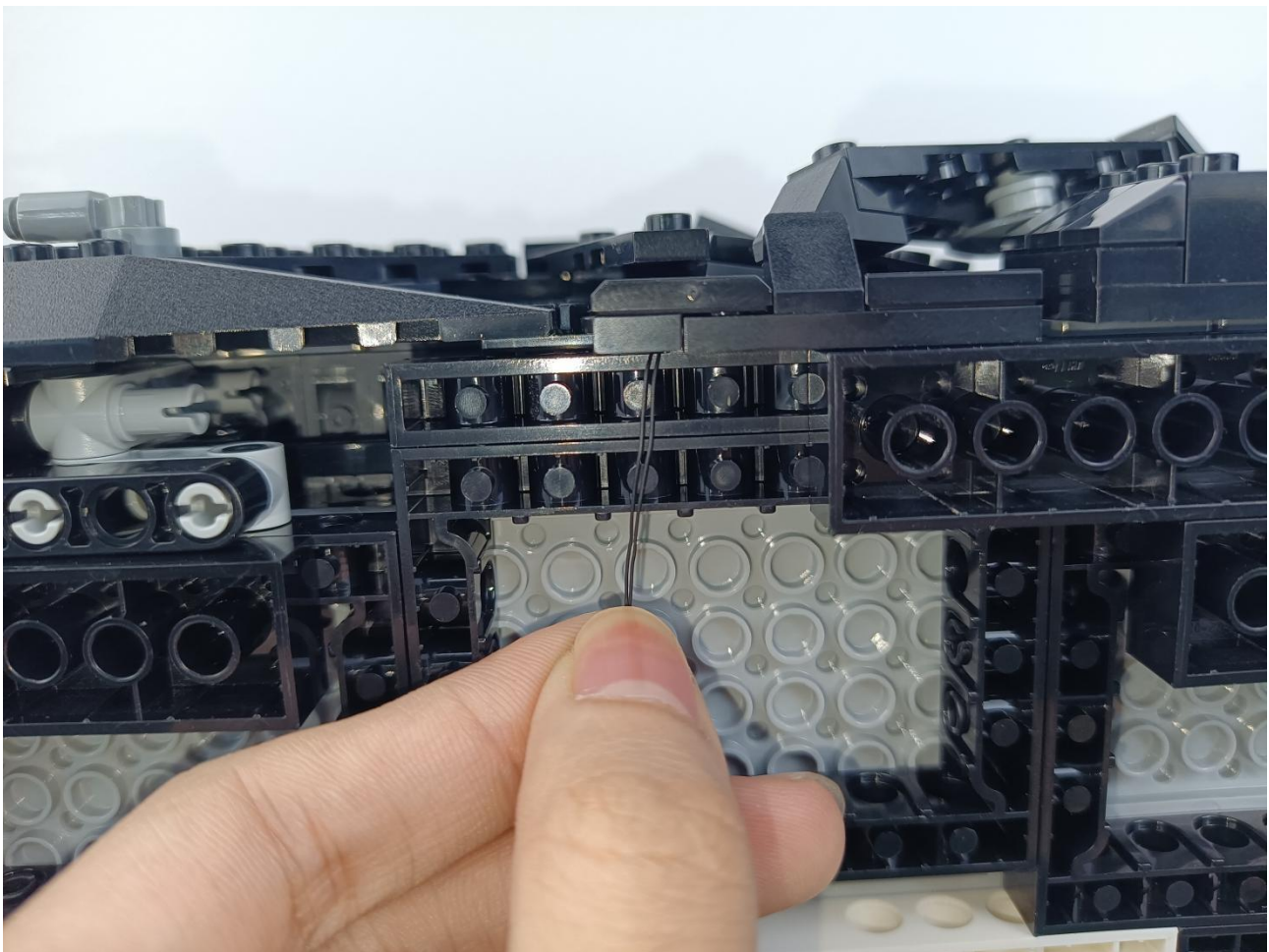
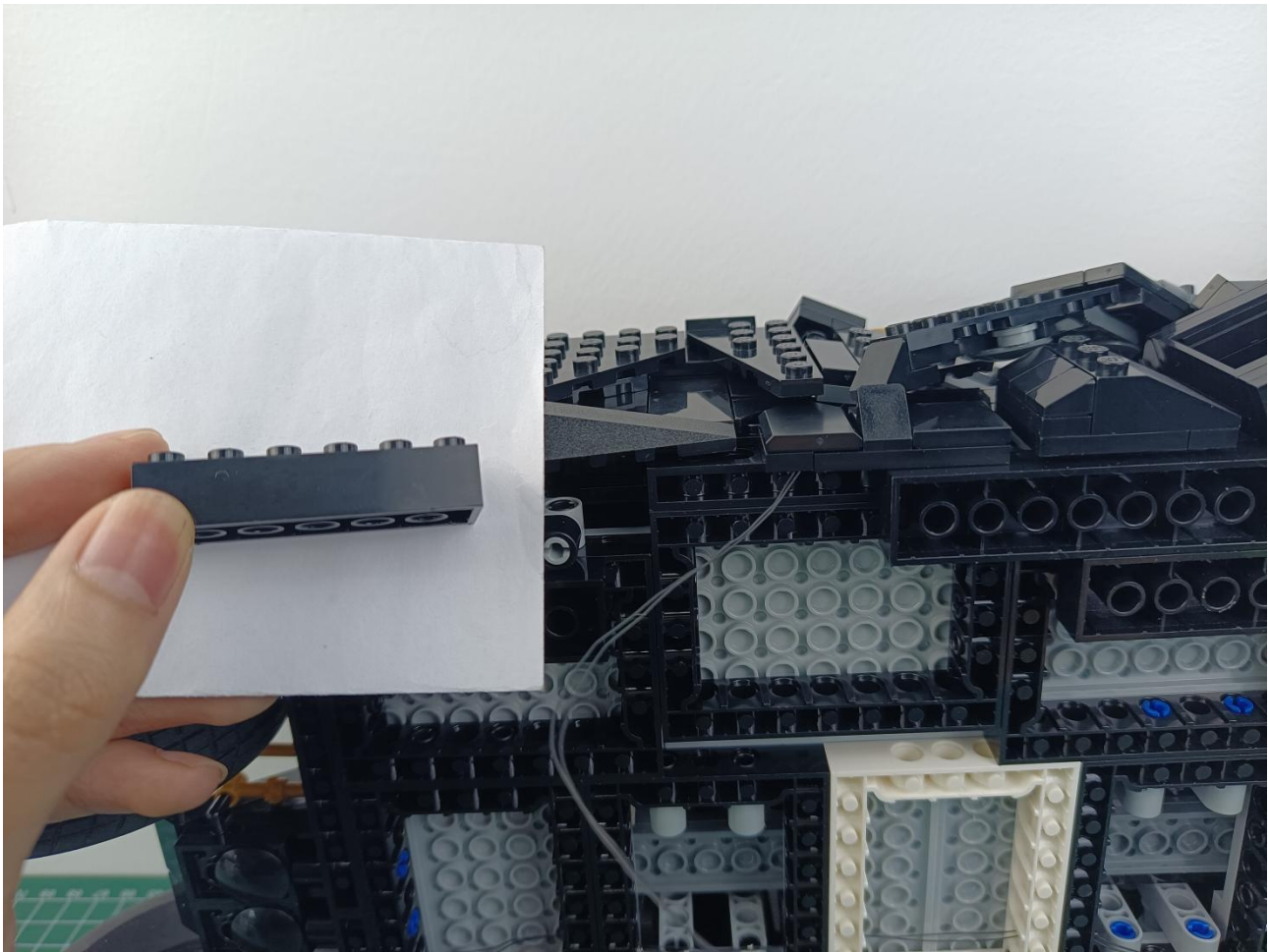

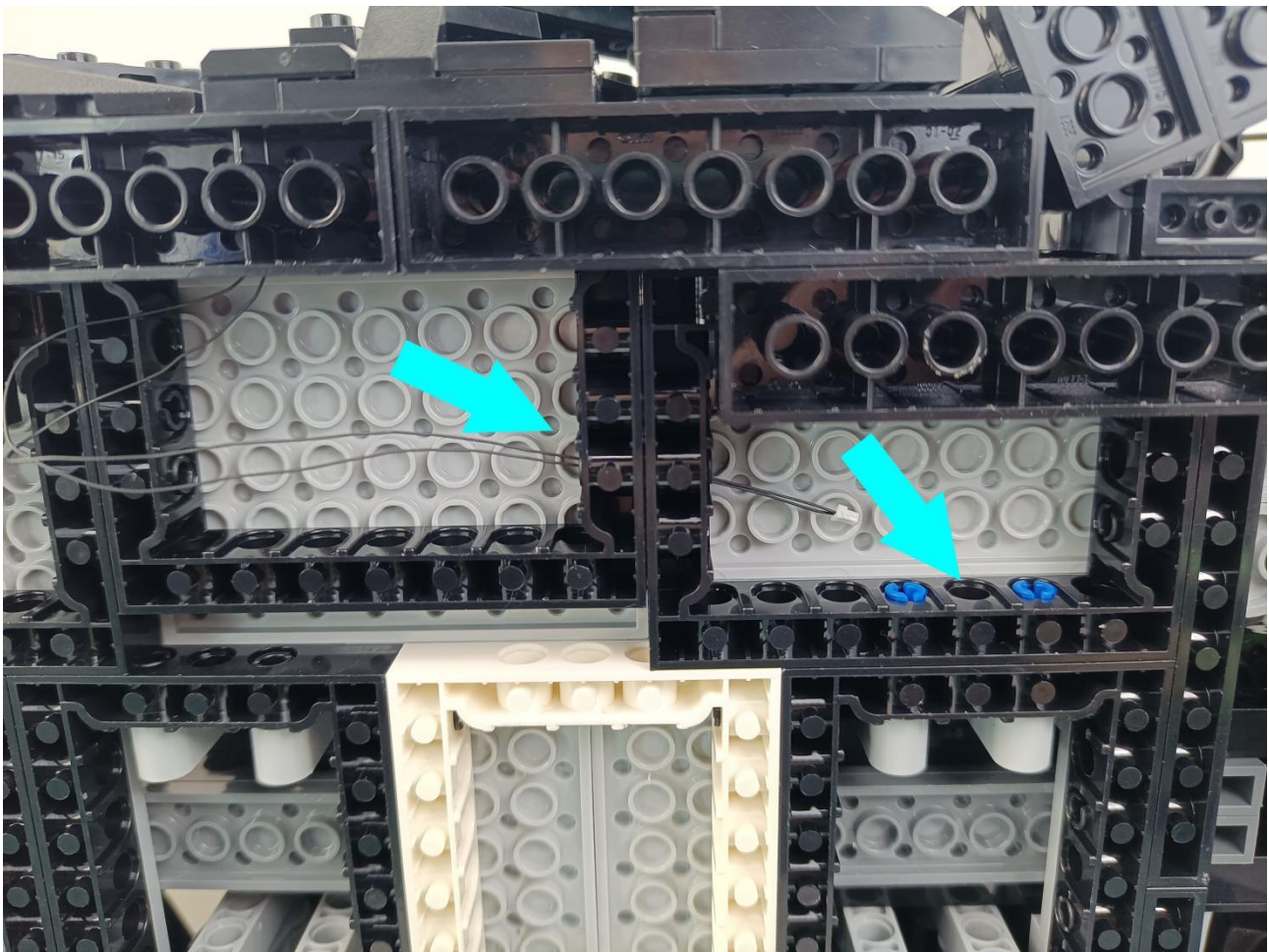
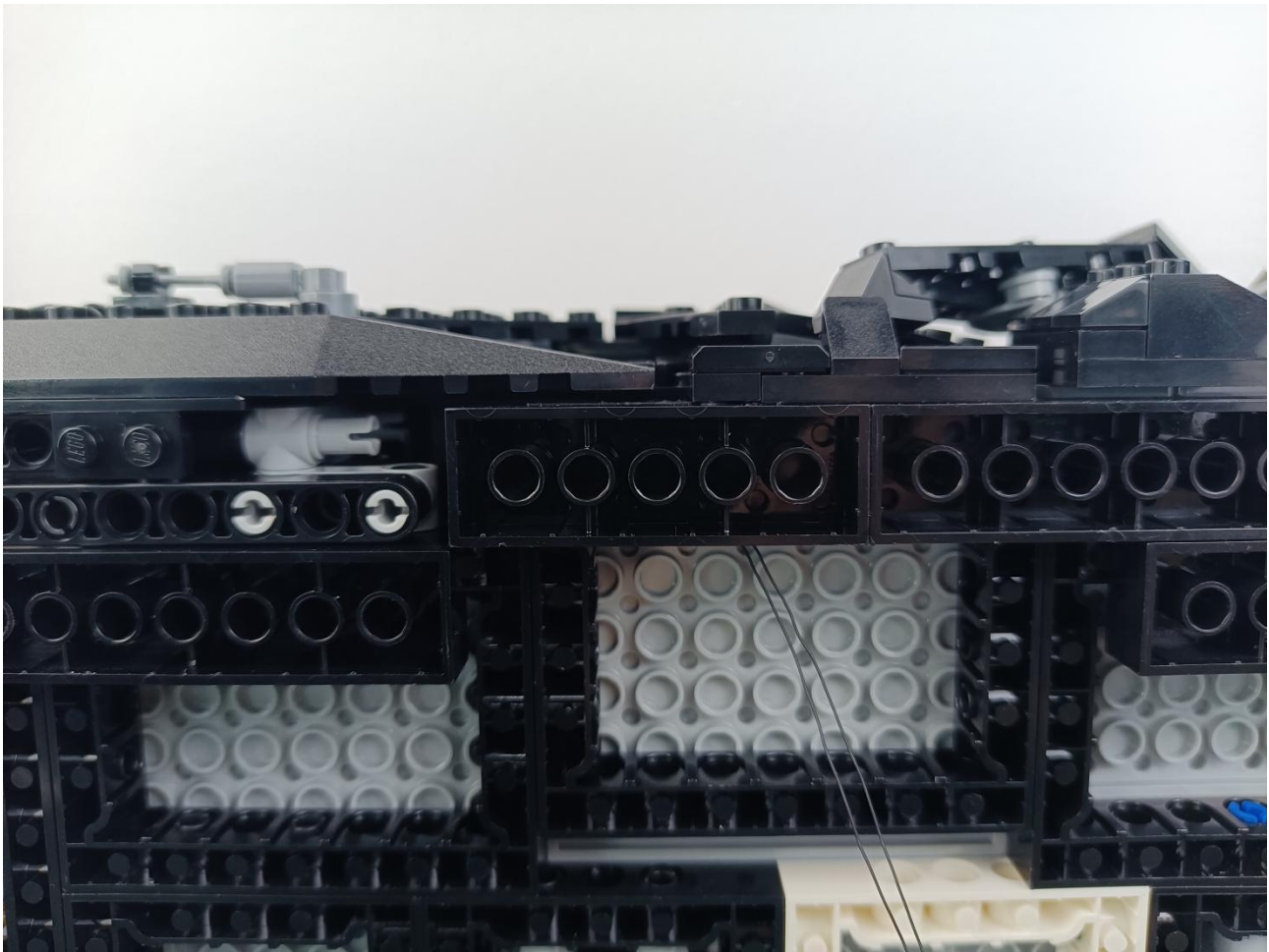

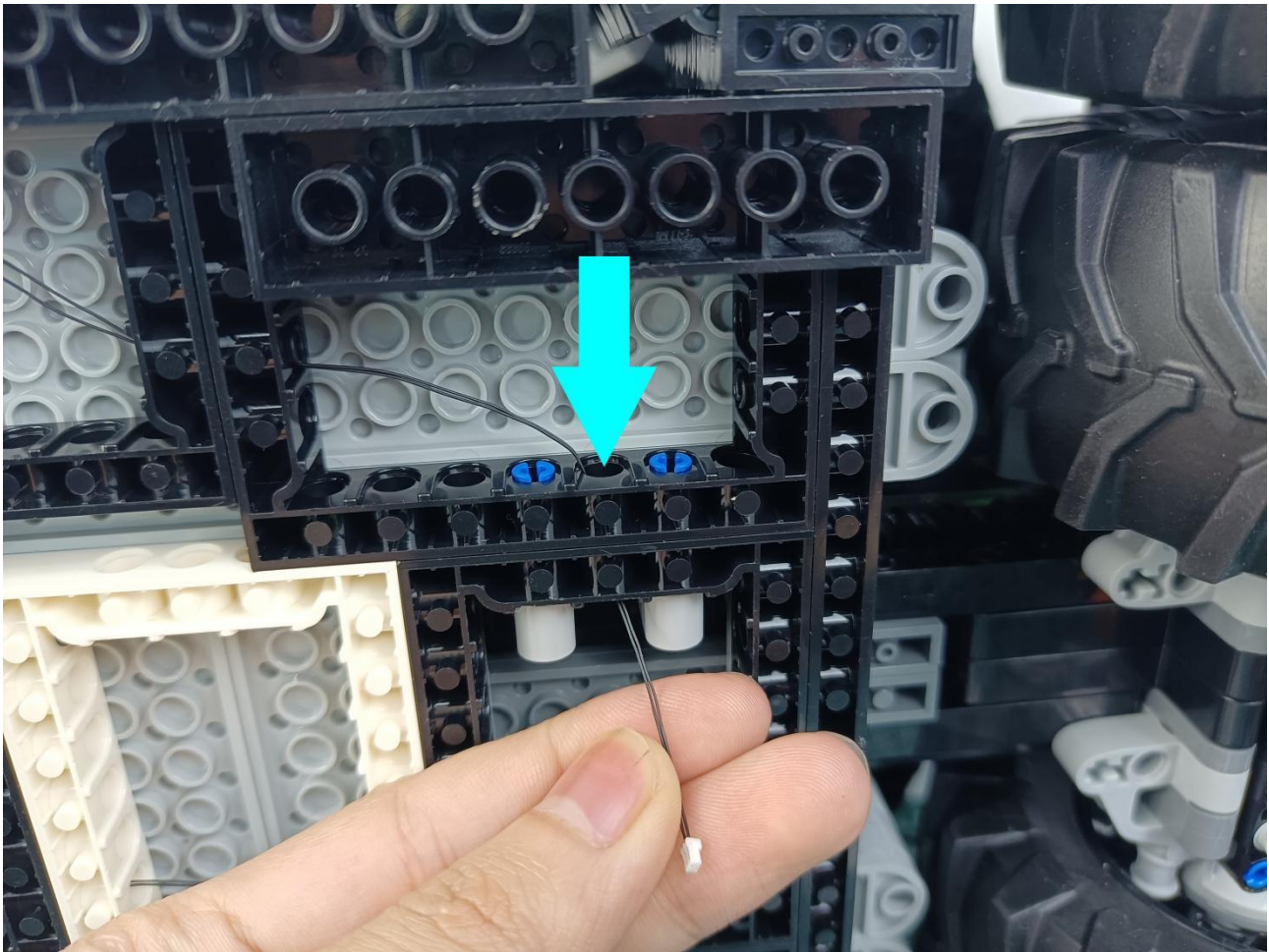

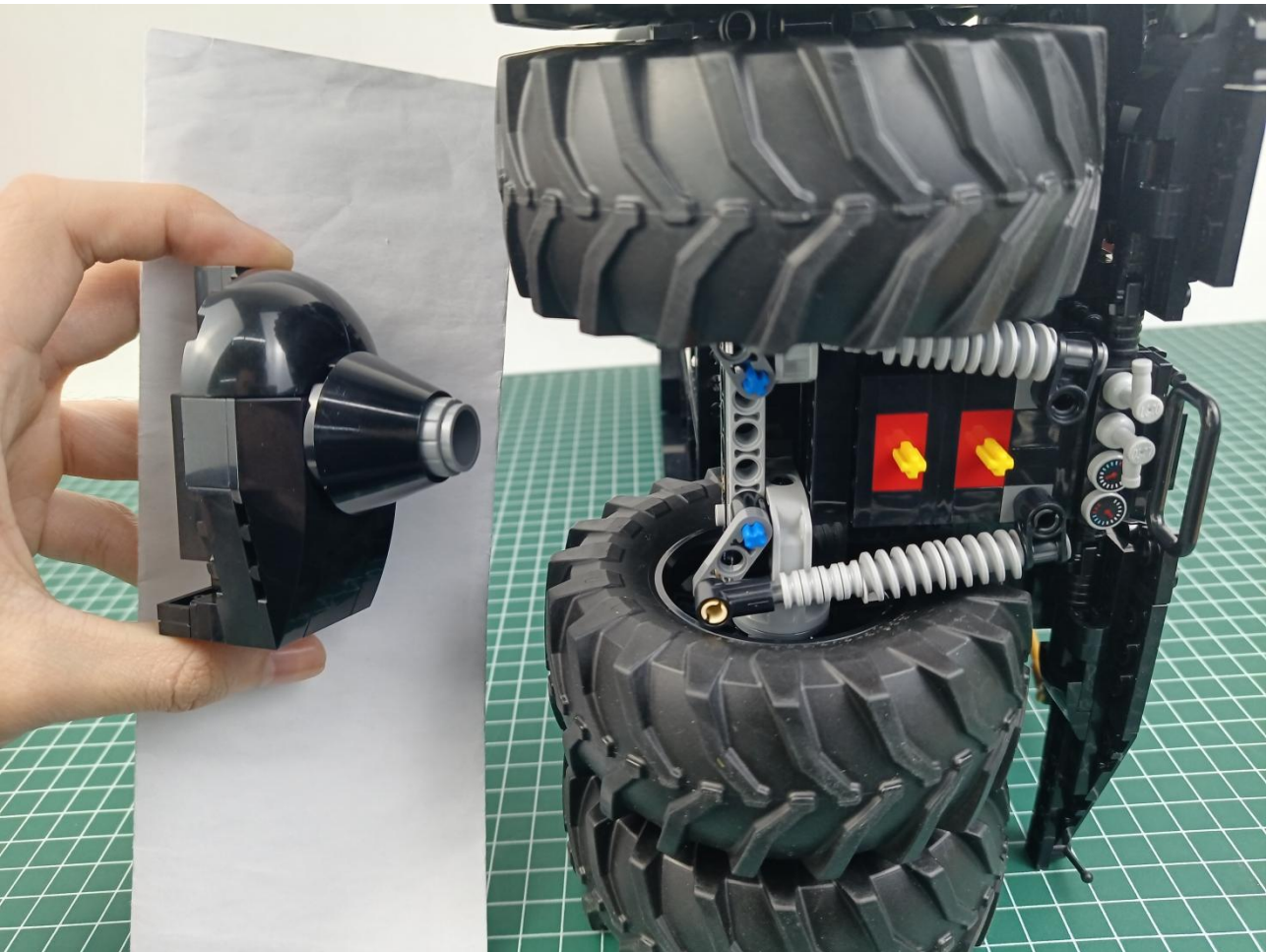
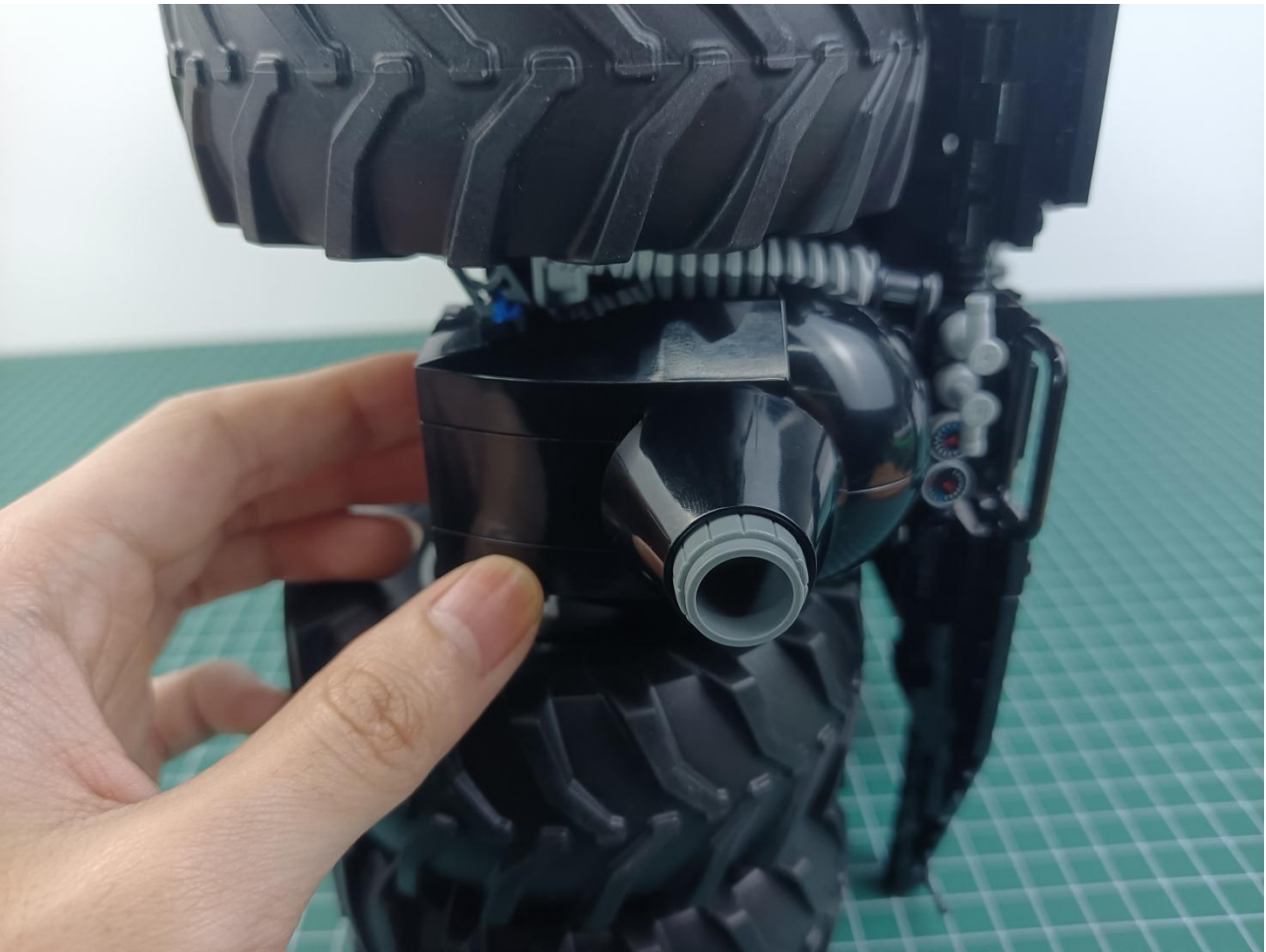

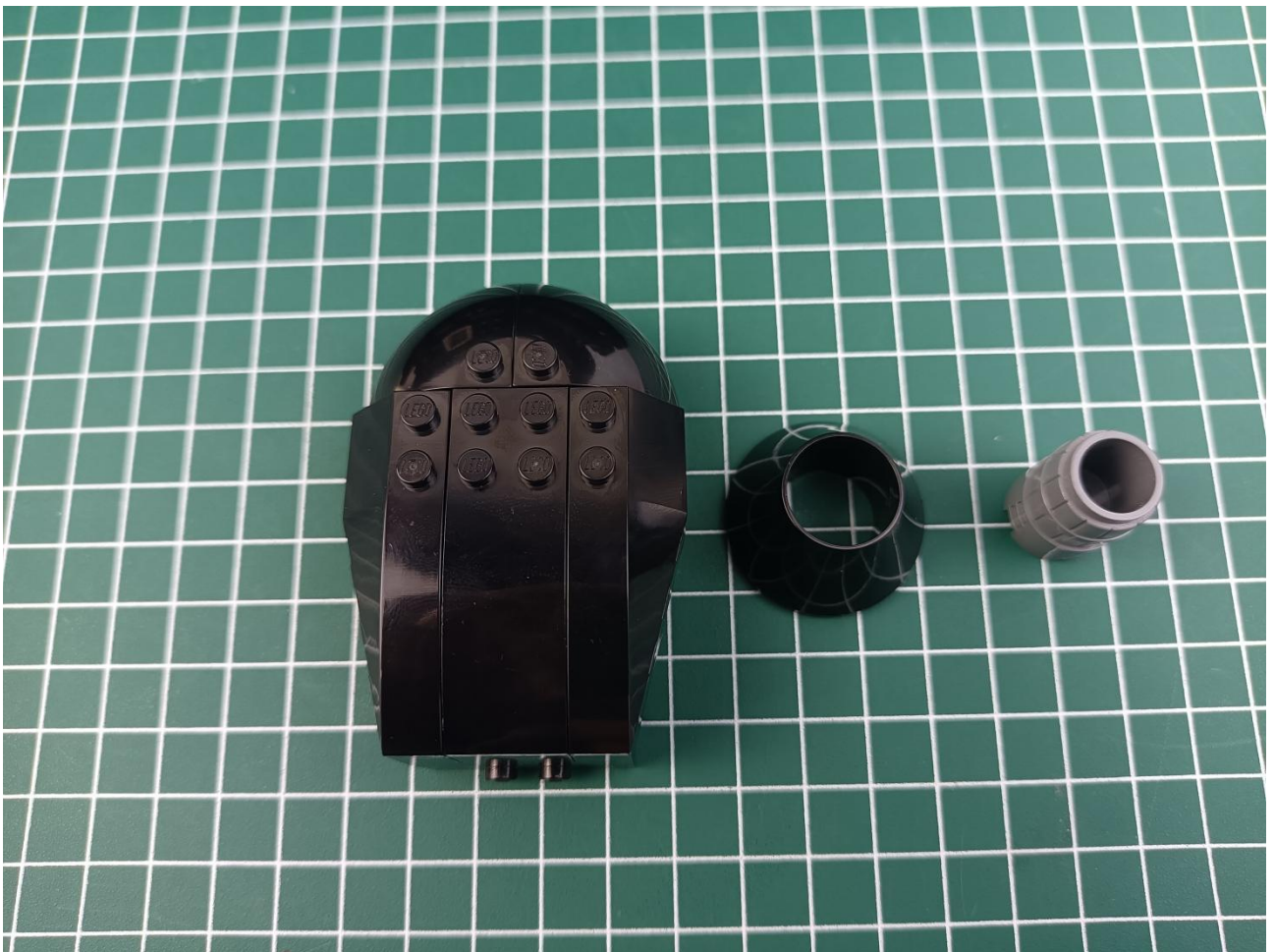



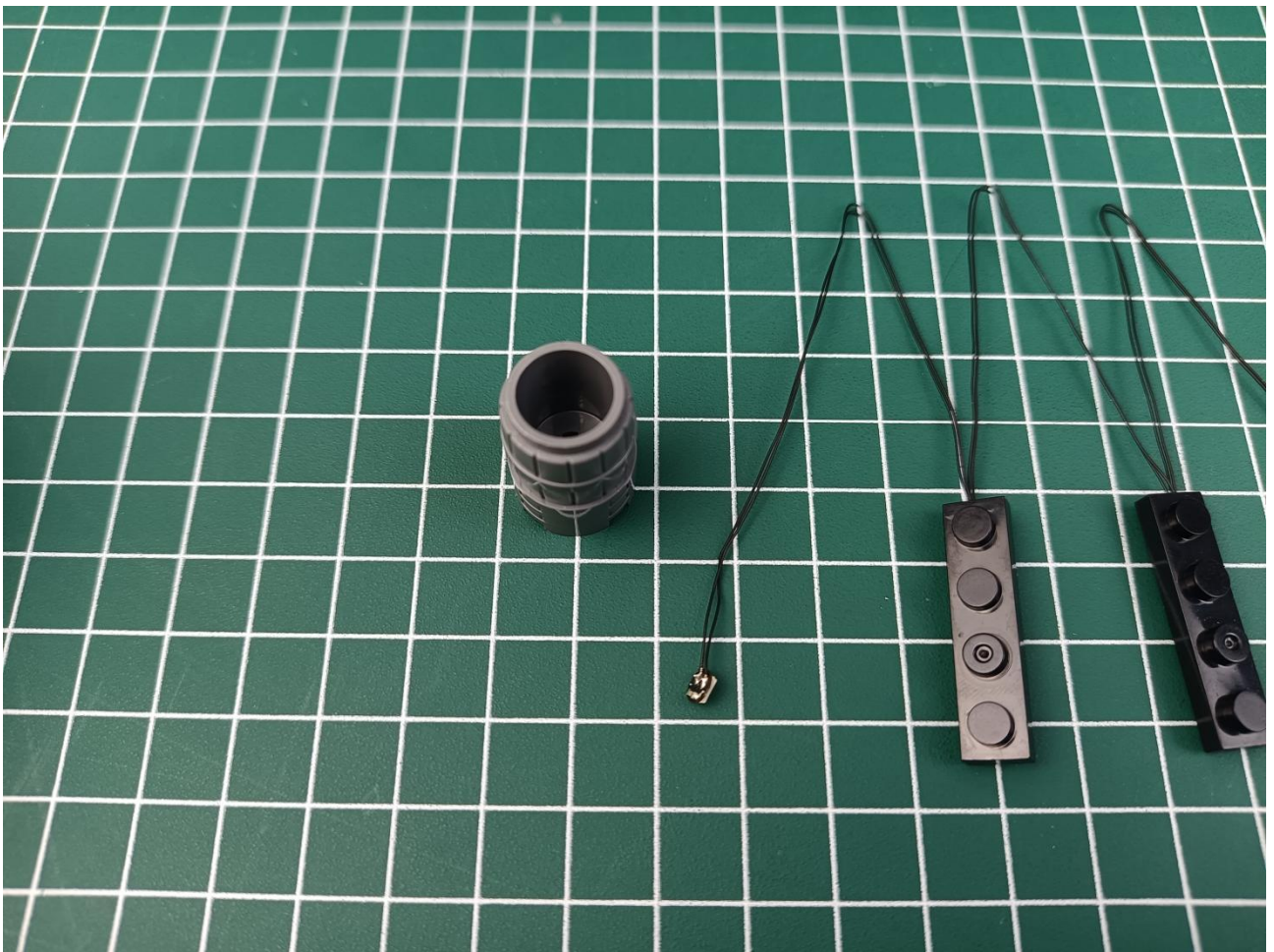
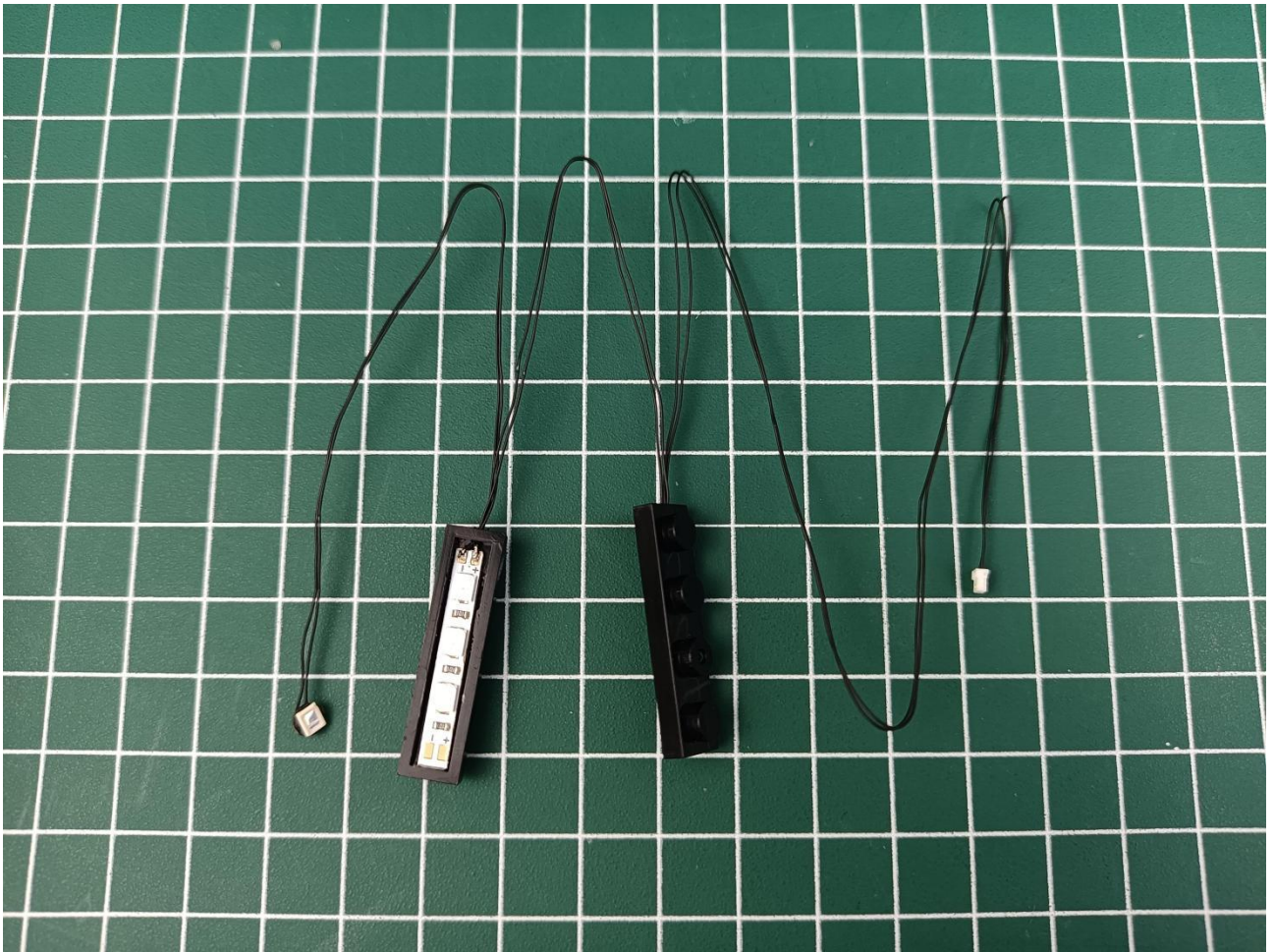

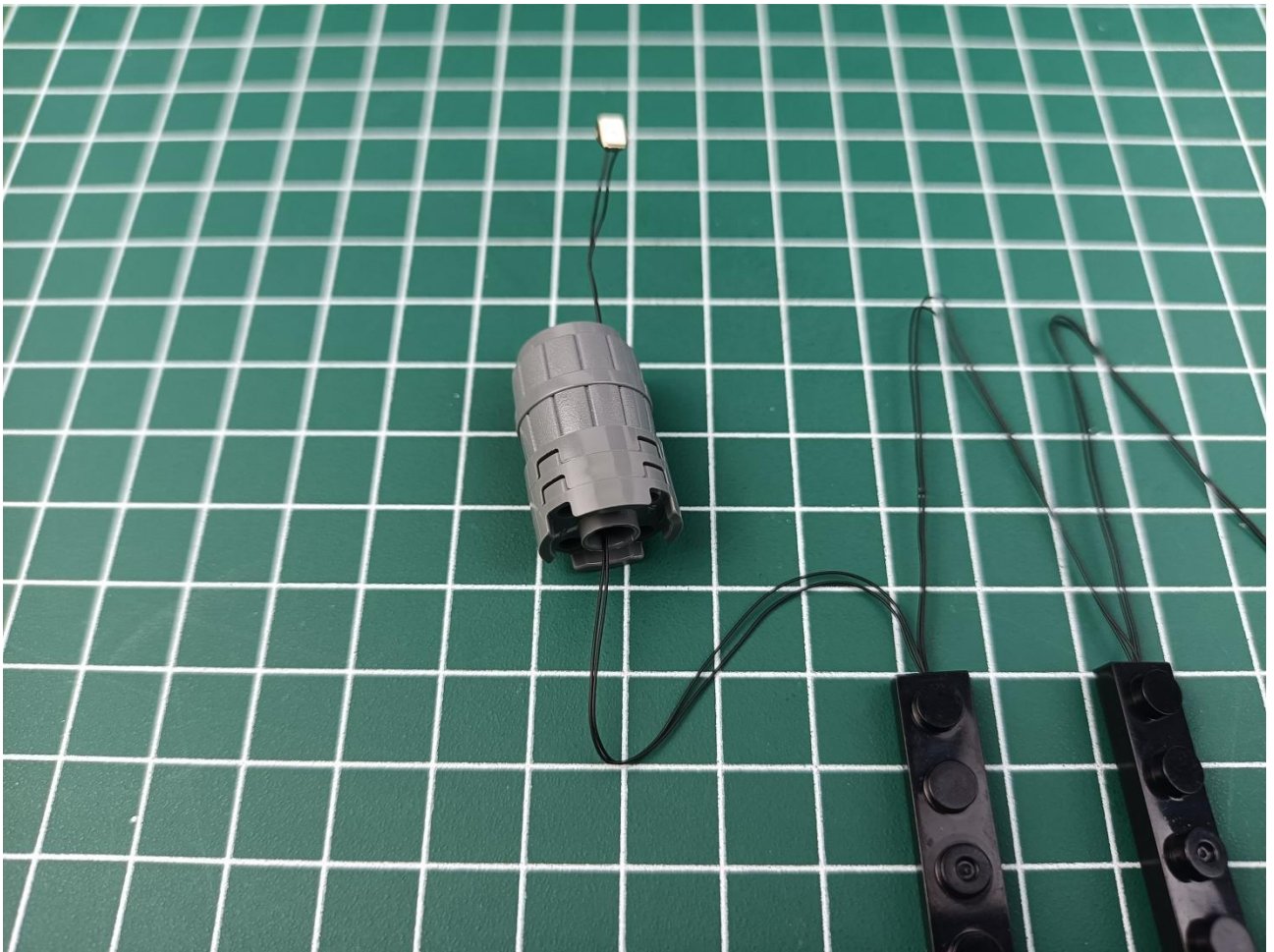

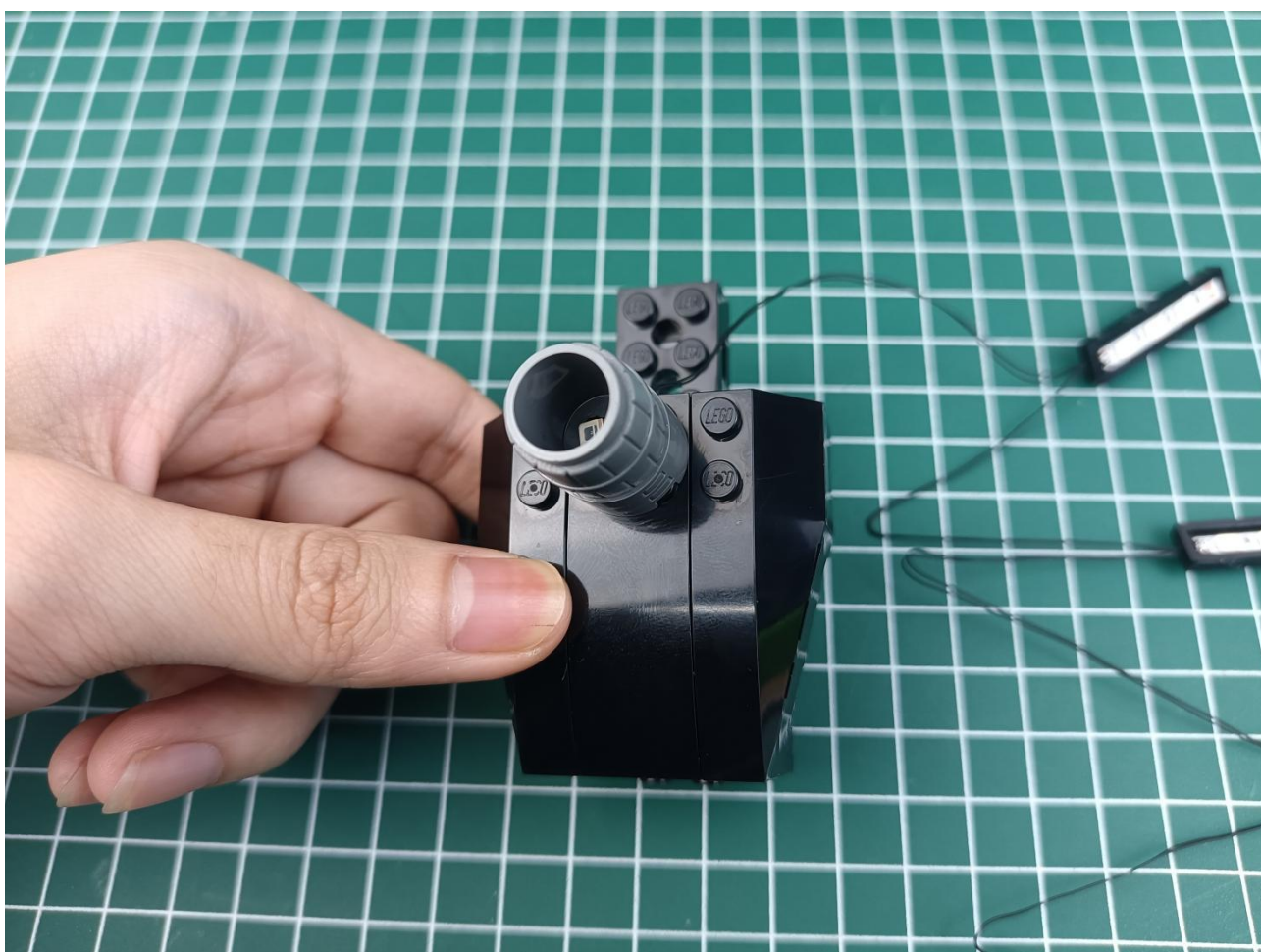

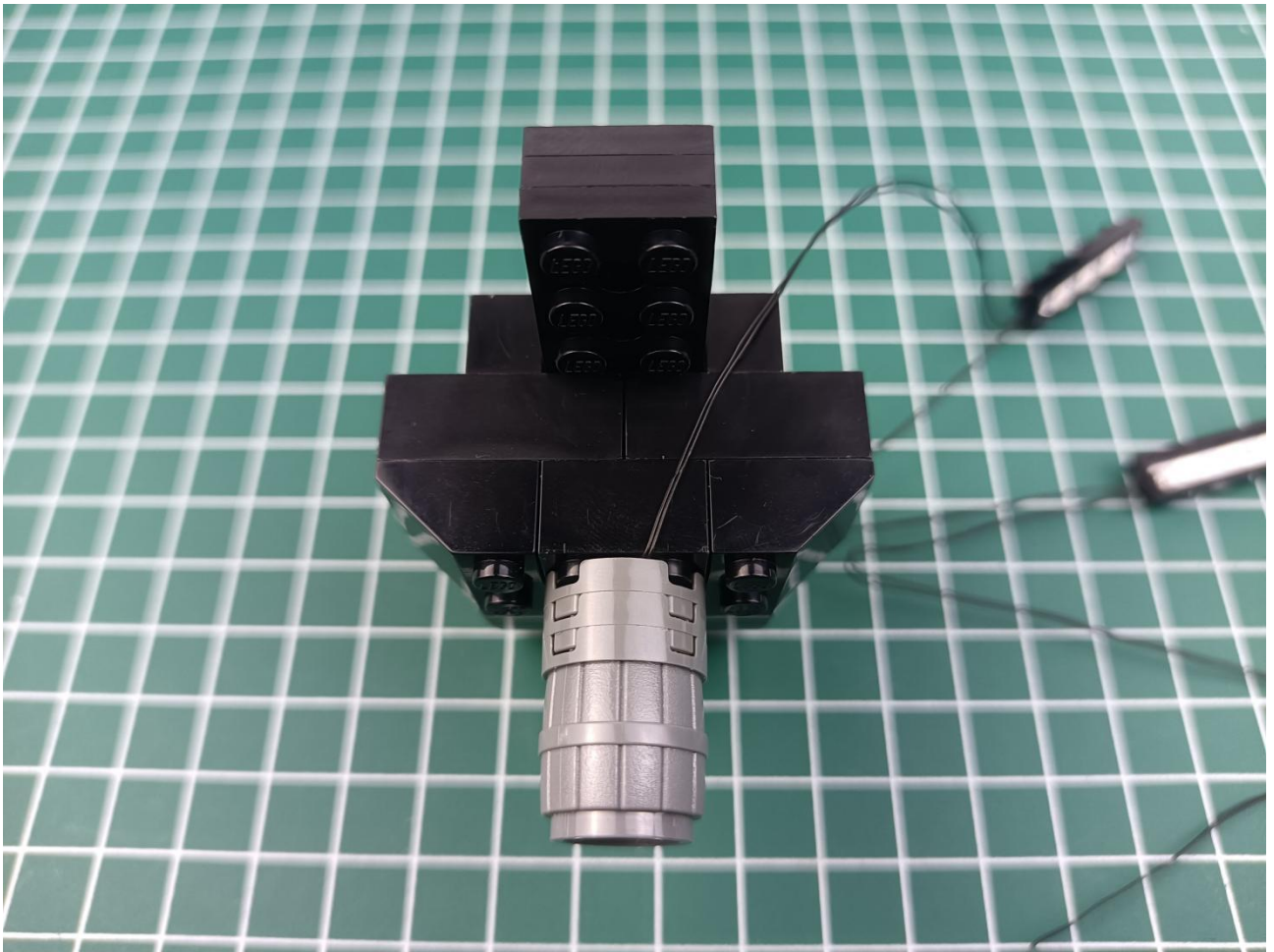

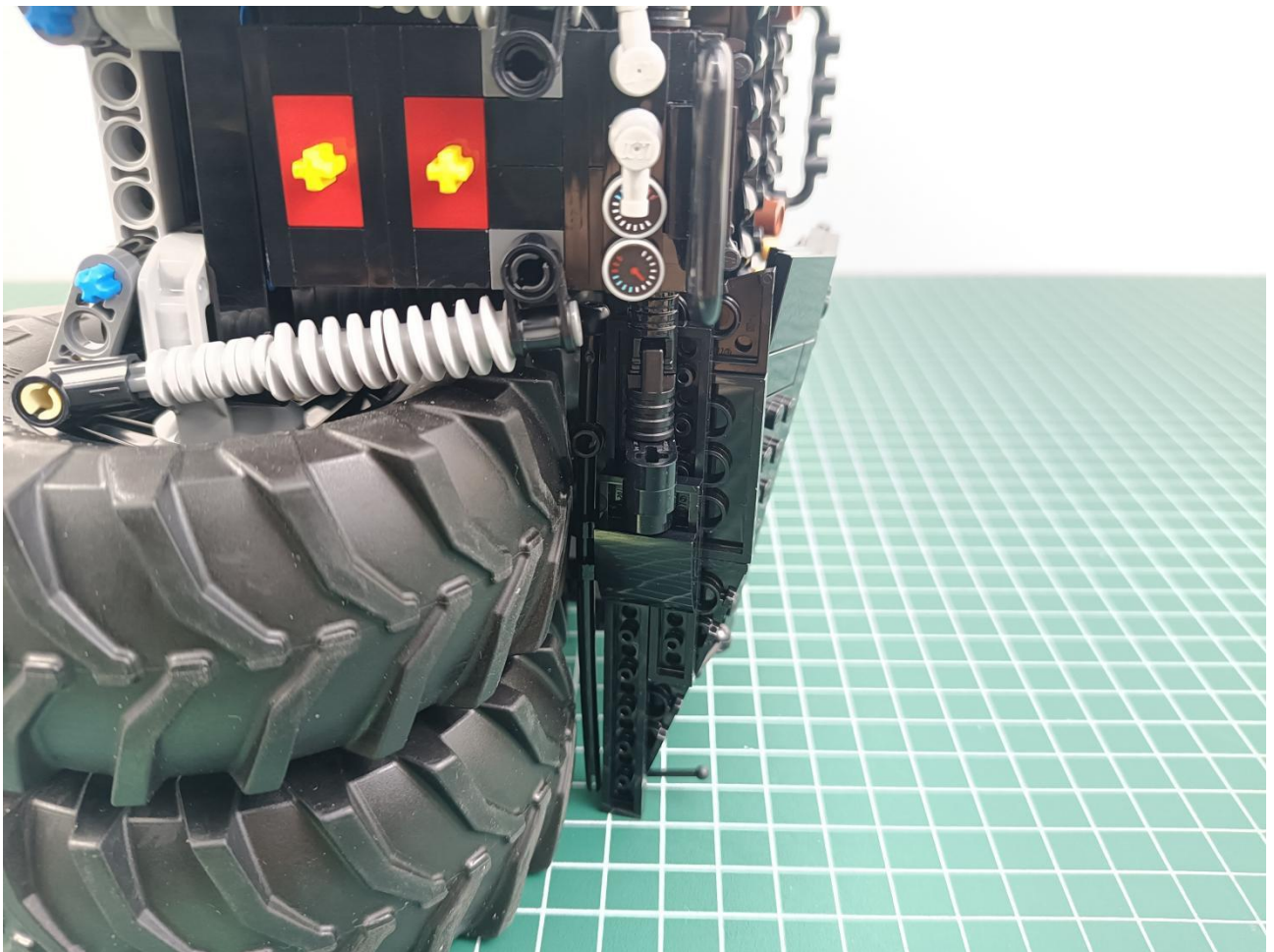

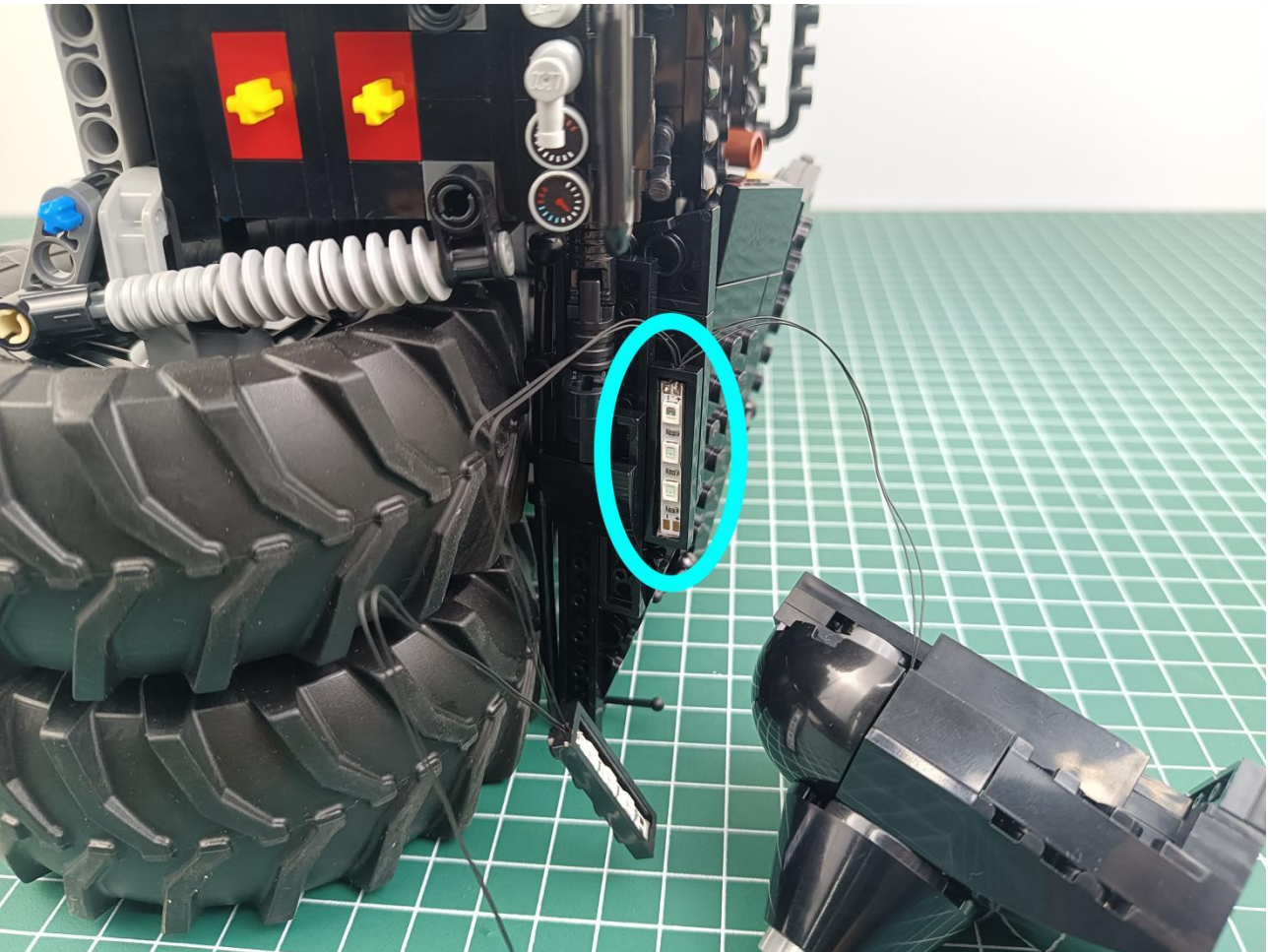

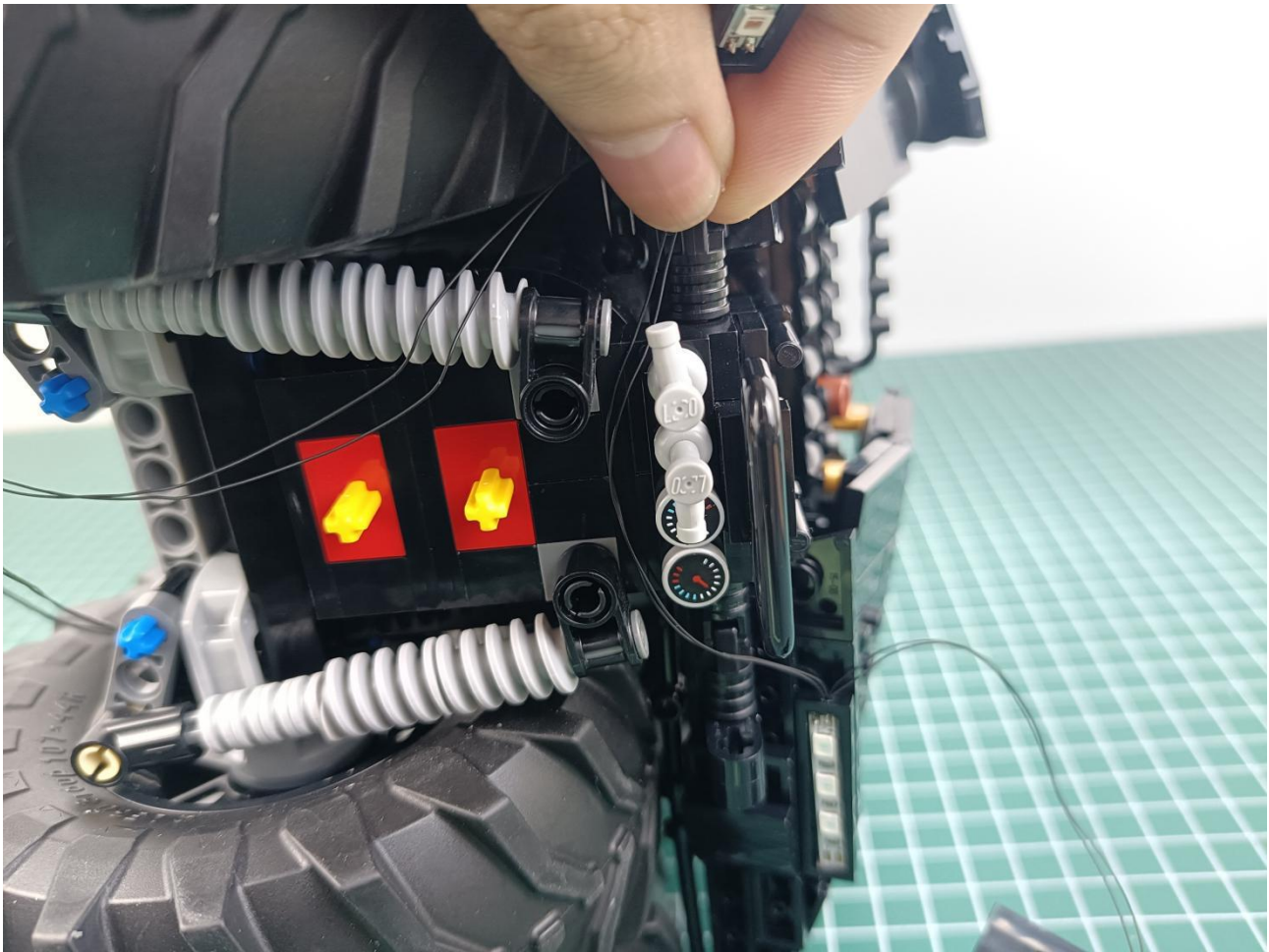

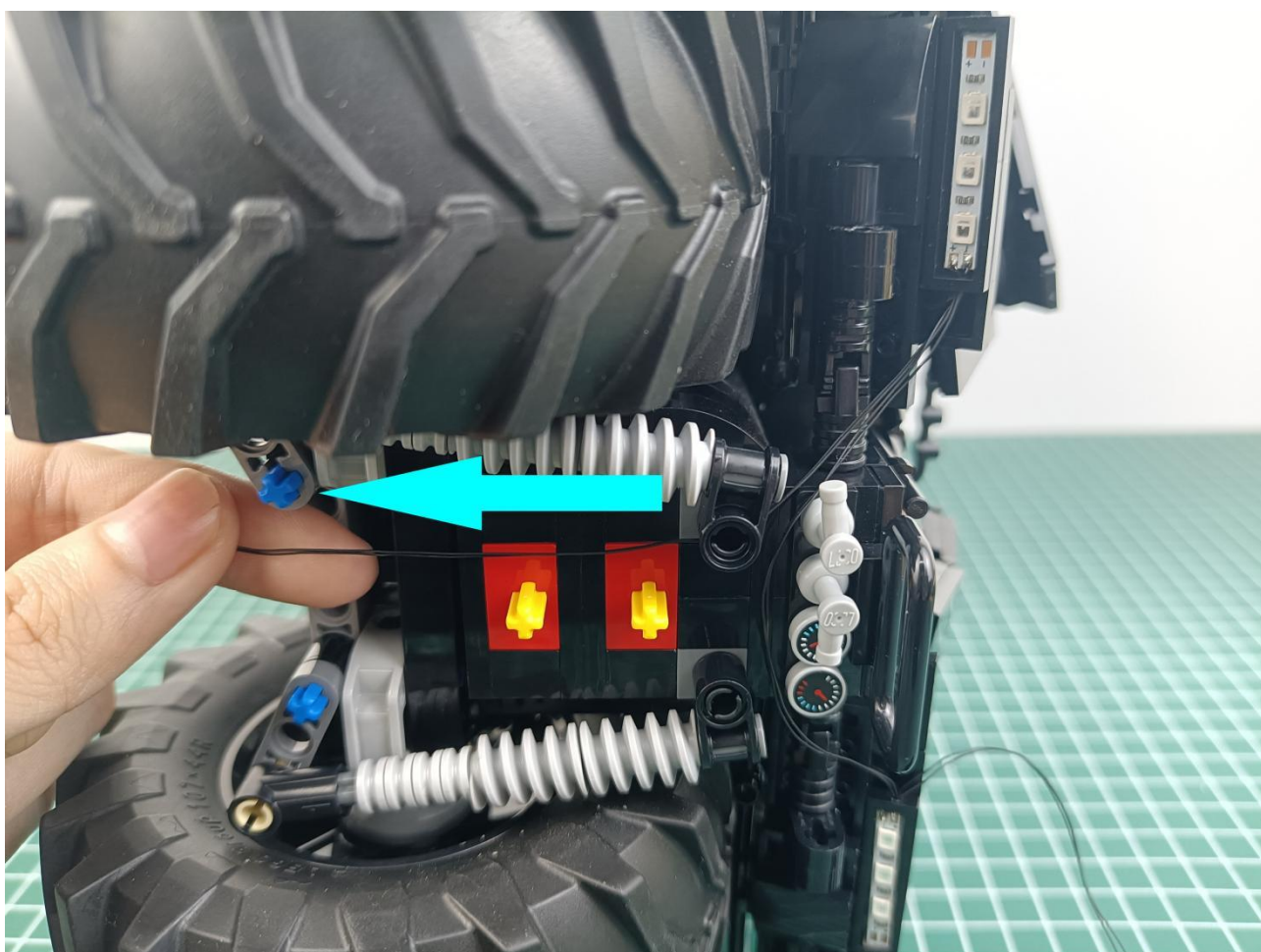
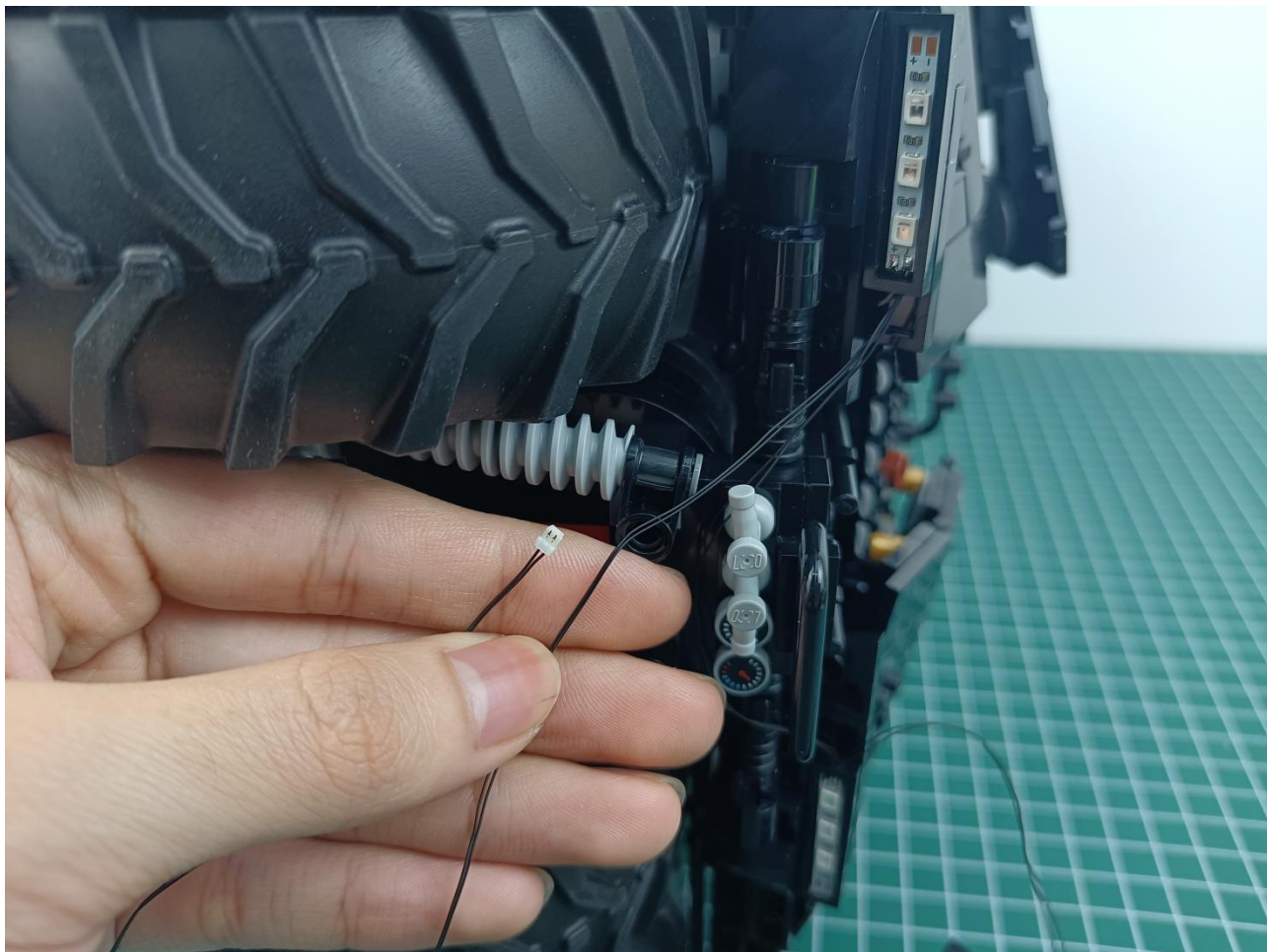

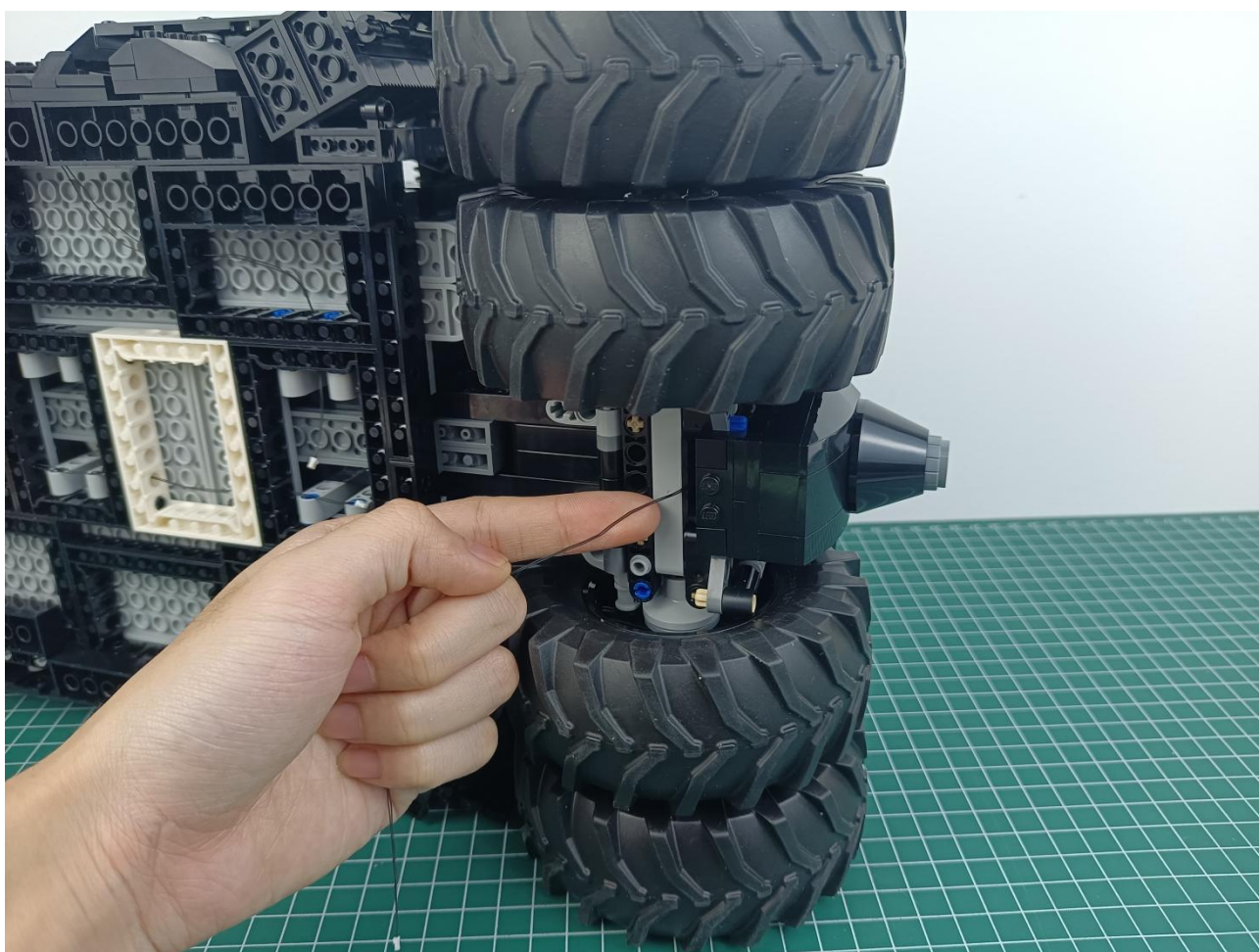
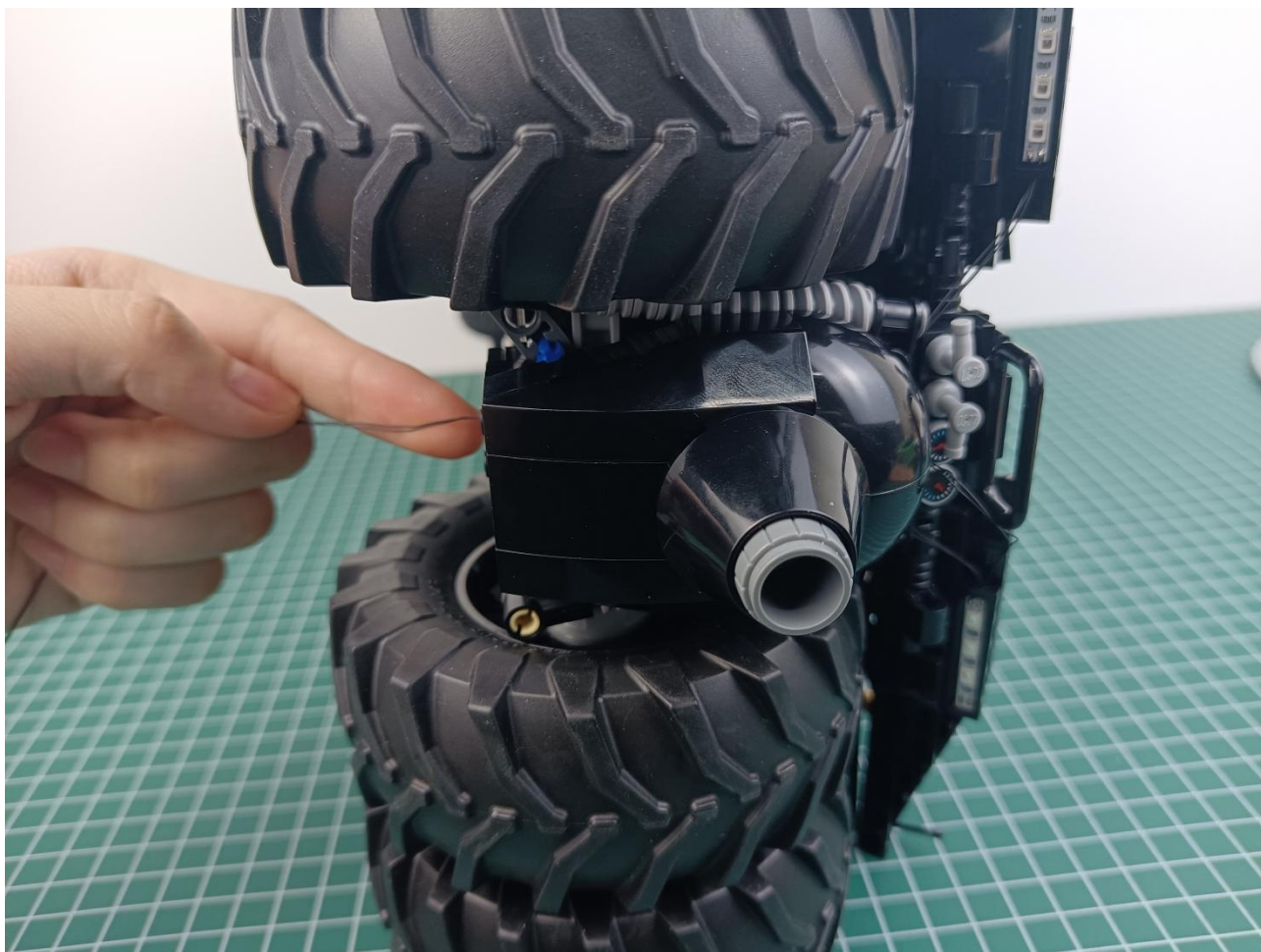

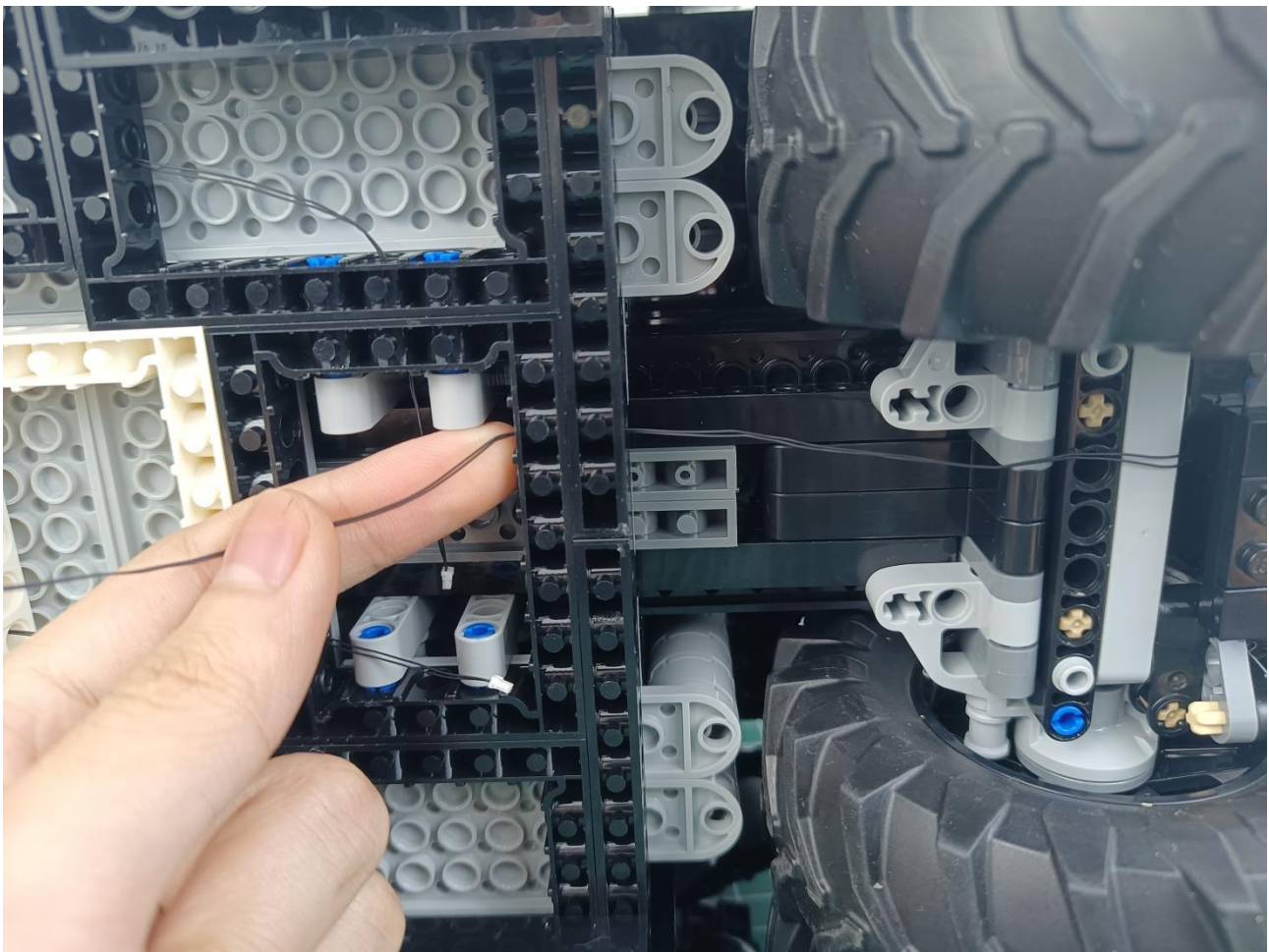
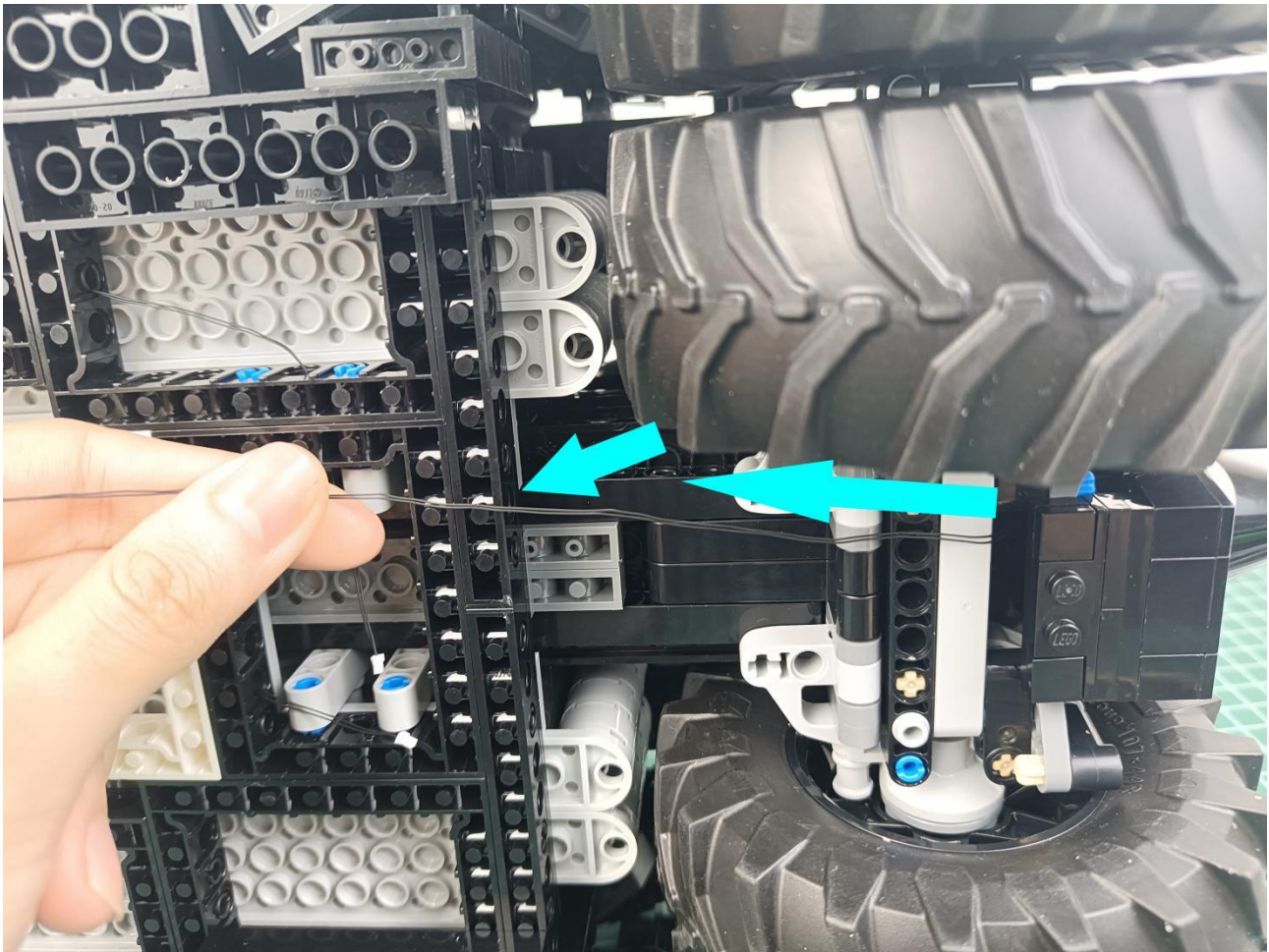

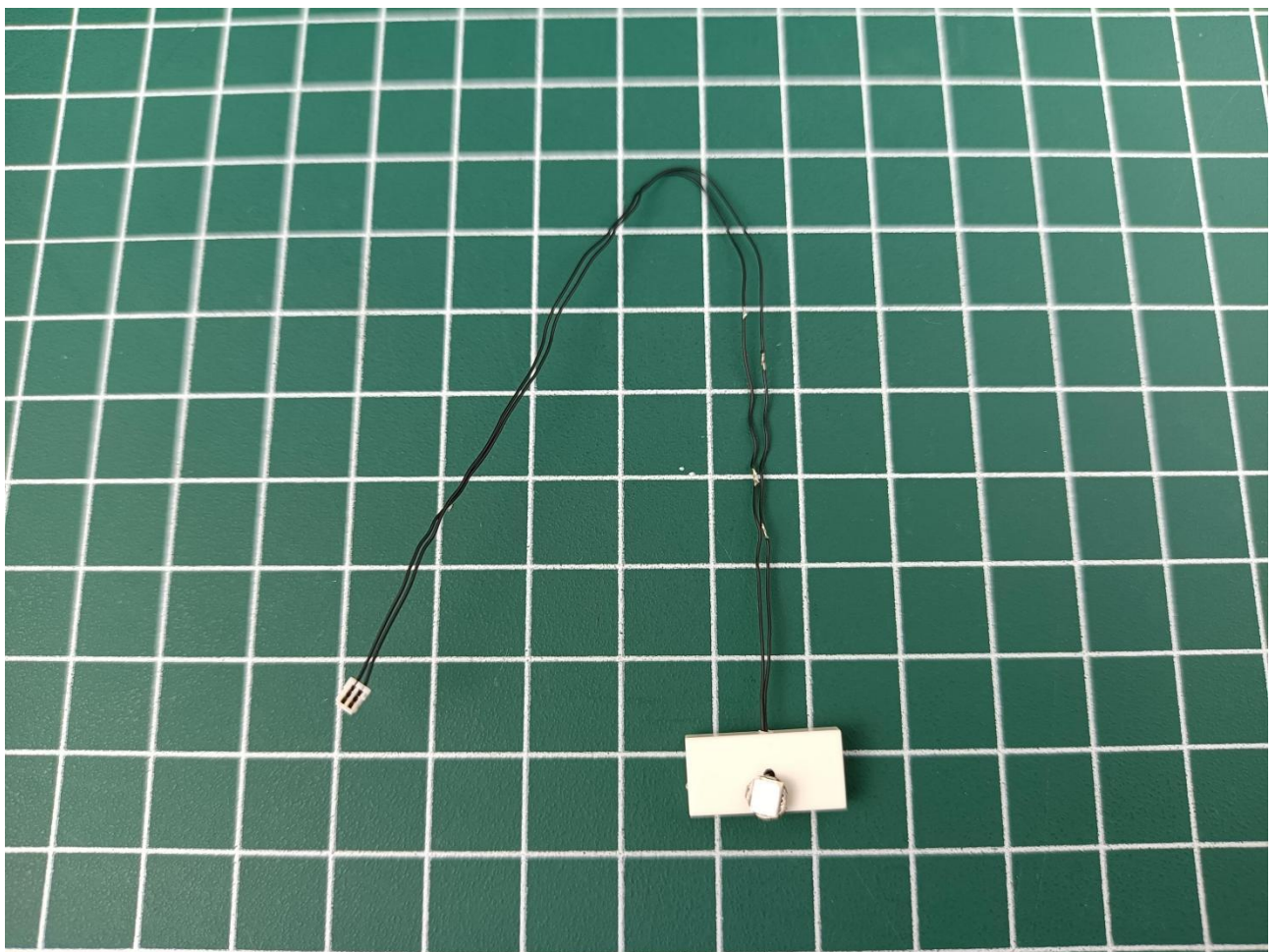

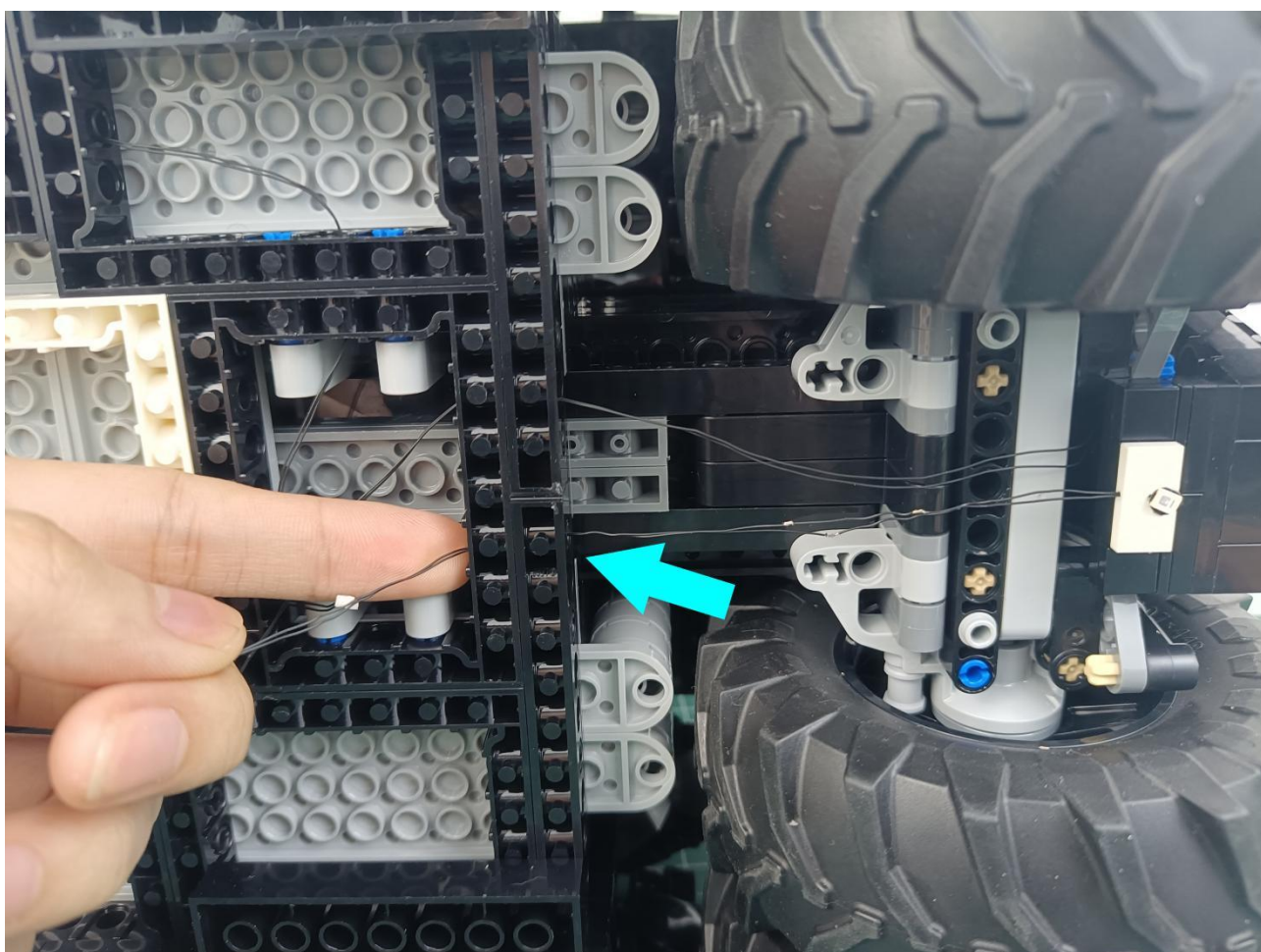
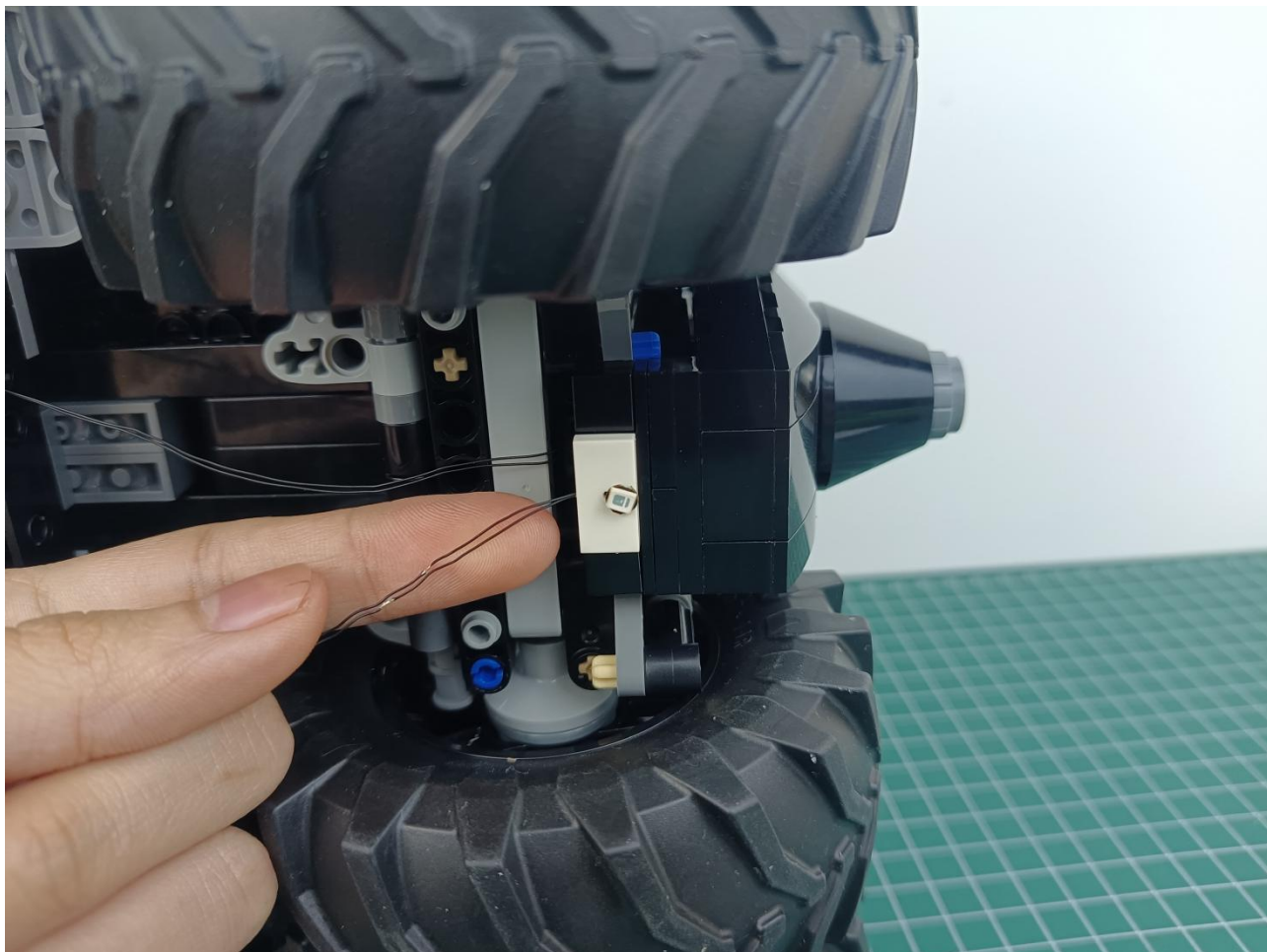

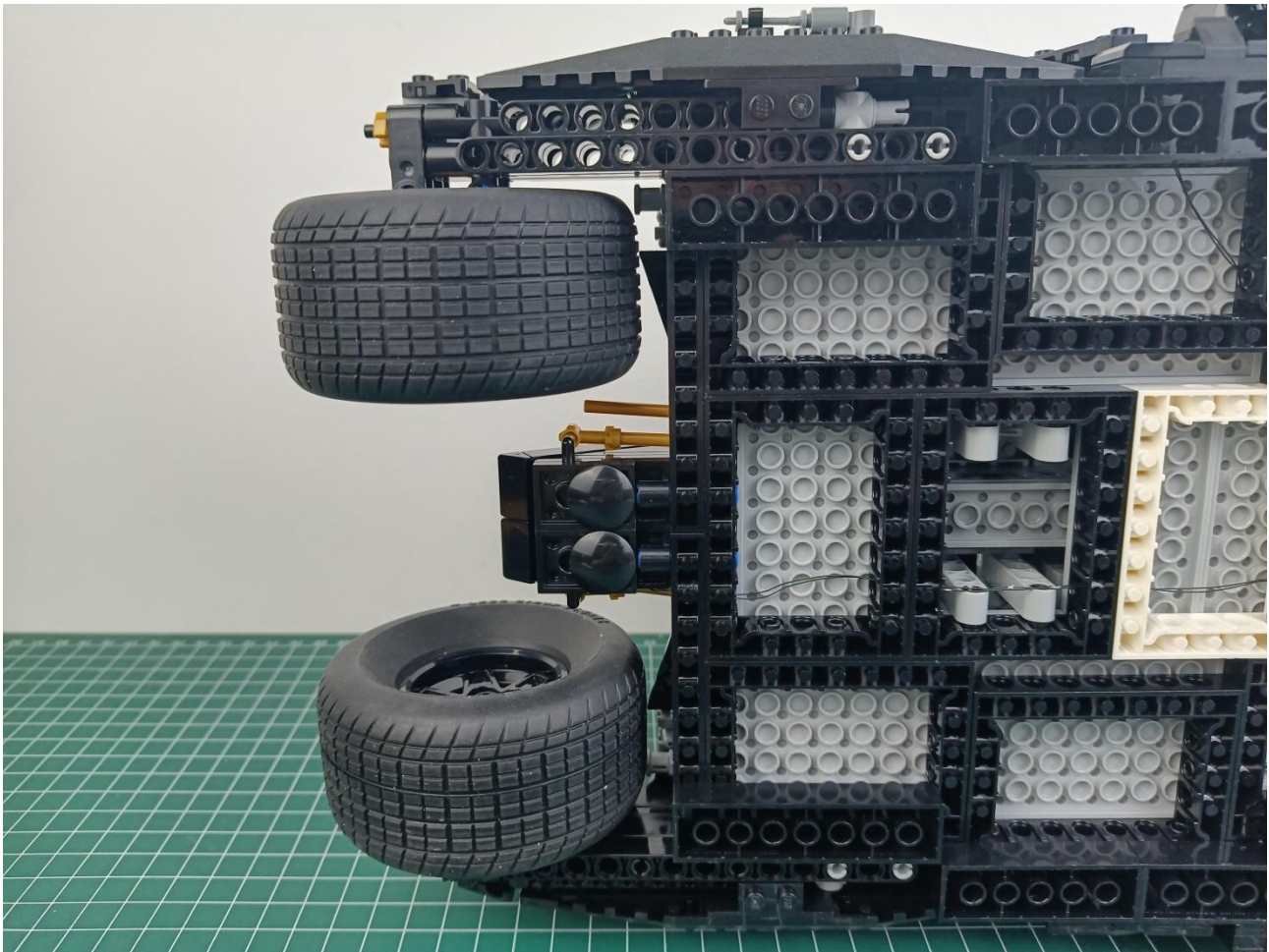

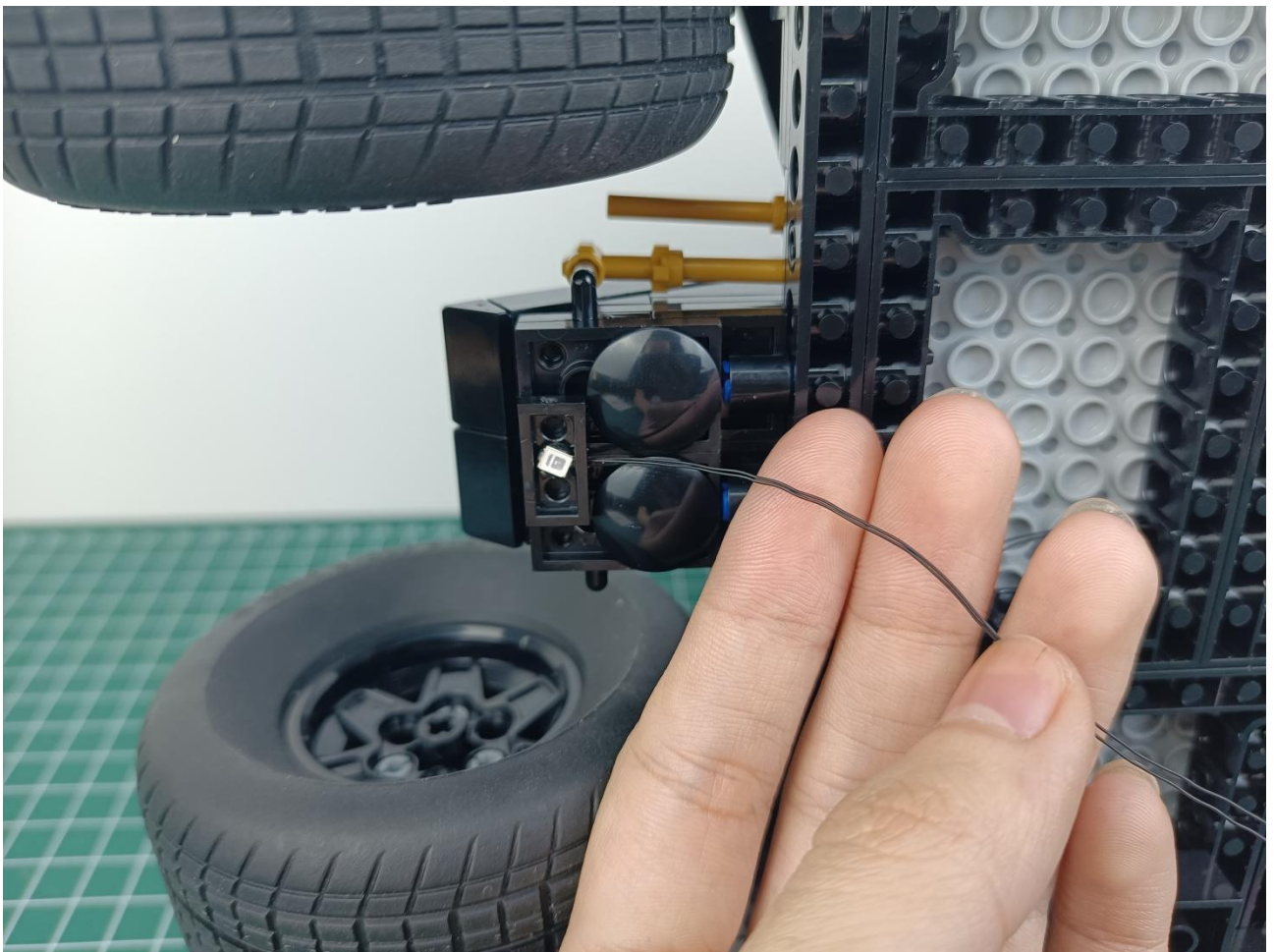
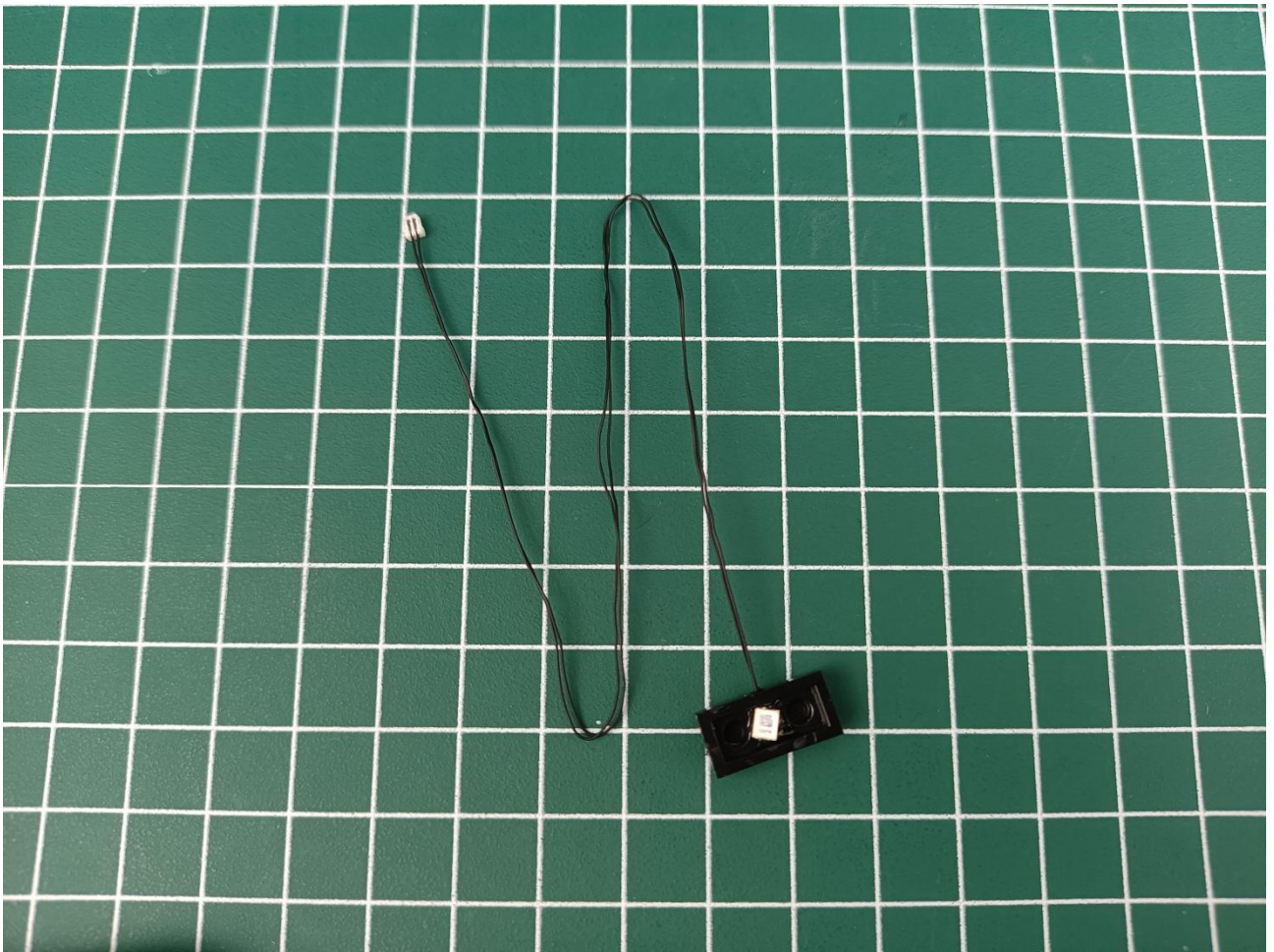

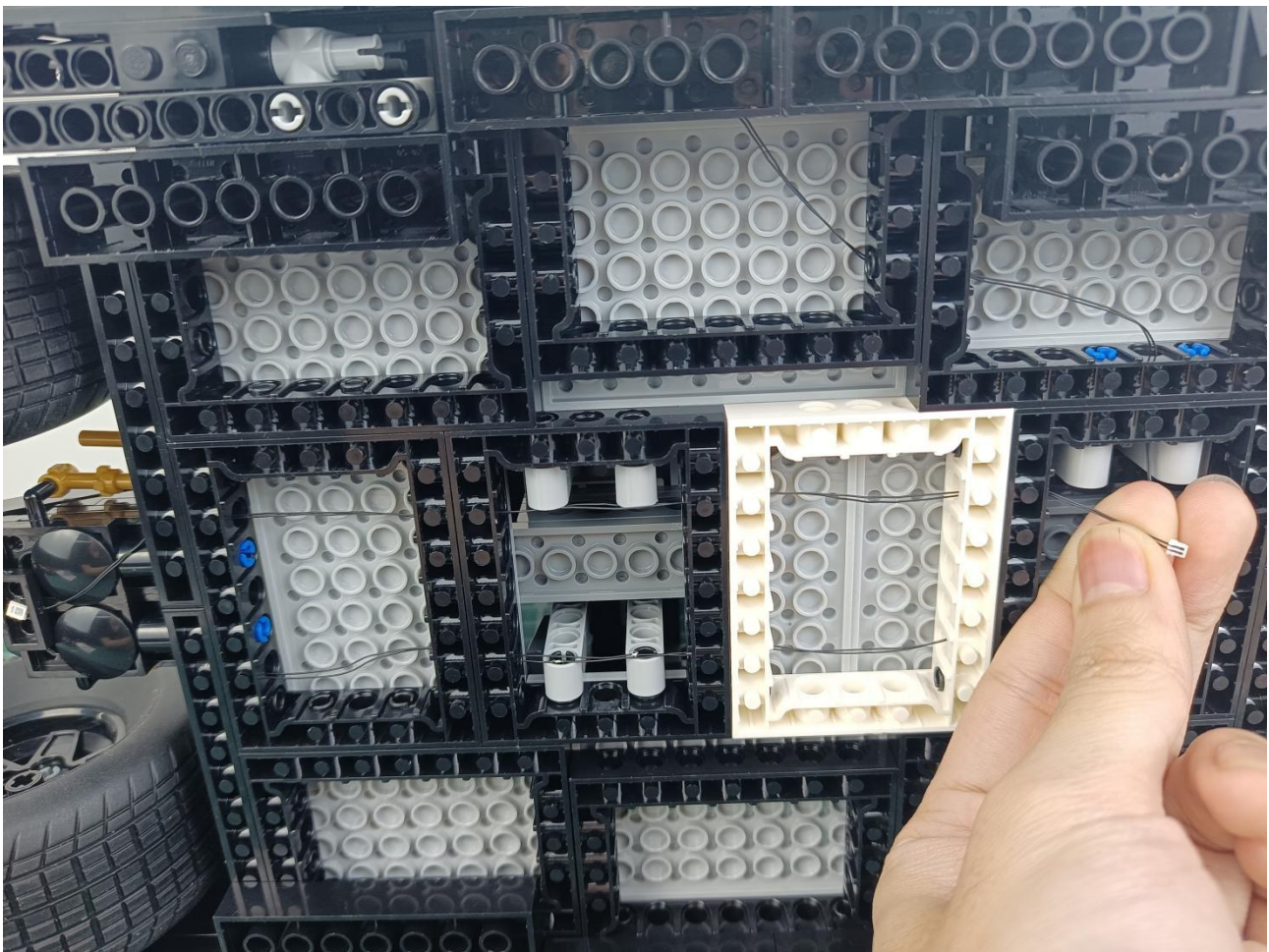
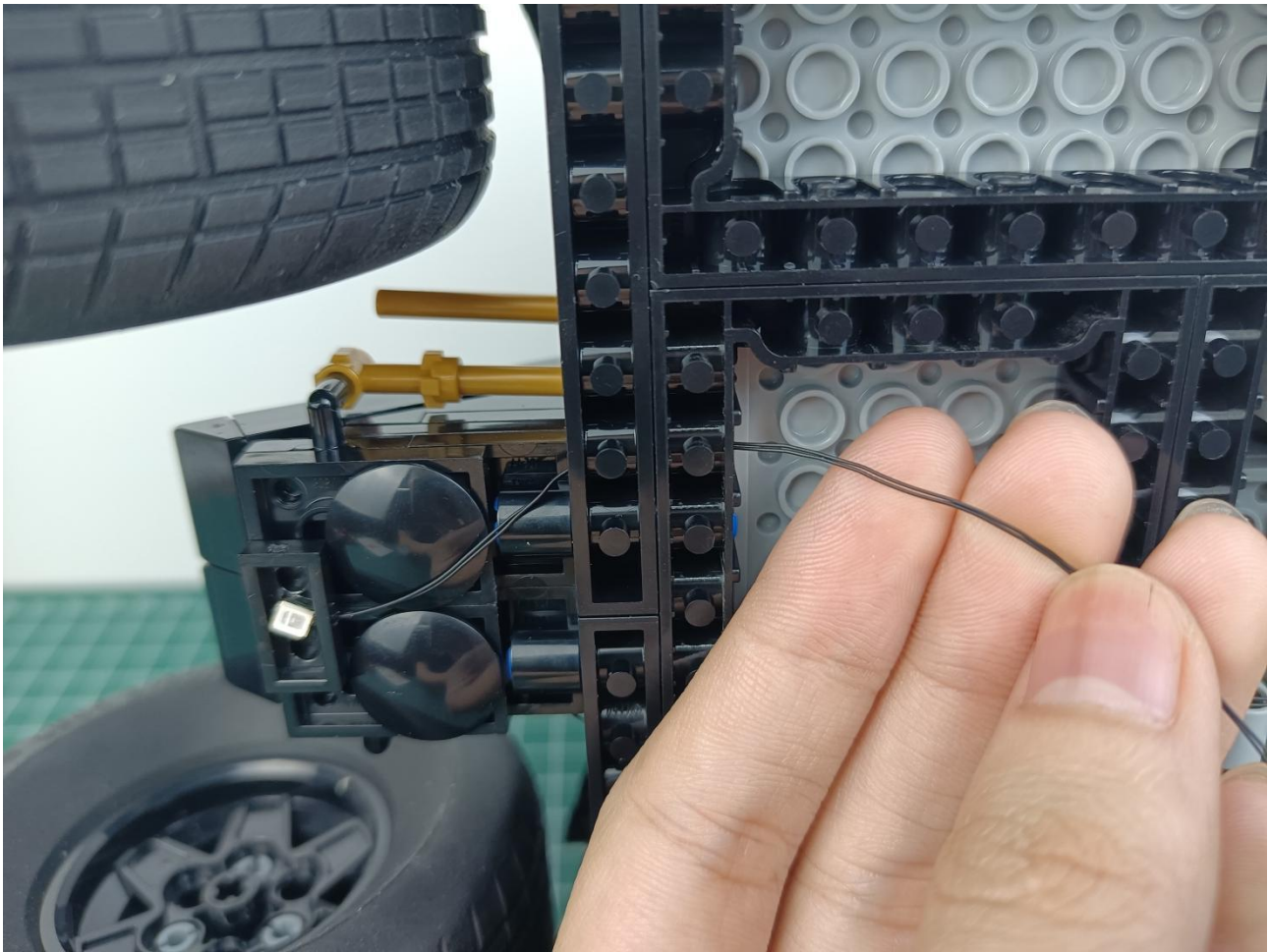

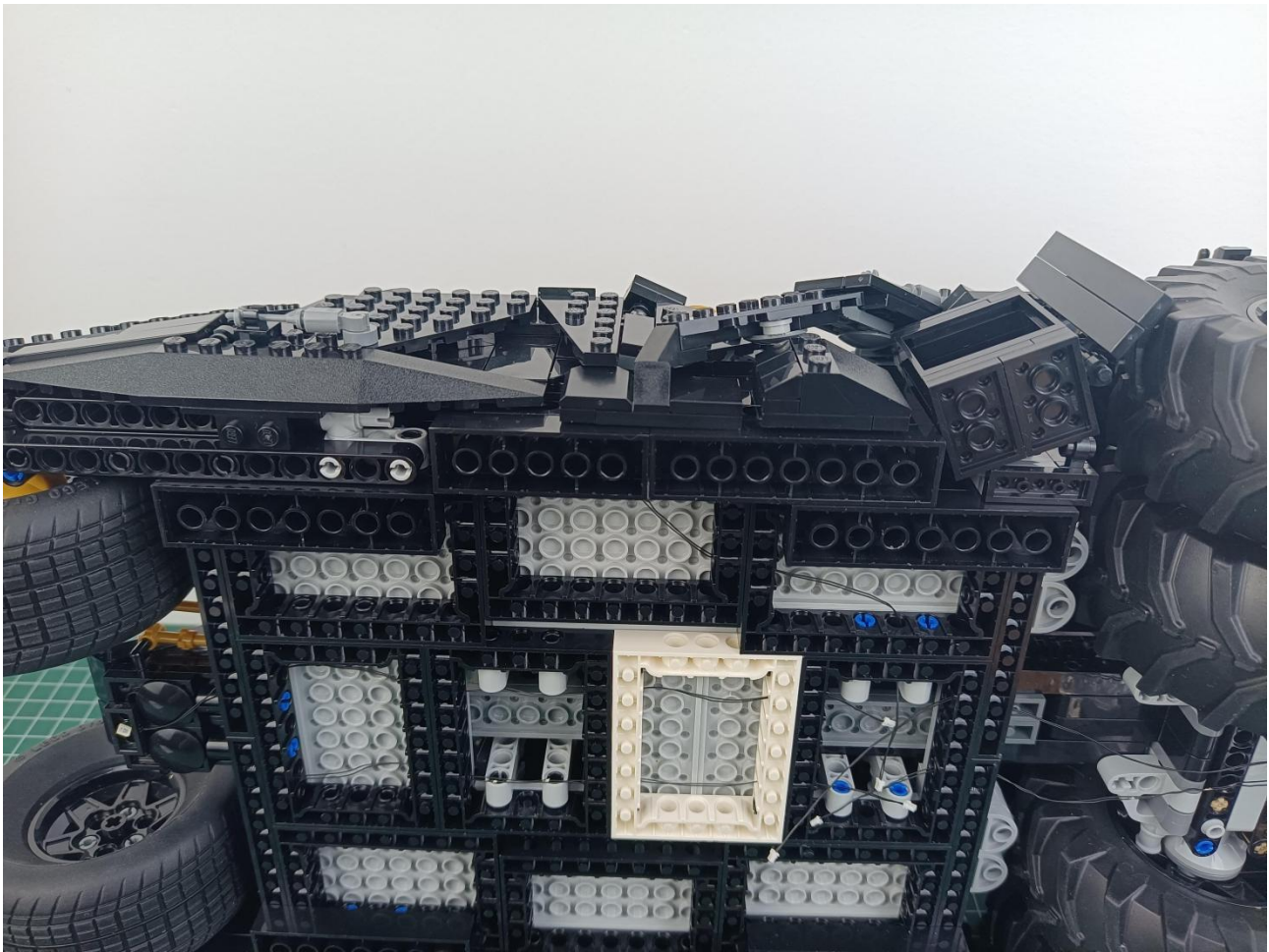

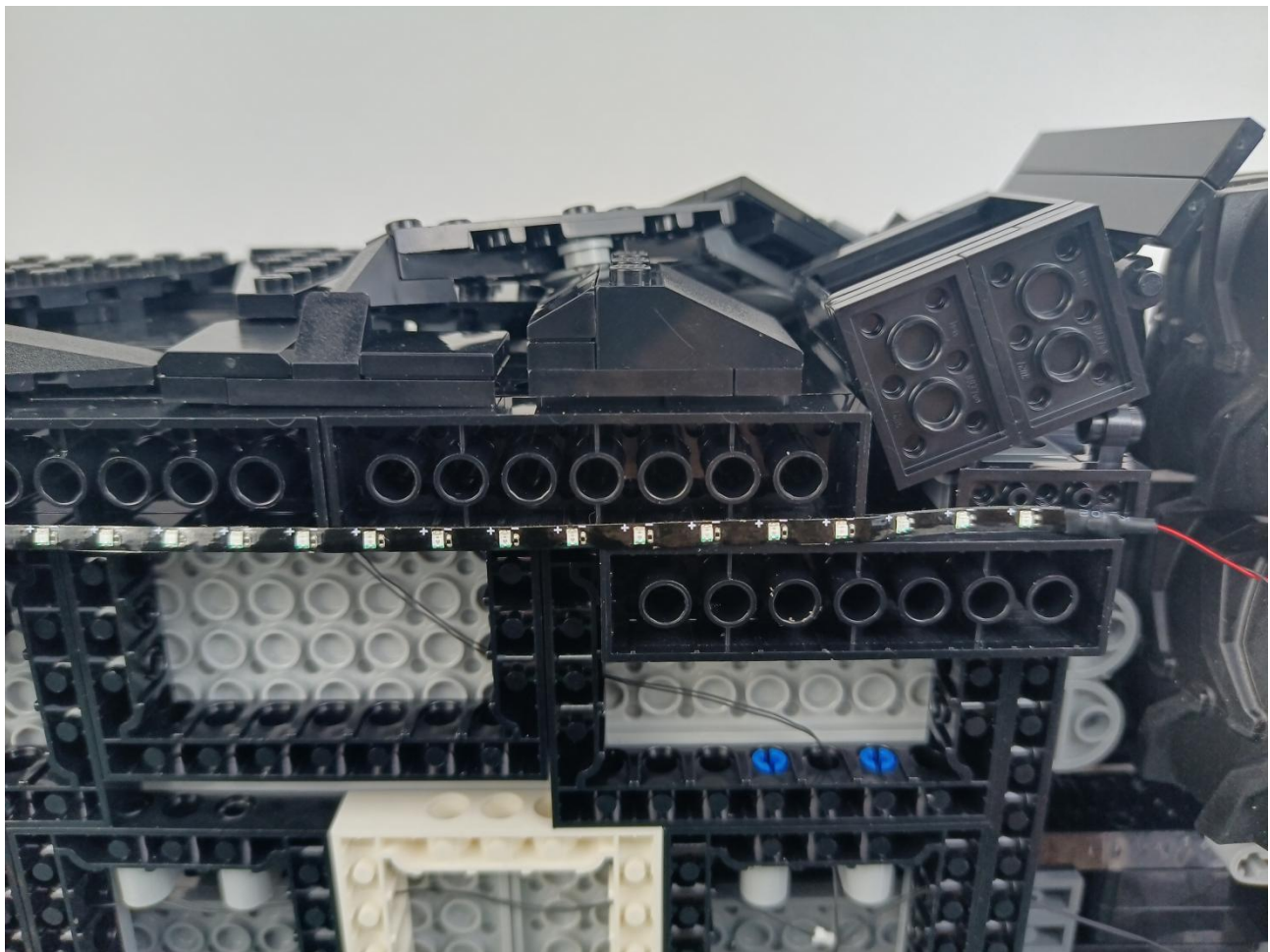
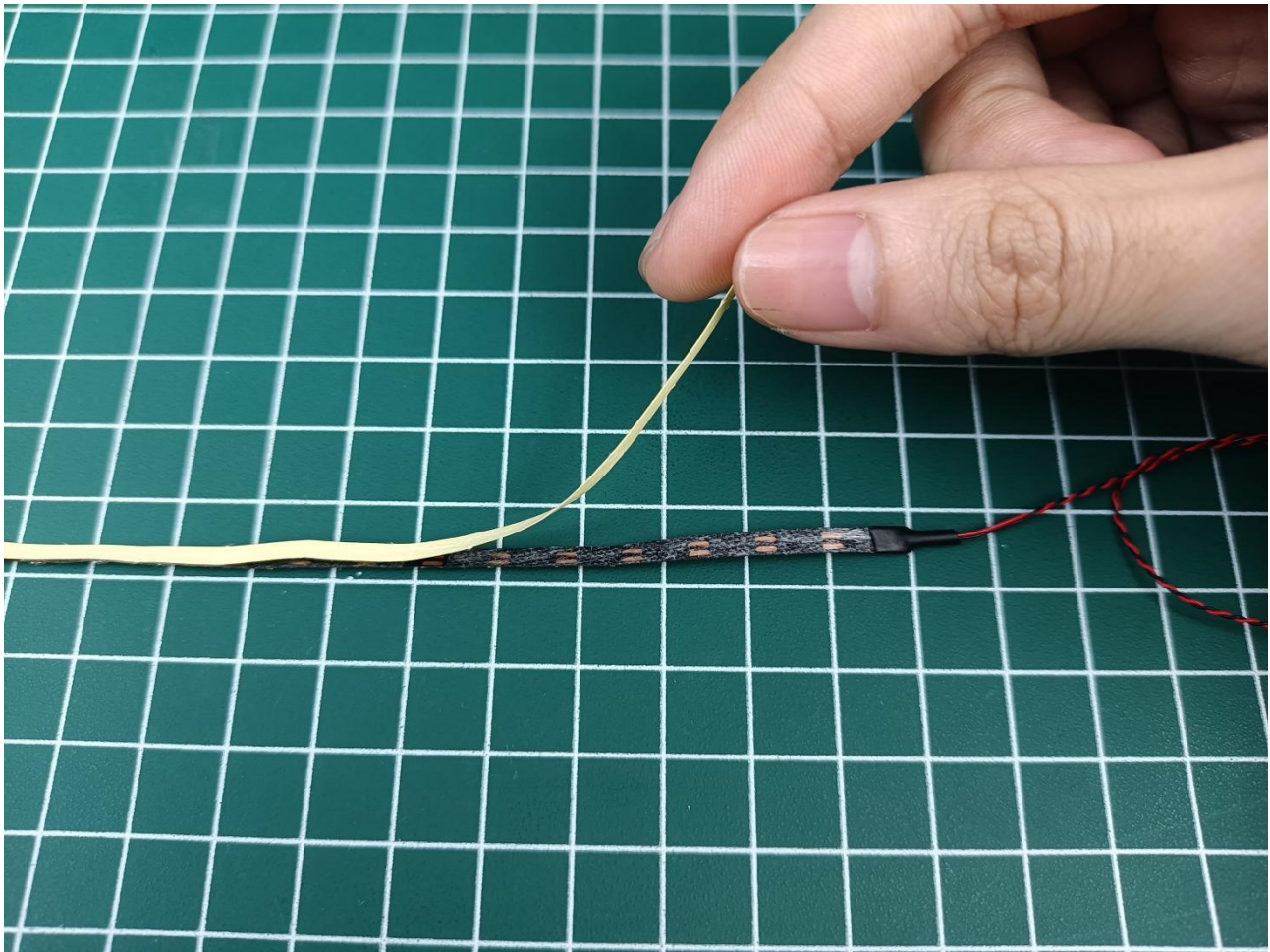

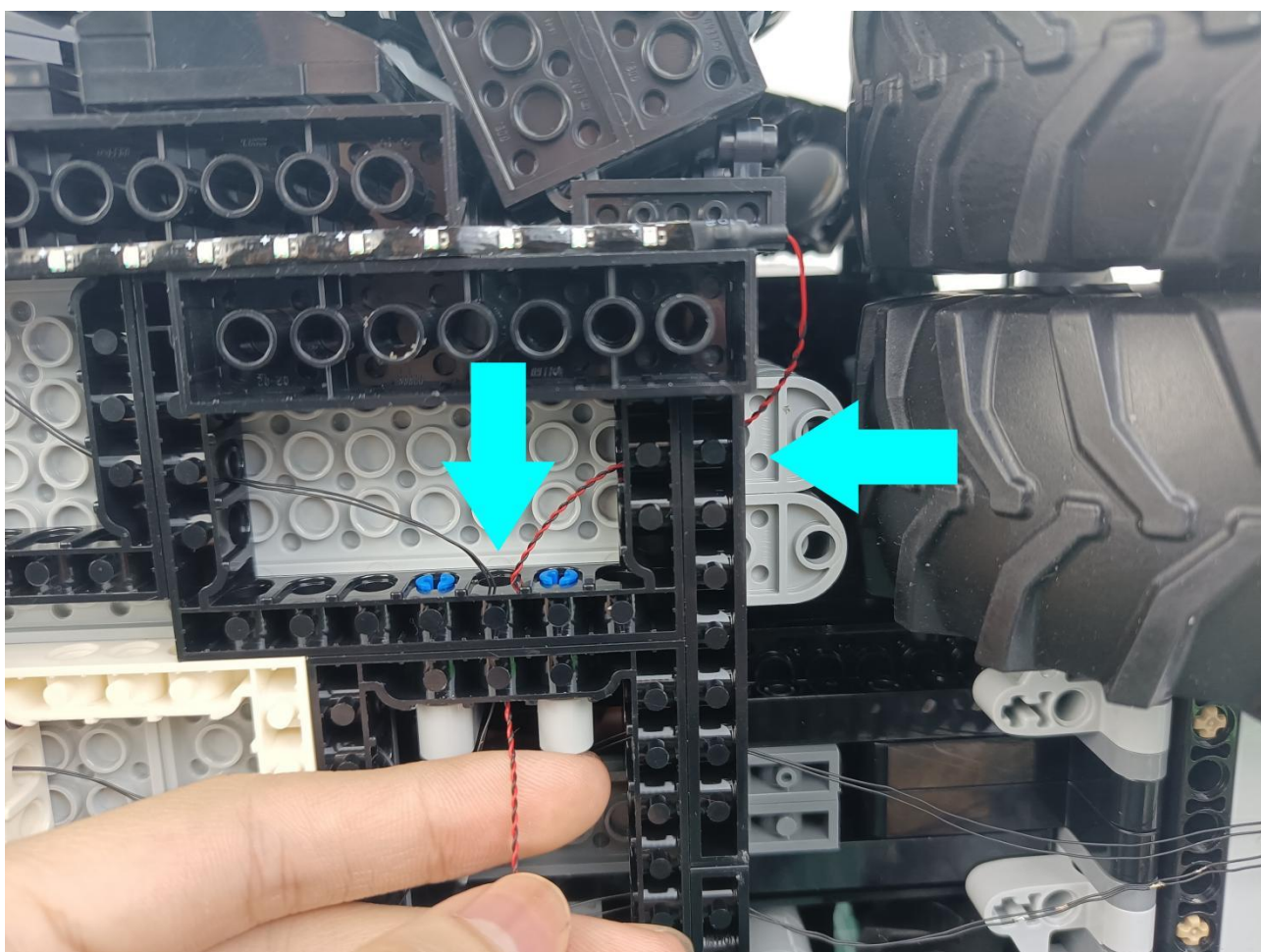

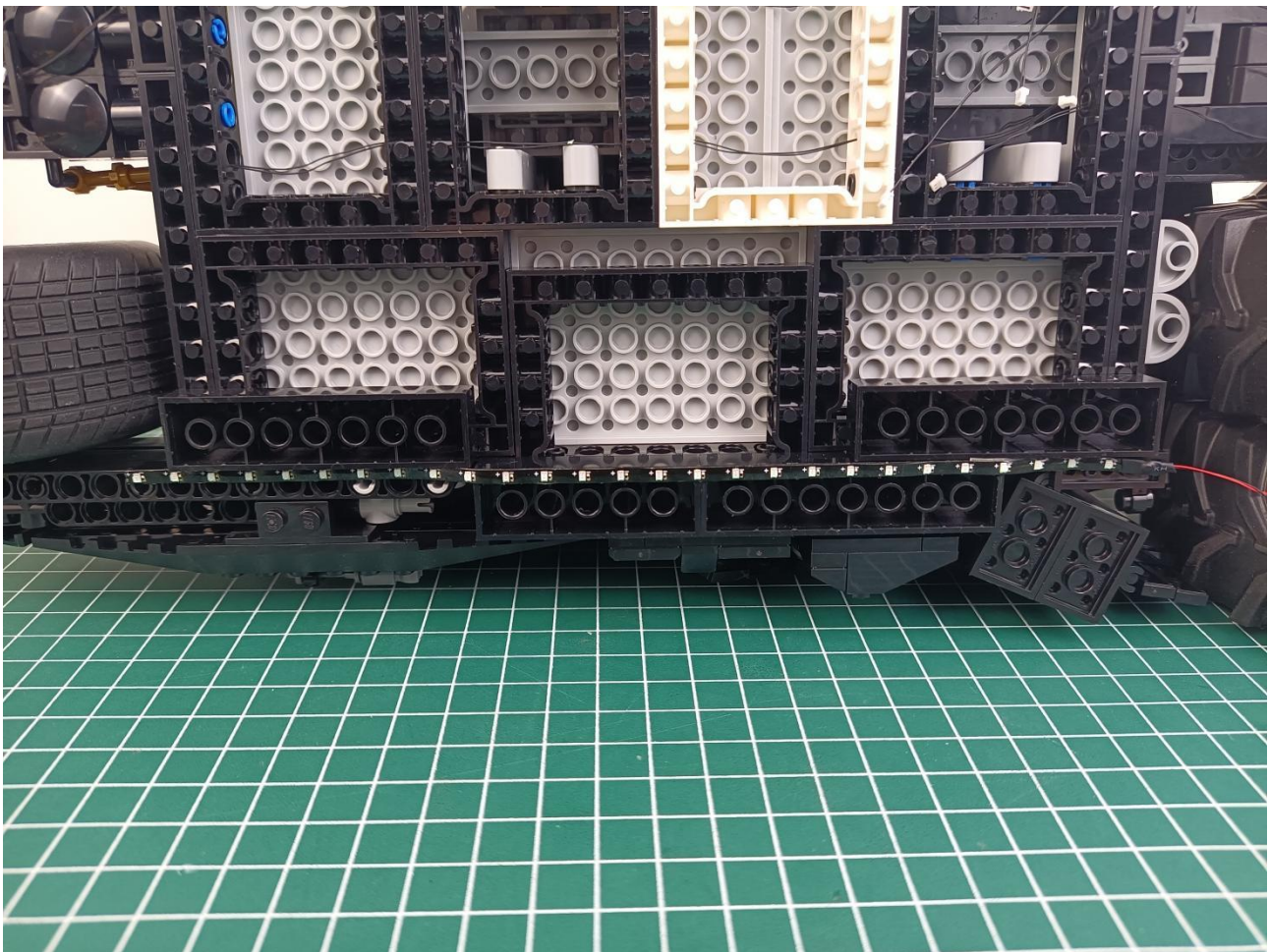
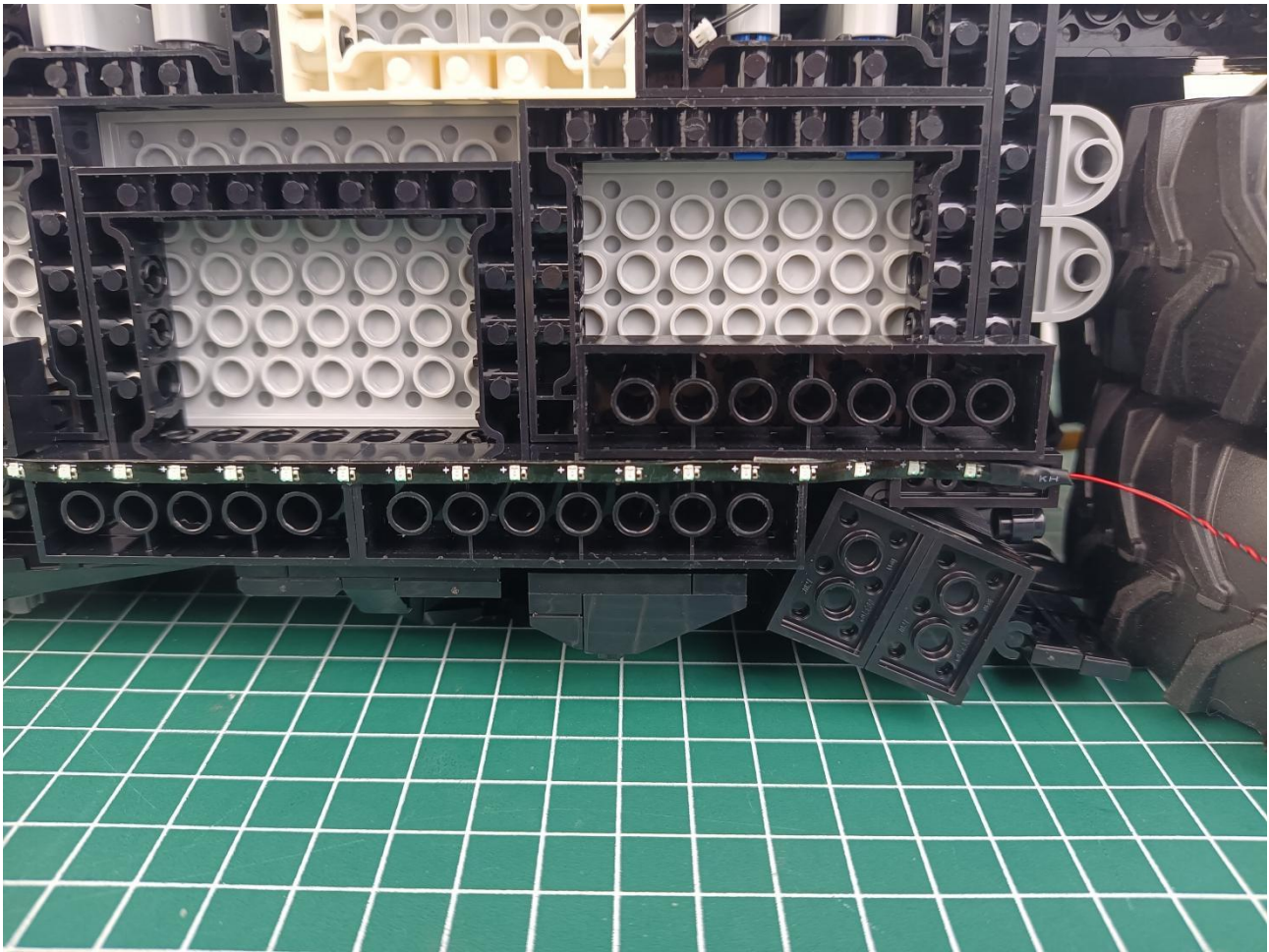

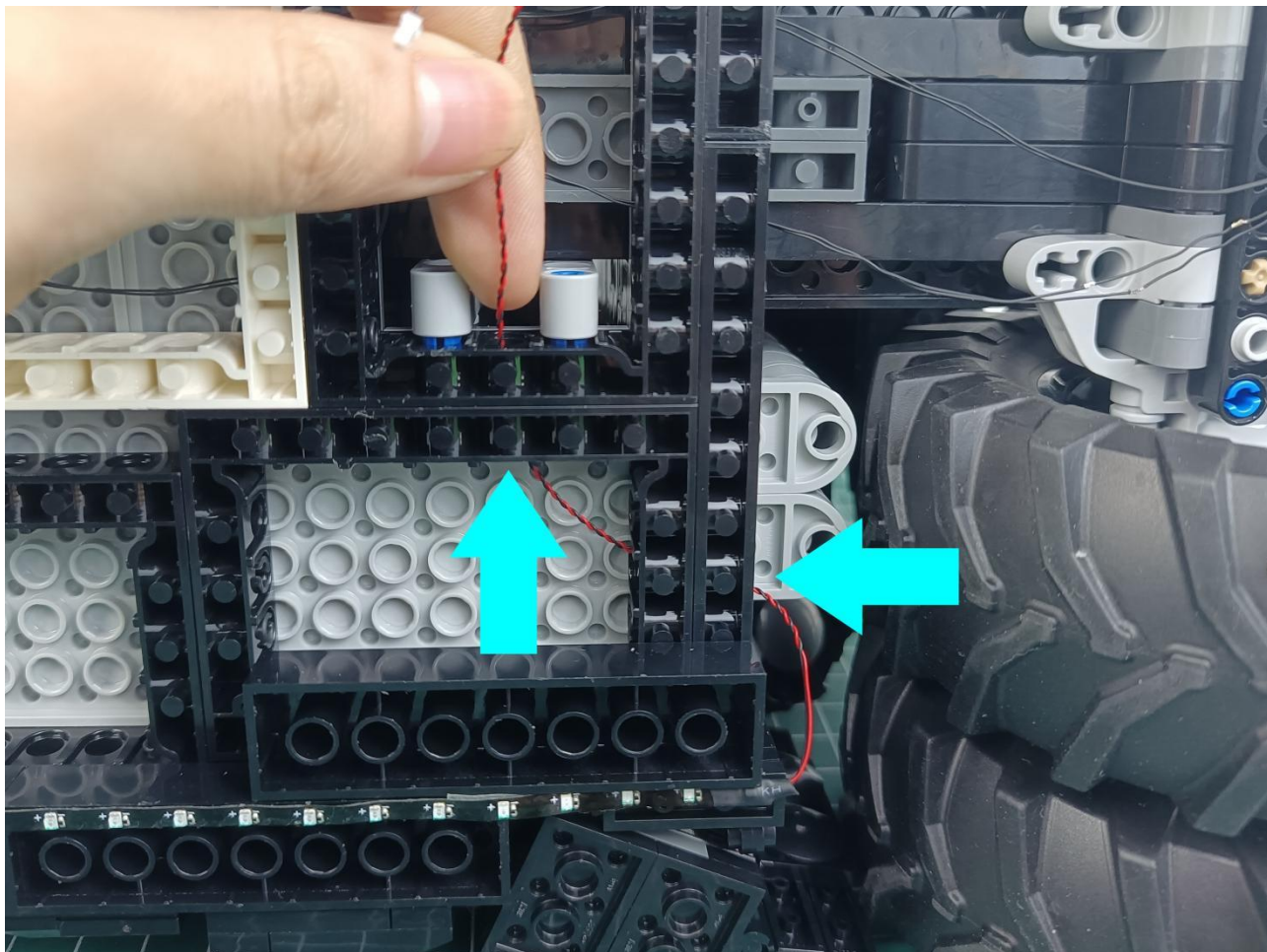

Please pay attention to the use of the interface. The interface is small. Please use it carefully: the = number of the 2P interface is aligned with the = number of the expansion board. The equal sign on the expansion board refers to the two solder joints on the outside, not the two inside the jack Metal pin.

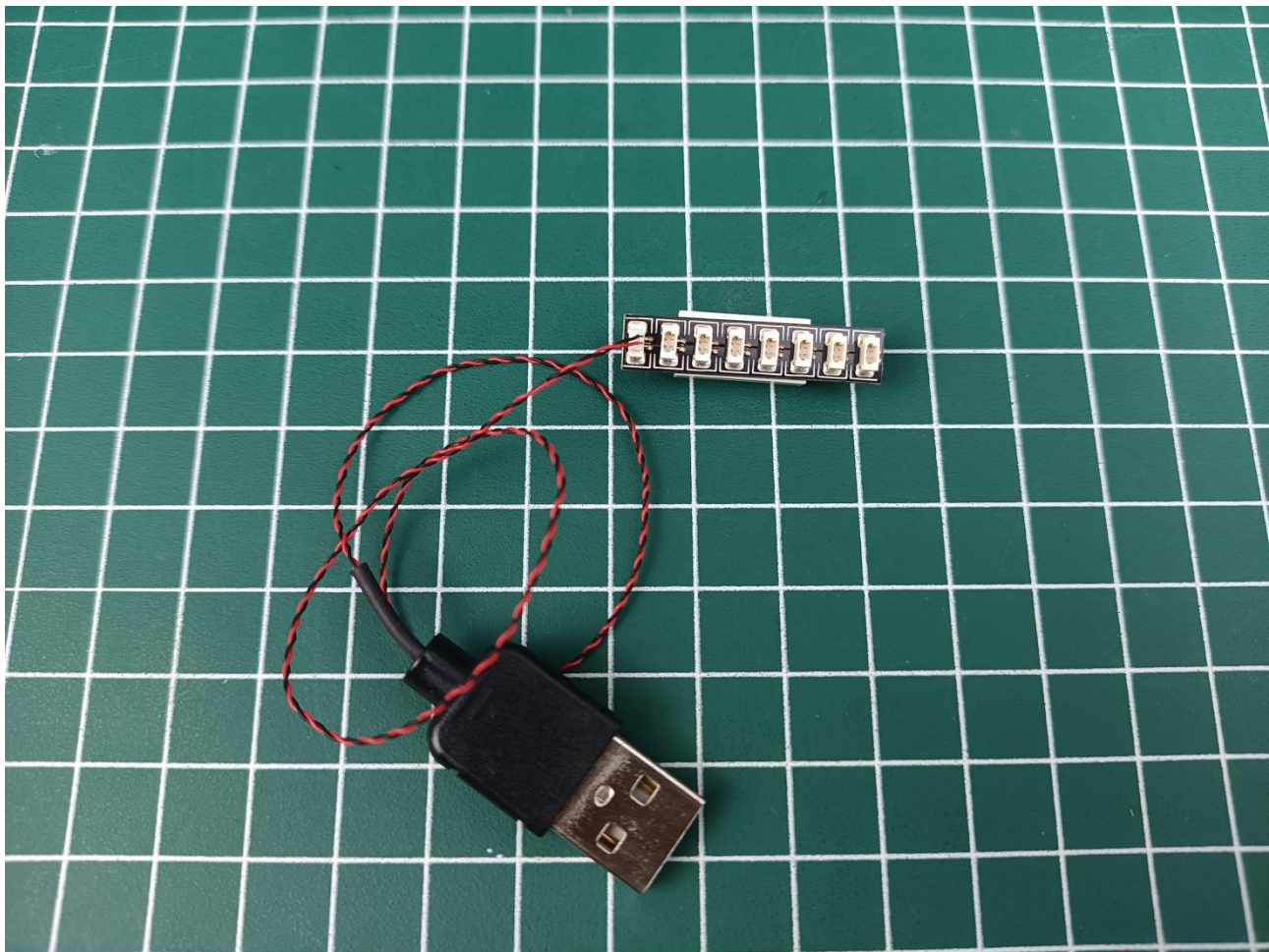
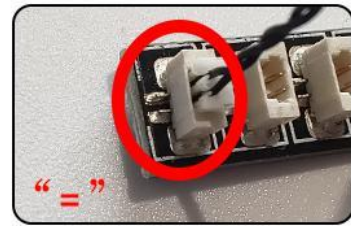
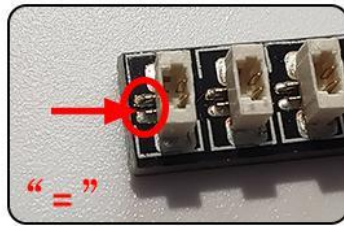
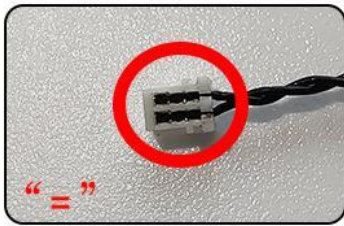

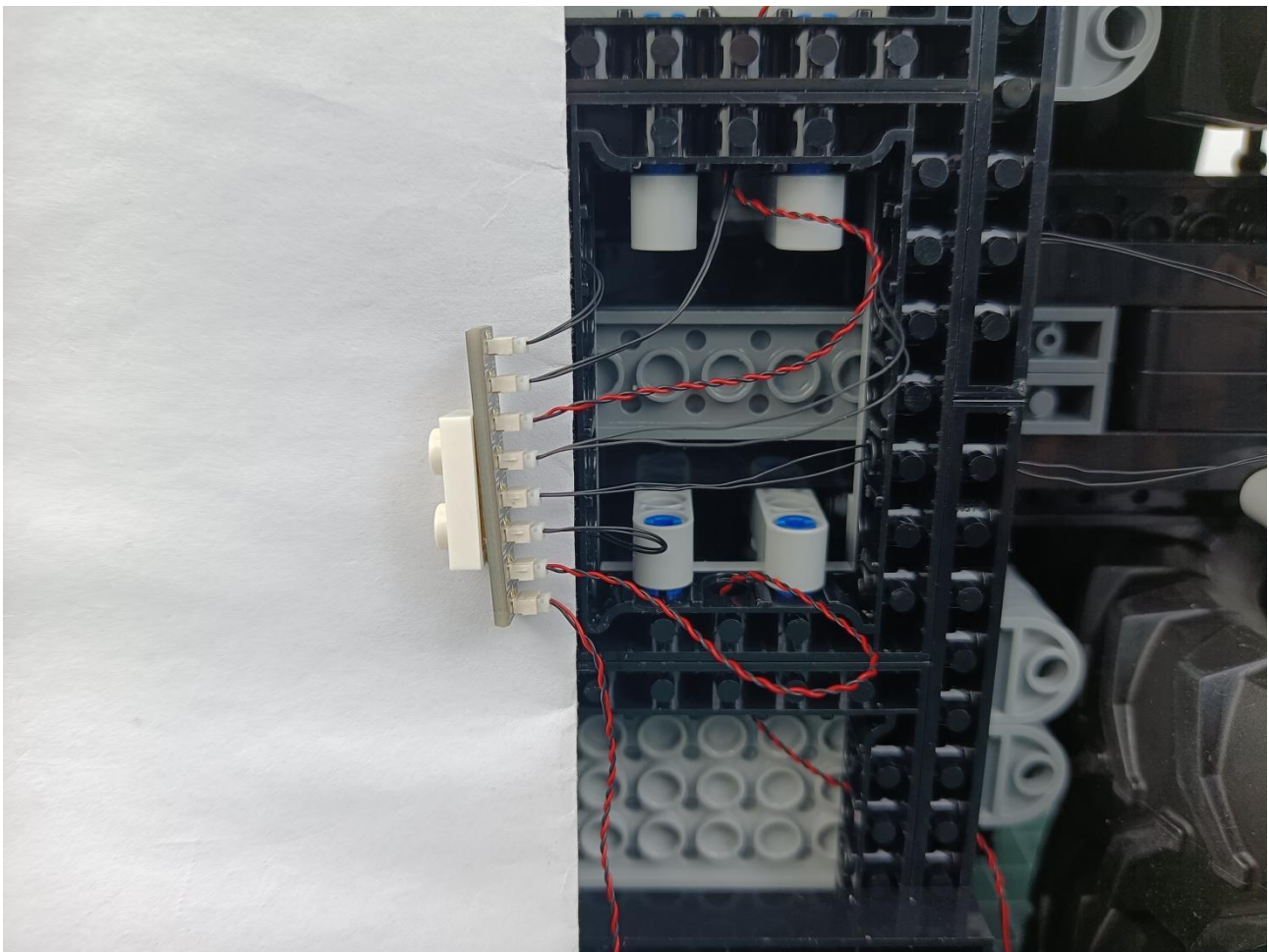
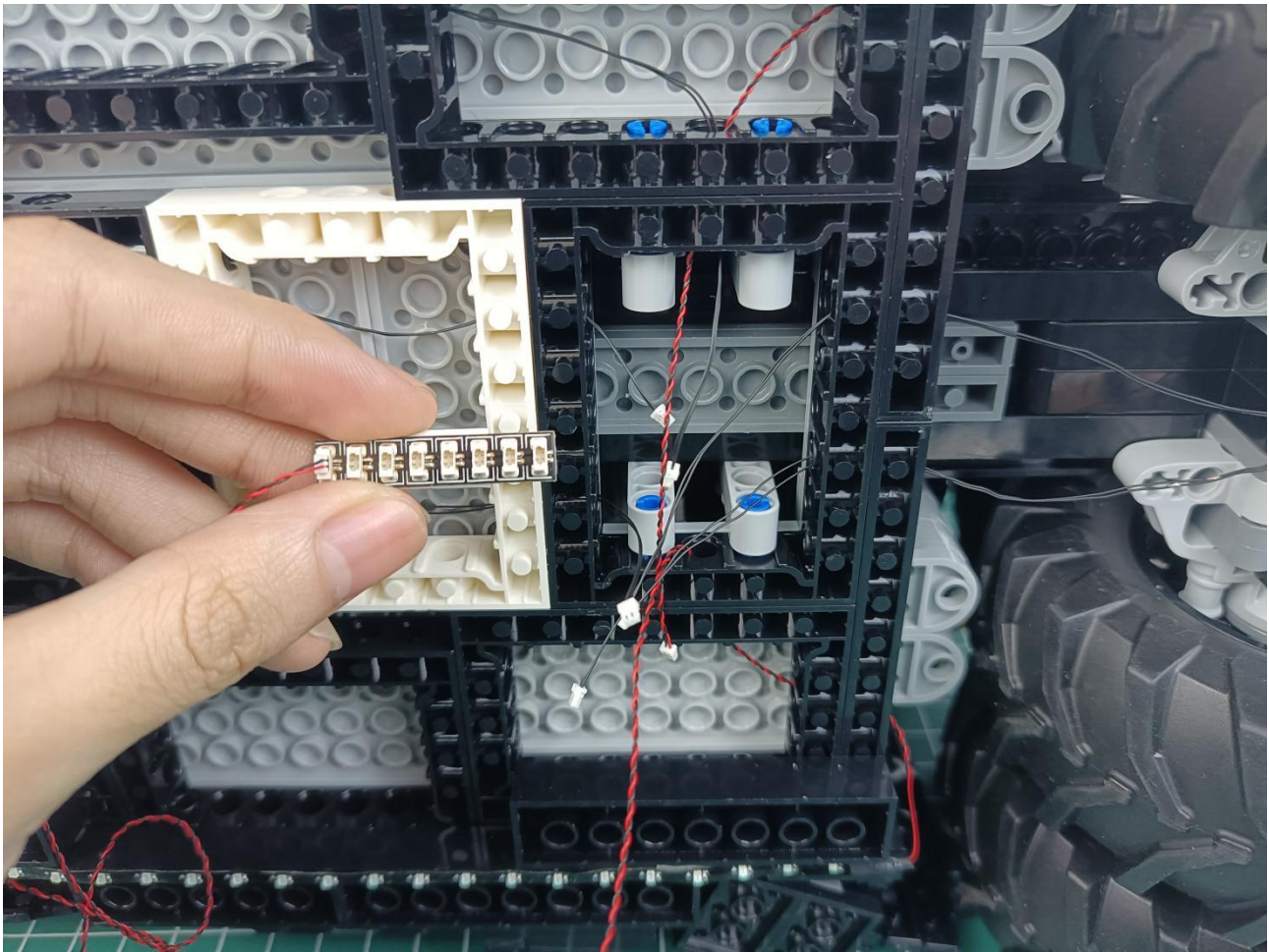

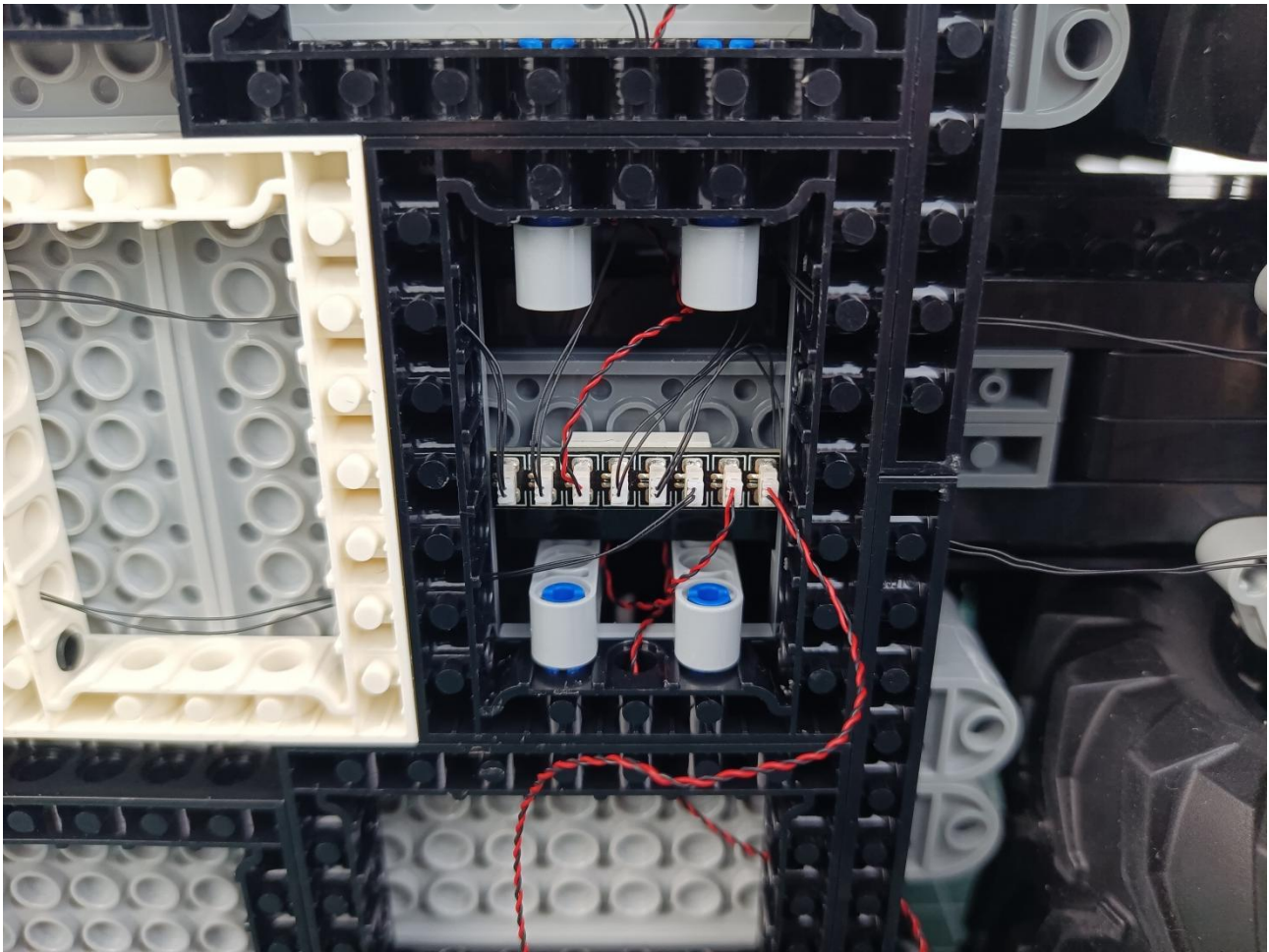

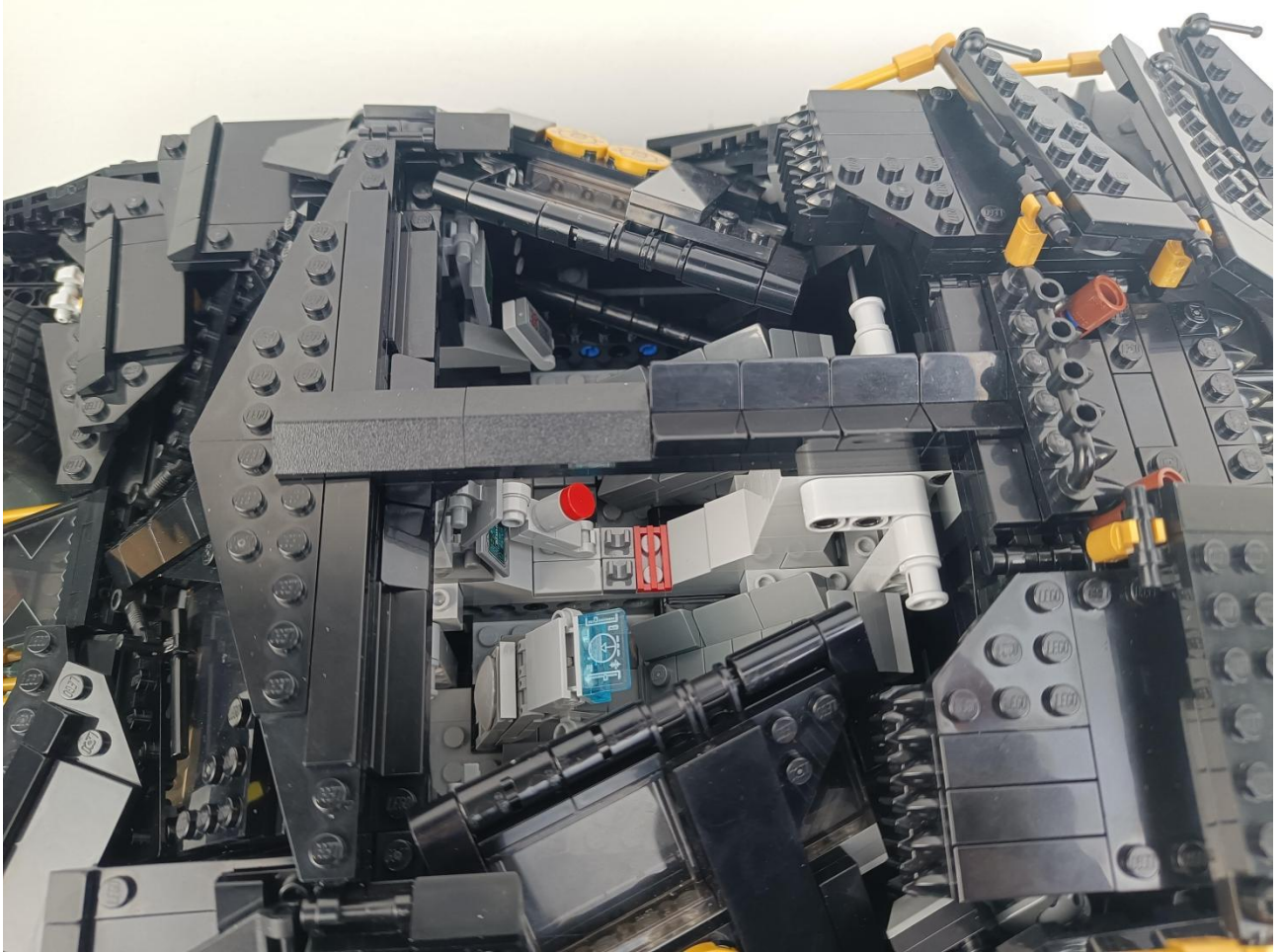

The installation is complete.



The above are ideas and instructions provided by our designers. Please move on:

- 1: Do you have any suggestions about the material and quality of our products?
- 2: Do you have any suggestions on the installation instructions and the degree of difficulty of the installation?
- 3: If you have better installation method and ideas, please contact us in time.