

# 75393 TIE Fighter & X-wing Mash-up

- Installation requires a lot of patience and great observation that your LEGO bricks will come alive when you get this finished. The bricks with lighting as below, so make sure you're ready and let's get started.



# Strategies for the Installation

This instruction divides three sections to complete the installation of the lighting set.

## **Section A:** Check the type and quantity of components.

The quantity and type of components of each products are different and it needs to be carefully checked to make sure there do have enough material. The type of components is indicated by the label on the bag.

## **Section B:** Test that each components is working properly.

Each components is Manual customization so it is necessary to test that each components is working properly to avoid the situation that the lighting does not work .

## **Section C:** laying out components following the instruction.

Our material is very small but not fragile, just be reminded that don't to pull the wires too hard. For different people, there may be some installation steps that you can't understand. Please look at the previous and later installation steps.

## Section A: Check the type and quantity of components.

This set contains eight bags labelled "1" "2" "3" "4" "5" "6" "7" "8", please make sure that the components in each bag are the same as shown in the pictures.





Please contact us immediately if there have any missing components.

**Section B:** Test that each components is working properly.

Take out the Expansion Boards and the USB Power Cable from N0.5 bag and No.7 bag.



It is worth reminding that our products are all customized. They have a unique way of connecting. The white plug on wire and the socket of the expansion board need to be connected together to transmit power.

Note that on one side of the white plug you can see two very small golden wires that should be connected to the two golden needles in socket of the expansion board. shown as blow.

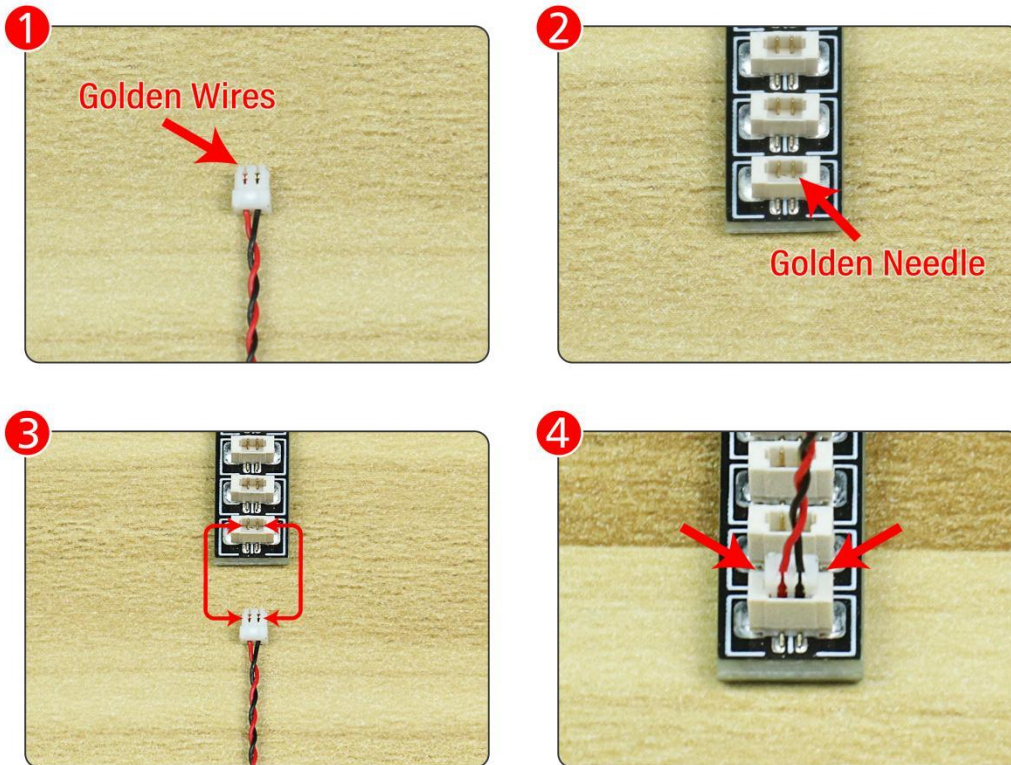

Connect the Expansion Board and USB Power Cable as shown.



**Connect the other end of the USB power cable to the power supply.**

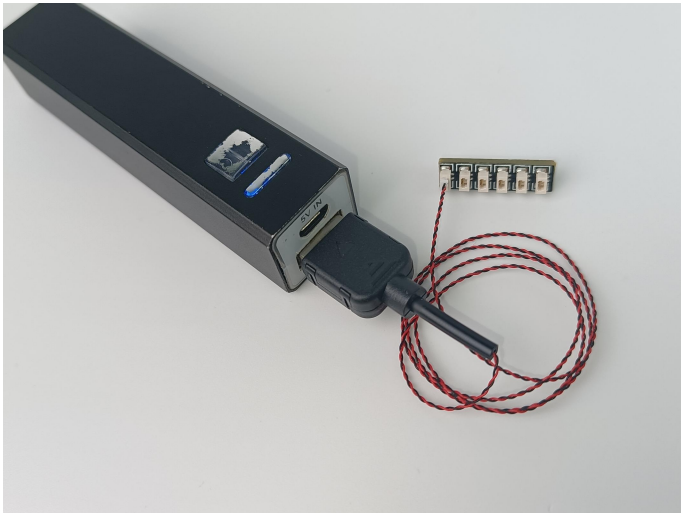

**The USB Power Cord can be powered by phone chargers, power banks, etc. This instruction will use the power bank as power supply.**

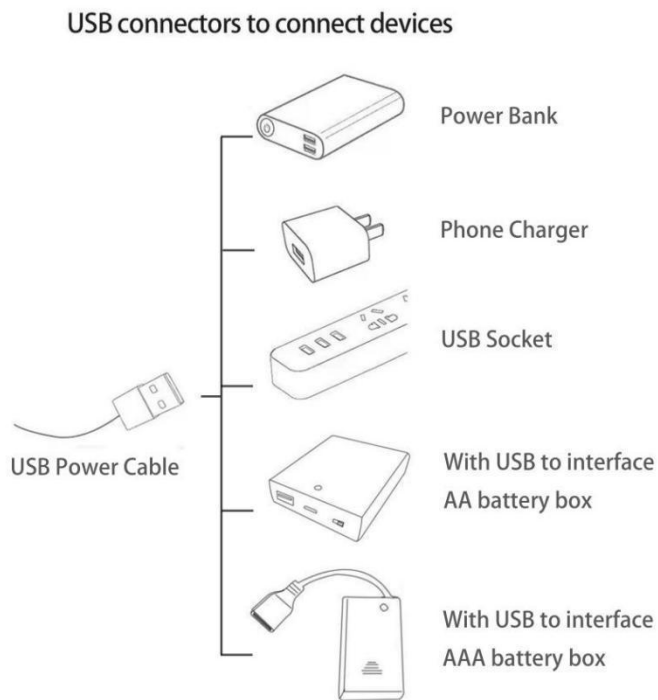

Connect all the components in No.1 bag to the Expansion Board in same way just as shown. Turn on the power bank, all the lights are on as shown. Remove the lamp after the test.

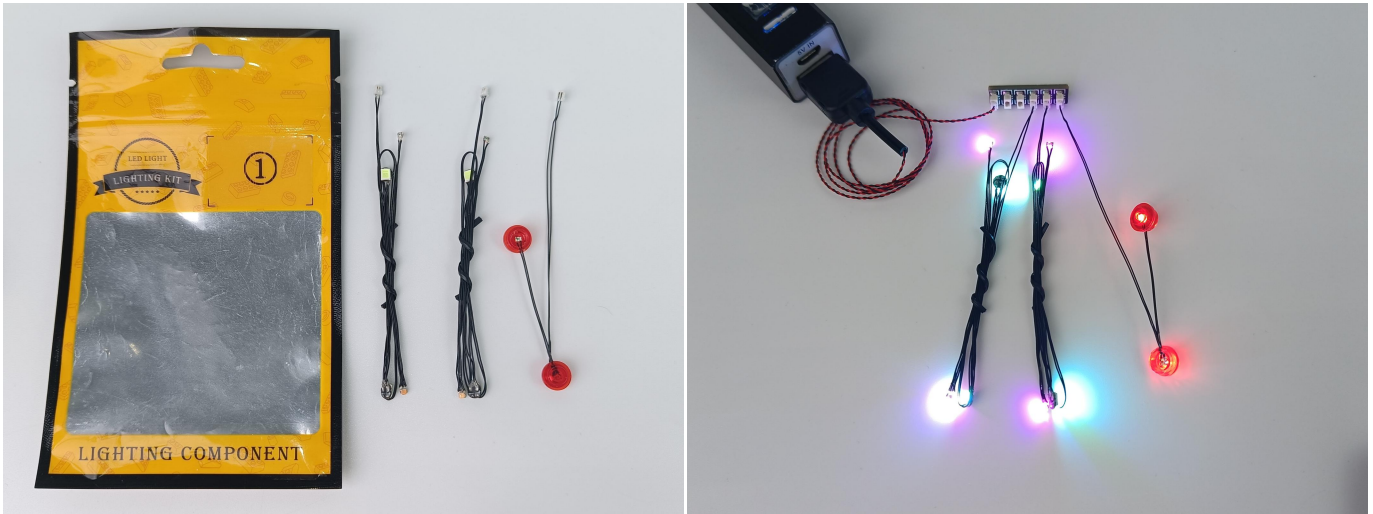

Unplug these three components and put them back in the corresponding bags. Attention that after the test is completed, each components should put back in the corresponding bag including the socket and the usb power cable. Please contact us immediately if any components don't work.

#### LED strip test:

Take out the LED light bar, connect the USB power cable, turn on the mobile power supply, the light will be on normally, as shown in the figure below.

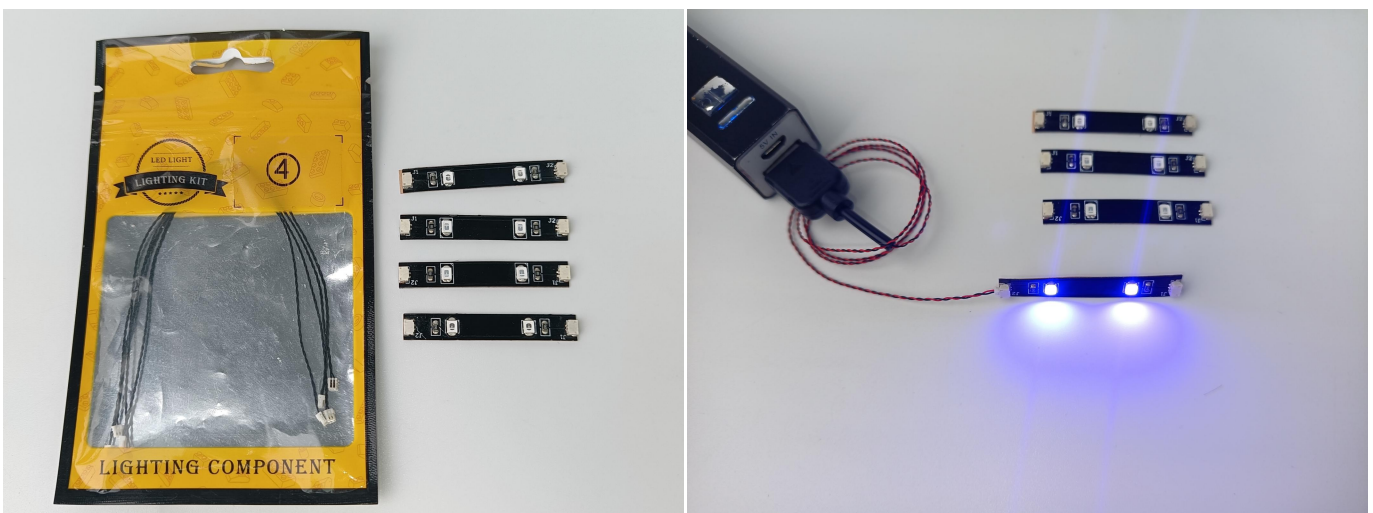

Attention that after the test is completed, each components should put back in the corresponding bag including the socket and the usb power cable.

Please test other components in the same way. Please contact us immediately if any components don't work.

**Section C:** laying out components following the instruction.

**1**



**2**



**3**

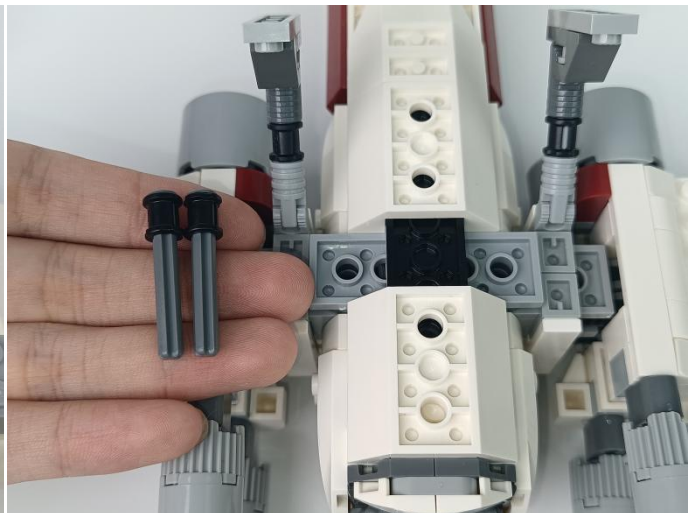
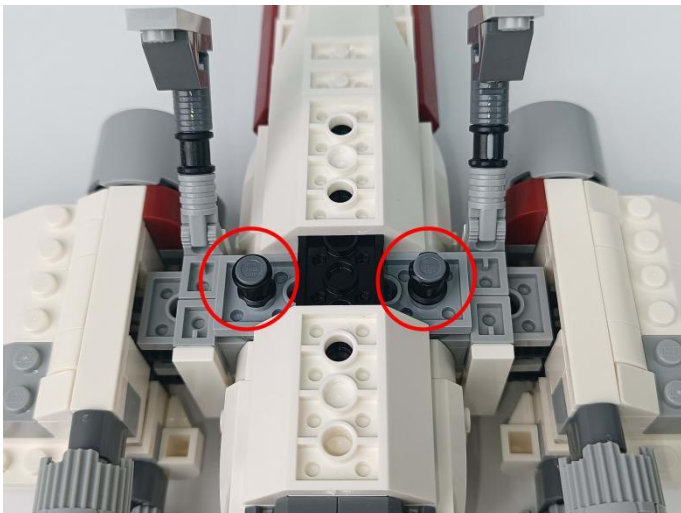



4



5



6

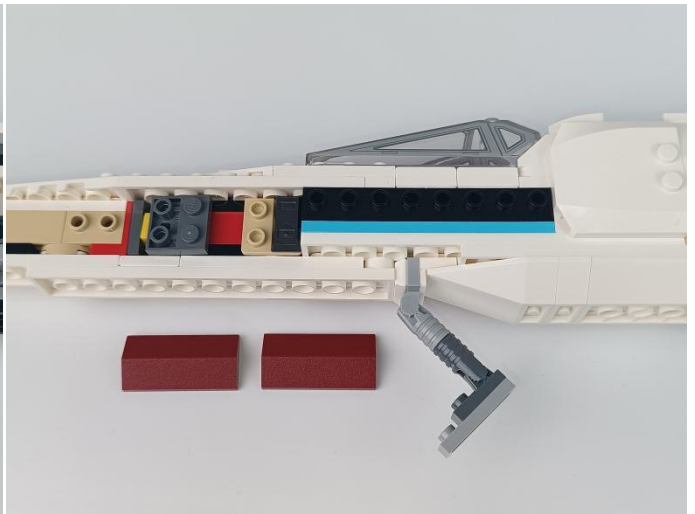
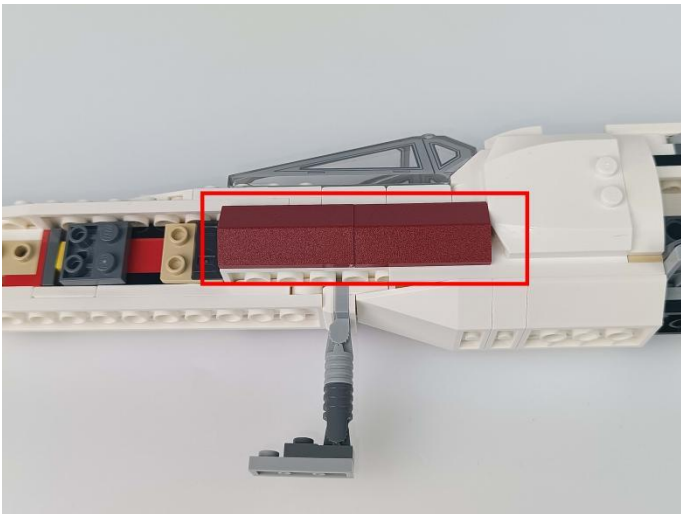

7



8

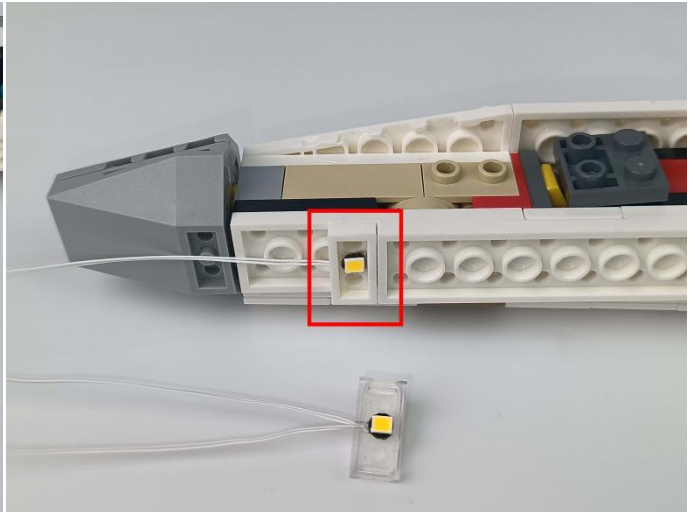
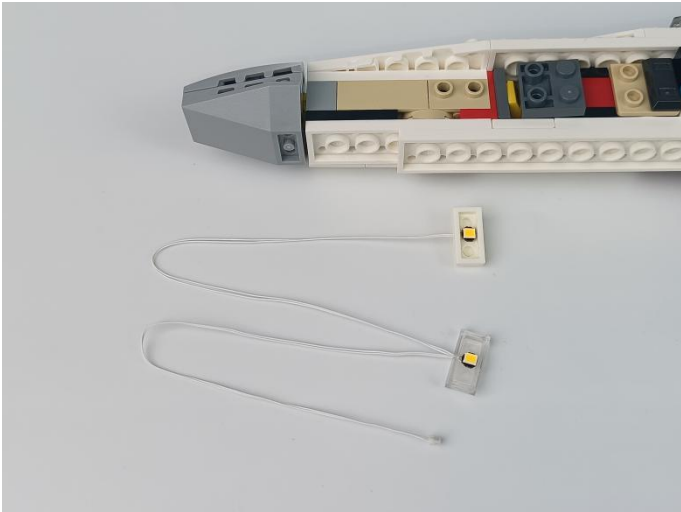

9

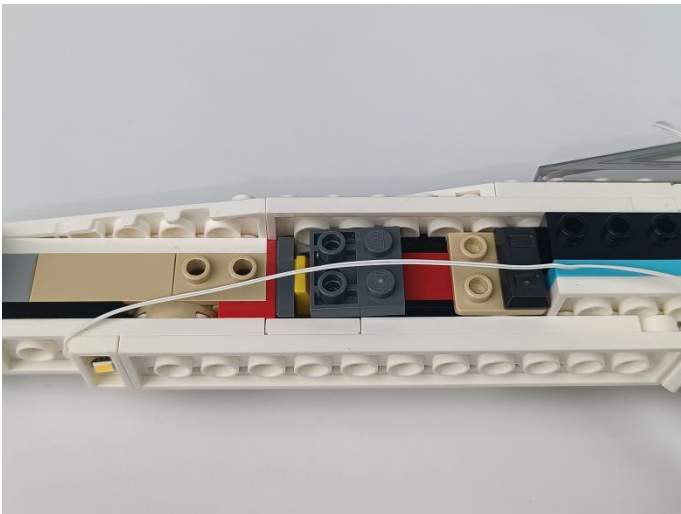

10



11

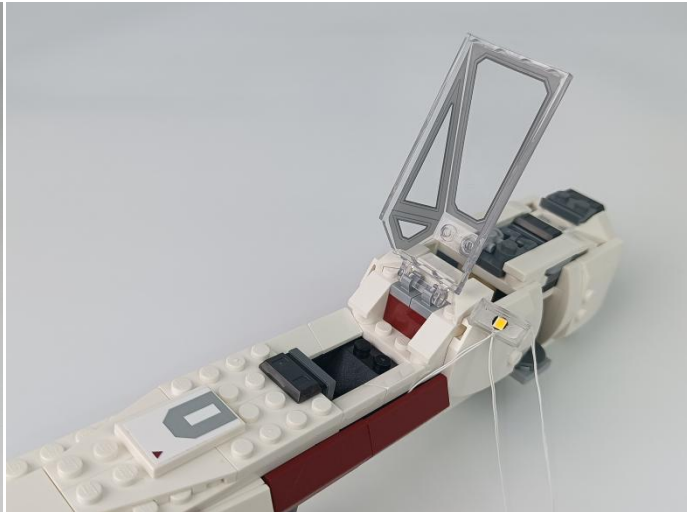

12

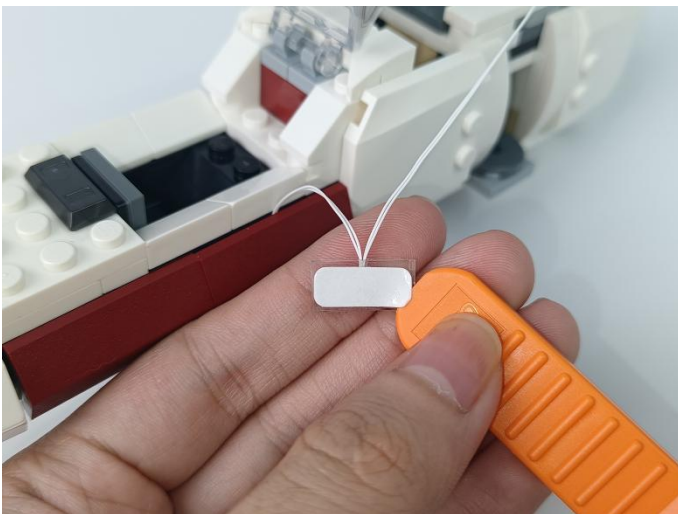

13



14

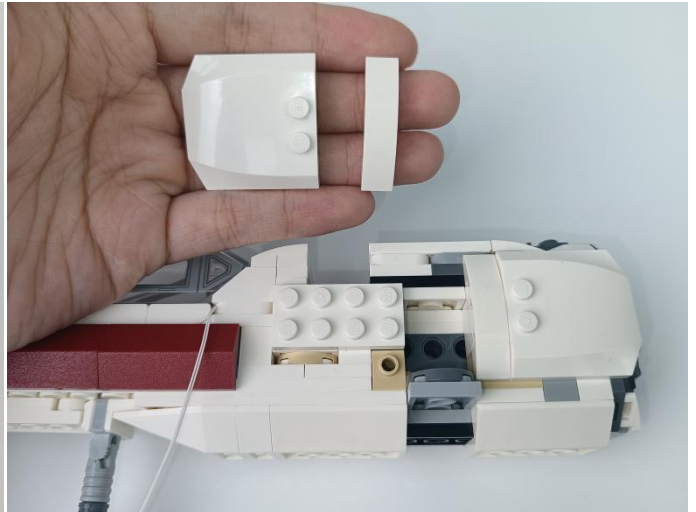
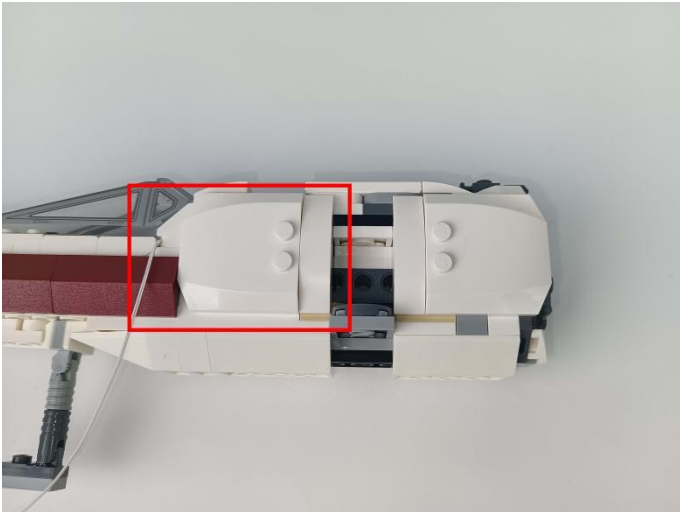

15

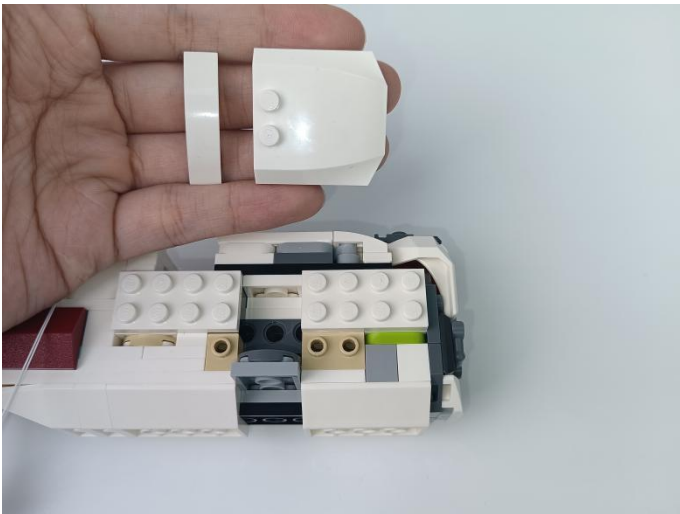

16

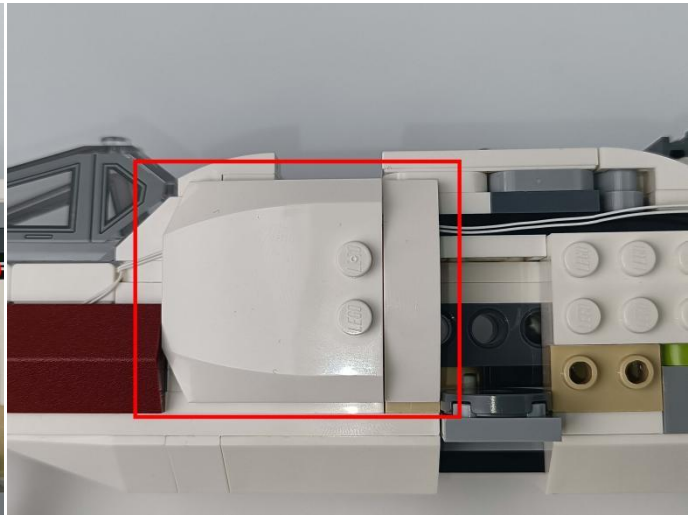
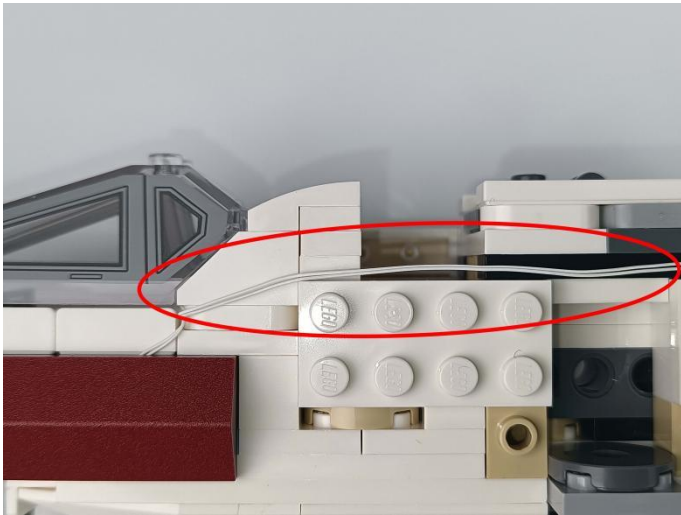

17

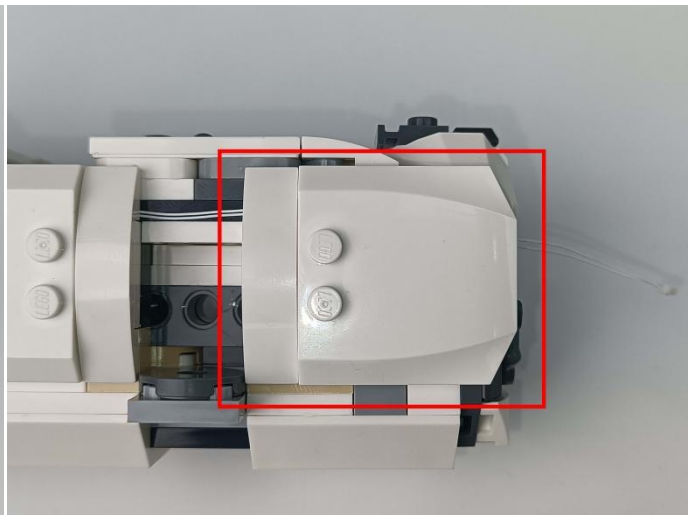

18



19



20

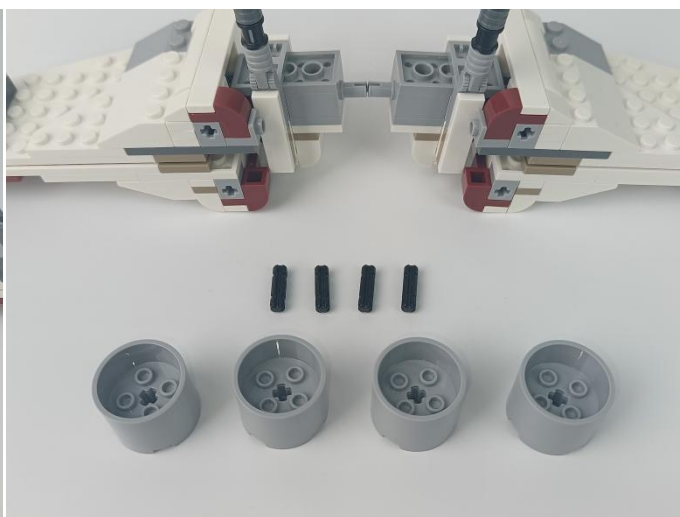
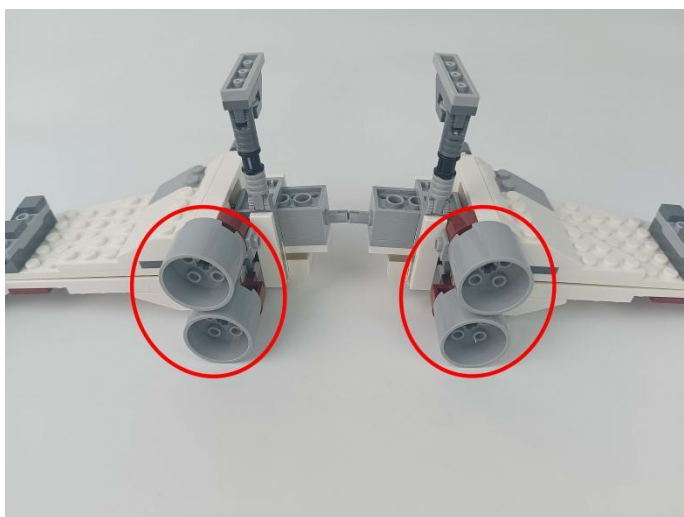

21

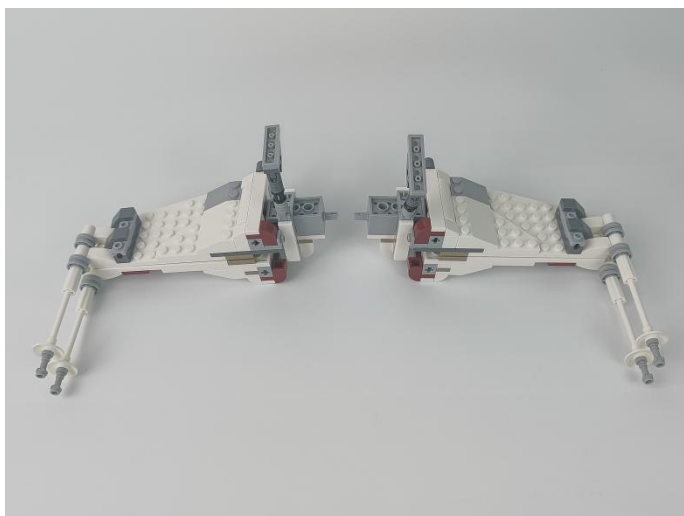

22

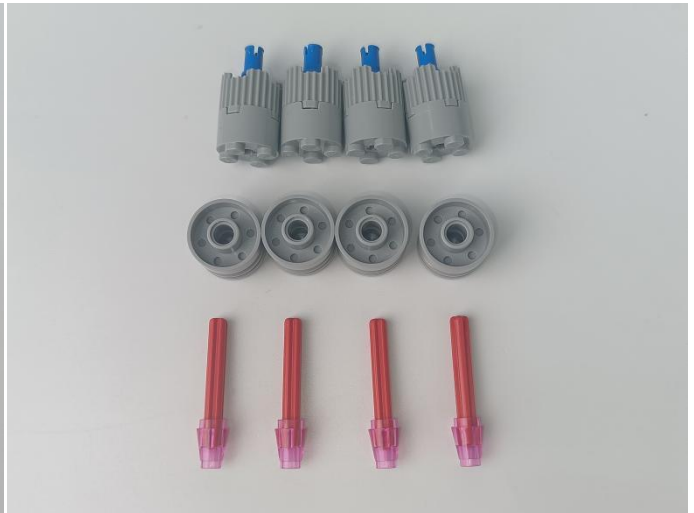

23



24

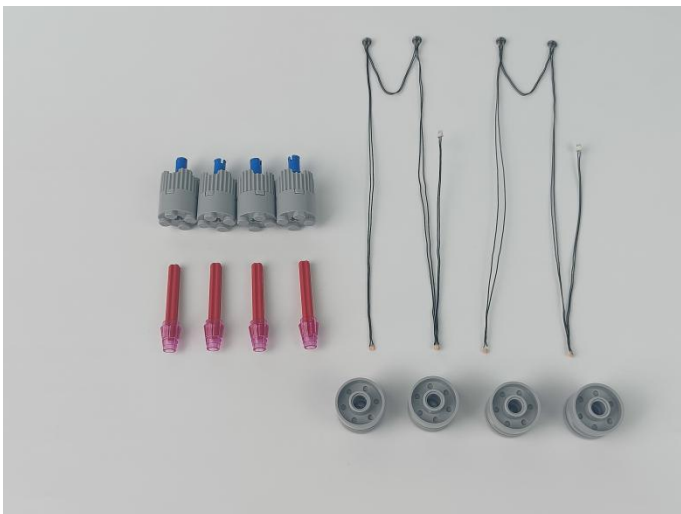

# 25



## Tips

The plate without slit:

### The plate without slit:

The squeeze causes the protective layer of the wire to be torn apart, the positive and negative wires touch together, and the set is short-circuited, and the hot wire is crushed, the wire to be disconnected and don't work.



The plate with slit:

### The plate with slit:

The wire has enough space to avoid being squeezed and endowed with longer service life and more stable effect.



The slit on the the plate round 1X1 are hand-made to avoid squeeze the wire and cause short circuit and abnormal heat during installation.

# 26

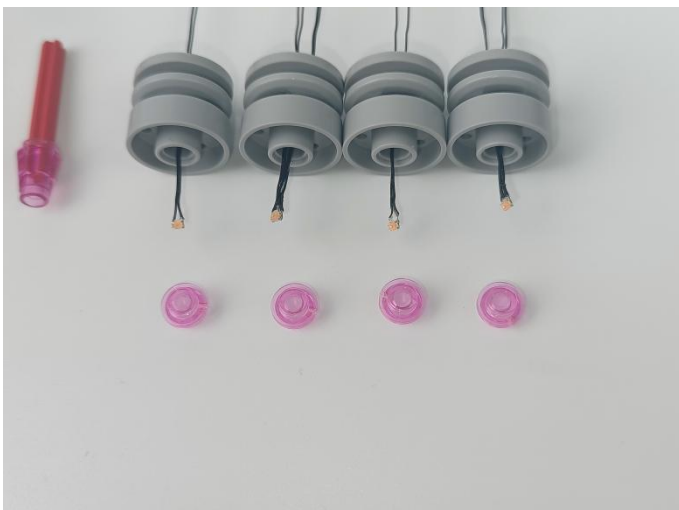



27

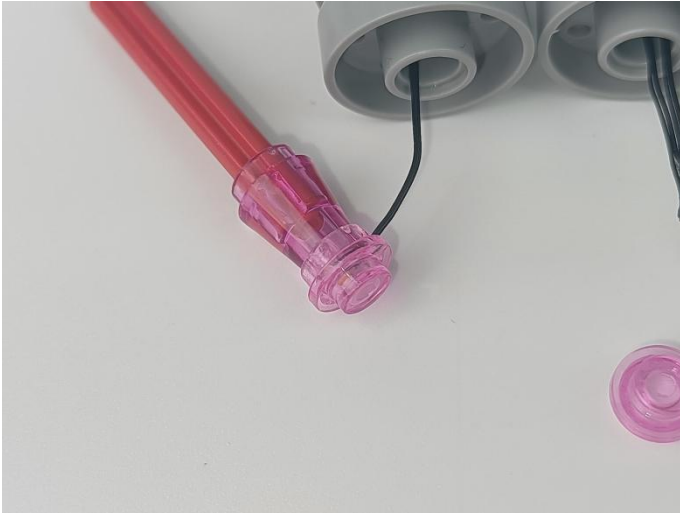

28

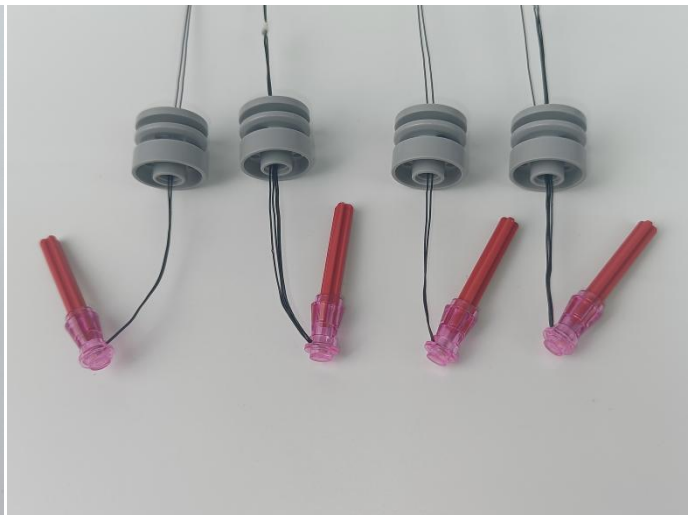
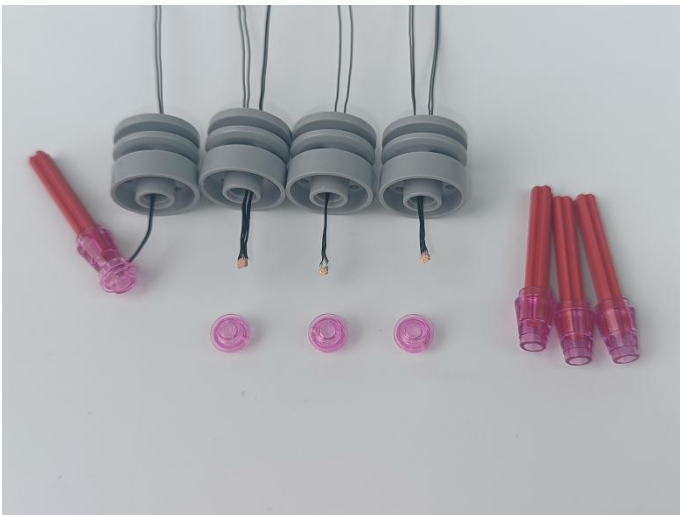

29

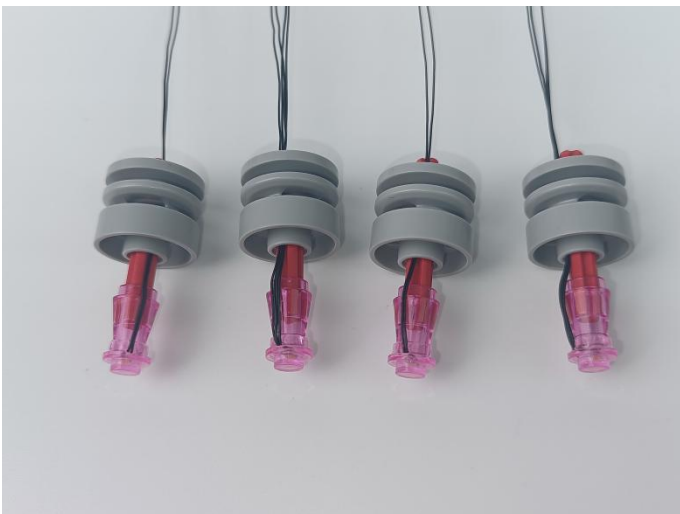

30

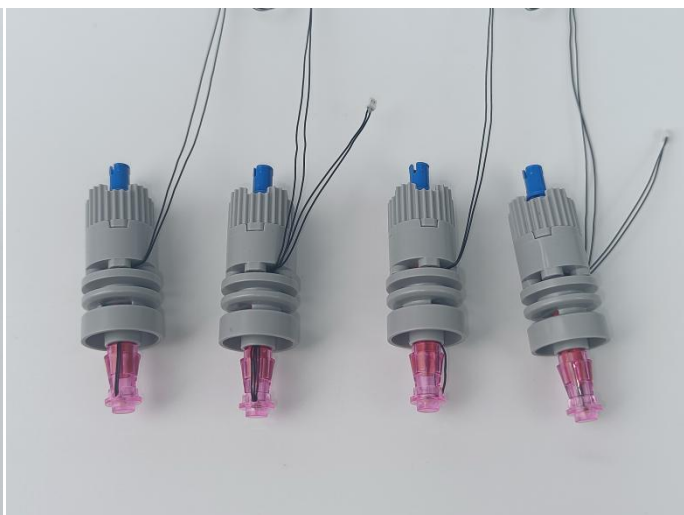
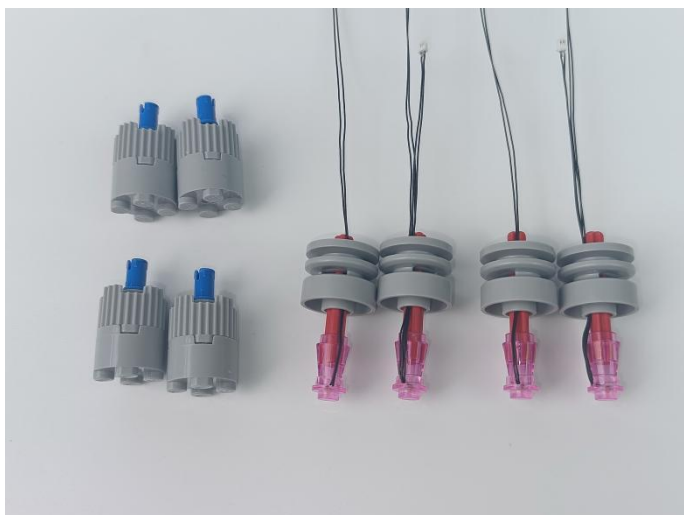

31

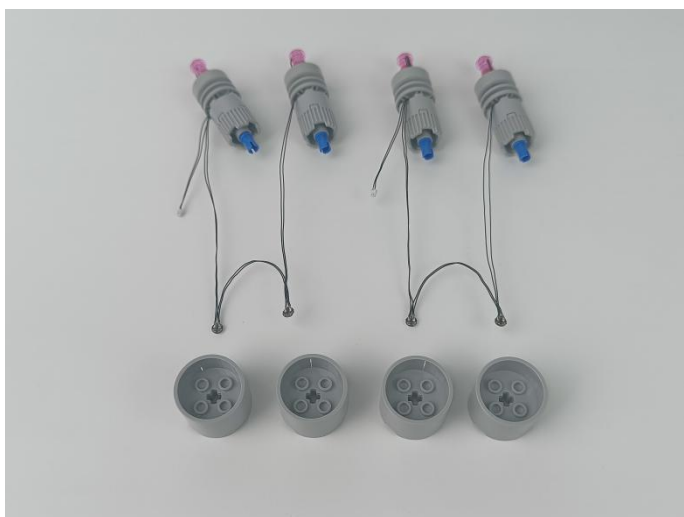

32

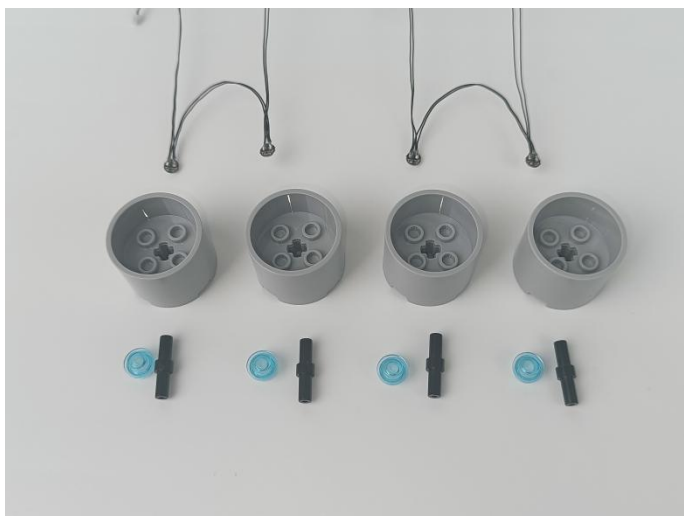

33

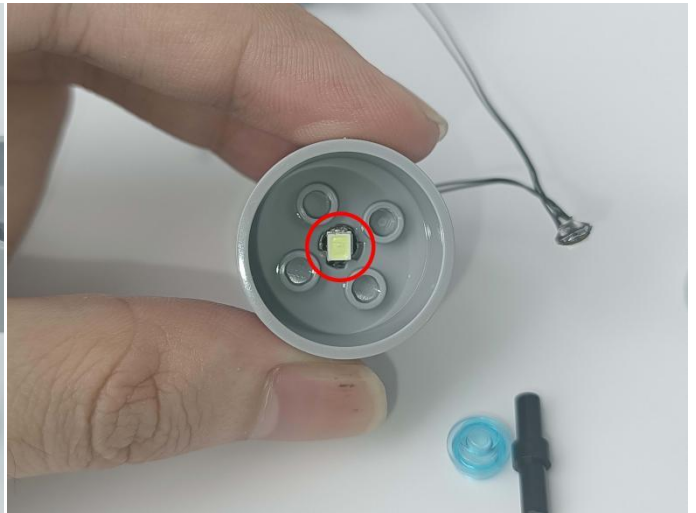

34



35

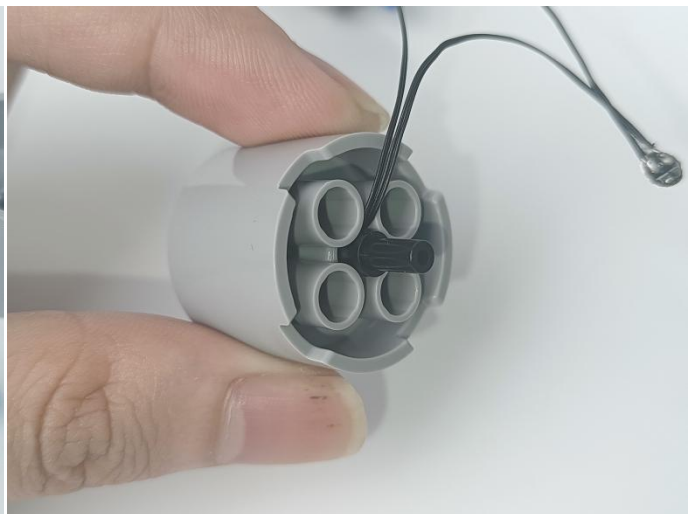
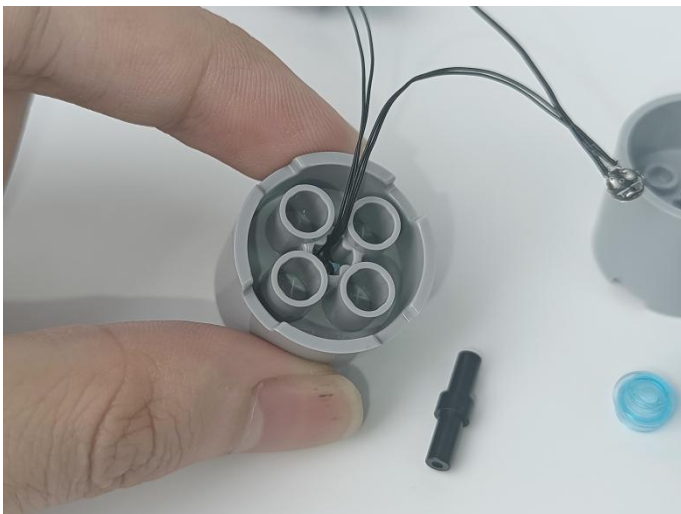

36

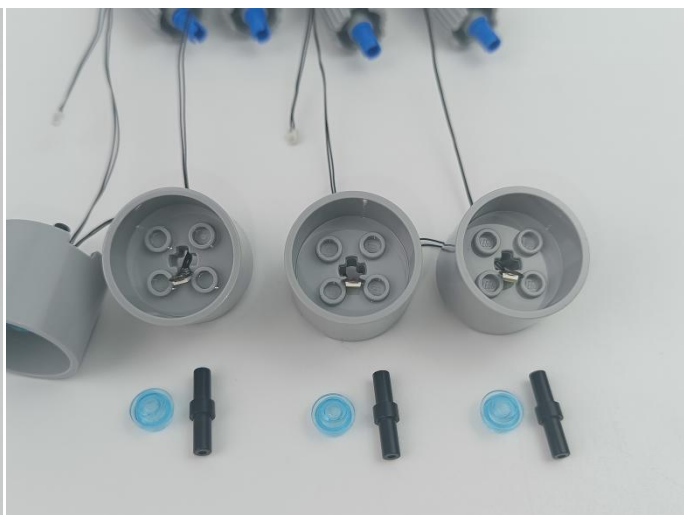
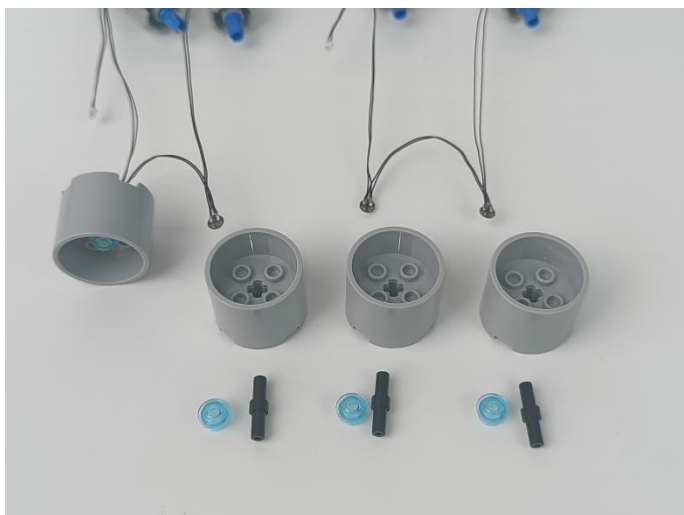

37



38

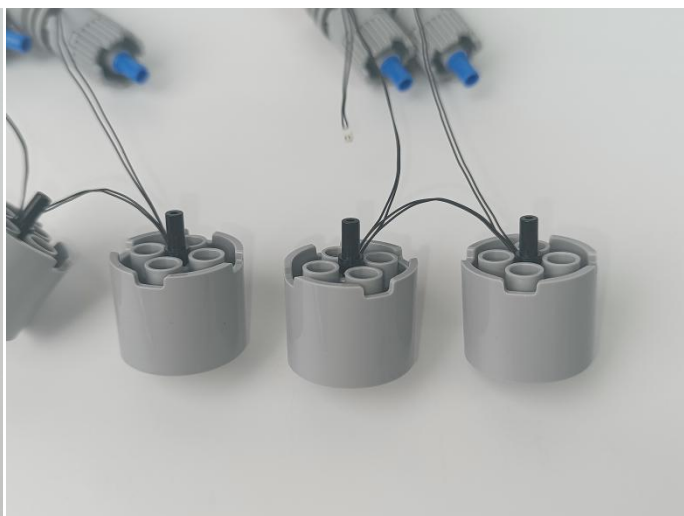
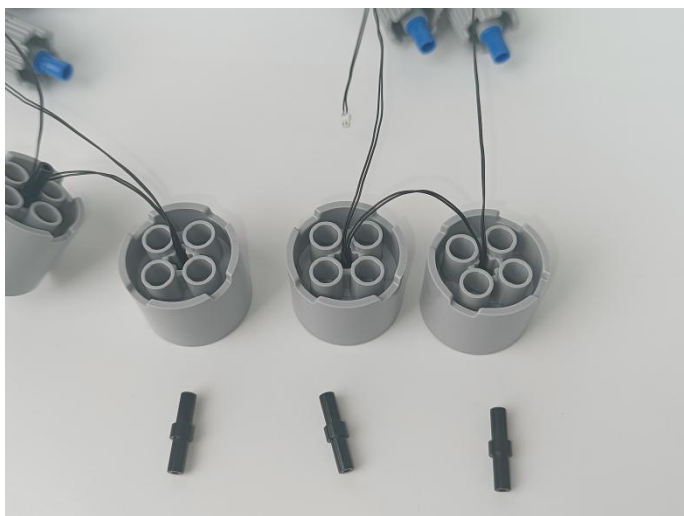

39

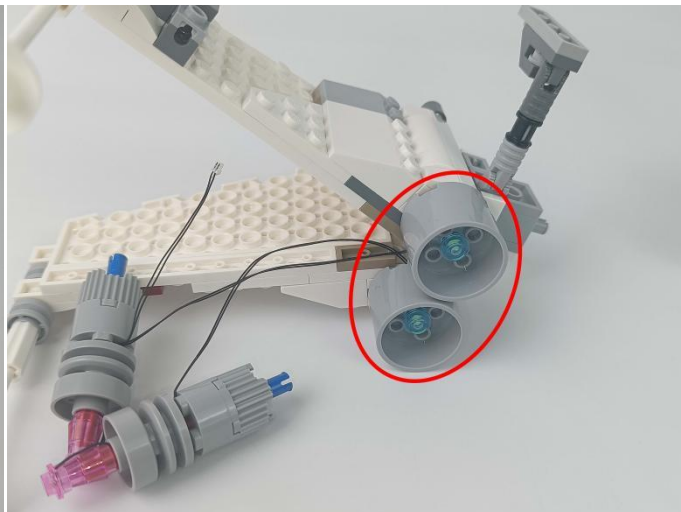
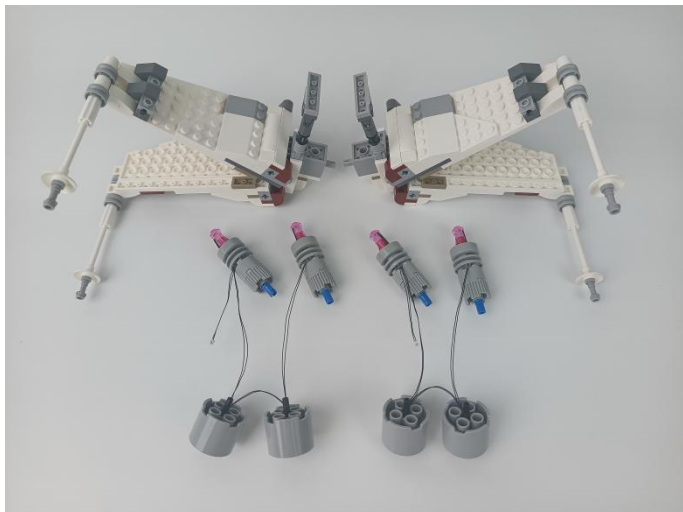

40

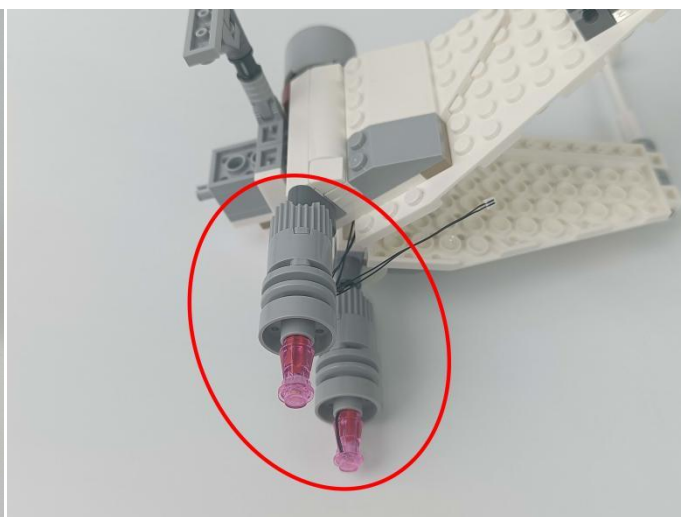
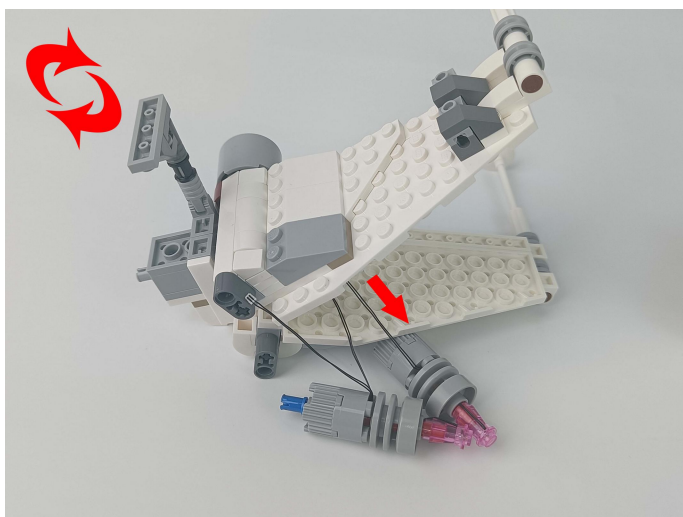

41

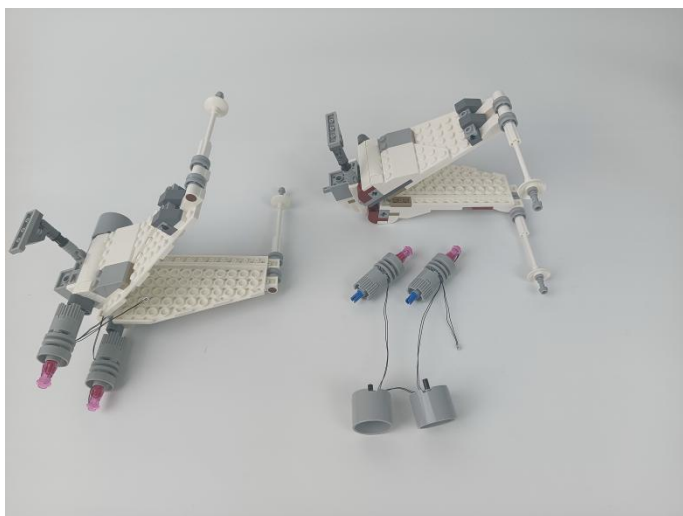

42

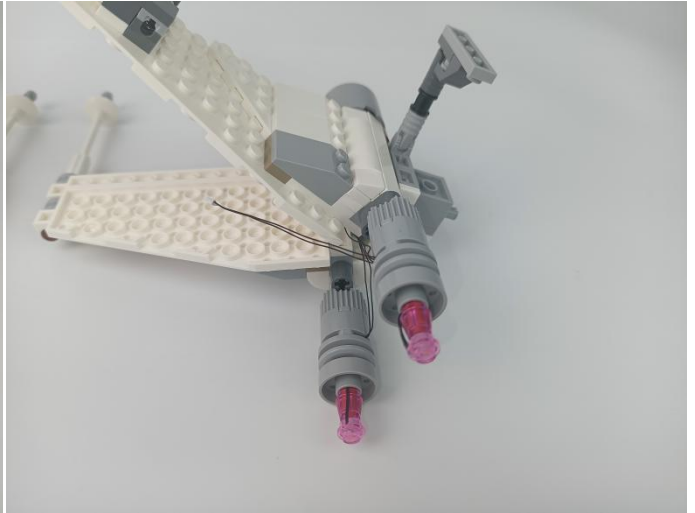
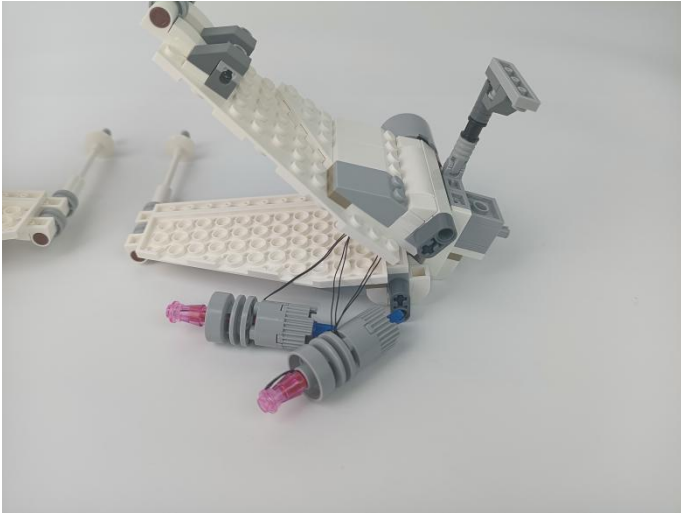

43

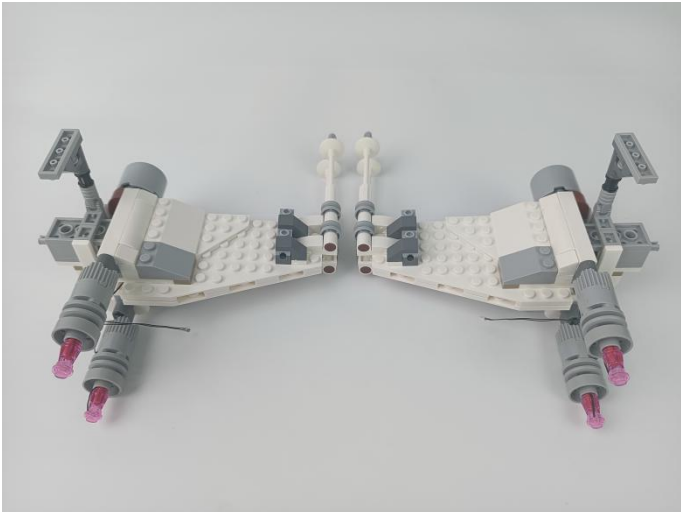

44

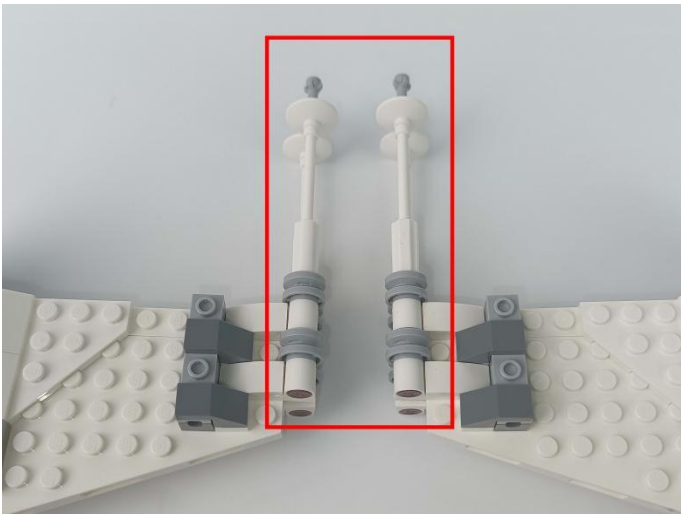

45

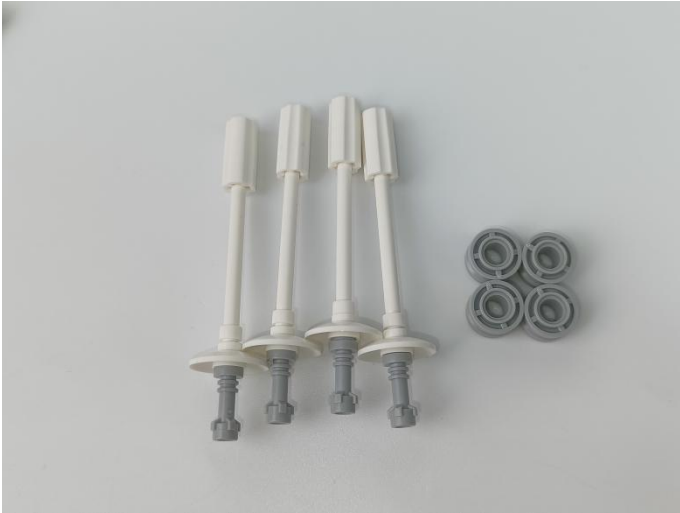

46

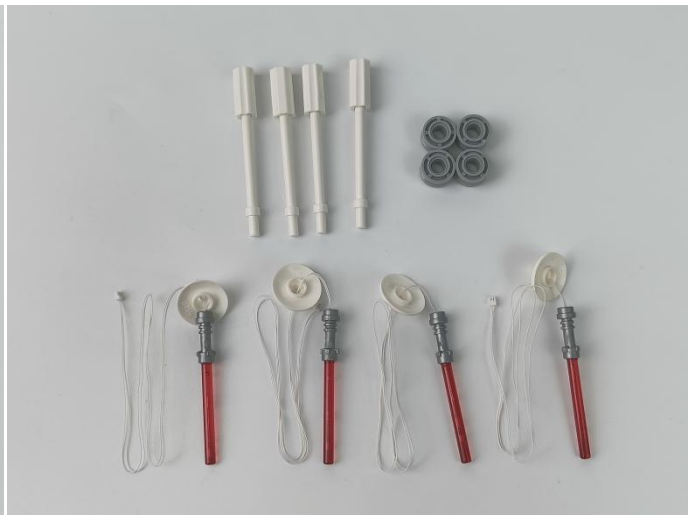

47

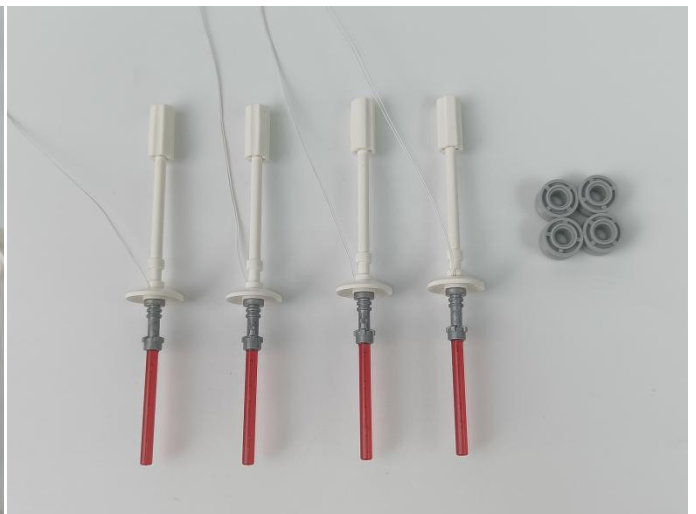
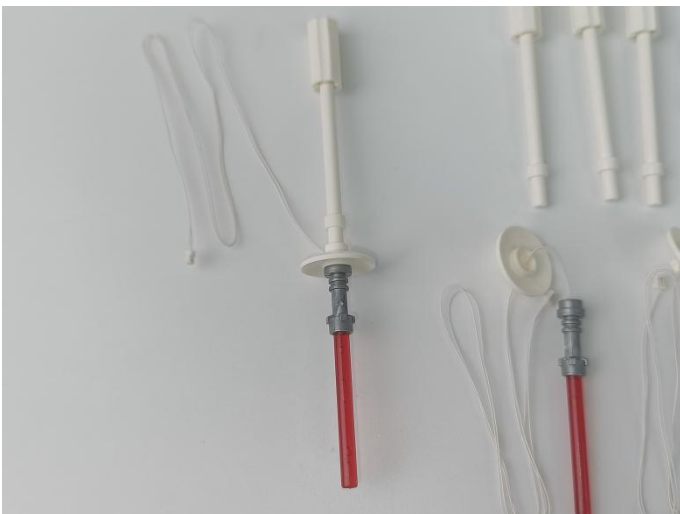

48

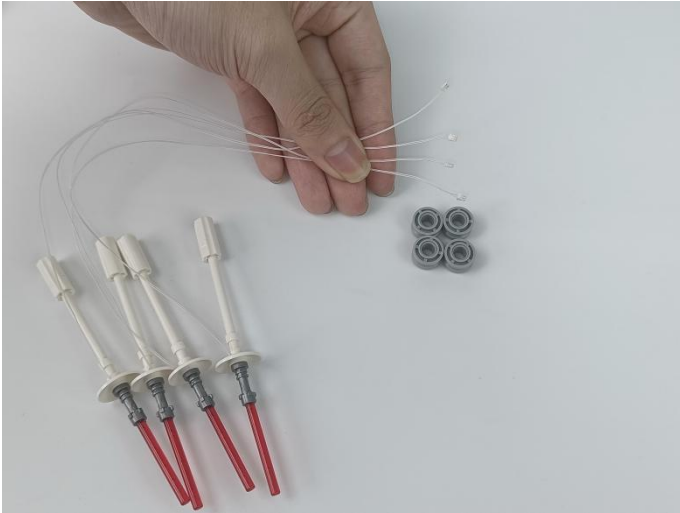

49

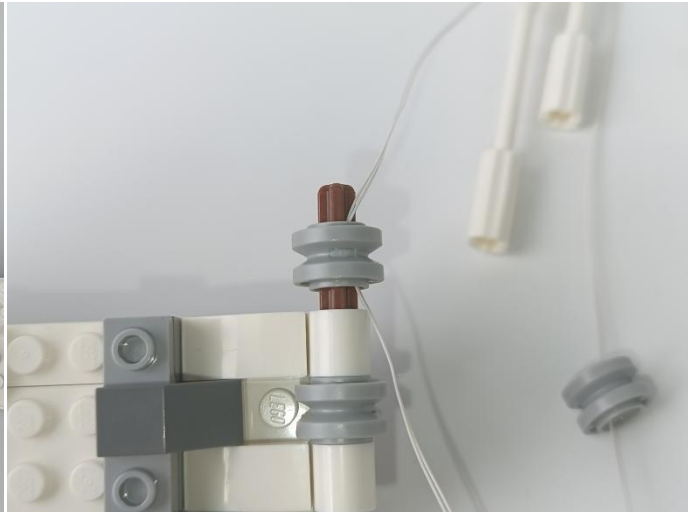
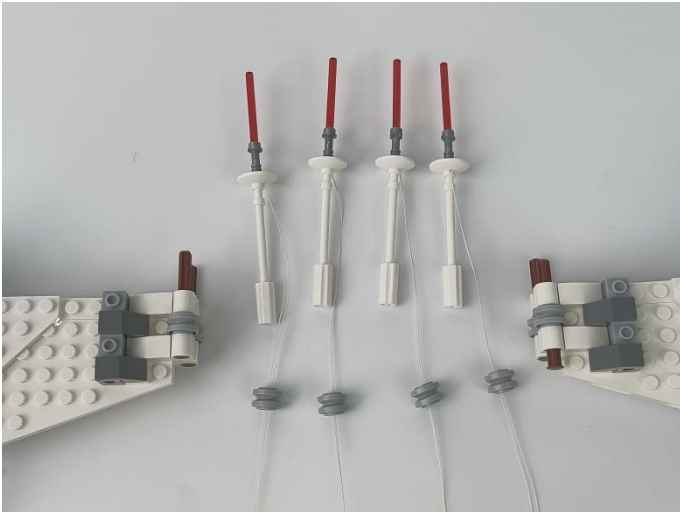

50

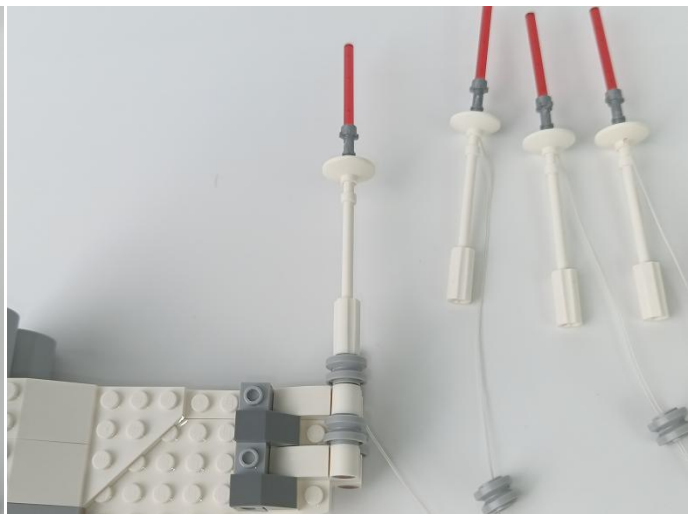
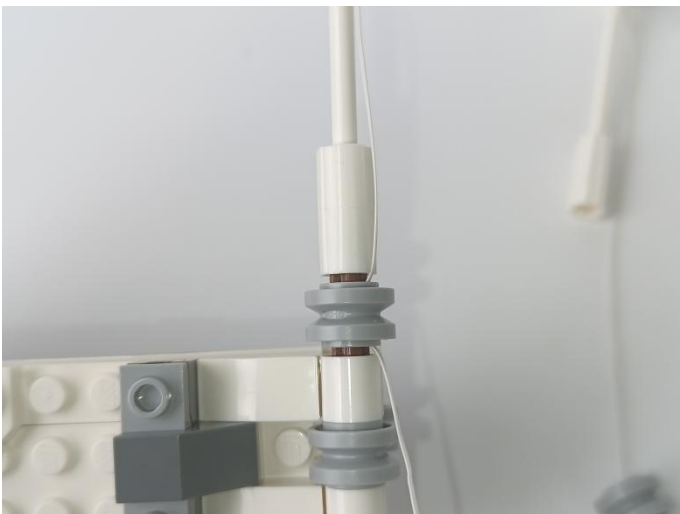



51

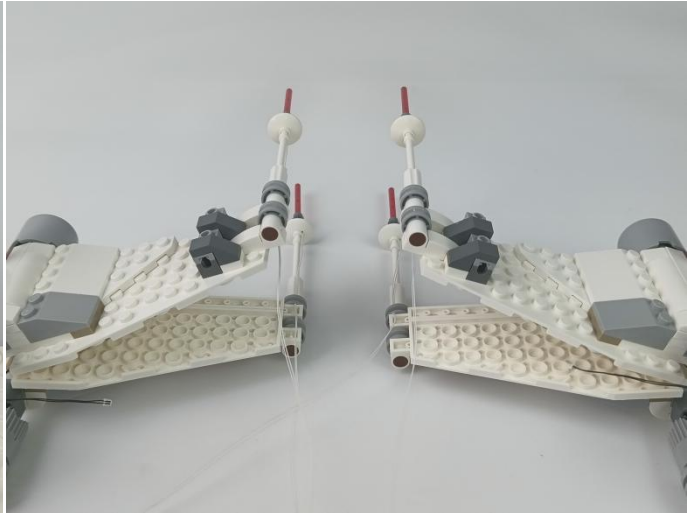
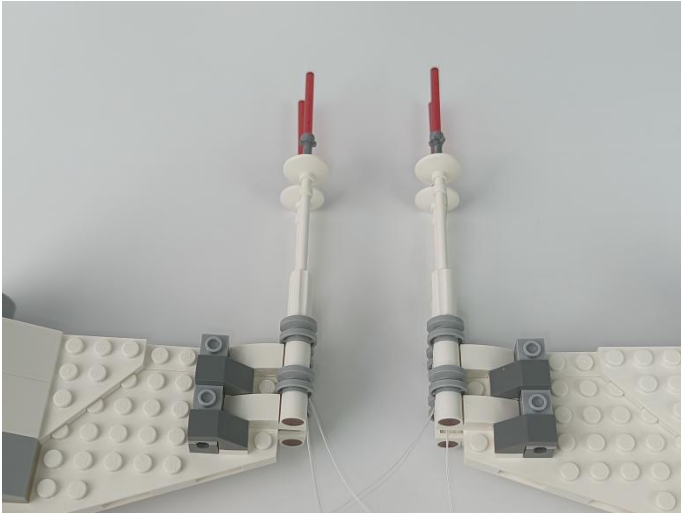

52

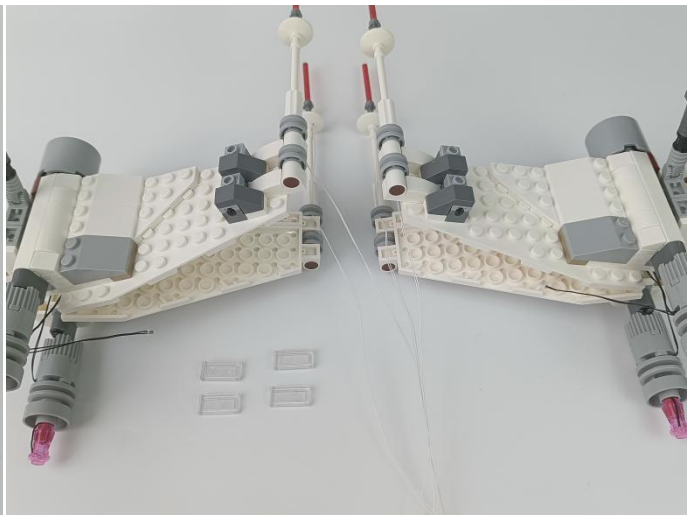

53

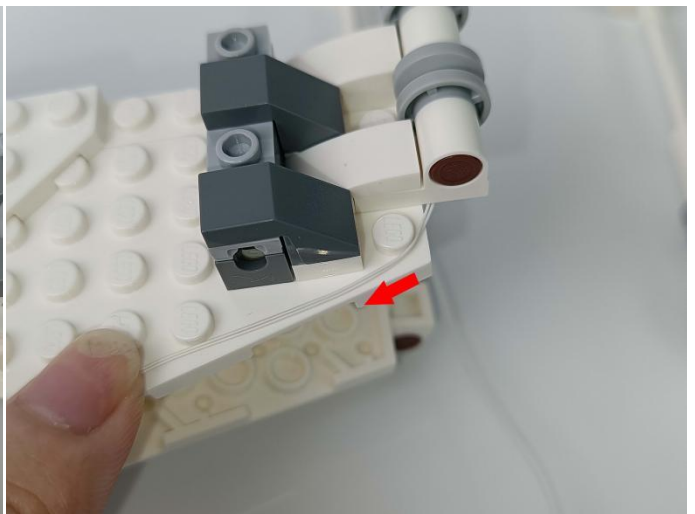
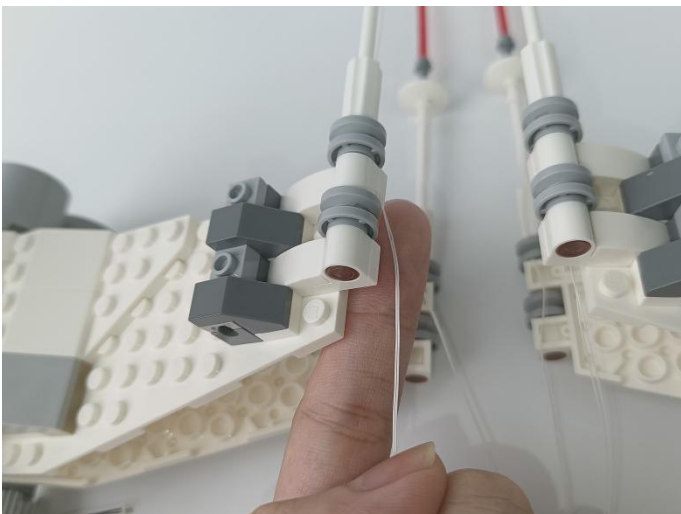

54

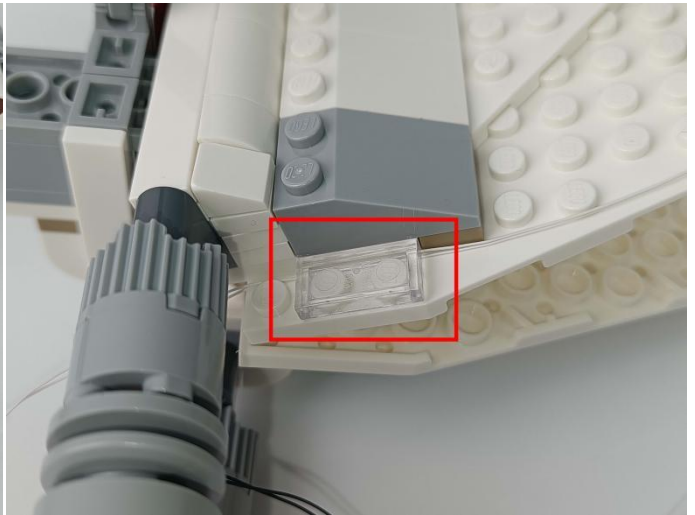
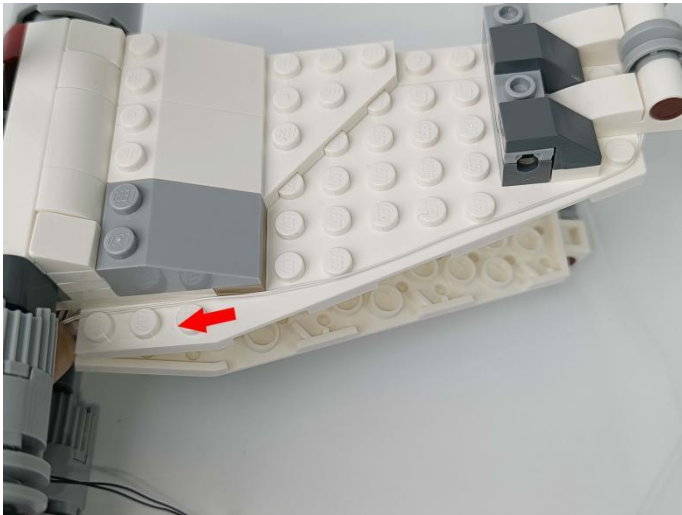

55

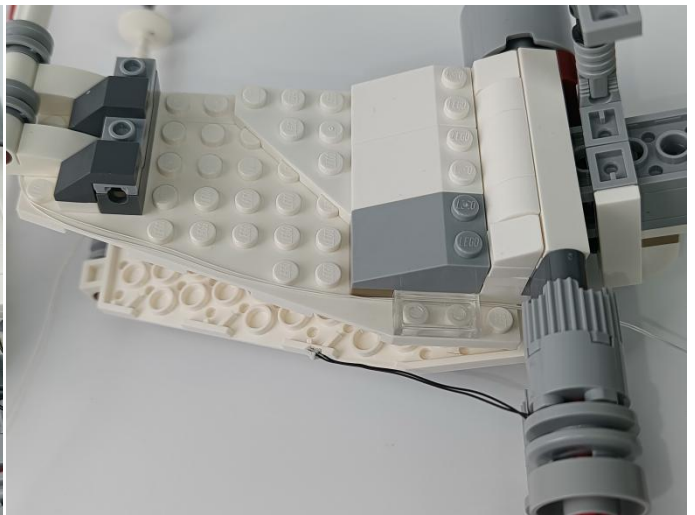
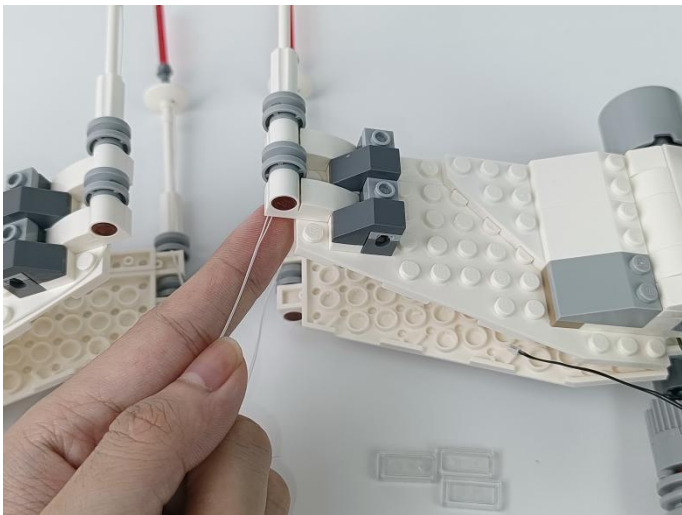

56

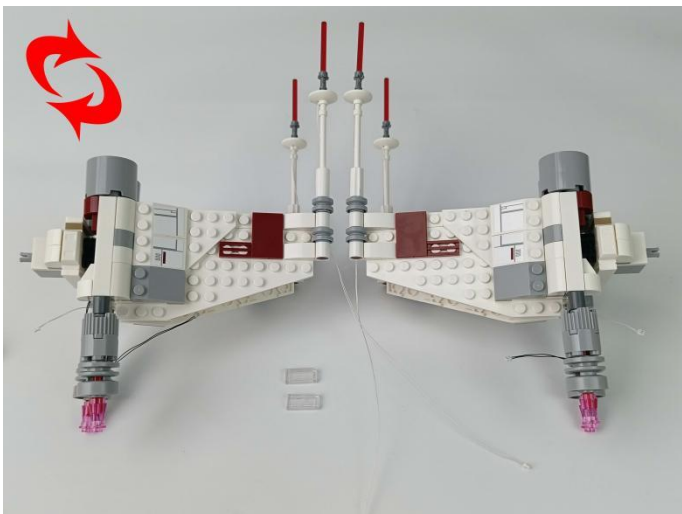

57

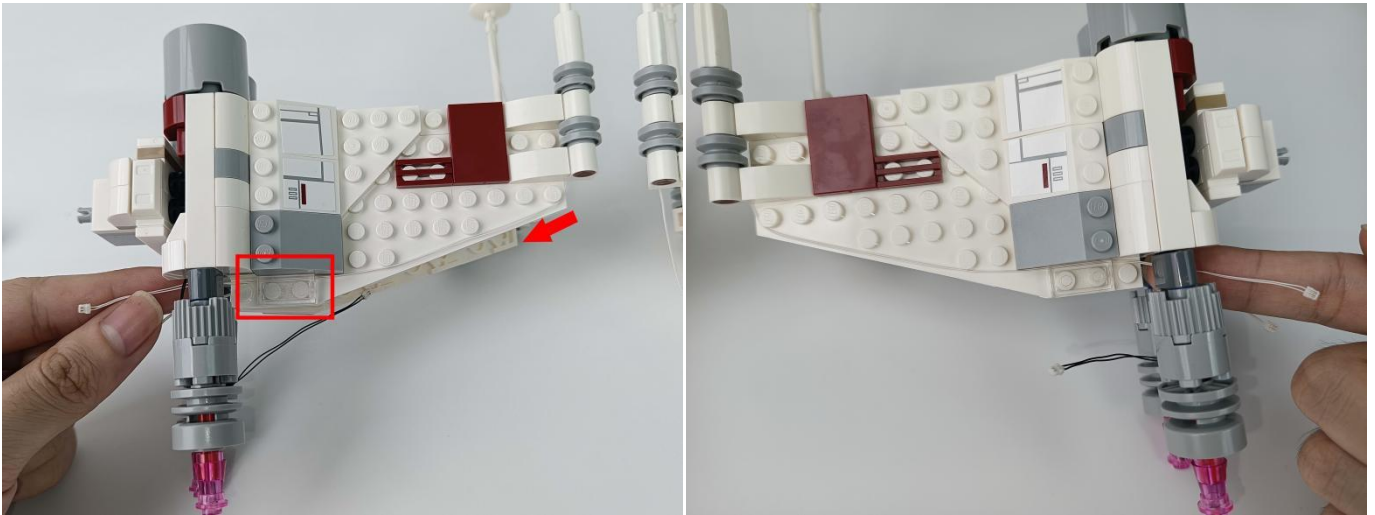

58

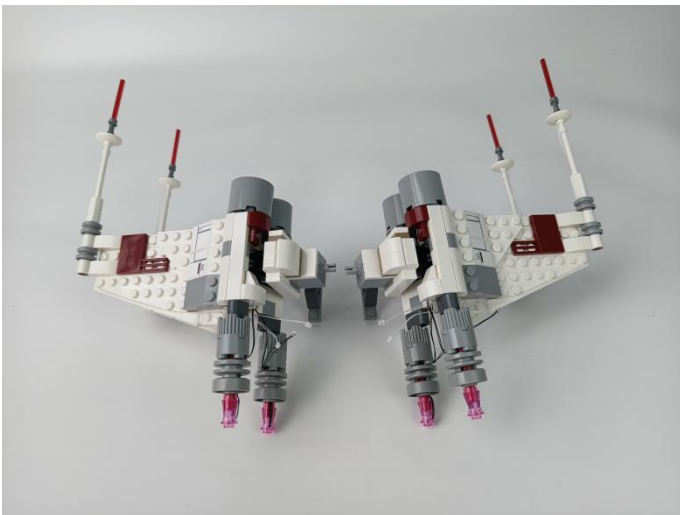

59



60

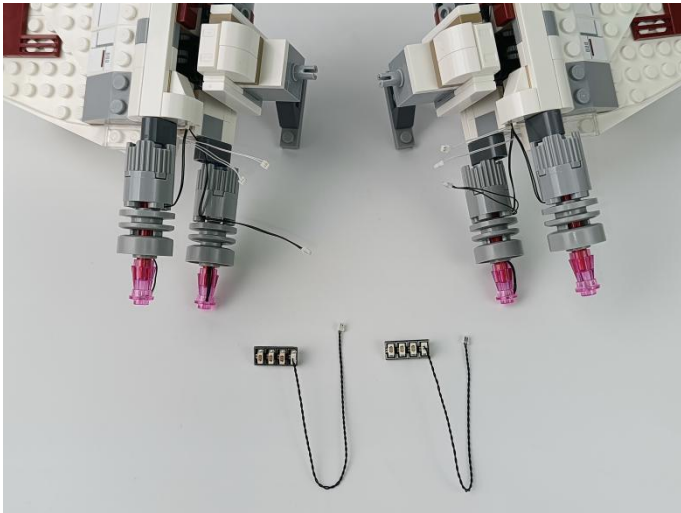

61

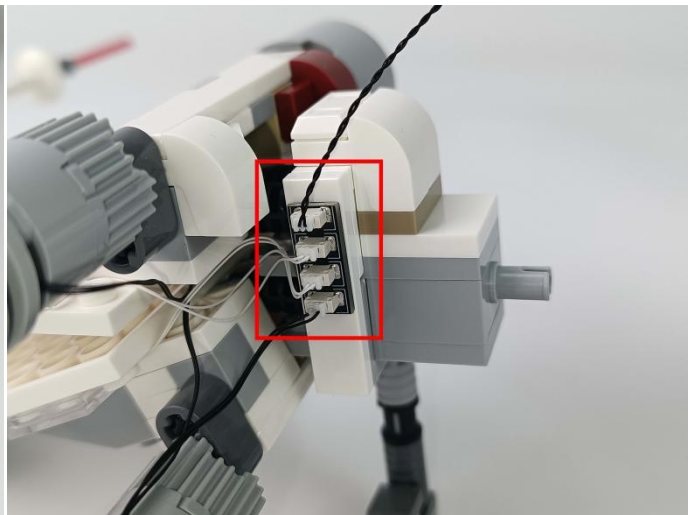

62

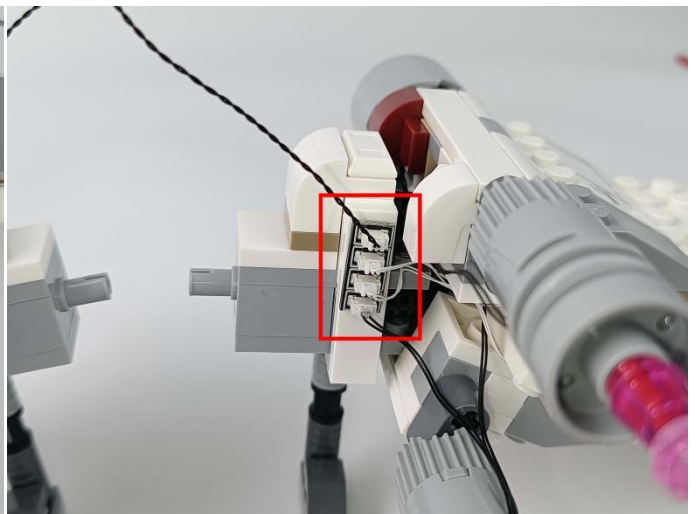

63

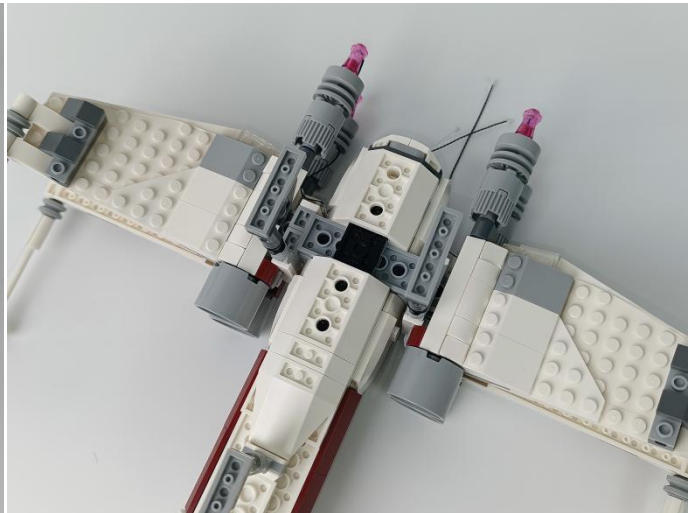

64

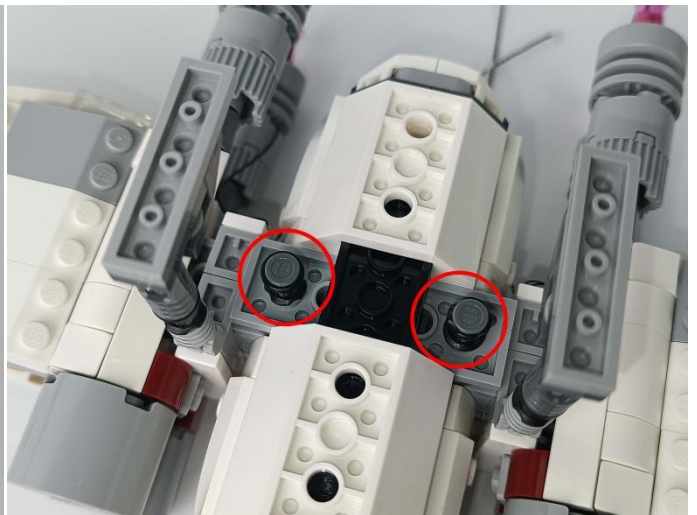

65



66

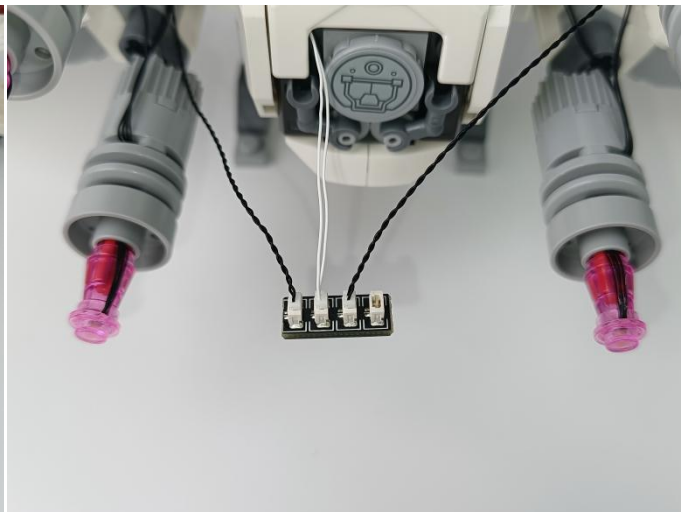
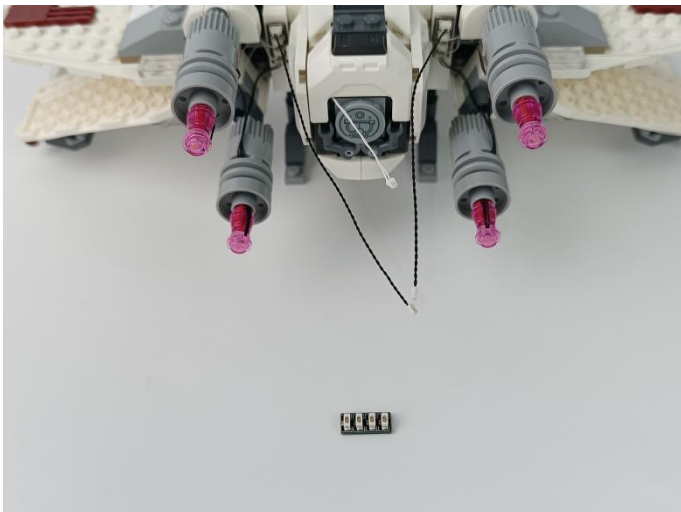

67

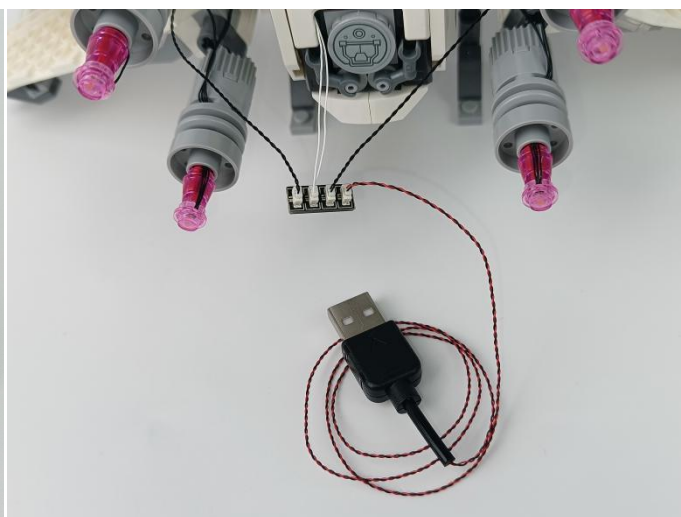

68

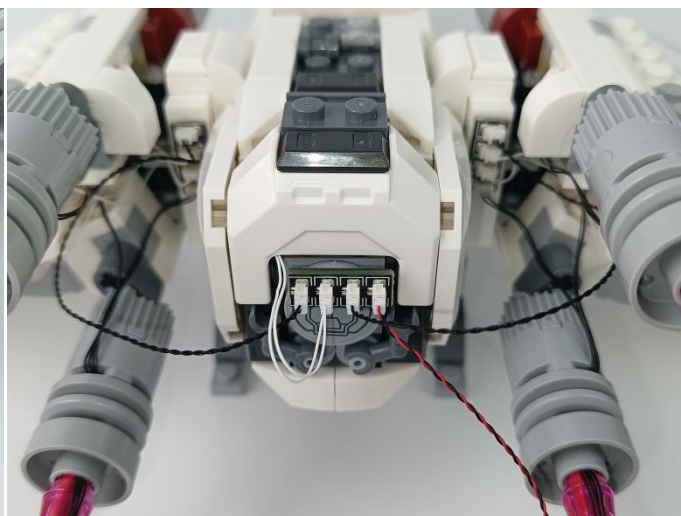
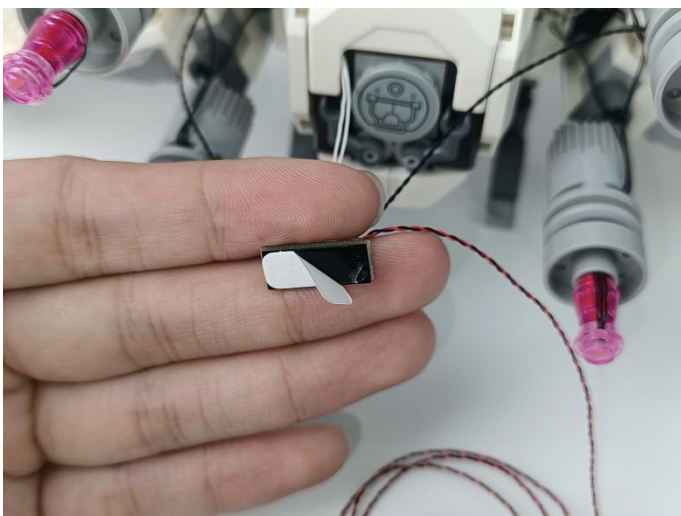

69

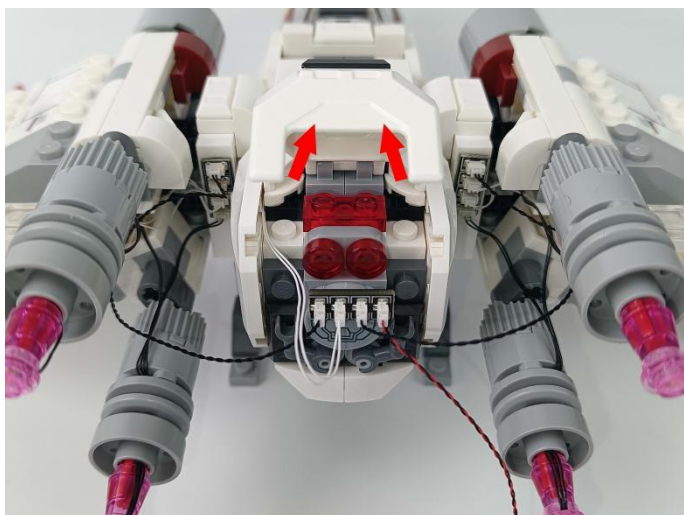

70

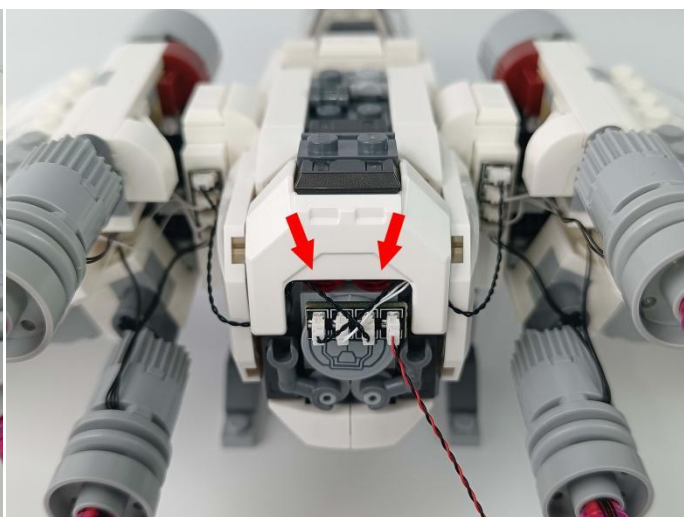
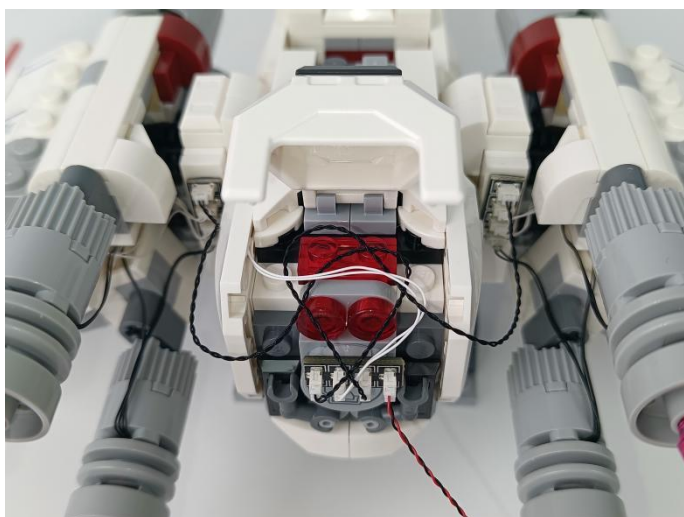

71

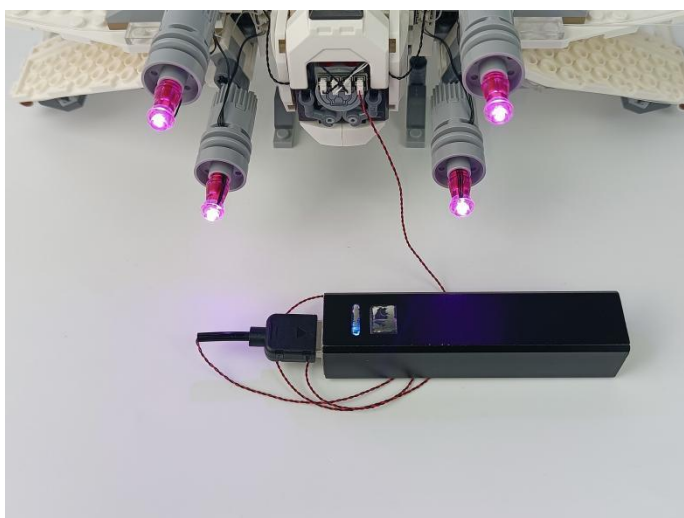

72



73

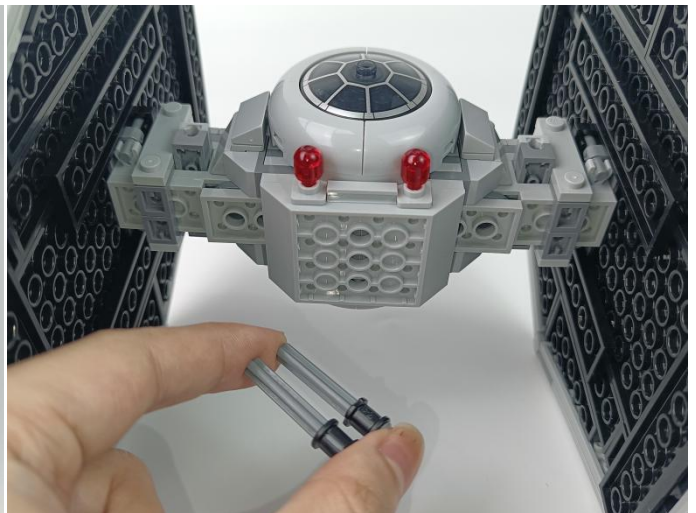
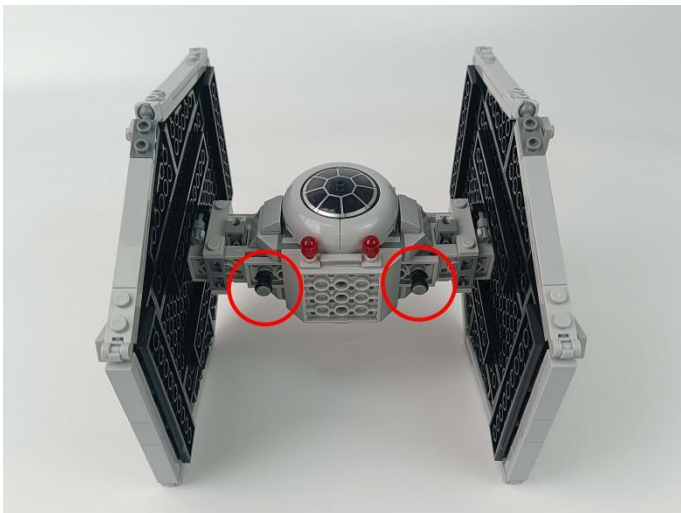

74





75

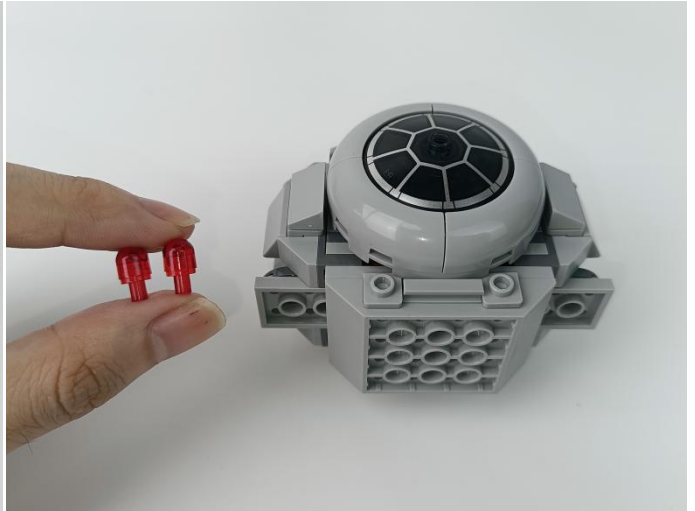
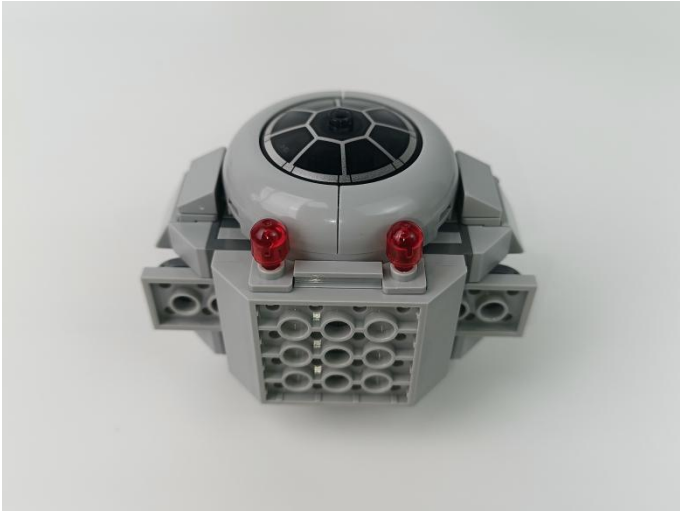

76

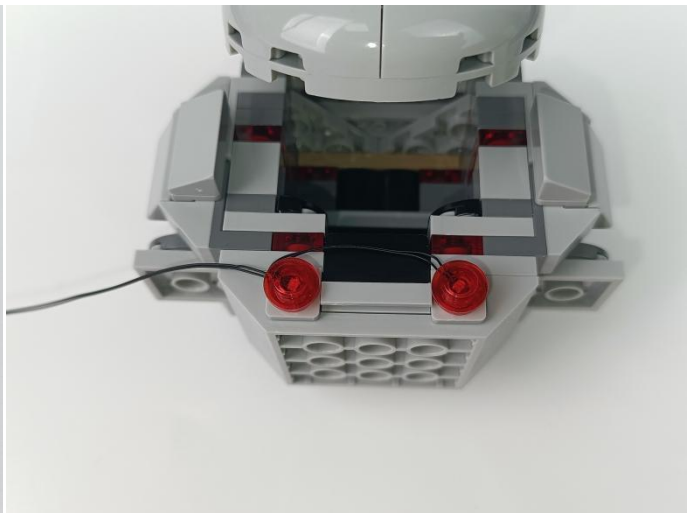

77

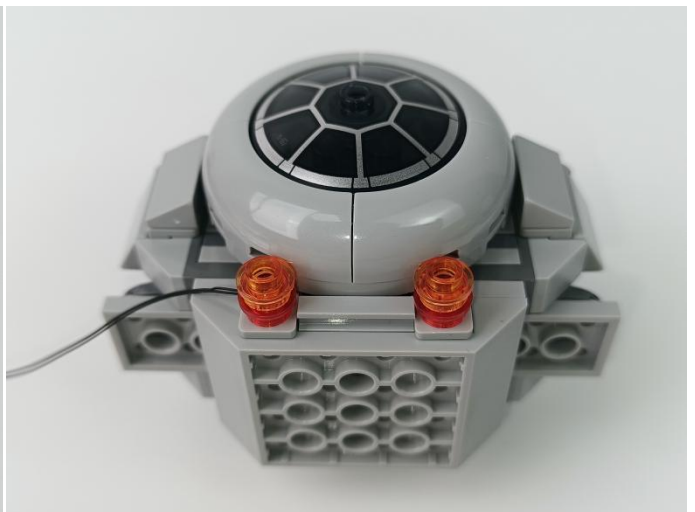

78

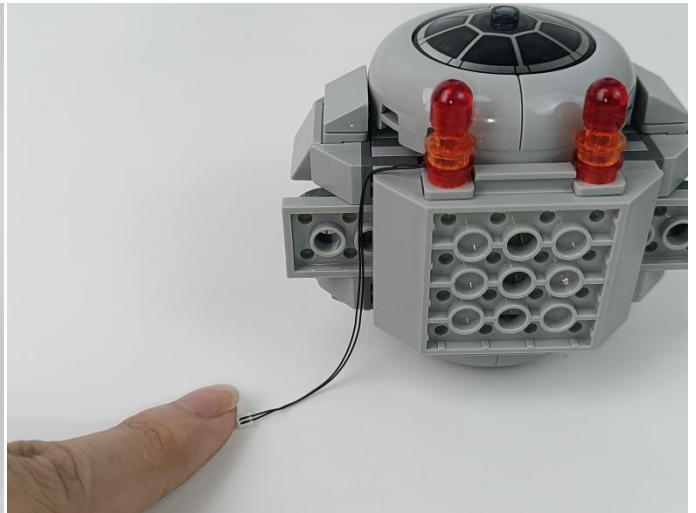
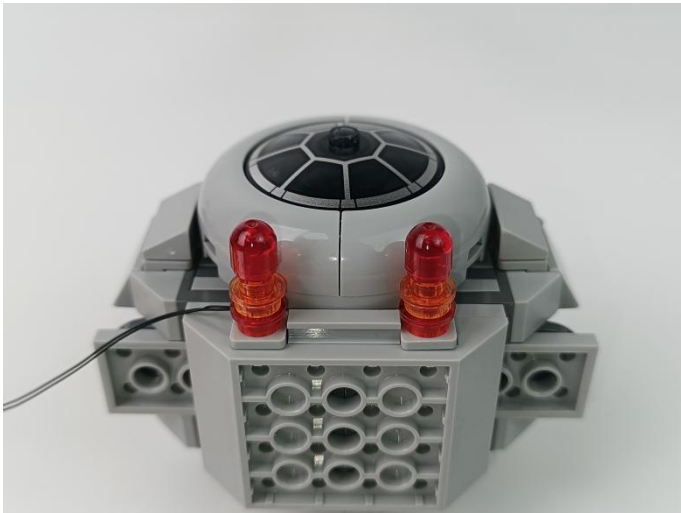

79

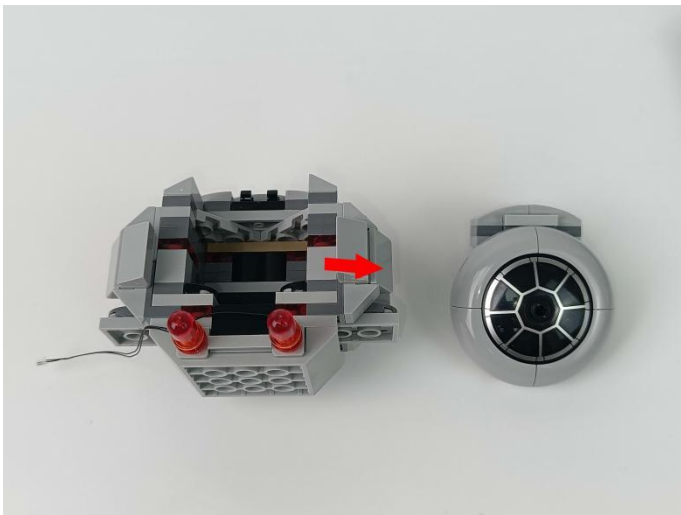

80



81



82

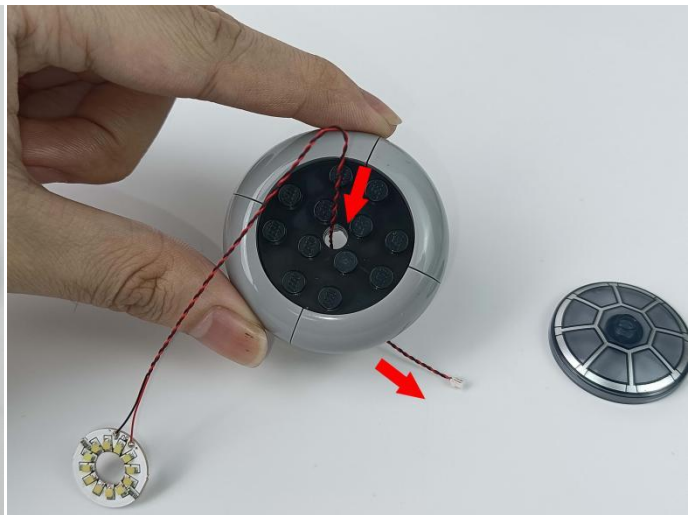

83



84

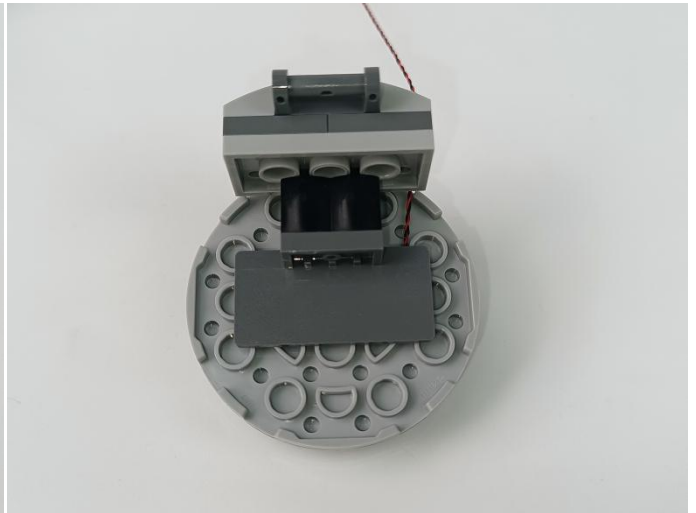
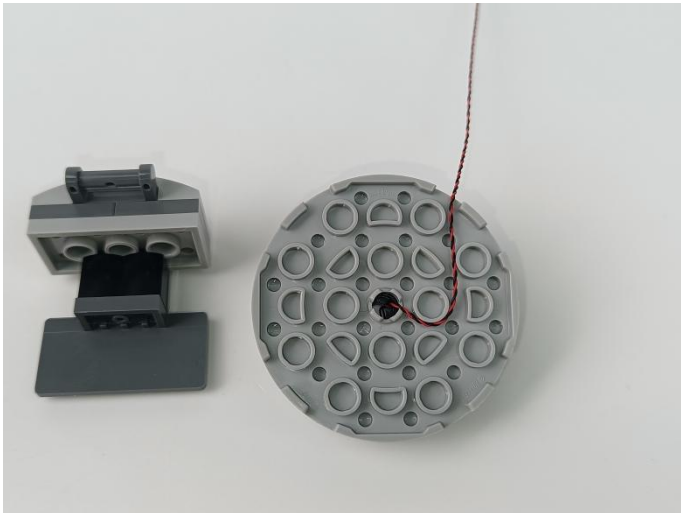

85

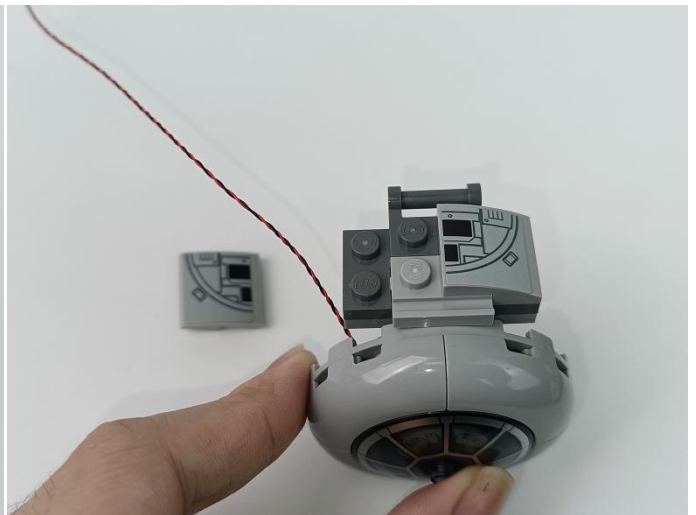
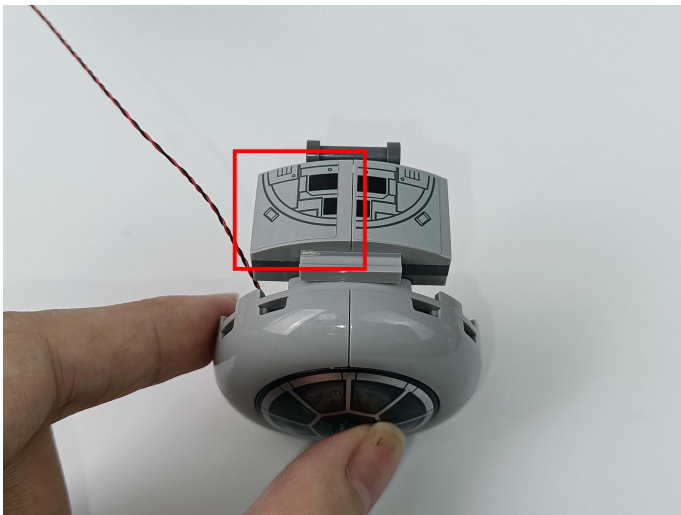

86

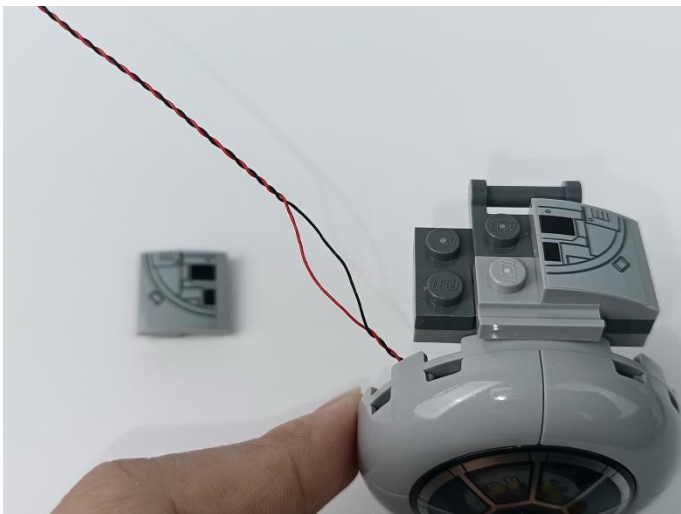

87

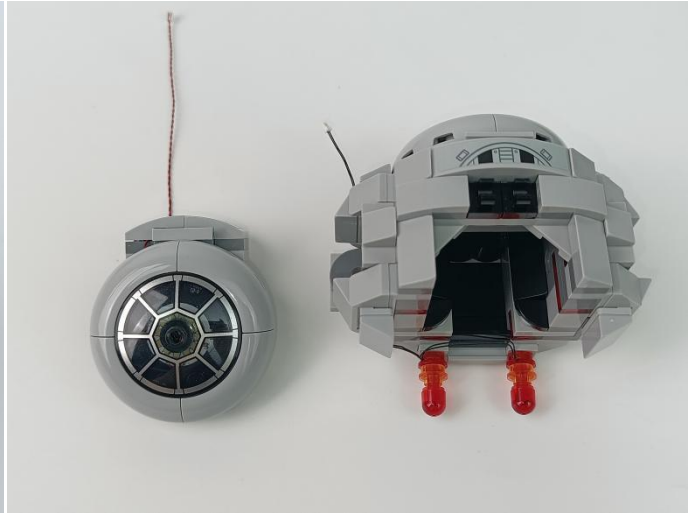
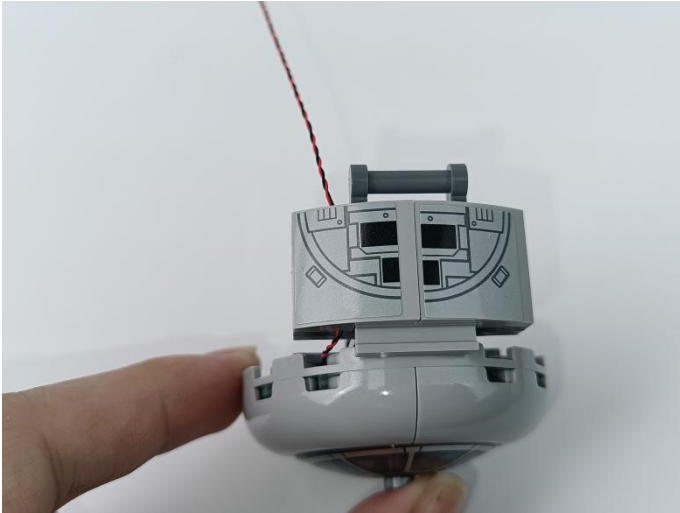

88

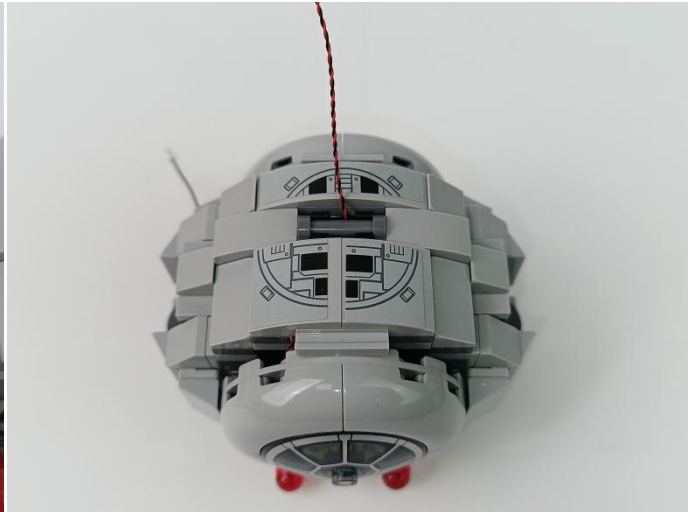
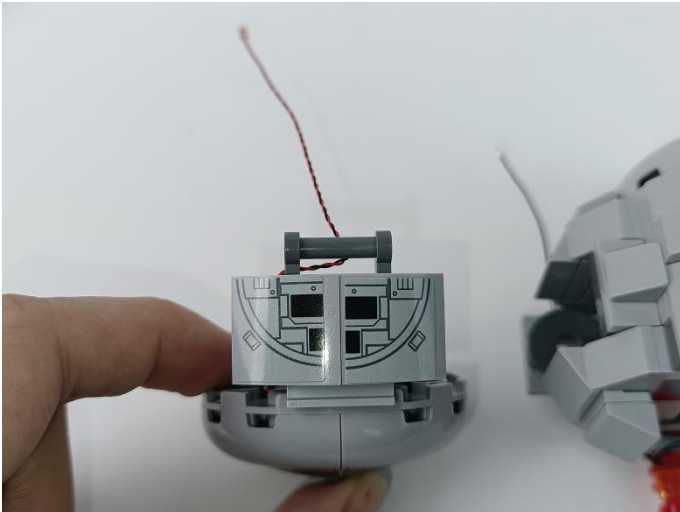

89

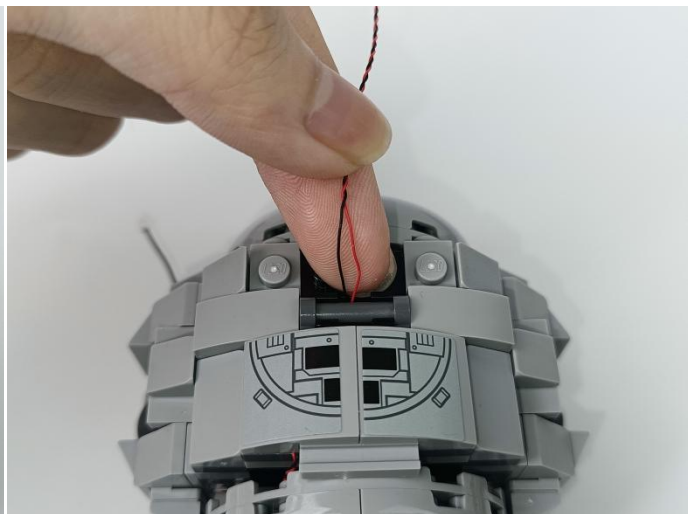
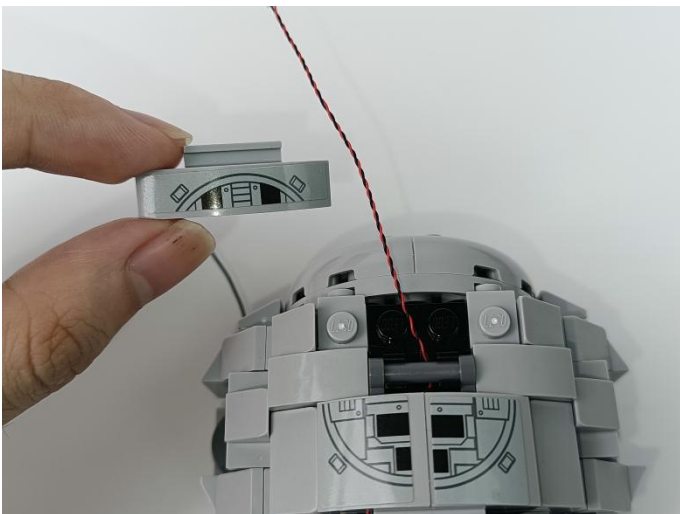

90

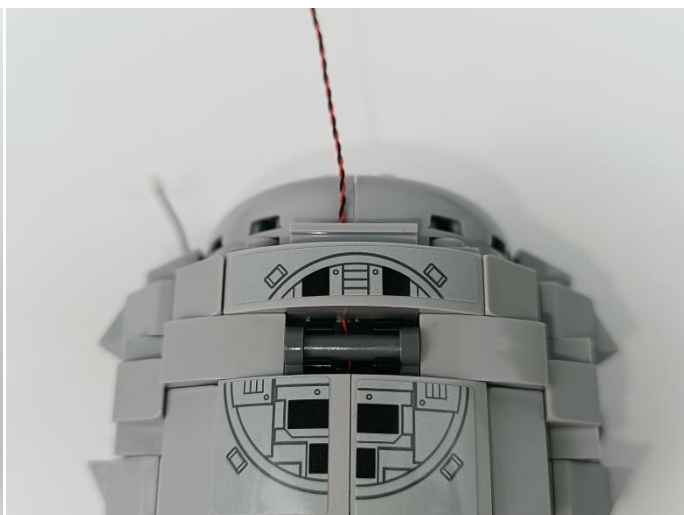
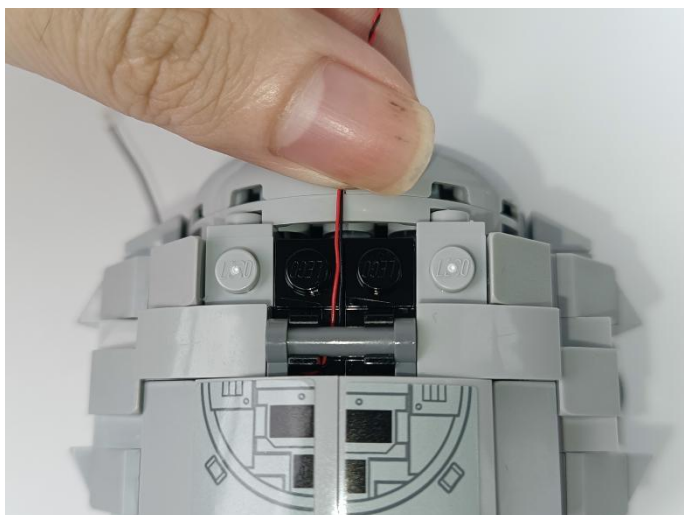

91

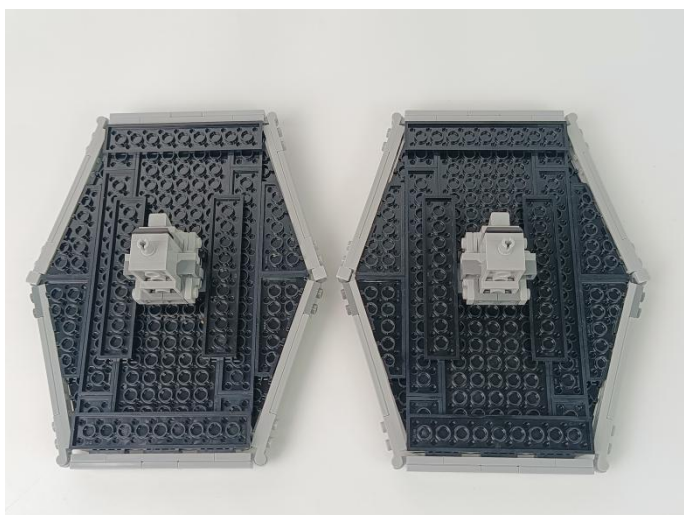

92

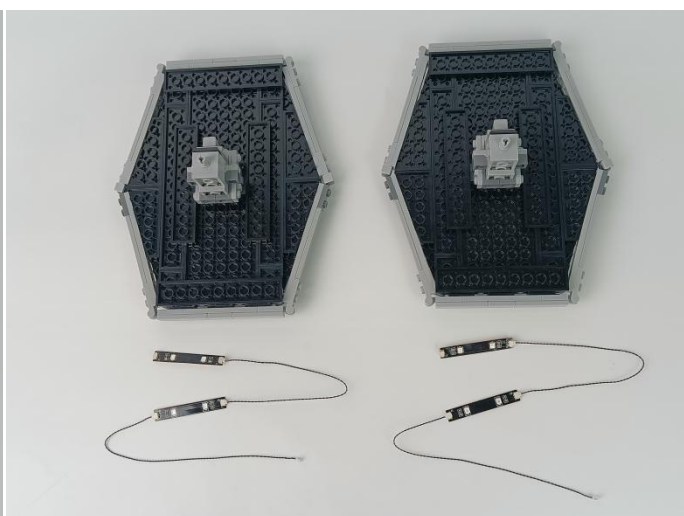

93

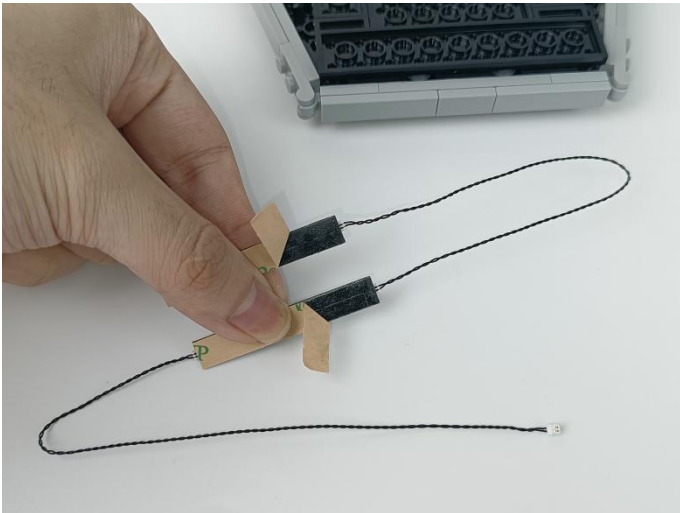

94

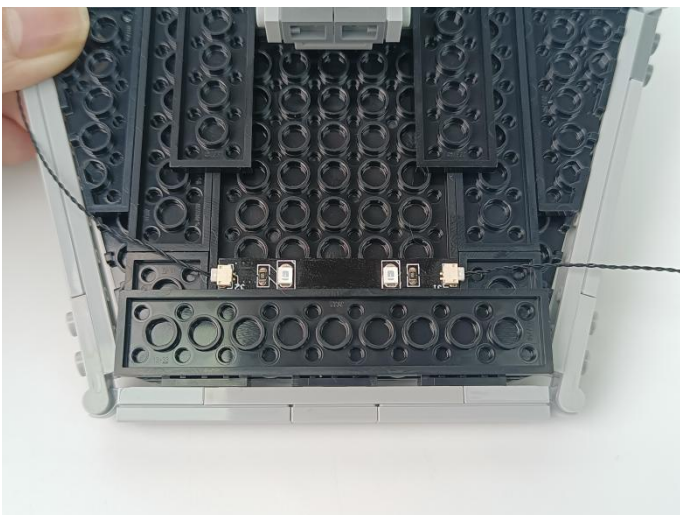

95

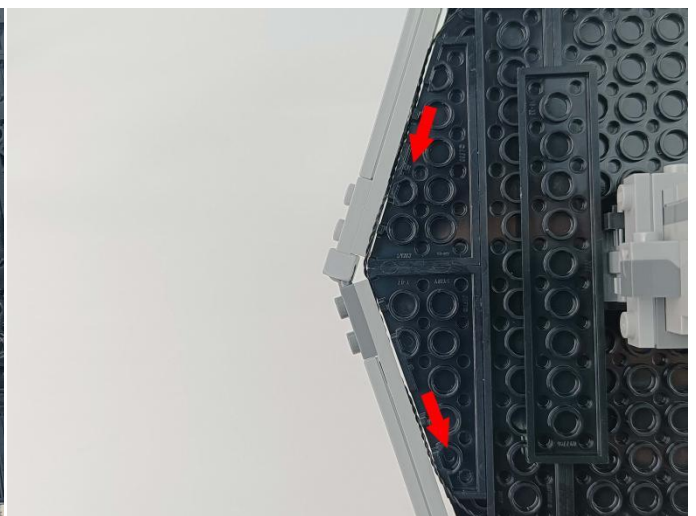
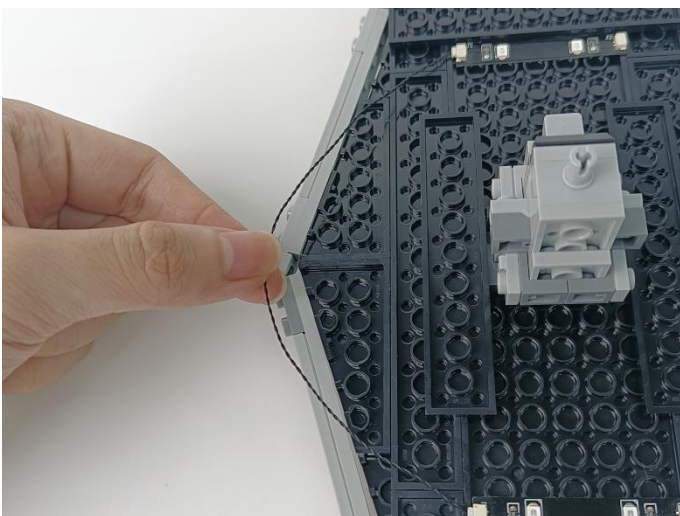

96

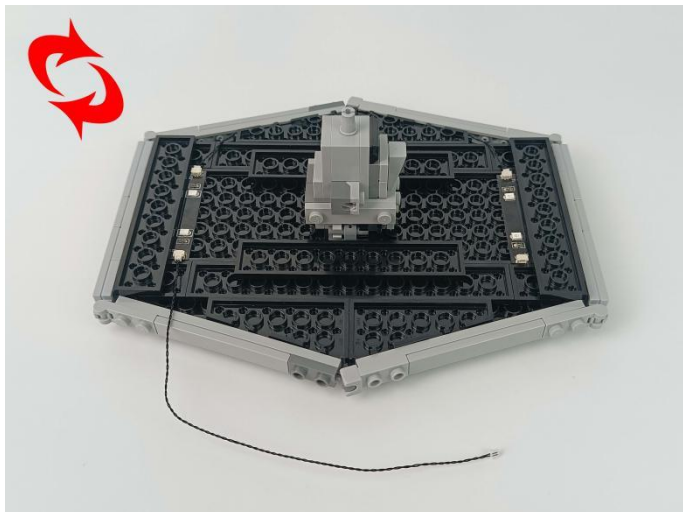

97

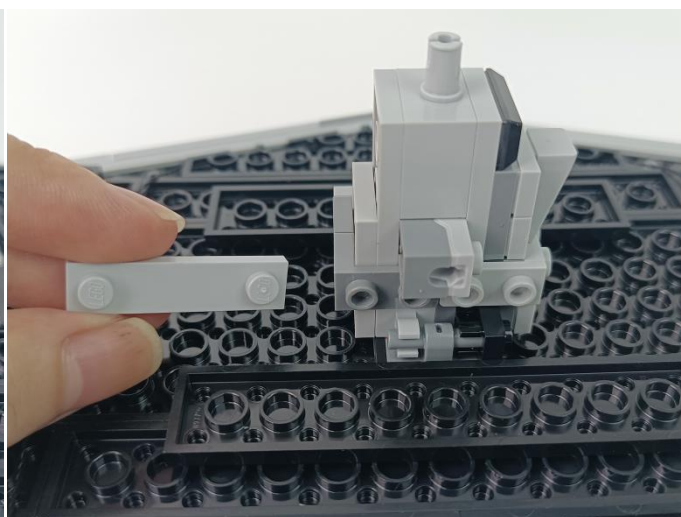
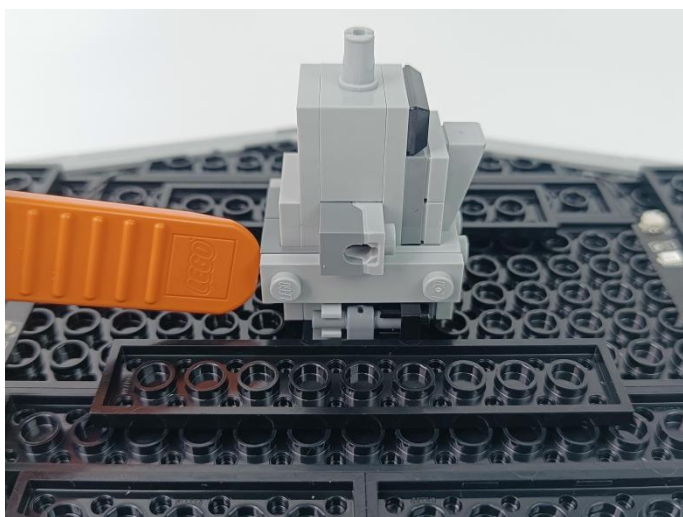

98

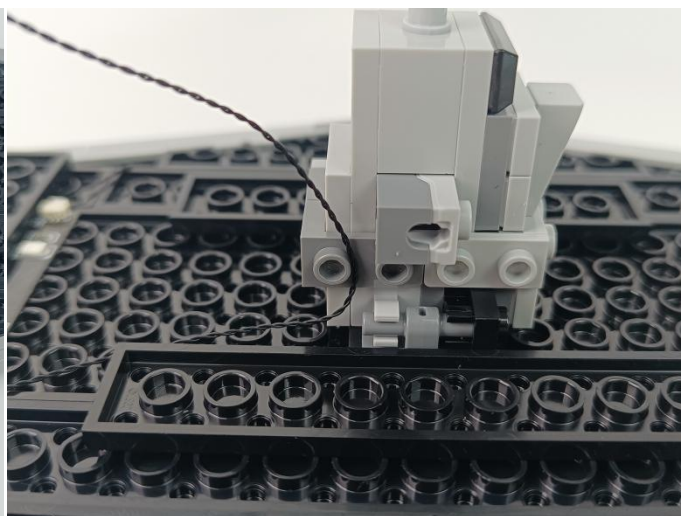
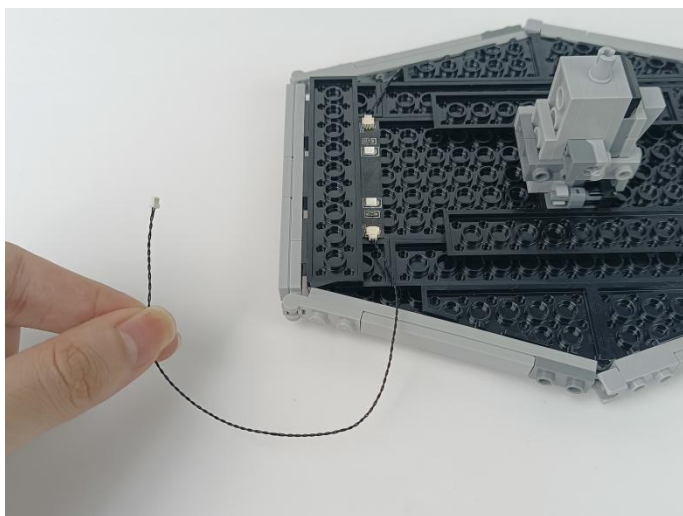



99

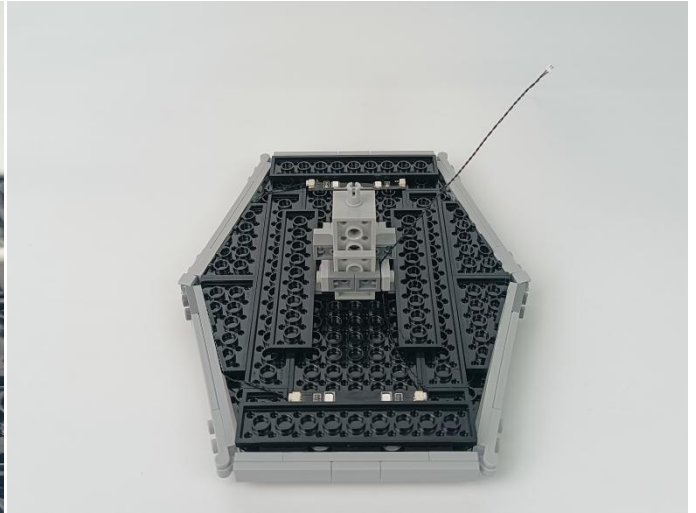
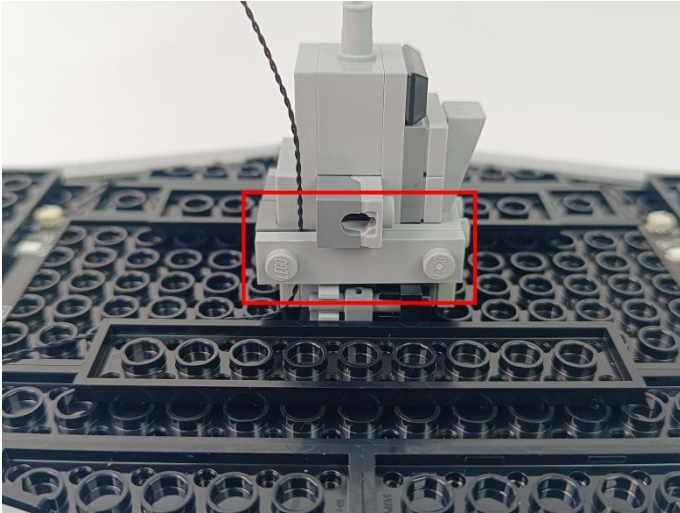

100

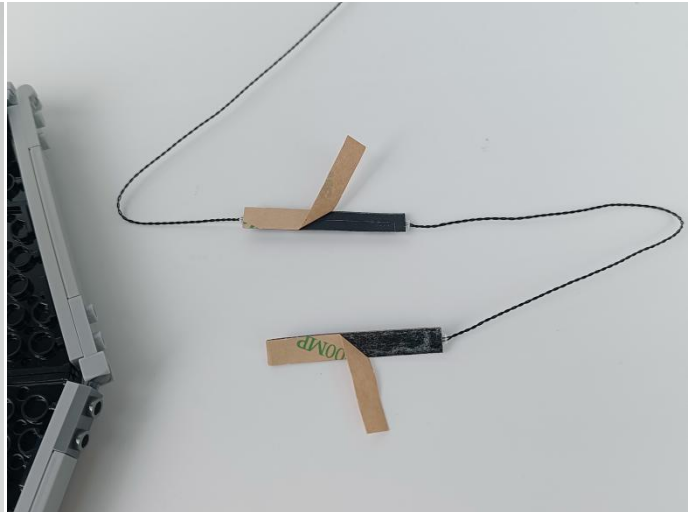
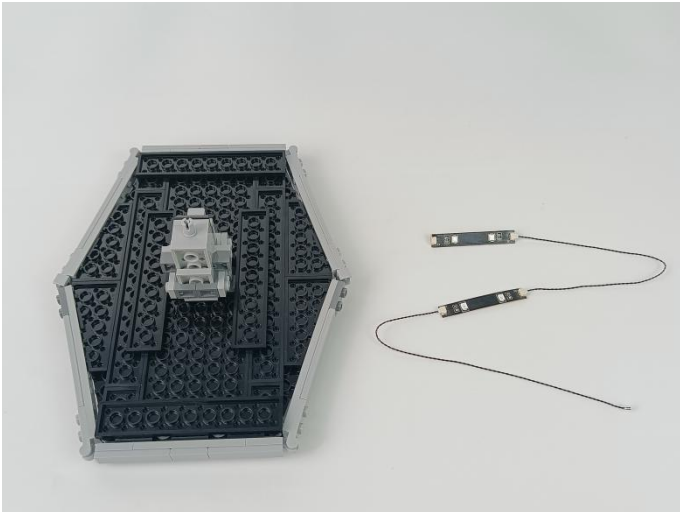

101

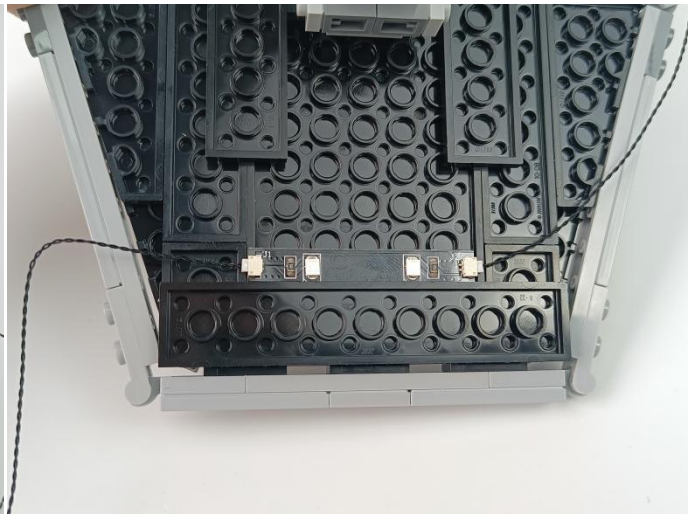

102

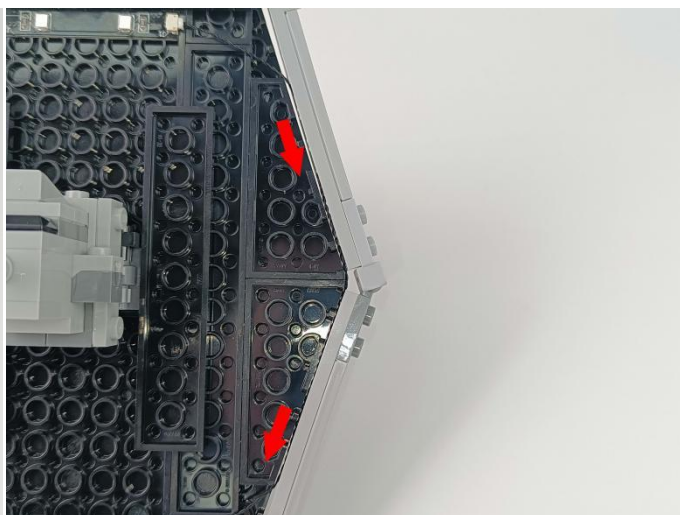

103

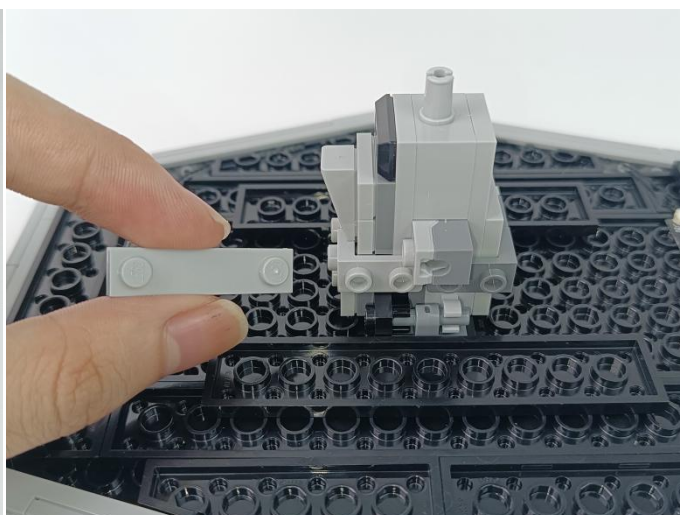
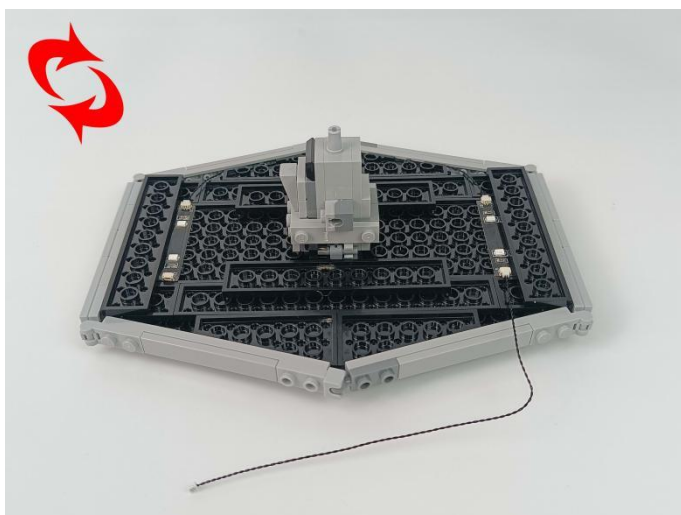

104

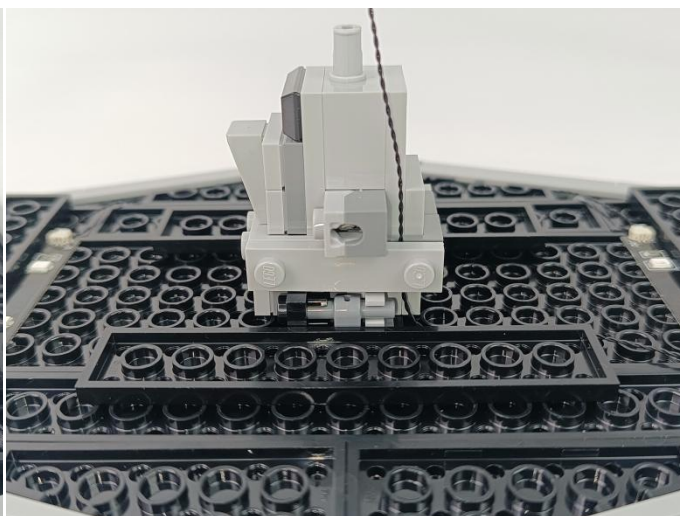
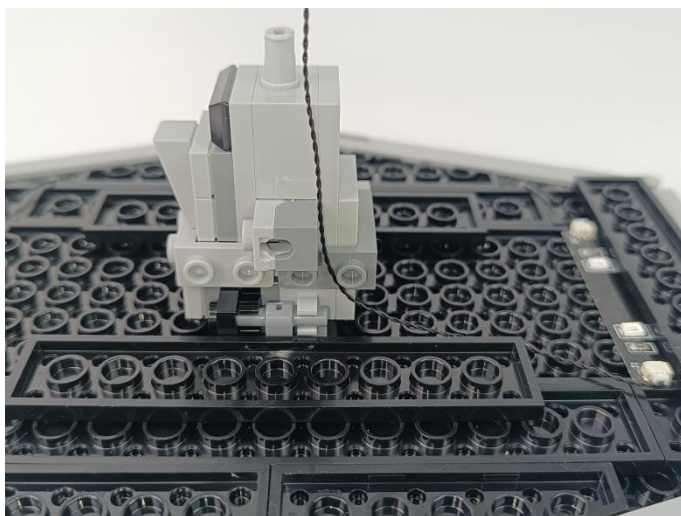

105

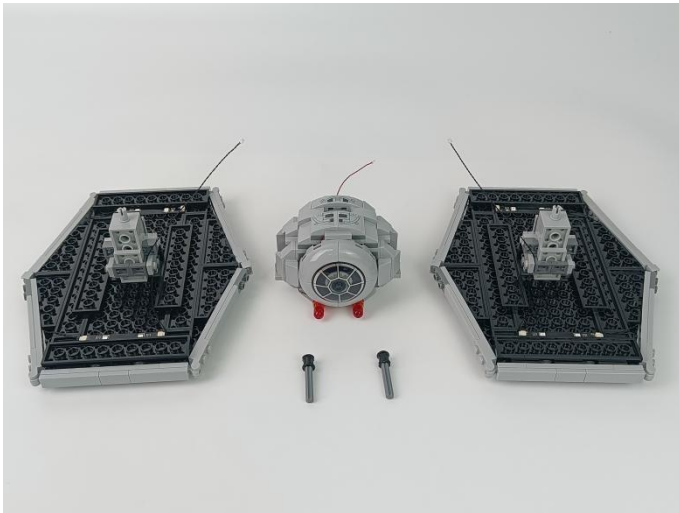

106

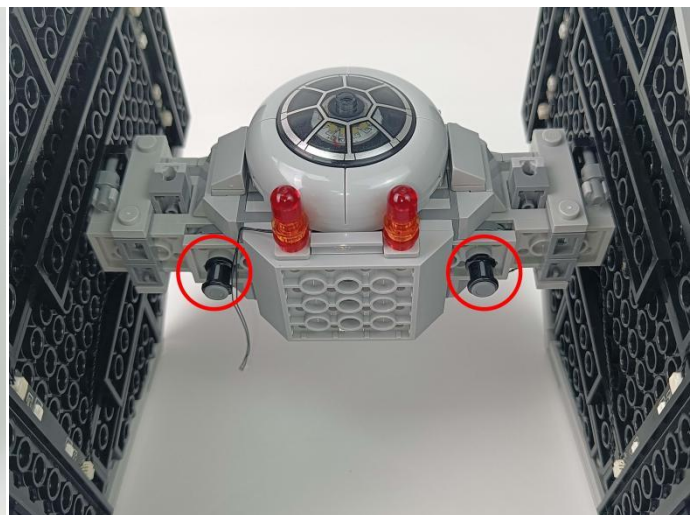

107

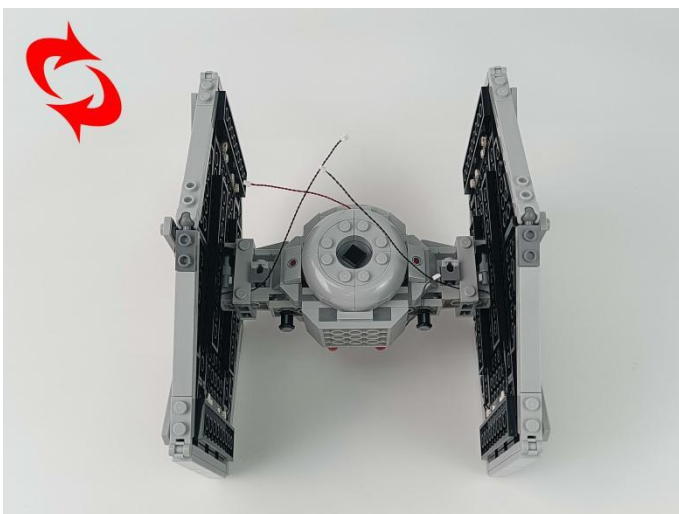

108

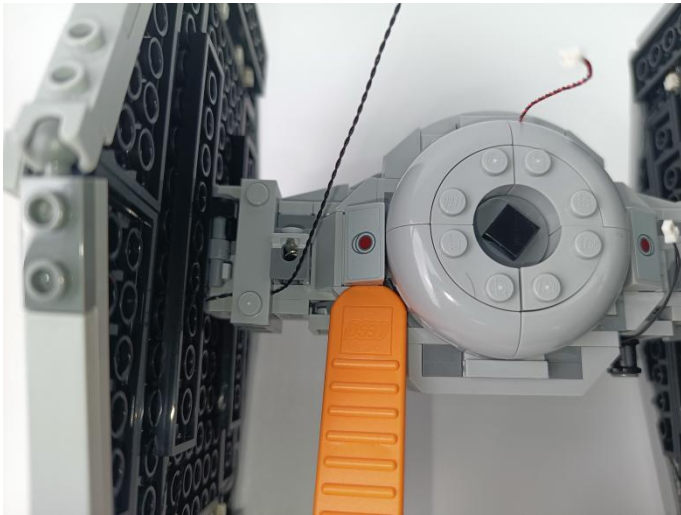

109

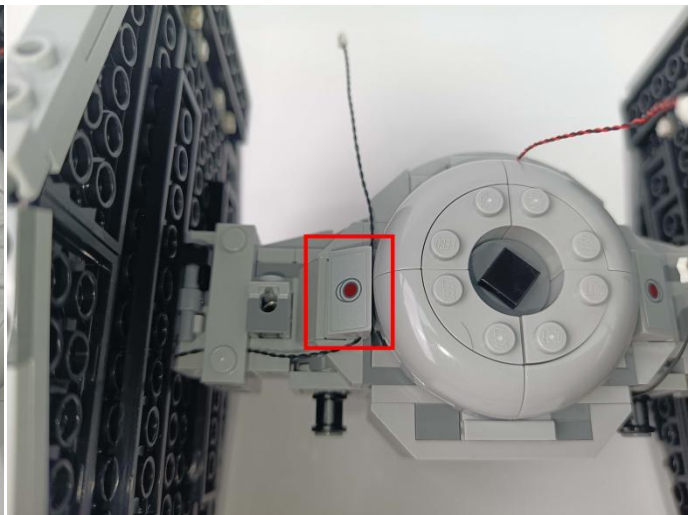
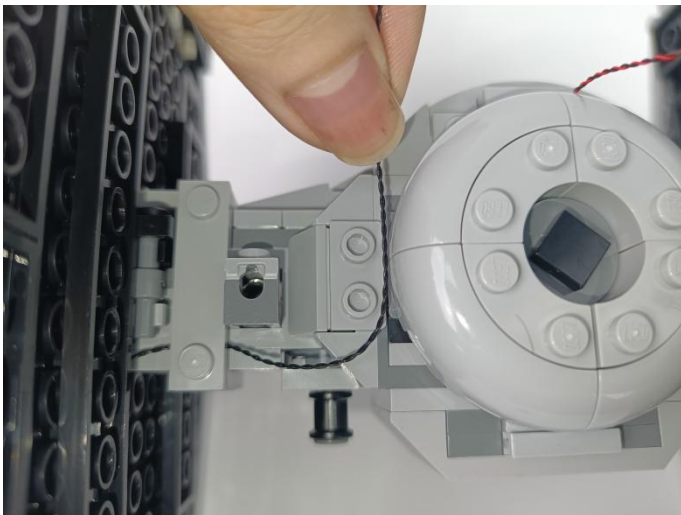

110

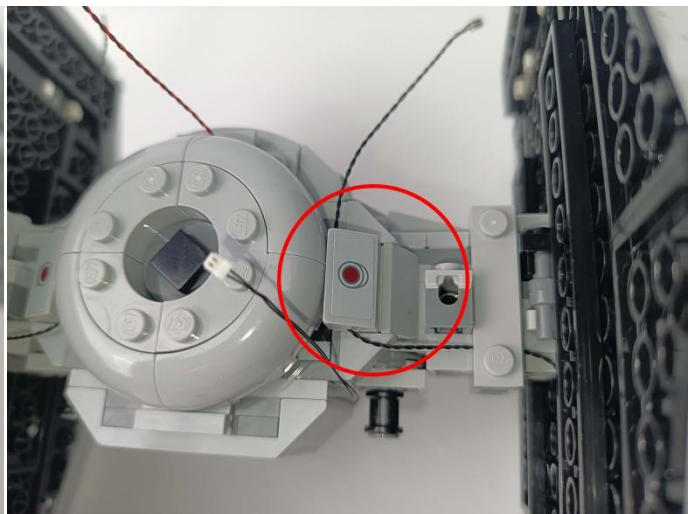
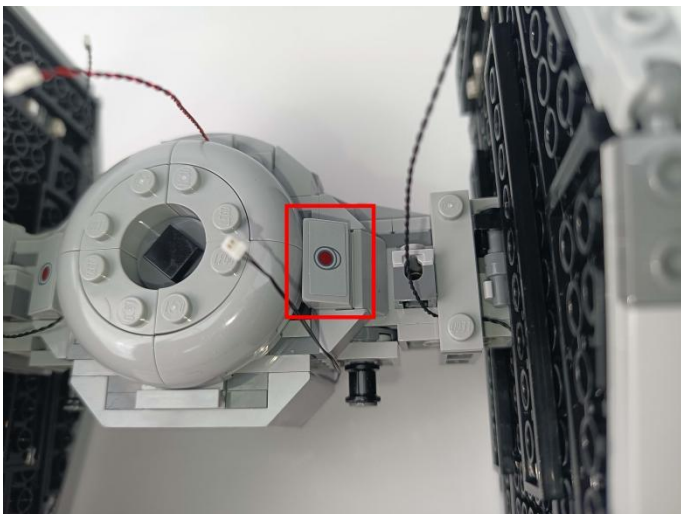

111

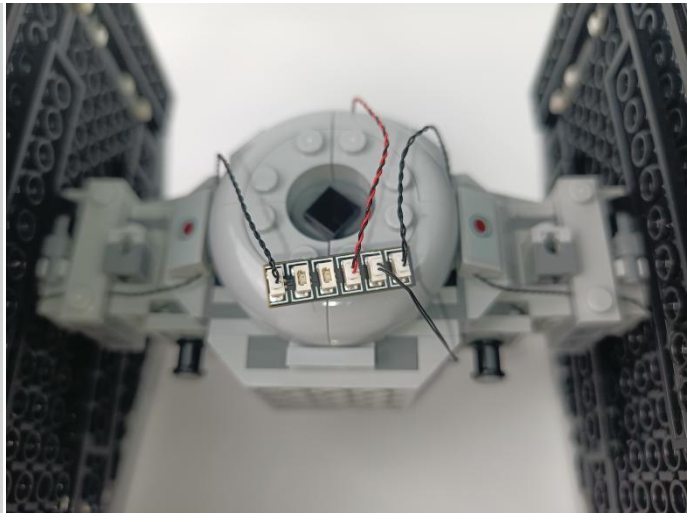

112

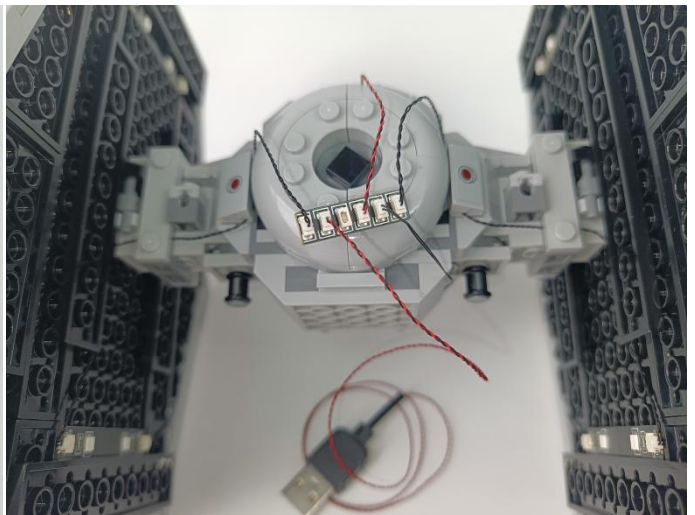

113

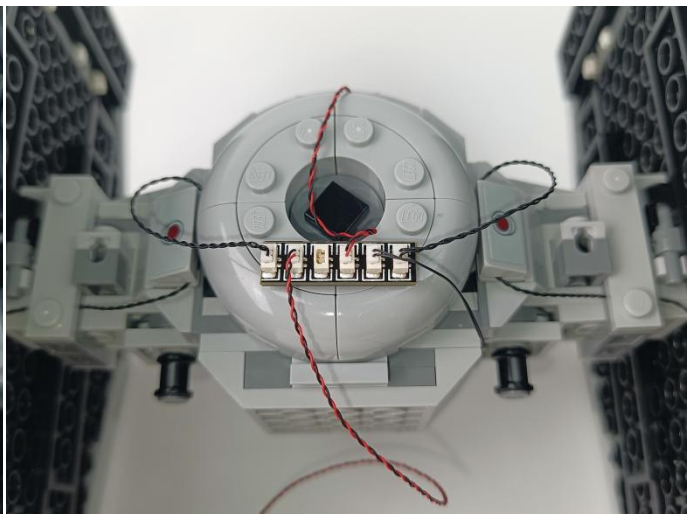
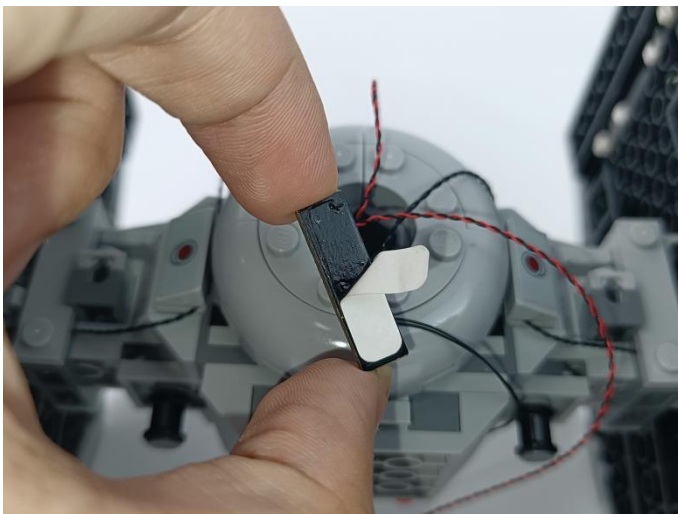

114

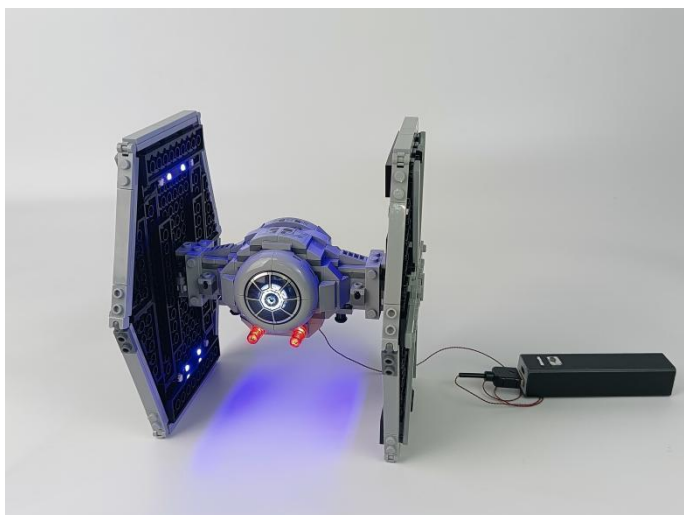

115



**Good job, you've done all the installation steps, power it up and enjoy your work.**



**The battery box in bag NO.7 and NO.8 can also power the set. If it is necessary to change the power supply , prepare three AAA batteries, install them in the battery box, turn on the switch on the battery box, remove the plug of the USB Power Cable from the socket of the expansion board,plug the plug of the battery box to the same socket in the expansion board to power the suit as well.**

**THANKS**