

42161 Lamborghini Huracán Tecnica GC517

- Installation requires a lot of patience and great observation that your LEGO bricks will come alive when you get this finished. The bricks with lighting as below, so make sure you're ready and let's get started.



Strategies for the Installation

This instruction divides three sections to complete the installation of the lighting set.

Section A: Check the type and quantity of components.

The quantity and type of components of each products are different and it needs to be carefully checked to make sure there do have enough material. The type of components is indicated by the label on the bag.

Section B: Test that each components is working properly.

Each components is Manual customization so it is necessary to test that each components is working properly to avoid the situation that the lighting does not work .

Section C: laying out components following the instruction.

Our material is very small but not fragile, just be reminded that don't to pull the wires too hard. For different people, there may be some installation steps that you can't understand. Please look at the previous and later installation steps.

Section A: Check the type and quantity of components.

This set contains four bags labelled "1" "2" "3" "4", please make sure that the components in each bag are the same as shown in the pictures.



Please contact us immediately if there have any missing components.

Section B: Test that each components is working properly.

Take out the Expansion Boards and the USB Power Cable from No.3 and No.4.



It is worth reminding that our products are all customized. They have a unique way of connecting. The white plug on wire and the socket of the expansion board need to be connected together to transmit power.

Note that on one side of the white plug you can see two very small golden wires that should be connected to the two golden needles in socket of the expansion board. shown as blow.

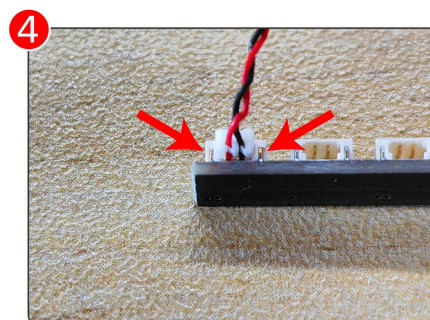
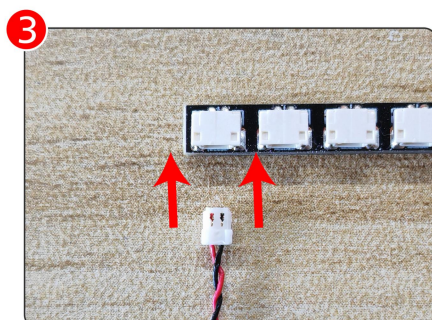
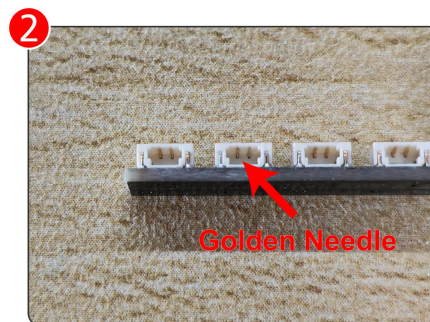
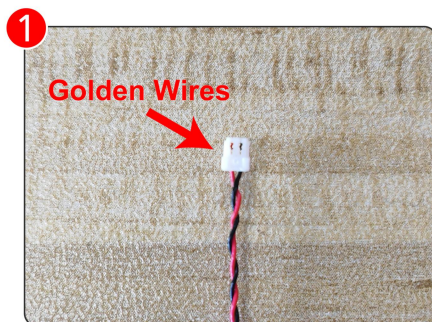

Connect the Expansion Board and USB Power Cable as shown.

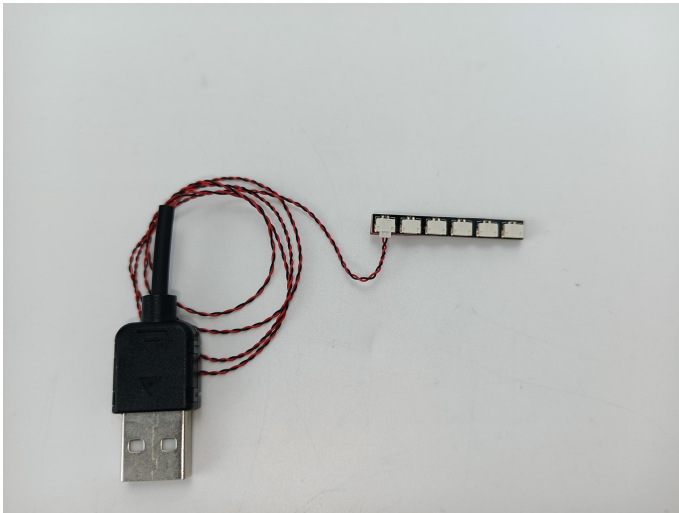

The USB Power Cord can be powered by phone chargers, power banks, etc. This instruction will use the power bank as power supply.

USB connectors to connect devices

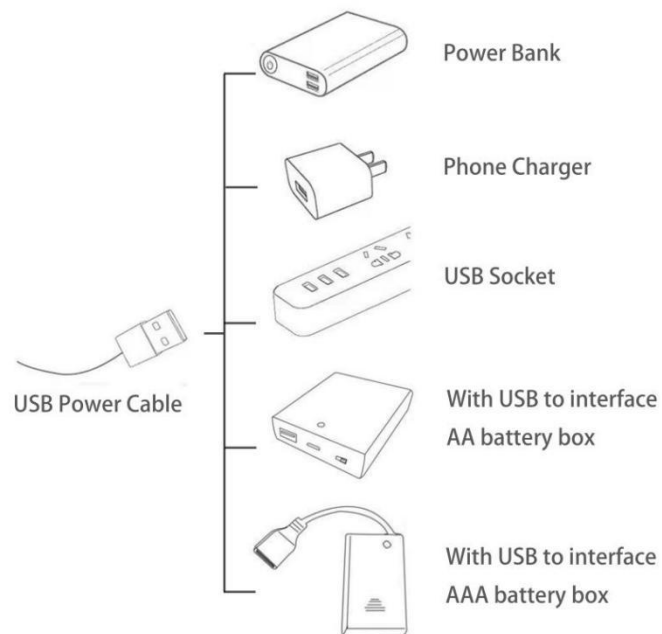

Connect the other end of the USB power cable to the power supply.



Connect all the components in No.1 bag to the Expansion Board in same way just as shown. Turn on the power bank, all the lights are on as shown. Remove the lamp after the test.

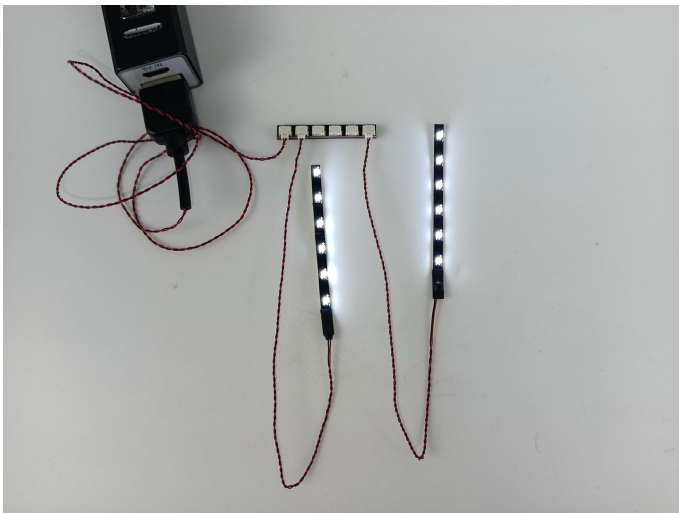

LED strip test:

Take out the LED light bar, connect the USB power cable, turn on the mobile power supply, the light will be on normally, as shown in the figure below.

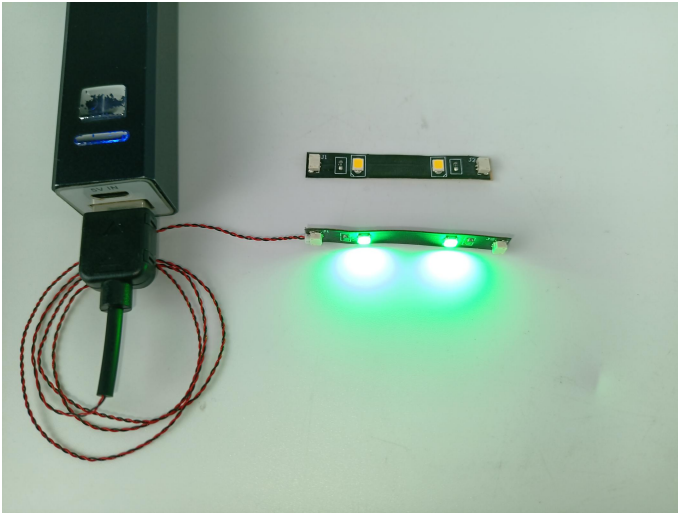

Unplug these three components and put them back in the corresponding bags. There are two in bag No.2 need to be tested.

Attention that after the test is completed, each components should put back in the corresponding bag including the socket and the usb power cable.

Please contact us immediately if any components don't work.

Section C: laying out components following the instruction.

1



2



3

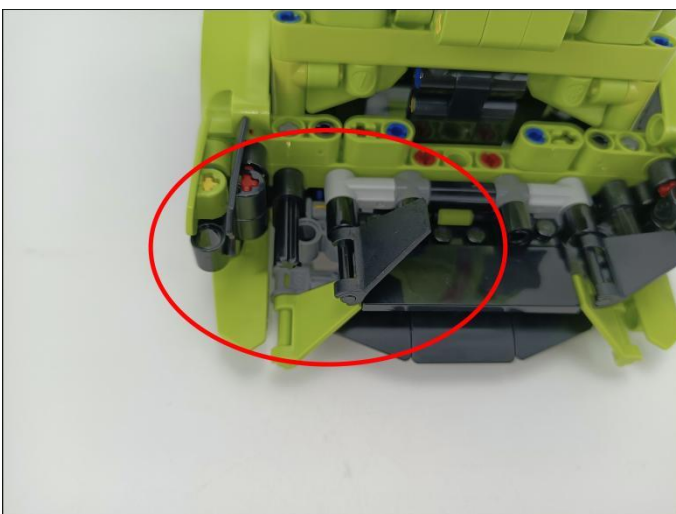
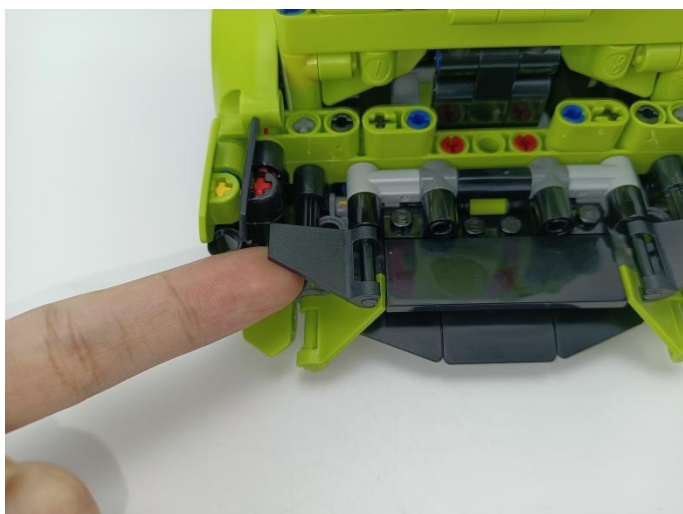

4

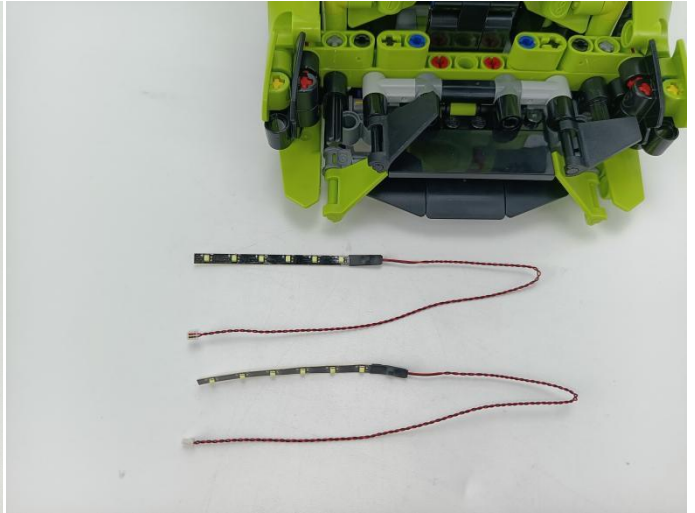

5

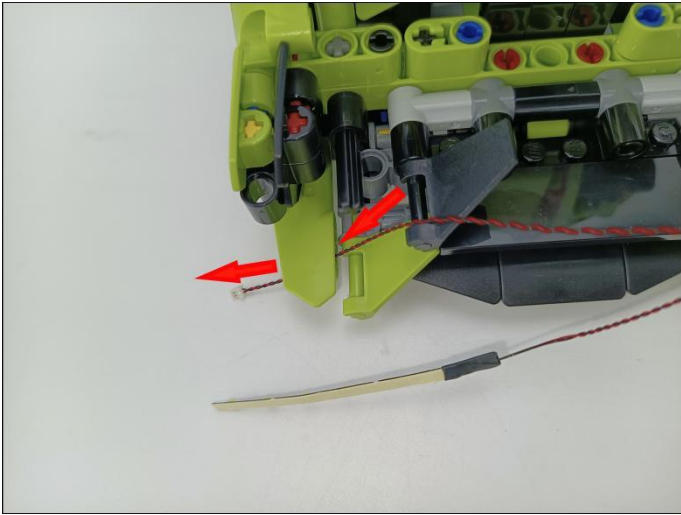

6

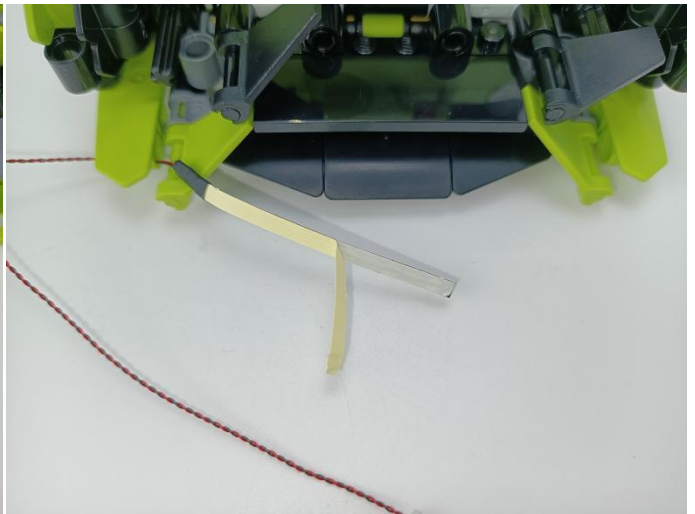
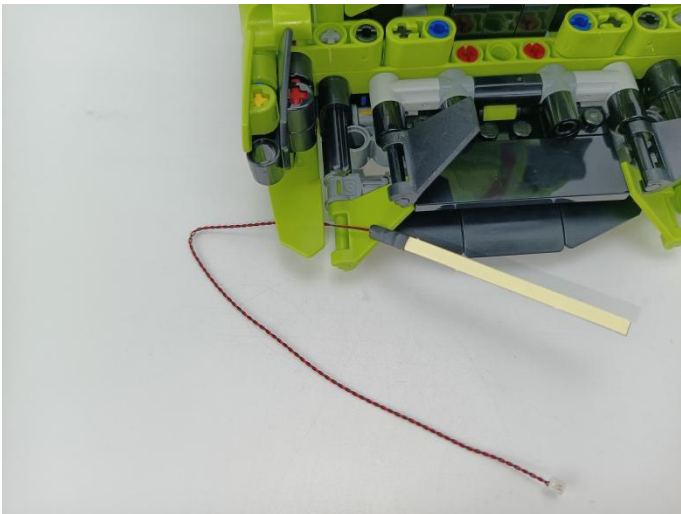

7

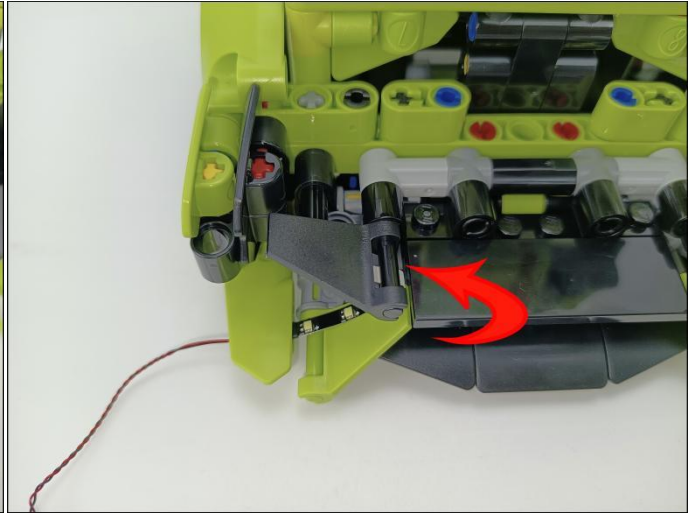
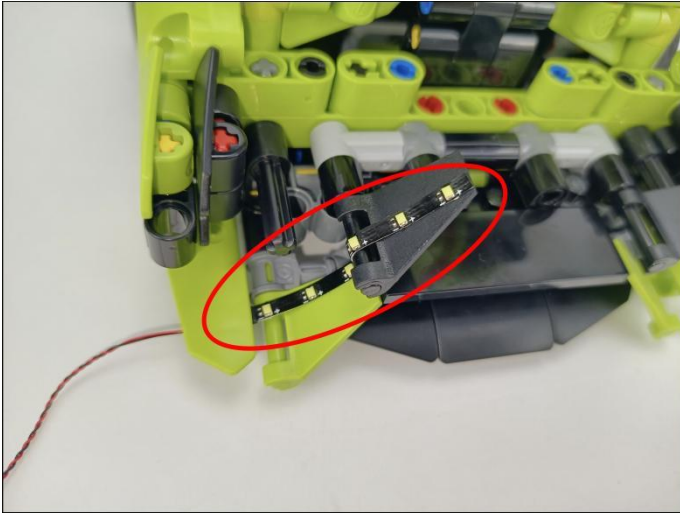

8



9

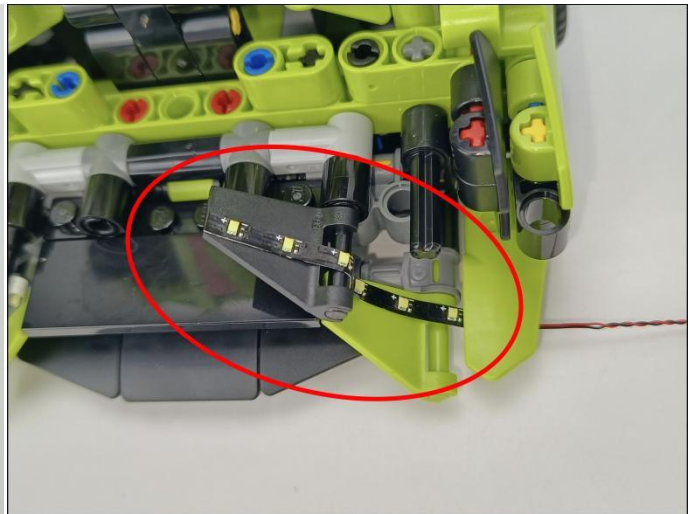
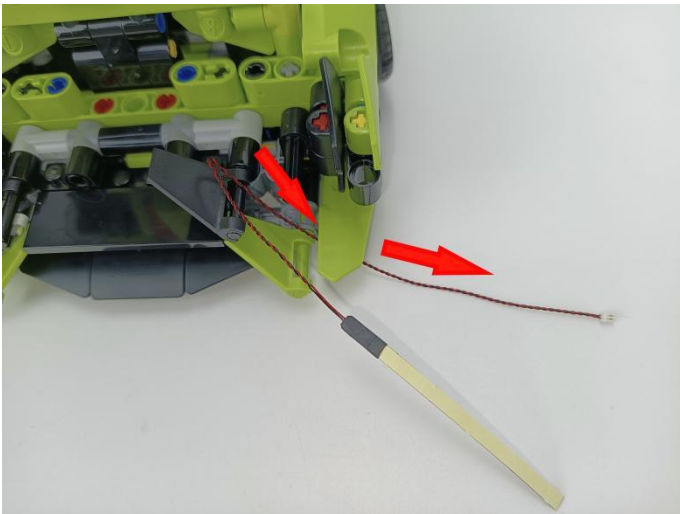

10

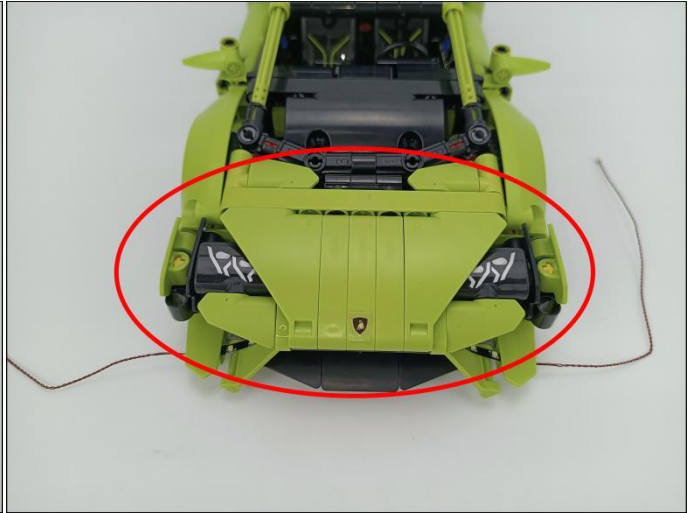
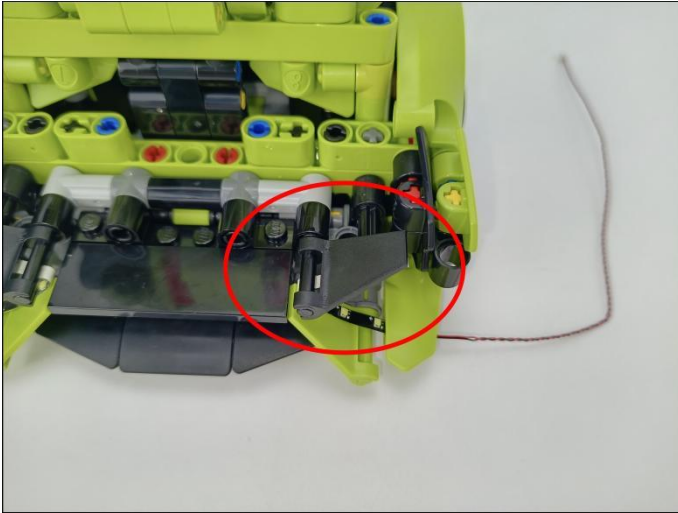

11



12

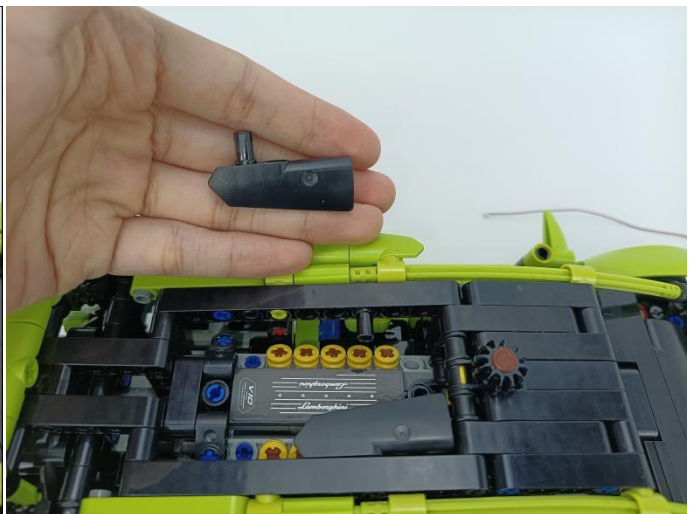
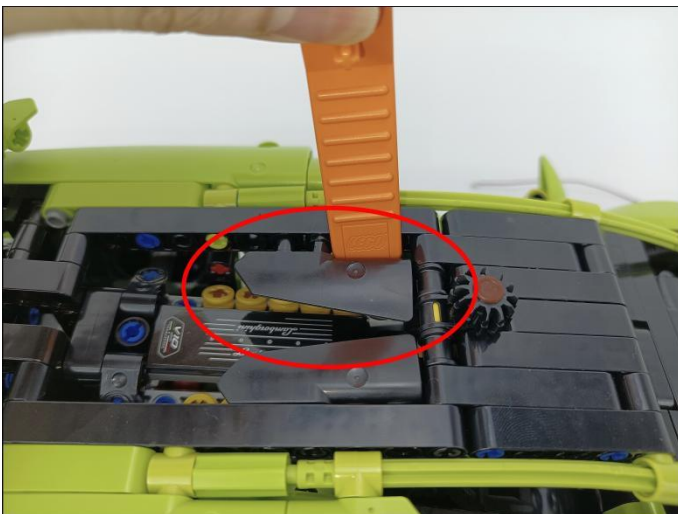

13

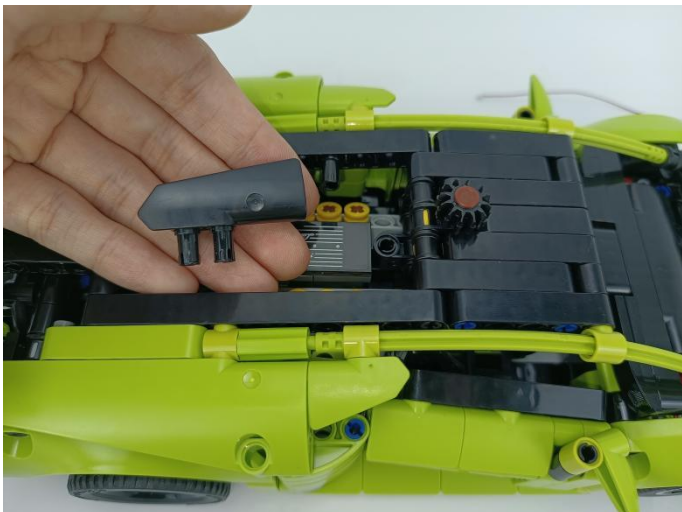

14

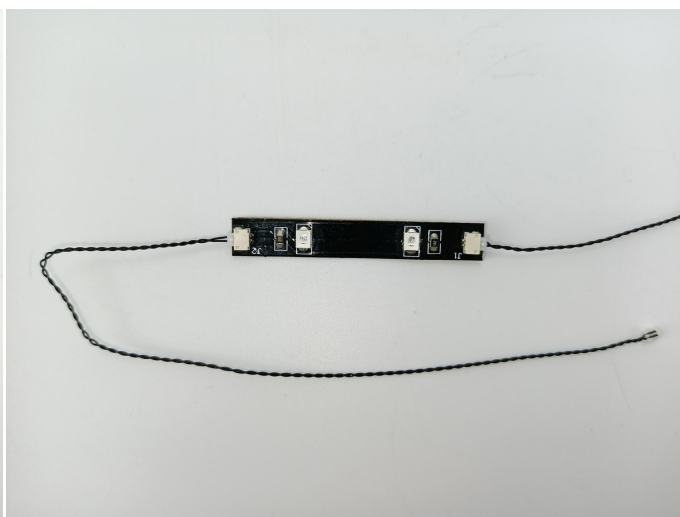

15

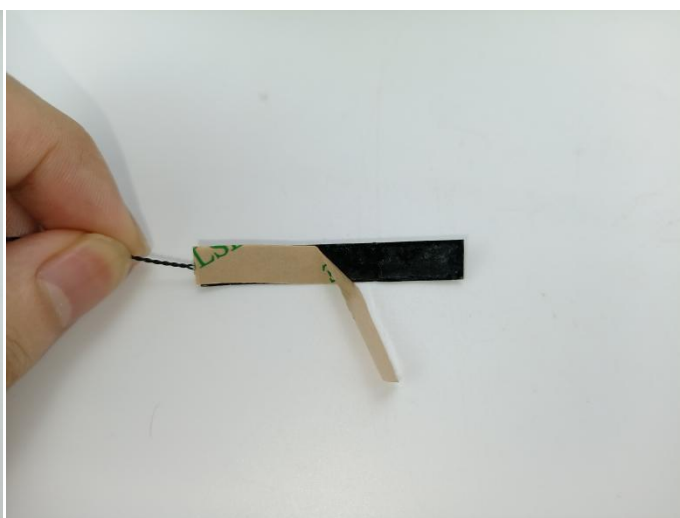
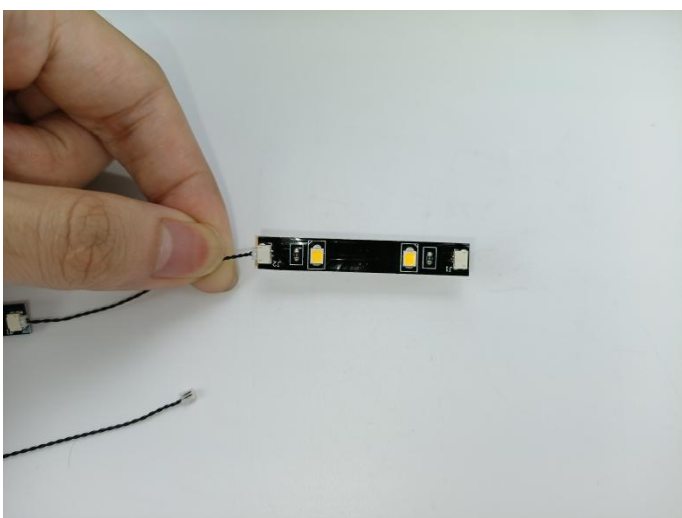

16

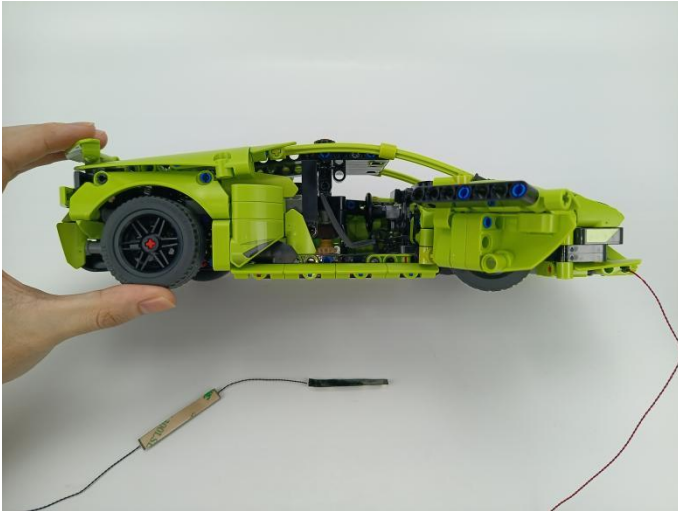

17

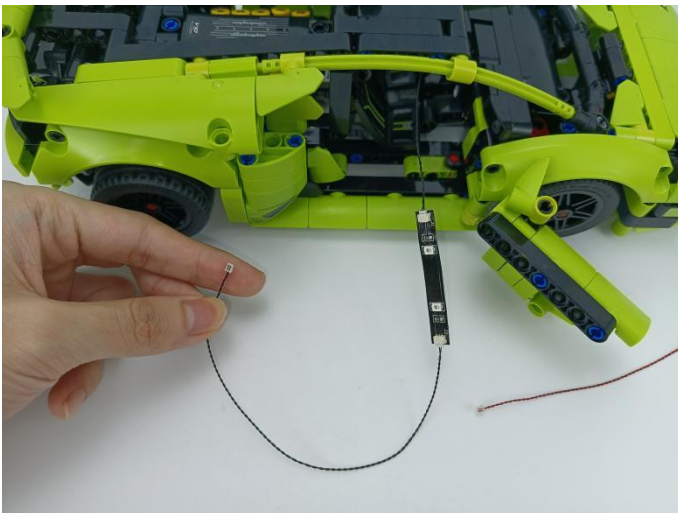

18

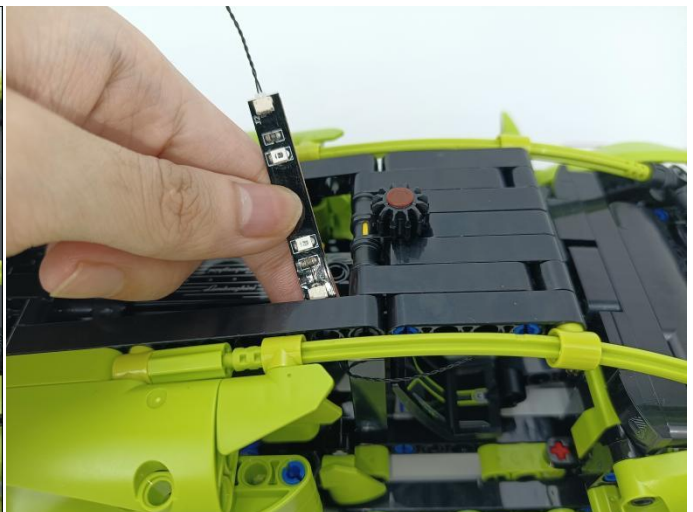
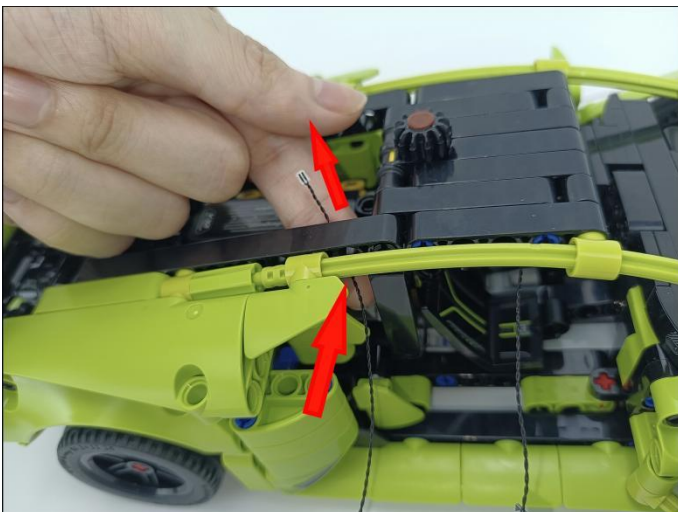

19

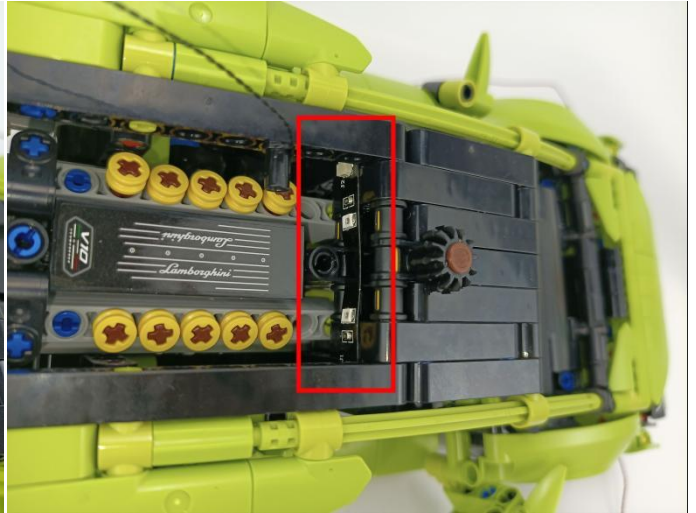
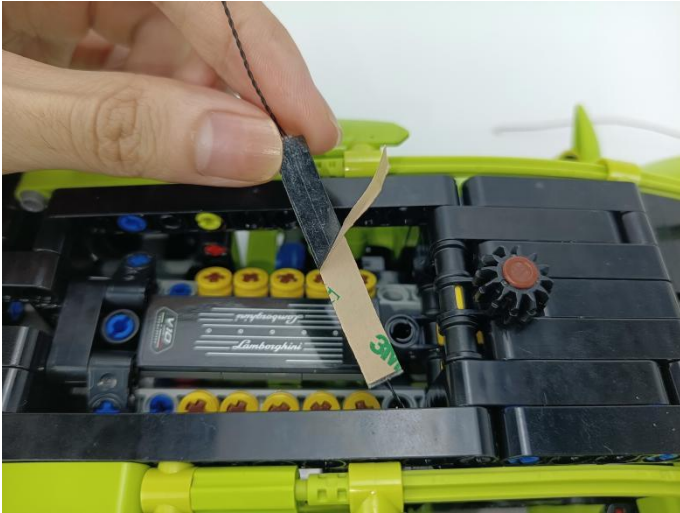

20

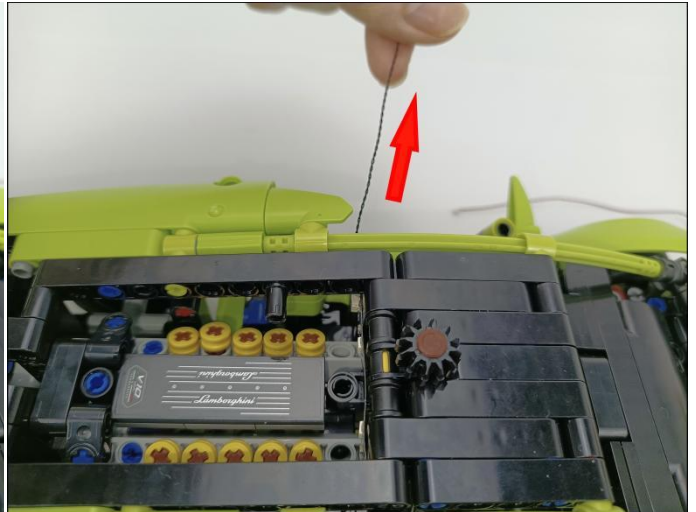

21

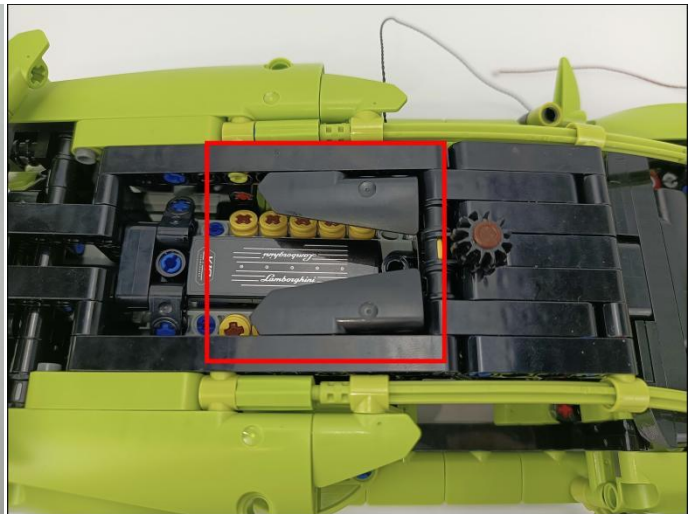

22

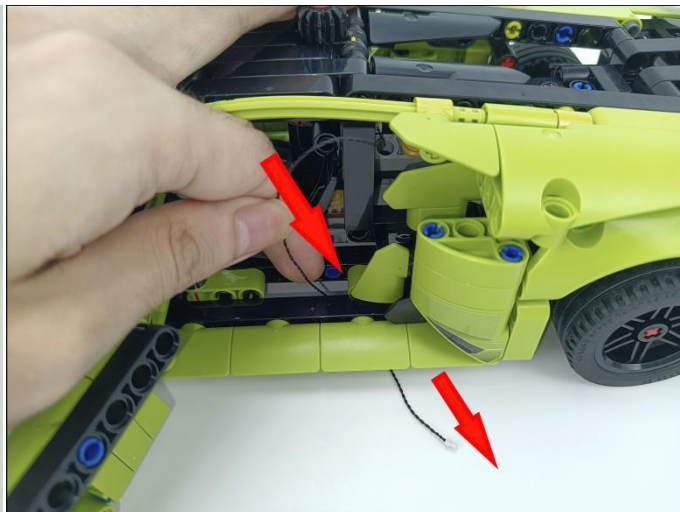
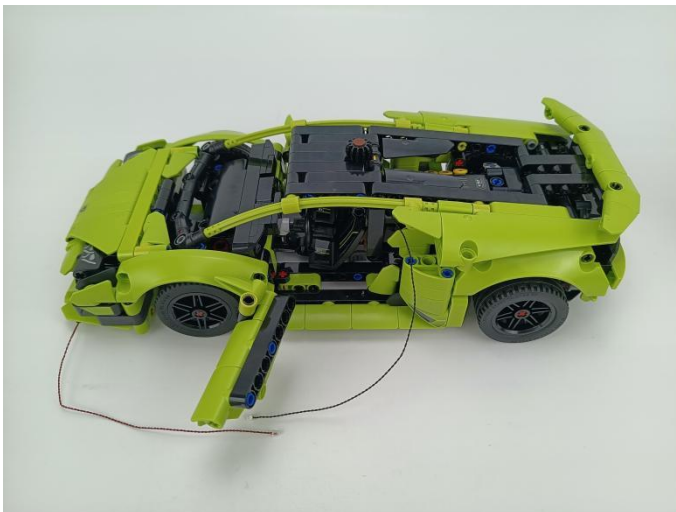

23

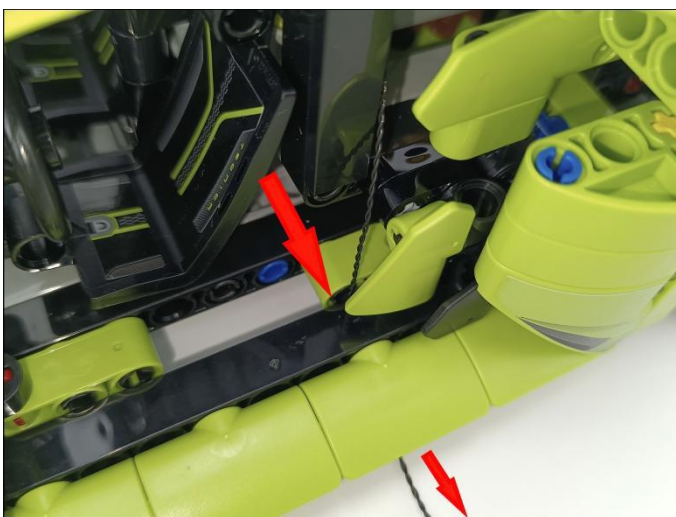

24

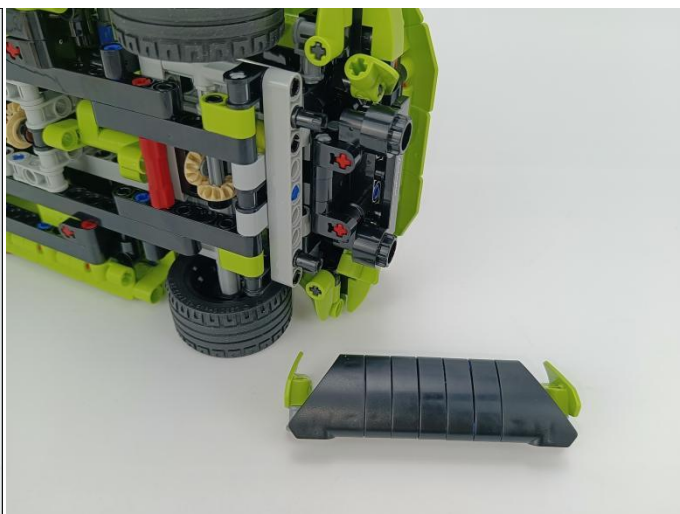
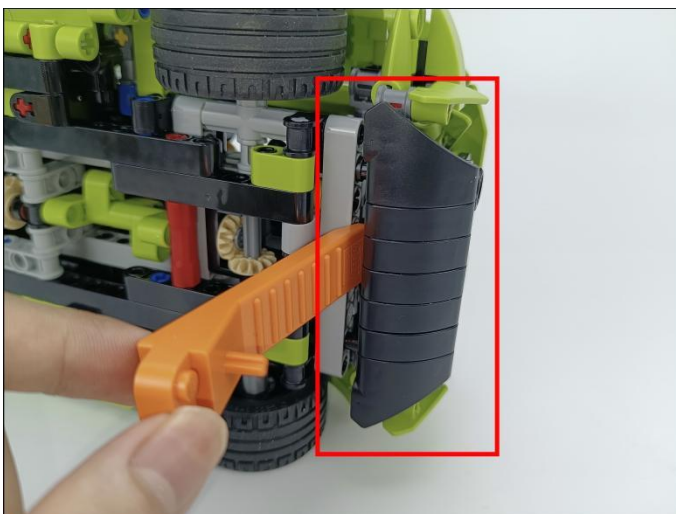

25

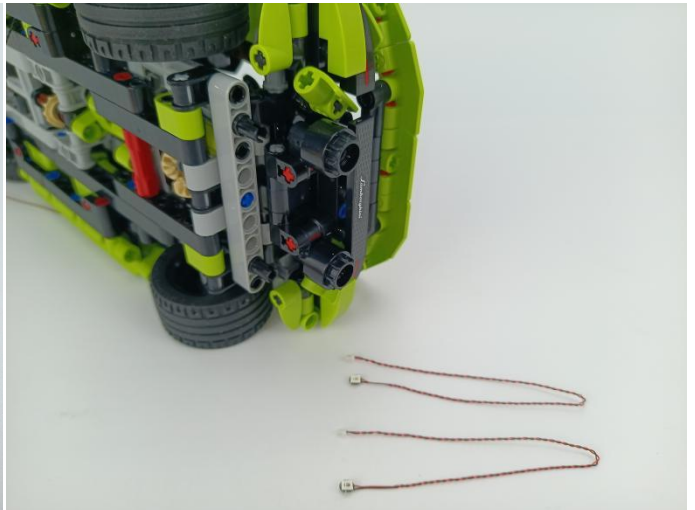

26

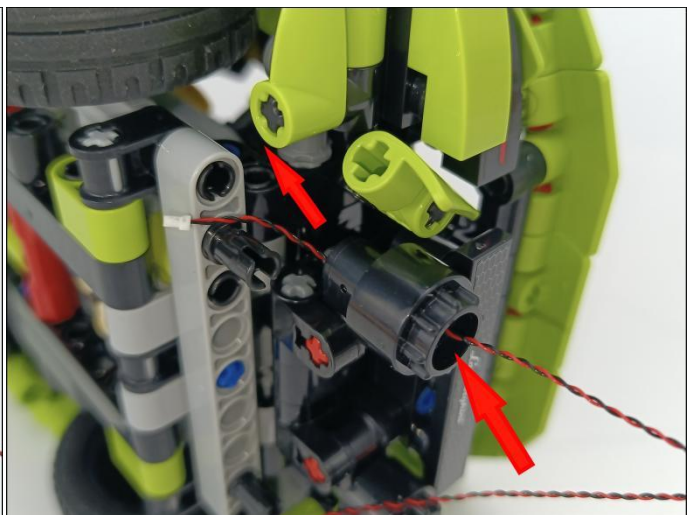
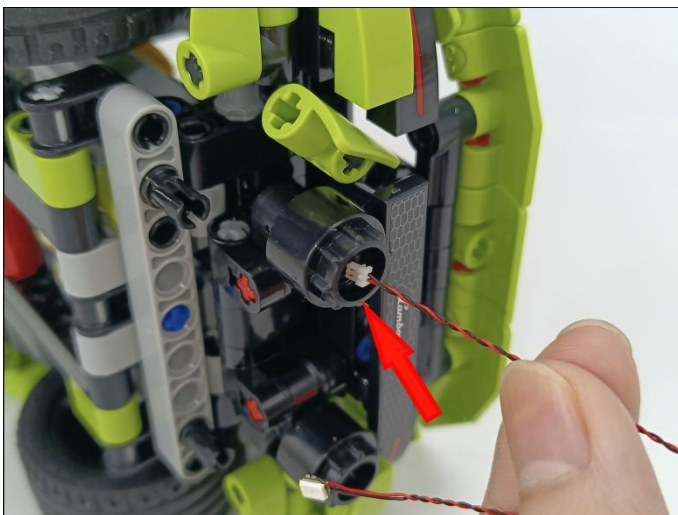

27

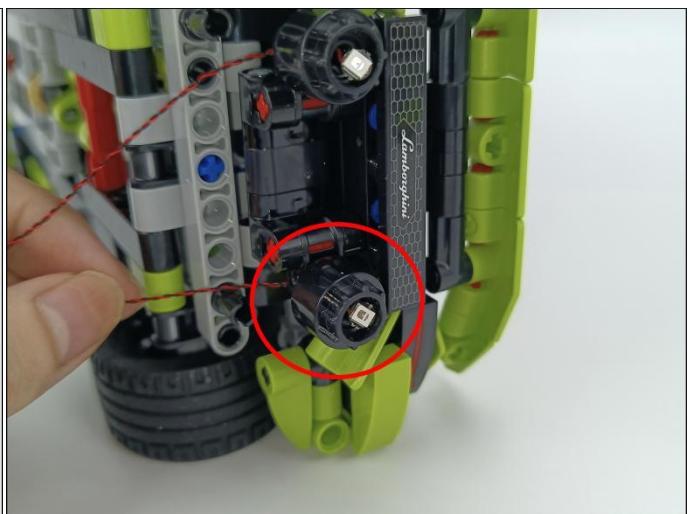

28

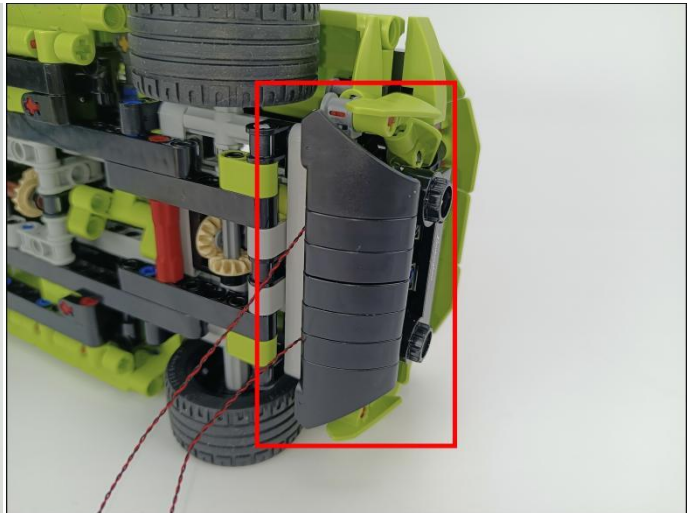
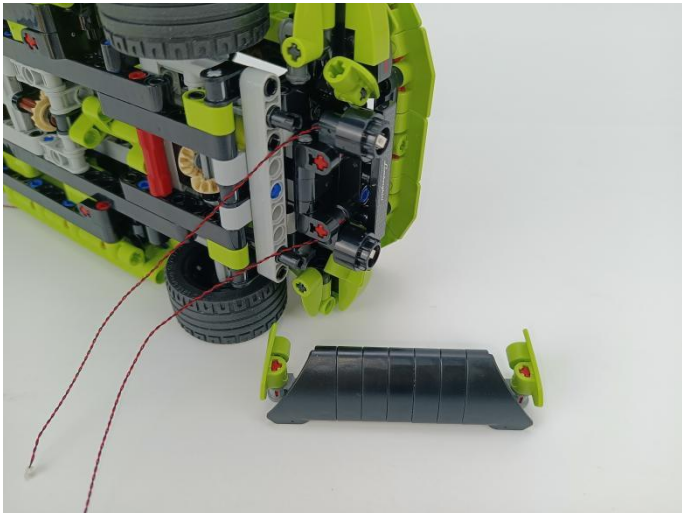

29

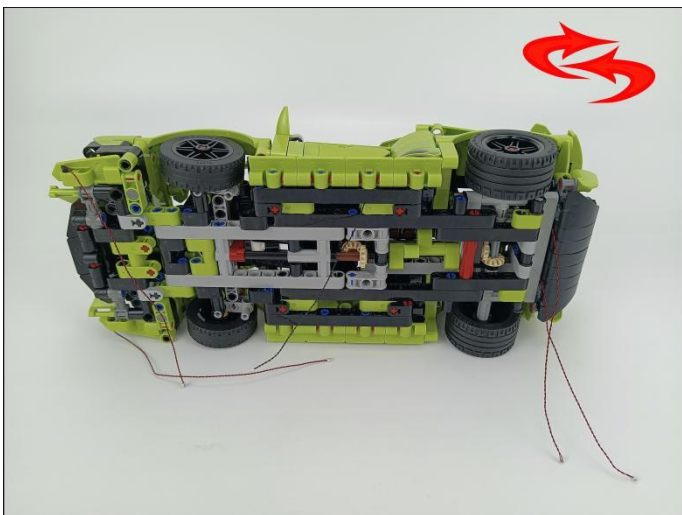

30

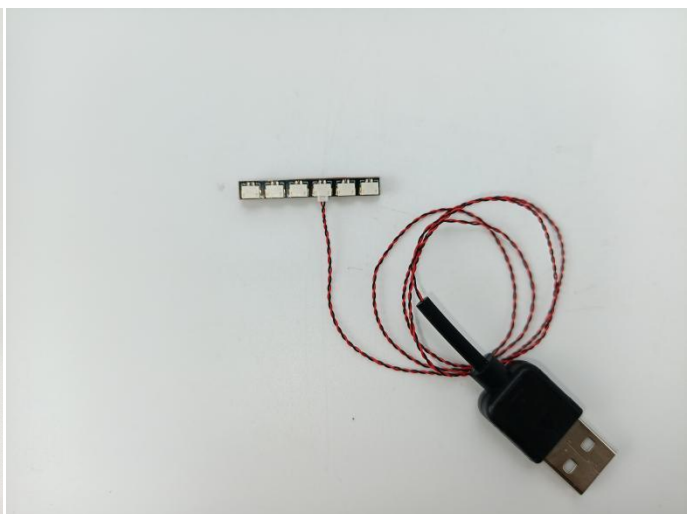

31

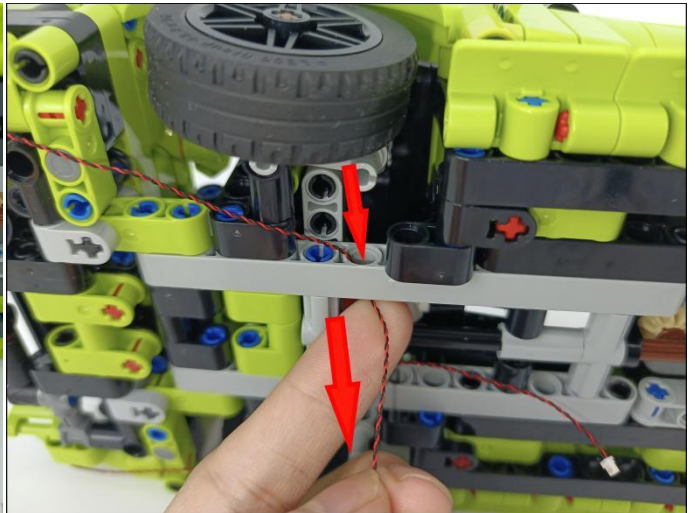
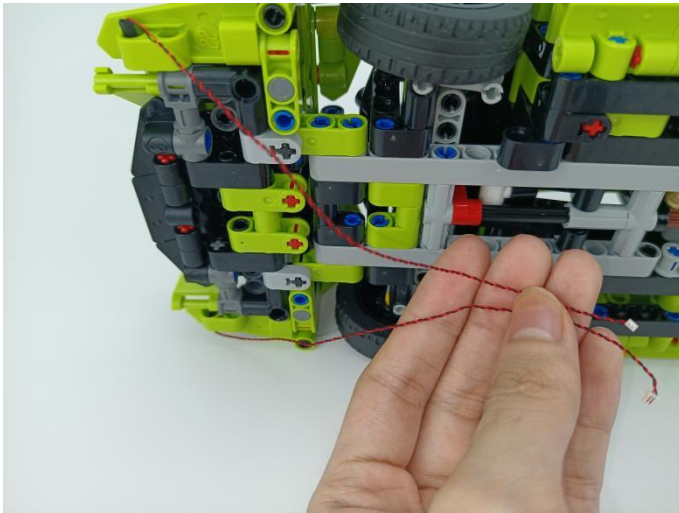

32

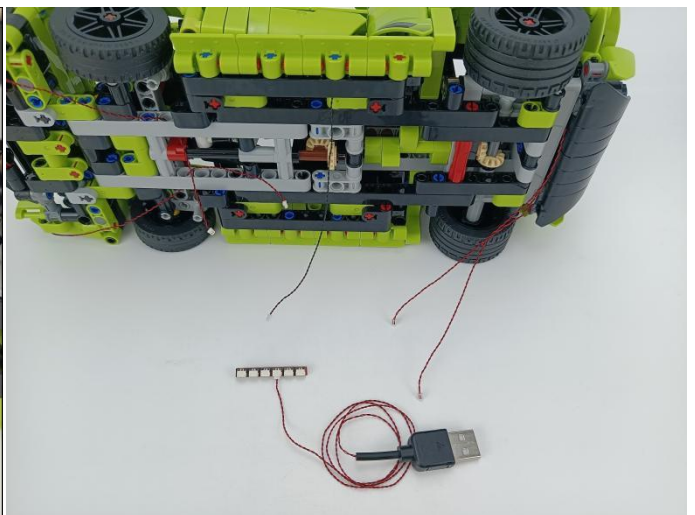
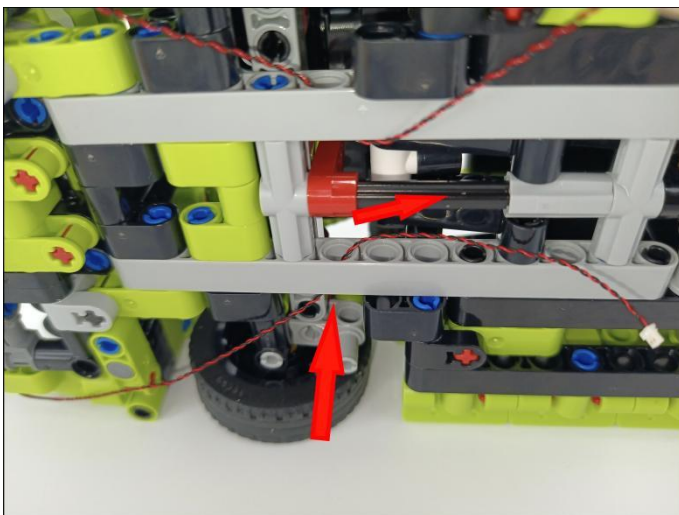

33

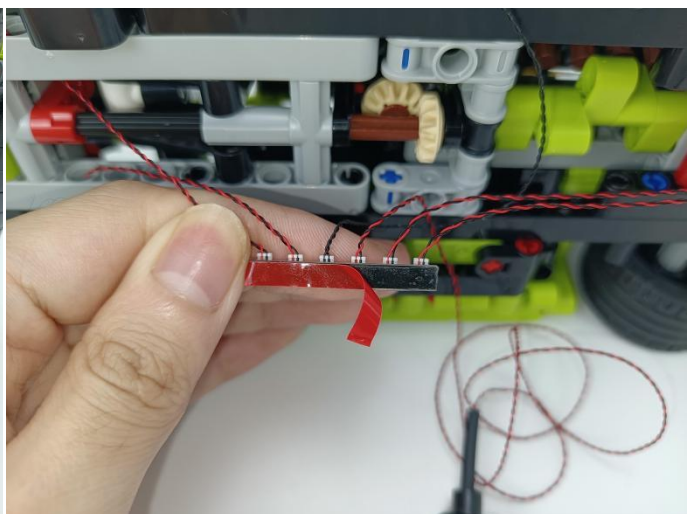
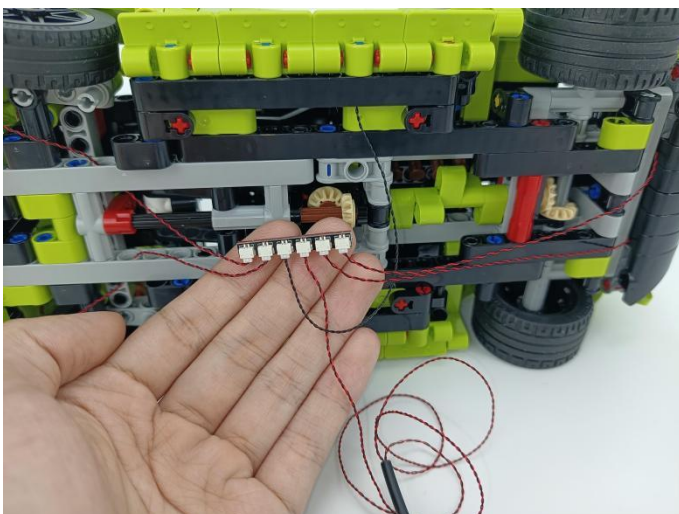

34

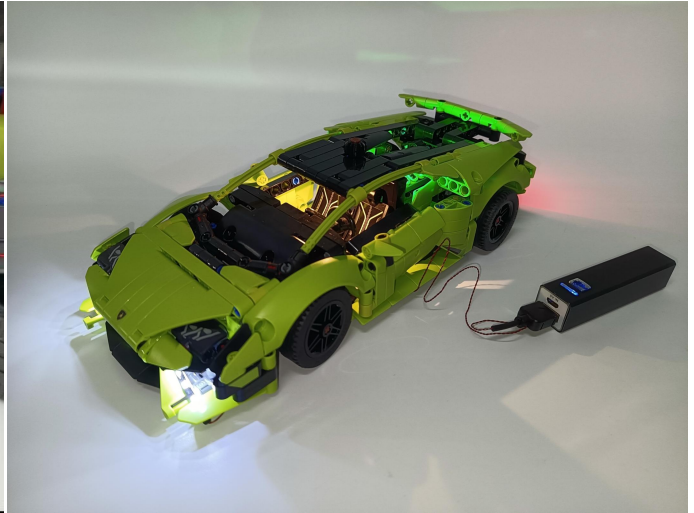
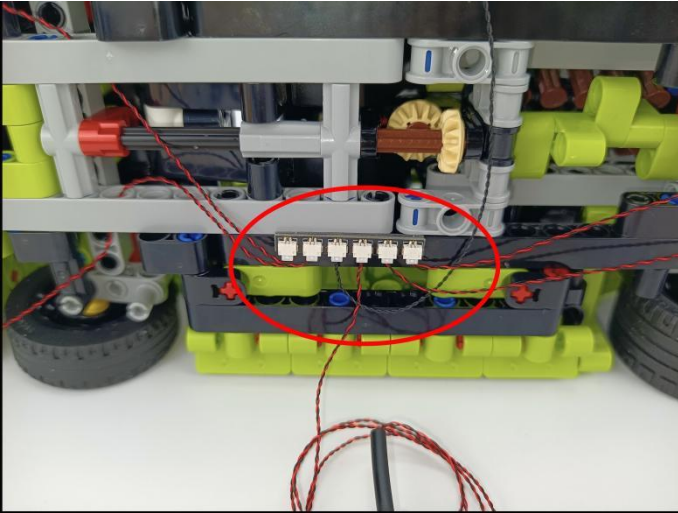

Good job, you've done all the installation steps, power it up and enjoy your work.



The battery box in bag NO.4 can also power the set. If it is necessary to change the power supply , prepare three AAA batteries, install them in the battery box, turn on the switch on the battery box, remove the plug of the USB Power Cable from the socket of the expansion board,plug the plug of the battery box to the same socket in the expansion board to power the suit as well.

THANKS