

175

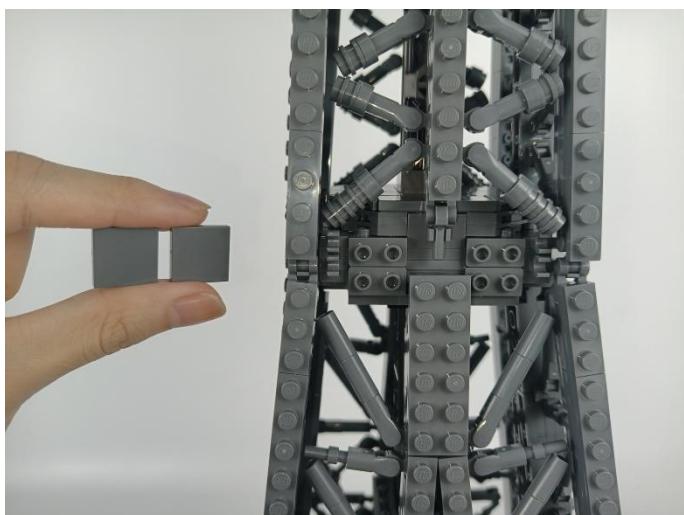

176



177

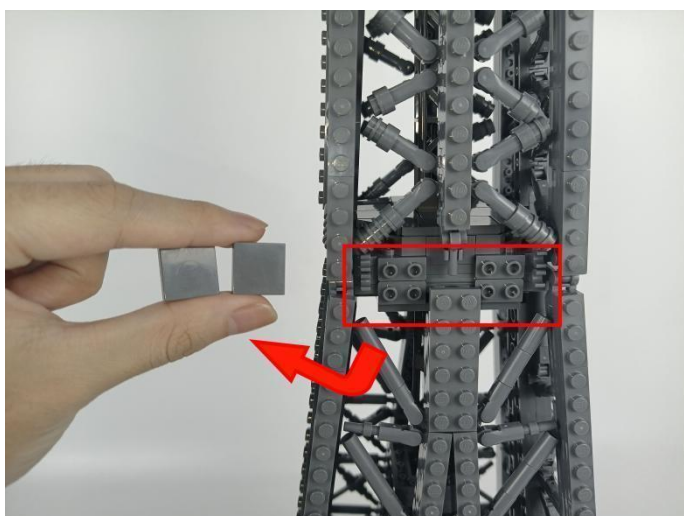

178



179

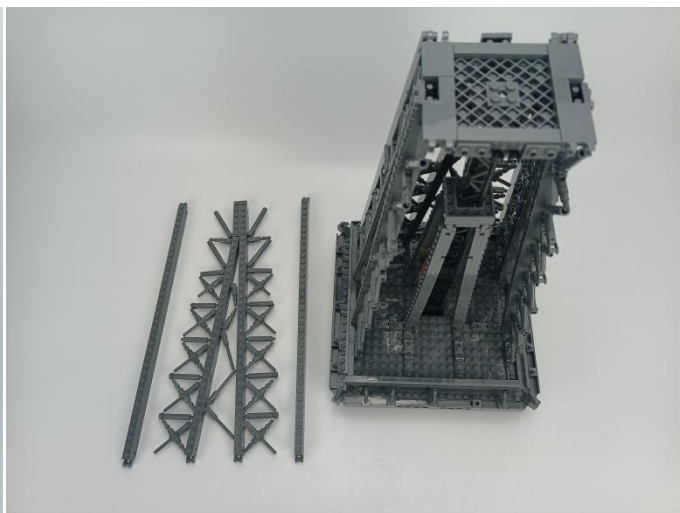
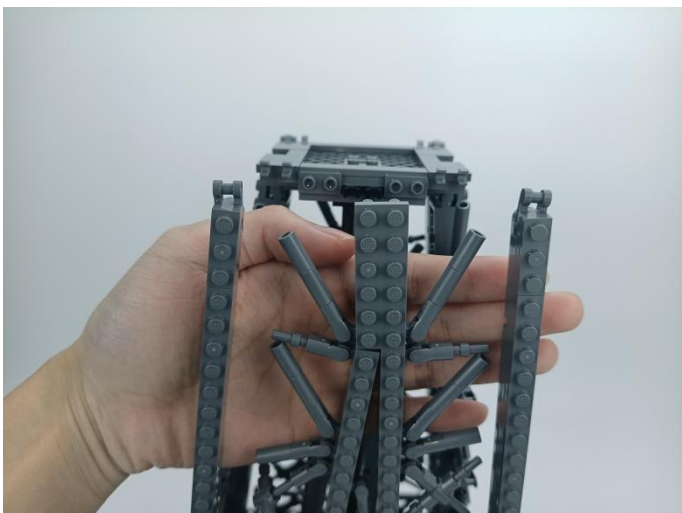

180

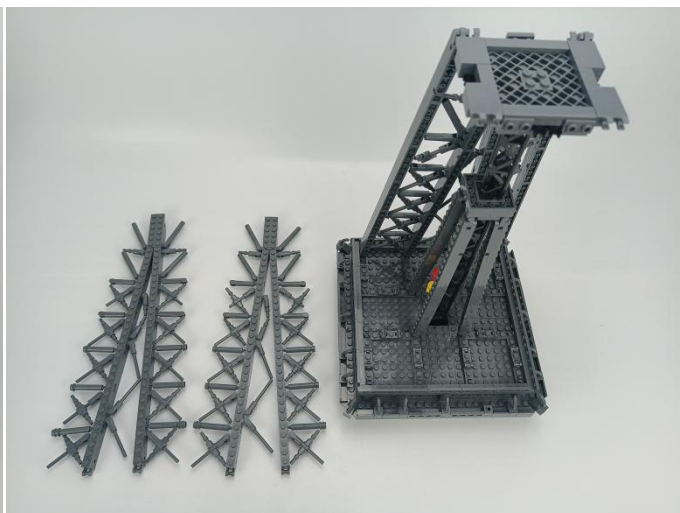

# 181

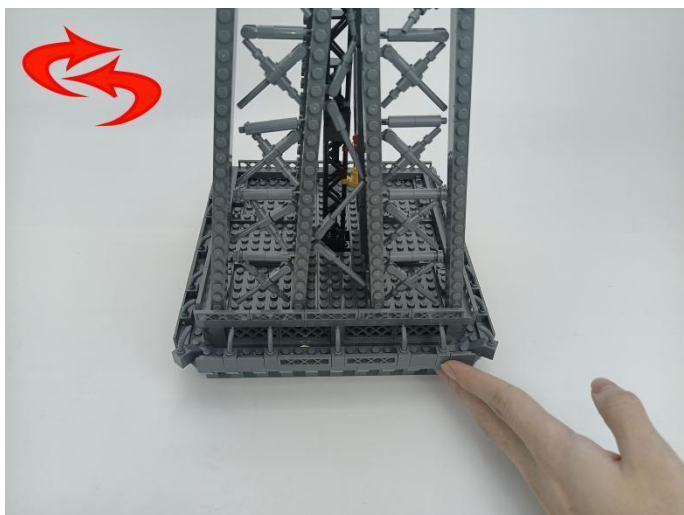

# 182

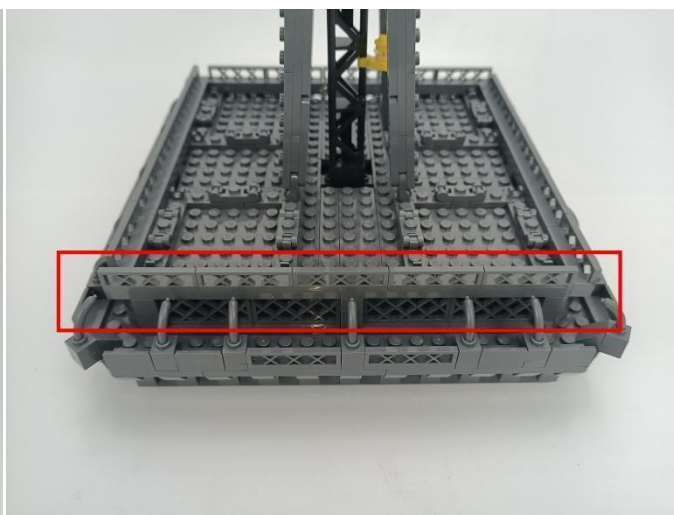

# 183

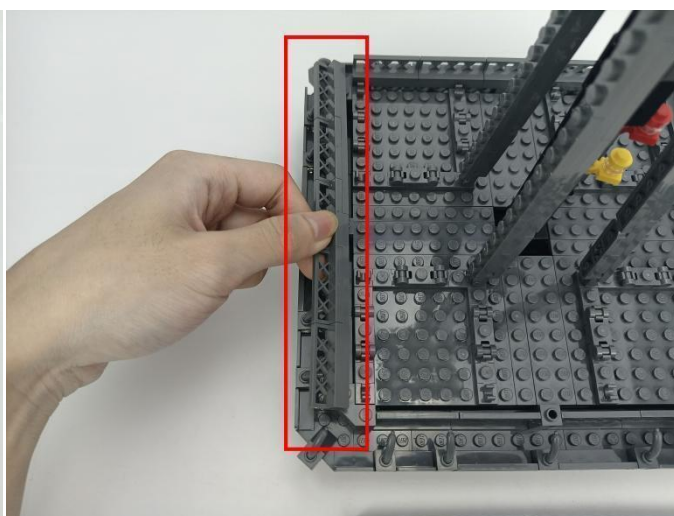
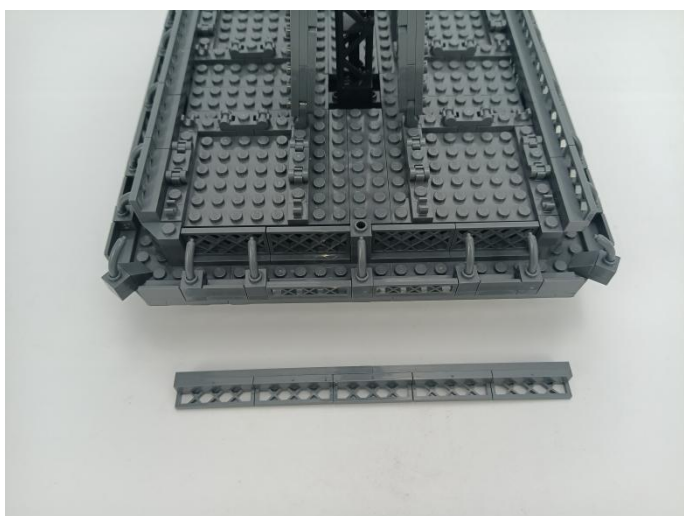



# 184

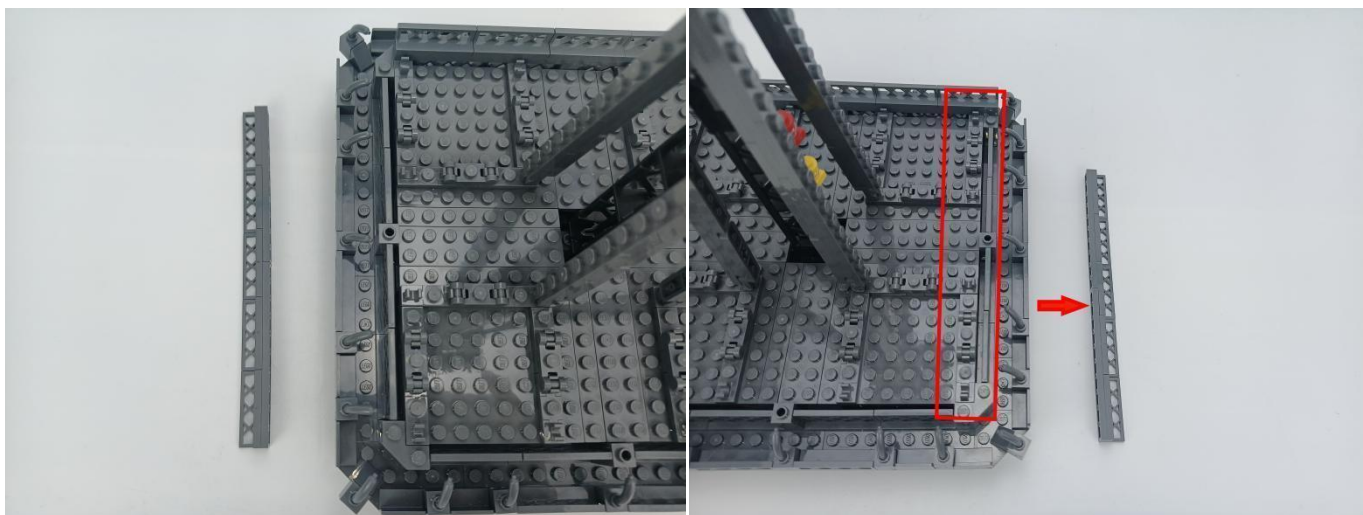

# 185

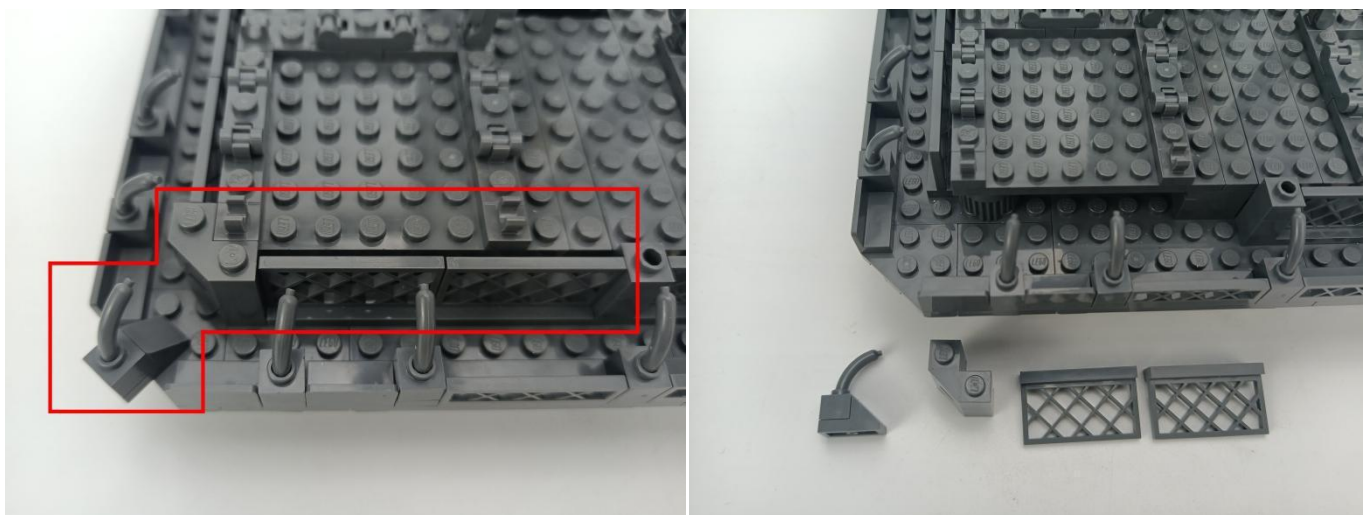

# 186





187

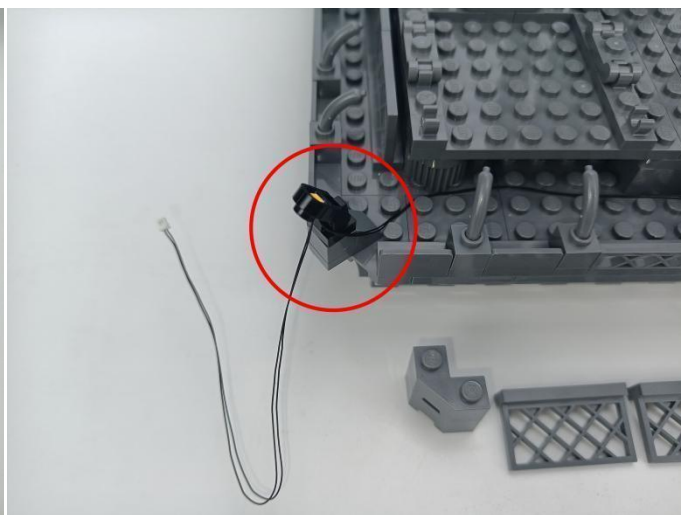

188

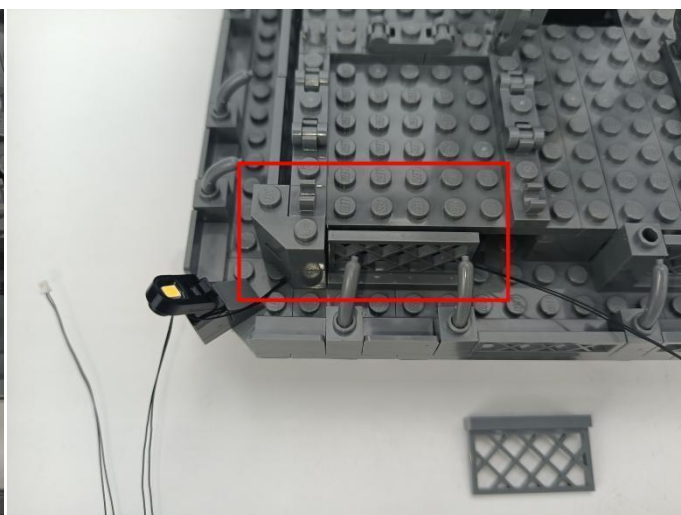
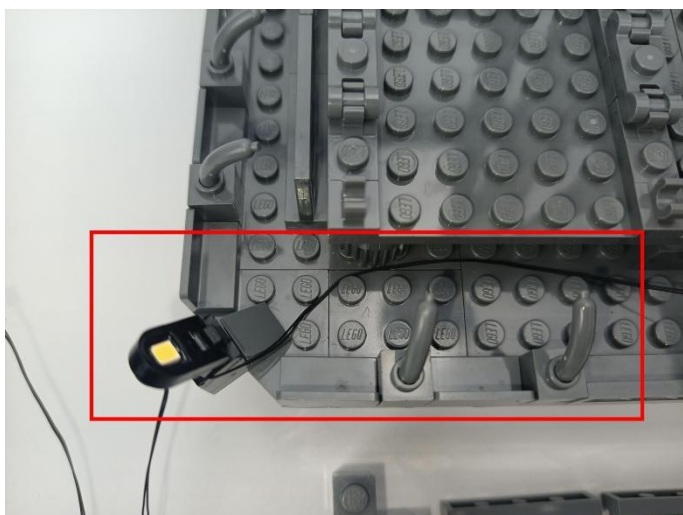

189

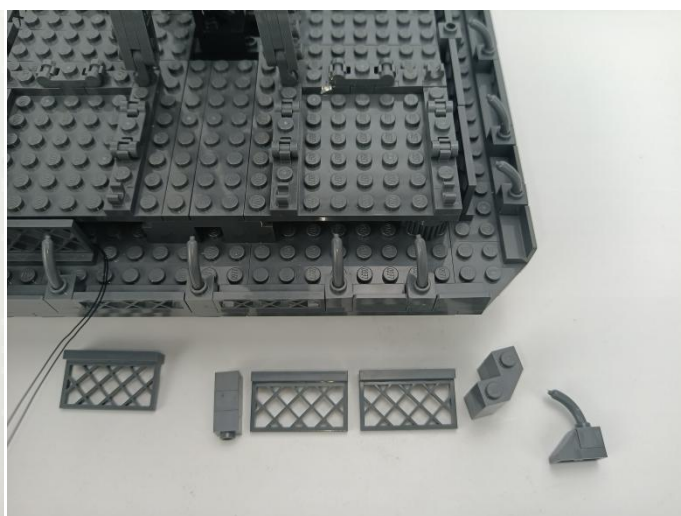
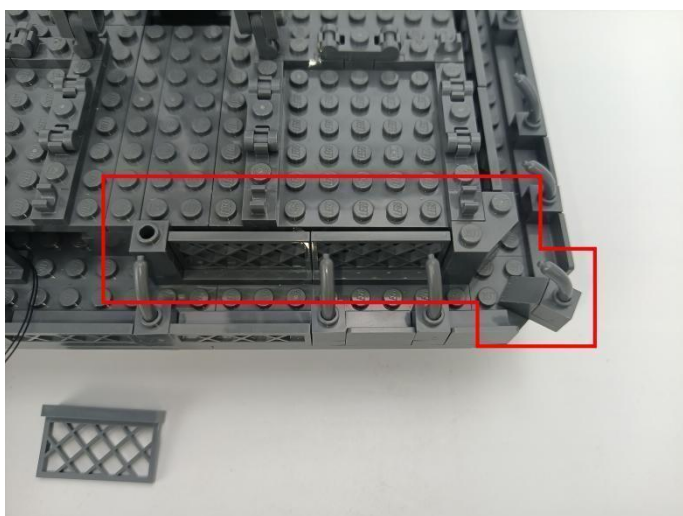

190

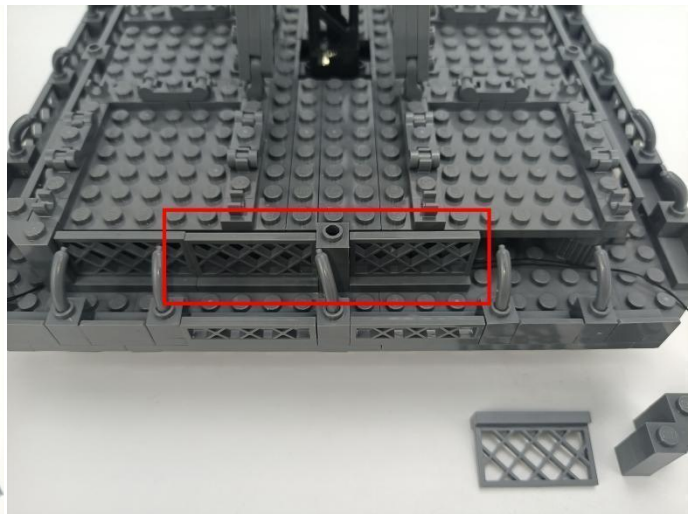
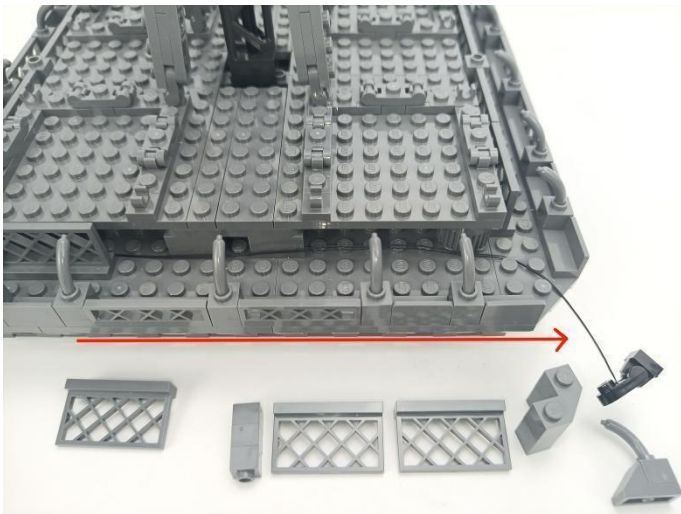

191

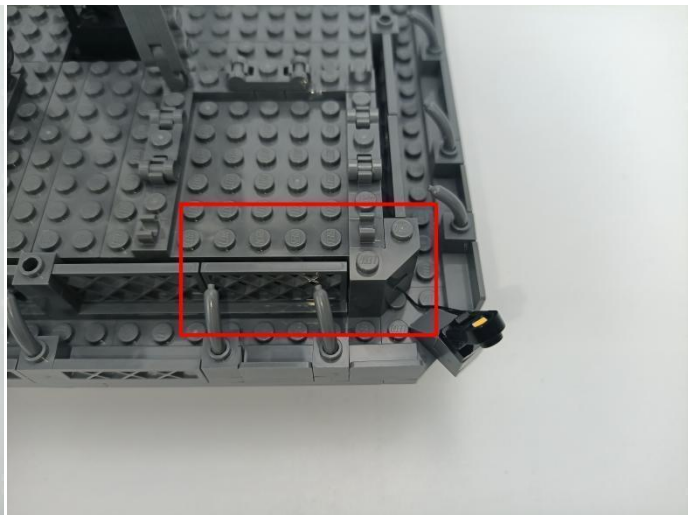
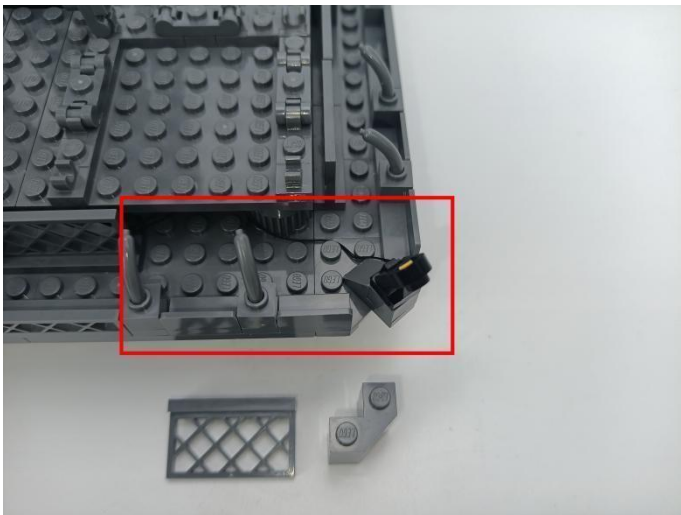

192

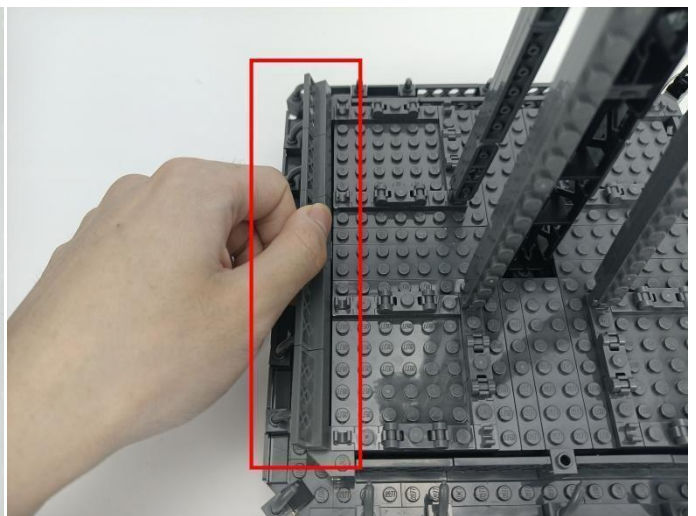
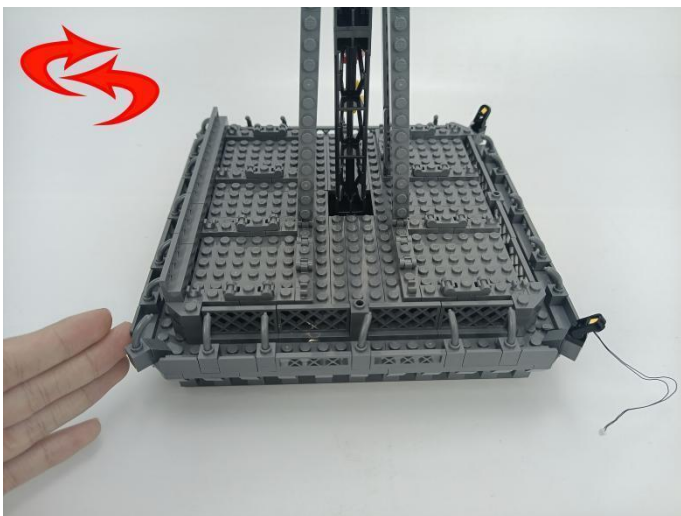



193

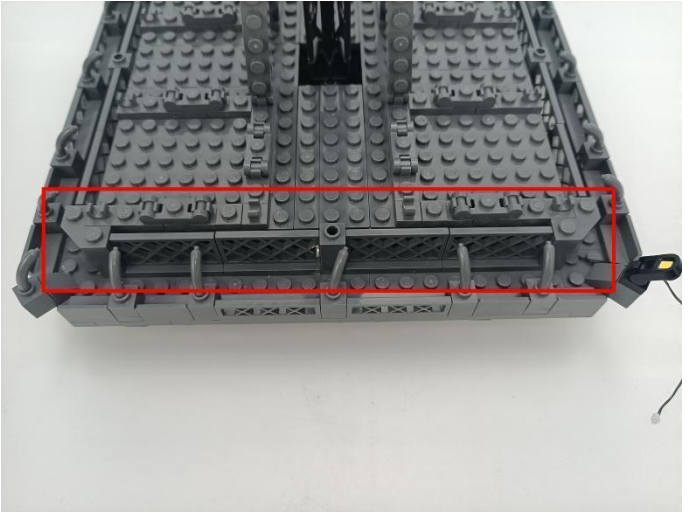
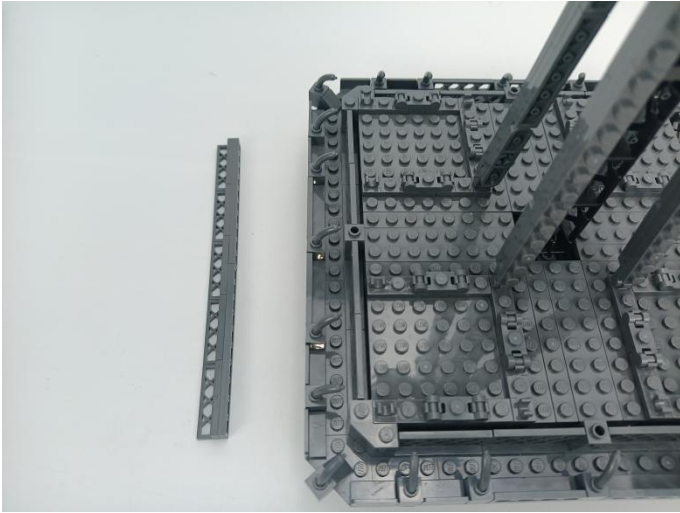

194

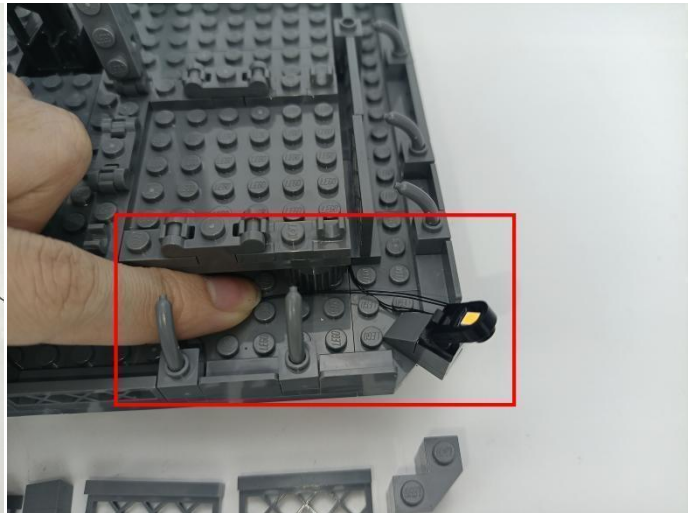
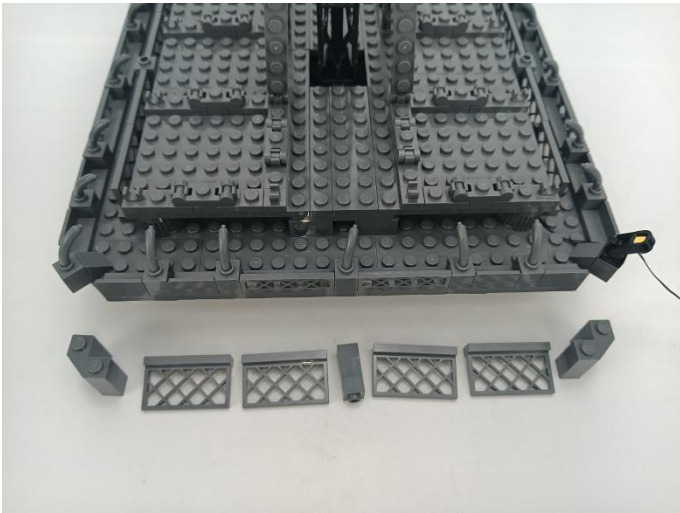

195

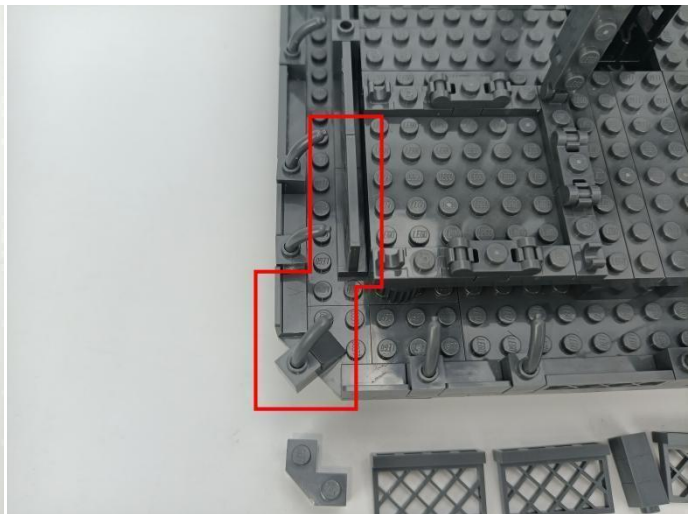
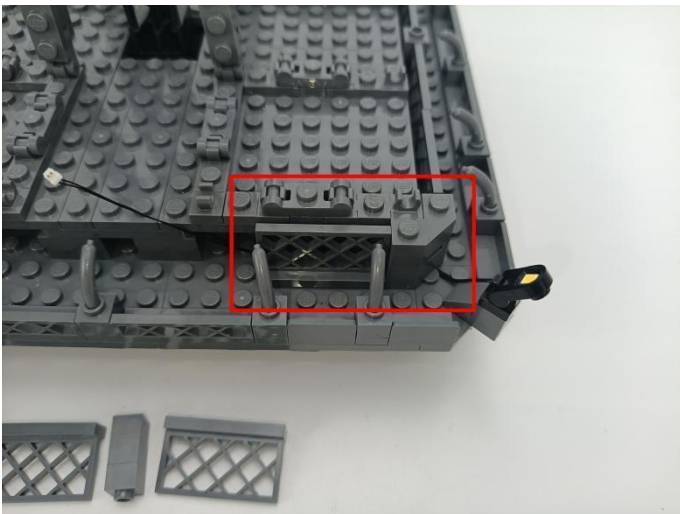



196

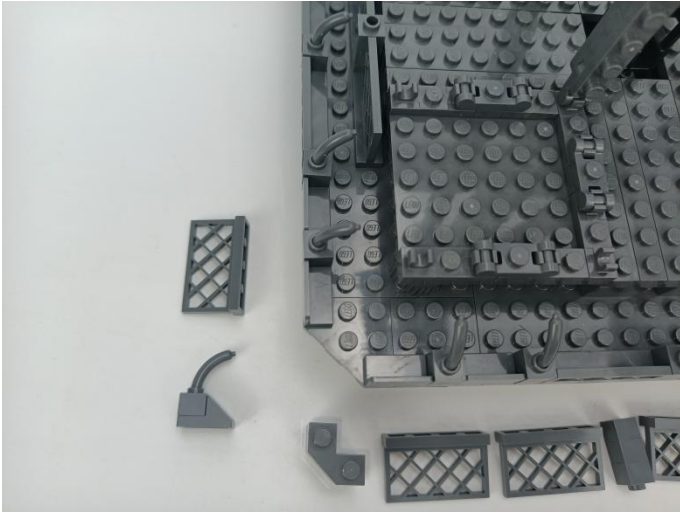

197



198

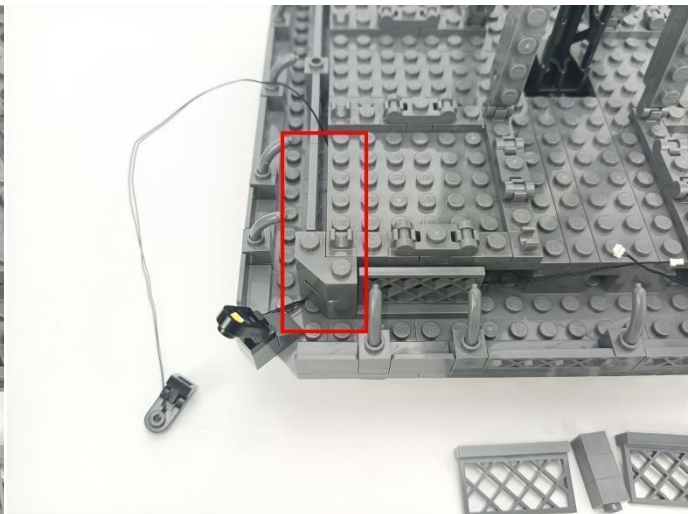
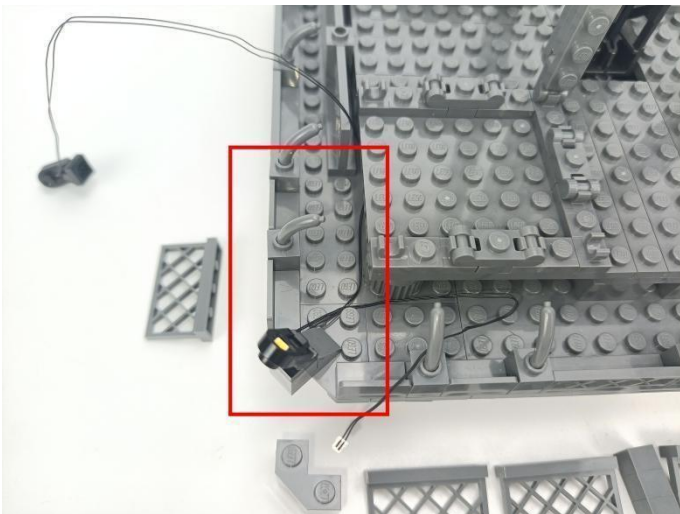

199

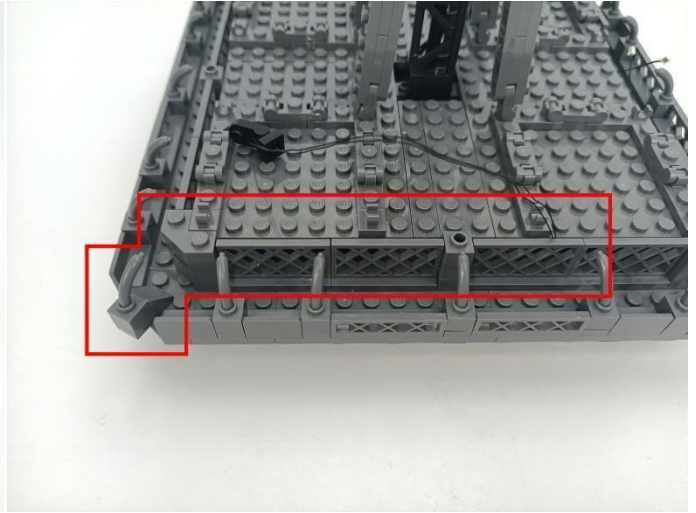
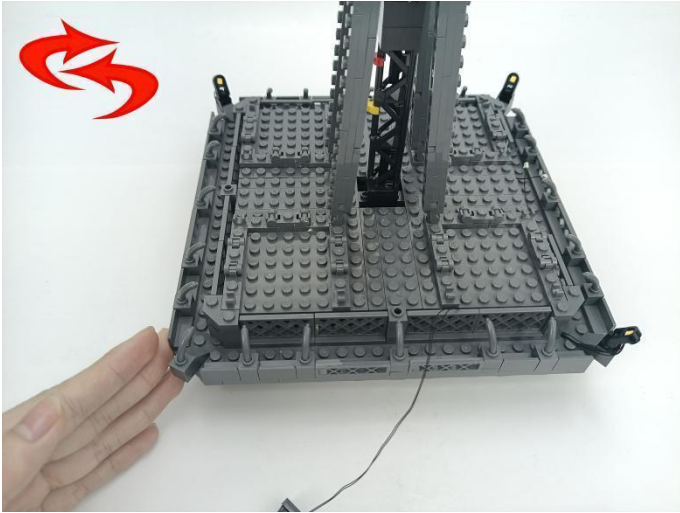

200

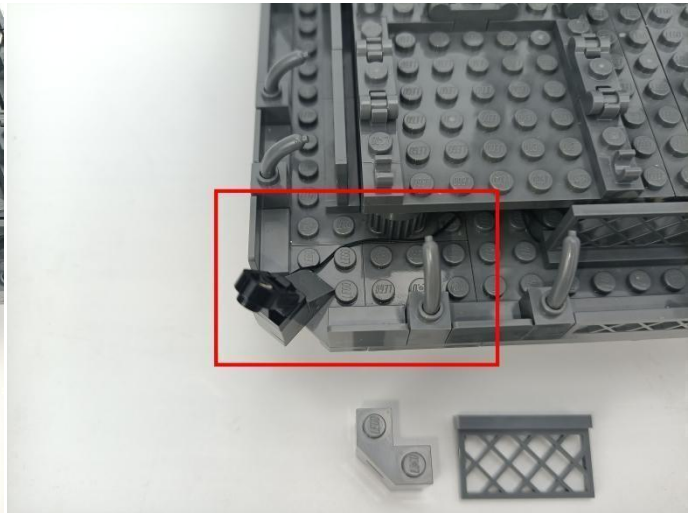
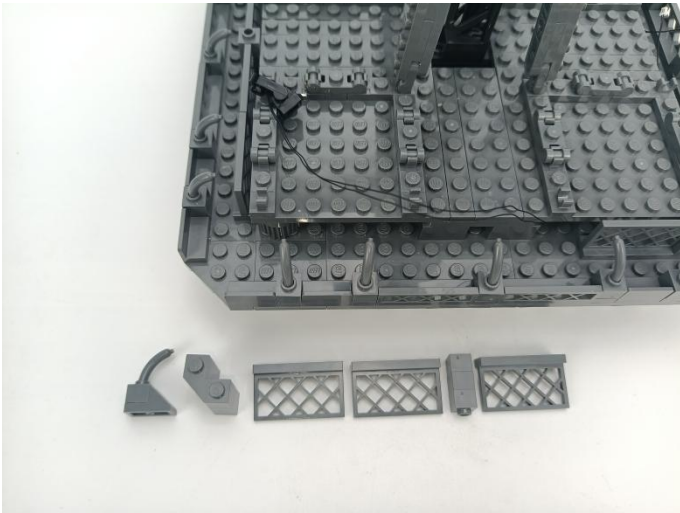

201

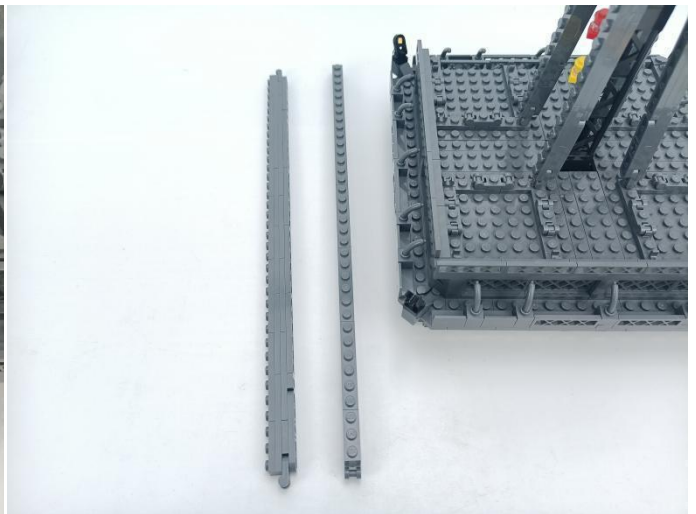
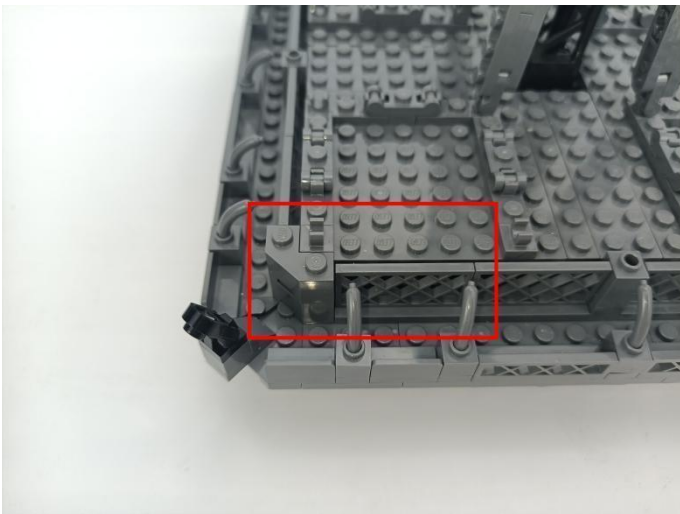



# 202

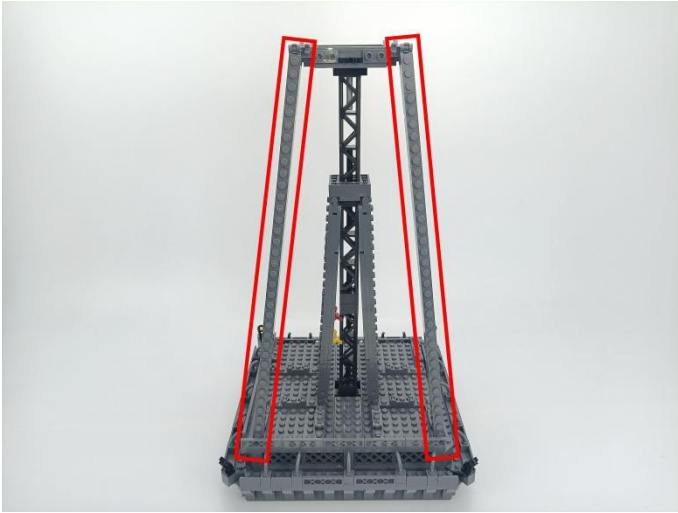

# 203

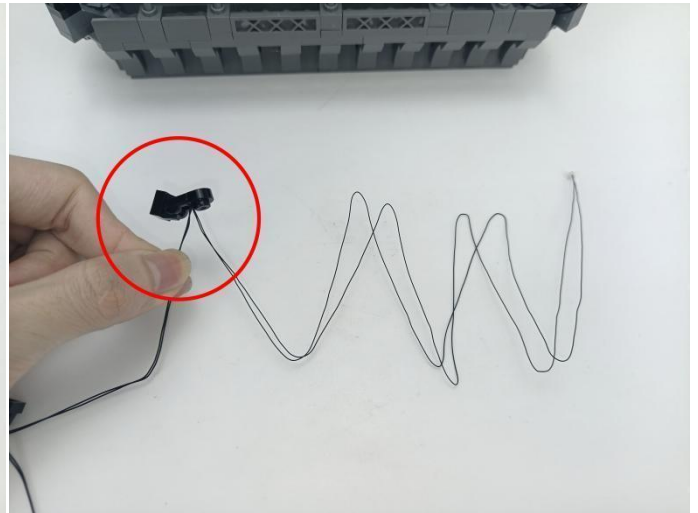
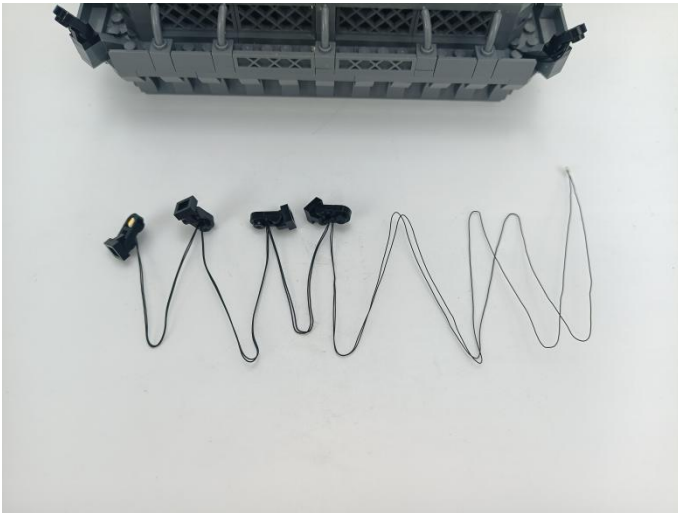

# 204





205

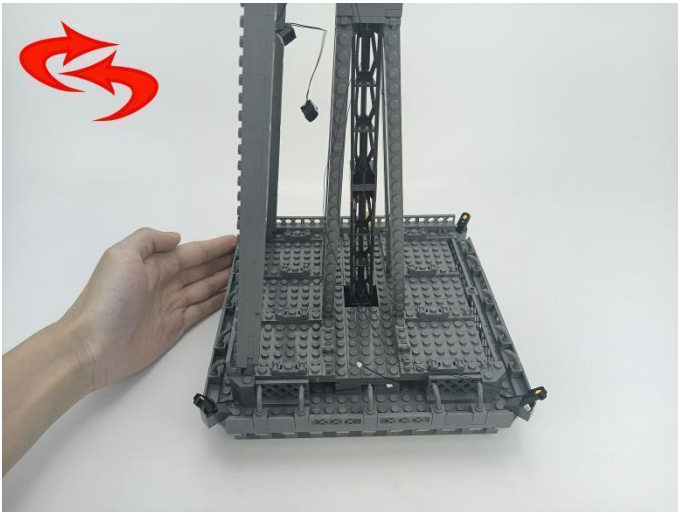

206

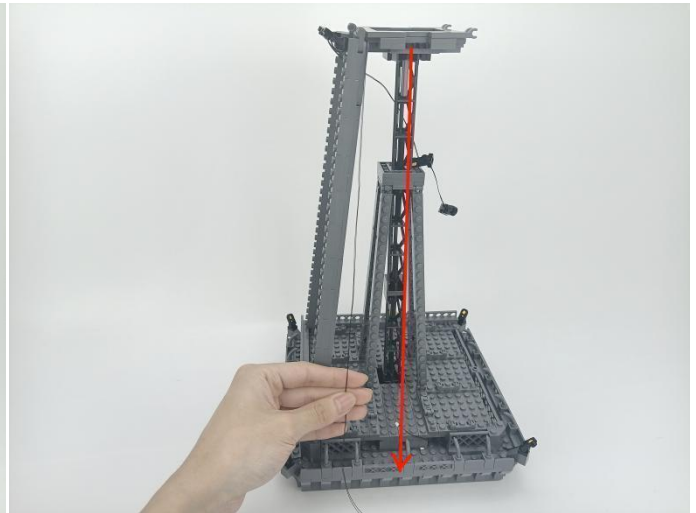
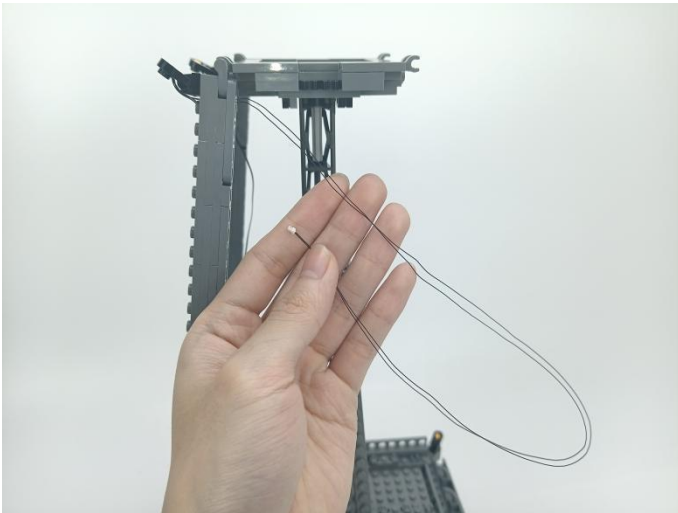

207

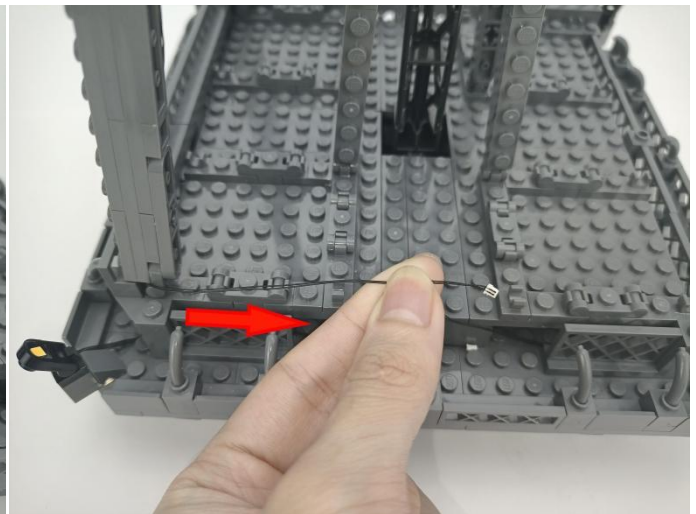
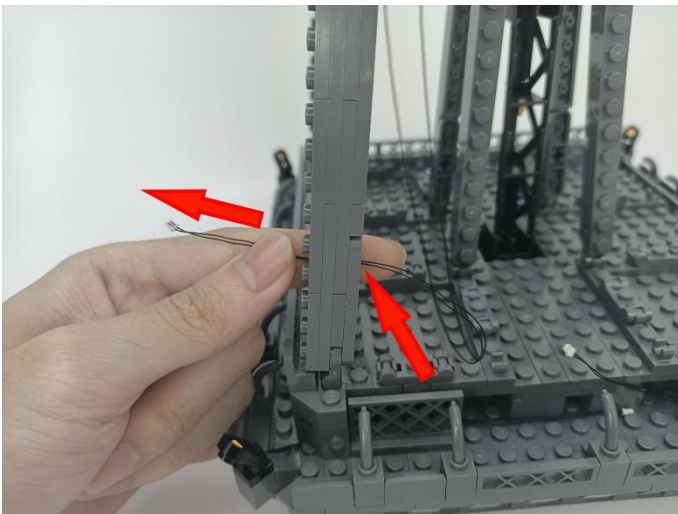

208



209

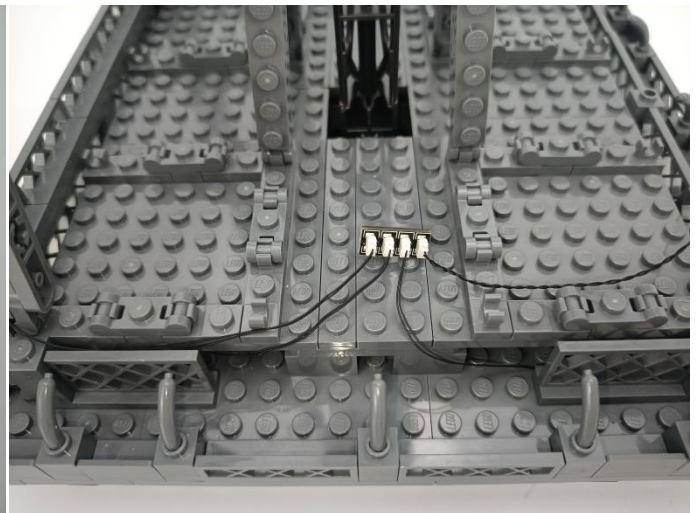



# 210

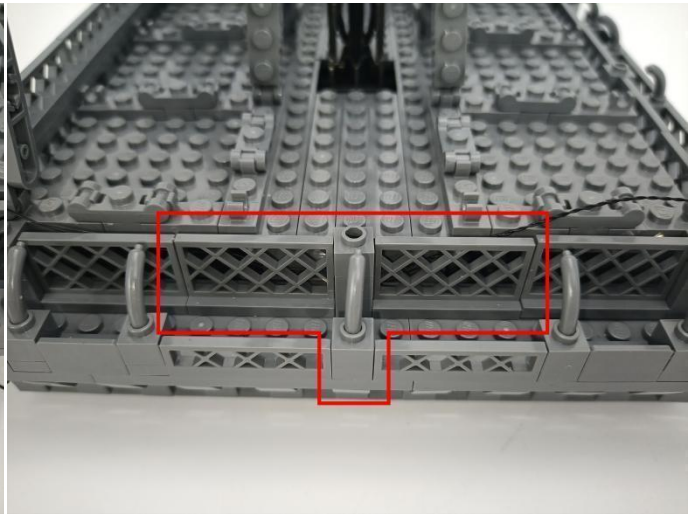
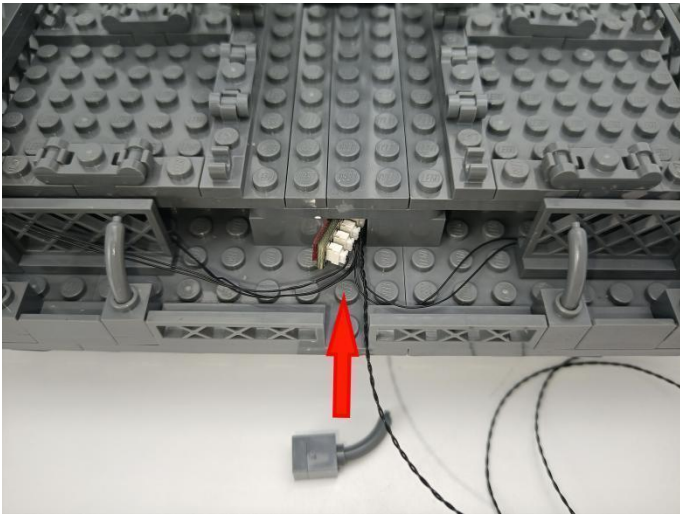

# 211

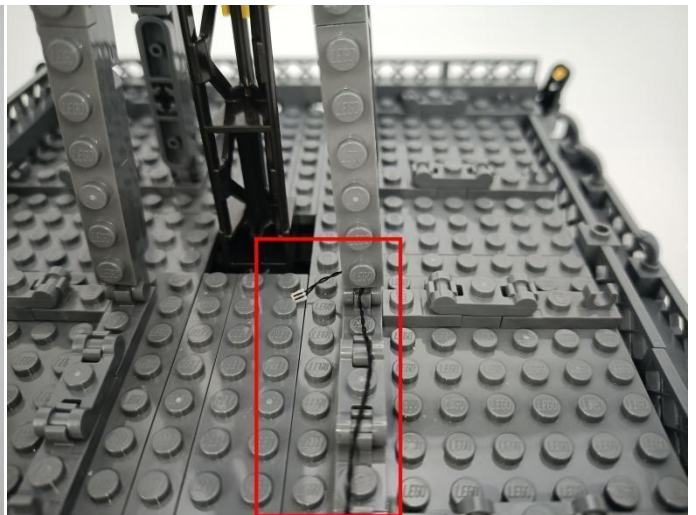
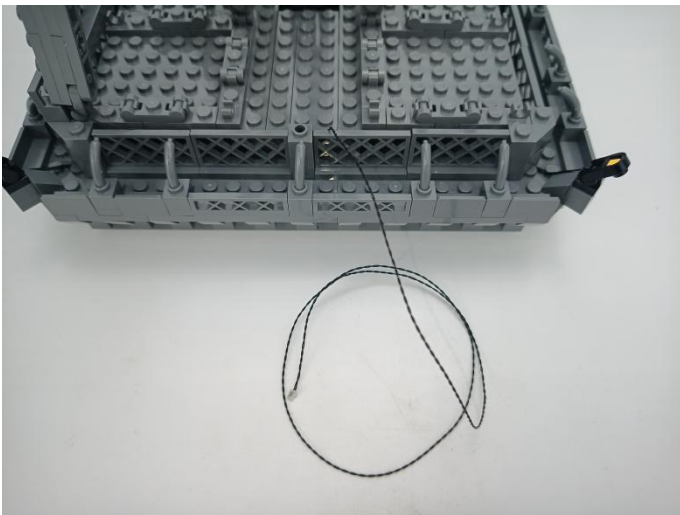

# 212

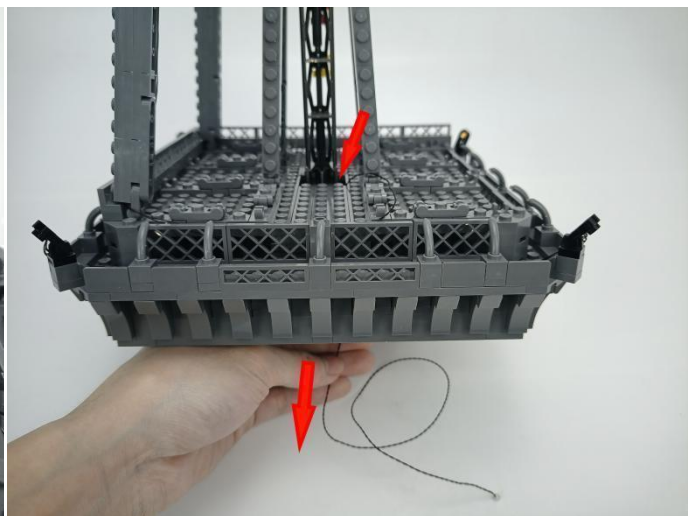
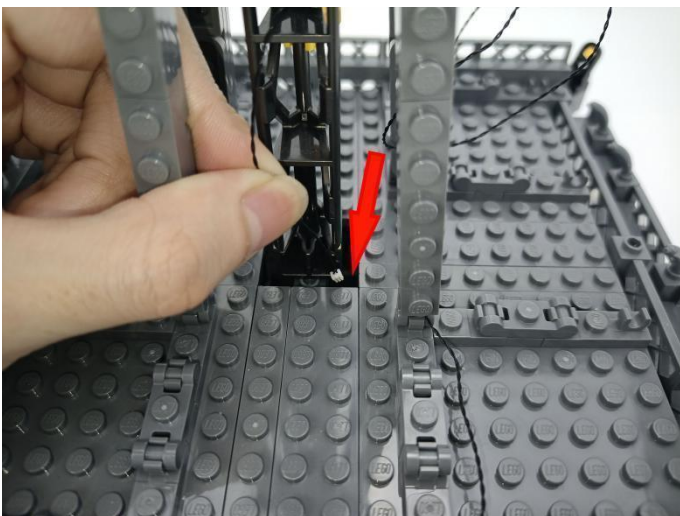



# 213

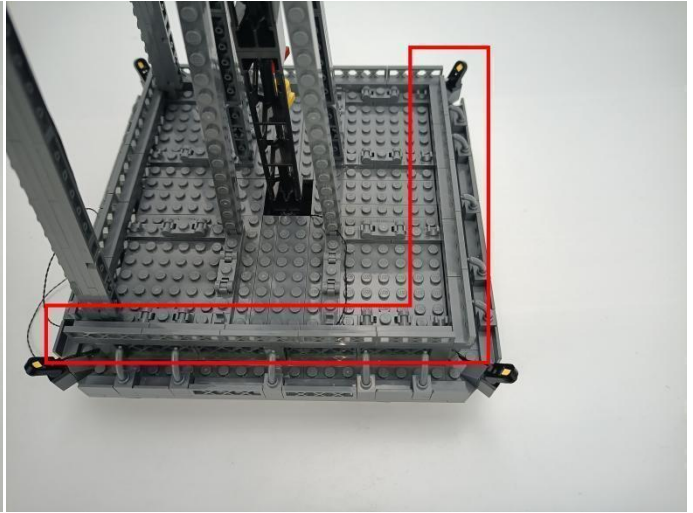
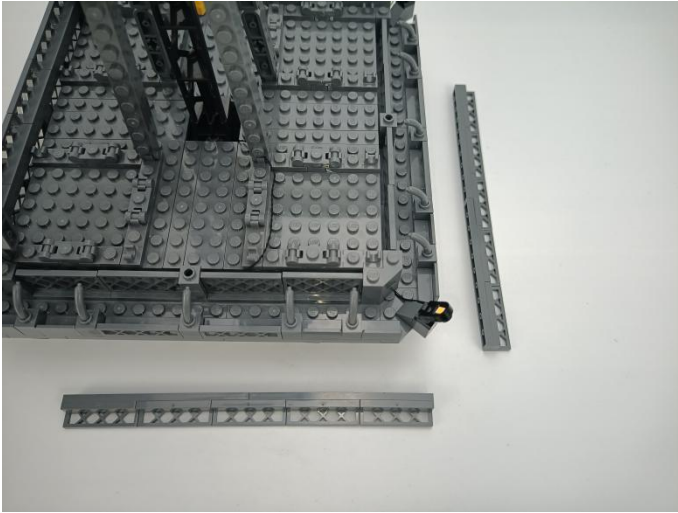

# 214

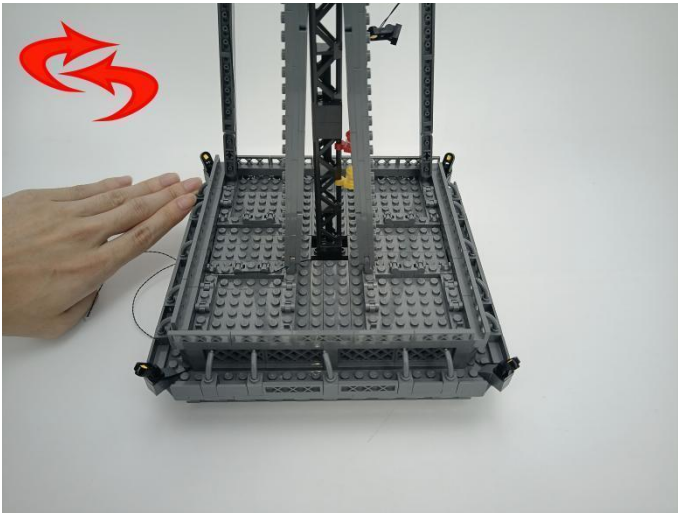

# 215

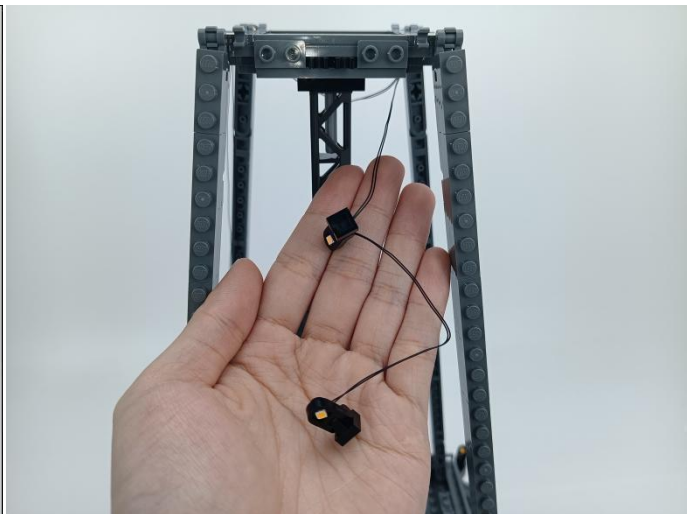
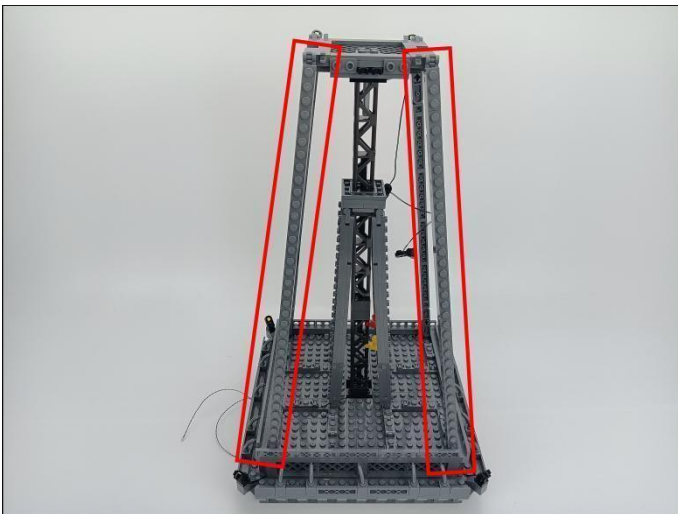

216

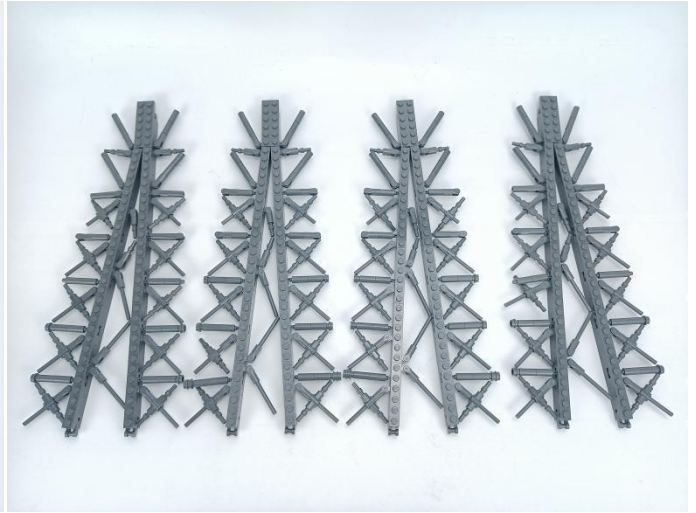
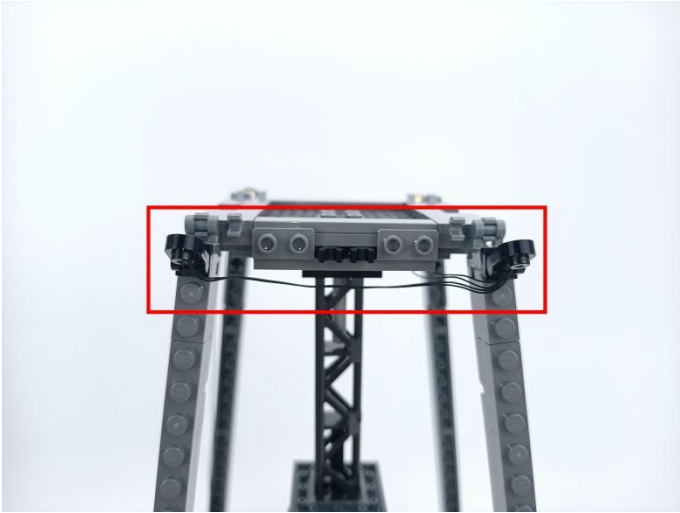

217



218

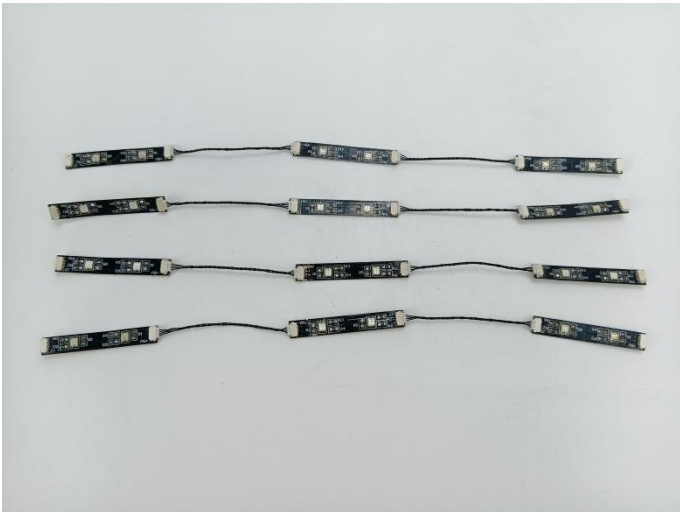



219

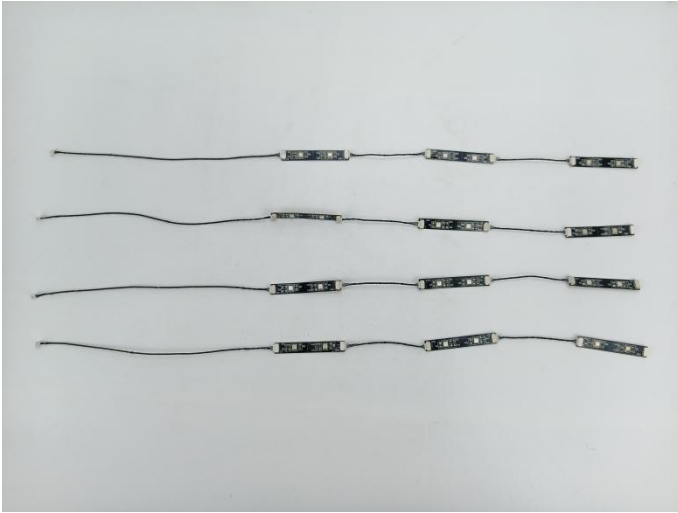

220

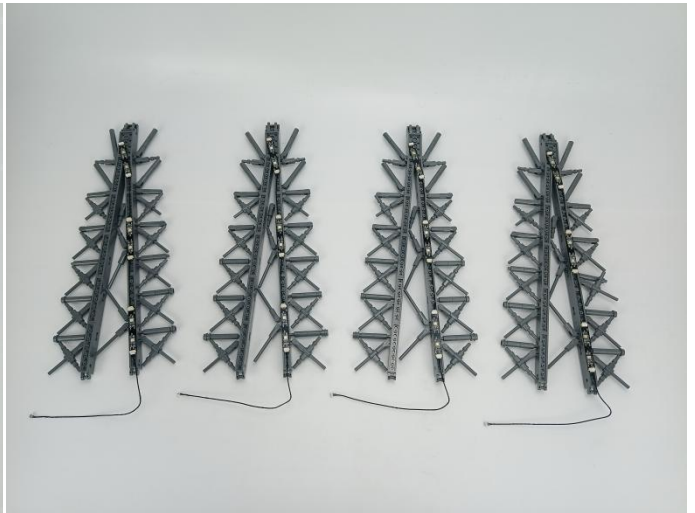
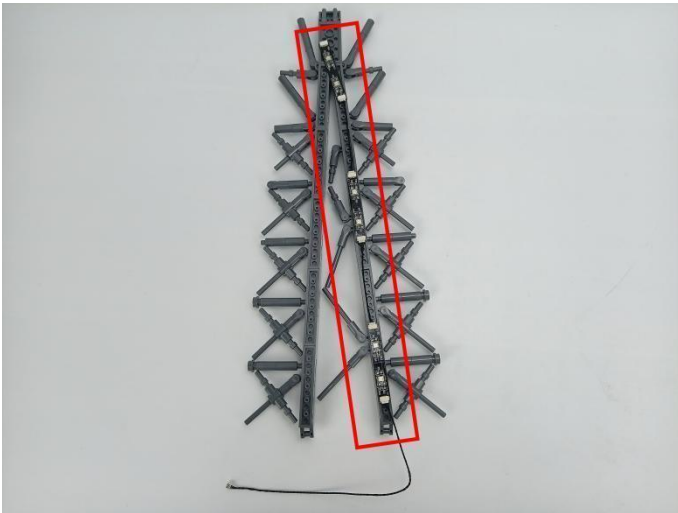

221

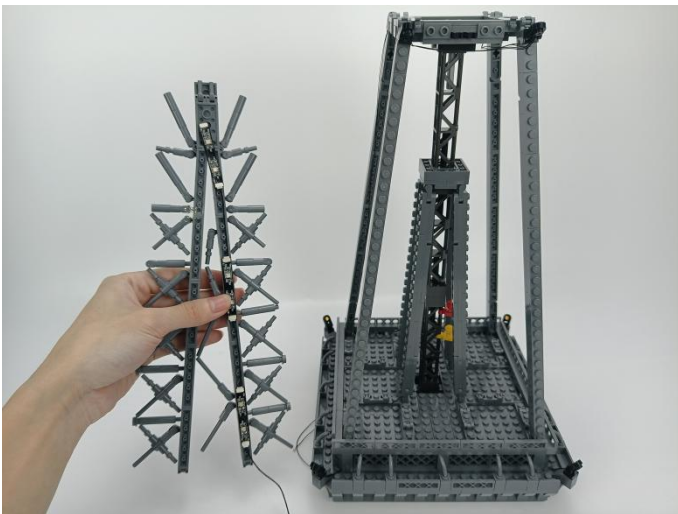

222

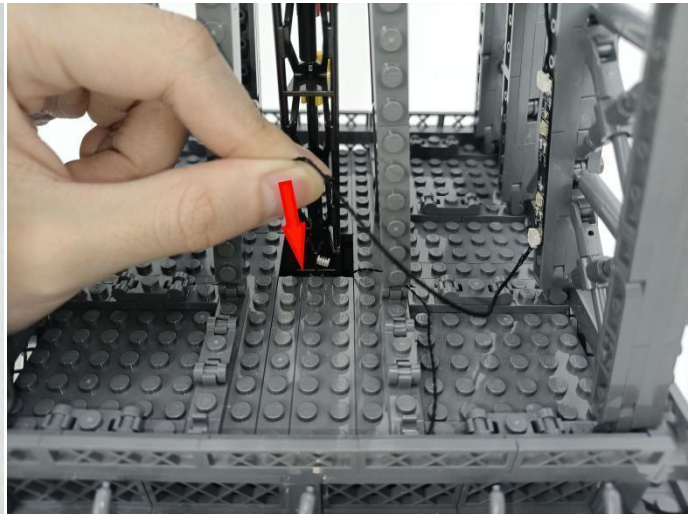
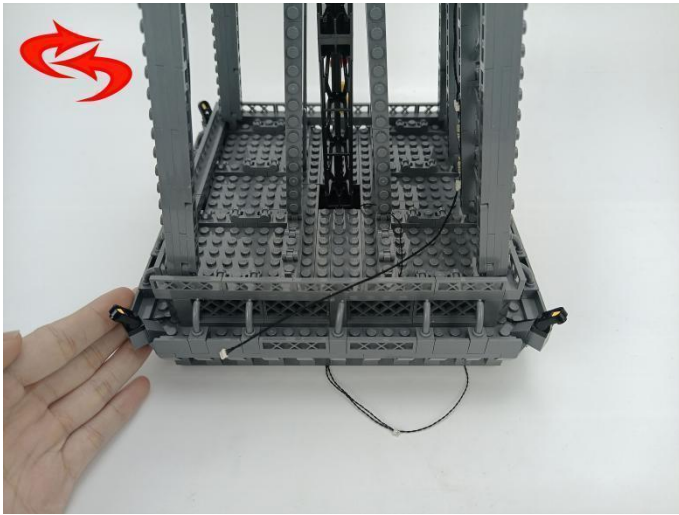

223

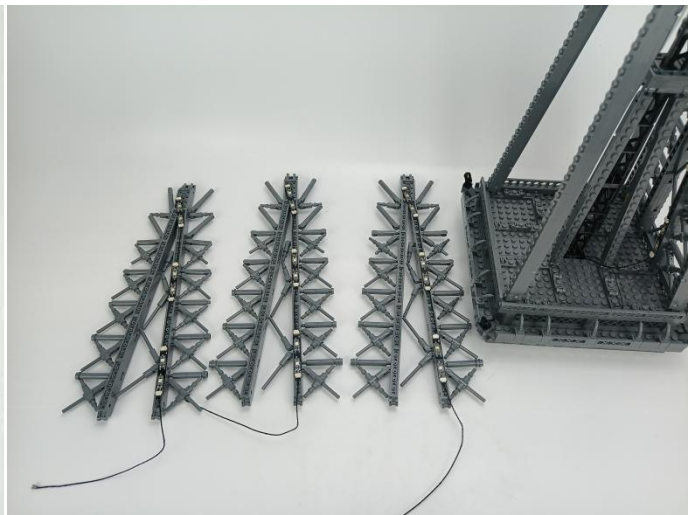
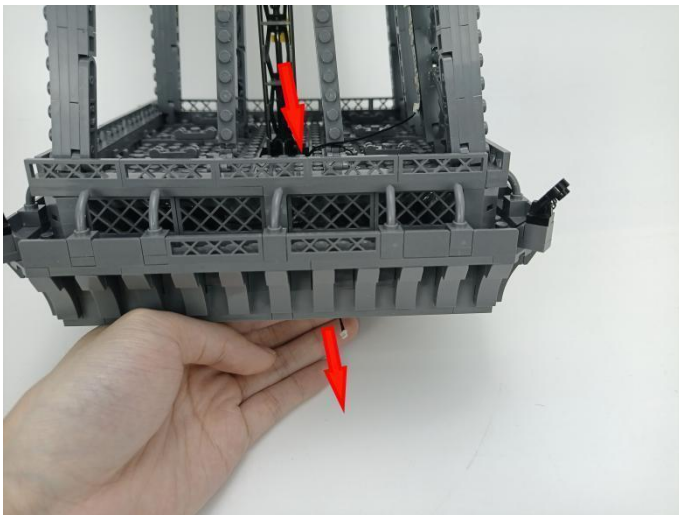

224

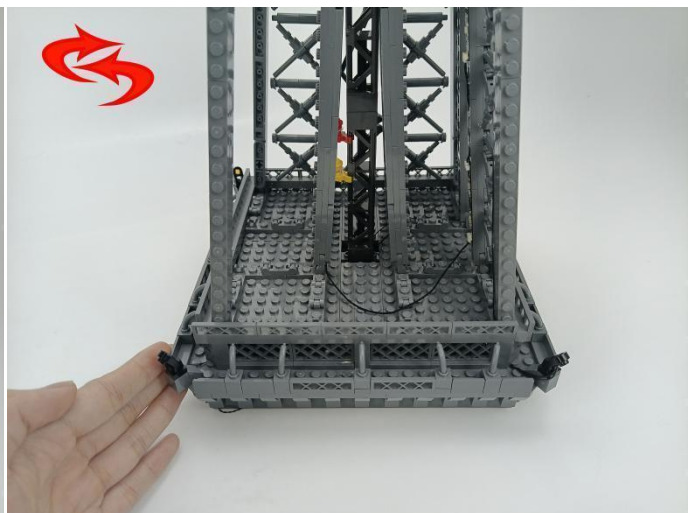



# 225

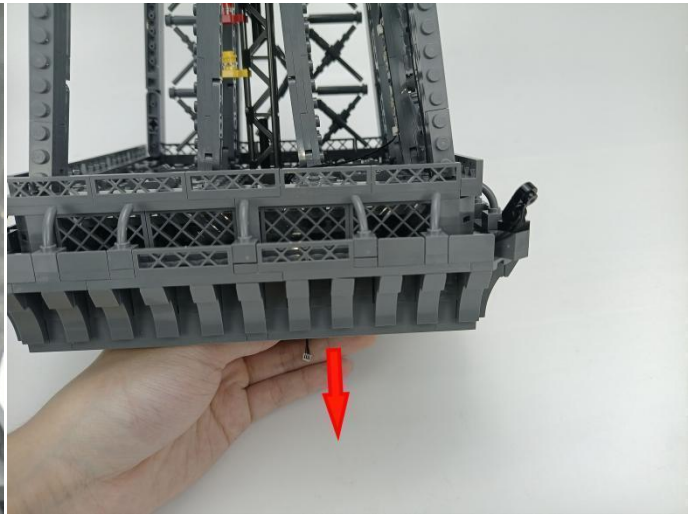
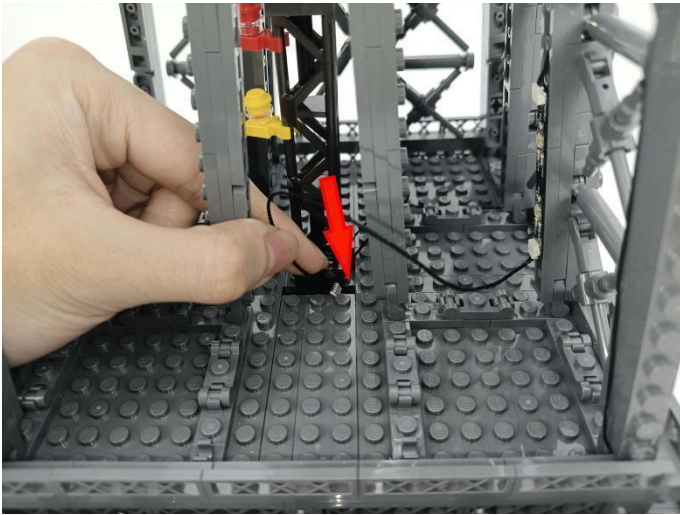

# 226

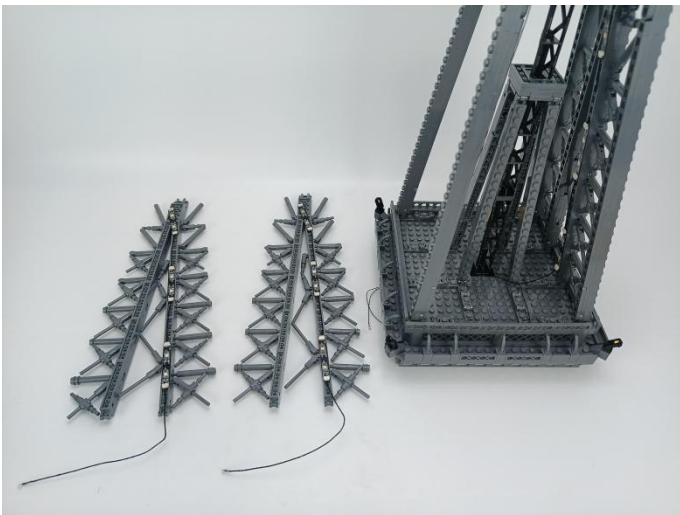

# 227

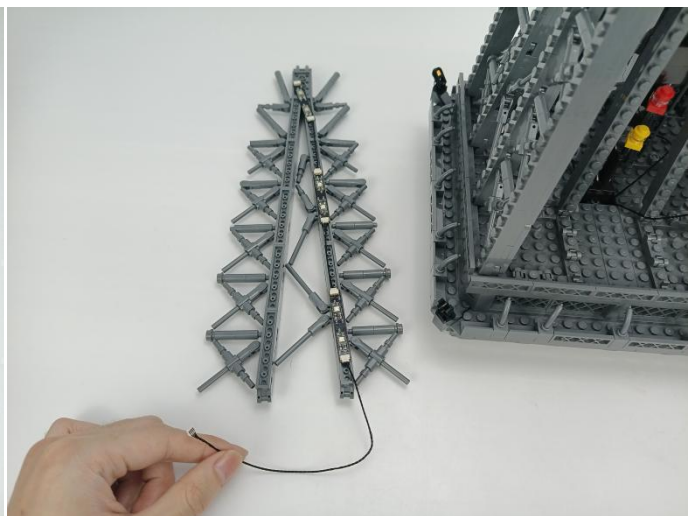
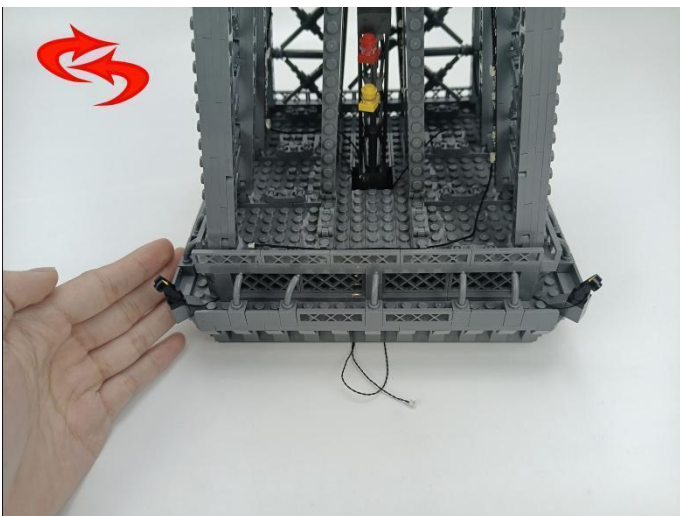

228

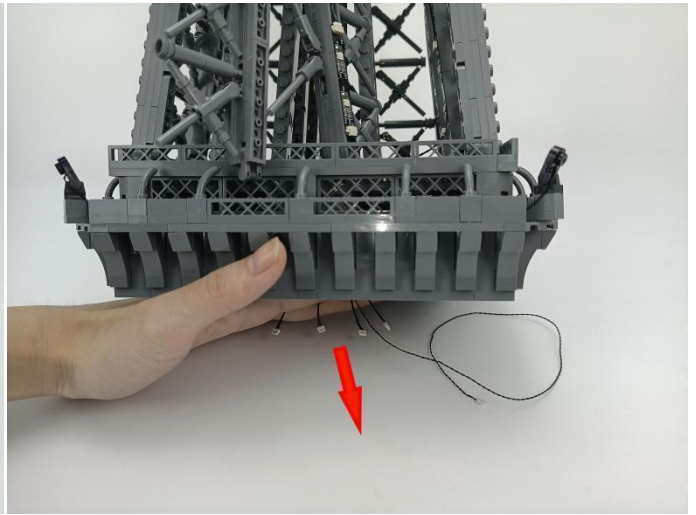
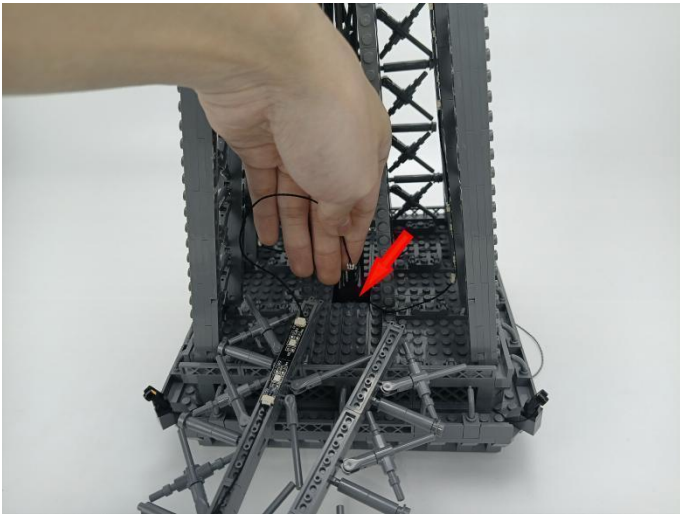

229

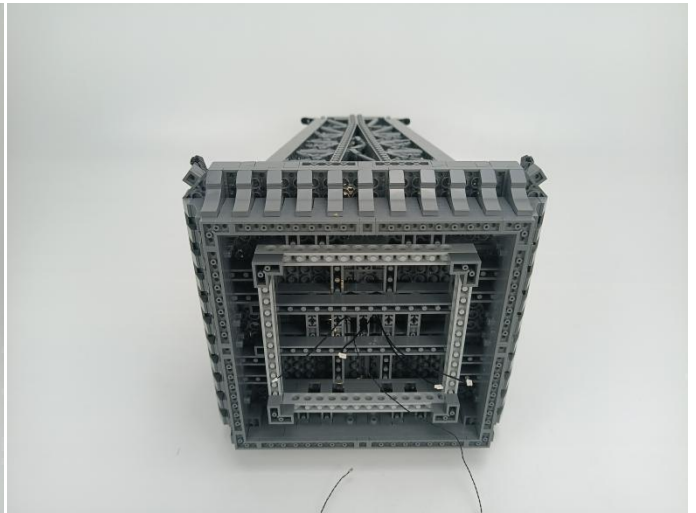

230





231

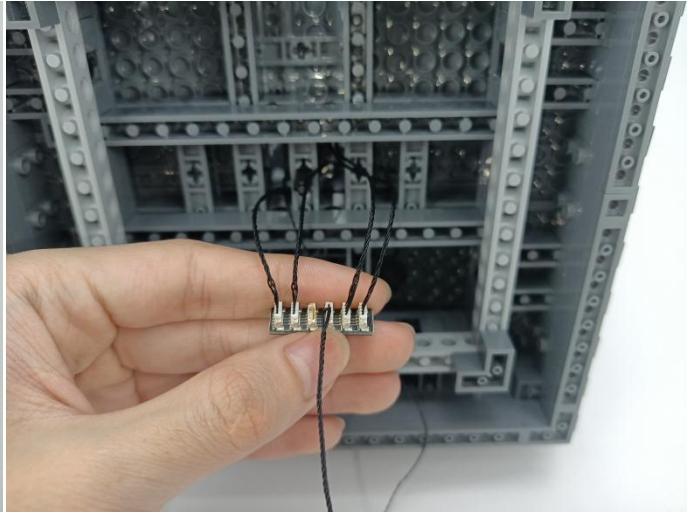

232

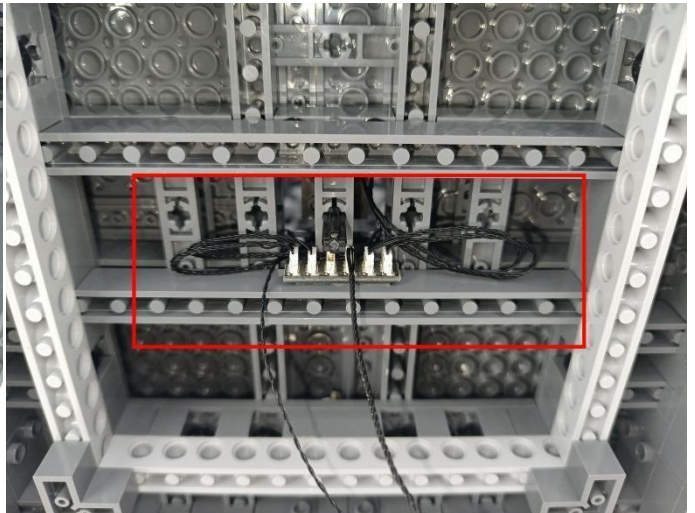
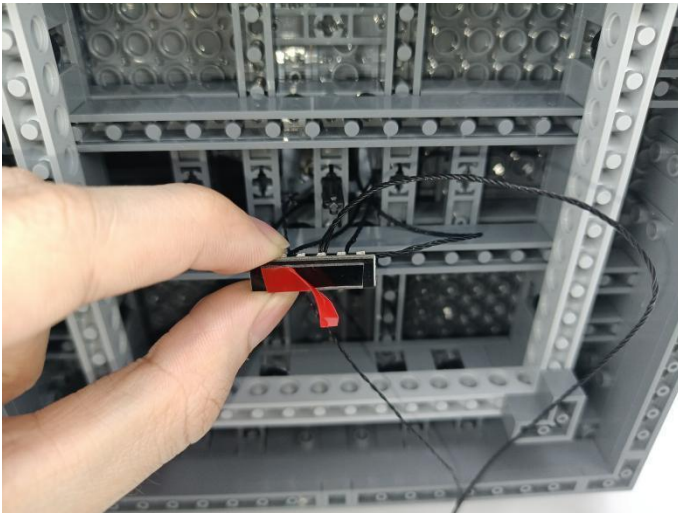

233



**234.** This instruction will use the usb socket as power supply . The test structure is shown as follow. All lamp in this set will be tested by this structure.



**235**

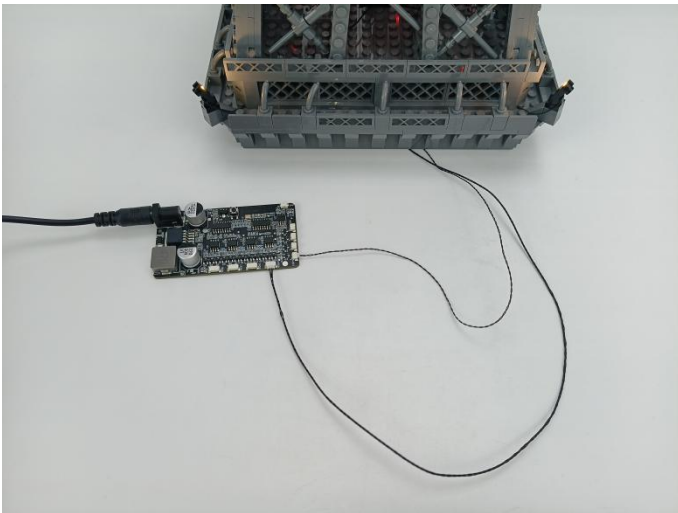

<p>①: Power interface, input DC voltage 12V.</p> <p>②: Function switching switch, press the switch to directly change the flashing mode of the lamp.</p> <p>③: External speaker.</p> <p>④: External speaker interface.</p> <p>⑤: 2P terminal port, used to connect ordinary lamps, divided into A, B, C, D, a total of 4 ports.</p> <p>⑥: 4P terminal port, used to connect RGB lamps, divided into F, G, H, I, a total of 4 ports.</p> <p>⑦: 12V charger, cable length 150cm.</p>	<p>①: Leistungsschnittstelle, Eingangsgleichspannung 12 V.</p> <p>②: Funktionsumschaltsschalter, drücken Sie den Schalter, um den Blinkmodus der Lampe direkt zu ändern.</p> <p>③: Externer Lautsprecher.</p> <p>④: Schnittstelle für externe Lautsprecher.</p> <p>⑤: 2P-Terminalanschluss zum Anschließen gewöhnlicher Lampen, unterteilt in A, B, C, D, insgesamt 4 Anschlüsse.</p> <p>⑥: 4P-Terminalanschluss zum Anschließen von RGB-Lampen, unterteilt in F, G, H, I, insgesamt 4 Anschlüsse.</p> <p>⑦: 12-V-Ladegerät, Kabellänge 150 cm.</p>
--	---

**236.** Power on and test the effect of the lighting installation, then disconnect and start the next part of the installation.





237

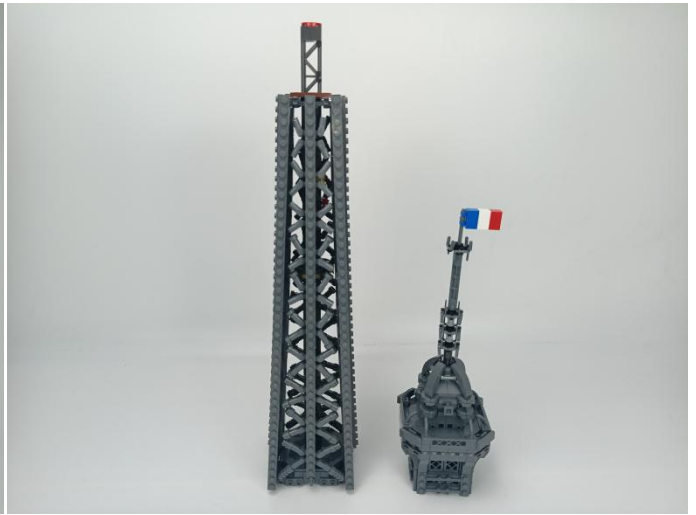

238

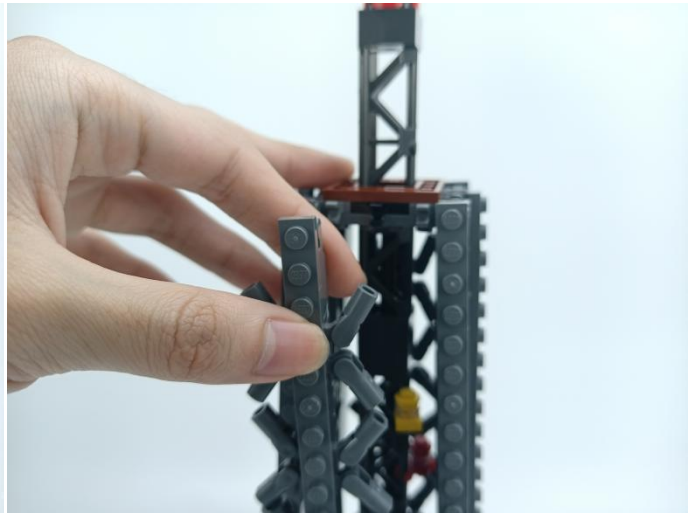

239

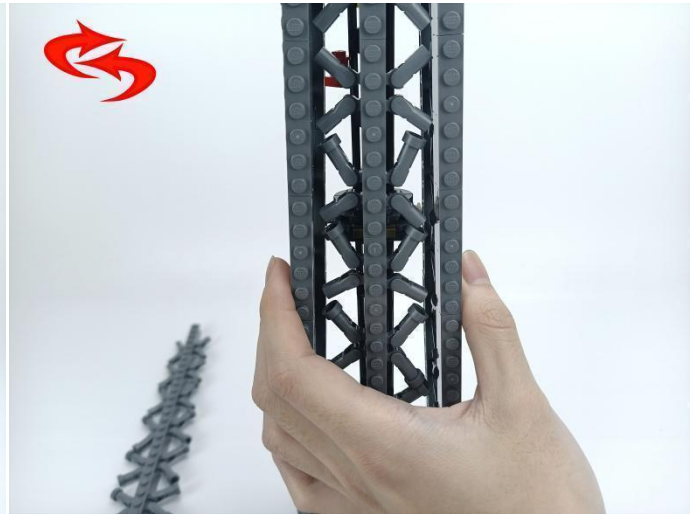
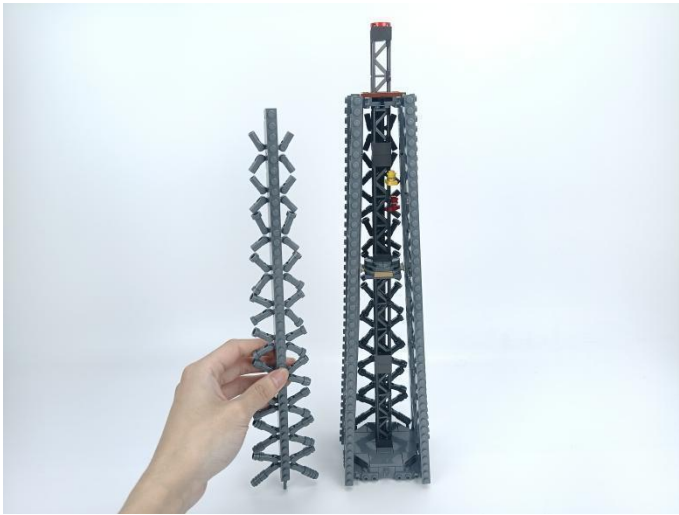

240

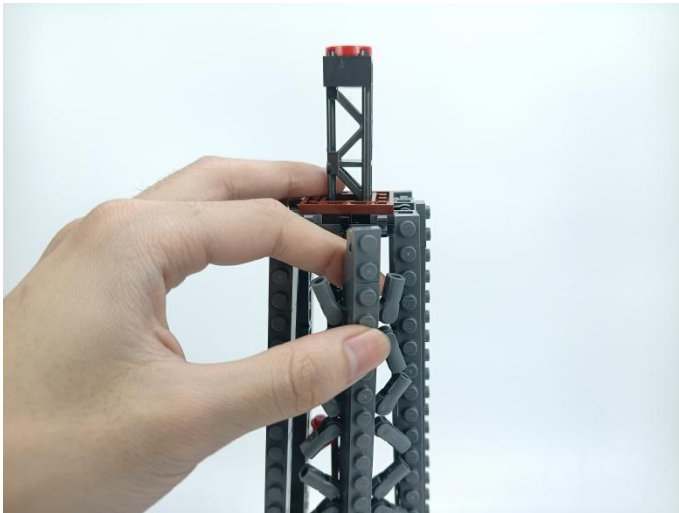

241

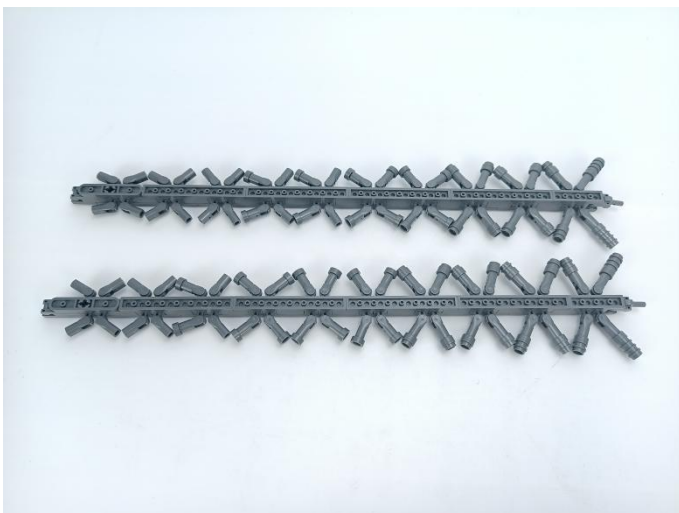



242



243

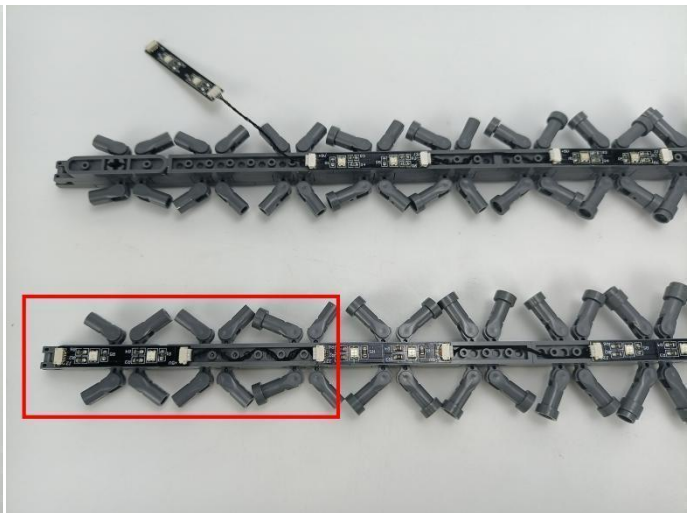
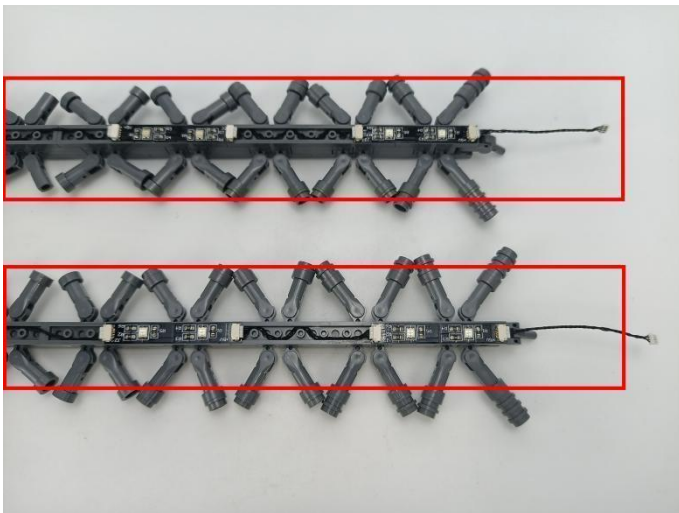

244

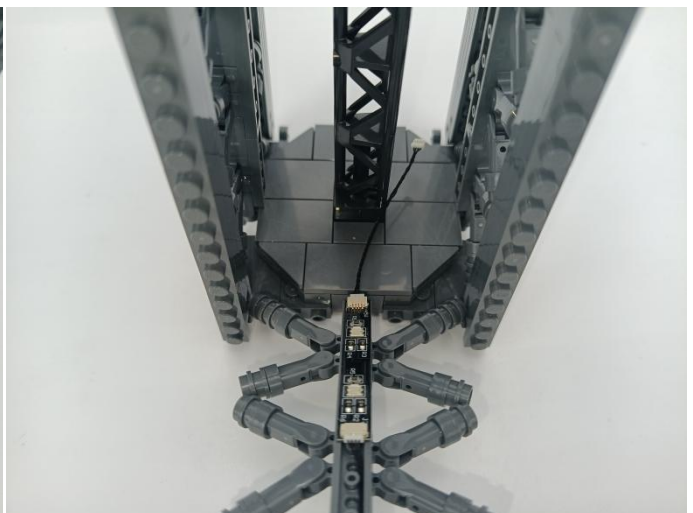
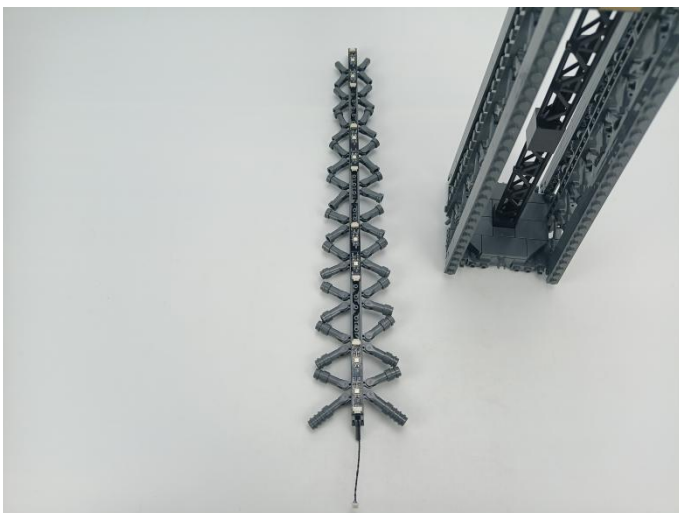

245



246

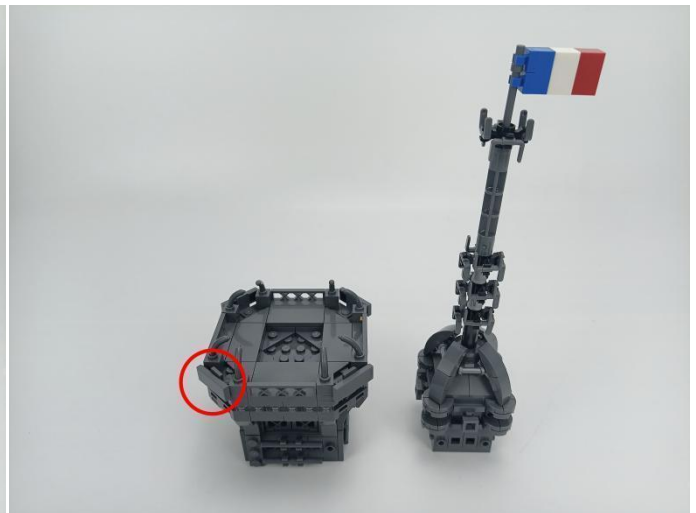

247

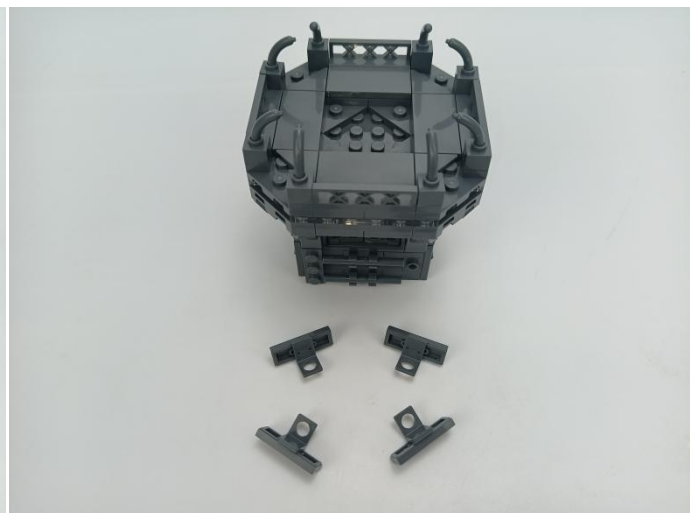
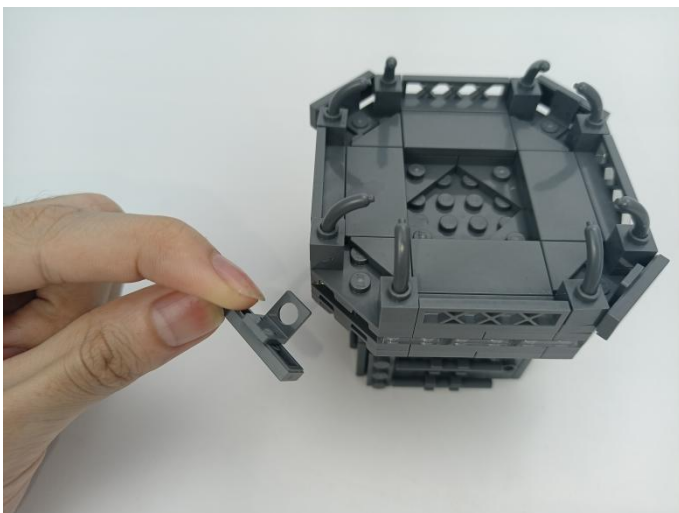



248



249

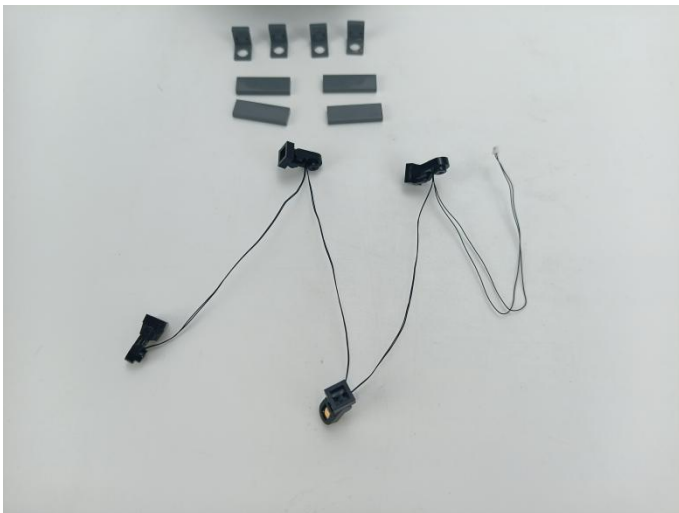

250

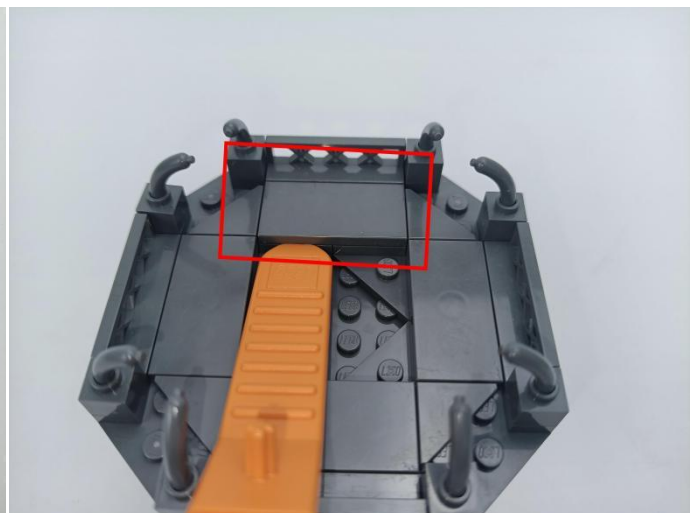
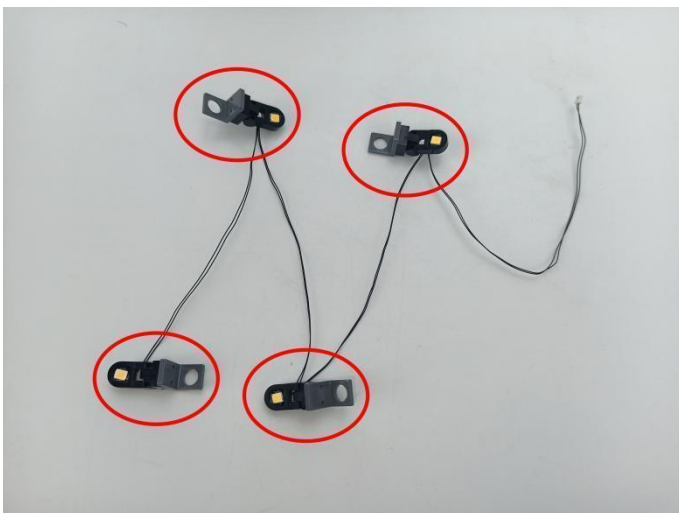

# 251

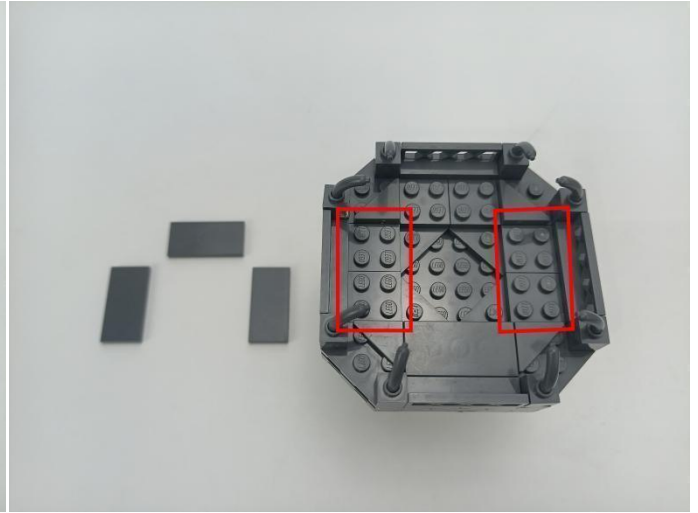
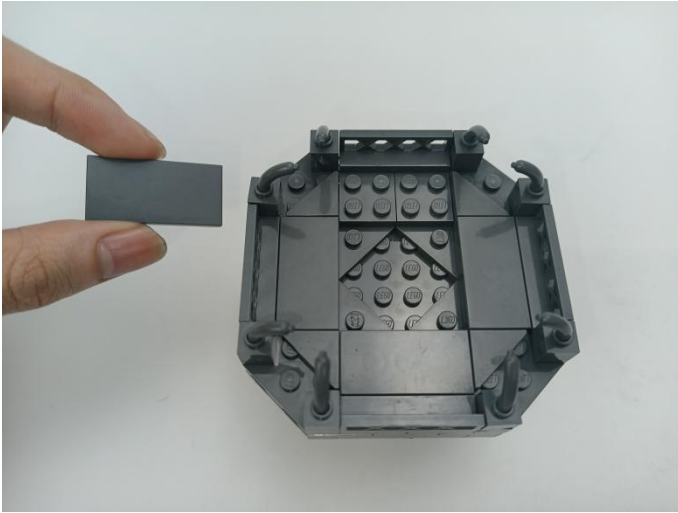

# 252

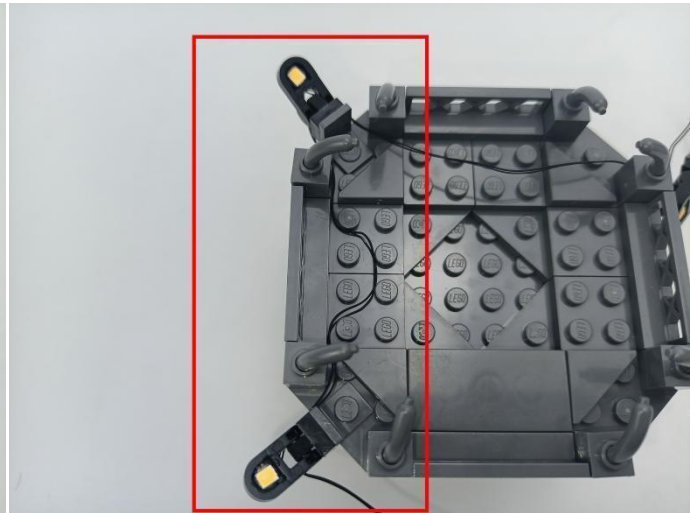

# 253

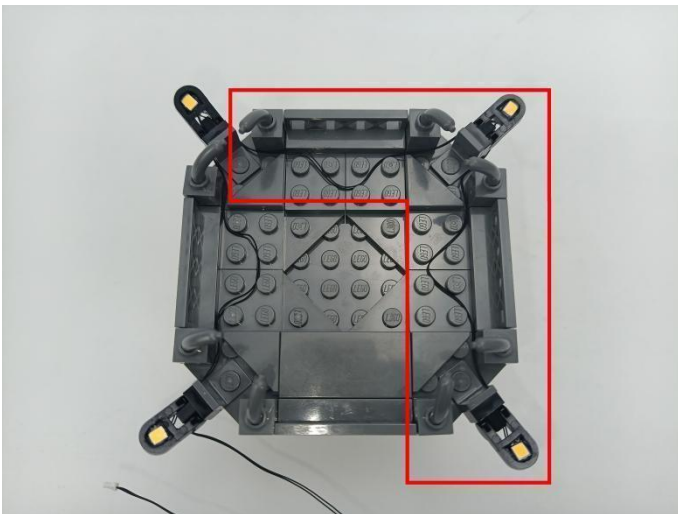



254



255

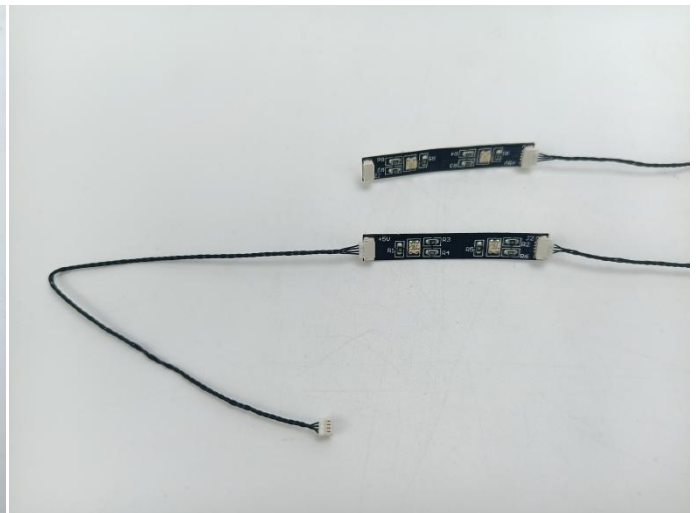

256

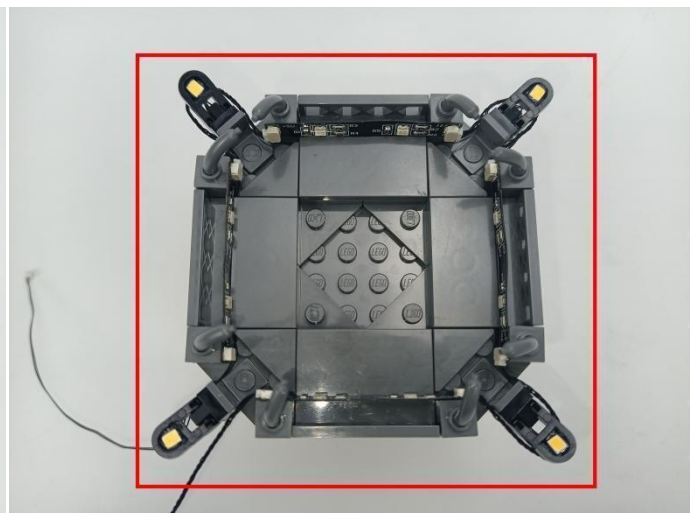
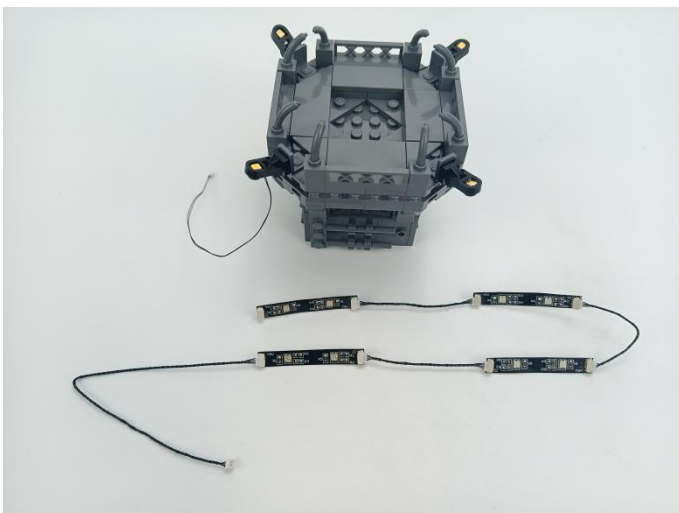

257

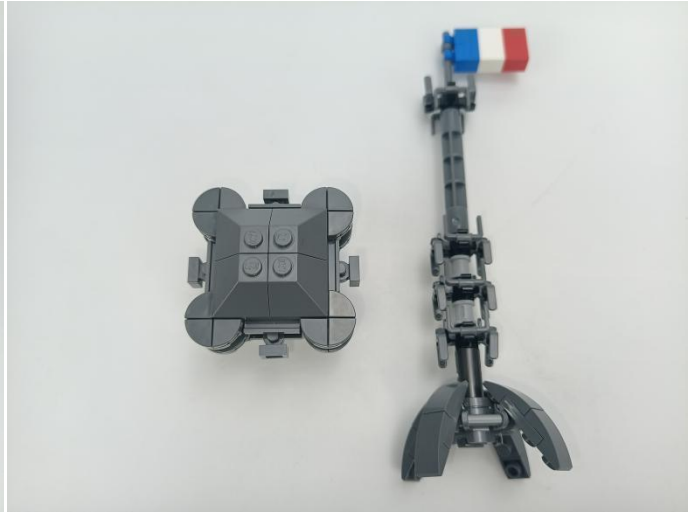

258

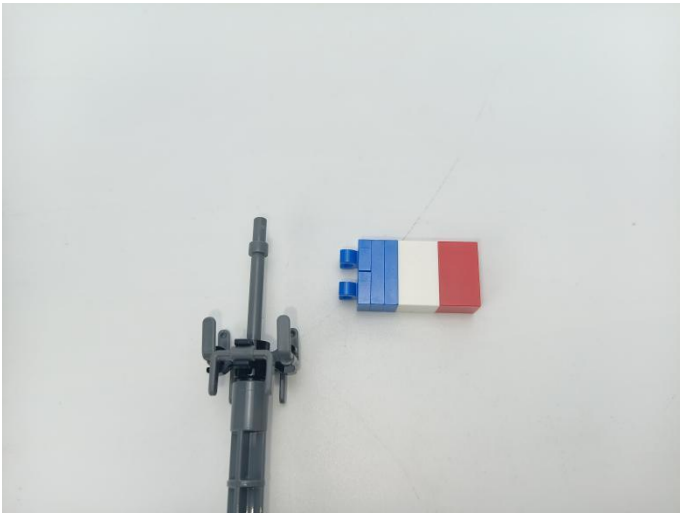

259

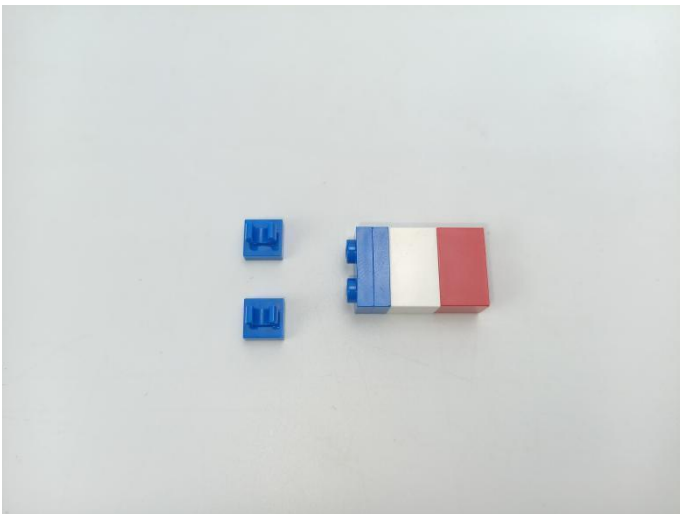



260



261

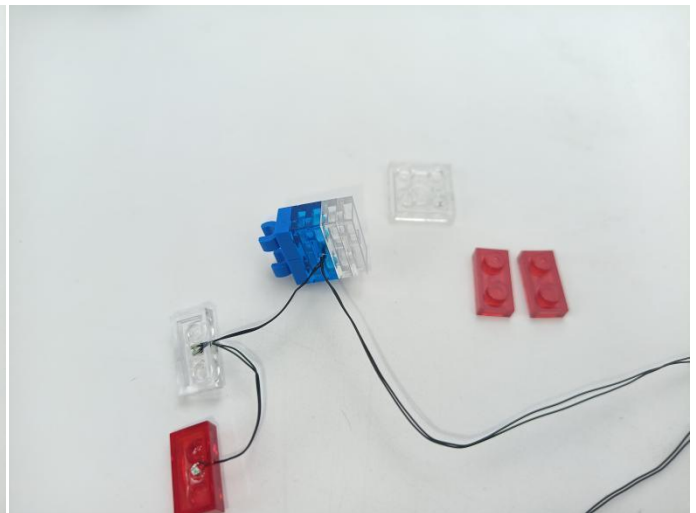
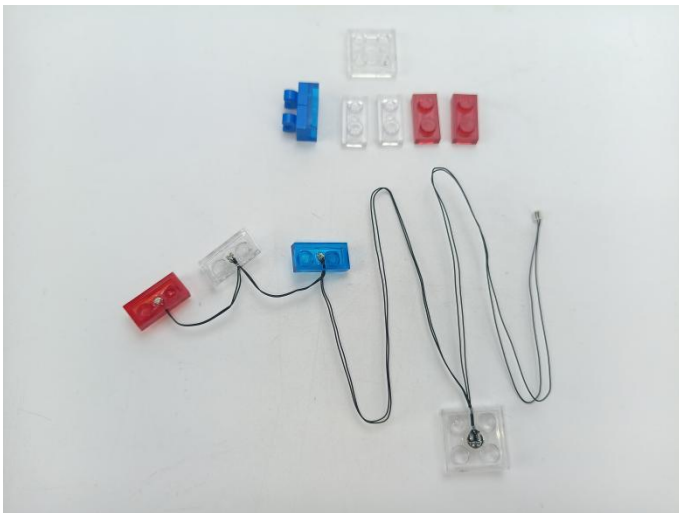

262

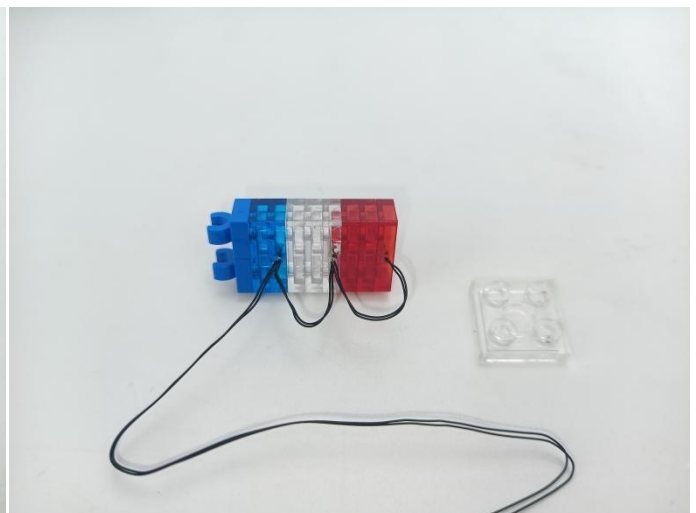
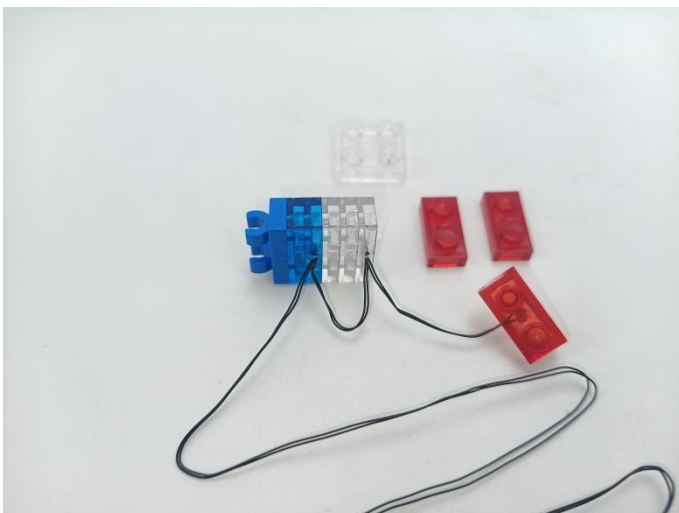

263

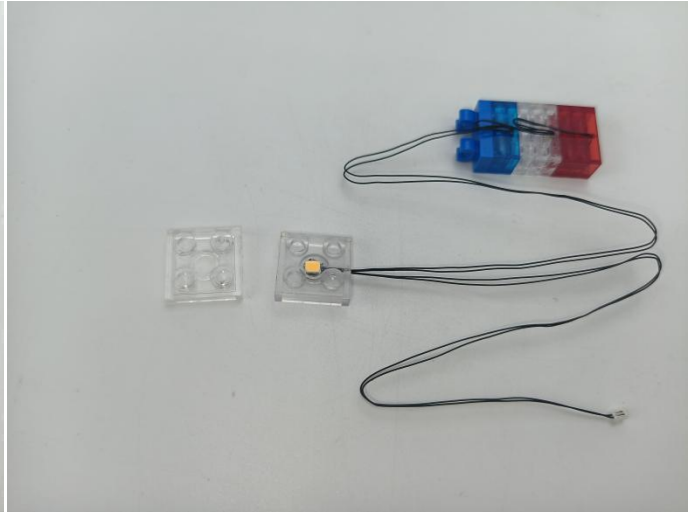
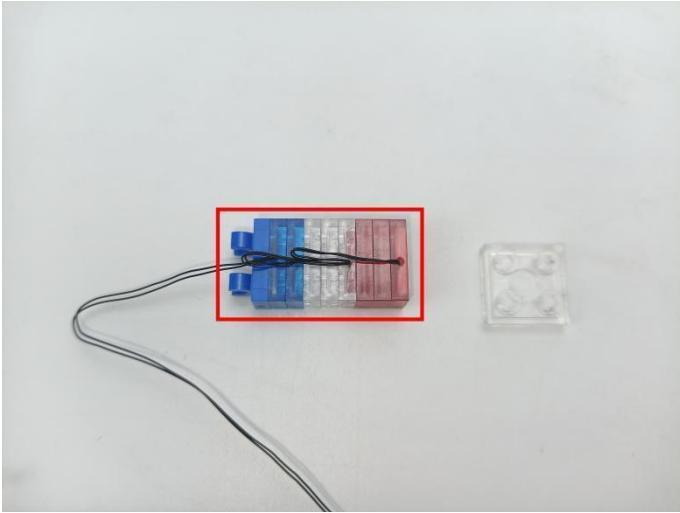

264

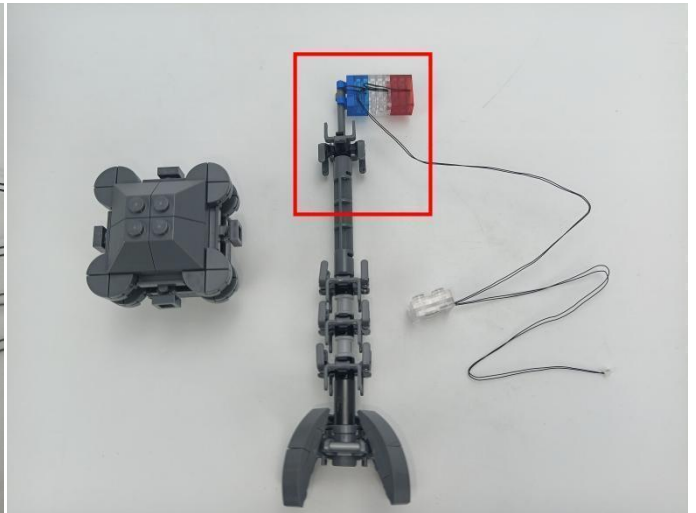
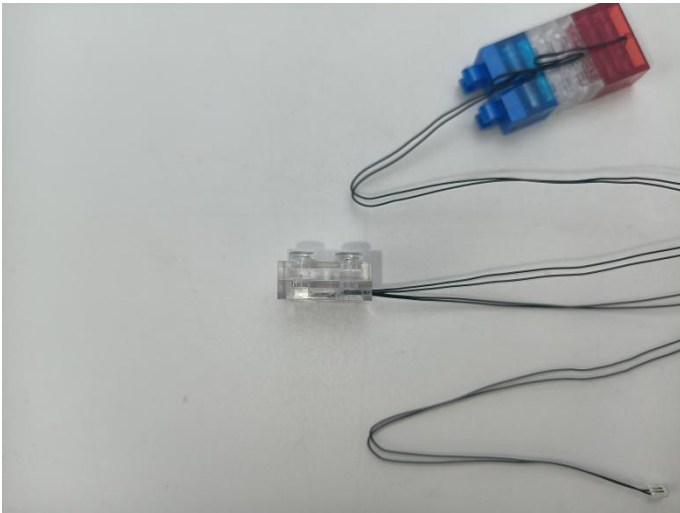

265

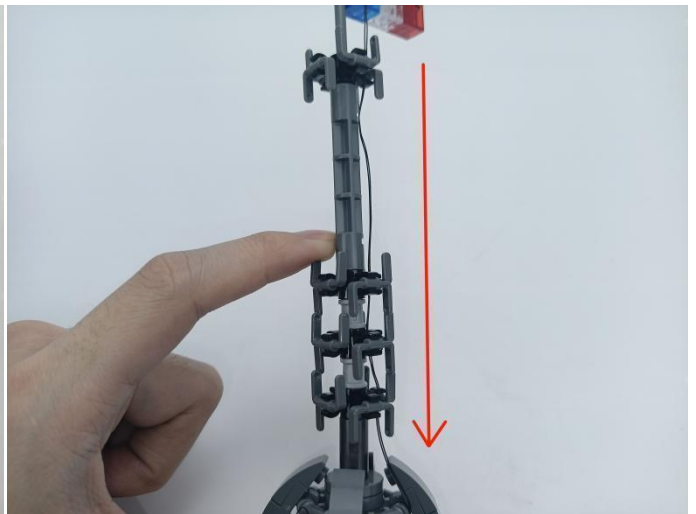
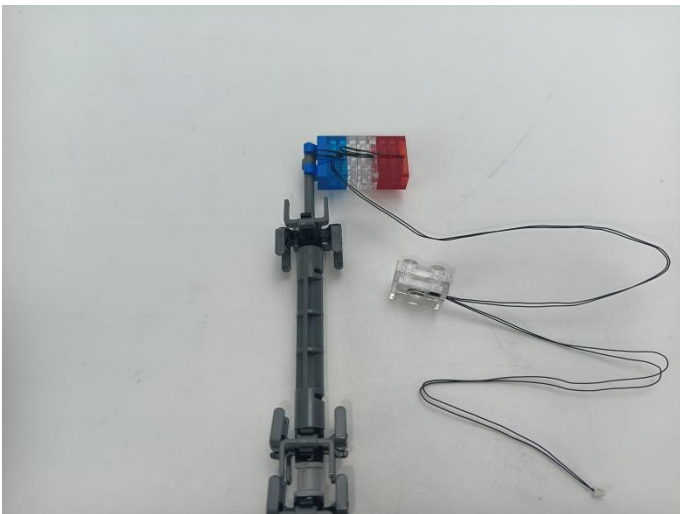



266

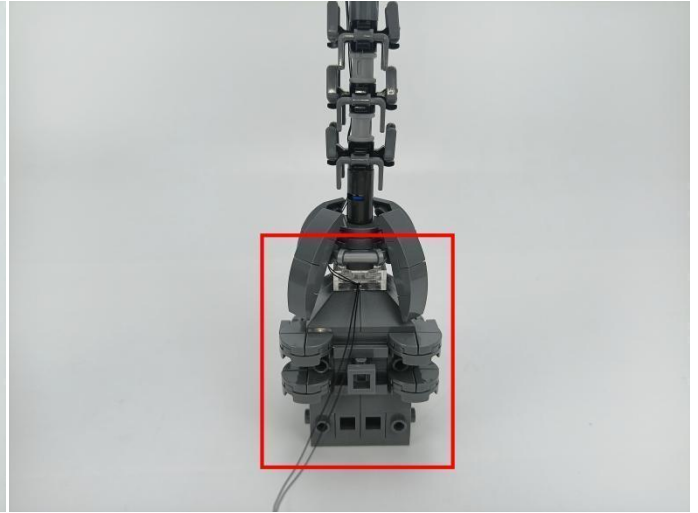
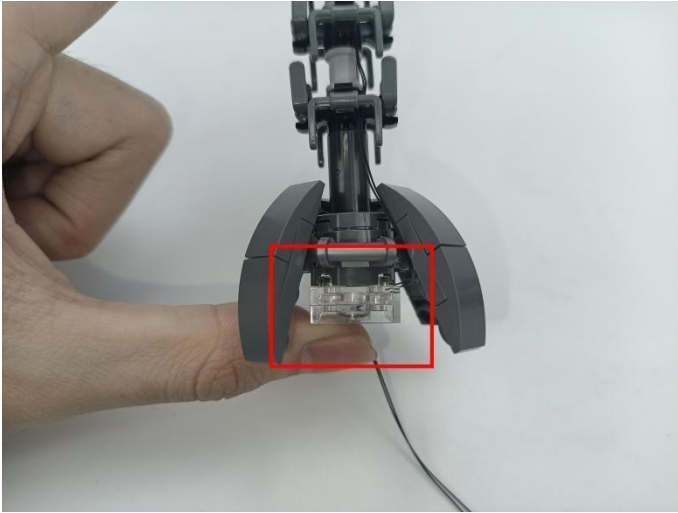

267

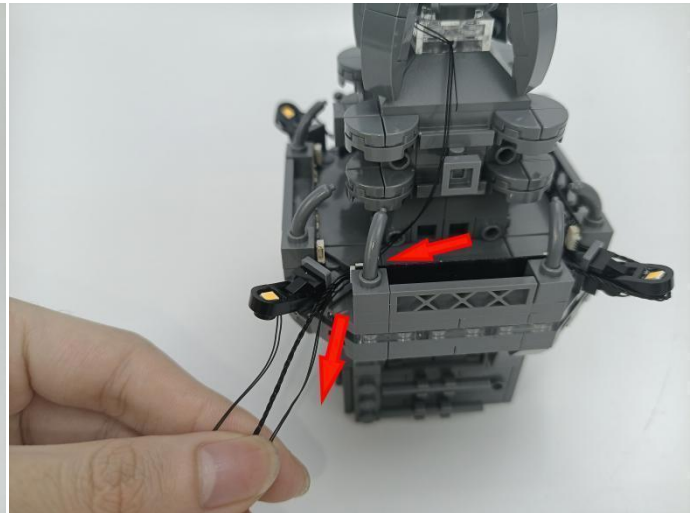
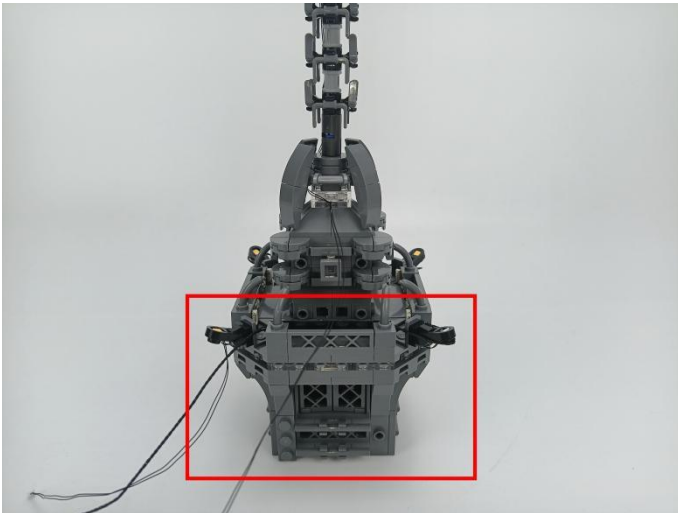

268

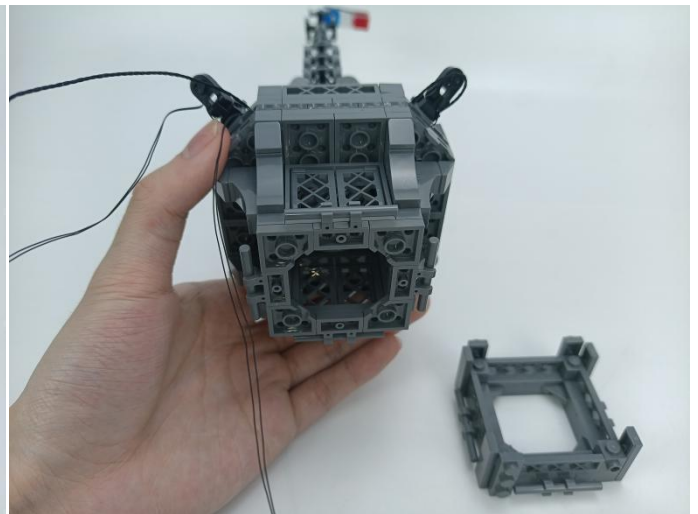
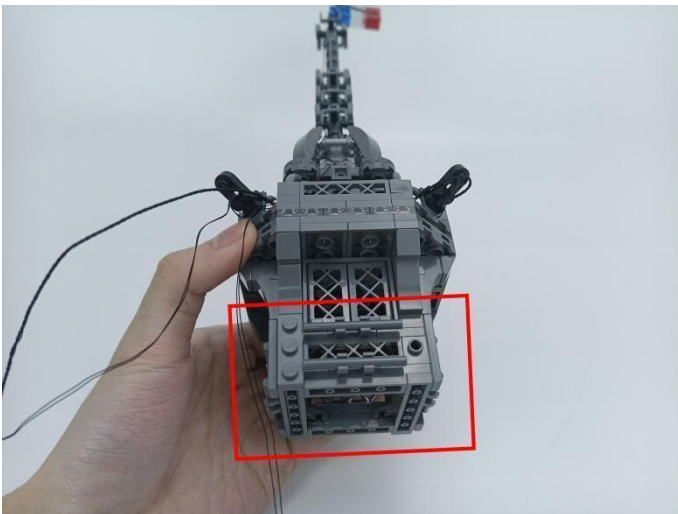

269

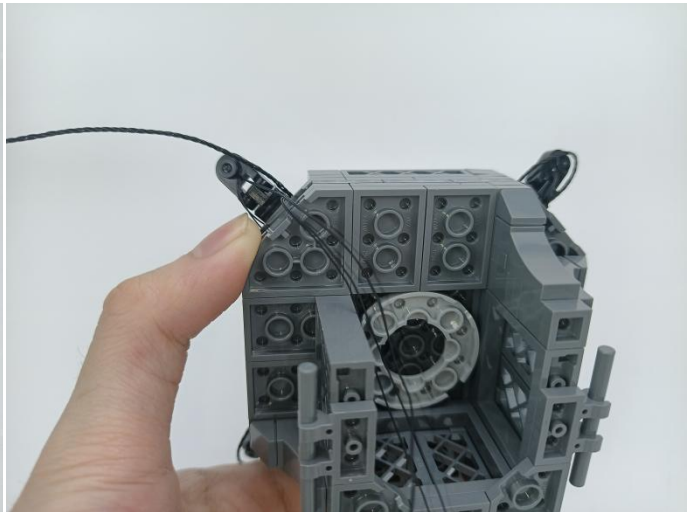
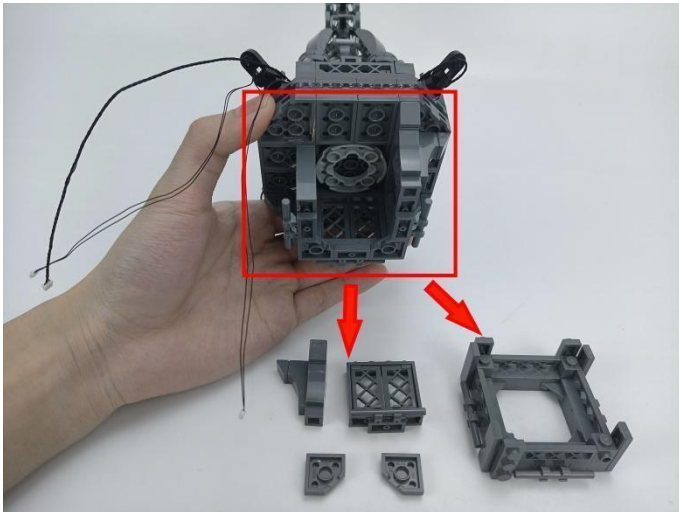

270

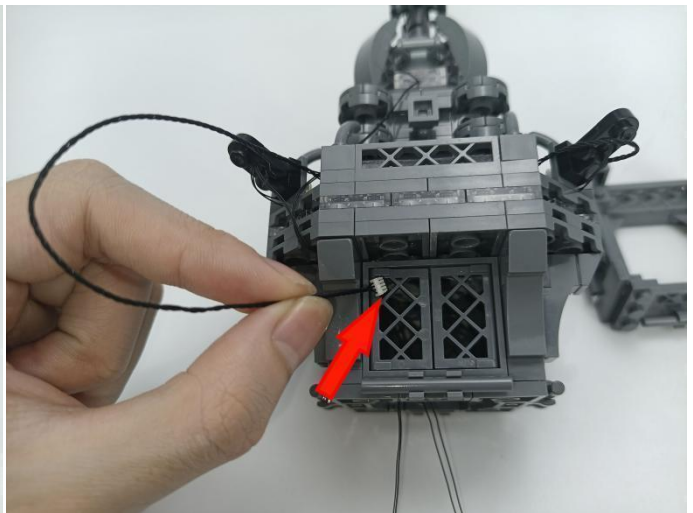
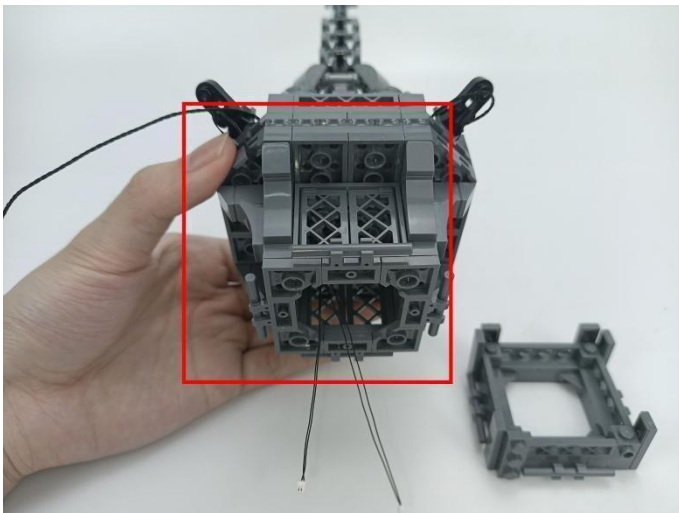

271

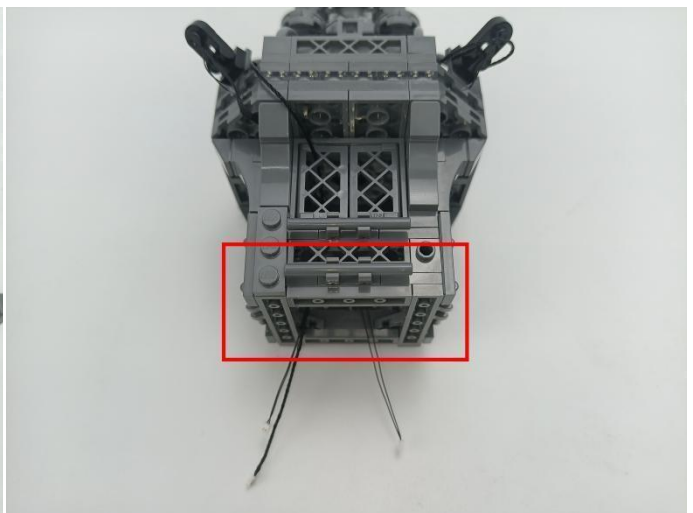
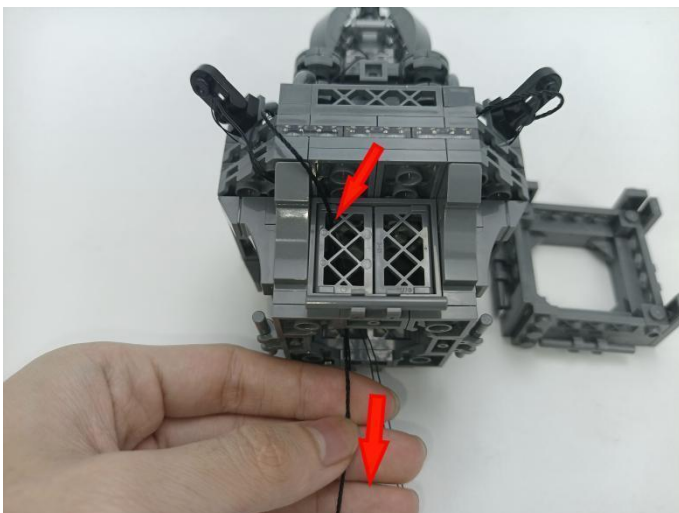

272



273

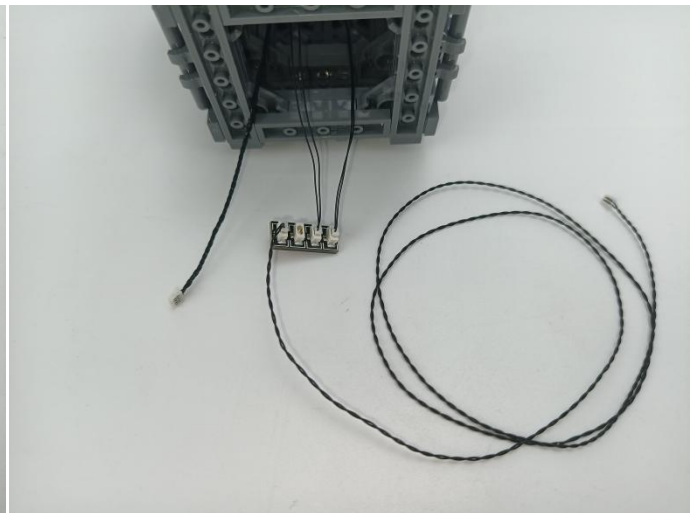
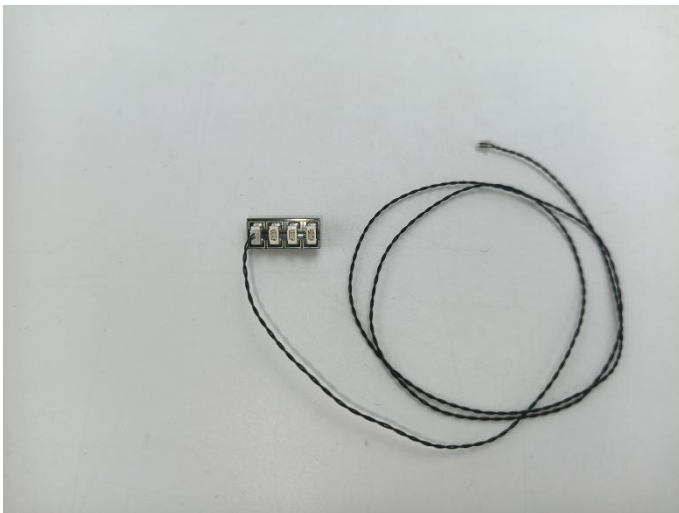

274

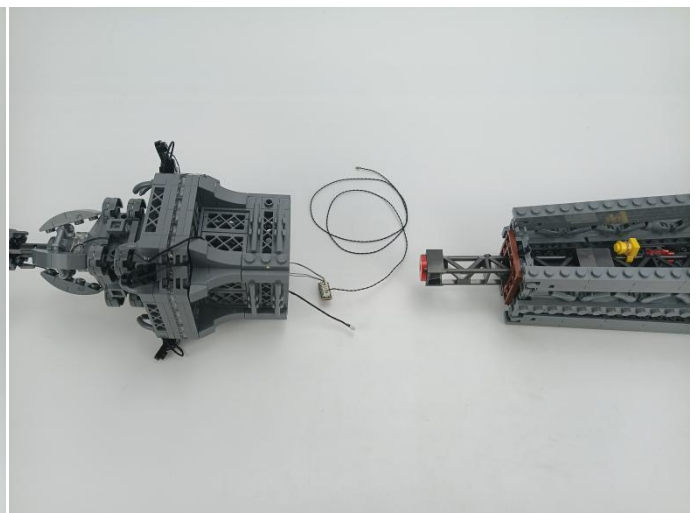
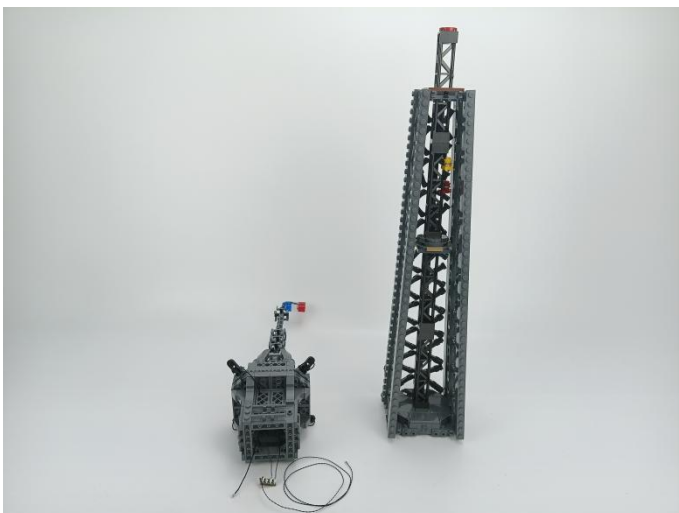



275

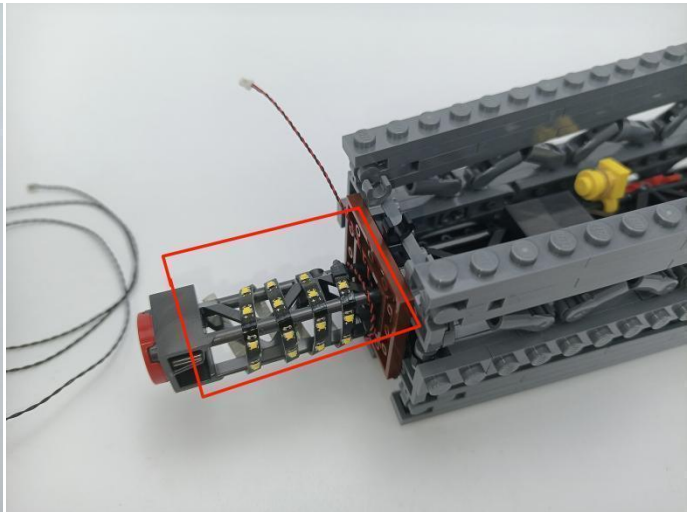

276

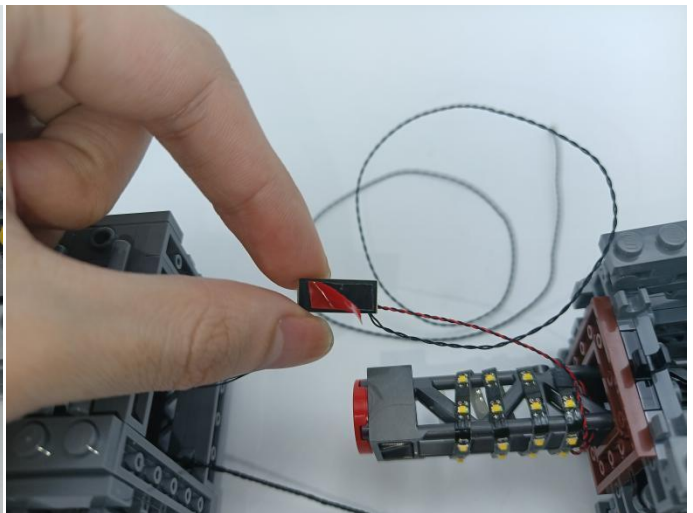
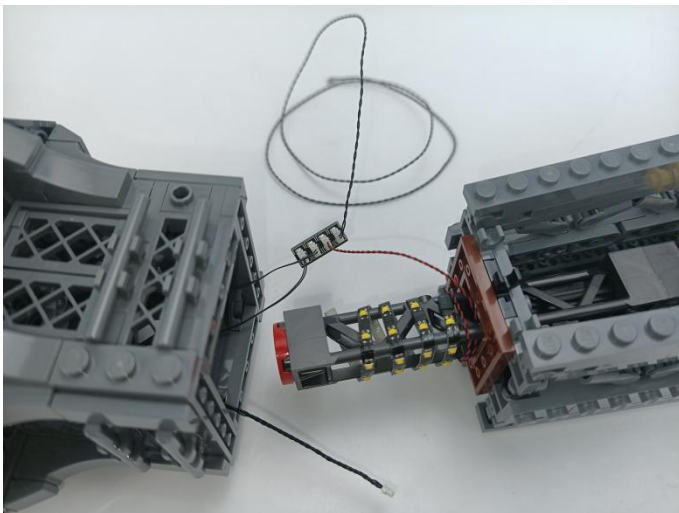

277

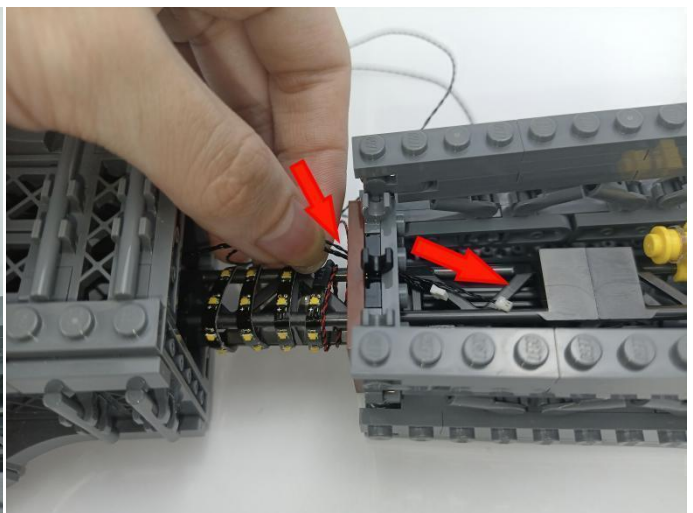
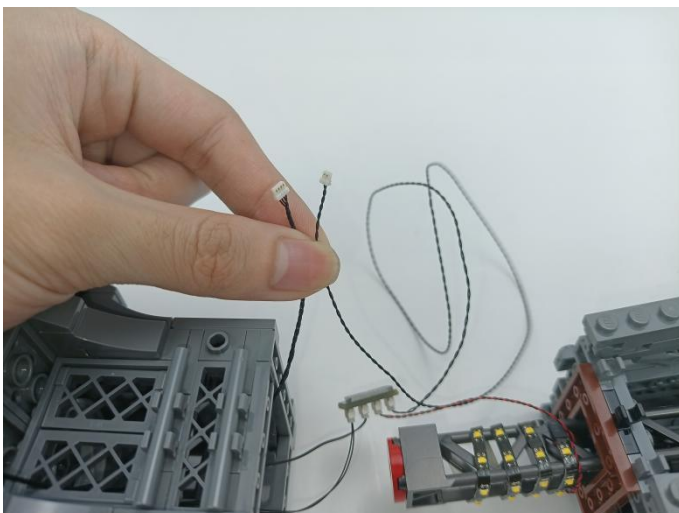

278

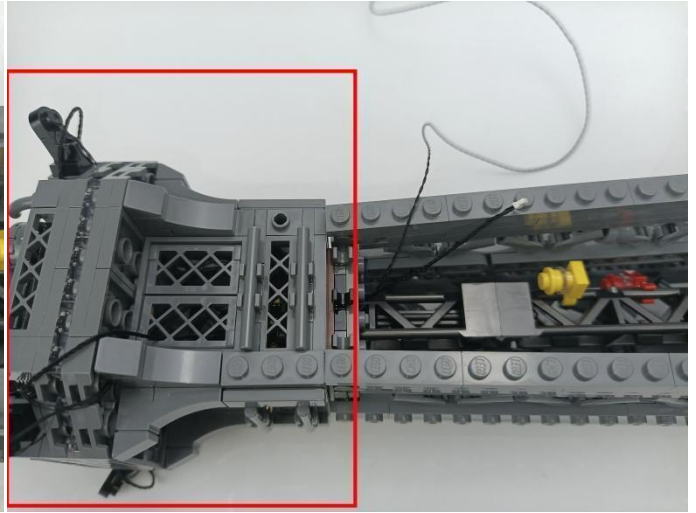
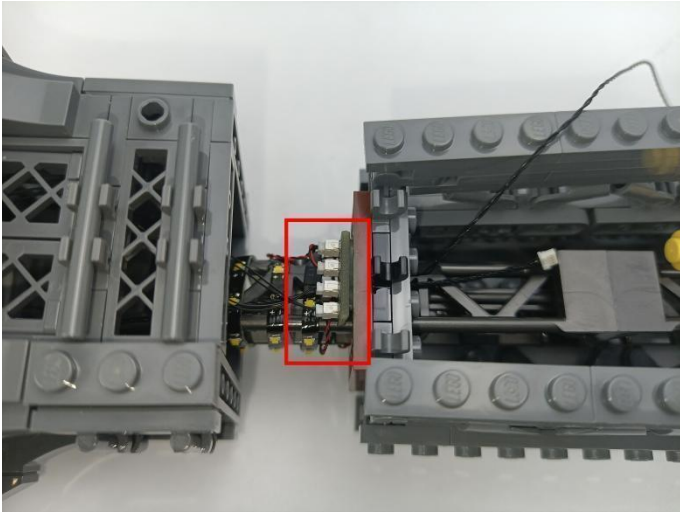

279

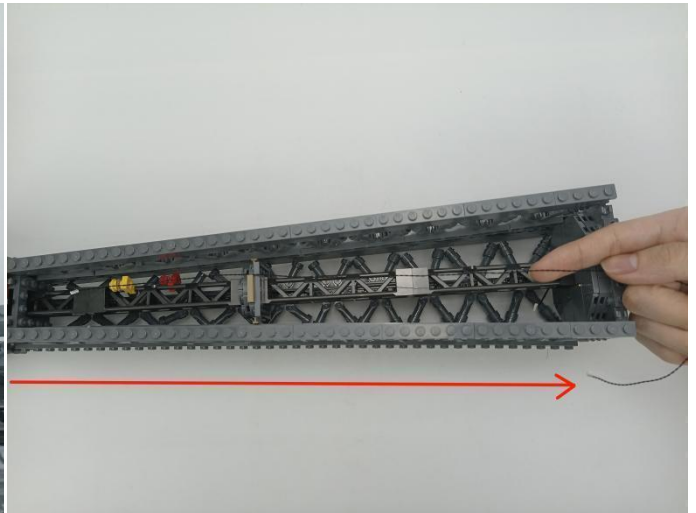
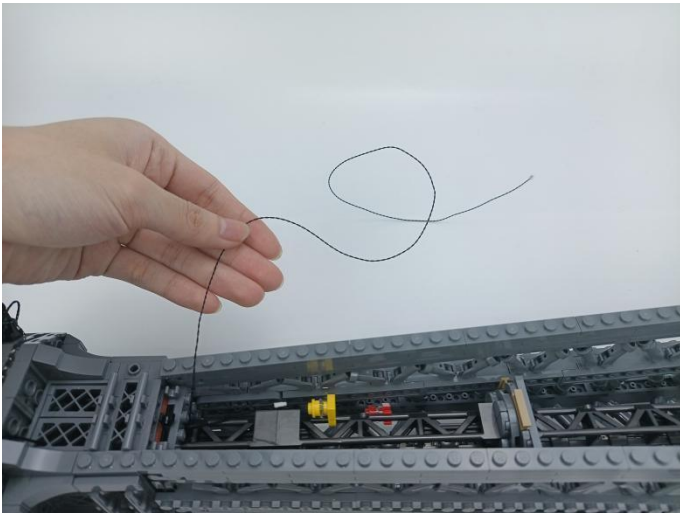

280

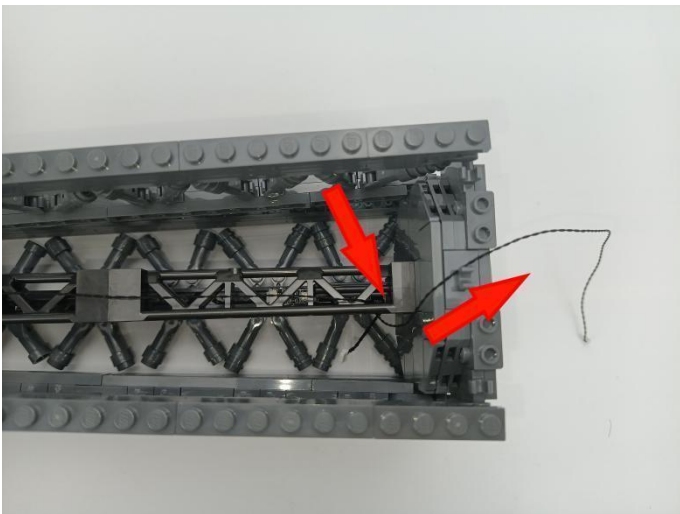



281

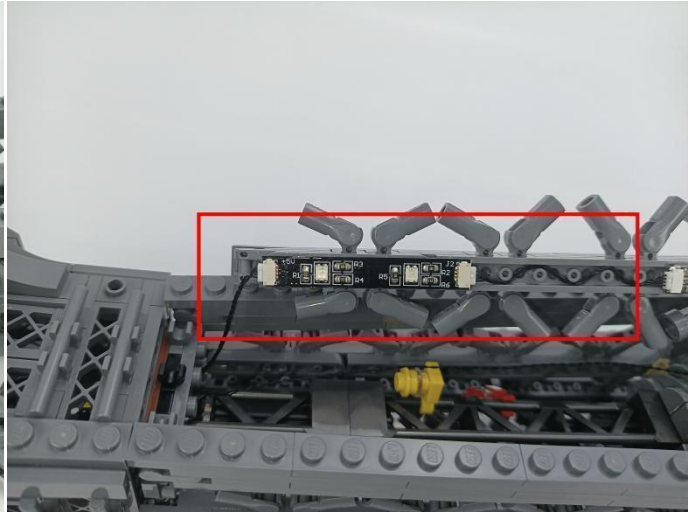
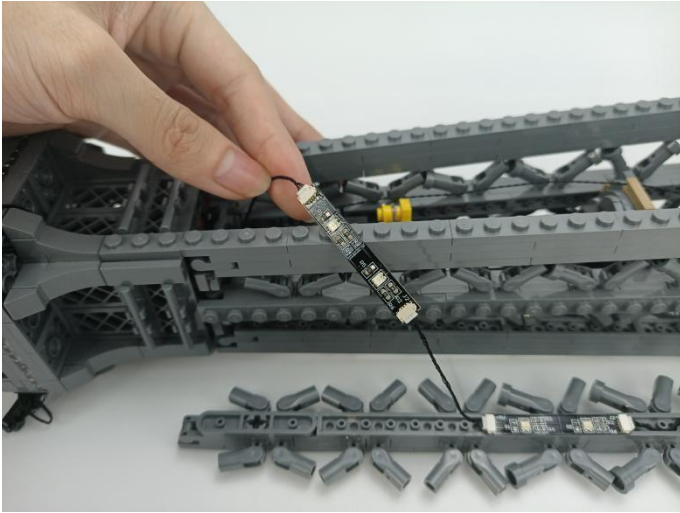

282

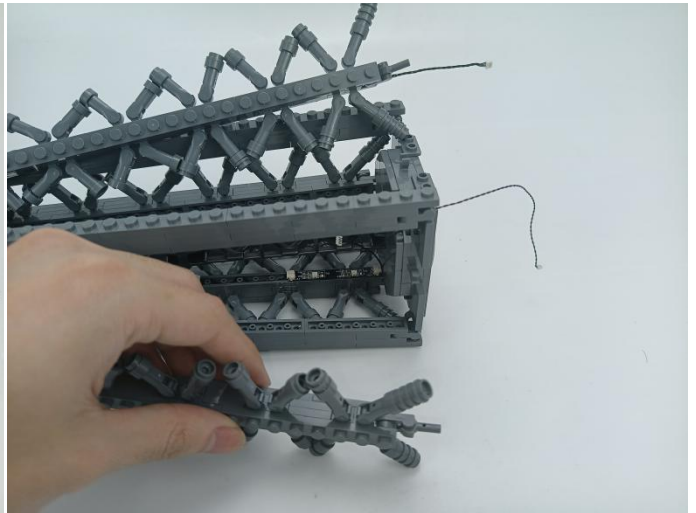
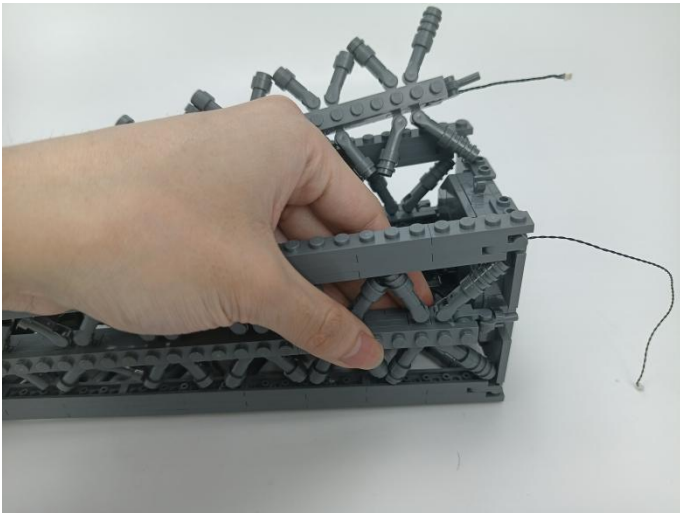

283





**284**

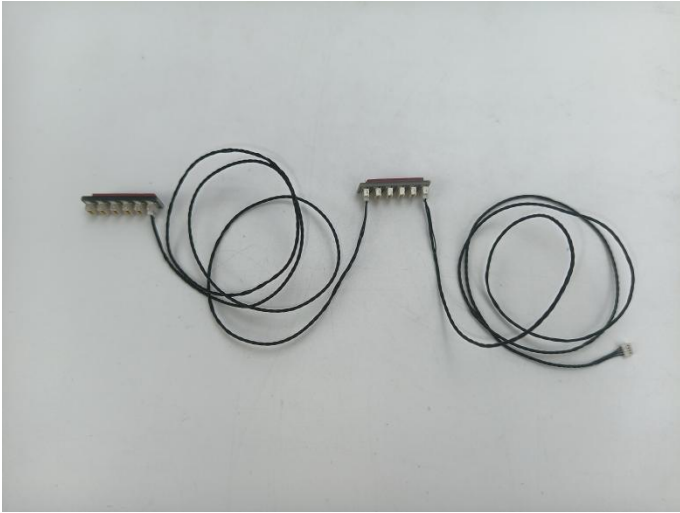

**285**

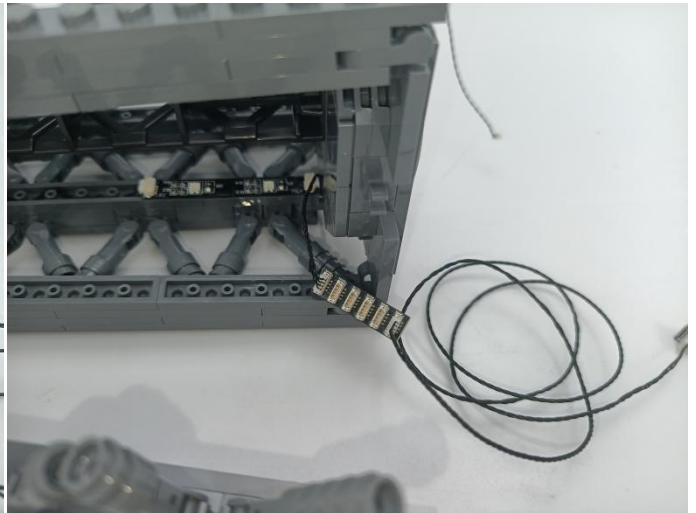
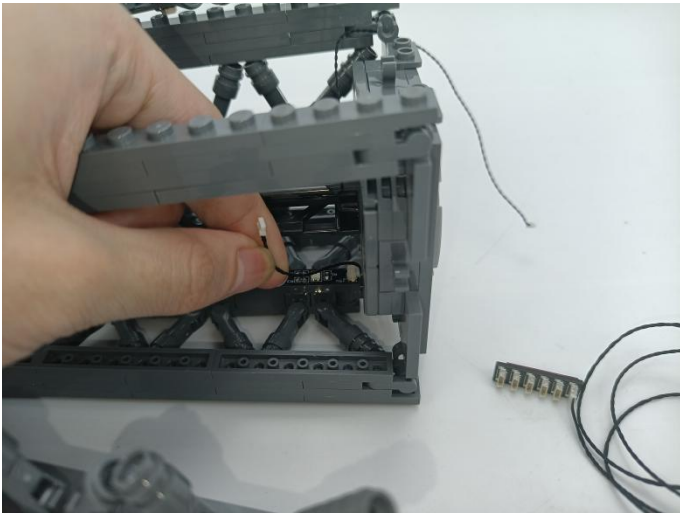

**286**

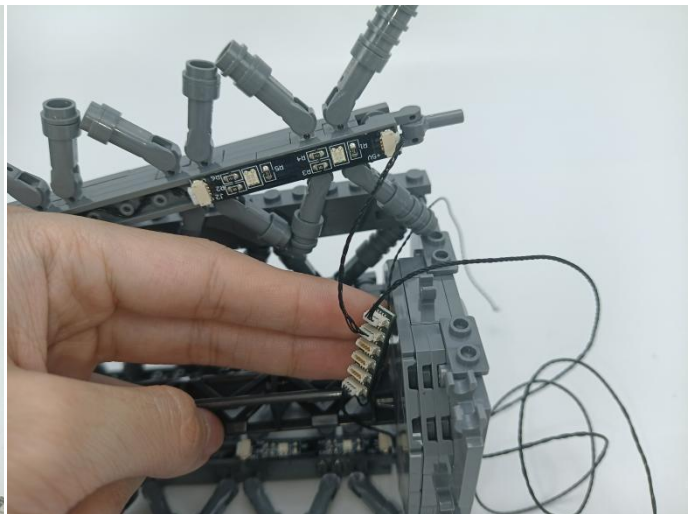
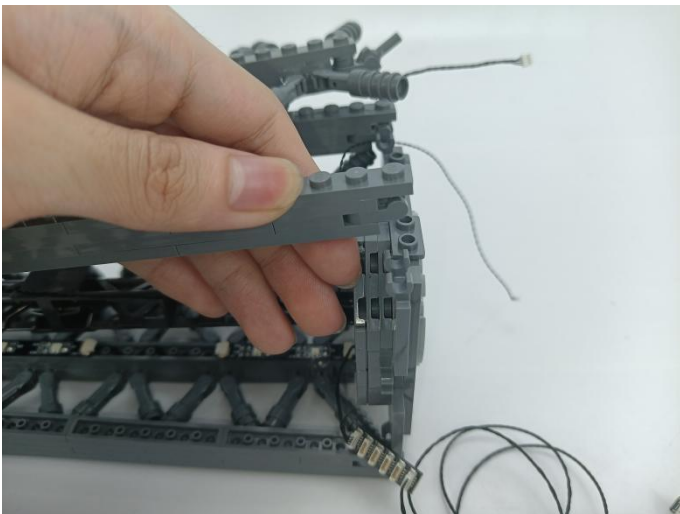

287

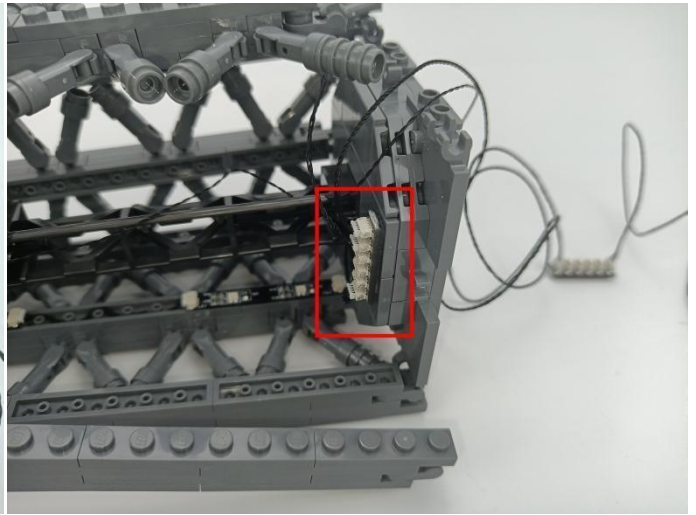
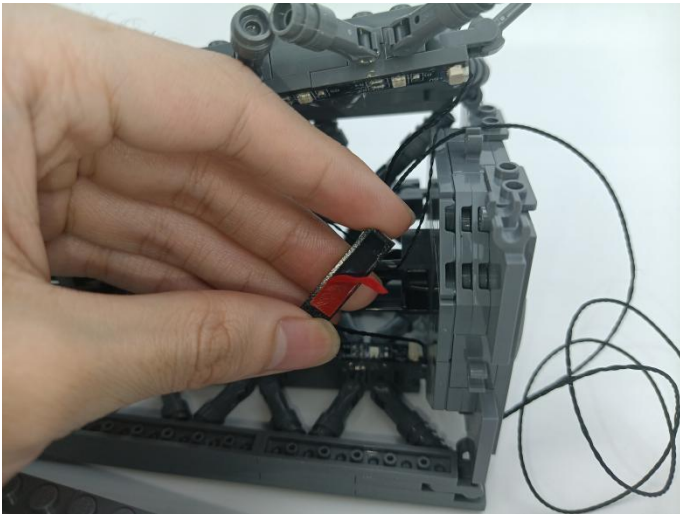

288

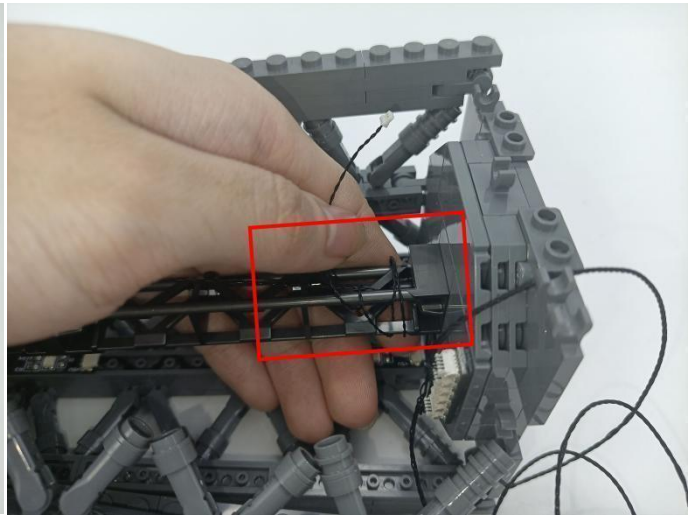
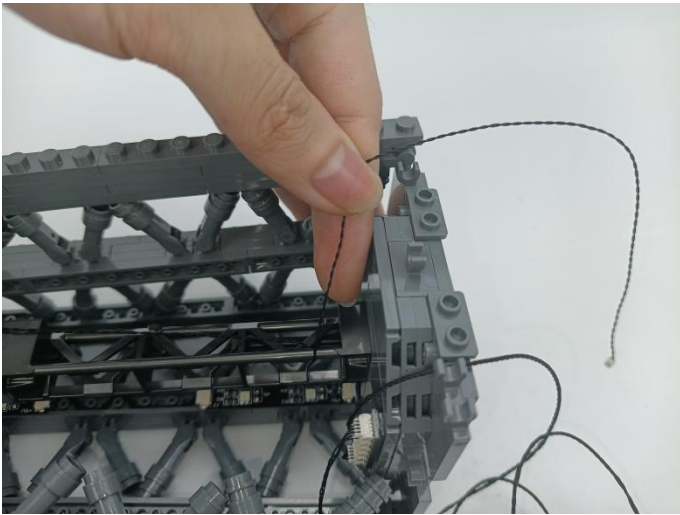

289



290

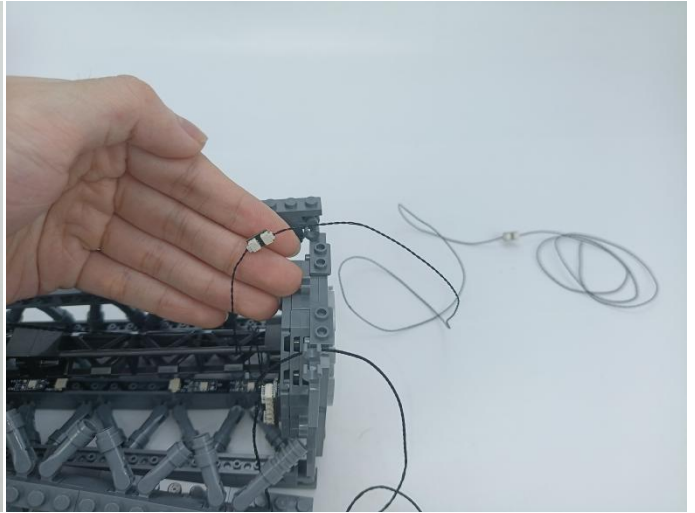
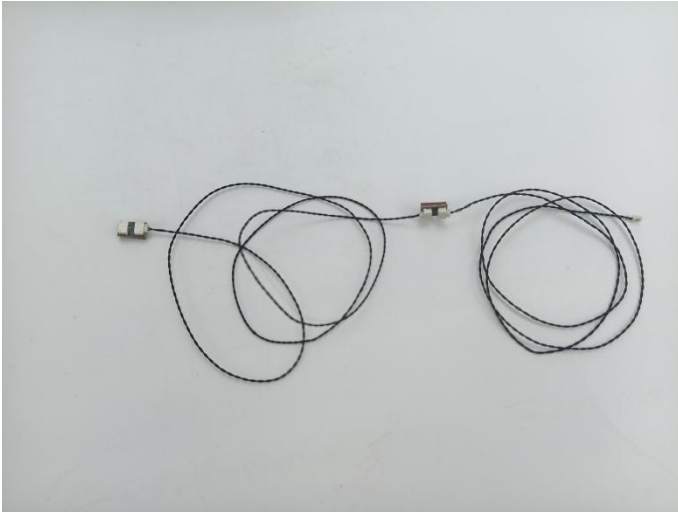

291

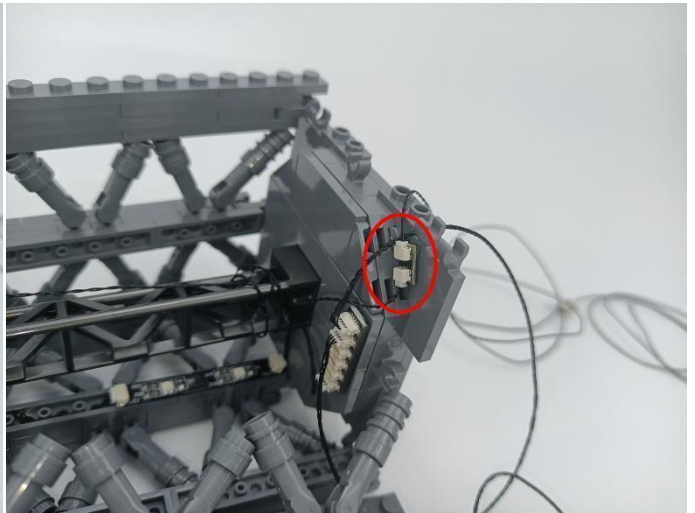
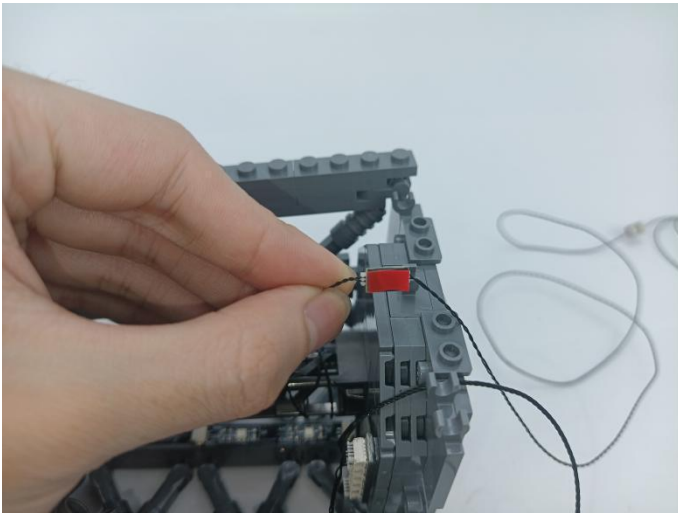

292

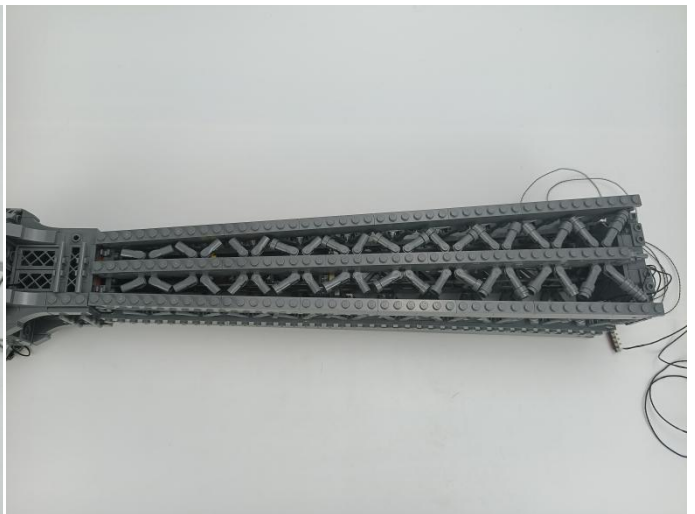
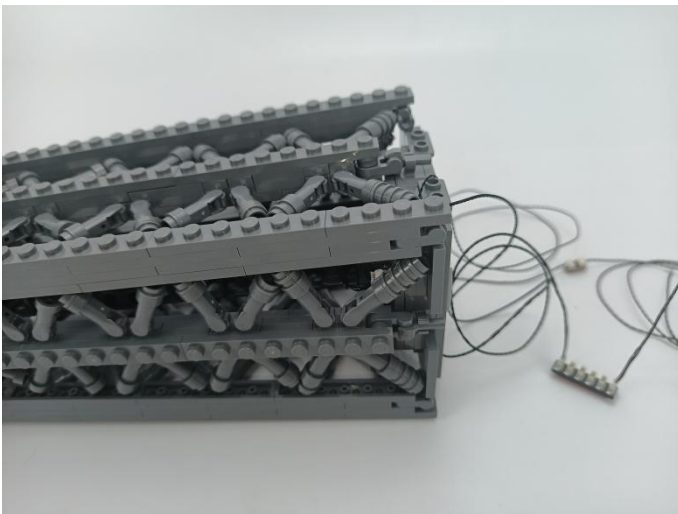



# 293



# 294

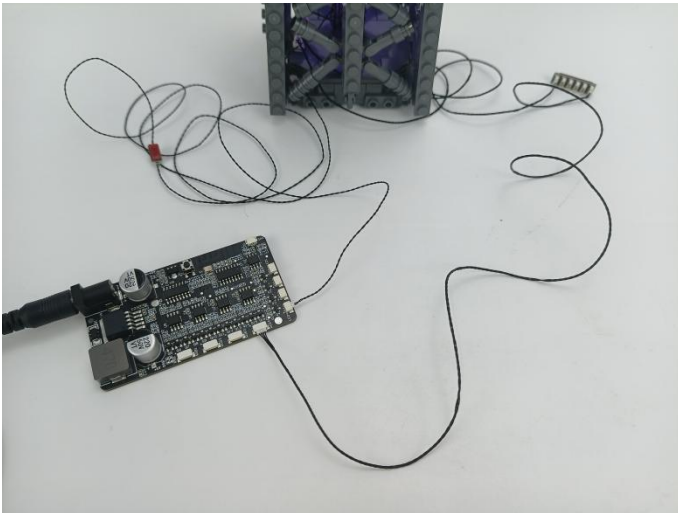

①: Power interface, input DC voltage 12V.  
②: Function switching switch, press the switch to directly change the flashing mode of the lamp.  
③: External speaker.  
④: External speaker interface.  
⑤: 2P terminal port, used to connect ordinary lamps, divided into A, B, C, D, a total of 4 ports.  
⑥: 4P terminal port, used to connect RGB lamps, divided into F, G, H, I, a total of 4 ports.  
⑦: 12V charger, cable length 150cm.

①: Leistungsschnittstelle, Eingangsgleichspannung 12 V.  
②: Funktionsumschaltswitch, drücken Sie den Schalter, um den Blinkmodus der Lampe direkt zu ändern.  
③: Externer Lautsprecher.  
④: Schnittstelle für externe Lautsprecher.  
⑤: 2P-Terminalanschluss zum Anschließen gewöhnlicher Lampen, unterteilt in A, B, C, D, insgesamt 4 Anschlüsse.  
⑥: 4P-Terminalanschluss zum Anschließen von RGB-Lampen, unterteilt in F, G, H, I, insgesamt 4 Anschlüsse.  
⑦: 12-V-Ladegerät, Kabellänge 150 cm.

**295.** This instruction will use the usb socket as power supply . The test structure is shown as follow. All lamp in this set will be tested by this structure.



**296.**Power on and test the effect of the lighting installation, then disconnect and start the next part of the installation.

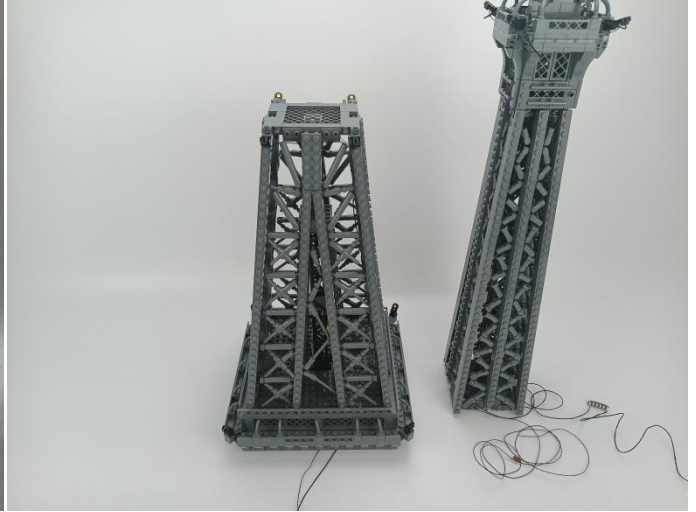

**297**

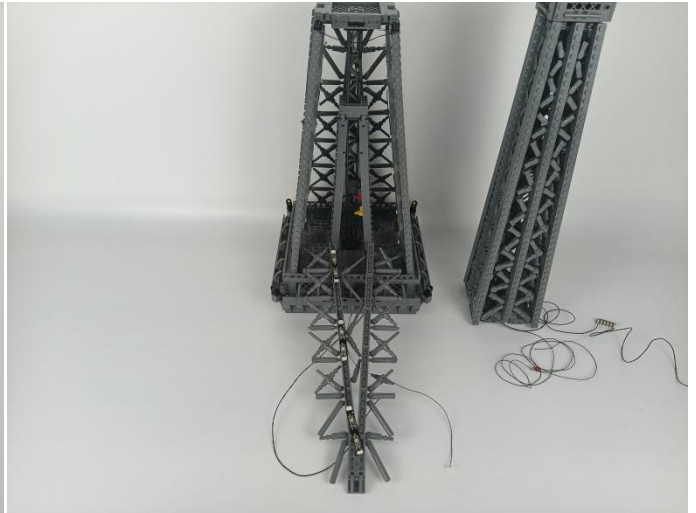
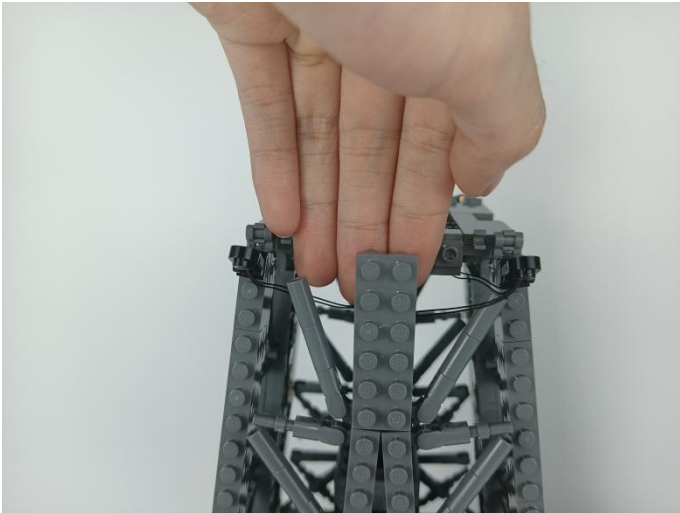

298

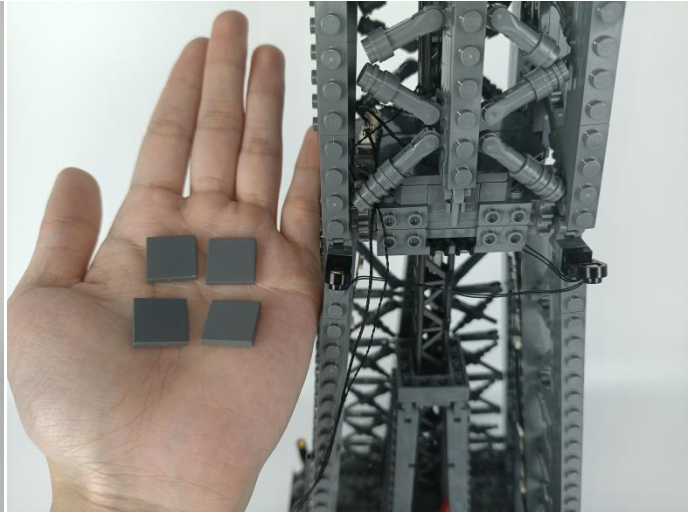

299

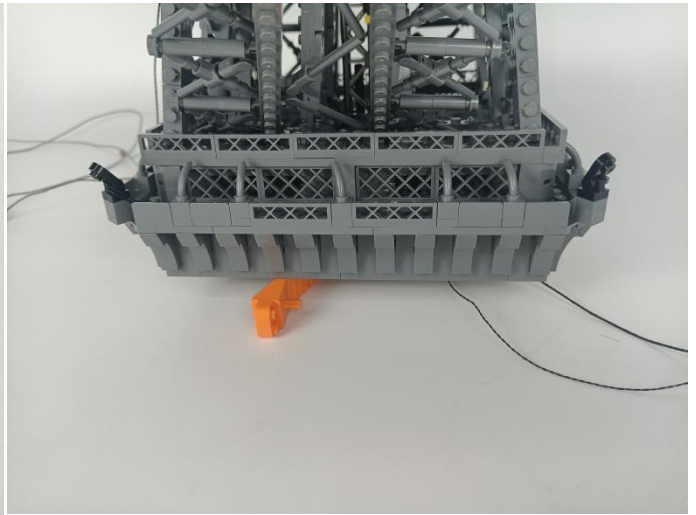
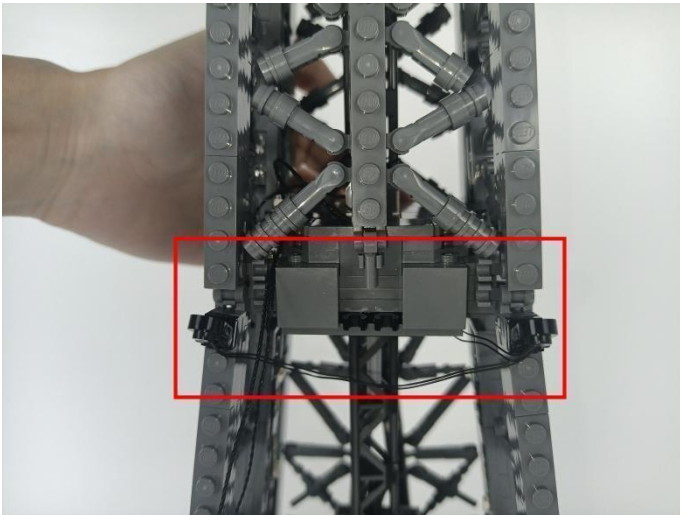

300

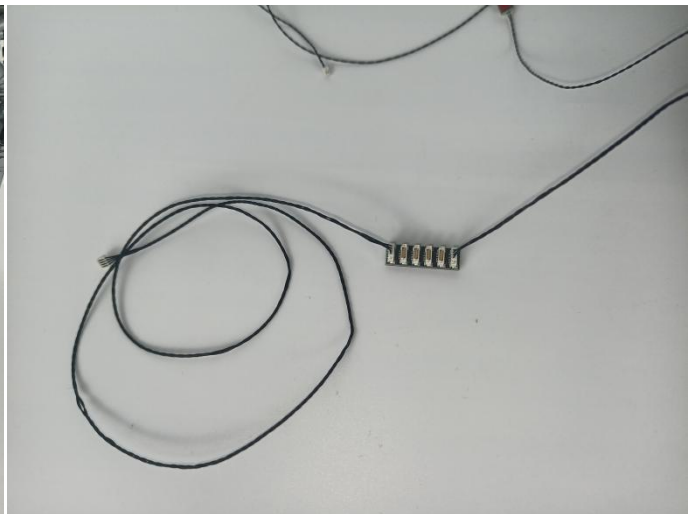
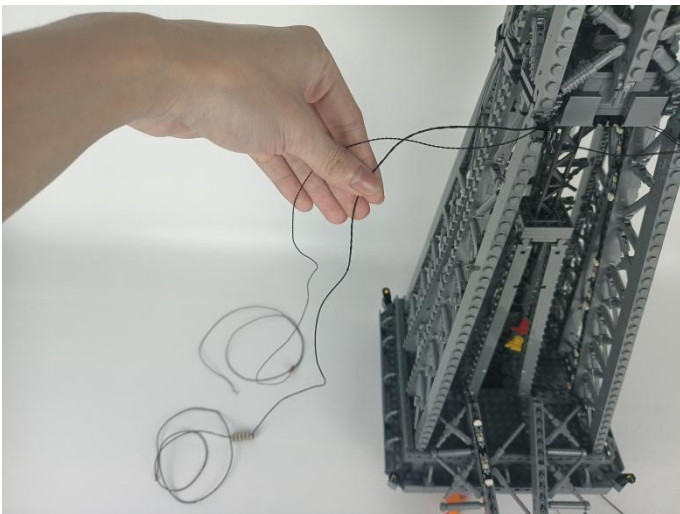



# 301



# 302

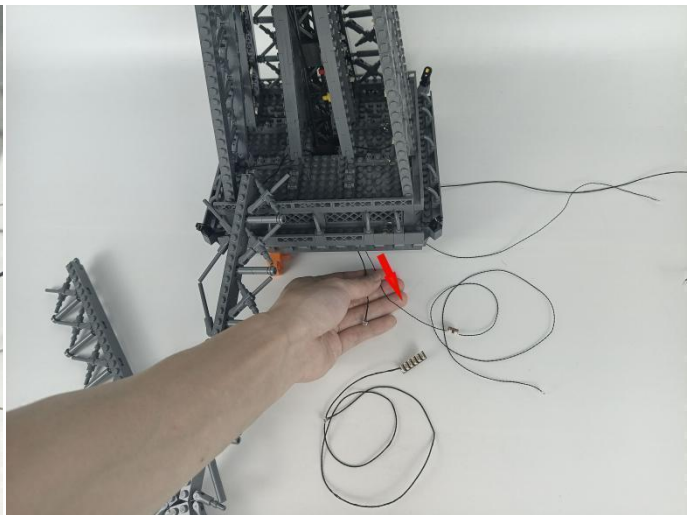
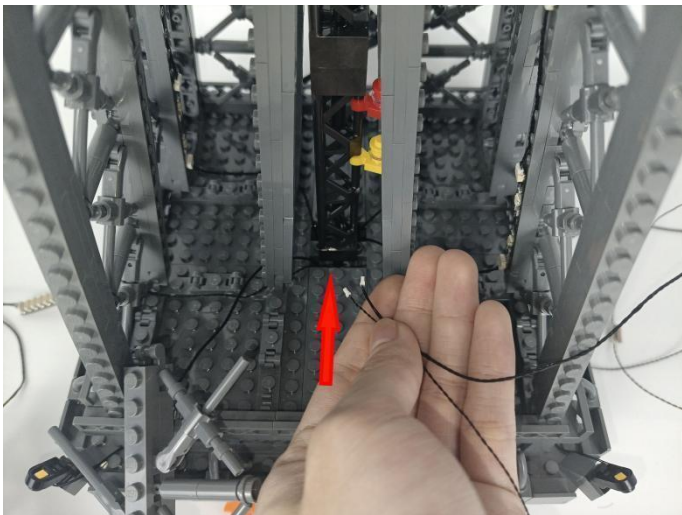

# 303

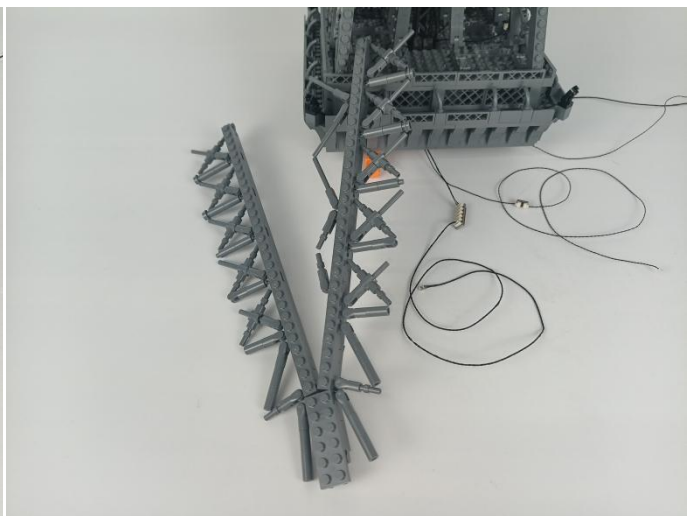
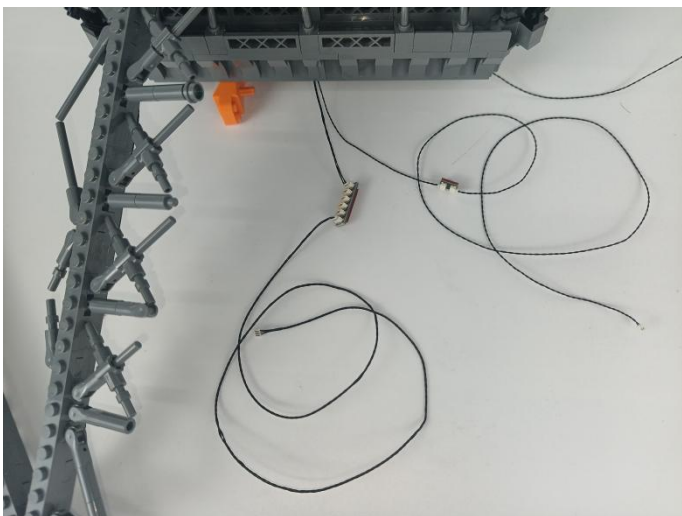

304



305

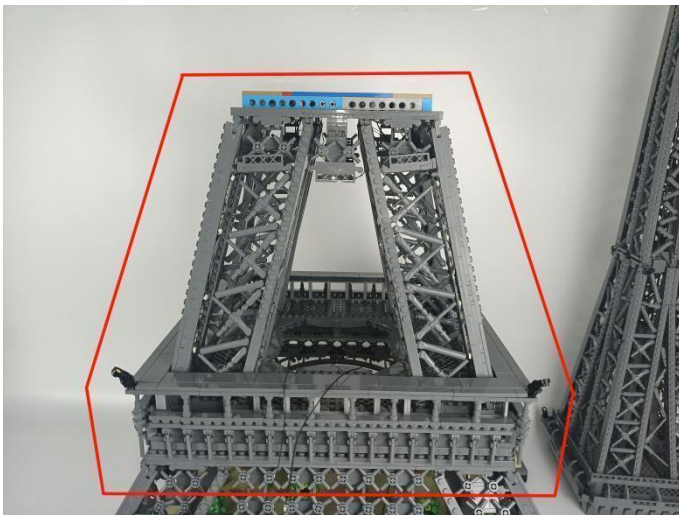

306

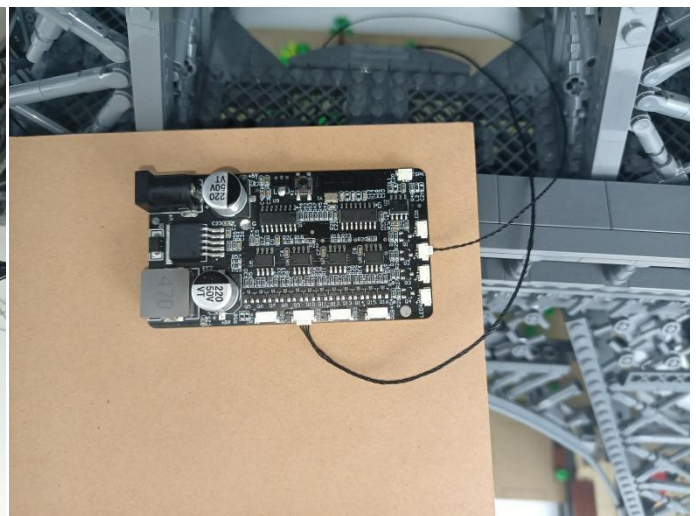
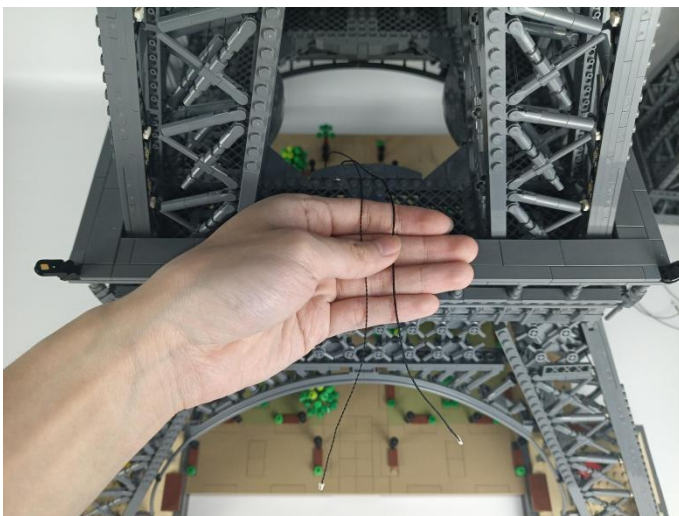



307

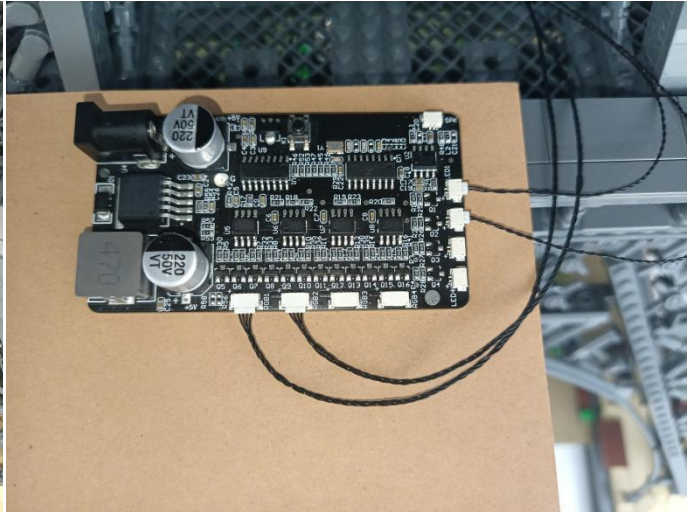
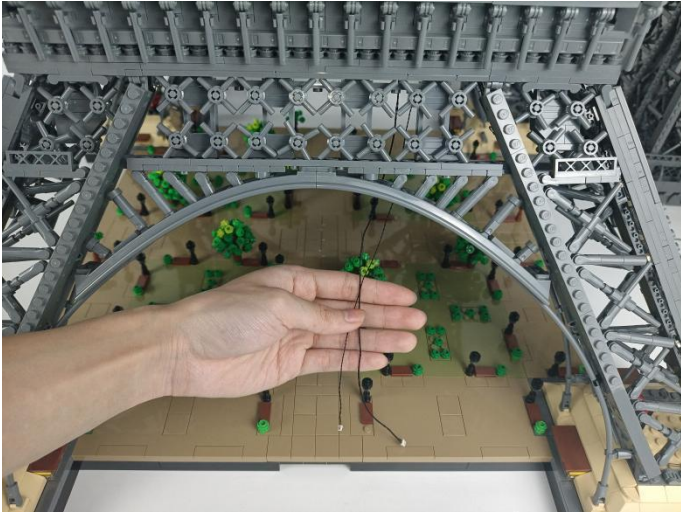

308





309

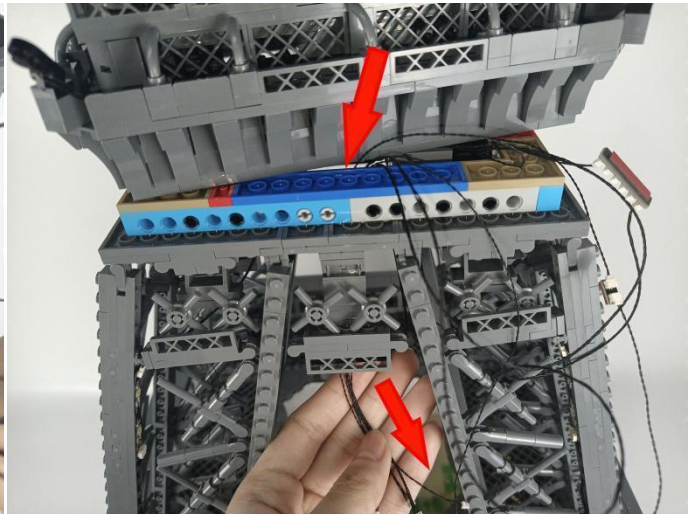
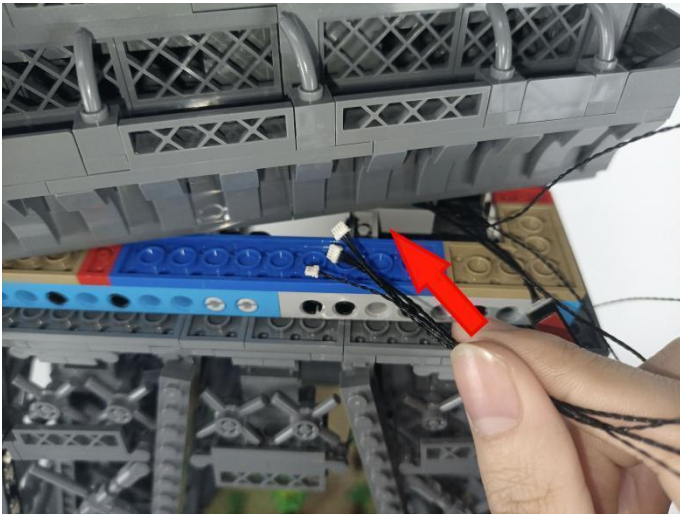

310

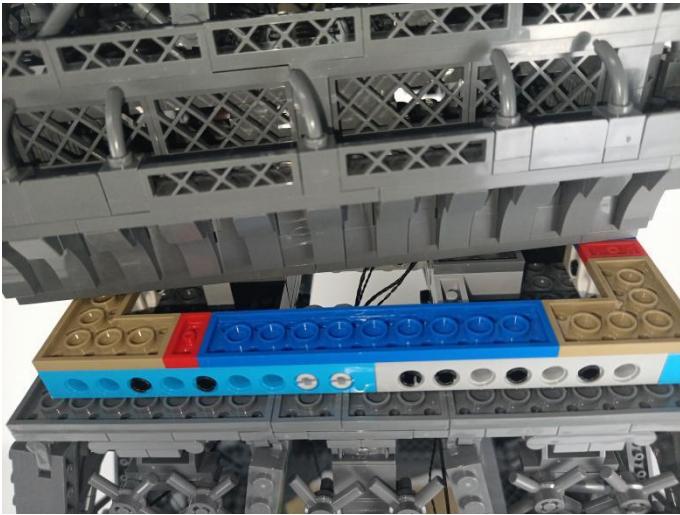

311





**312**

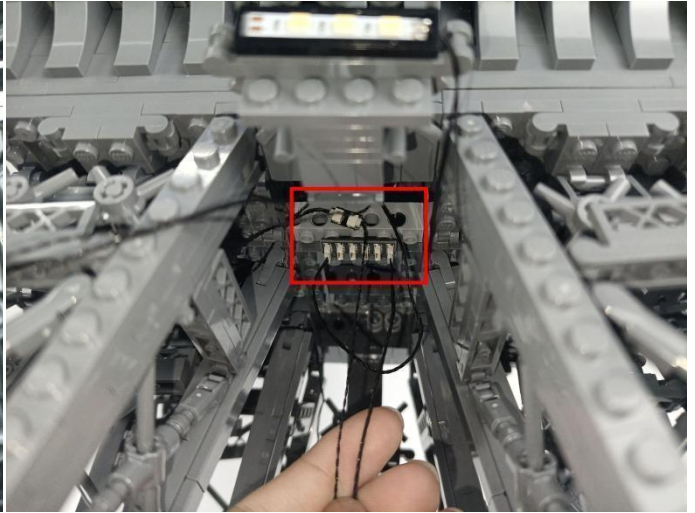
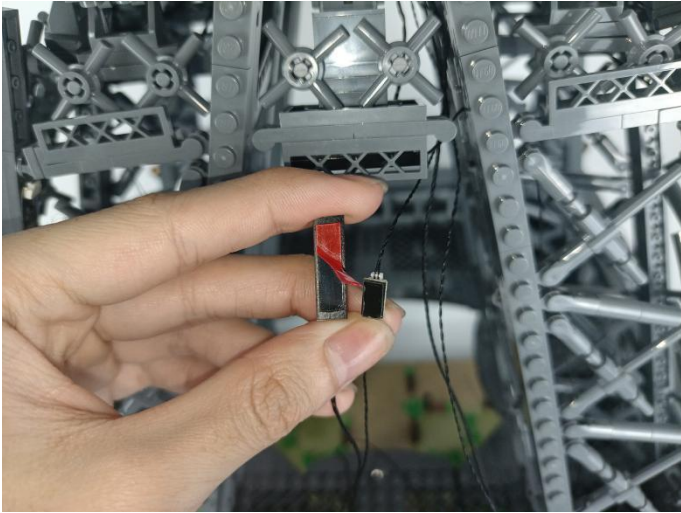

**313**

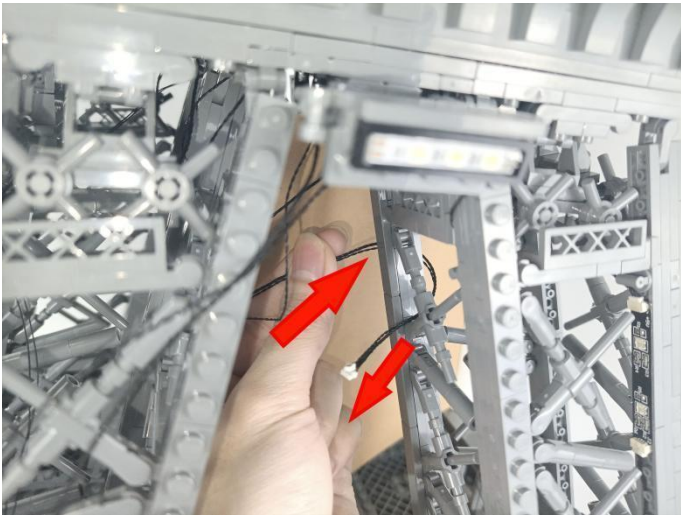

**314**

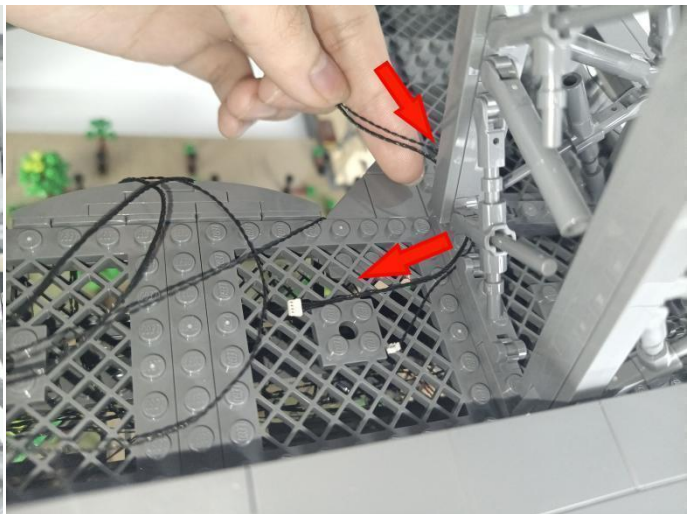
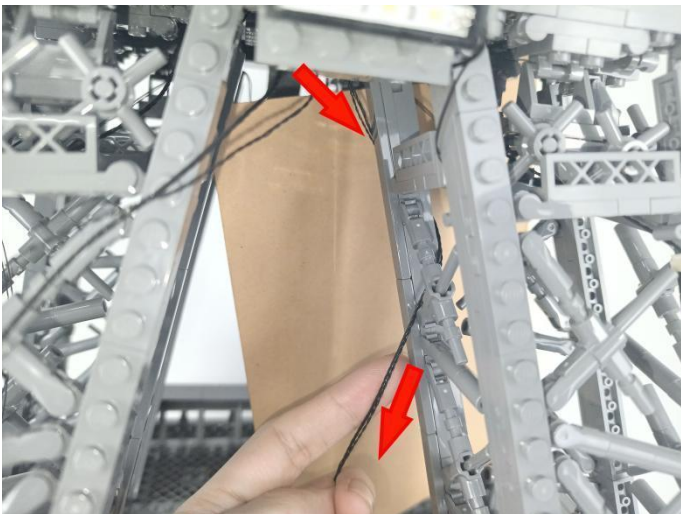



# 315

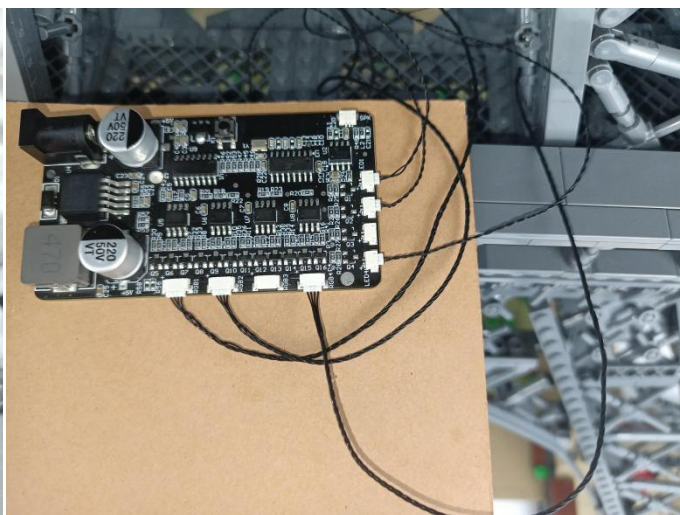
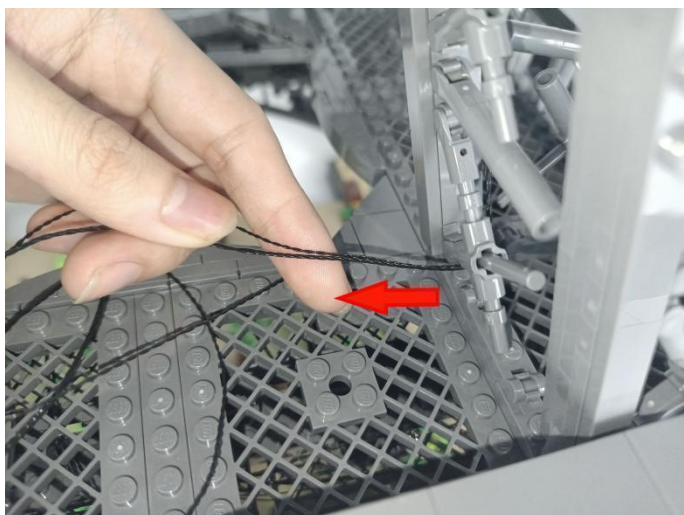

# 316

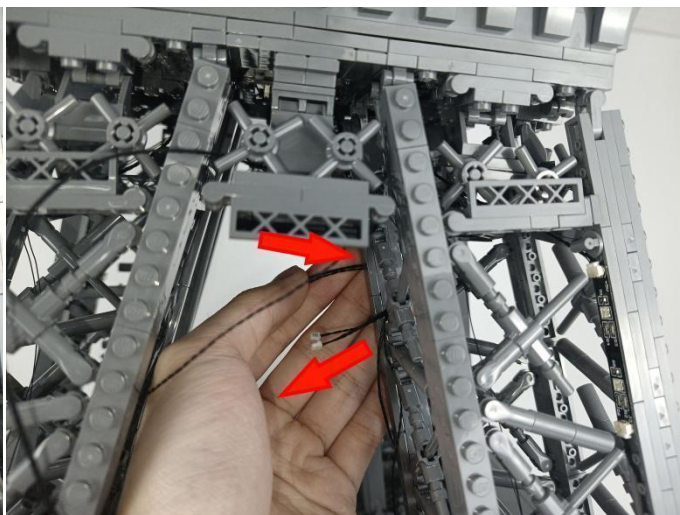
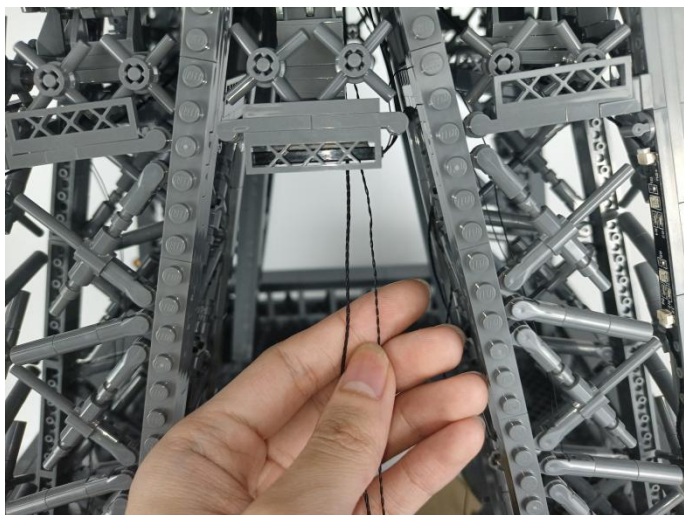

# 317

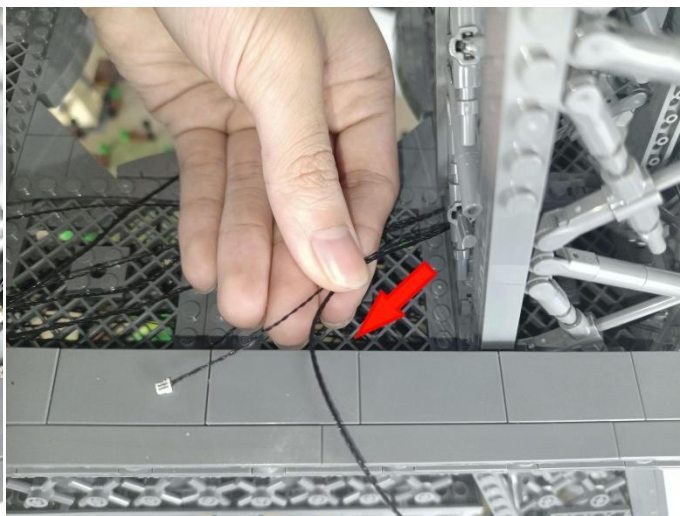
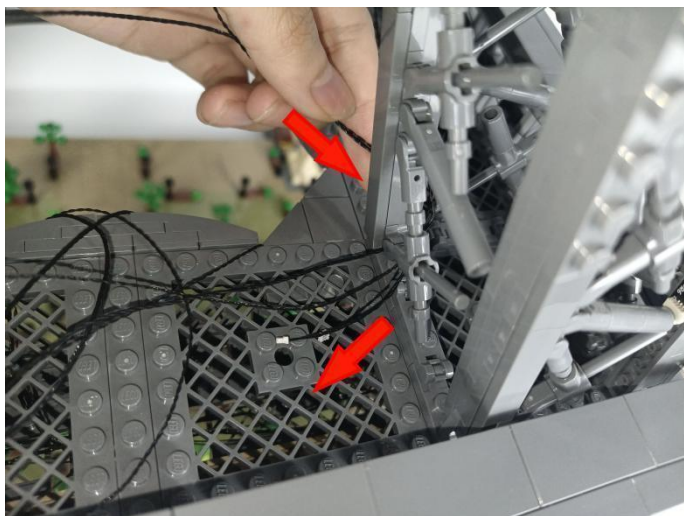



318

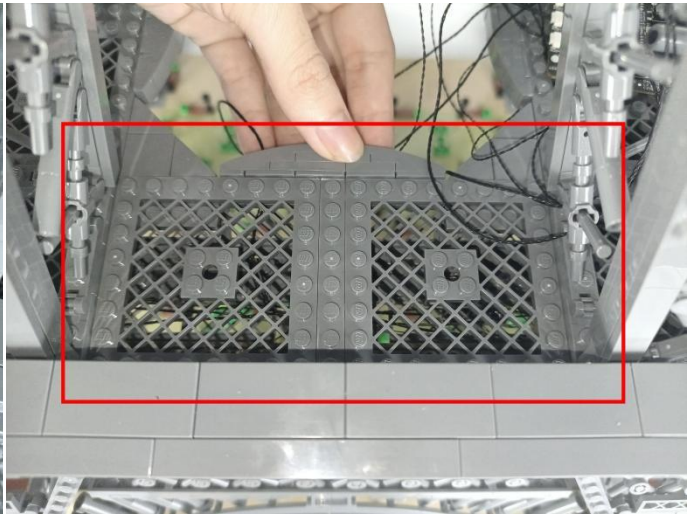
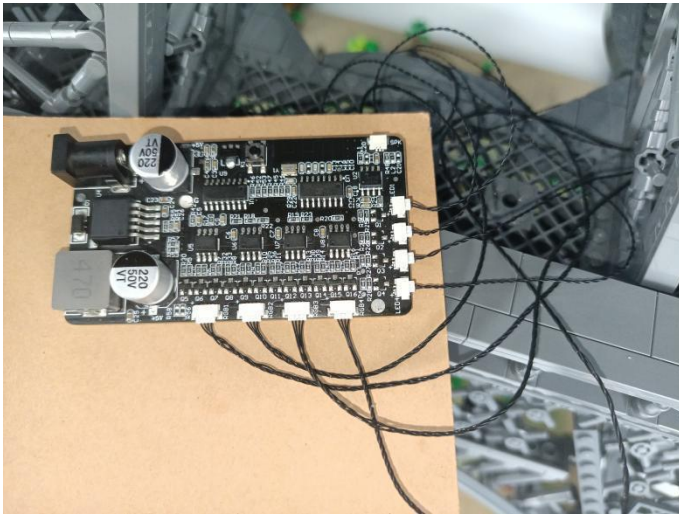

319

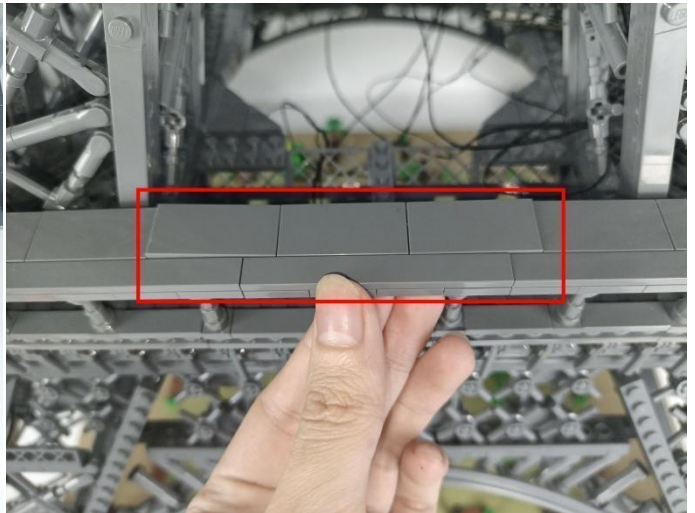
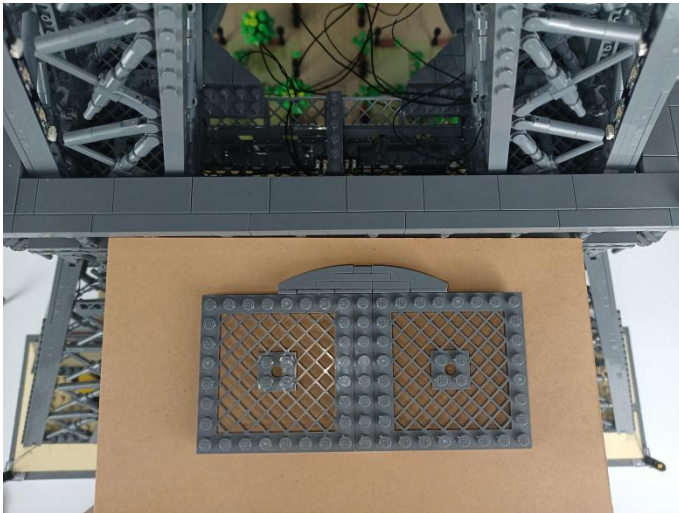

320

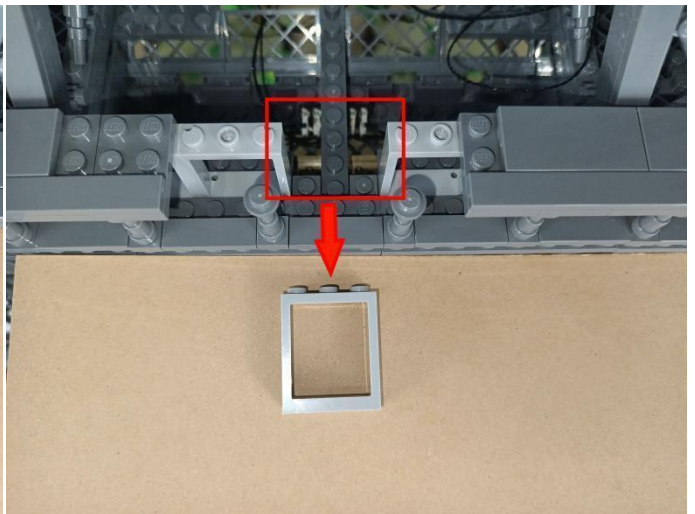
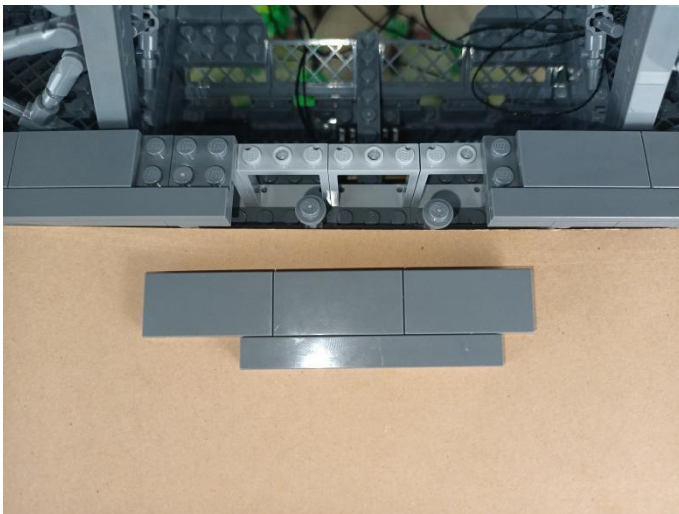



**321**

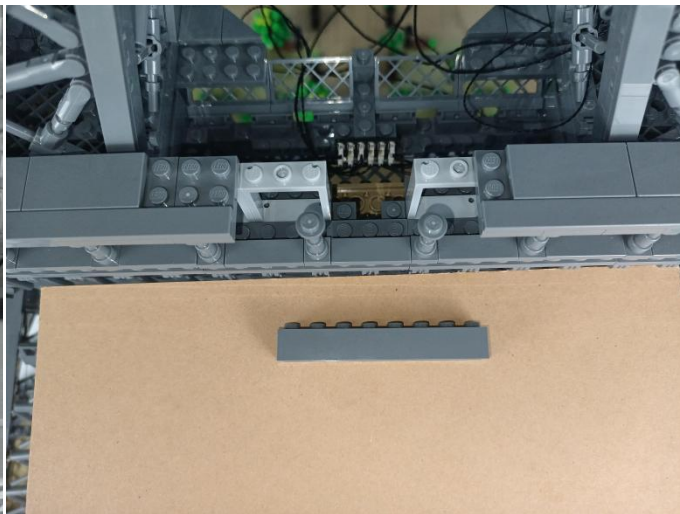
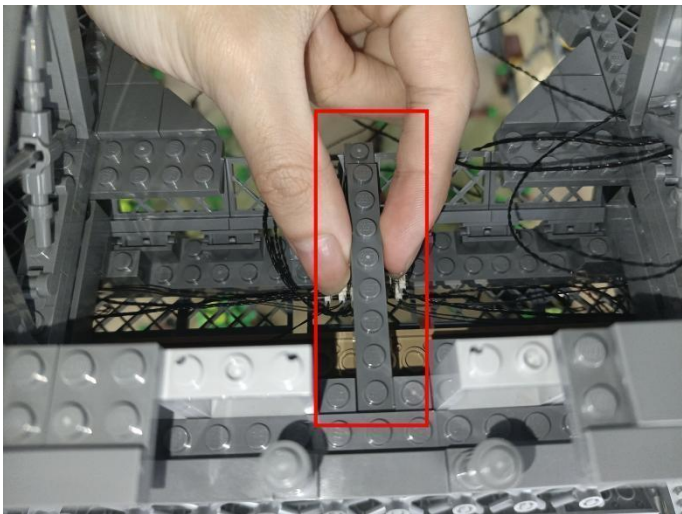

**322**

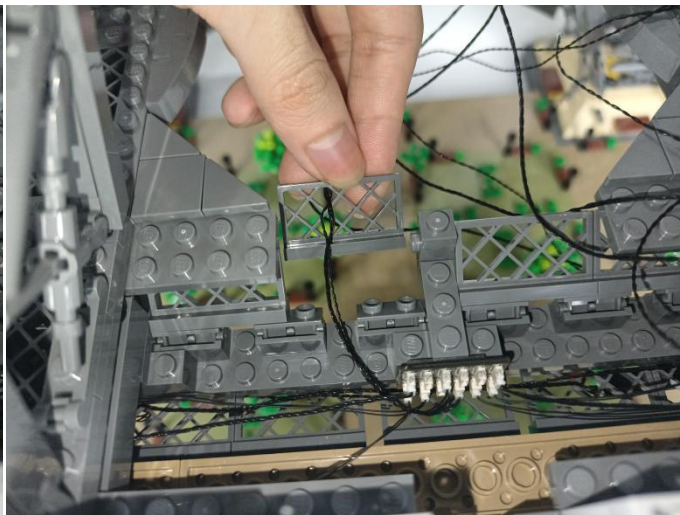
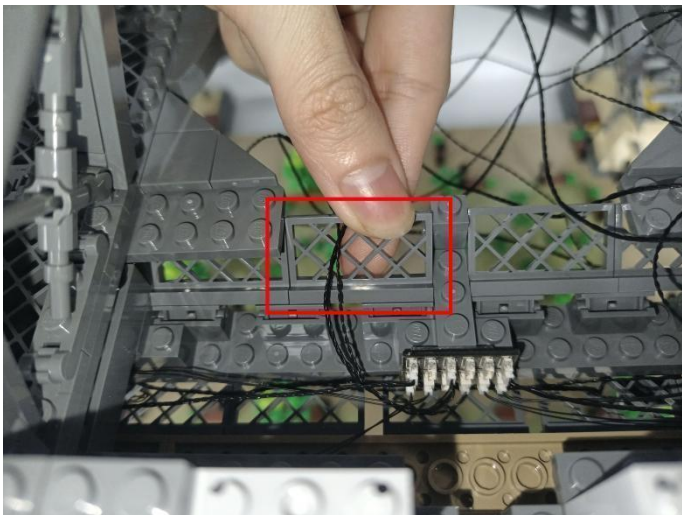

**323**

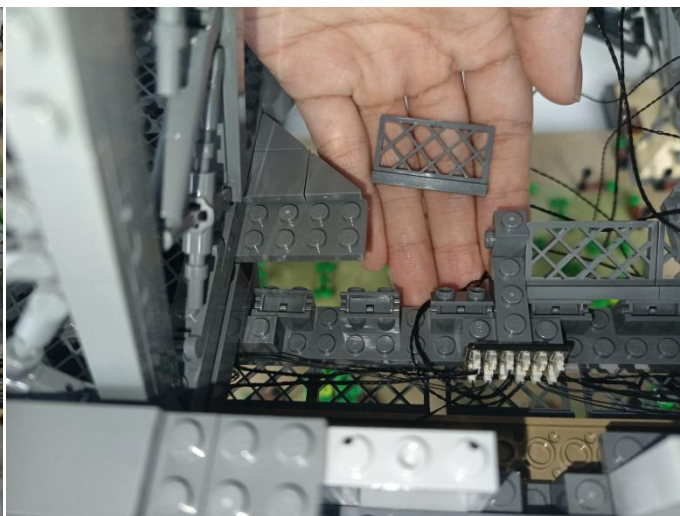
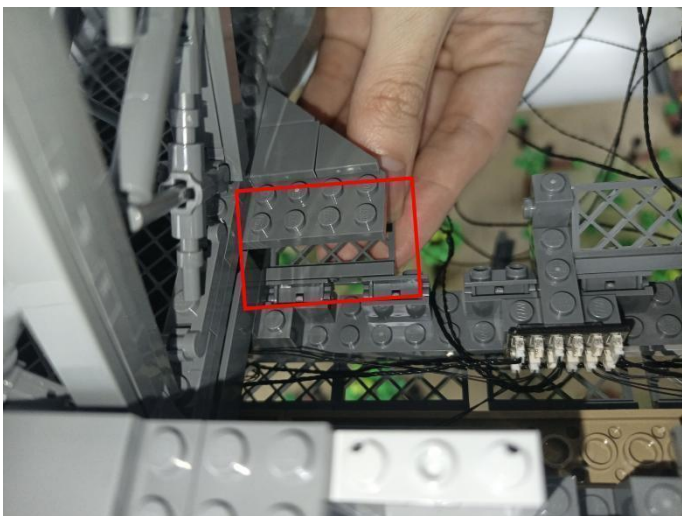

**324**

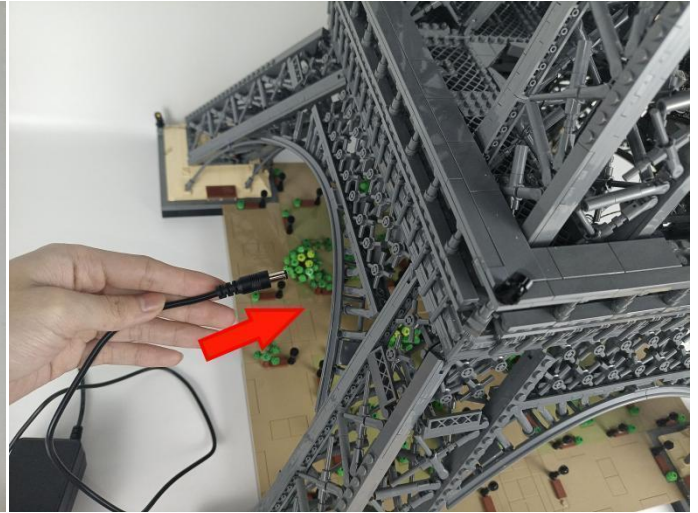

**325**

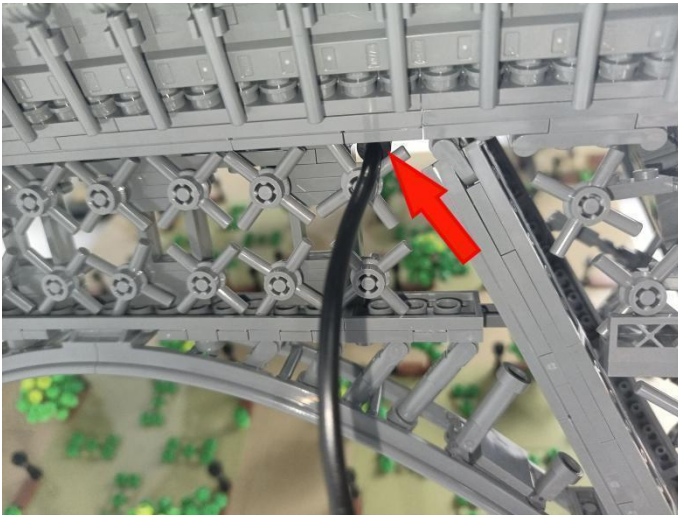

**326.** This instruction will use the usb socket as power supply . The test structure is shown as follow. All lamp in this set will be tested by this structure.

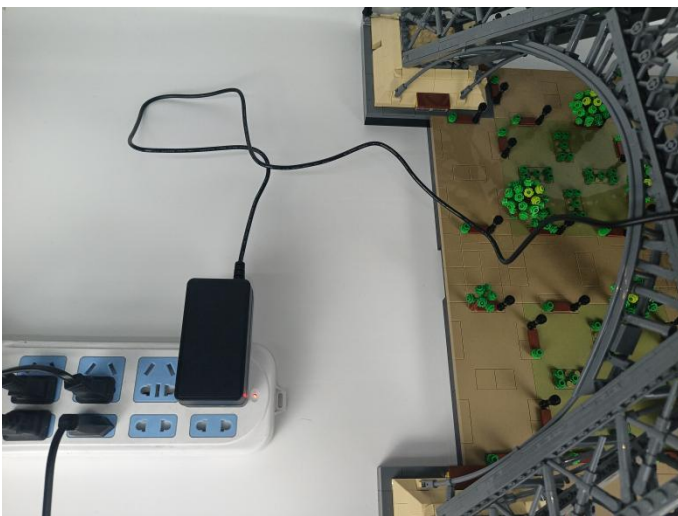



**327**.Connect the as shown.(When connecting the APP Module for the first time, it needs to be powered on three times to reset the module (need to disconnect the connection part in the figure), and the module is in matching mode after the lights start to flash.)

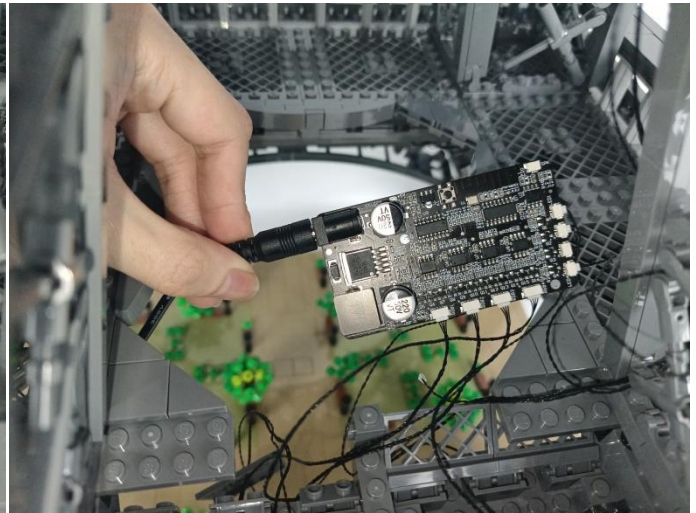
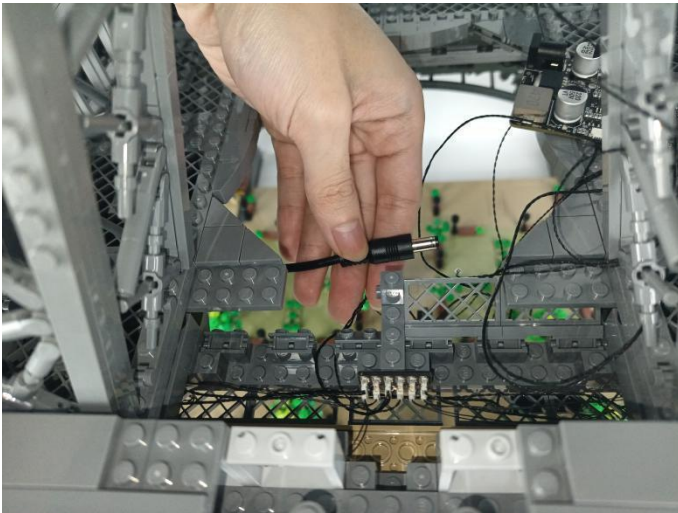

**328**

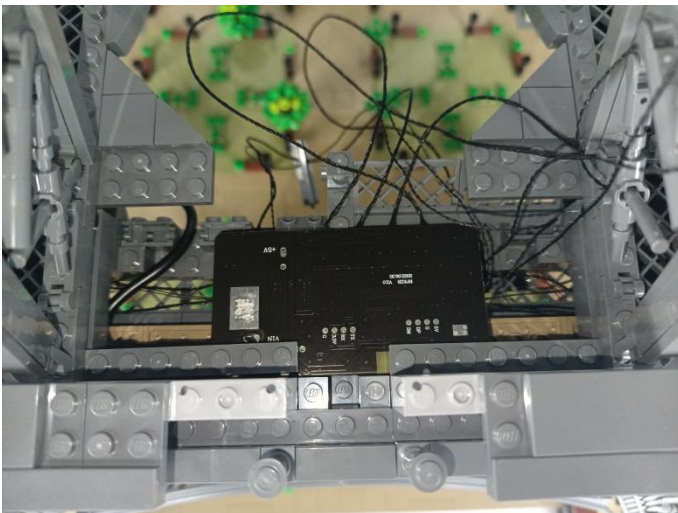

**329**

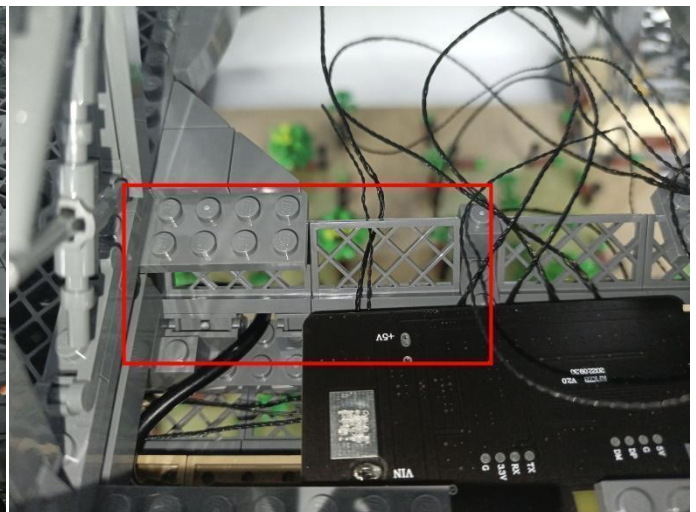
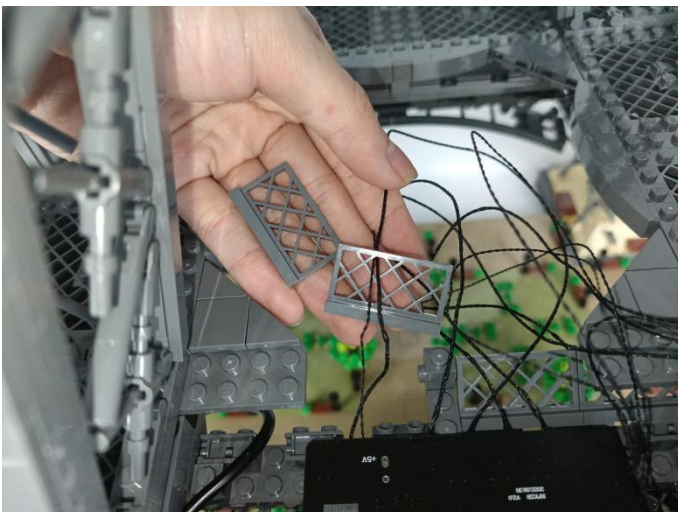

330

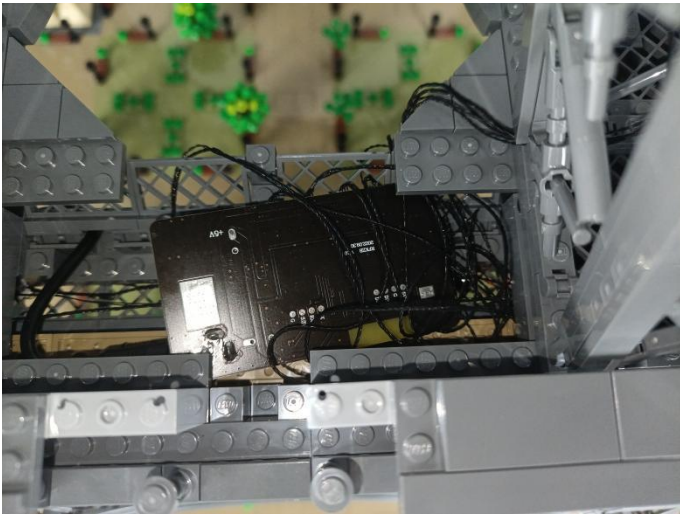

331

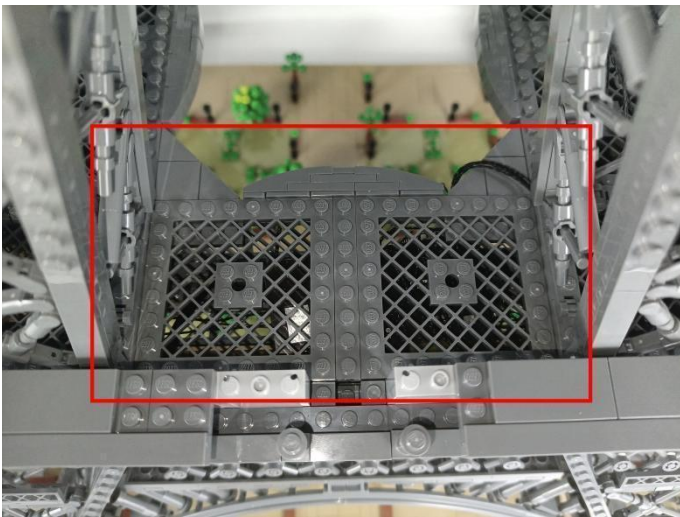

332

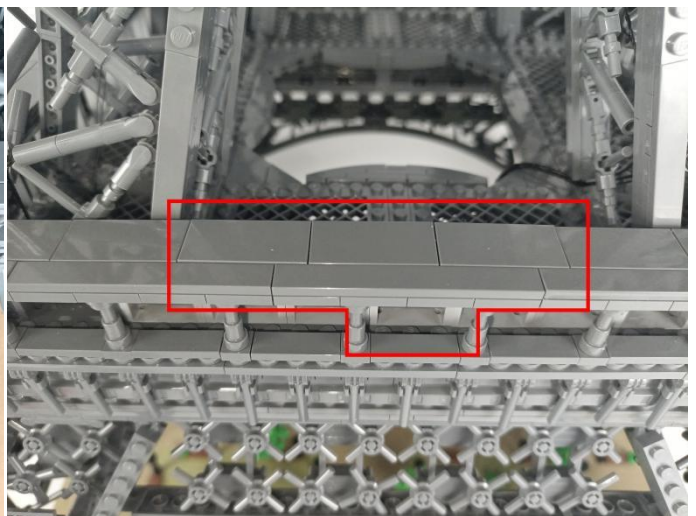
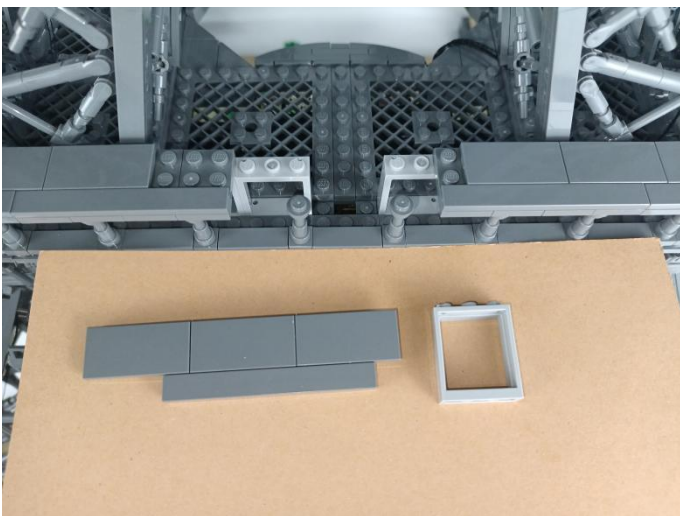



**Good job, you've done all the installation steps, power it up and enjoy your work.**

