

# 75292 The Razor Crest GC28

- Installation requires a lot of patience and great observation that your LEGO bricks will come alive when you get this finished. The bricks with lighting as below, so make sure you're ready and let's get started.

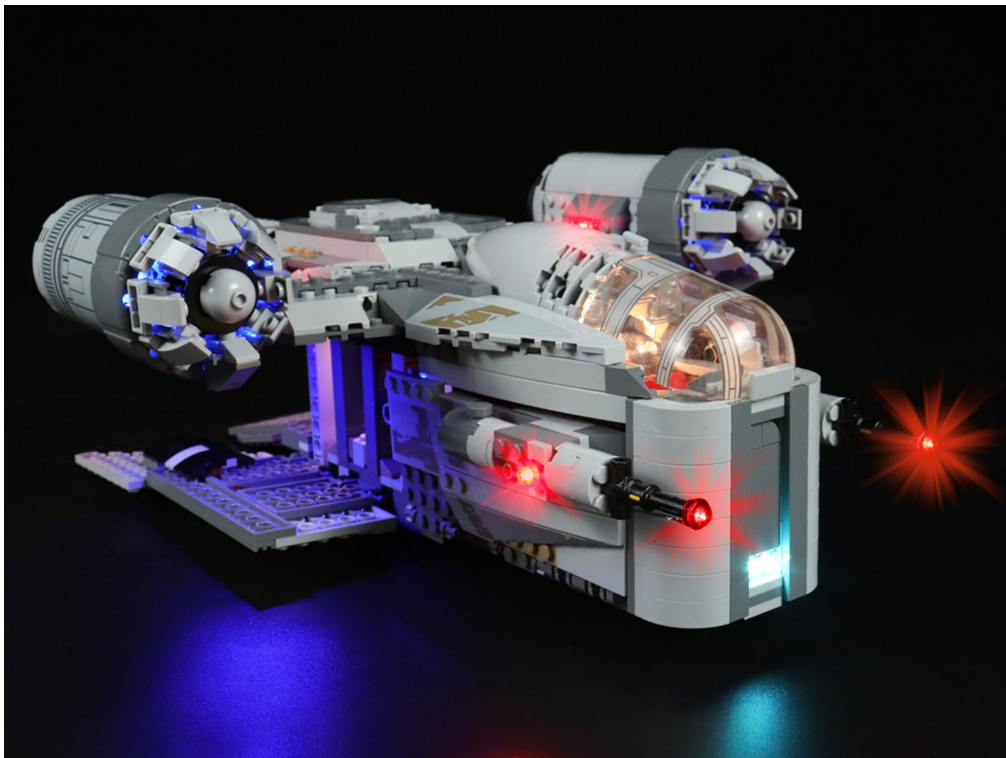

## **Strategies for the Installation**

**This instruction divides three sections to complete the installation of the lighting set.**

### **Section A: Check the type and quantity of components.**

**The quantity and type of components of each products are different and it needs to be carefully checked to make sure there do have enough material. The type of components is indicated by the label on the bag.**

### **Section B: Test that each components is working properly.**

**Each components is Manual customization so it is necessary to test that each components is working properly to avoid the situation that the lighting does not work .**

### **Section C: laying out components following the instruction.**

**Our material is very small but not fragile, just be reminded that don't to pull the wires too hard. For different people, there may be some installation steps that you can't understand. Please look at the previous and later installation steps.**

## Section A: Check the type and quantity of components.

This set contains five bags labelled "1" "2" "3" "4" "5", please make sure that the components in each bag are the same as shown in the pictures.

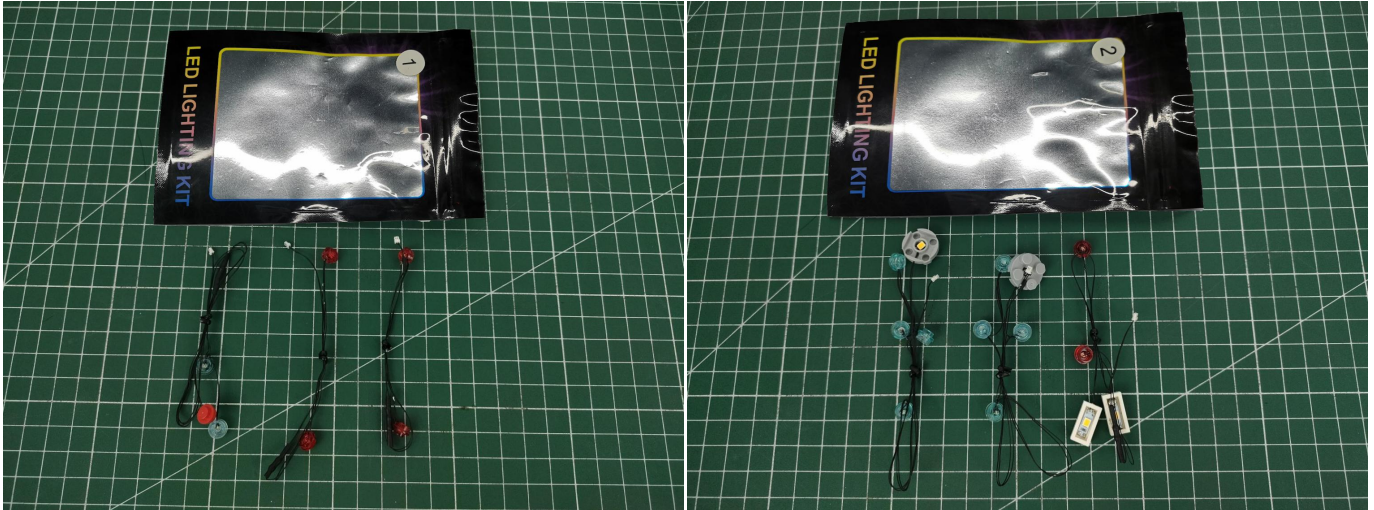

Please contact us immediately if there have any missing components.

## Section B: Test that each components is working properly.

Take out the Remote Control Board and the AAA Battery Box from No. 4 bag and No.5 bag.



The AAA Battery Box does not contain batteries, please buy three AAA batteries in the nearest store and install it in the AAA Battery Box.



The remote control does not contain batteries, please buy a CR2025 or CR2032 button battery in the nearest store and install it in the remote control.

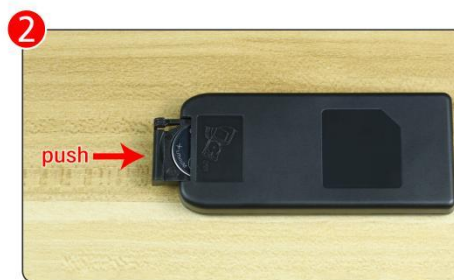

Connect the Remote Control Board and AAA Battery Box as shown.

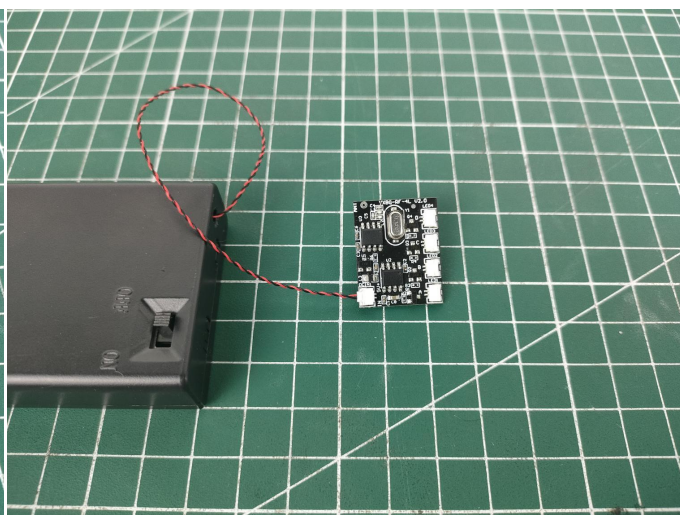
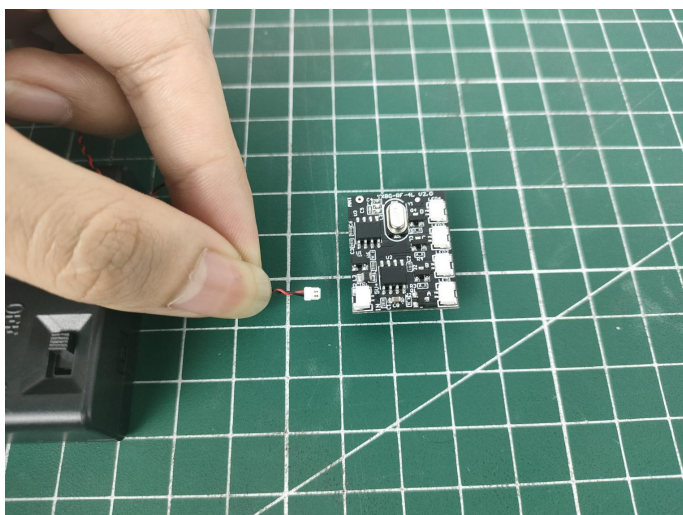

**Connect all the components in No.1 bag to the Remote Control Board in same way just as shown.**

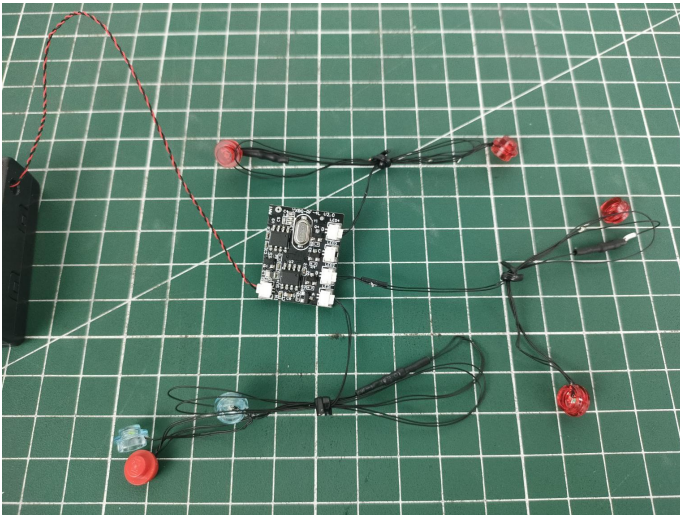

**Turn on the remote control, all the lights are on as shown.**

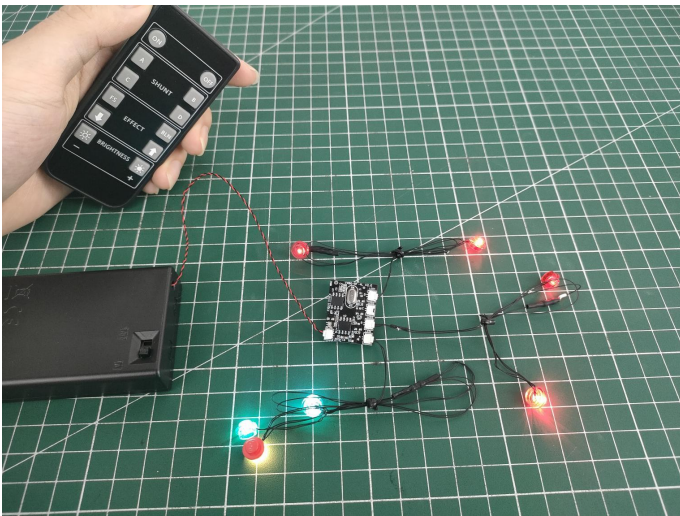

**Unplug these three components and put them back in the corresponding bags. There are three in bag No.2, one in bag No.3 need to be tested.**

**Attention that after the test is completed, each components should put back in the corresponding bag including the remote control board and the battery box.**

**Please contact us immediately if any components don't work.**

**Section C:** laying out components following the instruction.

**1**



**2**

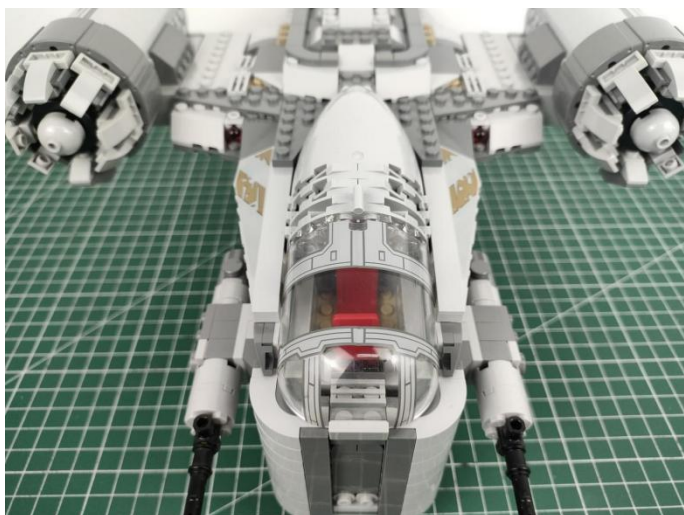

**3**

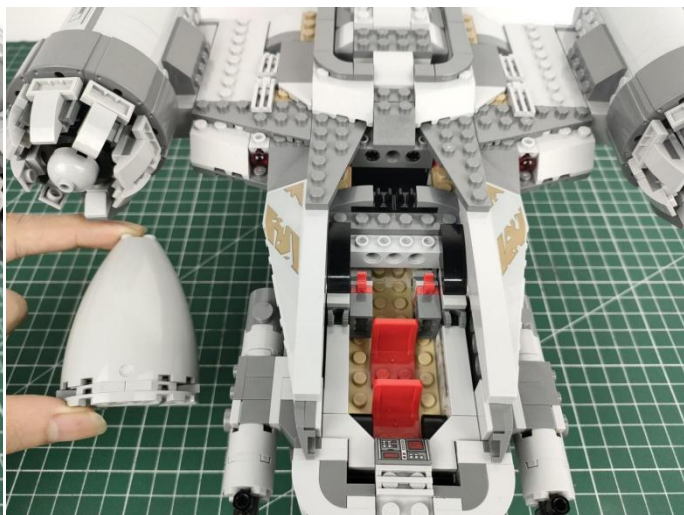
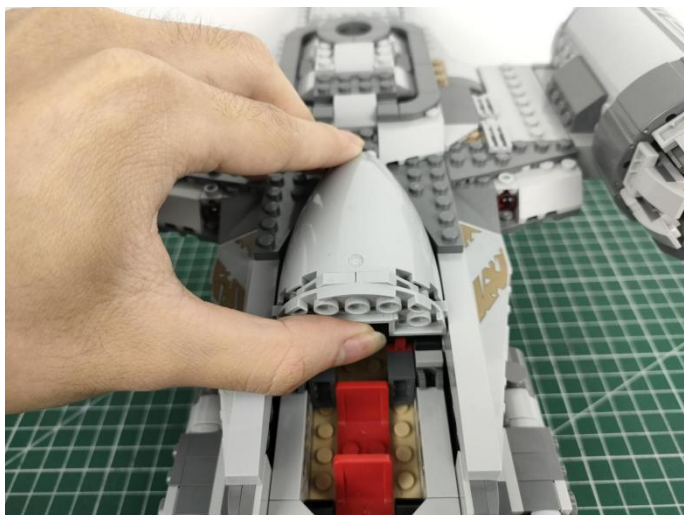

4

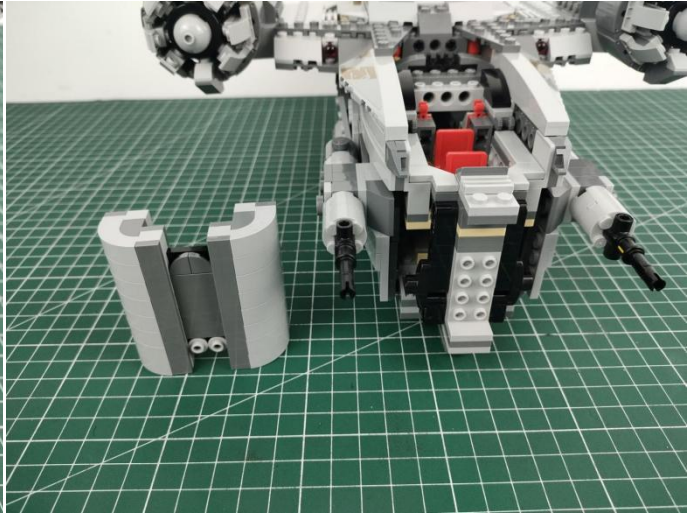
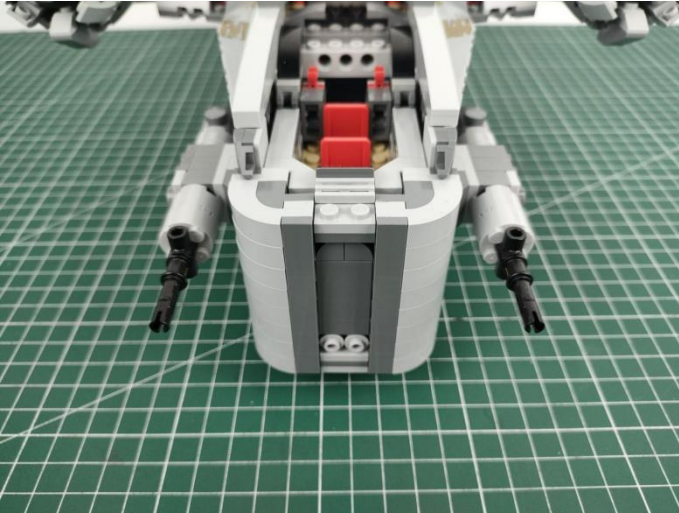

5

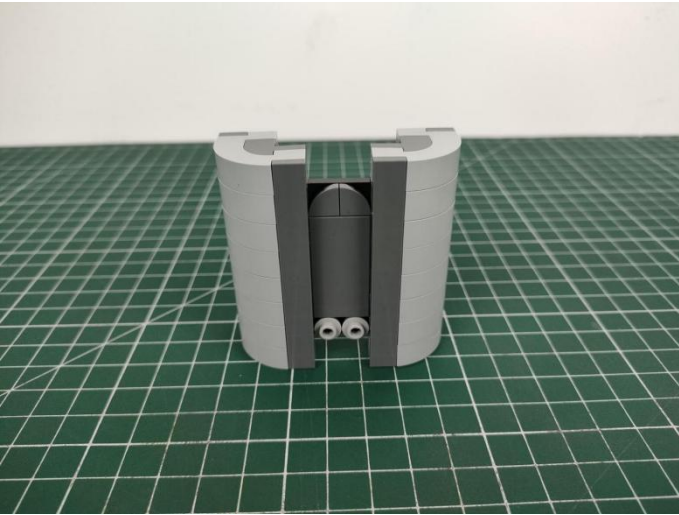

6

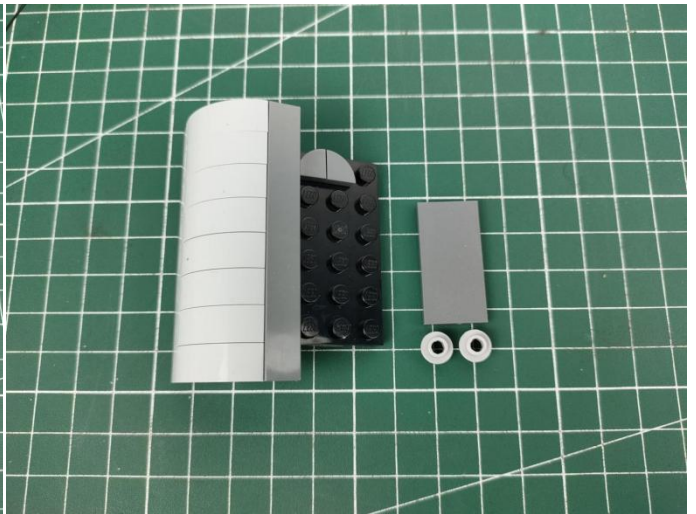
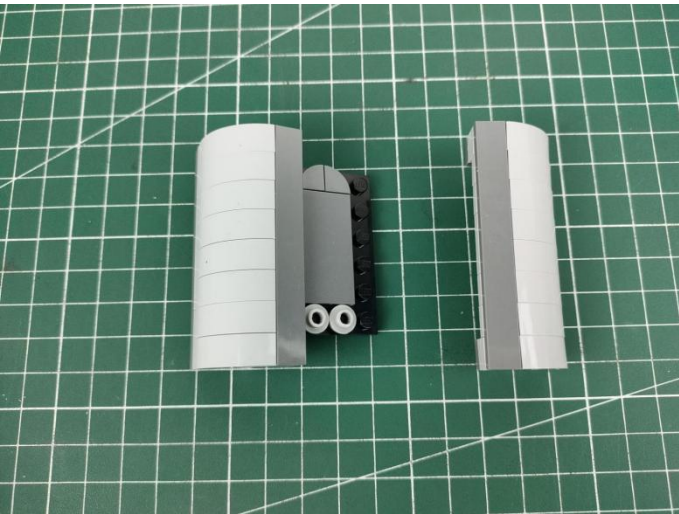



7

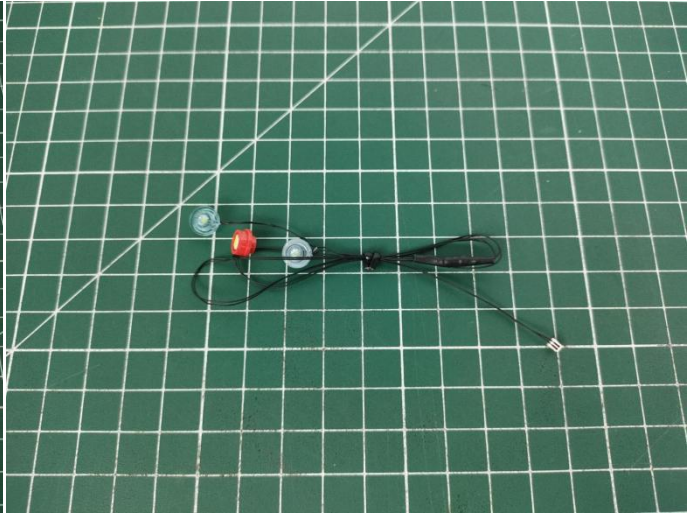

8

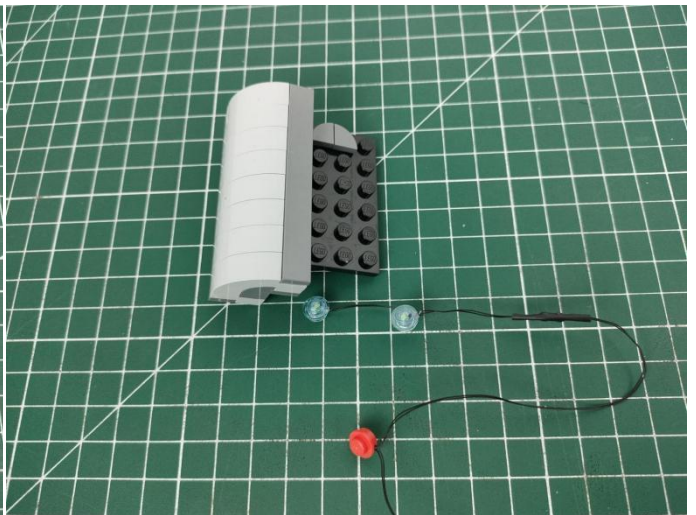
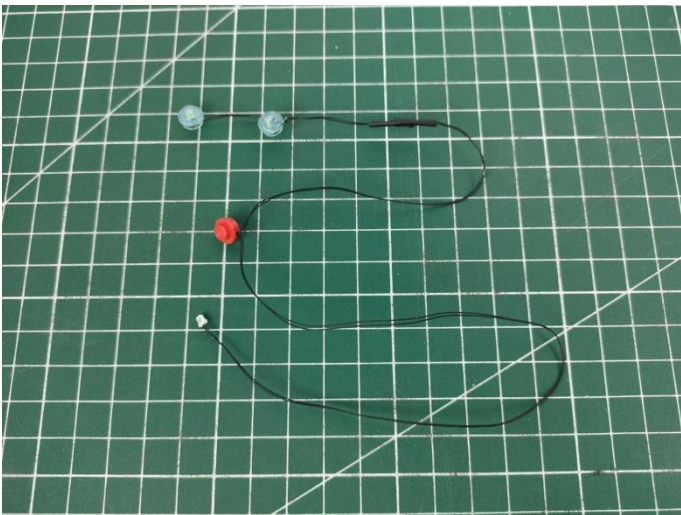

9

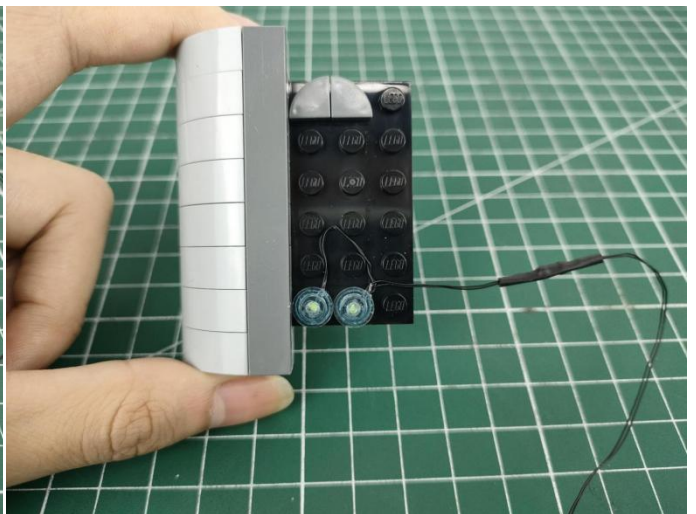

10

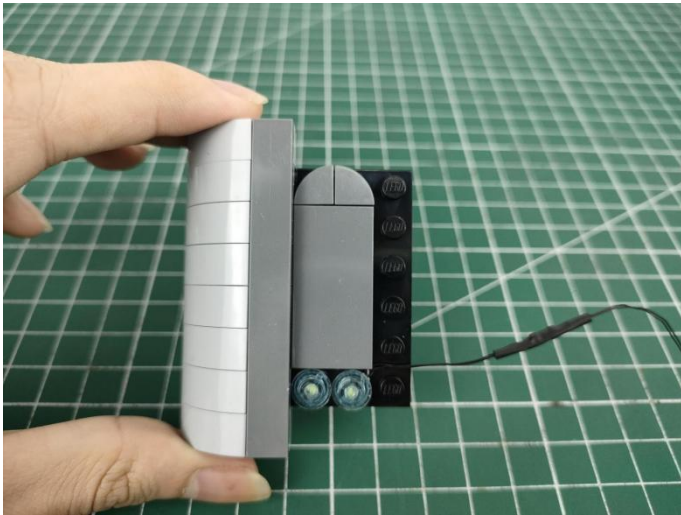

11

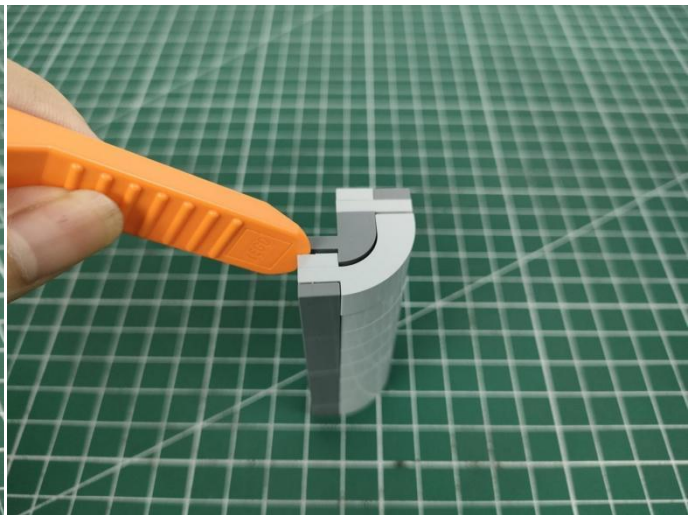
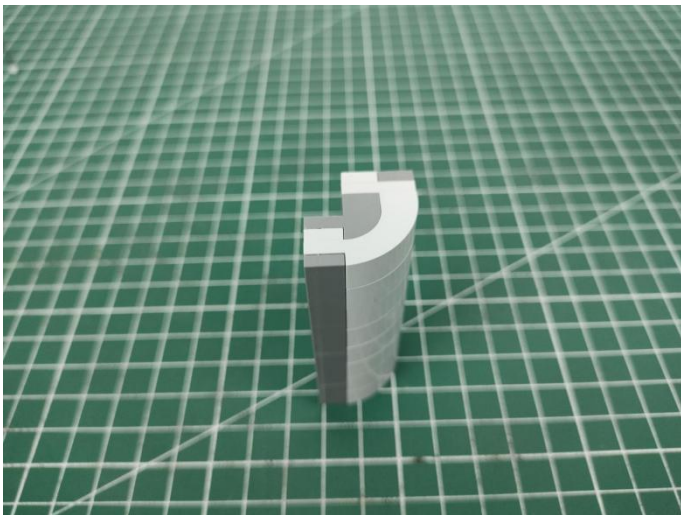

12

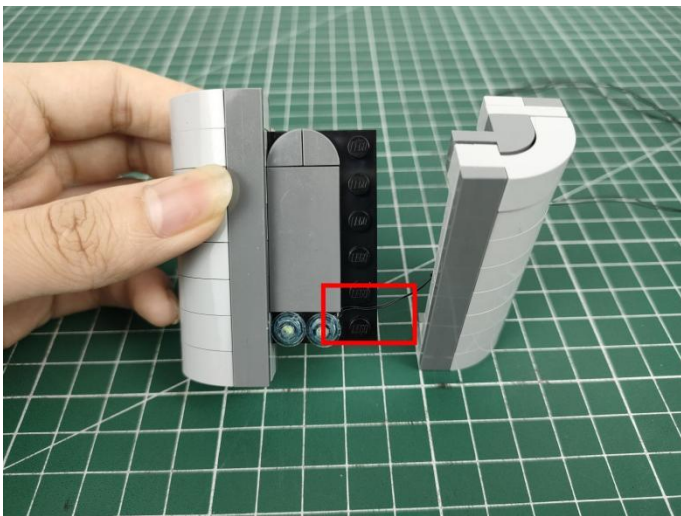

13

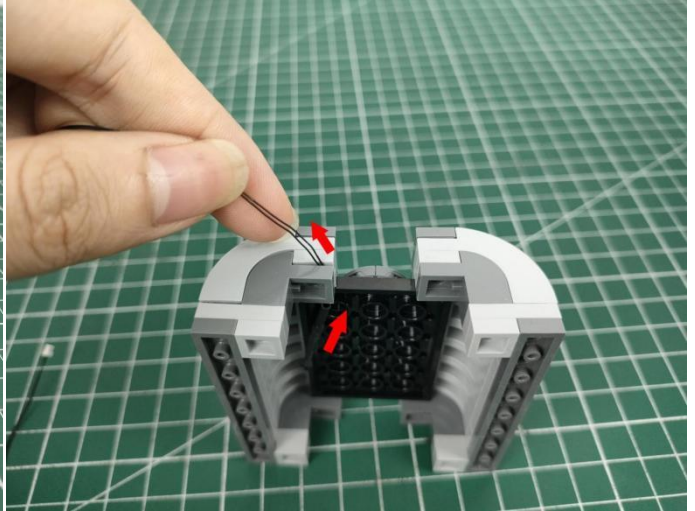
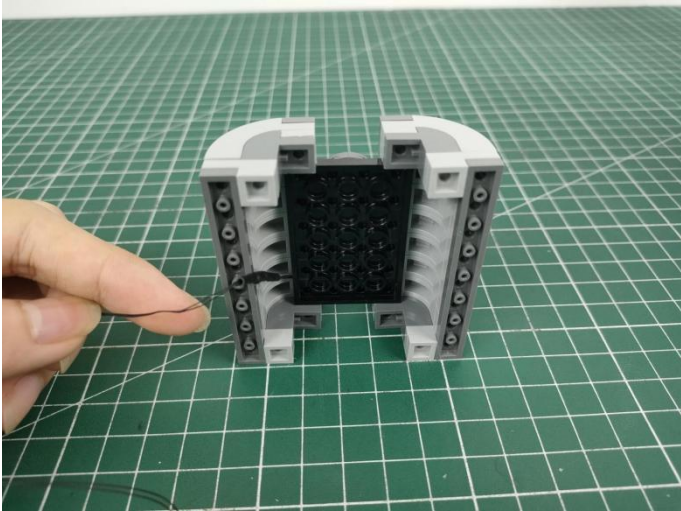

14

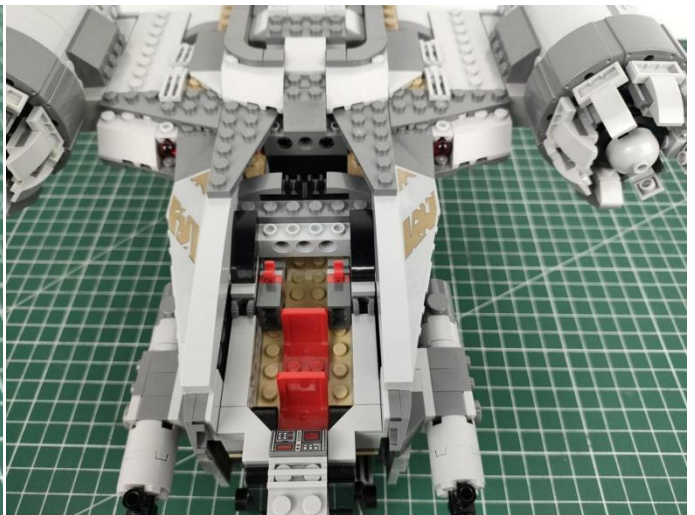
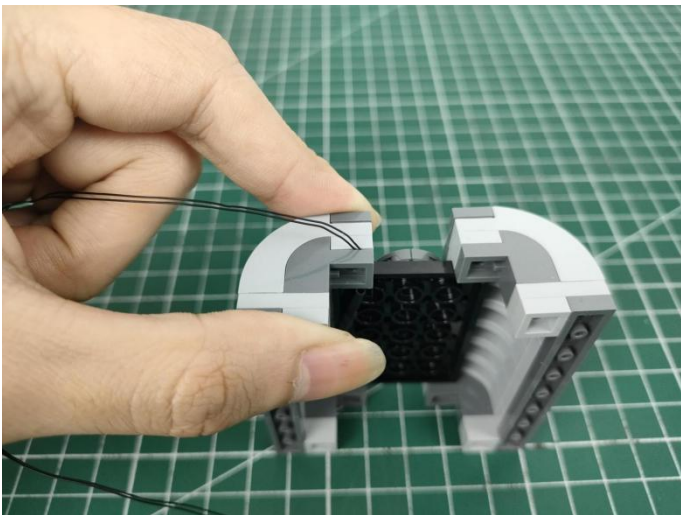

15

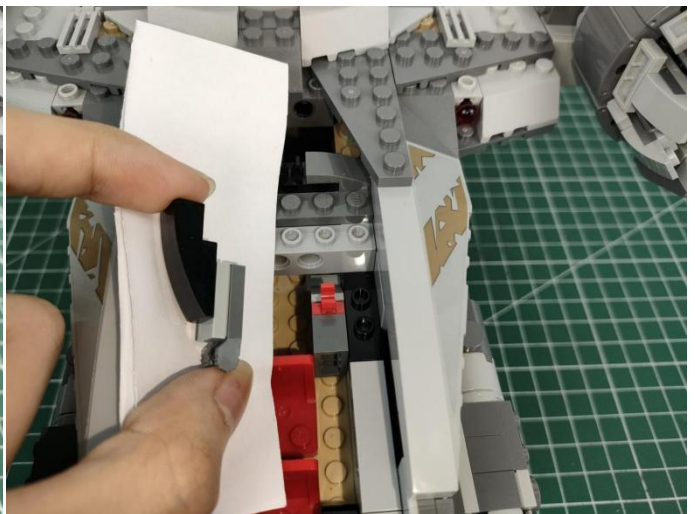
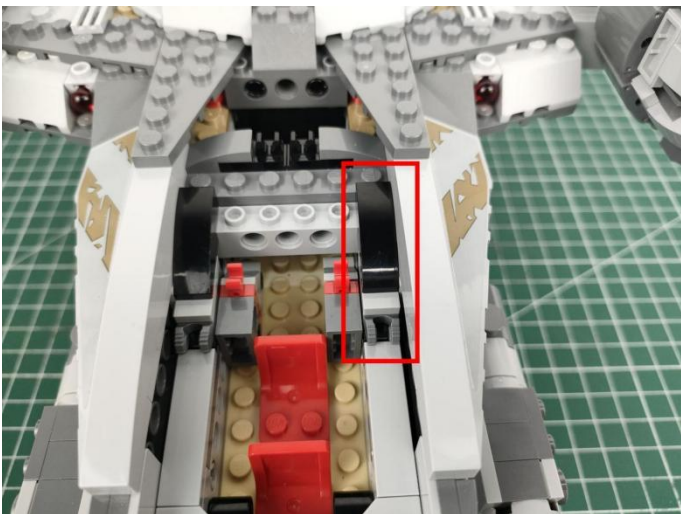

16

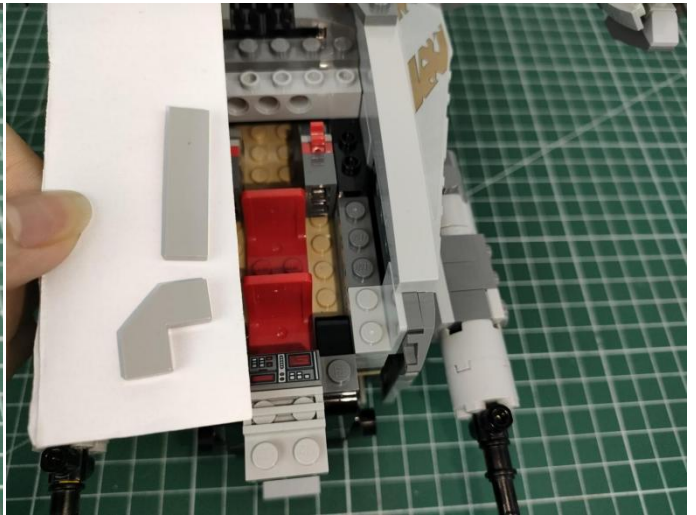
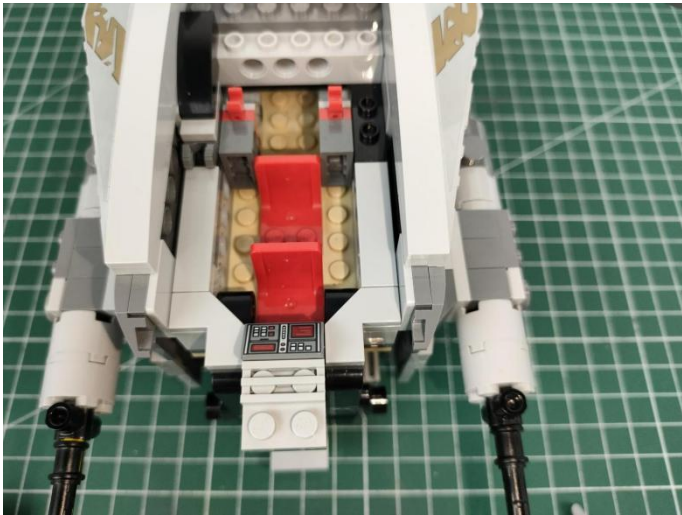

17

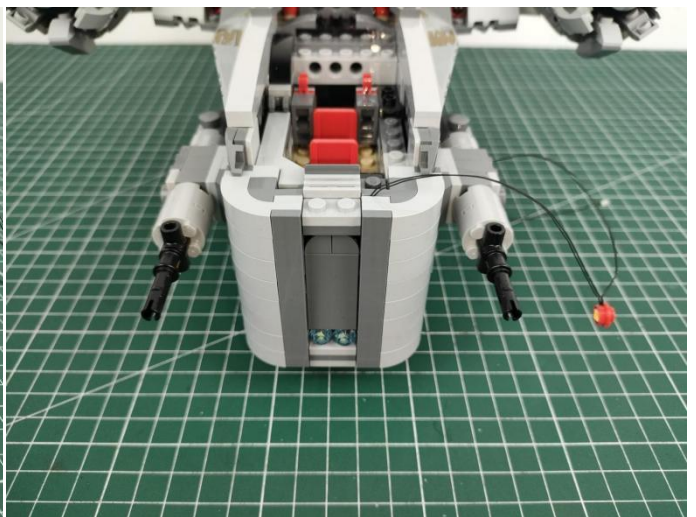
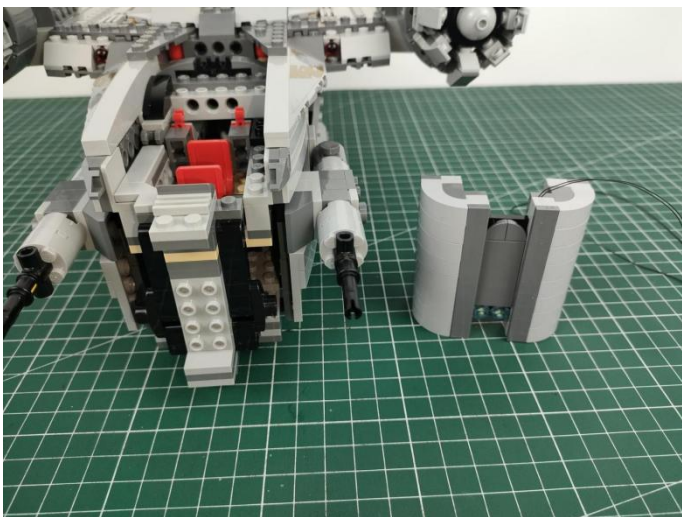

18

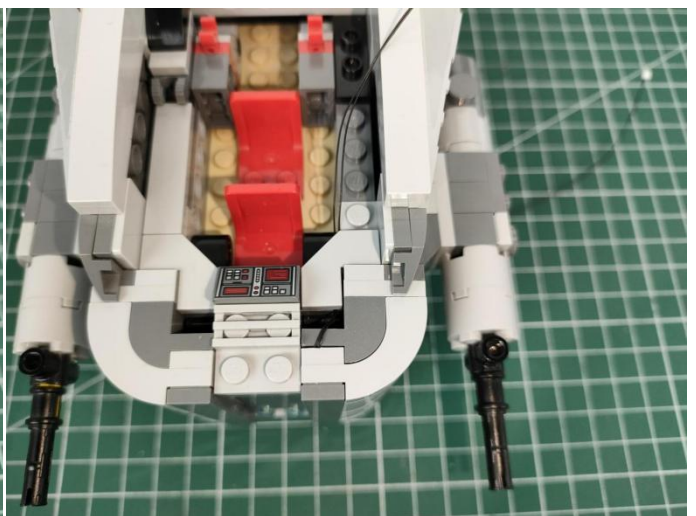
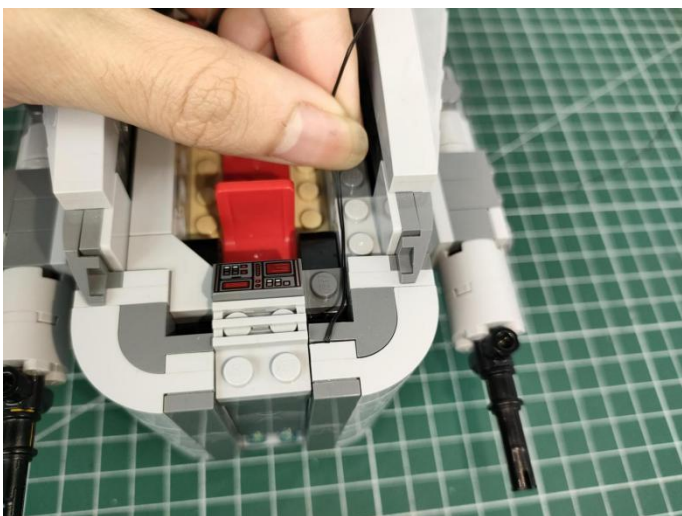

19

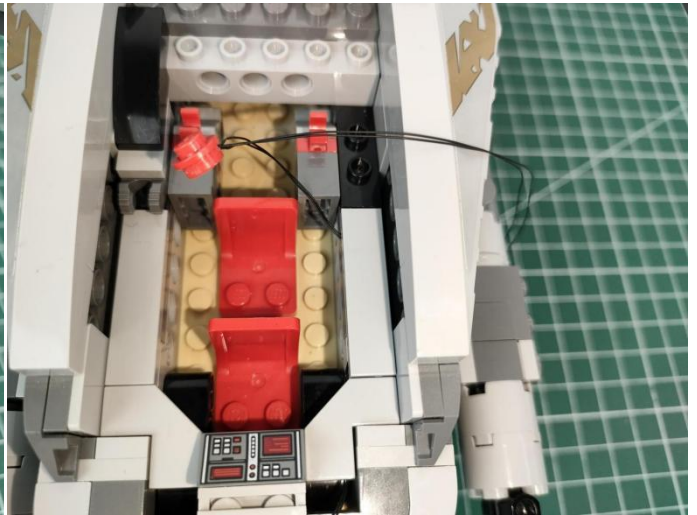
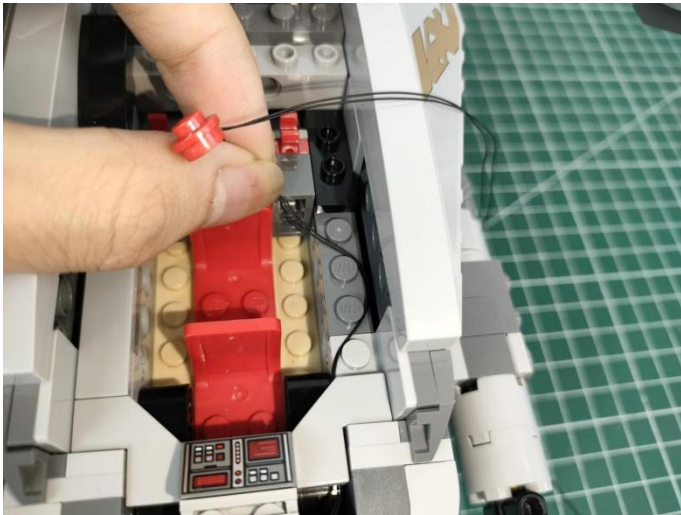

20

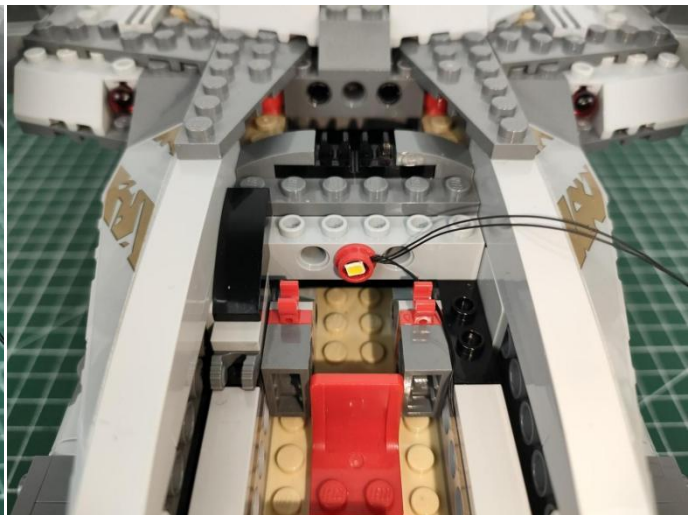
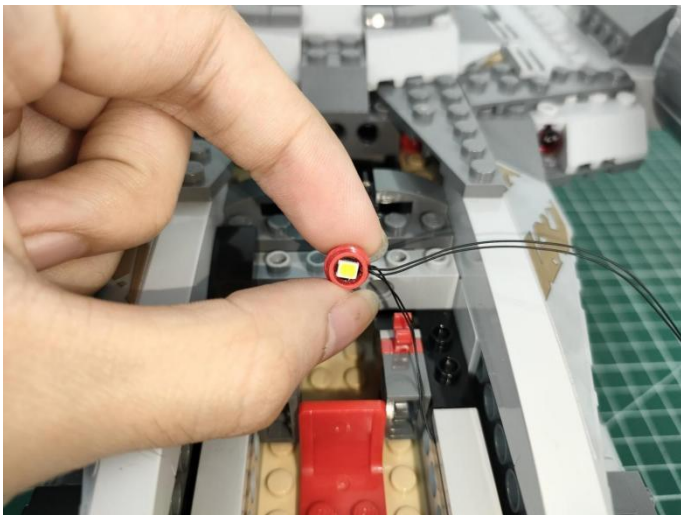

21

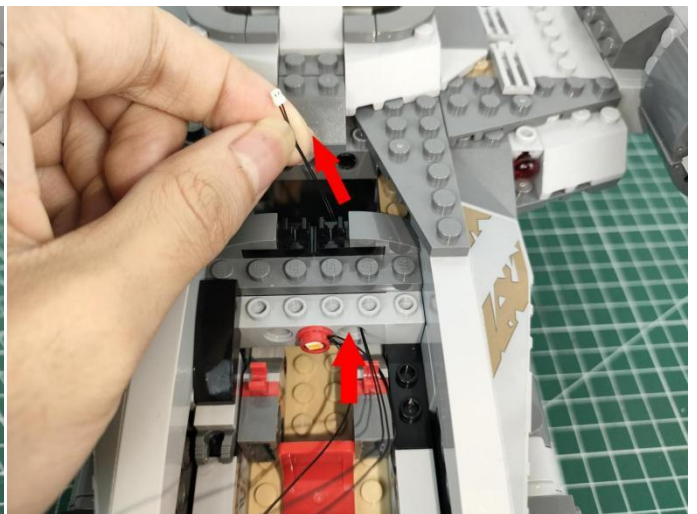
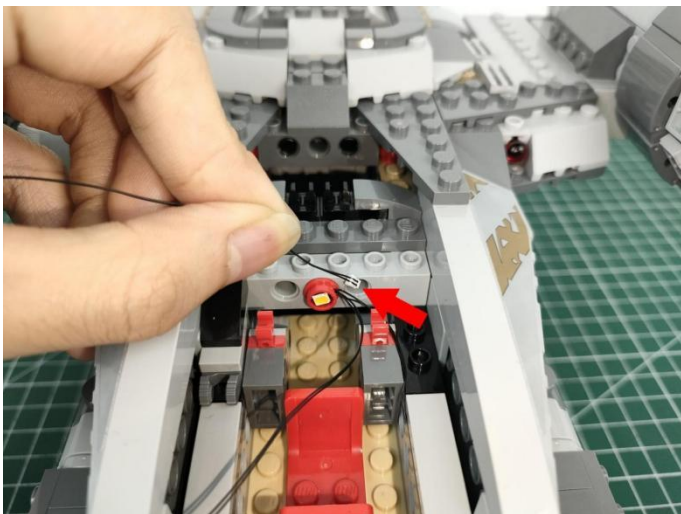

22

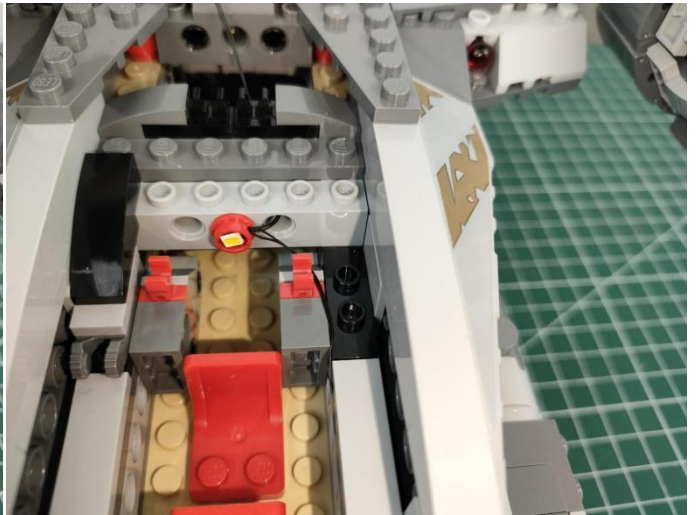
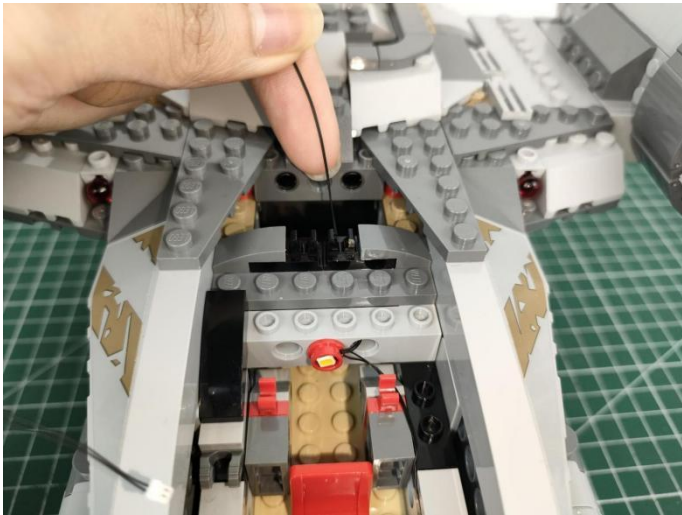

23

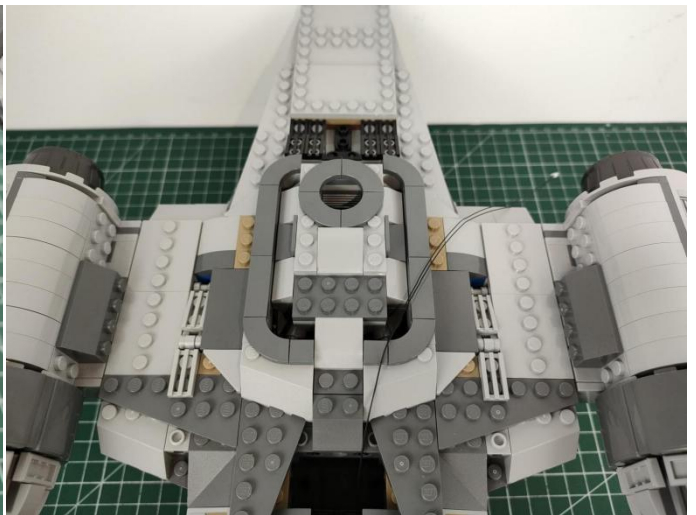
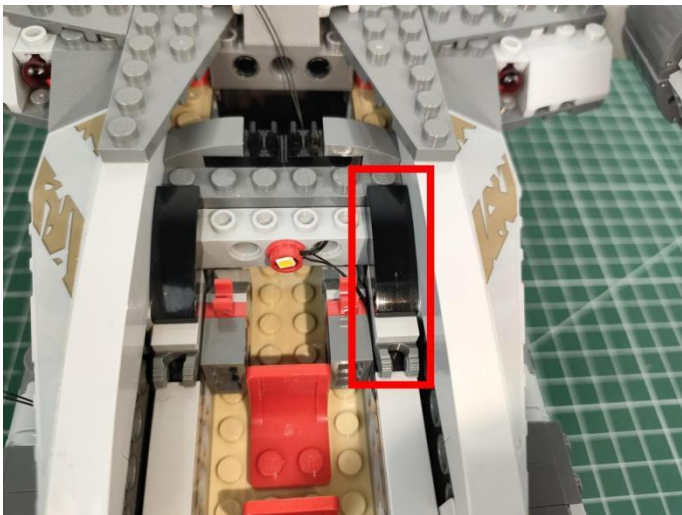

24

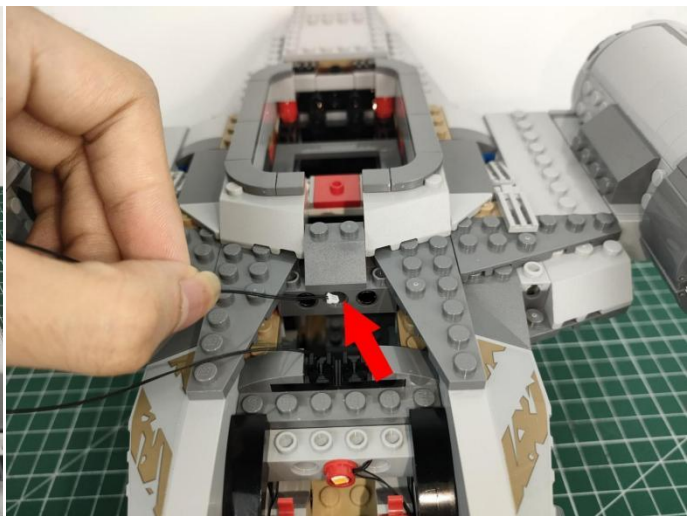
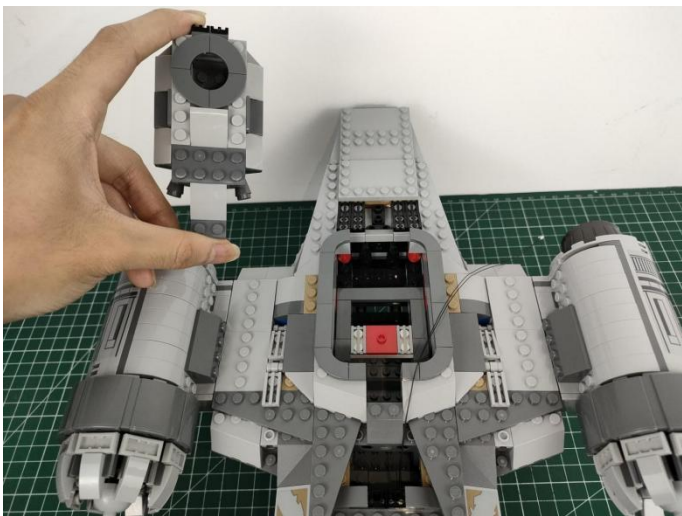

25

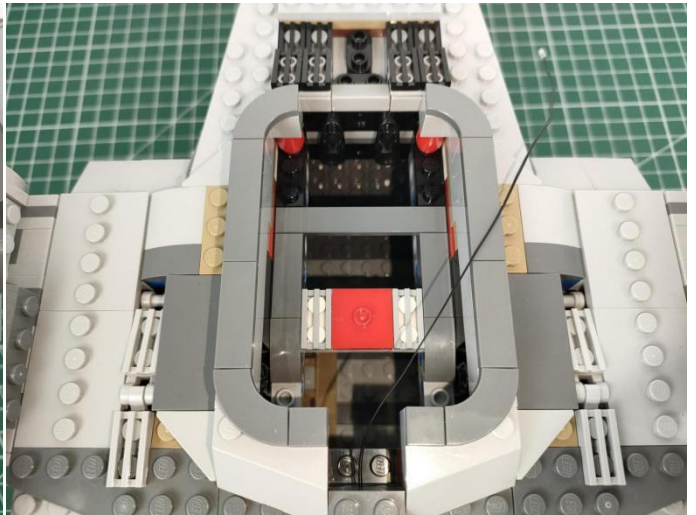
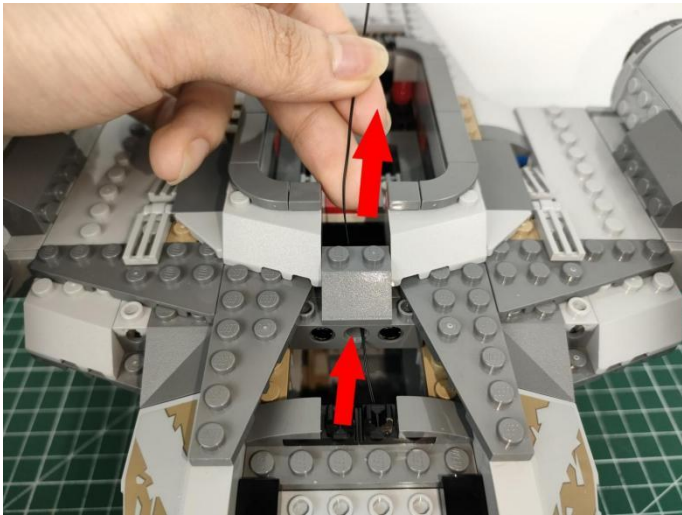

26

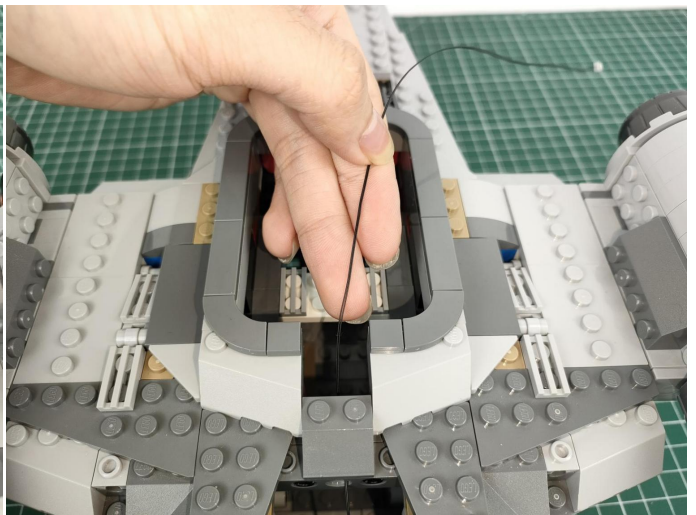
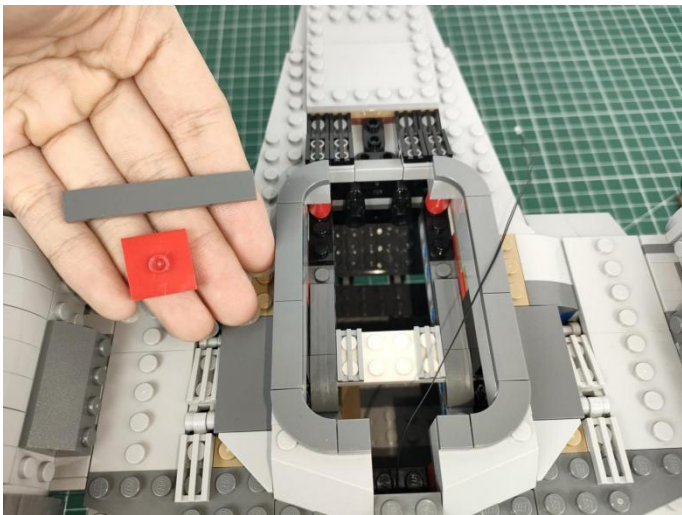

27

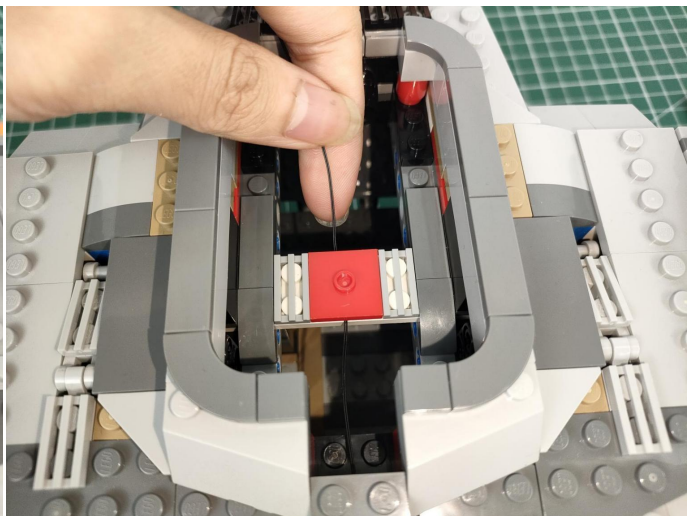
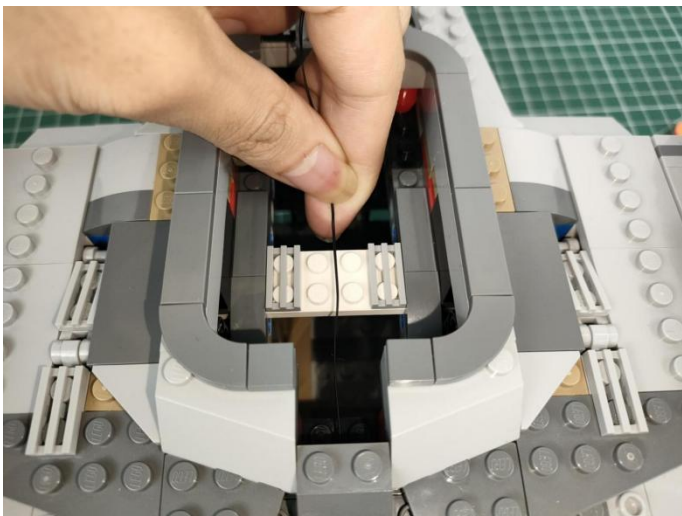

28



29

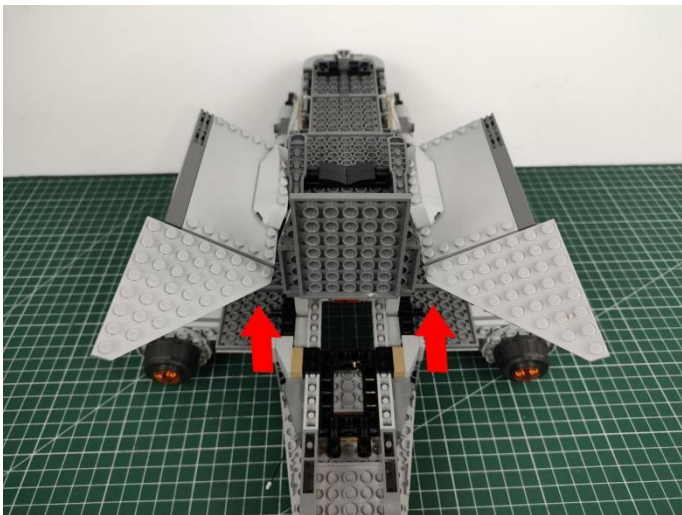

30

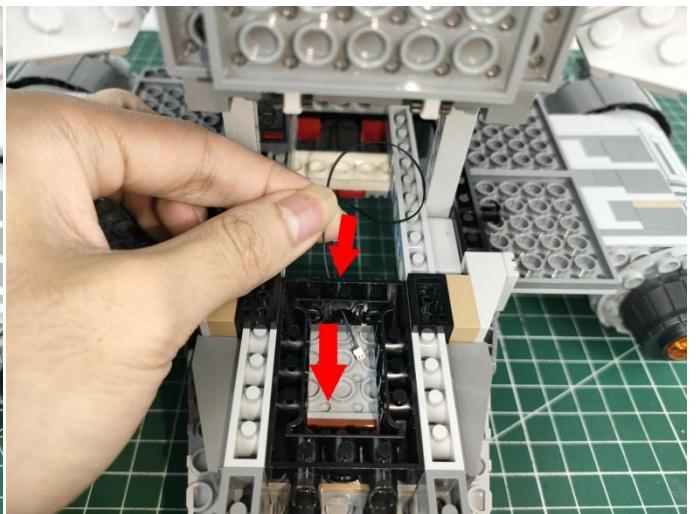
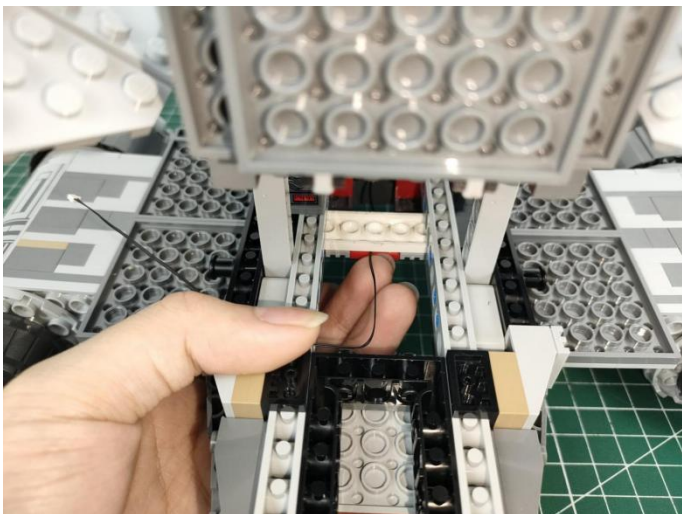



31

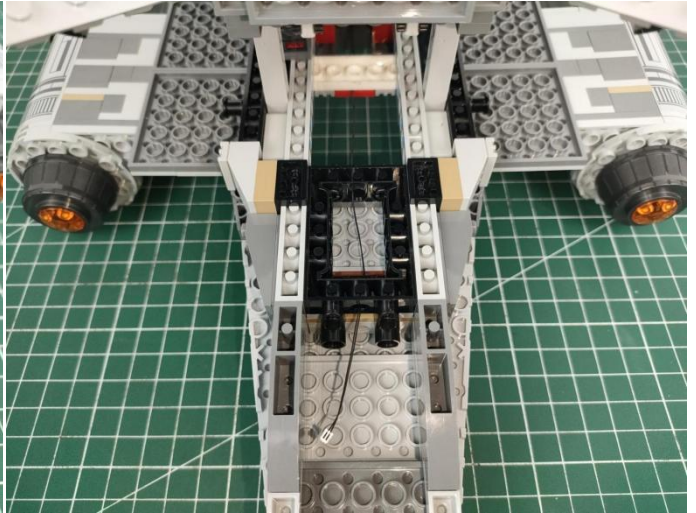
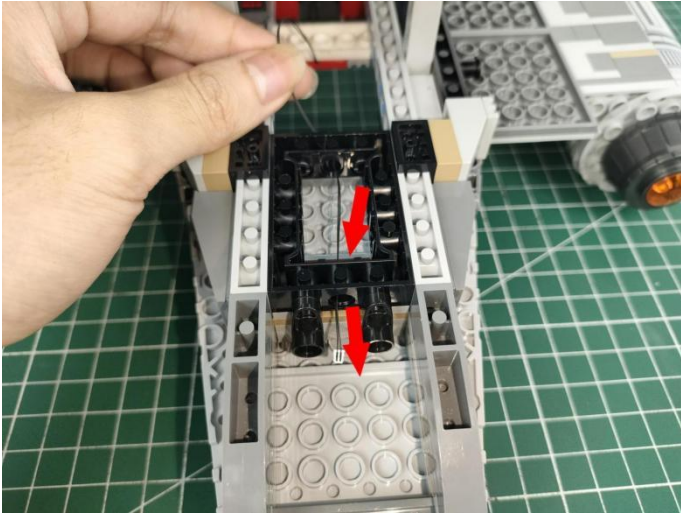

32

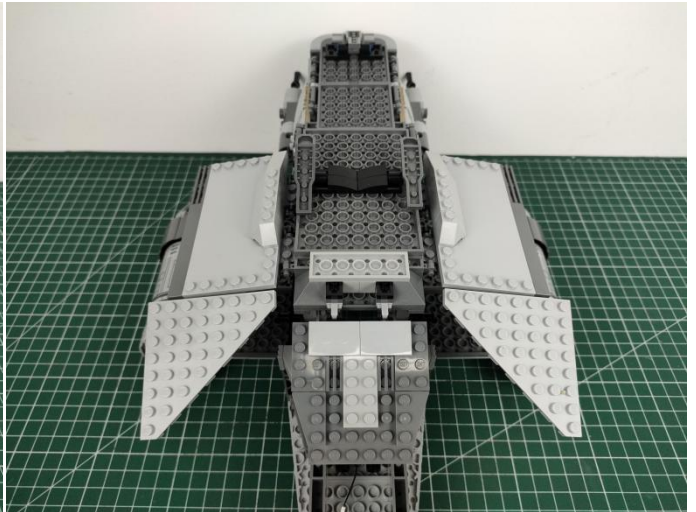
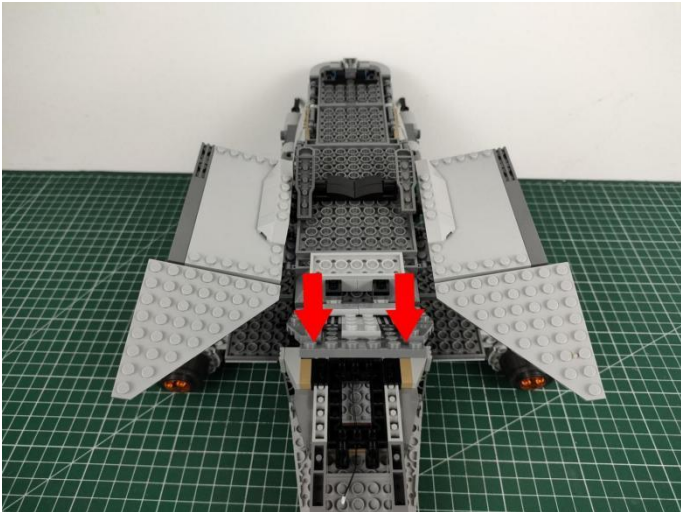

33



34

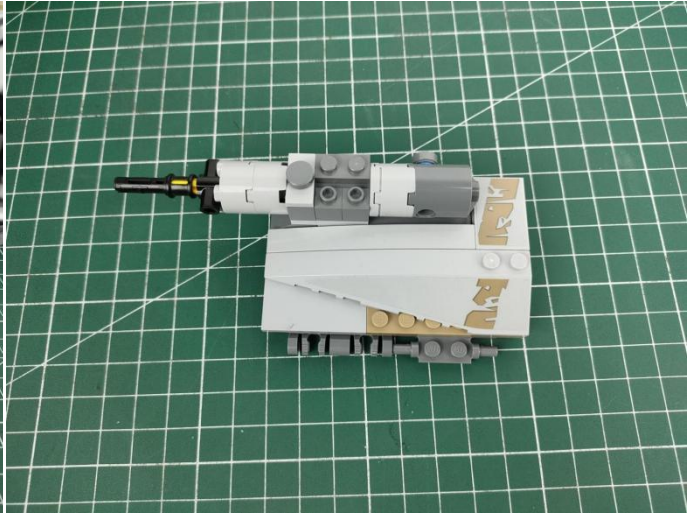
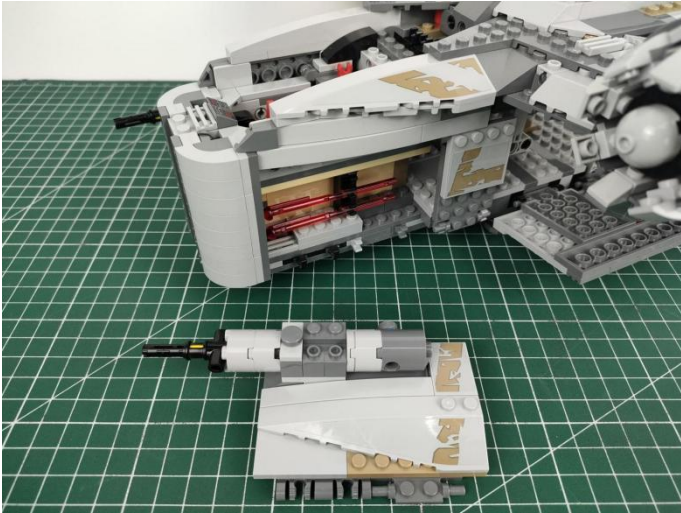

35

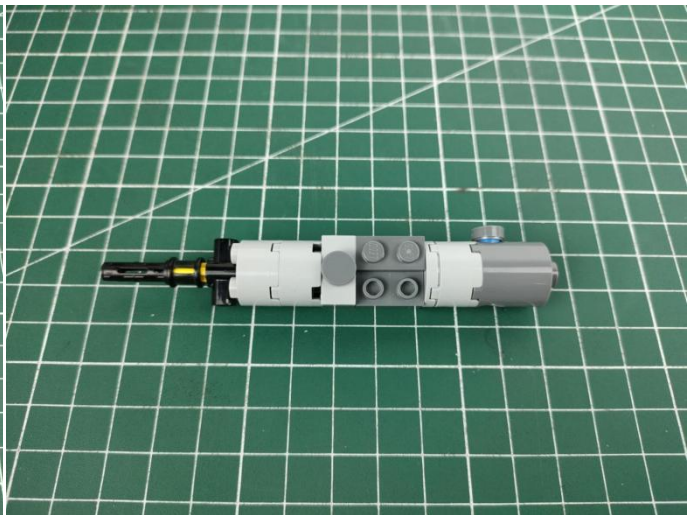
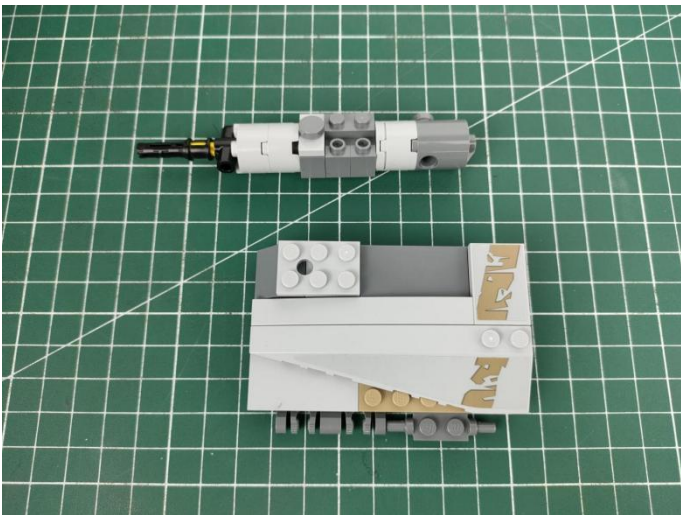

36

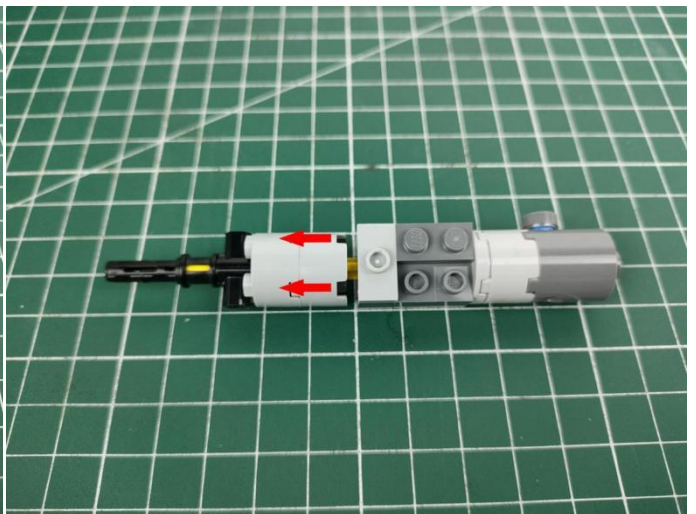
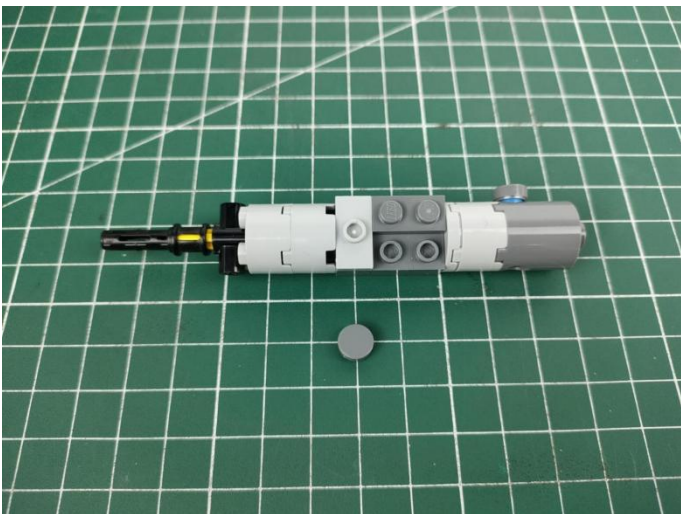

37

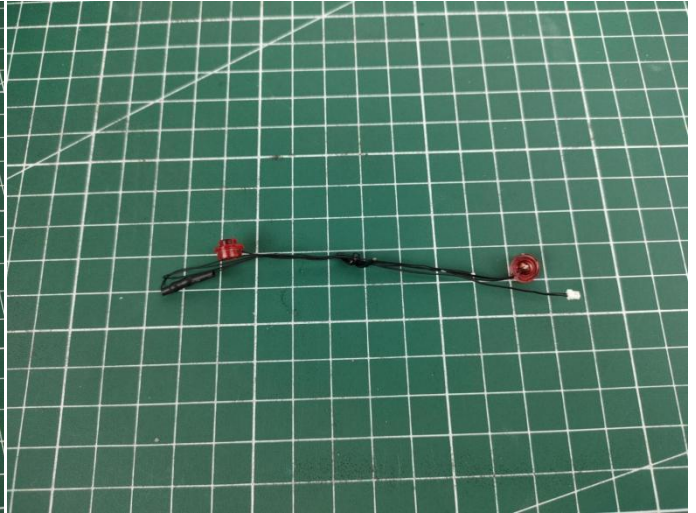
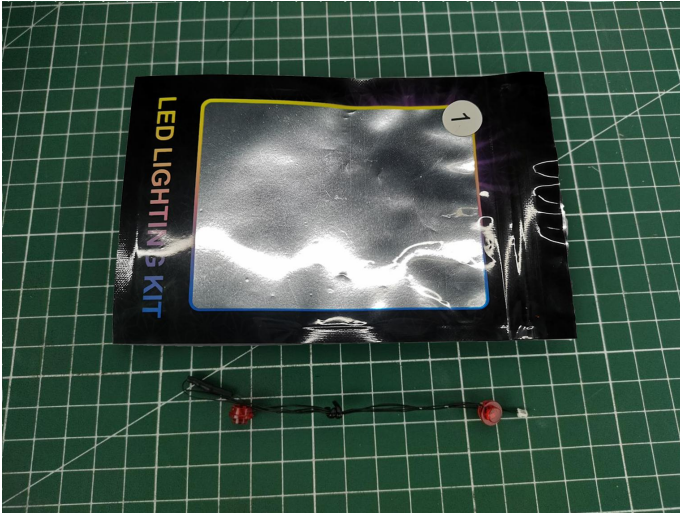

38

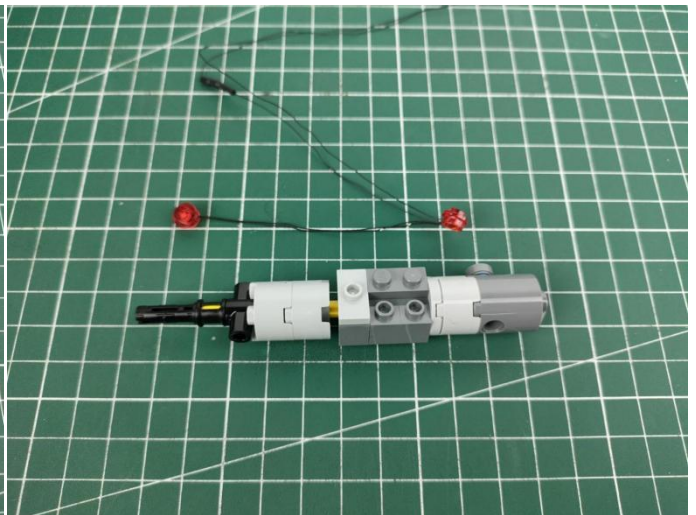
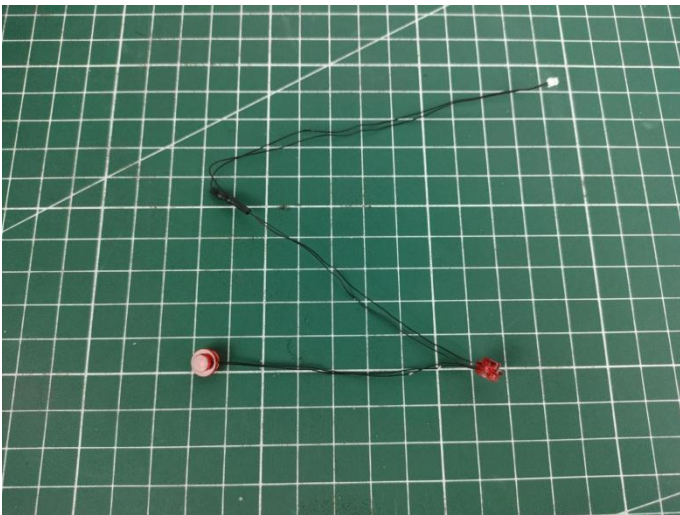

39

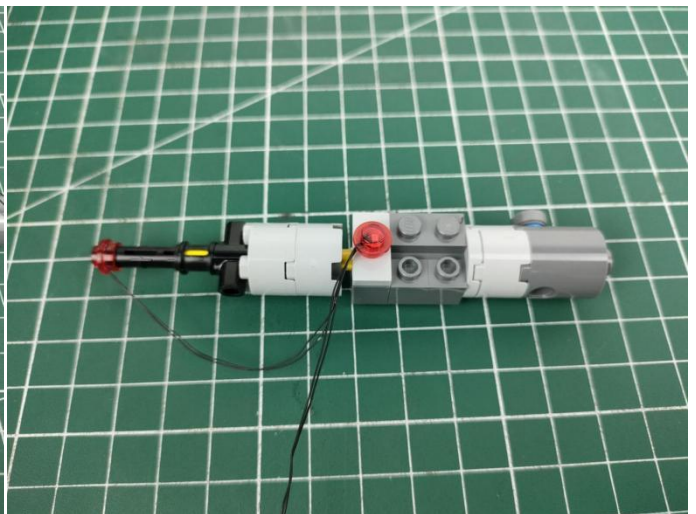
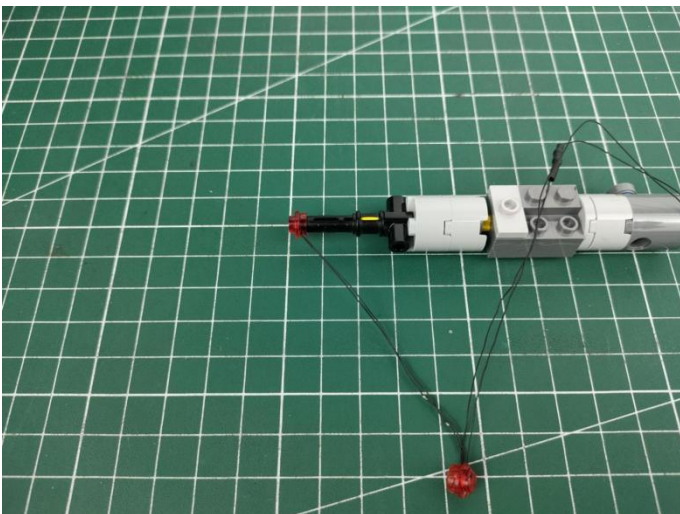

40

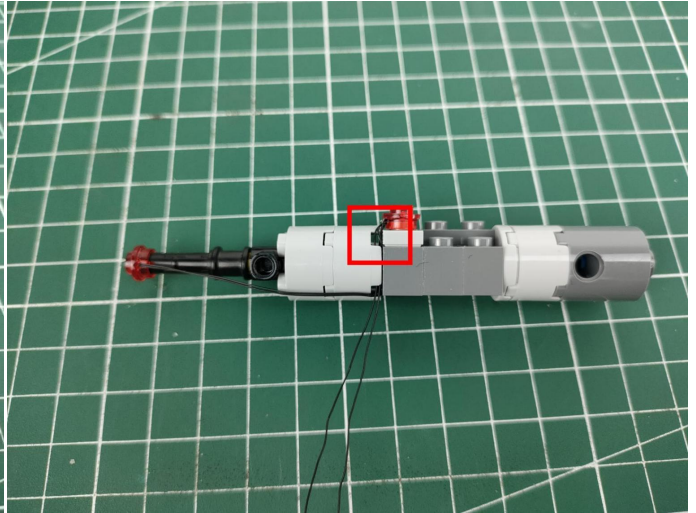
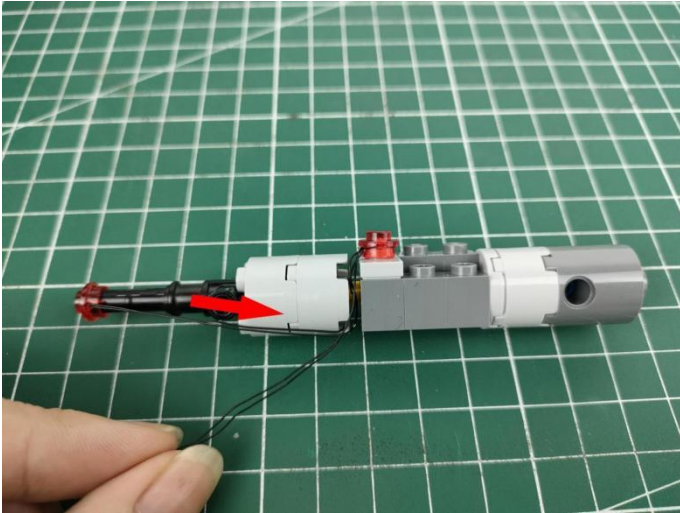

41

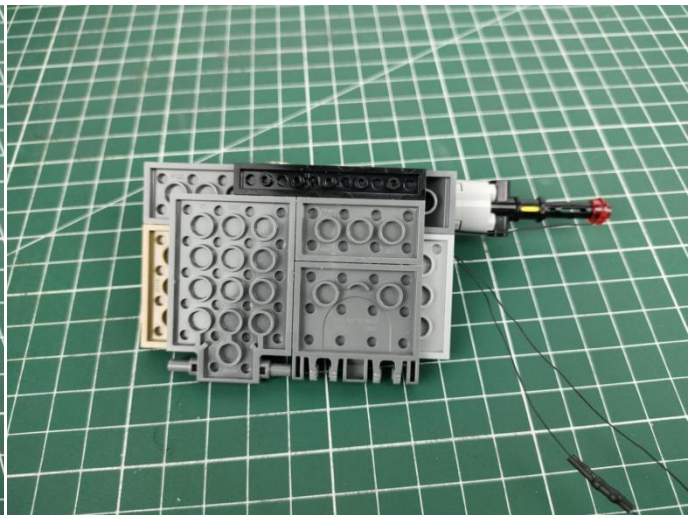
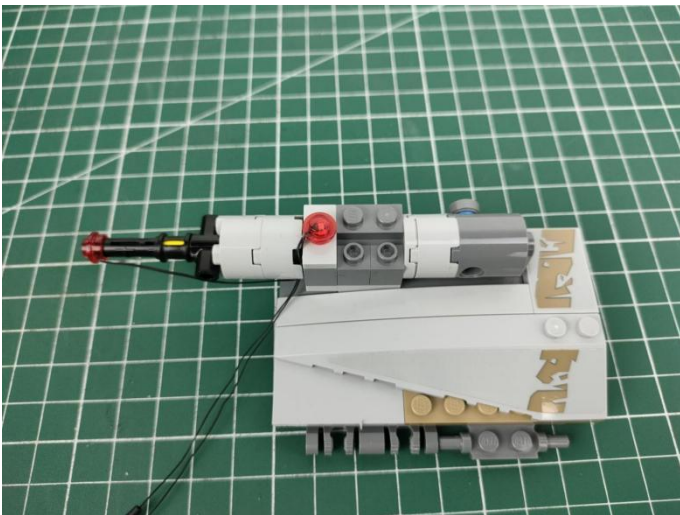

42

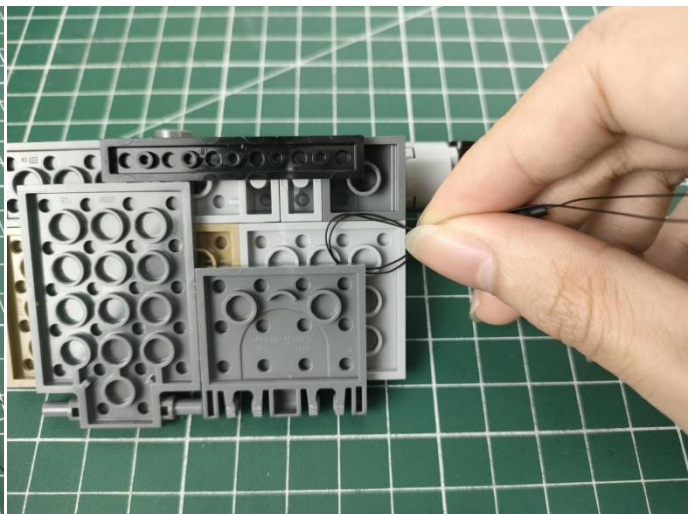
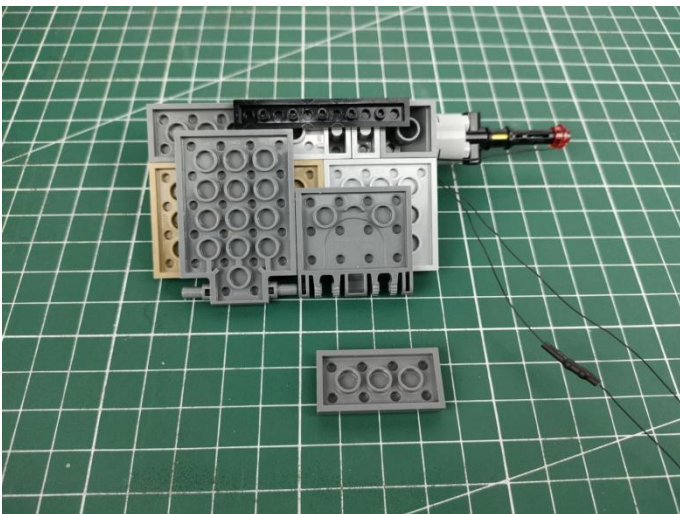

43

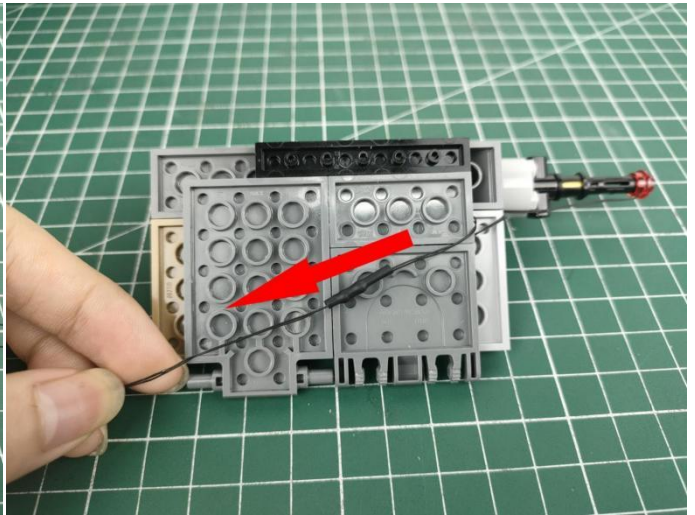
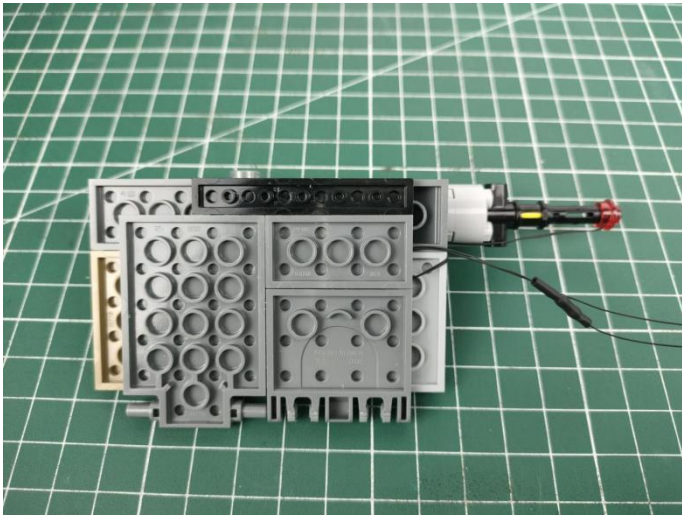

44

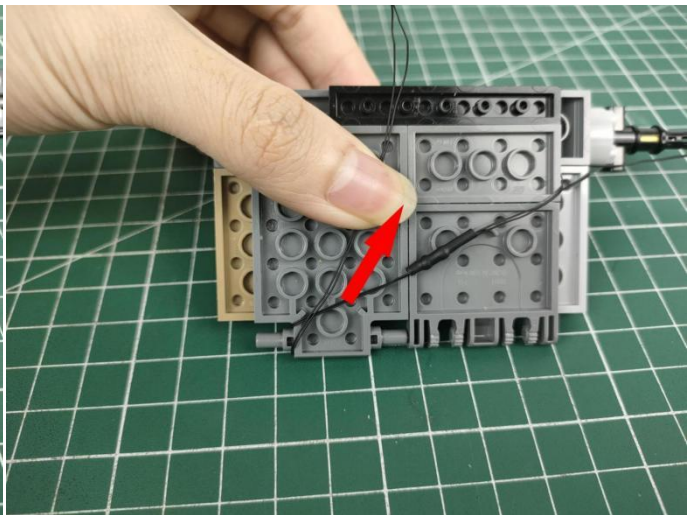
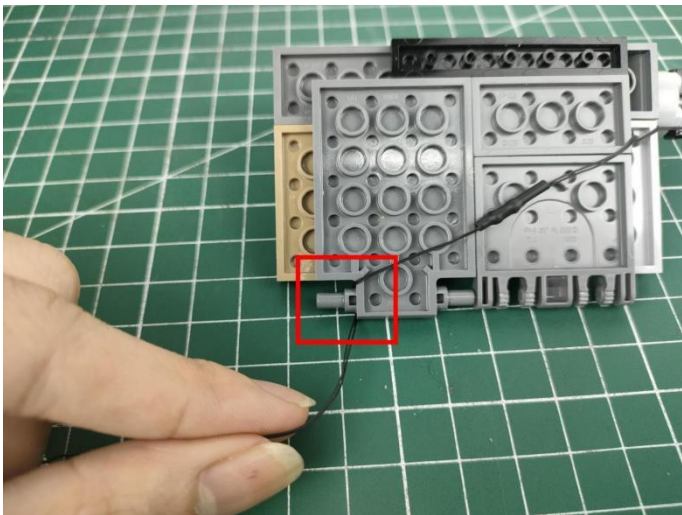

45

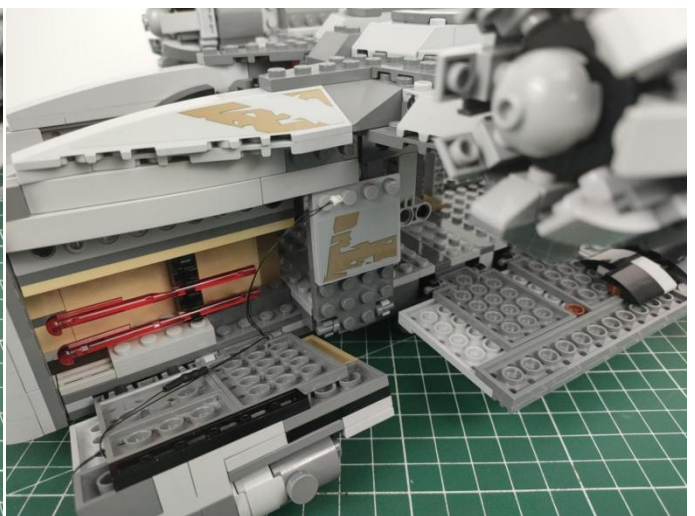

46

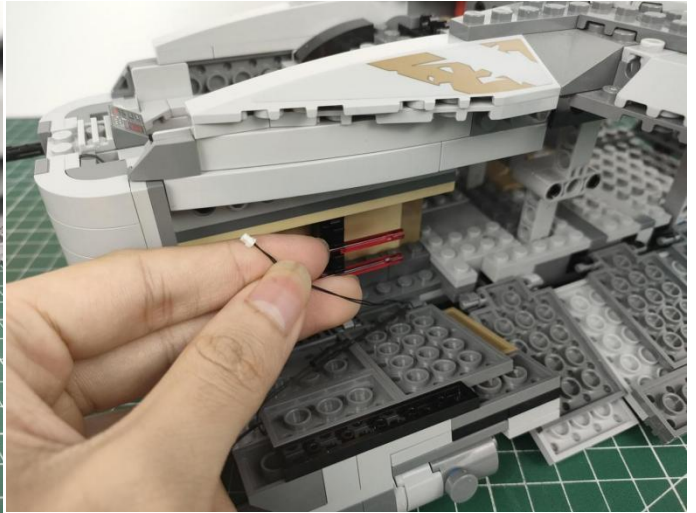
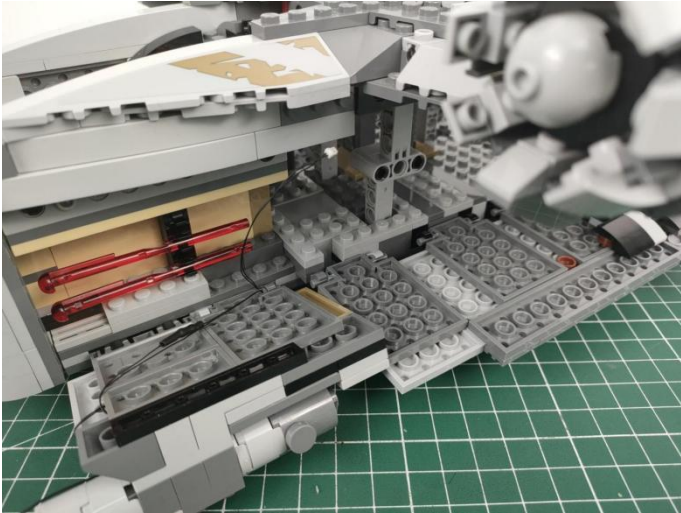

47

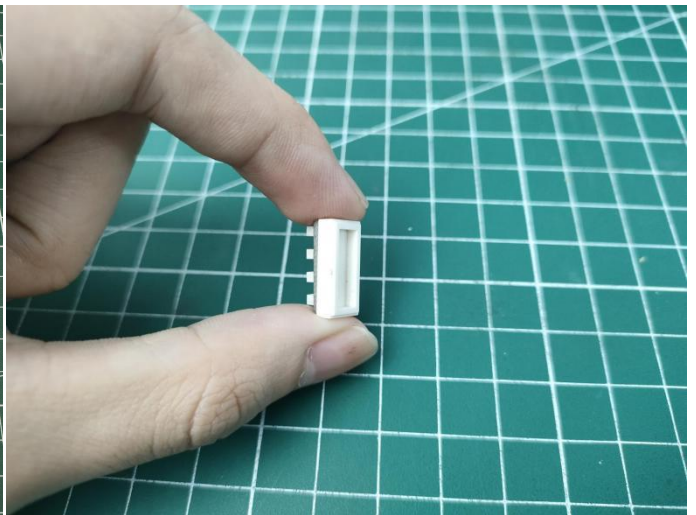

48

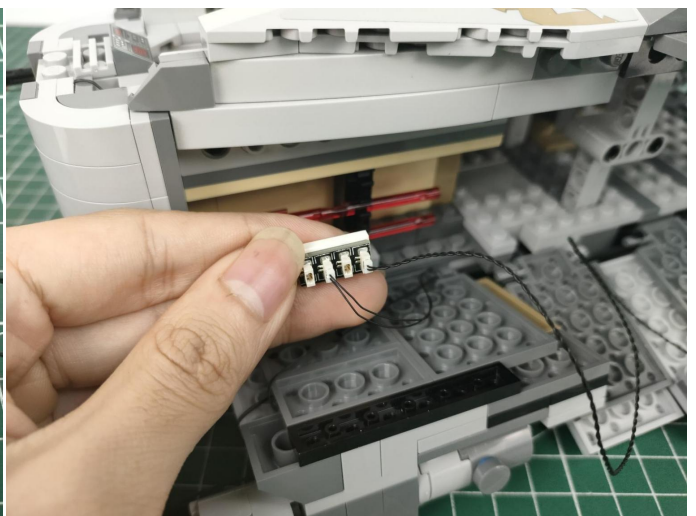
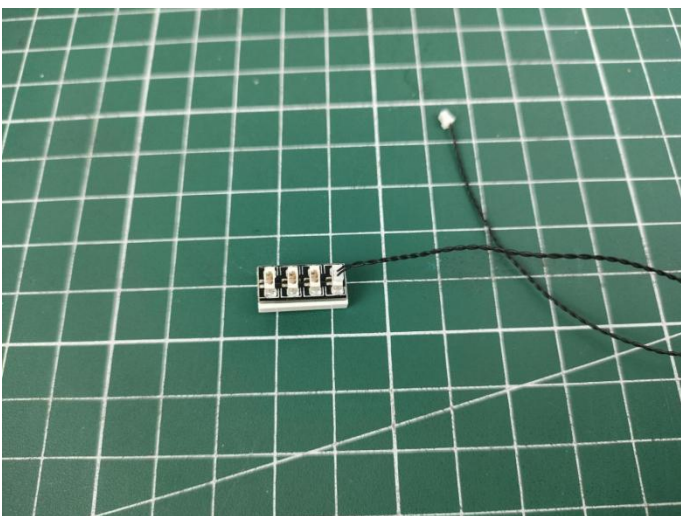

49

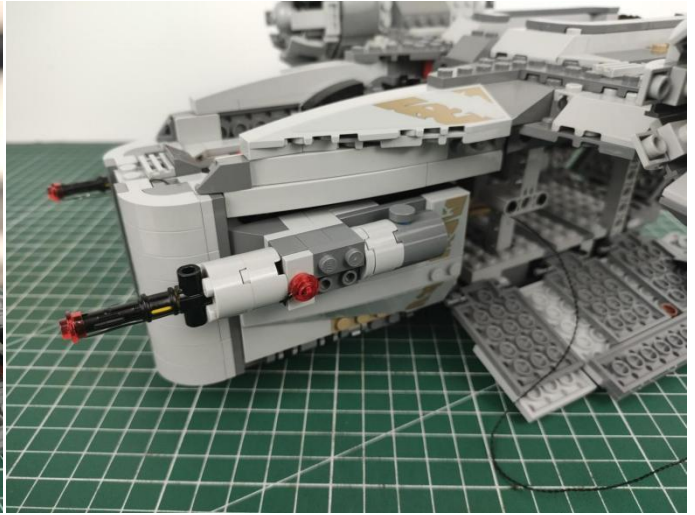

50



51

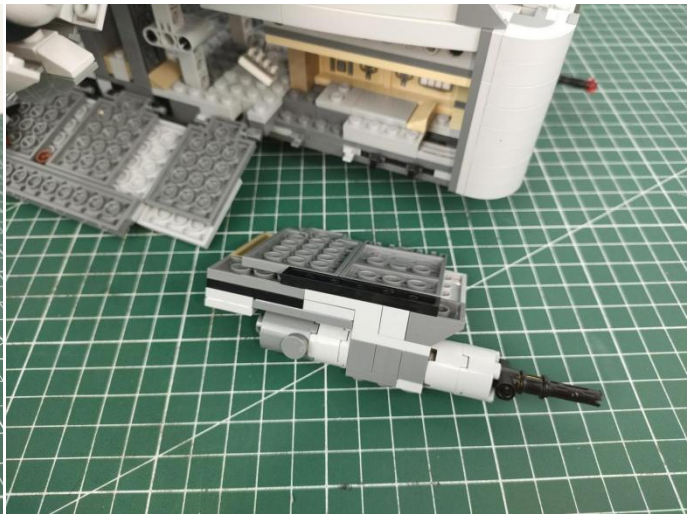
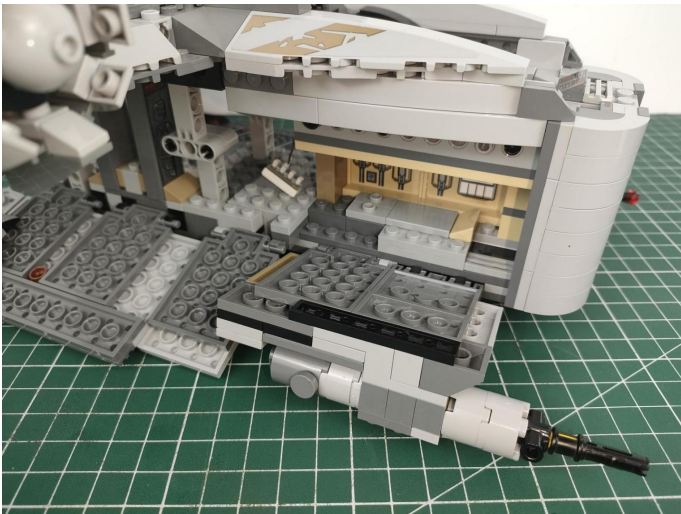

52

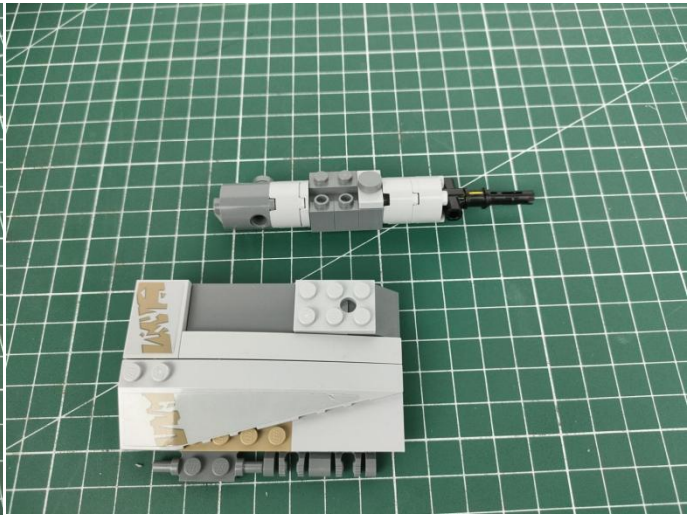
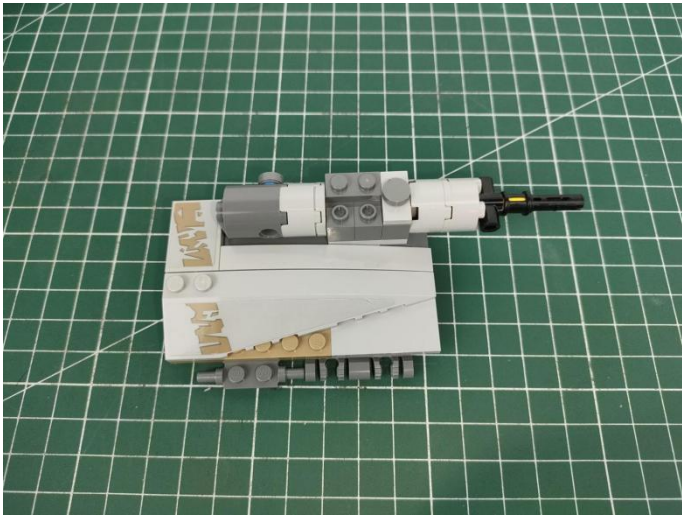

53

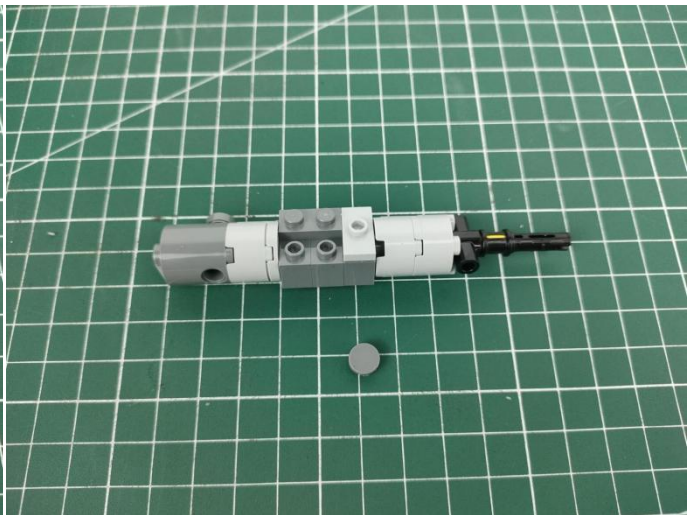

54

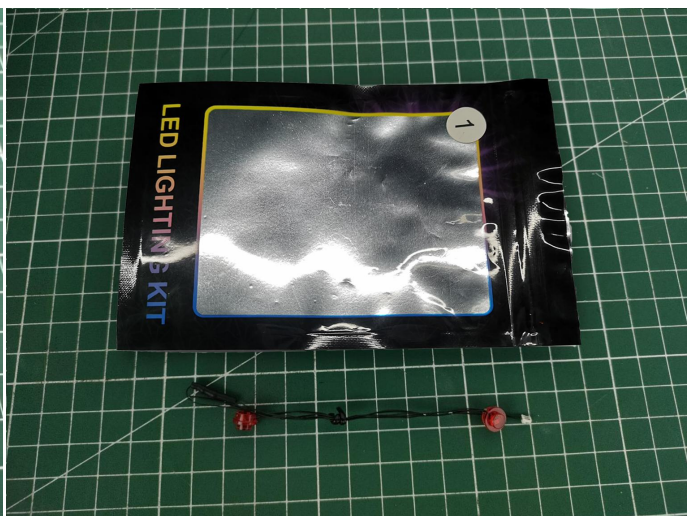
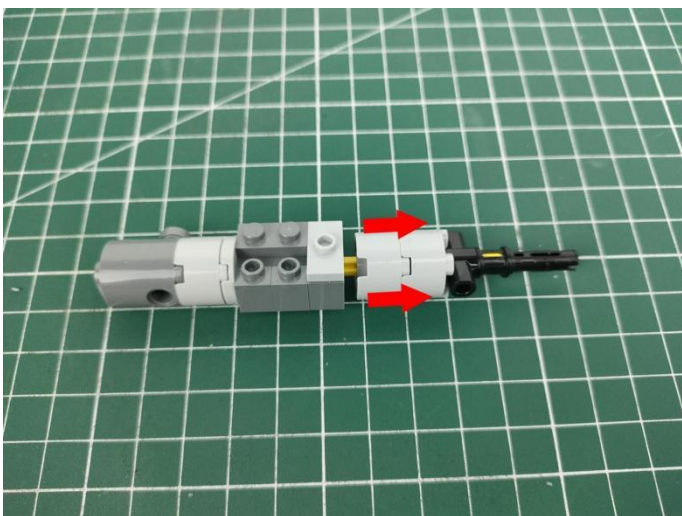



55

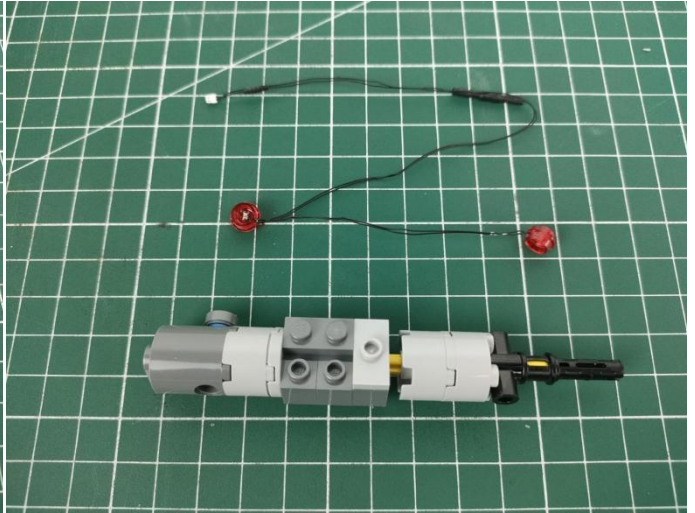
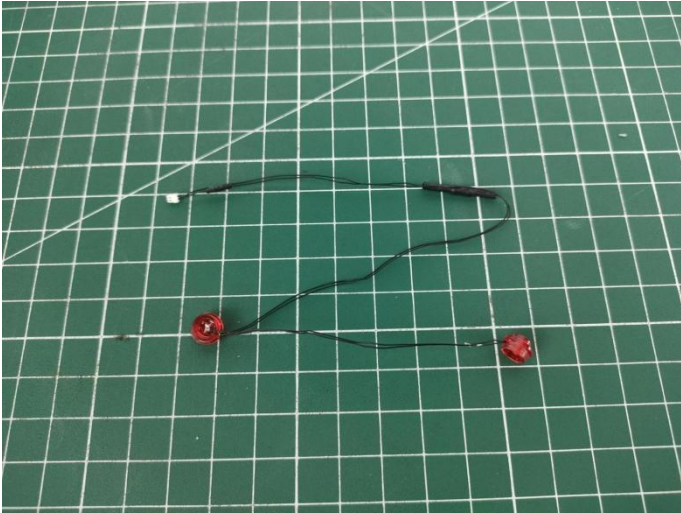

56

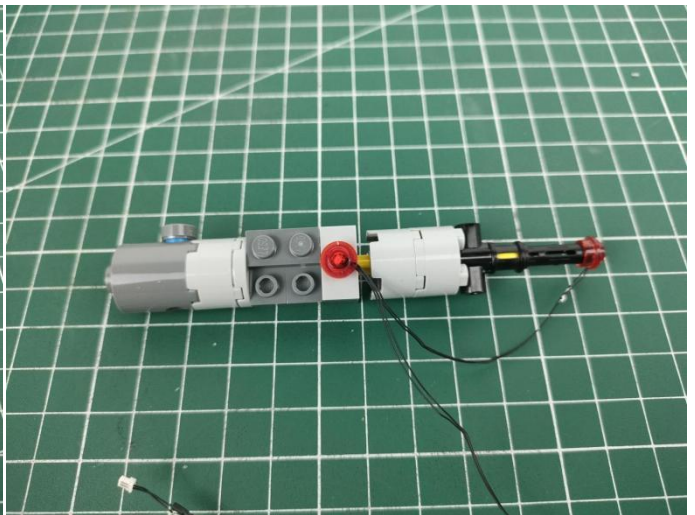
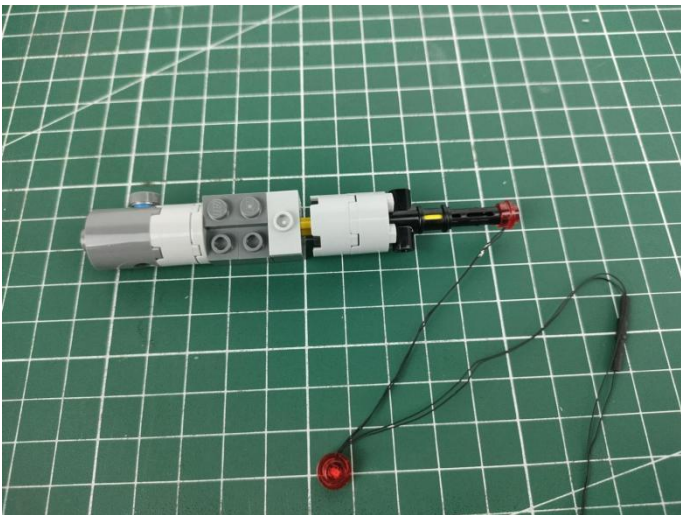

57

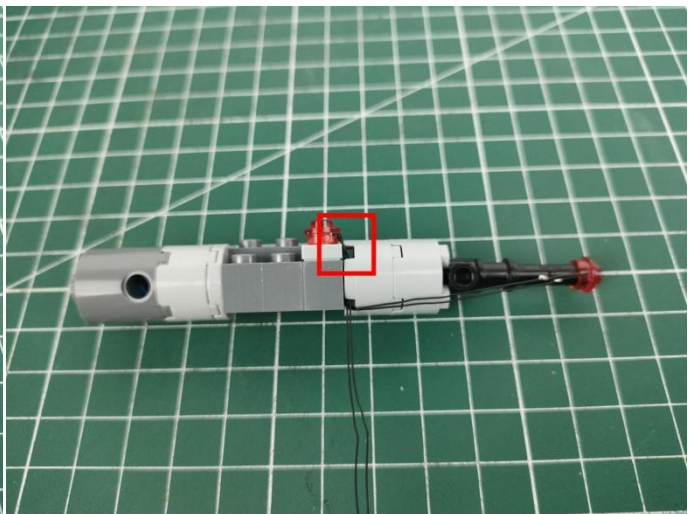
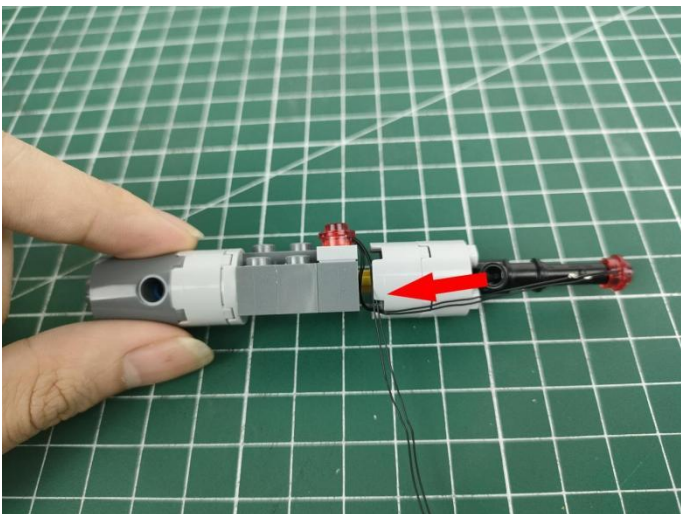

58

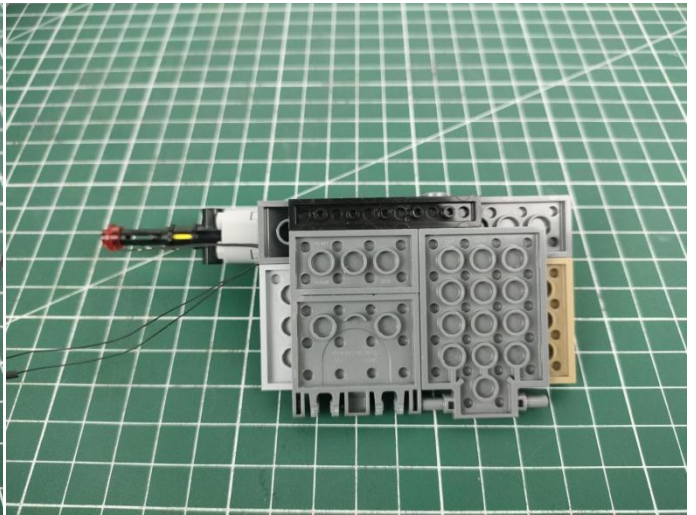
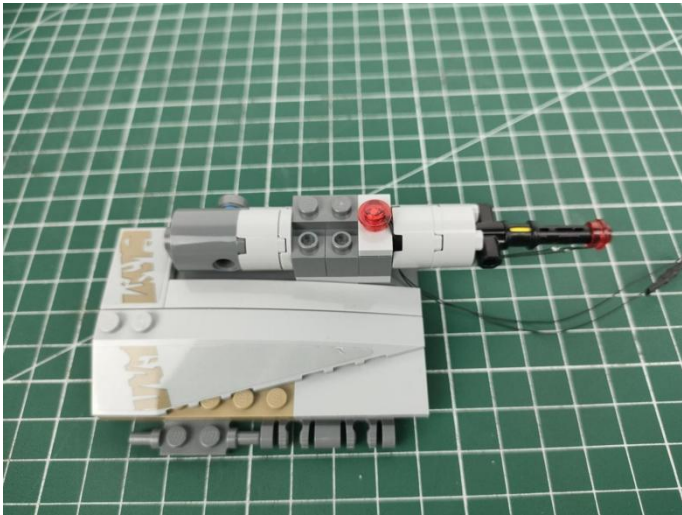

59

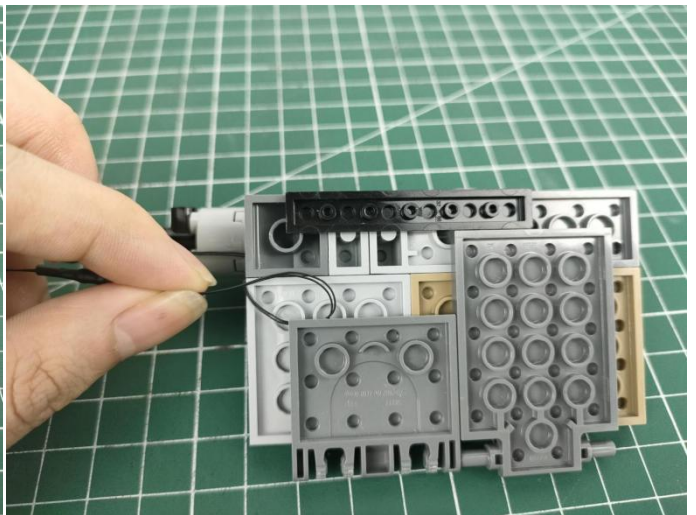
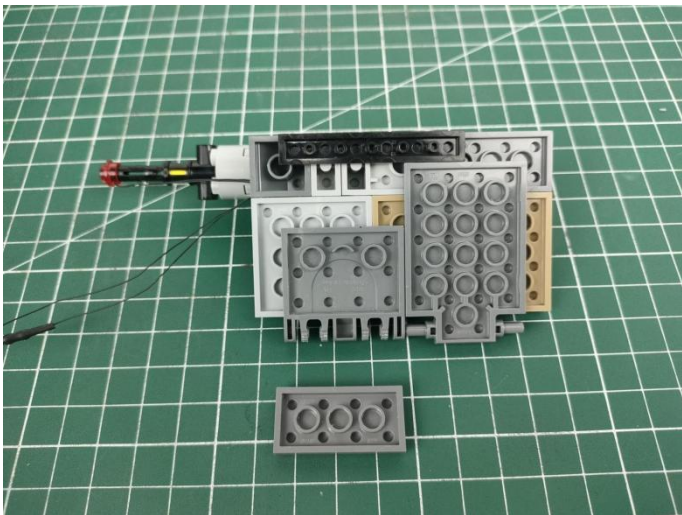

60

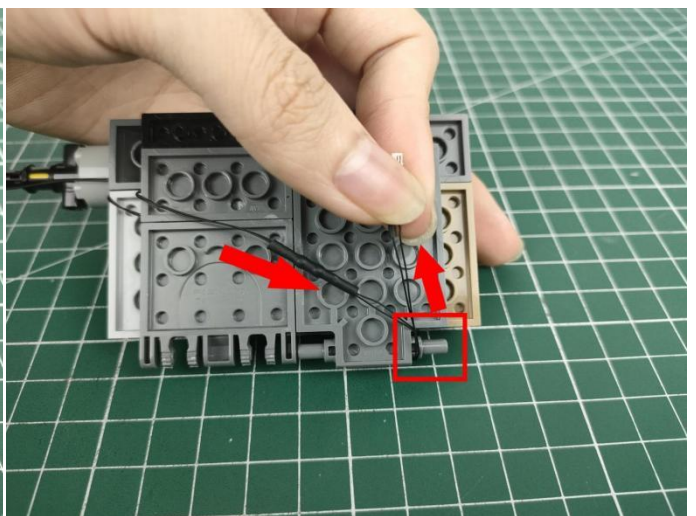
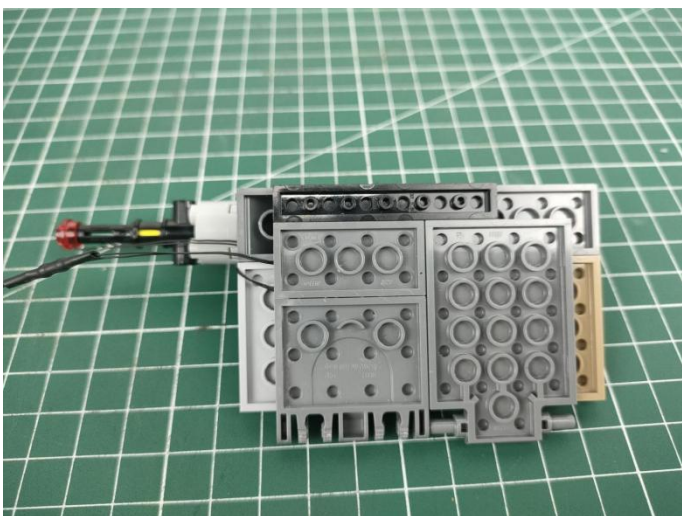

61

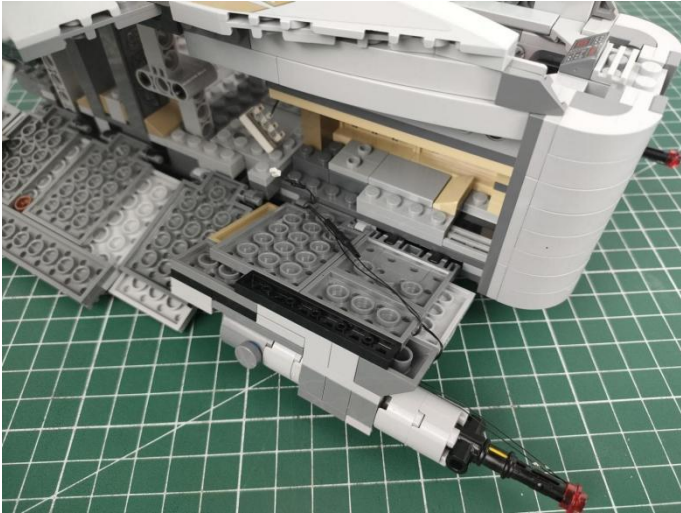

62

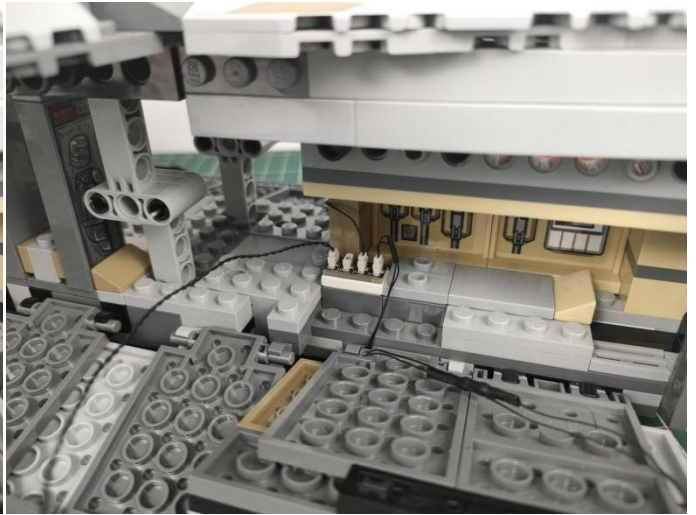

63

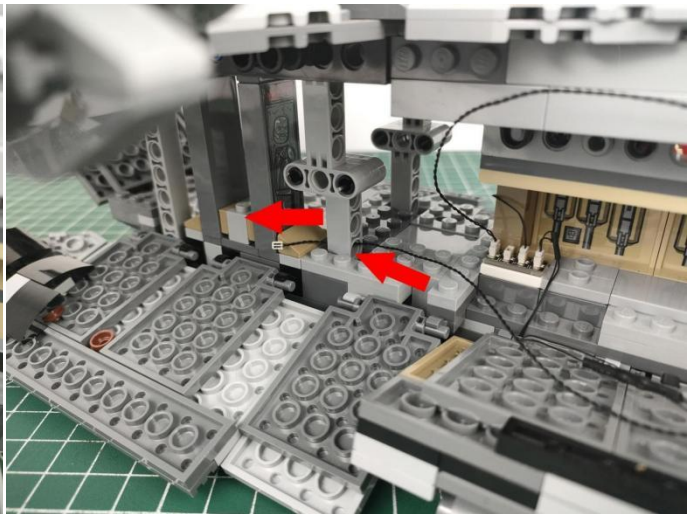
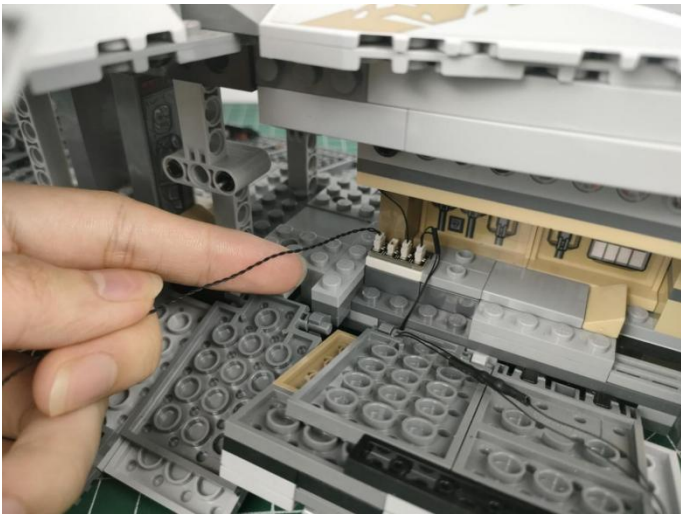

64



65

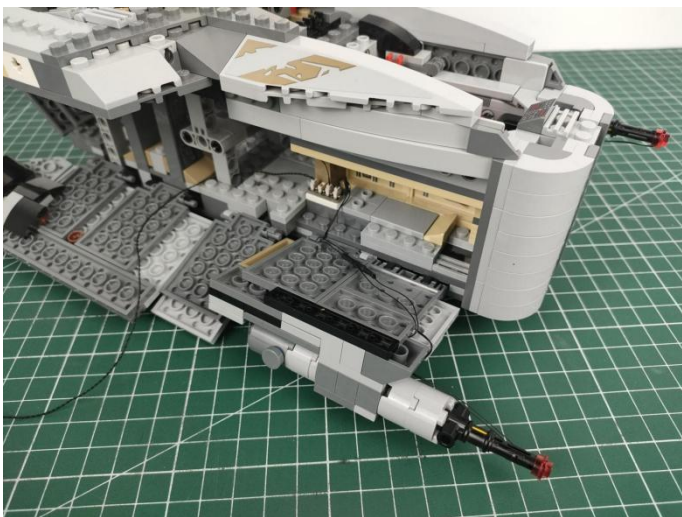

66

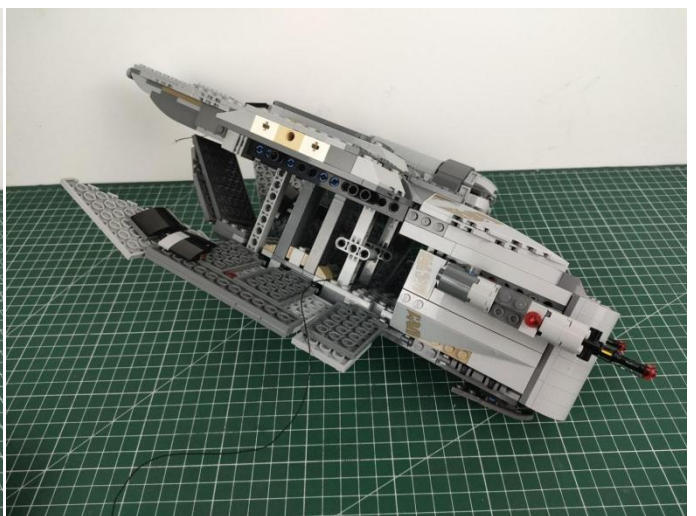

67

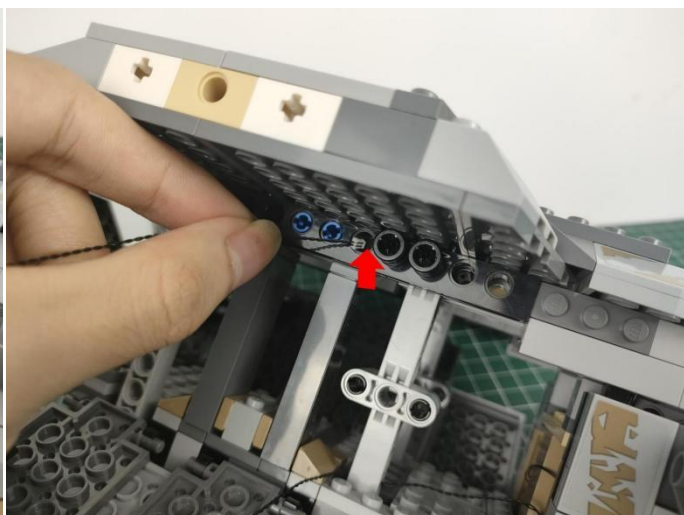
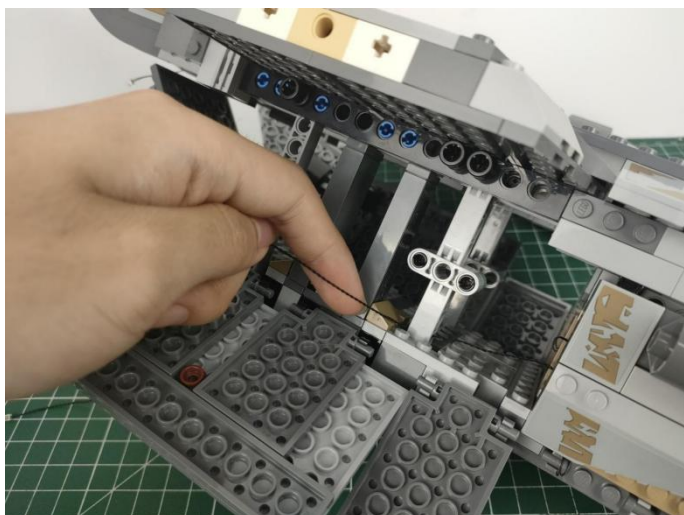

68

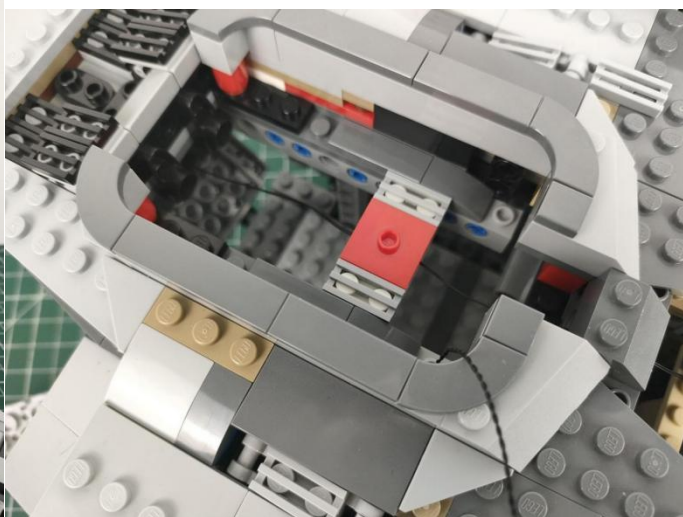
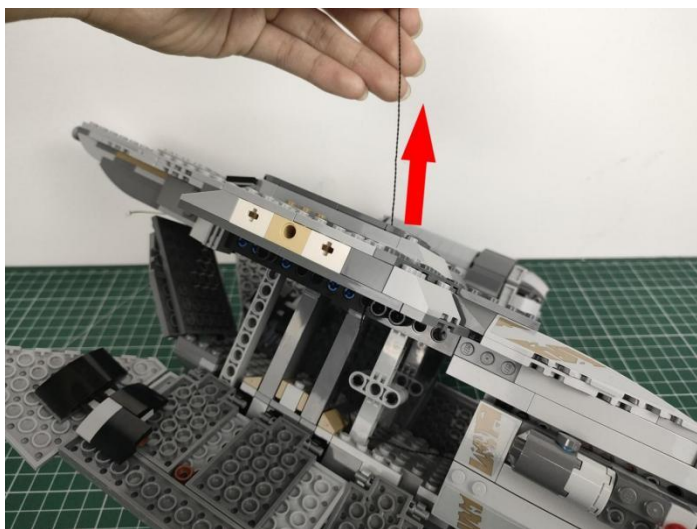

69

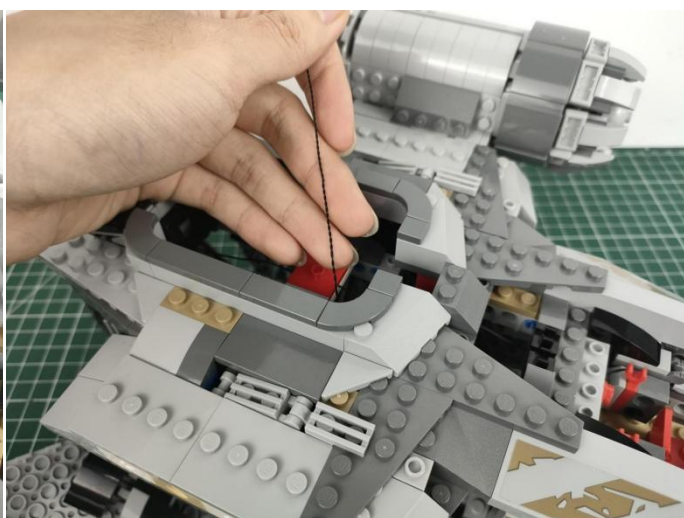
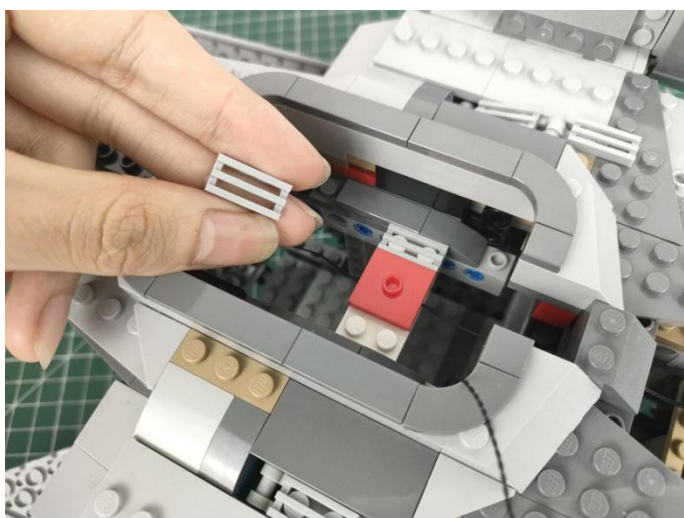

70

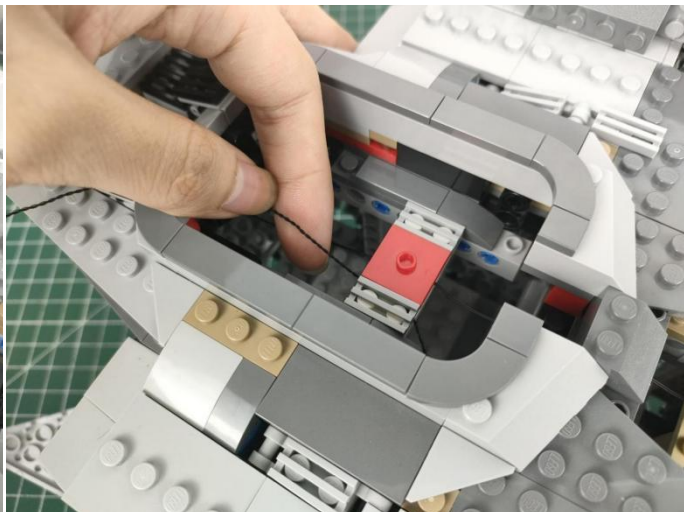
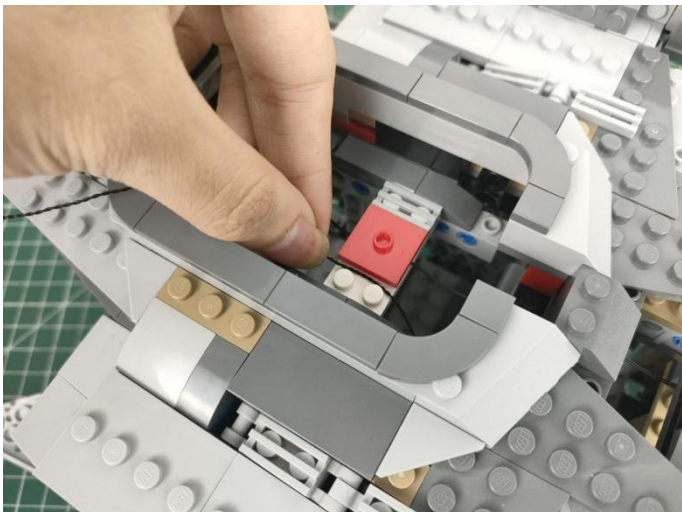

71

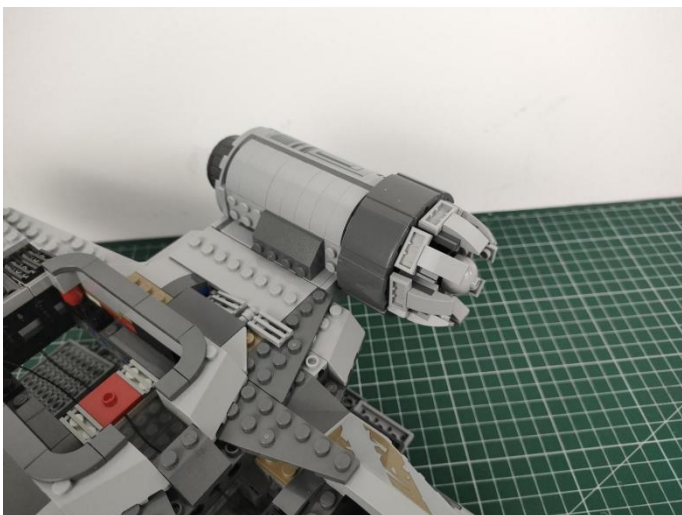

72



73

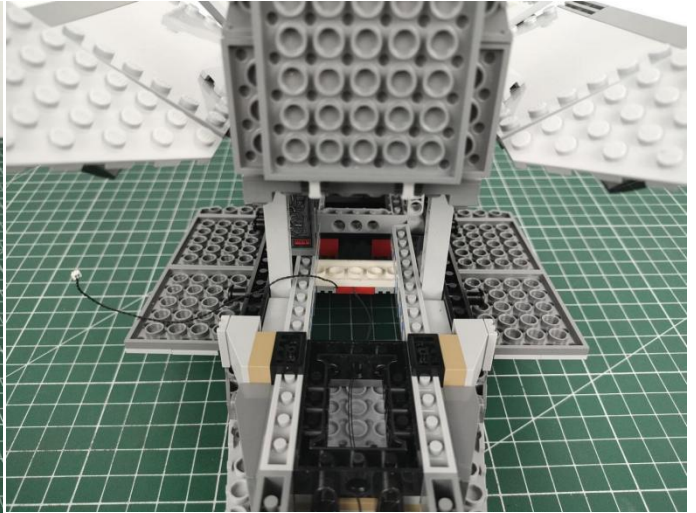
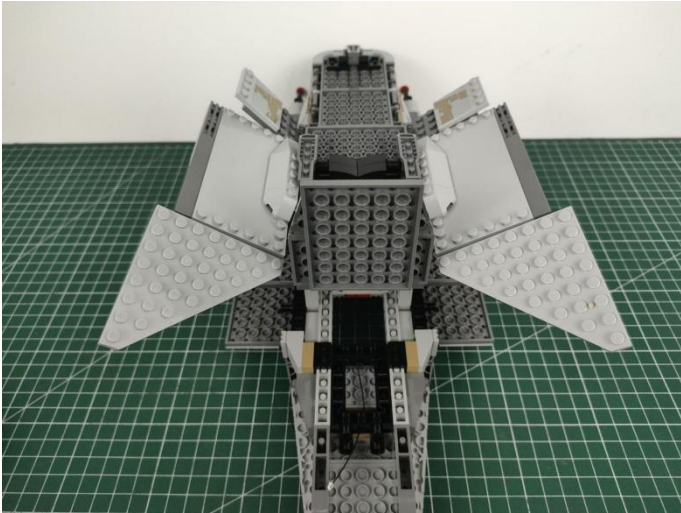

74

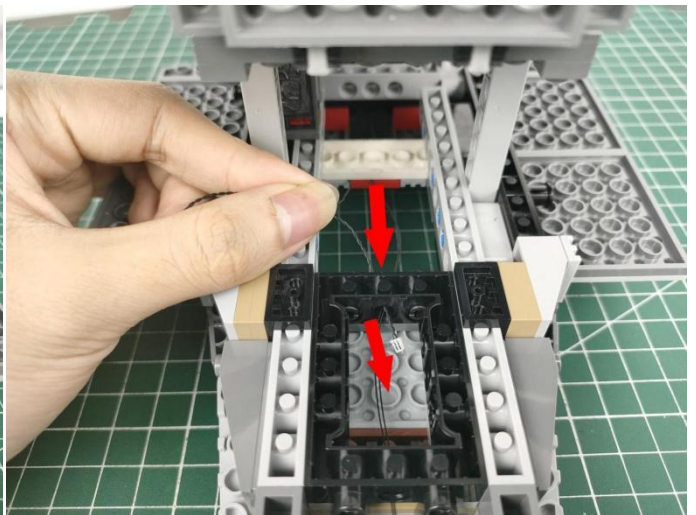
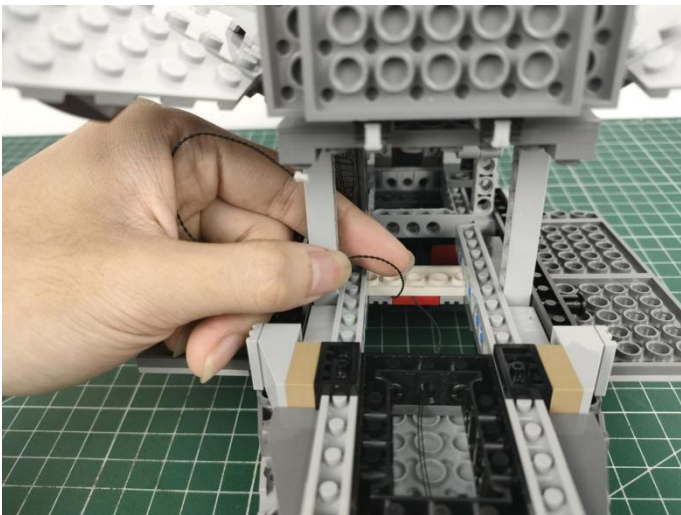

75

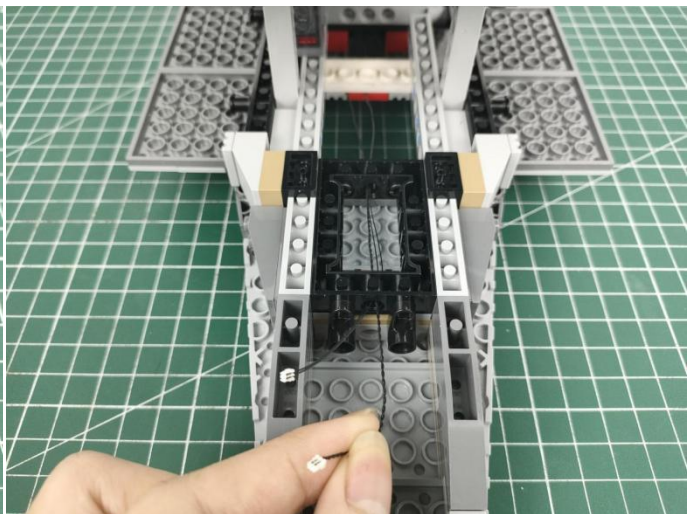
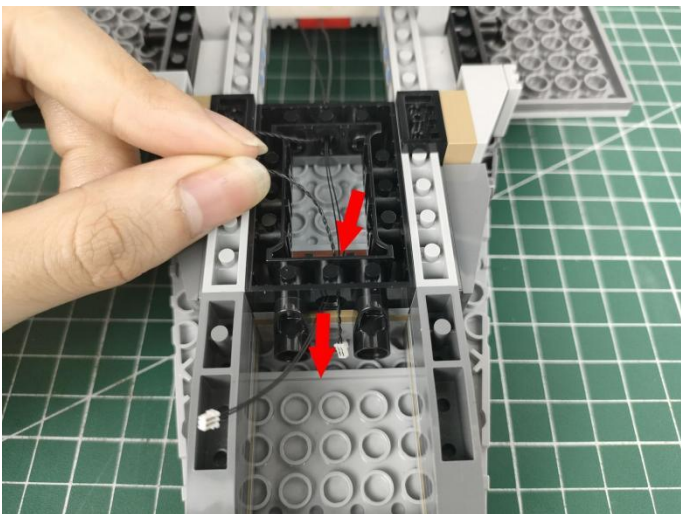

76

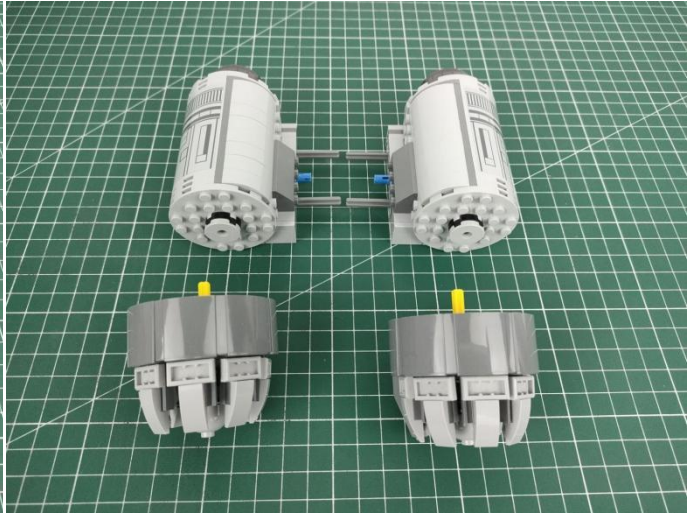
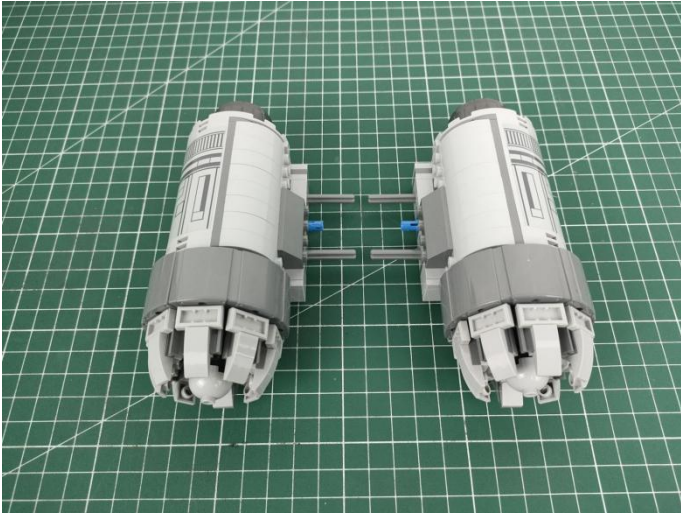

77



78

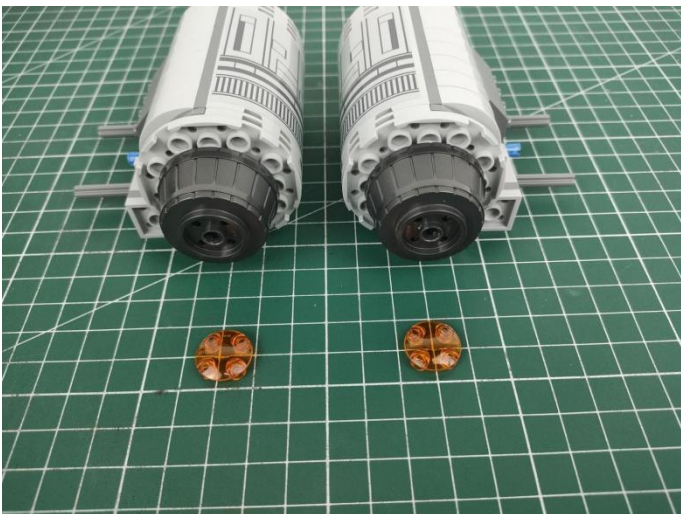



79

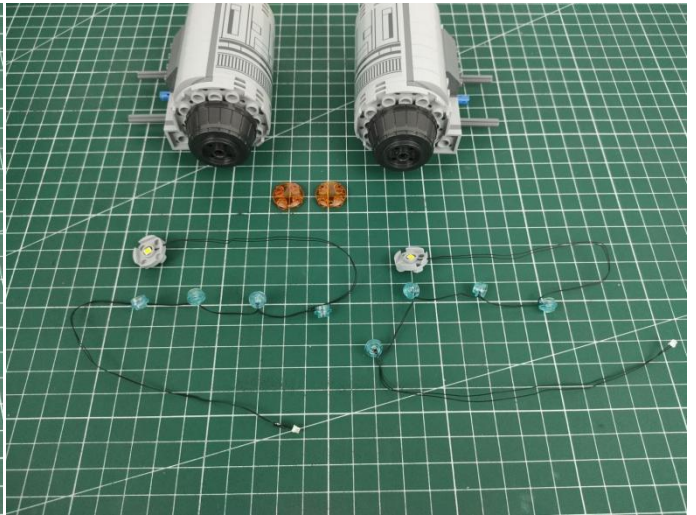
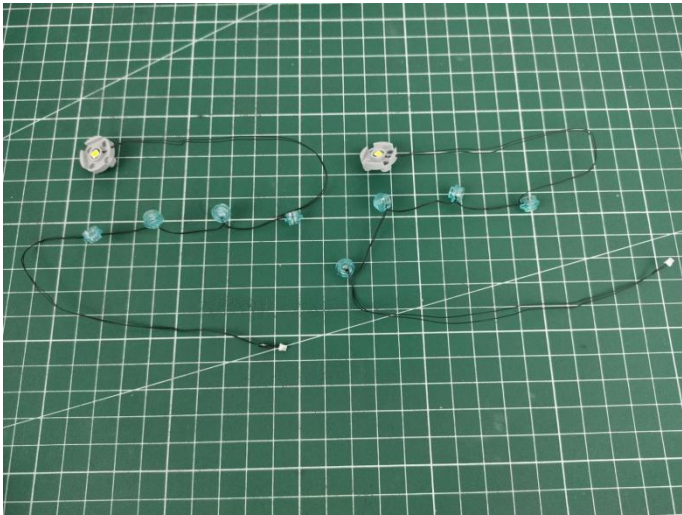

80

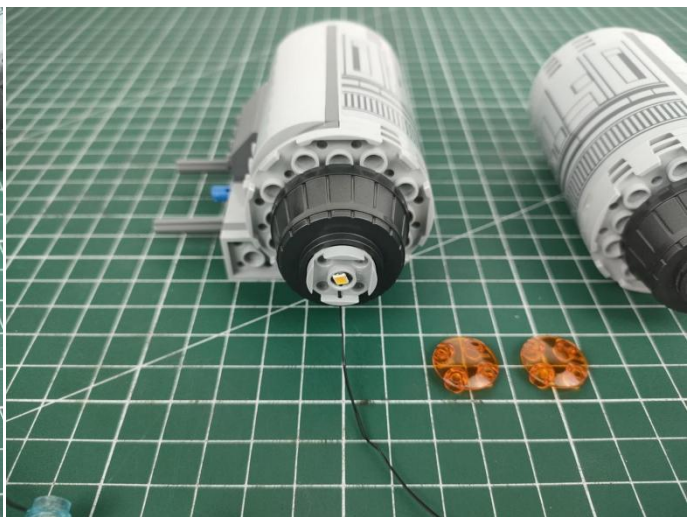

81

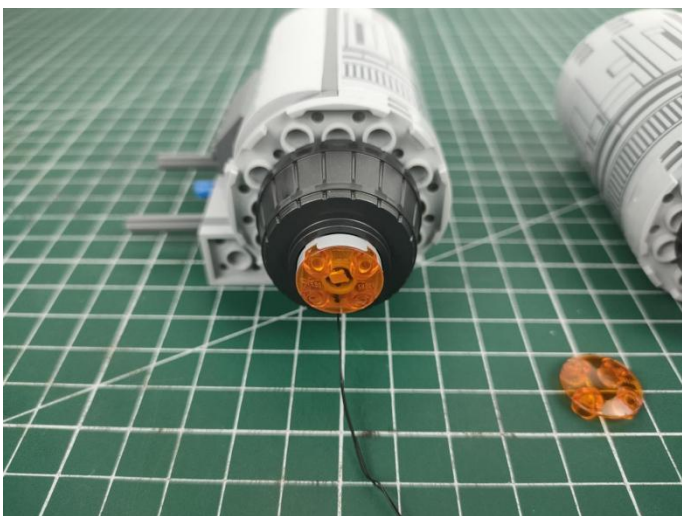

82

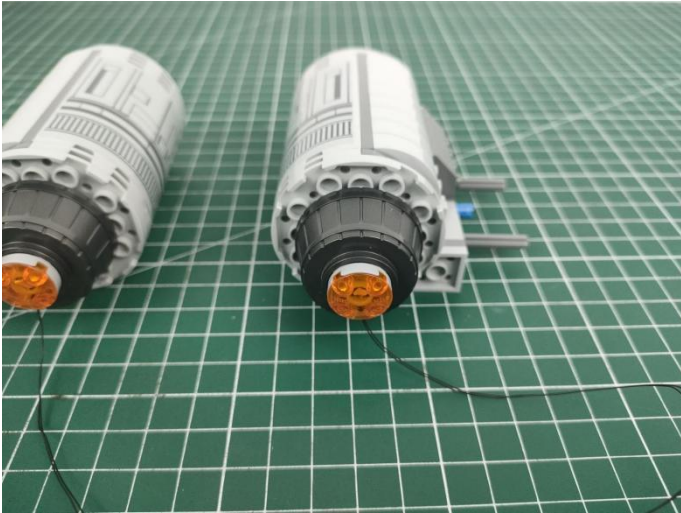

83

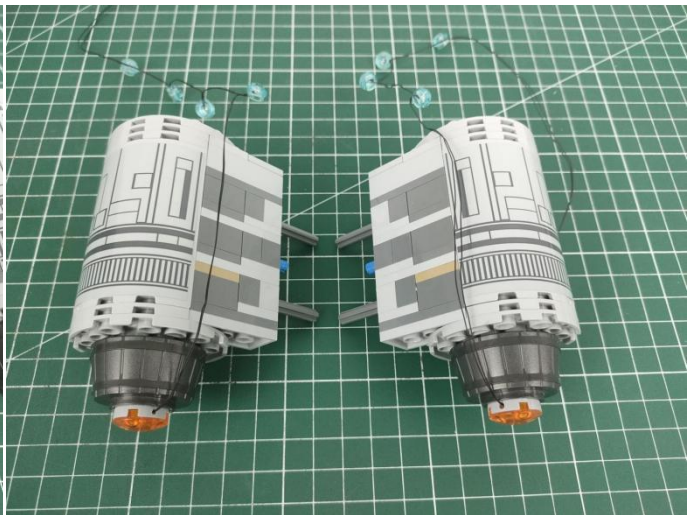
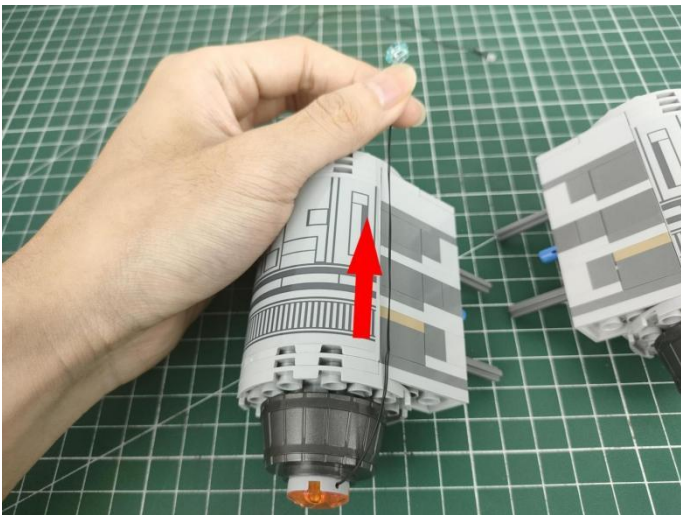

84

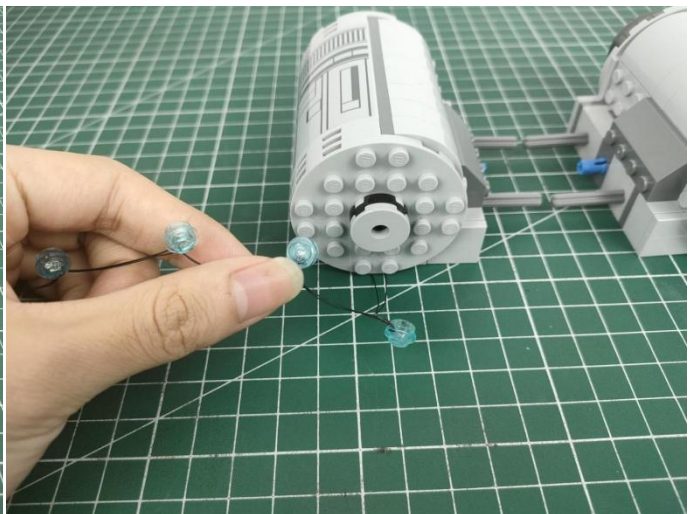
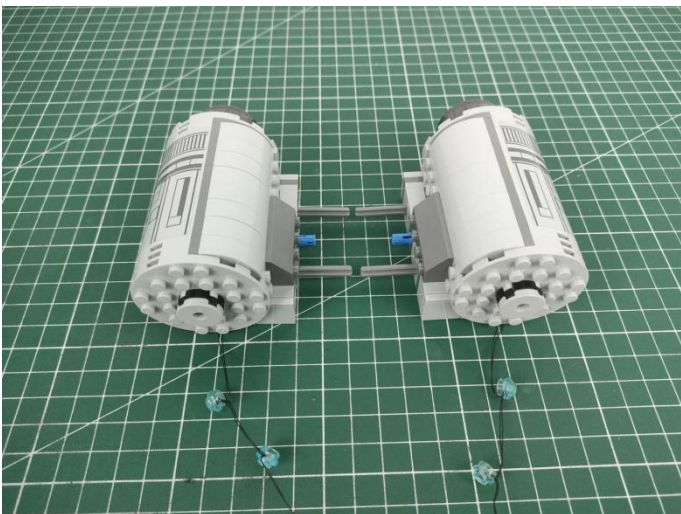

85

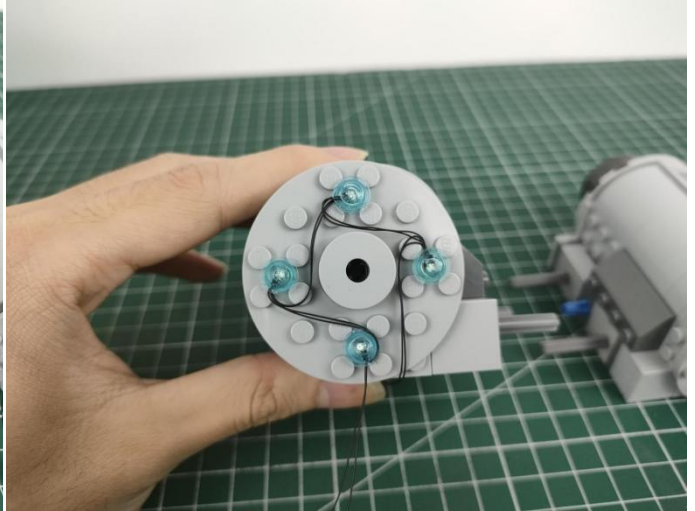
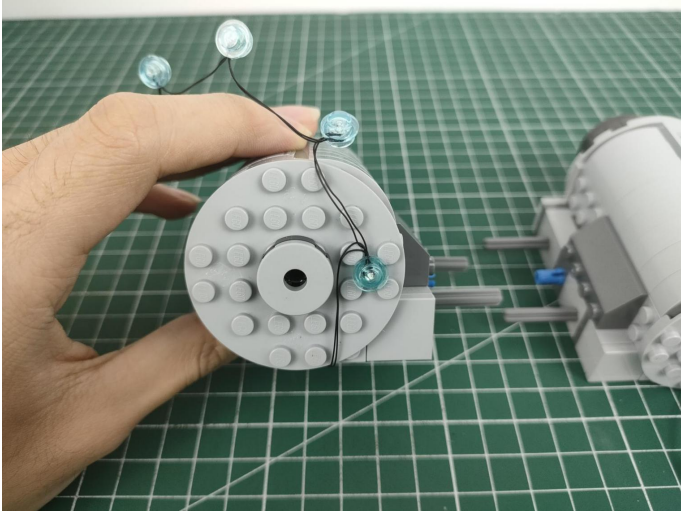

86

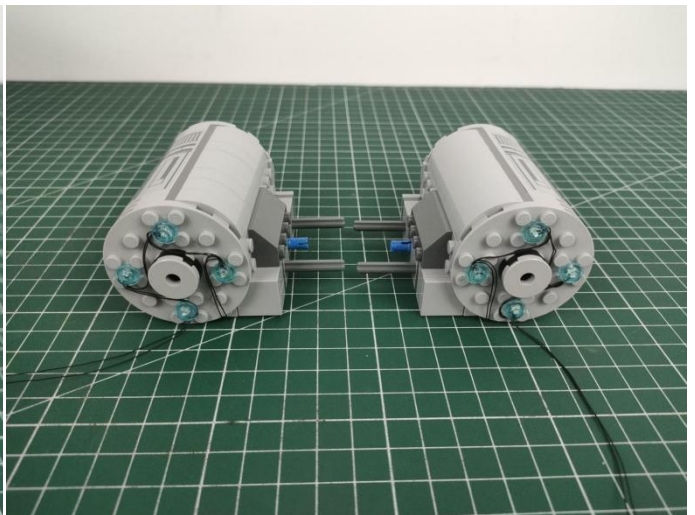
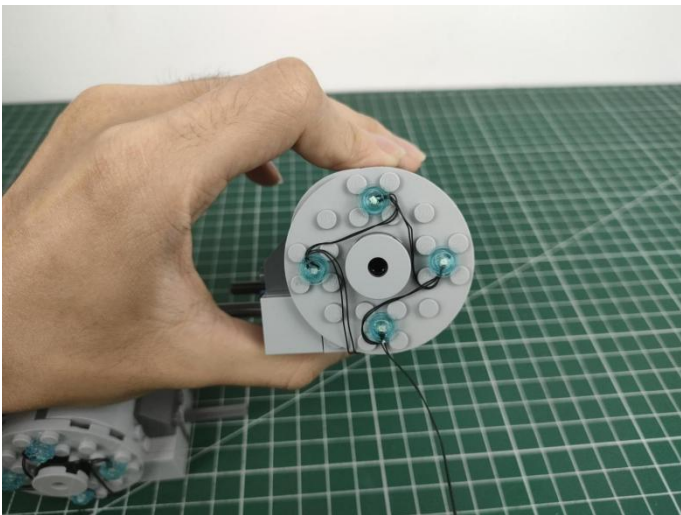

87

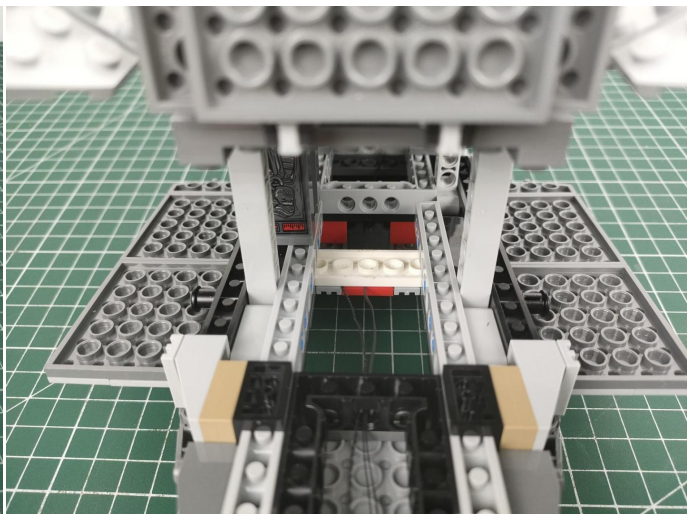
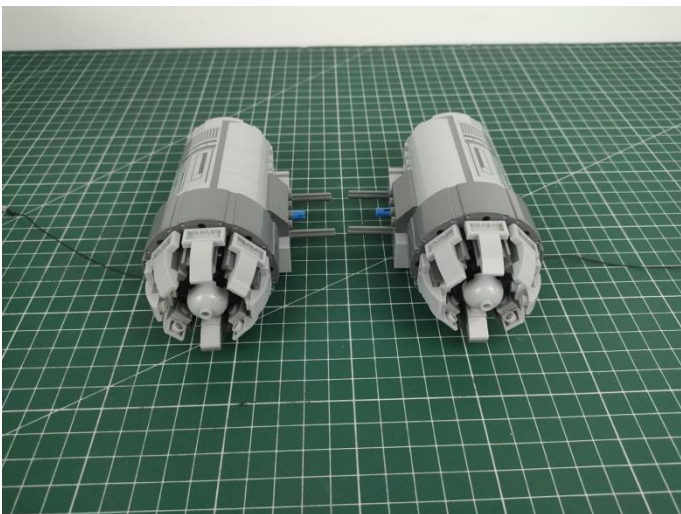

88

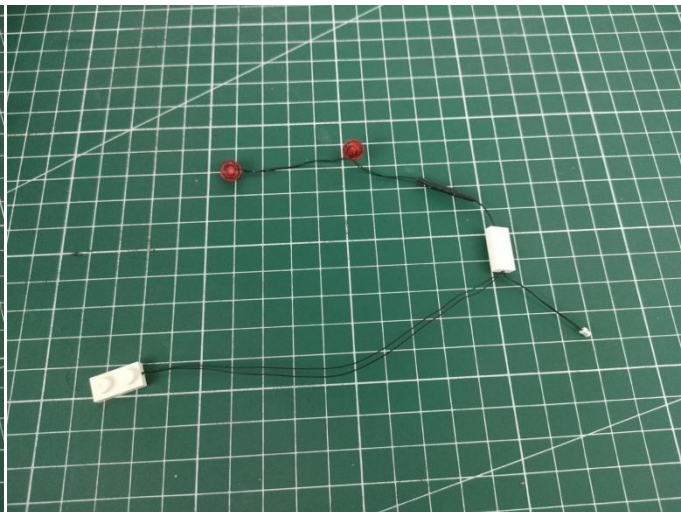

89

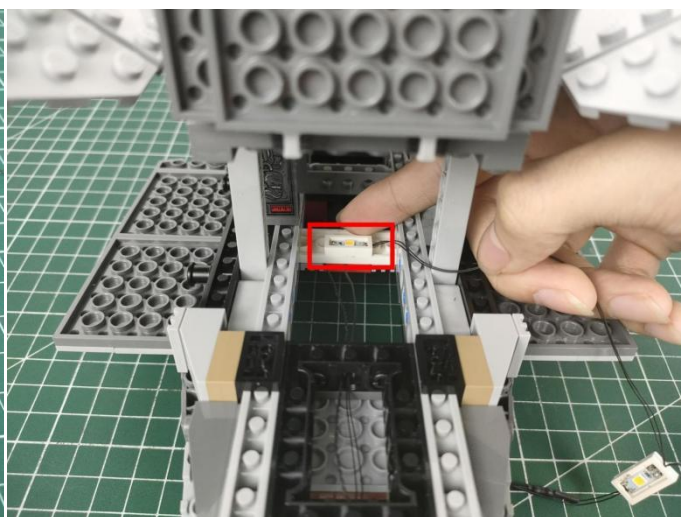

90

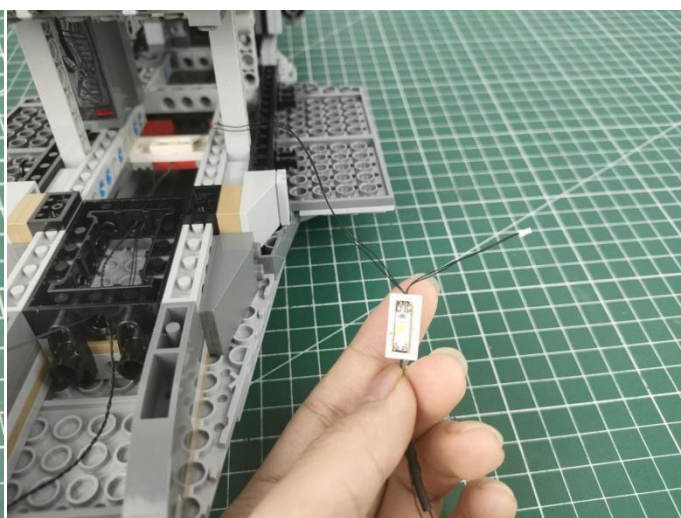
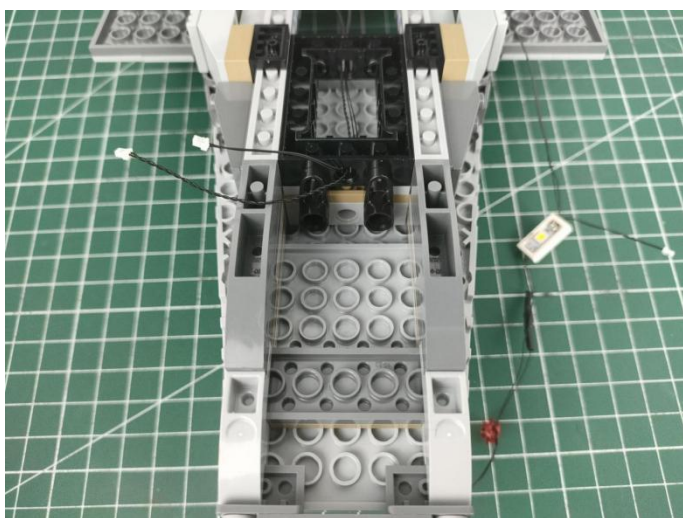

91

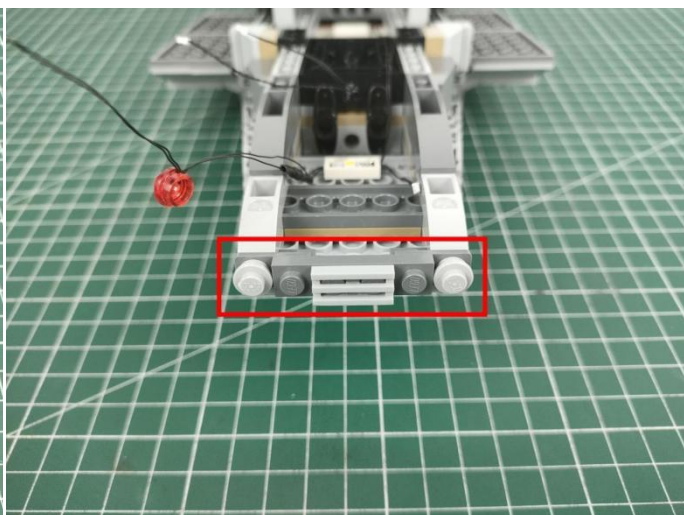
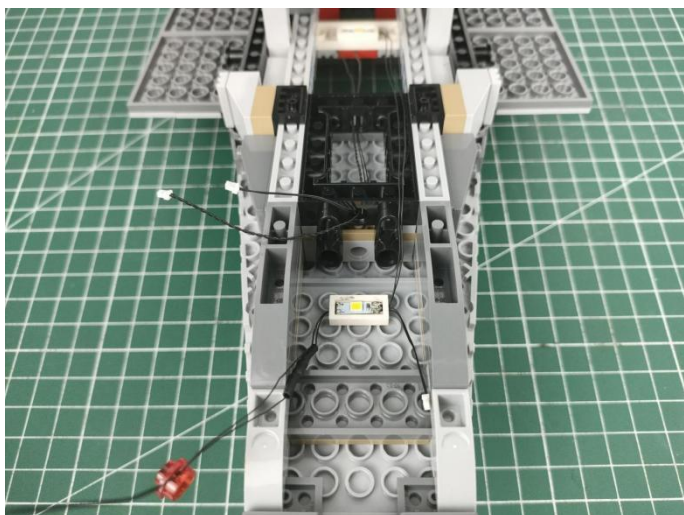

92

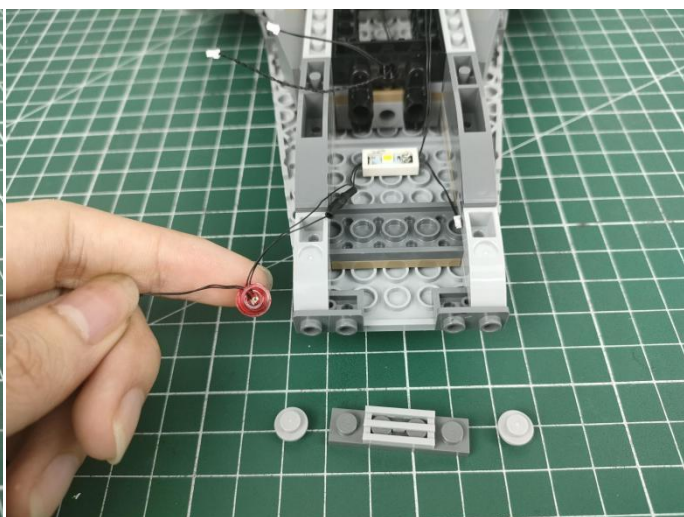
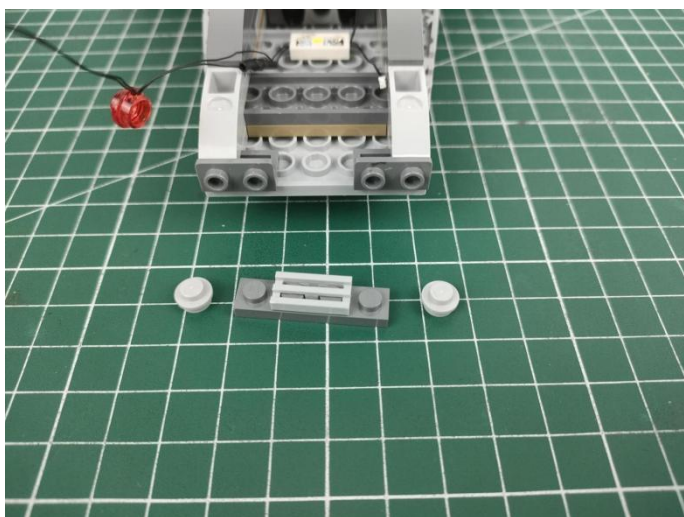

93

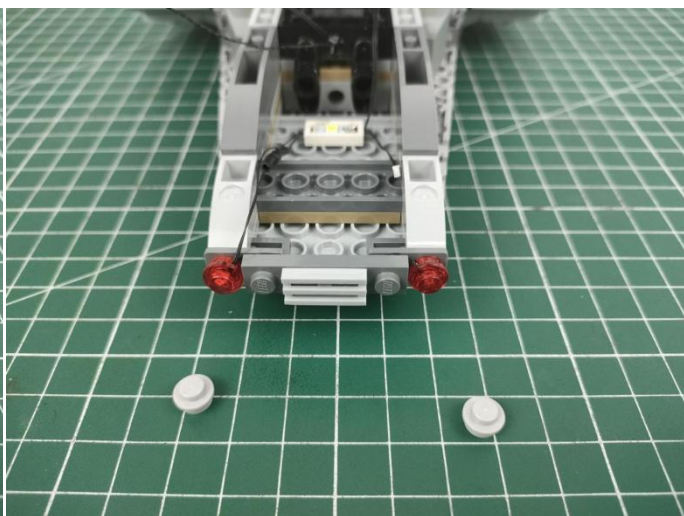
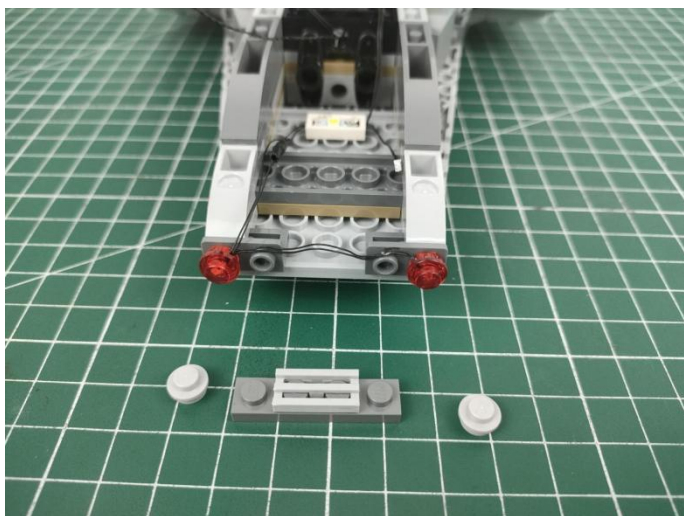

94

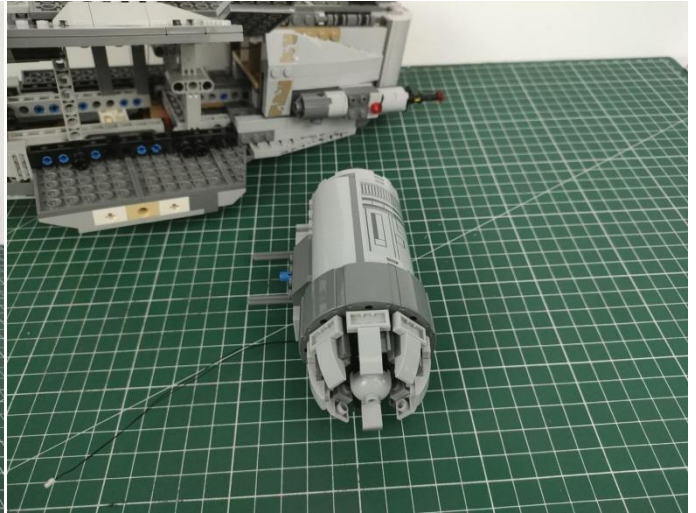

95

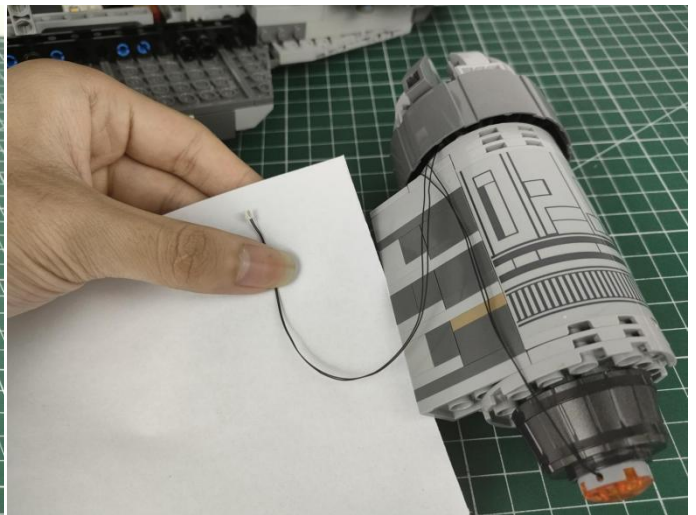
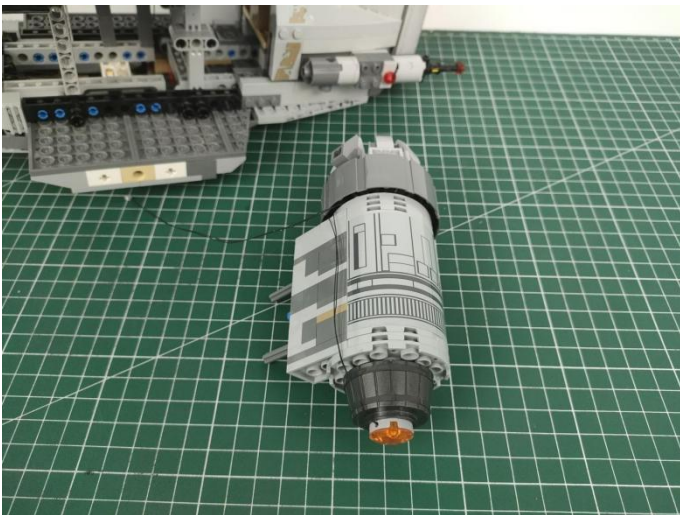

96

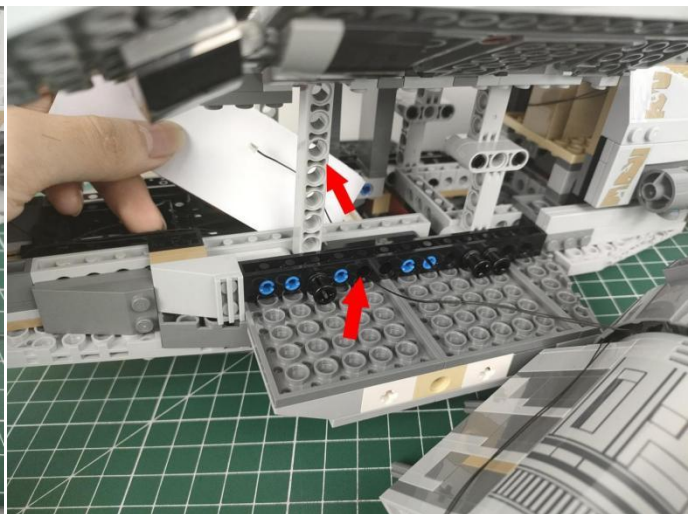
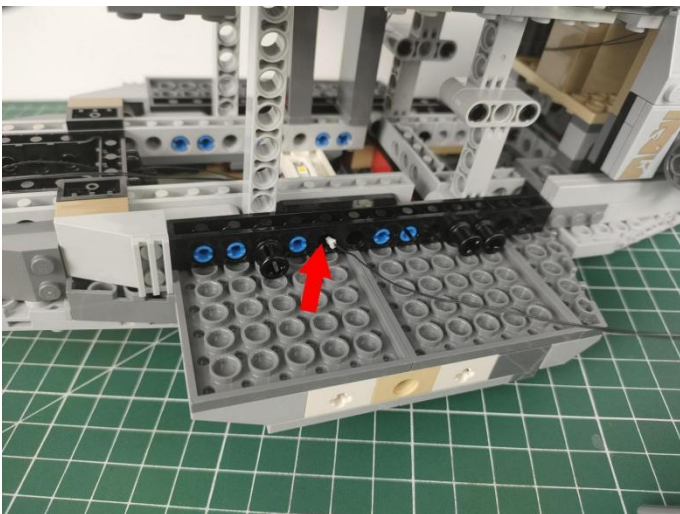

97



98

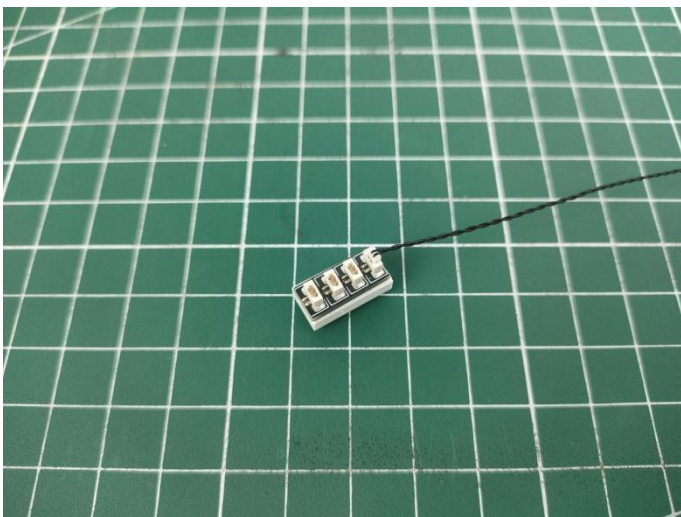

99

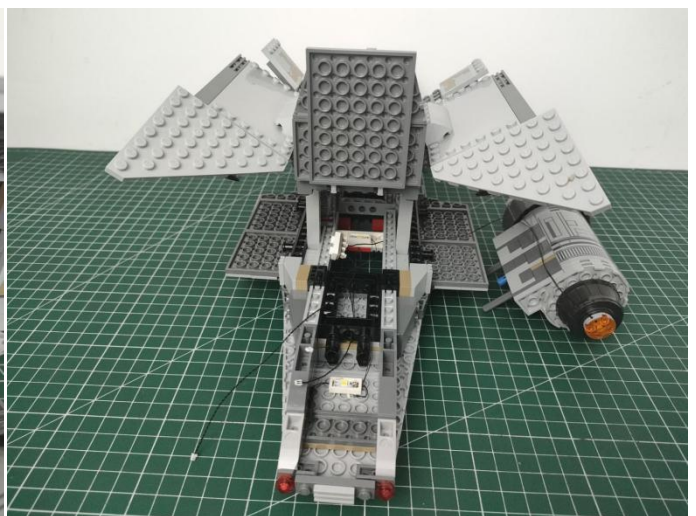
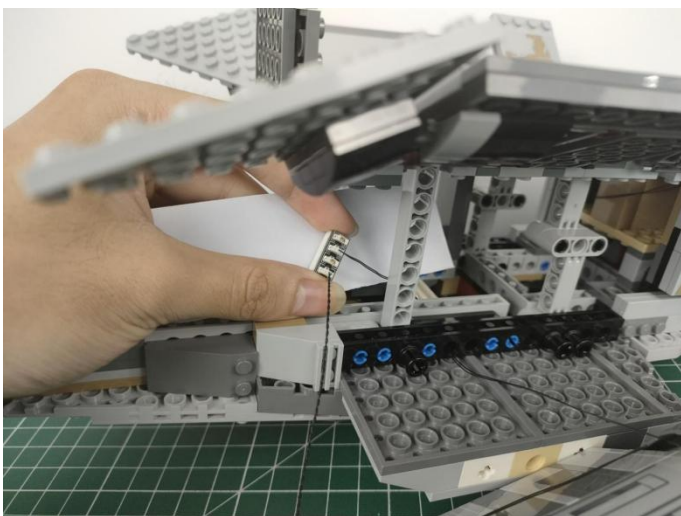

100

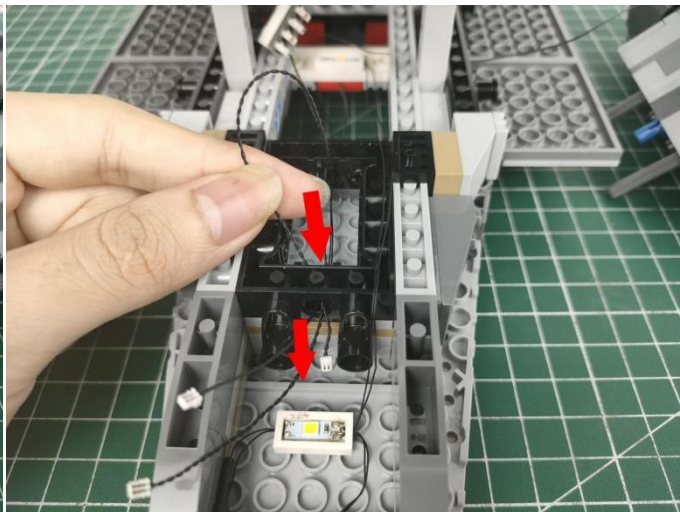
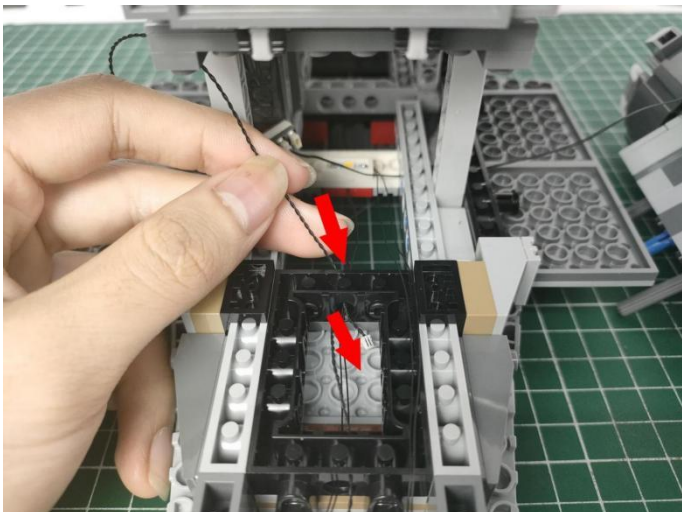

101

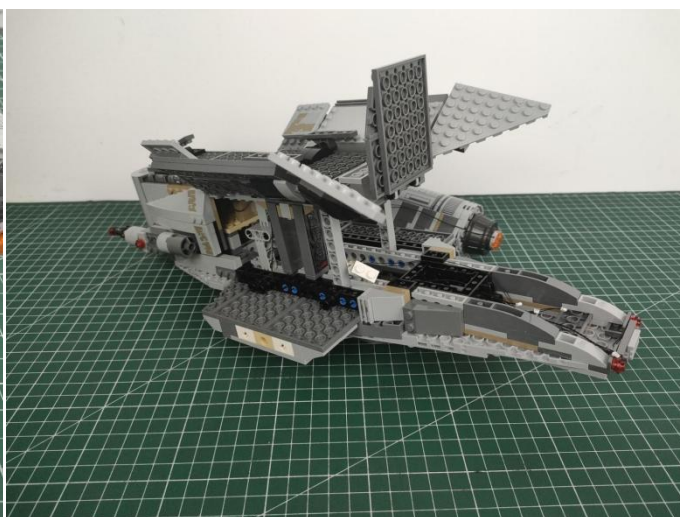
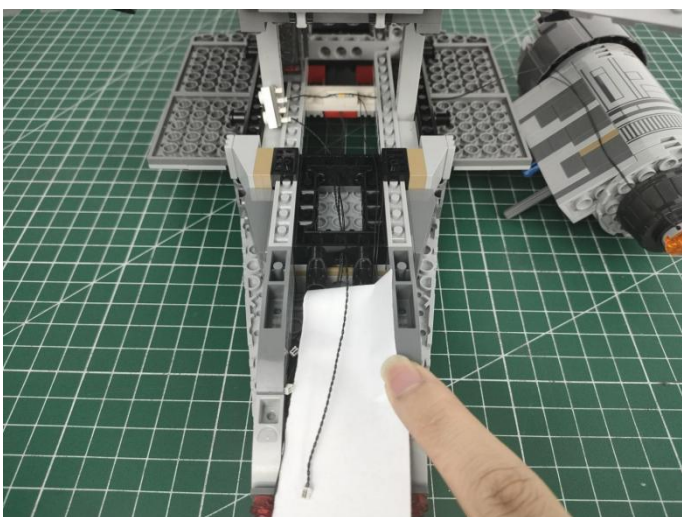

102

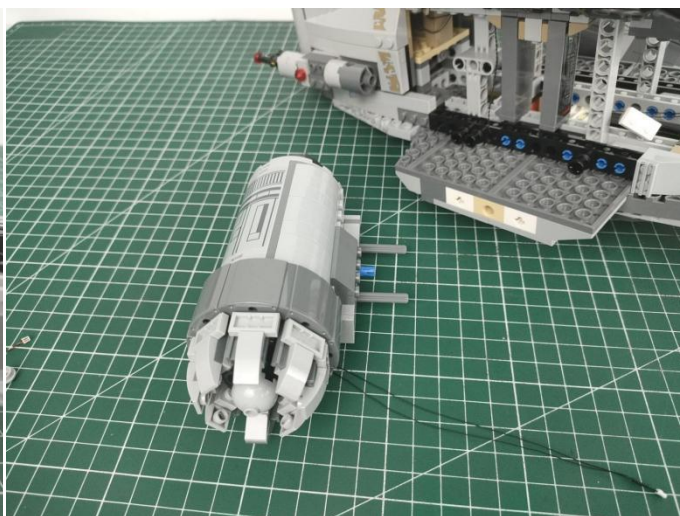
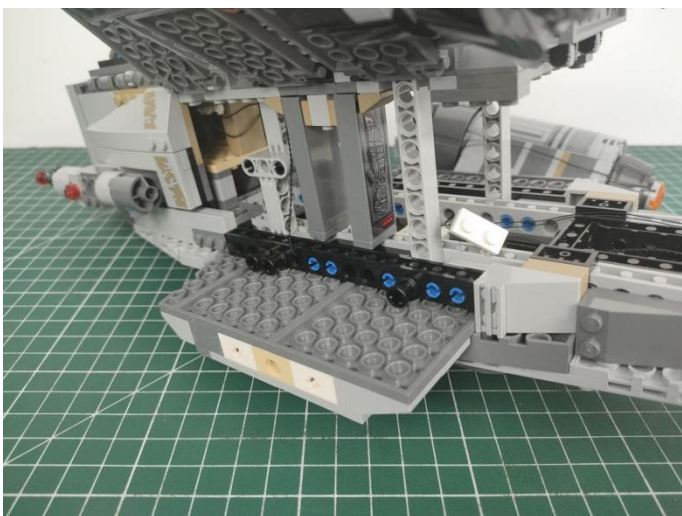



103

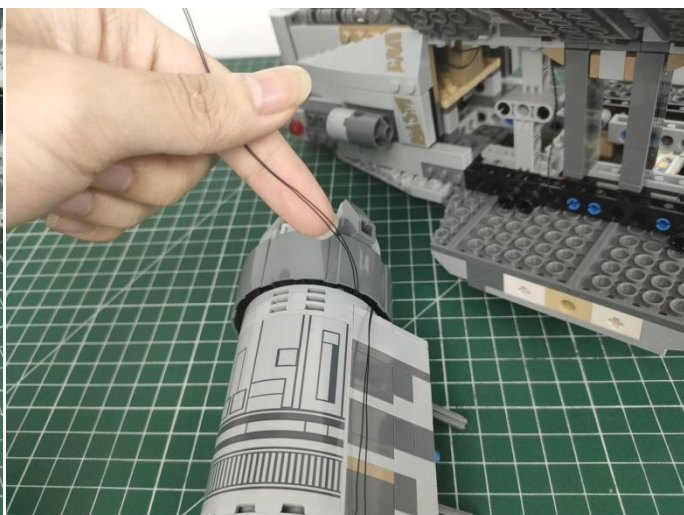
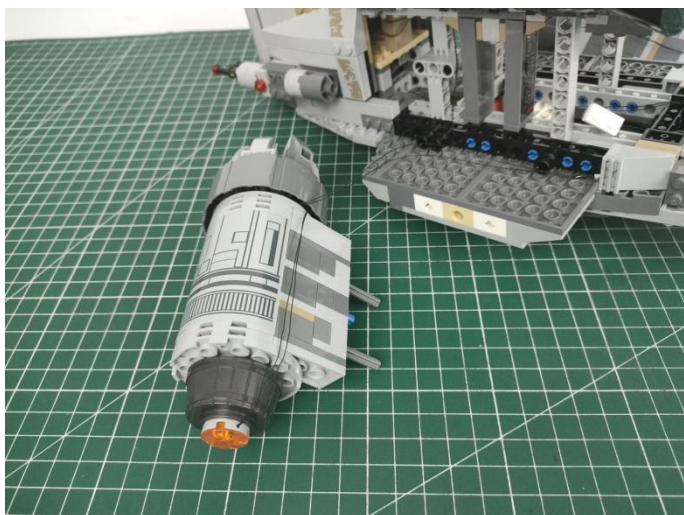

104

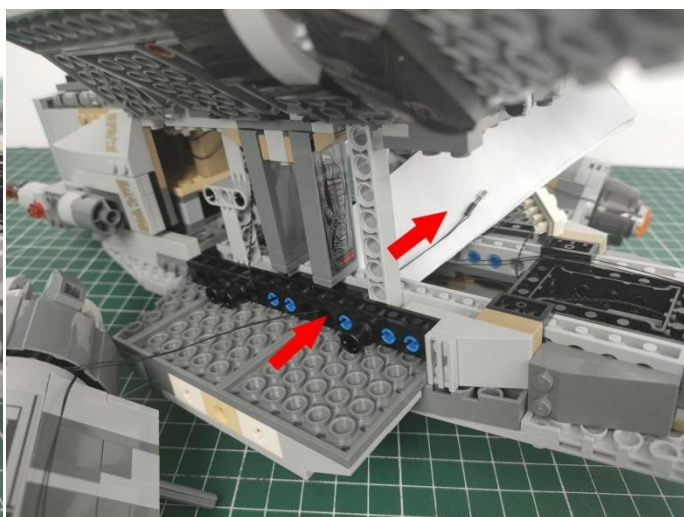
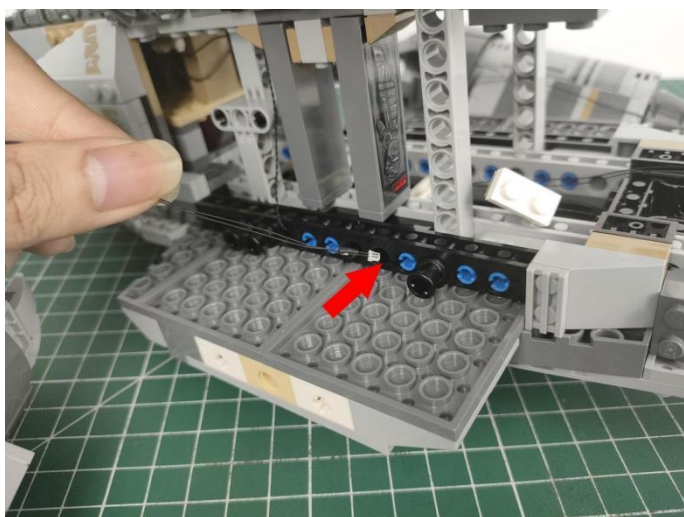

105

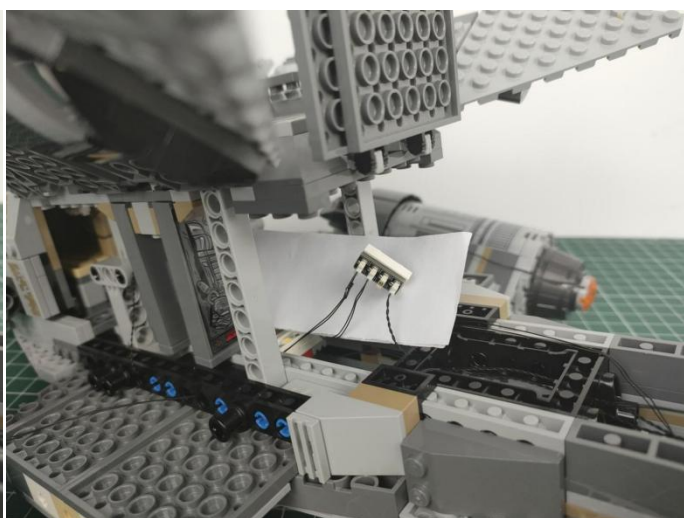

106

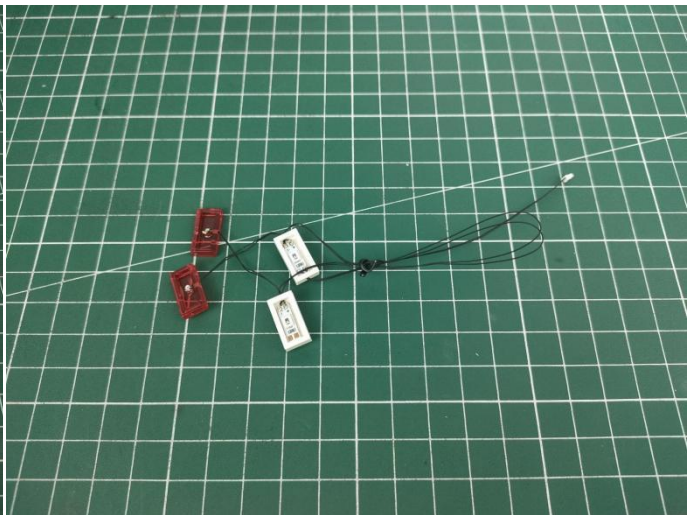

107

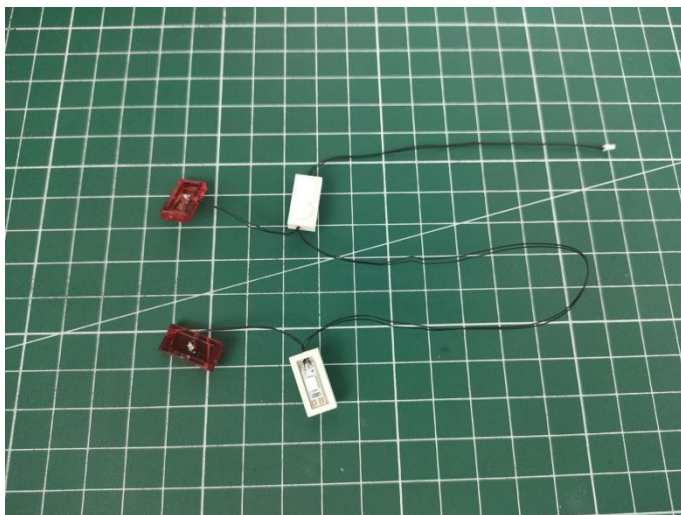

108

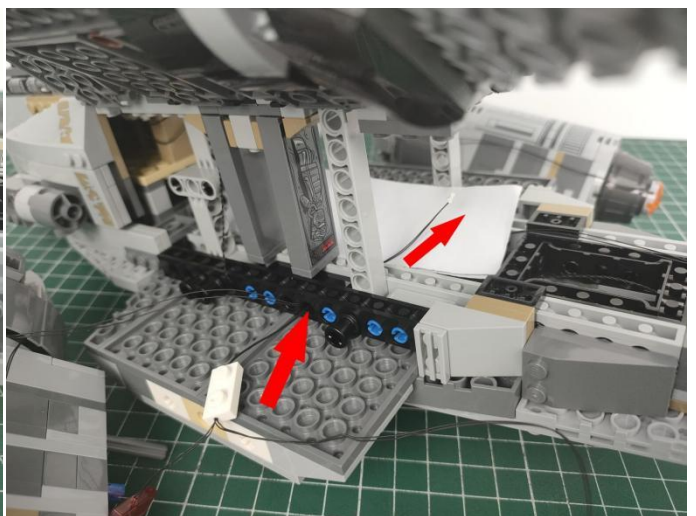
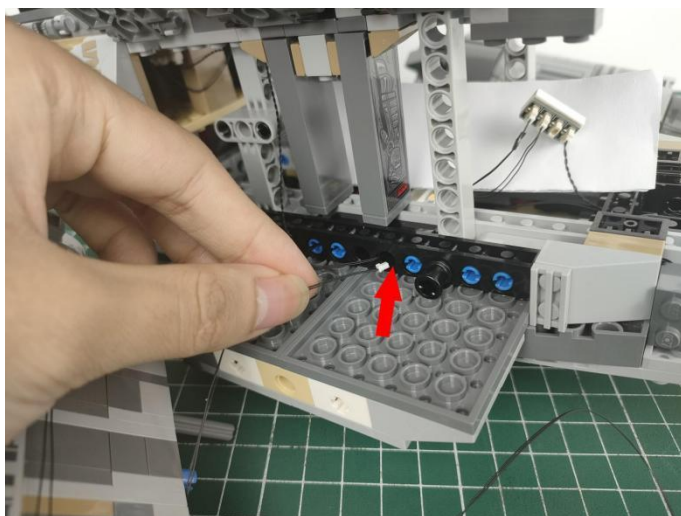

109

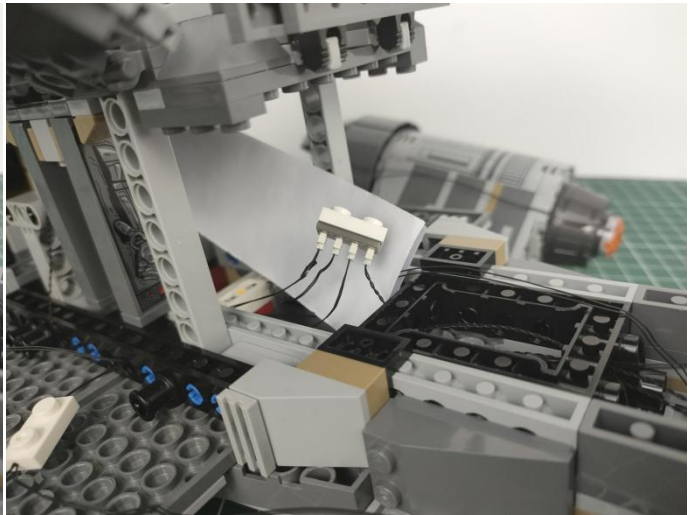
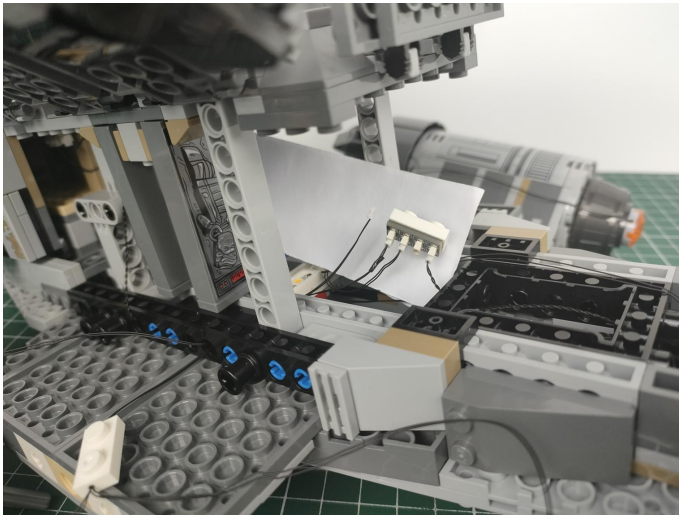

110

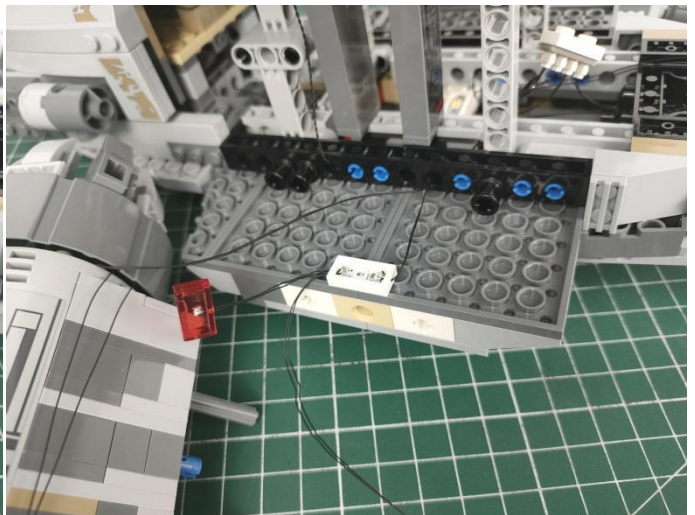
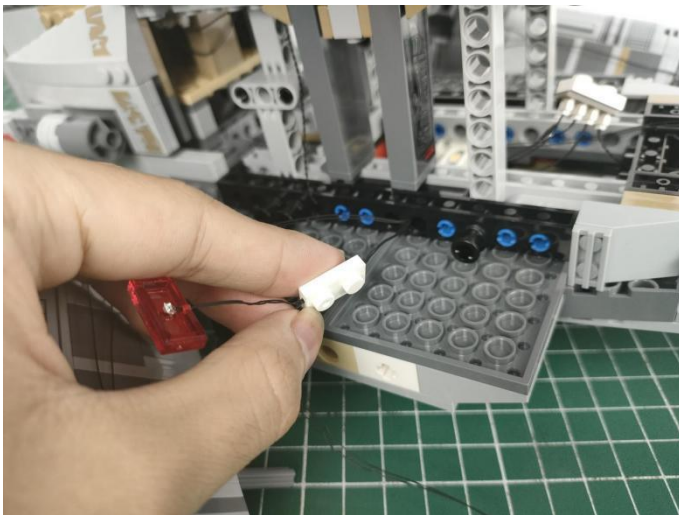

111

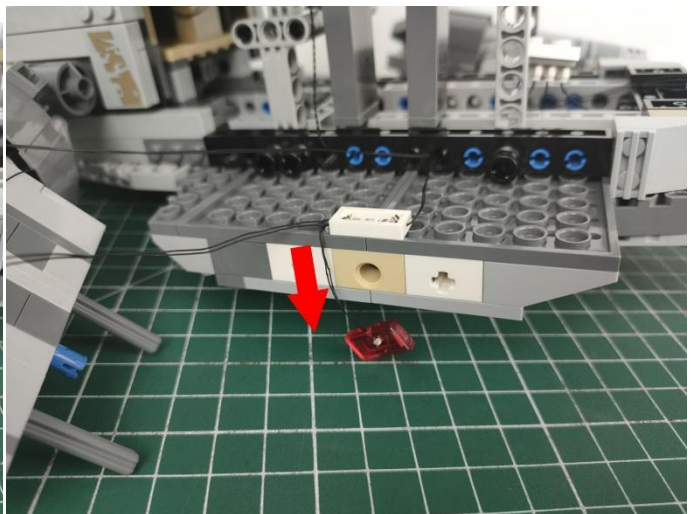
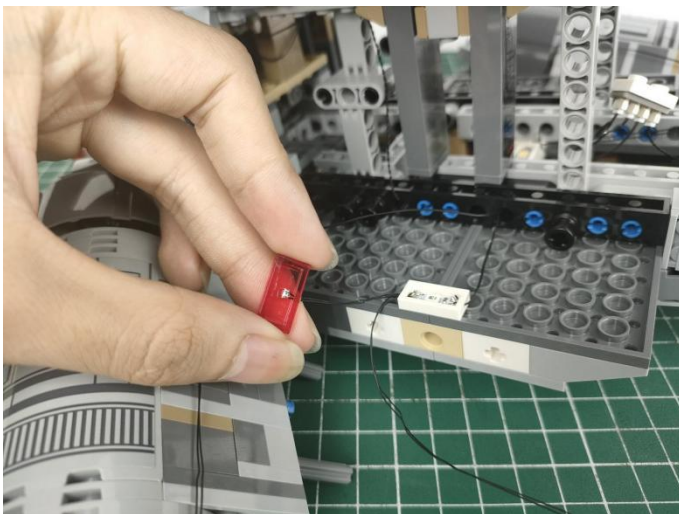

112

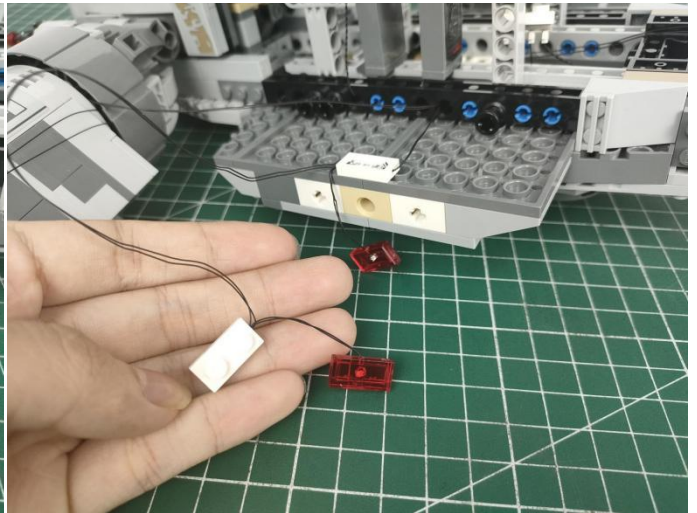

113

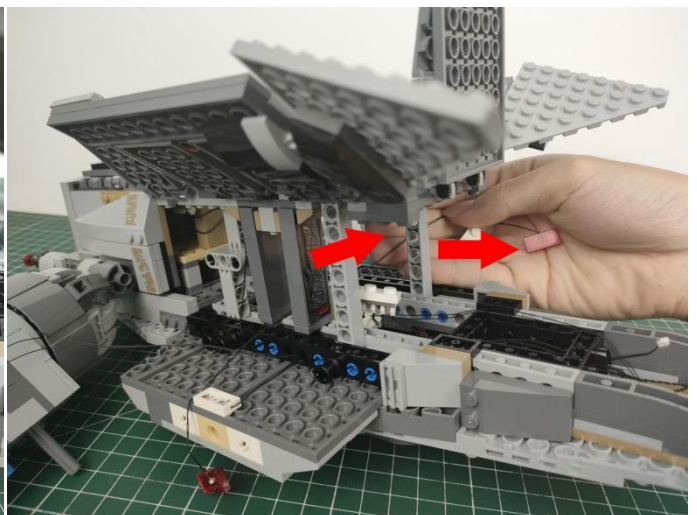
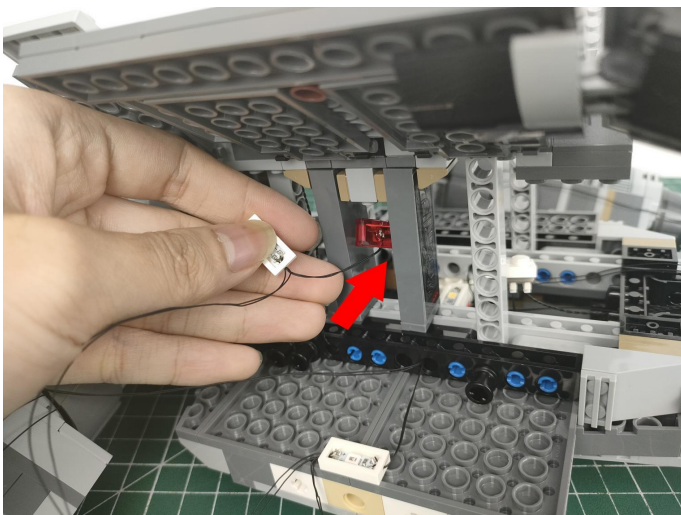

114

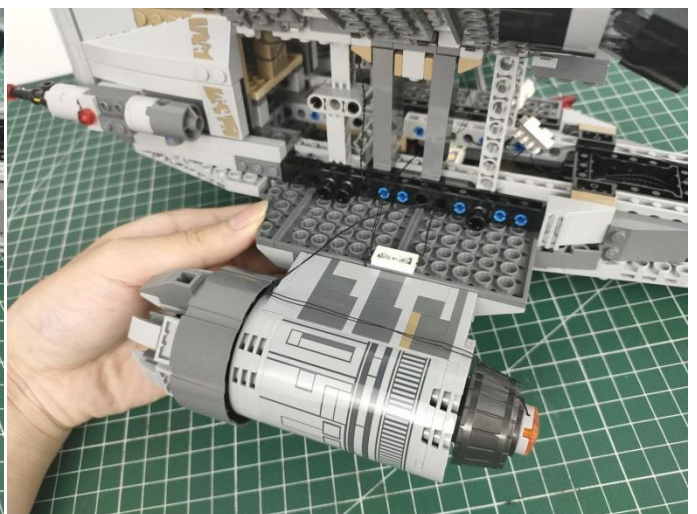
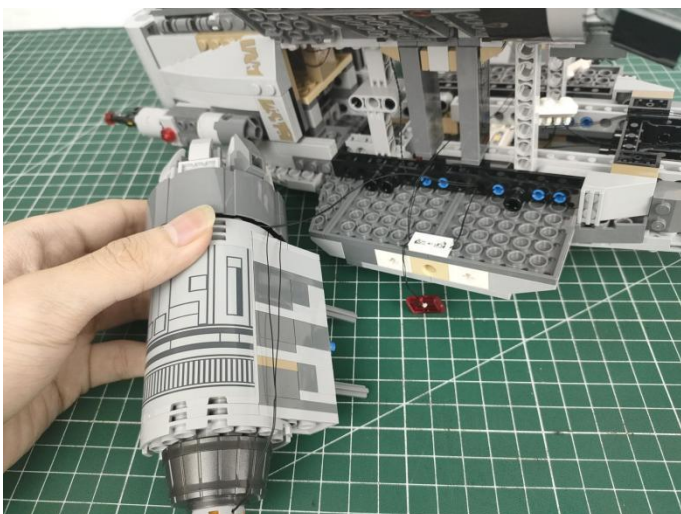

115

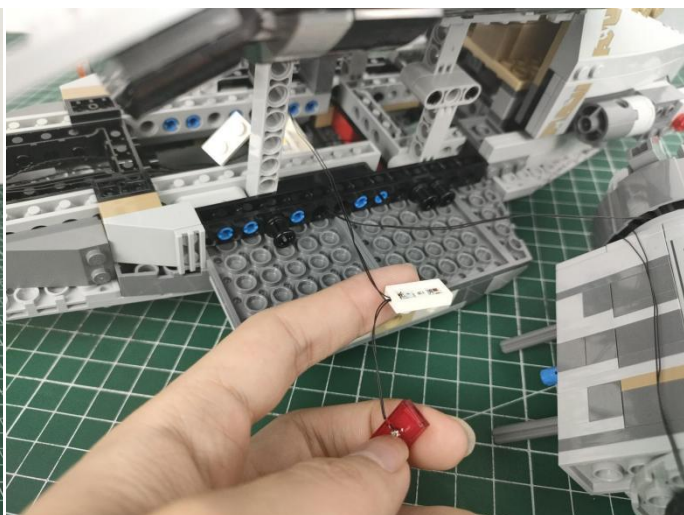
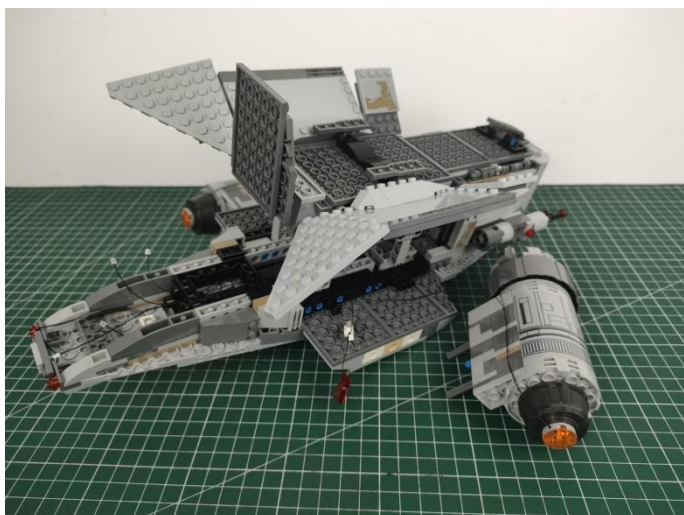

116

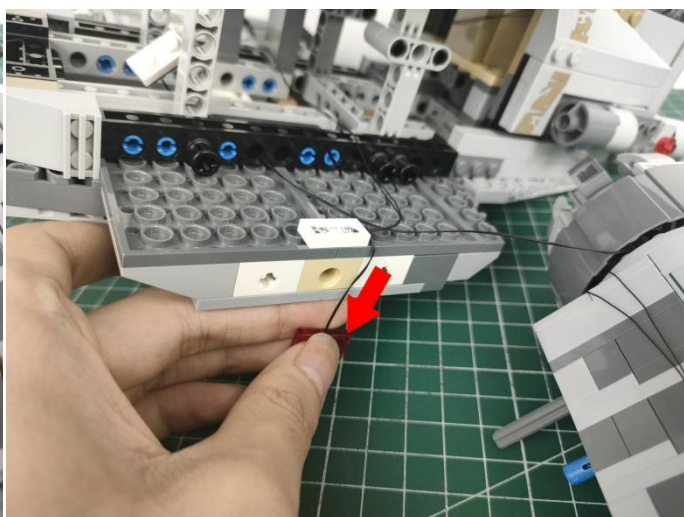
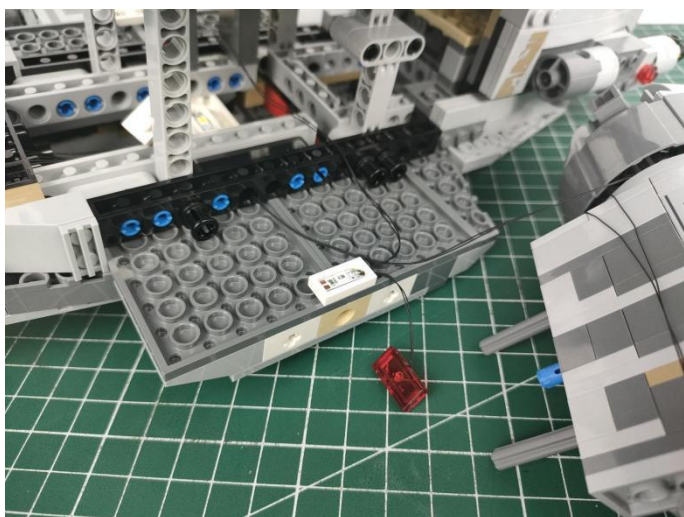

117

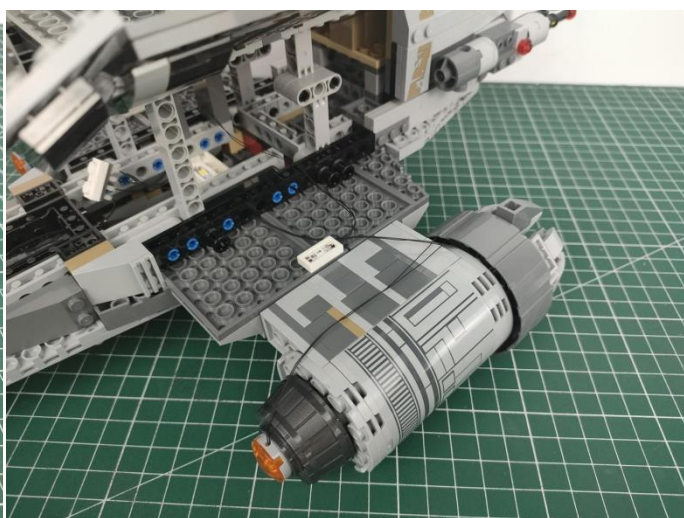
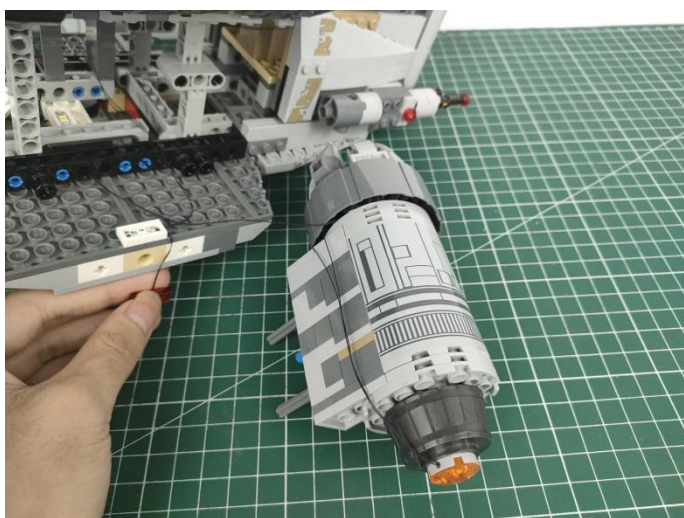

118

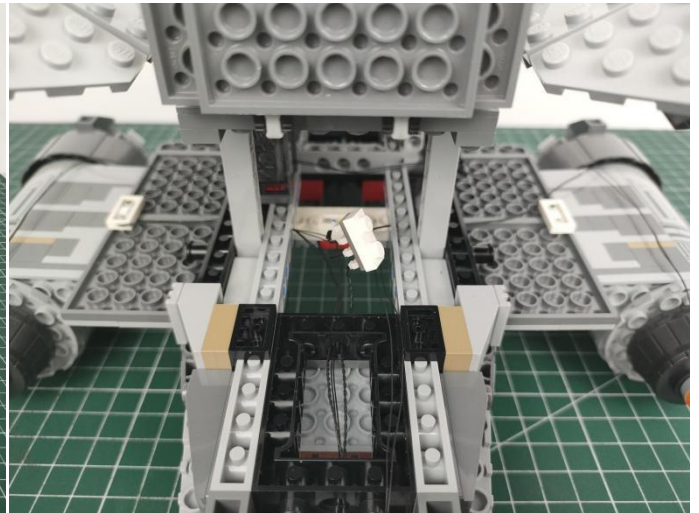

119

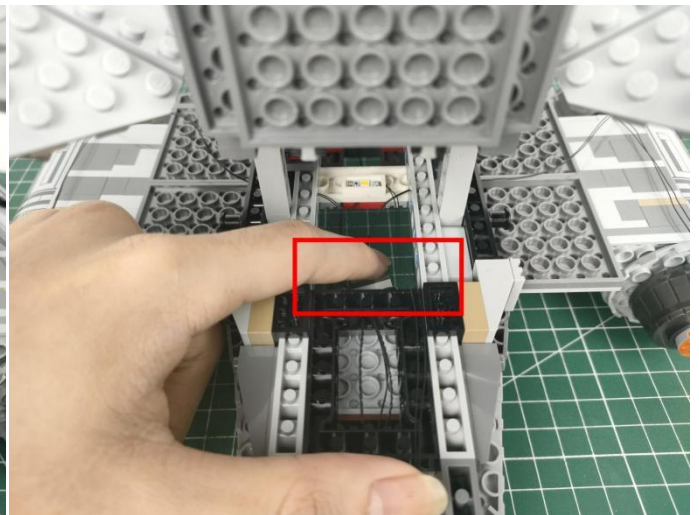
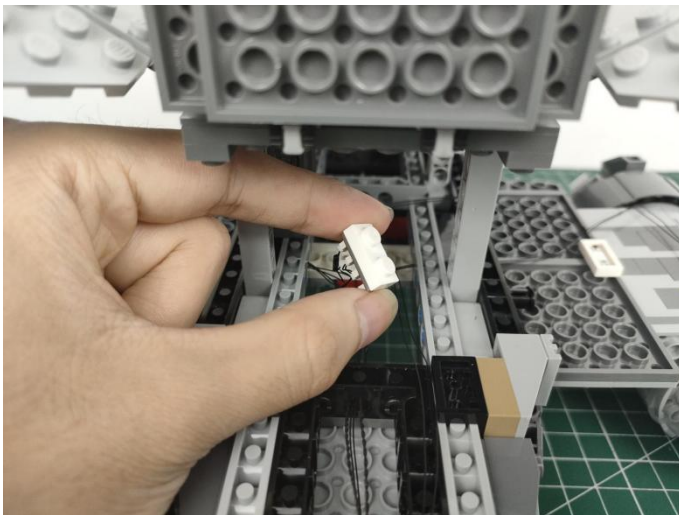

120

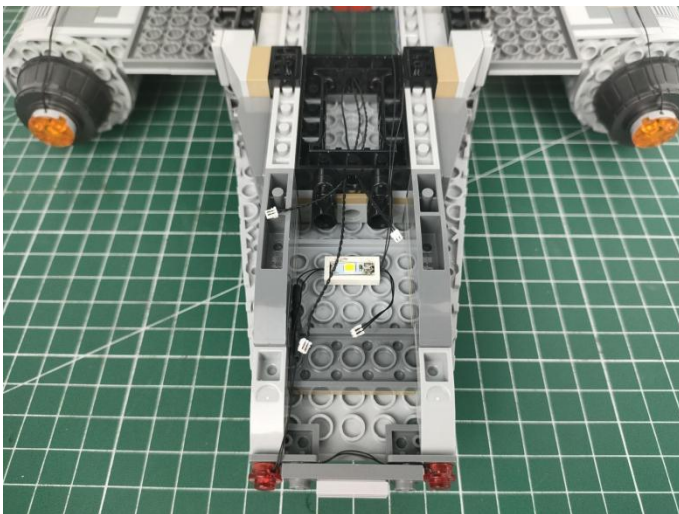

121

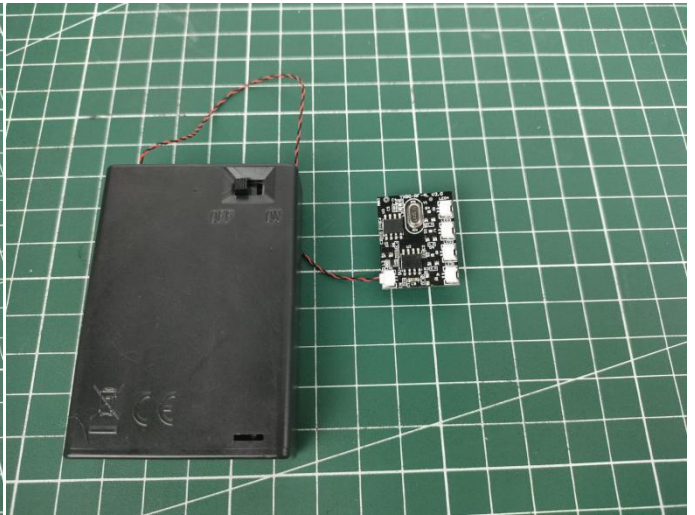

122

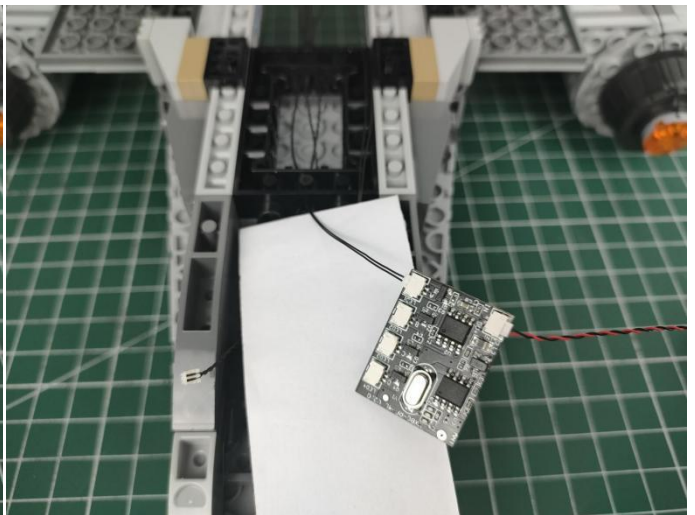
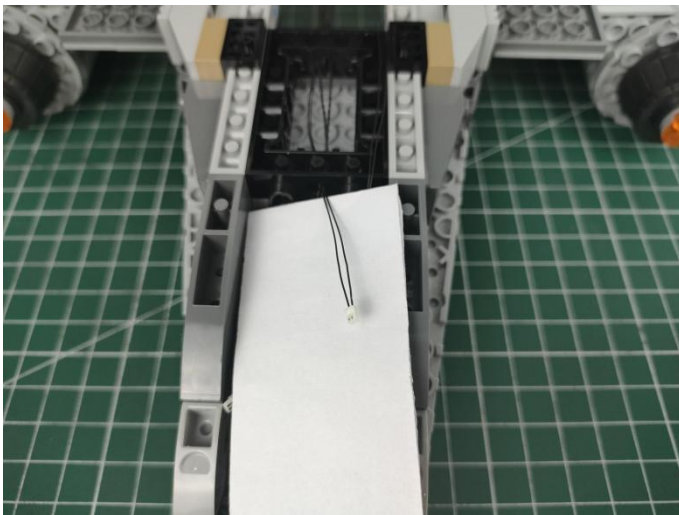

123

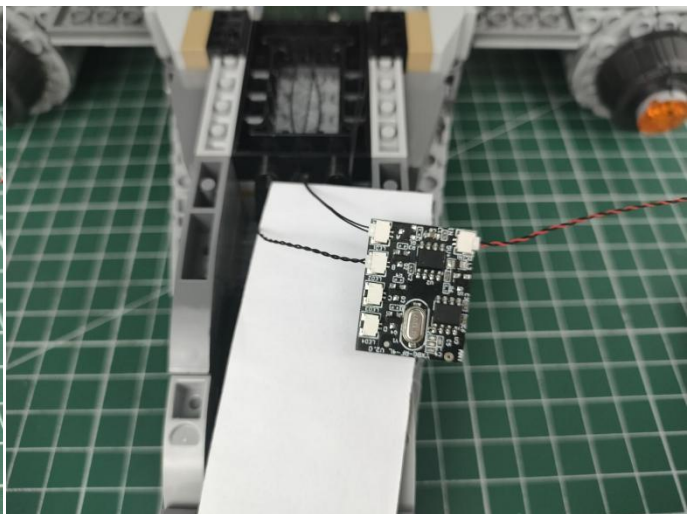
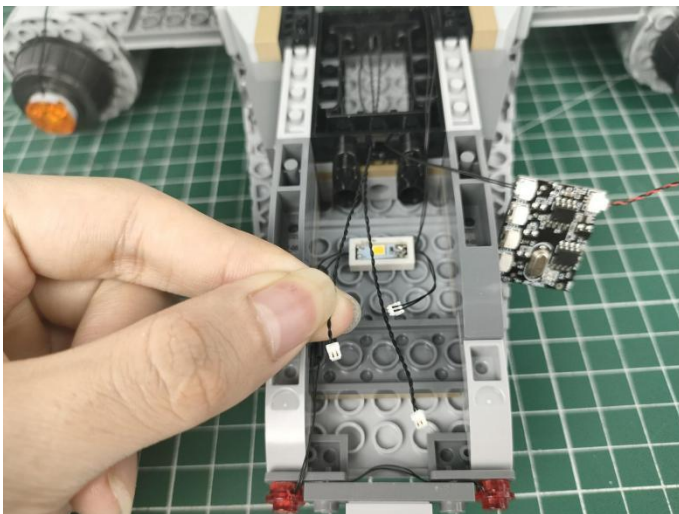

124

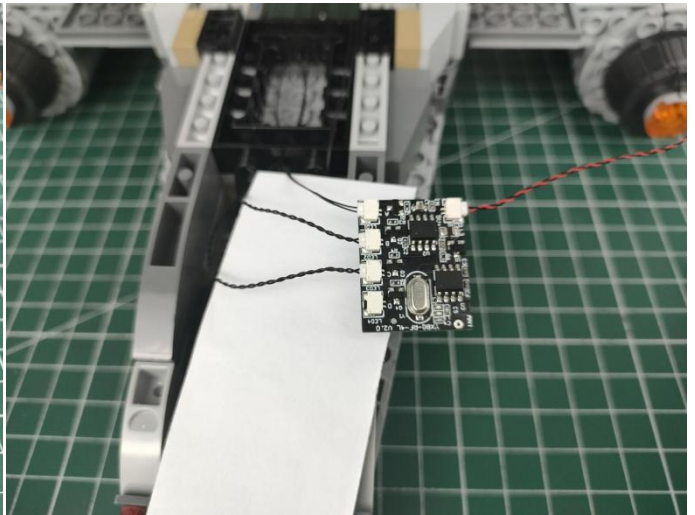
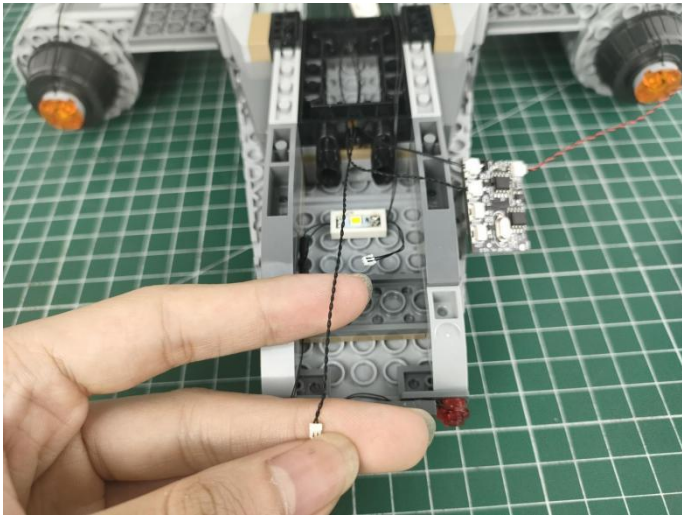

125

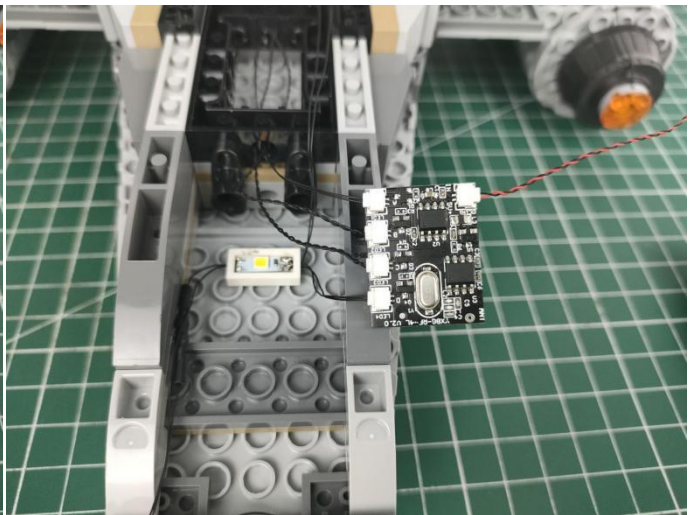
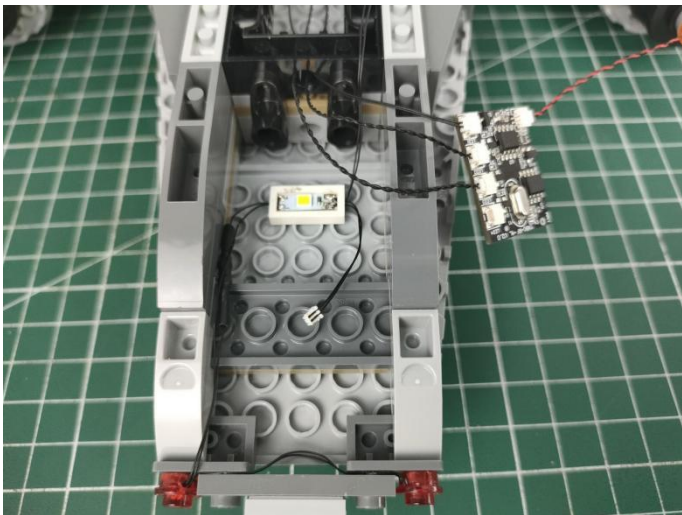

126

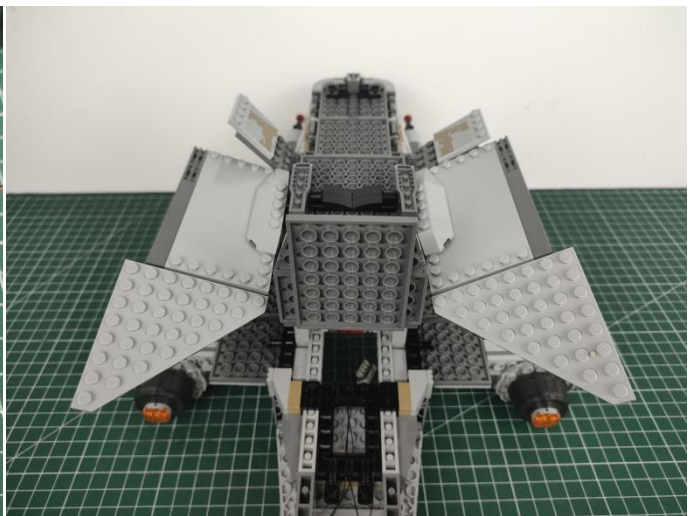
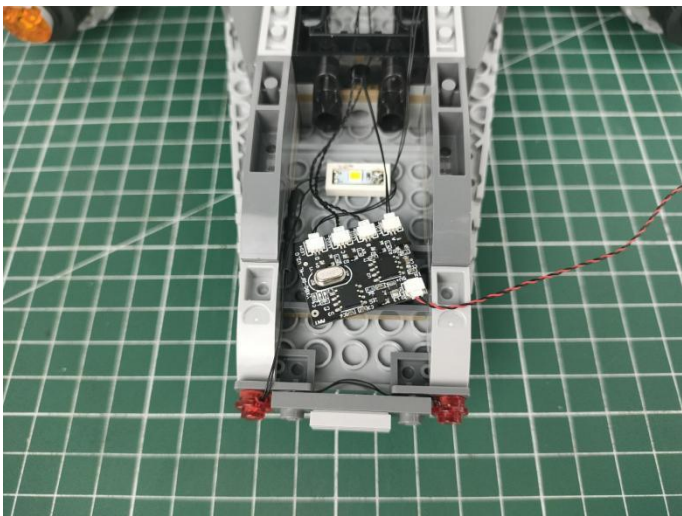



127



128

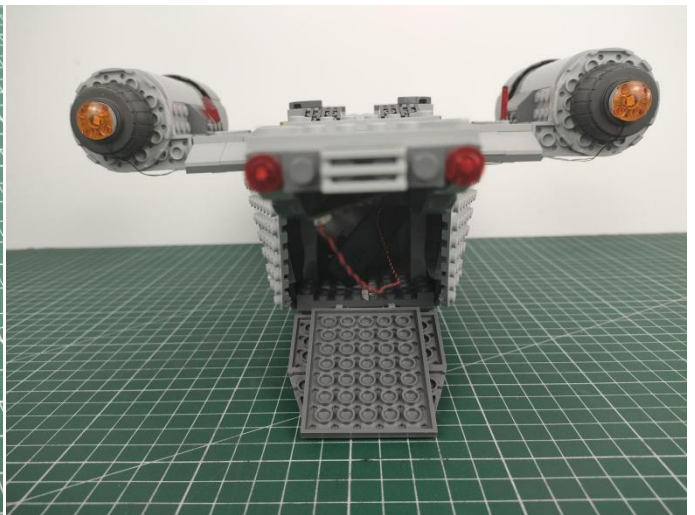
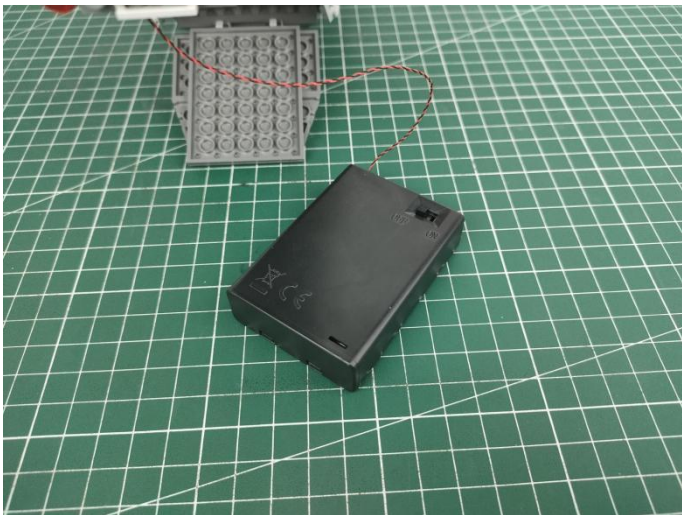

129

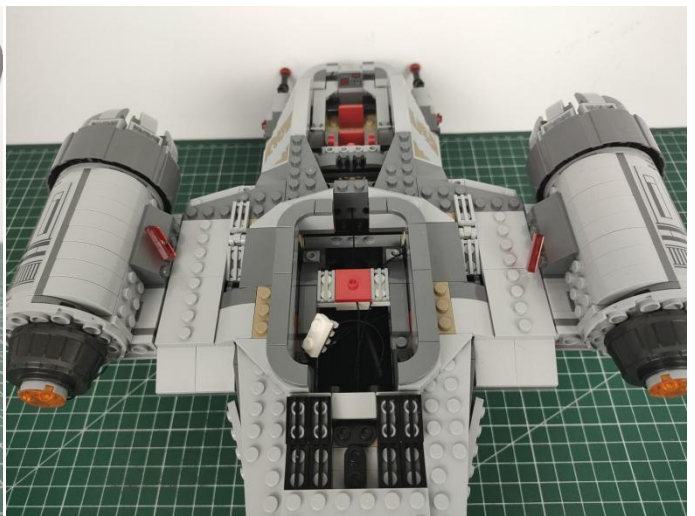
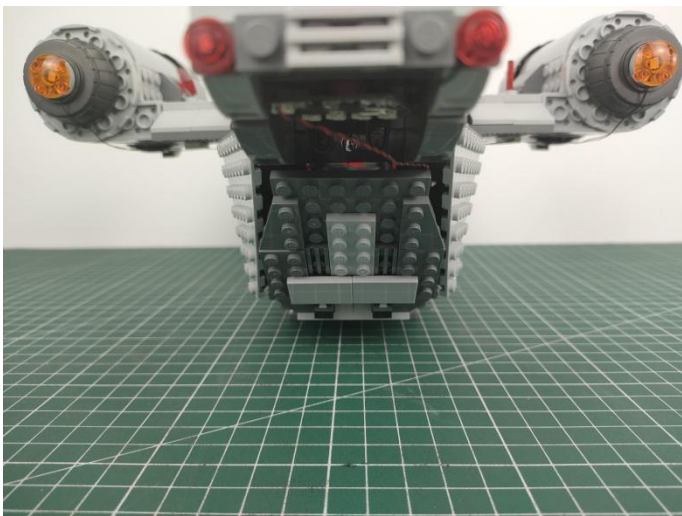

130

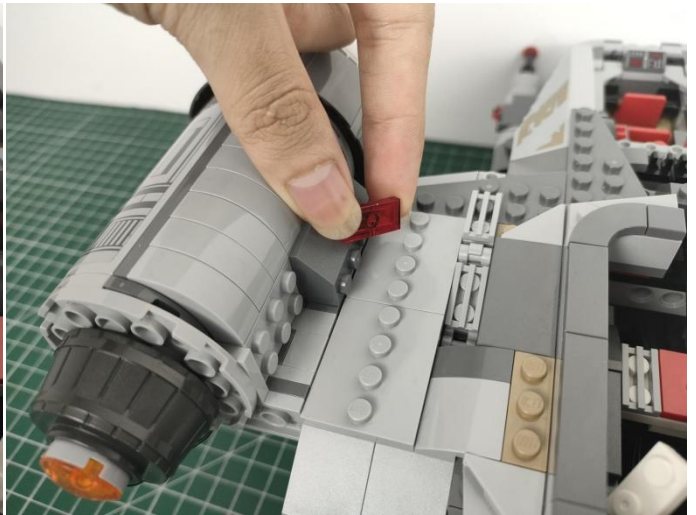
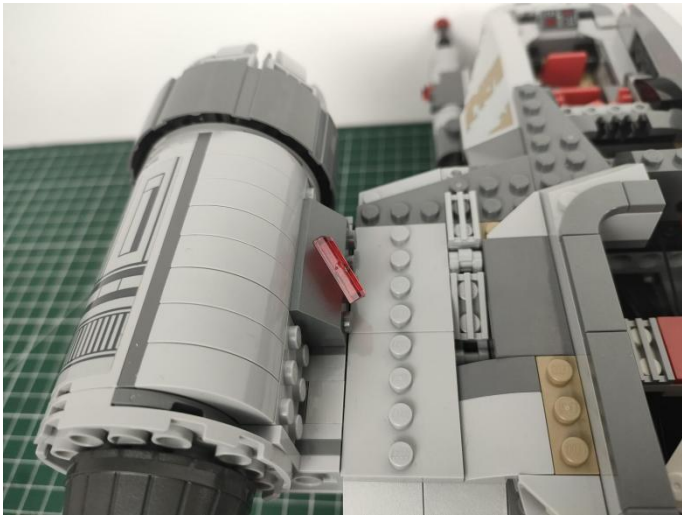

131



132

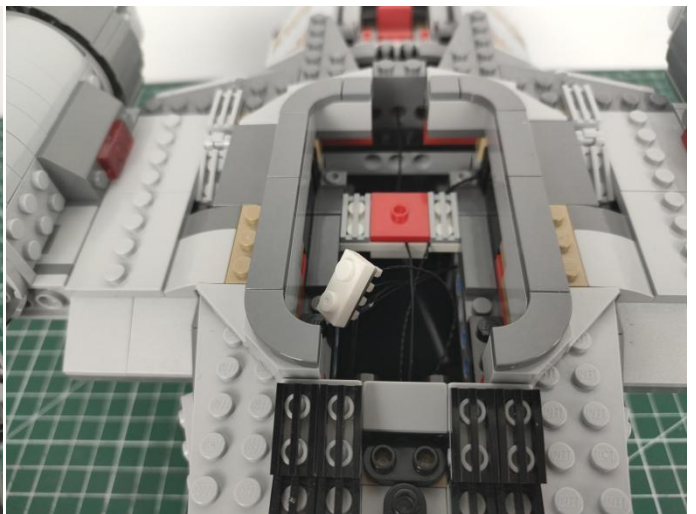

133

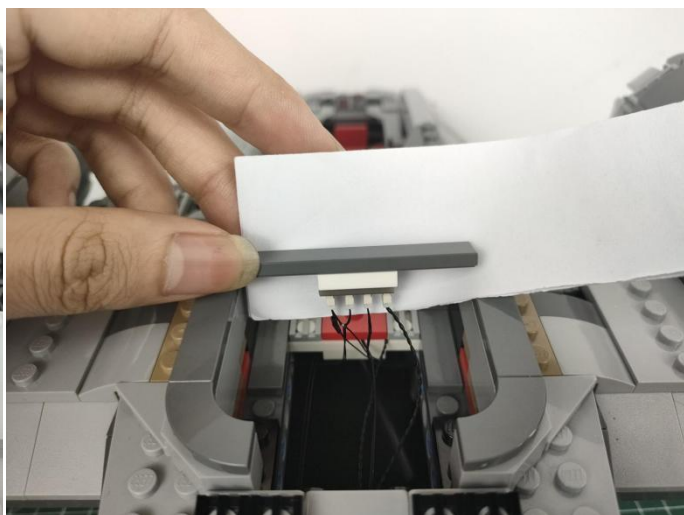

134

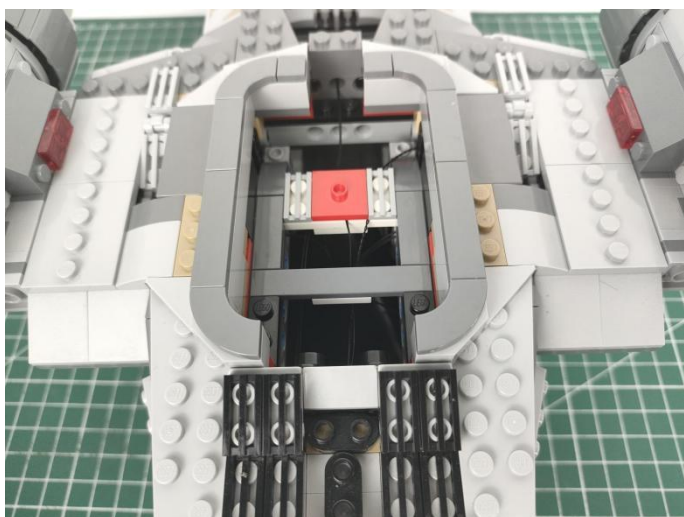

135

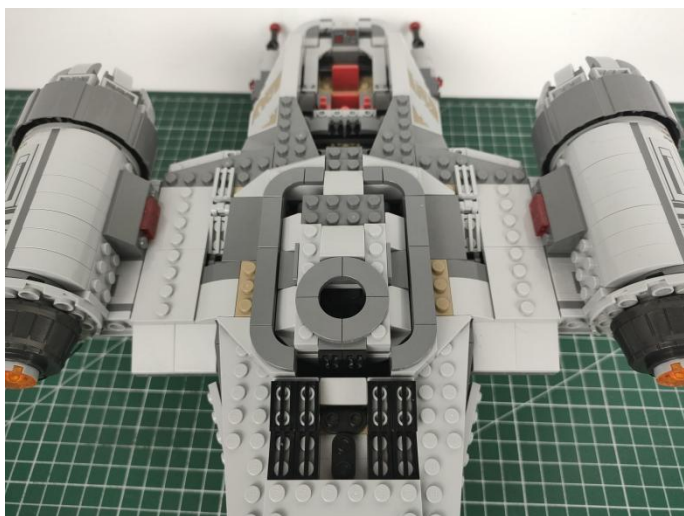

# 136

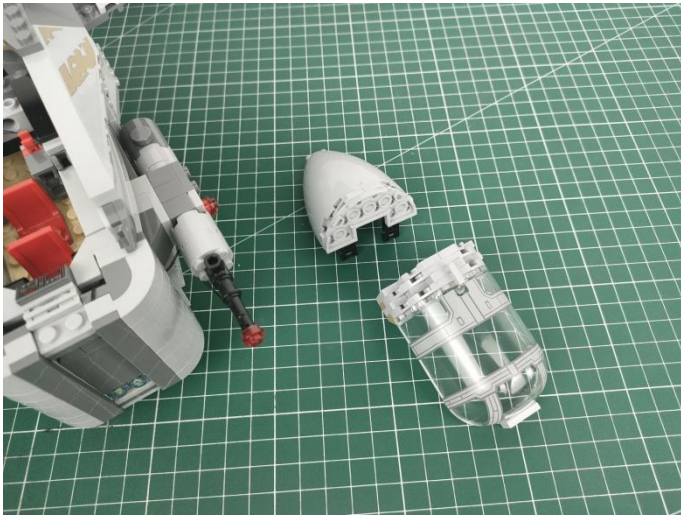

# 137



## Remote control function description



ON: All branches are opened

OFF: all branches are closed

A: open/close A road

B: open/close B road

C: open/close C road

D: open/close D road

FS: Turn on blinking for the last open channel

BLN: Start breathing for the last opened path

↑: Increase blinking/breathing rate

↓: Increase blinking/breathing rate

Brightness+: Increase brightness

Brightness -: Reduce brightness

Good job, you've done all the installation steps, power it up and enjoy your work.

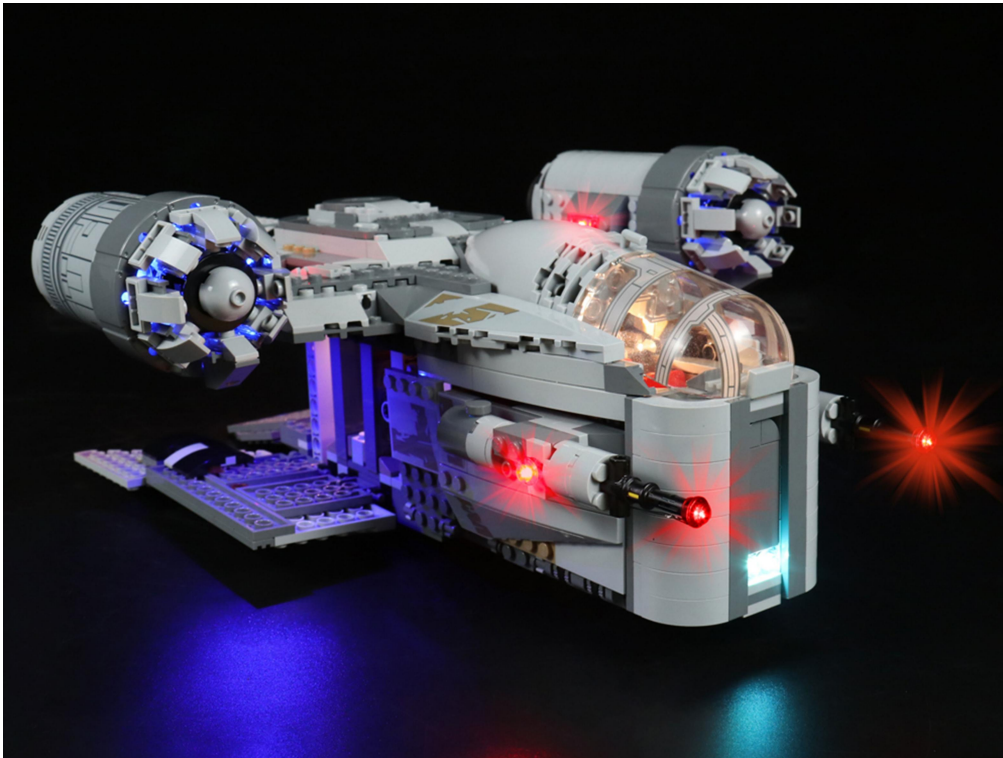

The USB Power Cable in bag NO.5 can also power the set. Remove the plug of the AAA Battery Box from the socket of the expansion board, plug the plug of the USB Power Cable to the same socket in the expansion board to power the suit as well.

The USB Power Cord can be powered by phone chargers, power banks, etc.

