

21330 Home Alone GC144/LG144

- Installation requires a lot of patience and great observation that your LEGO bricks will come alive when you get this finished. The bricks with lighting as below, so make sure you're ready and let's get started.



Strategies for the Installation

This instruction divides three sections to complete the installation of the lighting set.

Section A: Check the type and quantity of components.

The quantity and type of components of each products are different and it needs to be carefully checked to make sure there do have enough material. The type of components is indicated by the label on the bag.

Section B: Test that each components is working properly.

Each components is Manual customization so it is necessary to test that each components is working properly to avoid the situation that the lighting does not work .

Section C: laying out components following the instruction.

Our material is very small but not fragile, just be reminded that don't to pull the wires too hard. For different people, there may be some installation steps that you can't understand. Please look at the previous and later installation steps.

Section A: Check the type and quantity of components.

This set contains ten bags labelled "1" "2" "3" "4" "5" "6" "7" "8" "9" "10", please make sure that the components in each bag are the same as shown in the pictures.





Please contact us immediately if there have any missing components.

Section B: Test that each components is working properly.

Take out the Expansion Board and the USB Power Cable from No. 8 bag and No.9 bag.

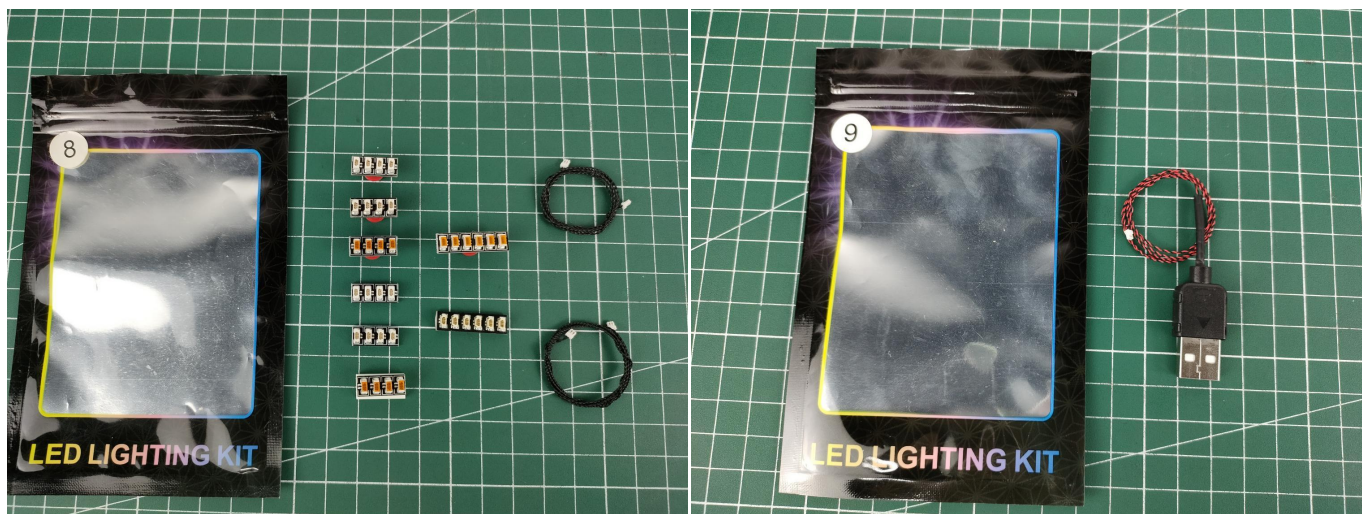

Remove the protective film from the Expansion Boards.

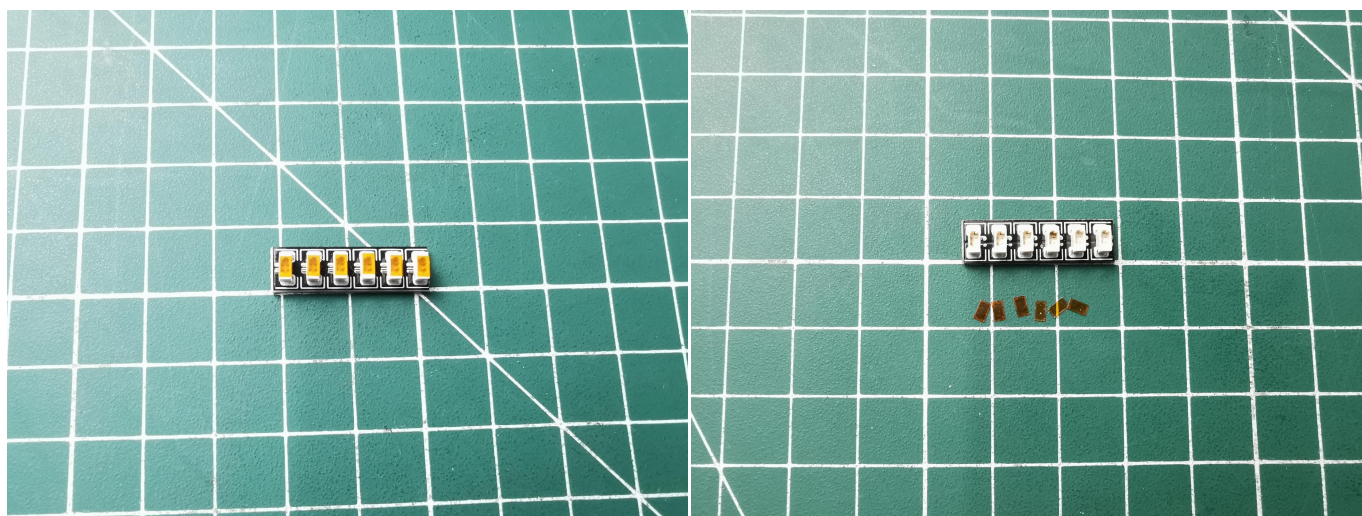

It is worth reminding that our products are all customized. They have a unique way of connecting. The white plug on wire and the socket of the expansion board need to be connected together to transmit power.

Note that on one side of the white plug you can see two very small golden wires that should be connected to the two golden needles in socket of the expansion board. shown as blow.

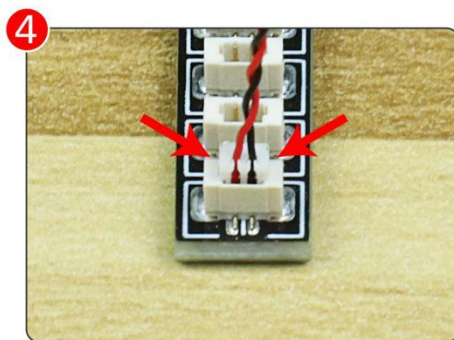
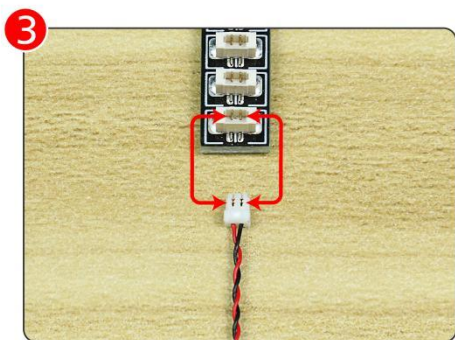

Connect the Expansion Board and USB Power Cable as shown.

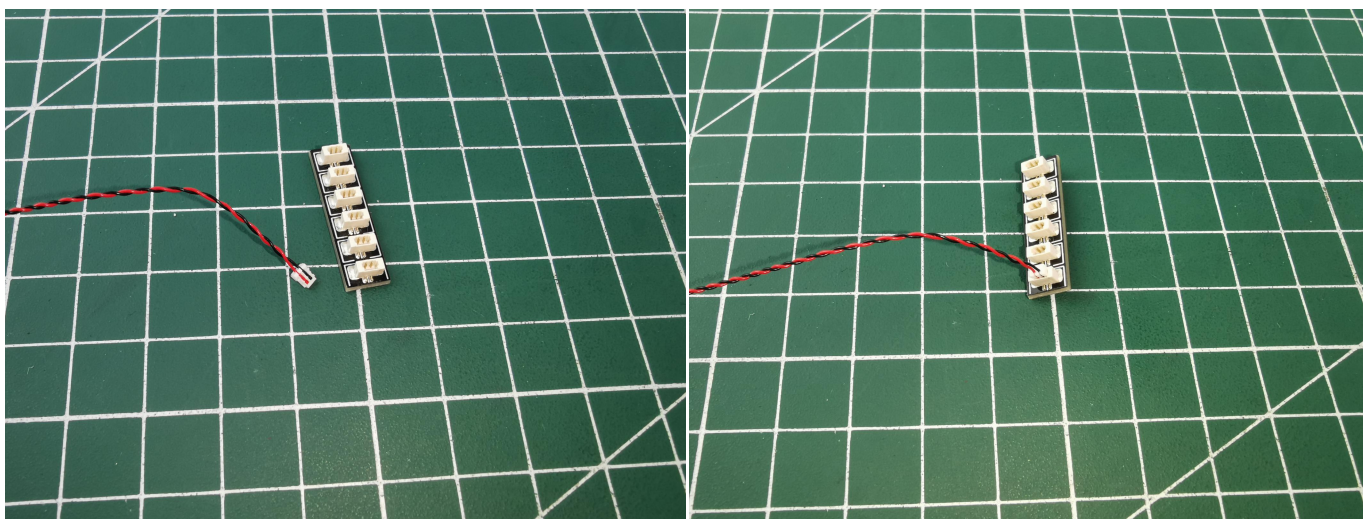

Turn on the power bank, all the lights are on as shown.

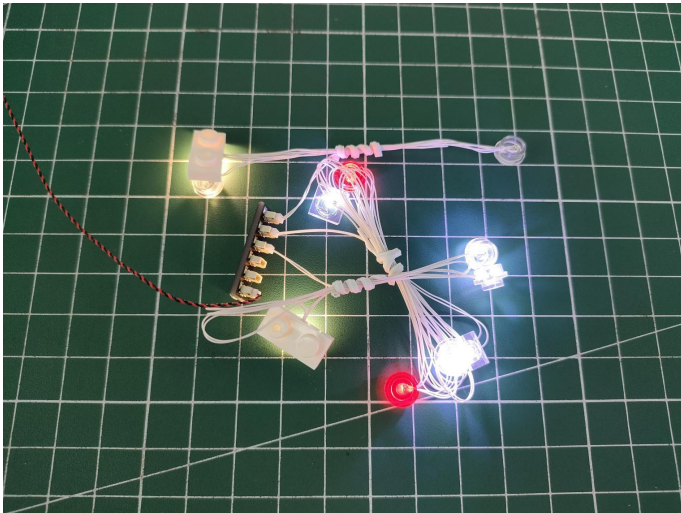

Unplug these three components and put them back in the corresponding bags. There are three in bag NO.2, three in bag NO.3, four in bag No.4, three in bag No.5 bag,three in bag No.6 need to be tested.

Attention that after the test is completed, each components should put back in the corresponding bag including the socket and the USB power cable.

Please contact us immediately if any components don't work.

Section C: laying out components following the instruction.

1



2

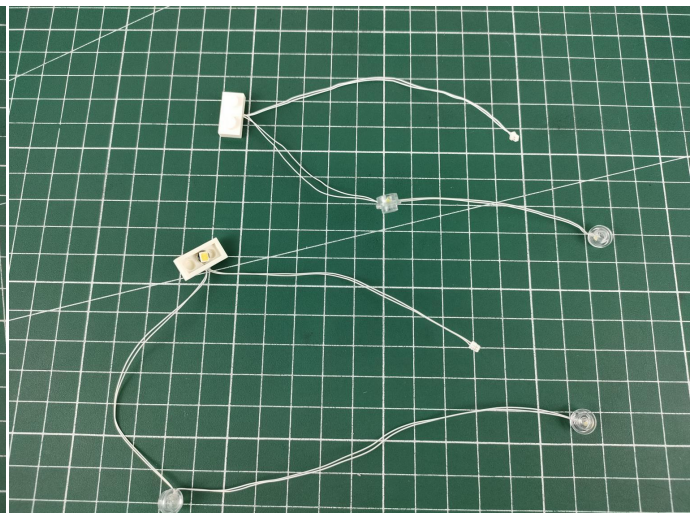

3

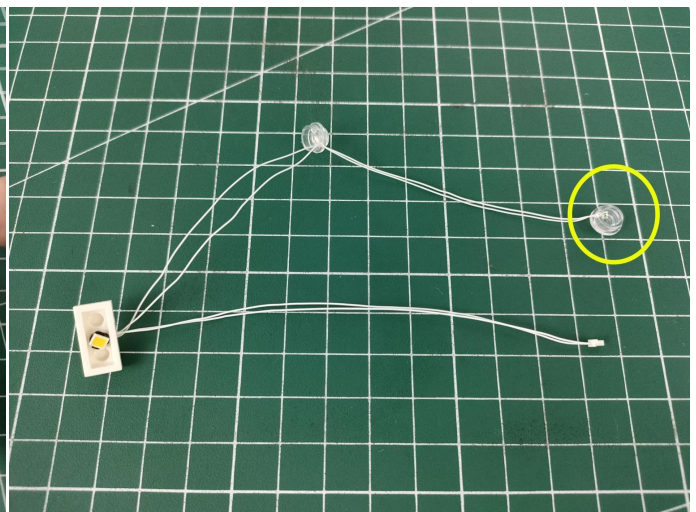
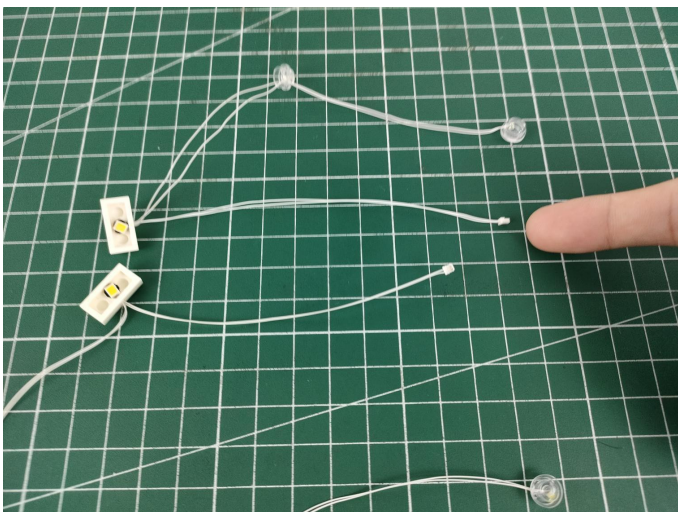

4

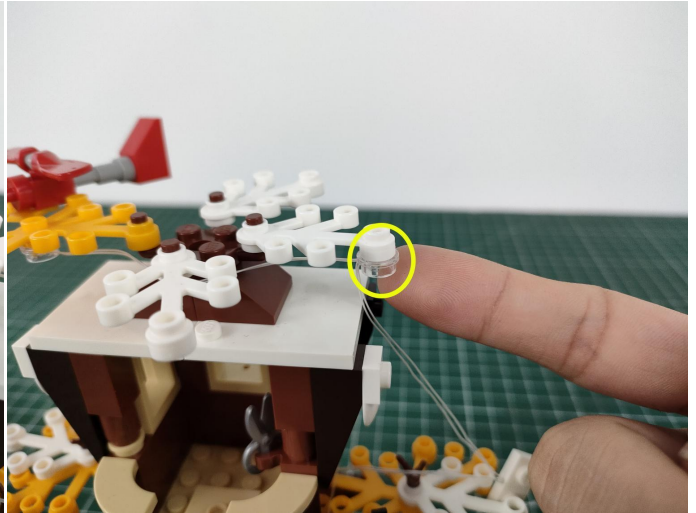

5

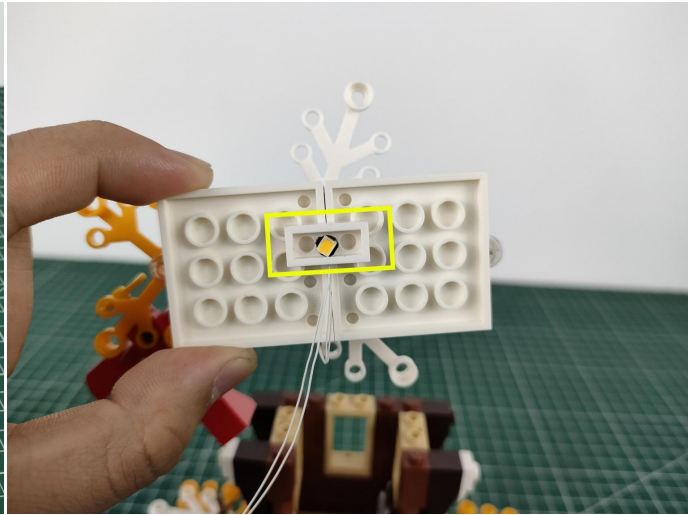
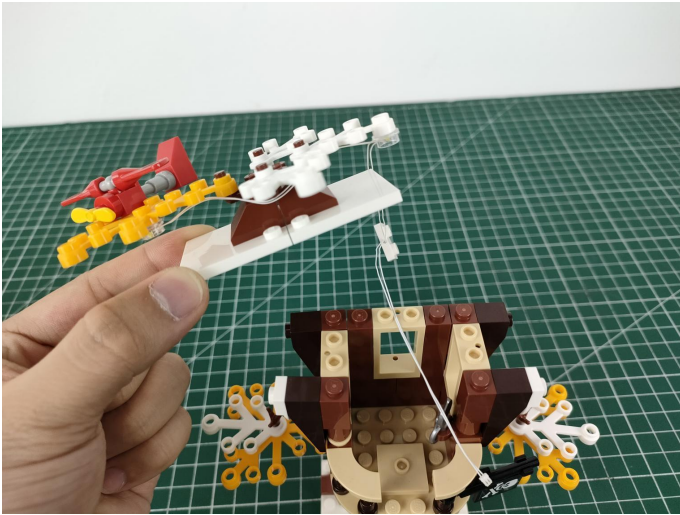

6

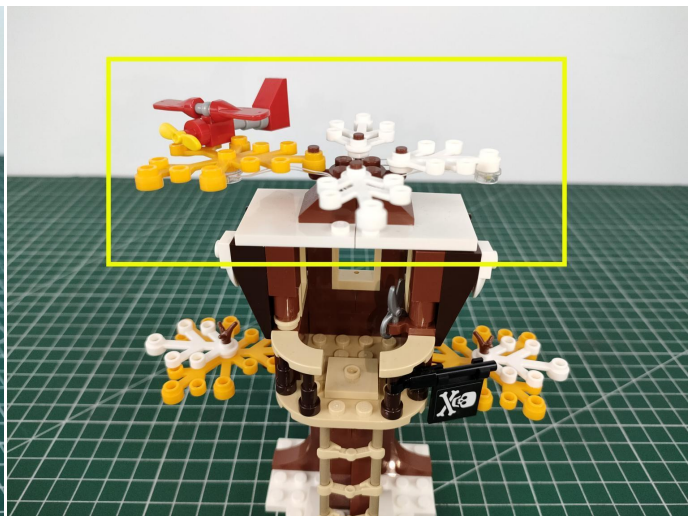
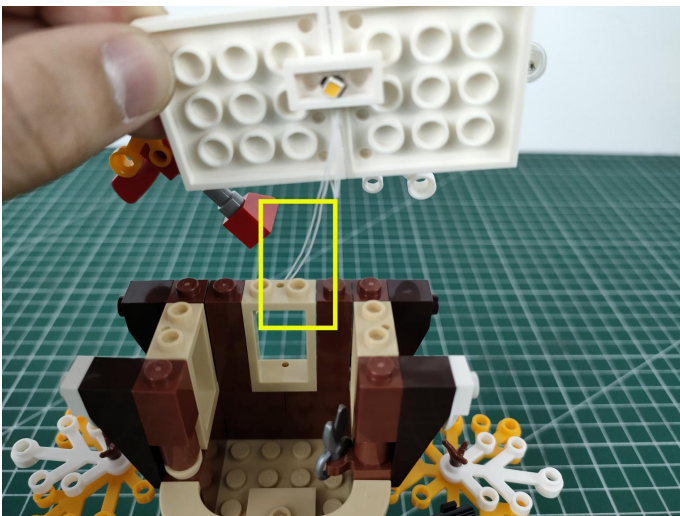

7

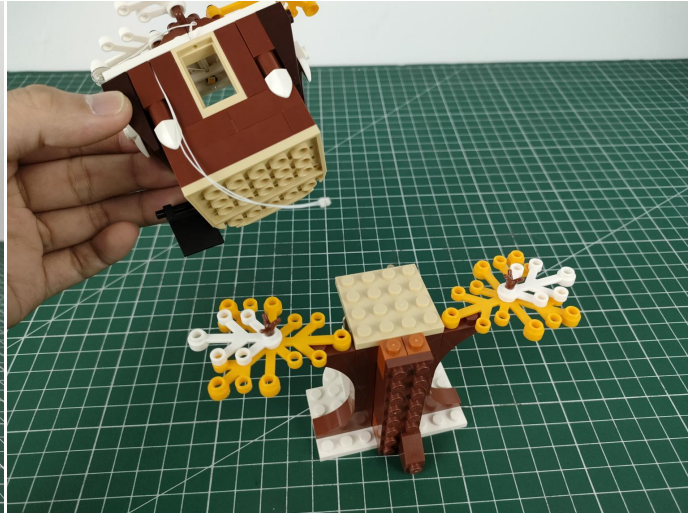
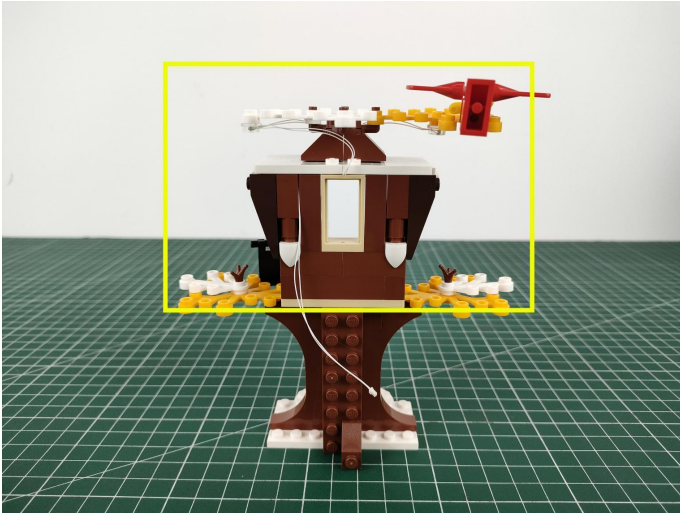

8

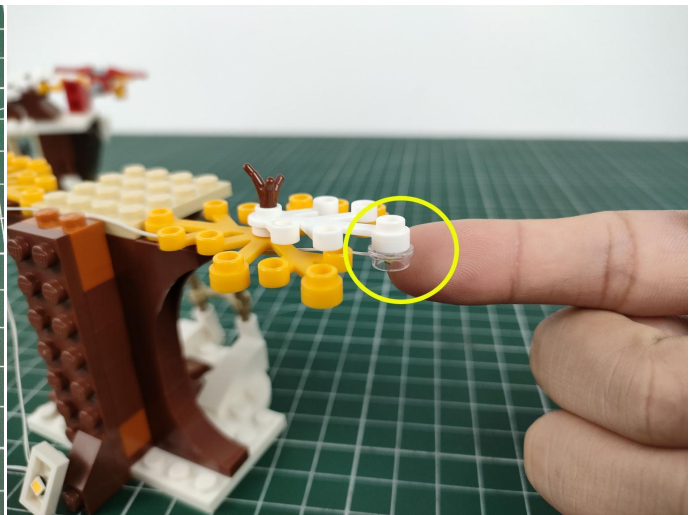
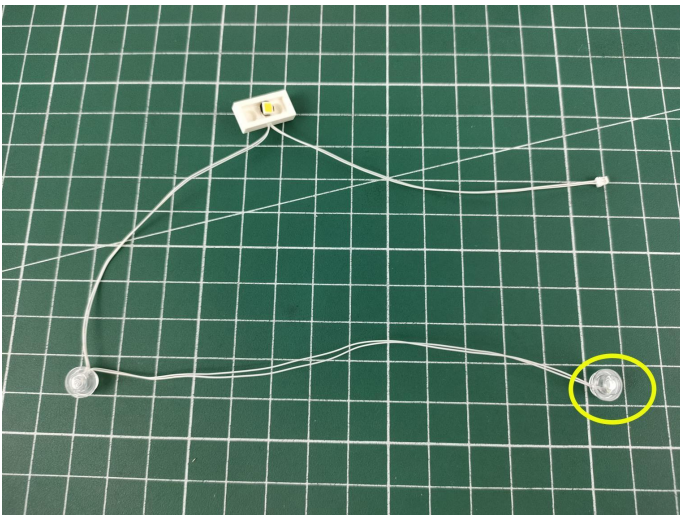

9

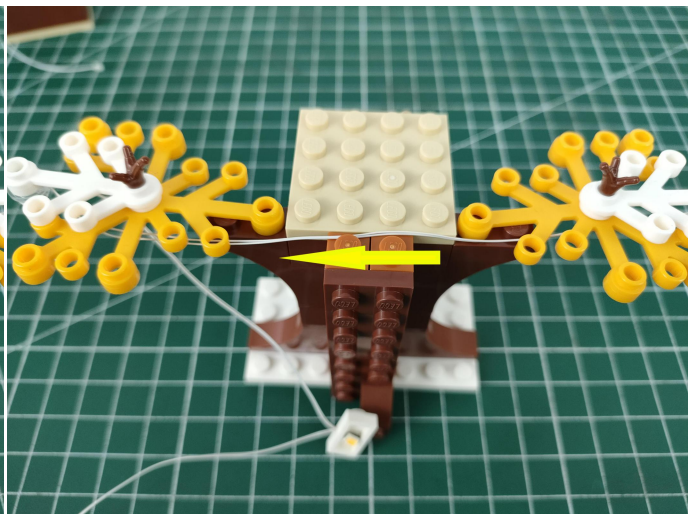
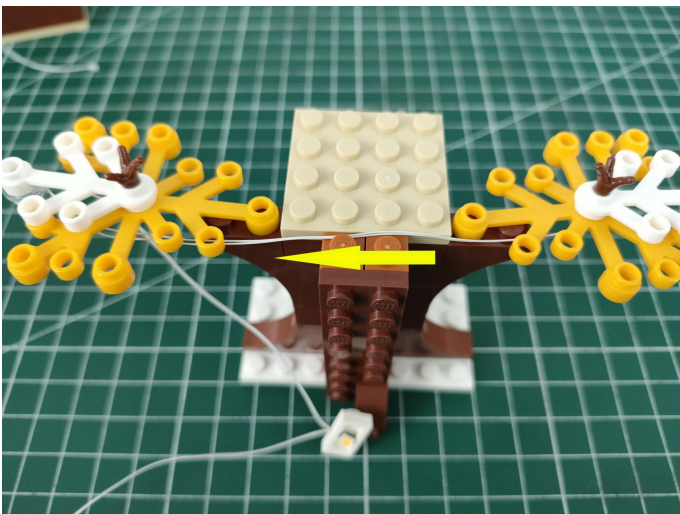

10

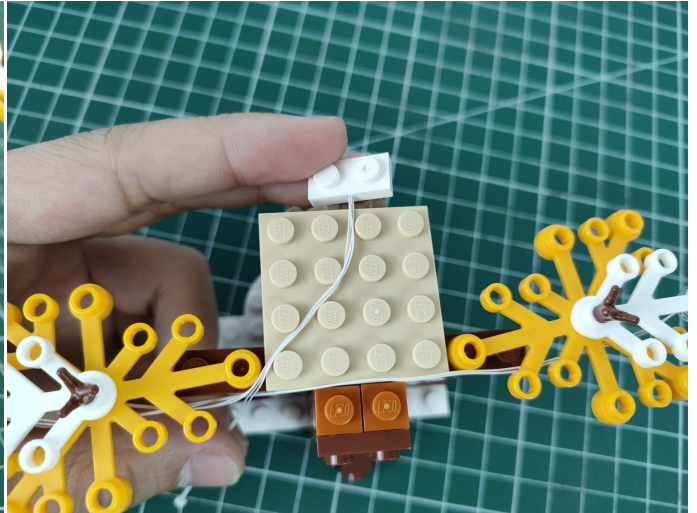
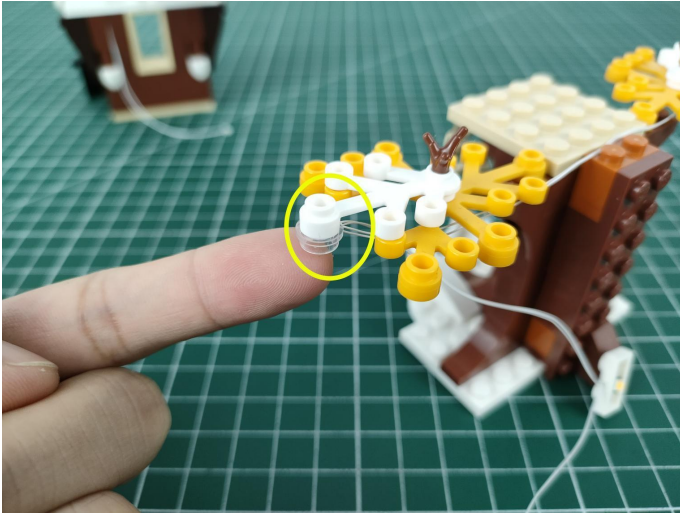

11



12

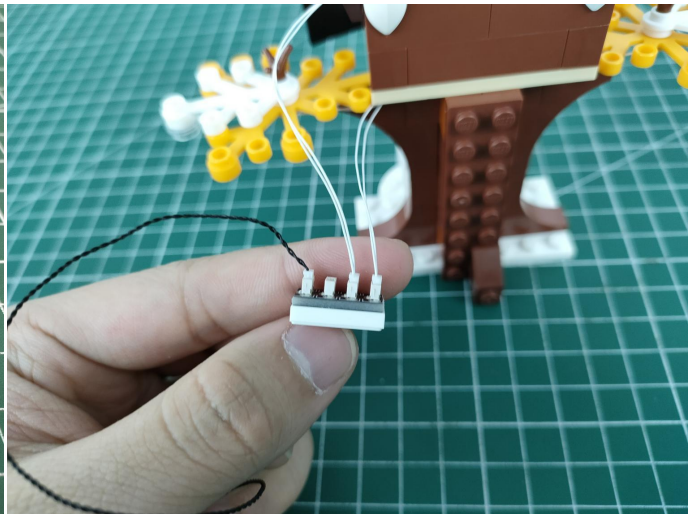

13

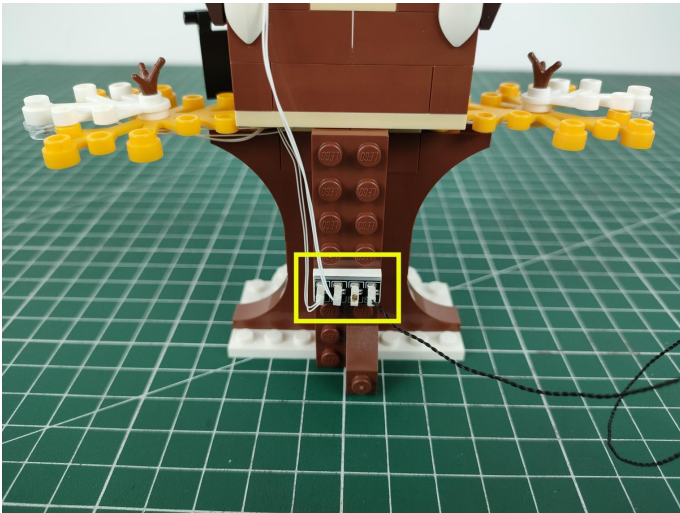

14

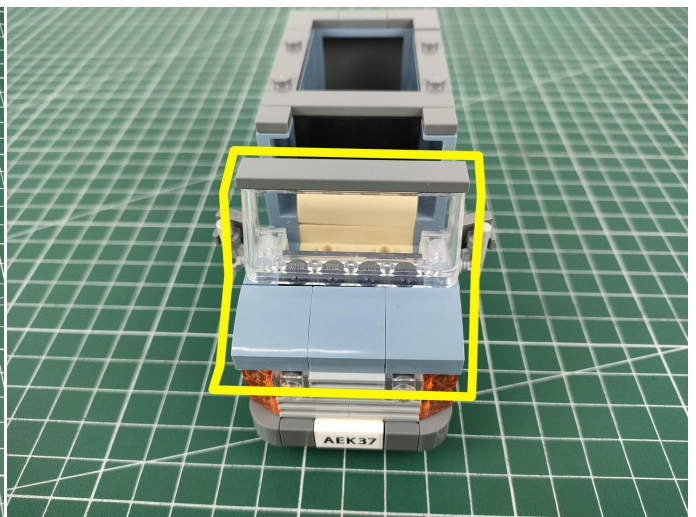
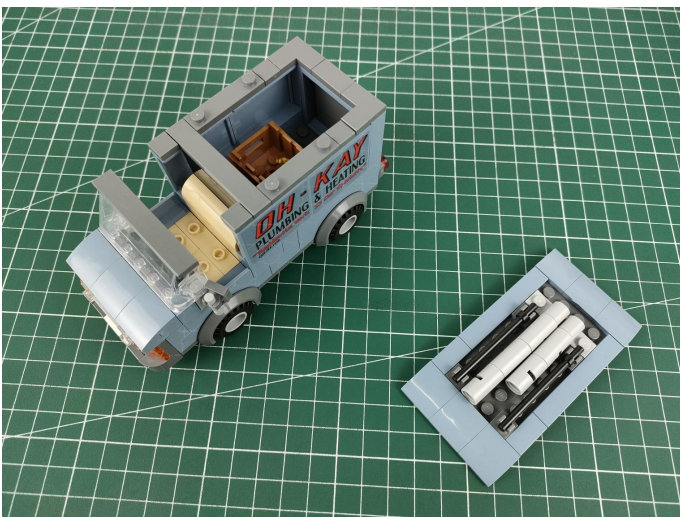

15

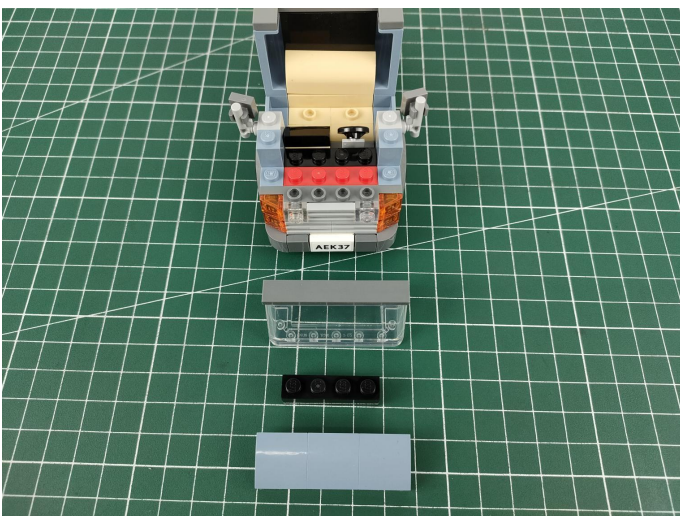

16

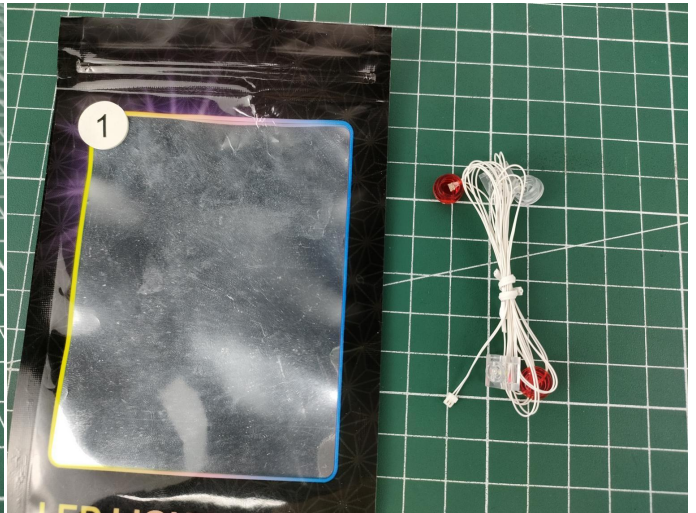
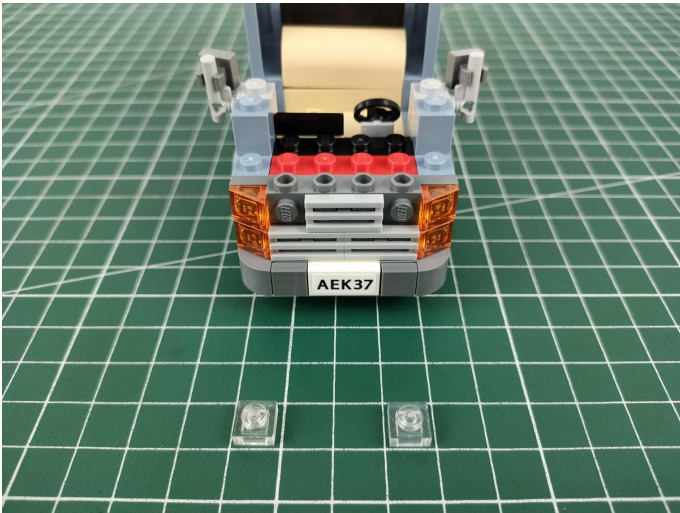

17

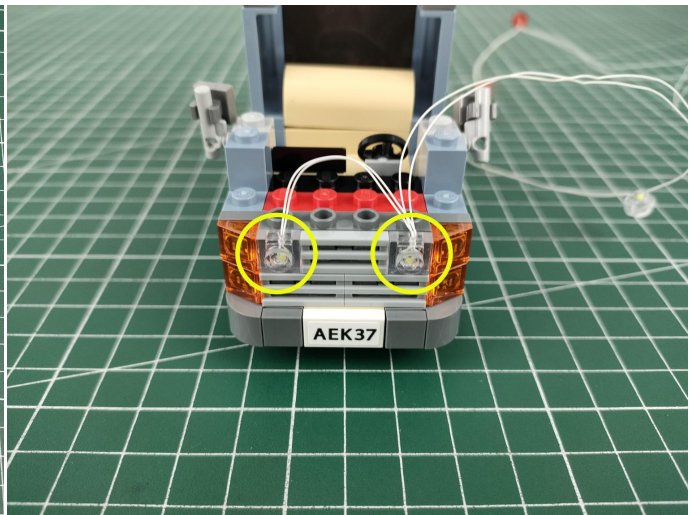
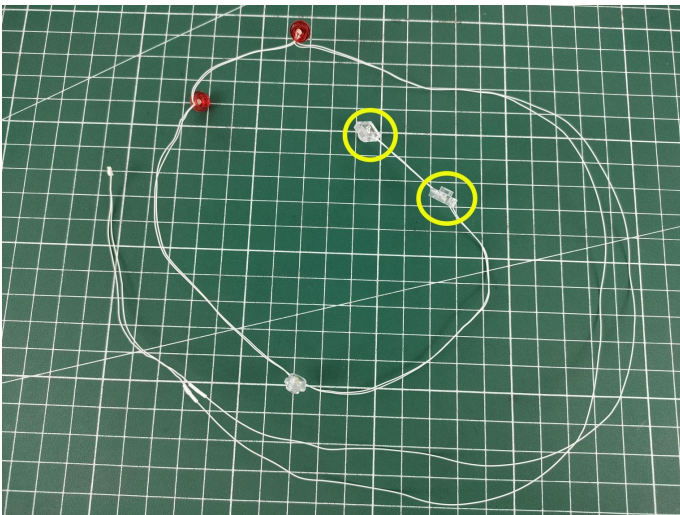

18

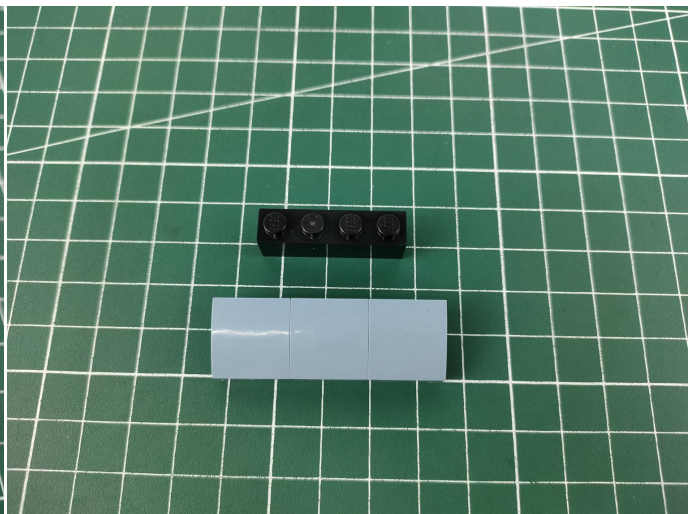
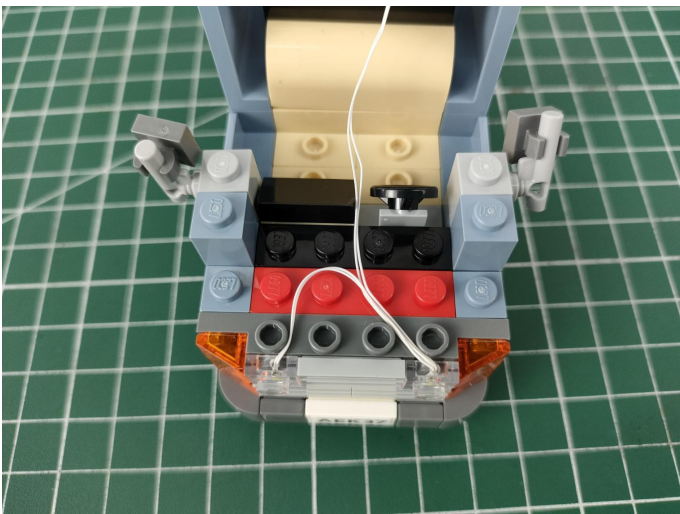

19

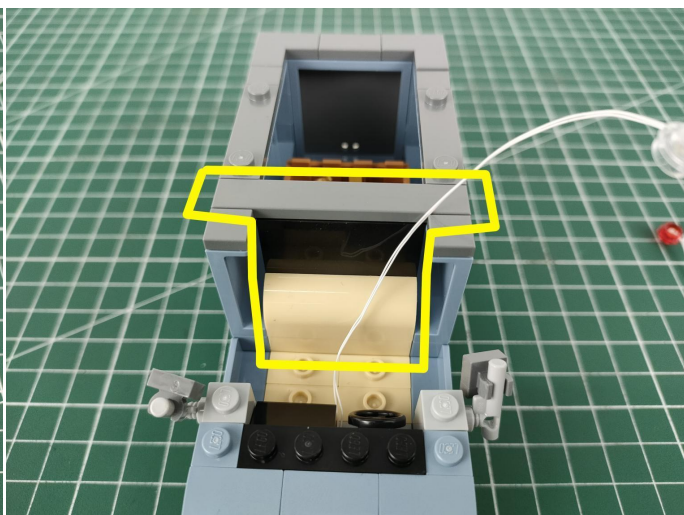
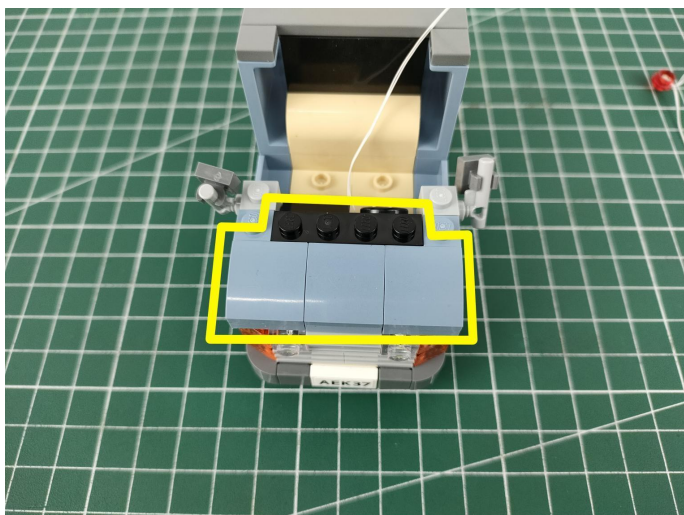

20

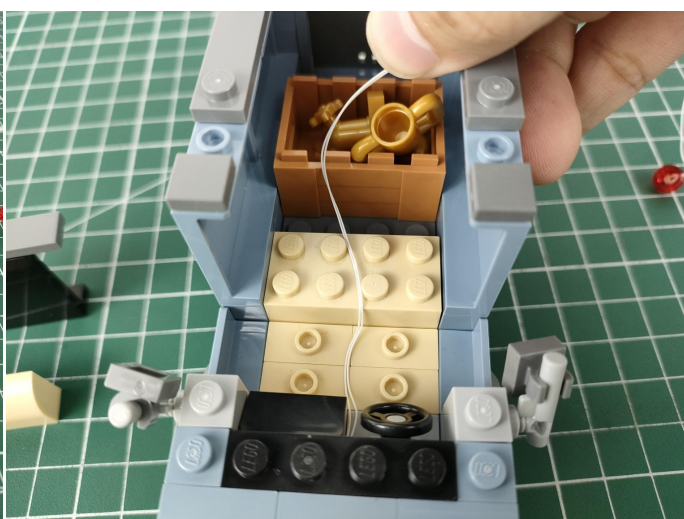
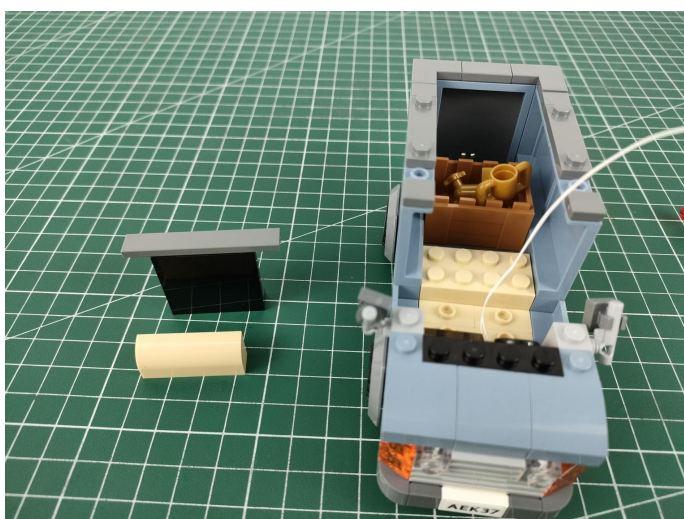

21

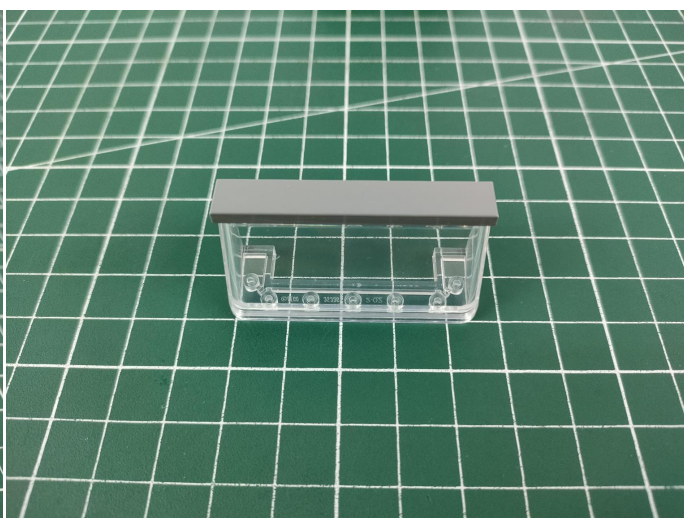
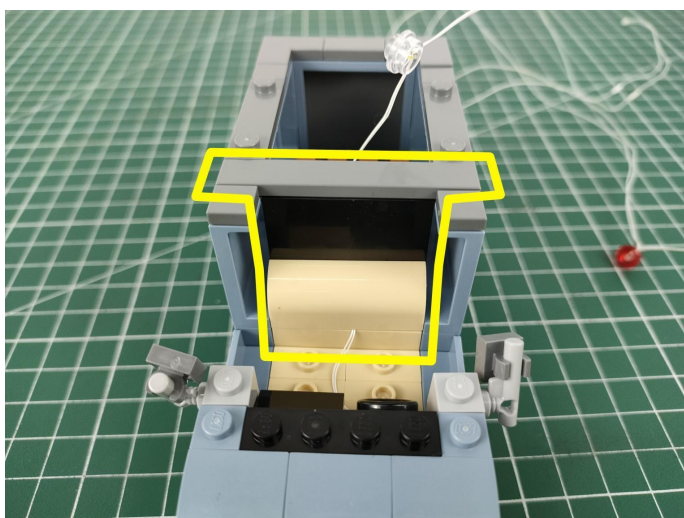

22

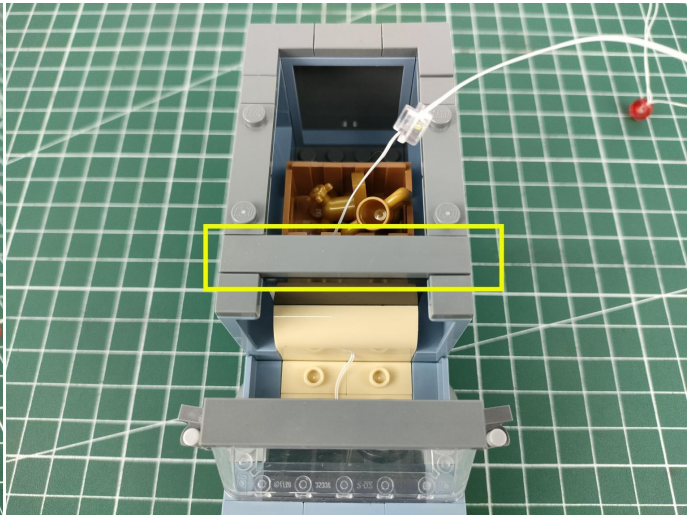
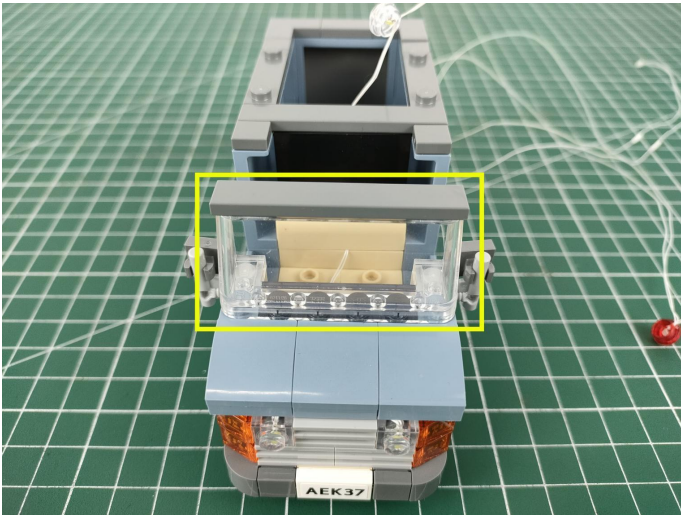

23

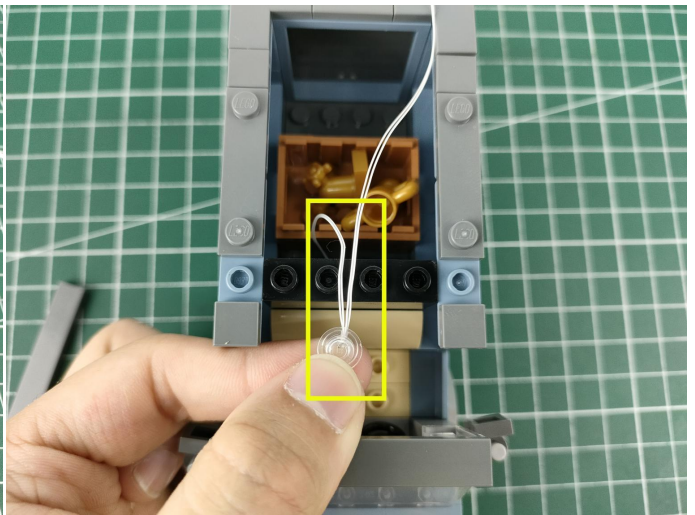
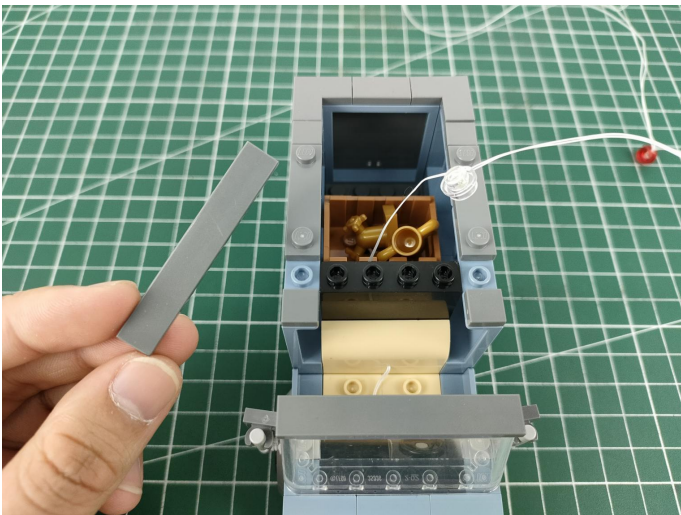

24

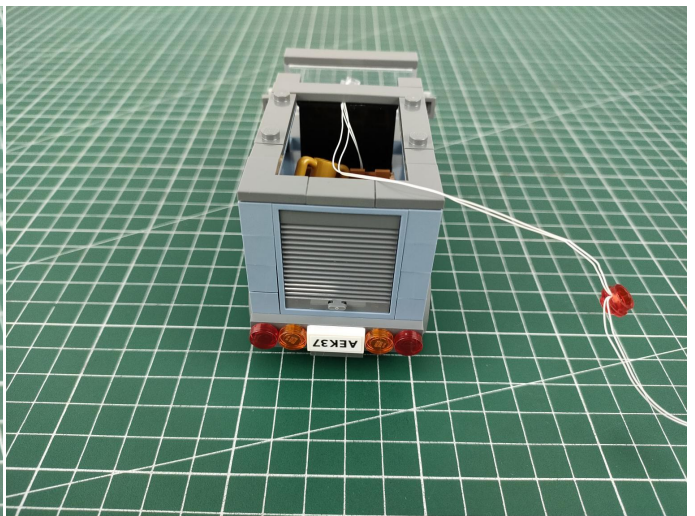
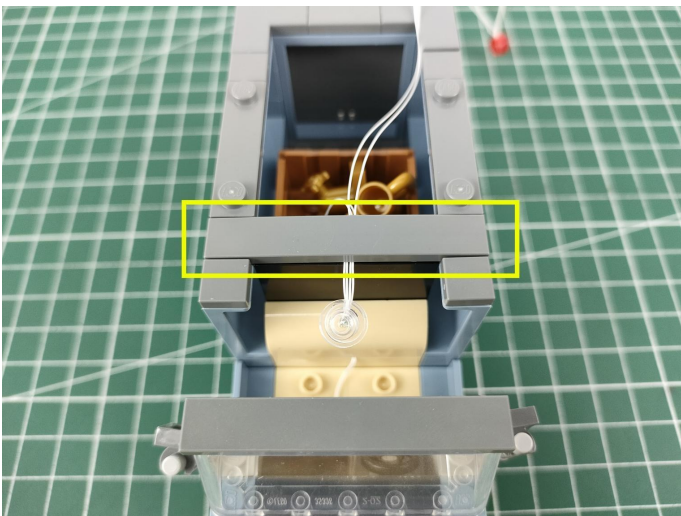

25

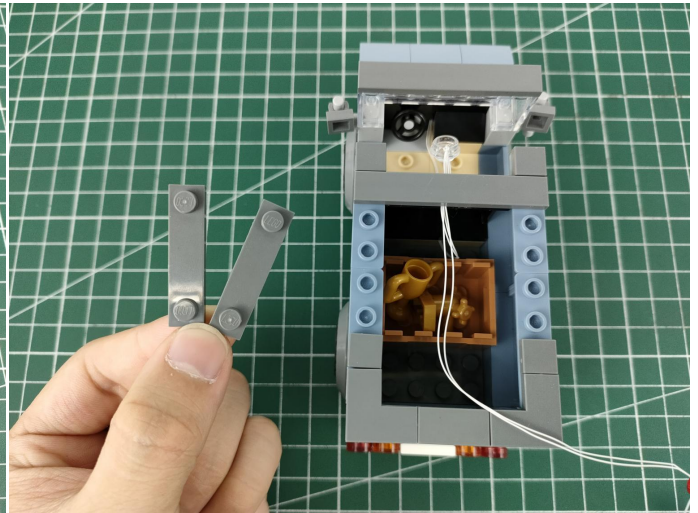
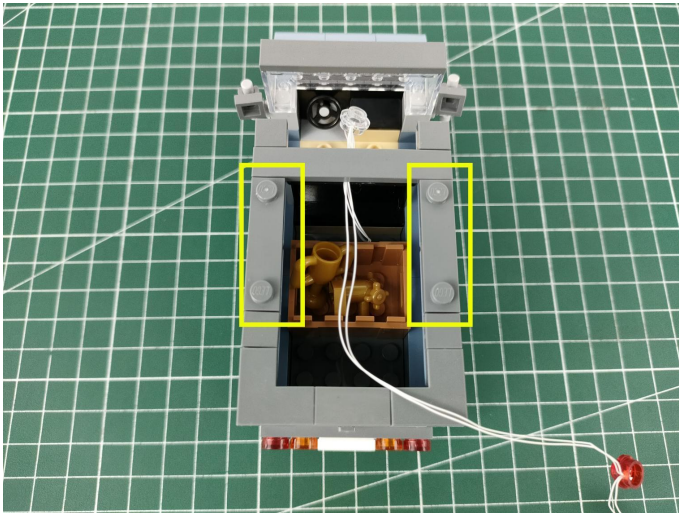

26

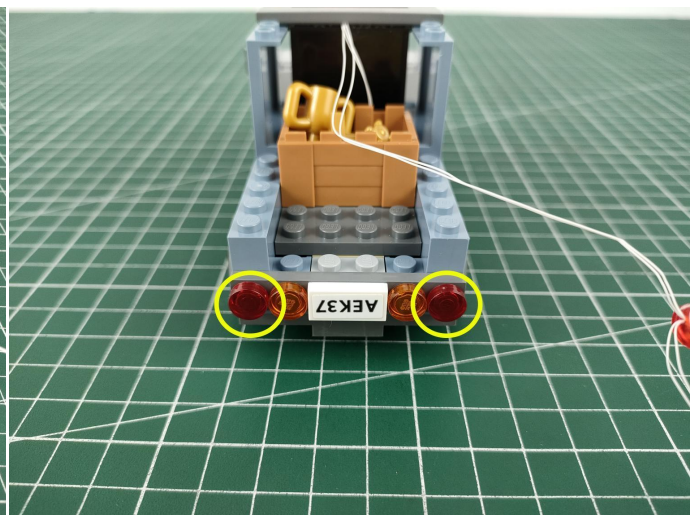
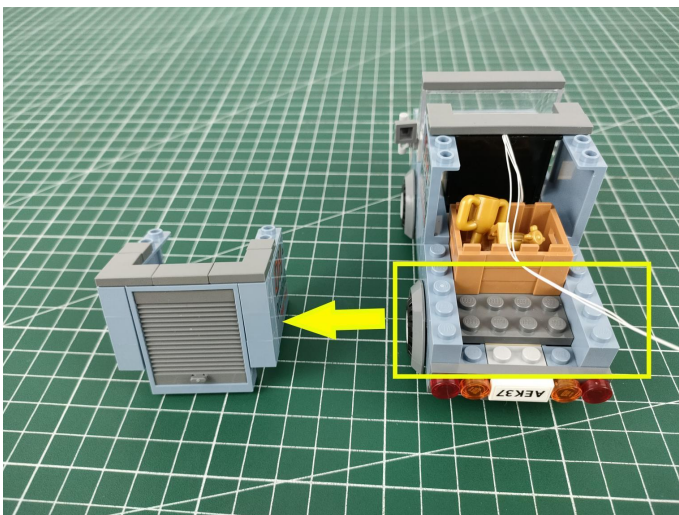

27

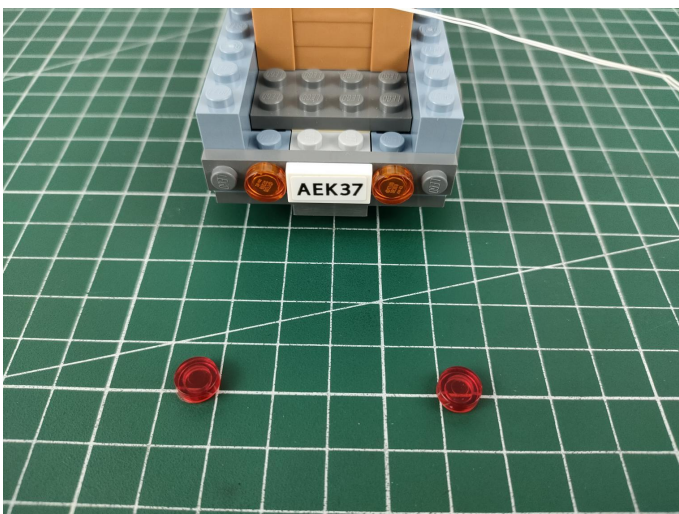

28

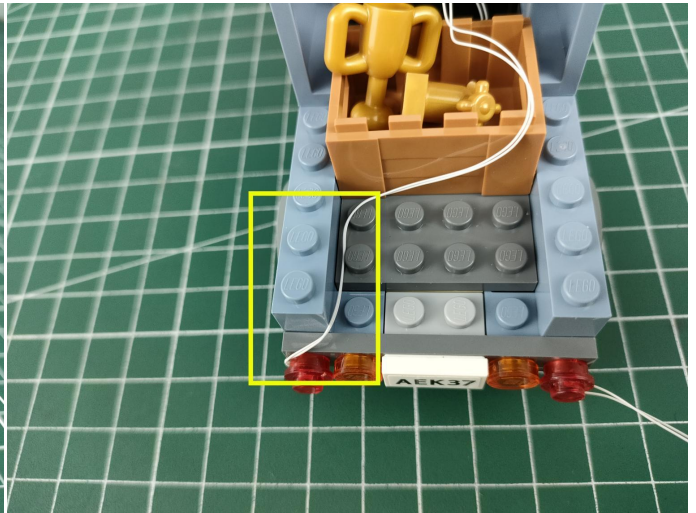
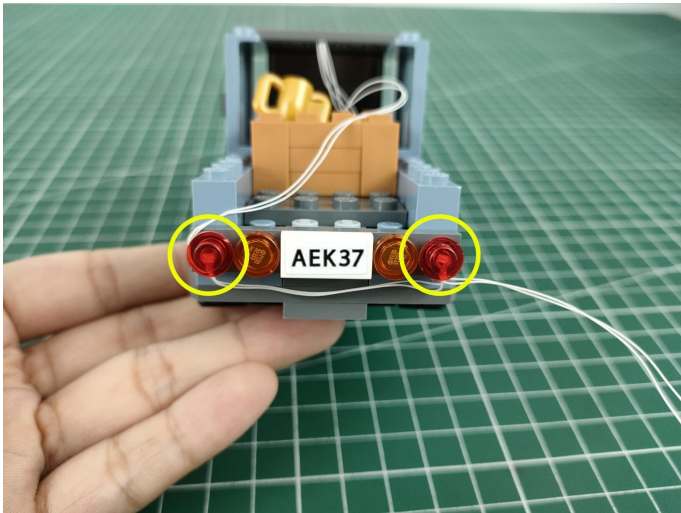

29

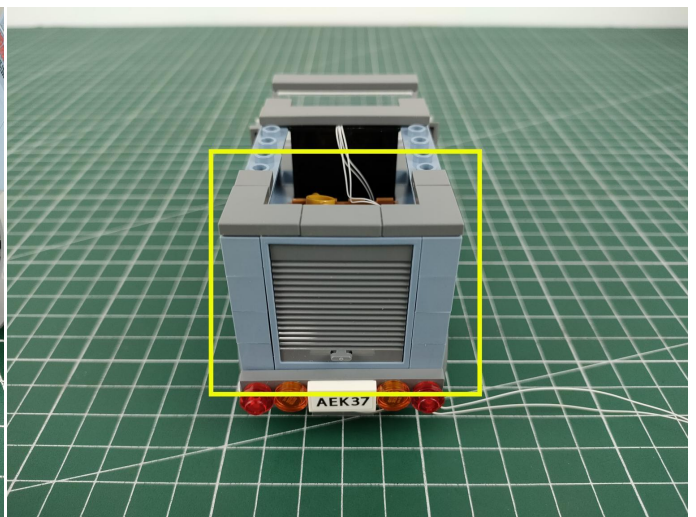
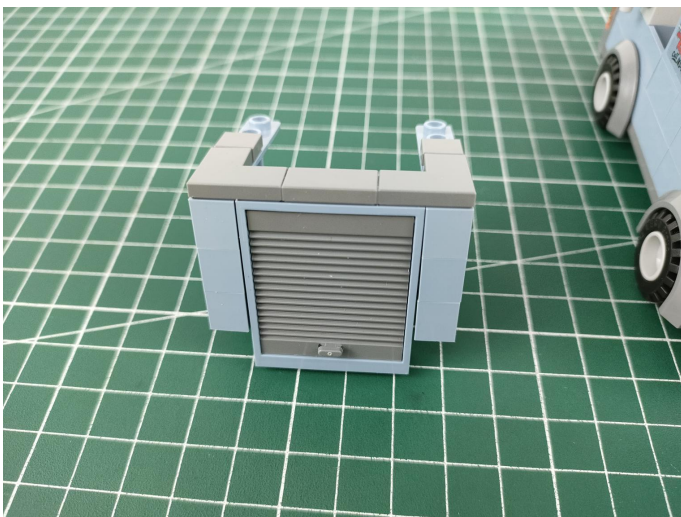

30

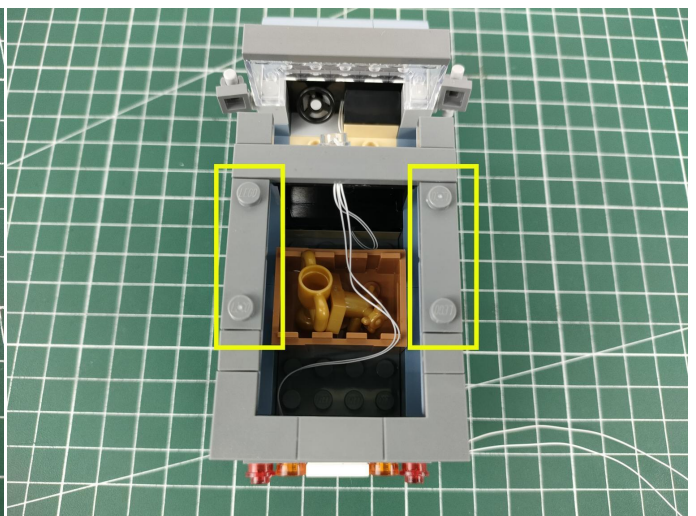
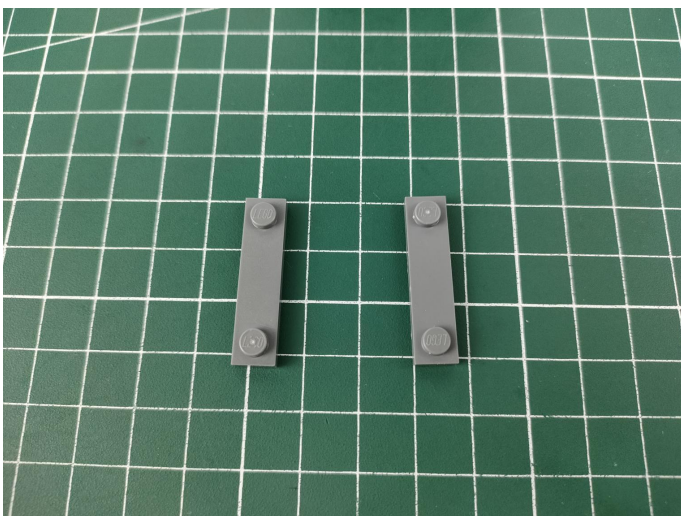

31

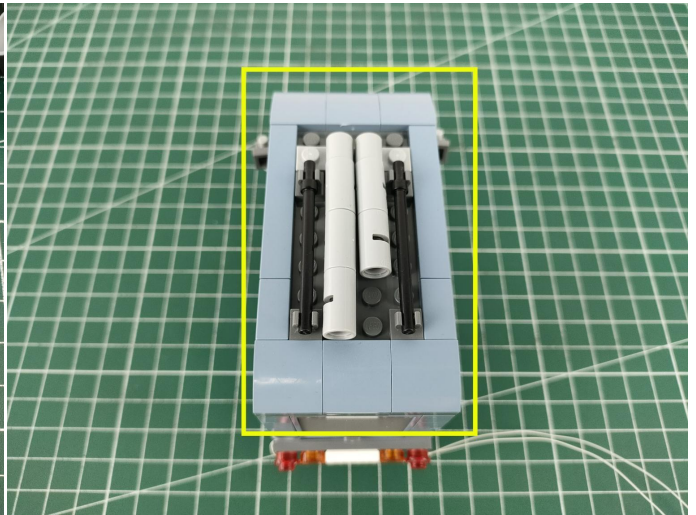
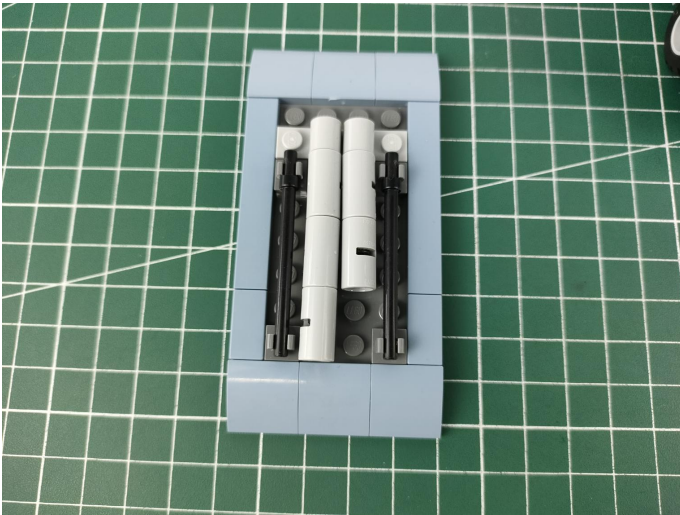

32

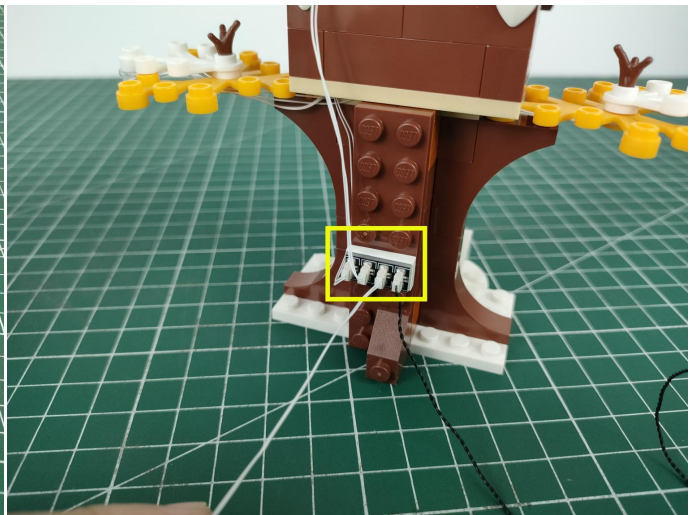
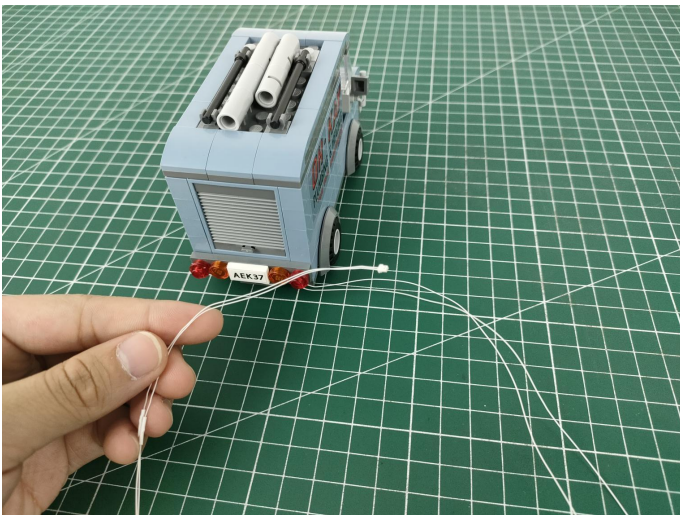

33



34

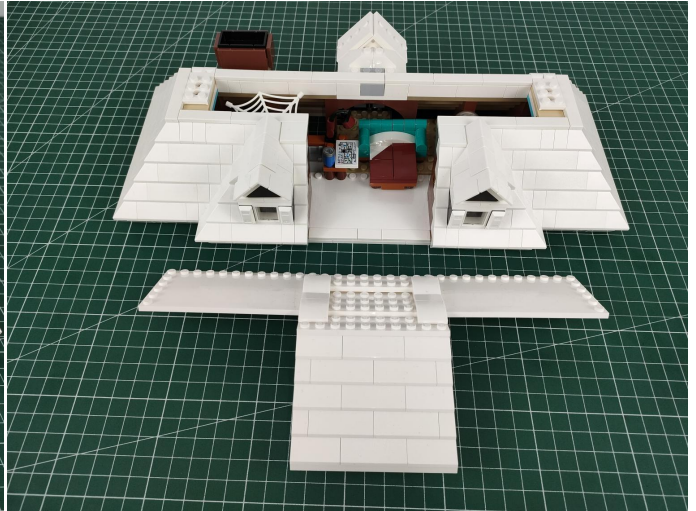
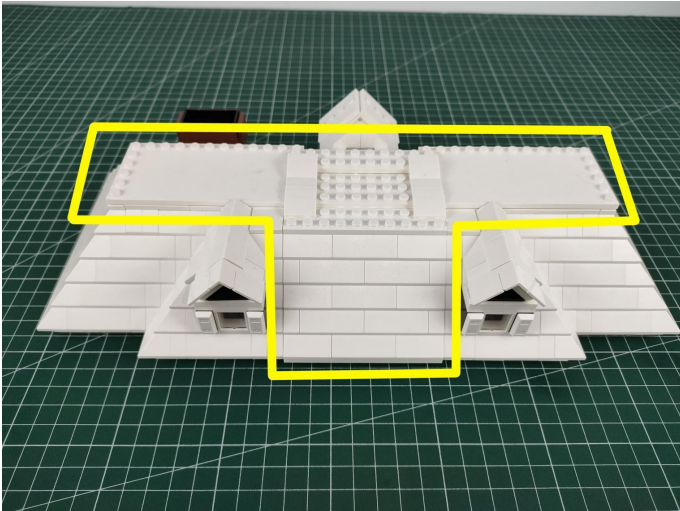

35

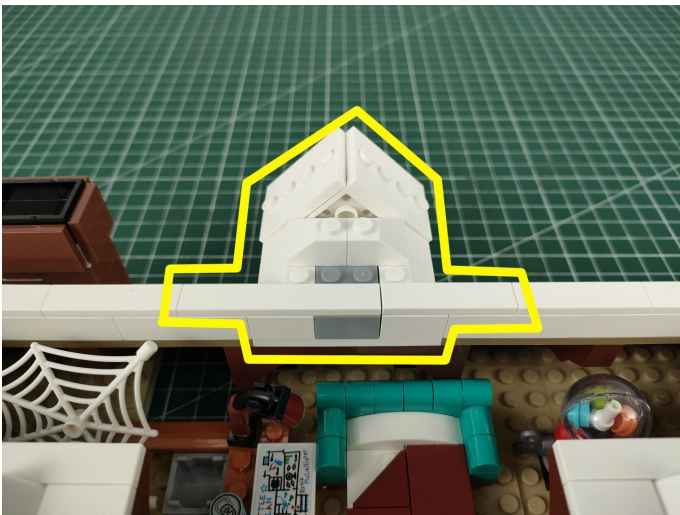

36

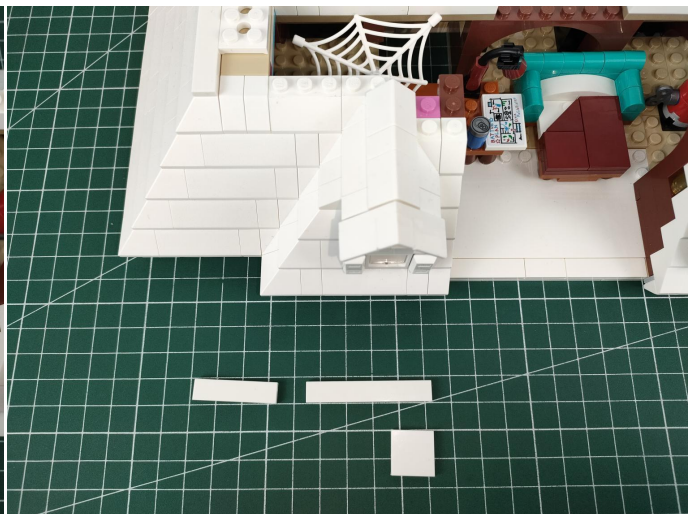
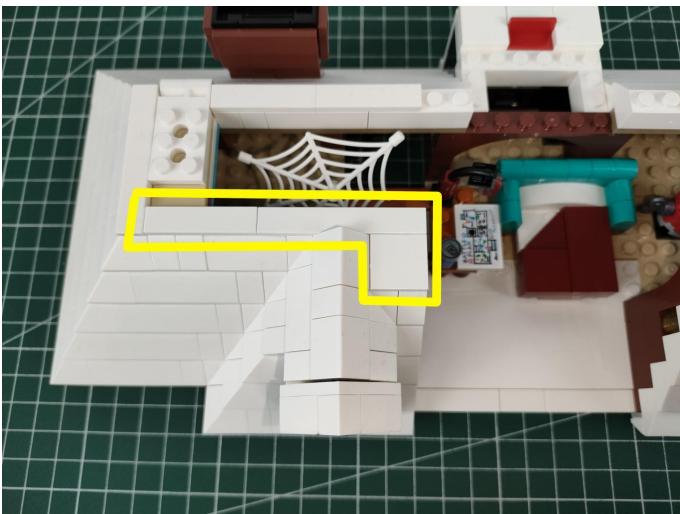

37

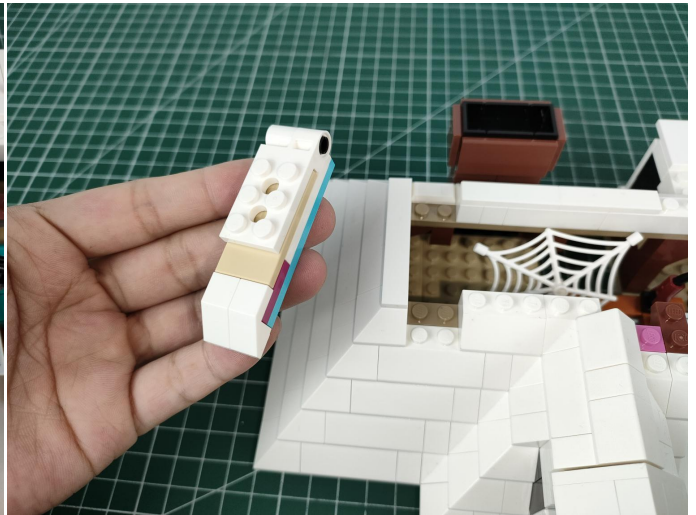
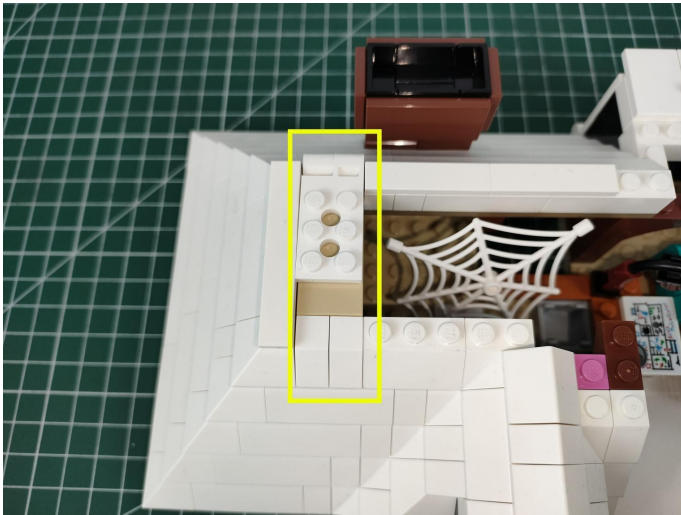

38

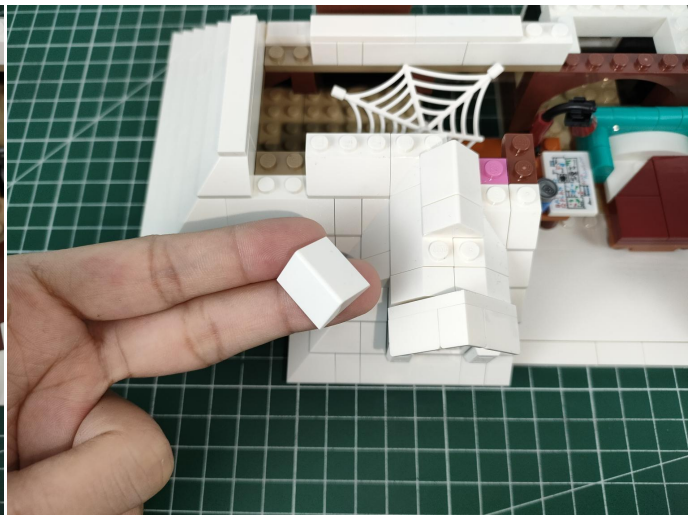
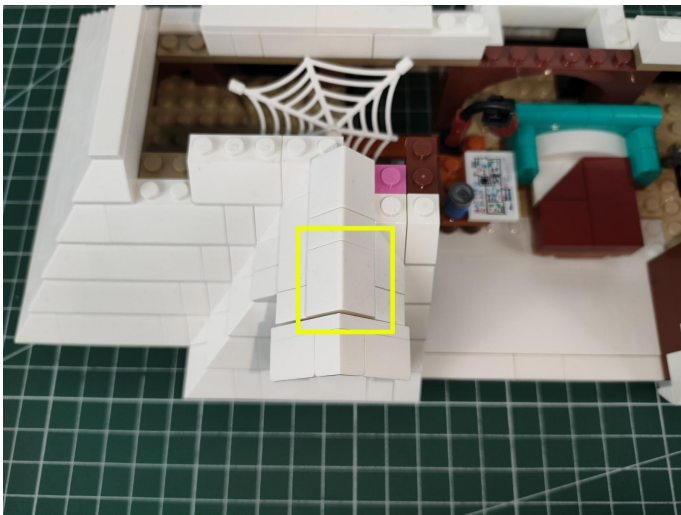

39

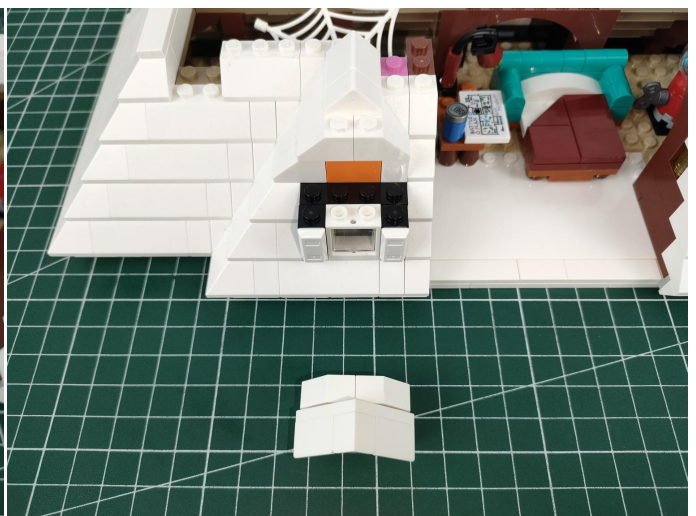
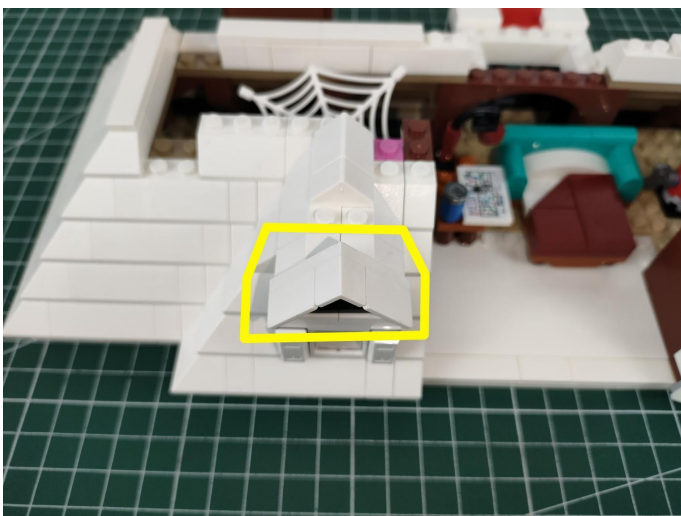

40

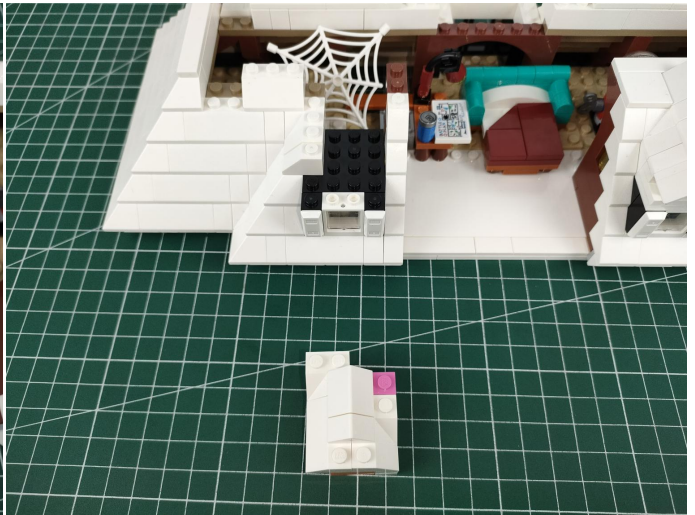
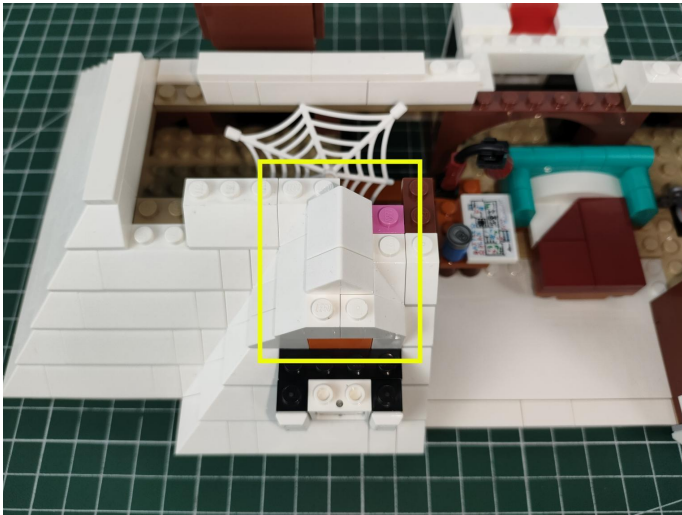

41

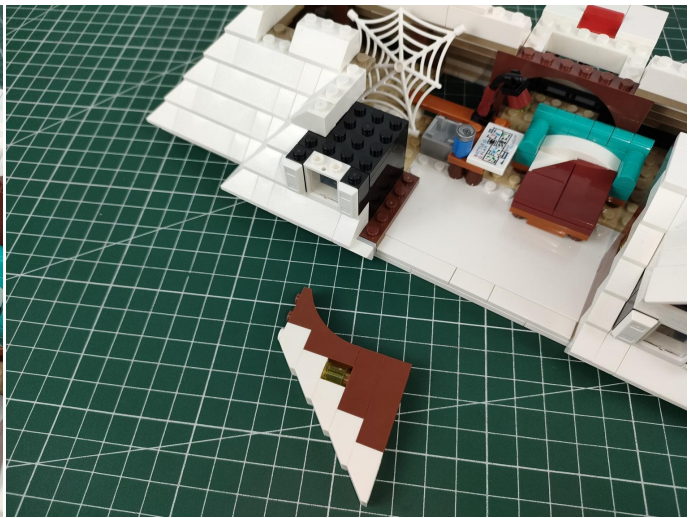
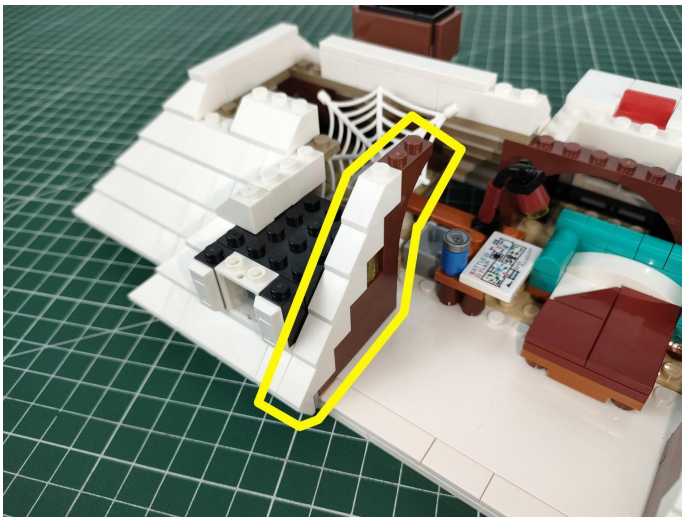

42

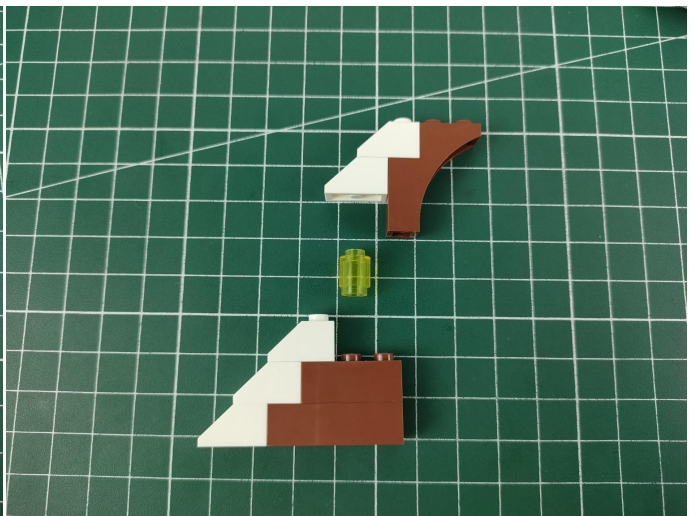
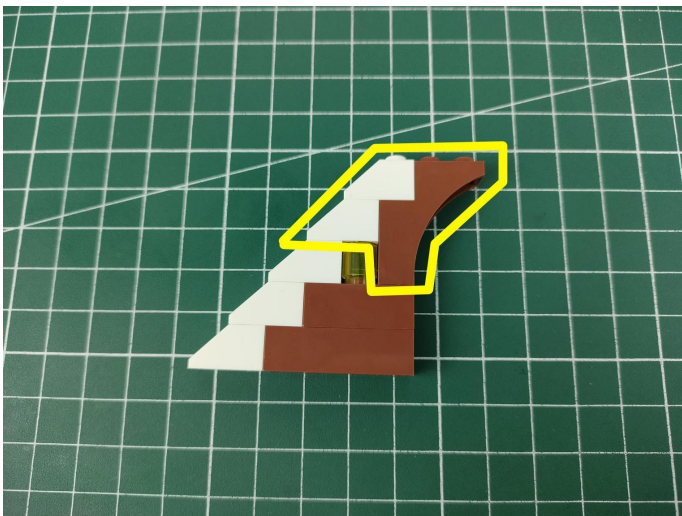

43

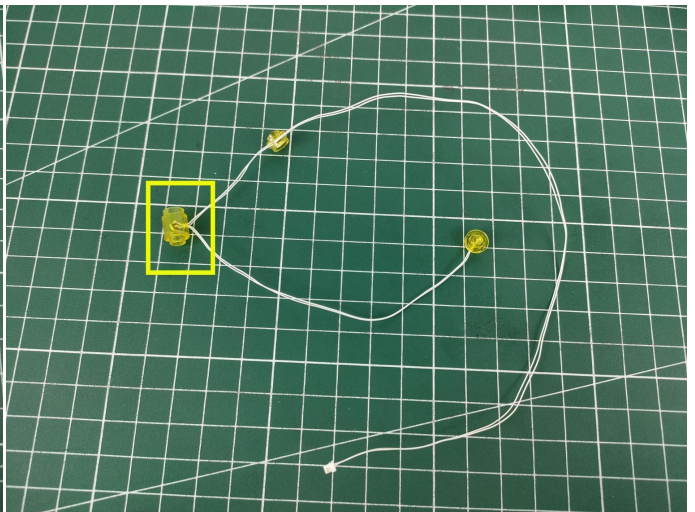

44

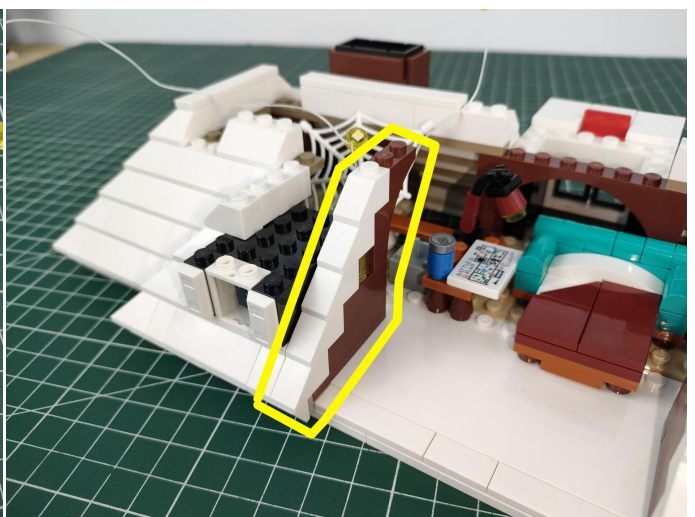
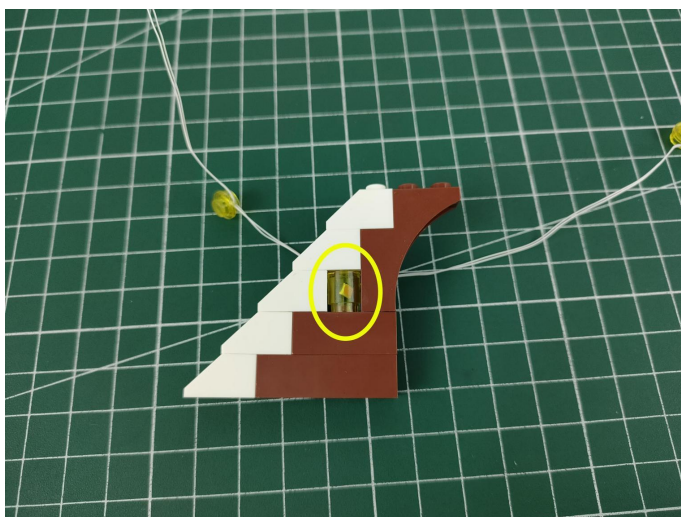

45

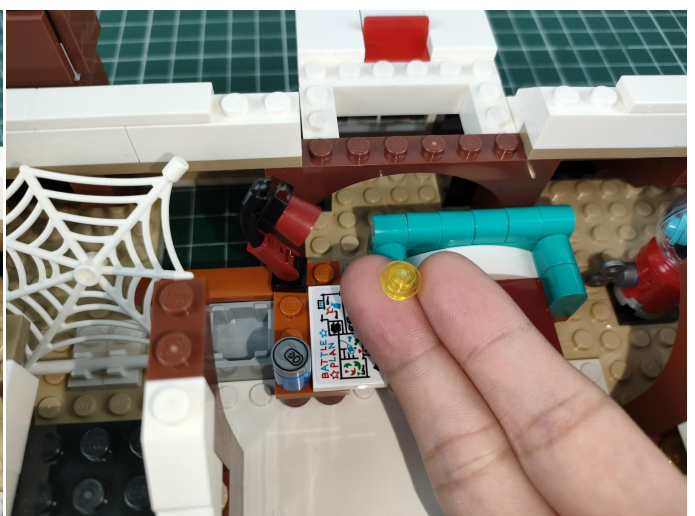
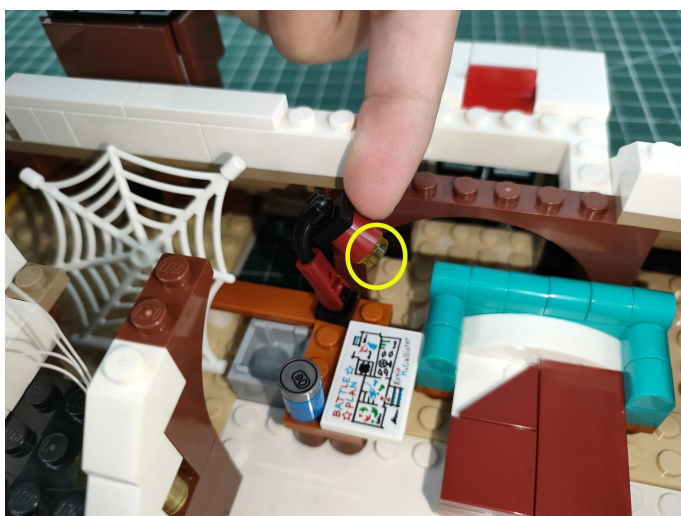

46

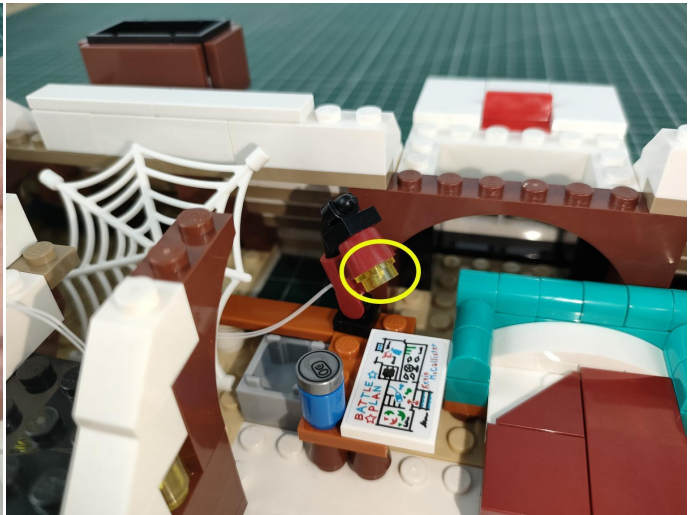
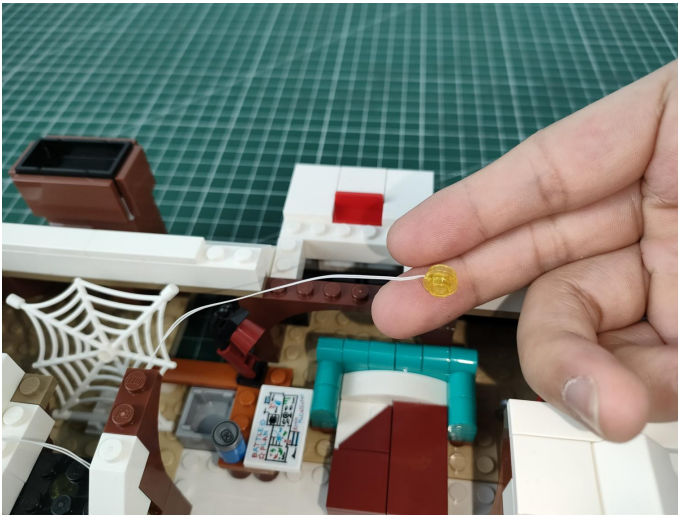

47

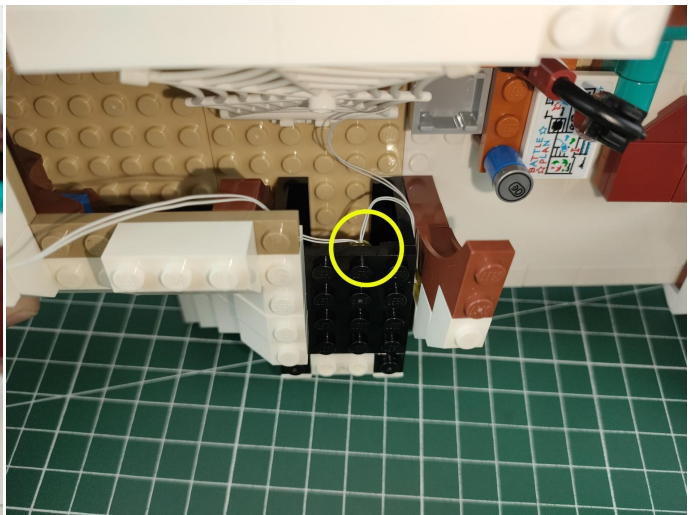
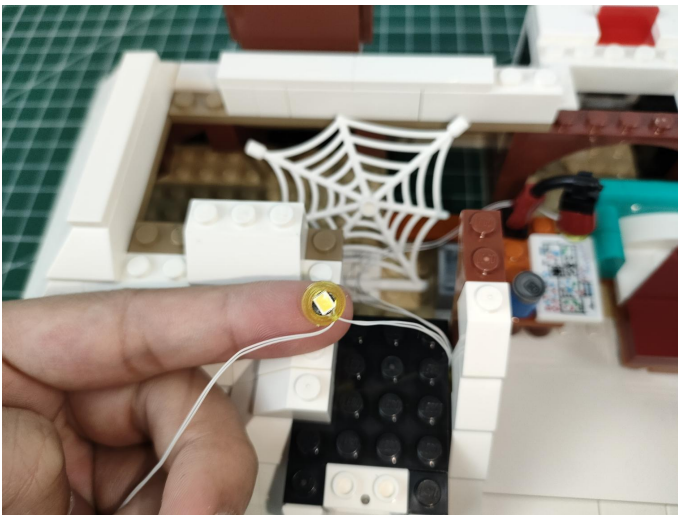

48

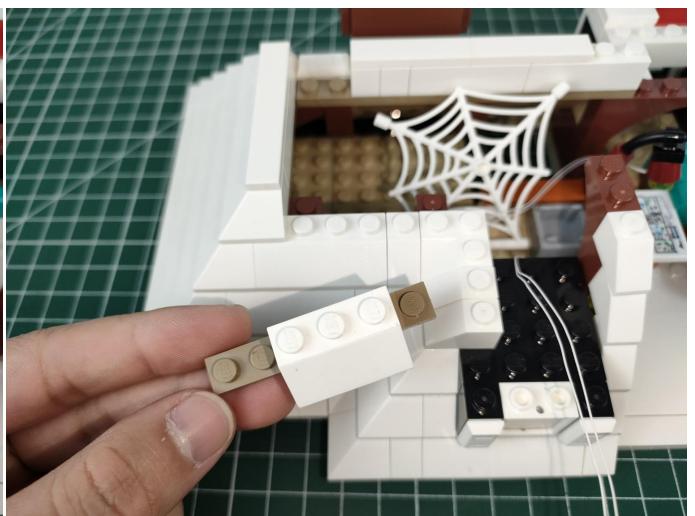
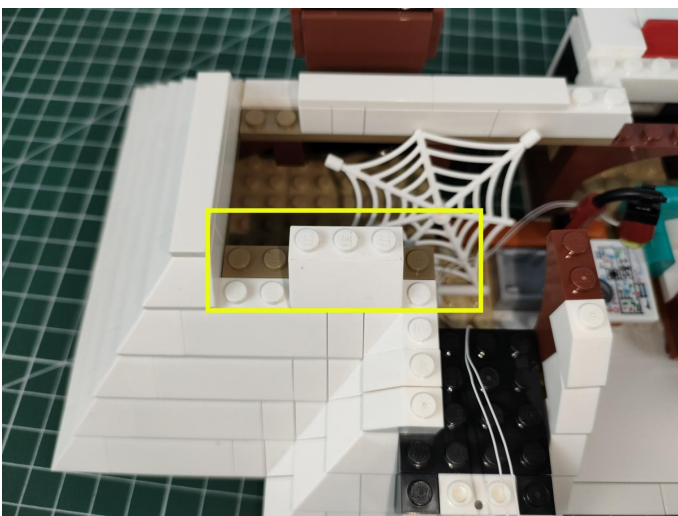

49

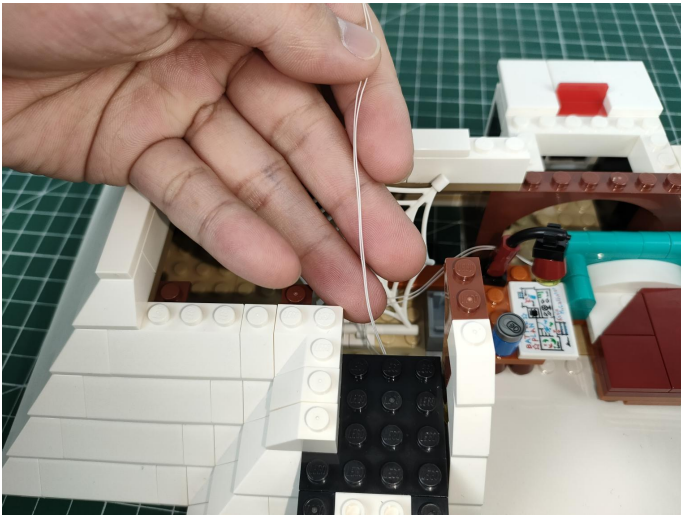

50

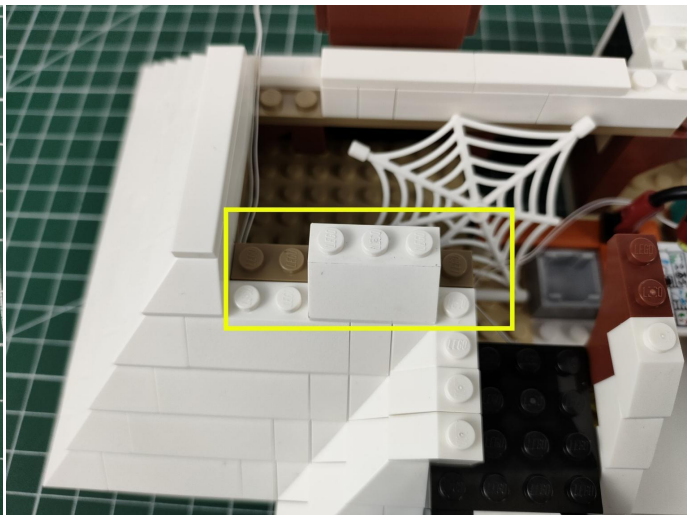
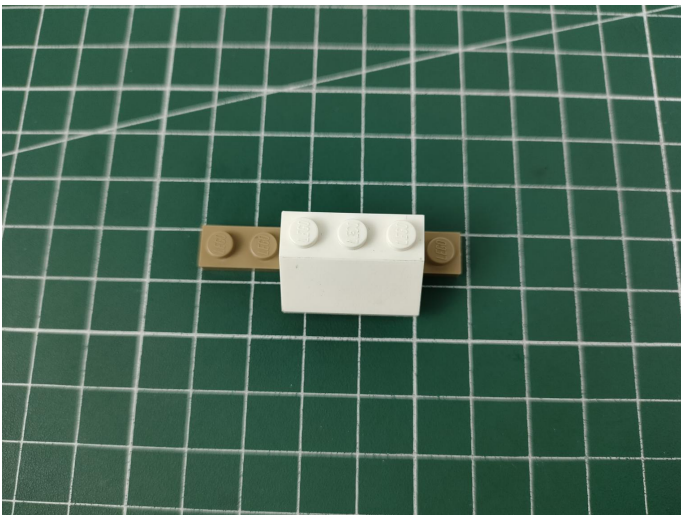

51

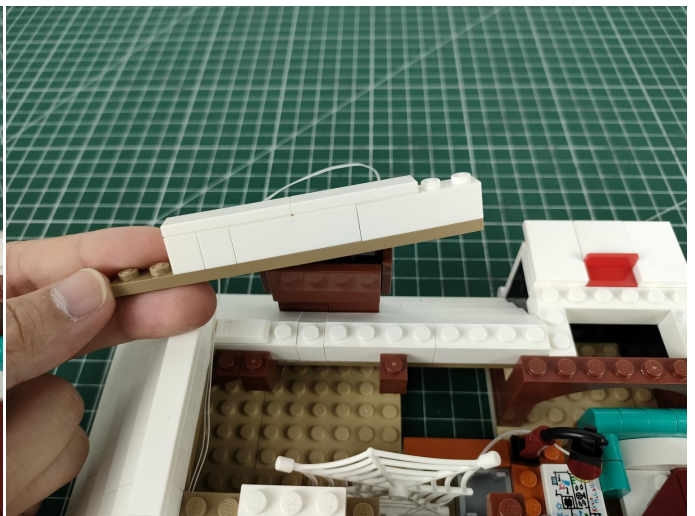
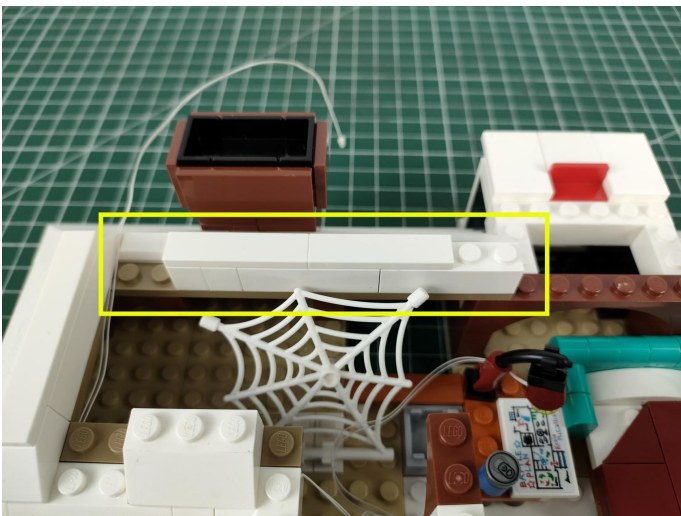

52

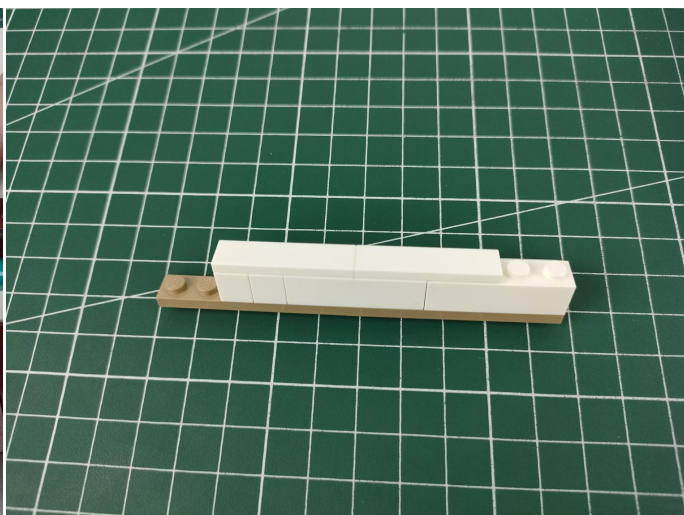
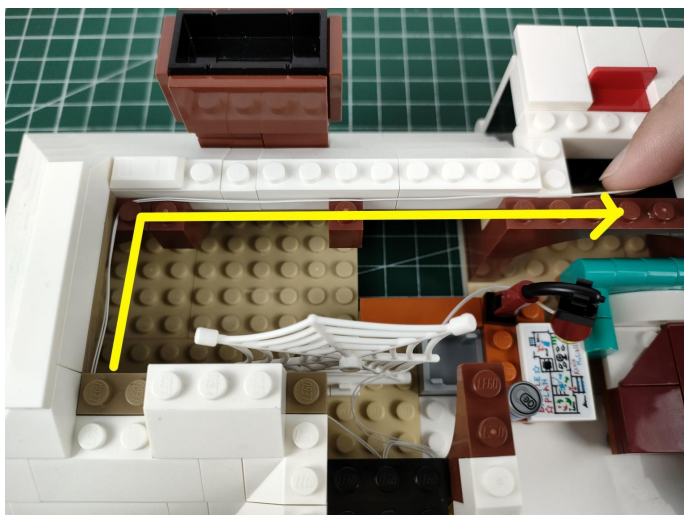

53

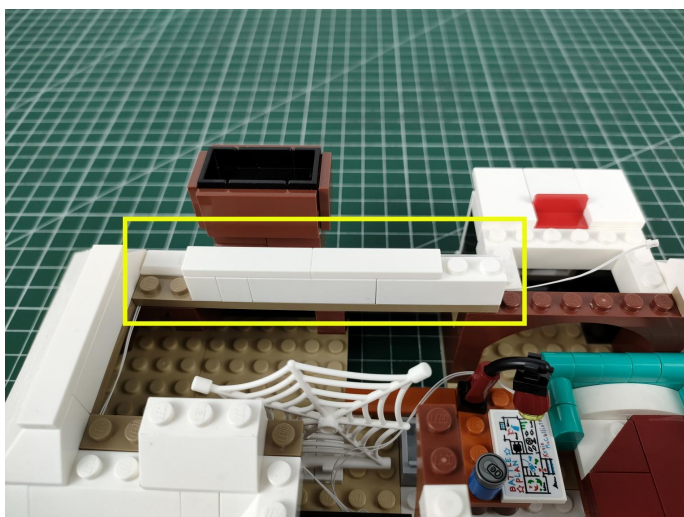

54

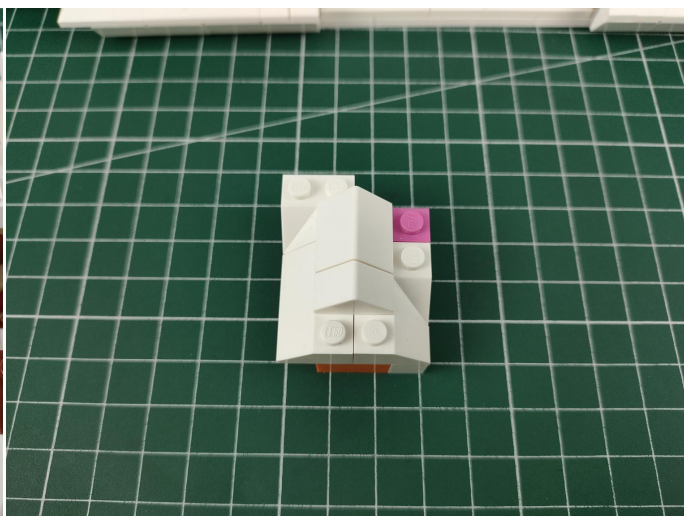
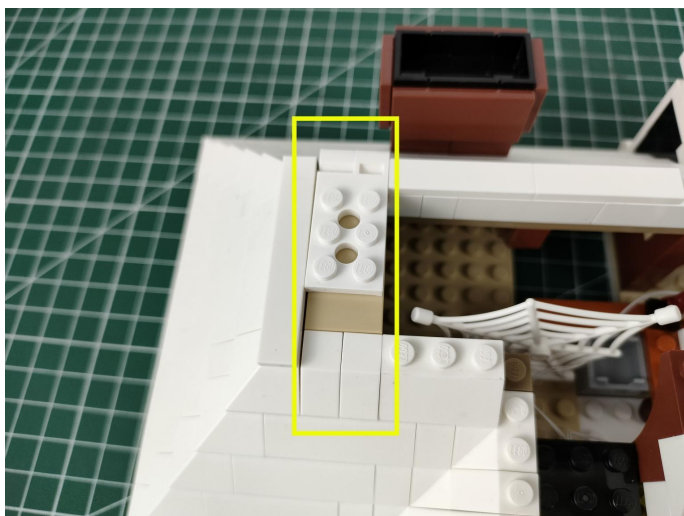

55

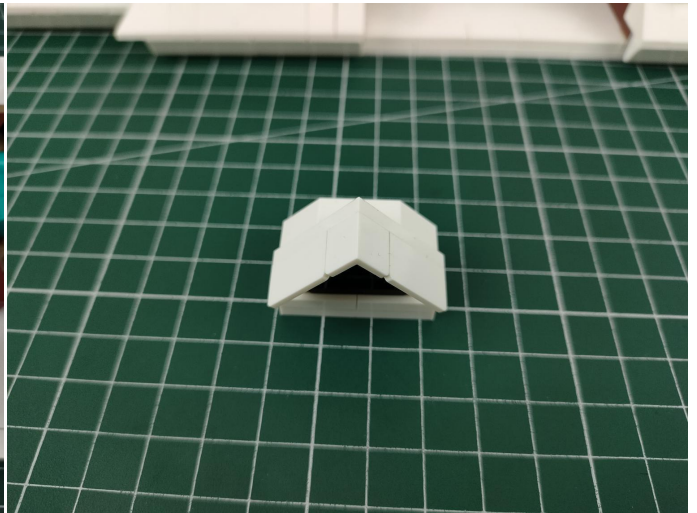
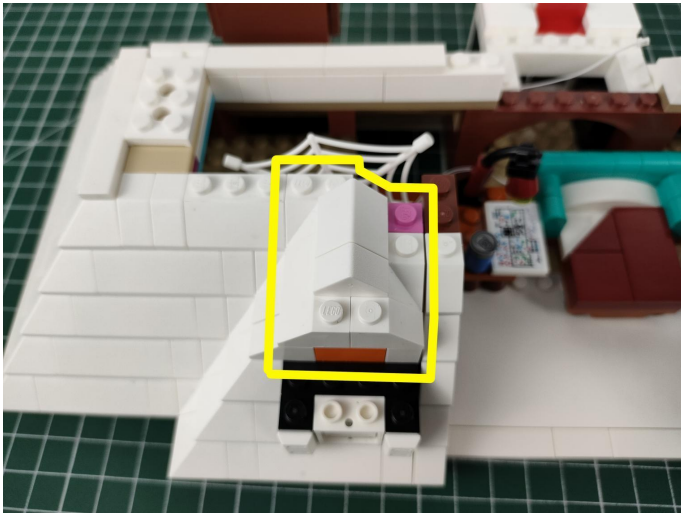

56

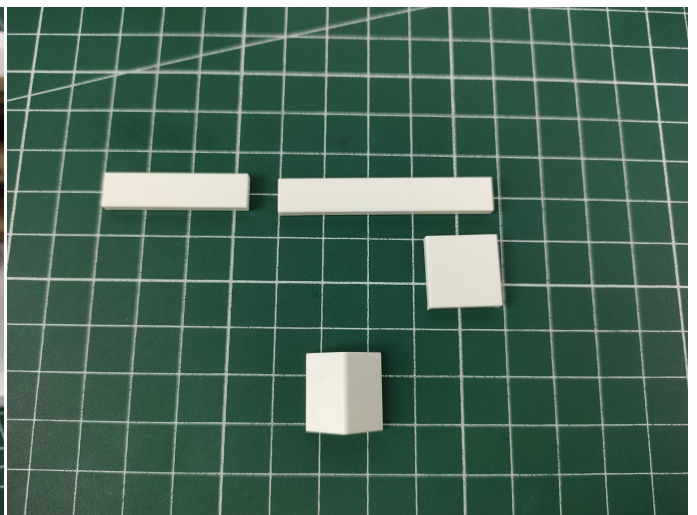
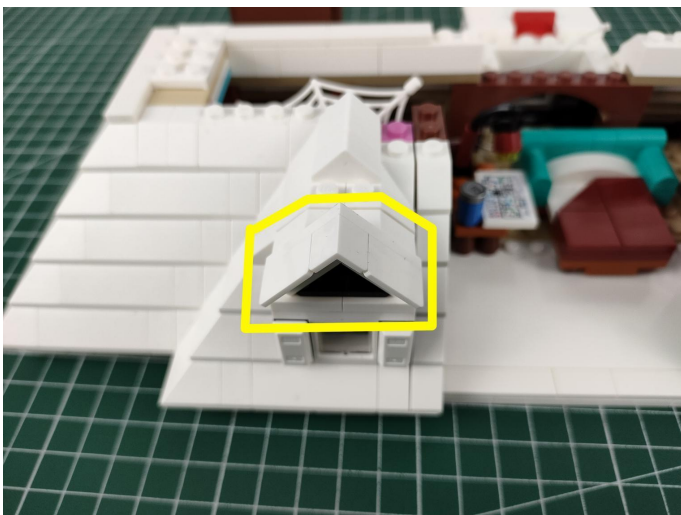

57

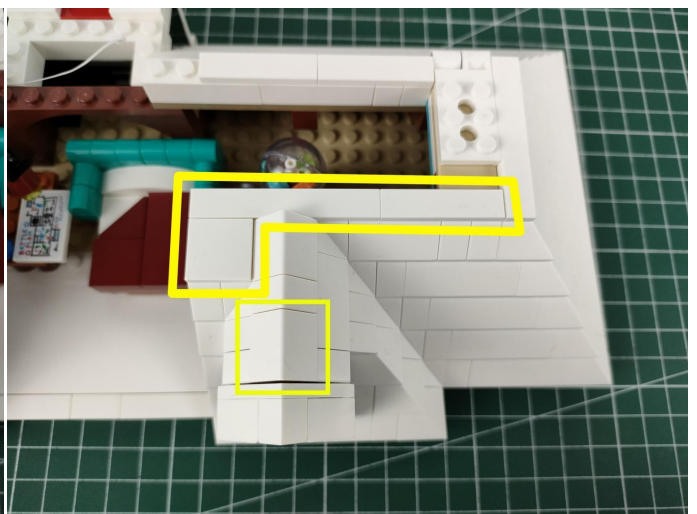
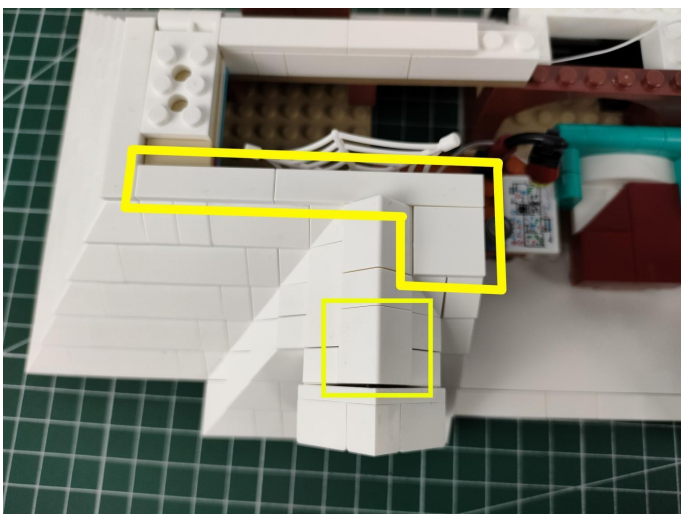

58

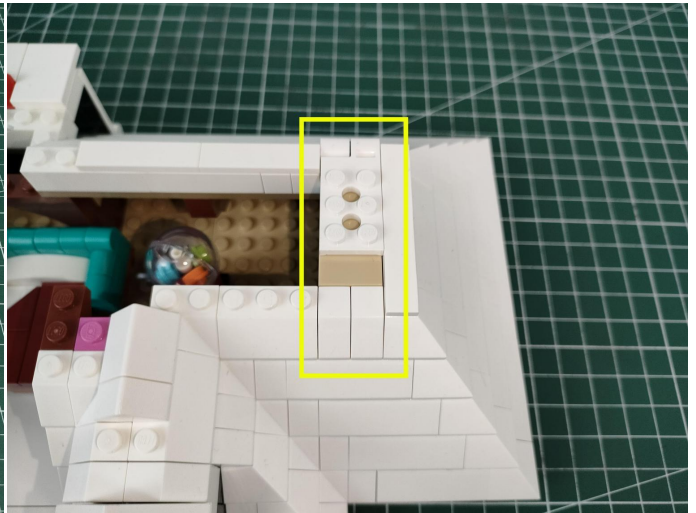
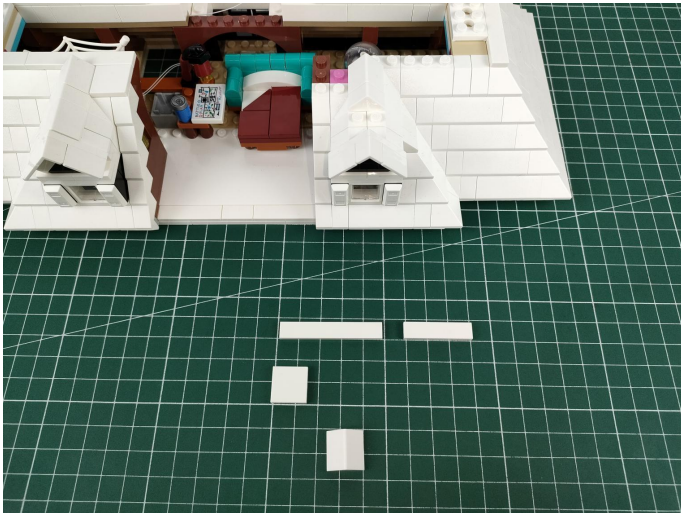

59

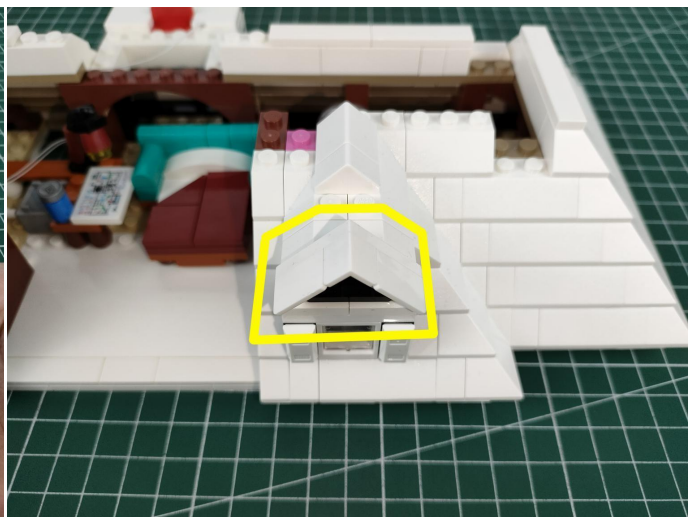
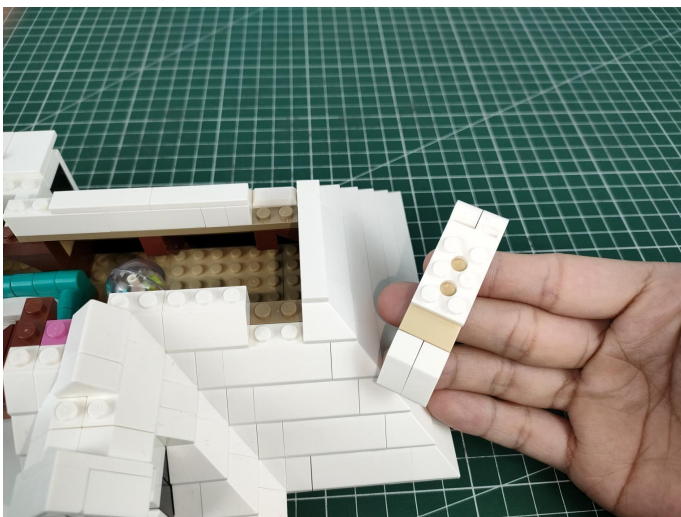

60

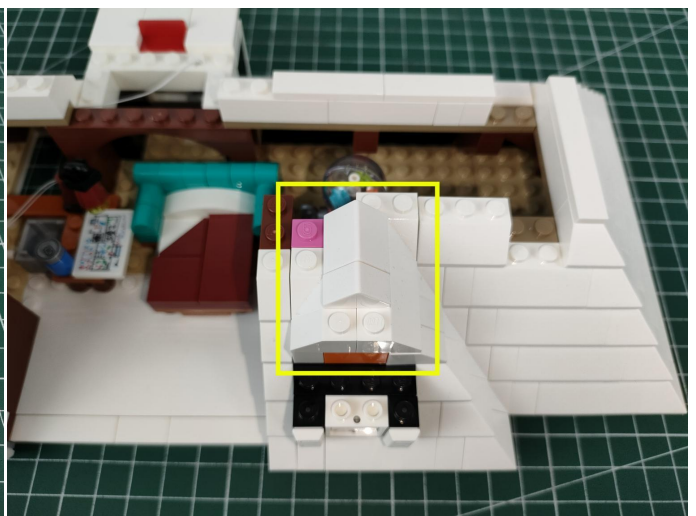
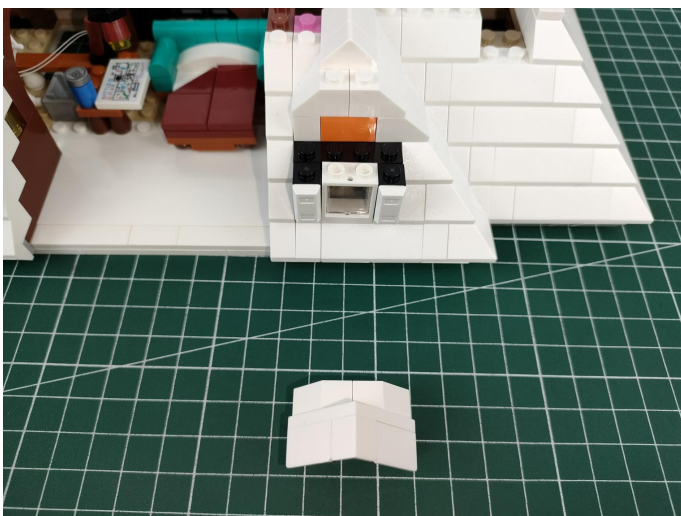

61

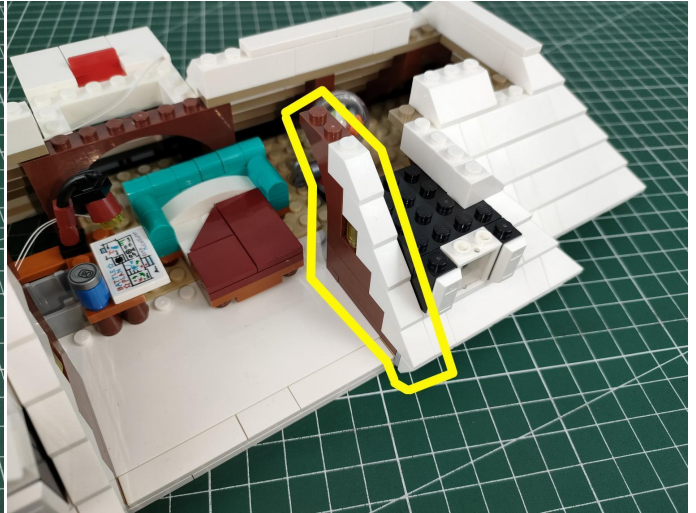
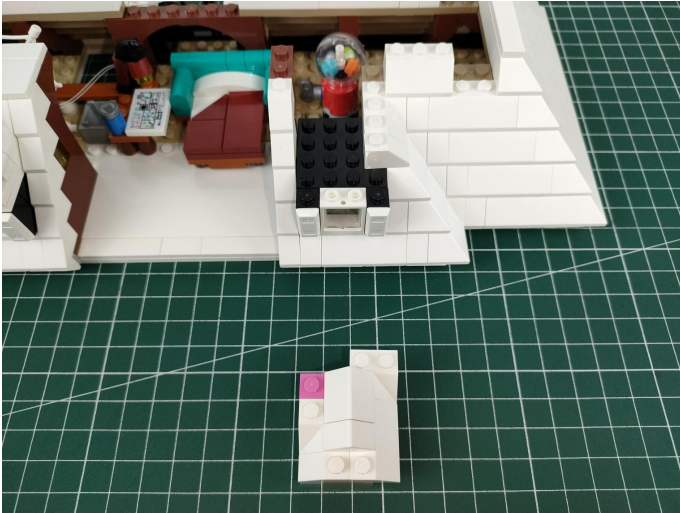

62

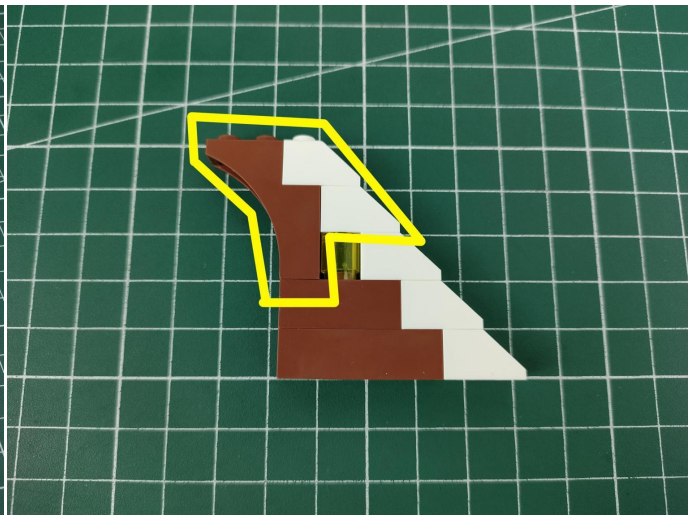
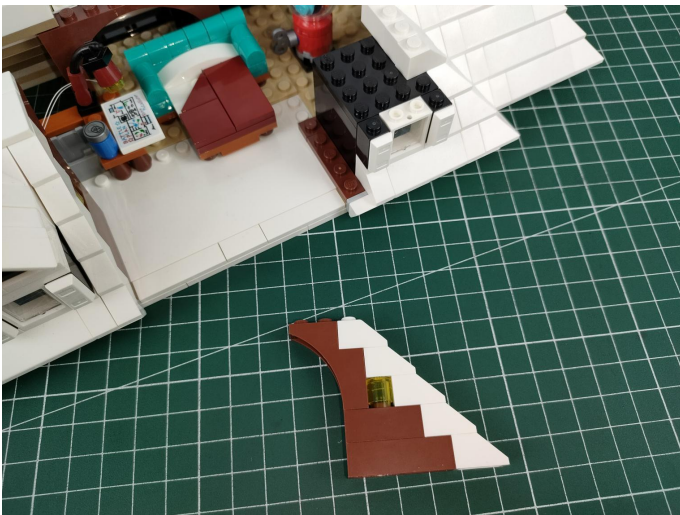

63

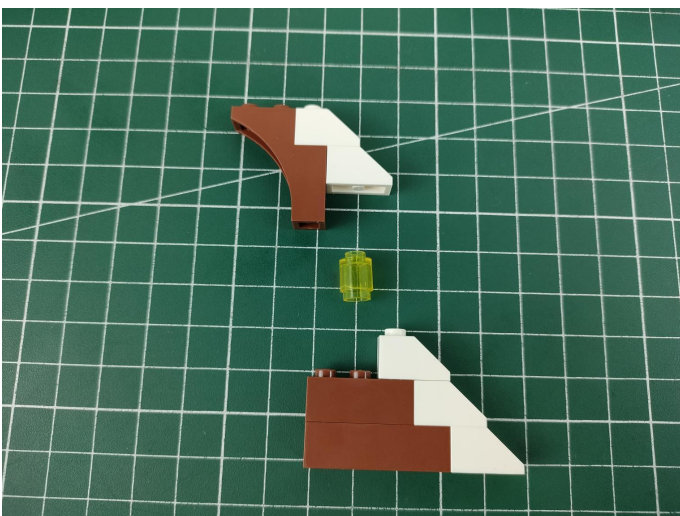

64

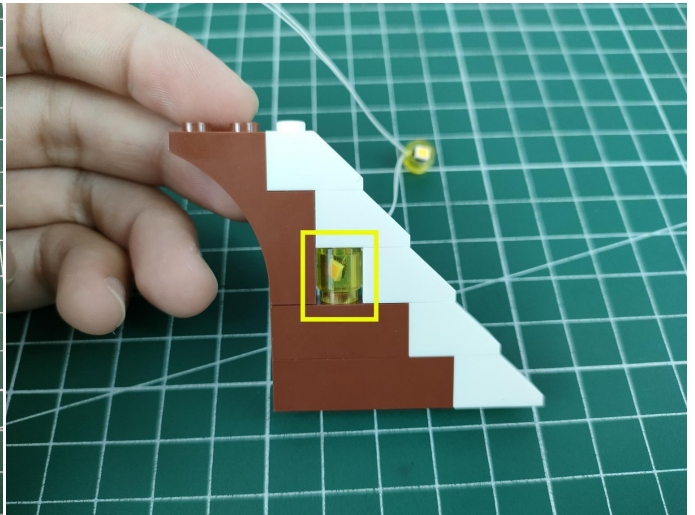
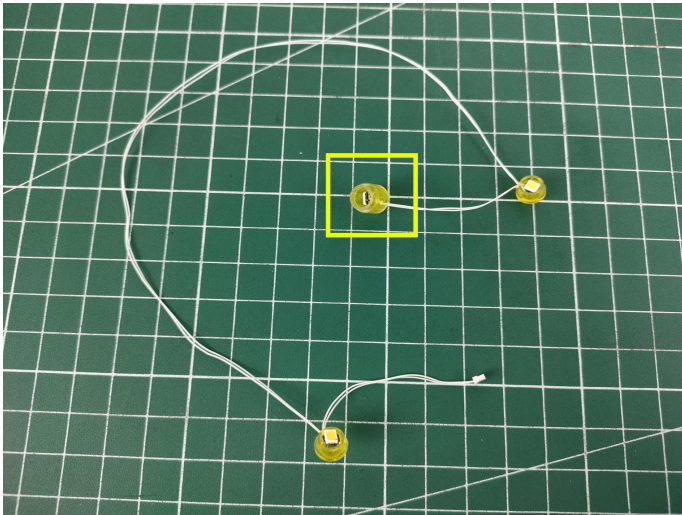

65

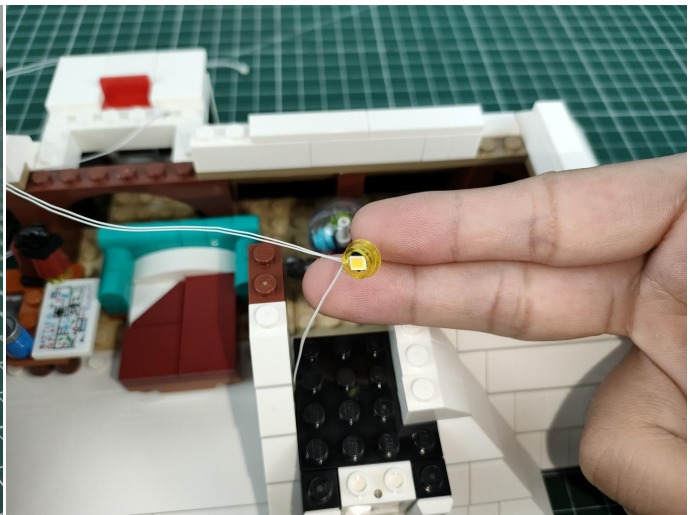
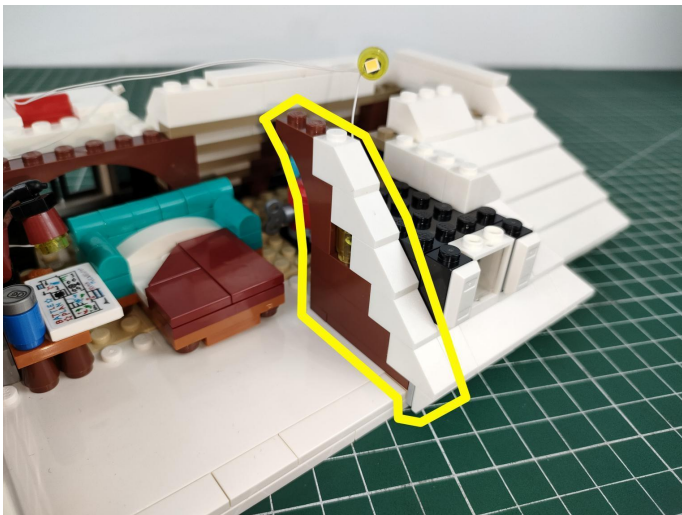

66

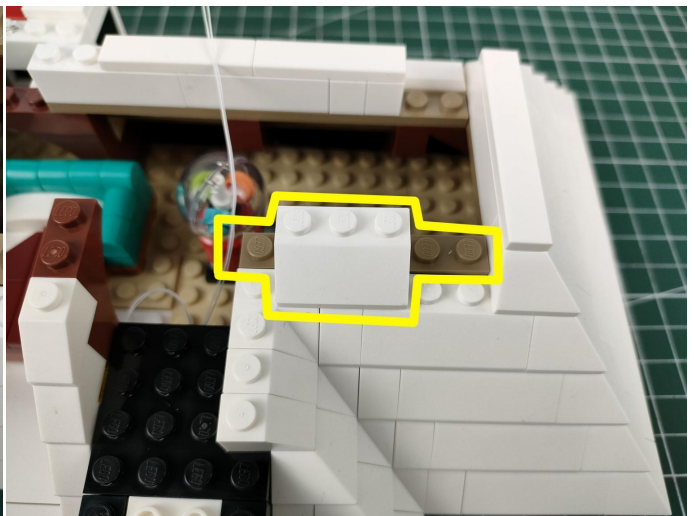
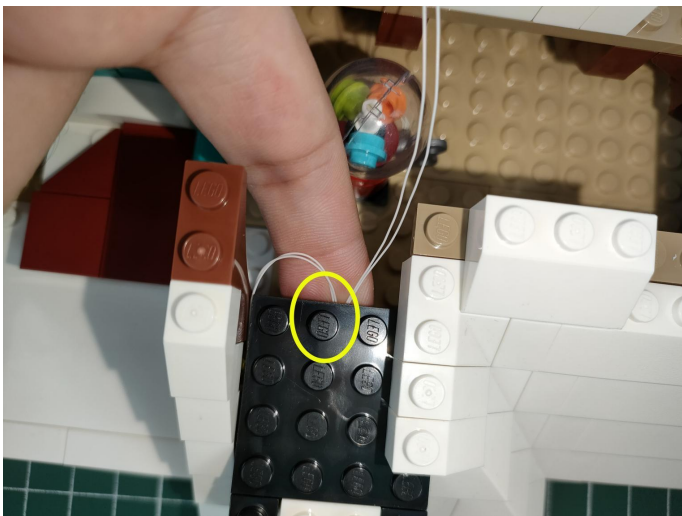

67

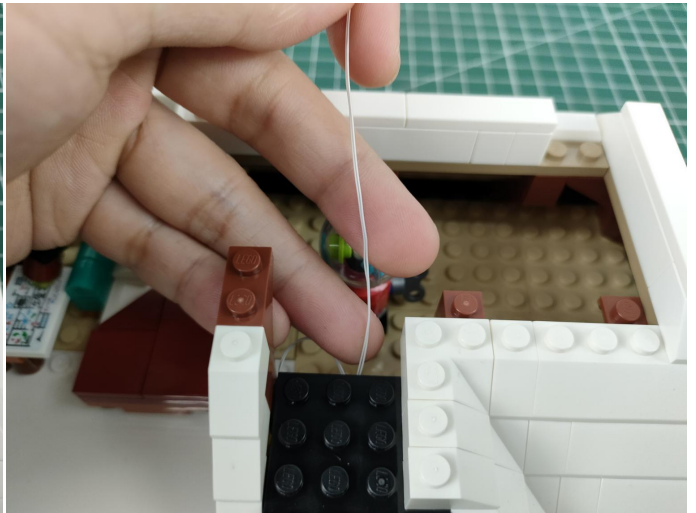
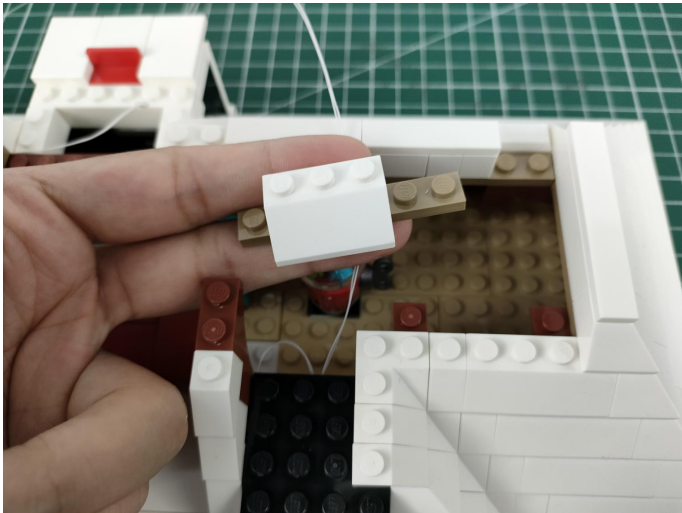

68

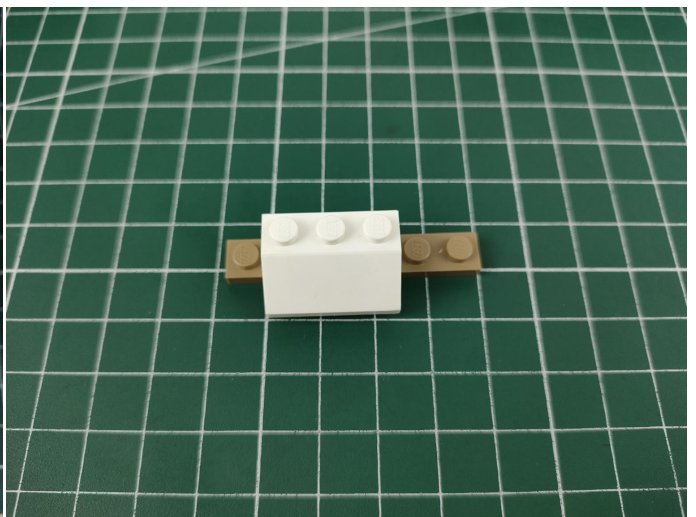
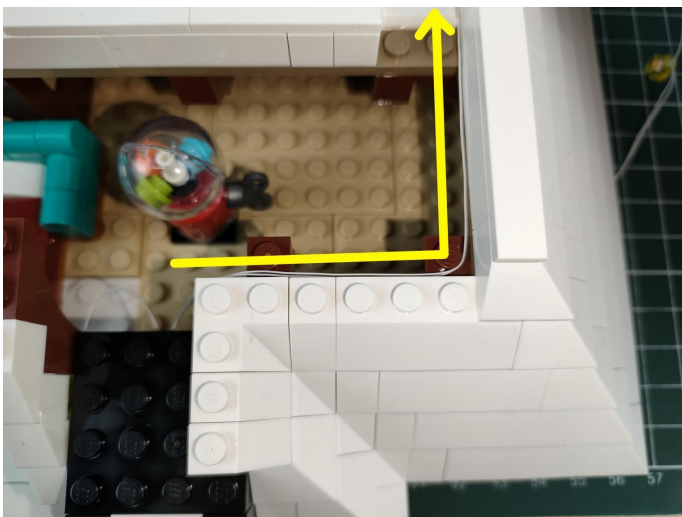

69

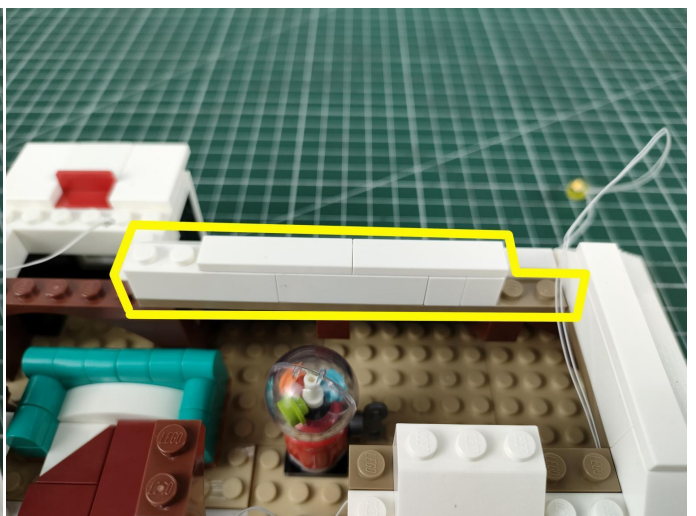
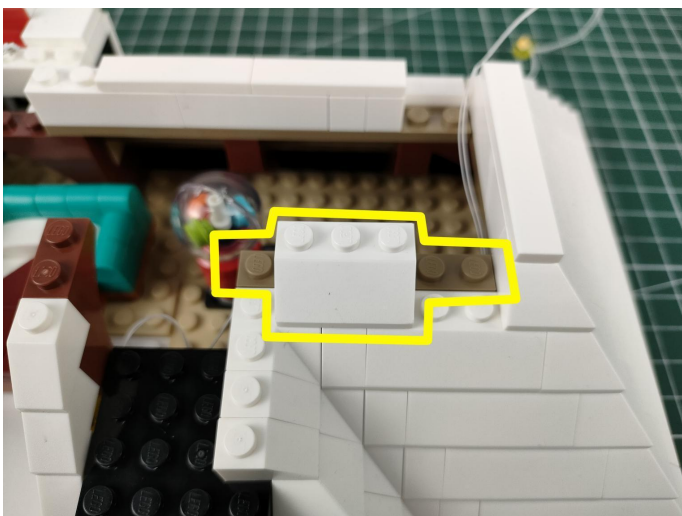

70

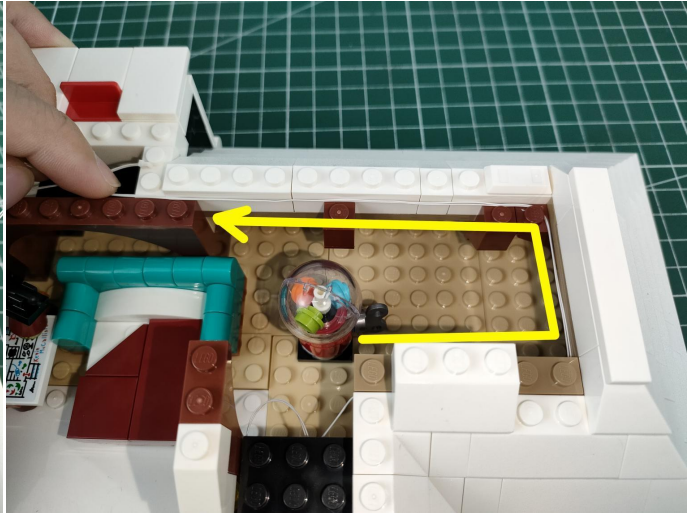
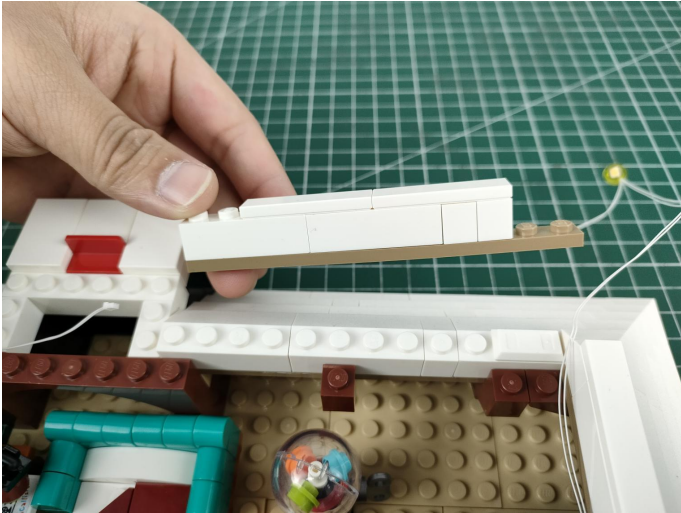

71

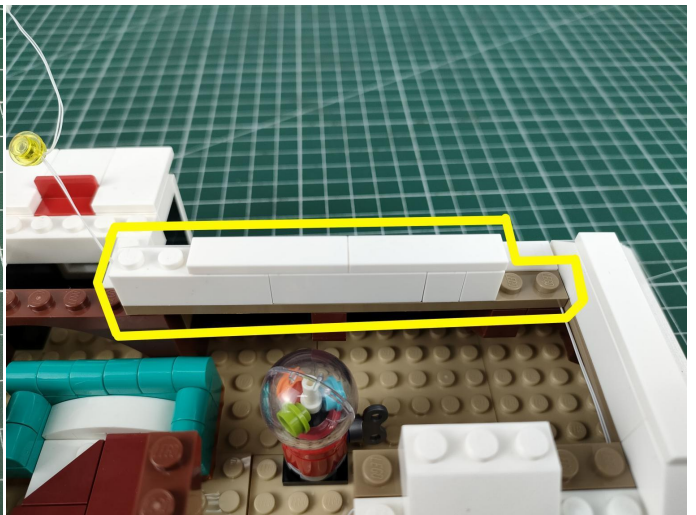
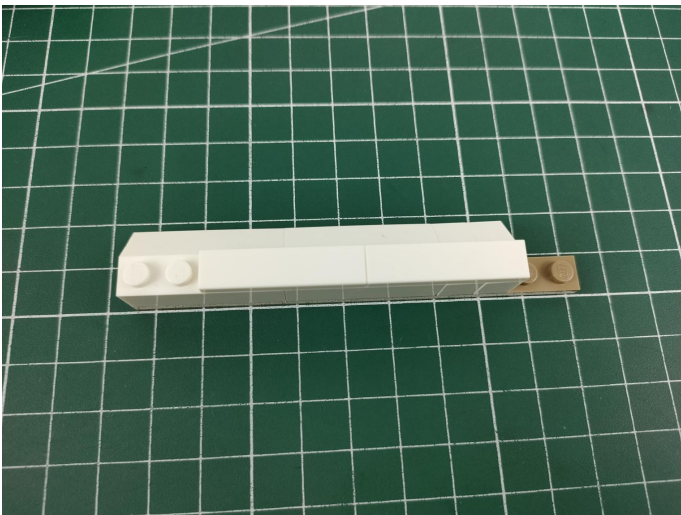

72

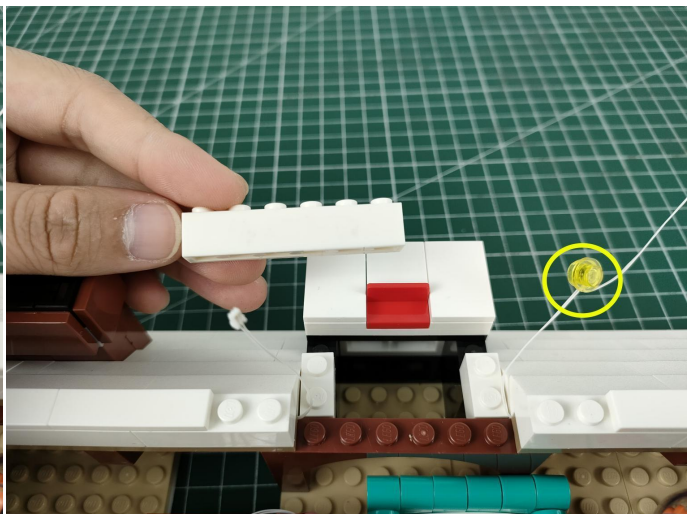
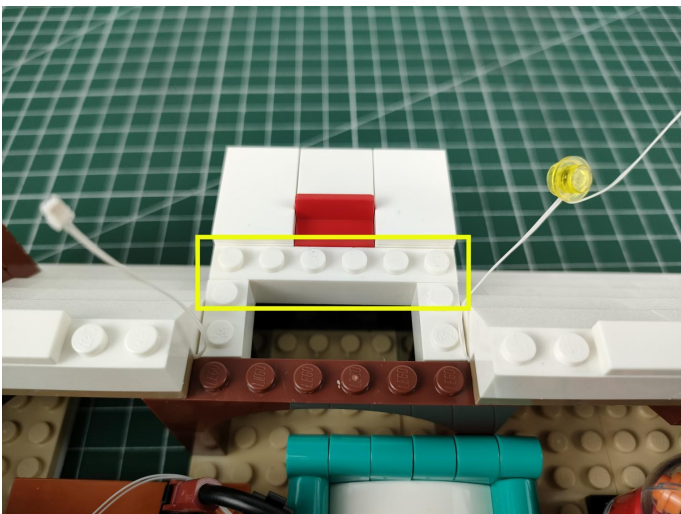

73

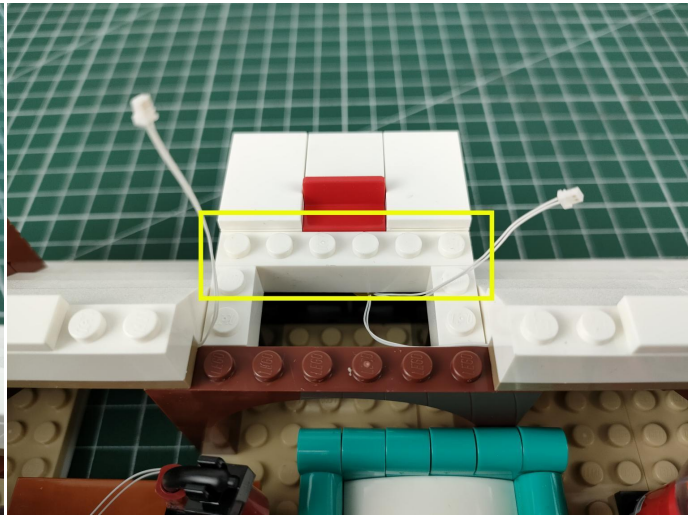
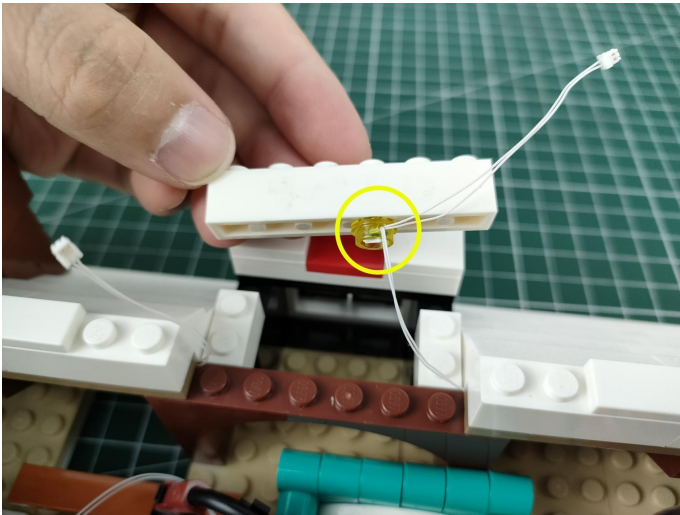

74



75

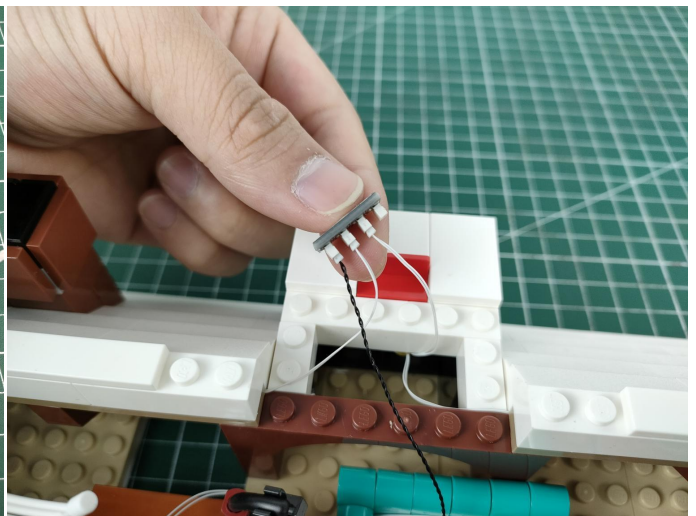
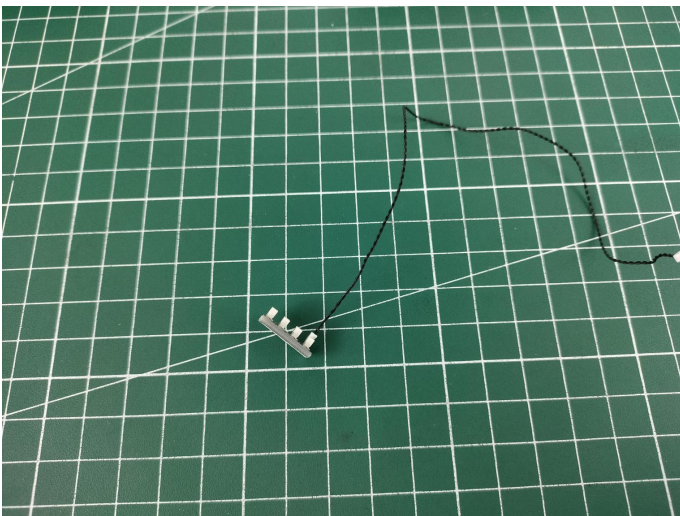

76

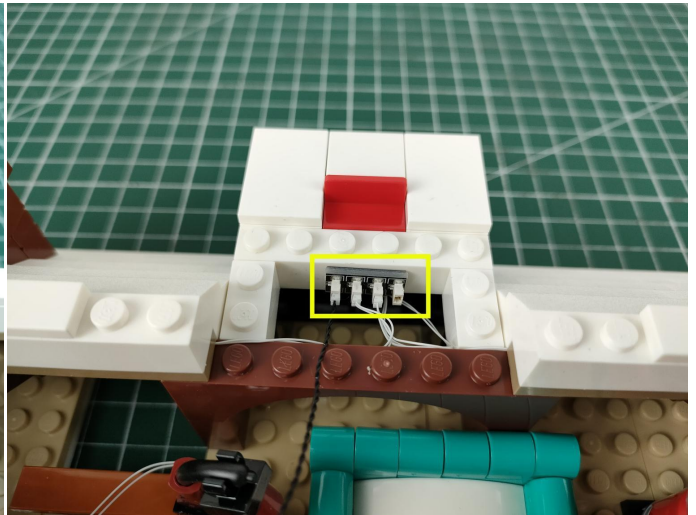
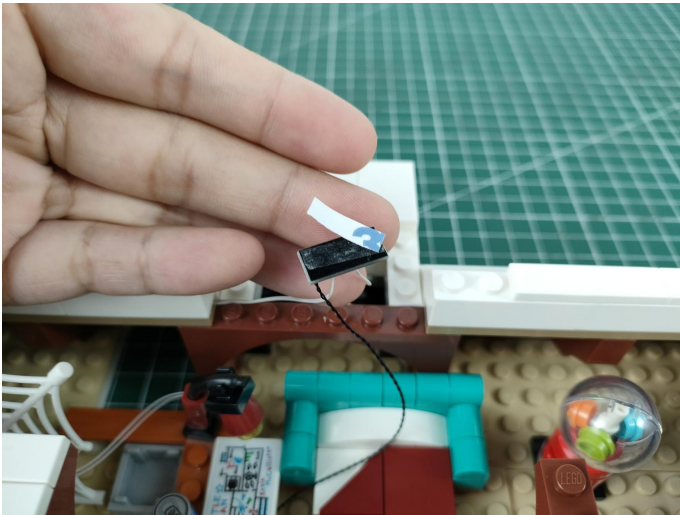

77

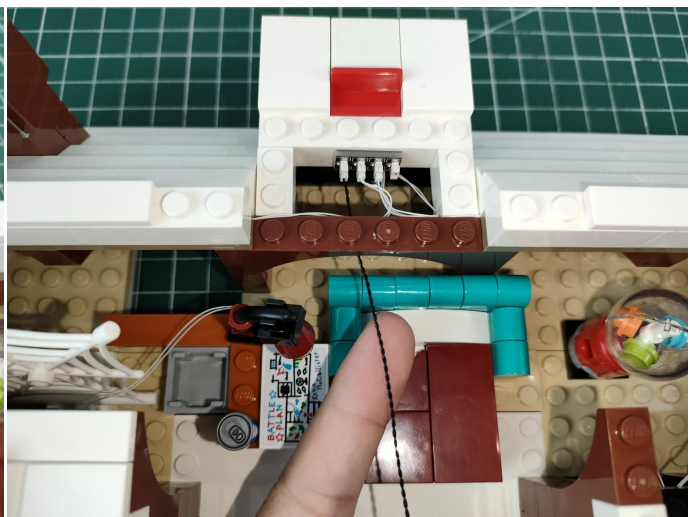
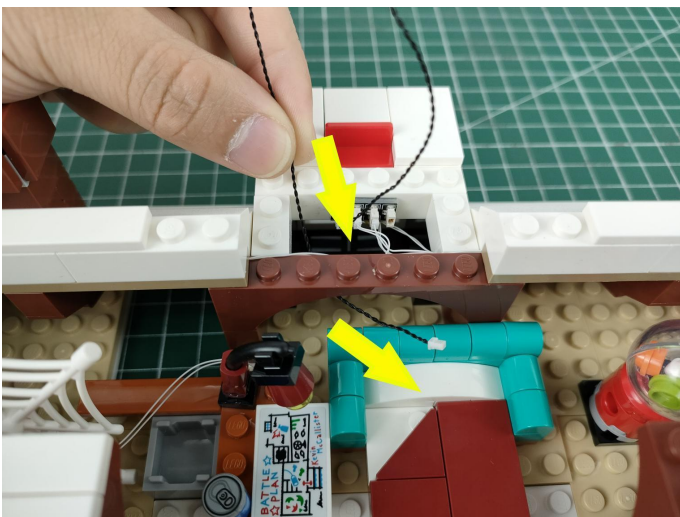

78

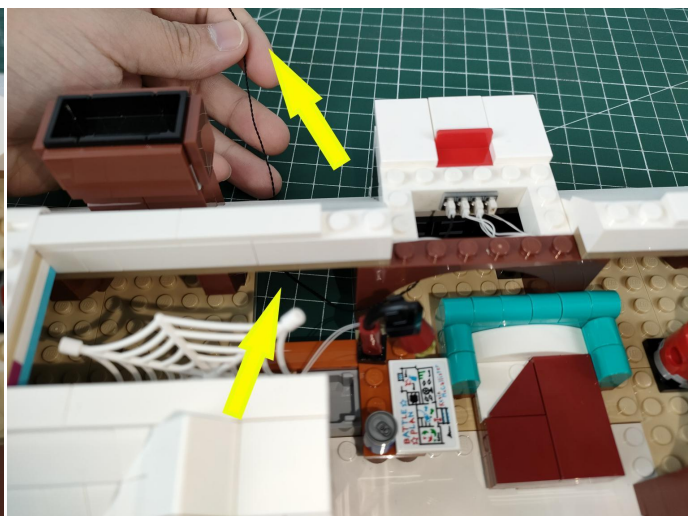
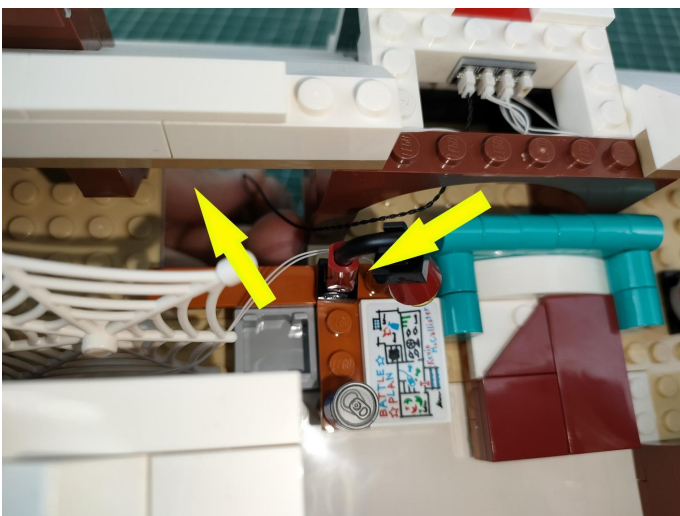

79

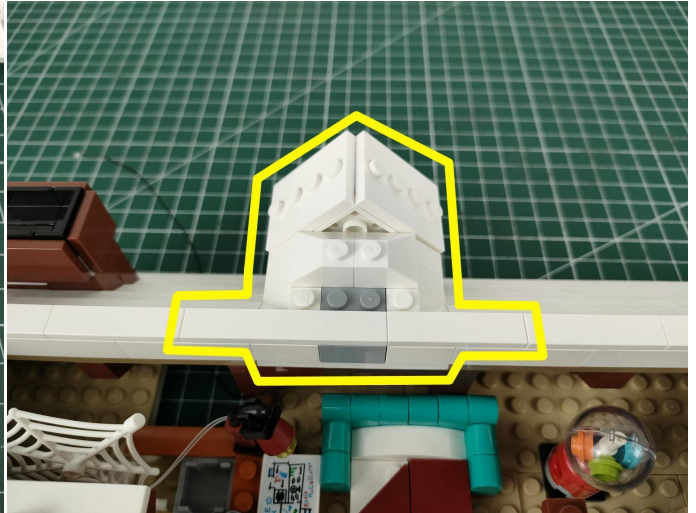
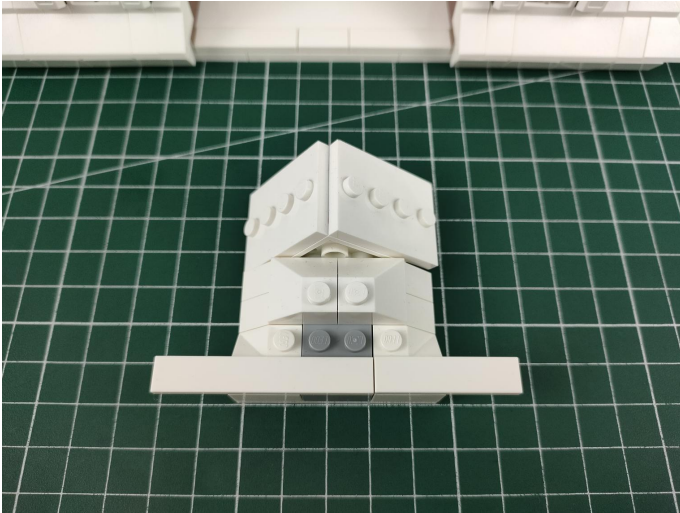

80

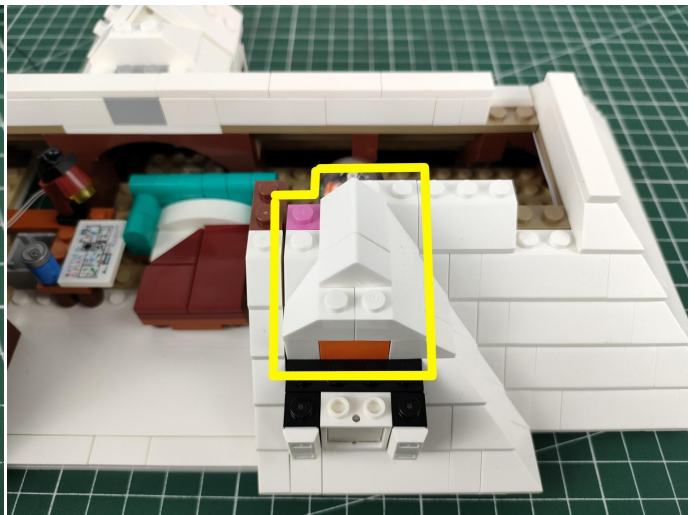
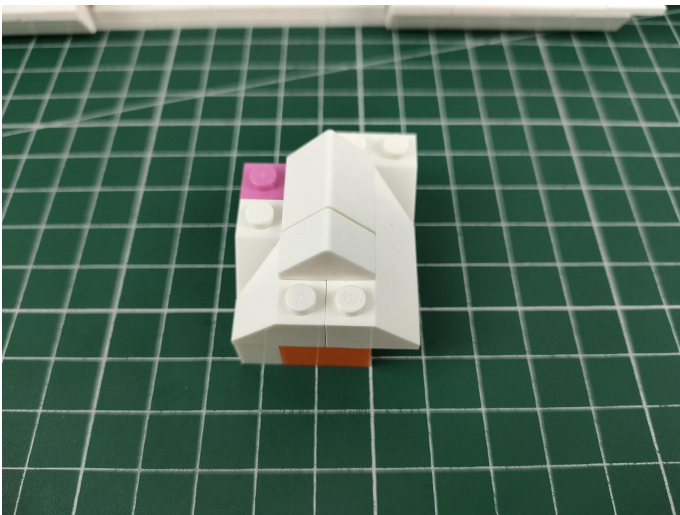

81

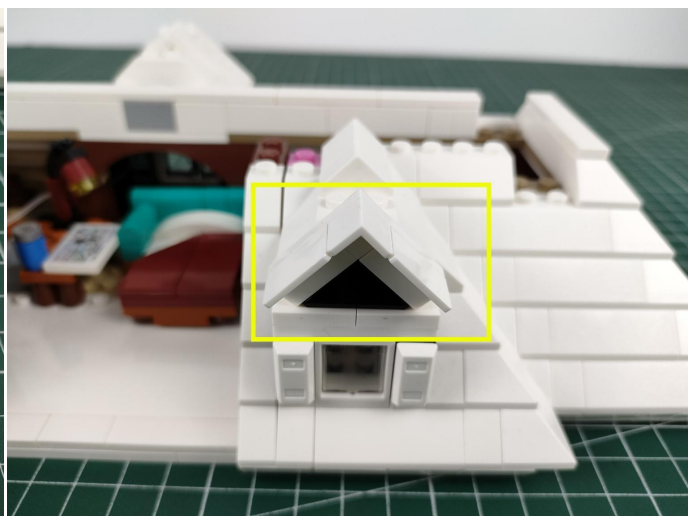
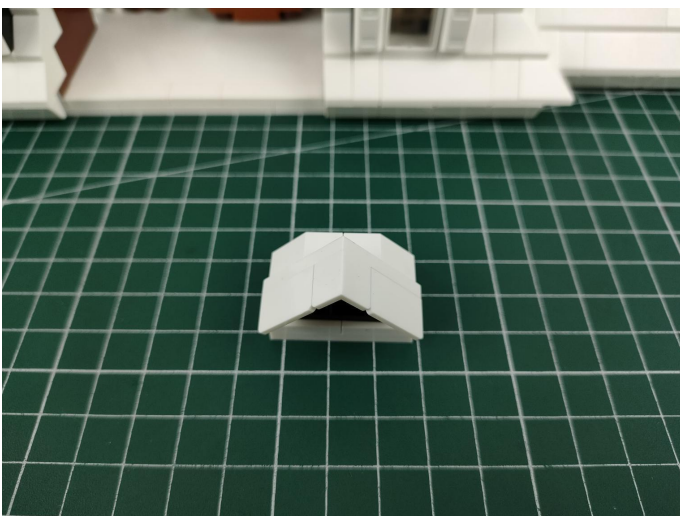

82

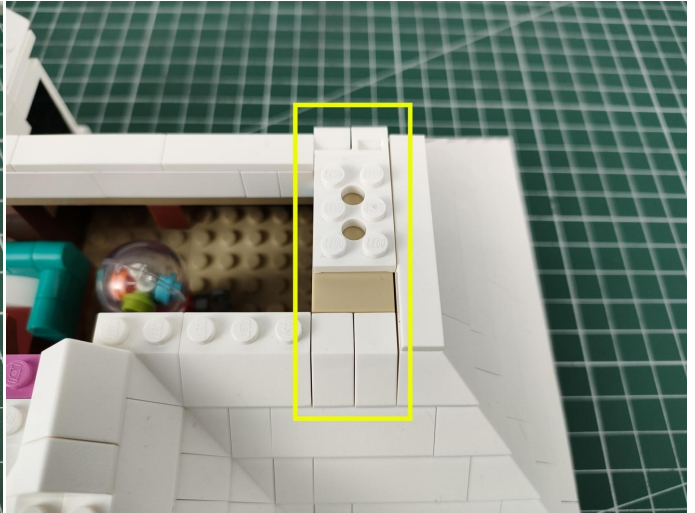
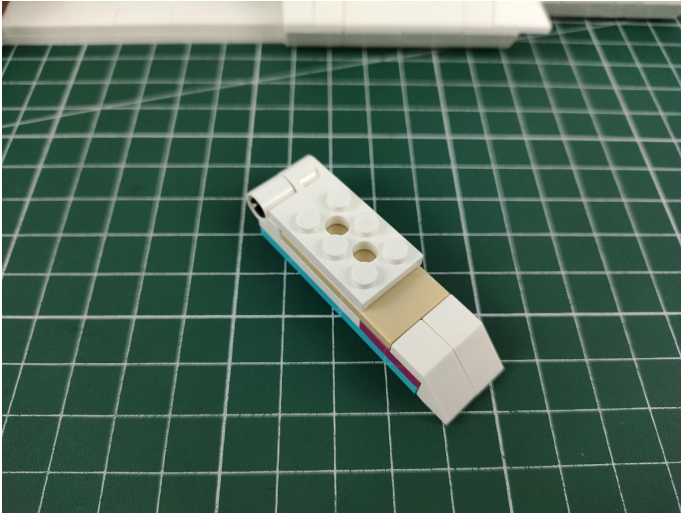

83

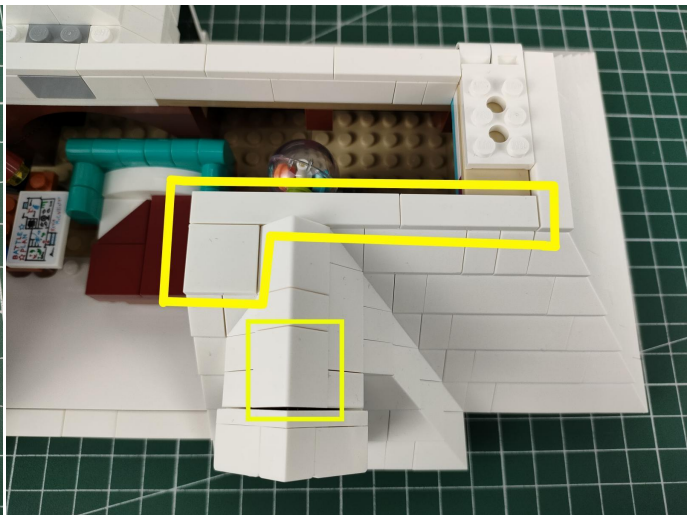
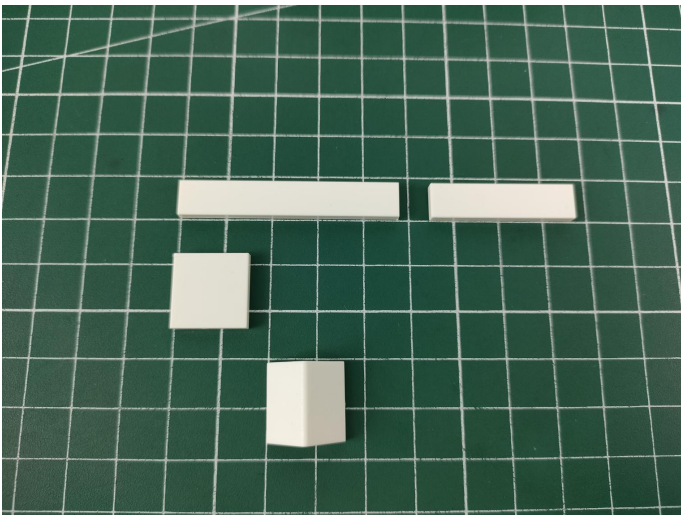

84

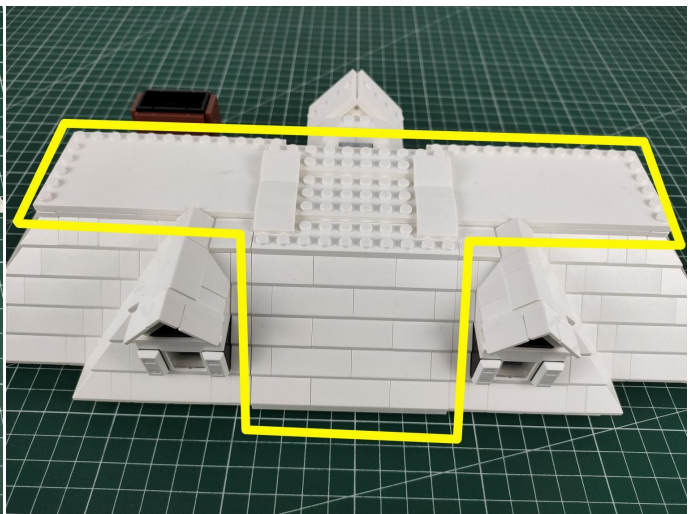
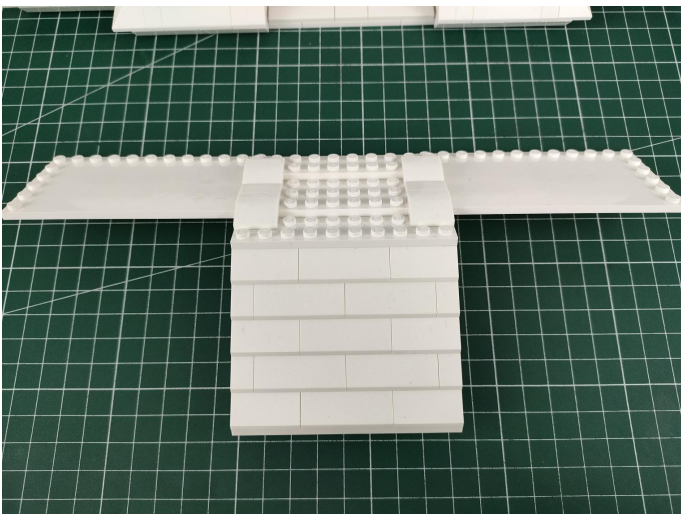

85

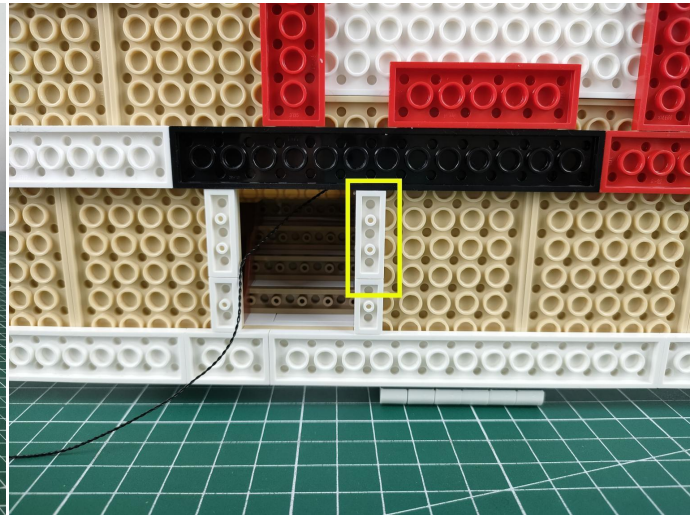

86

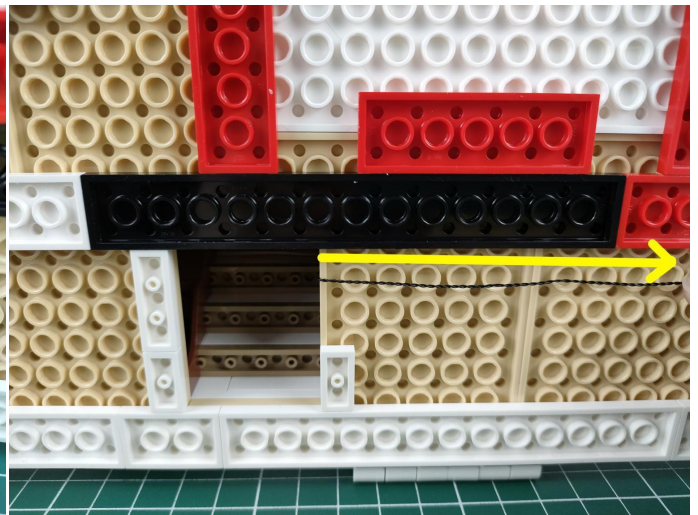
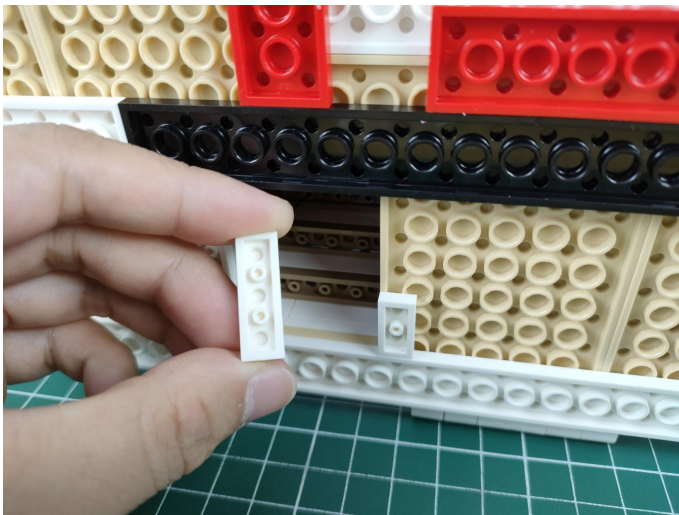

87

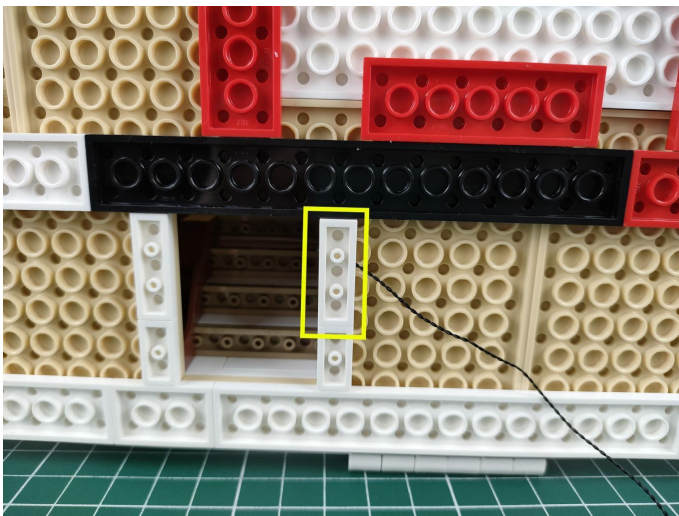

88

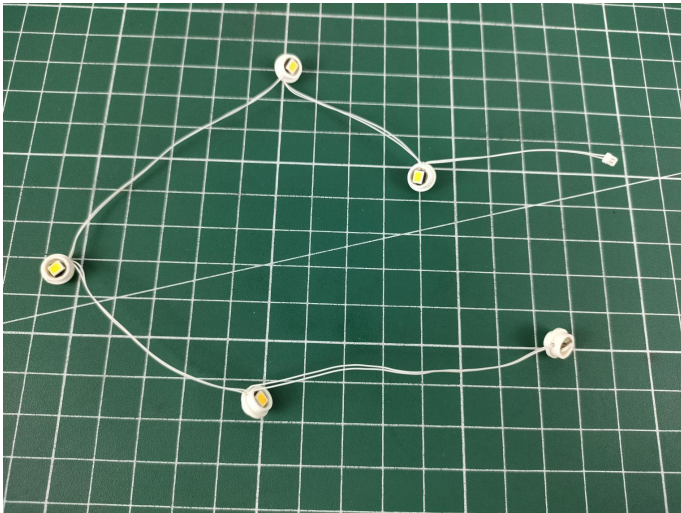

89



Wireless Power Connectors

1. Wireless Power Connectors are divided into two parts.
2. The two parts need to be combined when connecting, The positive pole is connected to the positive pole, The negative pole is connected to the negative pole.

90

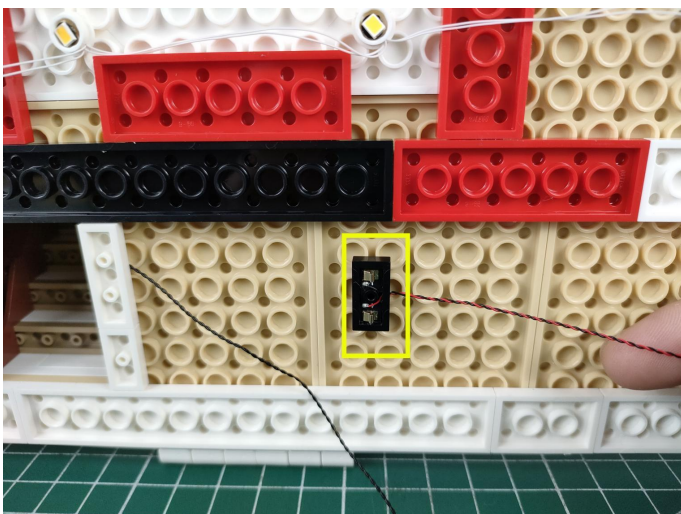

91

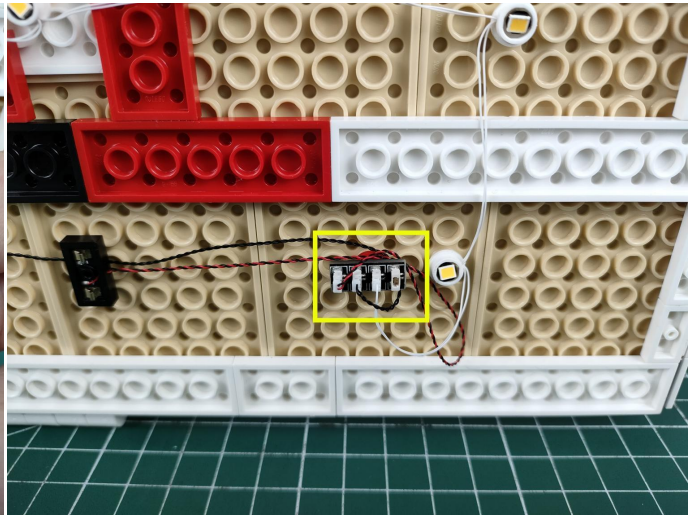
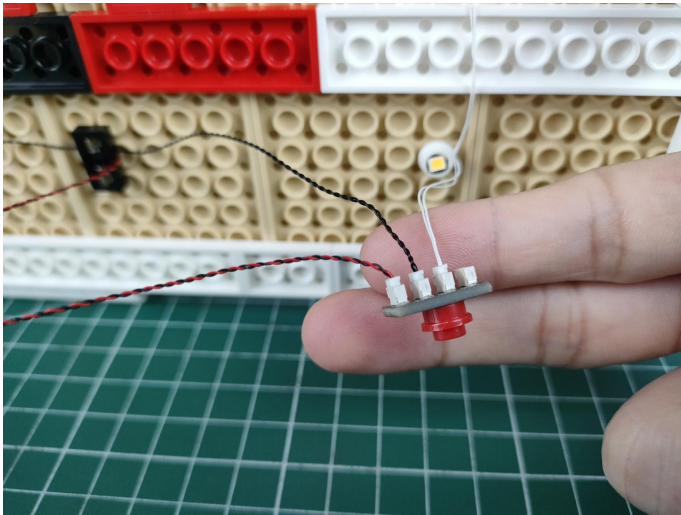

92



93

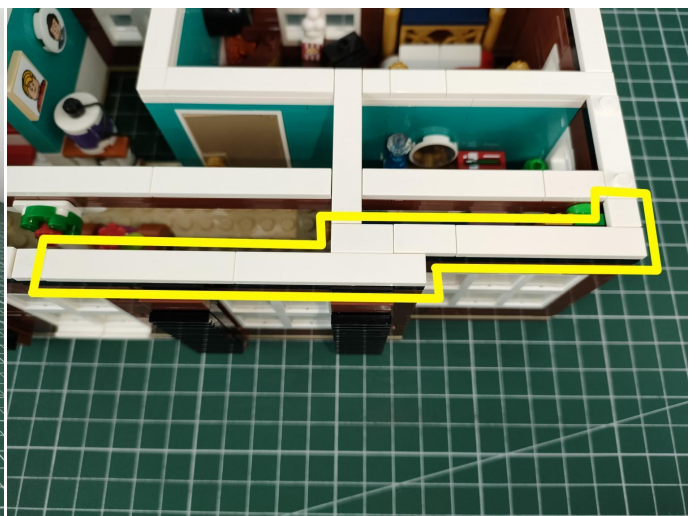

94

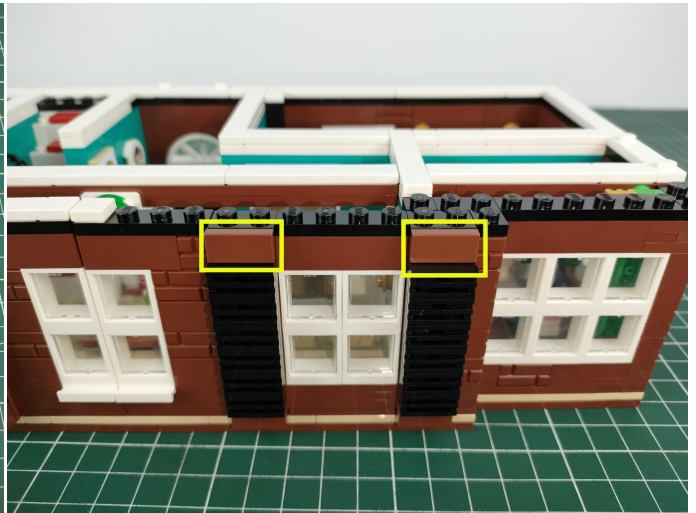
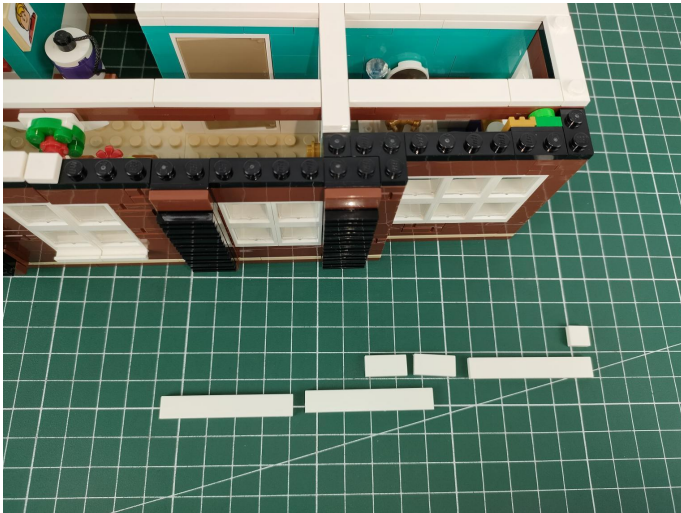

95



96

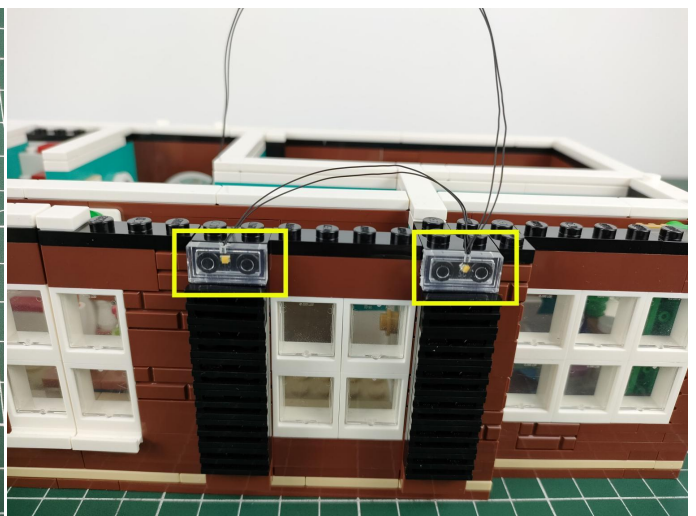
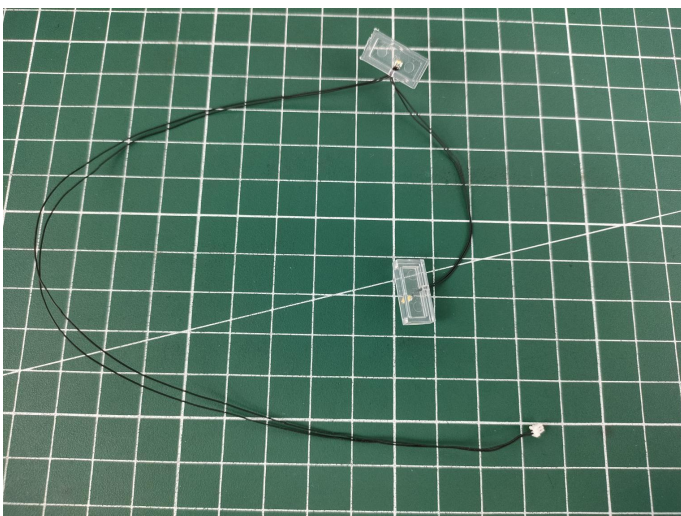

97

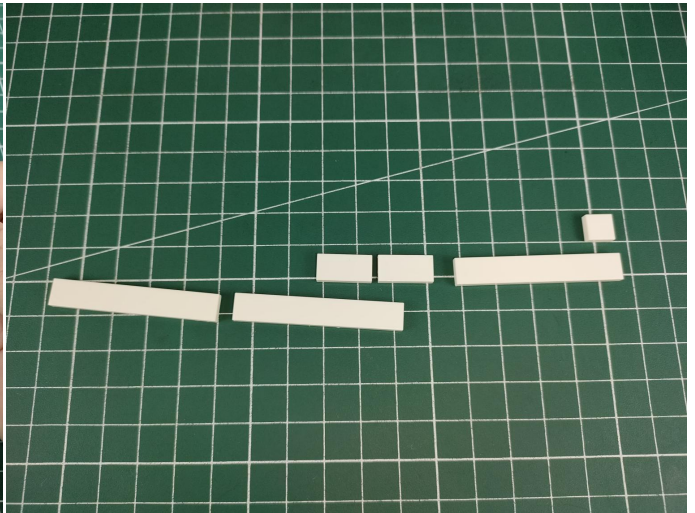
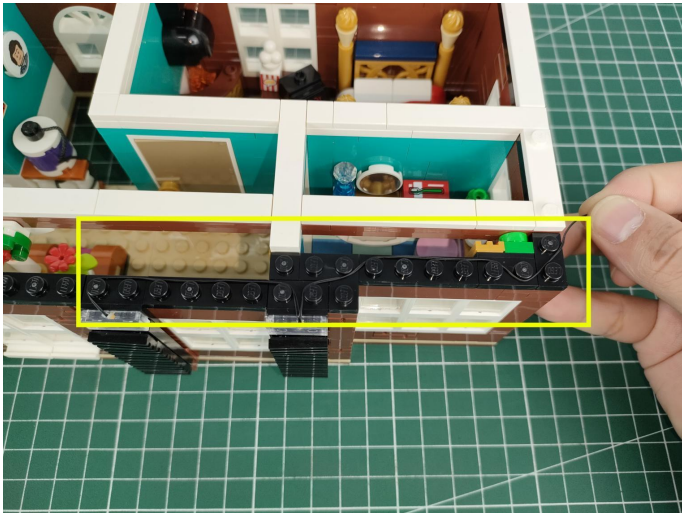

98

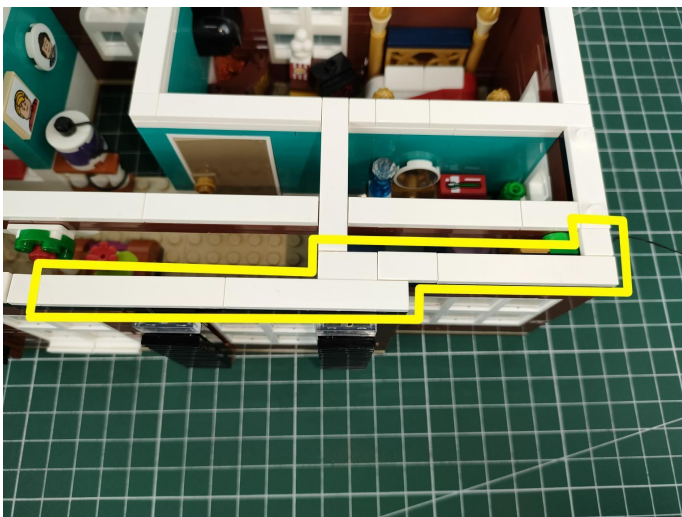

99

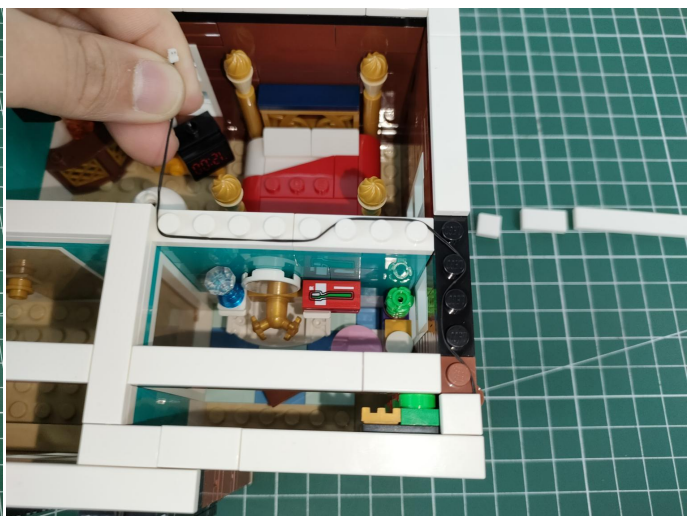
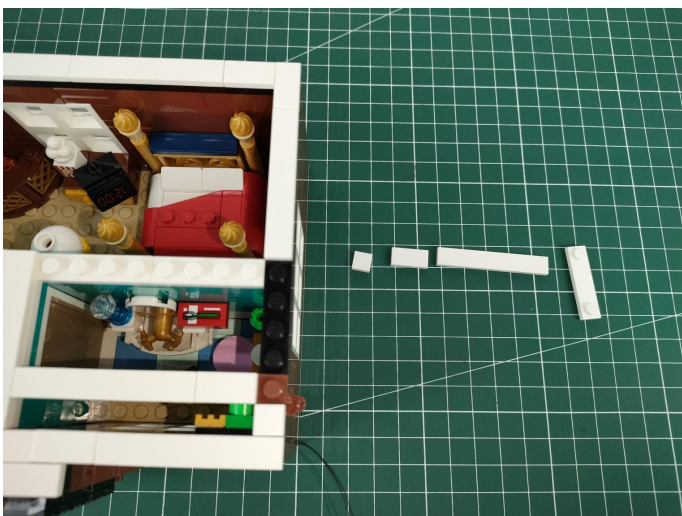

100

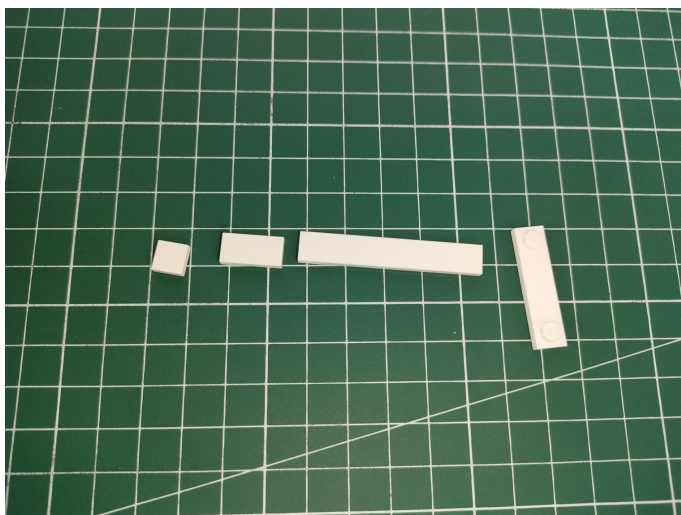

101

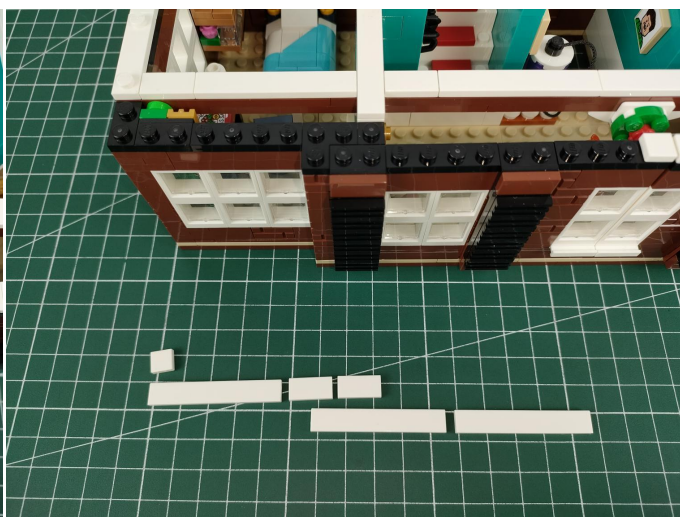
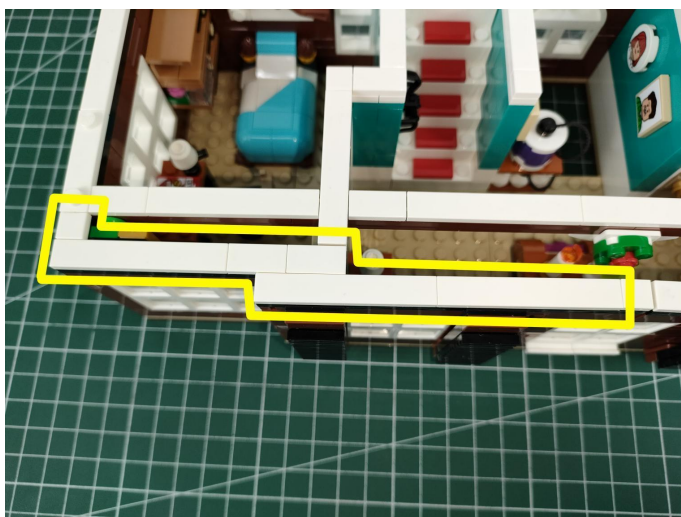

102

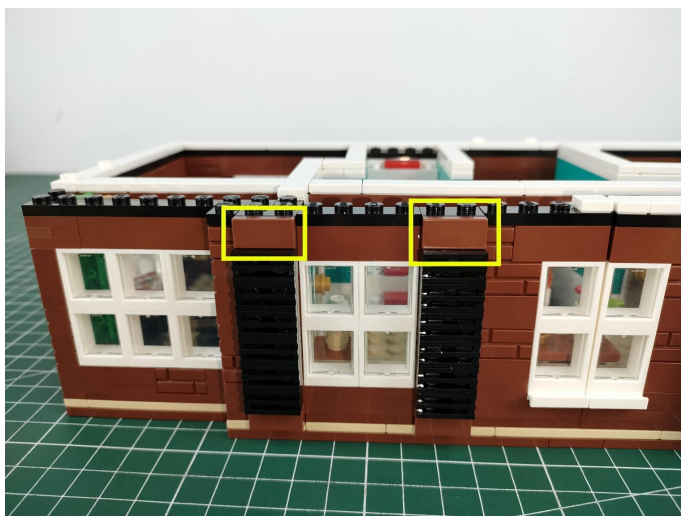

103

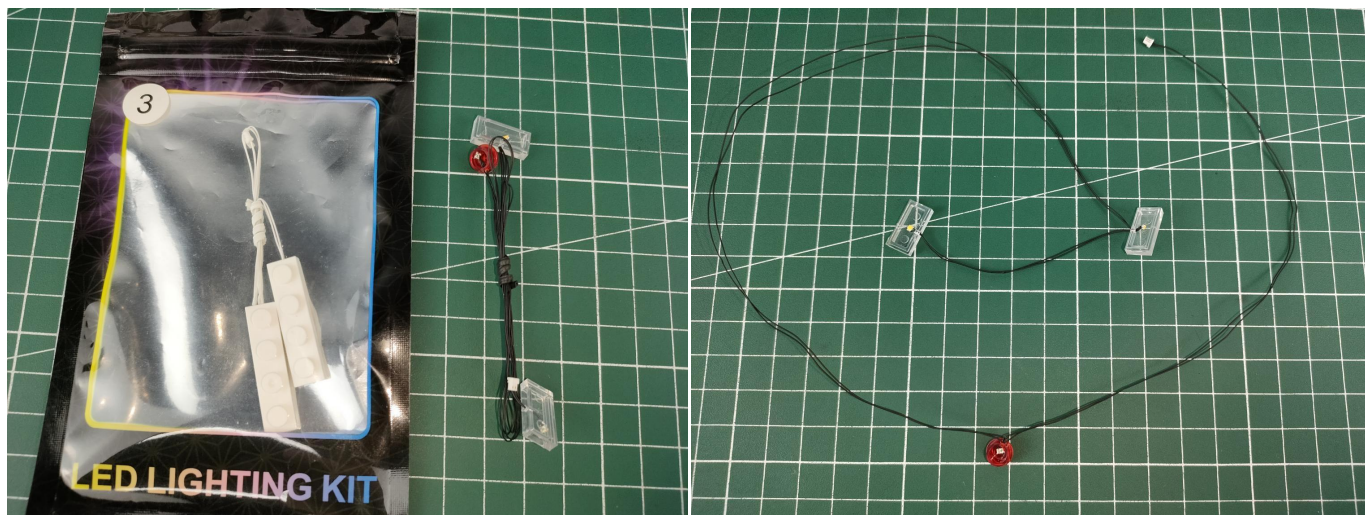

104

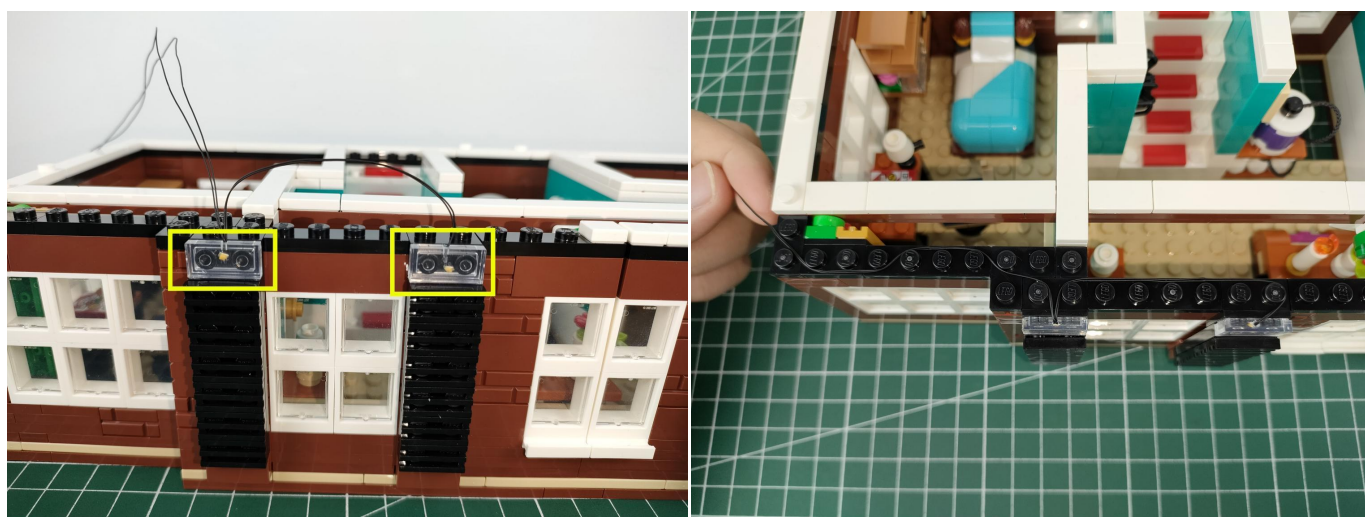

105

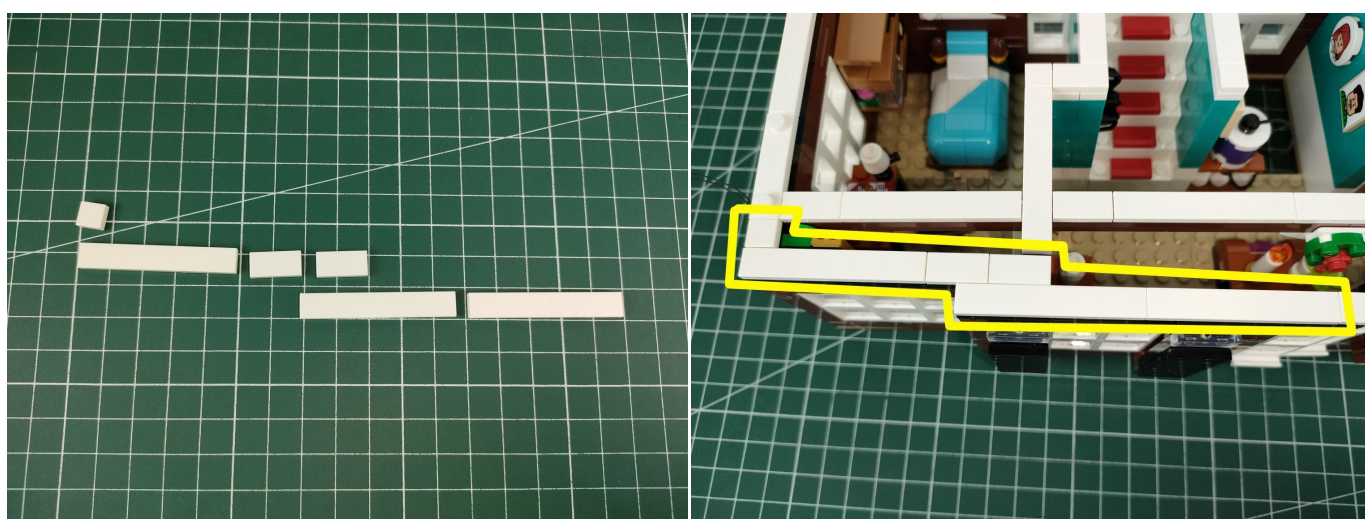

106

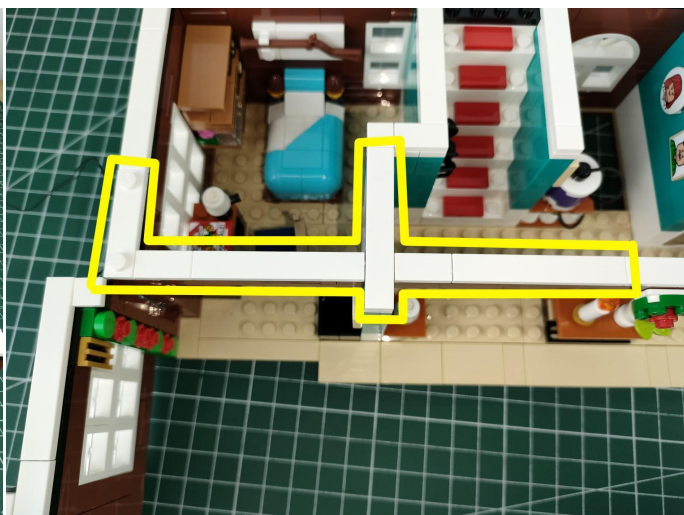

107

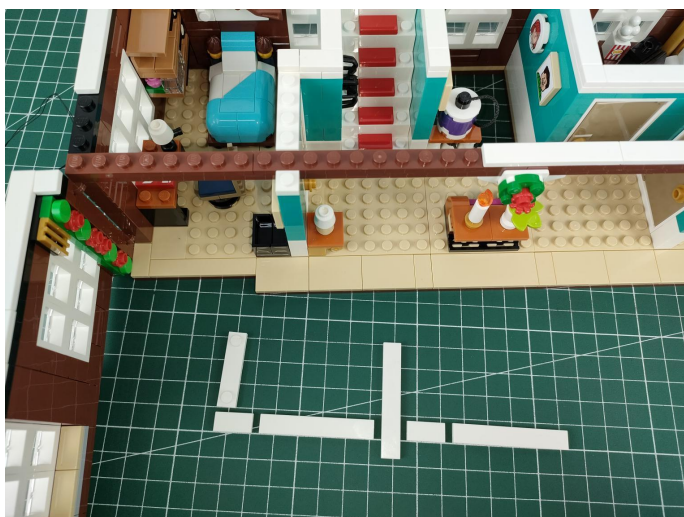

108

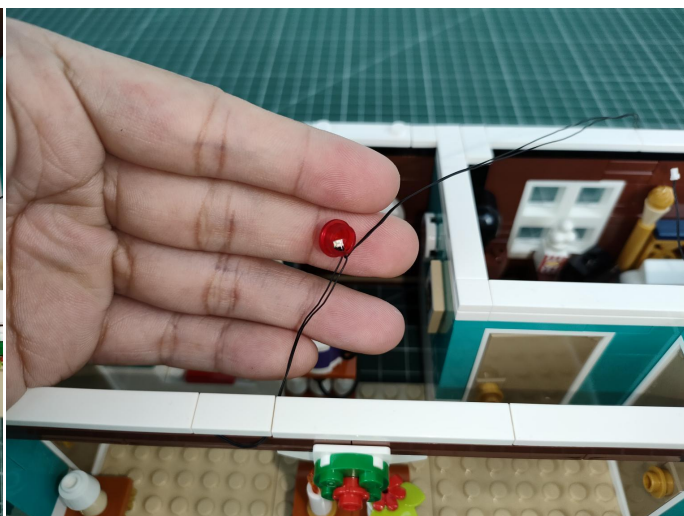
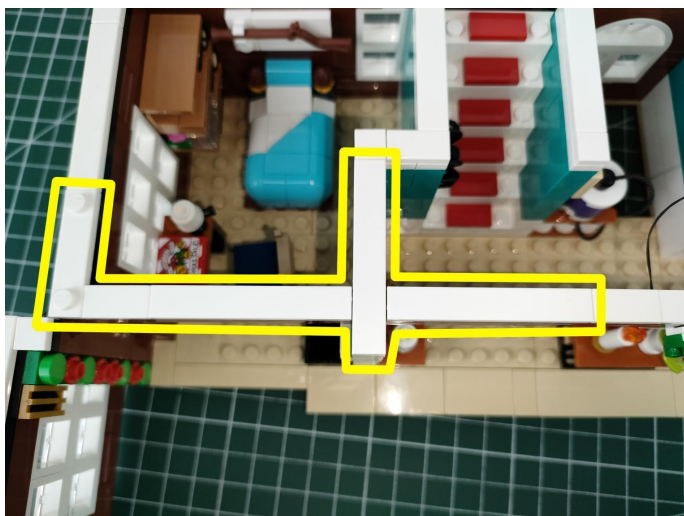

109

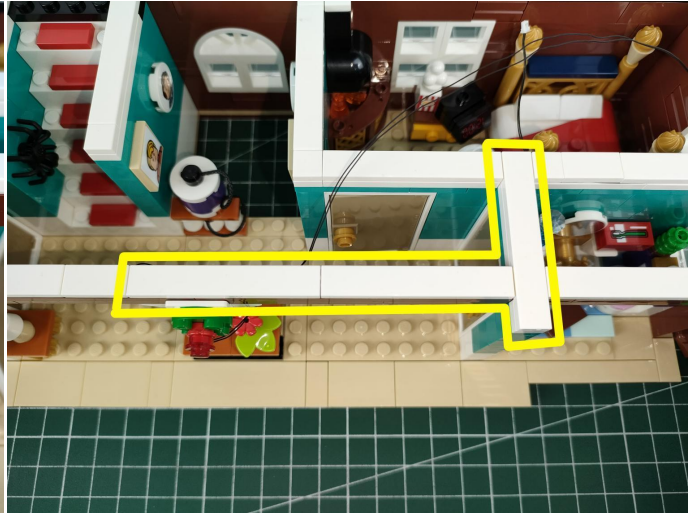

110

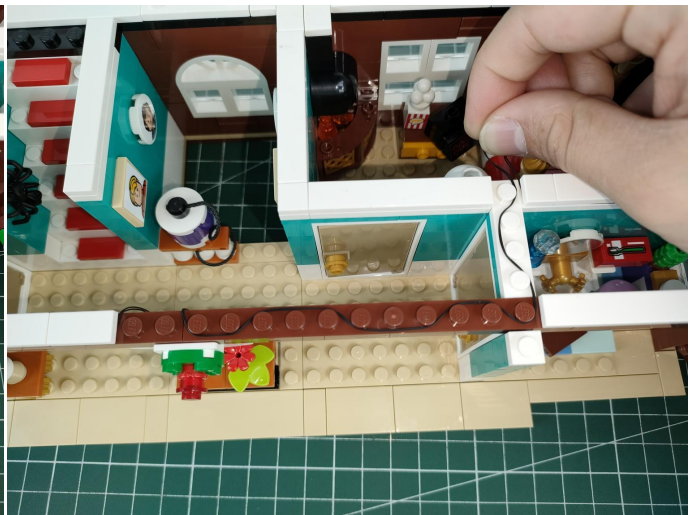
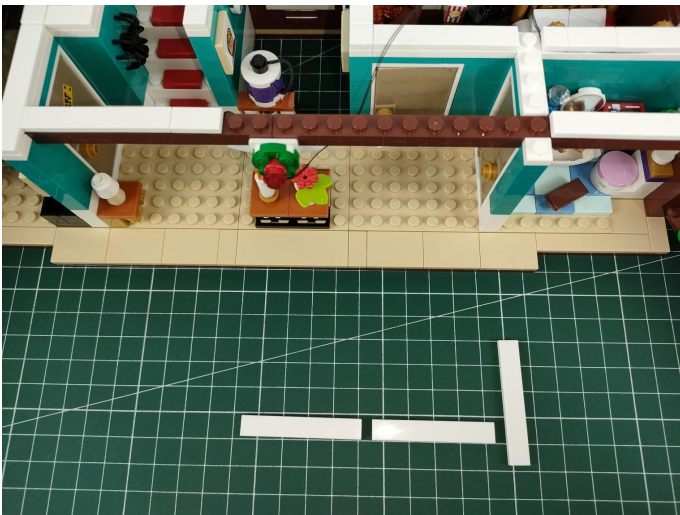

111

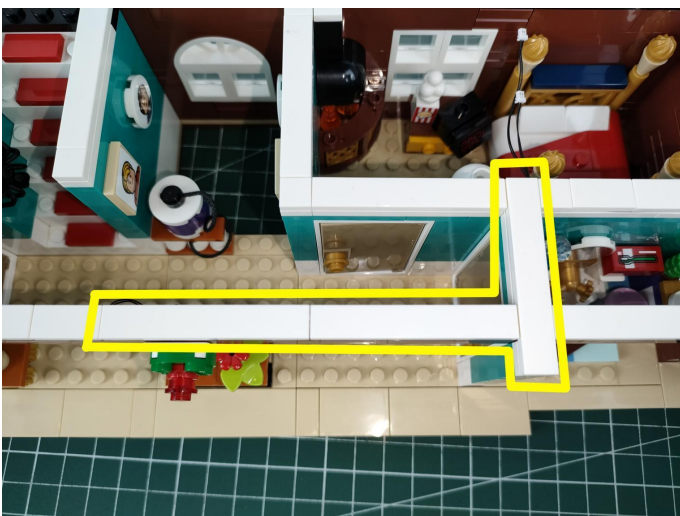

112

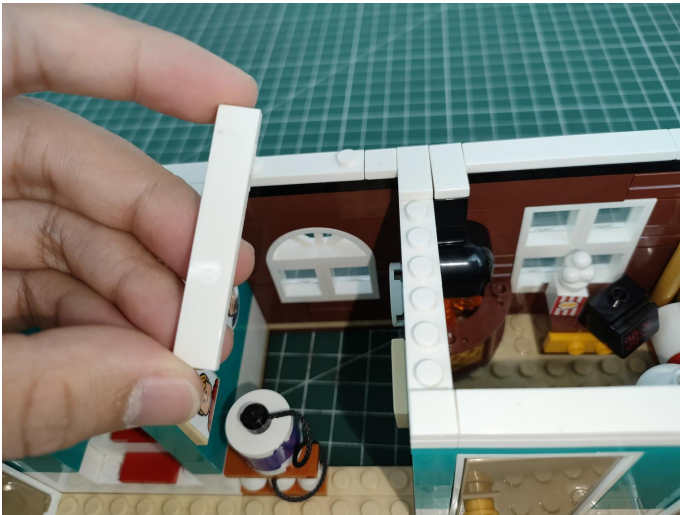

113

Wireless Power Connectors

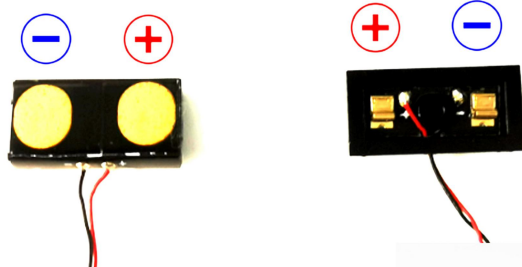

1. Wireless Power Connectors are divided into two parts.
2. The two parts need to be combined when connecting. The positive pole is connected to the positive pole, The negative pole is connected to the negative pole.

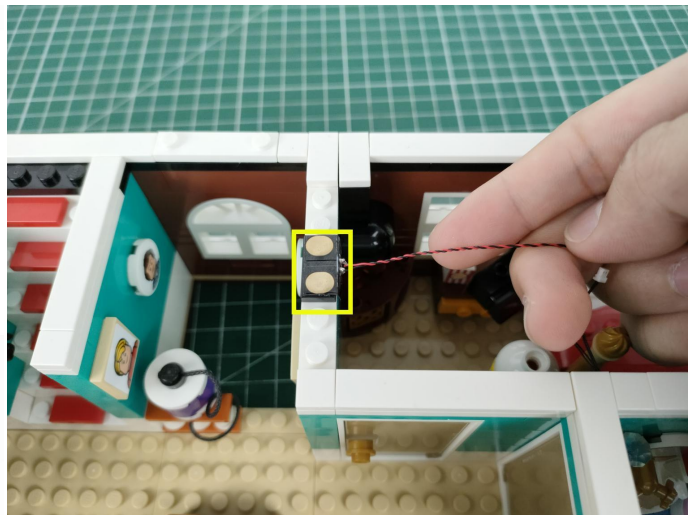

114



115

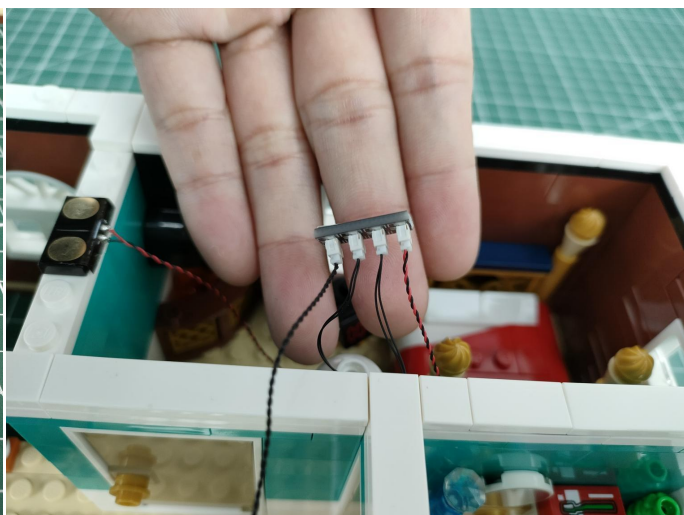
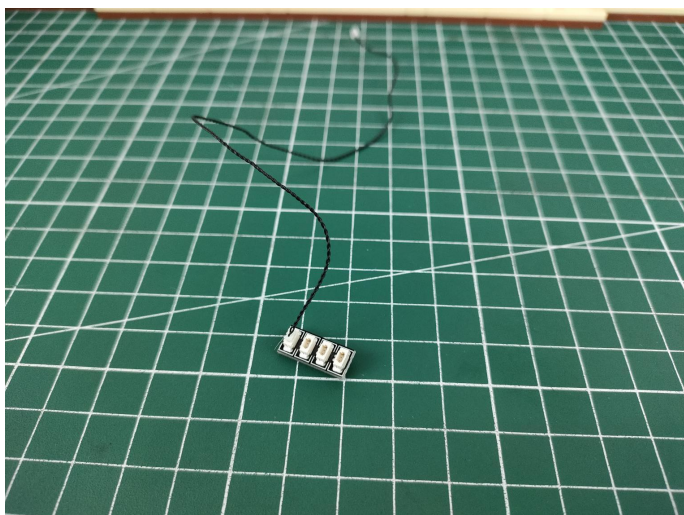

116

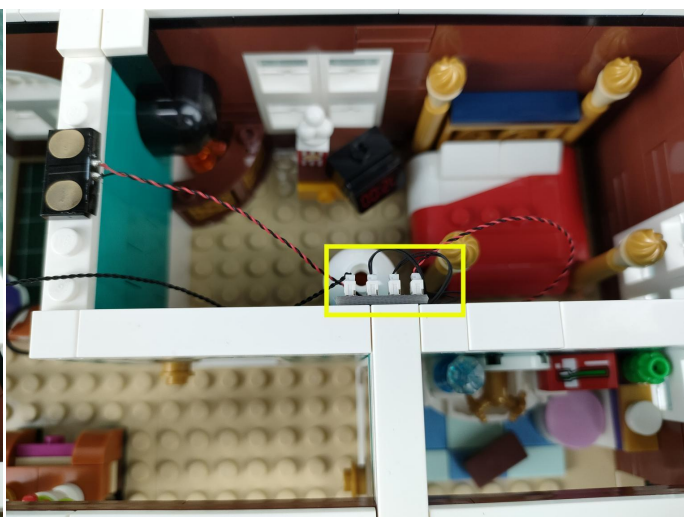
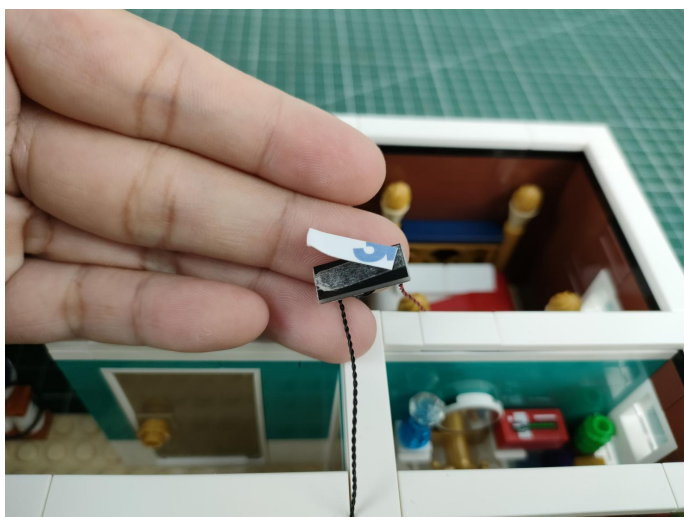

117

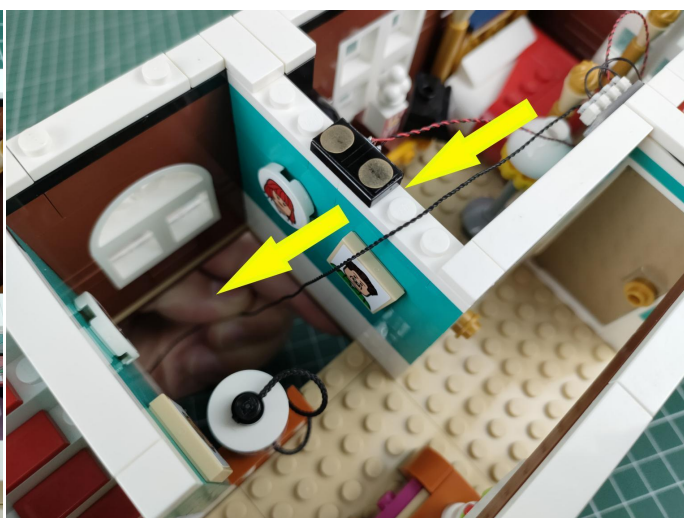
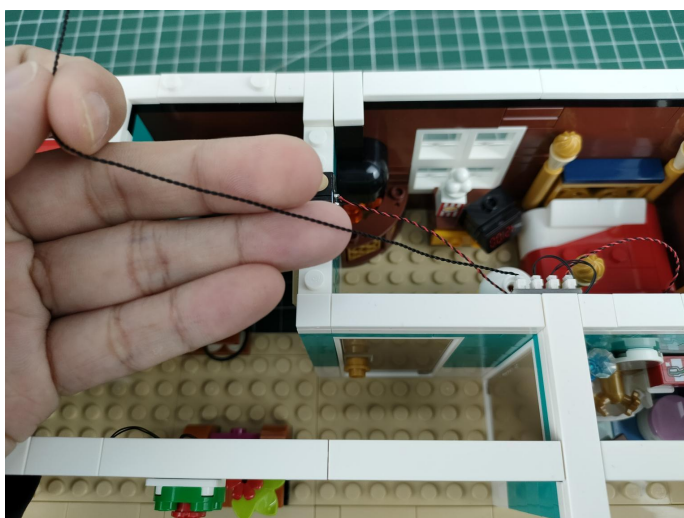

118

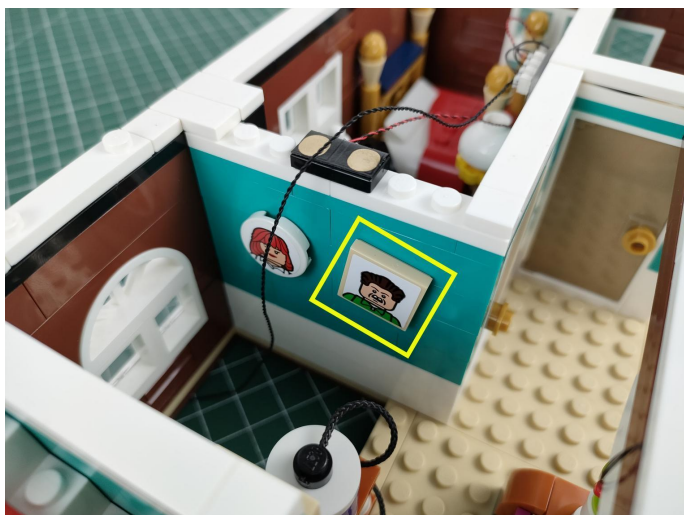

119

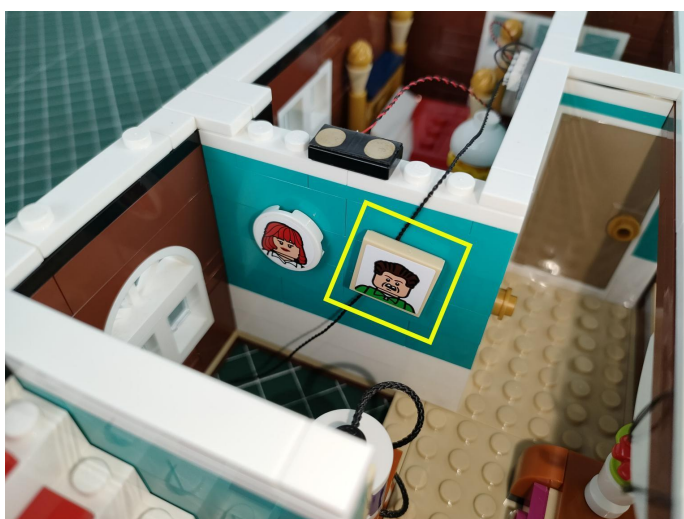

120

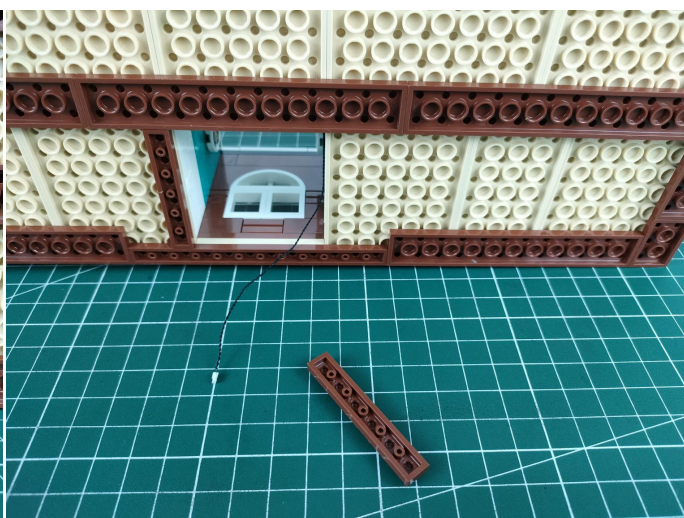
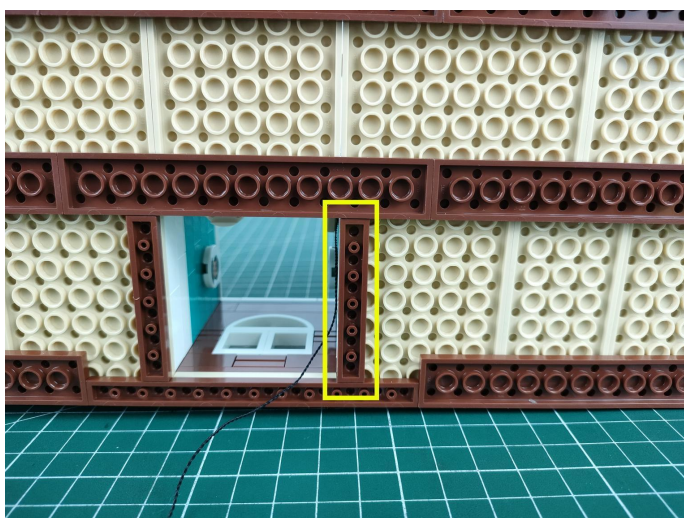

121

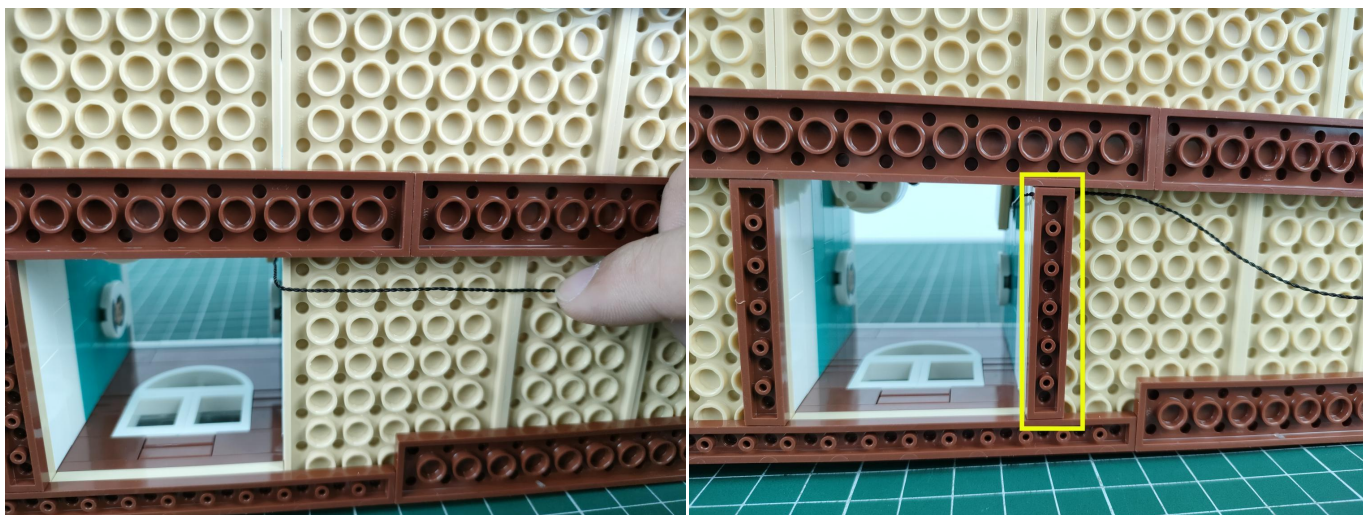

122

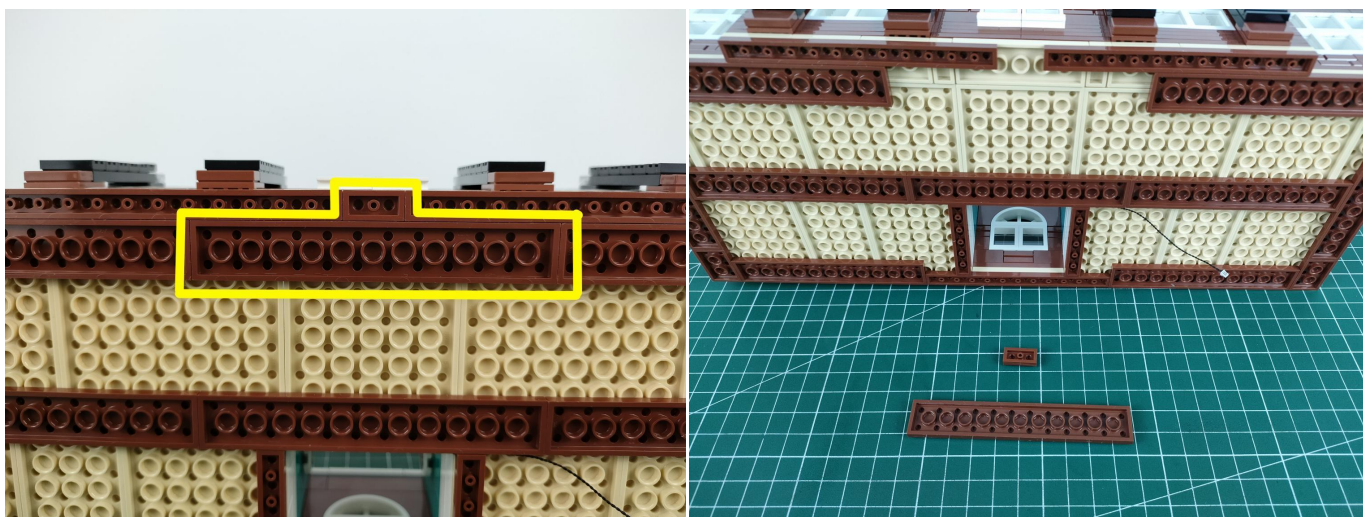

123



Wireless Power Connectors

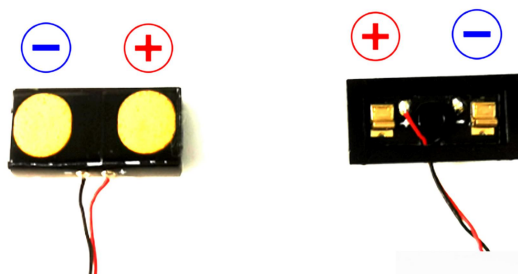

1. Wireless Power Connectors are divided into two parts.
2. The two parts need to be combined when connecting,
The positive pole is connected to the positive pole,
The negative pole is connected to the negative pole.



124

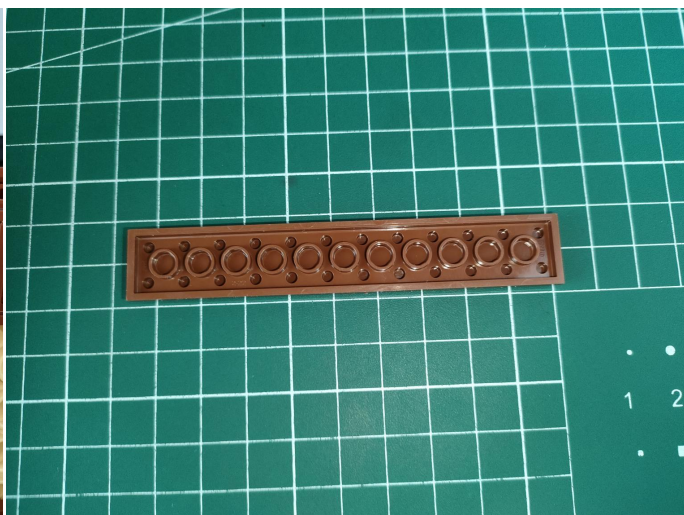
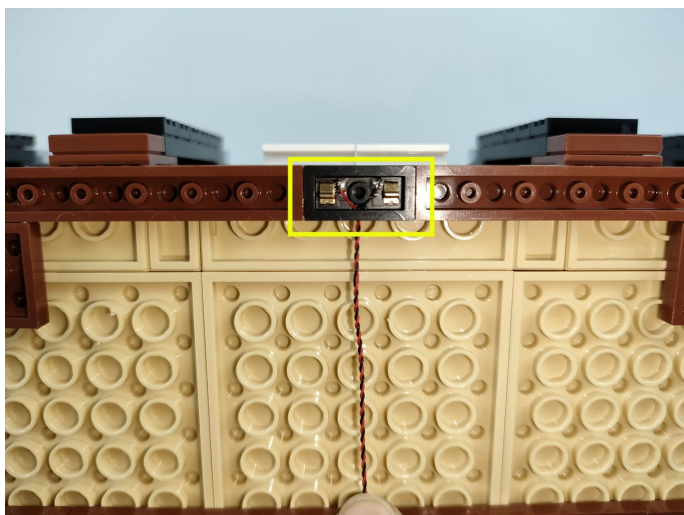

125

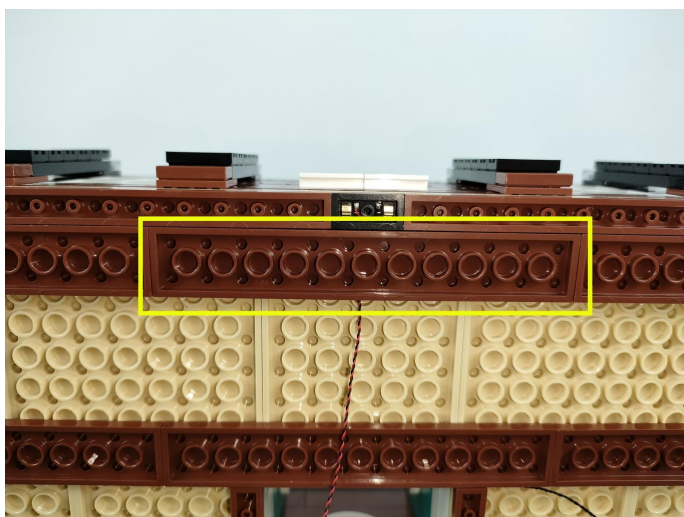

126

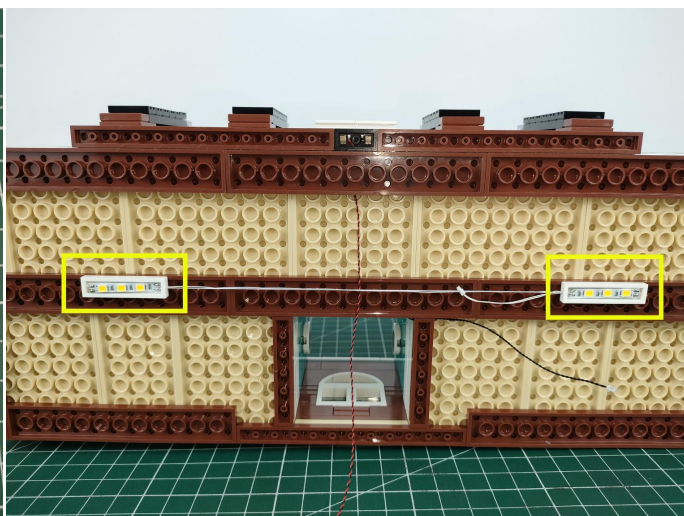
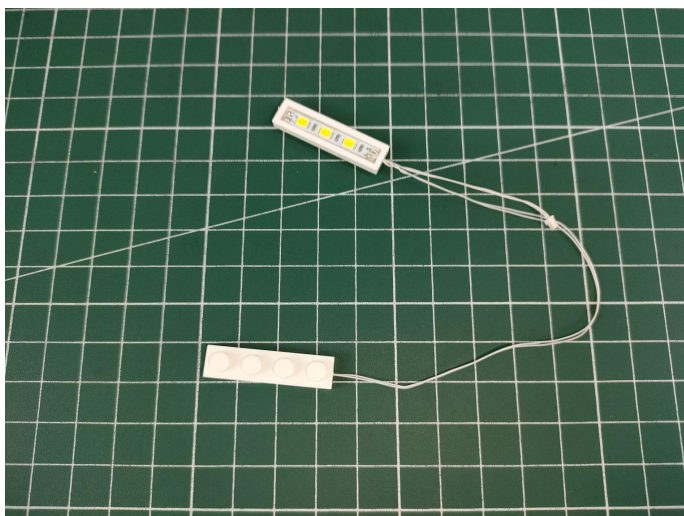

127

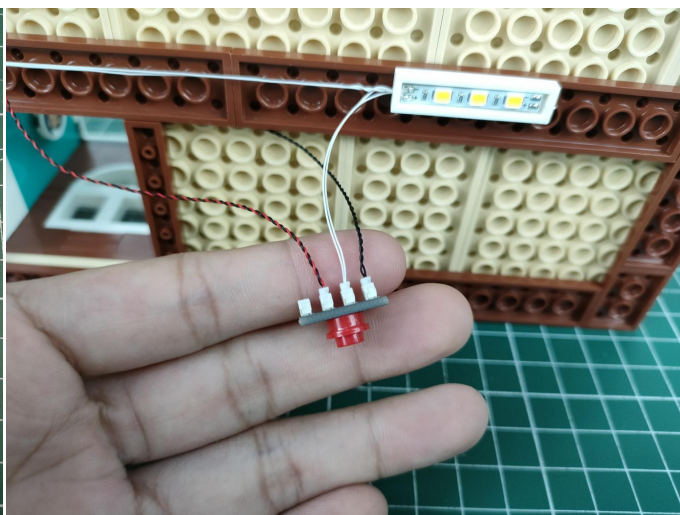

128

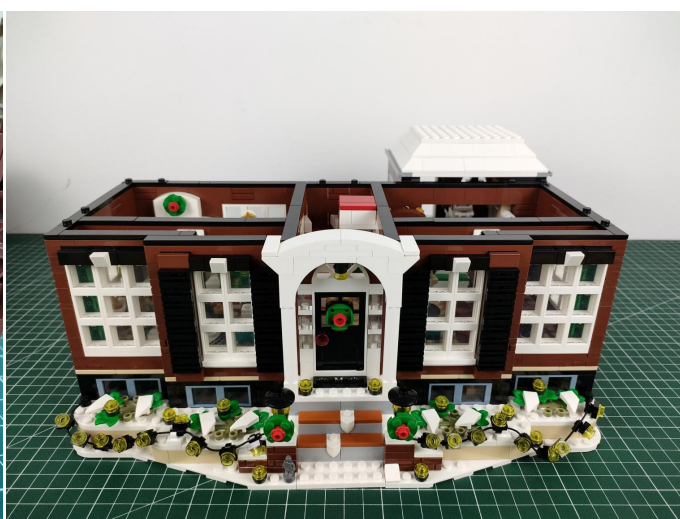
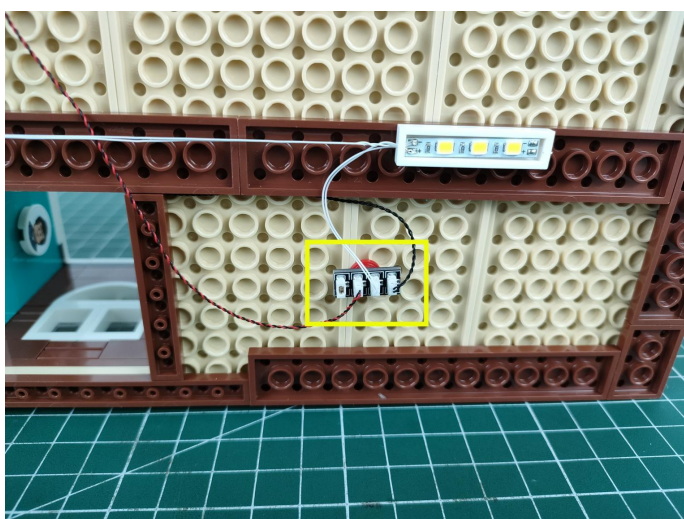

129

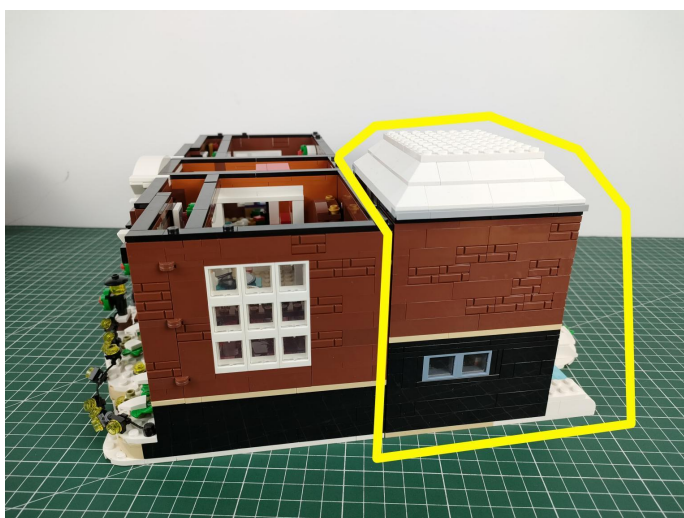

130

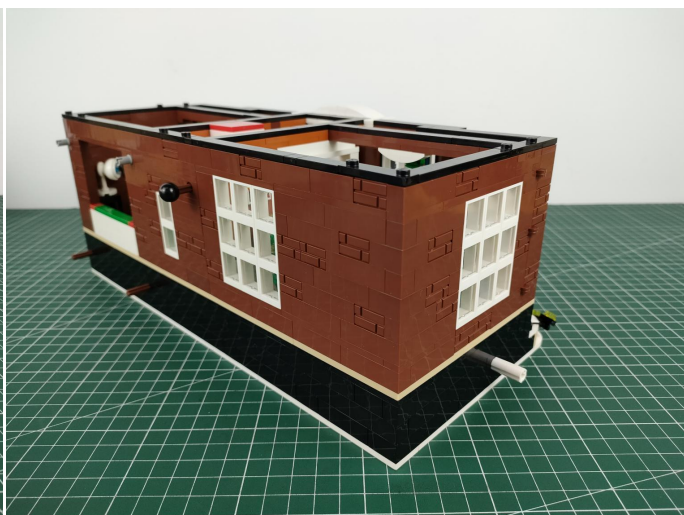

131

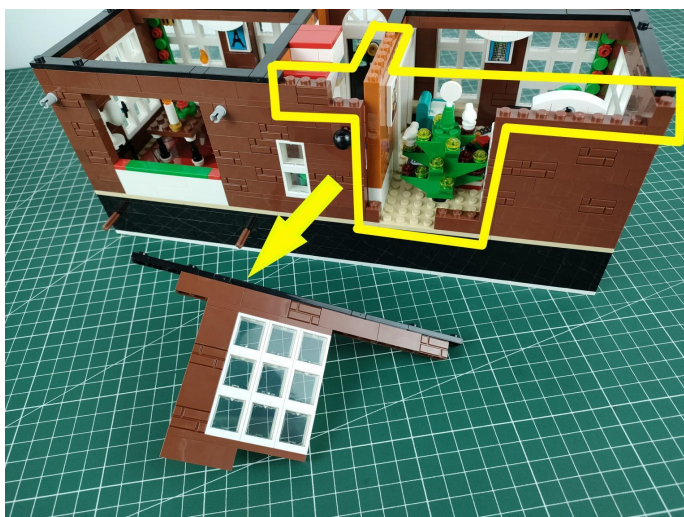

132

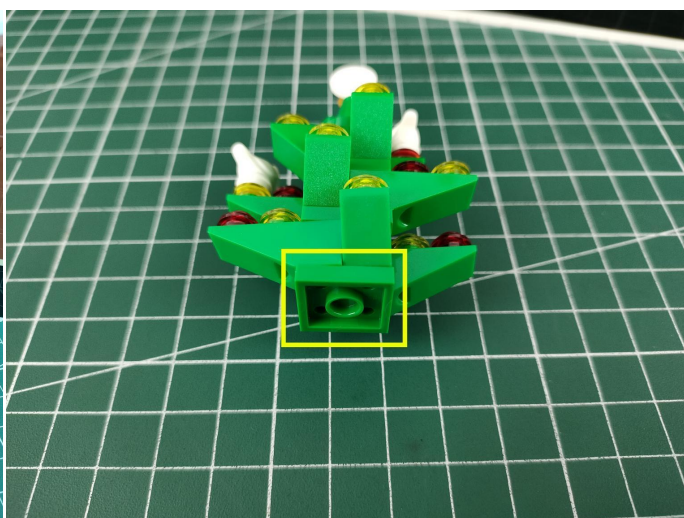

133

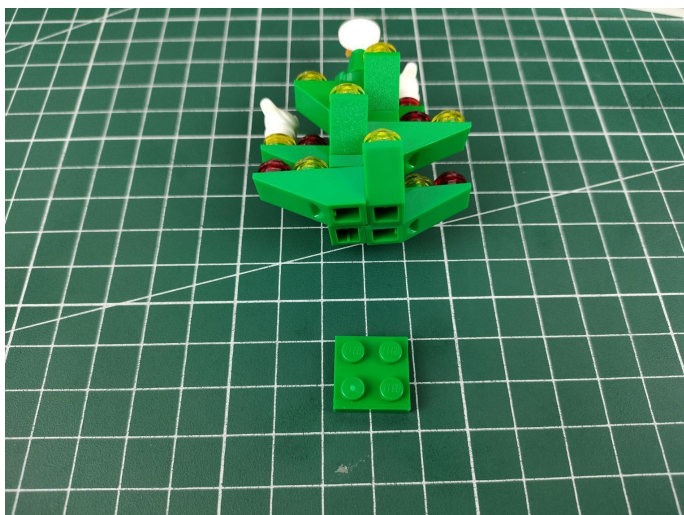

134

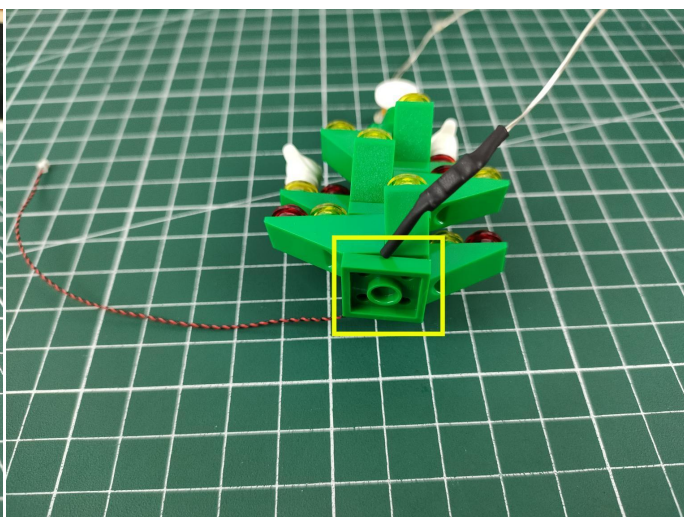
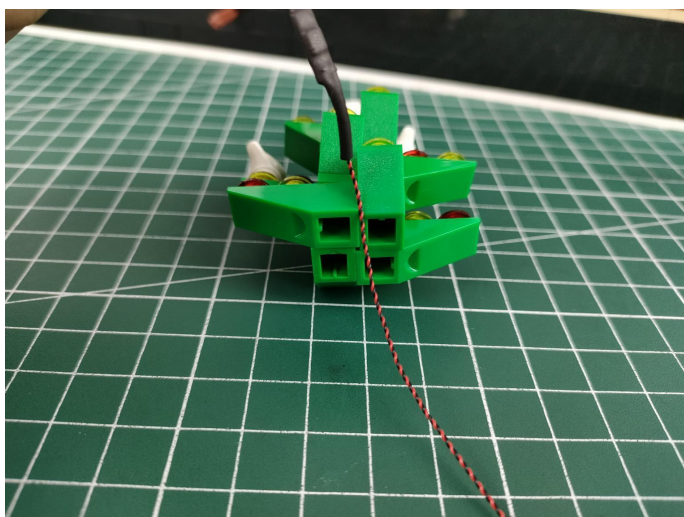

135

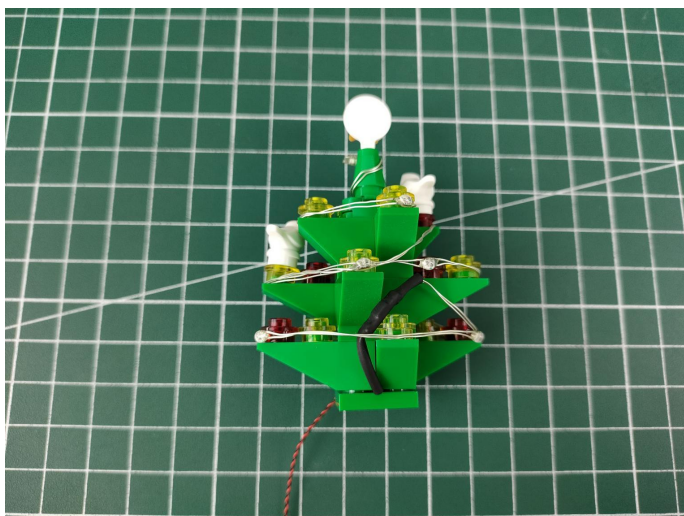

136

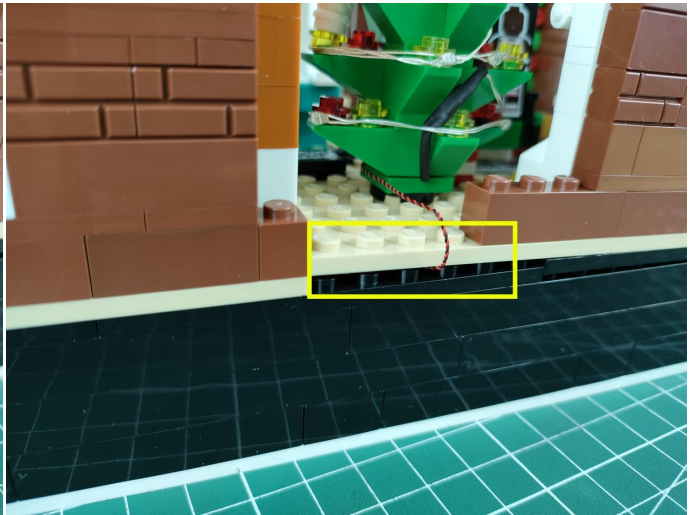

137

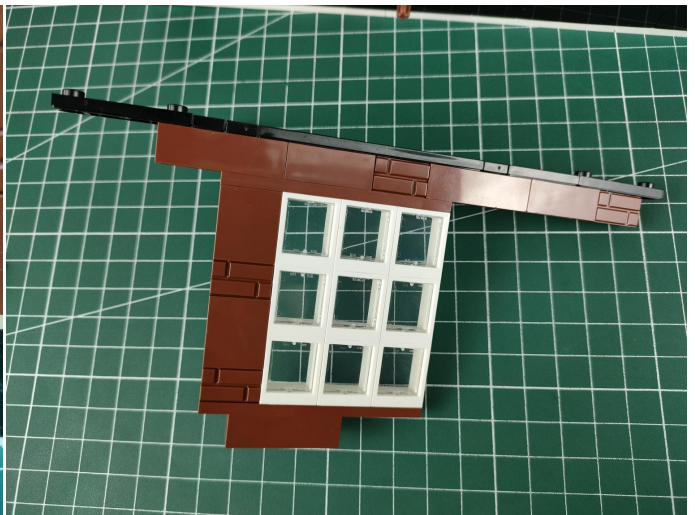

138

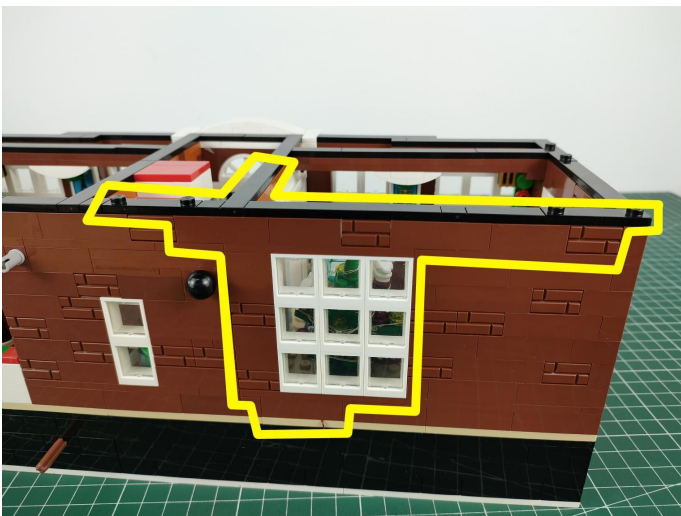

139



140

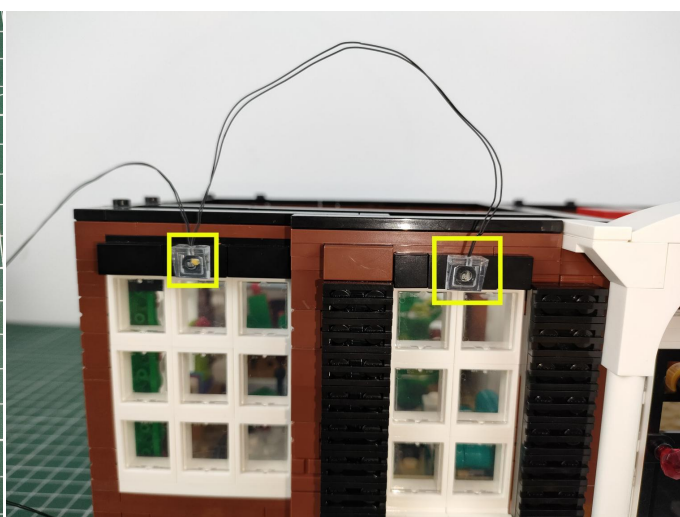
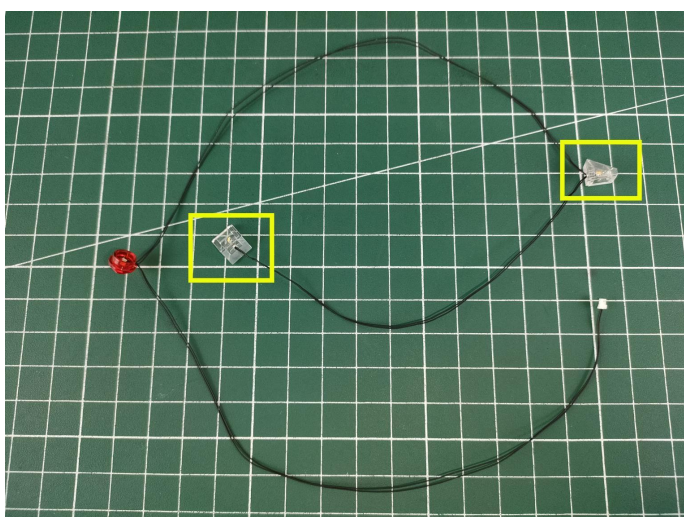

141

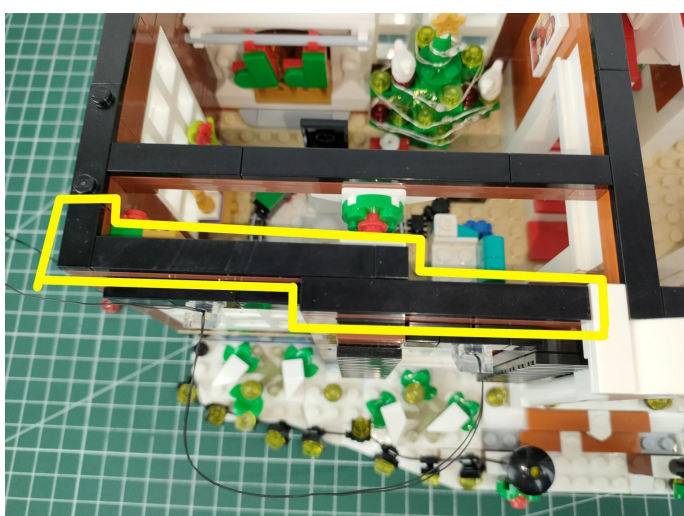

142

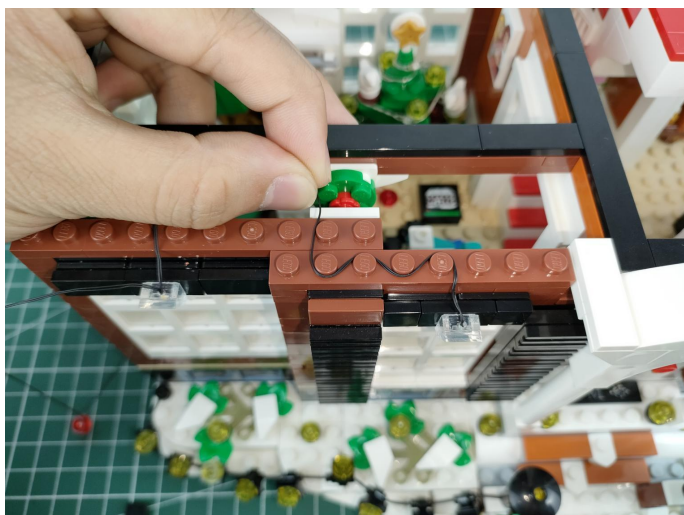

143

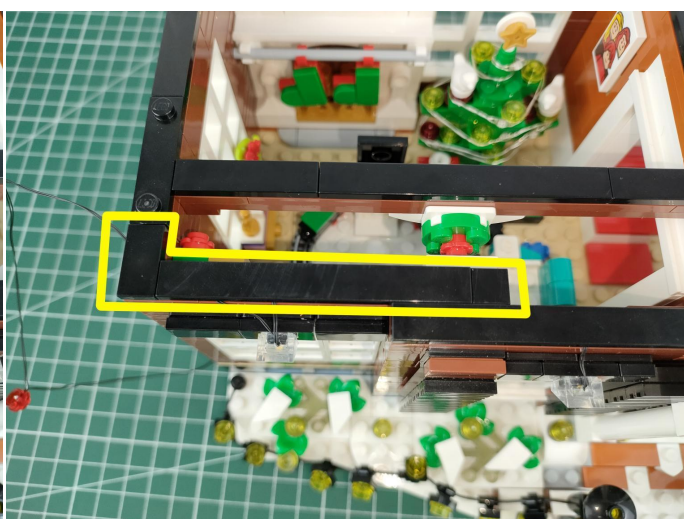
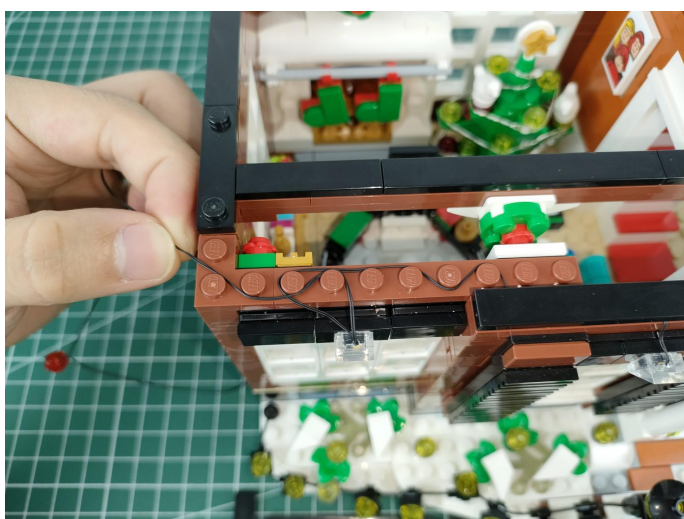

144



145

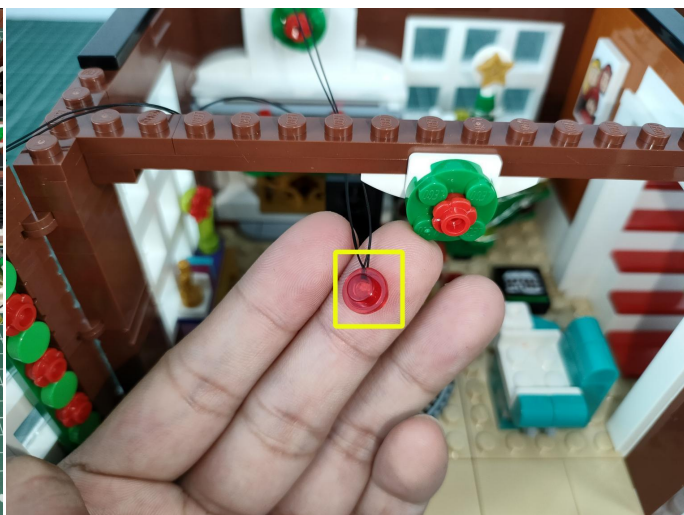

146



147

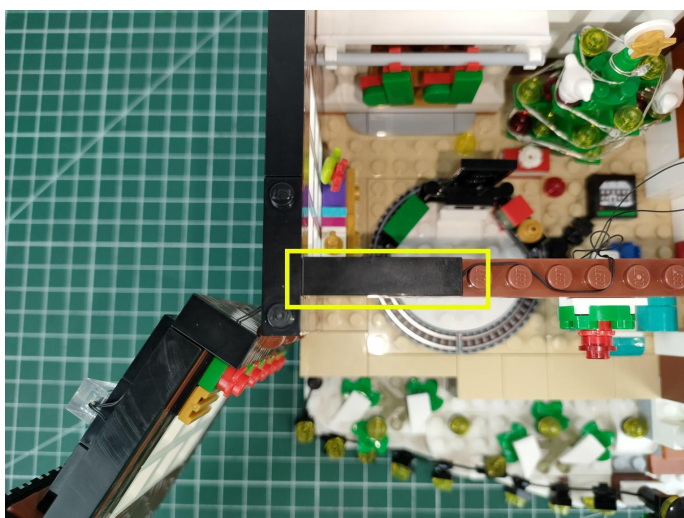

151



152

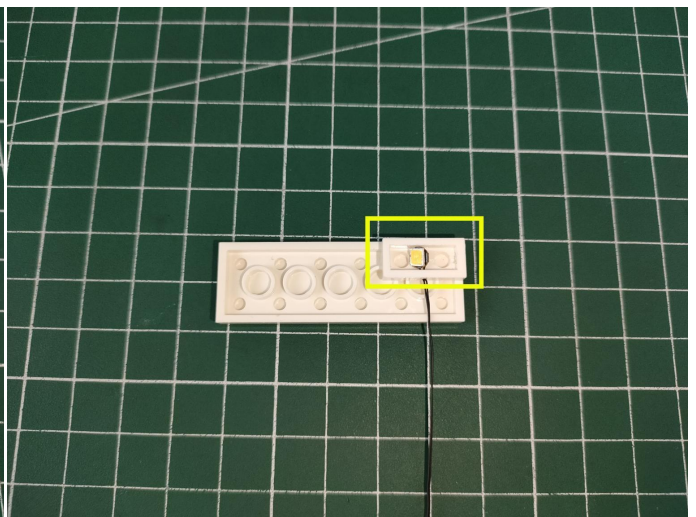

153

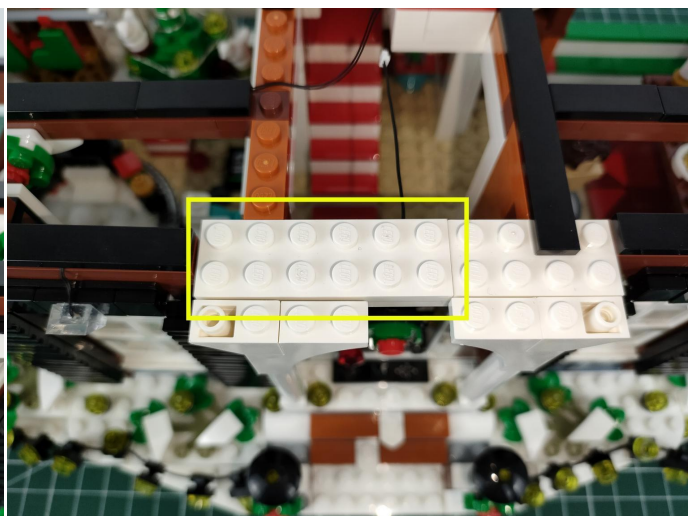
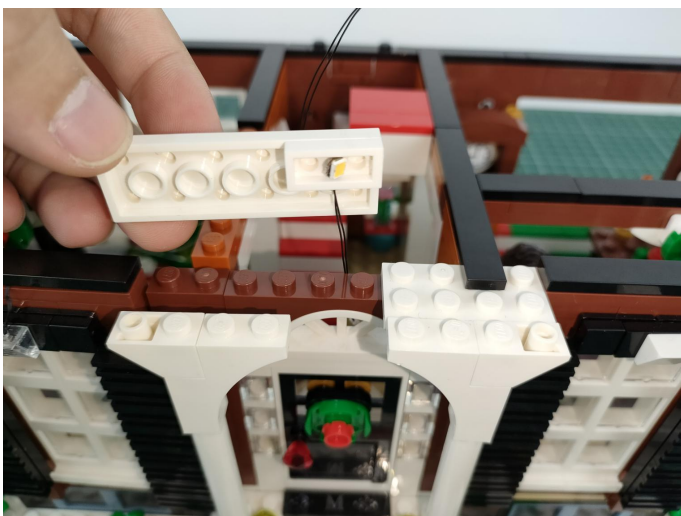

154

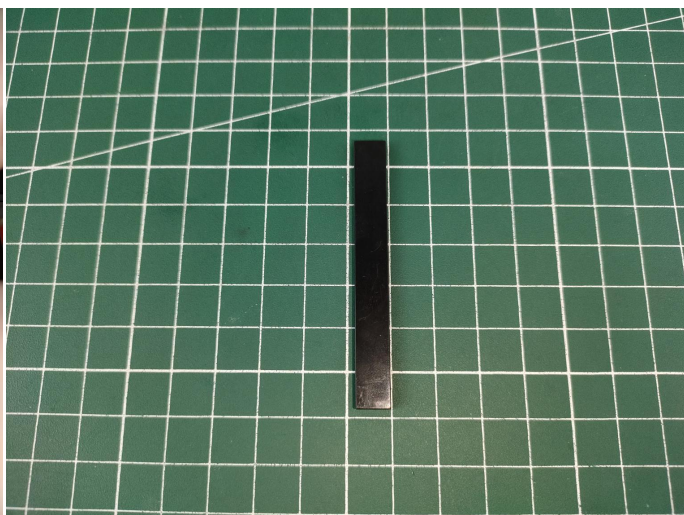

155



156

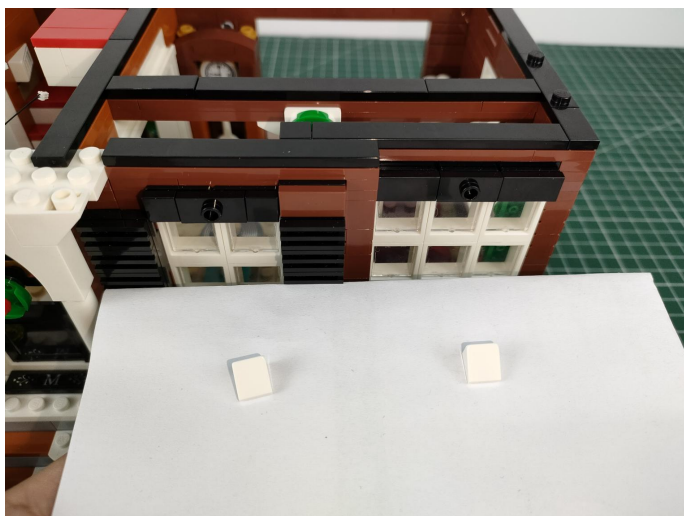

157

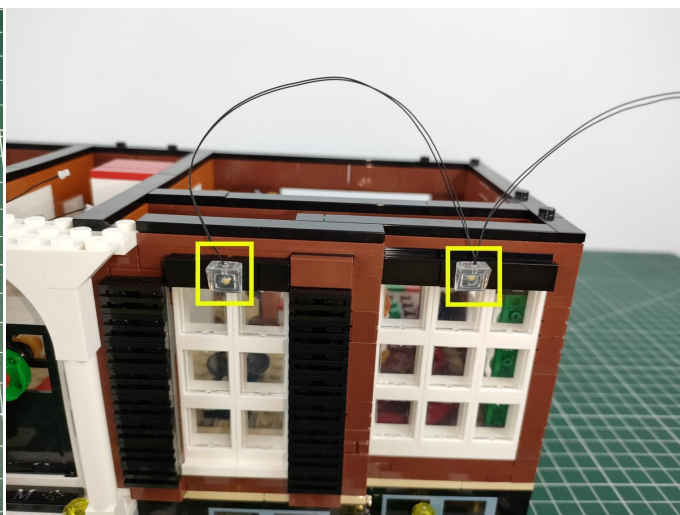
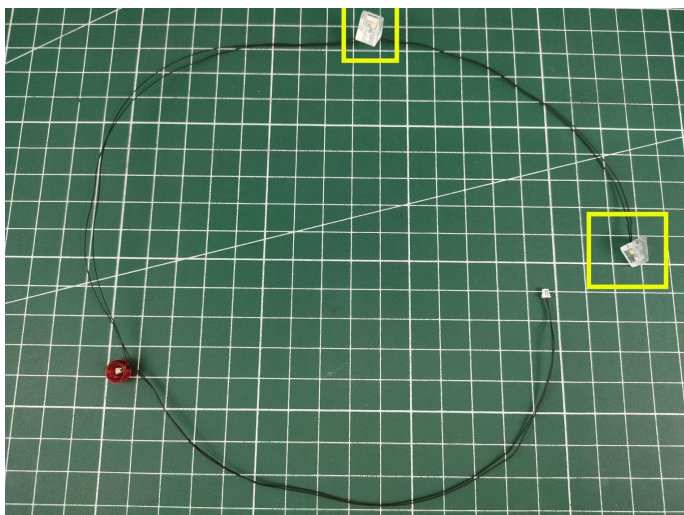

158

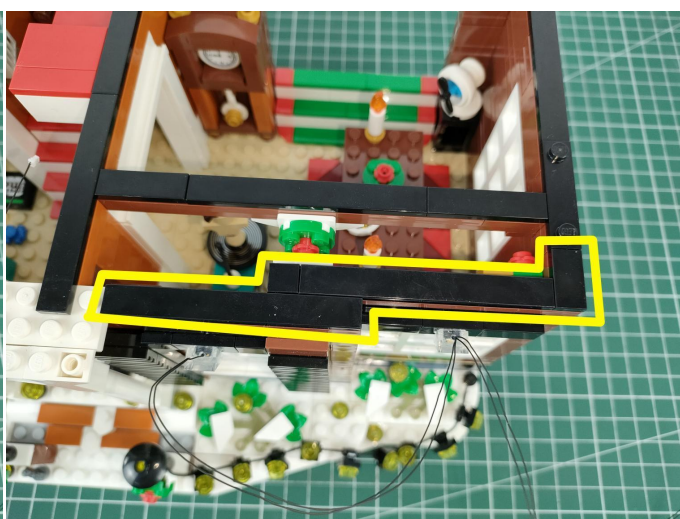

159

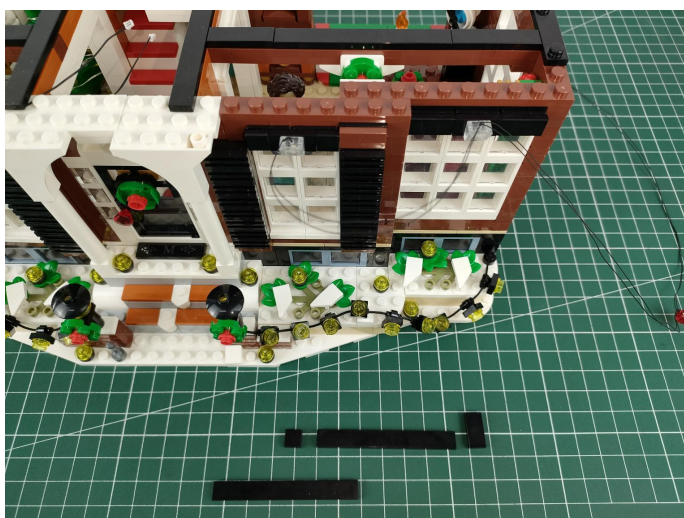

160

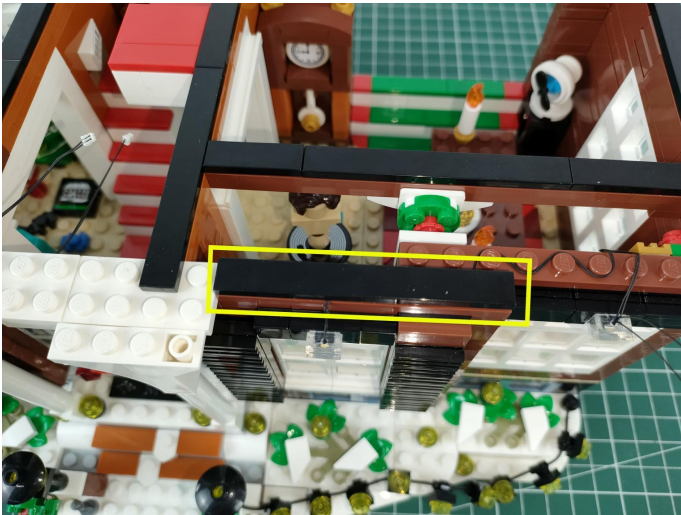

161



162



163



164



165

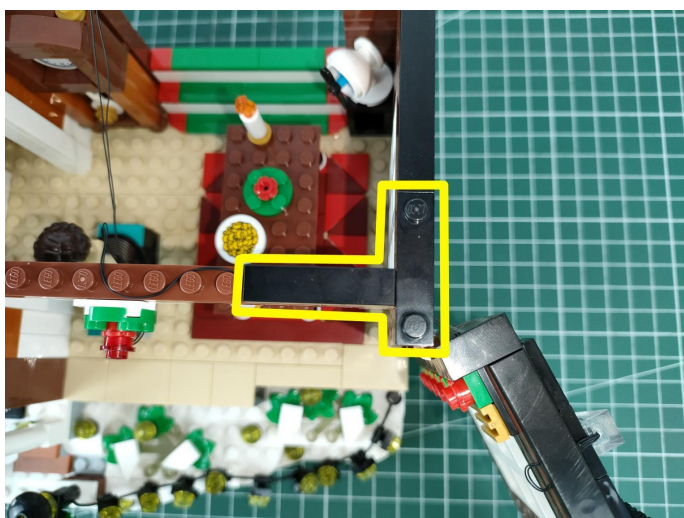

166



167



Wireless Power Connectors

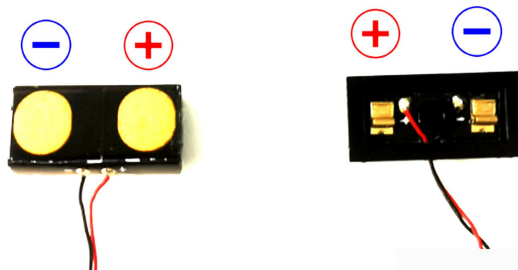

1. Wireless Power Connectors are divided into two parts.
2. The two parts need to be combined when connecting, The positive pole is connected to the positive pole, The negative pole is connected to the negative pole.



168

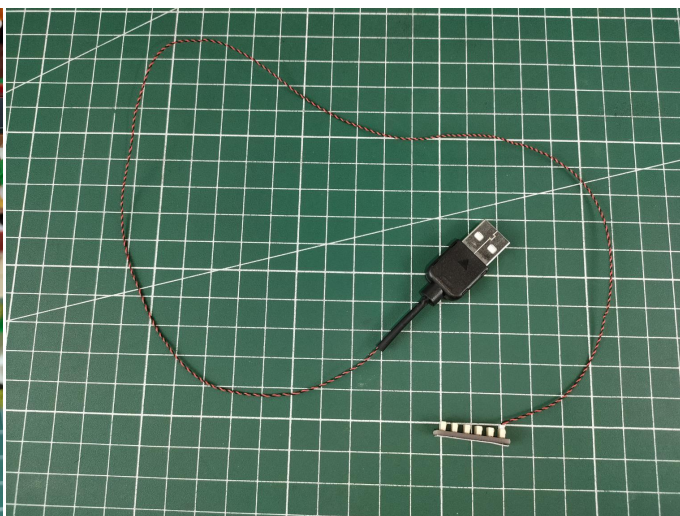
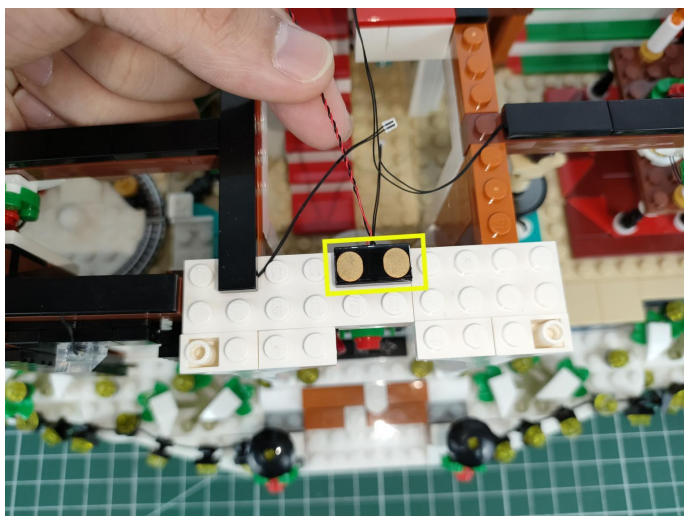

169

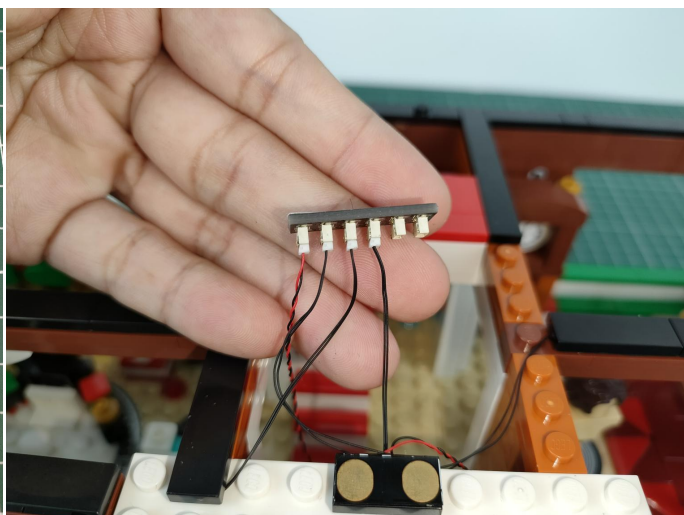
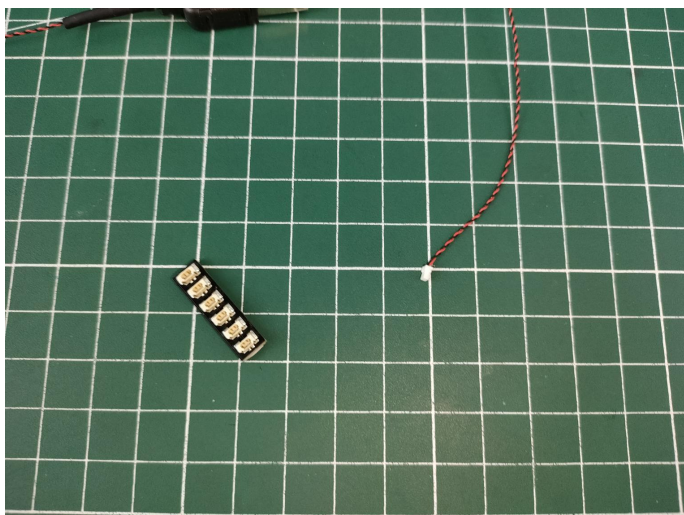

170

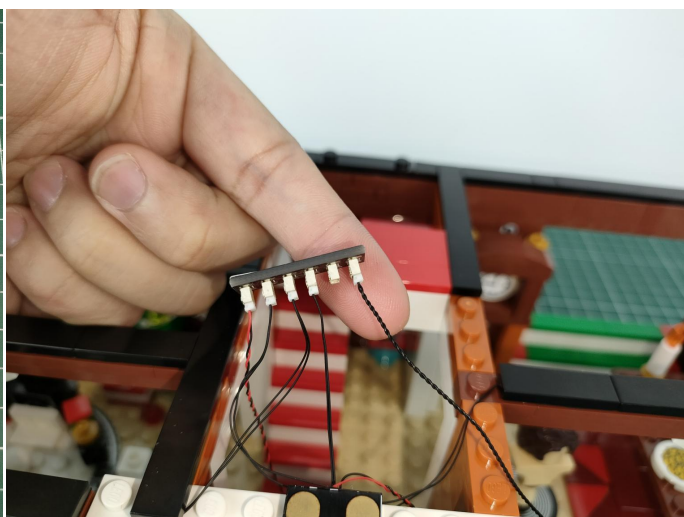

171

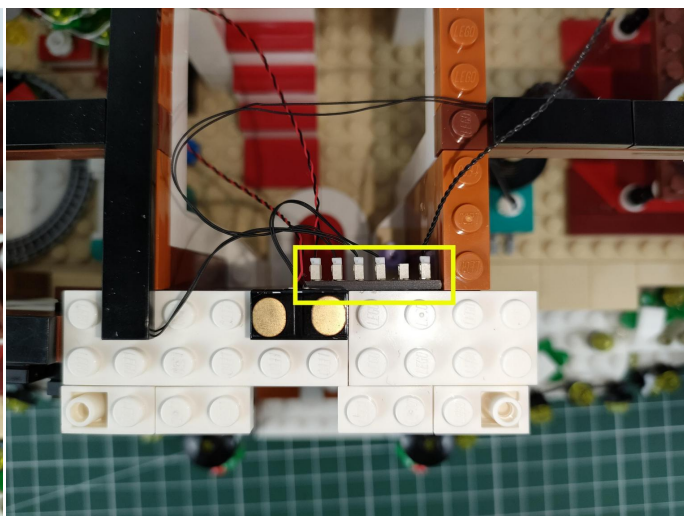
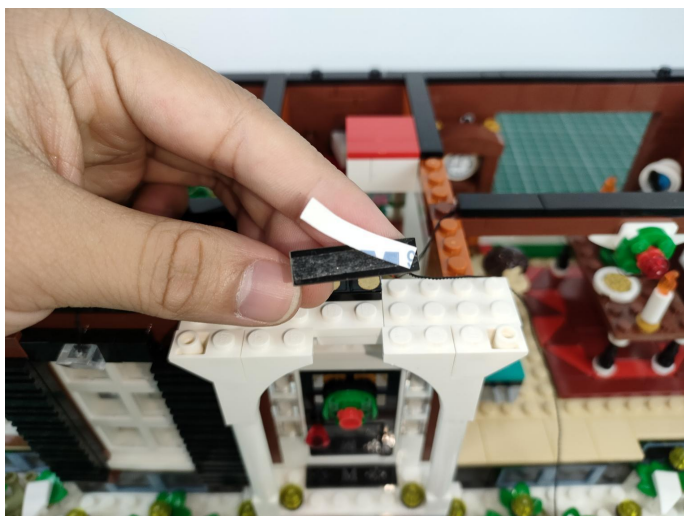

172

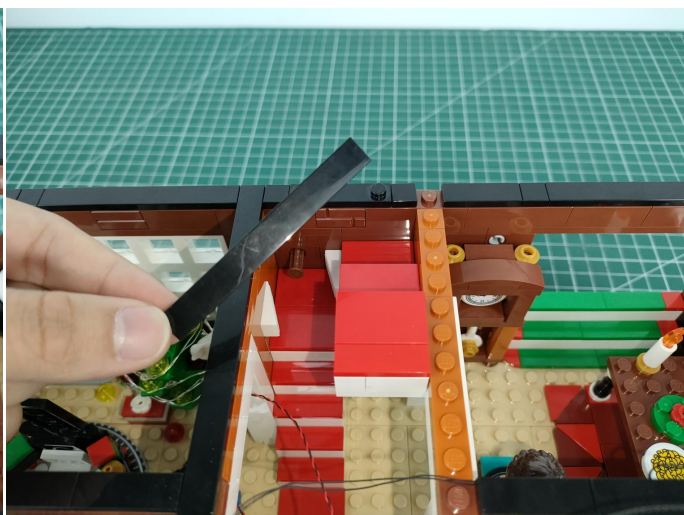
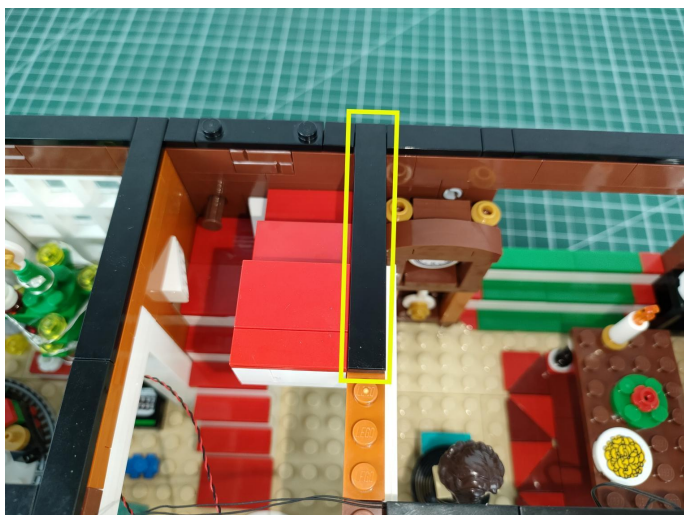

173

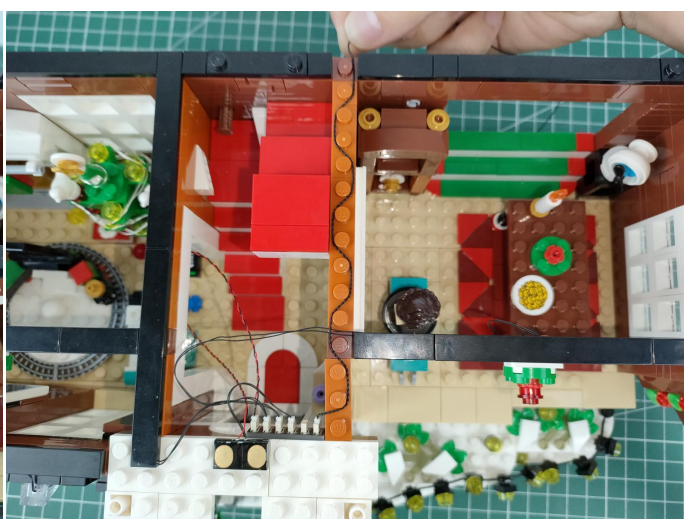
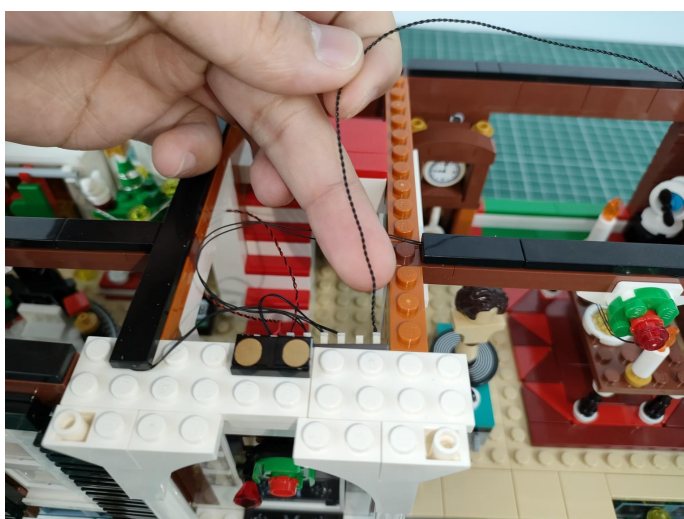

174



175

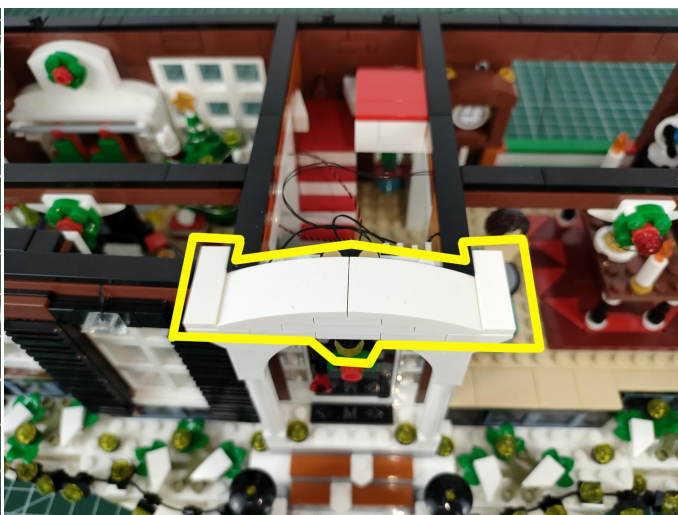
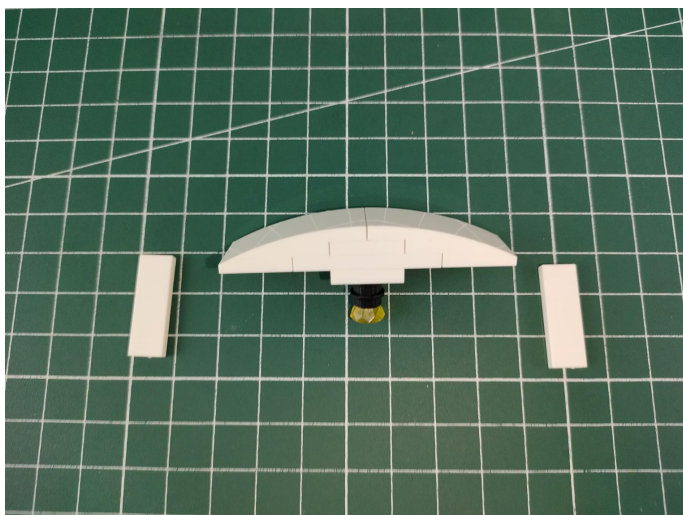

176

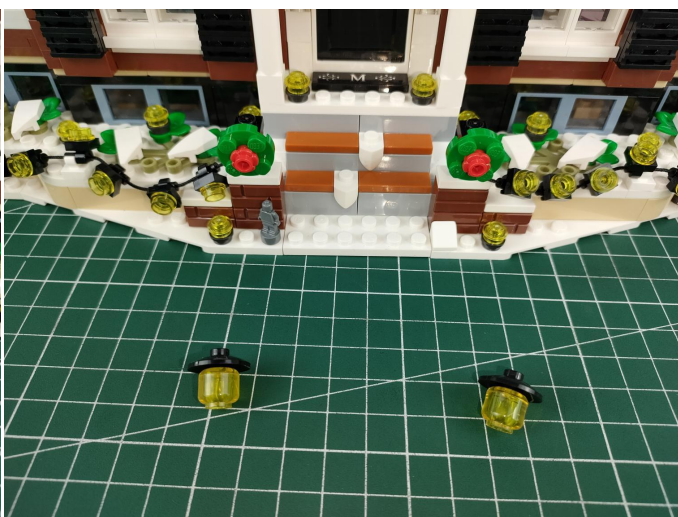
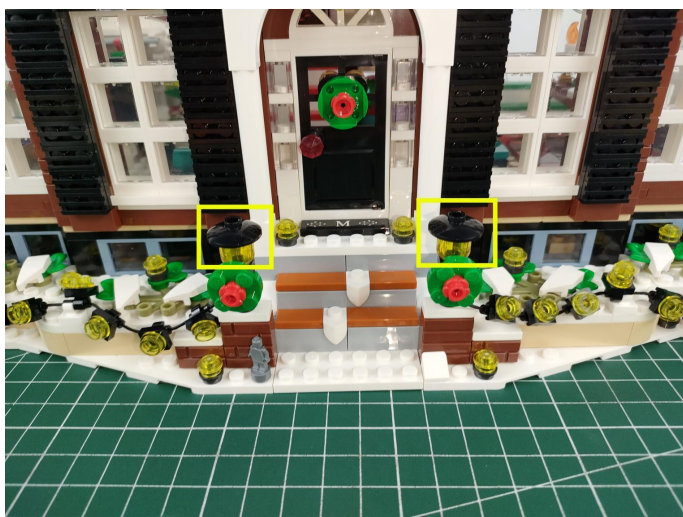

177

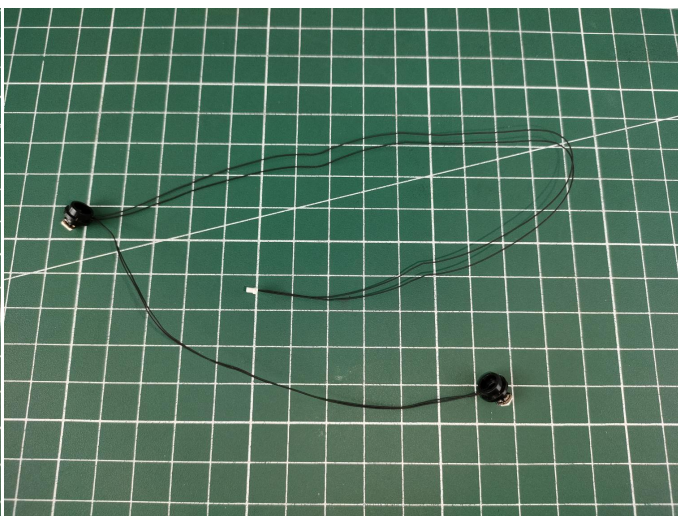

178

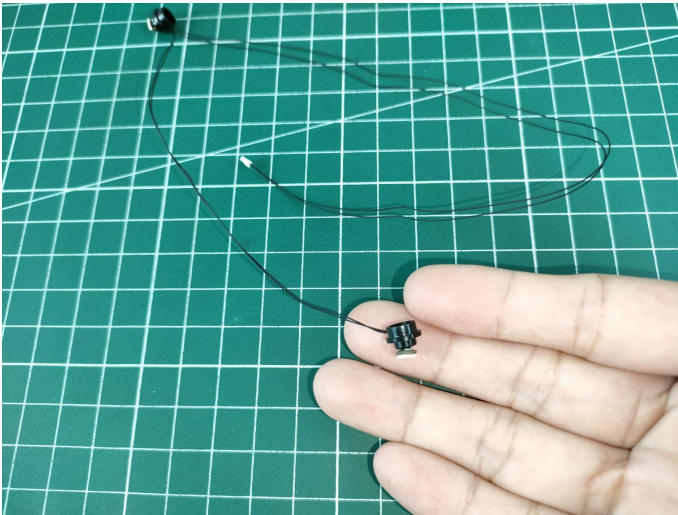

179

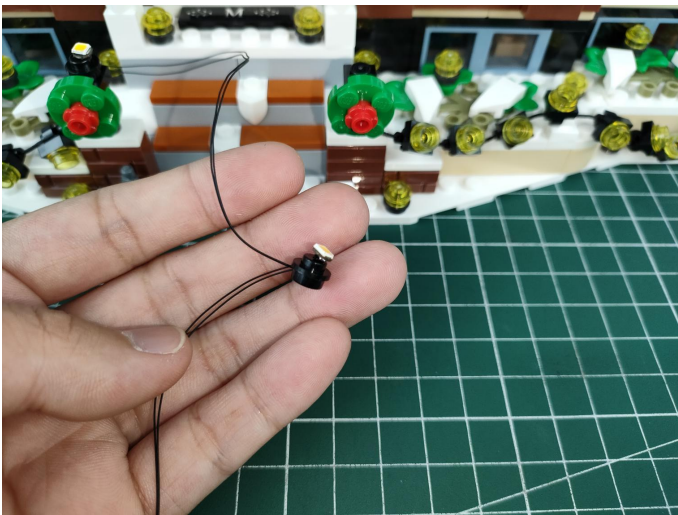

180

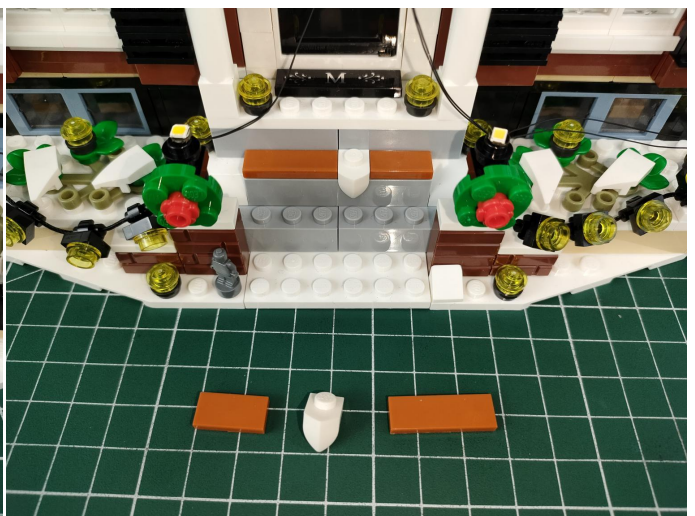
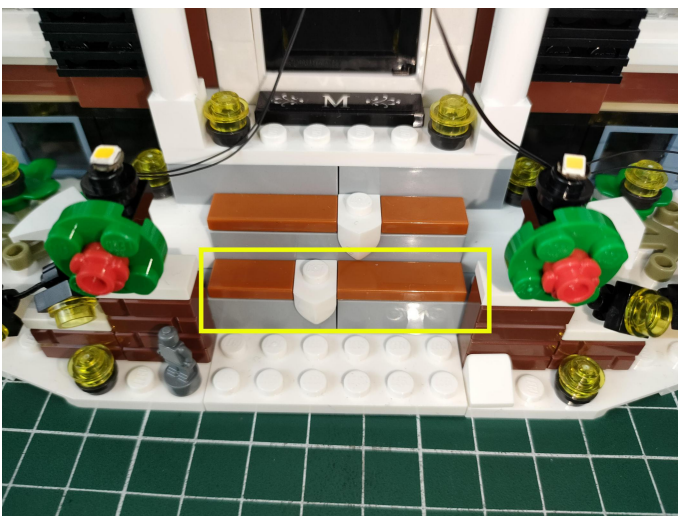

181

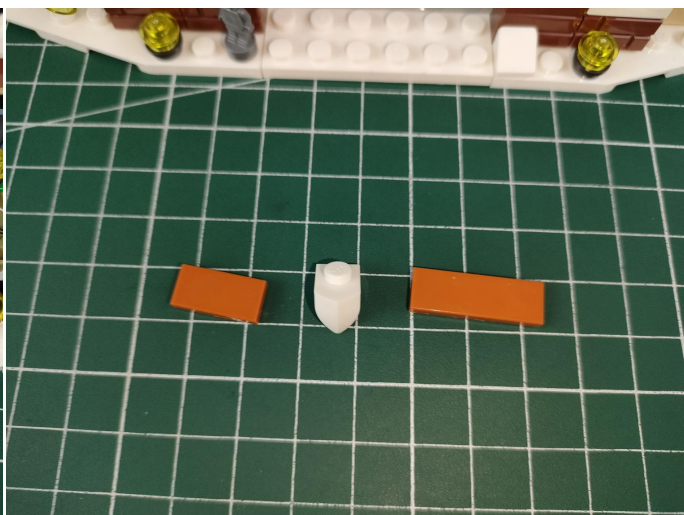
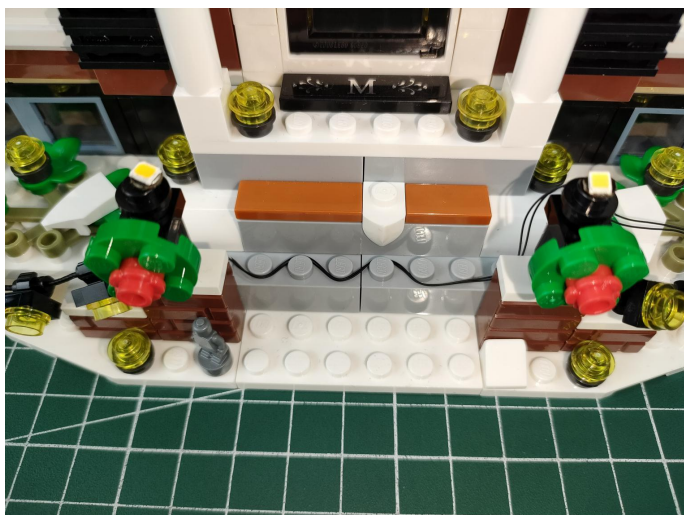

182

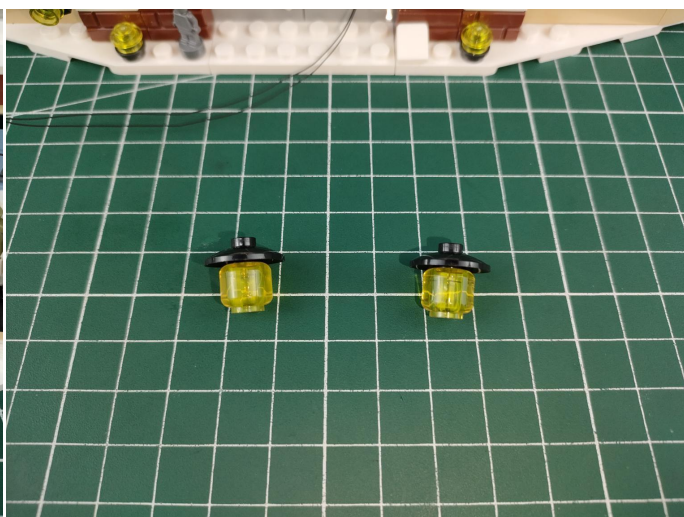
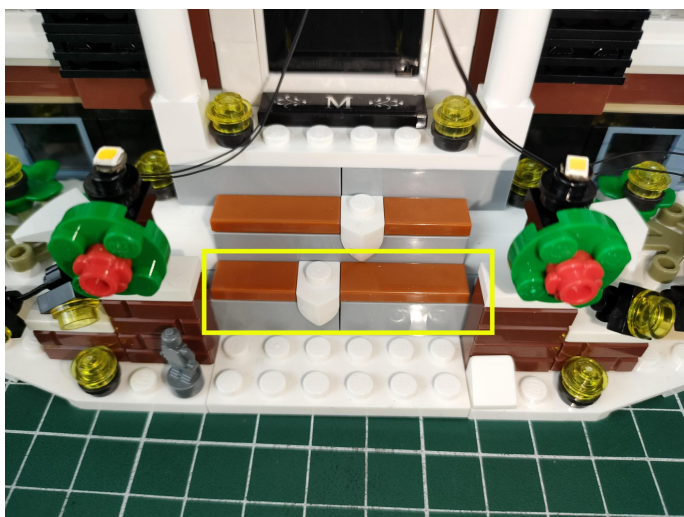

183

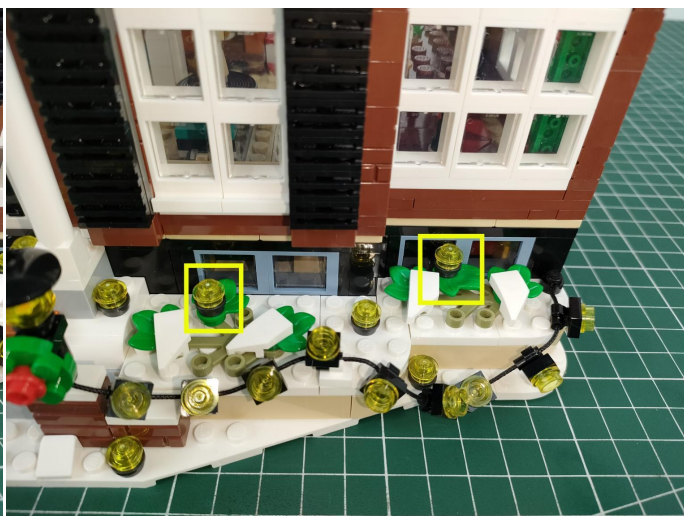
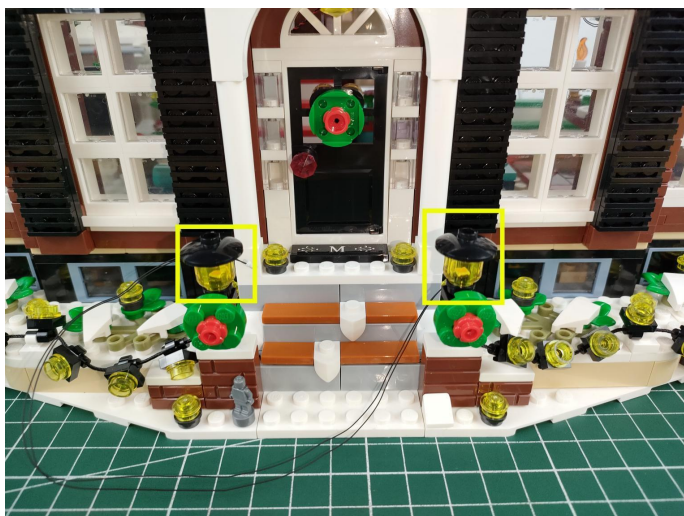

184

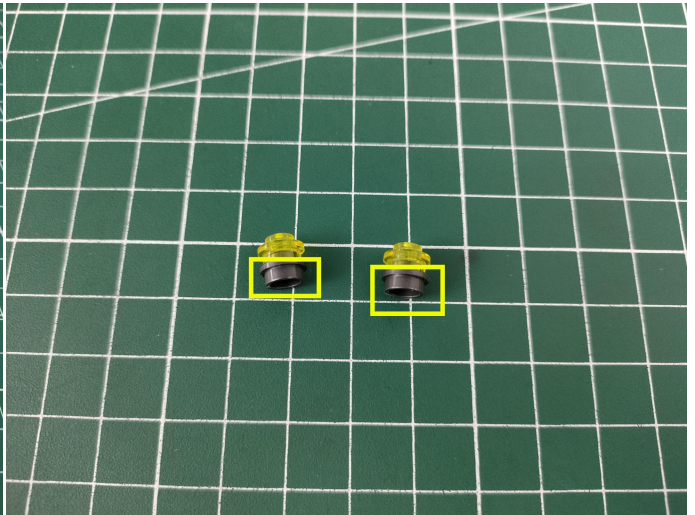
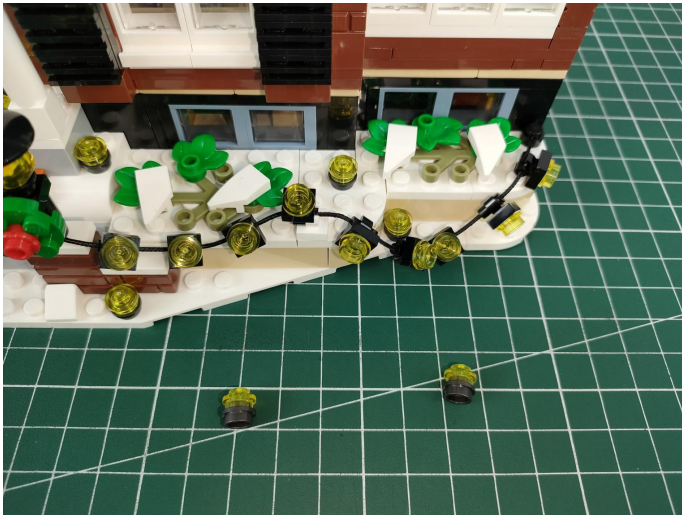

185

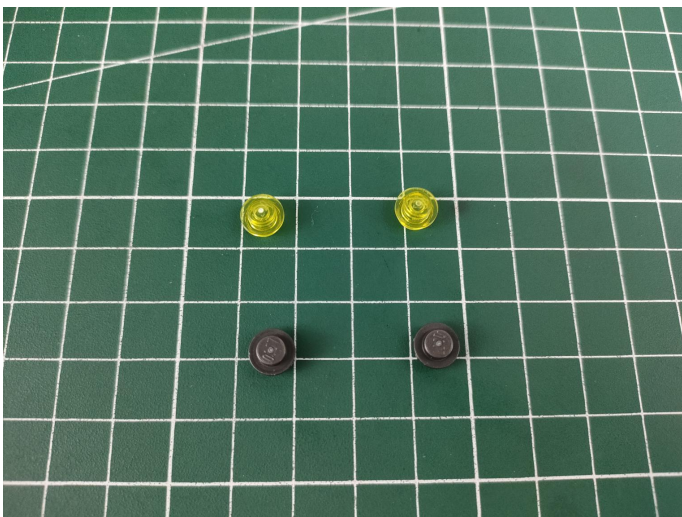

186

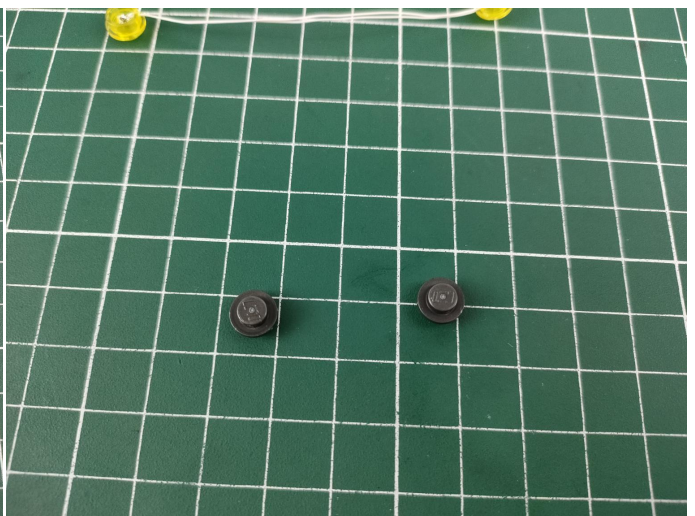
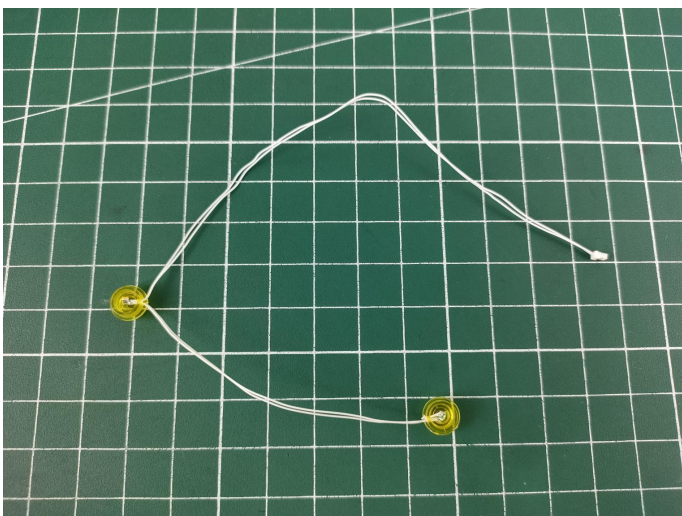

187

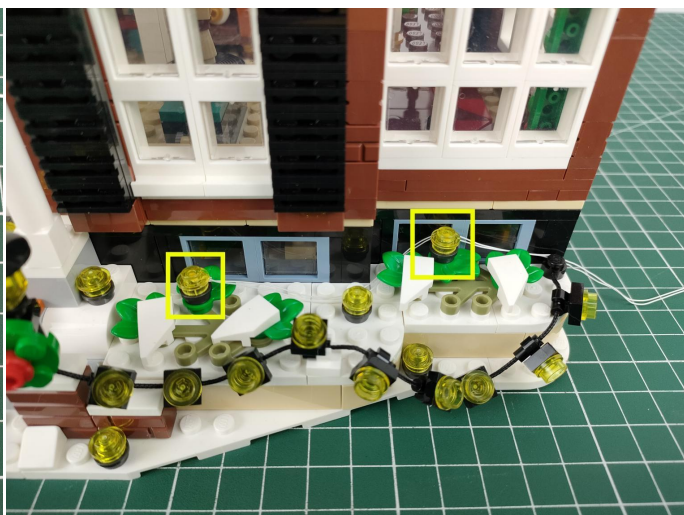
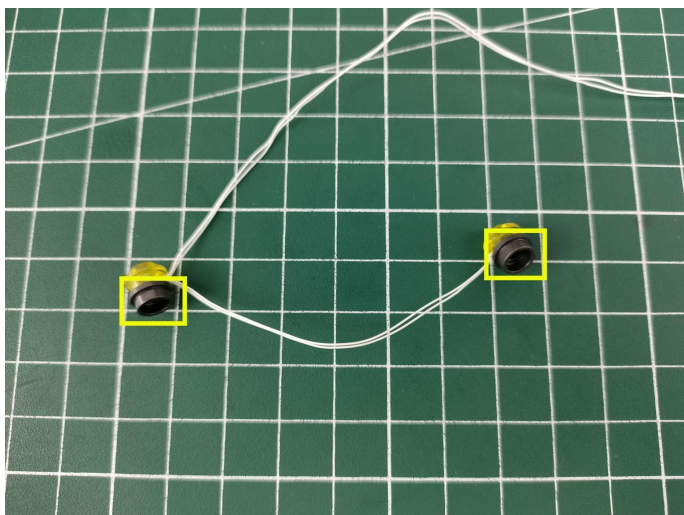

188

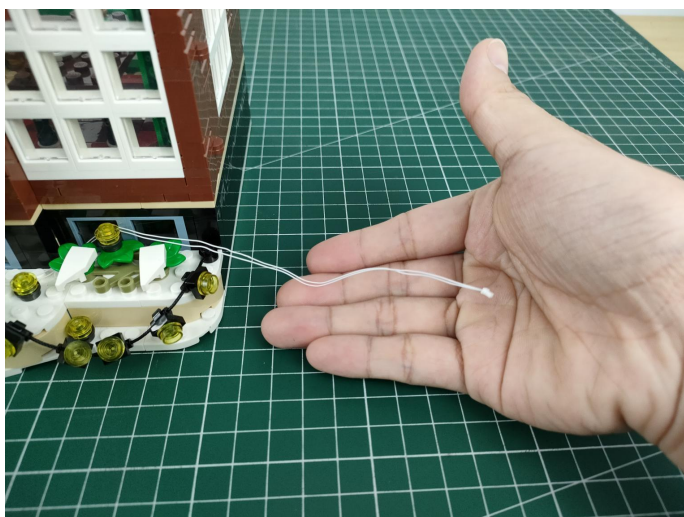

189

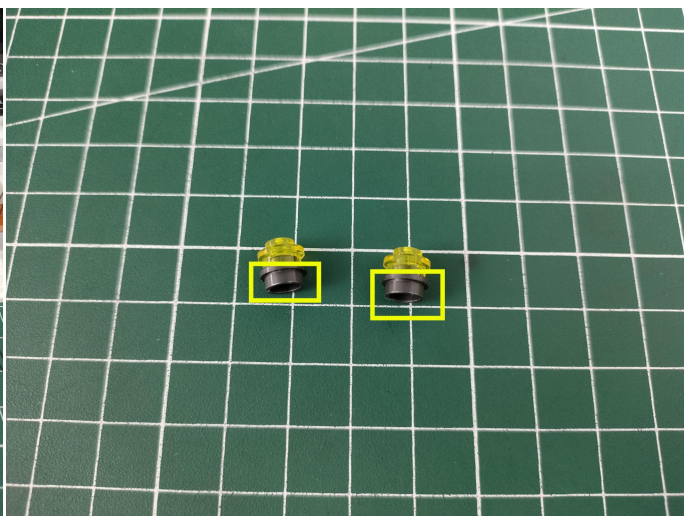

190



191

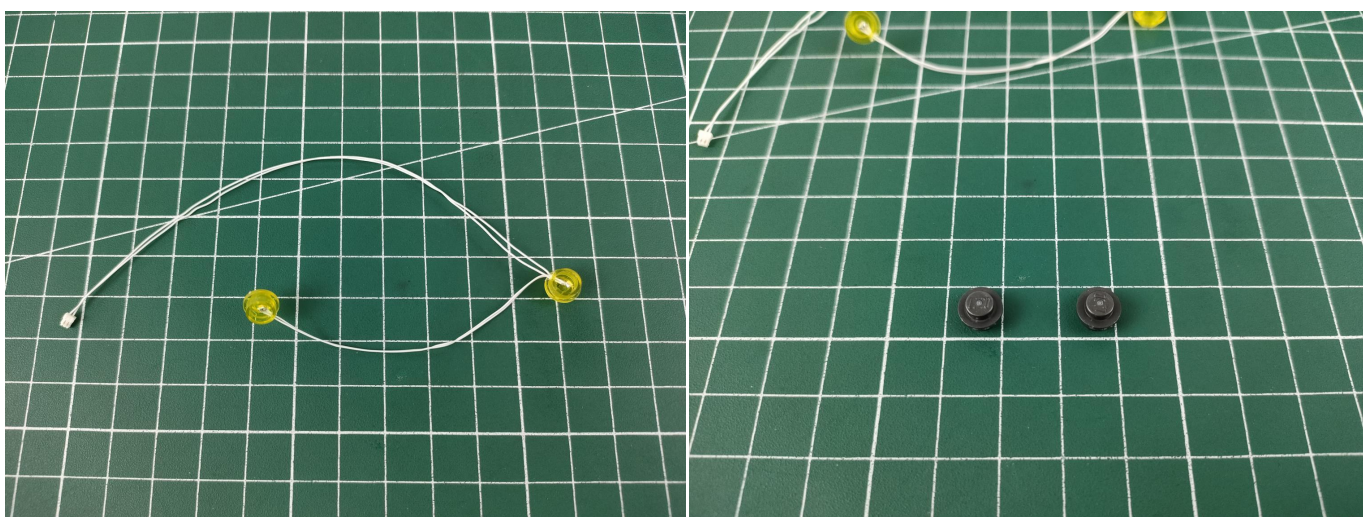

192

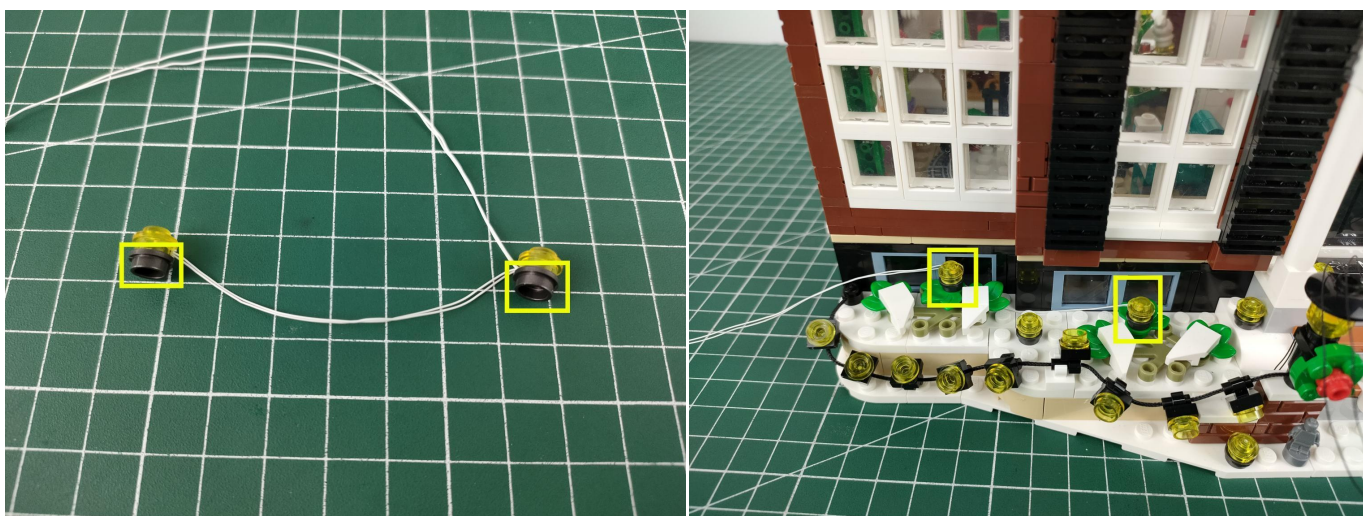

193



194

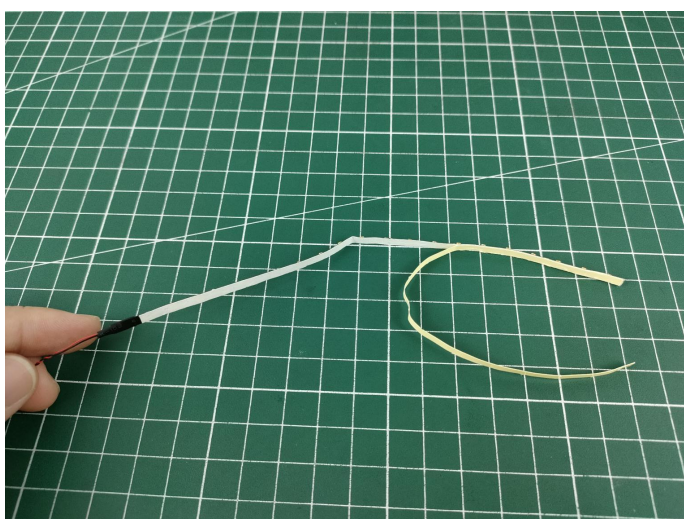

195

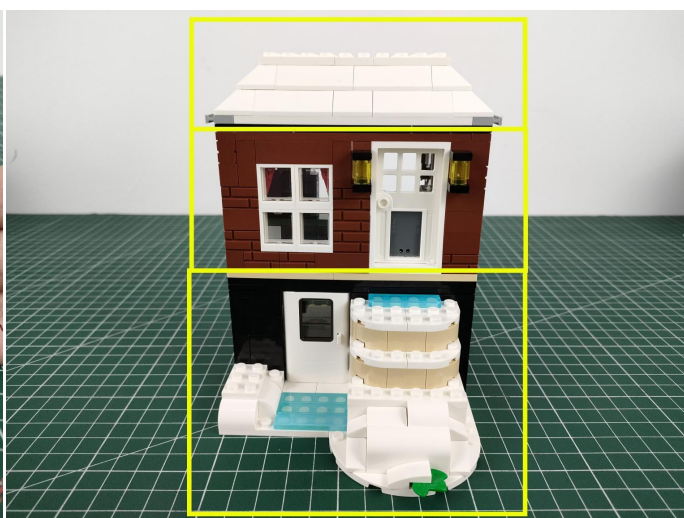

196

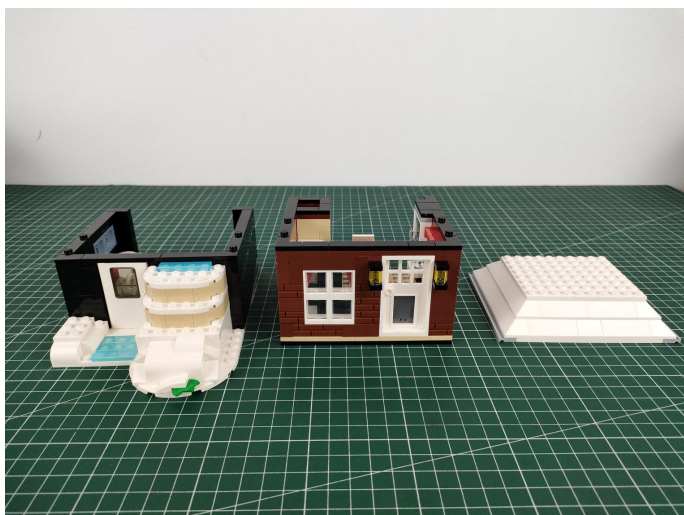

197

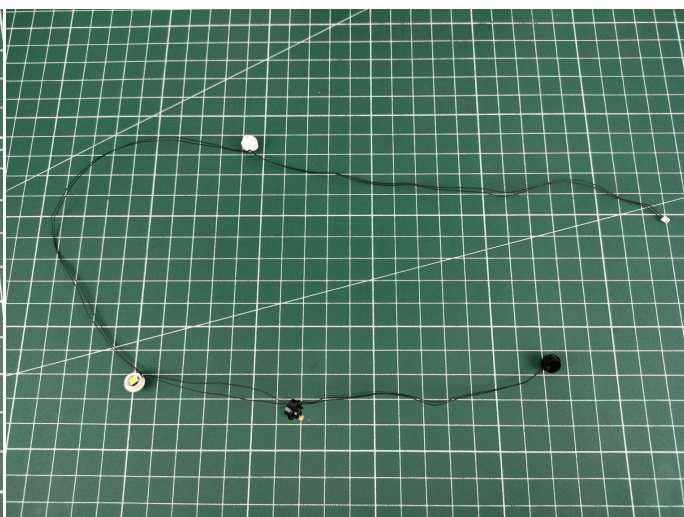

198



199

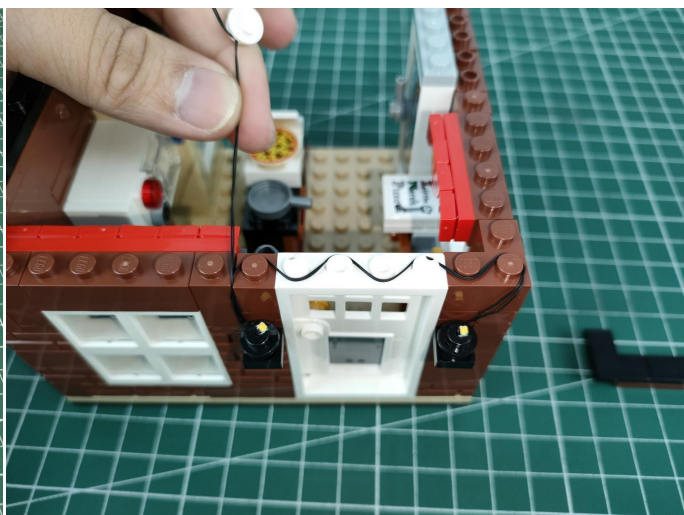
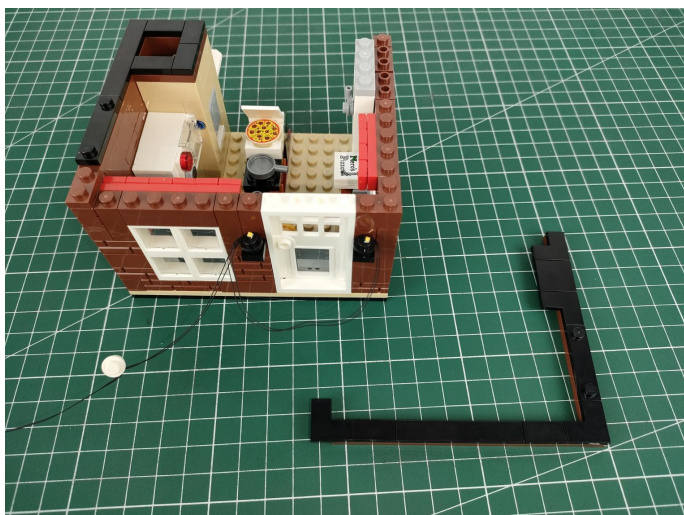

200

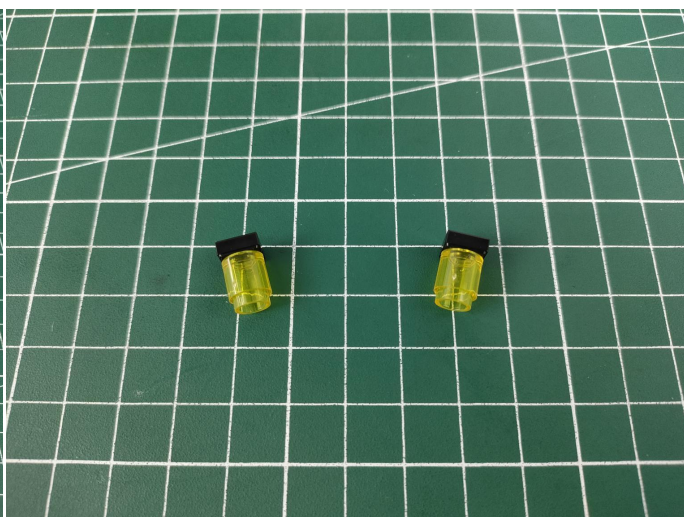
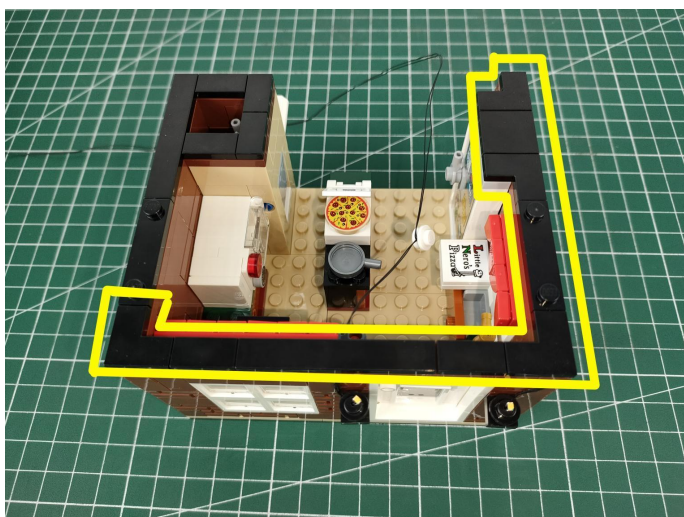

201

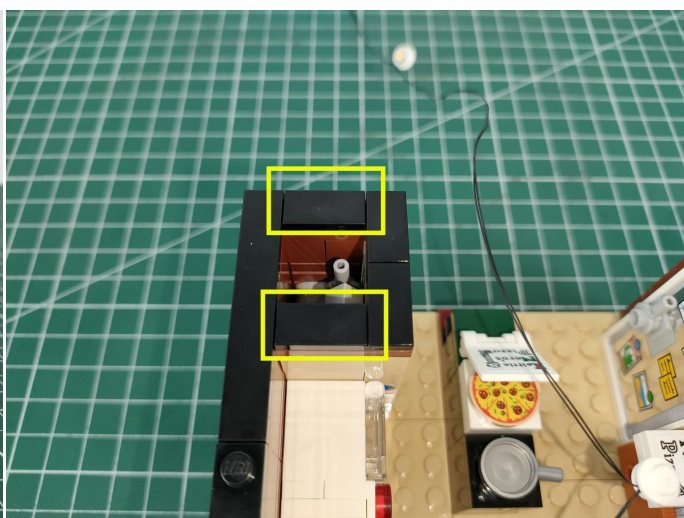

202

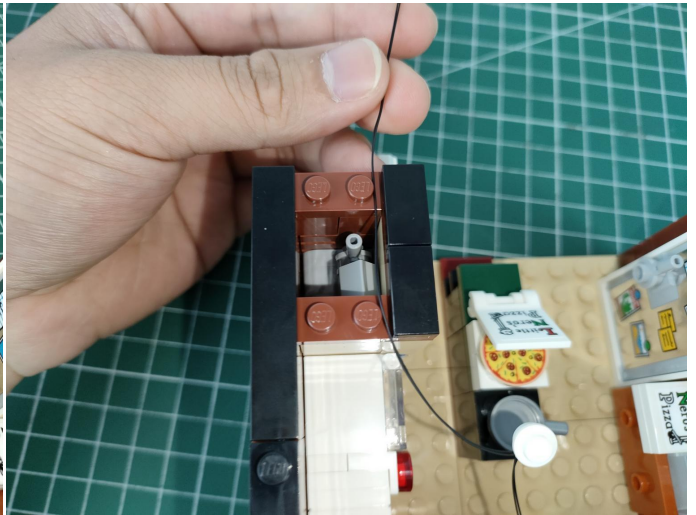
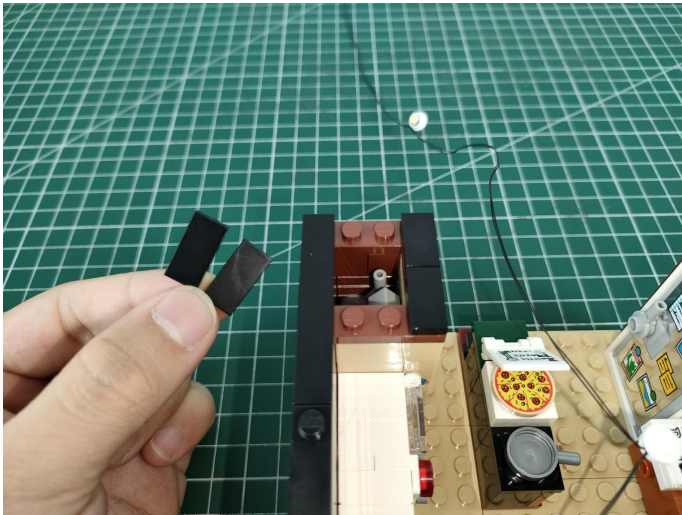

203

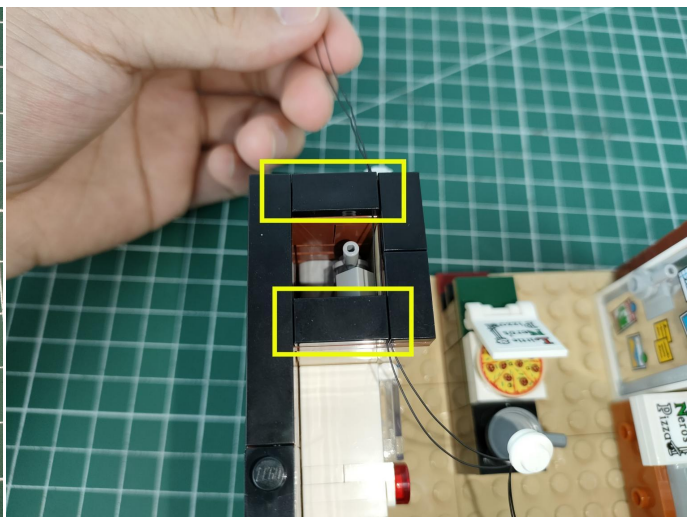
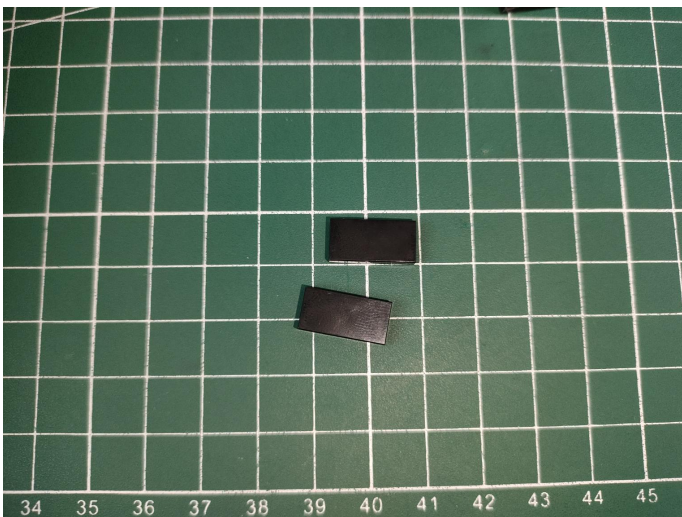

204

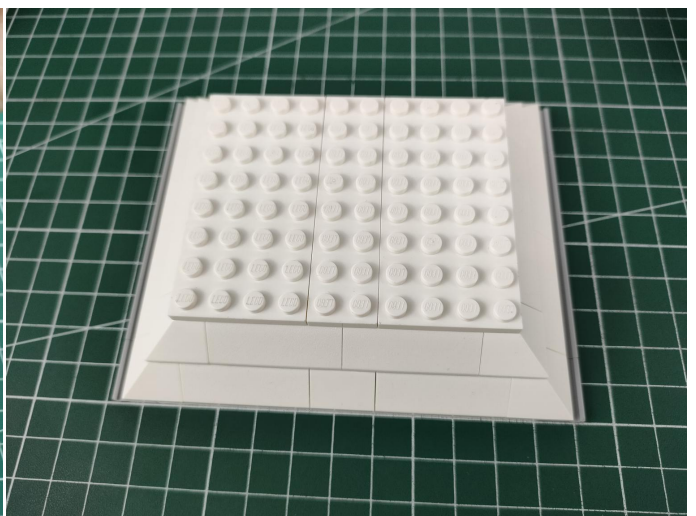
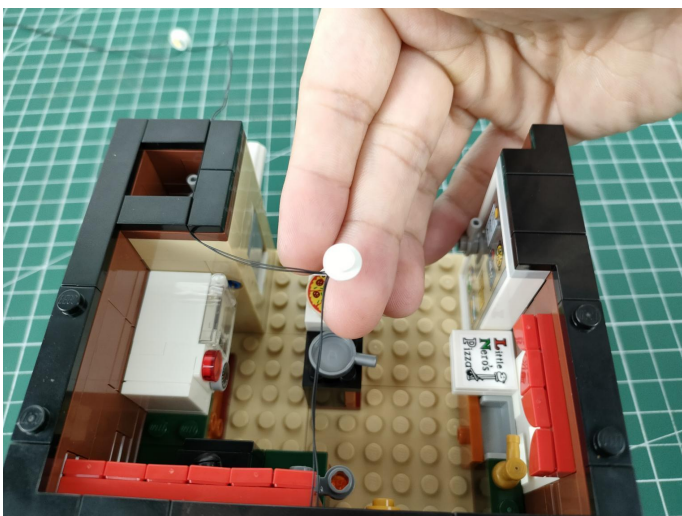

205

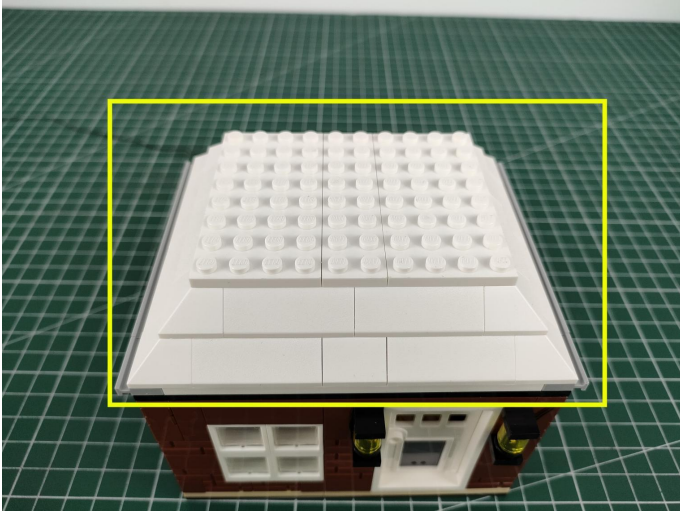

206

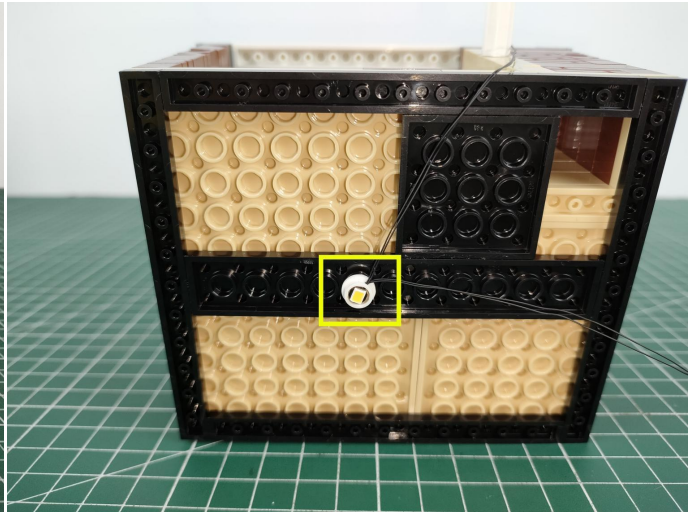
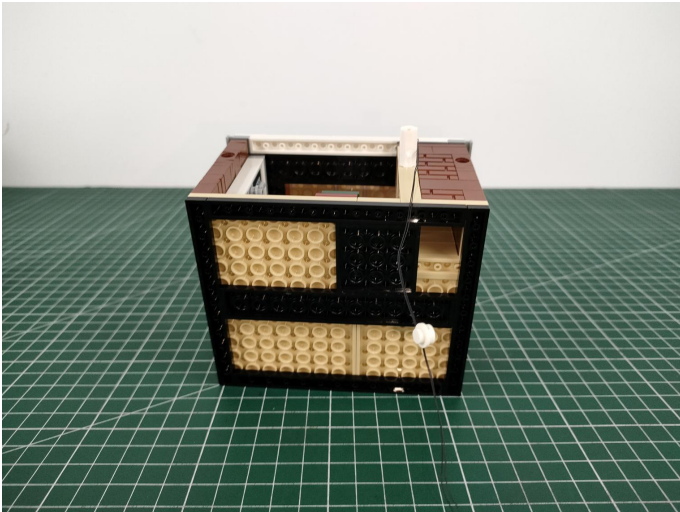

207

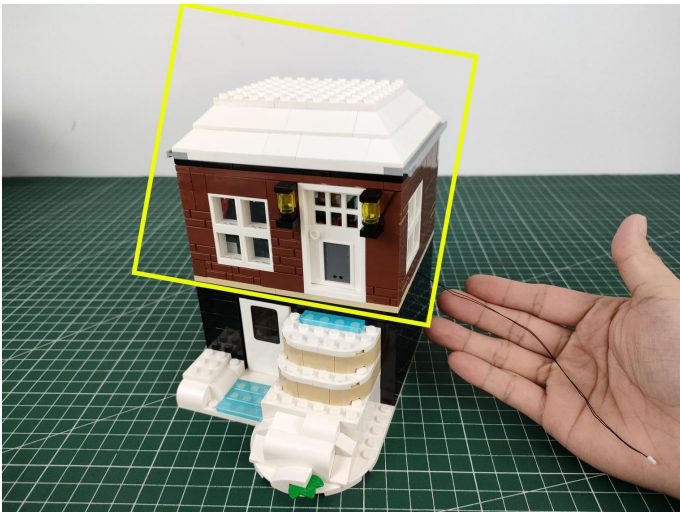

208

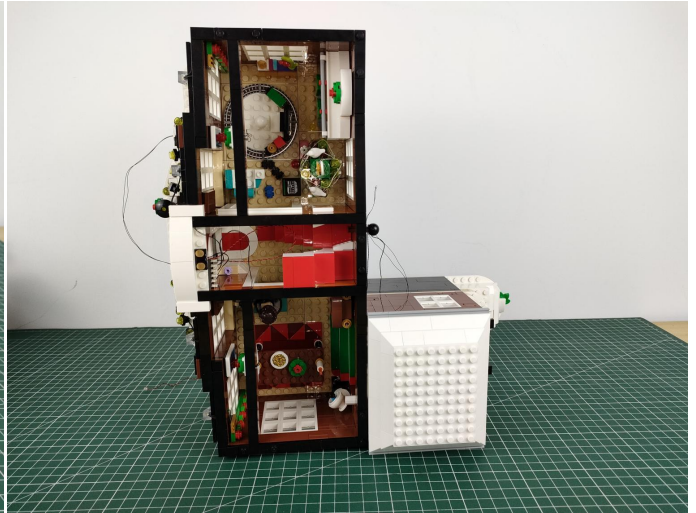

209

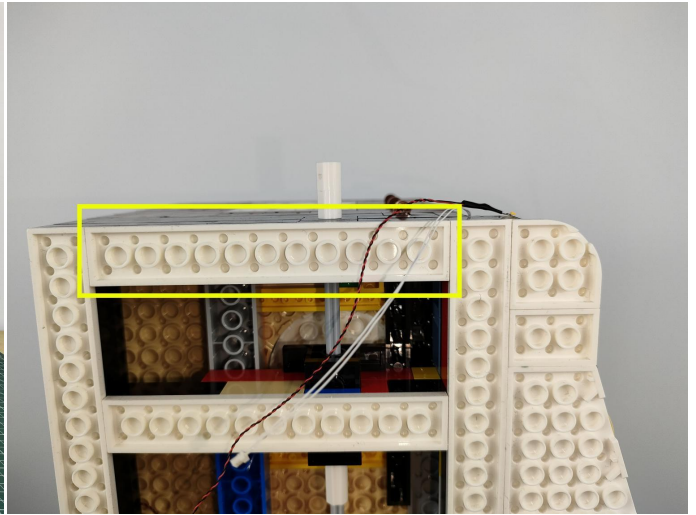
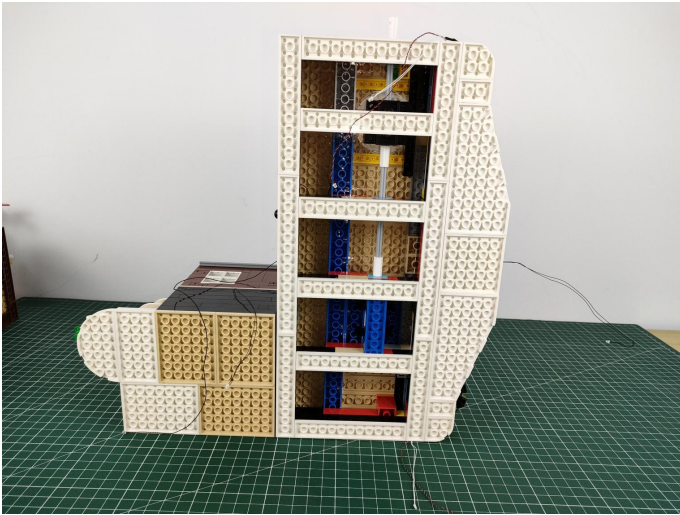

210

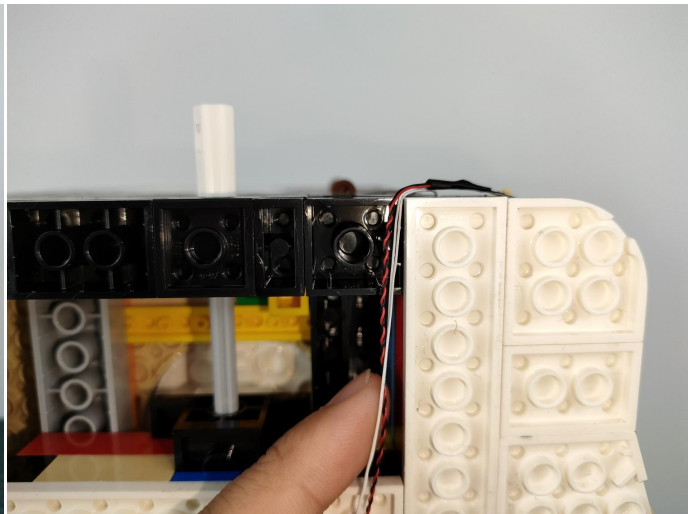
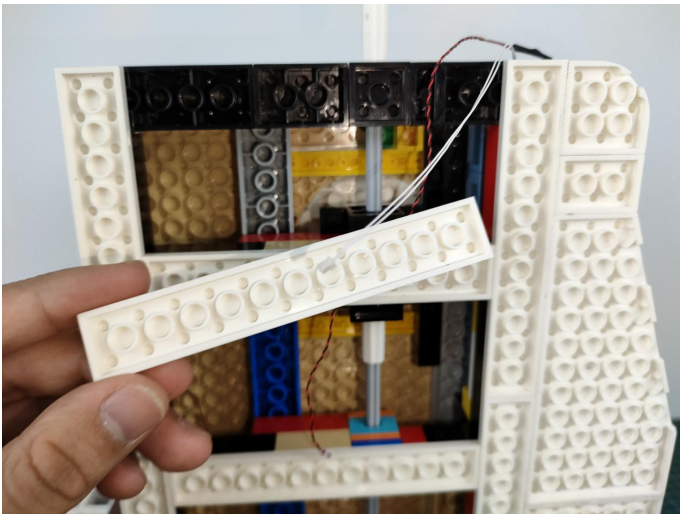

211

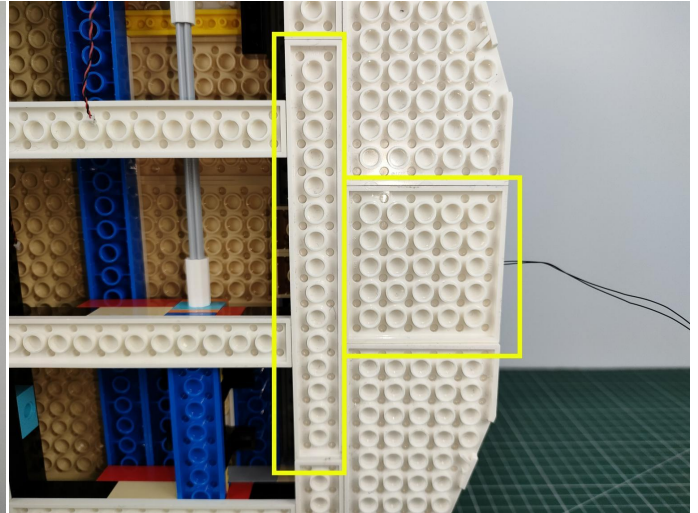
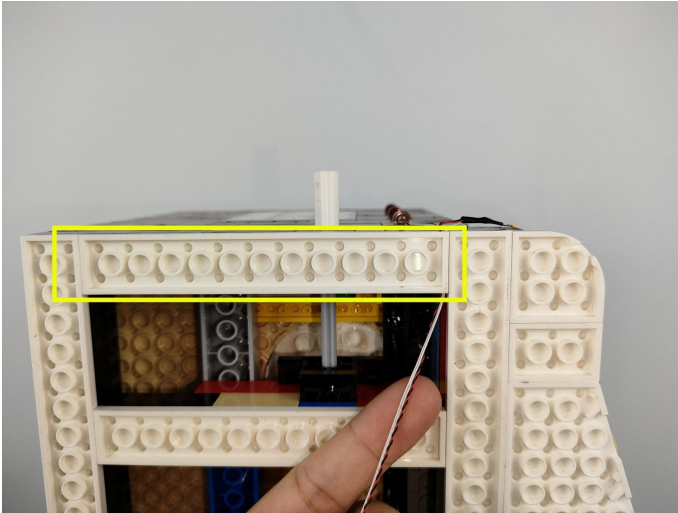

212

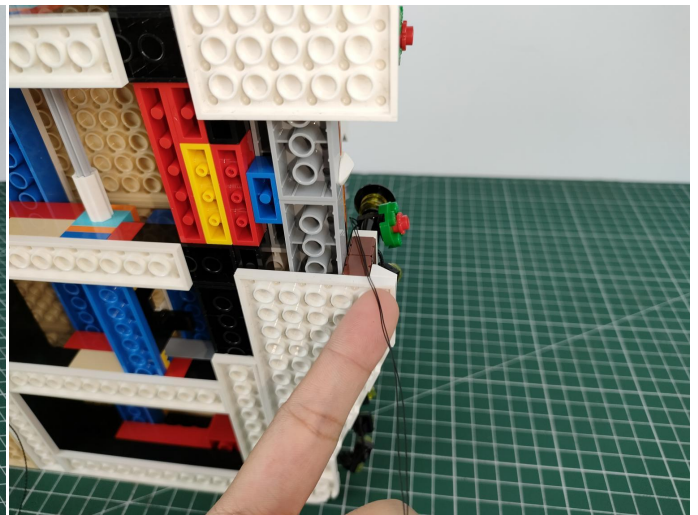
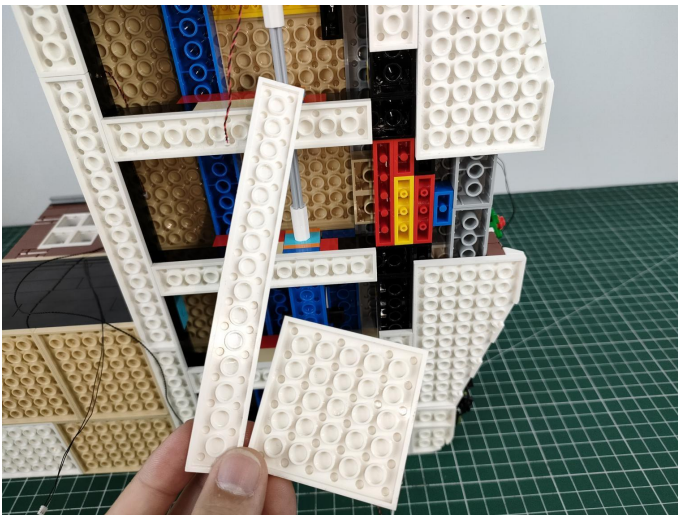

213

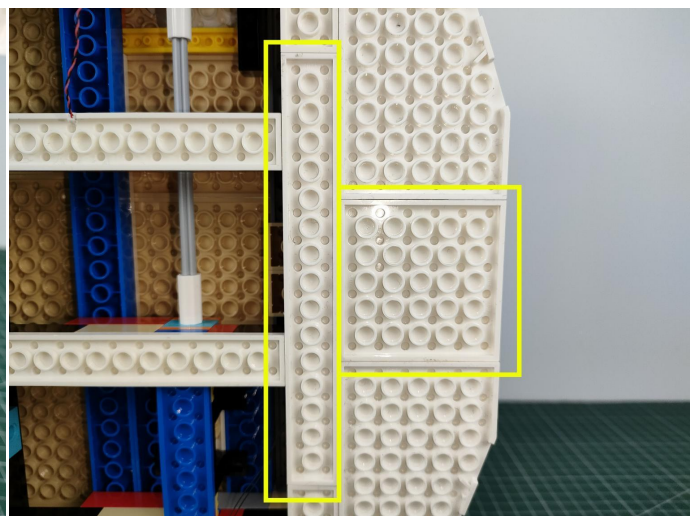
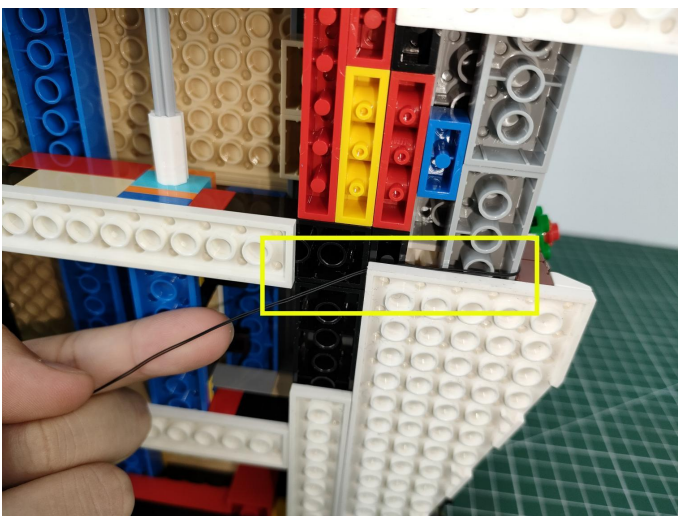

214

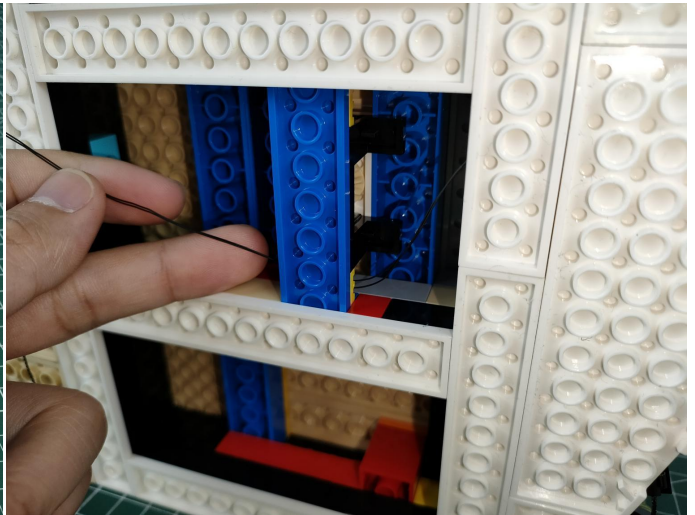
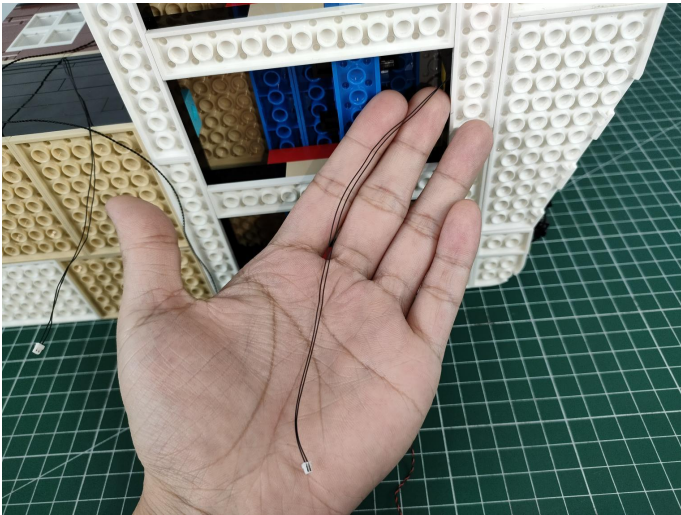

215

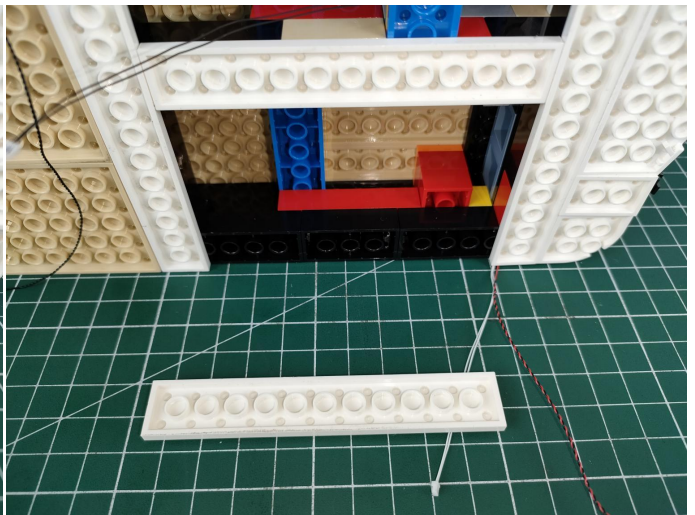
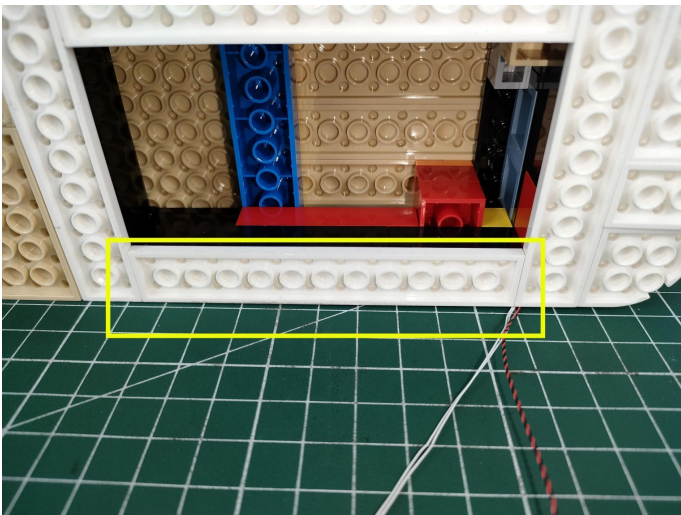

216

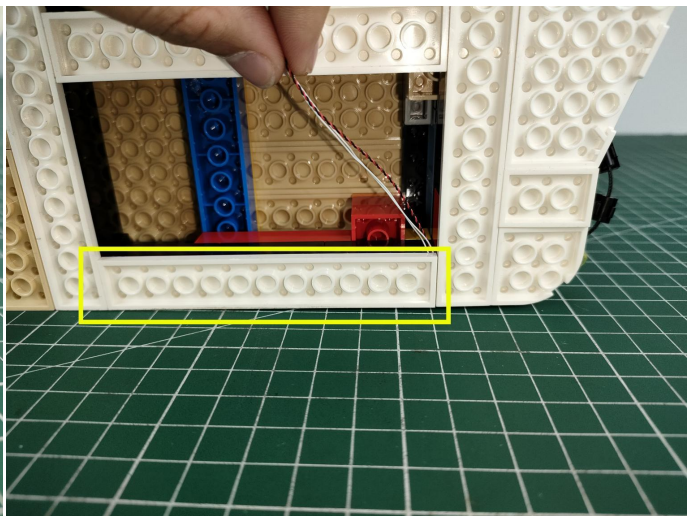
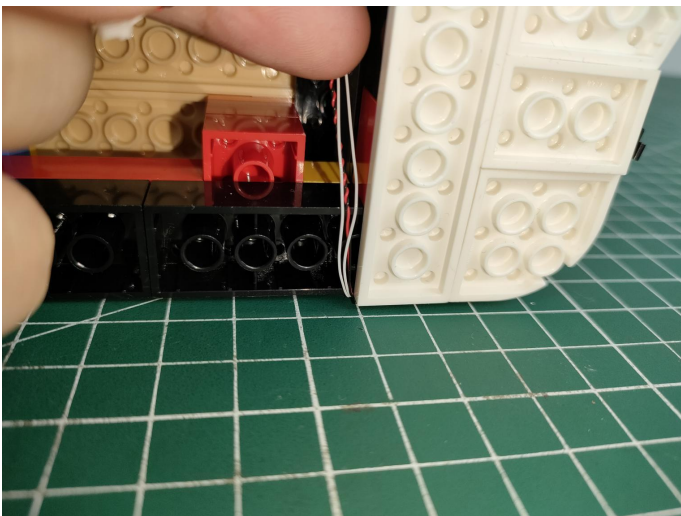

217



218

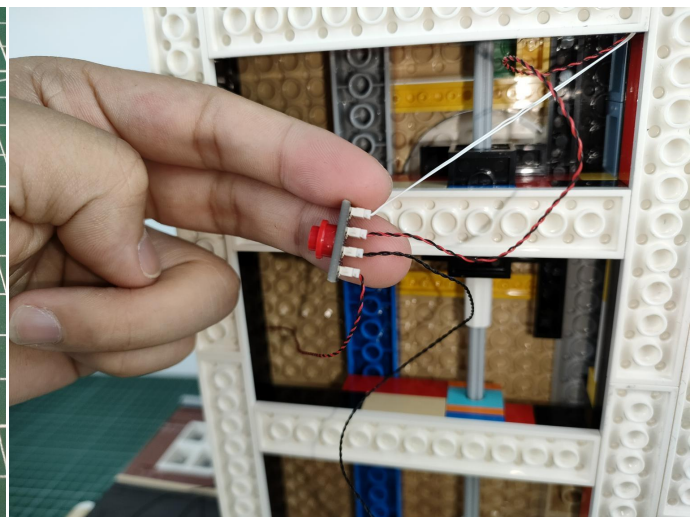
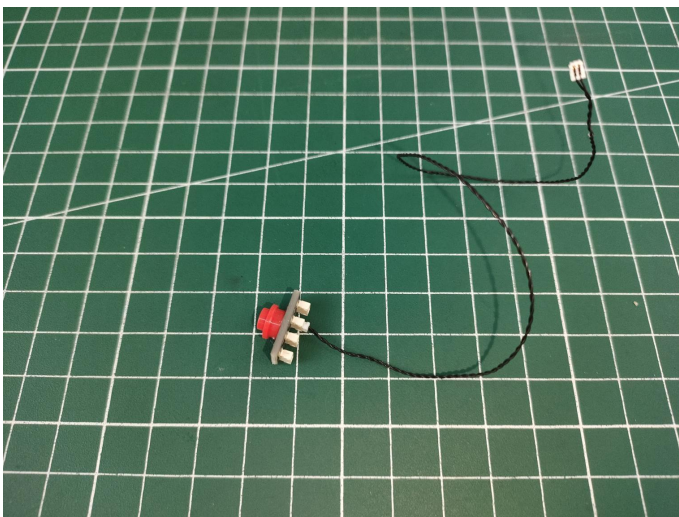

219

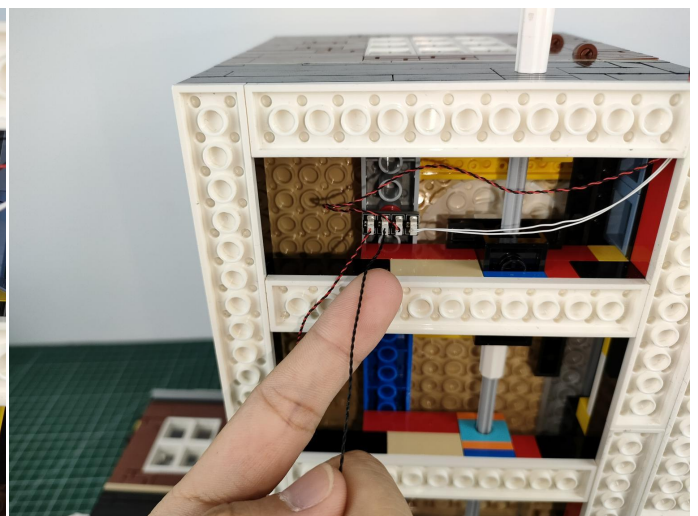
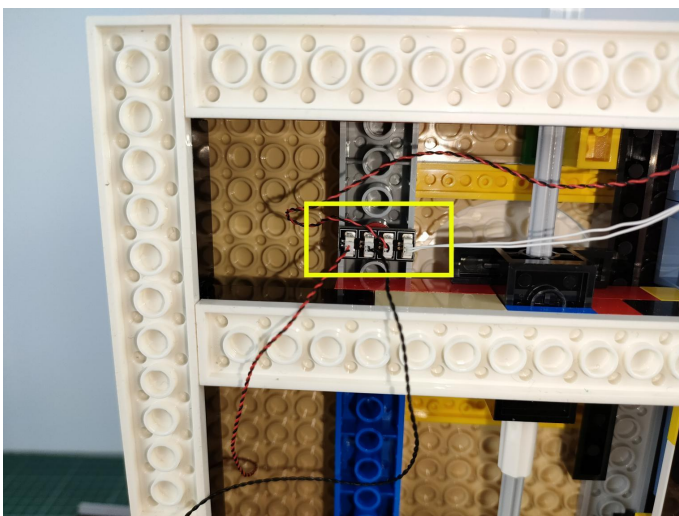

220



221



222

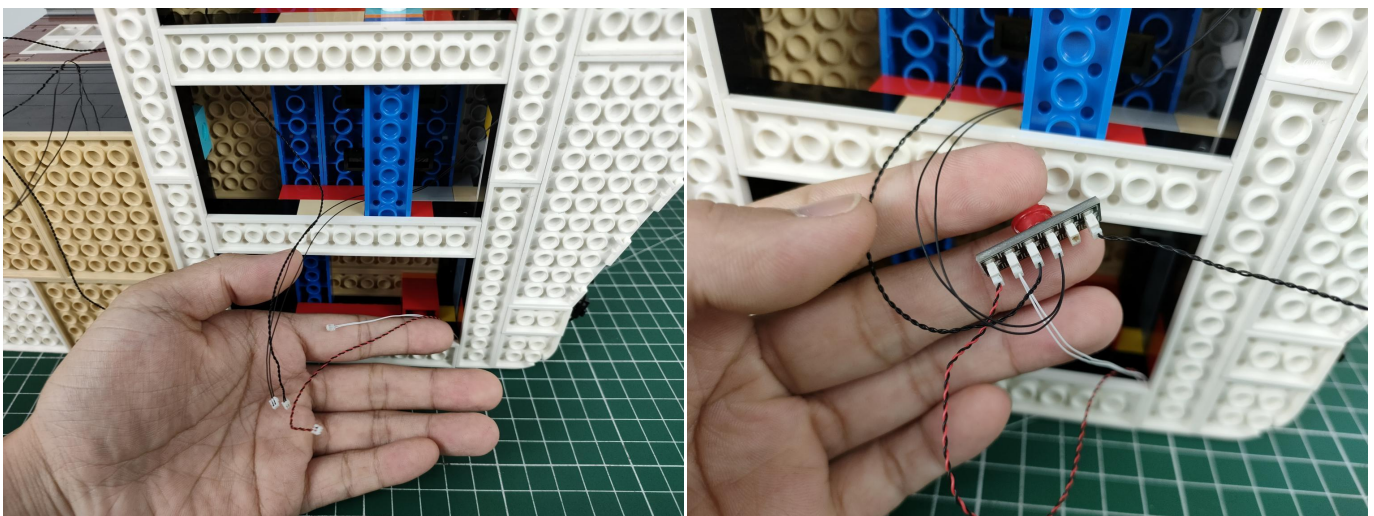

223

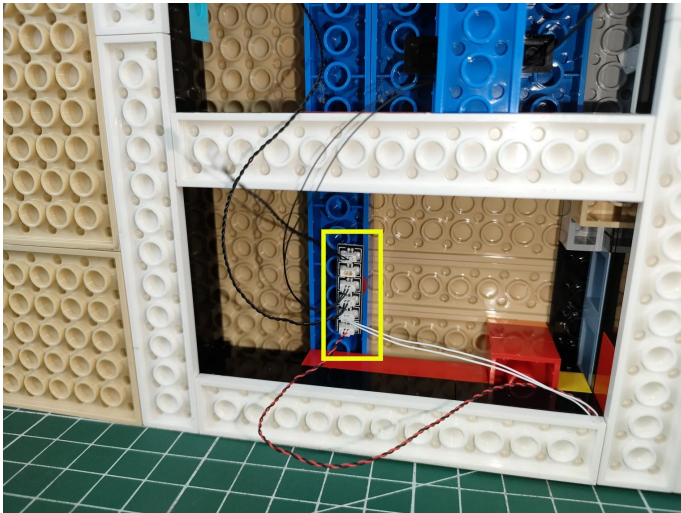

Remote control function description



ON: All branches are opened
 OFF: all branches are closed

A: open/close A road
 B: open/close B road
 C: open/close C road
 D: open/close D road

FS: Turn on blinking for the last open channel
 BLN: Start breathing for the last opened path

↑: Increase blinking/breathing rate
 ↓: Increase blinking/breathing rate

Brightness+: Increase brightness
 Brightness -: Reduce brightness

224

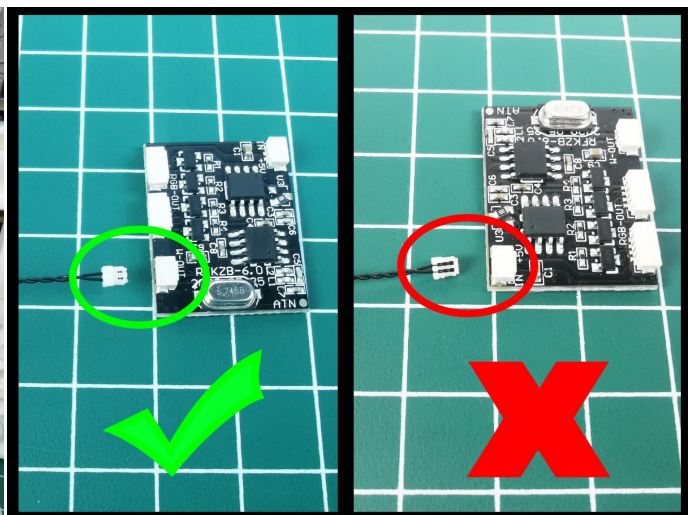
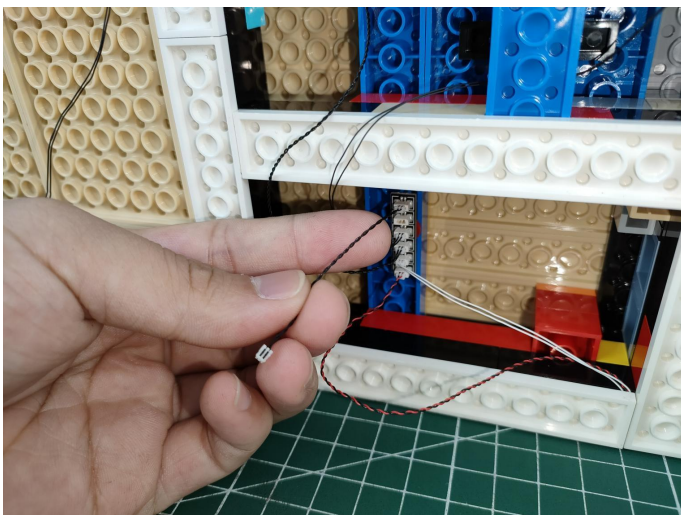

225

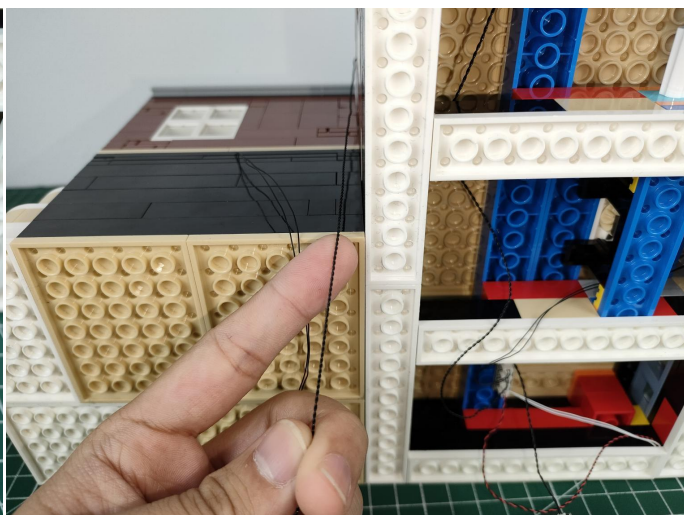
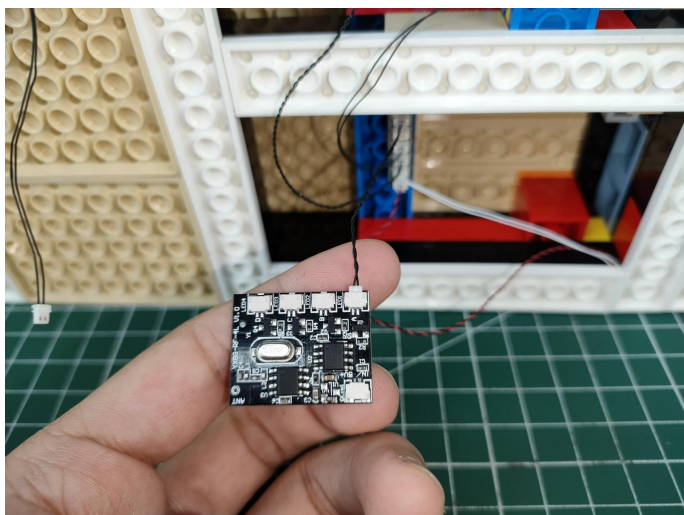

226

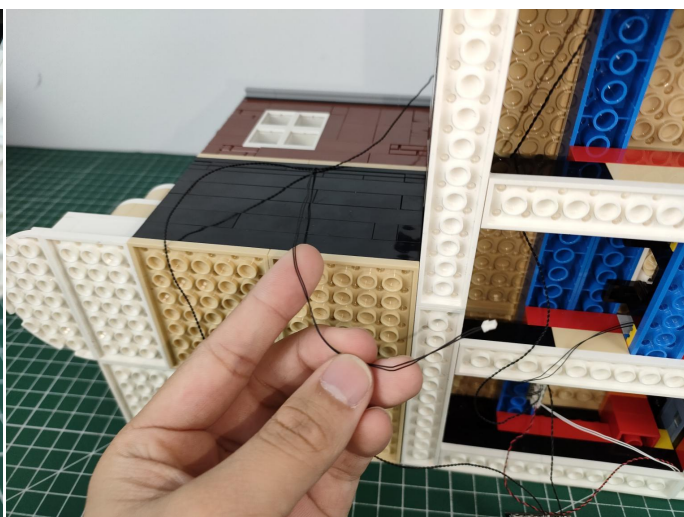
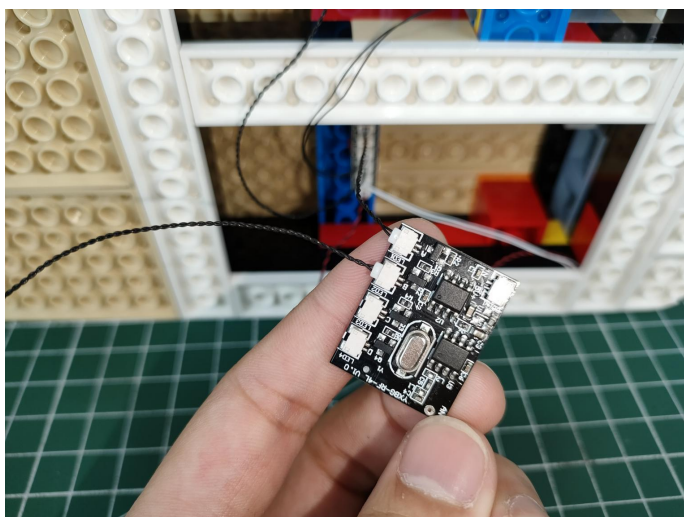

227

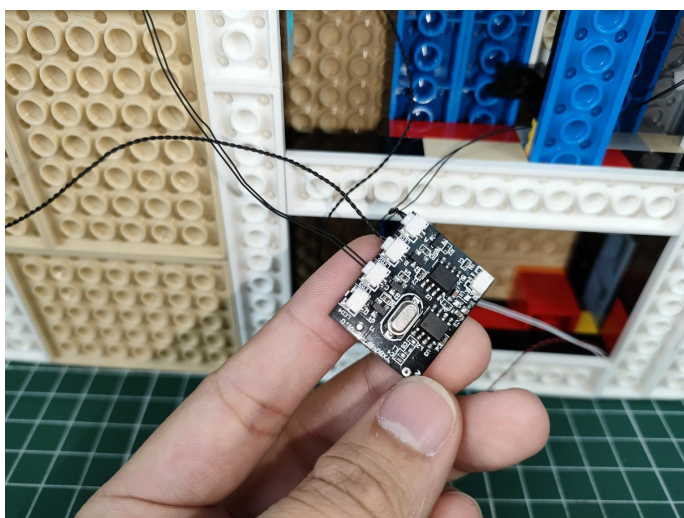

228

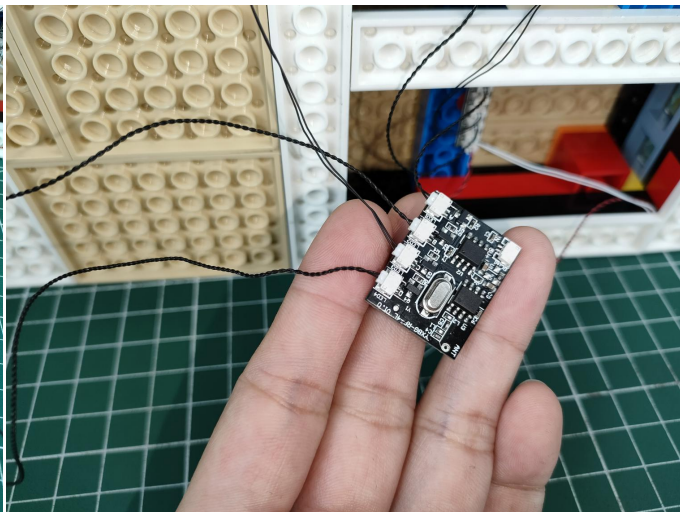
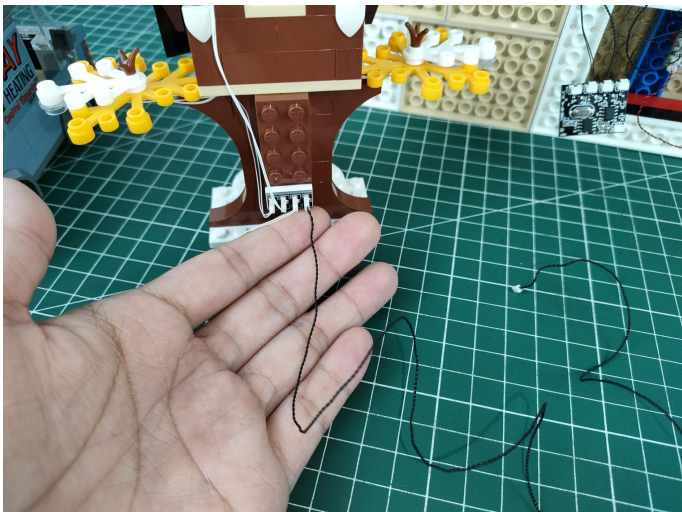

229

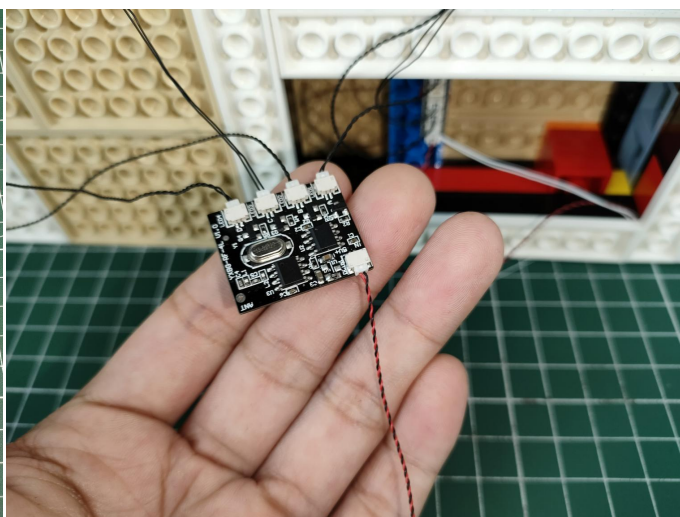
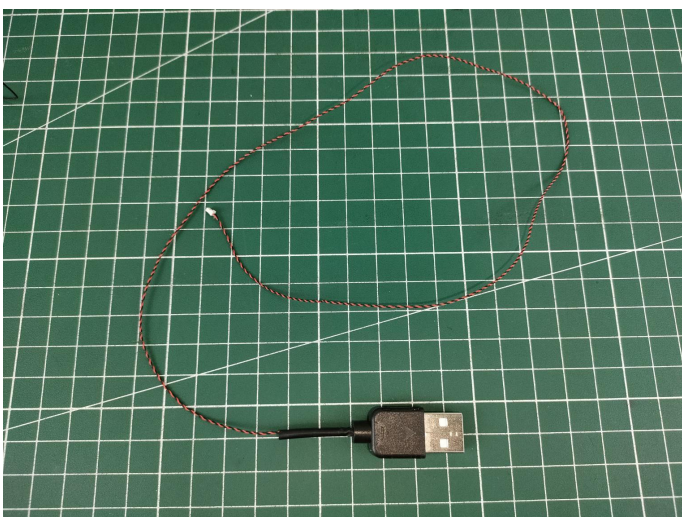

230

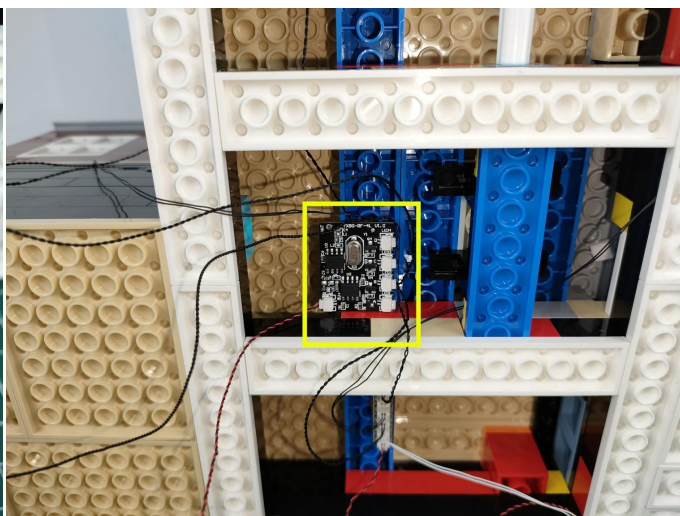
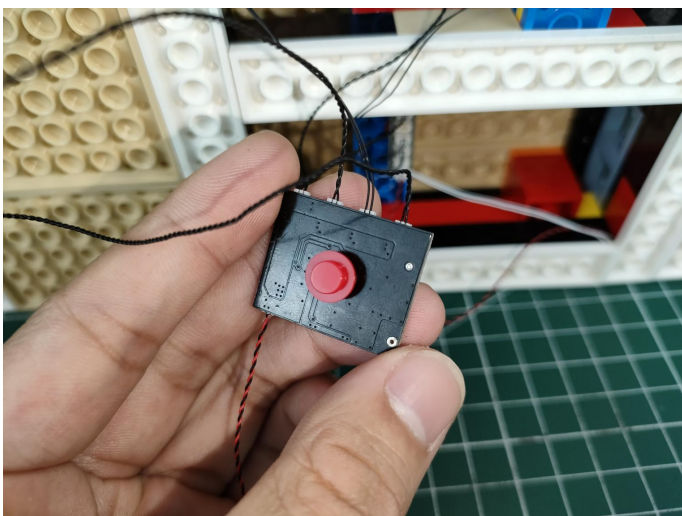



Remote control function description



ON: All branches are opened

OFF: all branches are closed

A: open/close A road

B: open/close B road

C: open/close C road

D: open/close D road

FS: Turn on blinking for the last open channel

BLN: Start breathing for the last opened path

↑: Increase blinking/breathing rate

↓: Increase blinking/breathing rate

Brightness+: Increase brightness

Brightness -: Reduce brightness

Good job, you've done all the installation steps, power it up and enjoy your work.



If everything is as excellent as expected, we'll be appreciate if a good review can be given.

THANKS