

10275 Elf Club House

LED lighting Kit (Standard style)

LG118/GC118

Instructions for installing this kit:



Step 1

Test:

This product has 4 bags, and the battery box is a gift. (Without battery)



Take out the parts in bag 4. (the parts used in this article are all samples, and may be slightly different from the finished product, please forgive me).



Then take out the USB power cord and an expansion board from the small bag. The usage of the USB power cord is similar to that of a battery box, and it can be powered by a power bank or a mobile phone charger. The battery box and the USB power cord can be freely chosen, choose one of the two (the USB power cord is used in this article).

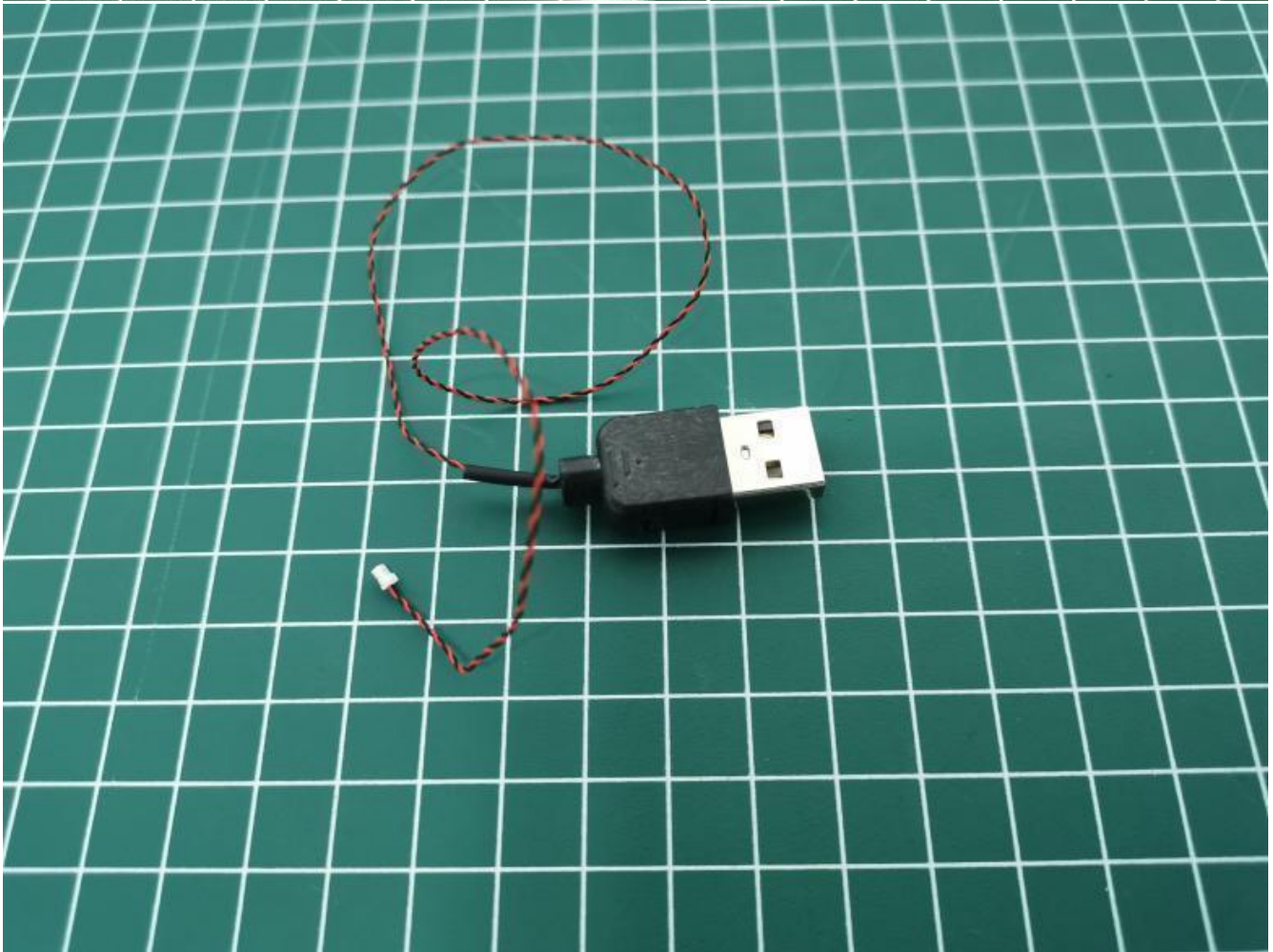

The power supplies that can be used with the USB power cord are as follows.

USB connectors to connect devices

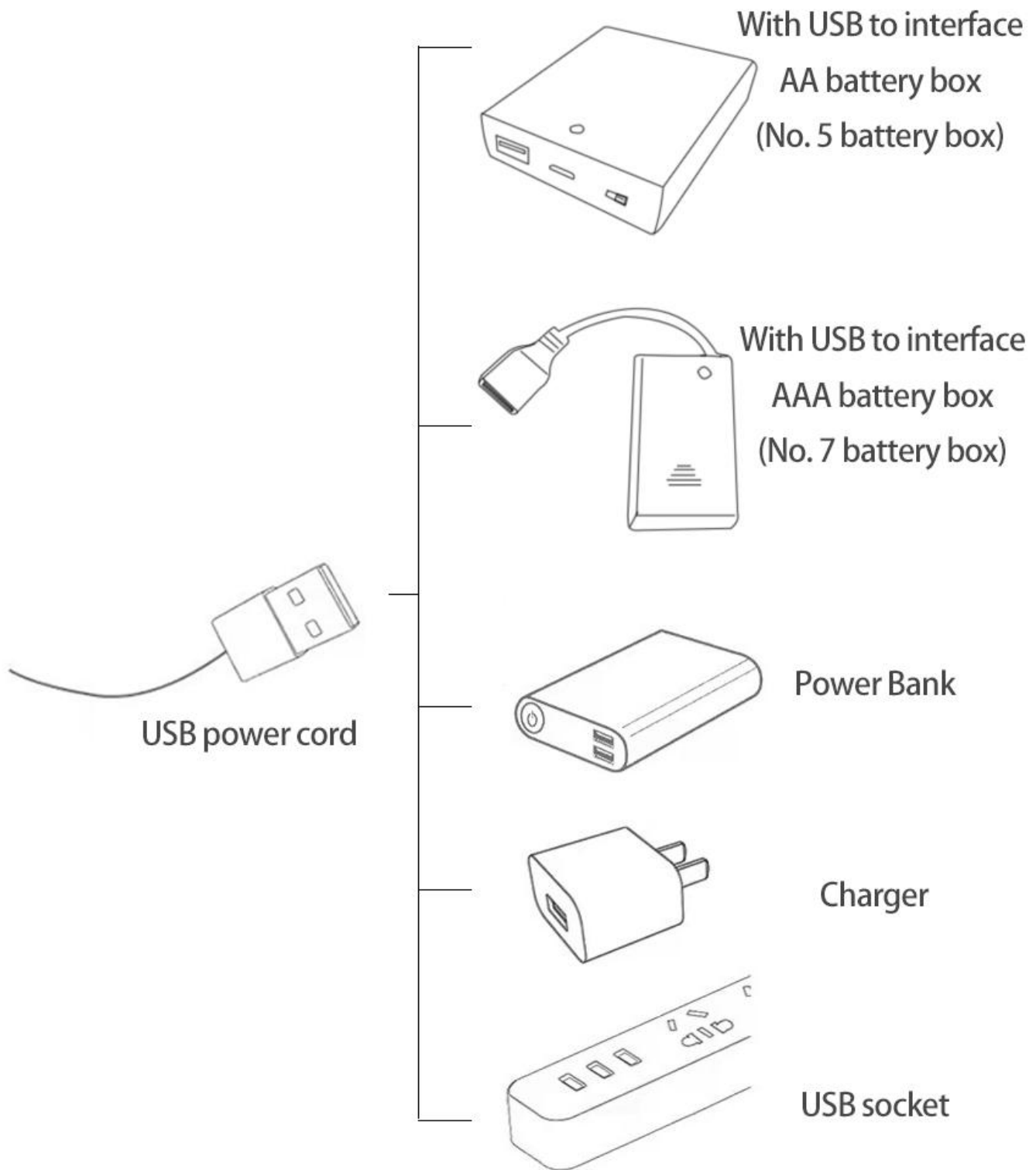

Tear off the seal of the expansion board.

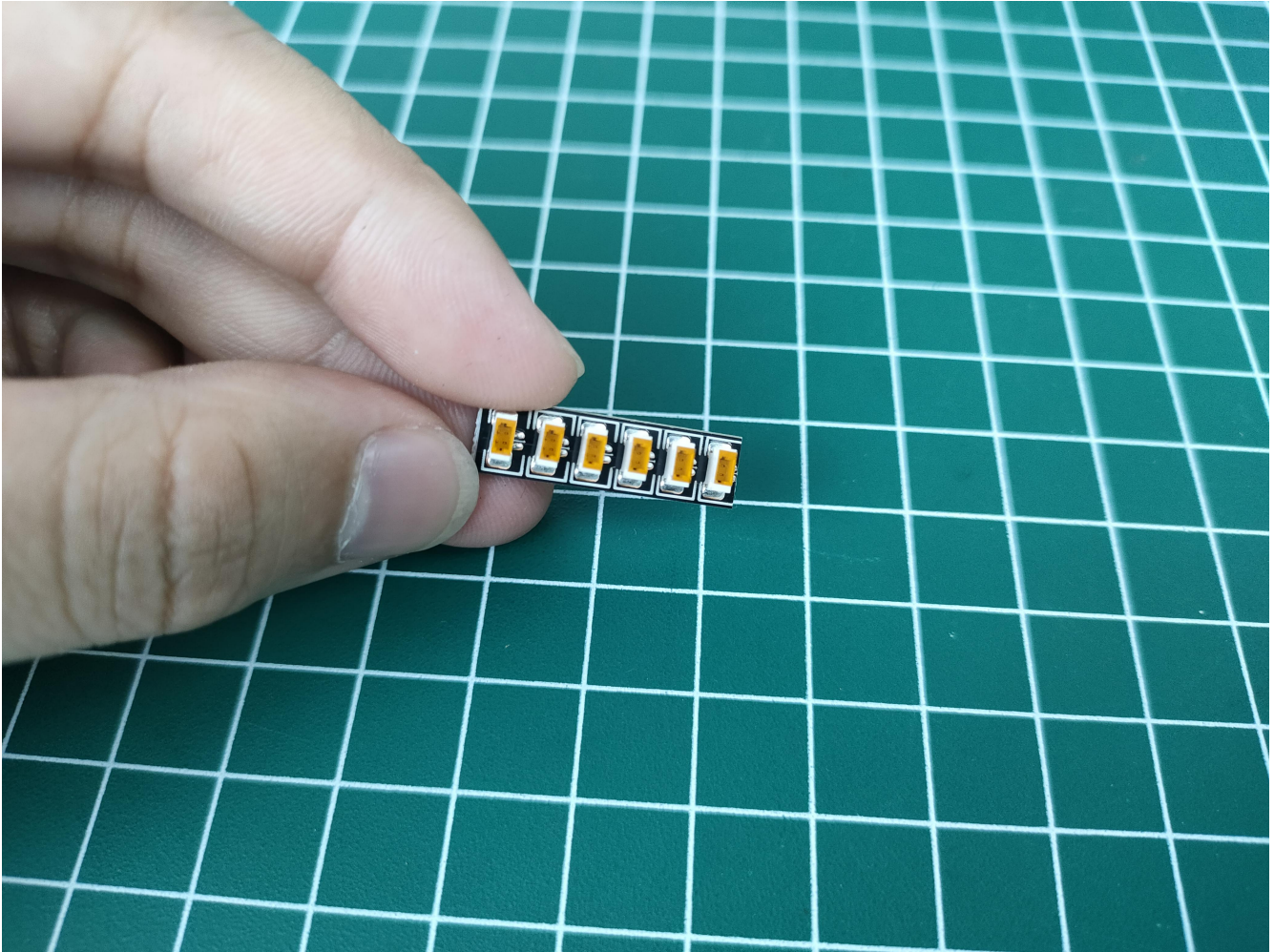

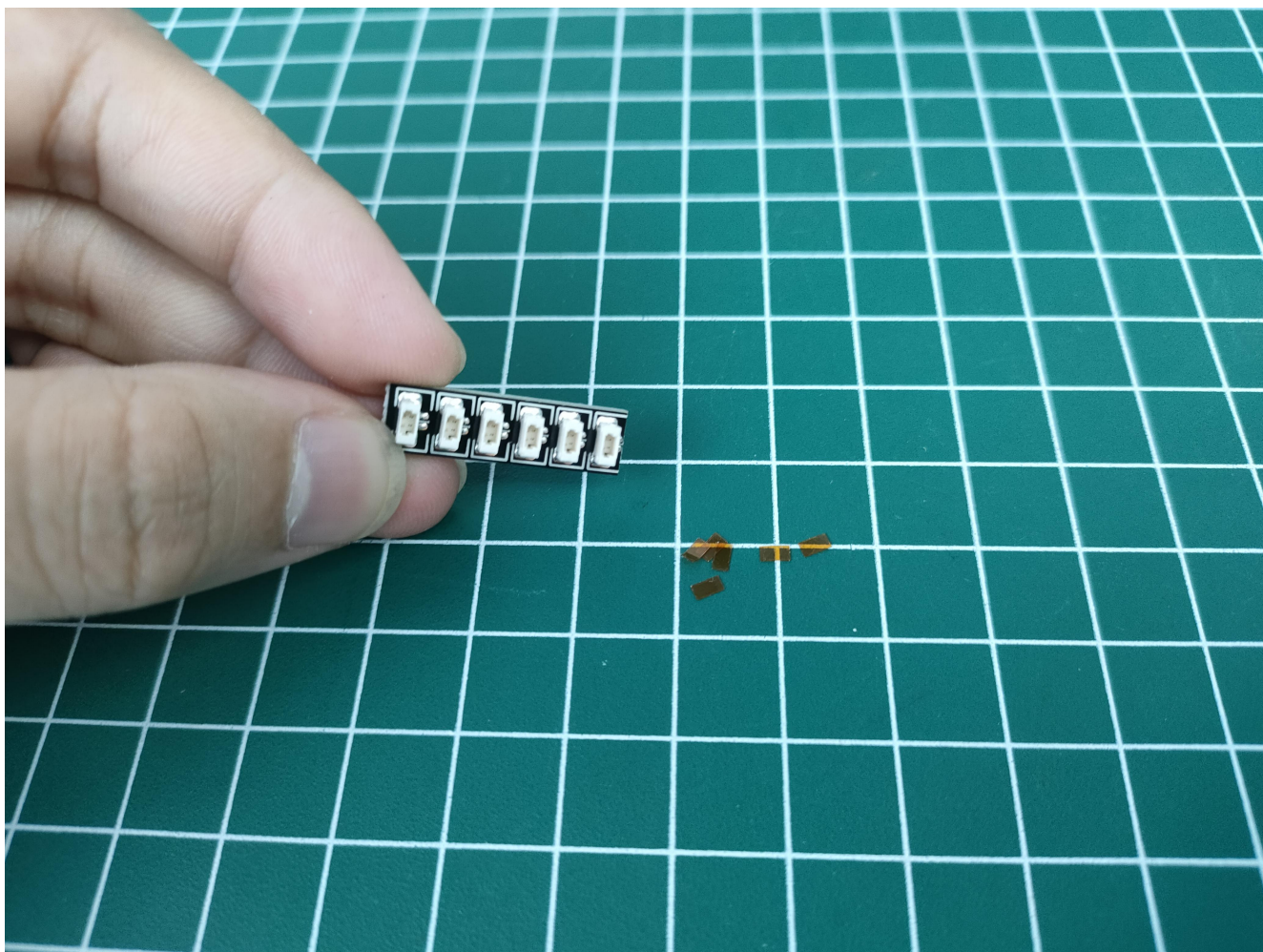

Please pay attention to the use of the interface. The interface is small. Please use it carefully: the = number of the 2P interface is aligned with the = number of the expansion board. The equal sign on the expansion board refers to the two solder joints on the outside, not the two inside the jack Metal pin.

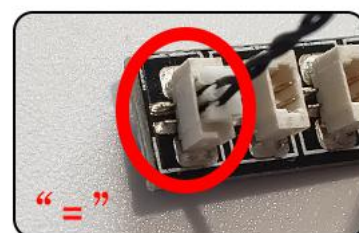
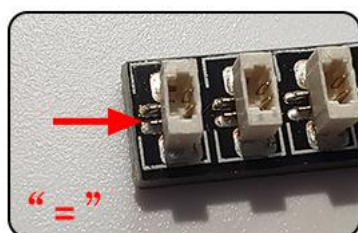
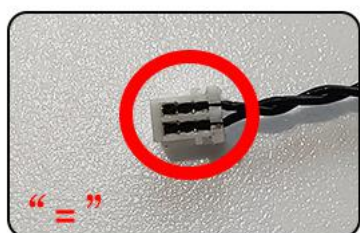

Connect the USB power cord to the expansion board.

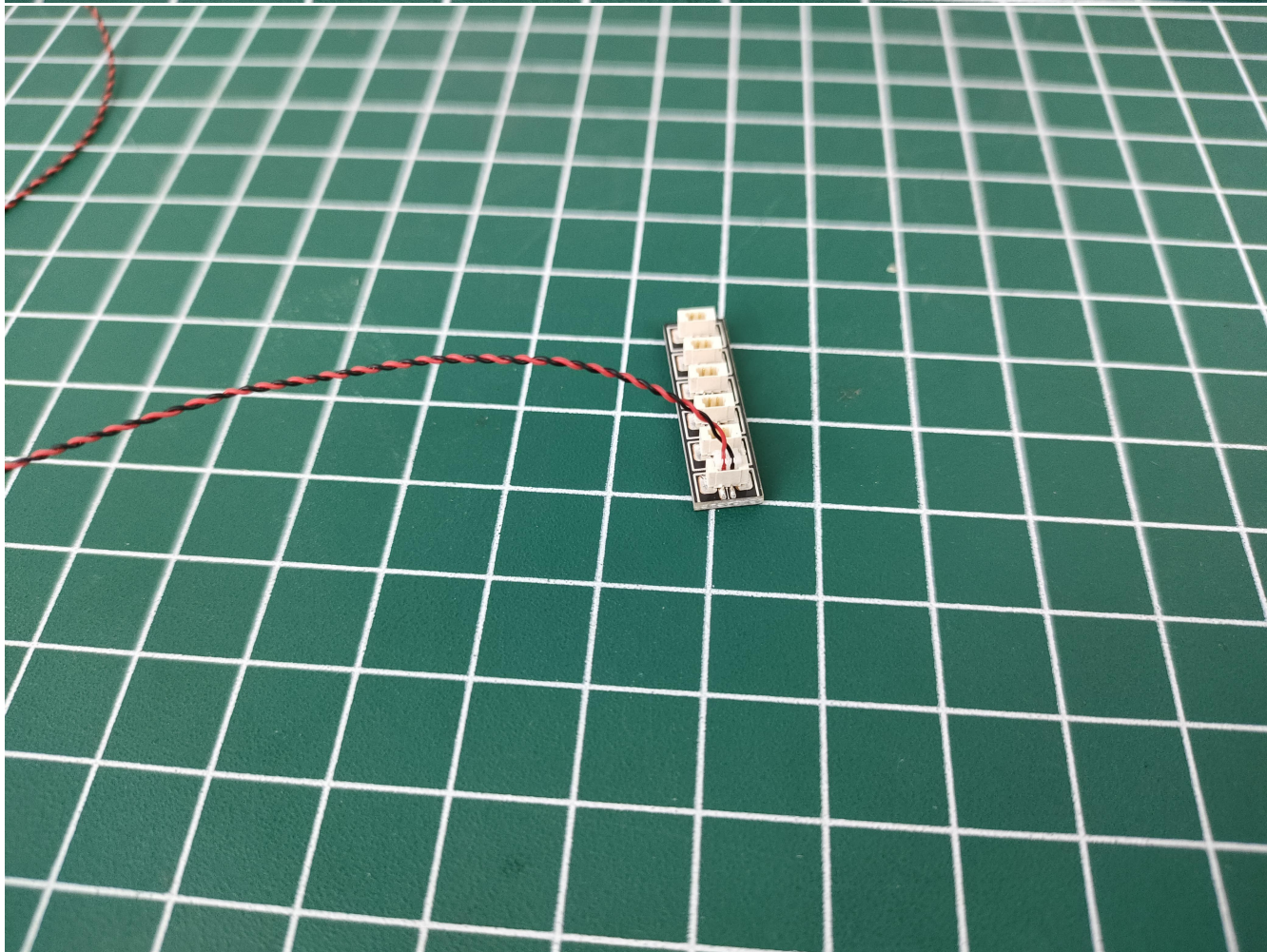
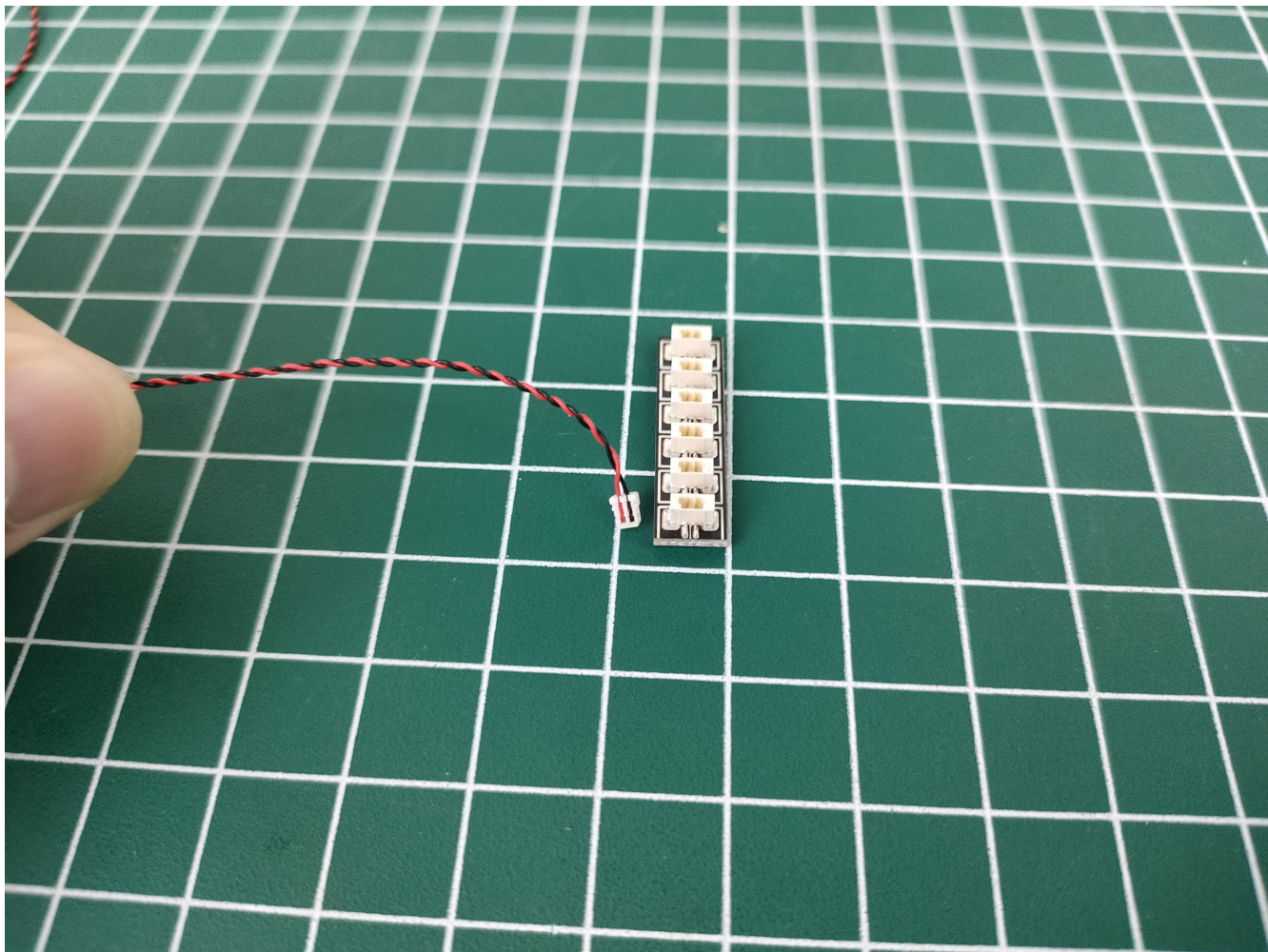

The other side of the USB power cord is connected to the mobile power supply (power supply is self-provided).





Take out the lighting from the No. 1 bag.



Connect them to the expansion board. Test whether the lighting is normal, if there is any abnormality, please contact us in time.

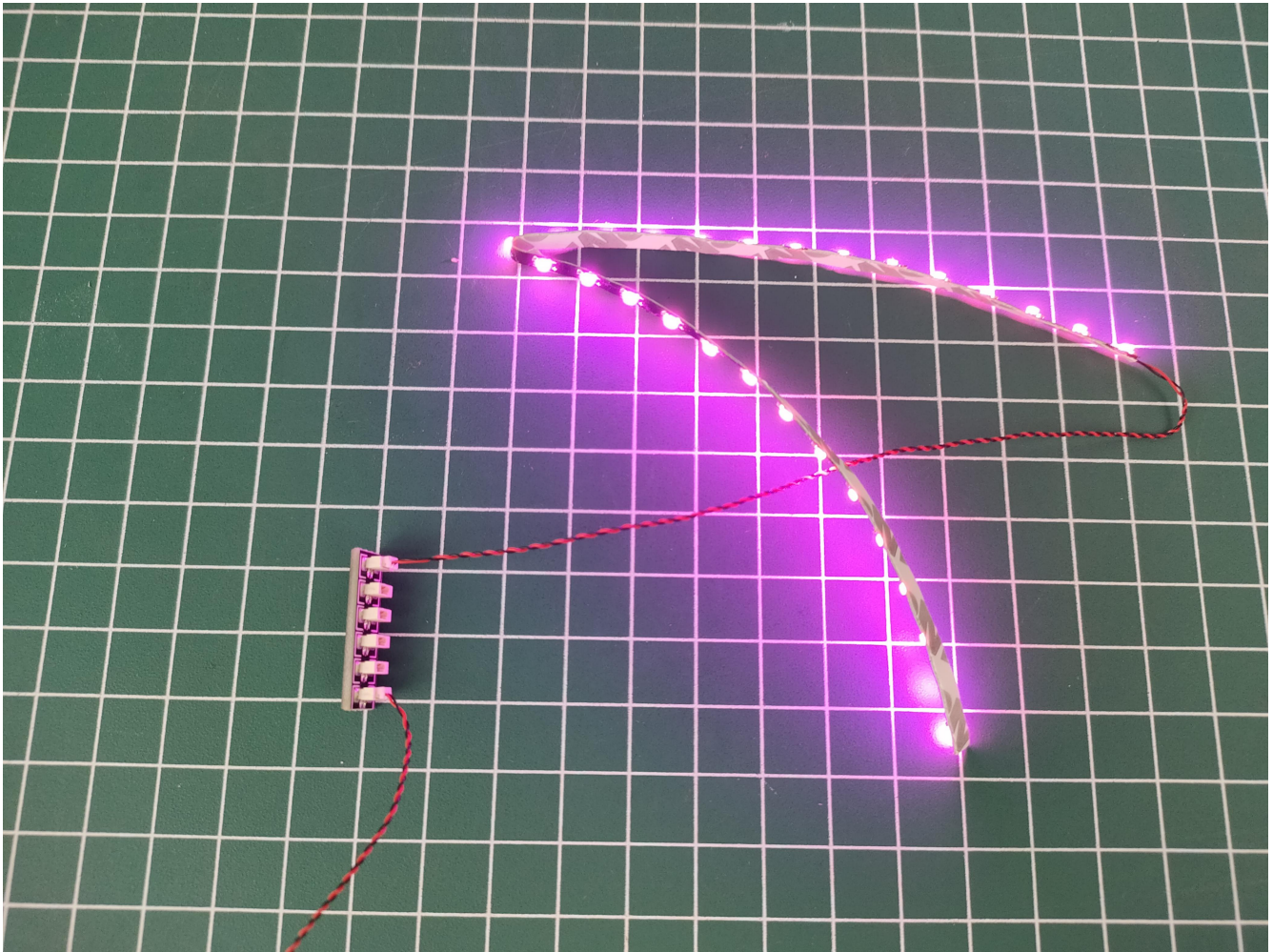

After the test is normal, remove the lighting from the expansion board and temporarily put it back in the original bag. In order to avoid the lighting failure after installation, please test it in the same way before installation.

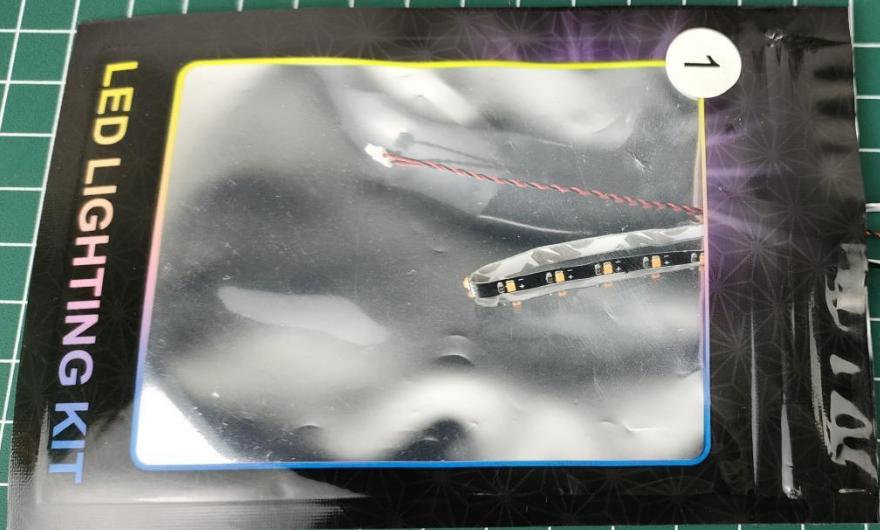
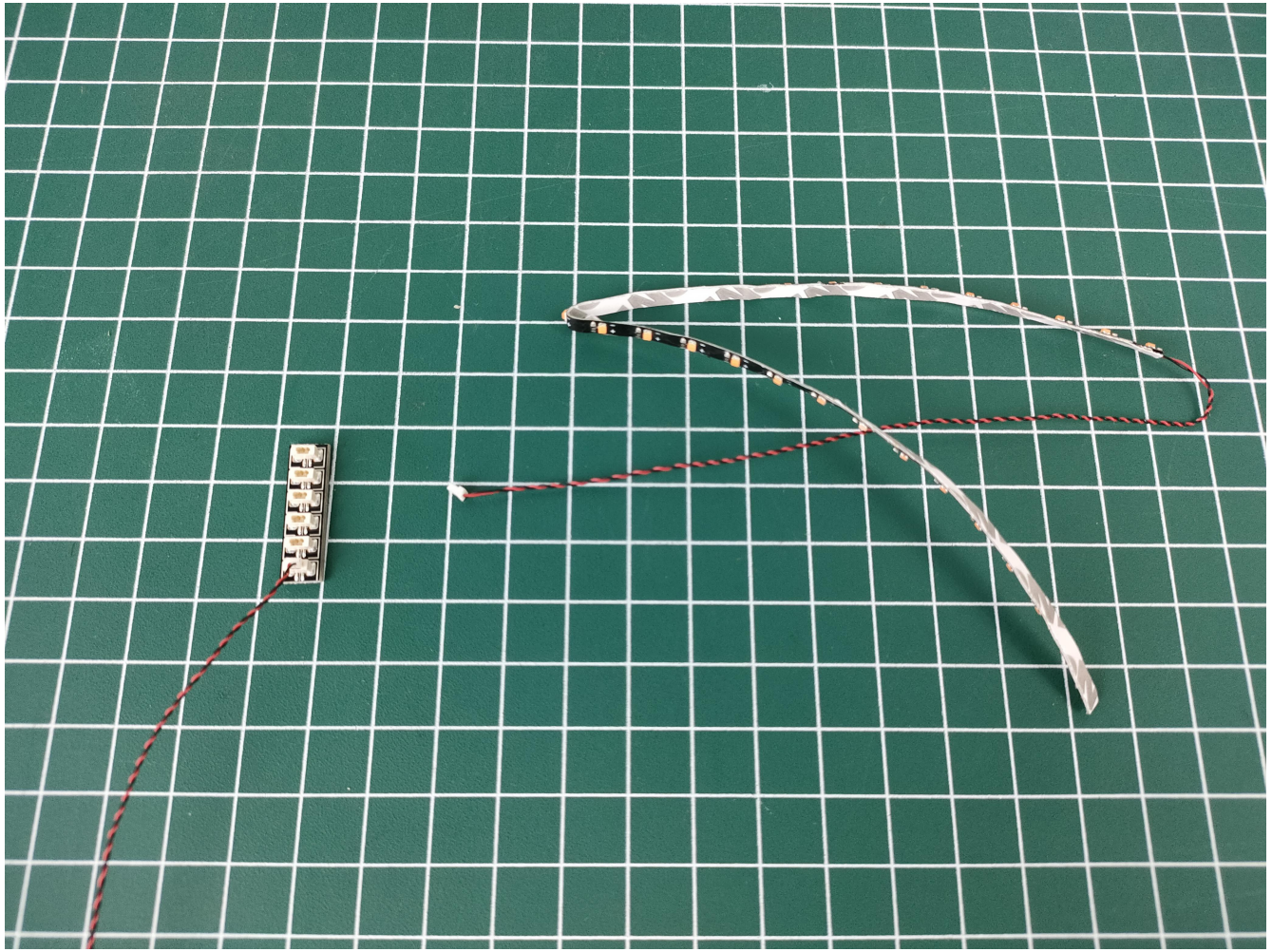

Note:

Please be careful when installing. The lamp wire is relatively slender and cannot be pressed on the raised position of the building block. It should pass along the gap, otherwise the lamp wire will be pinched.

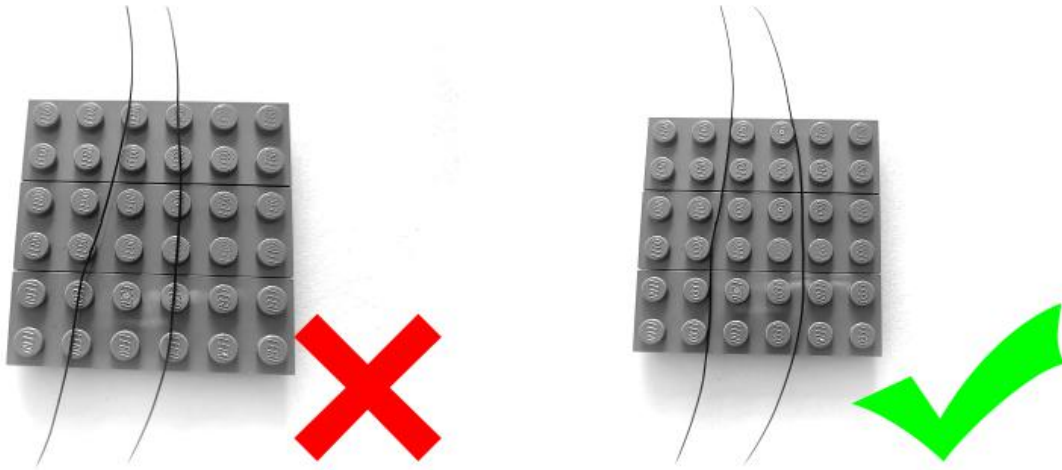

start installation:











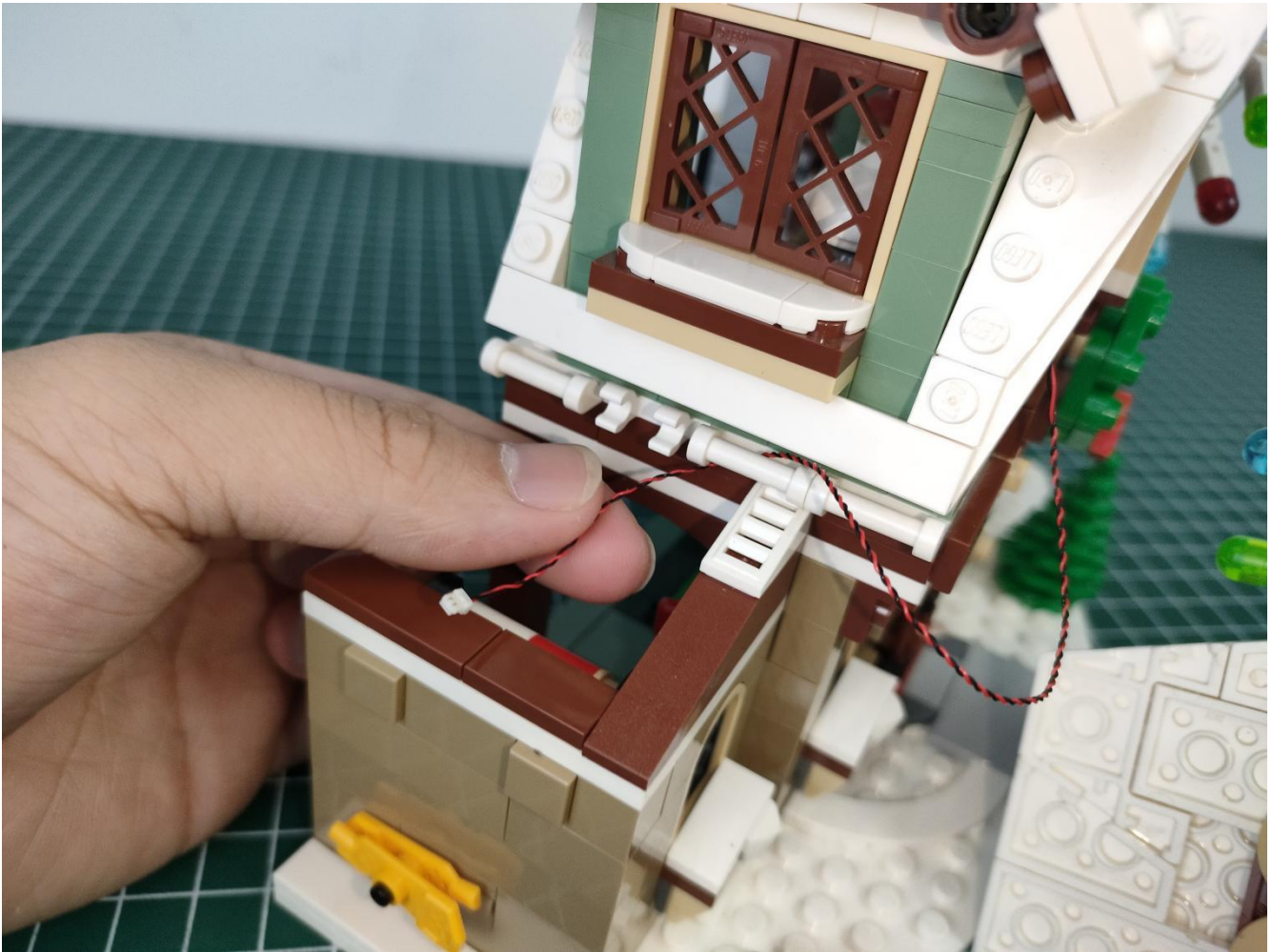



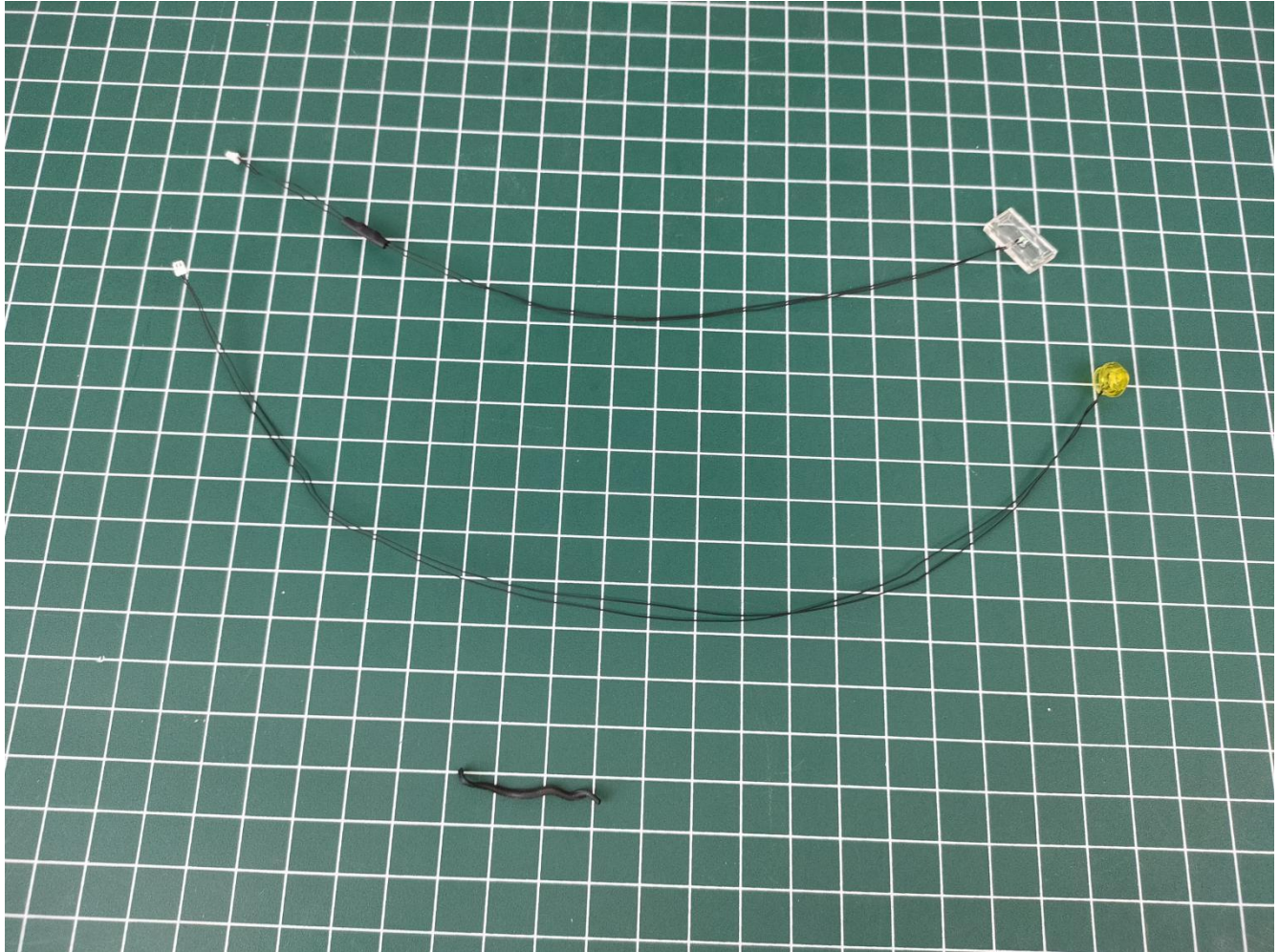

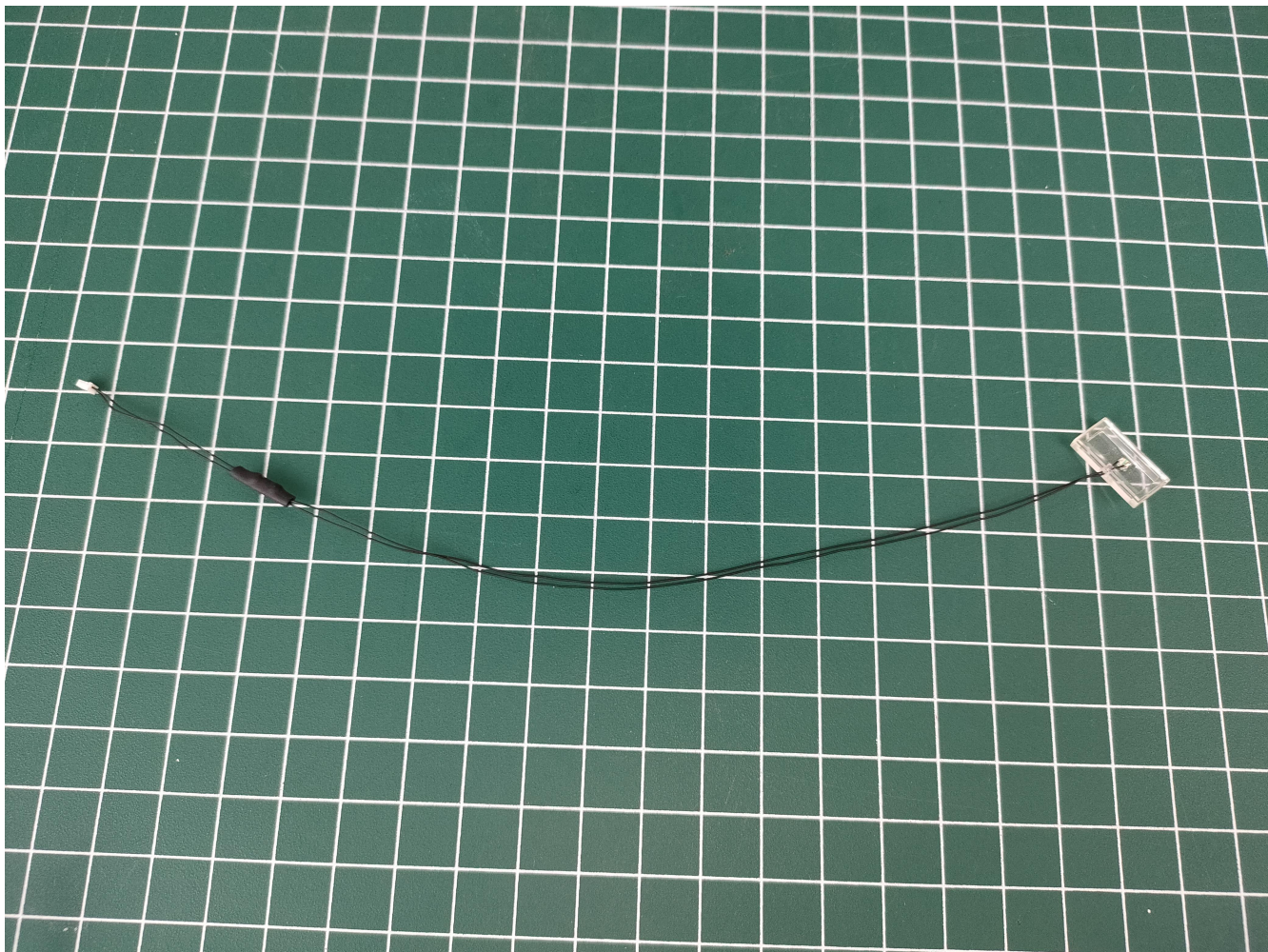

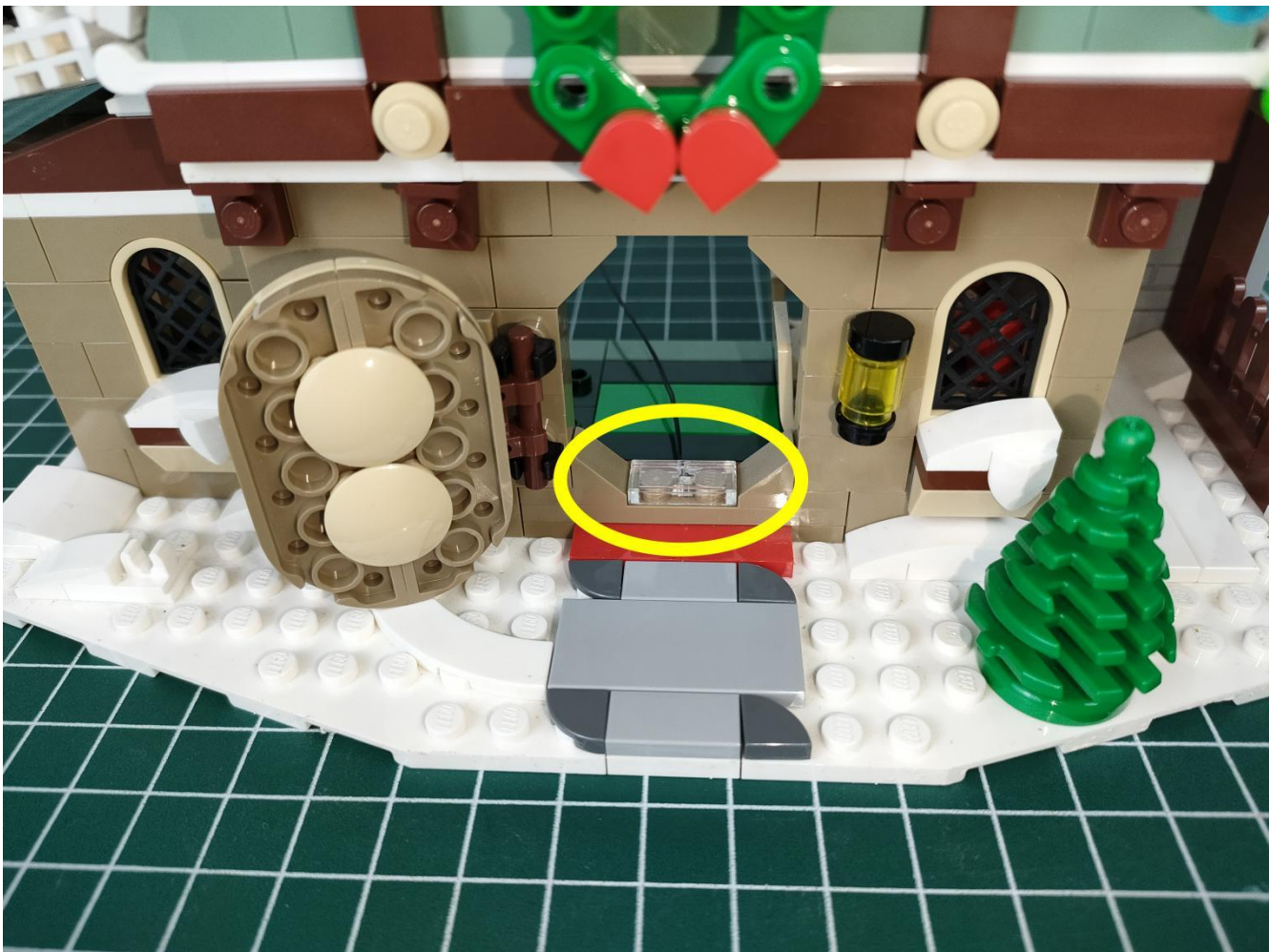



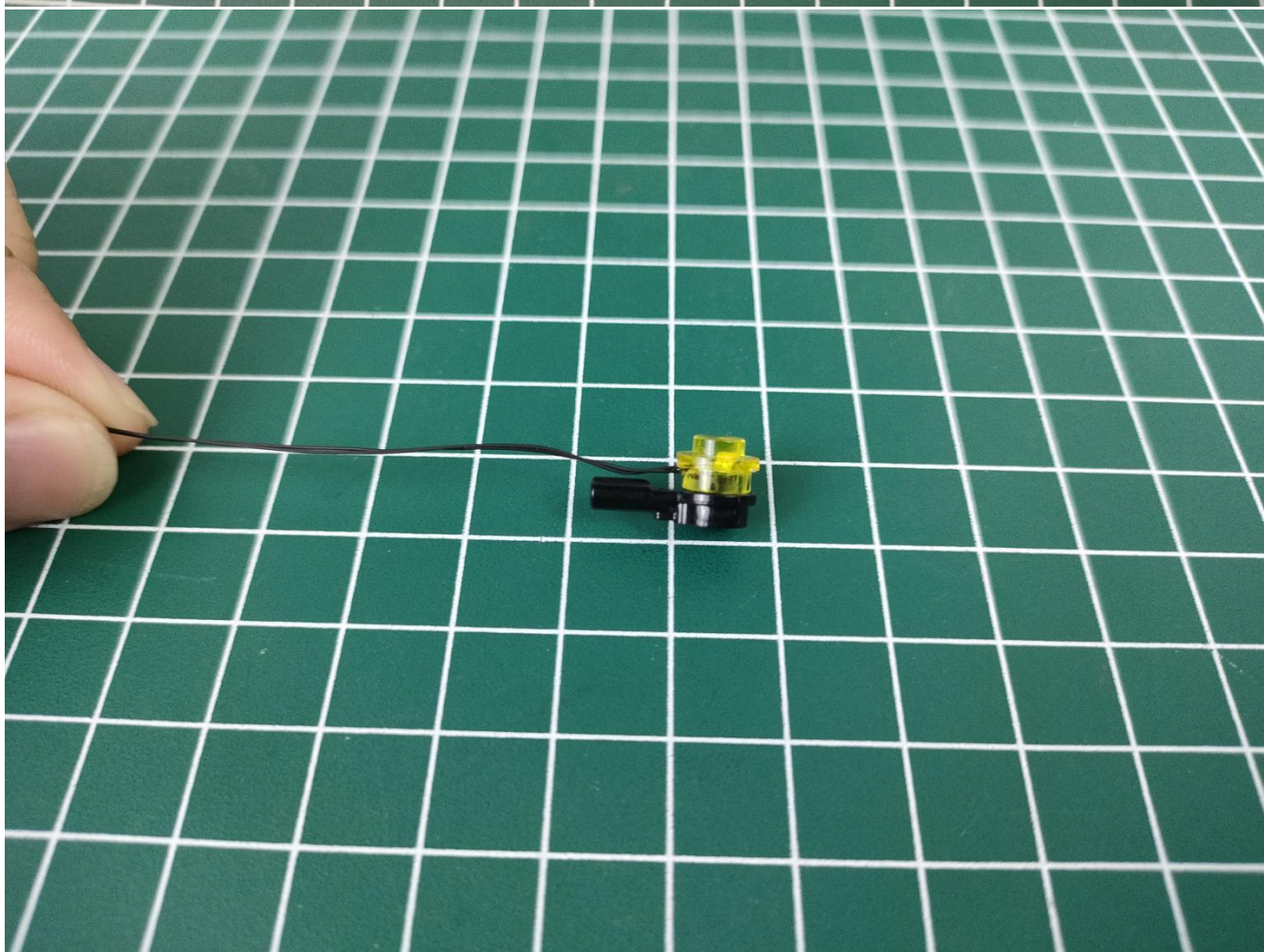
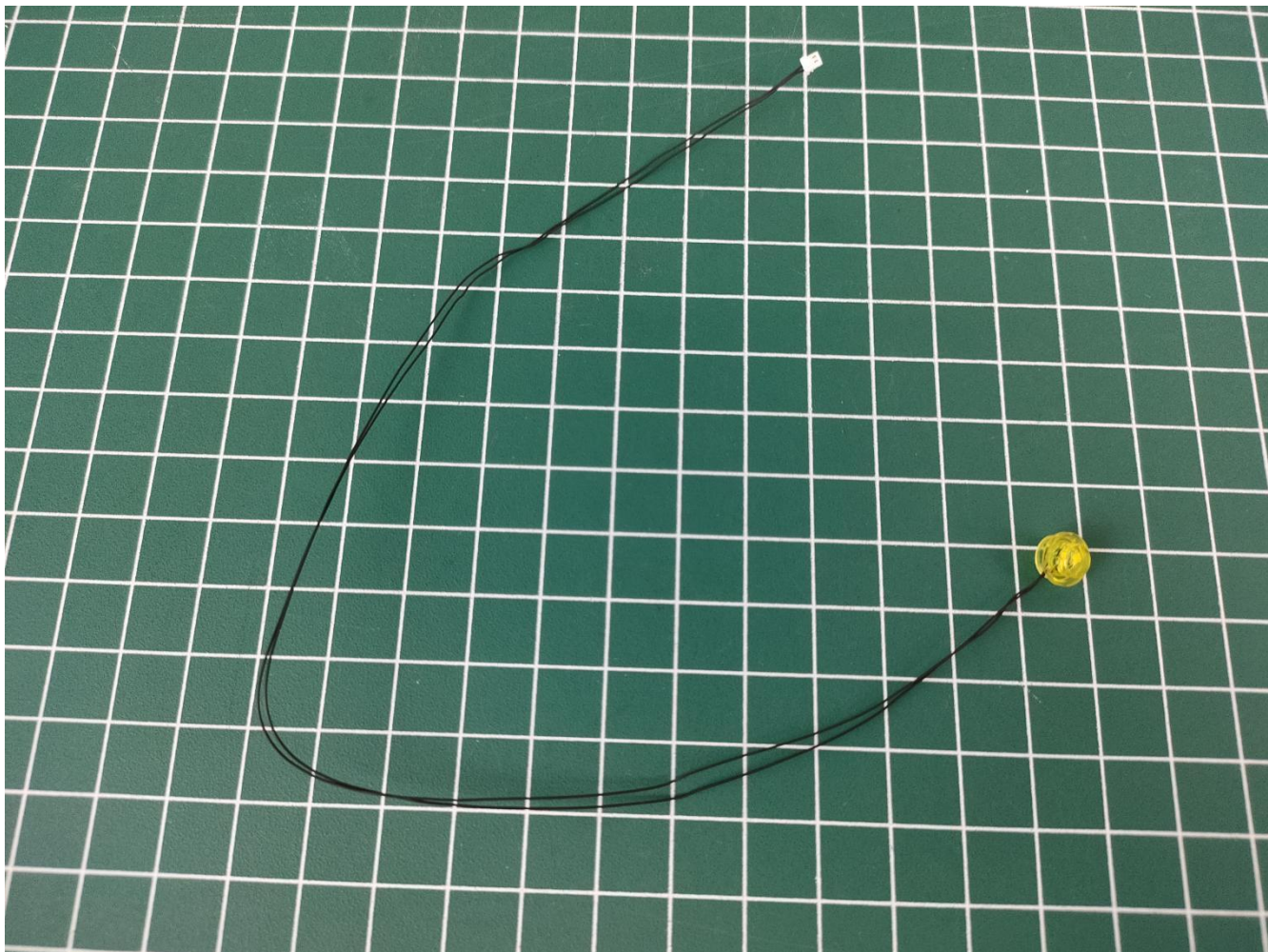

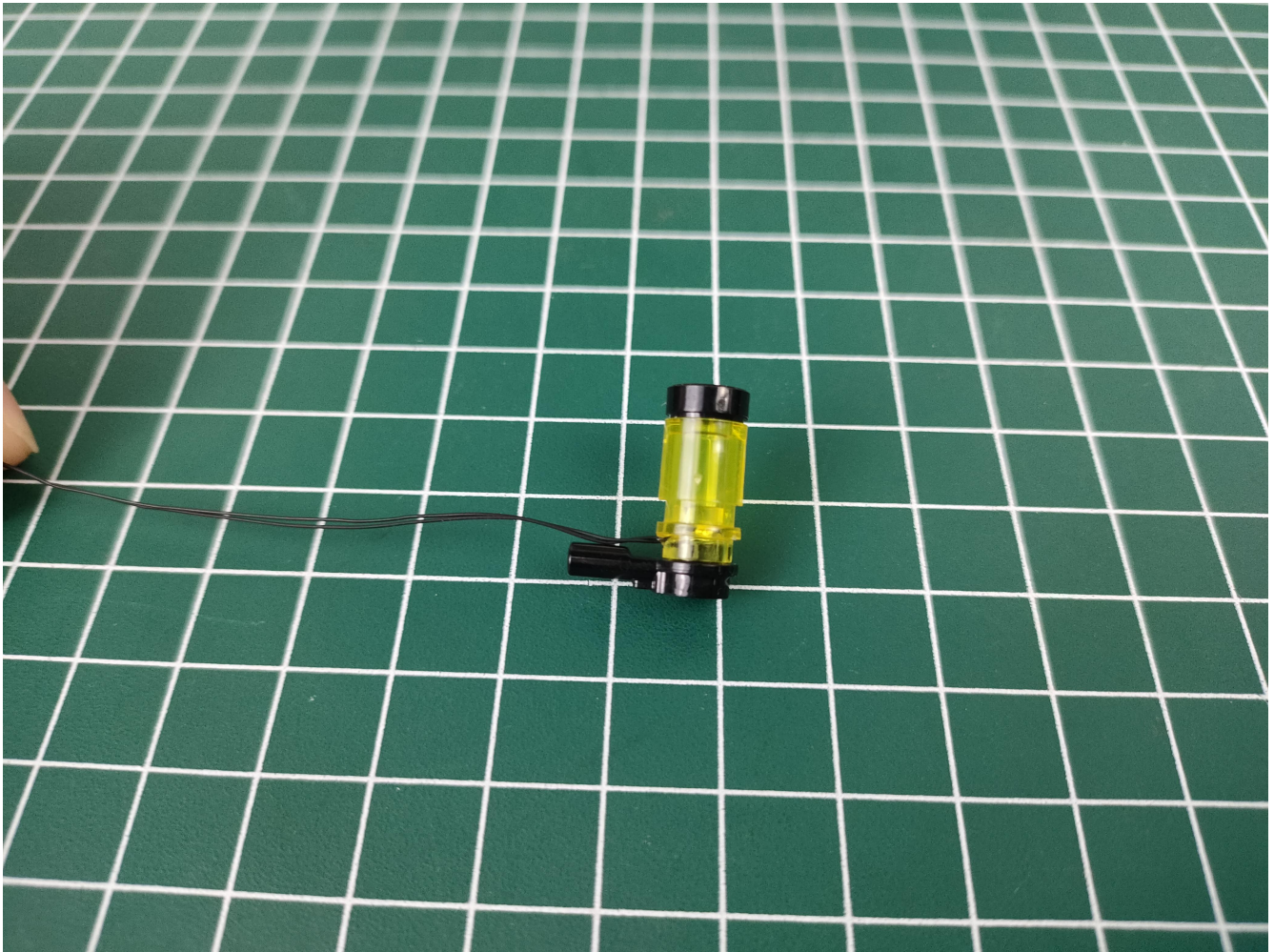



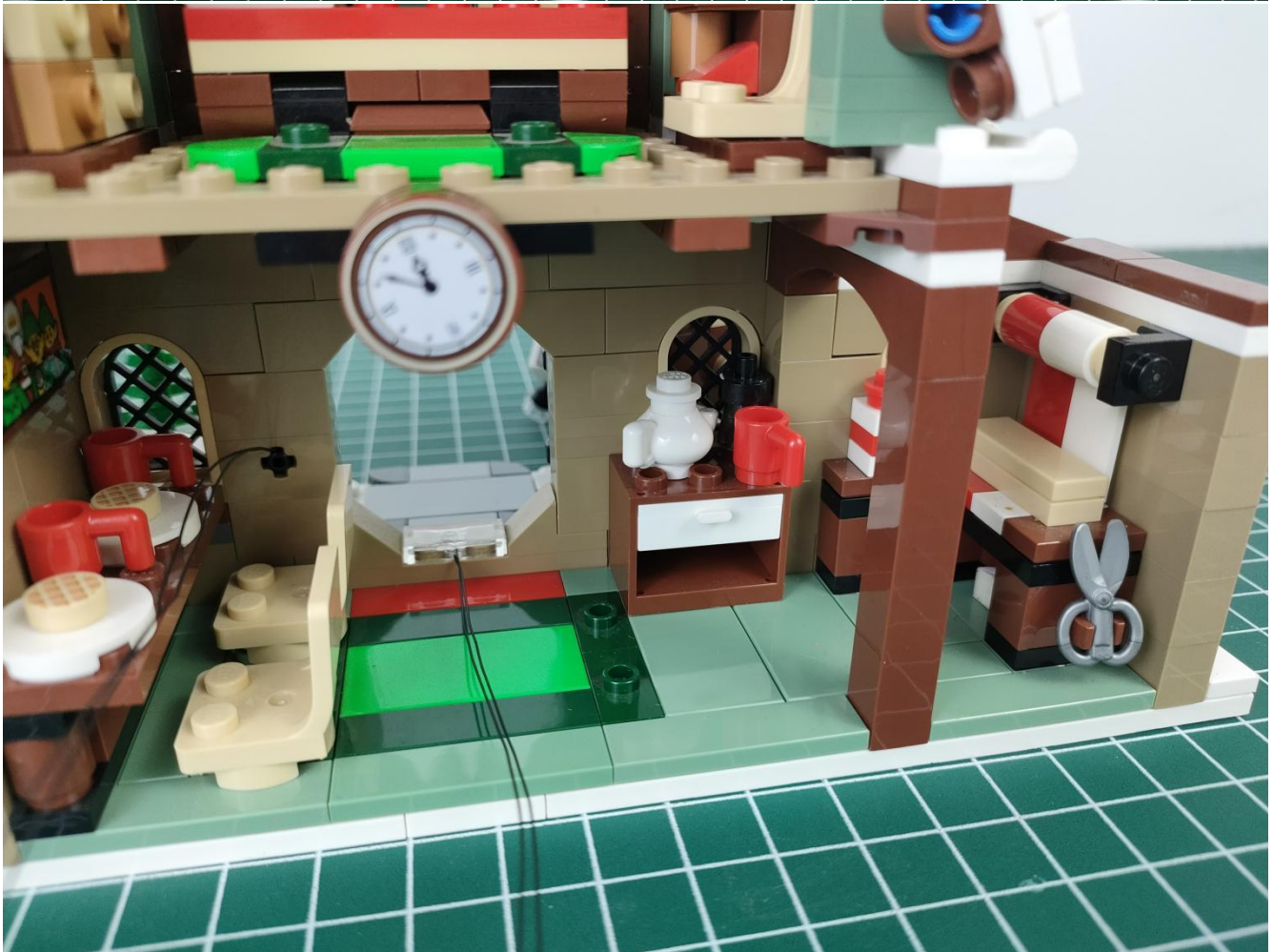

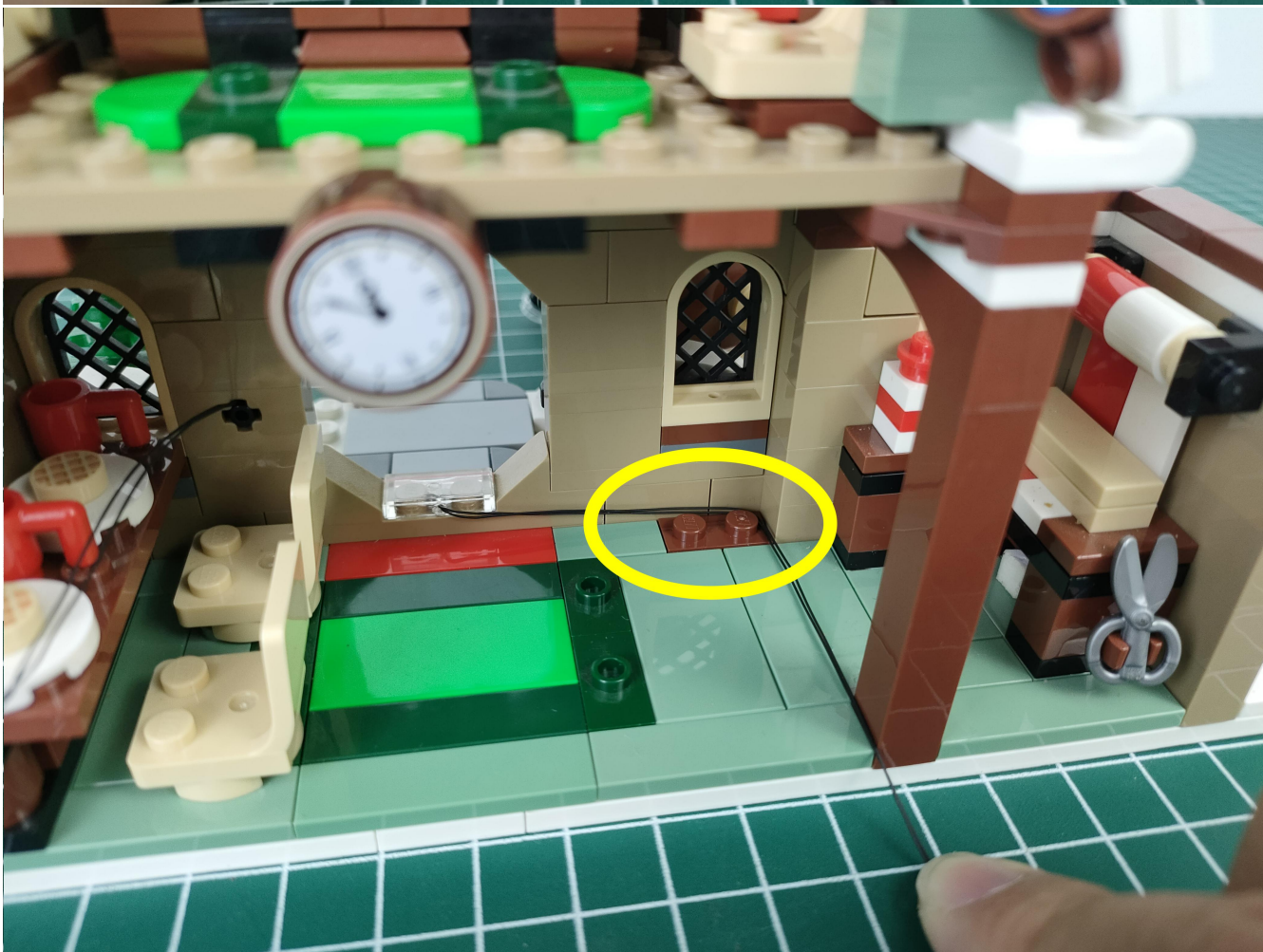



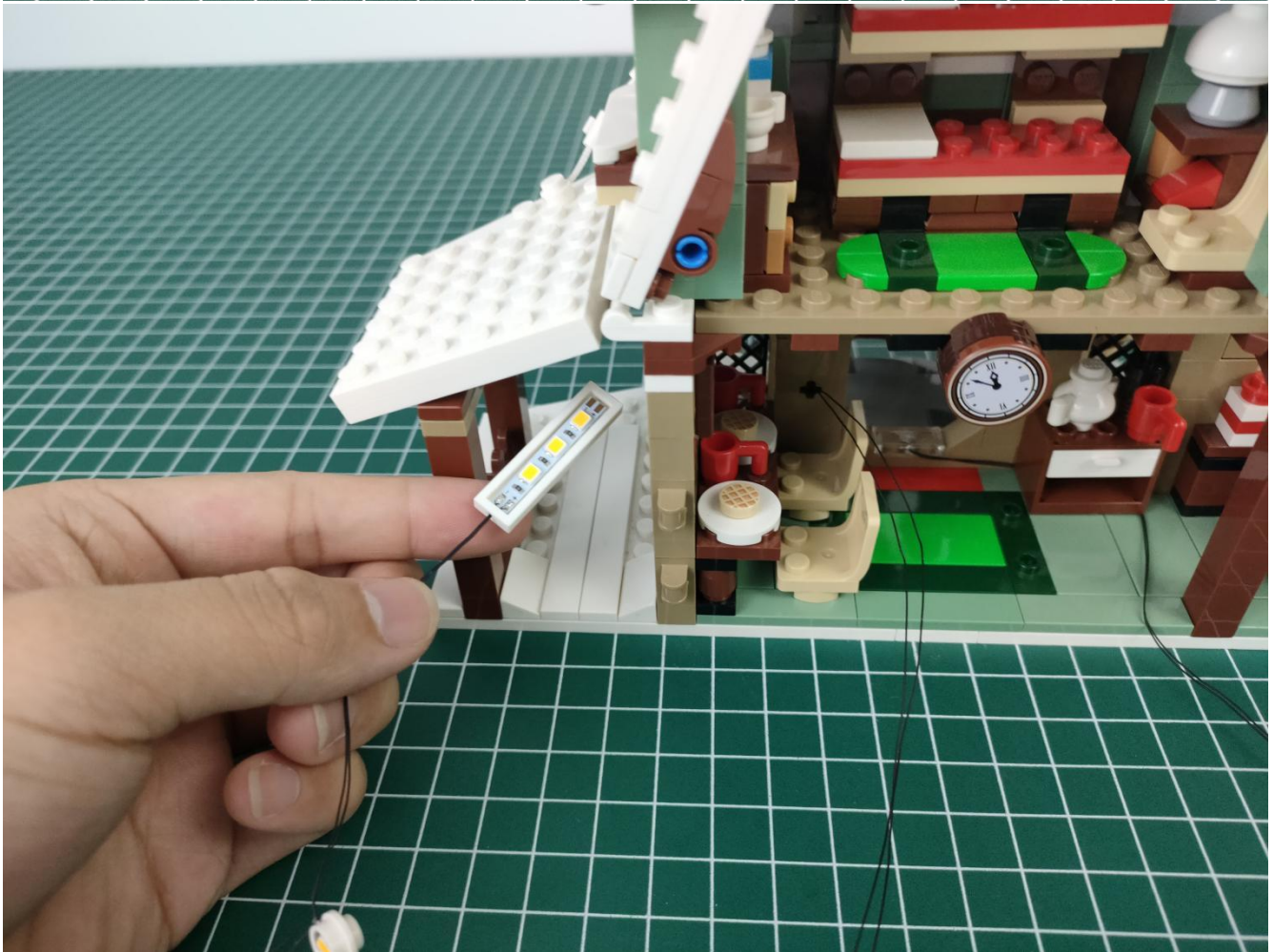
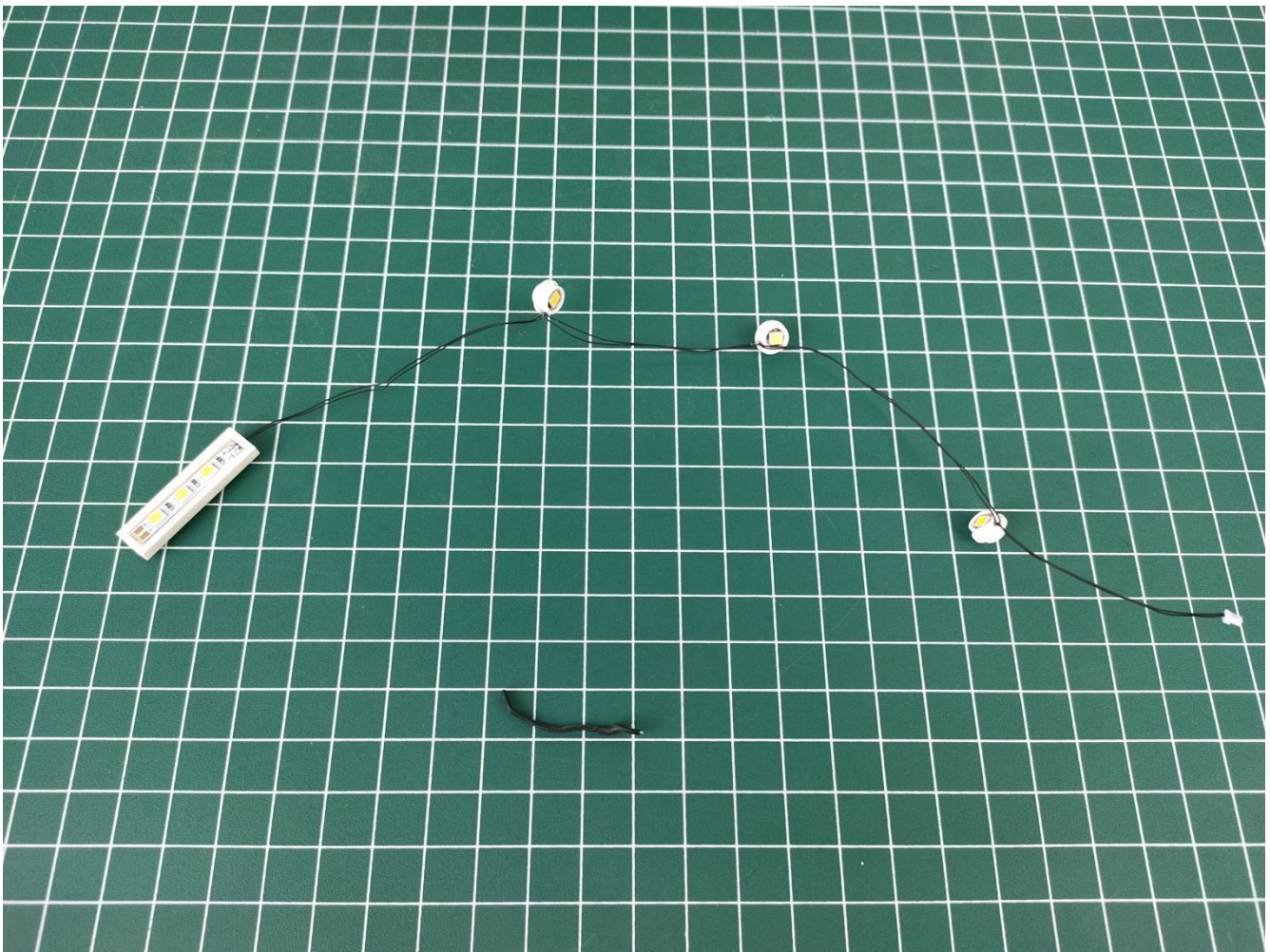

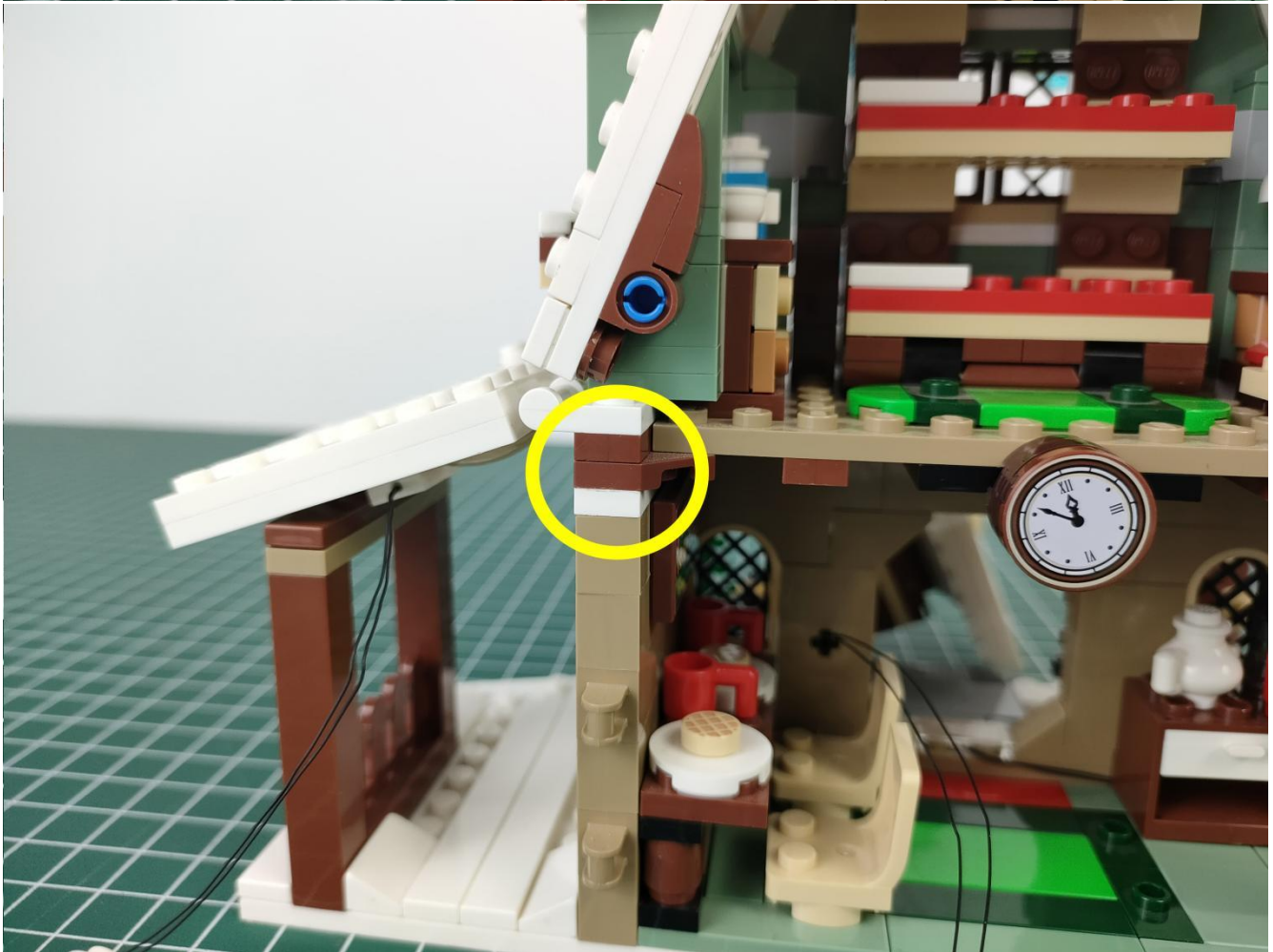

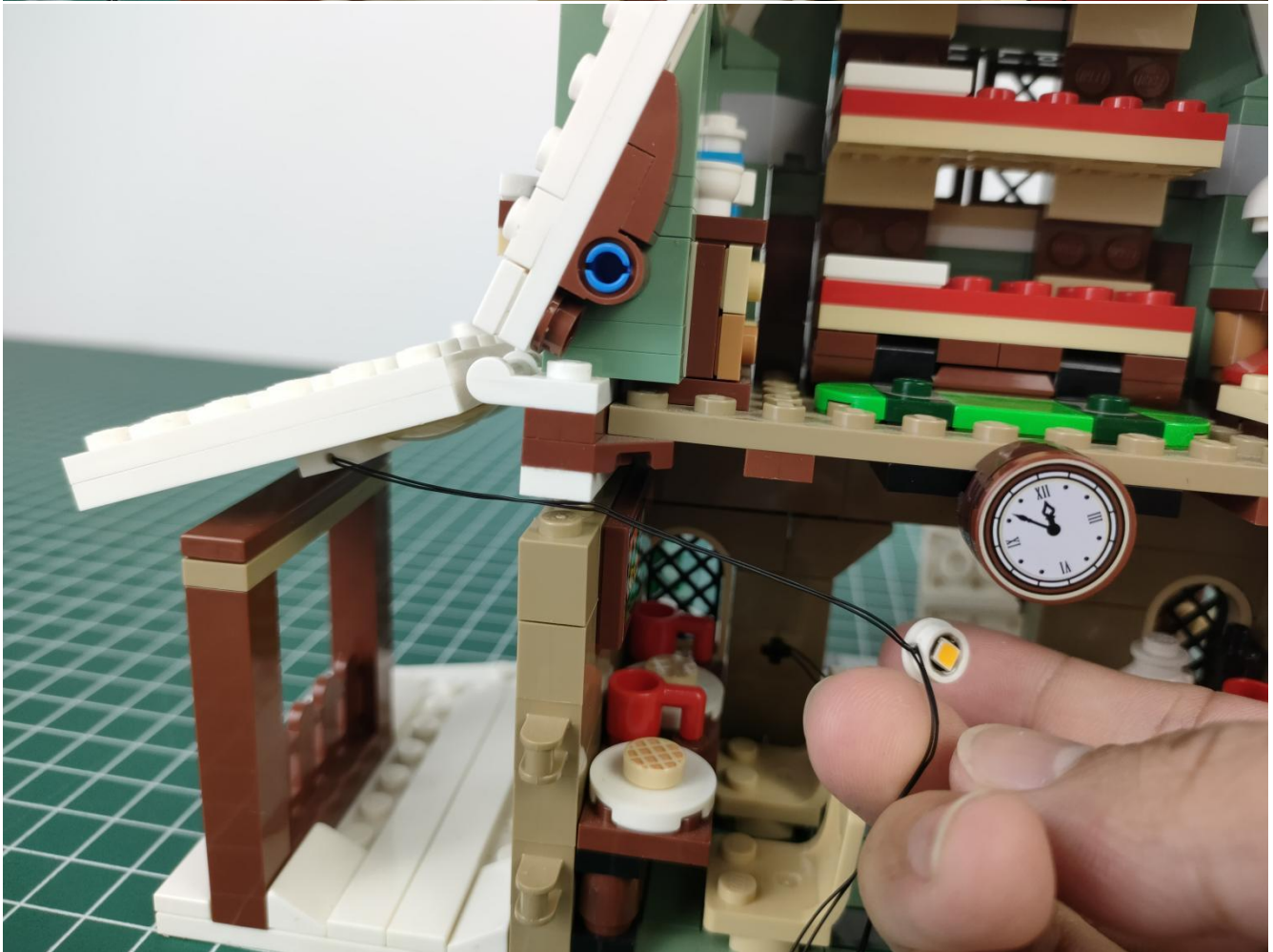
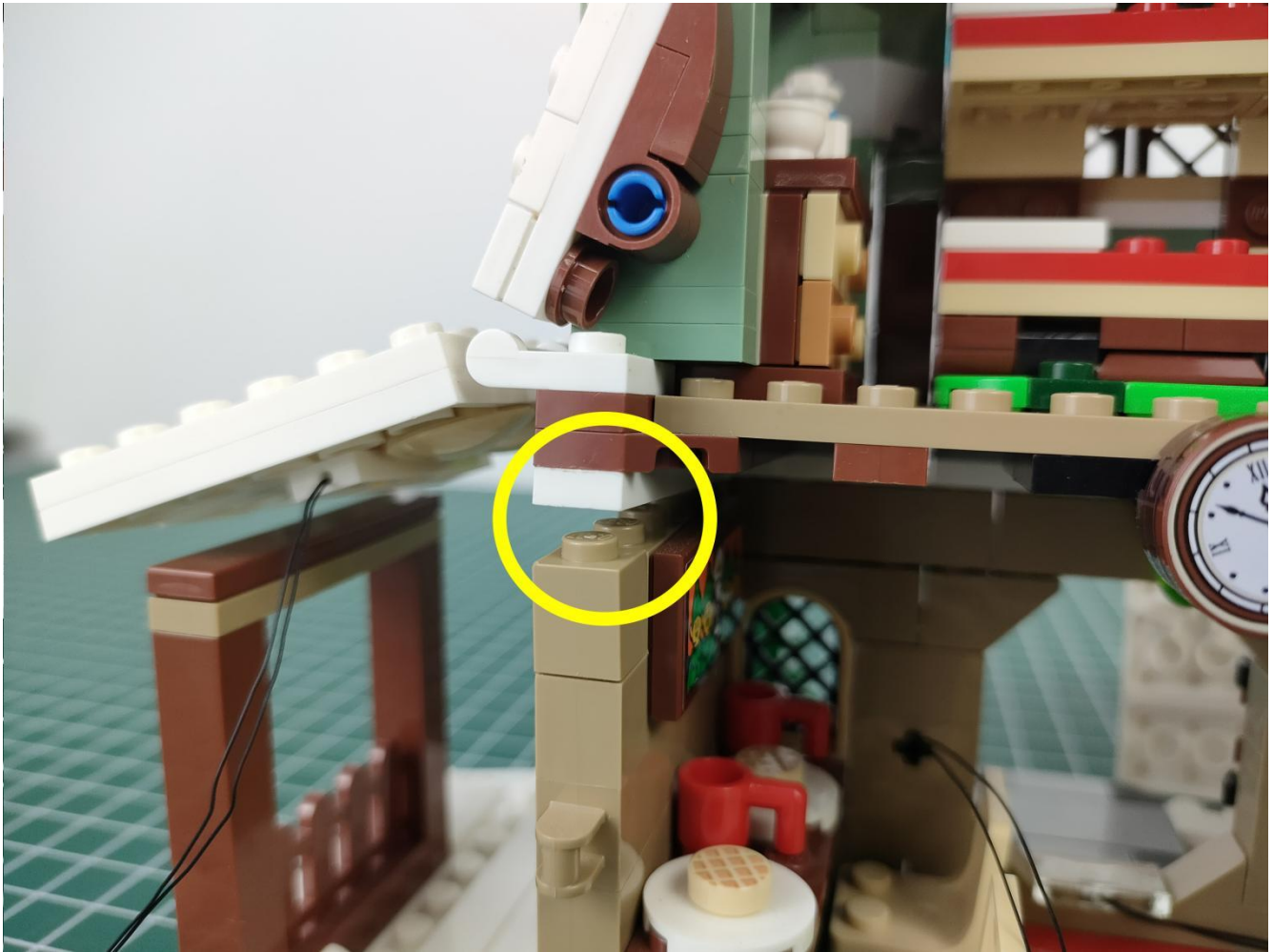

Note:

Please be careful when installing. The lamp wire is relatively slender and cannot be pressed on the raised position of the building block. It should pass along the gap, otherwise the lamp wire will be pinched.

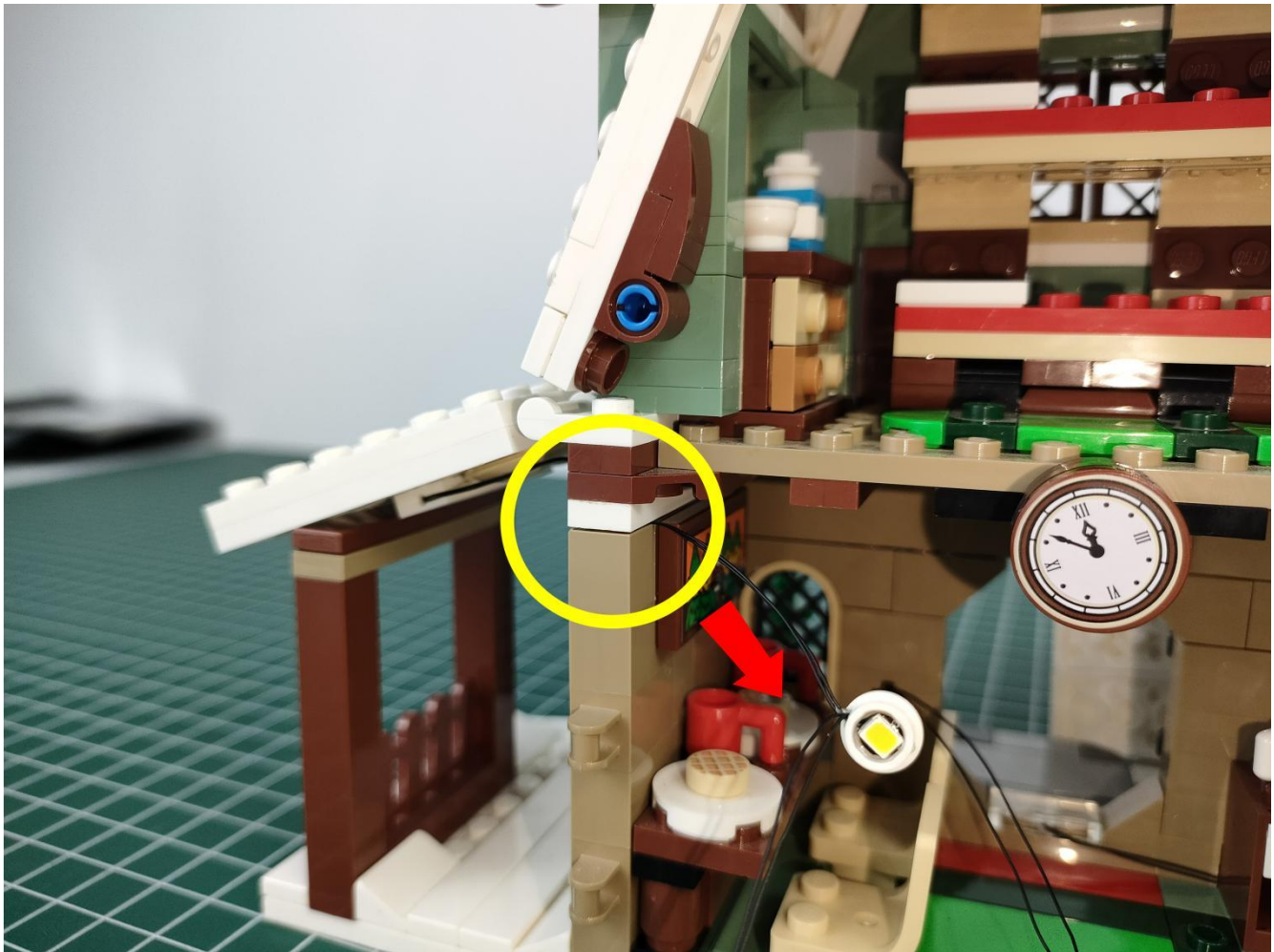
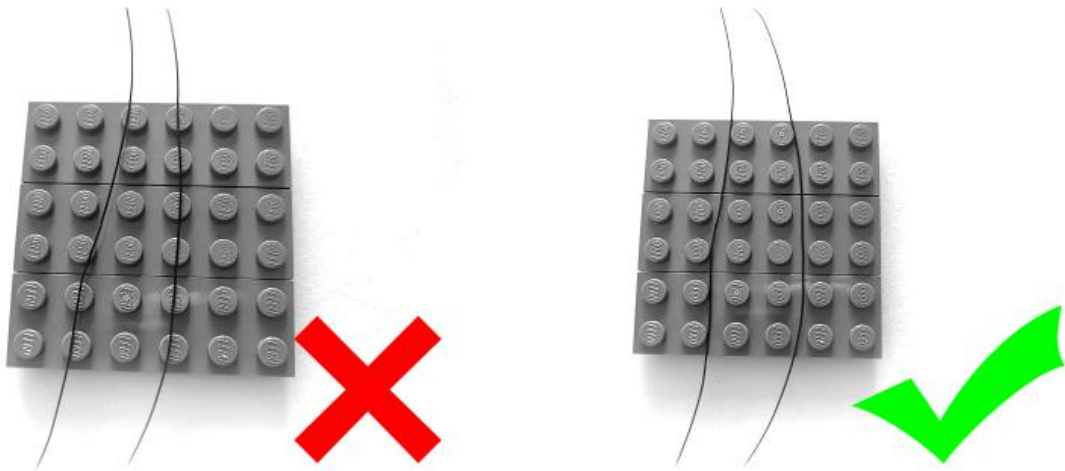

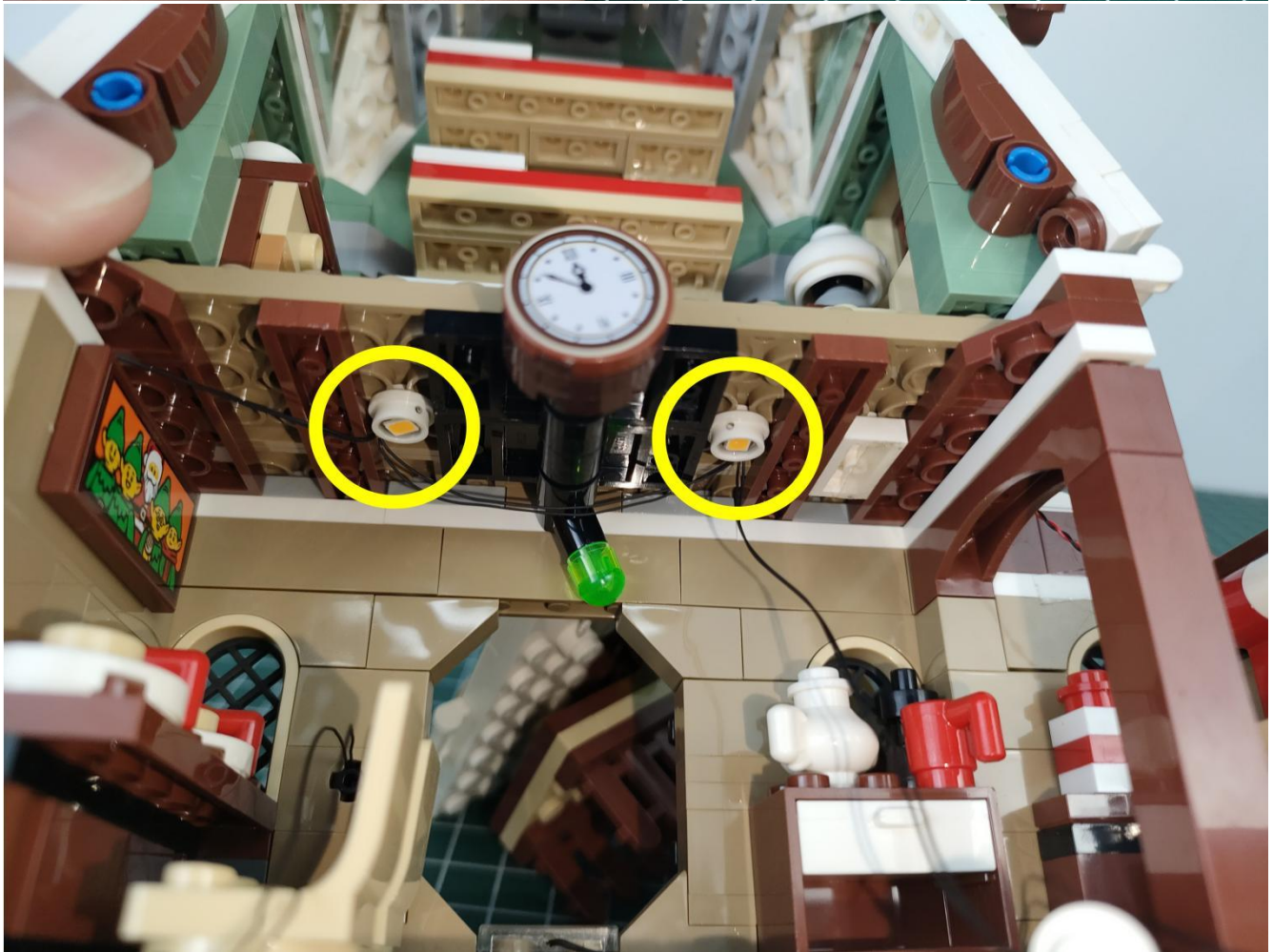

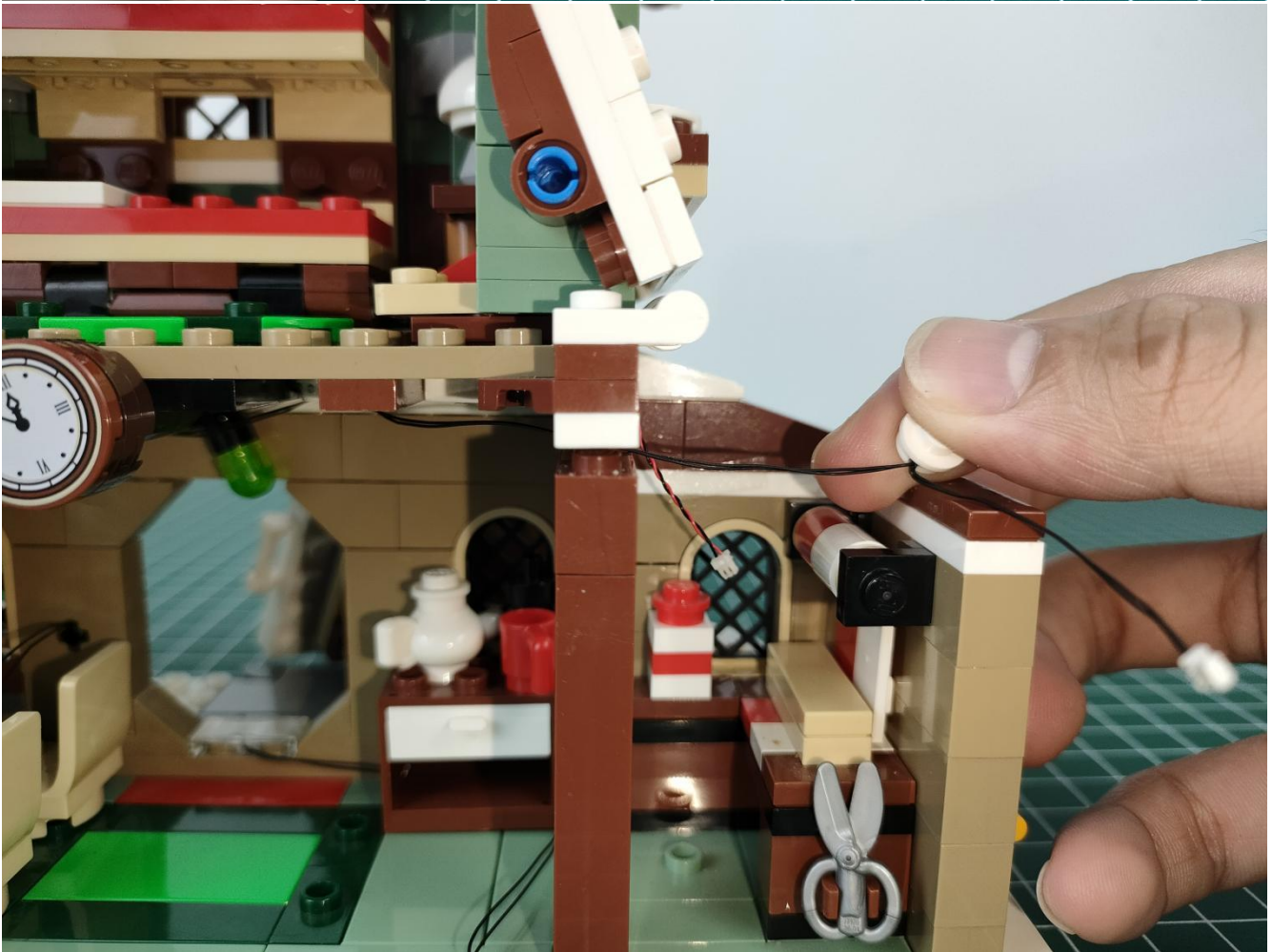

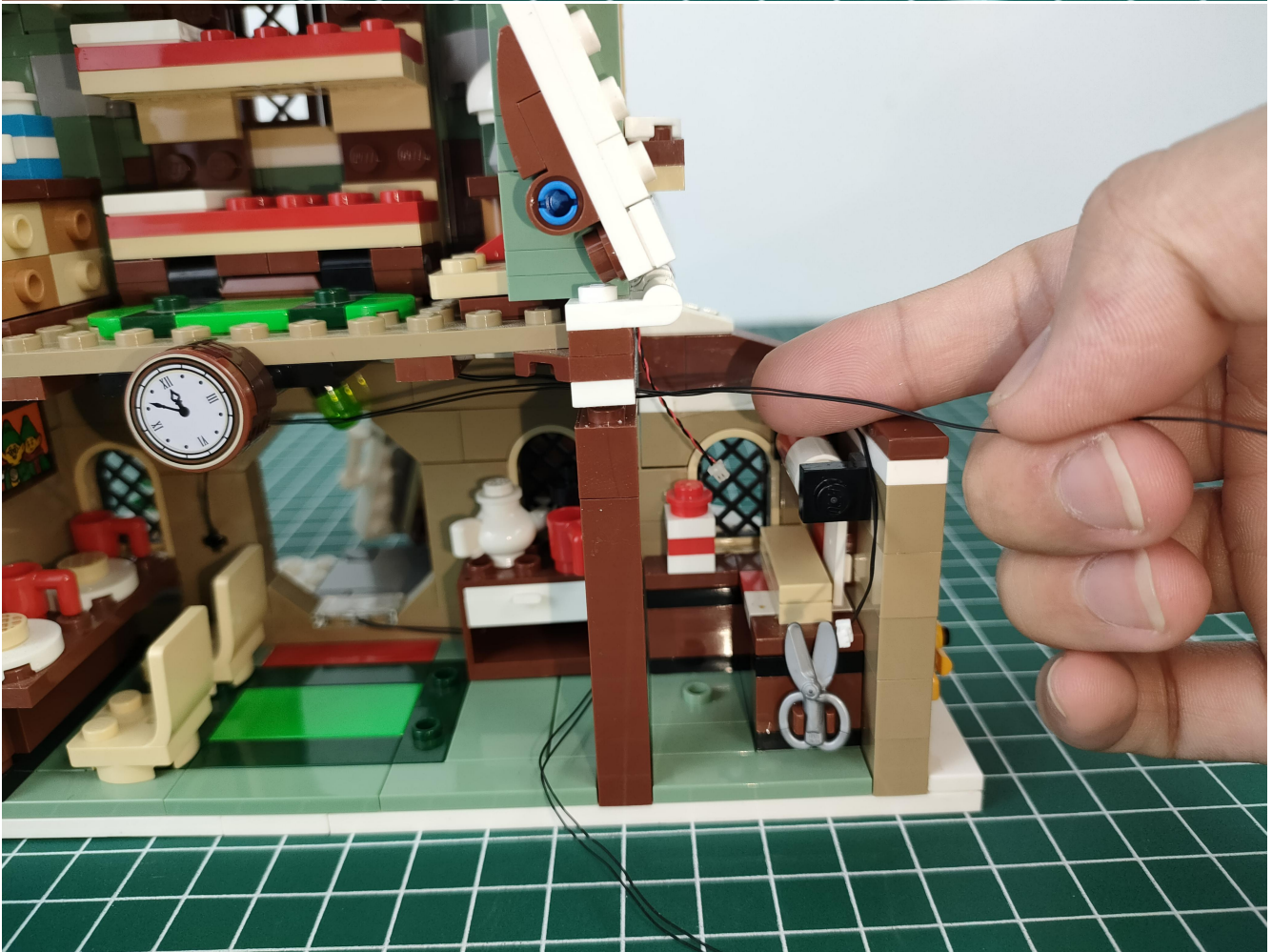

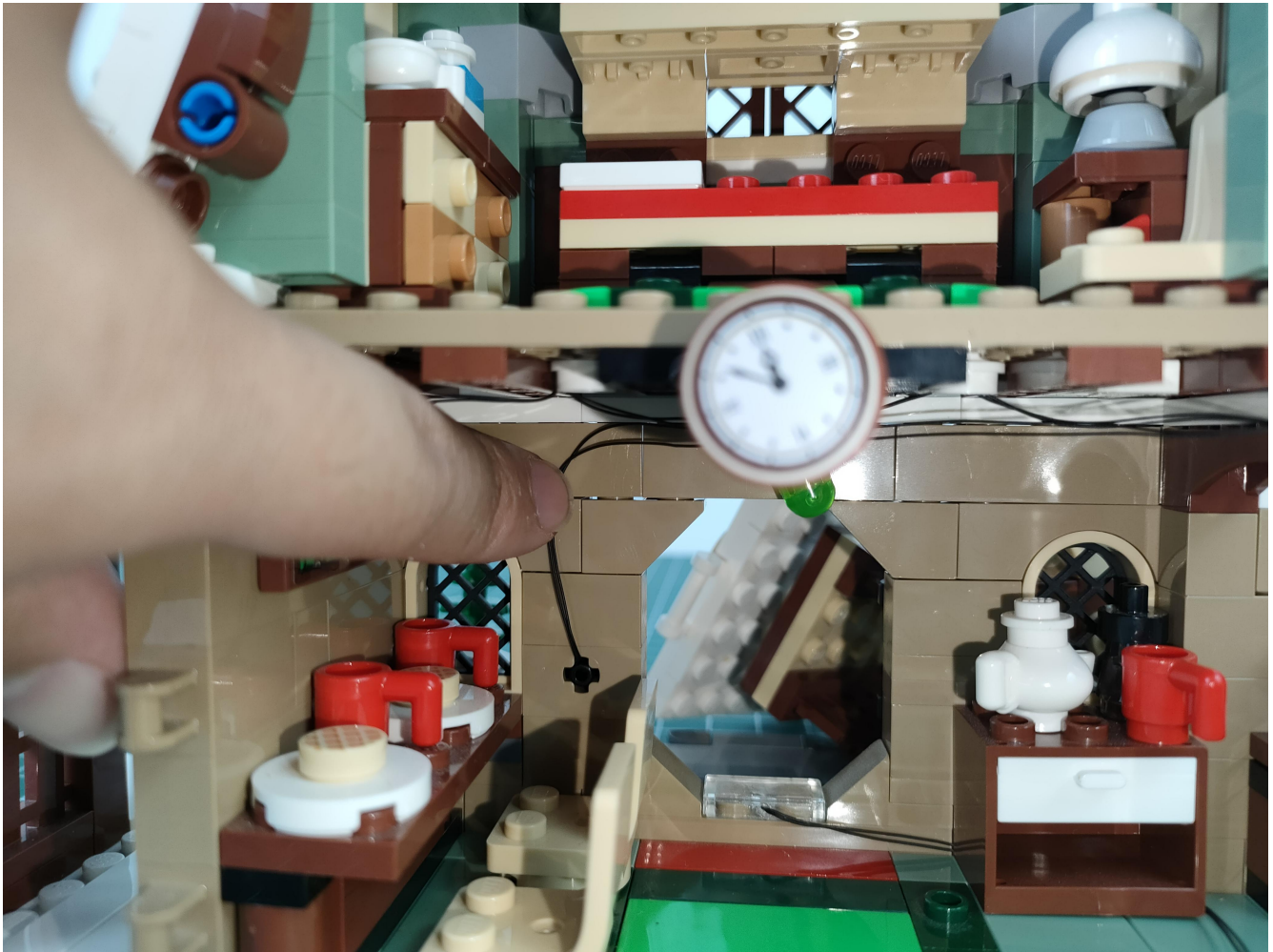

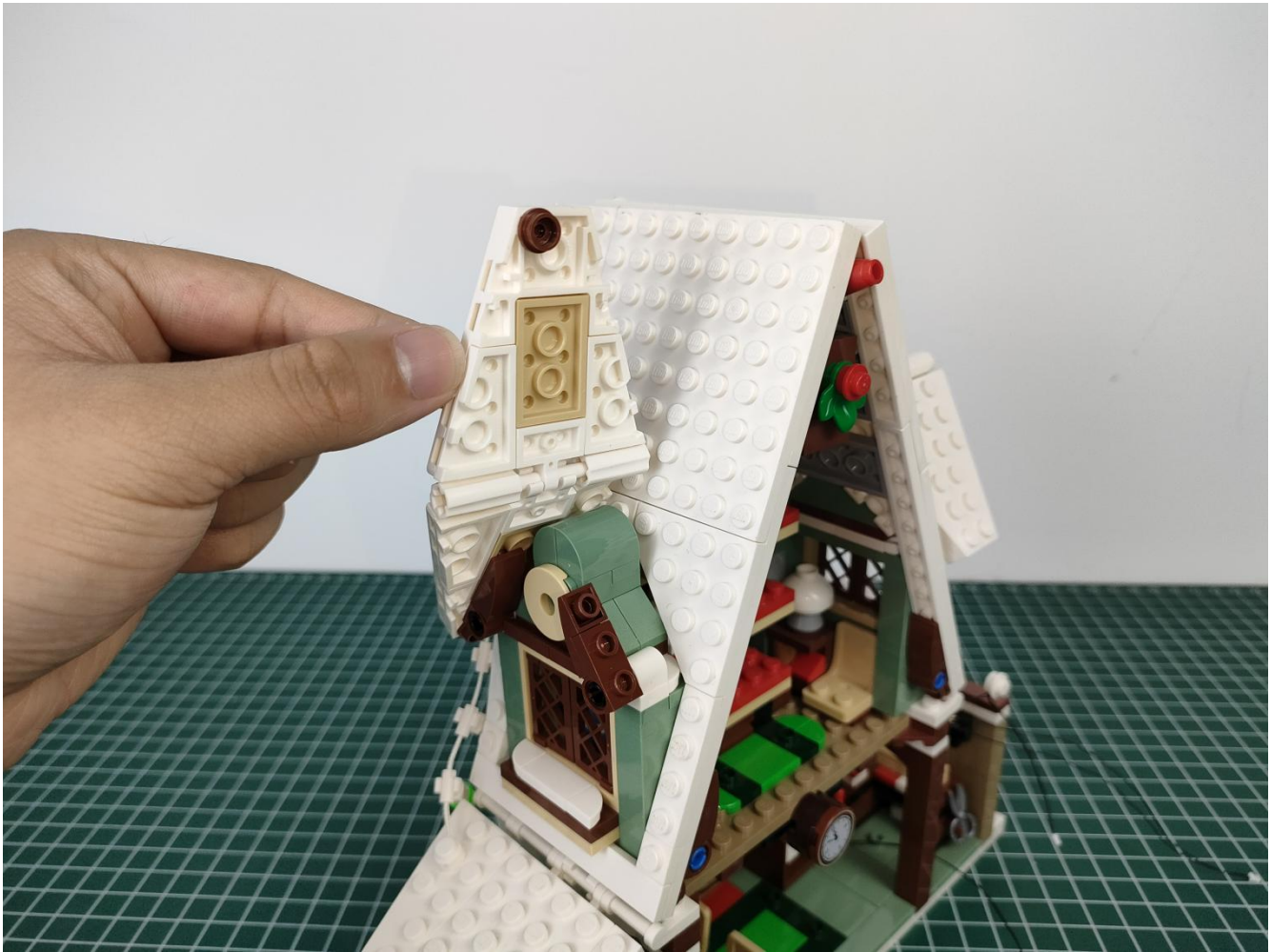

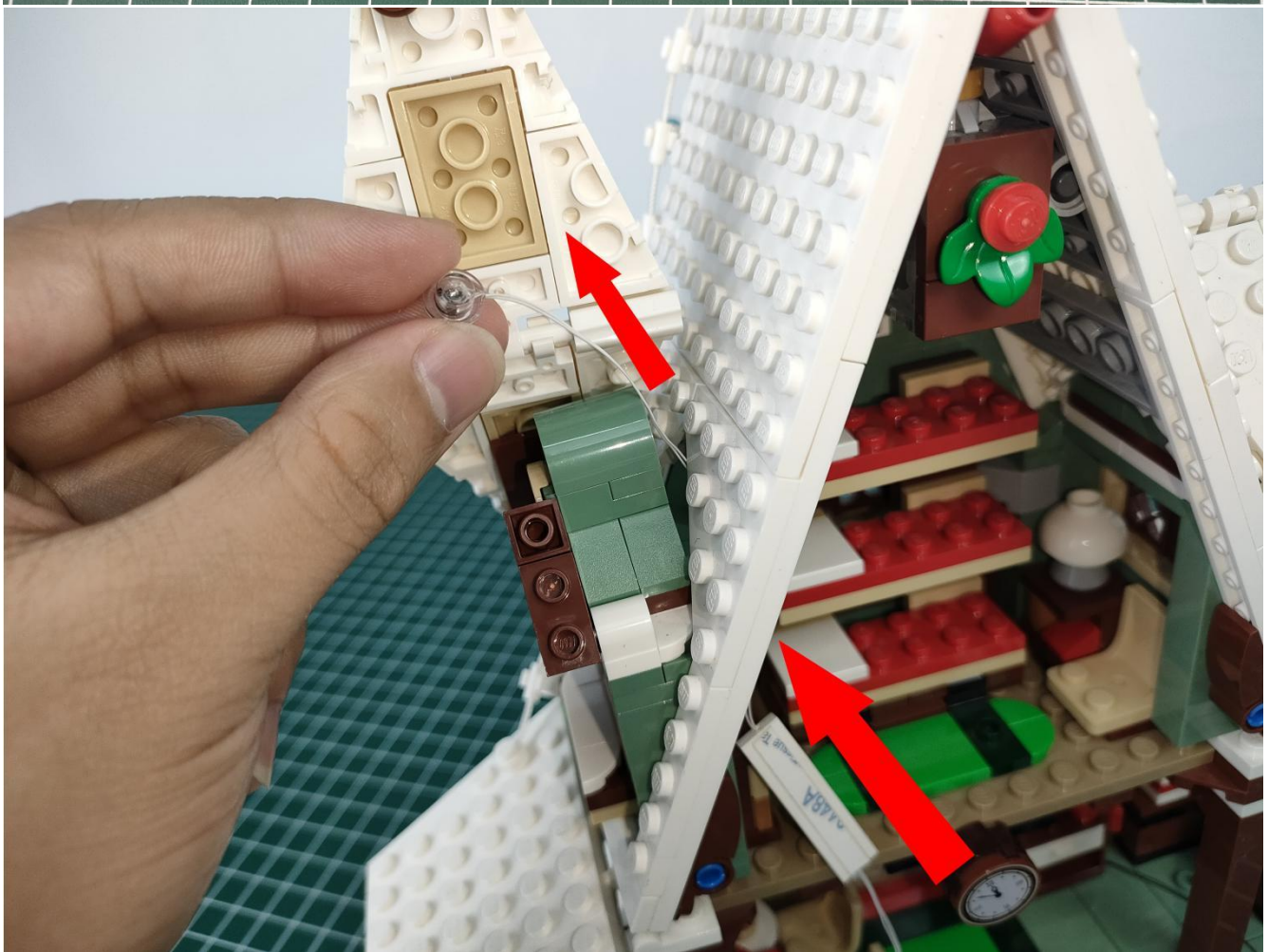
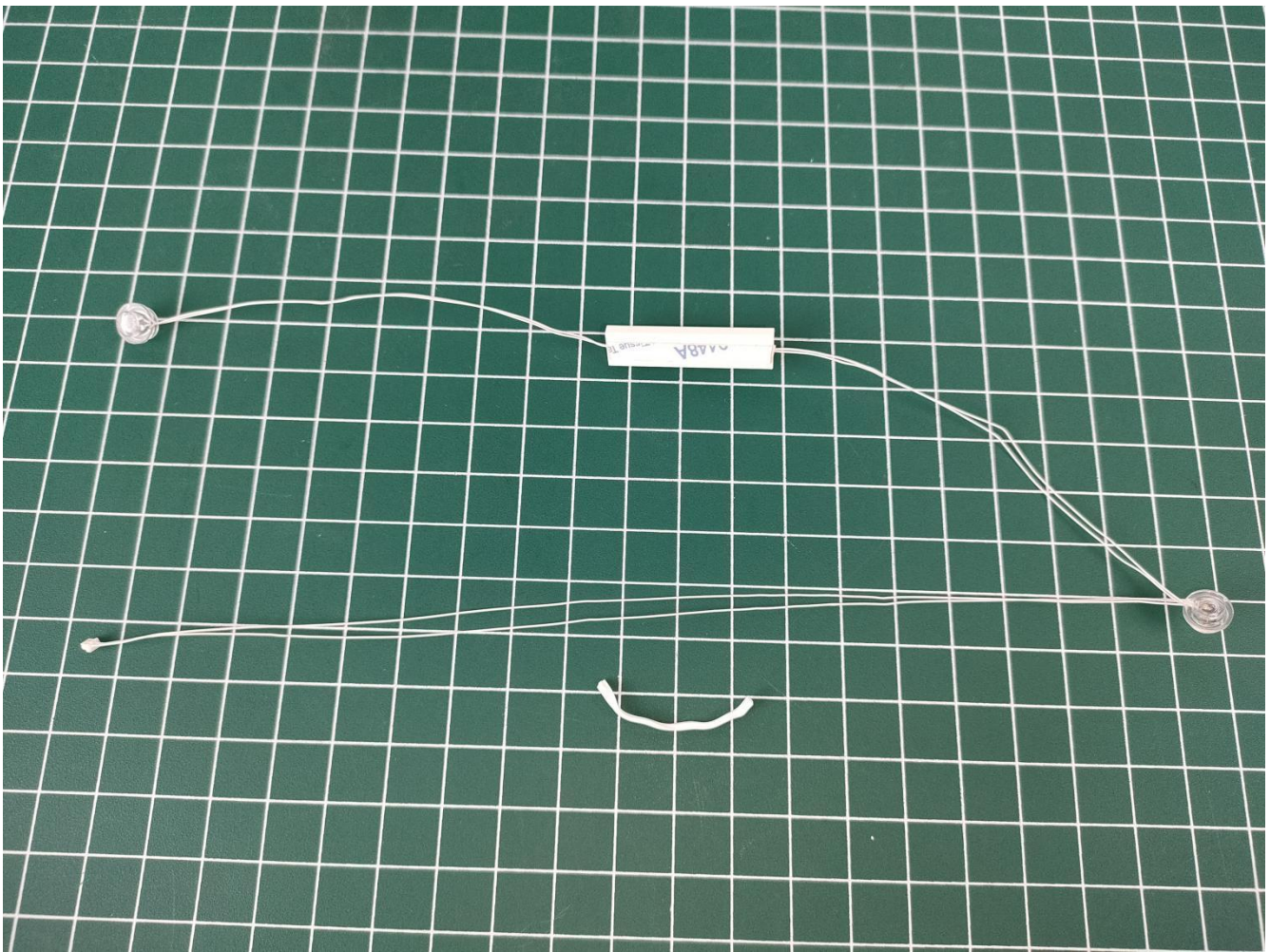

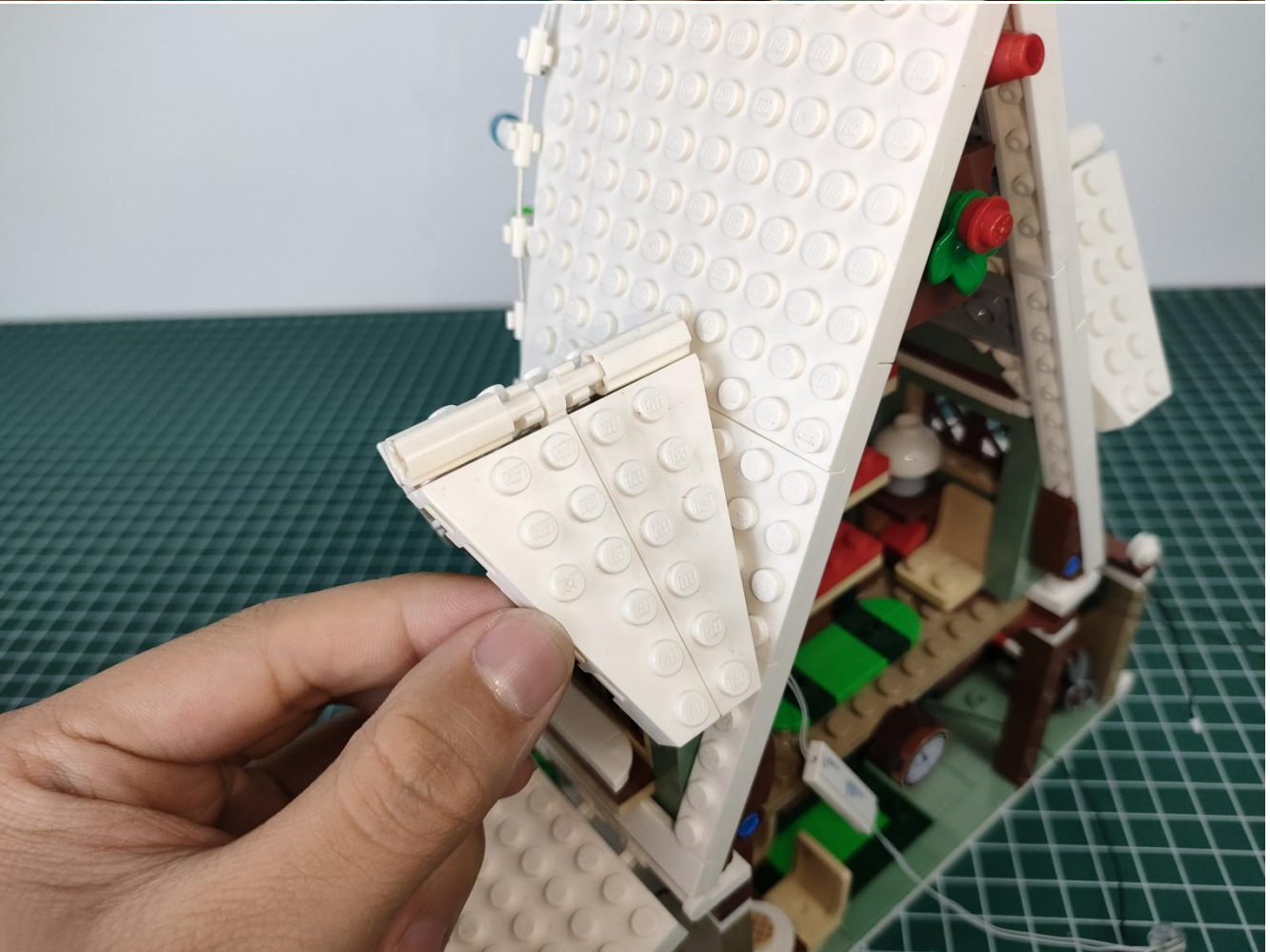
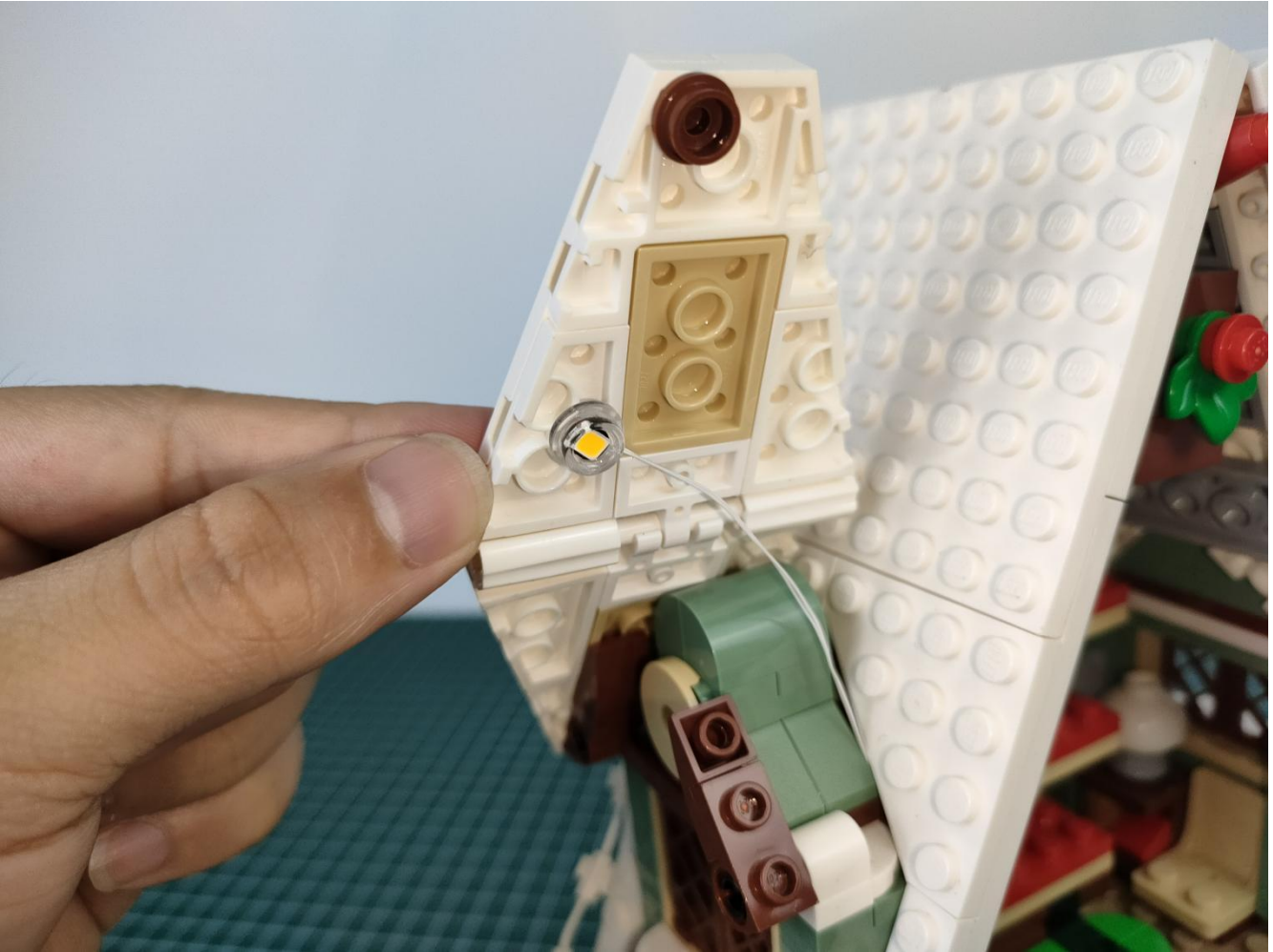

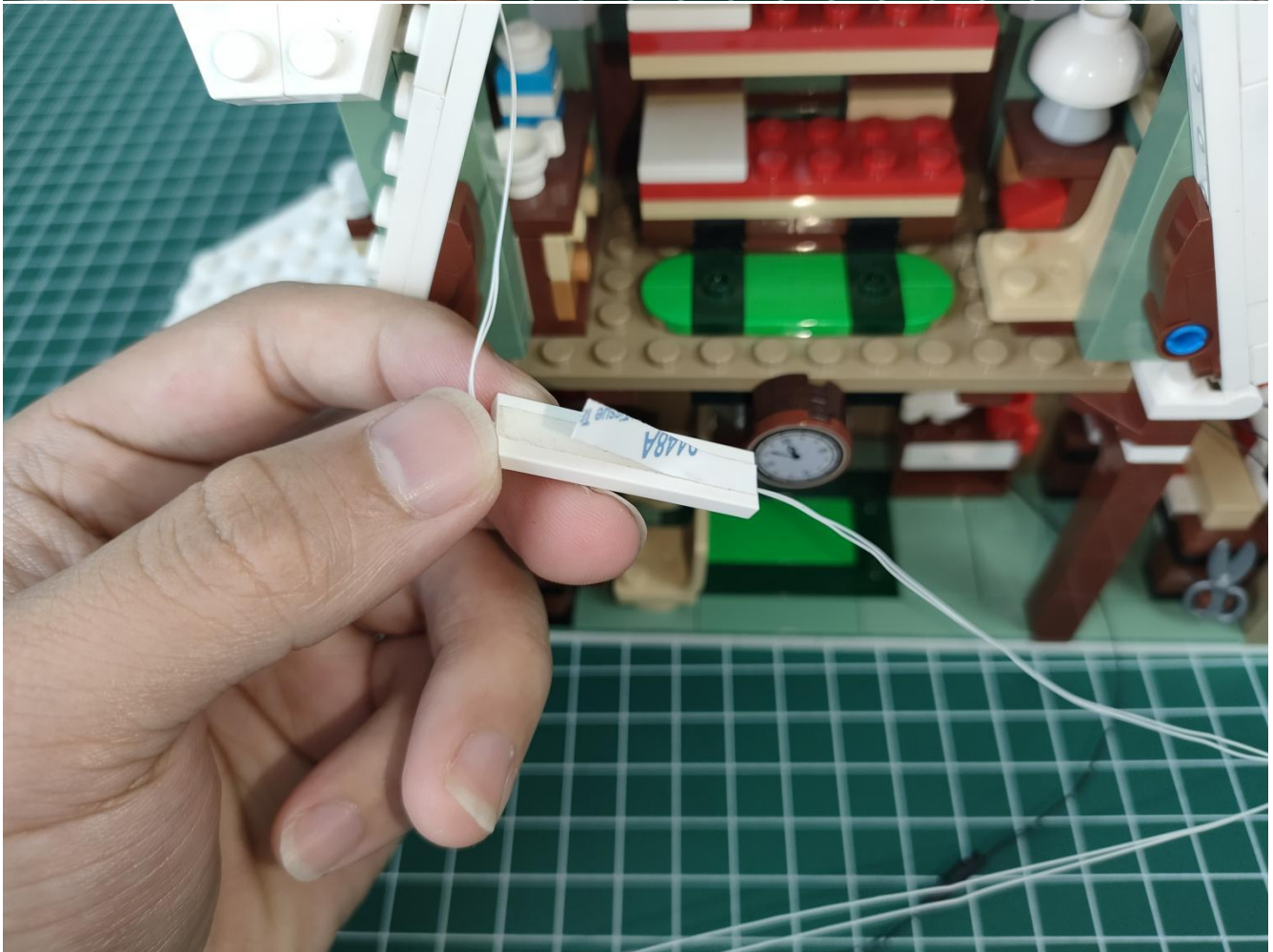
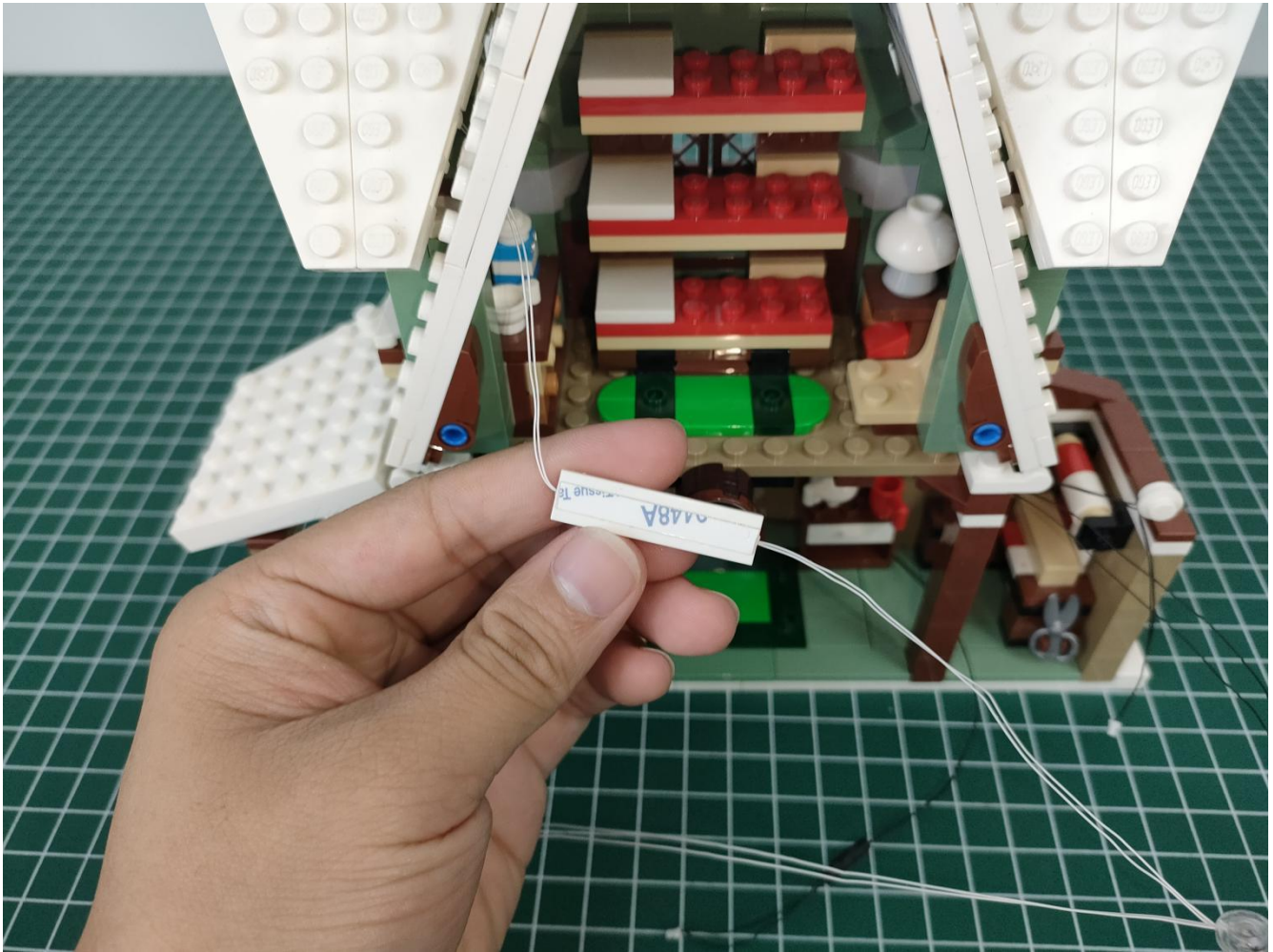

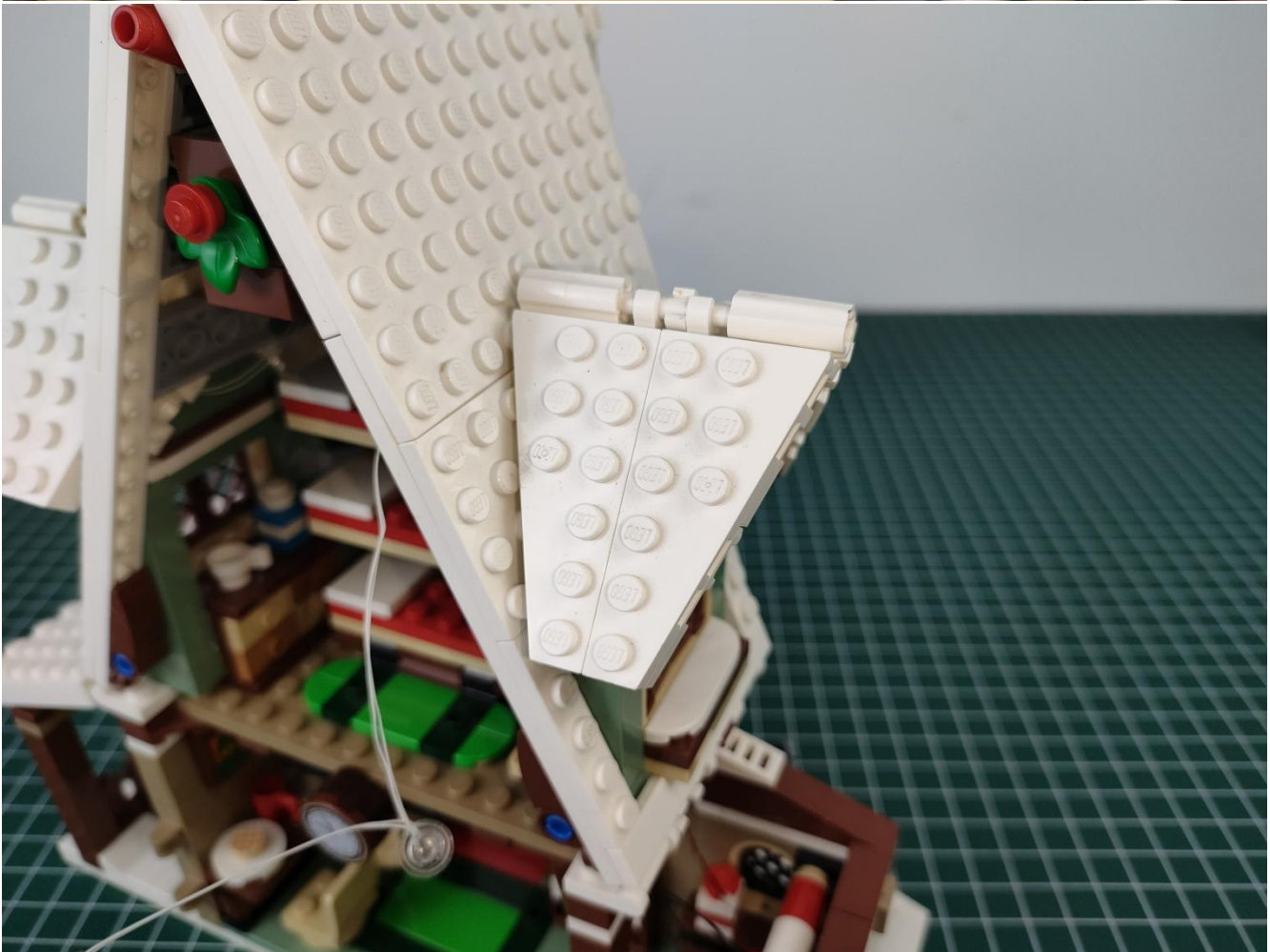



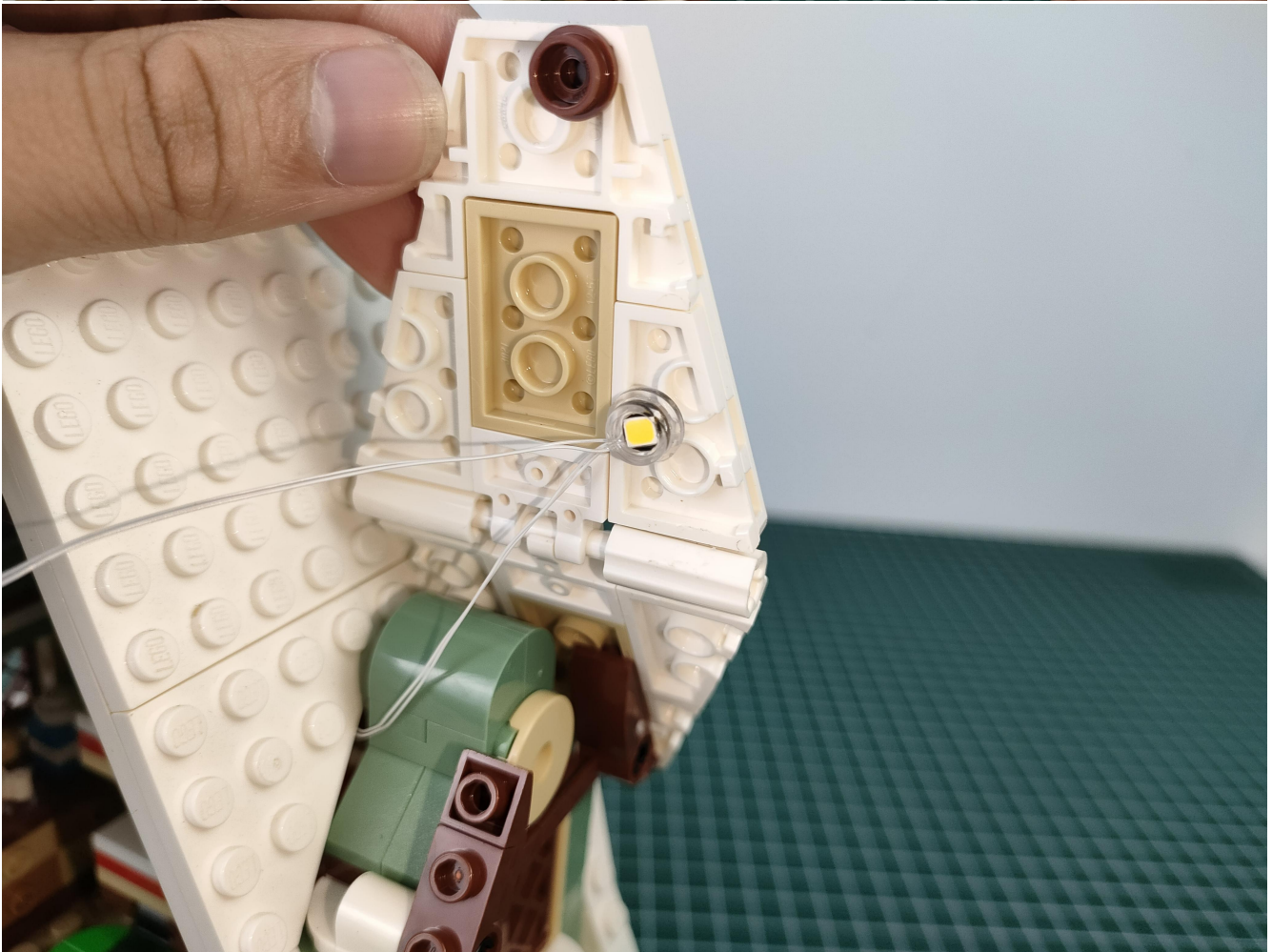
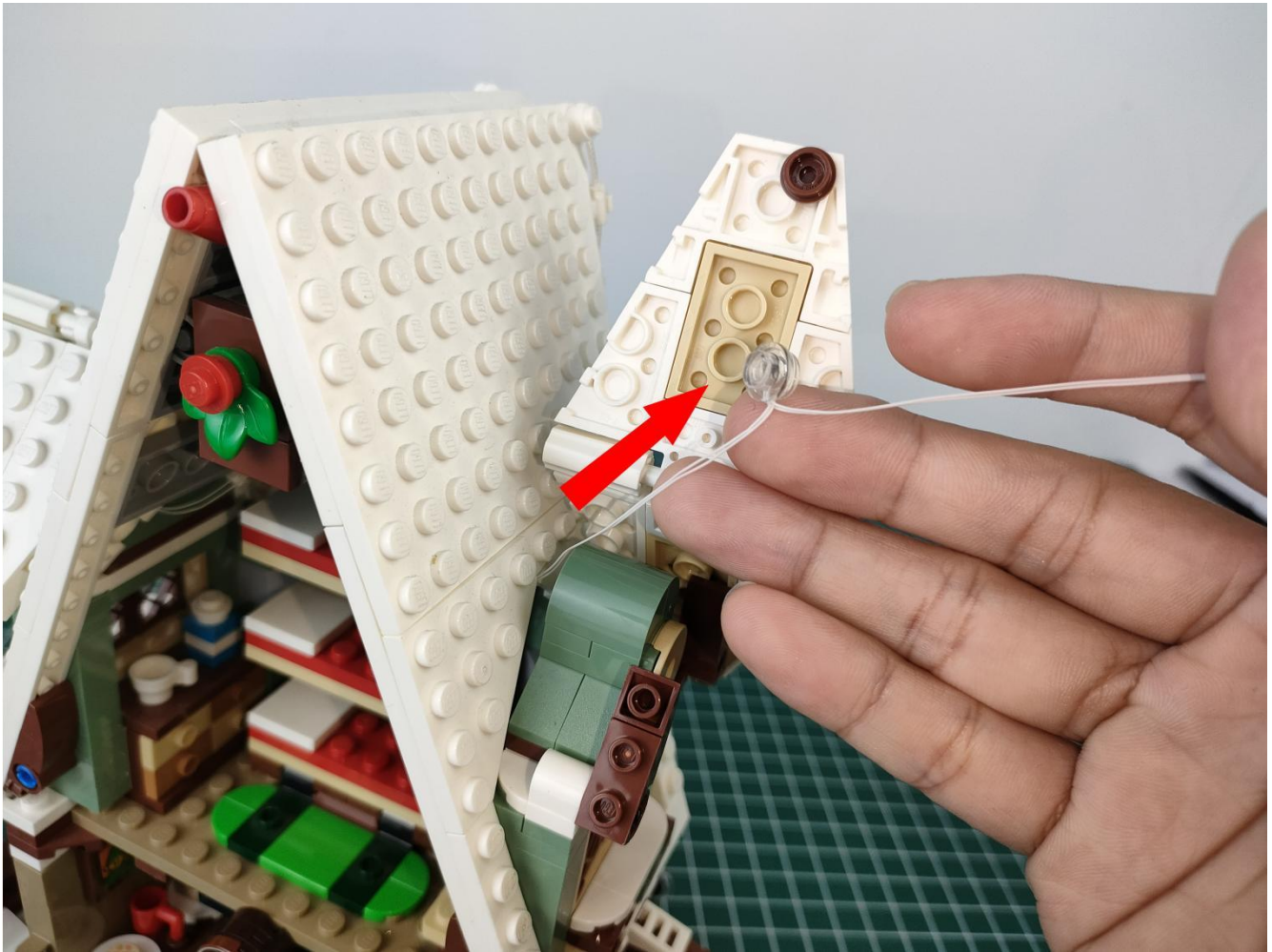

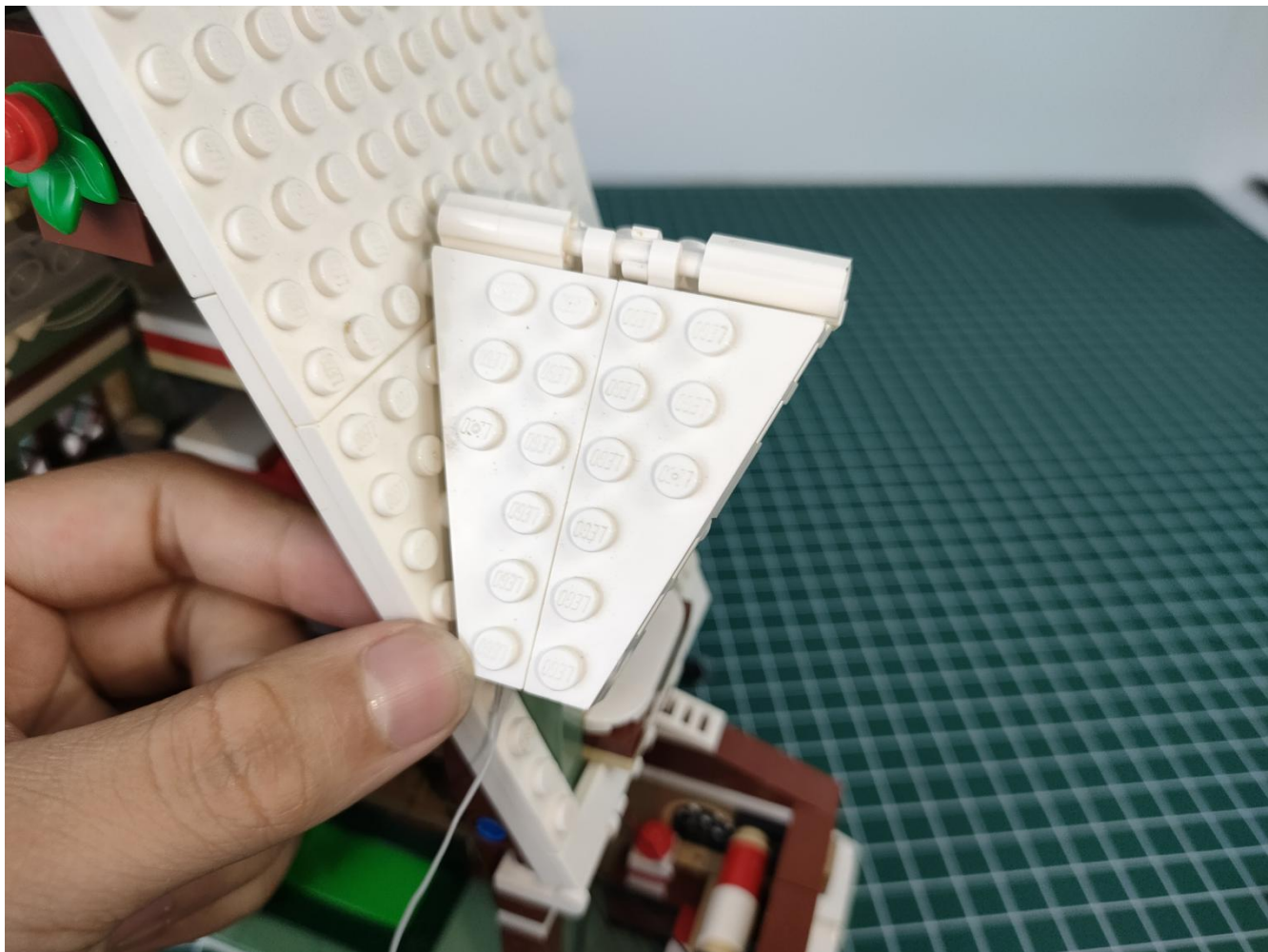

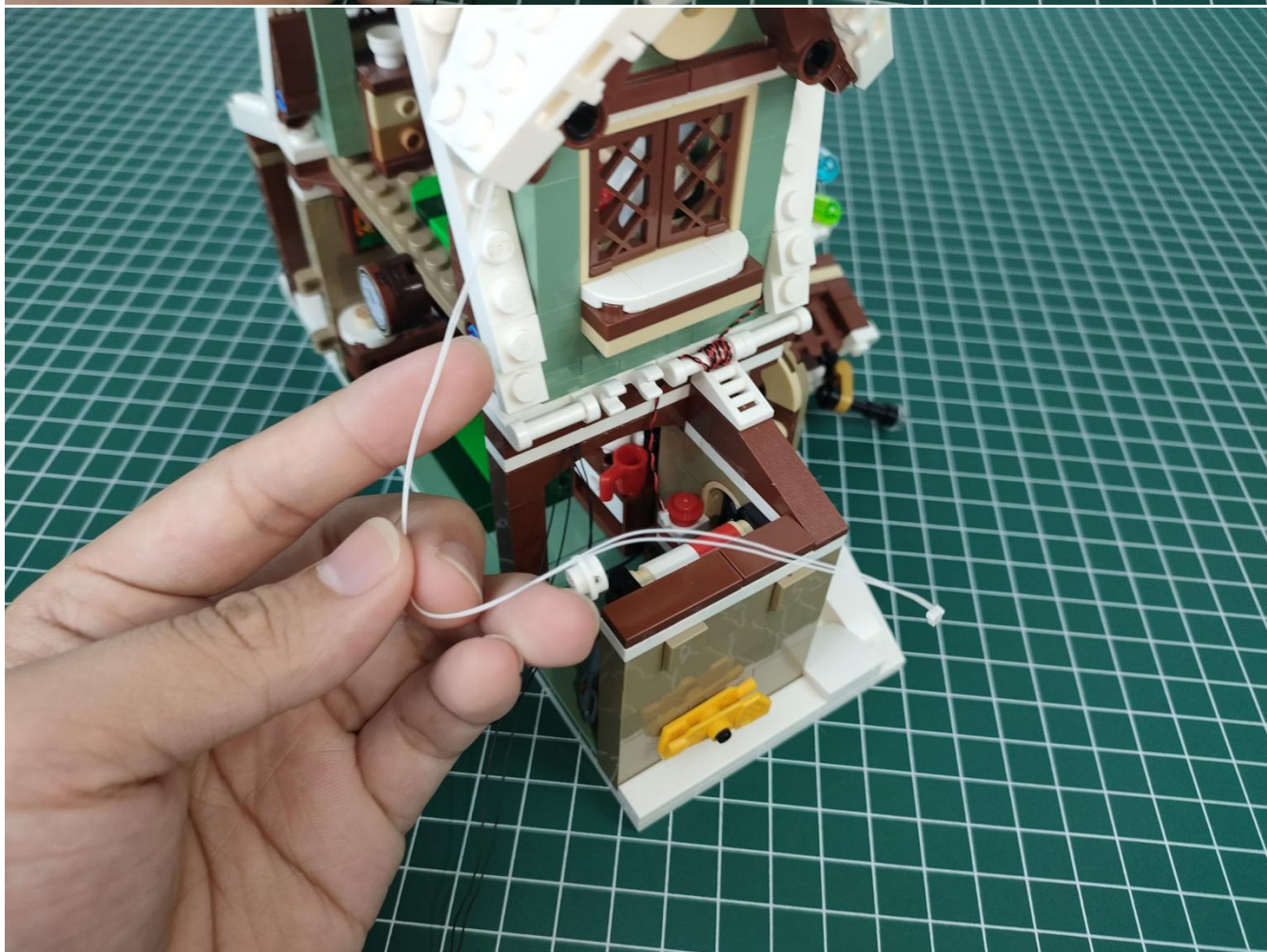
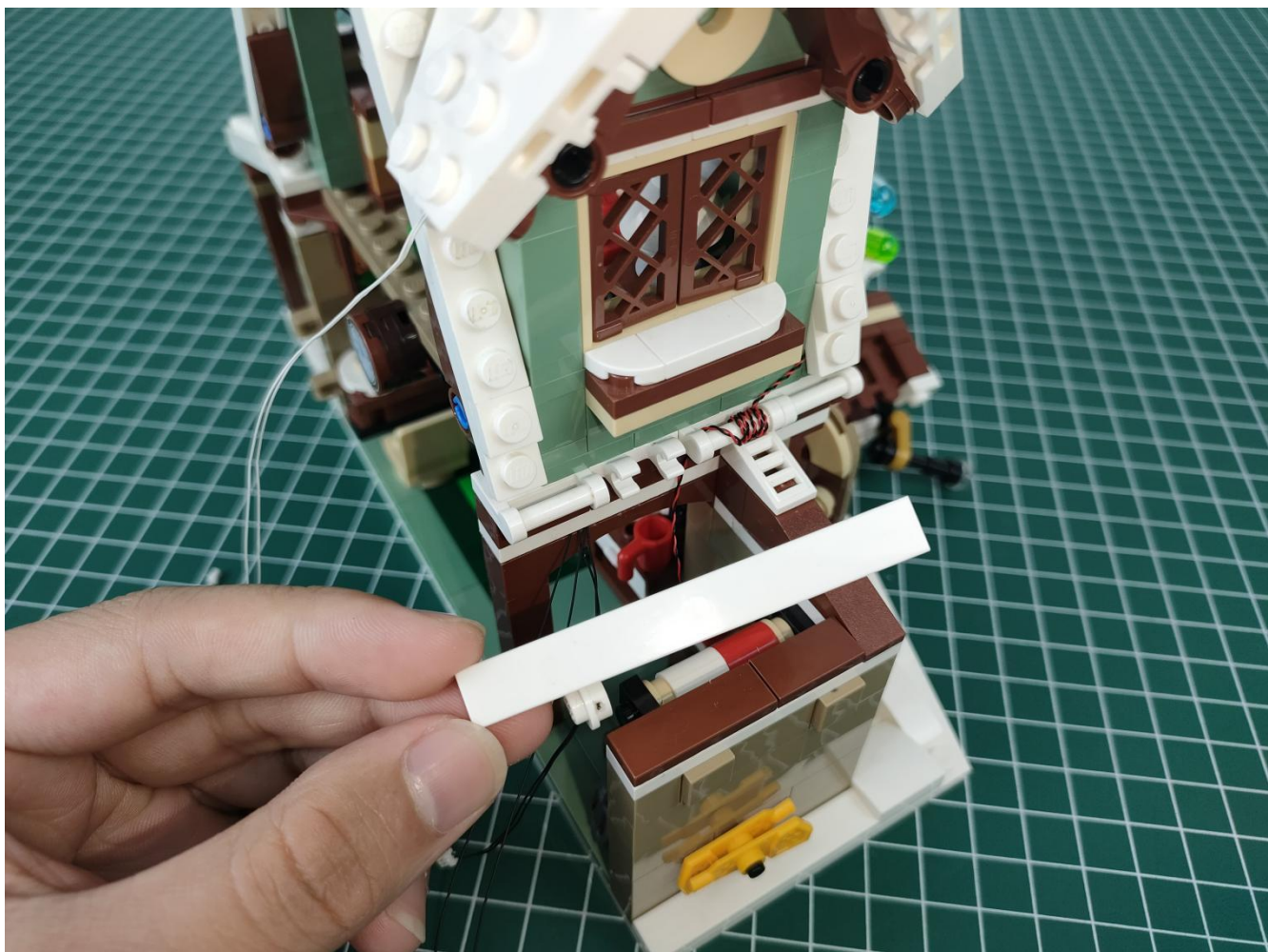

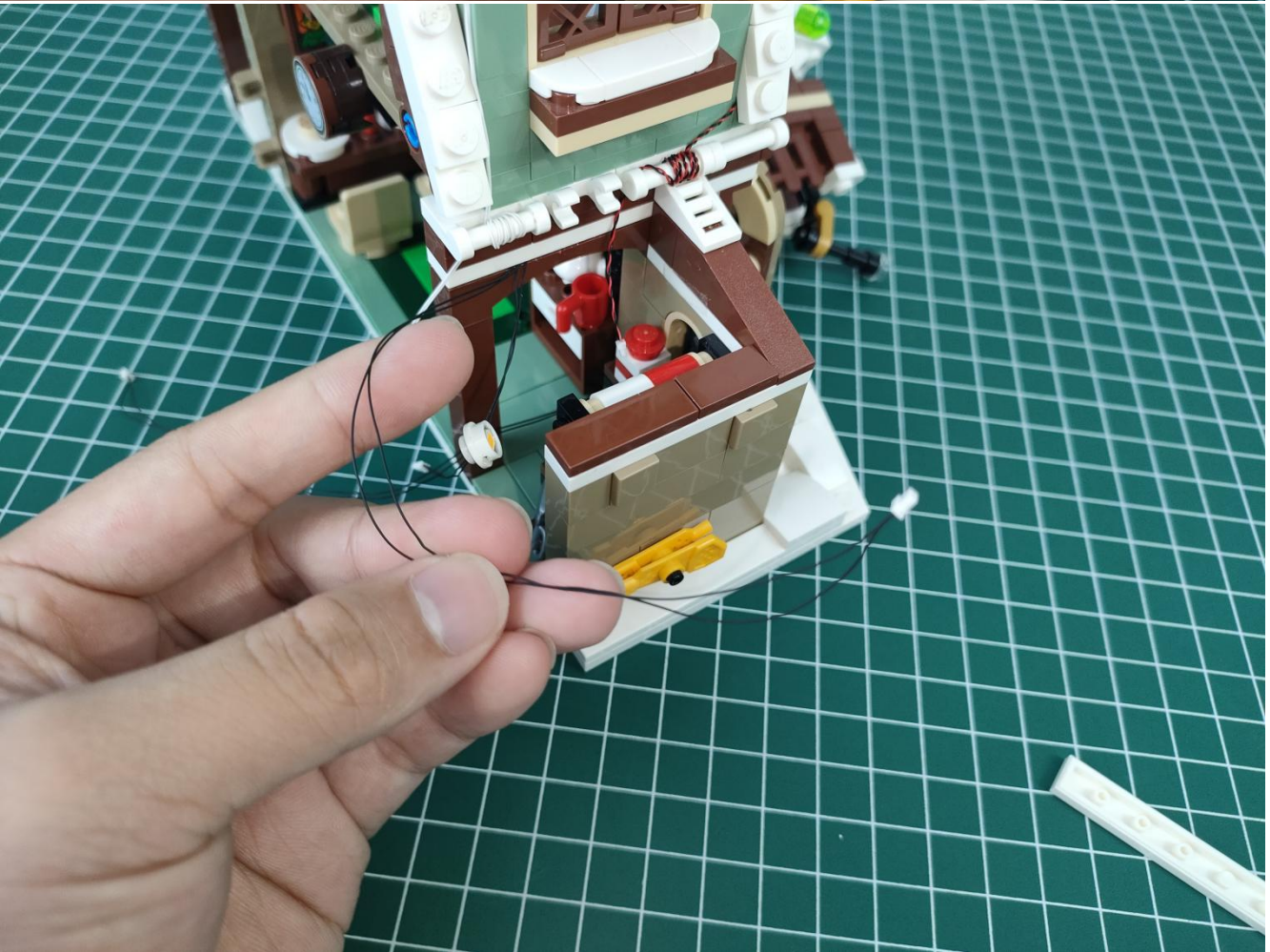
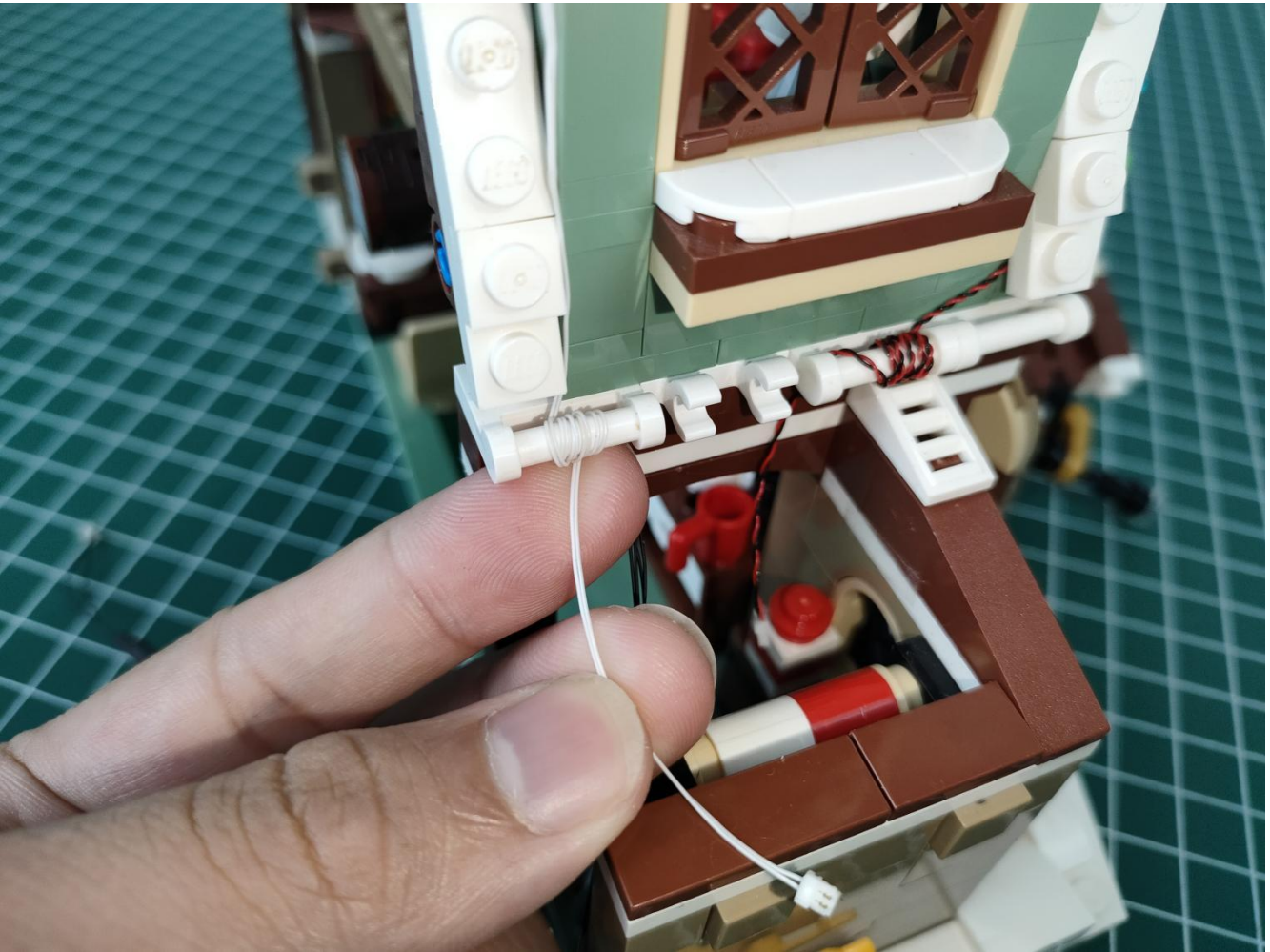

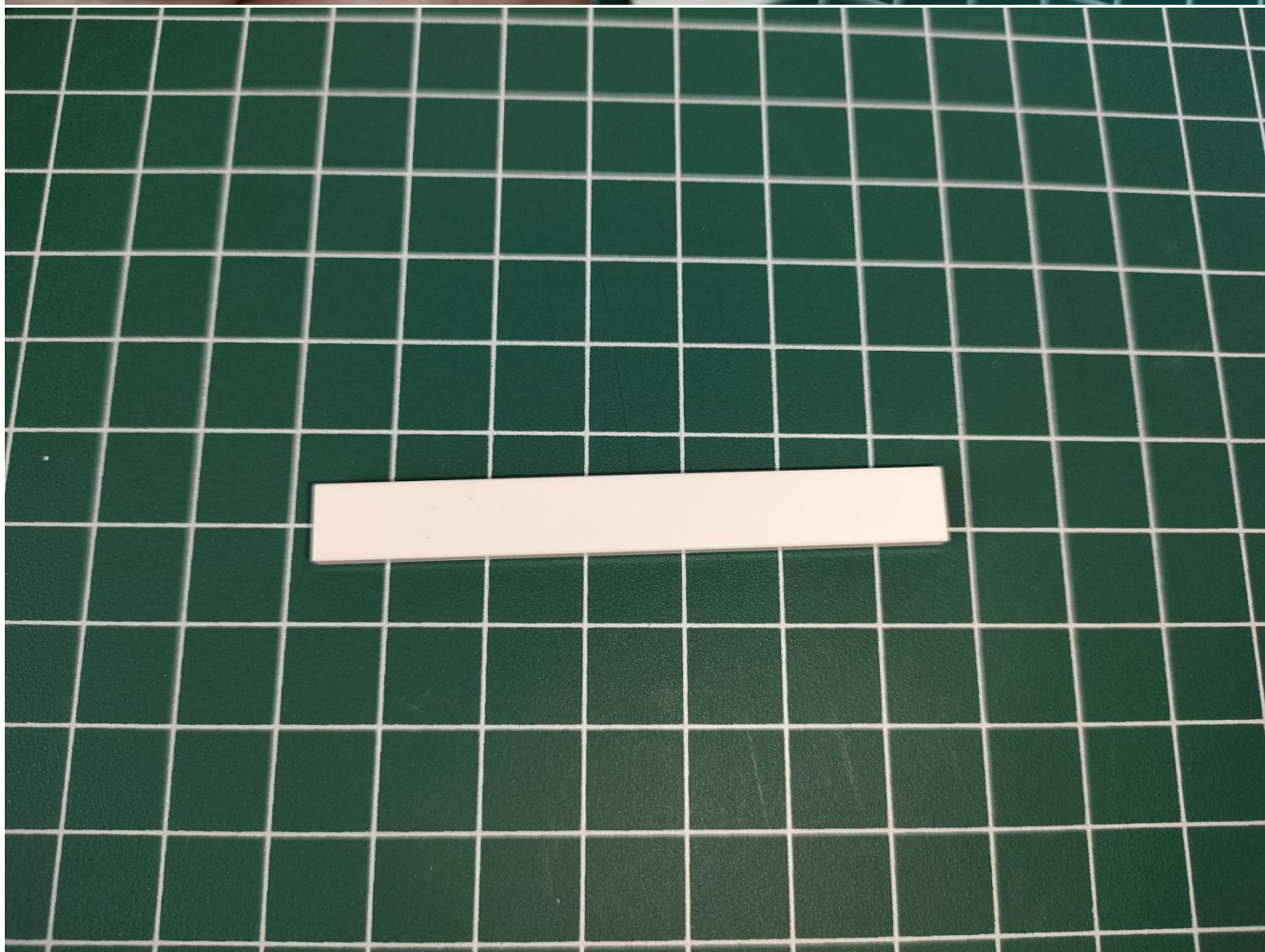
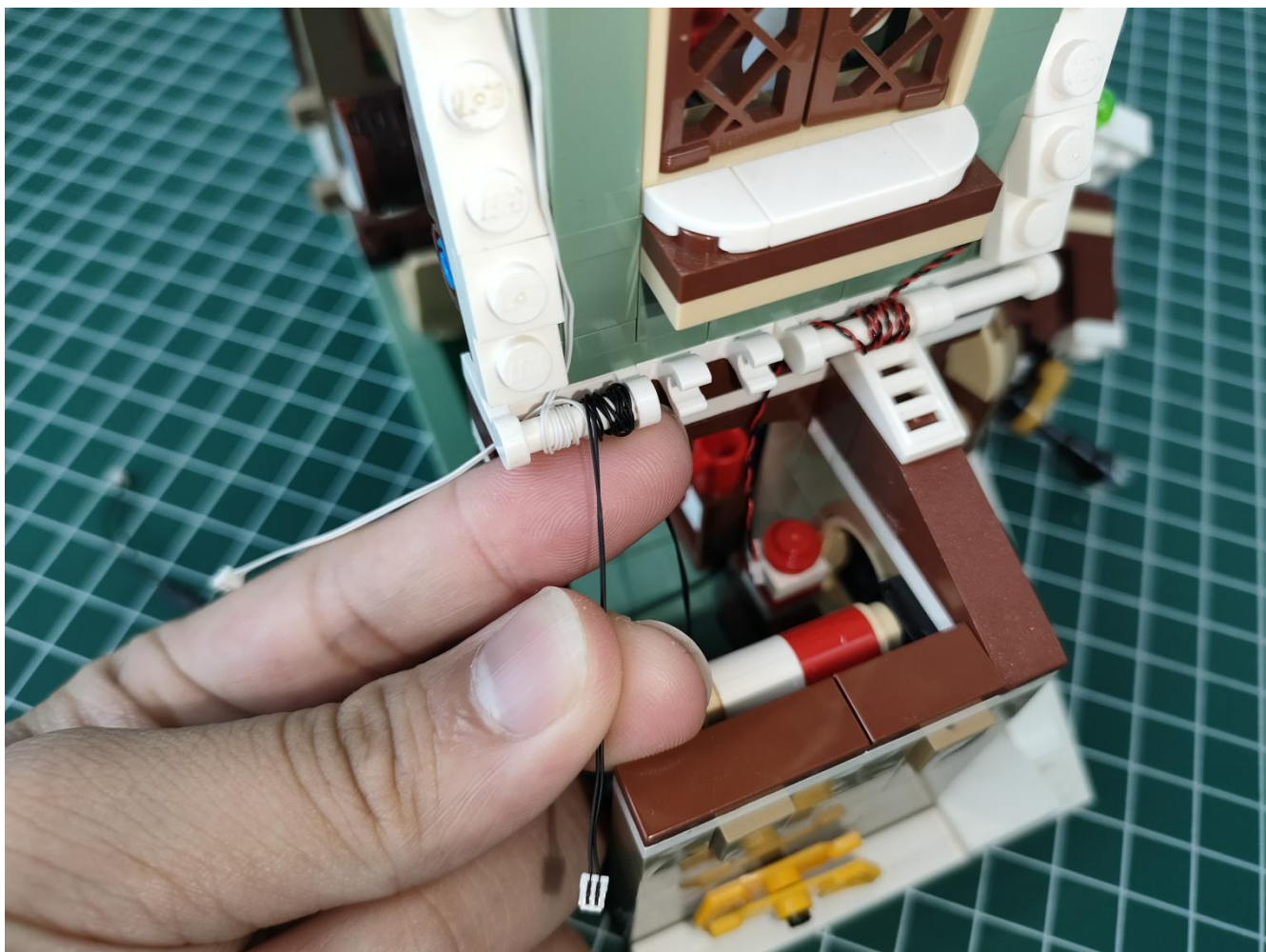



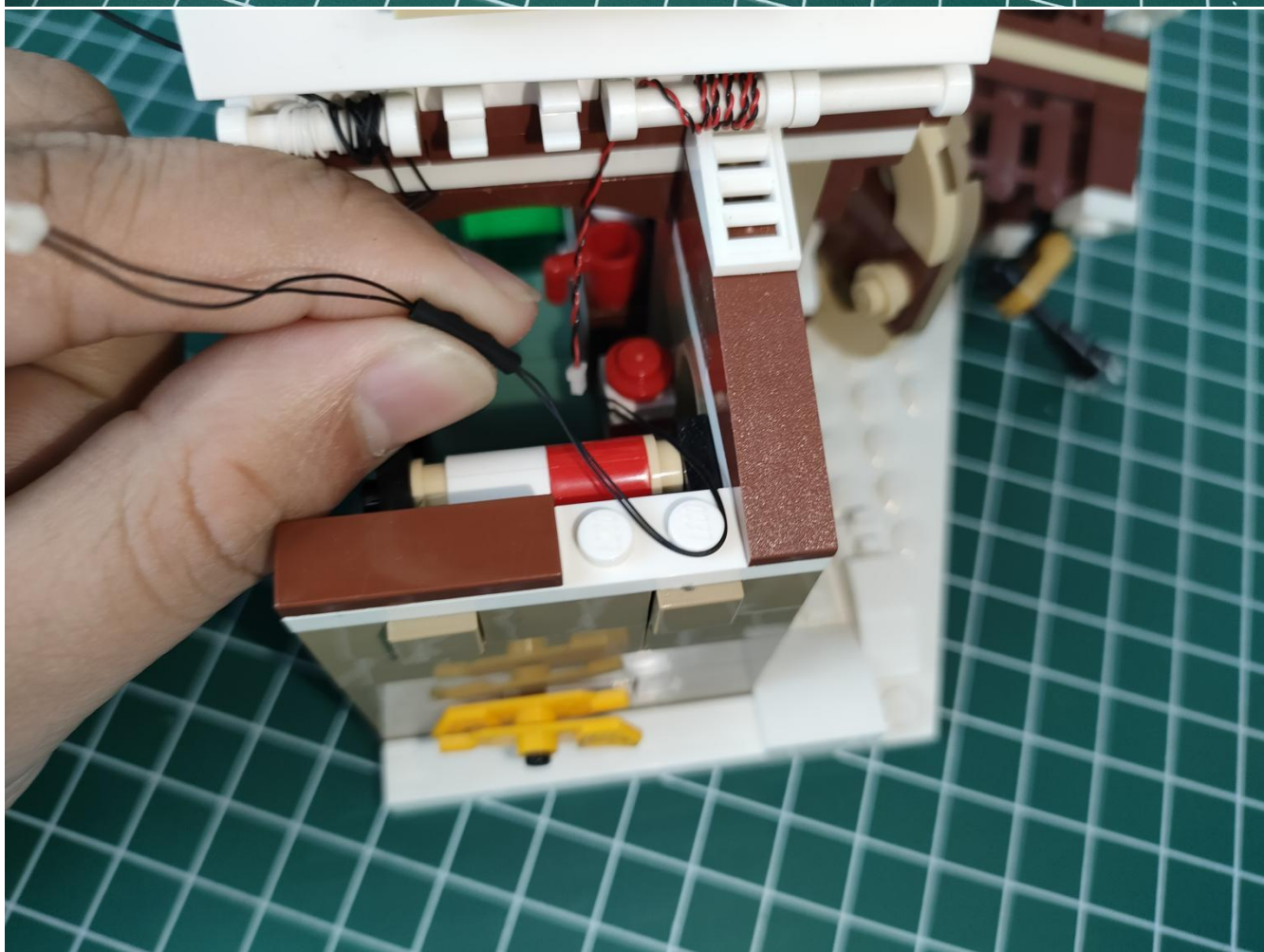
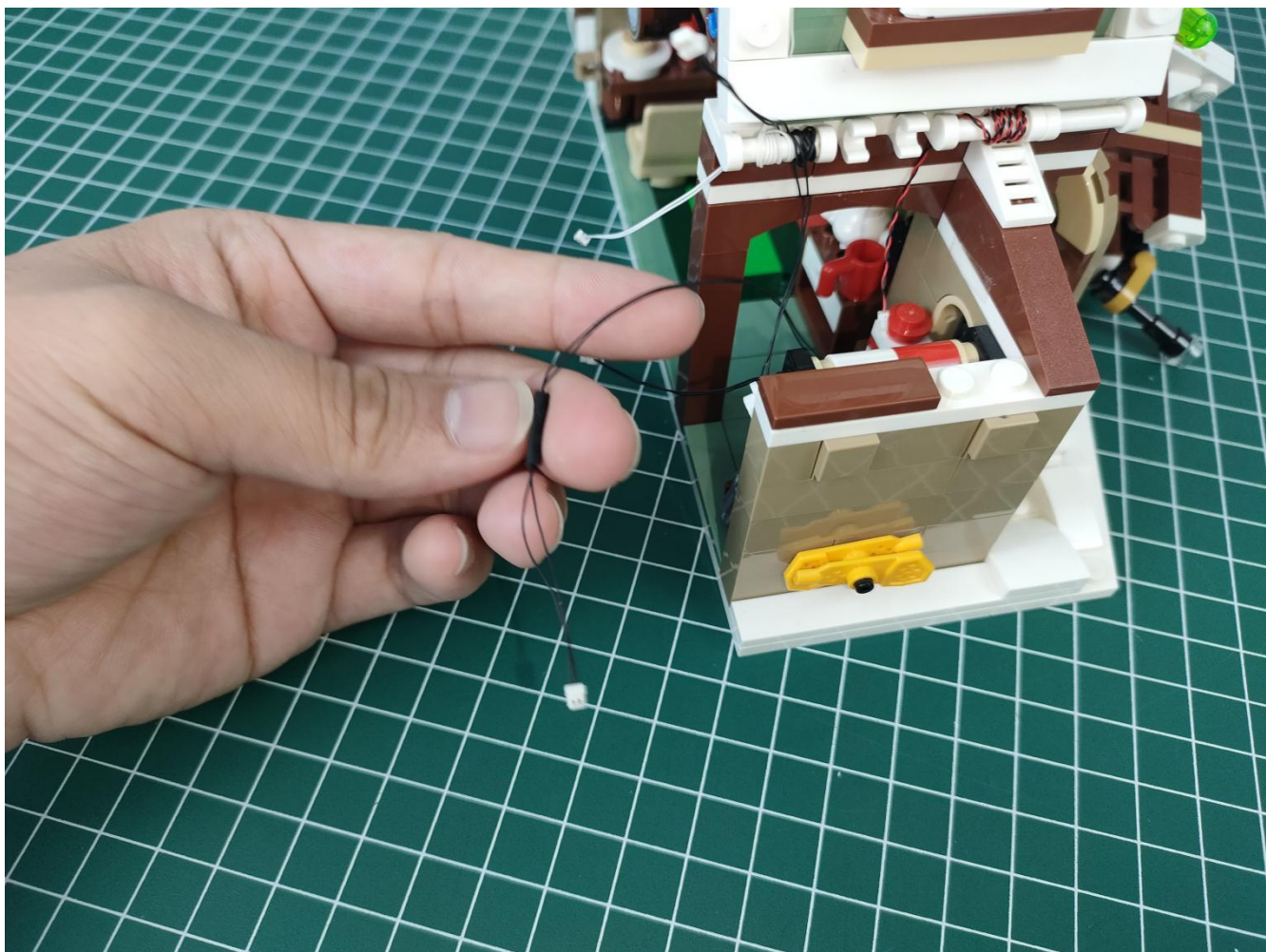

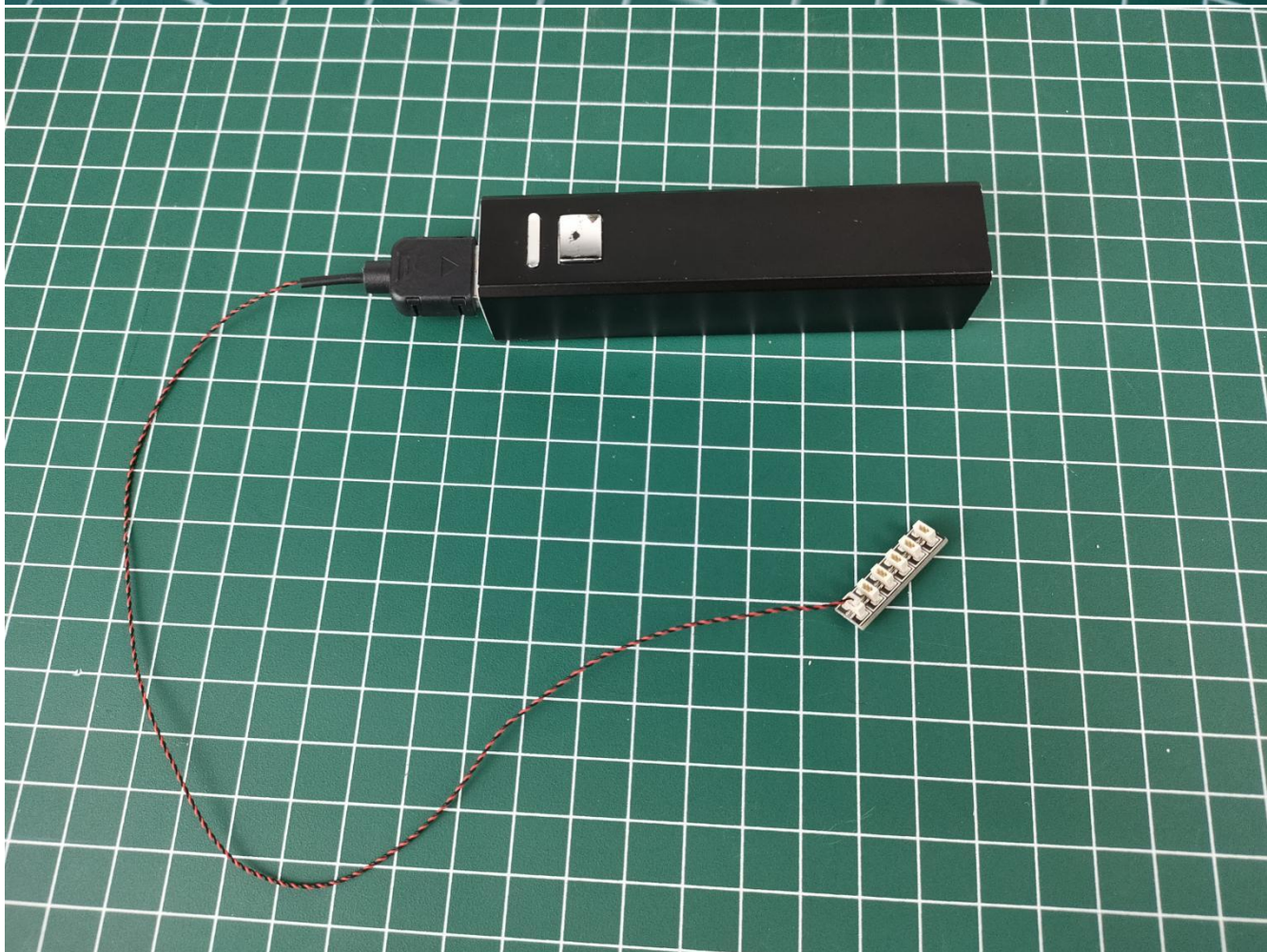

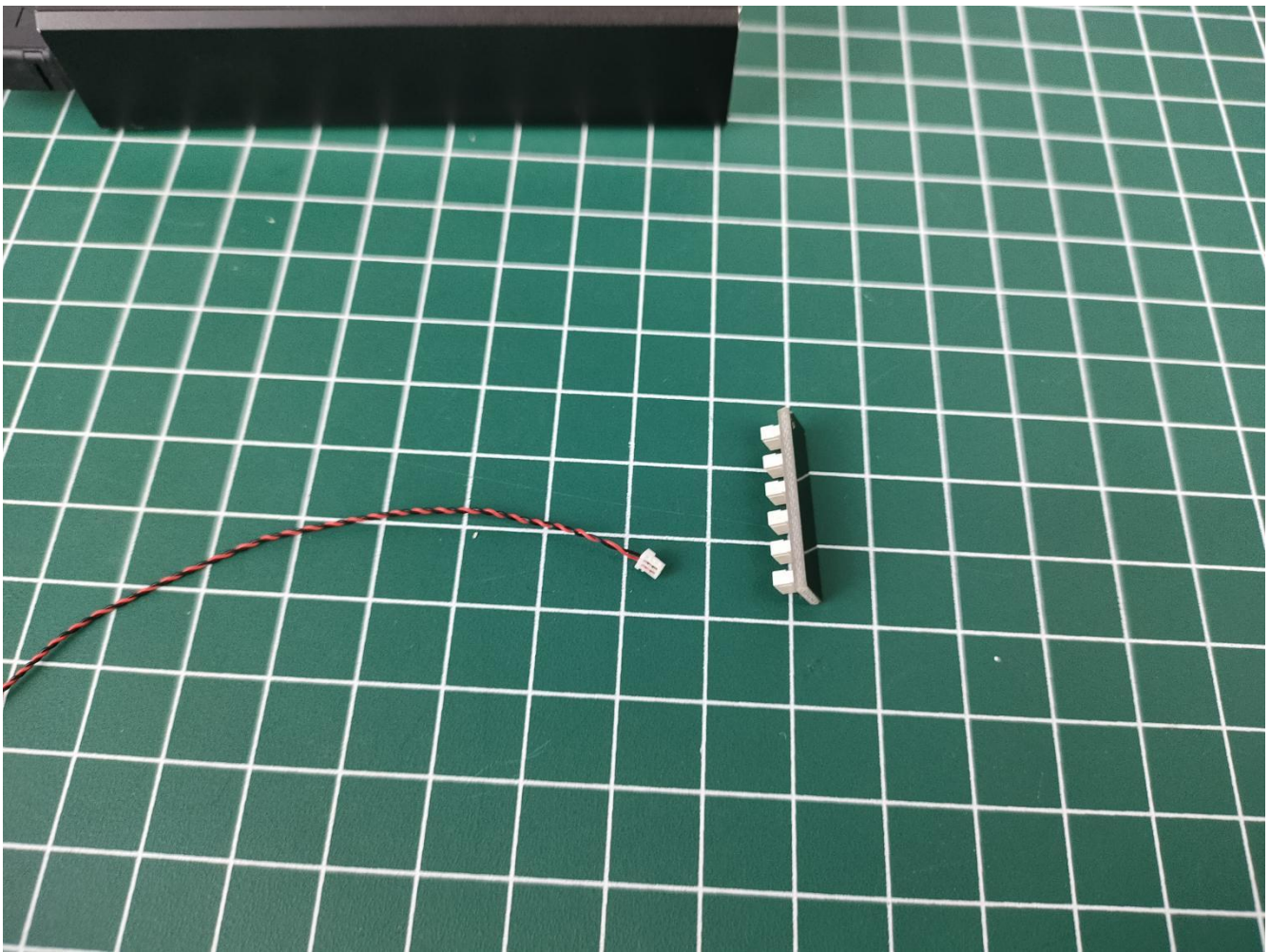



Please adjust the gear to the middle.

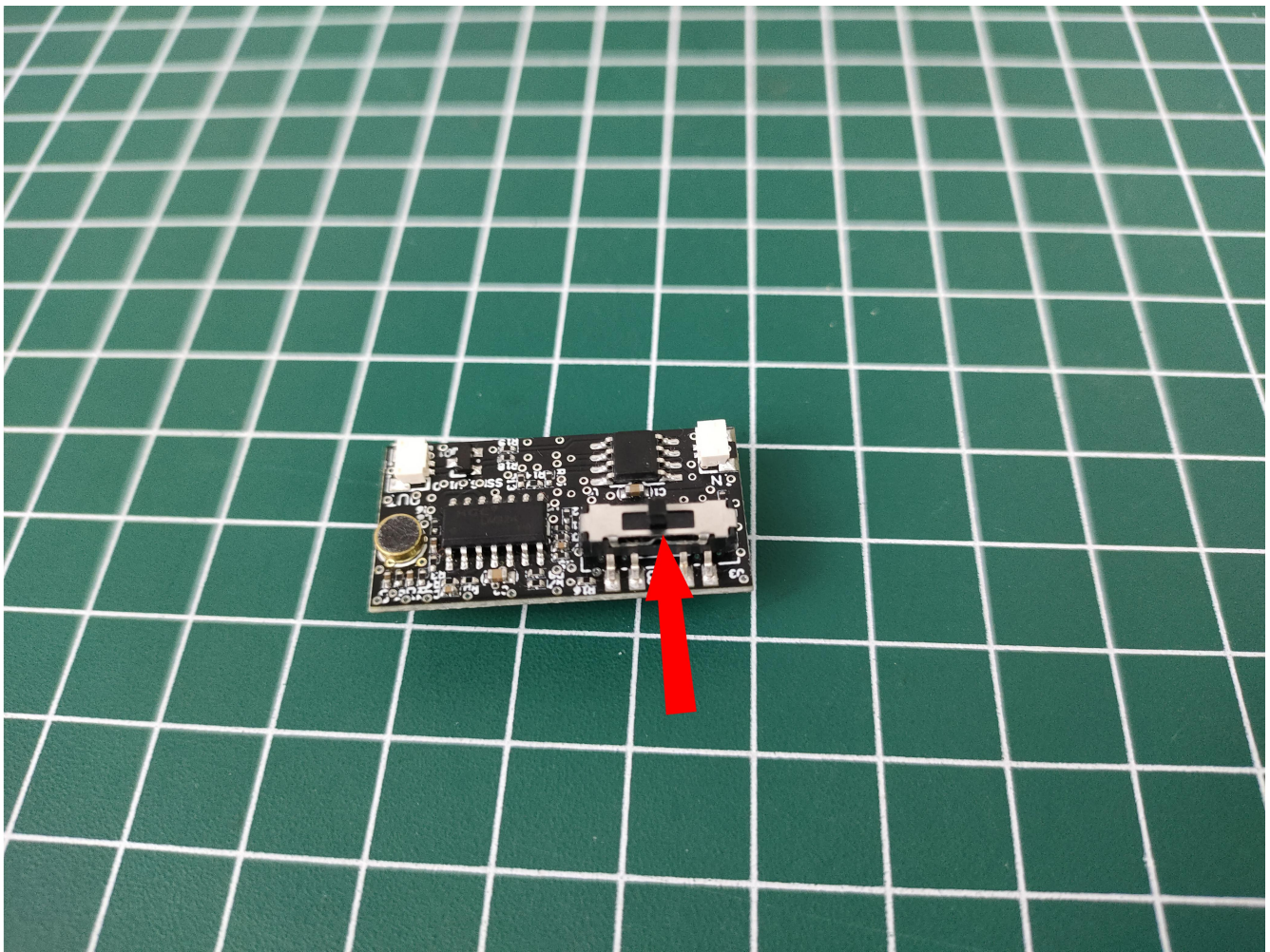

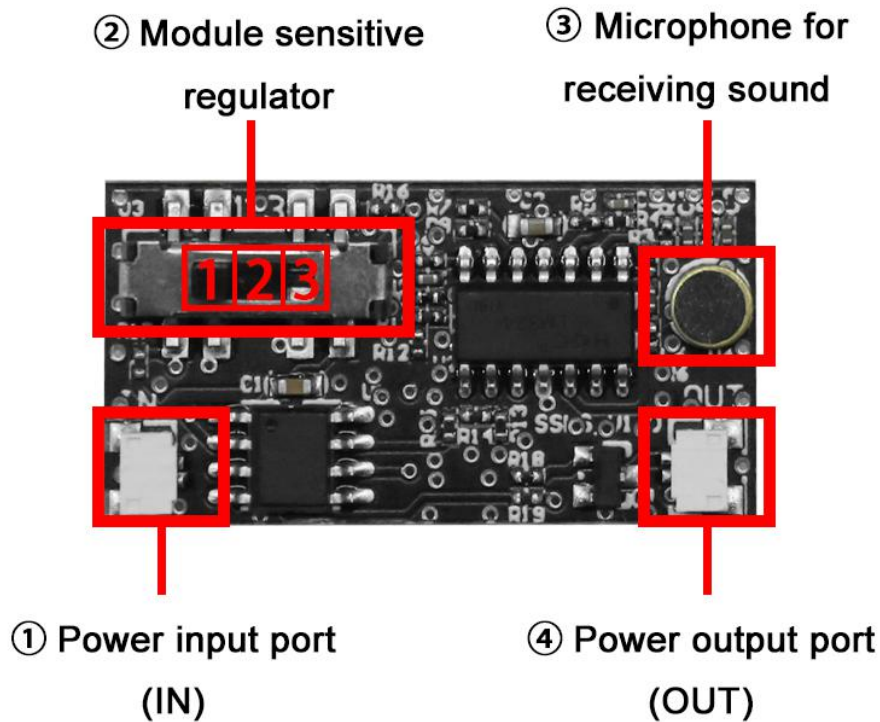

①: Power input port: This is the power input port, which is generally directly connected to the power supply or the controller.

②: Module sensitivity adjuster. There are three gears, **1, 2, and 3**. Received decibels respectively It is **15dB, 40dB, 80dB**. In a noisy environment, use the 1st gear, the light will be out If it has been lit and extinguished all the time, you need to increase the gear to 2 or 3 gears. normal work. In a quiet environment, gear 3 will be difficult to trigger, it is recommended to use 1 or 2Stalls. **Before starting the installation, please test and select the sound switch file suitable for your environment Bit.**

③: Sound receiver: This is the receiver for inputting sound. This component is responsible for receiving the input sound Audio instructions.

④: This is the power output port. Generally, it will be connected to the socket through a cable or directly connected to the lamp pellets.

(Note: Because the voltage of the power bank often changes, the lighting on the module sometimes flickers Case. It is recommended to use a battery box or a stable mobile phone charger for power supply.)

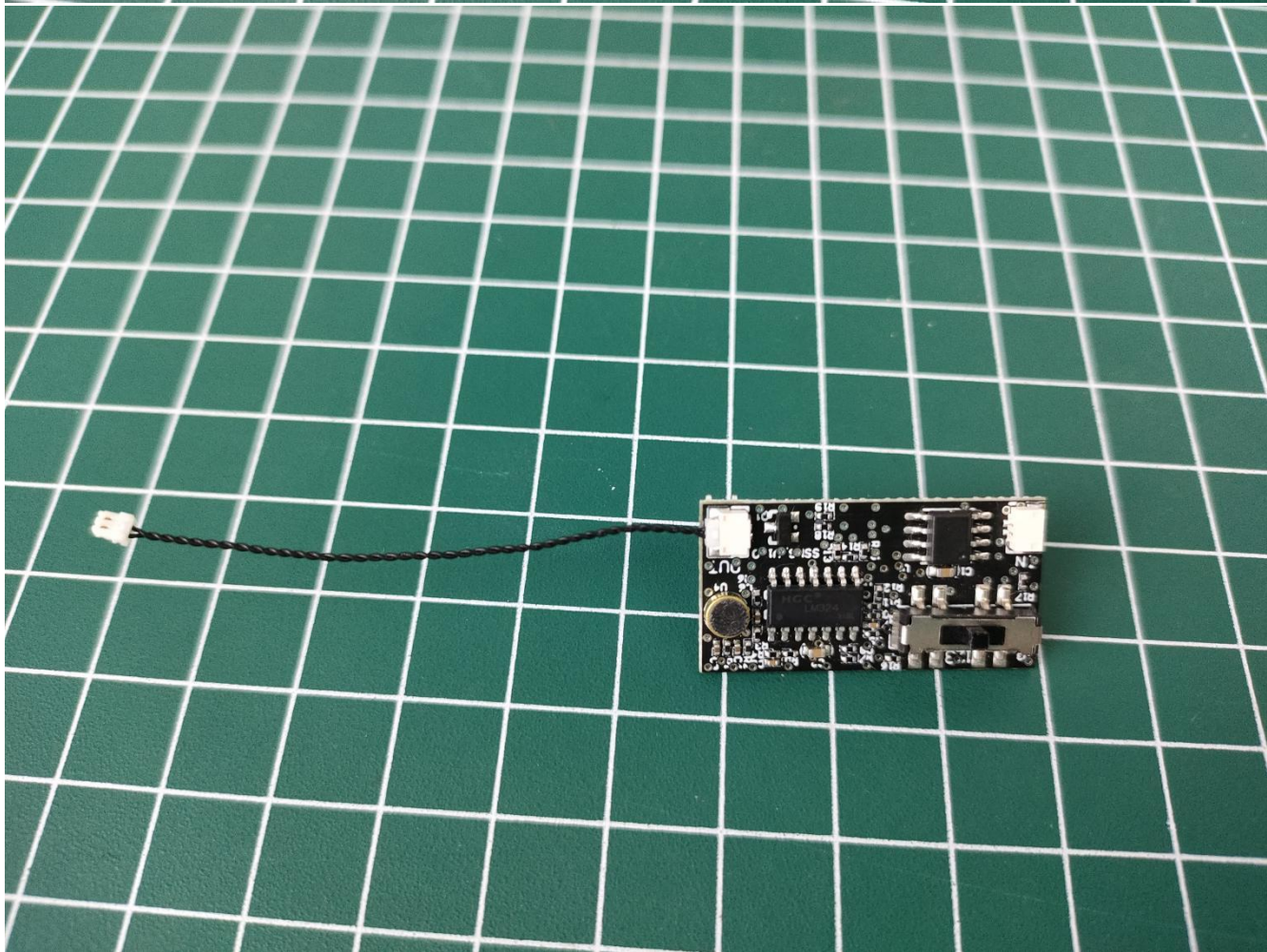
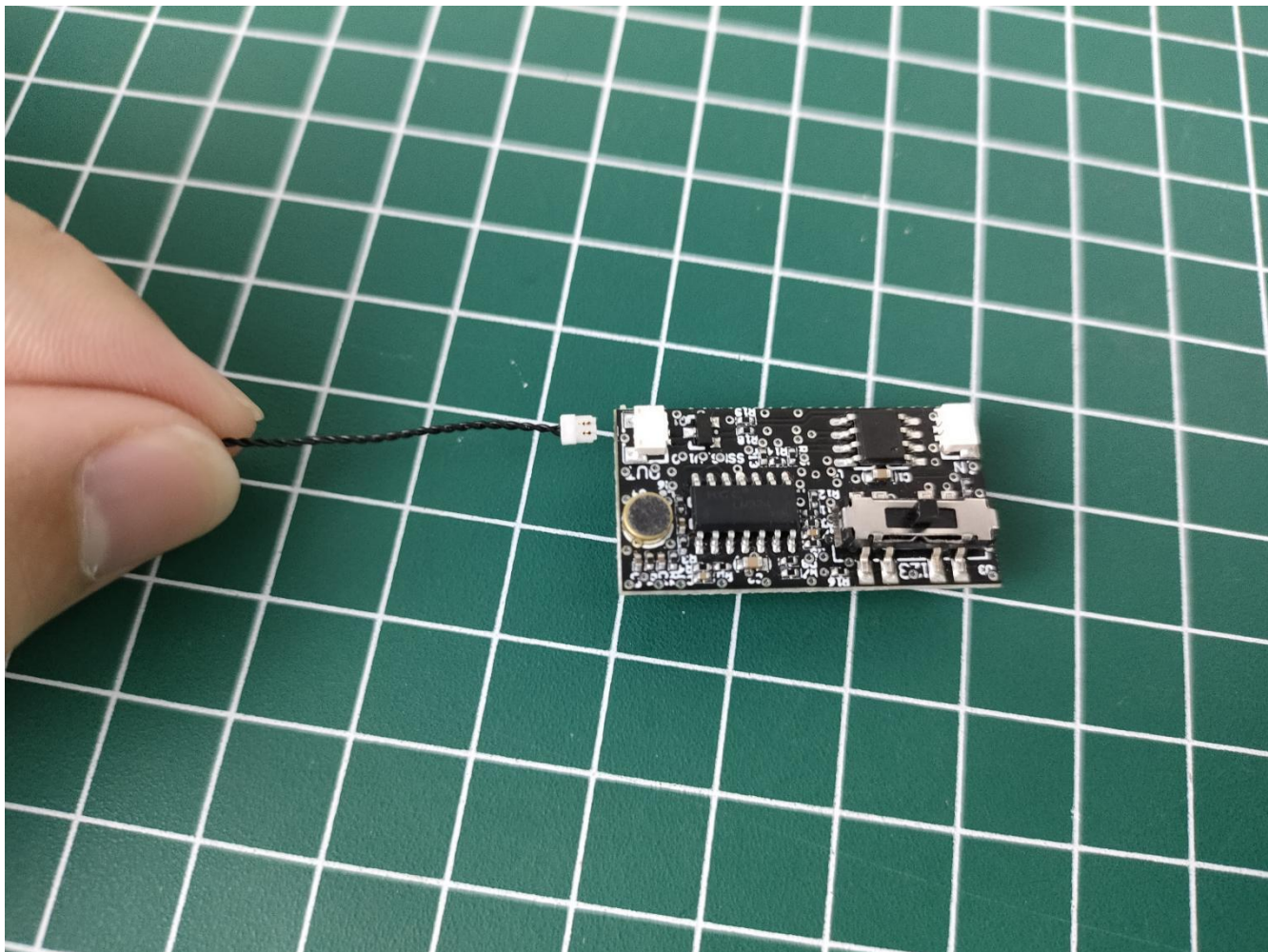

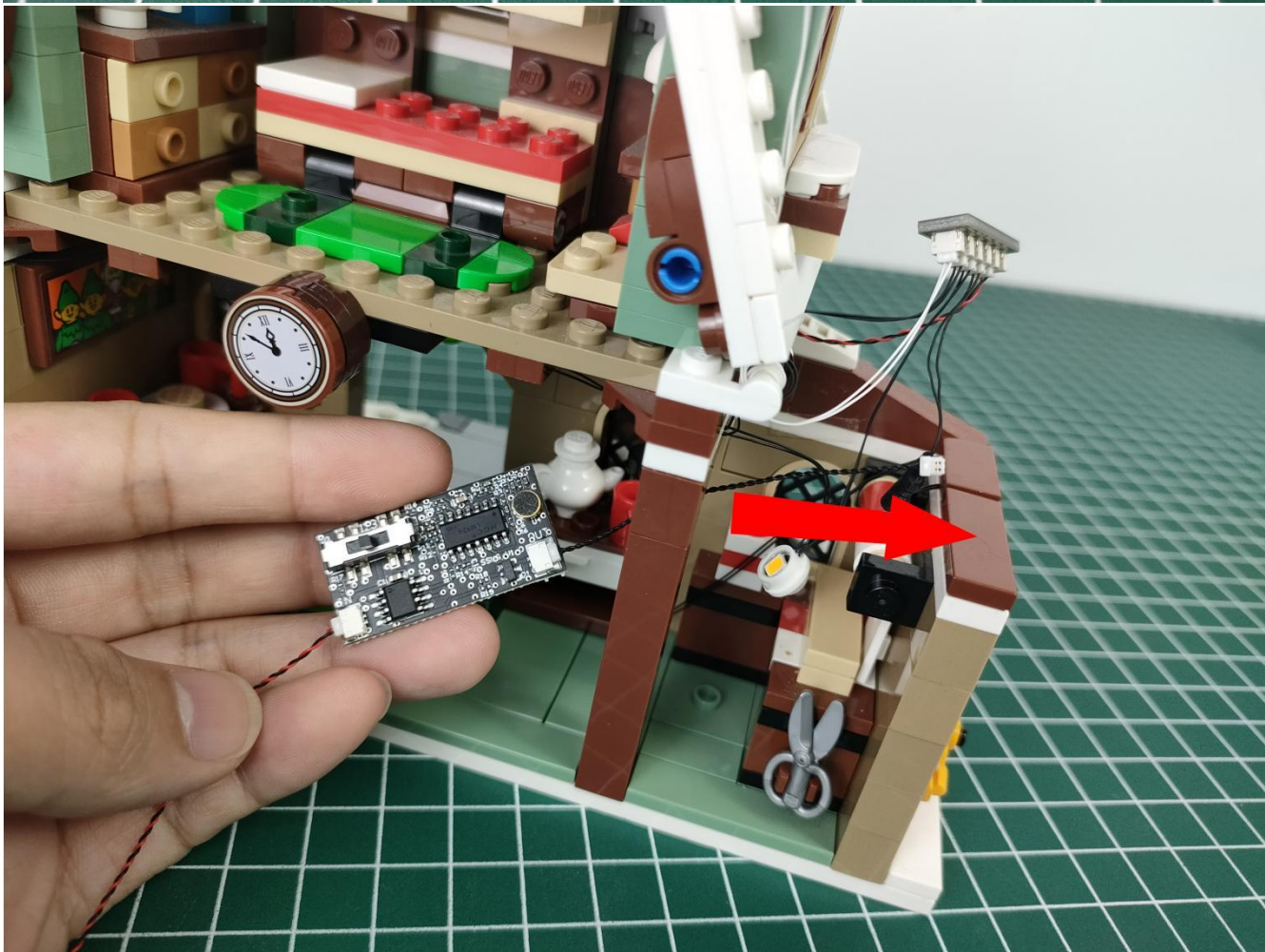
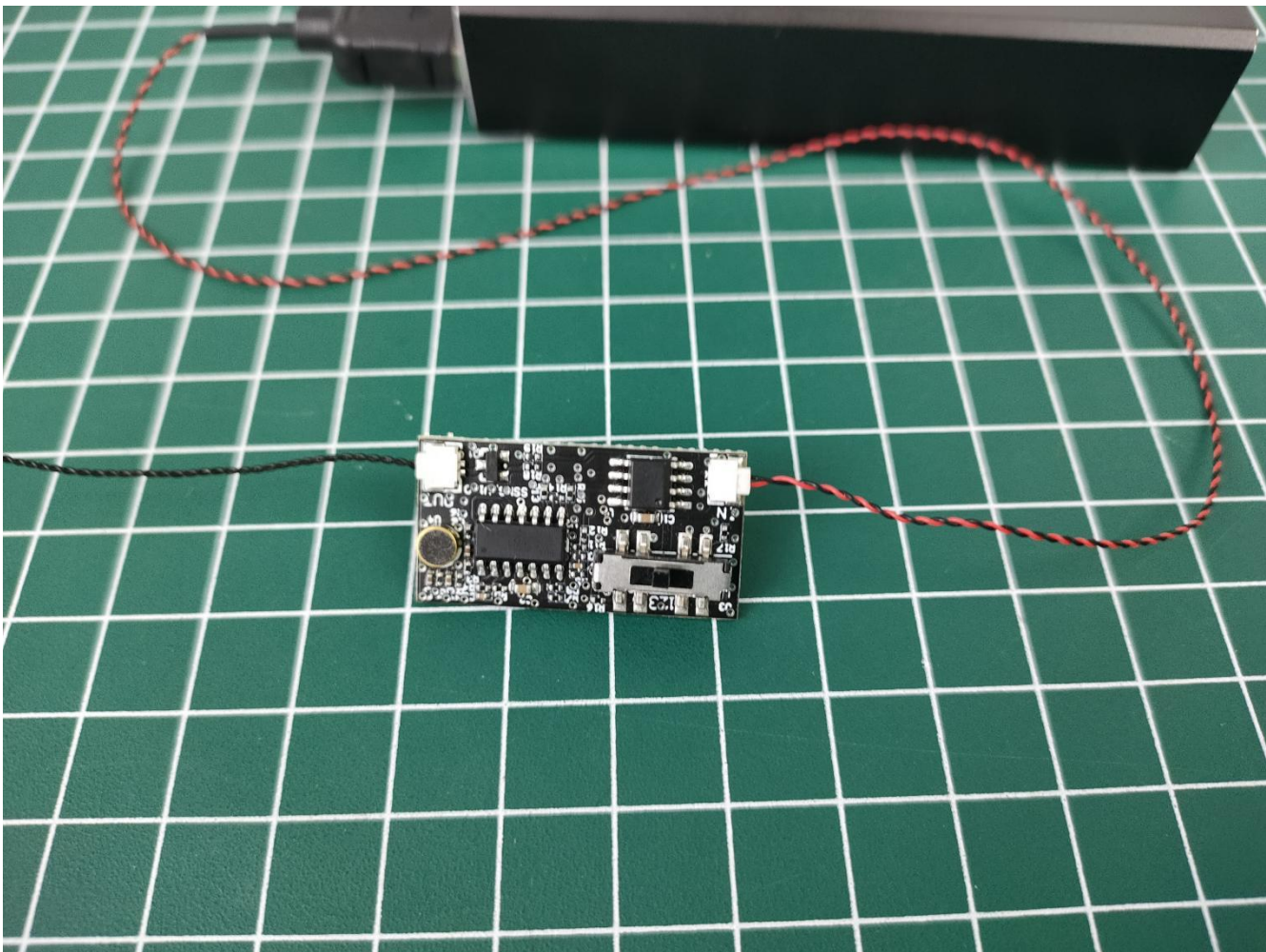

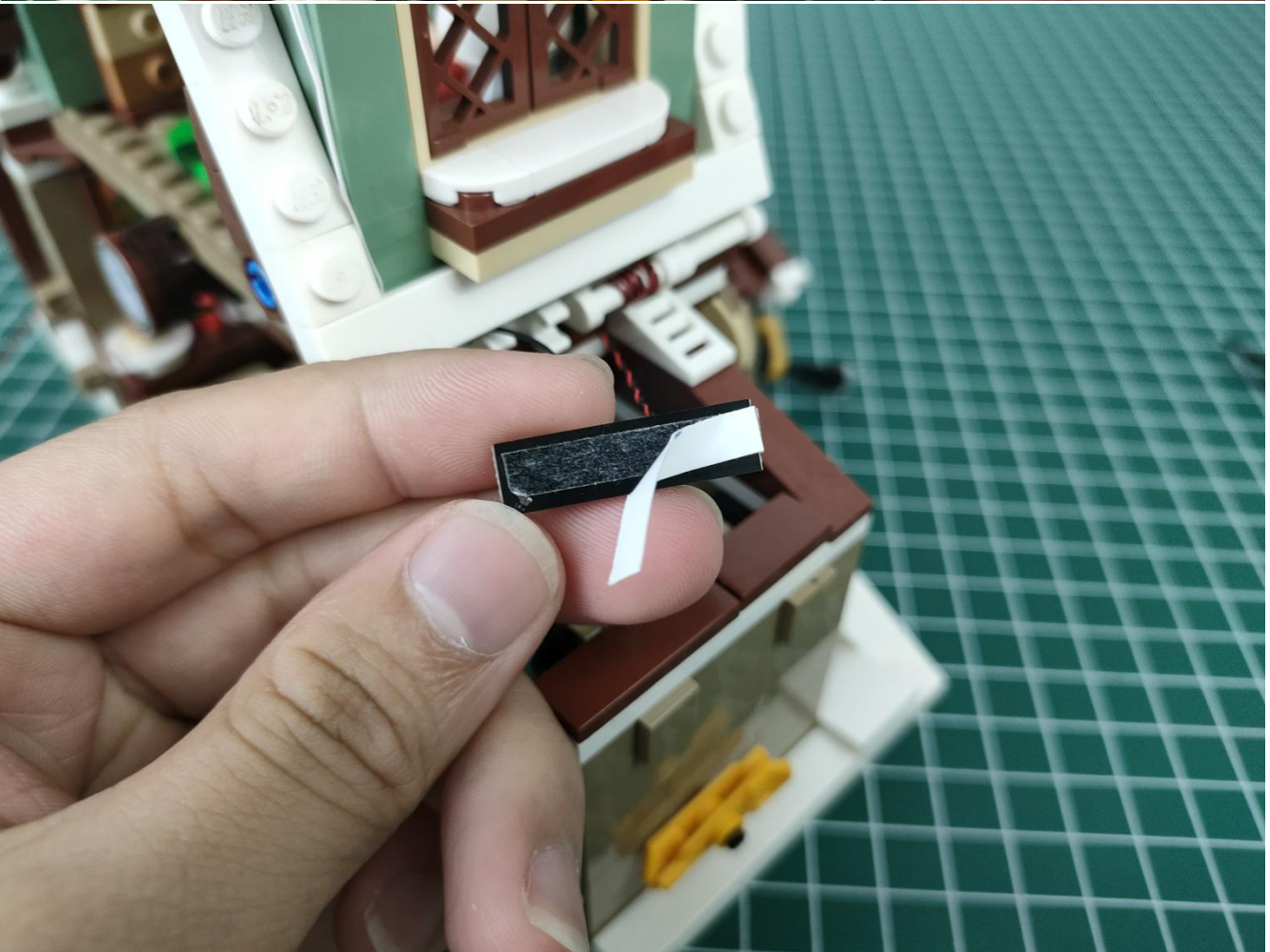
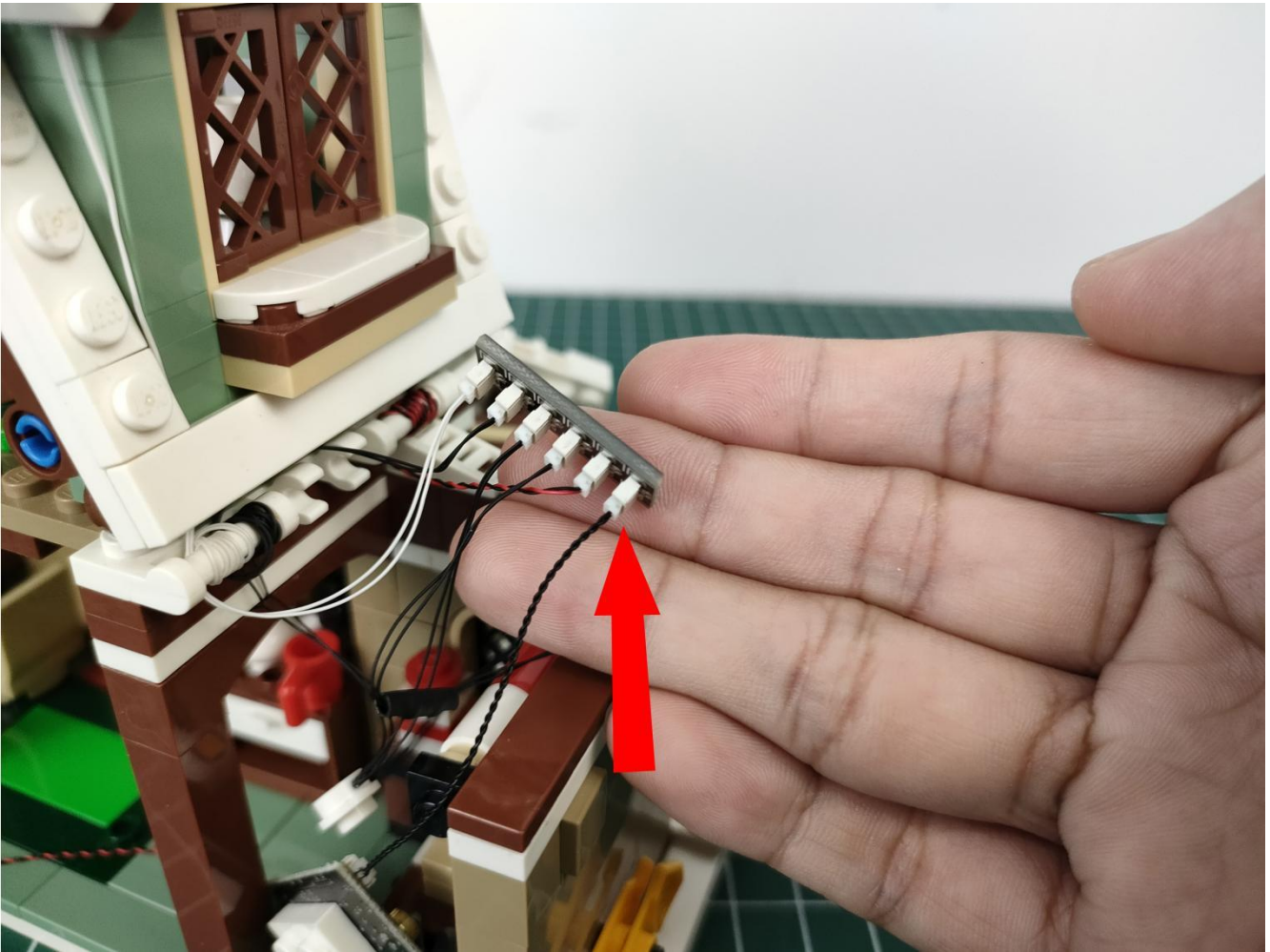

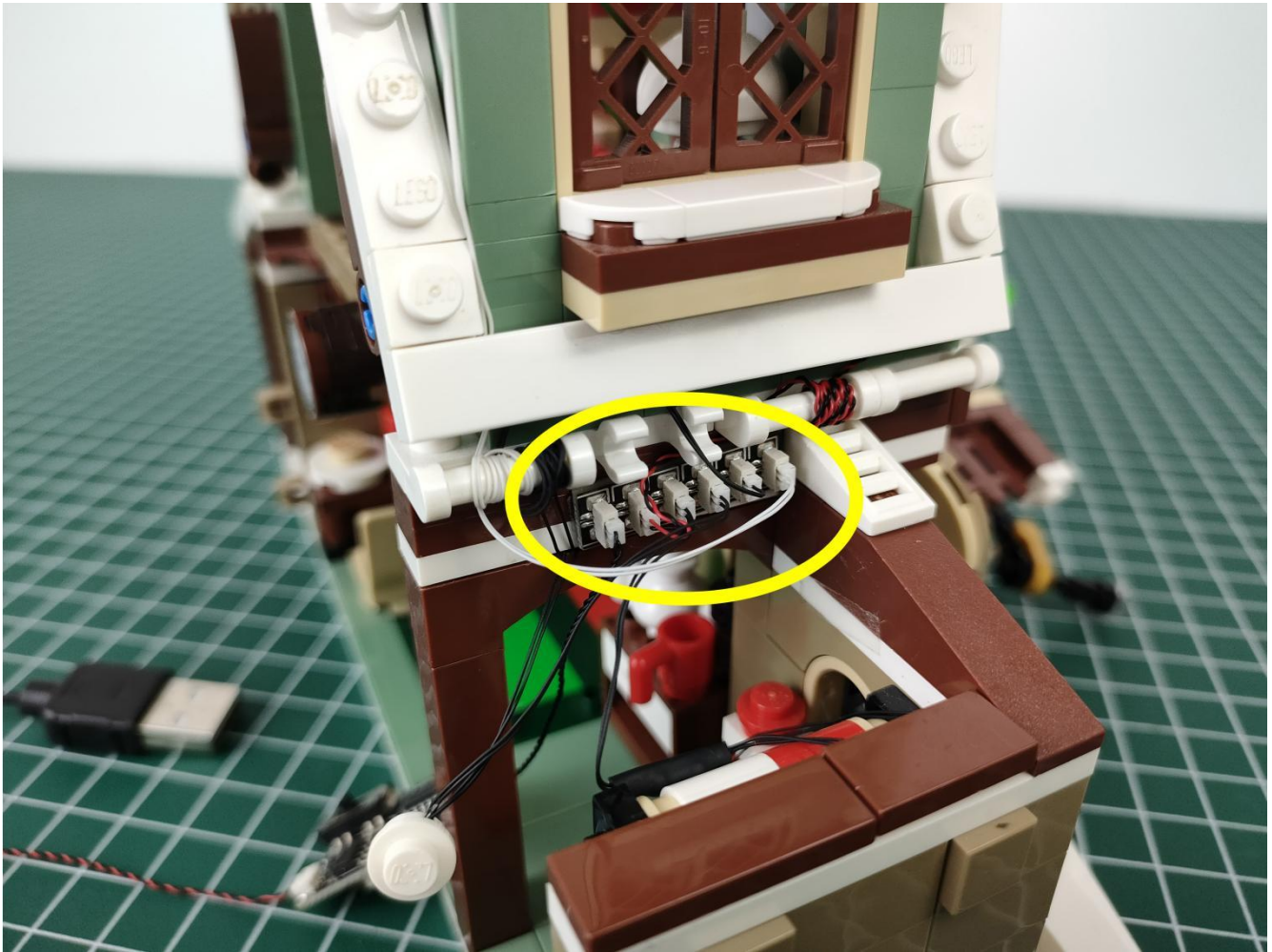







The above are ideas and instructions provided by our designers. Please move on:

- 1: Do you have any suggestions about the material and quality of our products?
- 2: Do you have any suggestions on the installation instructions and the degree of difficulty of the installation?
- 3: If you have better installation method and ideas, please contact us in time.