

# INSTALLATION GUIDE

**21368 PEANUTS:  
Snoopy's doghouse**  
Remote-controlled model



LED light kit compatible with Lego

# Instructions for installing this kit:

This set includes 6 pouches. (The battery case functions similarly; please select your own power source. This article uses a USB power cable.)

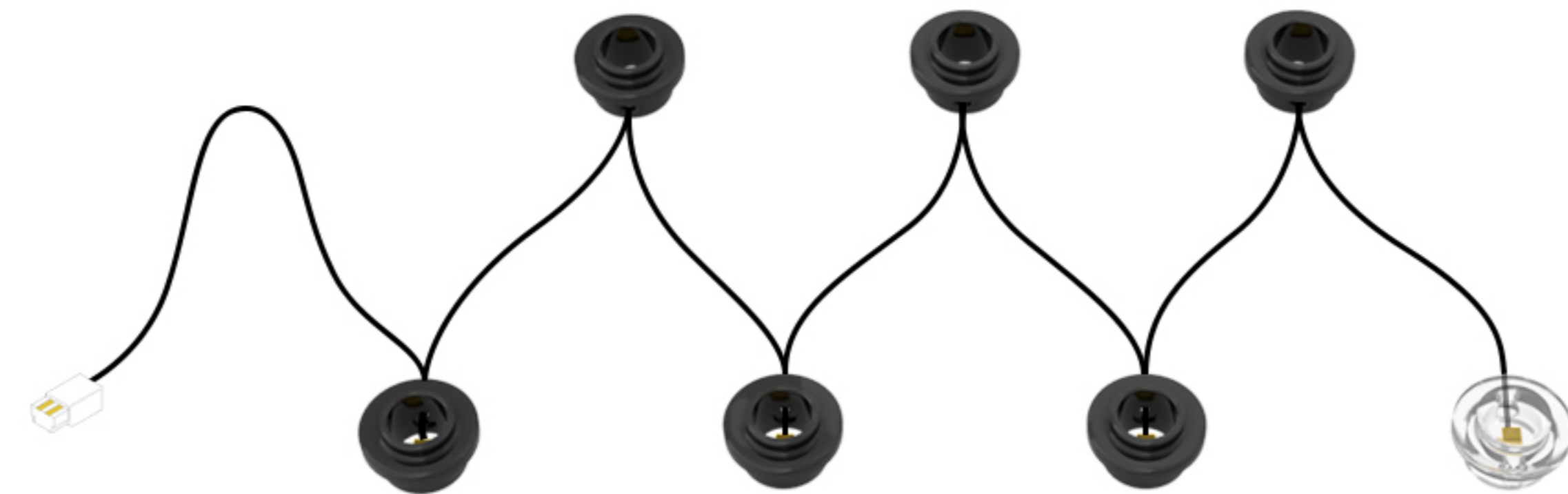
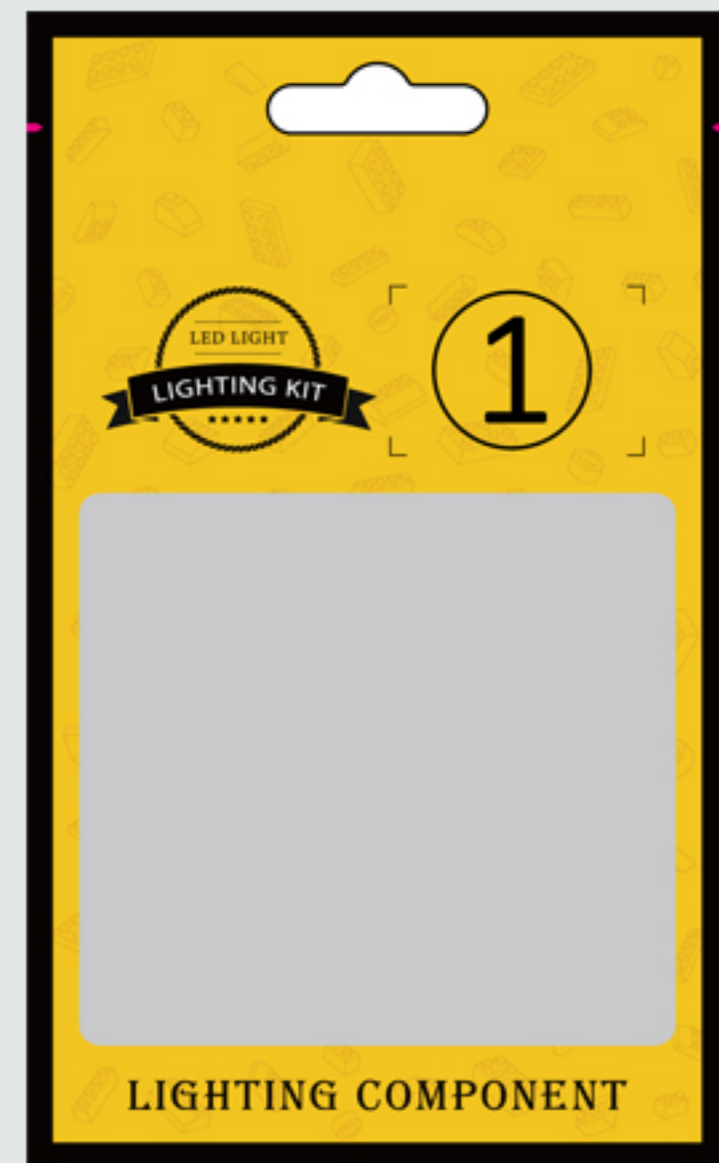

(X1)

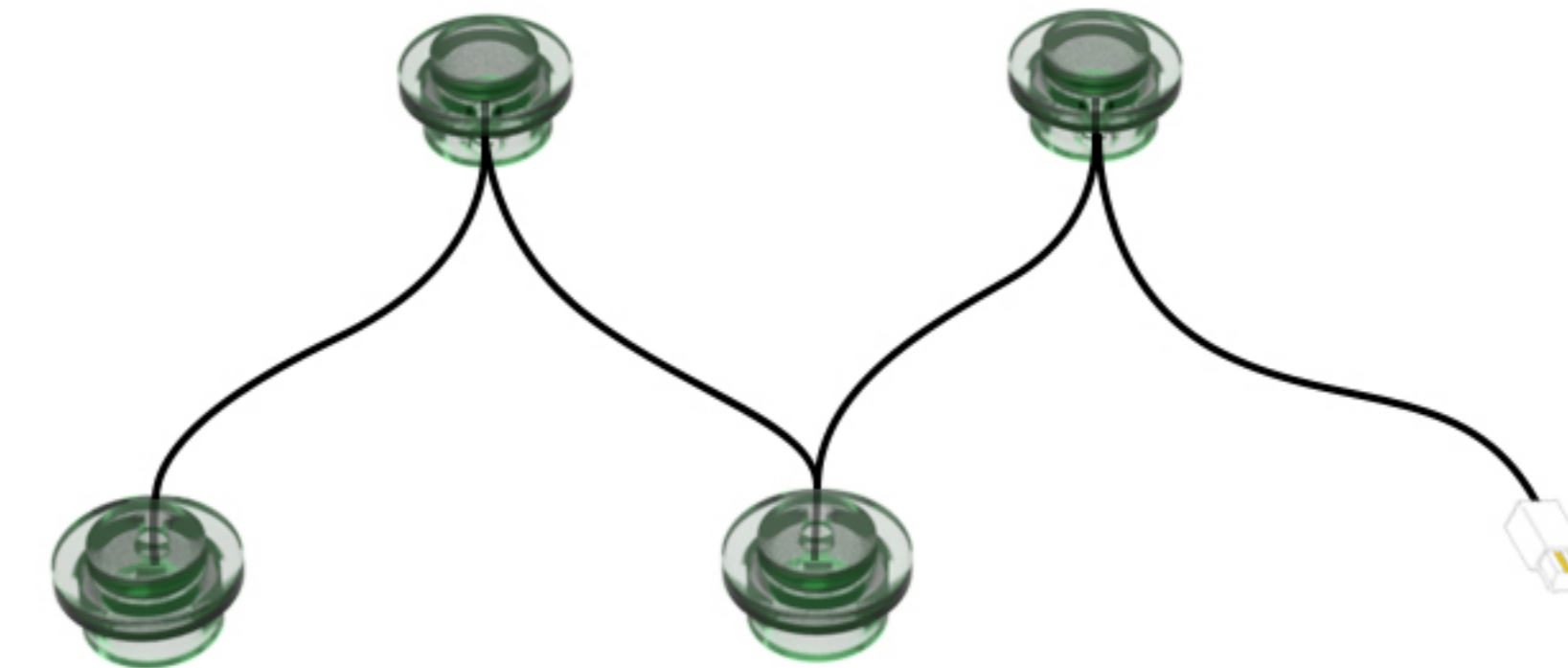

(X1)

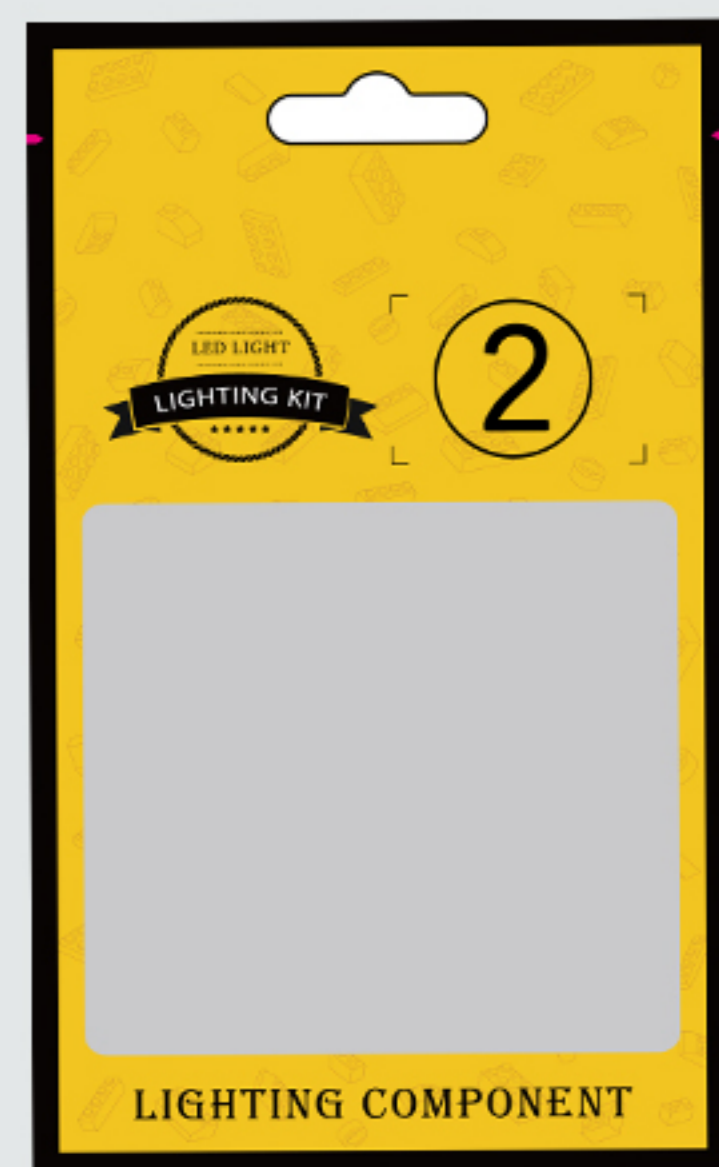

(X1)

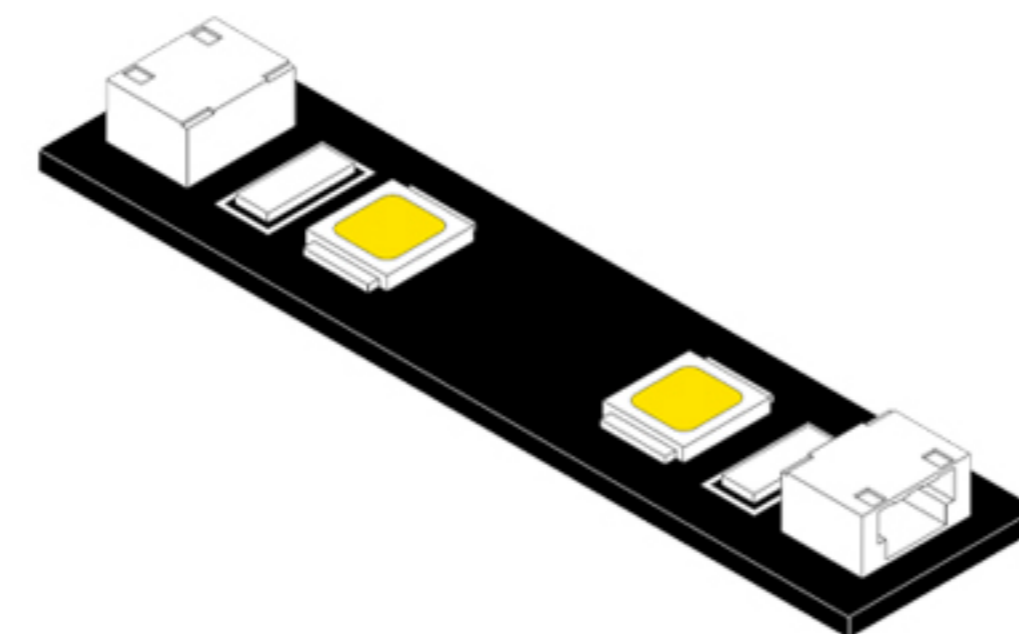

(X2)

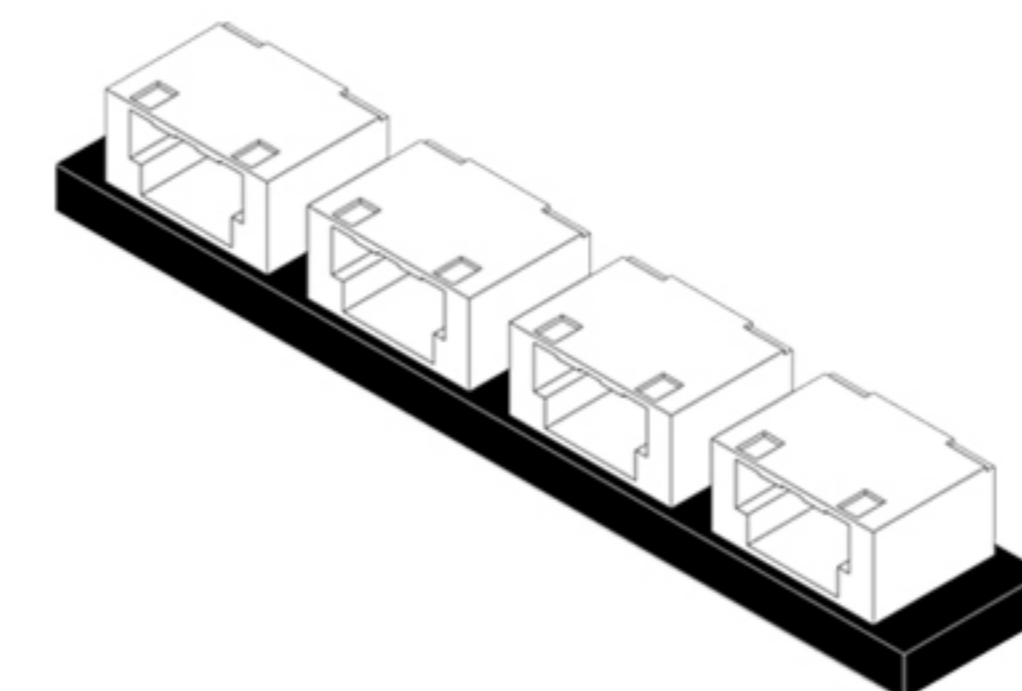

(X1)

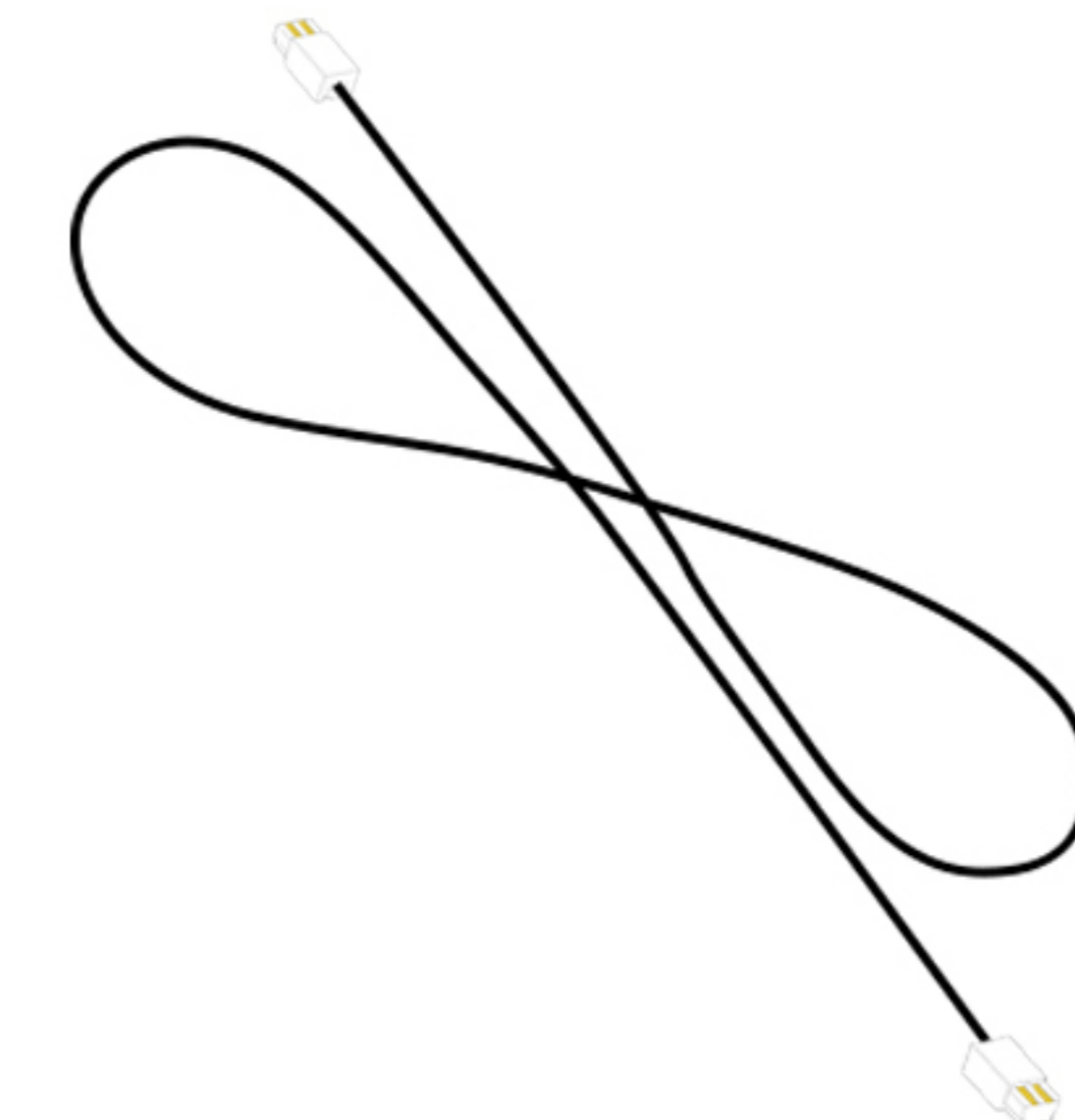

(X1)

10cm

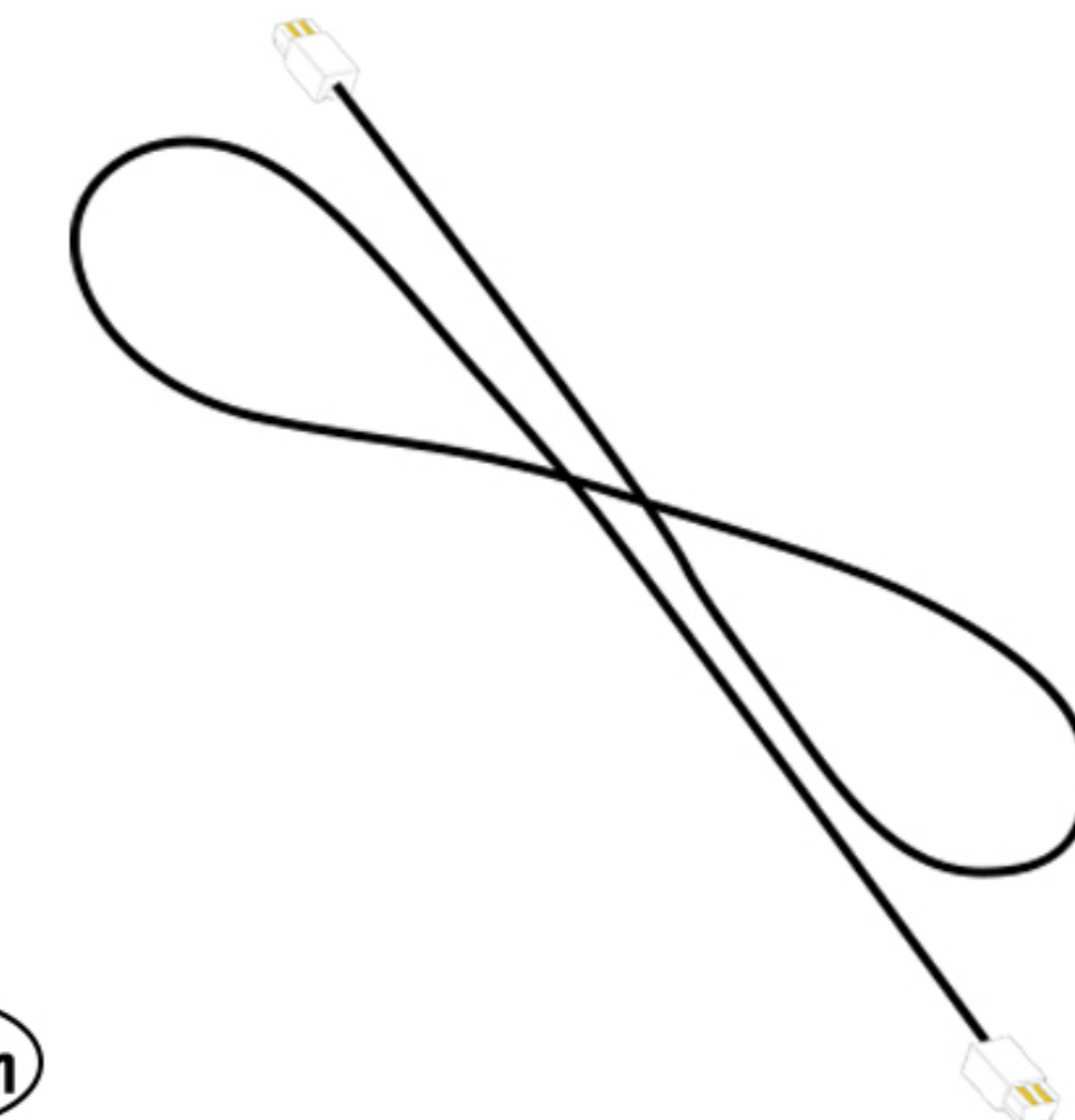

(X1)

15cm



(X1)

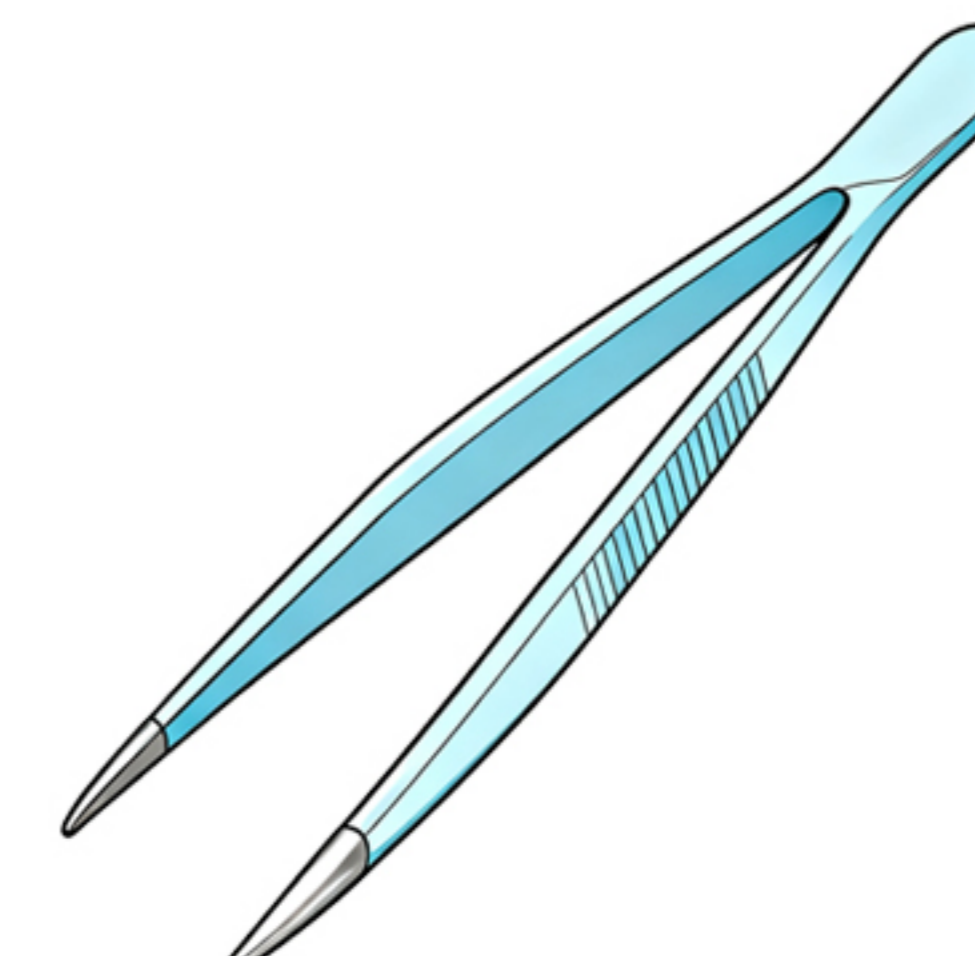
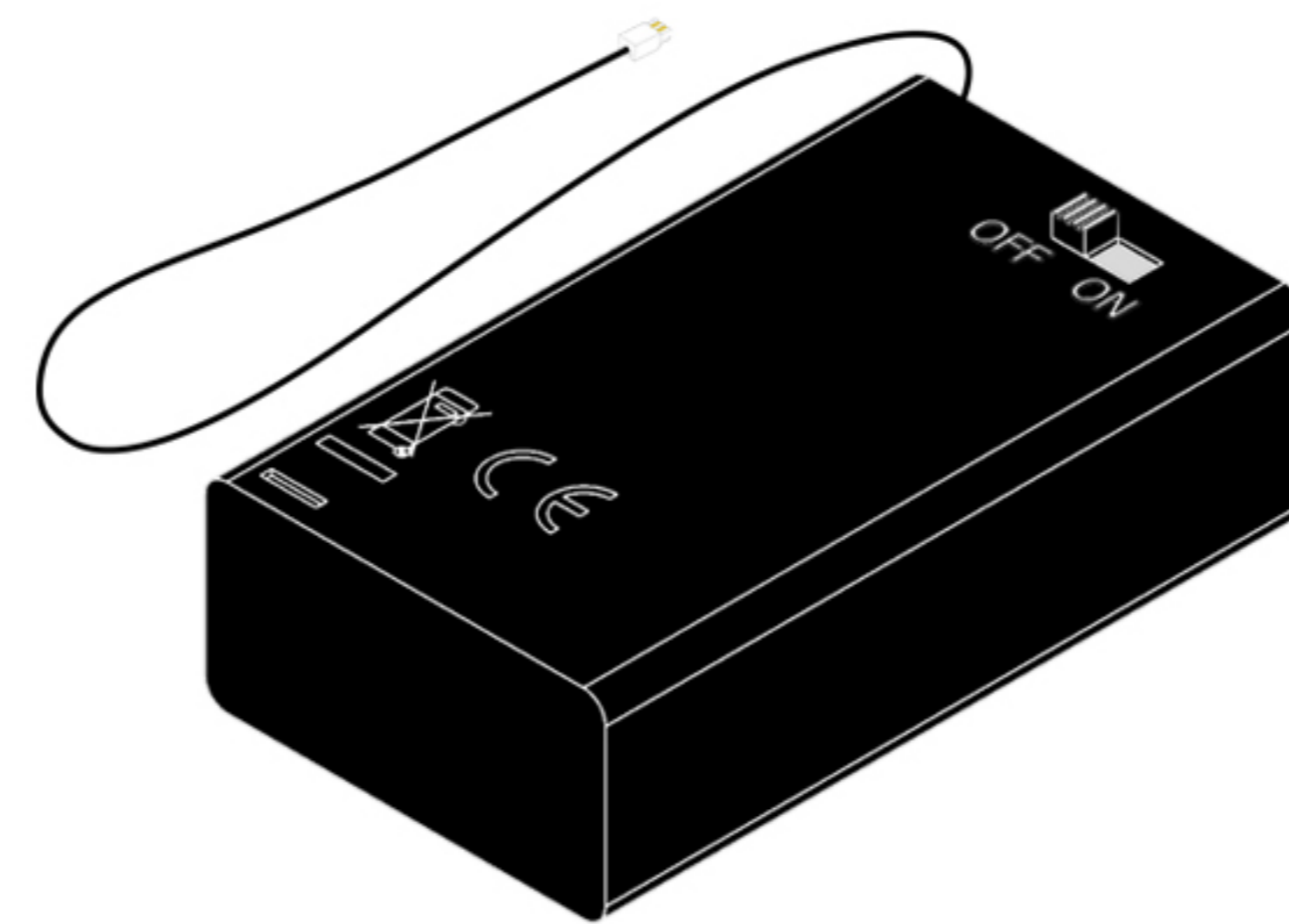
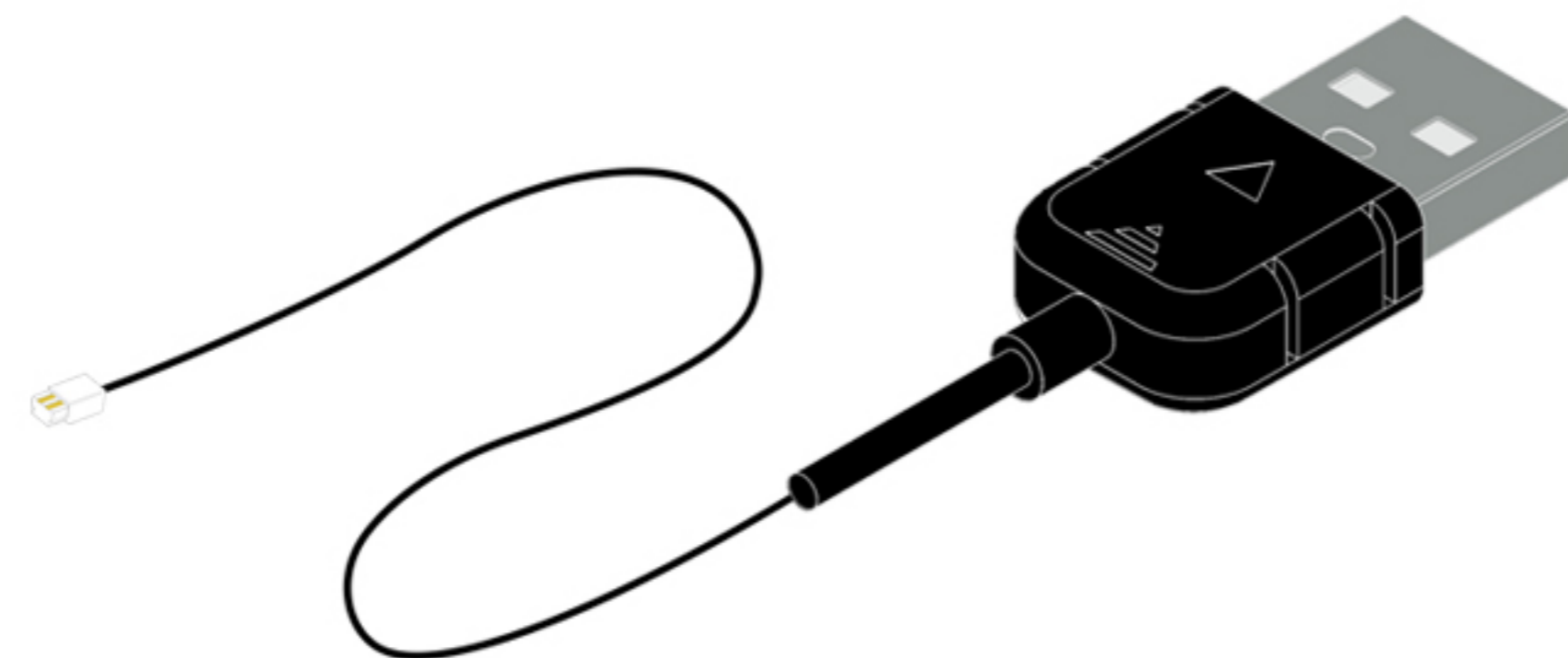
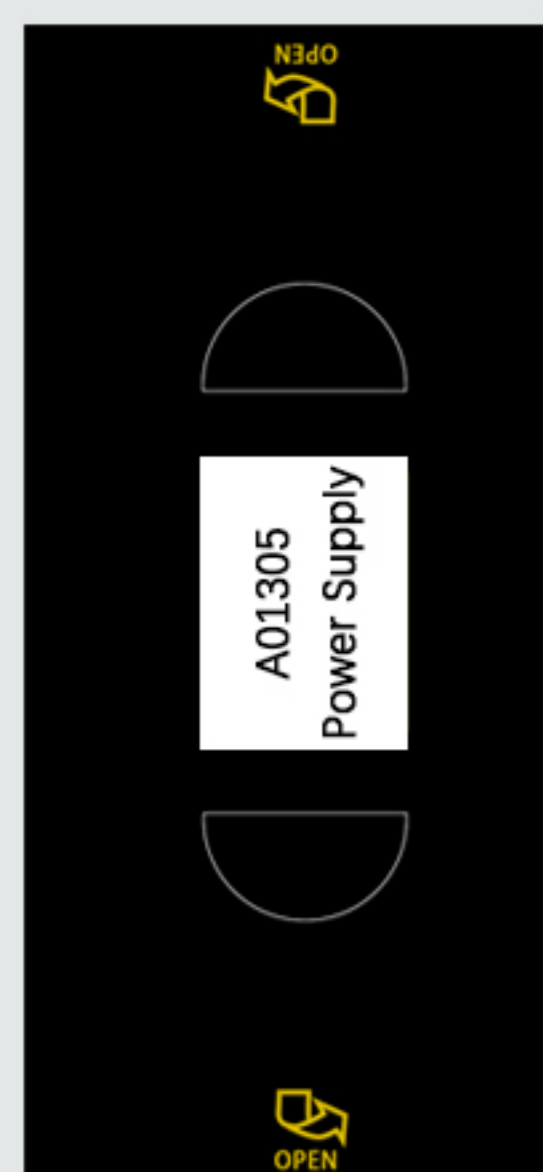
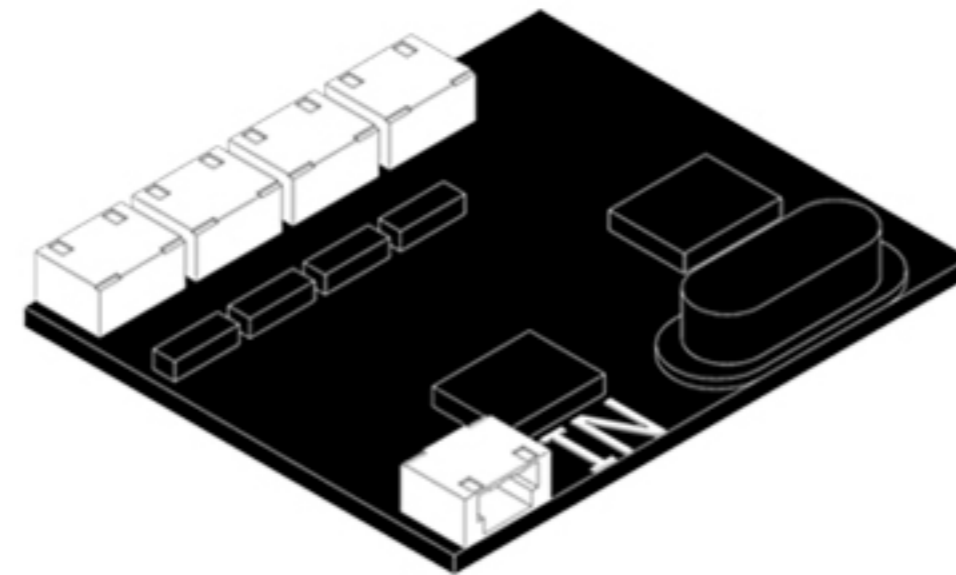
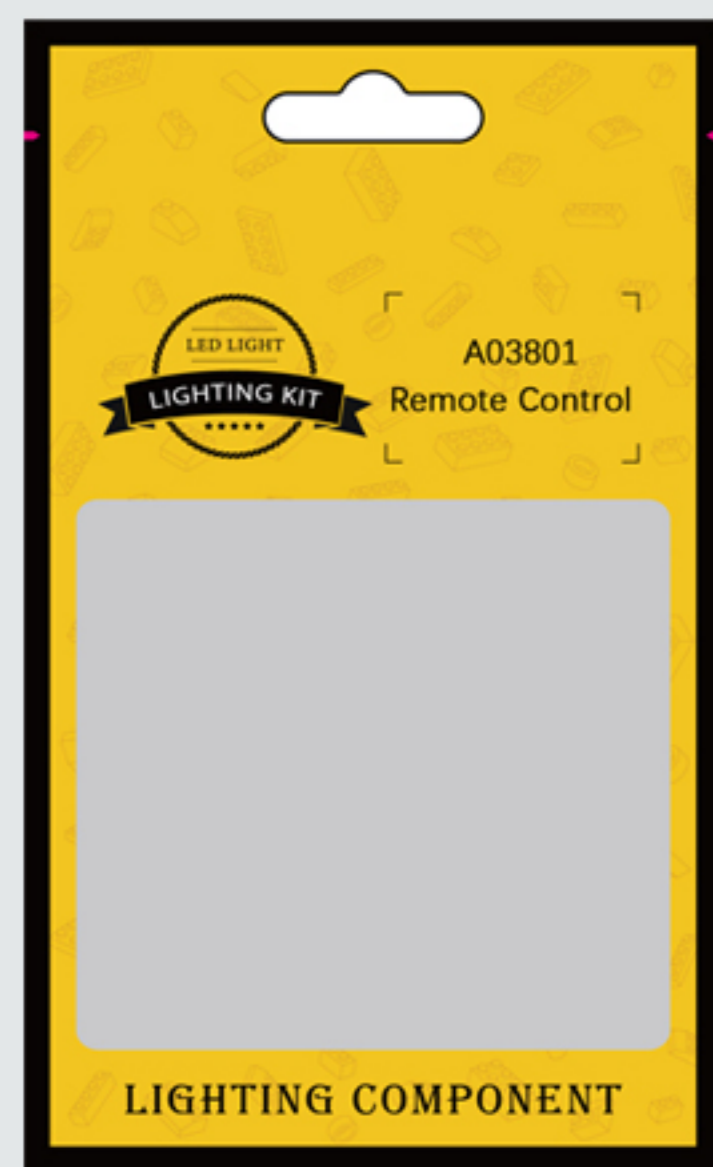
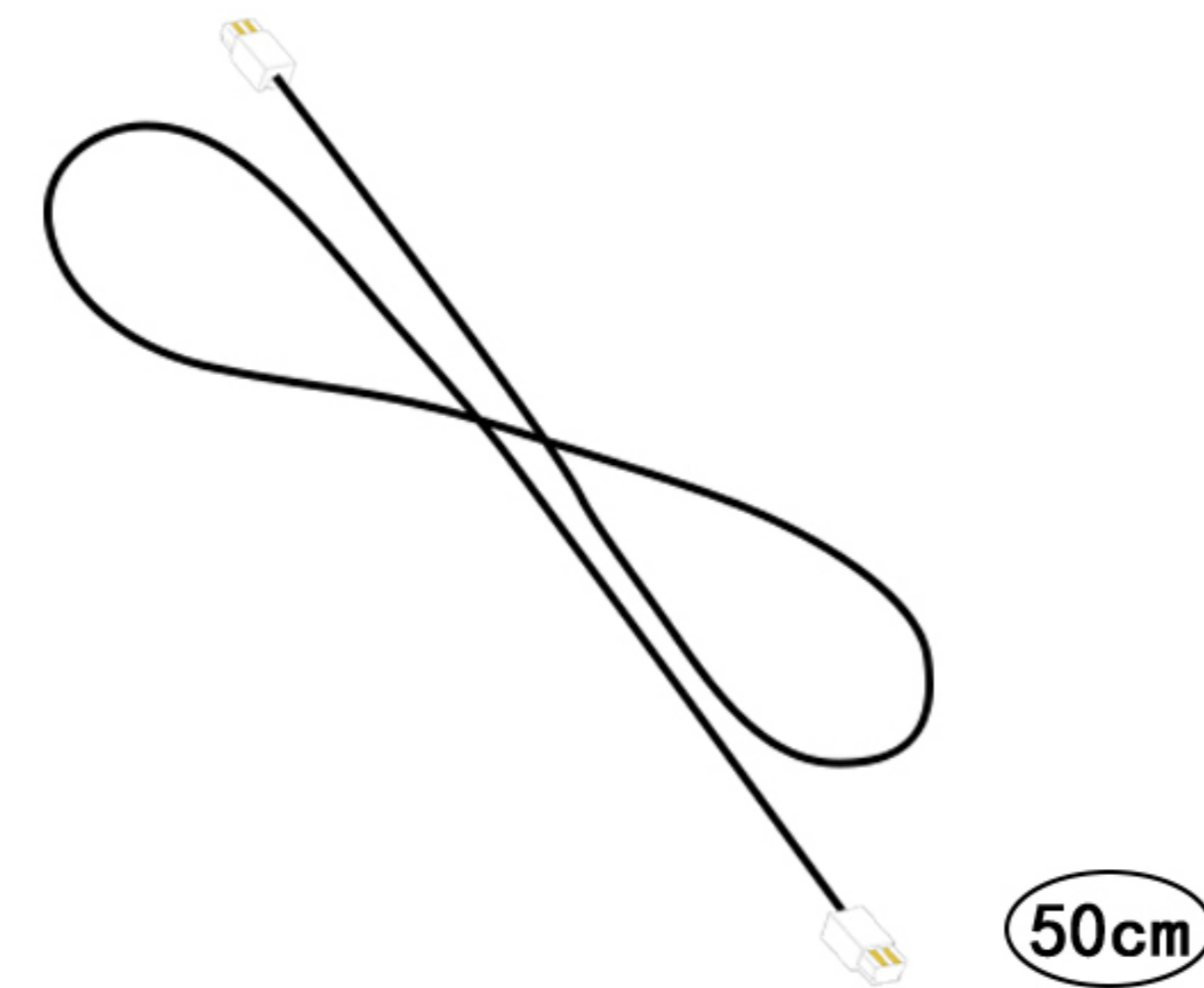
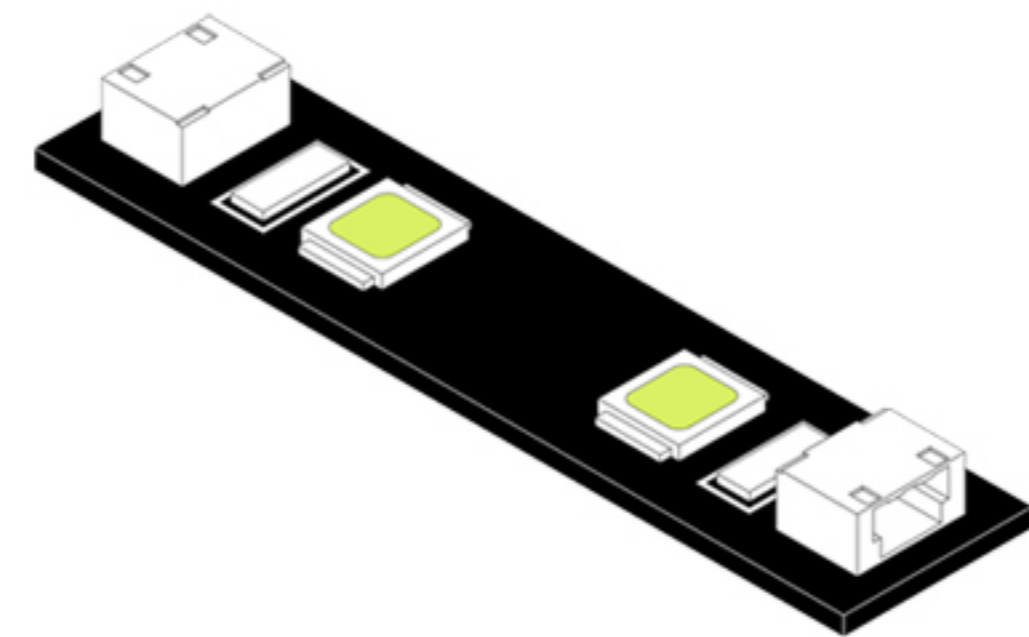
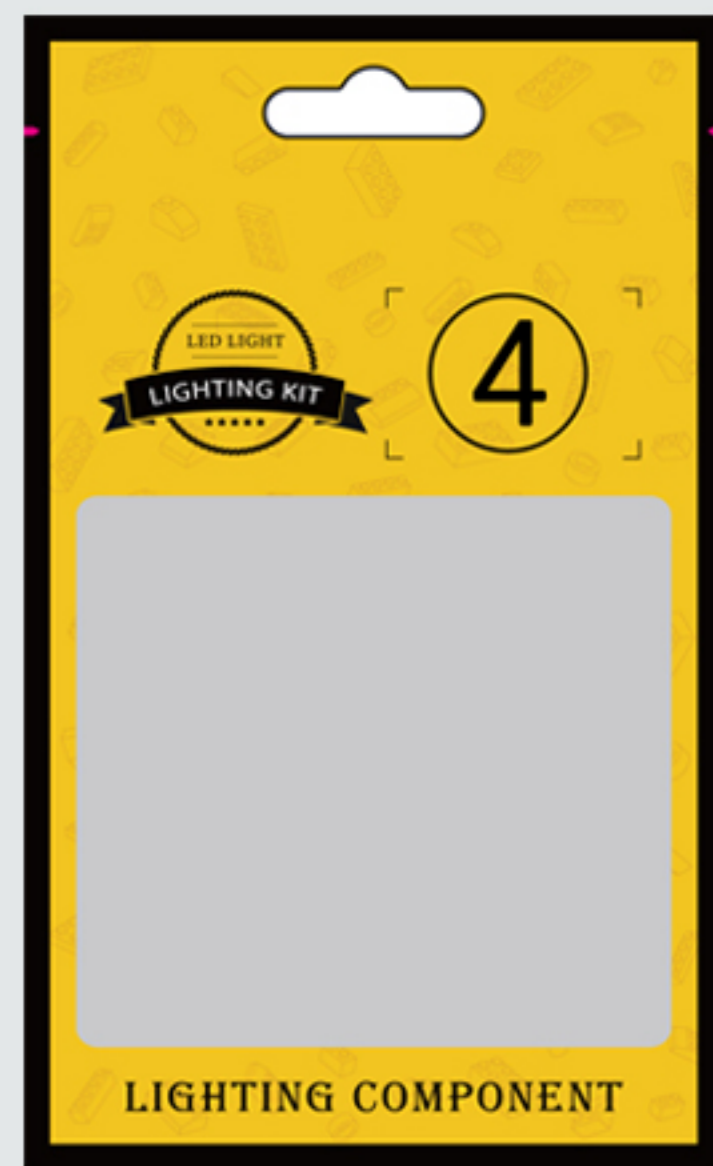

This post will complete the light installation in two main sections.

Step 1-test



Step 2-mounting

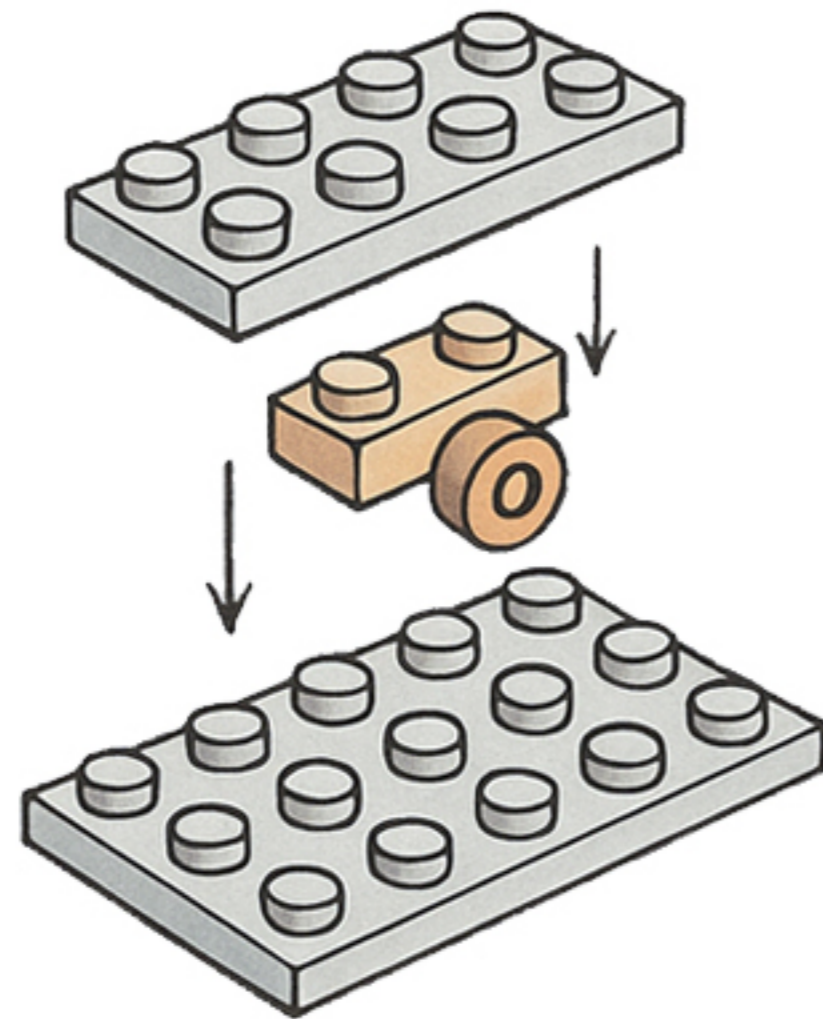

So let's get started!

## Step 1-Test.

1

EN: Remove the expansion board from Bag 2.

DE: Entnehmen Sie die Erweiterungskarte aus Beutel 2.

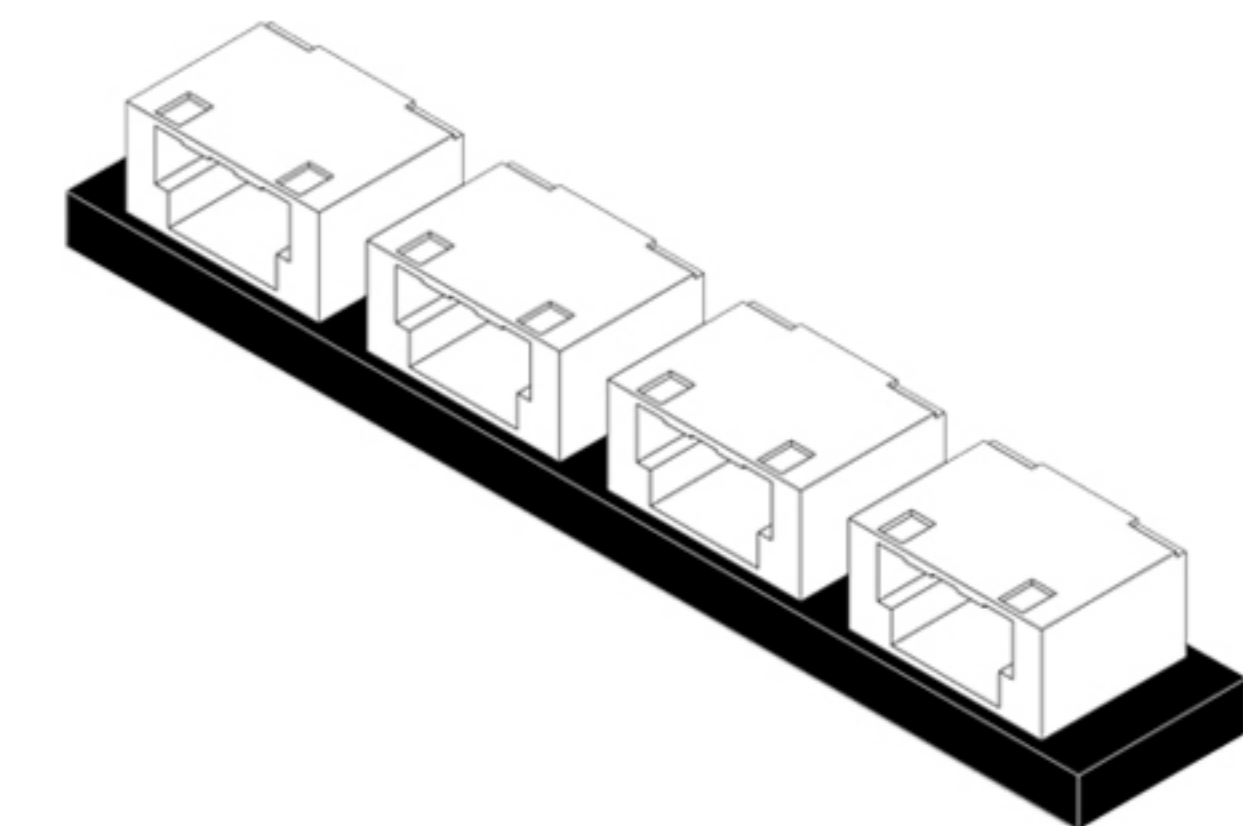

x1

2

EN: Take the USB power cable out of the box and connect it to the expansion board.

DE: Nehmen Sie das USB-Stromkabel aus der Verpackung und schließen Sie es an die Erweiterungskarte an.

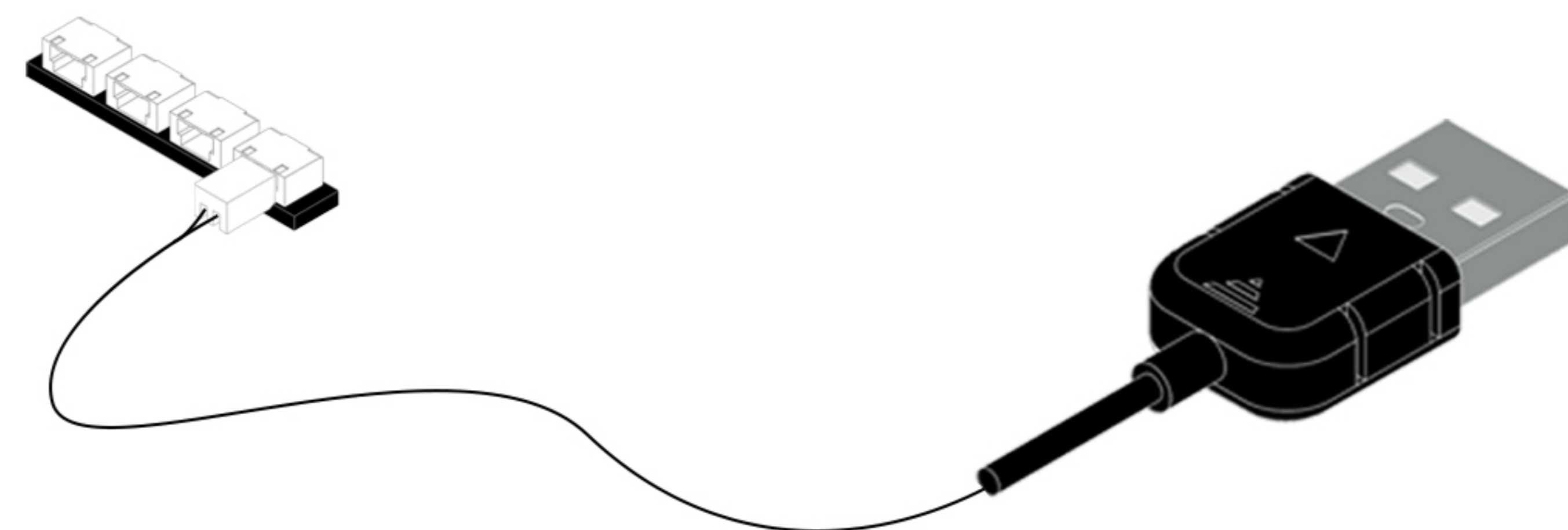
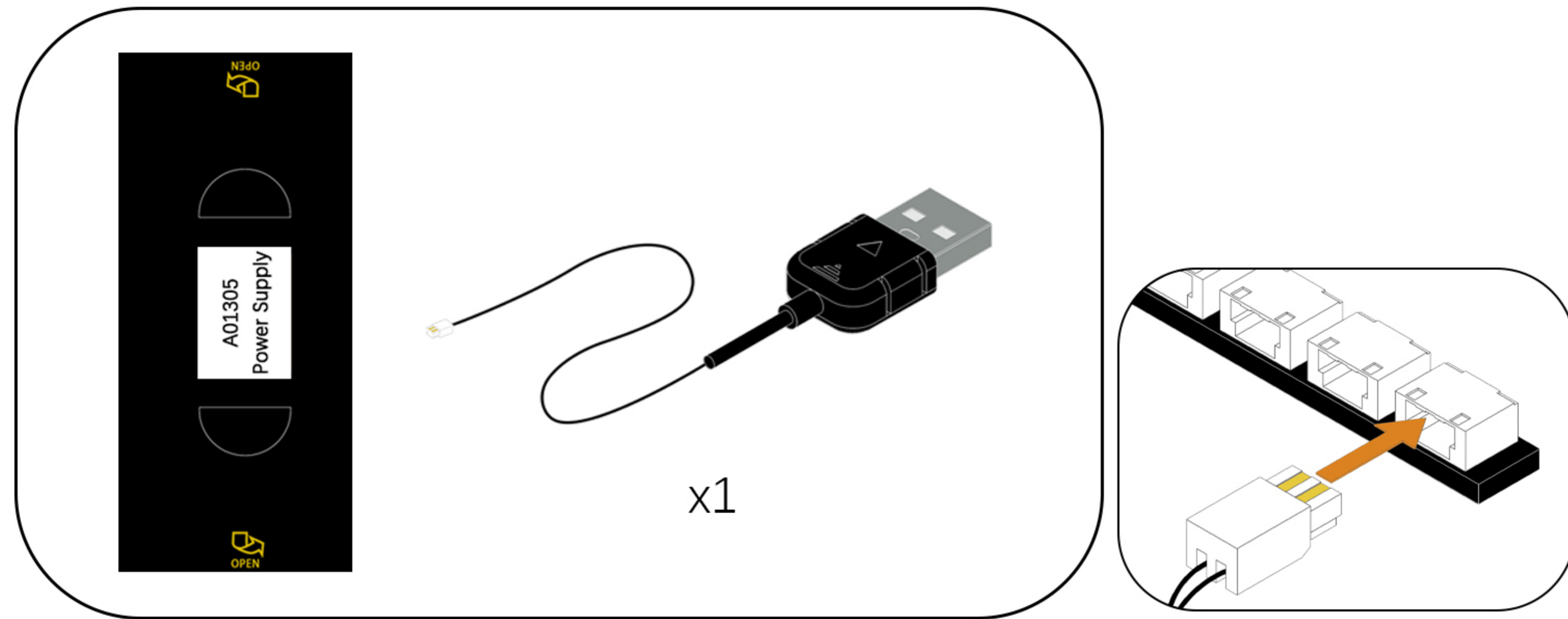

3

EN: Connect the USB power cable to the mobile power supply. (Power supply not included; see the diagram below for power supply options.)

DE: Schließen Sie das USB-Netz-kabel an die mobile Stromversorgung an. (Stromversorgung nicht im Lieferumfang enthalten, siehe Abbildung unten für die Stromversorgungsart.)

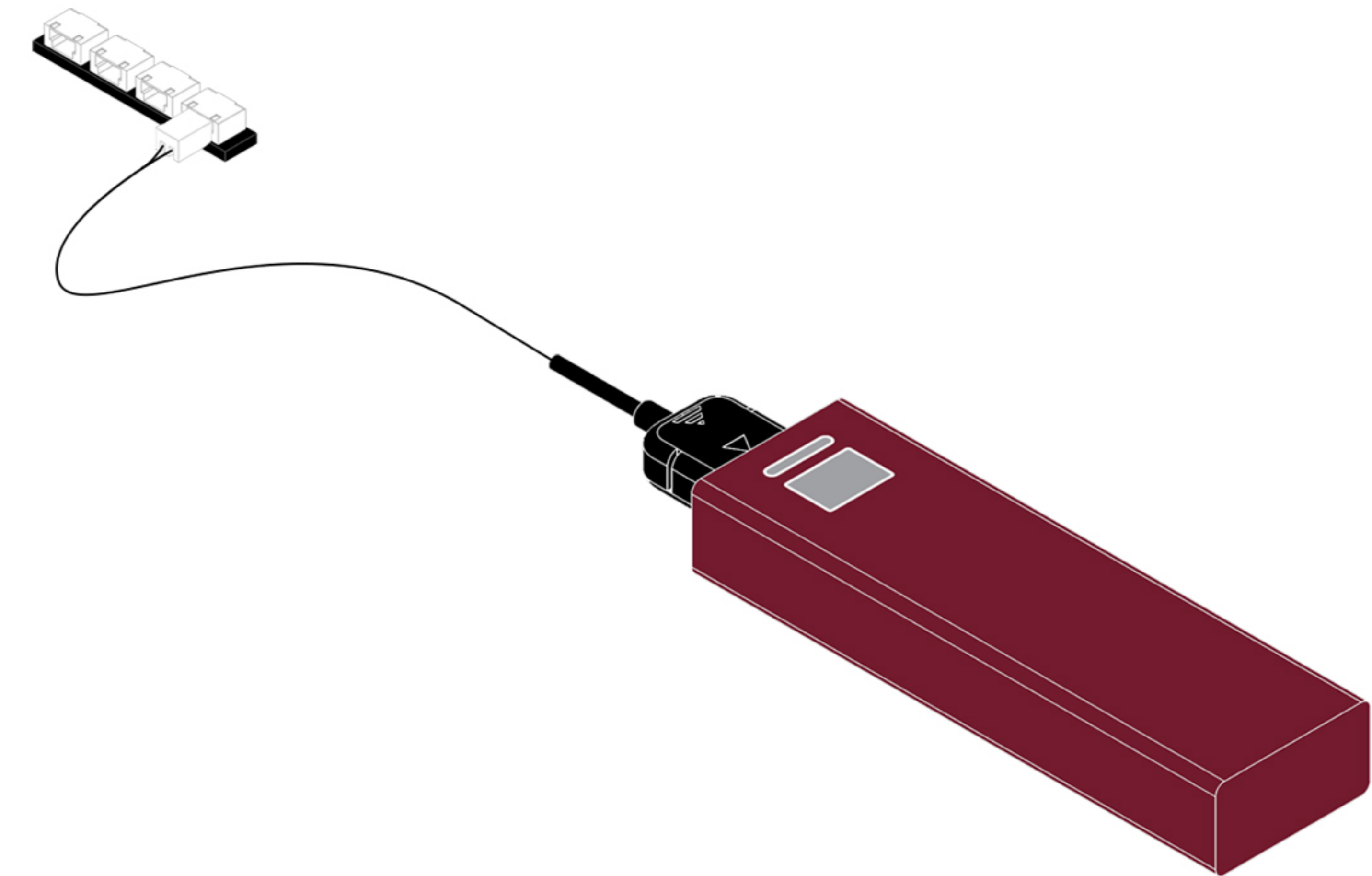

### USB Connectors to Connect Devices

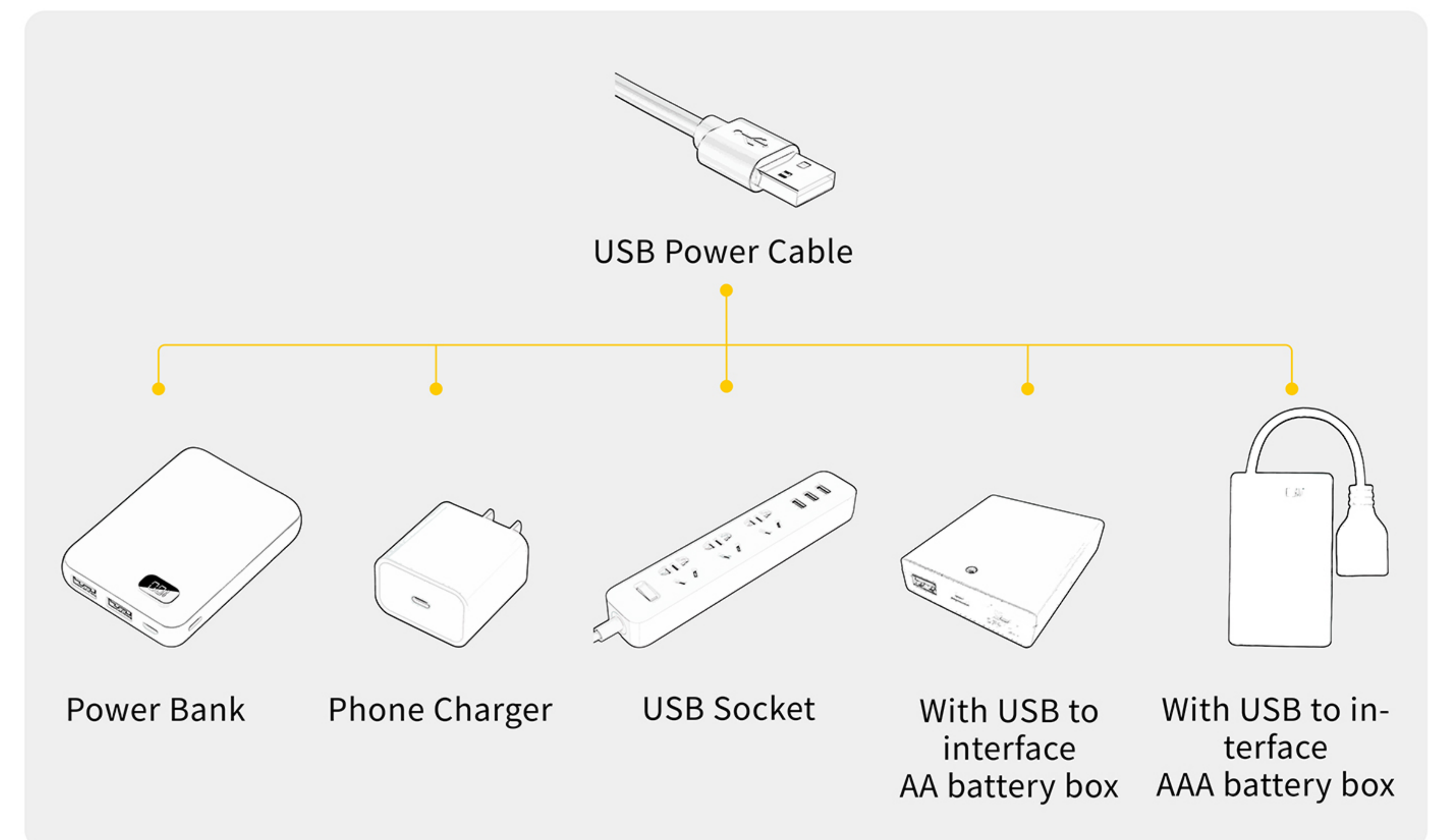

4

EN: Remove the string of lights from Bag 1, connect it to the expansion board, turn on the power, and check that the lights are working properly. If you notice any issues, please contact us immediately.

DE: Nehmen Sie die Lichterkette aus Beutel 1, schließen Sie sie an die Erweiterungskarte an, schalten Sie den Strom ein und überprüfen Sie, ob die Lichter ordnungsgemäß funktionieren. Sollten Sie Probleme feststellen, kontaktieren Sie uns bitte umgehend.

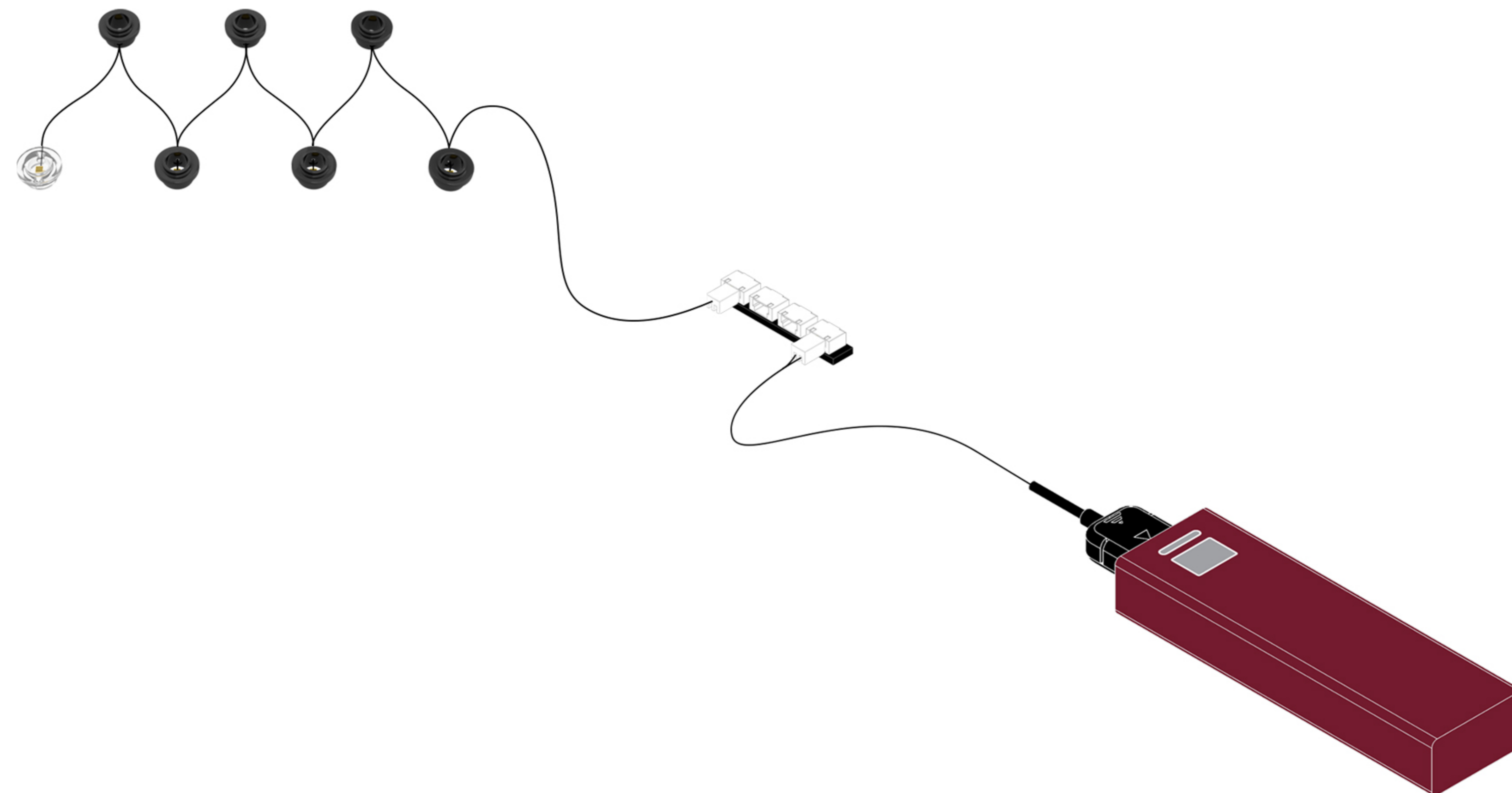
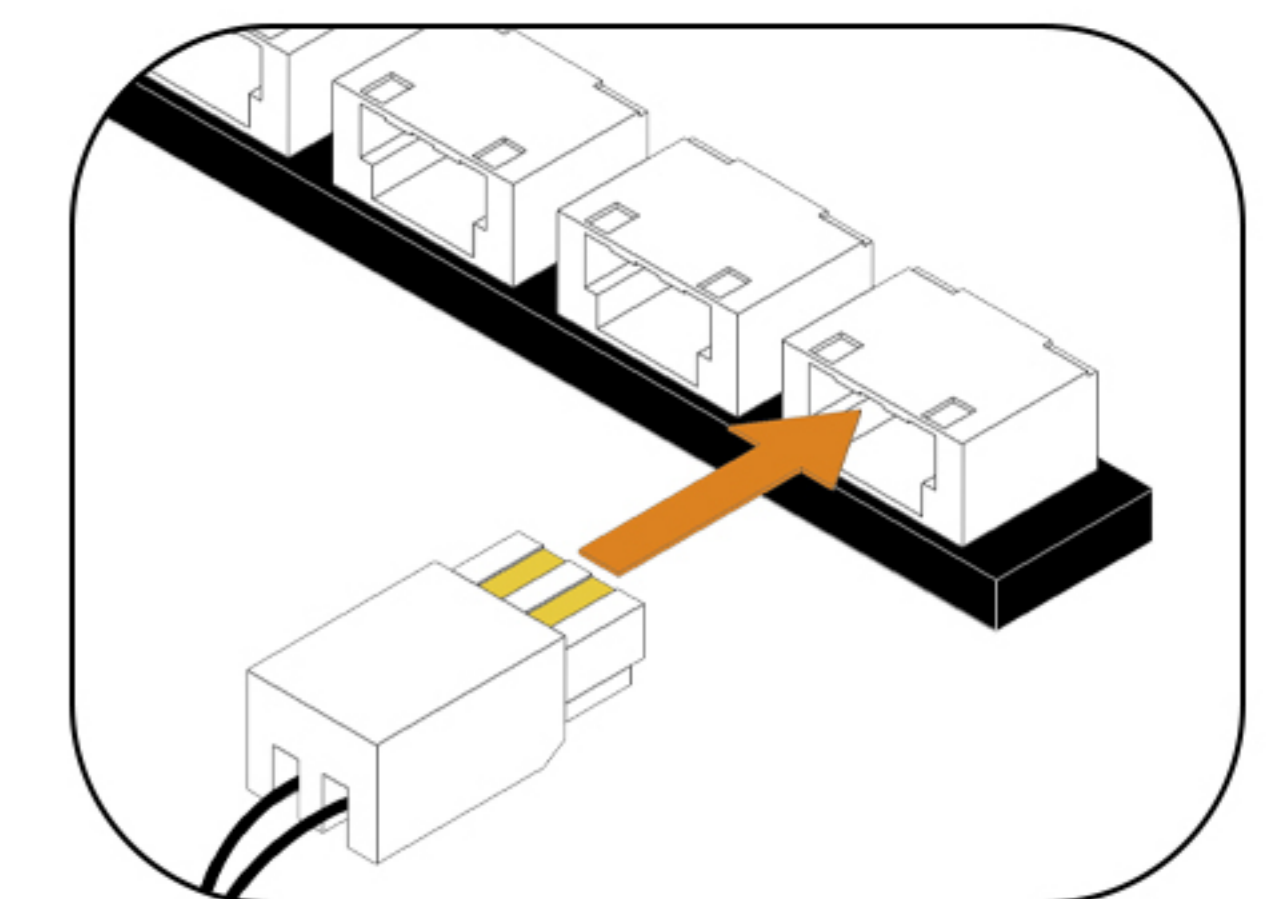
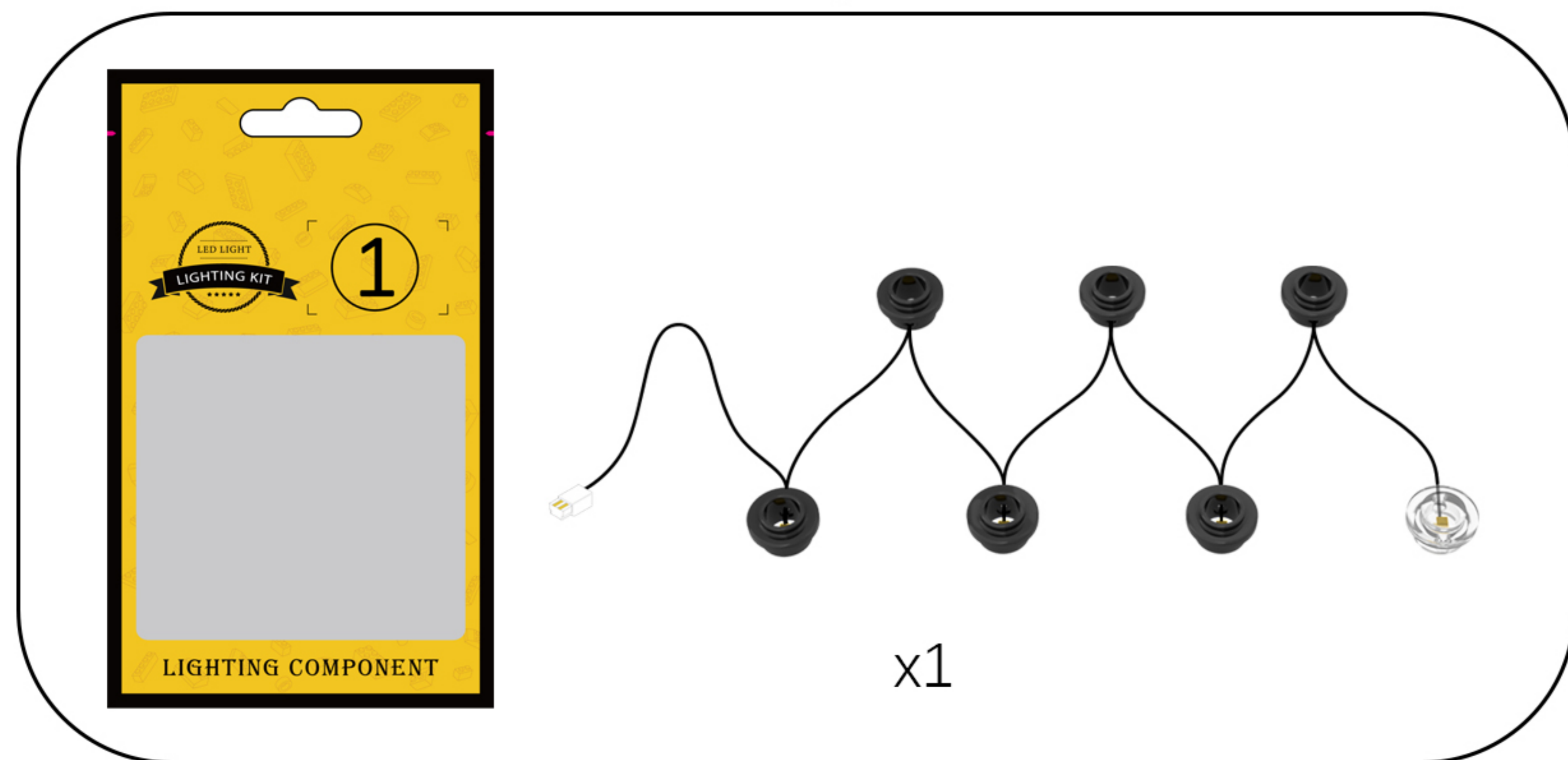

Once you've confirmed there are no issues, temporarily place the string lights and expansion board back in their original bag, then test the lights.

5

EN: Remove the light strip from Bag 2, connect it to the USB power cable, turn on the power, and check that the light strip is working properly. If you notice any issues, please contact us immediately.

DE: Nehmen Sie den Lichtstreifen aus Beutel 2, schließen Sie ihn an das USB-Stromkabel an, schalten Sie das Gerät ein und überprüfen Sie, ob der Lichtstreifen ordnungsgemäß funktioniert. Sollten Sie Probleme feststellen, kontaktieren Sie uns bitte umgehend.

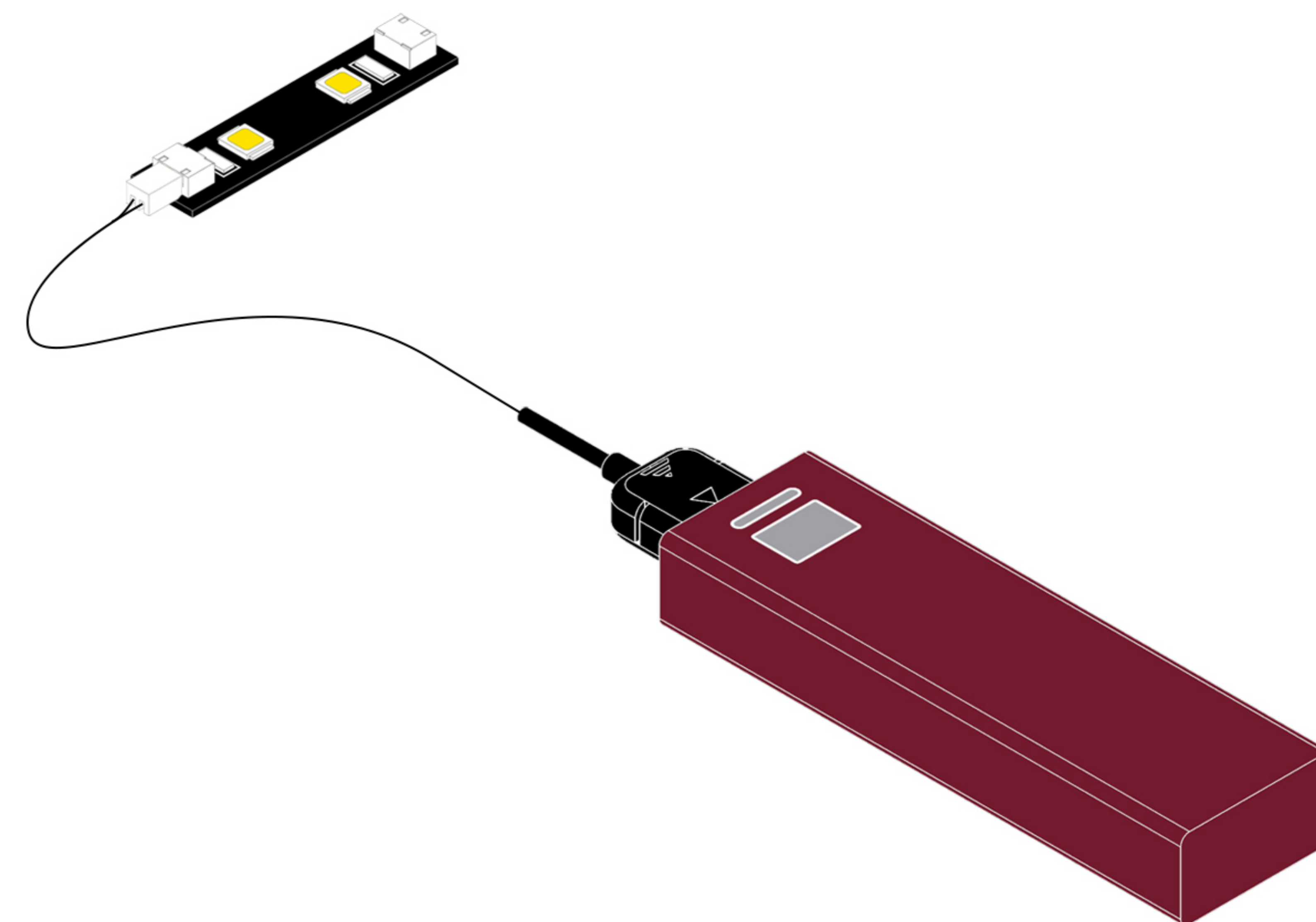
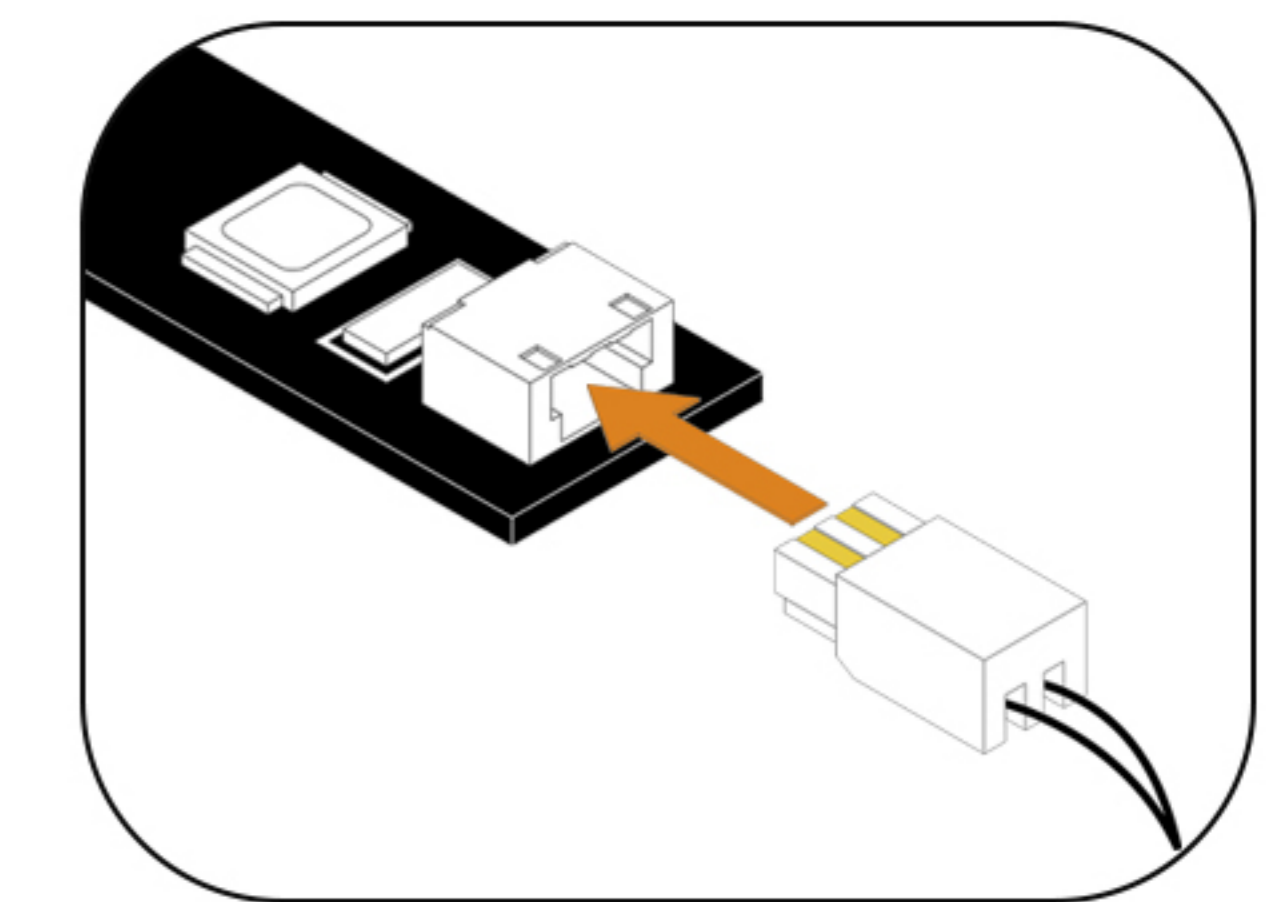
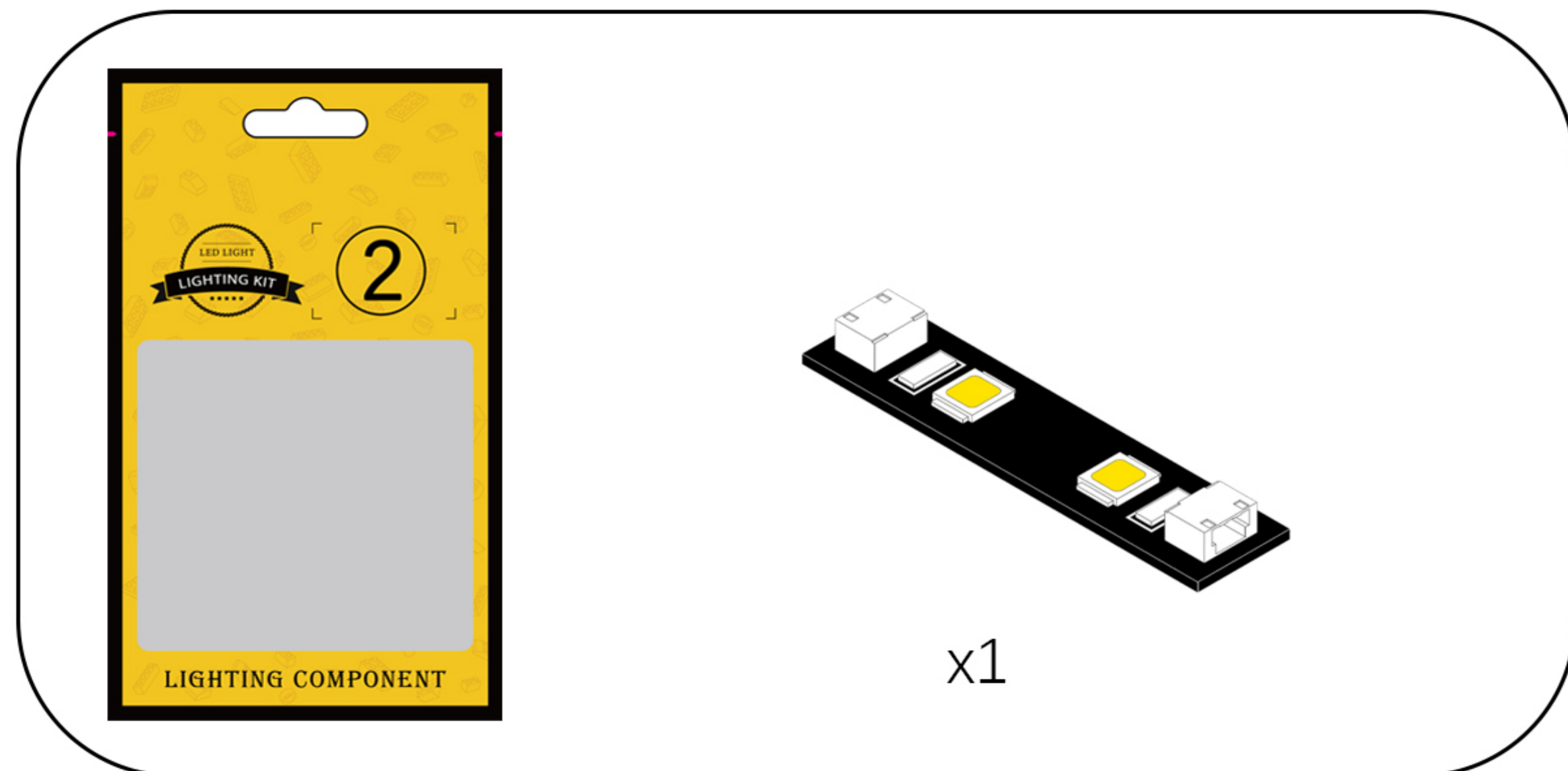

After confirming that there are no abnormalities, temporarily return each part to its original bag.

## Step 2-Mounting.

1

EN: Take out the building block model.

DE: Nimm das Bauklotzmodell heraus.



2

EN: Remove the building block.

DE: Entferne den Baustein.



3

EN: Split as shown in the figure.

DE: Wie in der Abbildung gezeigt, teilen Sie es auf.

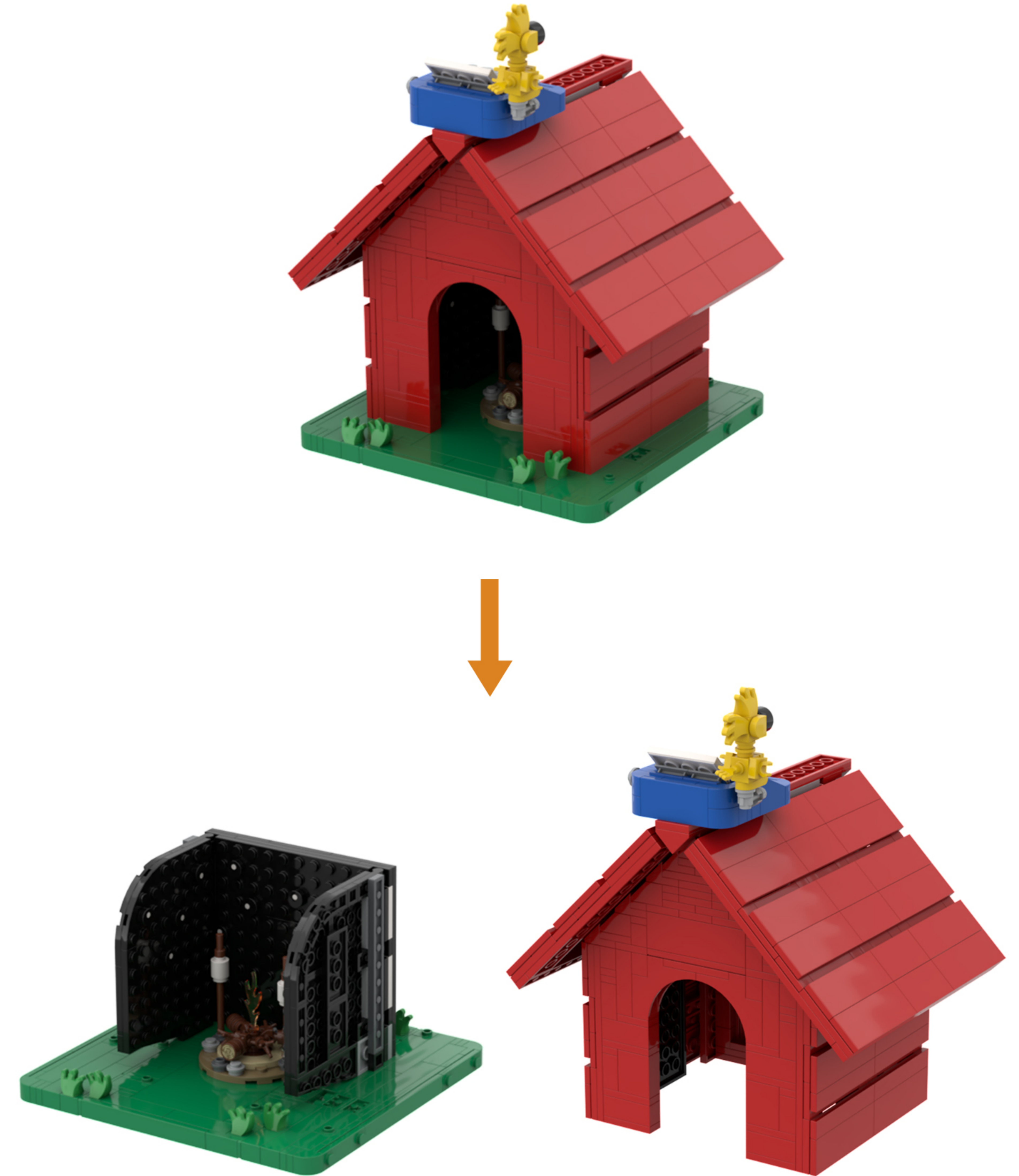

4

EN: Take out the disassembled building blocks and twist to open the blocks on both sides.

DE: Nehmen Sie die zerlegten Bausteine heraus und drehen Sie sie, um die Blöcke an beiden Seiten zu öffnen.

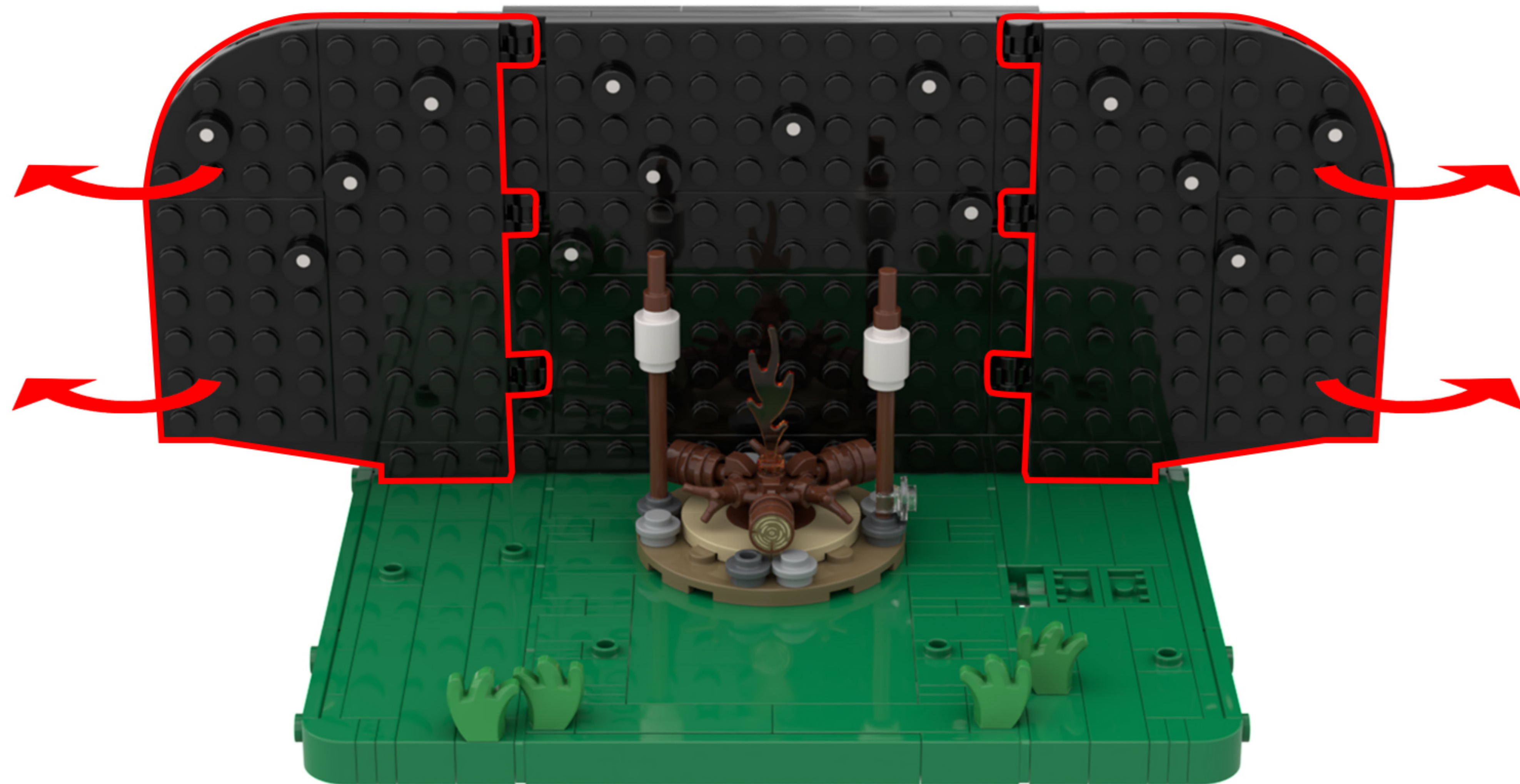
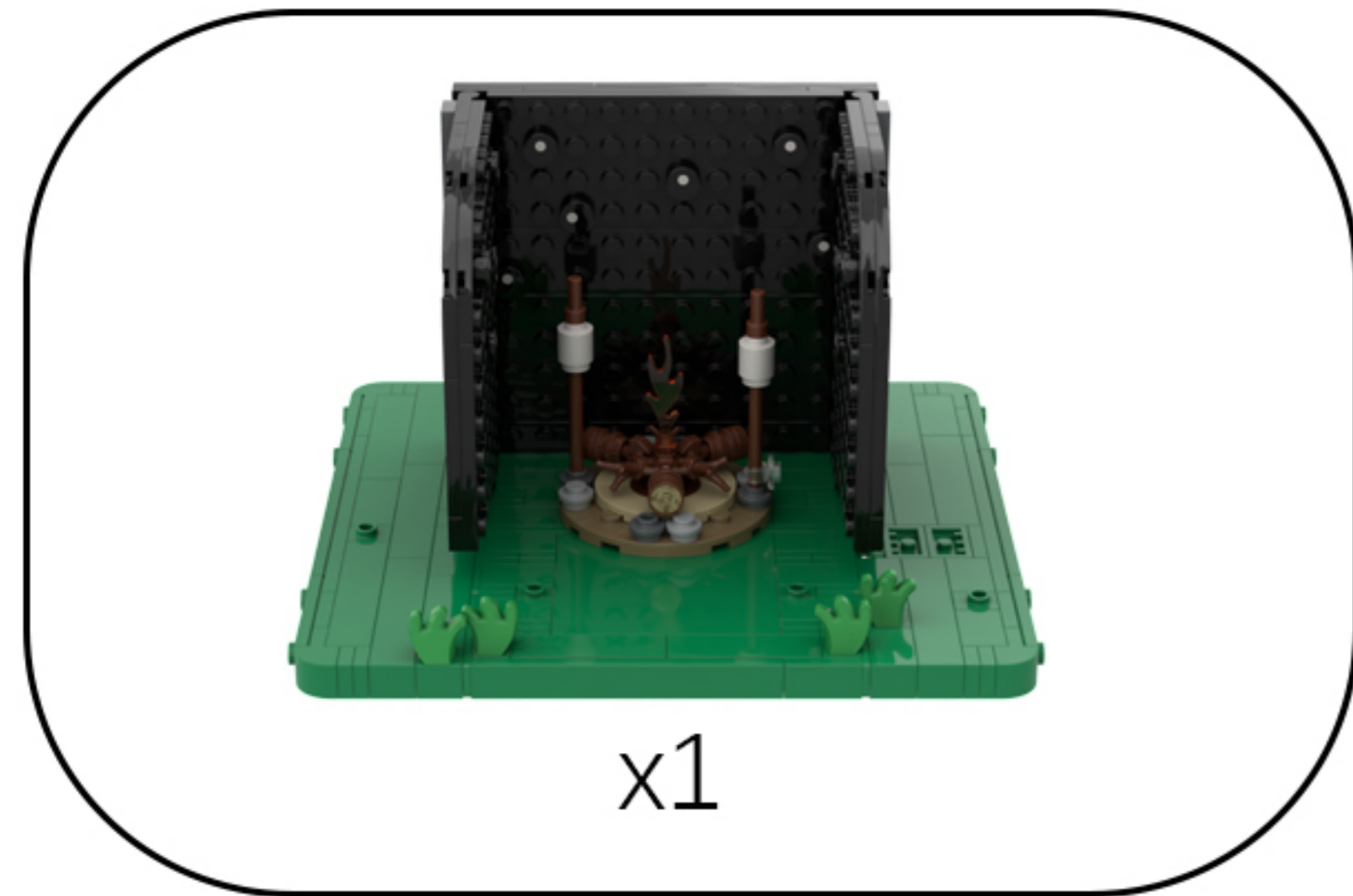

5

EN: Split as shown in the figure.

DE: Wie in der Abbildung gezeigt, teilen Sie es auf.

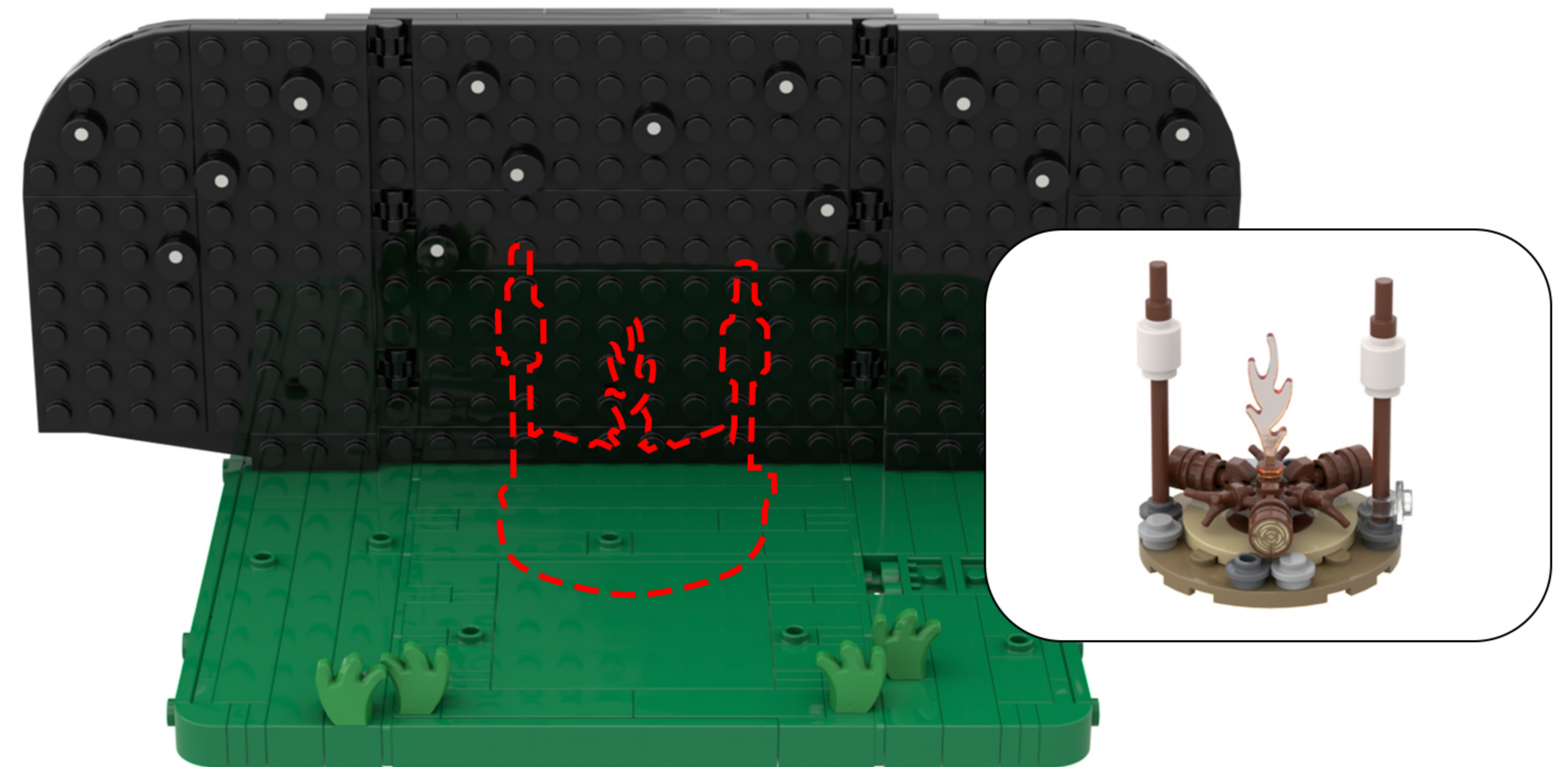

6

EN: Remove the building blocks one by one.

DE: Entfernen Sie die Bausteine nacheinander.

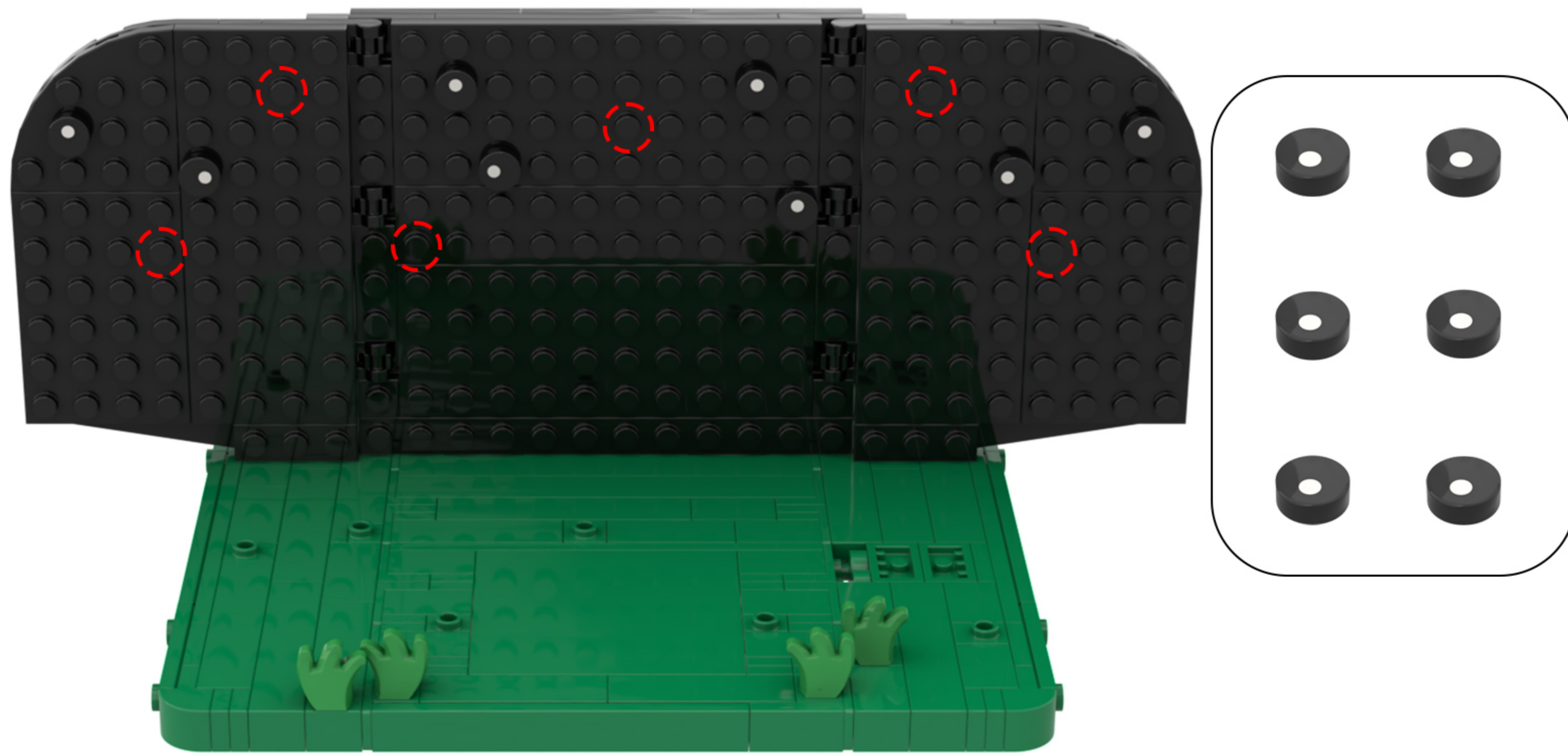

7

EN: Take the string of lights out of Bag 1, untie the zip tie, and locate the decorative lights on the string.

DE: Nimm die Lichterkette aus Beutel 1, löse den Kabelbinder und suche die dekorativen Lichter an der Kette.

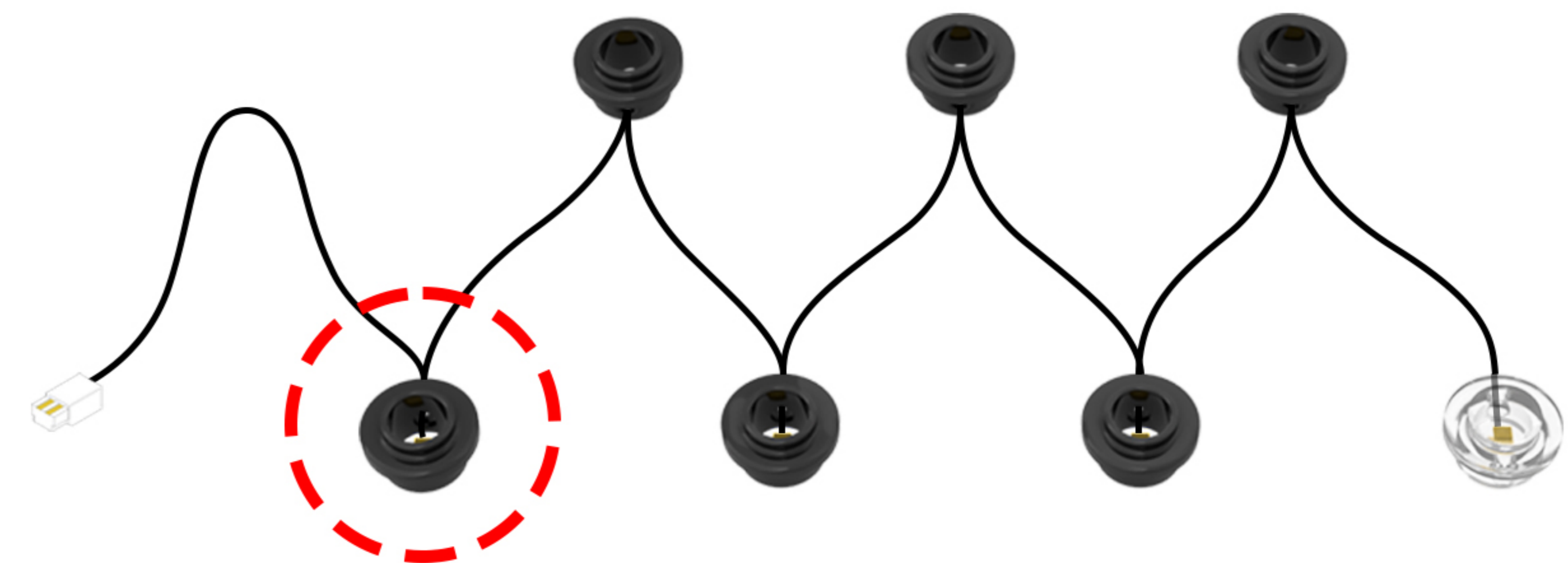
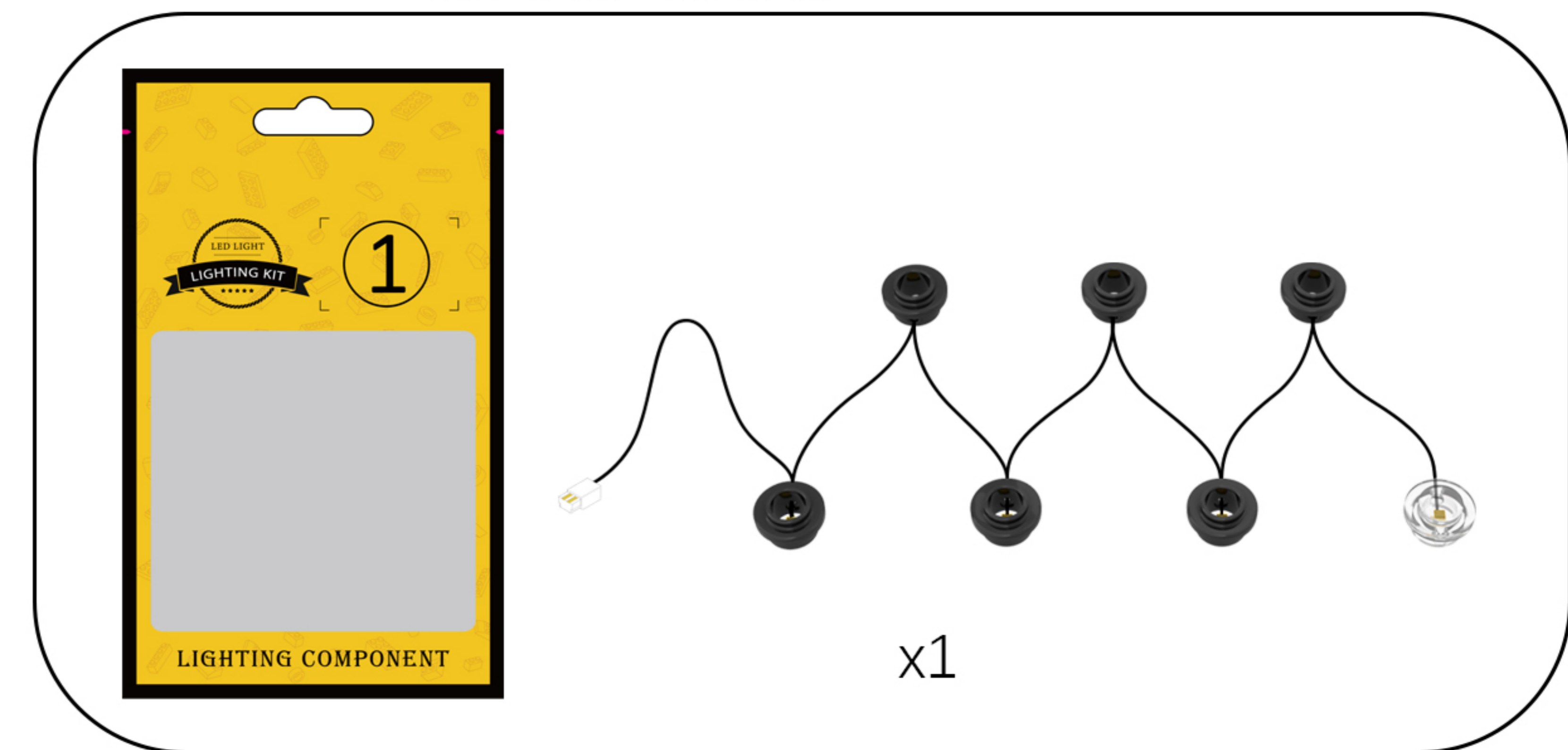

8

EN: Install the light fixture onto the building block.

DE: Installieren Sie die Leuchte auf dem Baustein.

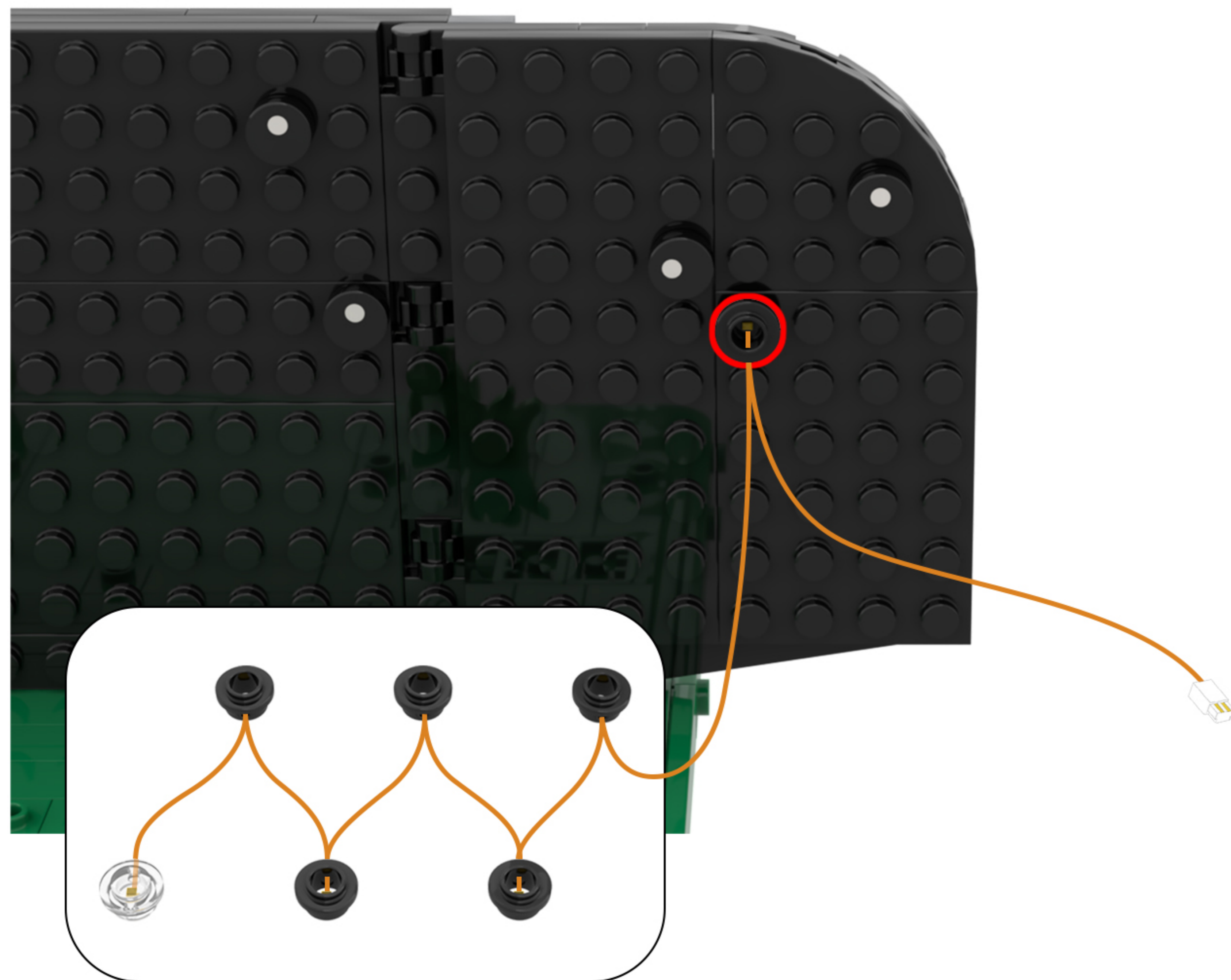

9

EN: Attach the 5 lights from the string to the building blocks in order.

DE: Befestige die 5 Lichter der Lichterkette der Reihe nach an den Bausteinen.

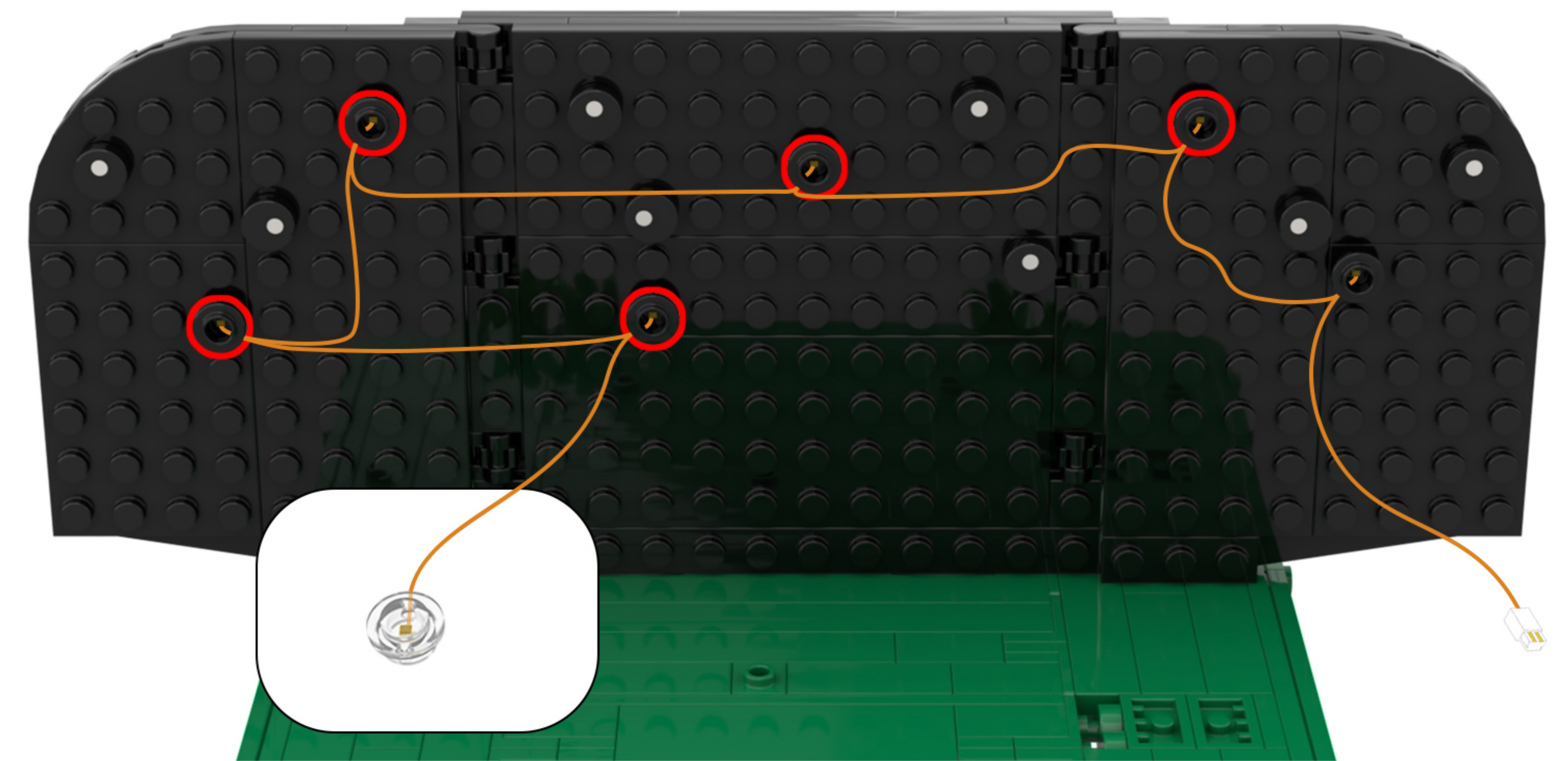

10

EN: Take out the disassembled building blocks and separate them.

DE: Nehmen Sie die zerlegten Bausteine heraus und trennen Sie sie voneinander.

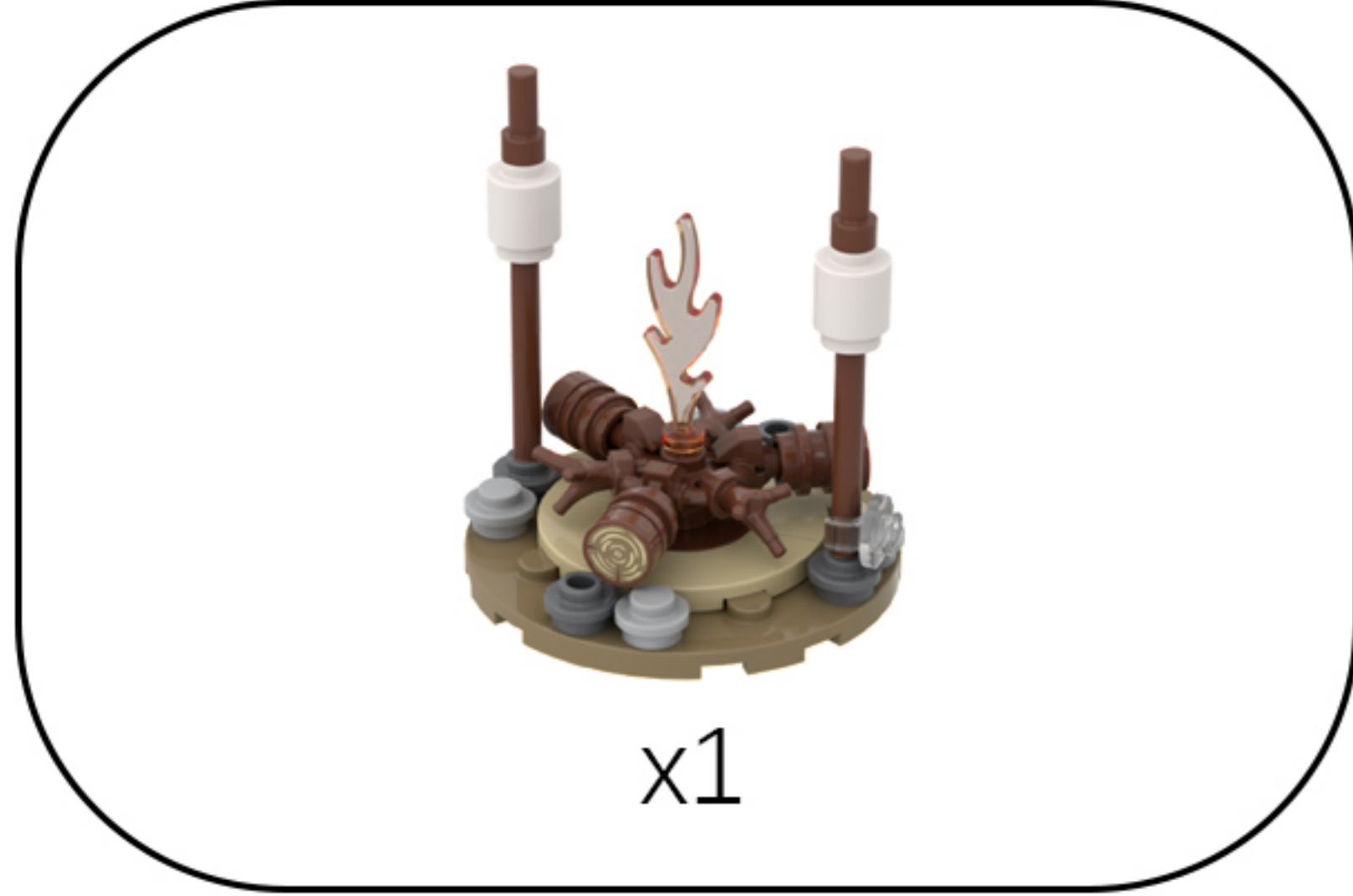

11

EN: Split as shown in the figure.

DE: Wie in der Abbildung gezeigt, teilen Sie es auf.



12

EN: Take out the disassembled building blocks and reassemble them.

DE: Nehmen Sie die zerlegten Bausteine heraus und setzen Sie sie wieder zusammen.

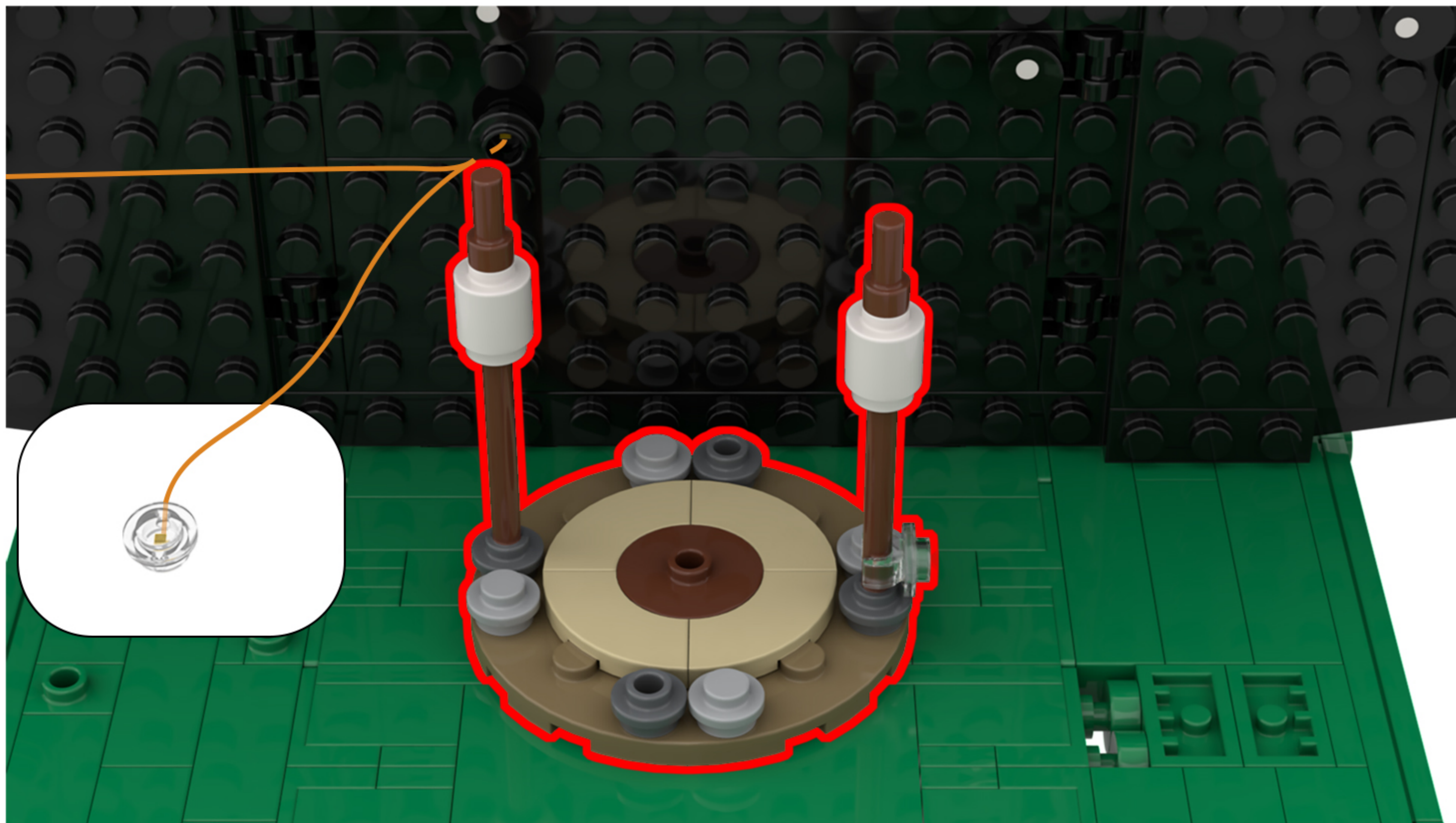
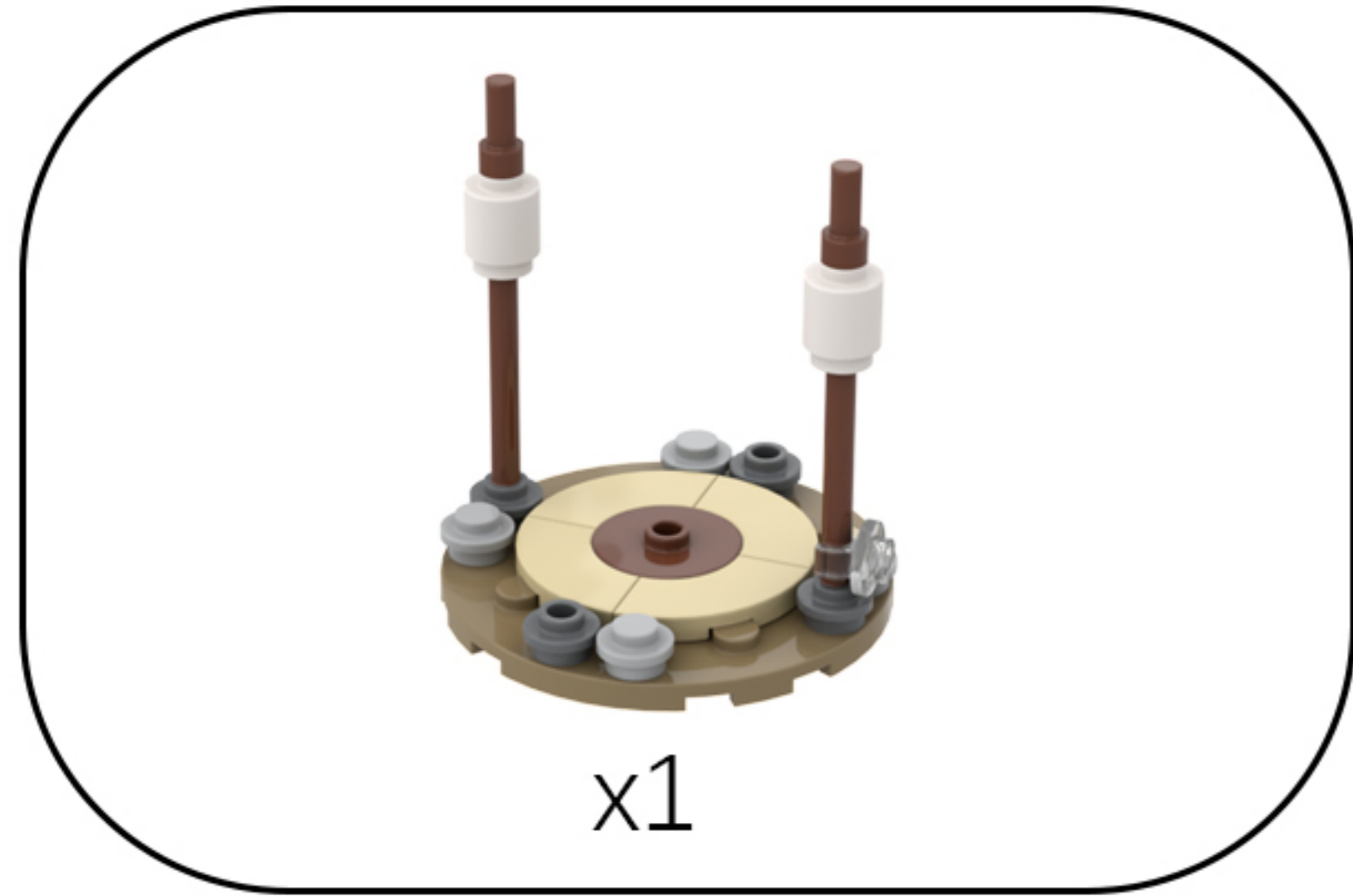

13

EN: Attach the lights from the string to the building blocks.

DE: Befestigen Sie die Lichter der Lichterkette an den Bausteinen.

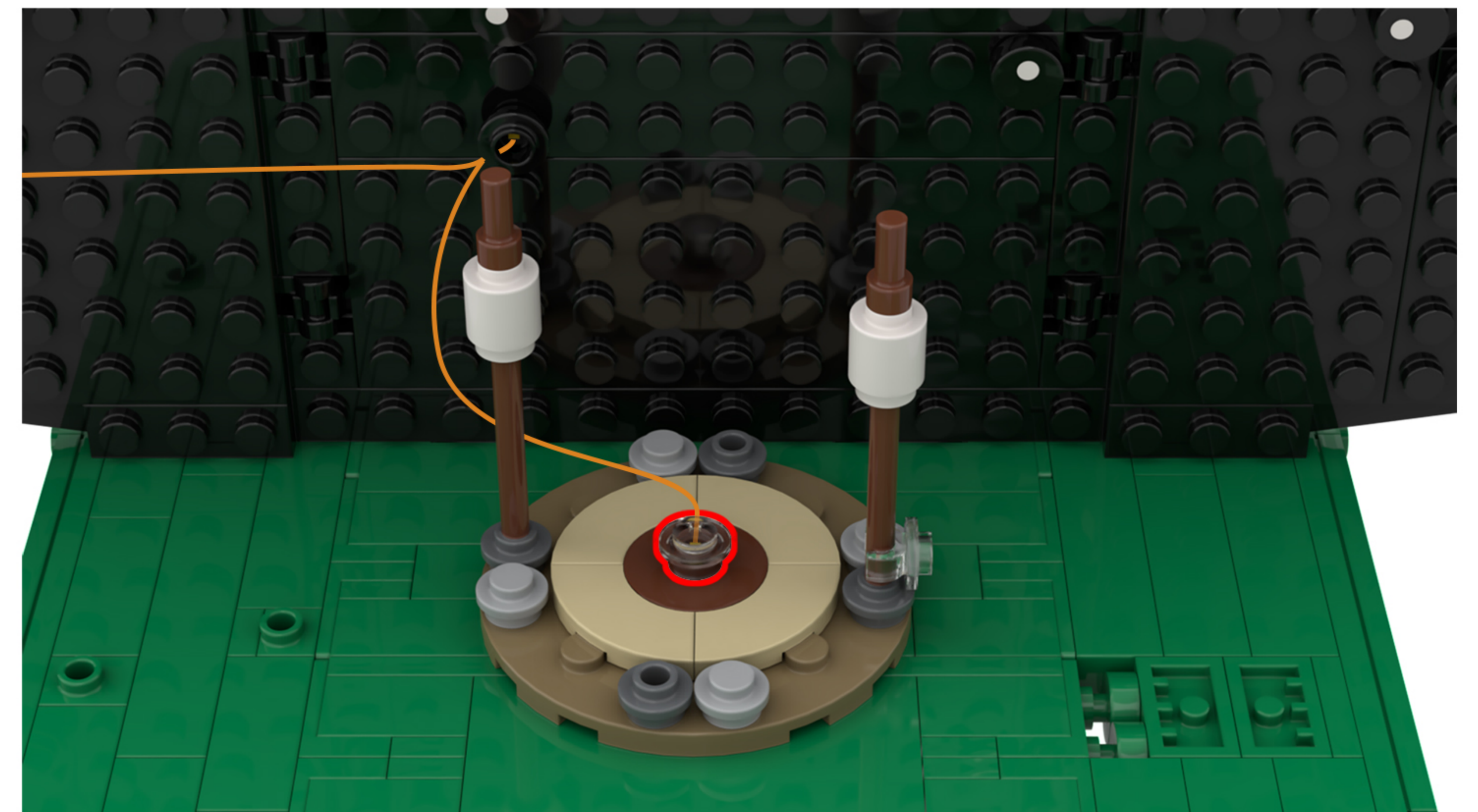

14

EN: Take out the disassembled building blocks and reassemble them.

DE: Nehmen Sie die zerlegten Bausteine heraus und setzen Sie sie wieder zusammen.

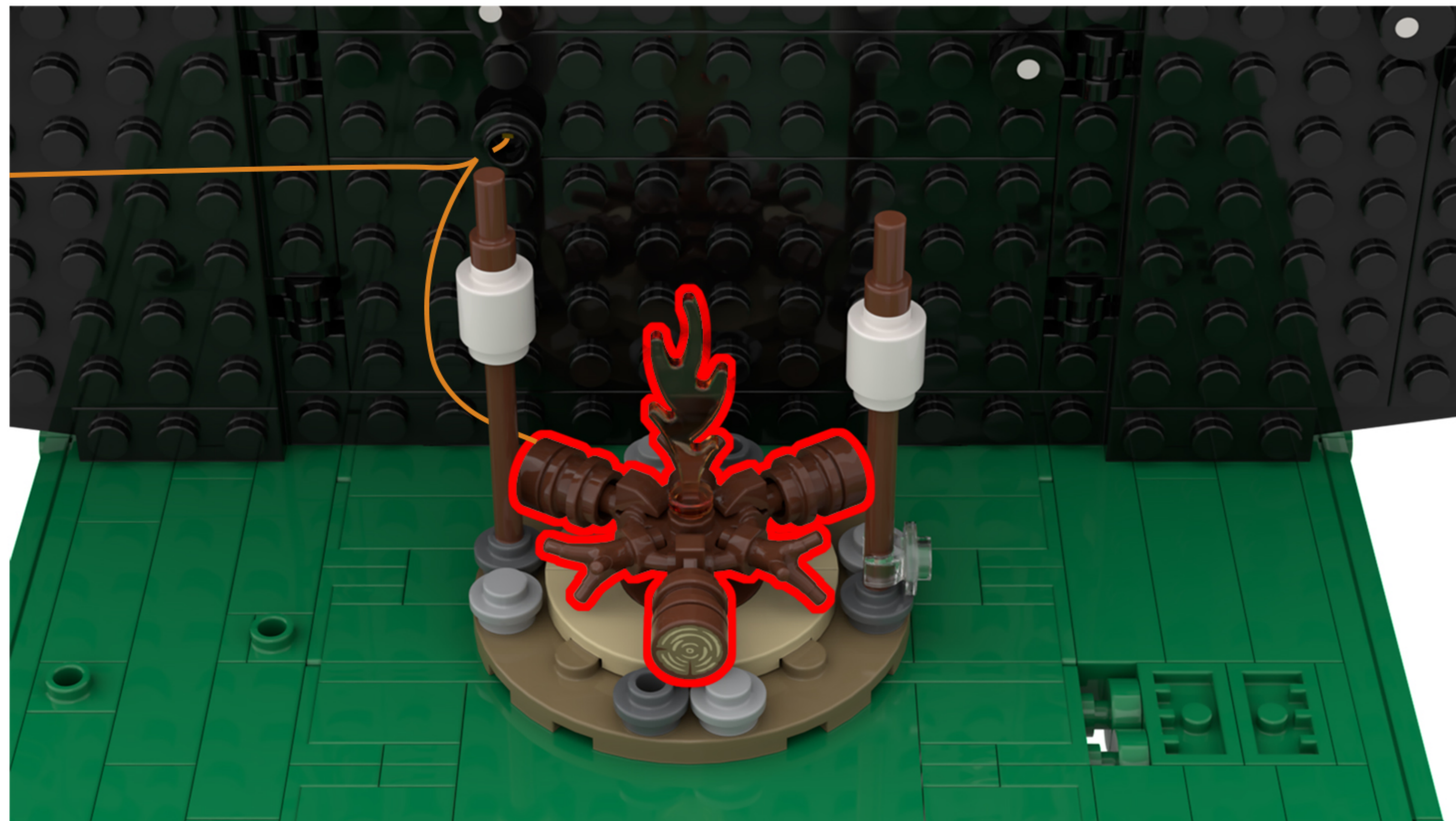
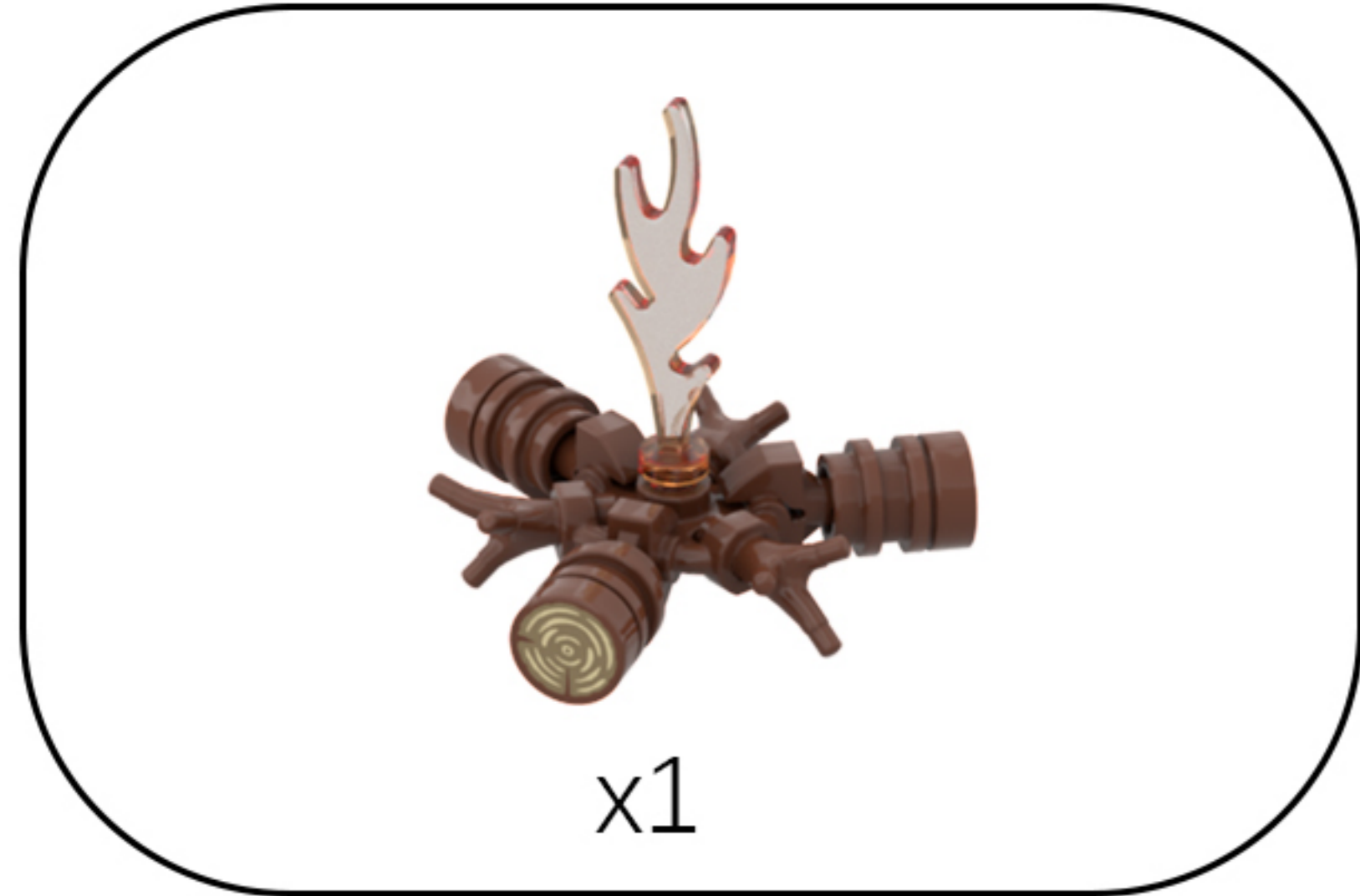

15

EN: Look at the block component highlighted in the image.

DE: Schauen Sie sich die im Bild hervorgehobene Blockkomponente an.

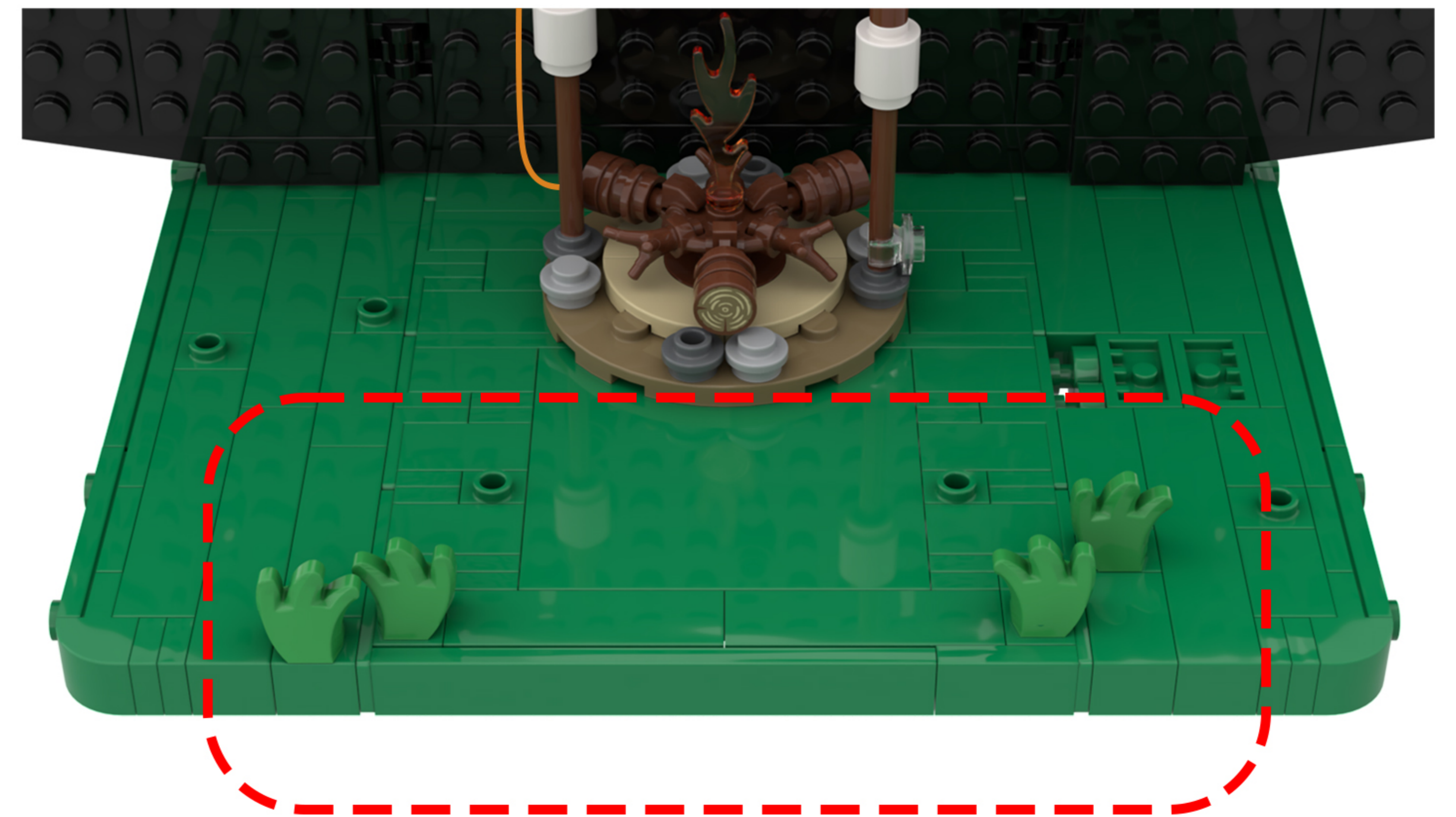

16

EN: Remove the building blocks one by one.  
DE: Entfernen Sie die Bausteine nacheinander.

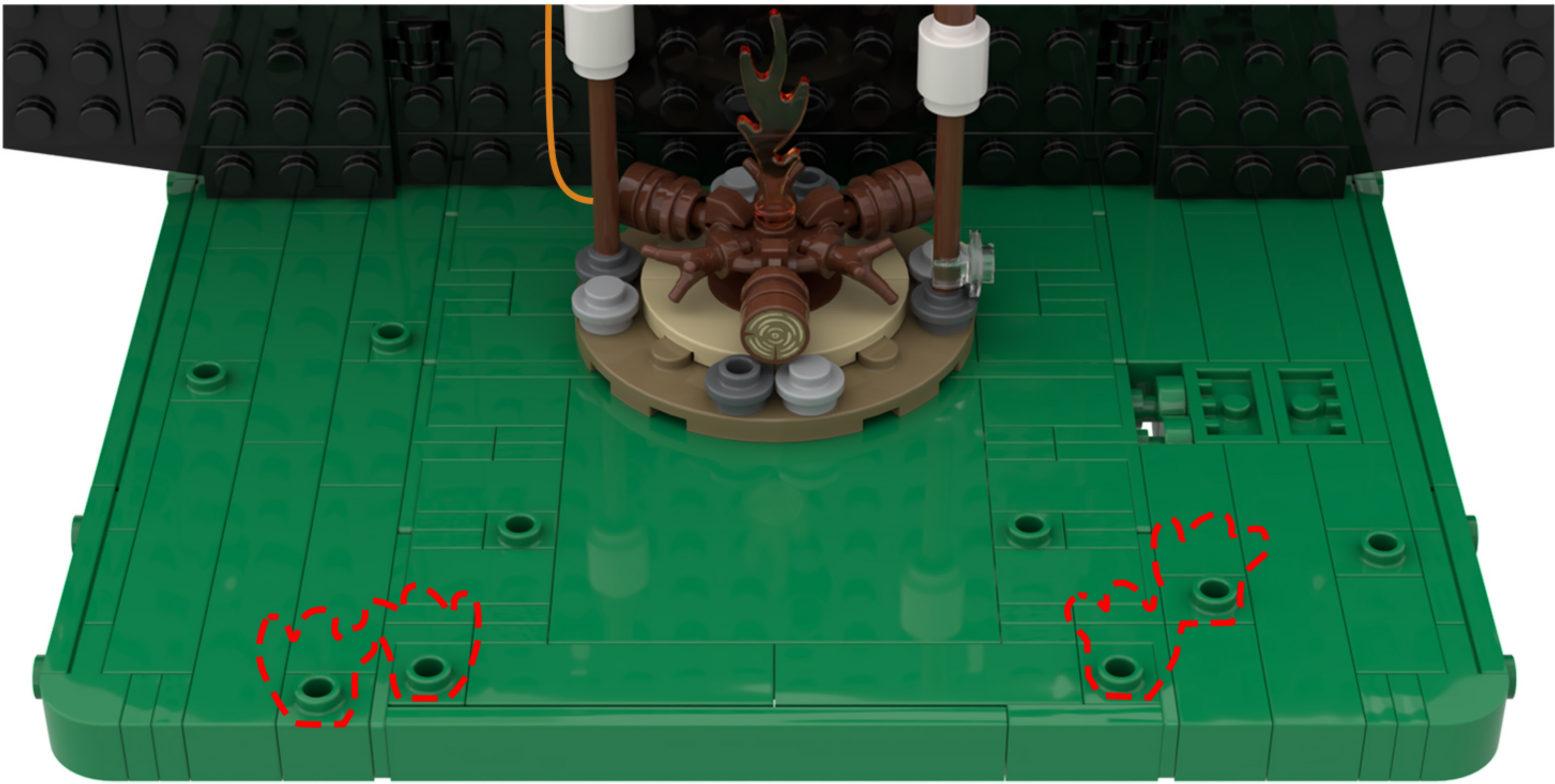
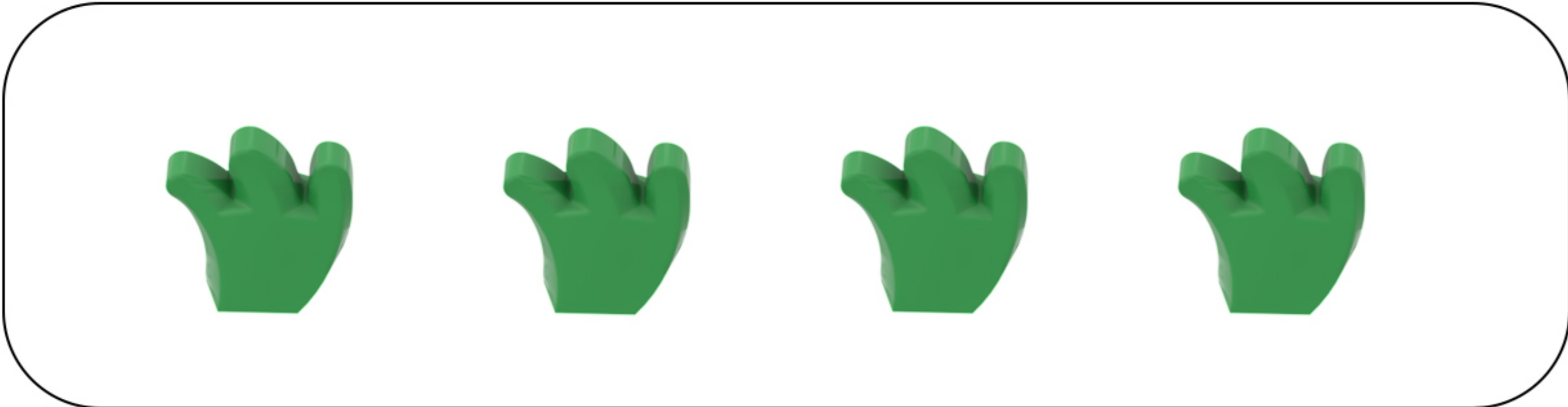

17

EN: Remove the building blocks one by one.  
DE: Entfernen Sie die Bausteine nacheinander.

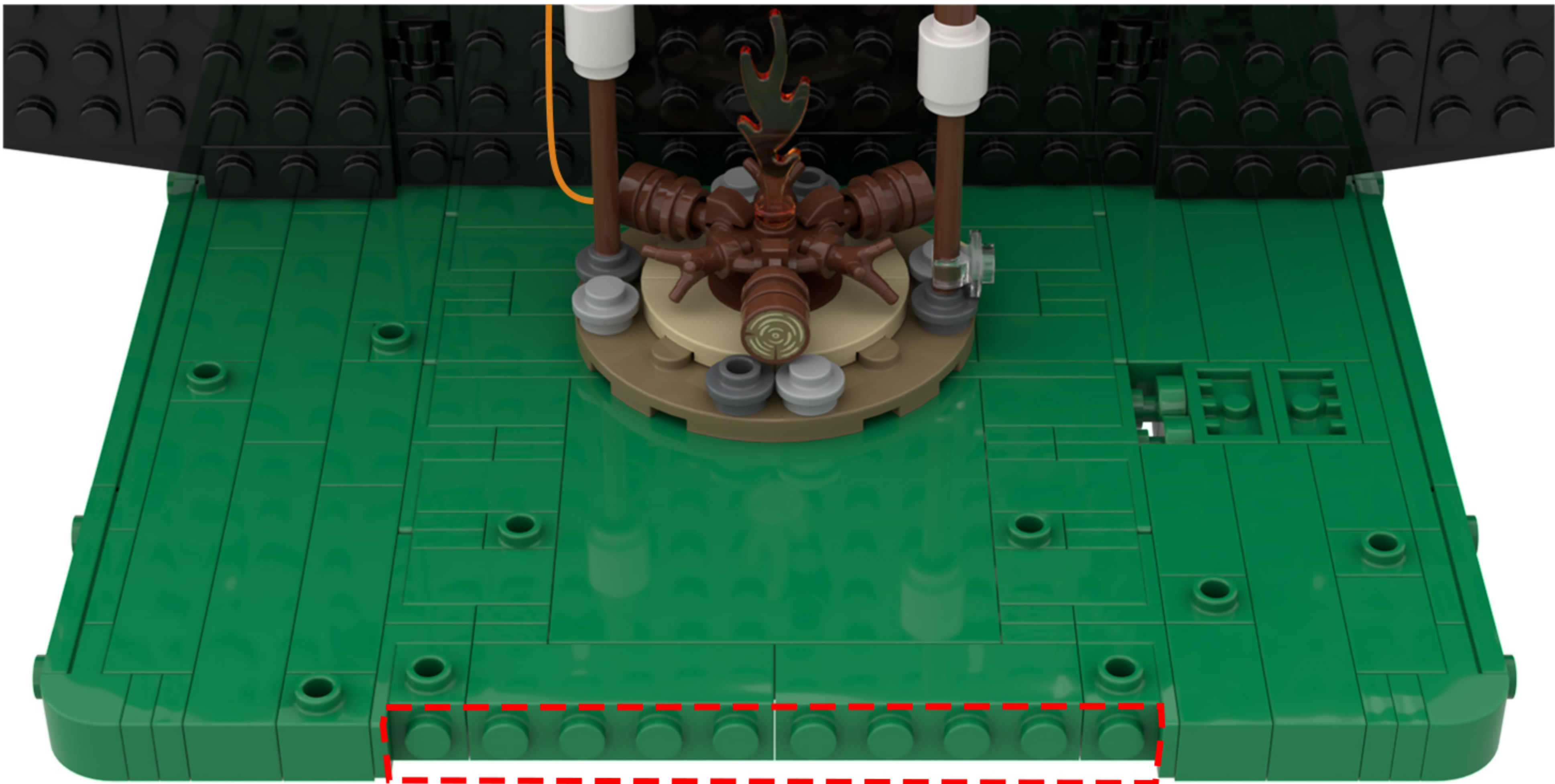
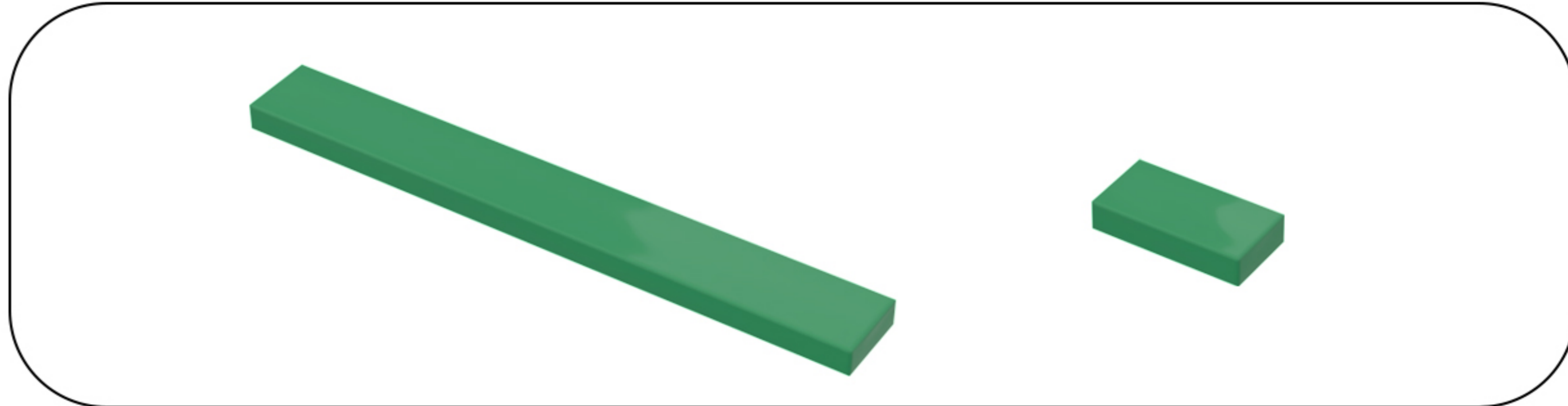

18

EN: Take the string of lights out of Bag 1, untie the zip tie, and attach the lights to the building blocks one by one.

DE: Nimm die Lichterkette aus Beutel 1, löse den Kabelbinder und befestige die Lichter nacheinander an den Bausteinen.

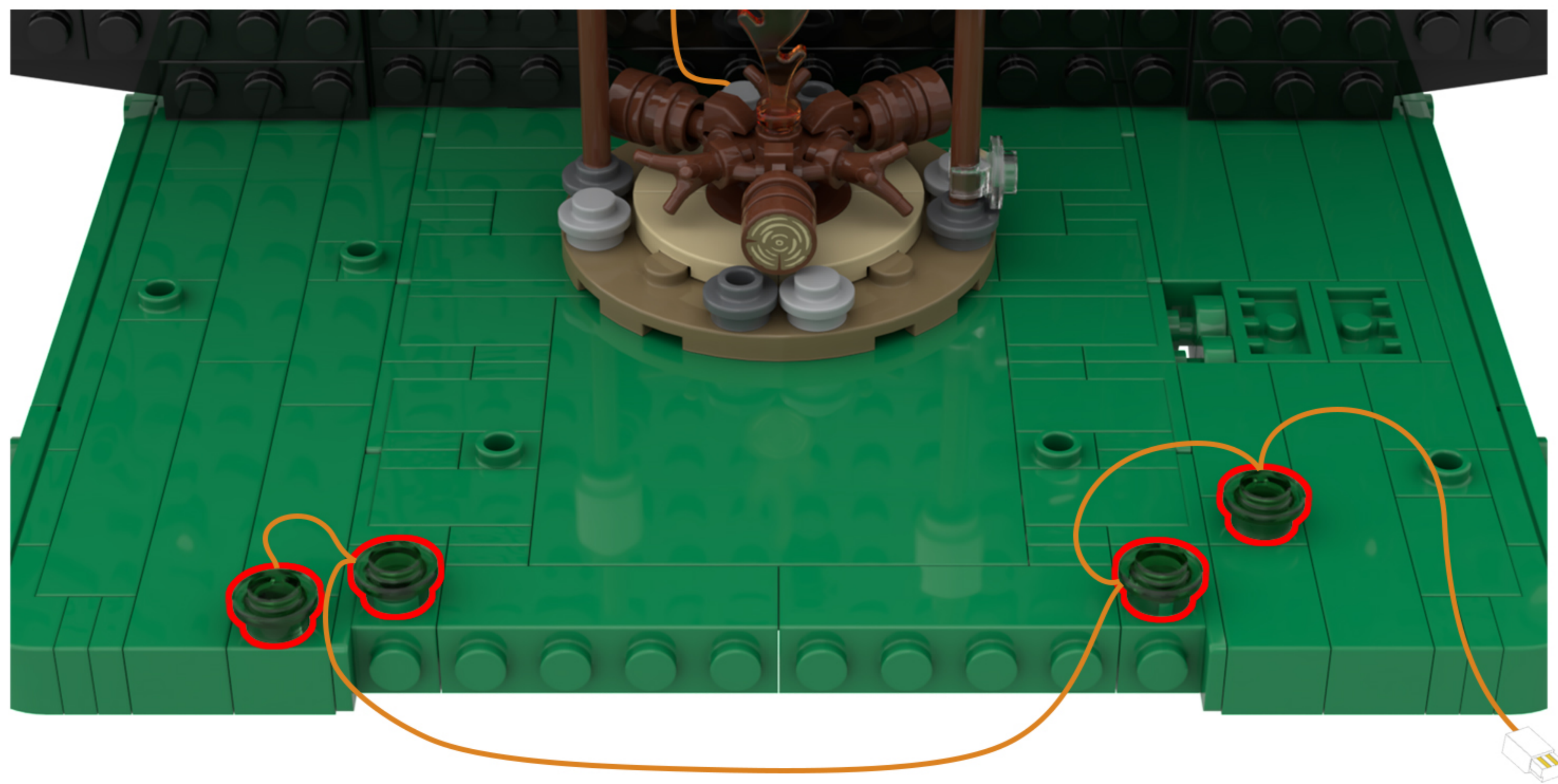
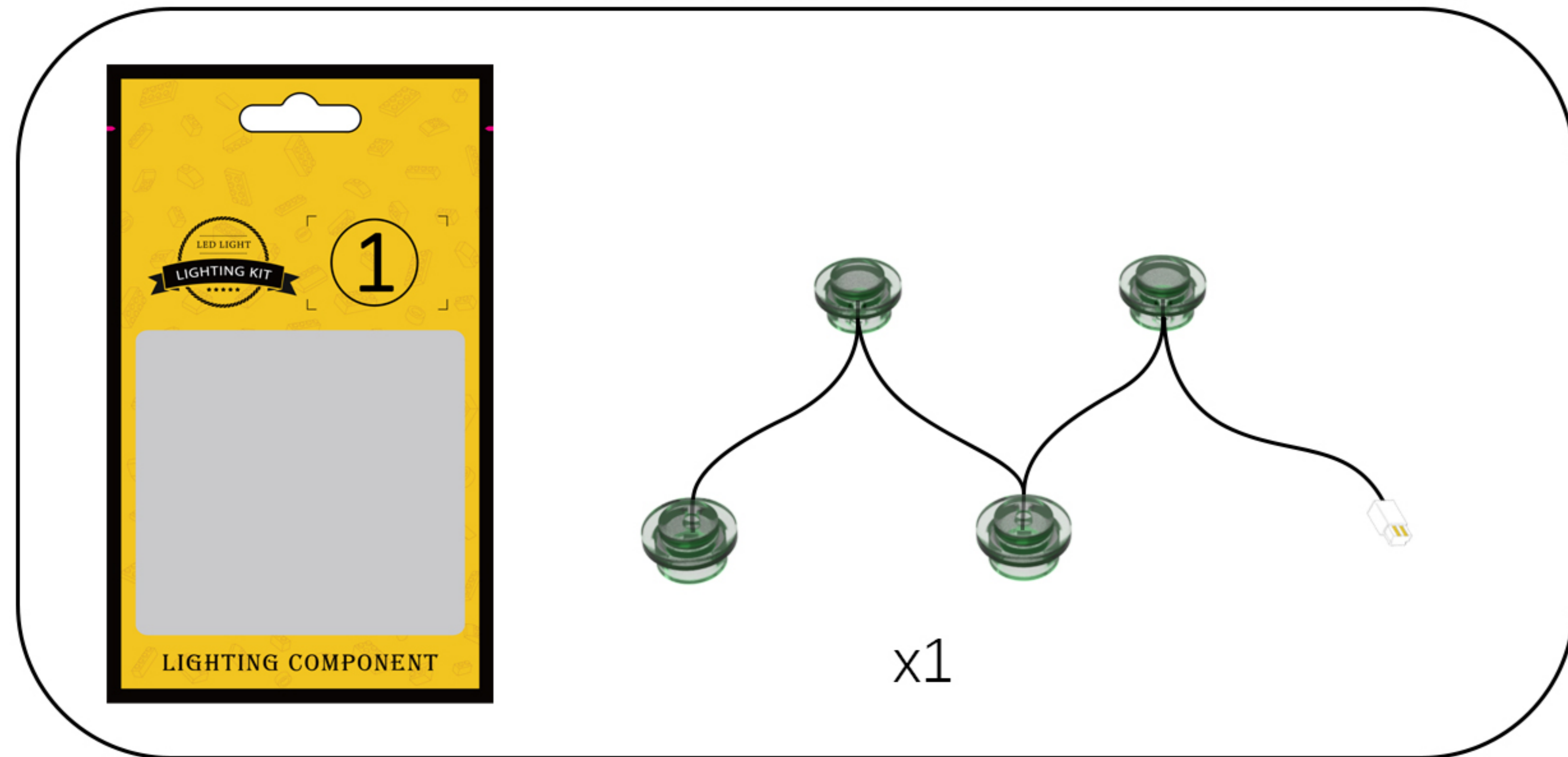

19

EN: Arrange the lighting lines according to the diagram.

DE: Ordnen Sie die Beleuchtungslinien gemäß der Abbildung an.

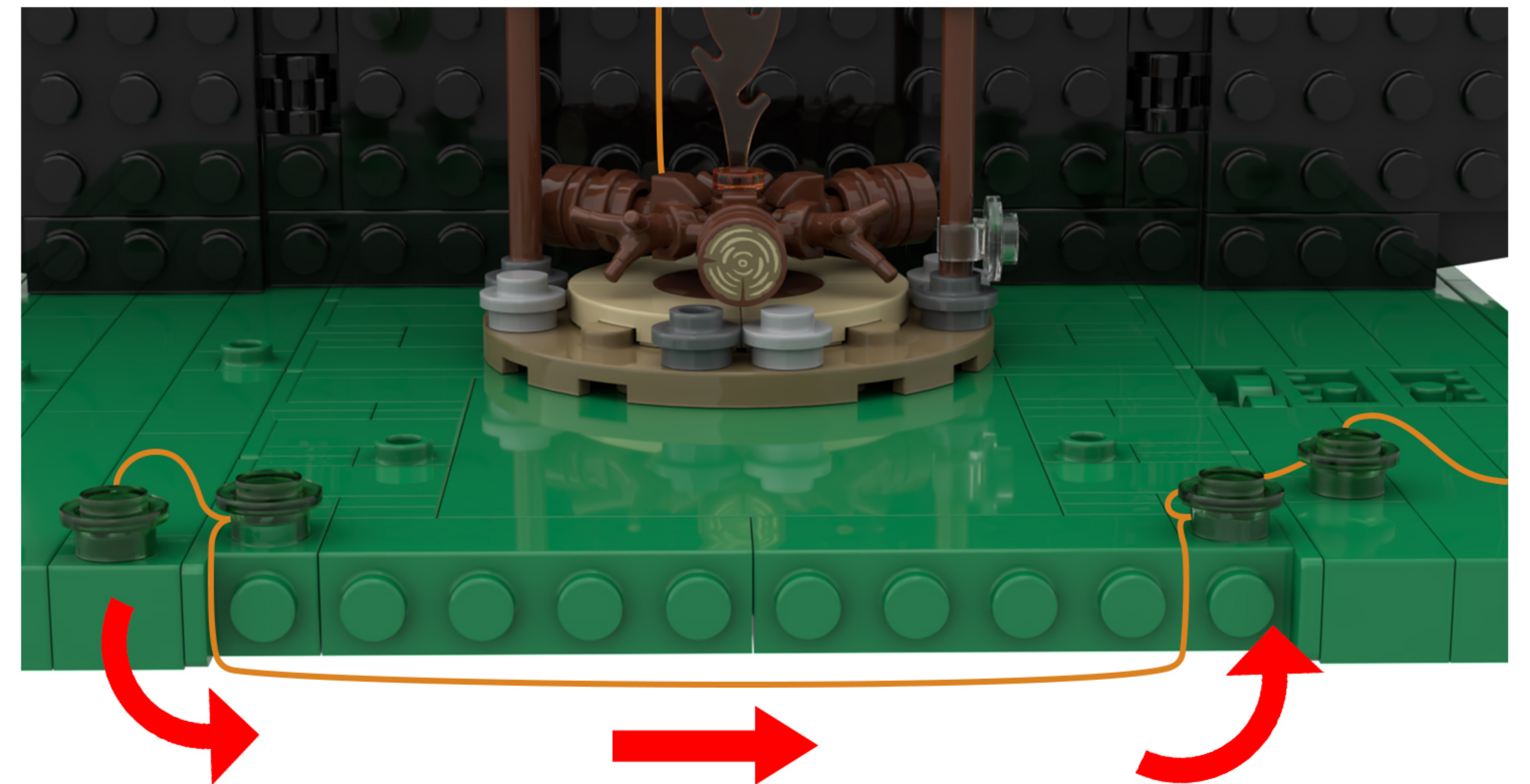

20

EN: Take out the disassembled building blocks and reassemble them in order.

DE: Nehmen Sie die zerlegten Bausteine heraus und setzen Sie sie der Reihe nach wieder zusammen.

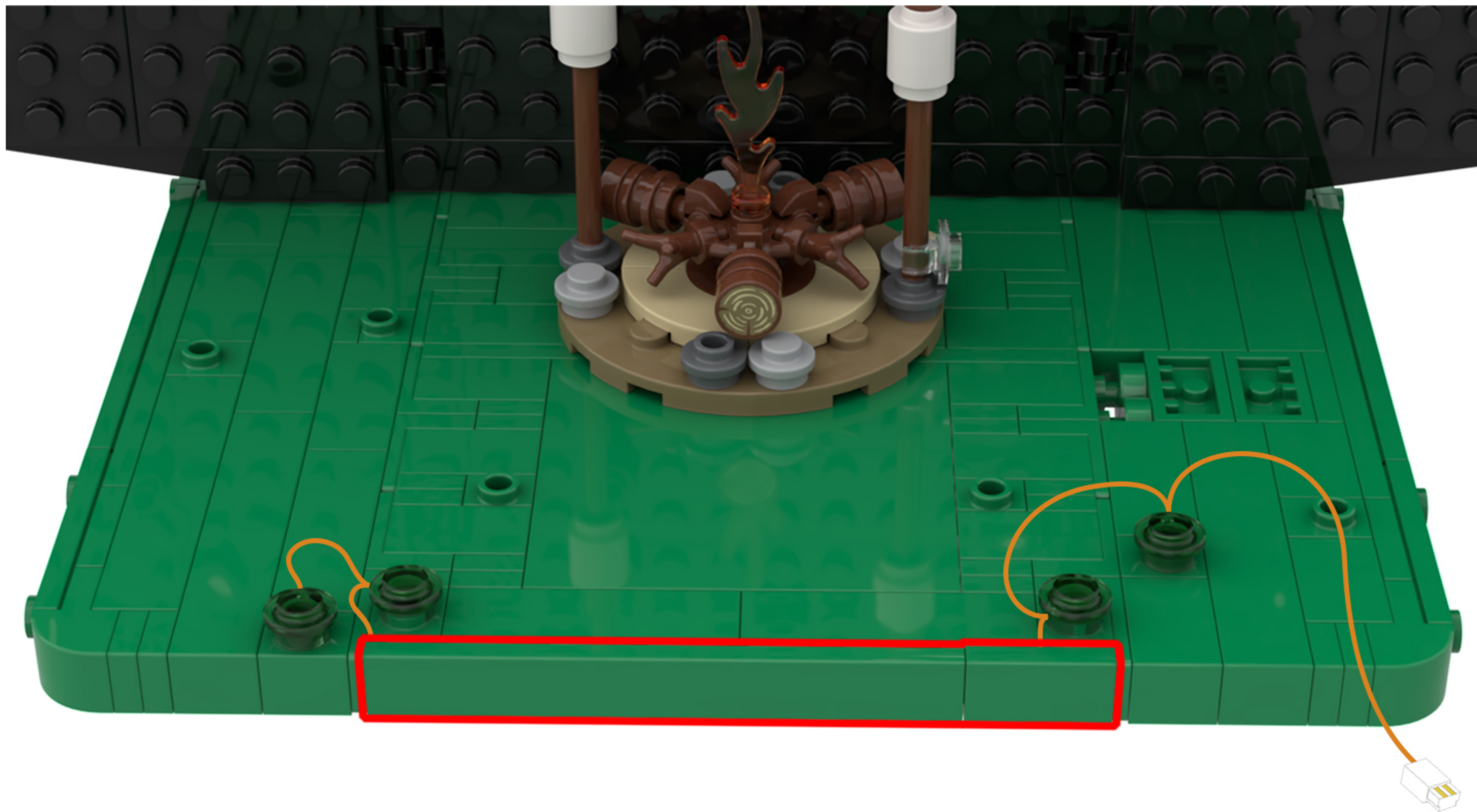
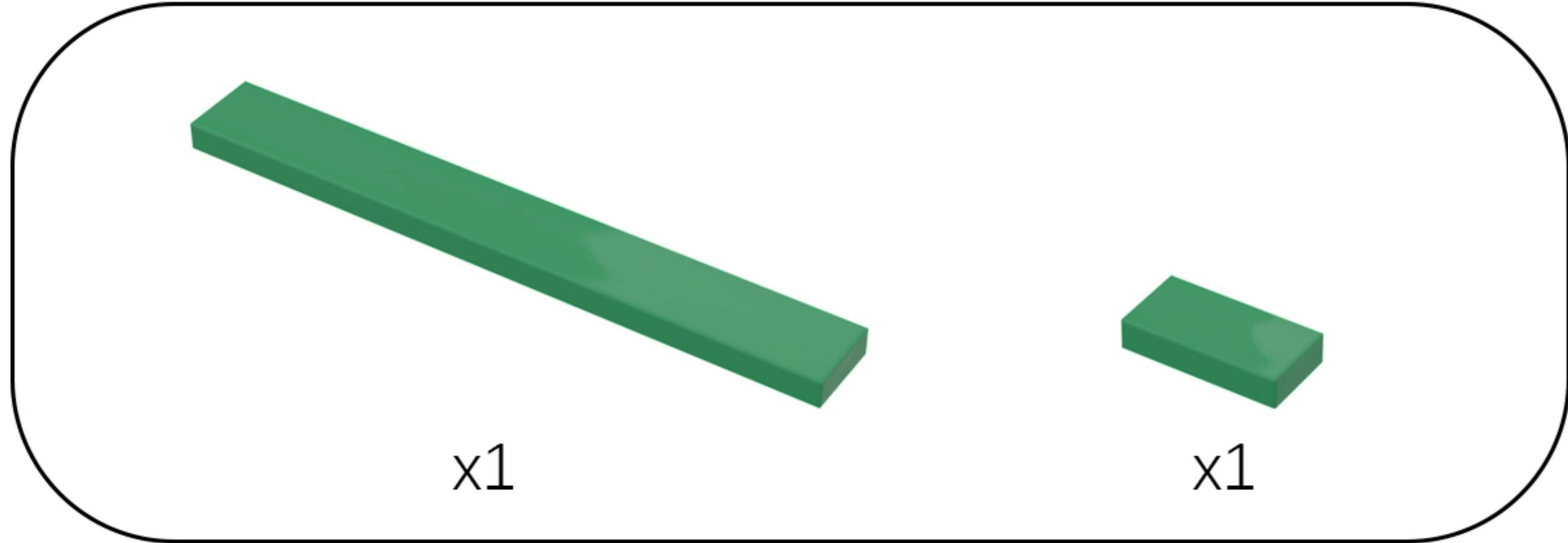

21

EN: Take out the disassembled building blocks and reassemble them in order.

DE: Nehmen Sie die zerlegten Bausteine heraus und setzen Sie sie der Reihe nach wieder zusammen.

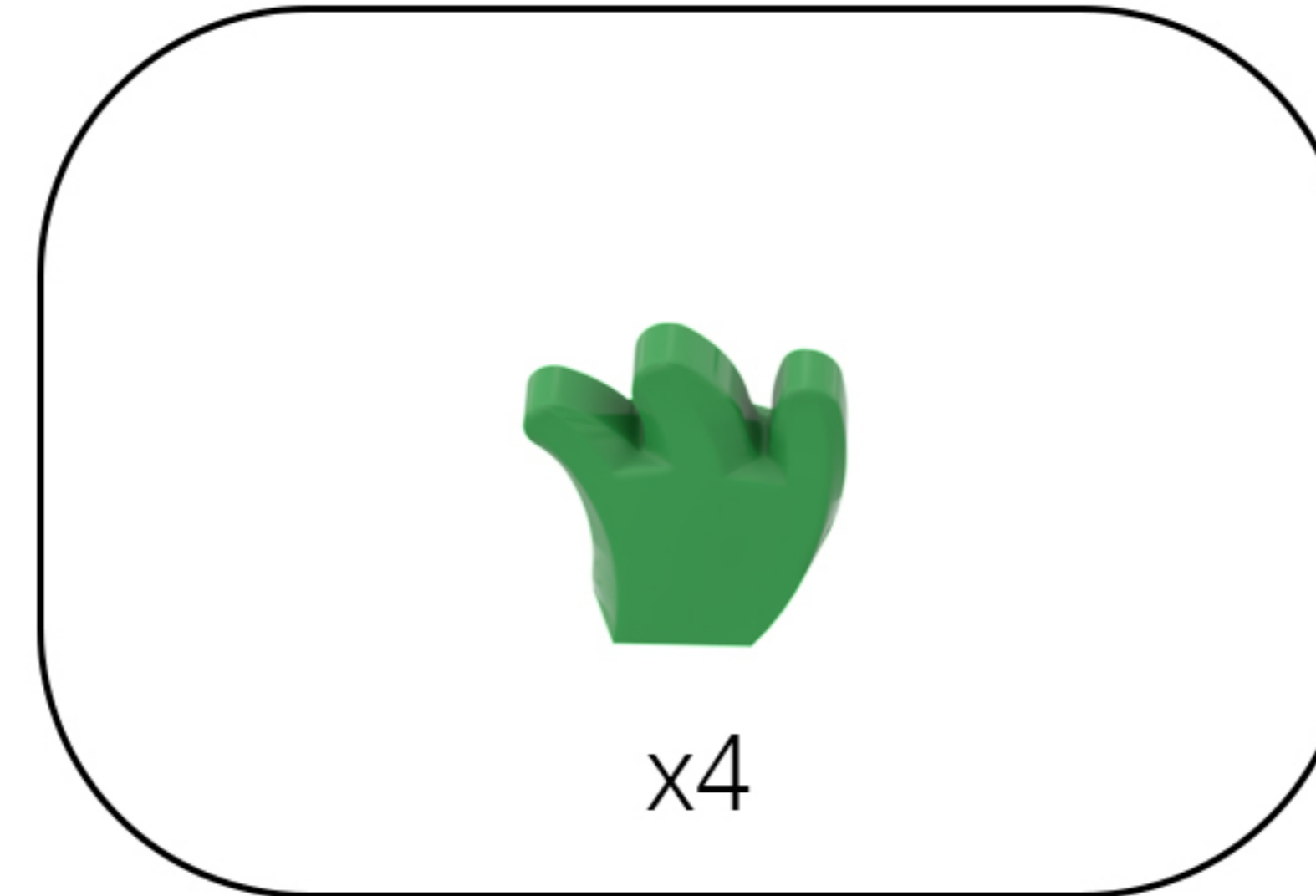

22

EN: Look at the right side of the model and rotate the brick back to its original position.

DE: Schau dir die rechte Seite des Modells an und drehe den Stein wieder in seine ursprüngliche Position zurück.

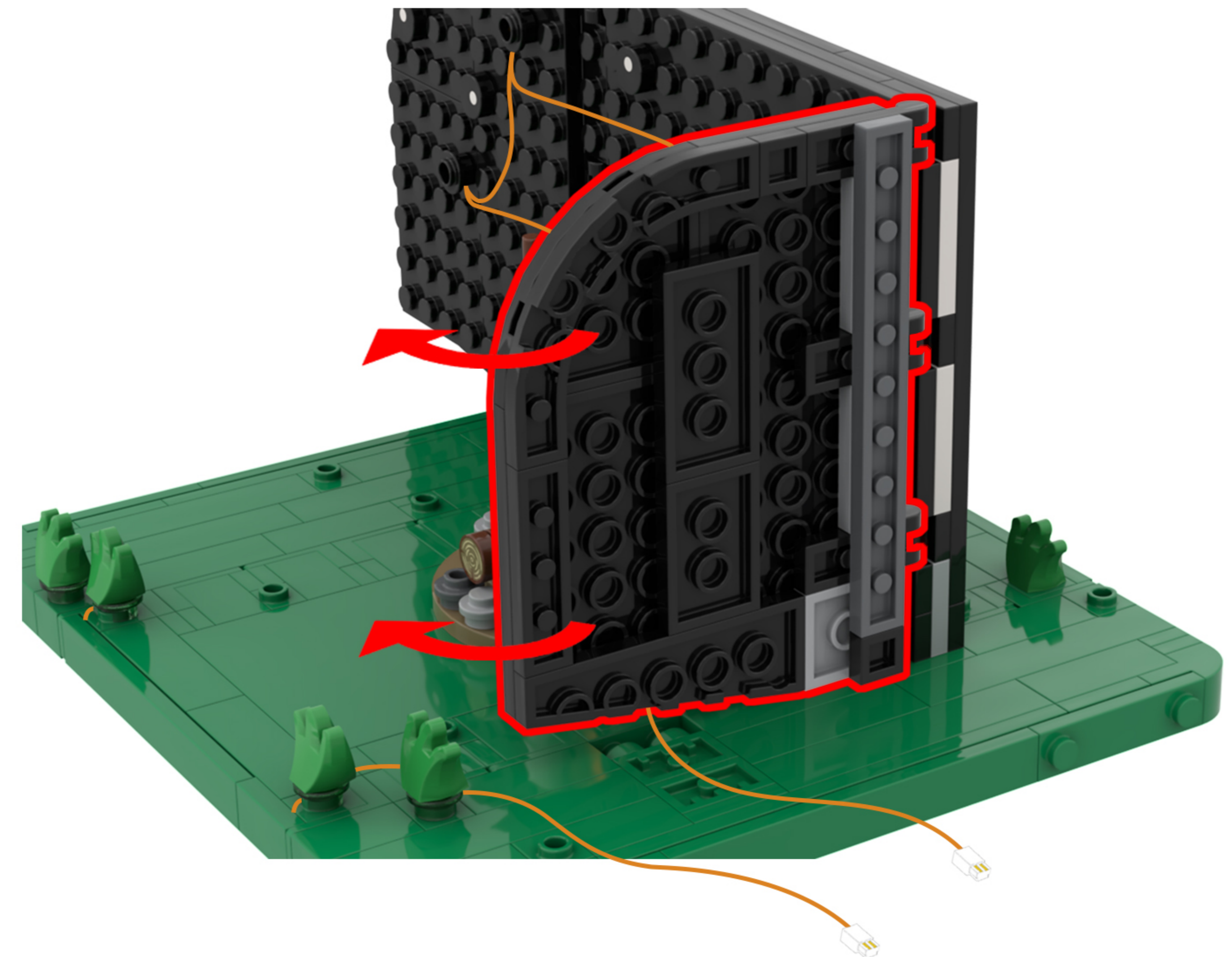
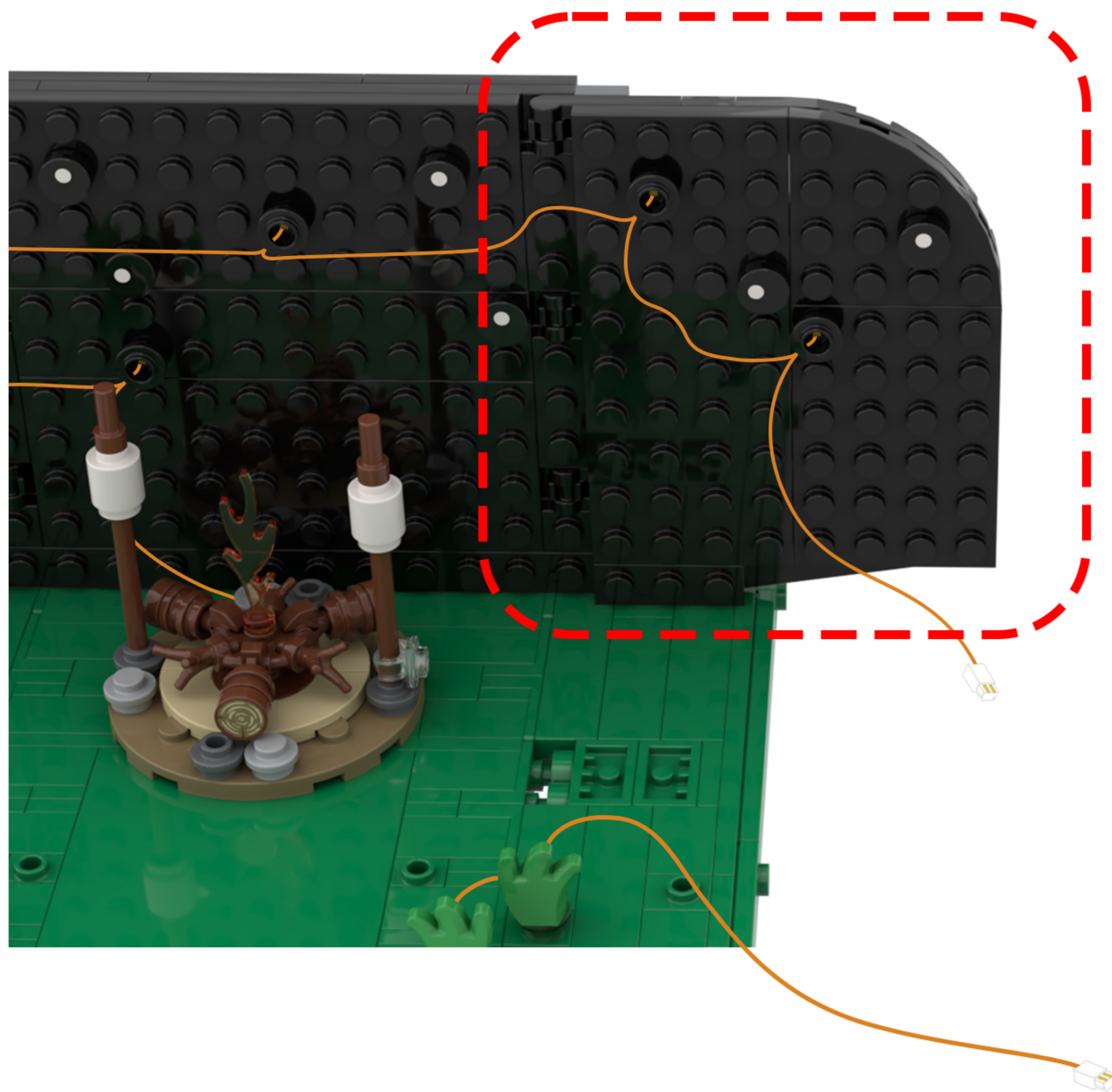

23

EN: Take the expansion board from Bag 2 and the connecting cable from Bag 4, and connect them together.

DE: Schließen Sie die beiden Lichtkabel nacheinander an die Erweiterungskarte an.

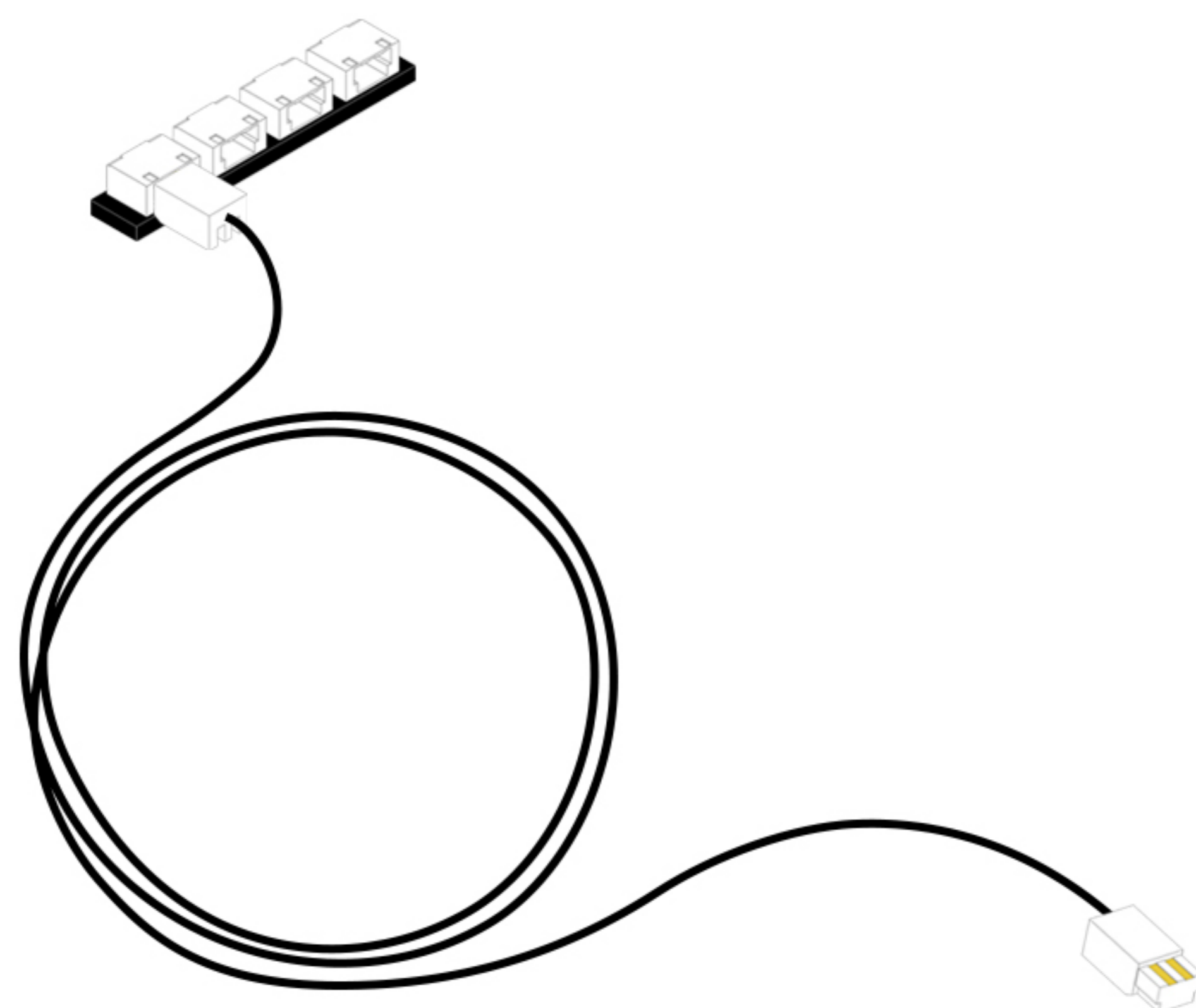
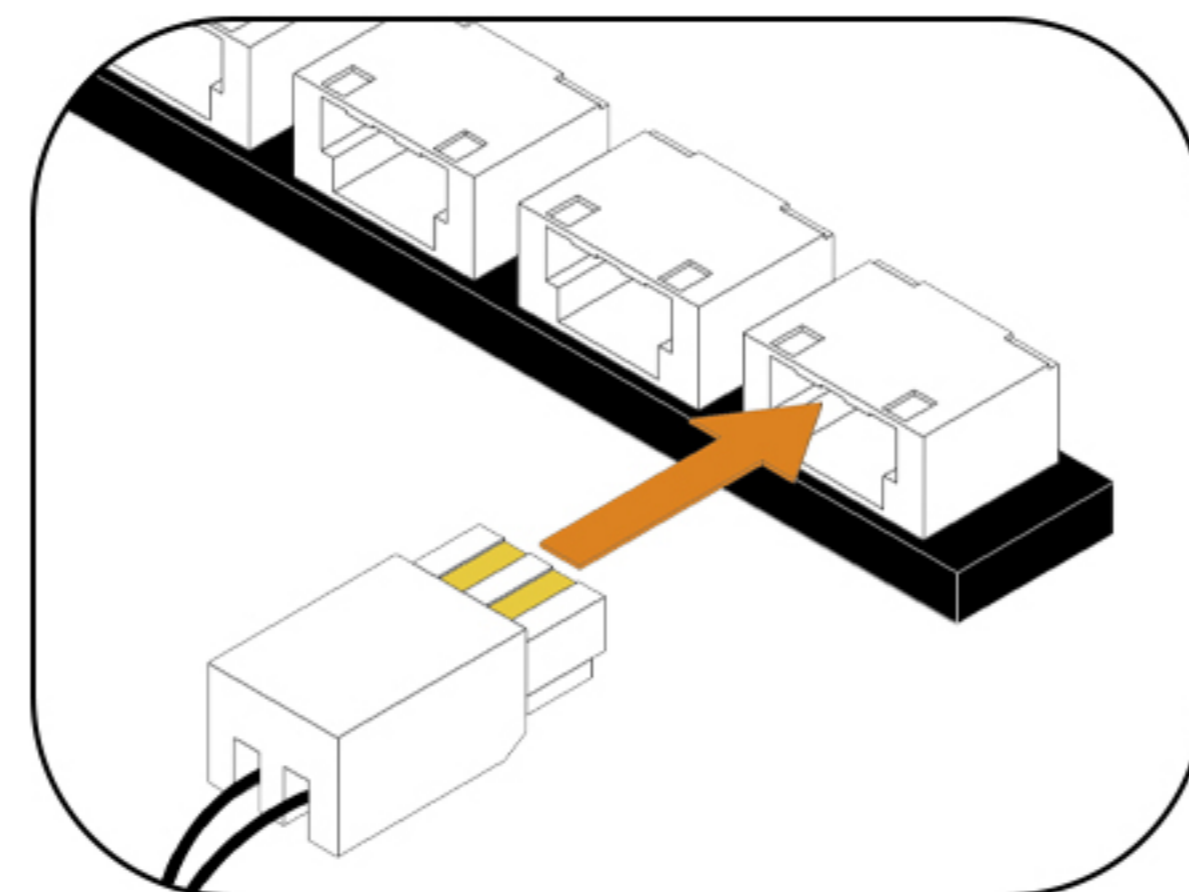
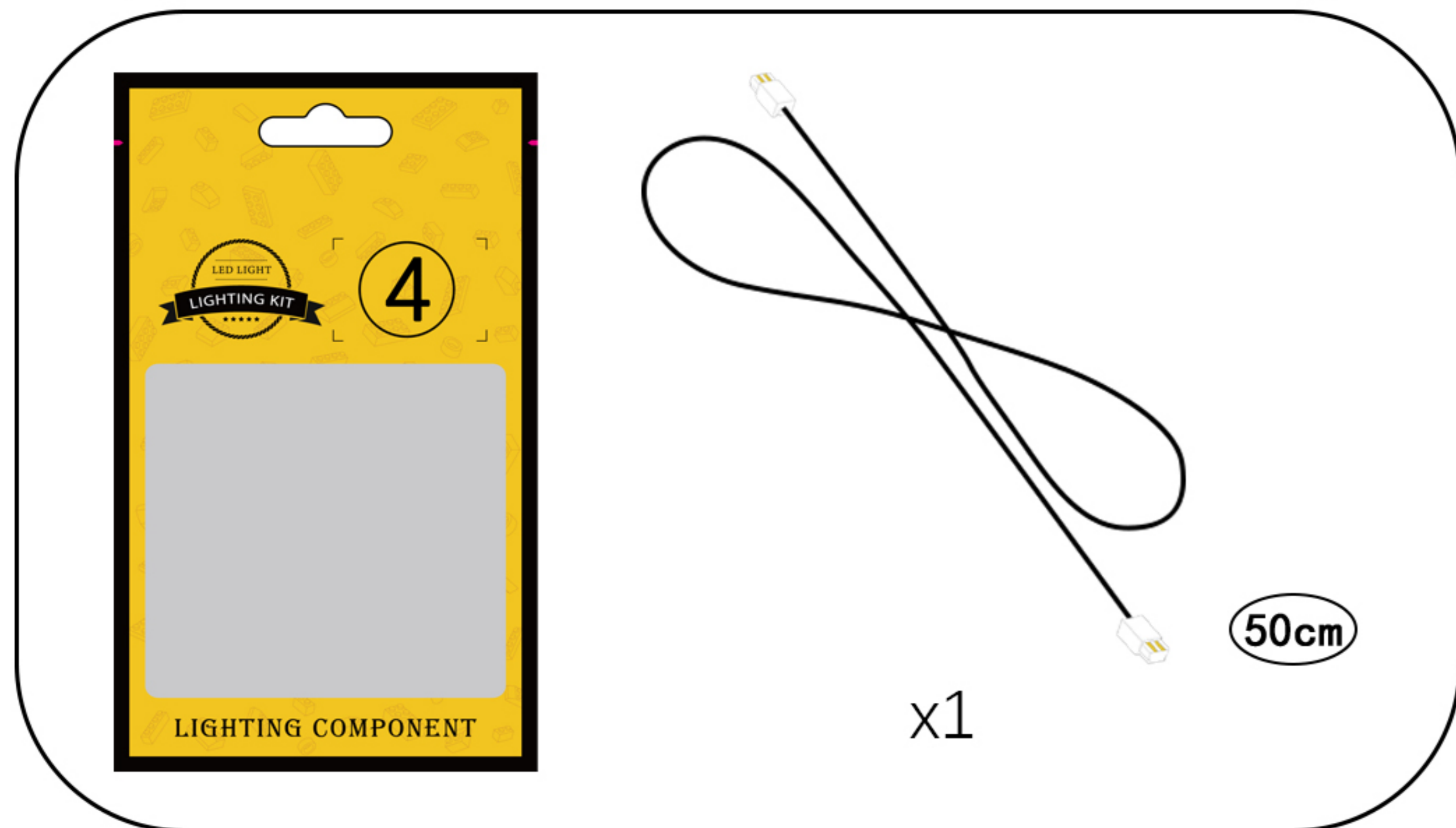
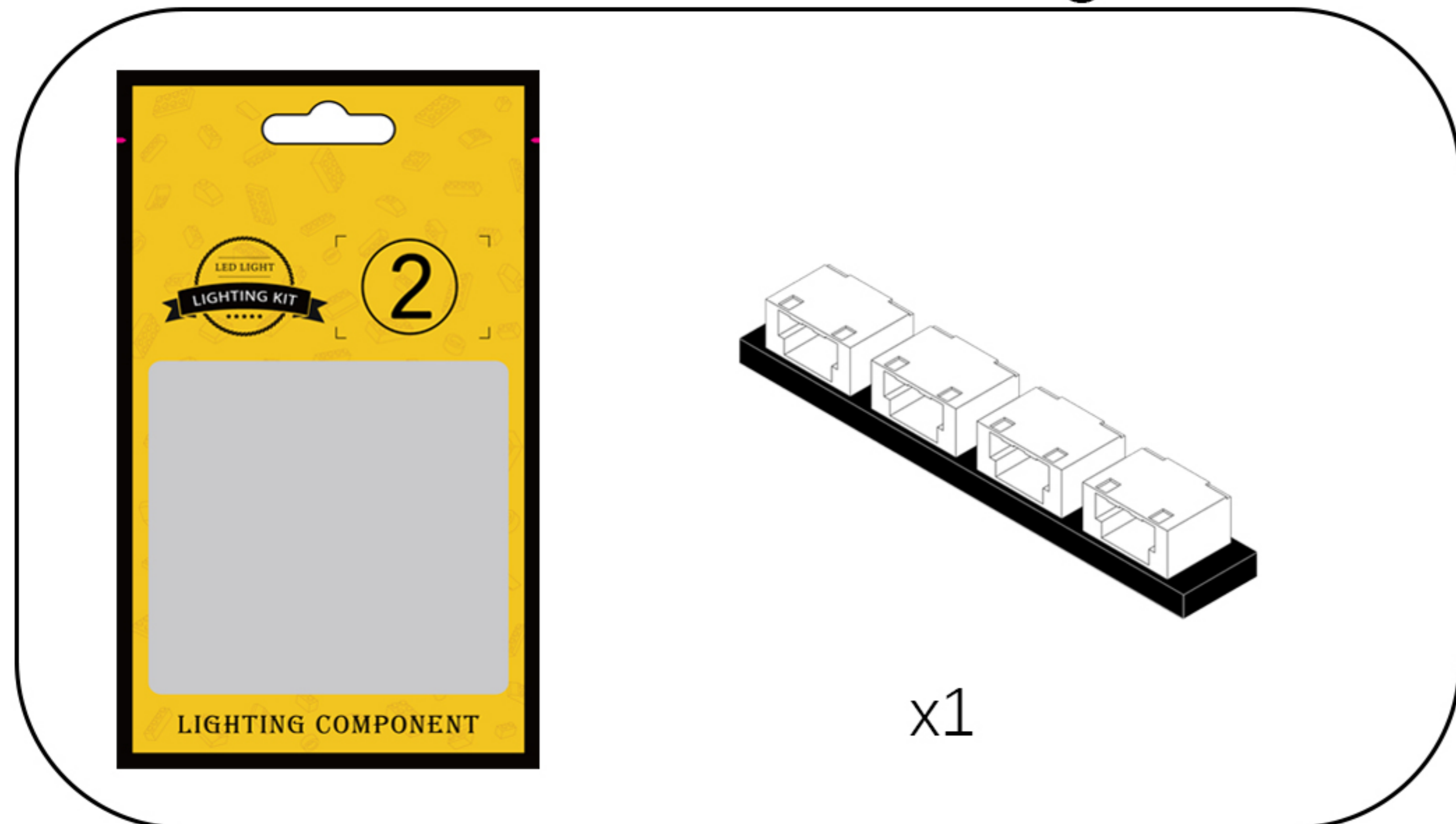

24

EN: Connect the two light cables to the expansion board one after the other.

DE: Schließen Sie die beiden Lichtkabel nacheinander an die Erweiterungskarte an.

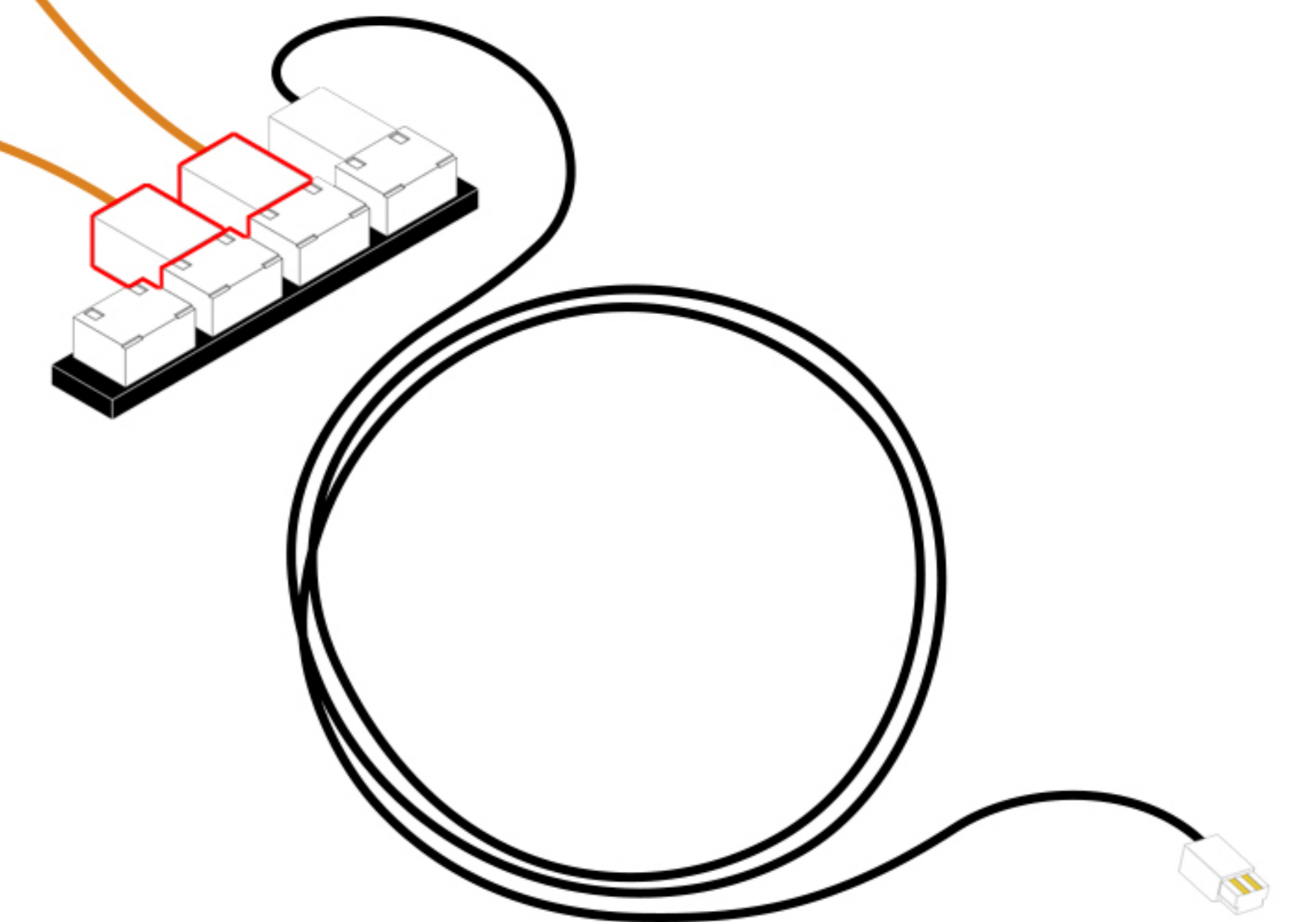
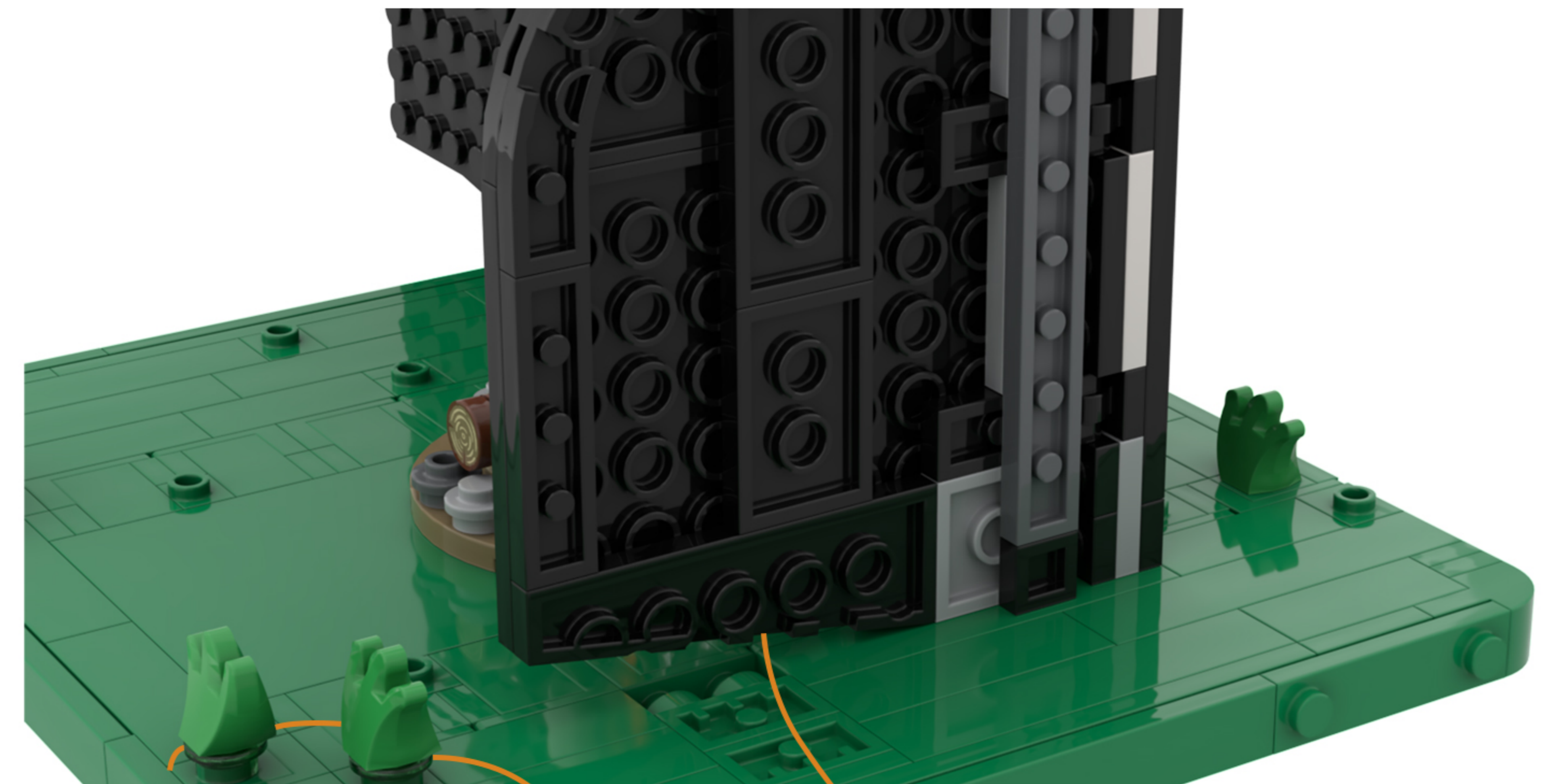
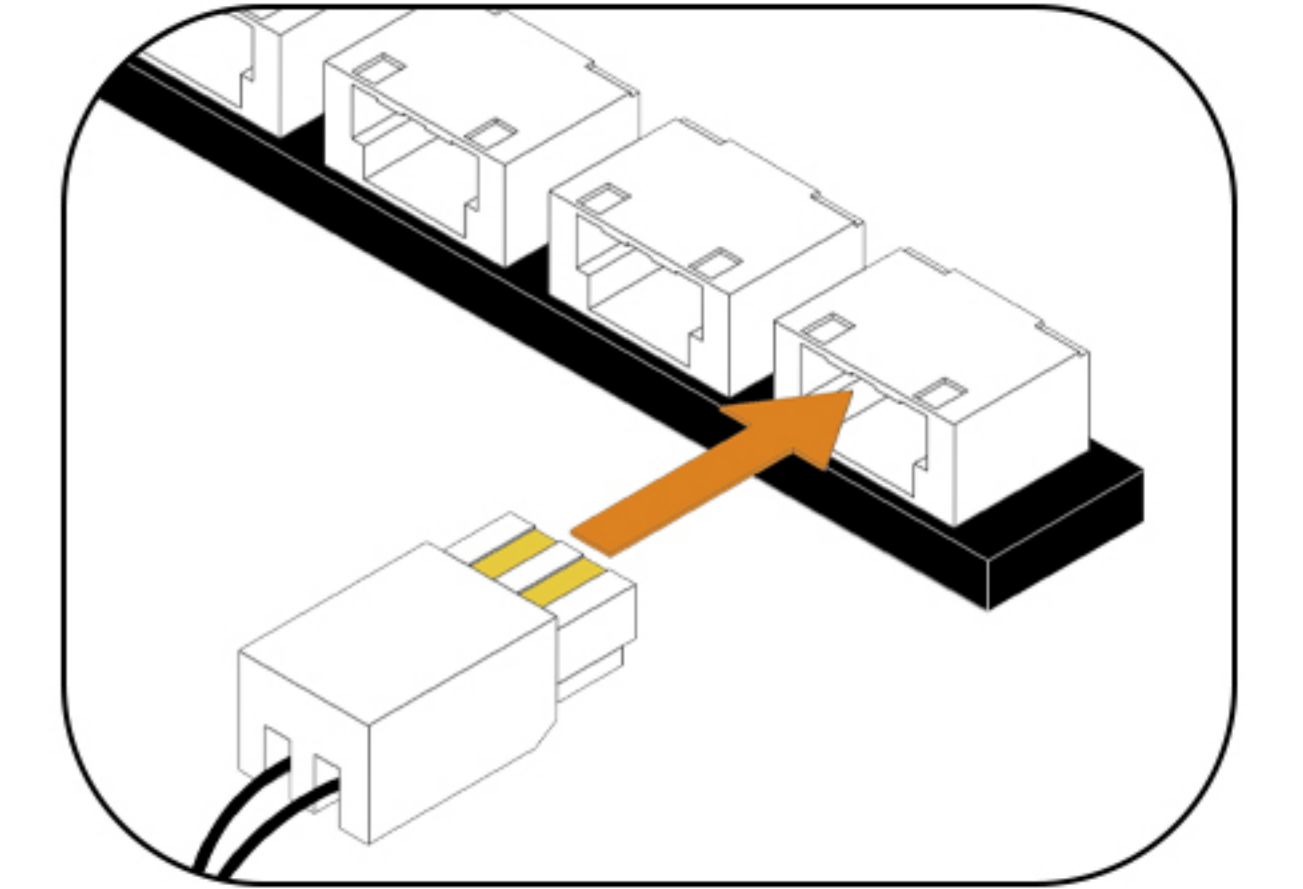

25

EN: Peel off the adhesive backing of the expansion board and attach it to the location shown in the illustration.

DE: Entfernen Sie die Schutzfolie von der Rückseite der Erweiterungsplatte und kleben Sie sie an die in der Abbildung gezeigte Stelle.

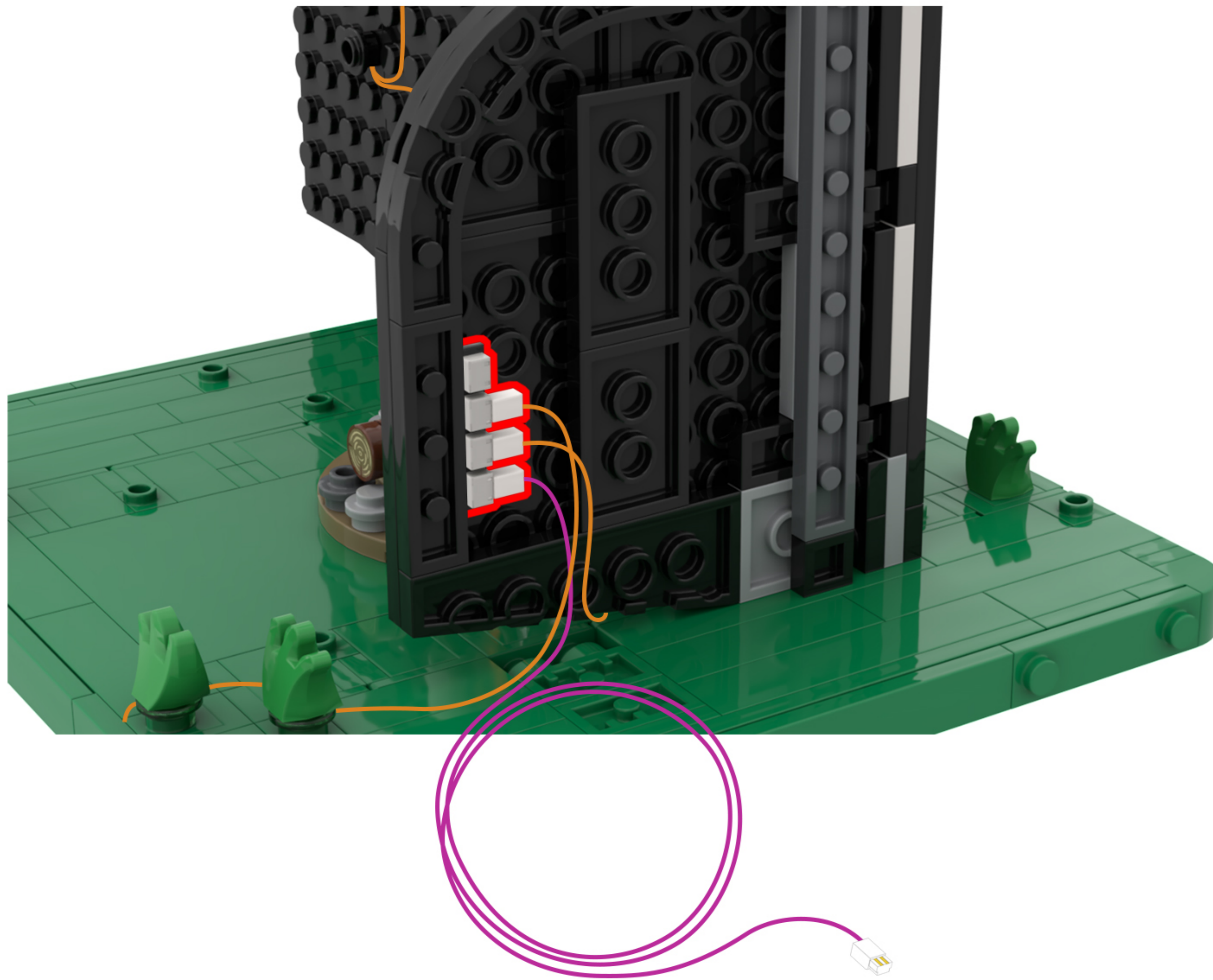

26

EN: Rotate the brick on the left side of the model back to its original position.

DE: Drehen Sie den Stein auf der linken Seite des Modells wieder in seine ursprüngliche Position zurück.

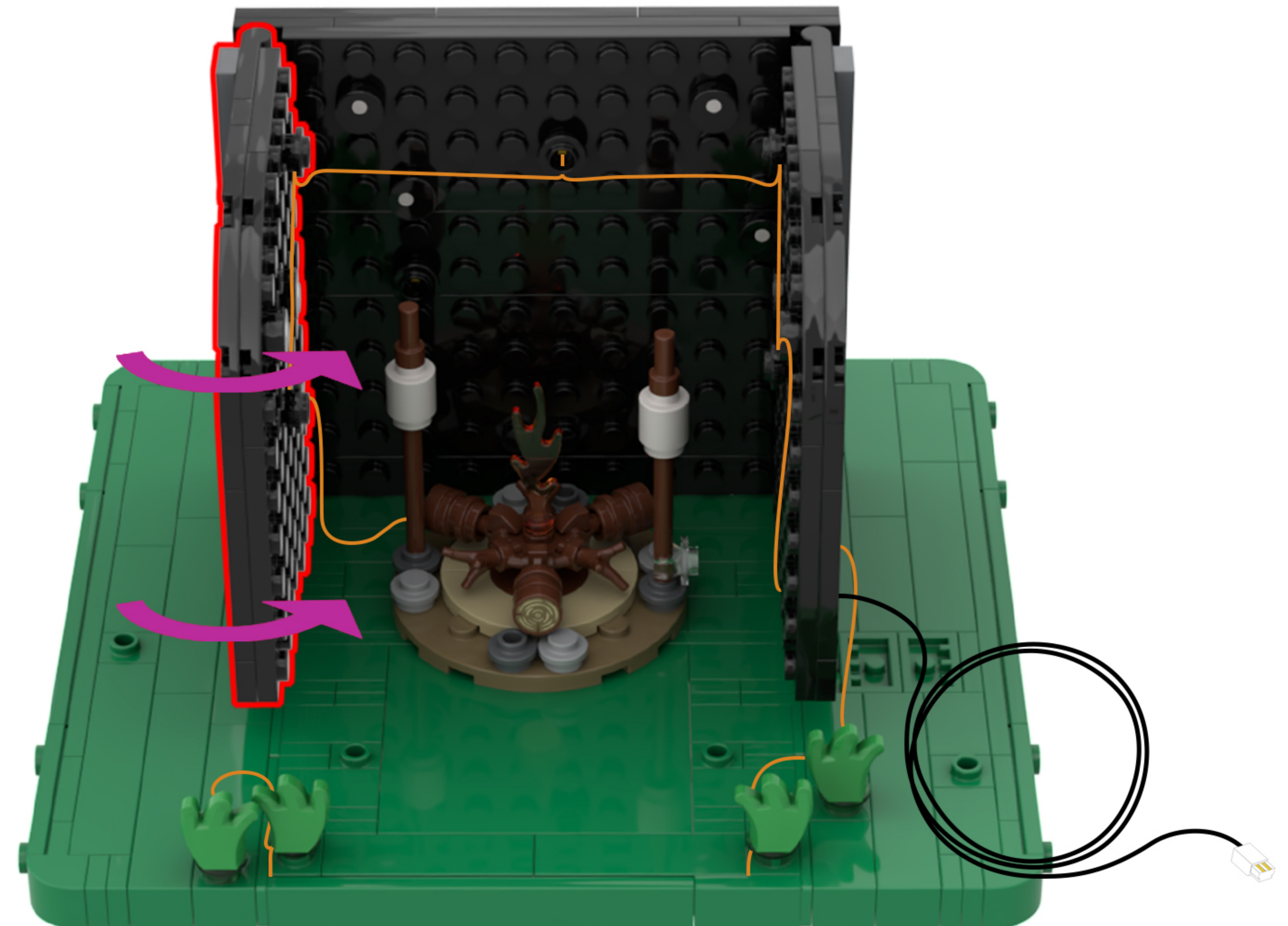

27

EN: Take out the building block model.

DE: Nimm das Bauklotzmodell heraus.



28

EN: Take the light strip and connecting cable out of Bag 4 and connect them together.

DE: Nehmen Sie den Lichtstreifen und das Verbindungskabel aus Beutel 4 und verbinden Sie beide miteinander.

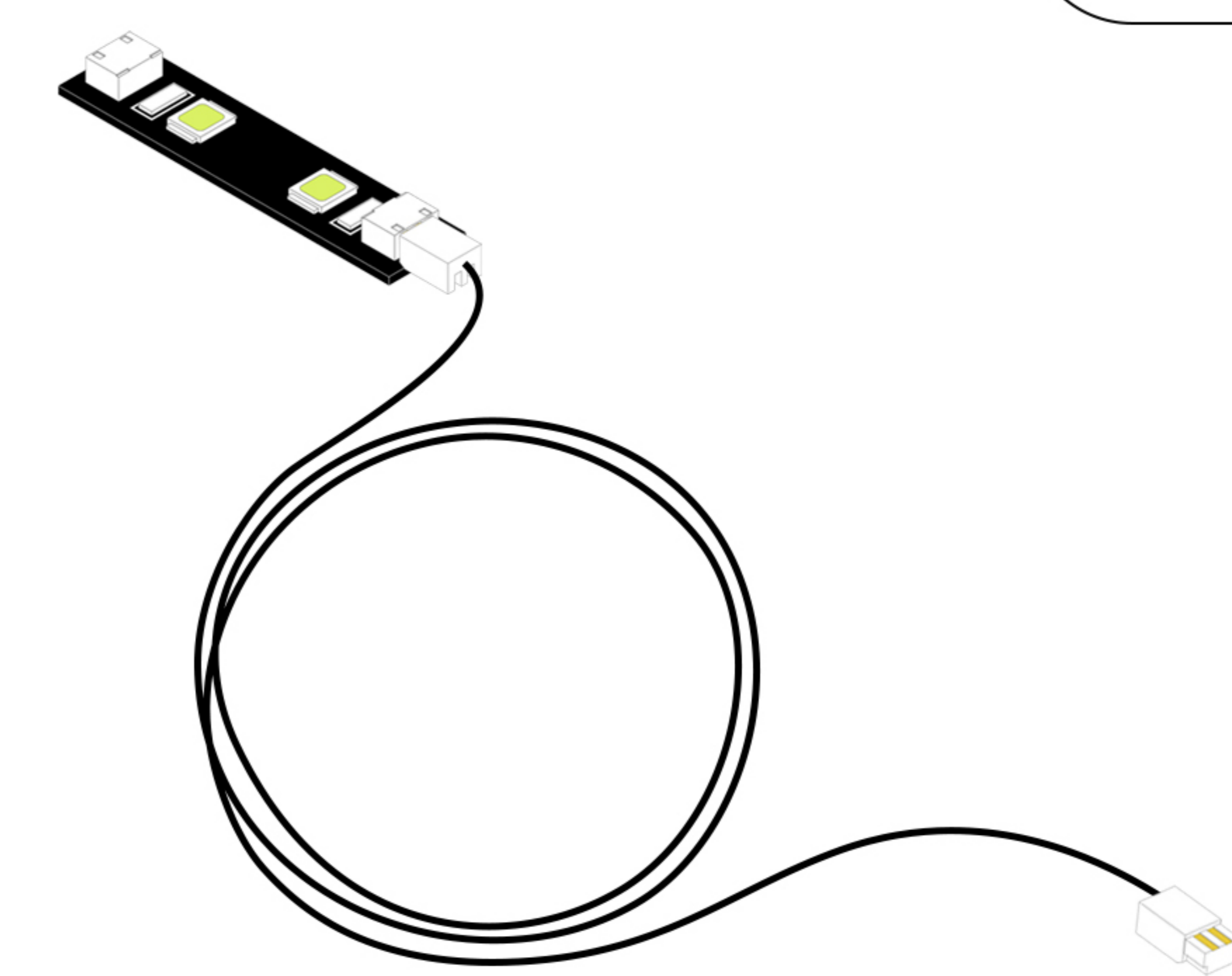
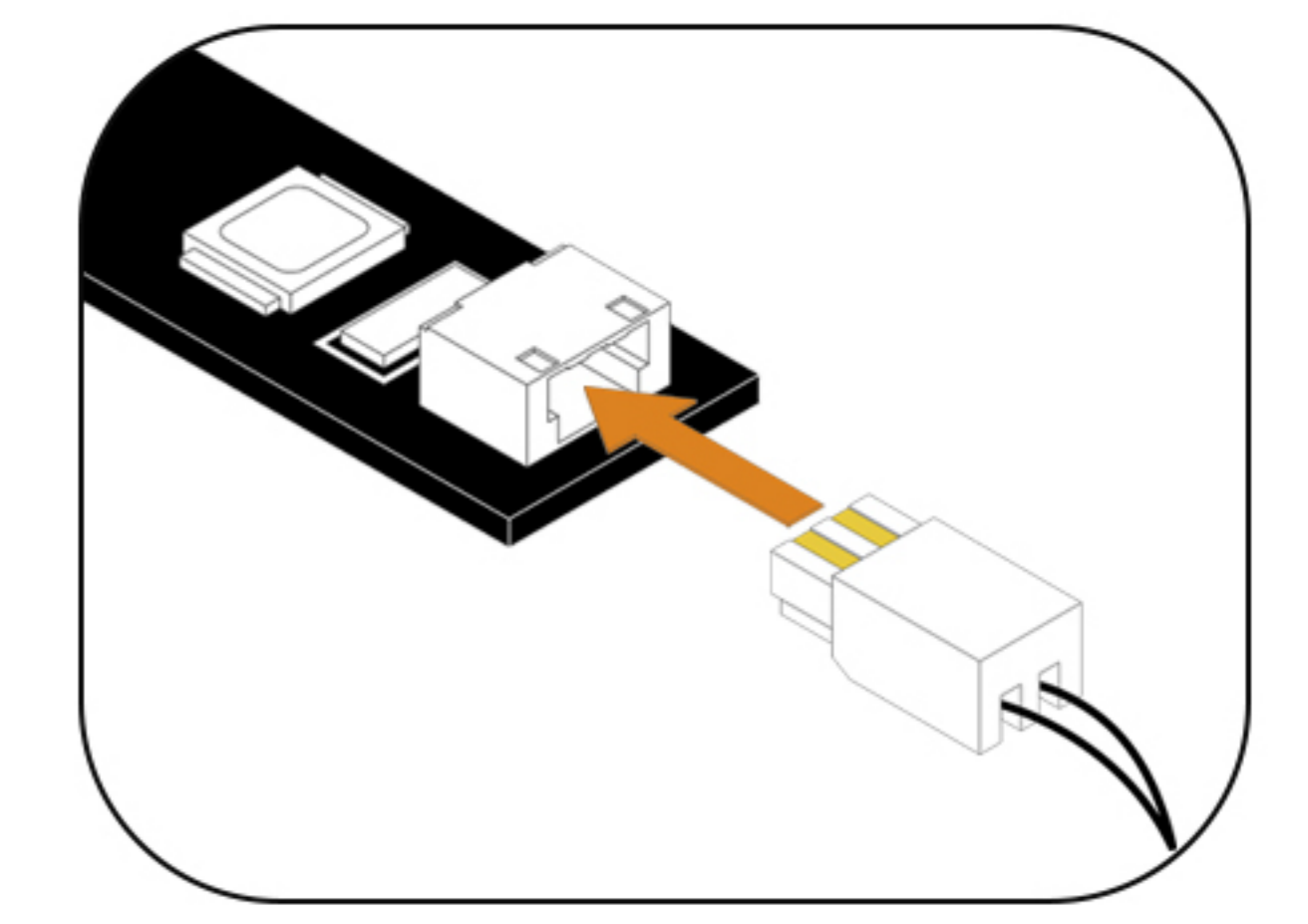
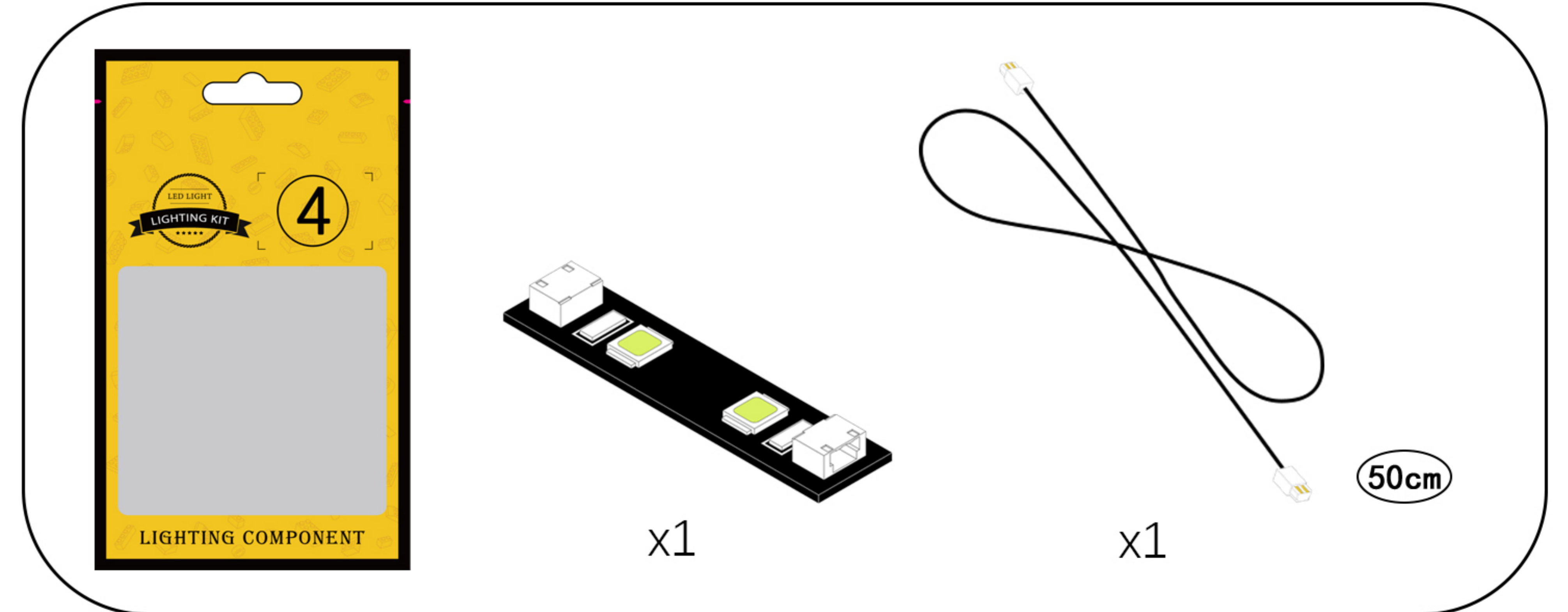

29

EN: Peel off the backing paper from the LED strip and attach it to the building block.

DE: Ziehen Sie das Trägerpapier vom LED-Streifen ab und befestigen Sie ihn am Baustein.

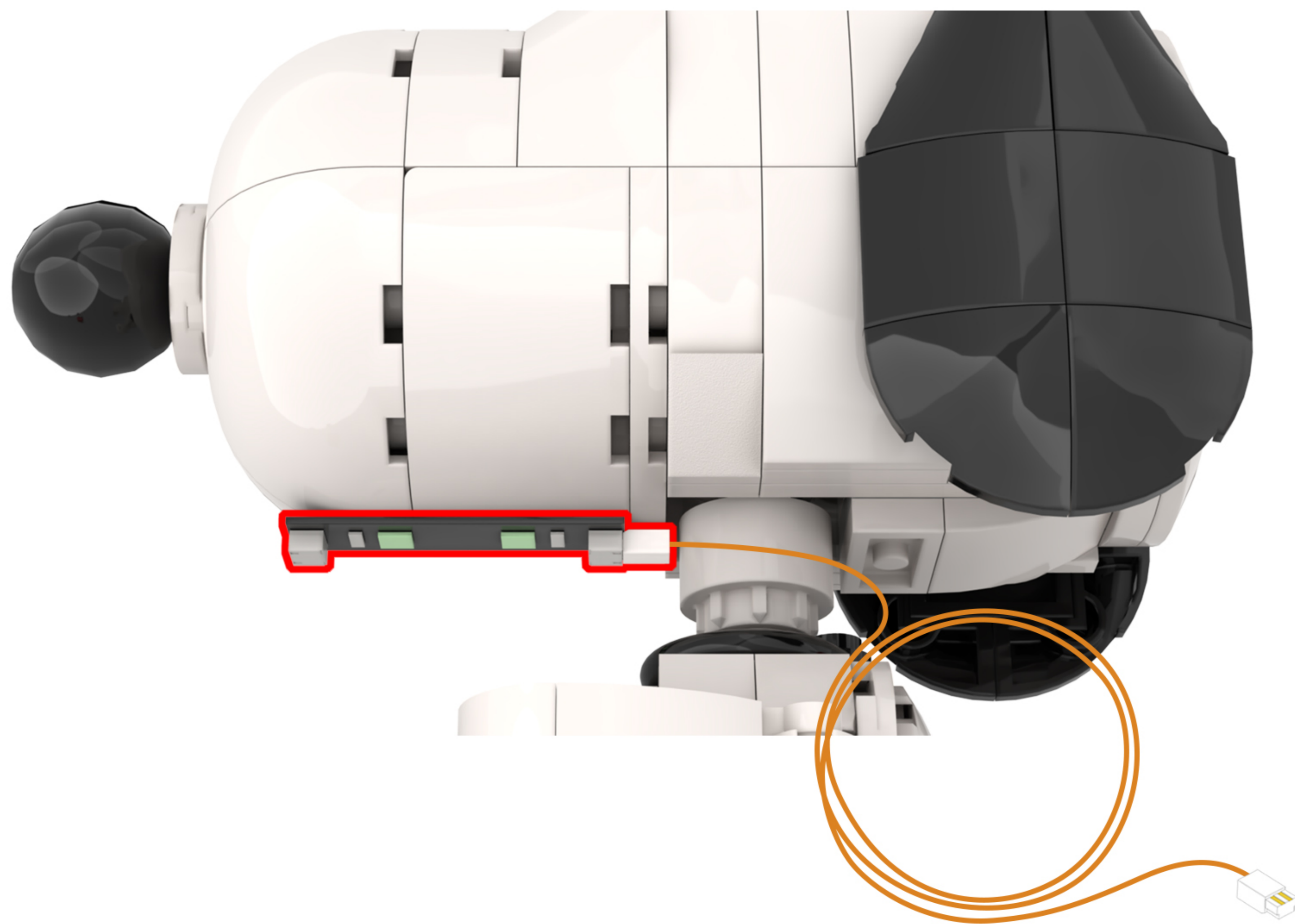

30

EN: Tuck the light cord into the gaps between the building blocks.

DE: Stecke das Kabel der Lampe in die Zwischenräume zwischen den Bausteinen.

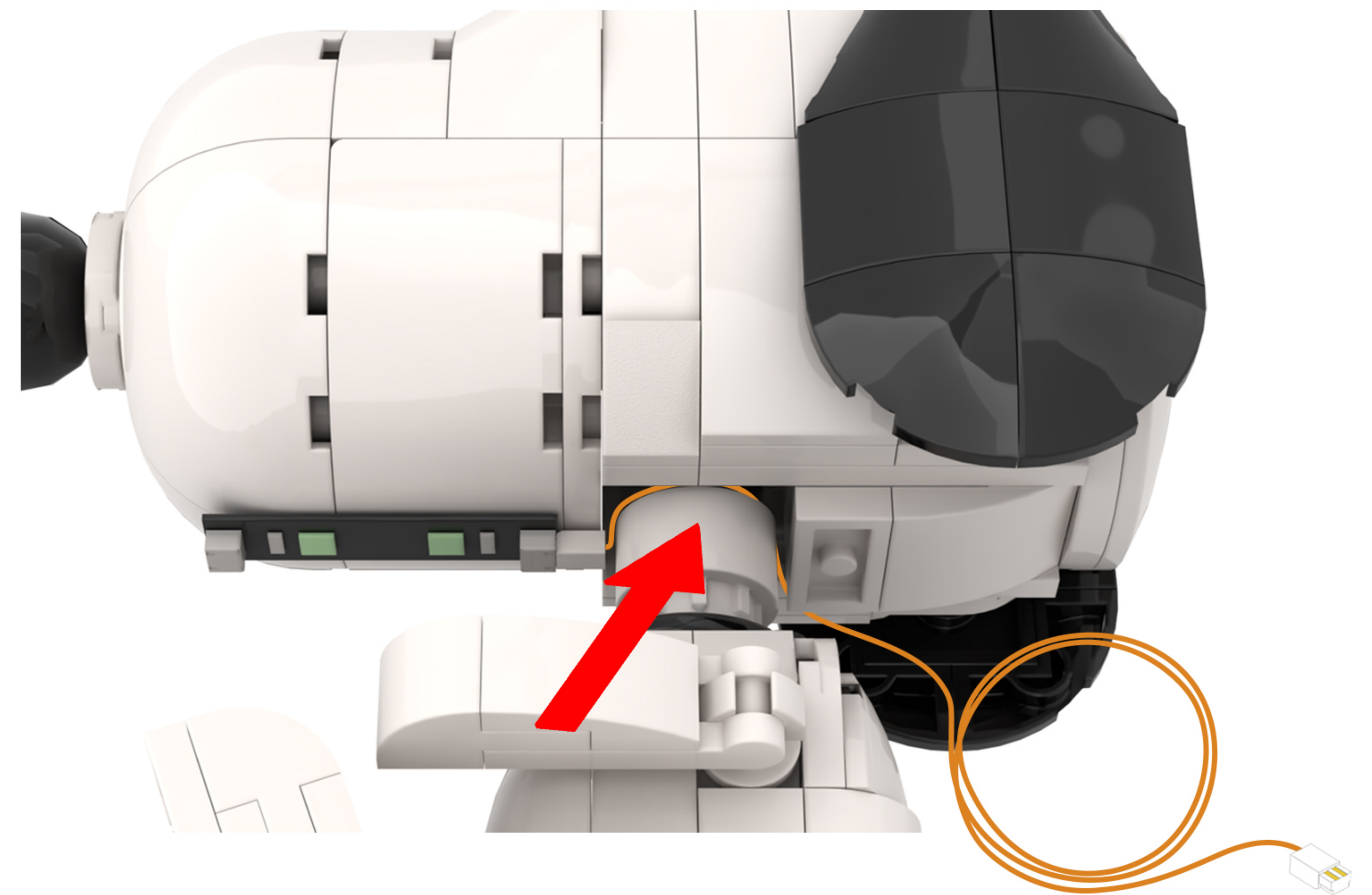

31

EN: Take out the disassembled building blocks and lay them flat on the table.  
DE: Nimm die zerlegten Bausteine heraus und lege sie flach auf den Tisch.

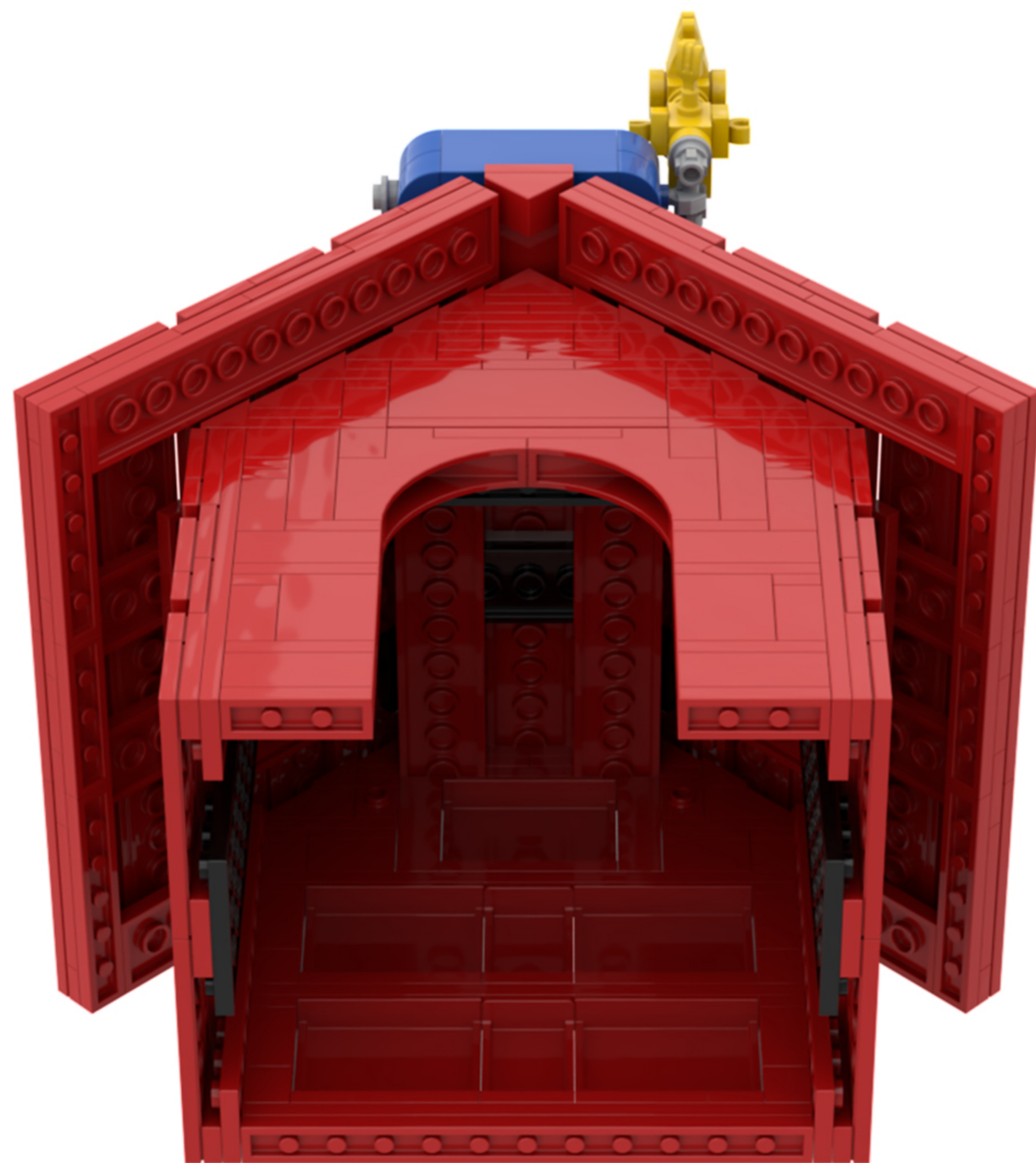
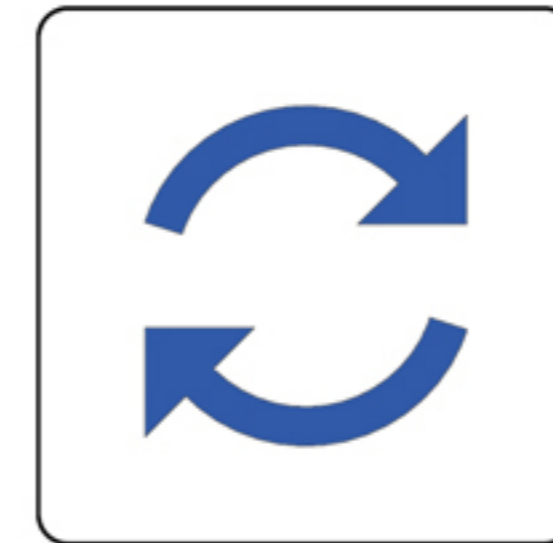
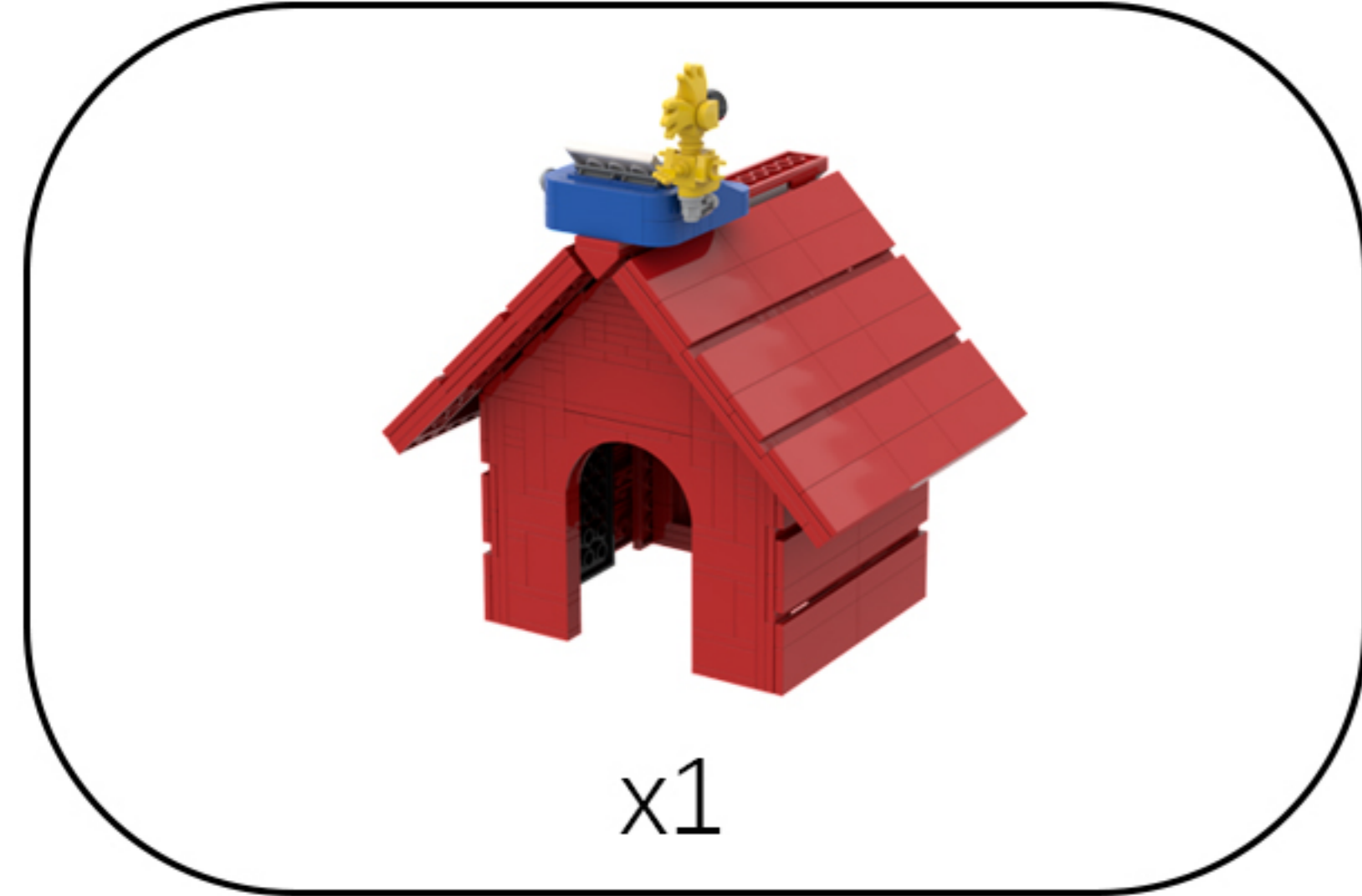

32

EN: Take out the building block with the lights attached and locate its light cord.  
DE: Nehmen Sie den Baustein mit den daran befestigten Lichtern heraus und suchen Sie das Lichtkabel.

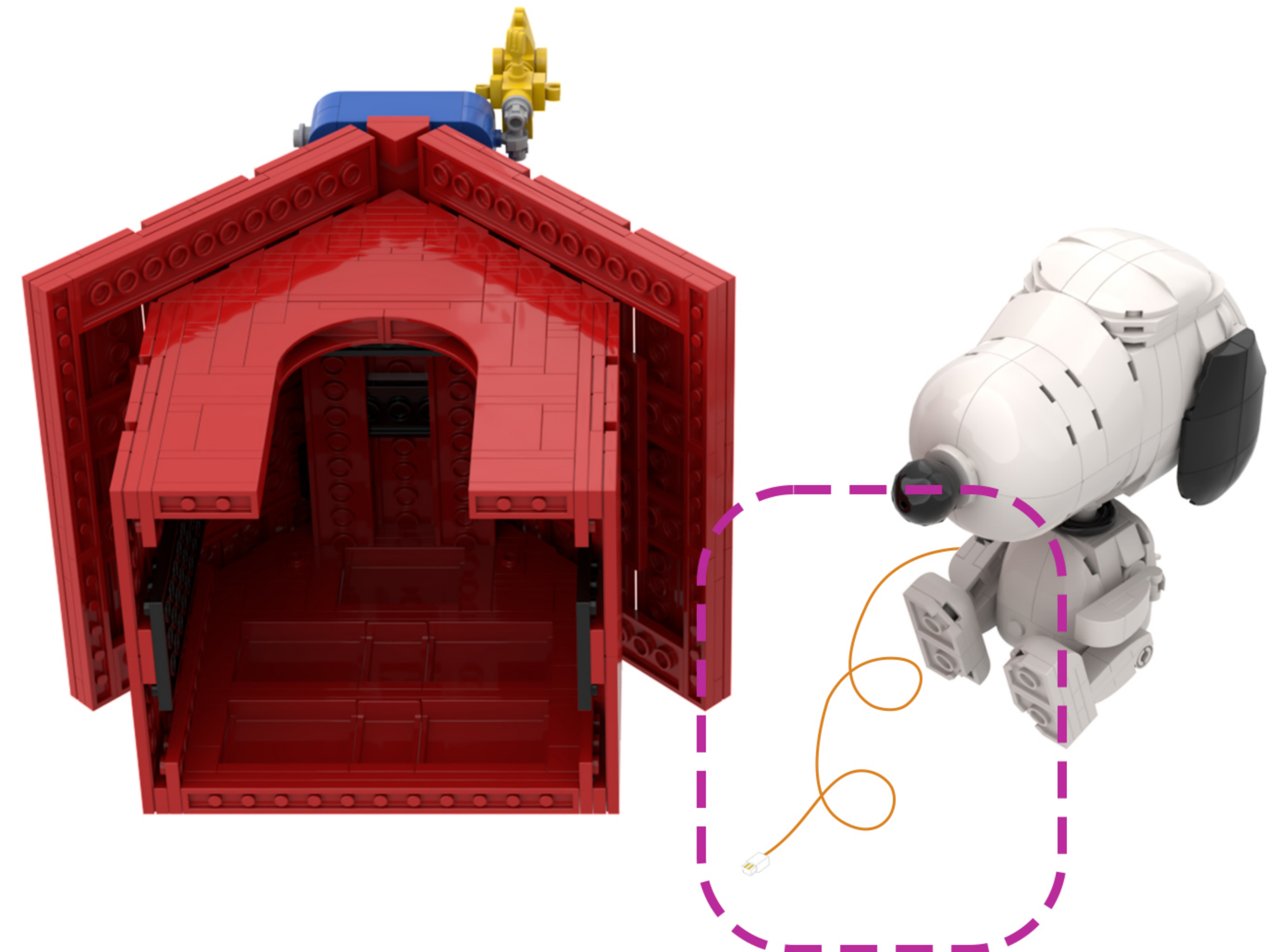
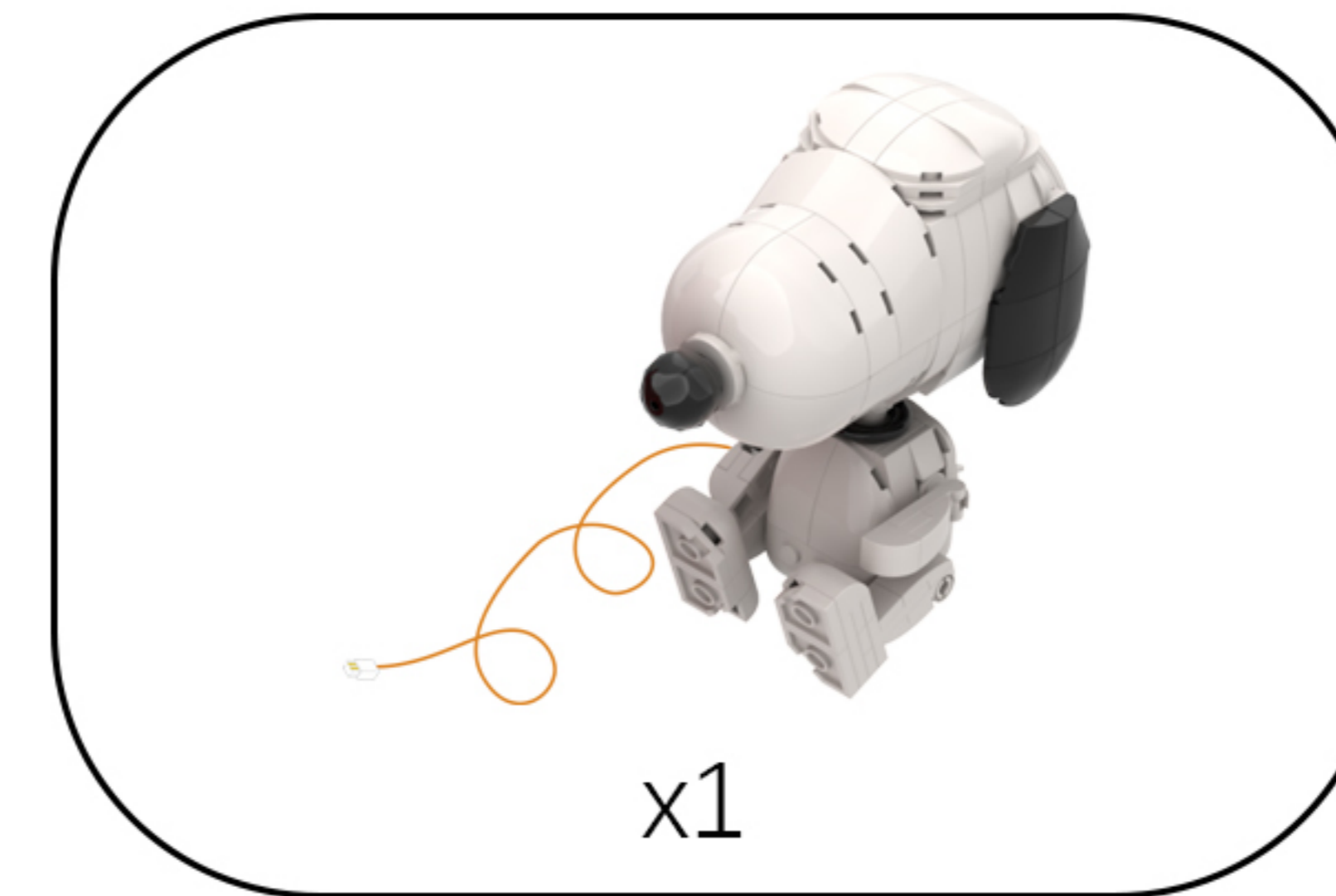

33

EN: Thread the light cord through the gap in the building block and place it inside the block.

DE: Führen Sie das Lichtschrur durch die Öffnung im Baustein und legen Sie es in den Block hinein.

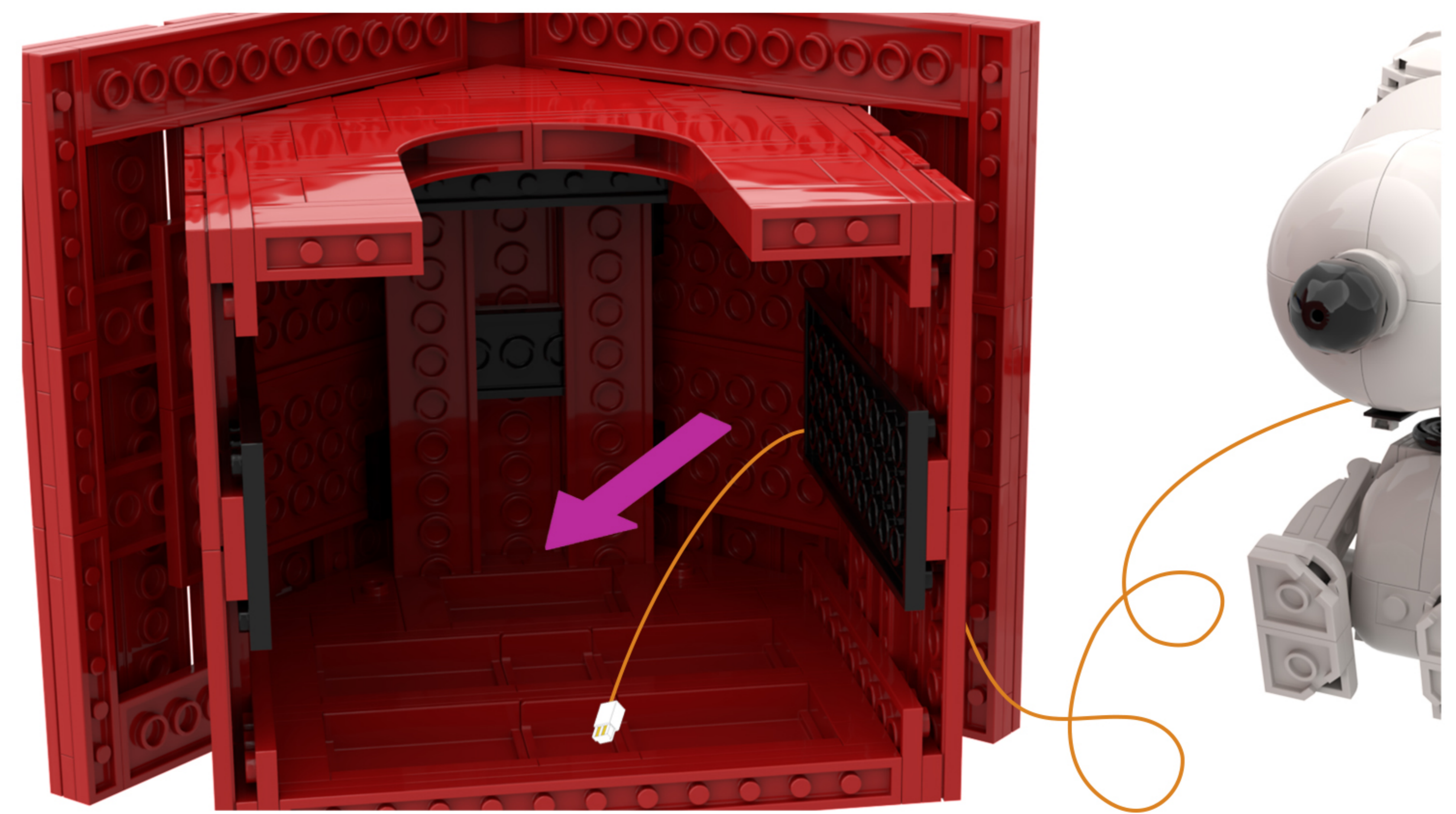
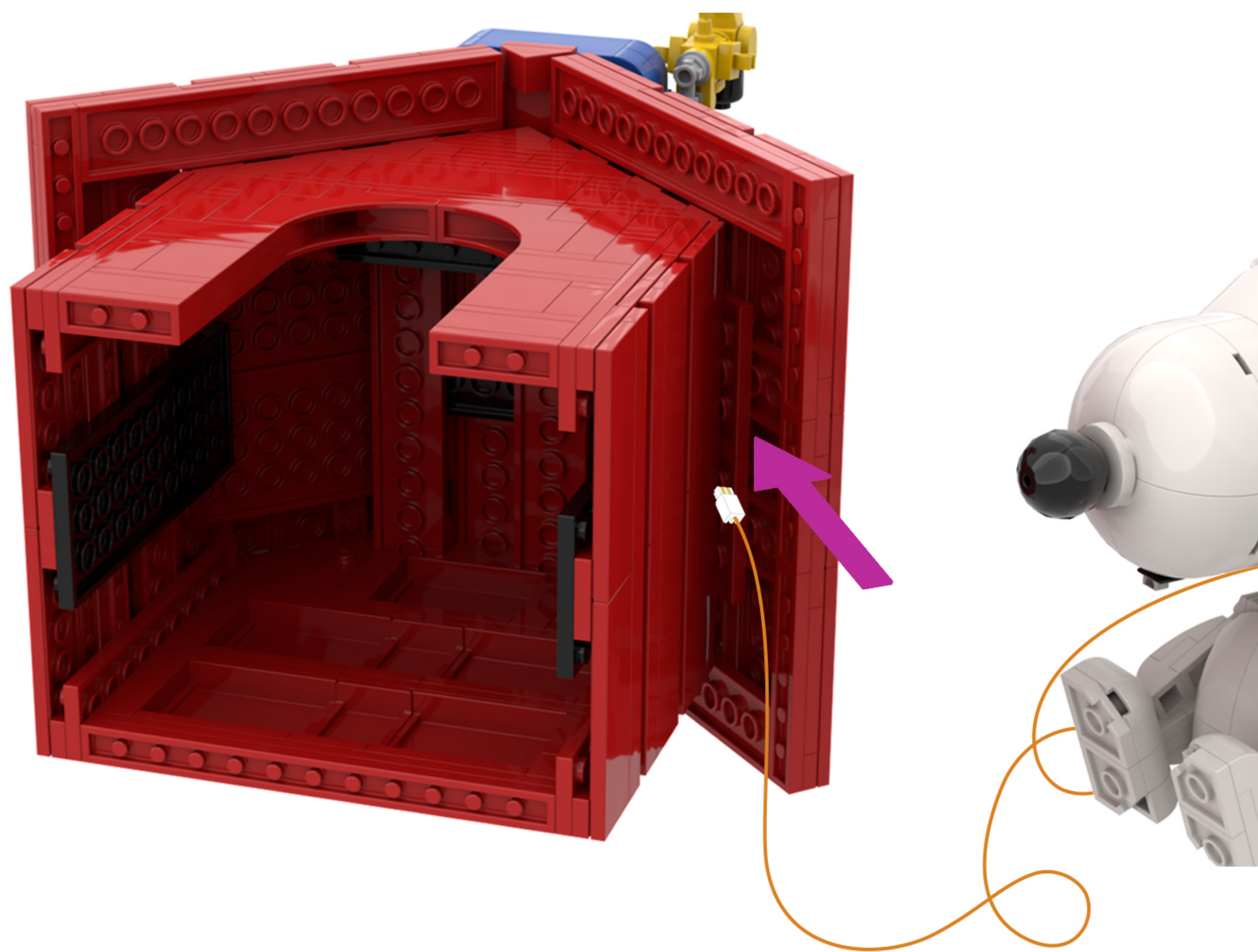

34

EN: Take the COB light strip out of Bag 3, peel off the adhesive backing, and attach it to the location shown in the diagram.

DE: Nehmen Sie den COB-Lichtstreifen aus Beutel 3, ziehen Sie die Schutzfolie ab und befestigen Sie ihn an der in der Abbildung gezeigten Stelle.

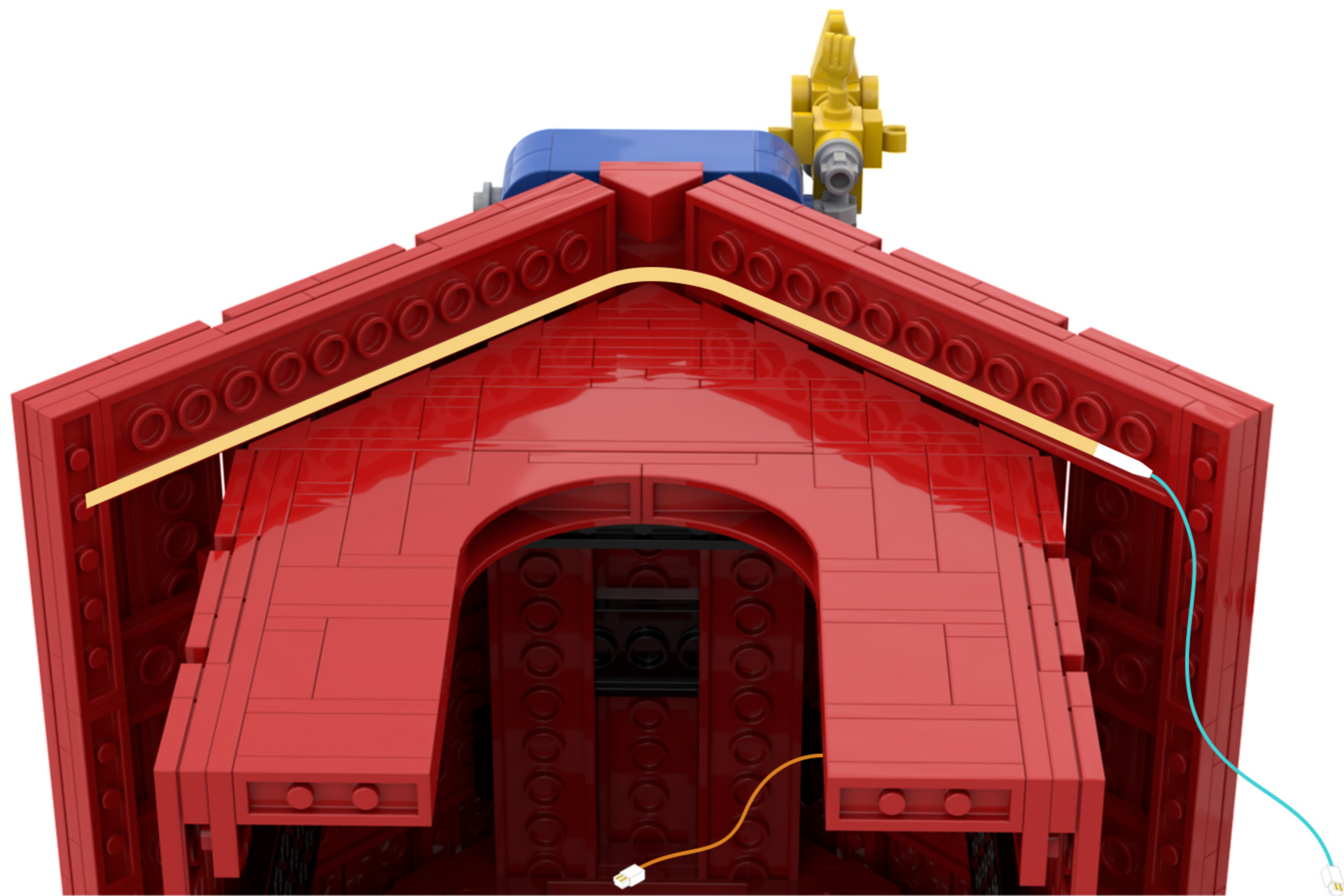
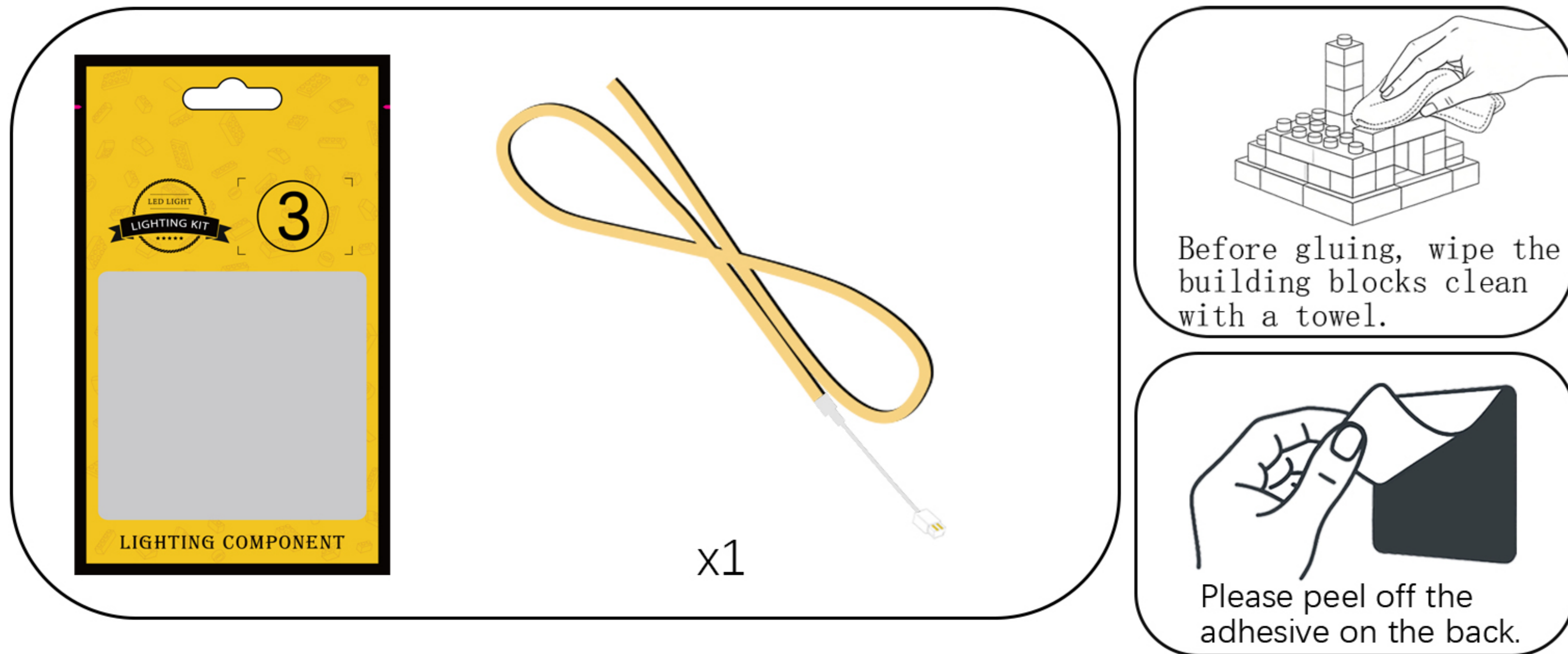

35

EN: Thread the light cord through the gap in the building block and place it inside the block.

DE: Führen Sie das Lichtschnur durch die Öffnung im Baustein und legen Sie es in den Block hinein.

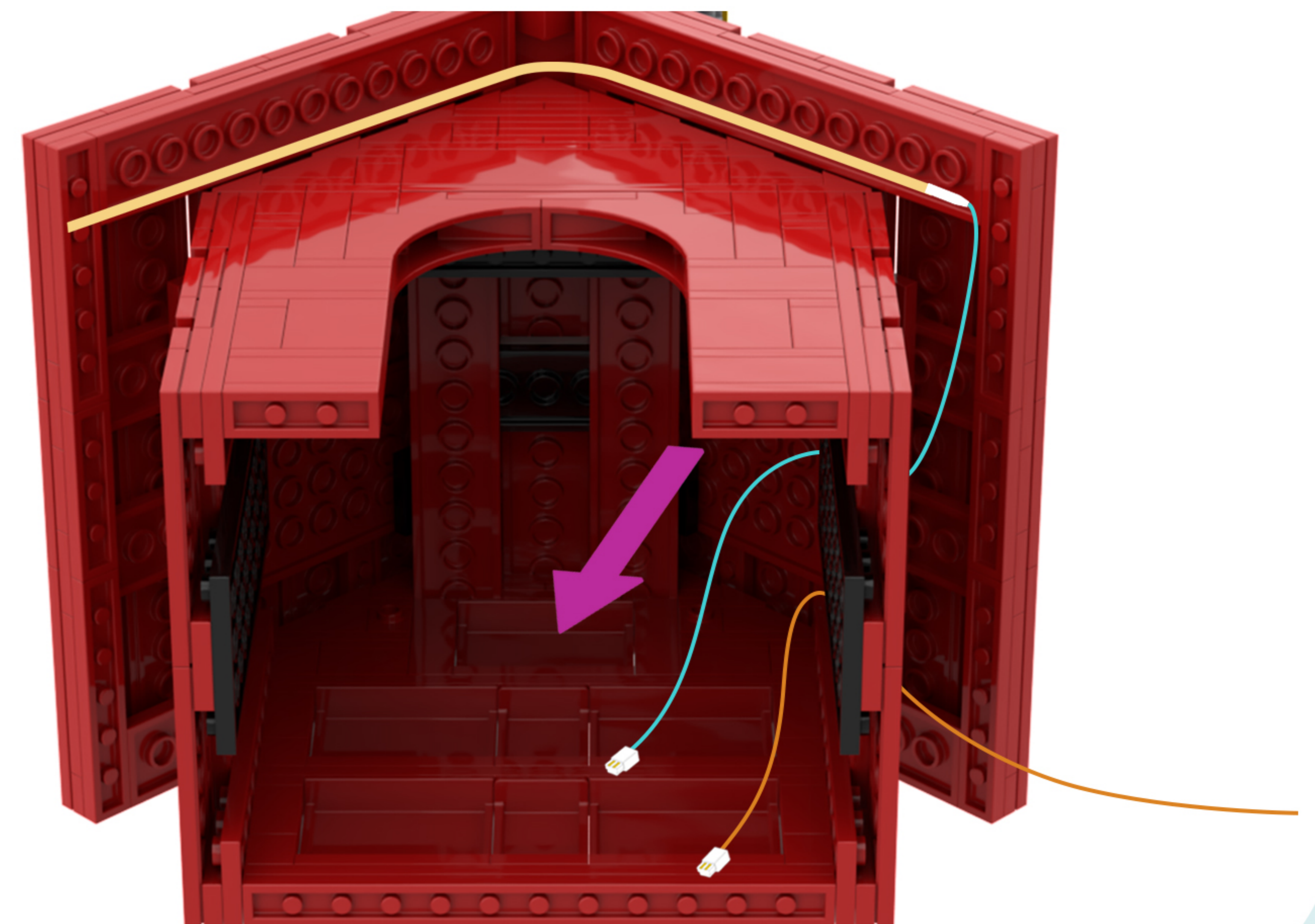
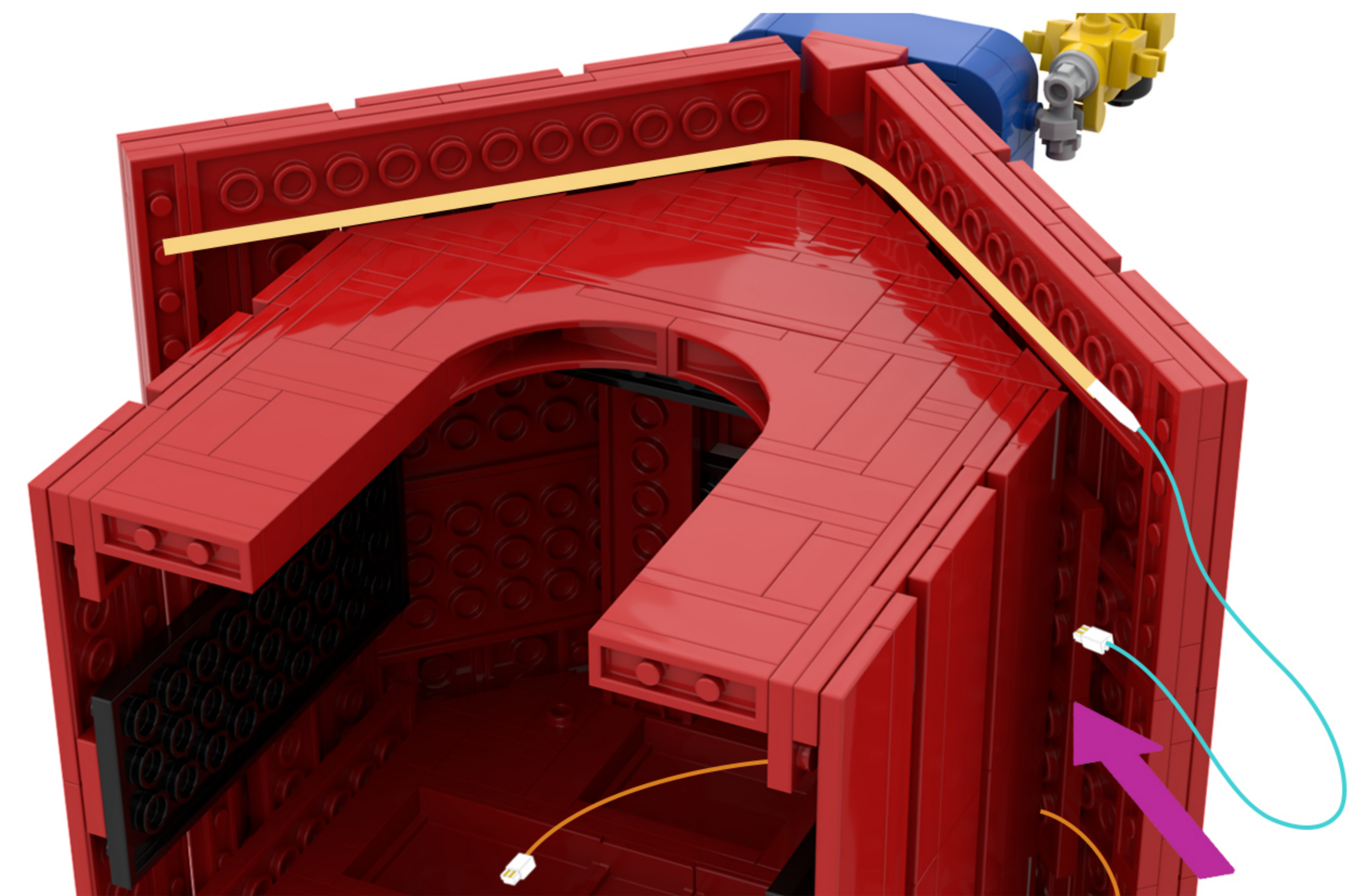

36

EN: Take the perforated circular board, LED strip, 10-cm connector wire, and 15-cm connector wire from Bag 2, and assemble them in the following order.

DE: Nehmen Sie die gelochte runde Platine, den LED-Streifen, das 10 cm lange Anschlusskabel und das 15 cm lange Anschlusskabel aus Beutel 2 und bauen Sie diese in der folgenden Reihenfolge zusammen.

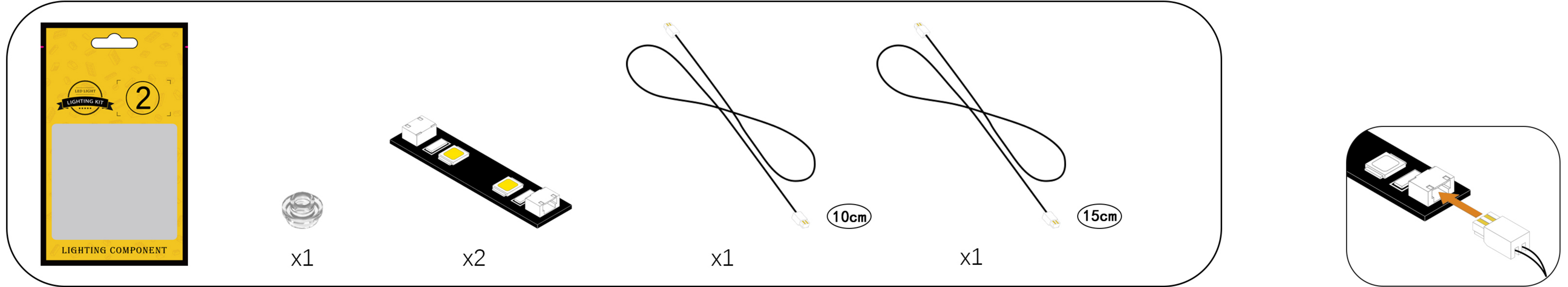

①. Connect the two cables to the two light strips, respectively.

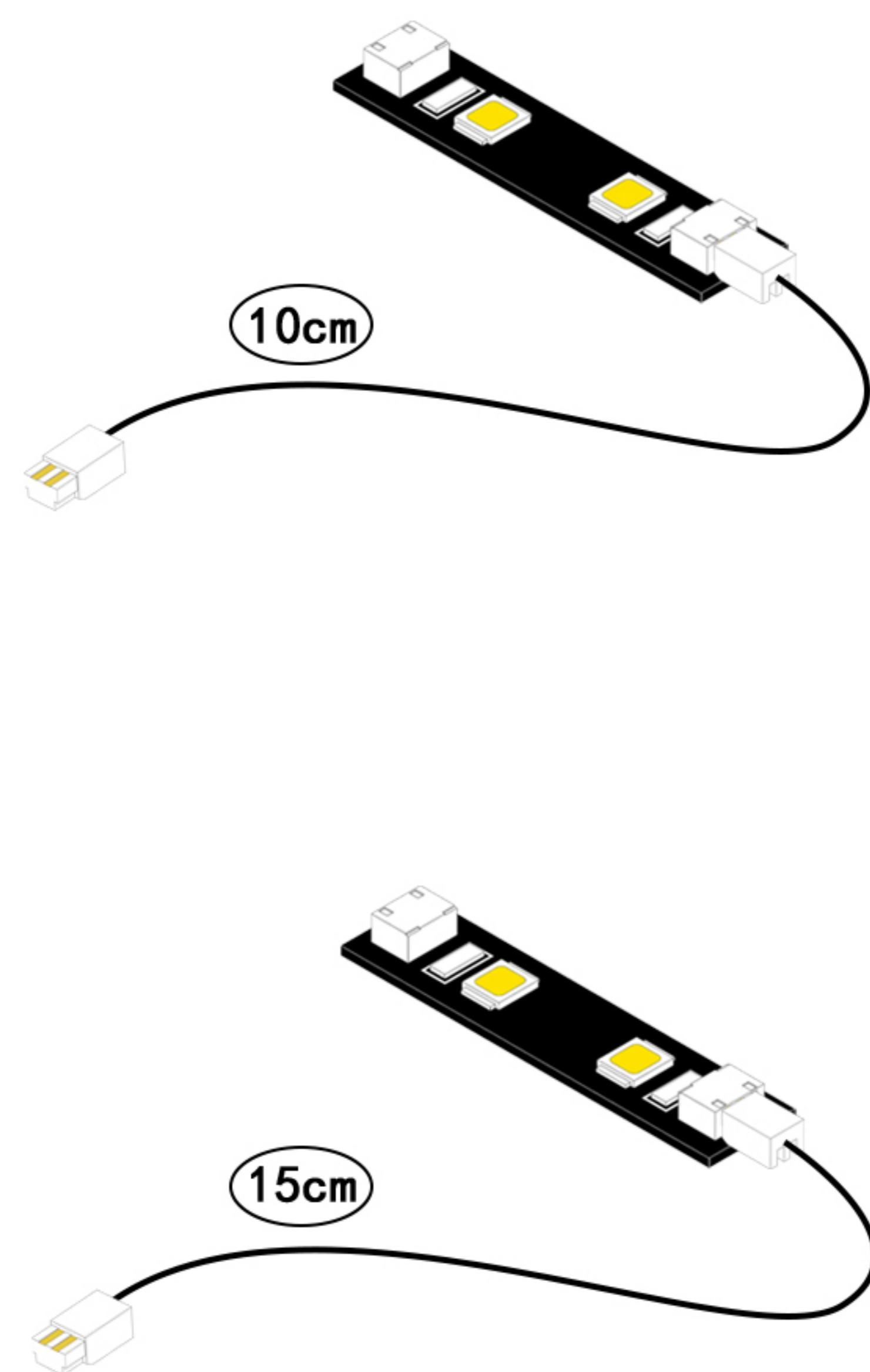

②. Thread the small round plate onto the 10-cm connecting wire.

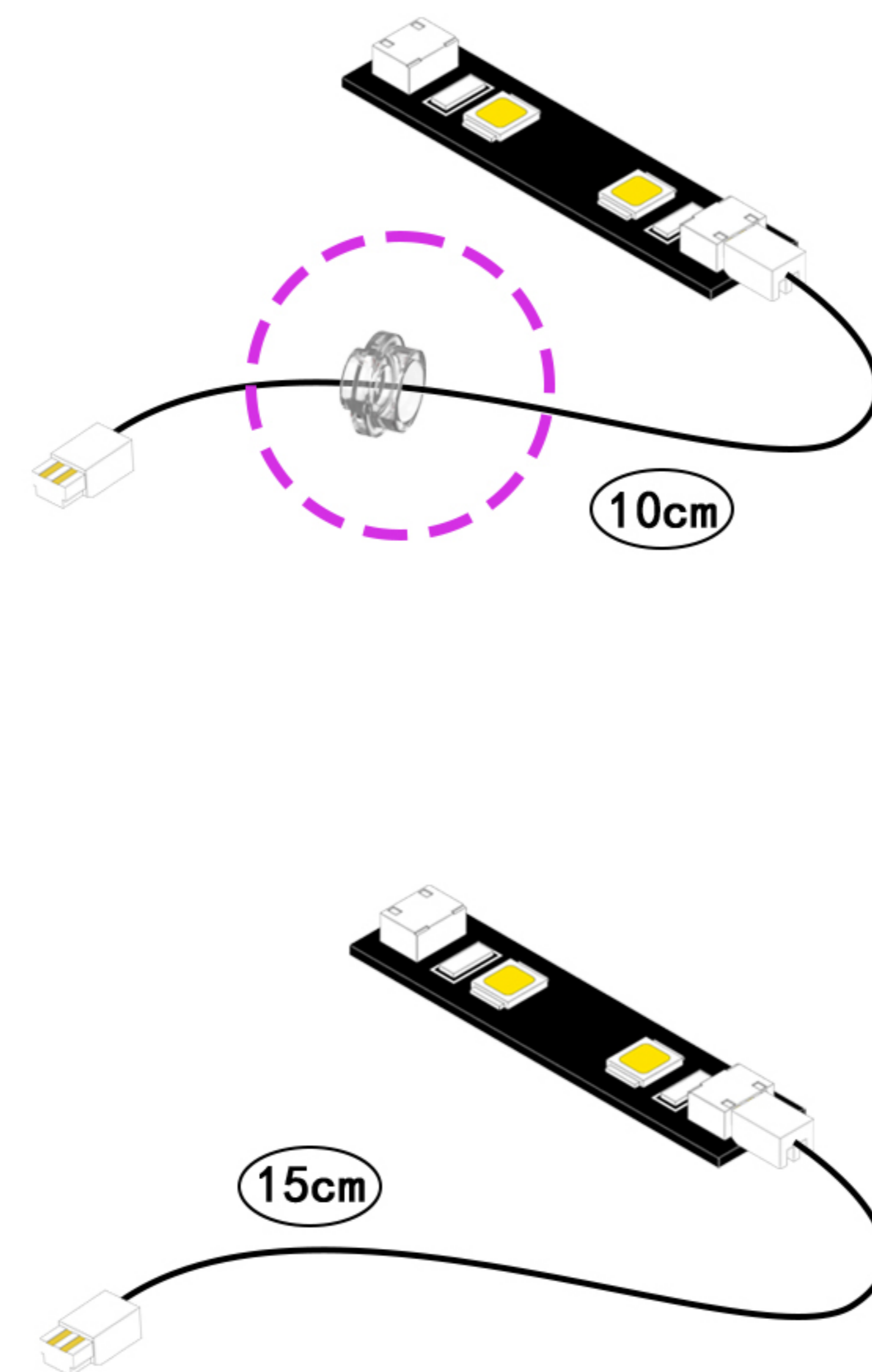

③. Connect the 10-cm connector cable to the other light strip.

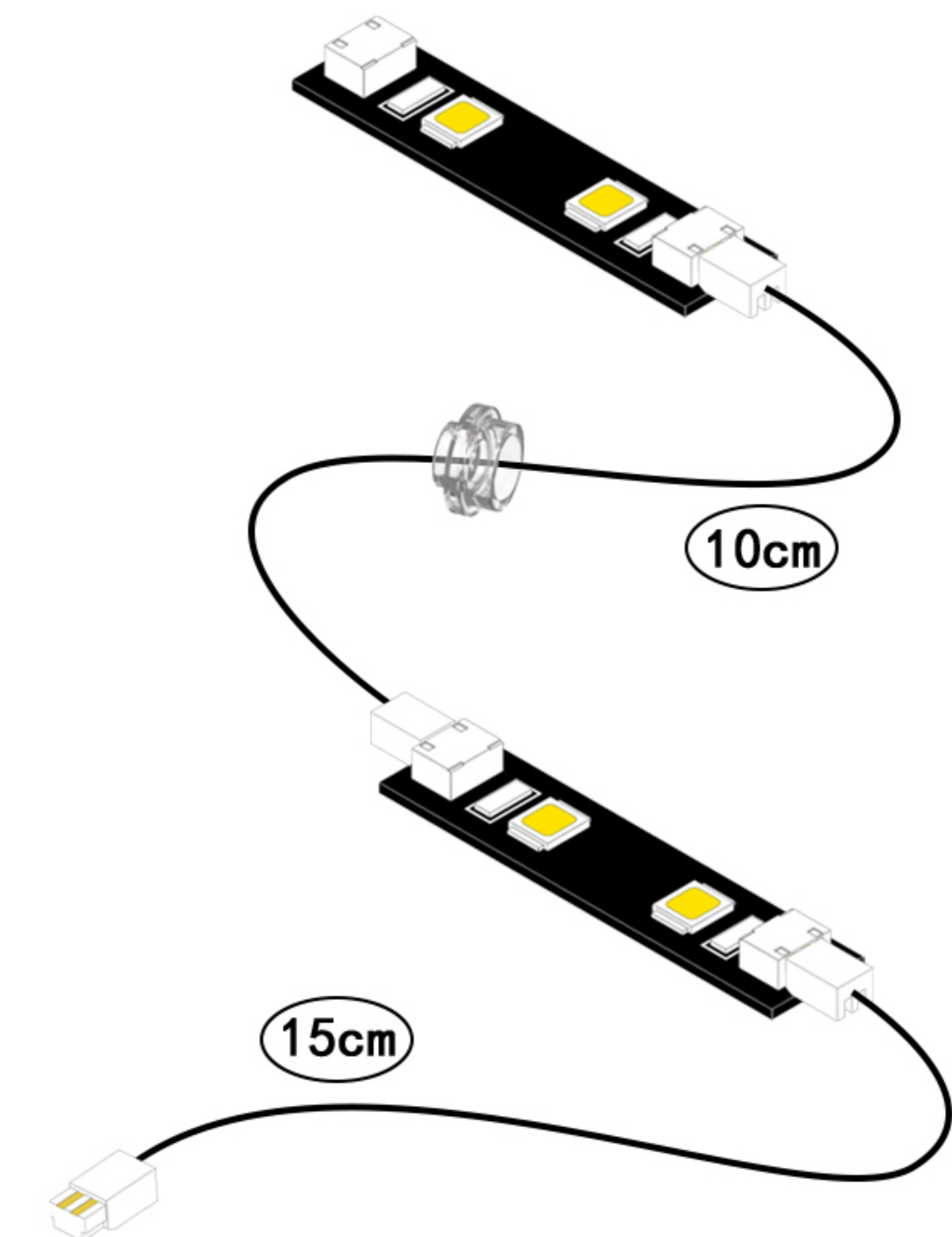

37

EN: Find the light strip shown in the picture.

DE: Suchen Sie den auf dem Bild gezeigten Lichtstreifen.

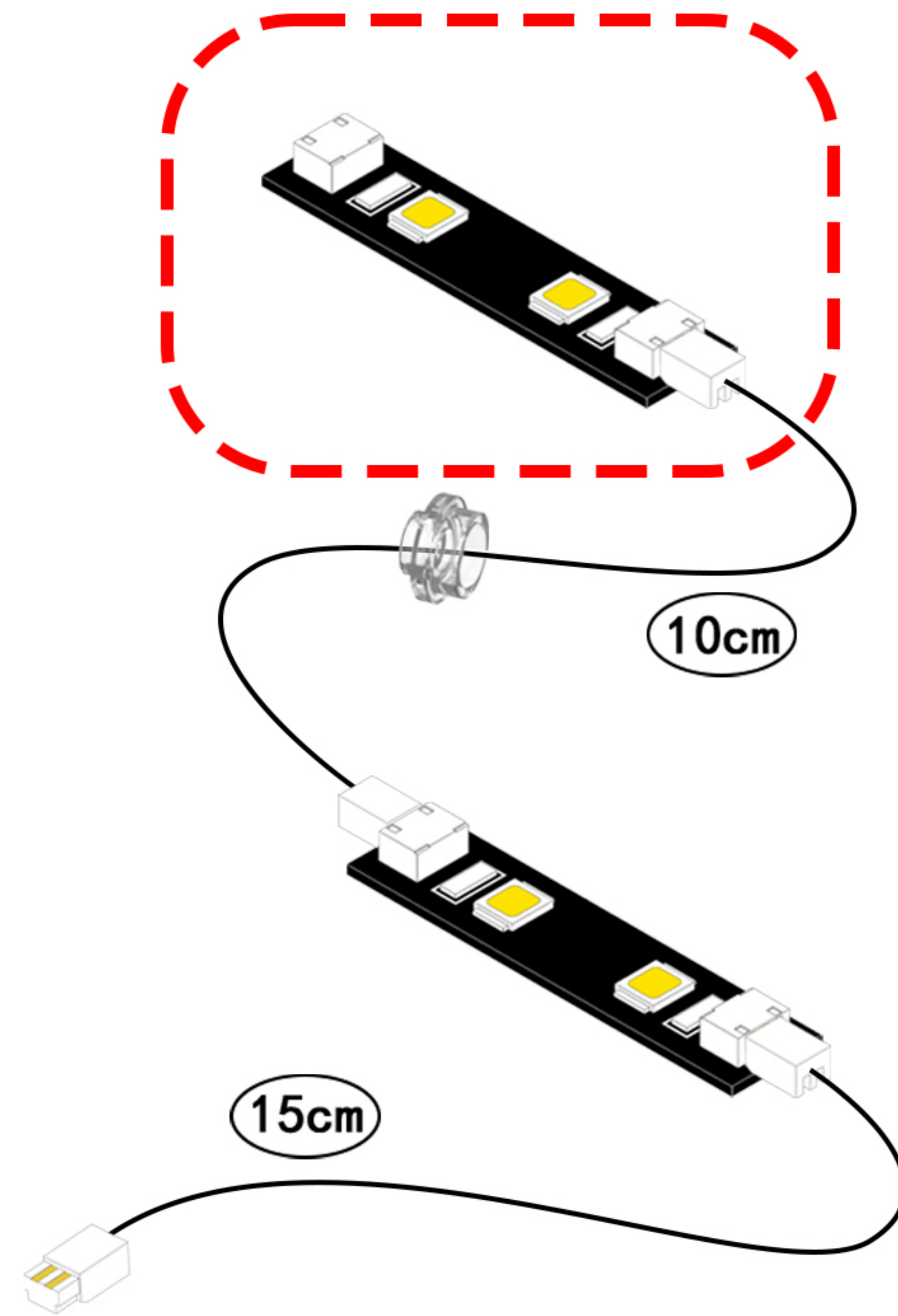

38

EN: Peel off the backing paper from the LED strip and attach it to the building block.

DE: Ziehen Sie das Trägerpapier vom LED-Streifen ab und befestigen Sie ihn am Baustein.

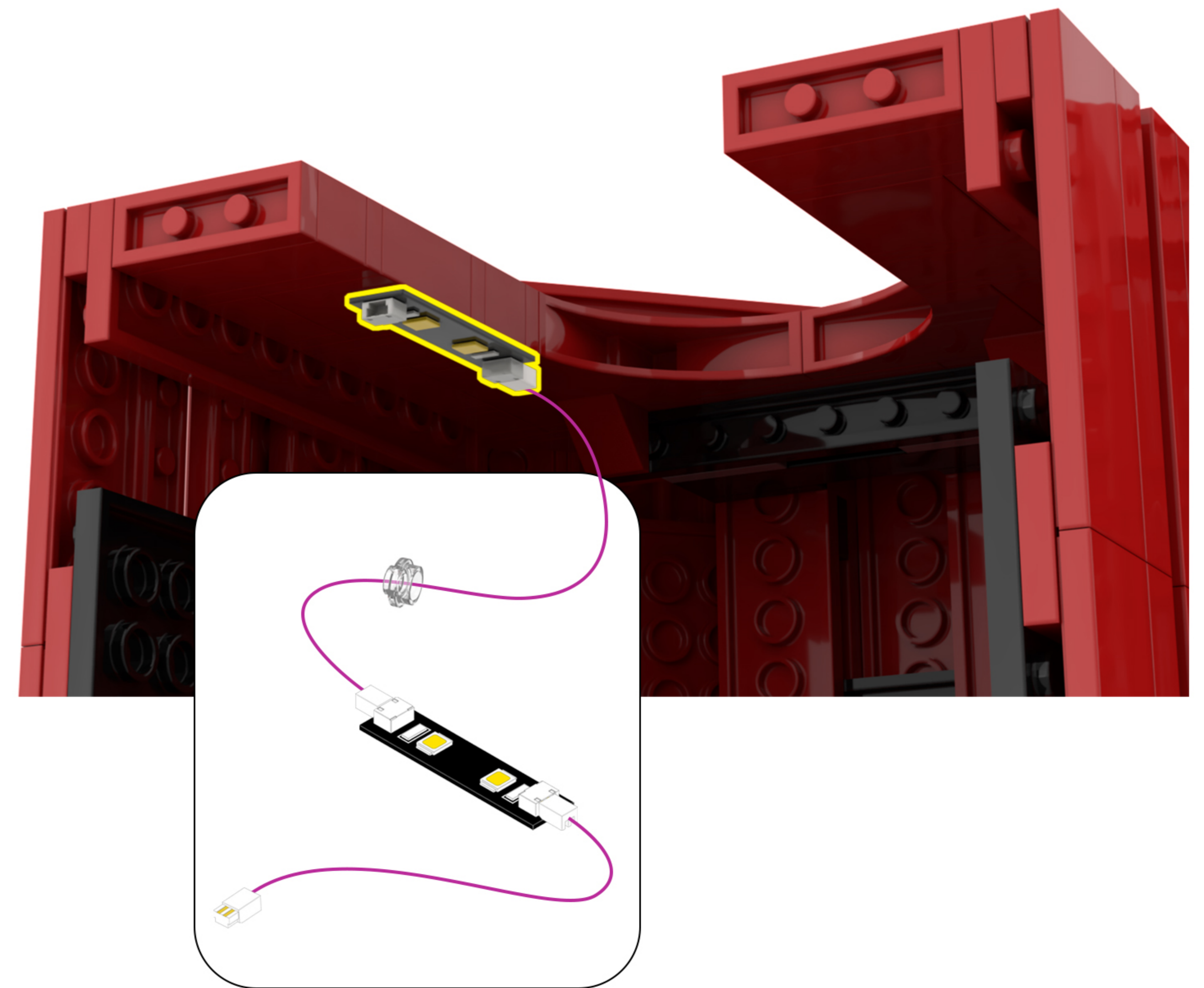

39

EN: Find the small round plate.

DE: Such den kleinen runden Teller.

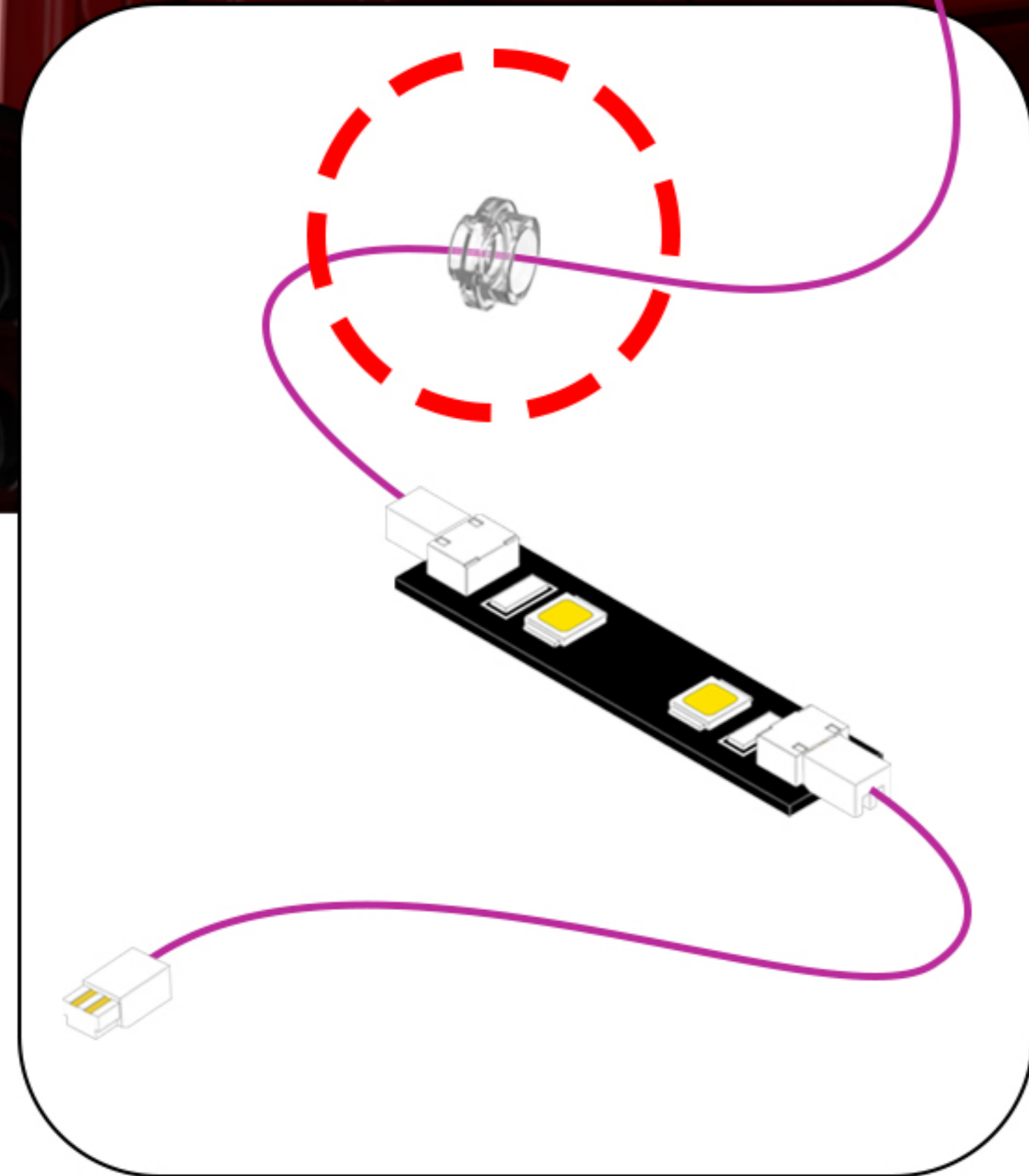
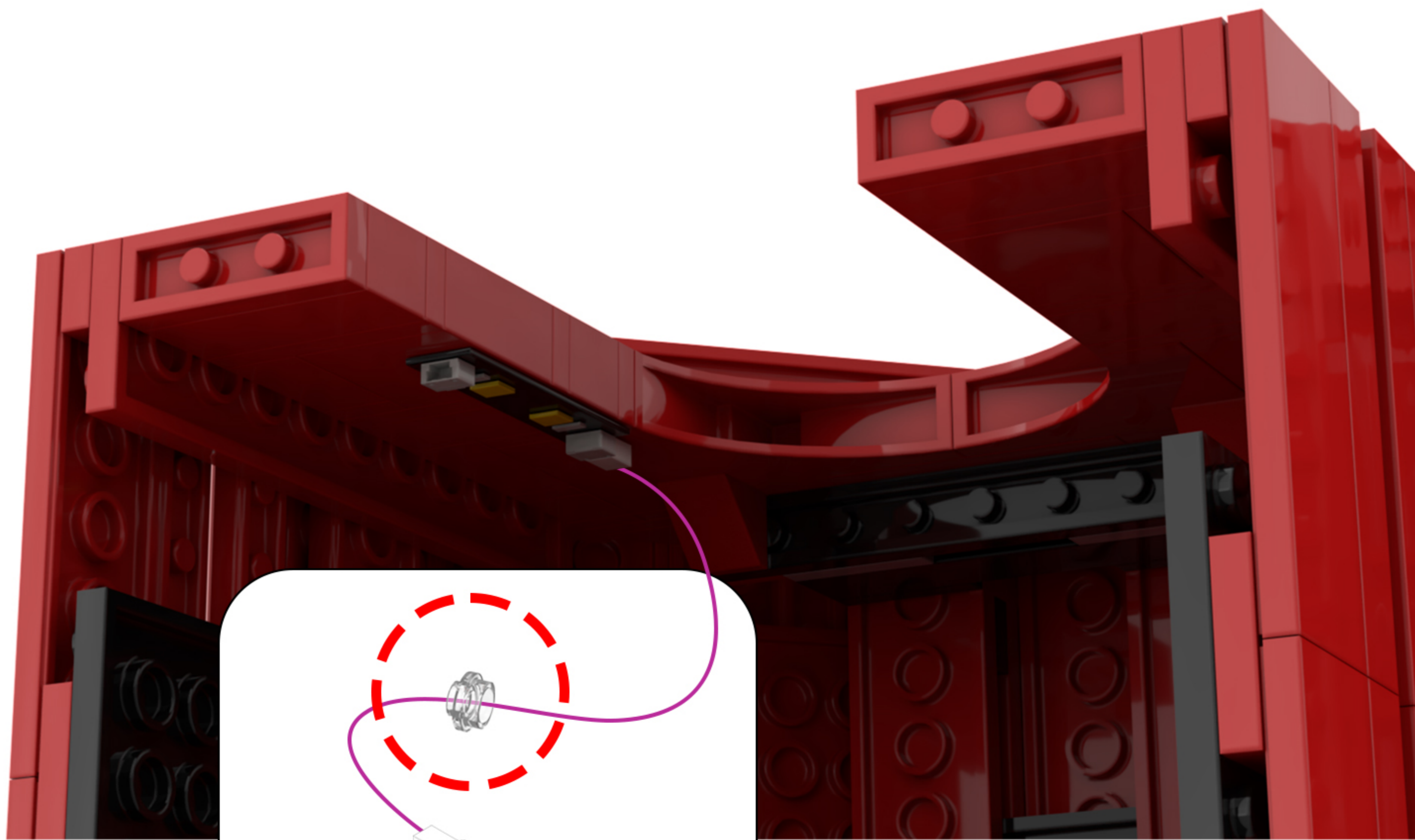

40

EN: Attach the small round plate to the building block.

DE: Befestigen Sie die kleine runde Platte am Baustein.

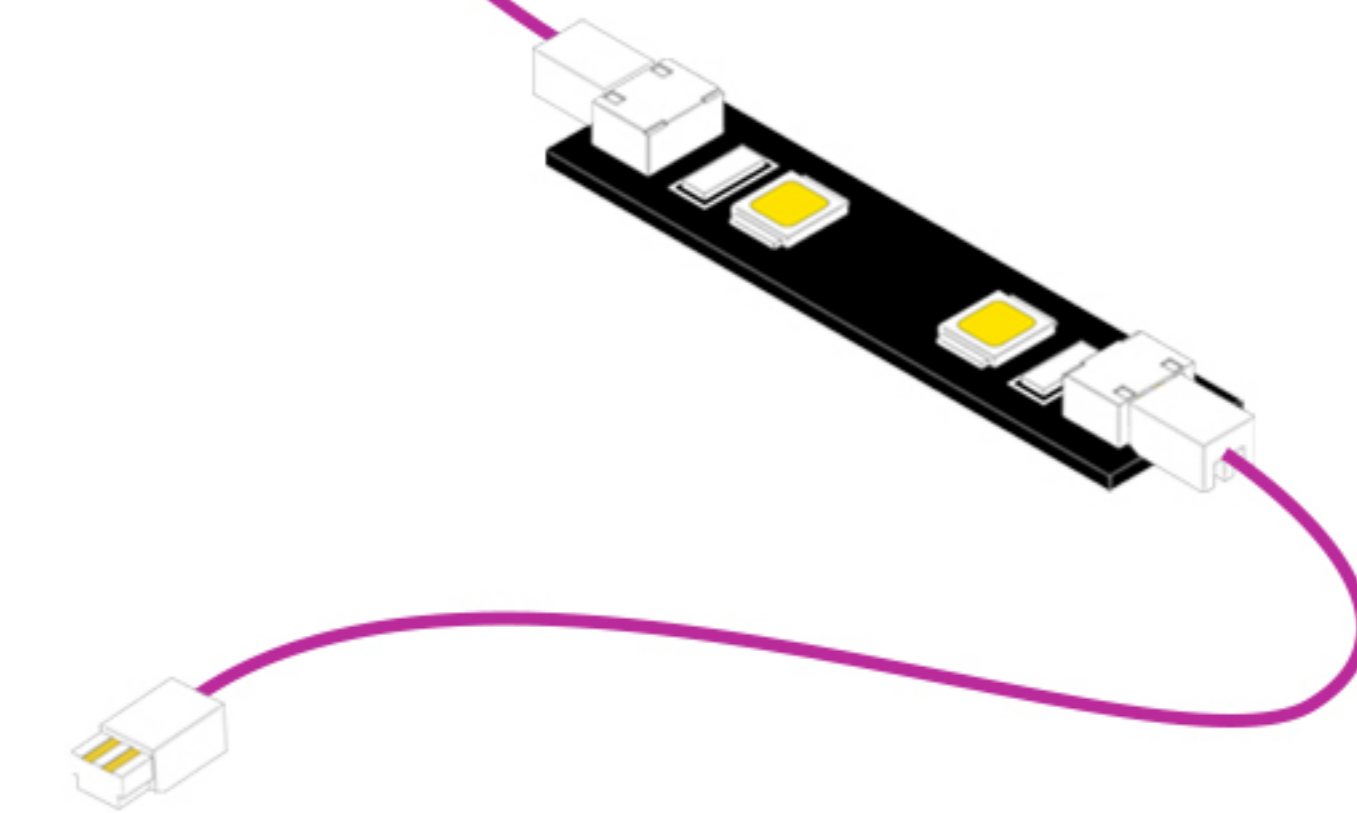
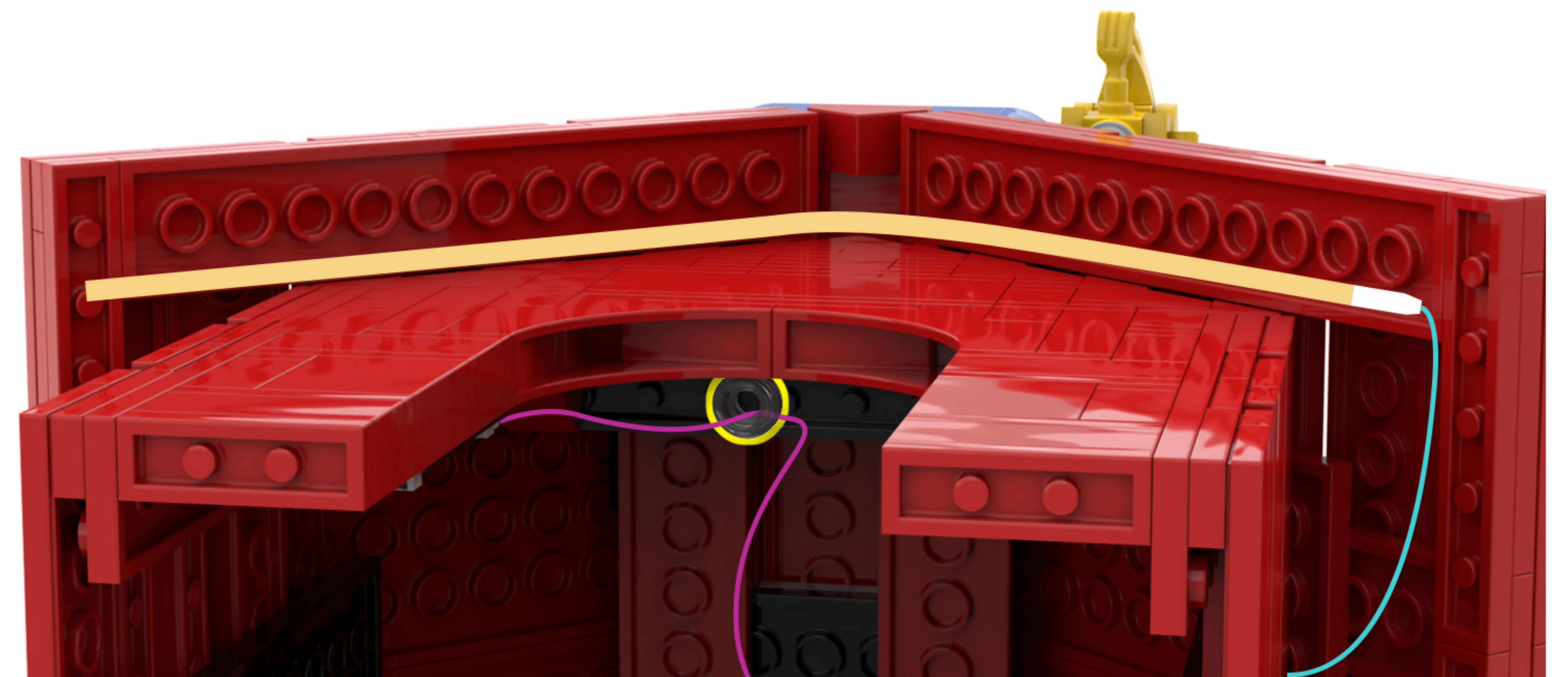

41

EN: Peel off the adhesive backing from the other light strip and attach it to the location shown in the illustration.

DE: Ziehen Sie die Schutzfolie vom anderen Lichtstreifen ab und bringen Sie ihn an der in der Abbildung gezeigten Stelle an.

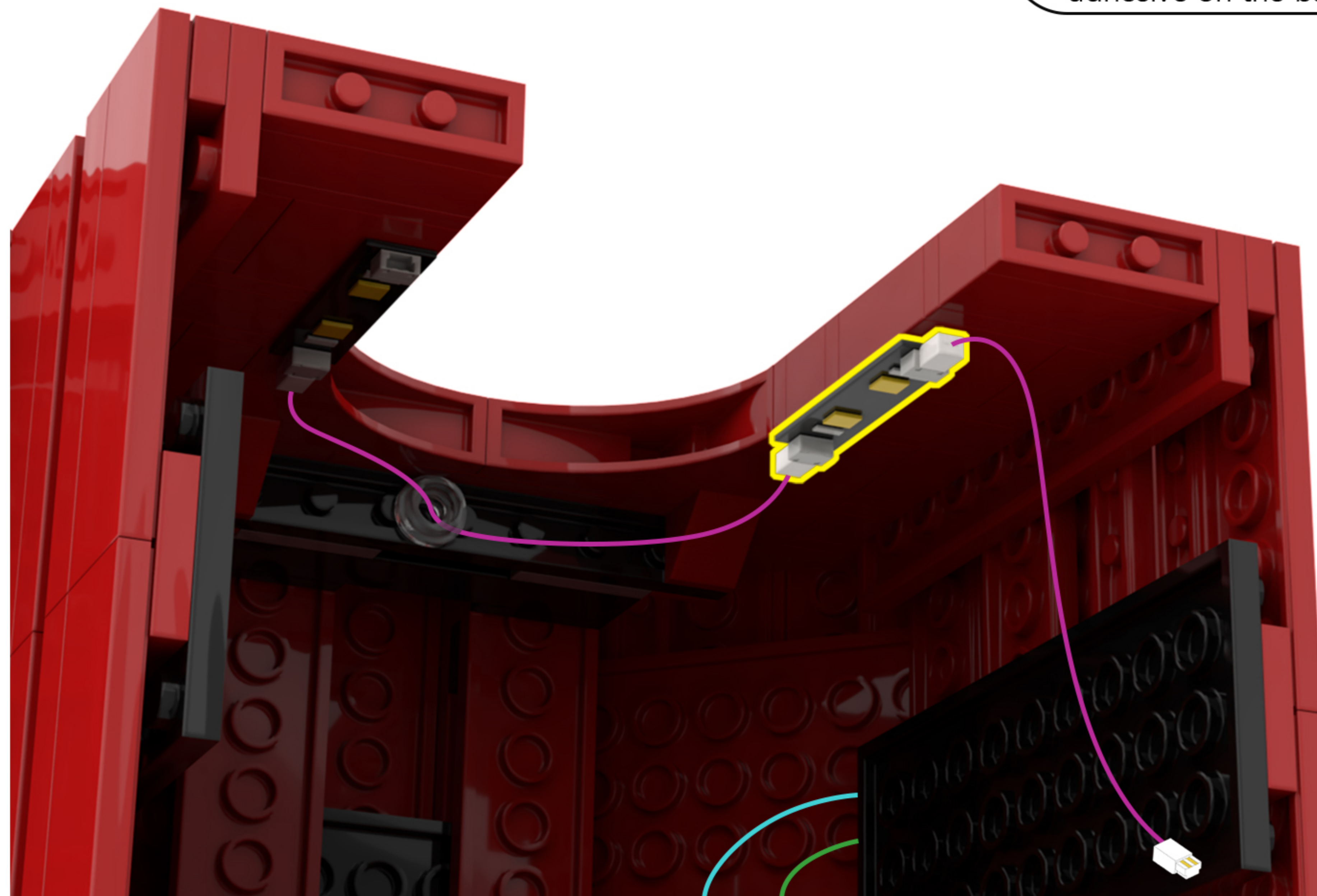

42

EN: Take out the building blocks with the lights already attached.

DE: Nimm die Bausteine heraus, an denen die Lichter bereits angebracht sind.

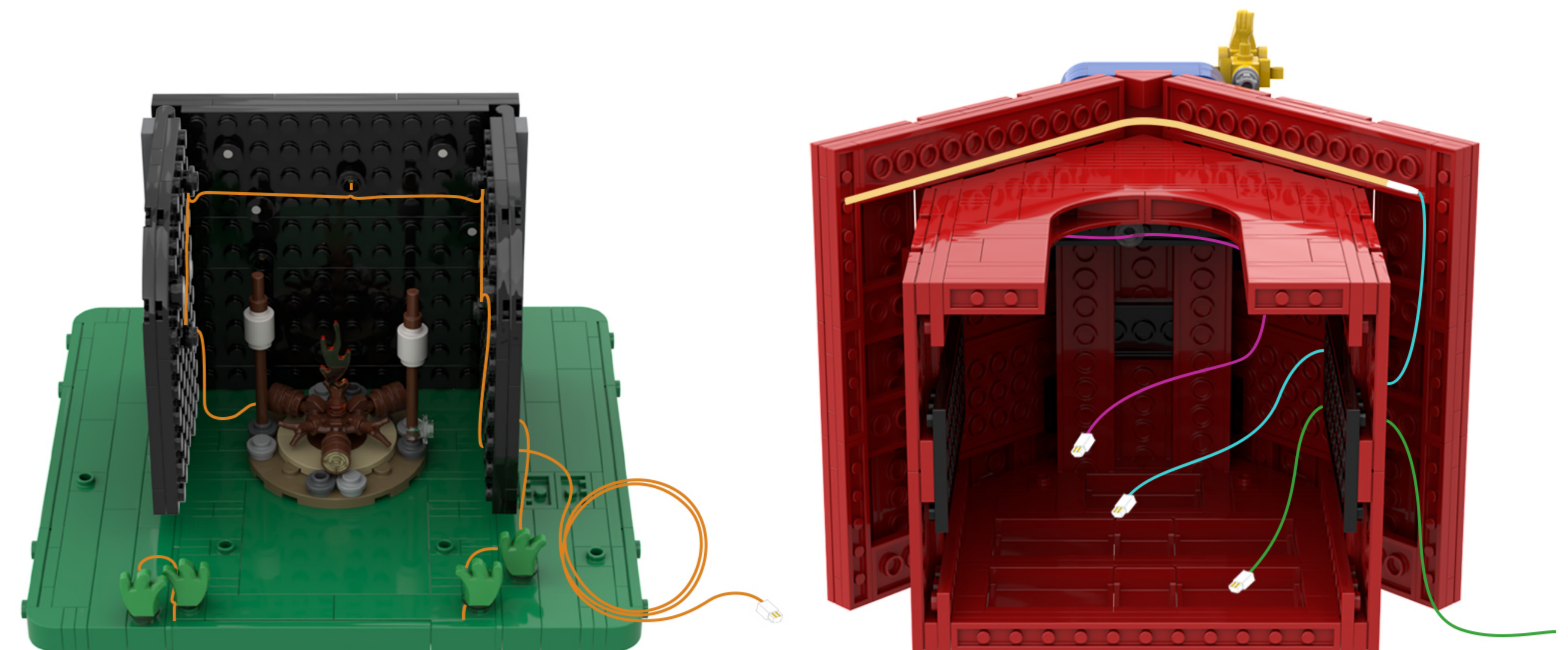

43

EN: Remove the remote control module and the remote control from bag A03801.

DE: Nehmen Sie das Fernbedienungsmodul und die Fernbedienung aus der Tasche A03801 heraus.

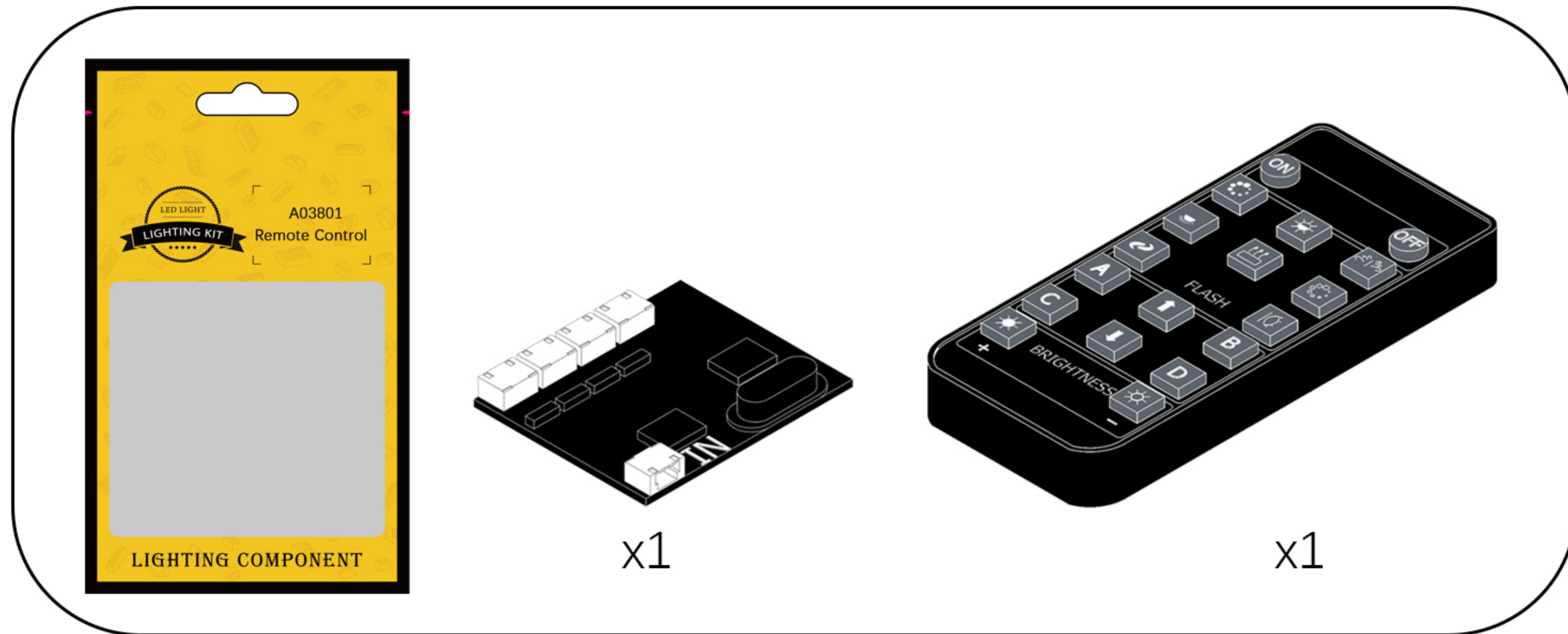

## Remote Control Function Introduce

**ON:** All lights turn on sequentially.  
**OFF:** All lights are off.

☼☼☼☼: A, B, C, D are turned on slowly in sequence.

☼: Breathing light mode.

☼☼☼☼: A and D the light is on and C and B flash alternately.

☼☼☼☼: A the light is on, B, C, D flow light effect I.

☼☼☼☼: A the light is on, B, C, D flow light effect II.

☼☼☼☼: Quickly open from A to D in turn.

☼☼☼☼: A, B, C, D flow light effect.

☼☼☼☼: A, B, C, D flash alternately.



**A:** Turn A on/off.  
**B:** Turn B on/off.  
**C:** Turn C on/off.  
**D:** Turn D on/off.

↑: Increase frequency.  
 ↓: Decrease frequency.

☼+: Brightness+: Increases brightness

☼-: Brightness-: Decreases brightness

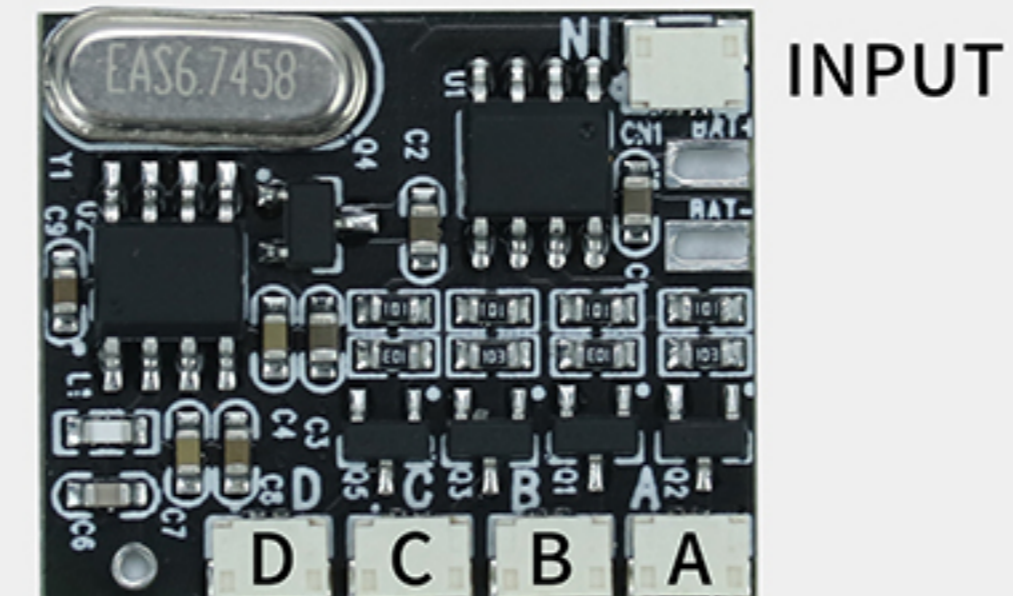

## Remote control safety lock and battery model description

Batteries are not included in the remote control, please go to the nearest store to buy CR2025 or CR2032 button batteries to install in the remote control.



44

EN: Take the USB power cable out of the box and connect it to the remote control module.

DE: Nehmen Sie das USB-Stromkabel aus der Verpackung und schließen Sie es an das Fernbedienungsmodul an.

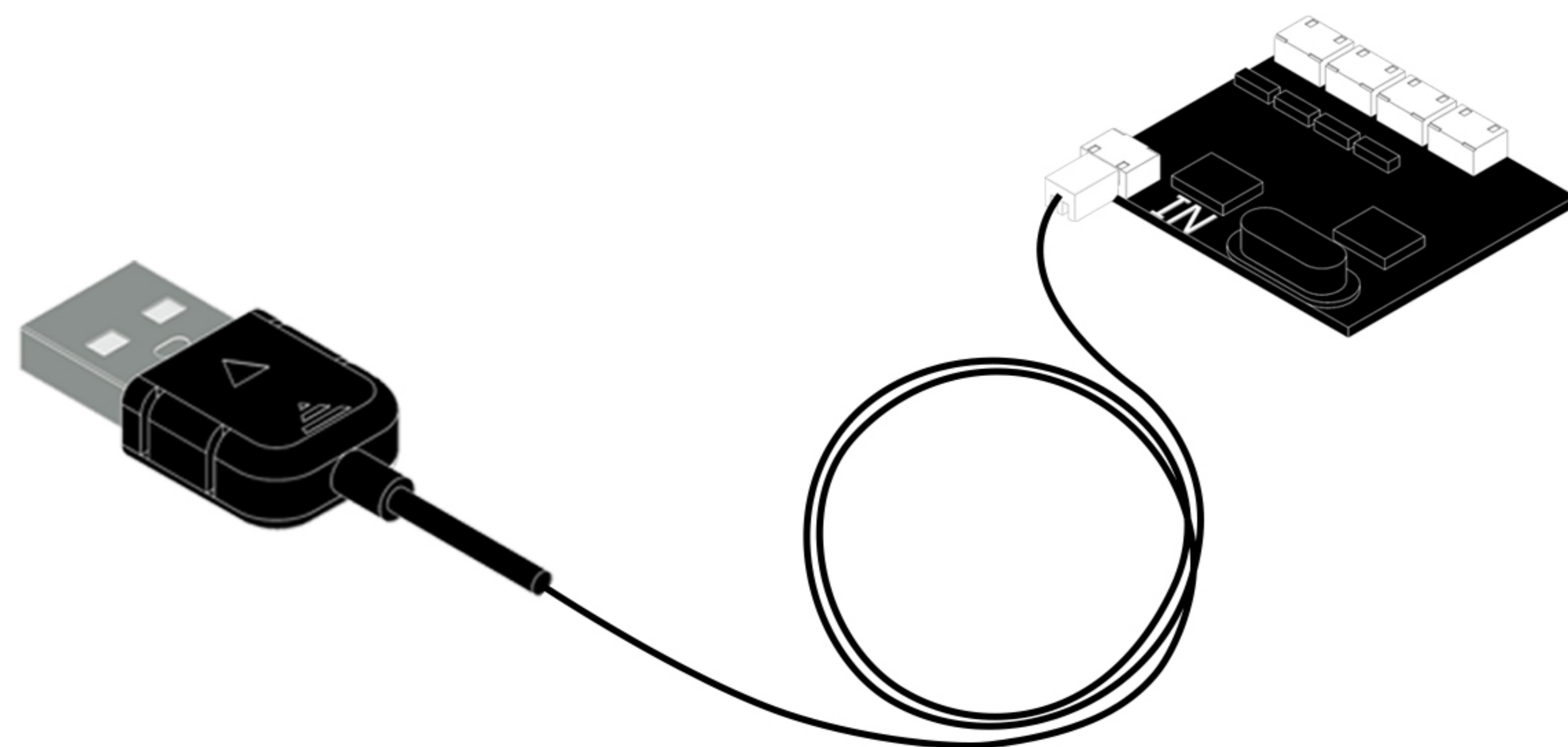
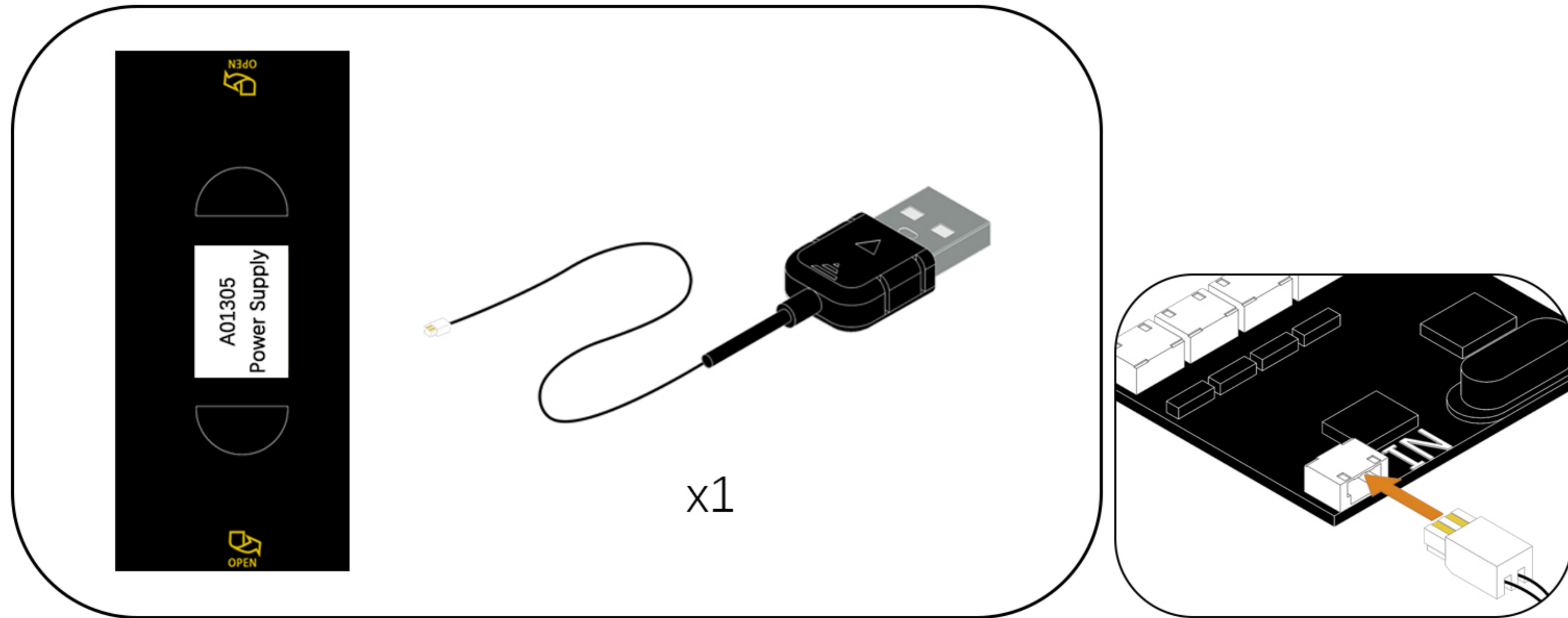

45

EN: Locate the four light wires in the diagram.

DE: Suchen Sie die vier Lichtkabel in der Abbildung.

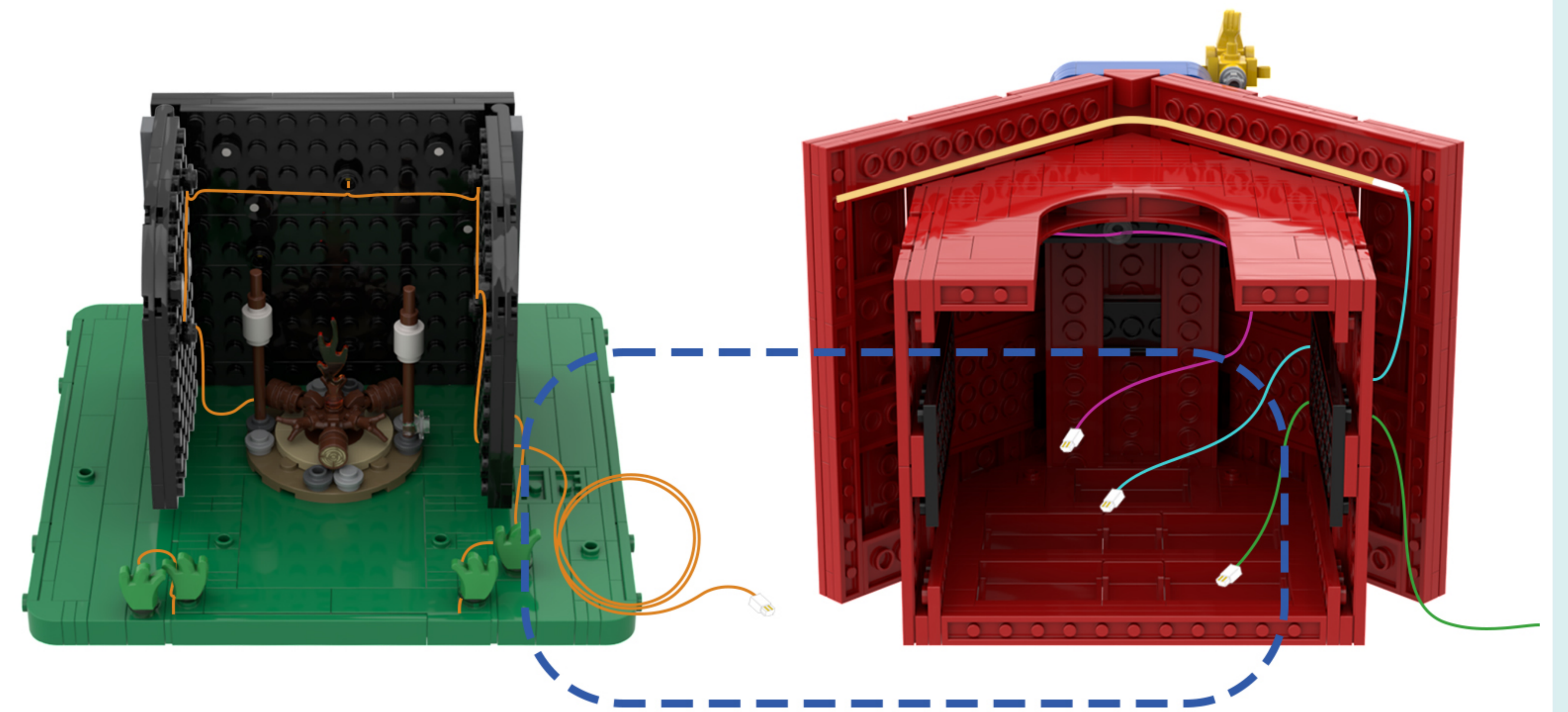

46

EN: Connect the four light strands to the remote control module one by one.

DE: Schließen Sie die vier Lichtketten nacheinander an das Fernbedienungsmodul an.

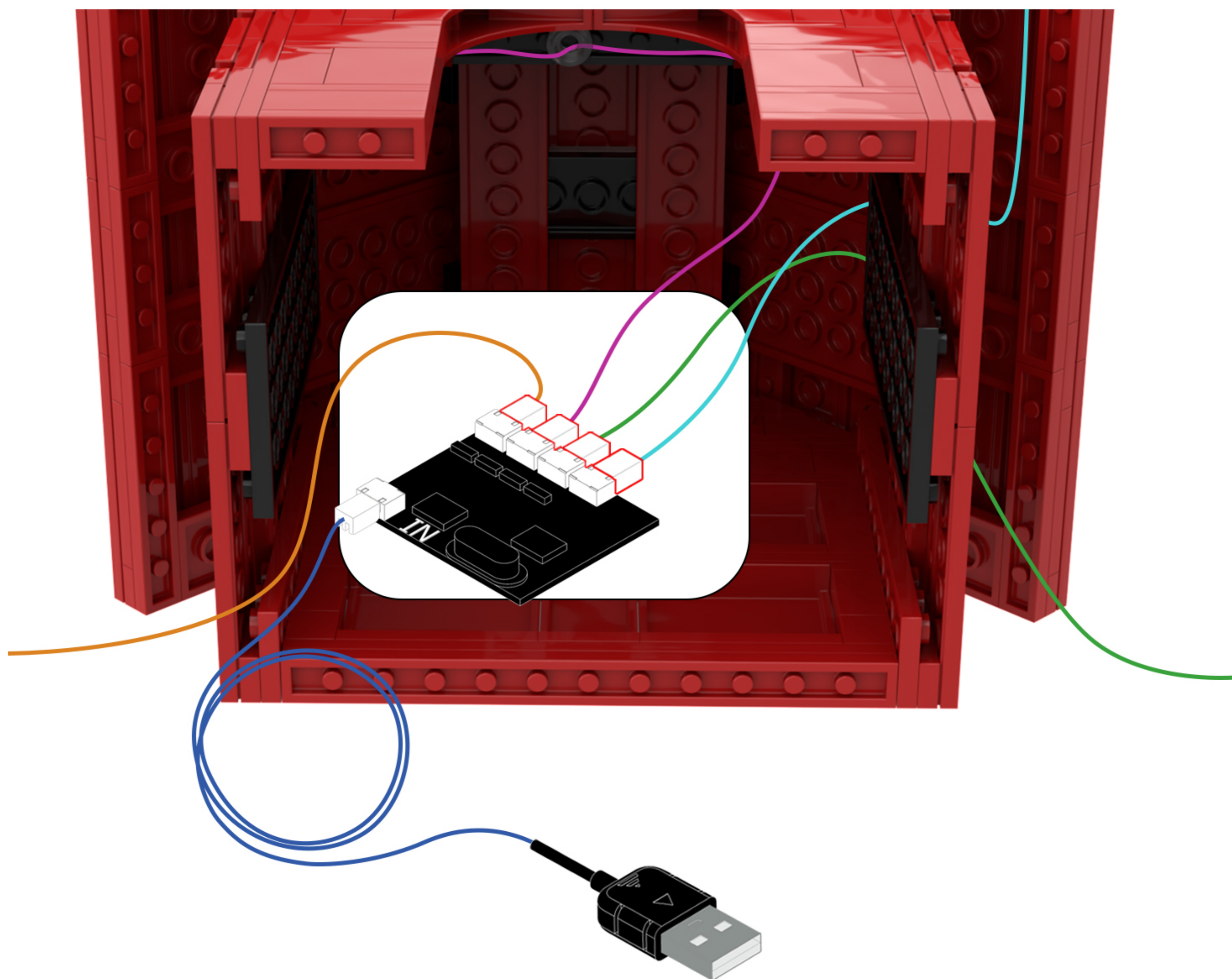
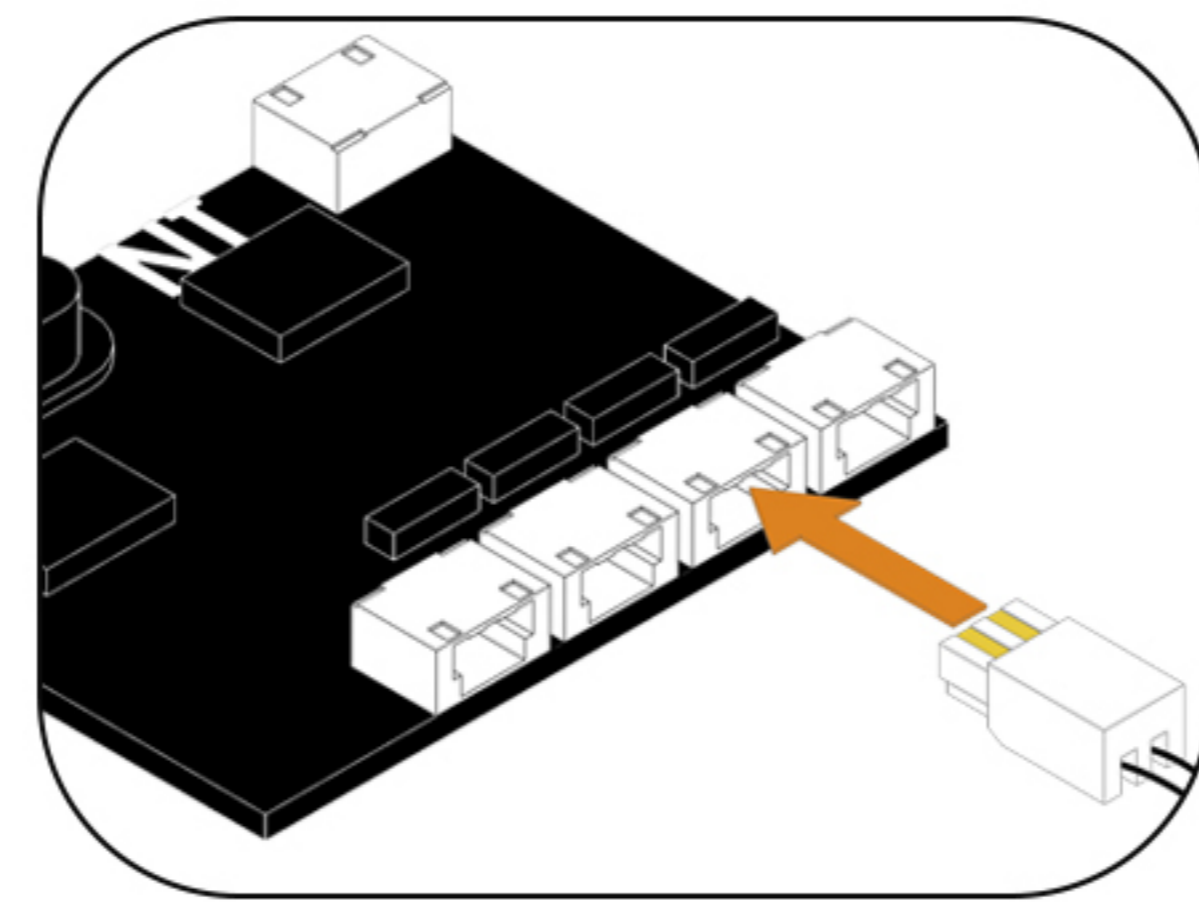

47

EN: Peel off the adhesive backing on the remote control module and attach it to the location shown in the diagram.

DE: Ziehen Sie die Klebefolie auf der Fernbedienung ab und befestigen Sie sie an der in der Abbildung gezeigten Stelle.

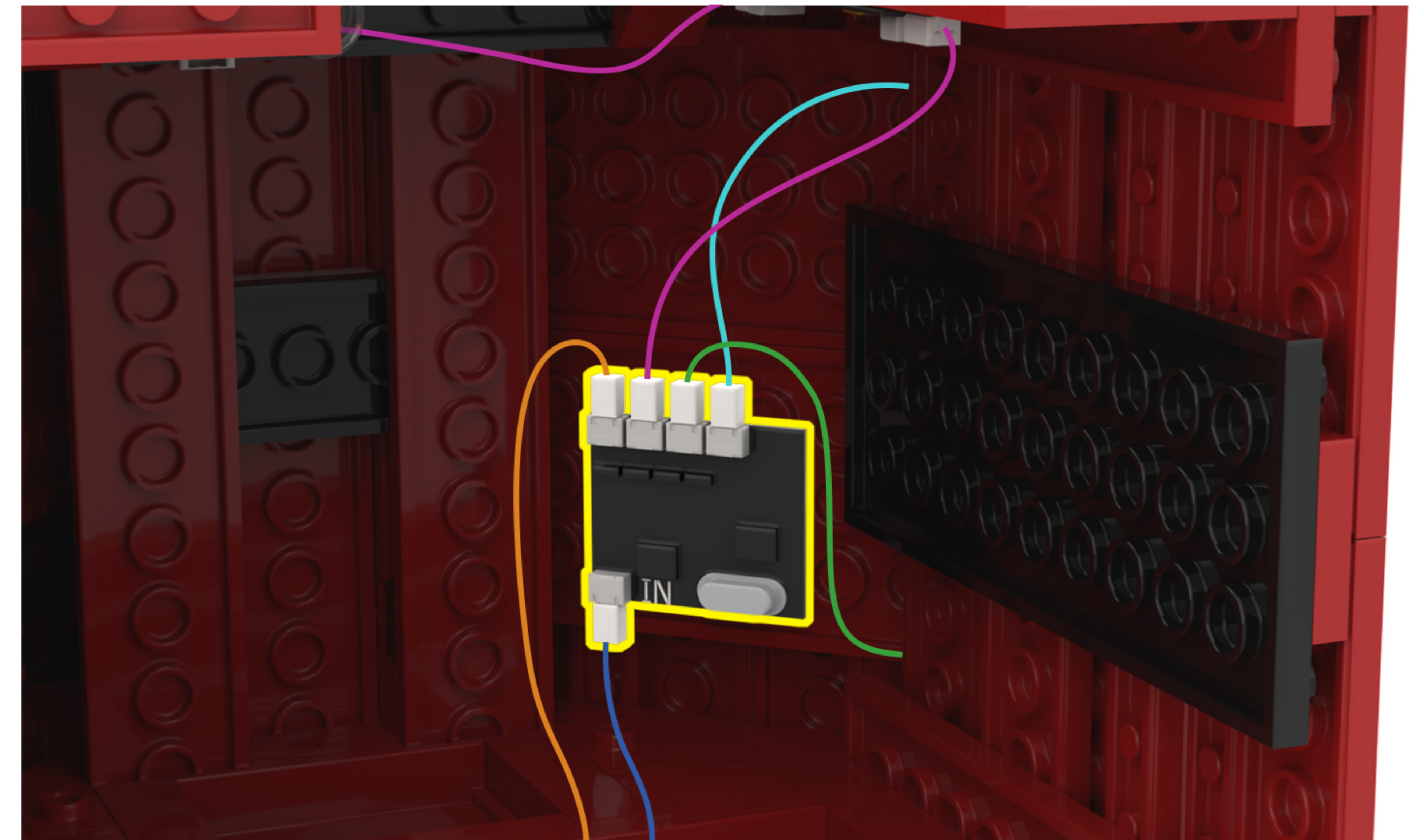

**48** EN: Locate this light cord in the diagram.  
DE: Suchen Sie dieses Lichtkabel in der Abbildung.

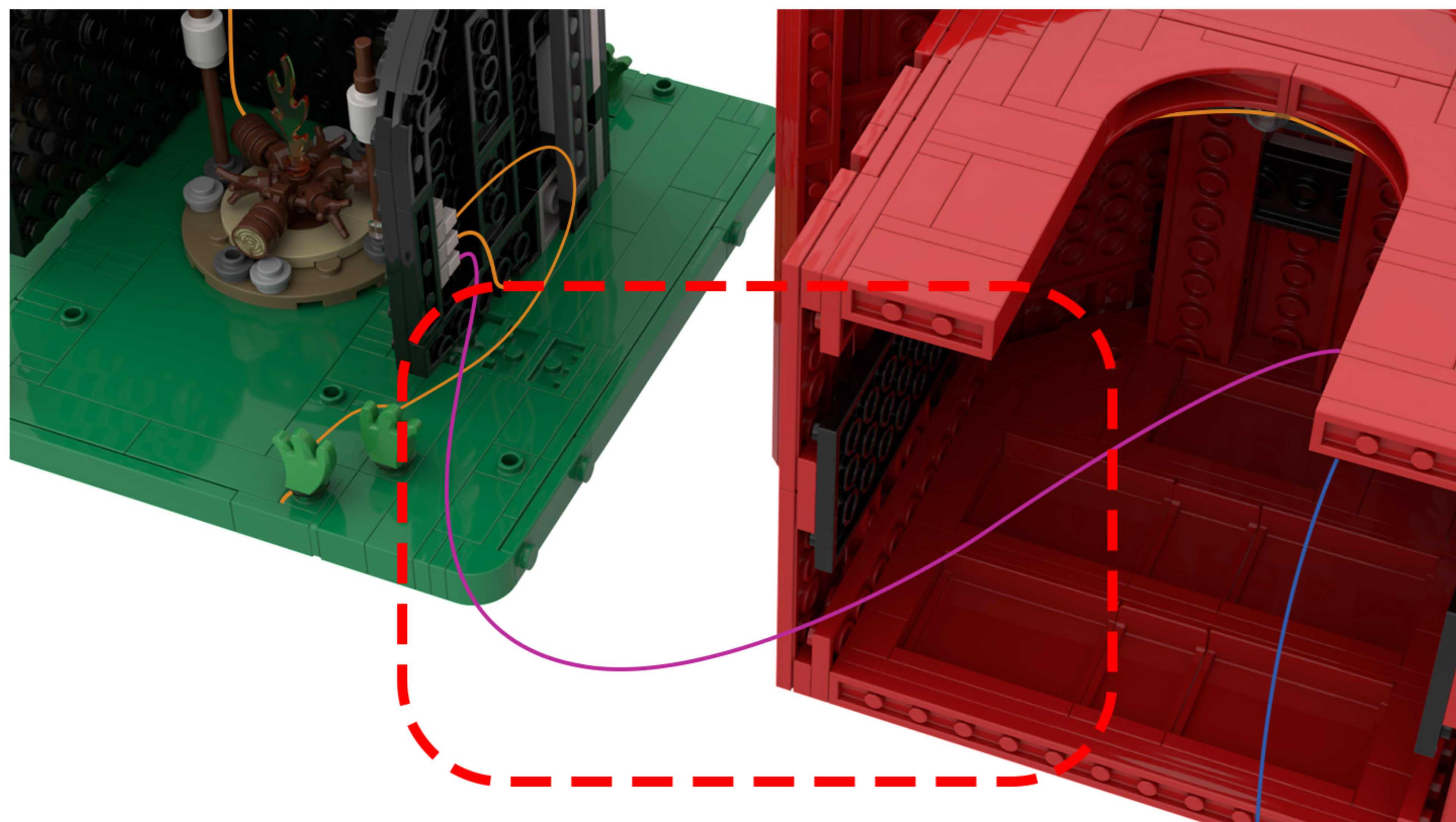

**49** EN: Tidy up the light cords and twist them together.  
DE: Räume die Lichtketten auf und verdrehe sie miteinander.

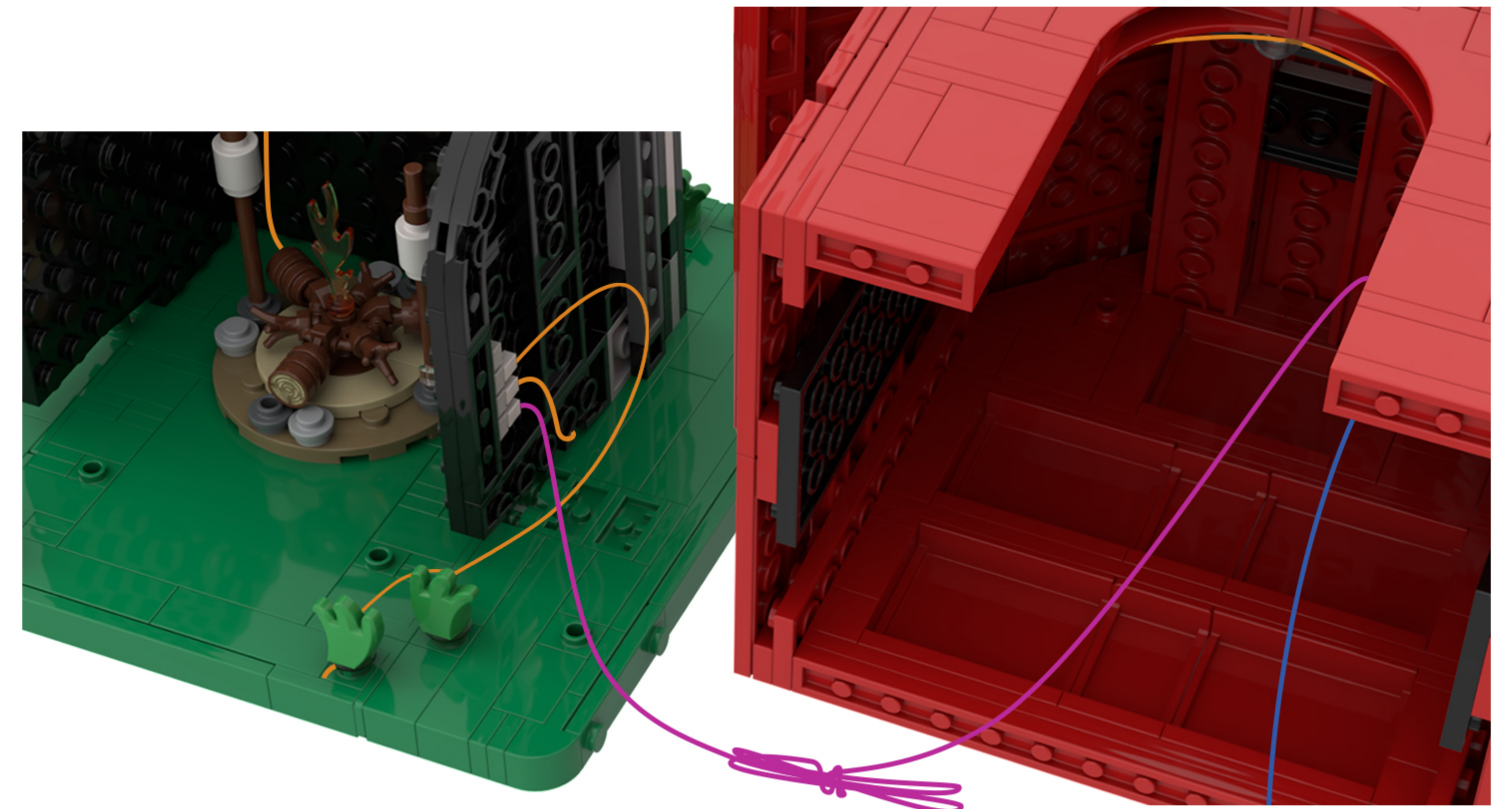

50

EN: Take out the disassembled building blocks, reassemble them, and secure the light cord.

DE: Nehmen Sie die zerlegten Bausteine heraus, setzen Sie sie wieder zusammen und befestigen Sie das Lichtkabel.

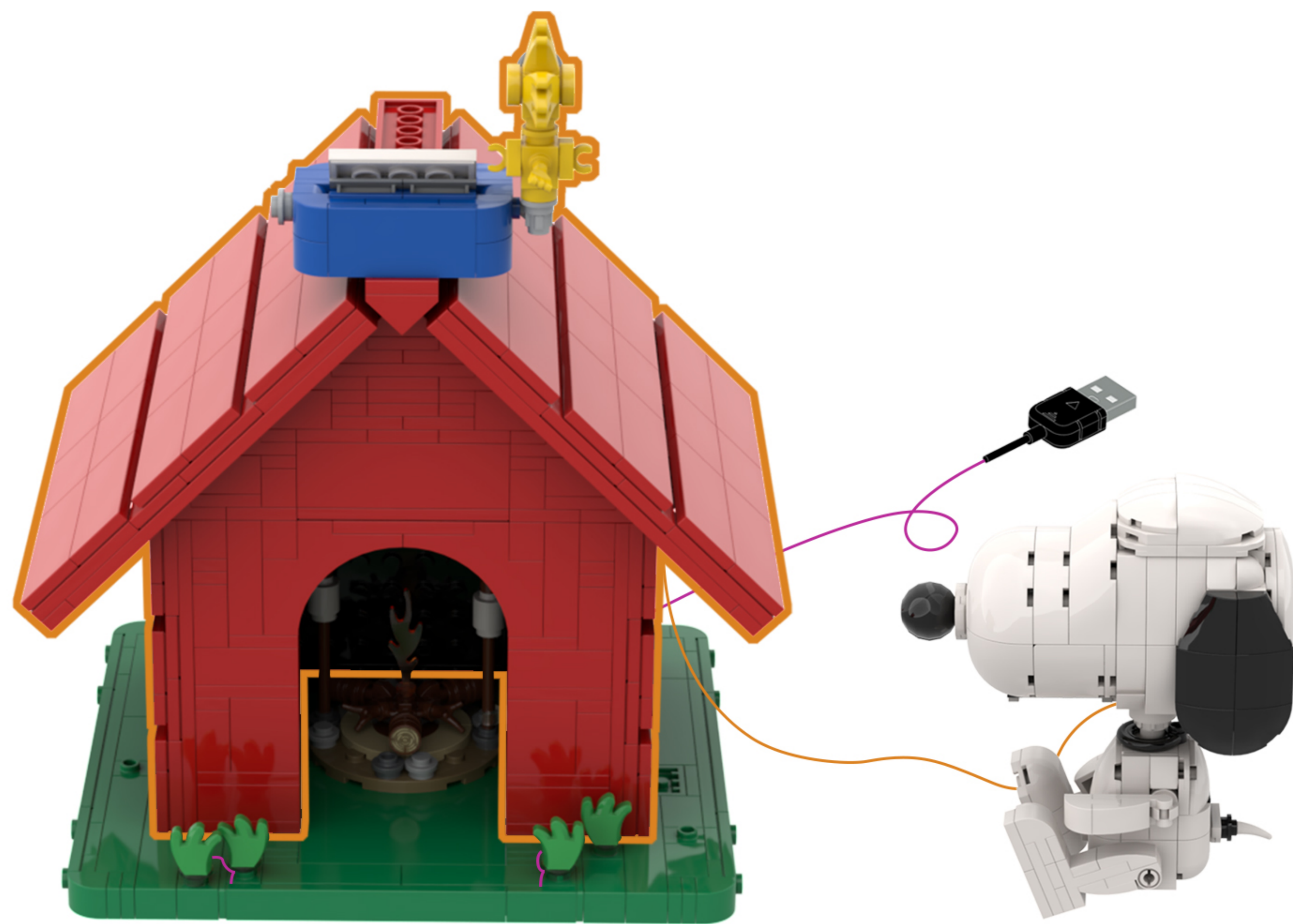

Note: When reassembling the building blocks, place the USB cable behind the model in advance.

51

EN: Rotate the model to its back side.

DE: Drehen Sie das Modell auf die Rückseite.

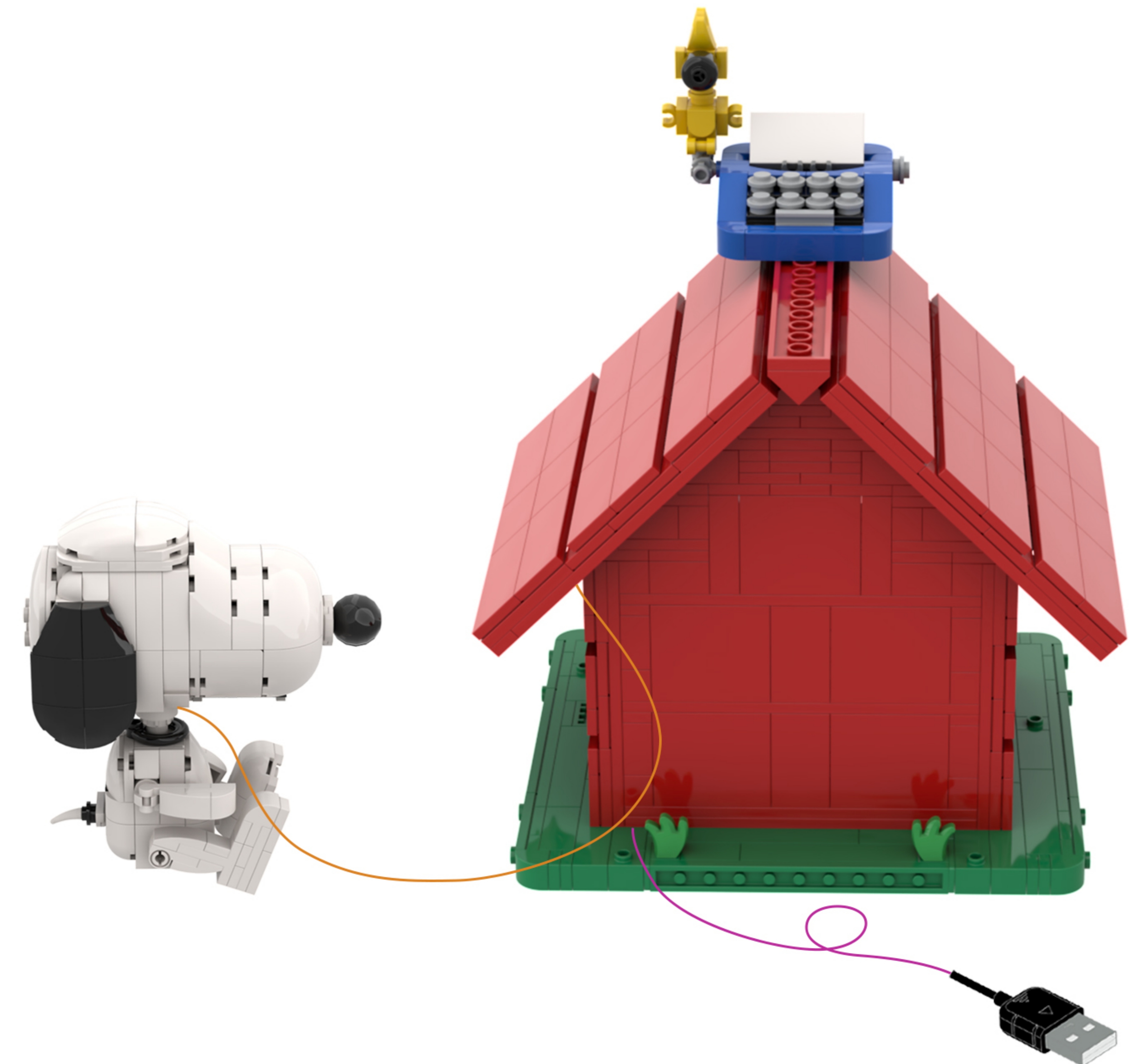

52

EN: Restore the building blocks.

DE: Stellen Sie die Bausteine wieder her.

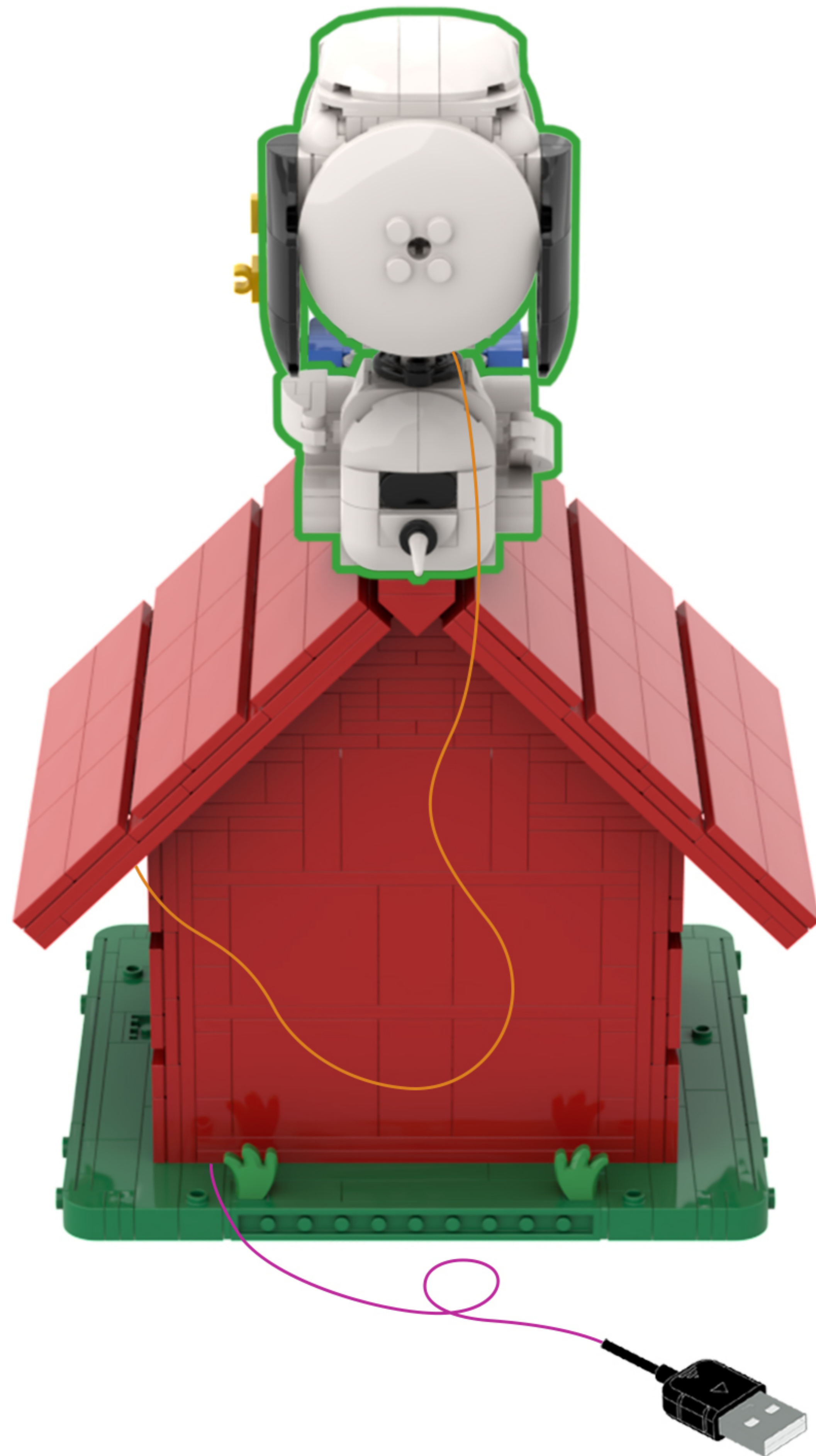

53

EN: Locate this light cord in the diagram.

DE: Suchen Sie dieses Lichtkabel in der Abbildung.

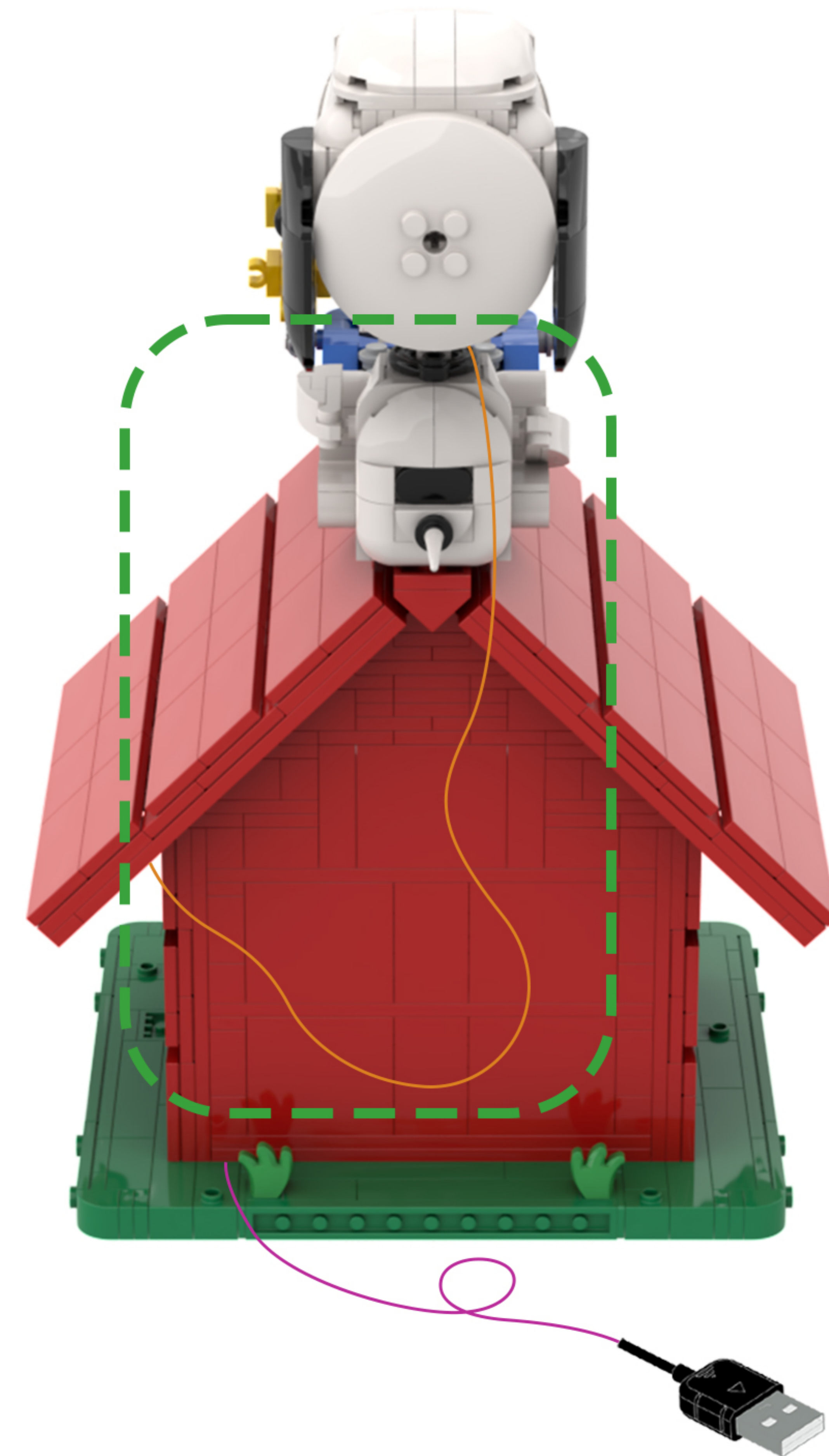

54

EN: Tidy up the light cords and twist them together.

DE: Räume die Lichterketten auf und verdrehe sie miteinander.

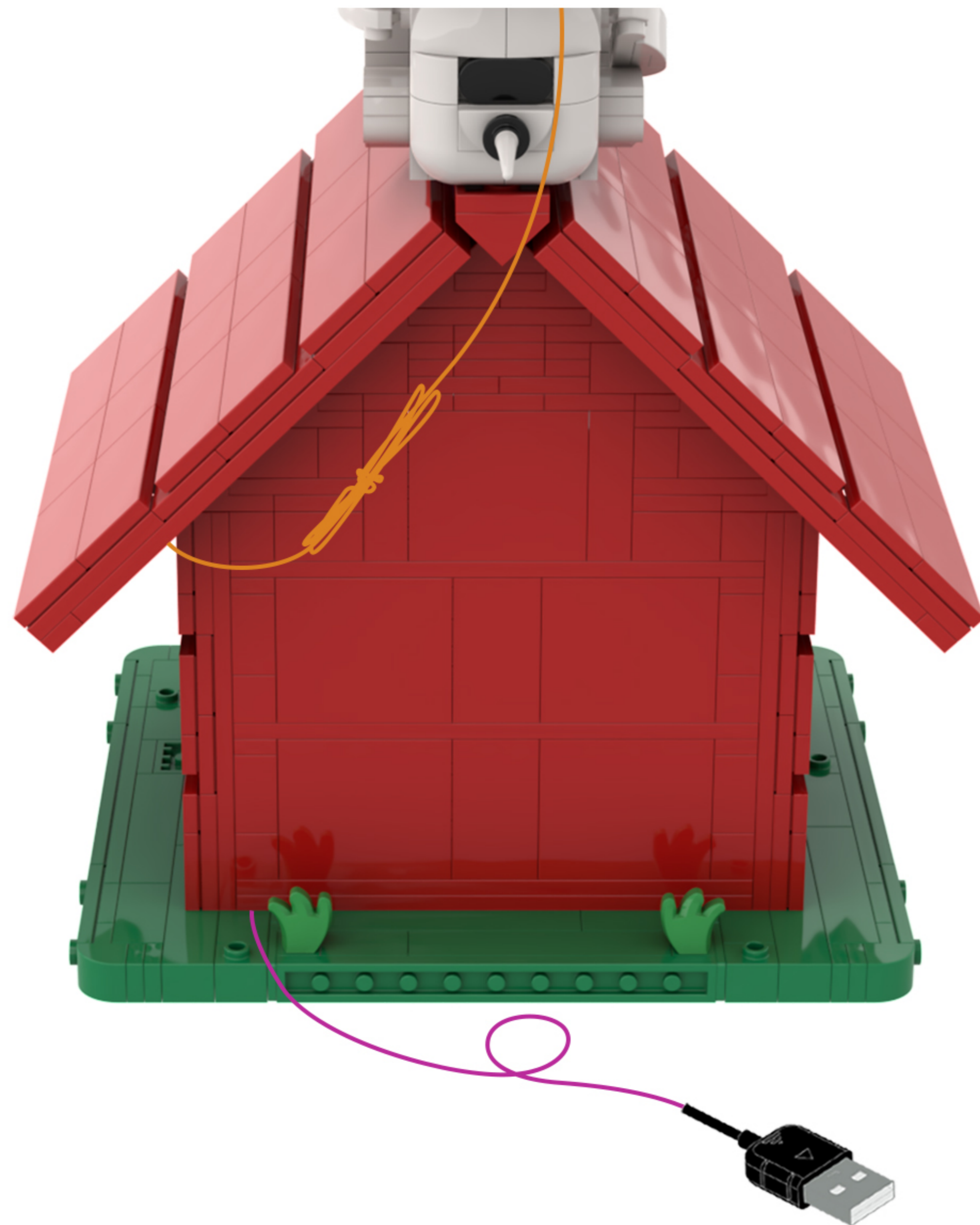

55

EN: Tuck the light cord into the gap in the building block.

DE: Stecke das Kabel der Lampe in den Spalt im Baustein.

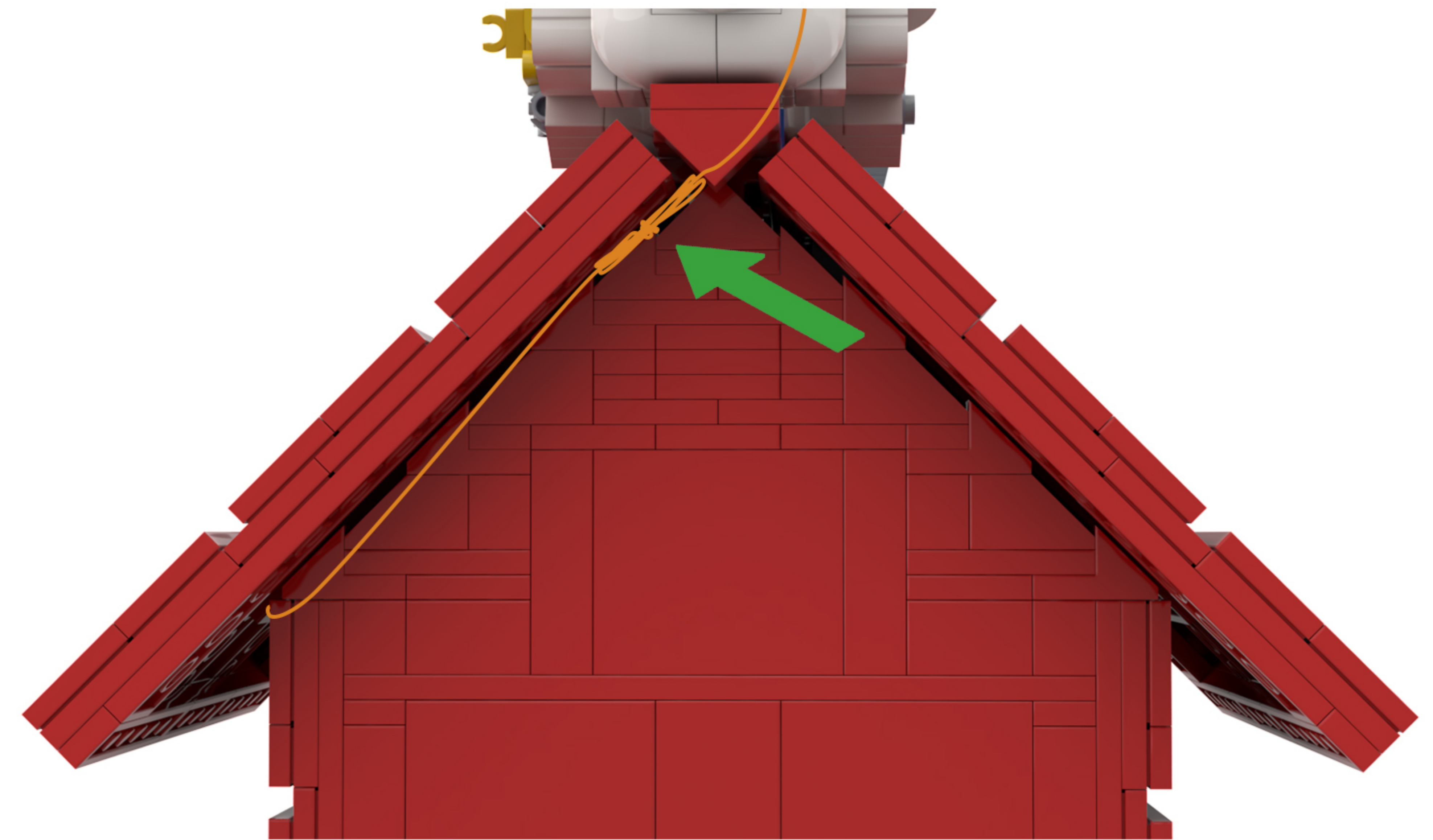

56

EN: Once installed, connect the power supply and give it a try!

DE: Die Installation ist abgeschlossen. Schließen Sie das Gerät an die Stromversorgung an und probieren Sie es aus!



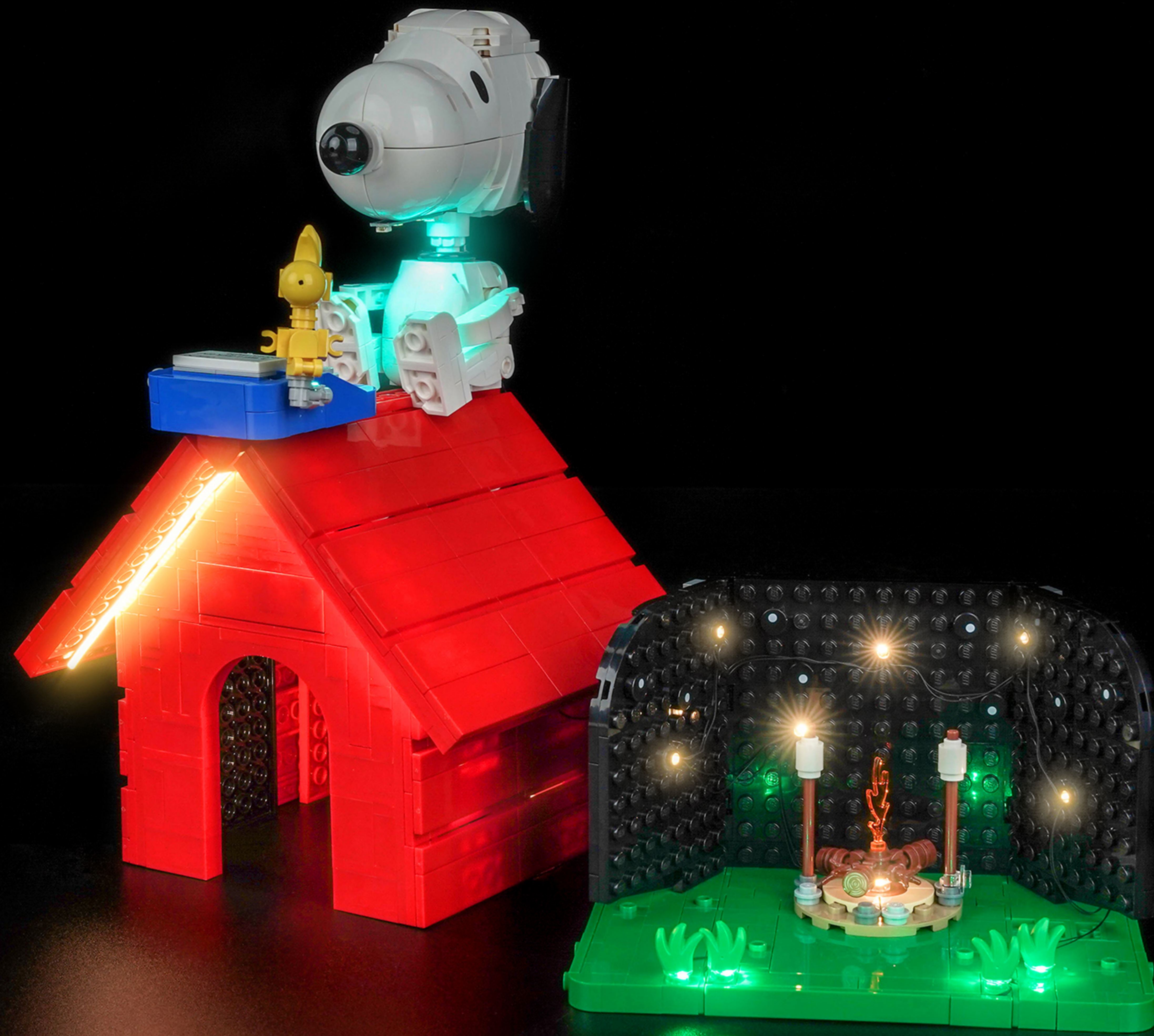

Above our designers to provide the relevant ideas and instructions. But please move to the following:

- 1: about our company this product parts material, product quality do you have comments and suggestions?
- 2: about this product installation instructions and installation of the degree of difficulty do you have views and suggestions?
- 3: if in the operation of the product we provide ideas encountered any problems, please contact us in a timely manner.

## Tips

If you encounter any installation problems please contact the seller, we will be happy to help you solve!