

INSTALLATION GUIDE

31383 Floral Décor Perfume Bottle



LED light kit compatible with Lego

Instructions for installing this kit:

This set includes 3 pouches. (The battery case functions similarly, please select your own power source. This article uses a USB power cable.)

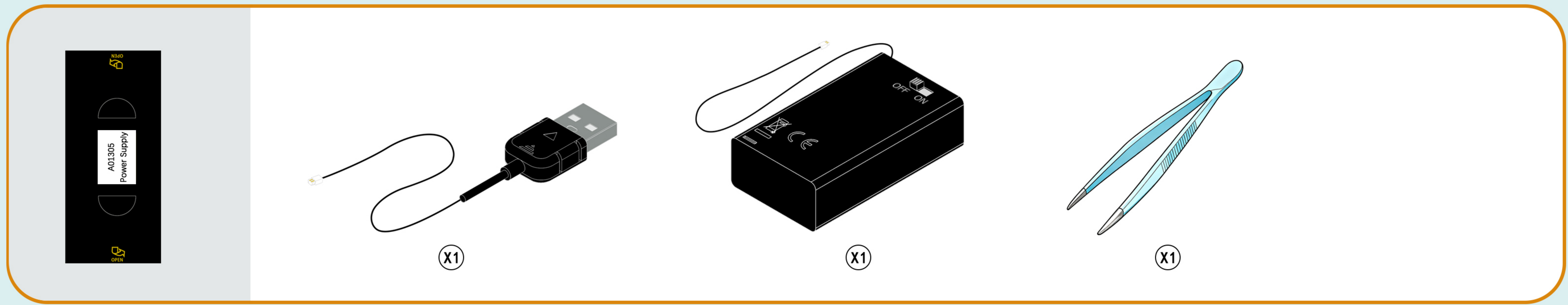
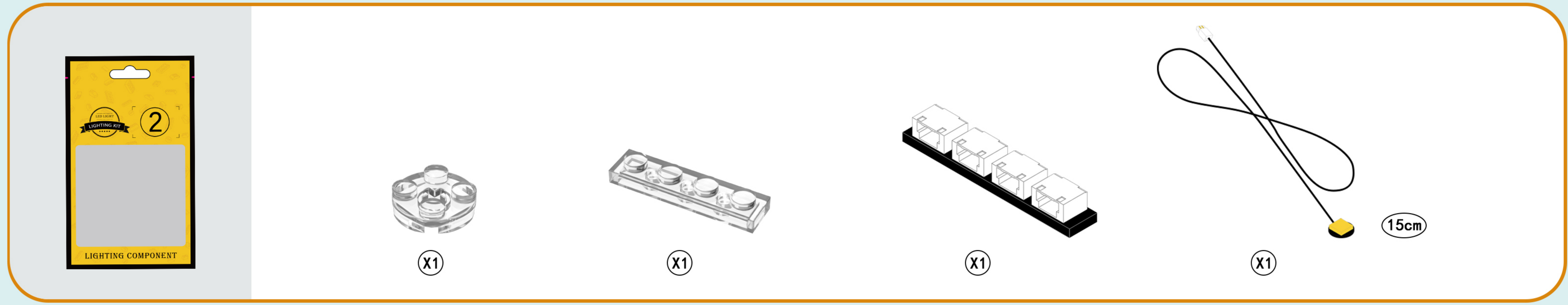
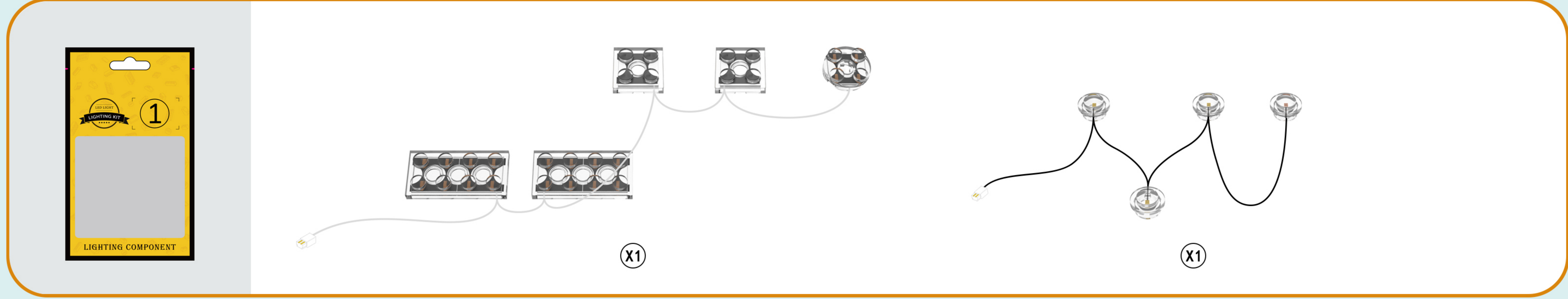

This post will complete the light installation in two main sections.

Step 1-test



Step 2-mounting

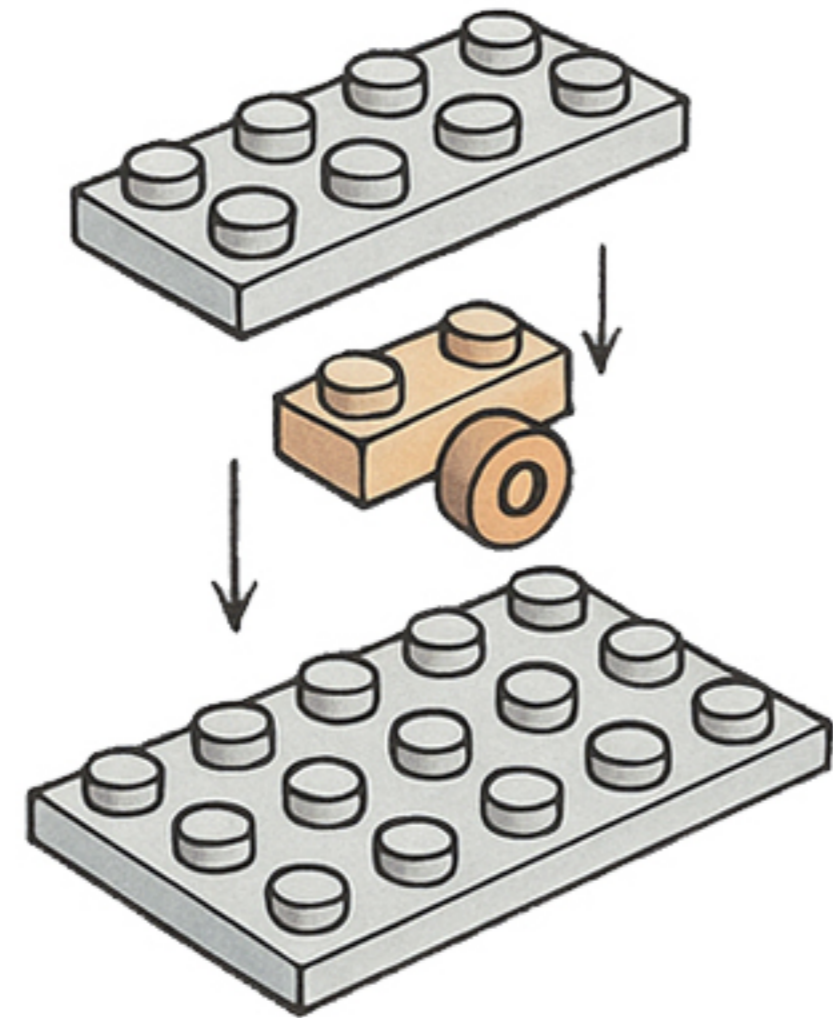

So let's get started!

Step 1-Test.

1

EN: Remove the expansion board from Bag 2.

DE: Entnehmen Sie die Erweiterungskarte aus Beutel 2.

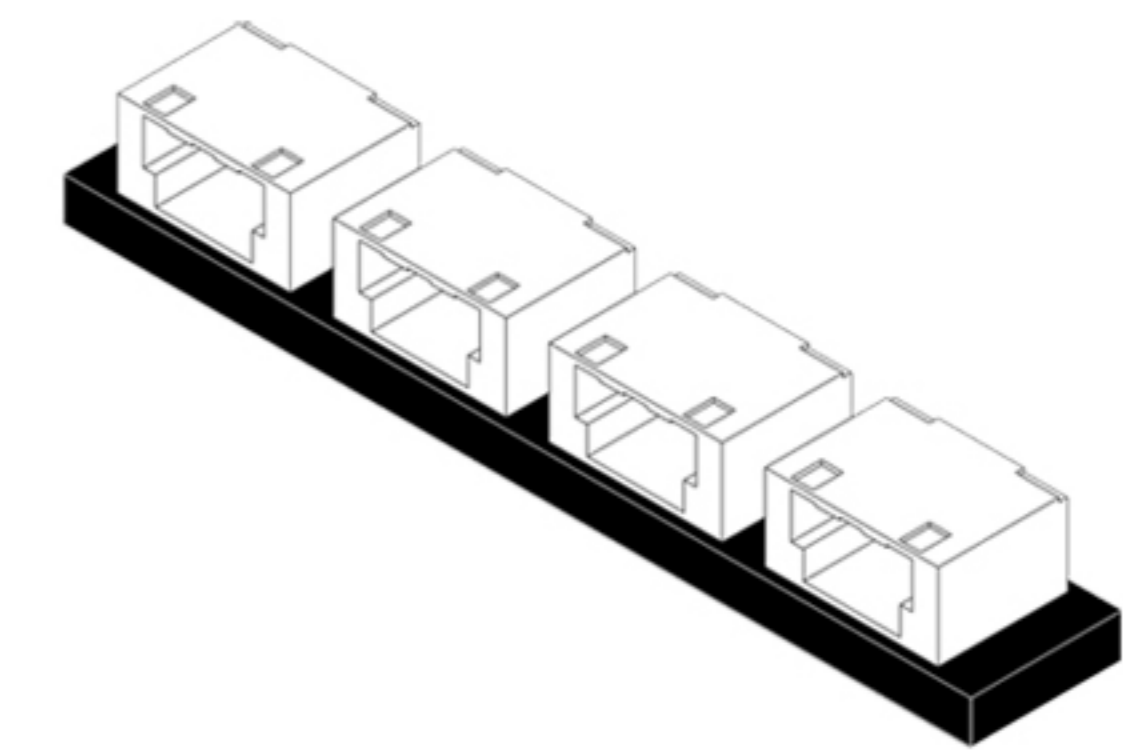

x1

2

EN: Take the USB power cable out of the box and connect it to the expansion board.

DE: Nehmen Sie das USB-Stromkabel aus der Verpackung und schließen Sie es an die Erweiterungskarte an.

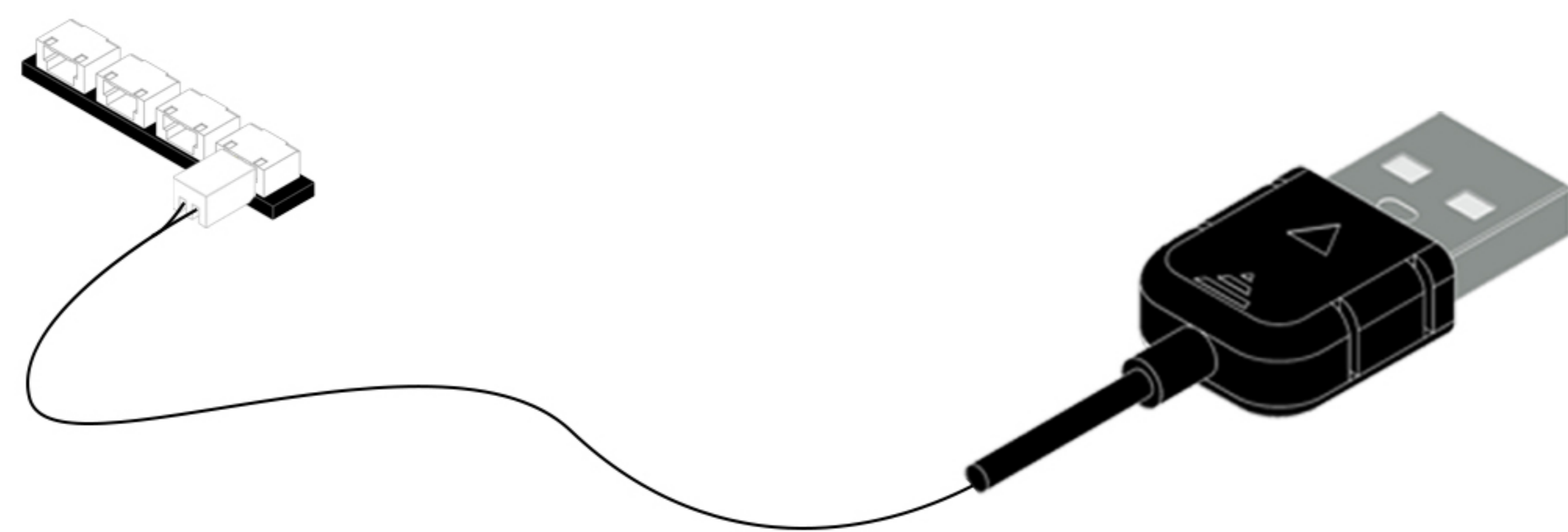
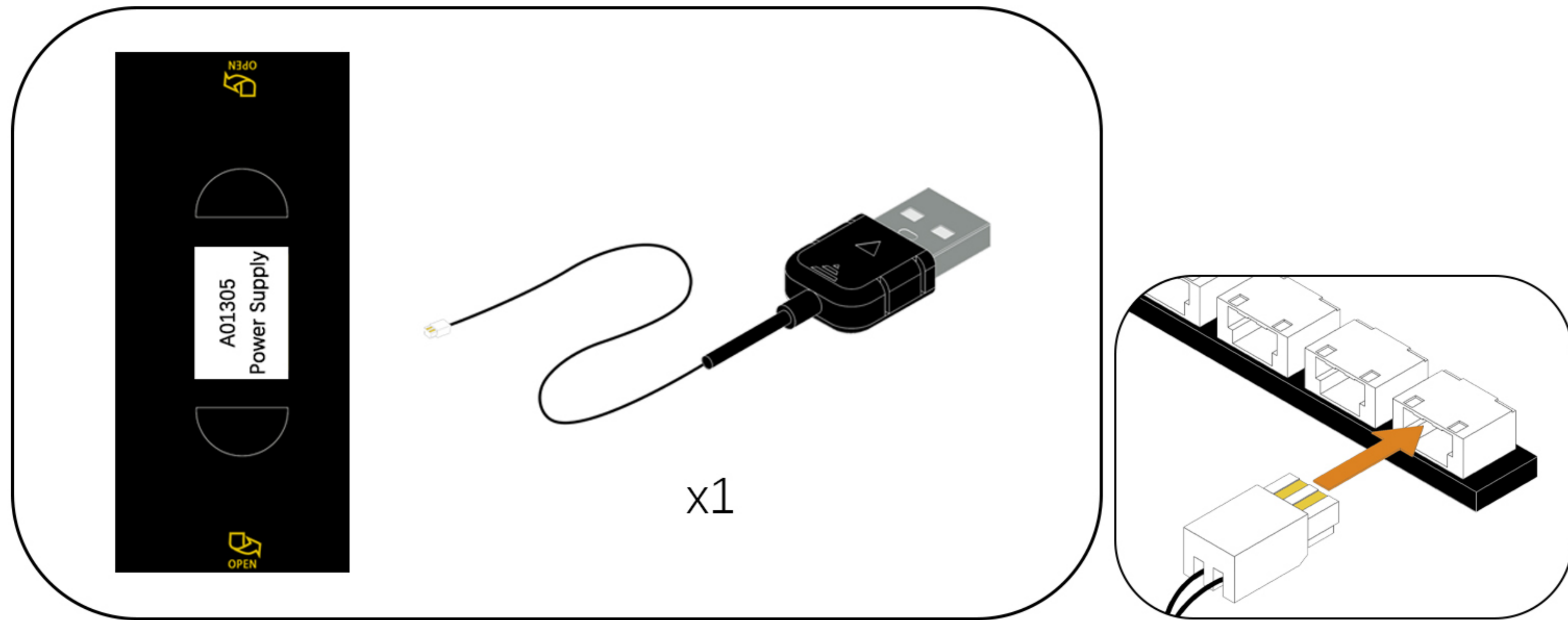

3

EN: Connect the USB power cable to the mobile power supply. (Power supply not included; see the diagram below for power supply options.)

DE: Schließen Sie das USB-Netz-kabel an die mobile Stromversorgung an. (Stromversorgung nicht im Lieferumfang enthalten, siehe Abbildung unten für die Stromversorgungsart.)

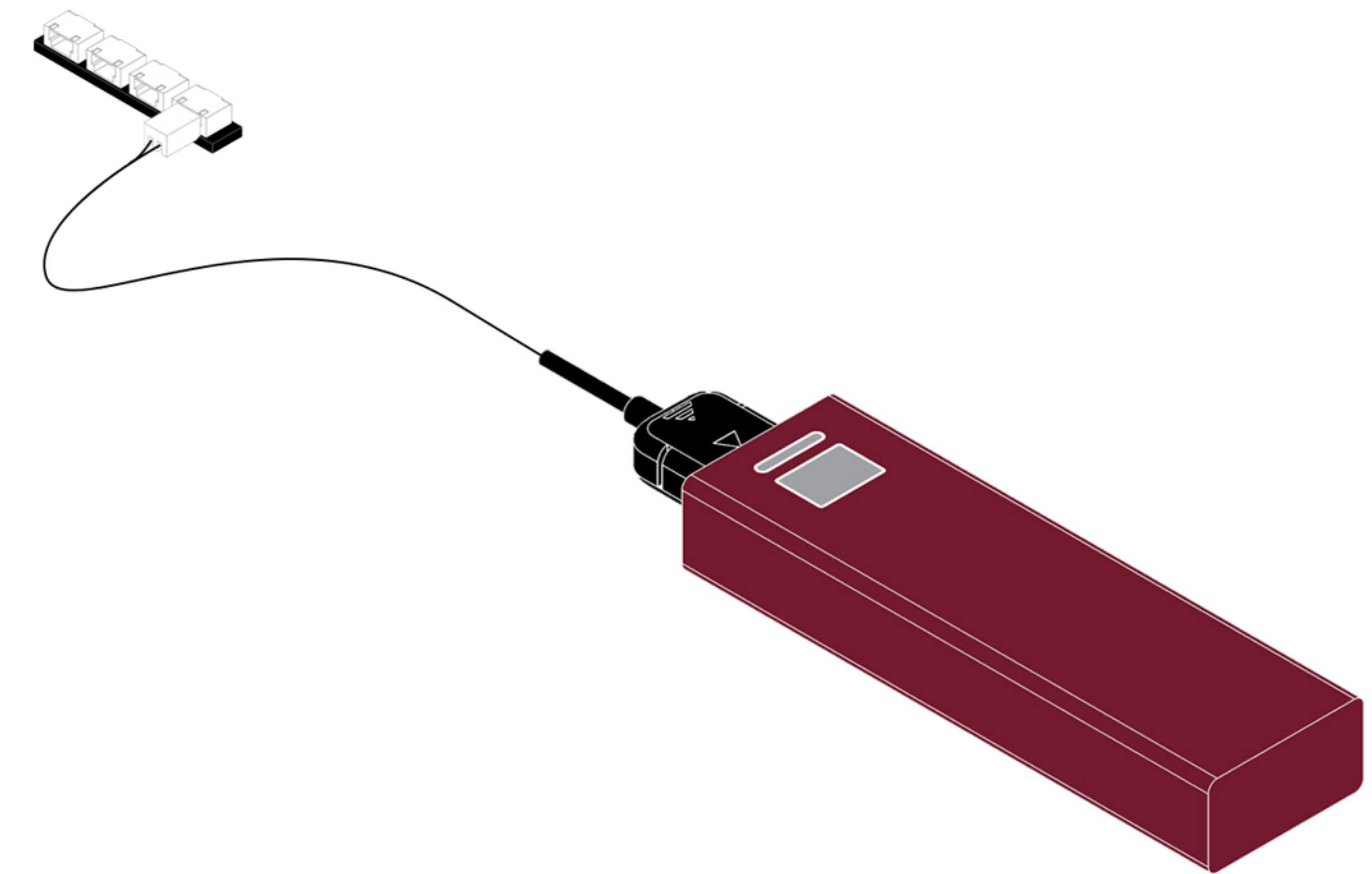

USB Connectors to Connect Devices

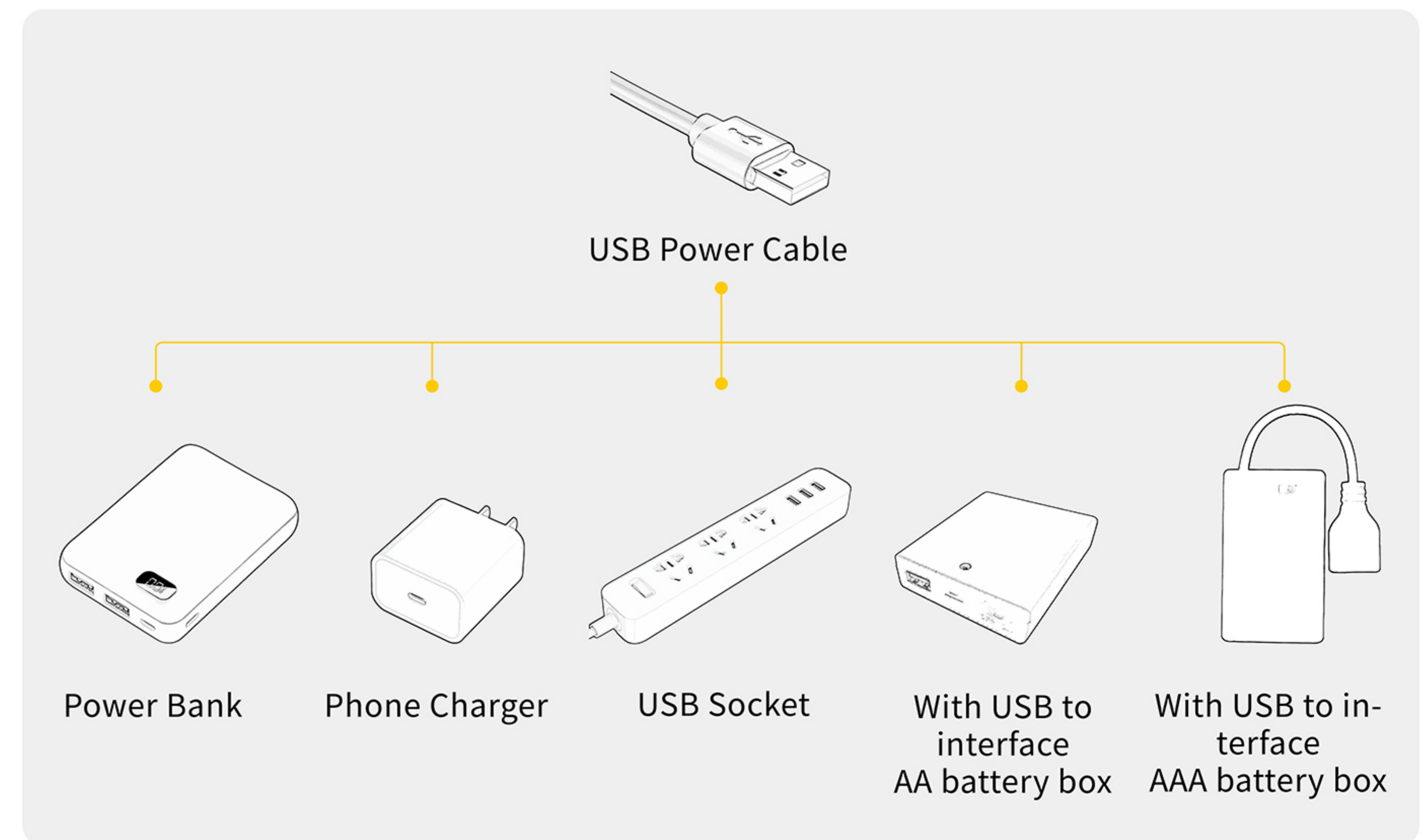

4

EN: Remove the LED beads from Bag No. 2, connect them to the expansion board, turn on the power, and check that the LEDs are functioning properly. If you notice any abnormalities, please contact us immediately.

DE: Nehmen Sie die LED-Perlen aus Beutel Nr. 2, schließen Sie sie an die Erweiterungsplatine an, schalten Sie die Stromversorgung ein und überprüfen Sie, ob die LEDs ordnungsgemäß funktionieren. Sollten Sie Unregelmäßigkeiten feststellen, setzen Sie sich bitte umgehend mit uns in Verbindung.

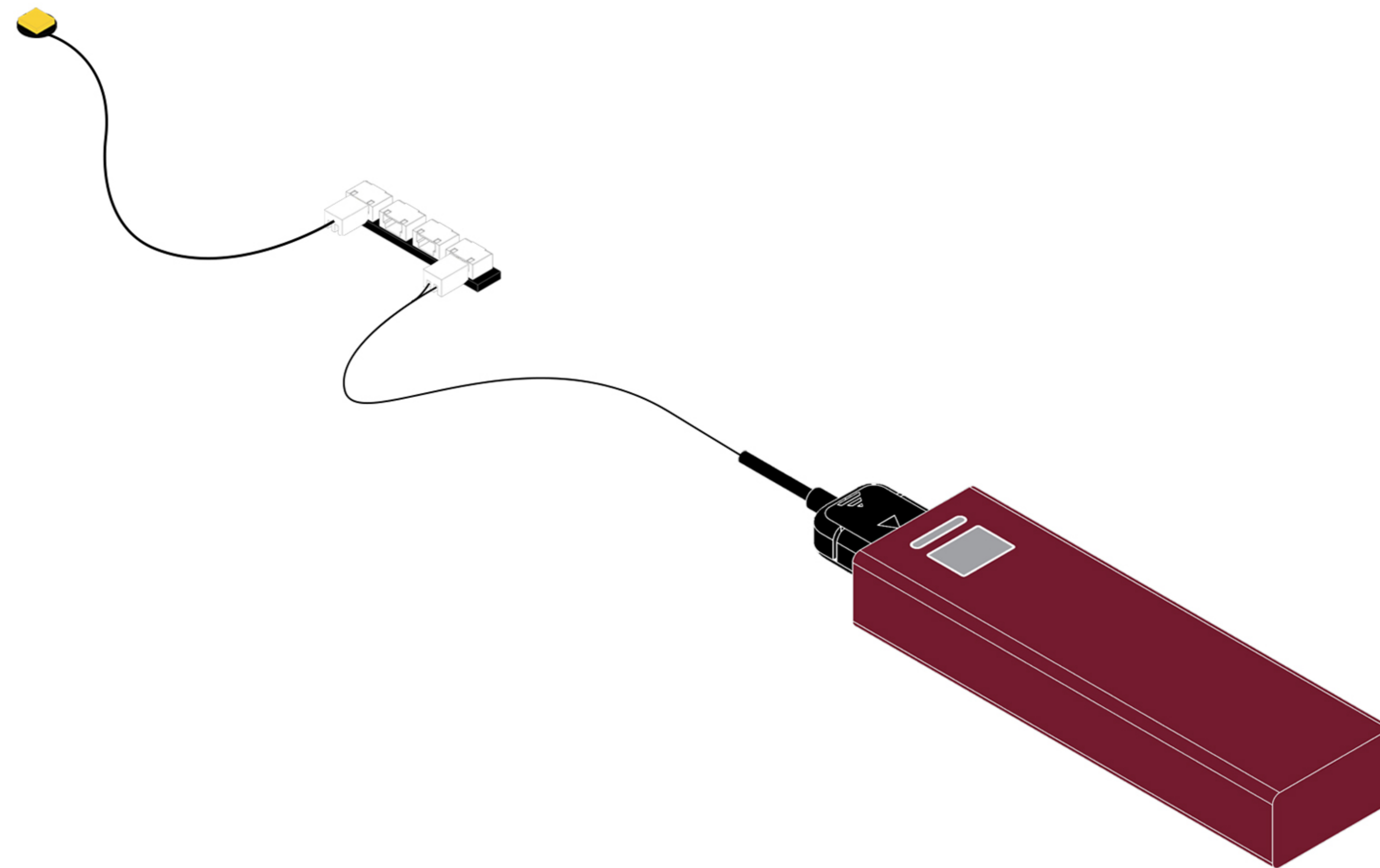
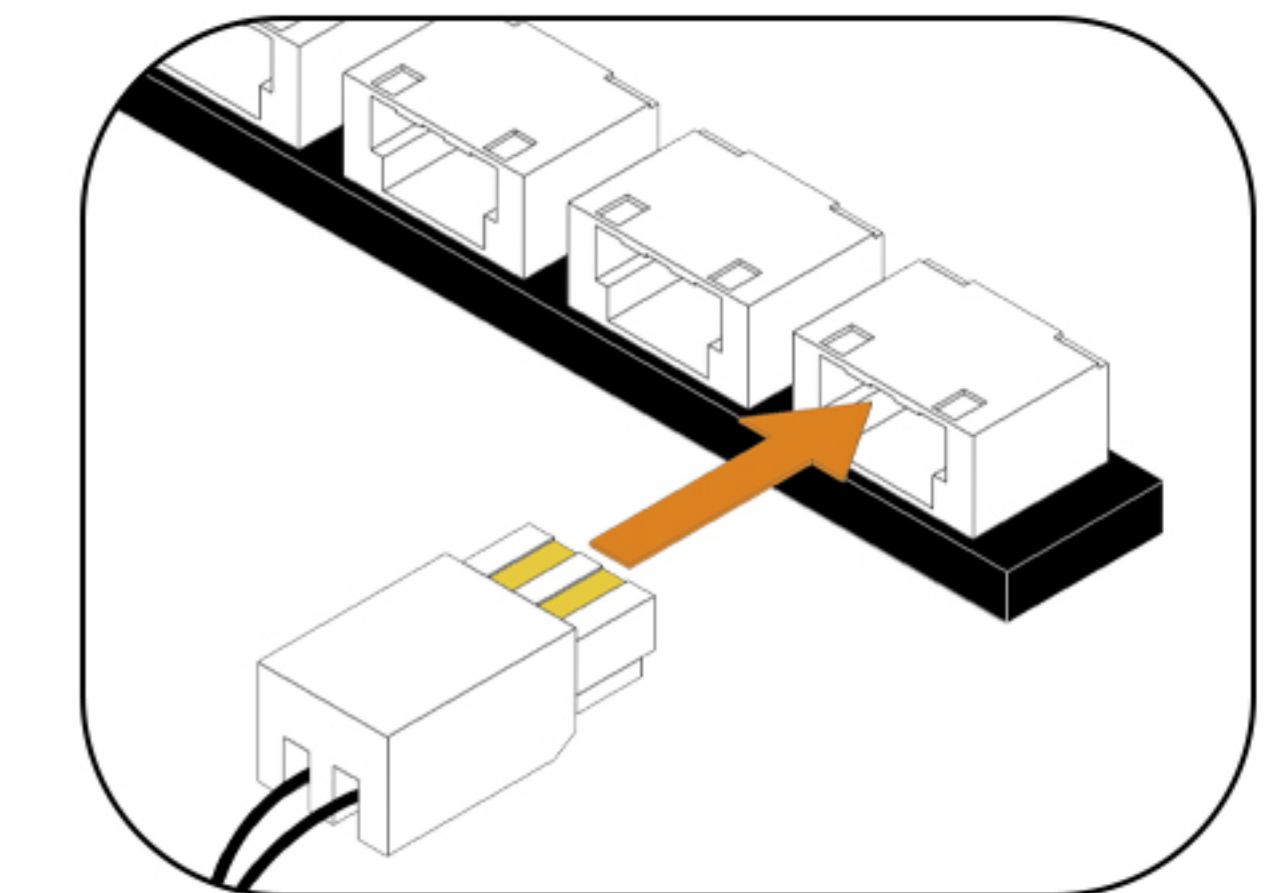
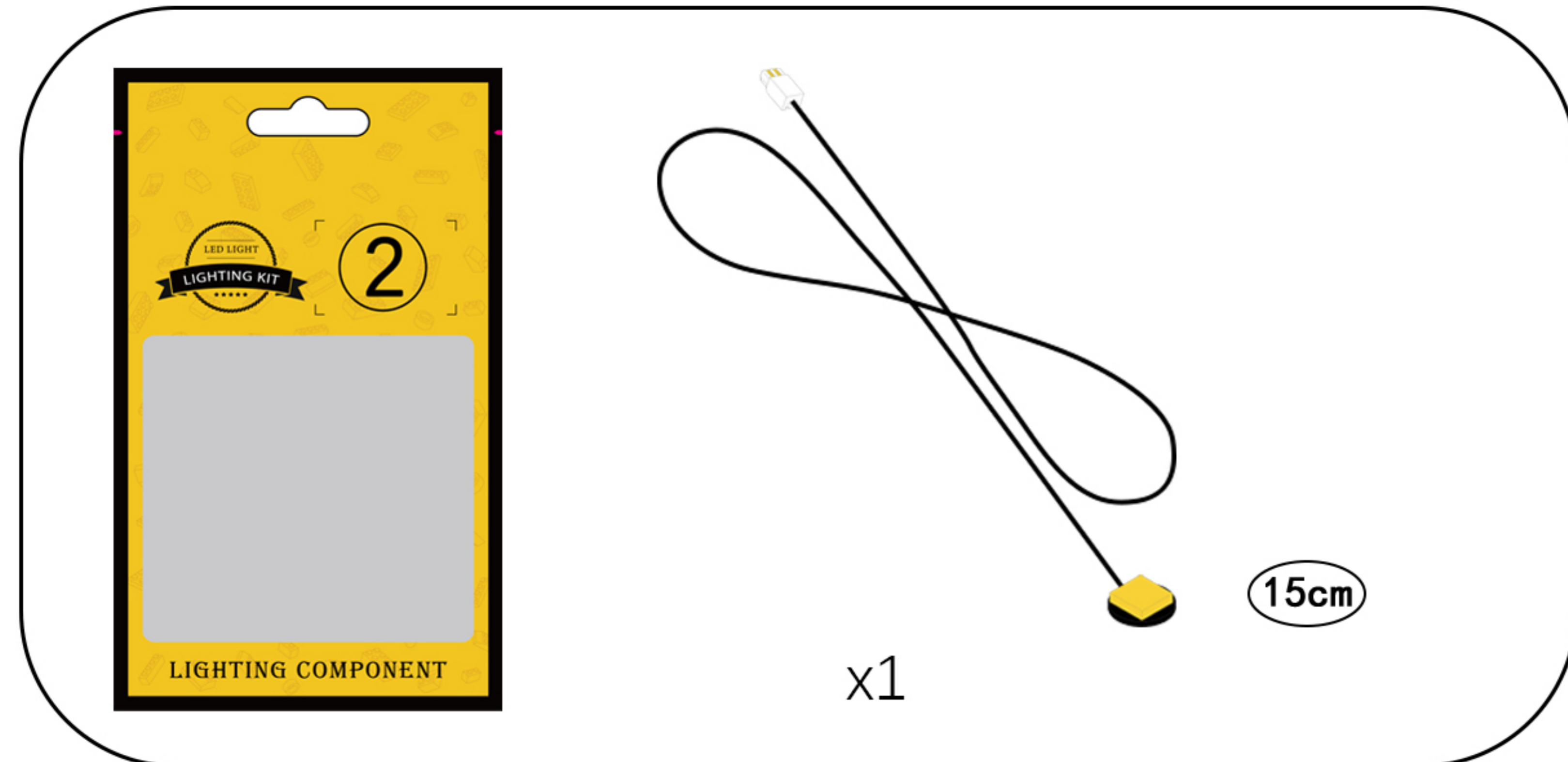

After confirming that there are no abnormalities, temporarily return each part to its original bag.

Step 2-Mounting.

1

EN: Take out the building block model.

DE: Nimm das Bauklotzmodell heraus.



2

EN: Split as shown in the figure.

DE: Wie in der Abbildung gezeigt, teilen Sie es auf.



3

EN: Split as shown in the figure.

DE: Wie in der Abbildung gezeigt, teilen Sie es auf.



4

EN: Disassemble the blocks at the bottom of the model one by one.

DE: Nehmen Sie die Blöcke am unteren Ende des Modells nacheinander auseinander.

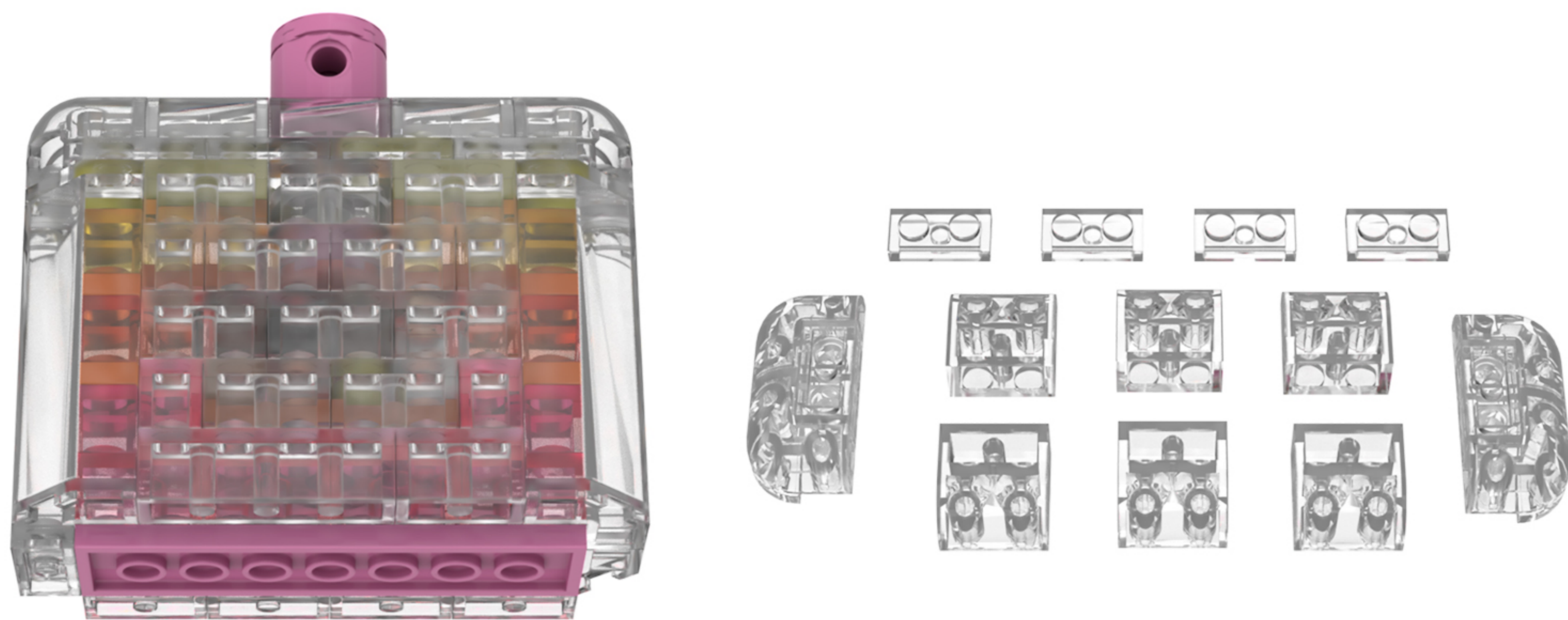

5

EN: Continue disassembling the building blocks.

DE: Zieh die Bausteine weiter auseinander.

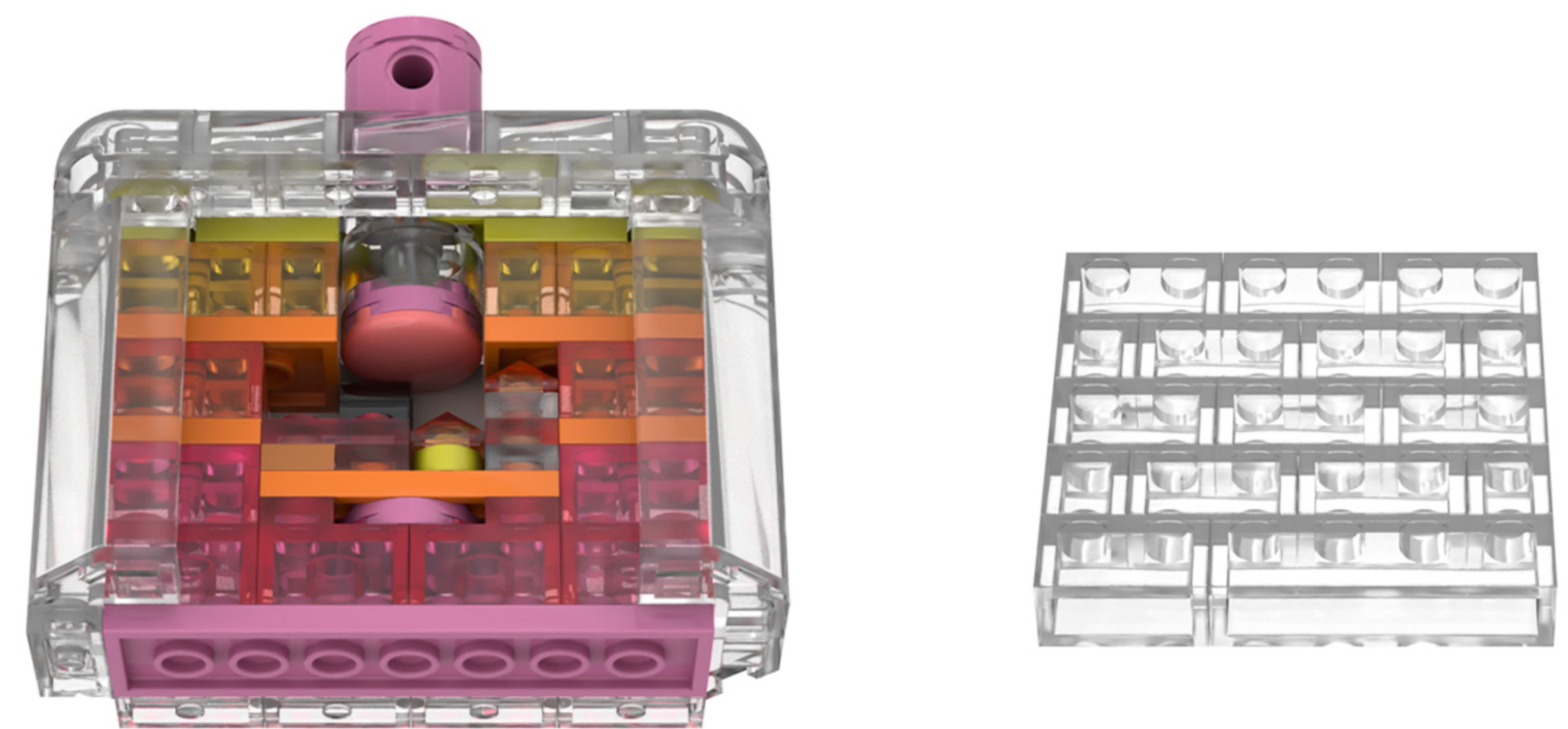

6

EN: Use a tool to remove the building blocks.

DE: Entferne die Bausteine mit einem Werkzeug.

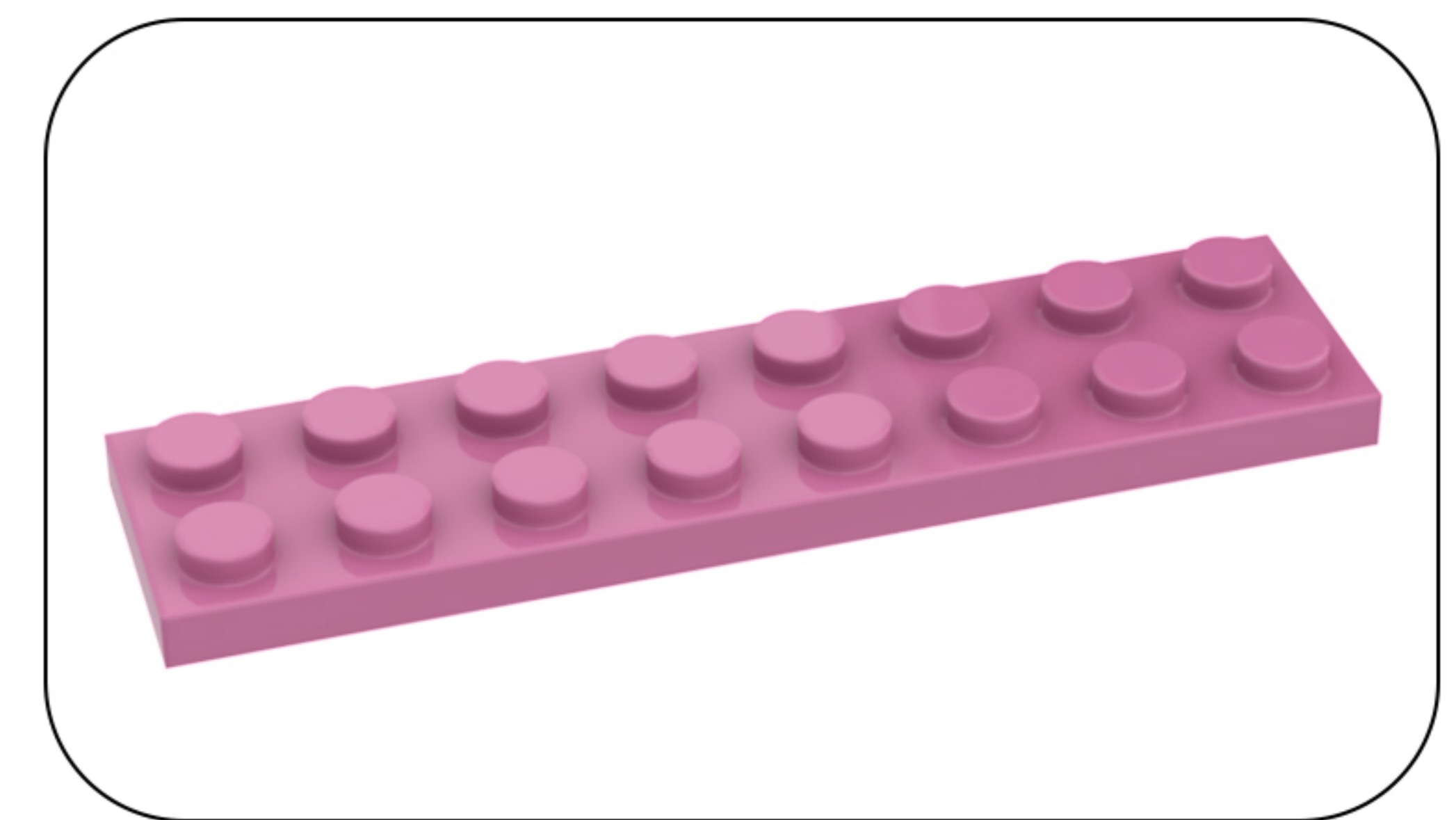
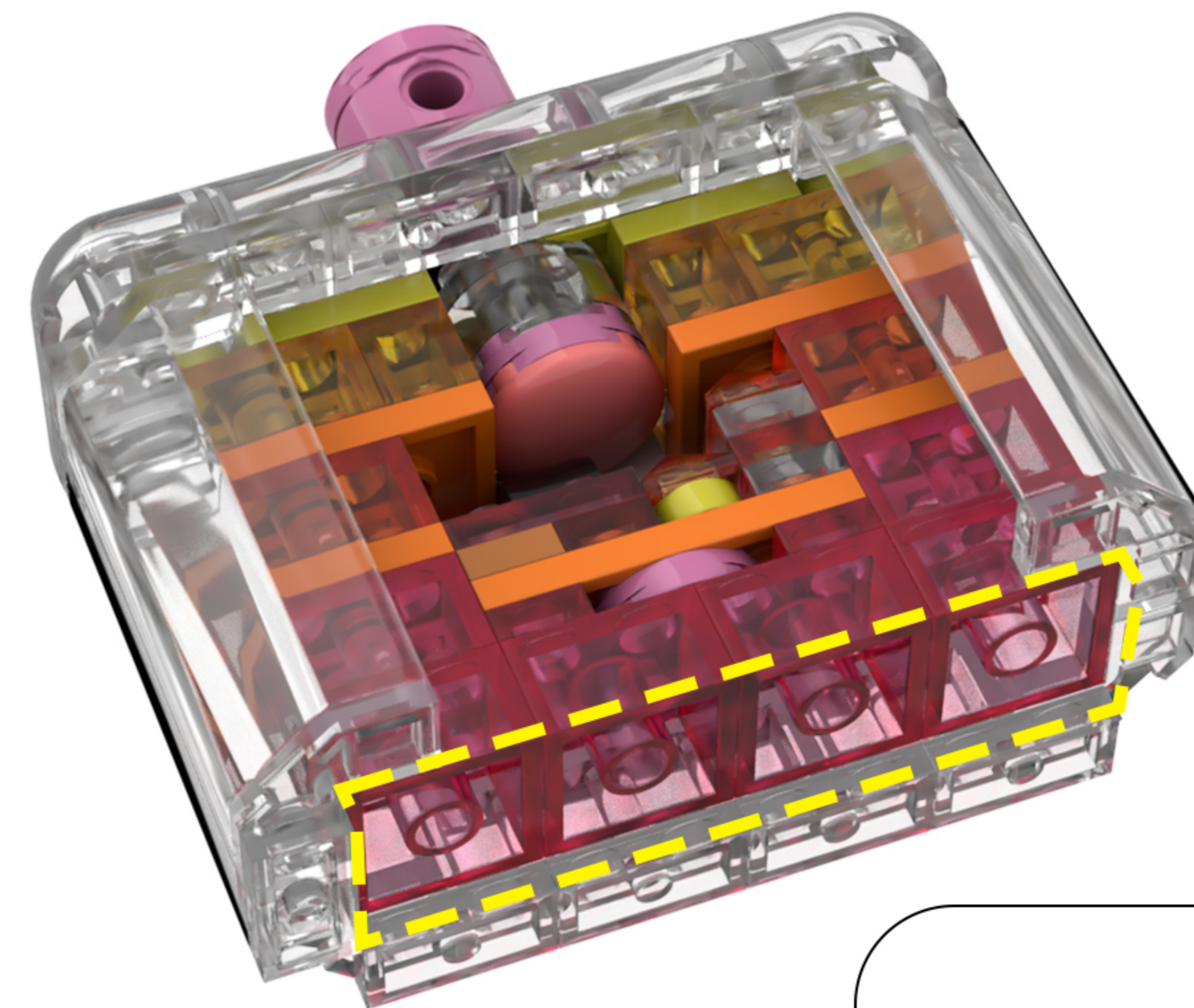
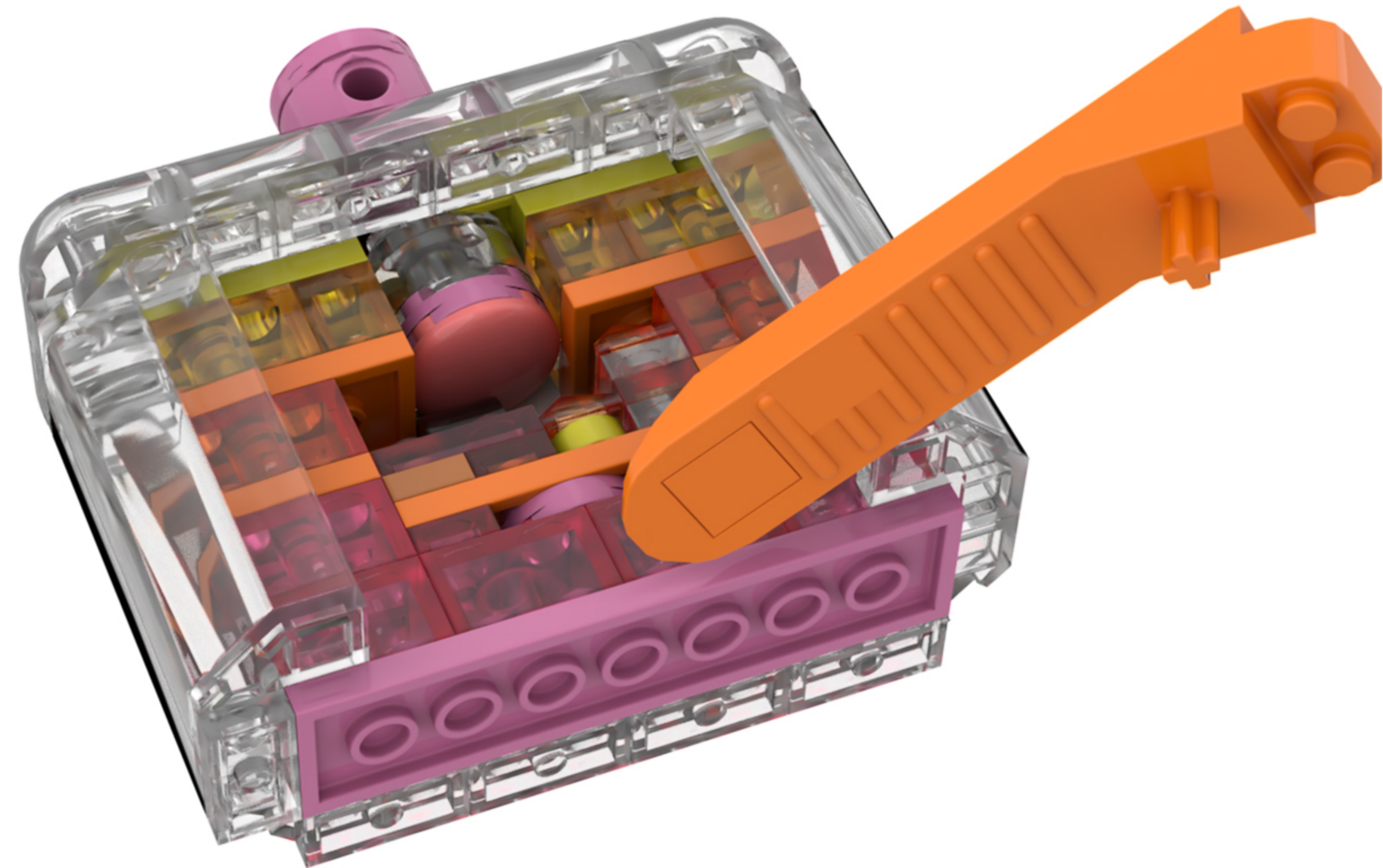

7

EN: Take the string of lights out of Bag 1, untie the zip tie, and locate the two decorative lights on the string.

DE: Nehmen Sie die Lichterkette aus Beutel 1, lösen Sie den Kabelbinder und suchen Sie die beiden Zierlichter an der Kette.

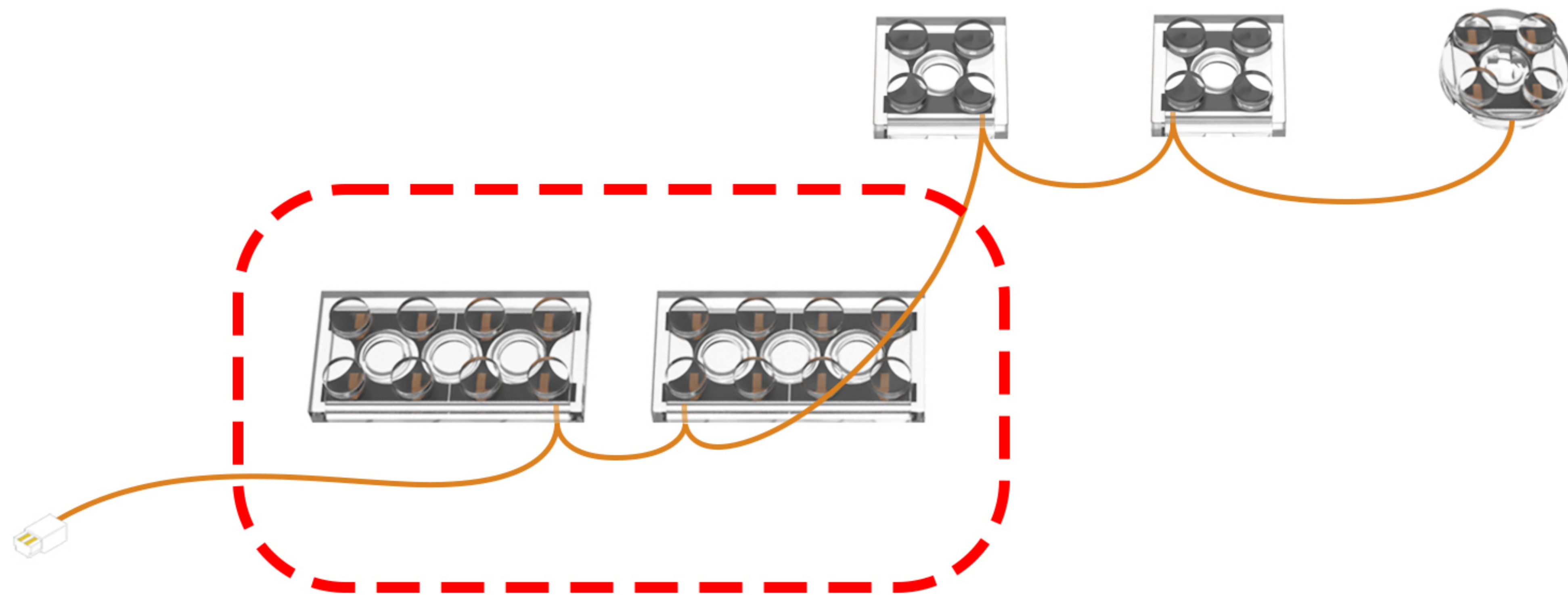
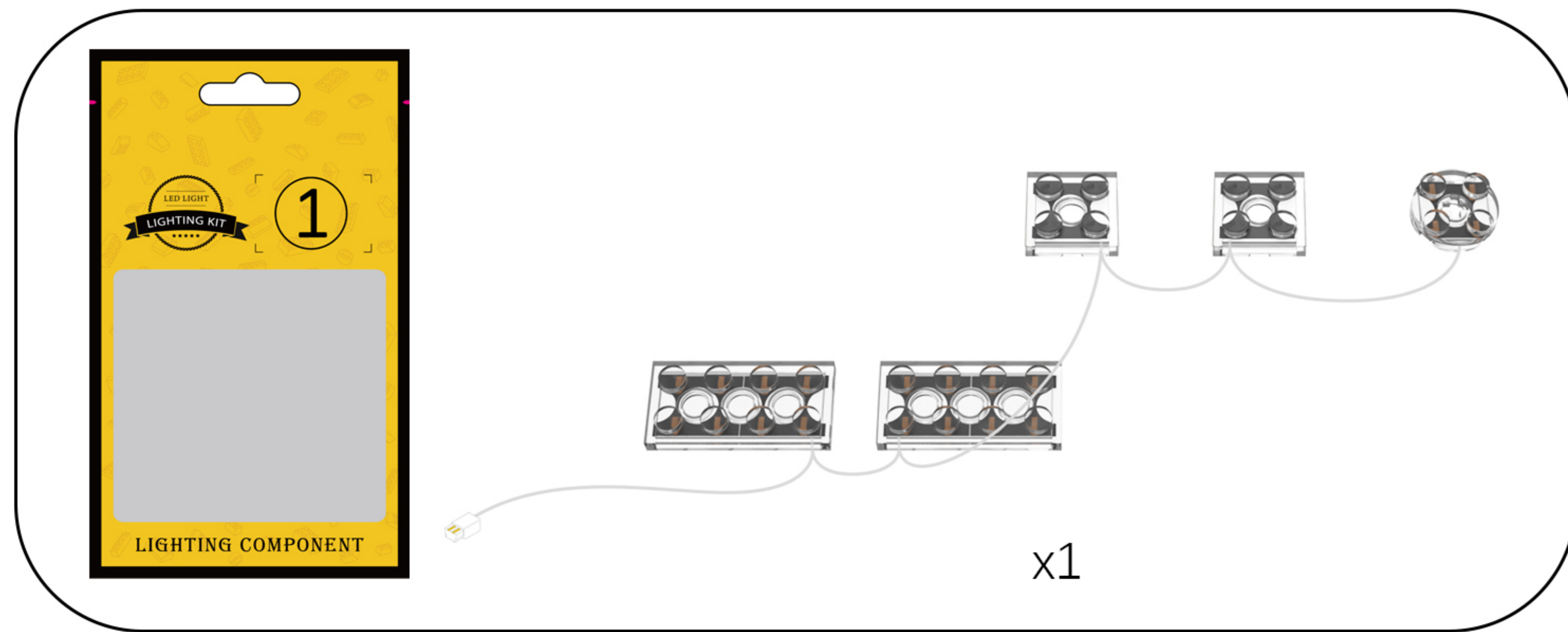

8

EN: Attach the two light fixtures to the building blocks one after the other.

DE: Befestige die beiden Leuchten nacheinander an den Bausteinen.

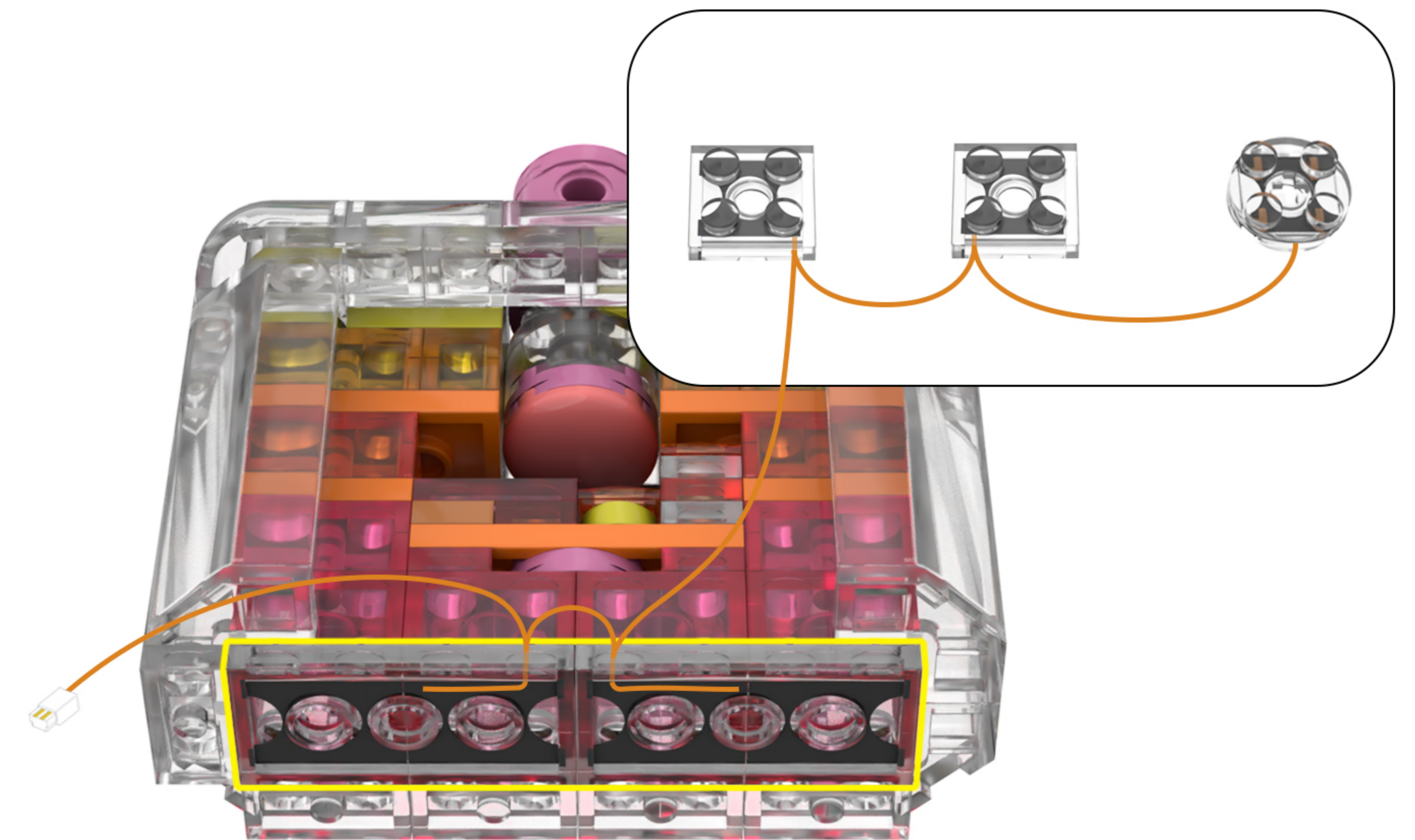

9

EN: Take out the disassembled building blocks and reassemble them.

DE: Nehmen Sie die zerlegten Bausteine heraus und setzen Sie sie wieder zusammen.

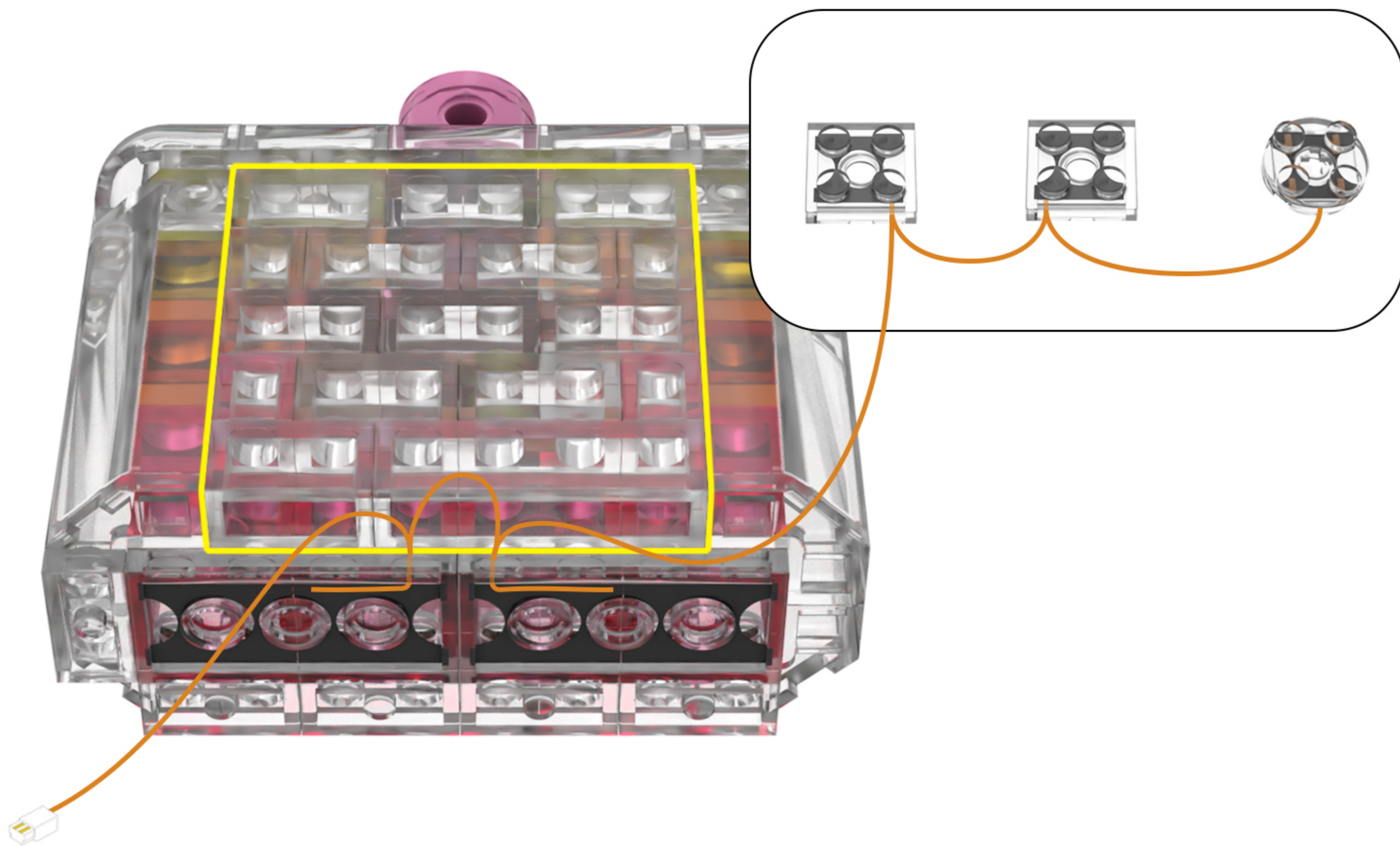
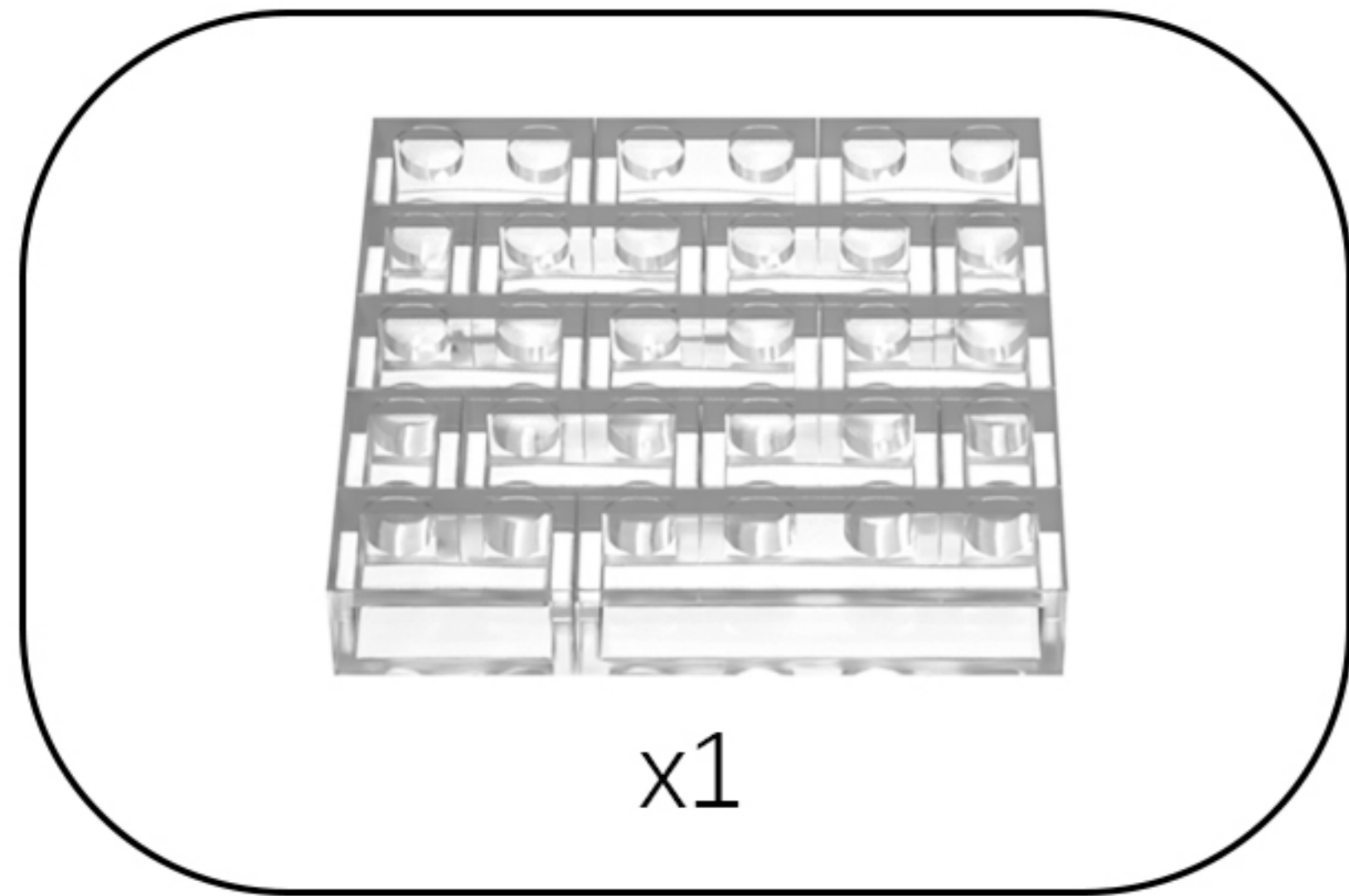

10

EN: Locate this light cord in the diagram.

DE: Suchen Sie dieses Lichtkabel in der Abbildung.

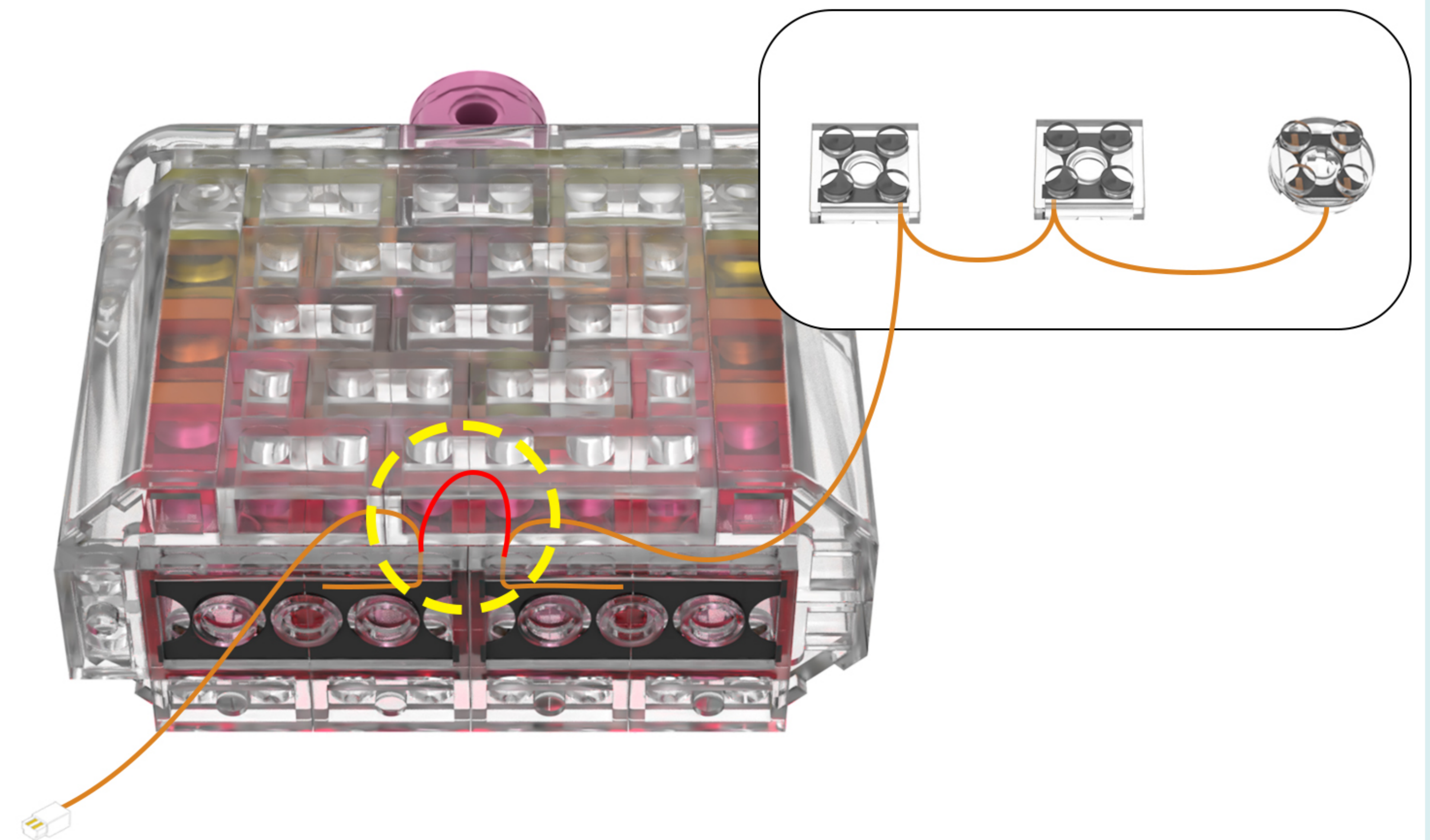

11

EN: Place the light cord from the light fixture inside the 1x4 clear base brick.

DE: Führen Sie das Kabel der Leuchte durch den durchsichtigen 1x4-Baustein.

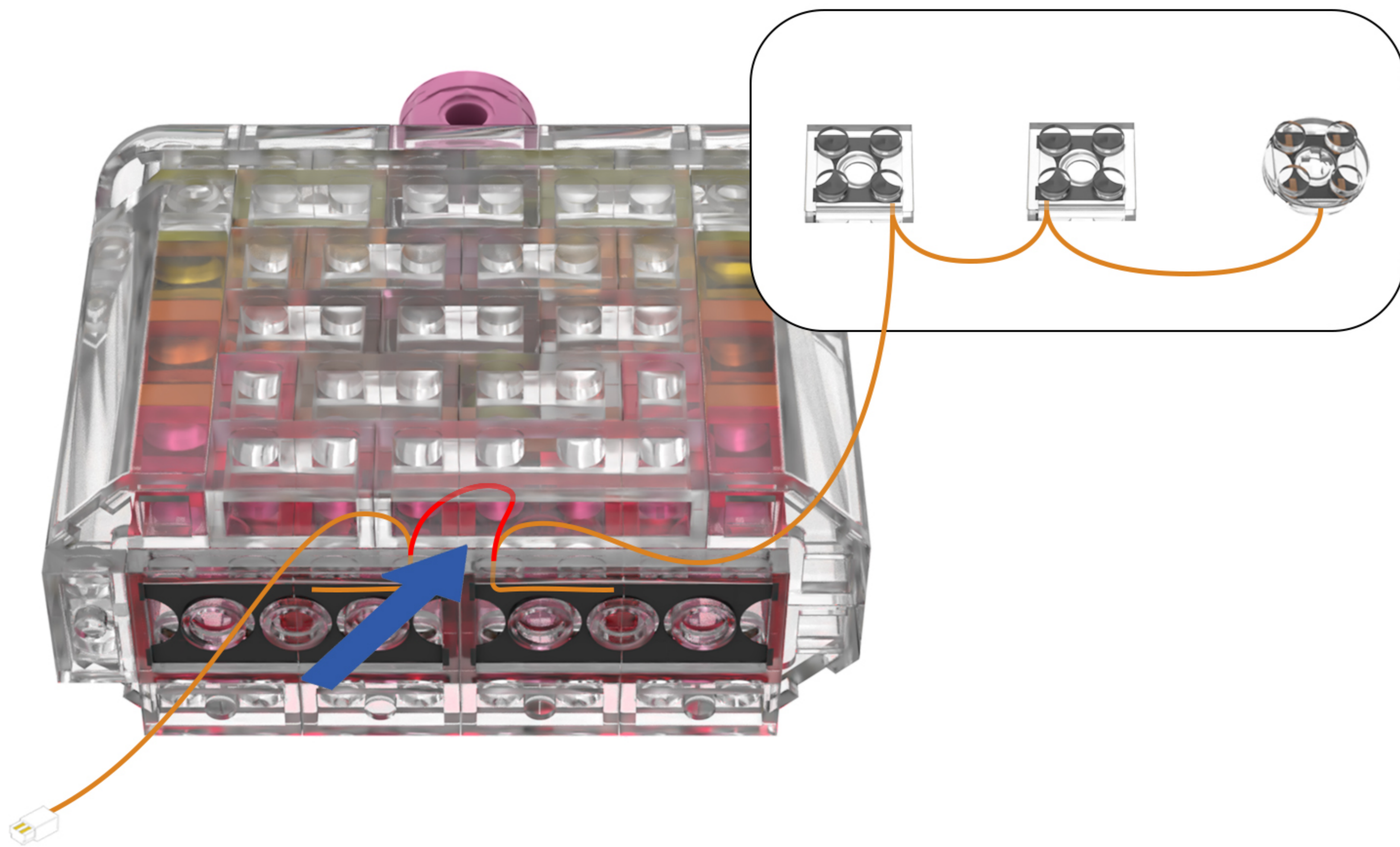
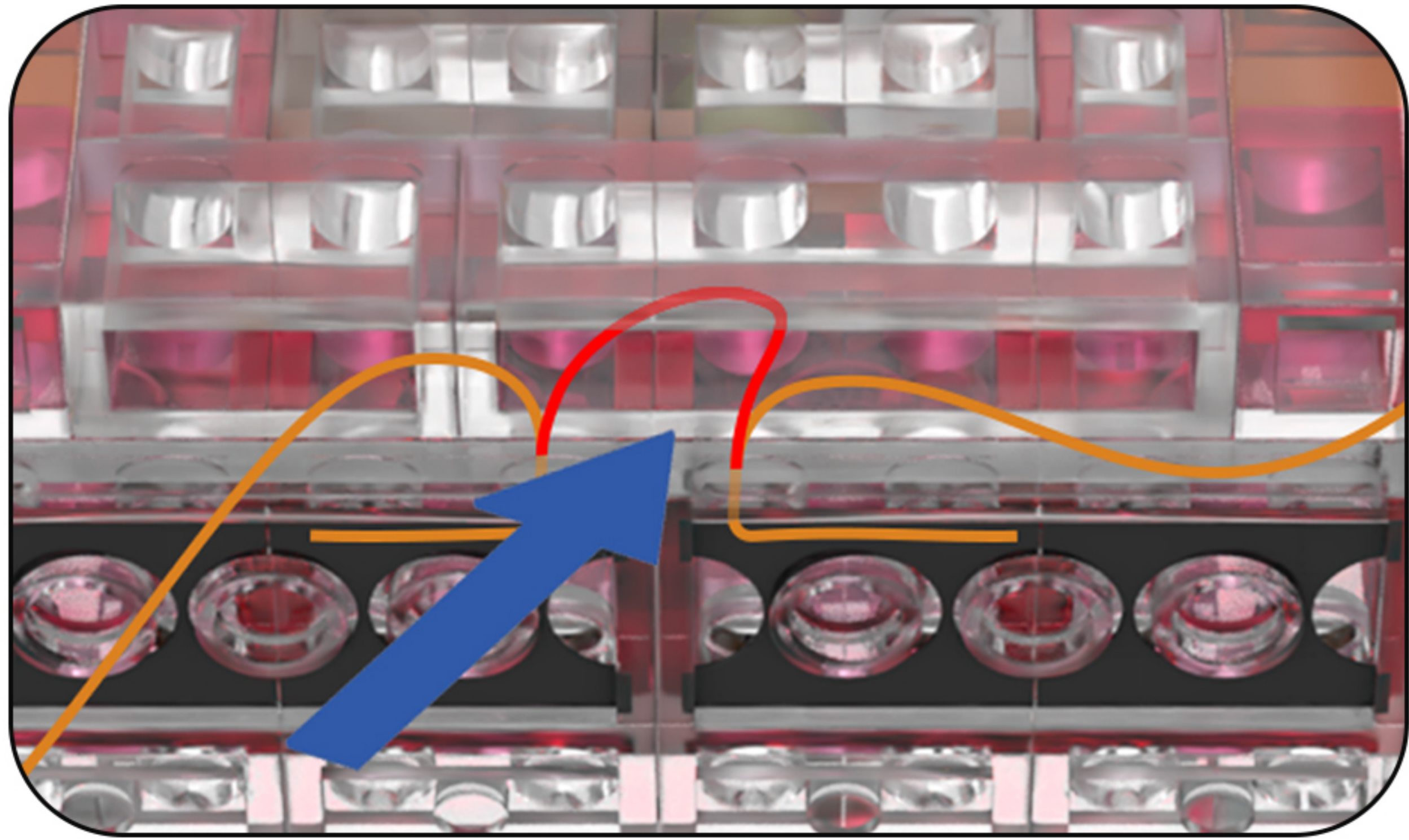

12

EN: Take out the disassembled building blocks and reassemble them in order.

DE: Nehmen Sie die zerlegten Bausteine heraus und setzen Sie sie der Reihe nach wieder zusammen.

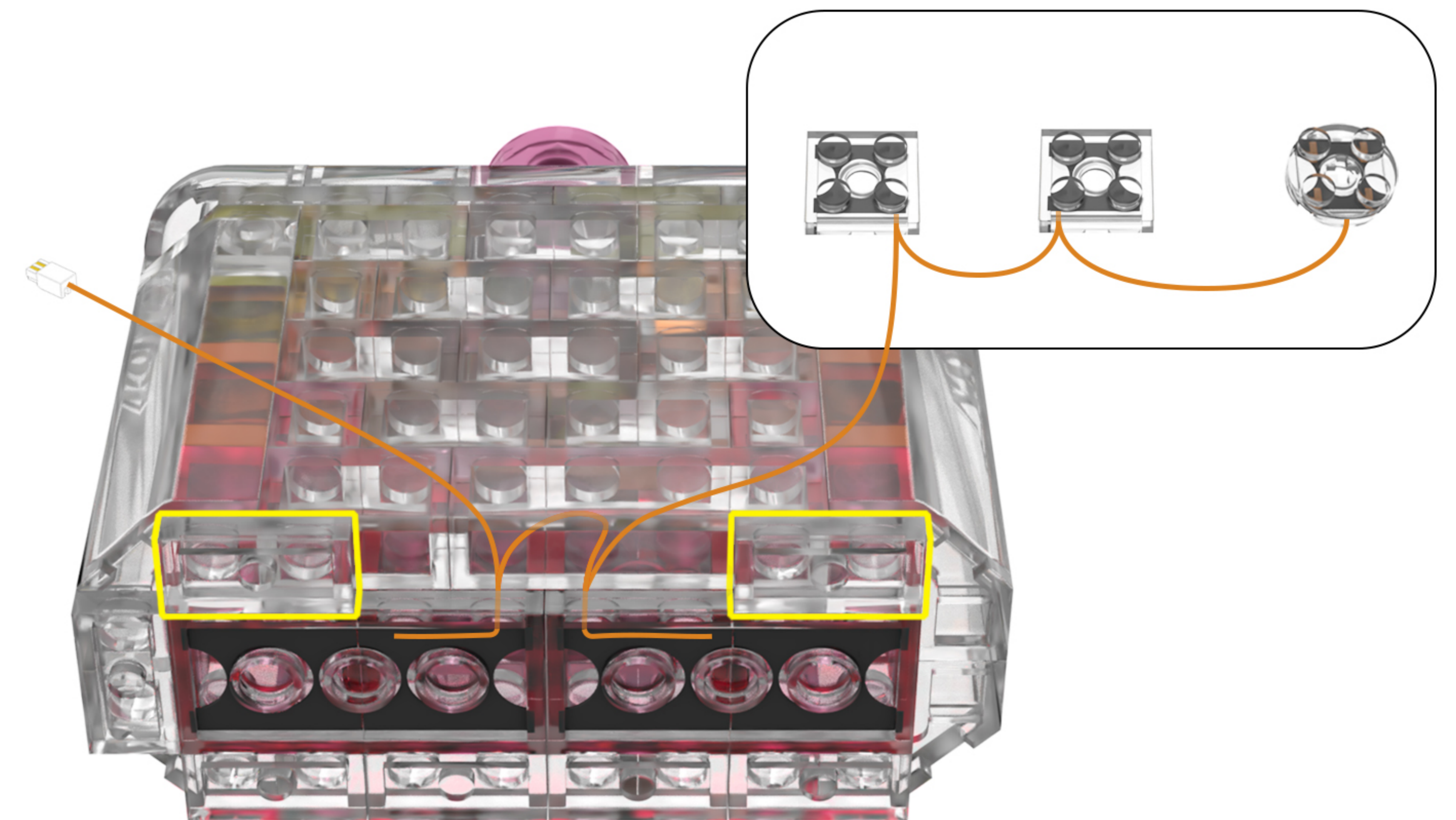
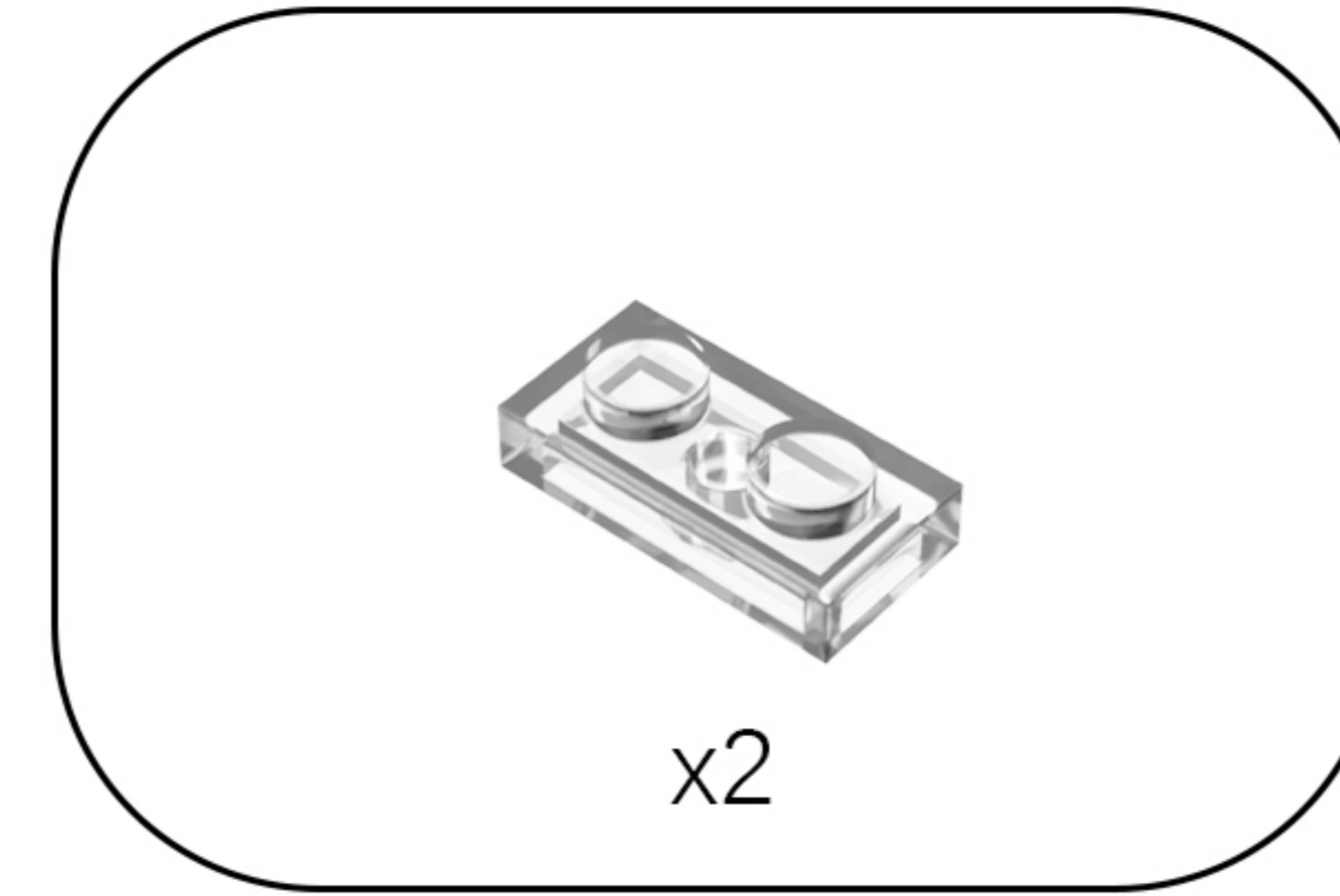

13

EN: Take the 1×4 baseplate from Bag 2, attach it to the brick, and secure the light cord underneath.

DE: Nimm die 1×4-Grundplatte aus Beutel 2, befestige sie am Stein und verlege das Lichtkabel darunter.

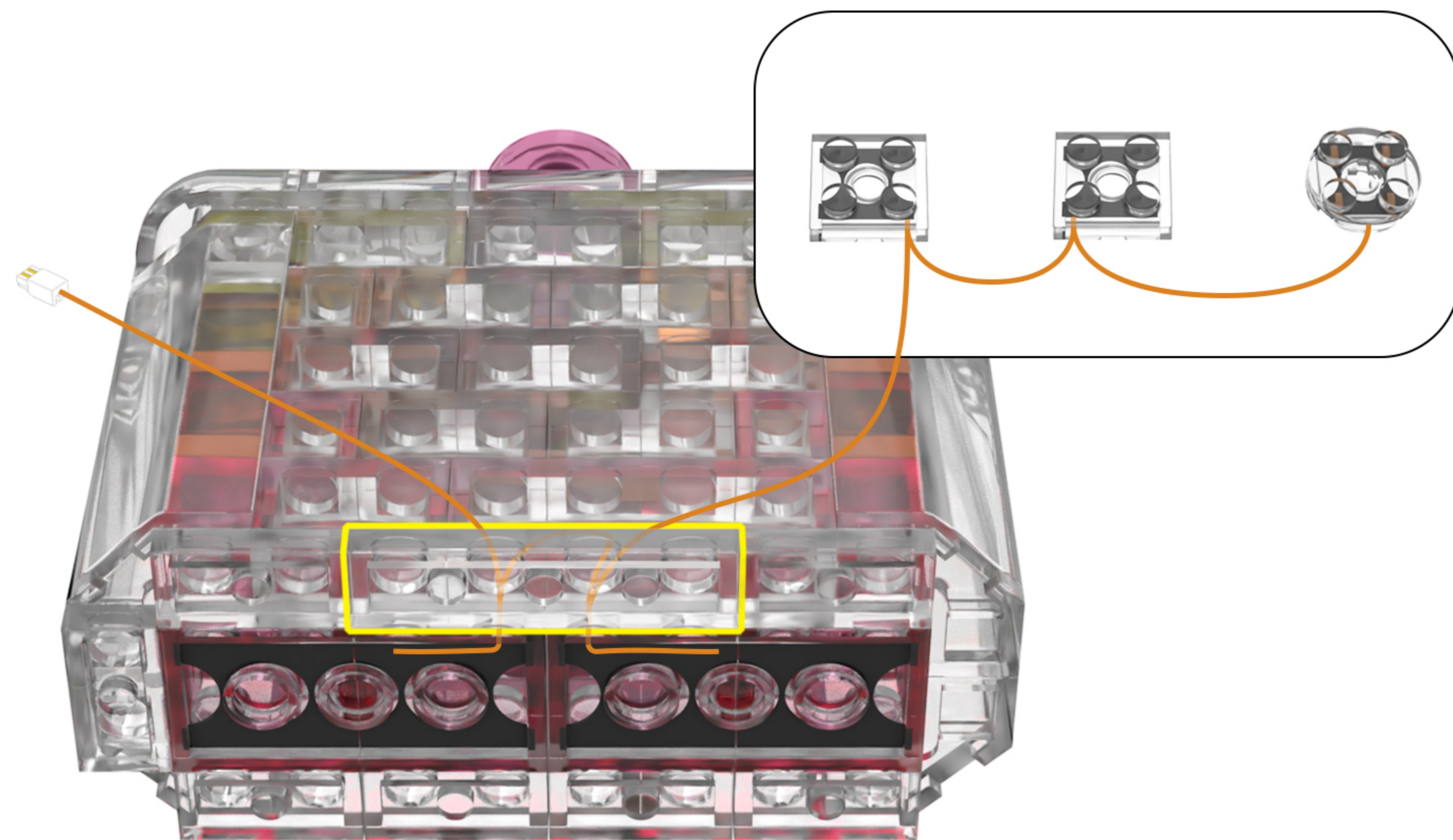
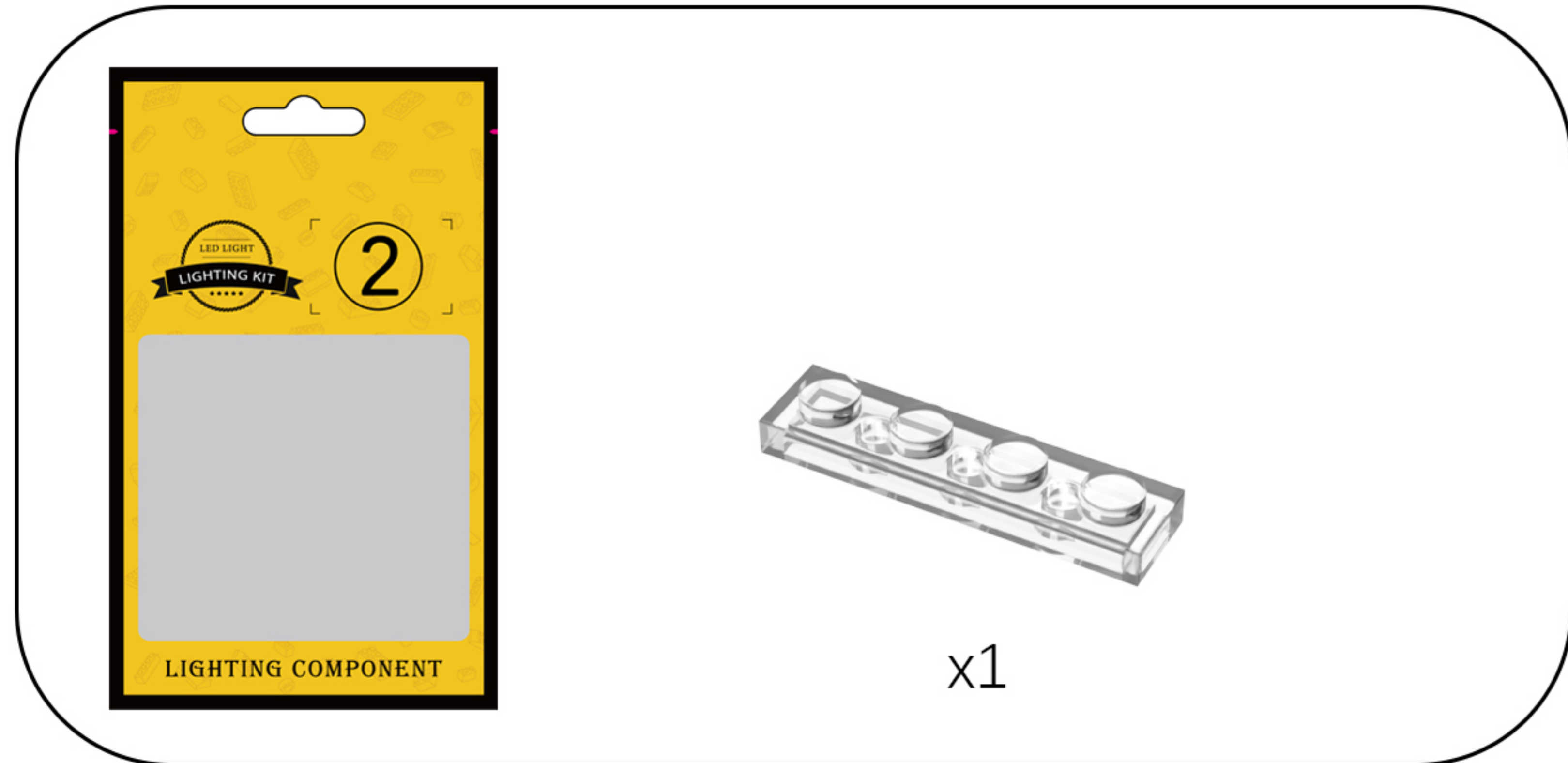

14

EN: Take out the disassembled building blocks and reassemble them in order.

DE: Nehmen Sie die zerlegten Bausteine heraus und setzen Sie sie der Reihe nach wieder zusammen.

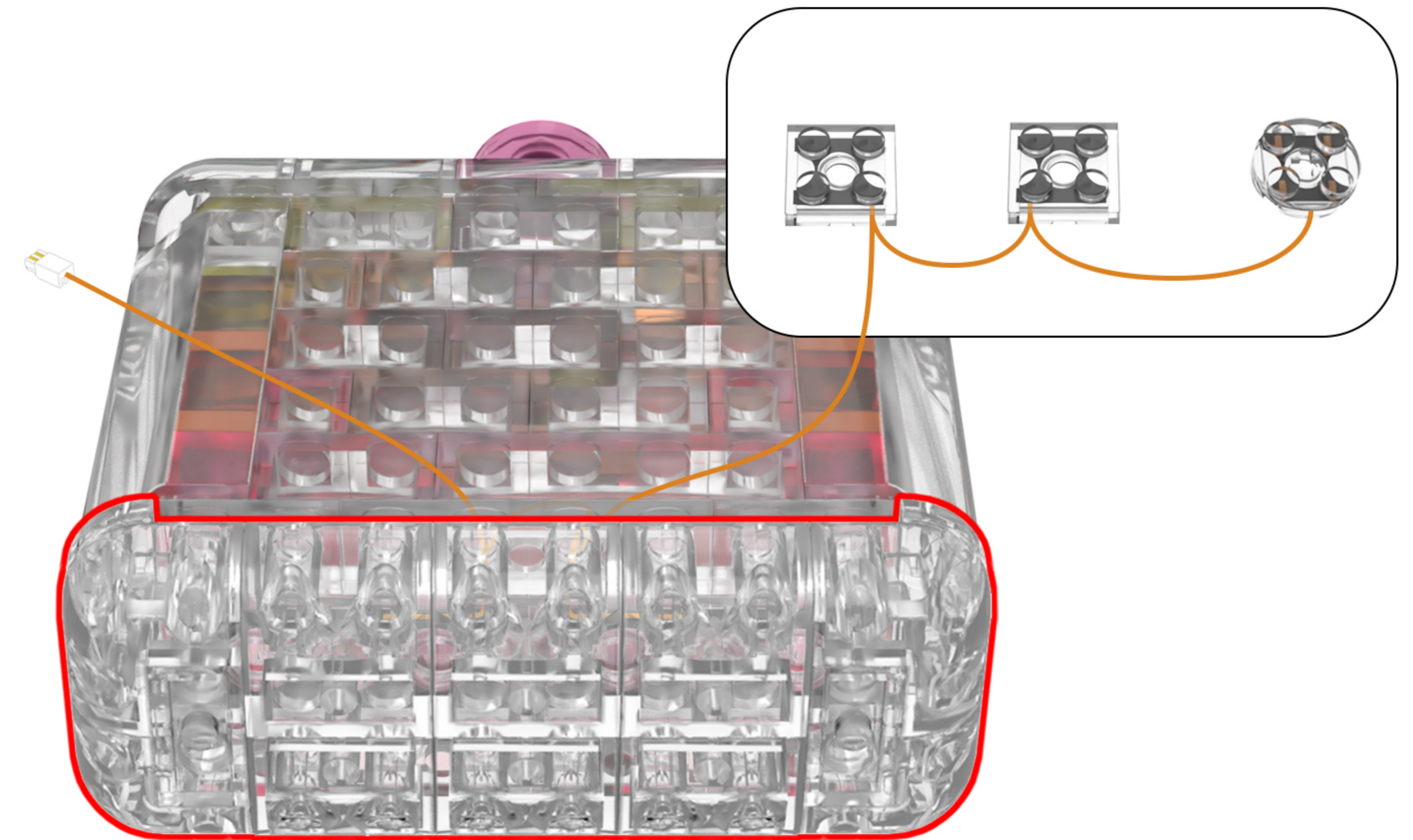
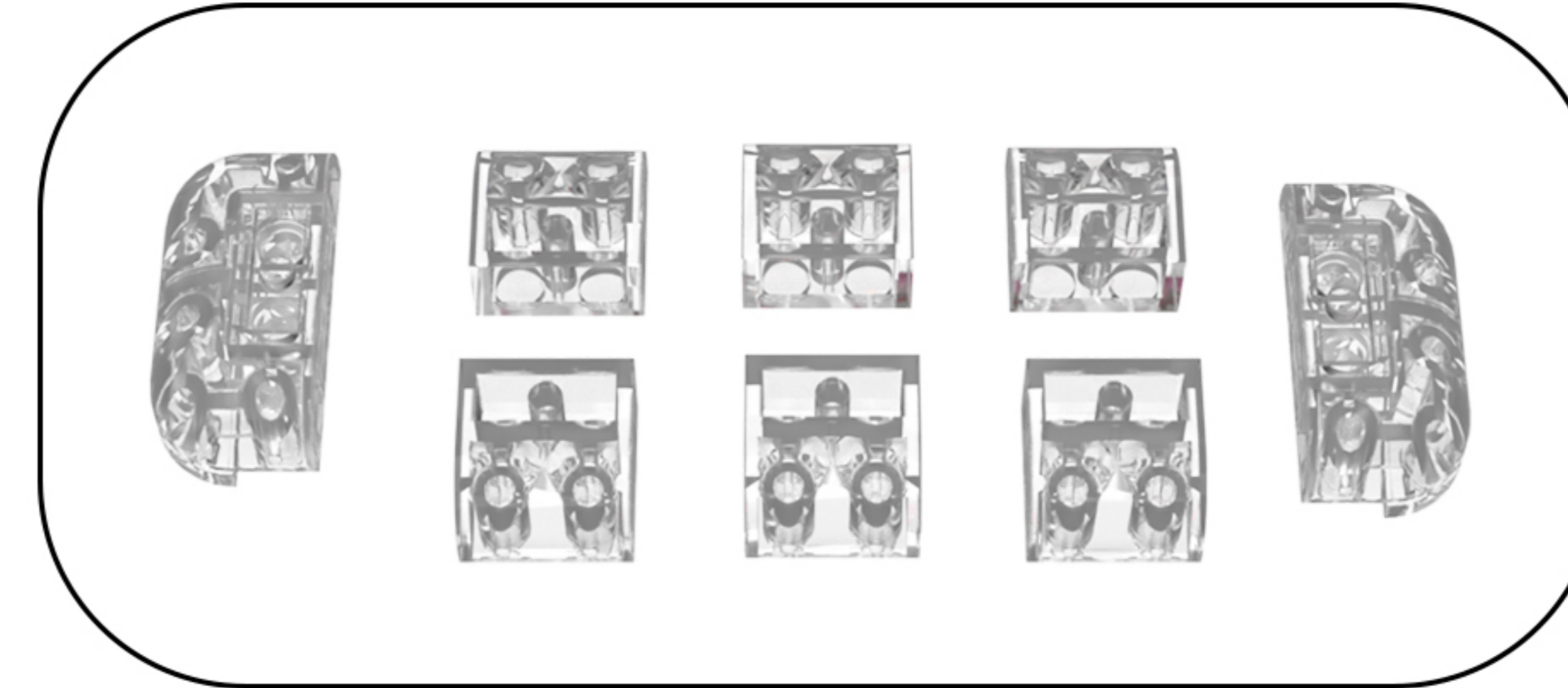

15

EN: Stand the model upright.

DE: Stellen Sie das Modell aufrecht hin.

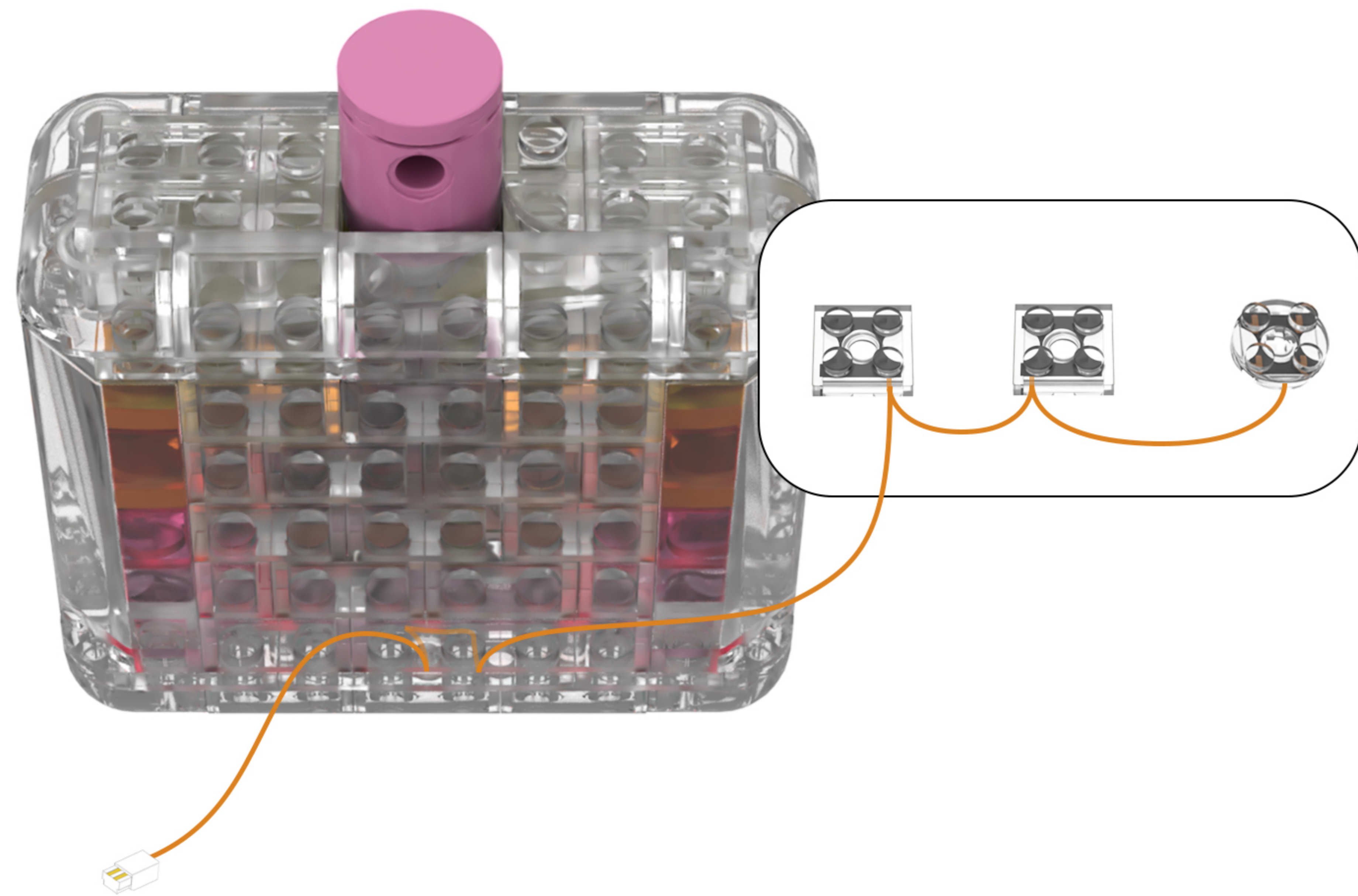

16

EN: Remove the building blocks one by one.

DE: Entfernen Sie die Bausteine nacheinander.

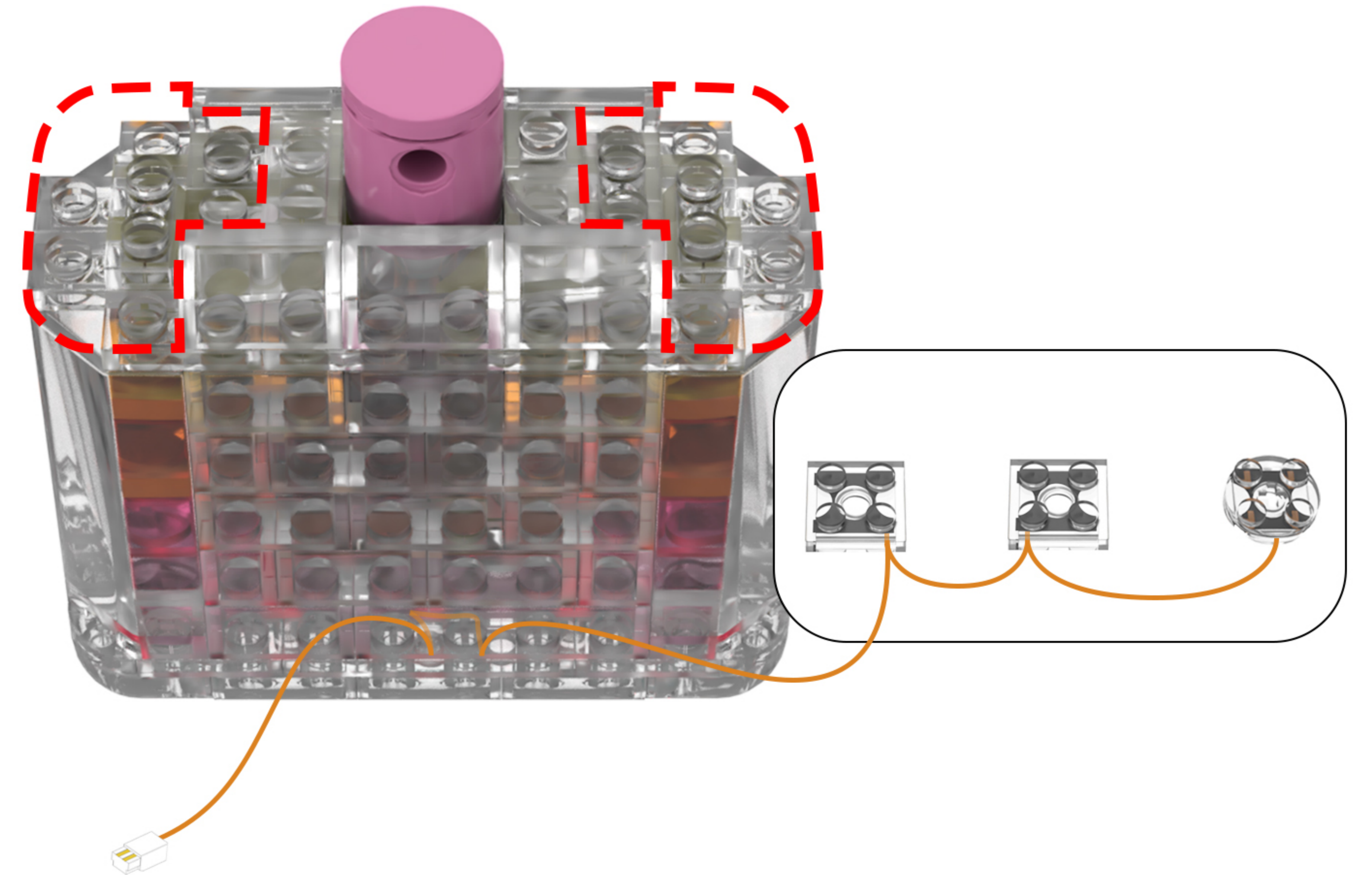
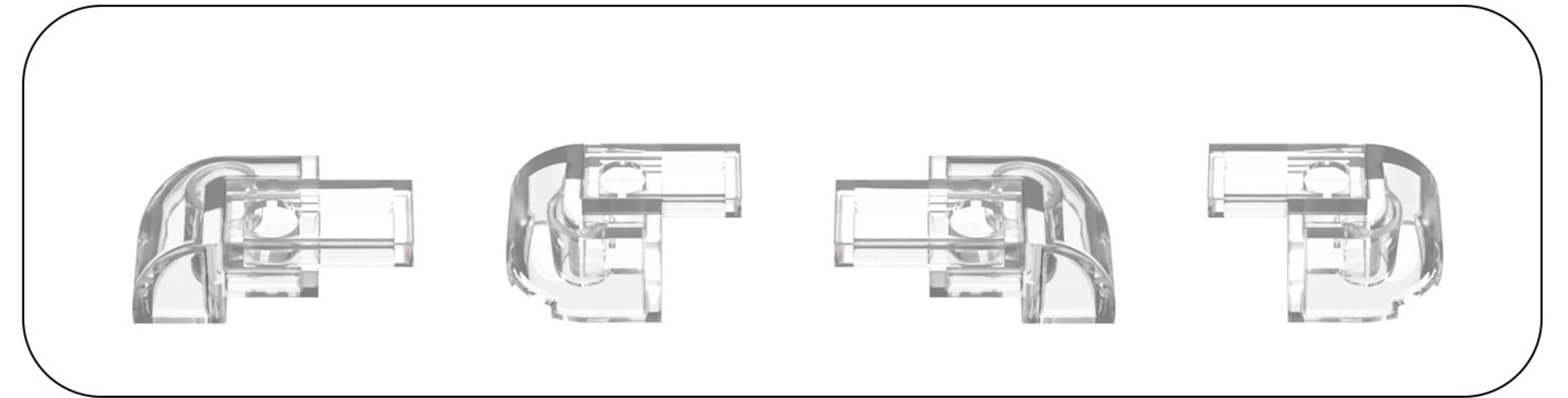

17

EN: Look at the left side of the model and disassemble the blocks one by one.

DE: Schau dir die linke Seite des Modells an und nimm die Blöcke nacheinander auseinander.

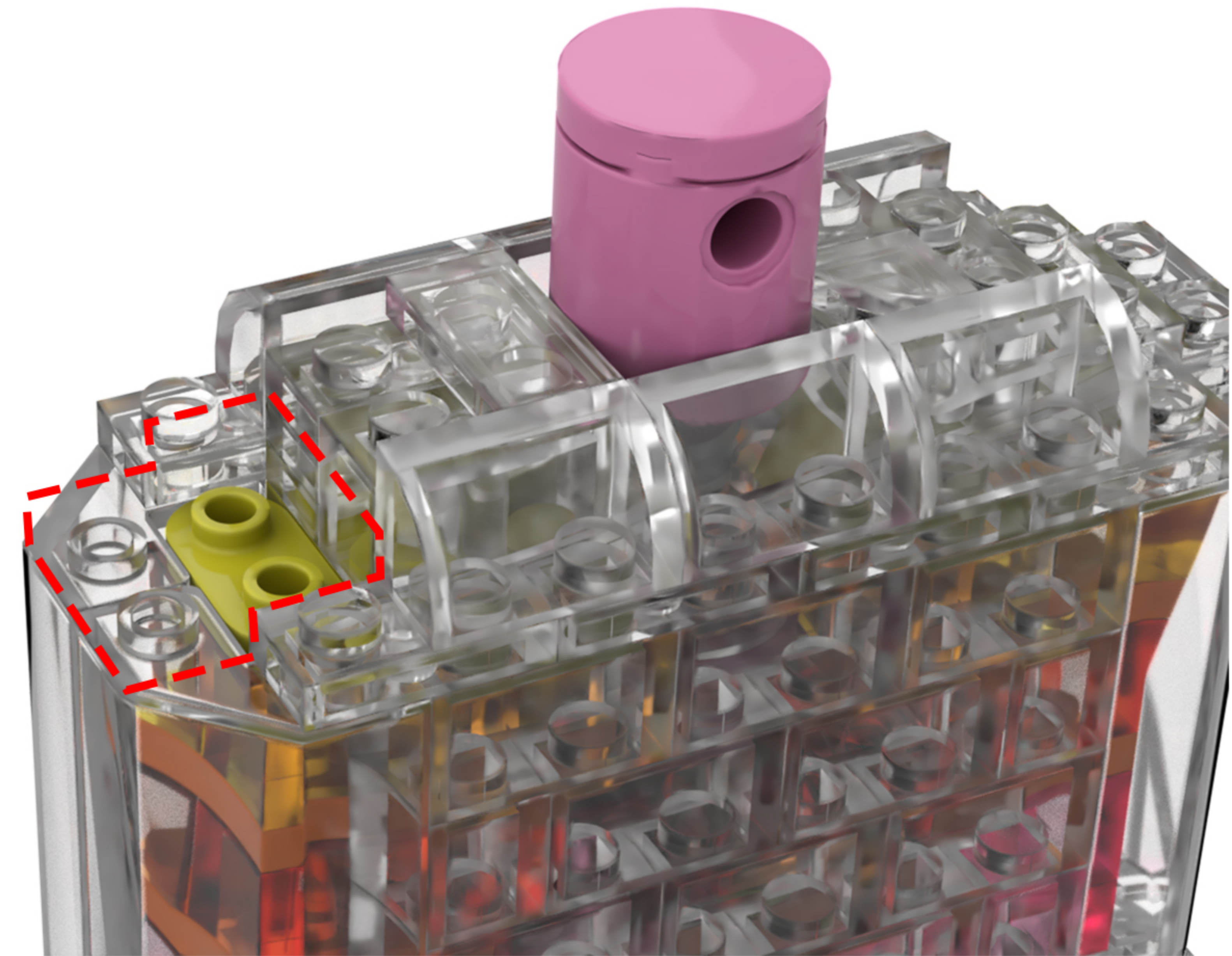
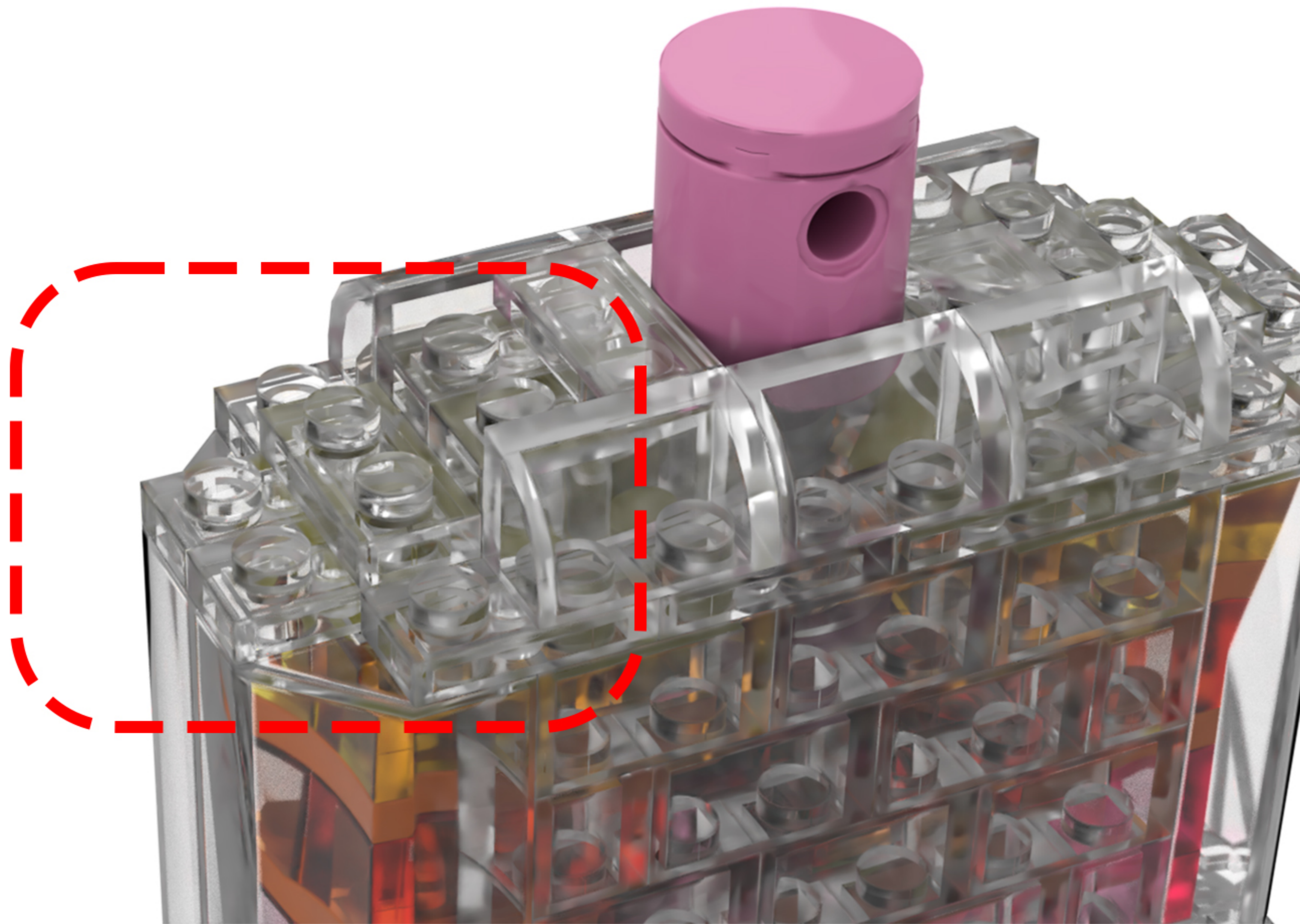

18

EN: Look at the right side of the model and remove the blocks one by one.

DE: Schau dir die rechte Seite des Modells an und entferne die Blöcke nacheinander.

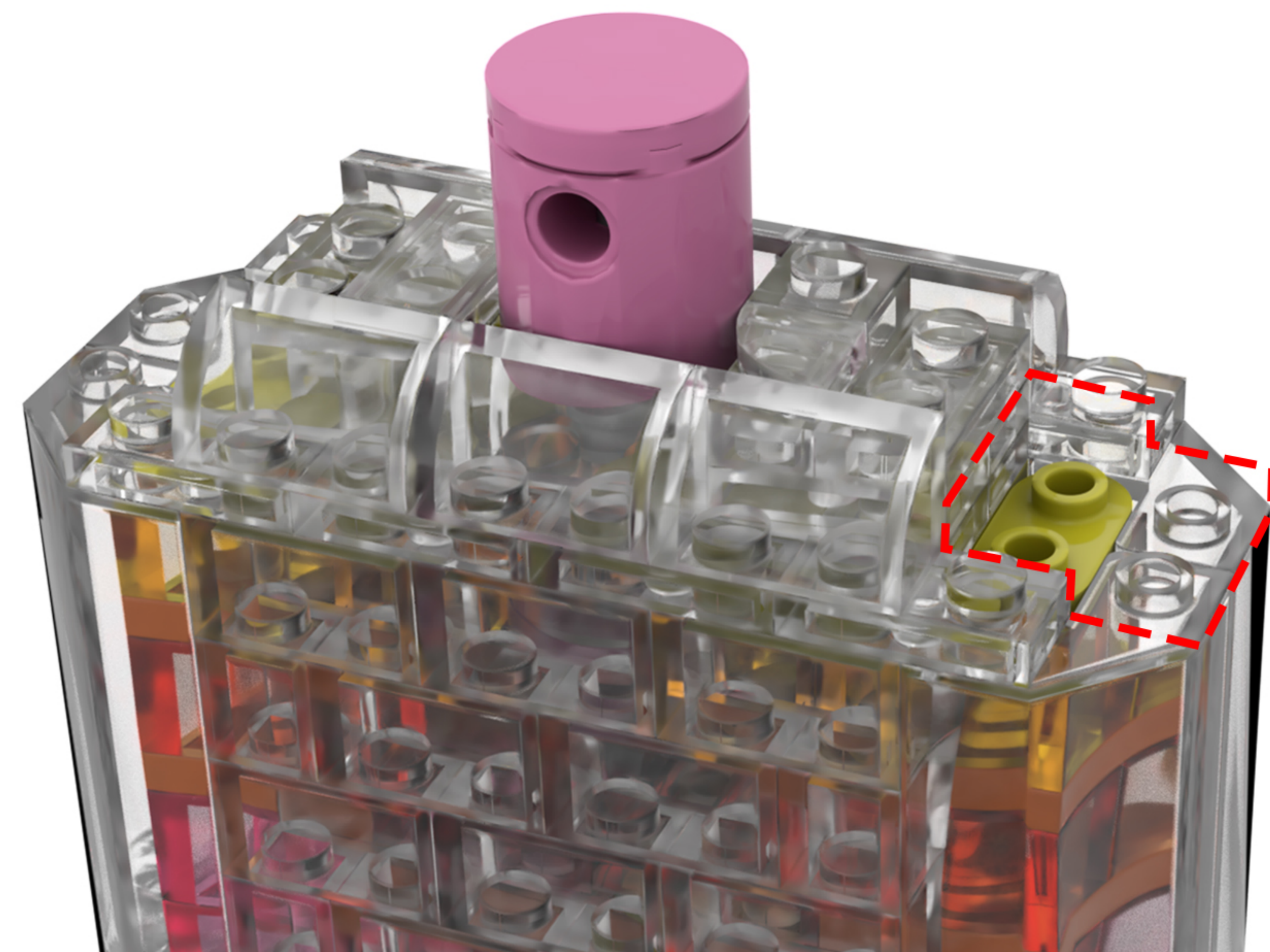
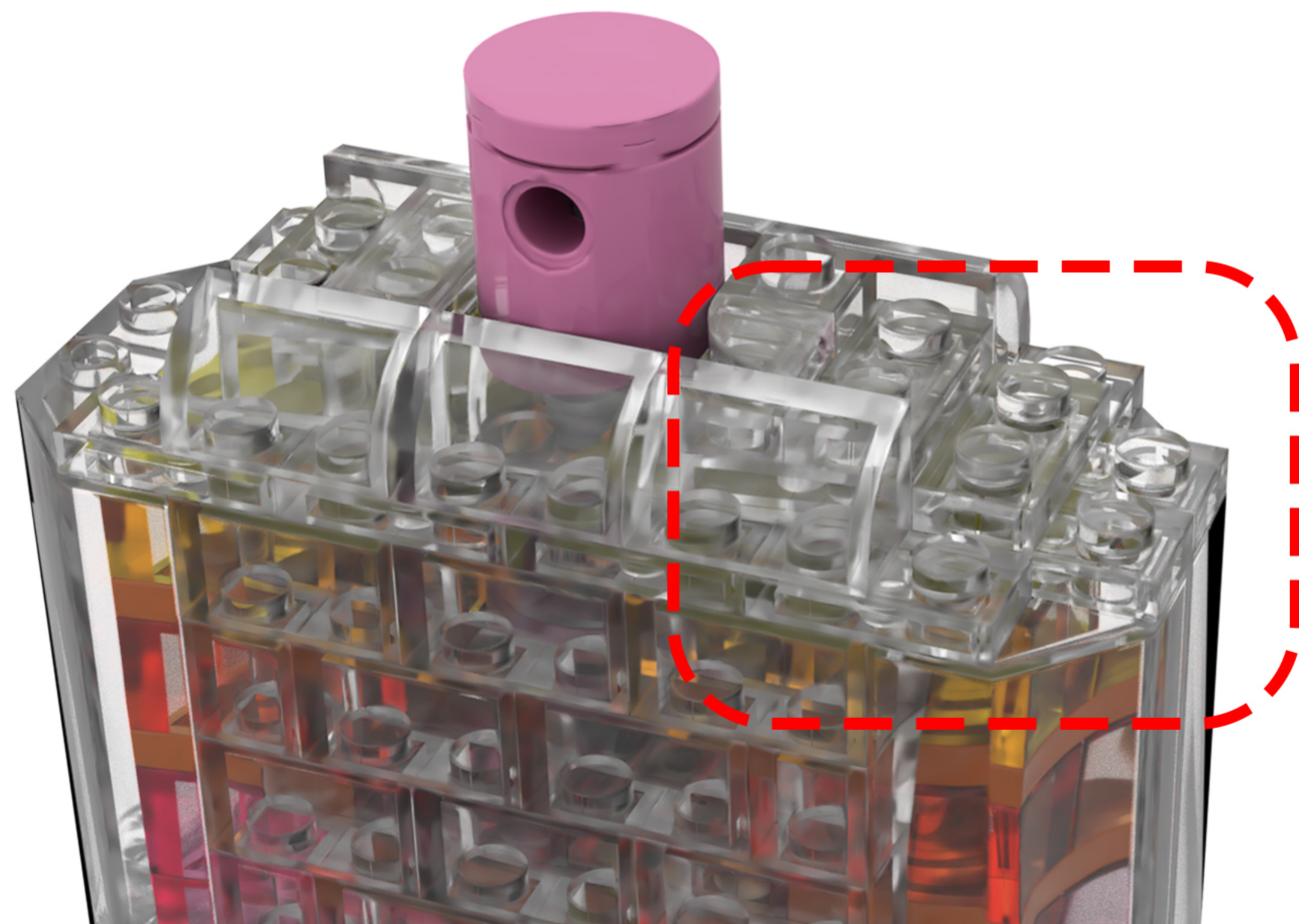

19

EN: Attach the two 2x2 double-row light strips from the string of lights to either side of the model.

DE: Befestige die beiden 2x2-Lichtleisten mit zwei Lichtreihen aus der Lichterkette an beiden Seiten des Modells.

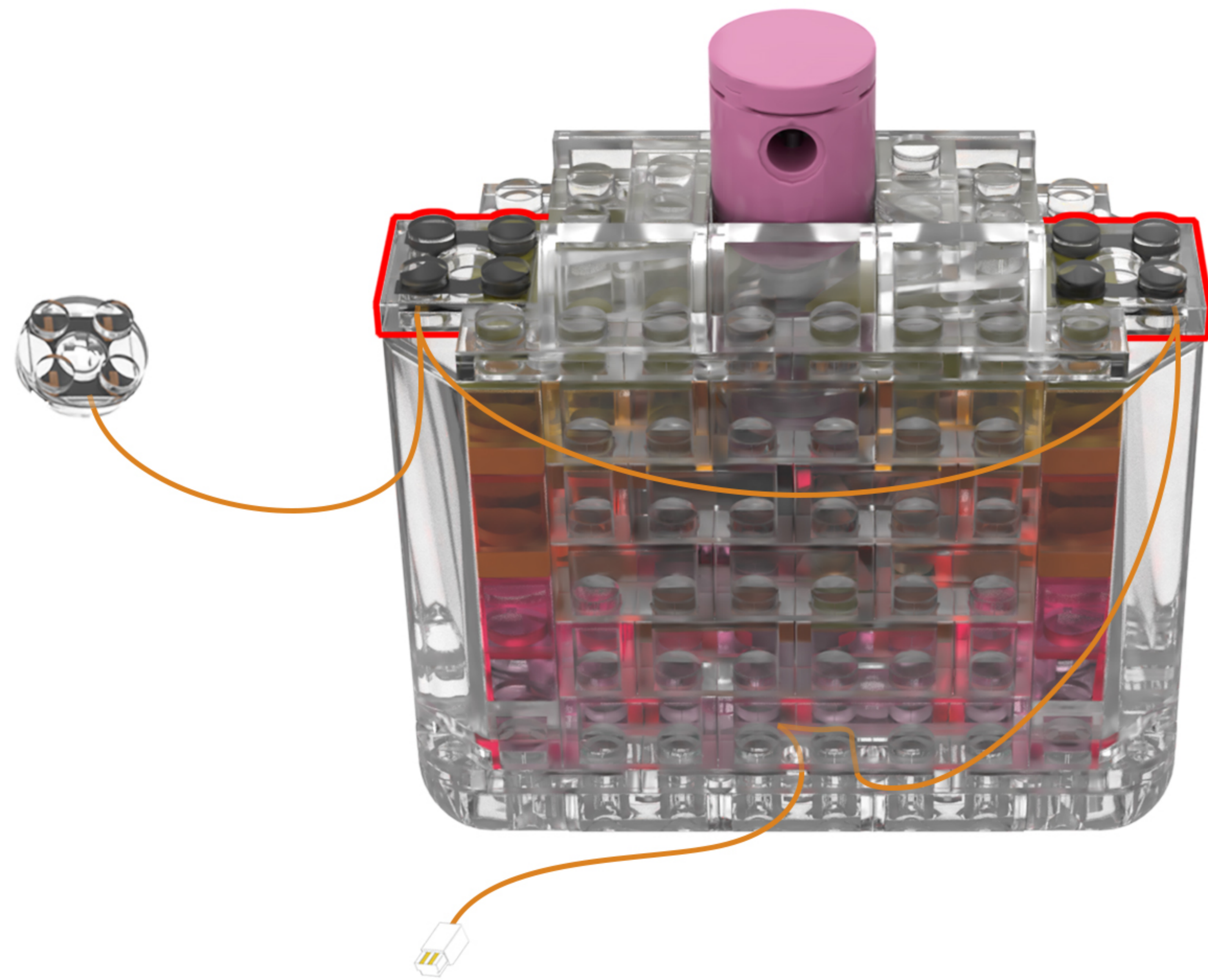

20

EN: Take out the disassembled building blocks and reassemble them in order.

DE: Nehmen Sie die zerlegten Bausteine heraus und setzen Sie sie der Reihe nach wieder zusammen.

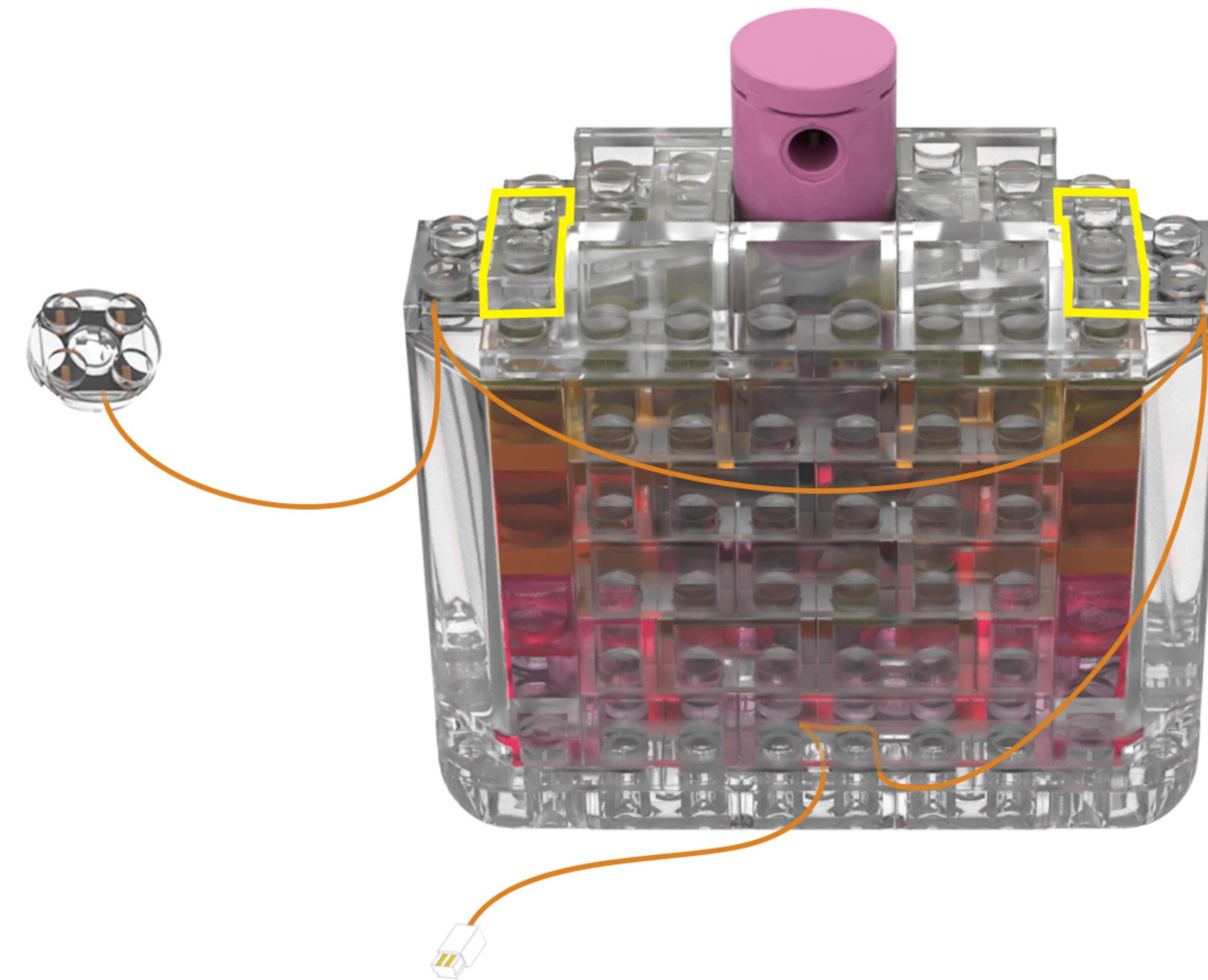
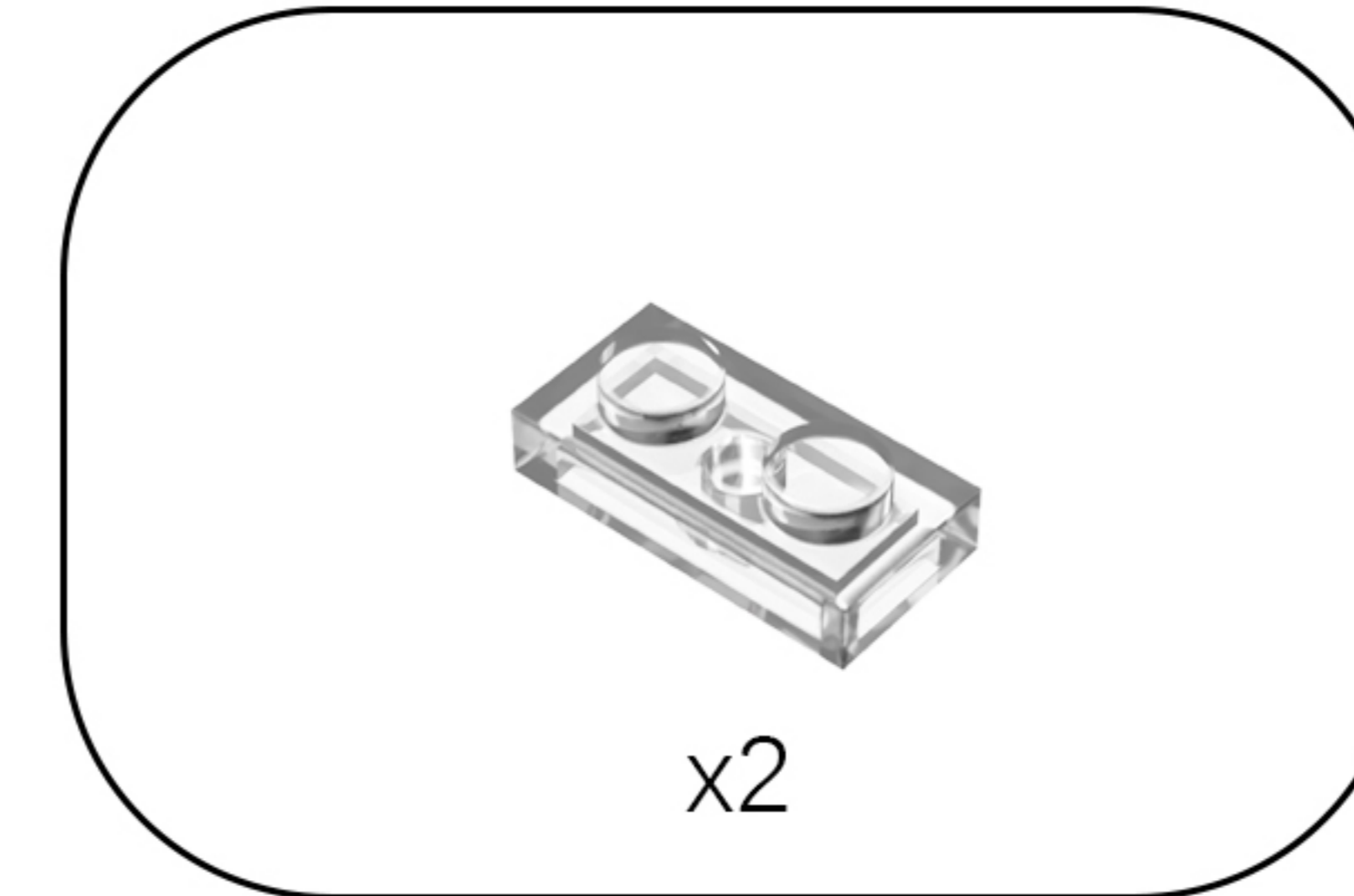

21

EN: Take out the disassembled building blocks and reassemble them in order.

DE: Nehmen Sie die zerlegten Bausteine heraus und setzen Sie sie der Reihe nach wieder zusammen.

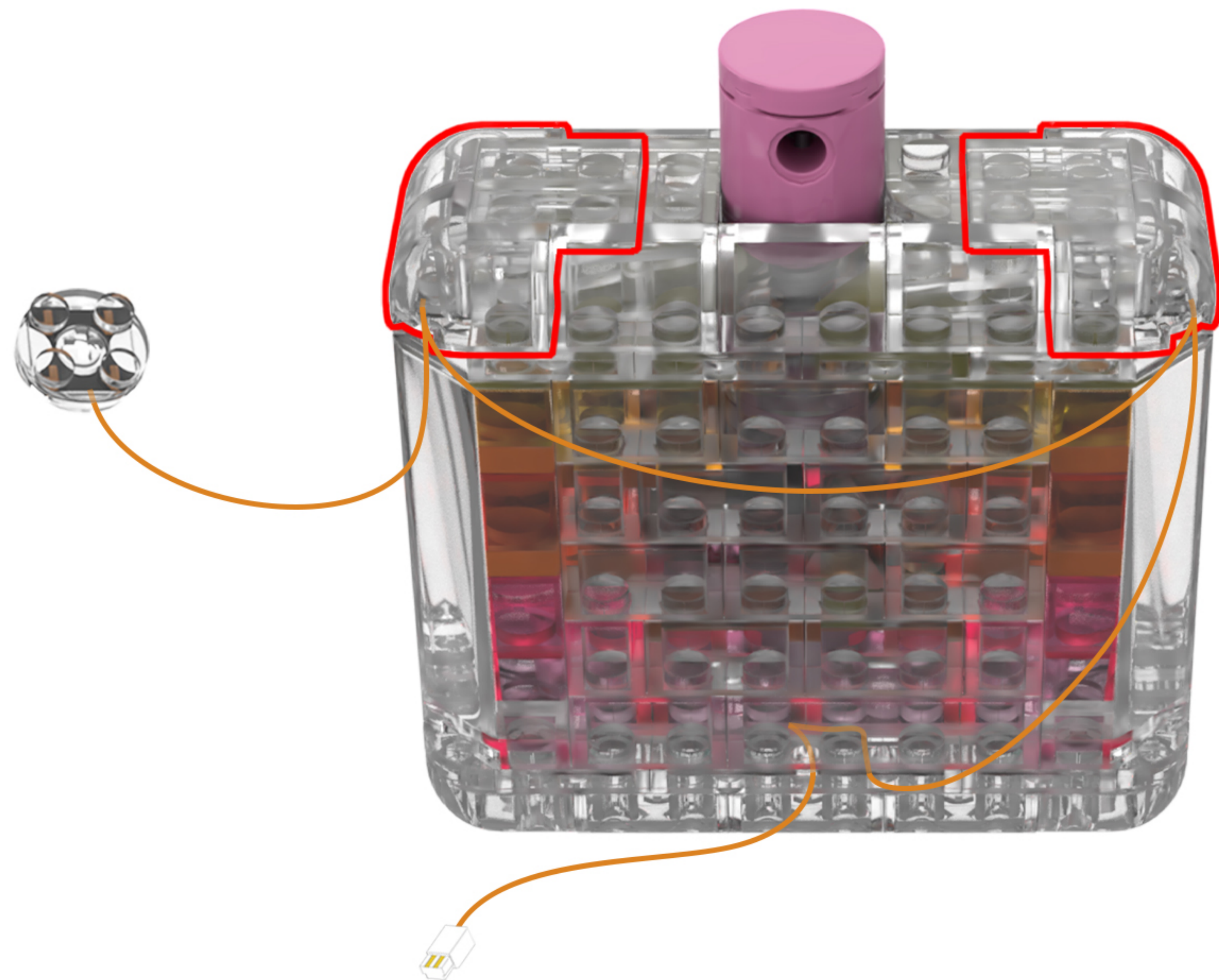
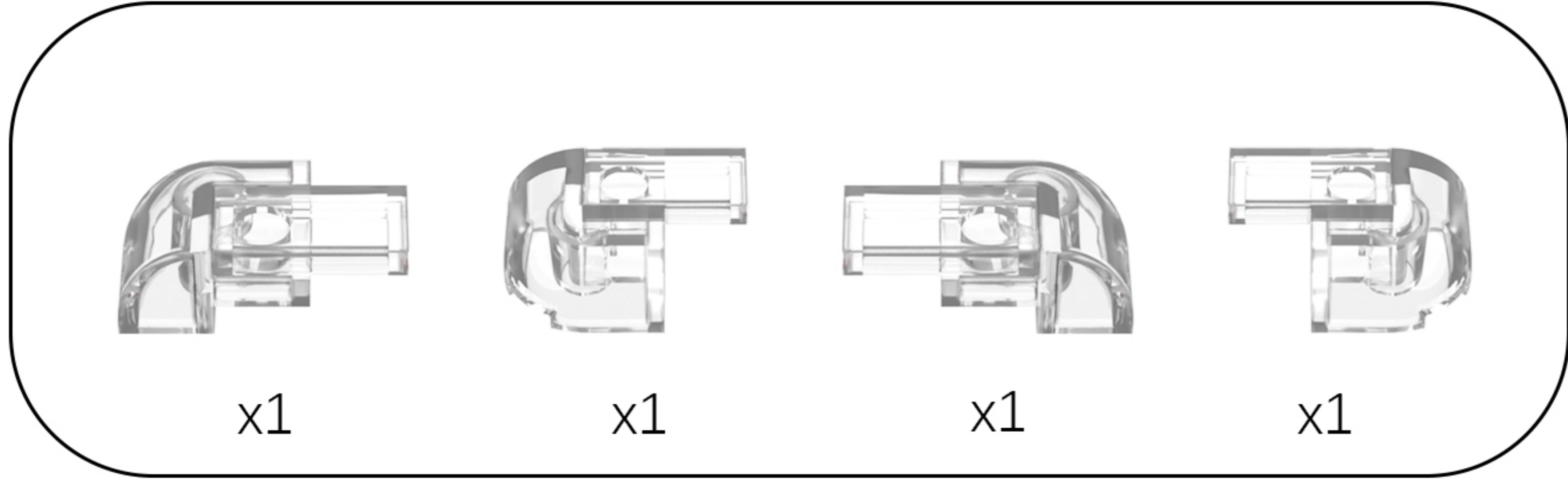

22

EN: Split as shown in the figure.

DE: Wie in der Abbildung gezeigt, teilen Sie es auf.

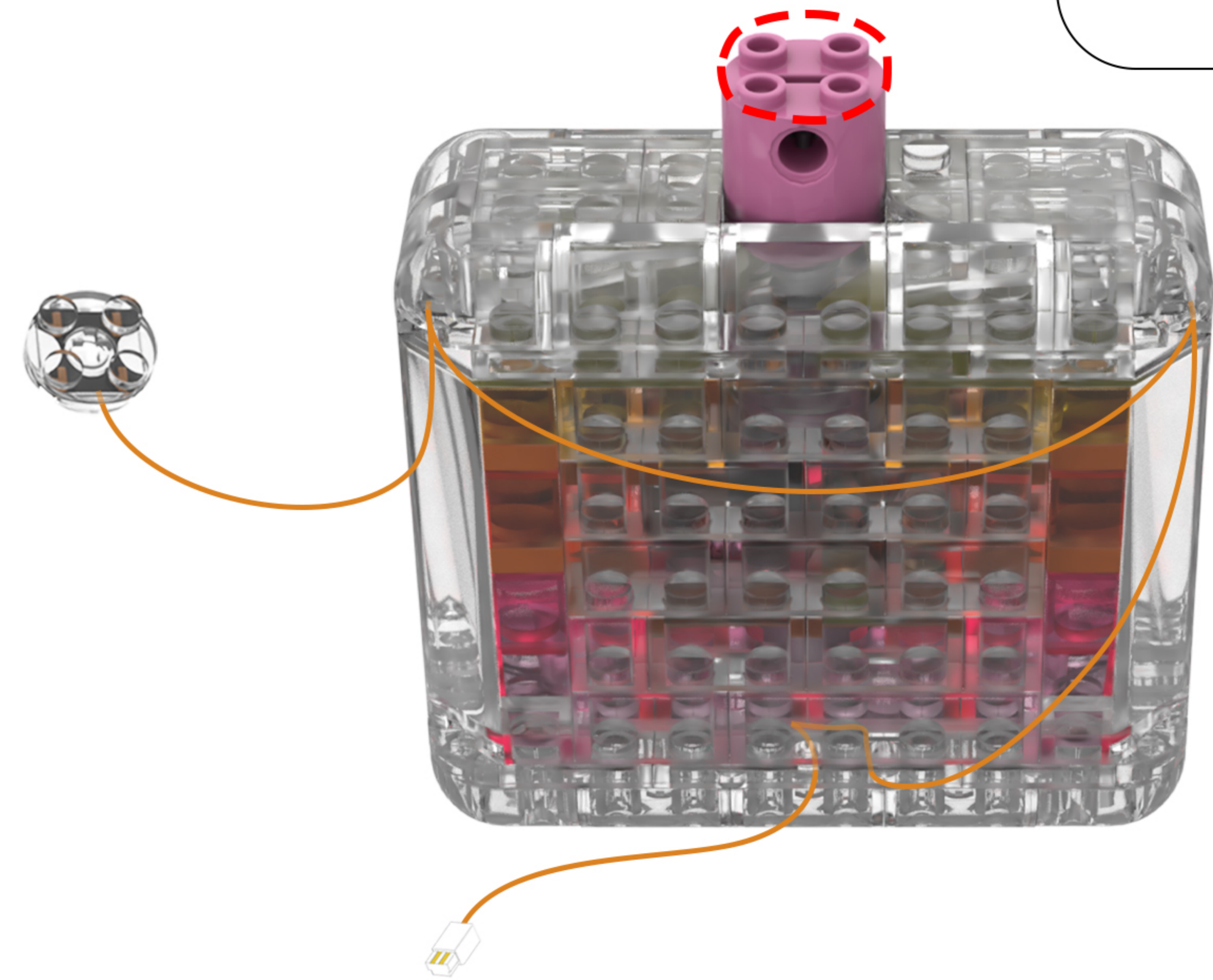
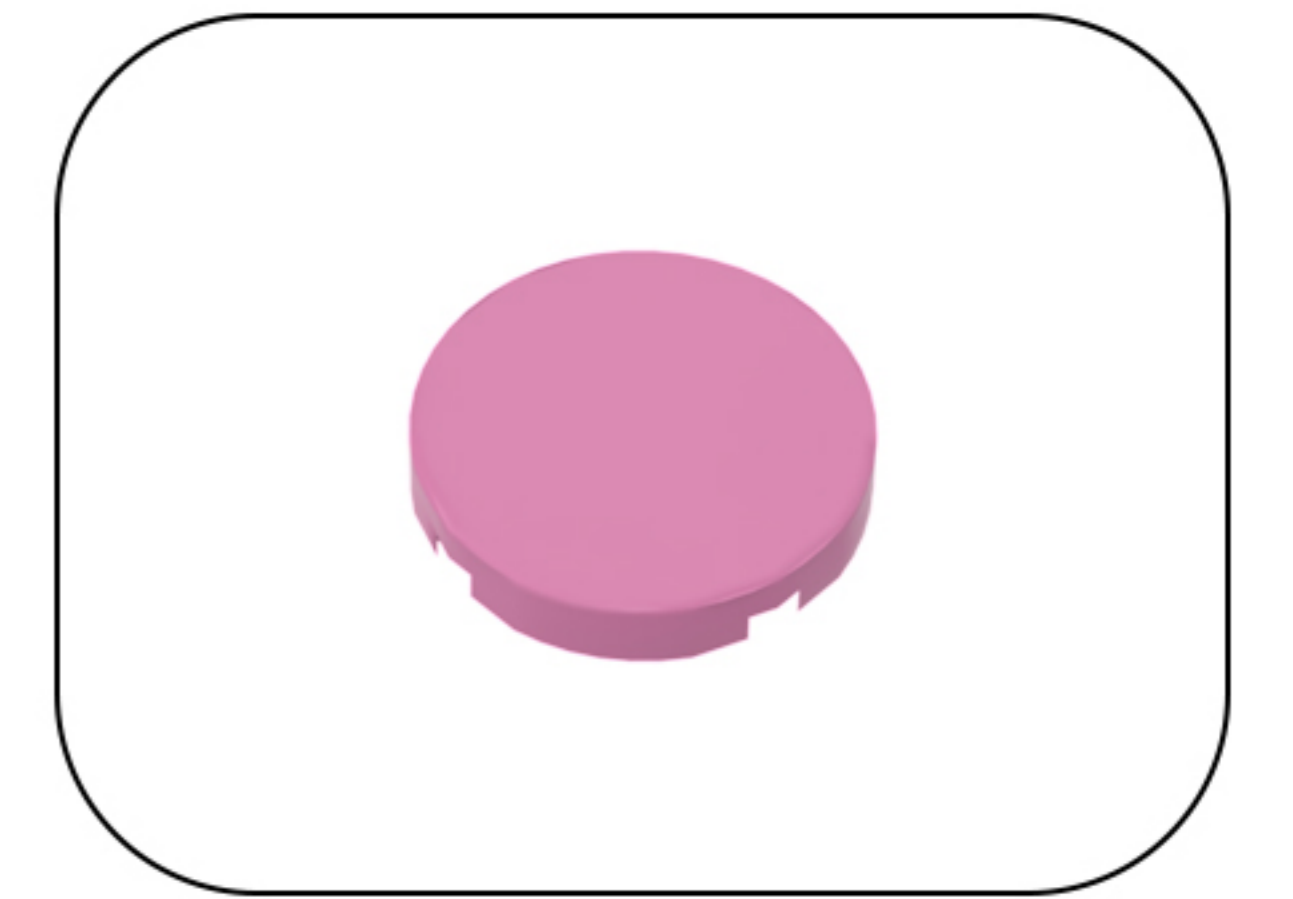

23

EN: Attach the last light from the string to the building block.

DE: Befestige die letzte Lampe der Lichterkette am Baustein.

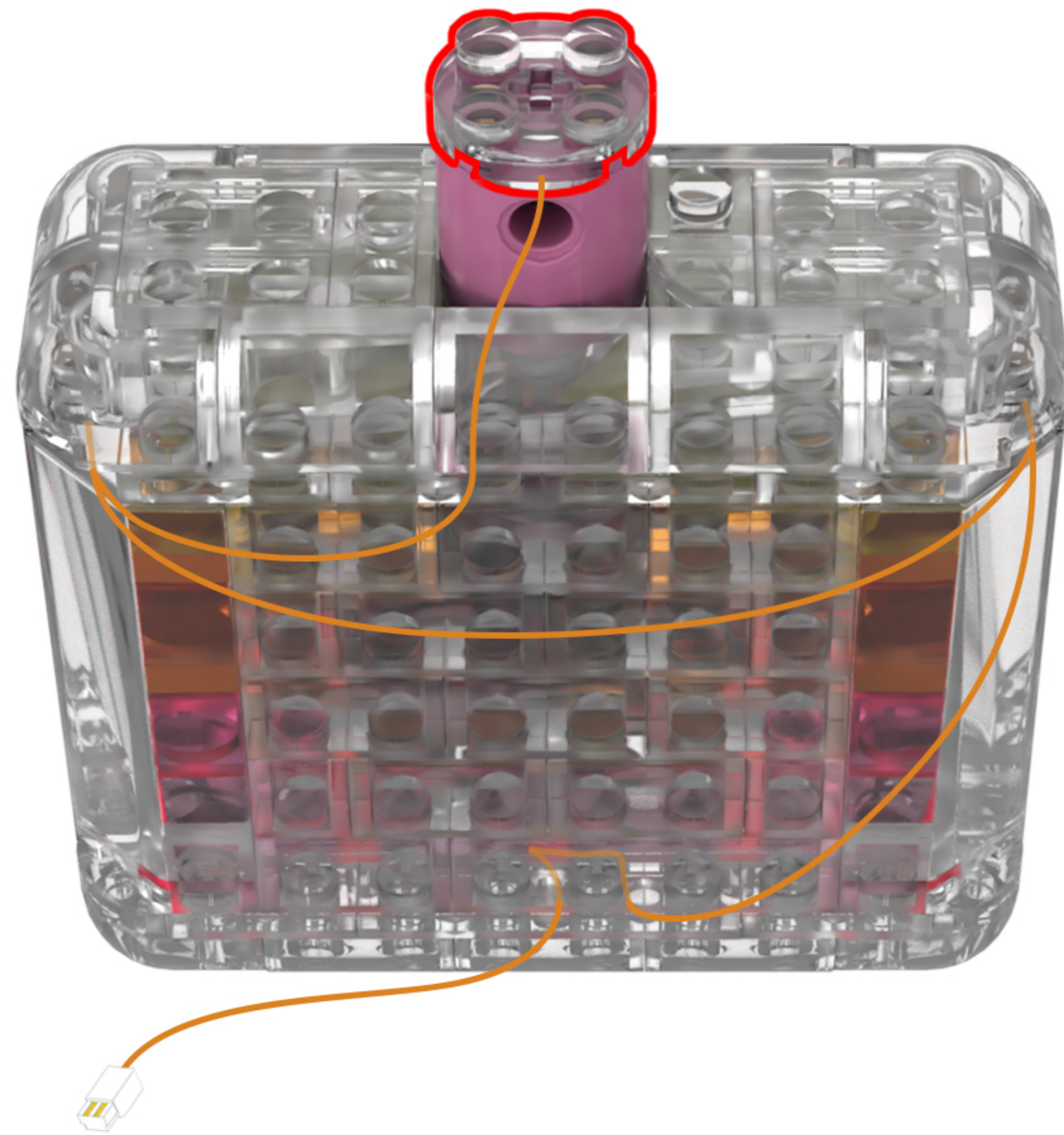

24

EN: Take out the disassembled building blocks and reassemble them.

DE: Nehmen Sie die zerlegten Bausteine heraus und setzen Sie sie wieder zusammen.

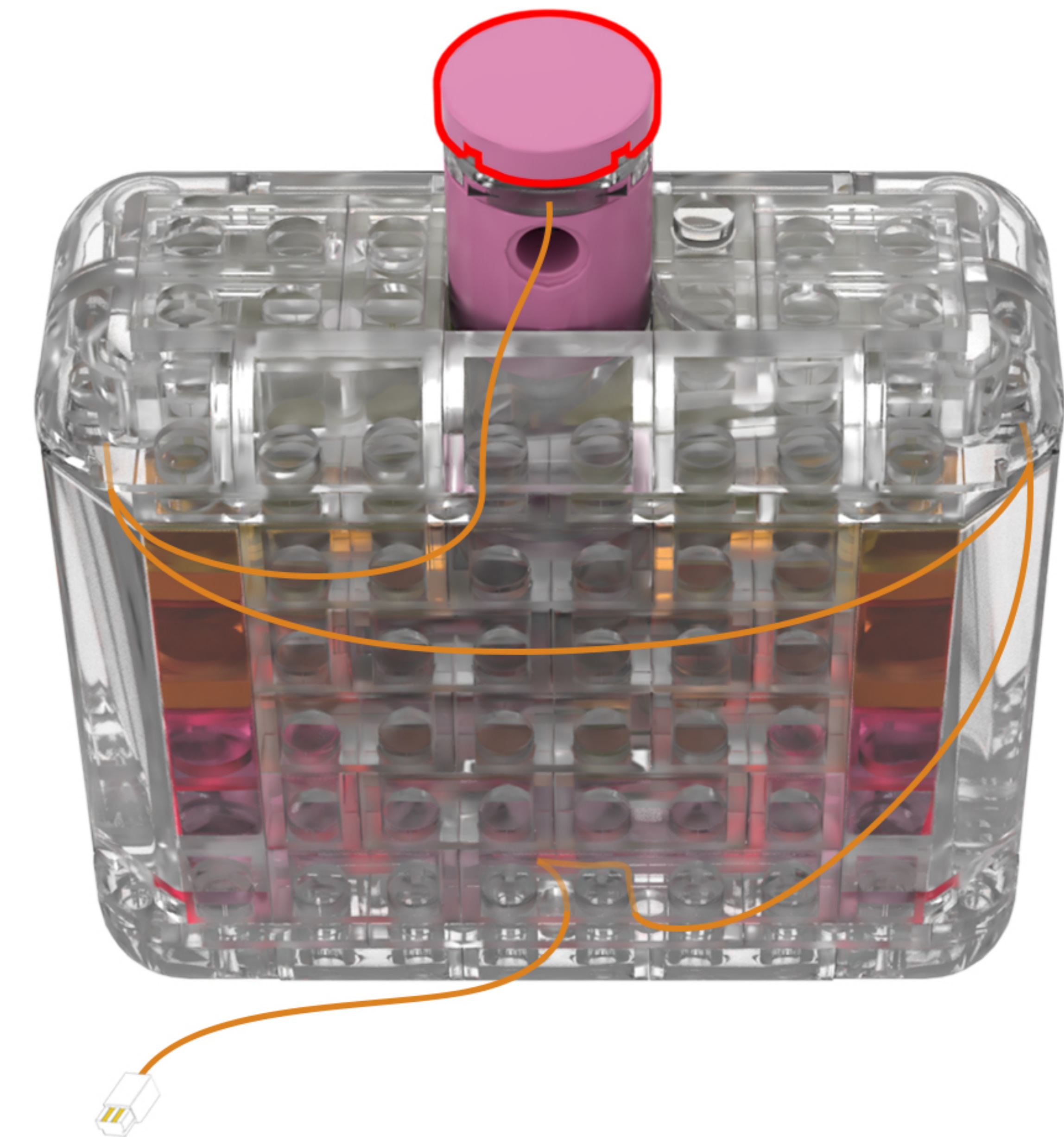
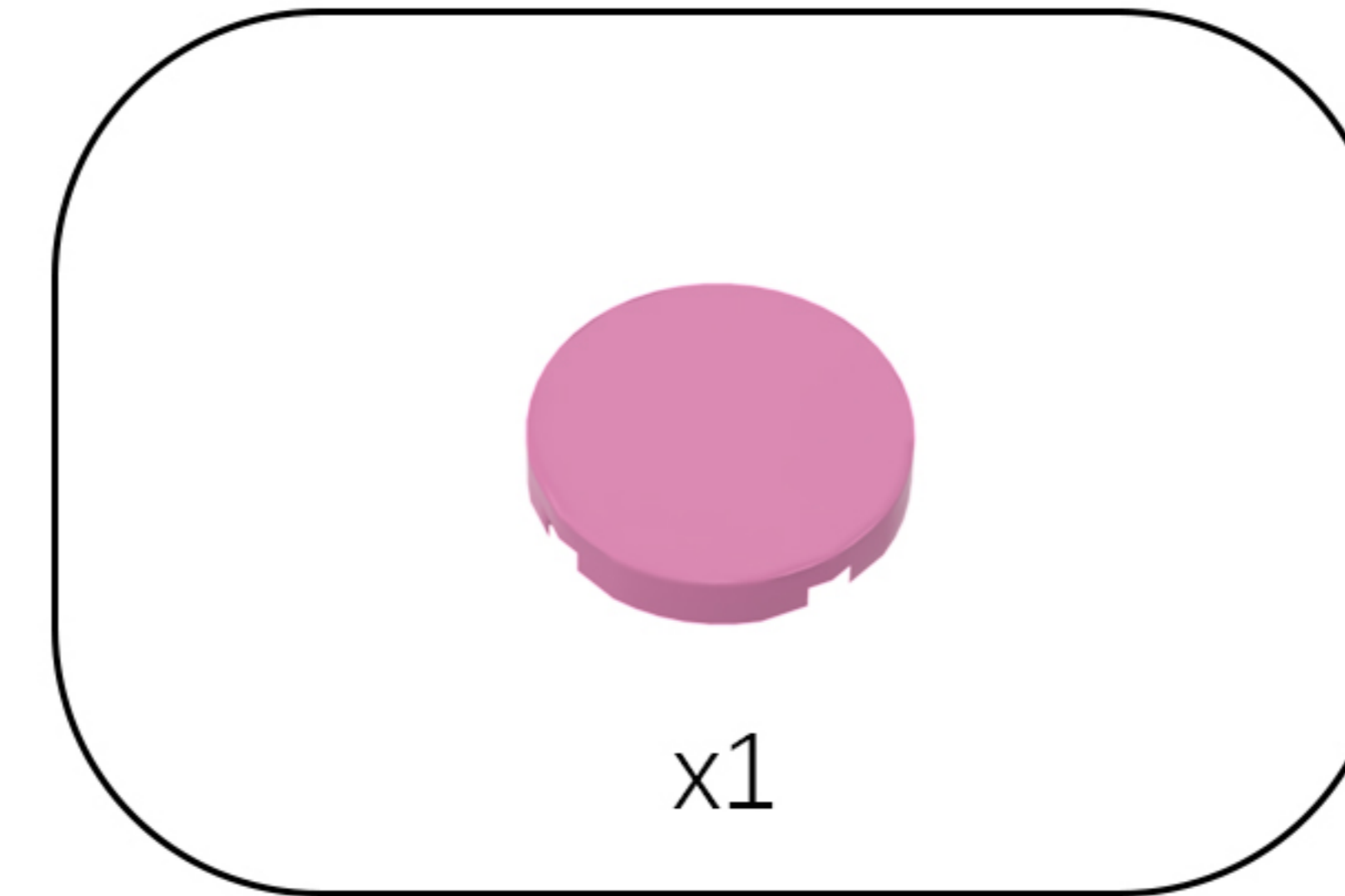

25

EN: Take out the disassembled building blocks and reassemble them.

DE: Nehmen Sie die zerlegten Bausteine heraus und setzen Sie sie wieder zusammen.

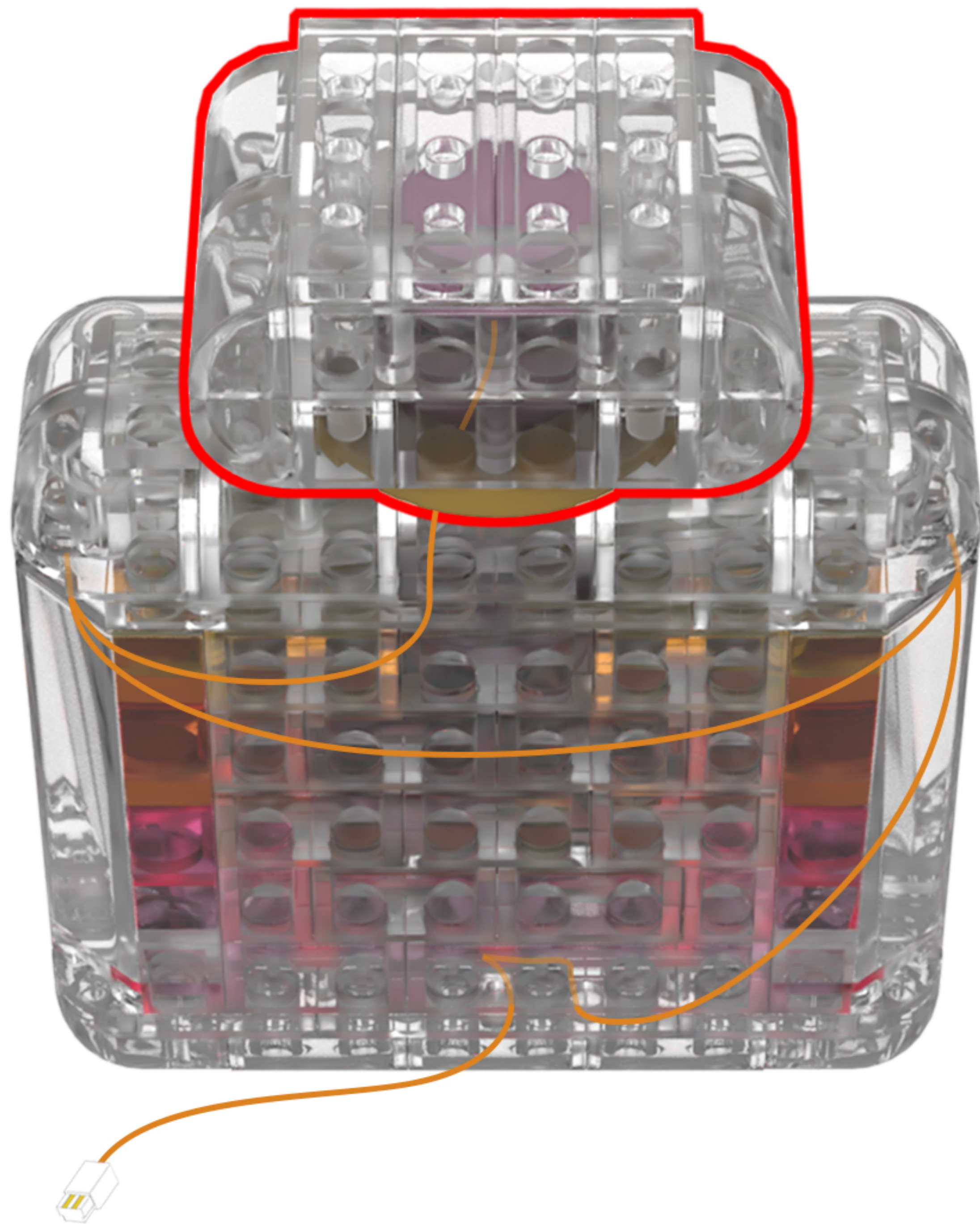
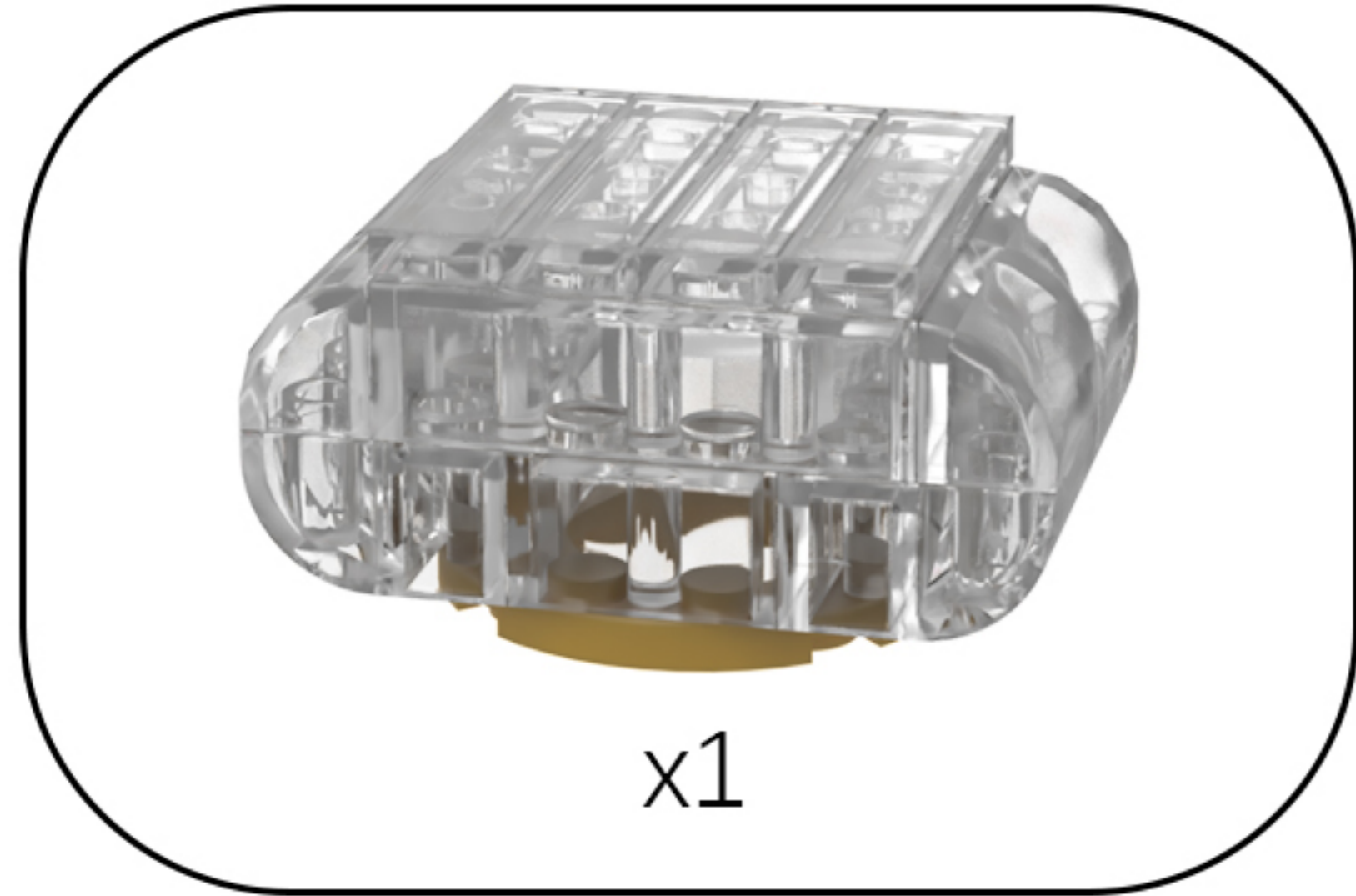

26

EN: Take out the disassembled building blocks and separate them.

DE: Nehmen Sie die zerlegten Bausteine heraus und trennen Sie sie voneinander.

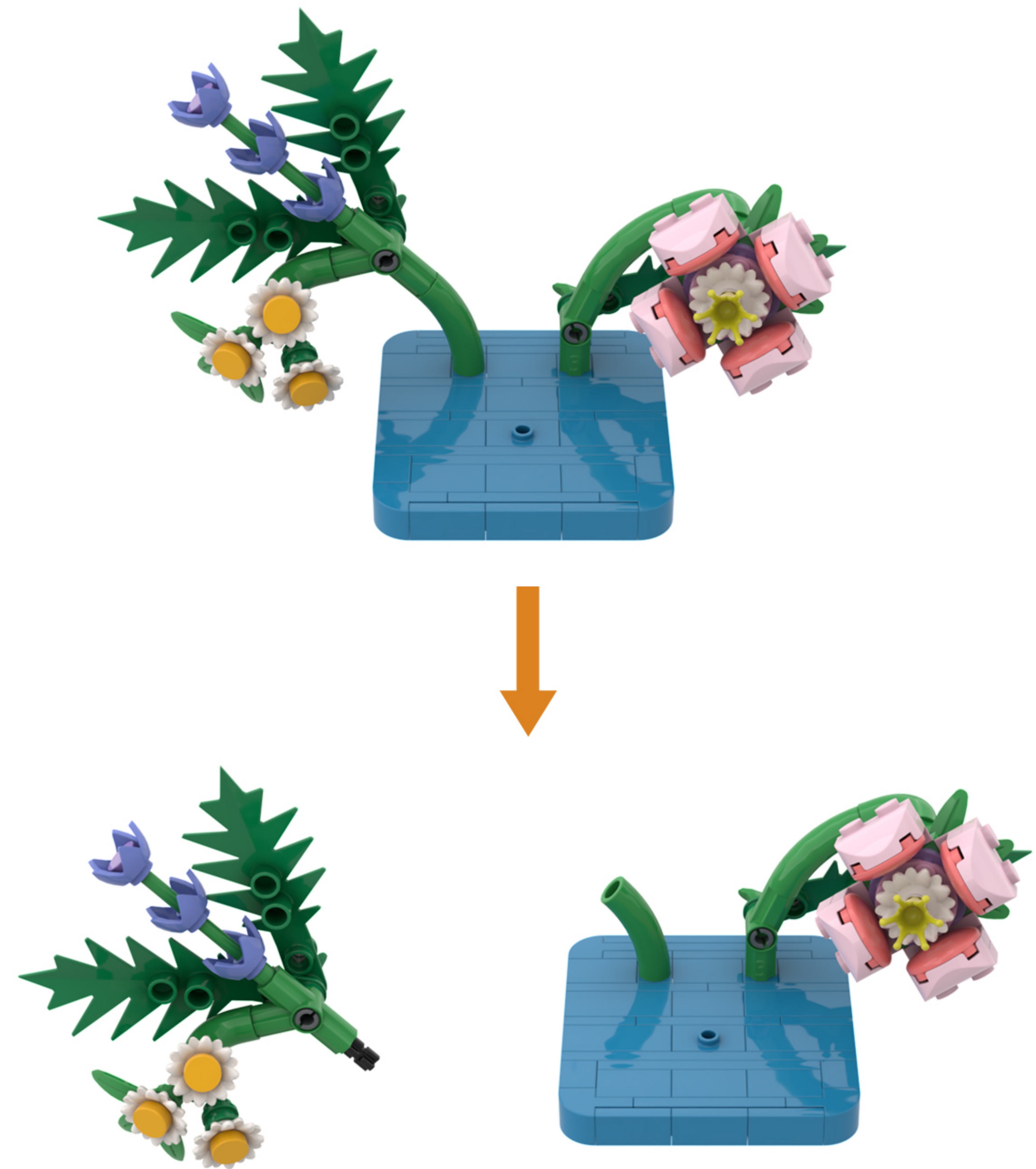
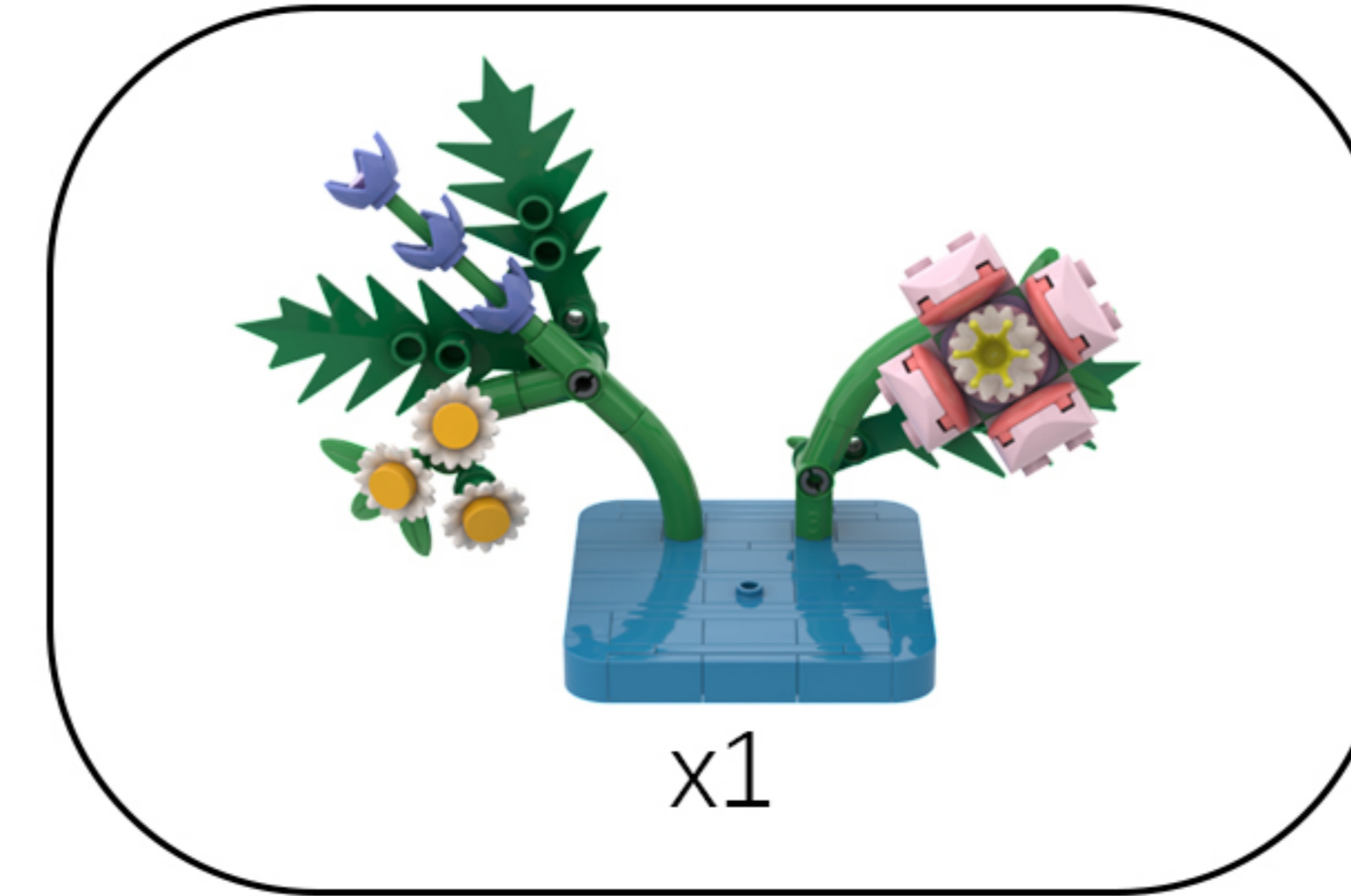

27

EN: Remove the building blocks one by one.
DE: Entfernen Sie die Bausteine nacheinander.

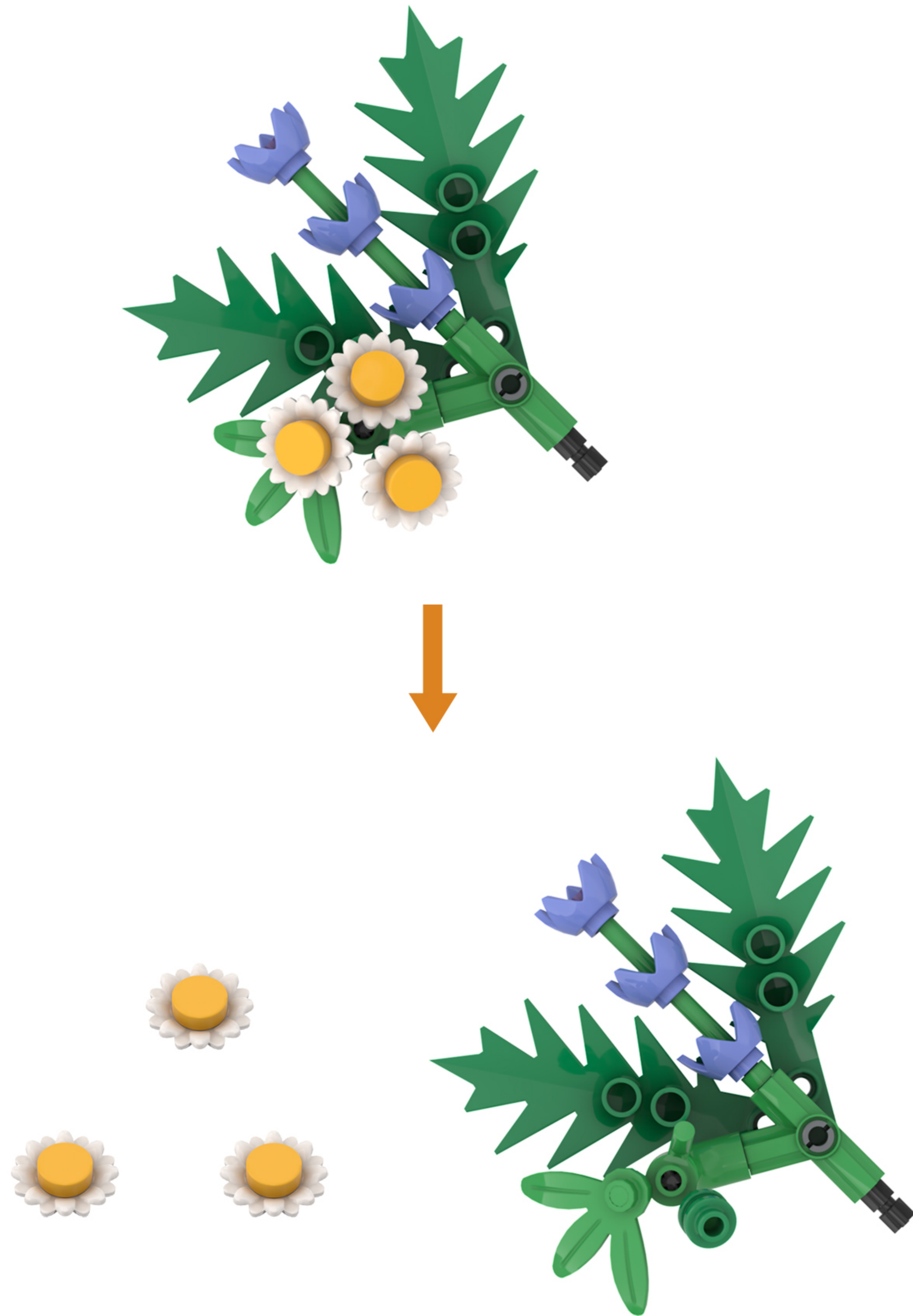

28

EN: Split as shown in the figure.
DE: Wie in der Abbildung gezeigt, teilen Sie es auf.

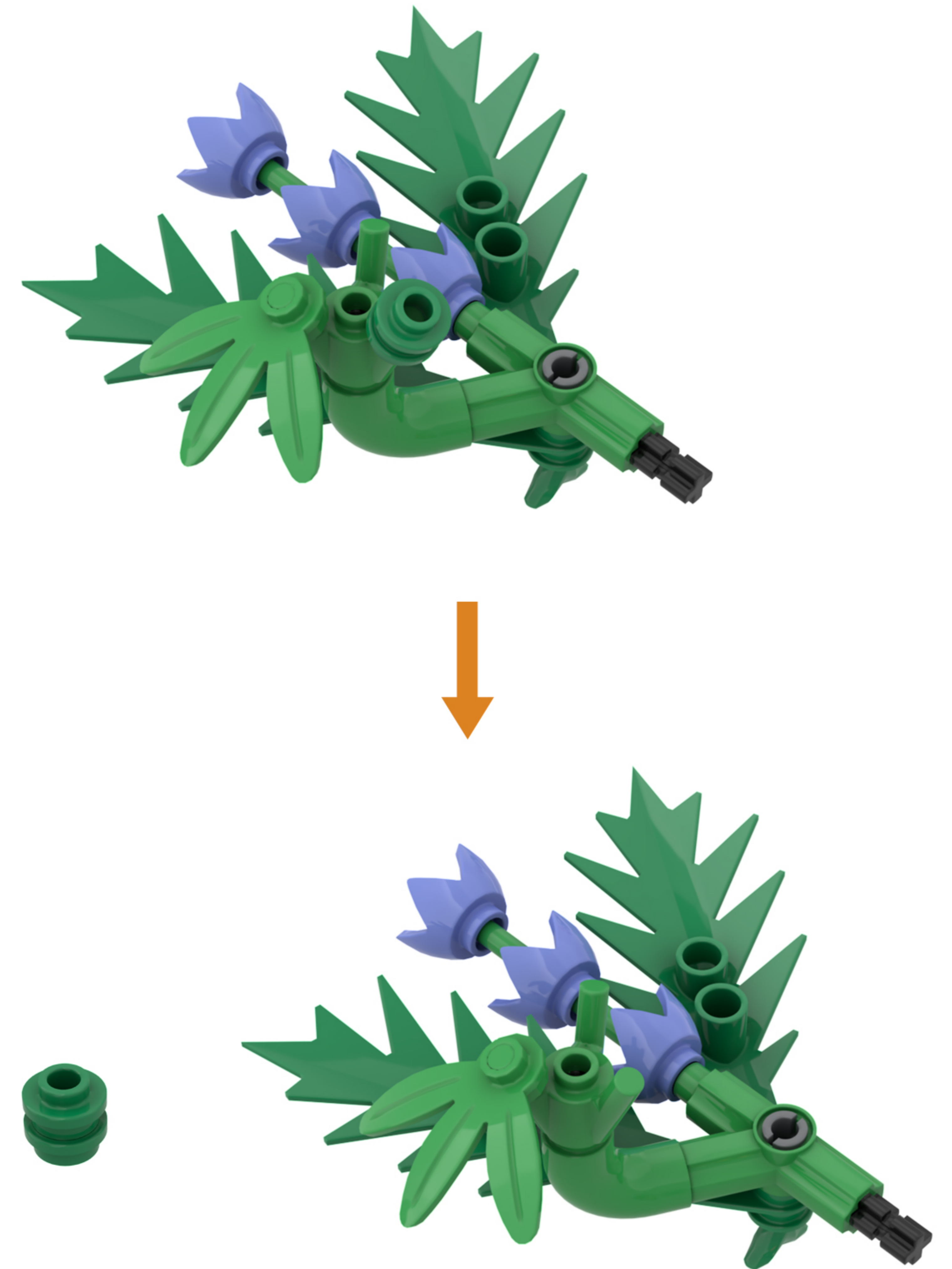

29

EN: Take out the disassembled building blocks and separate them.

DE: Nehmen Sie die zerlegten Bausteine heraus und trennen Sie sie voneinander.

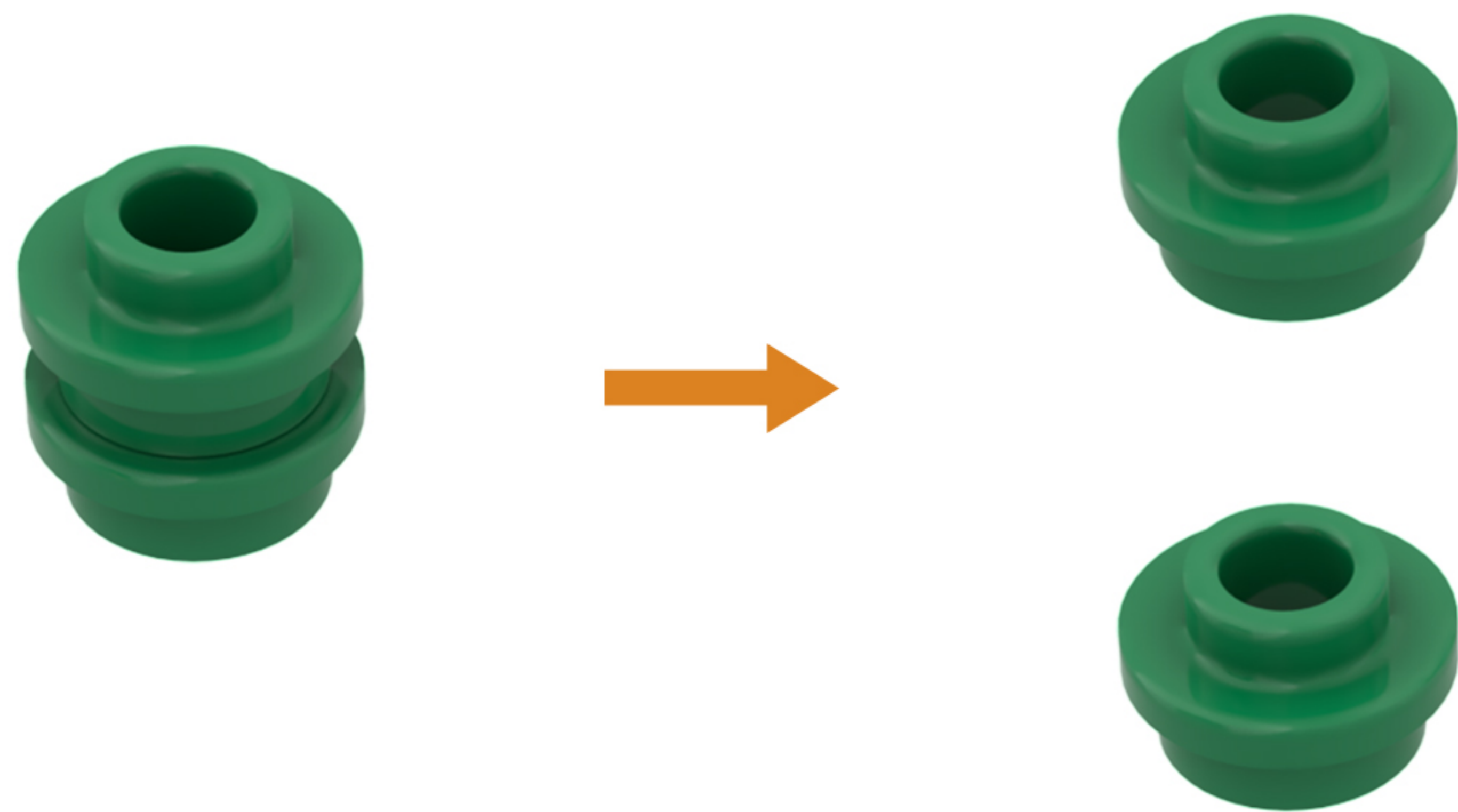
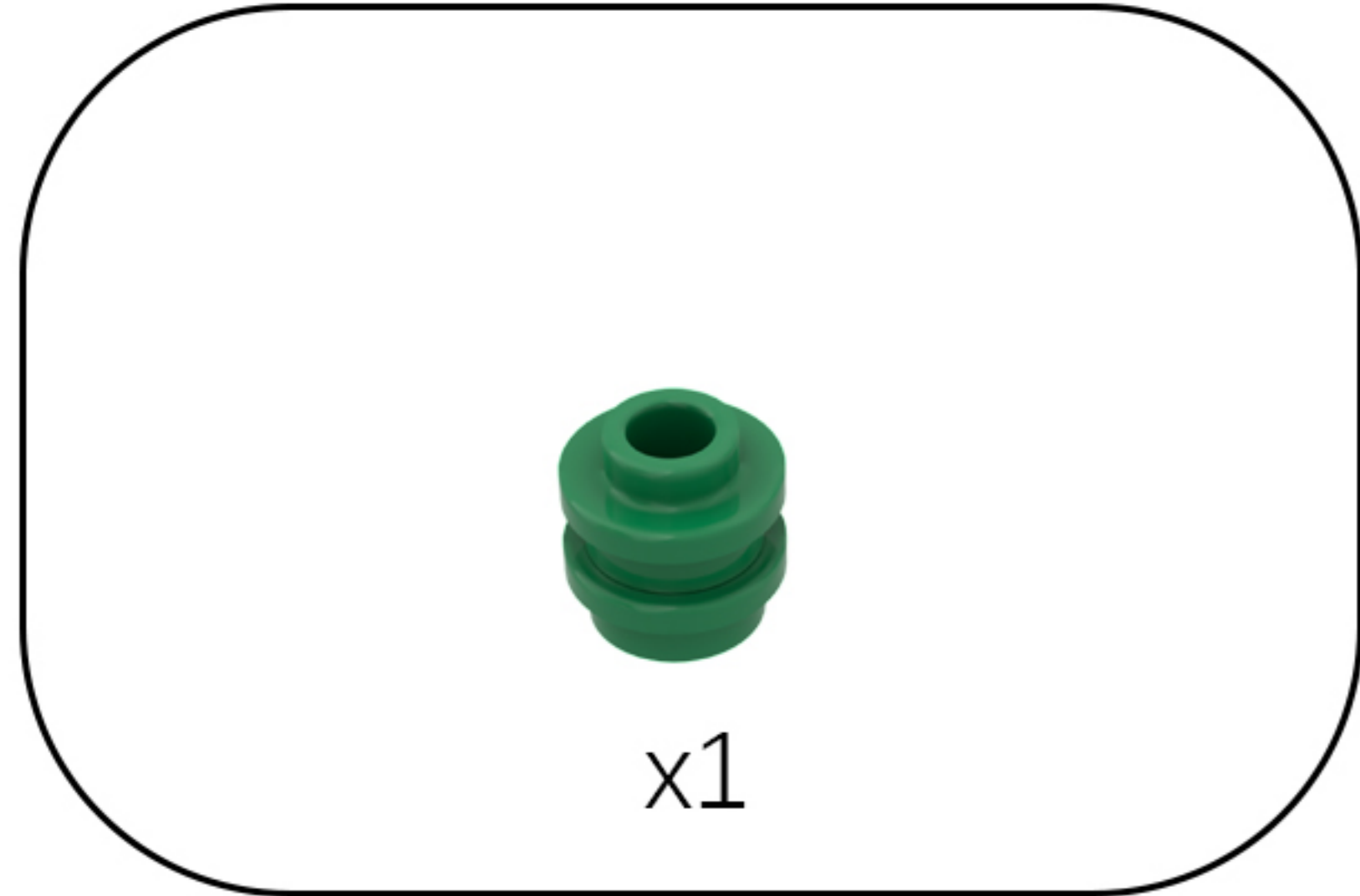

30

EN: Take the two disassembled building blocks and install them as shown in the illustration.

DE: Nehmen Sie die beiden zerlegten Bausteine und setzen Sie sie wie in der Abbildung gezeigt zusammen.

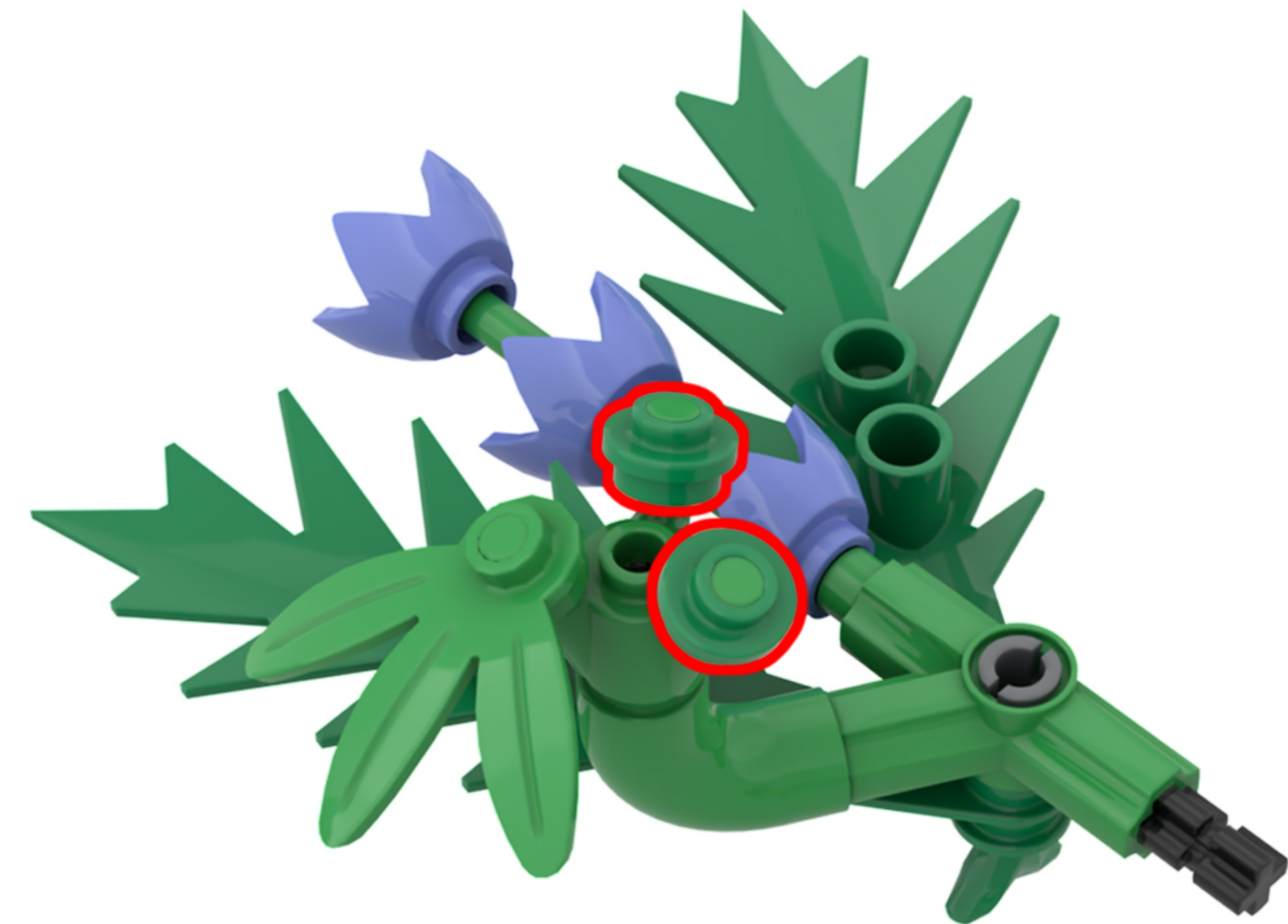
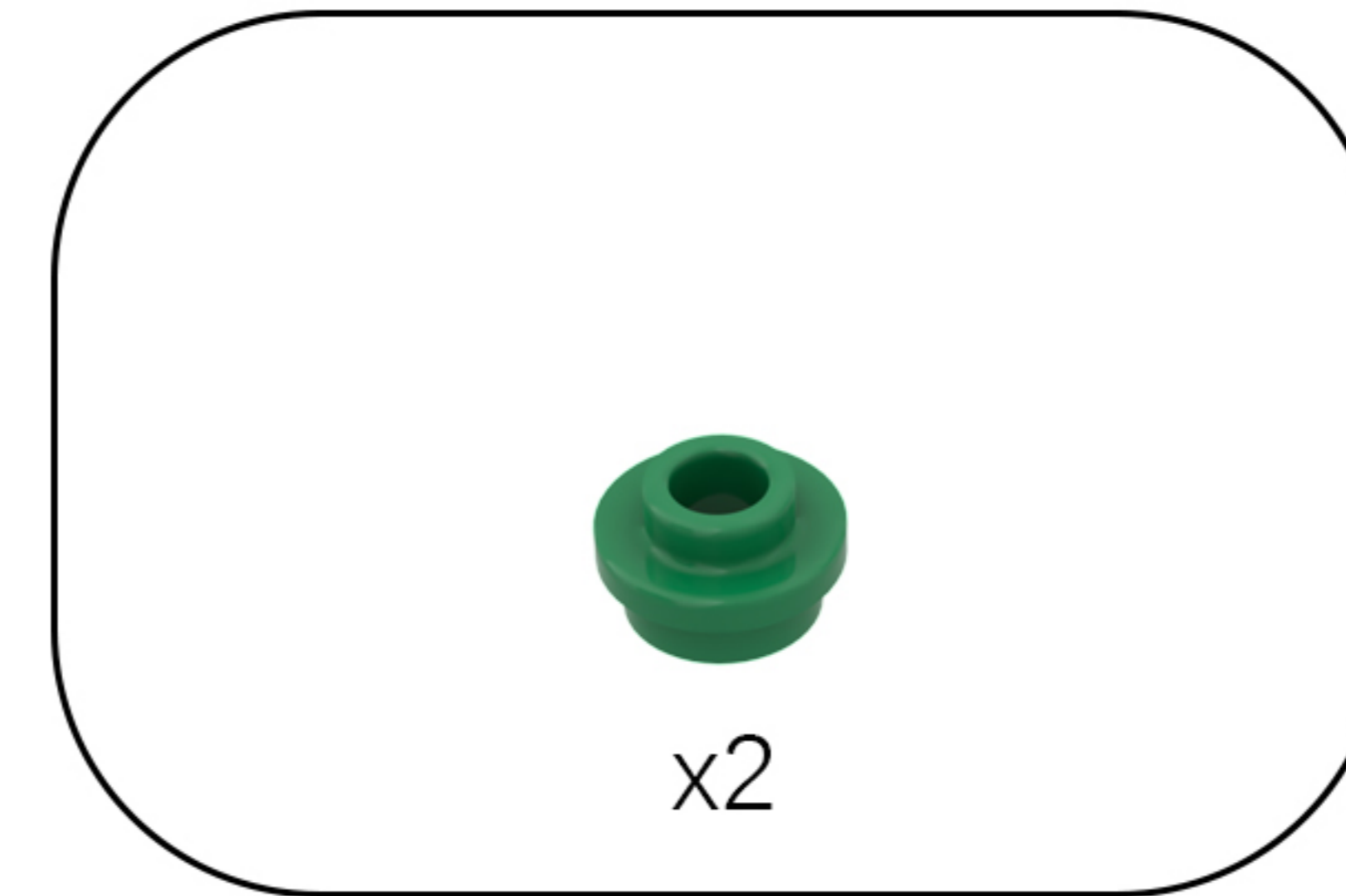

31

EN: Take the string of lights out of Bag 1, untie the zip tie, and locate the three decorative lights on the string.

DE: Nehmen Sie die Lichterkette aus Beutel 1, lösen Sie den Kabelbinder und suchen Sie die drei Zierlichter an der Kette.

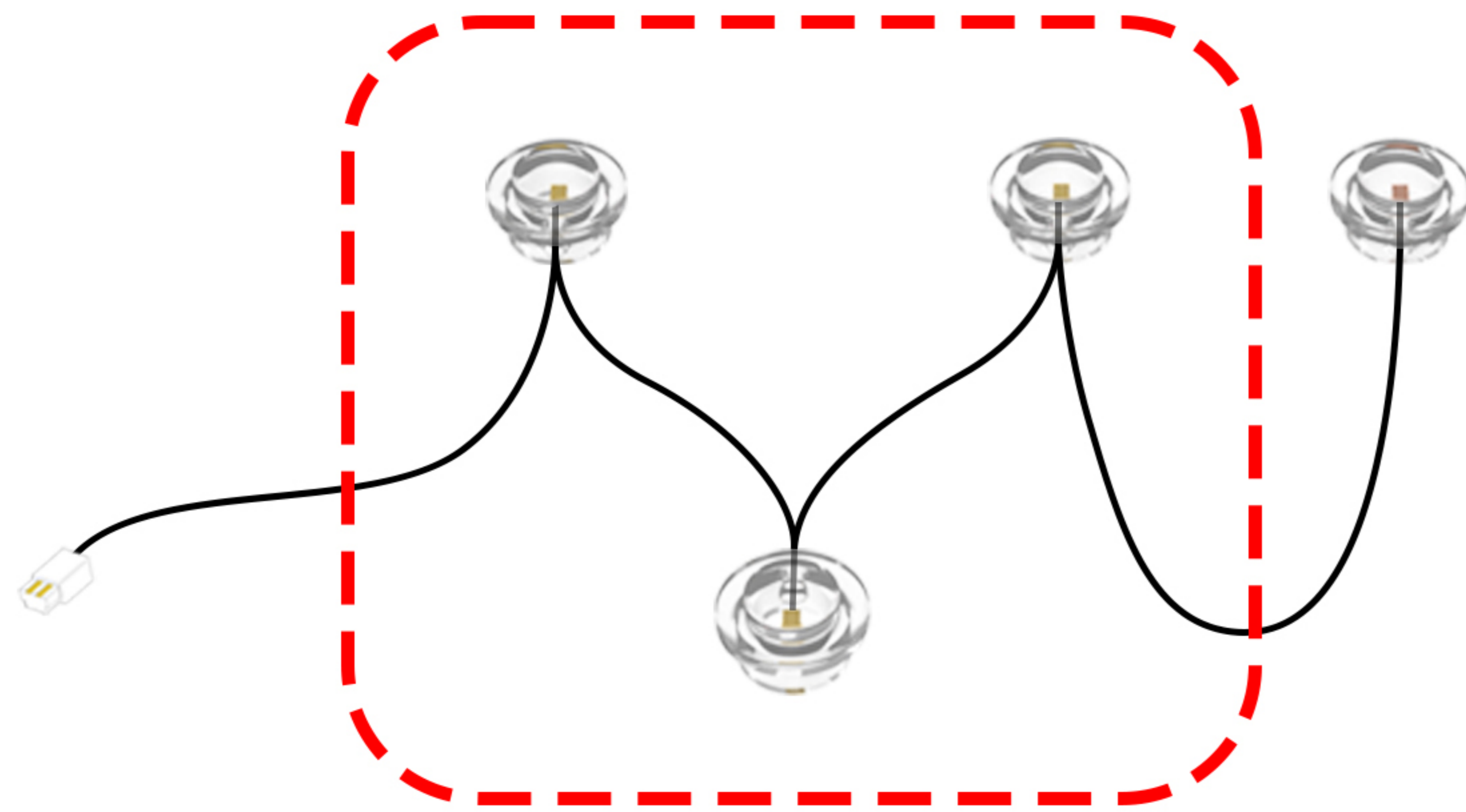
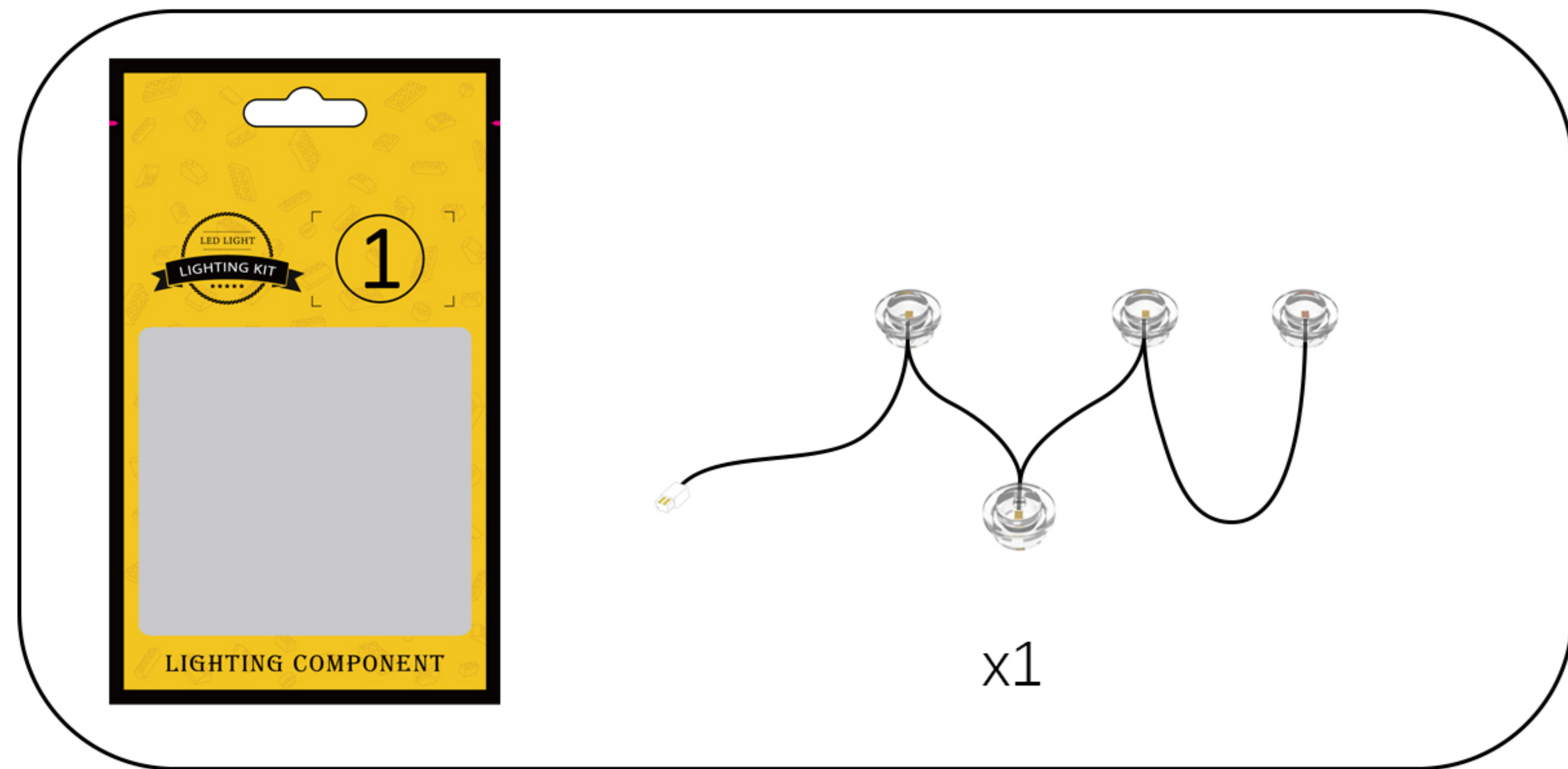

32

EN: Attach the three light fixtures to the building blocks one after another.

DE: Befestige die drei Leuchten nacheinander an den Bausteinen.

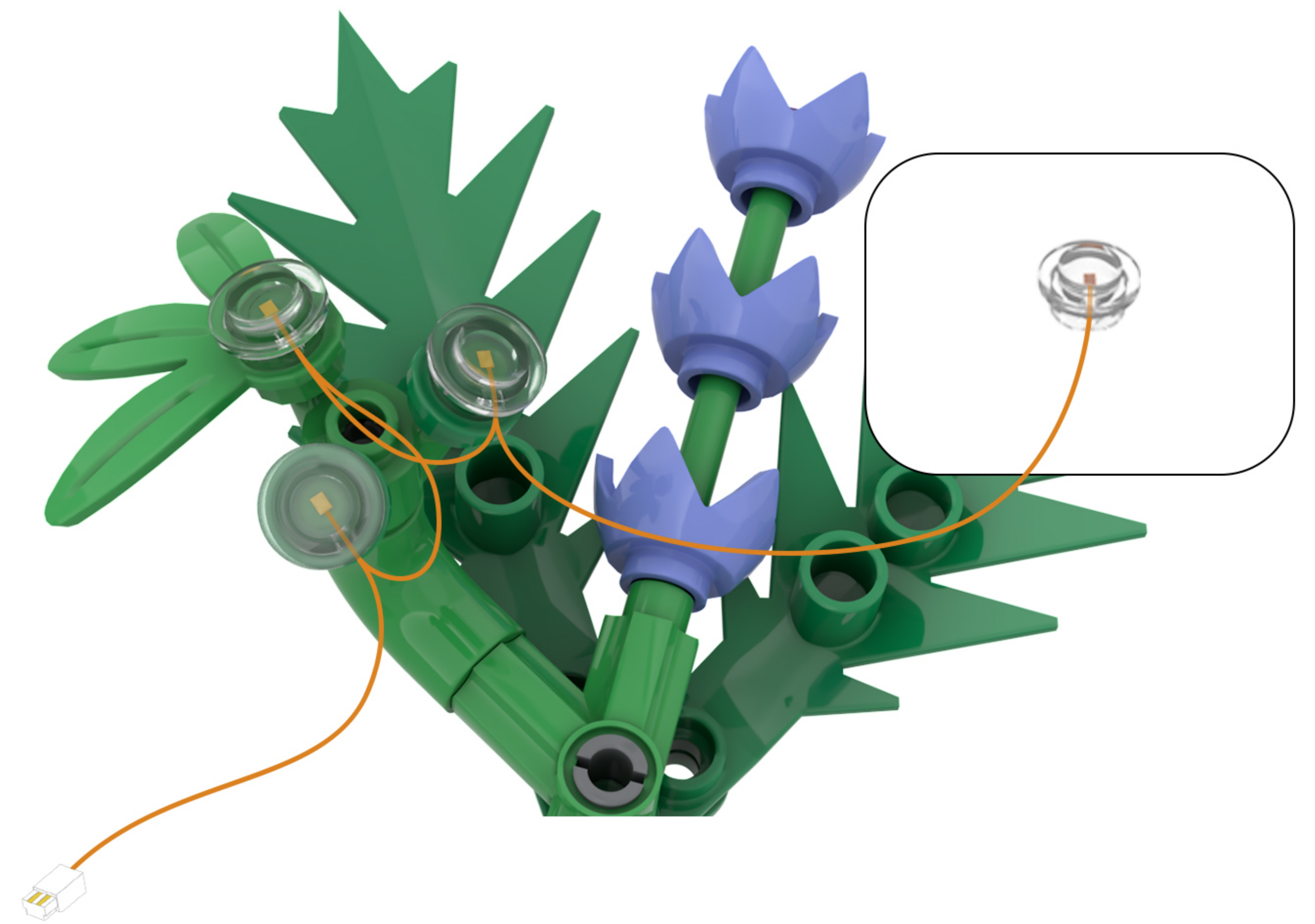

33

EN: Route all the lighting wires to the back of the model, as shown in the figure.

DE: Verlegen Sie alle Beleuchtungskabel zur Rückseite des Modells, wie in der Abbildung gezeigt.

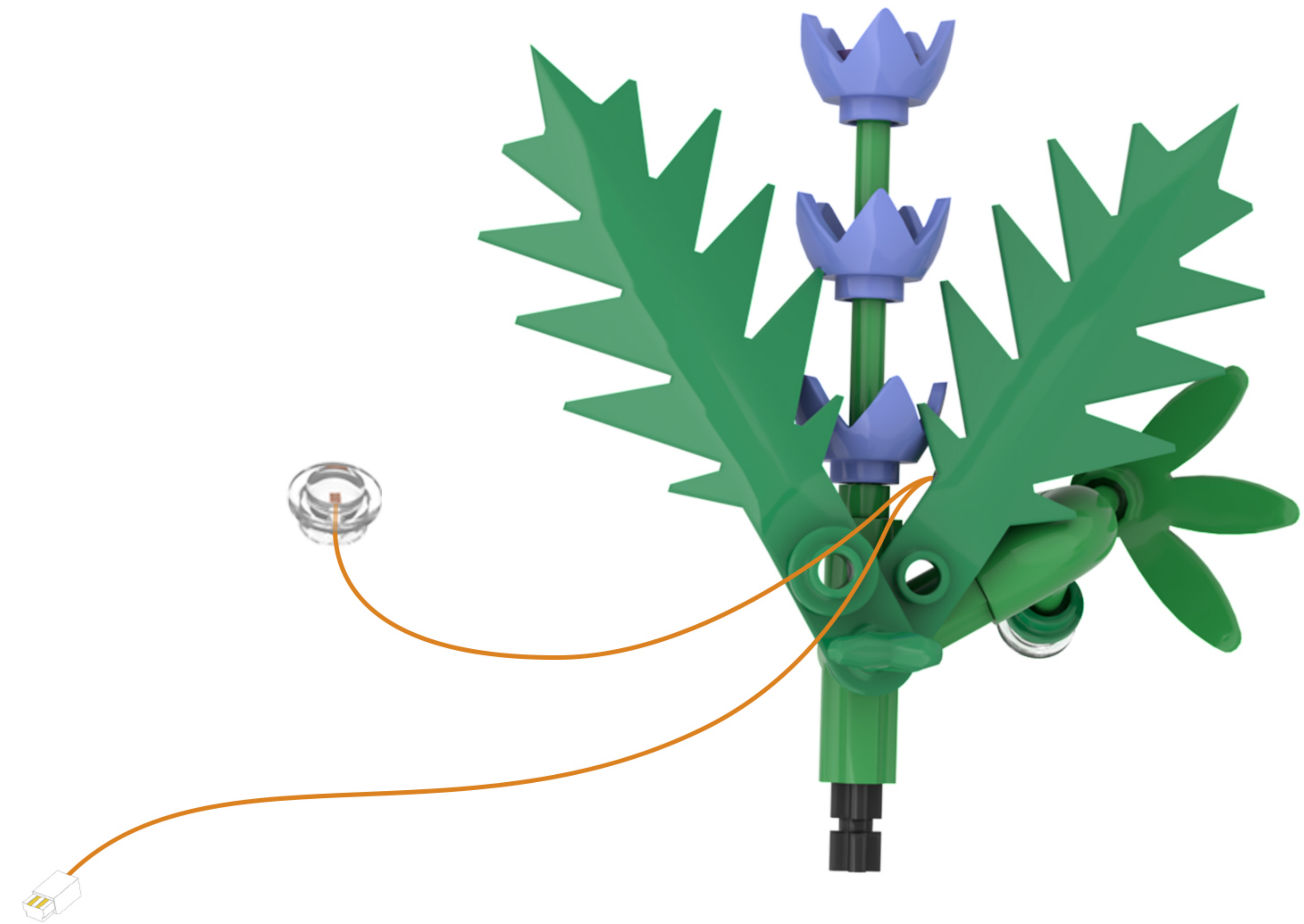
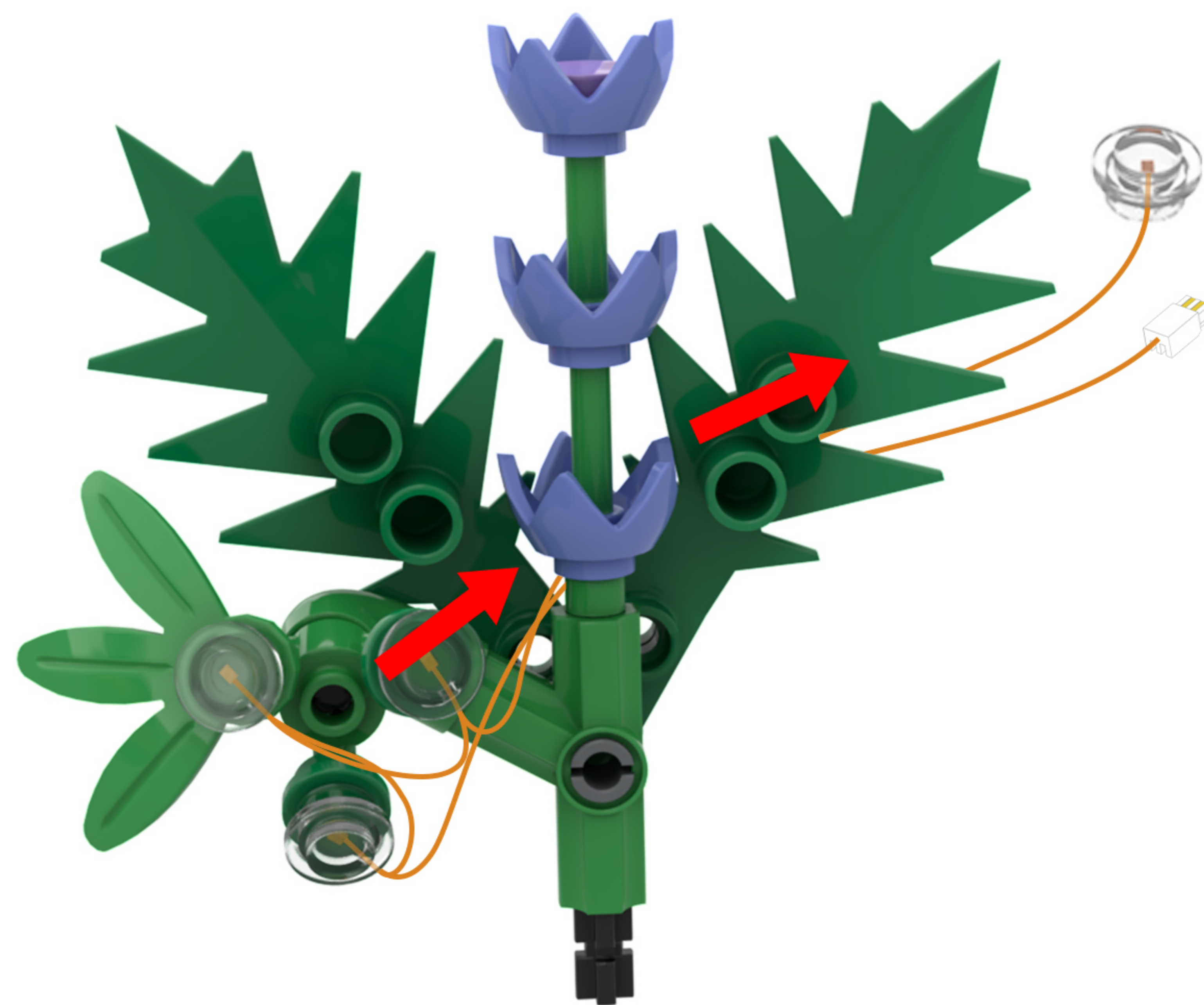

34

EN: Rotate the model to the perspective shown in the figure.

DE: Drehen Sie das Modell so, dass es der in der Abbildung gezeigten Perspektive entspricht.

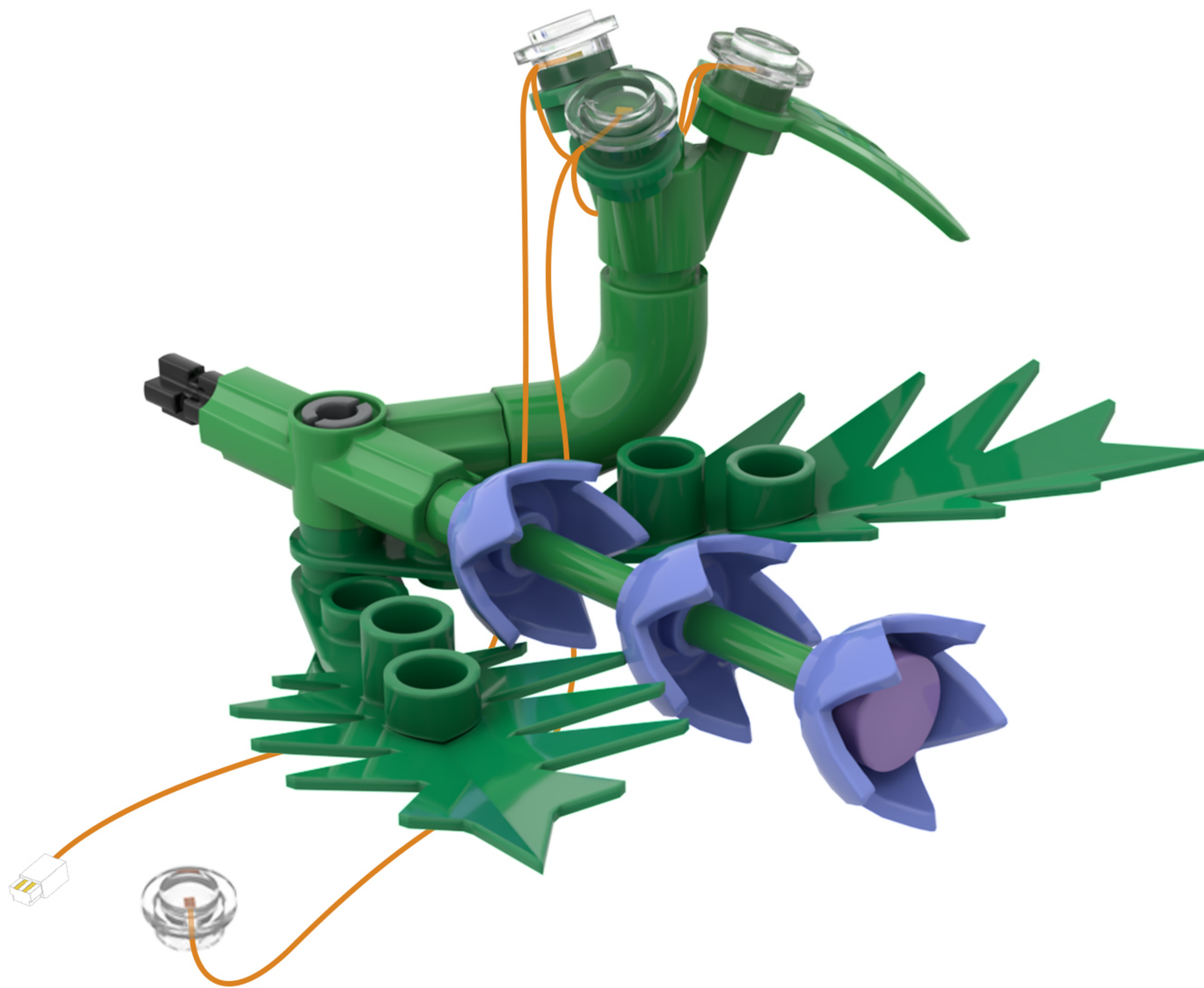
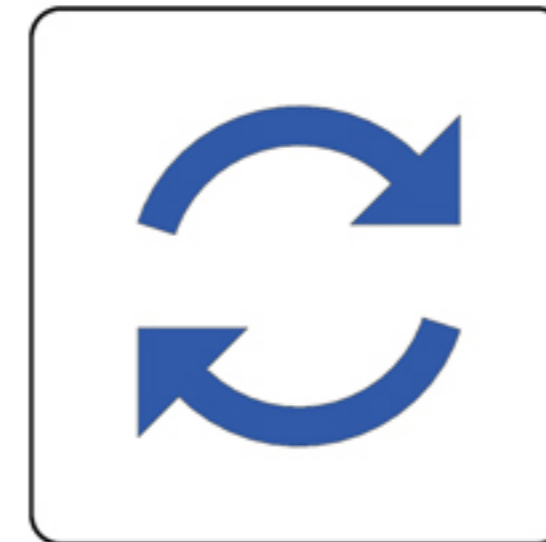

35

EN: Split as shown in the figure.

DE: Wie in der Abbildung gezeigt, teilen Sie es auf.

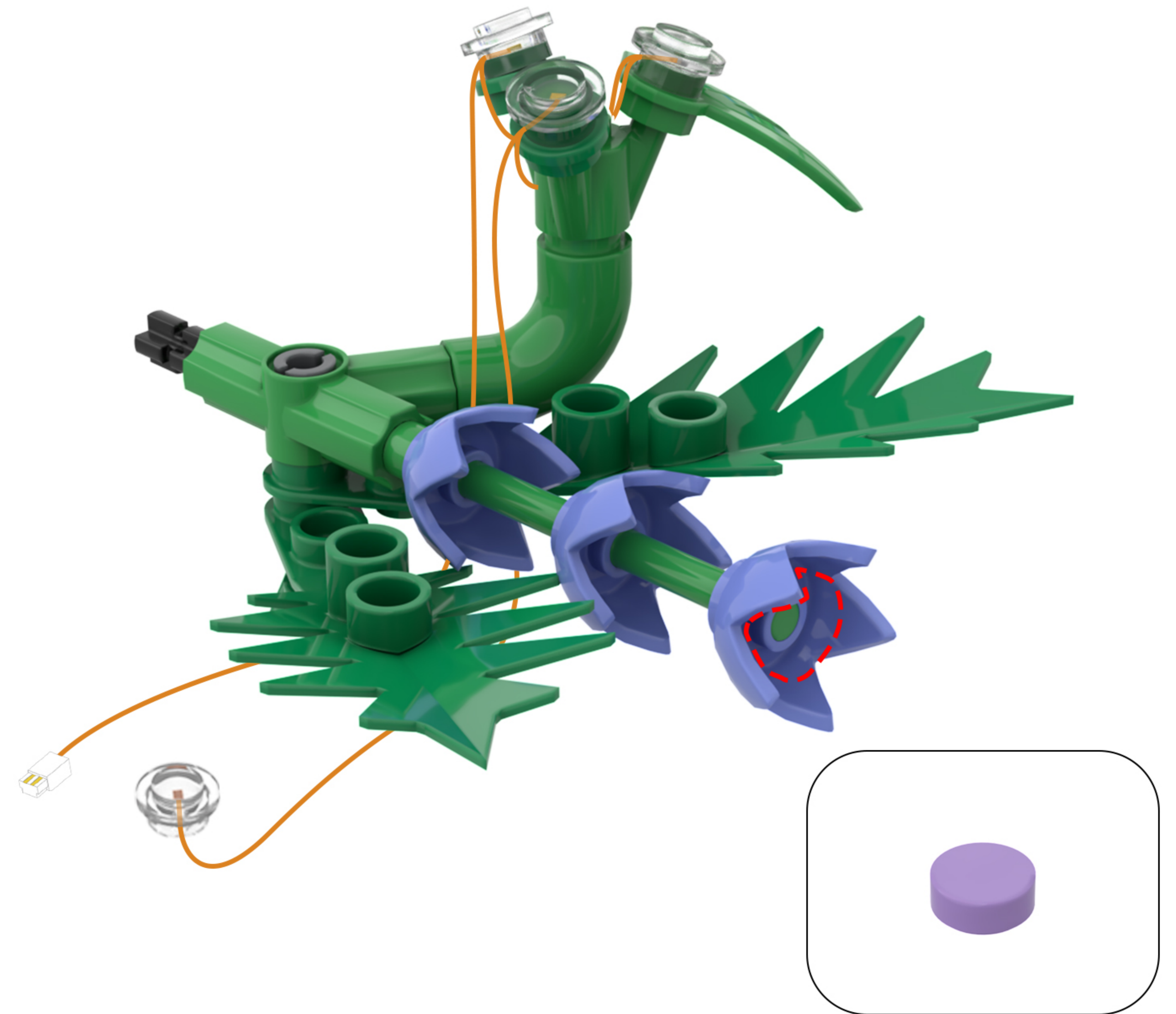

36

EN: Attach the last light from the string to the building block.

DE: Befestige die letzte Lampe der Lichterkette am Baustein.

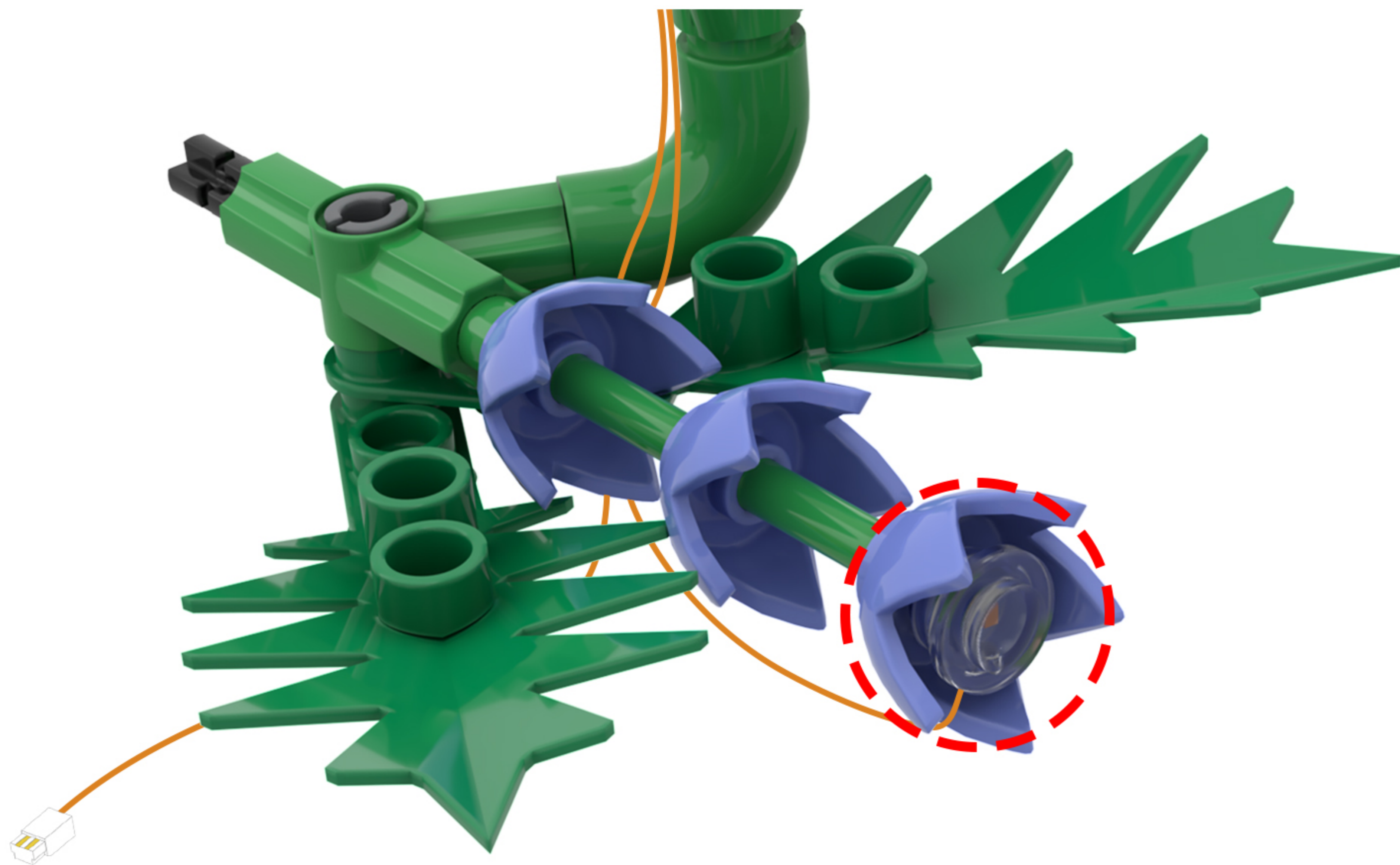

37

EN: Take out the disassembled building blocks and reassemble them.

DE: Nehmen Sie die zerlegten Bausteine heraus und setzen Sie sie wieder zusammen.

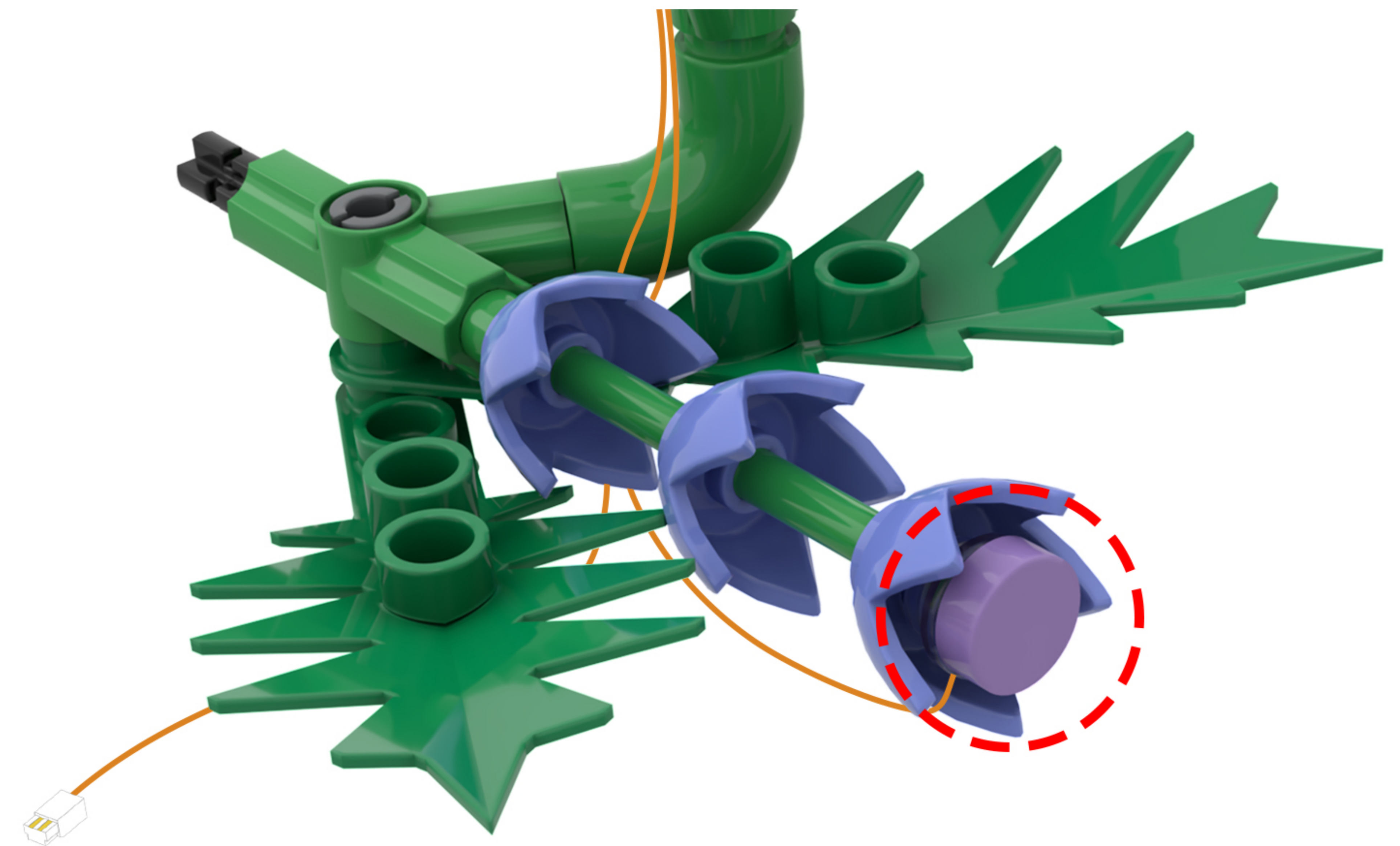
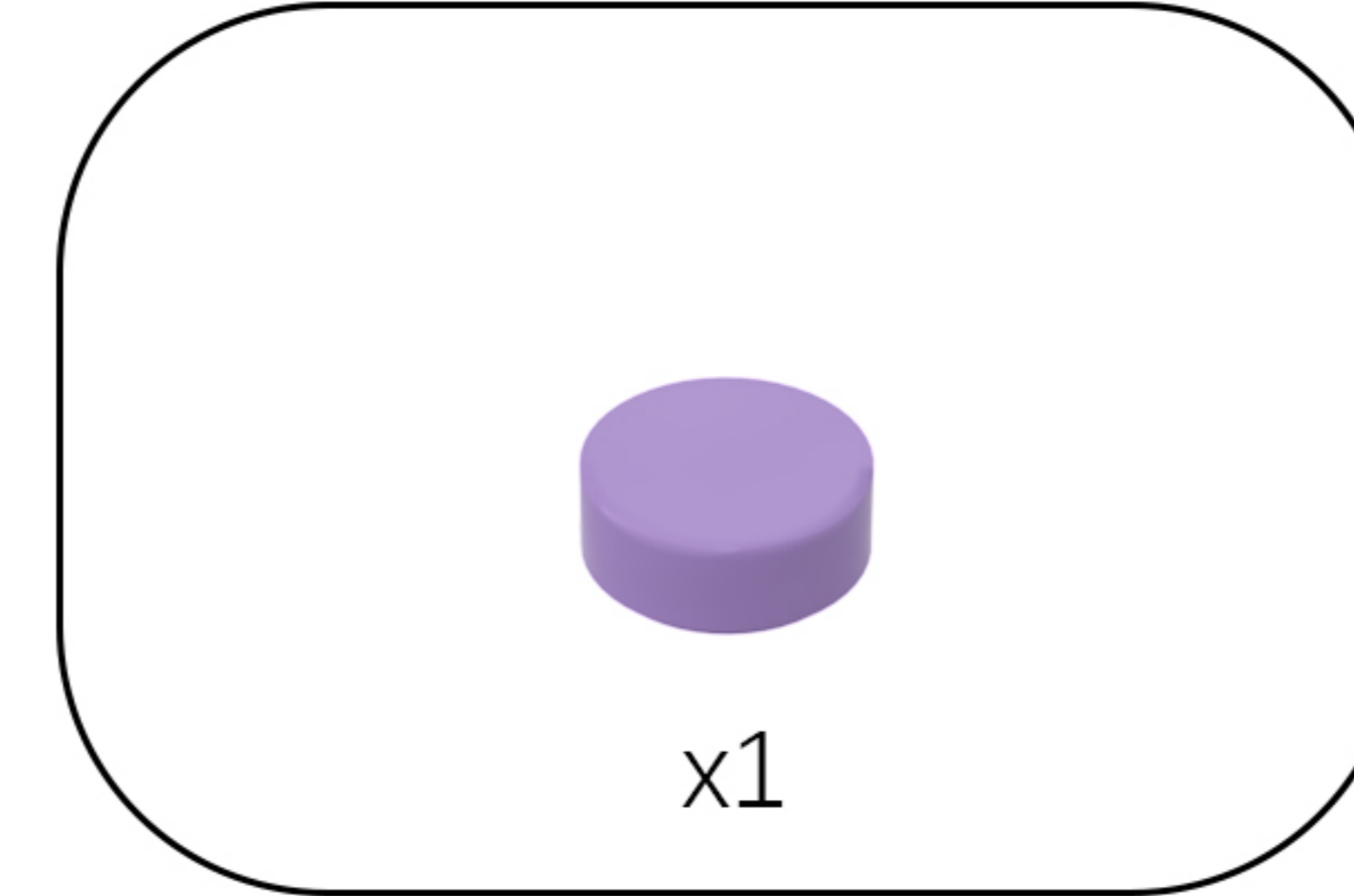

38

EN: Turn the model over and locate the wire from the string of lights.

DE: Drehen Sie das Modell um und suchen Sie den Draht der Lichterkette.

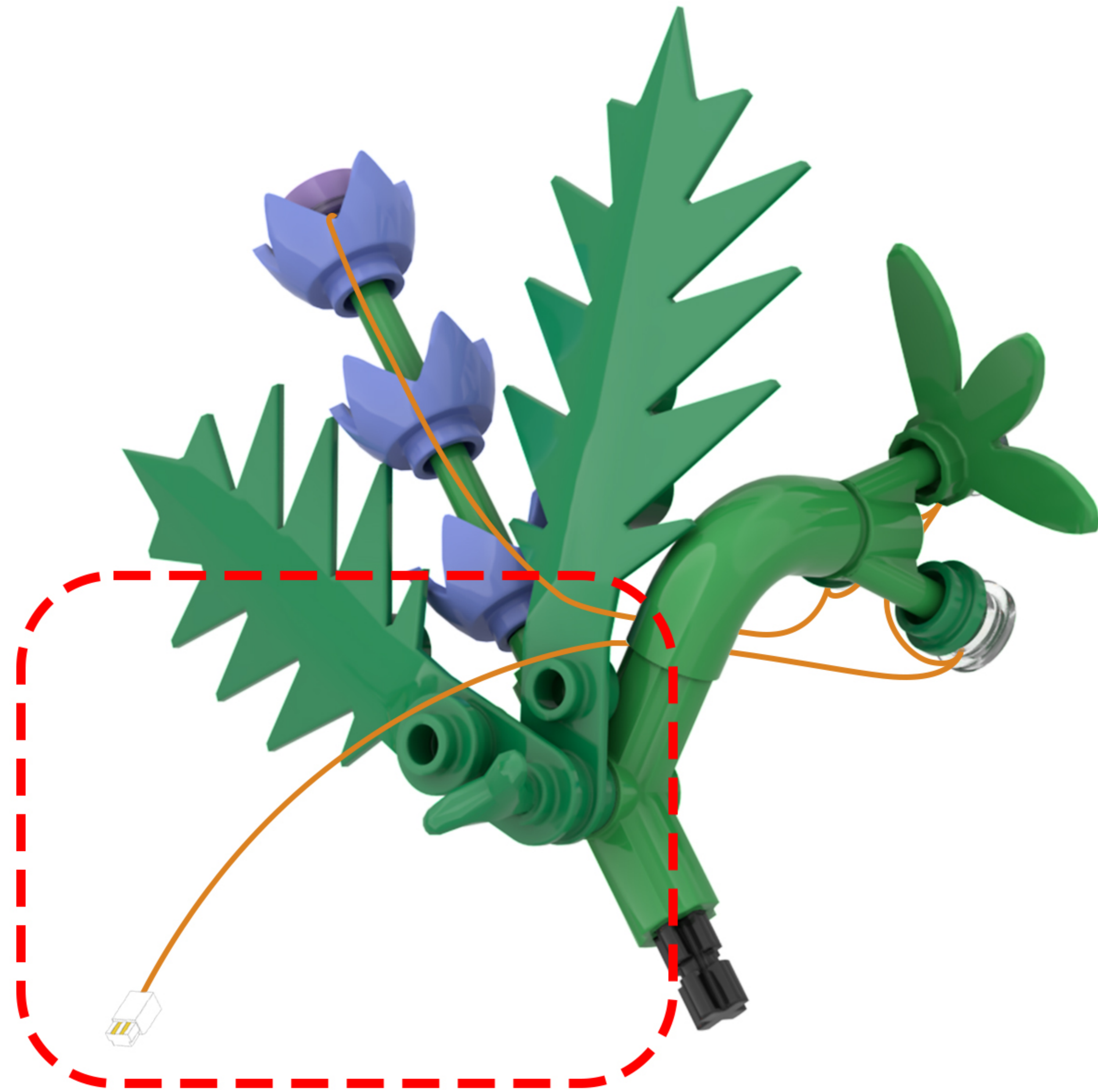
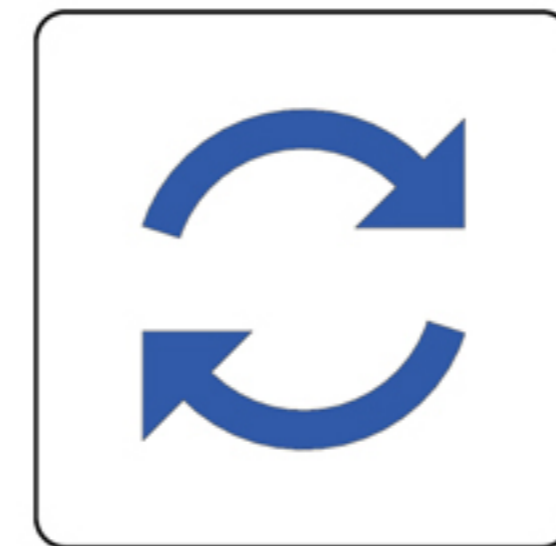

39

EN: Wrap the light cord around the building block once.

DE: Wickeln Sie das Lichtkabel einmal um den Baustein.

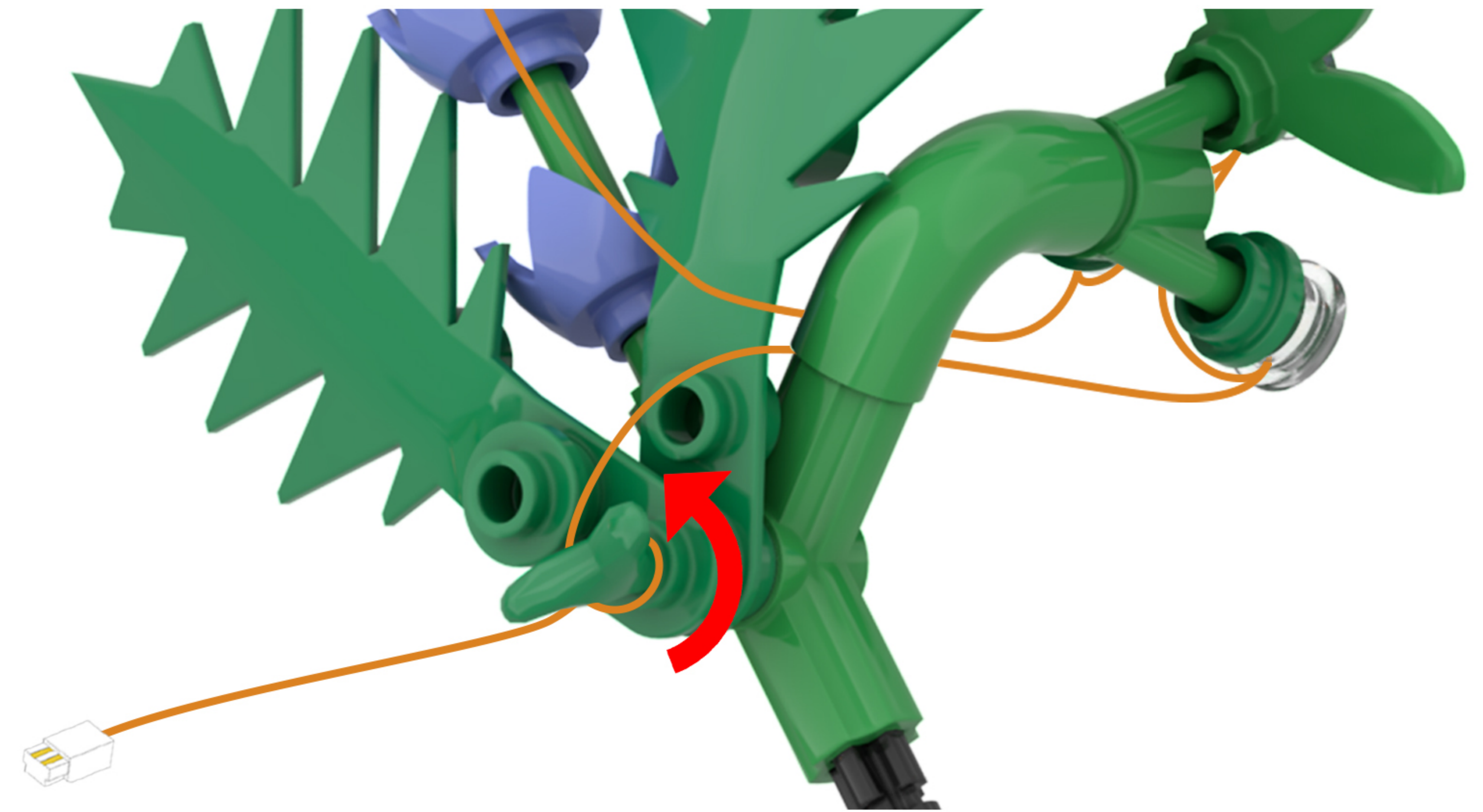

40

EN: Flip the model to restore it to its original state.

DE: Drehen Sie das Modell um, um es in seinen ursprünglichen Zustand zurückzusetzen.

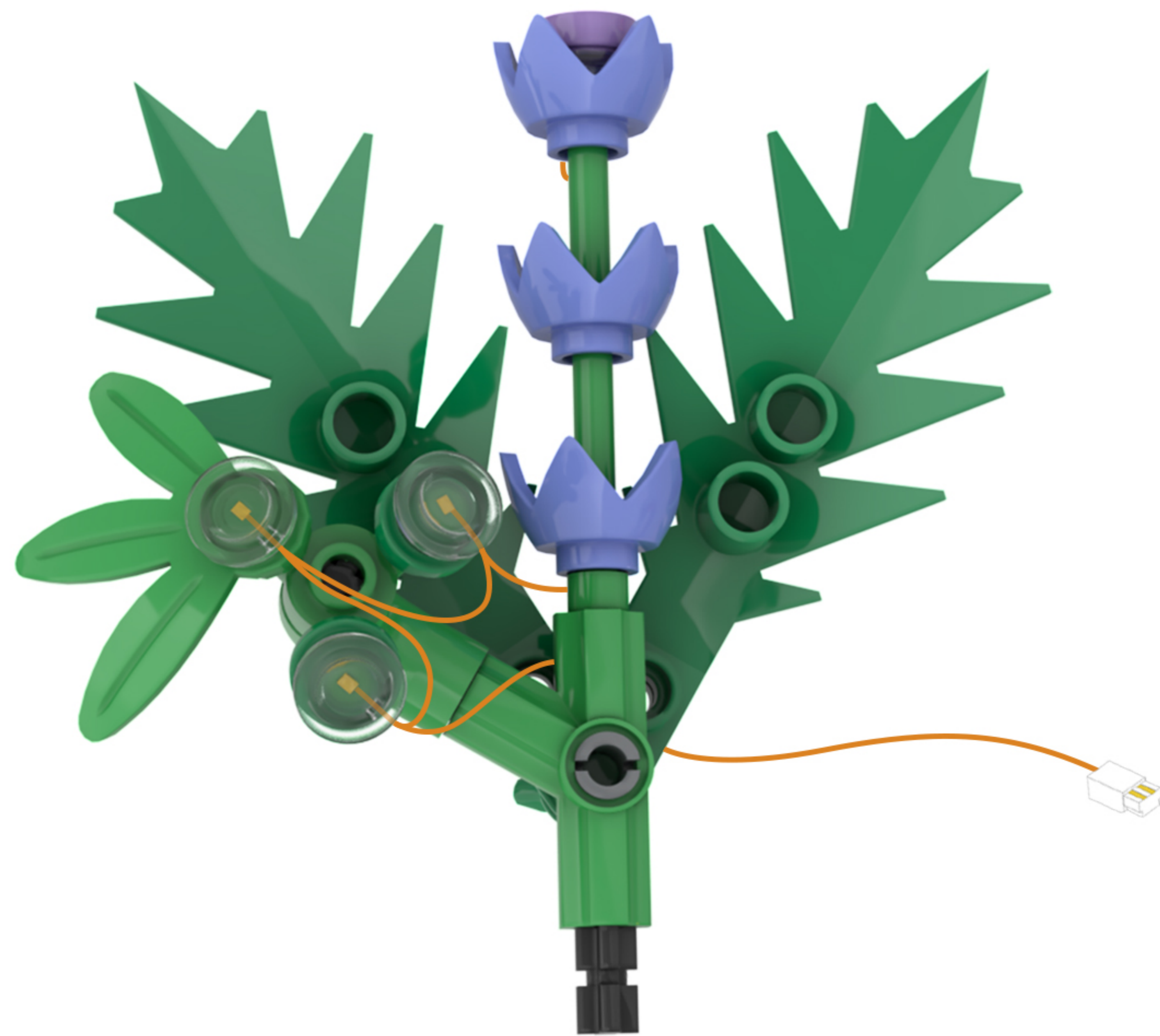
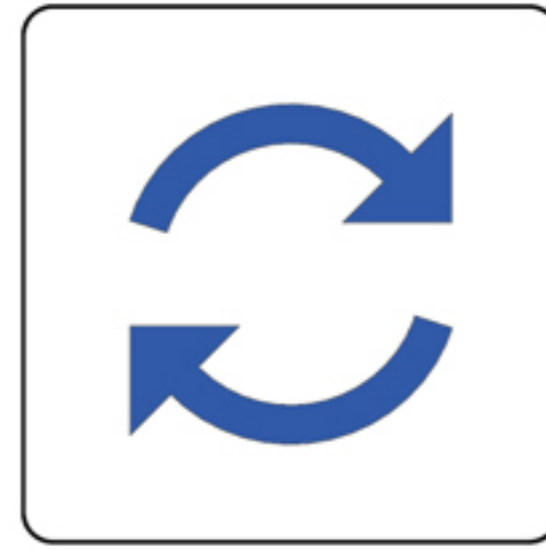

41

EN: Take out the disassembled building blocks and reassemble them in order.

DE: Nehmen Sie die zerlegten Bausteine heraus und setzen Sie sie der Reihe nach wieder zusammen.

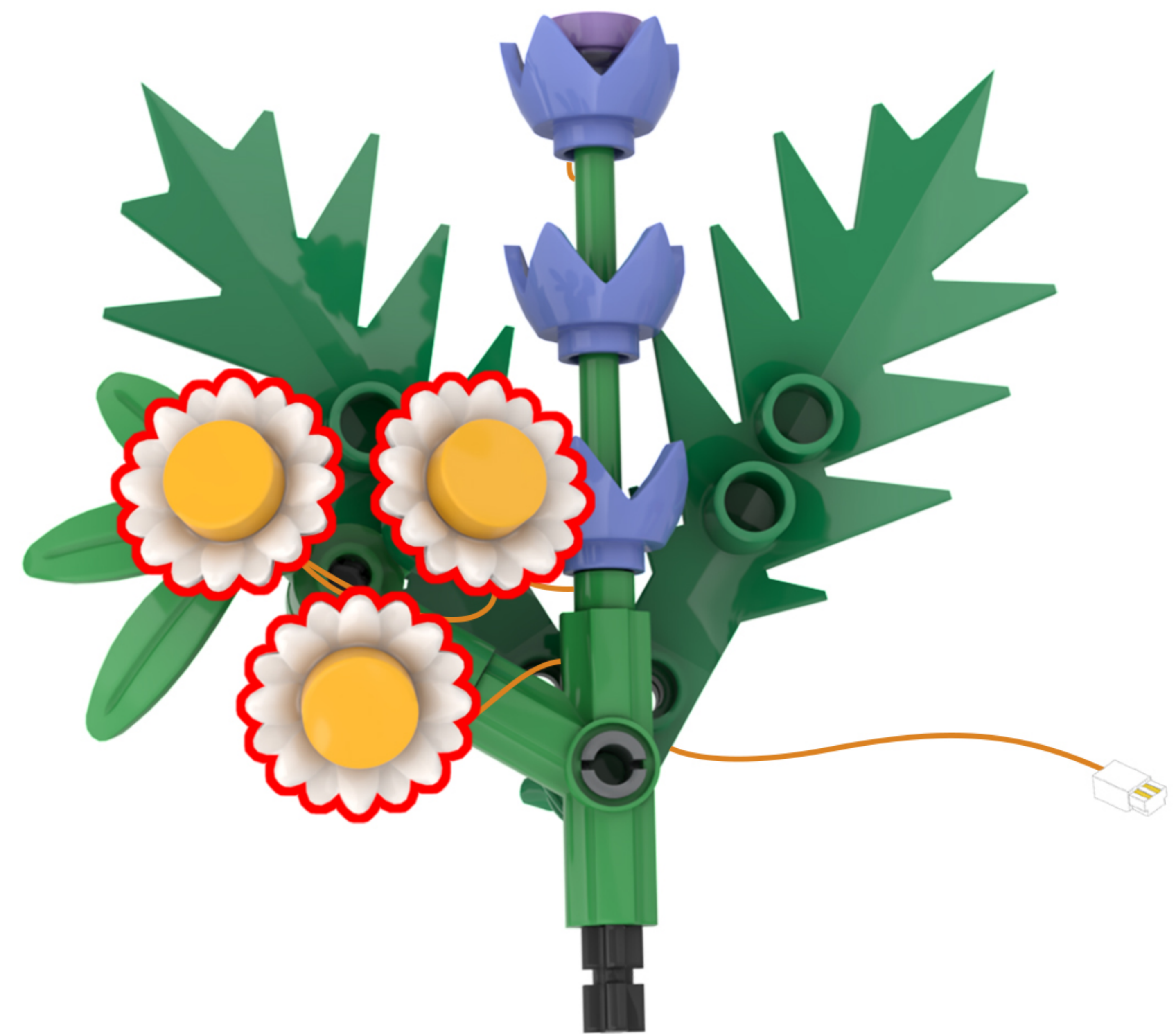
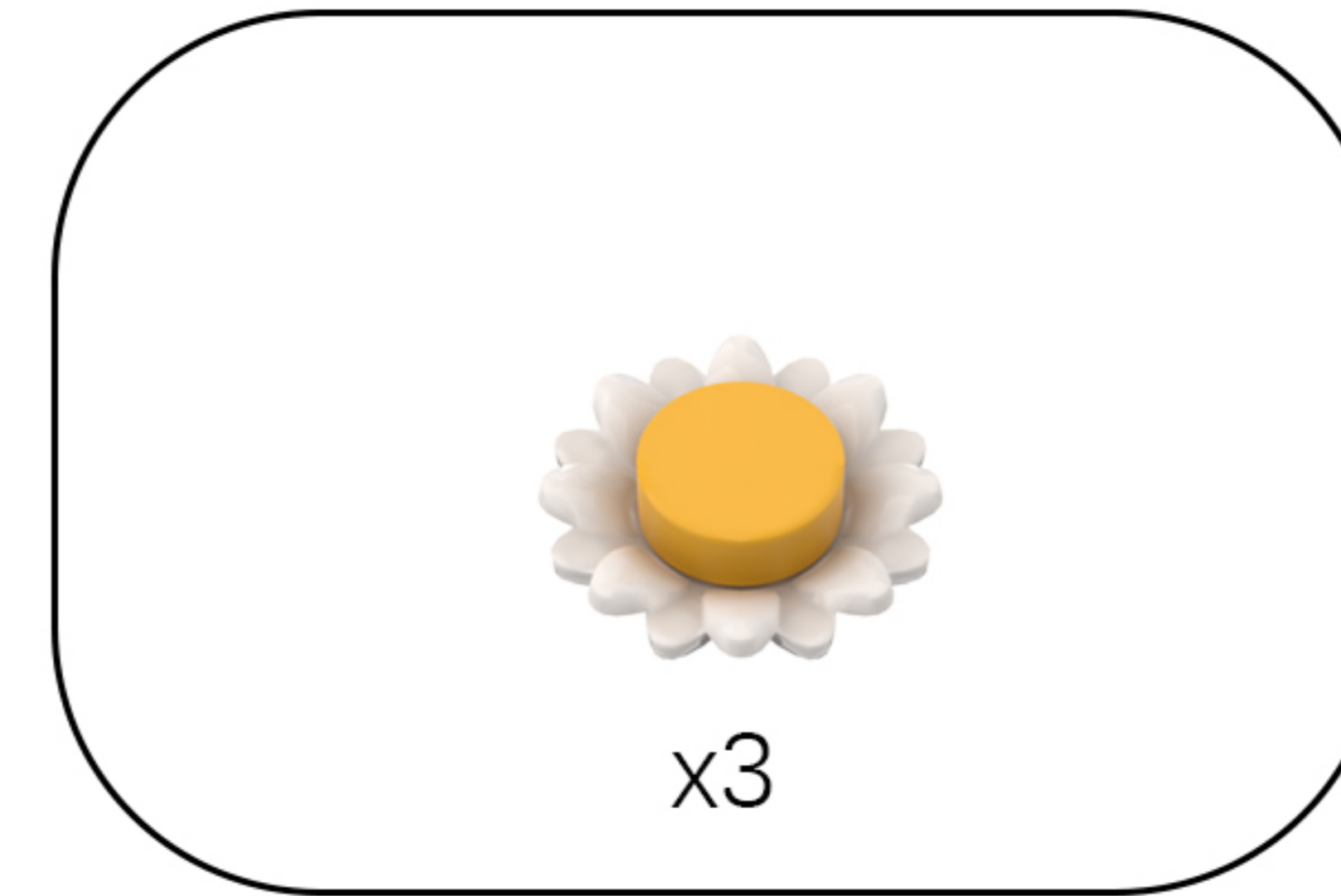

42

EN: Restore the building blocks.

DE: Stellen Sie die Bausteine wieder her.

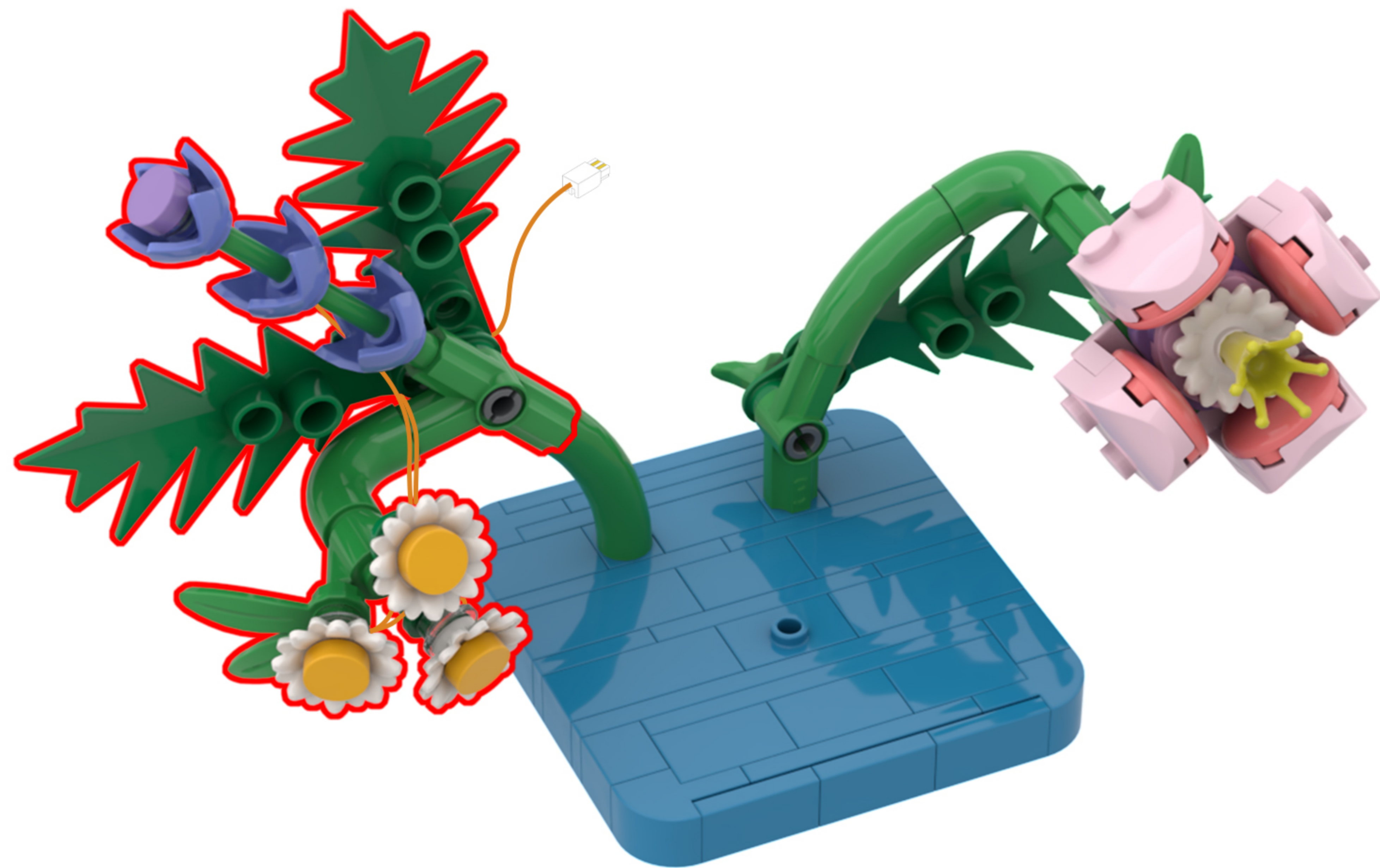

43

EN: Split as shown in the figure.

DE: Wie in der Abbildung gezeigt, teilen Sie es auf.

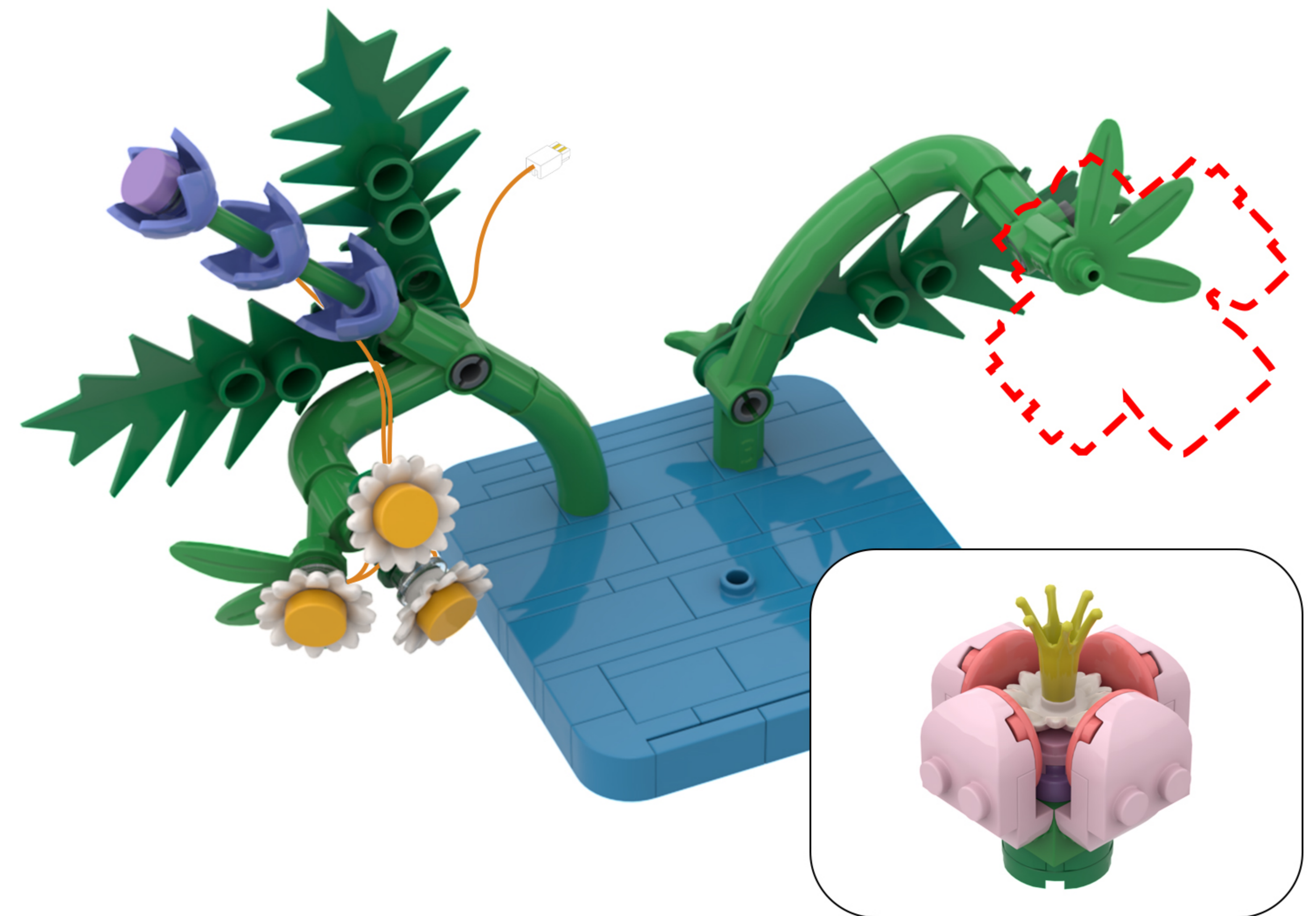

44

EN: Take out the disassembled building blocks and take them apart one by one.

DE: Nimm die zerlegten Bausteine heraus und nimm sie nacheinander auseinander.

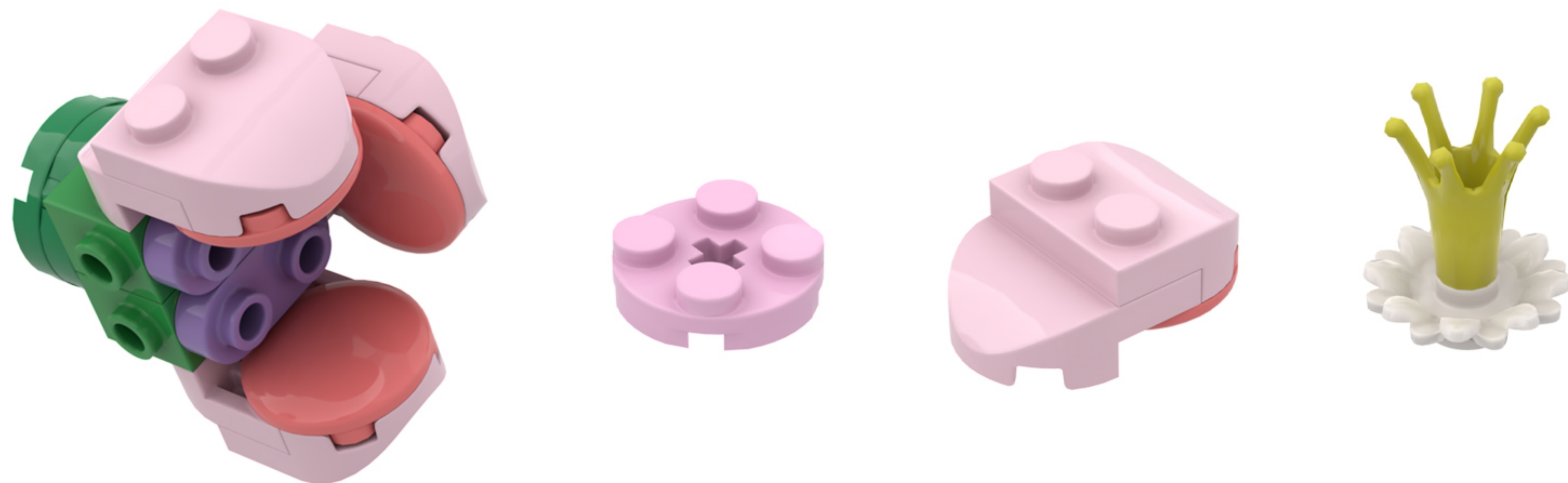
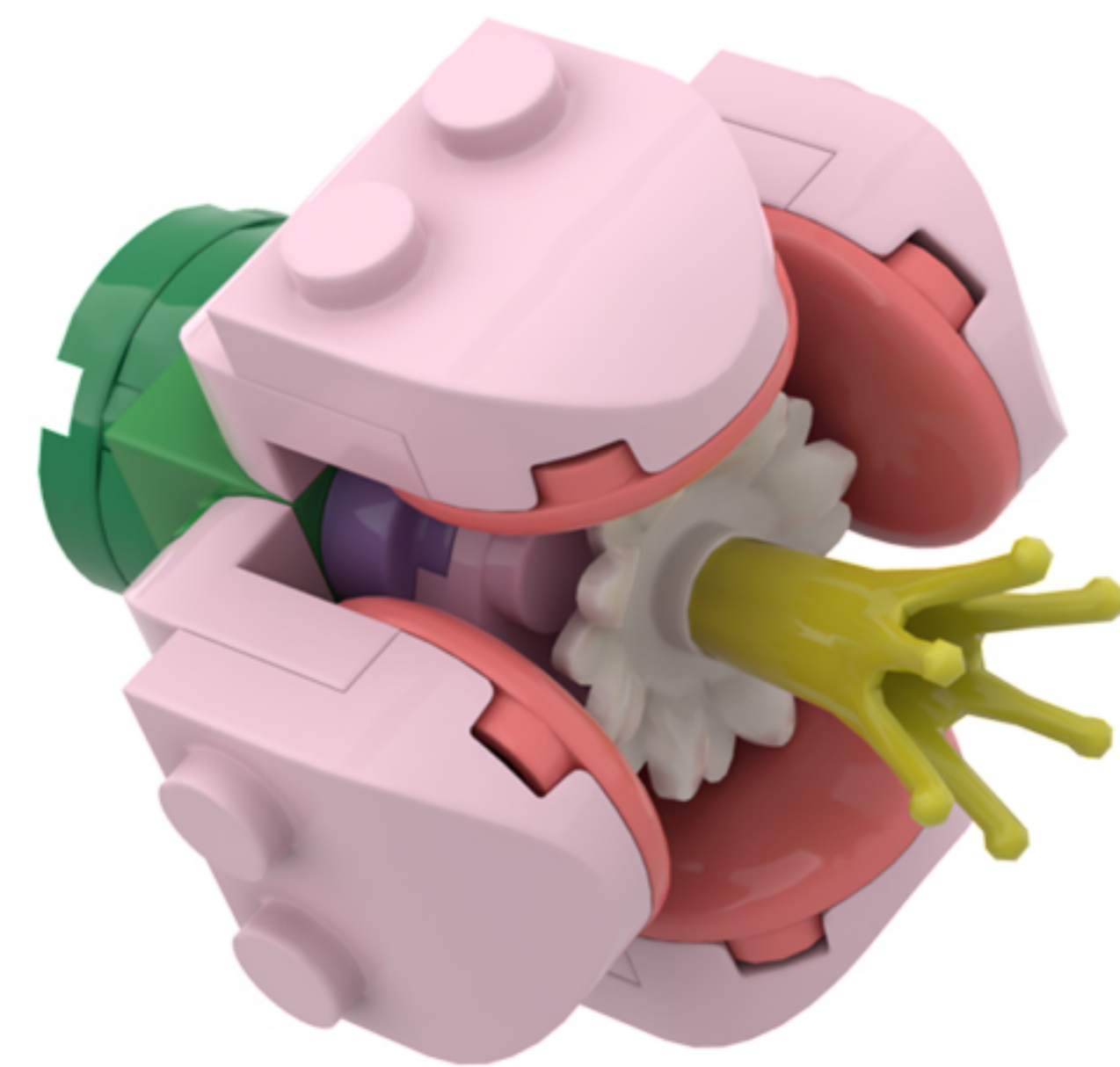
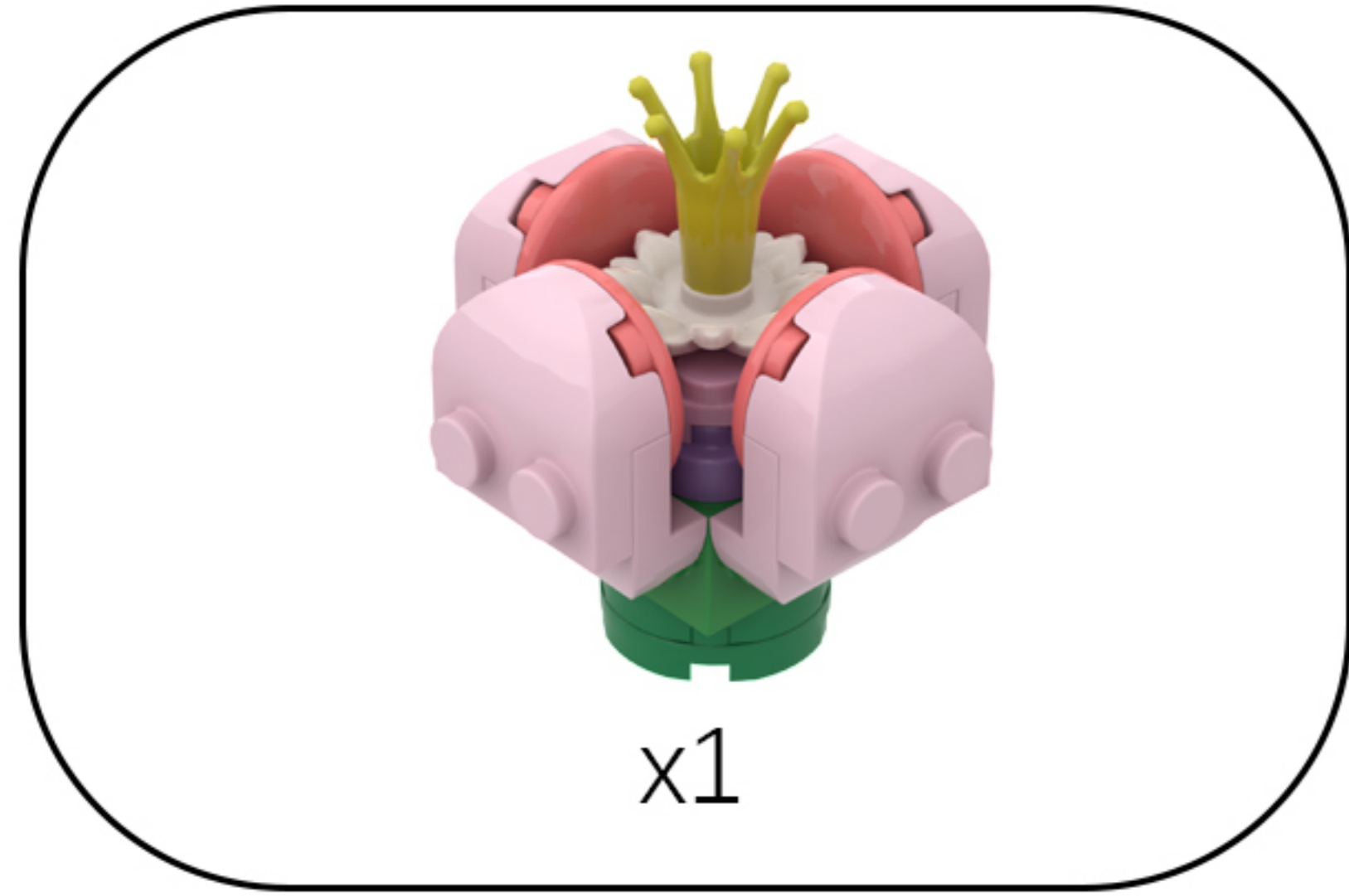

45

EN: Take the 2x2 disc and the light fixture from Bag 2, and follow the instructions step by step.

DE: Nimm die 2x2-Scheibe und die Leuchte aus Beutel 2 und befolge die Anleitung Schritt für Schritt.

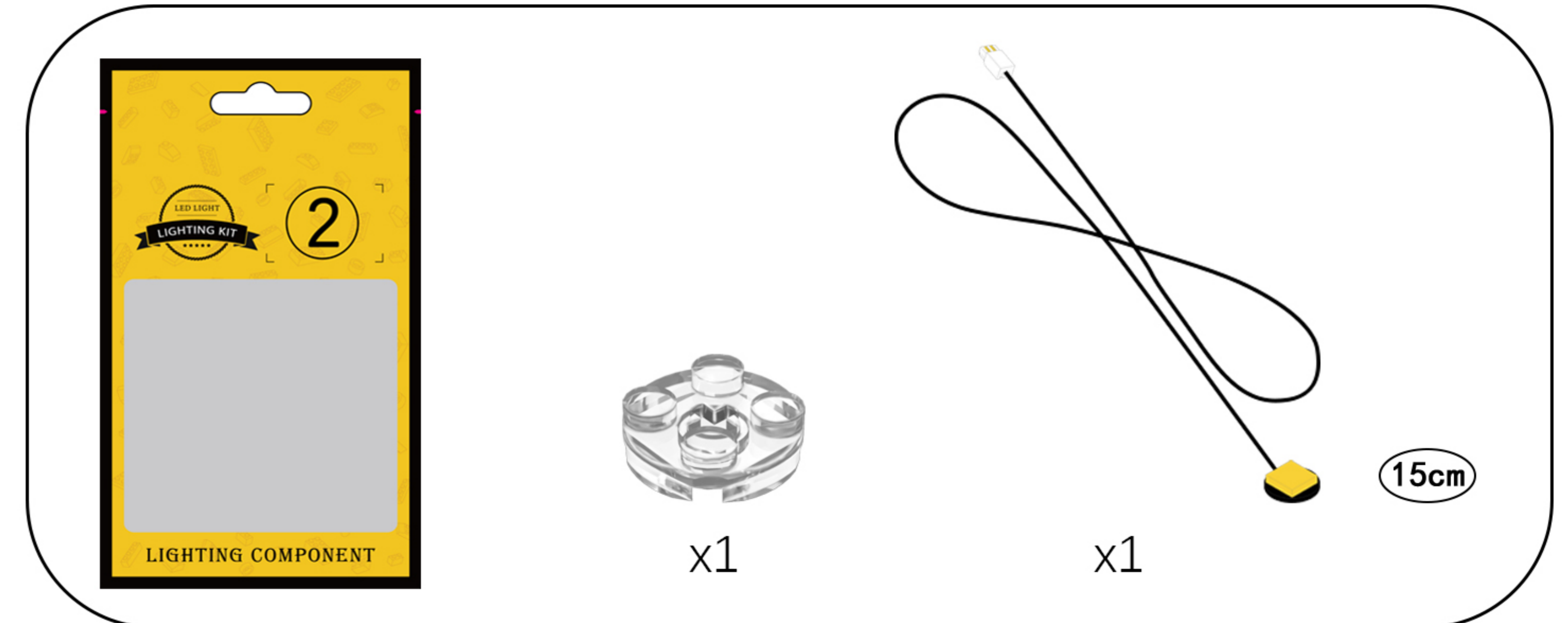

①. Thread the light bead onto the 2x2 disc.

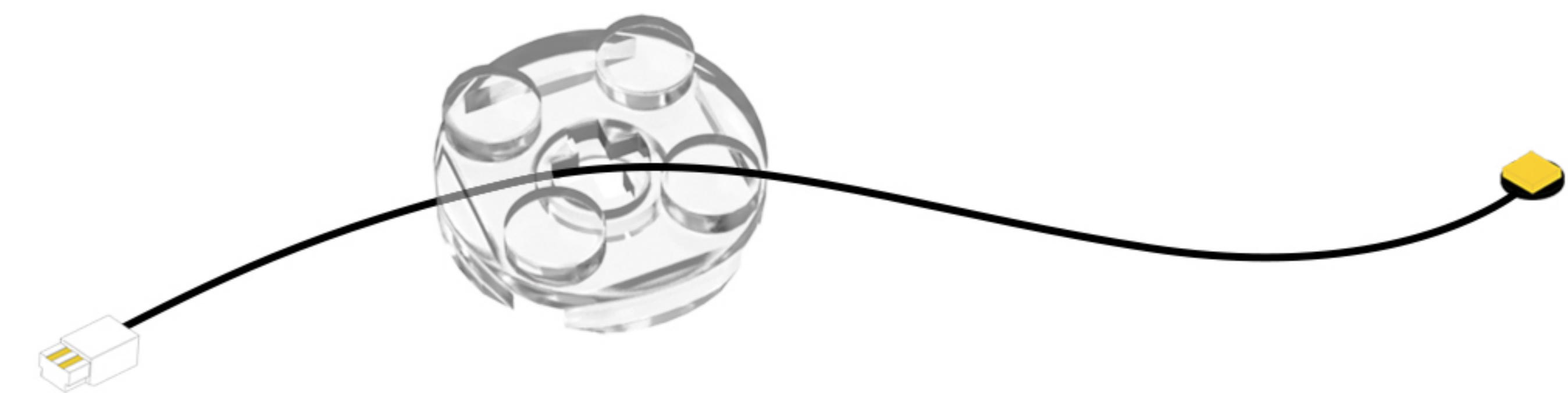

②. Pull the light cord so that the light-emitting surface is pressed against the 2x2 circular board.



46

EN: Attach the light fixture to the building block.

DE: Befestigen Sie die Leuchte am Baustein.

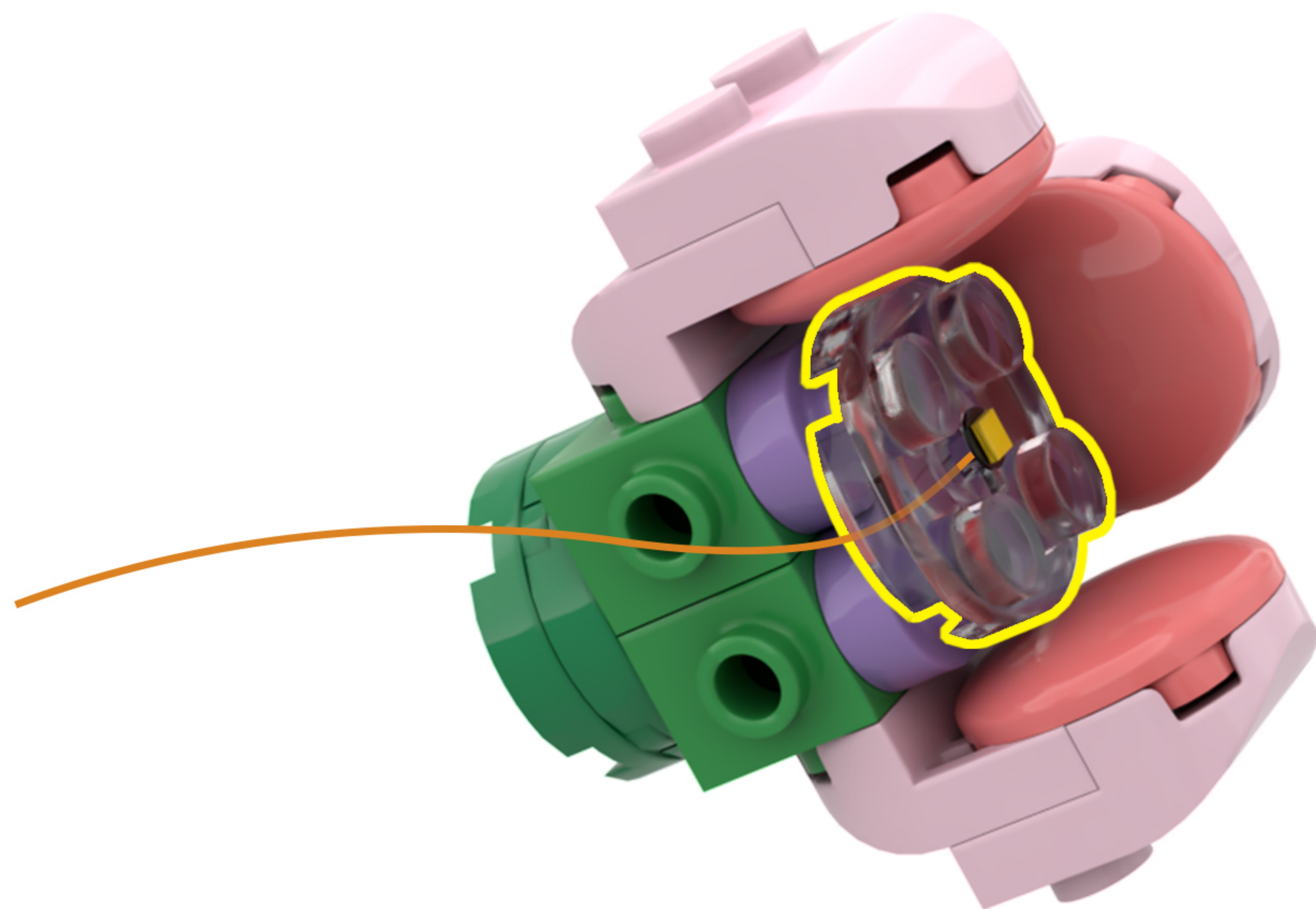

47

EN: Take out the disassembled building blocks and reassemble them.

DE: Nehmen Sie die zerlegten Bausteine heraus und setzen Sie sie wieder zusammen.

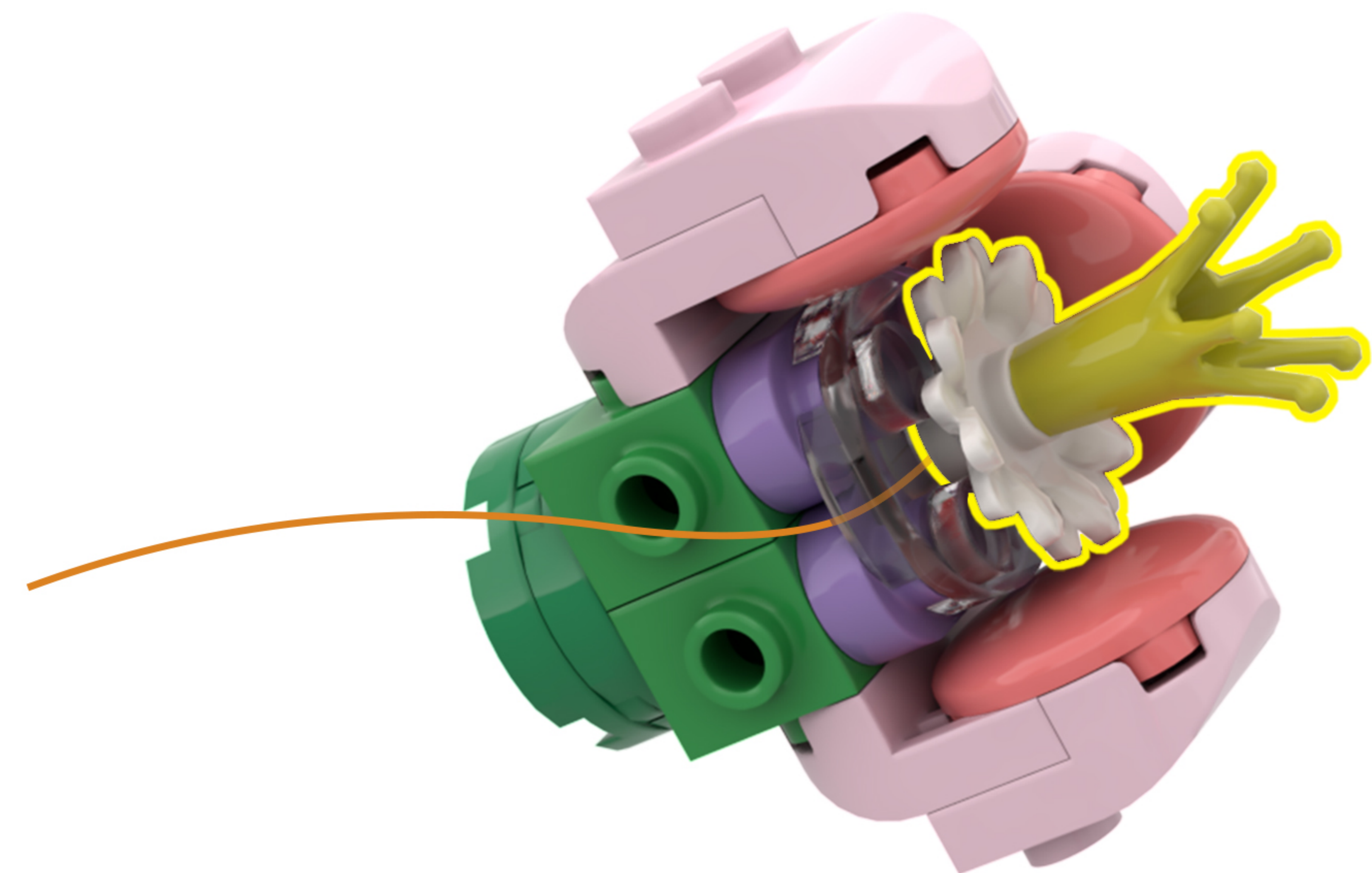
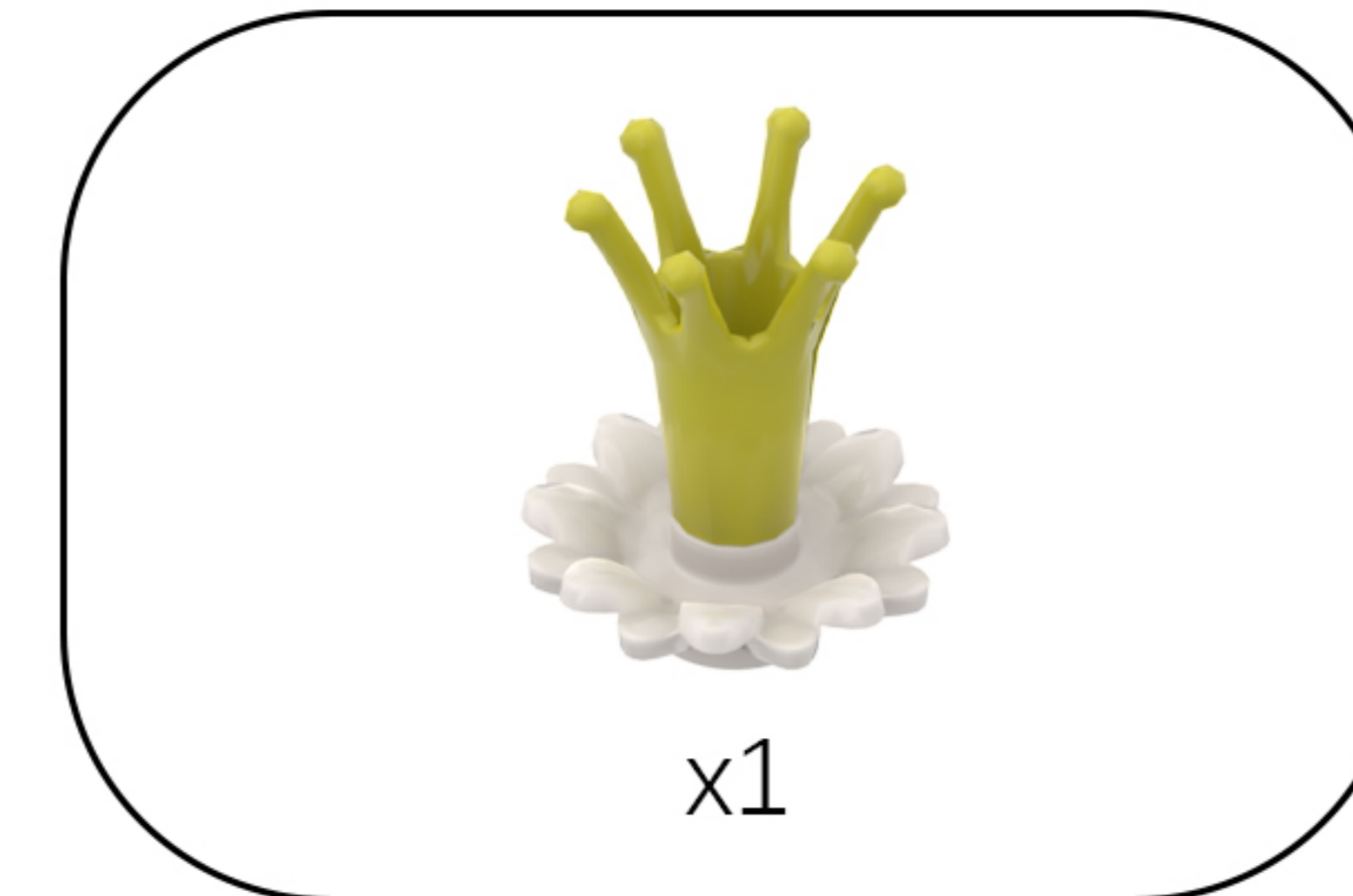

48

EN: Place the light cord between the two protrusions.

DE: Führen Sie das Lampenkabel zwischen den beiden Vorsprüngen hindurch.

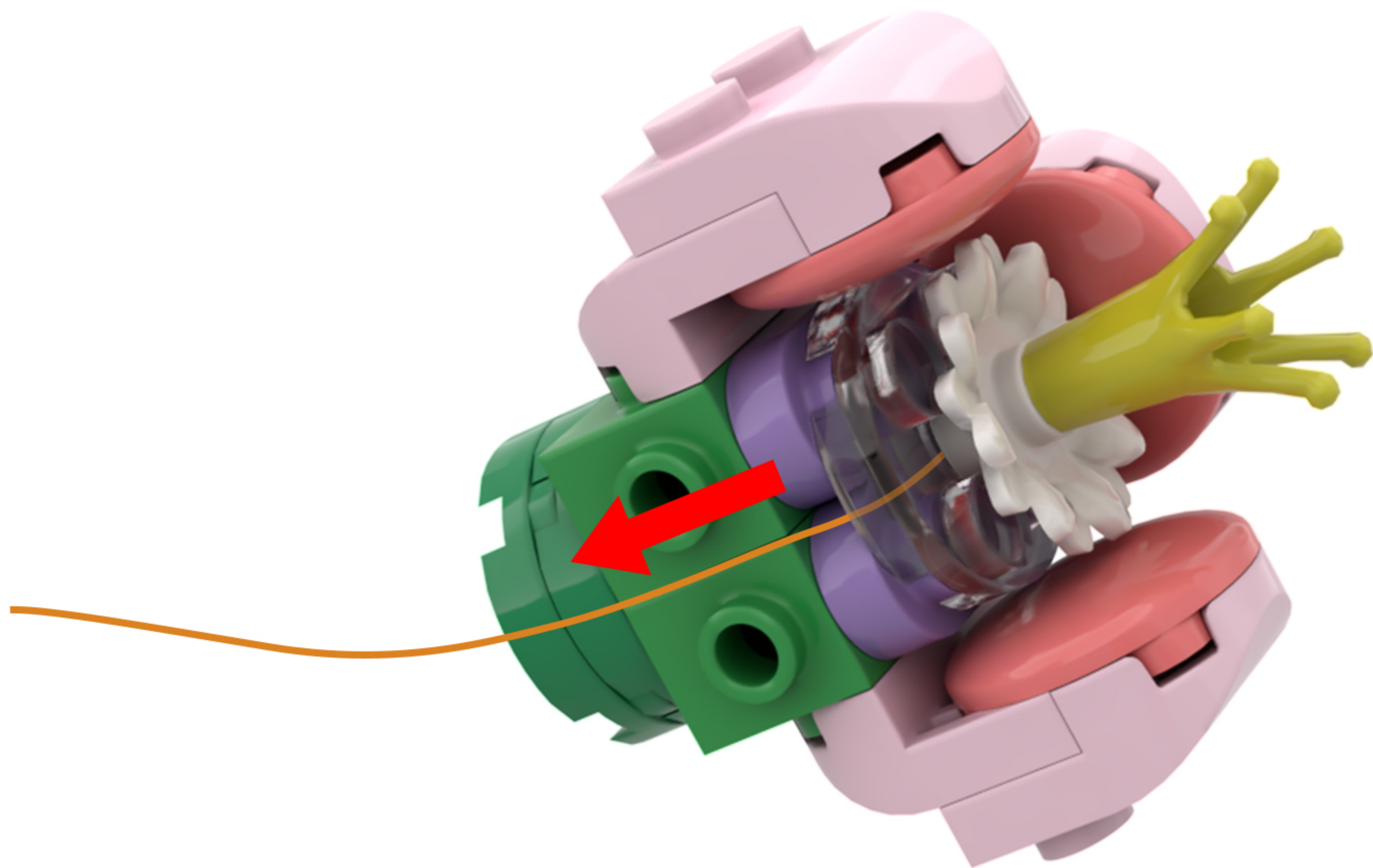

49

EN: Take out the disassembled building blocks, reassemble them, and secure the light cord.

DE: Nehmen Sie die zerlegten Bausteine heraus, setzen Sie sie wieder zusammen und befestigen Sie das Lichtkabel.

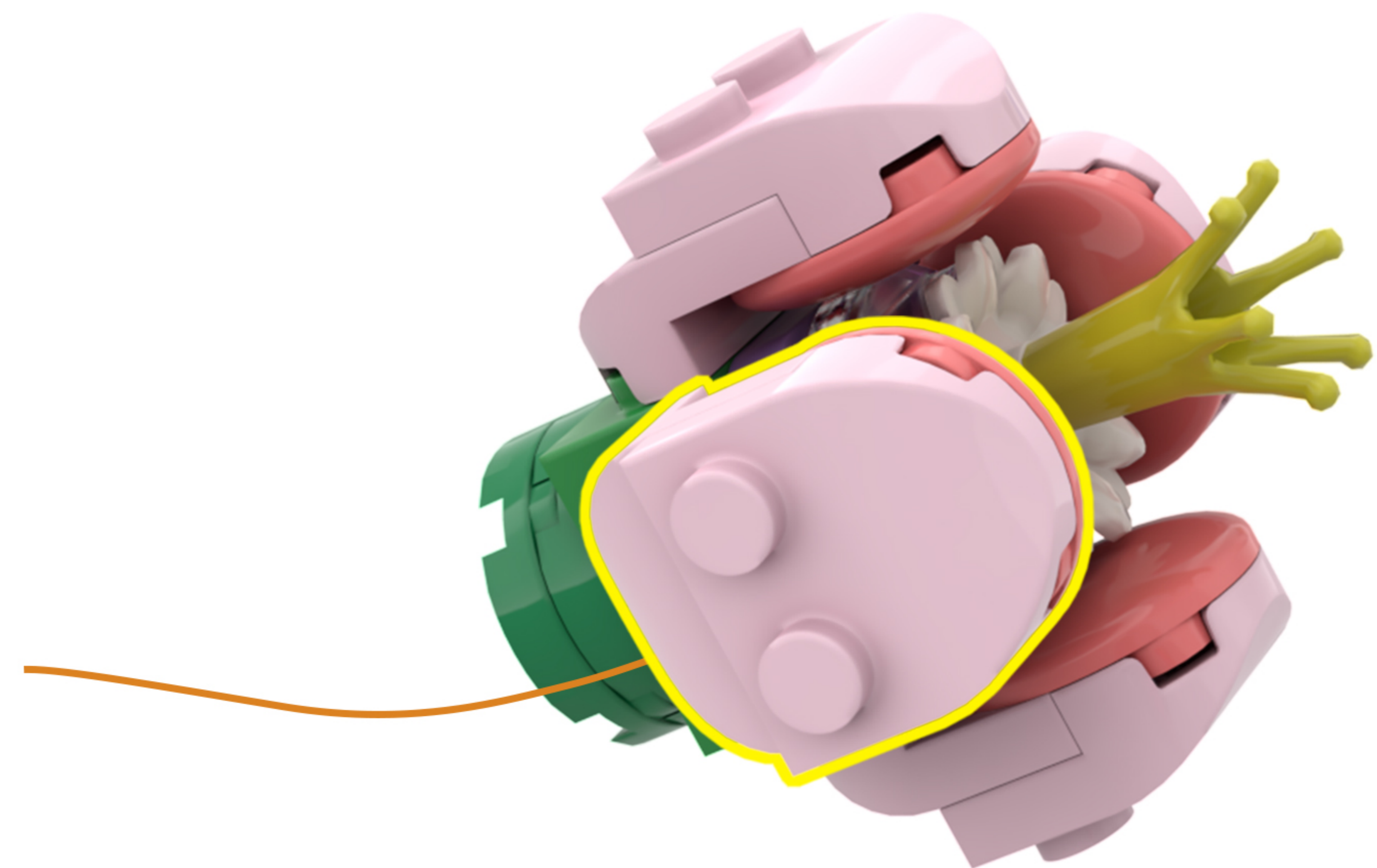
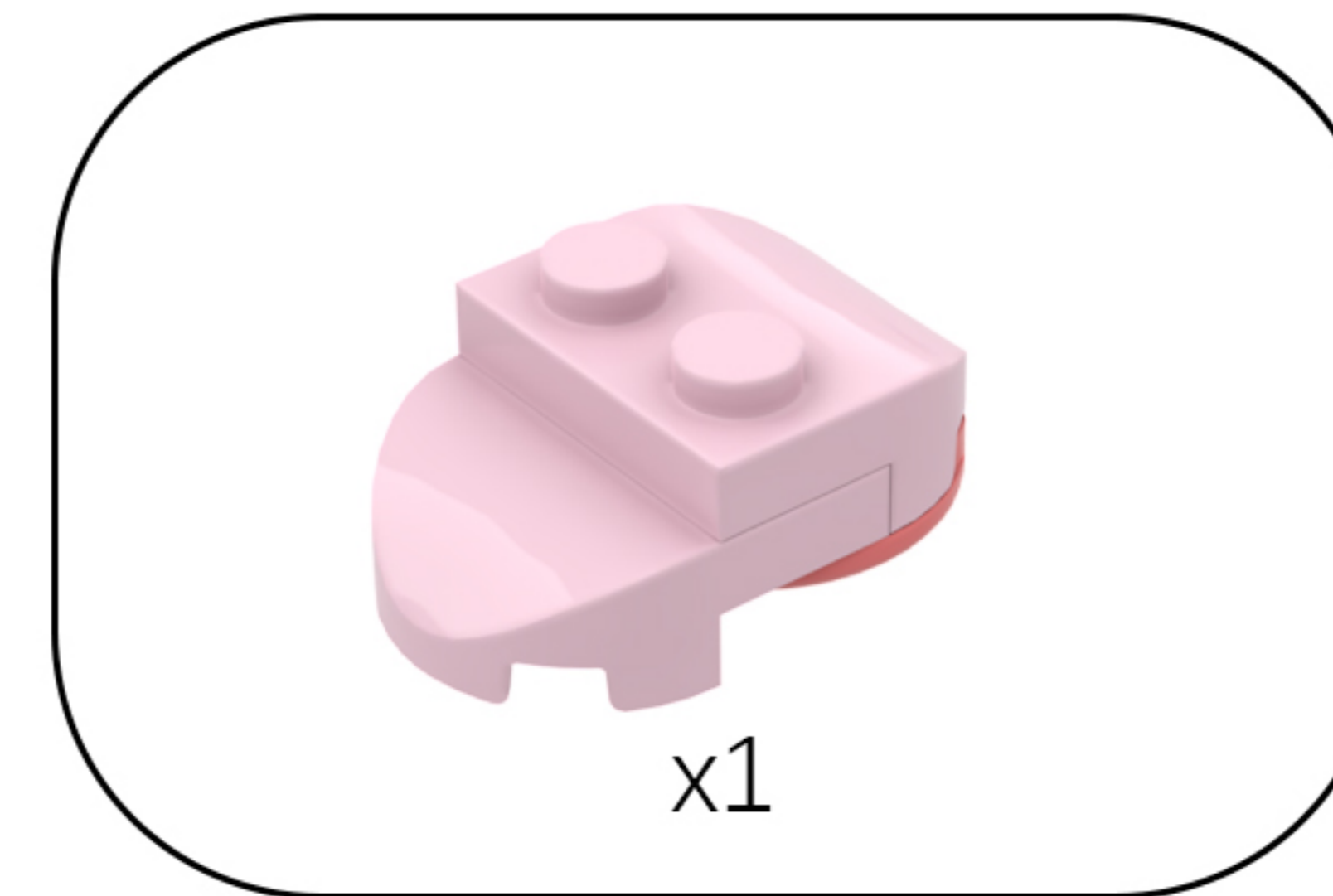

50

EN: Restore the building blocks.

DE: Stellen Sie die Bausteine wieder her.

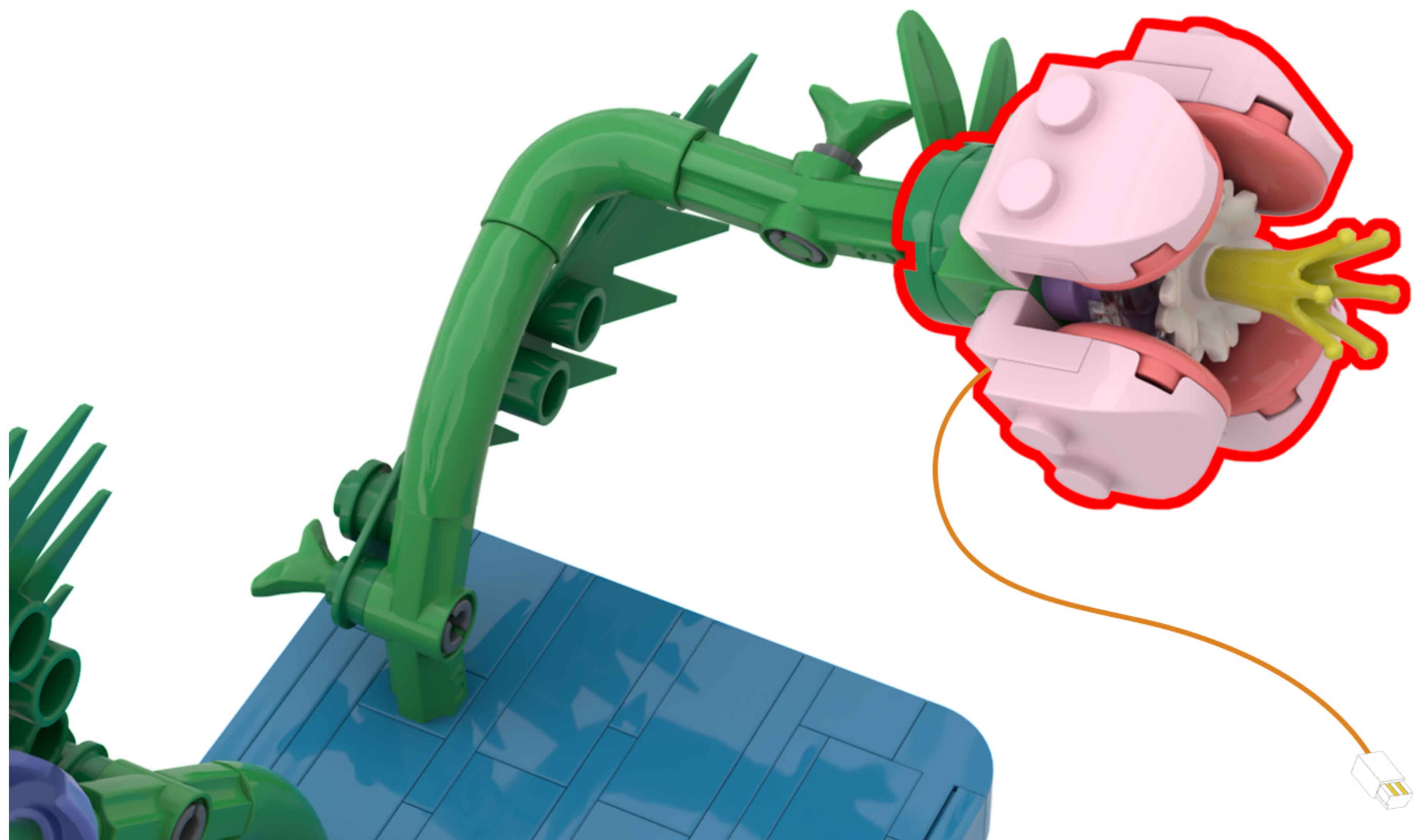

51

EN: Locate this light cord in the diagram.

DE: Suchen Sie dieses Lichtkabel in der Abbildung.

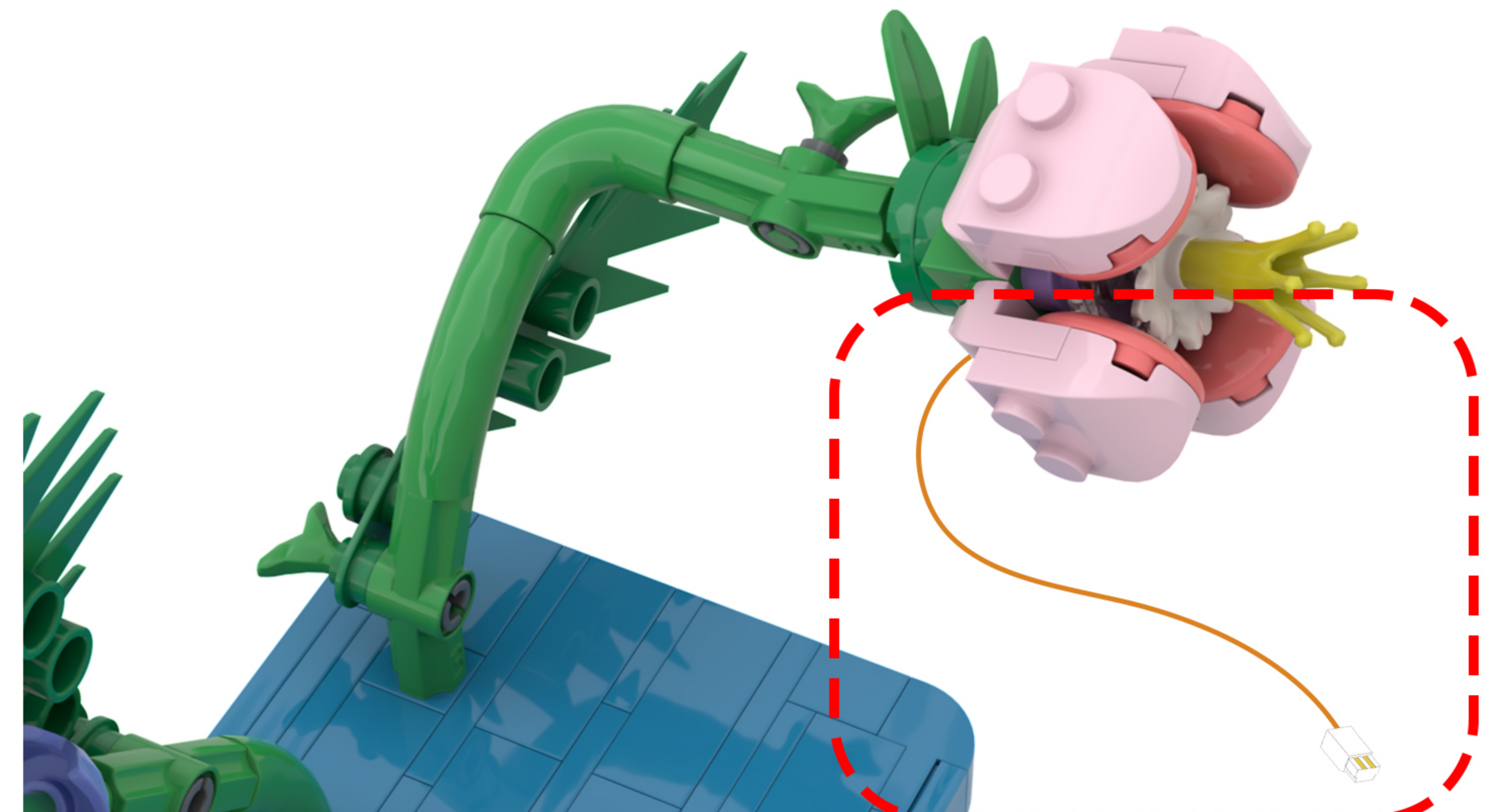

52

EN: Wrap the light cord around the building block, then route it to the back of the model.

DE: Wickeln Sie das Lichtkabel um den Baustein und führen Sie es dann zur Rückseite des Modells.

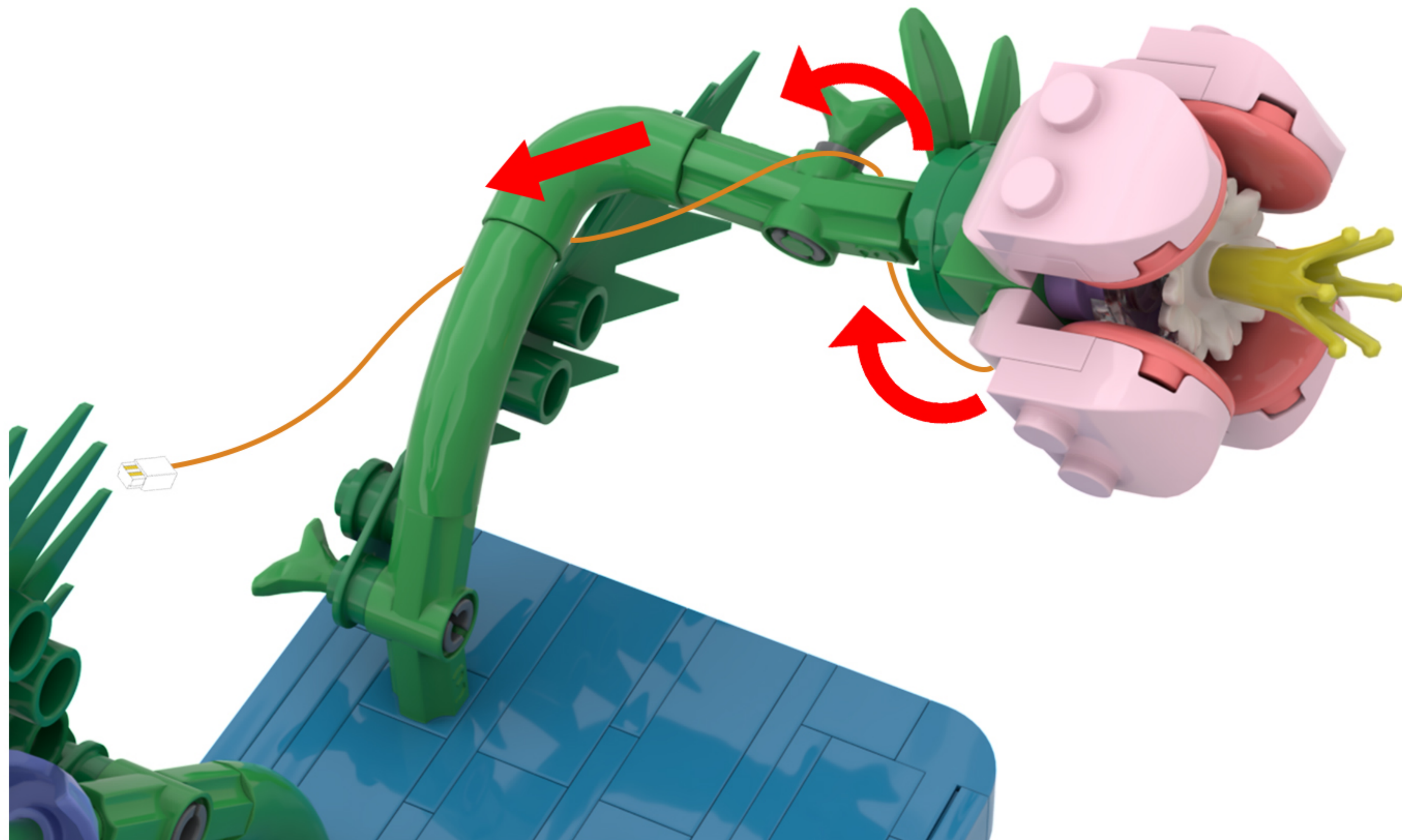

53

EN: Rotate the model to its back side.

DE: Drehen Sie das Modell auf die Rückseite.

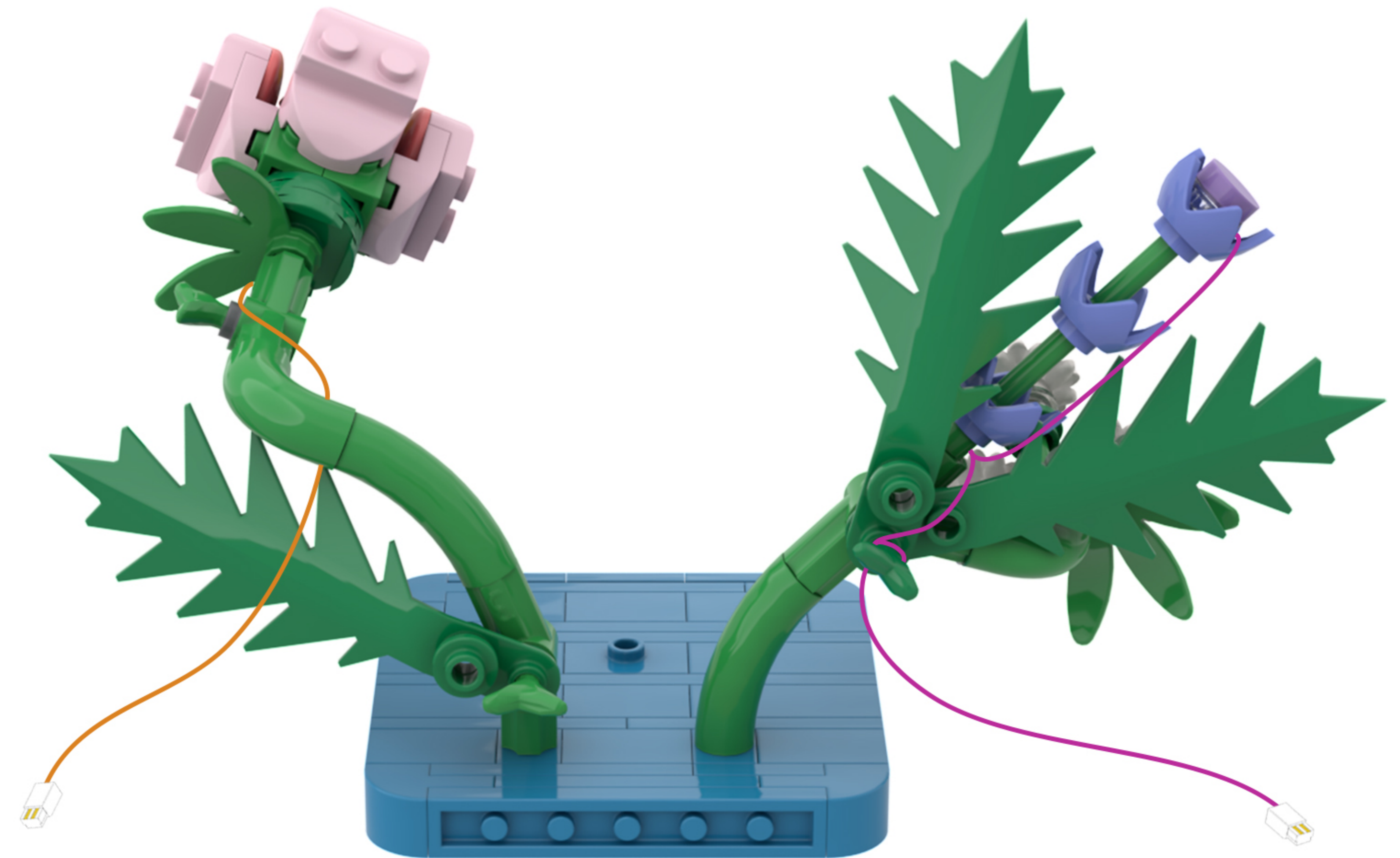

54

EN: Take the building block with the lights attached and put it back in its original place.

DE: Nimm den Baustein mit den Lichtern und setze ihn wieder an seinen ursprünglichen Platz.

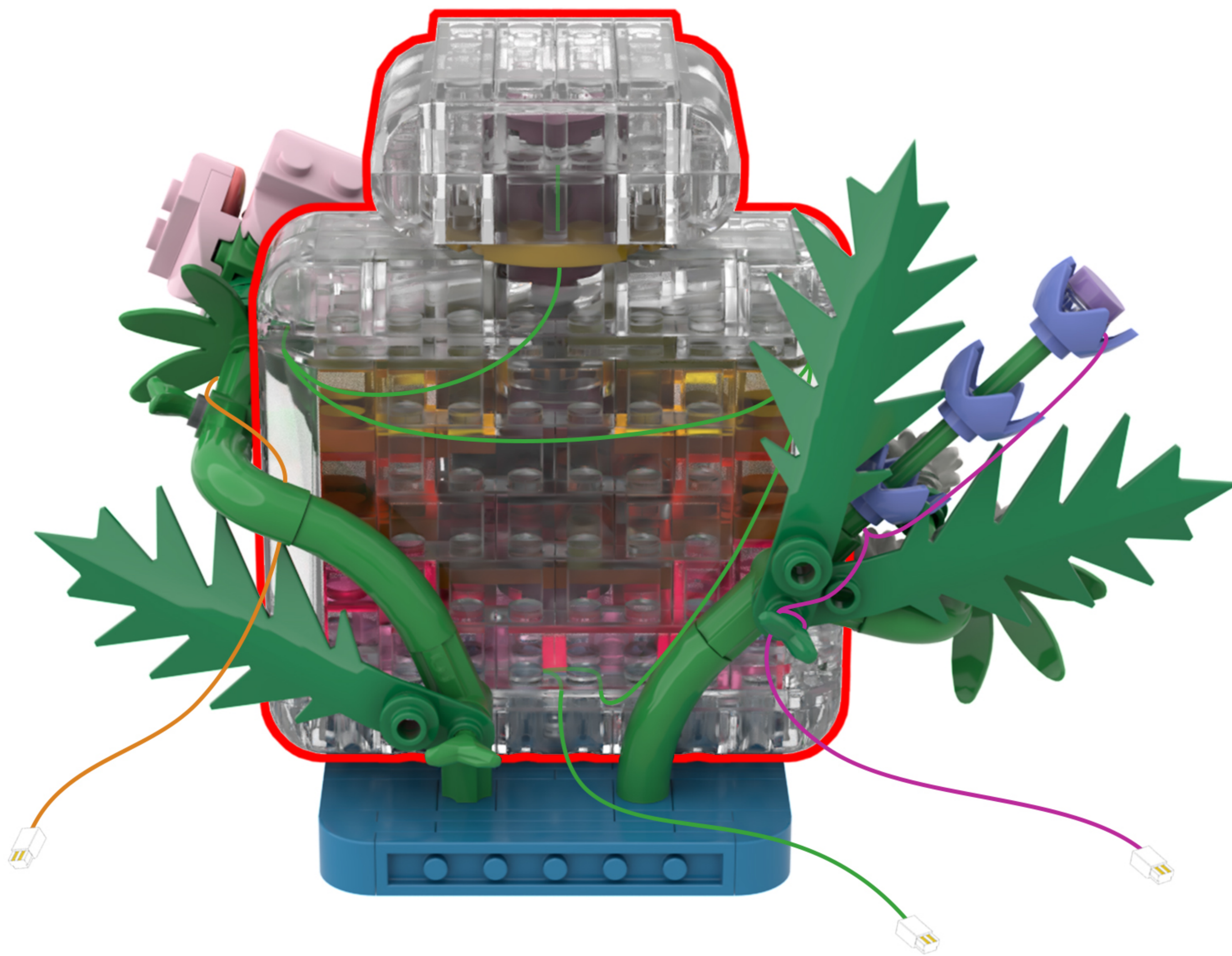
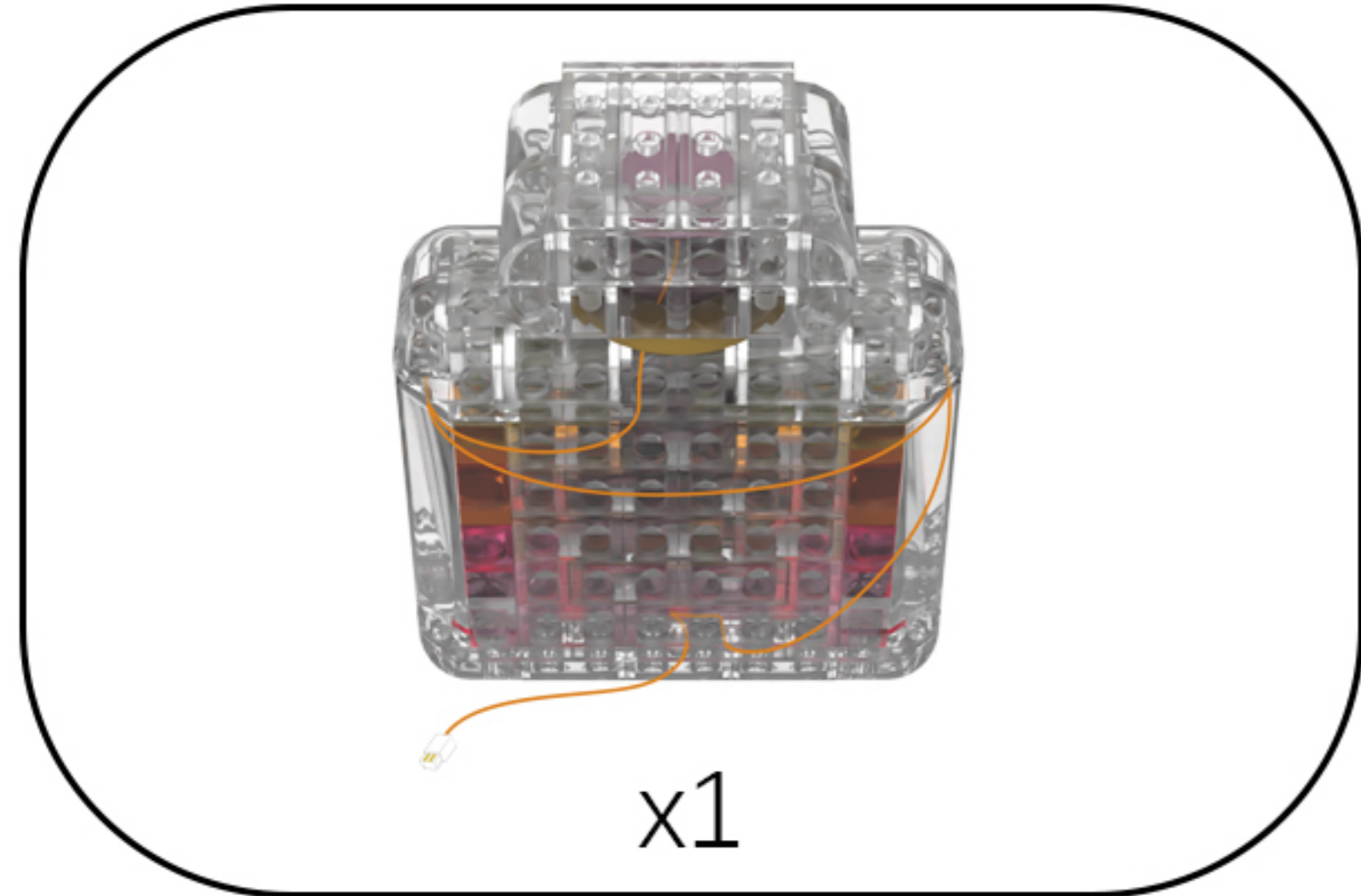

55

EN: Locate the three light wires in the diagram.

DE: Suchen Sie die drei Lichtkabel in der Abbildung.

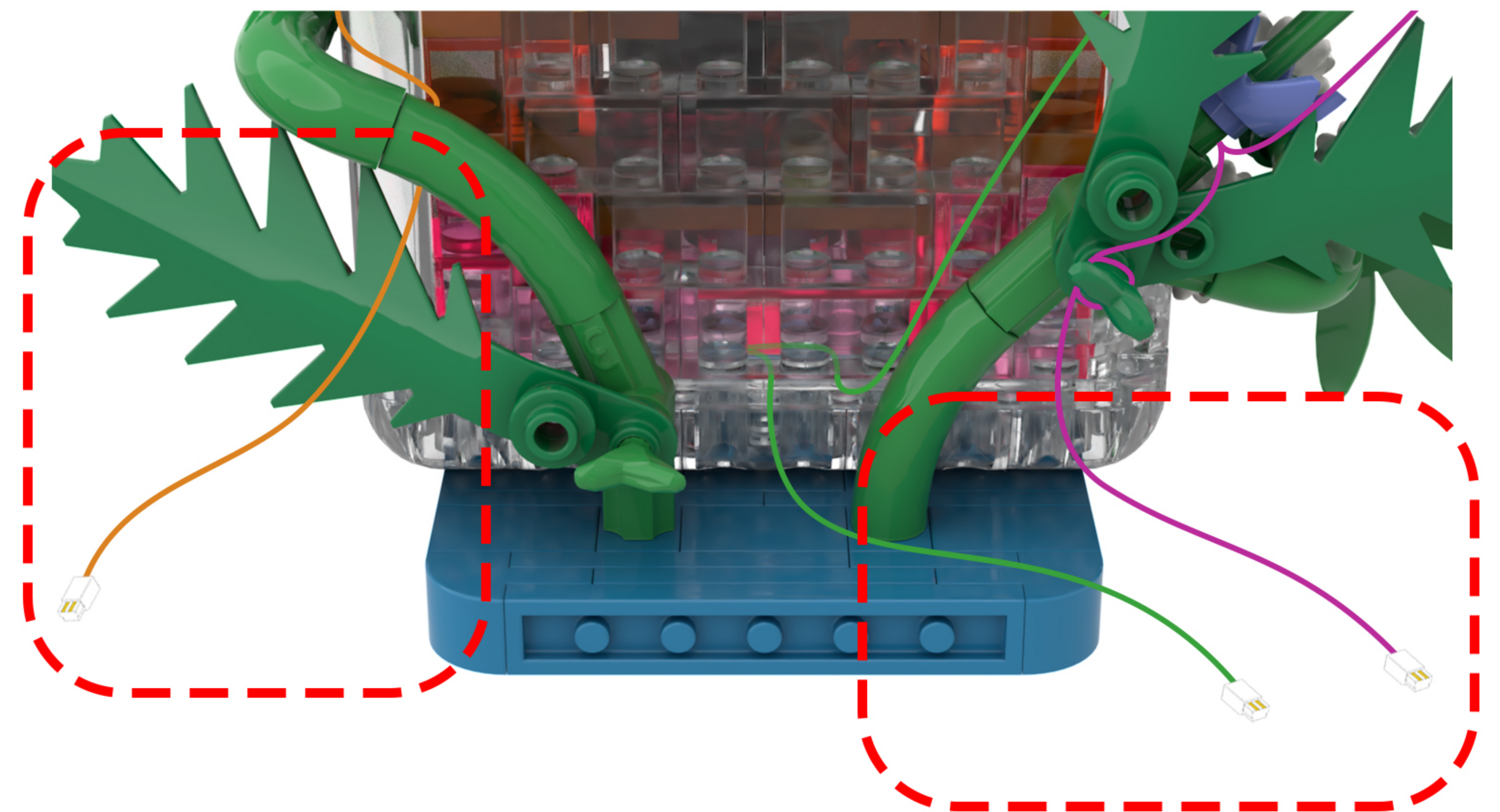

56

EN: Twist the wires from the three string lights together.

DE: Verdrehen Sie die Drähte der drei Lichterketten miteinander.

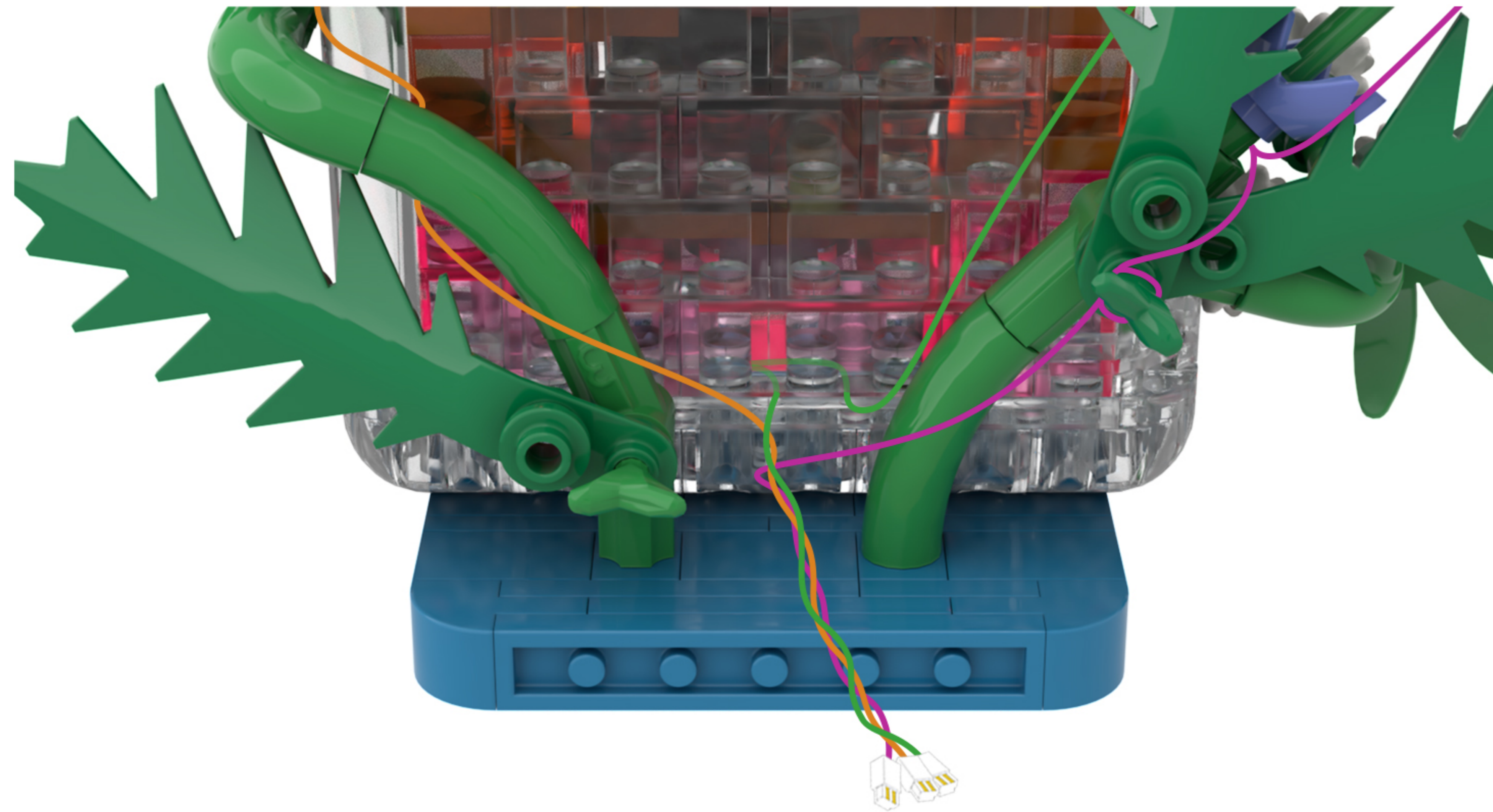

57

EN: Remove the expansion board from Bag 2.

DE: Entnehmen Sie die Erweiterungskarte aus Beutel 2.

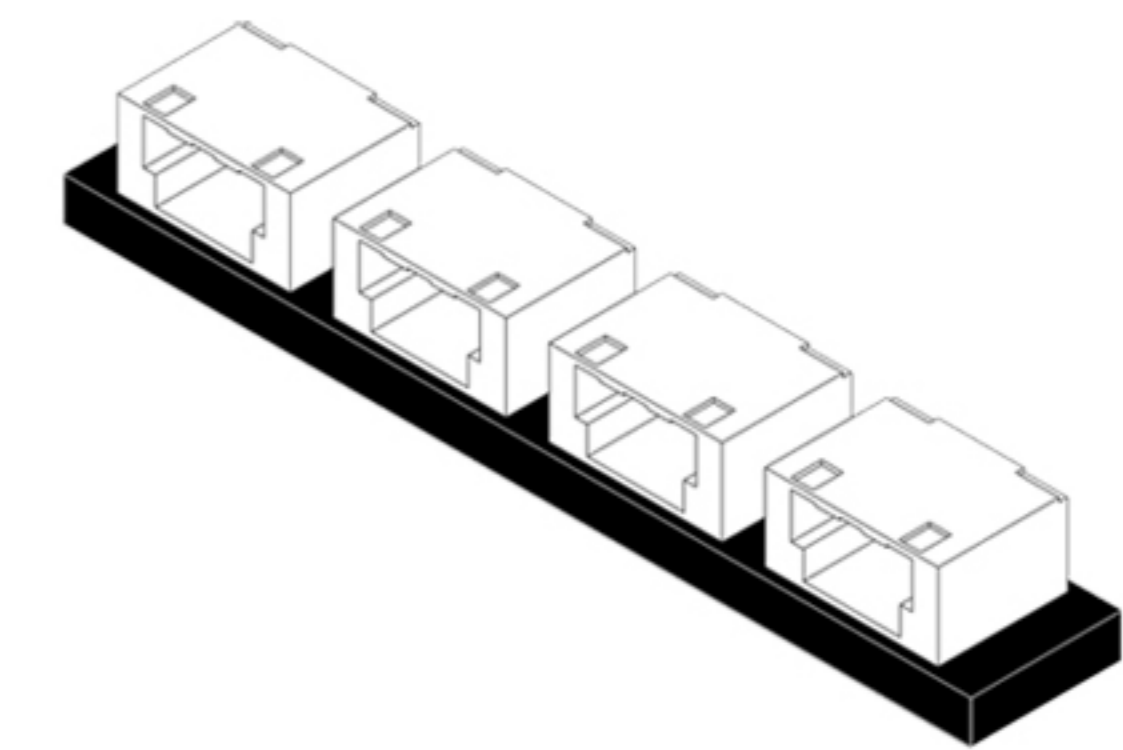

x1

58

EN: Take the USB power cable out of the box and connect it to the expansion board.

DE: Nehmen Sie das USB-Stromkabel aus der Verpackung und schließen Sie es an die Erweiterungskarte an.

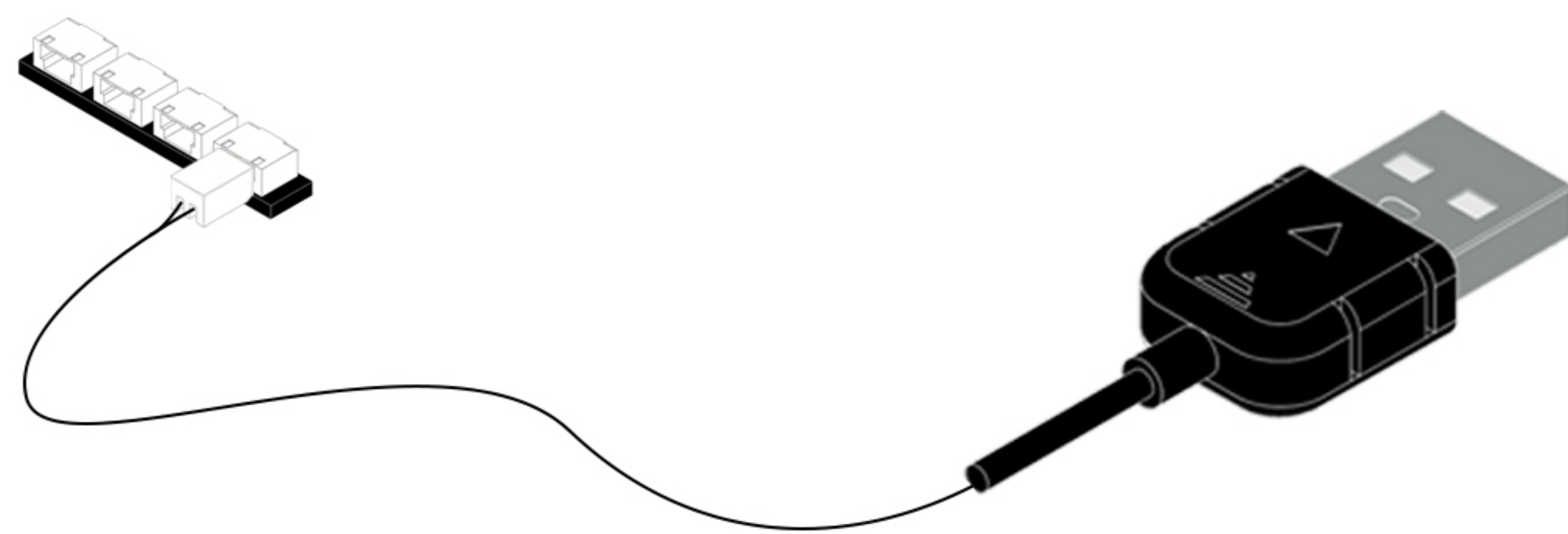
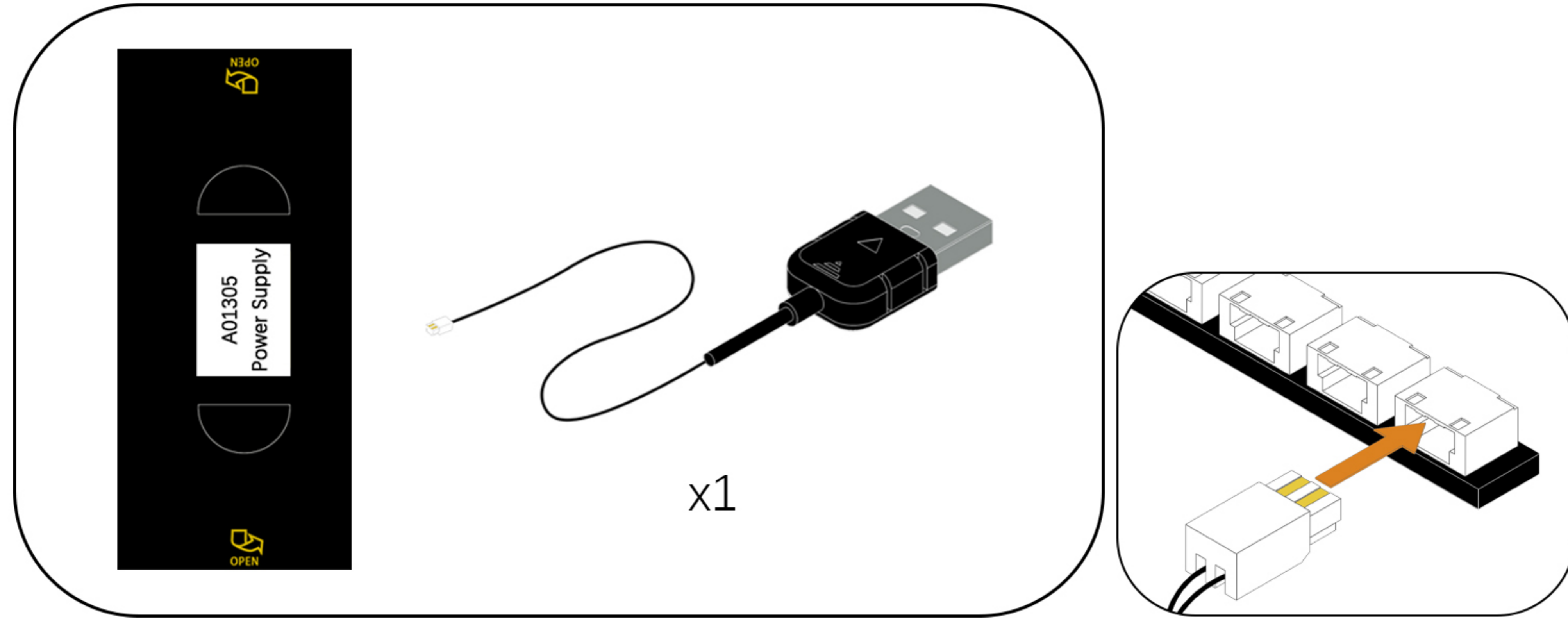

59

EN: Connect the three light cables to the expansion board in sequence.

DE: Schließen Sie die drei Lichtkabel nacheinander an die Erweiterungskarte an.

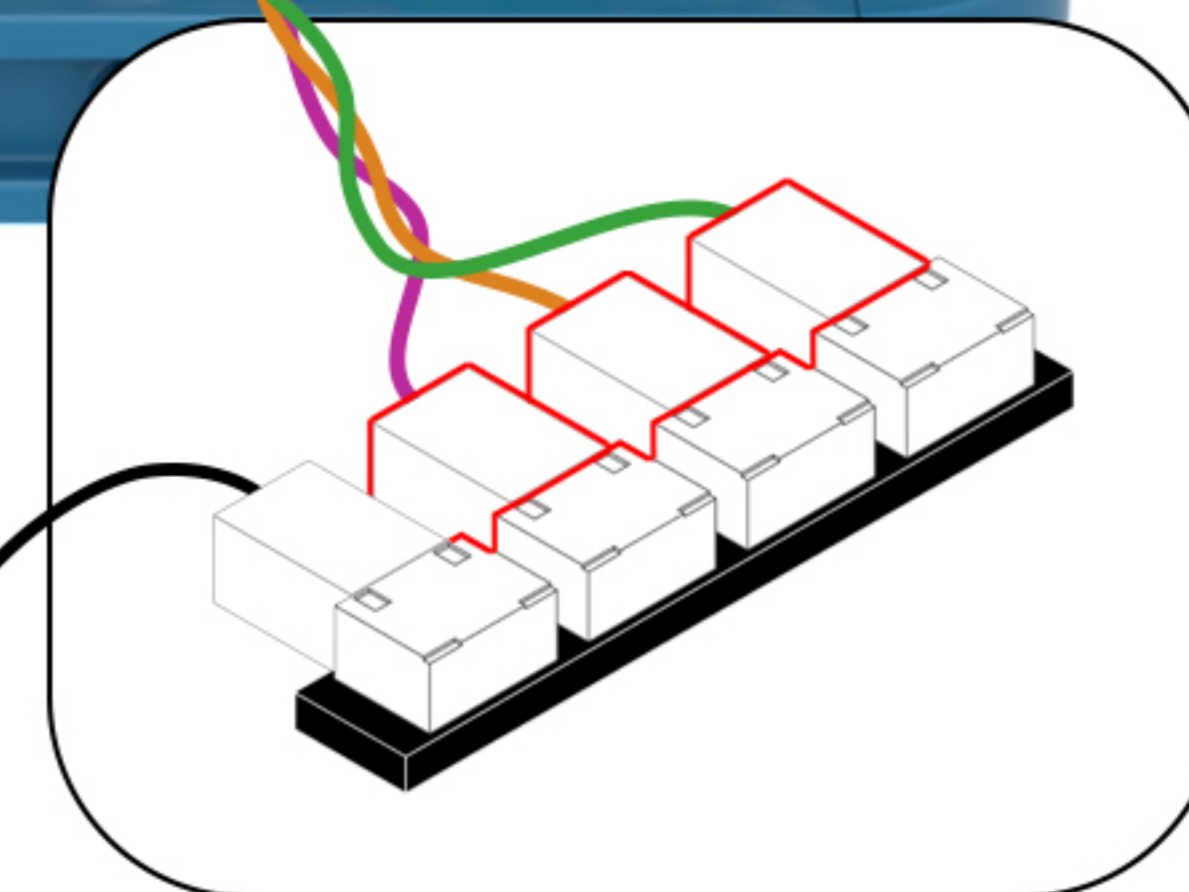
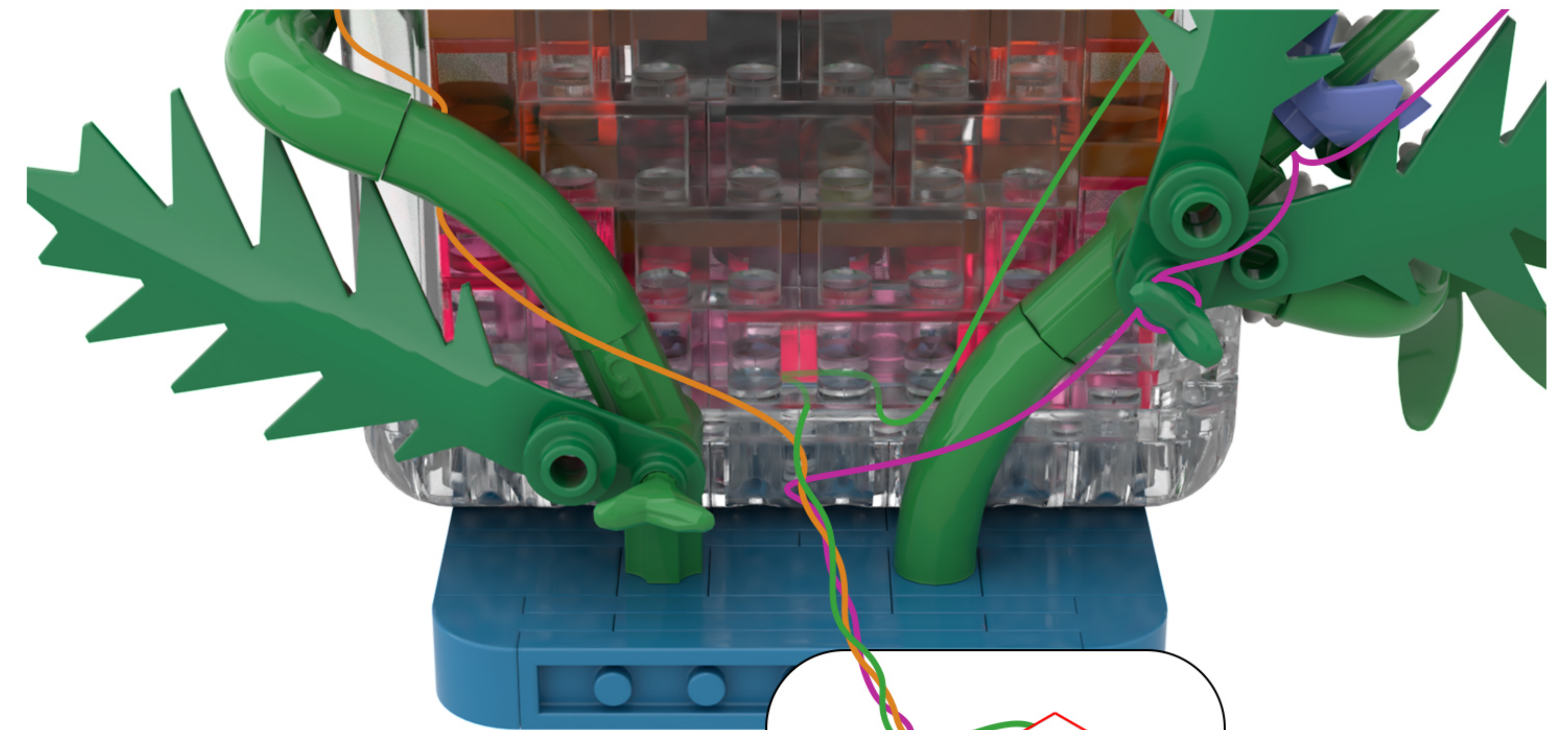
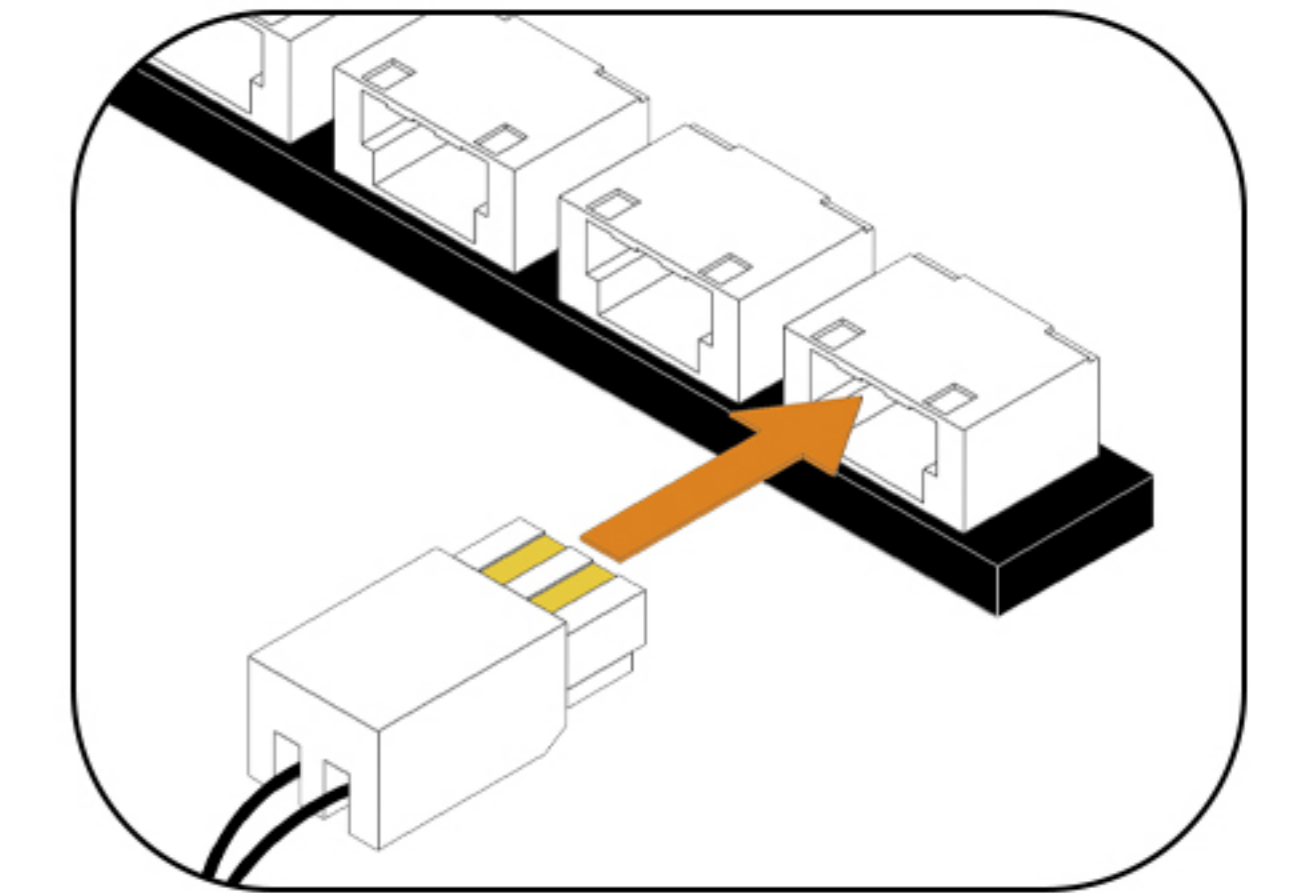

60

EN: Peel off the adhesive backing of the expansion board and attach it to the location shown in the illustration.

DE: Entfernen Sie die Schutzfolie von der Rückseite der Erweiterungsplatte und kleben Sie sie an die in der Abbildung gezeigte Stelle.

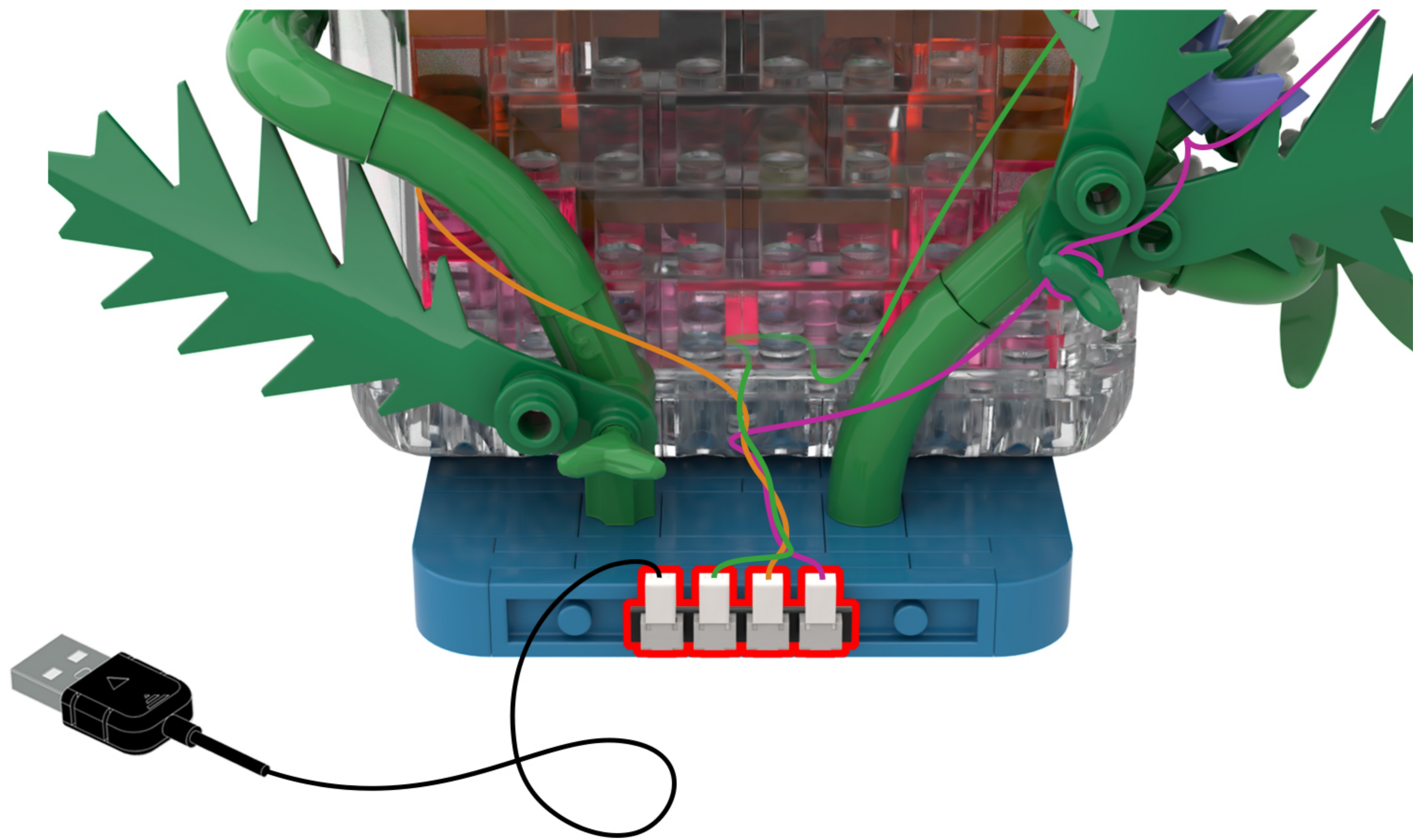

61

EN: Flip the model to restore it to its original state.

DE: Drehen Sie das Modell um, um es in seinen ursprünglichen Zustand zurückzusetzen.



62

EN: Once installed, connect the power supply and give it a try!

DE: Die Installation ist abgeschlossen. Schließen Sie das Gerät an die Stromversorgung an und probieren Sie es aus!





Above our designers to provide the relevant ideas and instructions. But please move to the following:

- 1: about our company this product parts material, product quality do you have comments and suggestions?
- 2: about this product installation instructions and installation of the degree of difficulty do you have views and suggestions?
- 3: if in the operation of the product we provide ideas encountered any problems, please contact us in a timely manner.

Tips

If you encounter any installation problems please contact the seller, we will be happy to help you solve!