

INSTALLATION GUIDE

11511 Water Lilies



LED light kit compatible with Lego

Instructions for installing this kit:

This set includes 4 pouches. (The battery case functions similarly; please select your own power source. This article uses a USB power cable.)

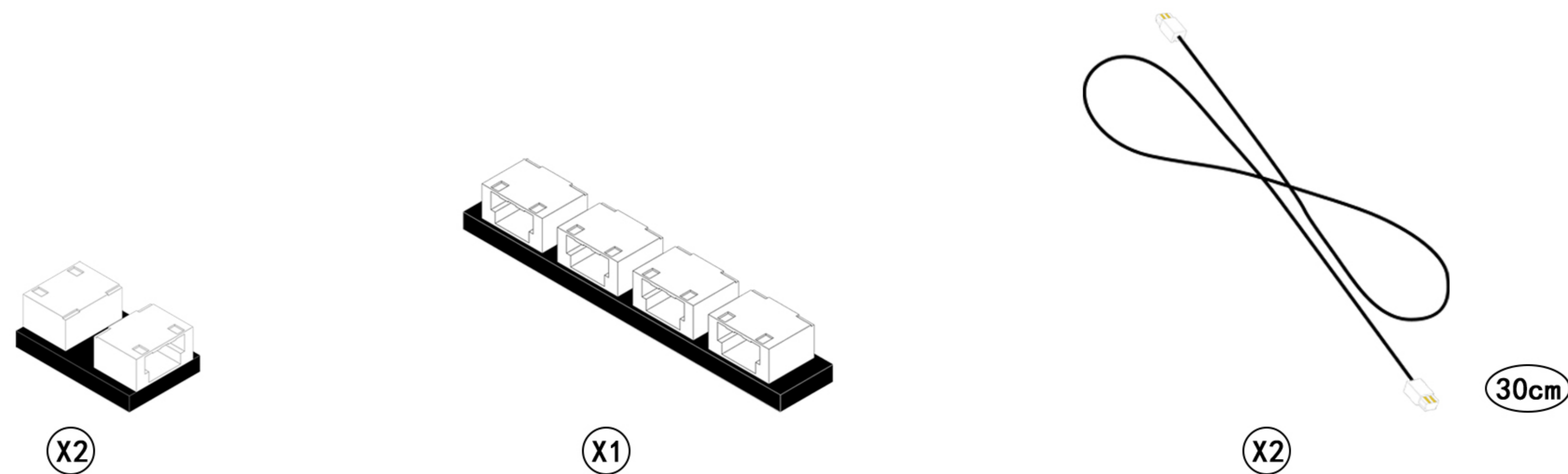
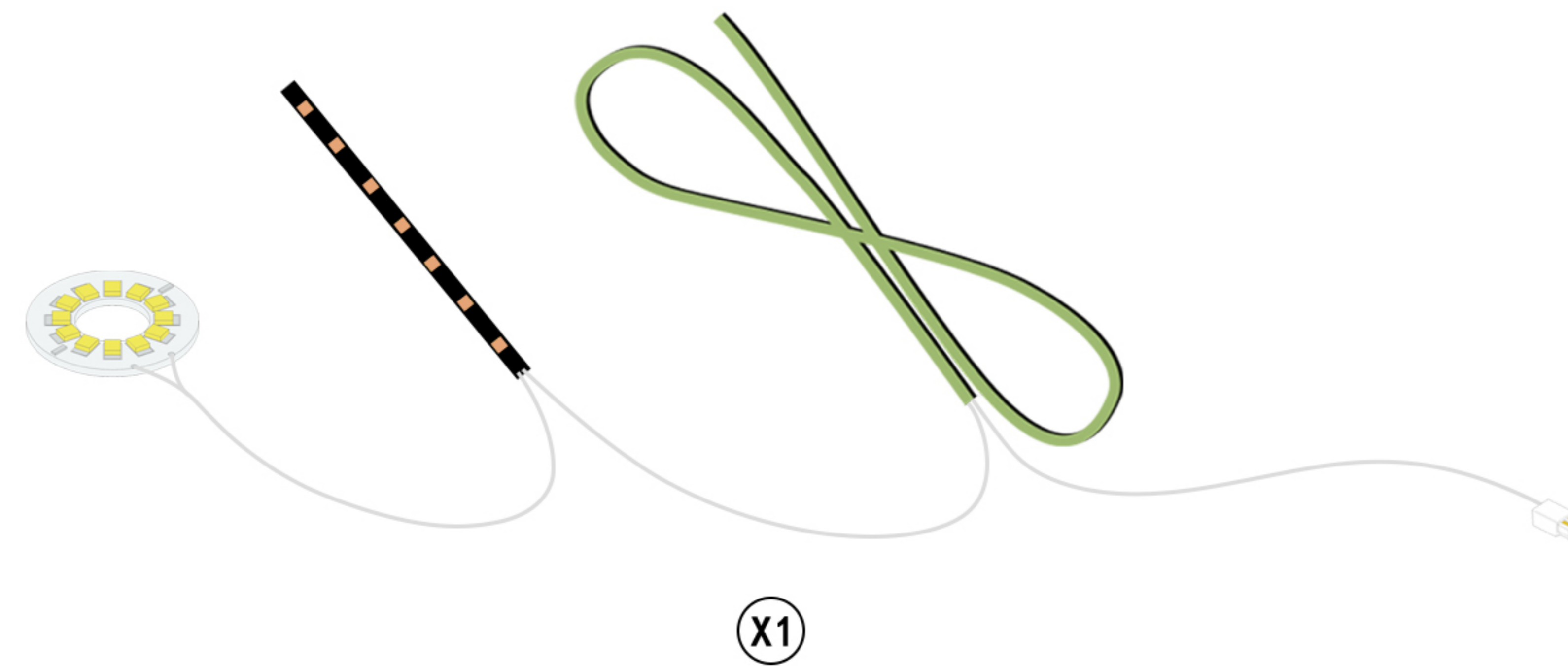
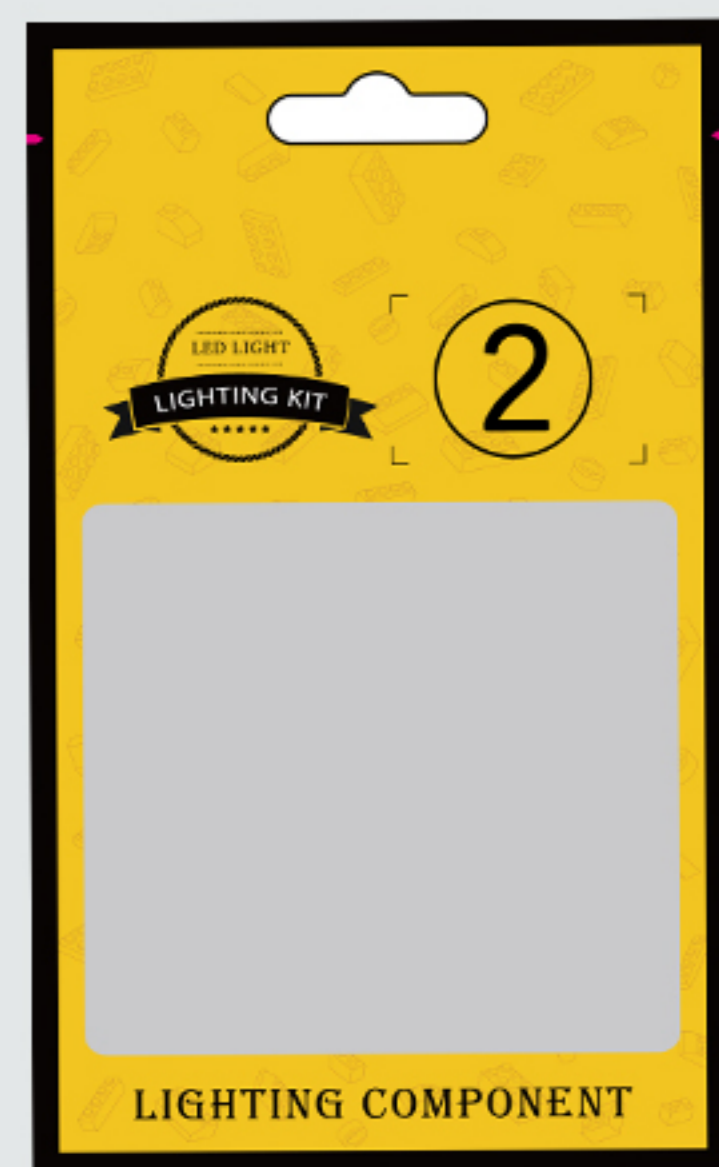
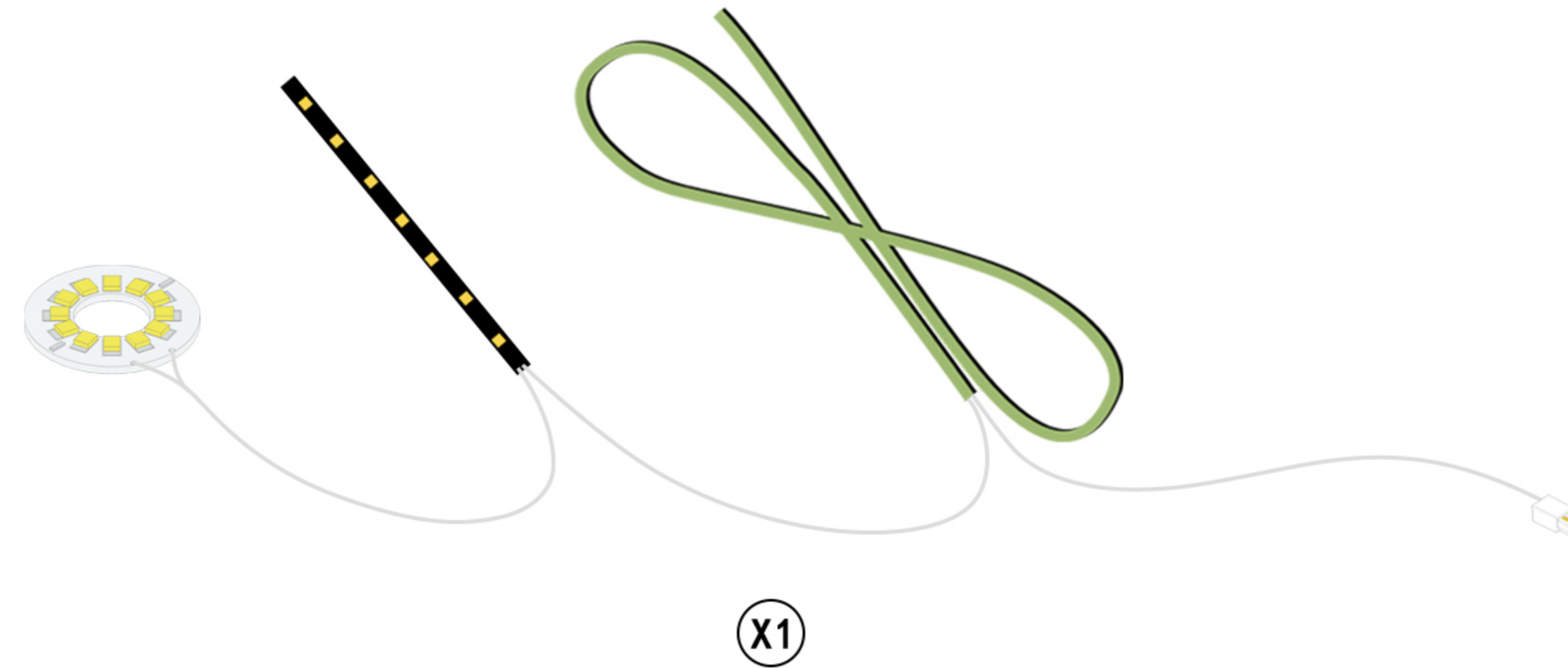
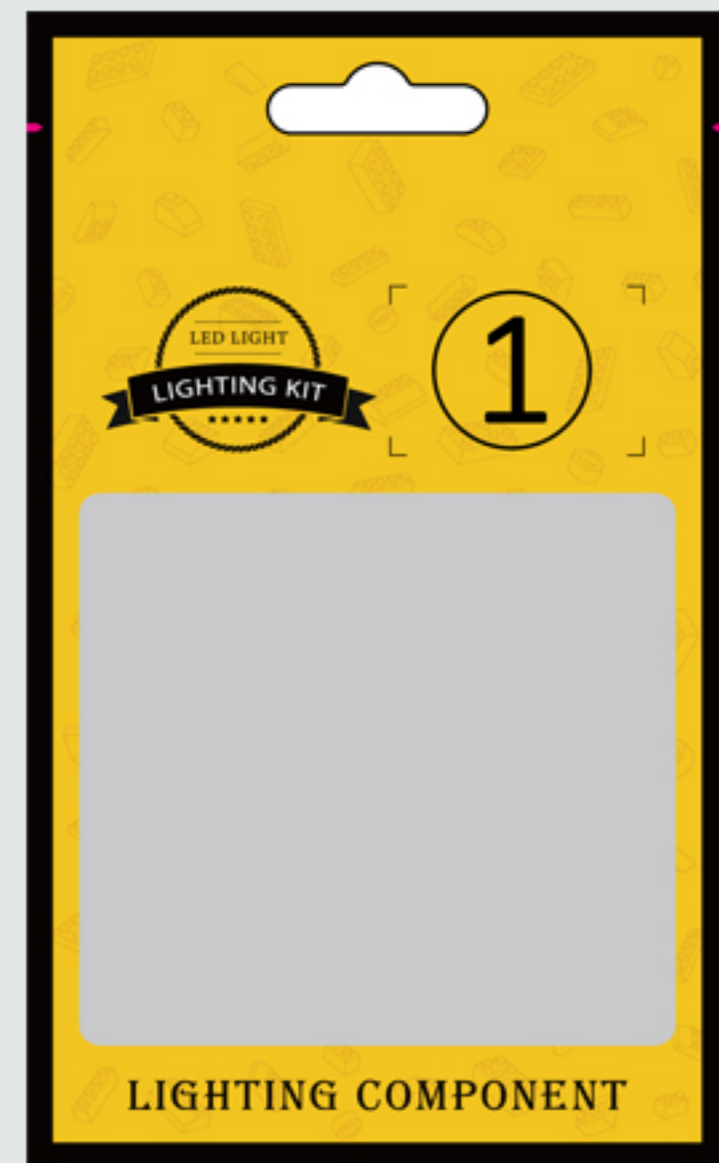

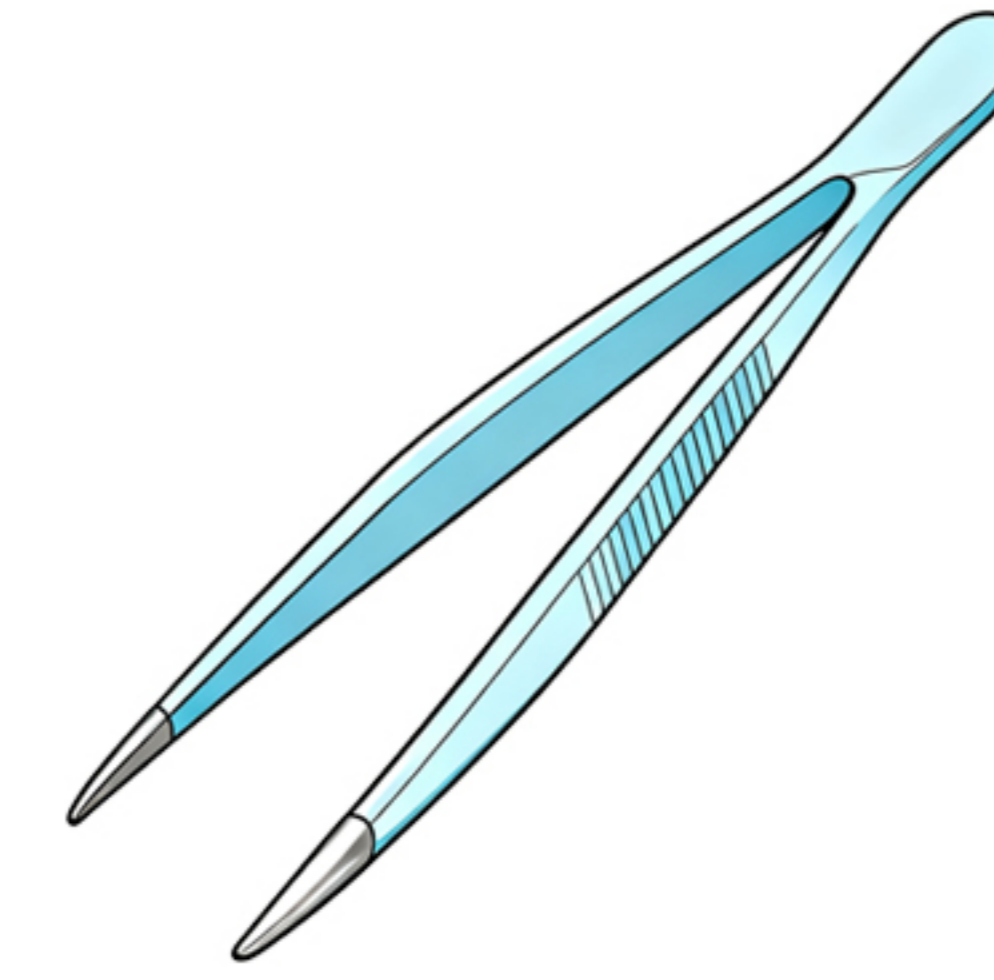
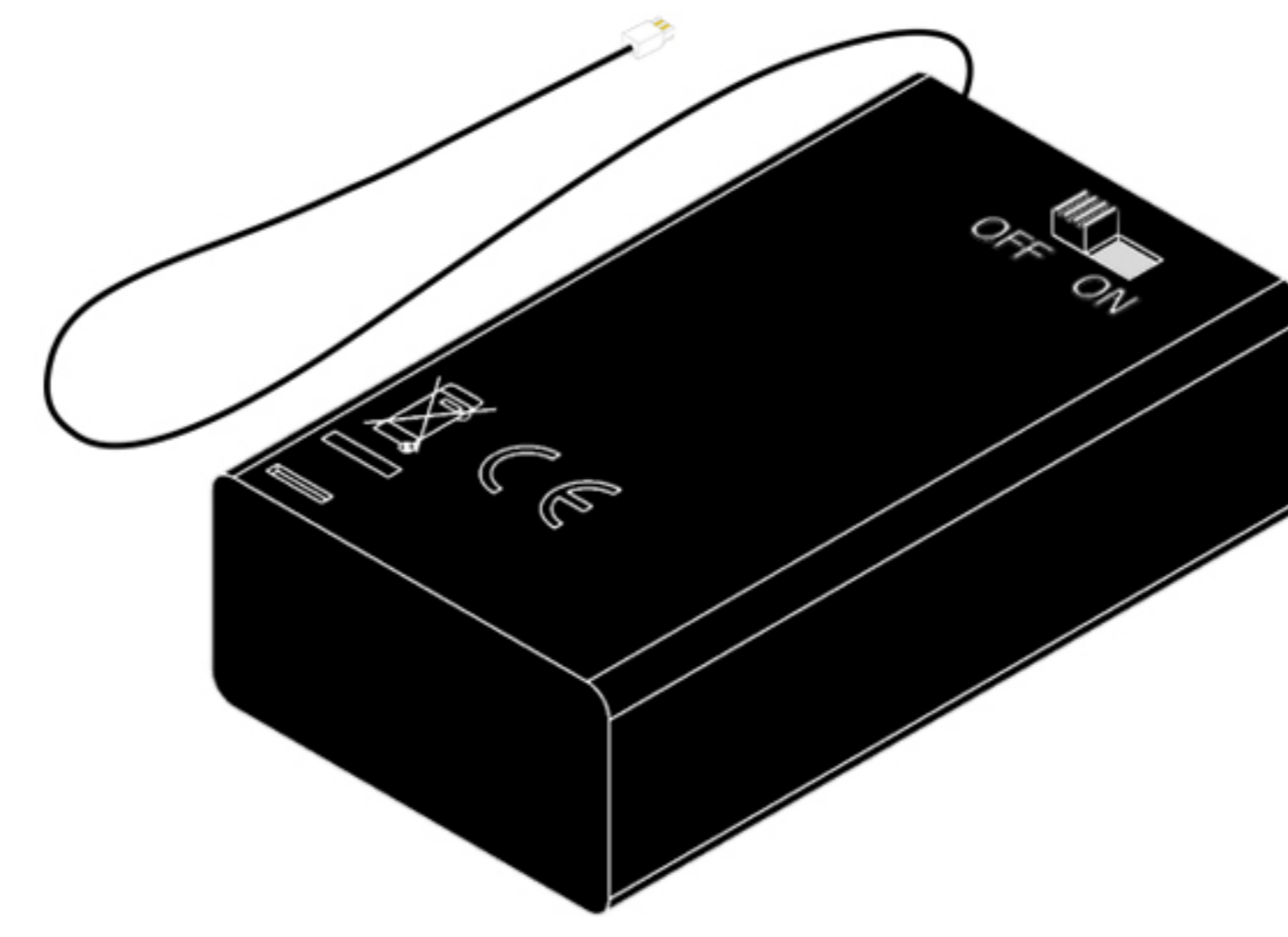
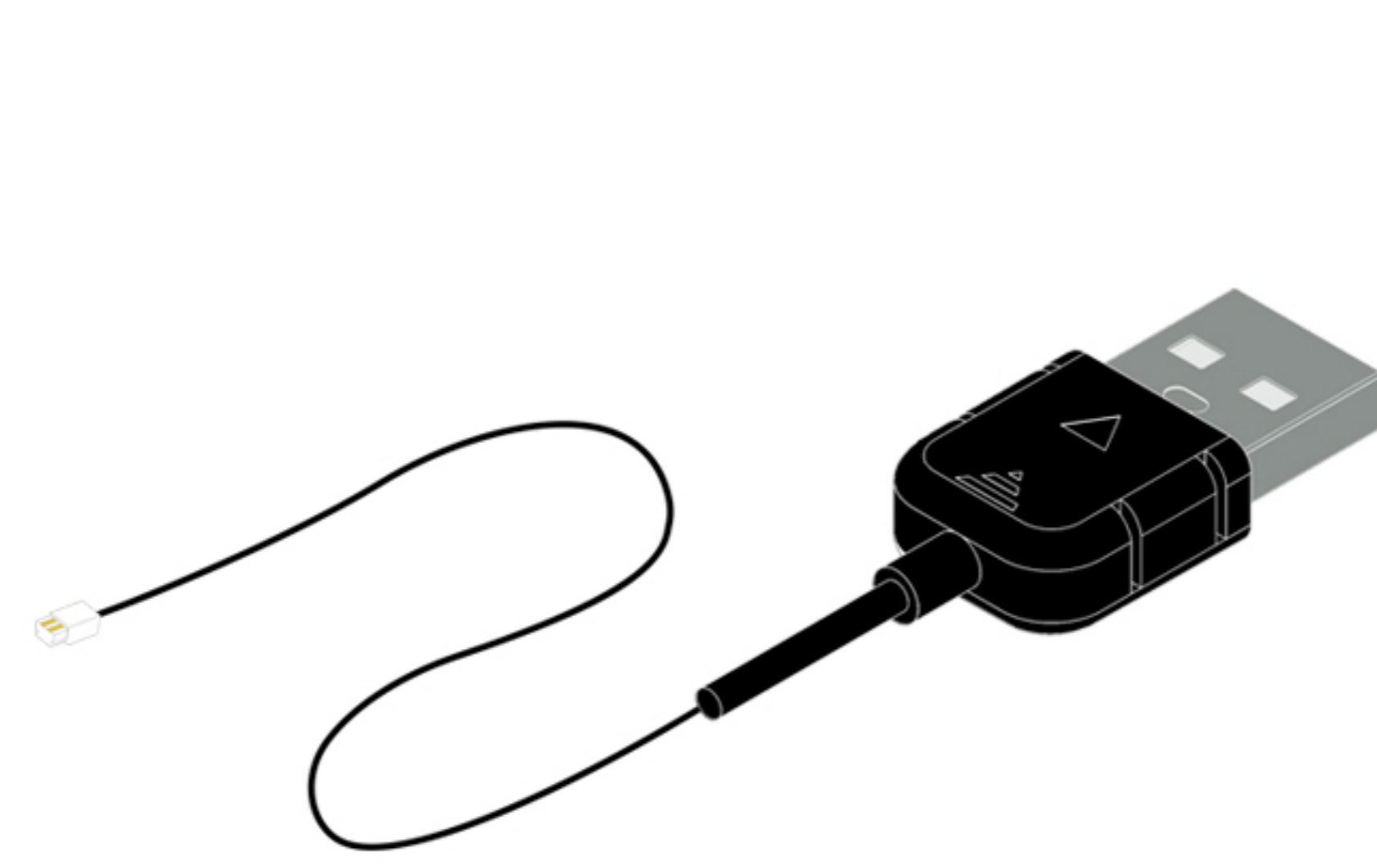
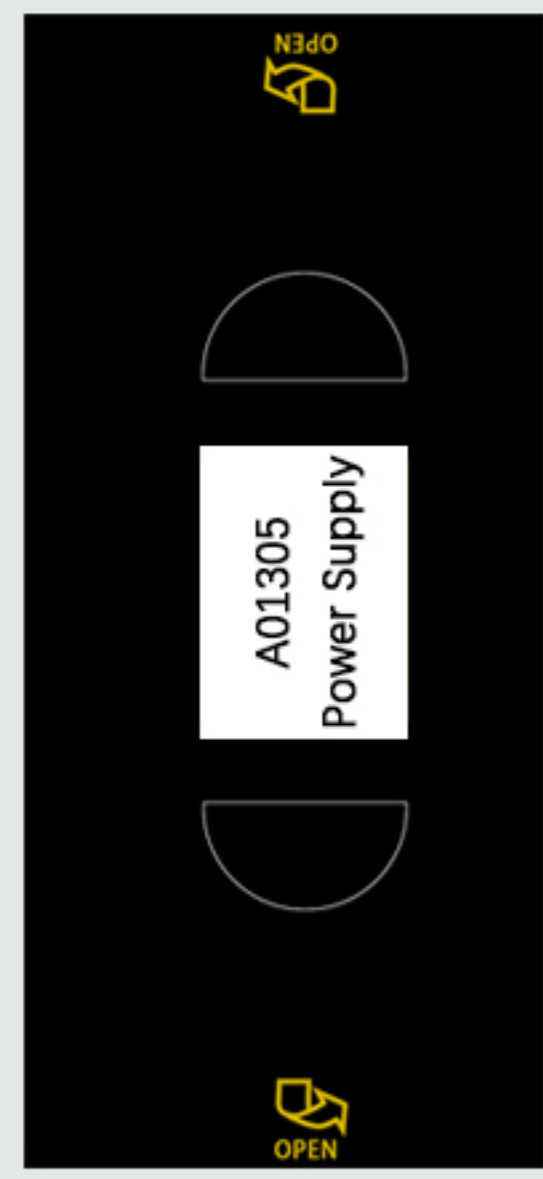

This post will complete the light installation in two main sections.

Step 1-test



Step 2-mounting

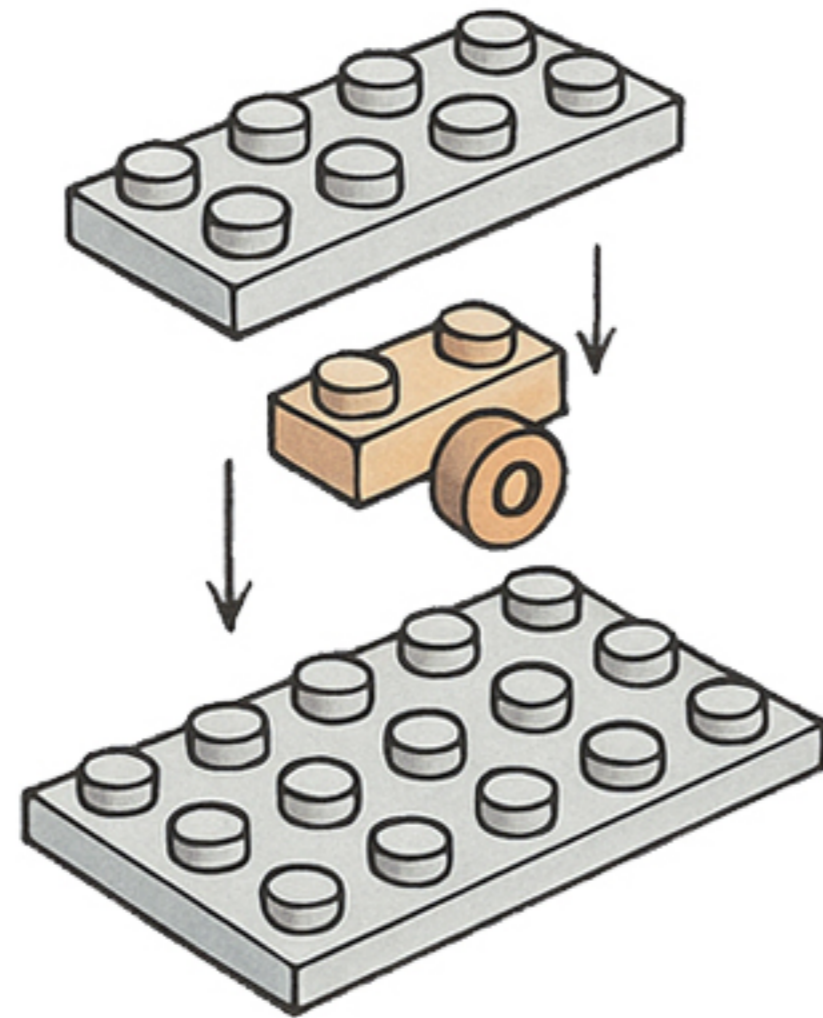

So let's get started!

Step 1-Test.

1

EN: Remove the expansion board from Bag 3.

DE: Entnehmen Sie die Erweiterungskarte aus Beutel 3.

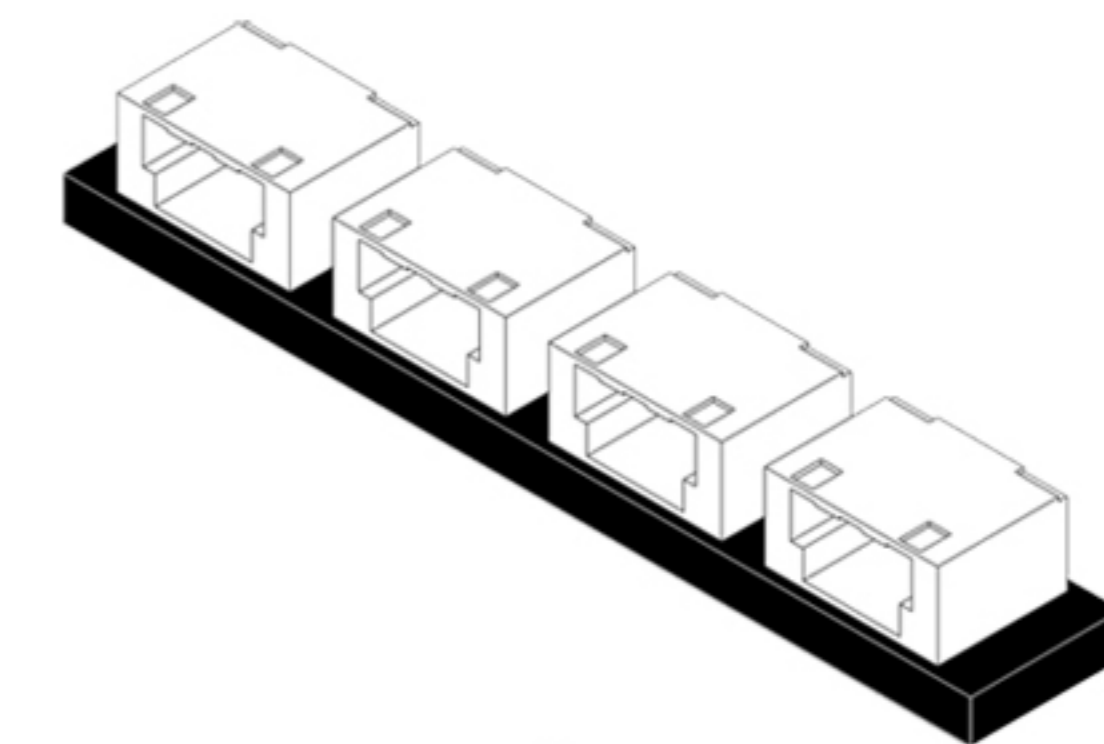

x1

2

EN: Take the USB power cable out of the box and connect it to the expansion board.

DE: Nehmen Sie das USB-Stromkabel aus der Verpackung und schließen Sie es an die Erweiterungskarte an.

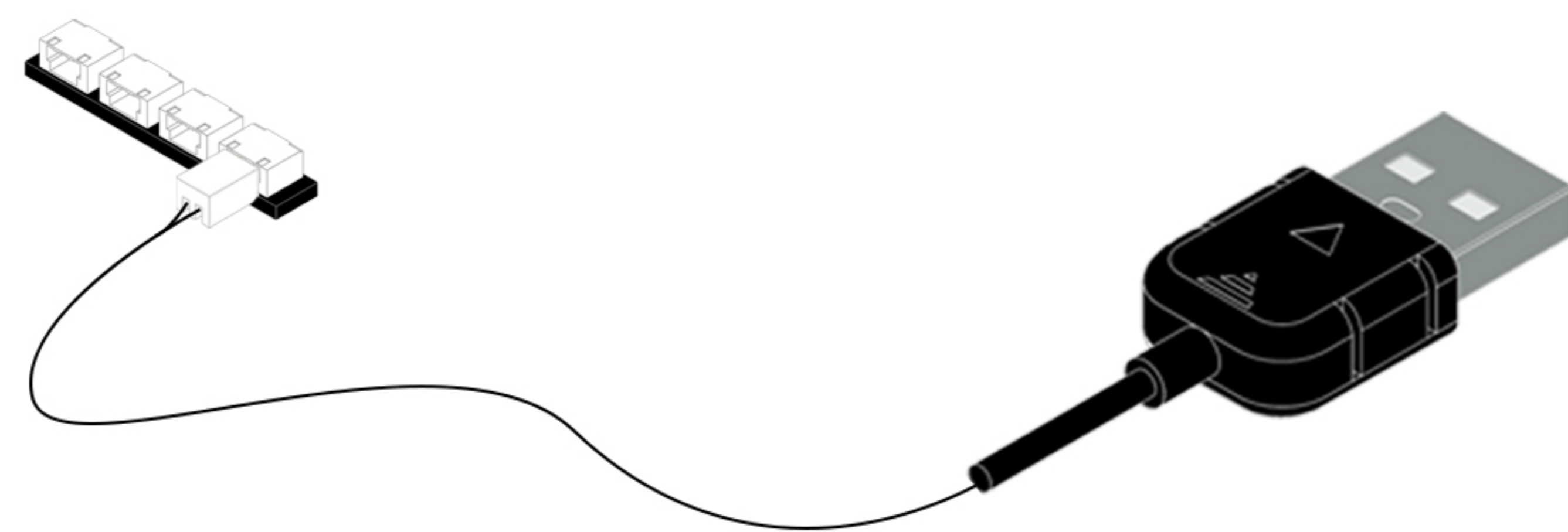
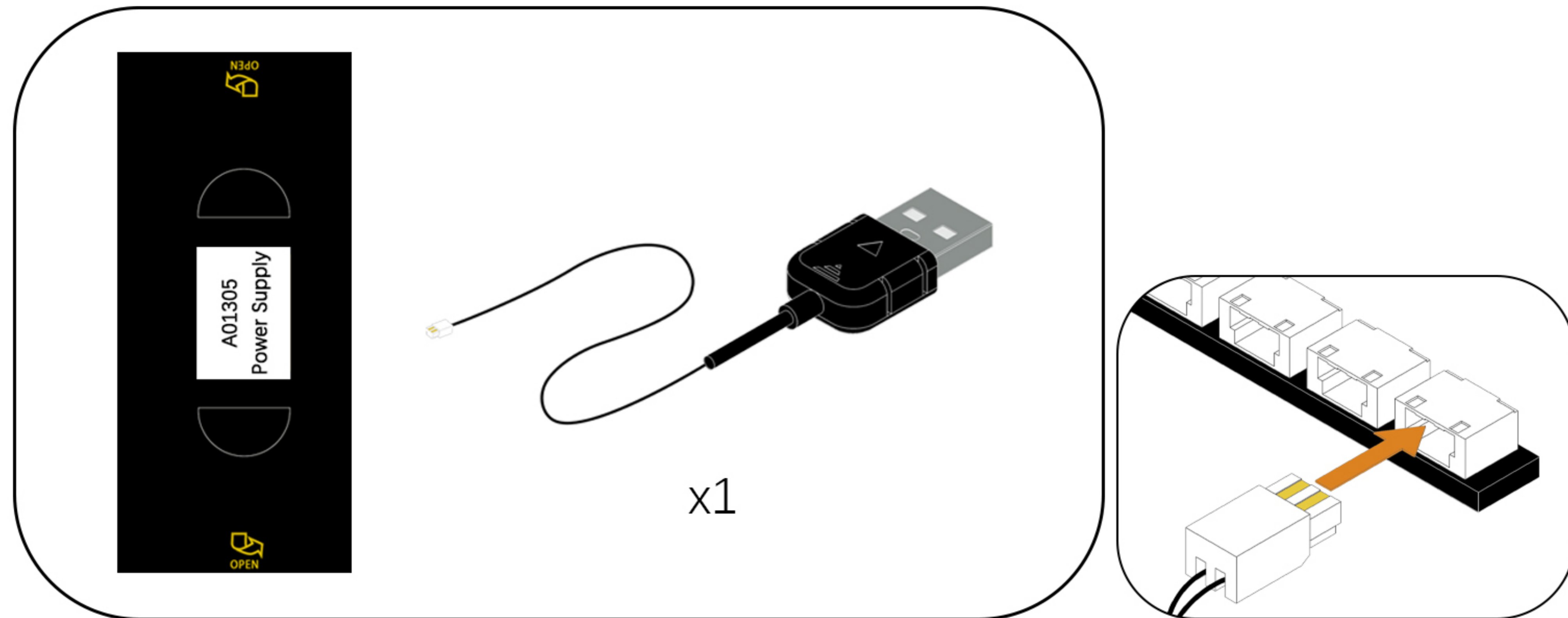

3

EN: Connect the USB power cable to the mobile power supply. (Power supply not included; see the diagram below for power supply options.)

DE: Schließen Sie das USB-Netz-kabel an die mobile Stromversorgung an. (Stromversorgung nicht im Lieferumfang enthalten, siehe Abbildung unten für die Stromversorgungsart.)

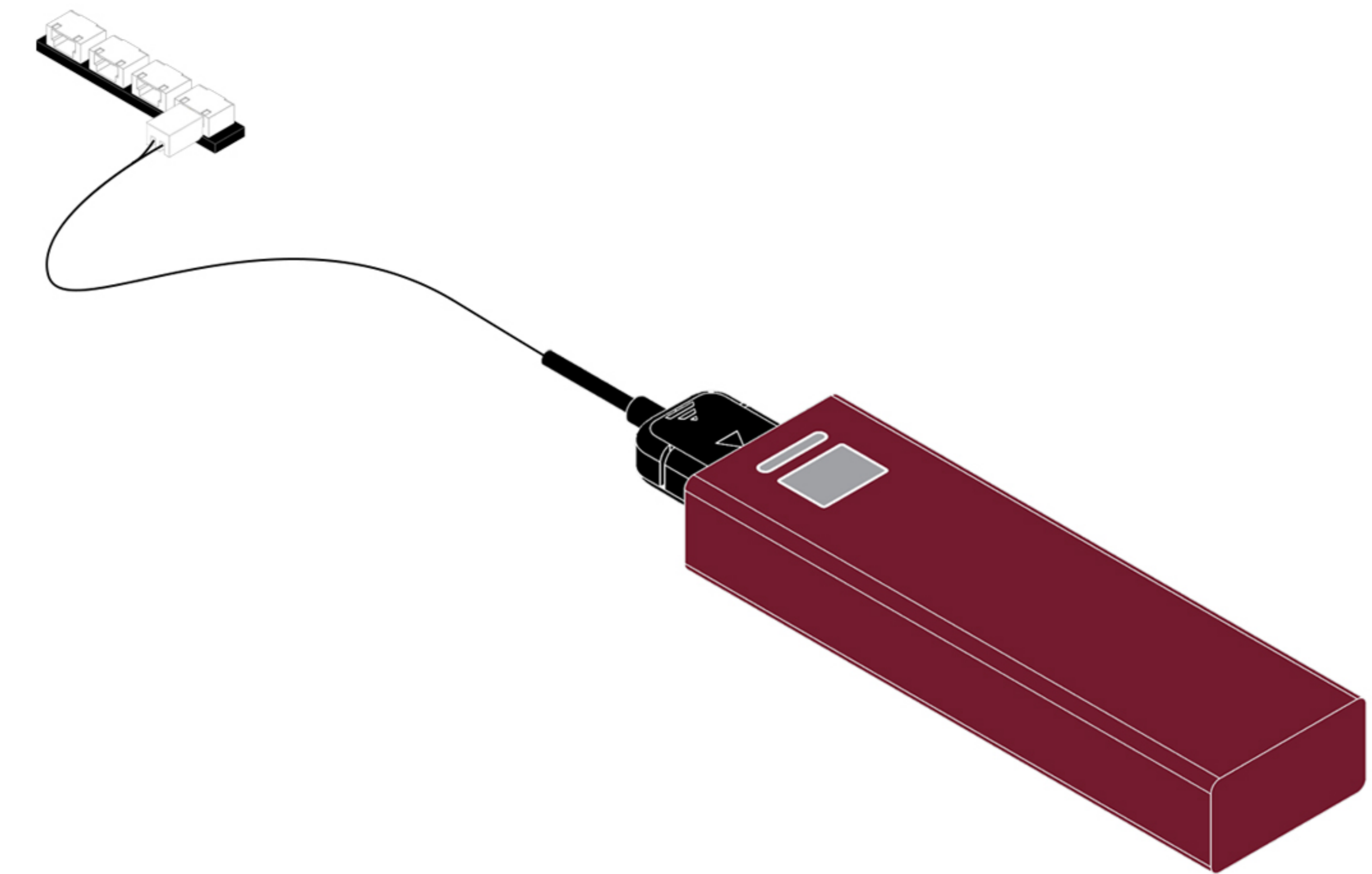

USB Connectors to Connect Devices

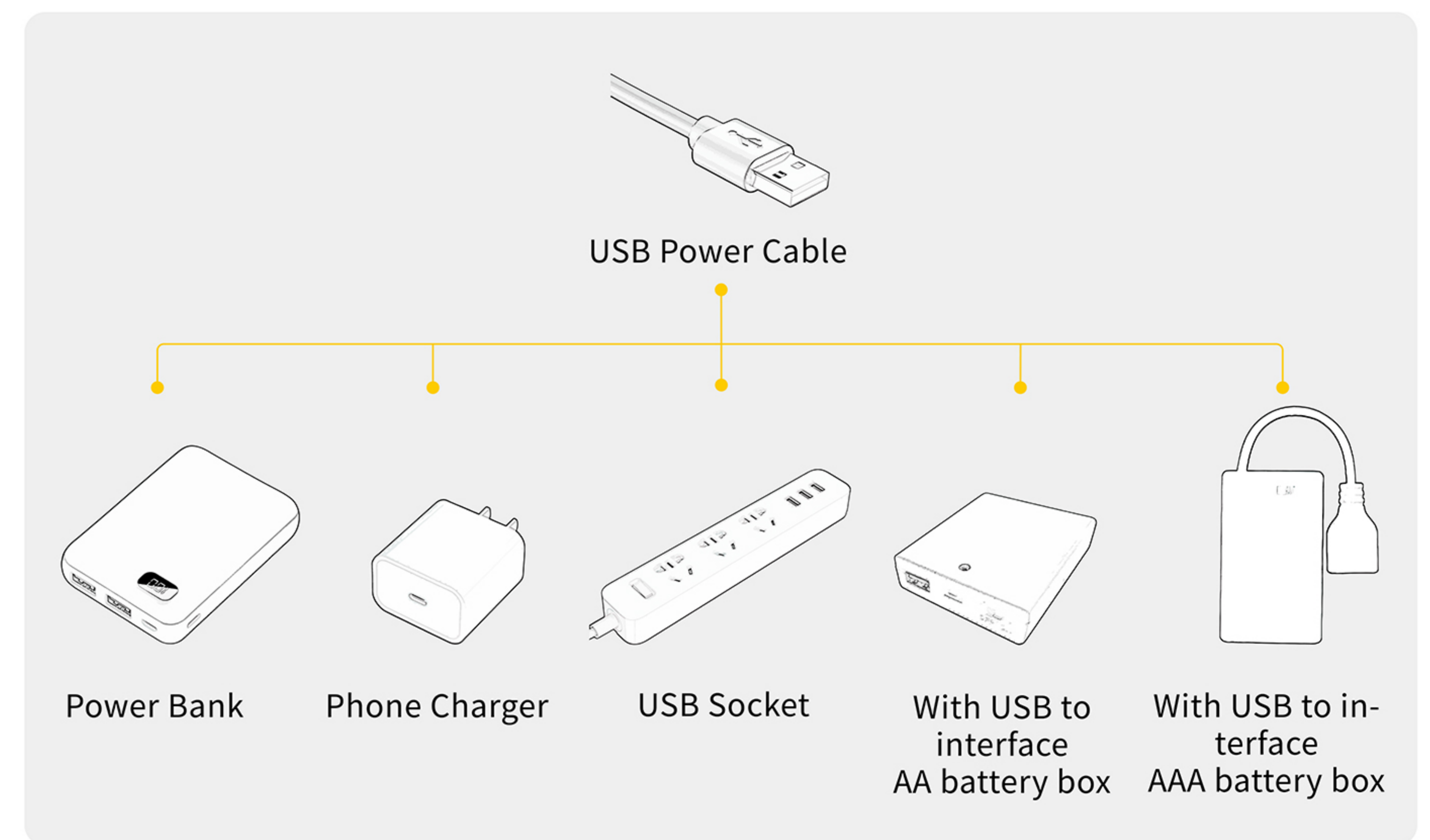

4

EN: Remove the string of lights from Bag 1, connect it to the expansion board, turn on the power, and check that the lights are working properly. If you notice any issues, please contact us immediately.

DE: Nehmen Sie die Lichterkette aus Beutel 1, schließen Sie sie an die Erweiterungskarte an, schalten Sie den Strom ein und überprüfen Sie, ob die Lichter ordnungsgemäß funktionieren. Sollten Sie Probleme feststellen, kontaktieren Sie uns bitte umgehend.

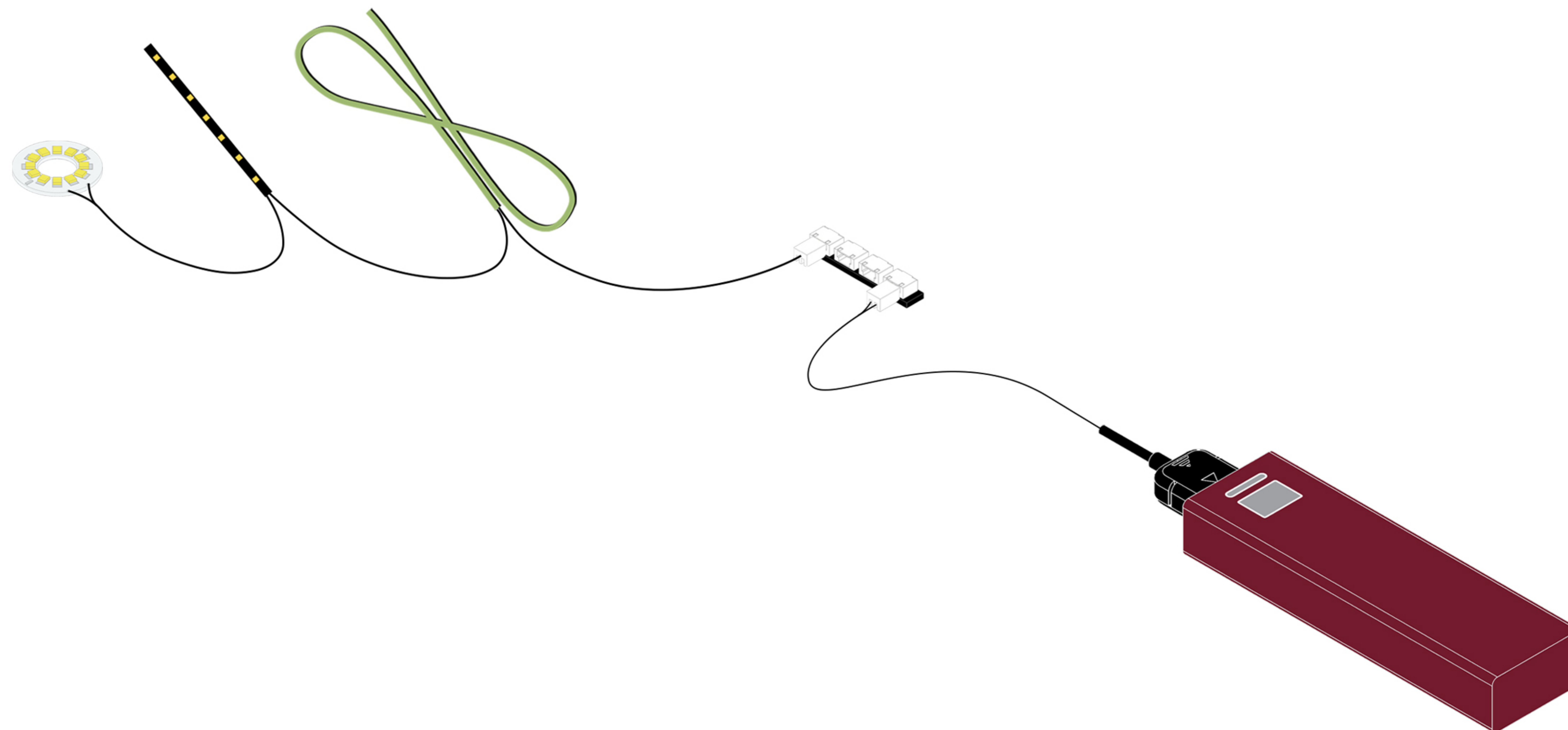
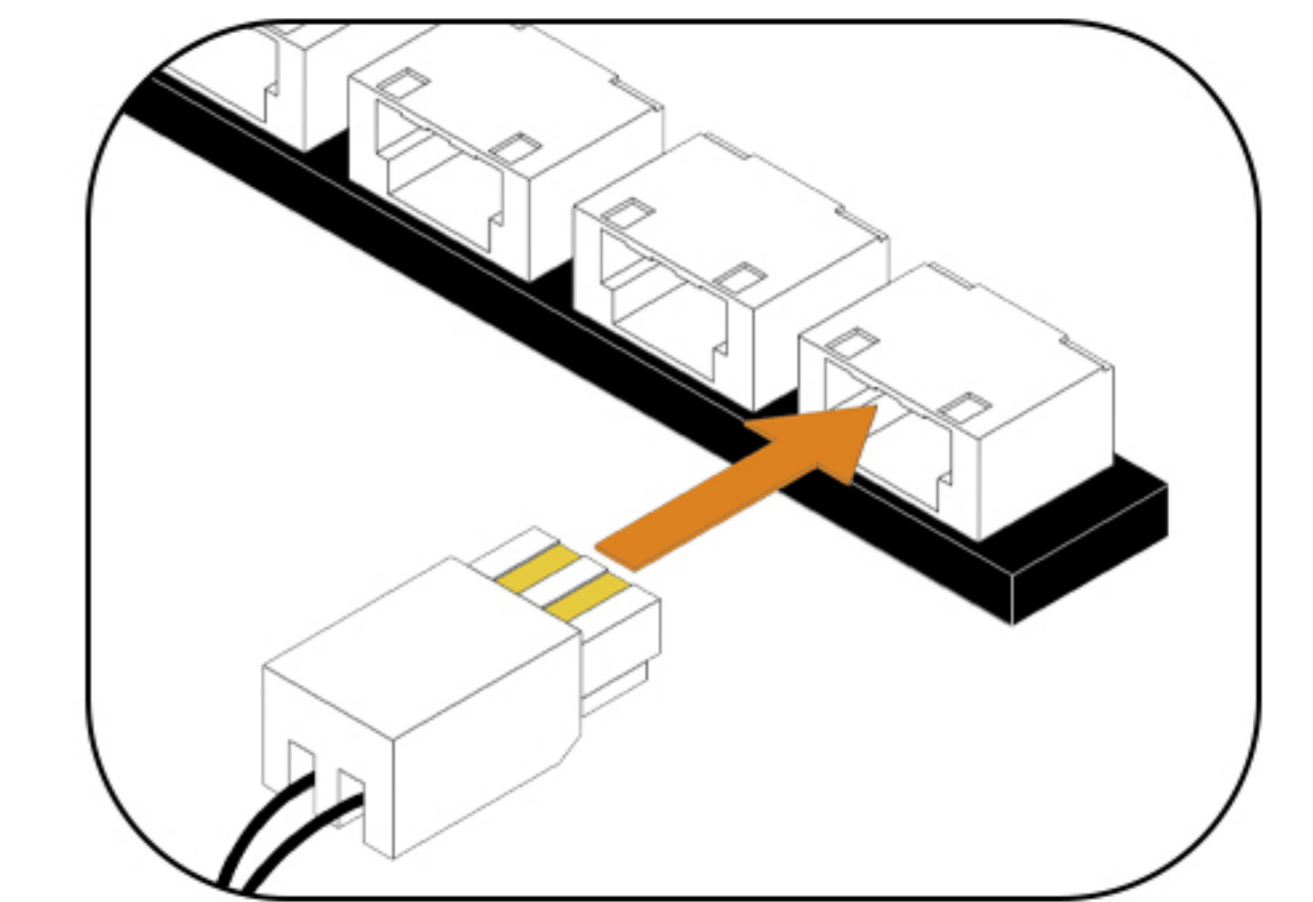
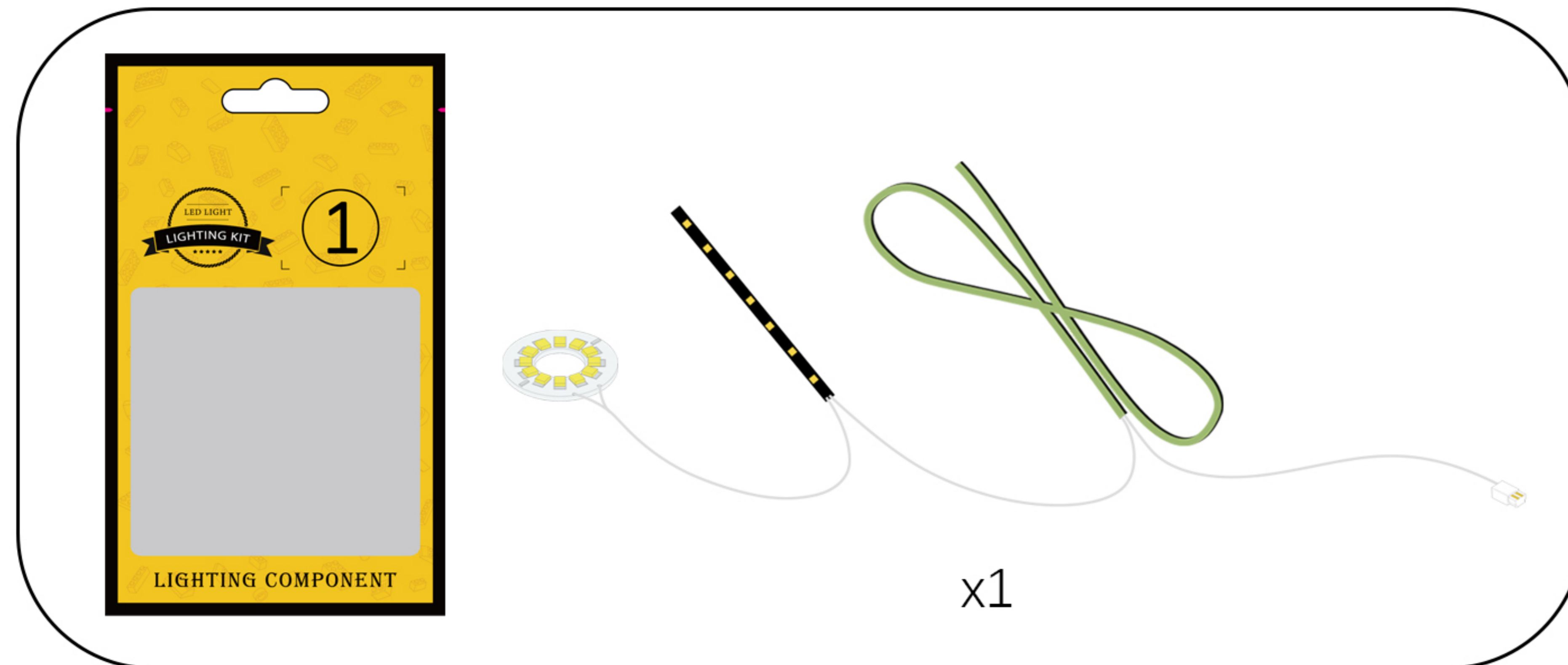

After confirming that there are no abnormalities, temporarily return each part to its original bag.

Step 2-Mounting.

1

EN: Take out the building block model.

DE: Nimm das Bauklotzmodell heraus.



2

EN: Take out the building blocks shown in the picture and take them apart.

DE: Nimm die auf dem Bild gezeigten Bausteine heraus und nimm sie auseinander.

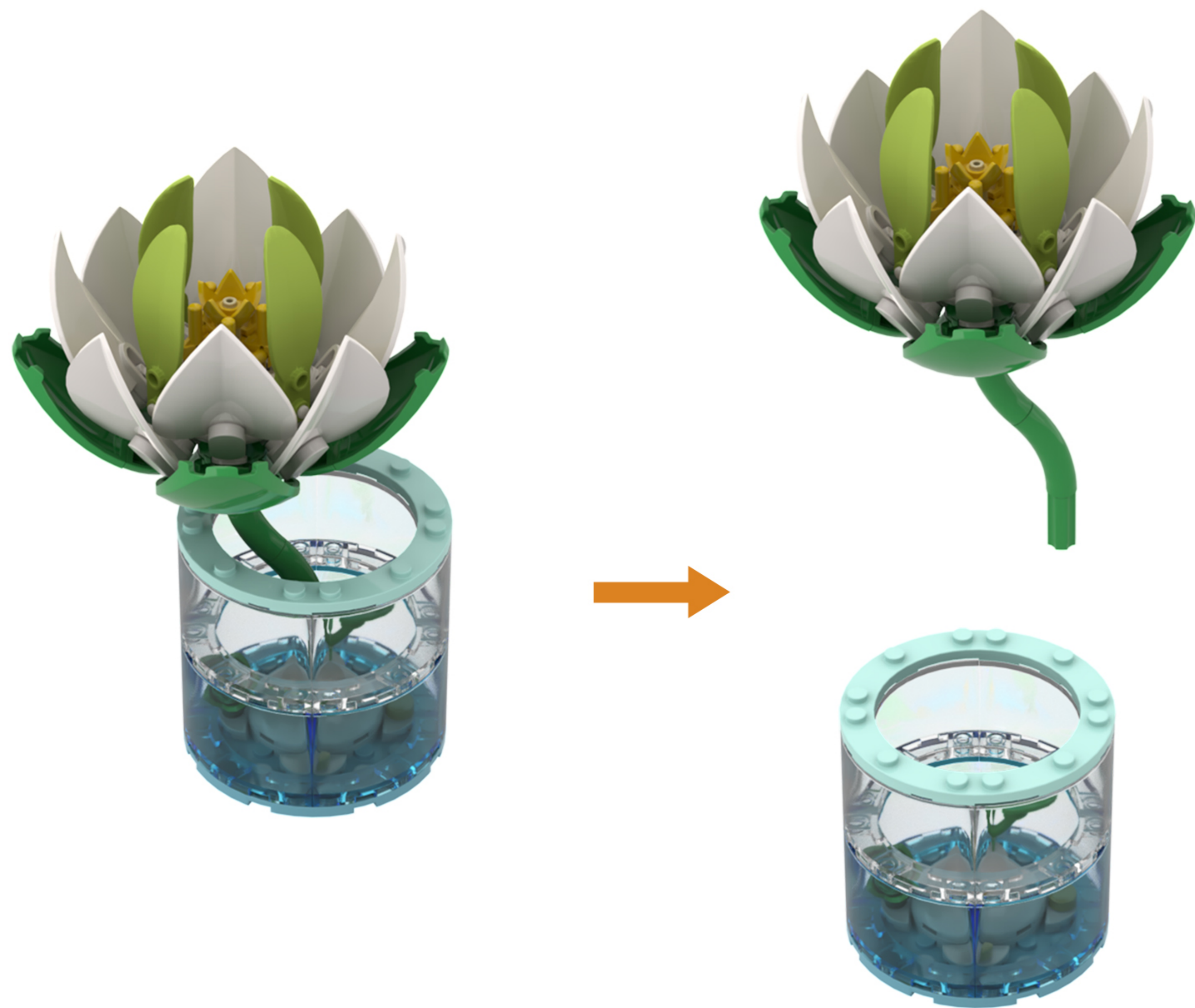
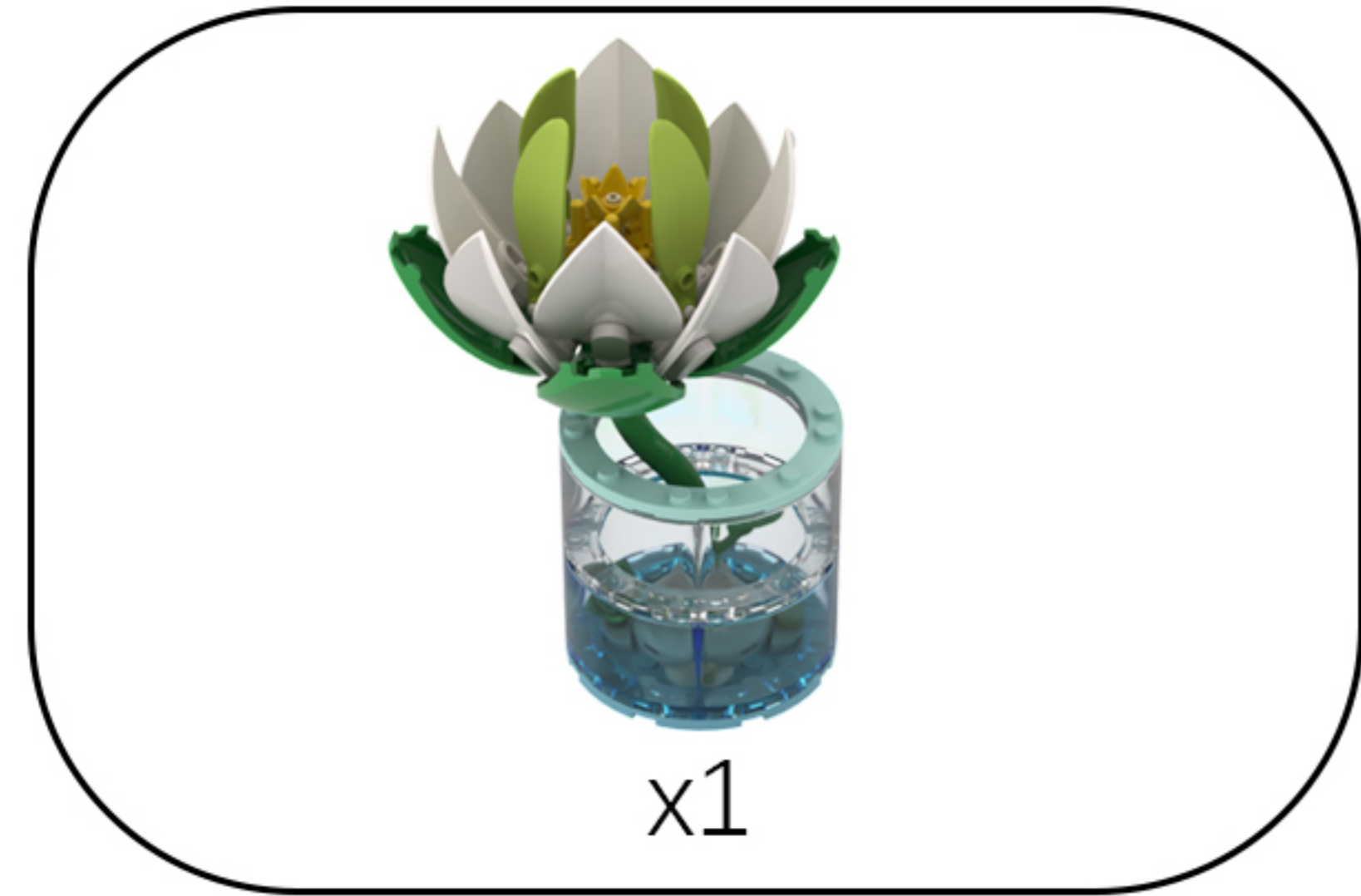

3

EN: Take out the disassembled building blocks and separate them.

DE: Nehmen Sie die zerlegten Bausteine heraus und trennen Sie sie voneinander.

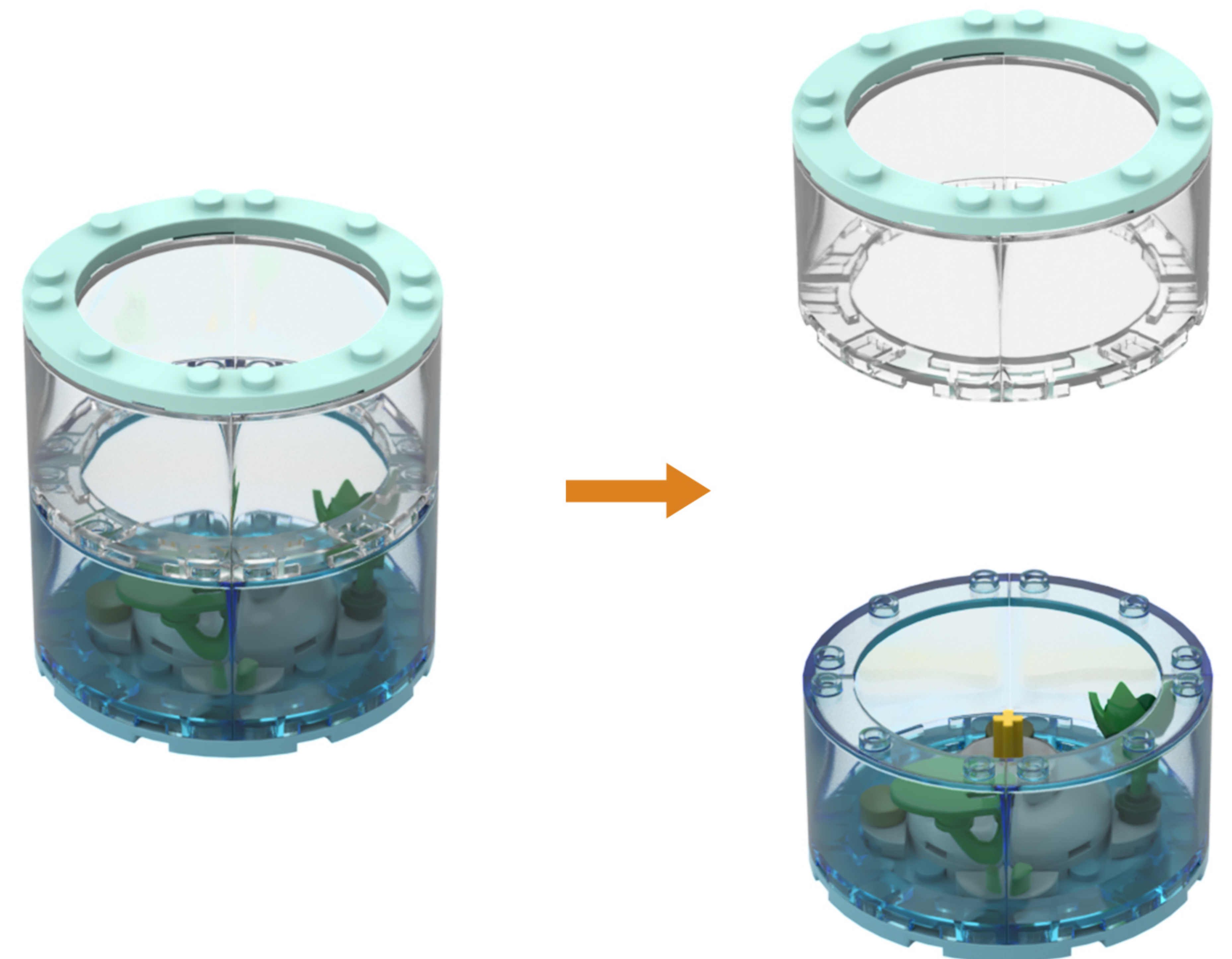
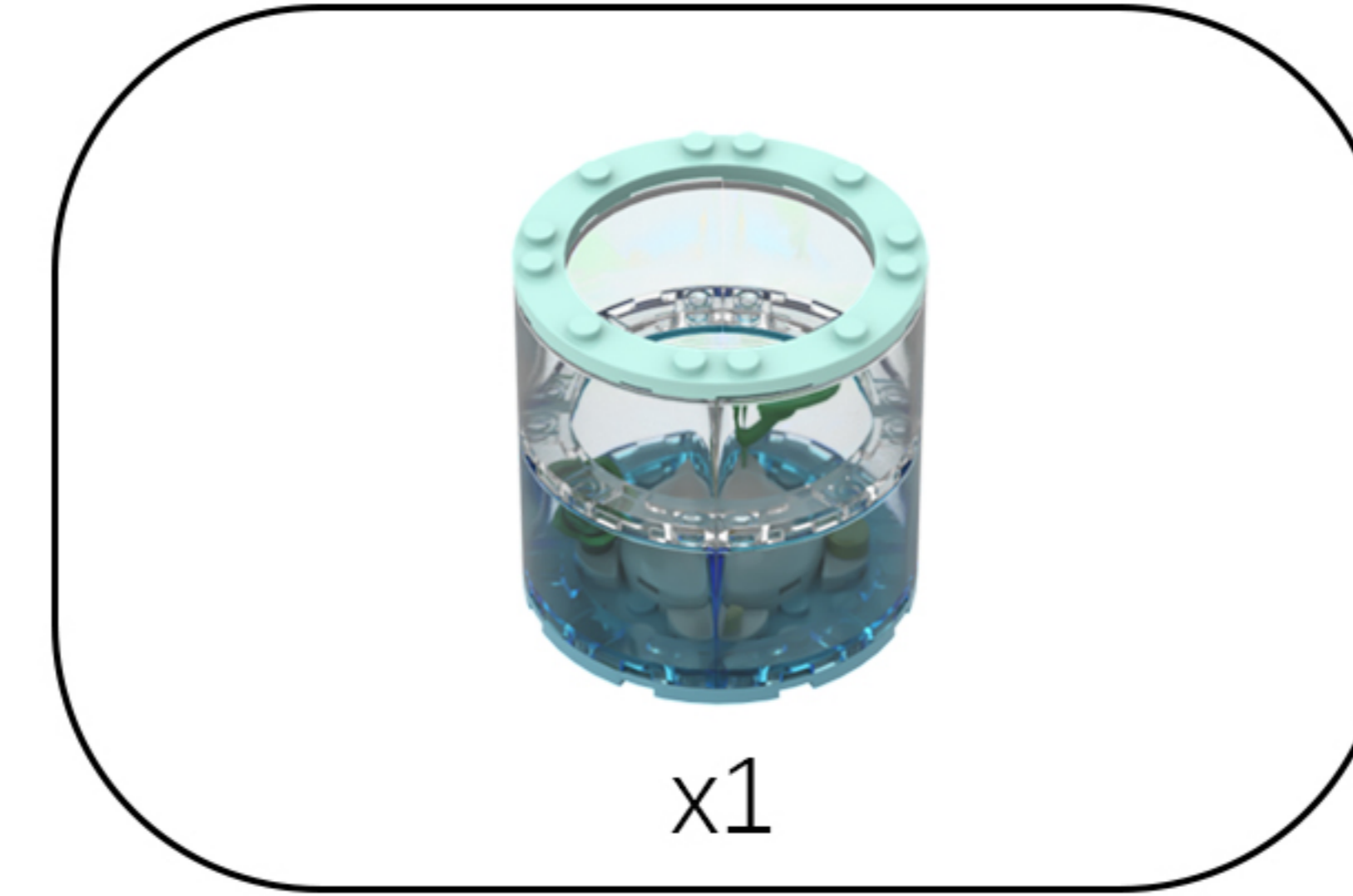

4

EN: Take the string of lights out of Bag 1, untie the zip tie, and locate the lights on the string.

DE: Nimm die Lichterkette aus Beutel 1, löse den Kabelbinder und suche die Lichter an der Kette.

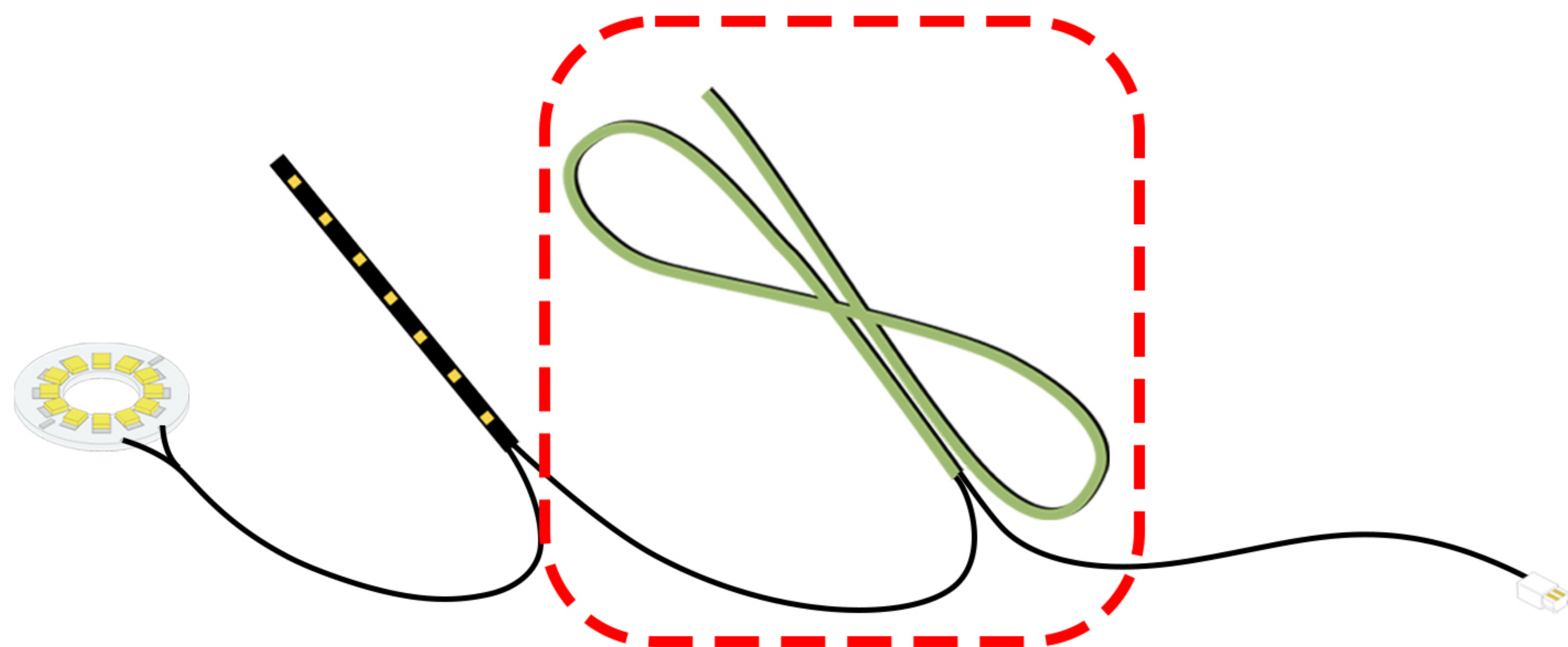
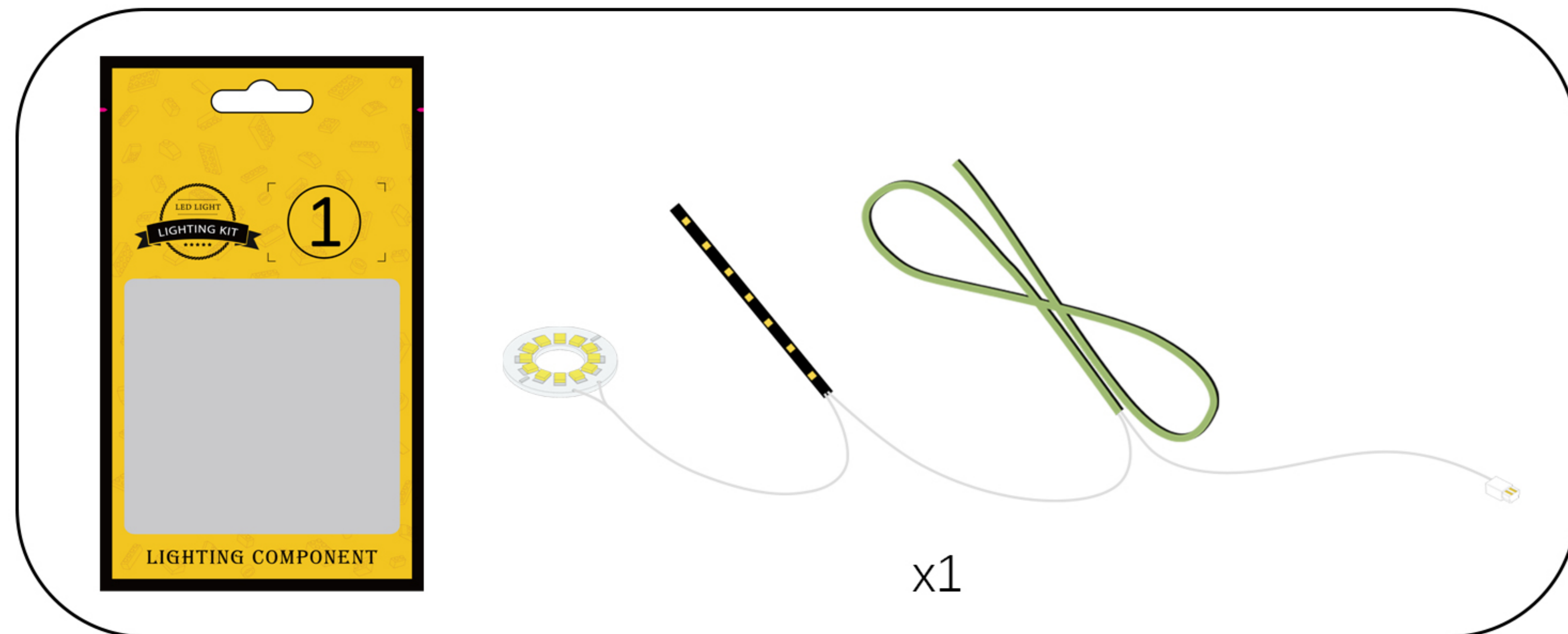

5

EN: Peel off the adhesive backing of the light fixture and attach it to the indicated location.

DE: Ziehen Sie die Klebefolie von der Leuchte ab und befestigen Sie sie an der angegebenen Stelle.

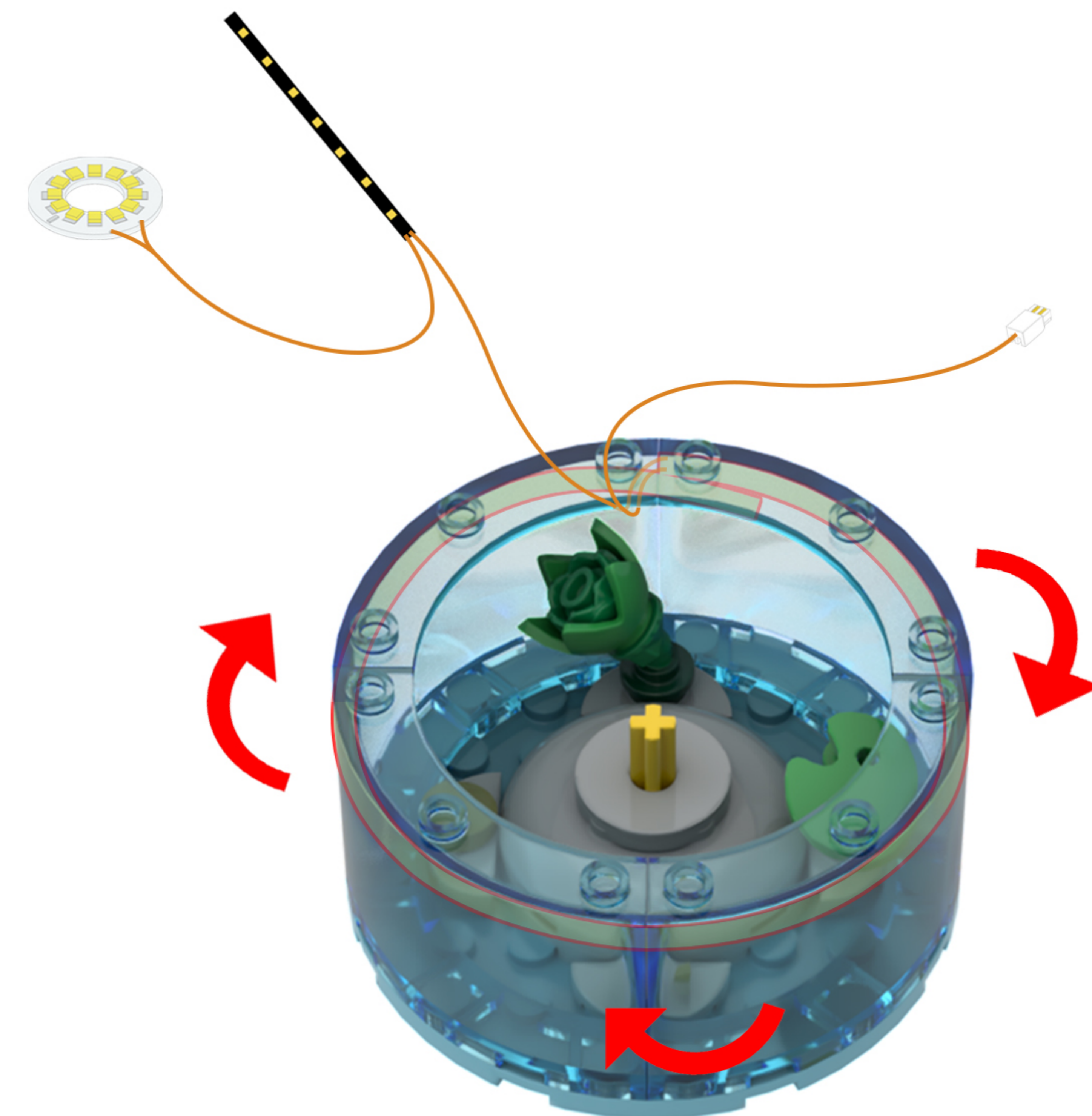
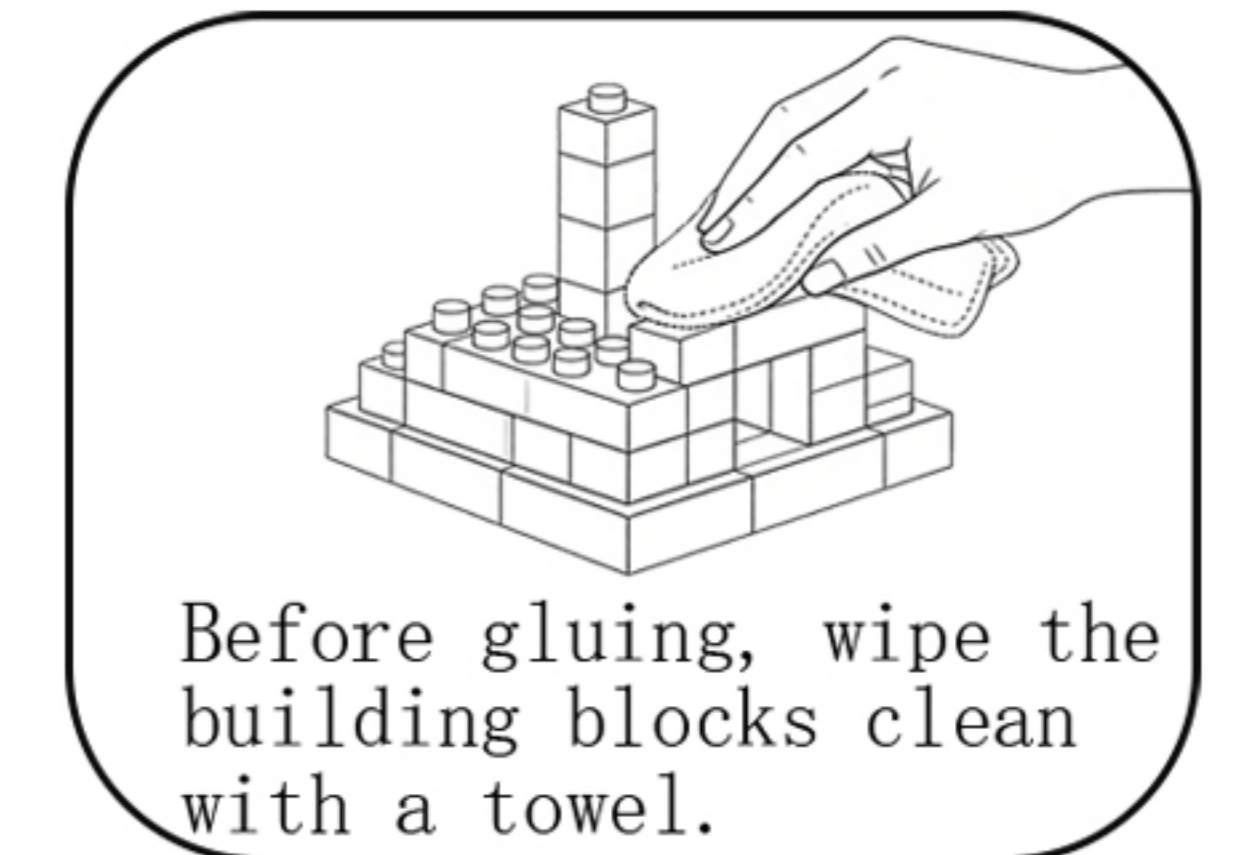

6

EN: Take out the disassembled building blocks and reassemble them.

DE: Nehmen Sie die zerlegten Bausteine heraus und setzen Sie sie wieder zusammen.

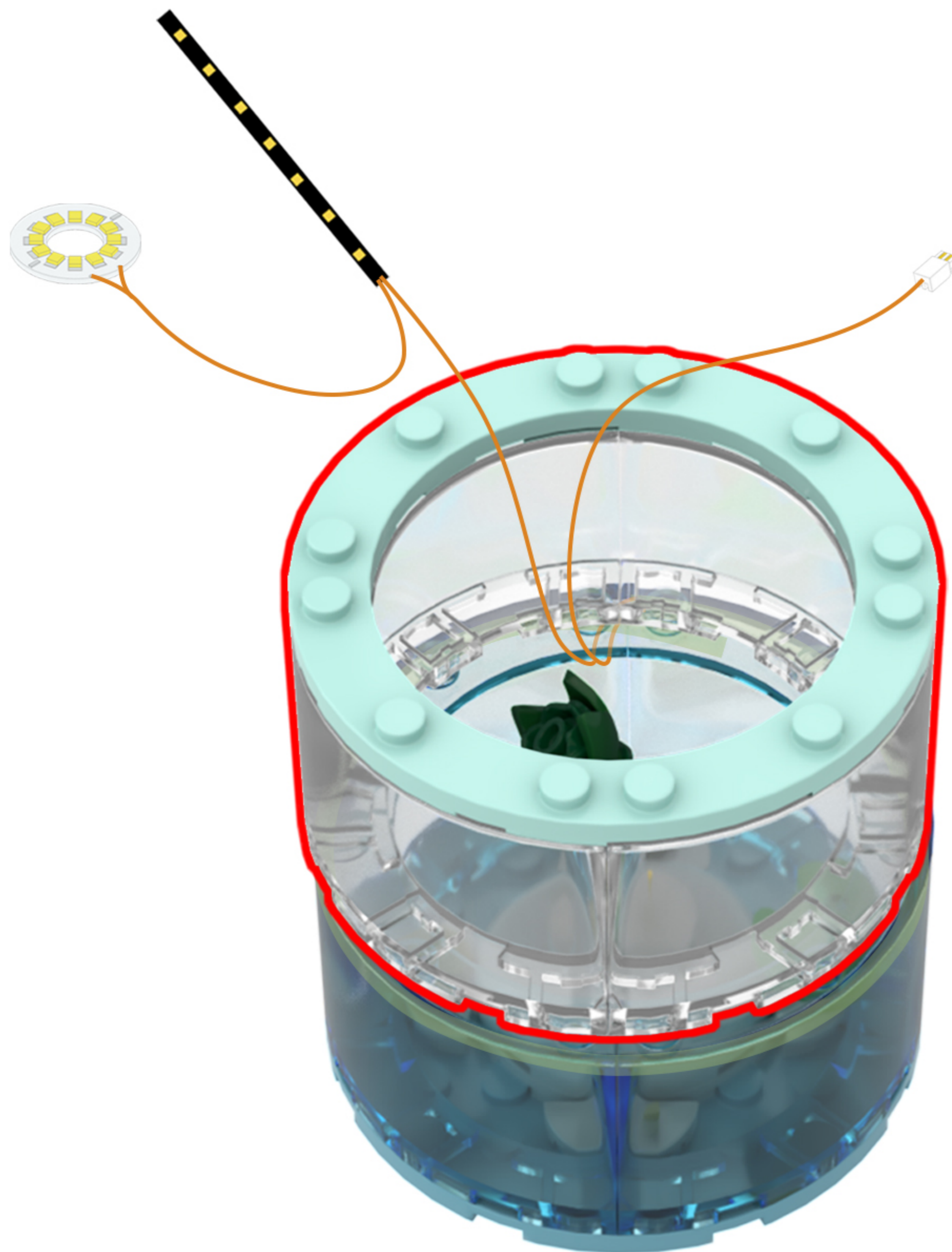
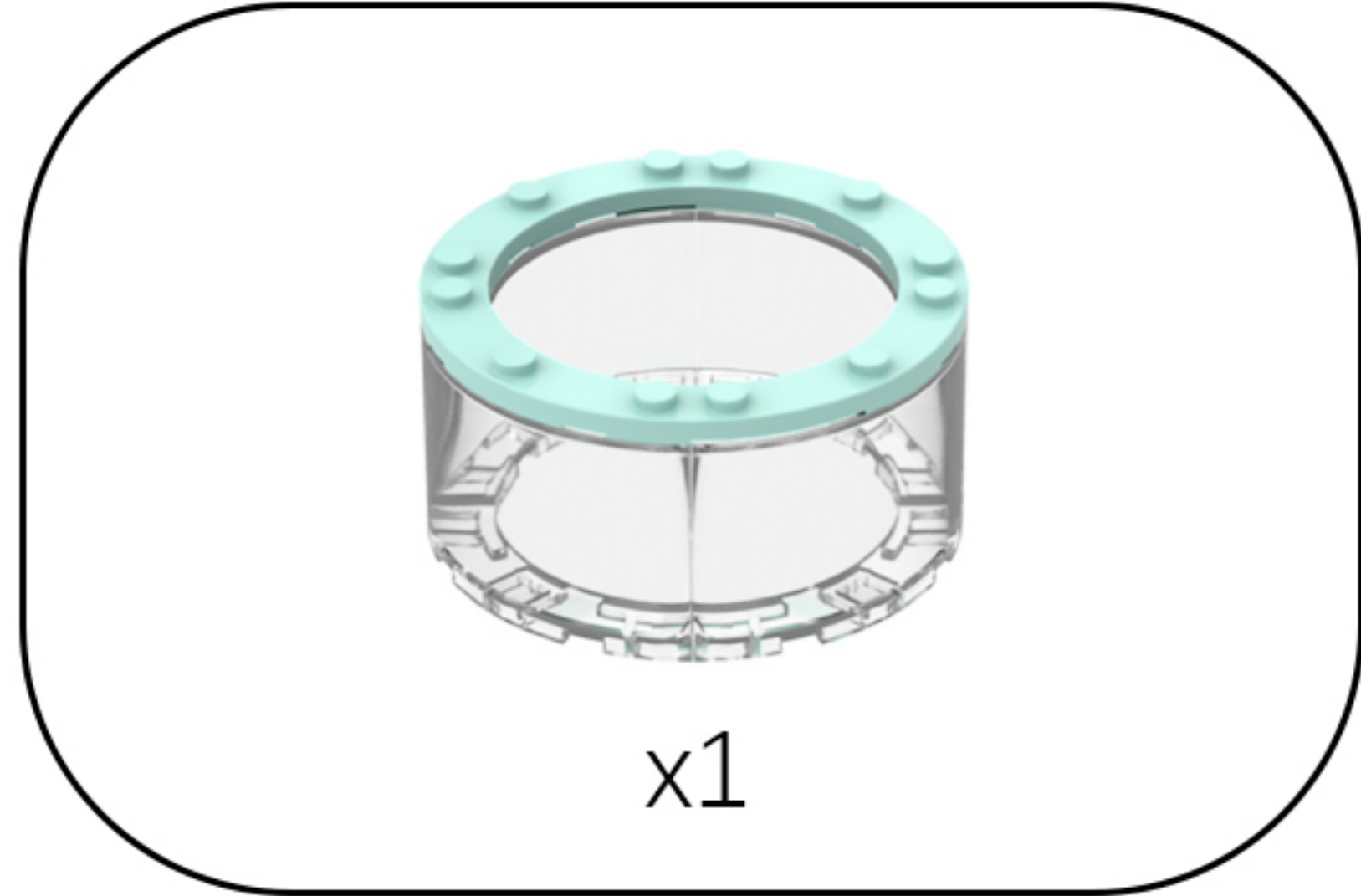

Note: Place the string lights on the outside of the model.

7

EN: Take out the disassembled building blocks and separate them.

DE: Nehmen Sie die zerlegten Bausteine heraus und trennen Sie sie voneinander.

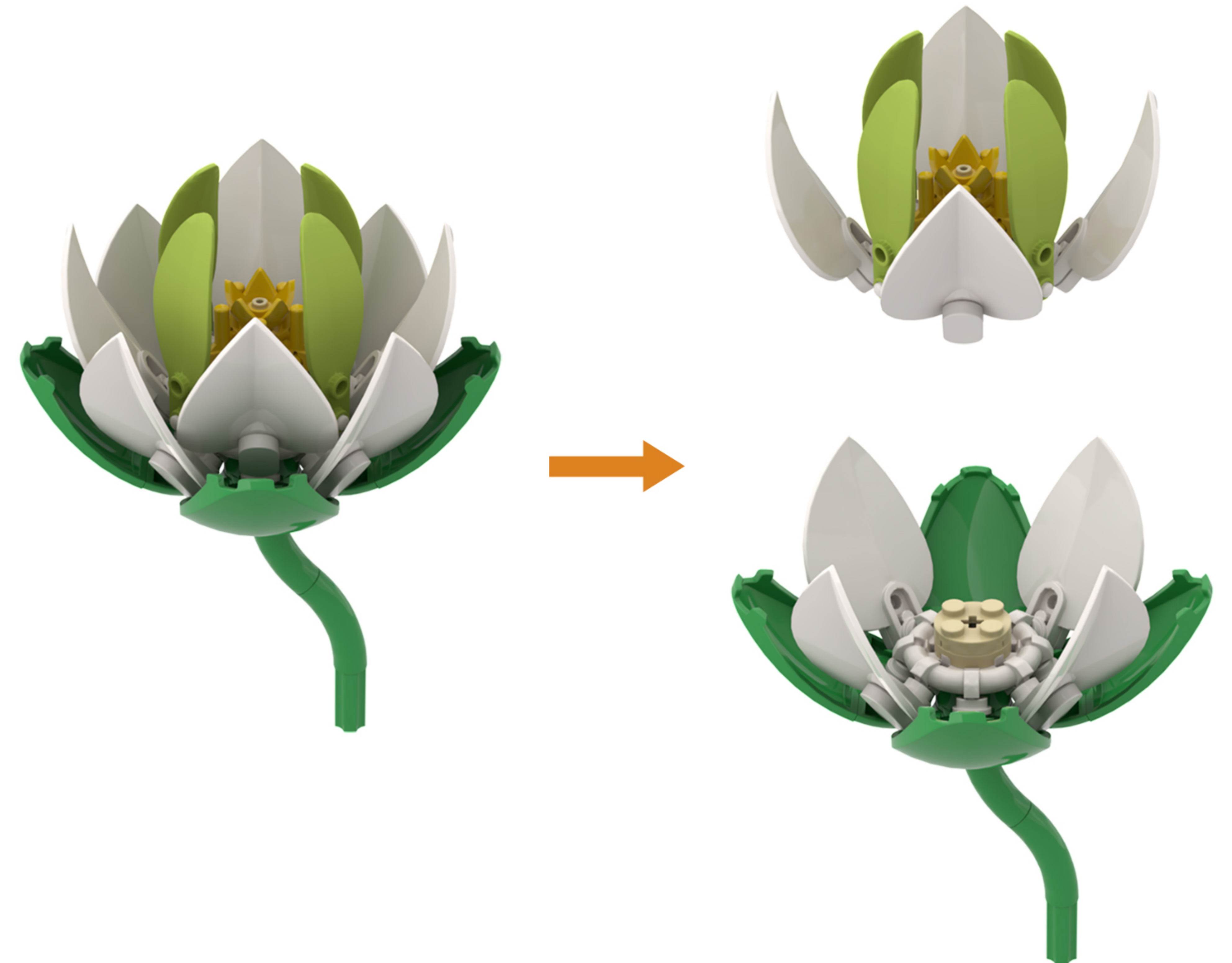
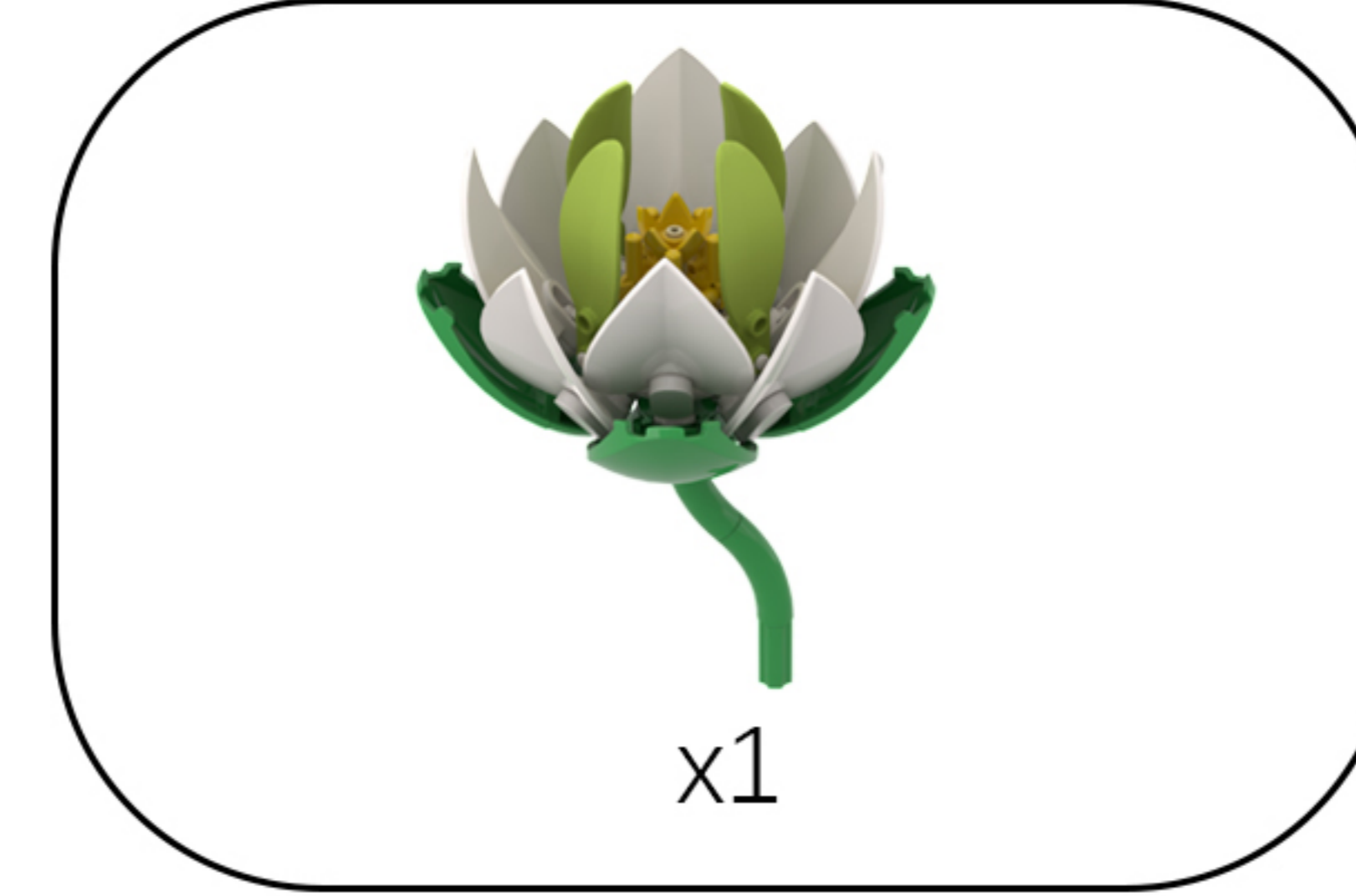

8

EN: Split as shown in the figure.

DE: Wie in der Abbildung gezeigt, teilen Sie es auf.

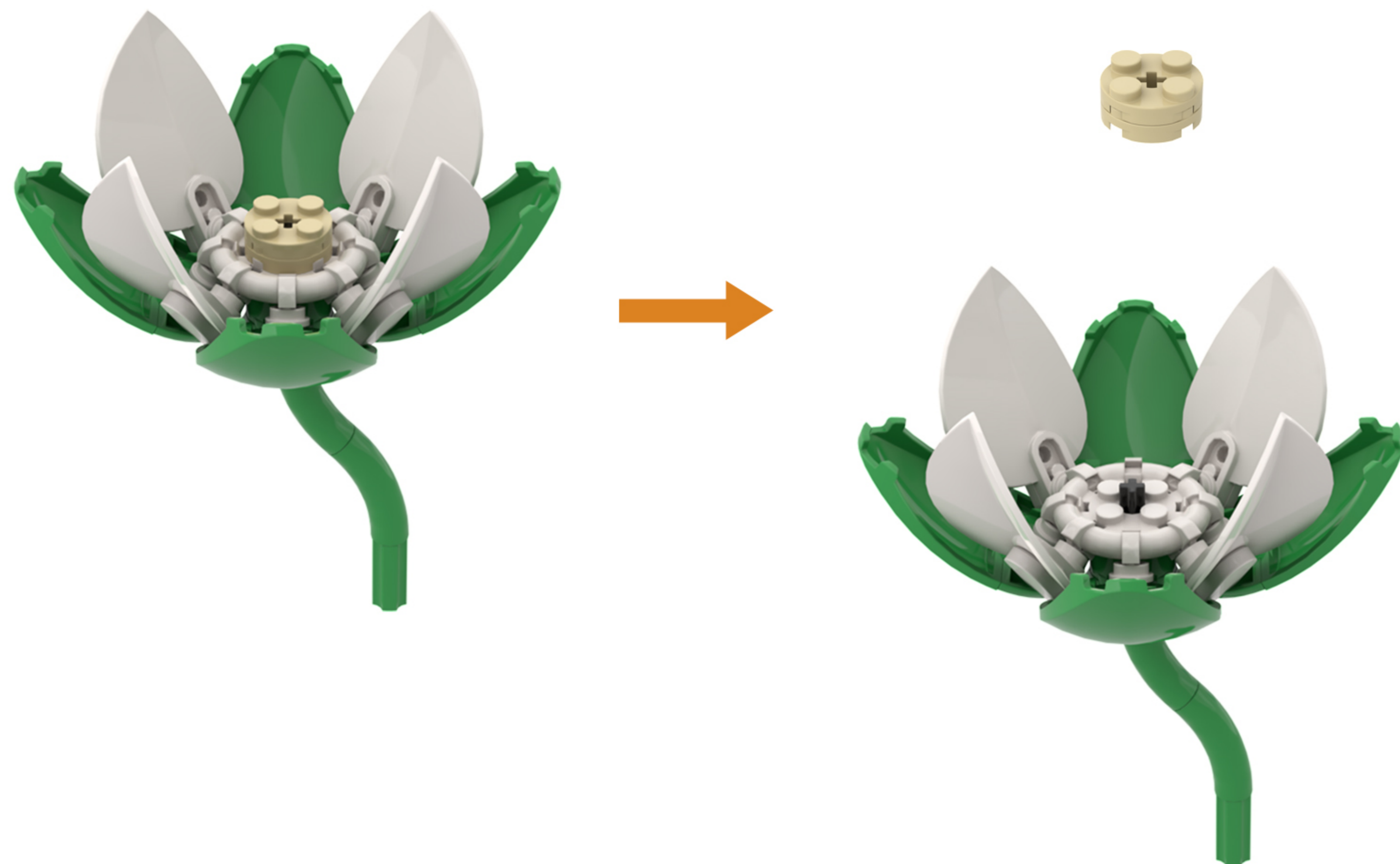

9

EN: Peel off the adhesive backing on the LED strip and wrap it around the building block.

DE: Zieh die Schutzfolie vom LED-Streifen ab und wickle ihn um den Baustein.

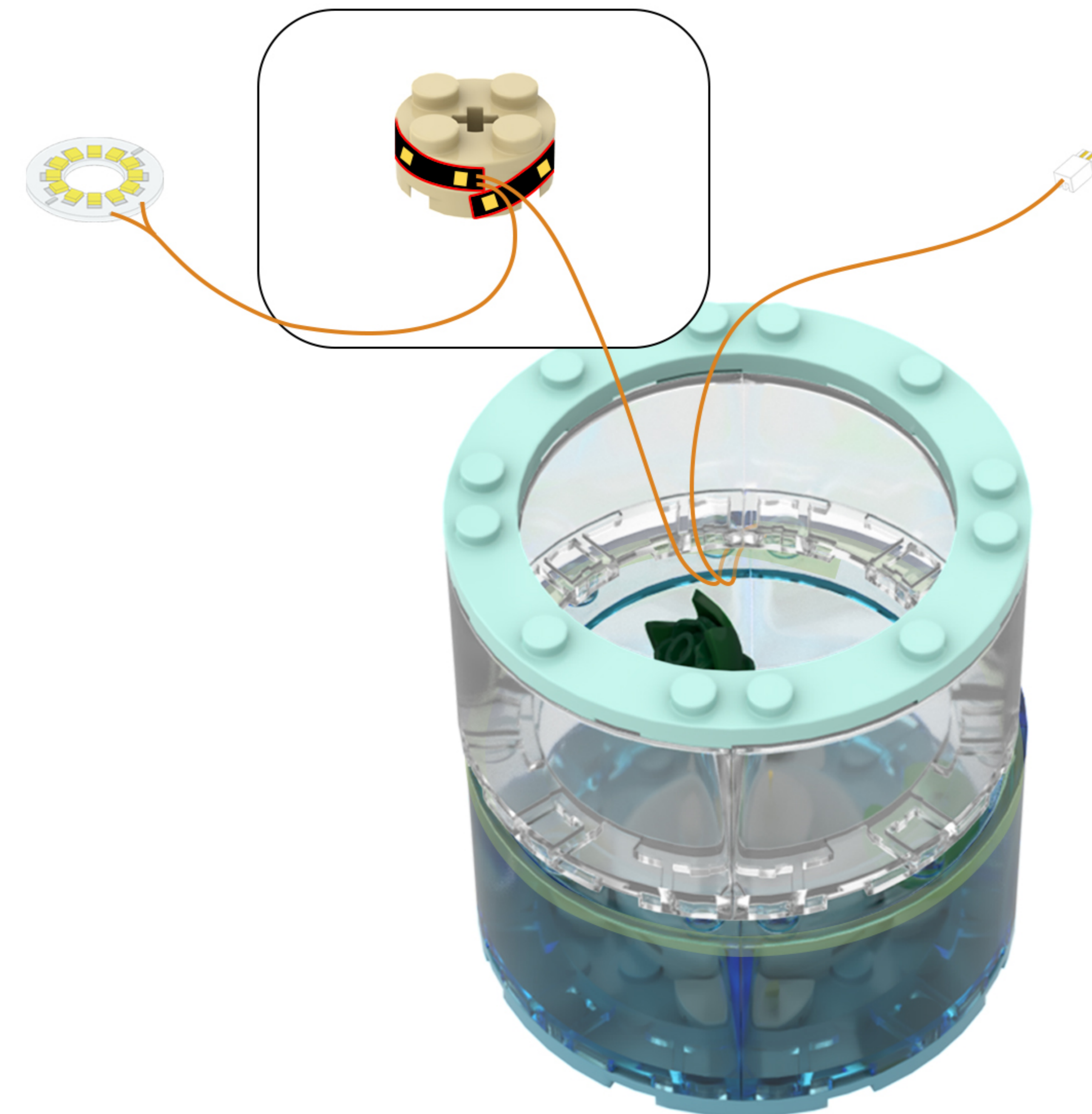

10

EN: Take out the disassembled building blocks and reassemble them.

DE: Nehmen Sie die zerlegten Bausteine heraus und setzen Sie sie wieder zusammen.

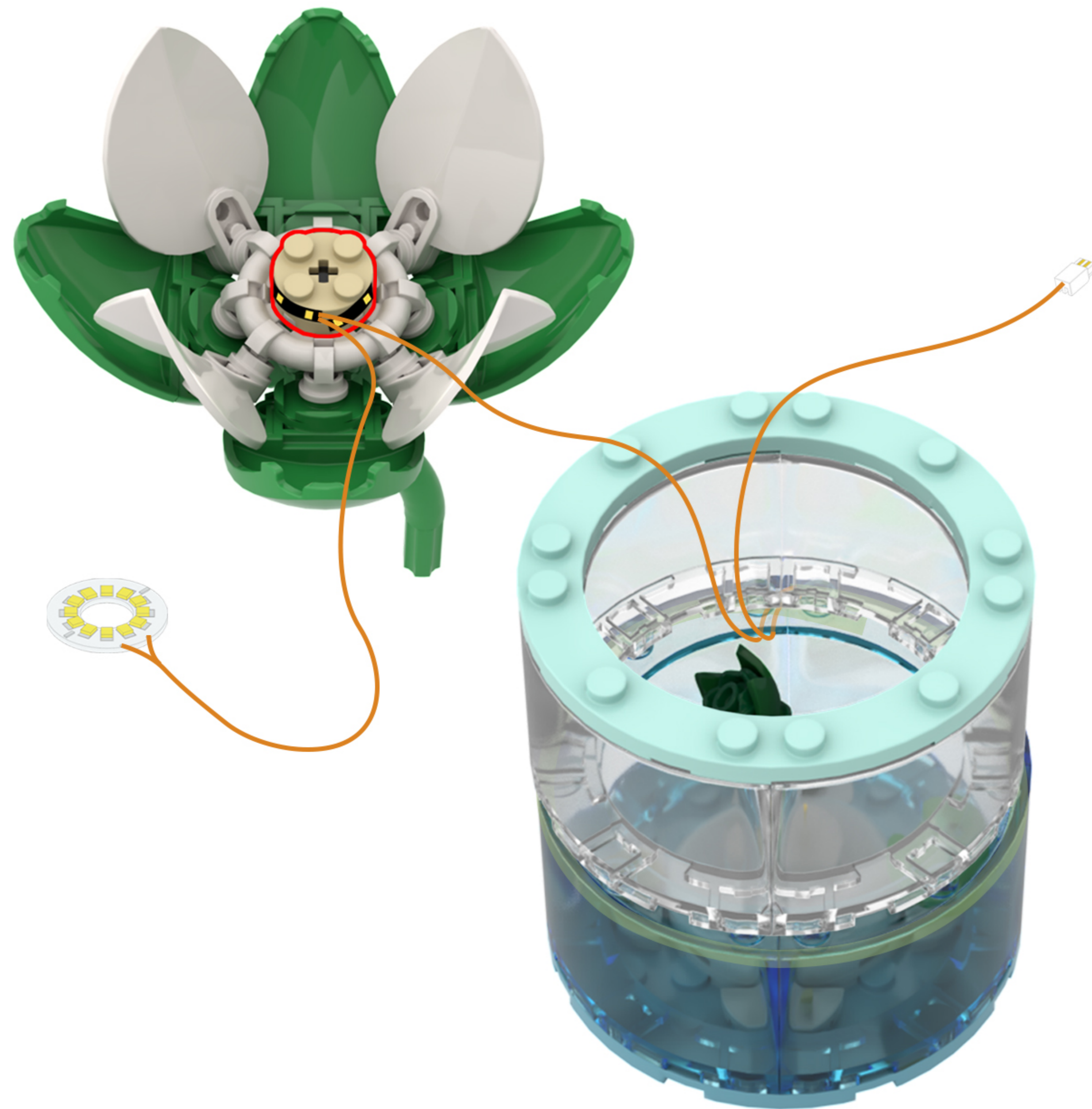
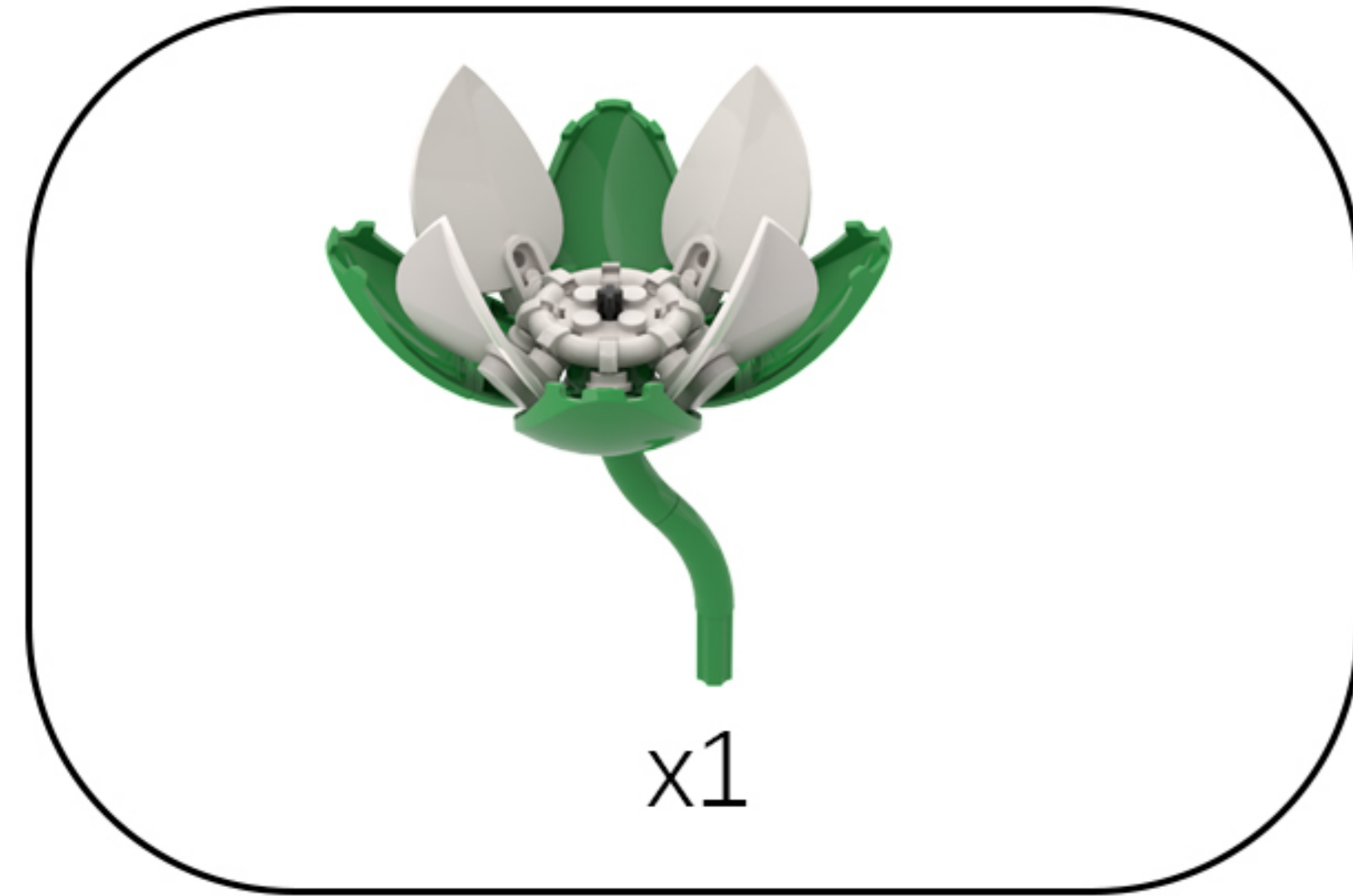

11

EN: Restore the building blocks.

DE: Stellen Sie die Bausteine wieder her.

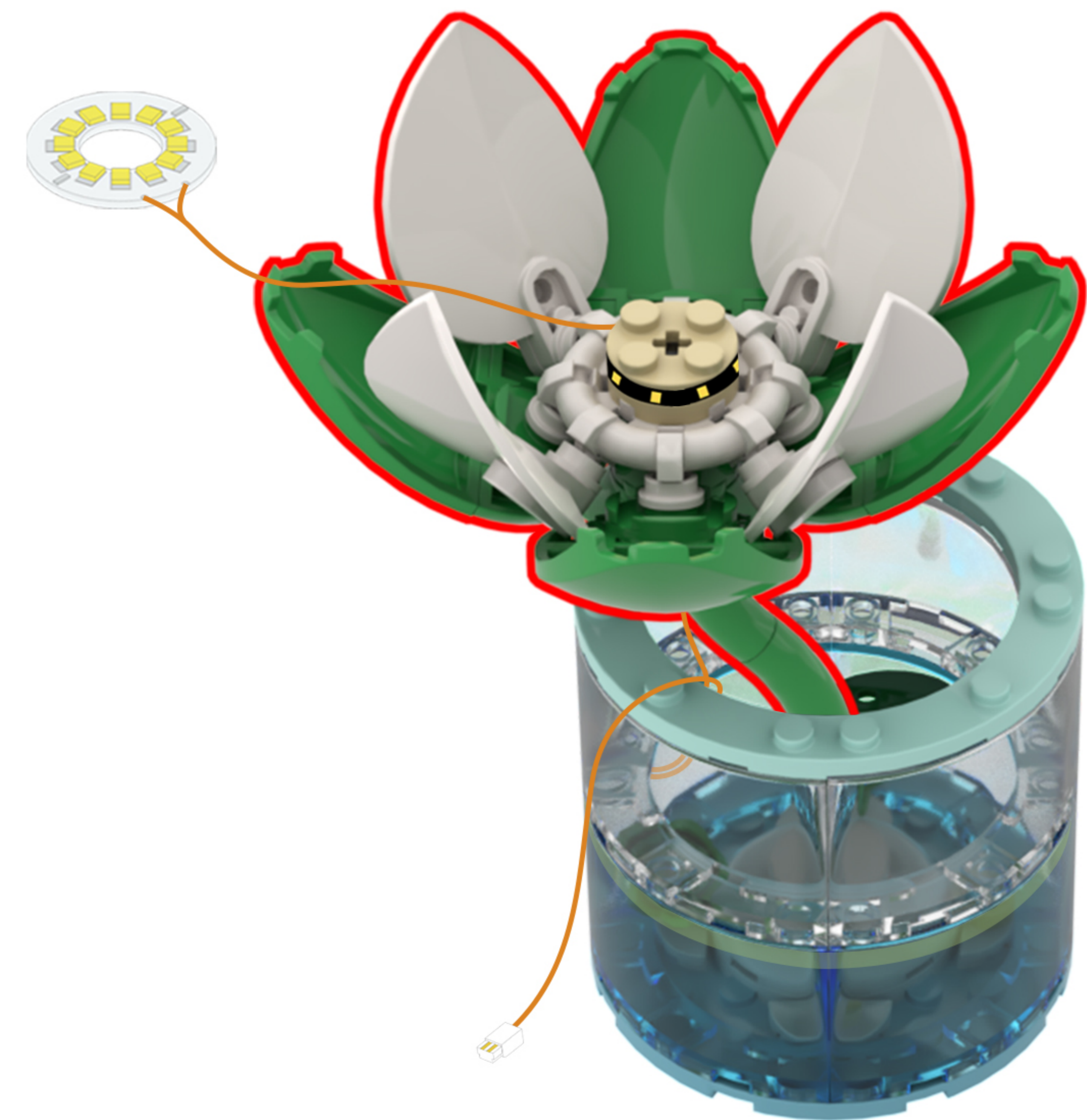

12

EN: Take out the disassembled building blocks and separate them.

DE: Nehmen Sie die zerlegten Bausteine heraus und trennen Sie sie voneinander.

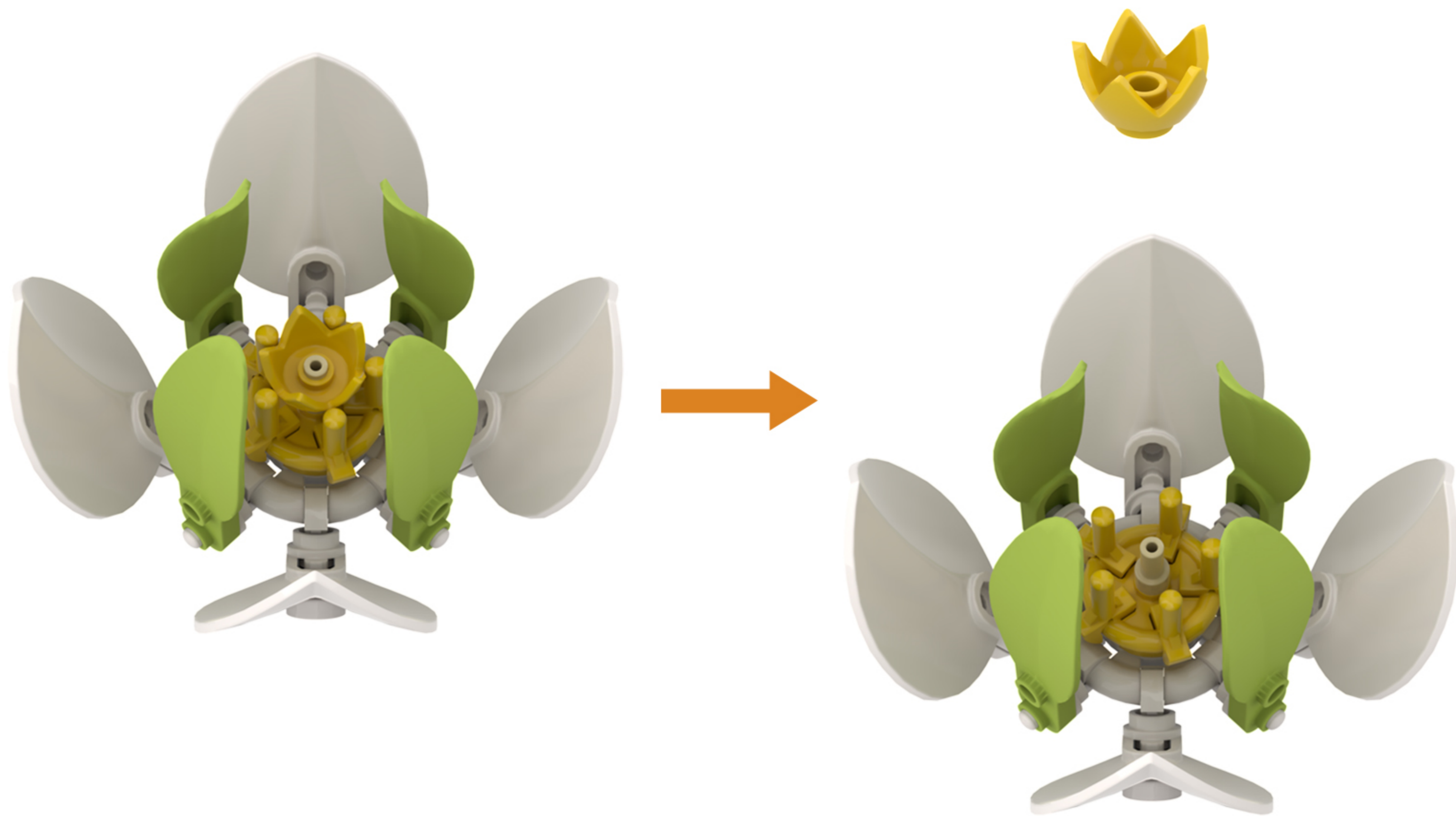
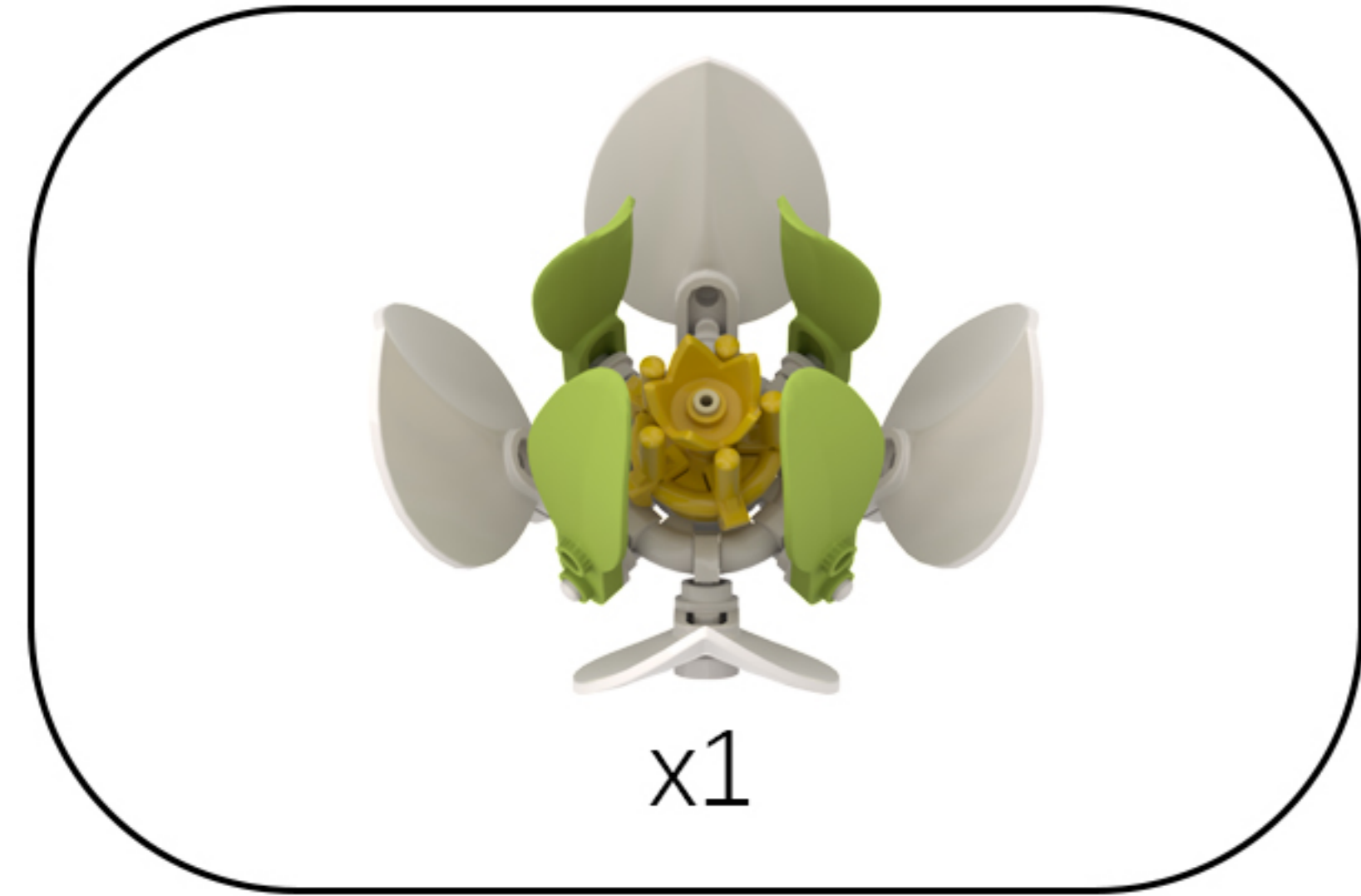

13

EN: Restore the building blocks.

DE: Stellen Sie die Bausteine wieder her.



14

EN: Place the light fixture with the light-emitting side facing down on the building block.

DE: Stellen Sie die Leuchte mit der leuchtenden Seite nach unten auf den Baustein.

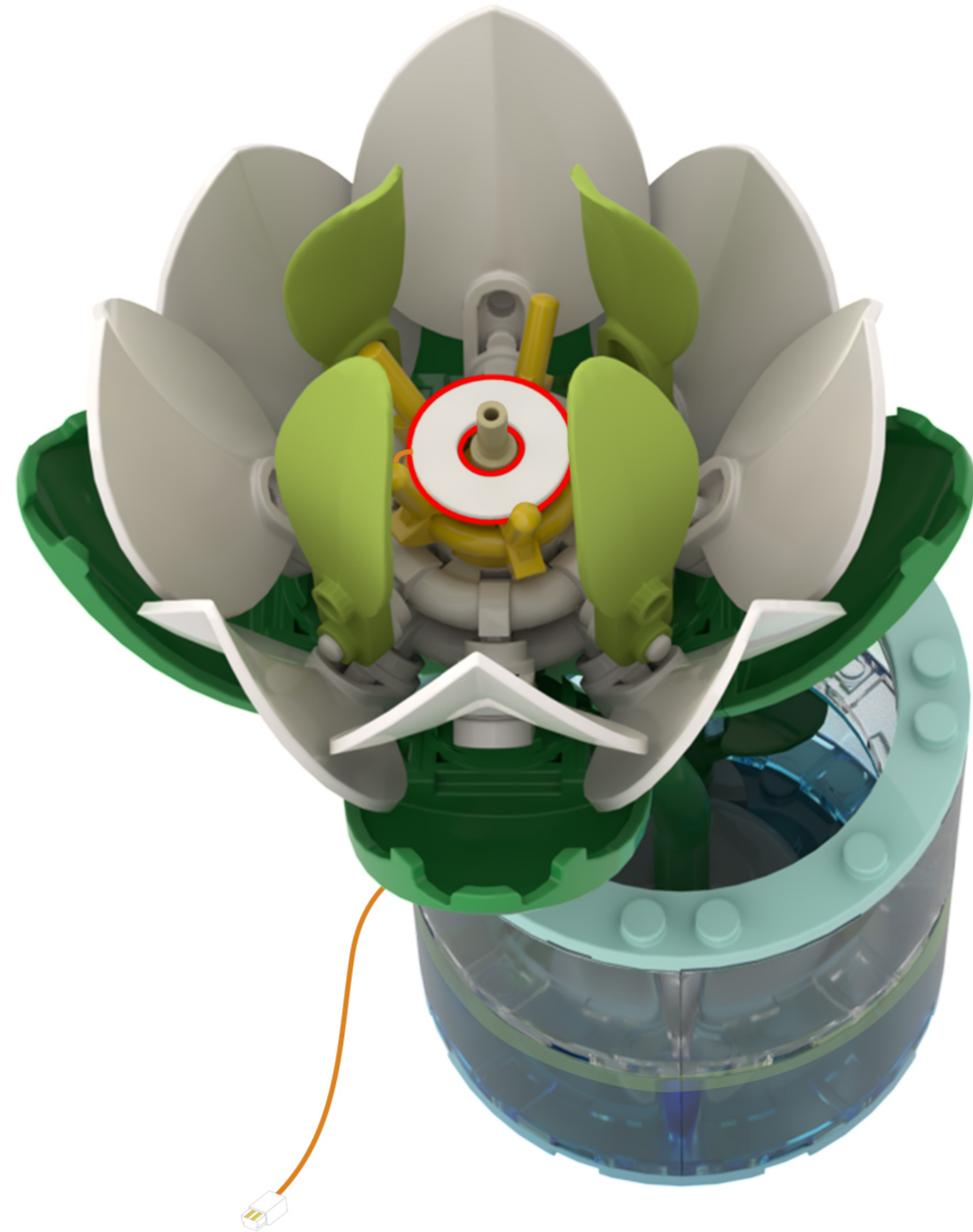

15

EN: Take out the disassembled building blocks and reassemble them.

DE: Nehmen Sie die zerlegten Bausteine heraus und setzen Sie sie wieder zusammen.

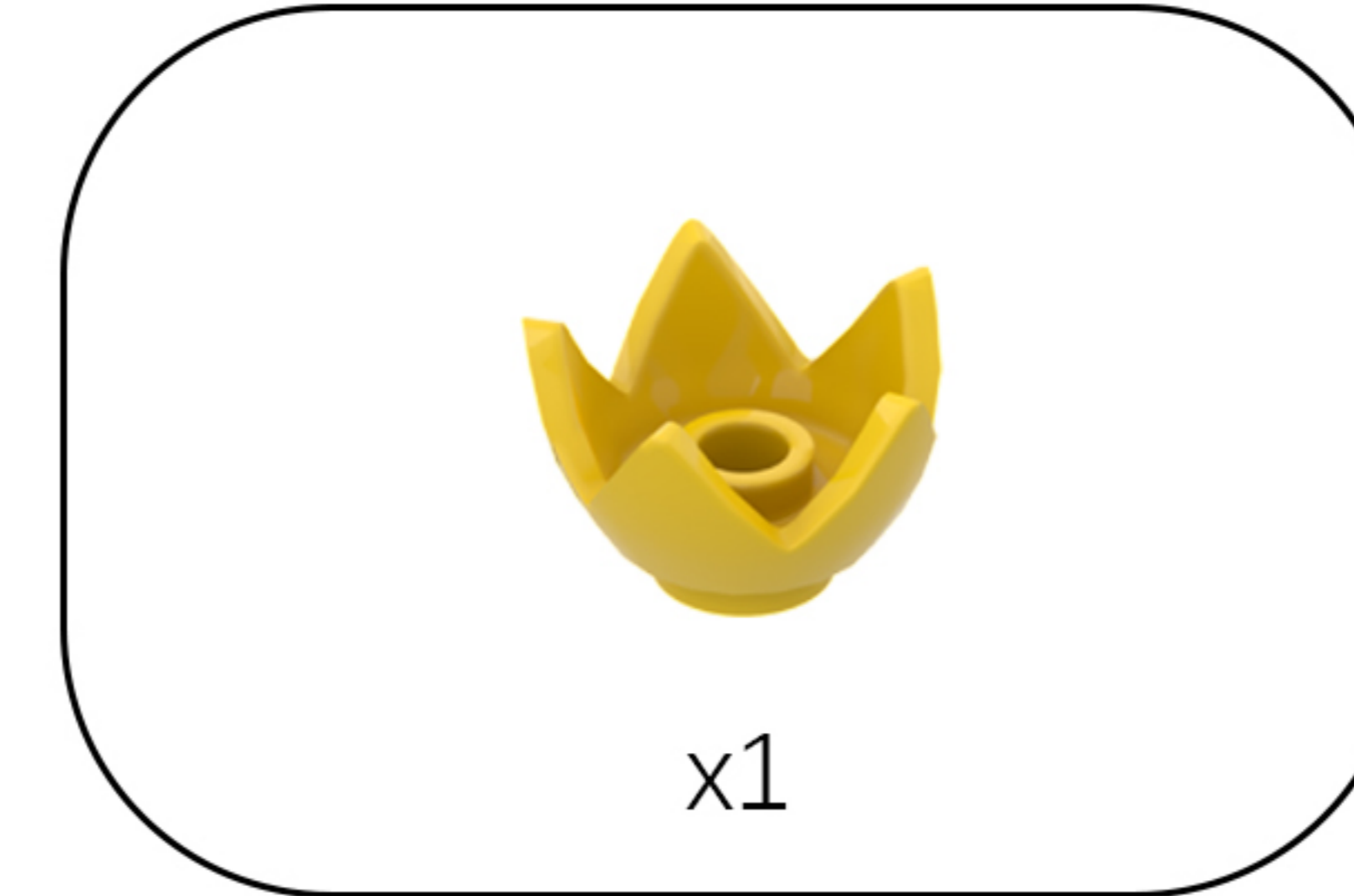

16

EN: Locate this light cord in the diagram.

DE: Suchen Sie dieses Lichtkabel in der Abbildung.

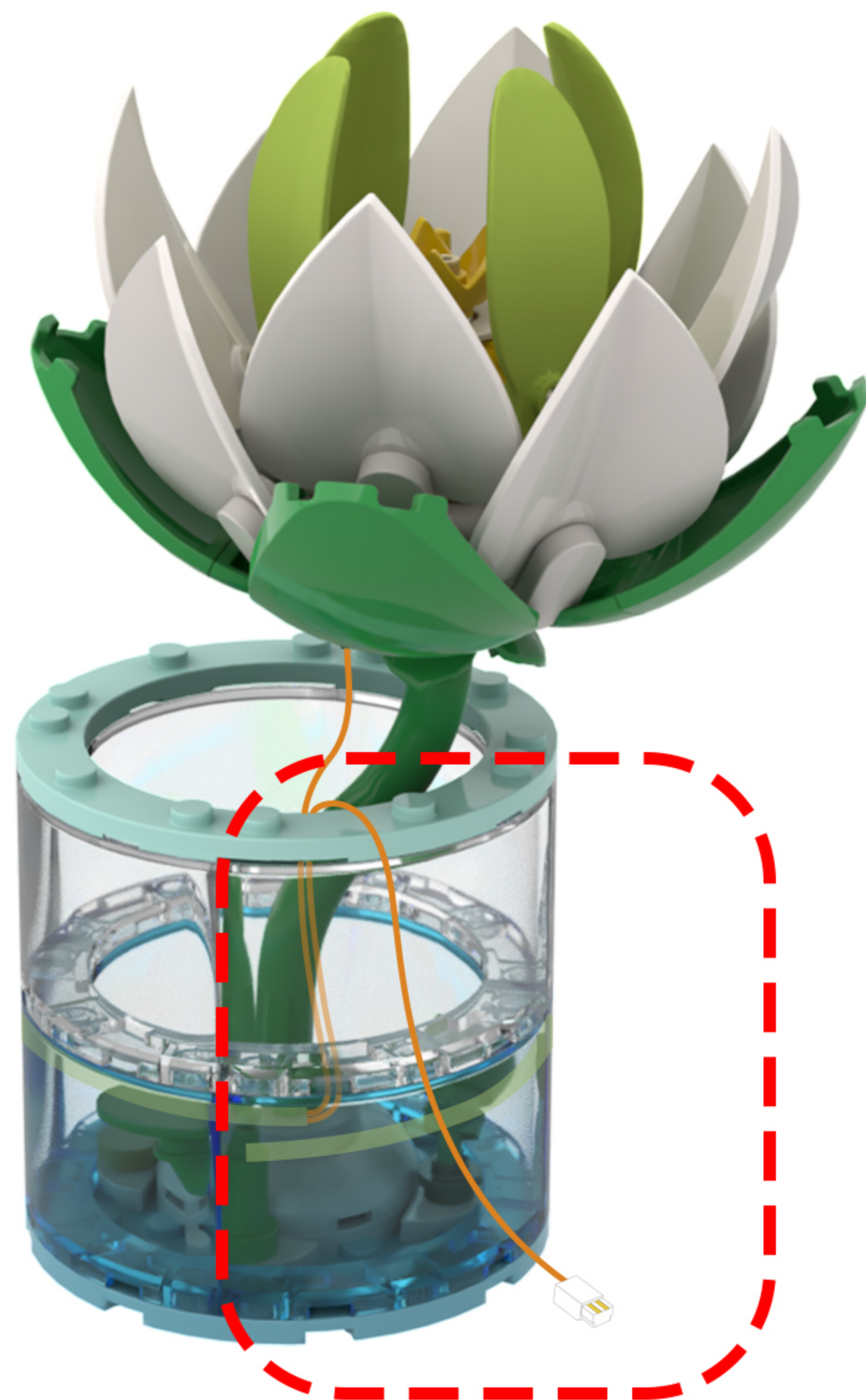

17

EN: Take the expansion board and the connecting cable out of Bag 3 and connect them together.

DE: Nehmen Sie die Erweiterungskarte und das Verbindungskabel aus Beutel 3 und verbinden Sie beide miteinander.

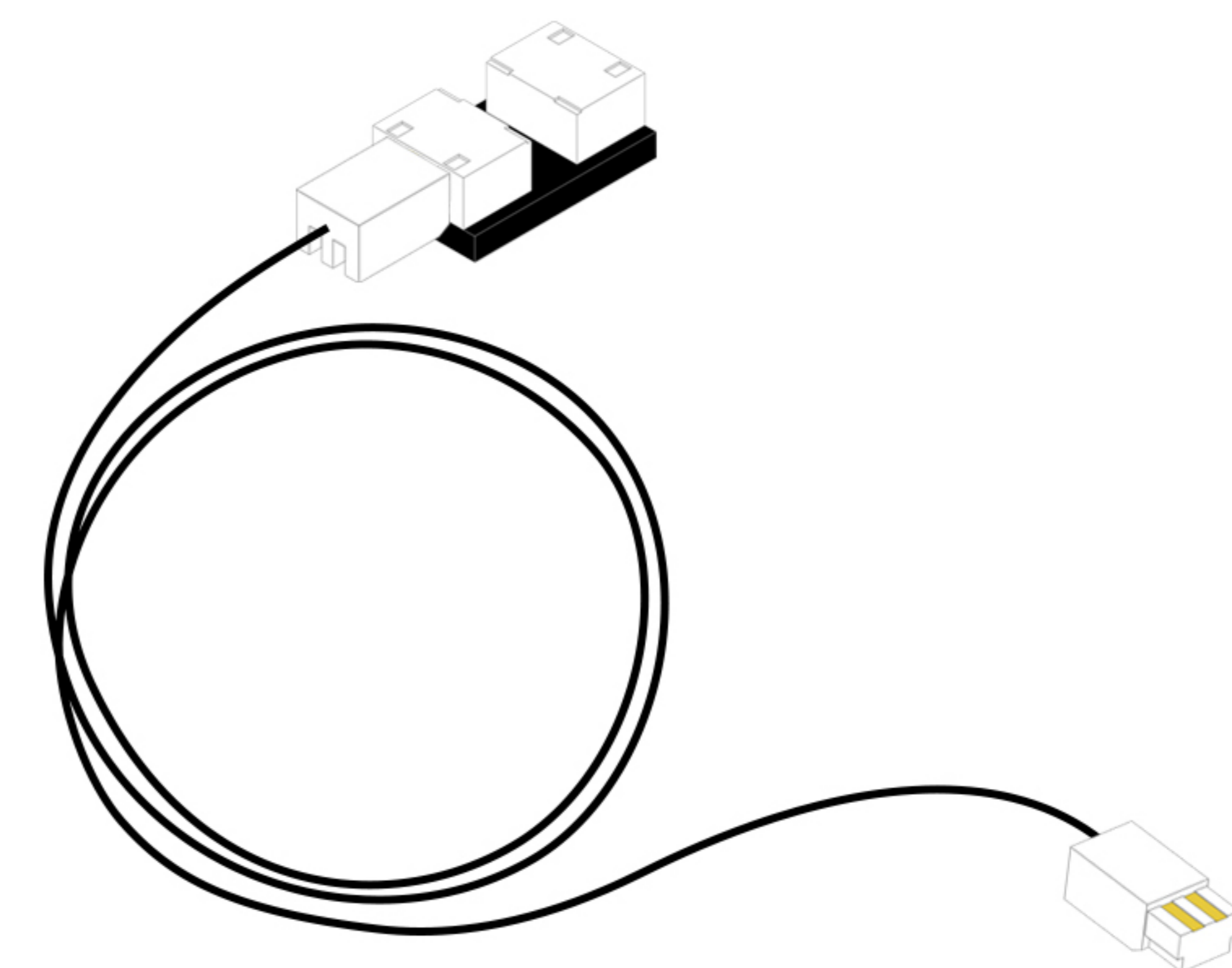
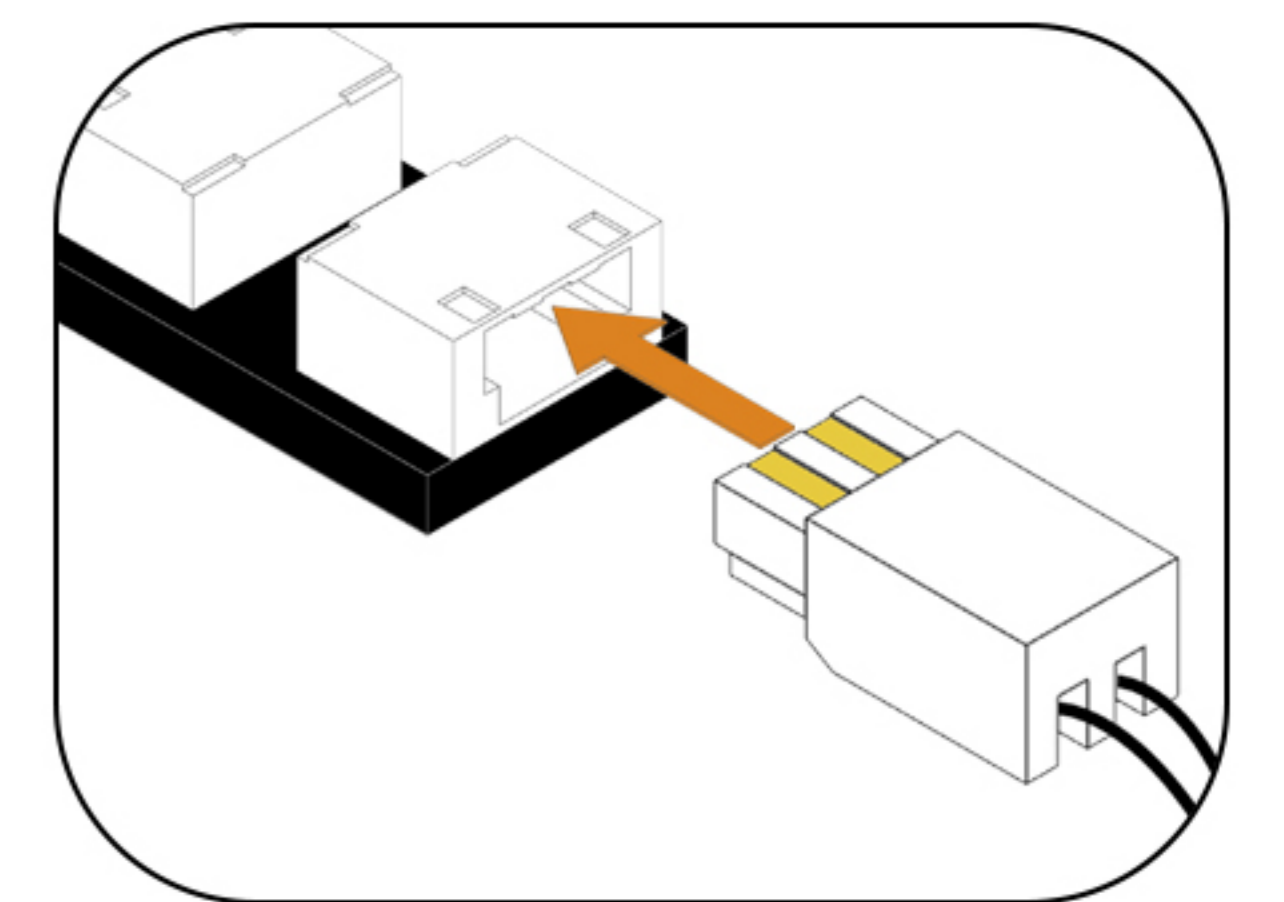
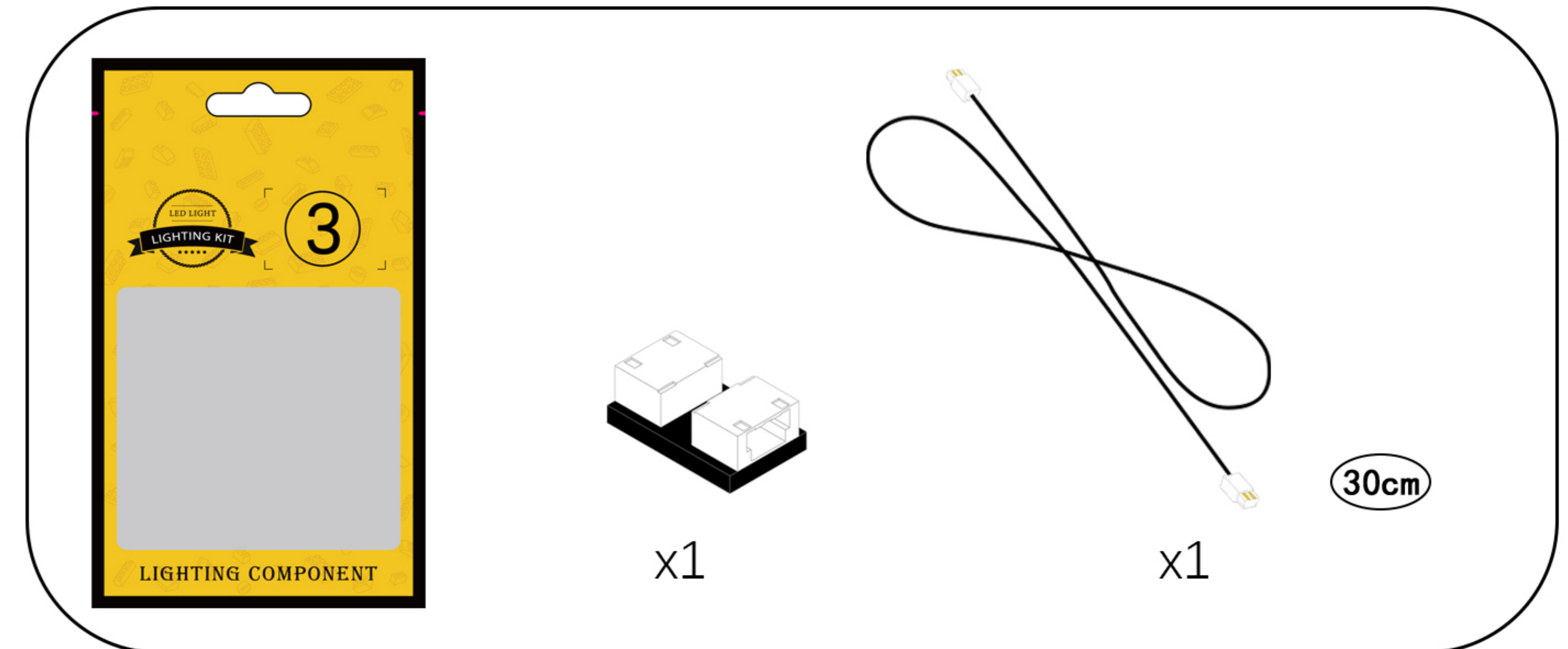

18

EN: Connect the lamp wires to the expansion board.

DE: Verbinden Sie die Lampenkabel mit der Erweiterungskarte.

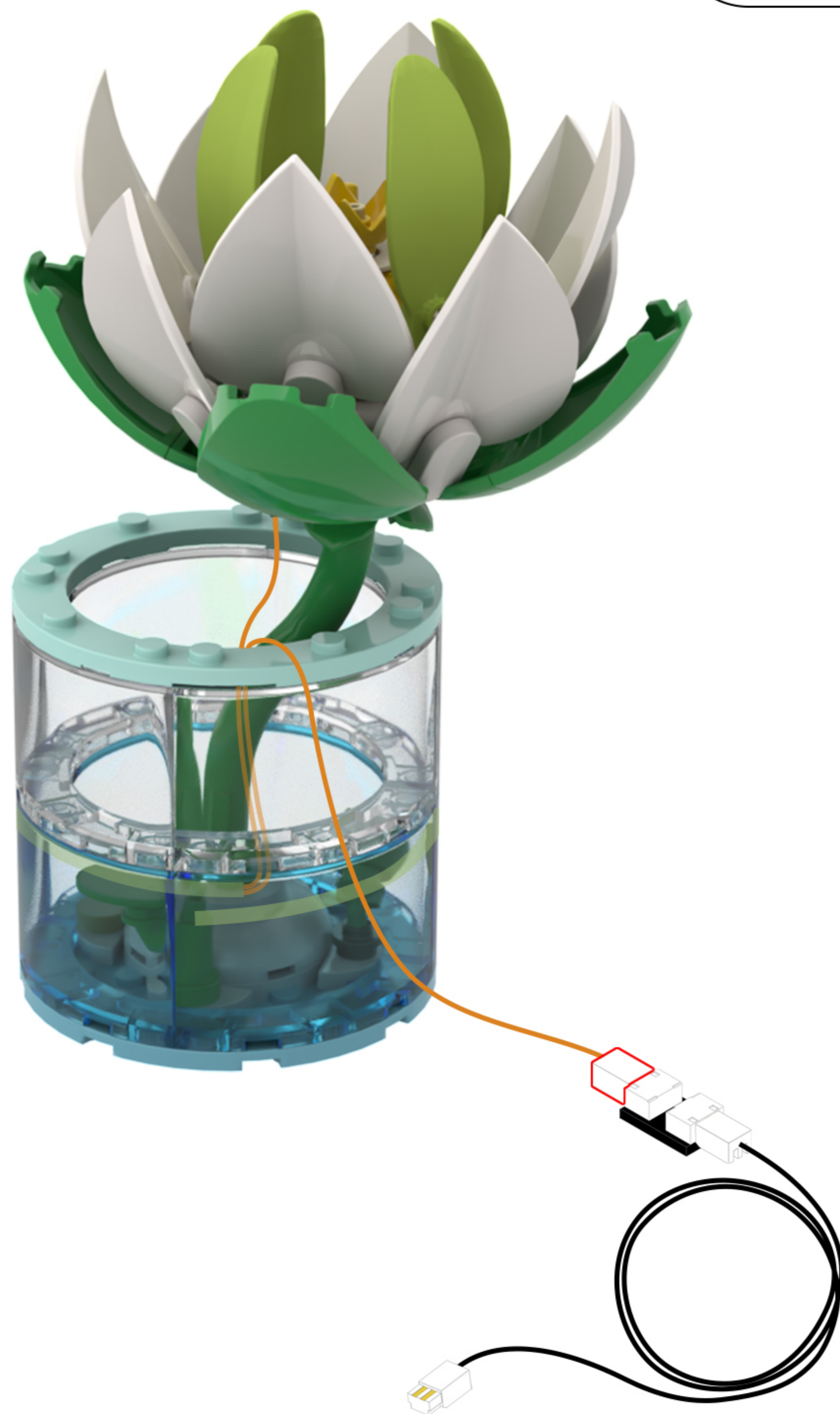
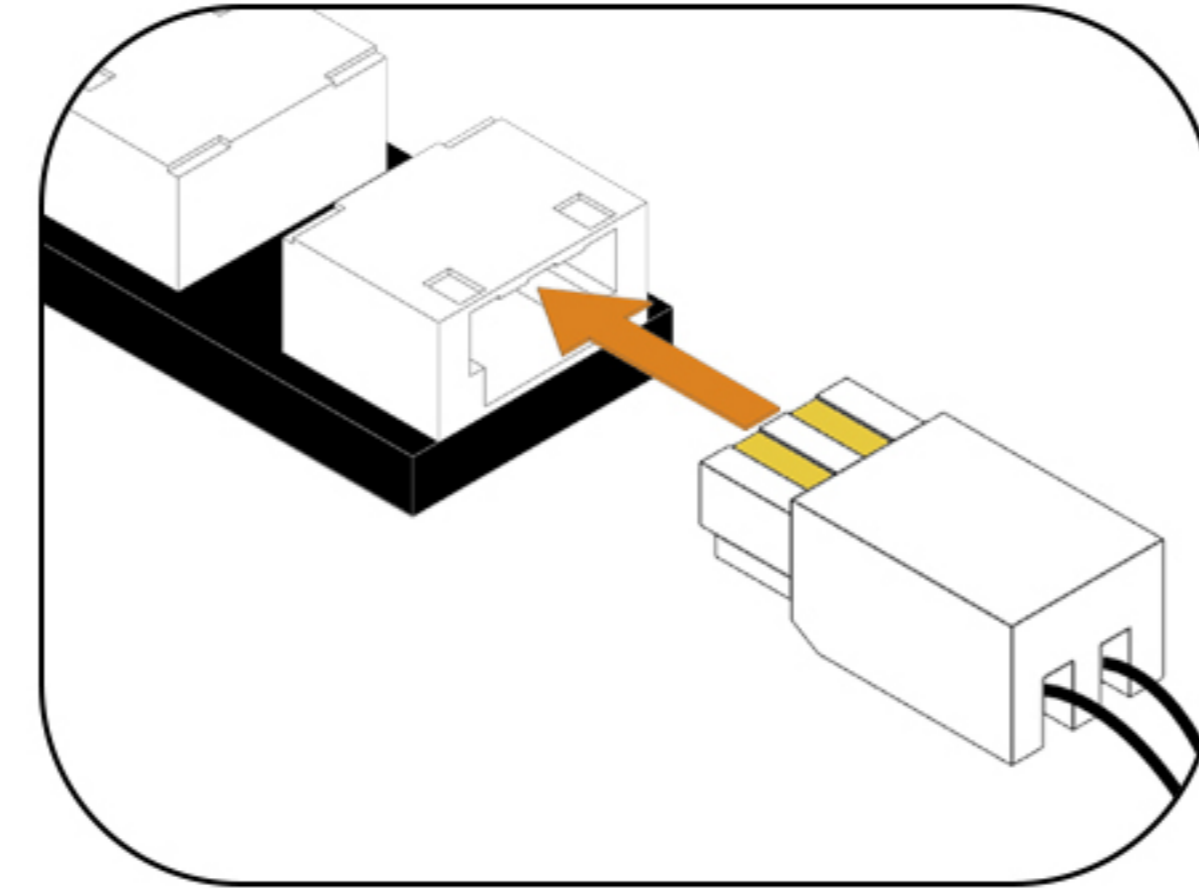

19

EN: Peel off the adhesive backing of the expansion board and attach it to the location shown in the illustration.

DE: Entfernen Sie die Schutzfolie von der Rückseite der Erweiterungsplatte und kleben Sie sie an die in der Abbildung gezeigte Stelle.

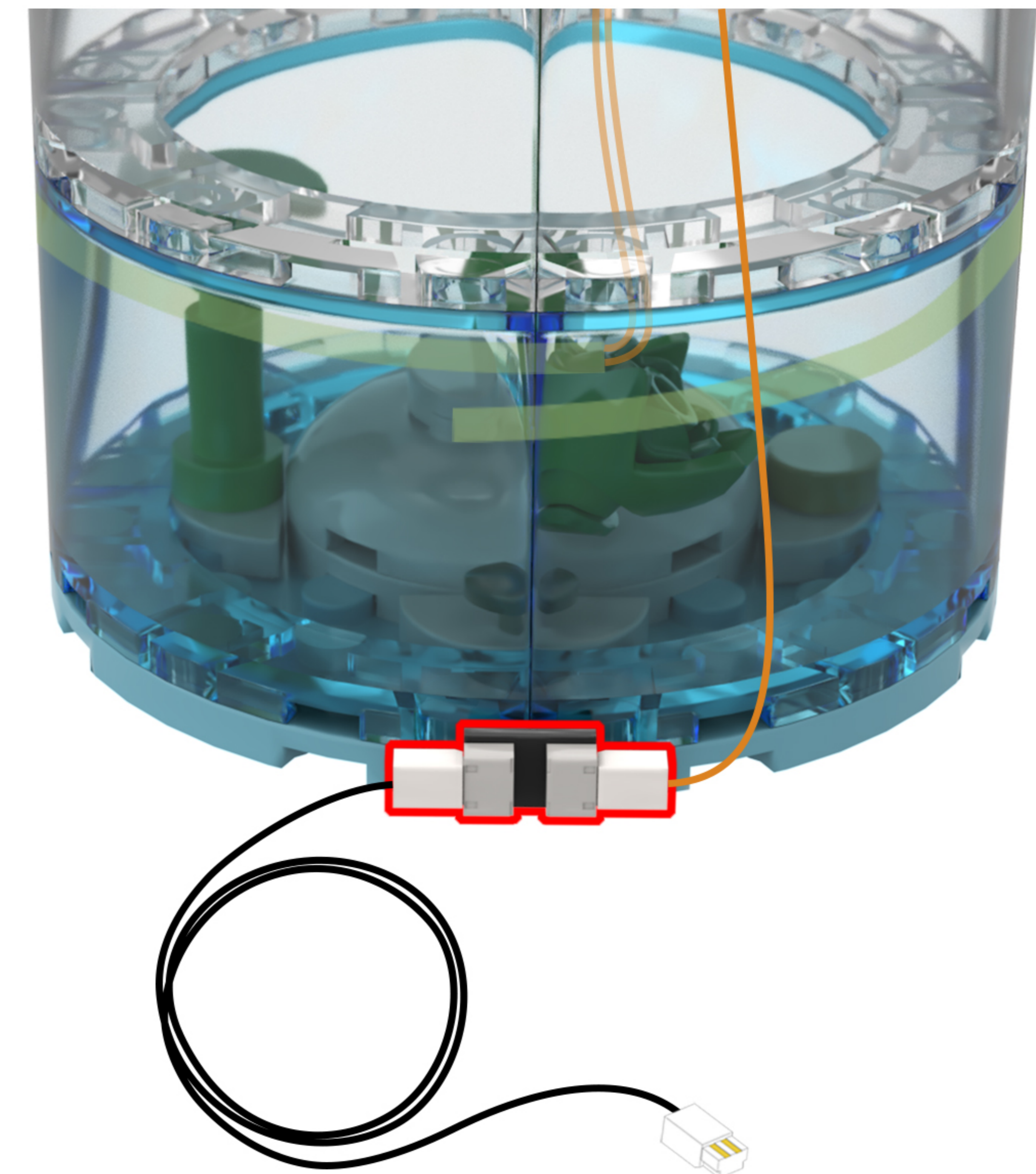
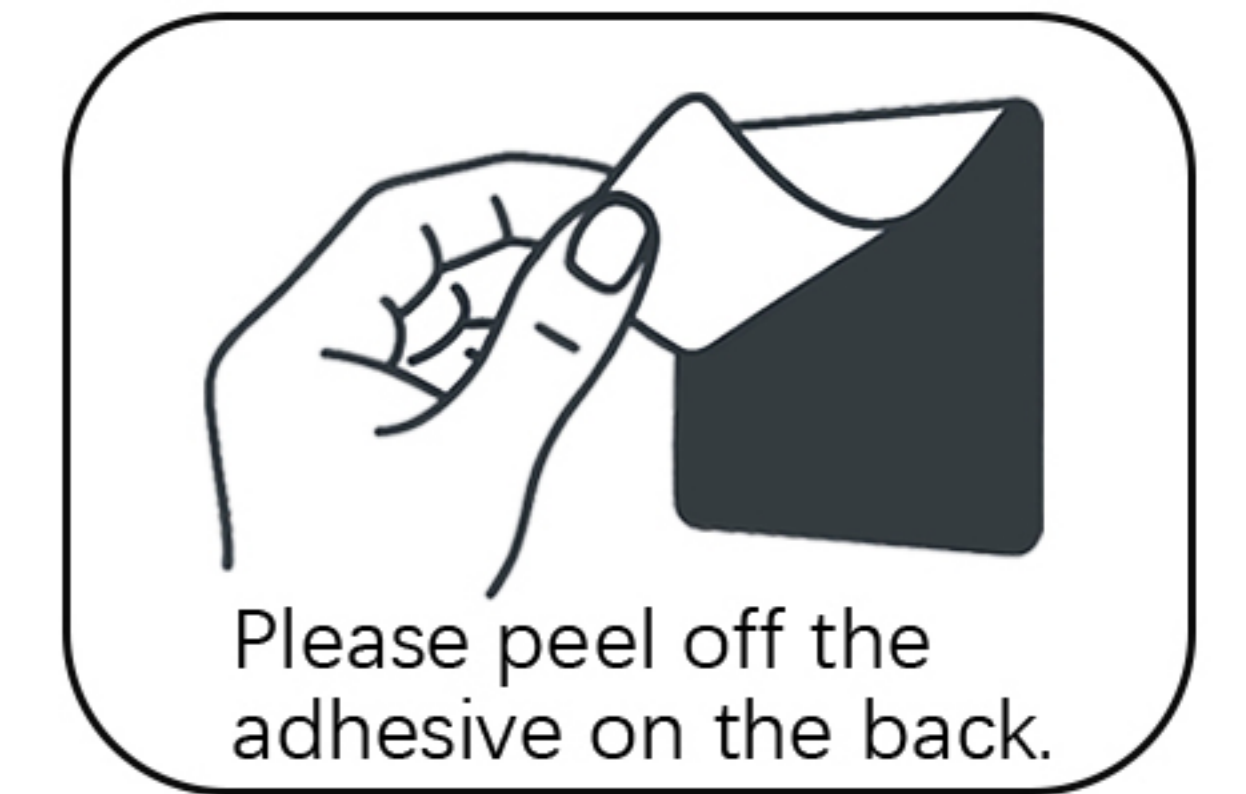

20

EN: Take out the disassembled building blocks and separate them.

DE: Nehmen Sie die zerlegten Bausteine heraus und trennen Sie sie voneinander.

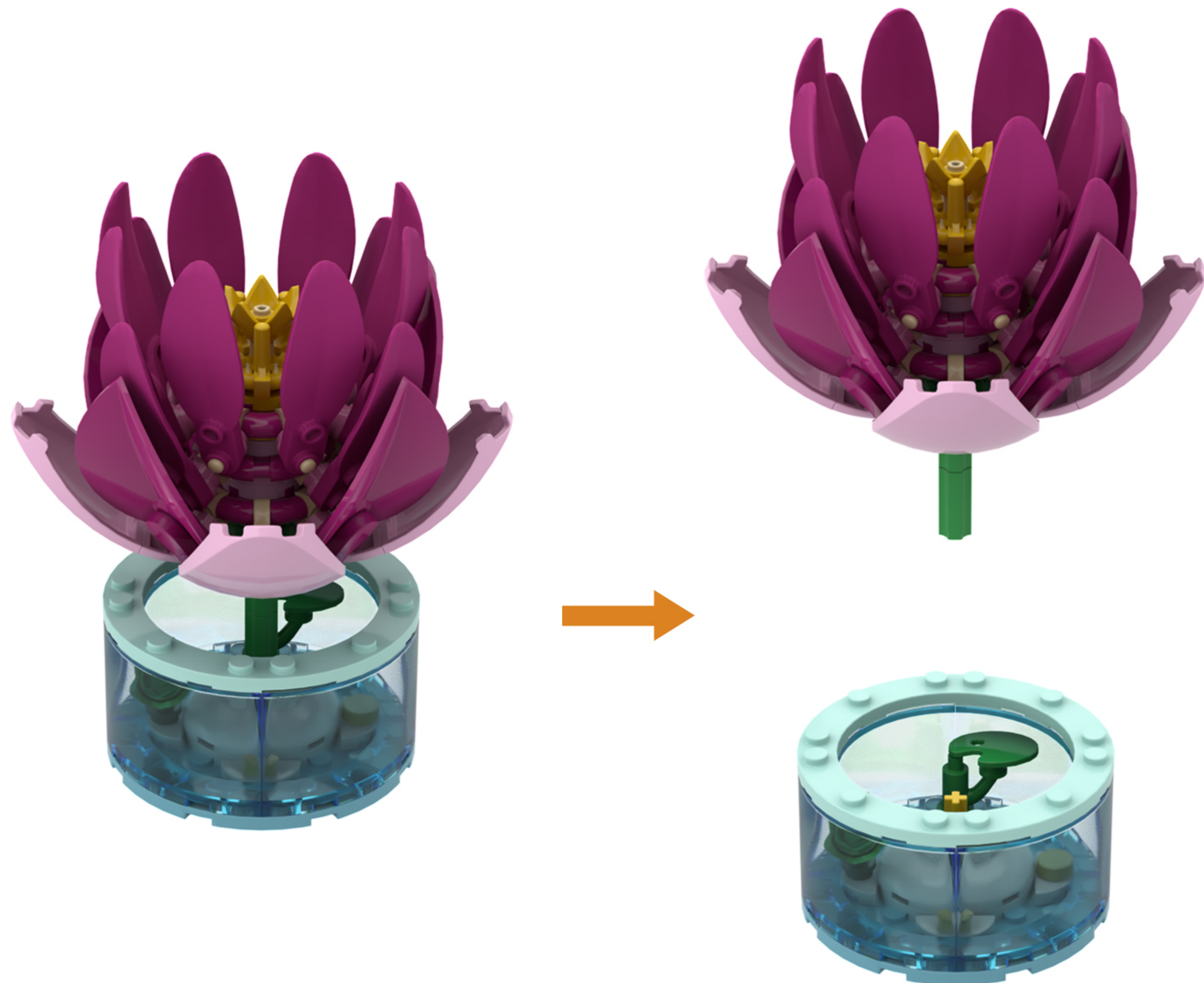
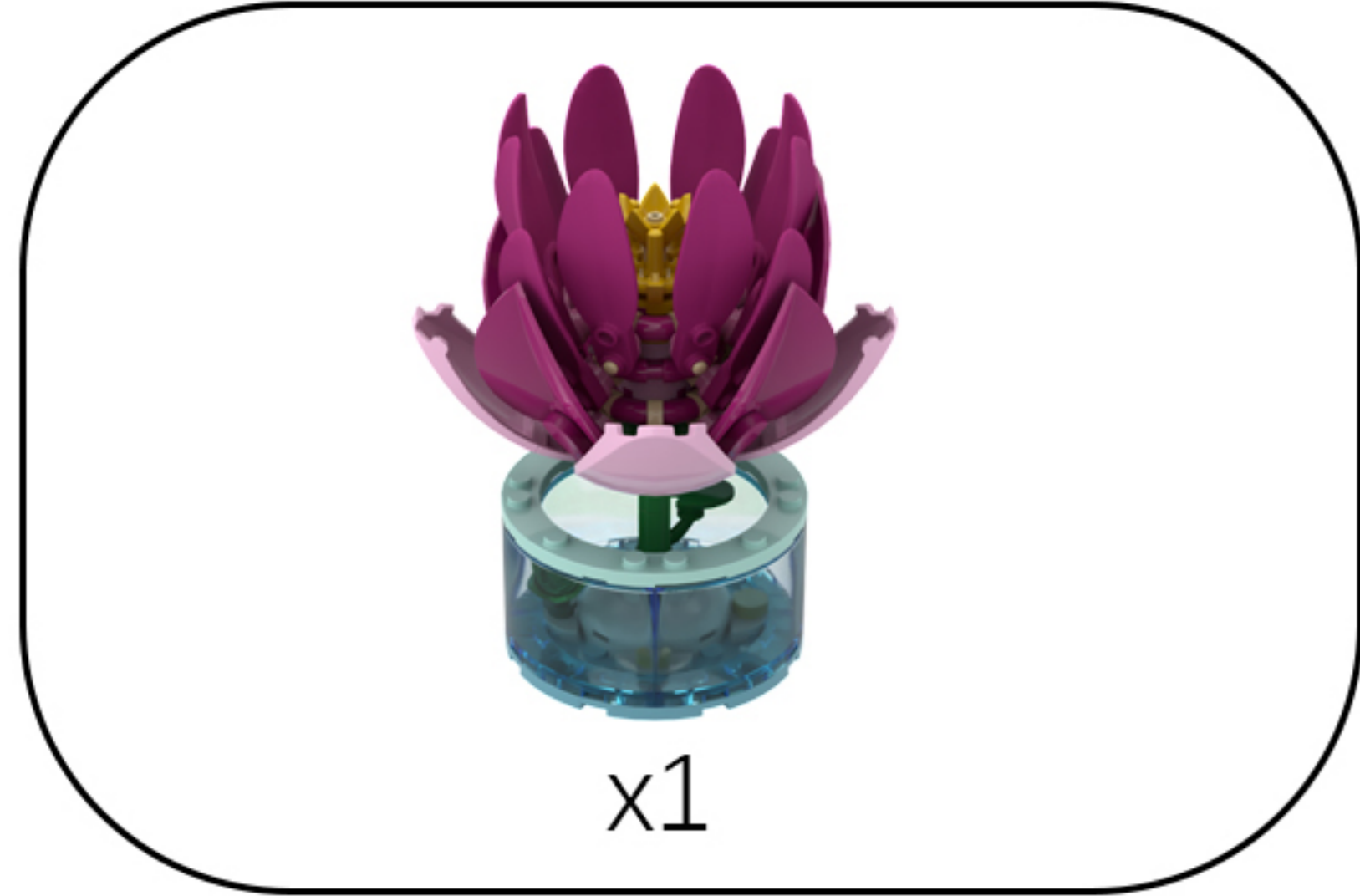

21

EN: Take the string of lights out of Bag 2, untie the zip tie, and locate the lights on the string.

DE: Nimm die Lichterkette aus Beutel 2, löse den Kabelbinder und suche die Lichter an der Kette.

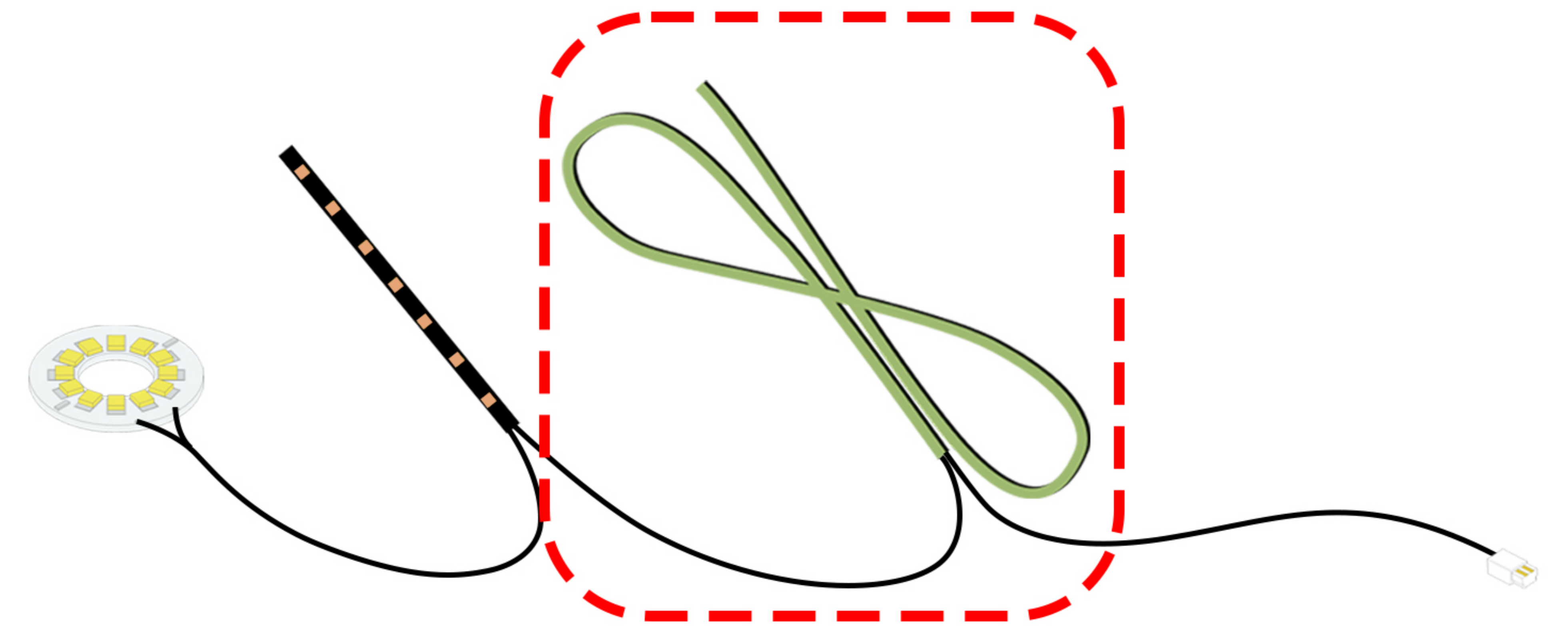
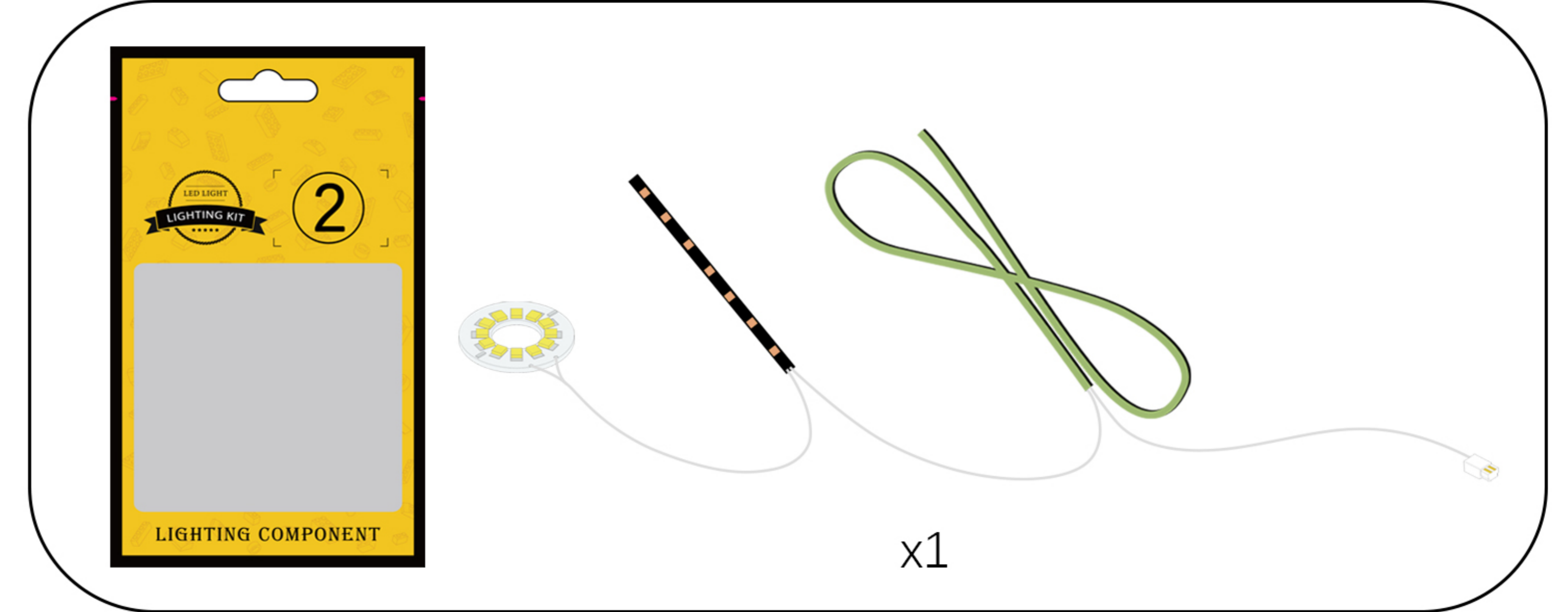

22

EN: Peel off the adhesive backing of the light fixture and attach it to the indicated location.

DE: Ziehen Sie die Klebefolie von der Leuchte ab und befestigen Sie sie an der angegebenen Stelle.

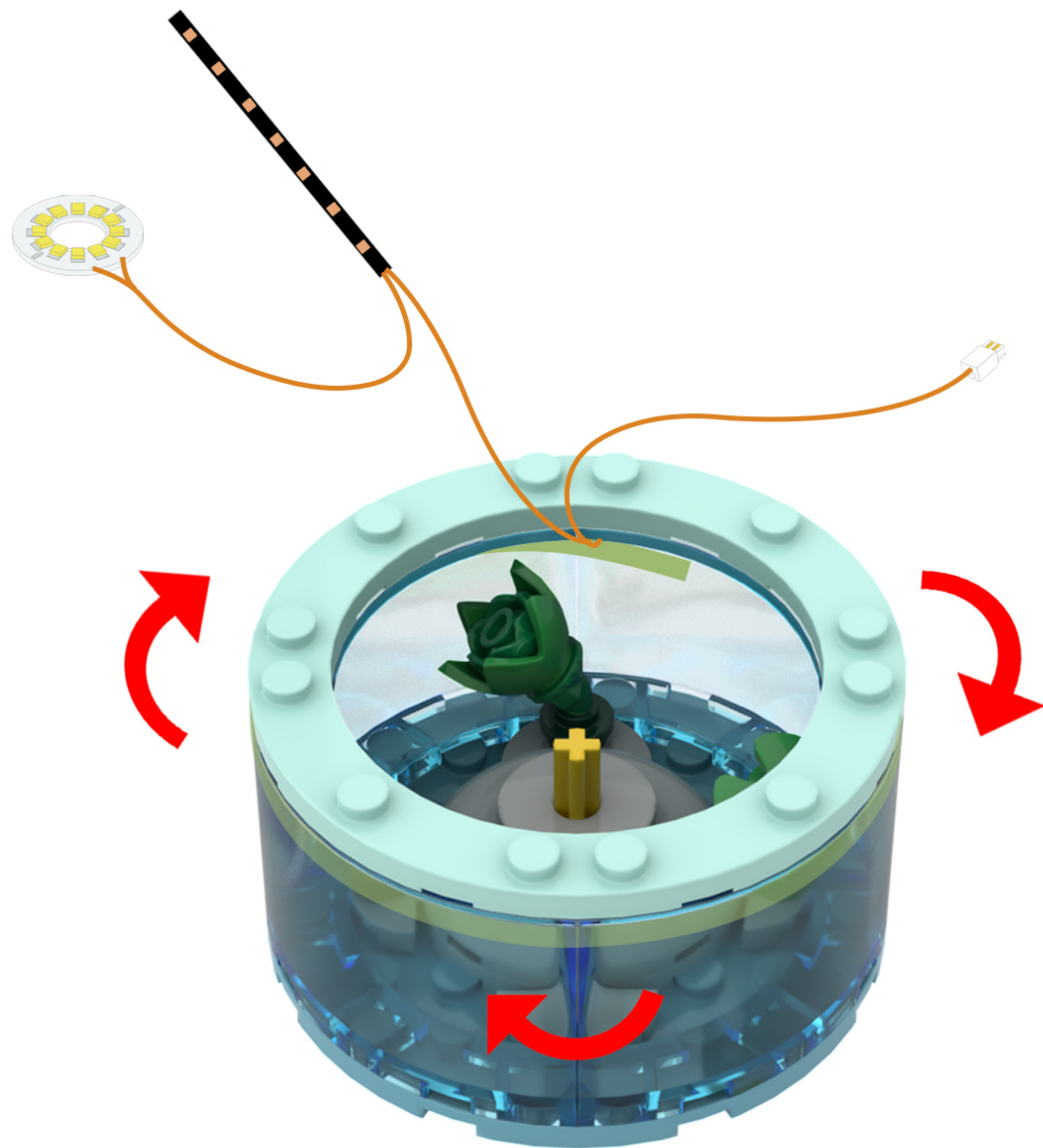
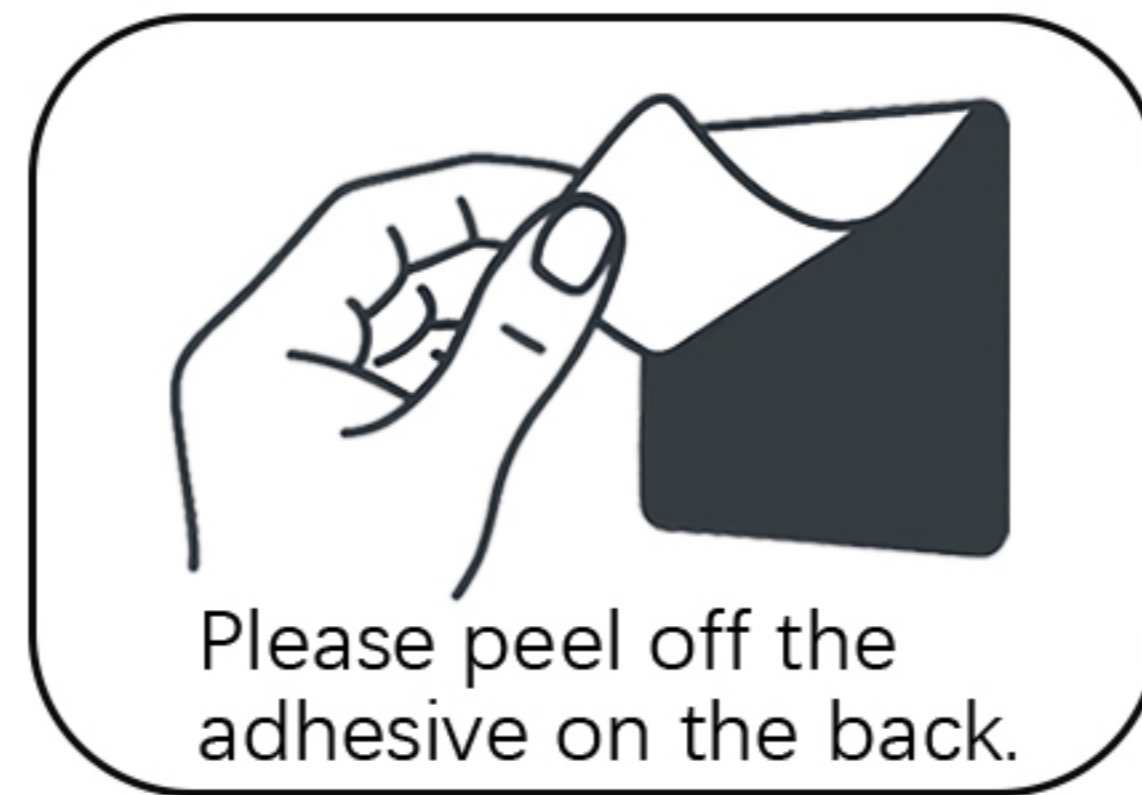

23

EN: Take out the disassembled building blocks and separate them.

DE: Nehmen Sie die zerlegten Bausteine heraus und trennen Sie sie voneinander.

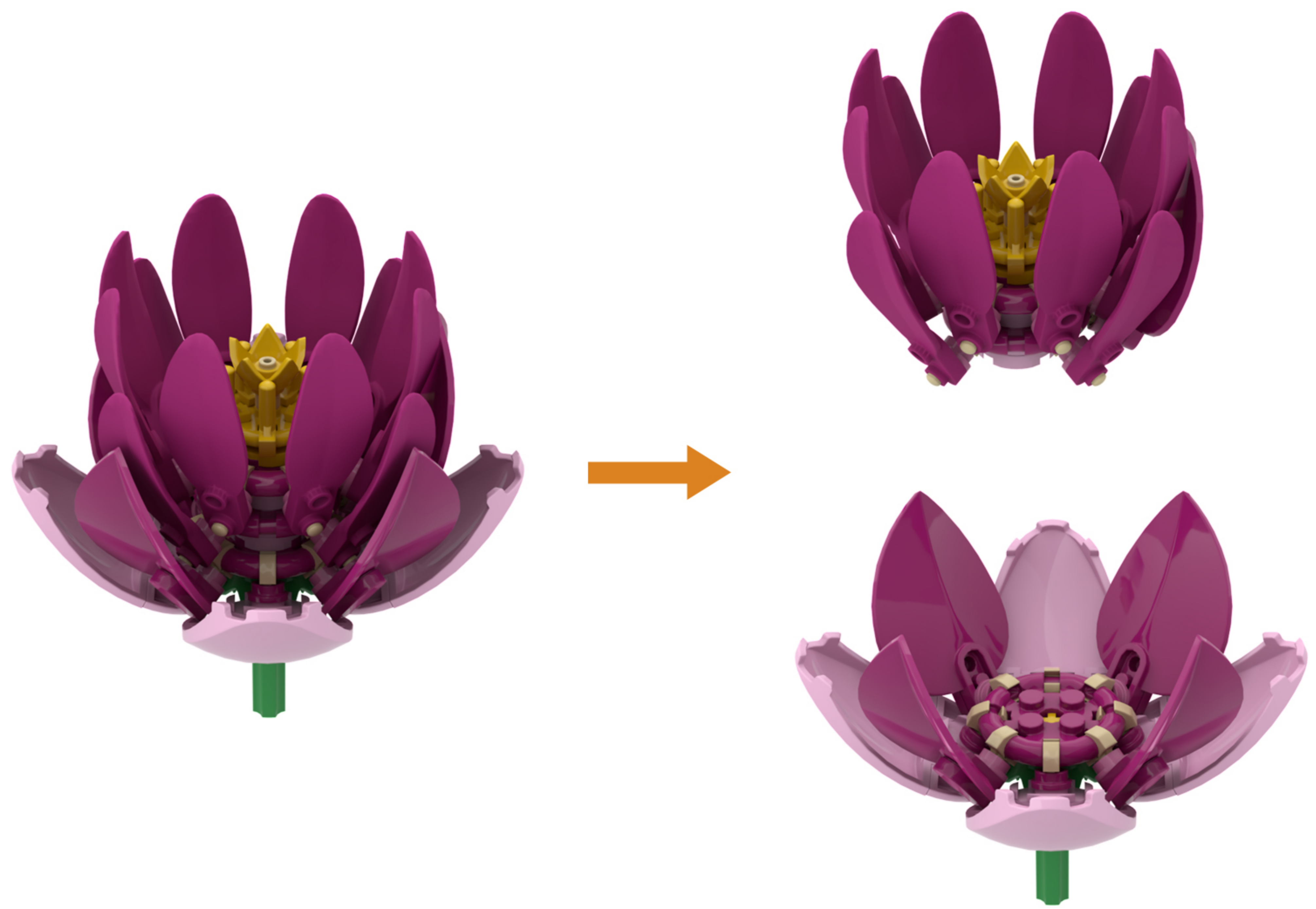
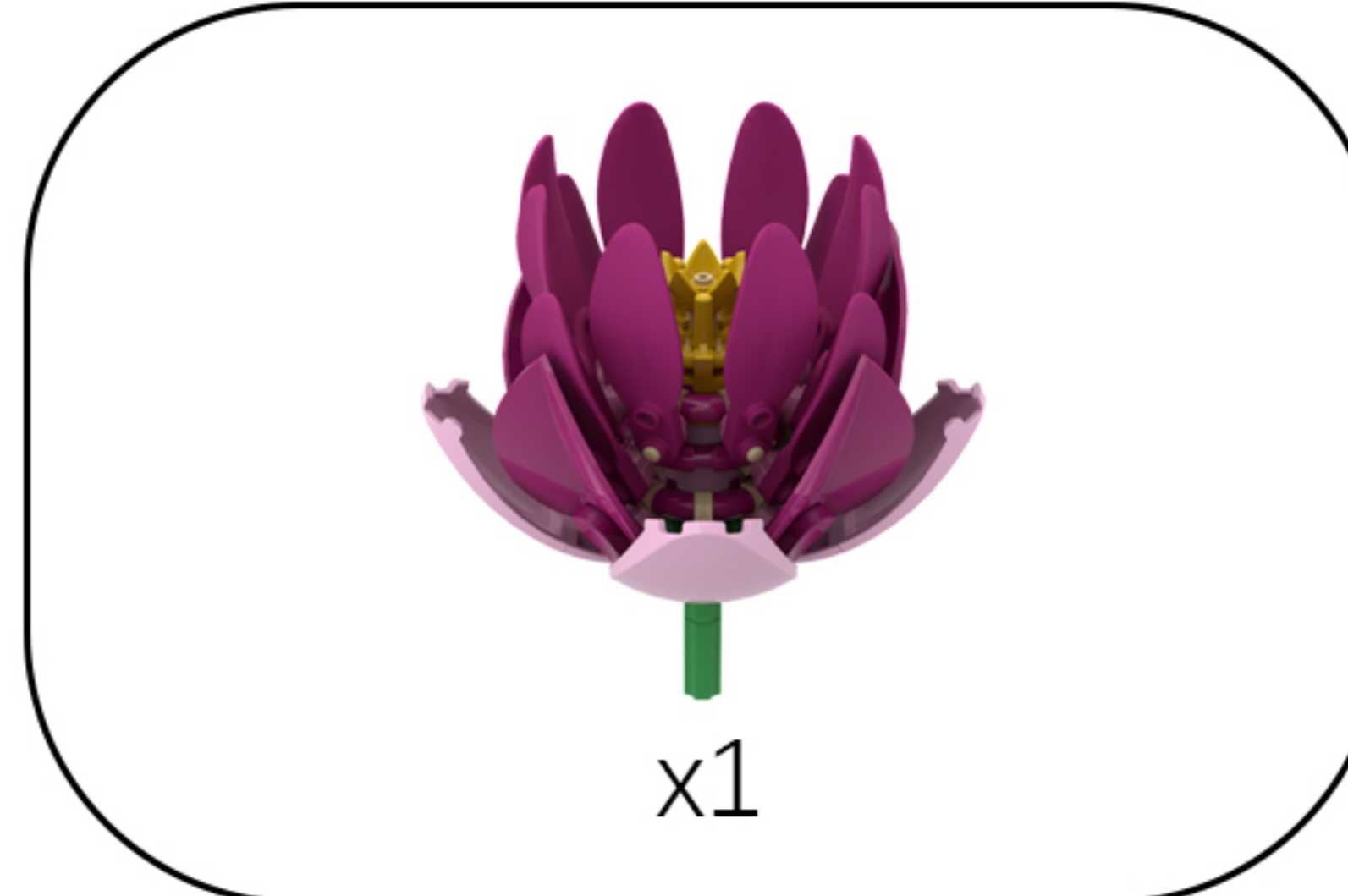

24

EN: Take out the disassembled building blocks and separate them.

DE: Nehmen Sie die zerlegten Bausteine heraus und trennen Sie sie voneinander.

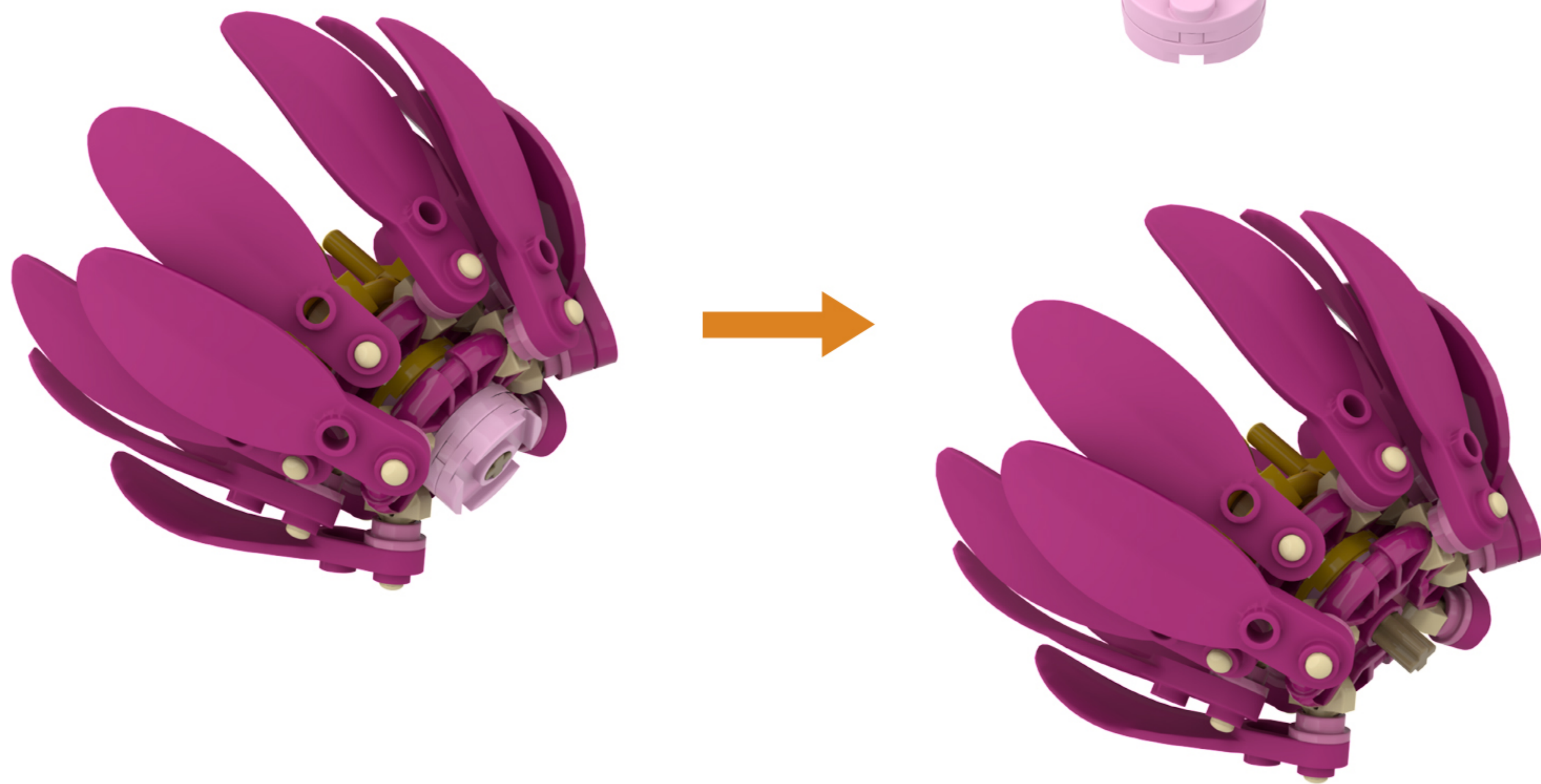
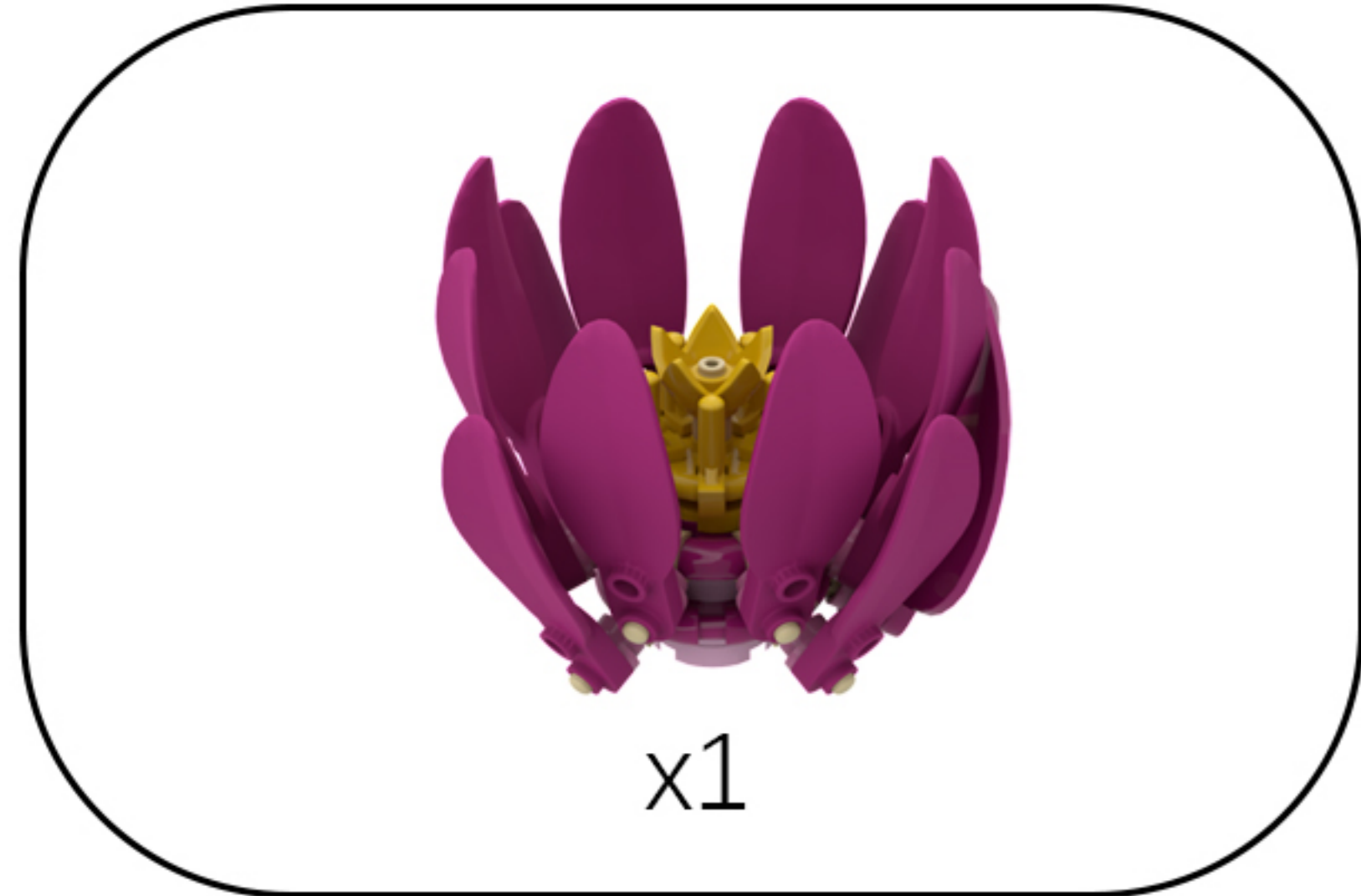

25

EN: Peel off the adhesive backing on the LED strip and wrap it around the building block.

DE: Zieh die Schutzfolie vom LED-Streifen ab und wickle ihn um den Baustein.

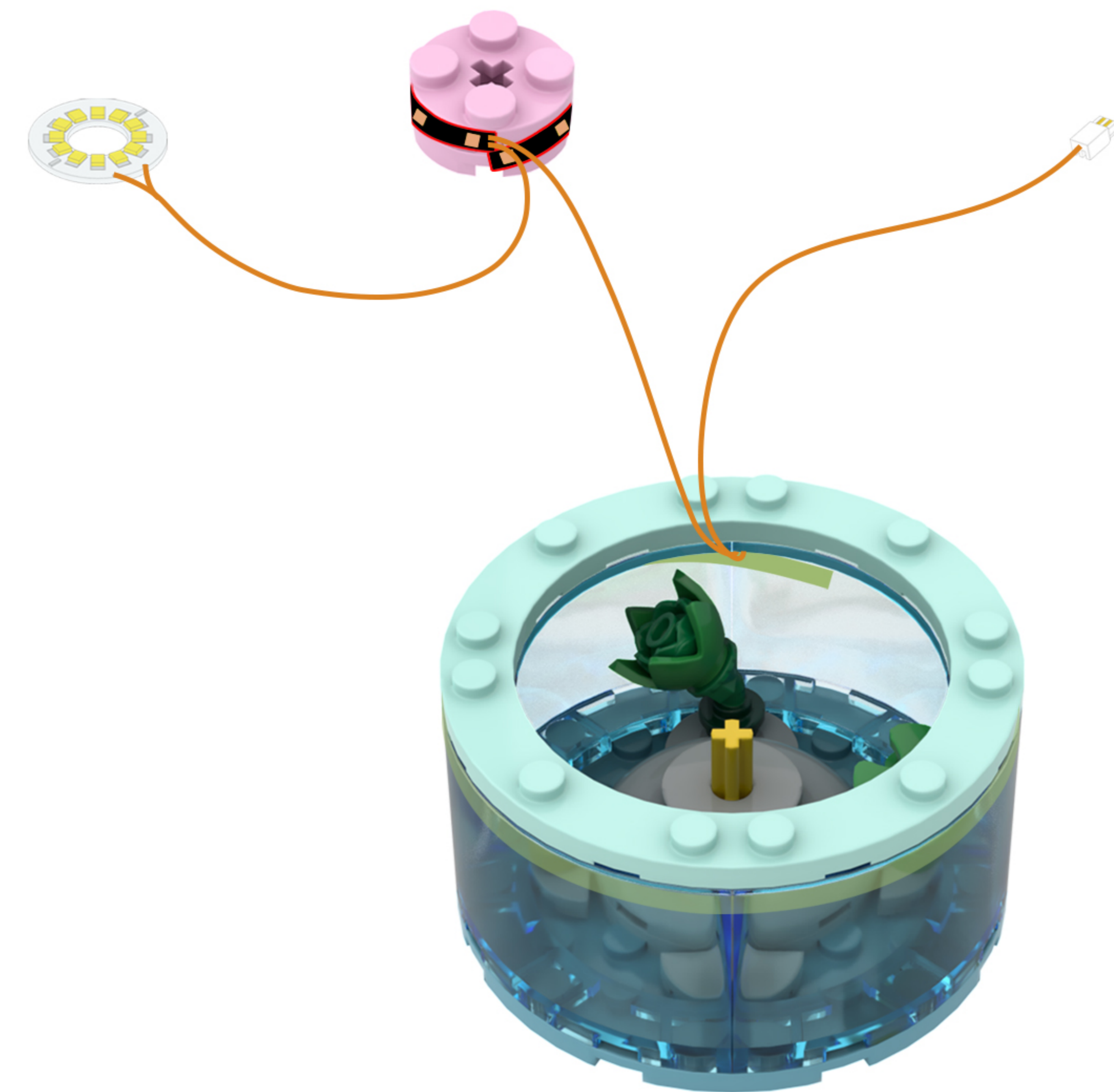

26

EN: Take out the disassembled building blocks and reassemble them.

DE: Nehmen Sie die zerlegten Bausteine heraus und setzen Sie sie wieder zusammen.

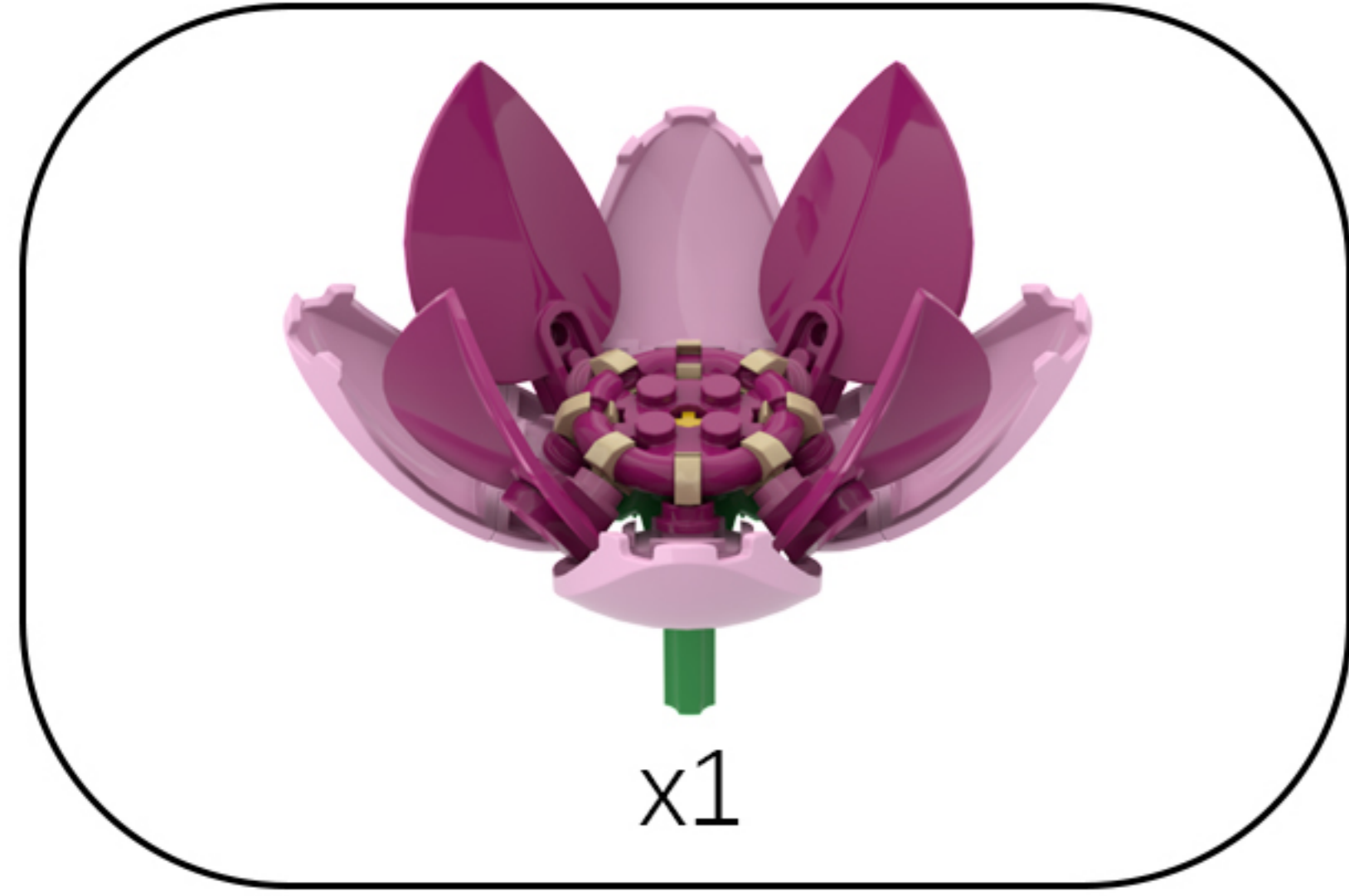

27

EN: Restore the building blocks.

DE: Stellen Sie die Bausteine wieder her.



28

EN: Take out the disassembled building blocks and separate them.

DE: Nehmen Sie die zerlegten Bausteine heraus und trennen Sie sie voneinander.

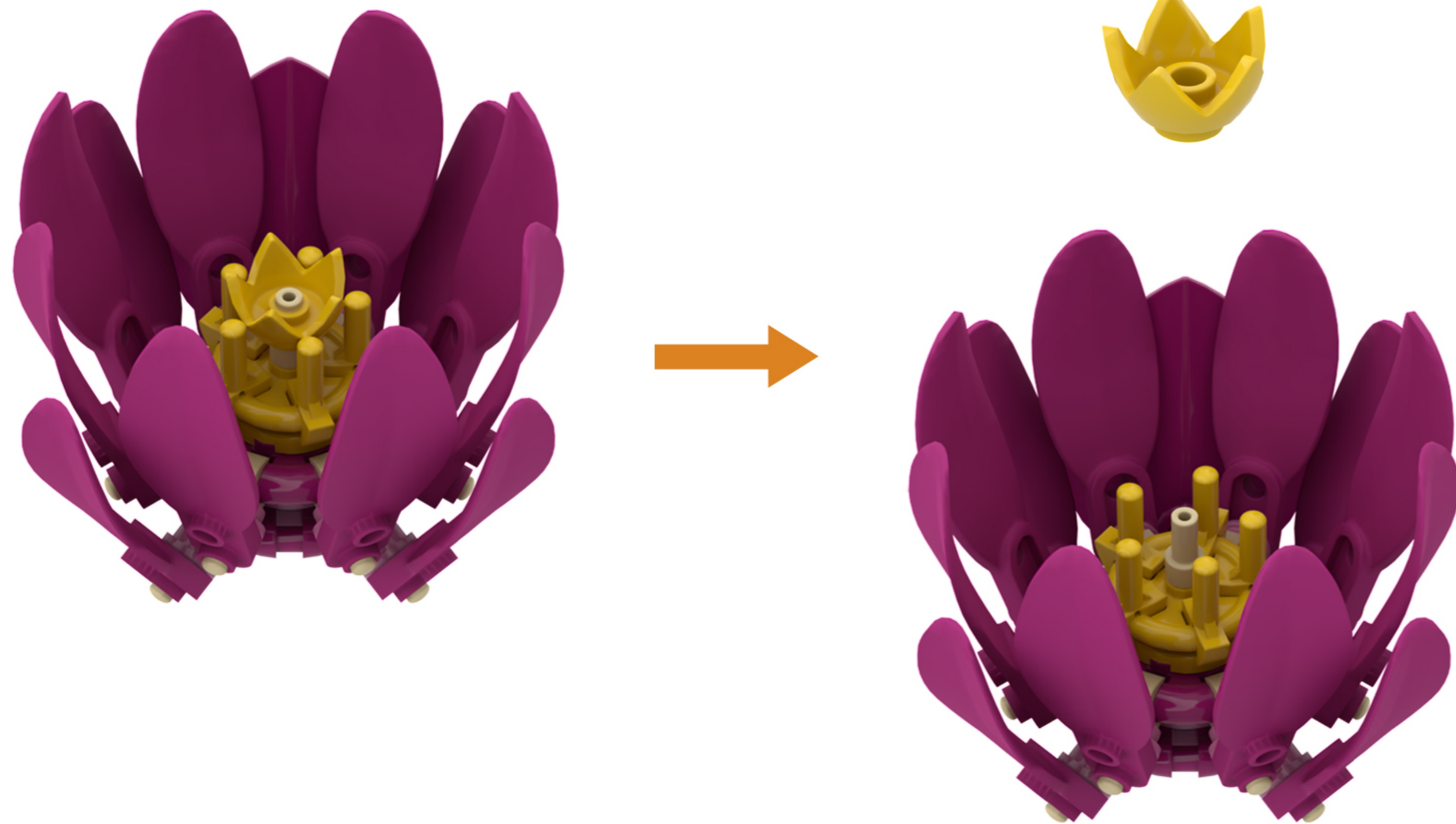
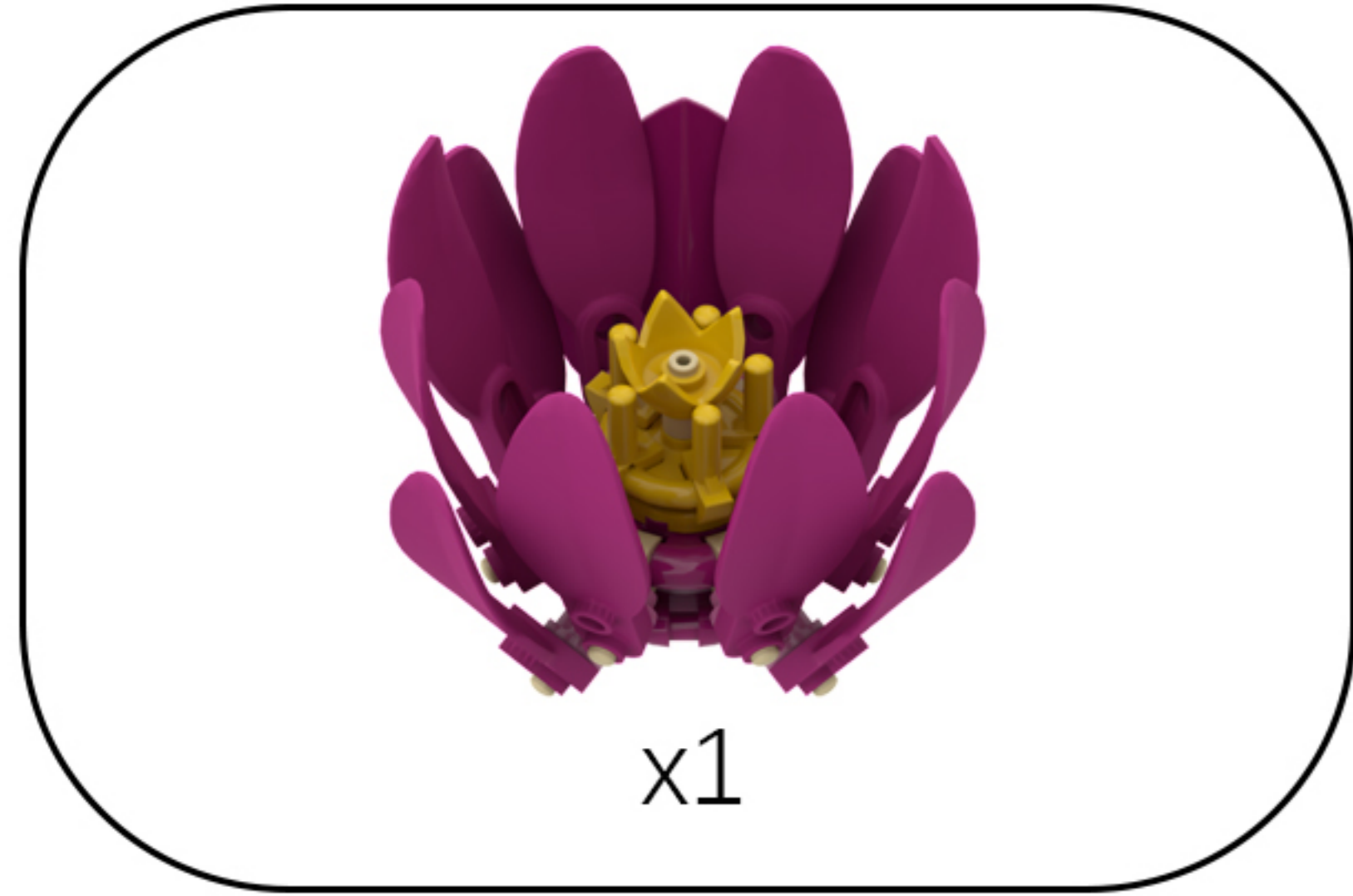

29

EN: Restore the building blocks.

DE: Stellen Sie die Bausteine wieder her.

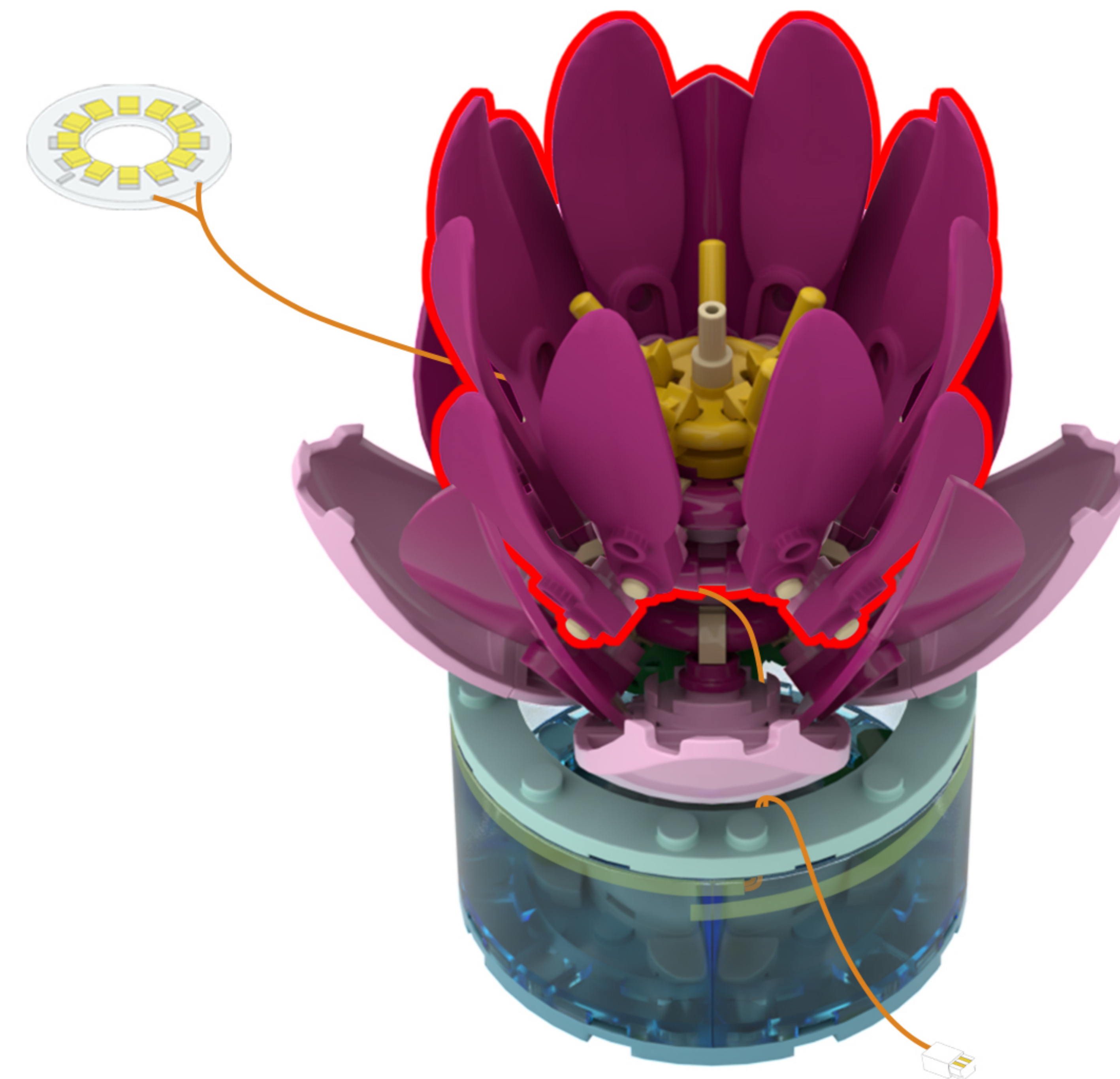

30

EN: Place the light fixture with the light-emitting side facing down on the building block.

DE: Stellen Sie die Leuchte mit der leuchtenden Seite nach unten auf den Baustein.

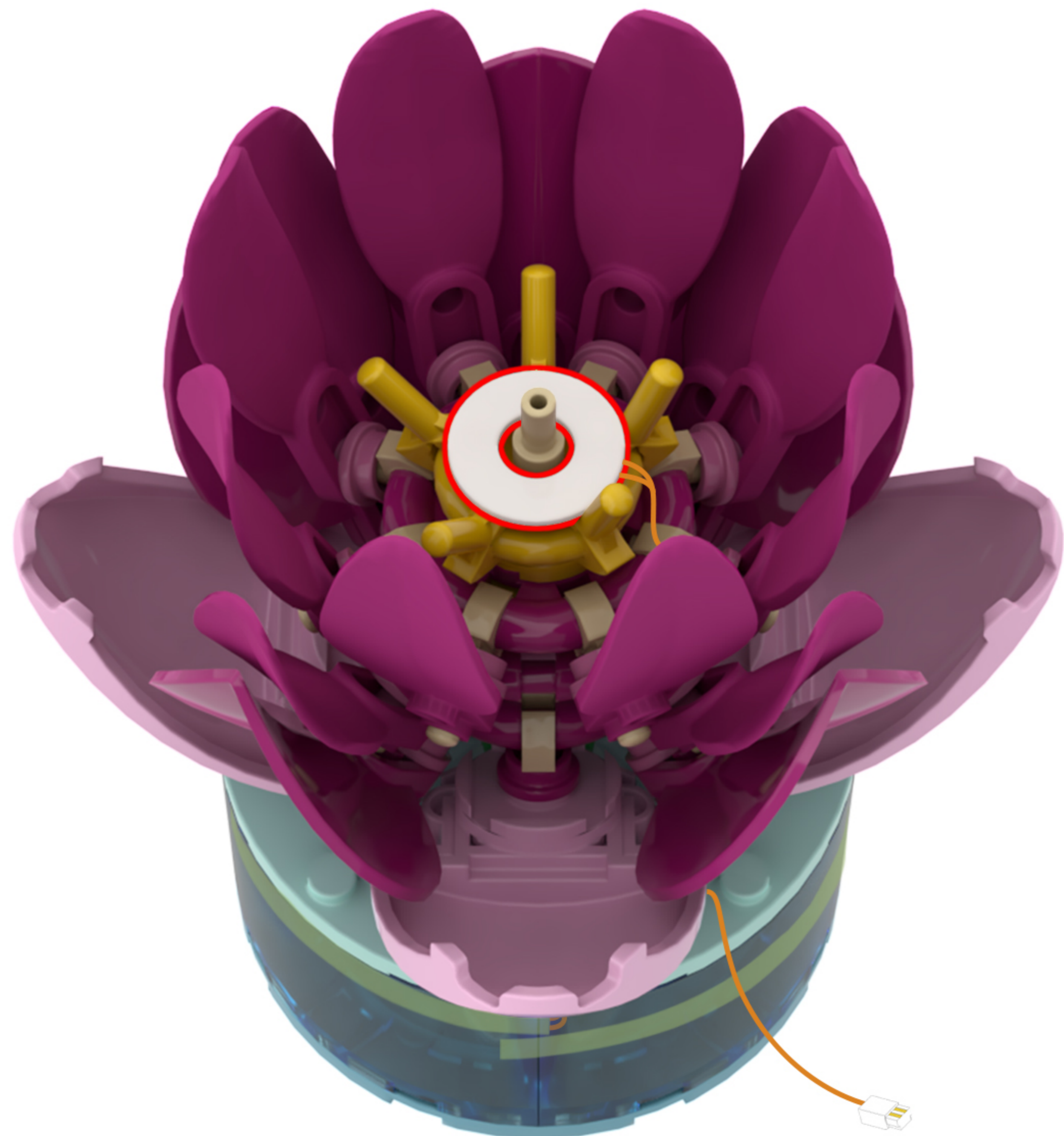

31

EN: Take out the disassembled building blocks and reassemble them.

DE: Nehmen Sie die zerlegten Bausteine heraus und setzen Sie sie wieder zusammen.

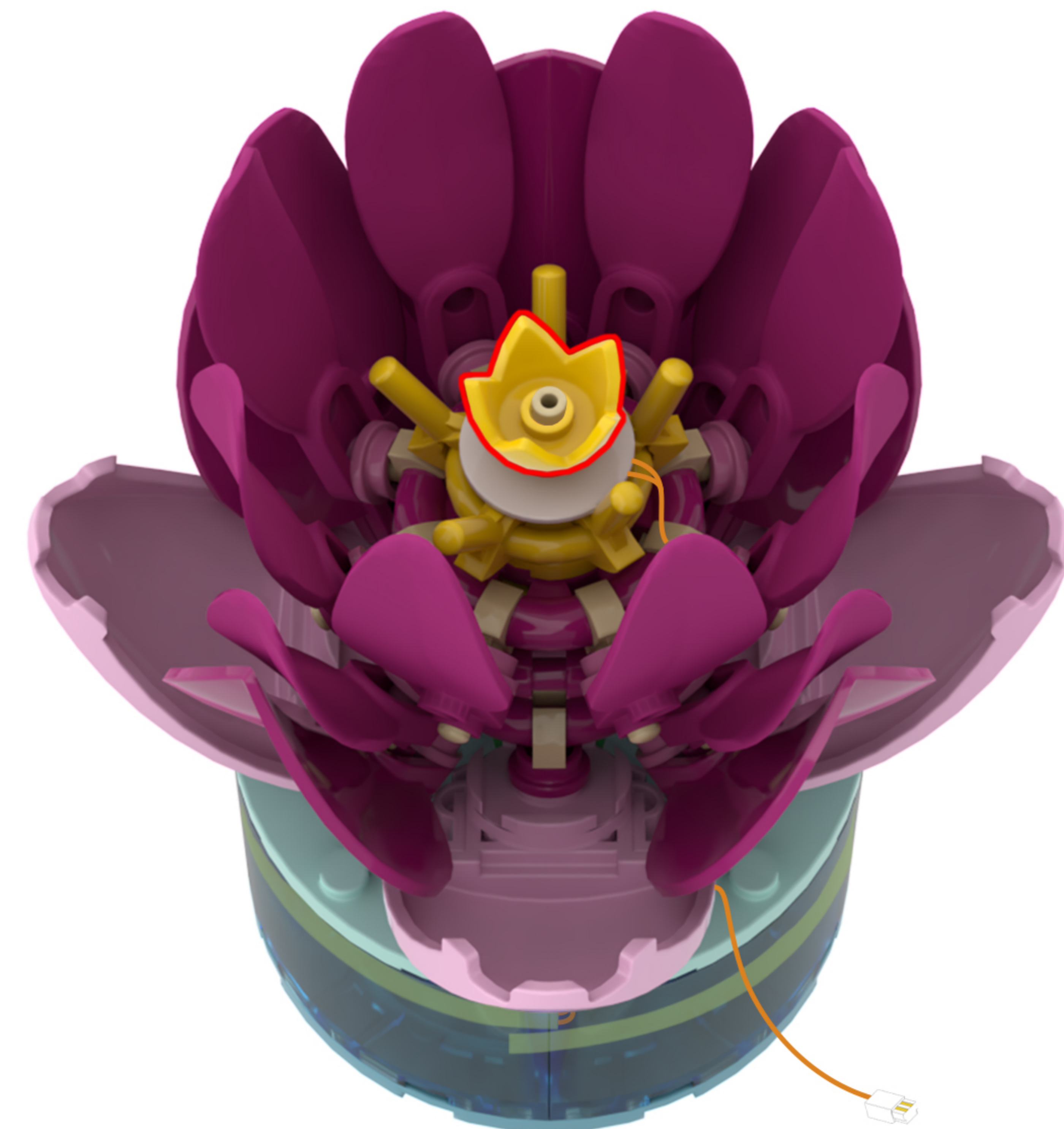
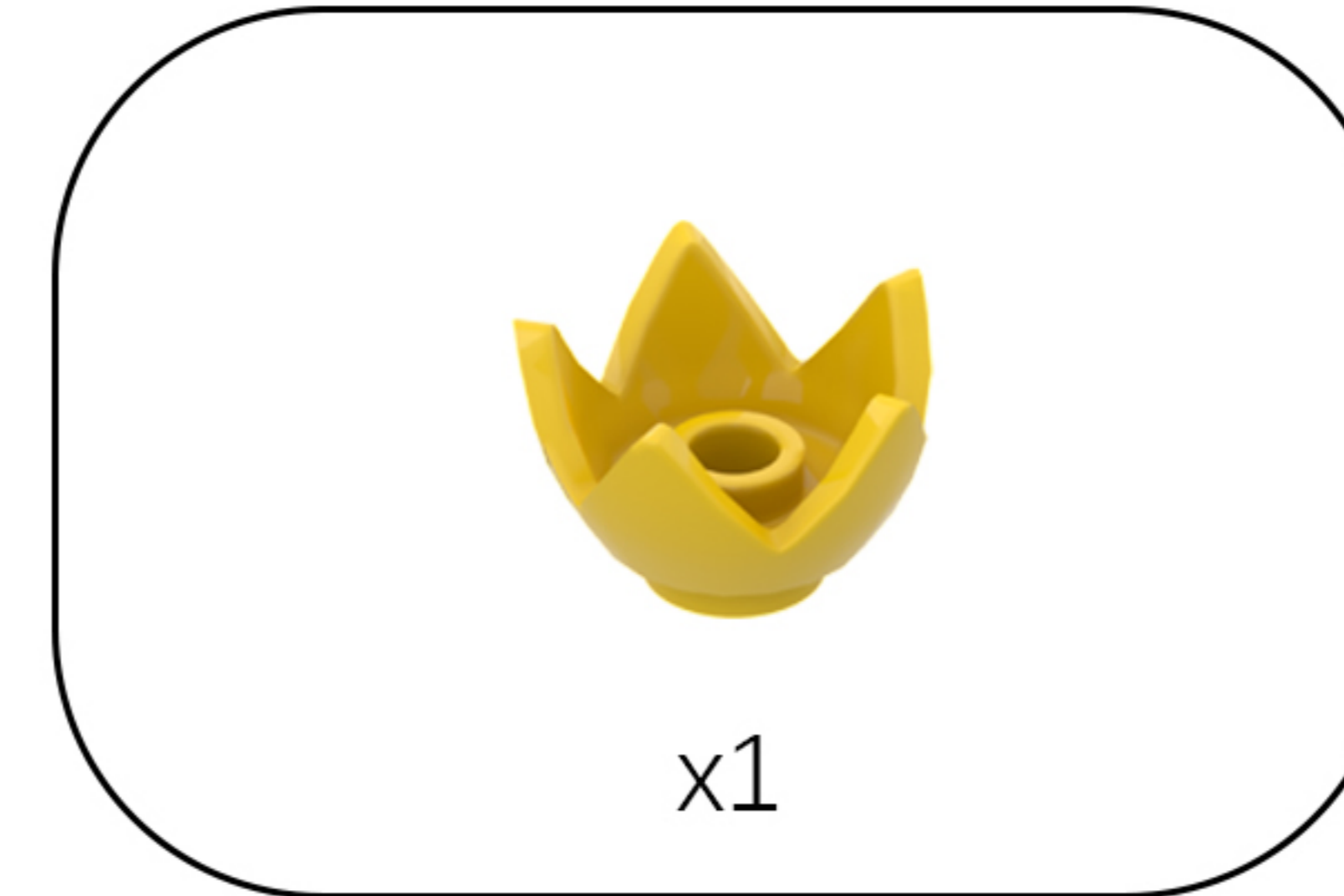

32

EN: Take the 2-port expansion board, the 4-port expansion board, and the connecting cable from Bag 3, and connect them together.

DE: Nehmen Sie die 2-Port-Erweiterungskarte, die 4-Port-Erweiterungskarte und das Verbindungskabel aus Beutel 3 und schließen Sie sie aneinander an.

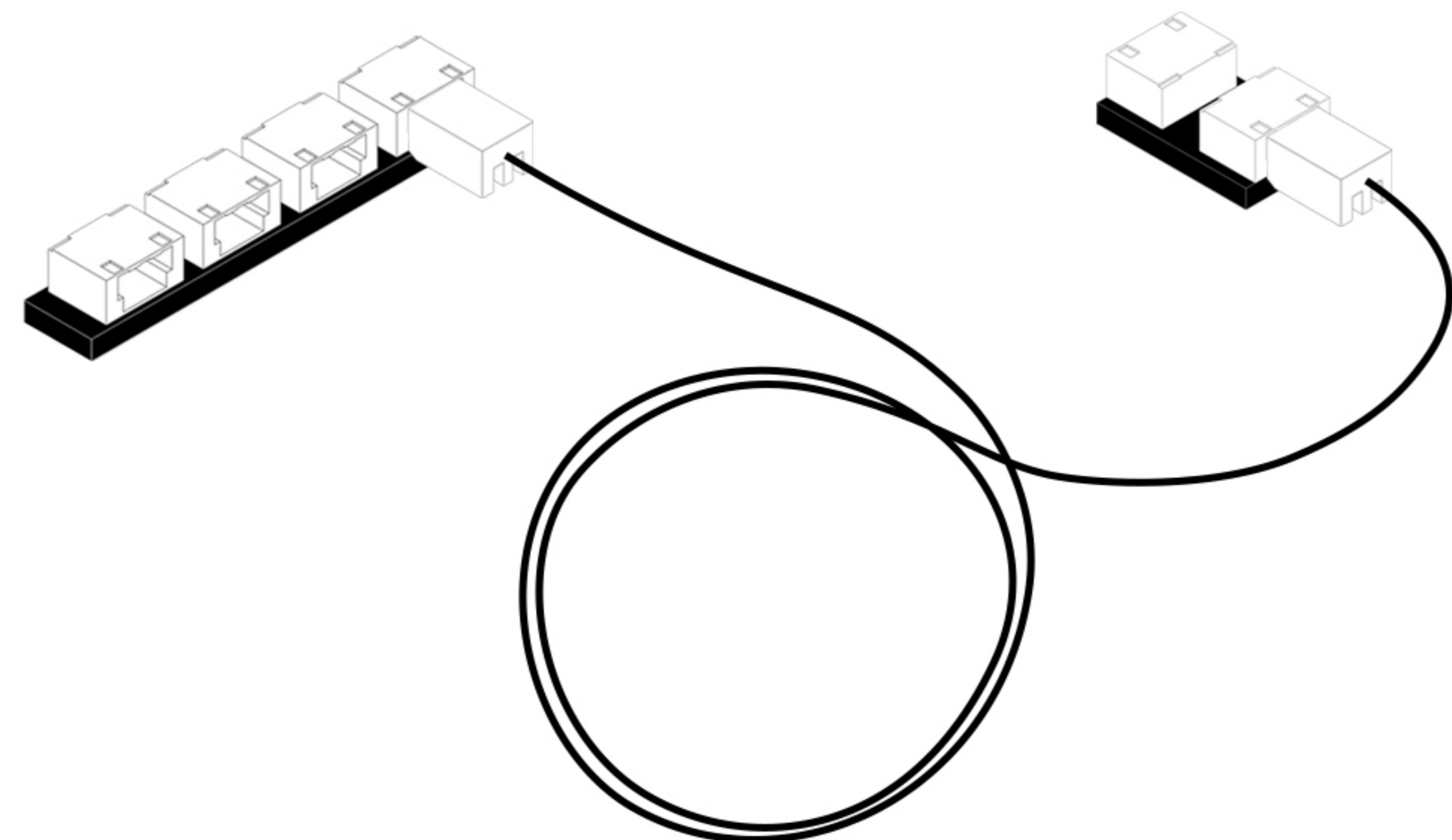
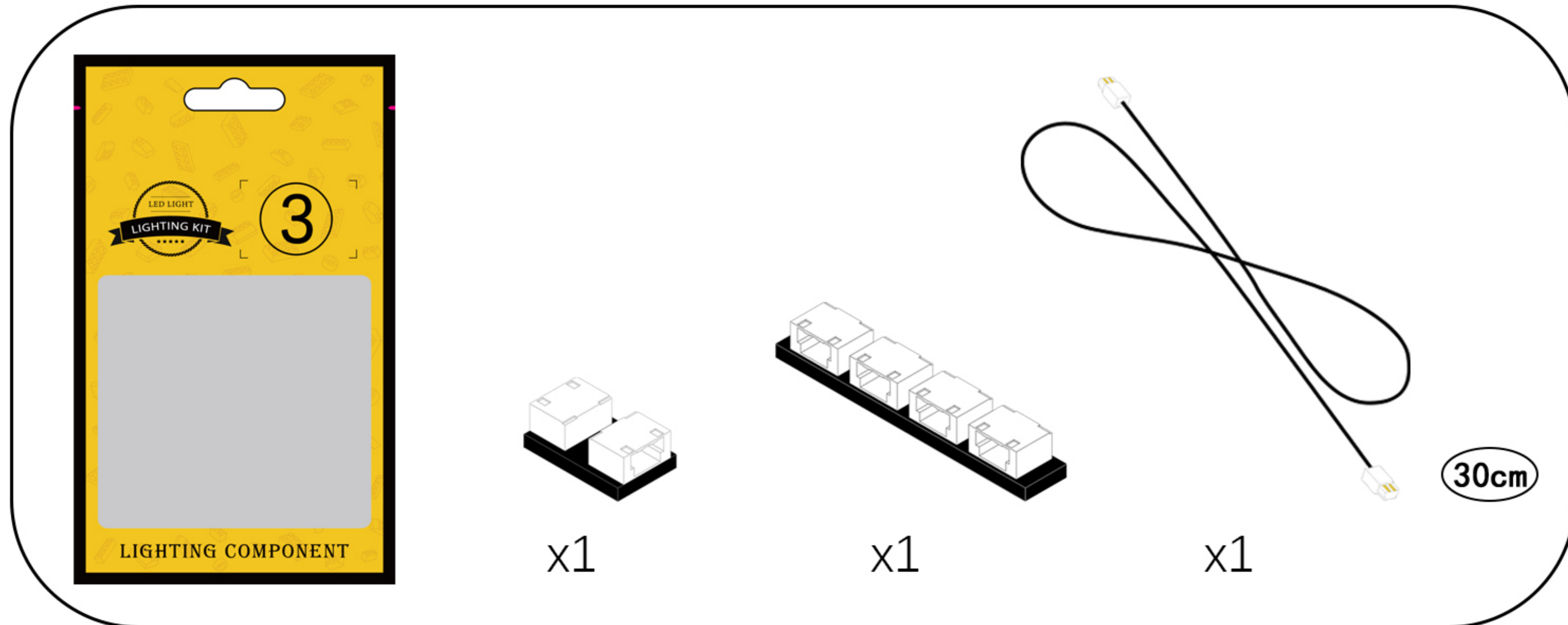

33

EN: Locate this light cord in the diagram.

DE: Suchen Sie dieses Lichtkabel in der Abbildung.

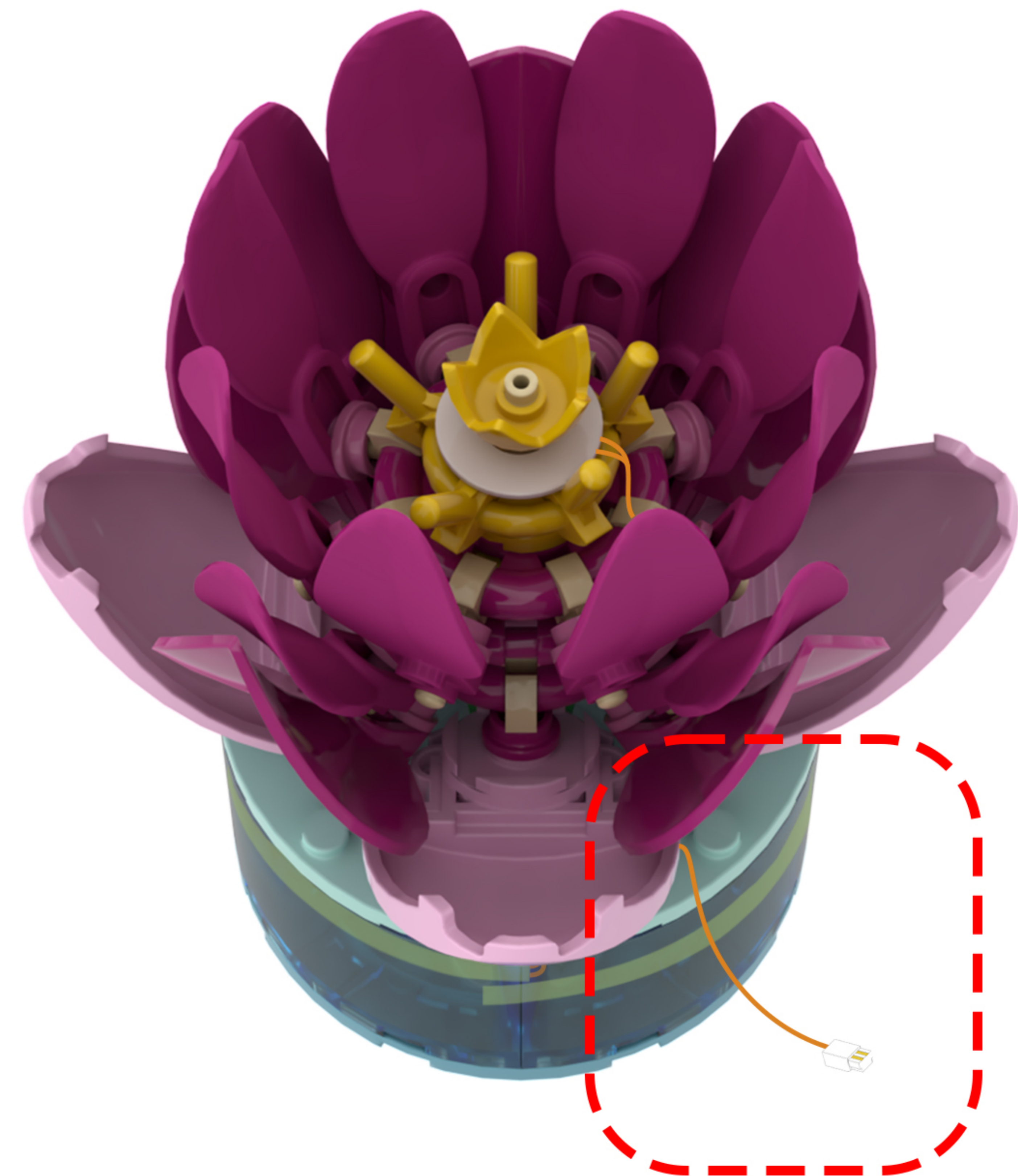

34

EN: Connect the lamp wires to the 2-outlet expansion board.

DE: Schließen Sie die Lampenkabel an die Erweiterungsplatine mit zwei Anschlüssen an.

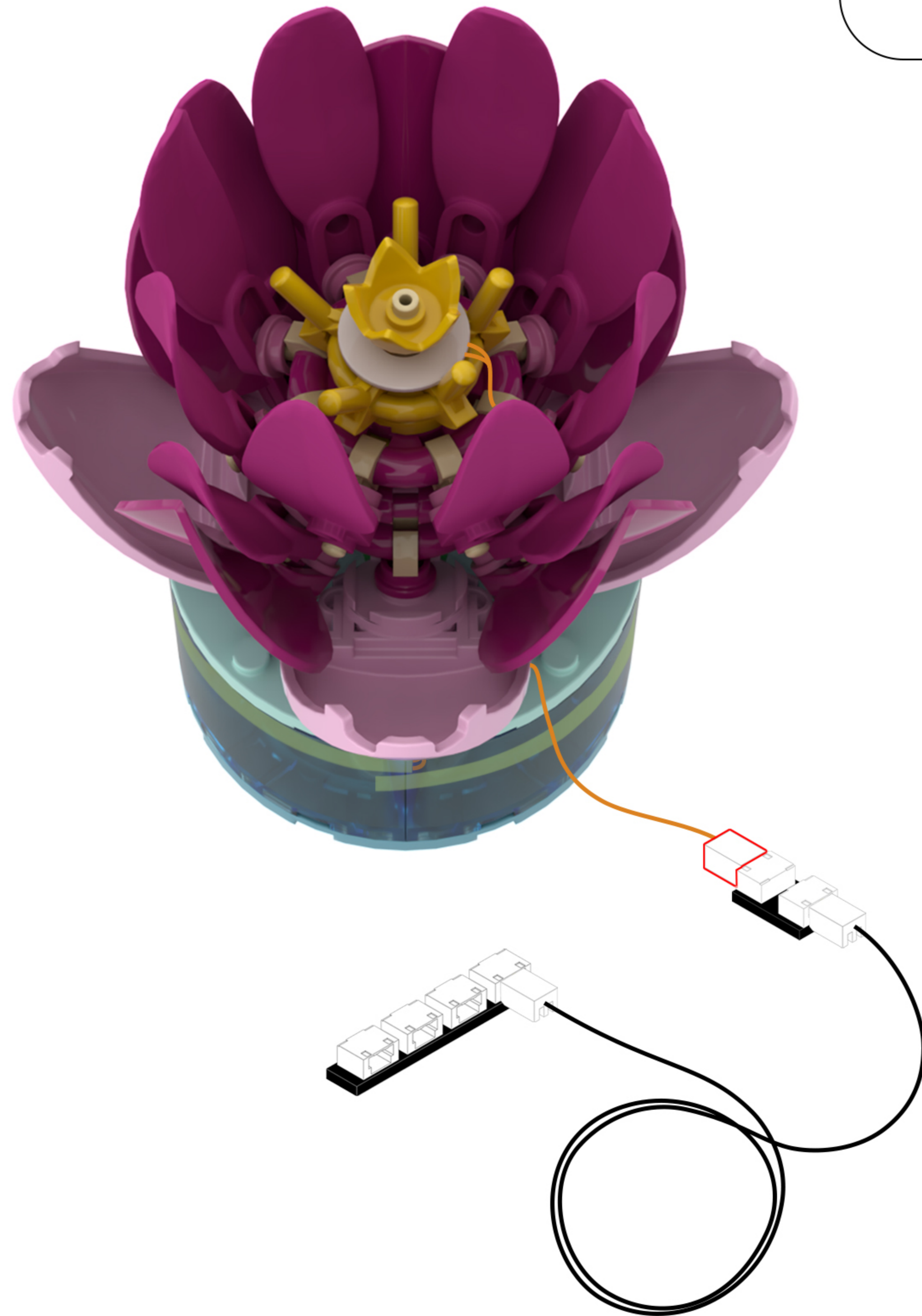
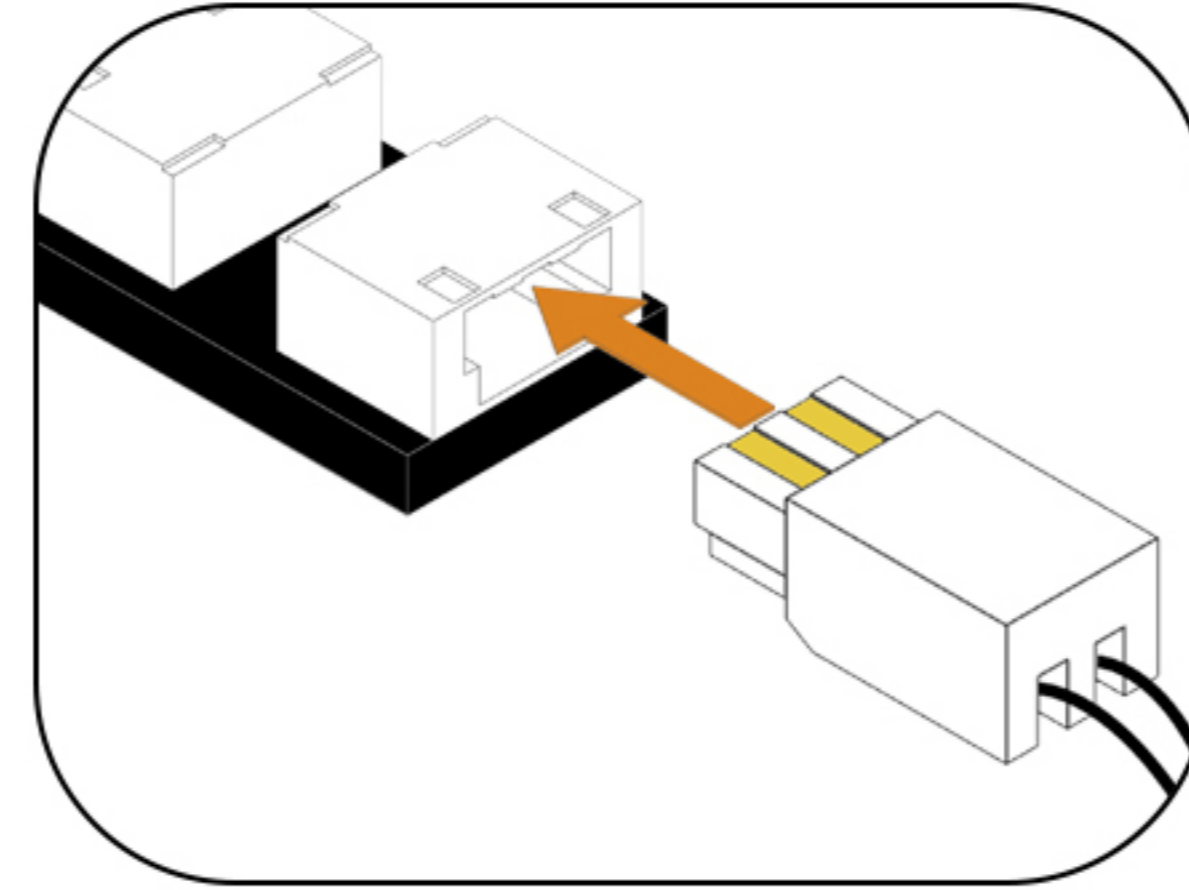

35

EN: Peel off the adhesive backing of the expansion board and attach it to the location shown in the illustration.

DE: Entfernen Sie die Schutzfolie von der Rückseite der Erweiterungsplatte und kleben Sie sie an die in der Abbildung gezeigte Stelle.

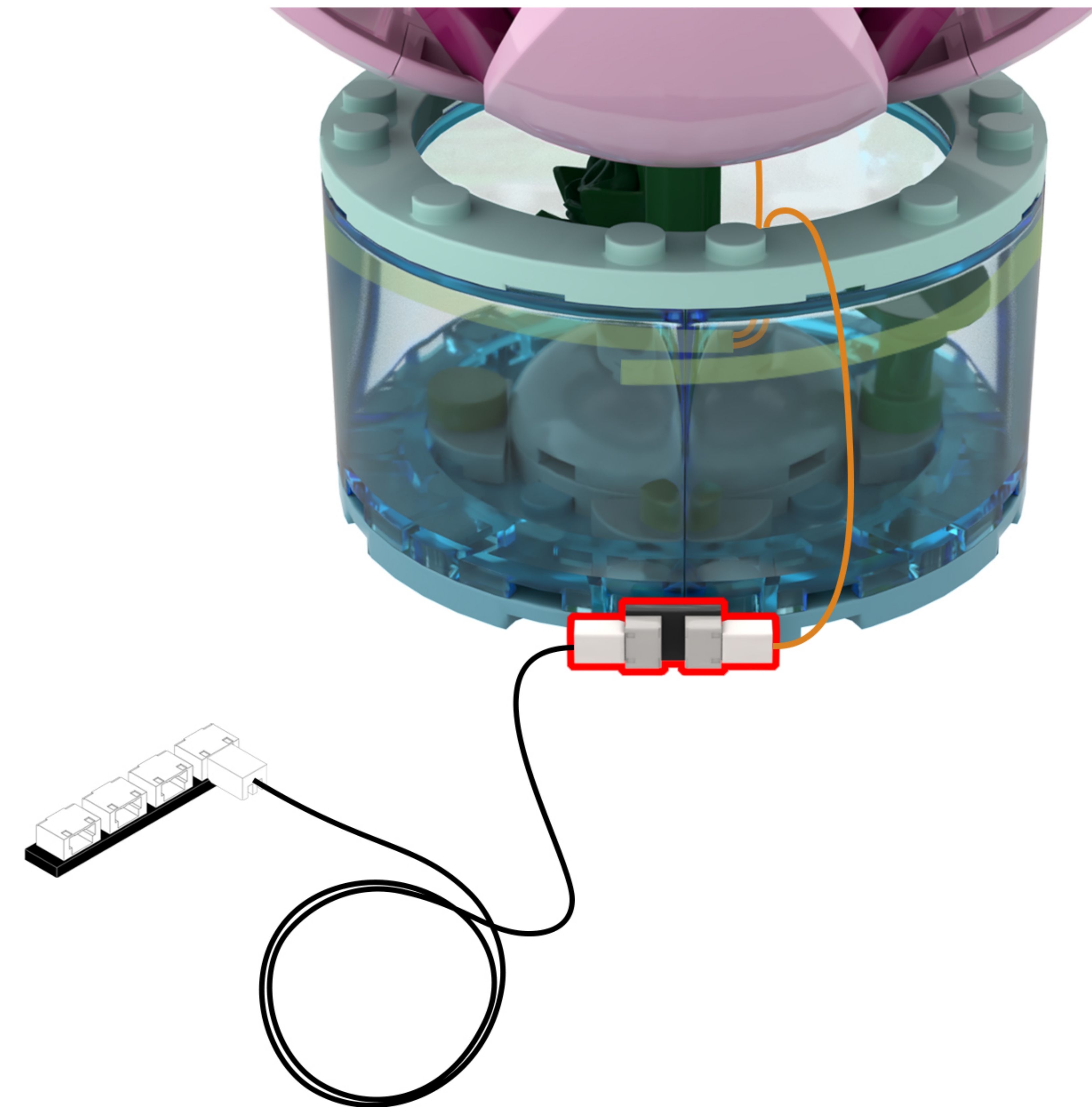

36

EN: Take out the building block with the lights attached and connect it to the 4-port expansion board.

DE: Nehmen Sie den Baustein mit den daran befestigten Leuchten heraus und schließen Sie ihn an die 4-Port-Erweiterungskarte an.

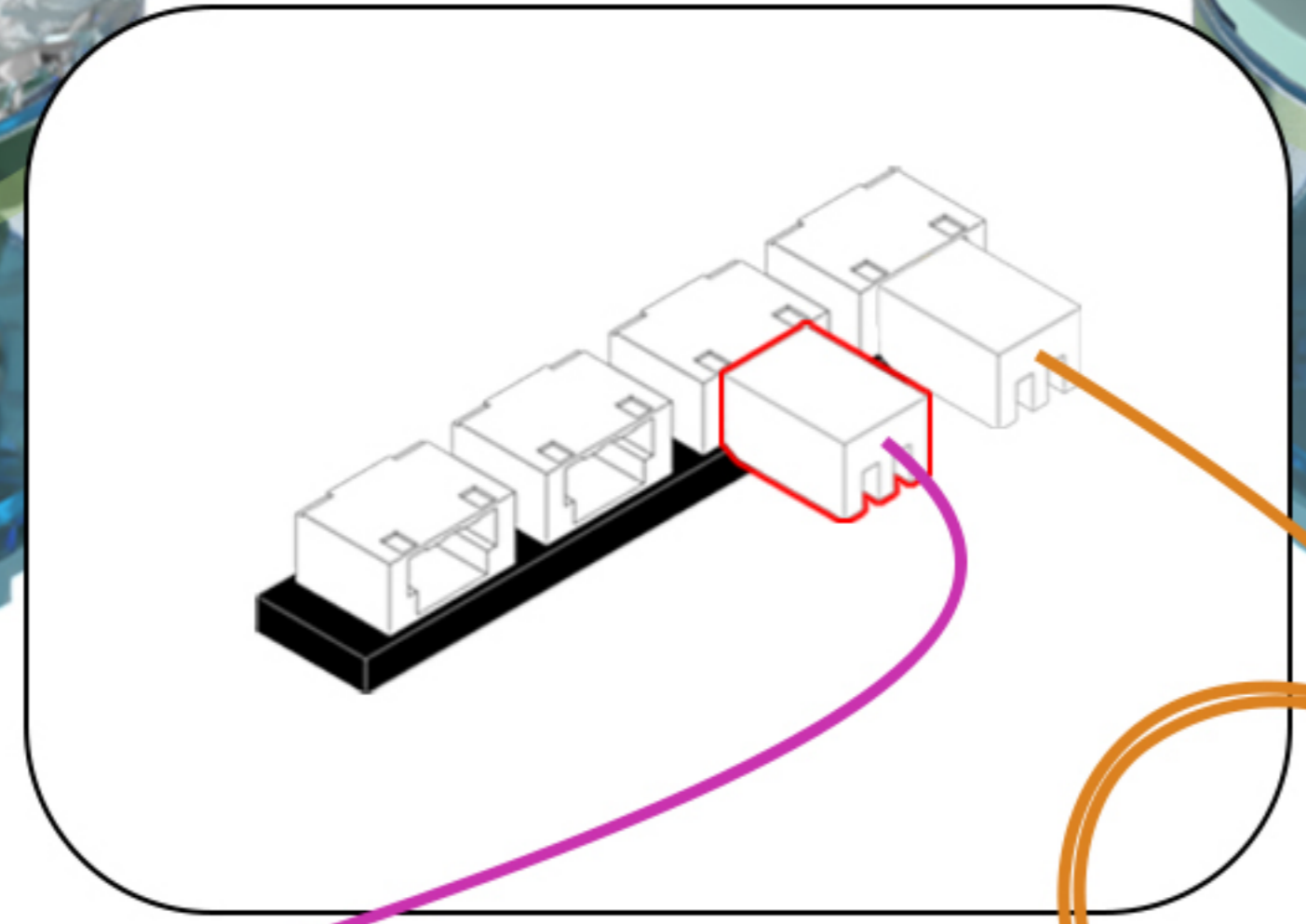
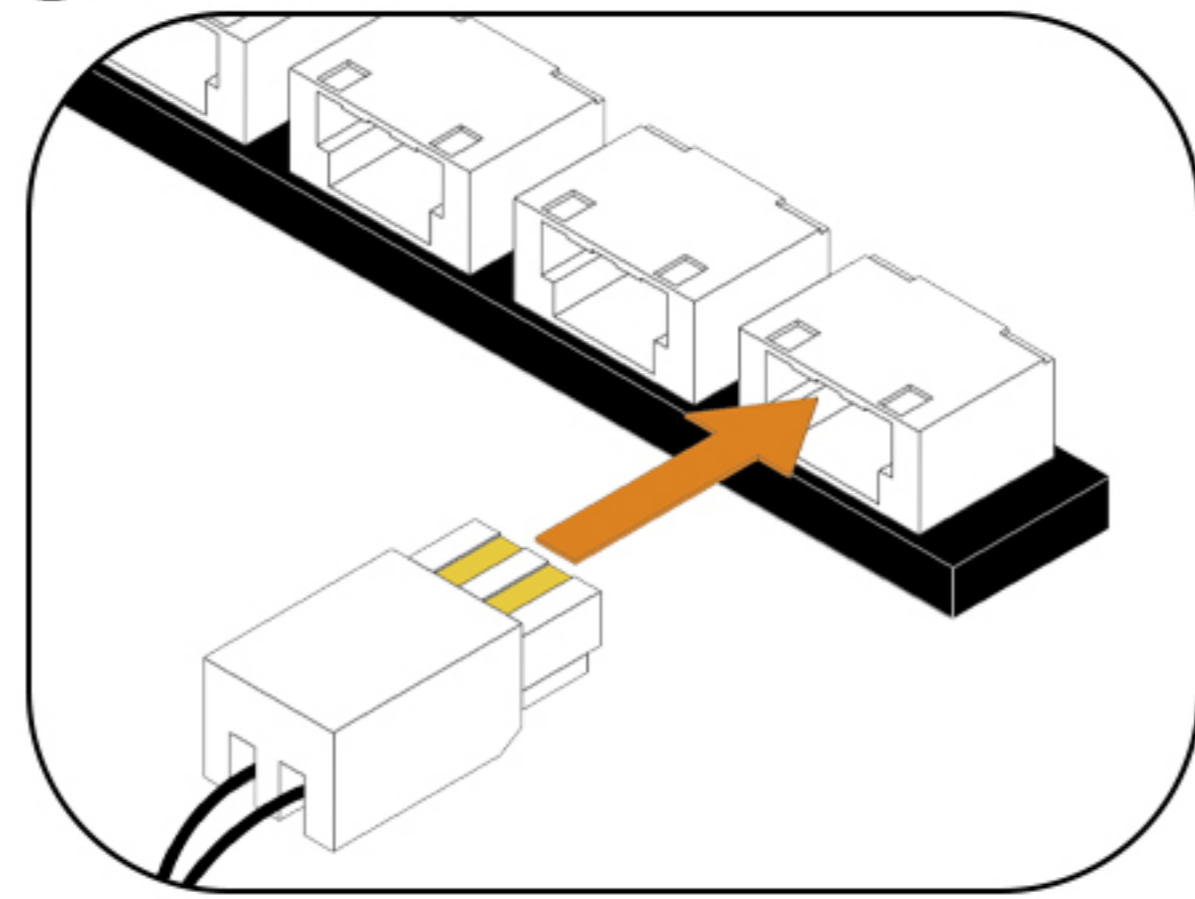
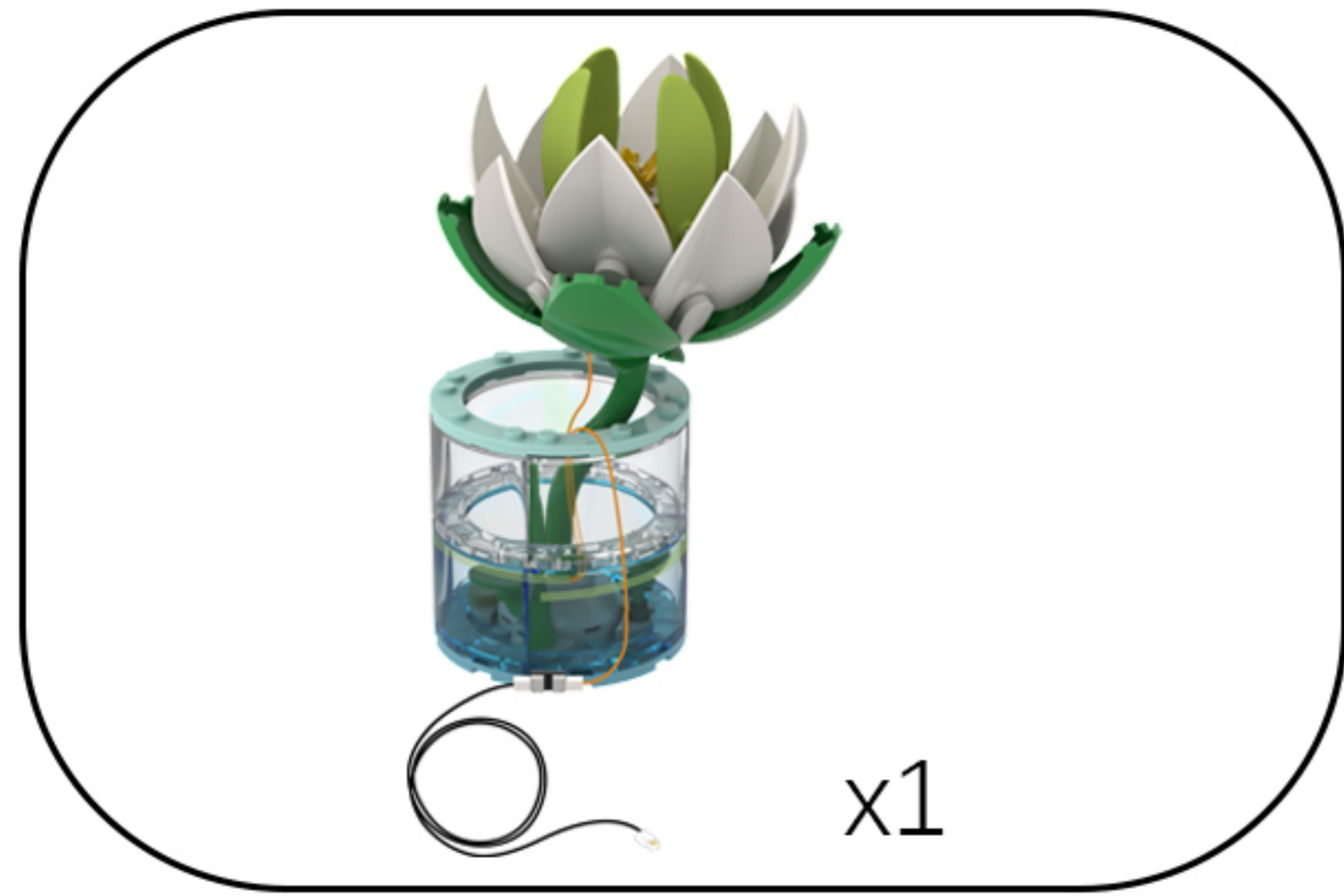

37

EN: Take the USB power cable out of the box and connect it to the expansion board.

DE: Nehmen Sie das USB-Stromkabel aus der Verpackung und schließen Sie es an die Erweiterungskarte an.

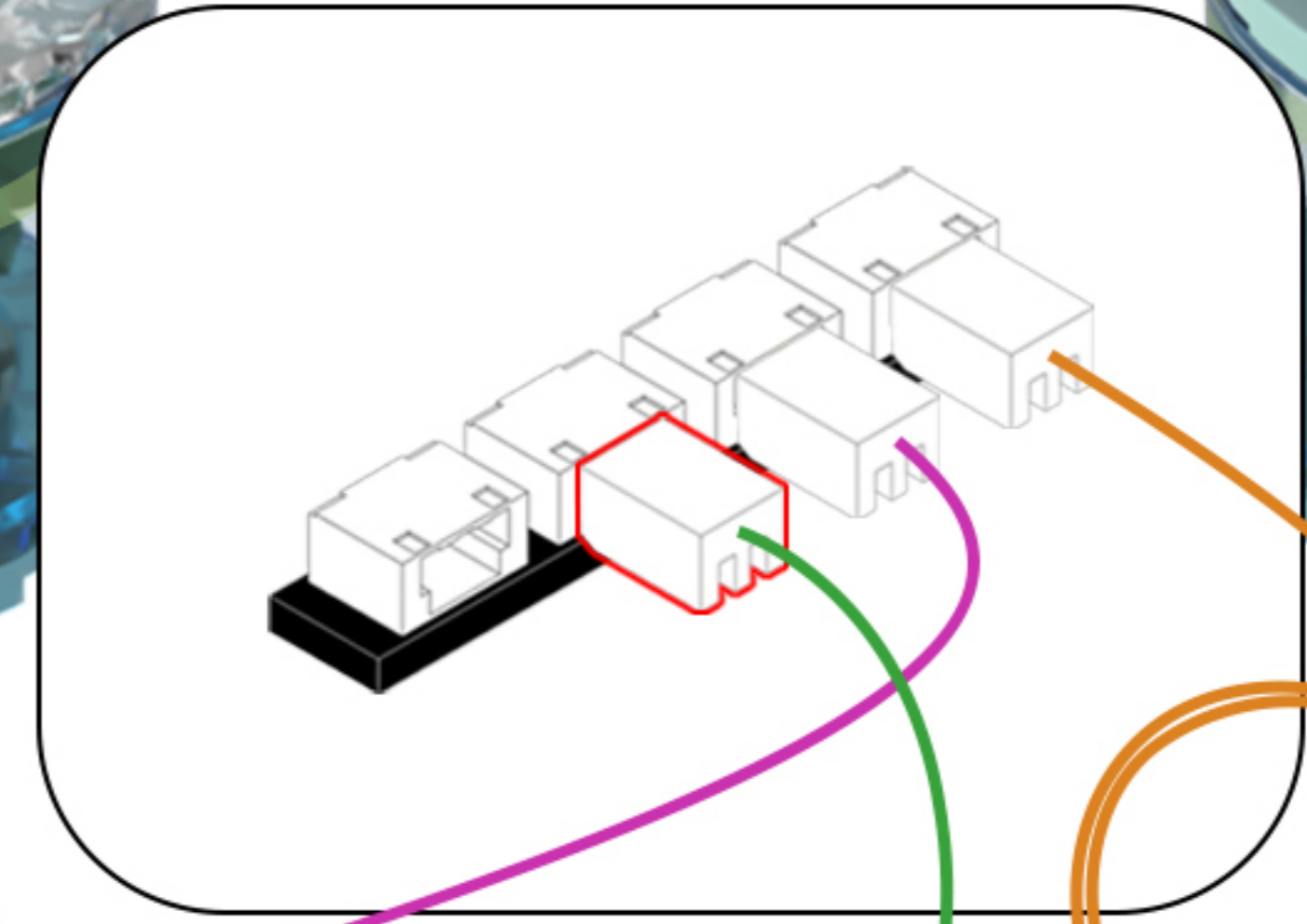
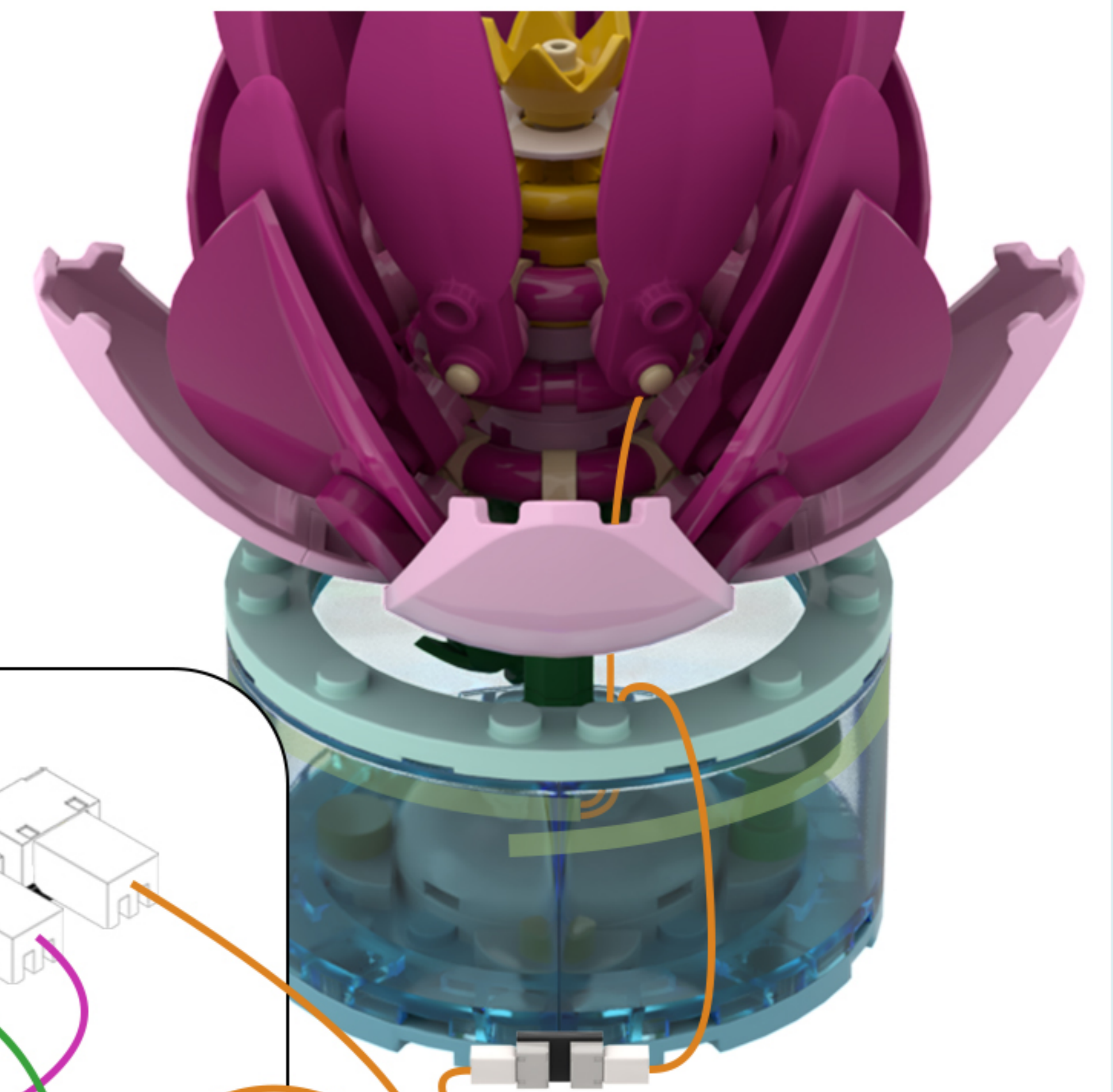
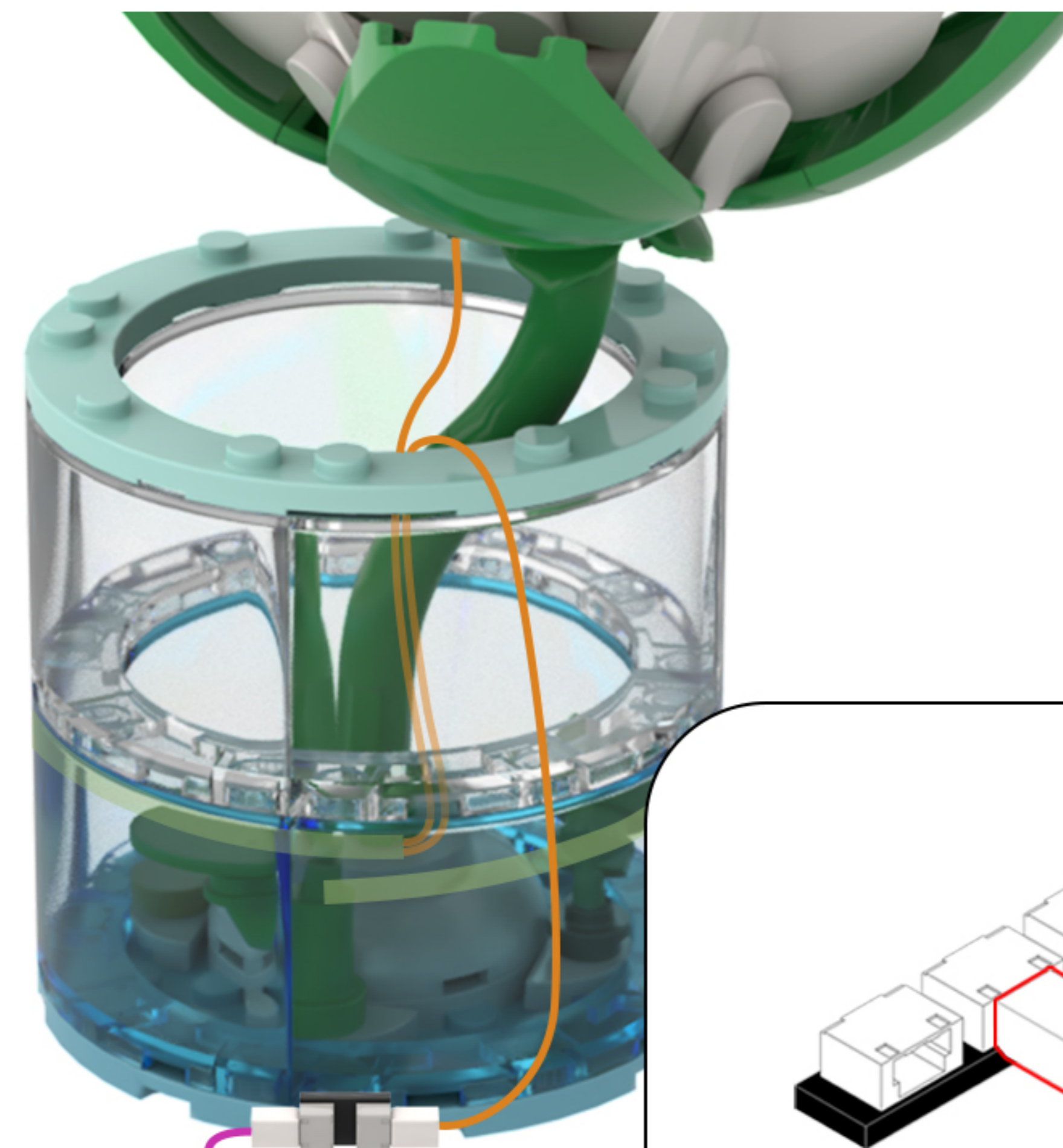
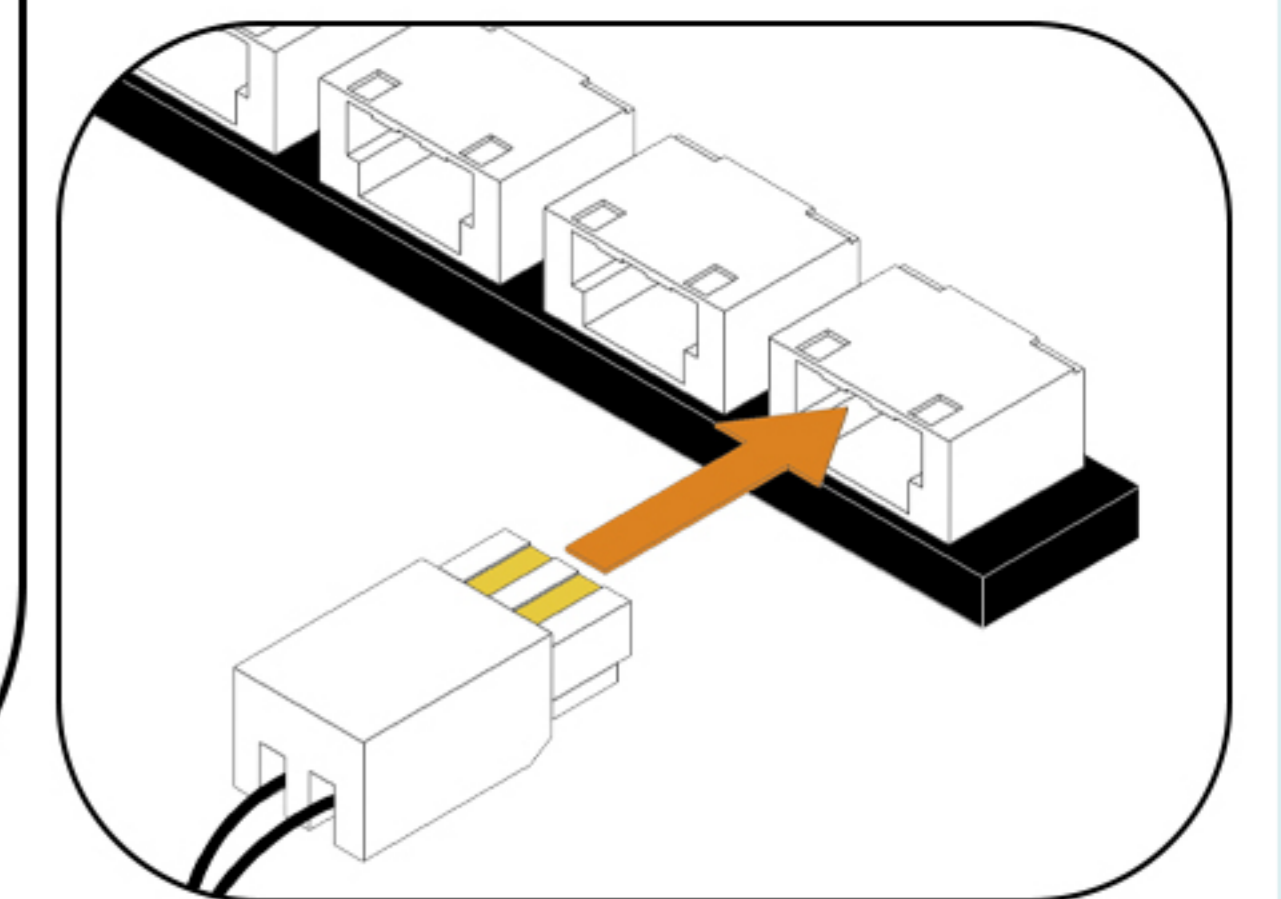
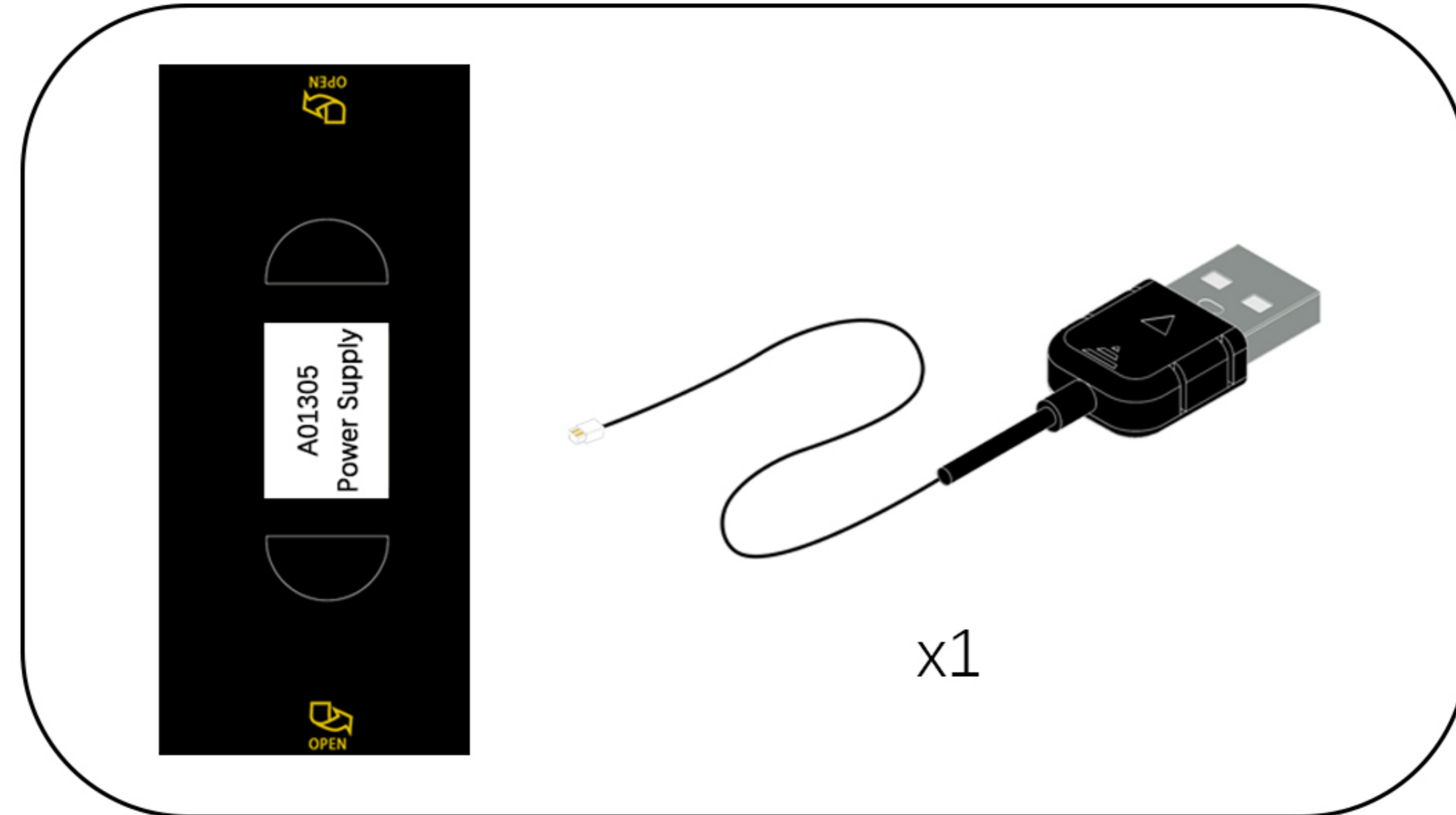

38

EN: Once installed, connect the power supply and give it a try!

DE: Die Installation ist abgeschlossen. Schließen Sie das Gerät an die Stromversorgung an und probieren Sie es aus!





Above our designers to provide the relevant ideas and instructions. But please move to the following:

- 1: about our company this product parts material, product quality do you have comments and suggestions?
- 2: about this product installation instructions and installation of the degree of difficulty do you have views and suggestions?
- 3: if in the operation of the product we provide ideas encountered any problems, please contact us in a timely manner.

Tips

If you encounter any installation problems please contact the seller, we will be happy to help you solve!