

INSTALLATION GUIDE

FIFA World Cup 2026
Official Emblem
43032



LED light kit compatible with Lego

Instructions for installing this kit:

This set includes 6 pouches. (The battery case functions similarly, please select your own power source. This article uses a USB power cable.)

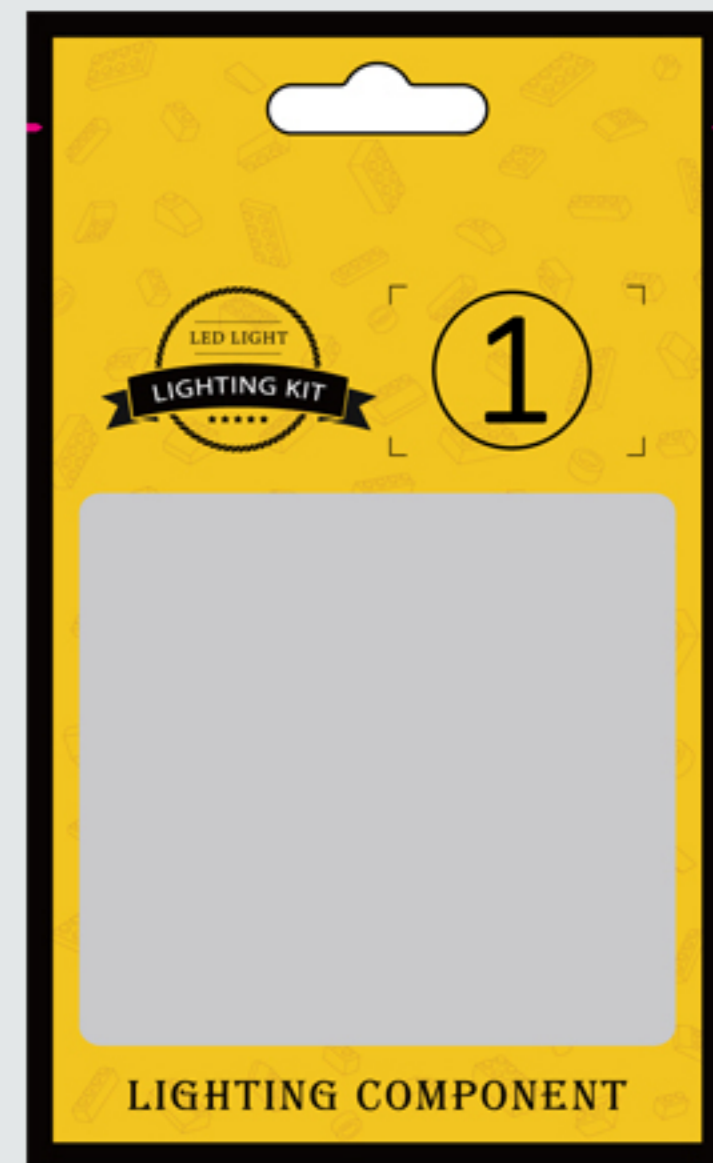

(X1)

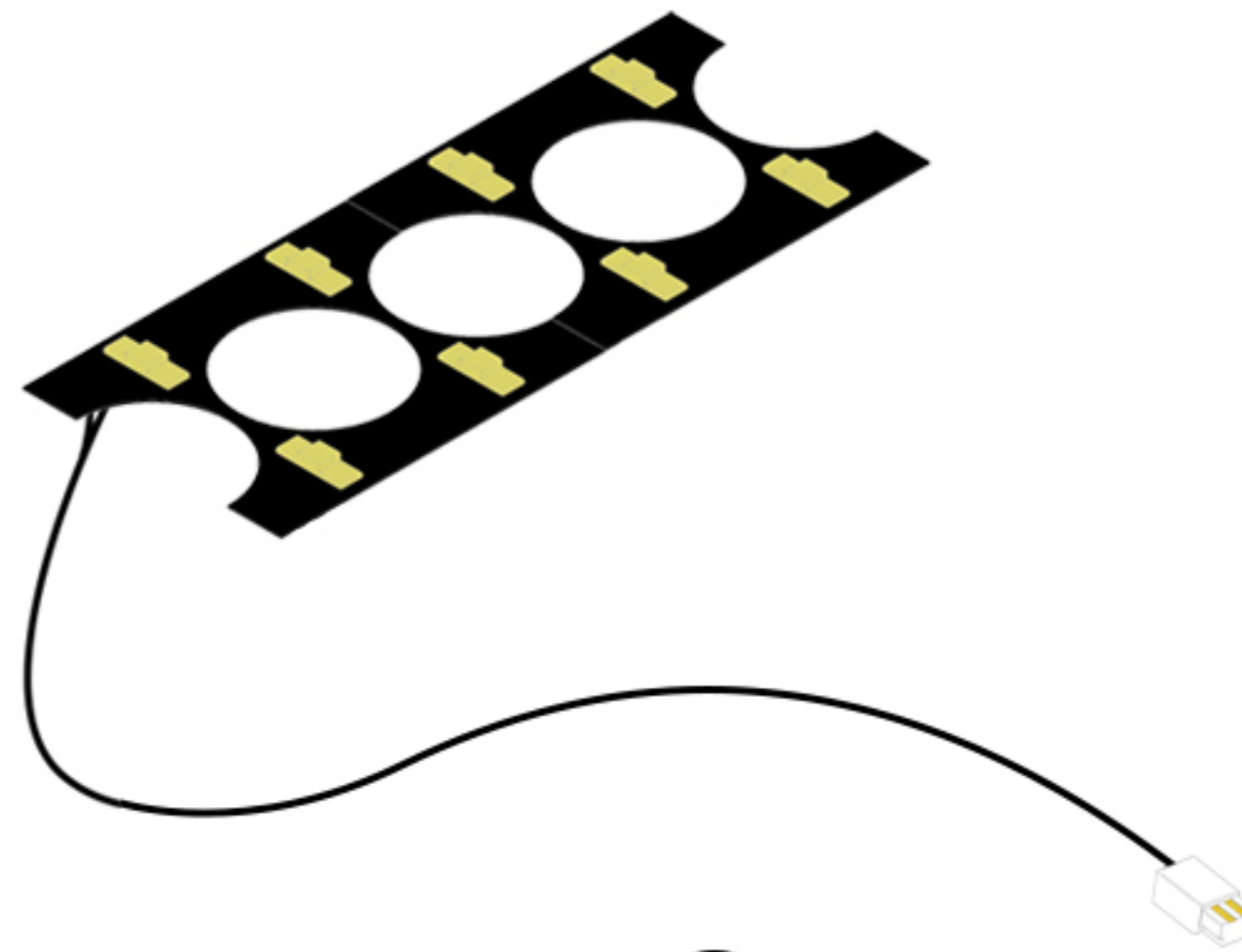

(X1)

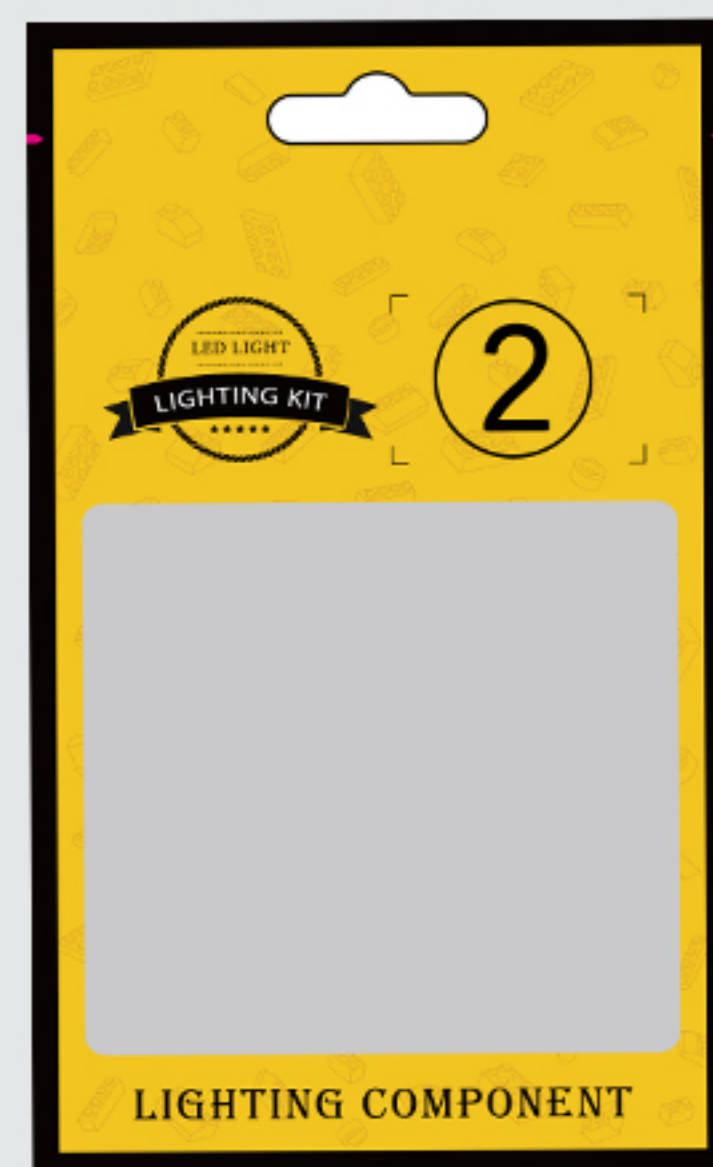

(X1)

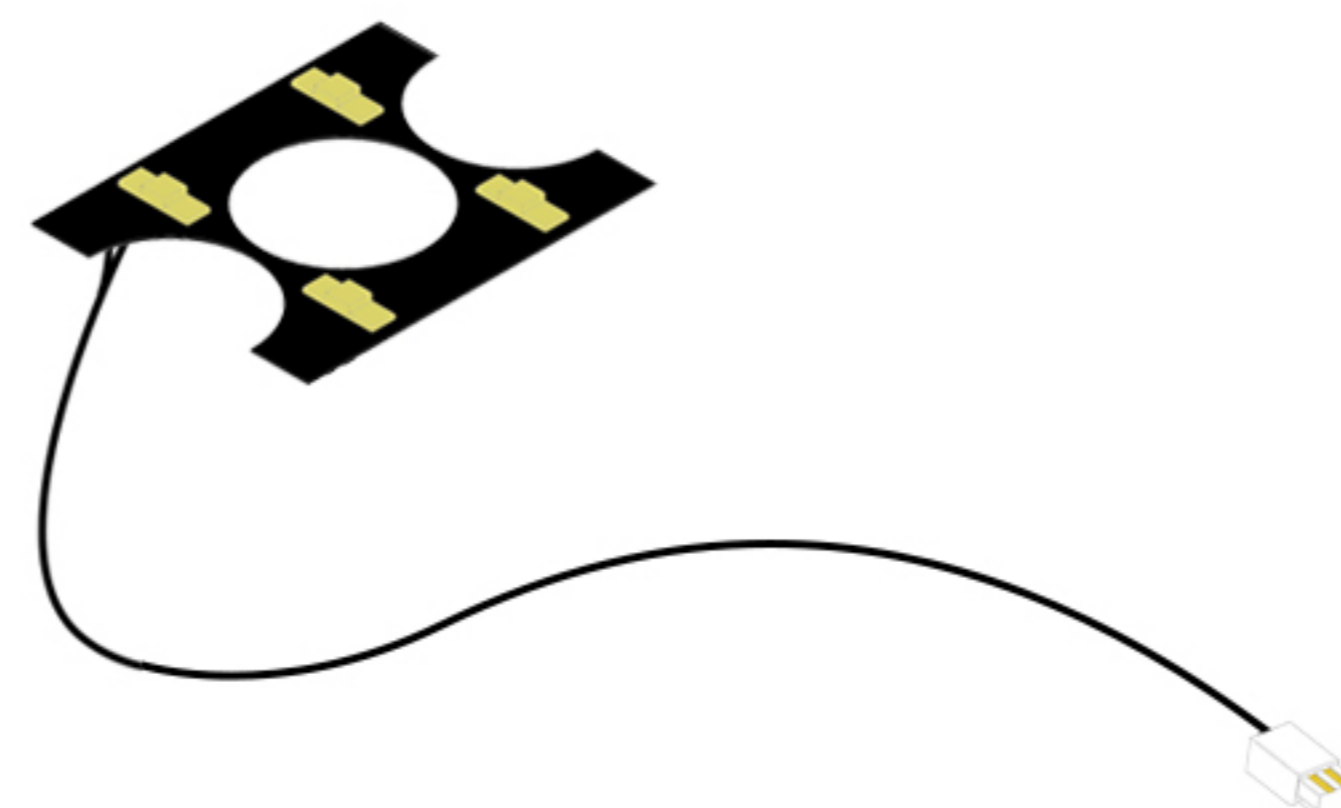

(X1)

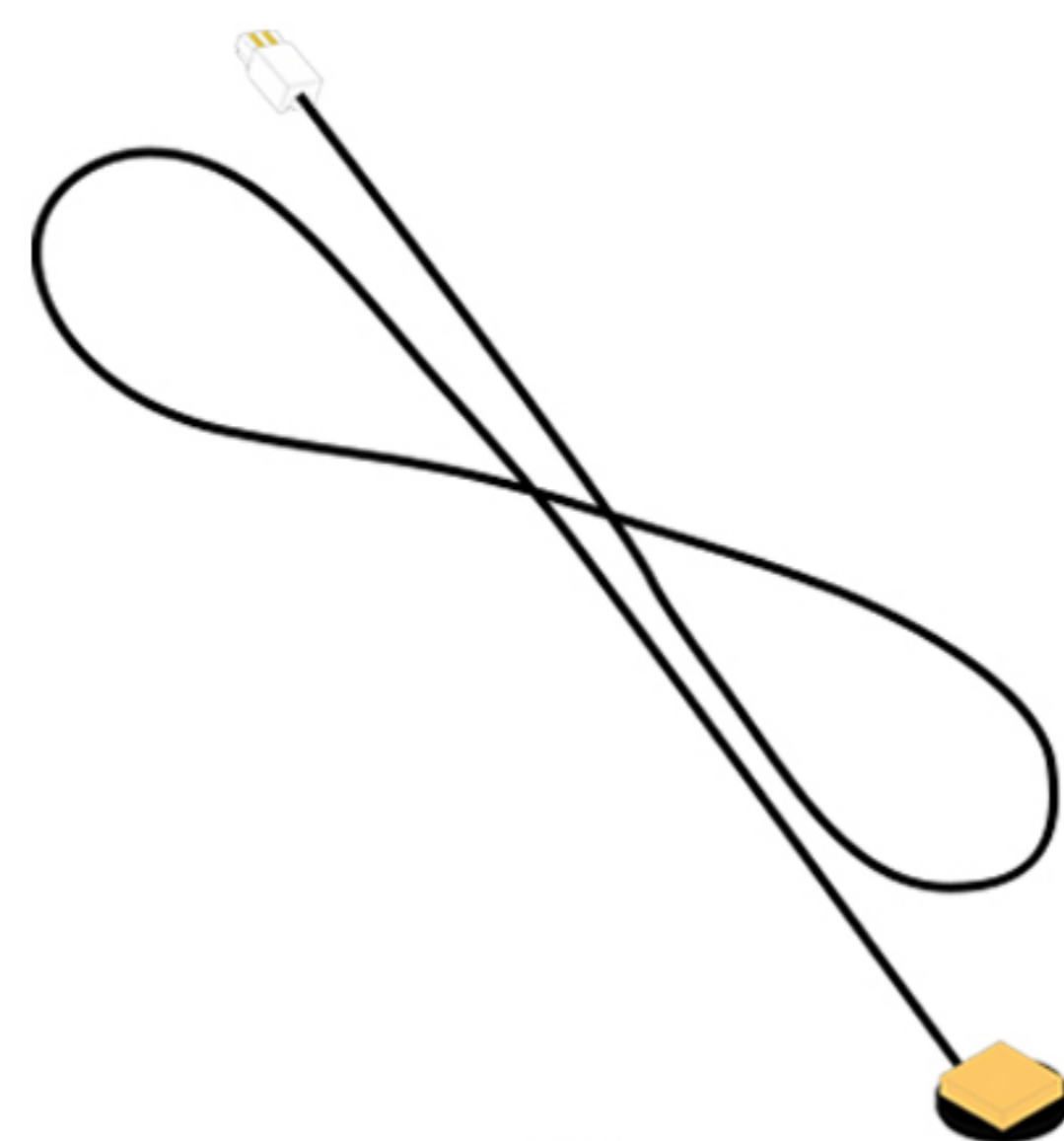

(X1)

15cm



(X1)

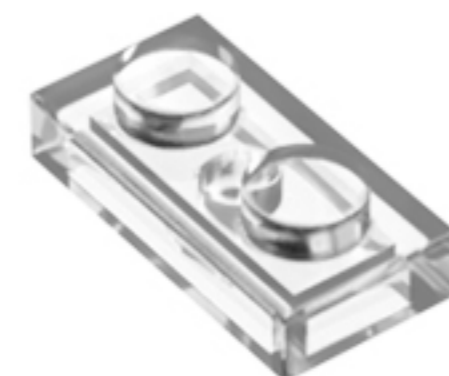

(X4)

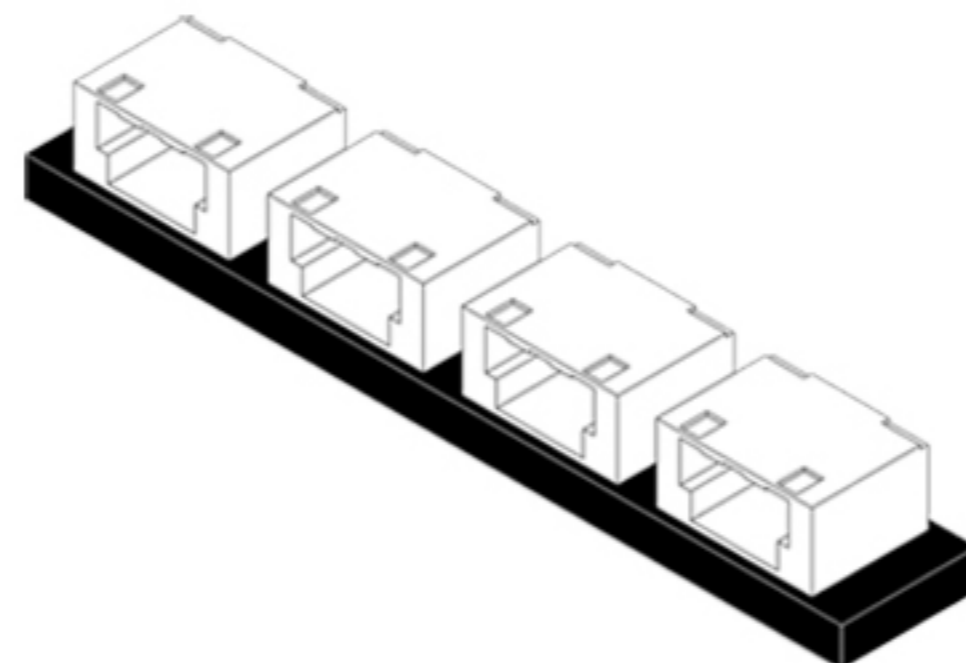

(X2)

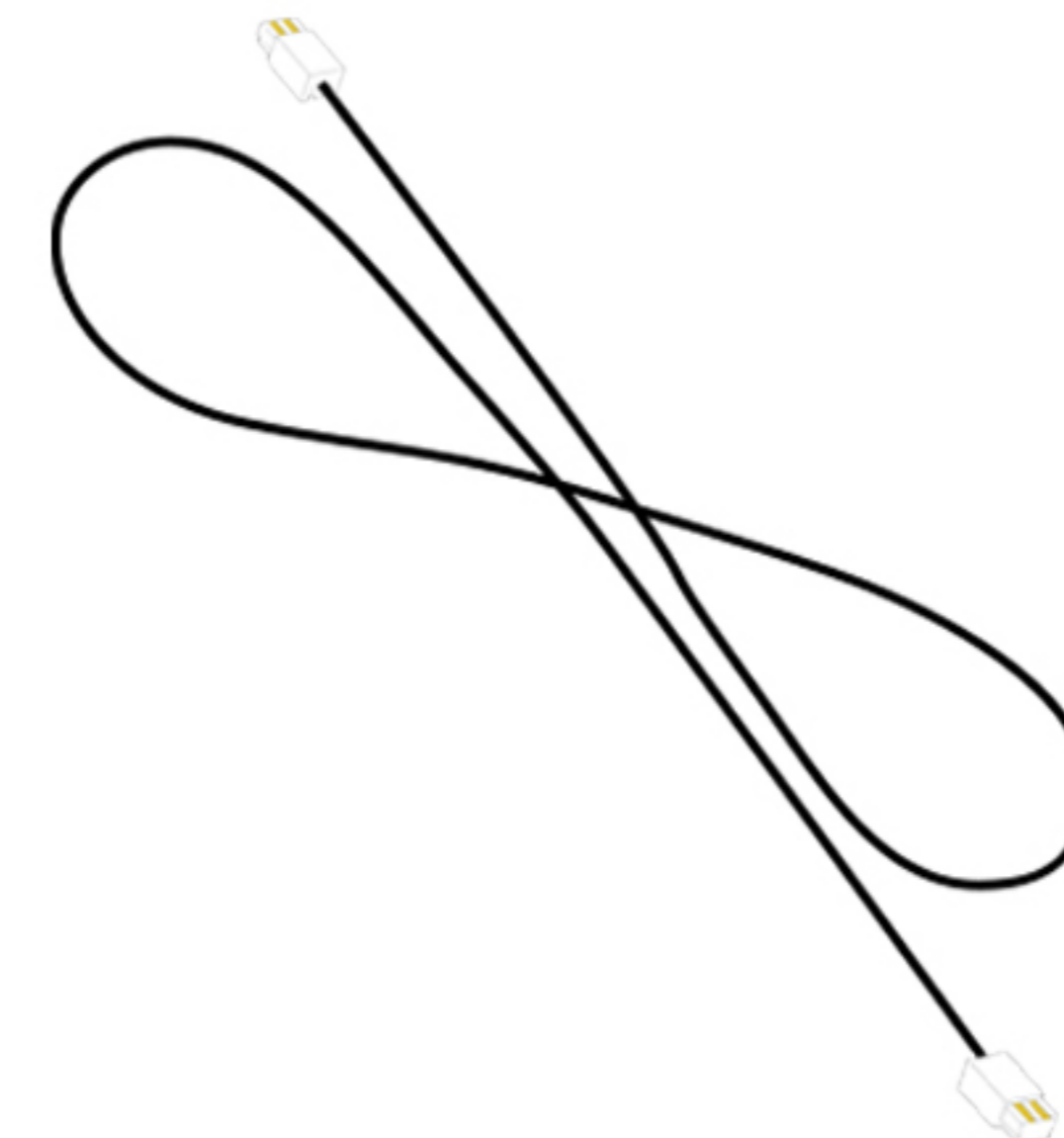

(20cm)

(X1)

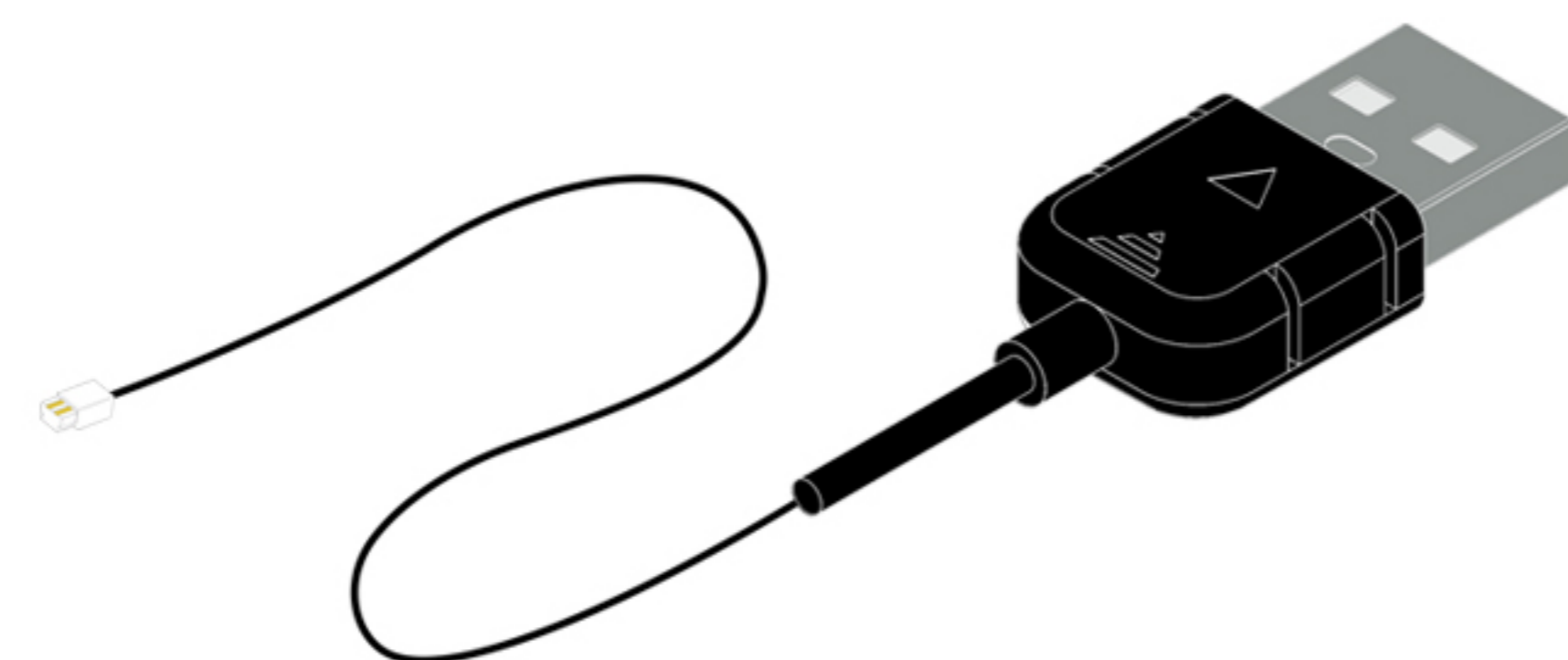
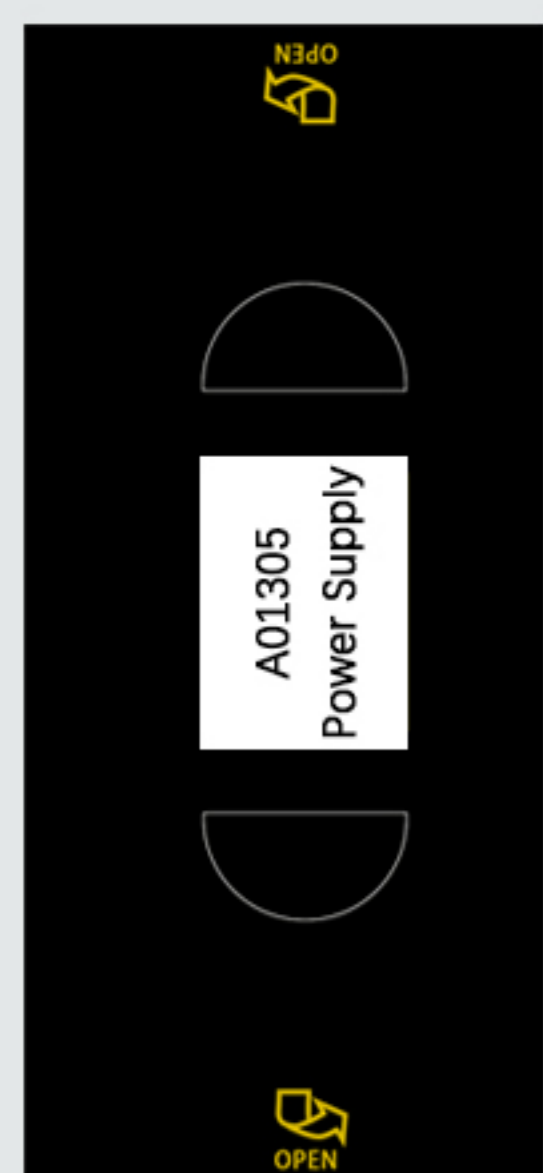

(X1)

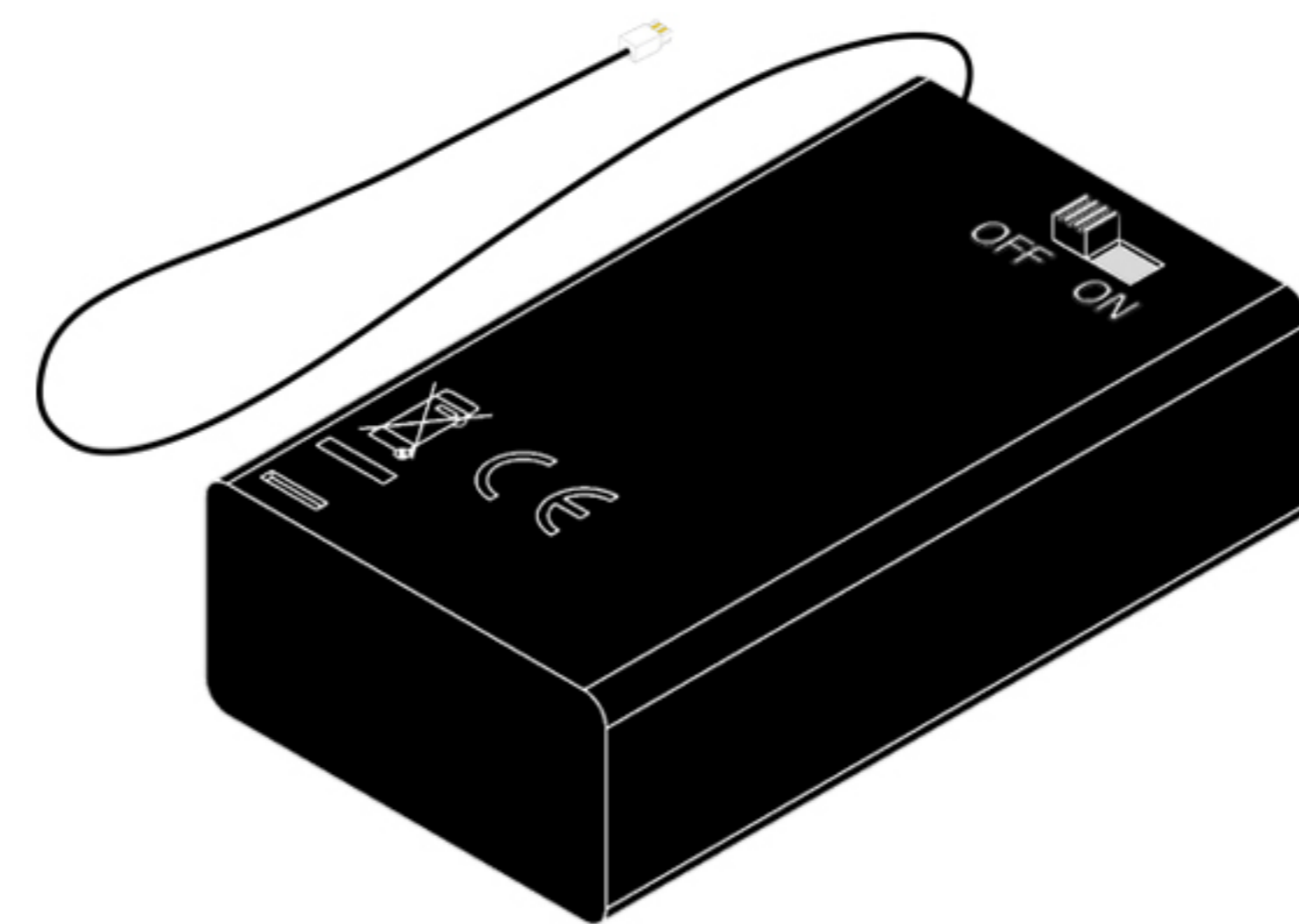

(X1)

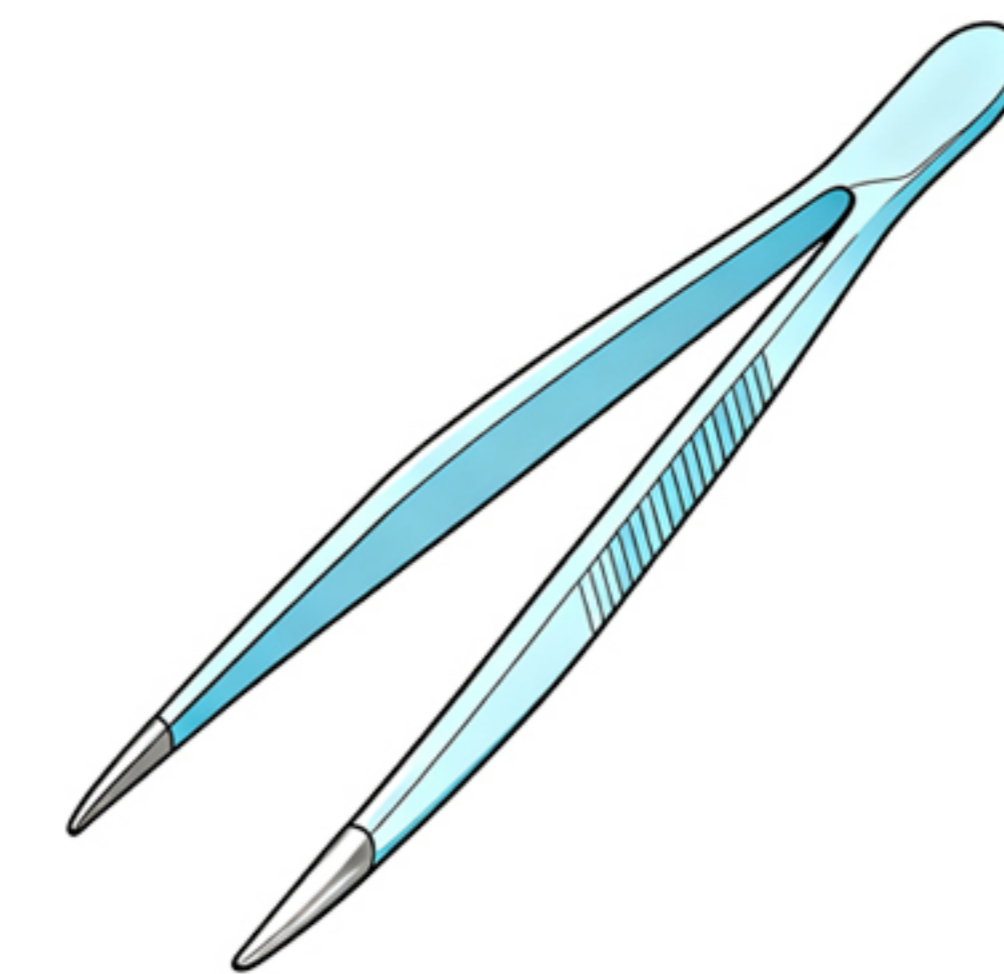

(X1)

This post will complete the light installation in two main sections.

Step 1-test



Step 2-mounting

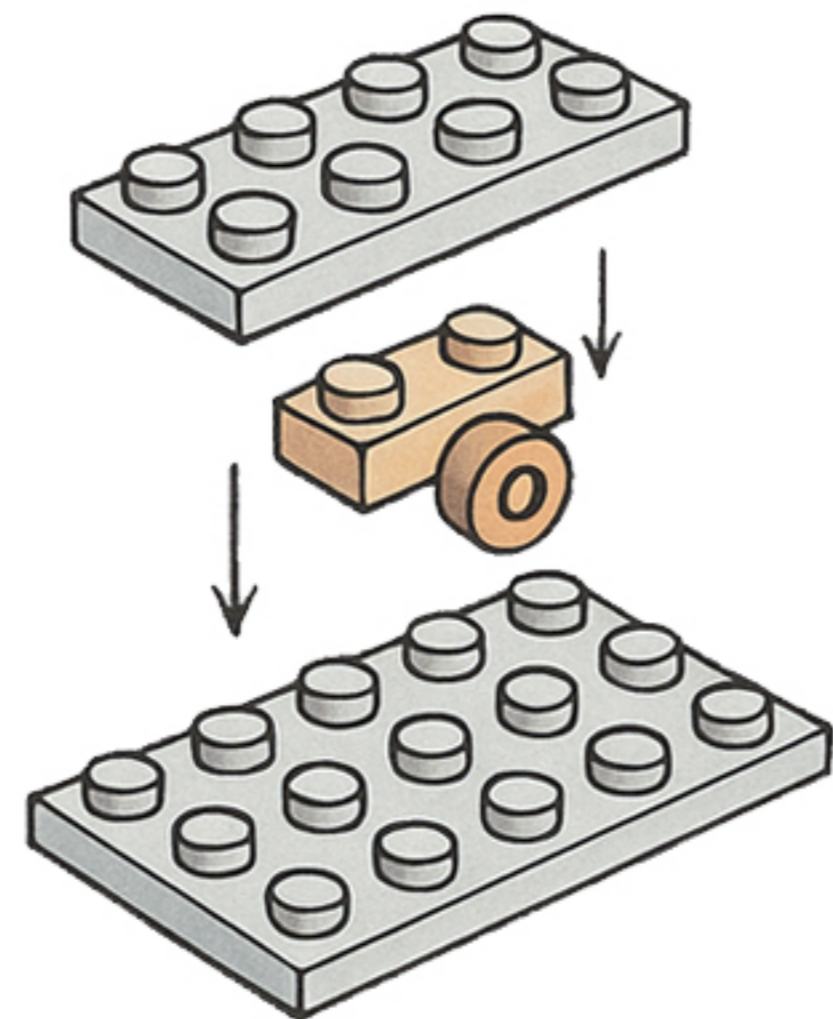

So let's get started!

Step 1-Test.

1

EN: Remove the expansion board from Bag 5.

DE: Entnehmen Sie die Erweiterungskarte aus Beutel 5.

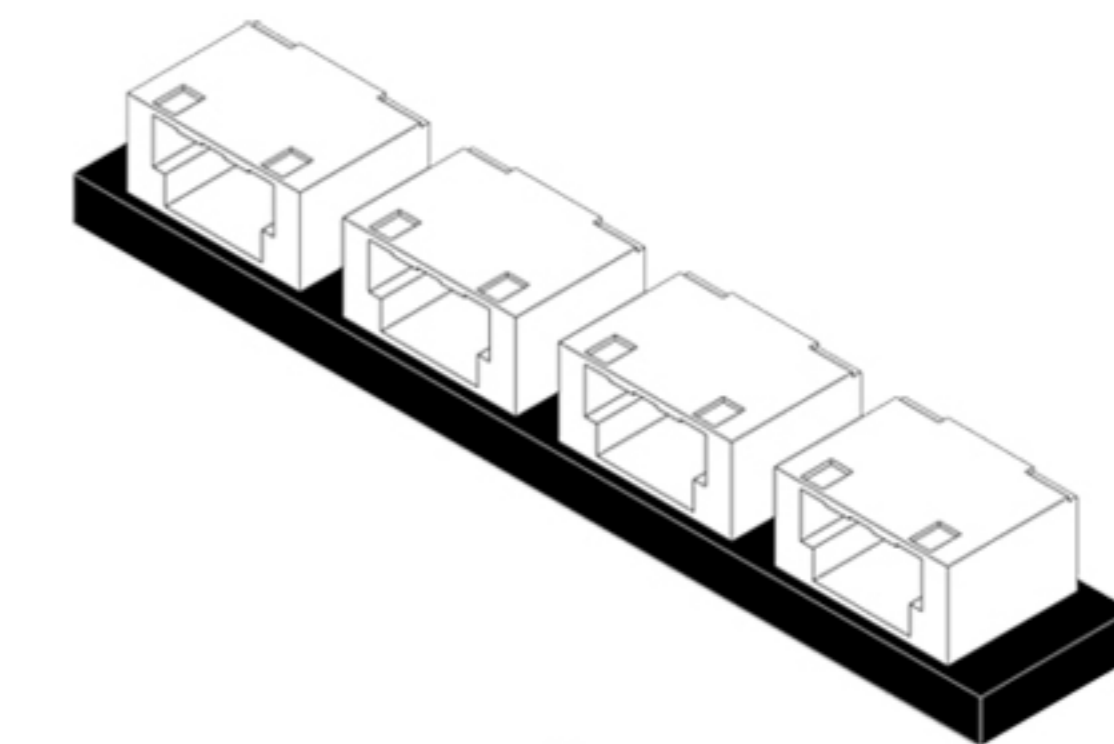

x1

2

EN: Take the USB power cable out of the box and connect it to the expansion board.

DE: Nehmen Sie das USB-Stromkabel aus der Verpackung und schließen Sie es an die Erweiterungskarte an.

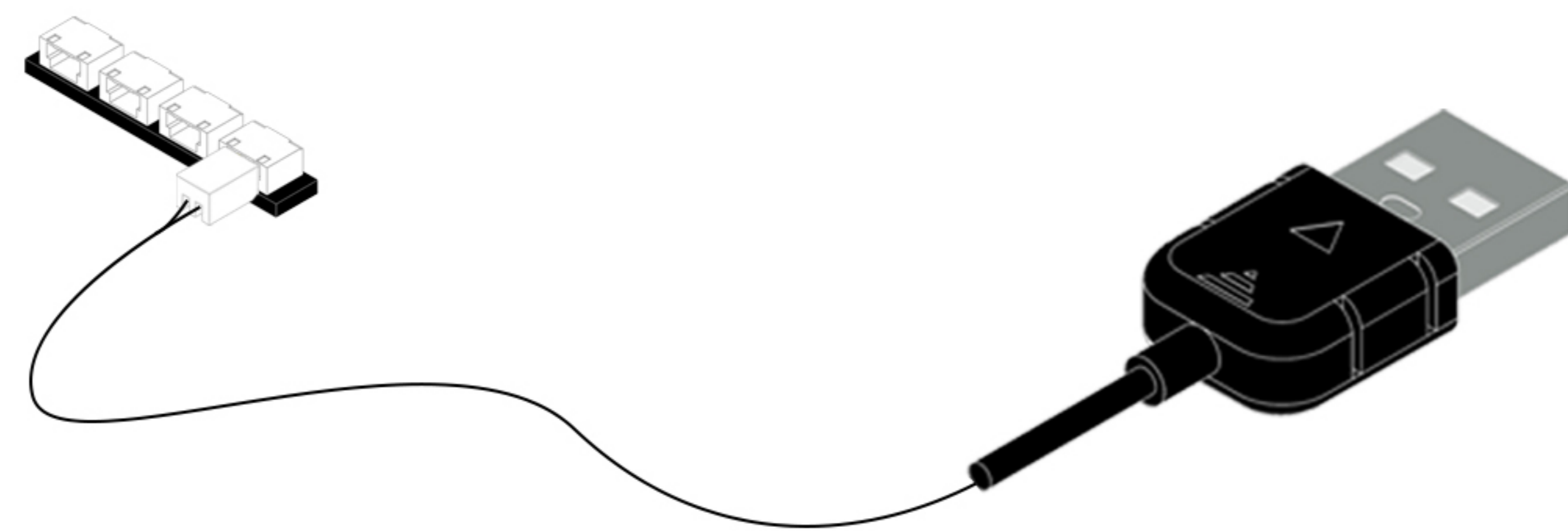
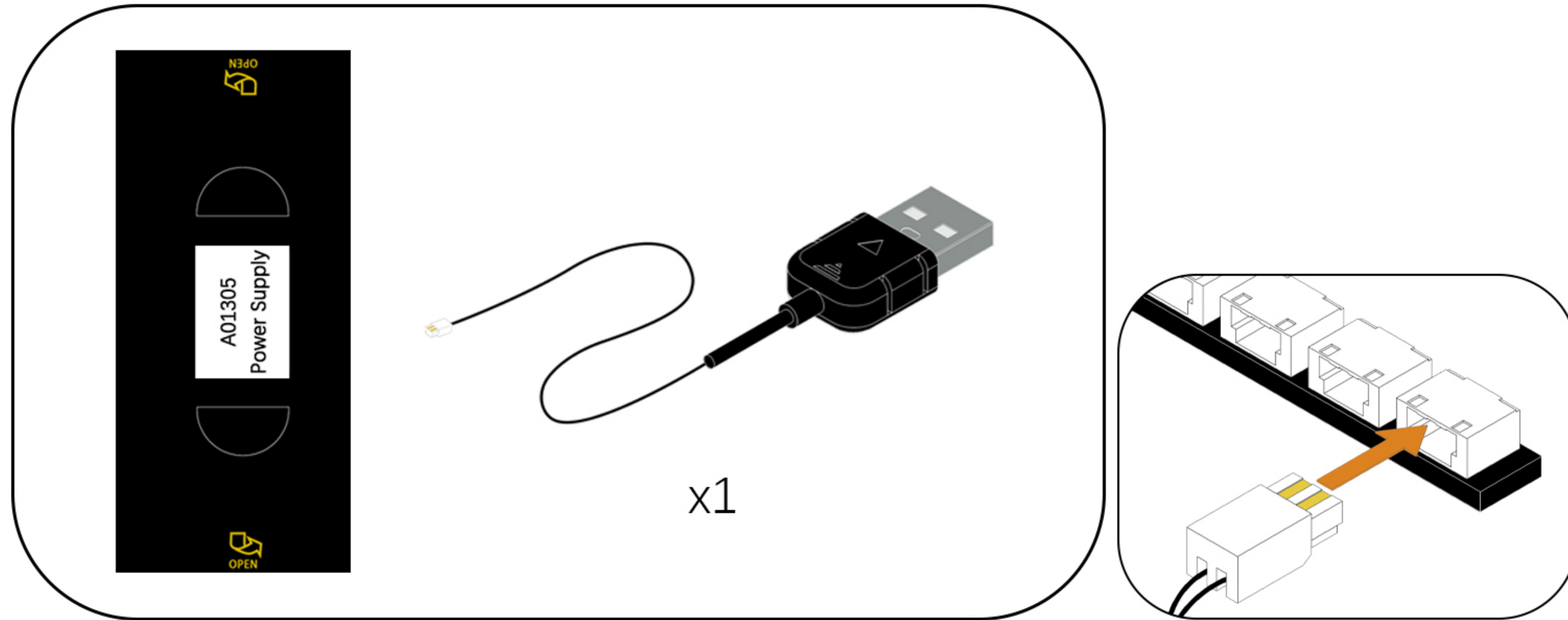

3

EN: Connect the USB power cable to the mobile power supply. (Power supply not included; see the diagram below for power supply options.)

DE: Schließen Sie das USB-Netz-kabel an die mobile Stromversorgung an. (Stromversorgung nicht im Lieferumfang enthalten, siehe Abbildung unten für die Stromversorgungsart.)

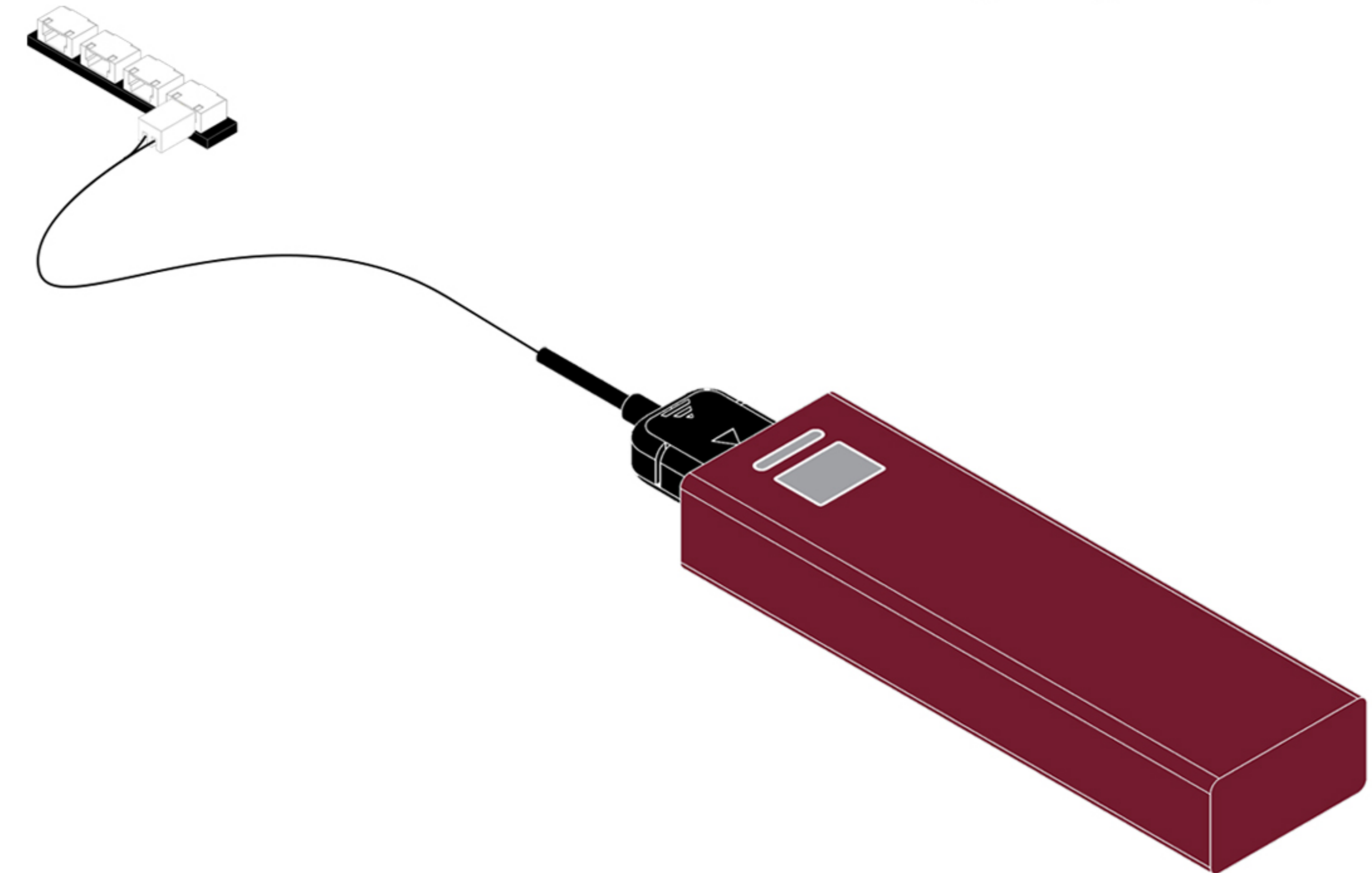

USB Connectors to Connect Devices

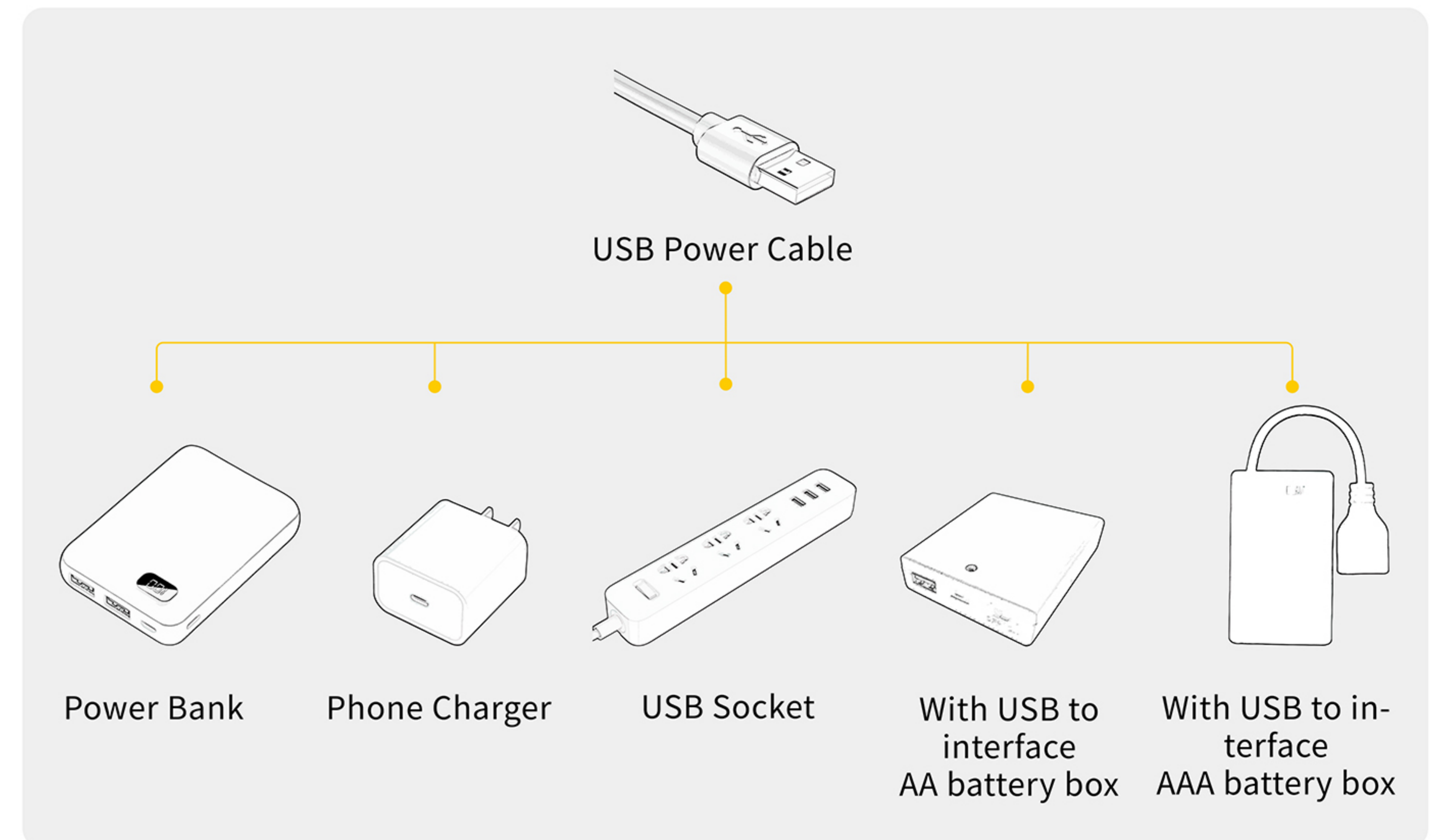

4

EN: Remove the dual-row LED strip from Bag 1, connect it to the expansion board, turn on the power, and check that the dual-row LED strip is functioning properly. If you notice any abnormalities, please contact us immediately.

DE: Nehmen Sie den zweireihigen LED-Streifen aus Beutel 1, schließen Sie ihn an die Erweiterungsplatine an, schalten Sie die Stromversorgung ein und überprüfen Sie, ob der zweireihige LED-Streifen ordnungsgemäß funktioniert. Sollten Sie Unregelmäßigkeiten feststellen, kontaktieren Sie uns bitte umgehend.

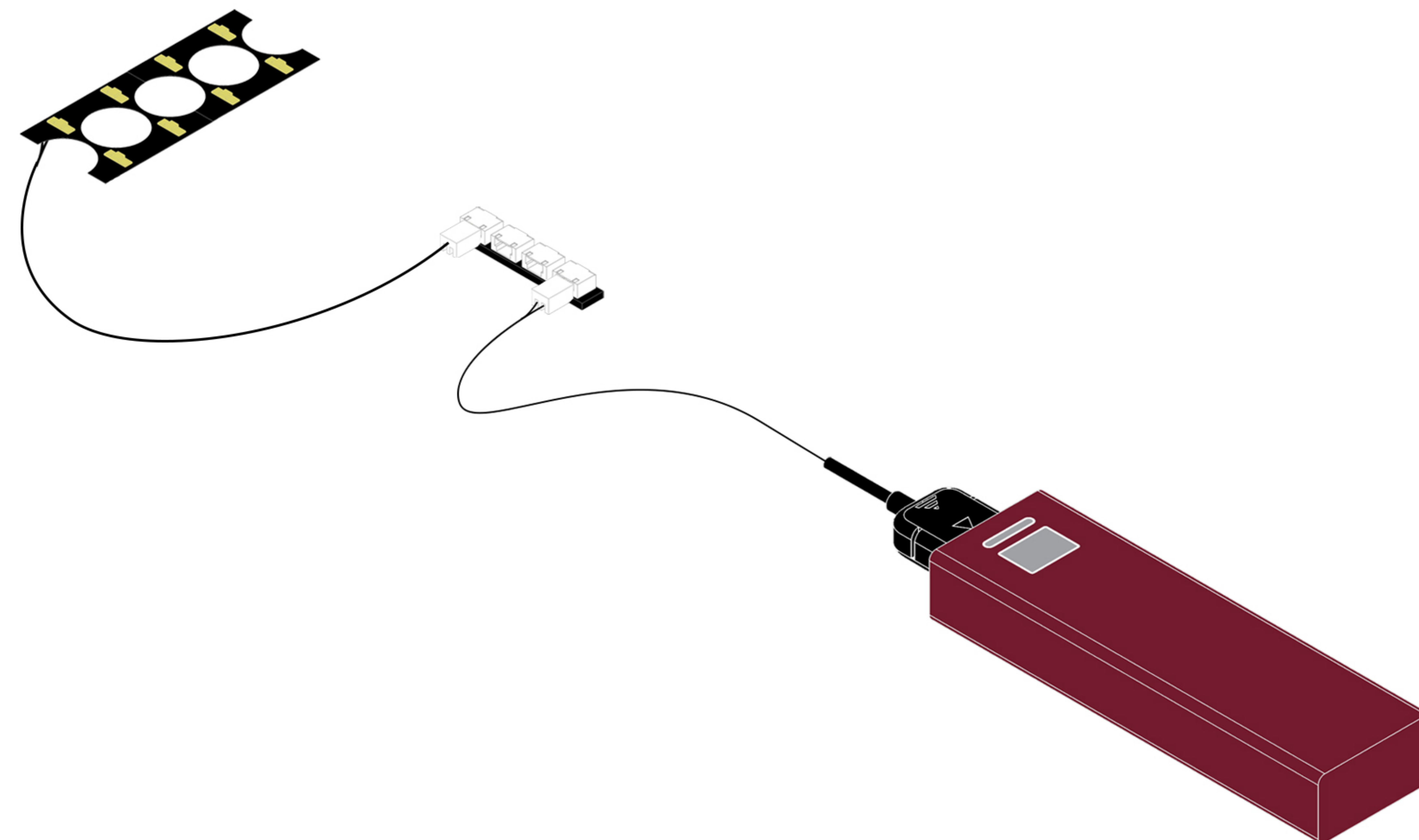
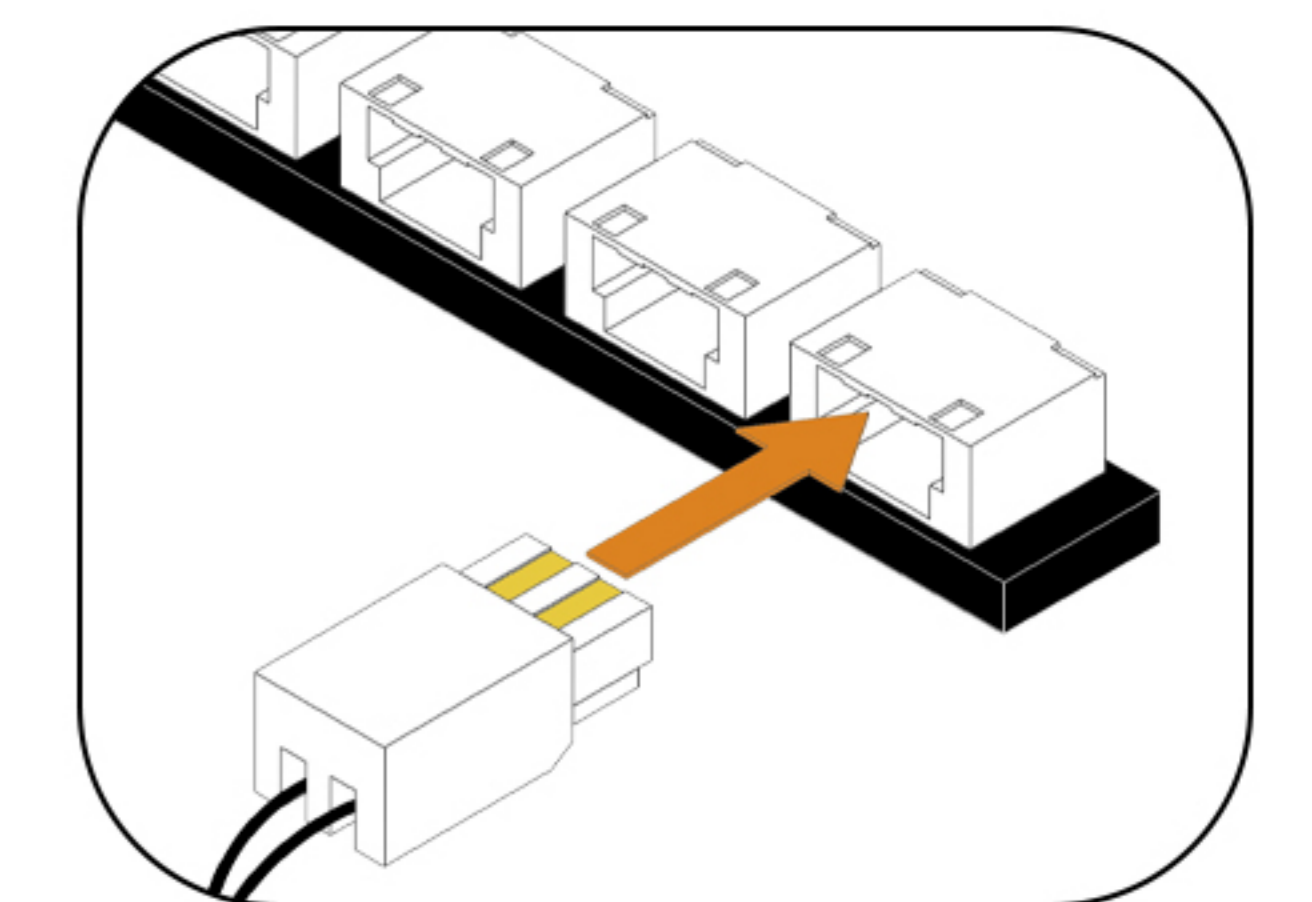
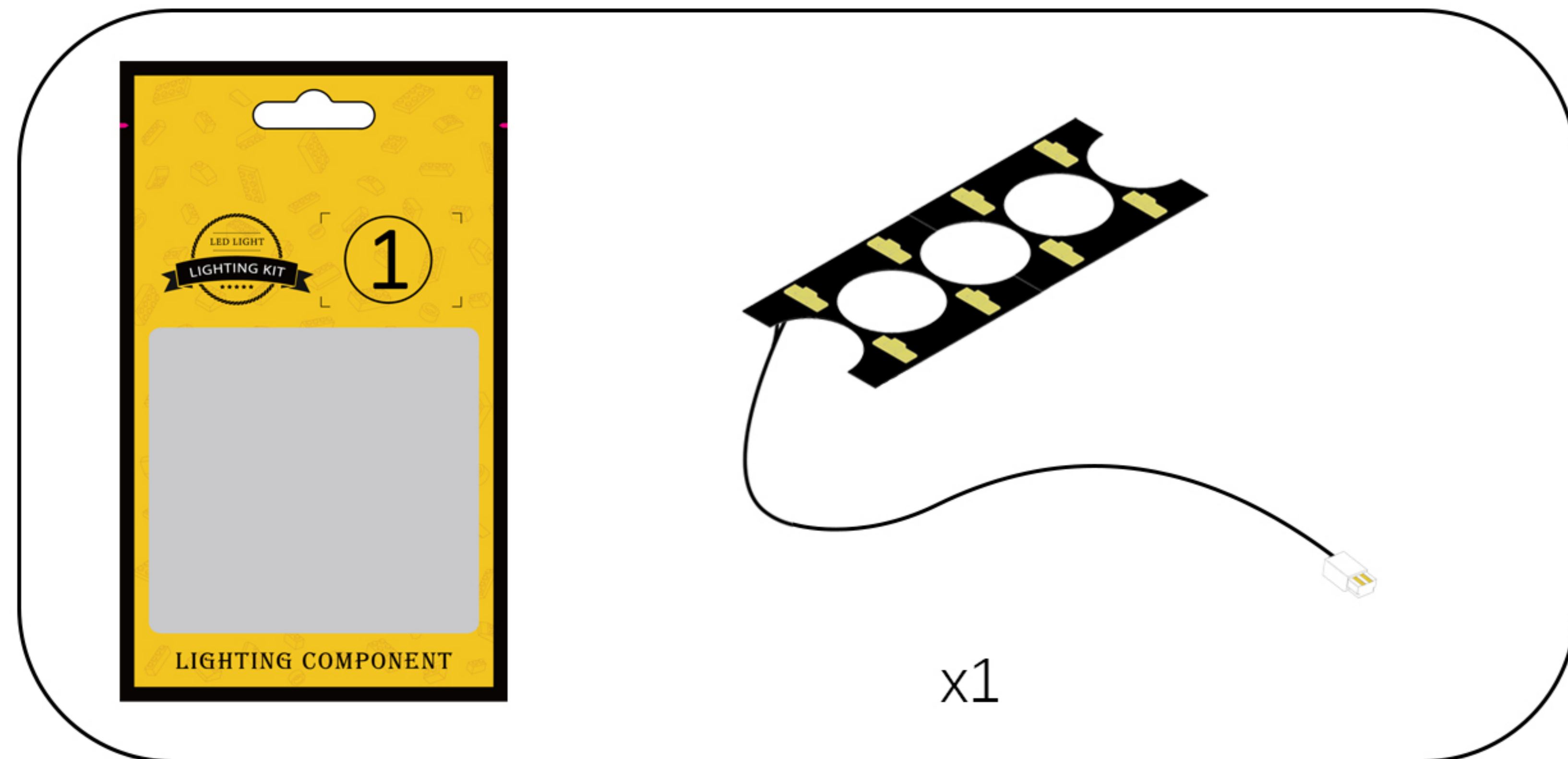

After confirming that there are no abnormalities, temporarily return each part to its original bag.

Step 2-Mounting.

1

EN: Take out the building block model.

DE: Nimm das Bauklotzmodell heraus.



2

EN: Remove the building blocks one by one.

DE: Entfernen Sie die Bausteine nacheinander.

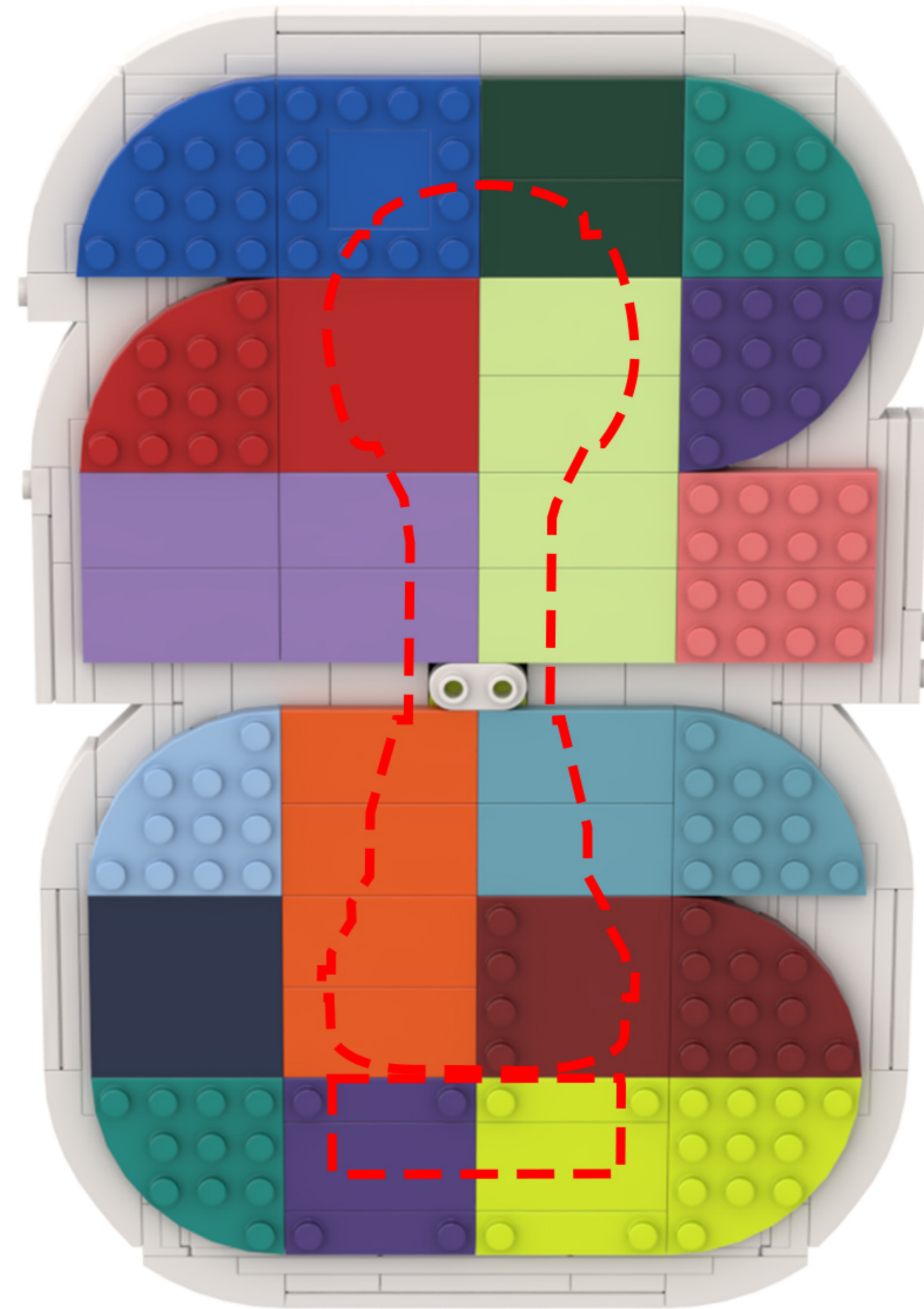

3

EN: Take the 2x4 base plate and the 2x4 dual-row light strip from Bag 1, and place the dual-row light strip on the brick.

DE: Nimm die 2x4-Grundplatte und die zweireihige Lichtleiste aus Beutel 1 und setze die zweireihige Lichtleiste auf den Stein.

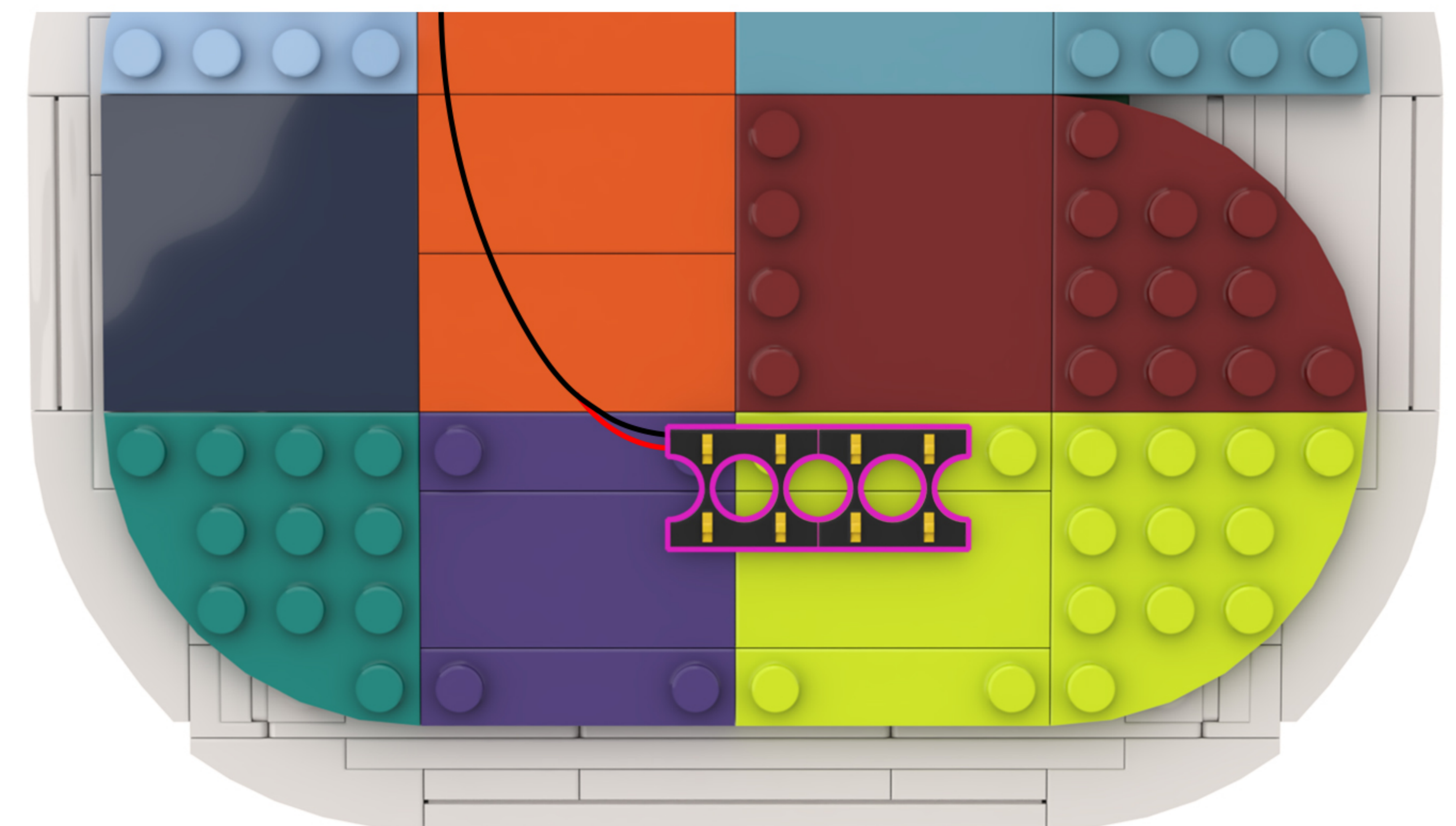
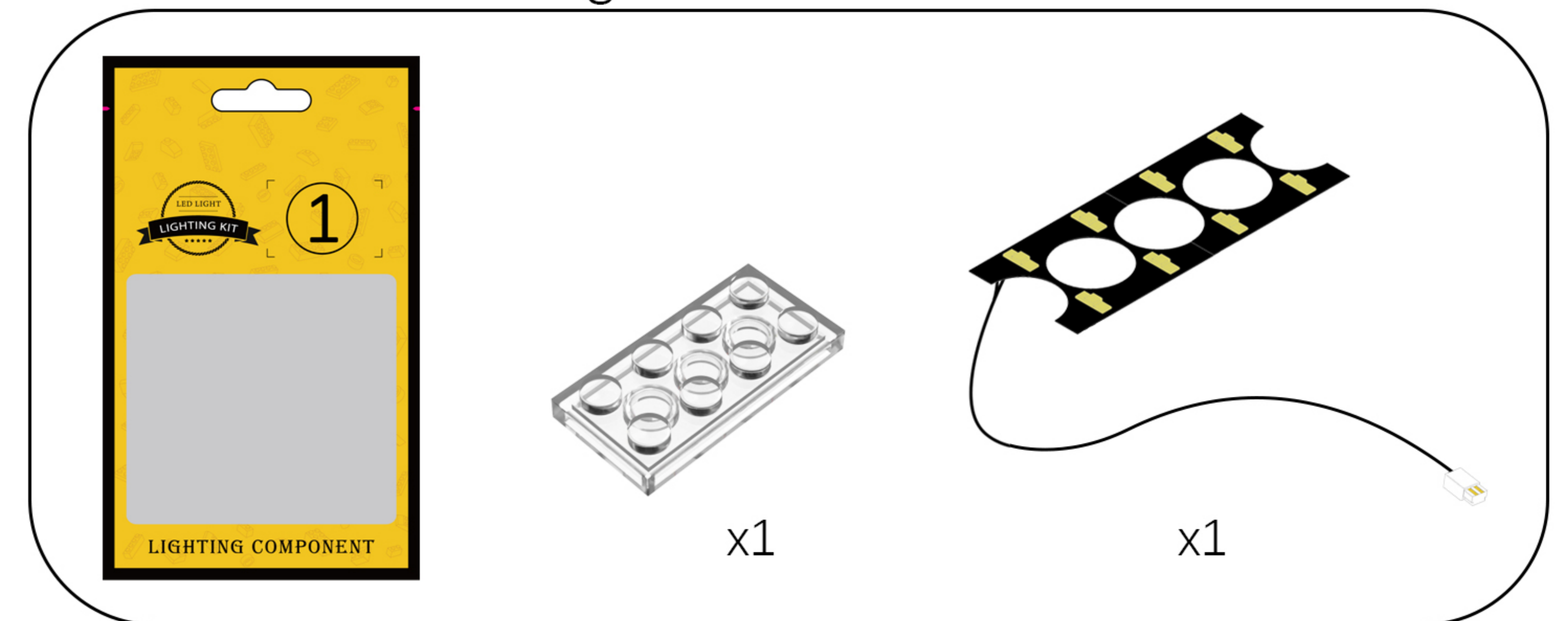

Note: Untwist the section of the light cord that is twisted together at one end of the string lights.

4

EN: Attach the 2x4 base plate to the building block, ensuring it holds the double-row light strip in place.

DE: Befestigen Sie die 2x4-Grundplatte am Baustein und achten Sie darauf, dass sie den zweireihigen Lichtstreifen sicher hält.

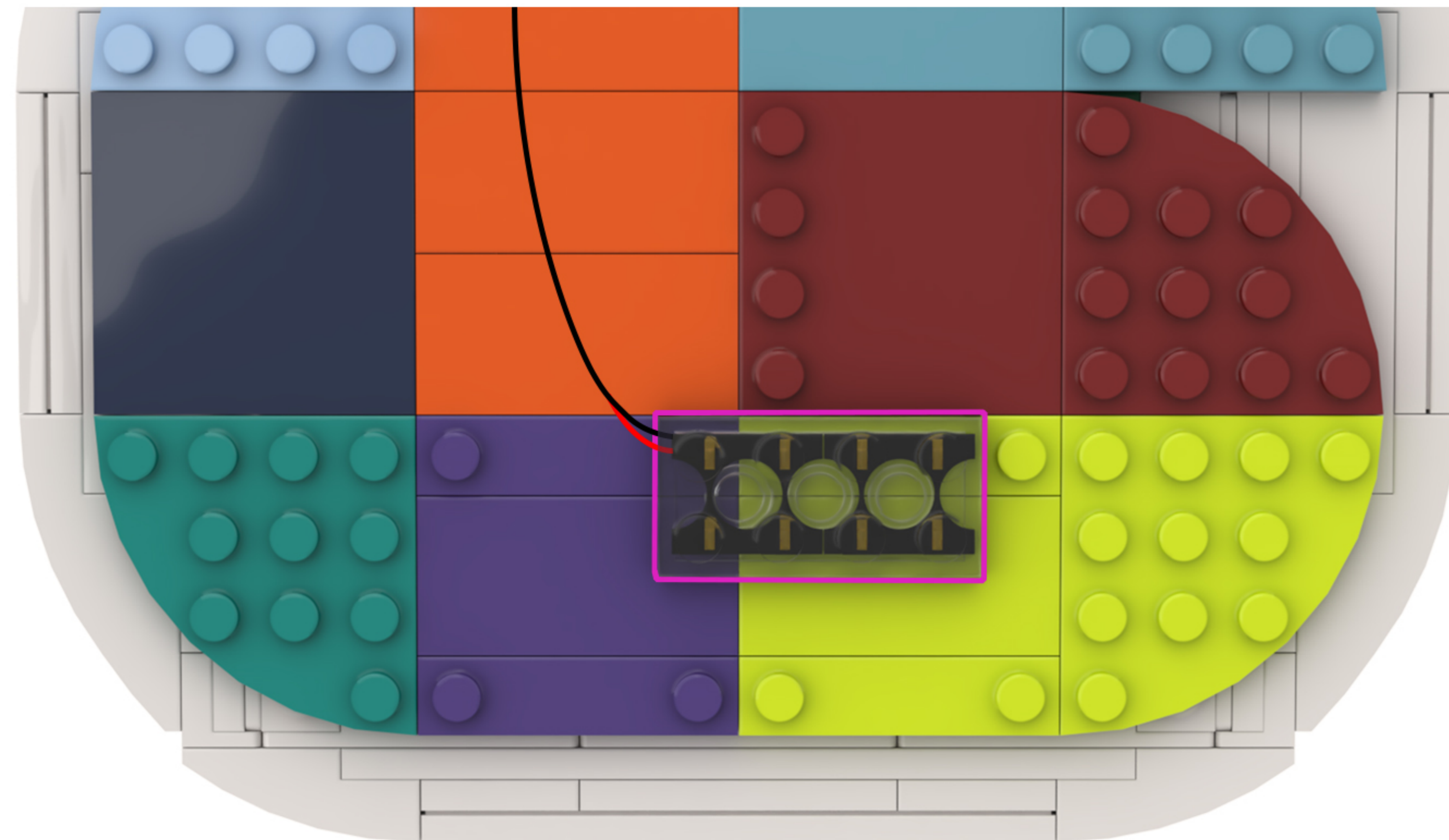

5

EN: Take the 2x2 base plate and the 2x2 dual-row light strip from Bag 2, and place the dual-row light strip on the brick.

DE: Nimm die 2x2-Grundplatte und die zweireihige Lichtleiste aus Beutel 2 und setze die zweireihige Lichtleiste auf den Stein.

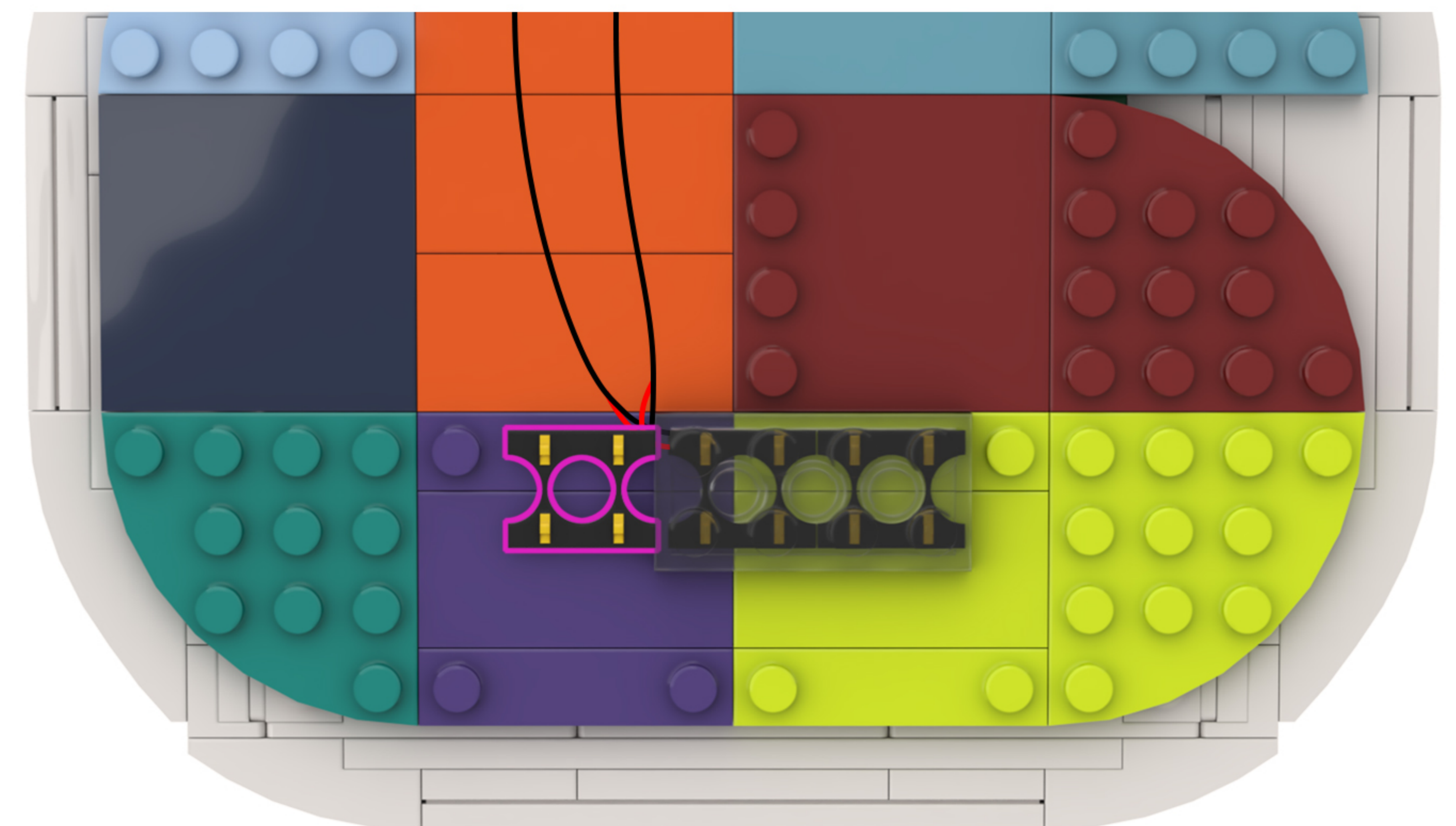
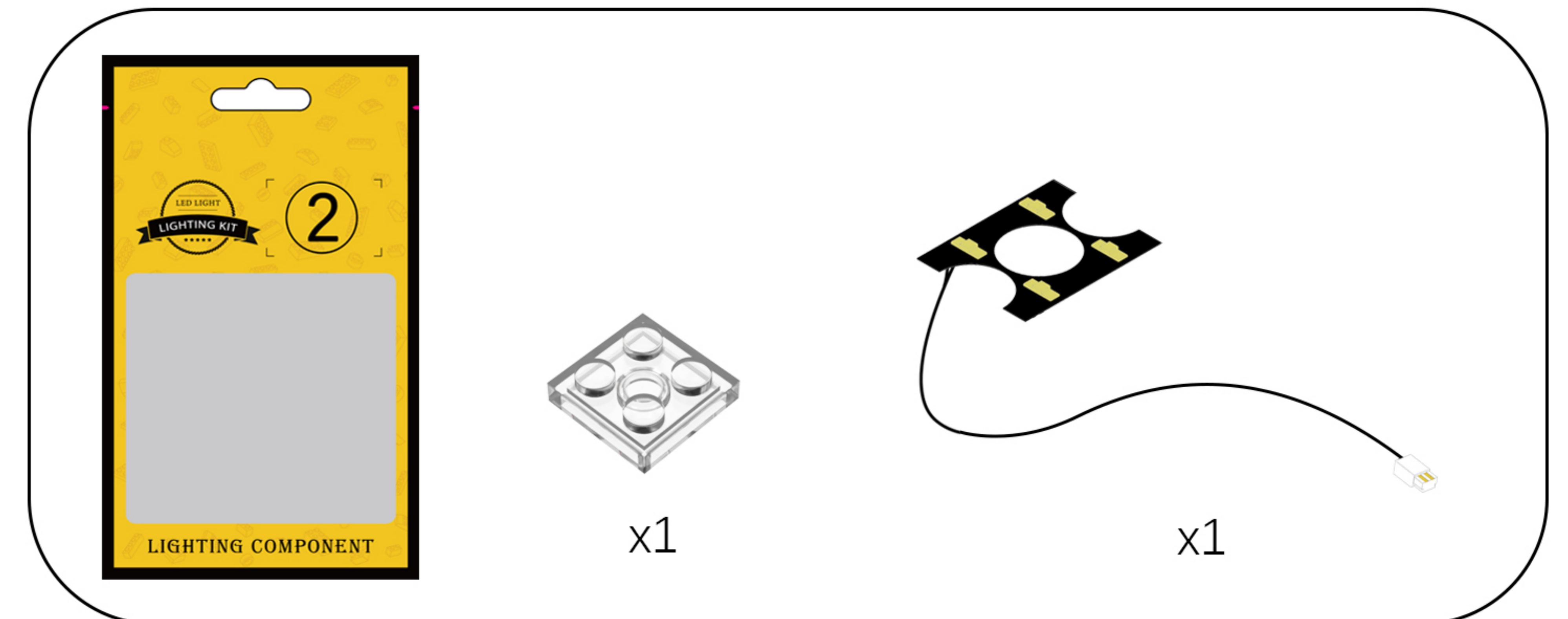

Note: Untwist the section of the light cord that is twisted together at one end of the string lights.

6

EN: Use a 2x2 base plate to secure the dual-row light strip.

DE: Befestigen Sie den zweireihigen Lichtstreifen mit einer 2x2-Grundplatte.

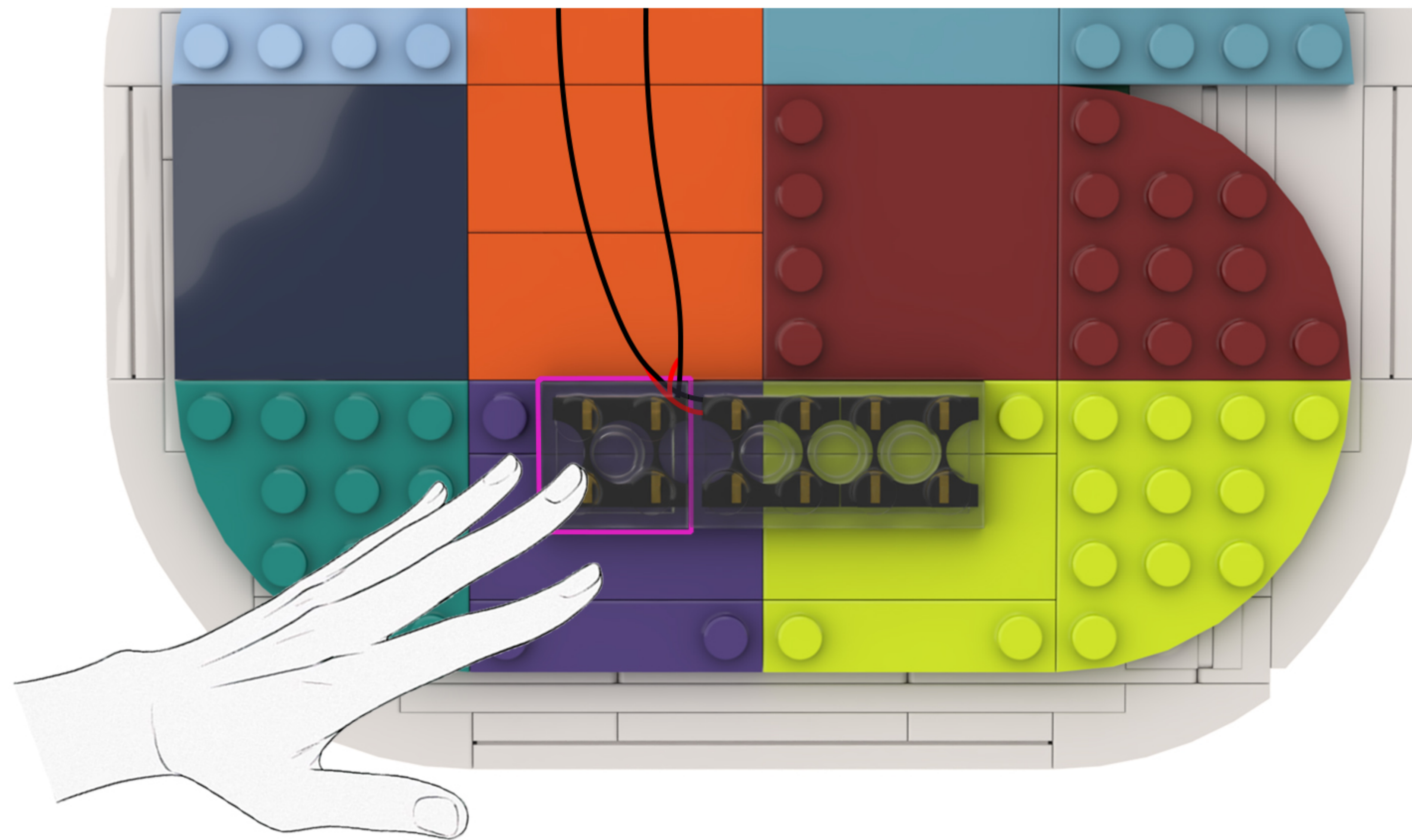

7

EN: Take out the disassembled building blocks and reassemble them.

DE: Nehmen Sie die zerlegten Bausteine heraus und setzen Sie sie wieder zusammen.

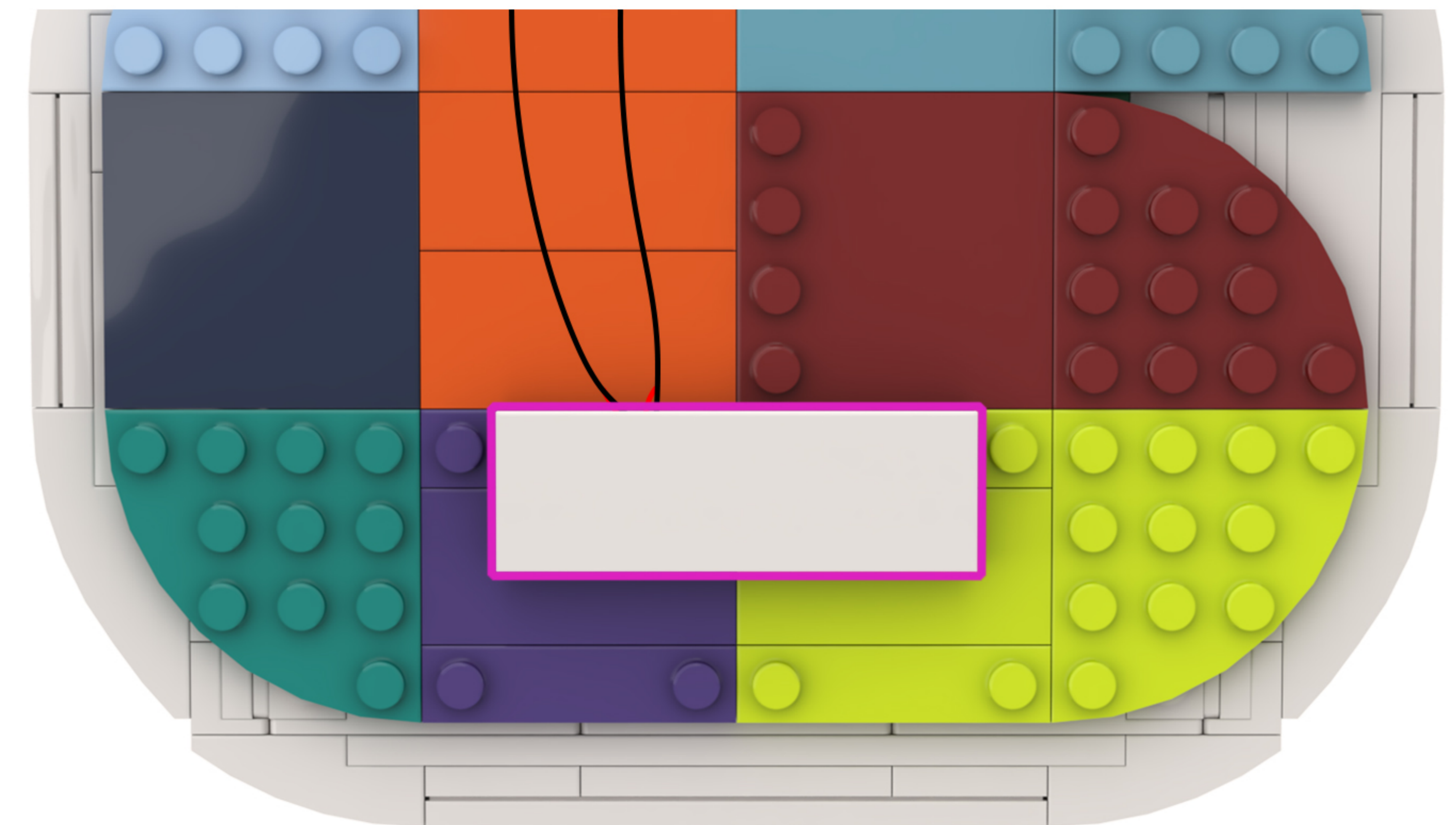
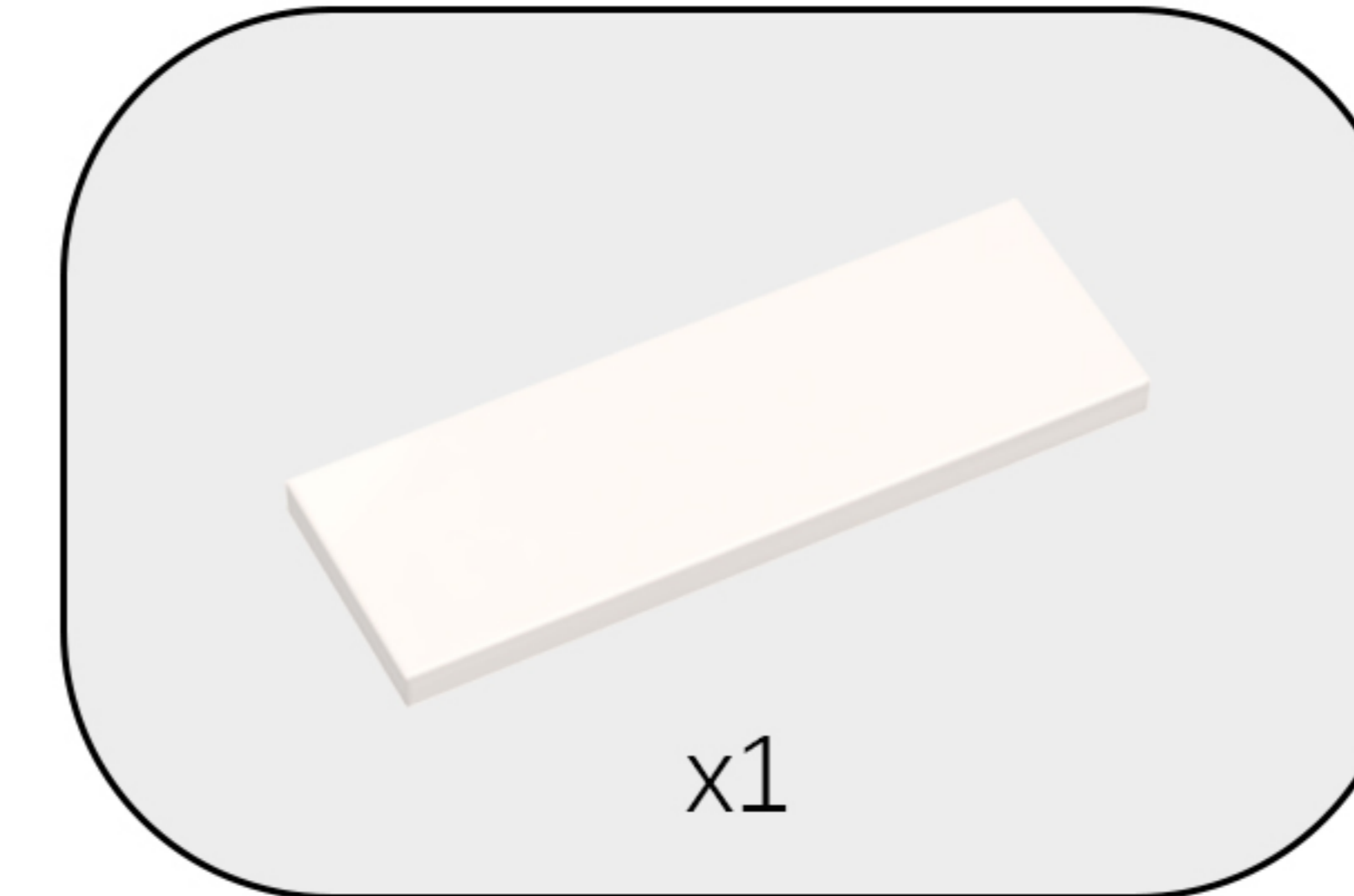

8

EN: Look at the building block component highlighted in the image.

DE: Schauen Sie sich die im Bild hervorgehobene Bausteinkomponente an.

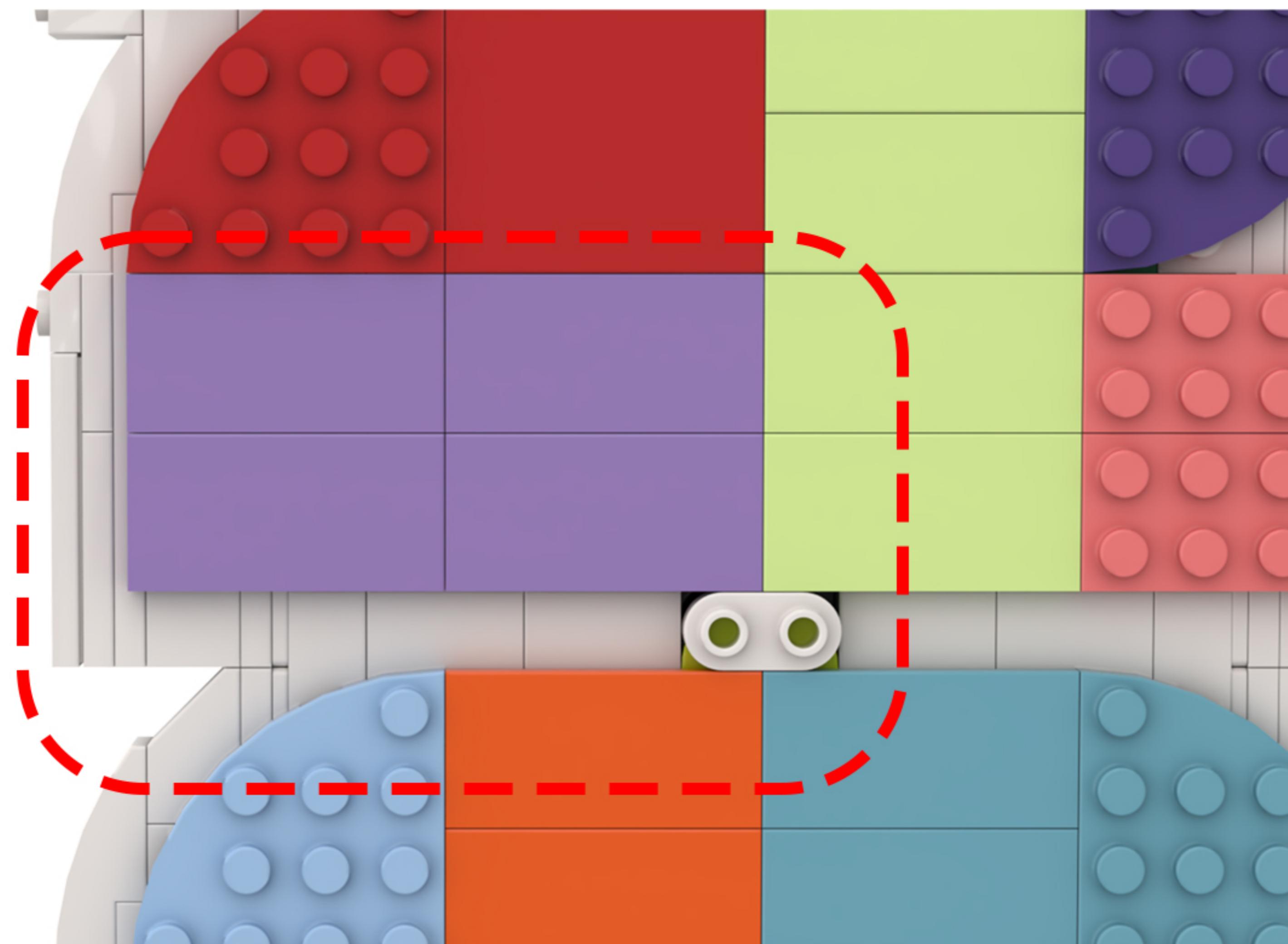

9

EN: Split as shown in the figure.

DE: Wie in der Abbildung gezeigt, teilen Sie es auf.

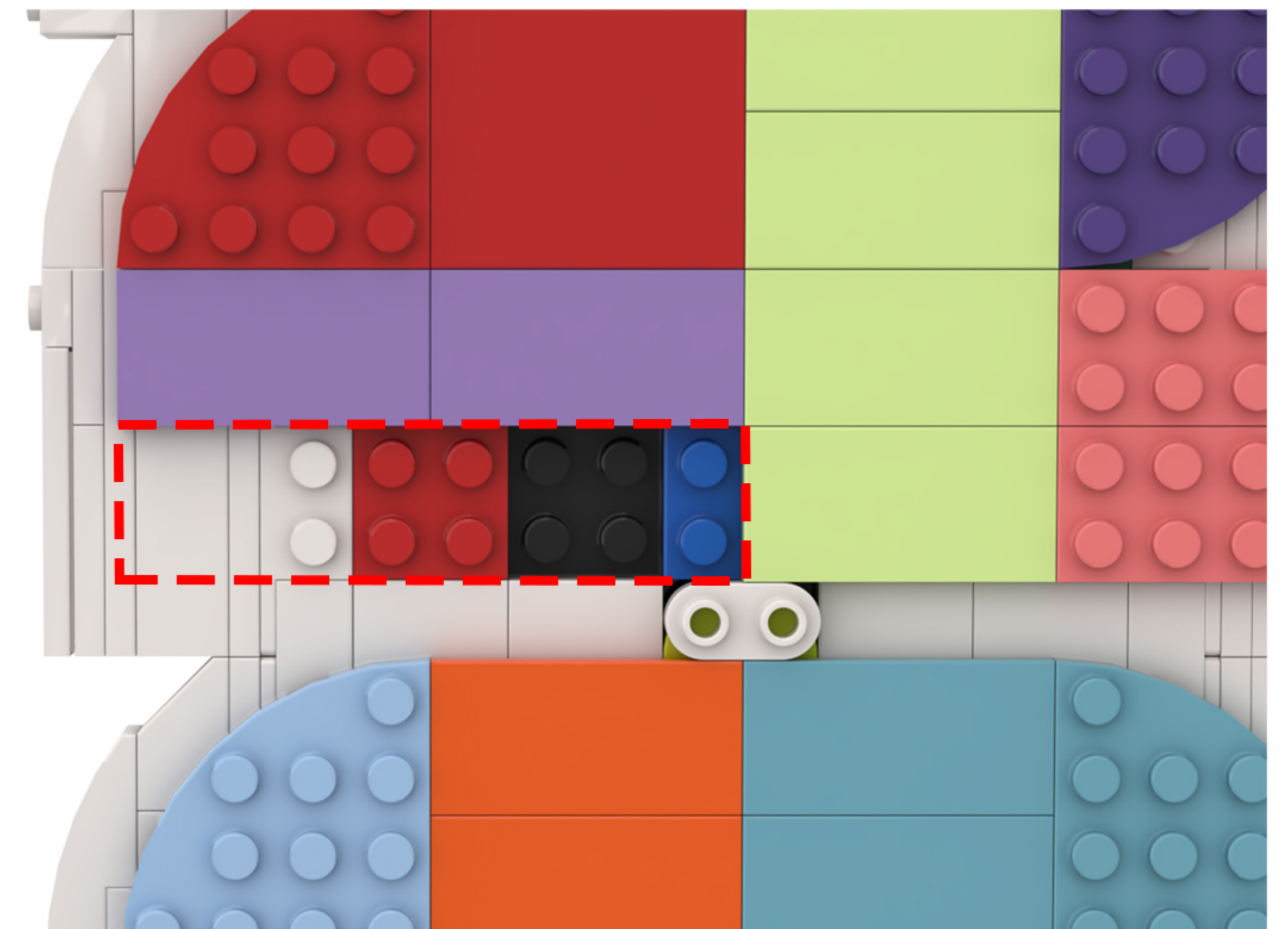
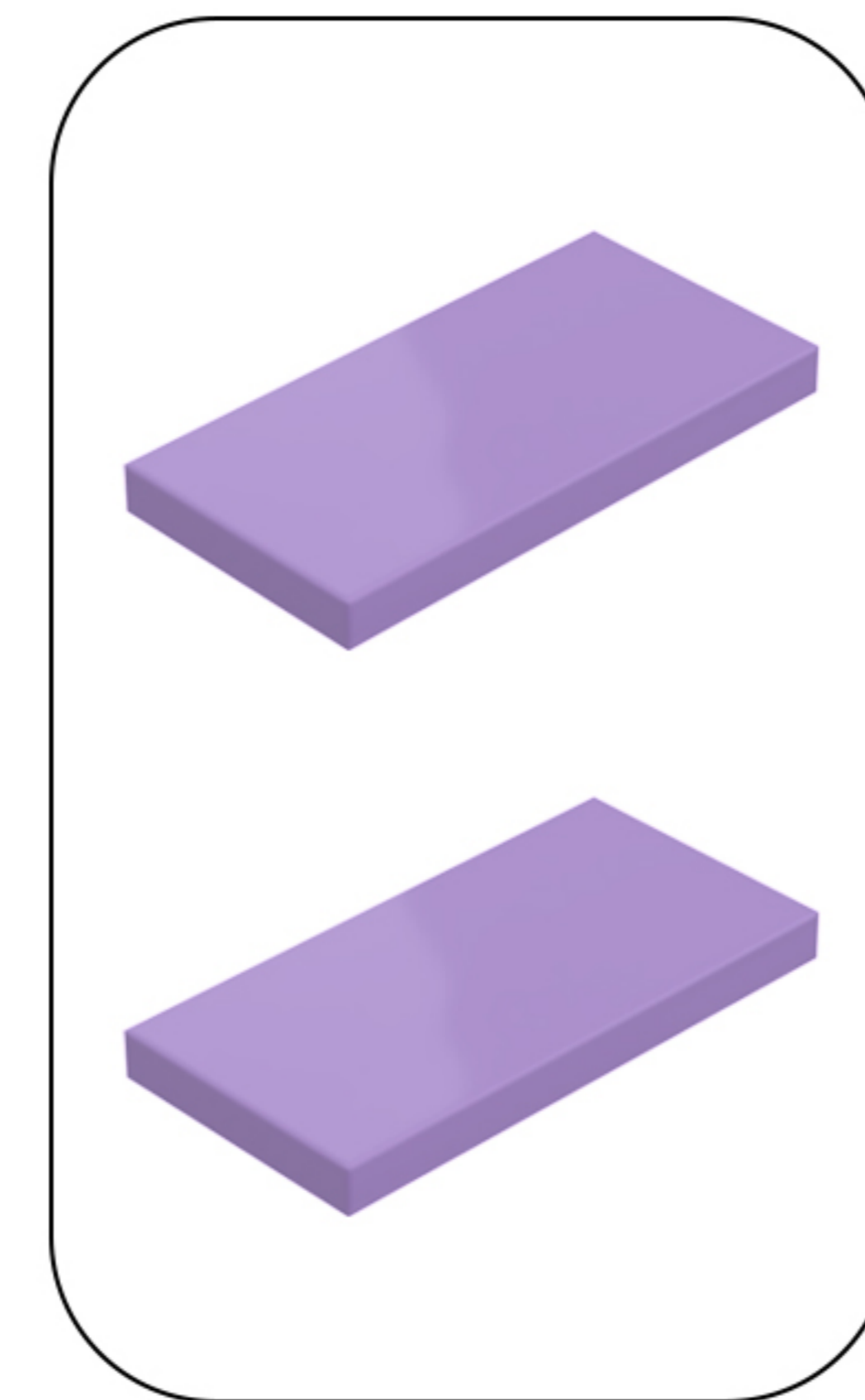

10

EN: Split as shown in the figure.

DE: Wie in der Abbildung gezeigt, teilen Sie es auf.

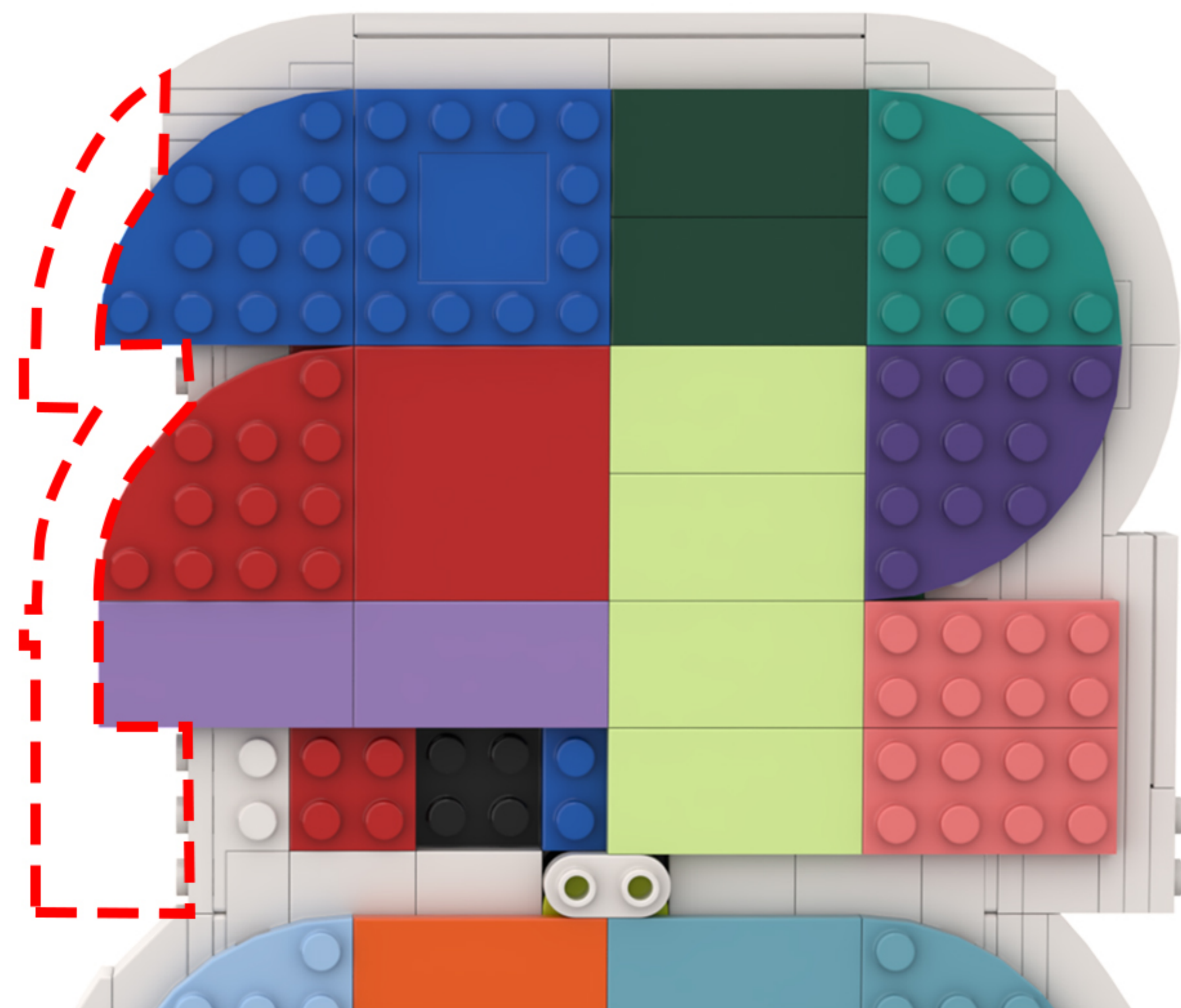
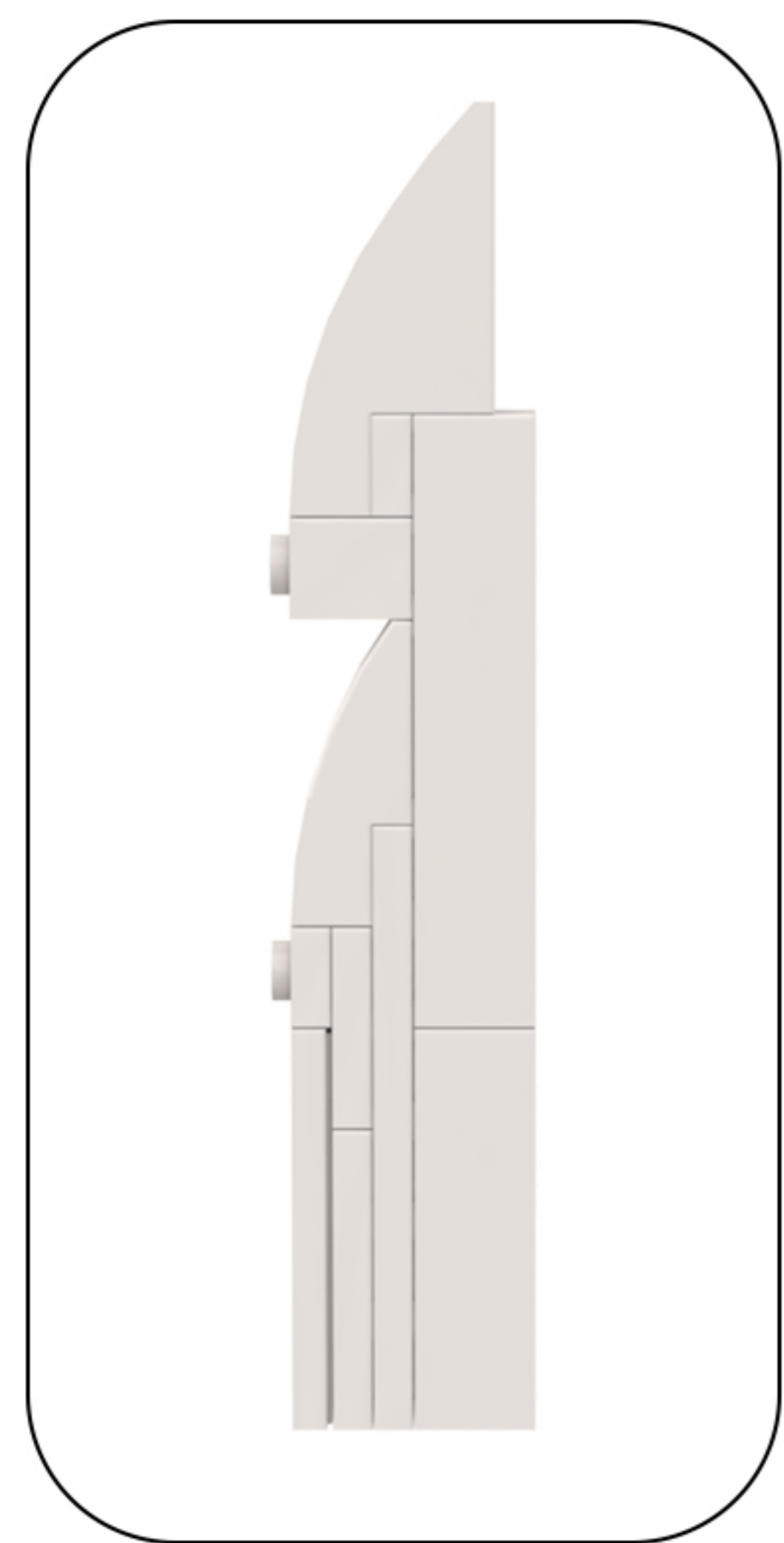

11

EN: Take the expansion board and the connecting cable out of Bag 5 and connect them together.

DE: Nehmen Sie die Erweiterungskarte und das Verbindungskabel aus Beutel 5 und verbinden Sie beide miteinander.

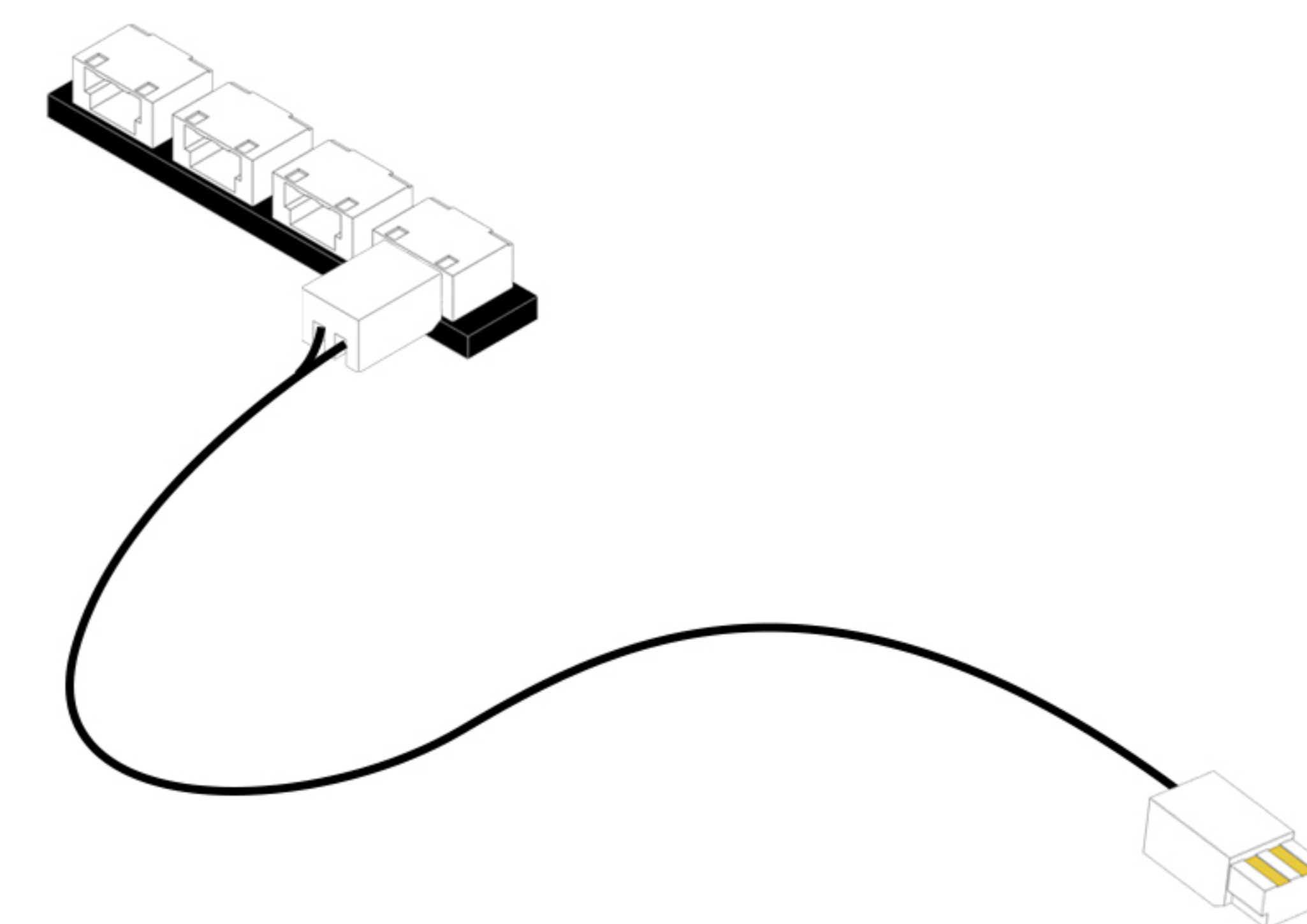
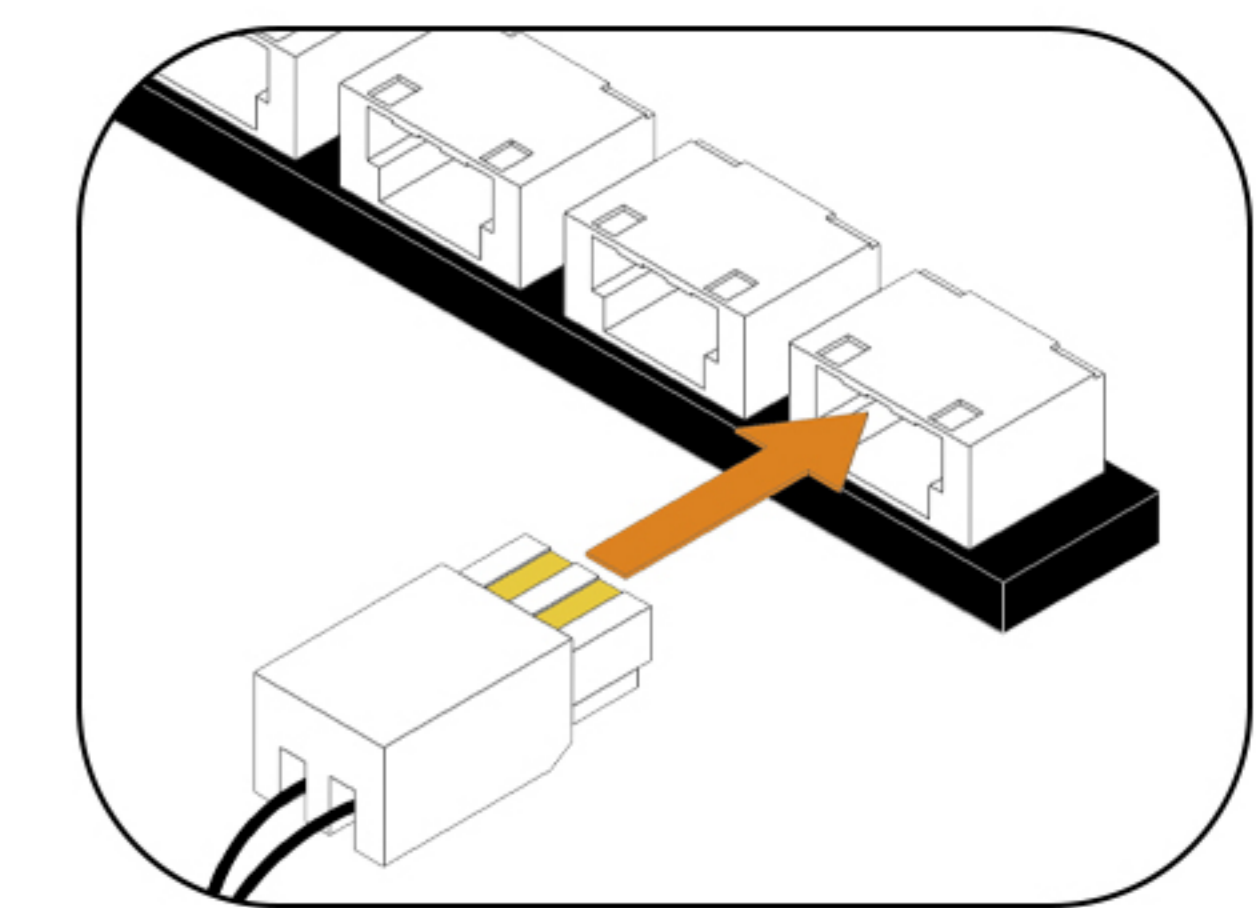
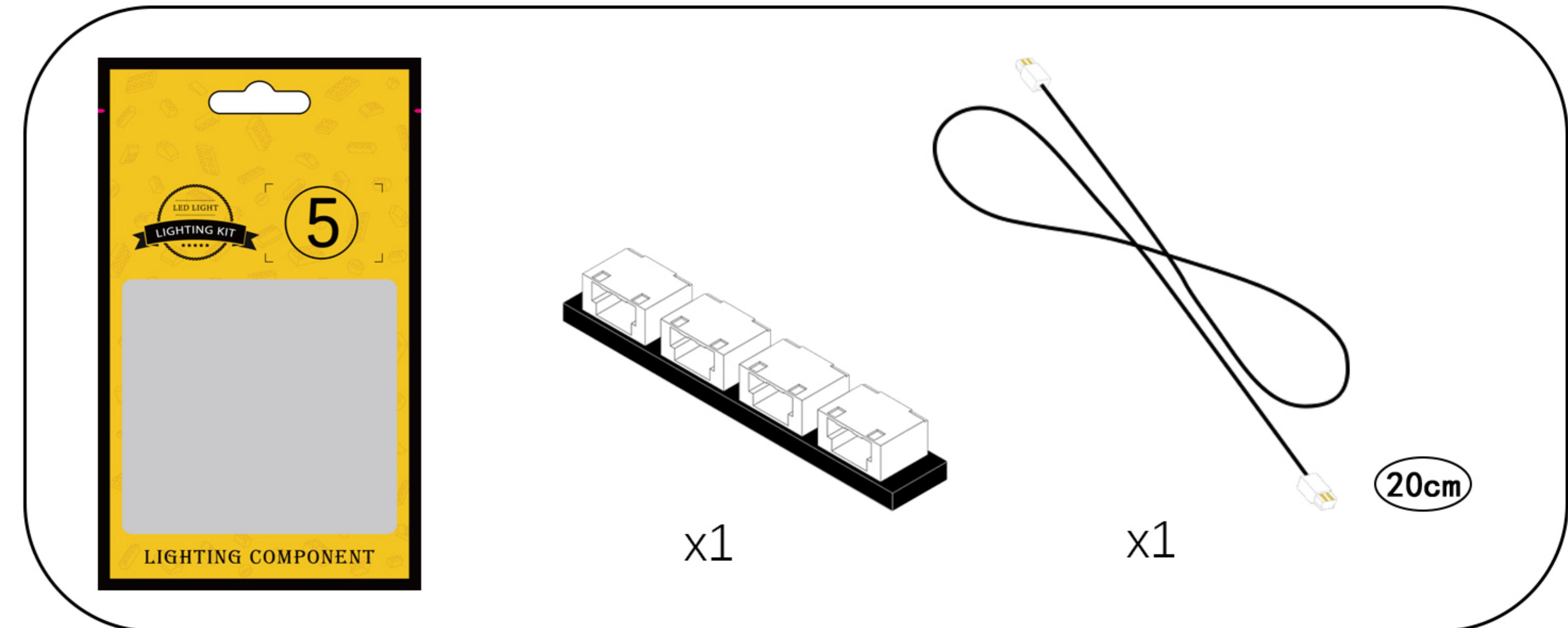

12

EN: Go back to the model and locate the three light lines shown in the diagram.

DE: Kehren Sie zum Modell zurück und suchen Sie die drei in der Abbildung dargestellten Lichtlinien.

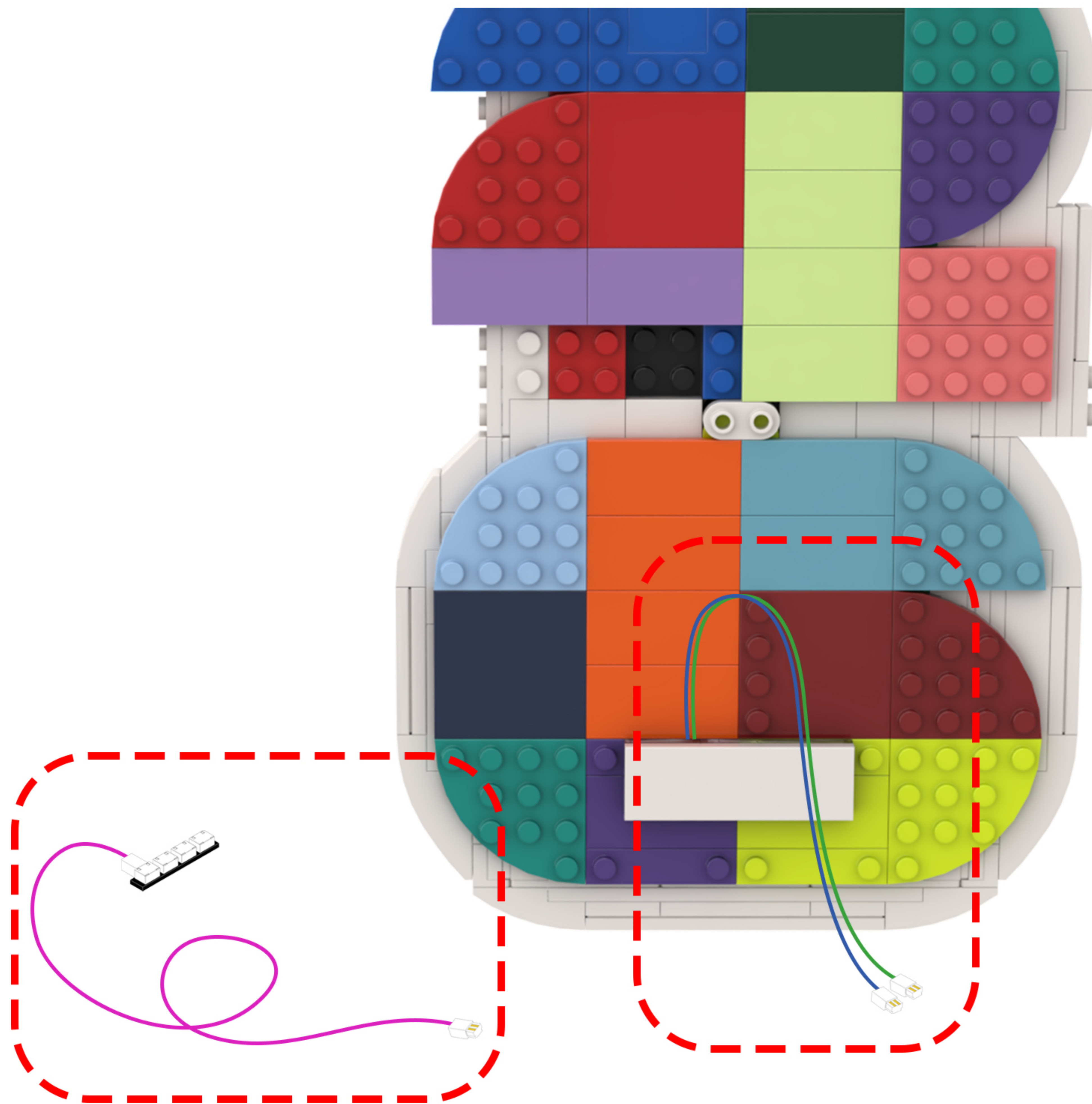

13

EN: Arrange the three strands of lights as shown in the figure.

DE: Ordnen Sie die drei Lichterketten wie in der Abbildung gezeigt an.

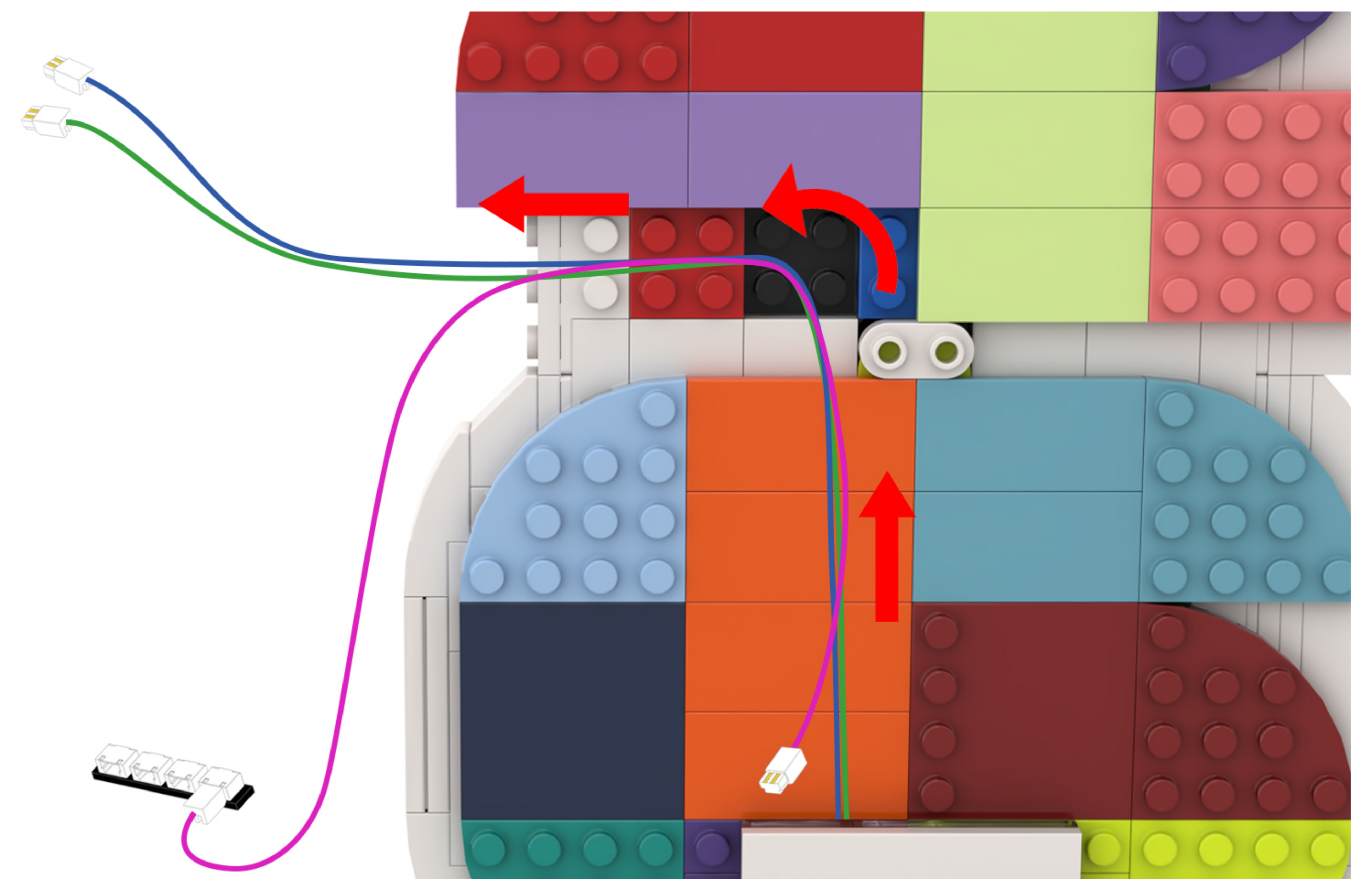

14

EN: Take out the disassembled building blocks, reassemble them, and secure the light cord.

DE: Nehmen Sie die zerlegten Bausteine heraus, setzen Sie sie wieder zusammen und befestigen Sie das Lichtkabel.

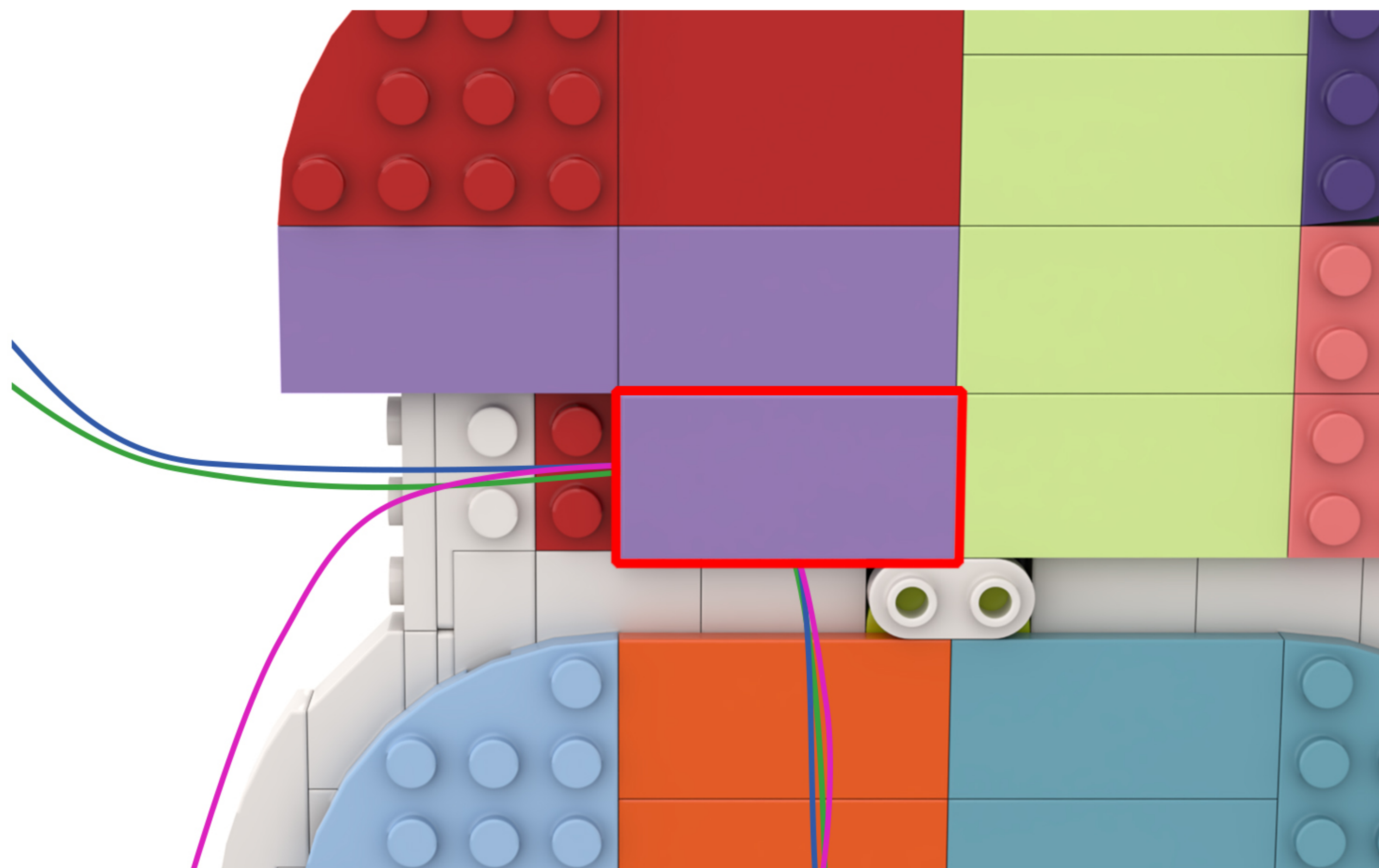
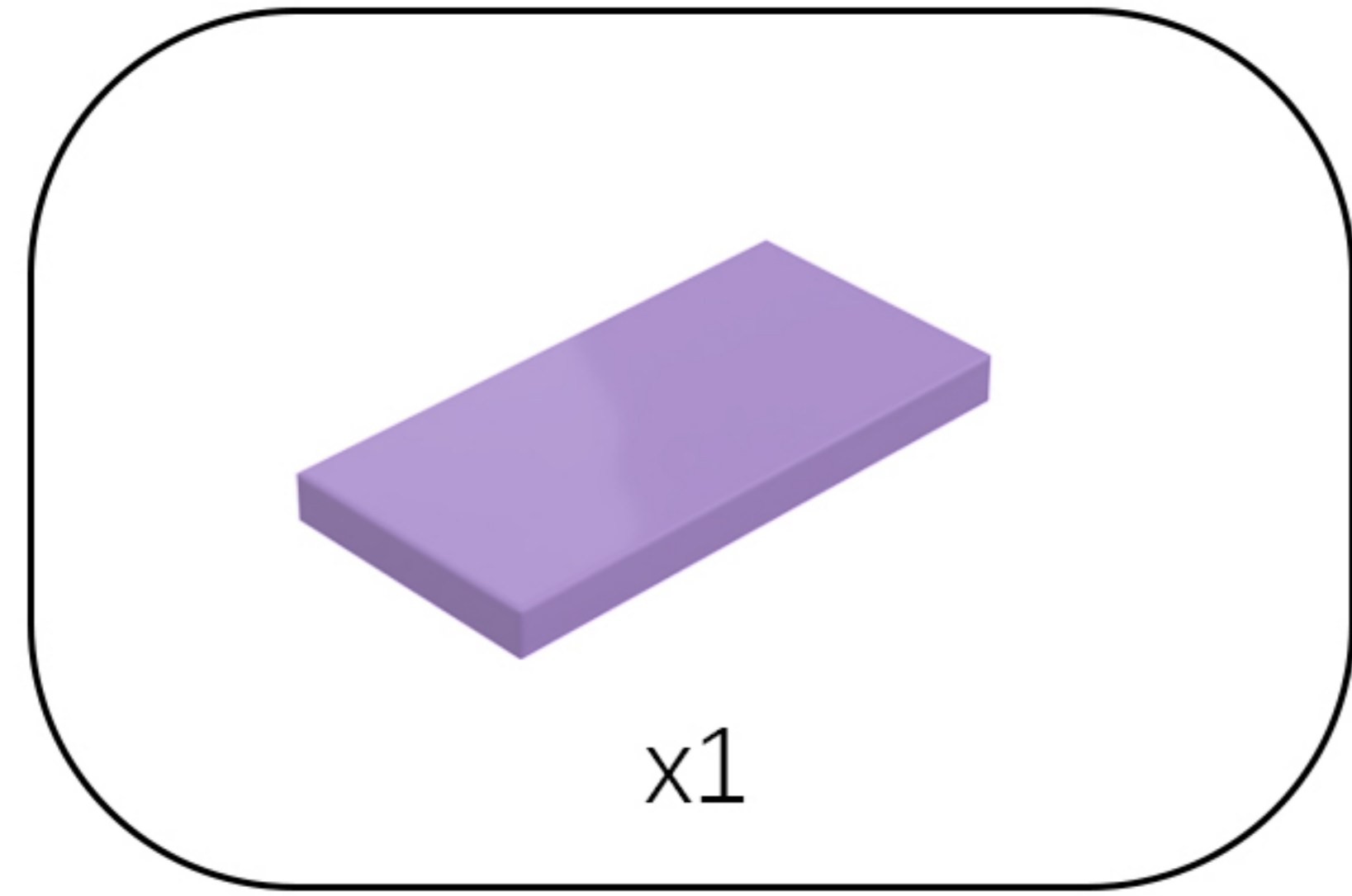

15

EN: Arrange the three strands of lights as shown in the figure.

DE: Ordnen Sie die drei Lichterketten wie in der Abbildung gezeigt an.

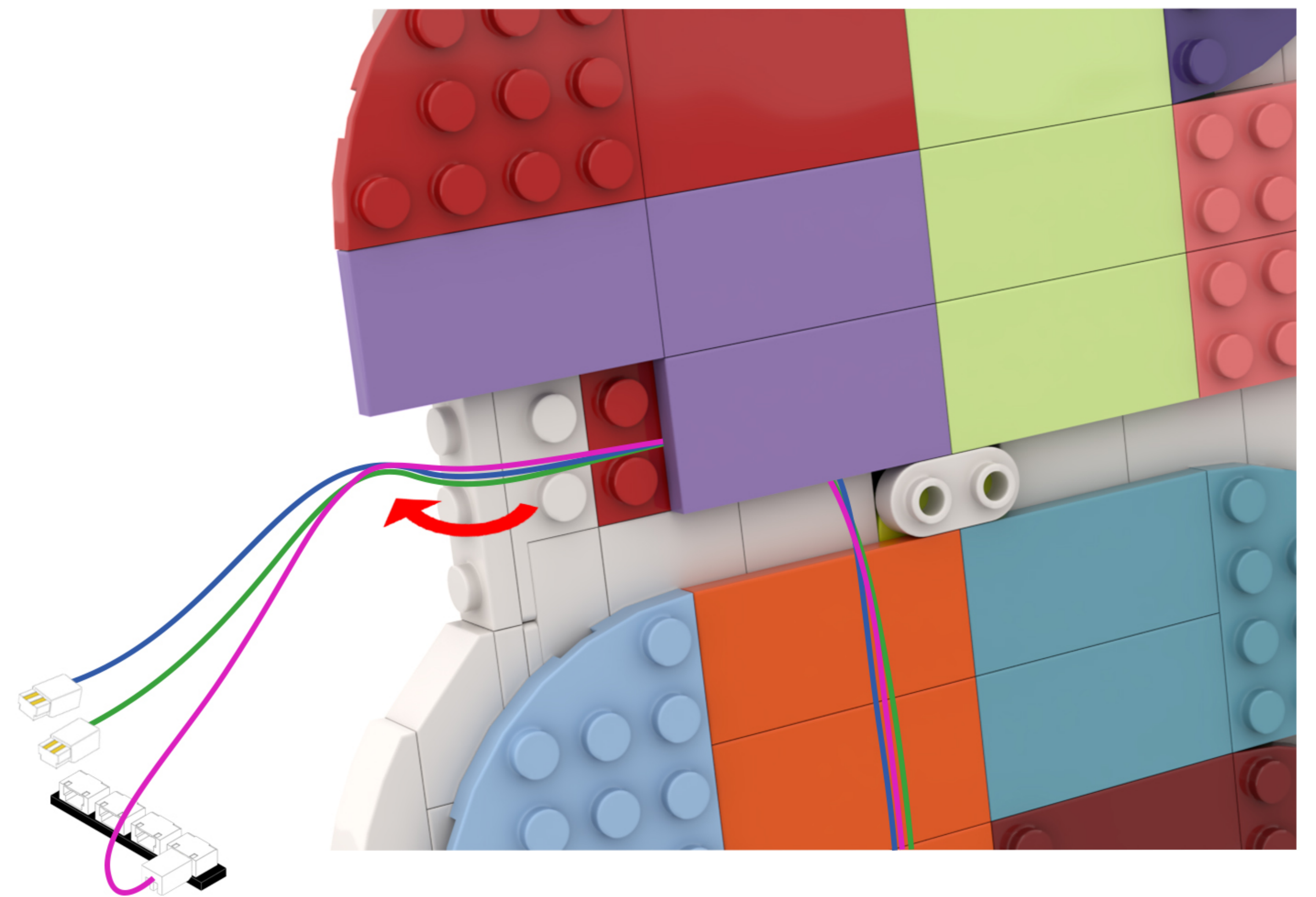

16

EN: Take out the disassembled building blocks, reassemble them, and secure the light cord.

DE: Nehmen Sie die zerlegten Bausteine heraus, setzen Sie sie wieder zusammen und befestigen Sie das Lichtkabel.

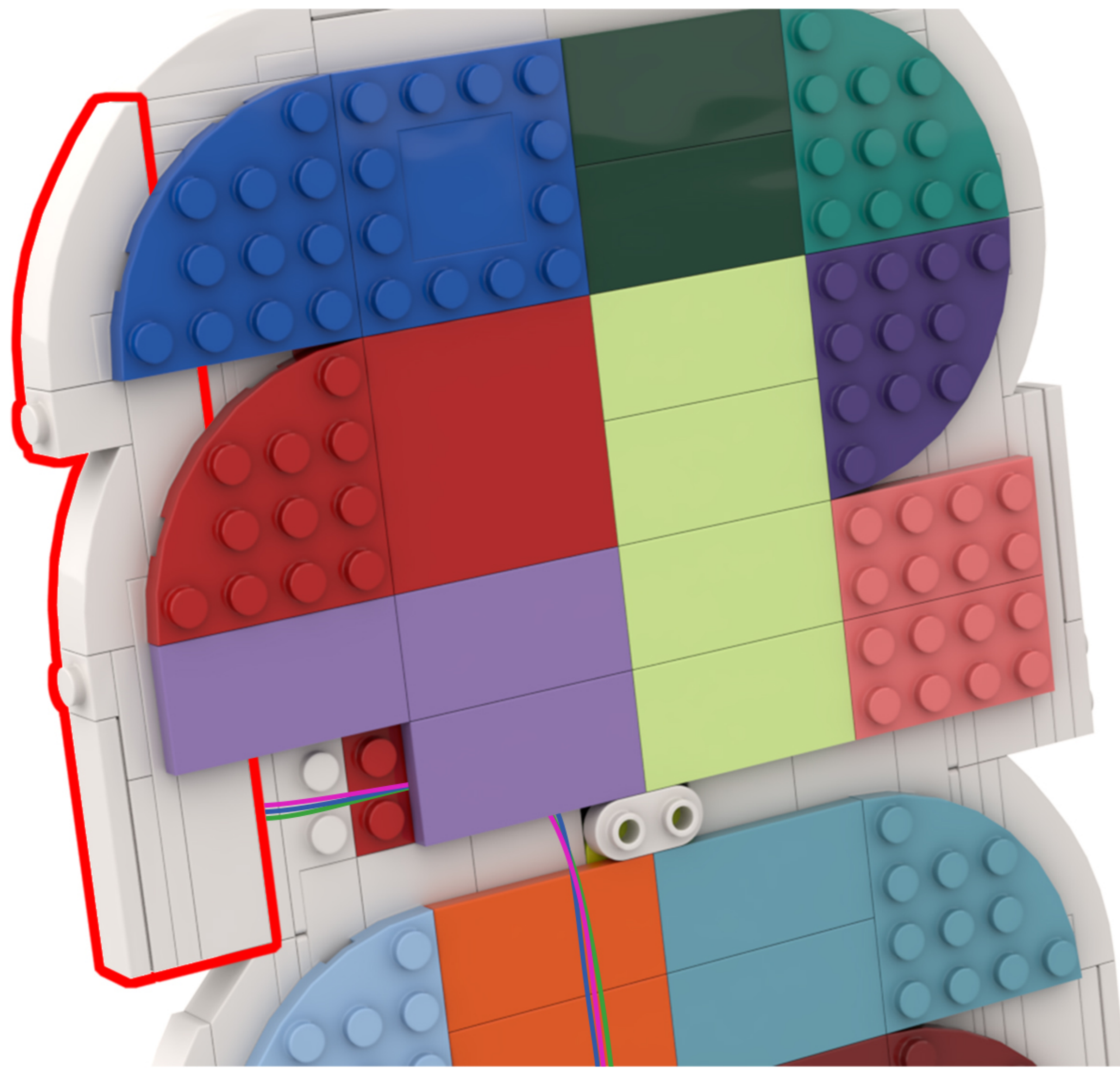
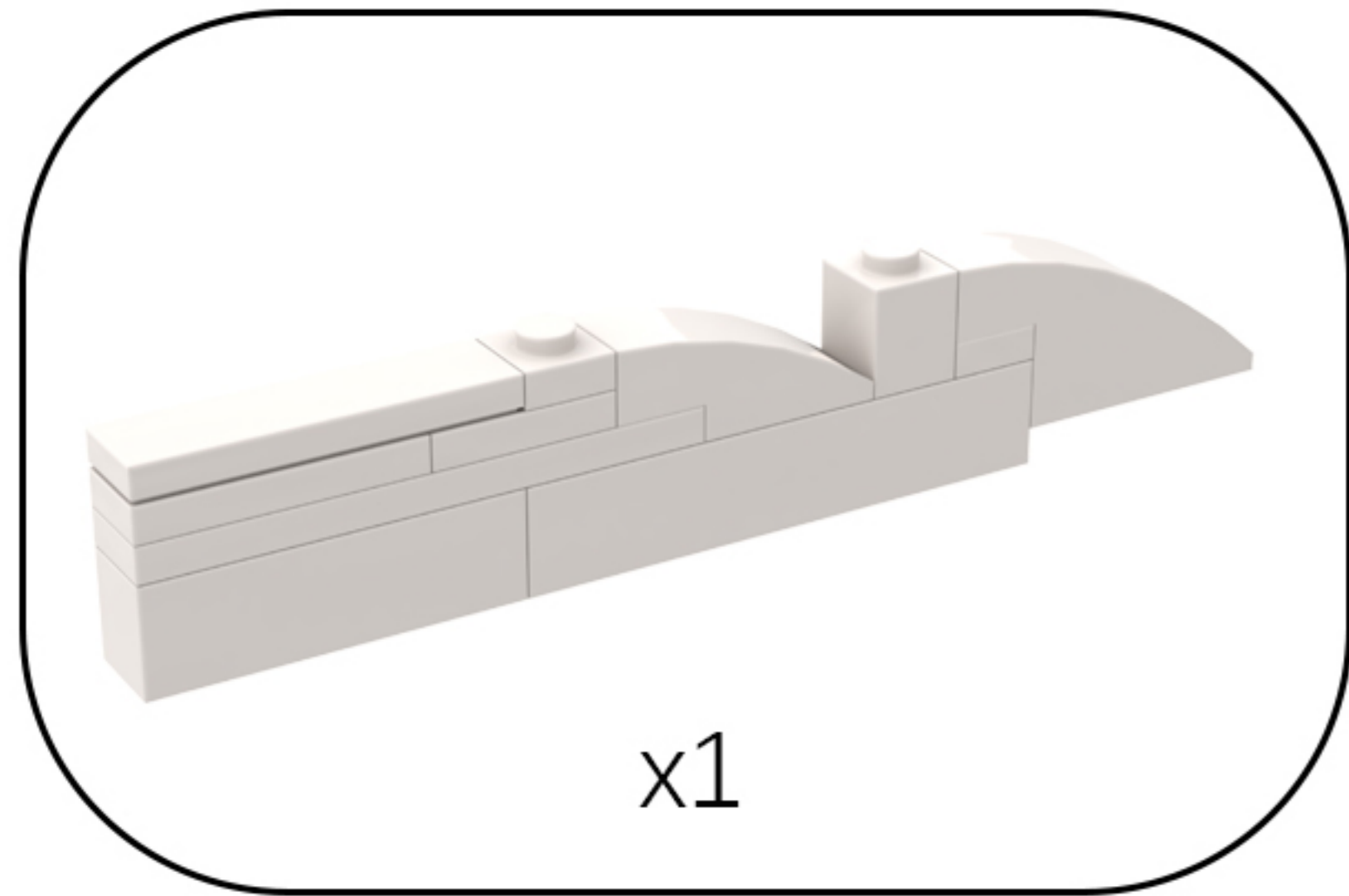

17

EN: Take out the disassembled building blocks, reassemble them, and secure the light cord.

DE: Nehmen Sie die zerlegten Bausteine heraus, setzen Sie sie wieder zusammen und befestigen Sie das Lichtkabel.

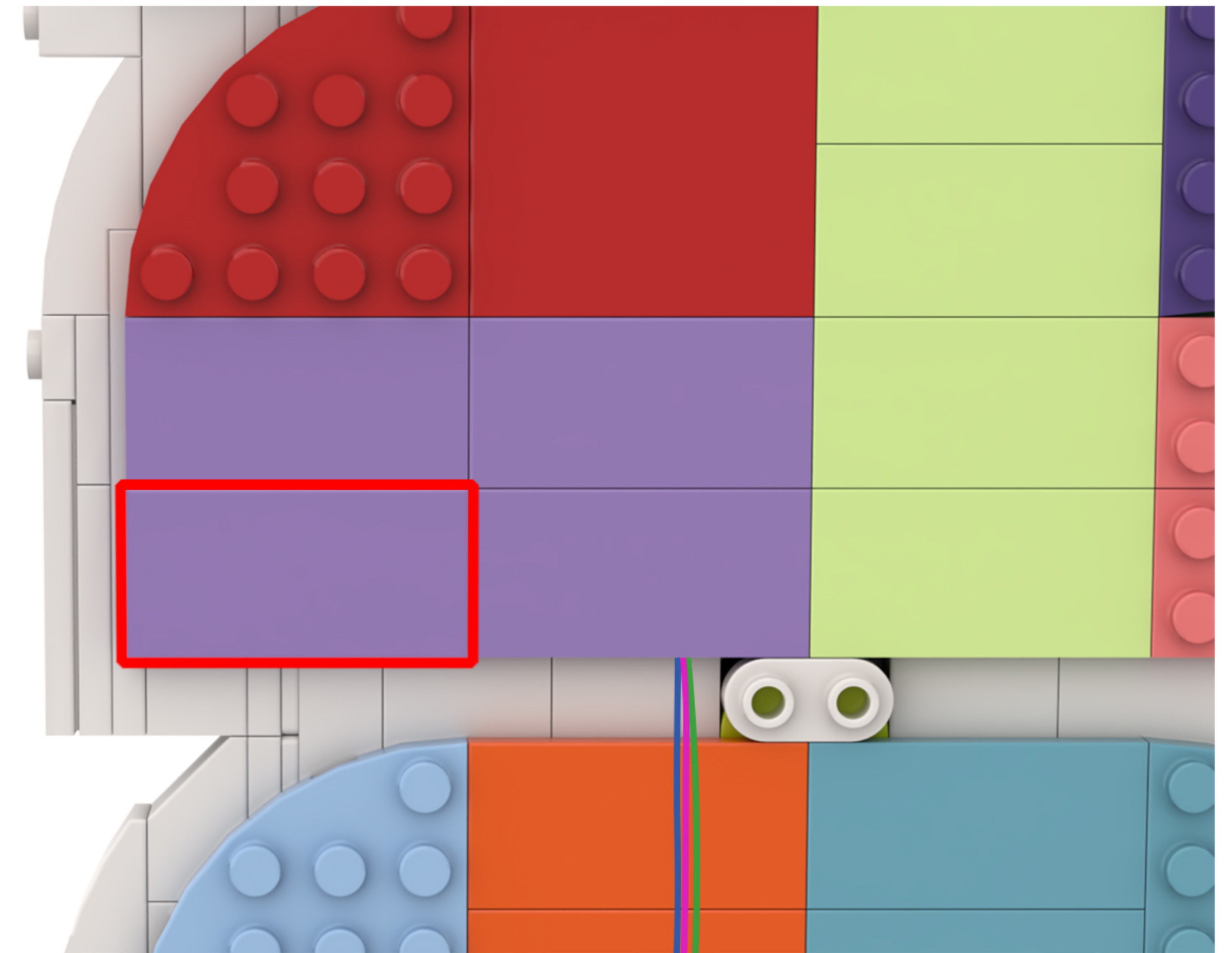
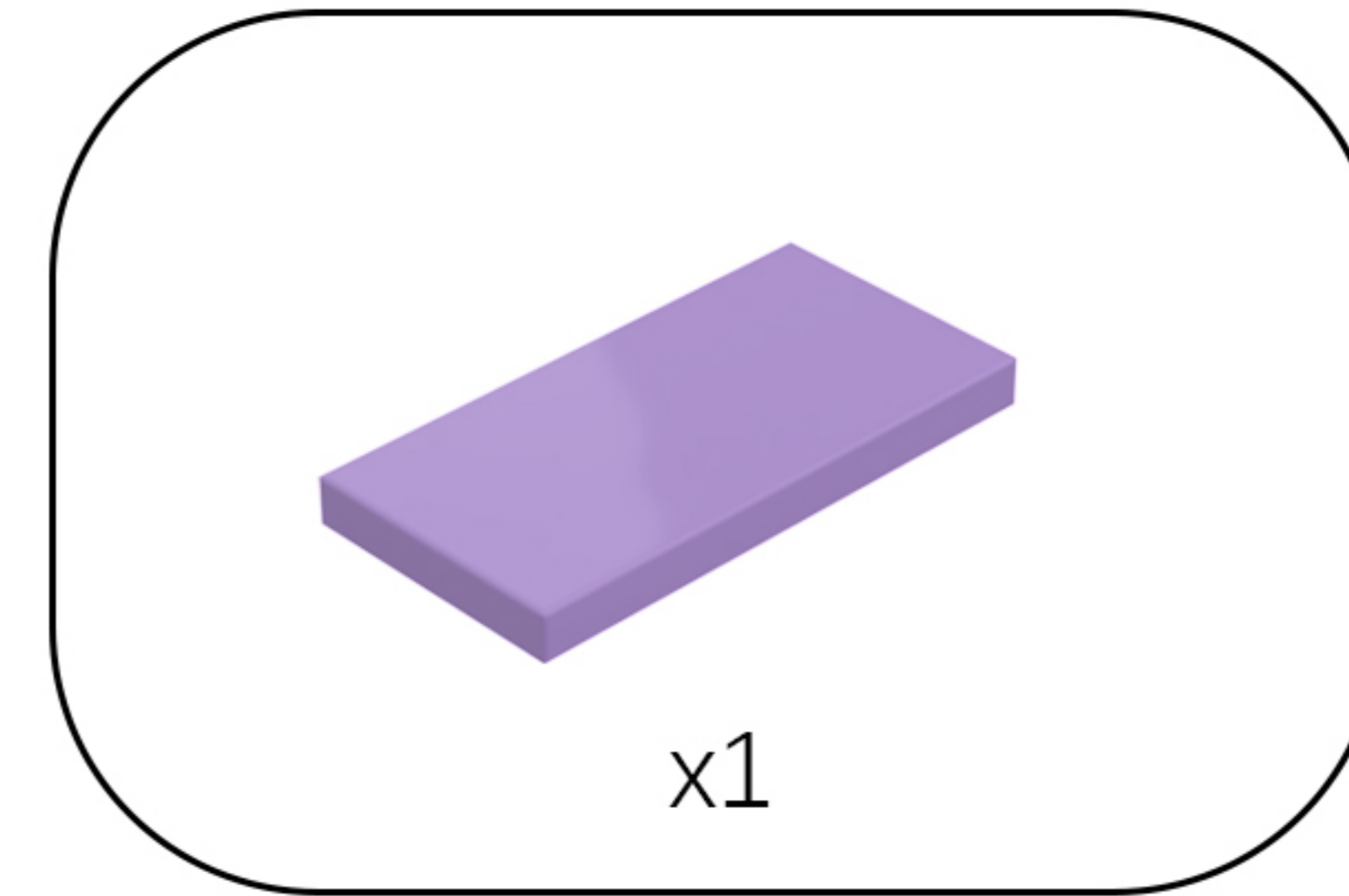

18

EN: Once the lighting fixtures have been installed in this step, the result will look as shown in the figure below.

DE: Sobald die Leuchten in diesem Schritt installiert wurden, sieht das Ergebnis wie in der folgenden Abbildung dargestellt aus.

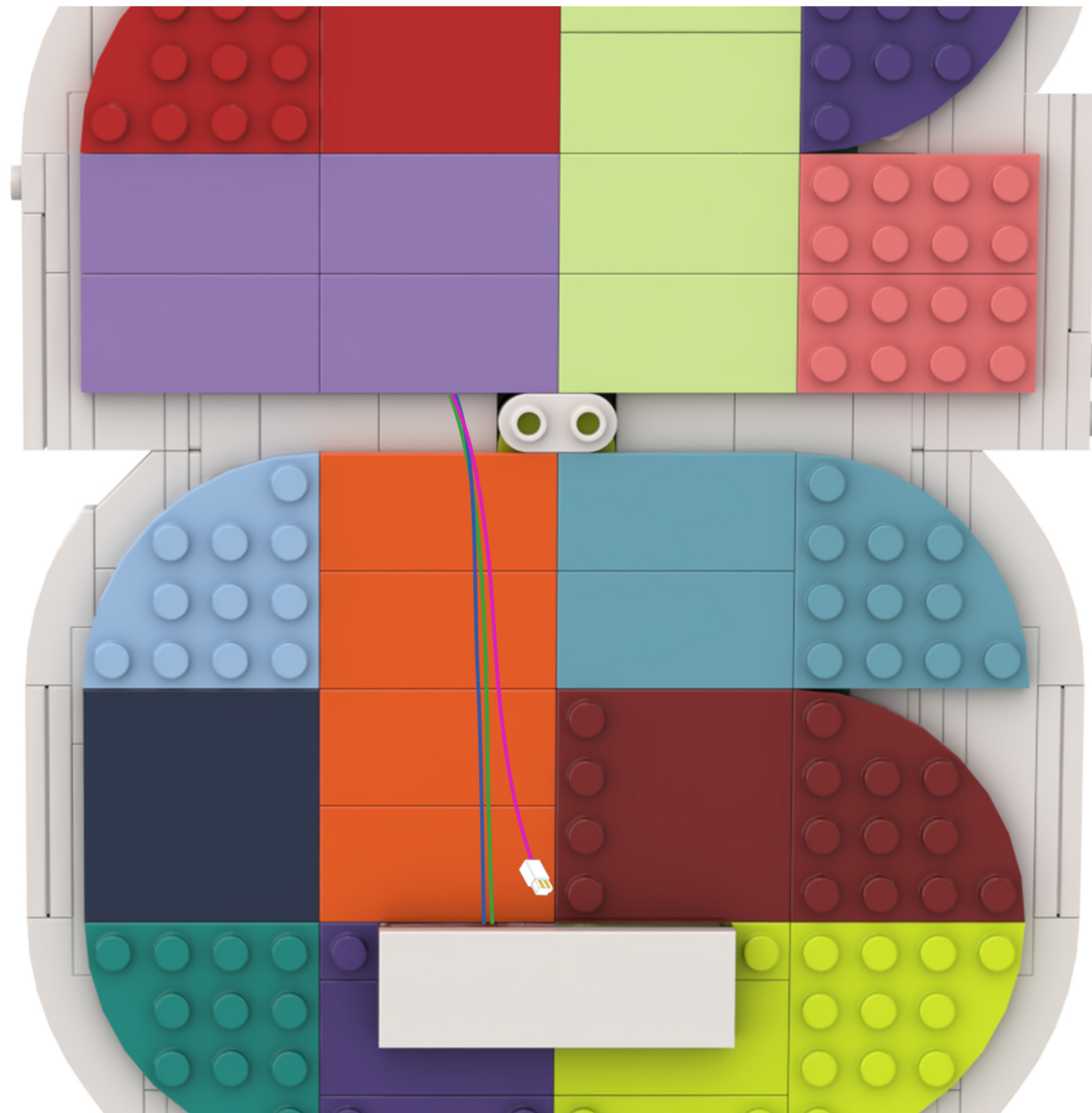

19

EN: Take out the disassembled building blocks and separate them.

DE: Nehmen Sie die zerlegten Bausteine heraus und trennen Sie sie voneinander.

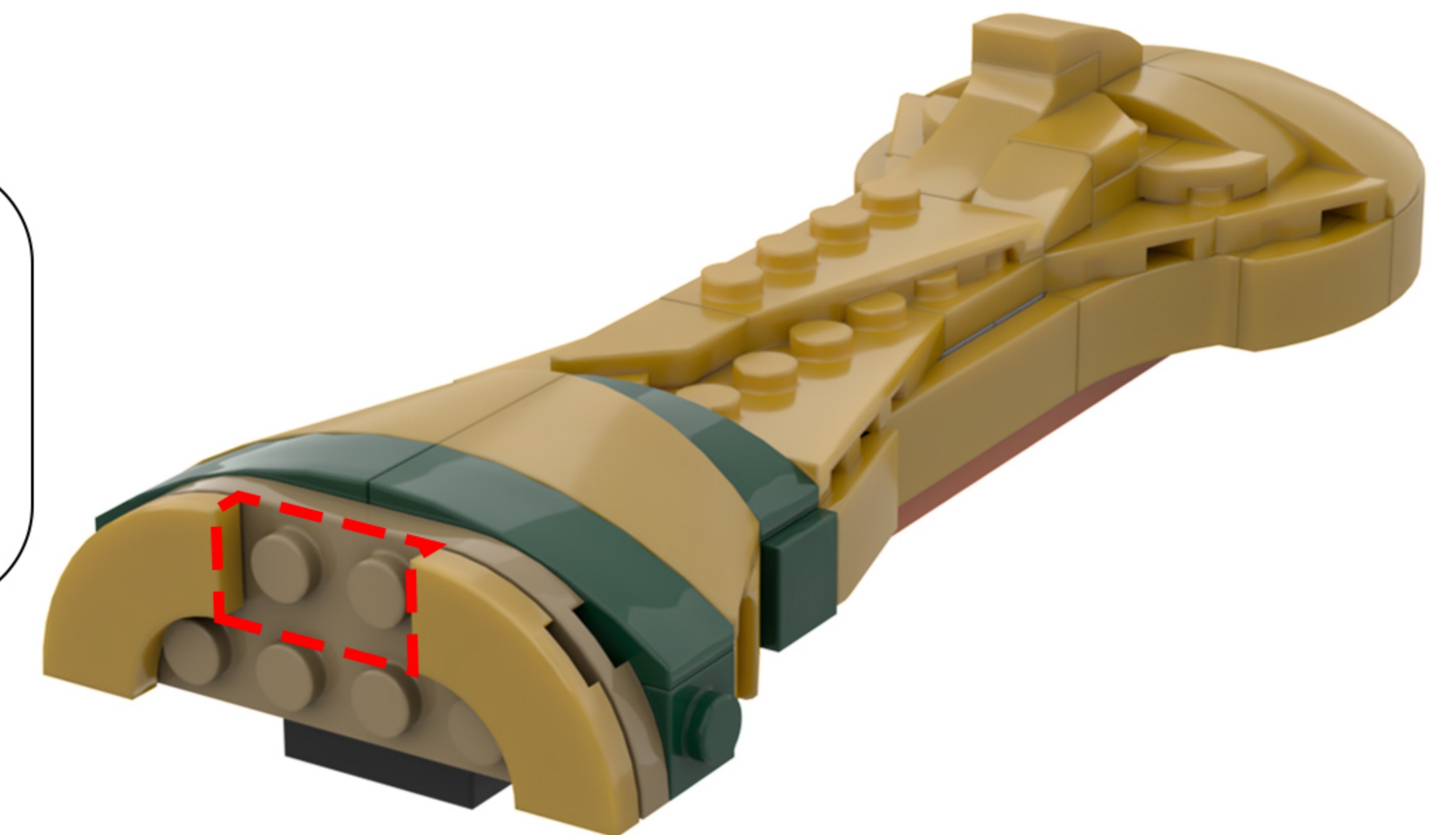
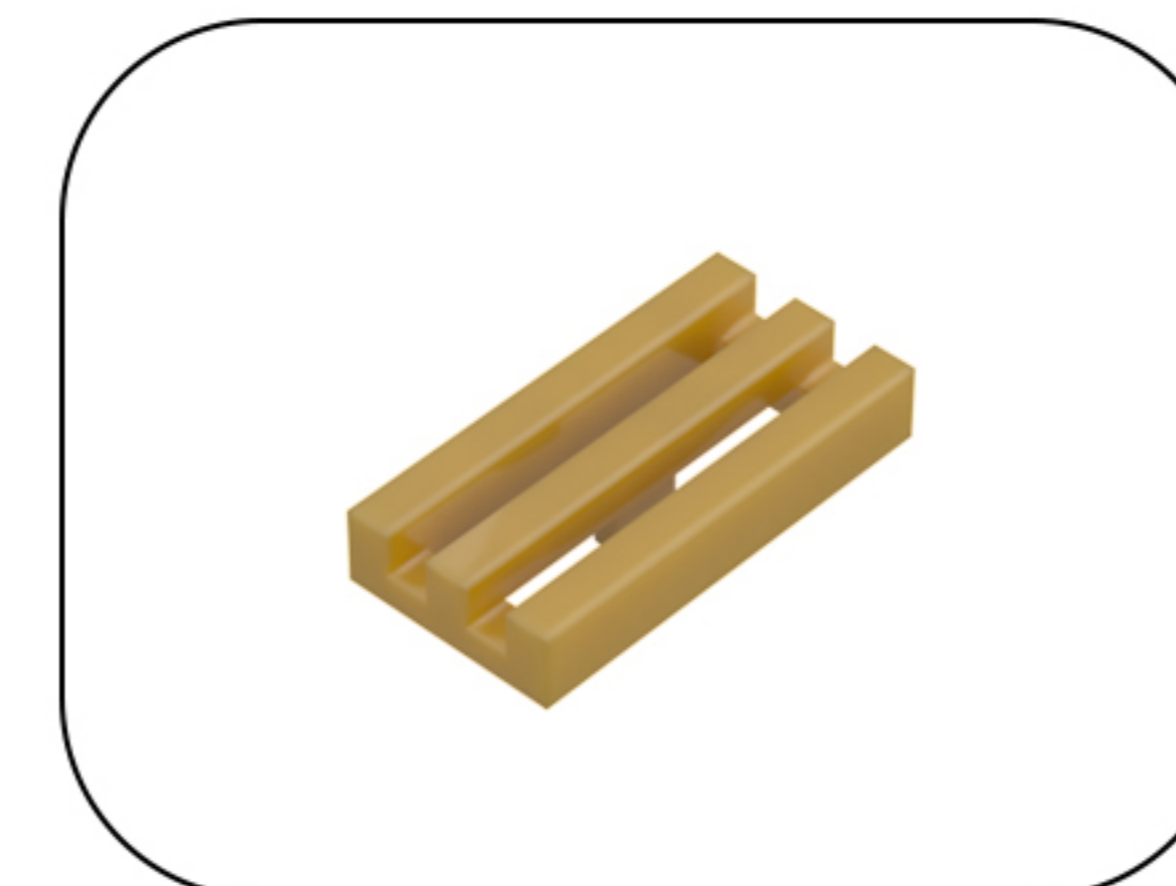
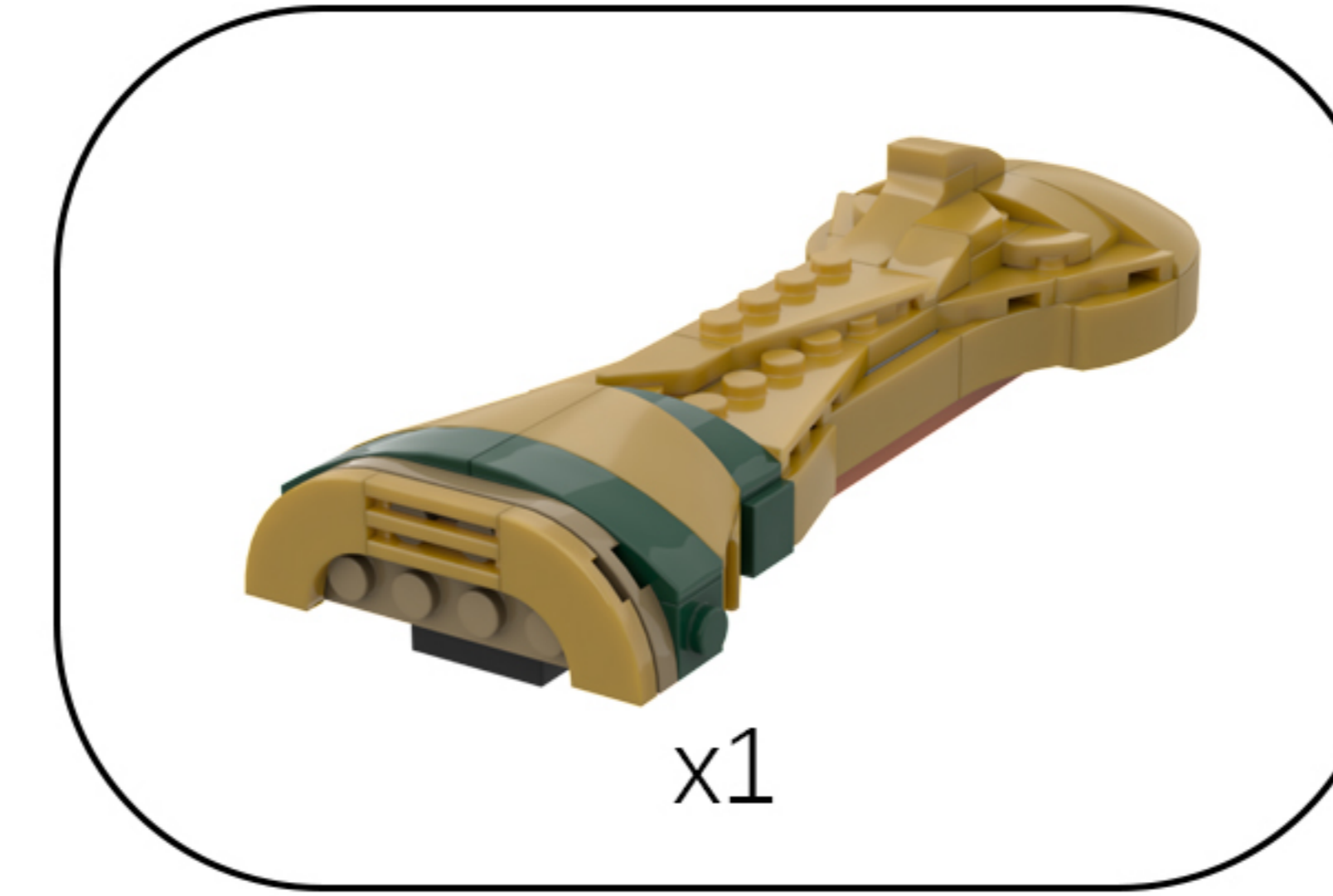

20

EN: Take the light beads out of Bag 3 and follow the instructions step by step.

DE: Nimm die Leuchtperlen aus Beutel 3 heraus und befolge die Anleitung Schritt für Schritt.

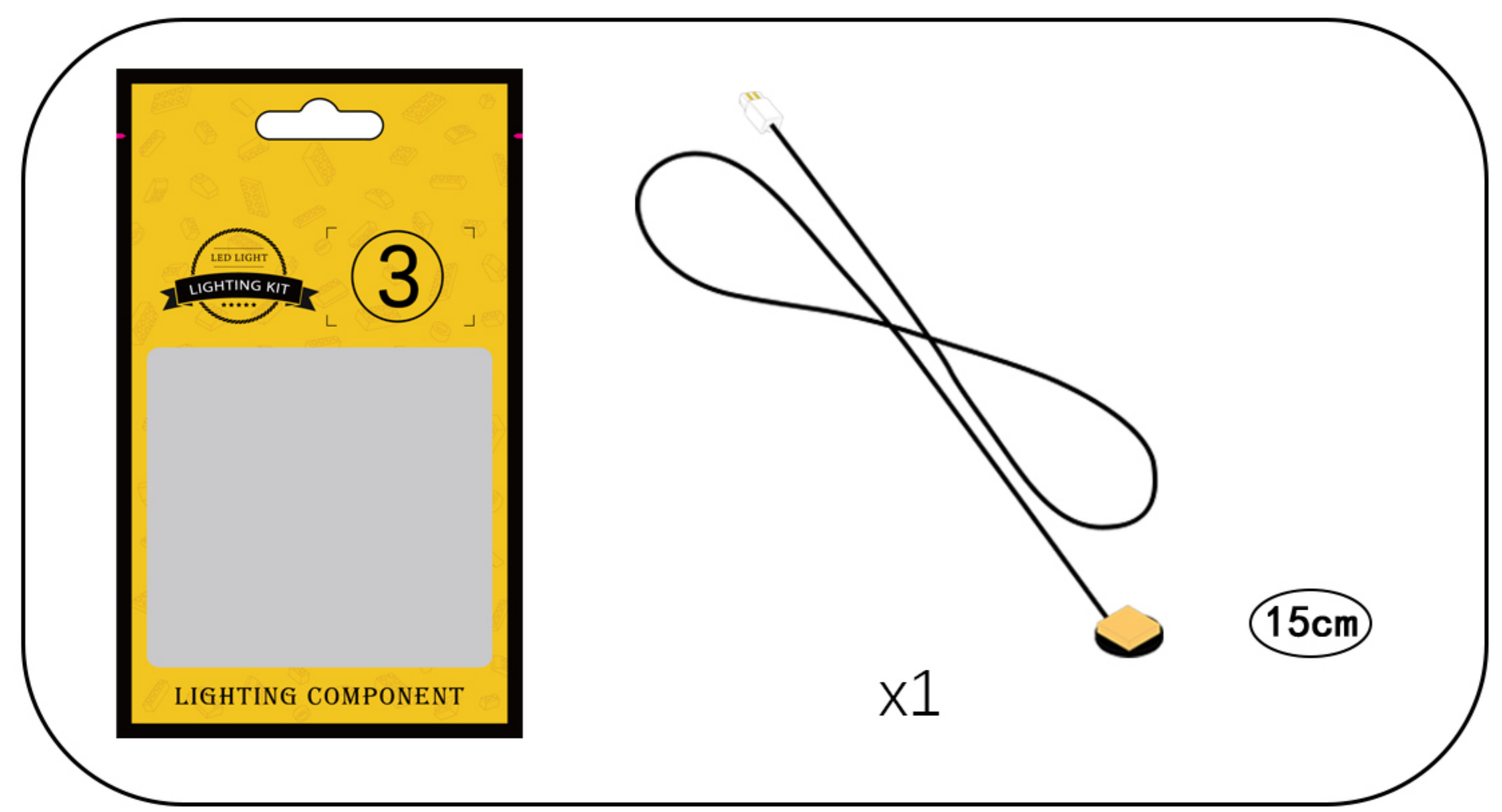

①. Untwist a short section of the twisted lamp cord.

②. Turn the light bulb upside down and twist the untangled light cord once.

③. Fold the light beads back.

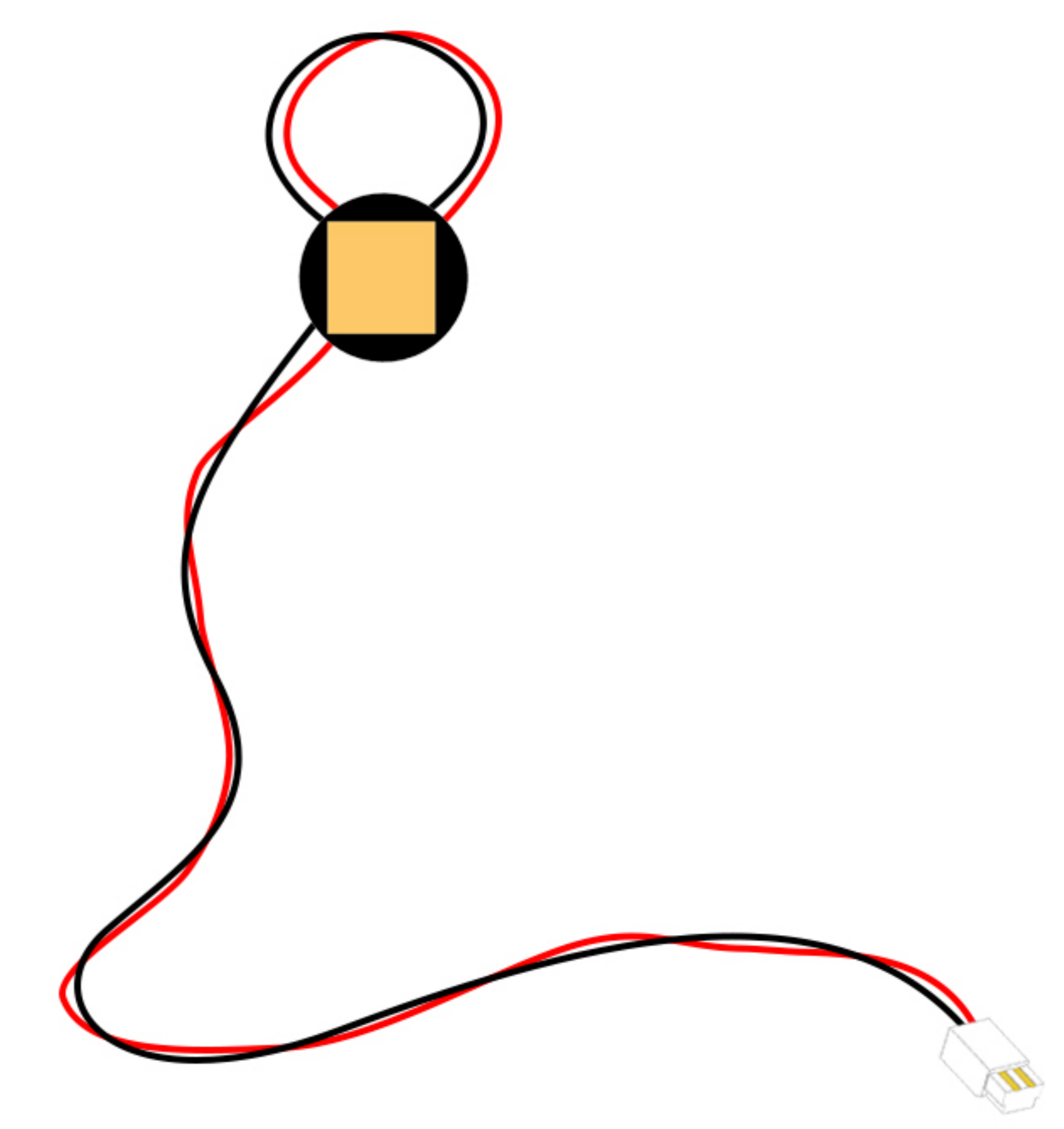
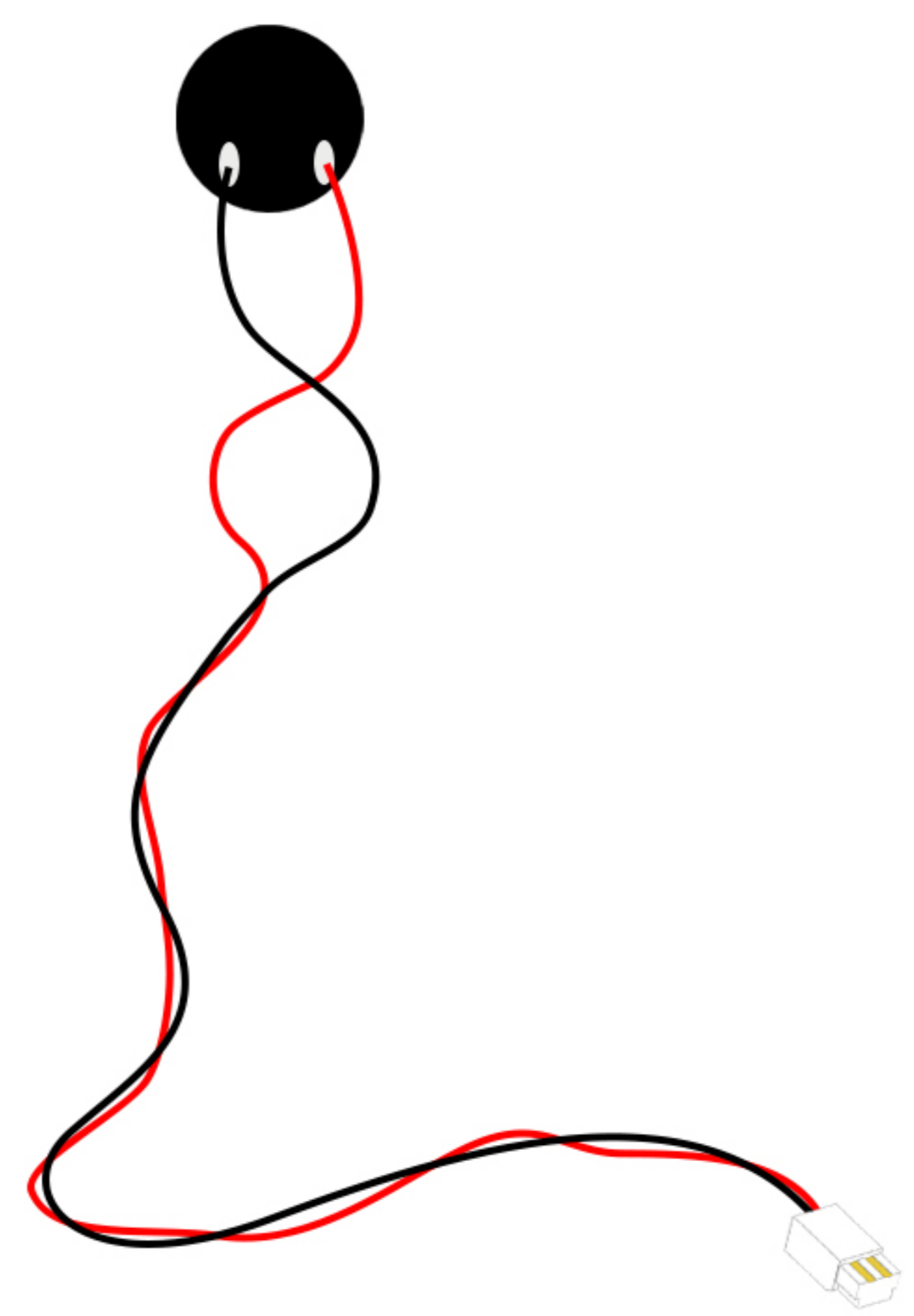
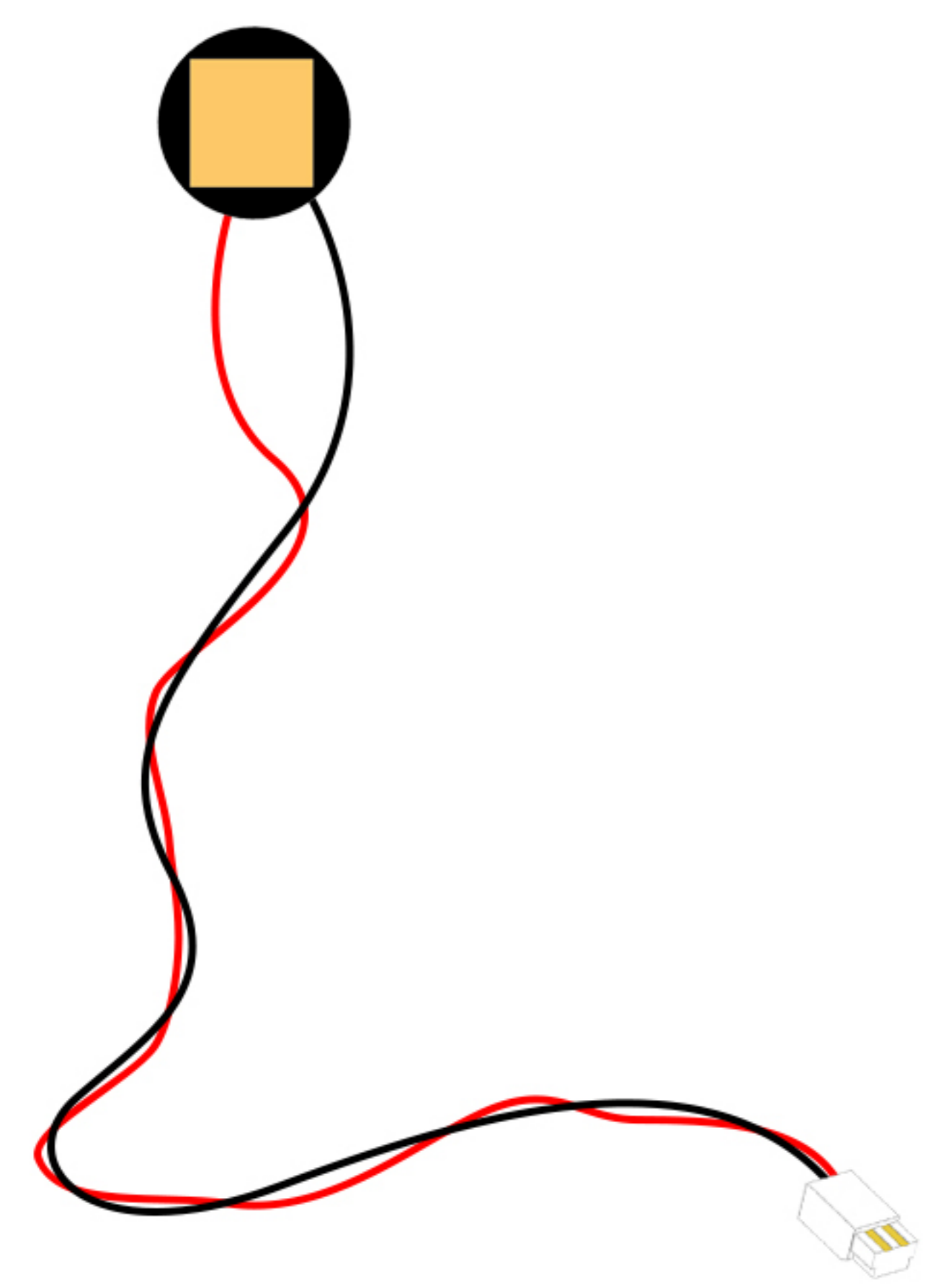

21

EN: Place the light beads on the building blocks.

DE: Setze die Leuchtperlen auf die Bausteine.

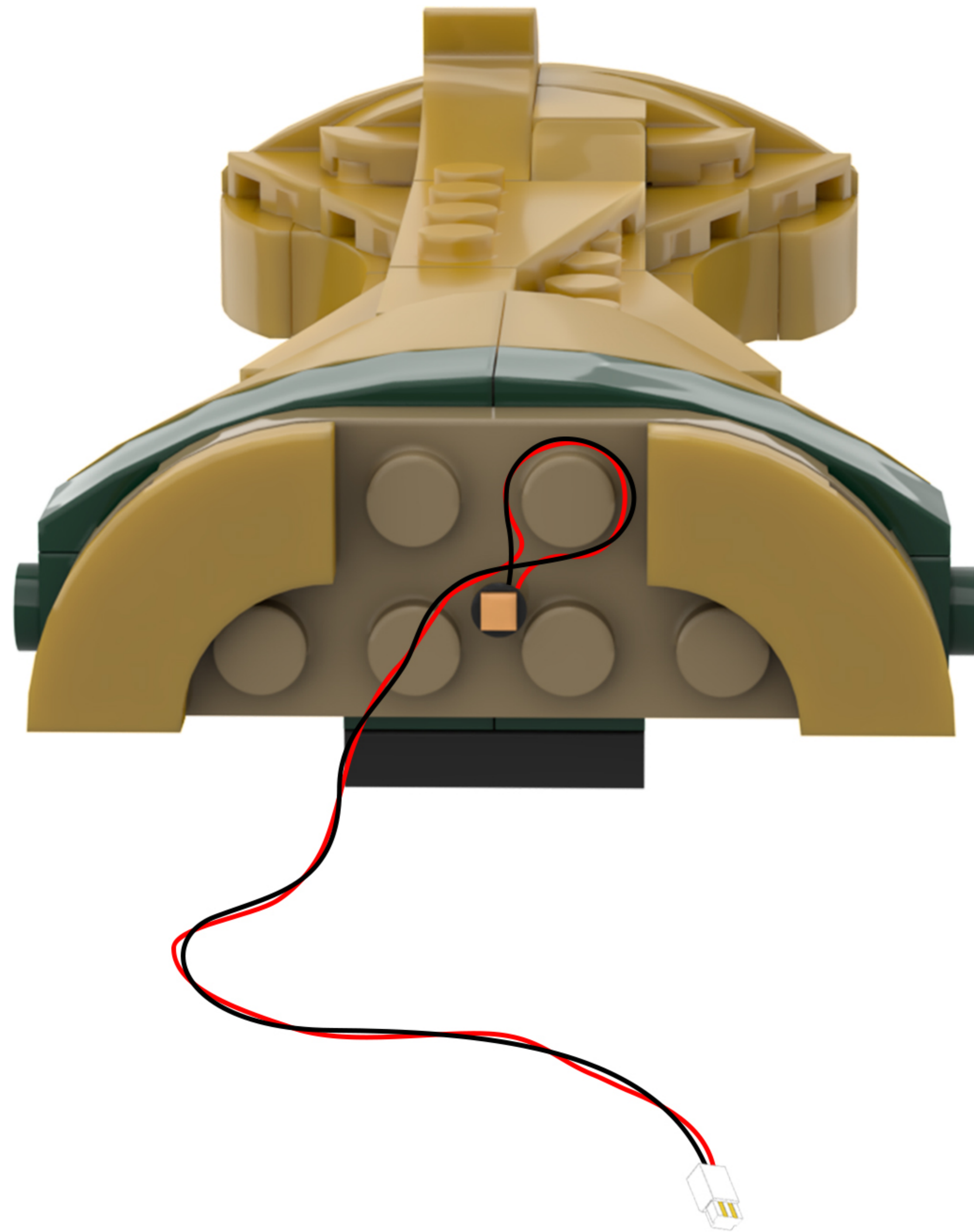

22

EN: Take out the disassembled building blocks, reassemble them, and secure the light cord.

DE: Nehmen Sie die zerlegten Bausteine heraus, setzen Sie sie wieder zusammen und befestigen Sie das Lichtkabel.

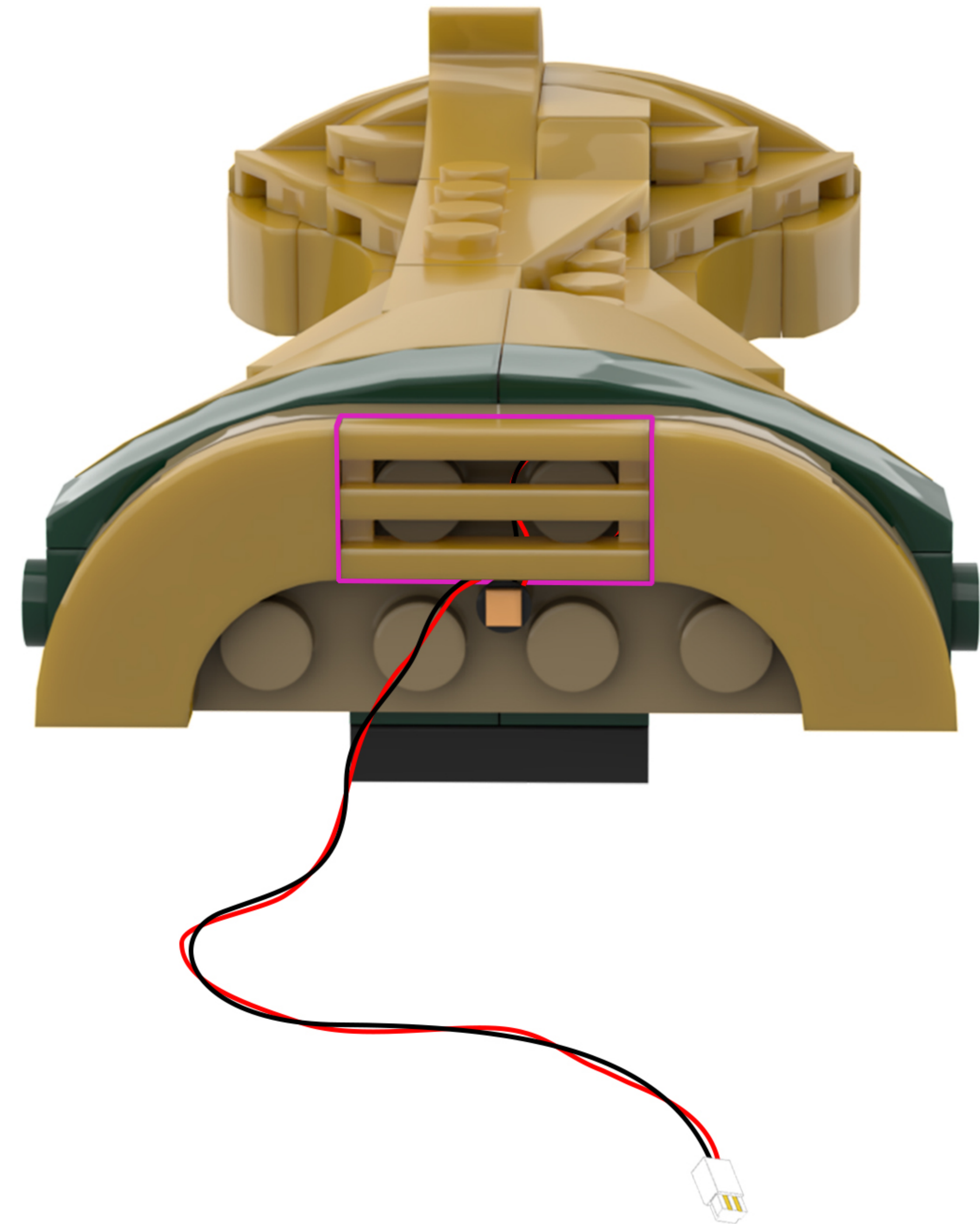
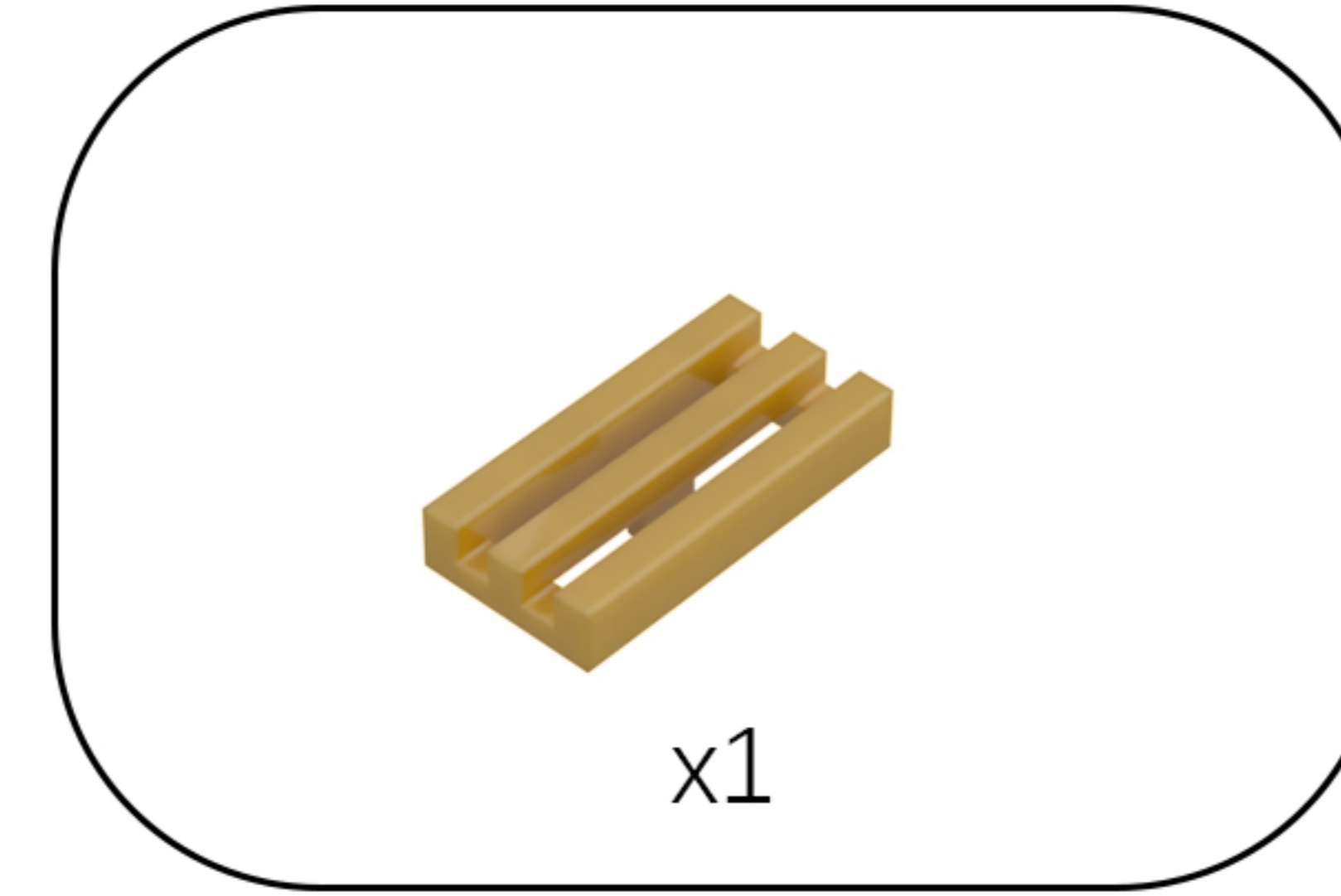

23

EN: Rotate the model to its back side.

DE: Drehen Sie das Modell auf die Rückseite.

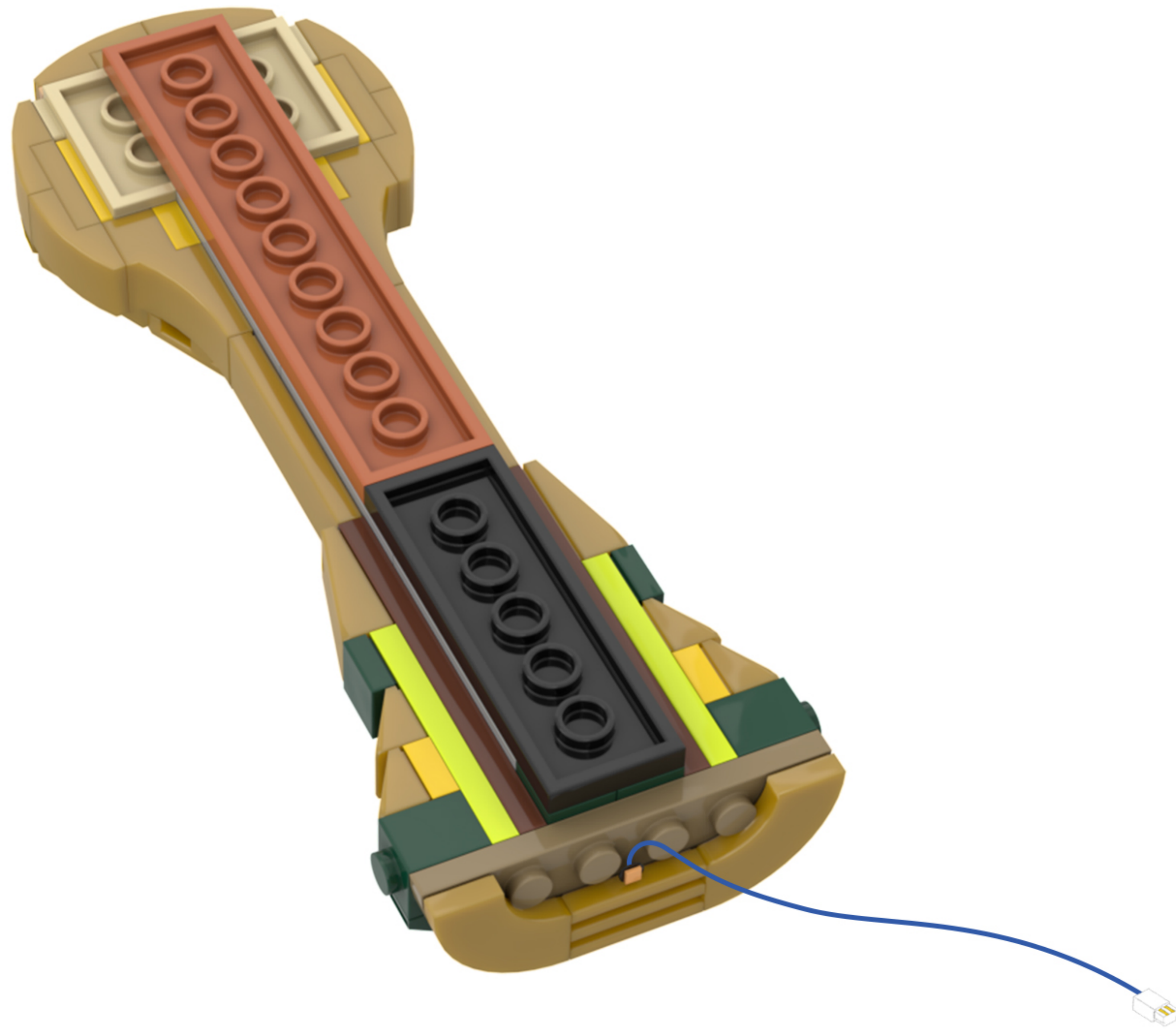
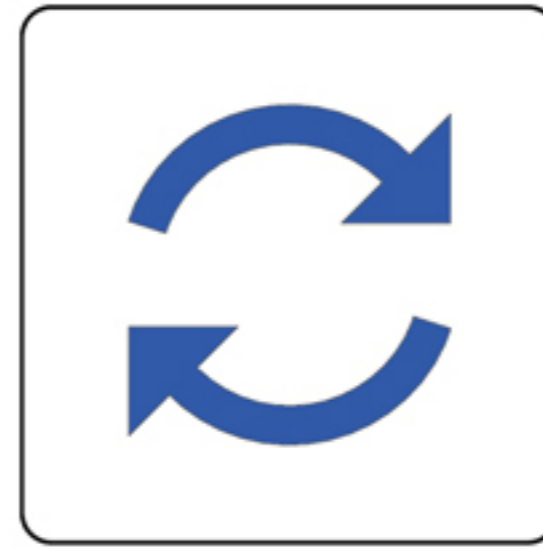

24

EN: Take the COB light strip out of Bag 4, peel off the adhesive backing, and attach it to the location shown in the diagram.

DE: Nehmen Sie den COB-Lichtstreifen aus Beutel 4, ziehen Sie die Schutzfolie ab und befestigen Sie ihn an der in der Abbildung gezeigten Stelle.

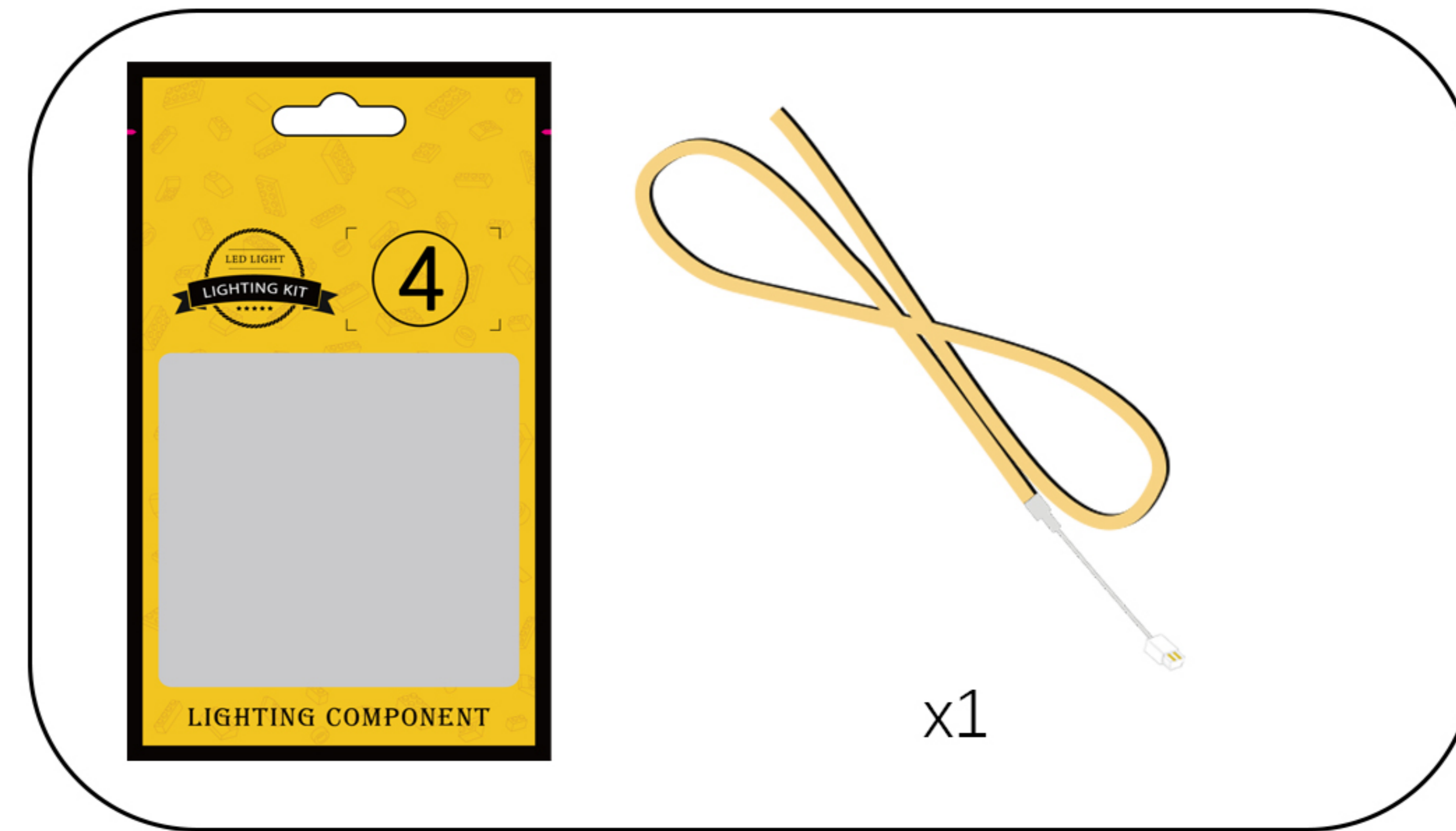

Please peel off the adhesive on the back.

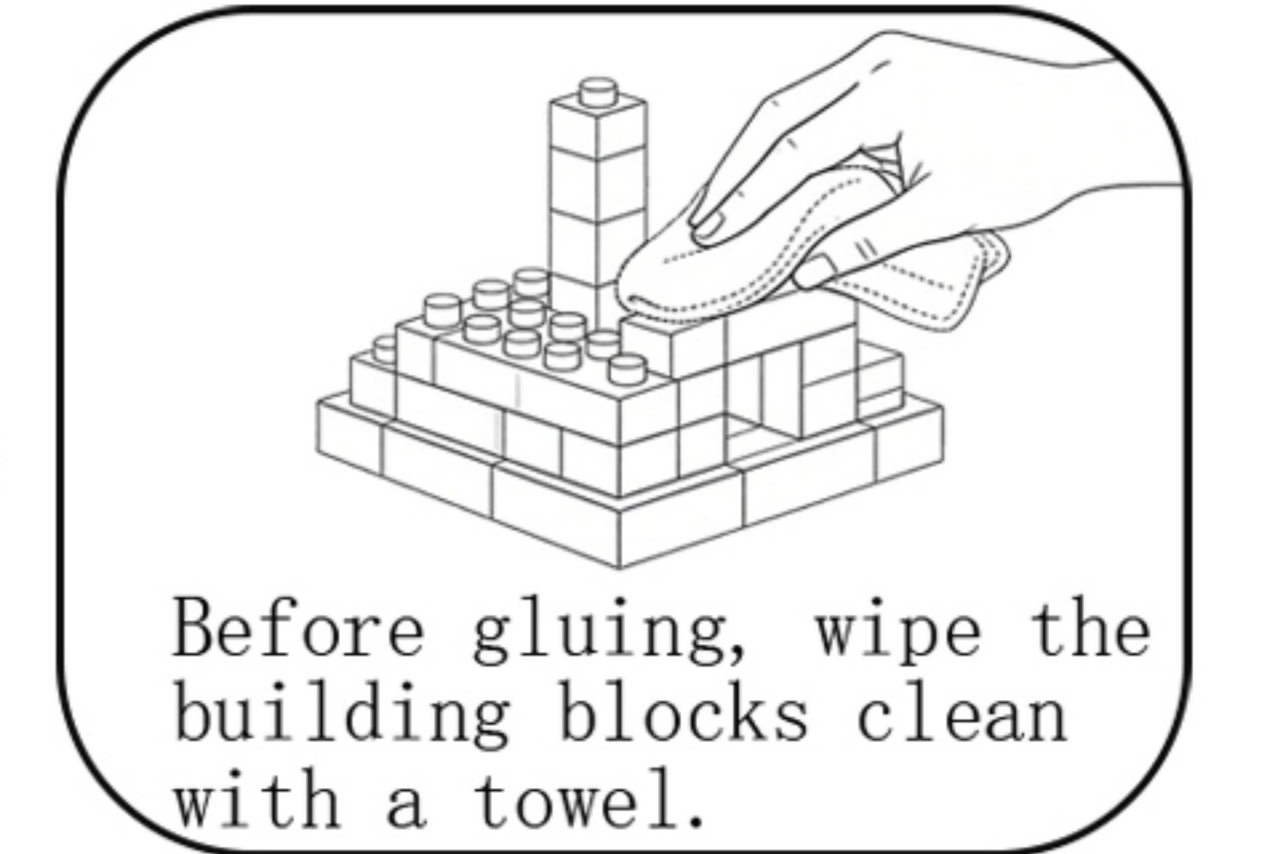

Before gluing, wipe the building blocks clean with a towel.

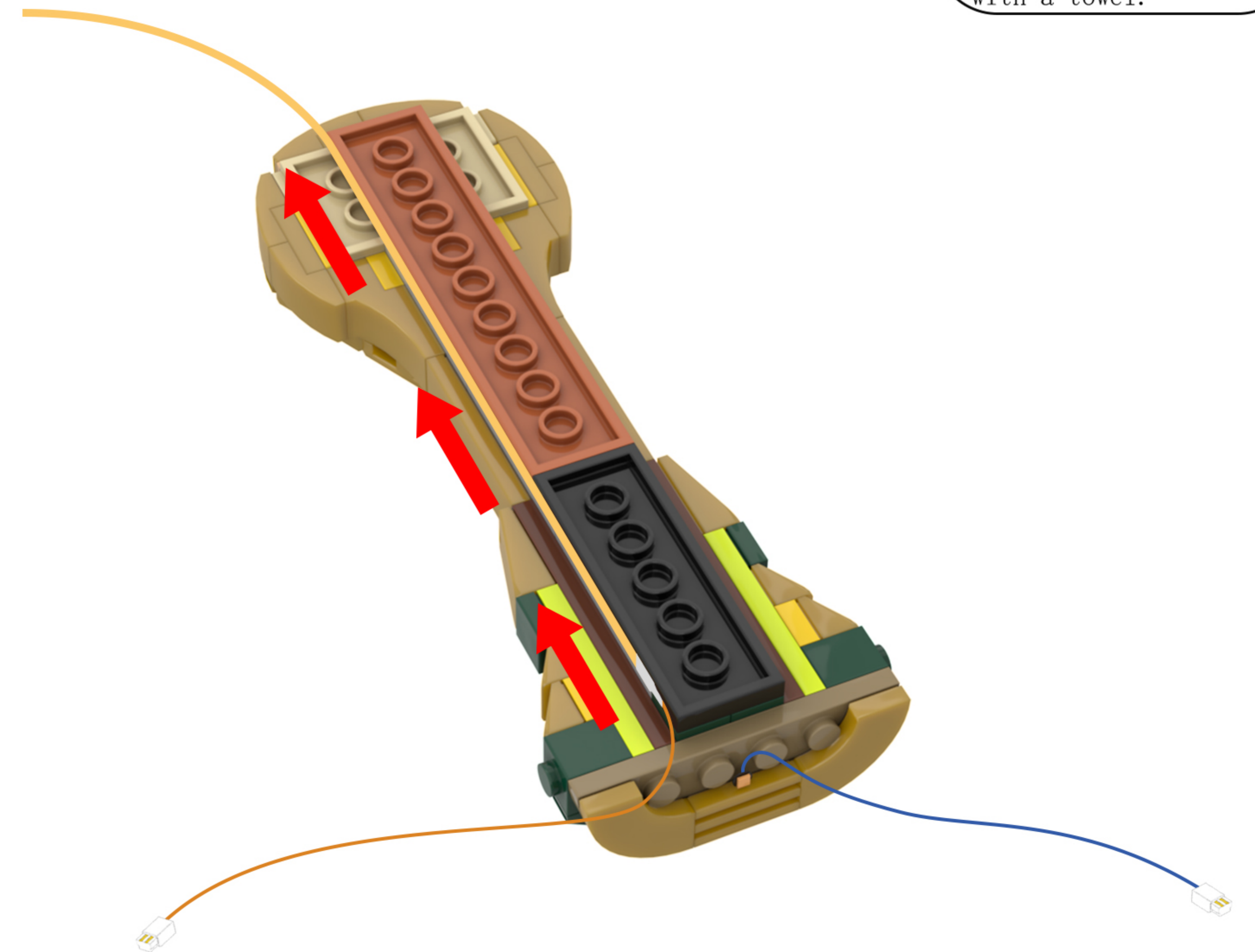

25

EN: Stick all the COB light strips onto the building blocks.

DE: Kleben Sie alle COB-Lichtleisten auf die Bausteine.

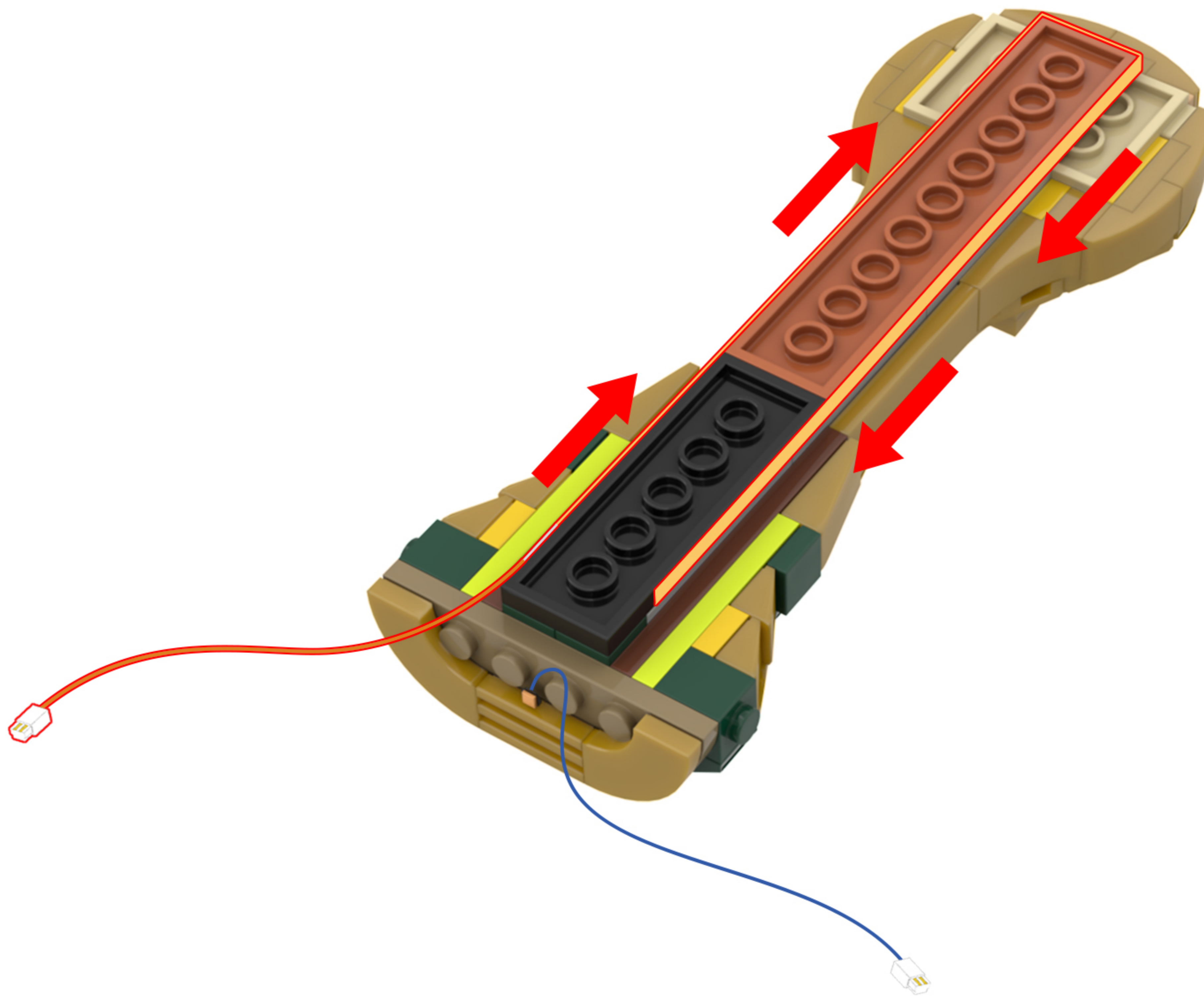

26

EN: Take the 1x2 base plates from Bag 5 and attach them to the building blocks.

DE: Nimm die 1x2-Grundplatten aus Beutel 5 und befestige sie an den Bausteinen.

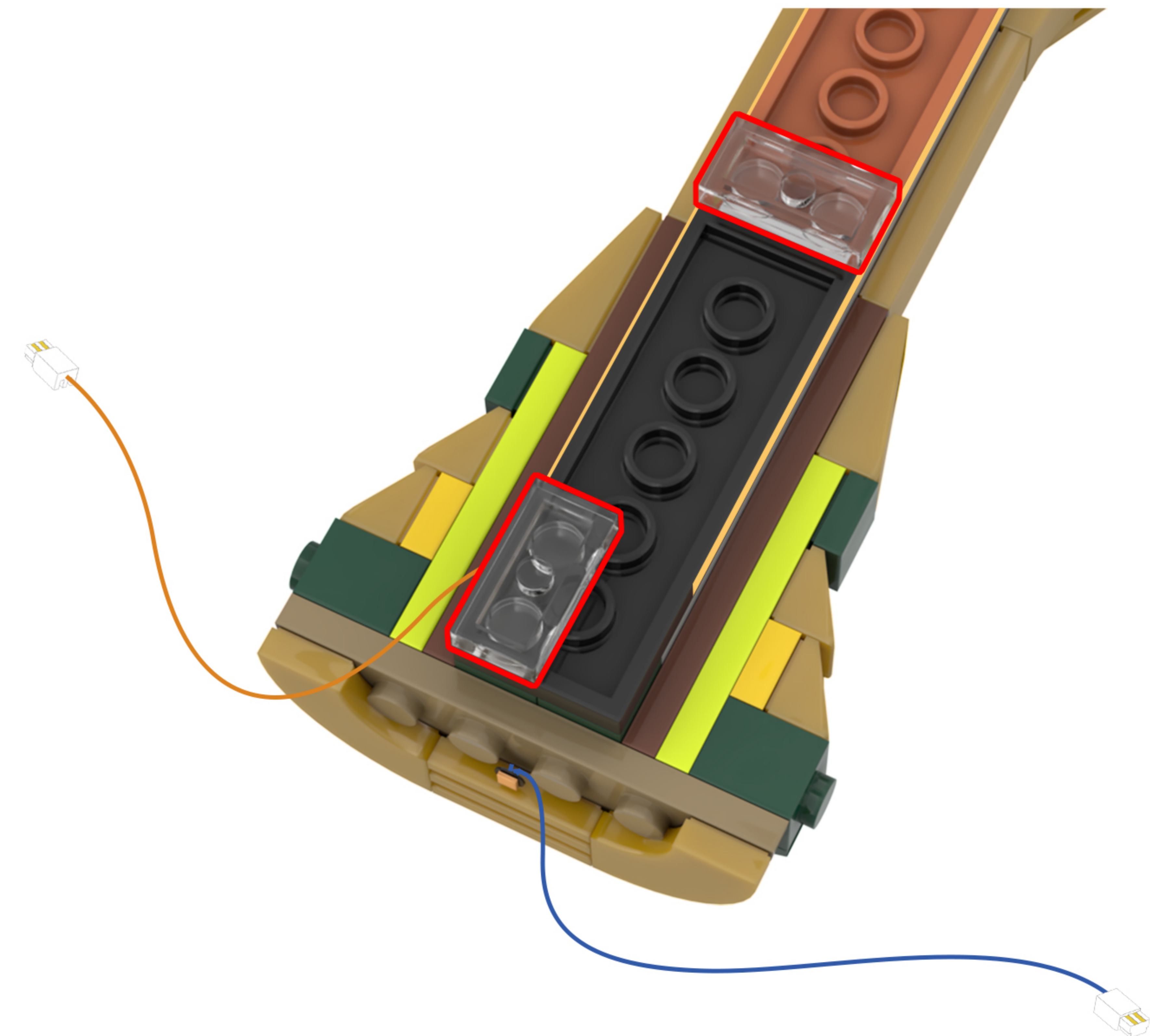
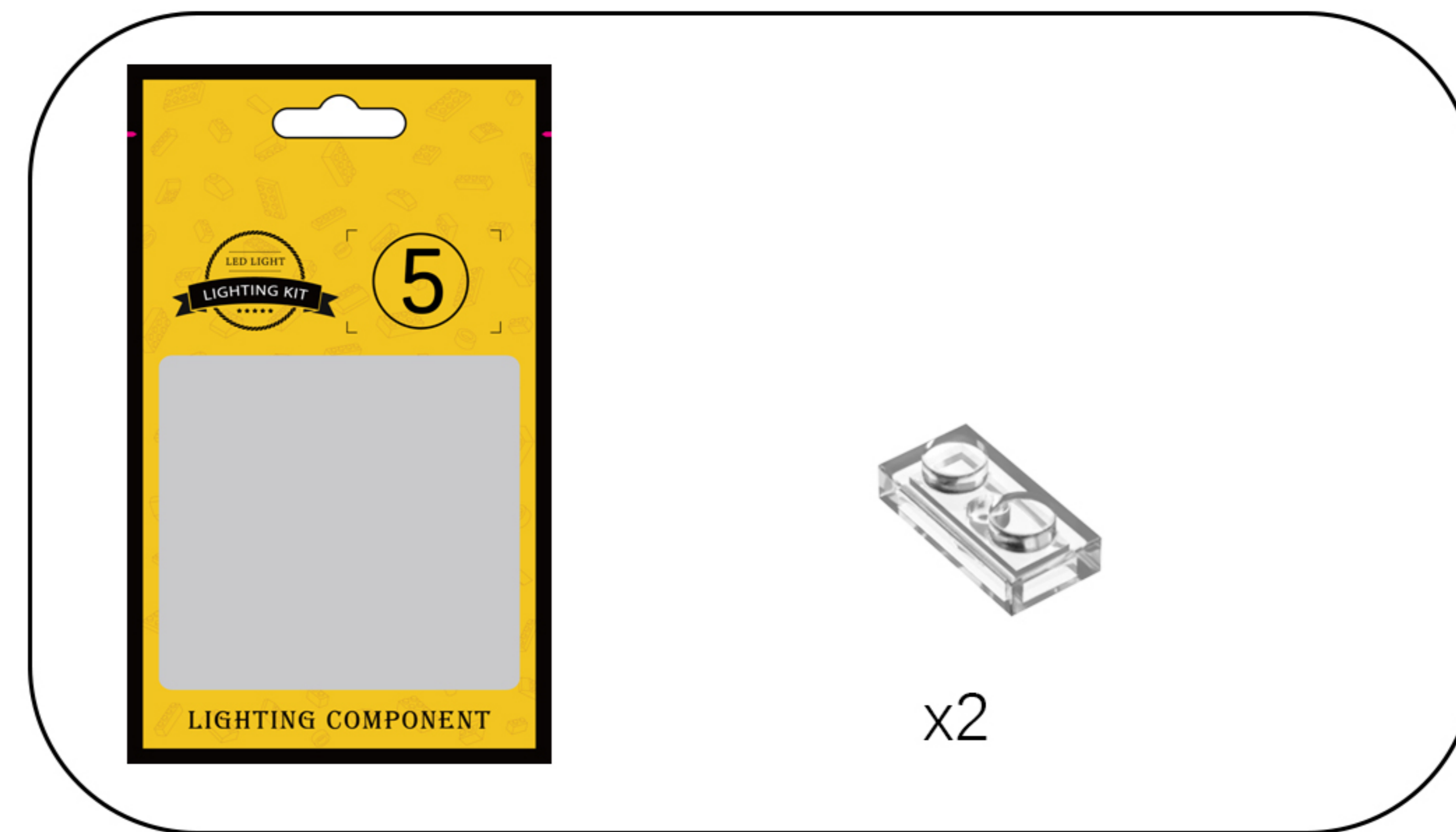

27

EN: Locate the two light wires in the diagram.

DE: Suchen Sie die beiden Lichtkabel in der Abbildung.

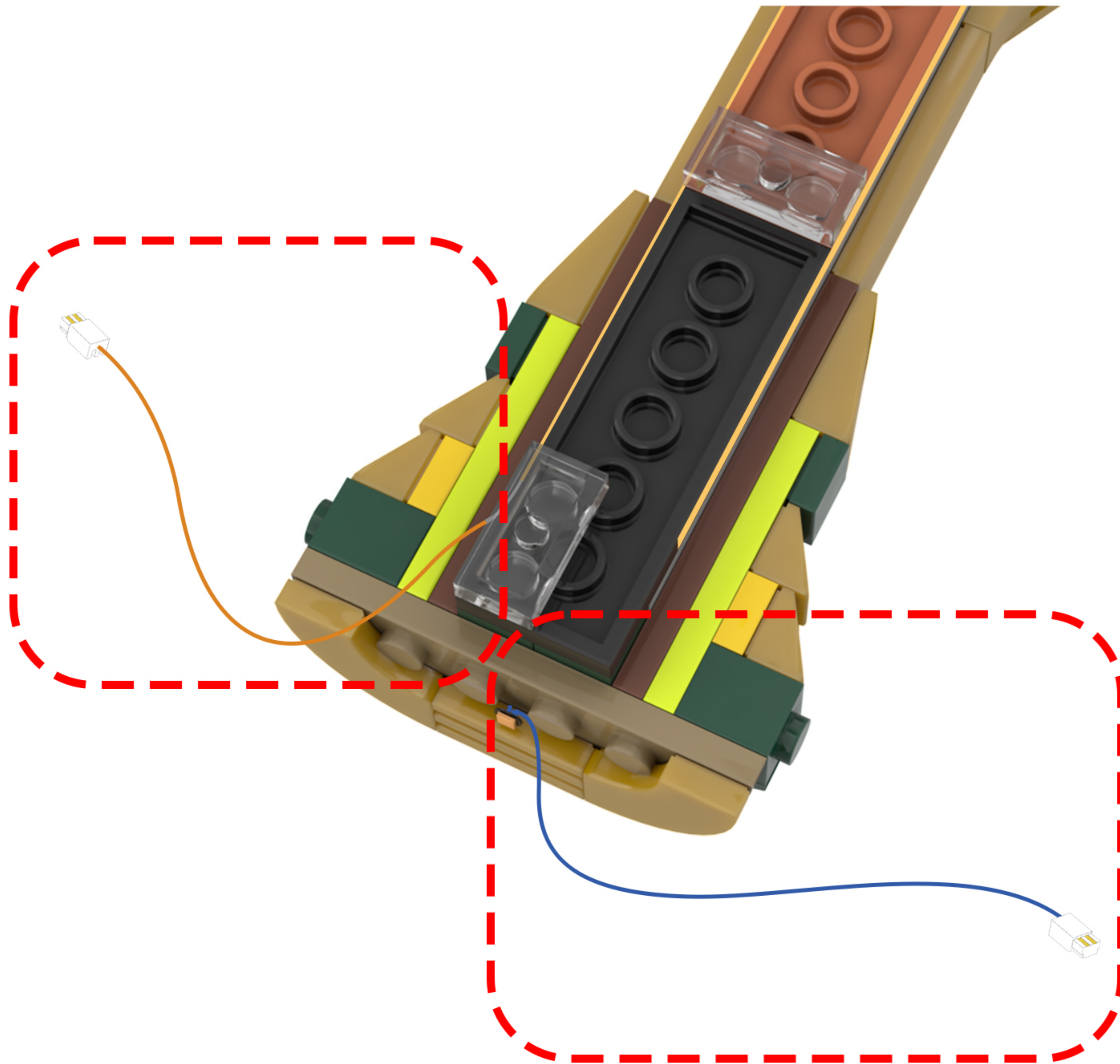

28

EN: Arrange the two strings of lights as shown in the figure.

DE: Ordne die beiden Lichterketten so an, wie es in der Abbildung gezeigt ist.

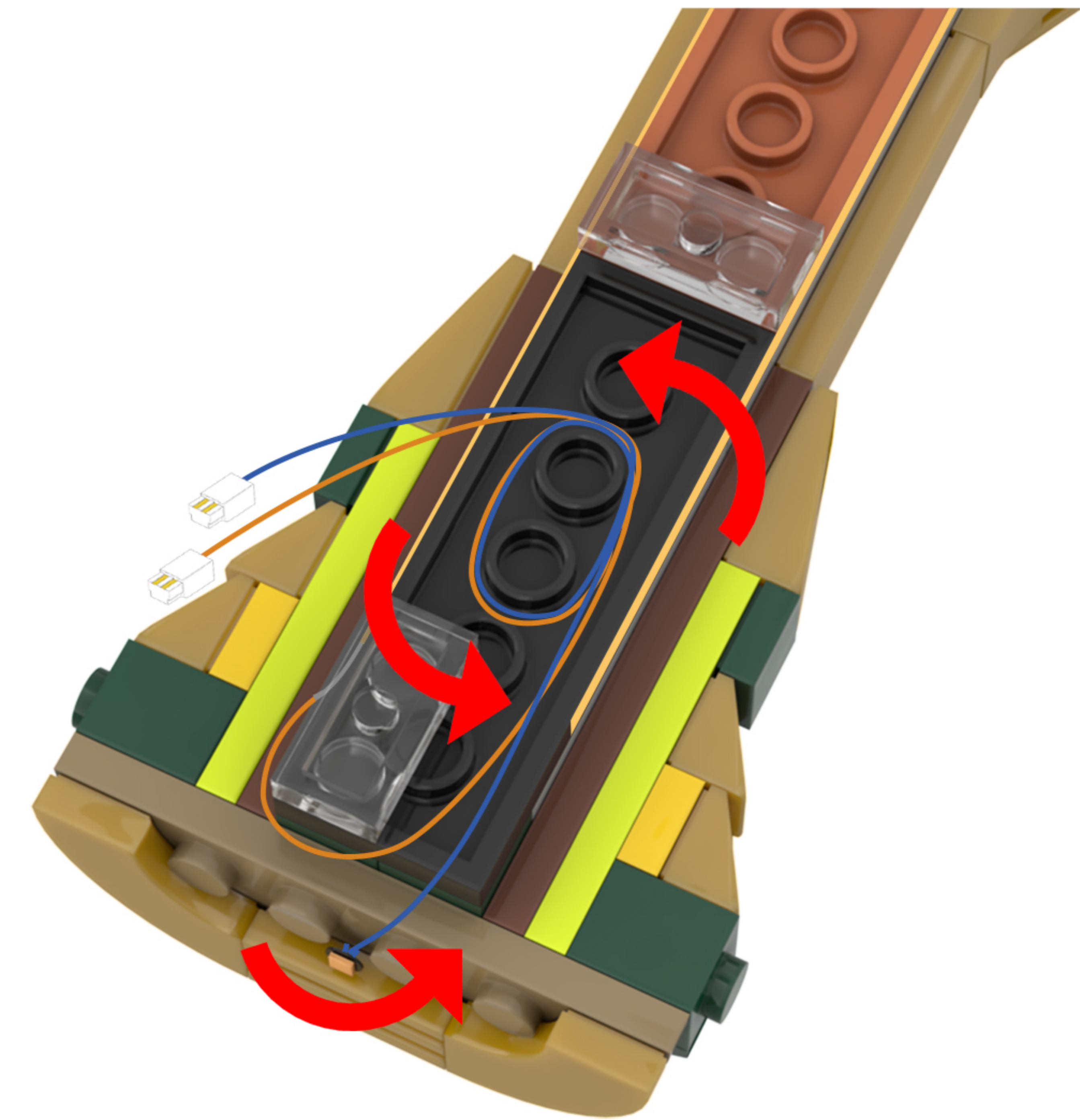

29

EN: Take the 1x2 baseplate from Bag 5, attach it to the brick, and secure the light cord underneath.

DE: Nimm die 1x2-Grundplatte aus Beutel 5, befestige sie am Stein und befestige das Lichtkabel darunter.

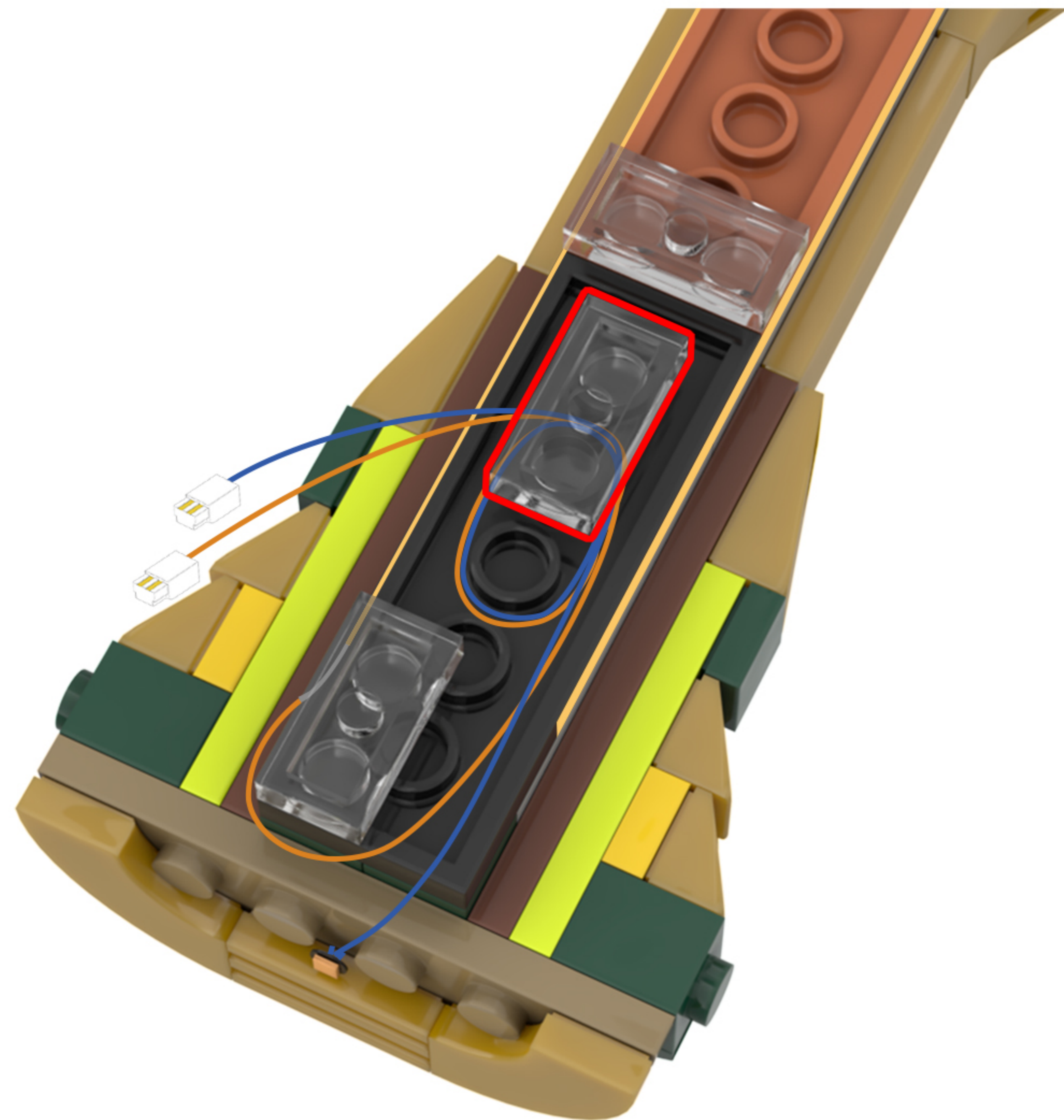
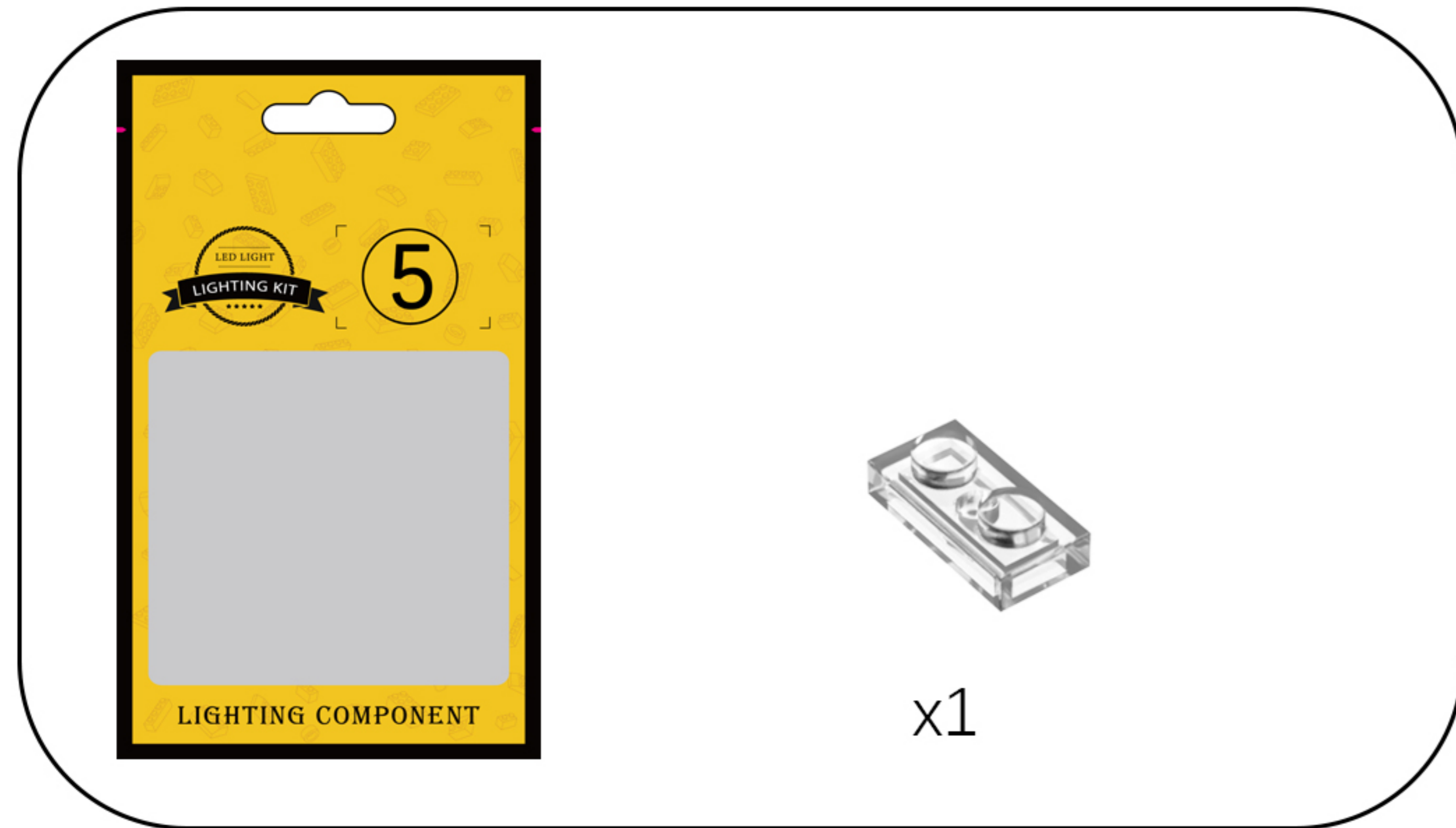

30

EN: Take the expansion board out of Bag 5 and connect the two light wires to the expansion board one after the other.

DE: Nehmen Sie die Erweiterungsplatine aus Beutel 5 und schließen Sie die beiden Lichtkabel nacheinander an die Erweiterungsplatine an.

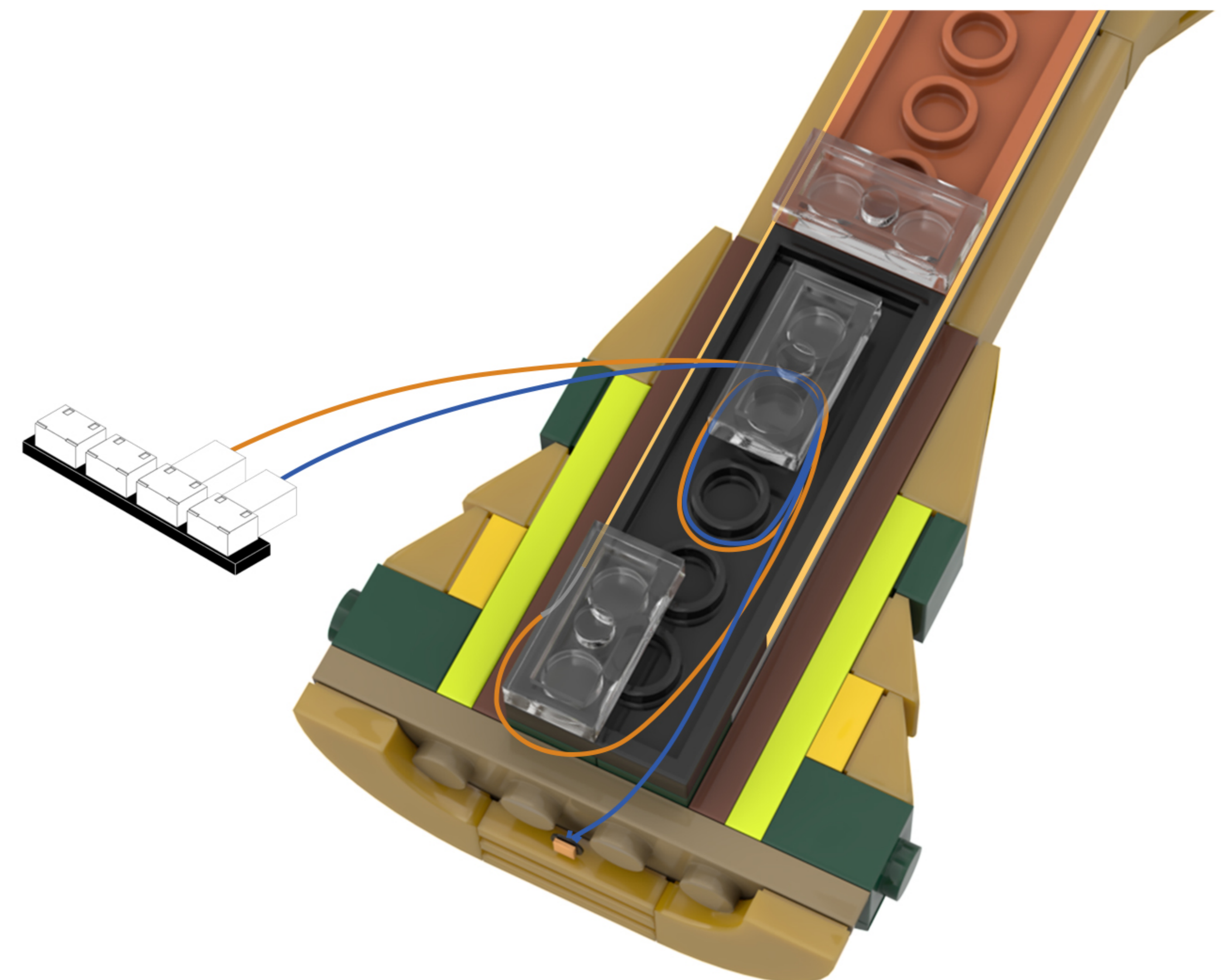
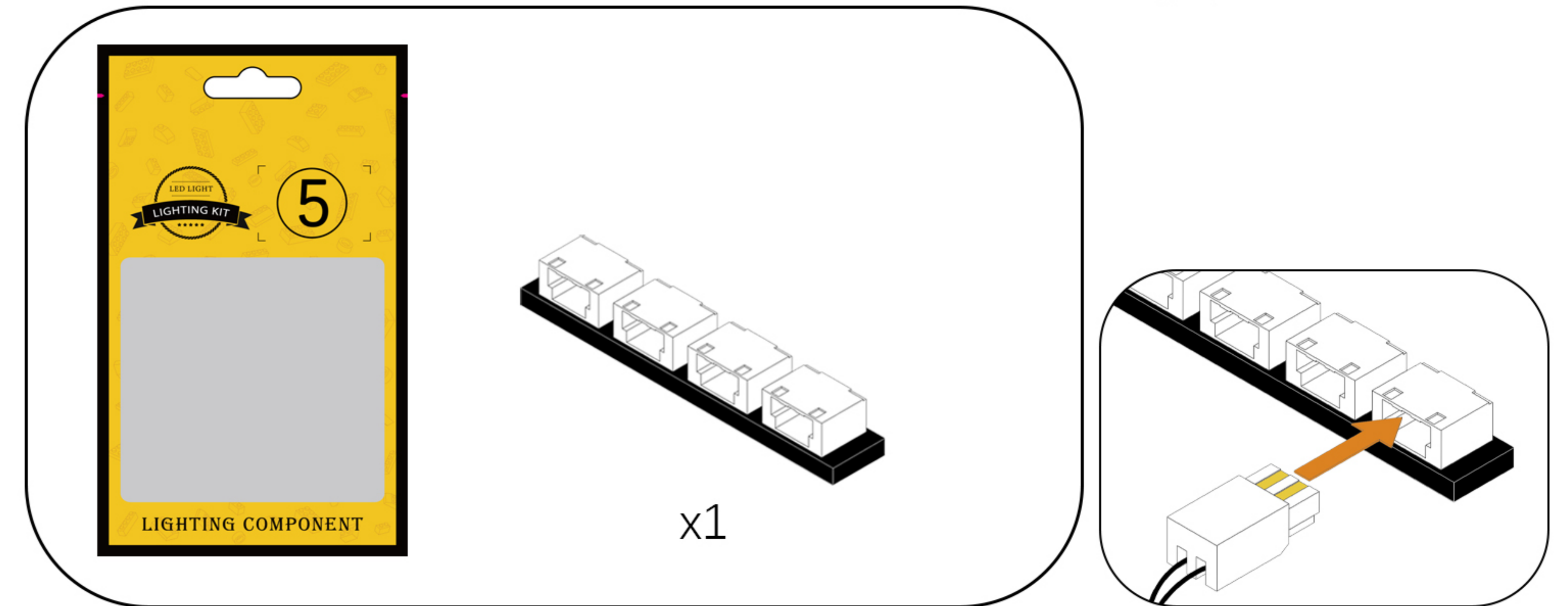

31

EN: Back to the model.

DE: Zurück zum Modell.

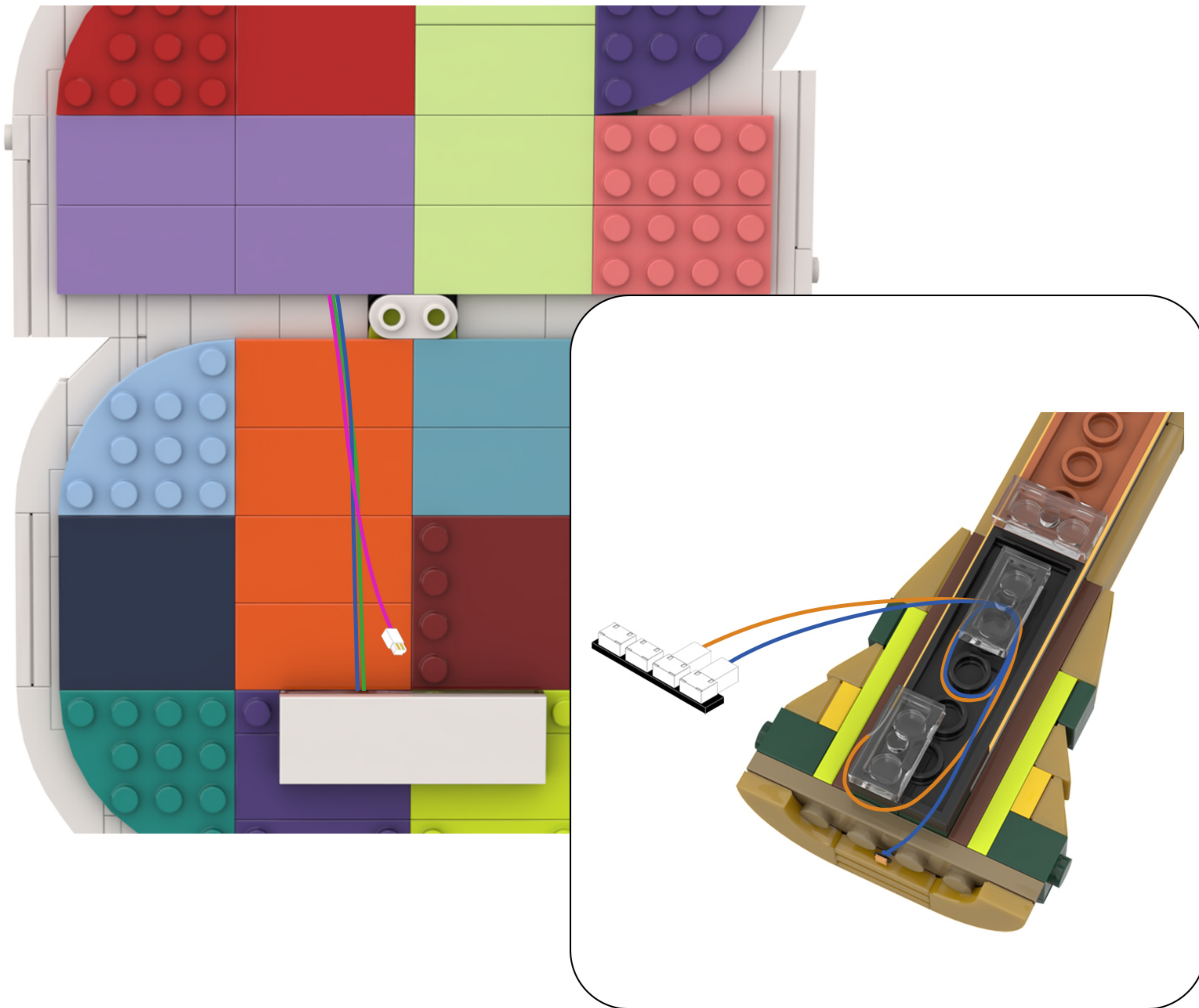

32

EN: Connect the lamp wires to the expansion board.

DE: Verbinden Sie die Lampenkabel mit der Erweiterungskarte.

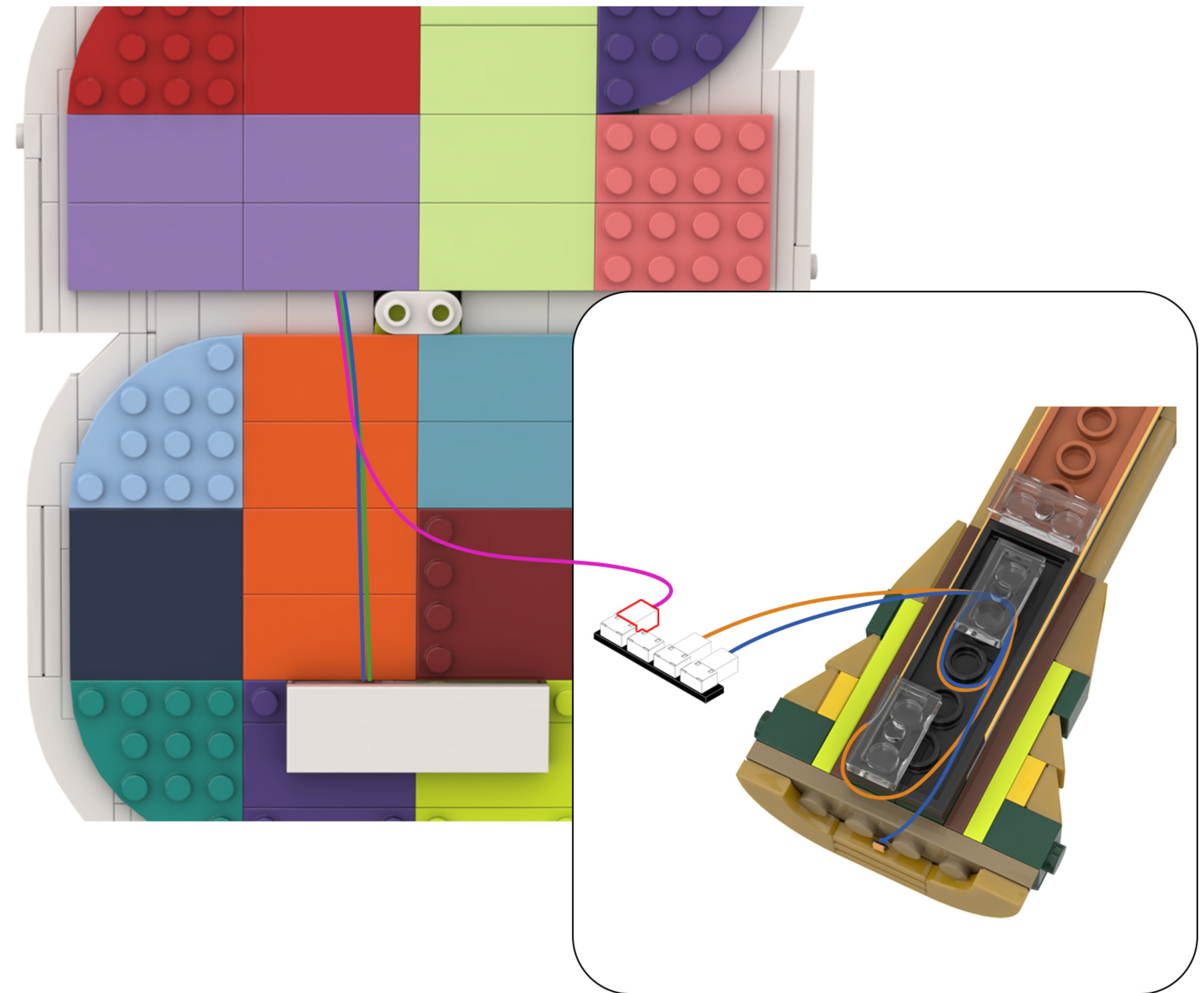
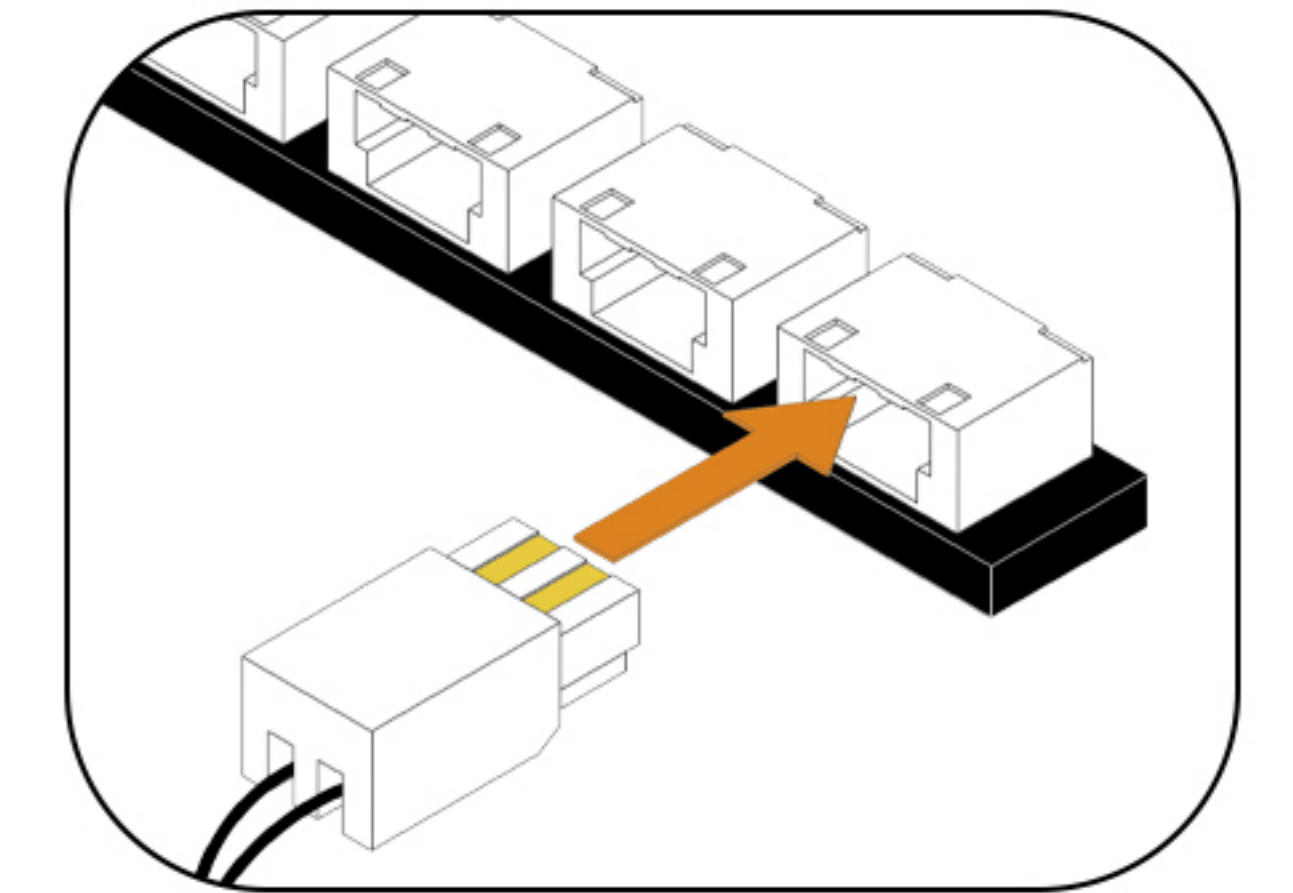

33

EN: Peel off the adhesive backing of the expansion board and attach it to the location shown in the illustration.

DE: Entfernen Sie die Schutzfolie von der Rückseite der Erweiterungsplatte und kleben Sie sie an die in der Abbildung gezeigte Stelle.

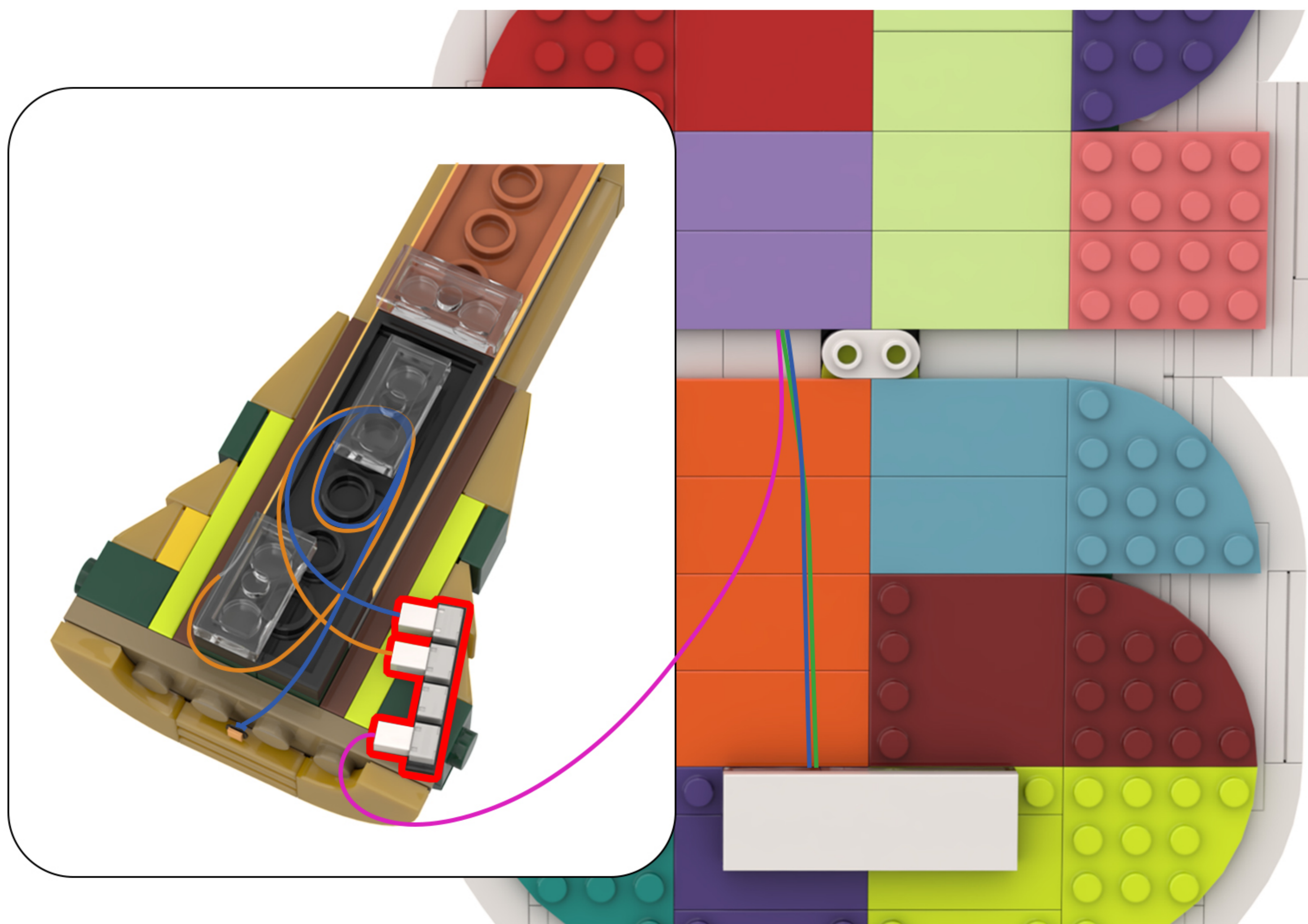

34

EN: Restore the building blocks.

DE: Stellen Sie die Bausteine wieder her.

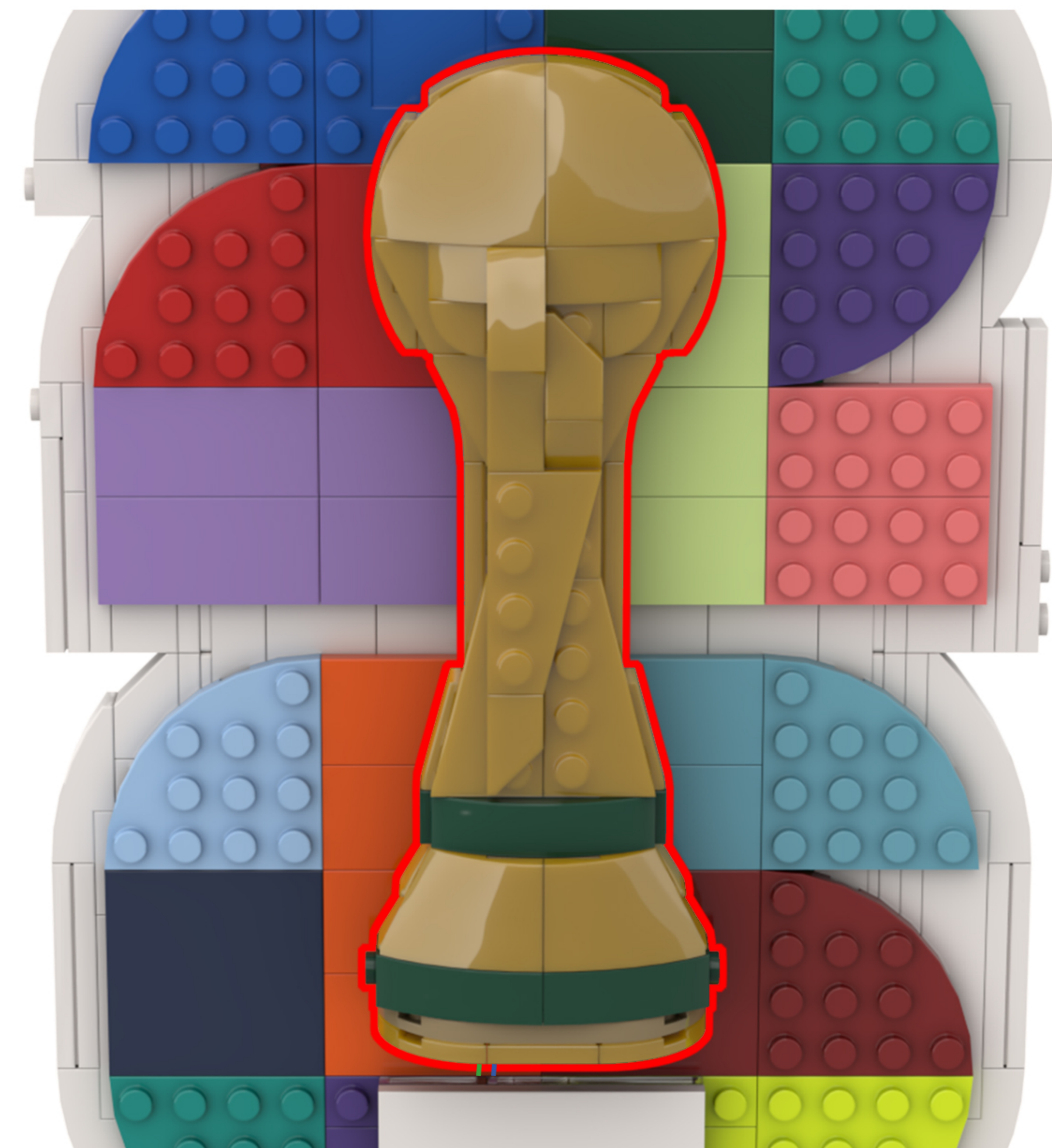

35

EN: Flip the model over so that the bottom is facing up.

DE: Drehen Sie das Modell um, sodass die Unterseite nach oben zeigt.

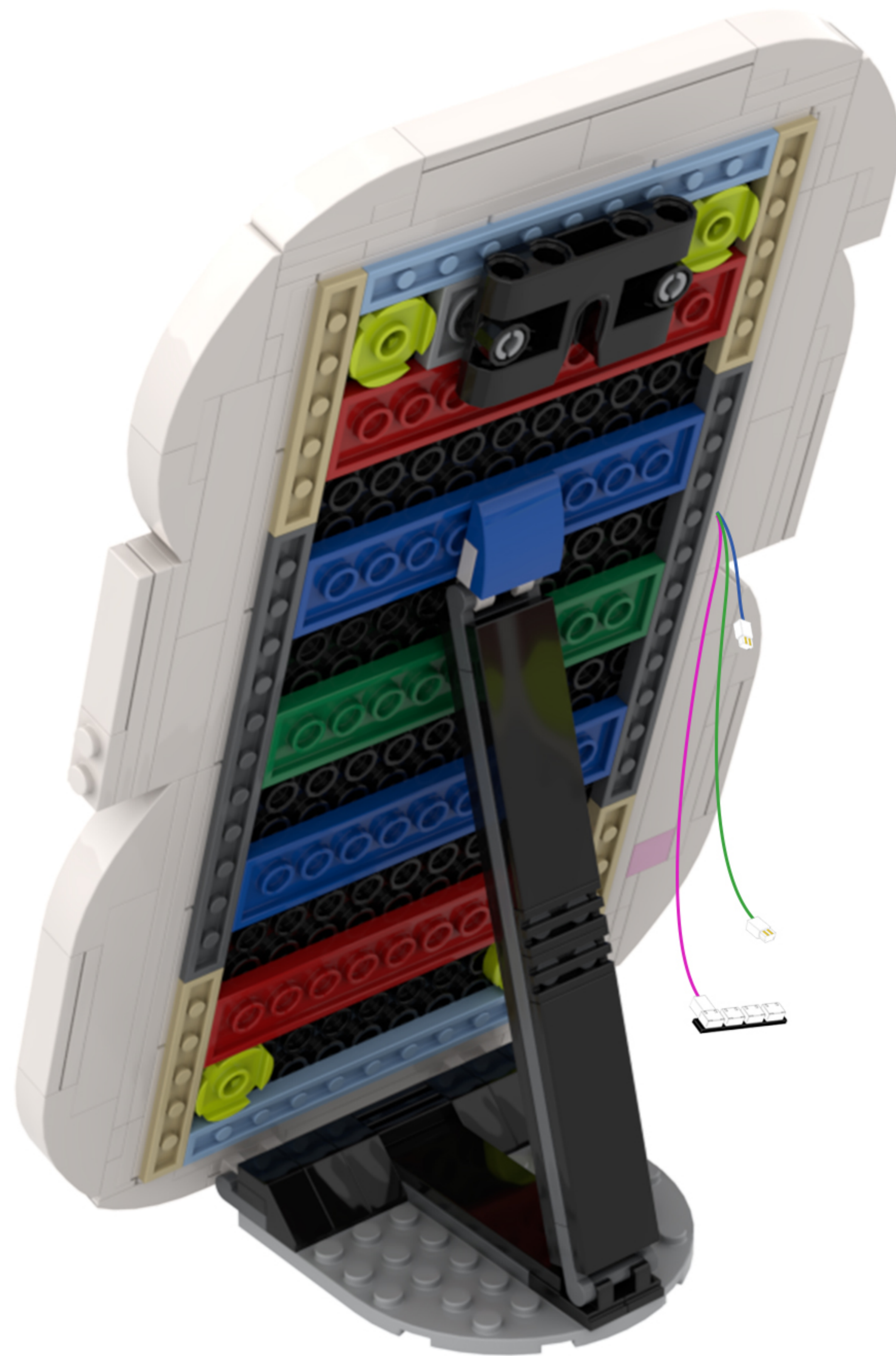
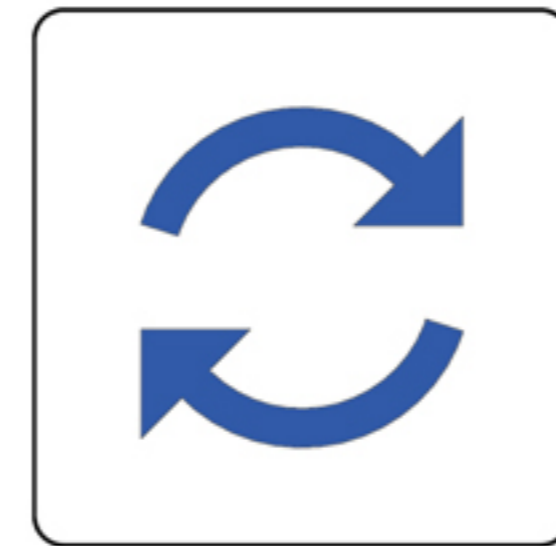

36

EN: Connect the two light cables to the expansion board one after the other.

DE: Schließen Sie die beiden Lichtkabel nacheinander an die Erweiterungskarte an.

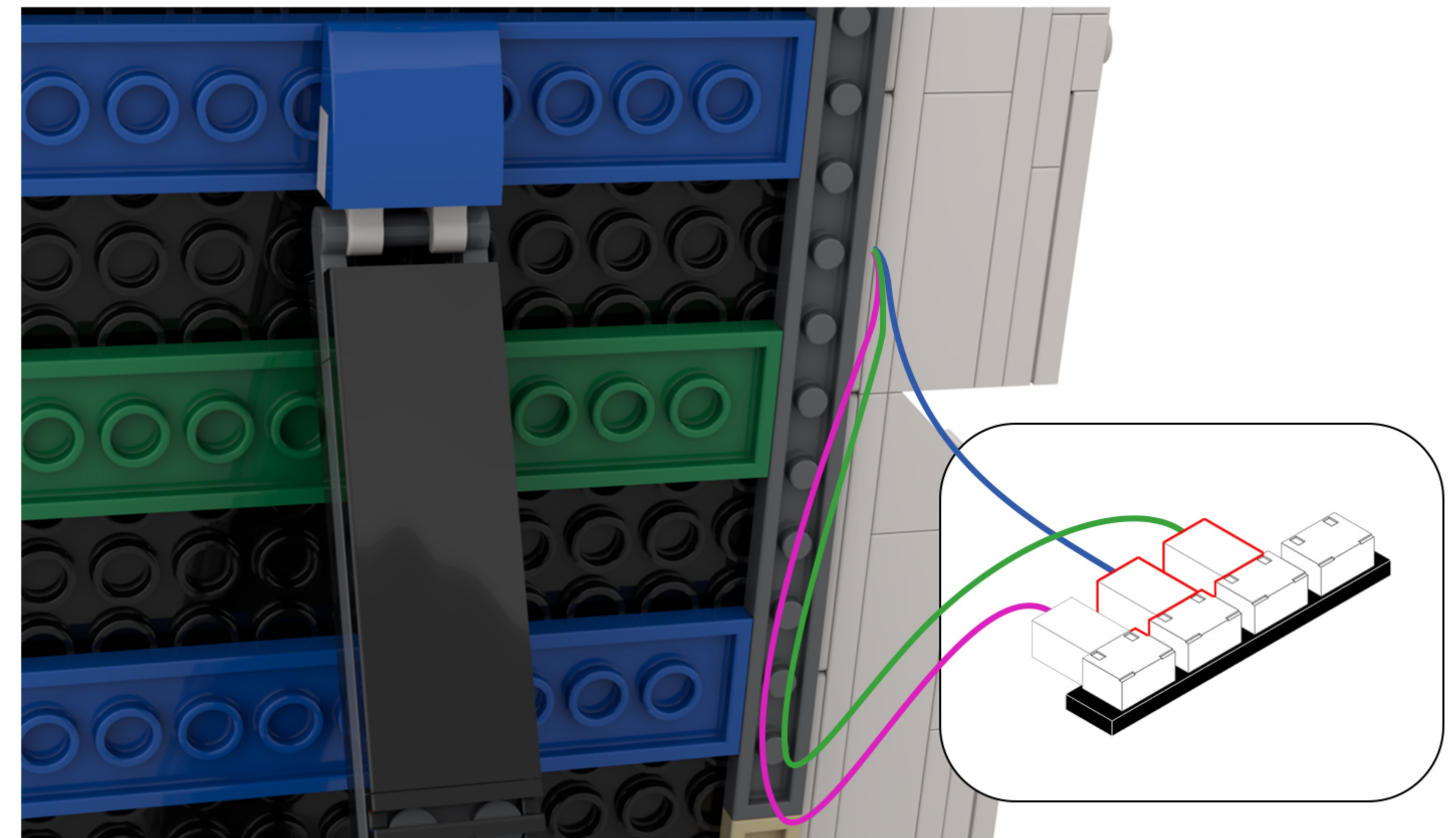
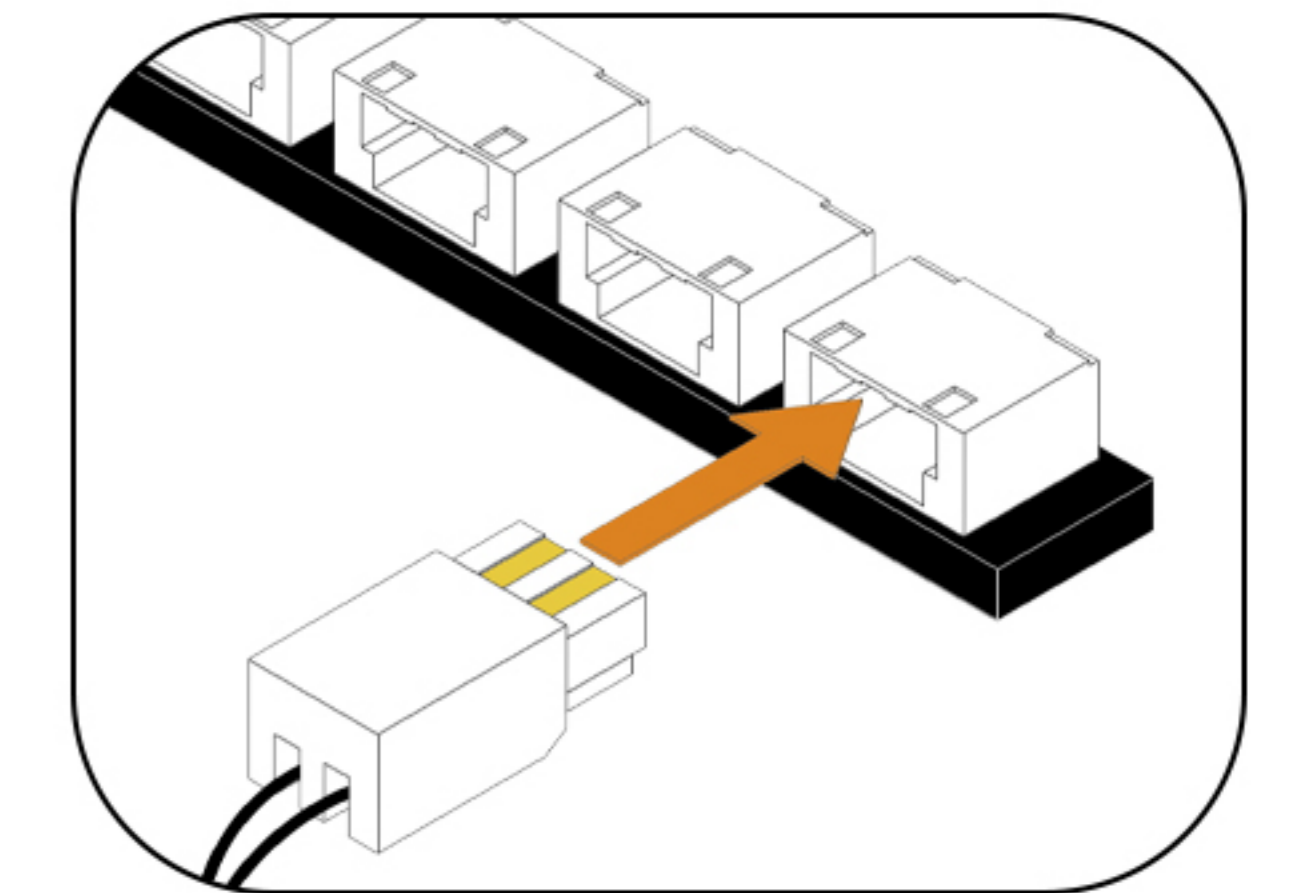

37

EN: Take the USB power cable out of the box and connect it to the expansion board.

DE: Nehmen Sie das USB-Stromkabel aus der Verpackung und schließen Sie es an die Erweiterungskarte an.

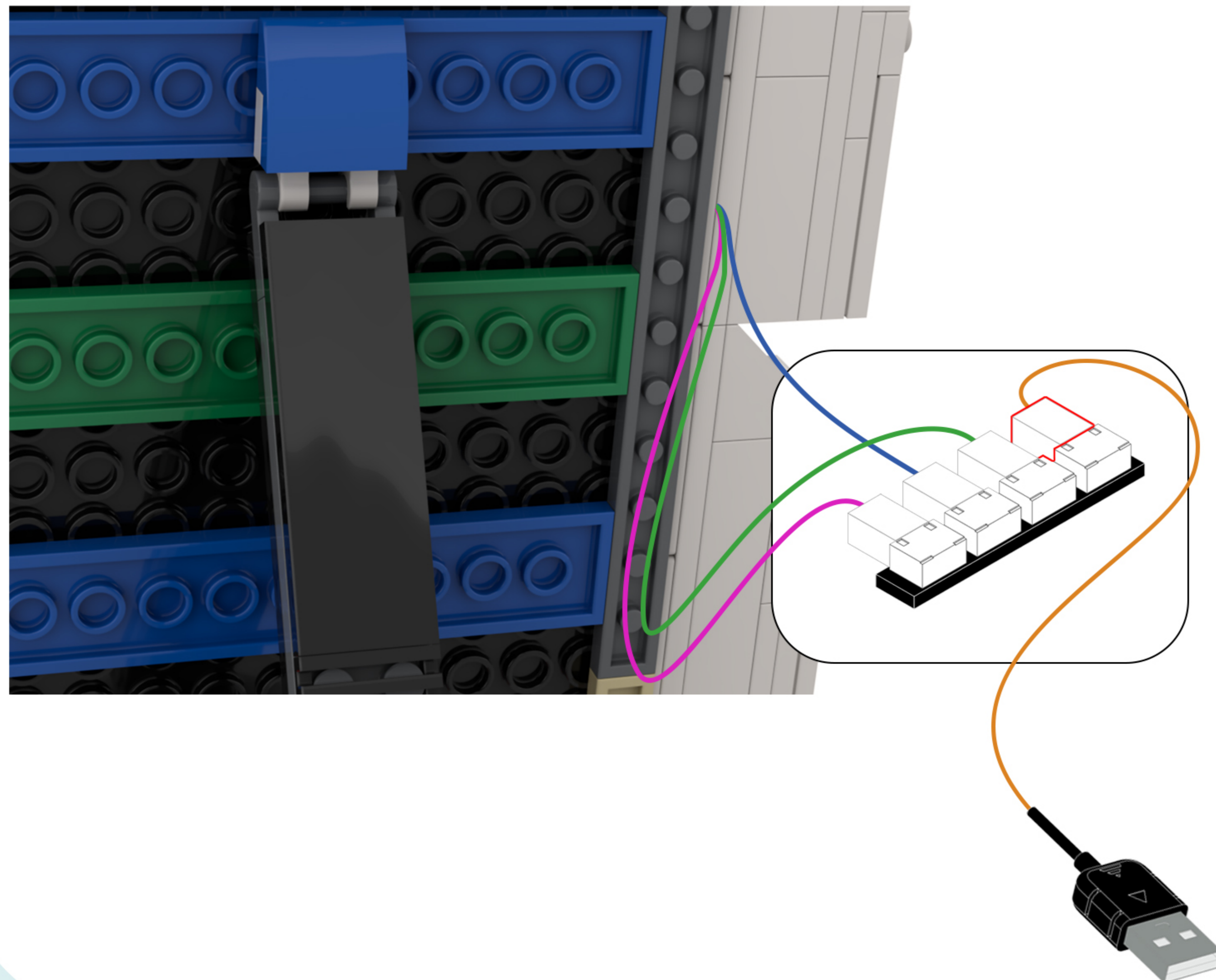
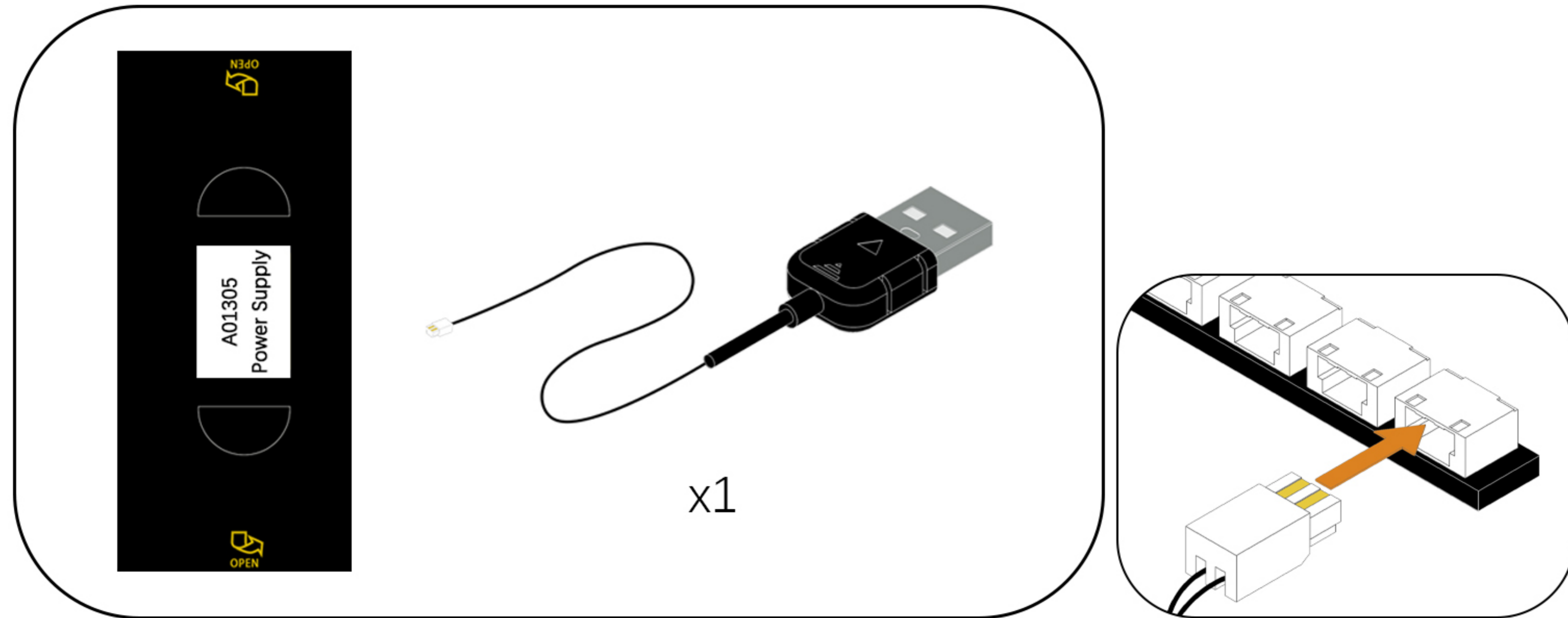

38

EN: Peel off the adhesive backing of the expansion board and attach it to the location shown in the illustration.

DE: Entfernen Sie die Schutzfolie von der Rückseite der Erweiterungsplatte und kleben Sie sie an die in der Abbildung gezeigte Stelle.

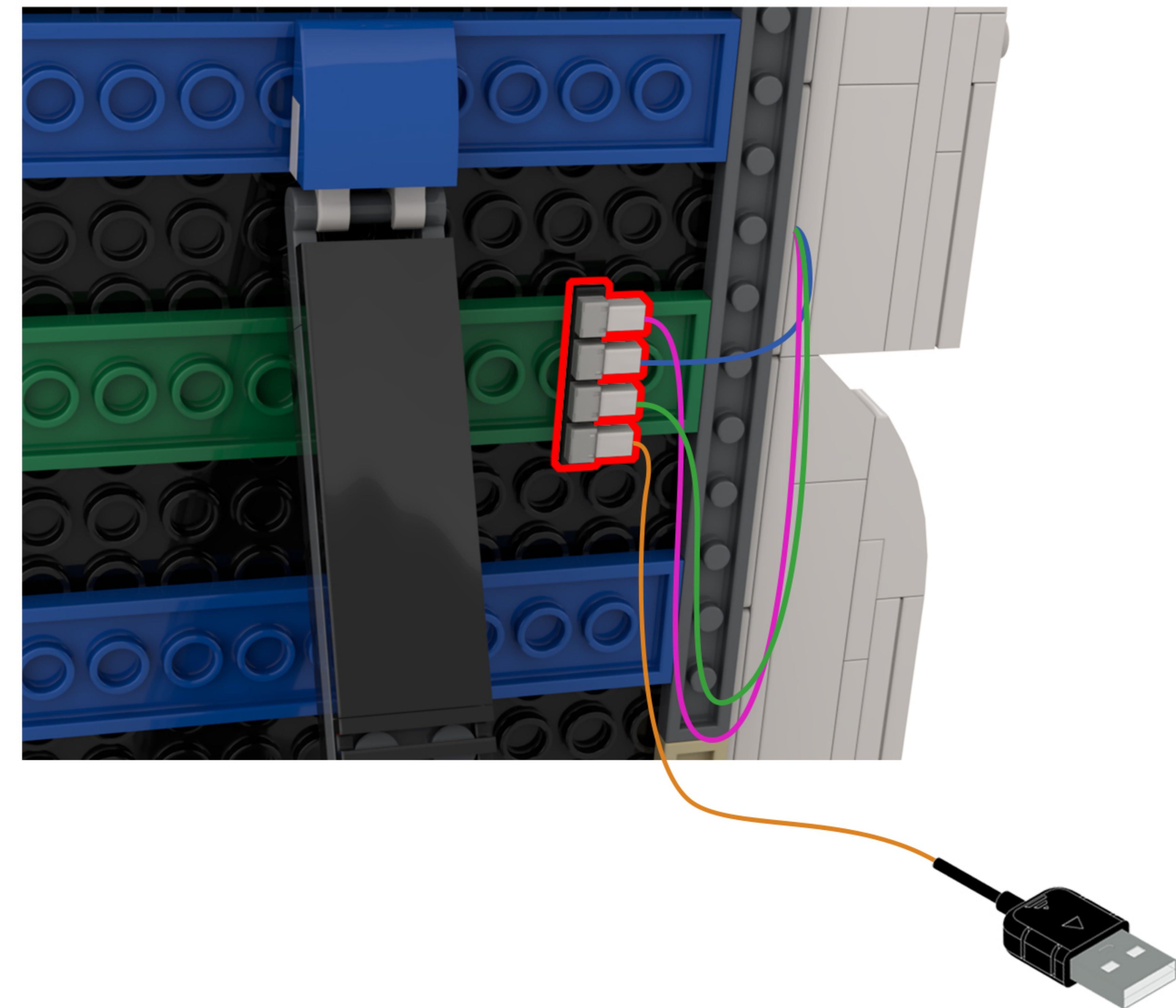

39

EN: Take the 1x2 baseplate from Bag 5, attach it to the brick, and secure the light cord underneath.

DE: Nimm die 1x2-Grundplatte aus Beutel 5, befestige sie am Stein und befestige das Lichtkabel darunter.

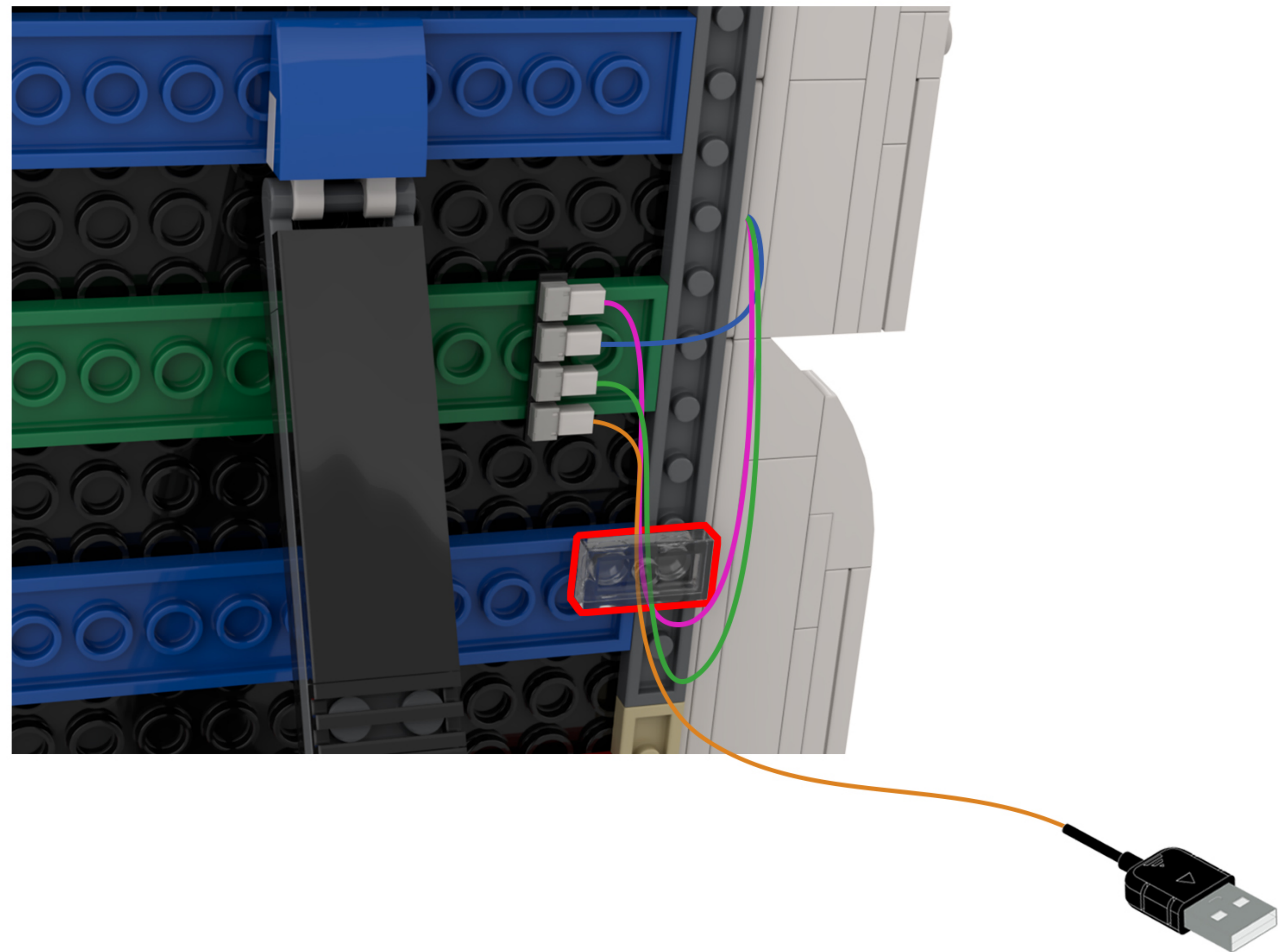
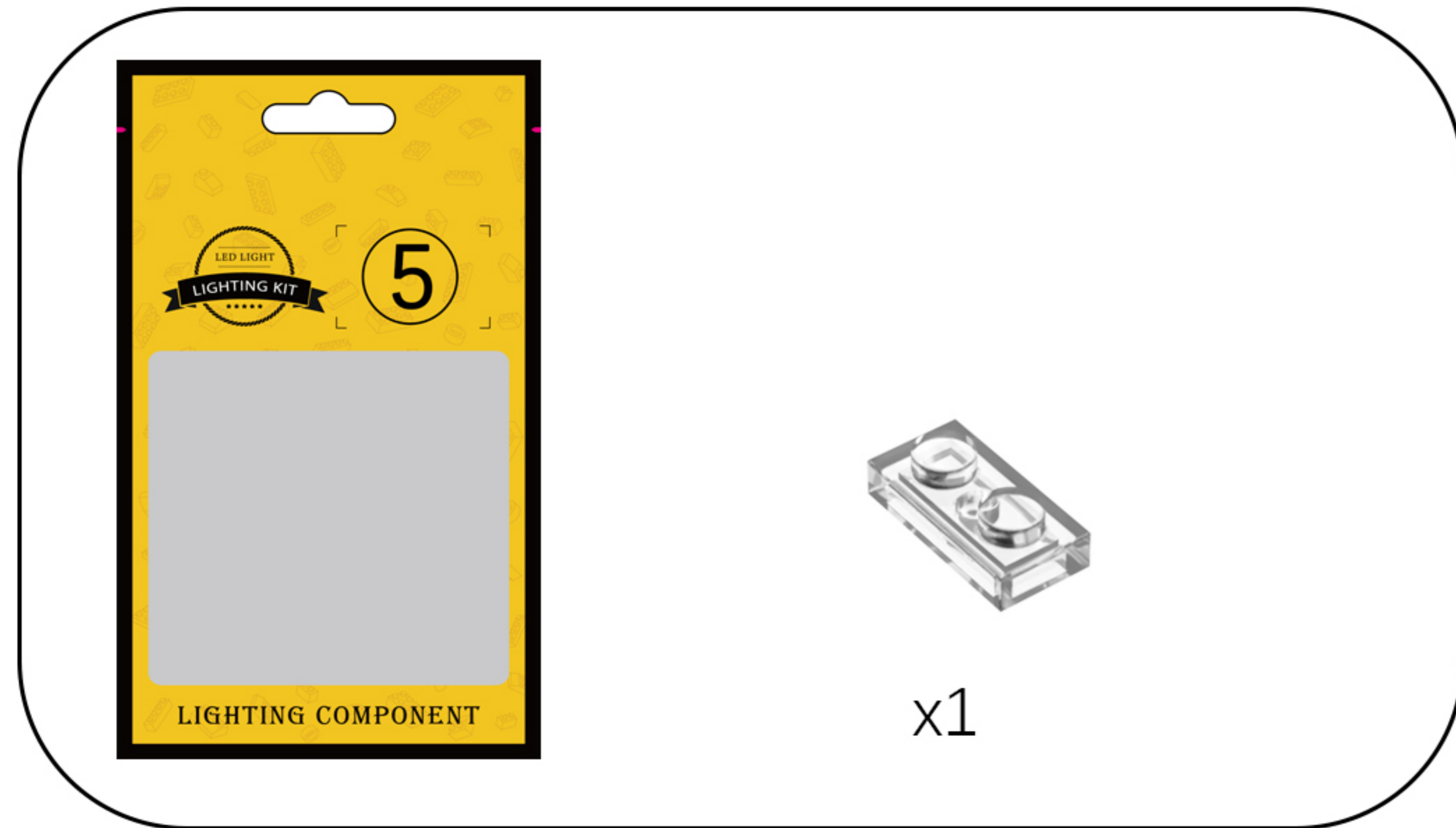

40

EN: Rotate the model to the front view.

DE: Drehen Sie das Modell in die Vorderansicht.



41

EN: Once installed, connect the power supply and give it a try!

DE: Die Installation ist abgeschlossen. Schließen Sie das Gerät an die Stromversorgung an und probieren Sie es aus!





Above our designers to provide the relevant ideas and instructions. But please move to the following:

- 1: about our company this product parts material, product quality do you have comments and suggestions?
- 2: about this product installation instructions and installation of the degree of difficulty do you have views and suggestions?
- 3: if in the operation of the product we provide ideas encountered any problems, please contact us in a timely manner.

Tips

If you encounter any installation problems please contact the seller, we will be happy to help you solve!