

# INSTALLATION GUIDE

## 43012 Cristiano Ronaldo – Football Highlights



LED light kit compatible with Lego

# Instructions for installing this kit:

This set includes 6 pouches. (The battery case functions similarly, please select your own power source. This article uses a USB power cable.)

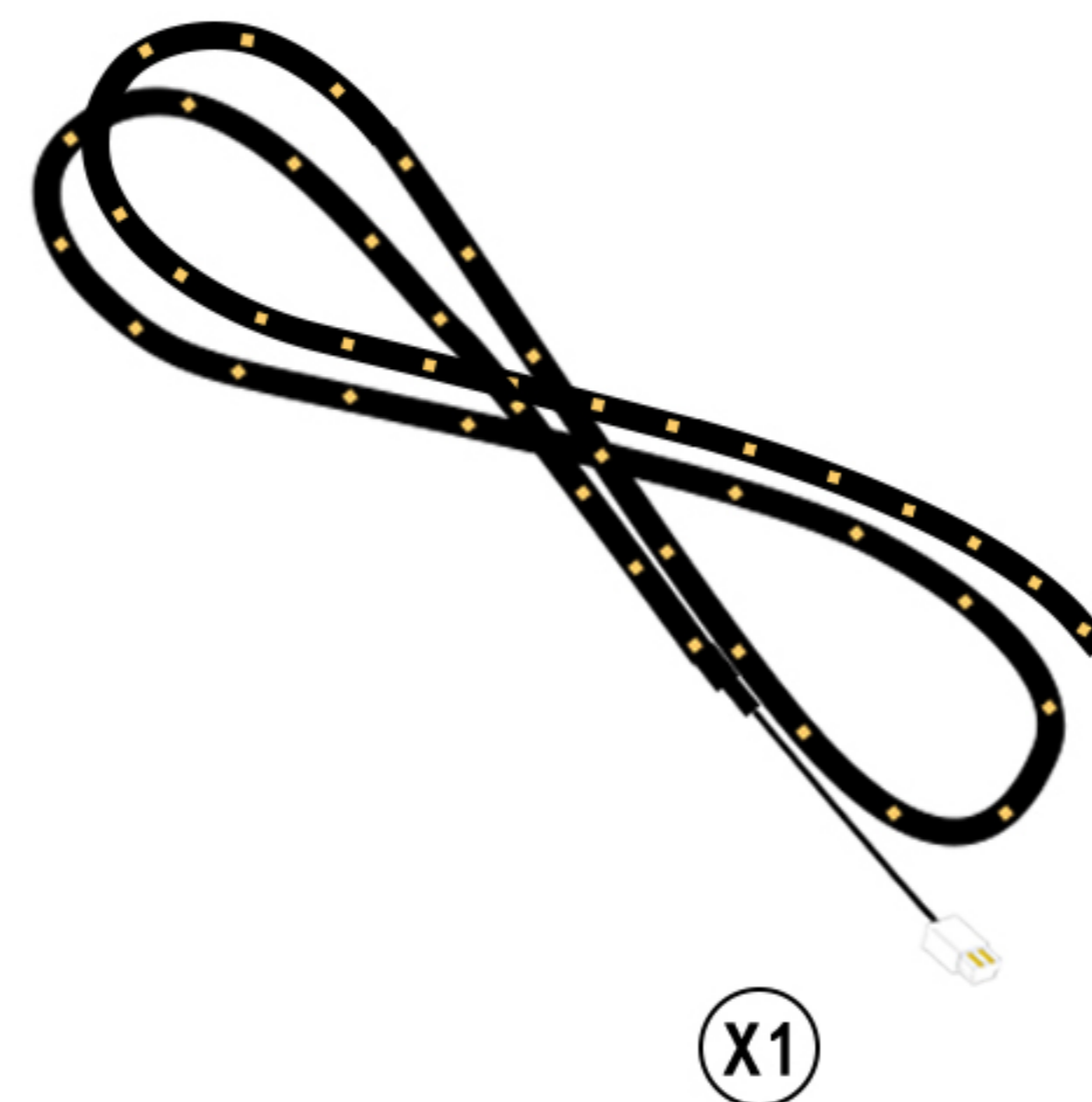
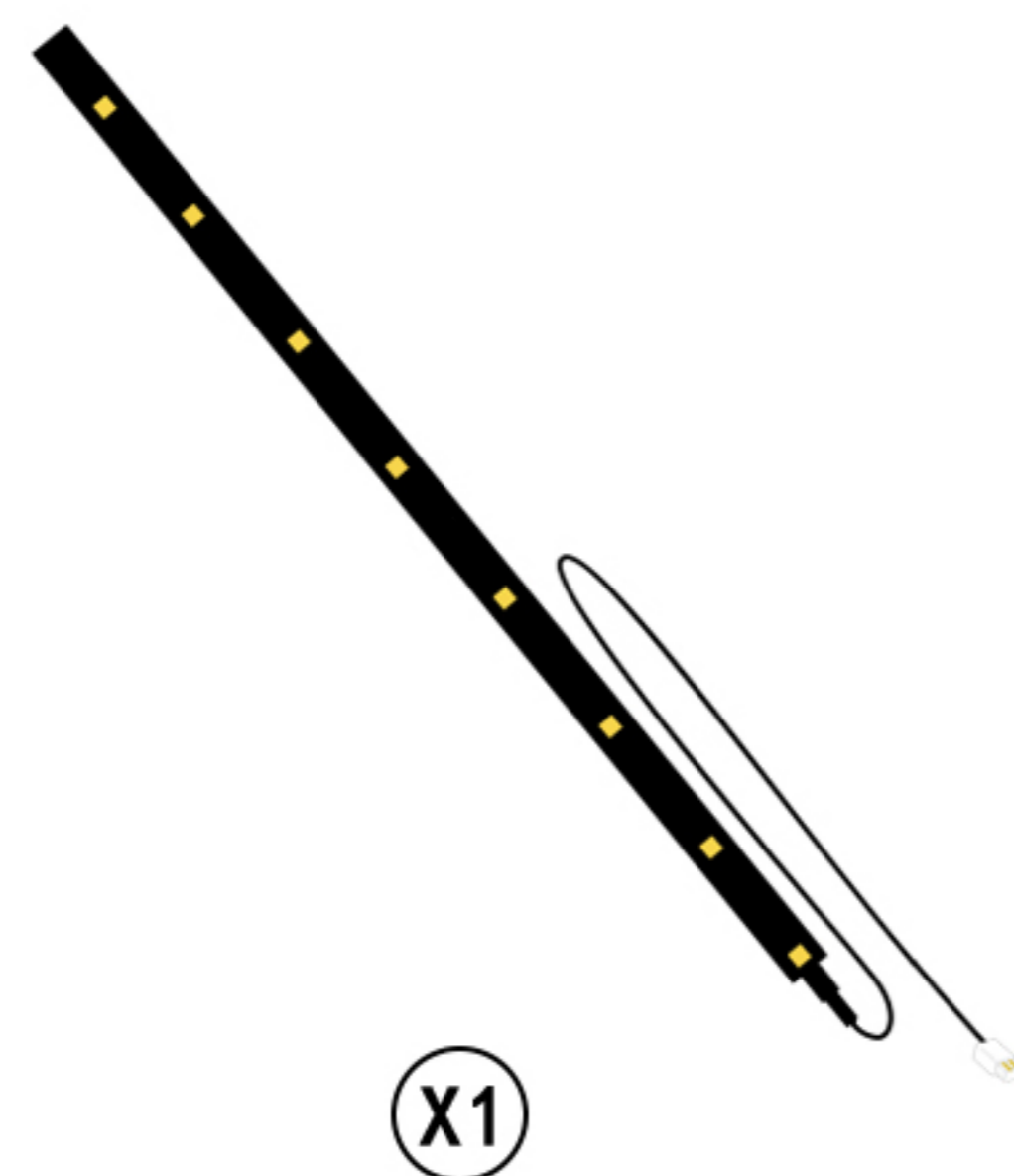
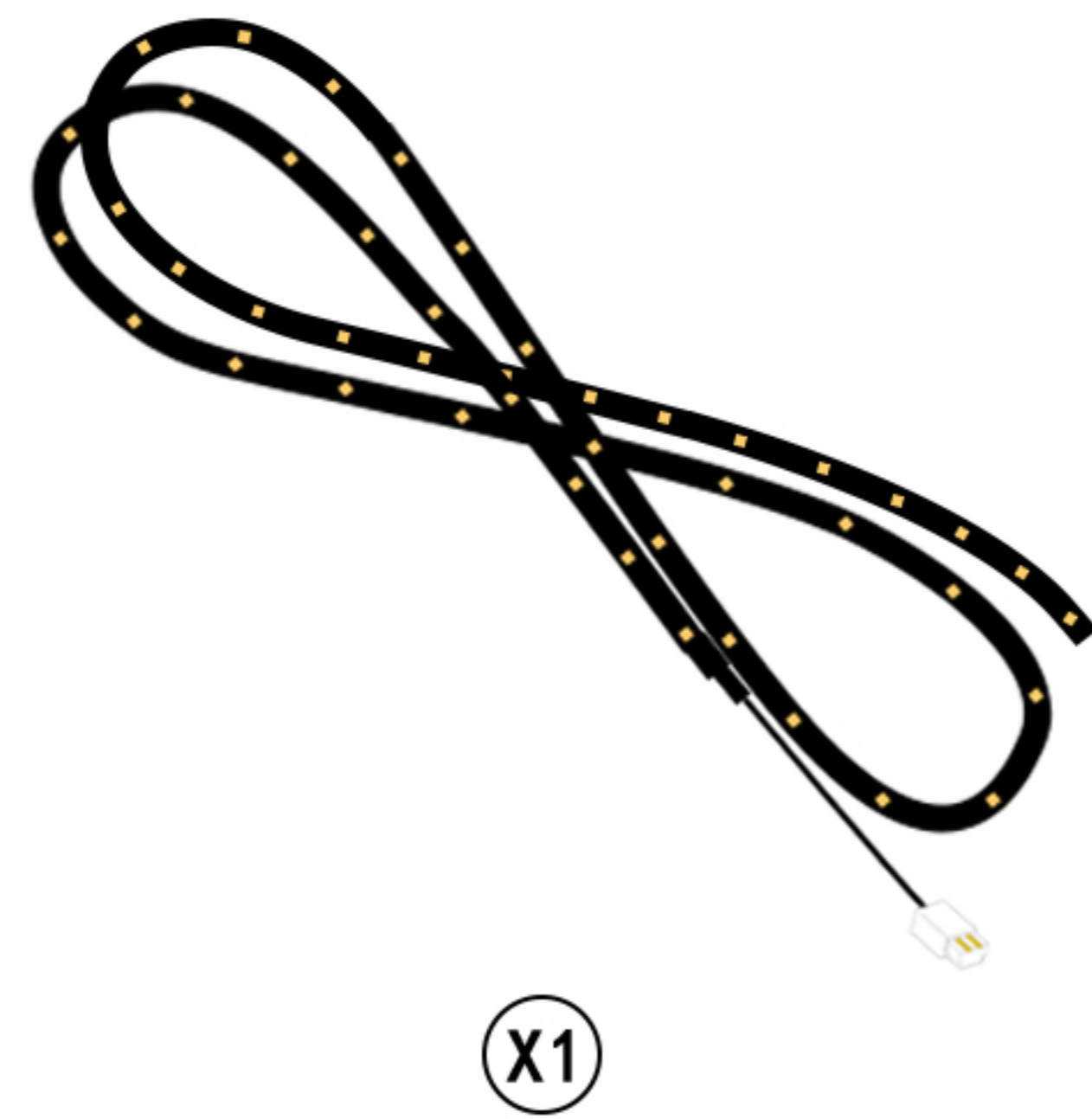
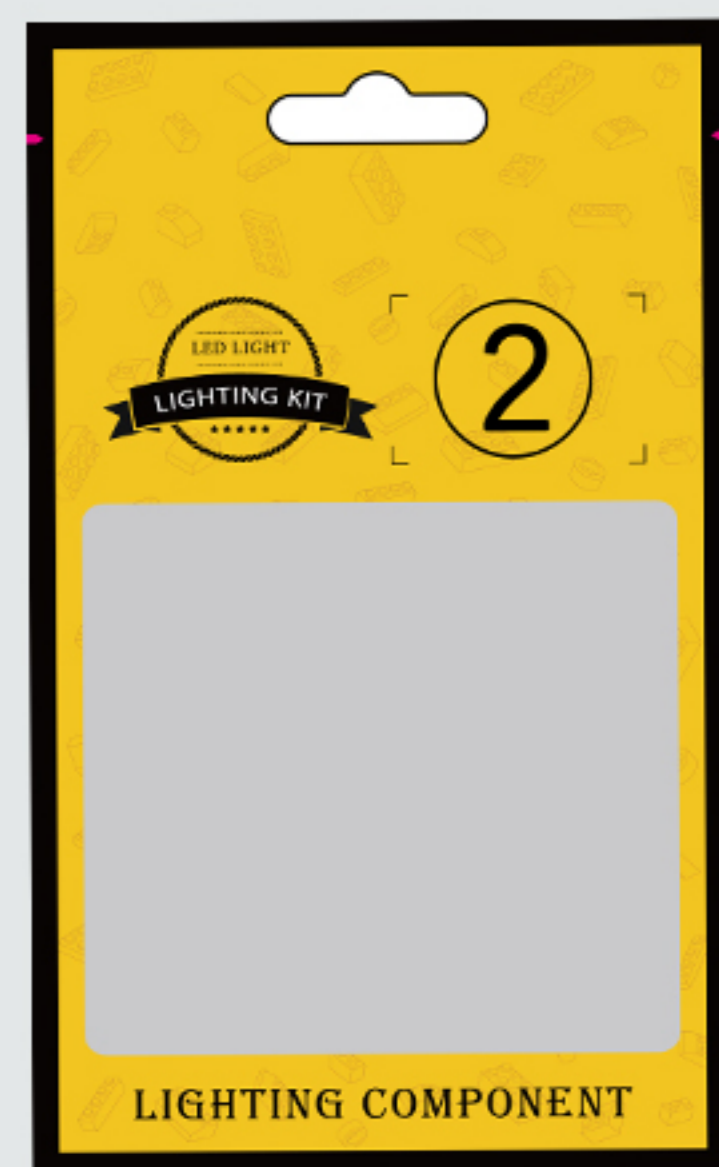
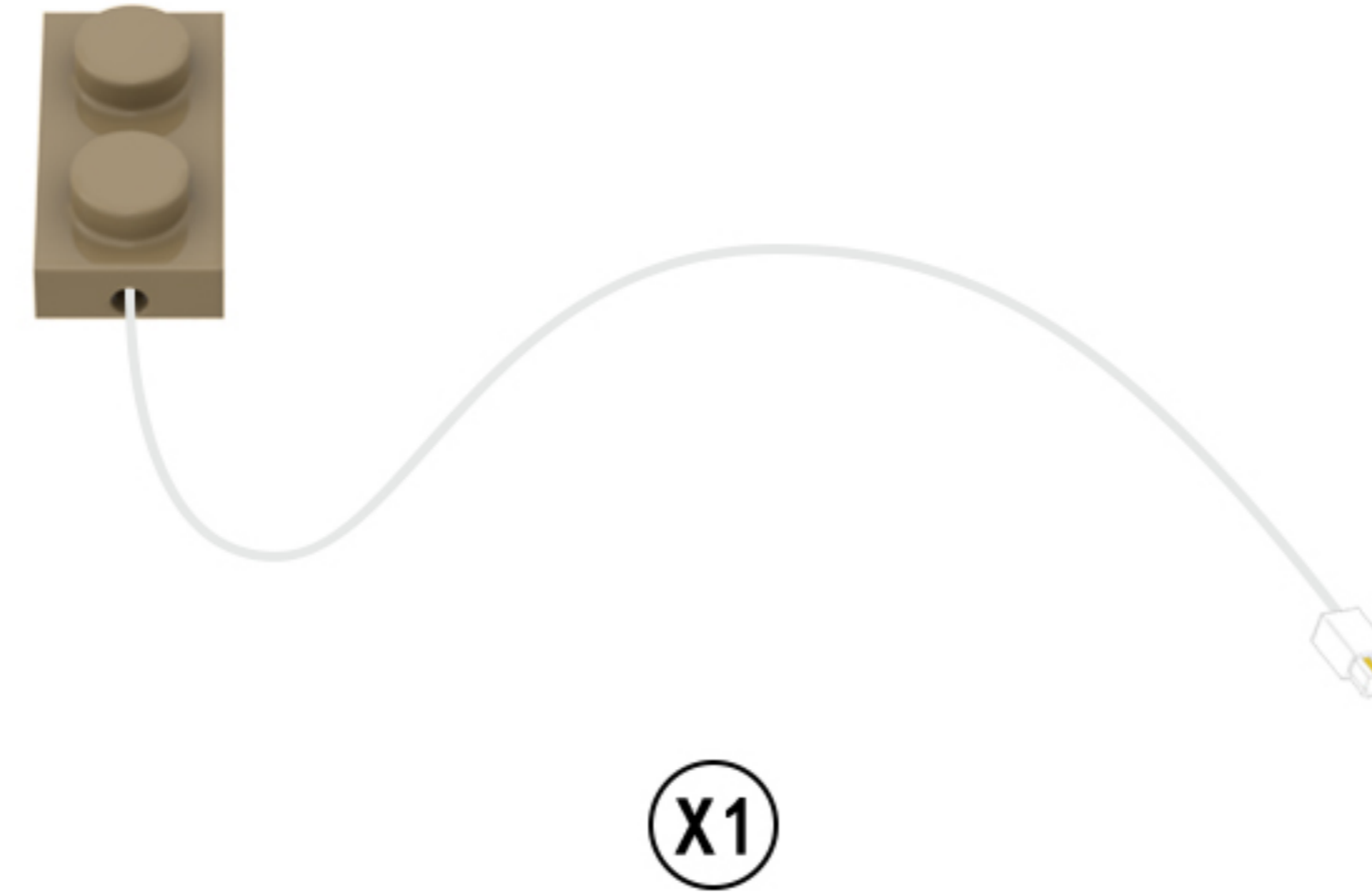
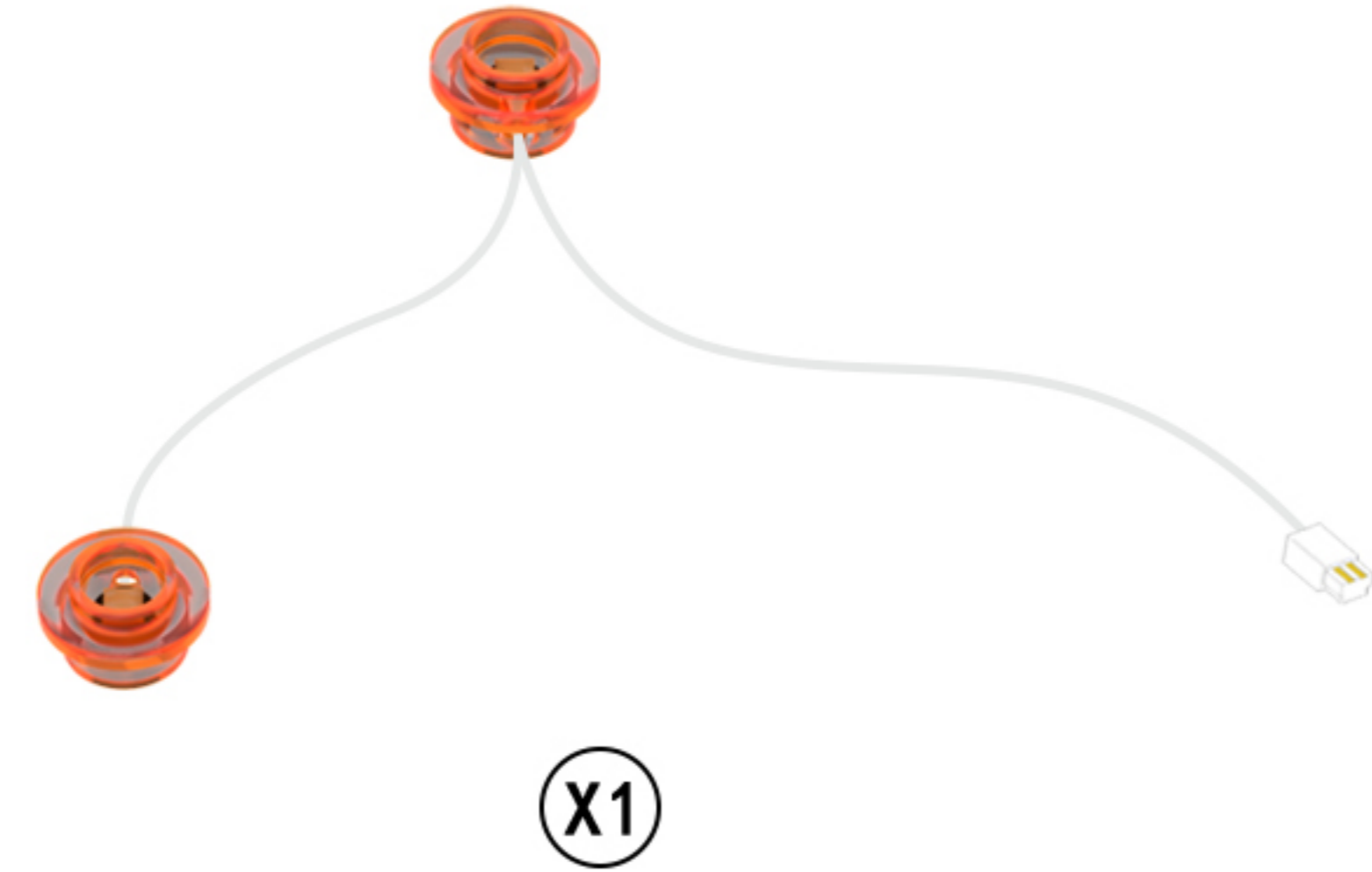

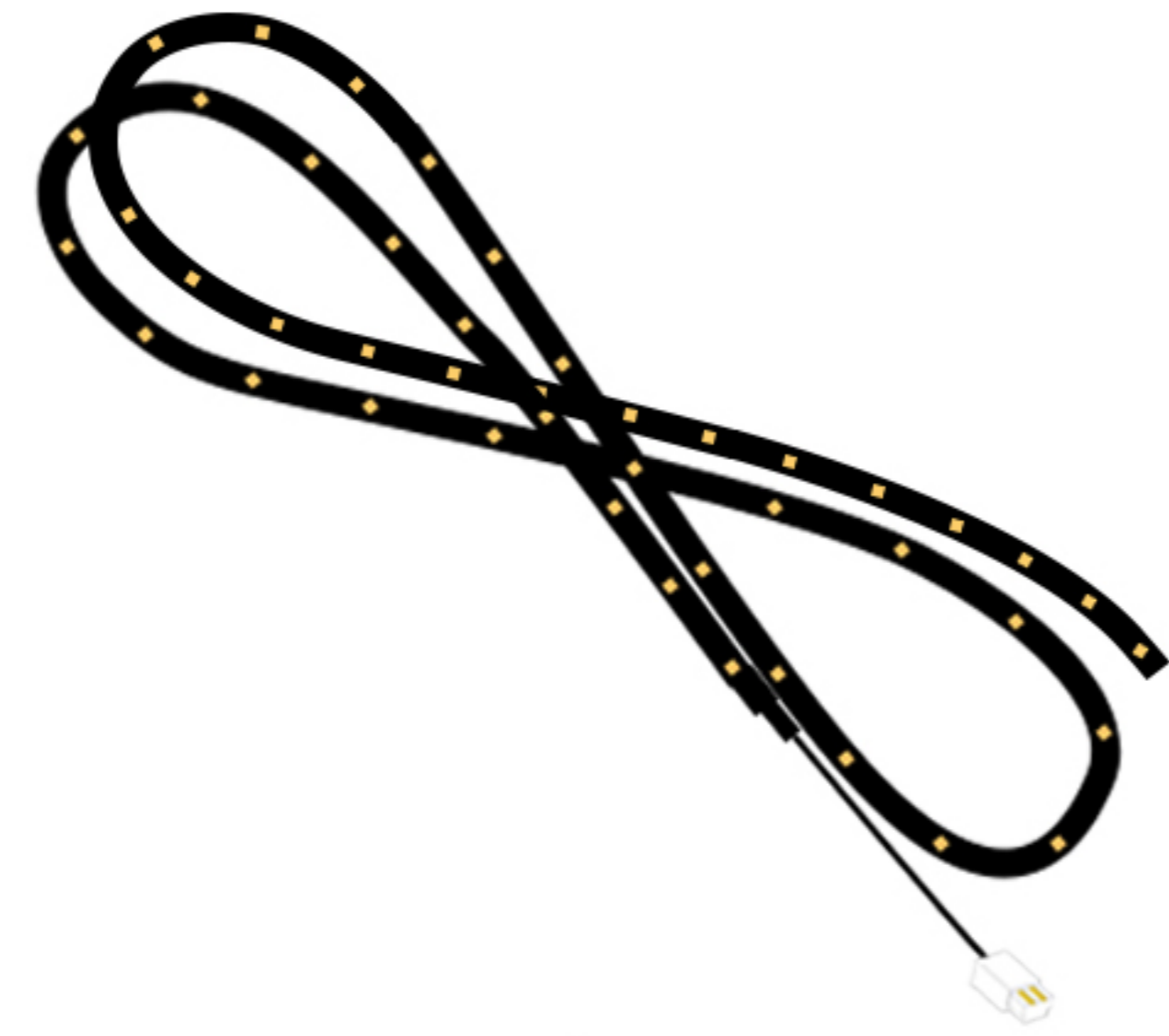
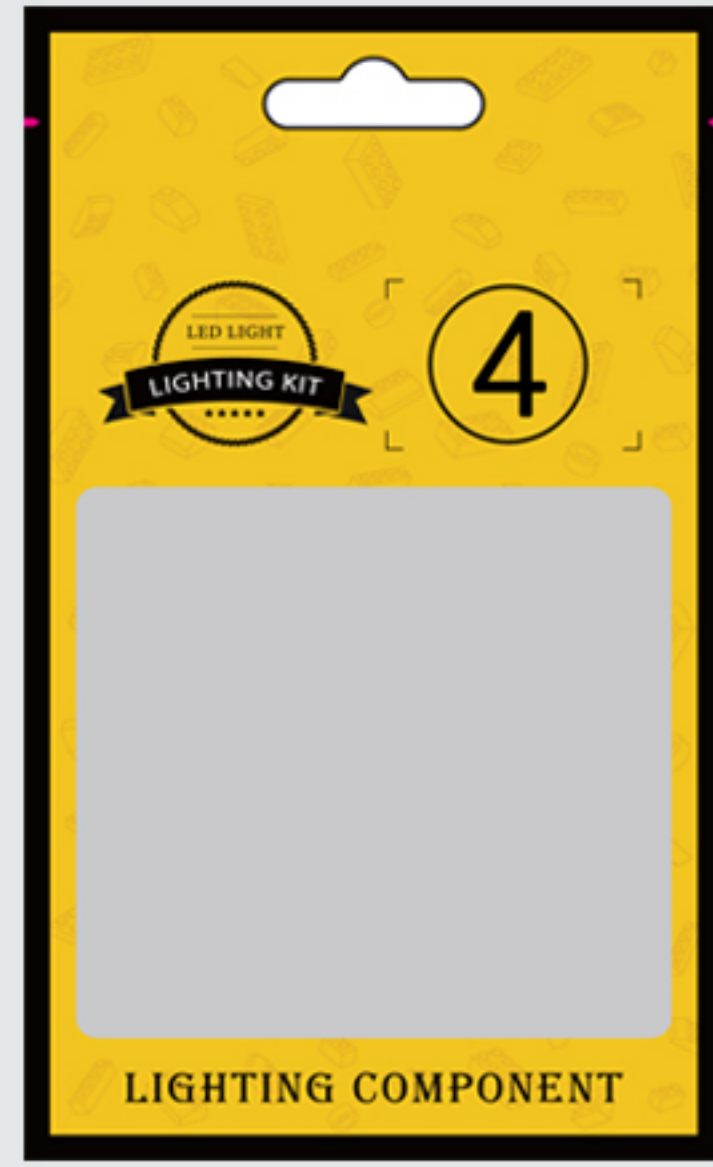

X1

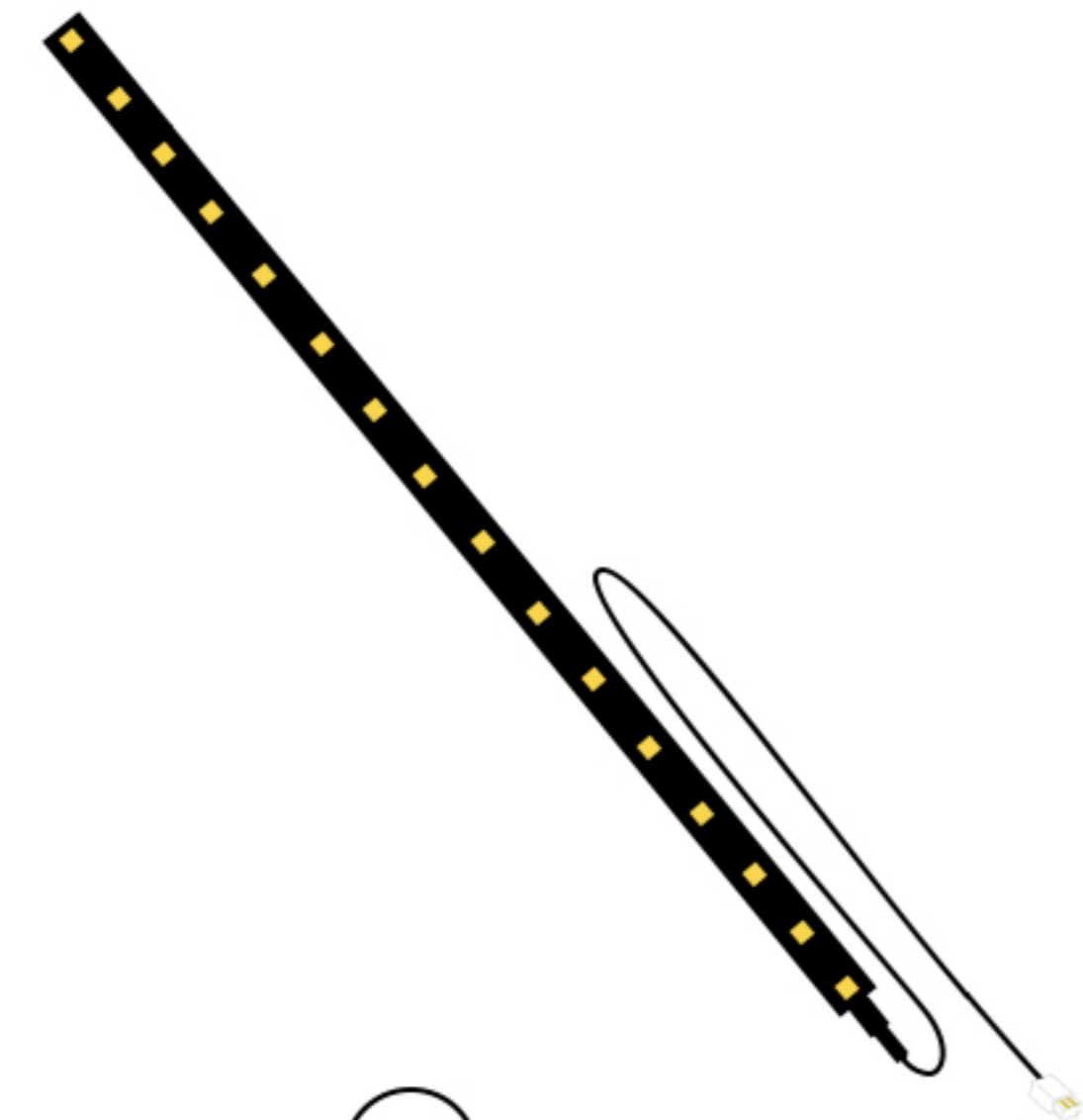

X1

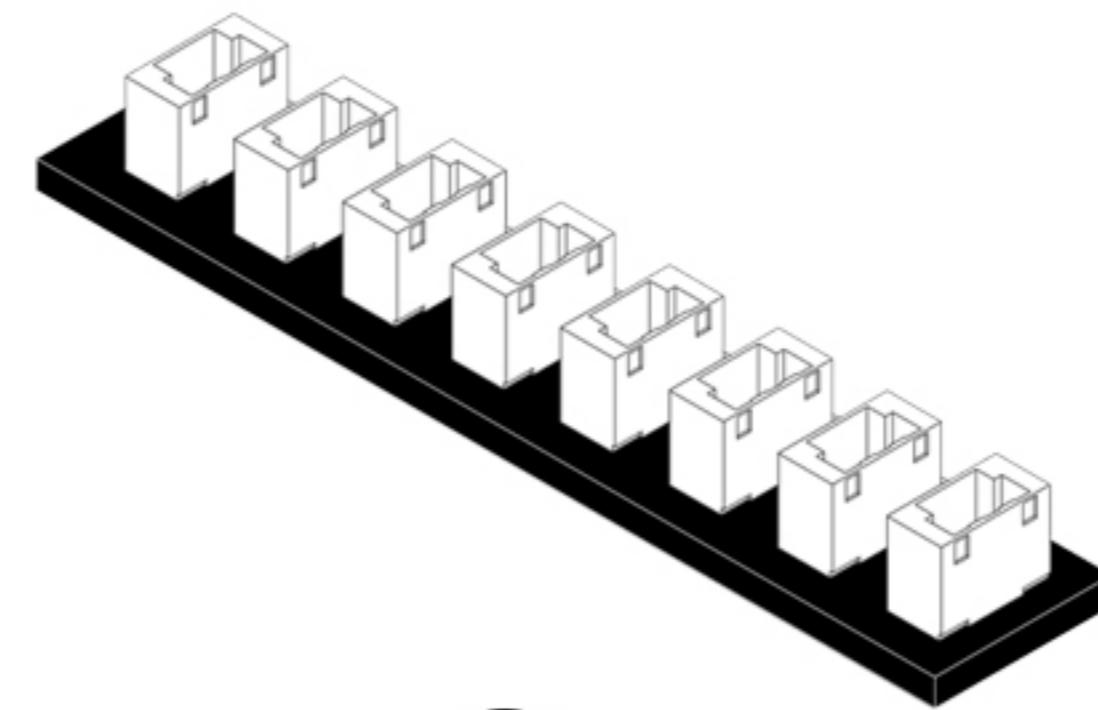

X1

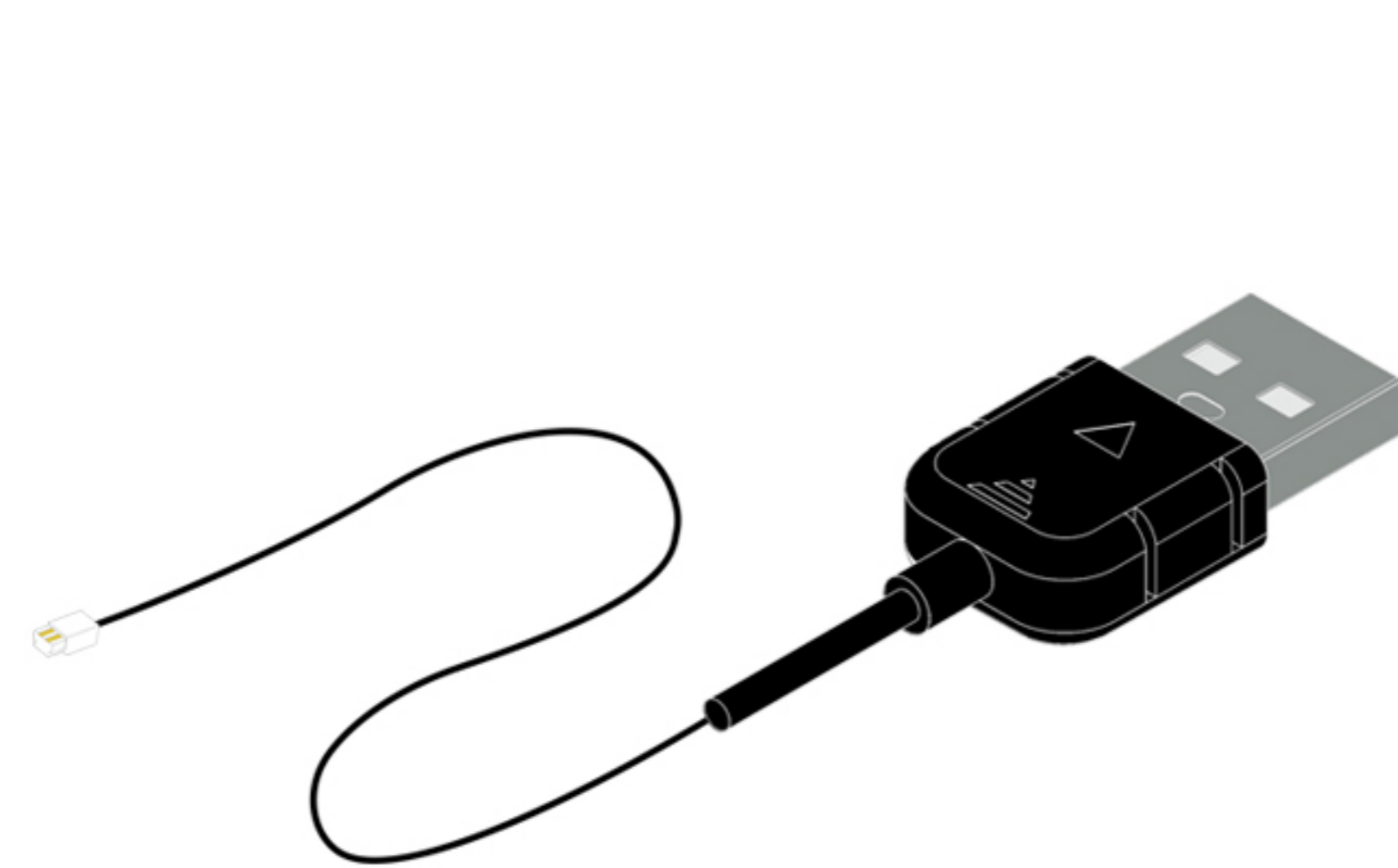
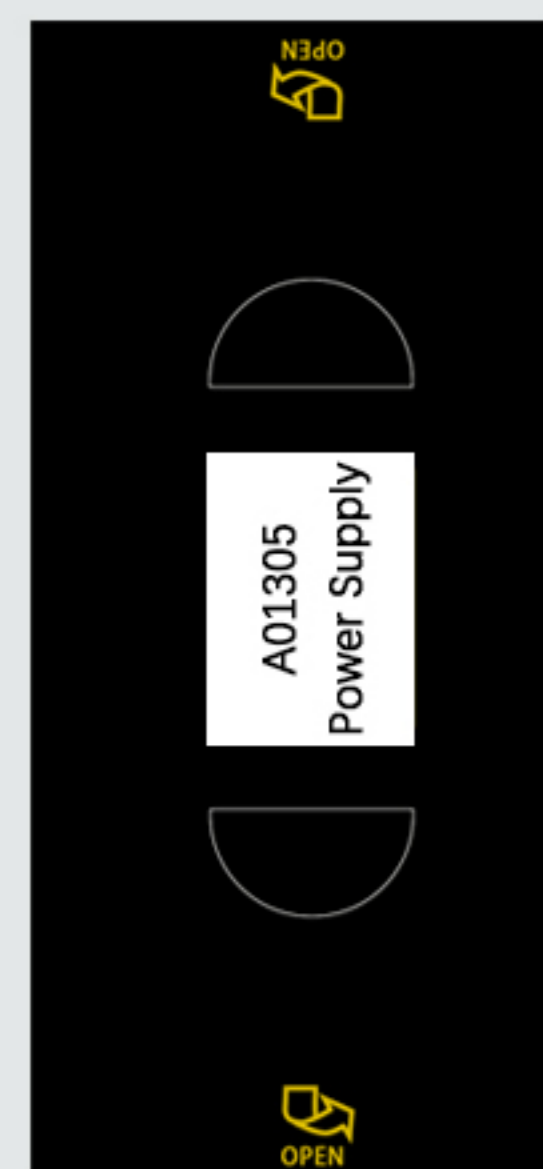

X1

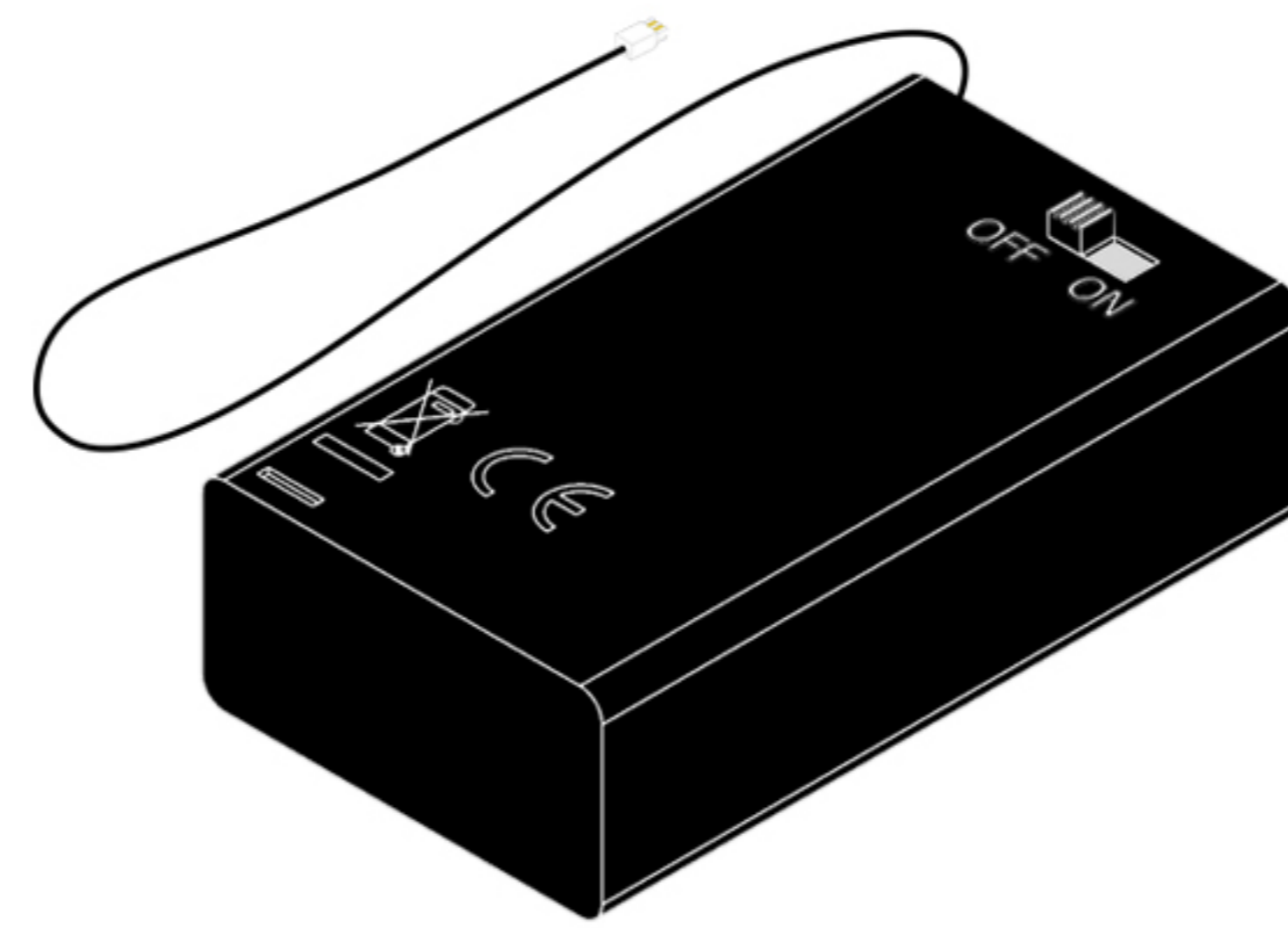

X1

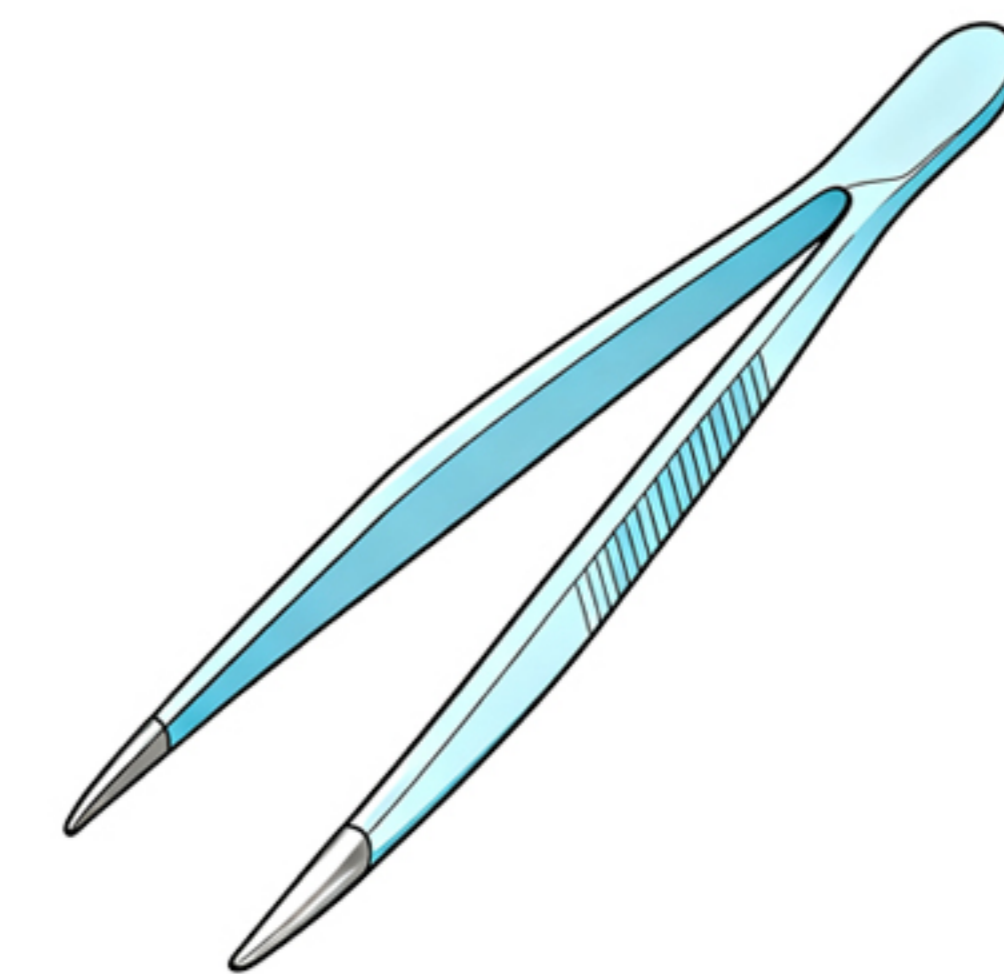

X1

This post will complete the light installation in two main sections.

Step 1-test



Step 2-mounting

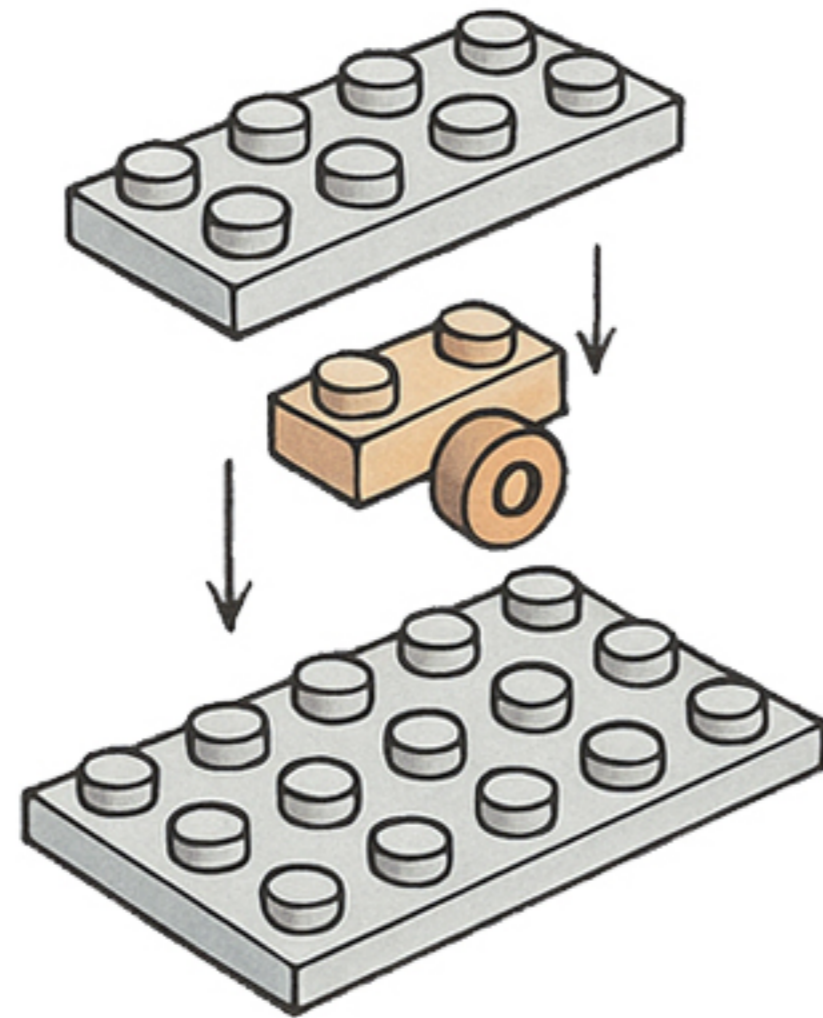

So let's get started!

## Step 1-Test.

1

EN: Remove the expansion board from Bag 5.

DE: Entnehmen Sie die Erweiterungskarte aus Beutel 5.

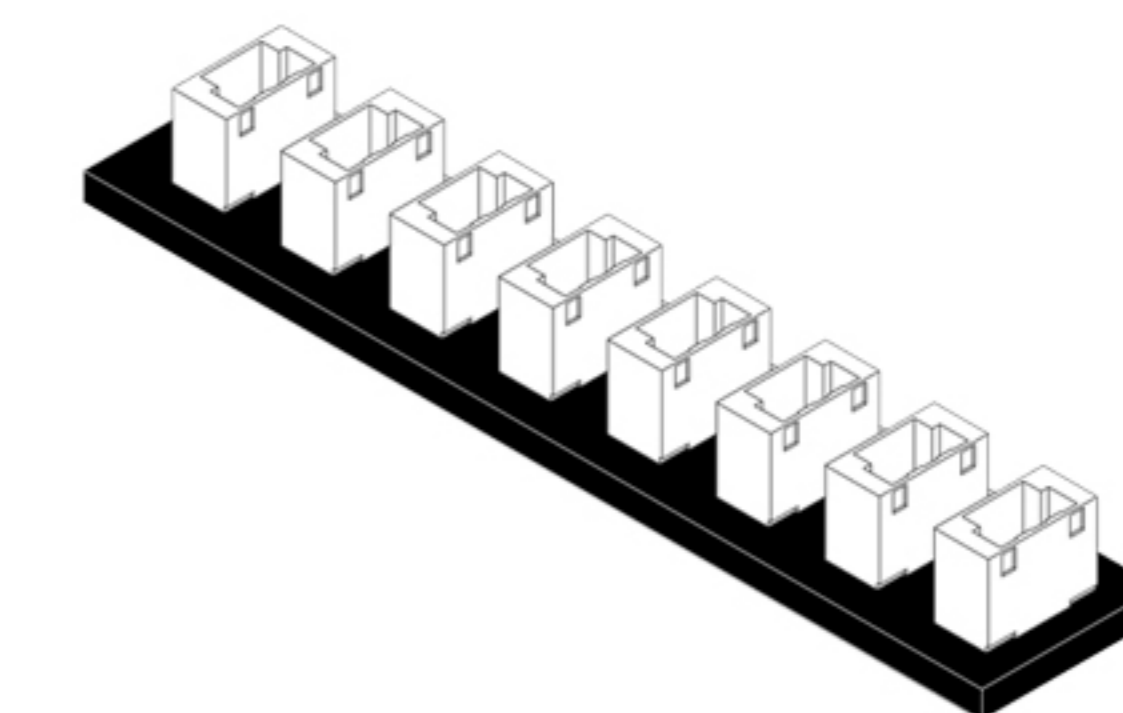

x1

2

EN: Take the USB power cable out of the box and connect it to the expansion board.

DE: Nehmen Sie das USB-Stromkabel aus der Verpackung und schließen Sie es an die Erweiterungskarte an.

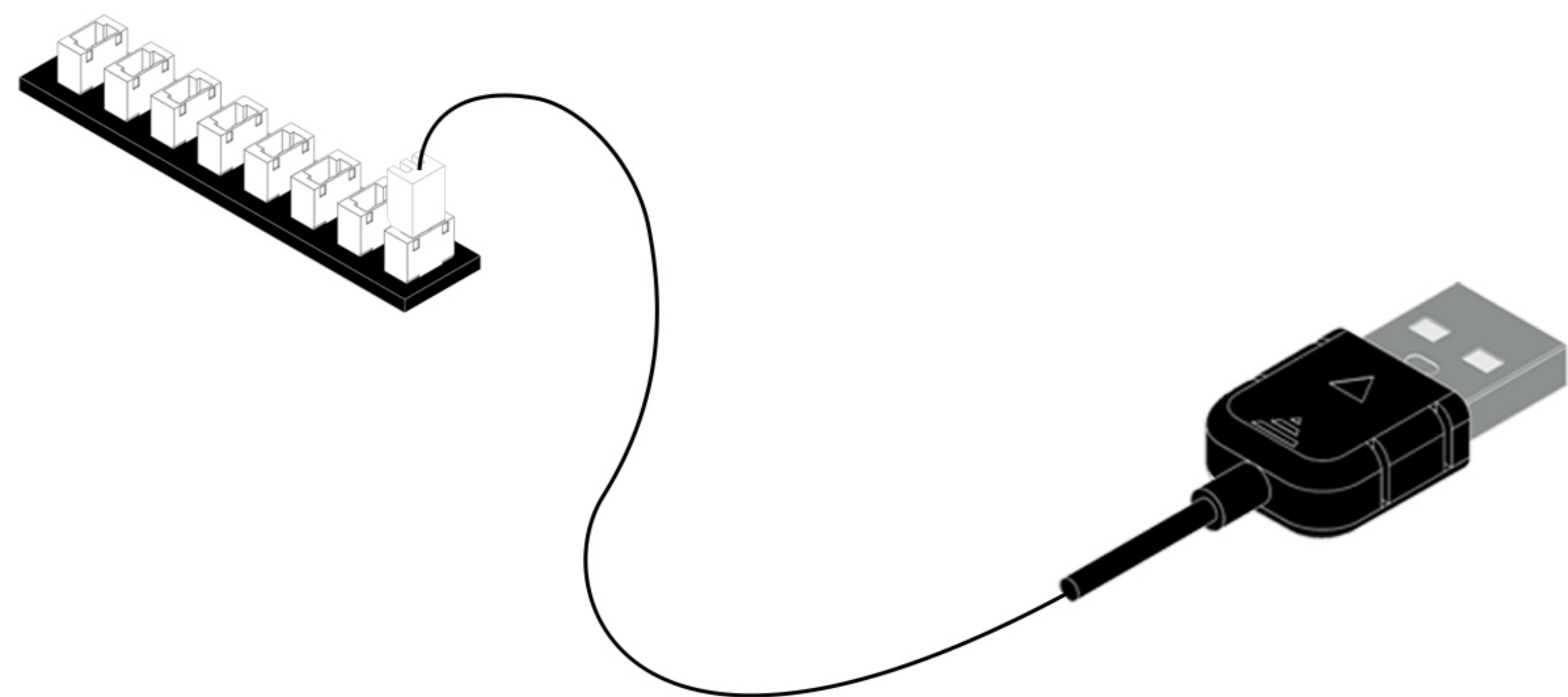
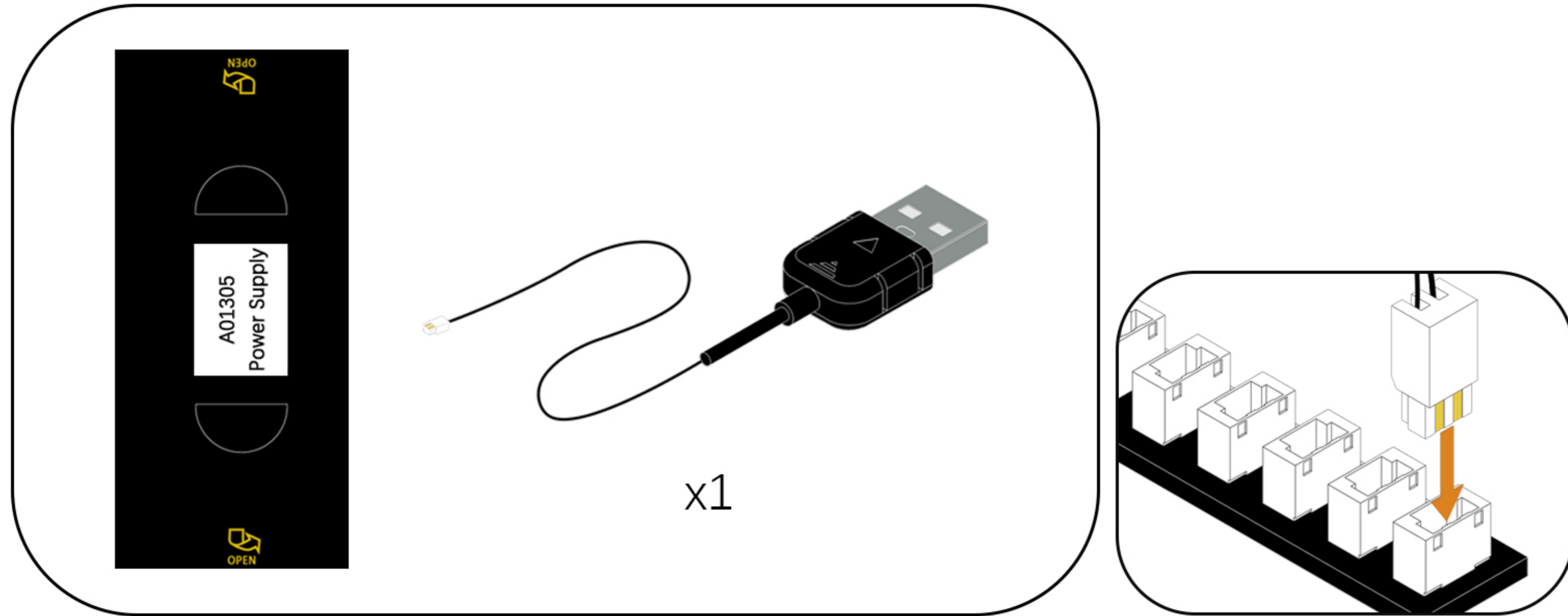

3

EN: Connect the USB power cable to the mobile power supply. (Power supply not included, see the diagram below for power supply options.)

DE: Schließen Sie das USB-Netzkabel an die mobile Stromversorgung an. (Stromversorgung nicht im Lieferumfang enthalten, siehe Abbildung unten für die Stromversorgungsart.)

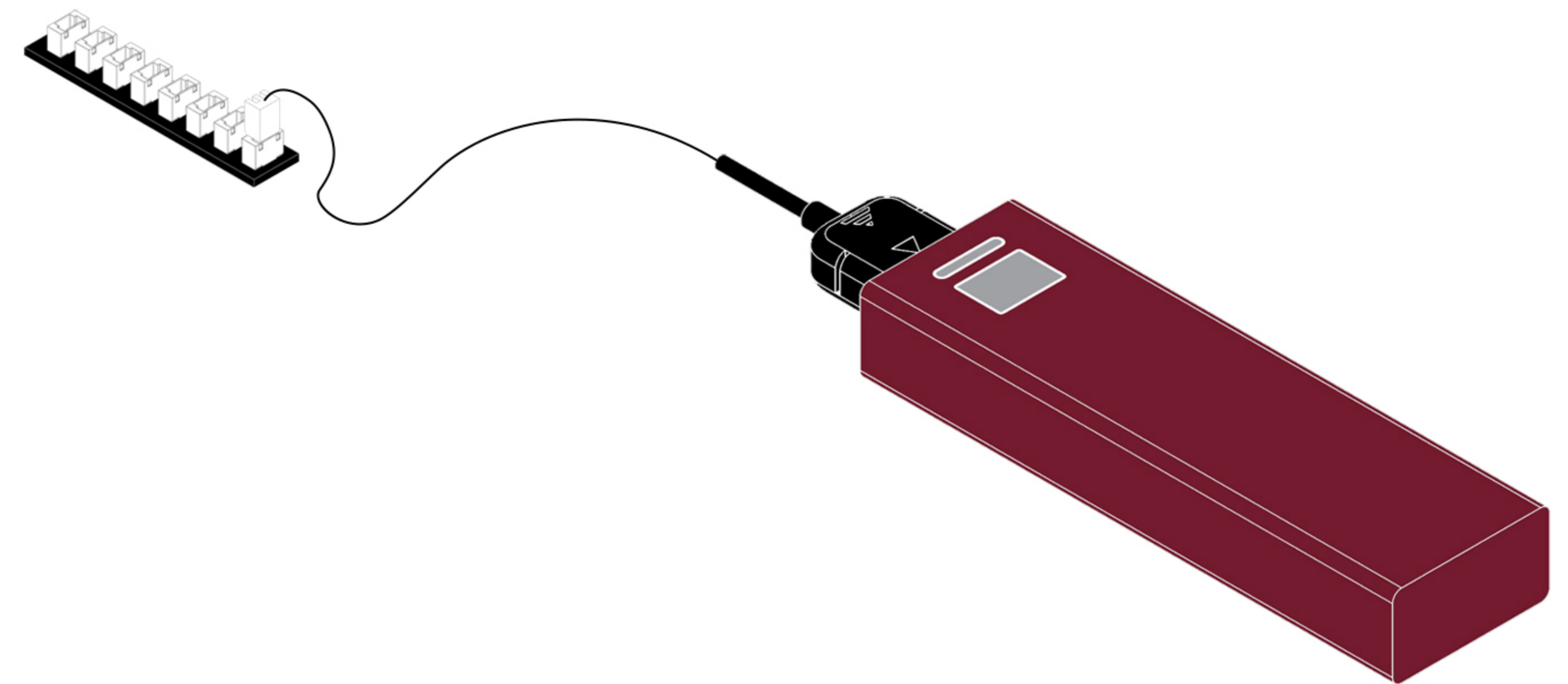

### USB Connectors to Connect Devices

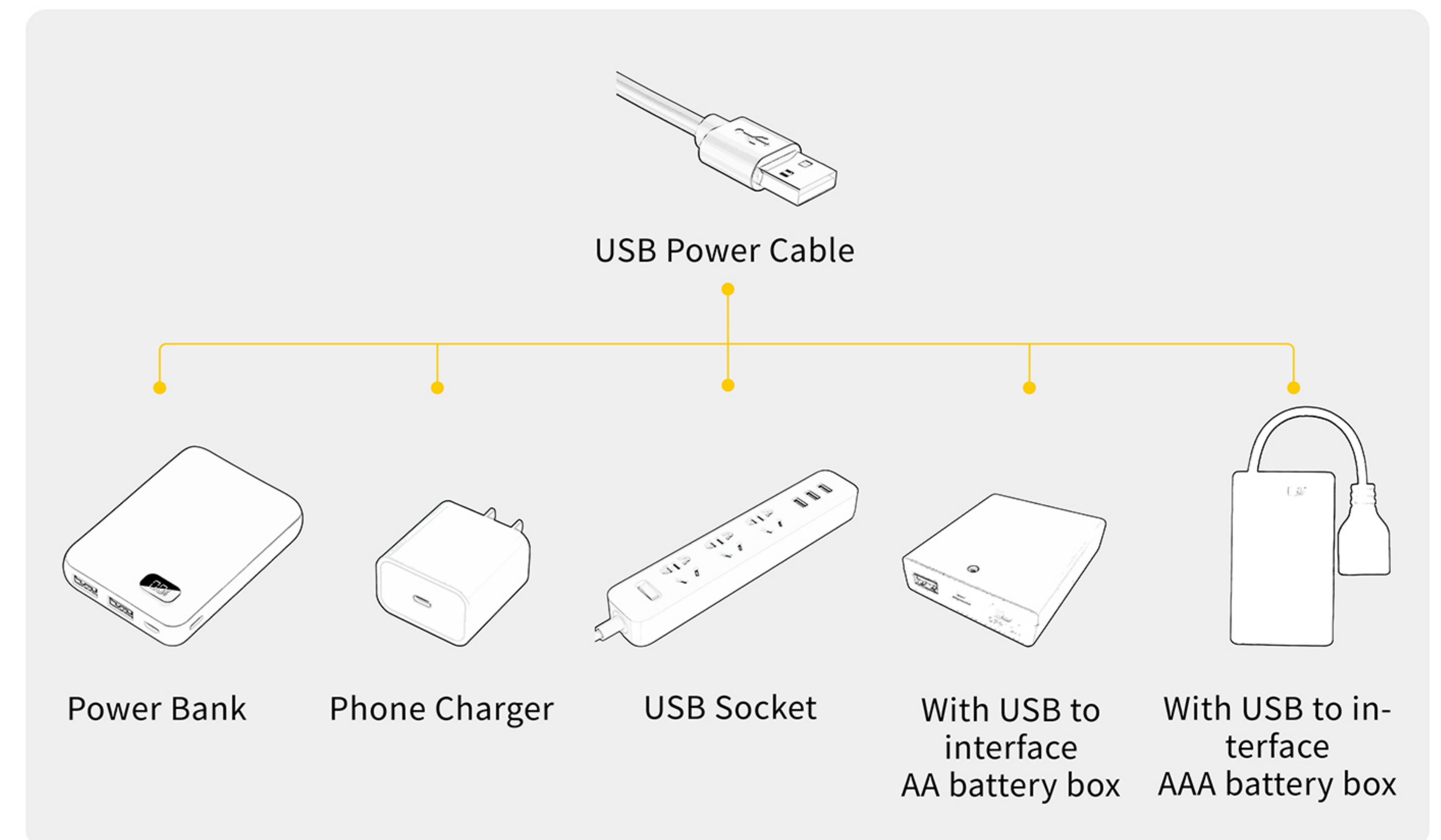

4

EN: Remove the string of lights from Bag 1, connect it to the expansion board, turn on the power, and check that the lights are working properly. If you notice any issues, please contact us immediately.

DE: Nehmen Sie die Lichterkette aus Beutel 1, schließen Sie sie an die Erweiterungskarte an, schalten Sie den Strom ein und überprüfen Sie, ob die Lichter ordnungsgemäß funktionieren. Sollten Sie Probleme feststellen, kontaktieren Sie uns bitte umgehend.

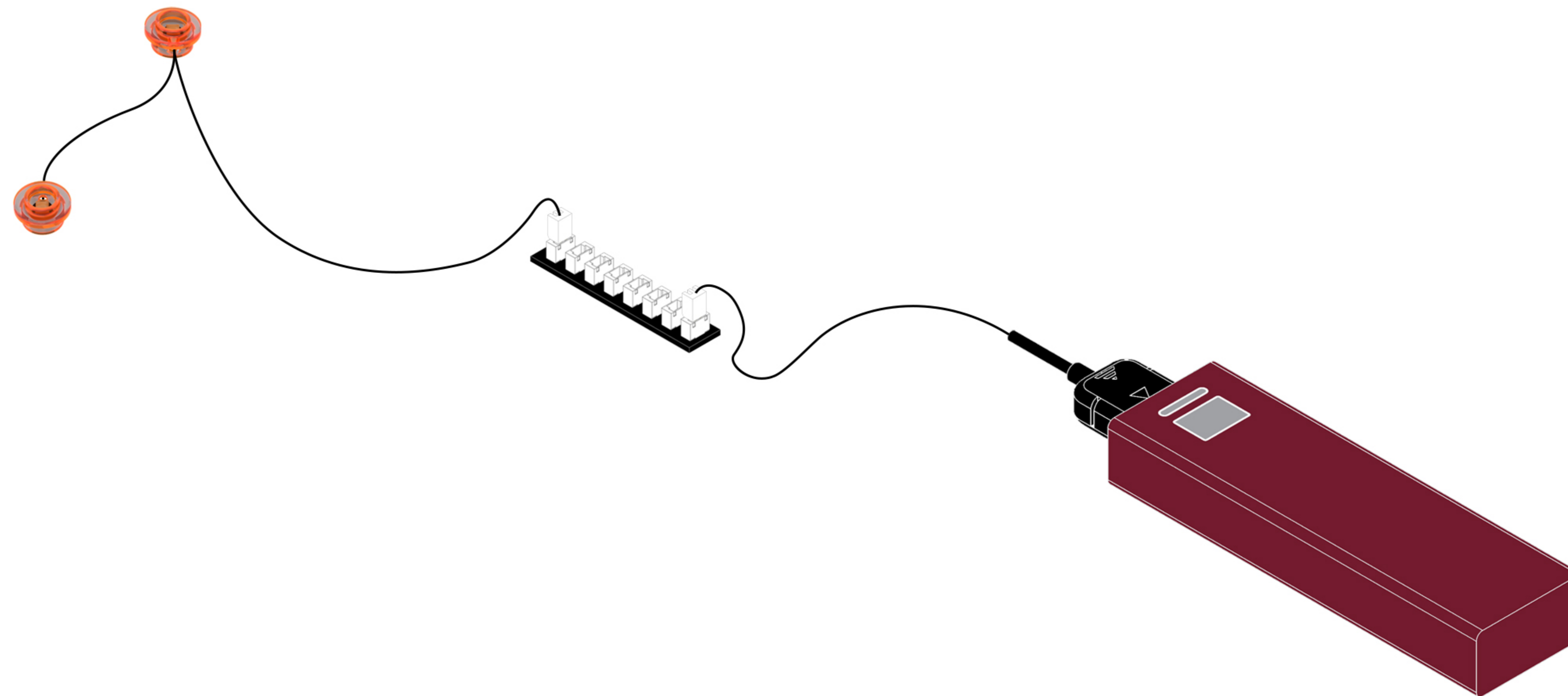
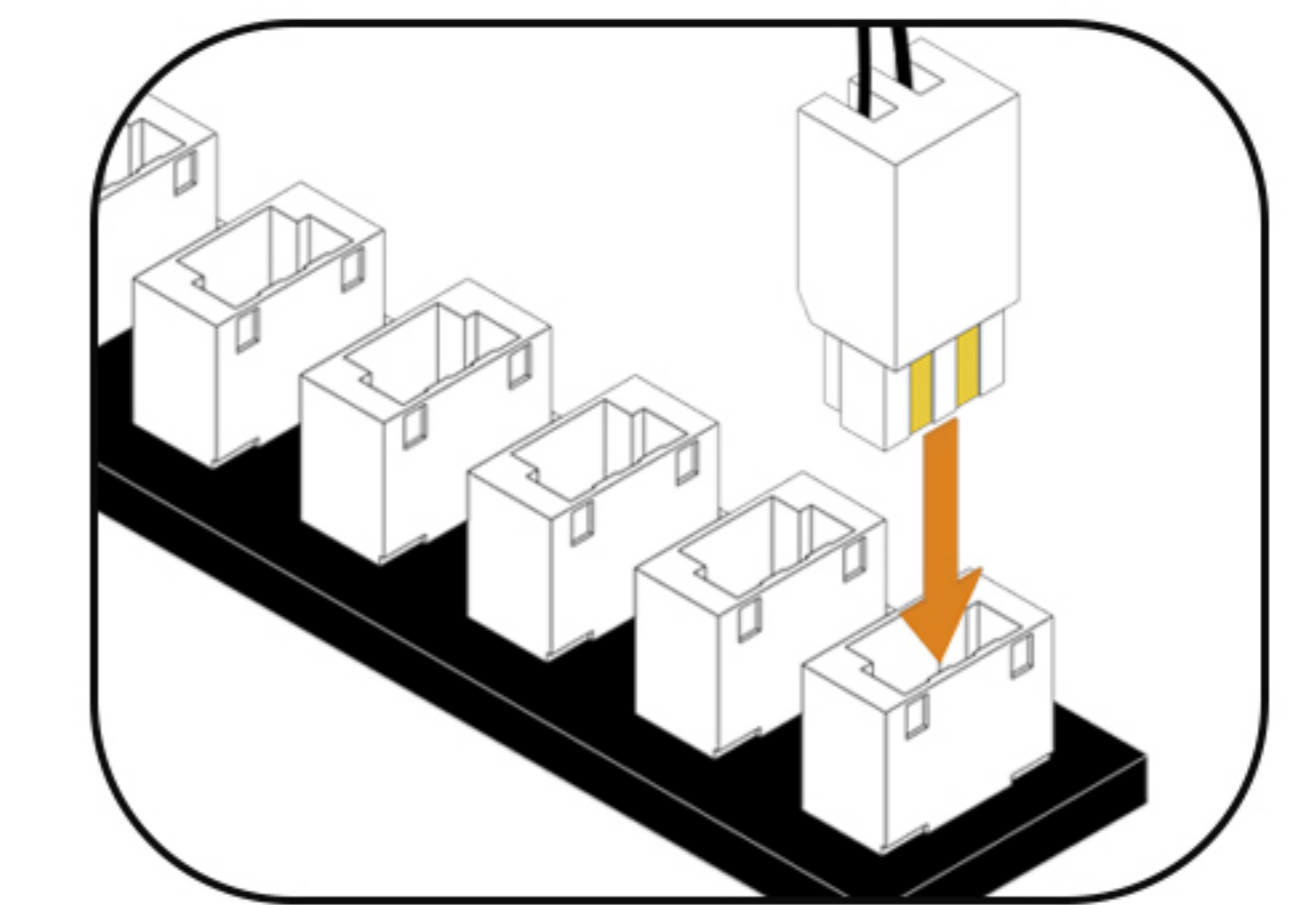
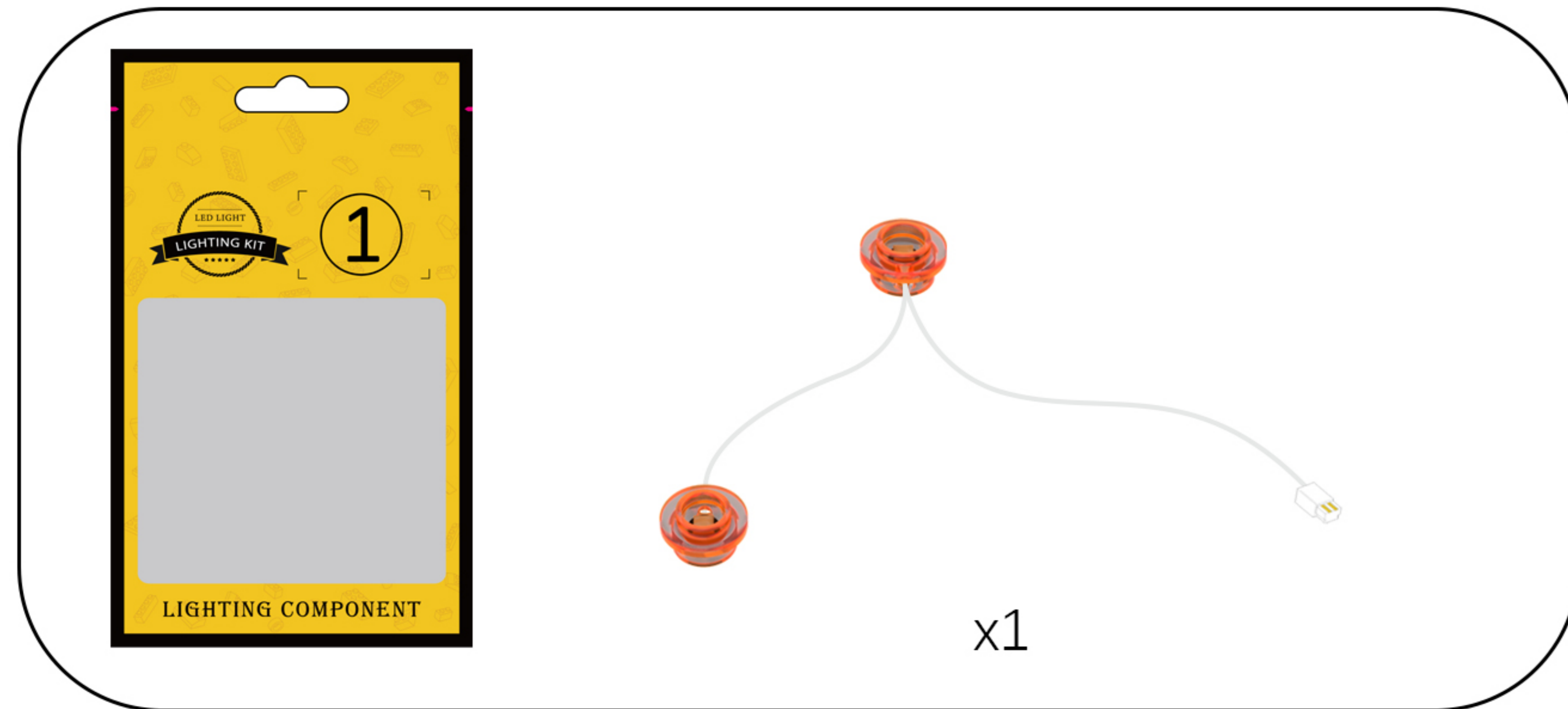

Once you've confirmed there are no issues, put the string lights back in their original bag, then test them.

5

EN: Remove the LED strip from Bag 3, connect it to the expansion board, turn on the power, and check that the LED strip is working properly. If you notice any issues, please contact us immediately.

DE: Nehmen Sie den LED-Streifen aus Beutel 3, schließen Sie ihn an die Erweiterungsplatine an, schalten Sie die Stromversorgung ein und überprüfen Sie, ob der LED-Streifen ordnungsgemäß funktioniert. Sollten Sie Probleme feststellen, kontaktieren Sie uns bitte umgehend.

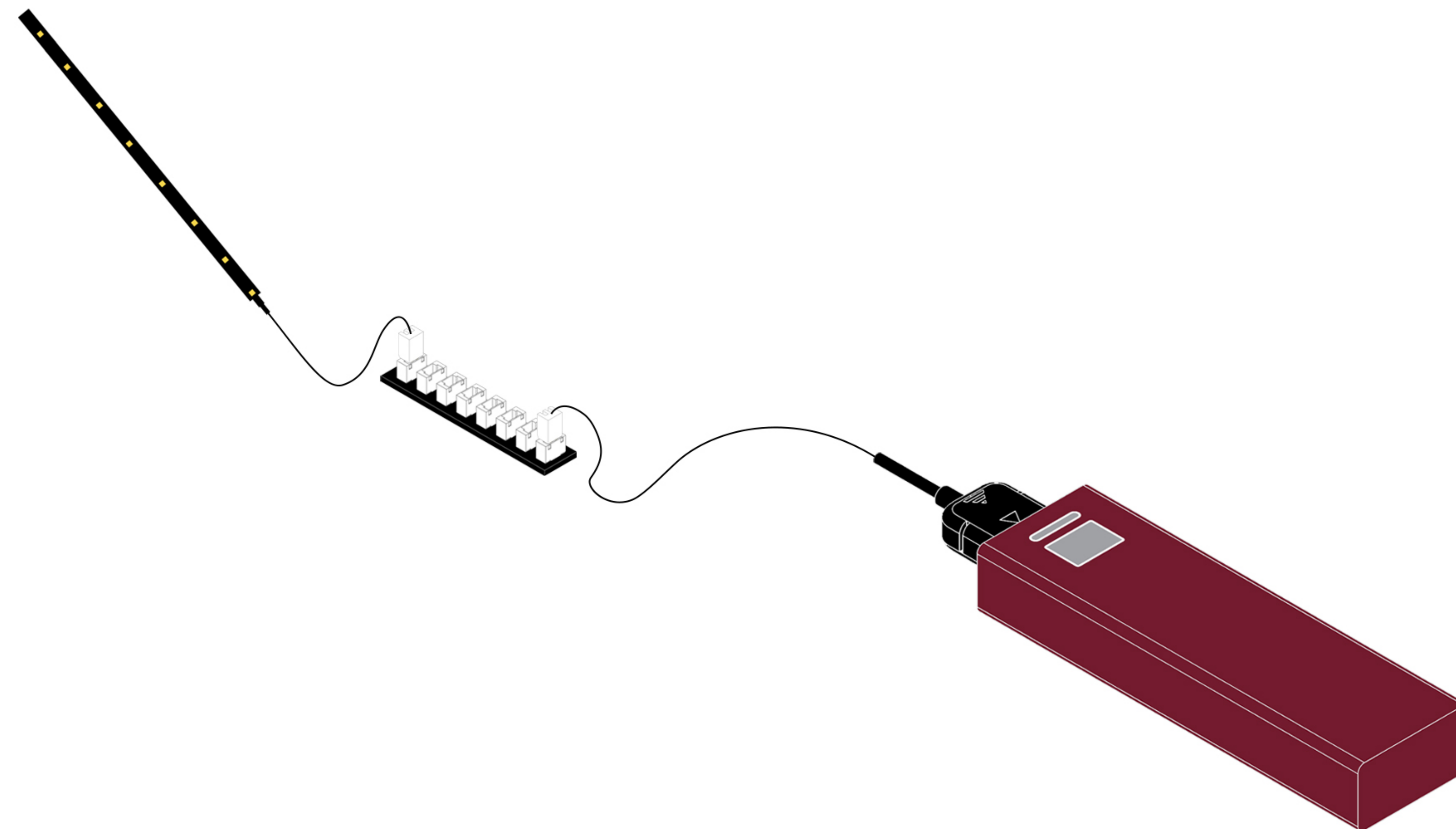
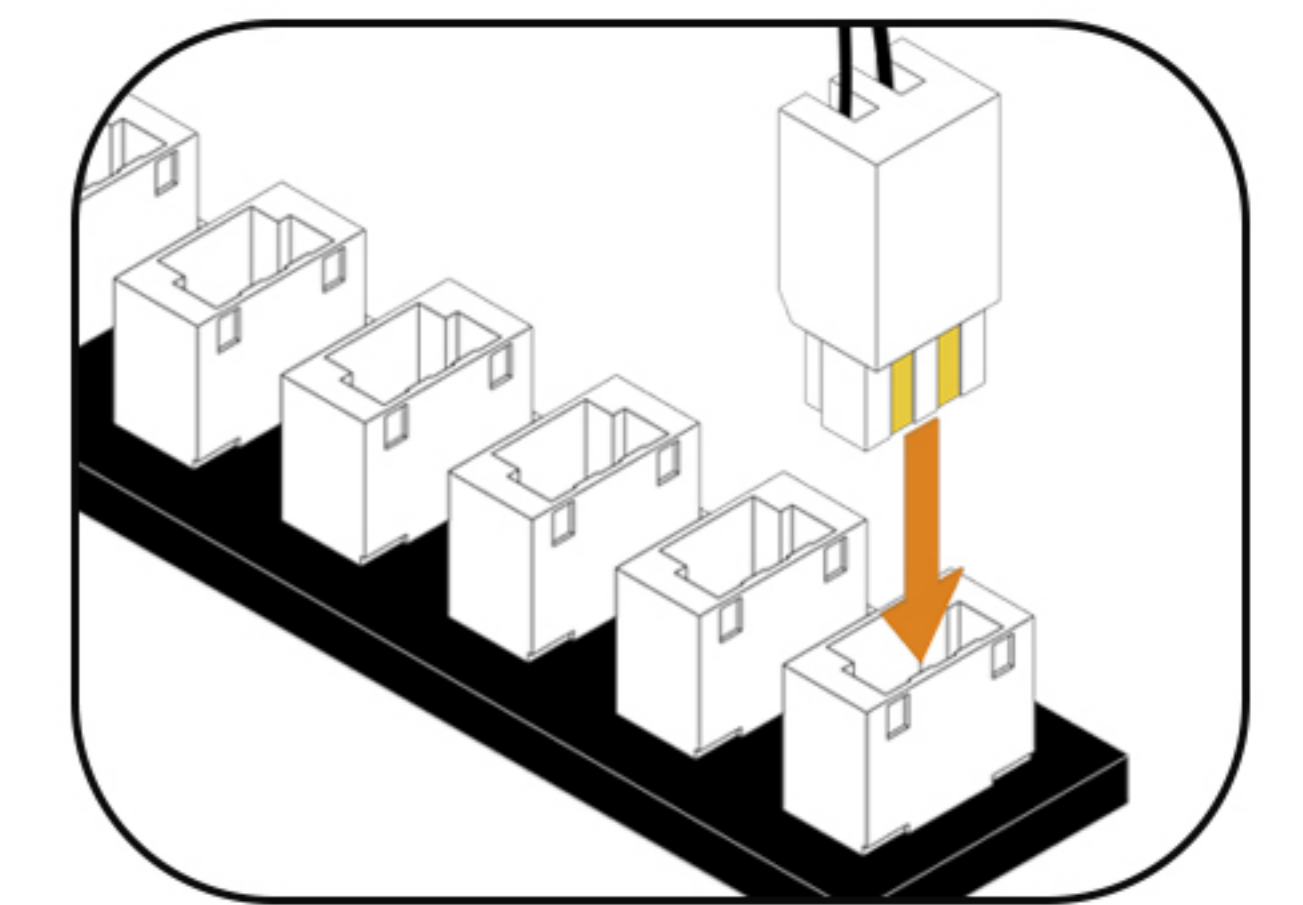
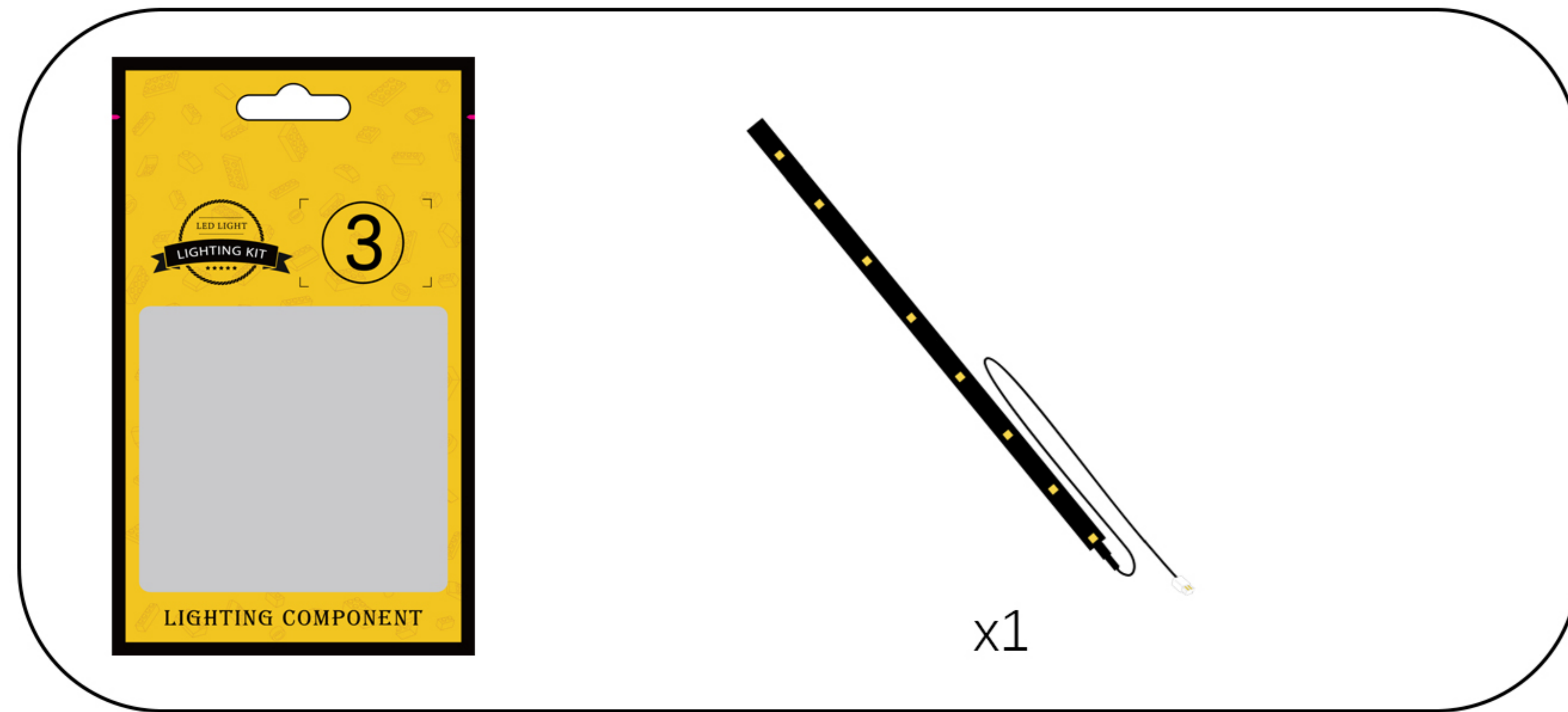

After confirming that there are no abnormalities, temporarily return each part to its original bag.

## Step 2-Mounting.

1

EN: Take out the building block model.

DE: Nimm das Bauklotzmodell heraus.



2

EN: Remove the building blocks one by one.

DE: Entfernen Sie die Bausteine nacheinander.

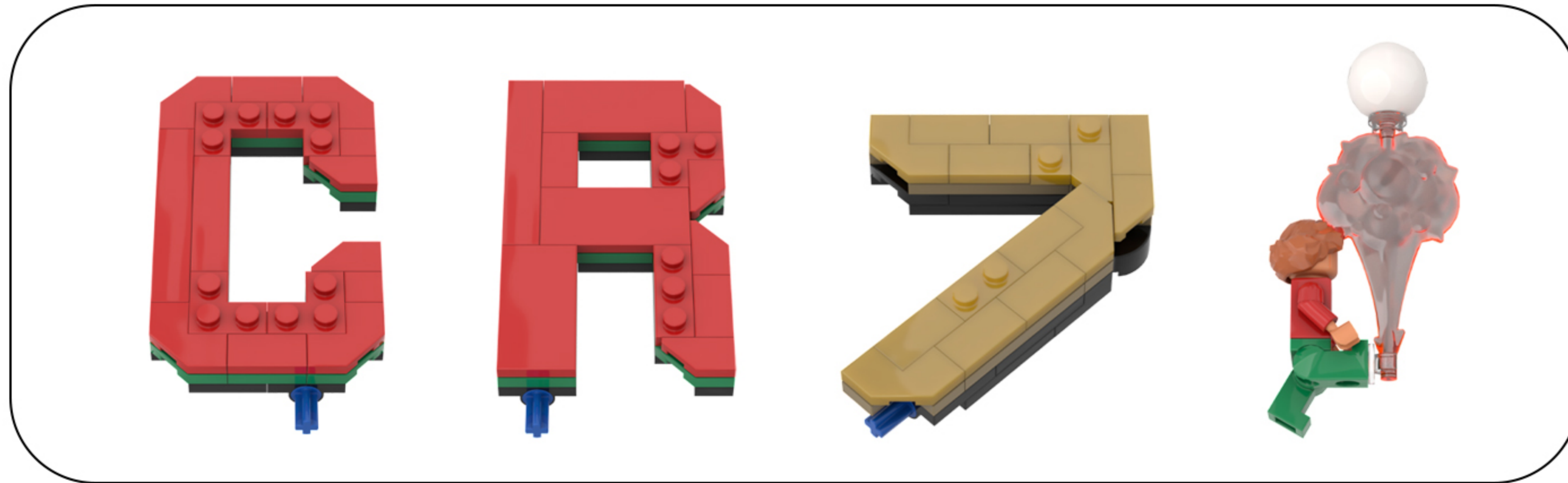

3

EN: Take the string lights out of Bag 2 and remove the disassembled building blocks.

DE: Nimm die Lichterkette aus Beutel 2 heraus und entferne die zerlegten Bausteine.

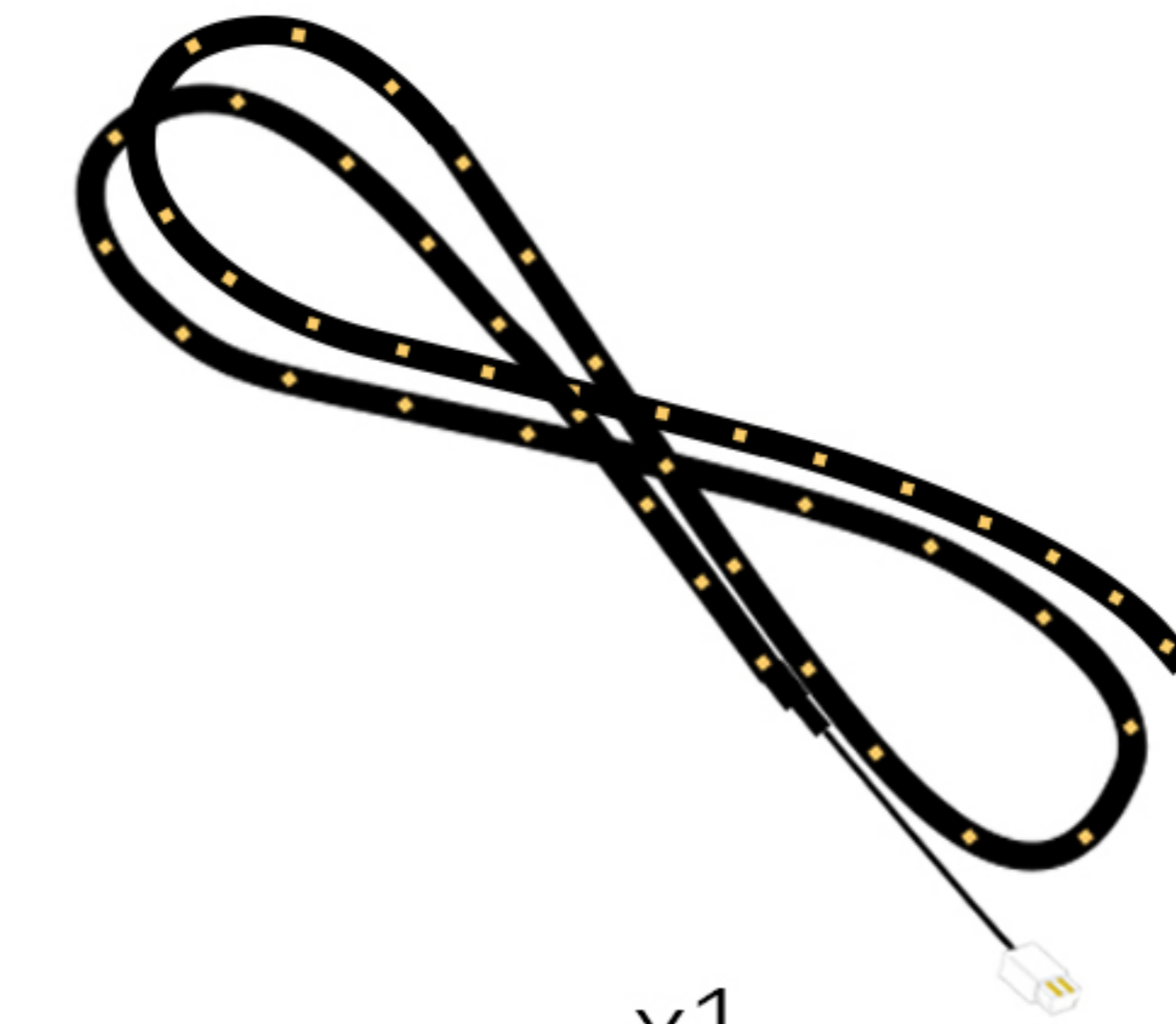
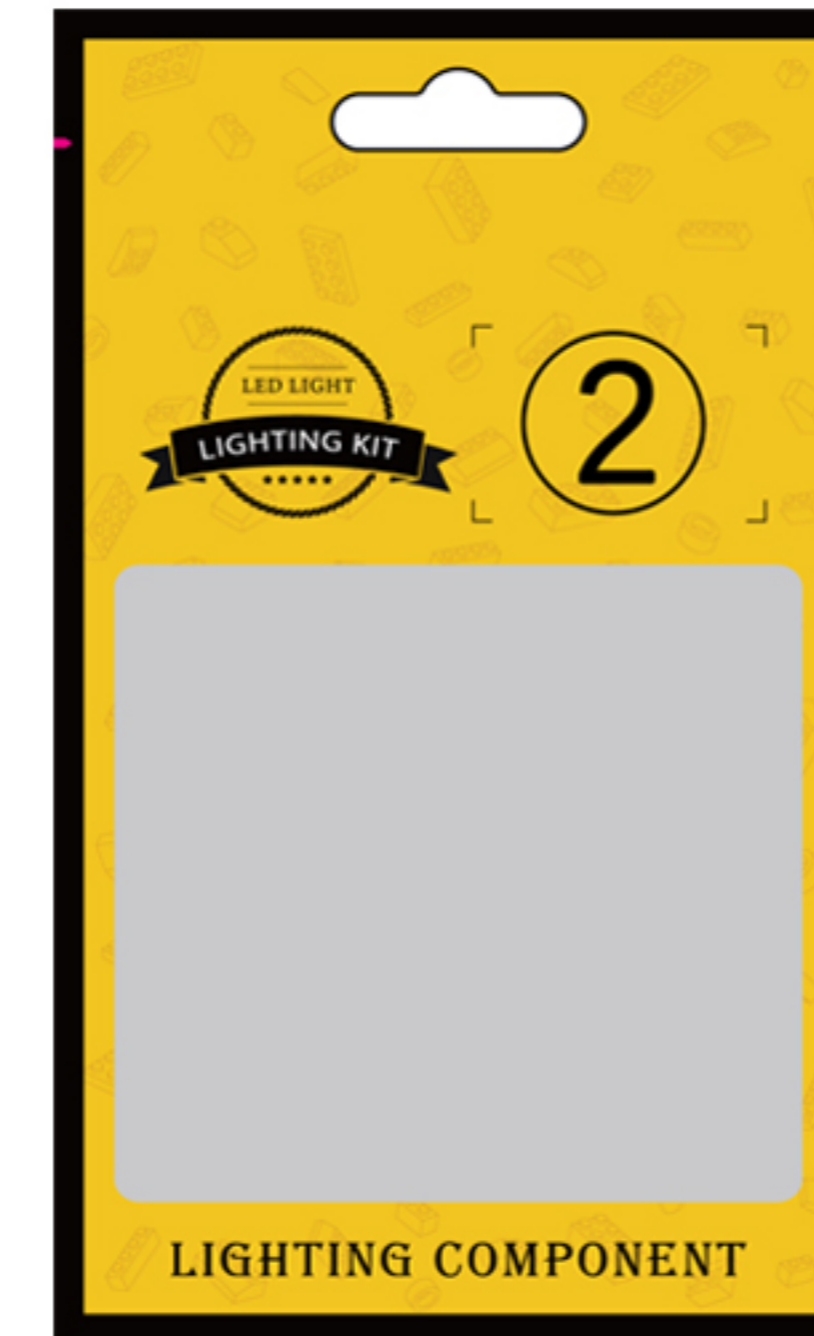

x1

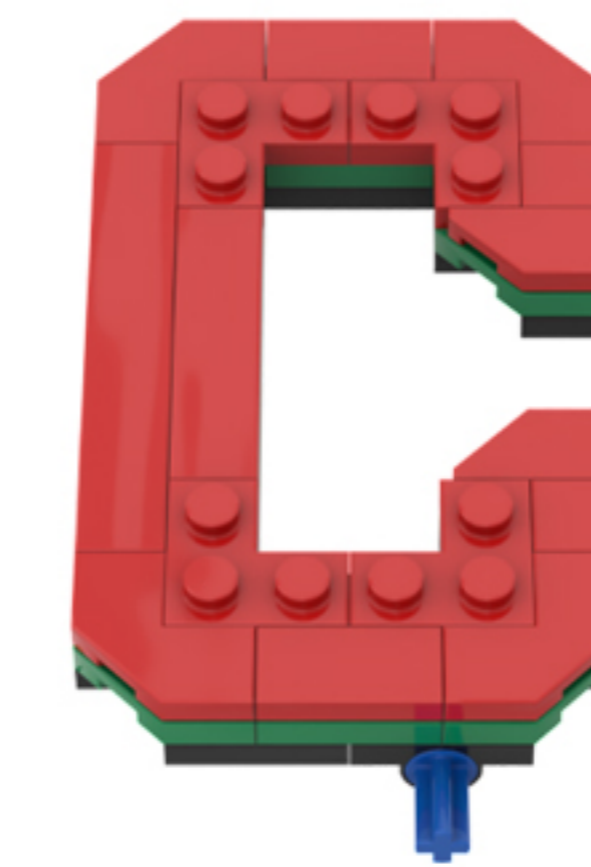

x1

4

EN: Peel off the adhesive backing from the light strip and wrap it around the building block.

DE: Zieh die Schutzfolie vom Leuchtband ab und wickle es um den Baustein.

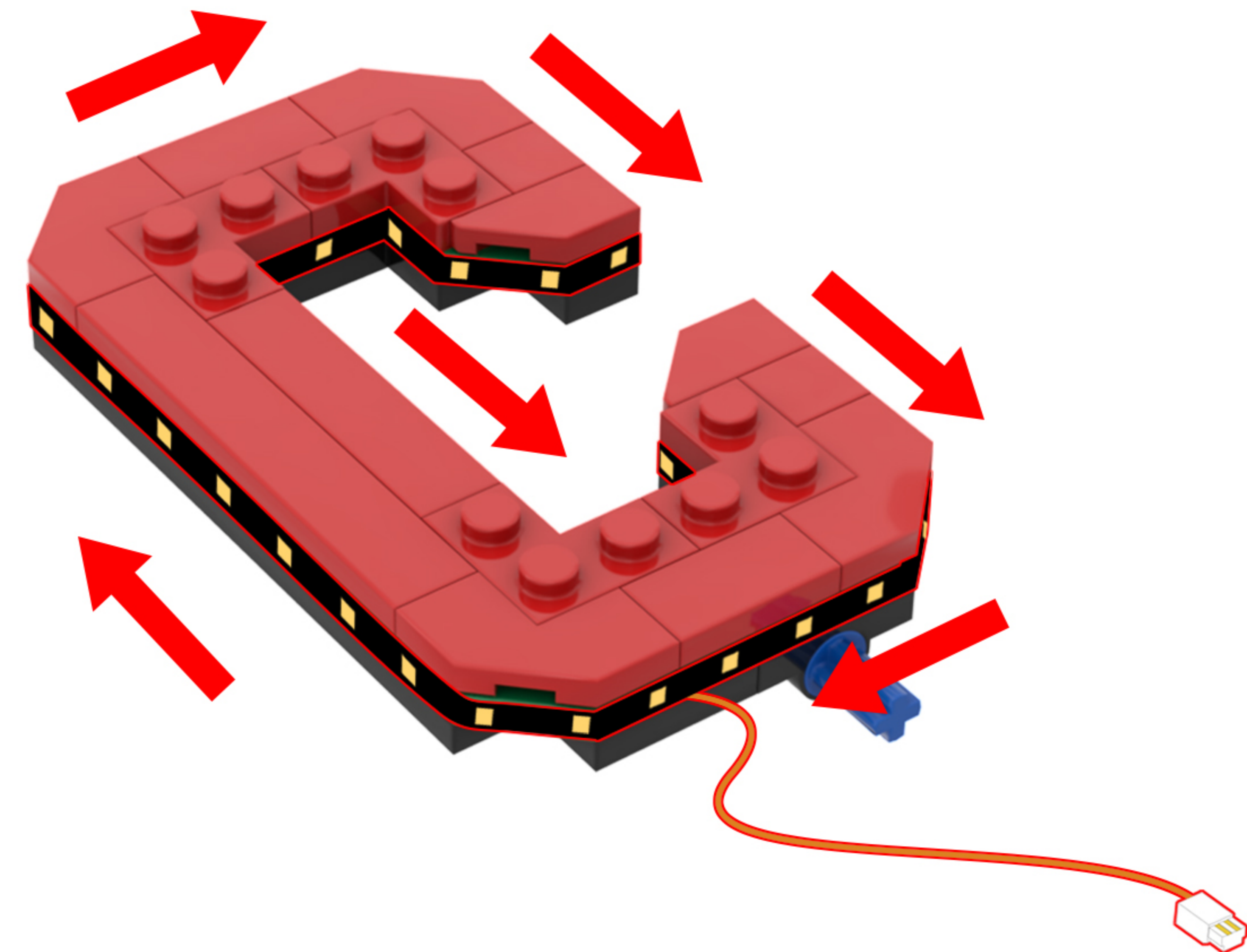
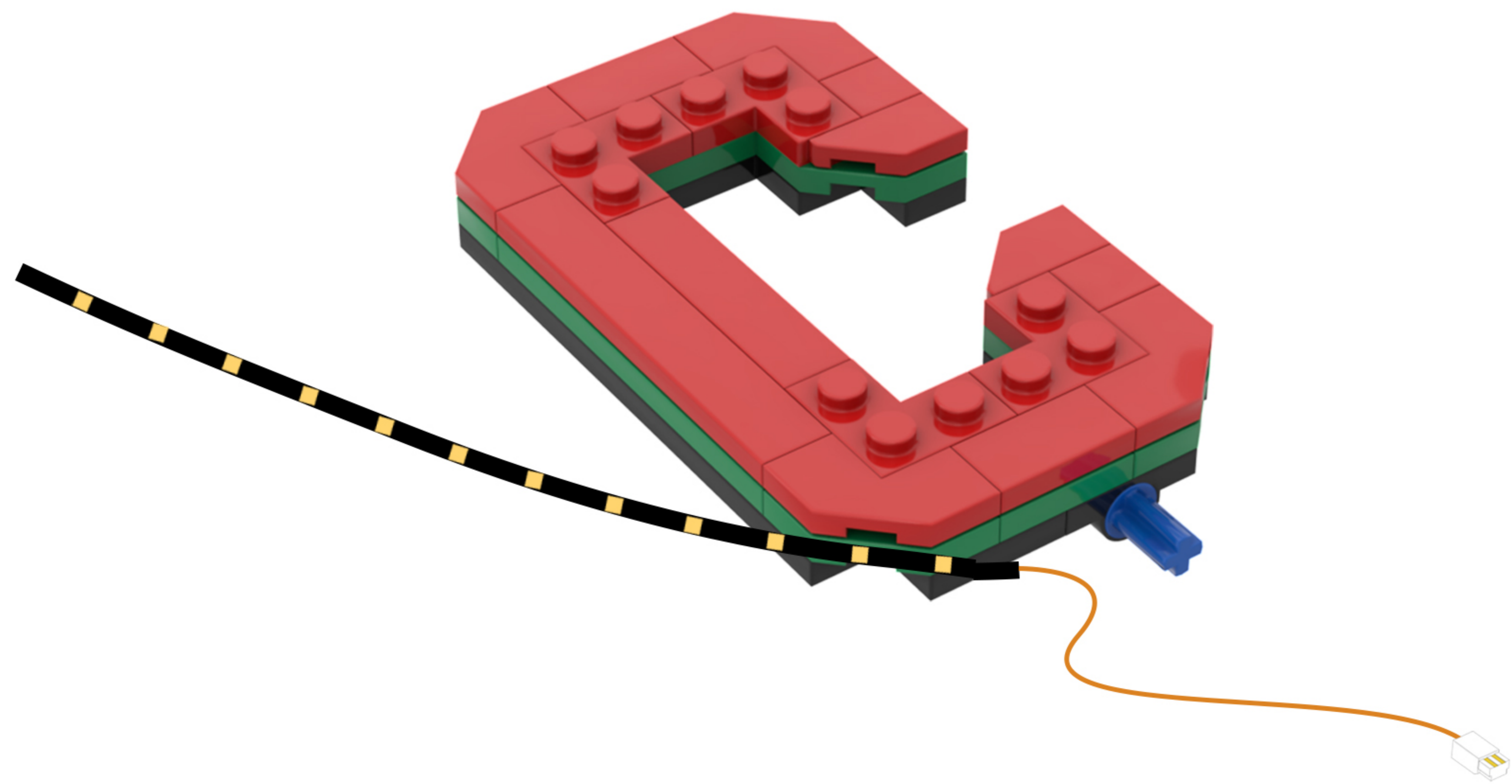

5

EN: Take the two light strips from Bag 3 and the disassembled building blocks. Peel back the adhesive backing on the longer light strip and wrap it around the building blocks.

DE: Nimm die beiden Leuchtstreifen aus Beutel 3 und die zerlegten Bausteine. Ziehe die Schutzfolie vom längeren Leuchtstreifen ab und wickle ihn um die Bausteine.

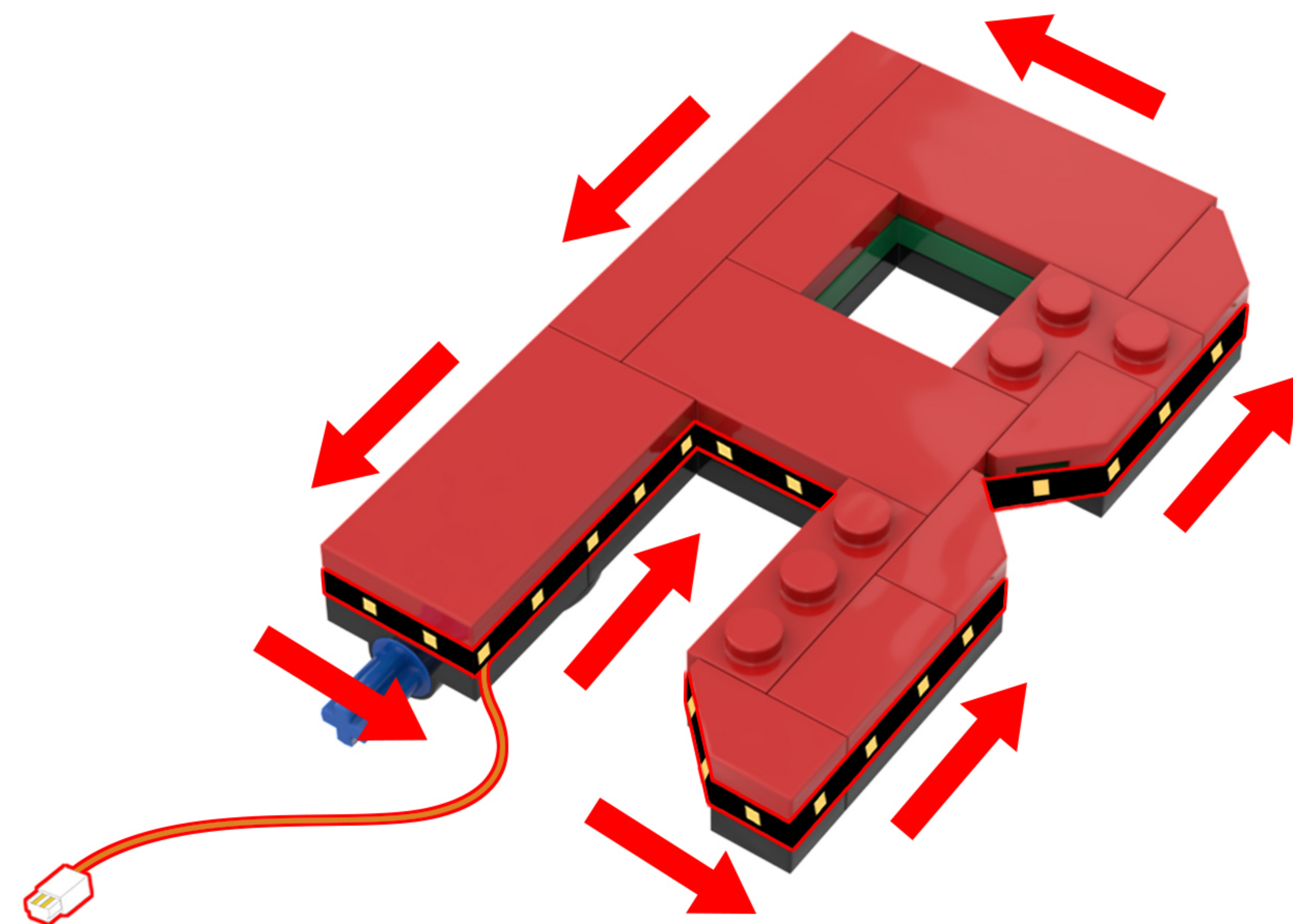
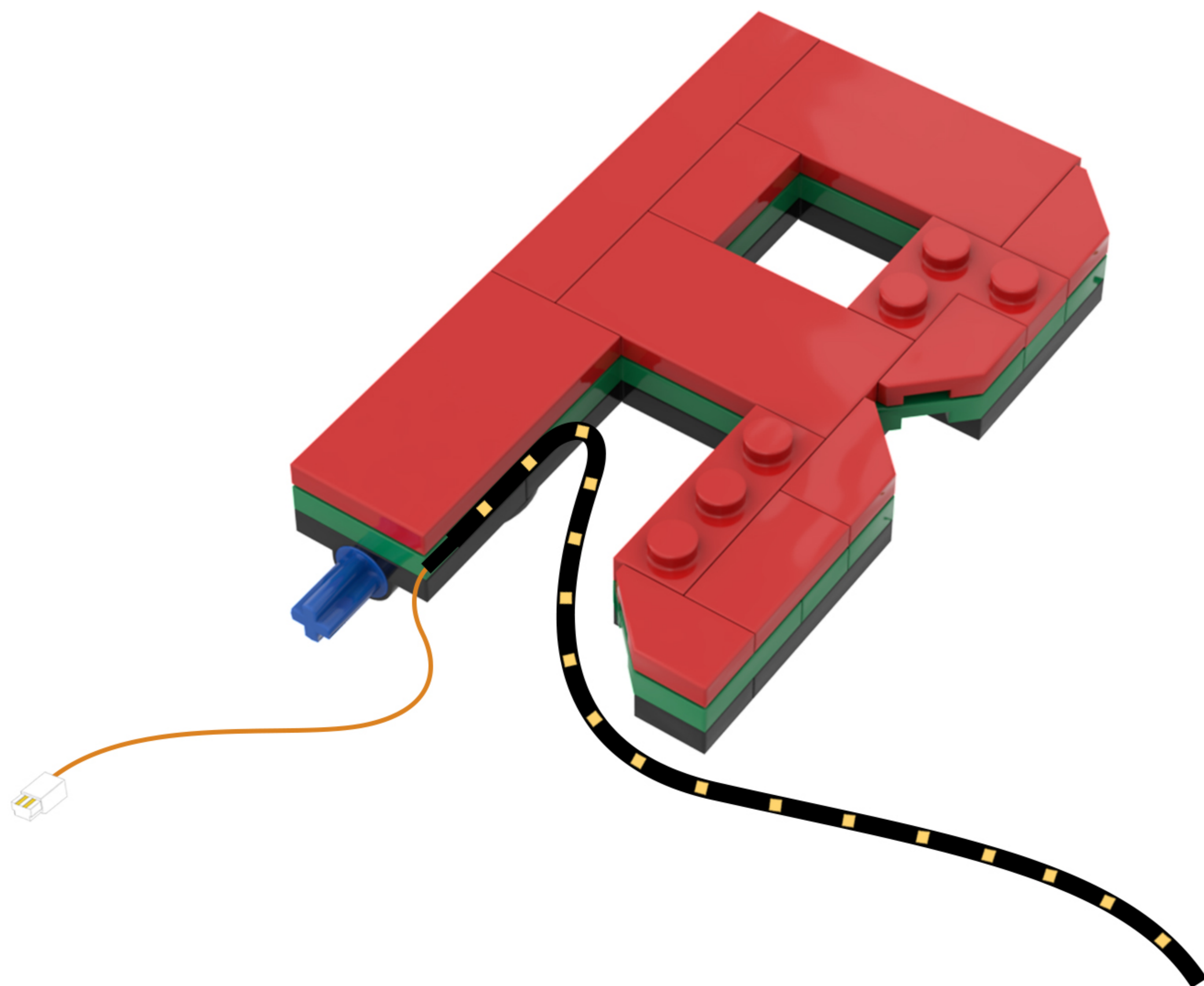
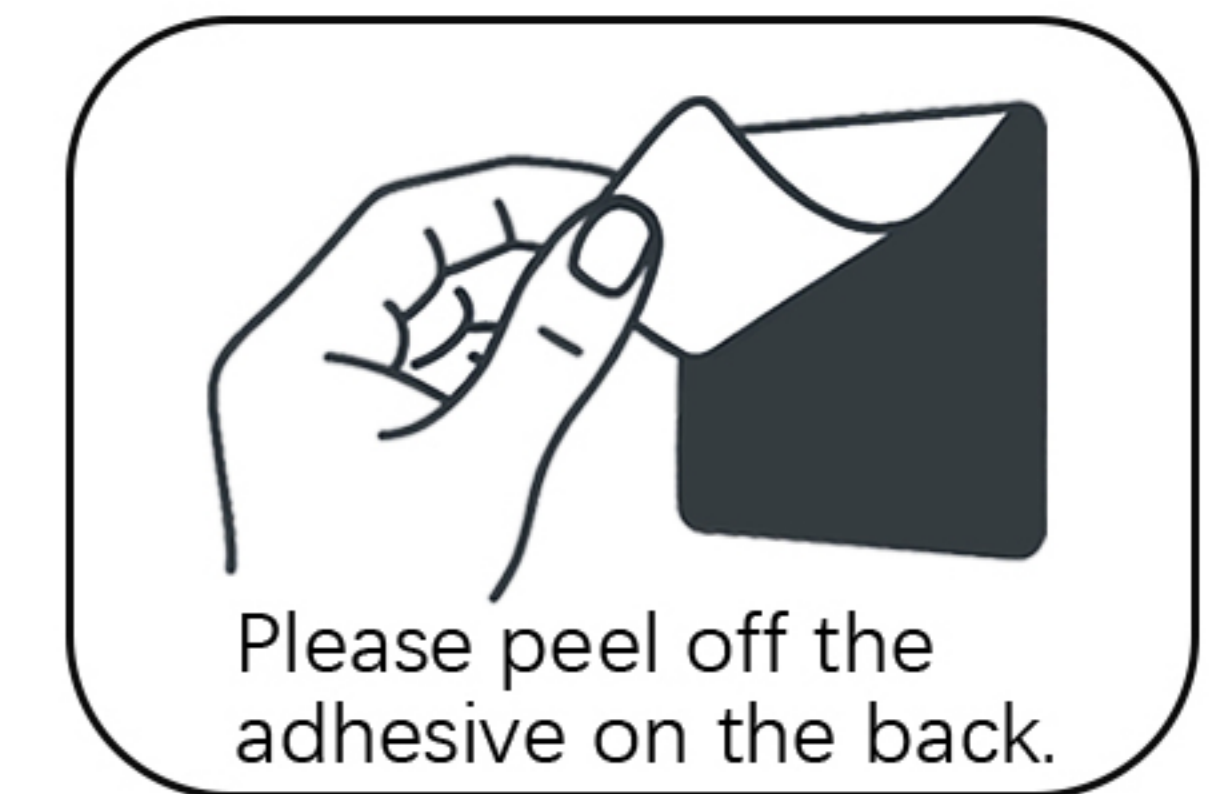
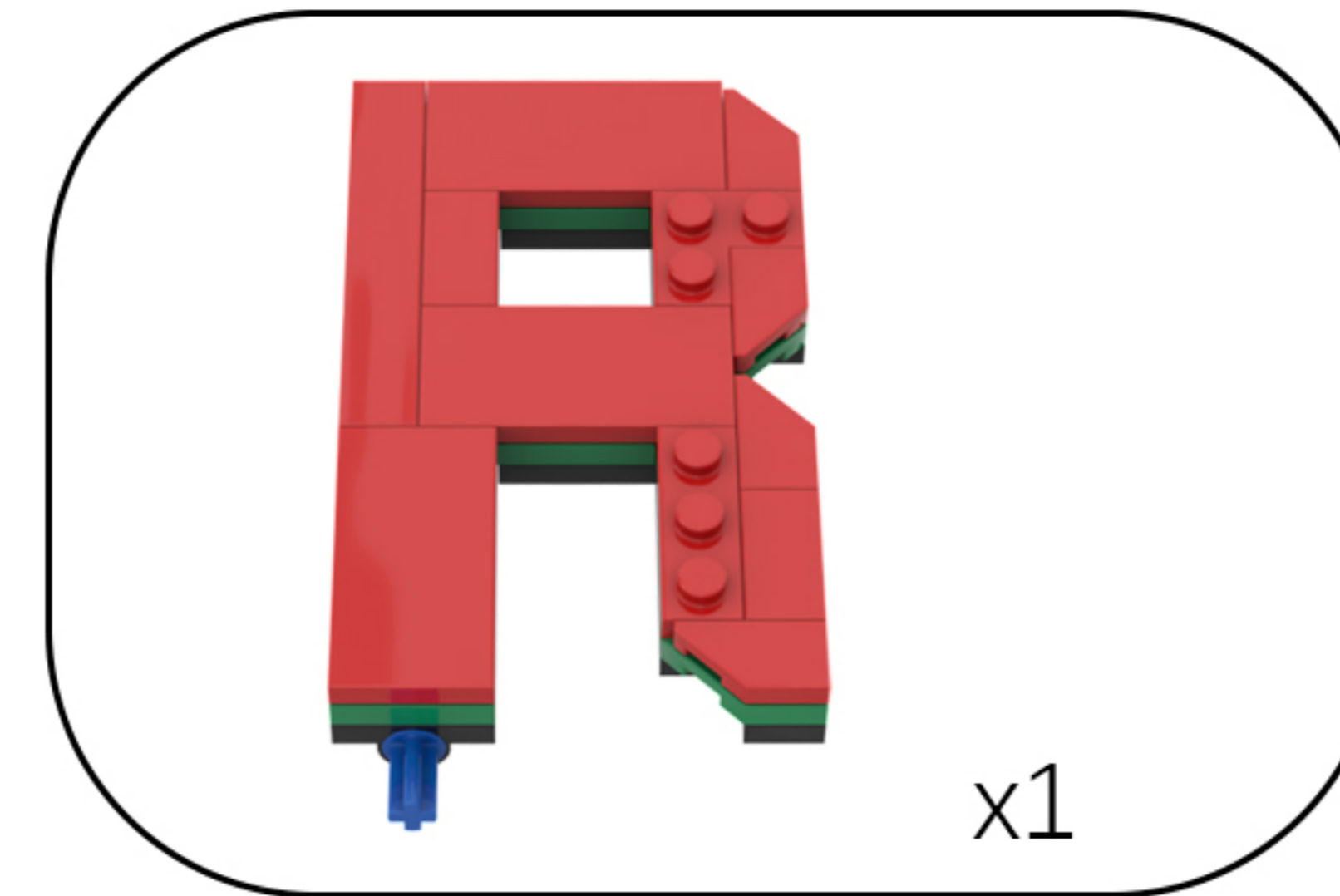
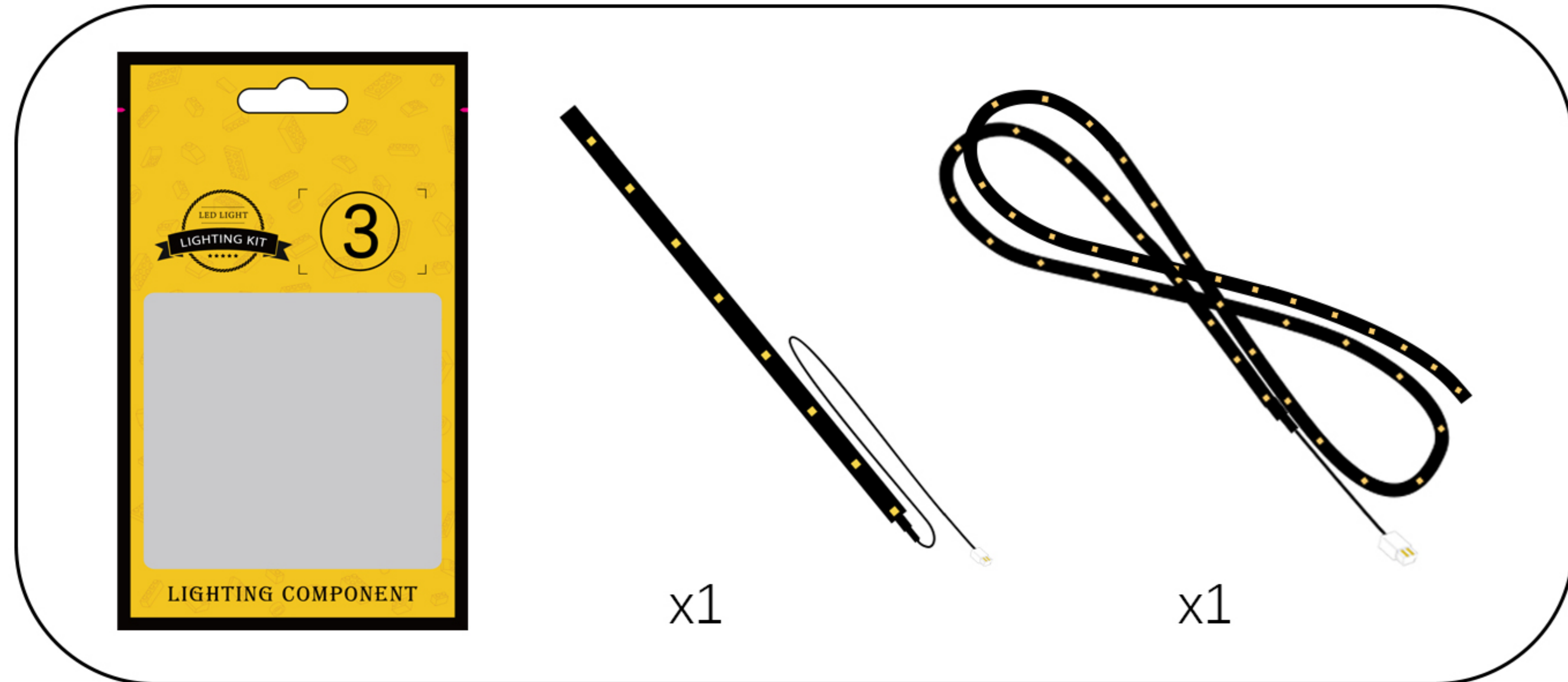

6

EN: Peel back the adhesive backing on the shorter strip of lights, and use tweezers to attach it to the location shown in the illustration.

DE: Ziehen Sie die Schutzfolie vom kürzeren Lichterkettenabschnitt ab und befestigen Sie ihn mit einer Pinzette an der in der Abbildung gezeigten Stelle.

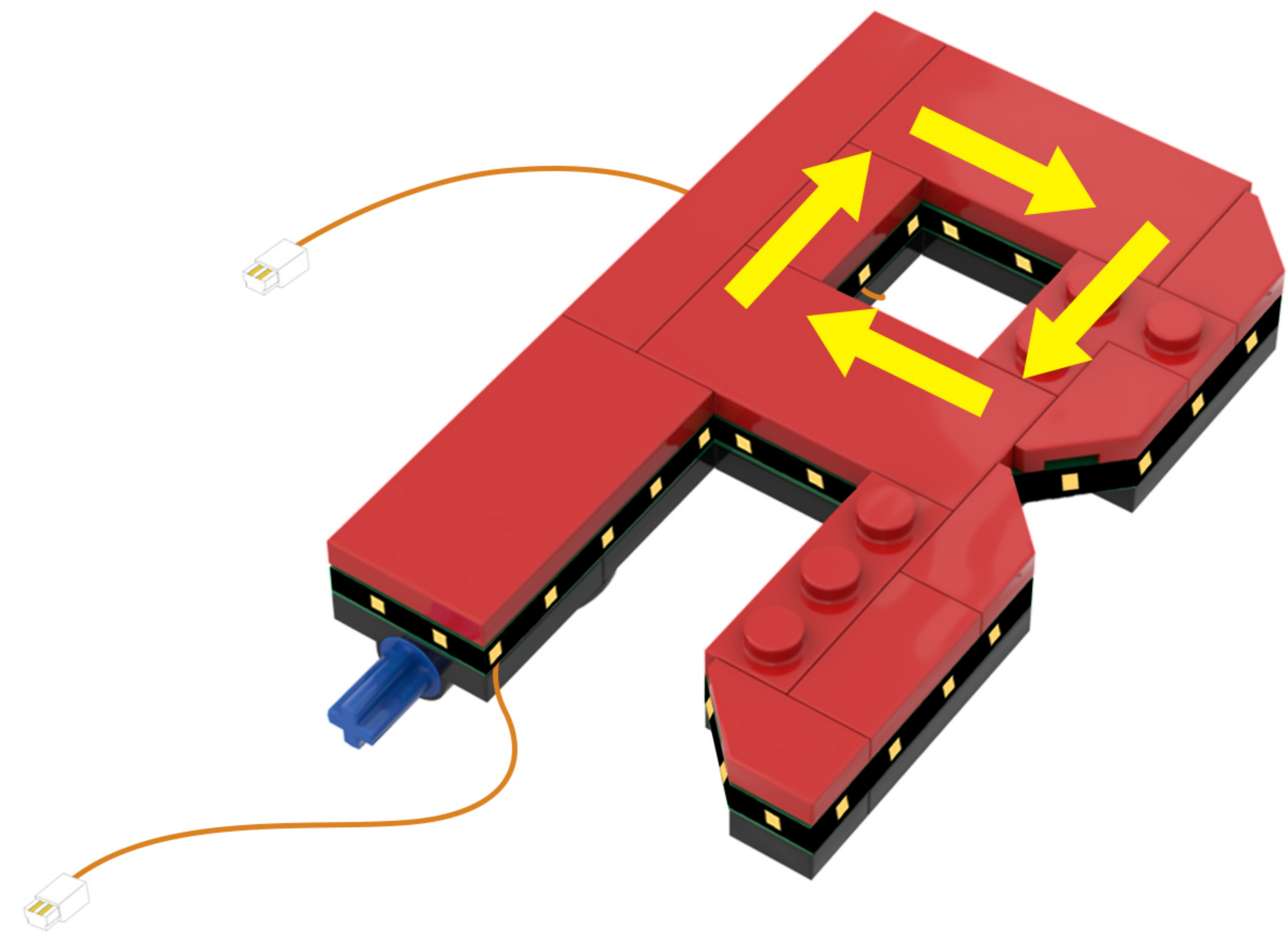
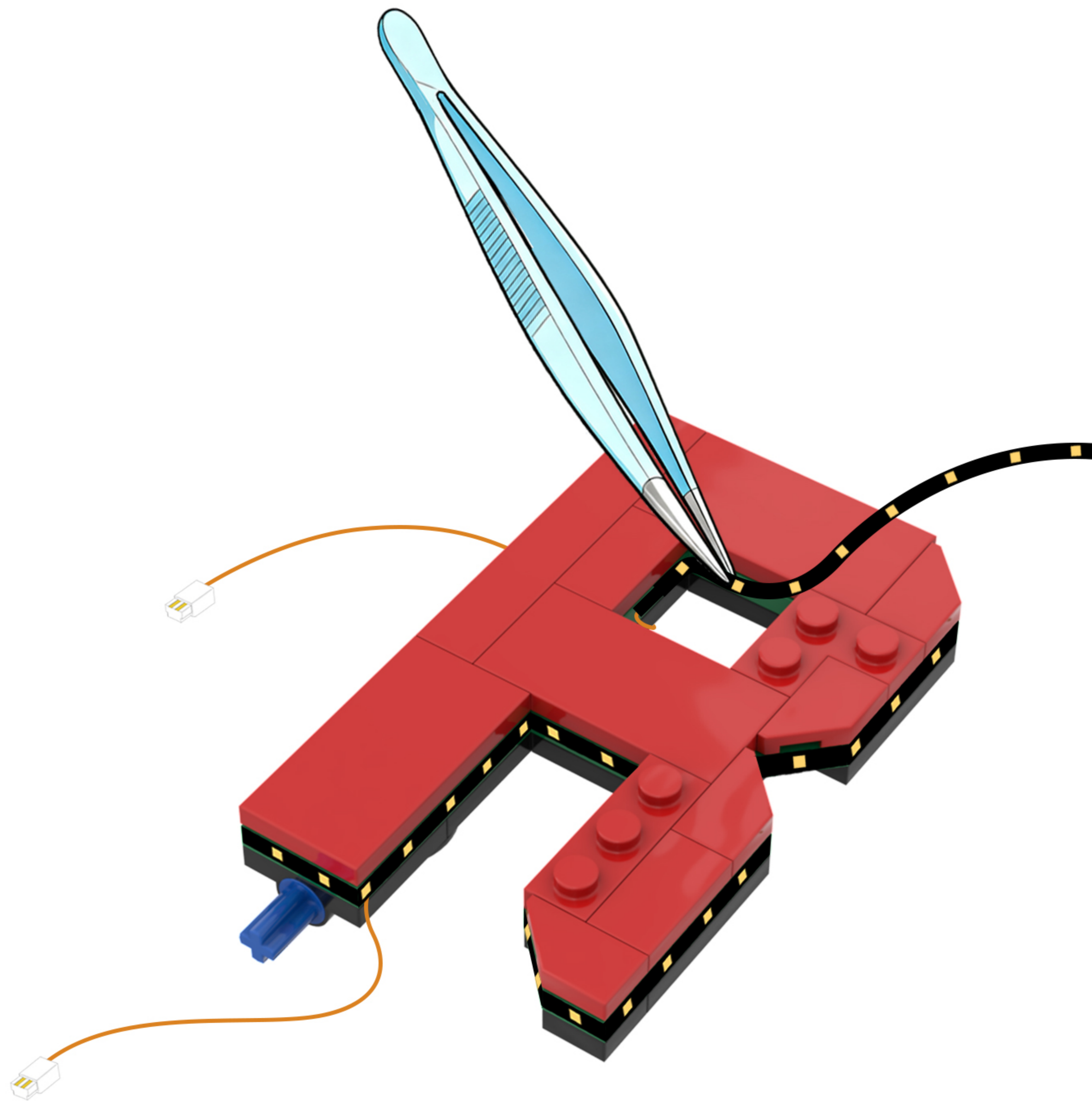

7

EN: Flip the model over so that the bottom is facing up.

DE: Drehen Sie das Modell um, sodass die Unterseite nach oben zeigt.

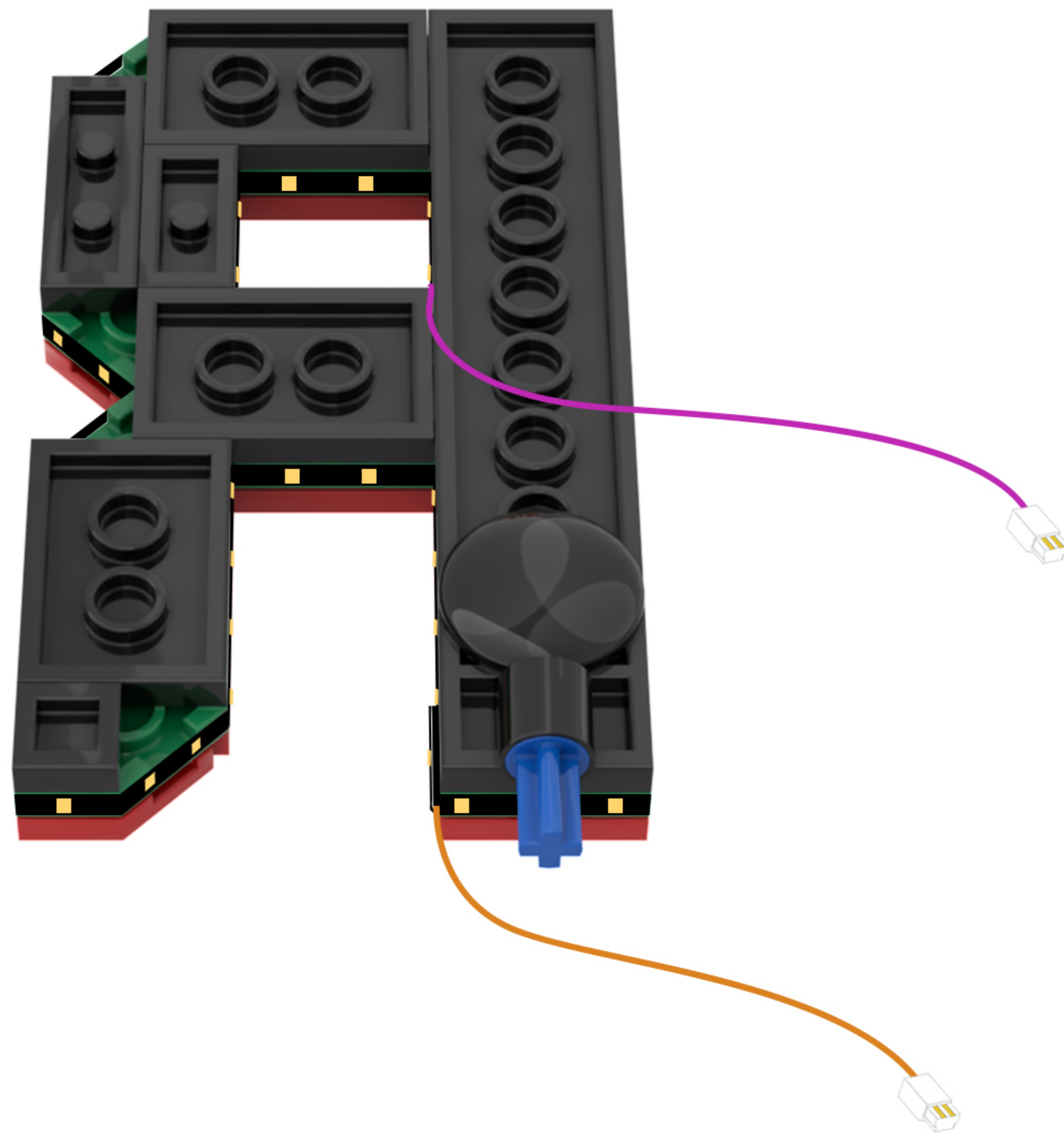
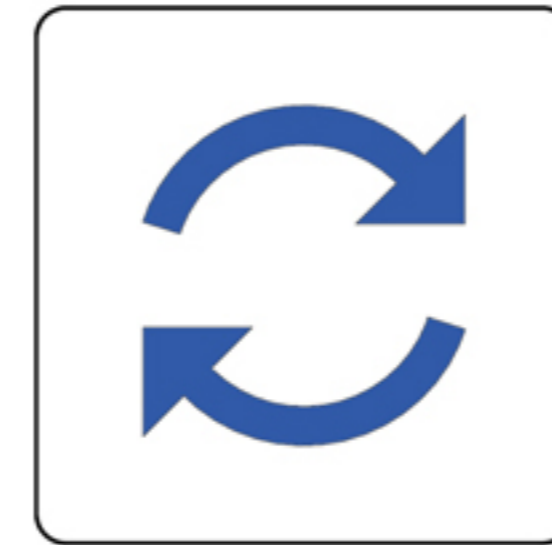

8

EN: Split as shown in the figure.

DE: Wie in der Abbildung gezeigt, teilen Sie es auf.

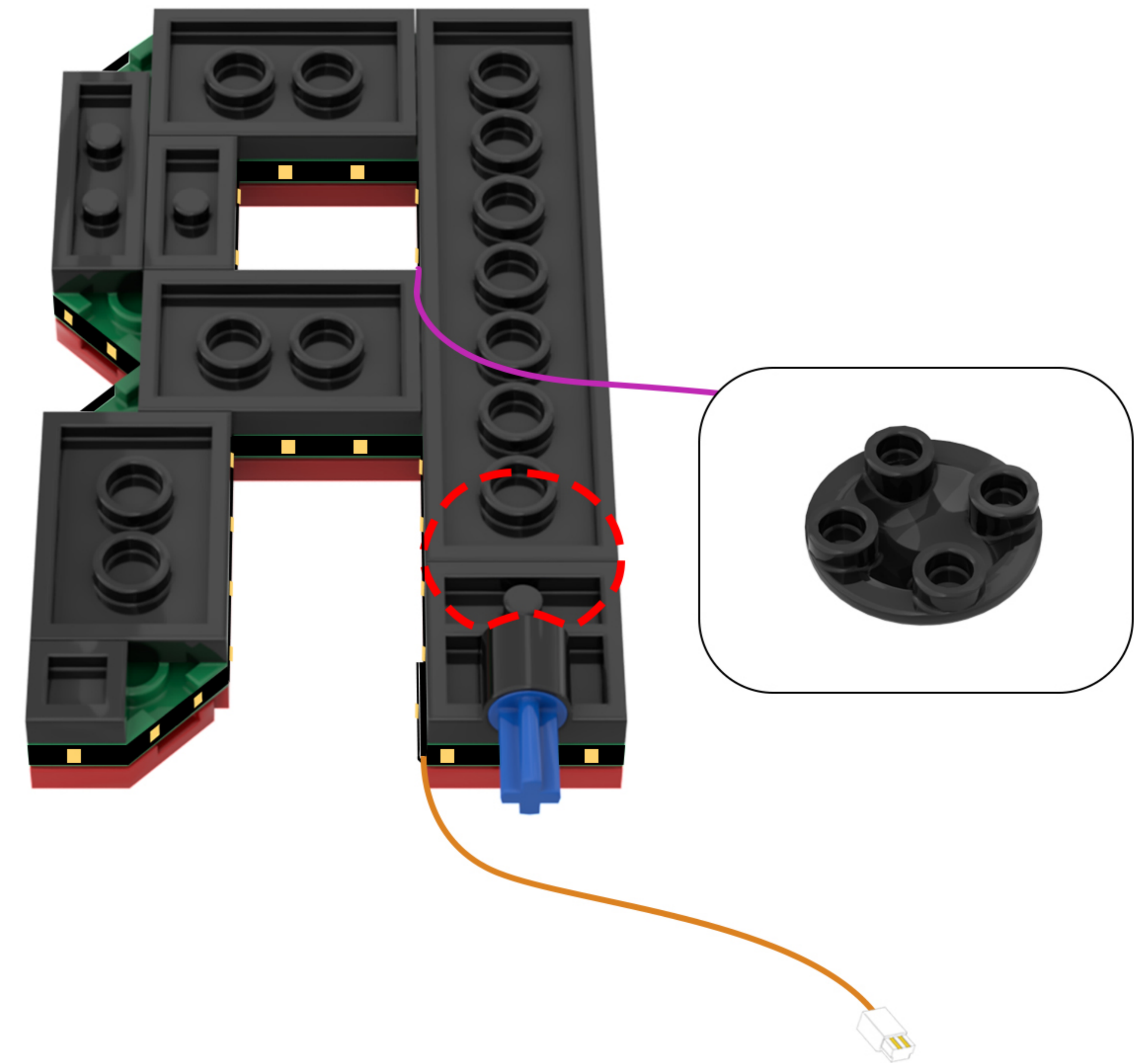

9

EN: Arrange the wires of the shorter light strip as shown in the diagram.

DE: Verlegen Sie die Kabel des kürzeren Lichterbands wie in der Abbildung gezeigt.

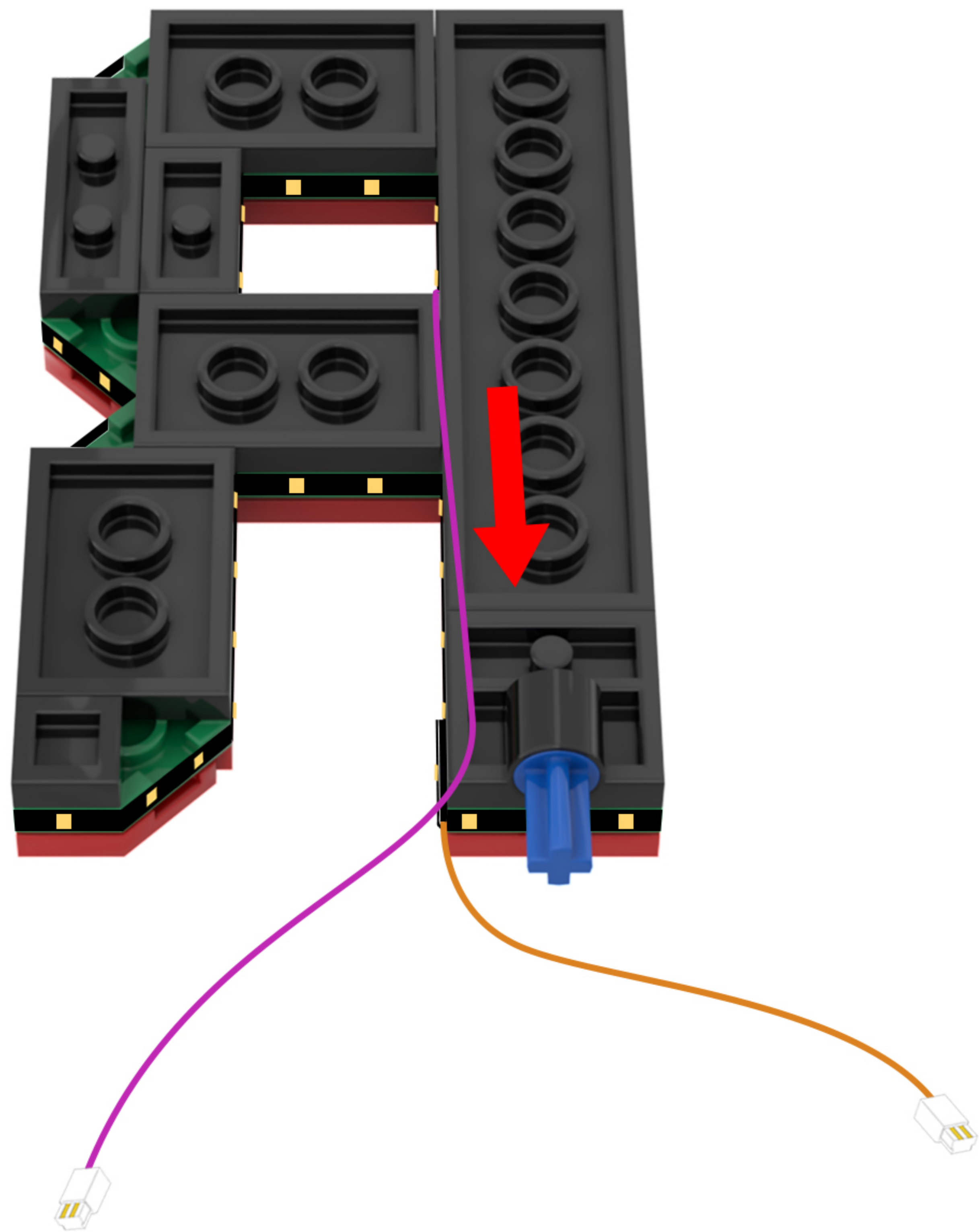

10

EN: Take out the disassembled building blocks, reassemble them, and secure the light cord.

DE: Nehmen Sie die zerlegten Bausteine heraus, setzen Sie sie wieder zusammen und befestigen Sie das Lichtkabel.

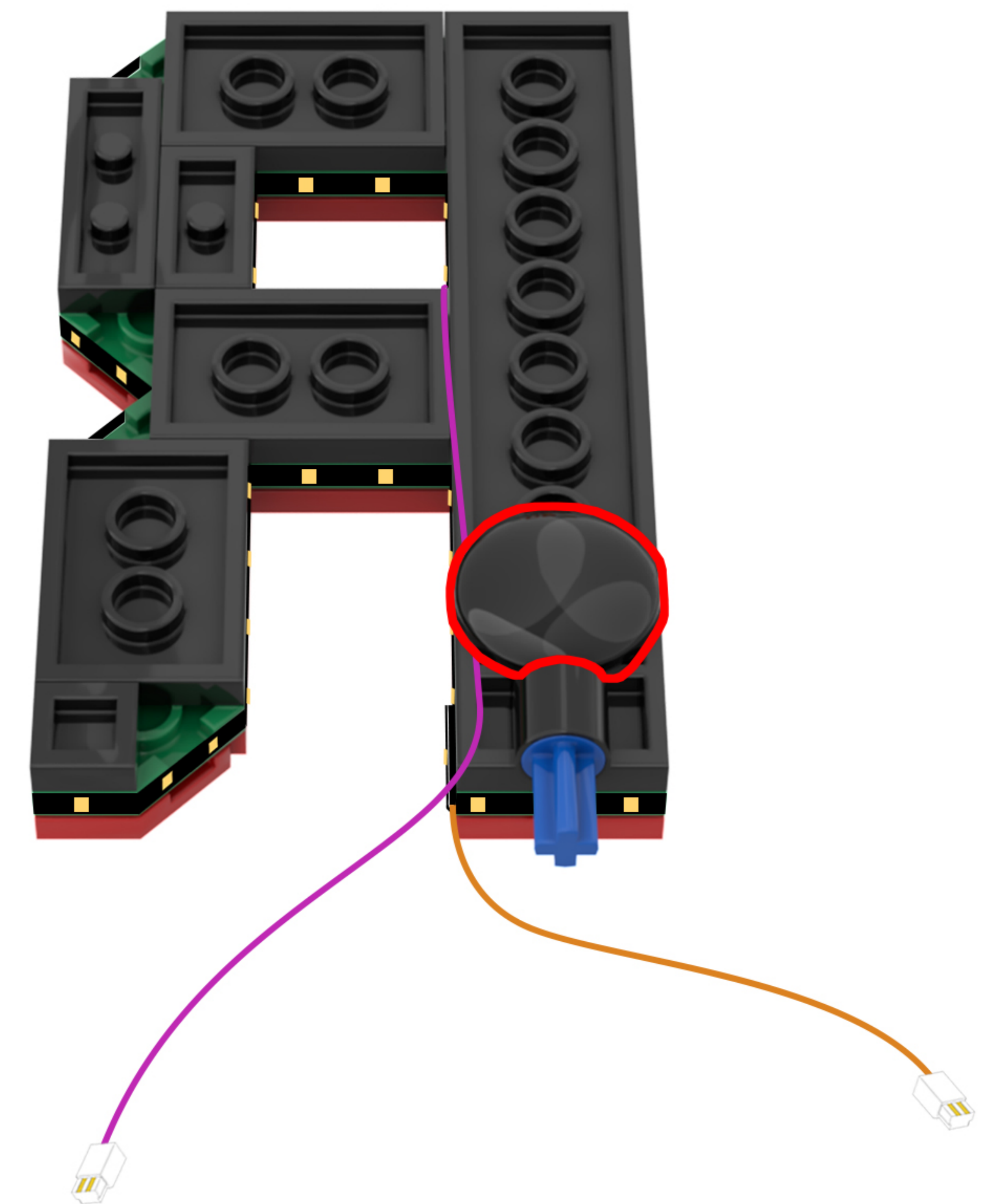
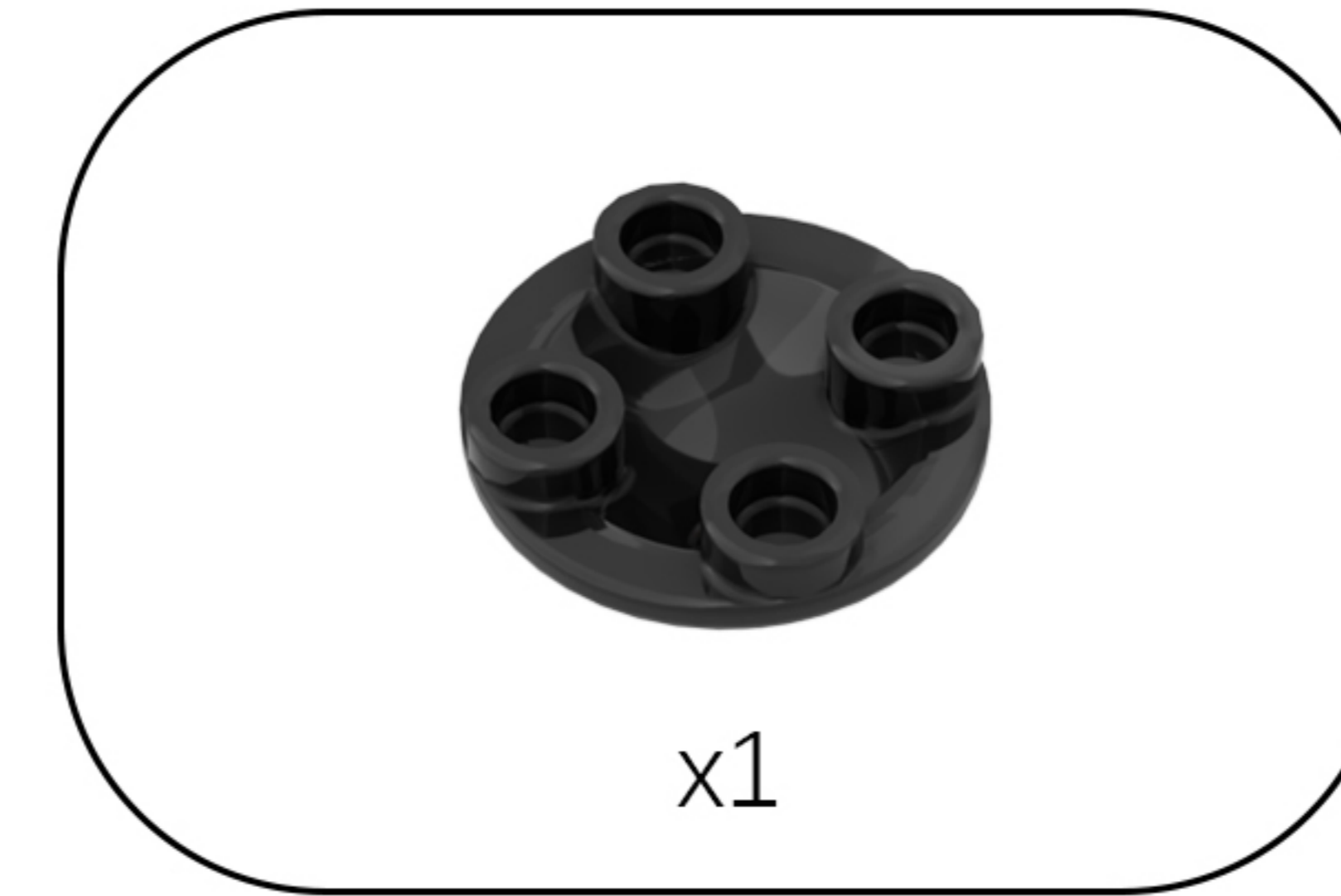

11

EN: Twist the two strands of string lights together.

DE: Verdrehen Sie die beiden Lichterketten miteinander.

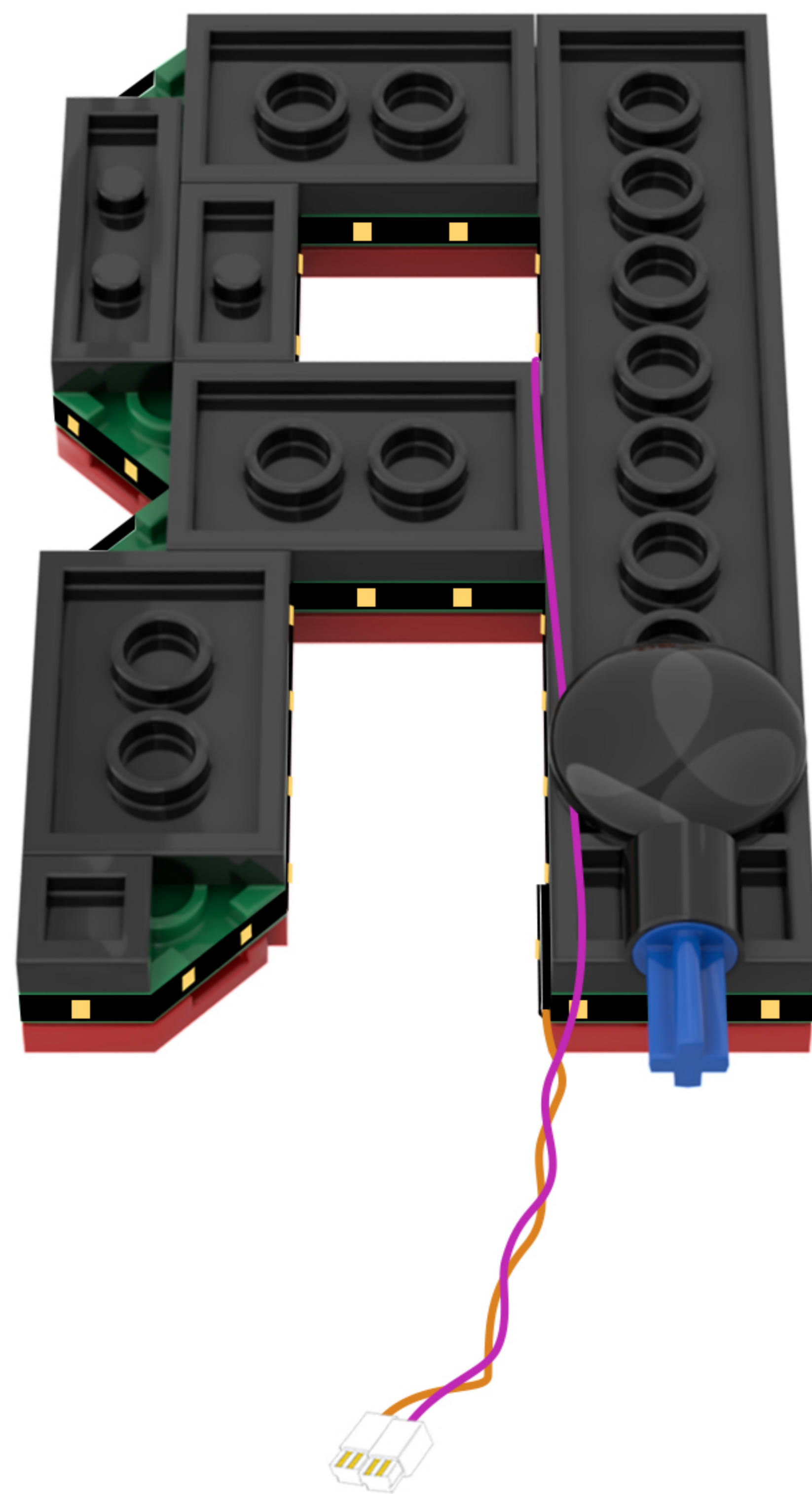

12

EN: Take the string lights out of Bag 4 and remove the disassembled building blocks.

DE: Nimm die Lichterkette aus Beutel 4 heraus und entferne die zerlegten Bausteine.

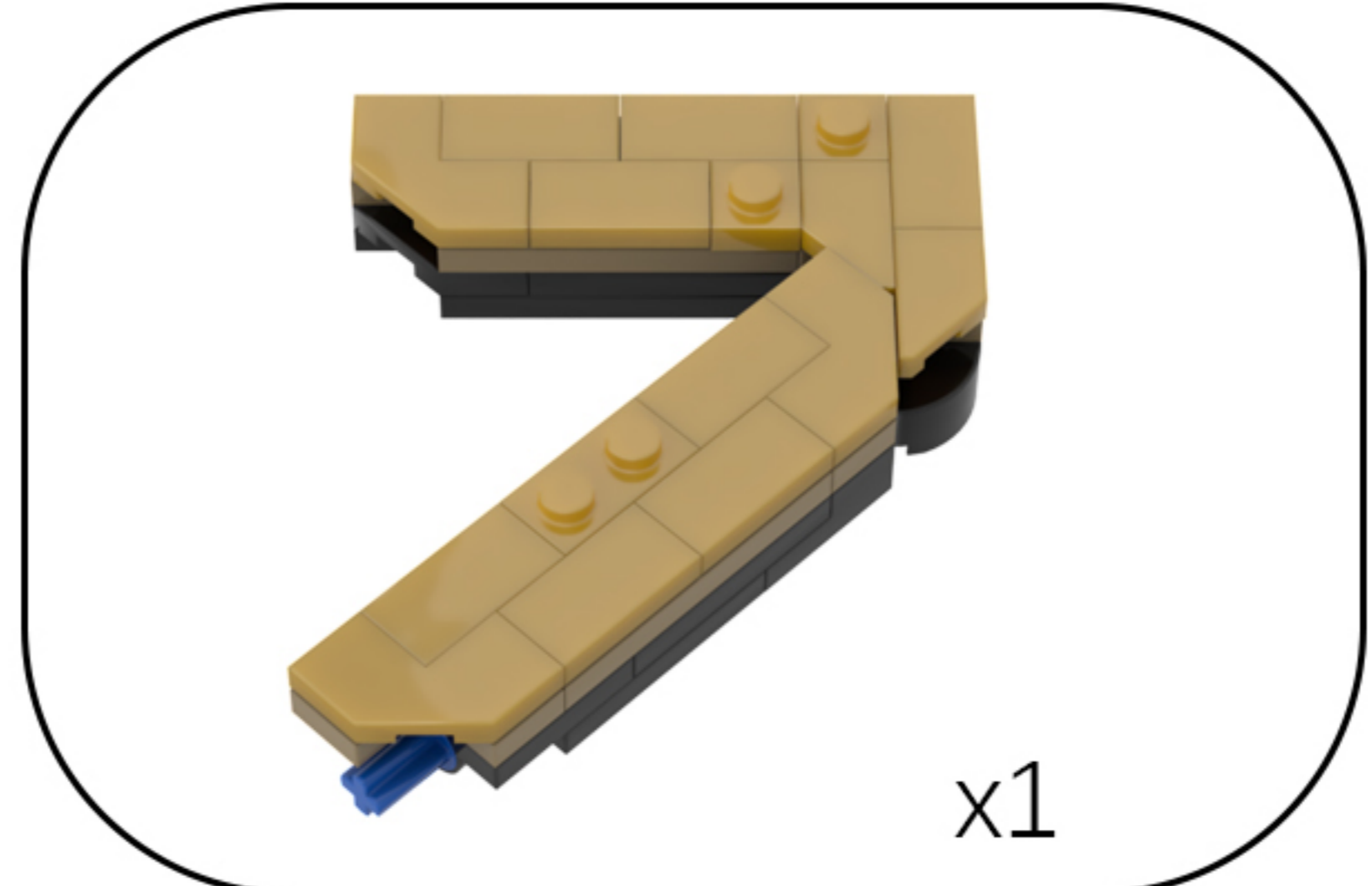
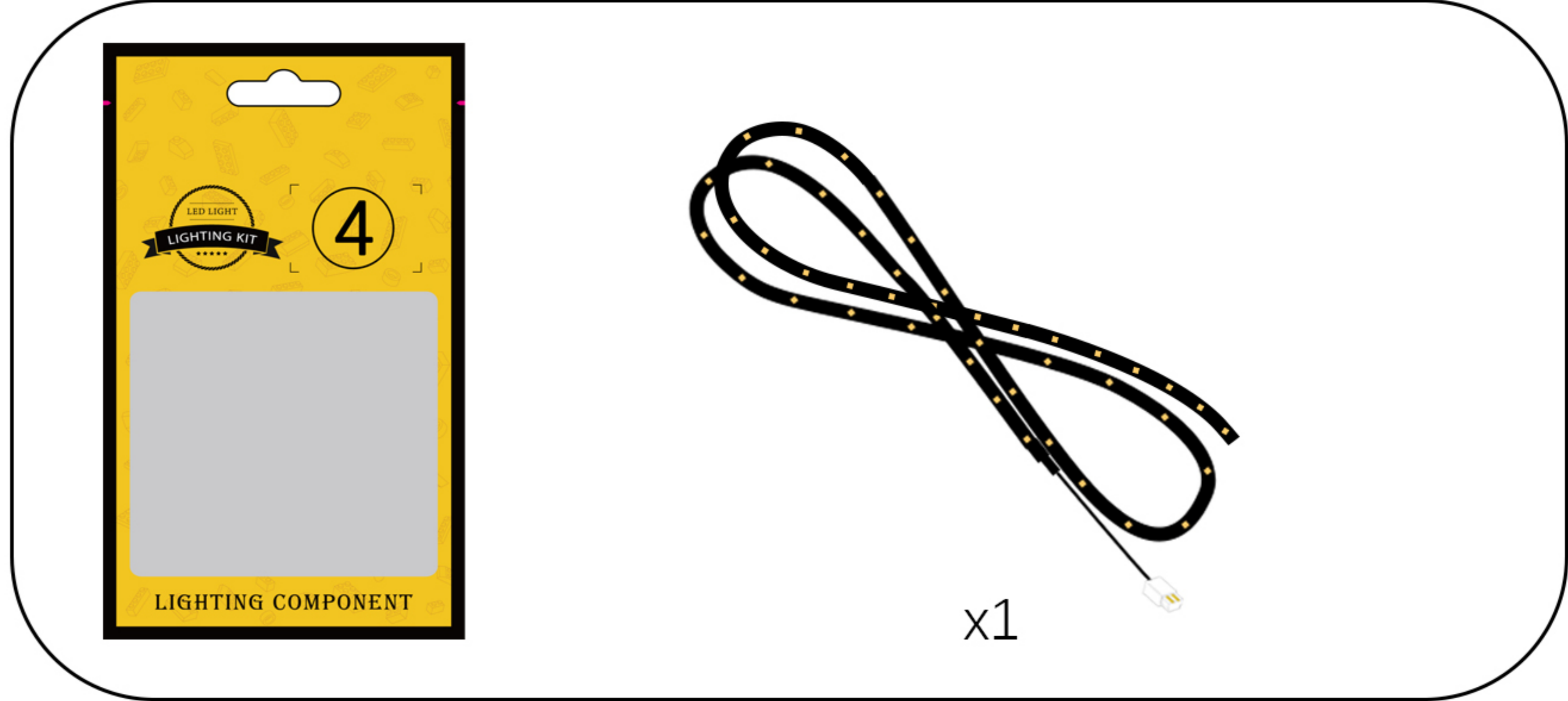

13

EN: Peel off the adhesive backing from the light strip and wrap it around the building block.

DE: Zieh die Schutzfolie vom Leuchtband ab und wickle es um den Baustein.

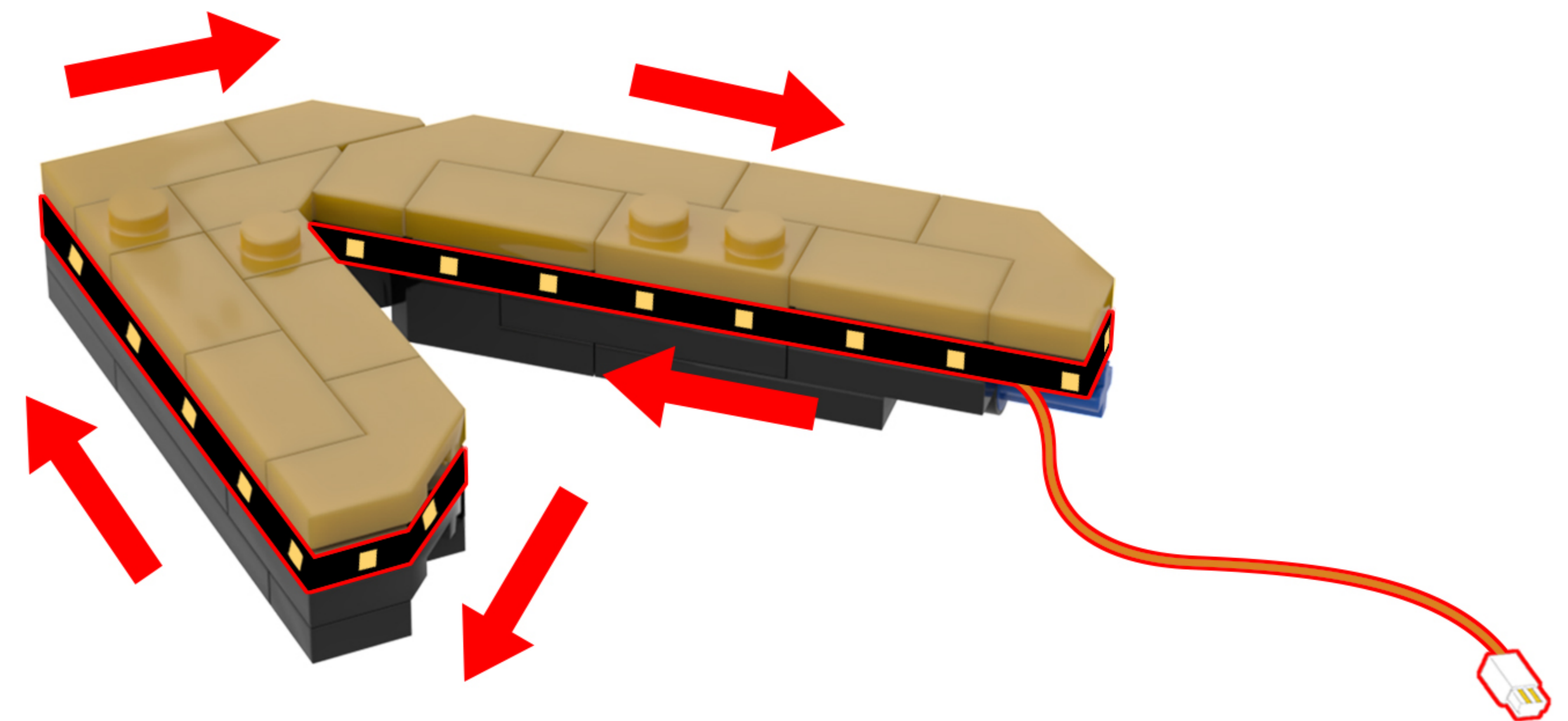
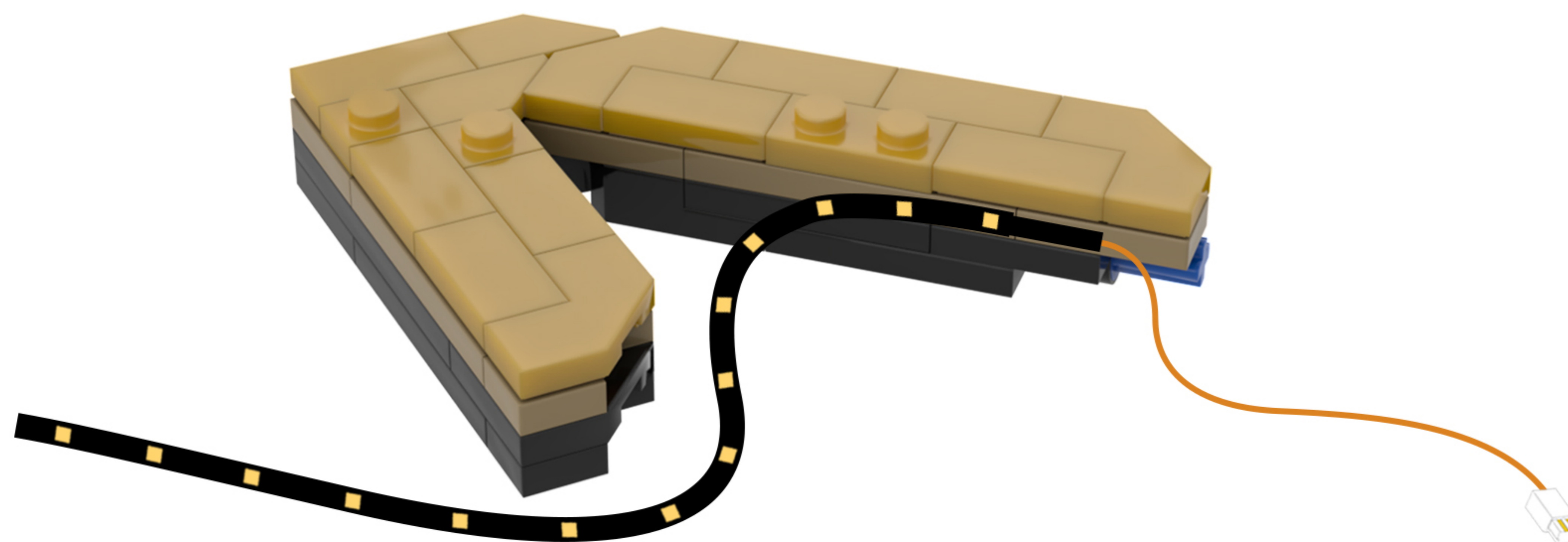

14

EN: Take the string lights out of Bag 5, along with the disassembled building blocks. Peel off the adhesive backing on the string lights and attach them to the locations shown in the diagram.

DE: Nimm die Lichterkette zusammen mit den zerlegten Bausteinen aus Beutel 5 heraus. Ziehe die Schutzfolie von der Lichterkette ab und befestige sie an den in der Abbildung gezeigten Stellen.

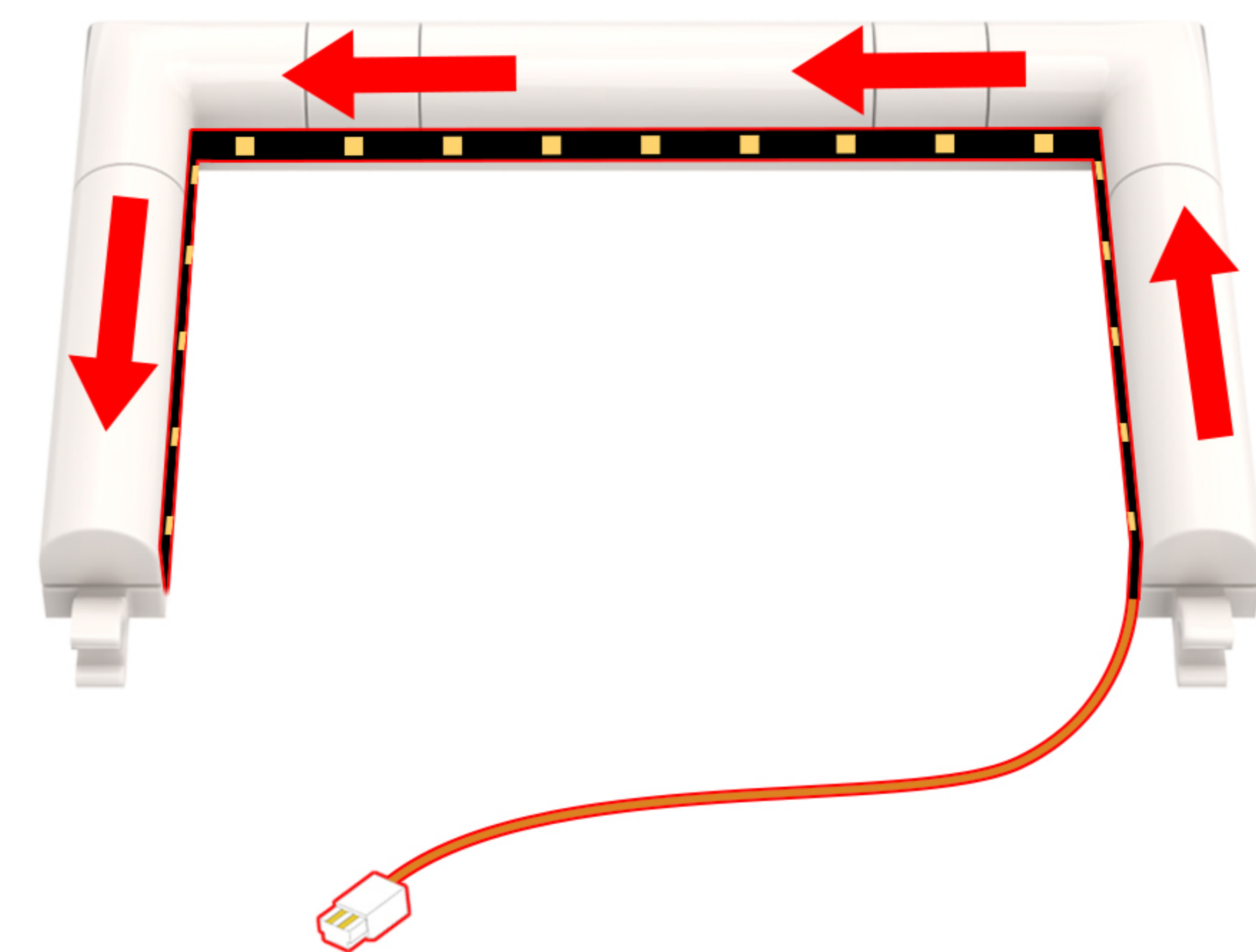
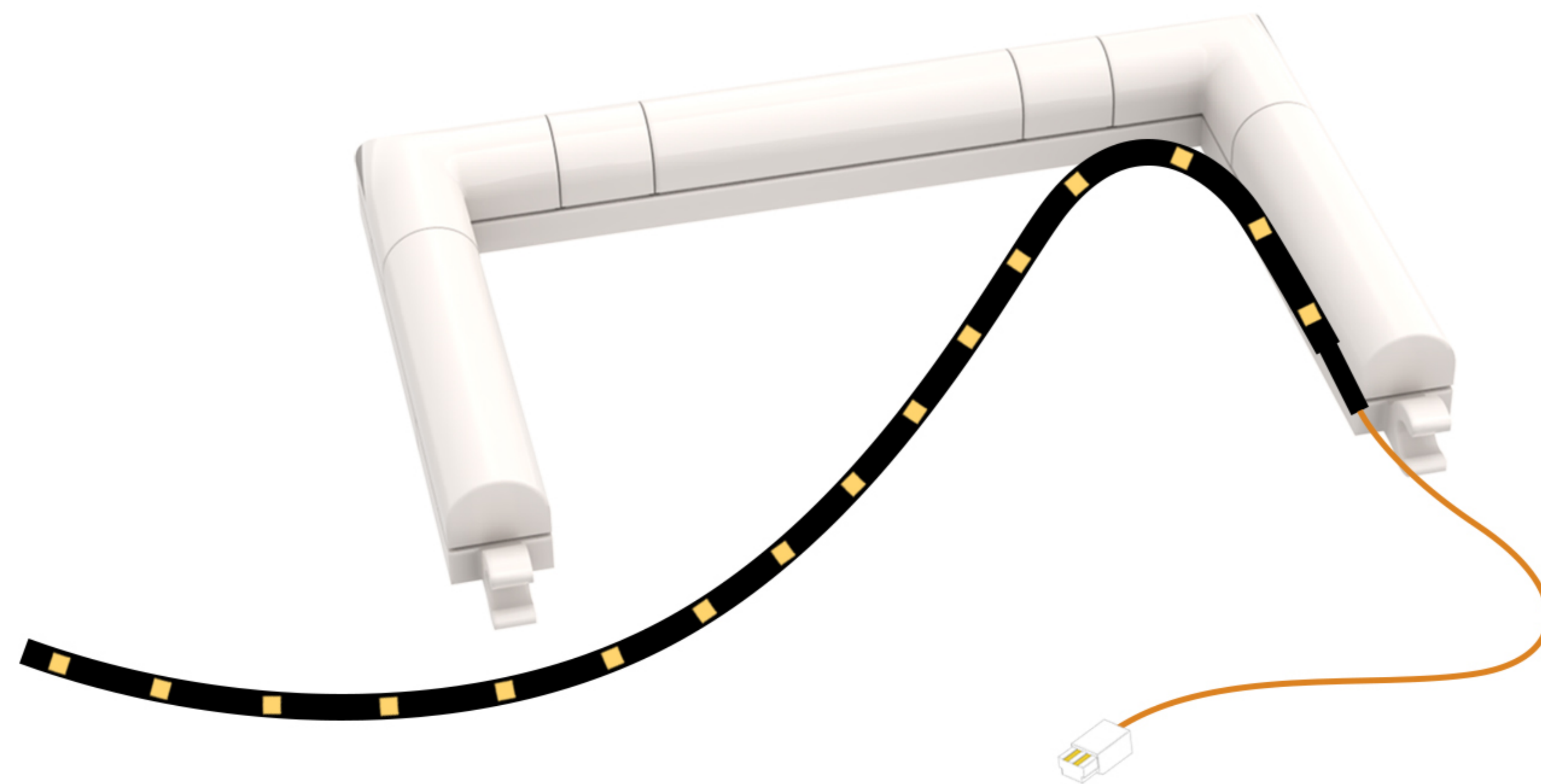
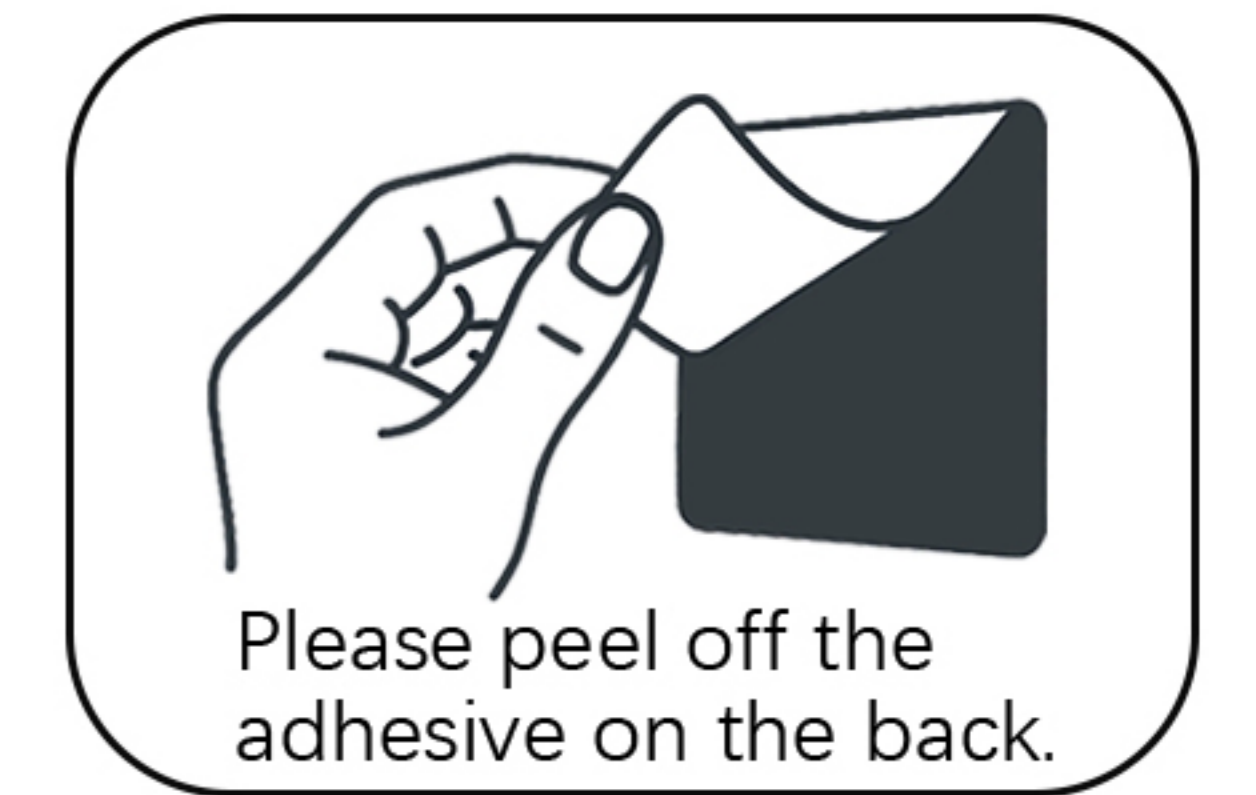
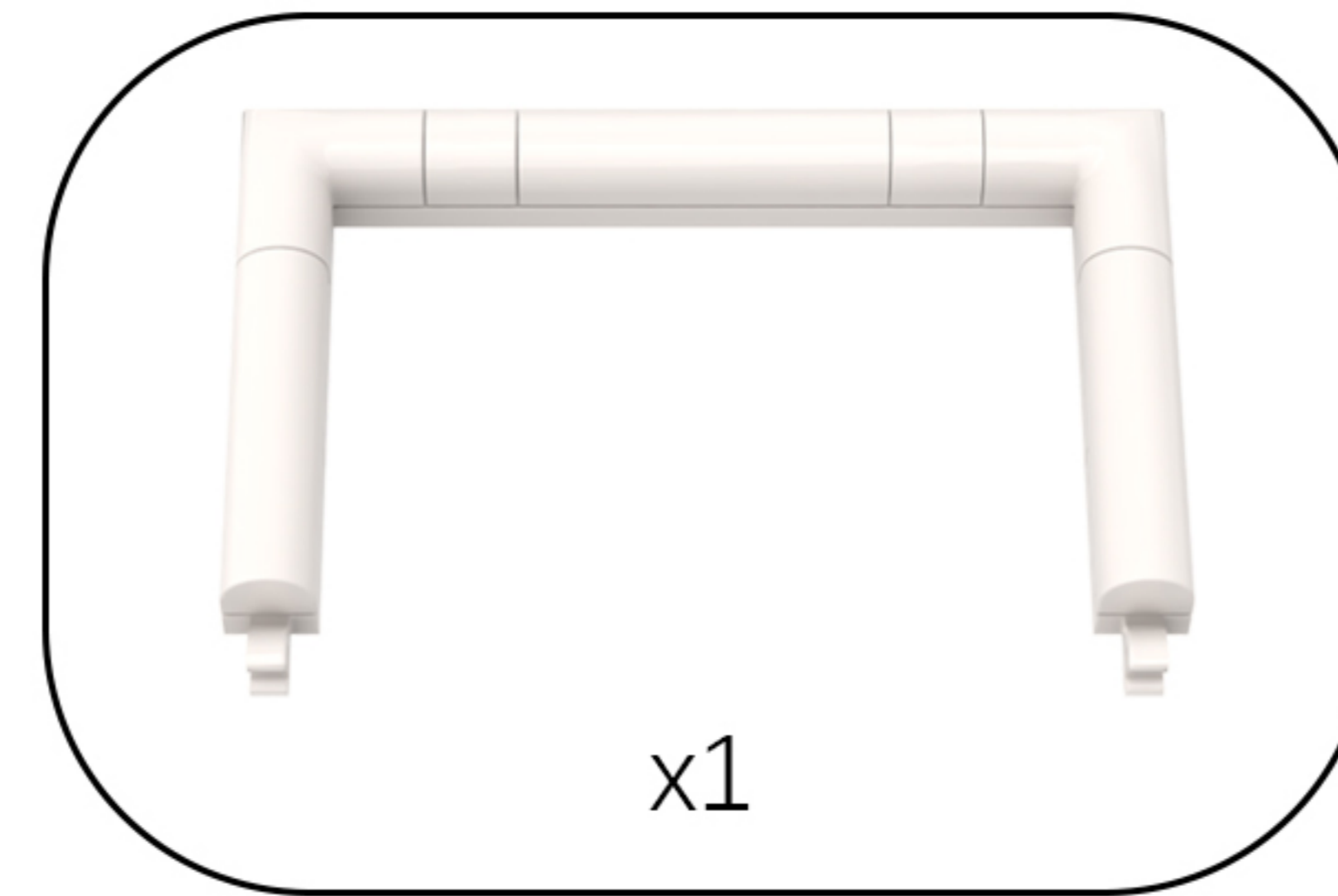
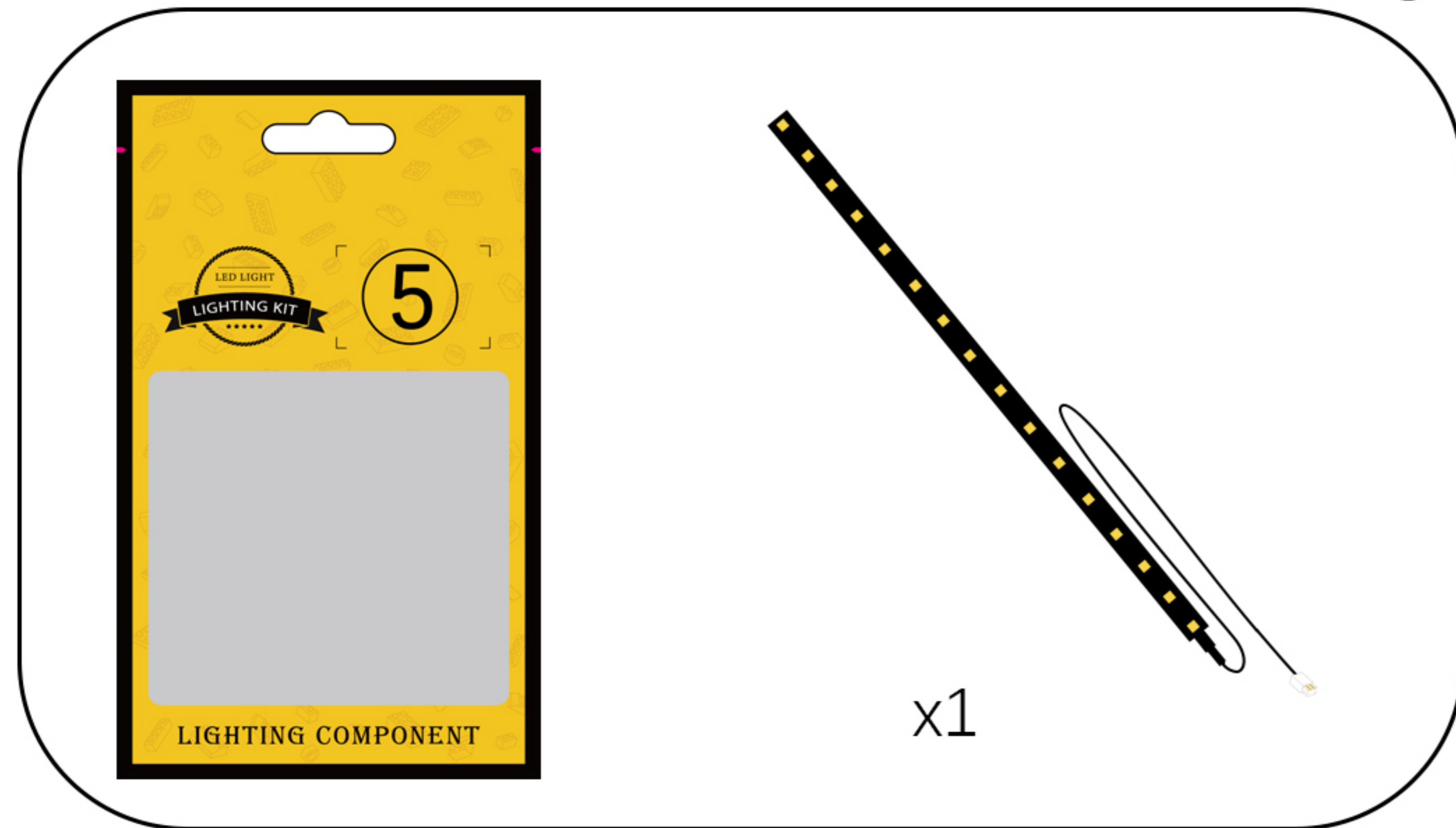

15

EN: Returning to the model, look at the brick component highlighted in the image.

DE: Kehren Sie zum Modell zurück und betrachten Sie die im Bild hervorgehobene Ziegelkomponente.



16

EN: Split as shown in the figure.

DE: Wie in der Abbildung gezeigt, teilen Sie es auf.

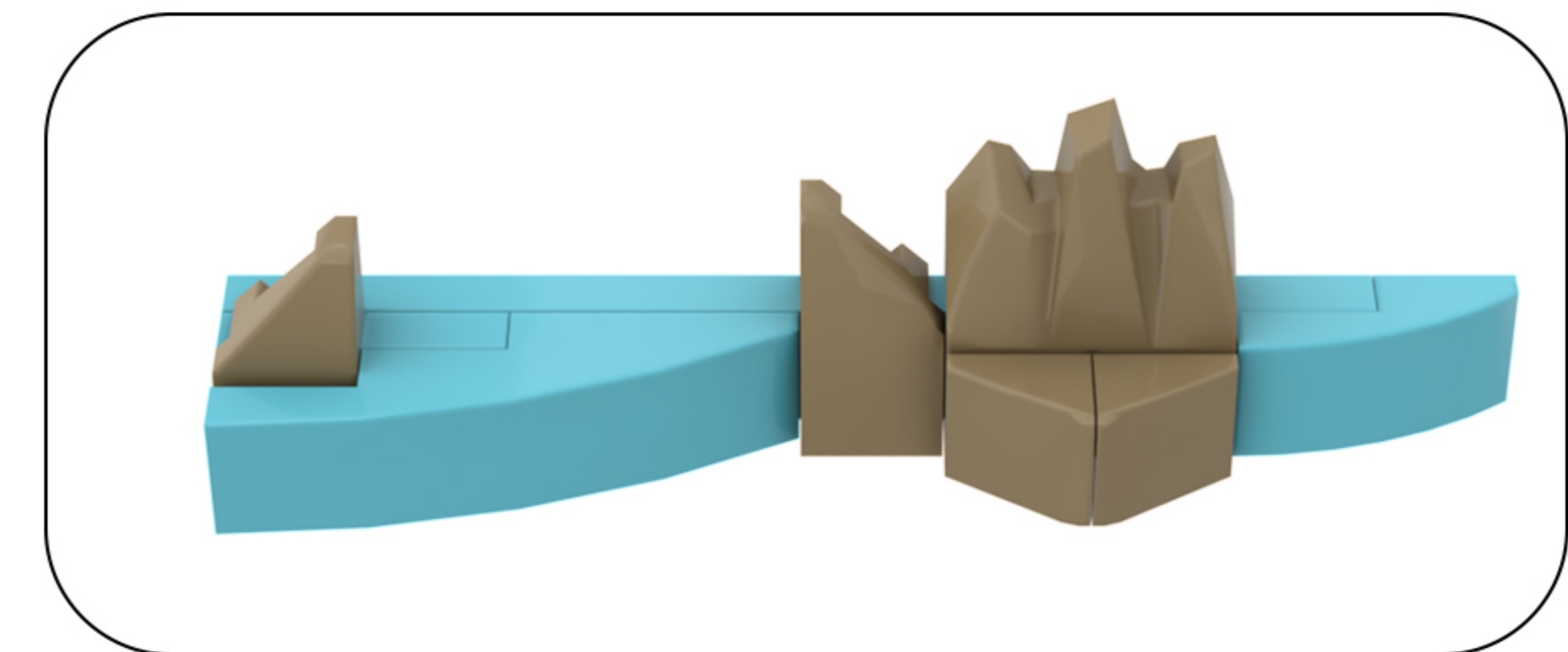
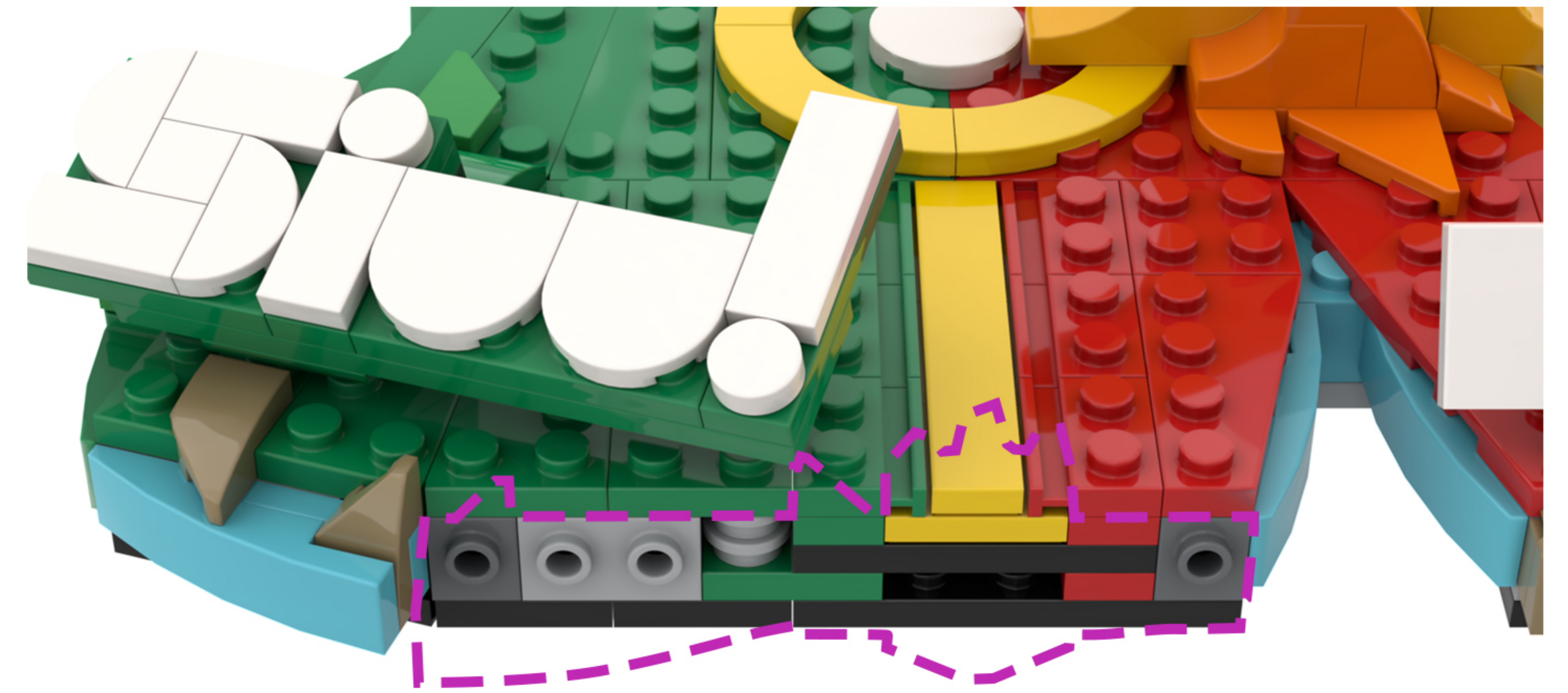

17

EN: Take out the disassembled building blocks and separate them.

DE: Nehmen Sie die zerlegten Bausteine heraus und trennen Sie sie voneinander.

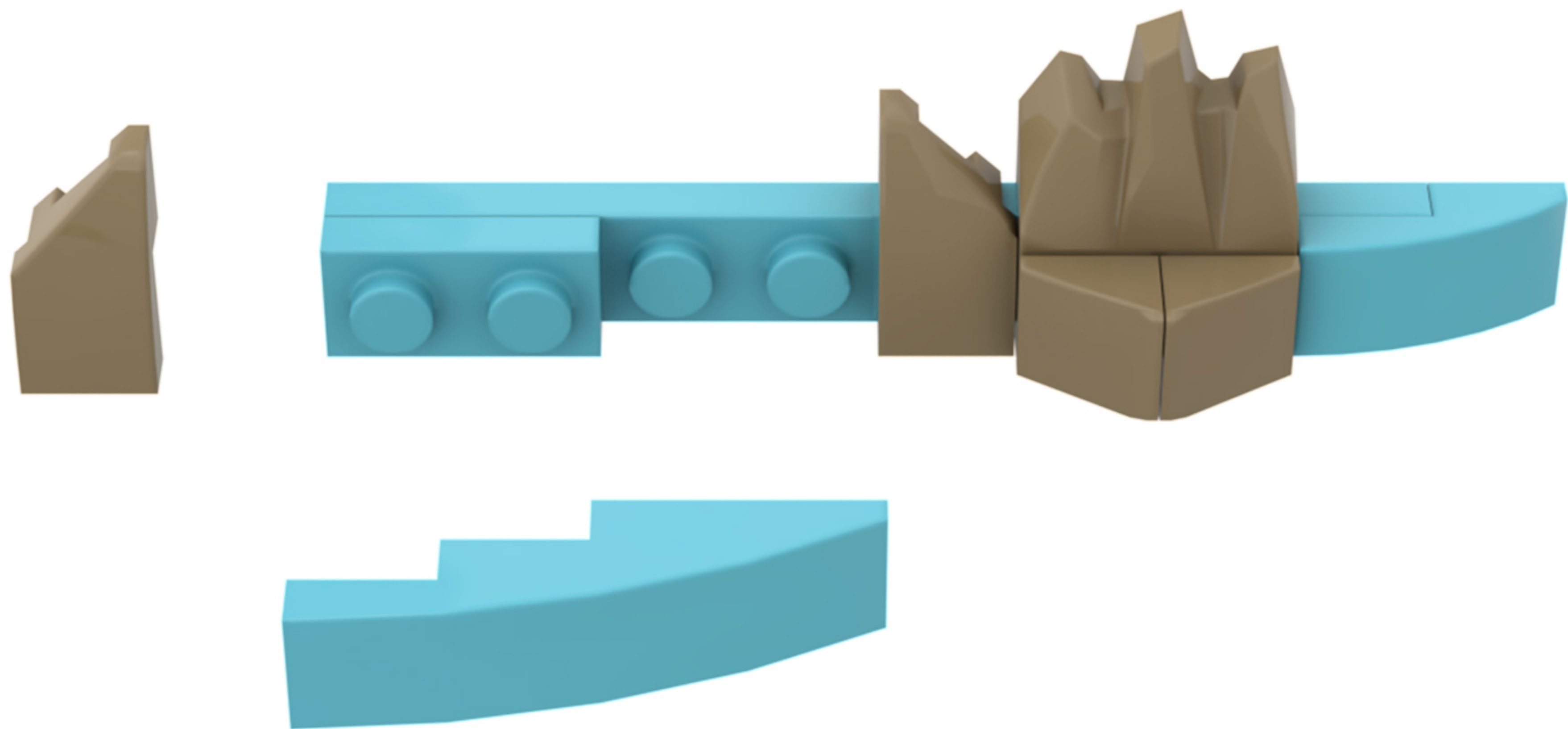
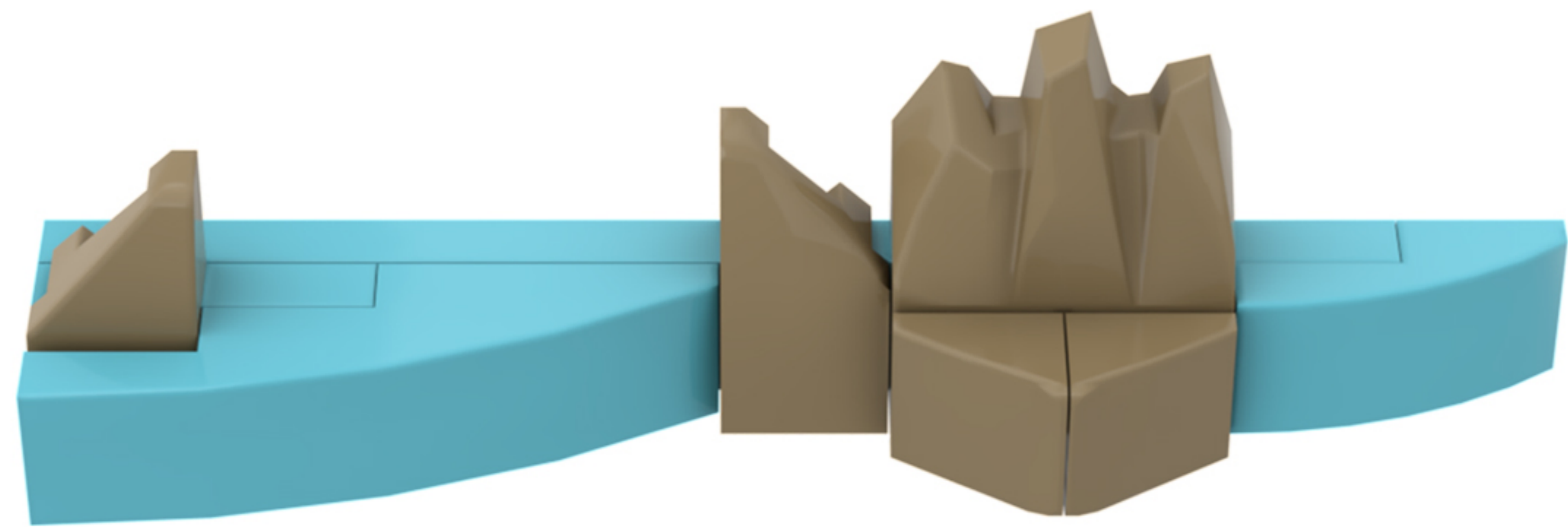
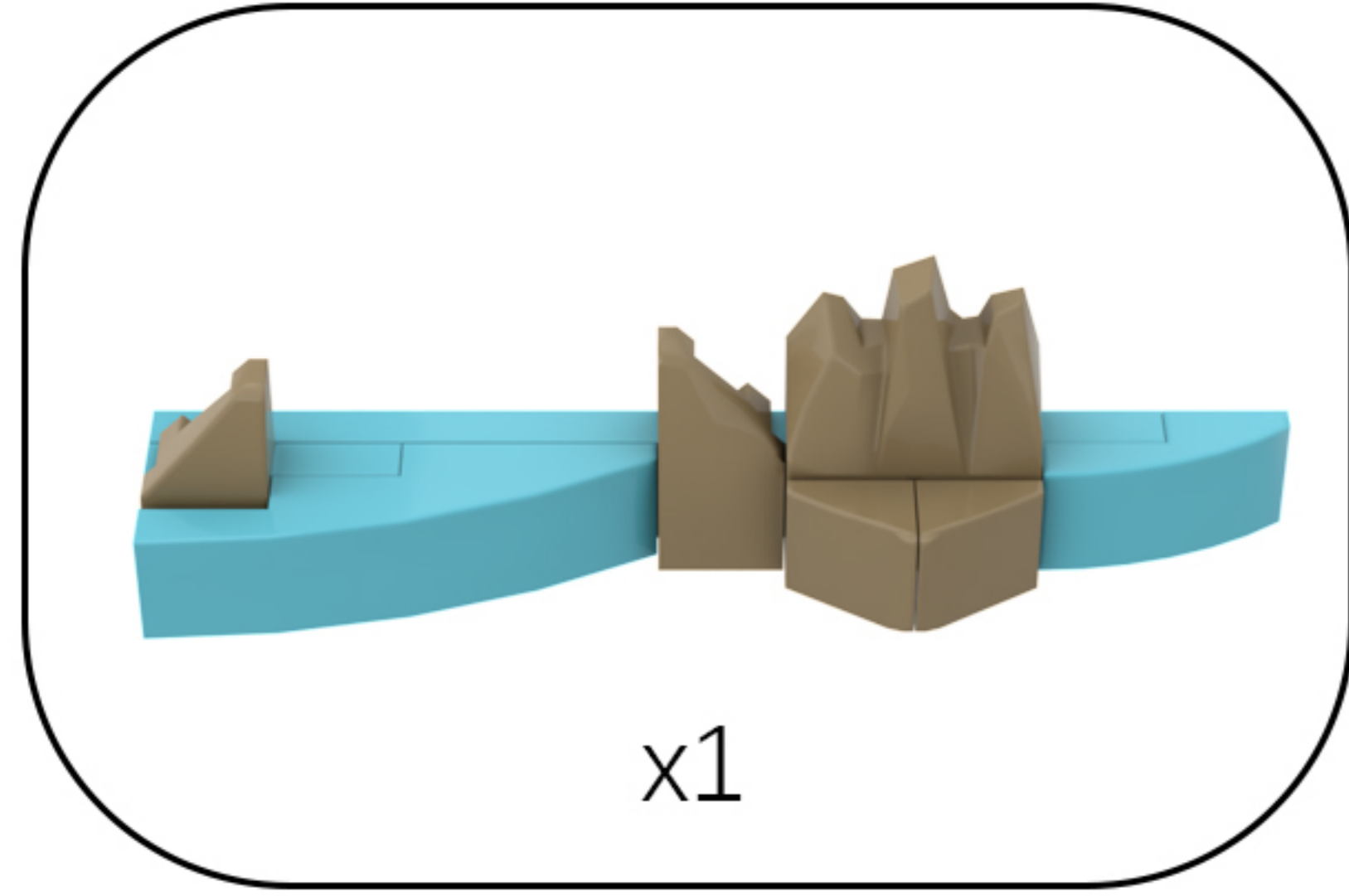

18

EN: Take the string of lights out of Bag 1 and attach it to the building block.

DE: Nimm die Lichterkette aus Beutel 1 heraus und befestige sie am Baustein.

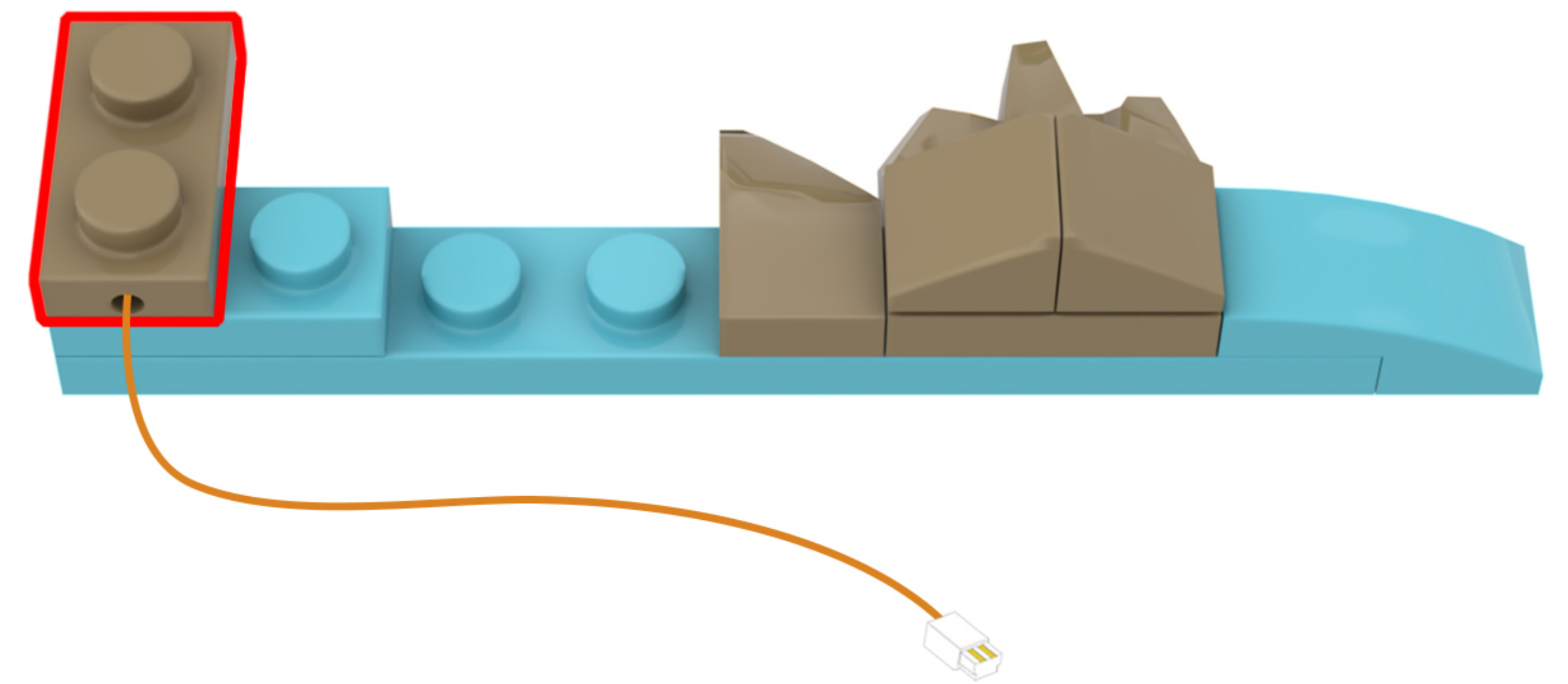
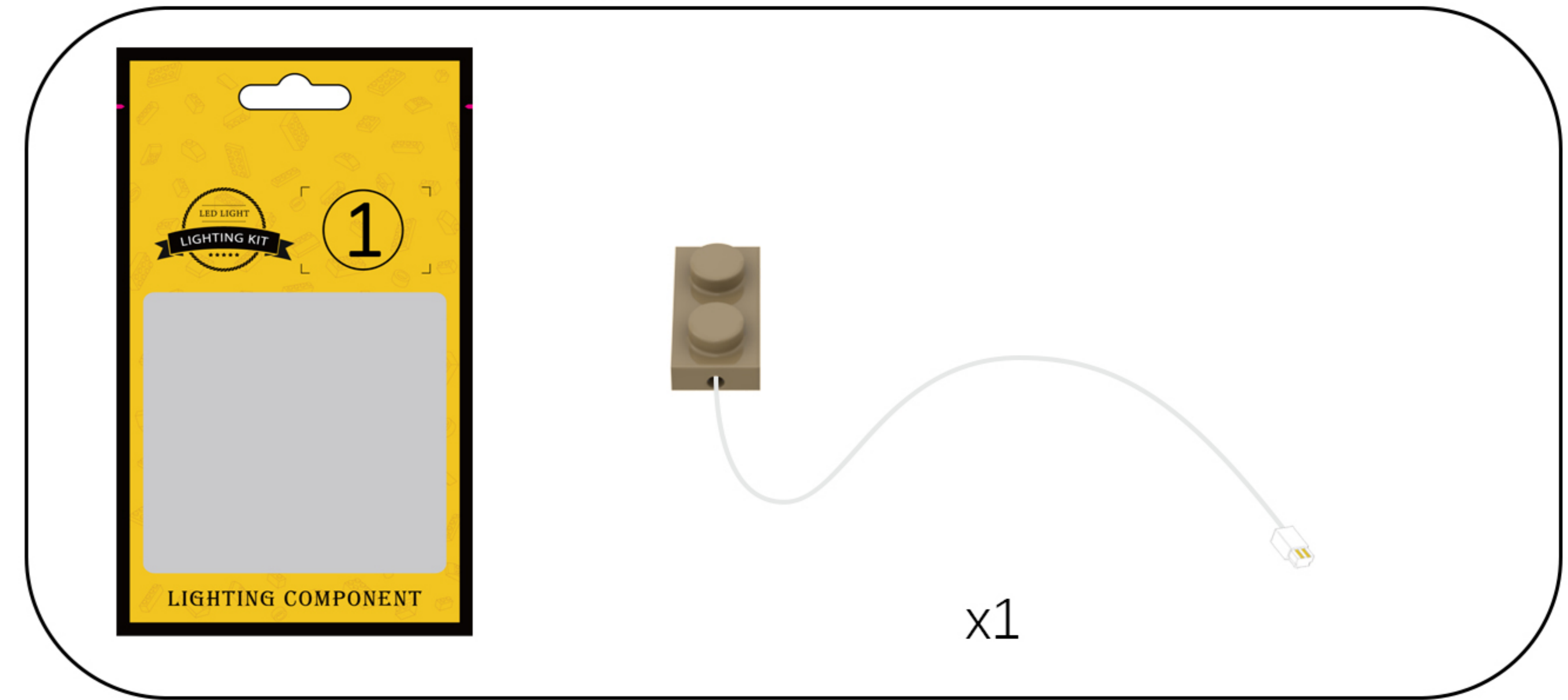

19

EN: Take out the disassembled building blocks and reassemble them.

DE: Nehmen Sie die zerlegten Bausteine heraus und setzen Sie sie wieder zusammen.

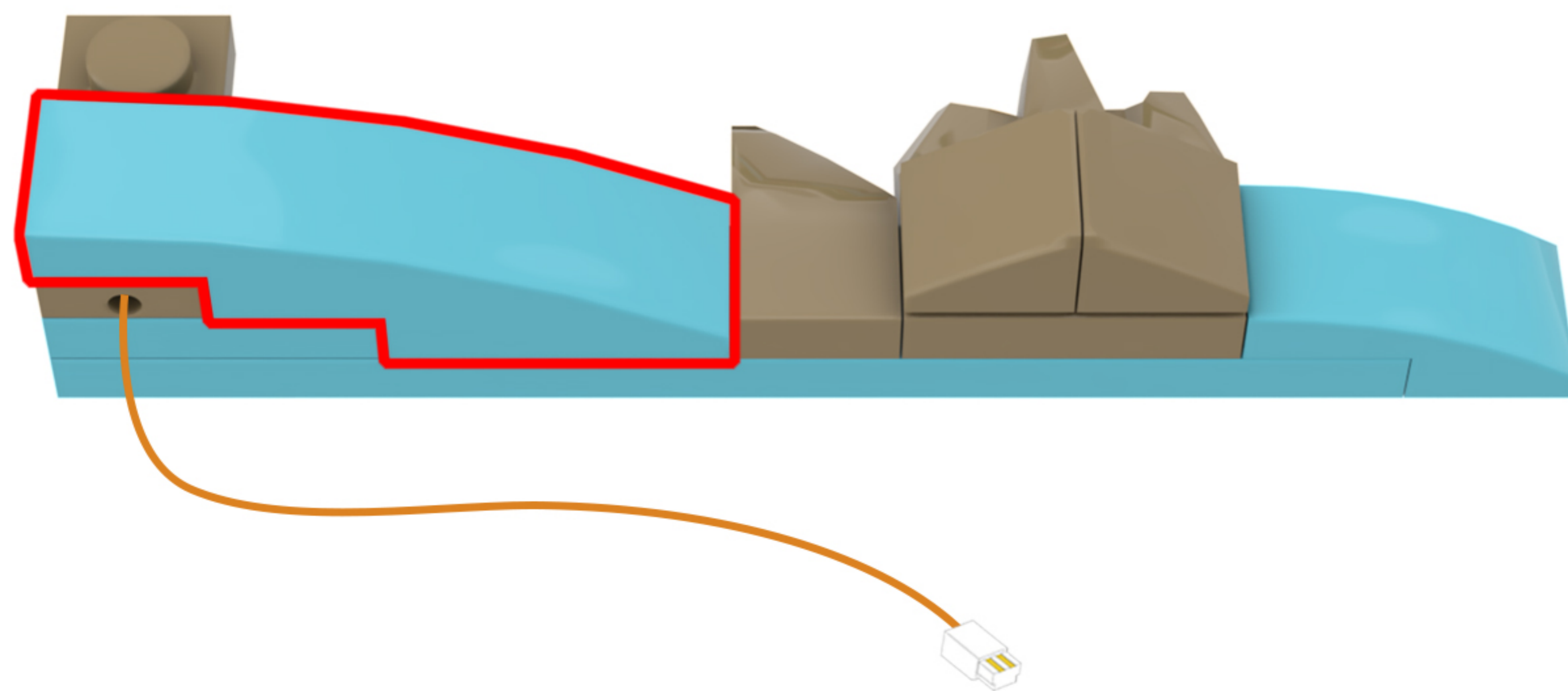
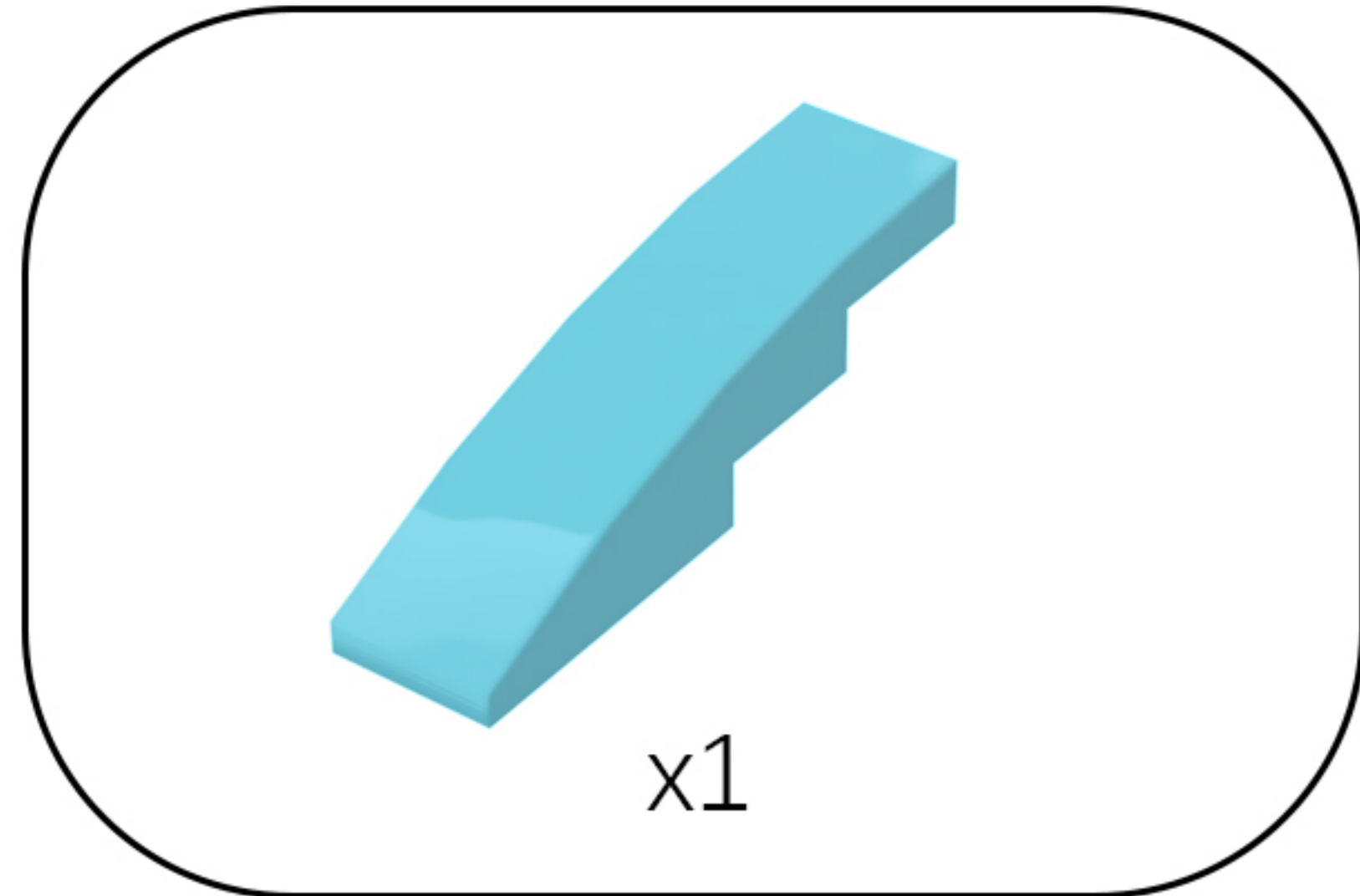

20

EN: Restore the building blocks.

DE: Stellen Sie die Bausteine wieder her.

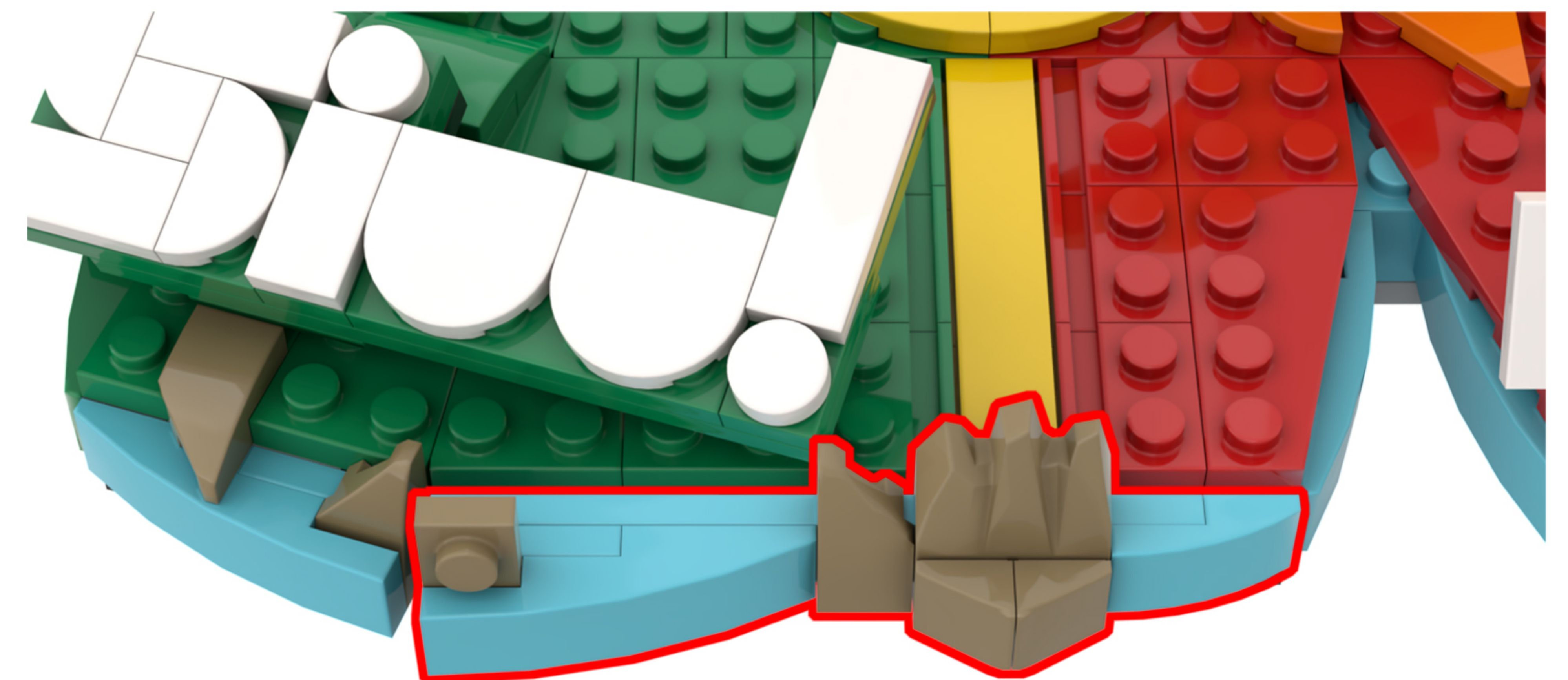

21

EN: Rotate the model to the side.

DE: Drehen Sie das Modell zur Seite.

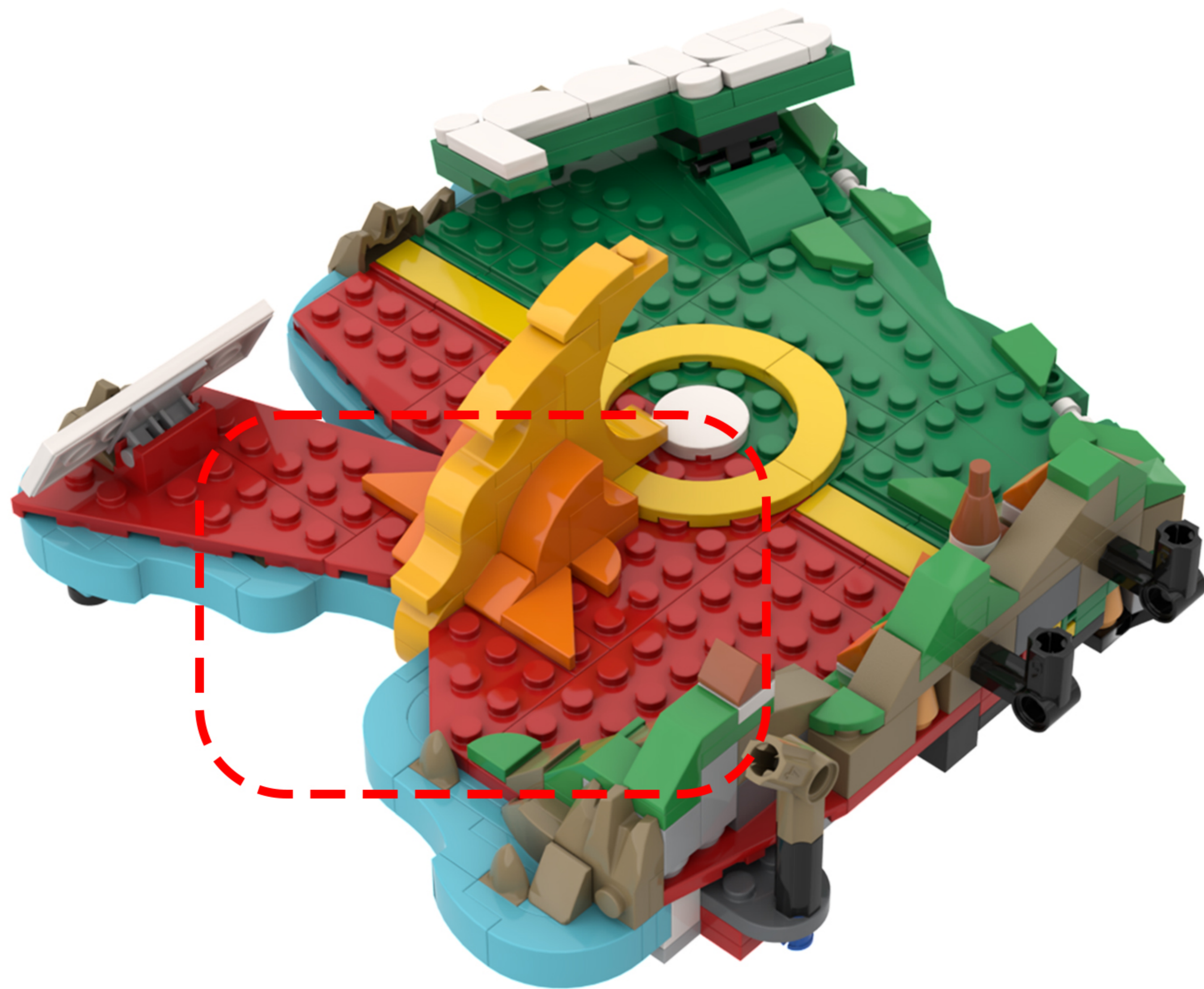
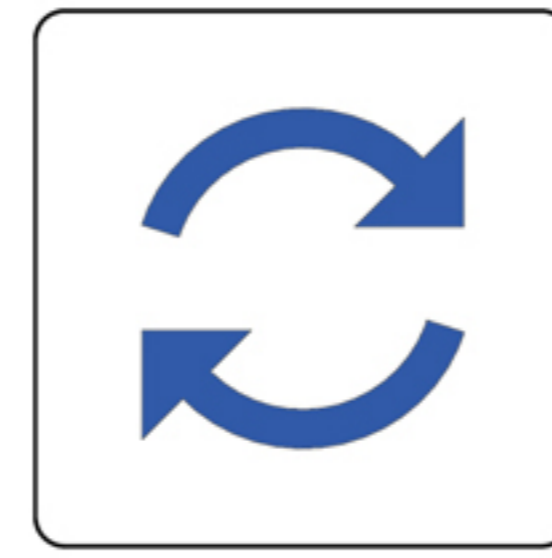

22

EN: Remove the building blocks one by one.

DE: Entfernen Sie die Bausteine nacheinander.

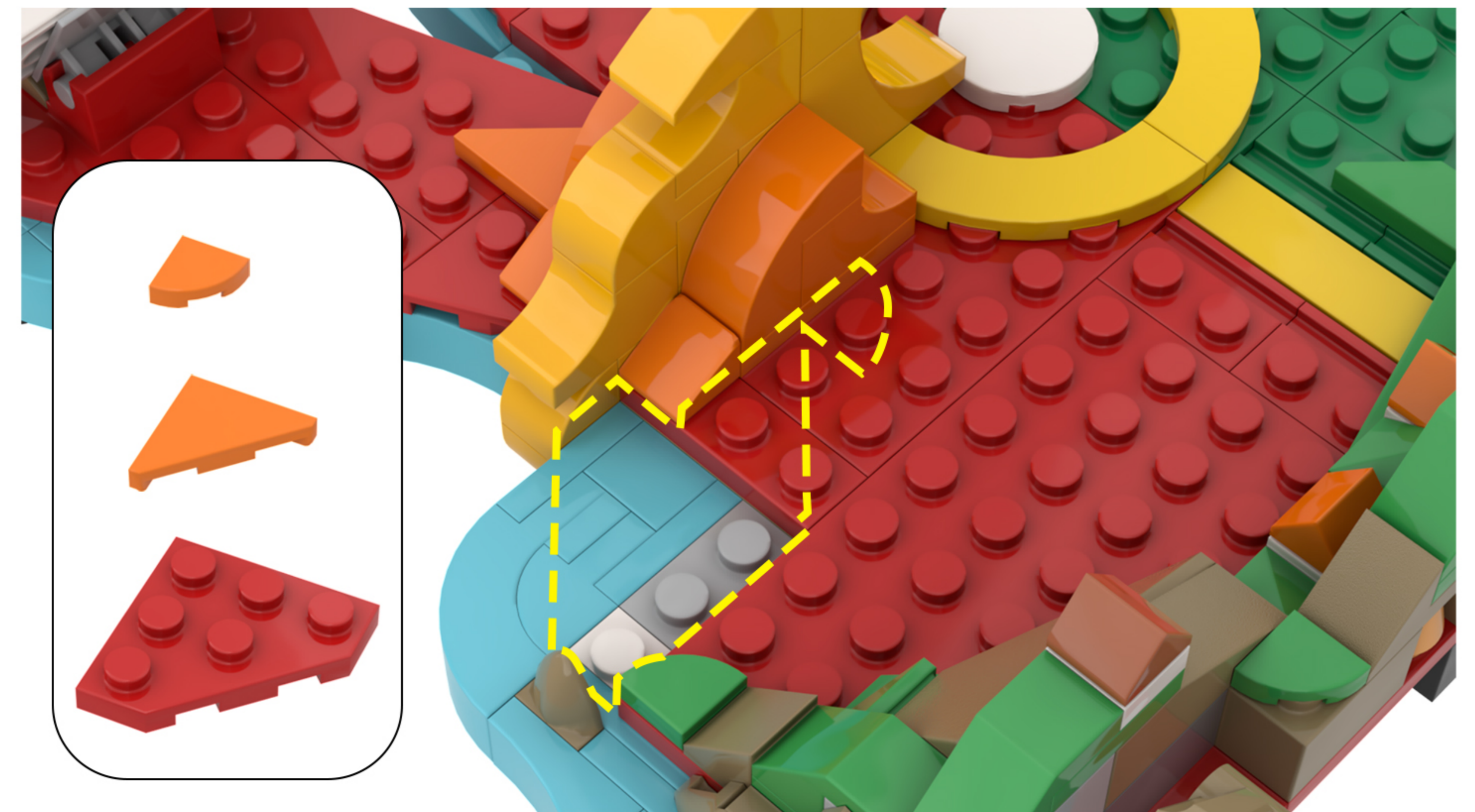

23

EN: Take the string of lights out of Bag 1 and place the wires connected to the terminals on the building blocks.

DE: Nimm die Lichterkette aus Beutel 1 heraus und befestige die an den Anschlüssen befindlichen Kabel an den Bausteinen.

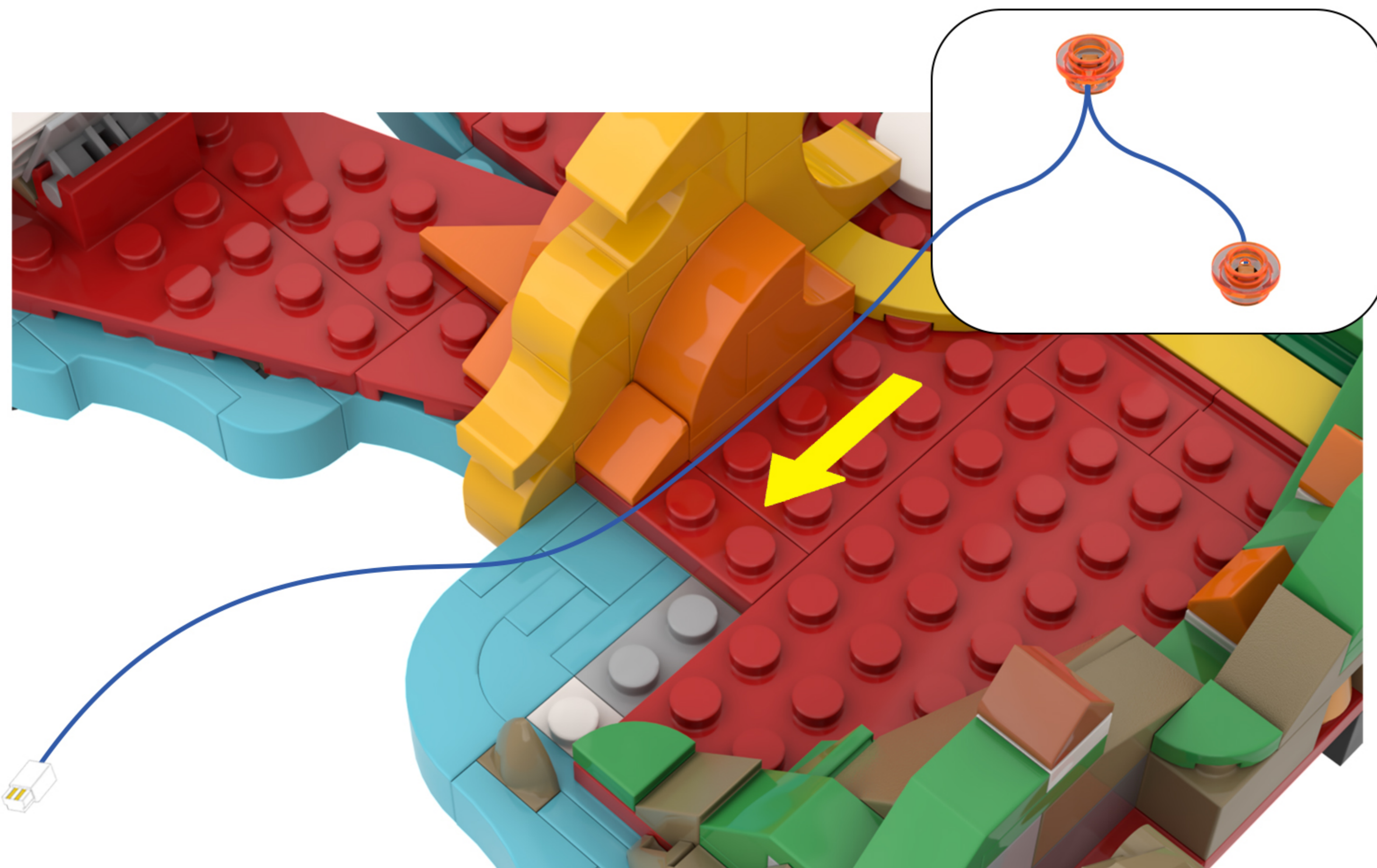
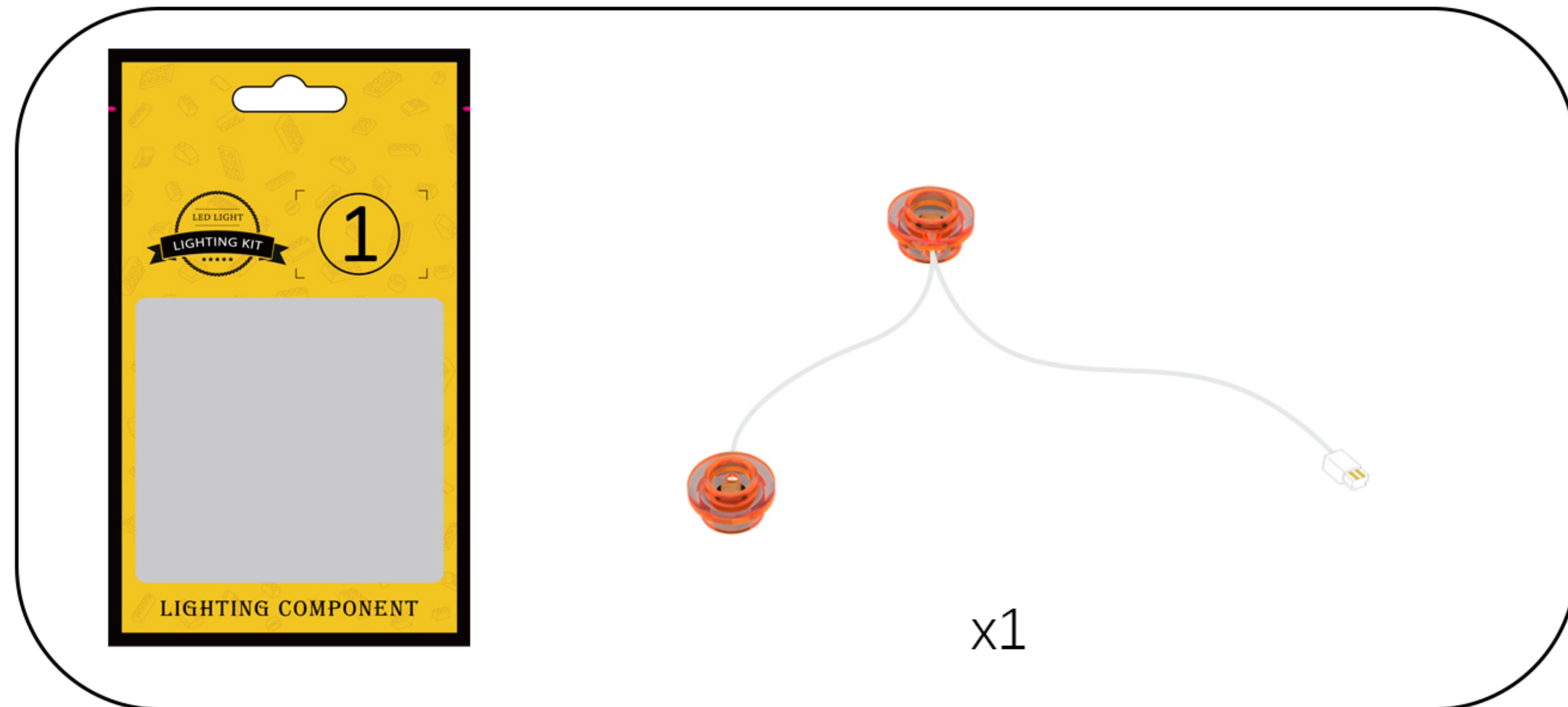

Note: Leave a little extra length on the light cord here.

24

EN: Take out the disassembled building blocks, reassemble them, and secure the light cord.

DE: Nehmen Sie die zerlegten Bausteine heraus, setzen Sie sie wieder zusammen und befestigen Sie das Lichtkabel.

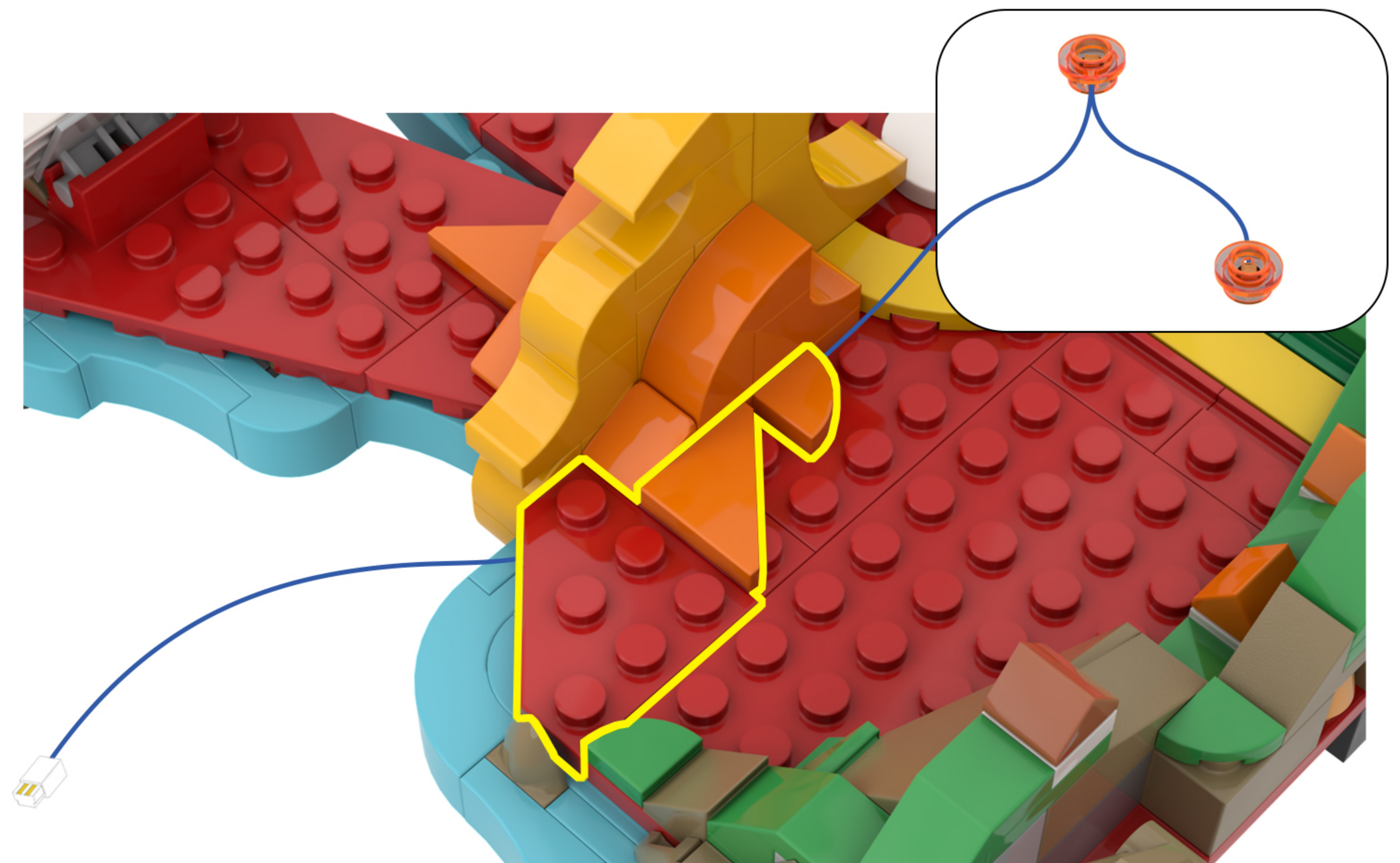
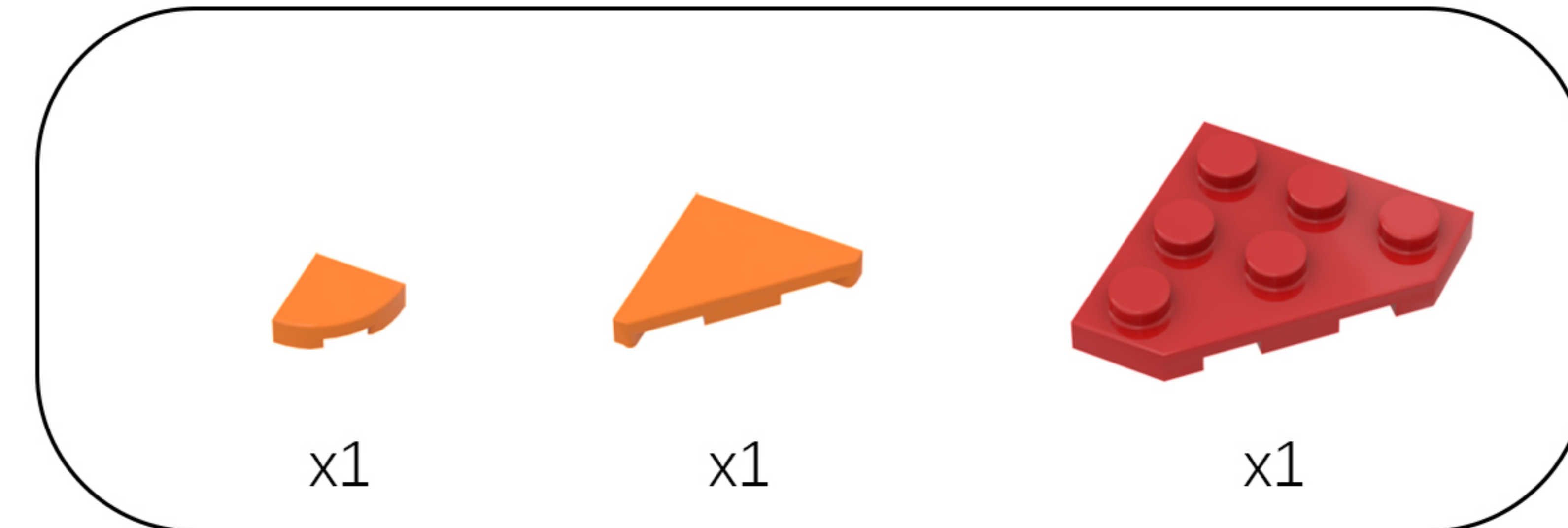

25

EN: Rotate the model to its back side.

DE: Drehen Sie das Modell auf die Rückseite.

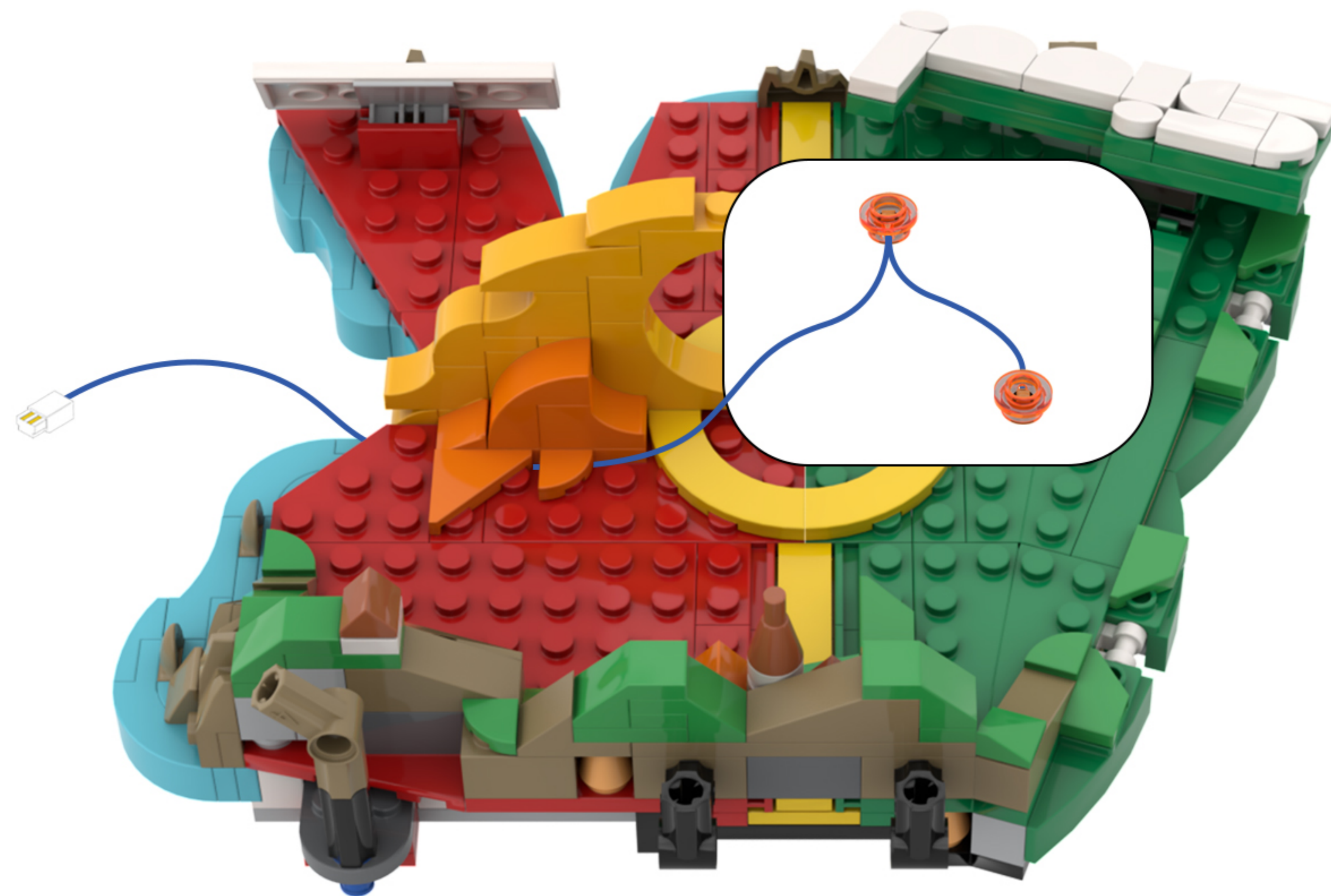
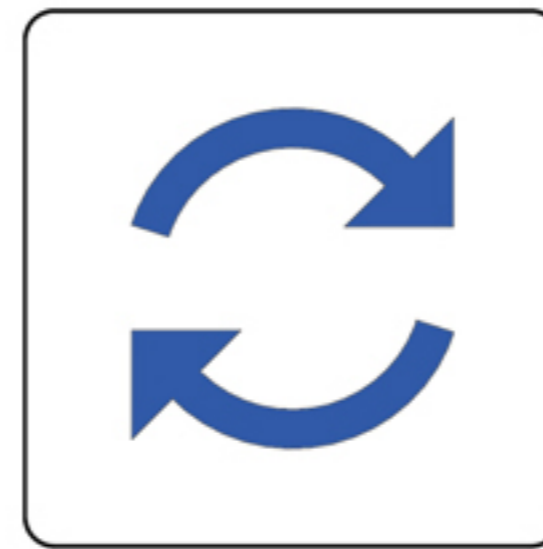

26

EN: Take out the building blocks with the lights attached and reassemble them in order.

DE: Nimm die Bausteine mit den daran befestigten Lichtern heraus und setze sie der Reihe nach wieder zusammen.

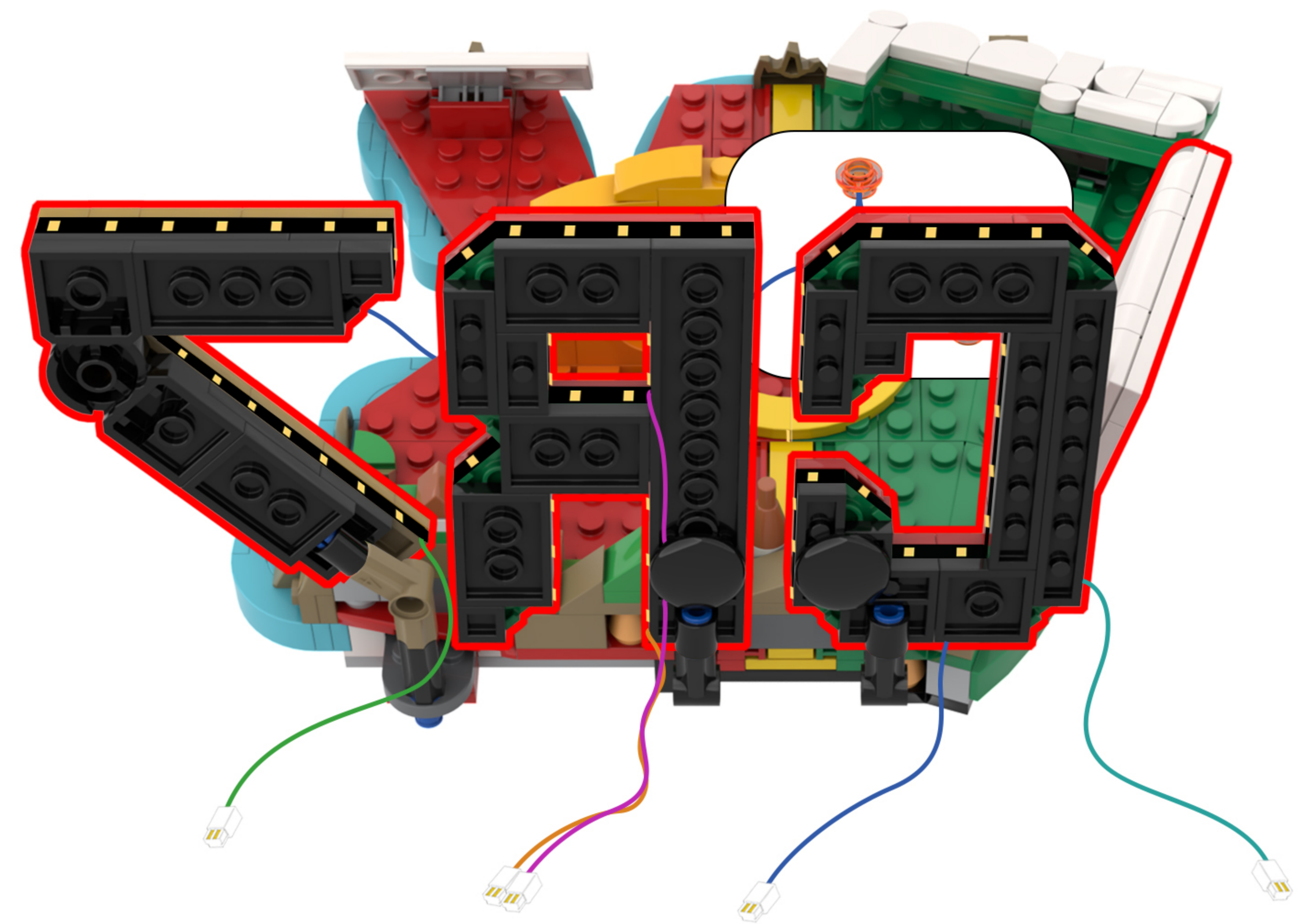
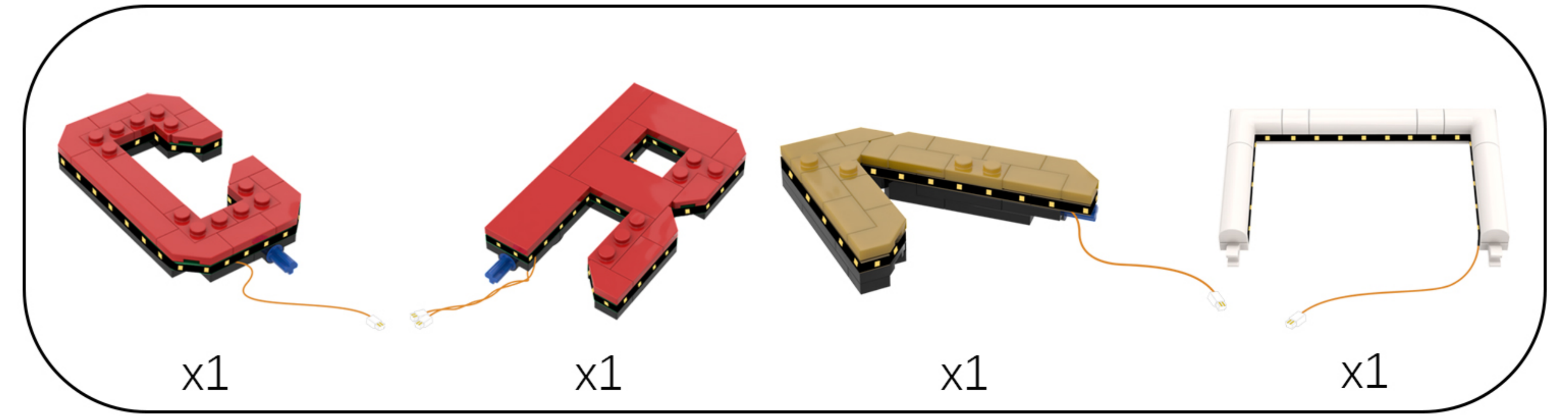

27

EN: Turn the model upside down and locate the four light lines shown in the diagram.

DE: Drehen Sie das Modell um und suchen Sie die vier in der Abbildung gezeigten hellen Linien.

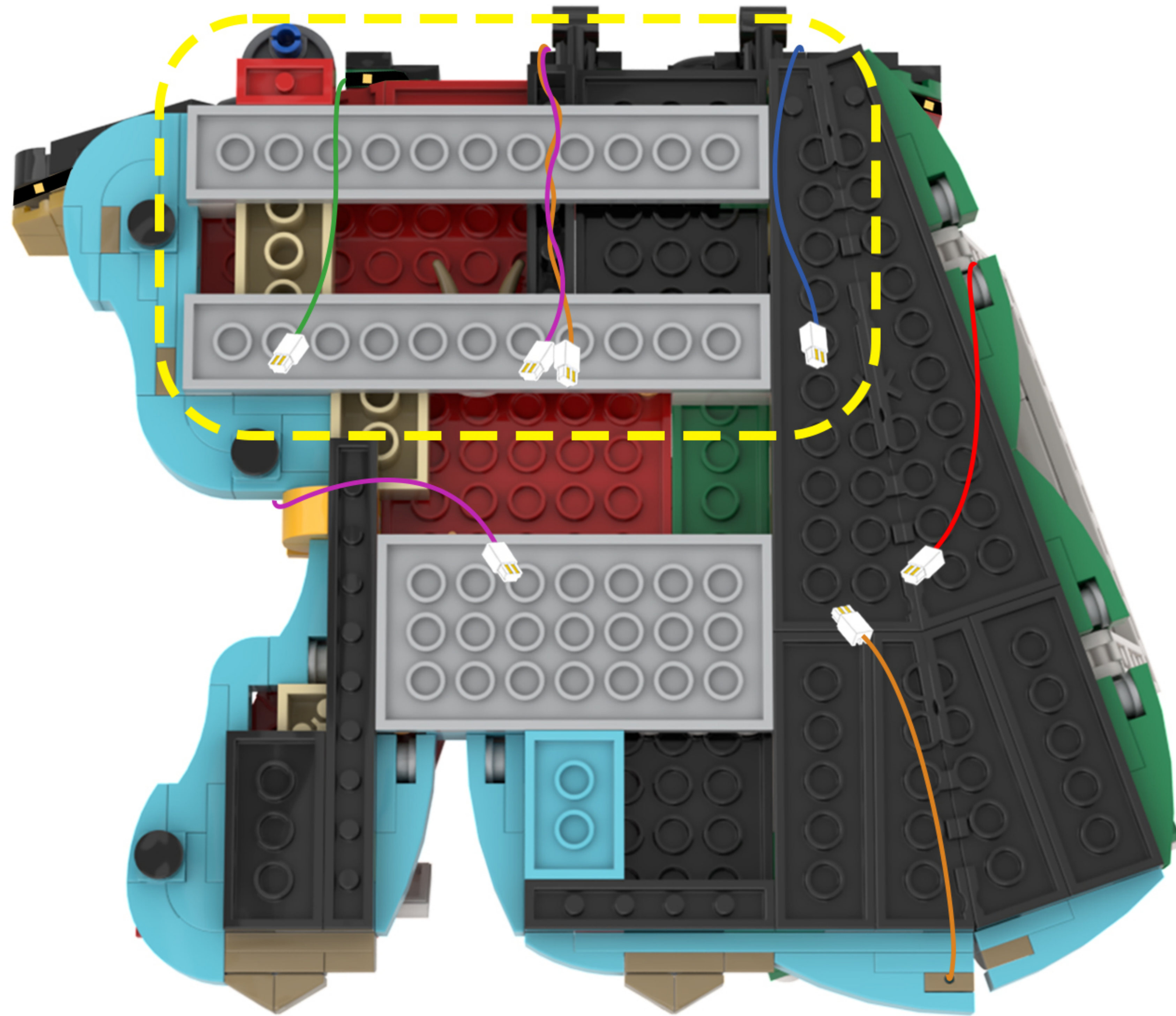

28

EN: Twist the wires from the four string lights together.

DE: Verdrehen Sie die Drähte der vier Lichterketten miteinander.

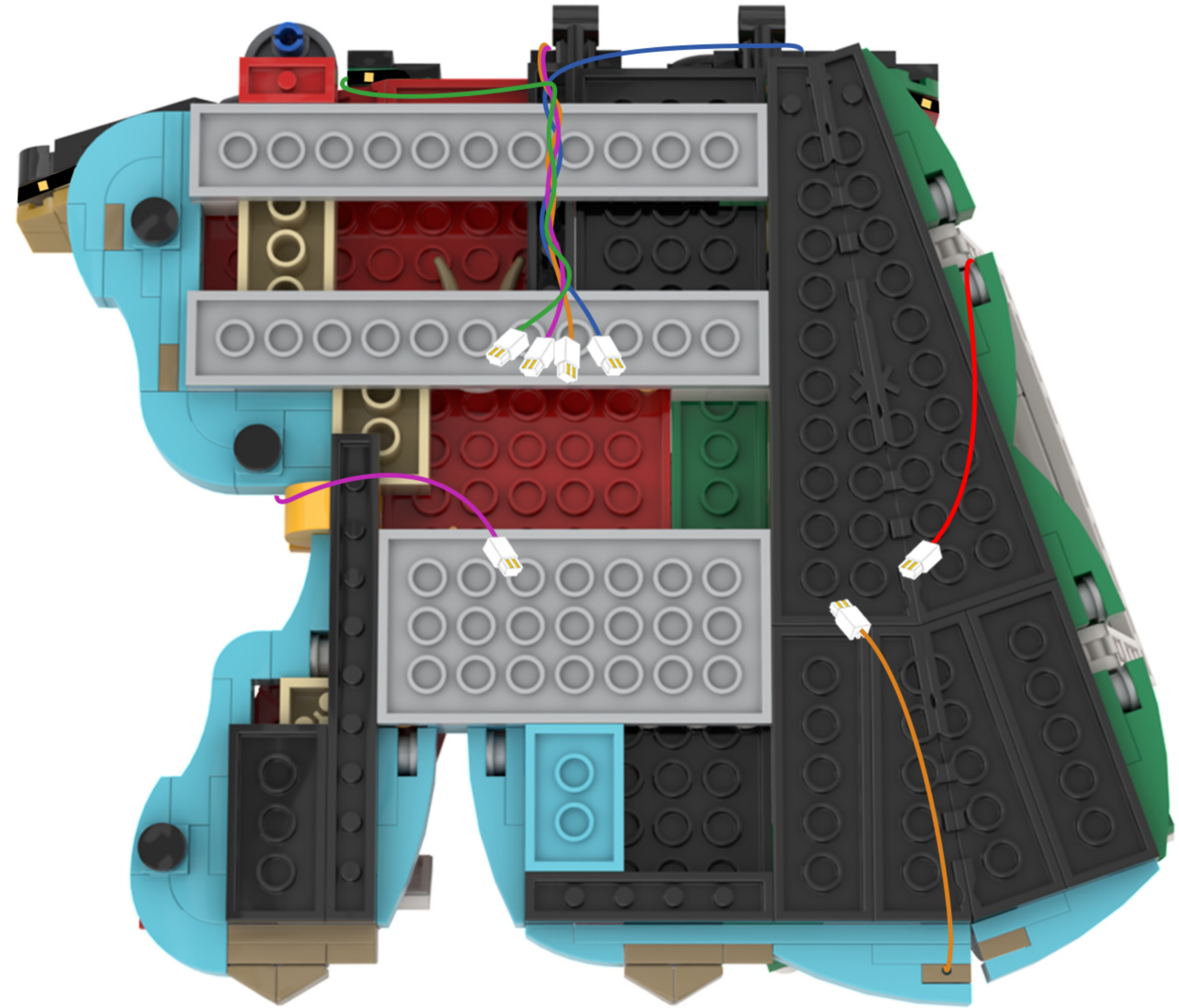

29

EN: Twist the wires from the remaining three string lights together.

DE: Verdrehen Sie die Drähte der übrigen drei Lichterketten miteinander.

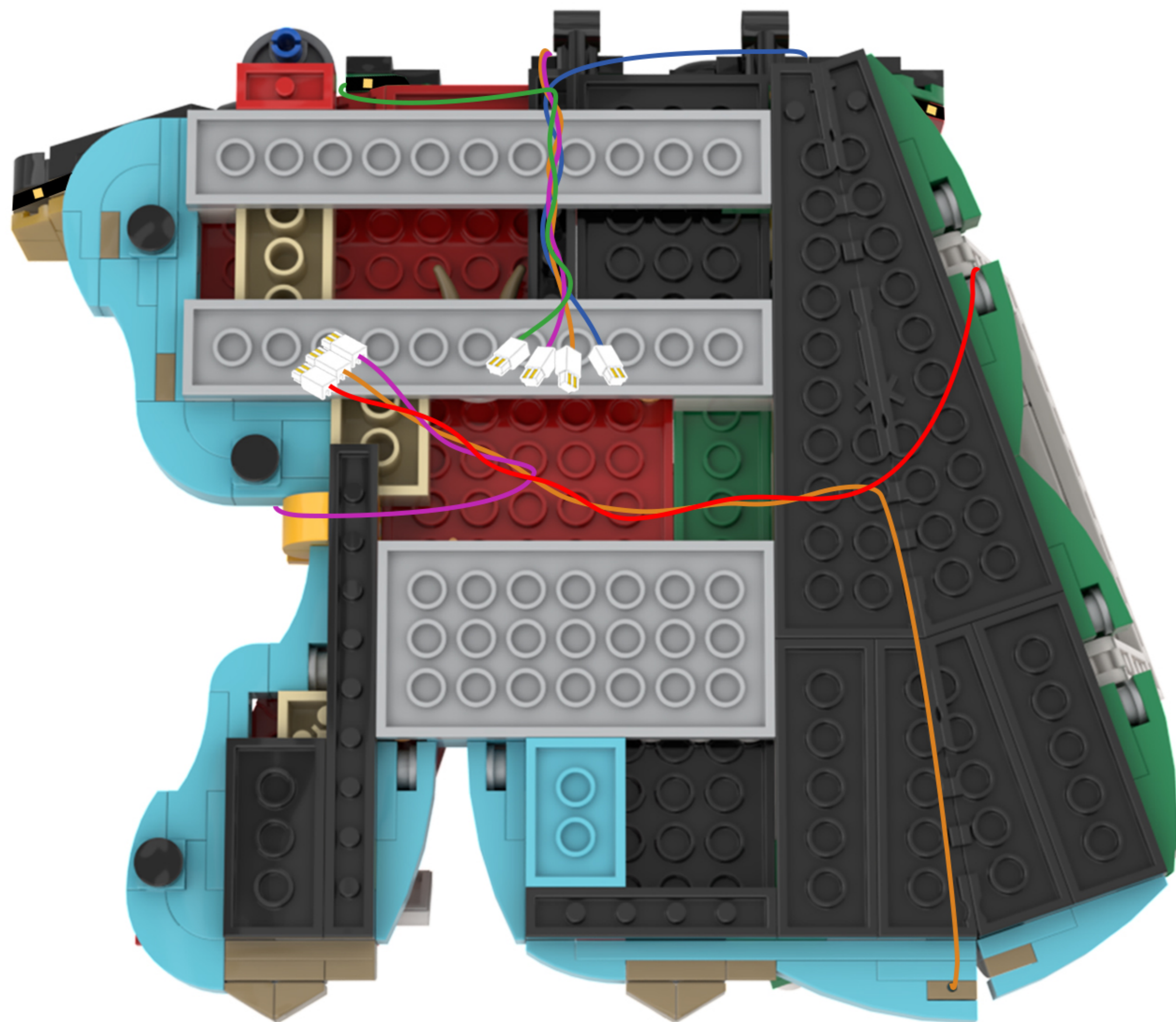

30

EN: Take the expansion board out of Bag 5 and connect the 7 light wires to the expansion board one by one.

DE: Nehmen Sie die Erweiterungsplatine aus Beutel 5 und schließen Sie die 7 Lichtkabel nacheinander an die Erweiterungsplatine an.

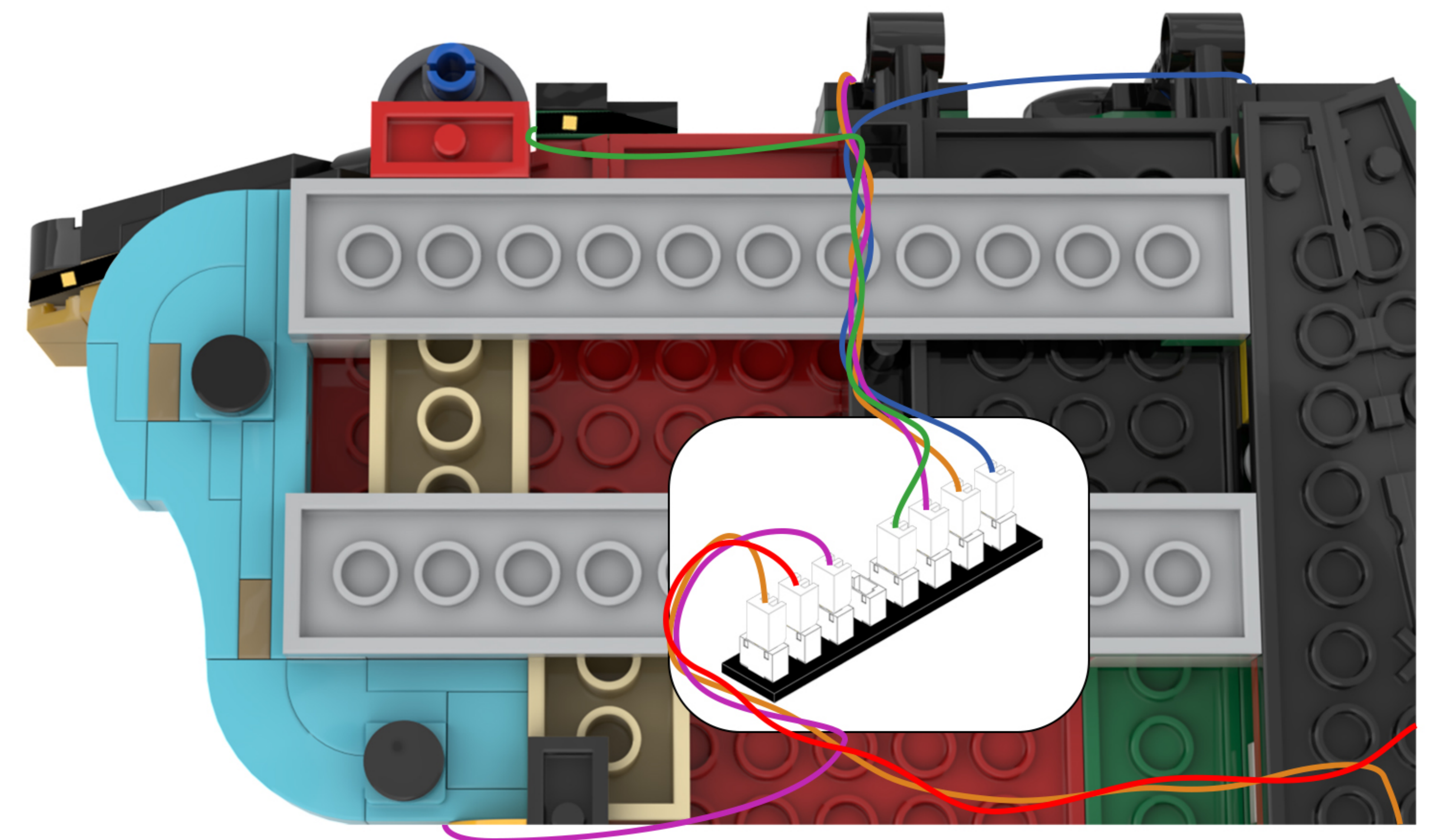
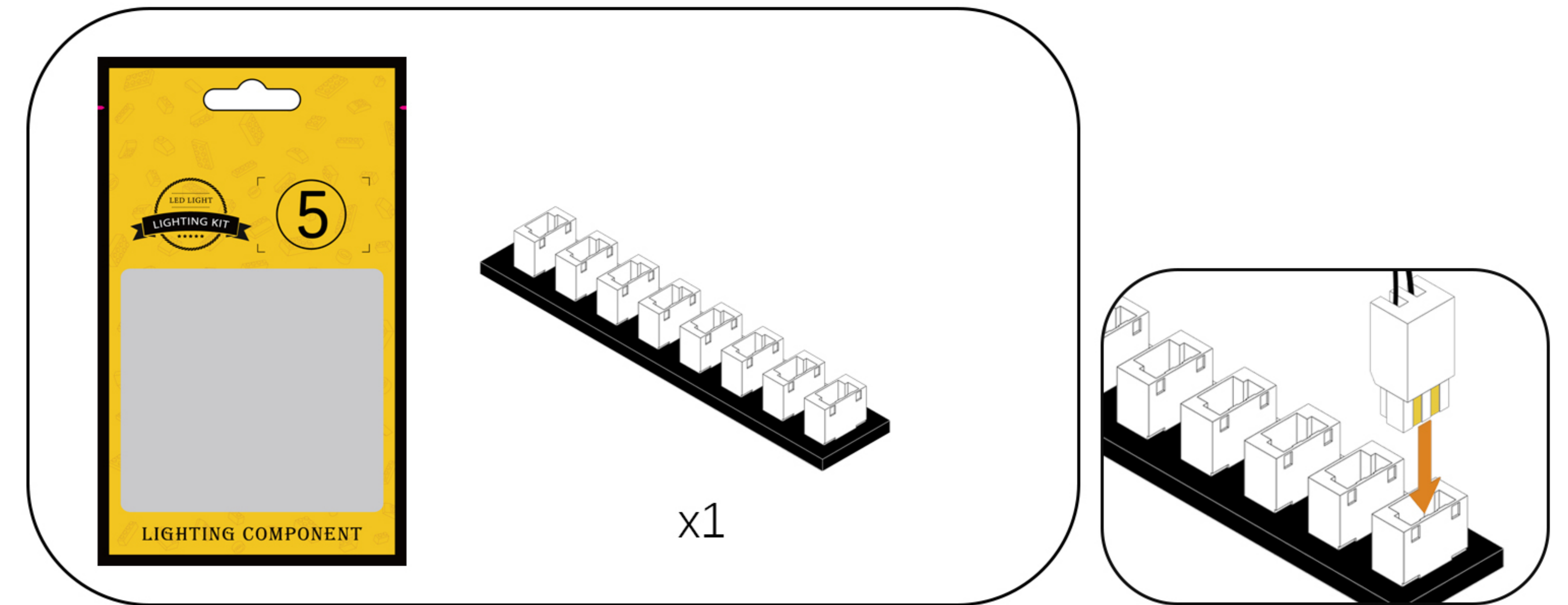

31

EN: Take the USB power cable out of the box and connect it to the expansion board.

DE: Nehmen Sie das USB-Stromkabel aus der Verpackung und schließen Sie es an die Erweiterungskarte an.

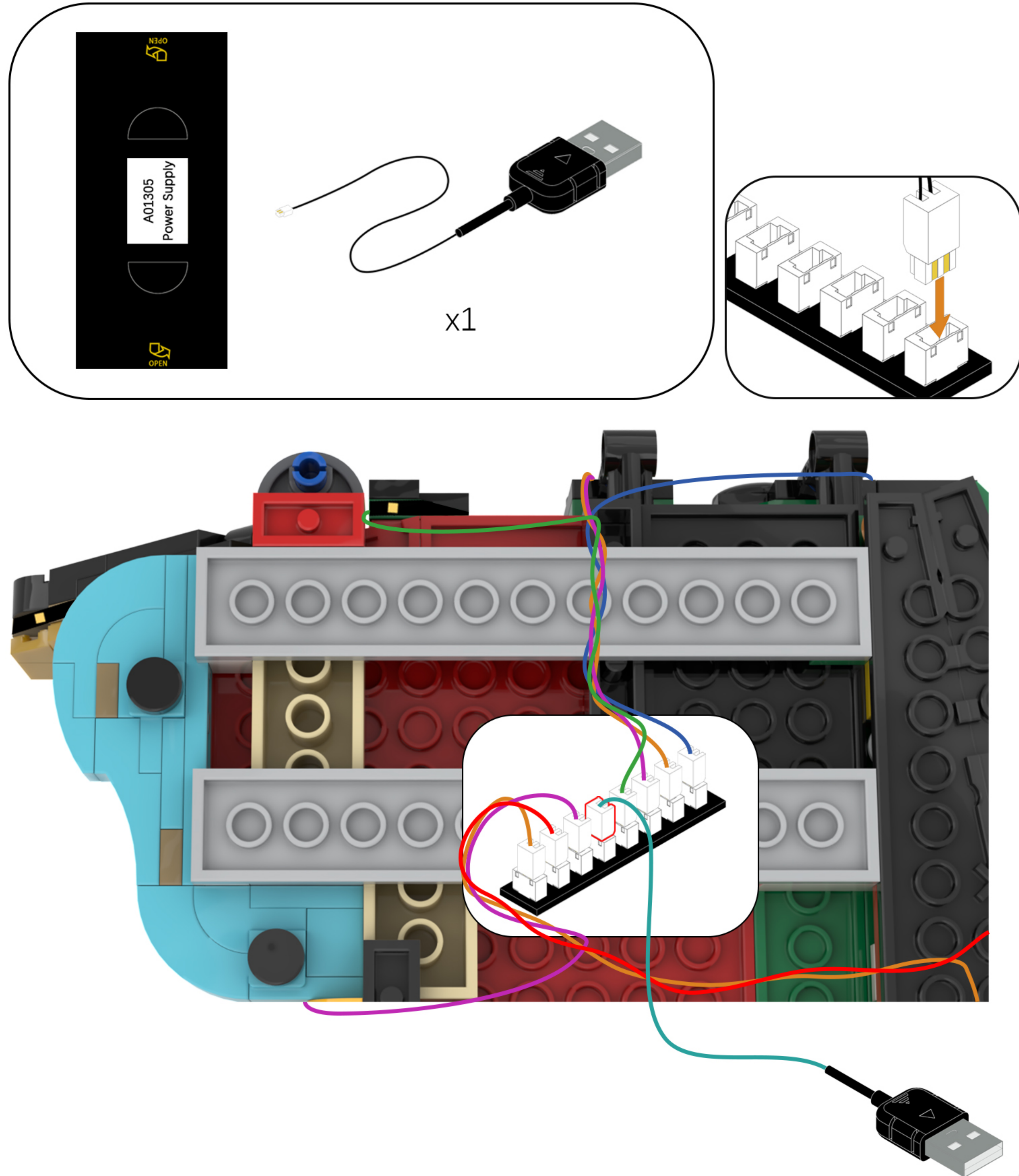

32

EN: Peel off the adhesive backing of the expansion board and attach it to the location shown in the illustration.

DE: Entfernen Sie die Schutzfolie von der Rückseite der Erweiterungsplatte und kleben Sie sie an die in der Abbildung gezeigte Stelle.

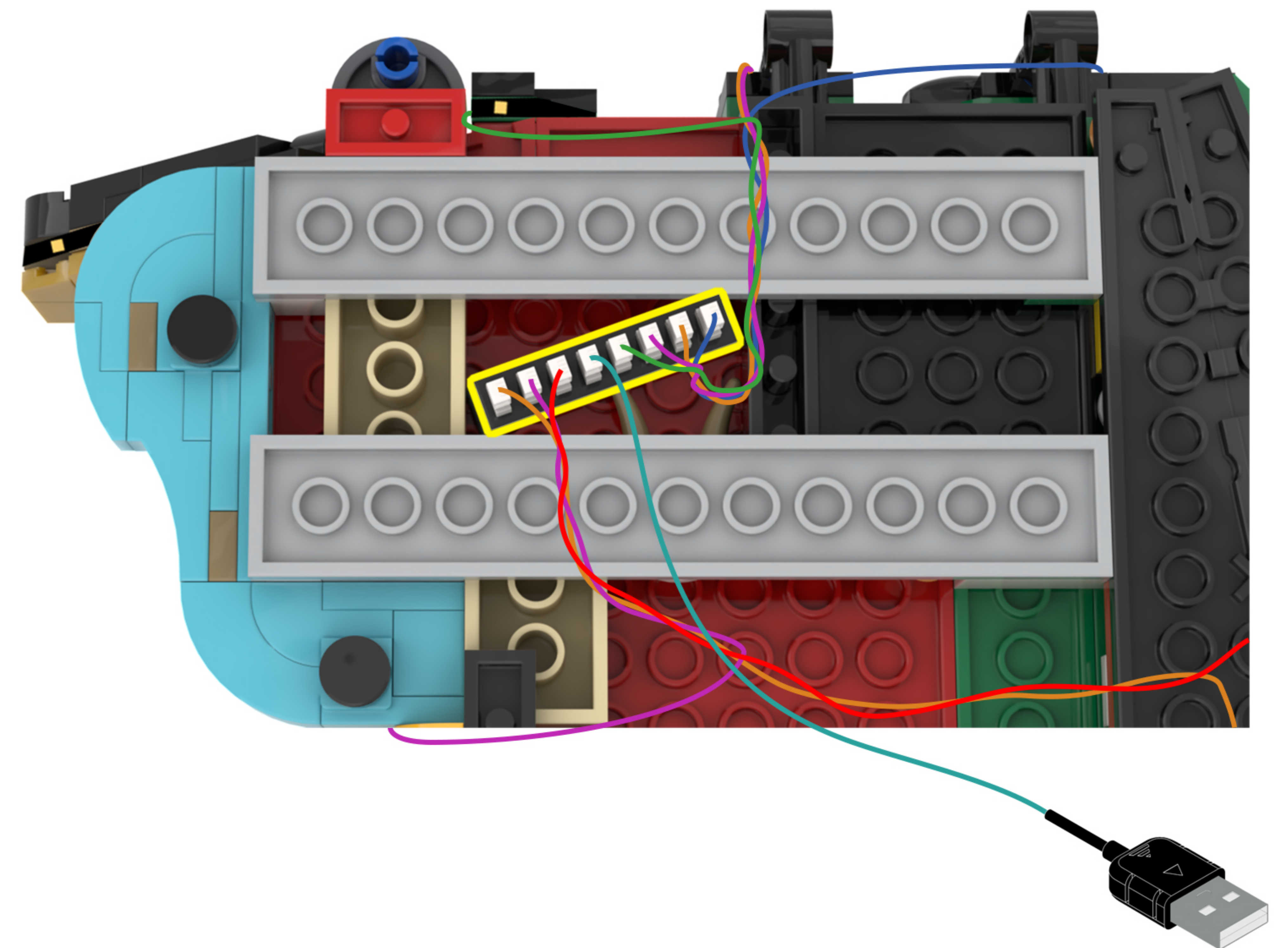

33

EN: Rotate the model to face you, and locate the string of lights from earlier.

DE: Drehen Sie das Modell so, dass es zu Ihnen zeigt, und suchen Sie die Lichterkette von vorhin.



34

EN: Take out the disassembled building blocks and separate them.

DE: Nehmen Sie die zerlegten Bausteine heraus und trennen Sie sie voneinander.

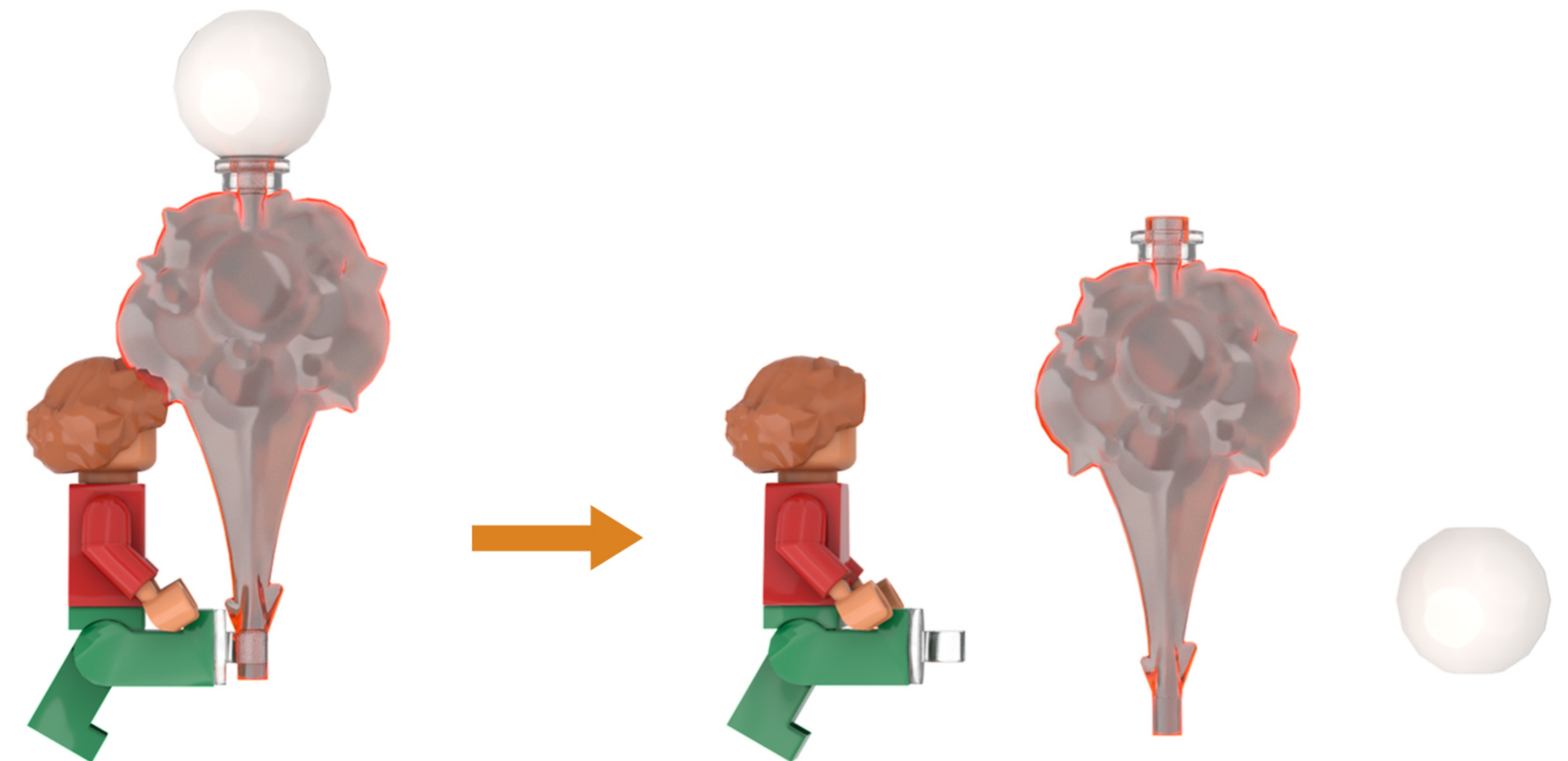
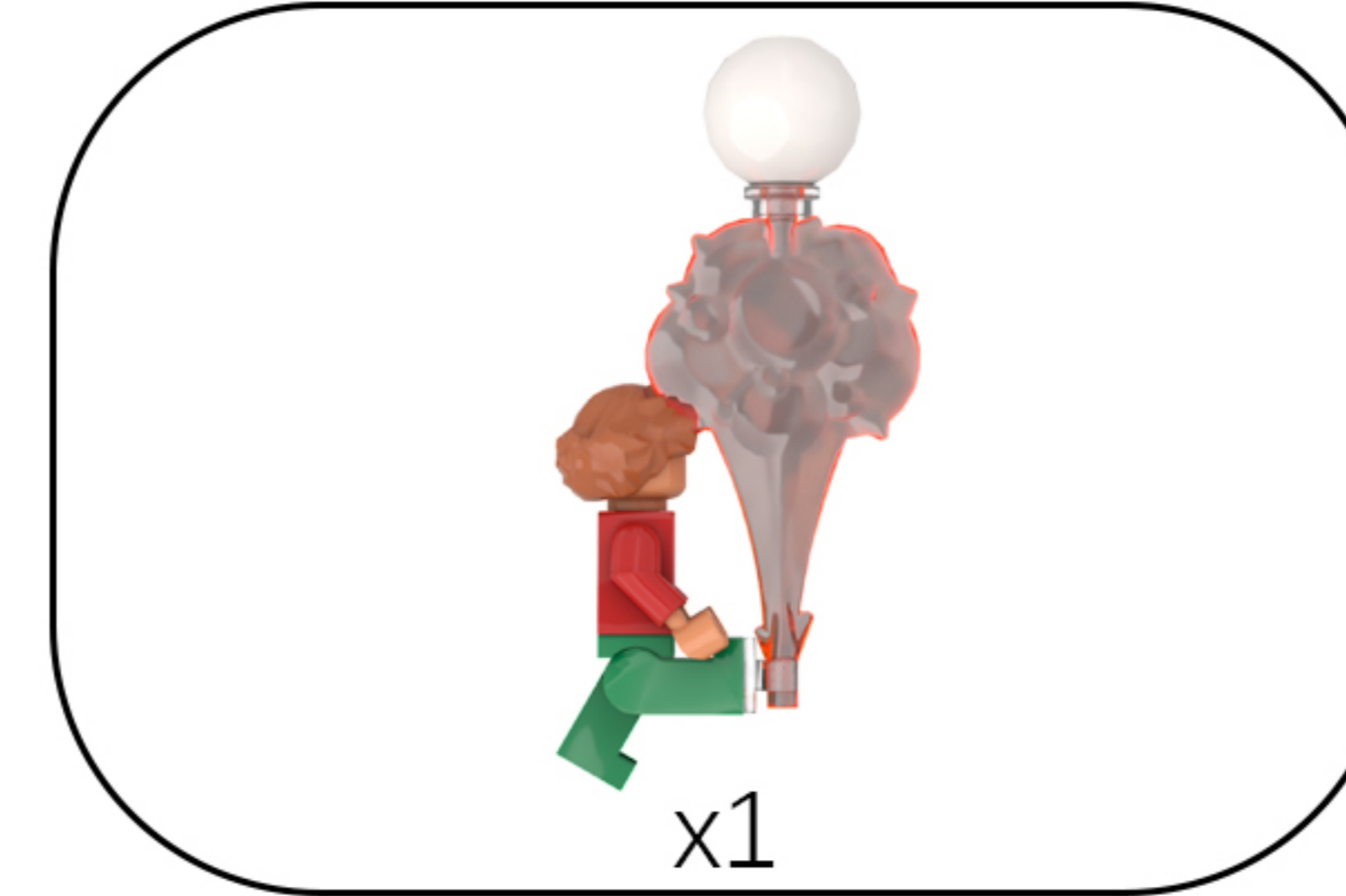

35

EN: Take out the disassembled building blocks and attach the lights from the string one by one to the blocks.

DE: Nimm die zerlegten Bausteine heraus und befestige die Lichter der Lichterkette nacheinander an den Bausteinen.

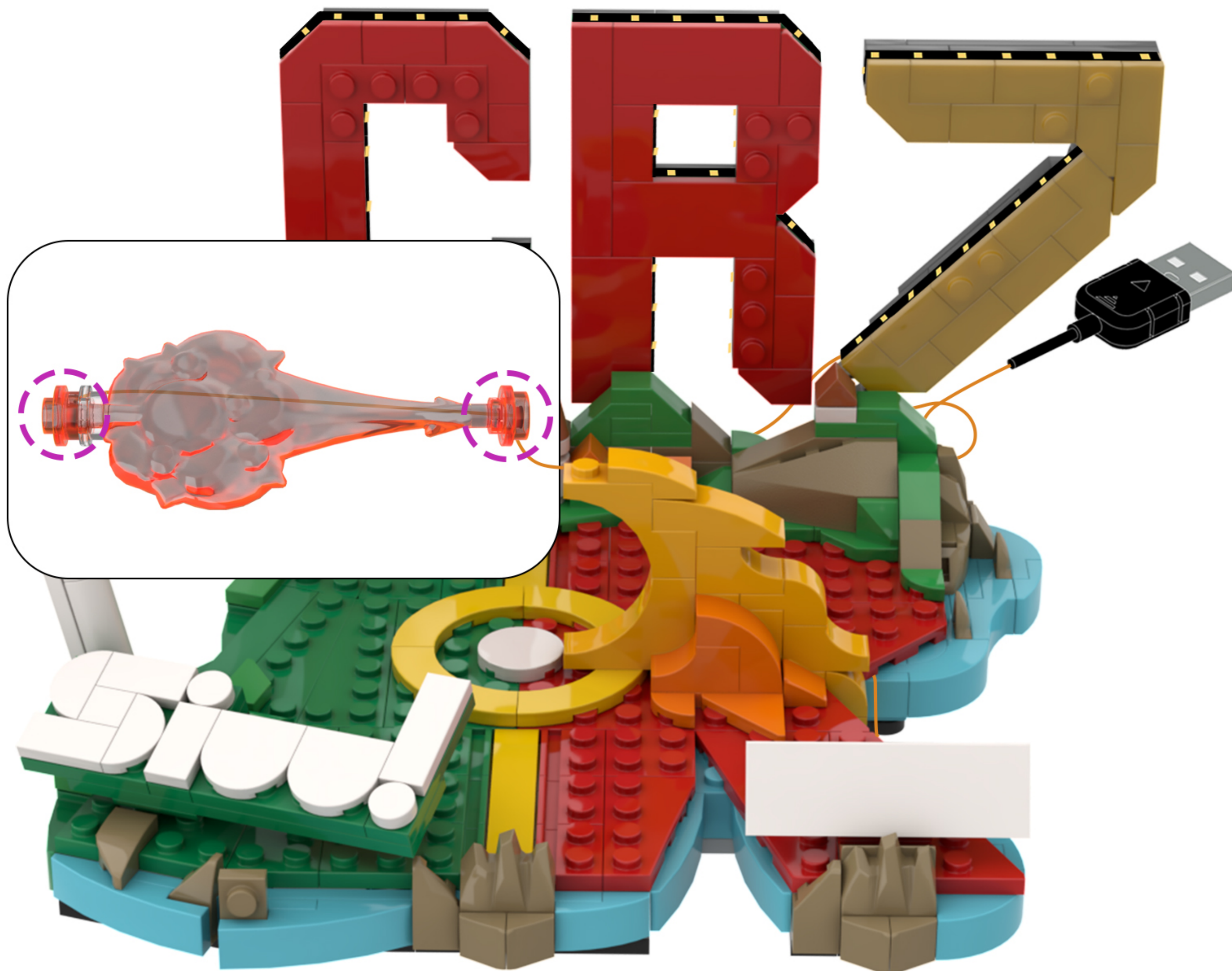
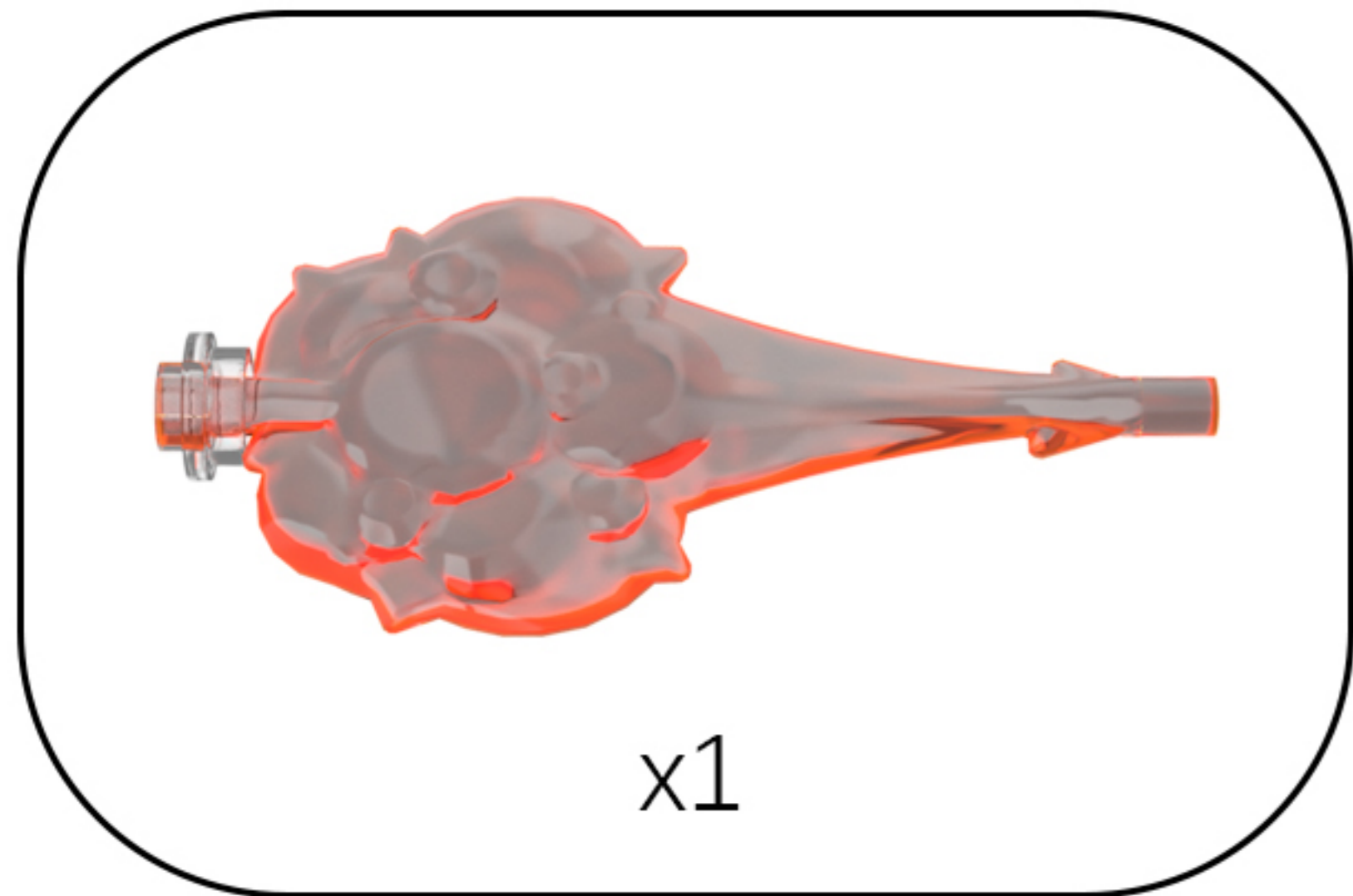

36

EN: Take out the disassembled building blocks and reassemble them.

DE: Nehmen Sie die zerlegten Bausteine heraus und setzen Sie sie wieder zusammen.

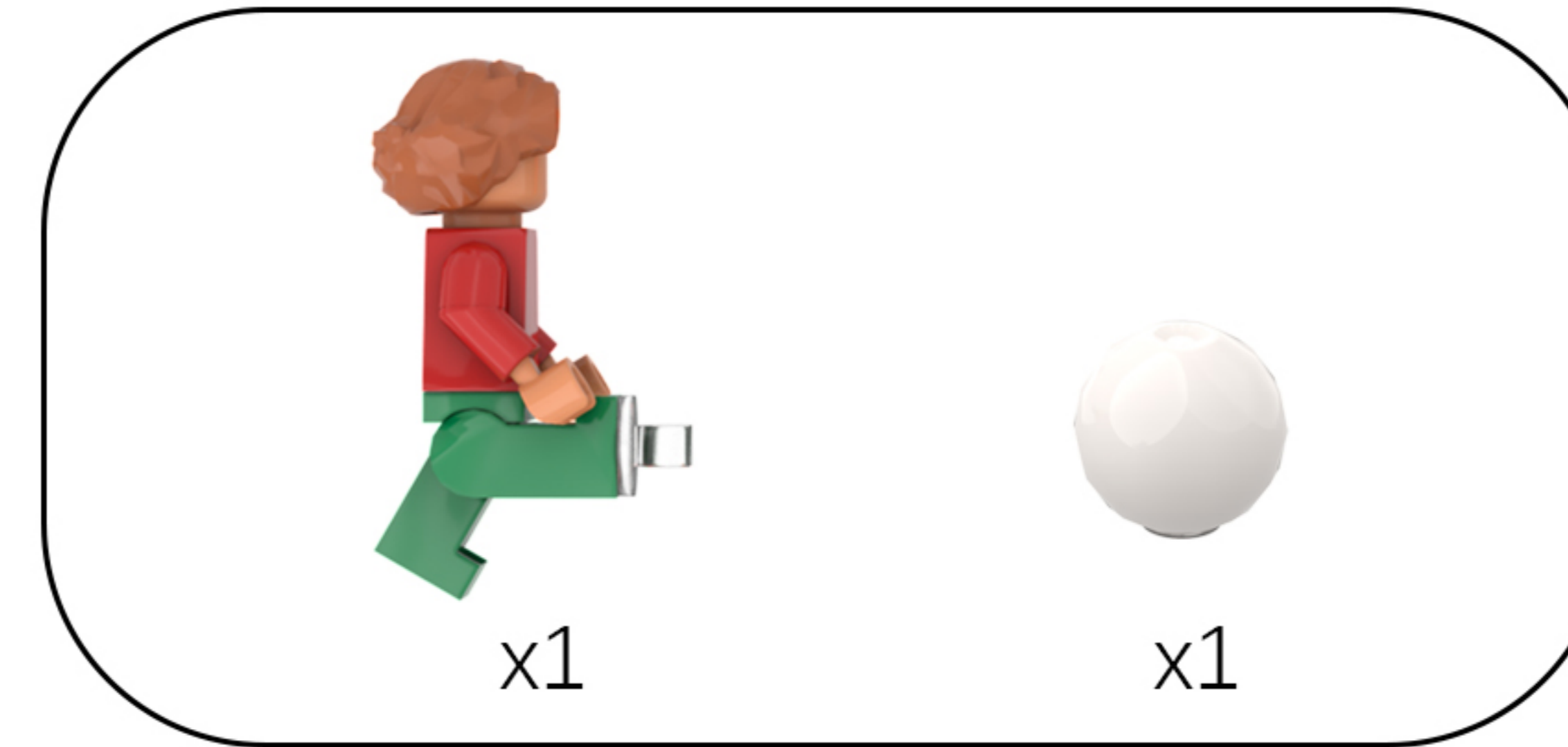

37

EN: Once installed, connect the power supply and give it a try!

DE: Die Installation ist abgeschlossen. Schließen Sie das Gerät an die Stromversorgung an und probieren Sie es aus!





Above our designers to provide the relevant ideas and instructions. But please move to the following:

- 1: about our company this product parts material, product quality do you have comments and suggestions?
- 2: about this product installation instructions and installation of the degree of difficulty do you have views and suggestions?
- 3: if in the operation of the product we provide ideas encountered any problems, please contact us in a timely manner.

## Tips

If you encounter any installation problems please contact the seller, we will be happy to help you solve!