

# 31146 Flatbed Truck with Helicopter

- Installation requires a lot of patience and great observation that your LEGO bricks will come alive when you get this finished. The bricks with lighting as below, so make sure you're ready and let's get started.



# Strategies for the Installation

This instruction divides three sections to complete the installation of the lighting set.

## **Section A:** Check the type and quantity of components.

The quantity and type of components of each products are different and it needs to be carefully checked to make sure there do have enough material. The type of components is indicated by the label on the bag.

## **Section B:** Test that each components is working properly.

Each components is made individually so it is necessary to test that each components is working properly to avoid the situation that the lighting does not work .

## **Section C:** laying out components following the instruction.

Our material is very small but not fragile, just be reminded that don't to pull the wires too hard. For different people, there may be some installation steps that you can't understand. Please look at the previous and later installation step.

## Section A: Check the type and quantity of components.

This set contains three bags labelled "1" "2" "A01305 Power Supply", please make sure that the components in each bag are the same as shown in the pictures.



Please contact us immediately if there have any missing components.

## Section B: Test that each components is working properly.

Take out the expansion board and usb power cable from "No. 2 bag " and the "A01305 Power Supply" .



It is worth reminding that our products are all customized. They have a unique way of connecting. The white plug on wire and the socket of the expansion board need to be connected together to transmit power.

Note that on one side of the white plug you can see two very small golden wires that should be connected to the two golden needles in socket of the expansion board. shown as blow.

### Side-Mounted Expansion Board

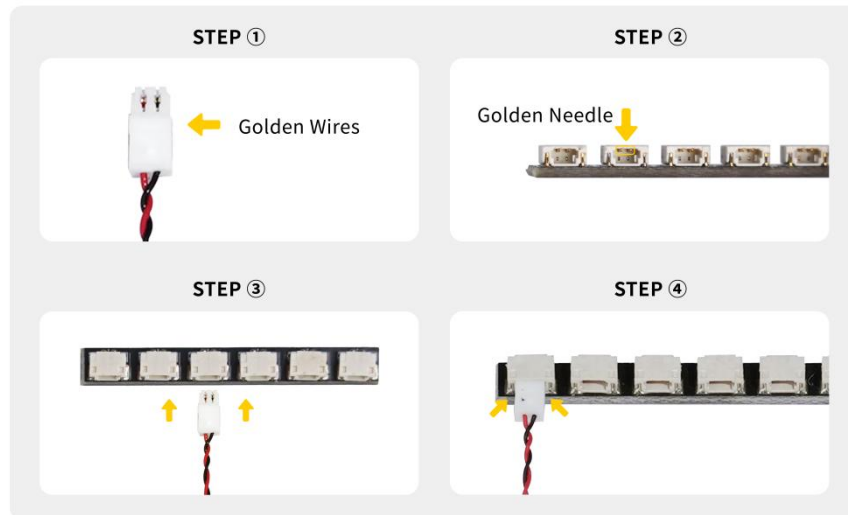

All our connections between plug and socket are all the same as shown above. So for any such structure with plug and socket, please pay attention to the golden wire of the plug and the golden needle of the socket, they must be touched together.

The connection method between the usb power cord and expansion Boards is as follows:



The usb power cord can be powered by phone chargers, power banks,etc.

## USB Connectors to Connect Devices

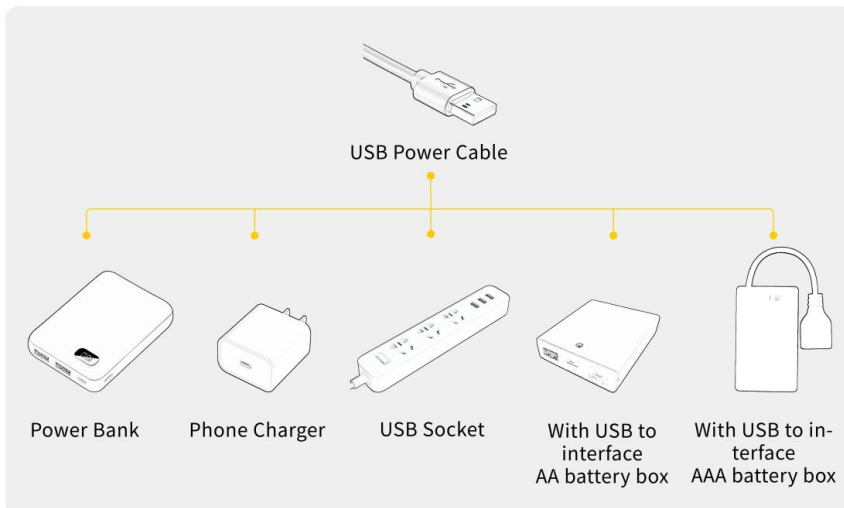

This instruction will use the power bank as power supply . The test structure is shown as follow. All lamp in this set will be tested by this structure.



When we test the "①" lighting fixtures, remove one of them and connect it to the socket. Turn on the portable power bank, and the light strip will light up normally, as shown in the figure below.



**Test each lamp according to this method. It should be noted that after the test, the lamp must be returned to the corresponding bag to avoid confusion of types.**



**Attention that after the test is completed, each components should put back in the corresponding bag including the socket and the usb power cable.**

**Please contact us immediately if any components don't work.**

## Section C: laying out components following the instruction.

1



2



3



4

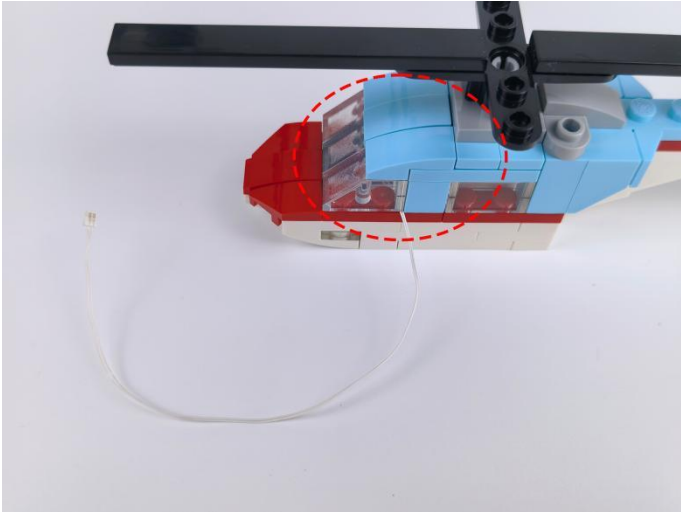

5

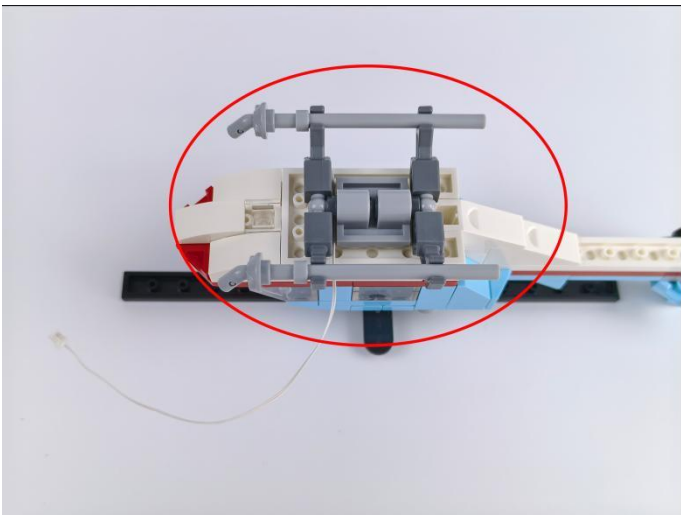
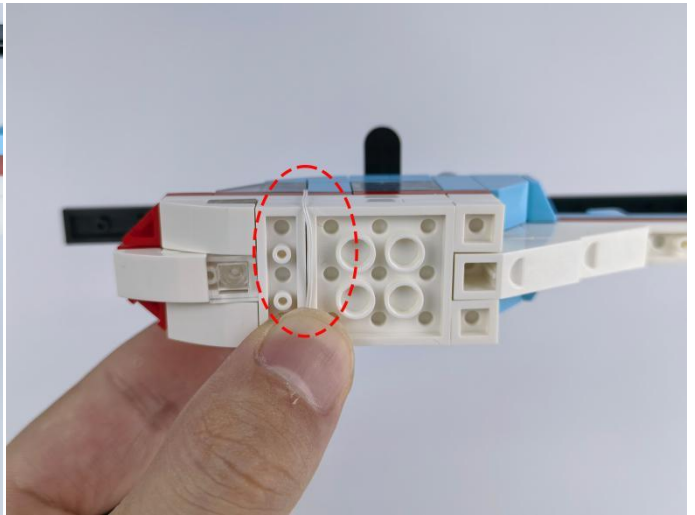
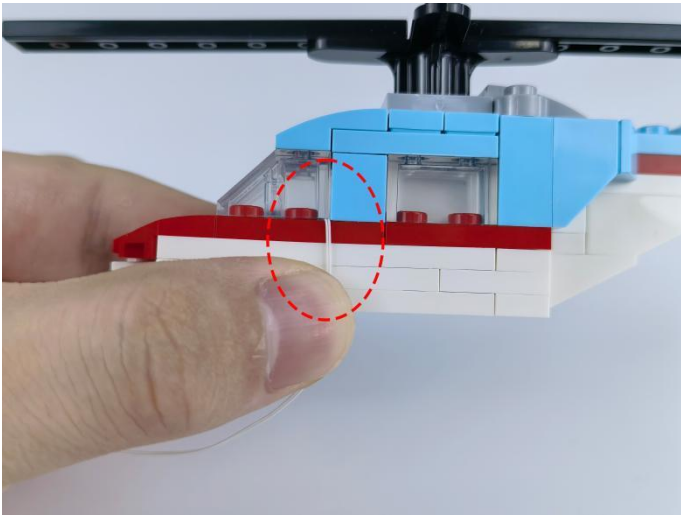

6

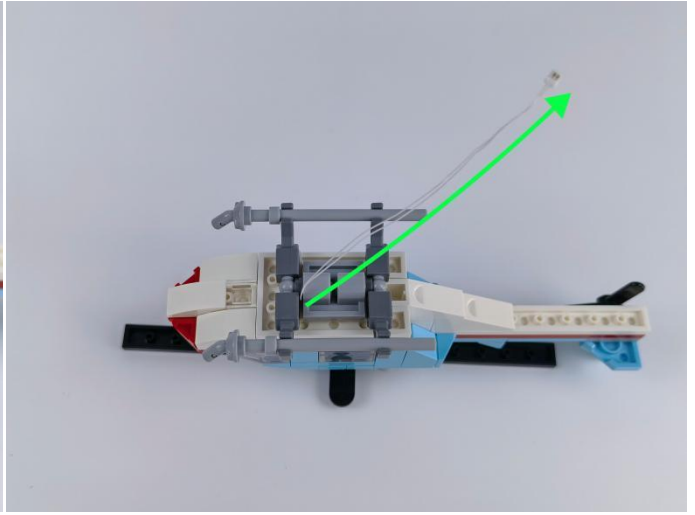
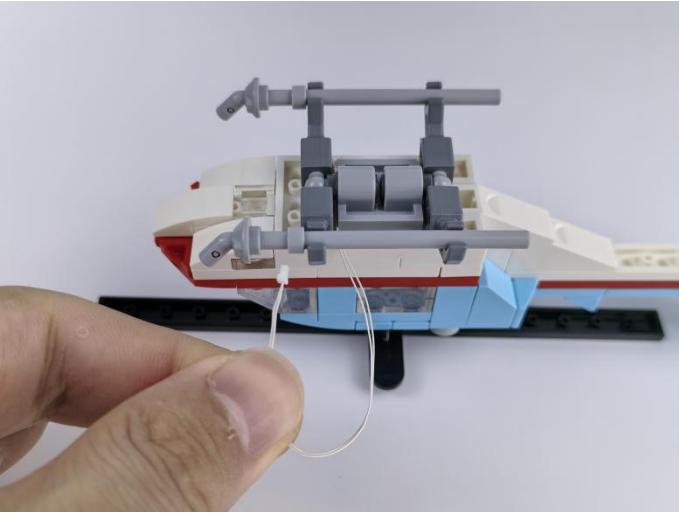

7



8

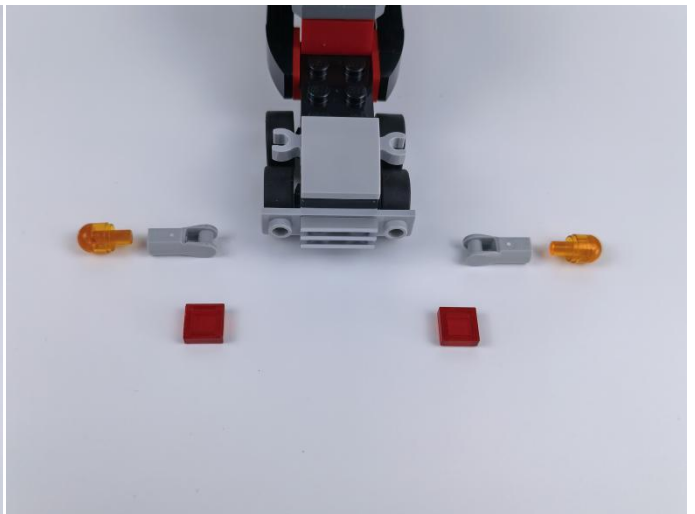
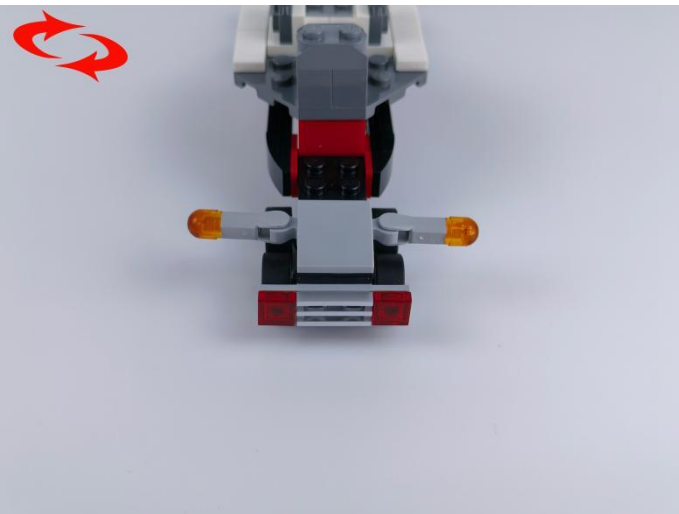

9

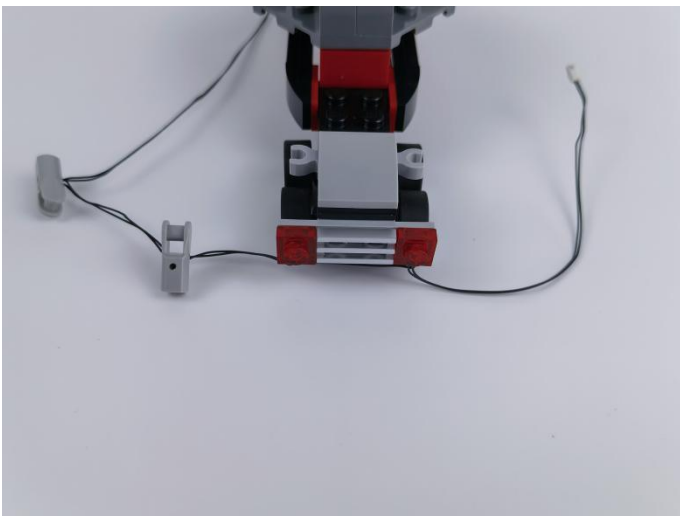
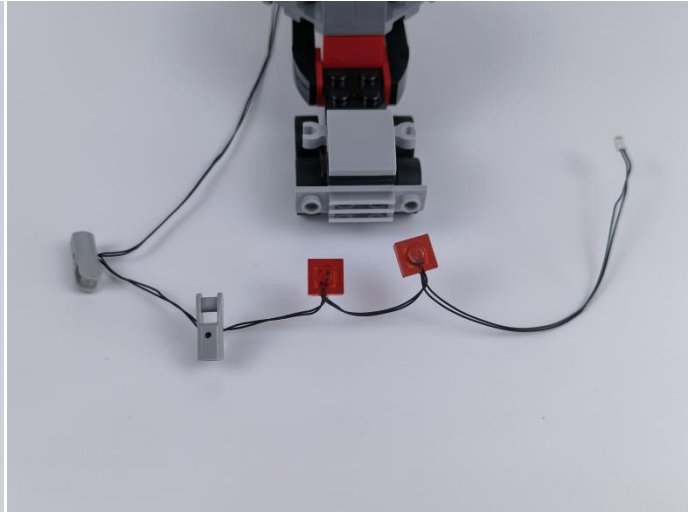

10

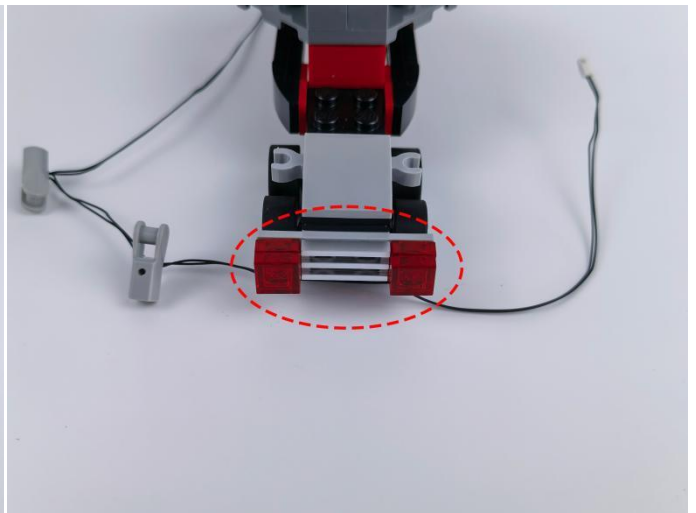
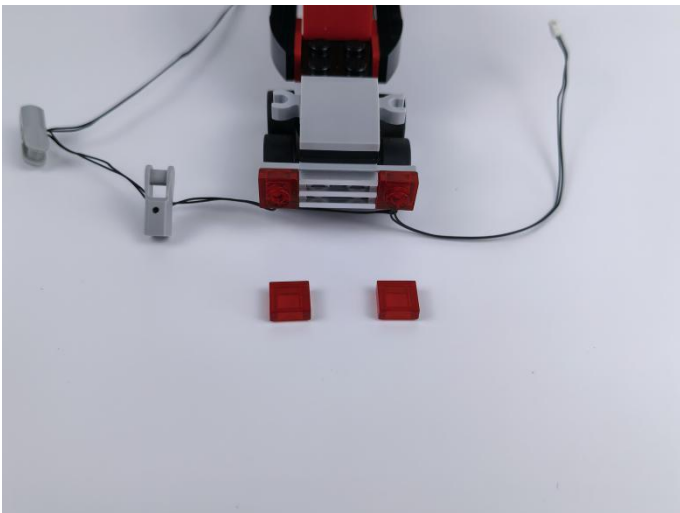

11

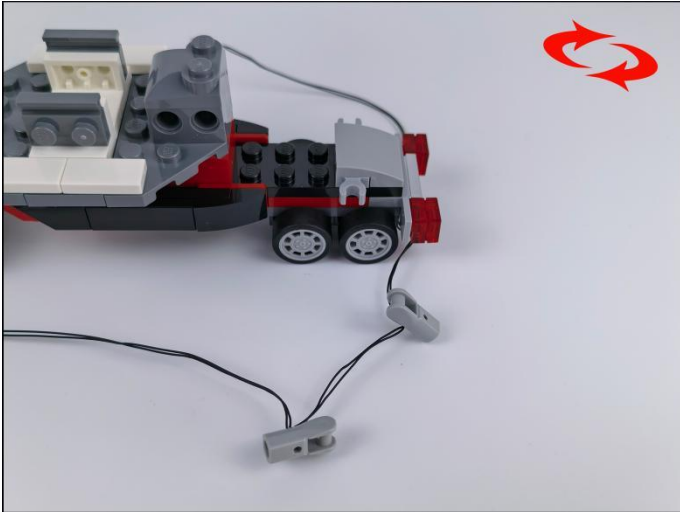

12

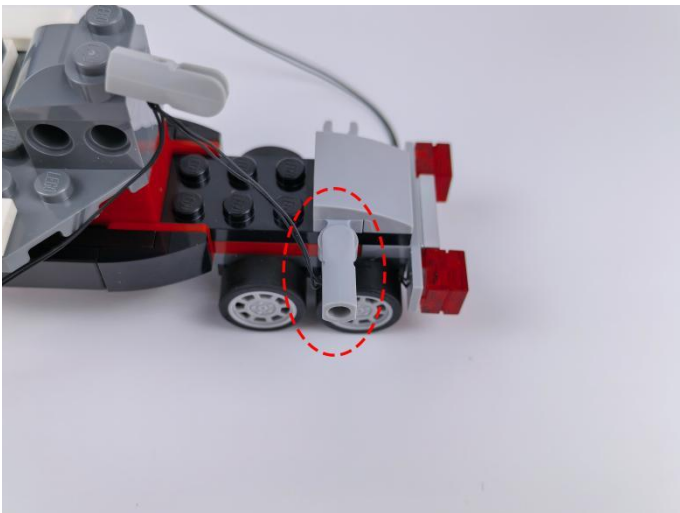
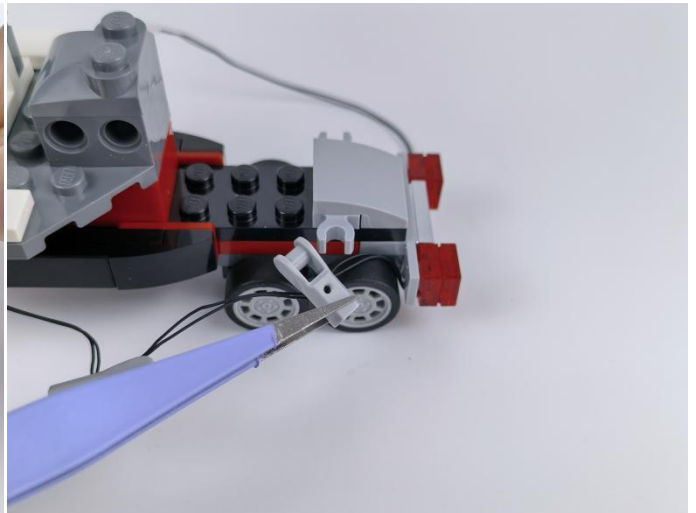
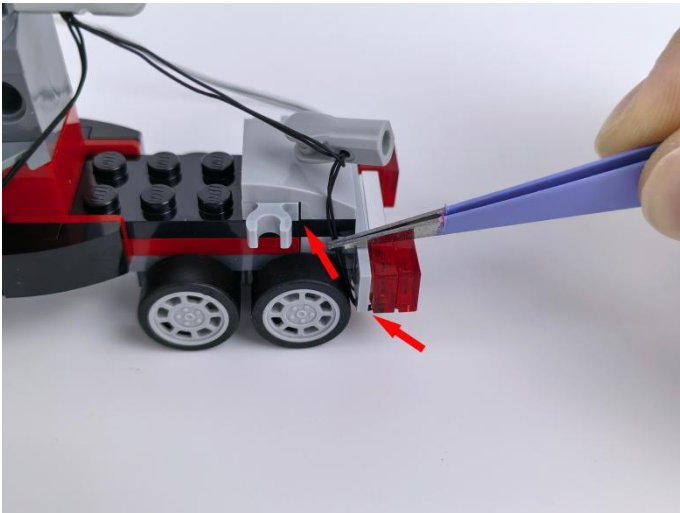

13

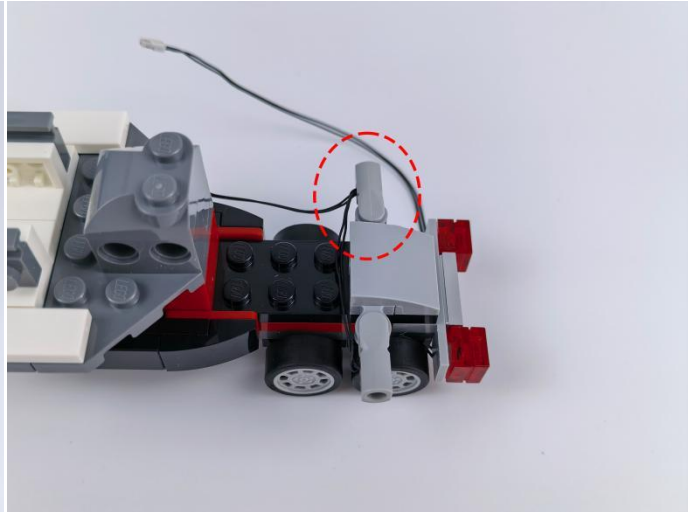
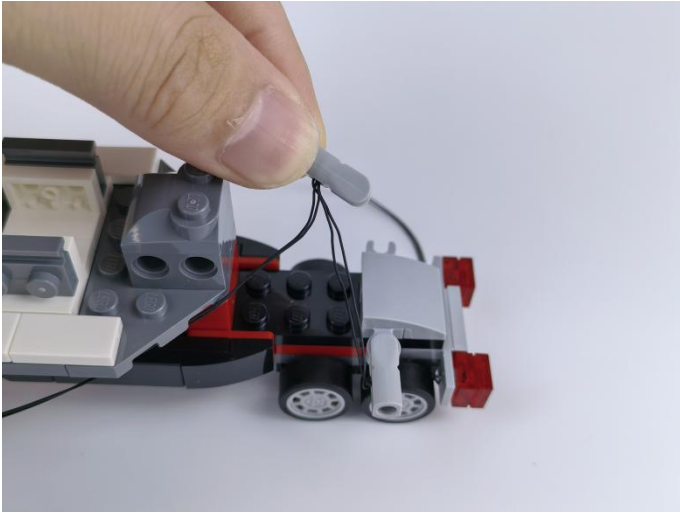

14

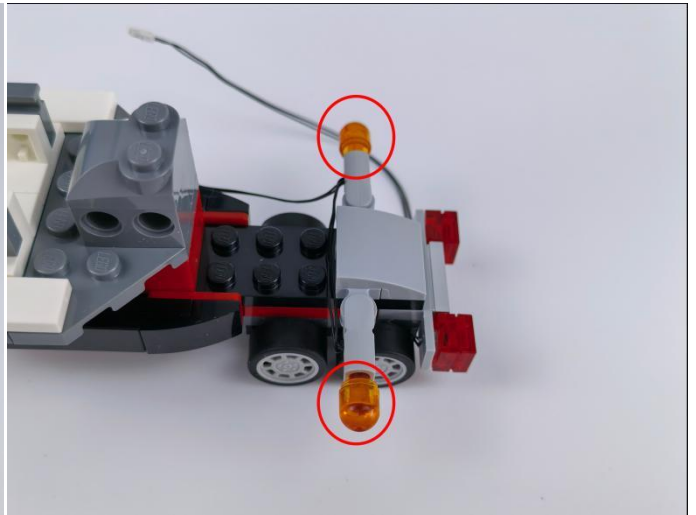
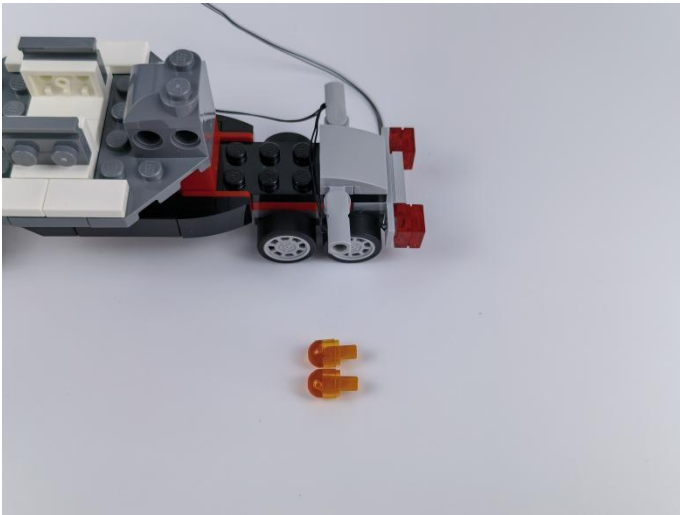

15

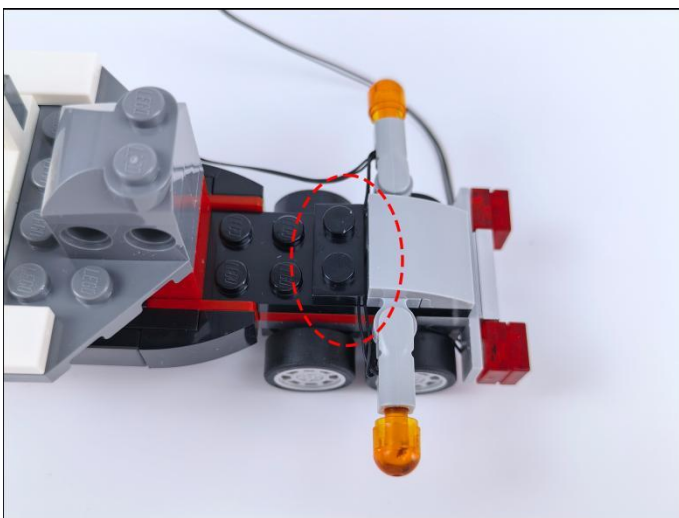
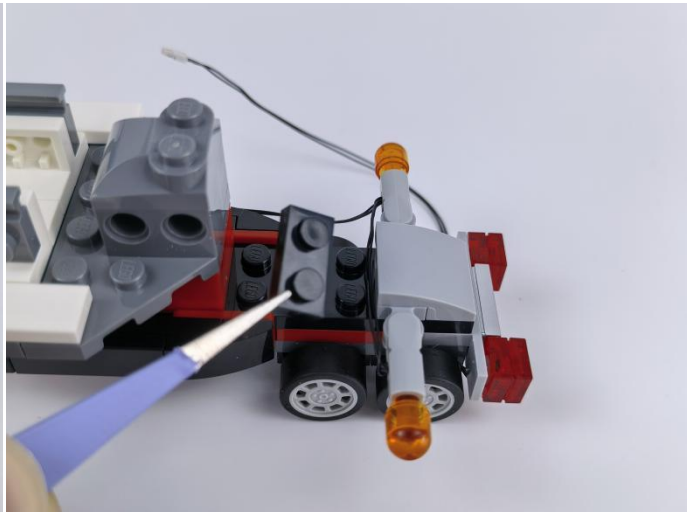

16

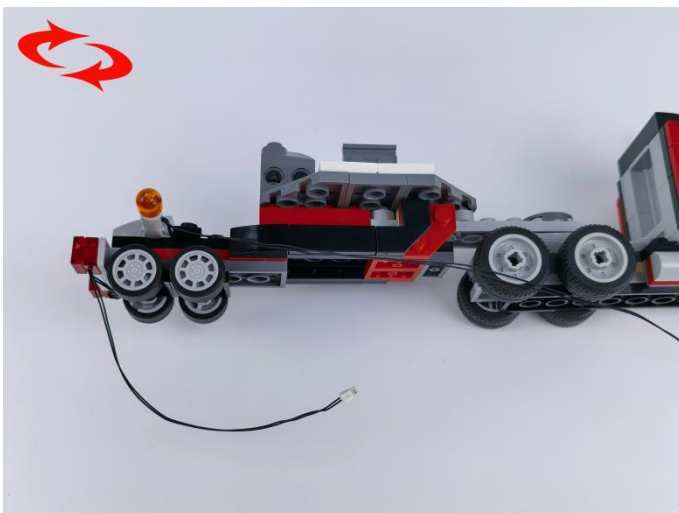

17

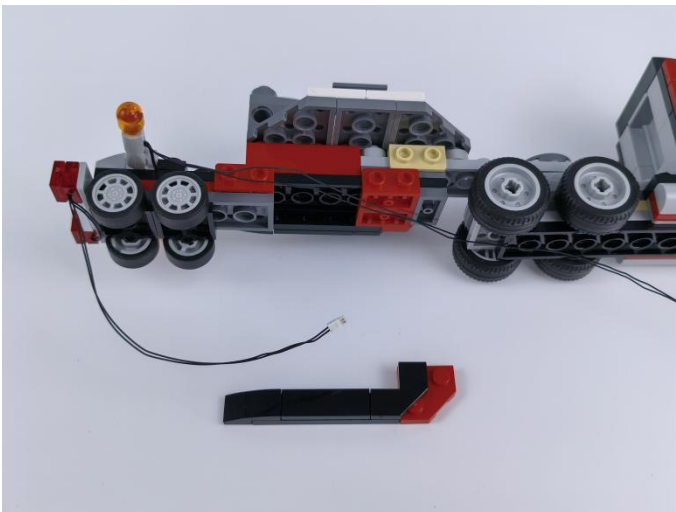

18

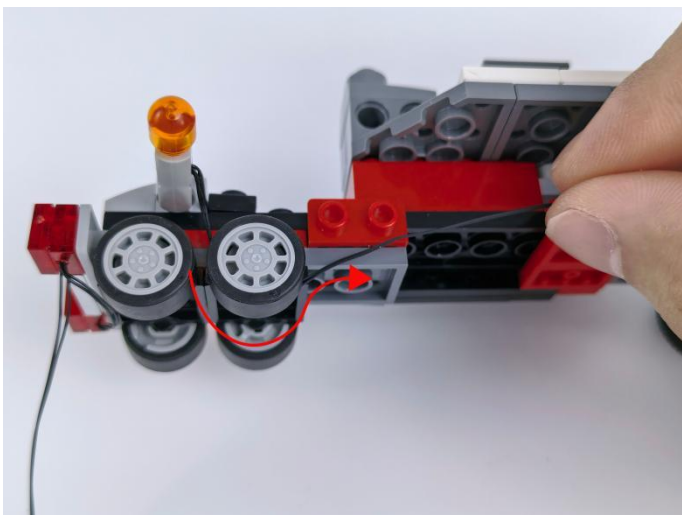
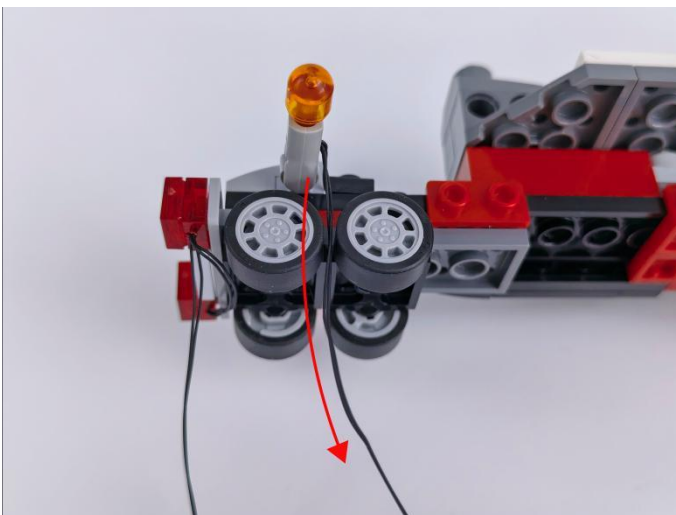
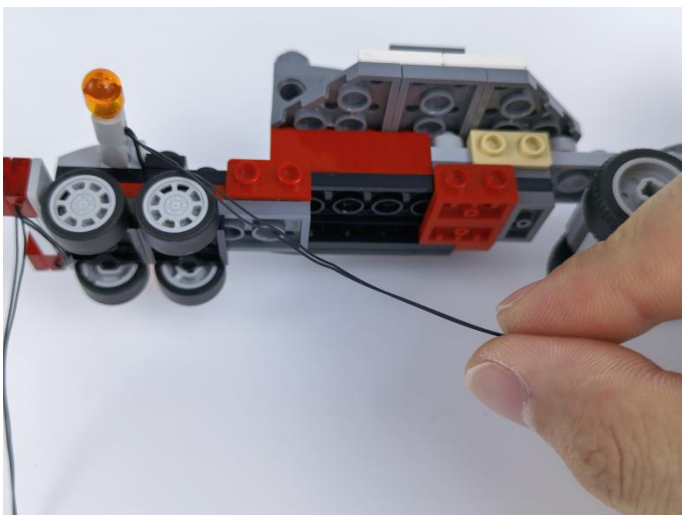

19



20



21



22

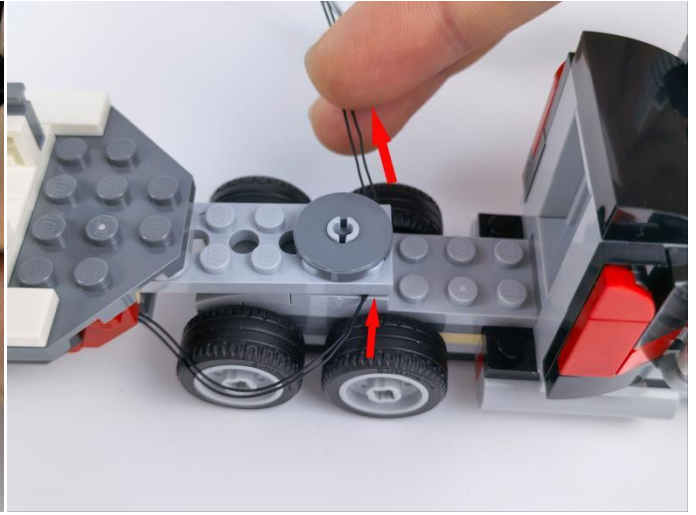
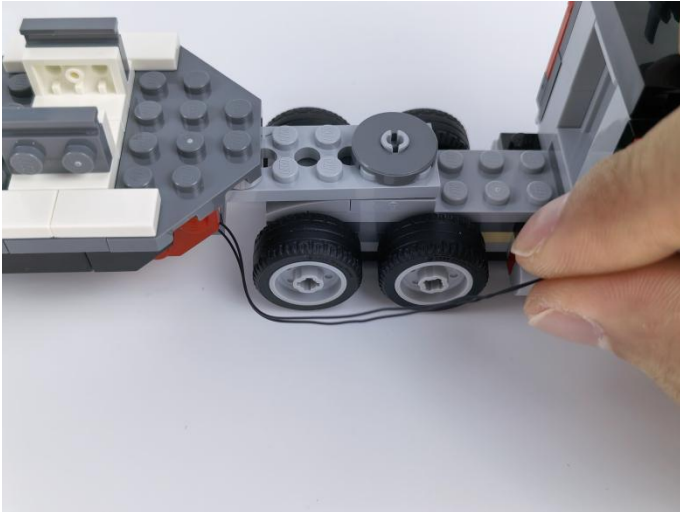

23

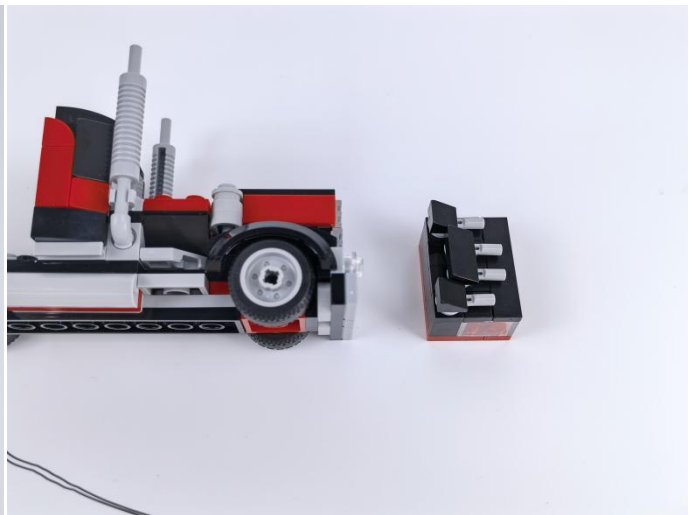
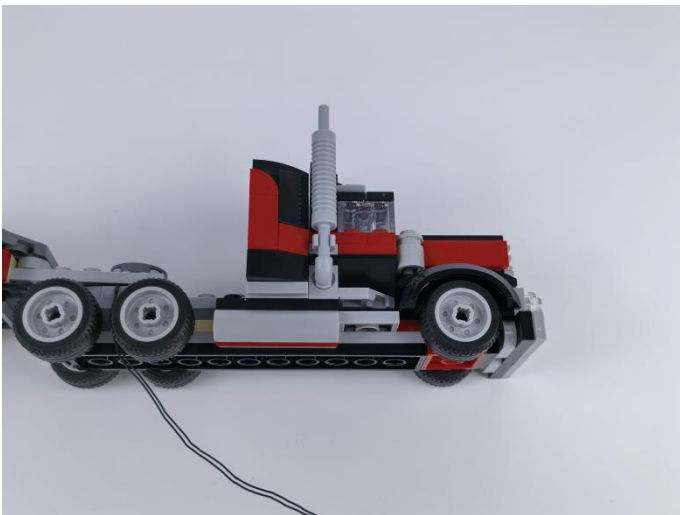
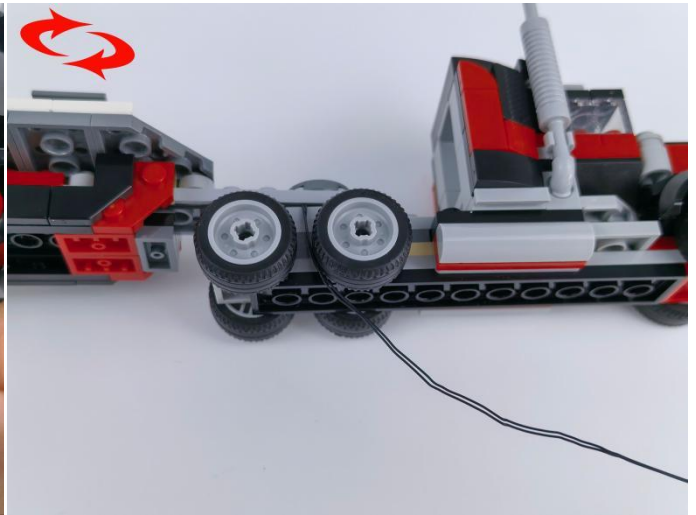
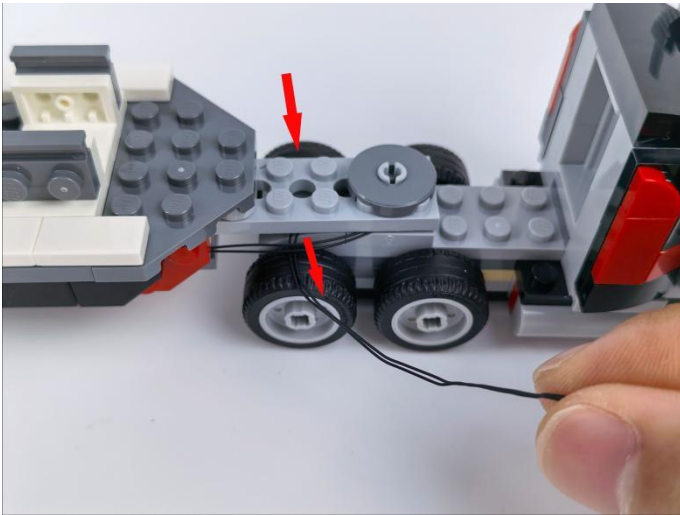

24



25

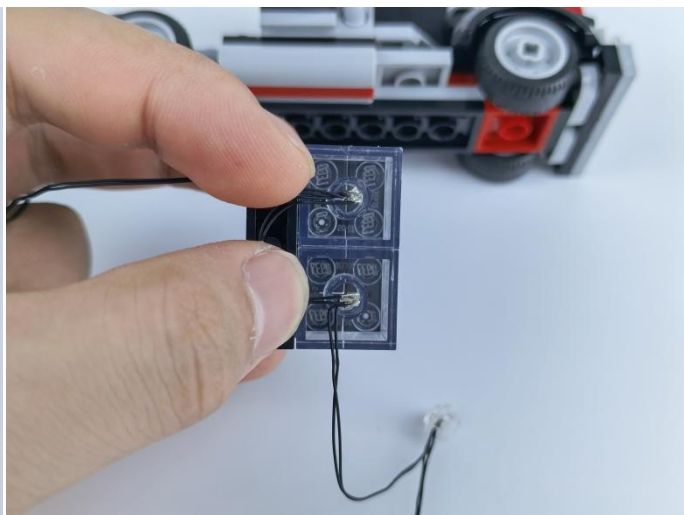

26

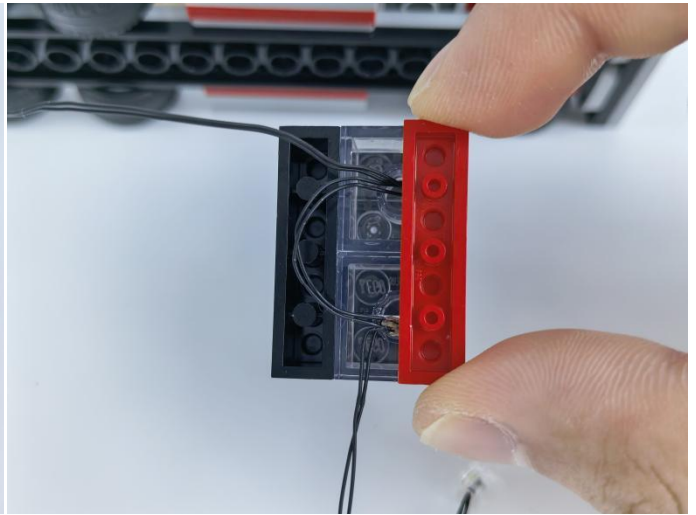
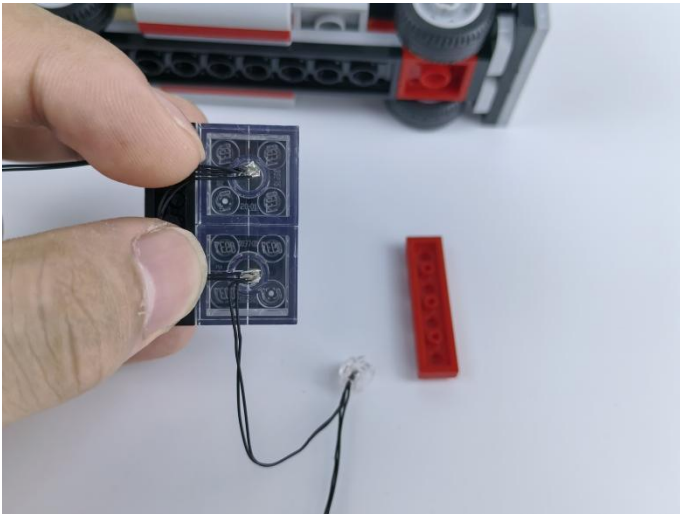

27

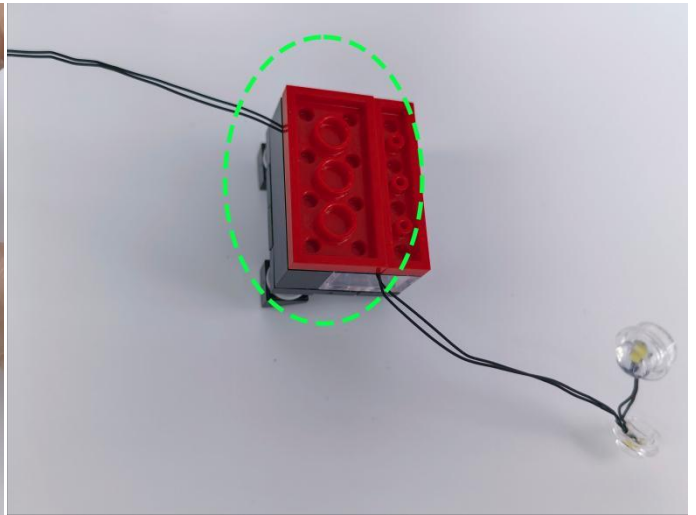
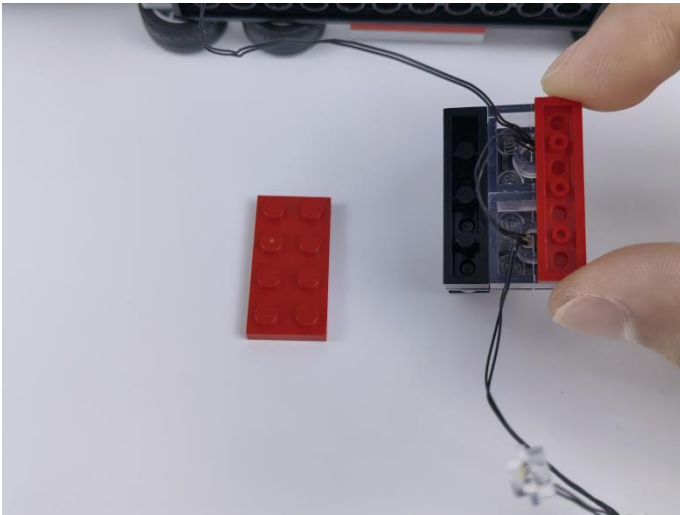

28

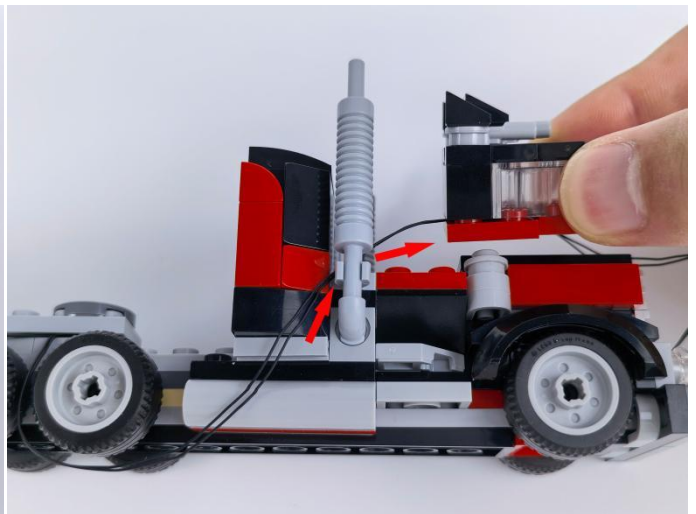

29

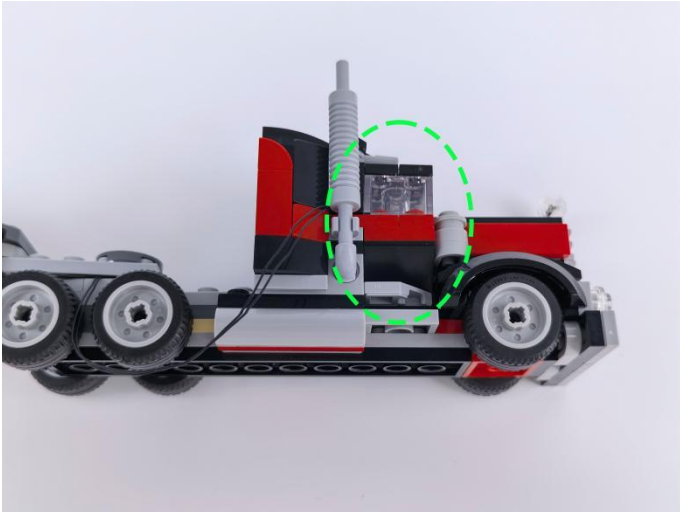

30

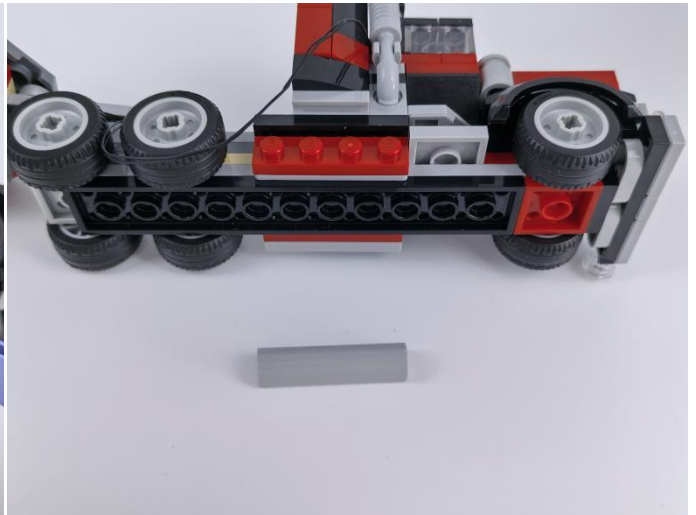
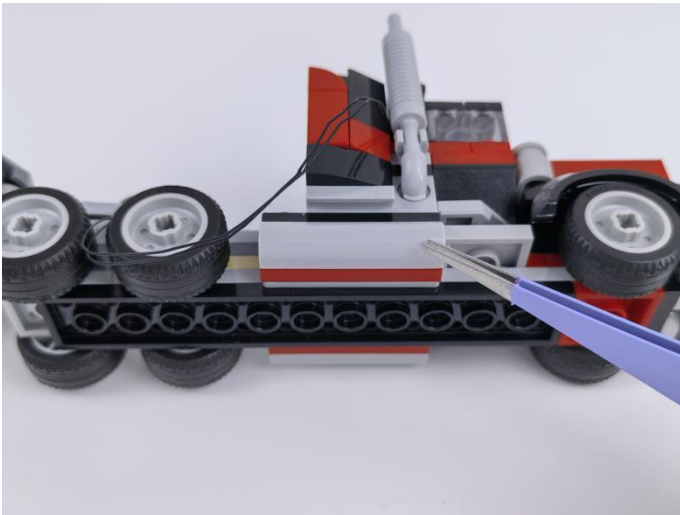

31

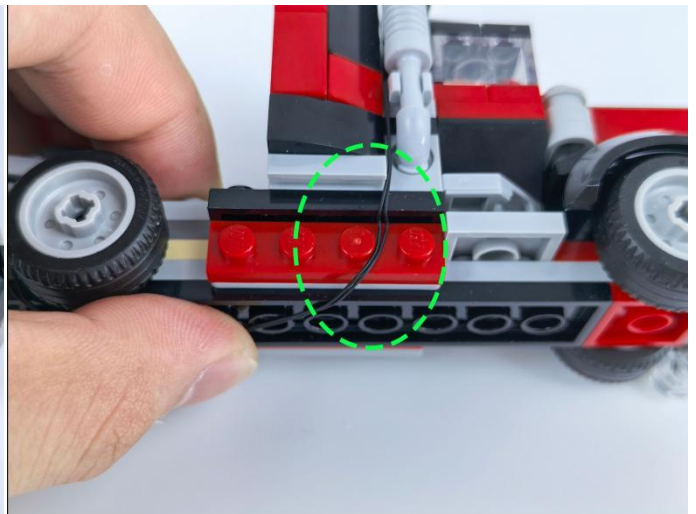
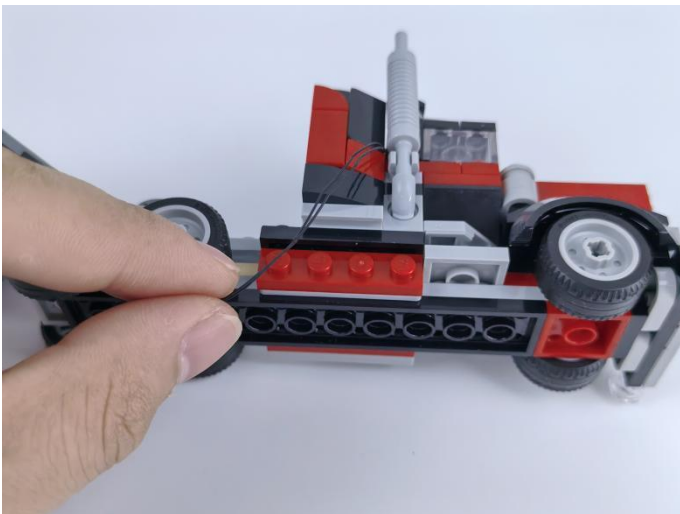

32

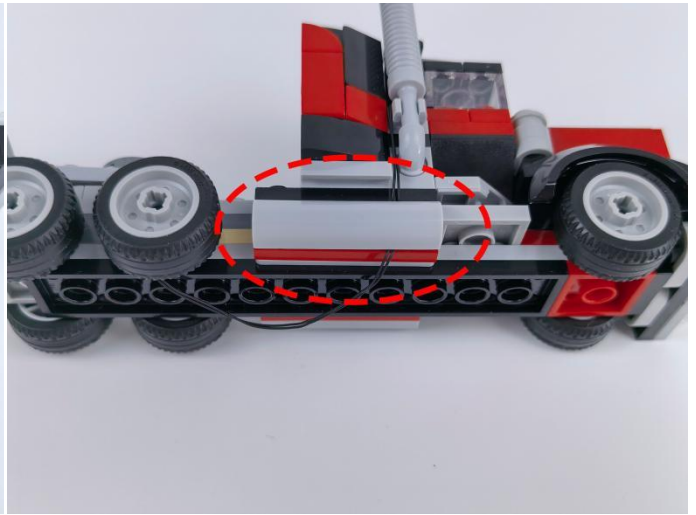
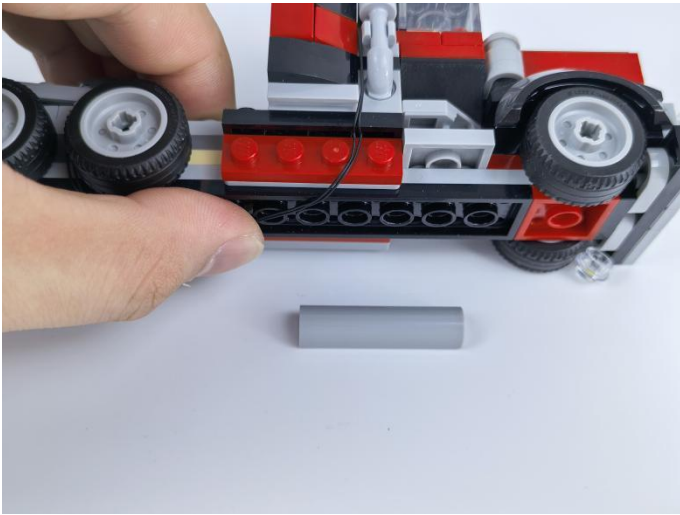

33

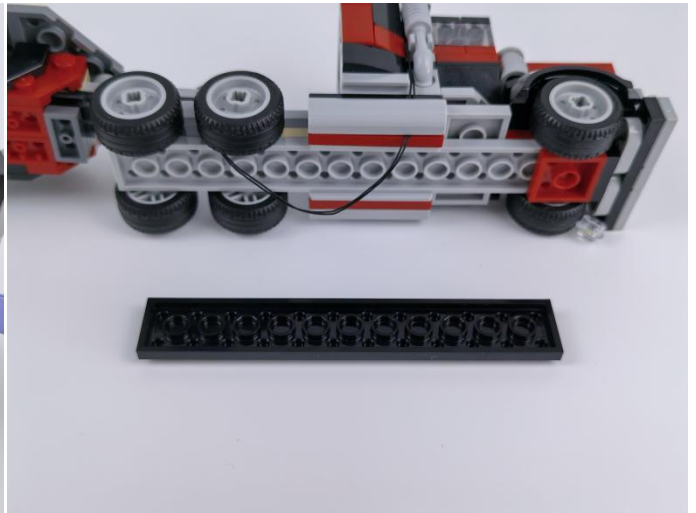
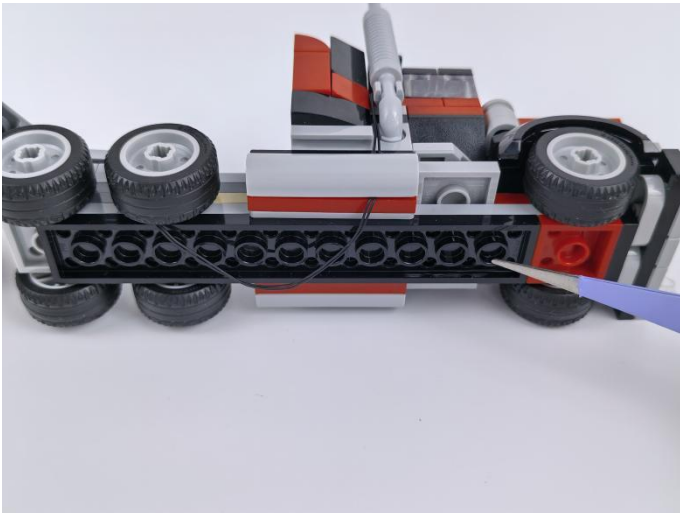

34

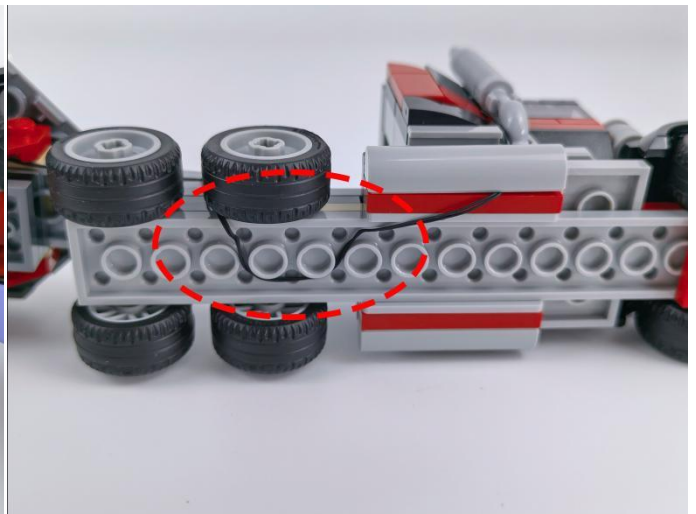
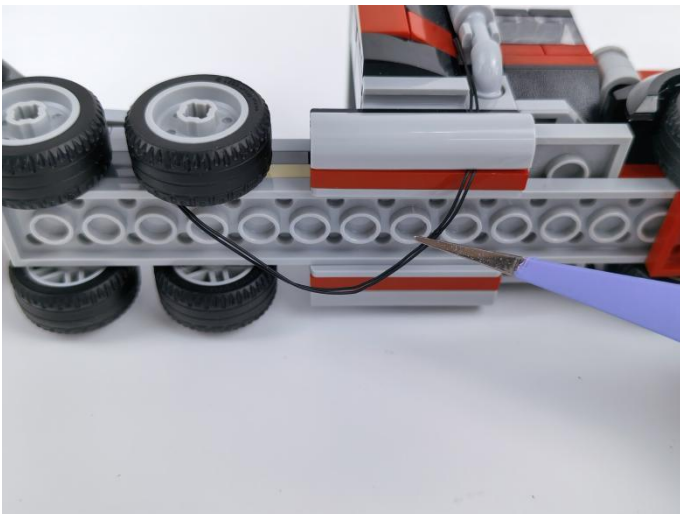

35

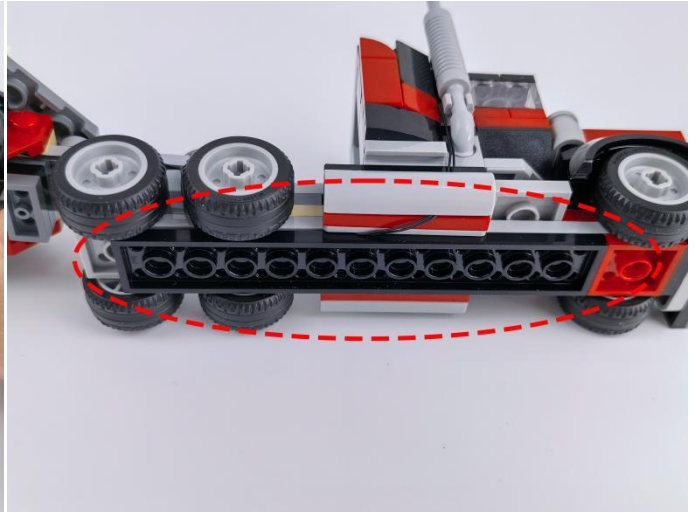
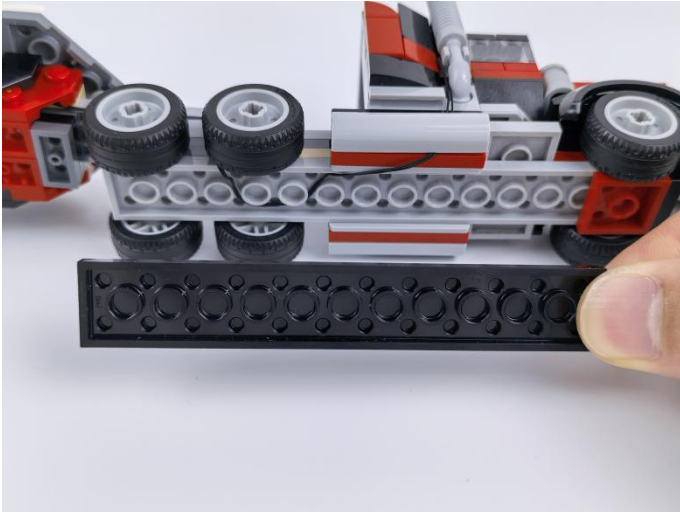

36

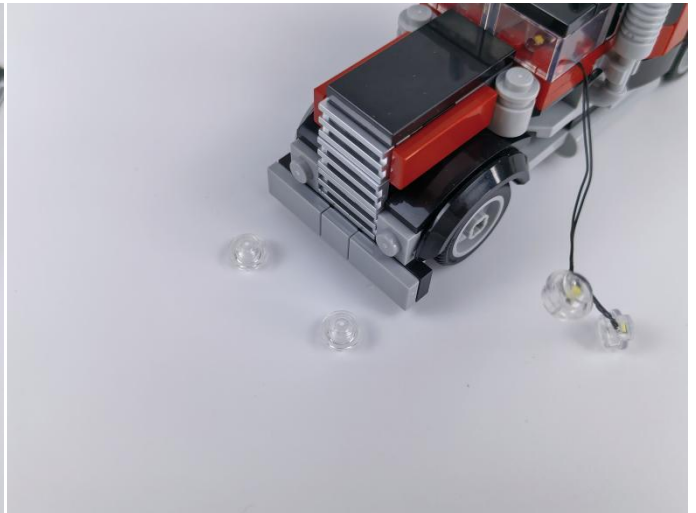
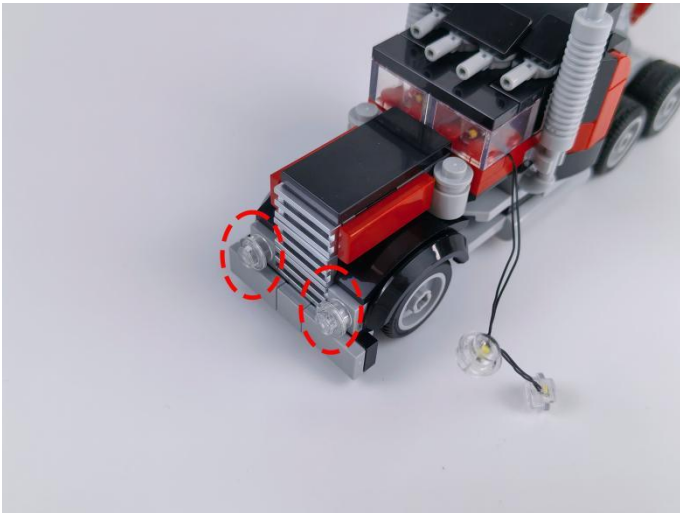

37



38

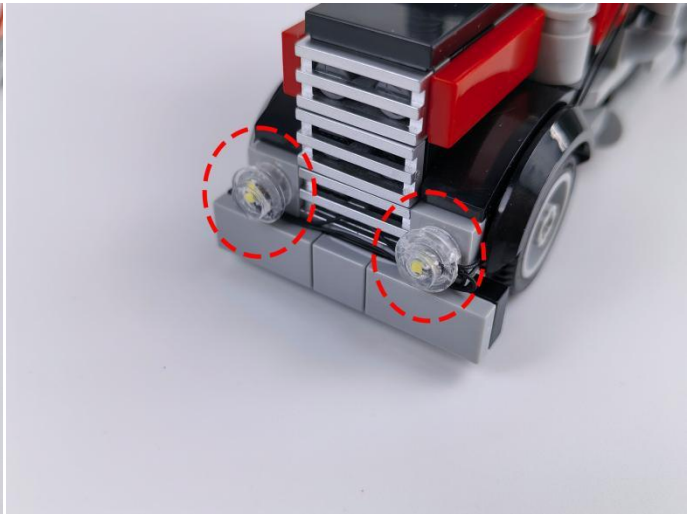
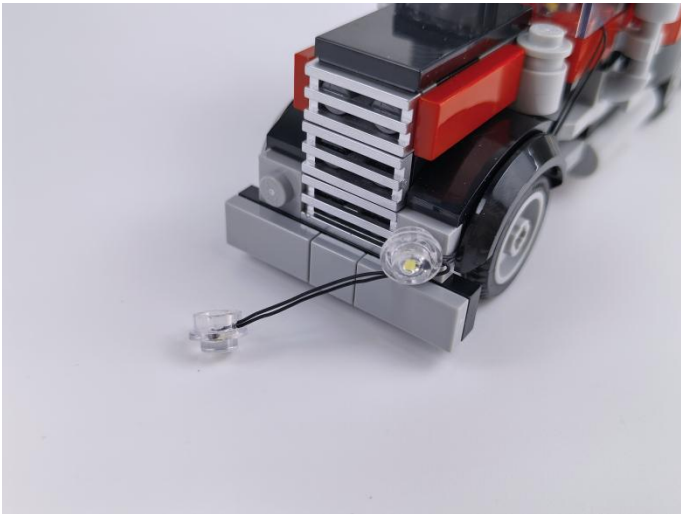

39



40

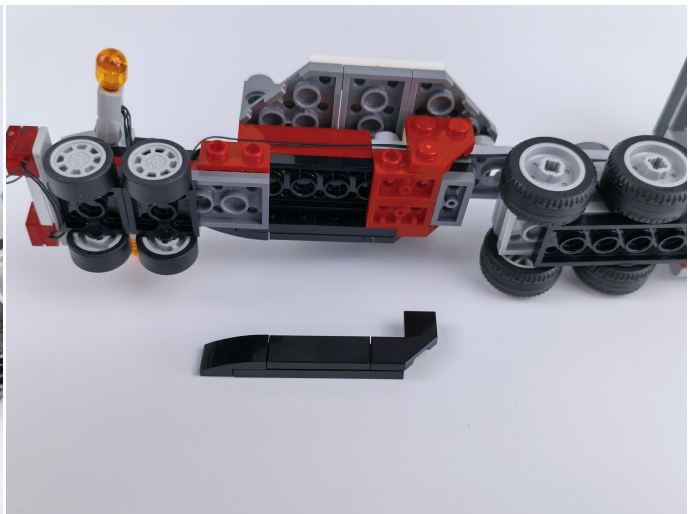
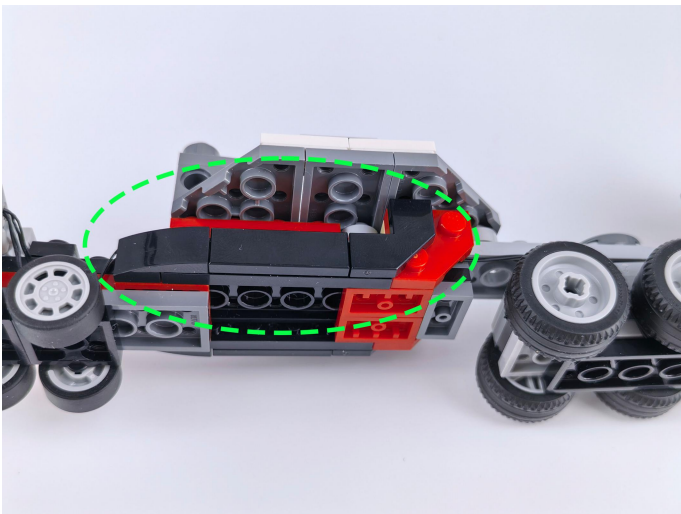

41

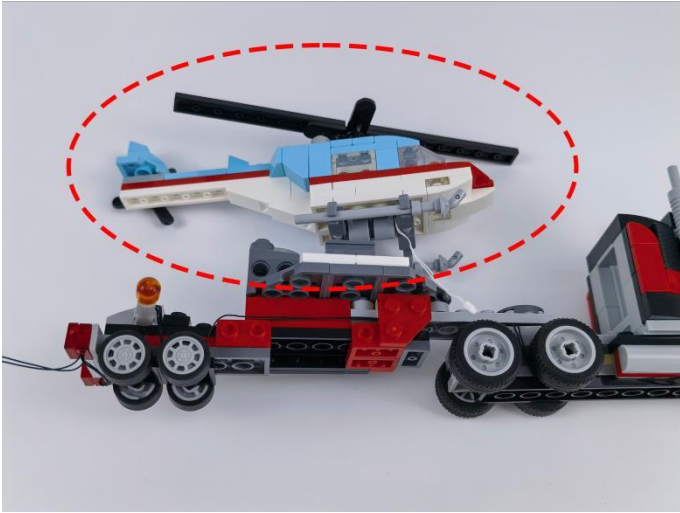

42

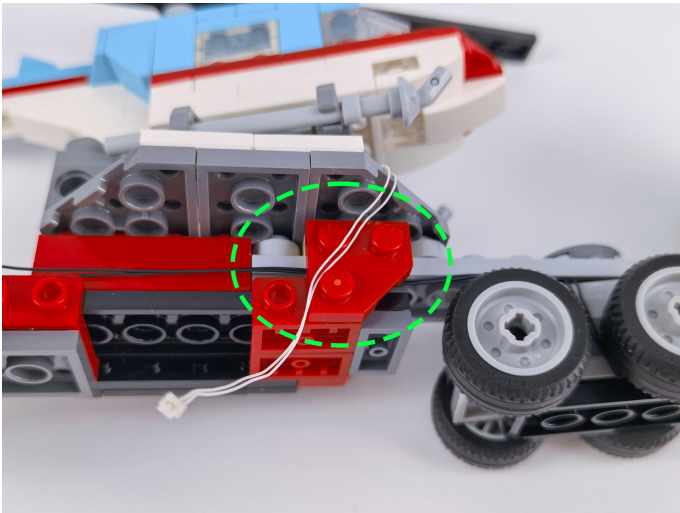

43

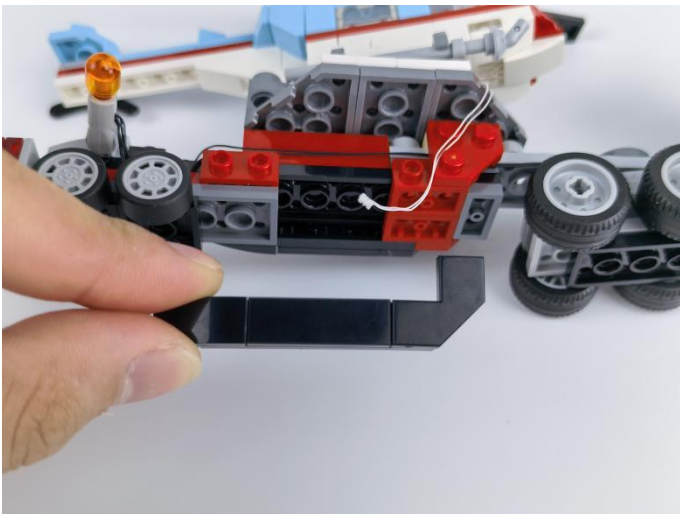

44



45



46

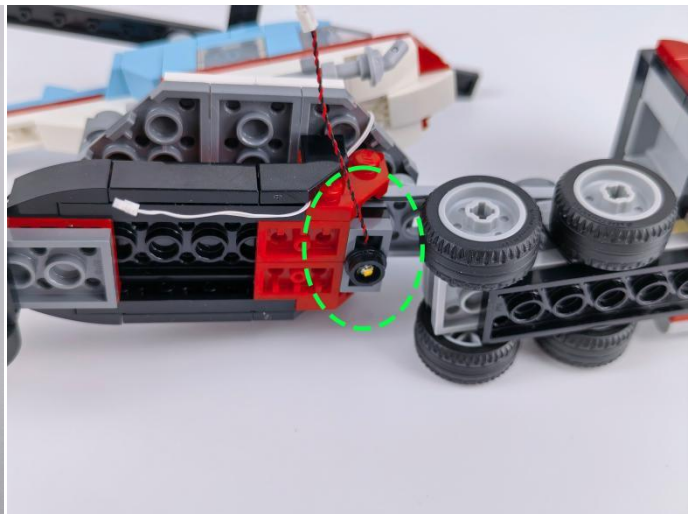

47

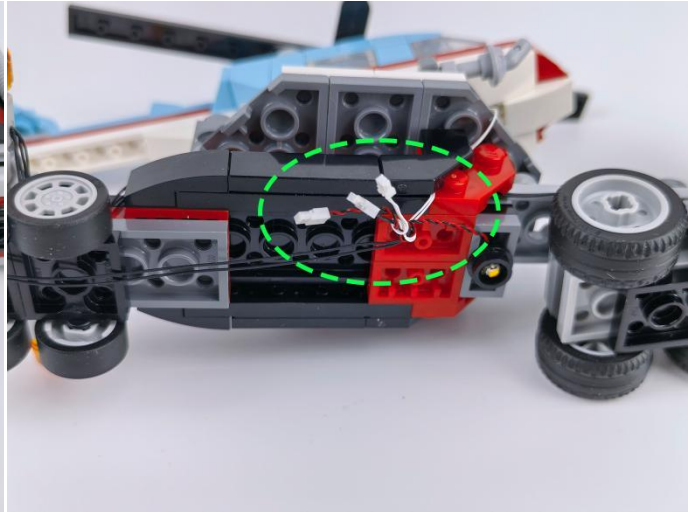
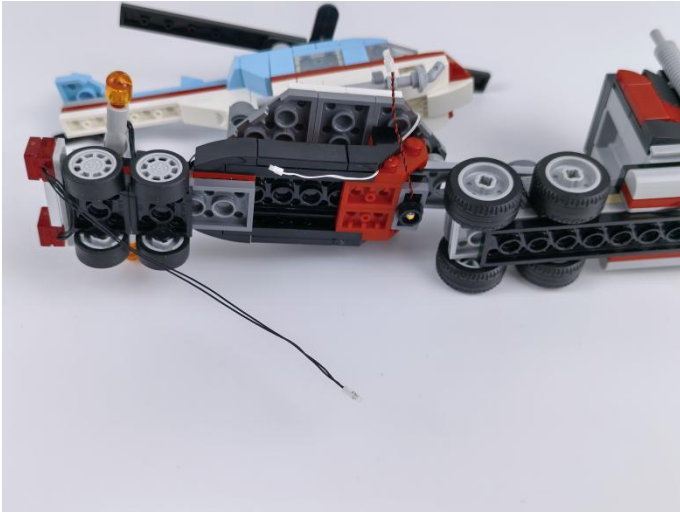

48

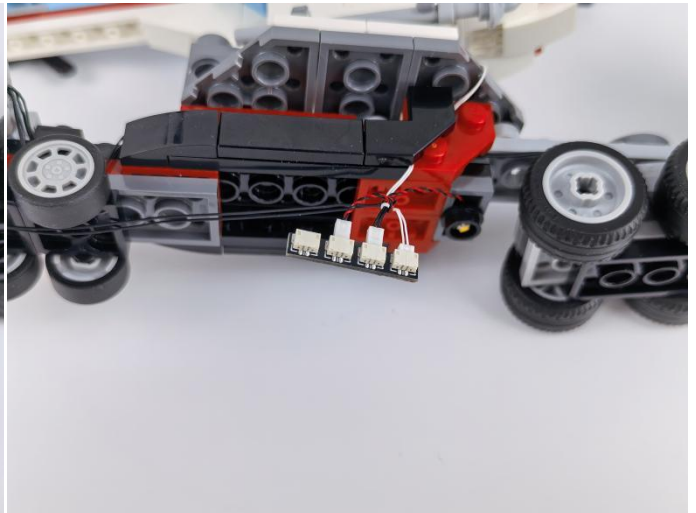

49

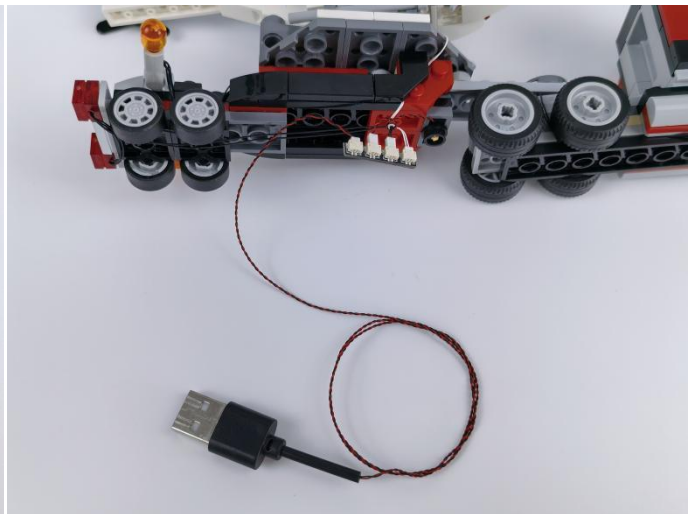

50

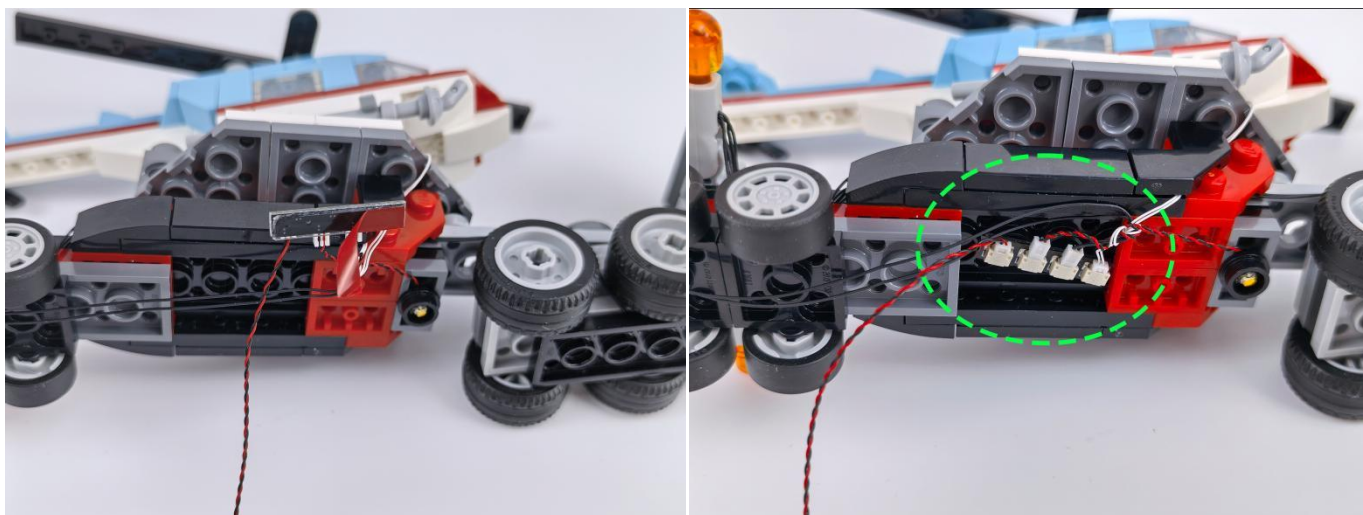

51



Good job, you've done all the installation steps, power it up and enjoy your work.



The battery box can also power the set. If it is necessary to change the power supply , prepare three aaa batteries, install them in the battery box, turn on the switch on the battery box, remove the plug of the usb power cable from the socket of the expansion board,plug the plug of the battery box to the same socket in the expansion board to power the suit as well.

**THANKS**

## Tips

If you encounter any installation problems please contact the seller, we will be happy to help you solve!