

INSTALLATION GUIDE

TinTin Moon Rocket

21367

LED light kit compatible with Lego

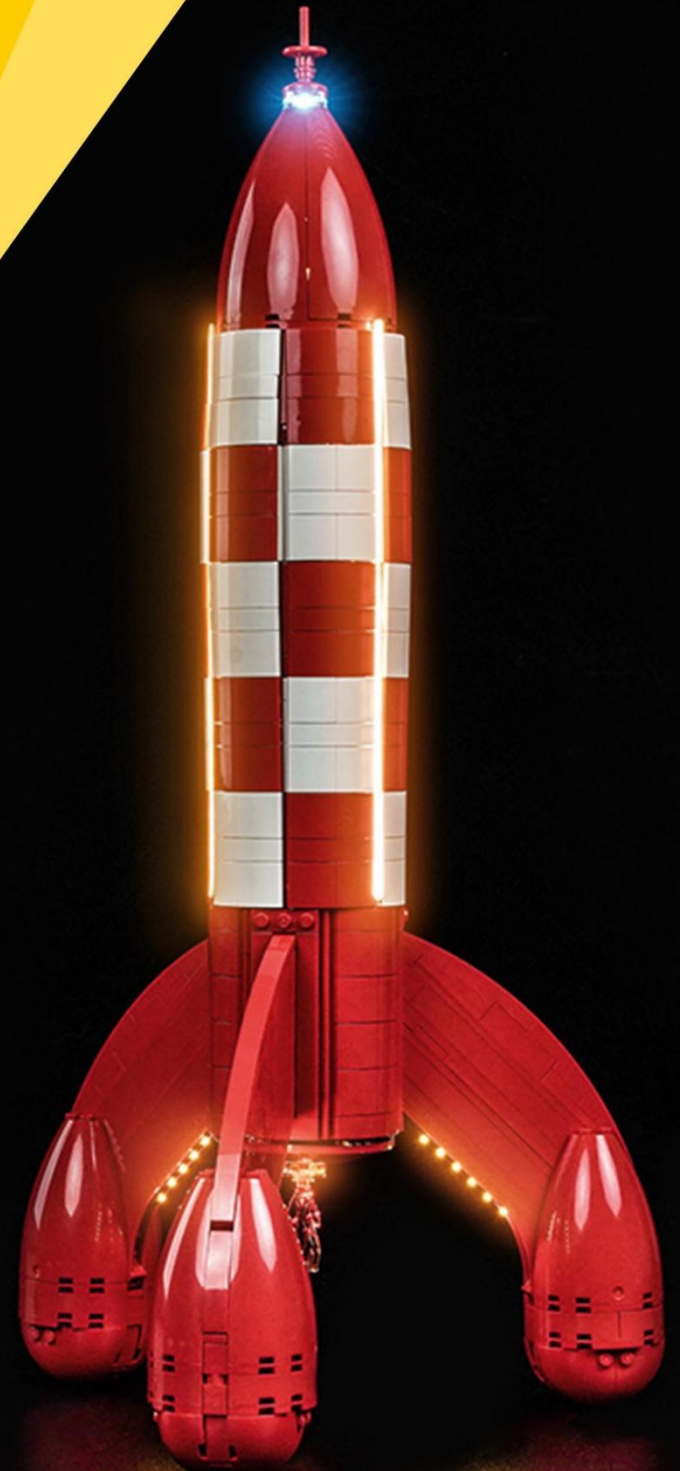

Instructions for installing this kit:

This set includes 6 pouches. (The battery case functions similarly, please select your own power source. This article uses a USB power cable.)

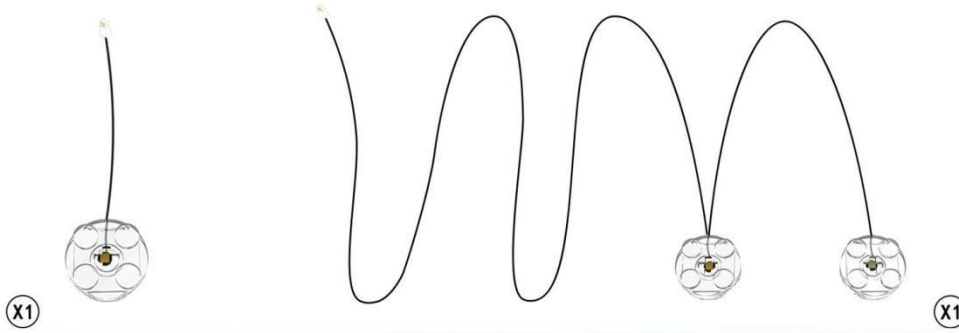

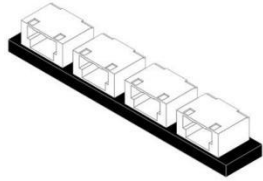

X2



X1



X2



X1

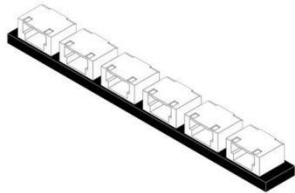

X1



X1

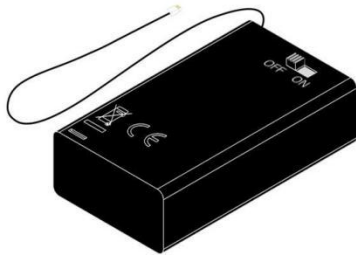

X1

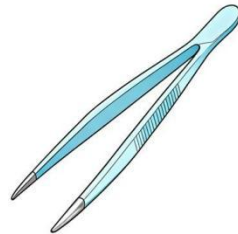

X1

This post will complete the light installation in two main sections.

Step 1-test



Step 2-mounting

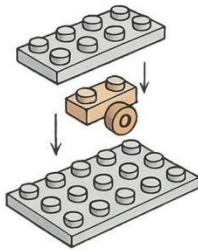

So let's get started!

Step 1-Test

1

EN: Remove the 6 expansion boards and the touch dimmer module from Bag 5.

DE: Nehmen Sie die 6 Erweiterungskarten und das Touch-Dimmer-Modul aus Beutel 5 heraus.



2

EN: Connect them together.
DE: Verbinde sie miteinander.



Touch Dimmer Module - 50CM Introduce

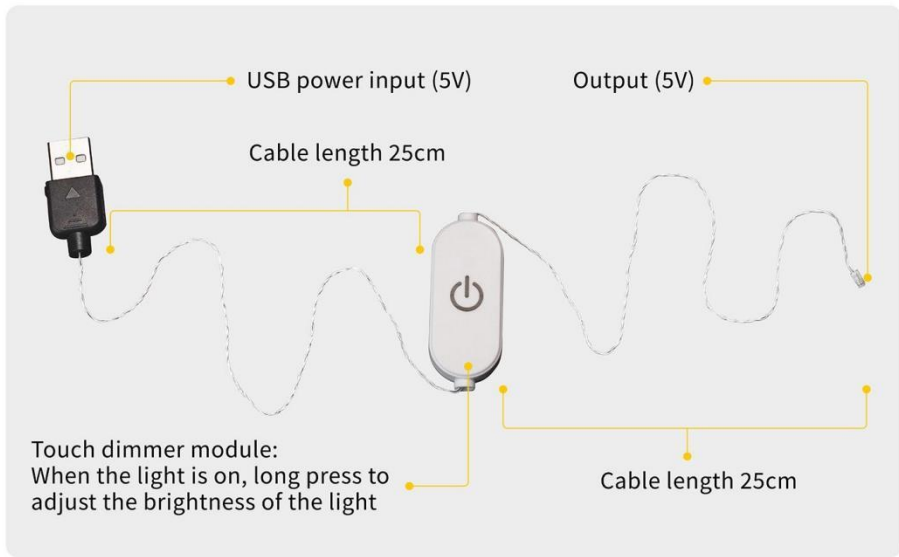

3

EN: Connect the USB power cable to the portable power bank.
DE: Schließen Sie das USB-Stromkabel an die tragbare Powerbank an.



USB Connectors to Connect Devices

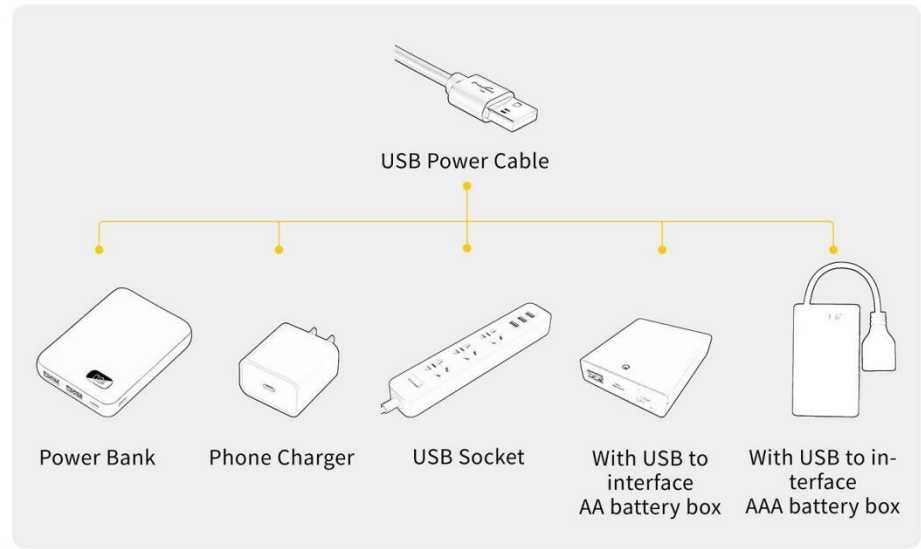

4

EN: Remove the lighting fixture from bag 1, connect it to the expansion board, turn on the power, and check if the lighting fixture is functioning properly. If any problems arise, please contact us immediately.

DE: Entfernen Sie die Leuchte aus Tasche 1, verbinden Sie sie mit der Expansionsplatte, schalten Sie die Strom, und überprüfen, ob die Lichteinrichtung ordnungsgemäß funktioniert. Wenn Probleme auftreten, bitte kontaktieren Sie uns sofort.

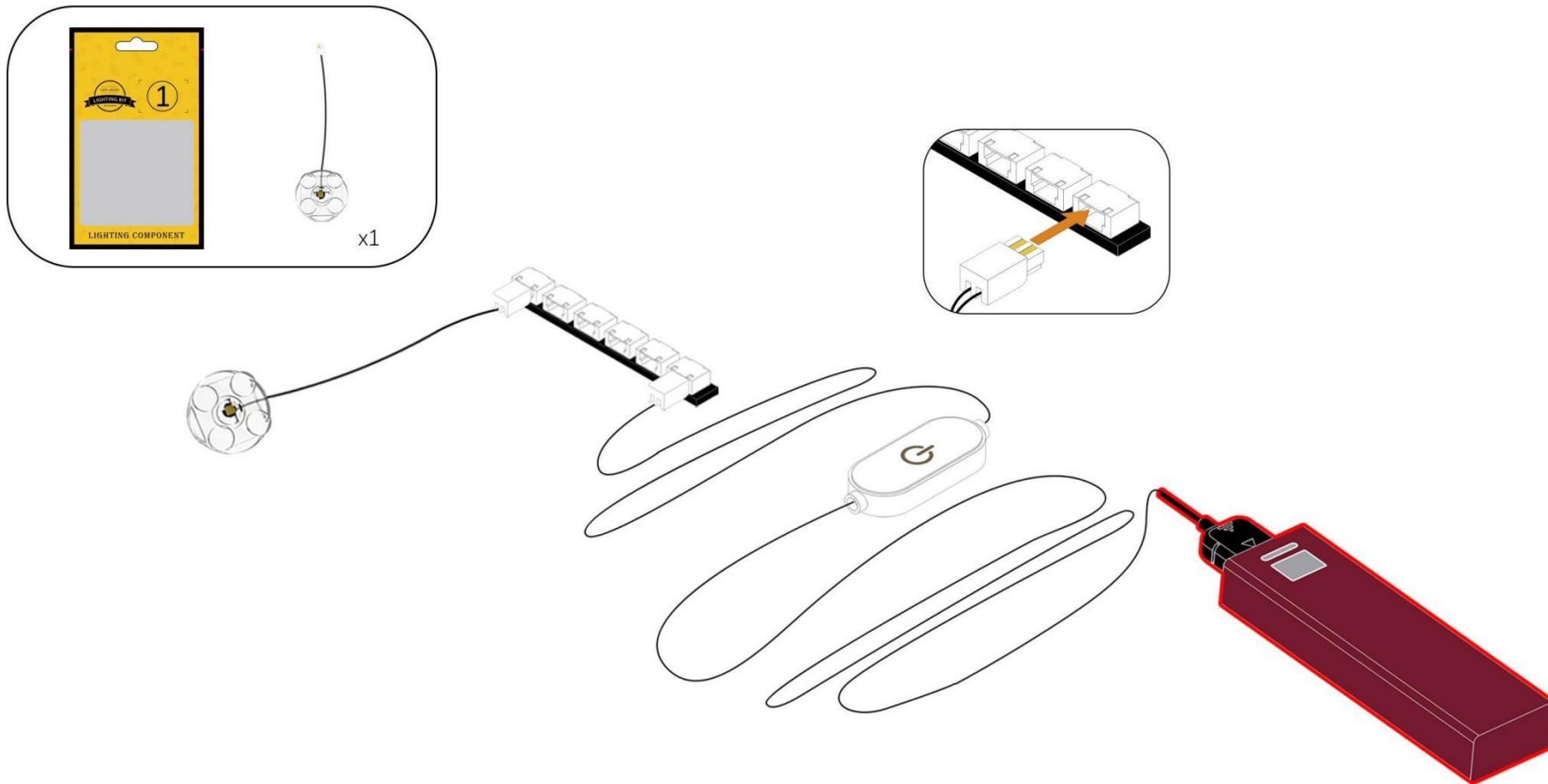

After confirming that there are no abnormalities, temporarily return each part to its original bag.

Step 2-Mounting.

1

EN: Take out the rocket model.

DE: Nimm das Modell heraus.



2

EN: Remove the building blocks.

DE: Entferne die Bausteine.



3

EN: Split as shown in the figure.

DE: Teilen Sie es wie in der Abbildung gezeigt.

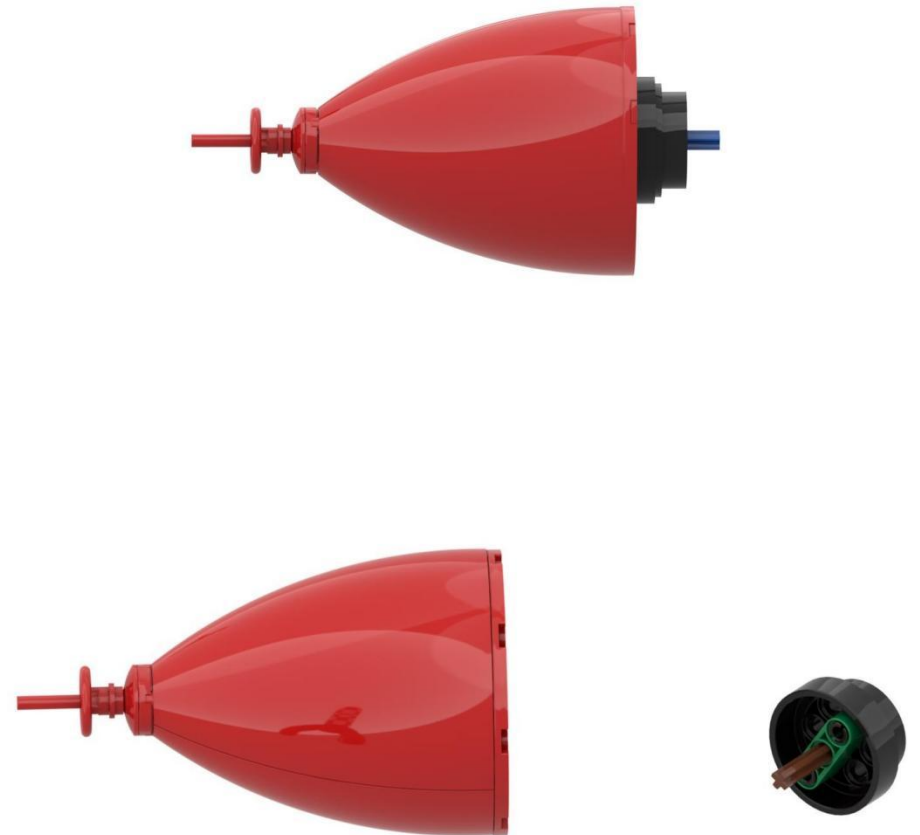

4

EN: Split as shown in the figure.

DE: Teilen Sie es wie in der Abbildung gezeigt.

①



②

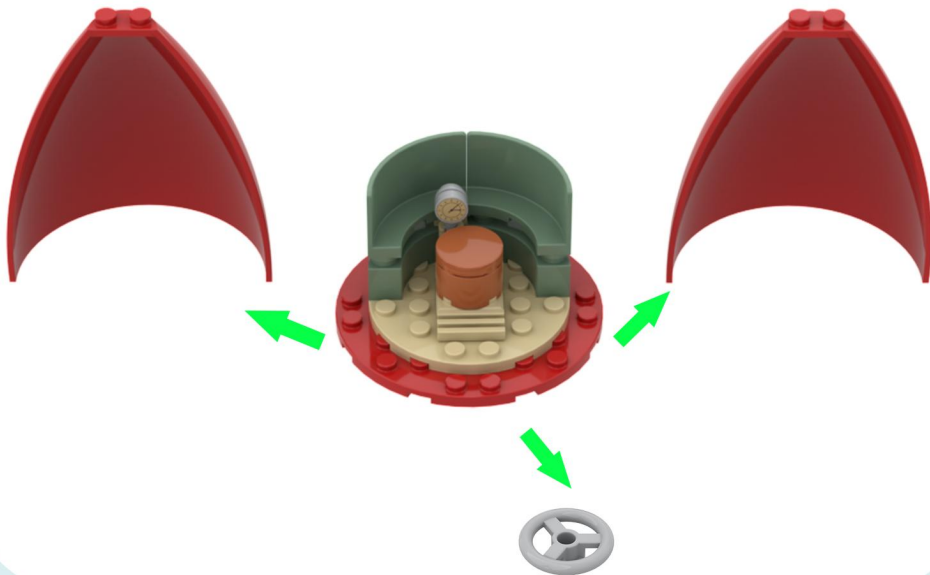

5

EN: Split as shown in the figure.

DE: Teilen Sie es wie in der Abbildung gezeigt.

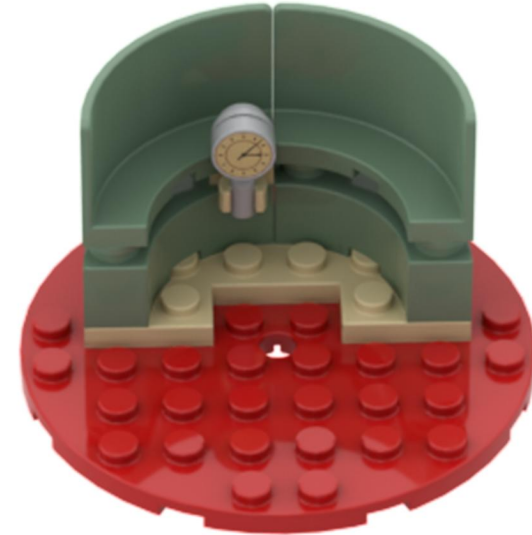

6

EN: Split as shown in the figure.

DE: Teilen Sie es wie in der Abbildung gezeigt.

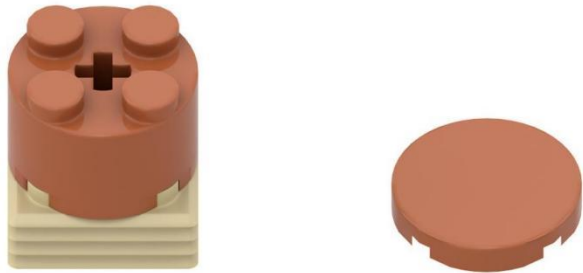
**7**

EN: Take the string of lights out of Bag 1, remove the zip tie, secure it to the building block, and reassemble the block.

DE: Nehmen Sie die Lichterkette aus Beutel 1, entfernen Sie den Kabelbinder, befestigen Sie sie am Baustein und setzen Sie den Baustein wieder zusammen.

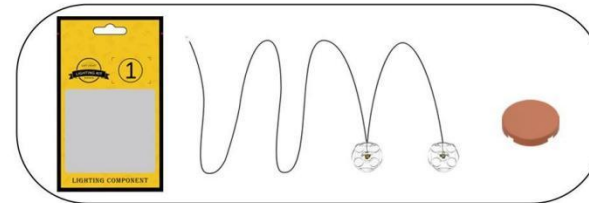
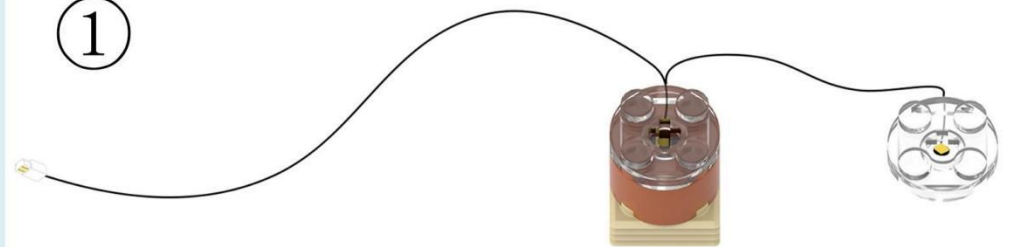
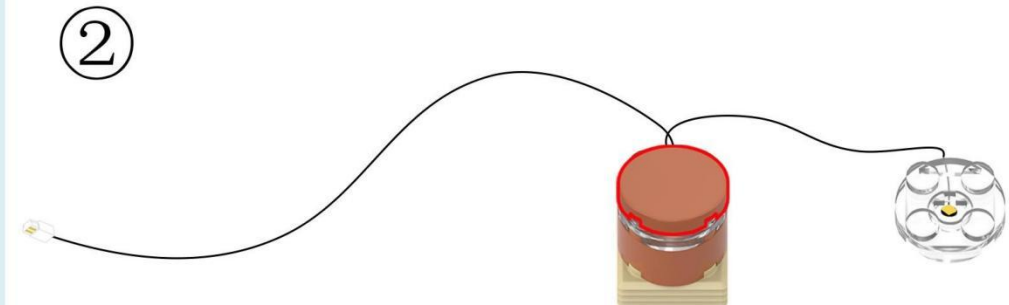
**1****2**

8

EN: Thread the light cord through the hole in the brick to the other side and tighten it, then reassemble the brick.

DE: Führen Sie das Lichtschnur durch die Öffnung im Baustein auf die andere Seite und ziehen Sie es fest; setzen Sie den Baustein anschließend wieder zusammen.

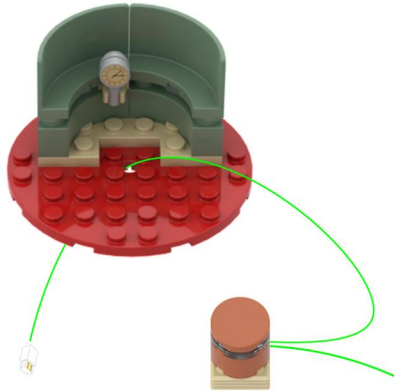
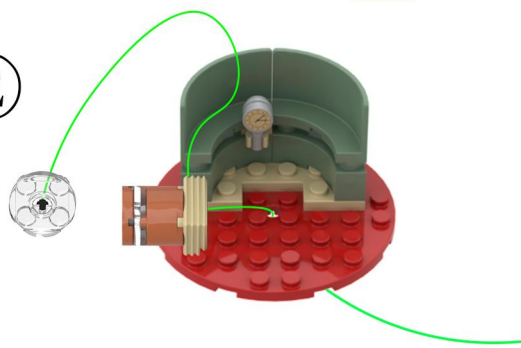
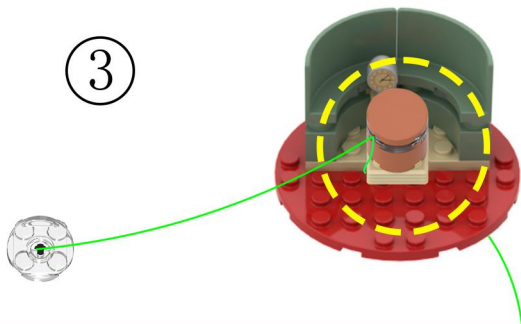
1**2****3****9**

EN: Remove the building blocks.

DE: Entferne die Bausteine.

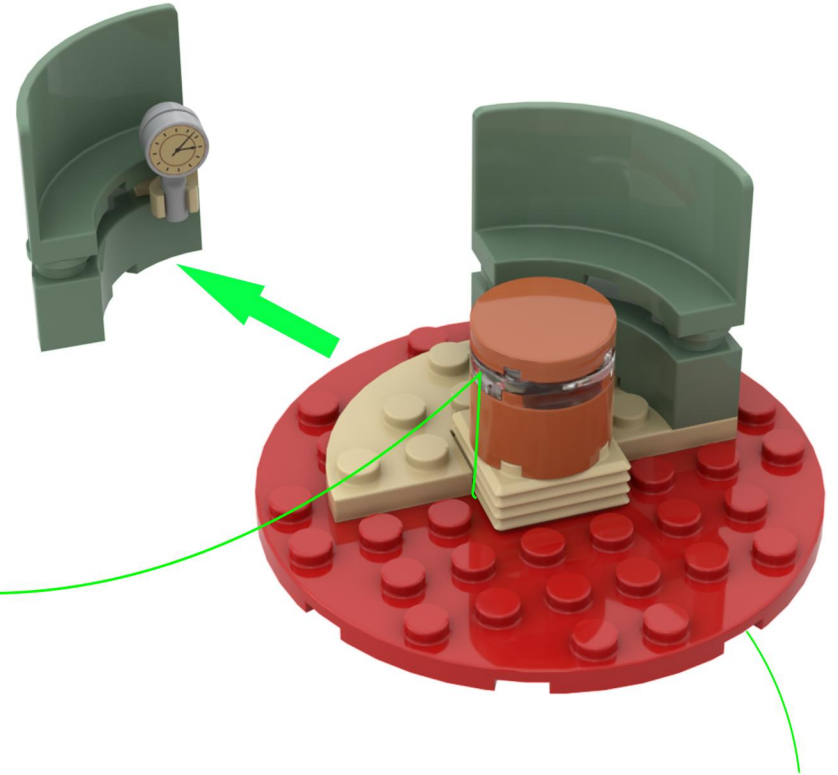

10

EN: Pull the light cord to the left, then reassemble the block.

DE: Ziehen Sie die Zugschnur nach links und bauen Sie den Block anschließend wieder zusammen.

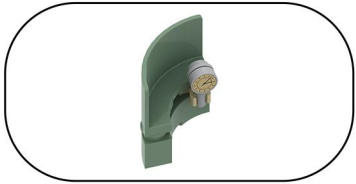

①

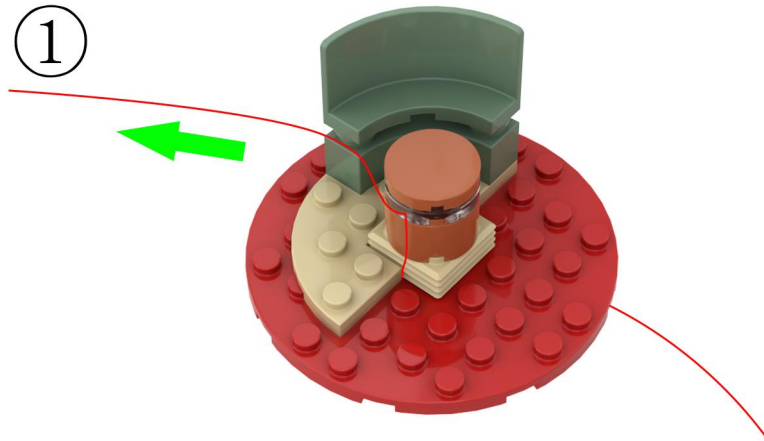

②

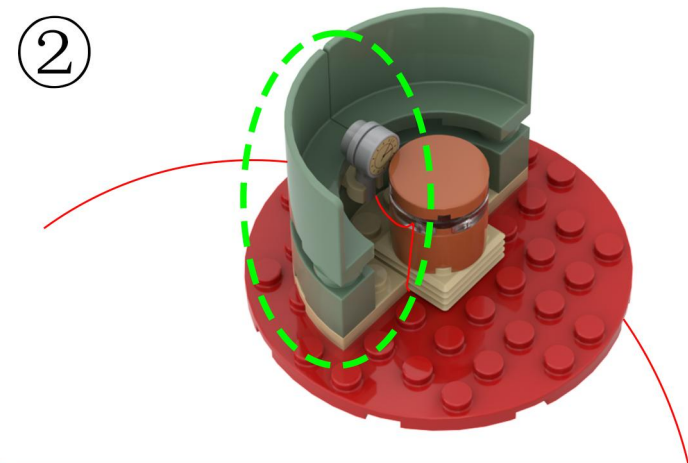

11

EN: Take out the building blocks you disassembled earlier and put them back together.

DE: Nimm die Bausteine, die du zuvor auseinandergenommen hast, und setze sie wieder zusammen.

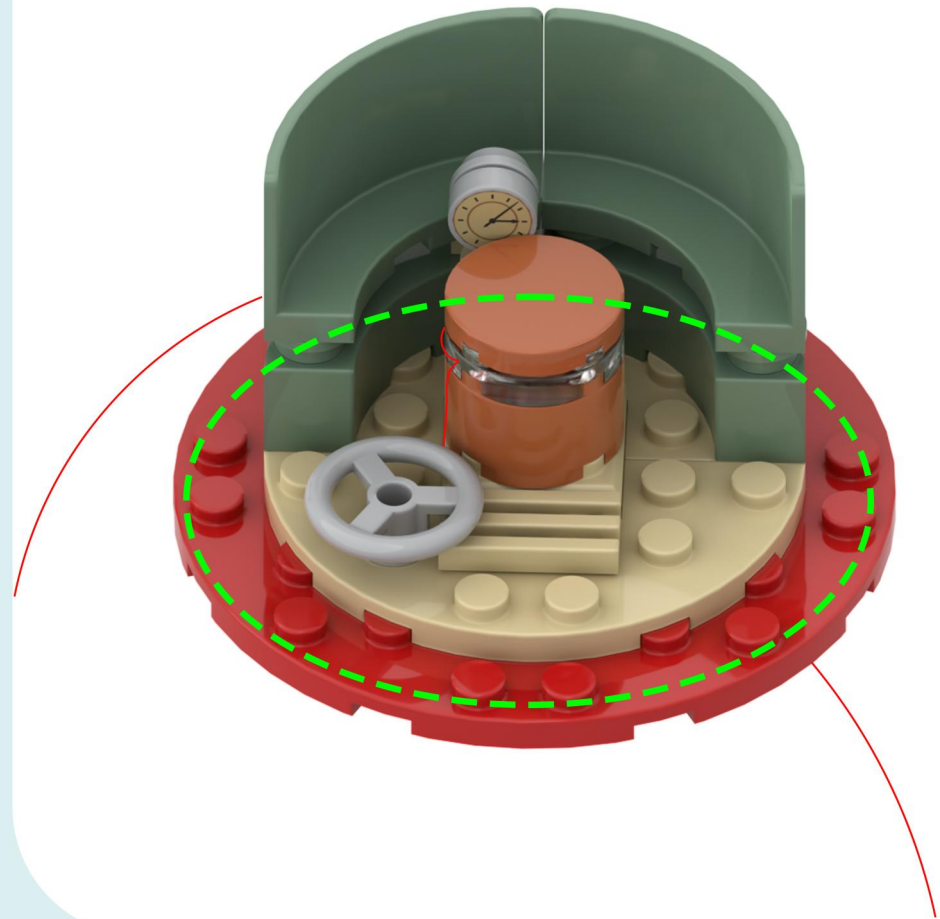
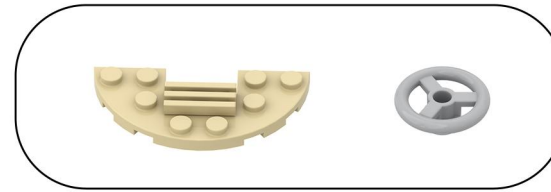

12

EN: Take out the red building block shell and put it back together.

DE: Nimm die rote Bausteinhülle heraus und setze sie wieder zusammen.

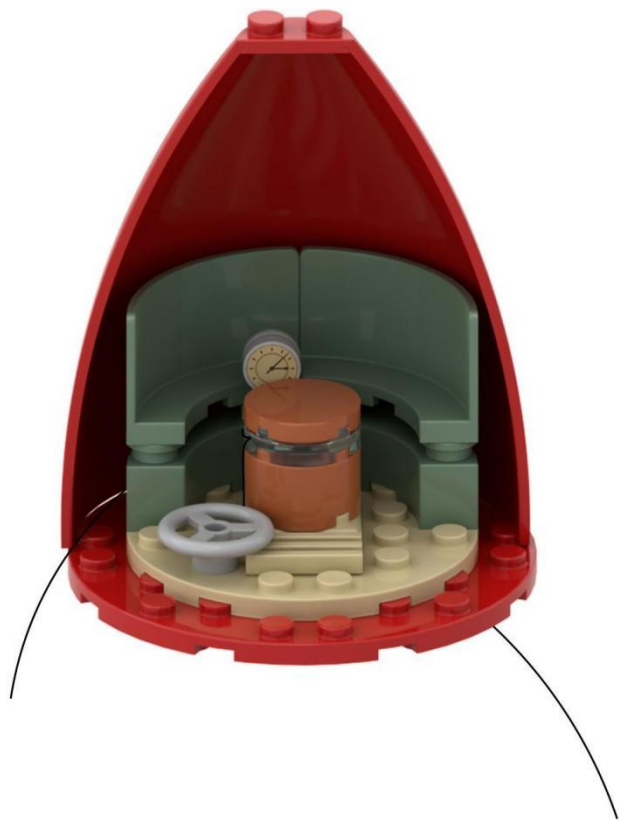
**13**

EN: Place the string of lights as shown in the picture, then reassemble the red brick casing.

DE: Bringen Sie die Lichterkette wie auf dem Bild gezeigt an und setzen Sie dann die rote Ziegelverkleidung wieder zusammen.

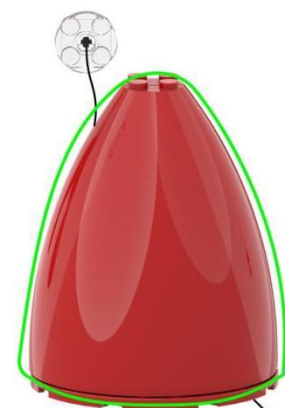
**1****2**

14

EN: Attach the light fixture to the building block.

DE: Befestigen Sie die Leuchte am Baustein.



15

EN: Restore the building blocks.

DE: Stelle die Bausteine wieder her.



16

EN: Take out the building blocks you disassembled earlier, then place the spaceship building blocks on top.

DE: Nimm die Bausteine heraus, die du zuvor auseinandergenommen hast, und setze dann die Raumschiff-Bausteine darauf.

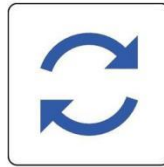
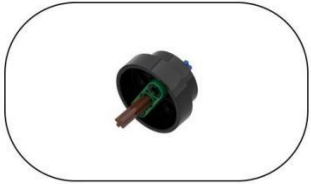

17

EN: Pull the light cord down and reassemble the building blocks.

DE: Zieh die Schnur nach unten und setze die Bausteine wieder zusammen.

①

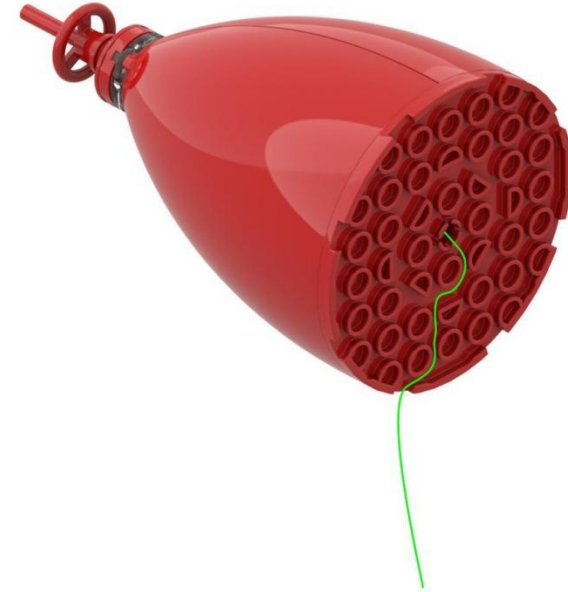

②

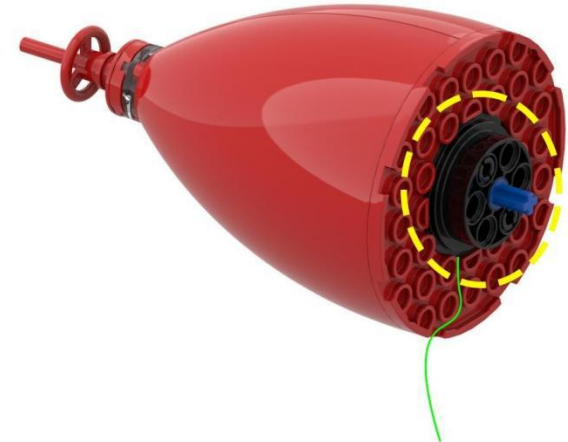

18

EN: Be sure to route the light cord away from the buckle before reassembling the building blocks.

DE: Achten Sie darauf, das Lichtkabel von der Schnalle wegzuführen, bevor Sie die Bausteine wieder zusammenbauen.

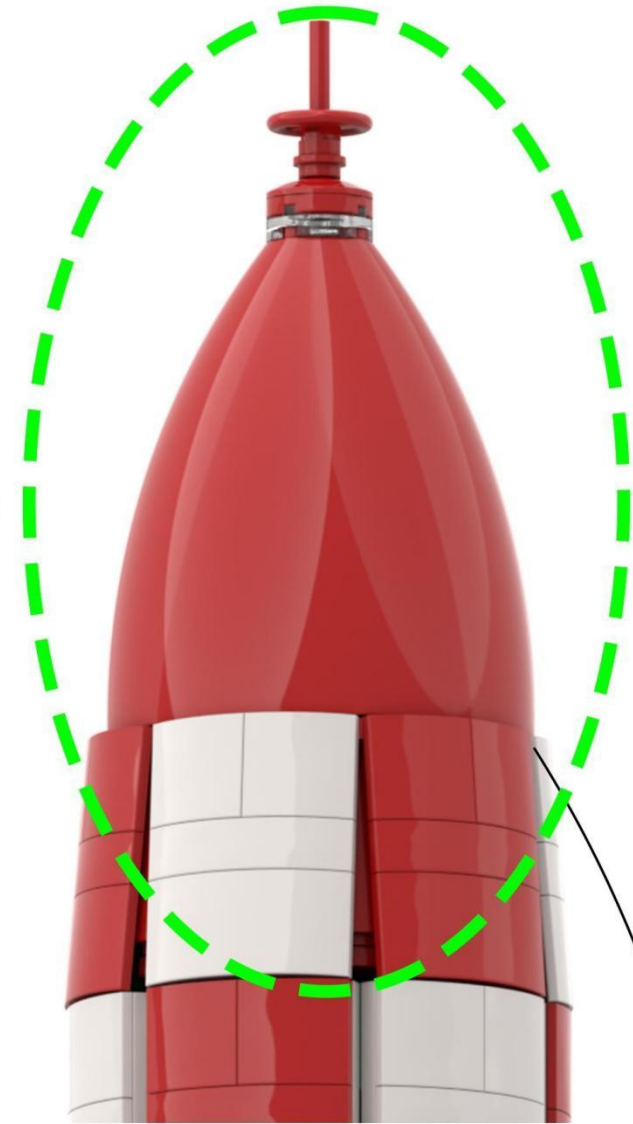
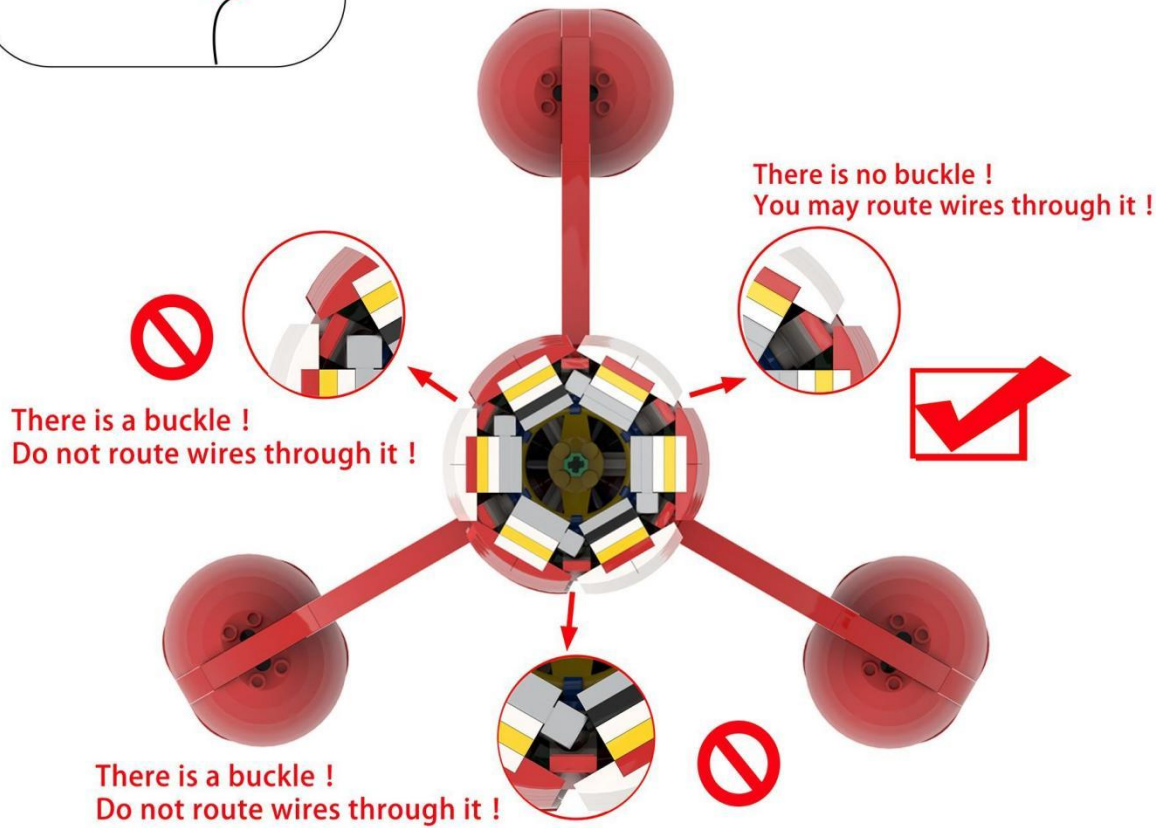
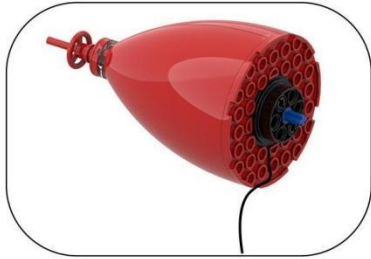

19

EN: Knock over the rocket model.

DE: Stürze das Raketenmodell um.



20

EN: Remove the building blocks.

DE: Entferne die Bausteine.

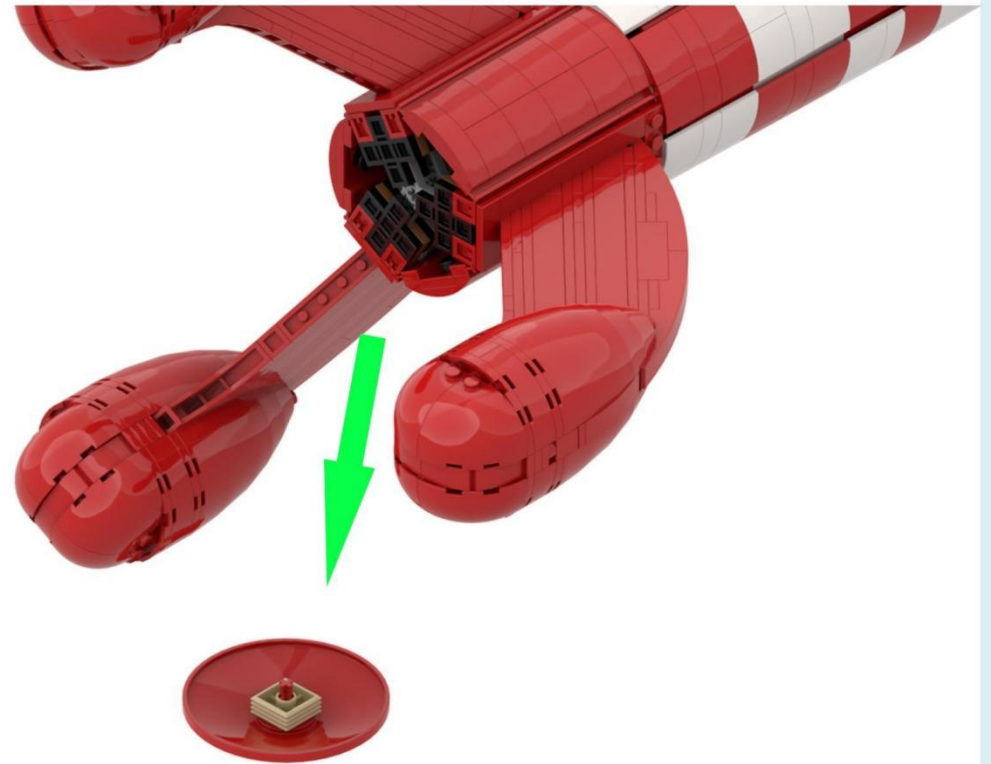

21

EN: Remove the building blocks.

DE: Entferne die Bausteine.

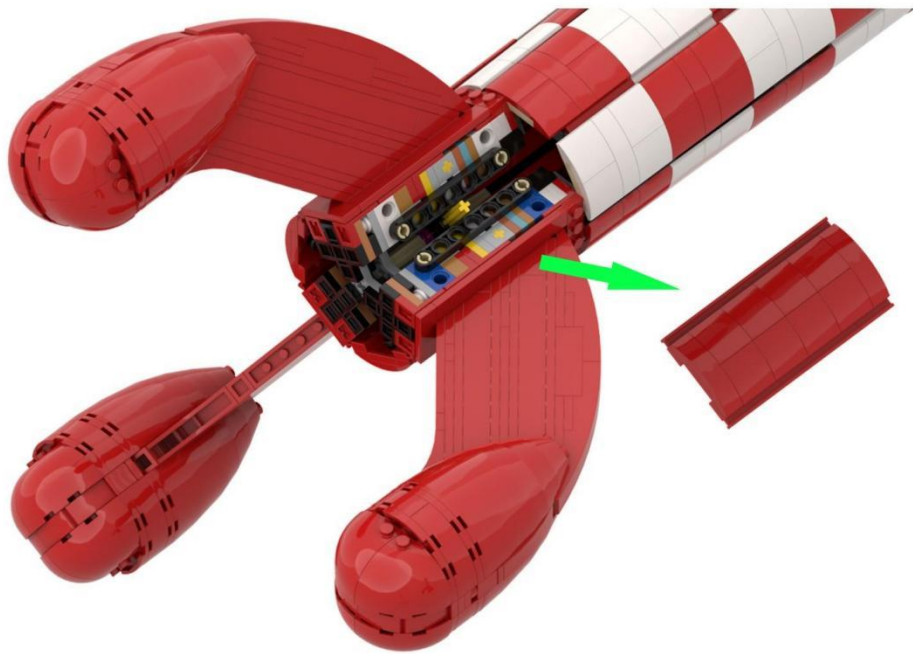

22

EN: Split as shown in the figure.

DE: Teilen Sie es wie in der Abbildung gezeigt.

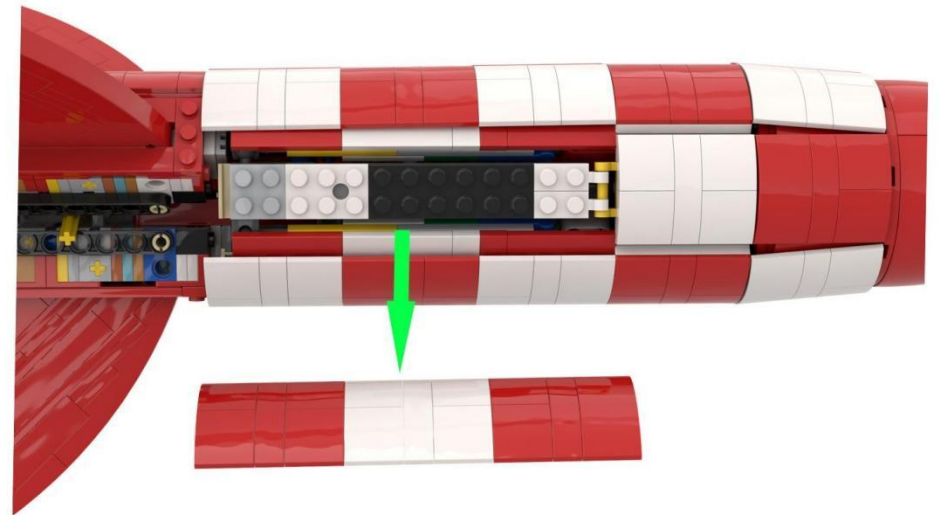

23

EN: Slide the light cord into the gap between the blocks and pull it to the left.

DE: Schieben Sie das Lichtkabel in den Spalt zwischen den Blöcken und ziehen Sie es nach links.

①

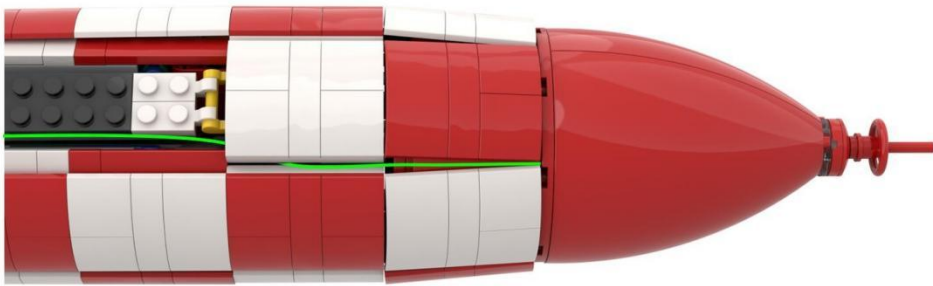

②



24

EN: Restore the building blocks.

DE: Stelle die Bausteine wieder her.

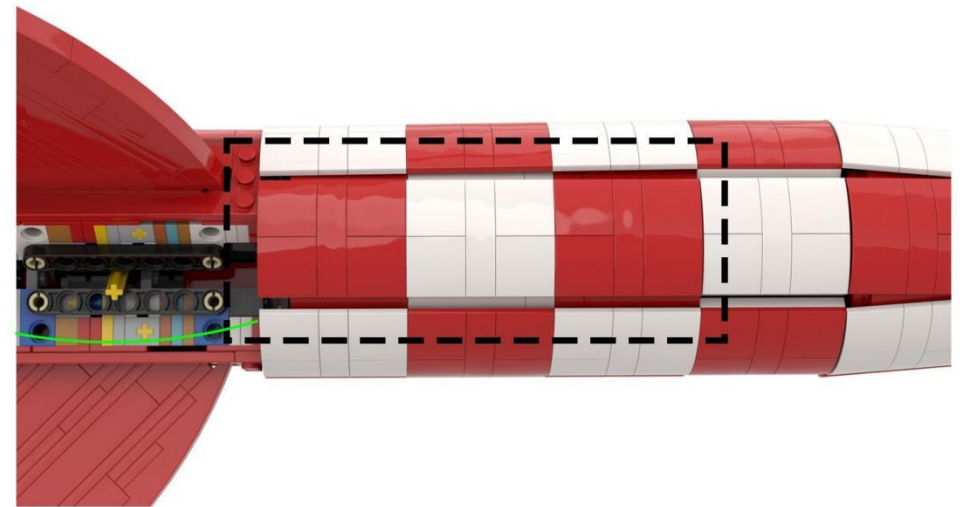
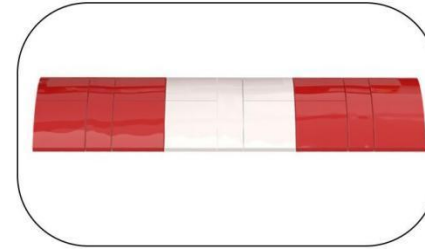

25

EN: Take the three COB light strips from Bag 2 and remove the white protective covers.

DE: Nehmen Sie die drei COB-Lichtleisten aus Beutel 2 und entfernen Sie die weißen Schutzfolien.

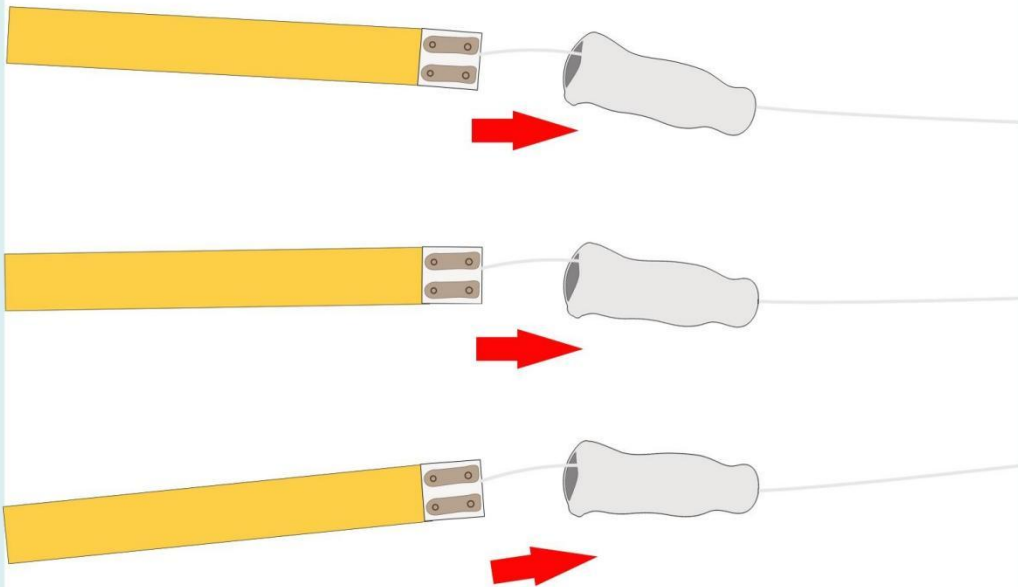

26

EN: Peel off the adhesive backing from the COB light strip and attach it to the building block.

DE: Ziehen Sie die Schutzfolie vom COB-Lichtstreifen ab und befestigen Sie ihn am Baustein.

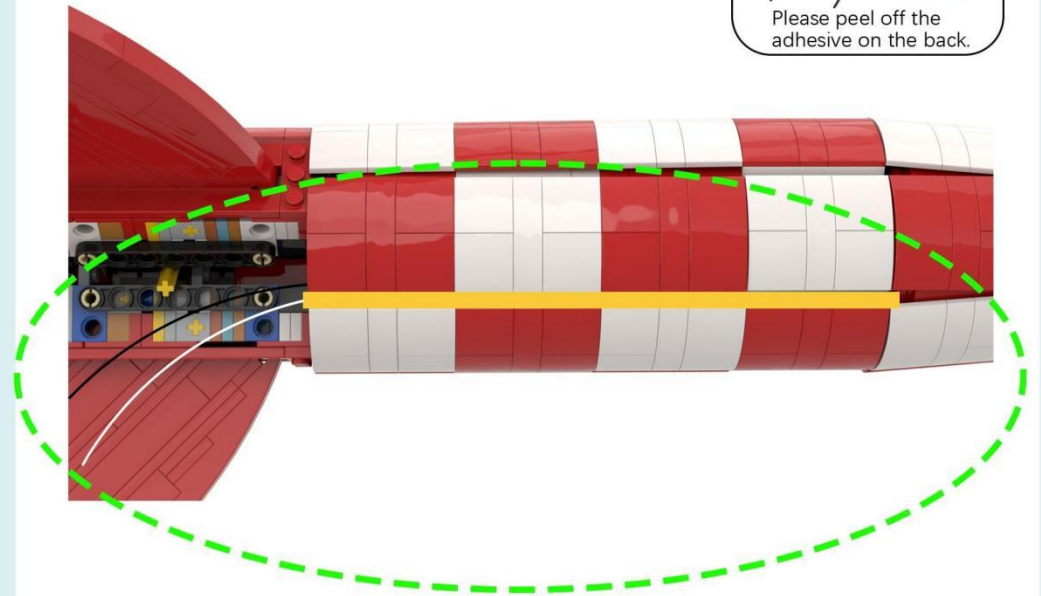

27

EN: Rotate the rocket model to the other side and remove the building blocks.

DE: Drehen Sie das Raketenmodell auf die andere Seite und entfernen Sie die Bausteine.

①

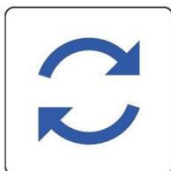

②

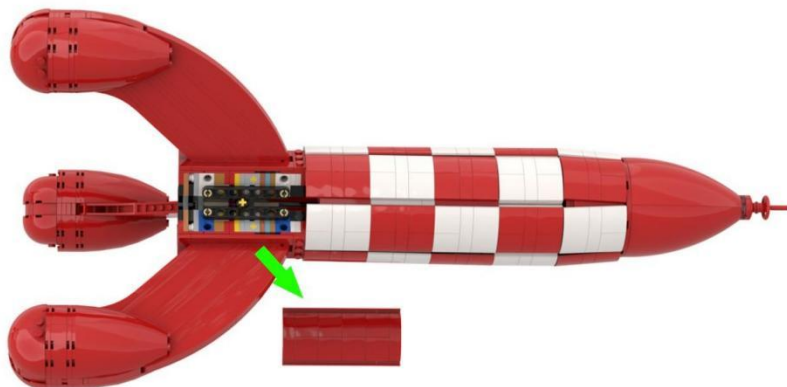

28

EN: Peel off the adhesive backing from the COB light strip and attach it to the building block.

DE: Ziehen Sie die Schutzfolie vom COB-Lichtstreifen ab und befestigen Sie ihn am Baustein.

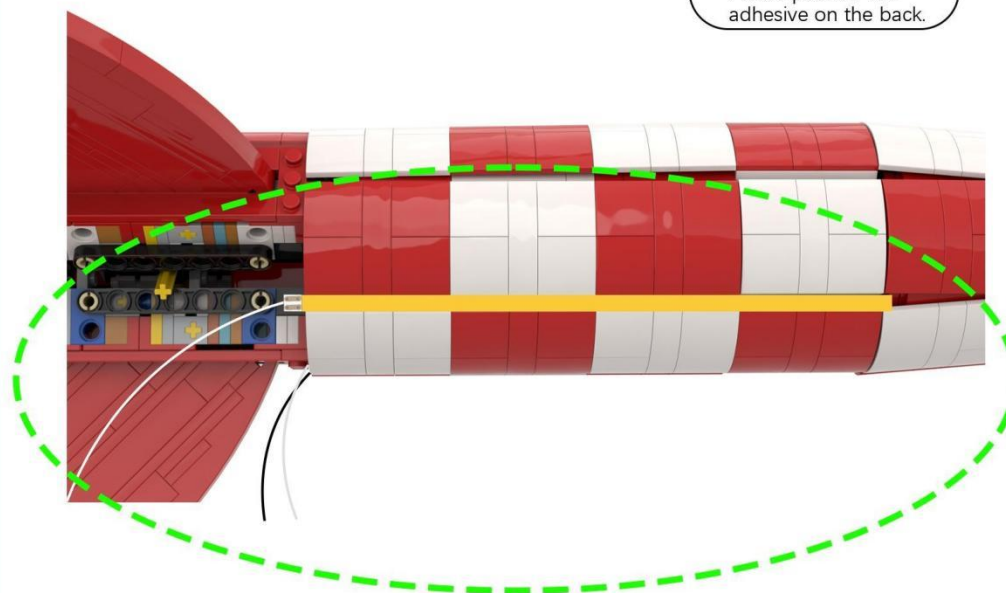

29

EN: Locate the light cord, then thread it through the gap in the building blocks to the other side and pull it tight.

DE: Suchen Sie das Kabel der Leuchte, führen Sie es durch die Öffnung in den Bausteinen auf die andere Seite und ziehen Sie es fest.

①

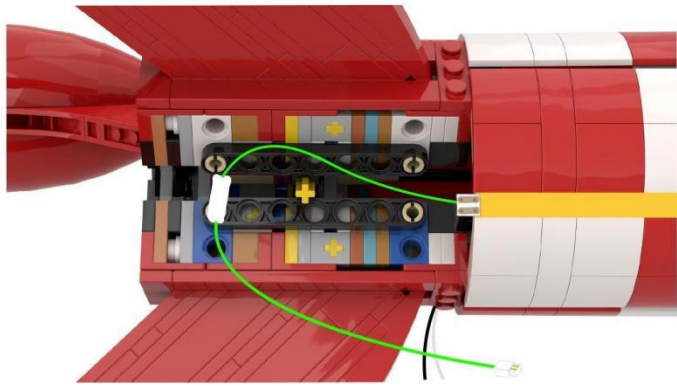

②

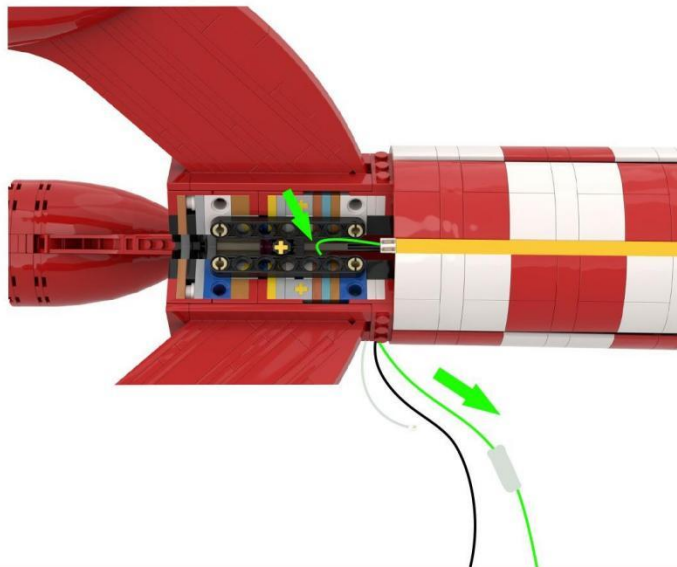

30

EN: Flip the rocket model over to the other side.

DE: Drehe das Raketenmodell auf die andere Seite.

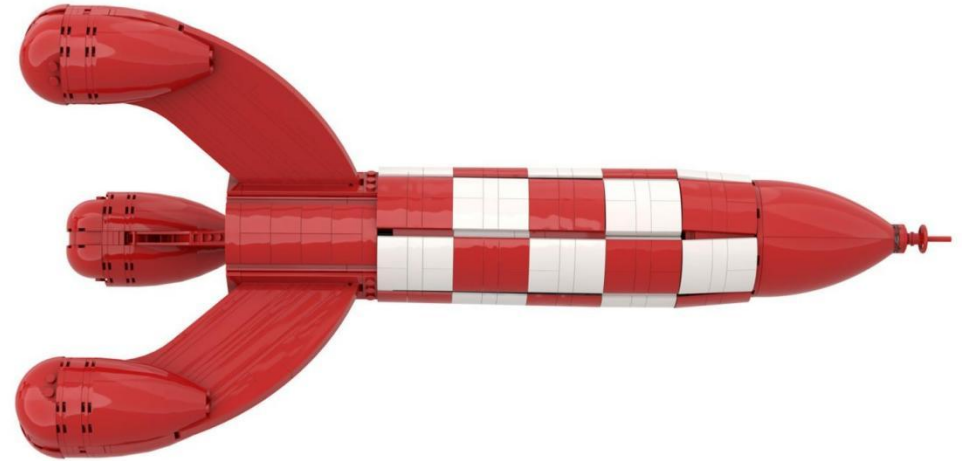
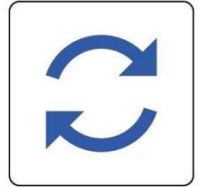

31

EN: Remove the red building blocks.

DE: Entferne die roten Bausteine.

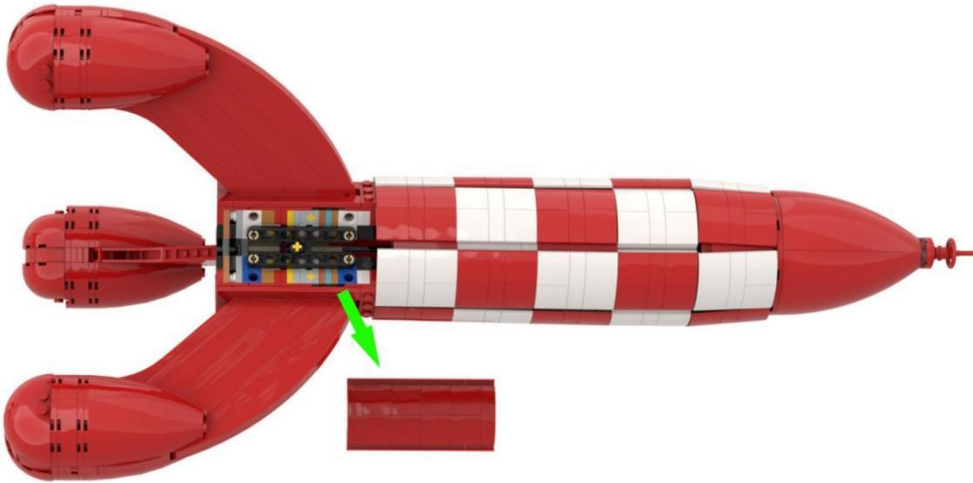

32

EN: Peel off the adhesive backing from the COB light strip and attach it to the building block.

DE: Ziehen Sie die Schutzfolie vom COB-Lichtstreifen ab und befestigen Sie ihn am Baustein.

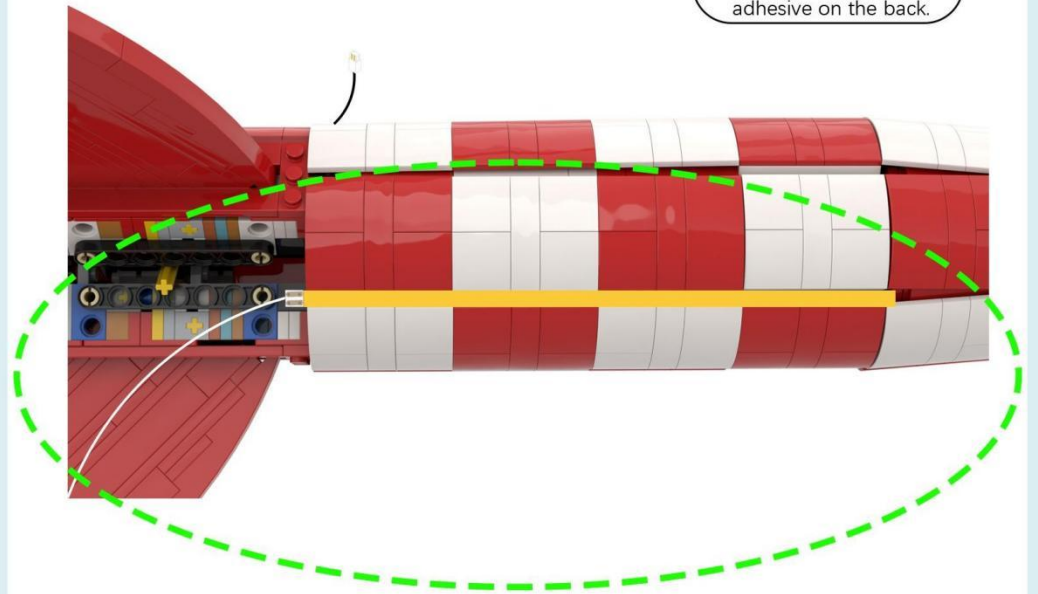

33

EN: Locate the light cord, then thread it through the gap in the building blocks to the other side and pull it tight.

DE: Suchen Sie das Kabel der Leuchte, führen Sie es durch die Öffnung in den Bausteinen auf die andere Seite und ziehen Sie es fest.

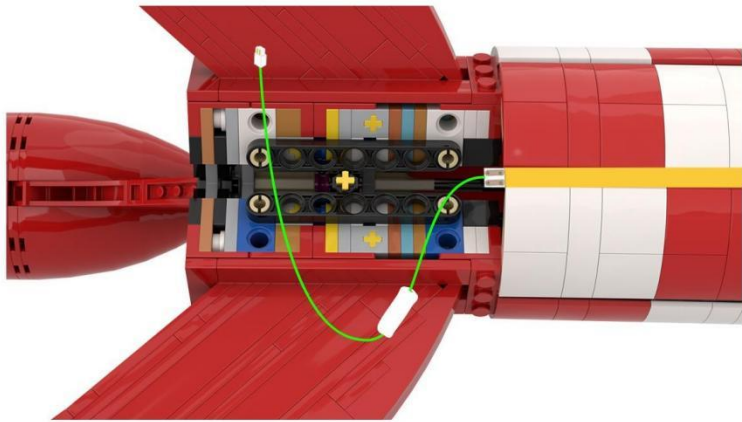
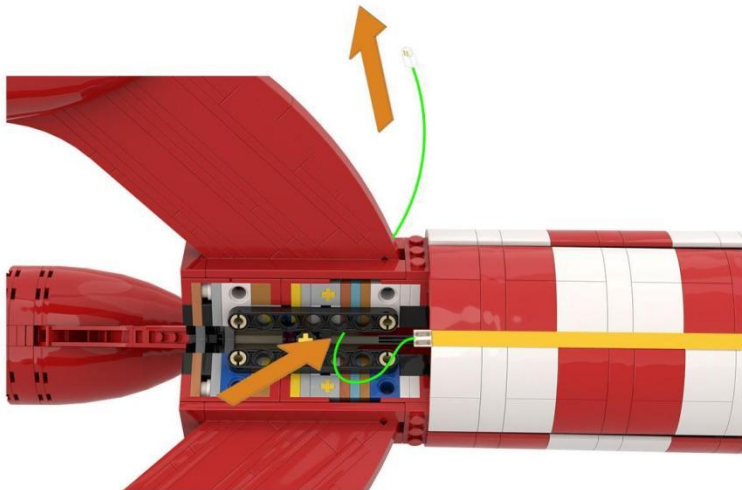
1**2****34**

EN: Flip the rocket model over to the other side.

DE: Drehe das Raketenmodell auf die andere Seite.

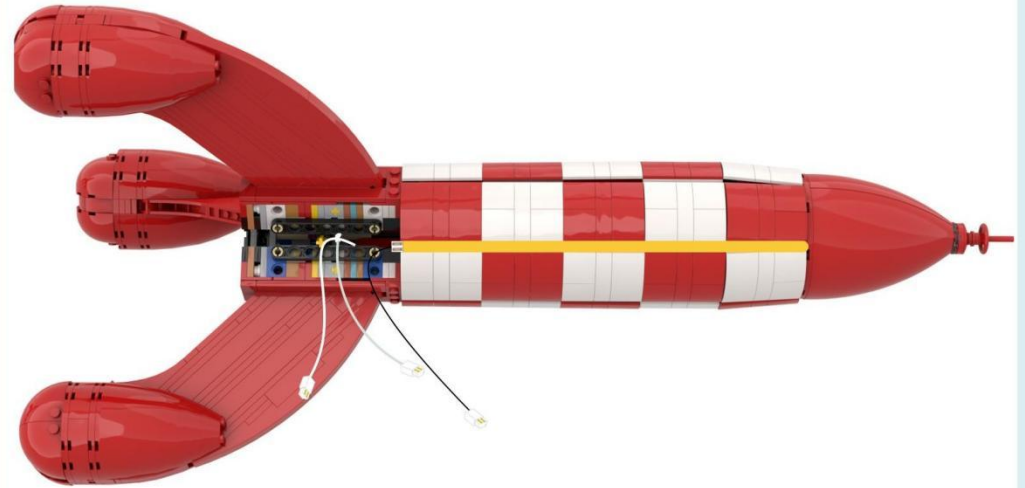
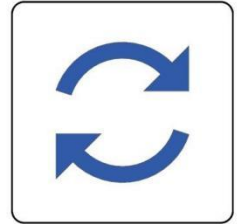

35

EN: Take 1 four-port expansion board and 1 5-cm connector cable from Bag 4, then connect them together.

DE: Nehmen Sie 1 Erweiterungskarte mit vier Anschlüssen und 1 5 cm langes Verbindungskabel aus Beutel 4 und verbinden Sie diese miteinander.

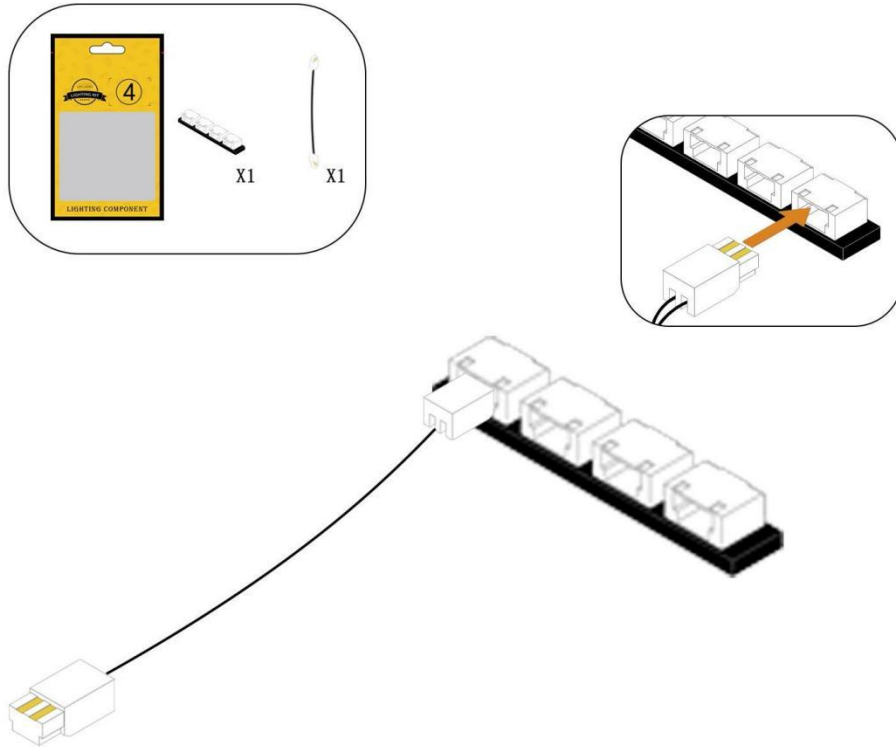

36

EN: Connect the lamp wires to the expansion board.

DE: Schließen Sie die Lampenkabel an die Erweiterungskarte an.

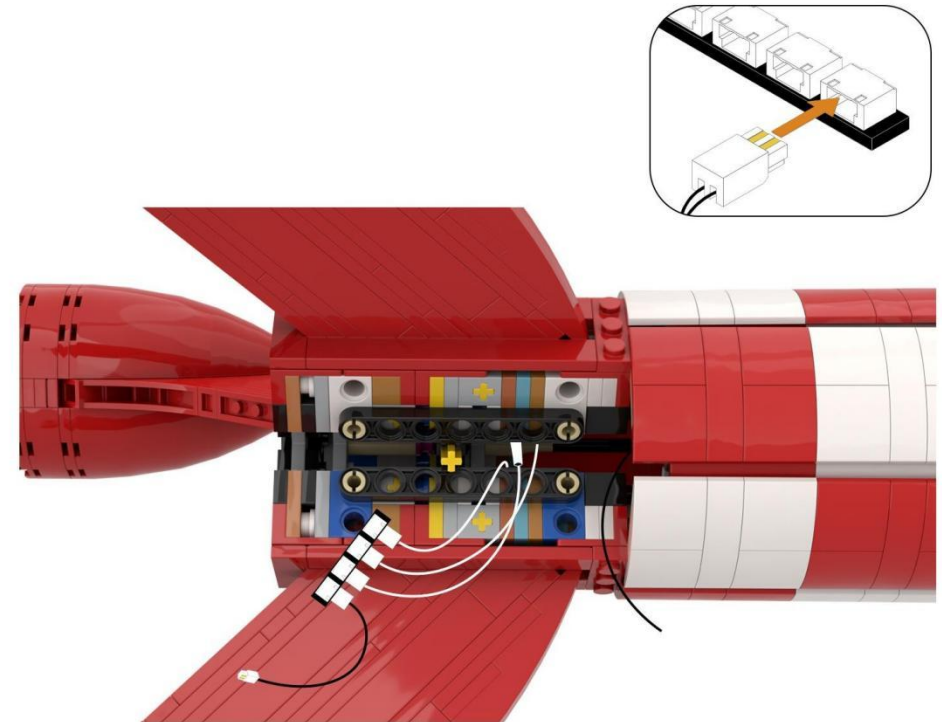

37

EN: Peel off the adhesive backing on the expansion board and stick it to the building block.

DE: Zieh die Schutzfolie von der Erweiterungskarte ab und klebe sie auf den Baustein.

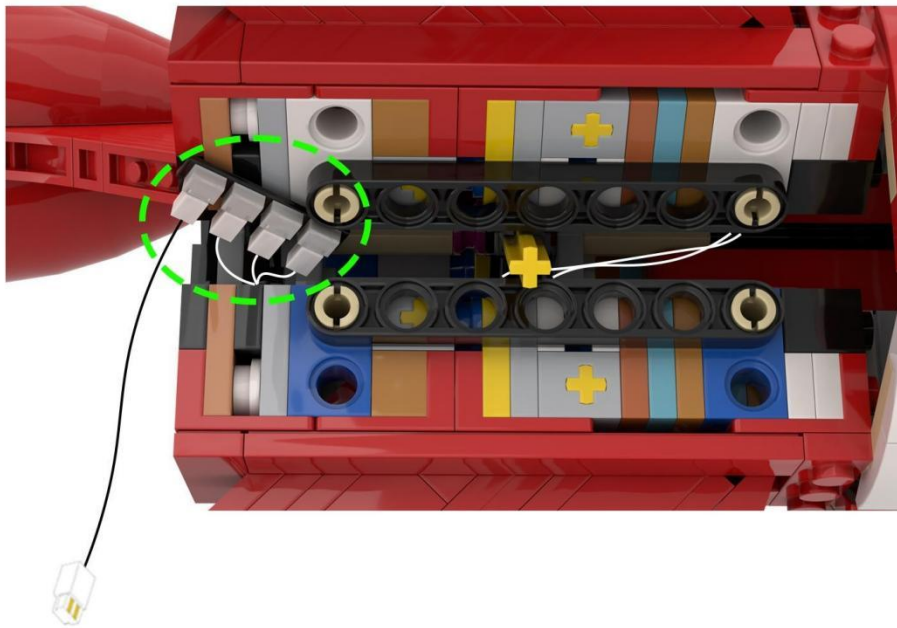

38

EN: Rotate the rocket model to the position shown in the illustration.

DE: Drehen Sie das Raketenmodell in die in der Abbildung gezeigte Position.

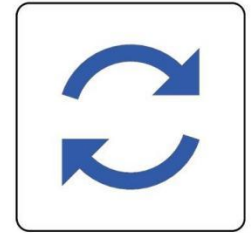

39

EN: Remove the red light panel.

DE: Entfernen Sie die rote Leuchtblende.

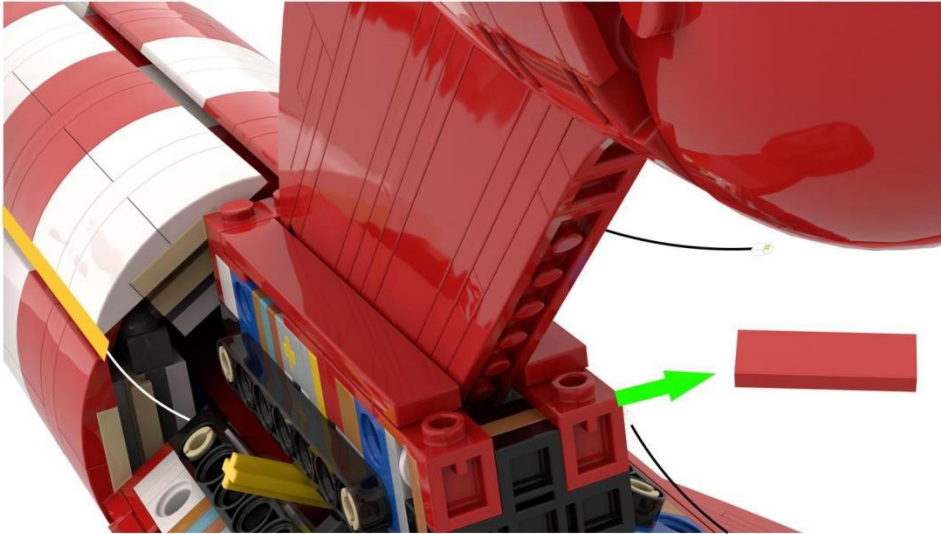

40

EN: Remove the red light panels from both sides of the model one by one.

DE: Entfernen Sie nacheinander die roten Leuchtpaneele von beiden Seiten des Modells.

①

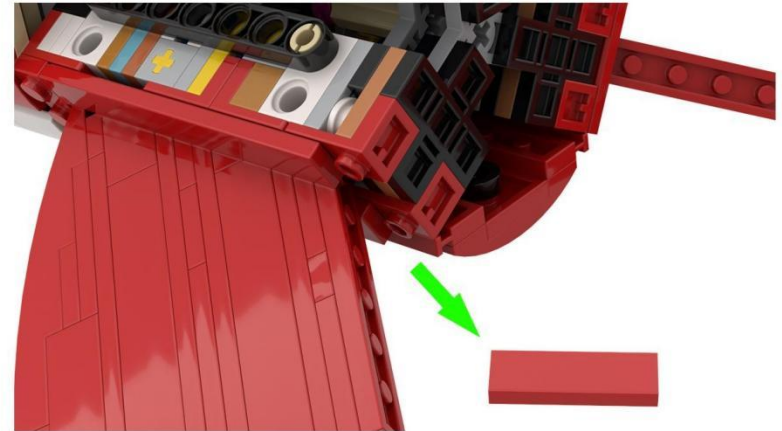

②

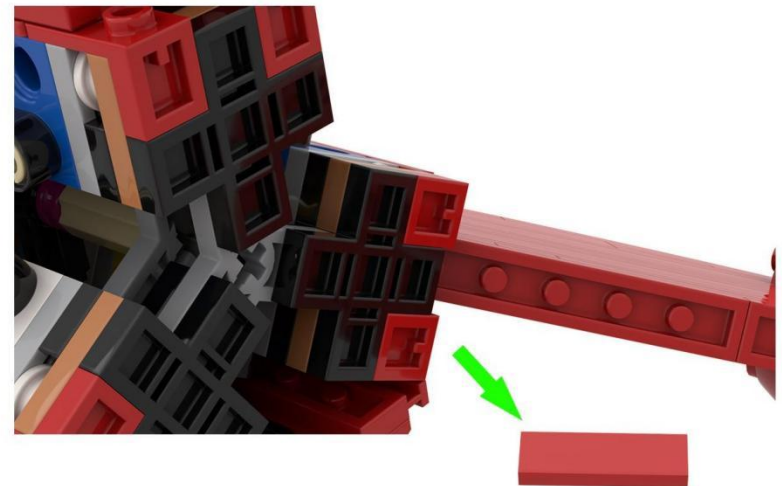

41

EN: Take the three COB warm white LED strips from Bag 3, then peel off the adhesive backing from one of the strips and attach it to the building block.

DE: Nimm die drei warmweißen COB-LED-Streifen aus Beutel 3, ziehe dann die Schutzfolie von einem der Streifen ab und befestige ihn am Baustein.

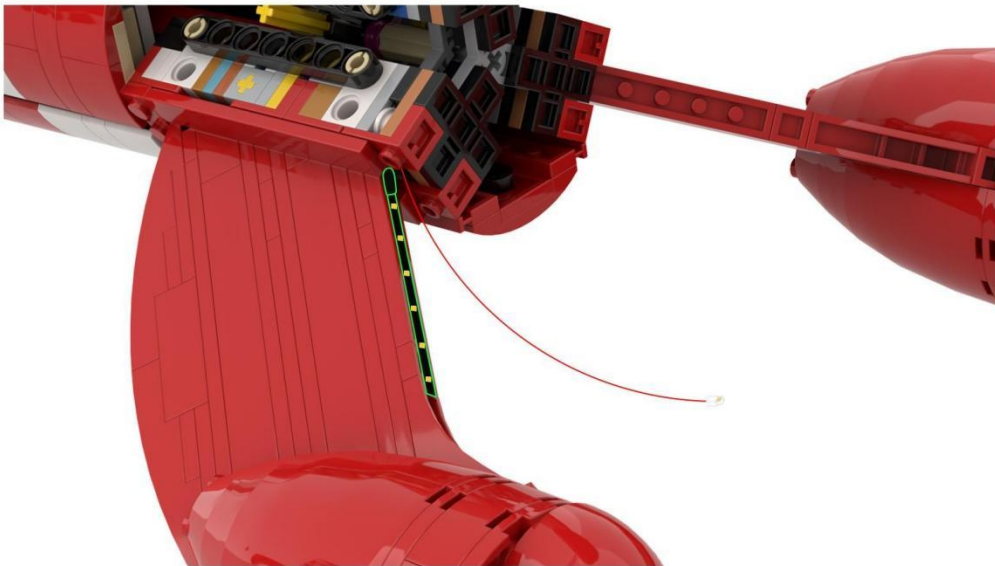
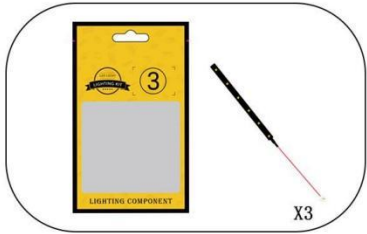
**42**

EN: Place the light strip between the studs on the bricks, then reattach the red light panel.

DE: Legen Sie den Lichtstreifen zwischen die Stege der Steine und bringen Sie dann die rote Lichtblende wieder an.

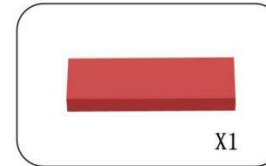
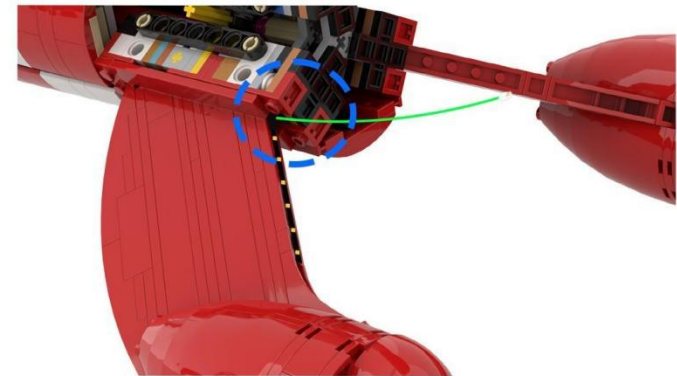
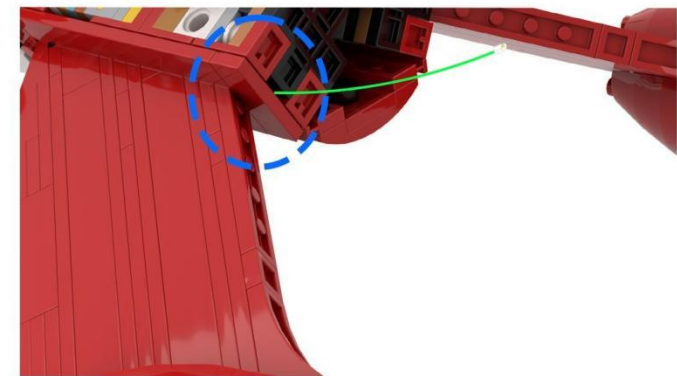
**1****2**

43

EN: Look at the right side of the model, then peel off the adhesive backing from the LED strip and attach it to the building block.

DE: Schau dir die rechte Seite des Modells an, zieh dann die Schutzfolie vom LED-Streifen ab und befestige ihn am Baustein..

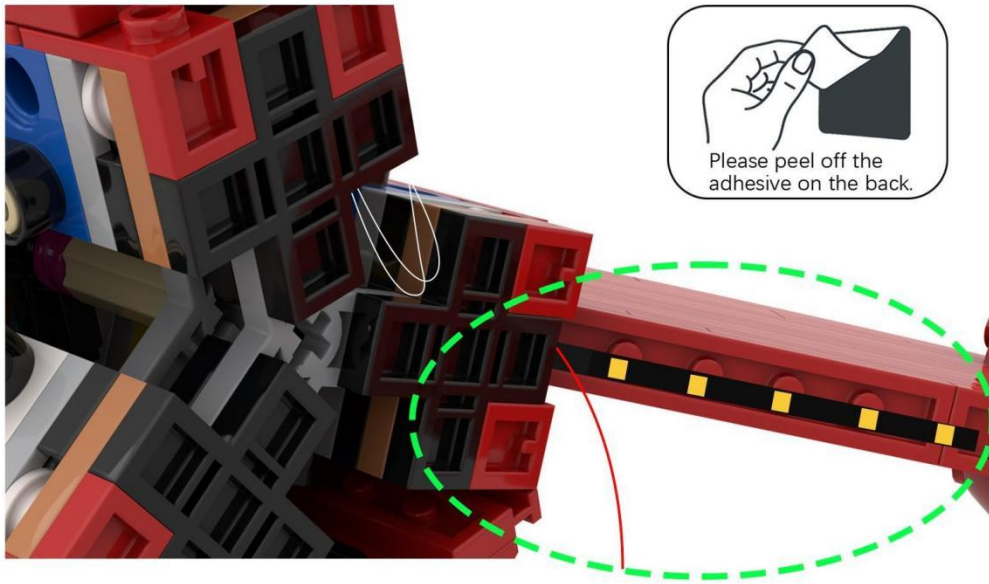

44

EN: Place the light strip between the studs on the bricks, then reattach the red light panel.

DE: Legen Sie den Lichtstreifen zwischen die Stege der Steine und bringen Sie dann die rote Lichtblende wieder an.

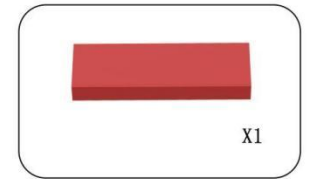

①

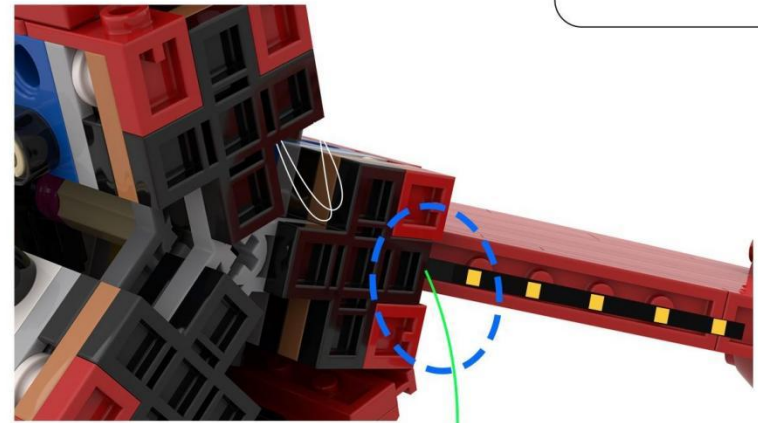

②

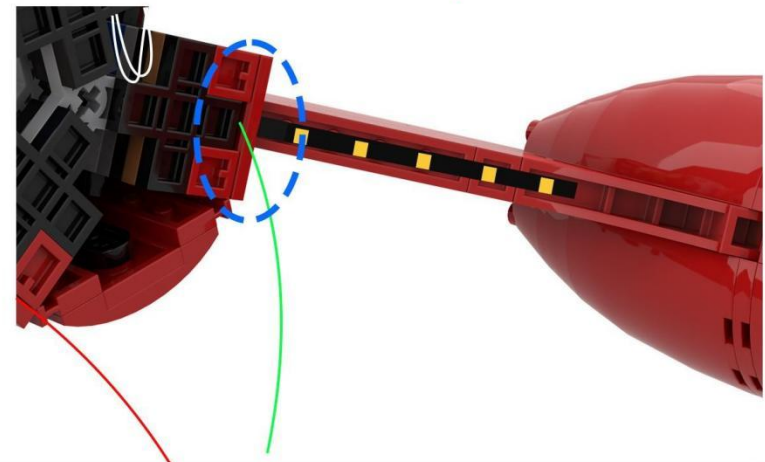

45

EN: Look at the location shown in the illustration, then peel off the adhesive backing of the light strip and attach it to the building block.

DE: Schau dir die in der Abbildung gezeigte Stelle an, zieh dann die Schutzfolie vom Leuchtstreifen ab und befestige ihn am Baustein.

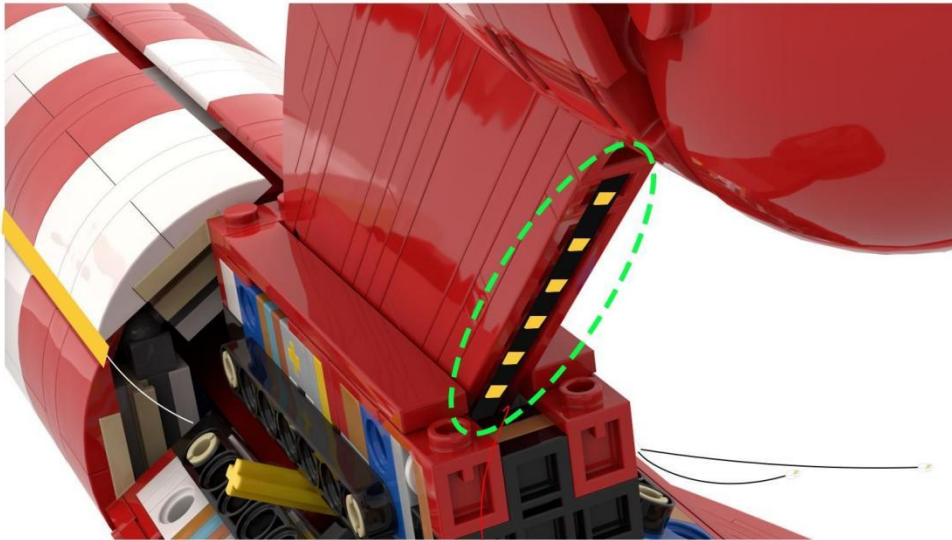

46

EN: Place the light strip between the studs on the bricks, then reattach the red light panel.

DE: Legen Sie den Lichtstreifen zwischen die Stege der Steine und bringen Sie dann die rote Lichtblende wieder an.

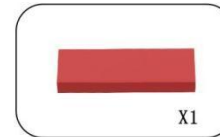

①

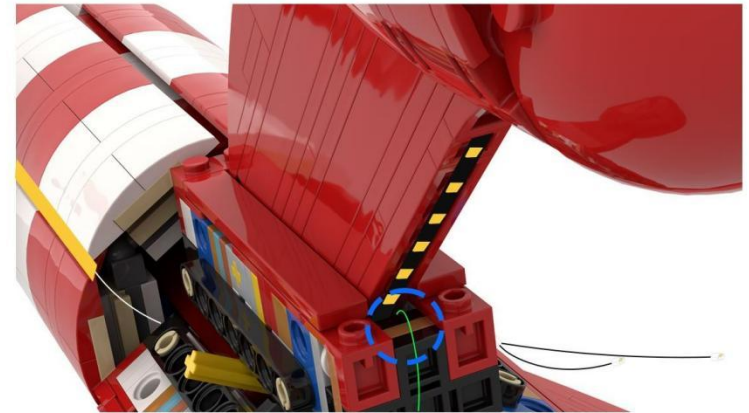

②

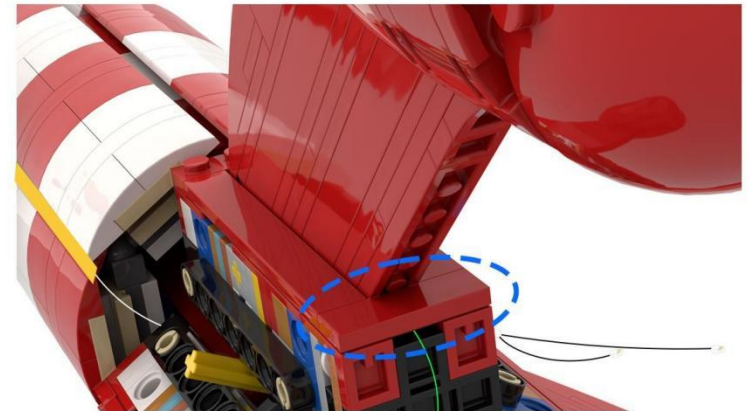

47

EN: Take 1 four-port expansion board and 1 5-cm connector cable from Bag 4, then connect them together.

DE: Nehmen Sie 1 Erweiterungskarte mit vier Anschlüssen und 1 5 cm langes Verbindungskabel aus Beutel 4 und verbinden Sie diese miteinander.

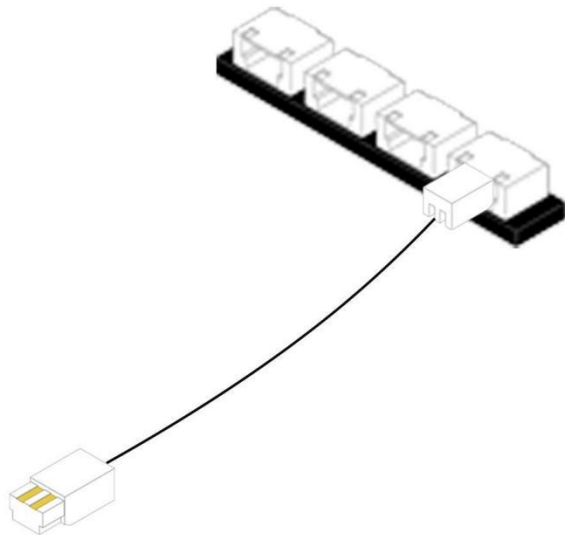
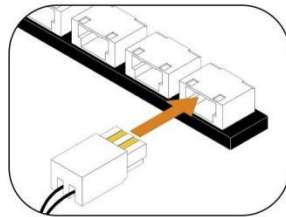
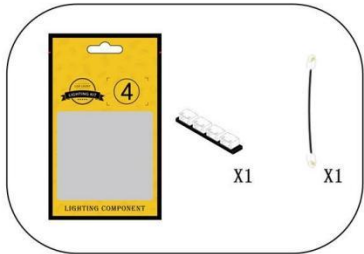
**48**

EN: Connect the lamp wires to the expansion board.

DE: Schließen Sie die Lampenkabel an die Erweiterungskarte an.

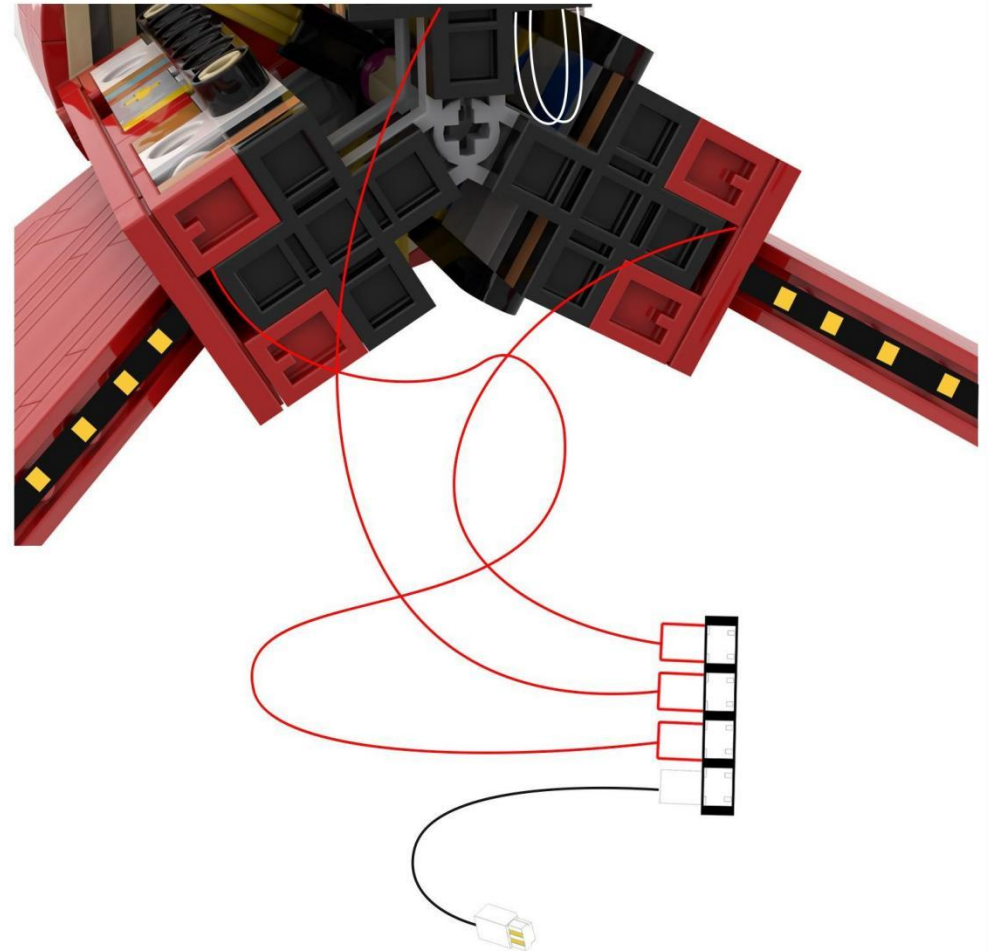

49

EN: Twist the longer strands of wire into a single strand.

DE: Verdrehen Sie die längeren Drahtstränge zu einem einzigen Strang.

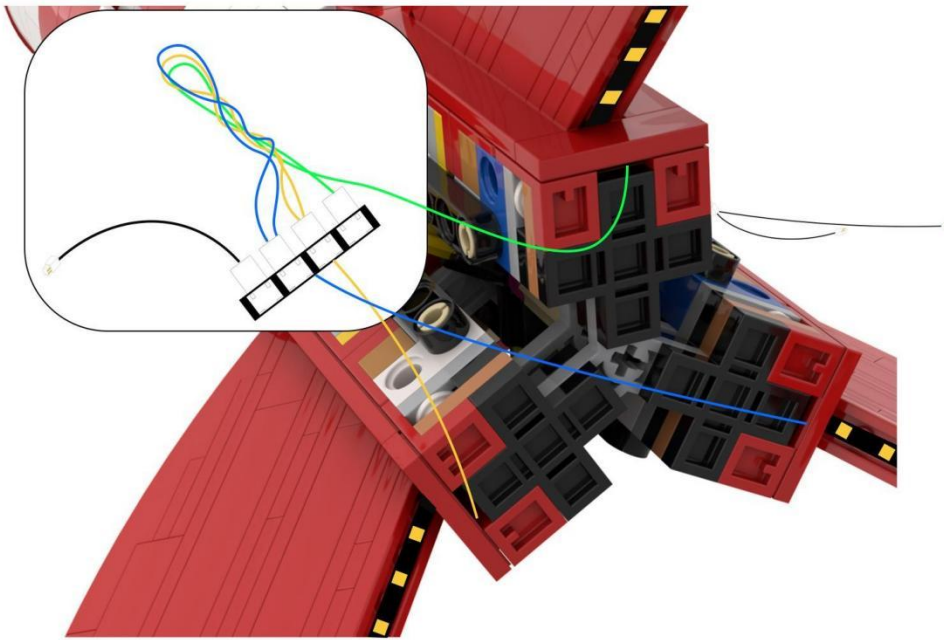
**50**

EN: Peel off the adhesive backing on the expansion board, then attach it to the building block, making sure the light cord is tucked inside the gap in the block.

DE: Ziehen Sie die Schutzfolie von der Erweiterungsplatine ab und befestigen Sie diese dann am Baustein. Achten Sie dabei darauf, dass das Kabel der Leuchte in der Aussparung des Bausteins verstaut ist.

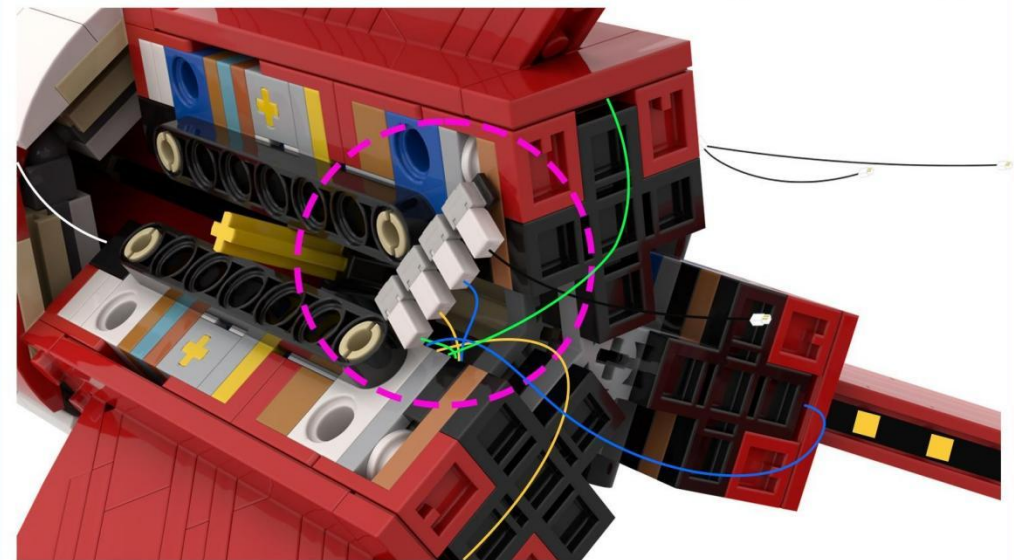

51

EN: Take out the building block parts you disassembled earlier and take them apart one by one.

DE: Nimm die zuvor zerlegten Bausteine heraus und nimm sie nacheinander auseinander.

①



②



52

EN: Take out the building block parts you disassembled earlier and take them apart one by one.

DE: Nimm die zuvor zerlegten Bausteine heraus und nimm sie nacheinander auseinander.

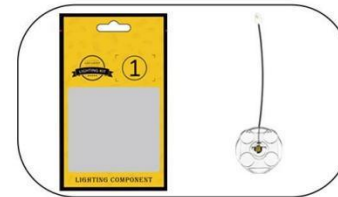

①

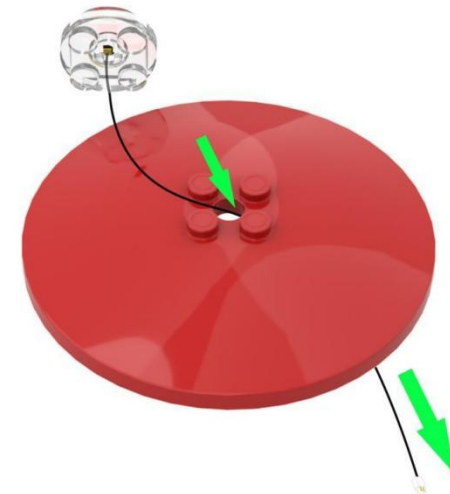

②

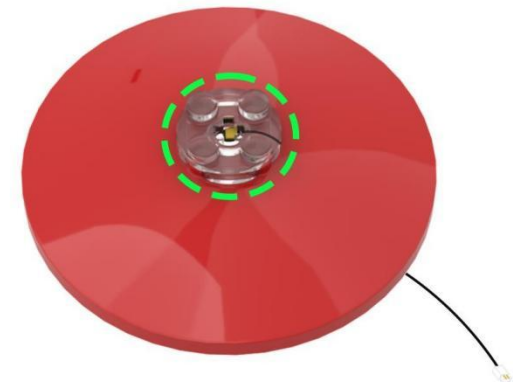

53

EN: Take 1 transparent red-orange flame and 1 1x1 transparent white disc with a hole (closed) from Bag 4, then assemble them together.

DE: Nimm 1 durchsichtige rot-orangefarbene Flamme und 1 durchsichtige weiße 1x1-Scheibe mit Loch (geschlossen) aus Beutel 4 und setze sie zusammen..

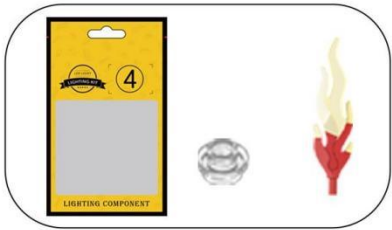

54

EN: Attach the flame-shaped blocks to the circular plate.

DE: Befestige die flammenförmigen Blöcke an der runden Platte.



55

EN: Lay the building blocks flat, pull the light cord down, and then reassemble the blocks.

DE: Legen Sie die Bausteine flach hin, ziehen Sie das Lichtkabel nach unten und setzen Sie die Bausteine dann wieder zusammen.

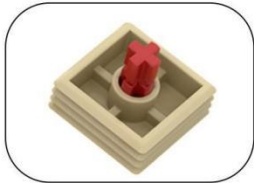

①

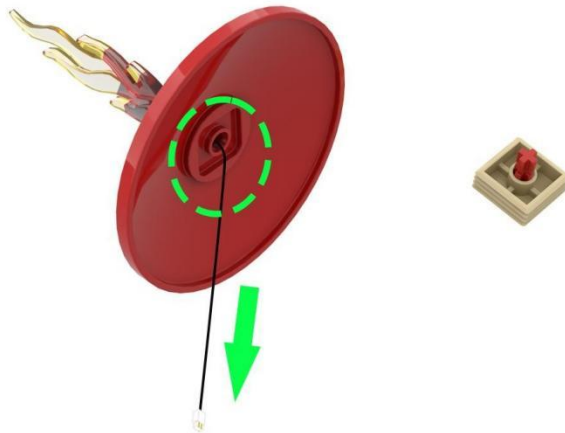

②

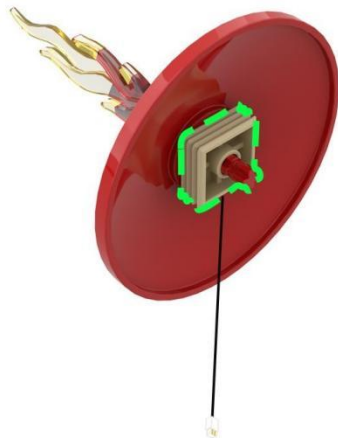

56

EN: Take out the building blocks you disassembled earlier and put them back together in order.

DE: Nimm die Bausteine, die du zuvor auseinandergenommen hast, wieder heraus und setze sie der Reihe nach wieder zusammen.

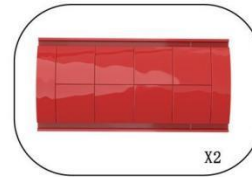

①

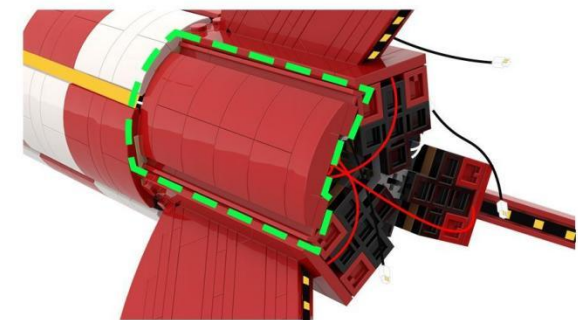

②

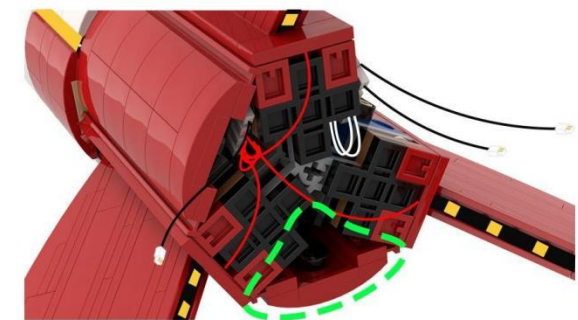

57

EN: Flip the rocket model over to the other side and remove the building blocks.

DE: Drehen Sie das Raketenmodell auf die andere Seite und entfernen Sie die Bausteine.

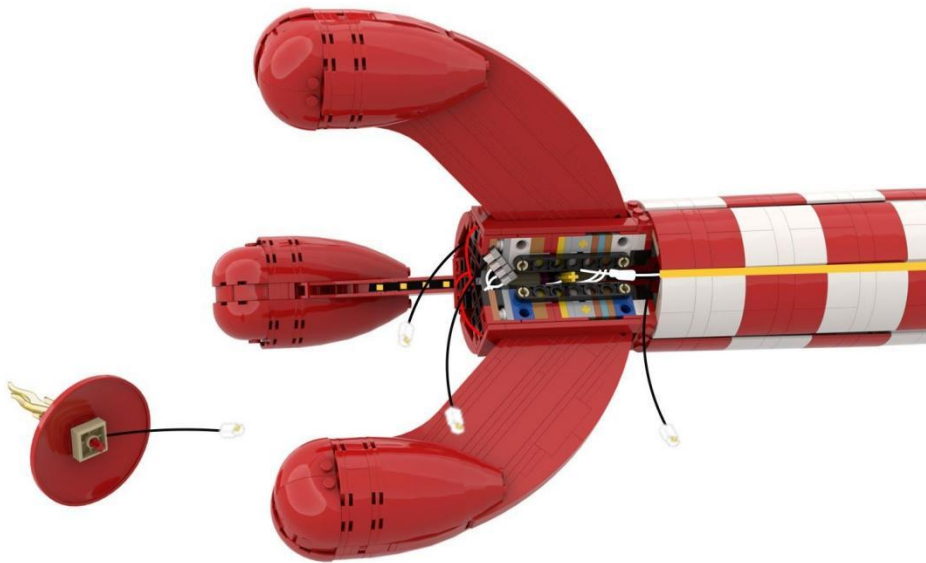
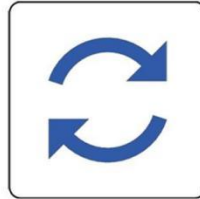

58

EN: Take the touch dimmer module and one 6-port expansion board from Bag 5, then connect them together.

DE: Nehmen Sie das Touch-Dimmer-Modul und eine 6-Port-Erweiterungskarte aus Beutel 5 und verbinden Sie diese miteinander.

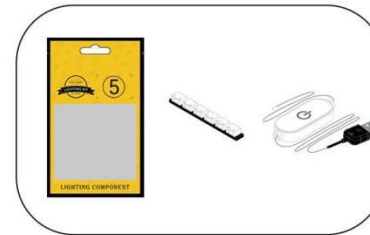

59

EN: Connect the light wires from the circular board to the expansion board.

DE: Verbinden Sie die Lichtkabel von der runden Platine mit der Erweiterungsplatine.

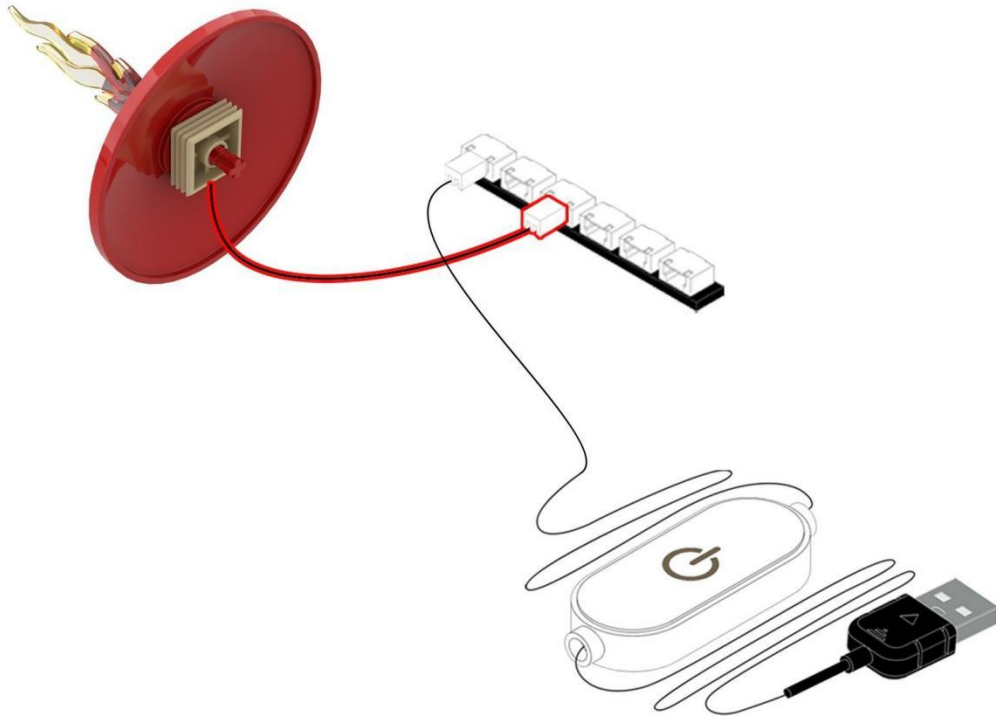

60

EN: Connect the rocket's light wires to the expansion board one by one.

DE: SchlieÙe die Lichtkabel der Rakete nacheinander an die Erweiterungsplatine an.

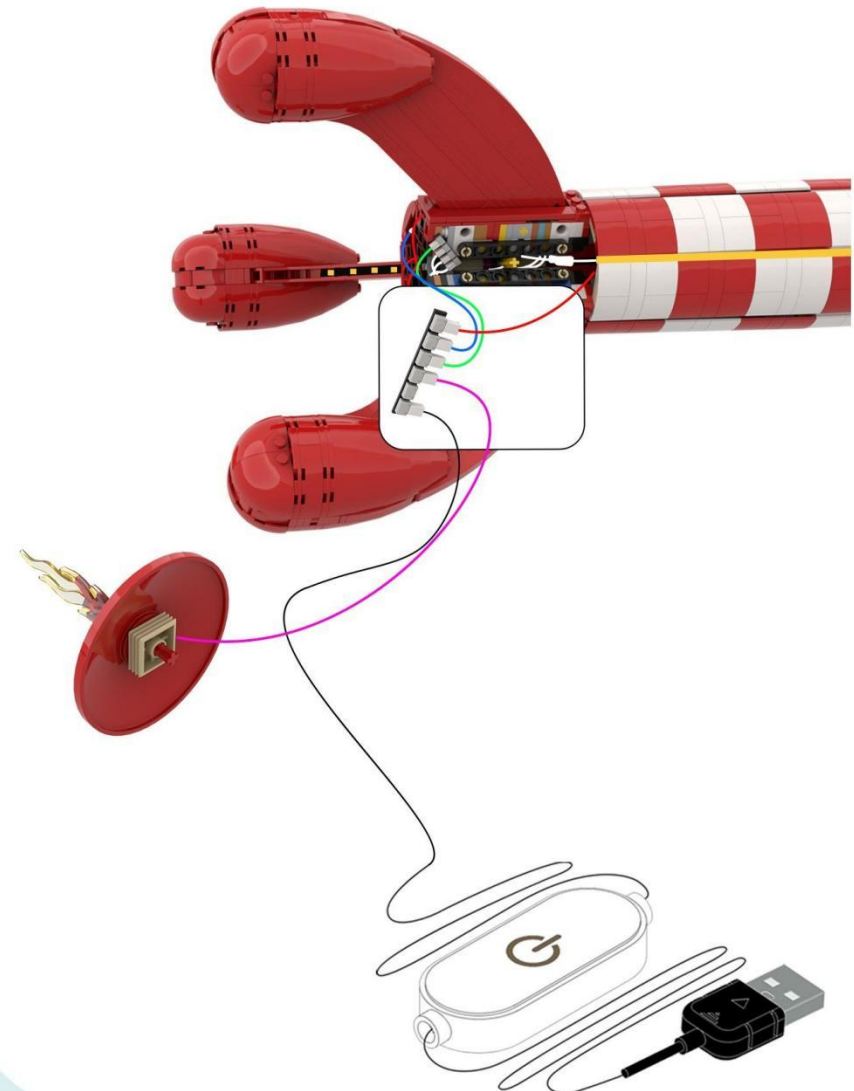

61

EN: Peel off the adhesive backing on the expansion board and stick it to the building block.

DE: Zieh die Schutzfolie von der Erweiterungskarte ab und klebe sie auf den Baustein.

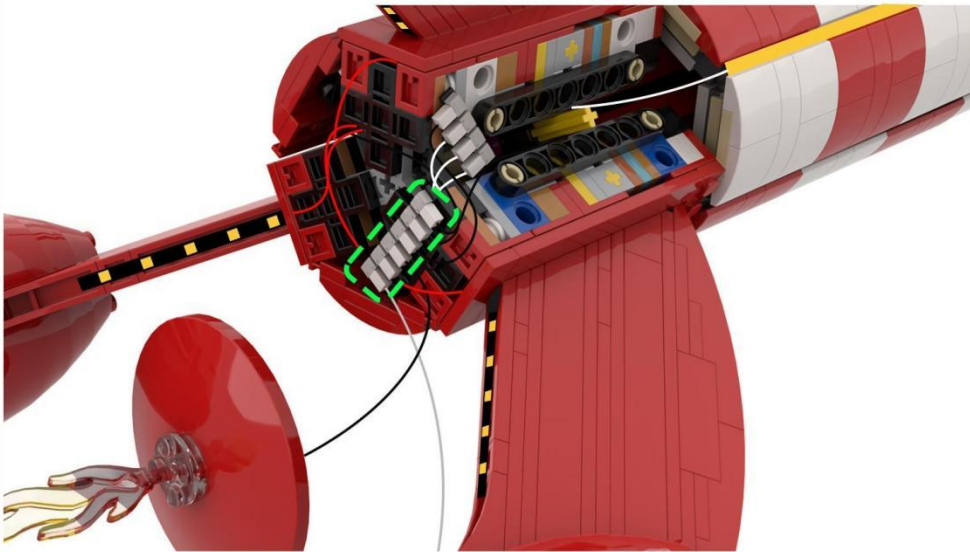

62

EN: Restore the building blocks.

DE: Stelle die Bausteine wieder her.

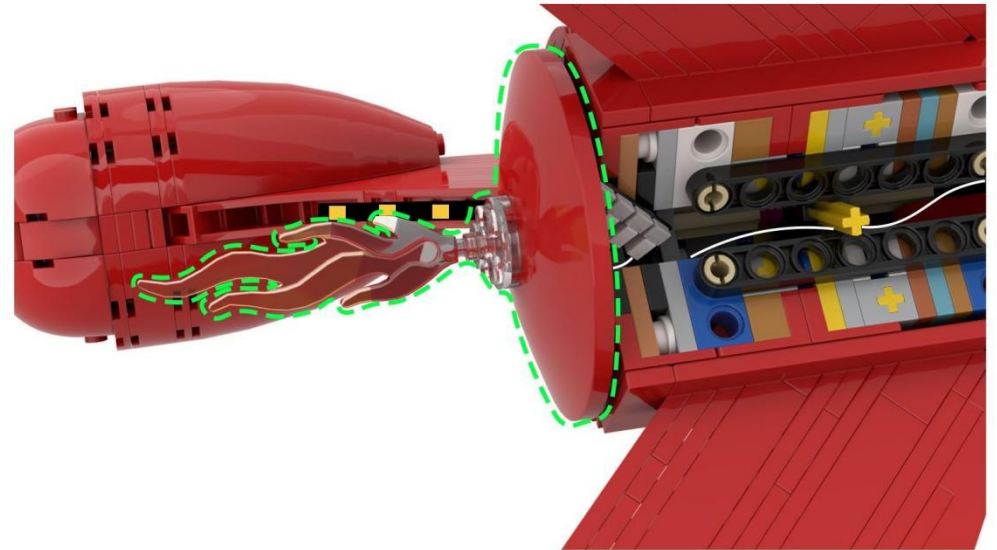

63

EN: Restore the building blocks.

DE: Stelle die Bausteine wieder her.

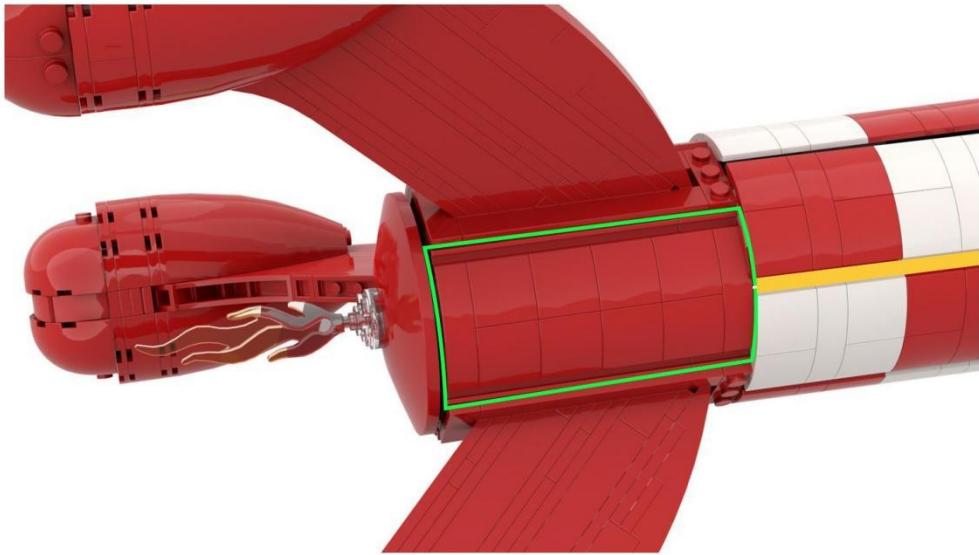

64

EN: Stand the rocket model upright, then remove the red bricks.

DE: Stelle das Raketenmodell aufrecht hin und entferne dann die roten Steine.

①



②

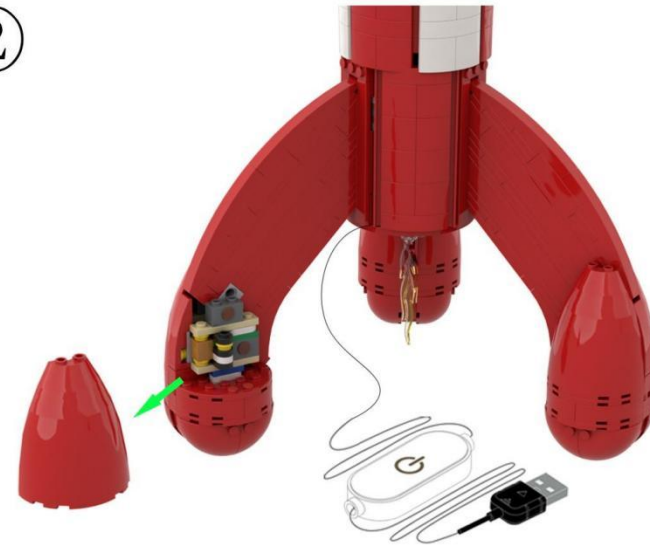

65

EN: Pull the light cord to the left, then put the red brick back in place.

DE: Zieh die Schnur der Lampe nach links und setz dann den roten Ziegelstein wieder ein.

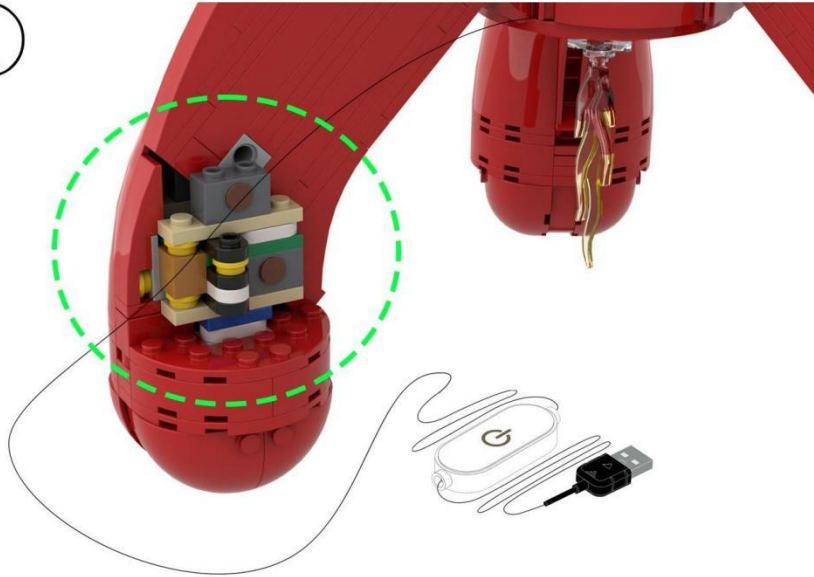
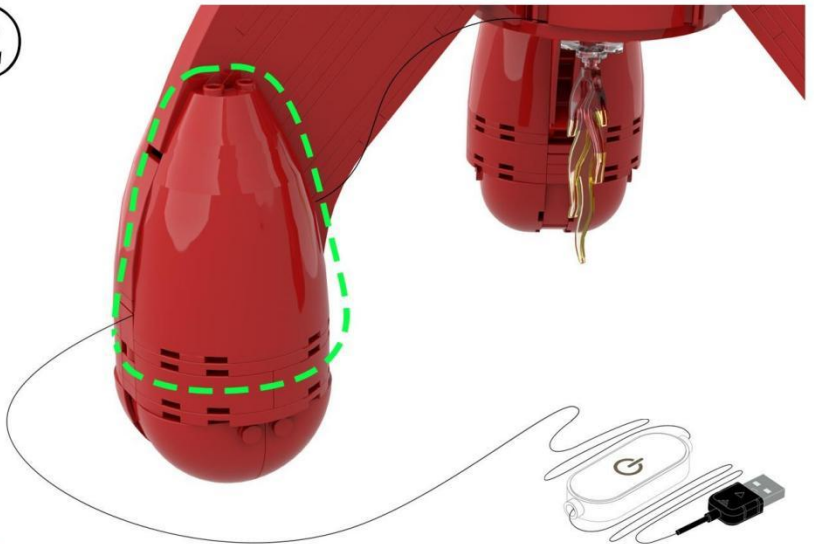
1**2****66**

EN: Connect the portable power bank and touch module, then install them as shown in the figure.

DE: Verbinden Sie die tragbare Powerbank und das Touch-Modul miteinander und montieren Sie sie dann wie in der Abbildung gezeigt.

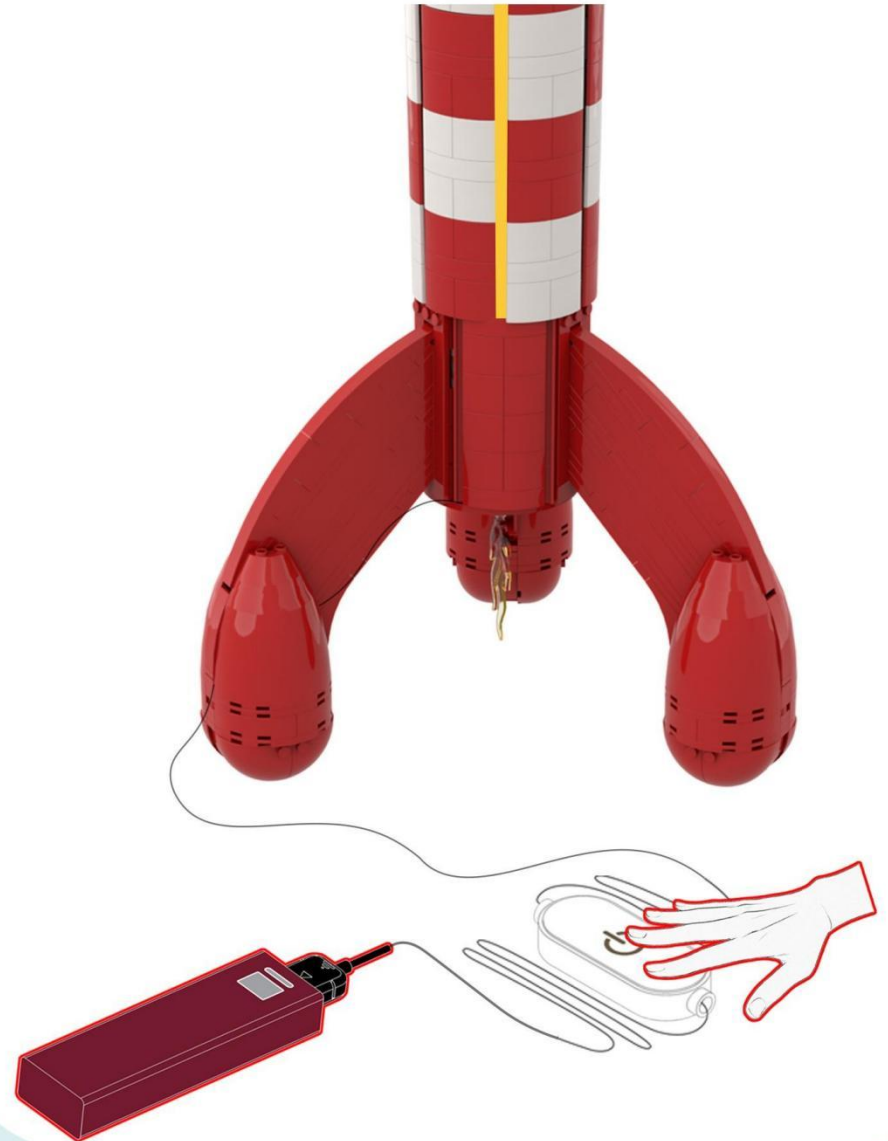

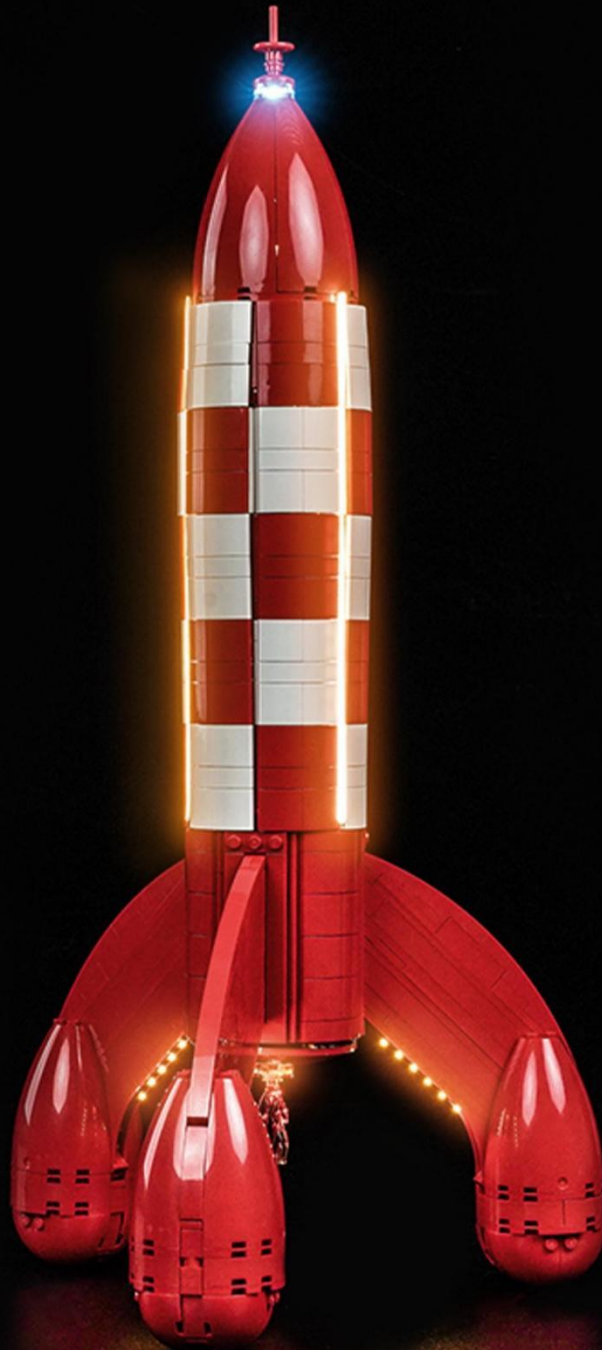

Above our designers to provide the relevant ideas and instructions. But please move to the following:

- 1: about our company this product parts material, product quality do you have comments and suggestions?
- 2: about this product installation instructions and installation of the degree of difficulty do you have views and suggestions?
- 3: if in the operation of the product we provide ideas encountered any problems, please contact us in a timely manner.

Tips

If you encounter any installation problems please contact the seller, we will be happy to help you solve!