

# INSTALLATION GUIDE

## Soccer Ball Football 43019 Remote-controlled model



LED light kit compatible with Lego

# Instructions for installing this kit:

This set includes 12 pouches. (The battery case functions similarly; please select your own power source. This article uses a USB power cable.)

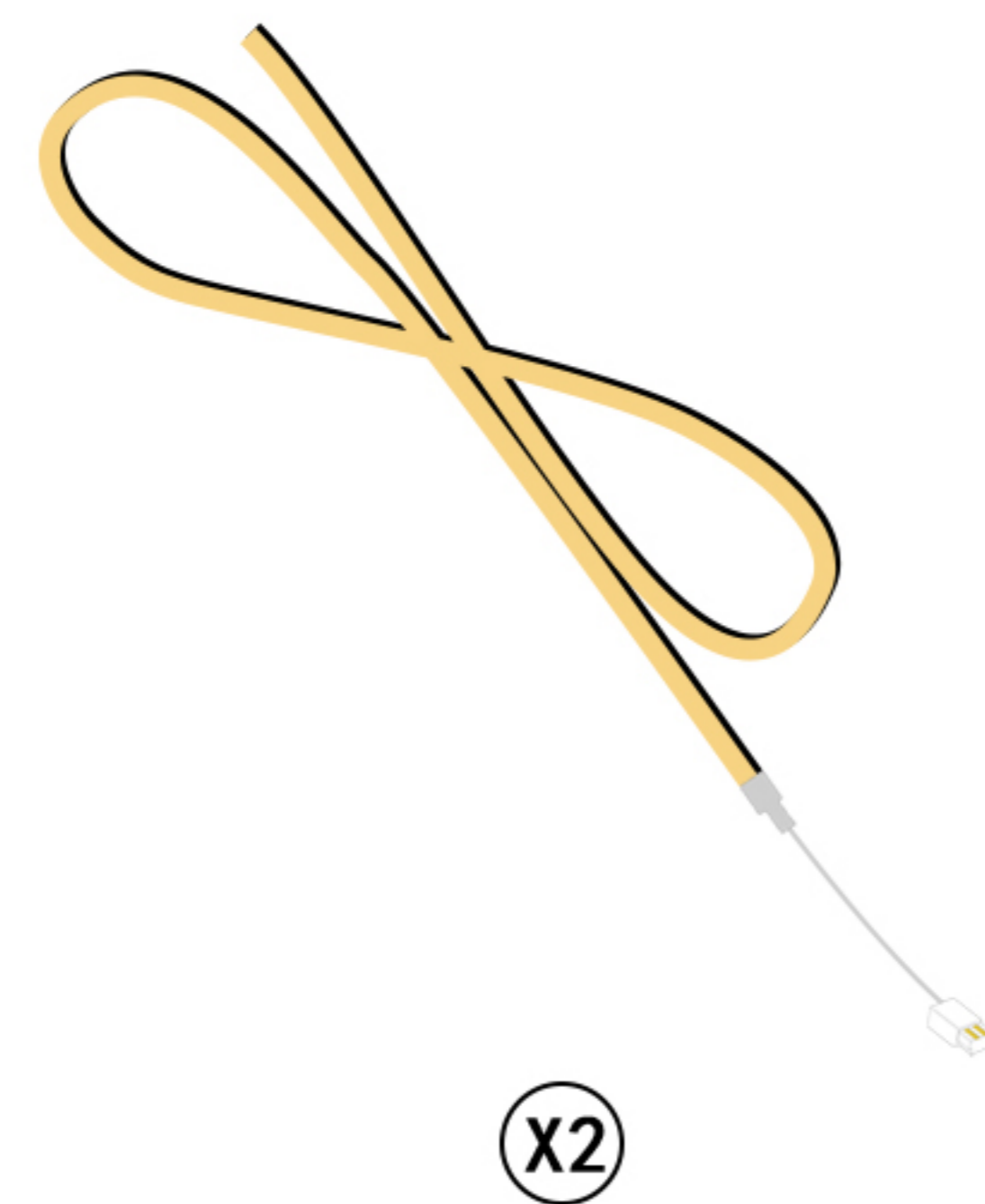
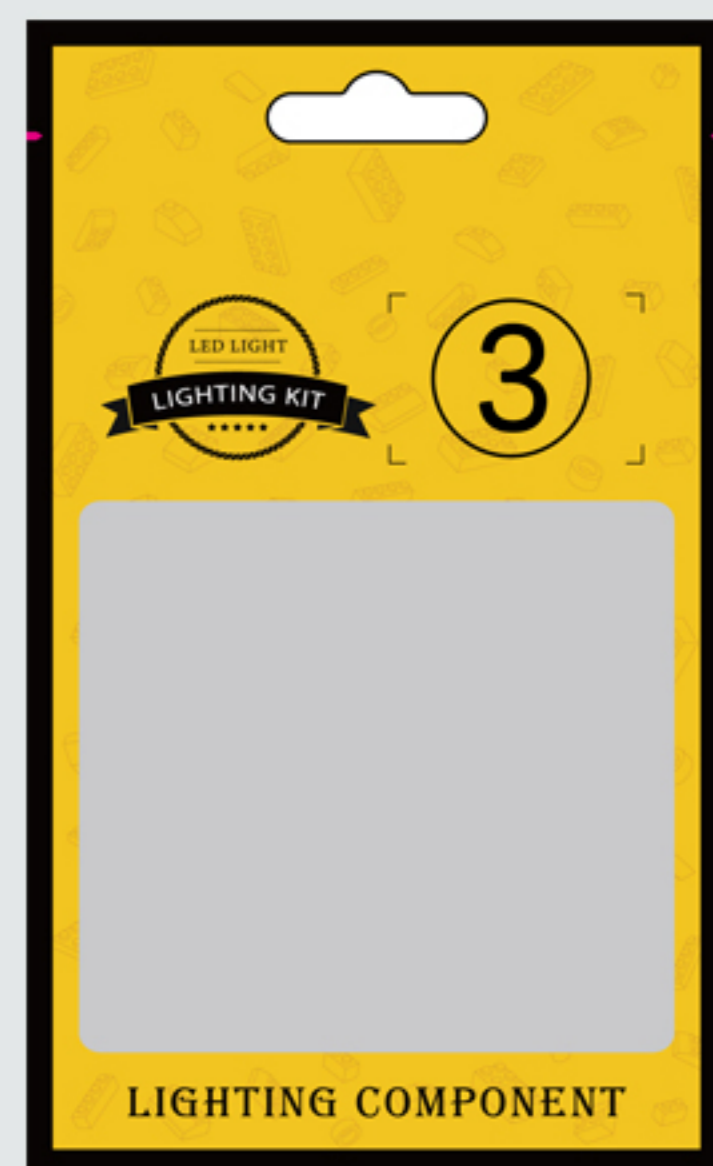
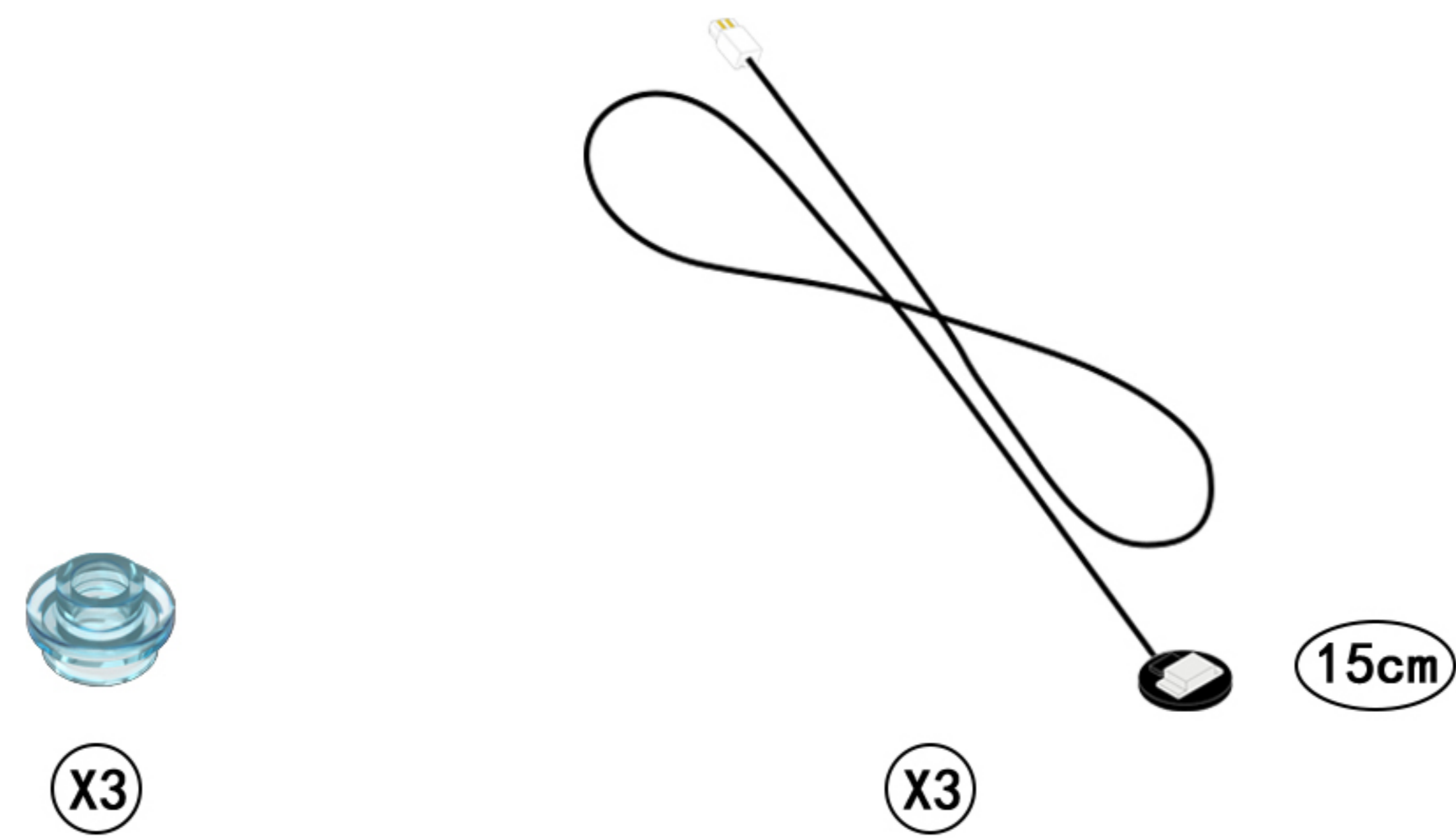
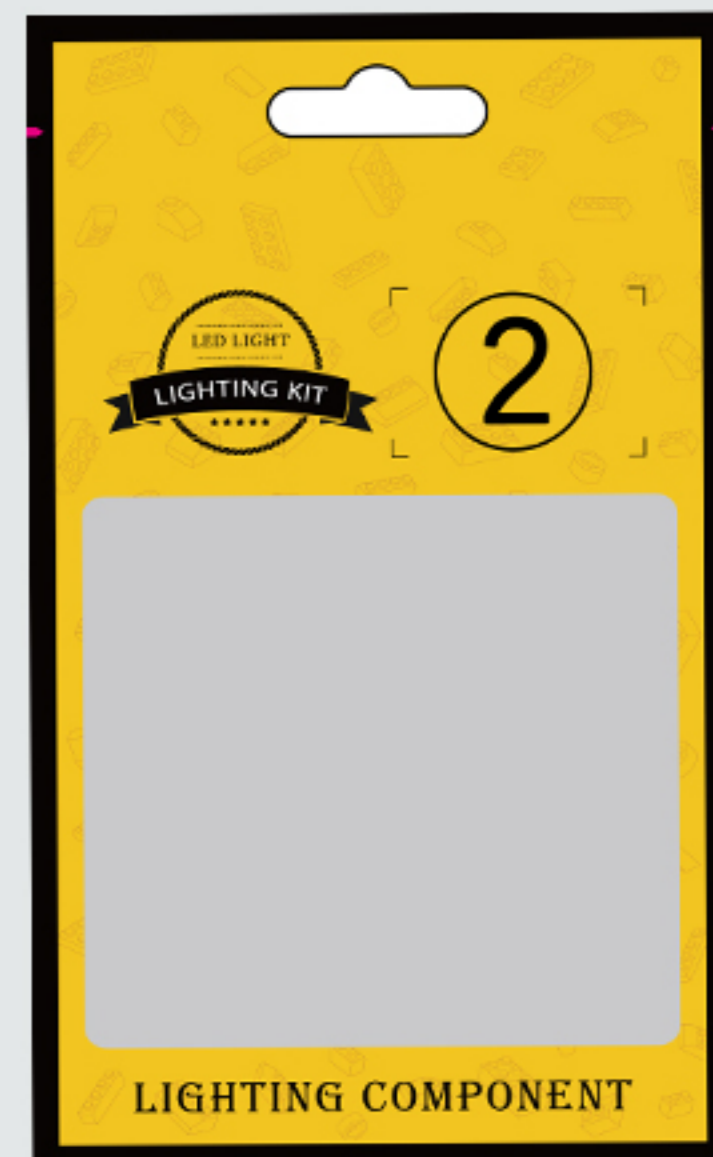
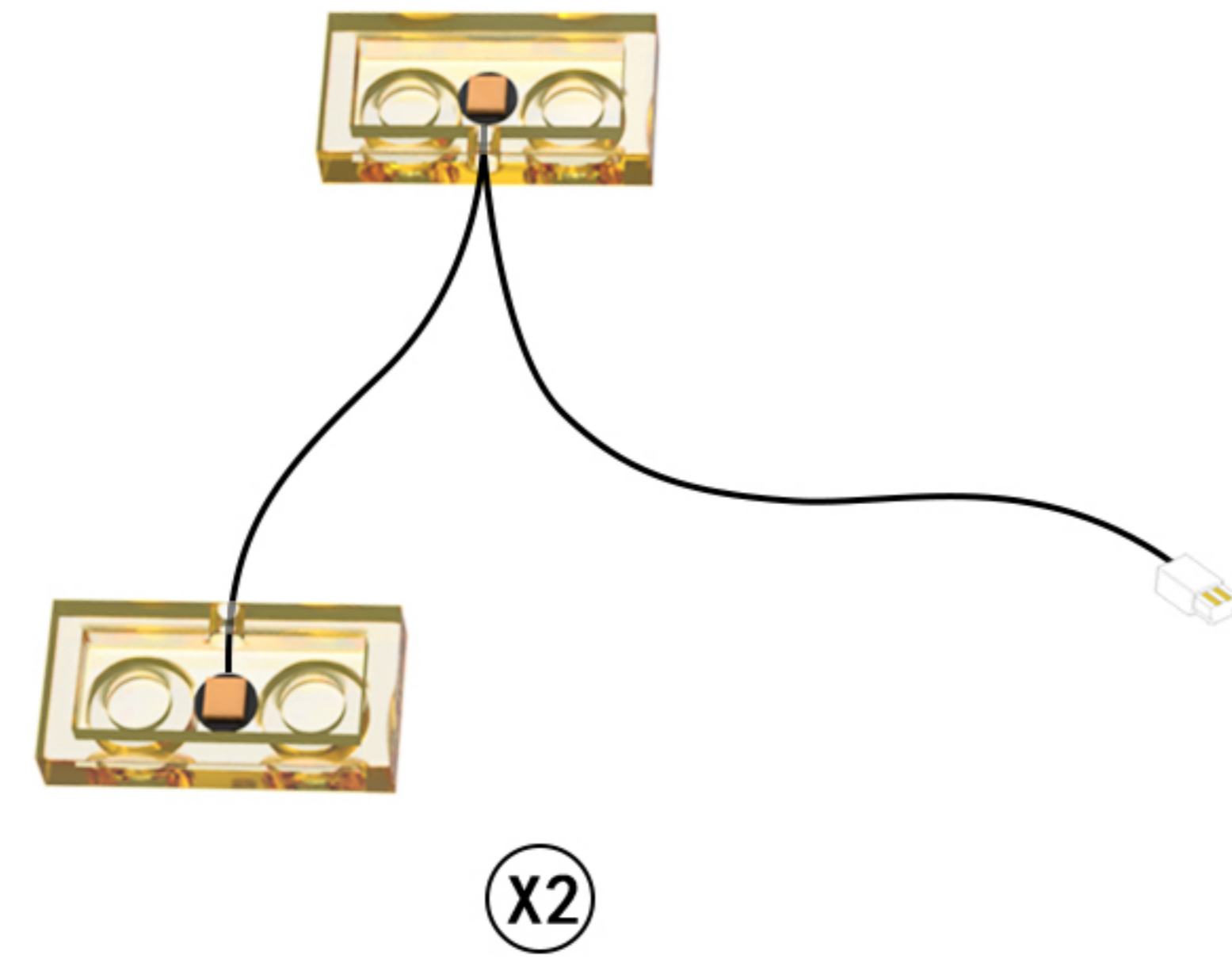
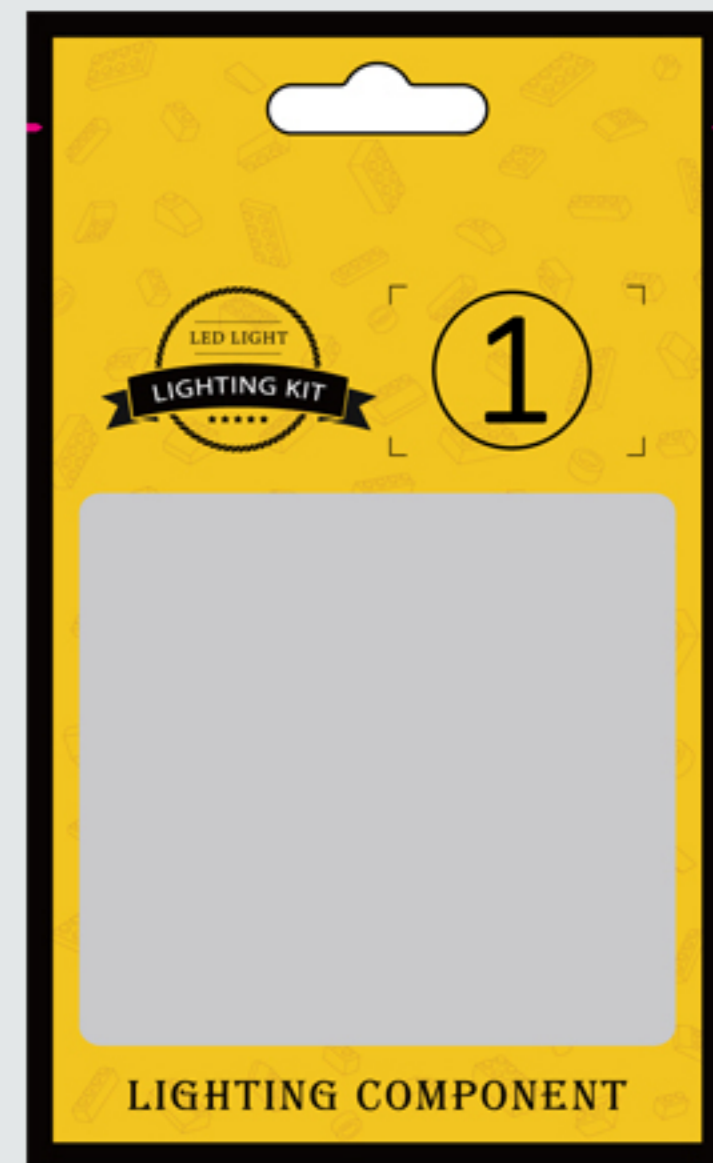



(X1)

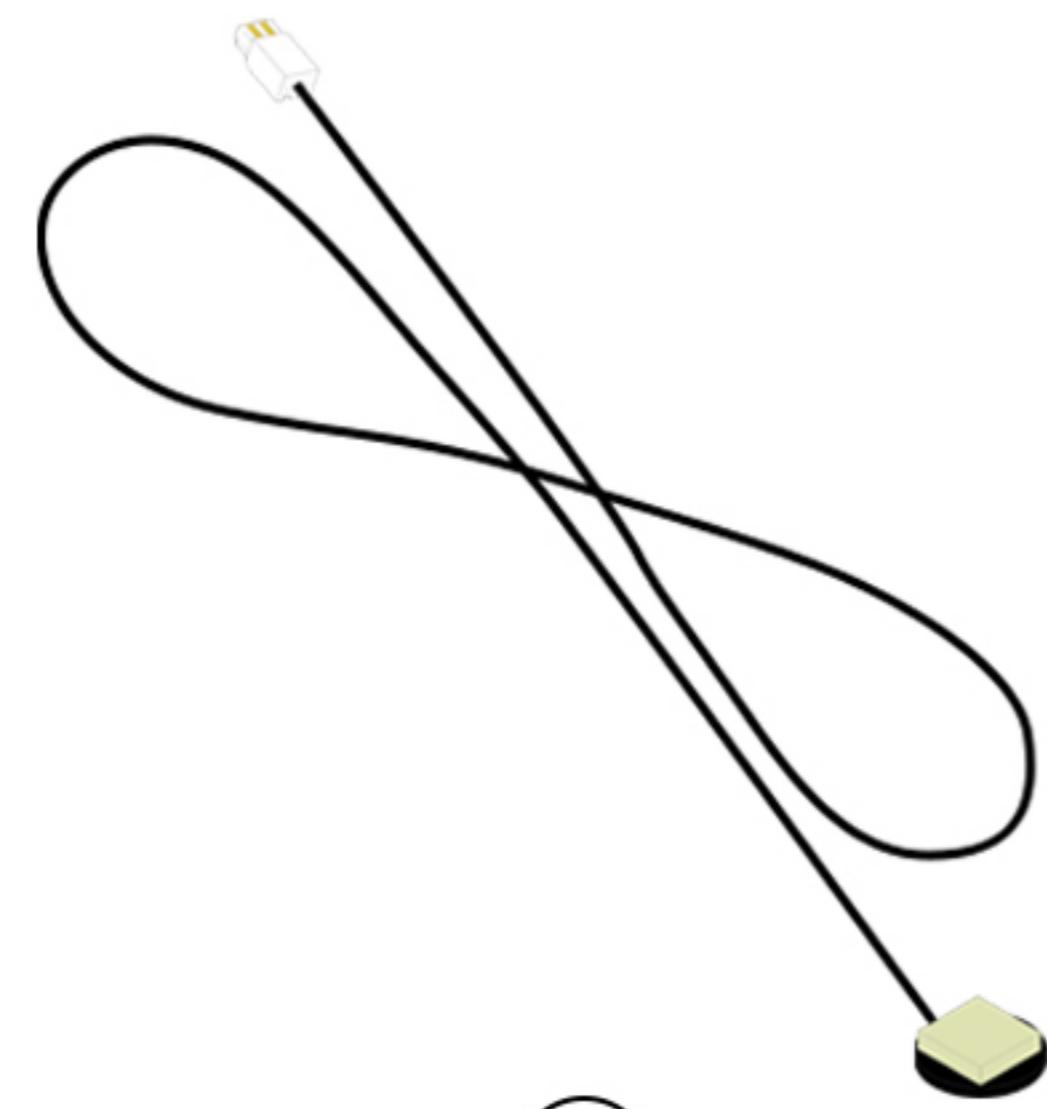

(X6)

15cm

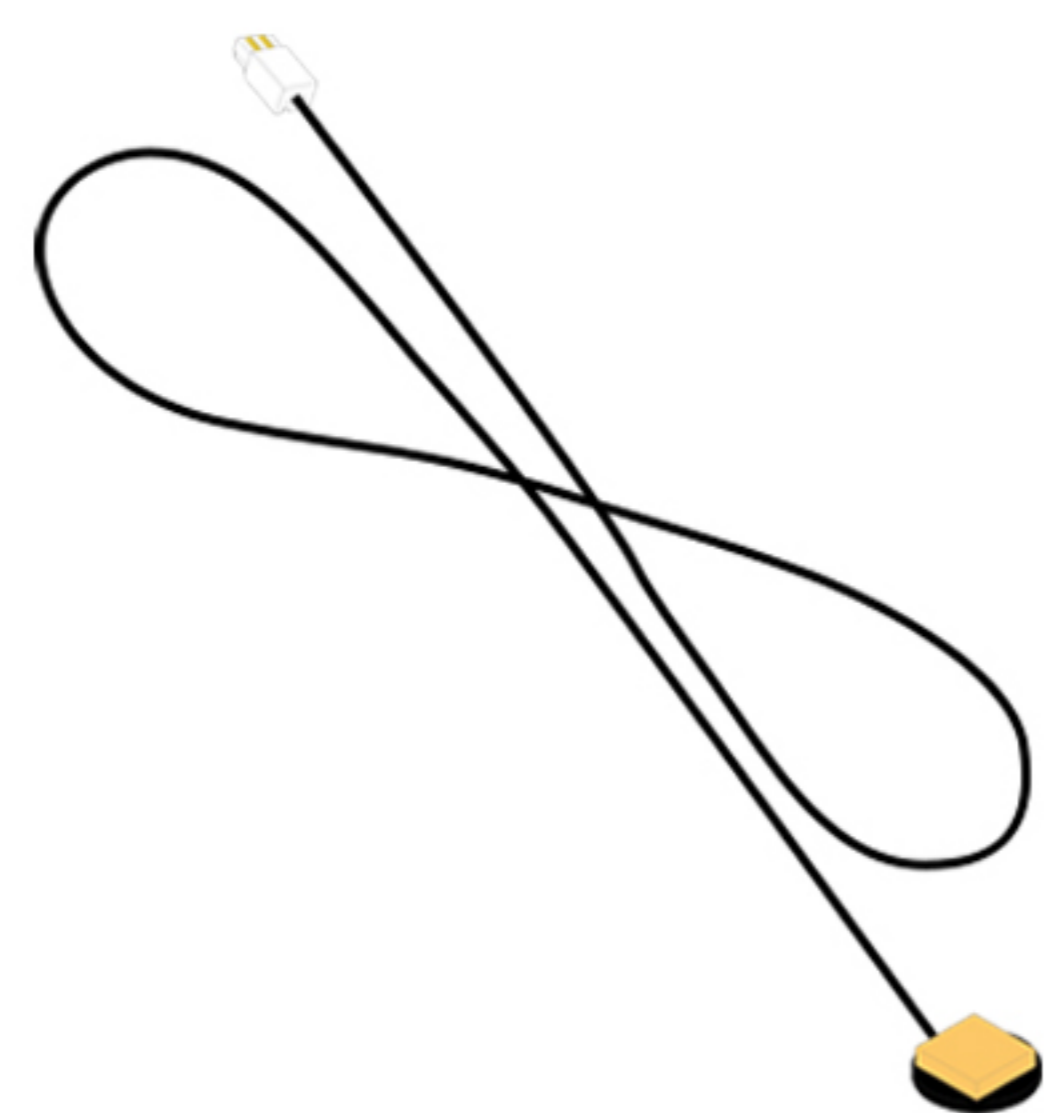

(X11)

15cm

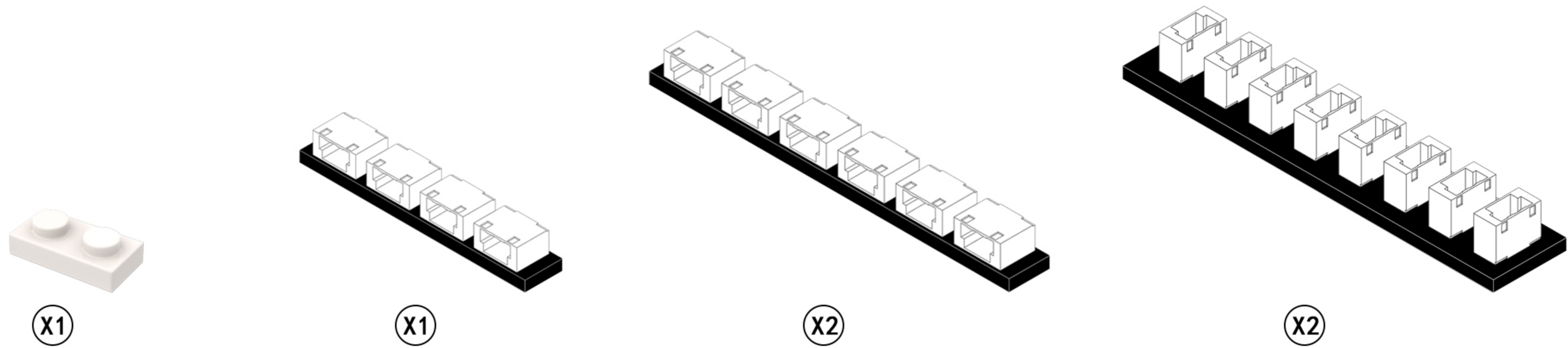
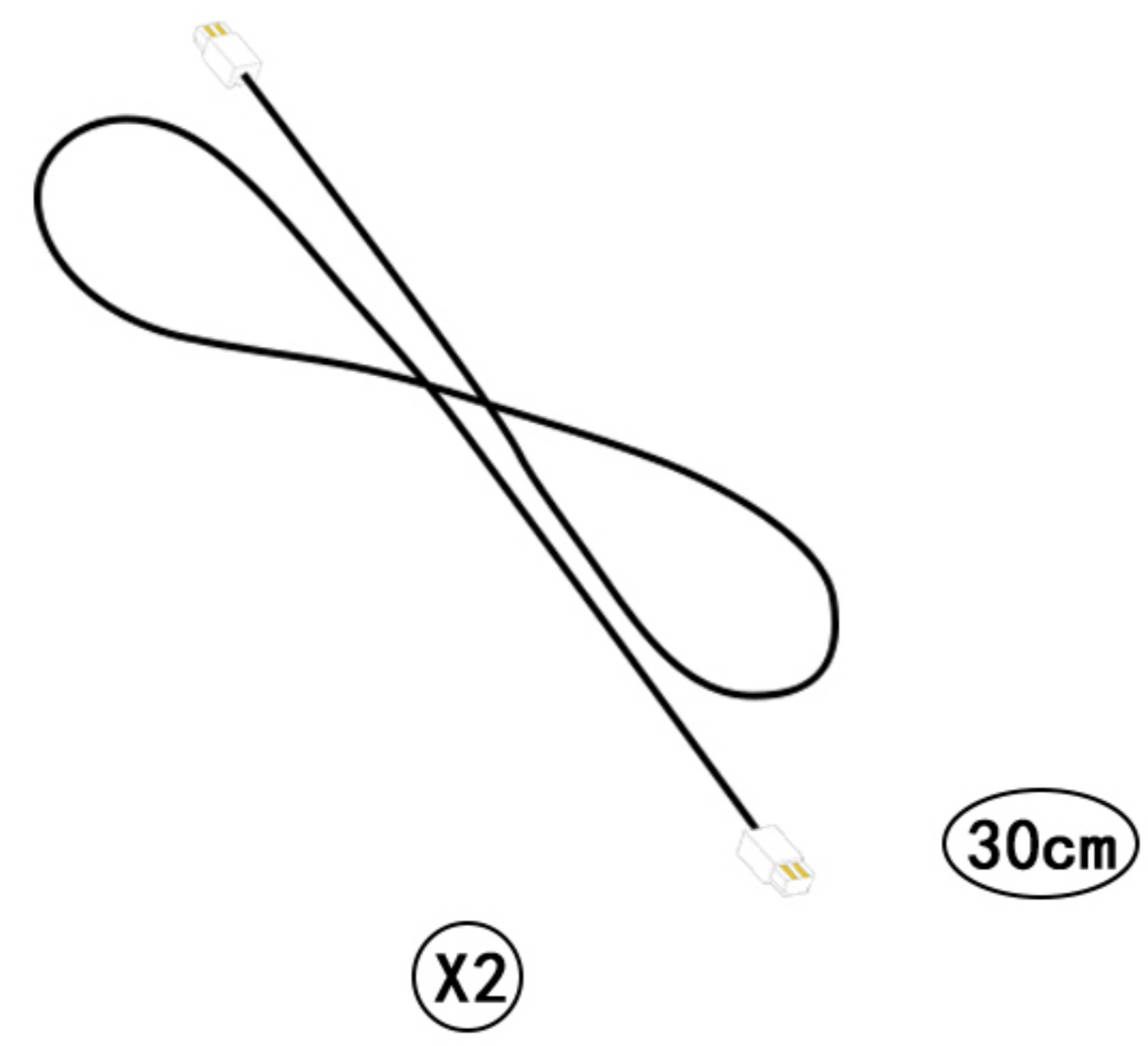
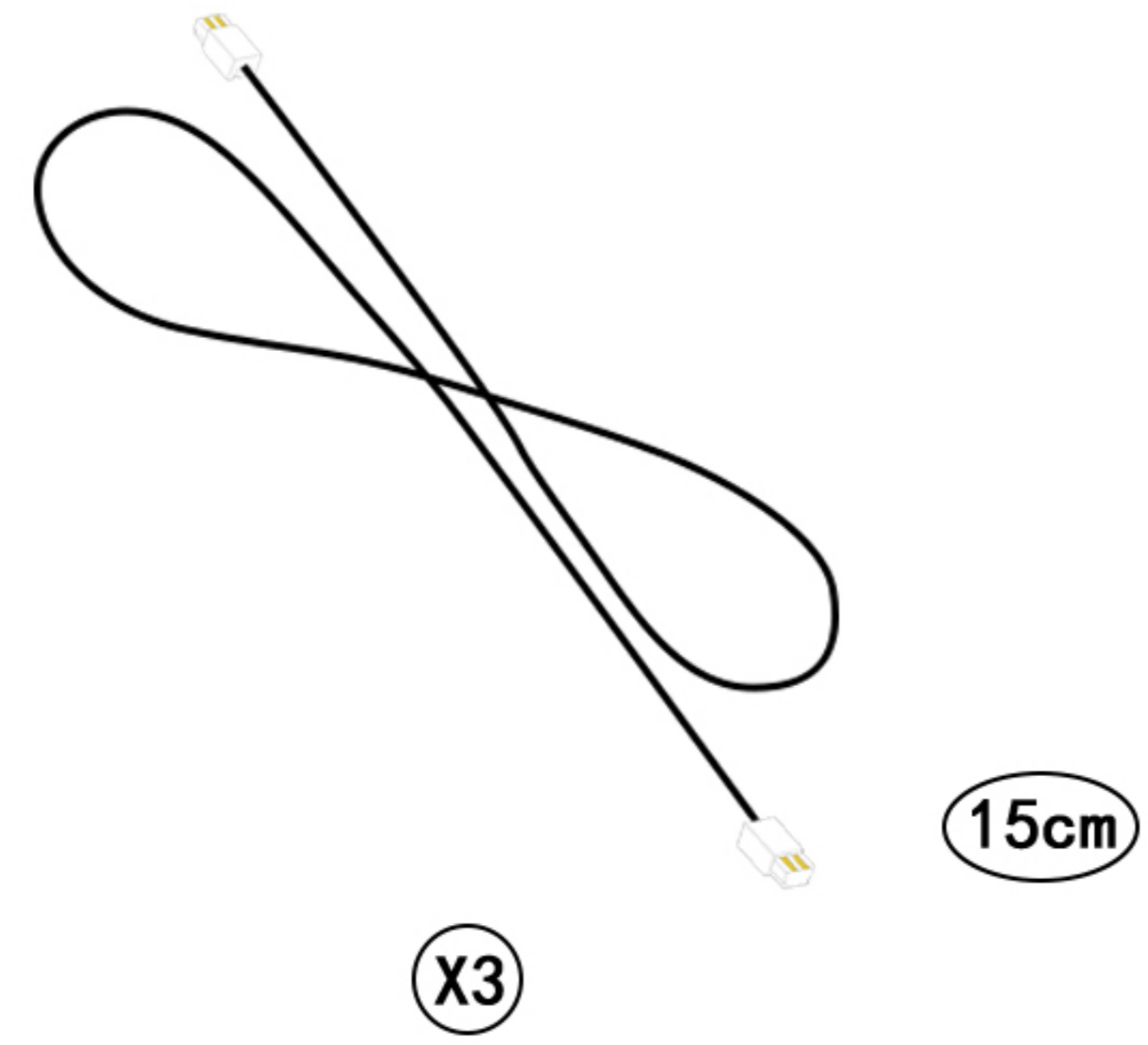

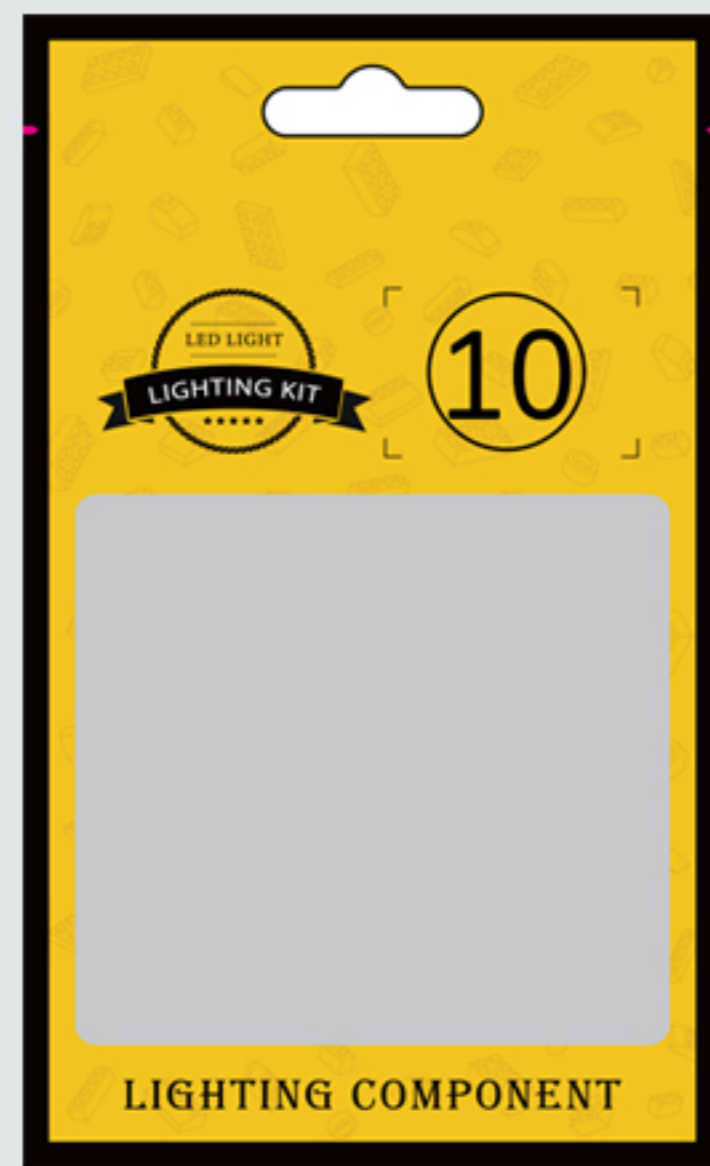

(X17)

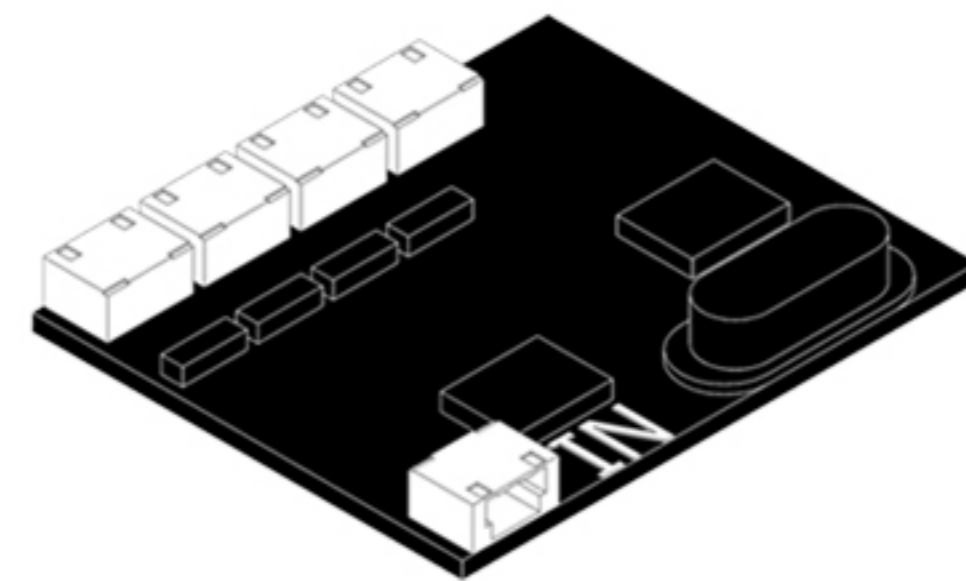
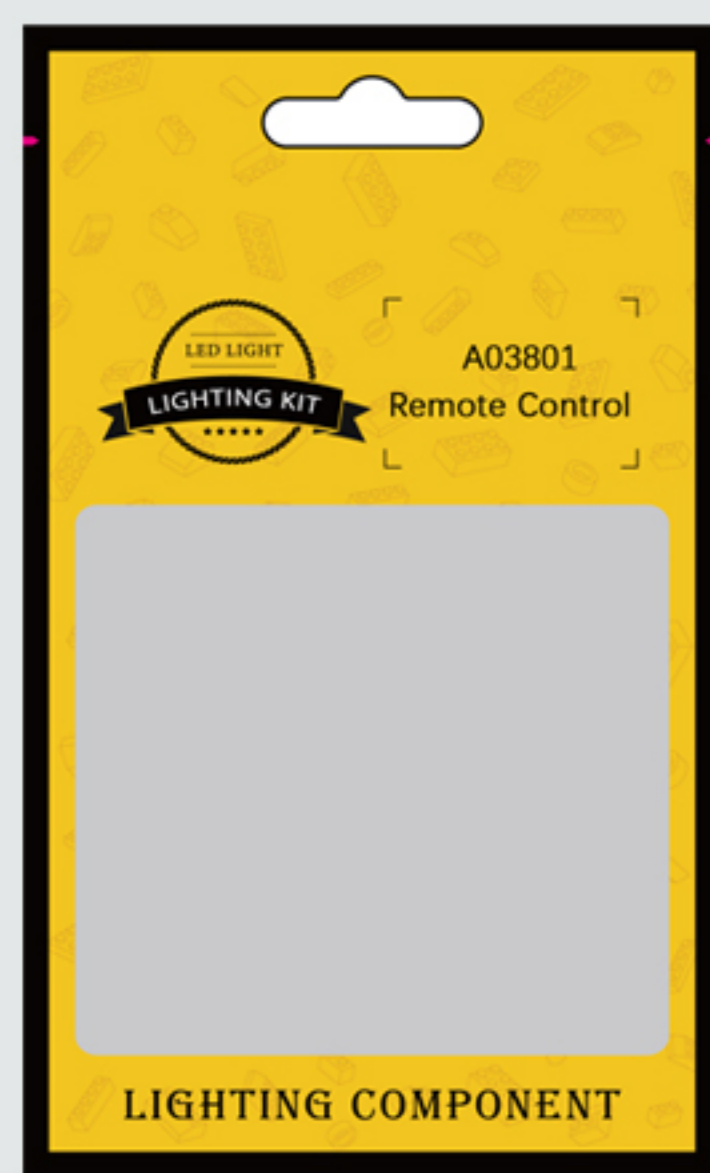

(X1)



(X1)

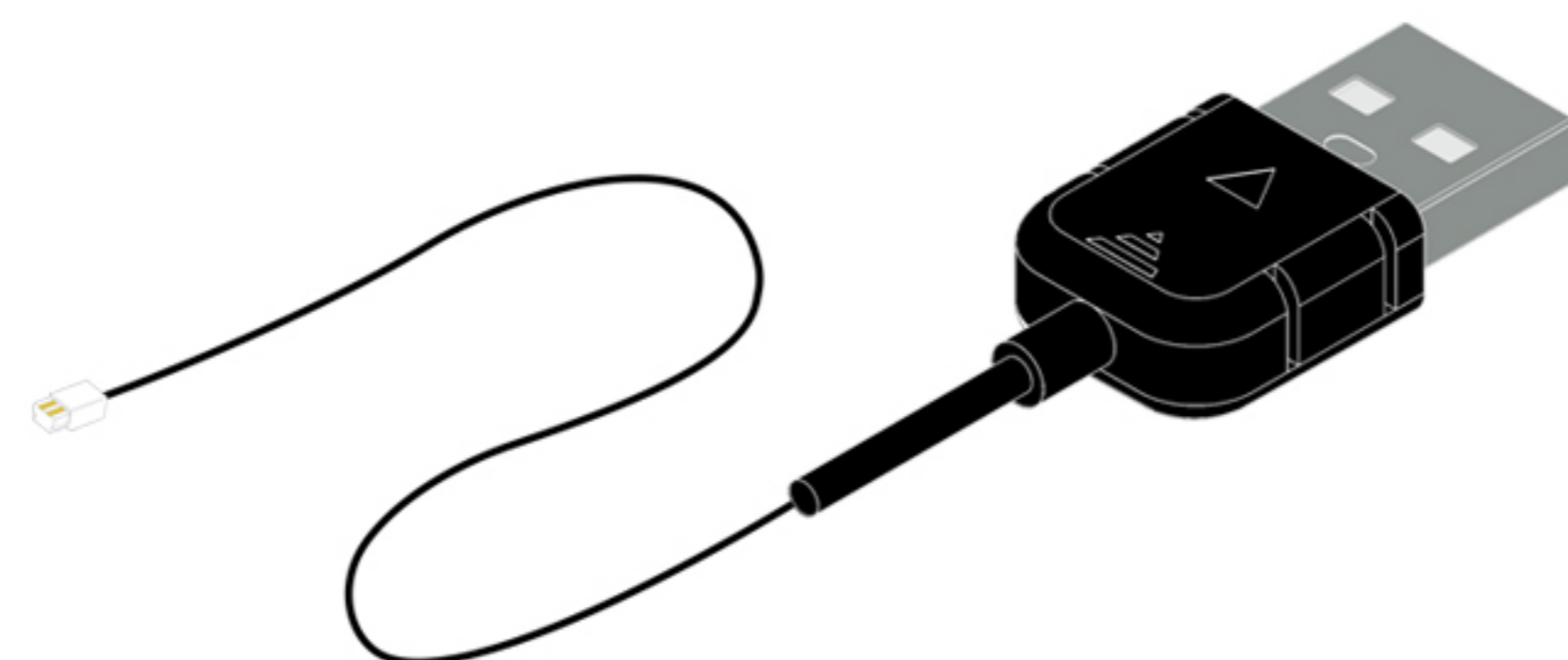
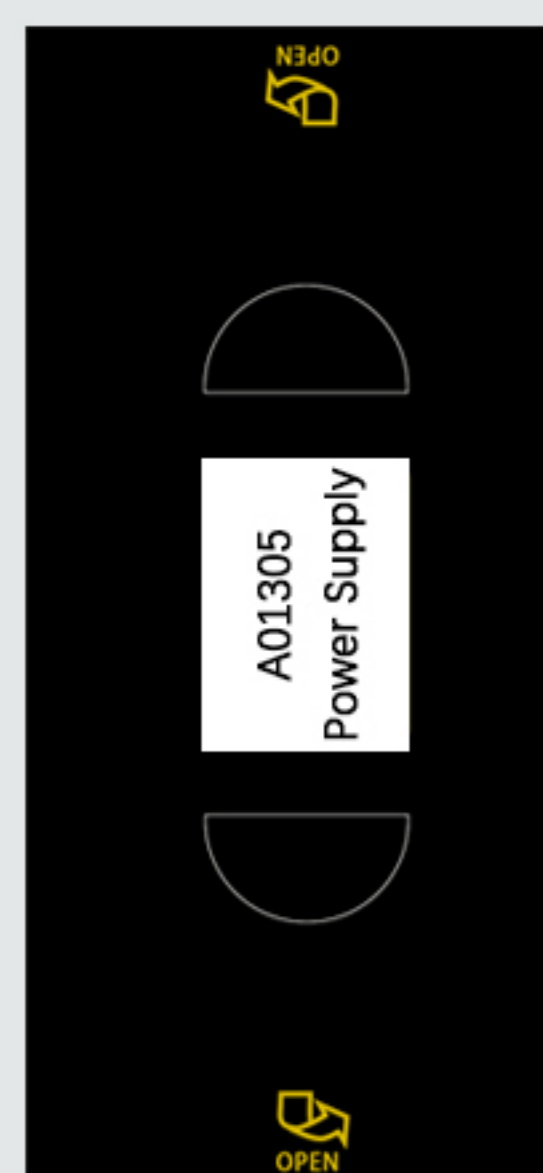

(X1)

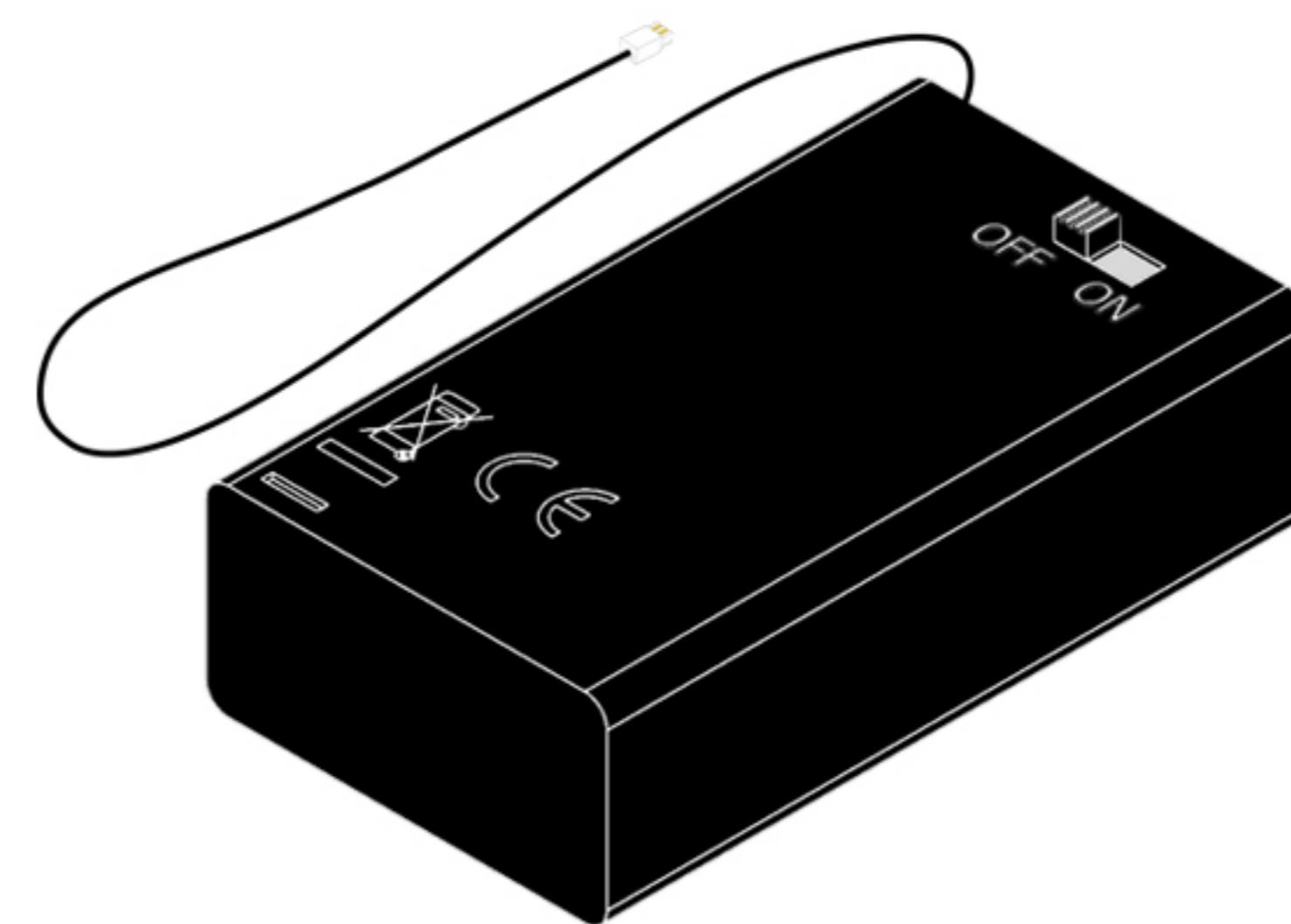

(X1)

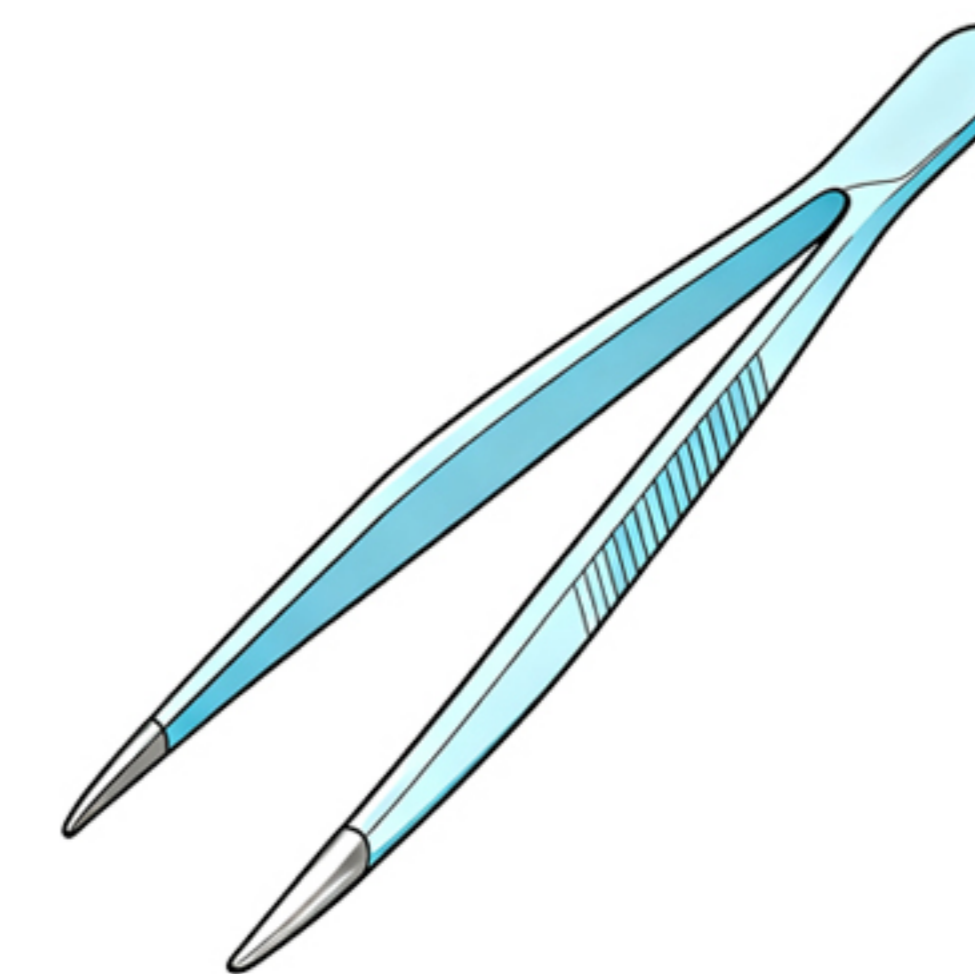

(X1)

This post will complete the light installation in two main sections.

Step 1-test



Step 2-mounting

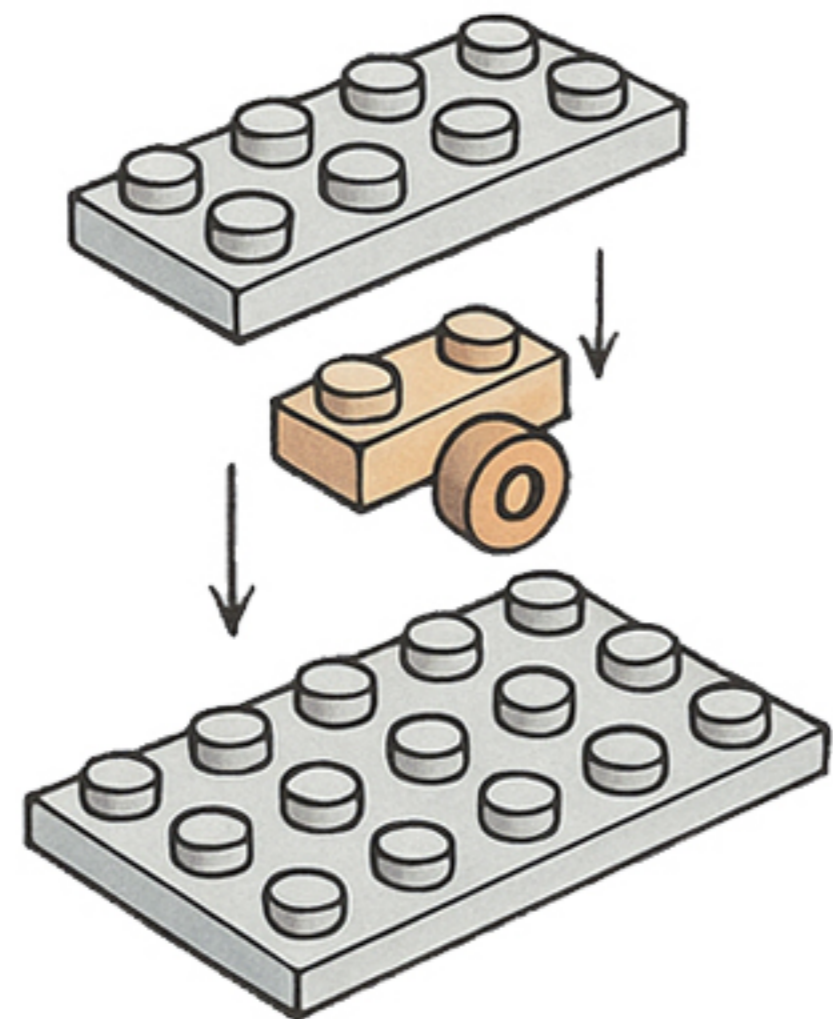

So let's get started!

## Step 1-Test.

1

EN: Remove the expansion board from Bag 9.

DE: Entnehmen Sie die Erweiterungskarte aus Beutel 9.

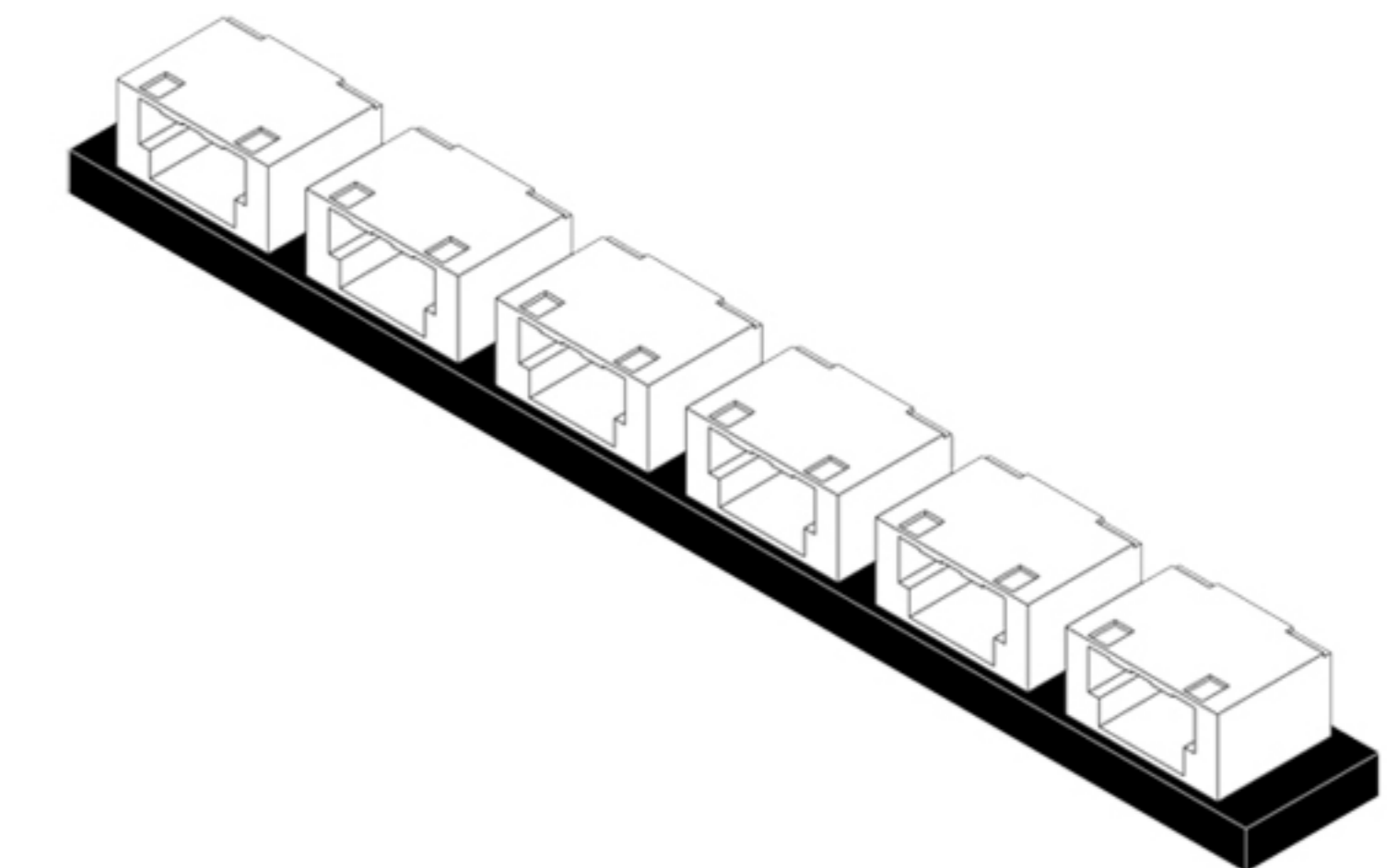

x1

2

EN: Take the USB power cable out of the box and connect it to the expansion board.

DE: Nehmen Sie das USB-Stromkabel aus der Verpackung und schließen Sie es an die Erweiterungskarte an.

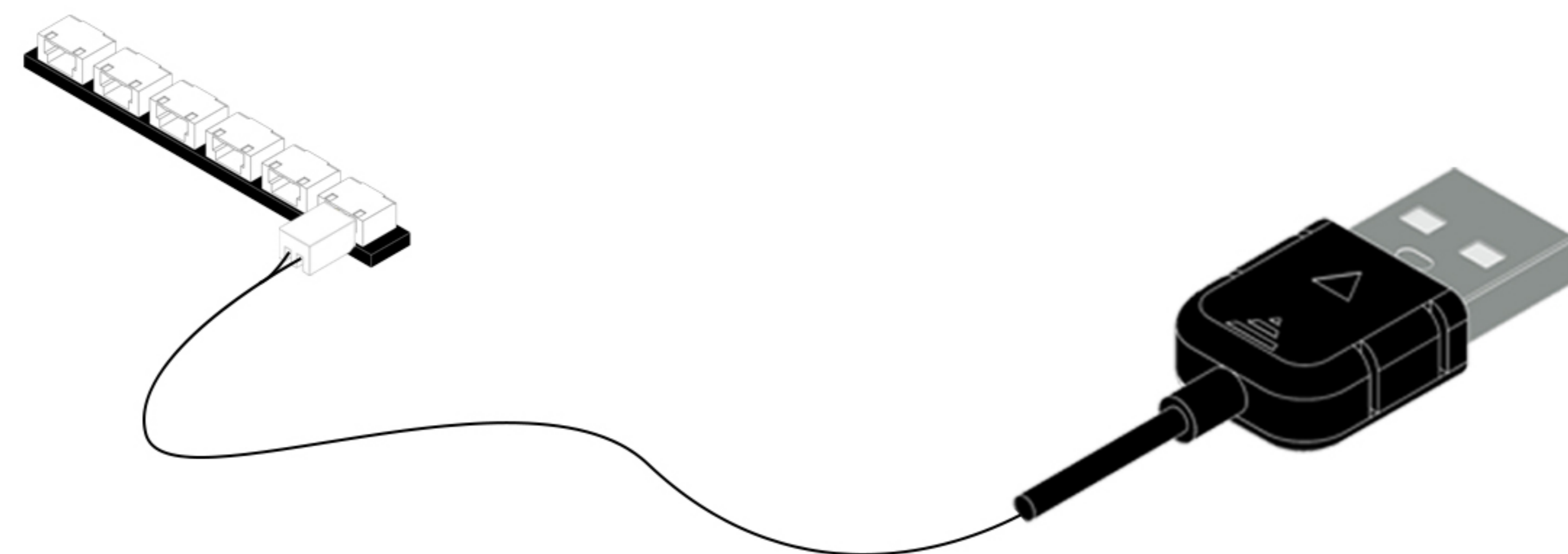
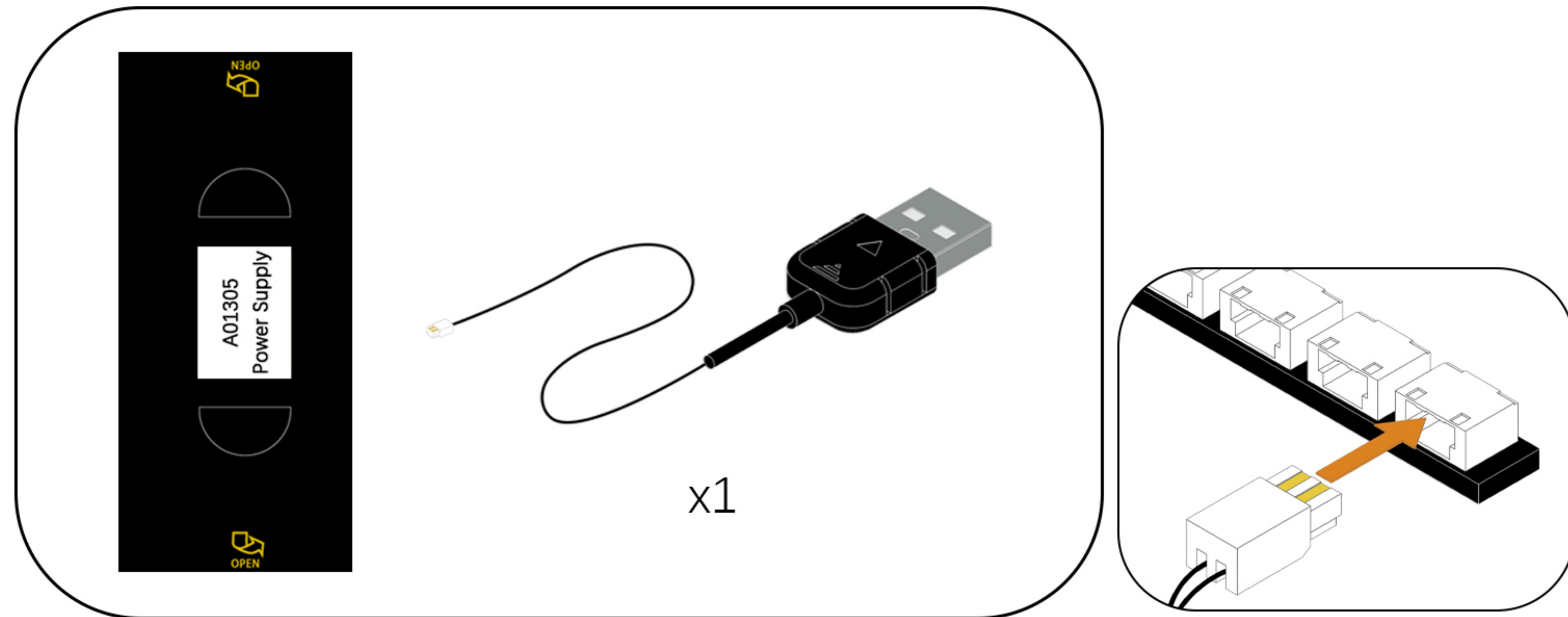

3

EN: Connect the USB power cable to the mobile power supply. (Power supply not included; see the diagram below for power supply options.)

DE: Schließen Sie das USB-Netz-kabel an die mobile Stromversorgung an. (Stromversorgung nicht im Lieferumfang enthalten, siehe Abbildung unten für die Stromversorgungsart.)

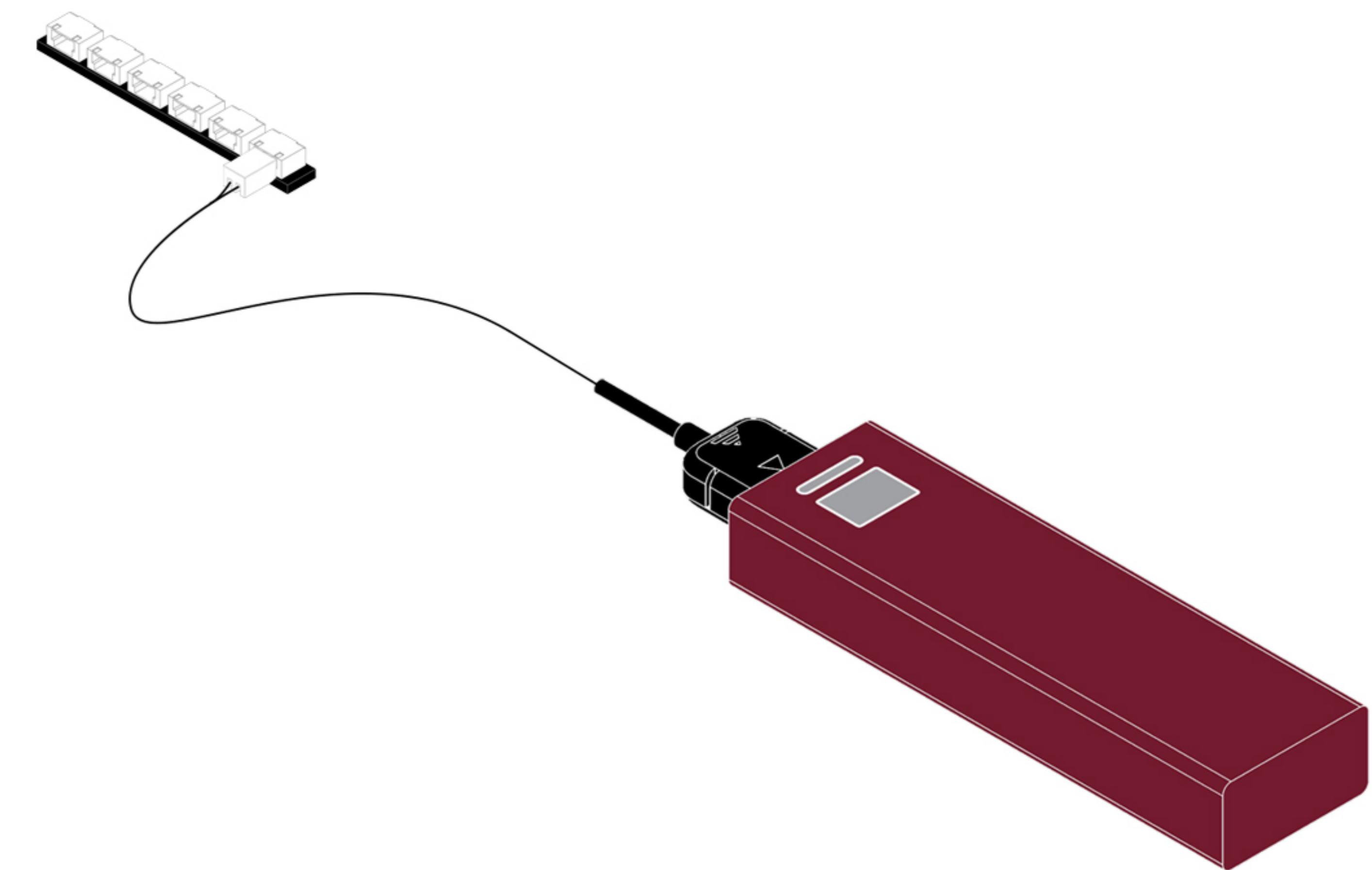

### USB Connectors to Connect Devices

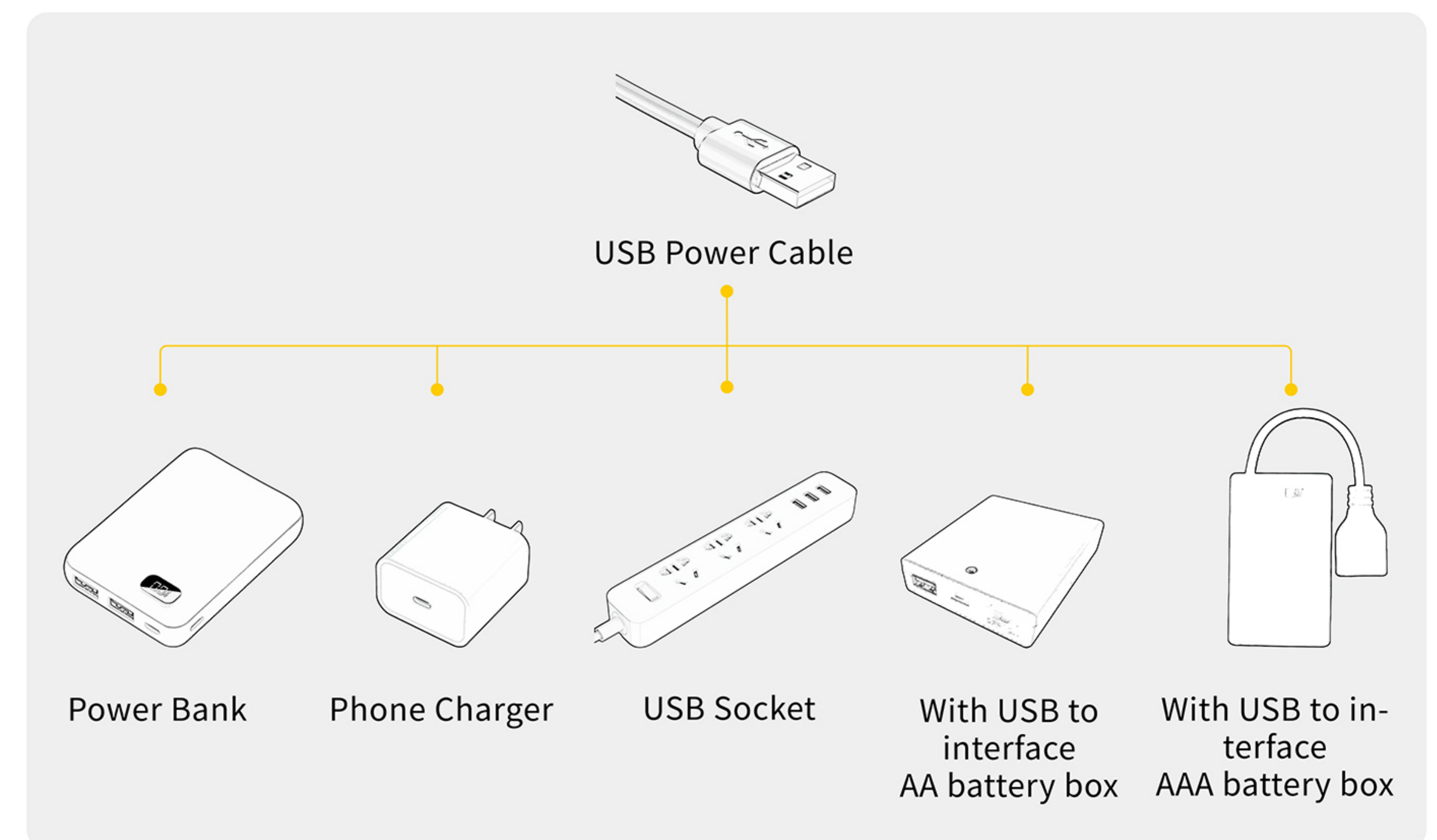

4

EN: Remove the string of lights from Bag No. 1, connect them to the extension board in order, turn on the power, and check that all the lights are working properly. If you notice any abnormalities, please contact us immediately.

DE: Nehmen Sie die Lichterkette aus Beutel Nr. 1 heraus, schließen Sie die Lichter der Reihe nach an die Verlängerungsplatine an, schalten Sie den Strom ein und überprüfen Sie, ob alle Lichter ordnungsgemäß funktionieren. Sollten Sie Unregelmäßigkeiten feststellen, wenden Sie sich bitte umgehend an uns.

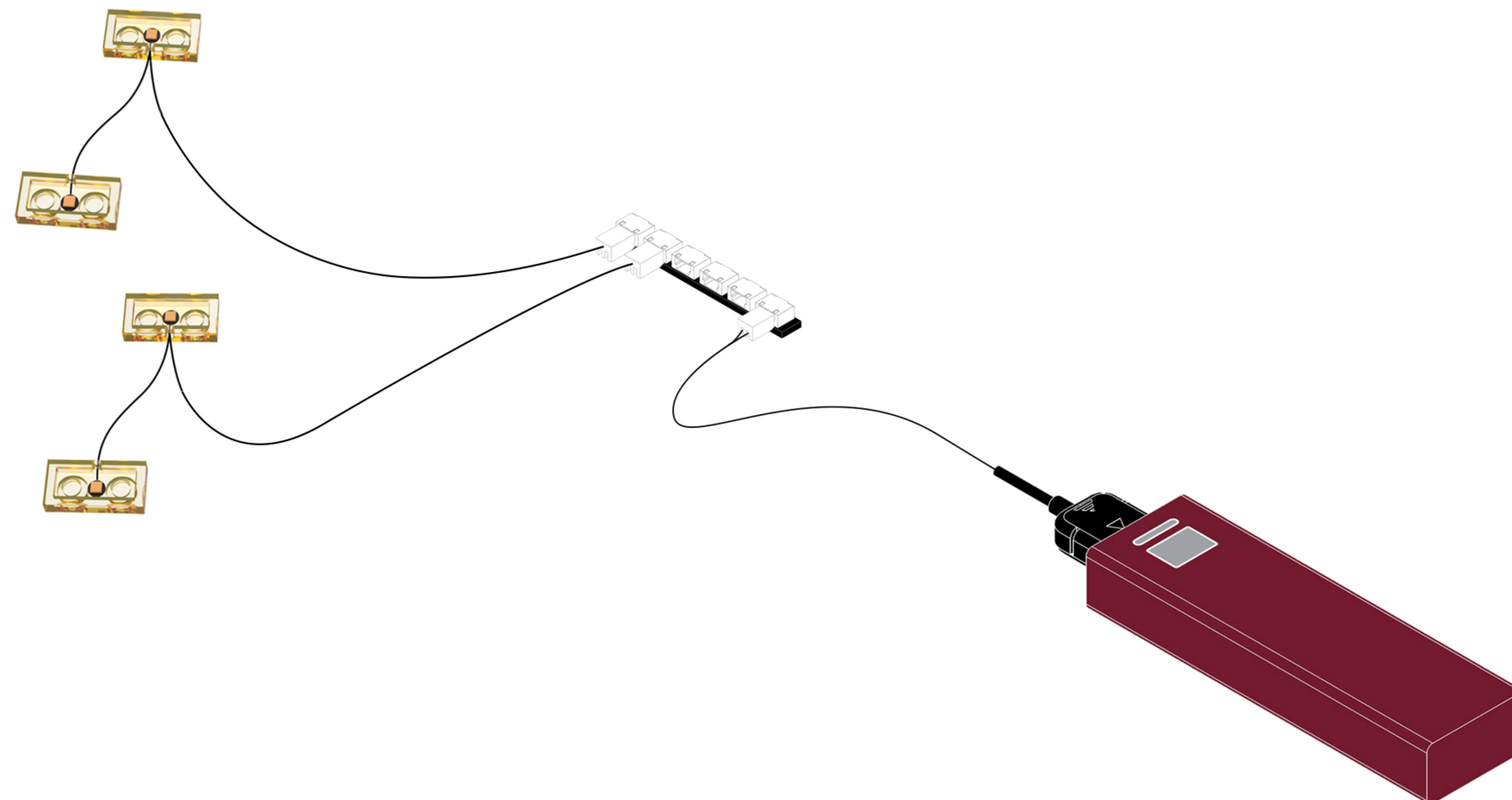
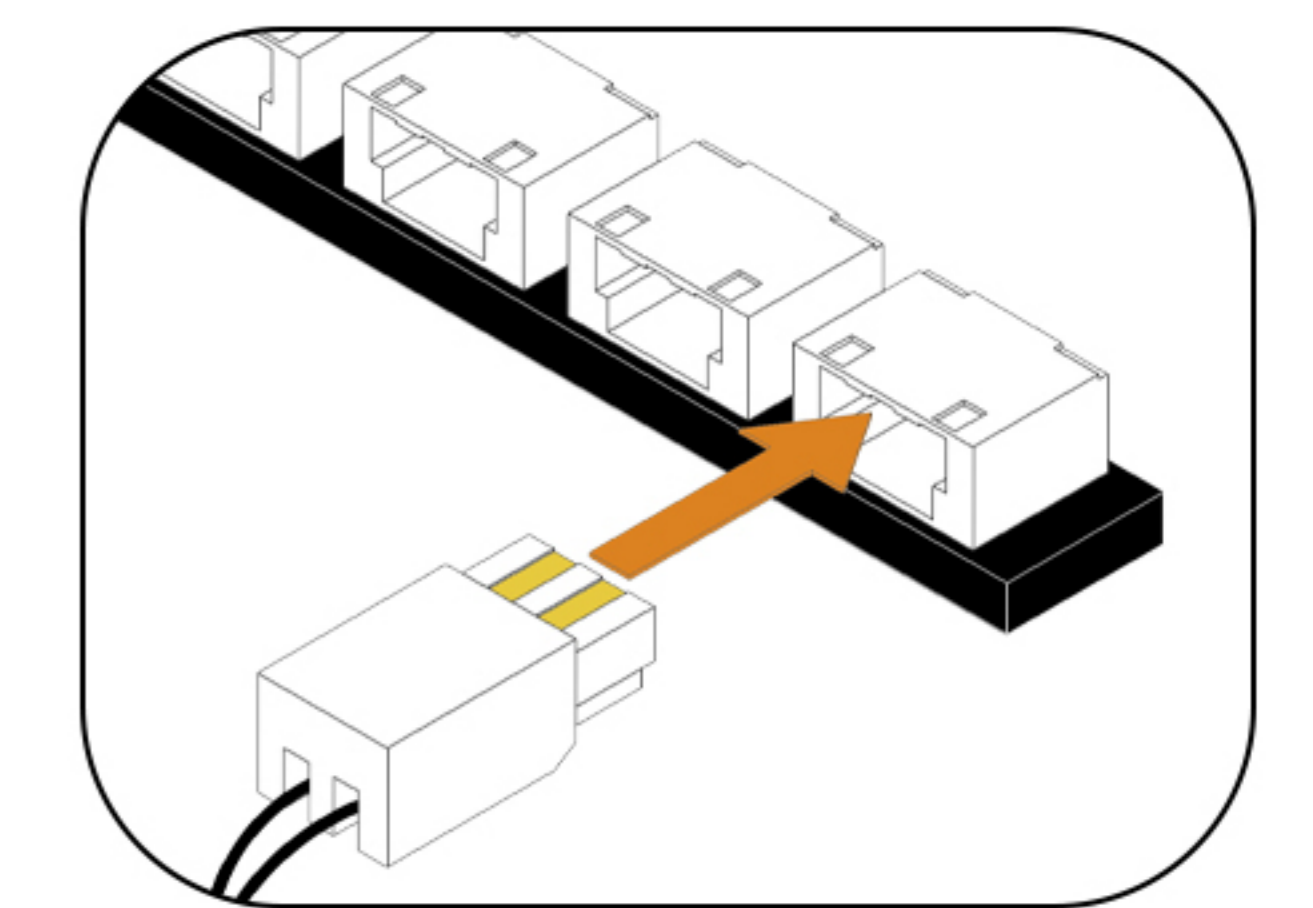
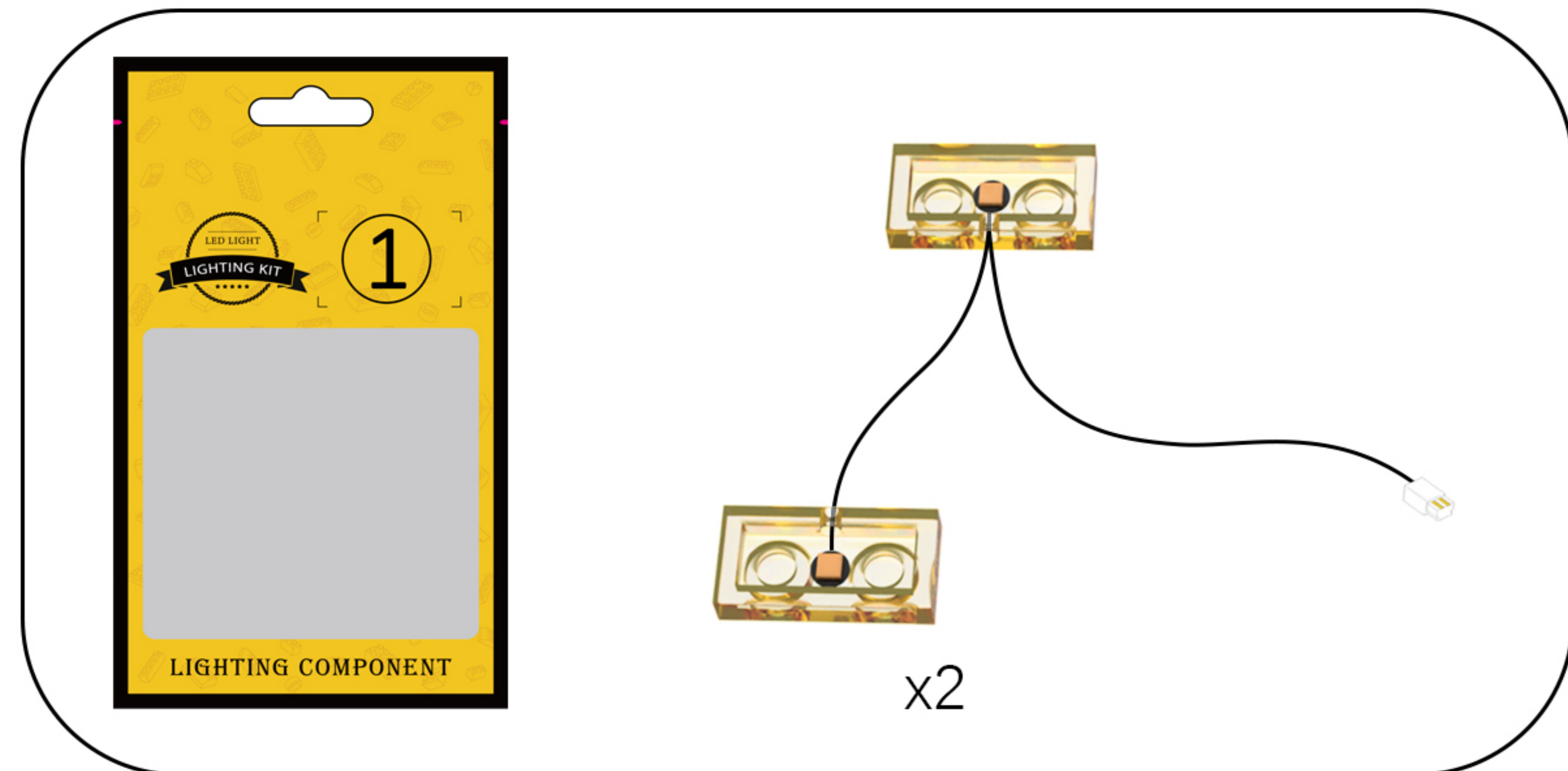

After confirming that there are no abnormalities, temporarily return each part to its original bag.

## Step 2-Mounting.

1

EN: Take out the building block model.

DE: Nimm das Bauklotzmodell heraus.

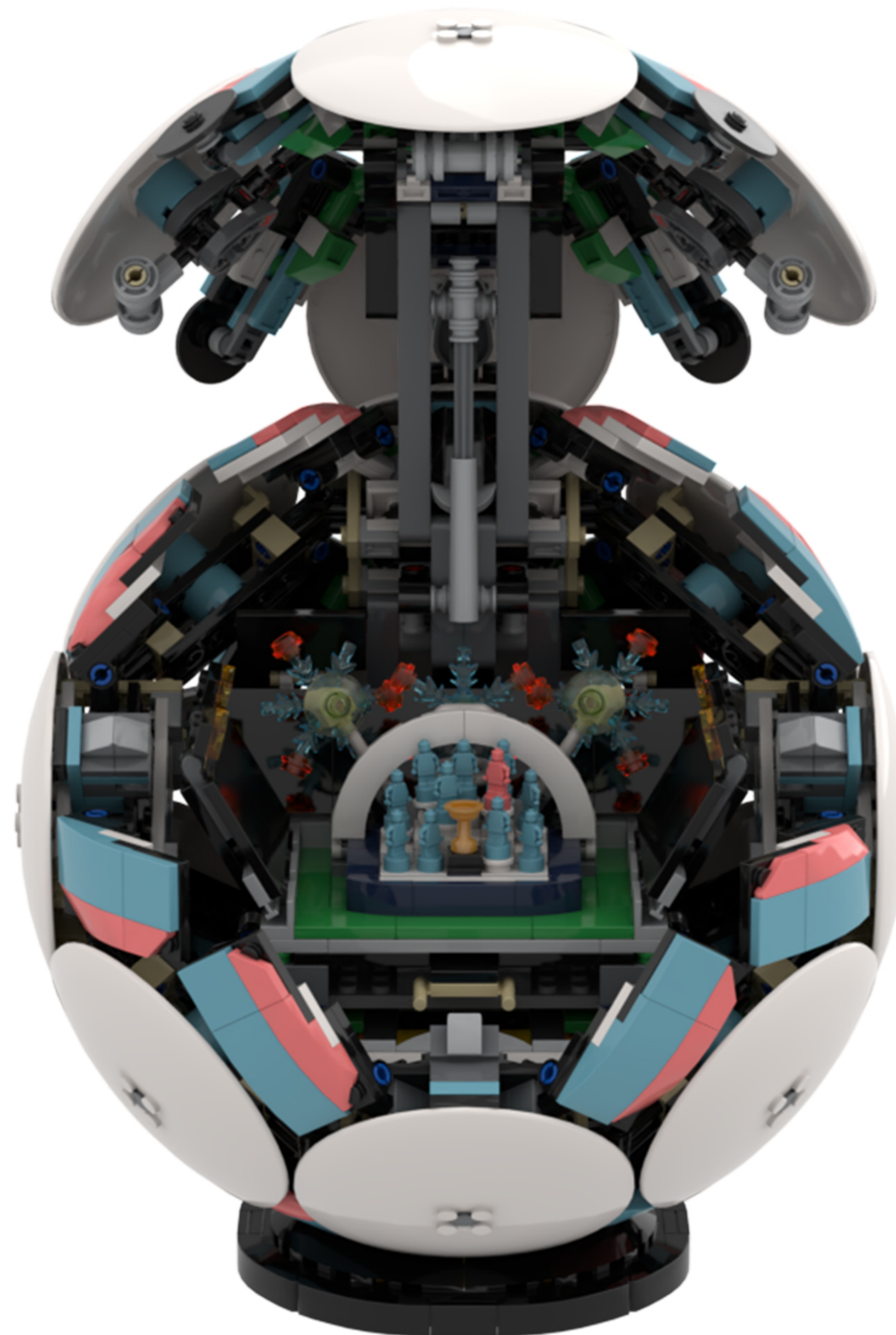

2

EN: Split as shown in the figure.

DE: Wie in der Abbildung gezeigt, teilen Sie es auf.



3

EN: Take out the disassembled building blocks and separate them.

DE: Nehmen Sie die zerlegten Bausteine heraus und trennen Sie sie voneinander.

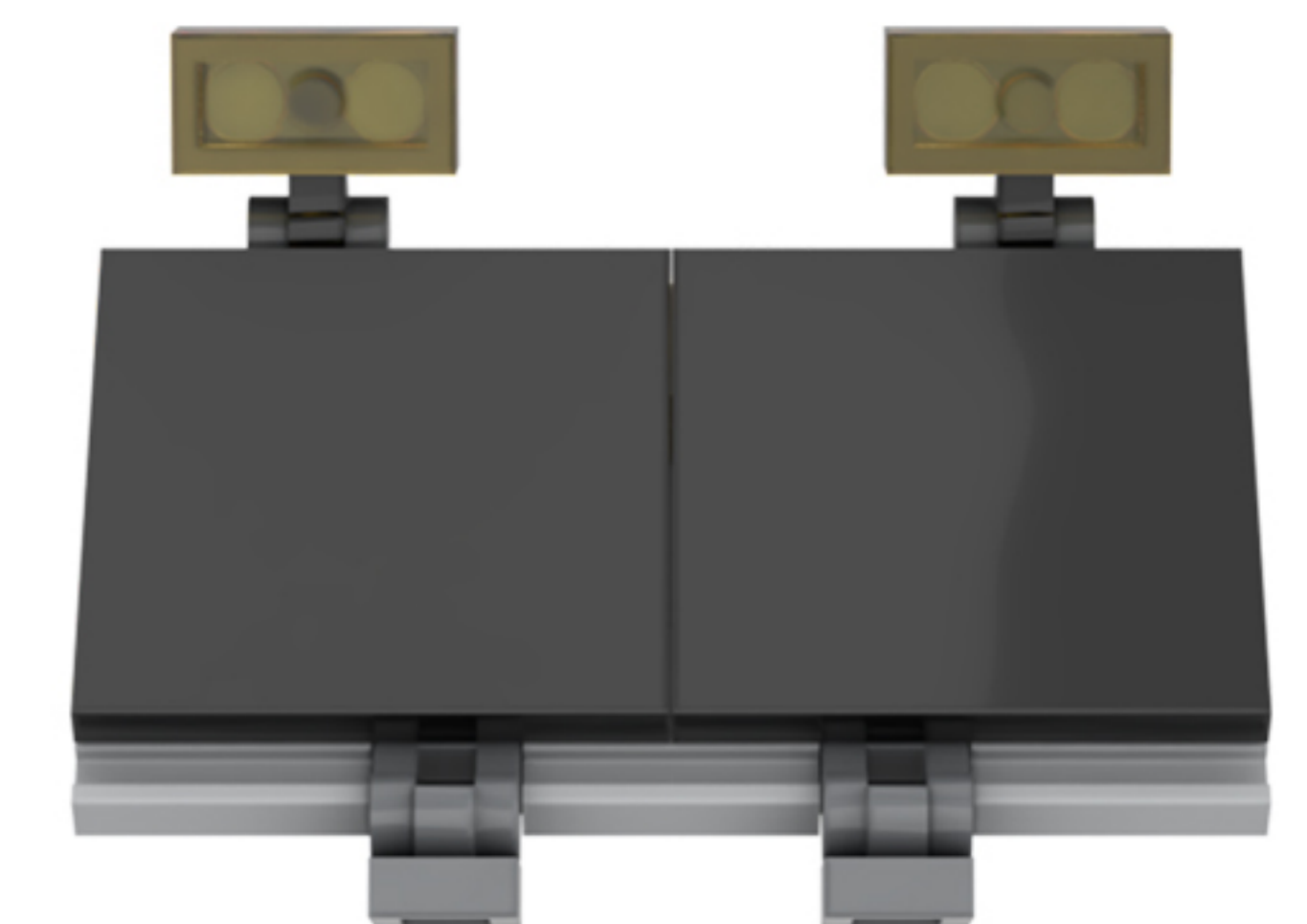
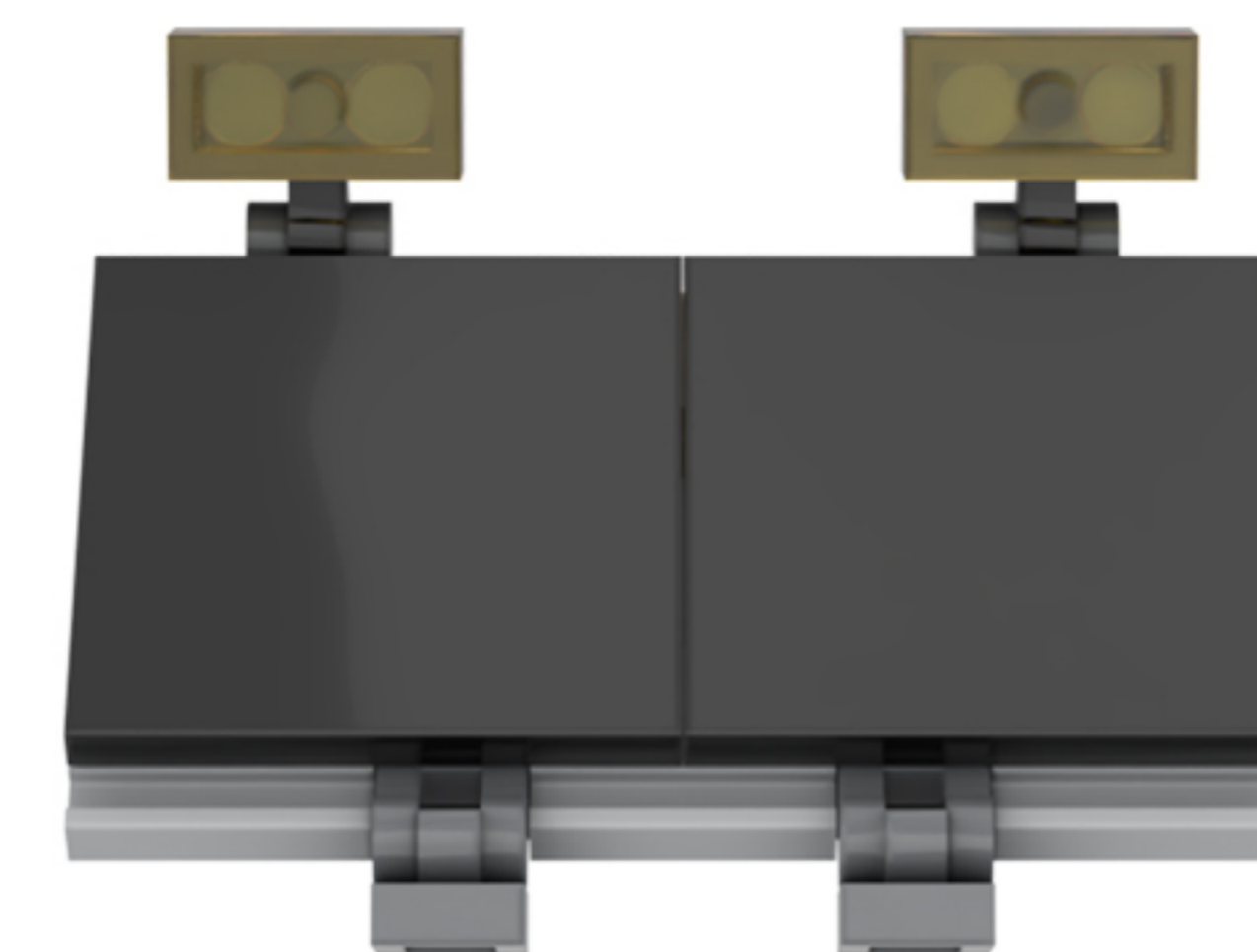
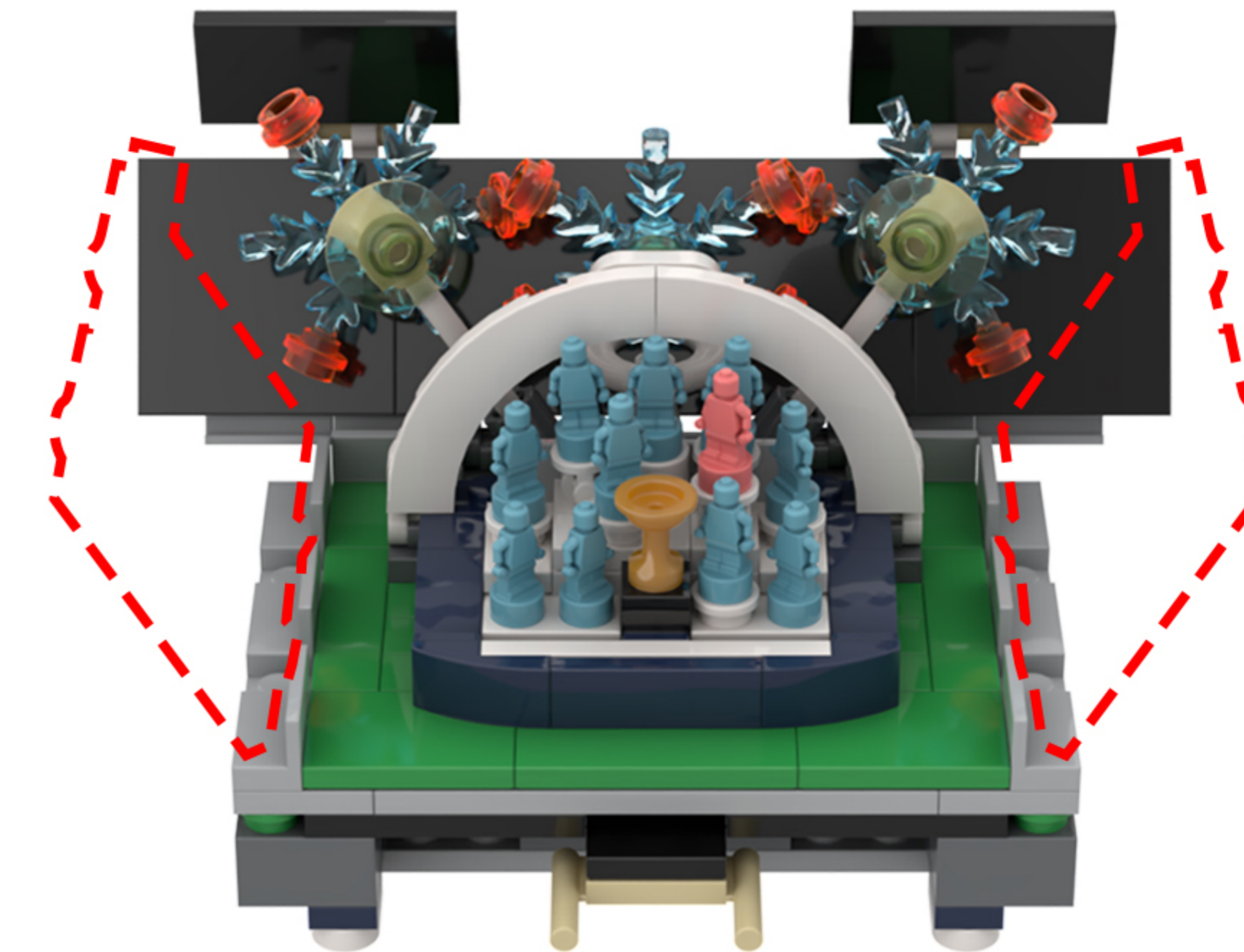
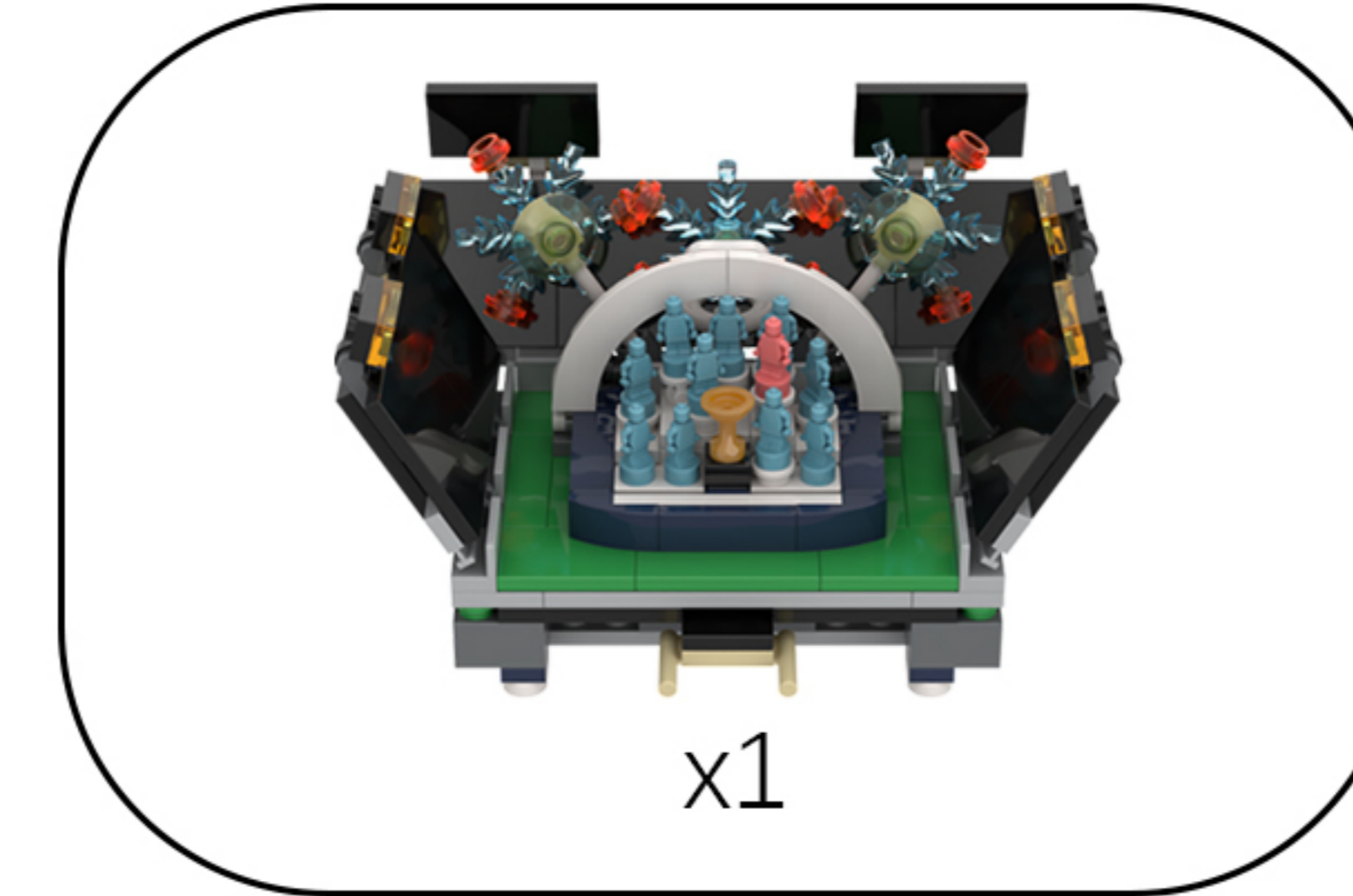

4

EN: Take out the disassembled building blocks and separate them.

DE: Nehmen Sie die zerlegten Bausteine heraus und trennen Sie sie voneinander.

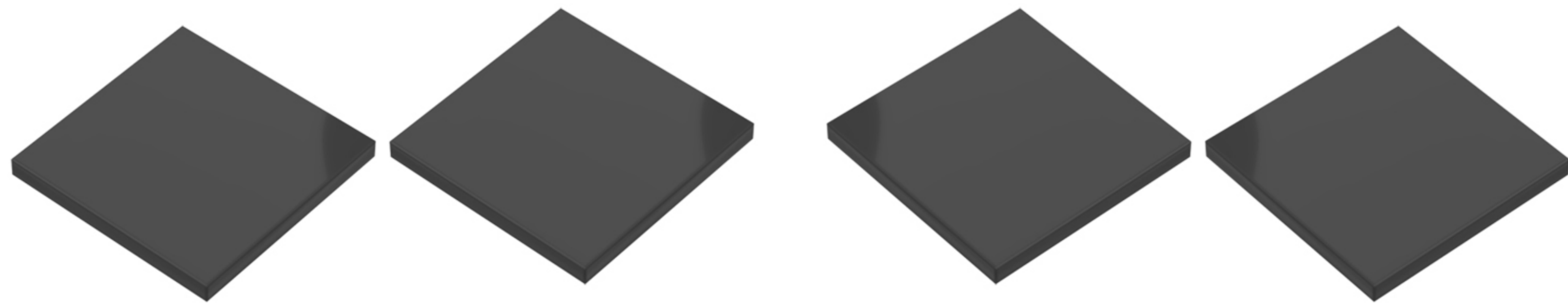
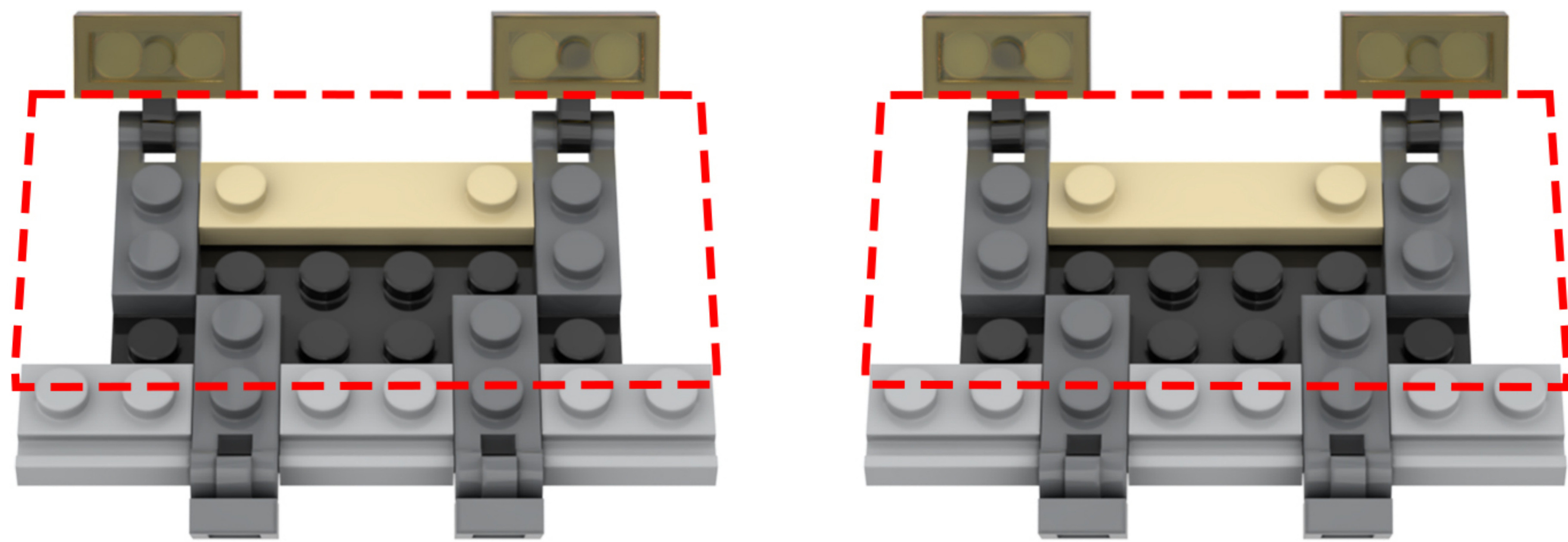
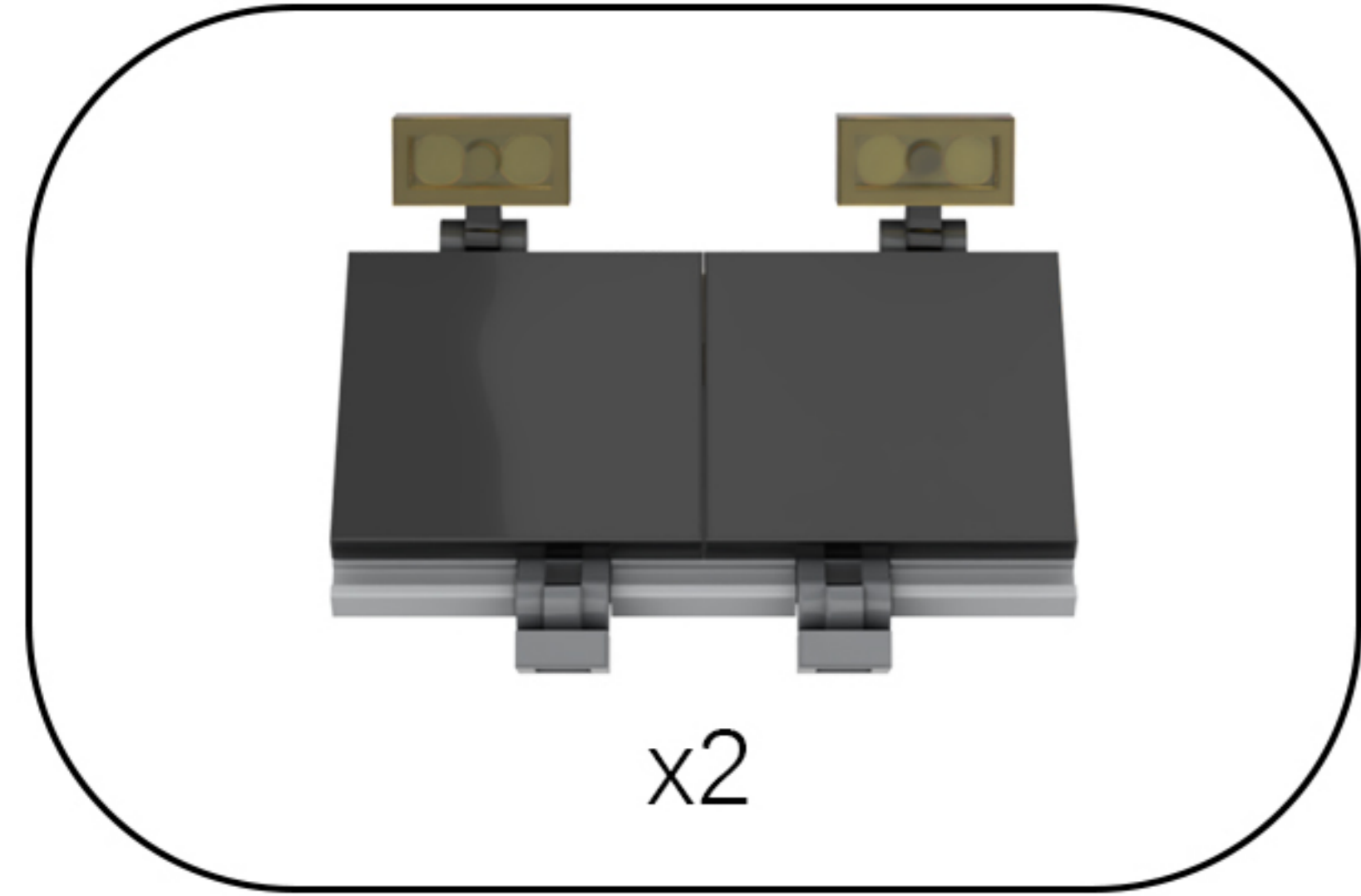

5

EN: Remove the building blocks one by one.

DE: Entfernen Sie die Bausteine nacheinander.

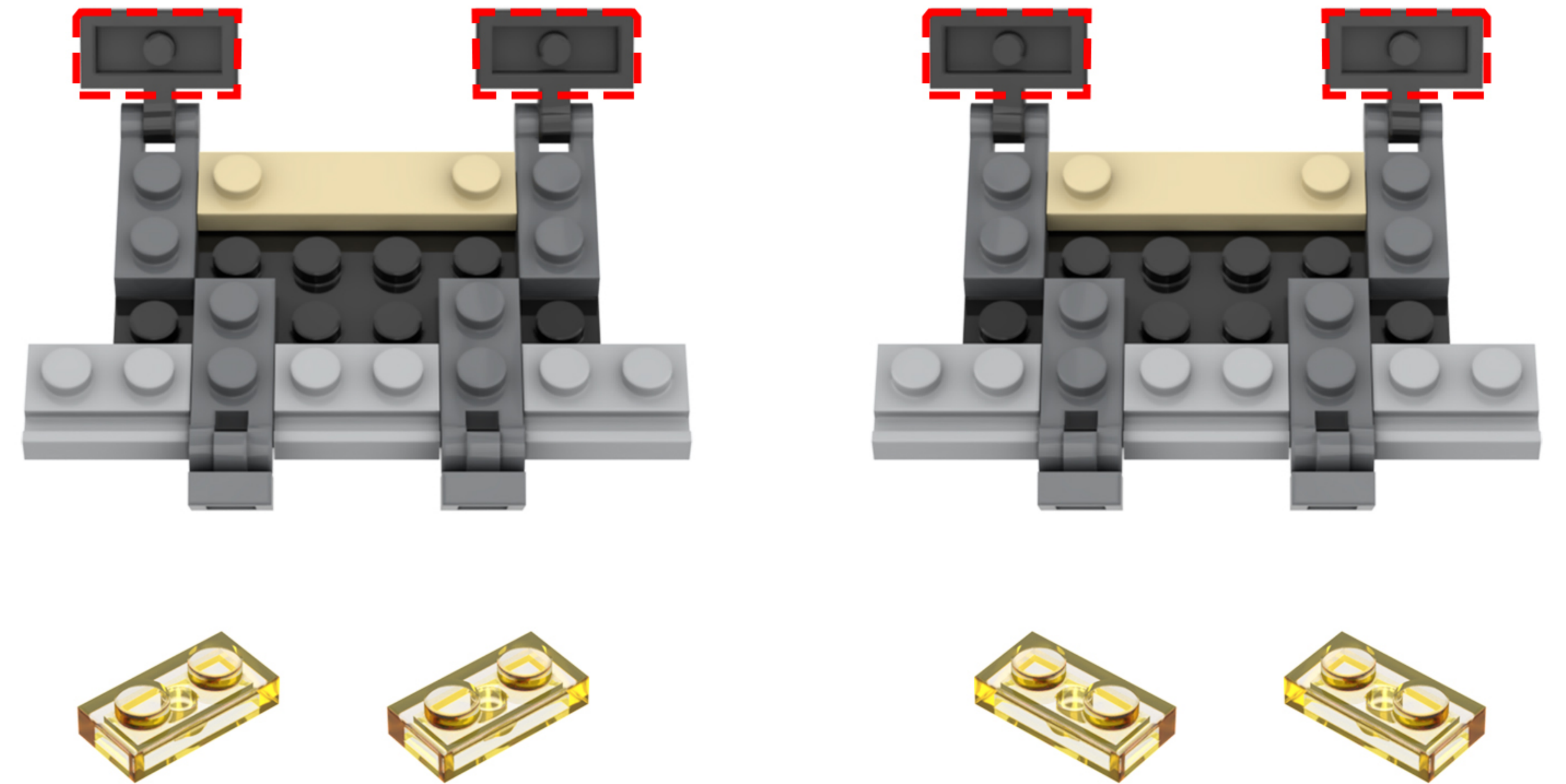

6

EN: Remove the string lights from Bag 1 and install them sequentially onto the building blocks.

DE: Nehmen Sie die Lichterkette aus Beutel 1 heraus und befestigen Sie sie nacheinander an den Bausteinen.

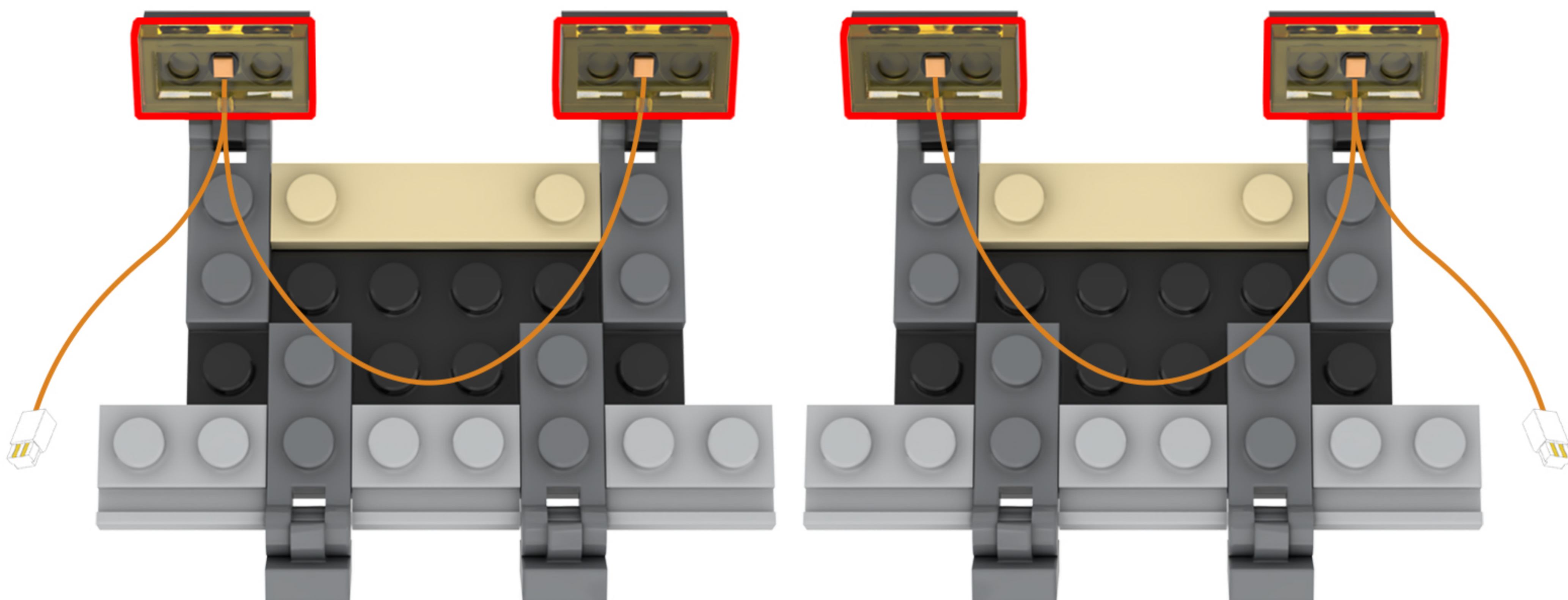
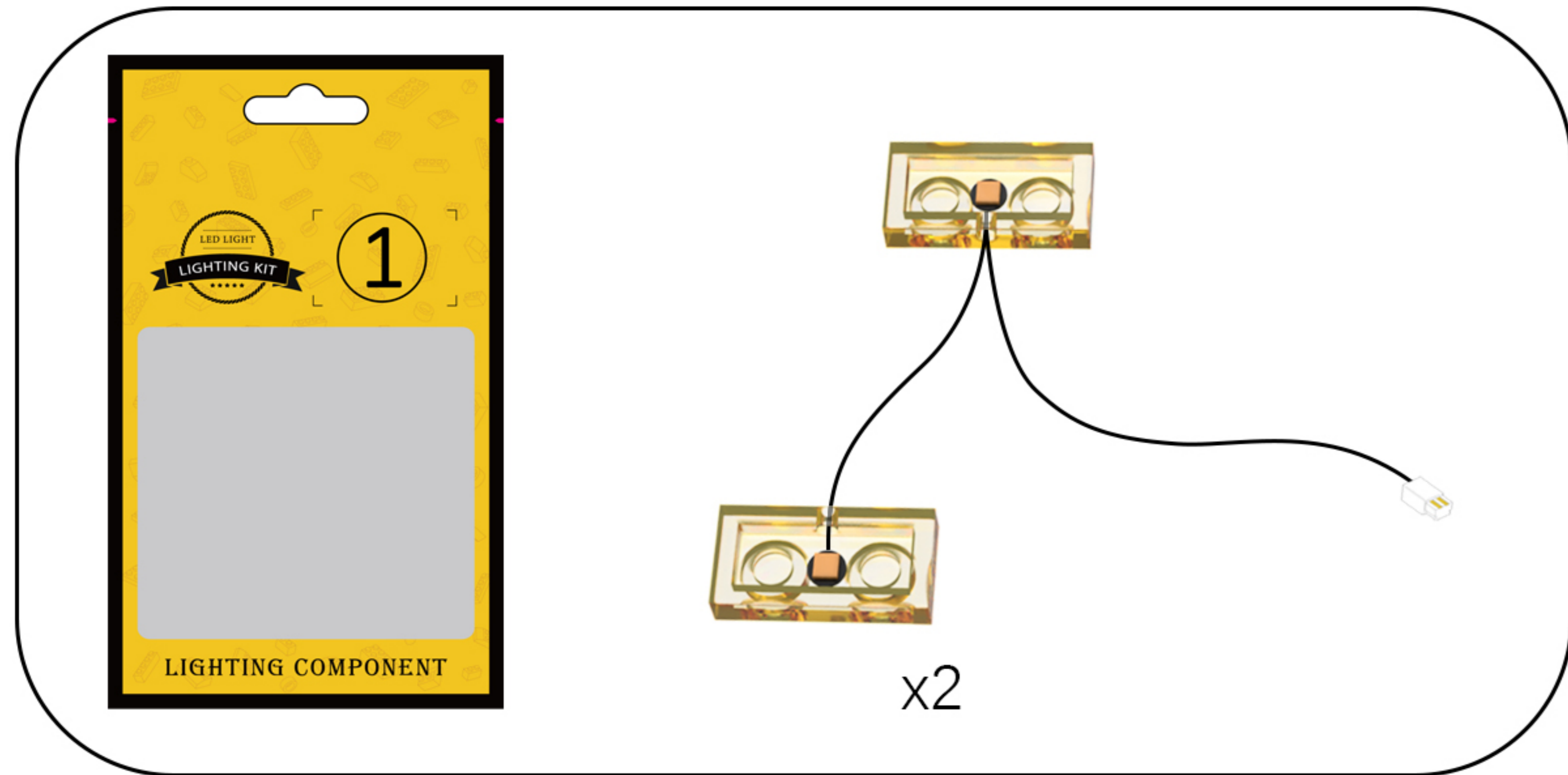

7

EN: Arrange the light strings from two sets of string lights as shown in the diagram.

DE: Ordnen Sie die Lichterketten aus zwei Sets wie in der Abbildung gezeigt an.

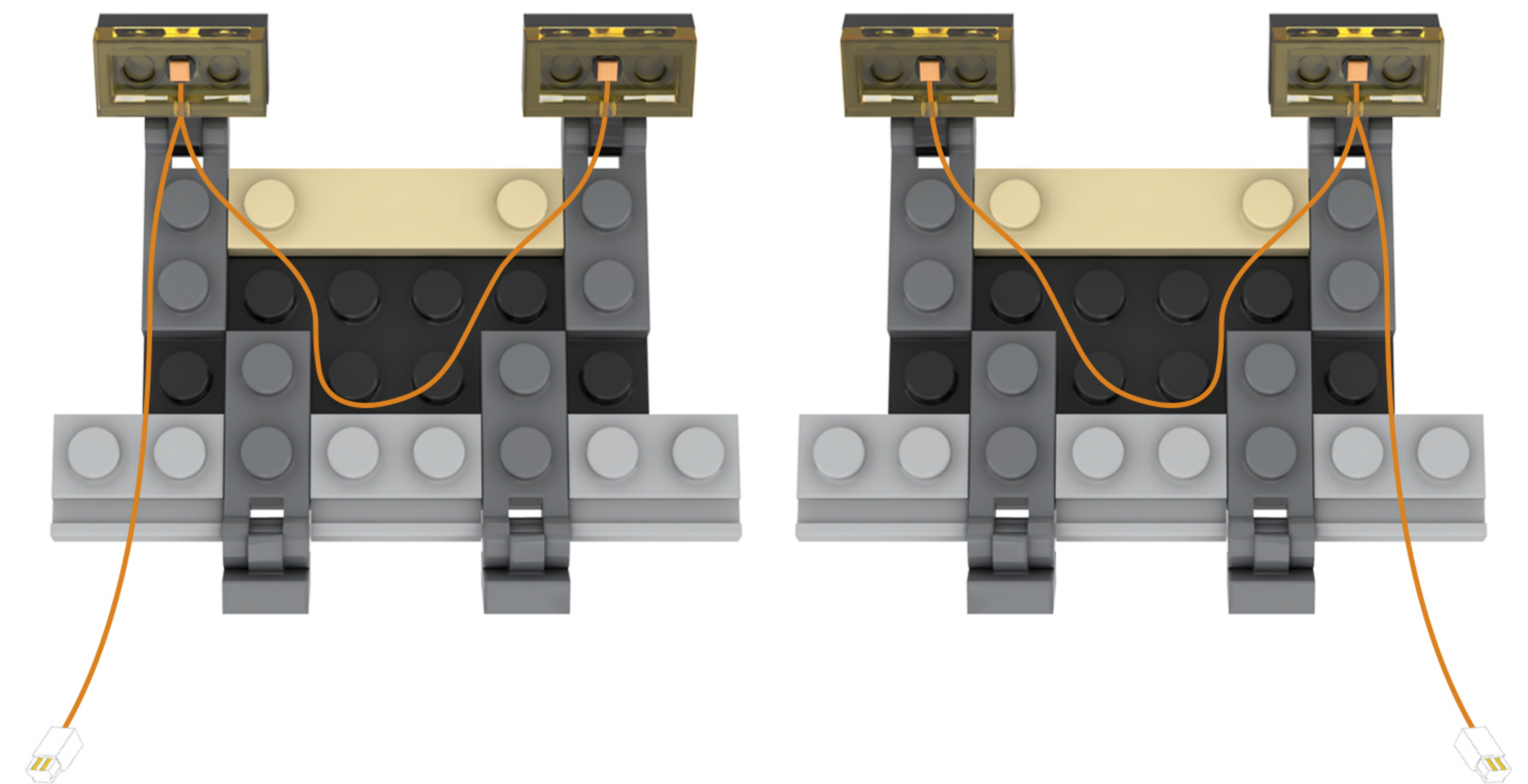

8

EN: Take out the disassembled building blocks and reassemble them in order.

DE: Nehmen Sie die zerlegten Bausteine heraus und setzen Sie sie der Reihe nach wieder zusammen.

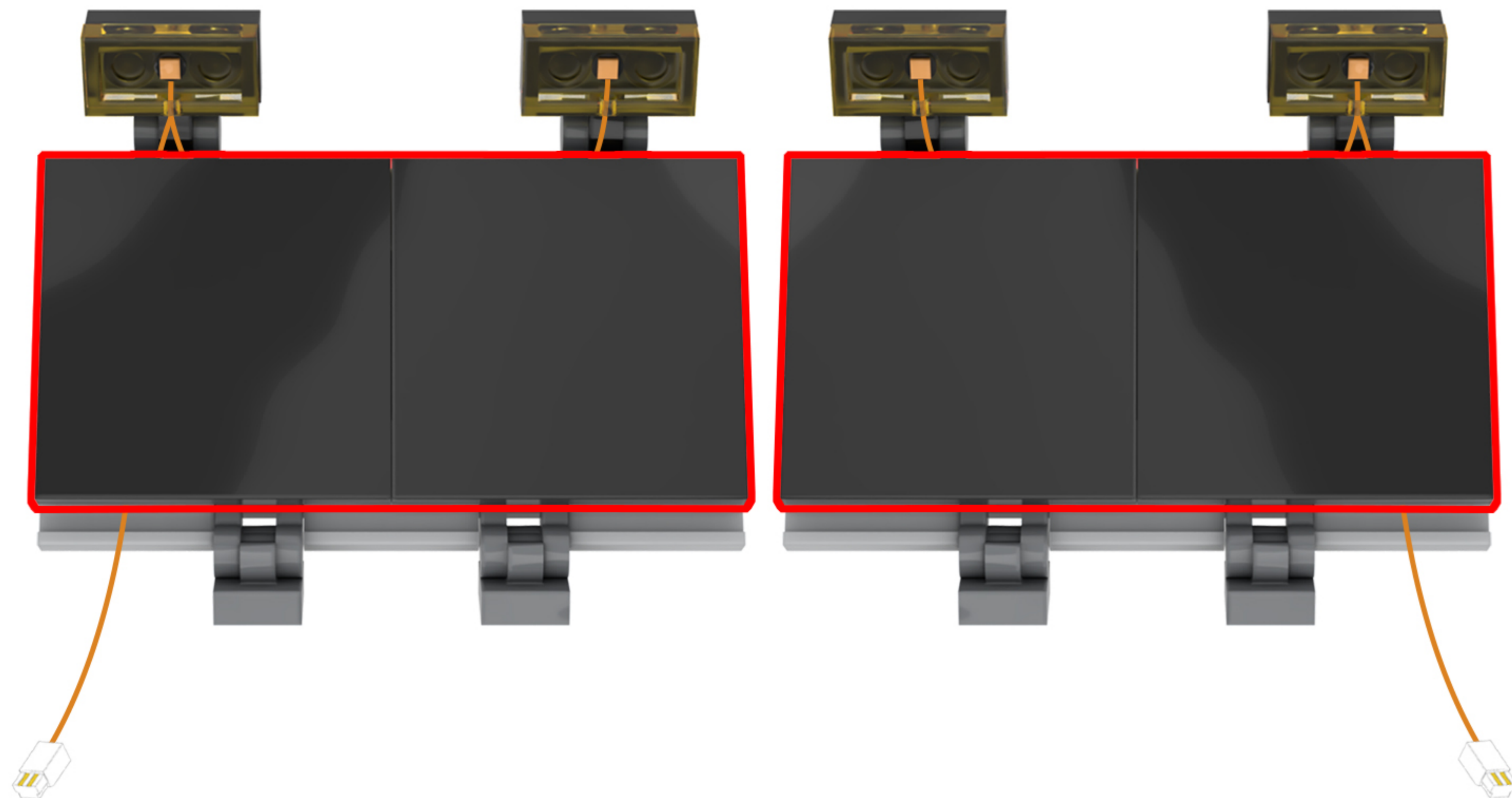
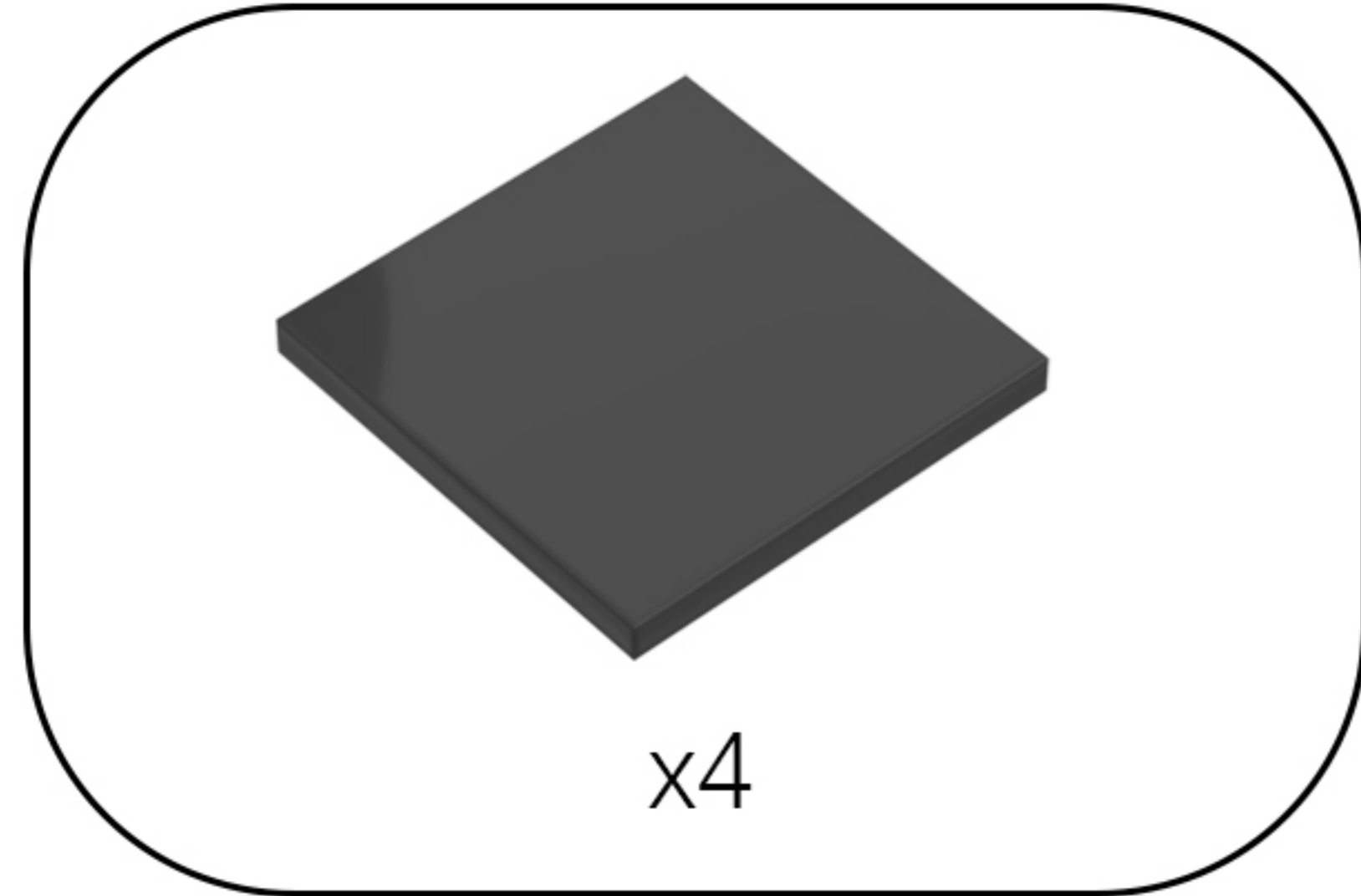

9

EN: Take out the disassembled building blocks and reassemble them.

DE: Nehmen Sie die zerlegten Bausteine heraus und setzen Sie sie wieder zusammen.

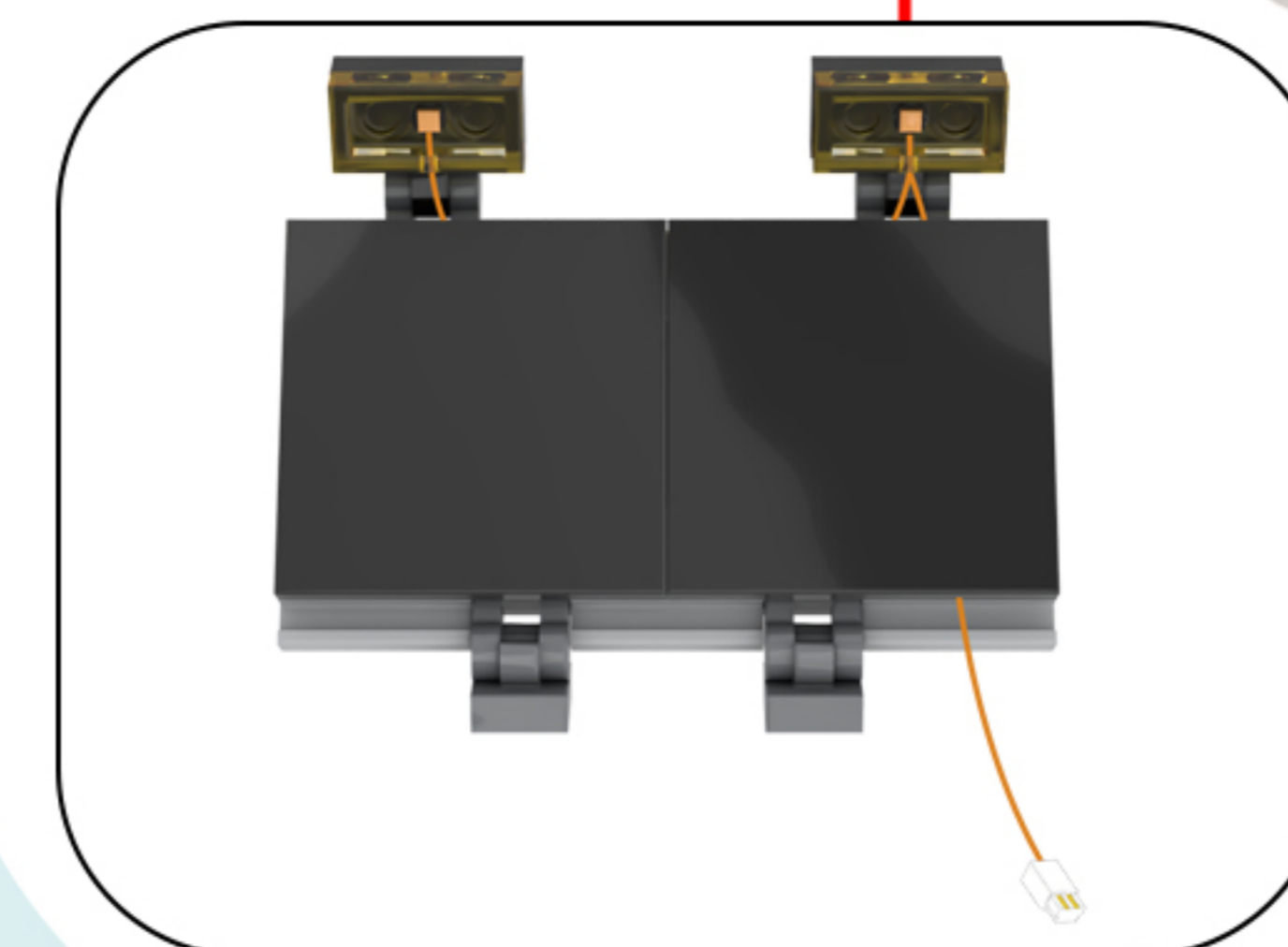
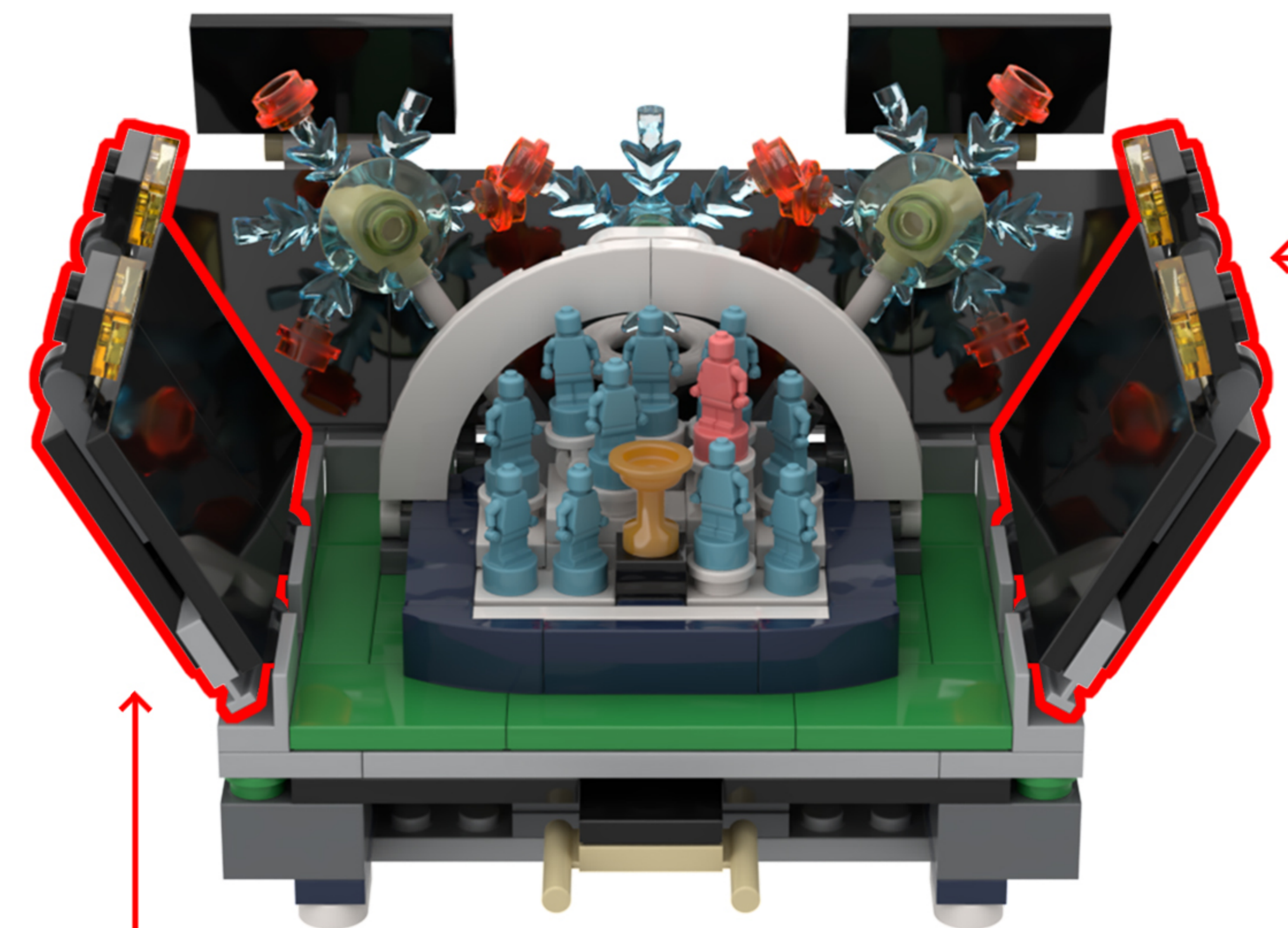
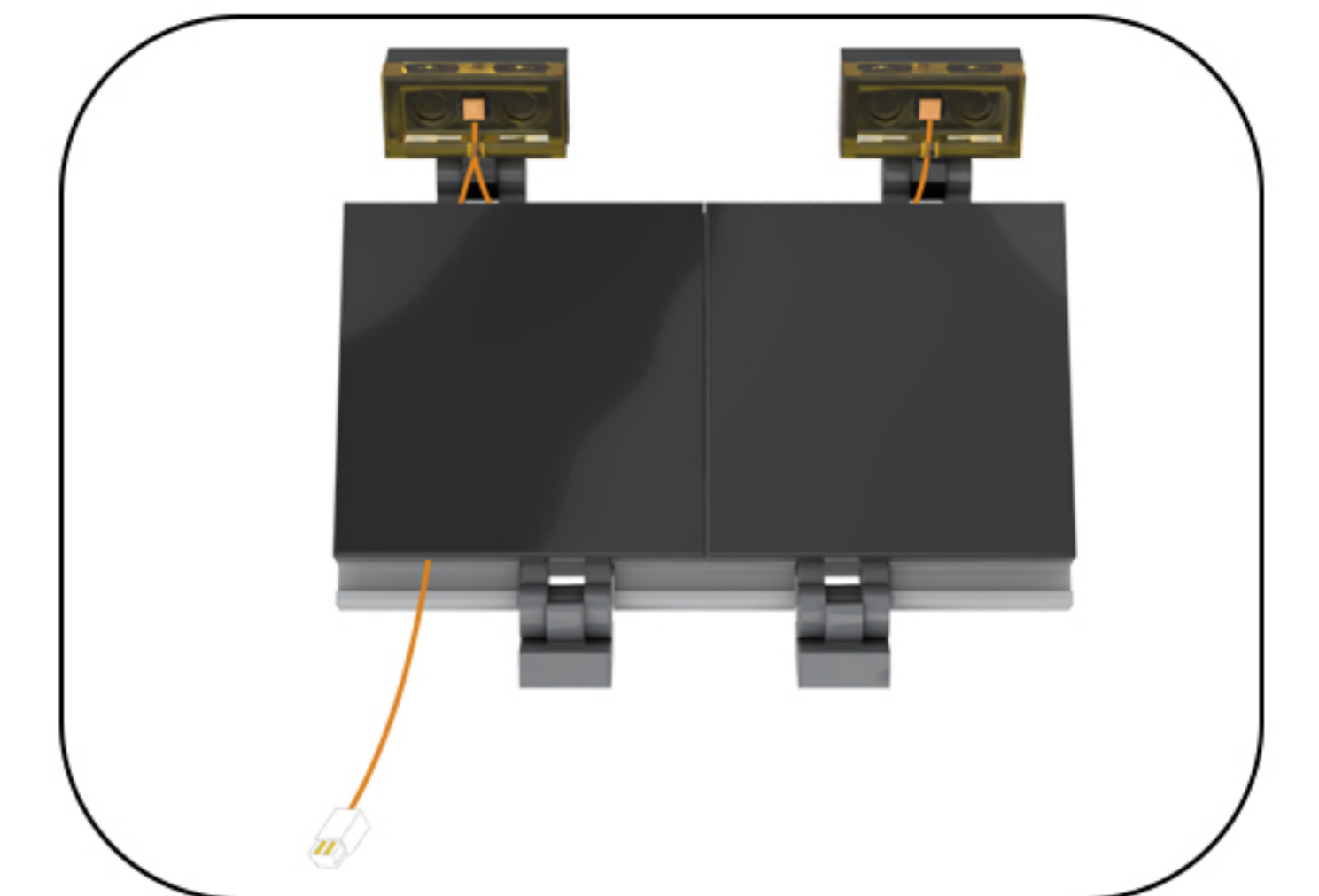
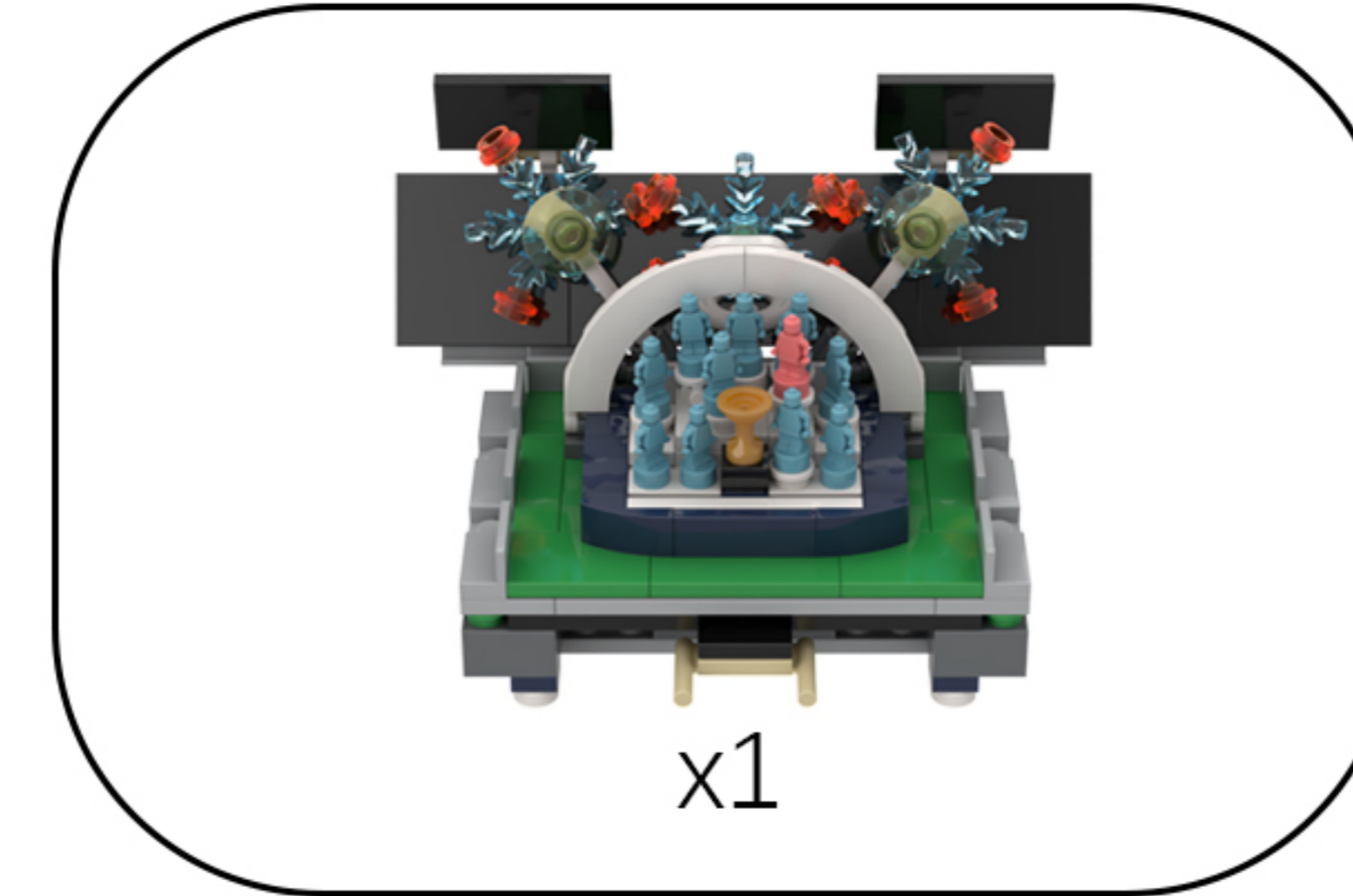

10

EN: Rotate the model to its back side.

DE: Drehen Sie das Modell auf die Rückseite.

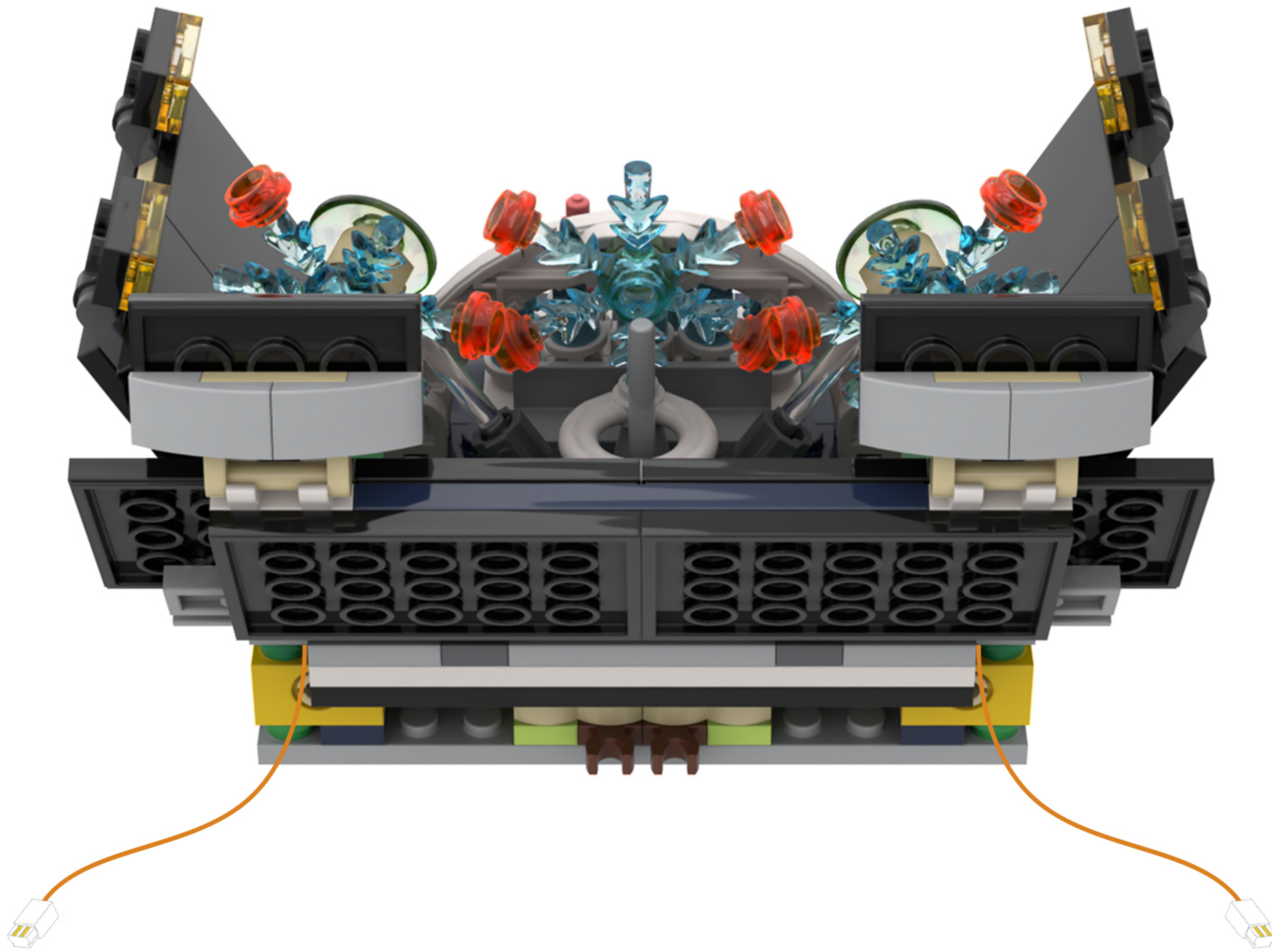
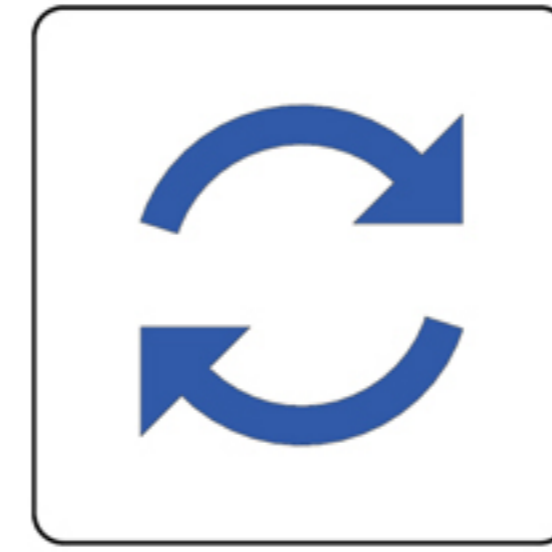

11

EN: Split as shown in the figure.

DE: Wie in der Abbildung gezeigt, teilen Sie es auf.

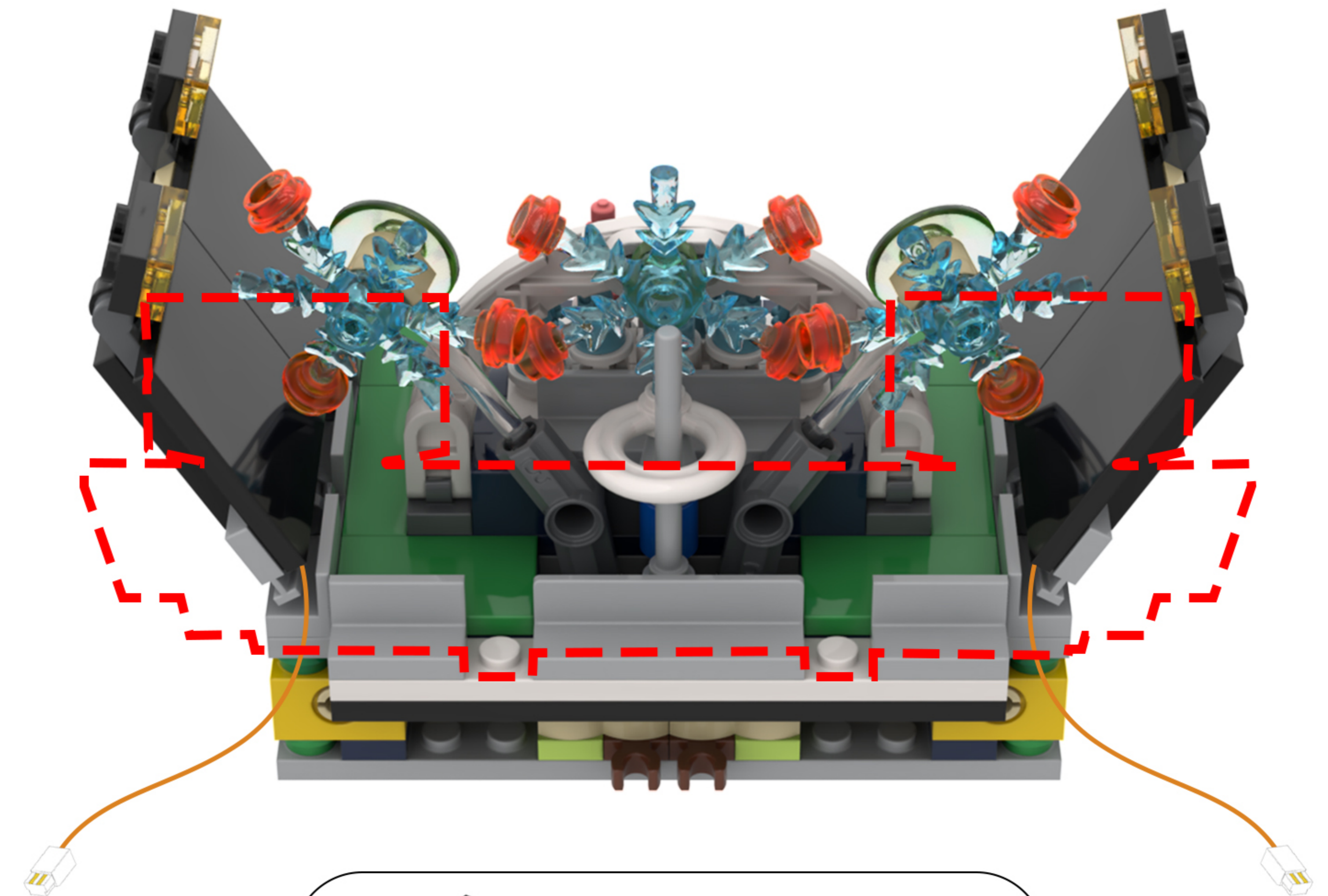

**12**

EN: Remove the building blocks one by one.

DE: Entfernen Sie die Bausteine nacheinander.

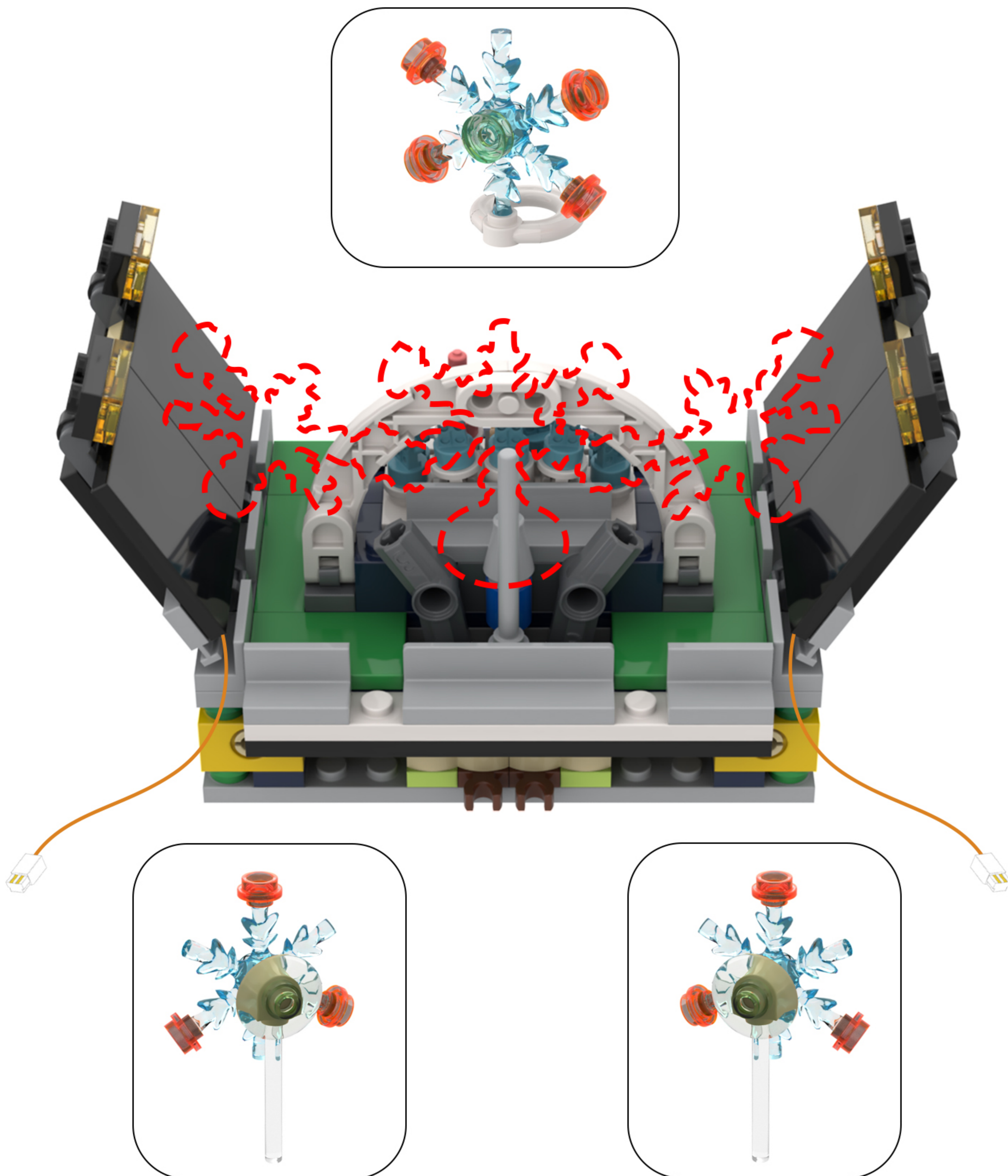
**13**

EN: Remove the 1x1 perforated round plate and light bulb from Bag 2, then proceed with the following steps.

DE: Entfernen Sie die 1x1 perforierte runde Platte und die Glühbirne aus Beutel 2 und fahren Sie dann mit den folgenden Schritten fort.

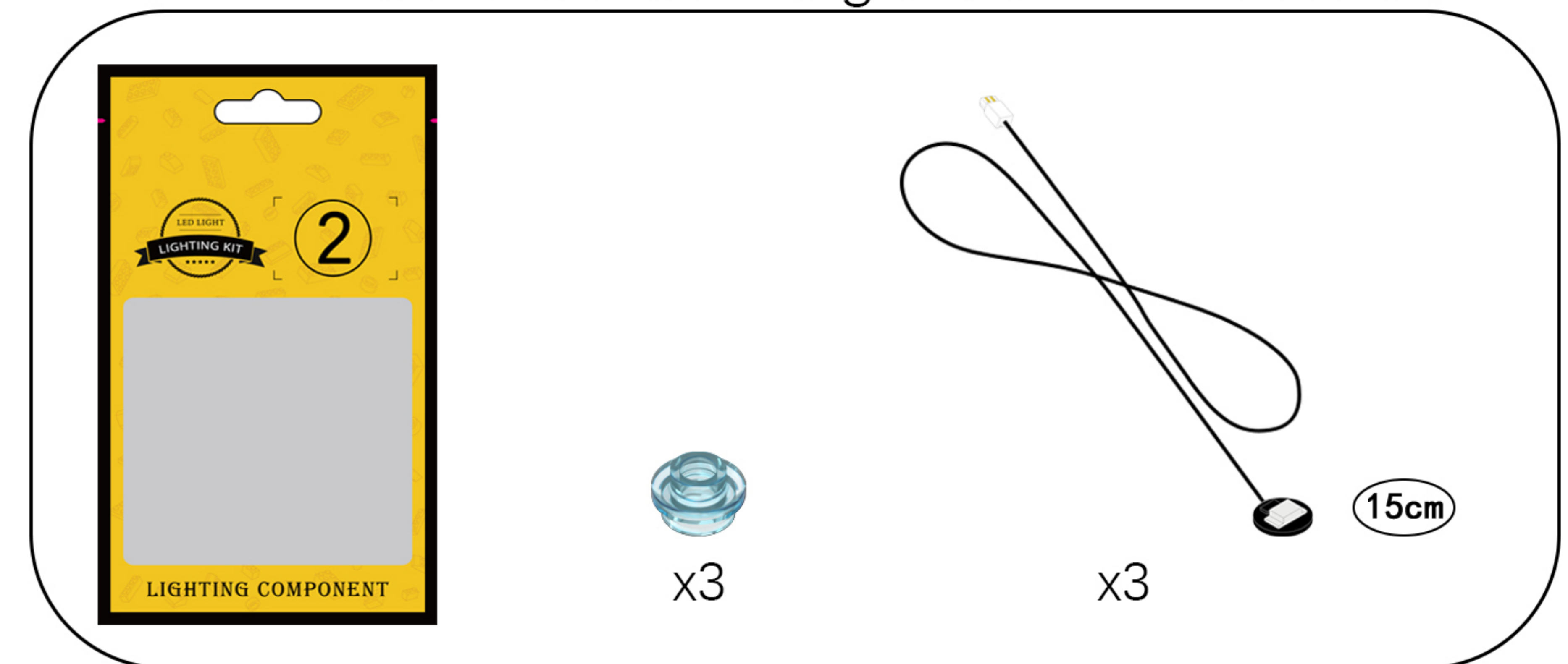

①. Thread the lamp cord through the small round plate with holes.

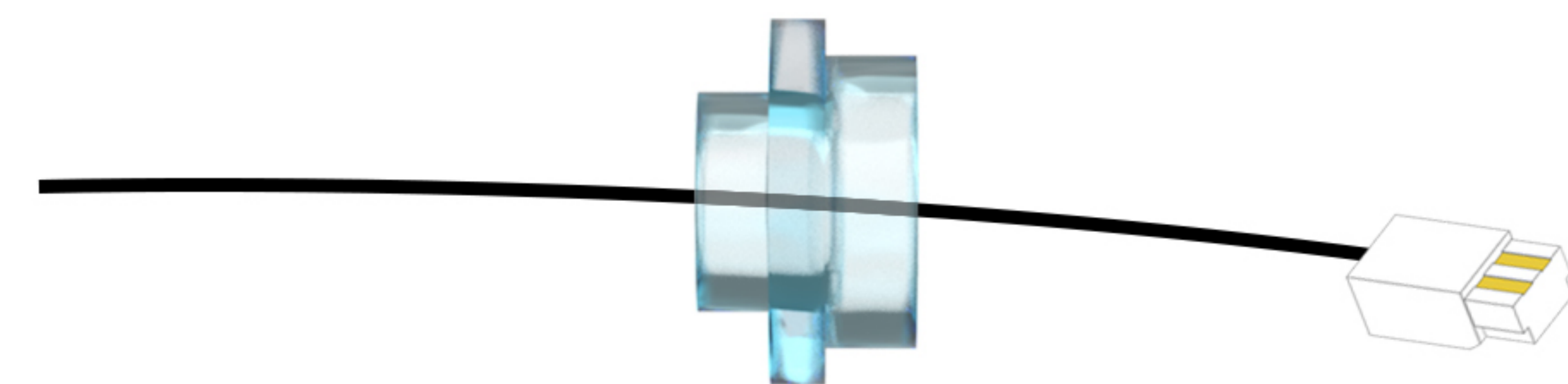

②. Pull the lamp cord to attach the light fixture to the perforated small round plate, then adjust the fixture's position so its flat surface forms a right angle with the cord.



14

EN: Repeat the above steps to obtain three lamps.

DE: Wiederholen Sie die oben genannten Schritte, um drei Lampen zu erhalten.

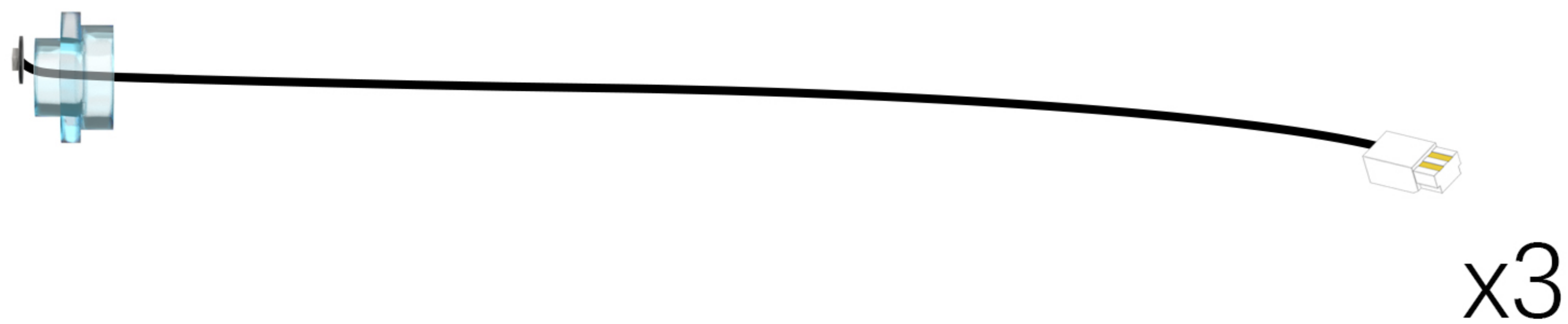

15

EN: Take out the disassembled building blocks and attach the light fixtures to each of the three blocks.

DE: Nehmen Sie die zerlegten Bausteine heraus und befestigen Sie die Leuchten an jedem der drei Blöcke.

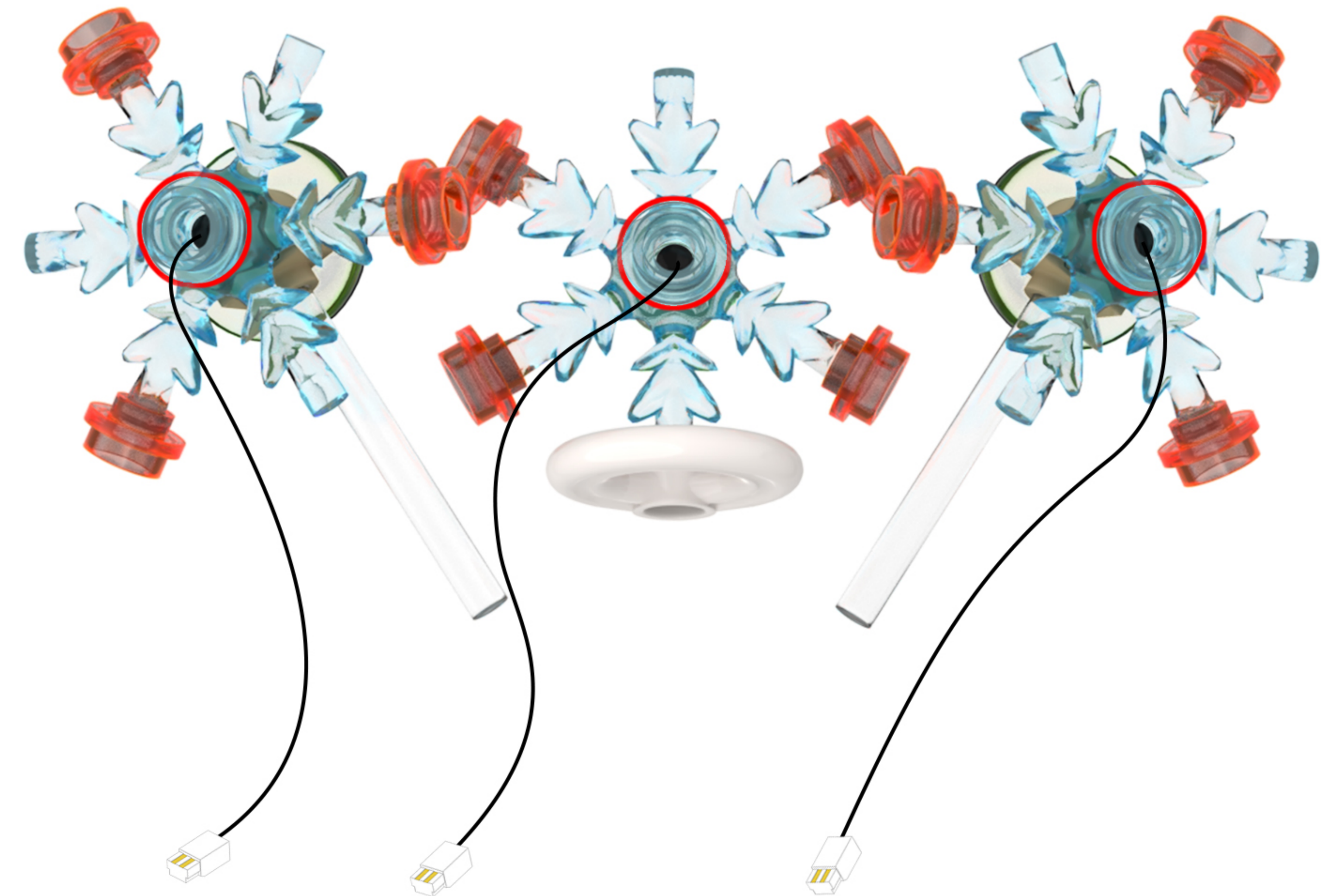
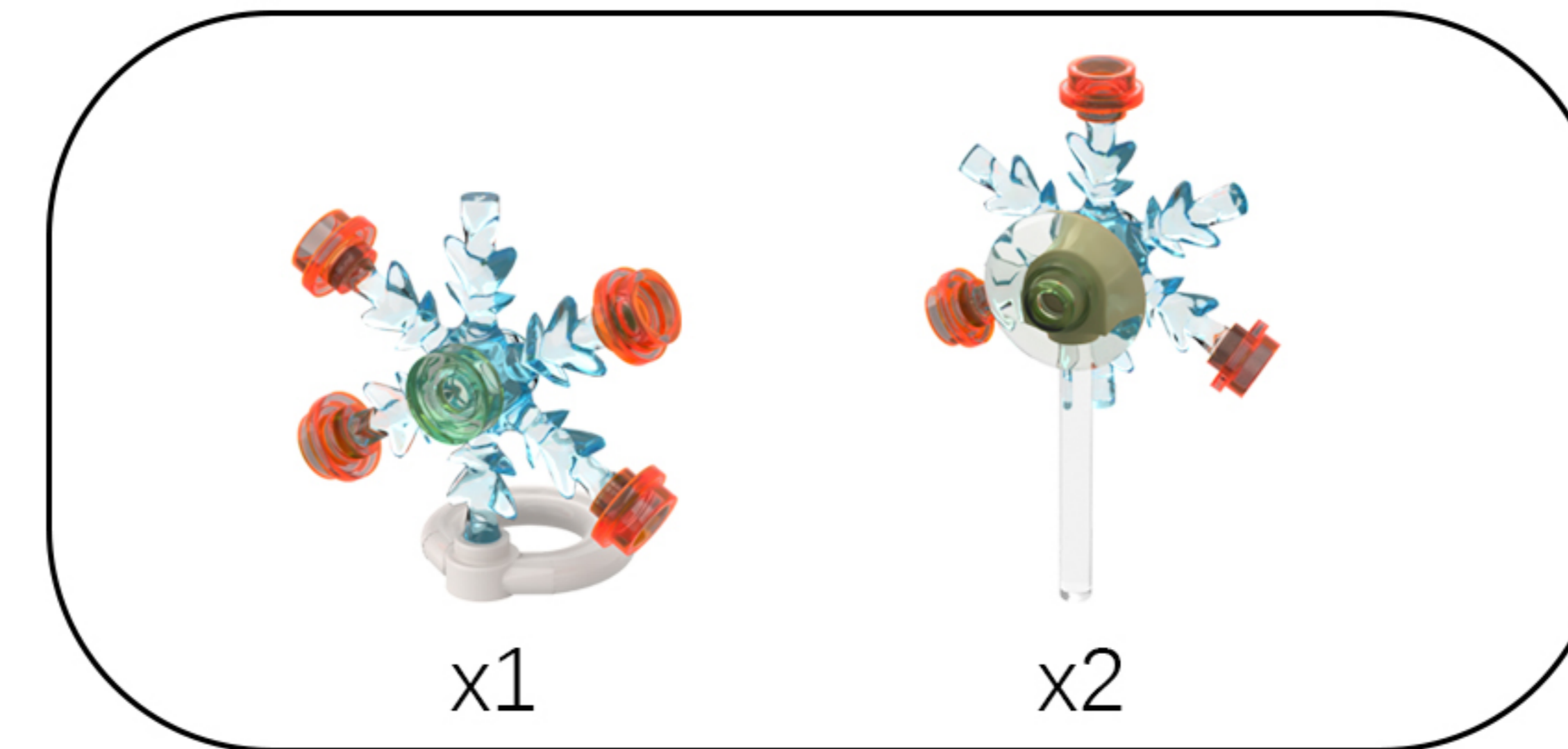

16

EN: Thread the three light cords through the gap in the center block.

DE: Führen Sie die drei Lichtschnüre durch die Öffnung im mittleren Block.

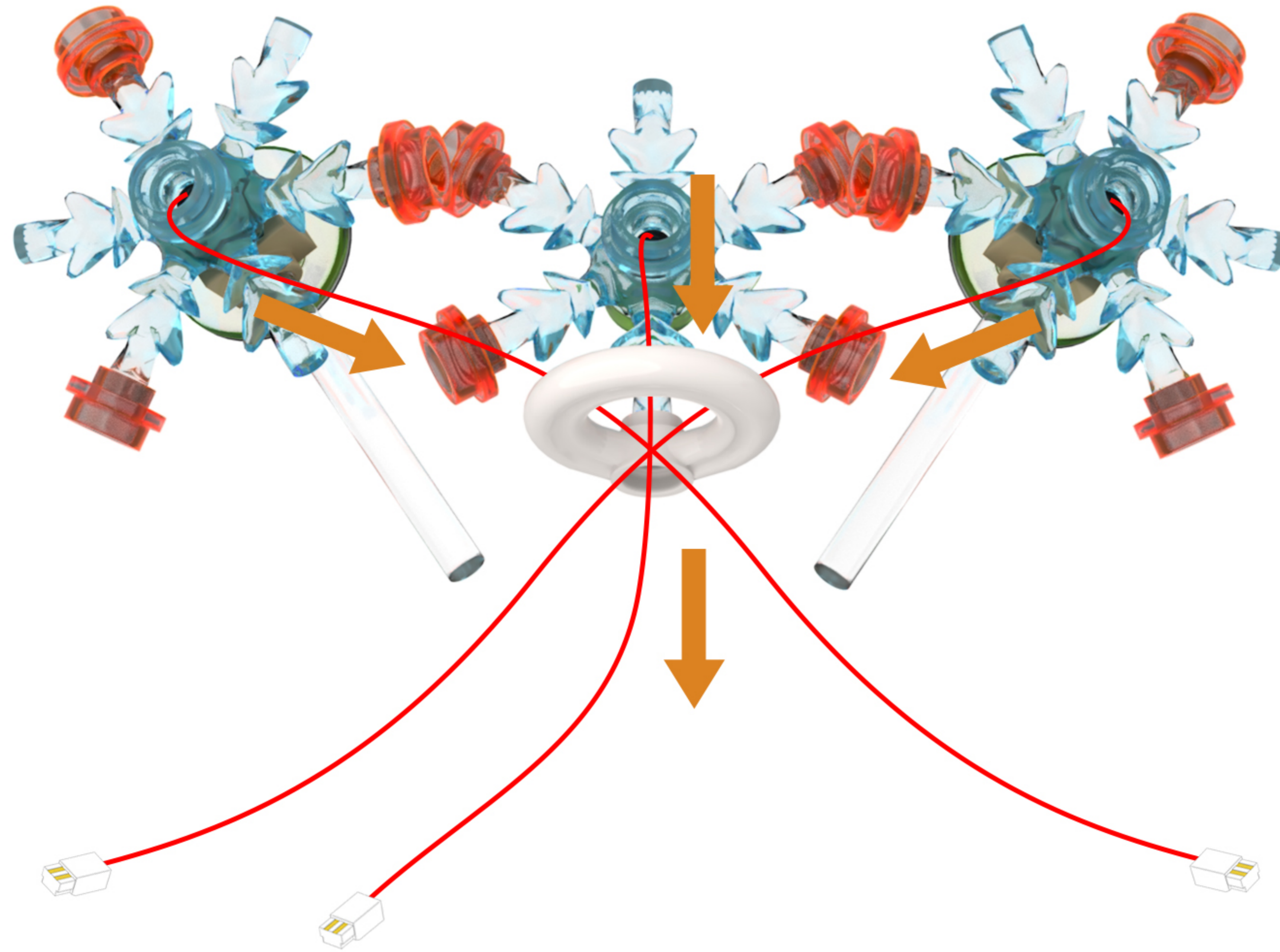

17

EN: Restore the building blocks.

DE: Stellen Sie die Bausteine wieder her.

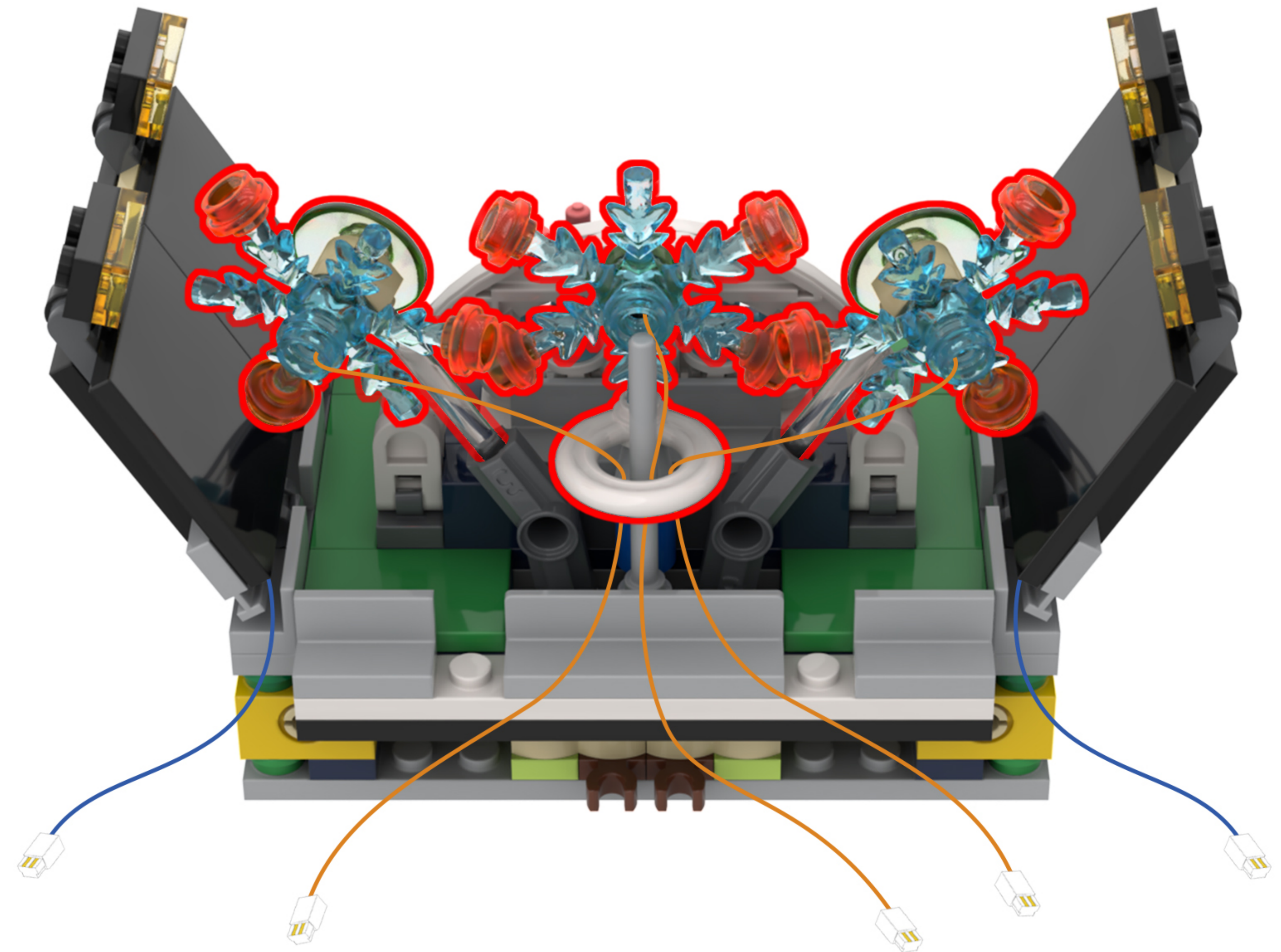

18

EN: Take out the disassembled building blocks and reassemble them.

DE: Nehmen Sie die zerlegten Bausteine heraus und setzen Sie sie wieder zusammen.

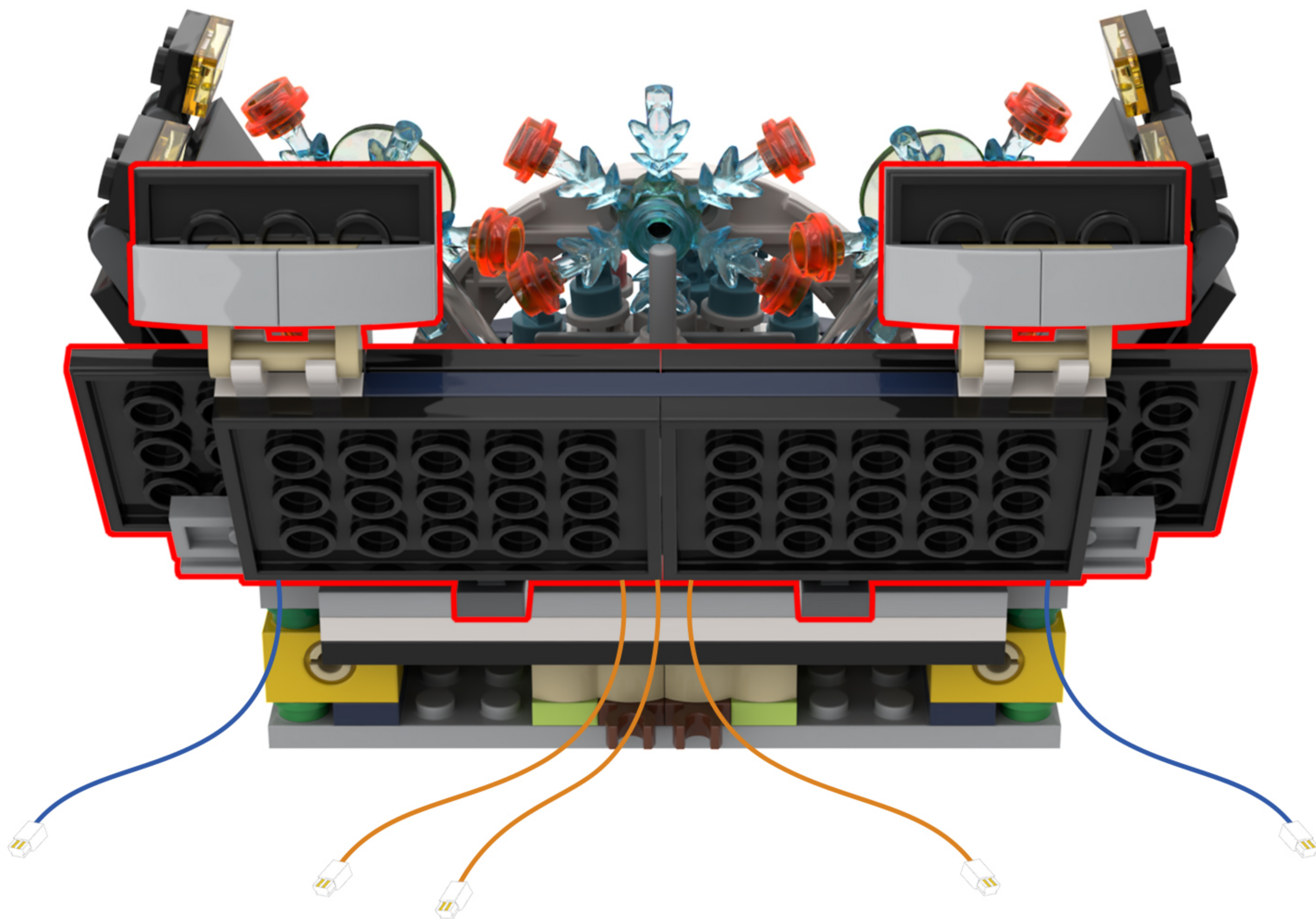
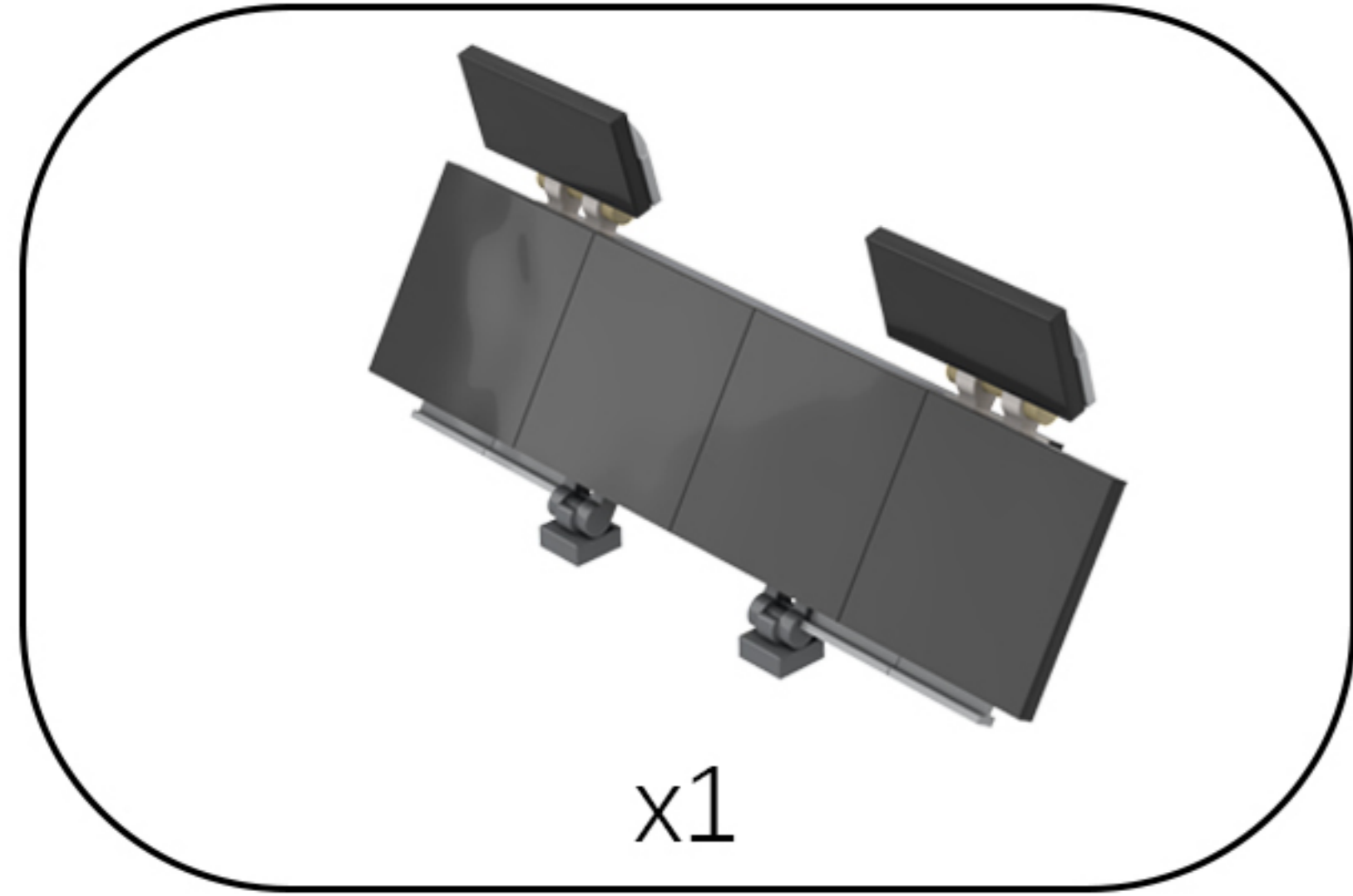

19

EN: Take the 1x2 base plate and the 6-port expansion board from Bag 9, and connect the 5 light wires to the 6-port expansion board in sequence.

DE: Nehmen Sie die 1x2-Grundplatte und die 6-Port-Erweiterungsplatine aus Beutel 9 und schließen Sie die 5 Lichtkabel der Reihe nach an die 6-Port-Erweiterungsplatine an.

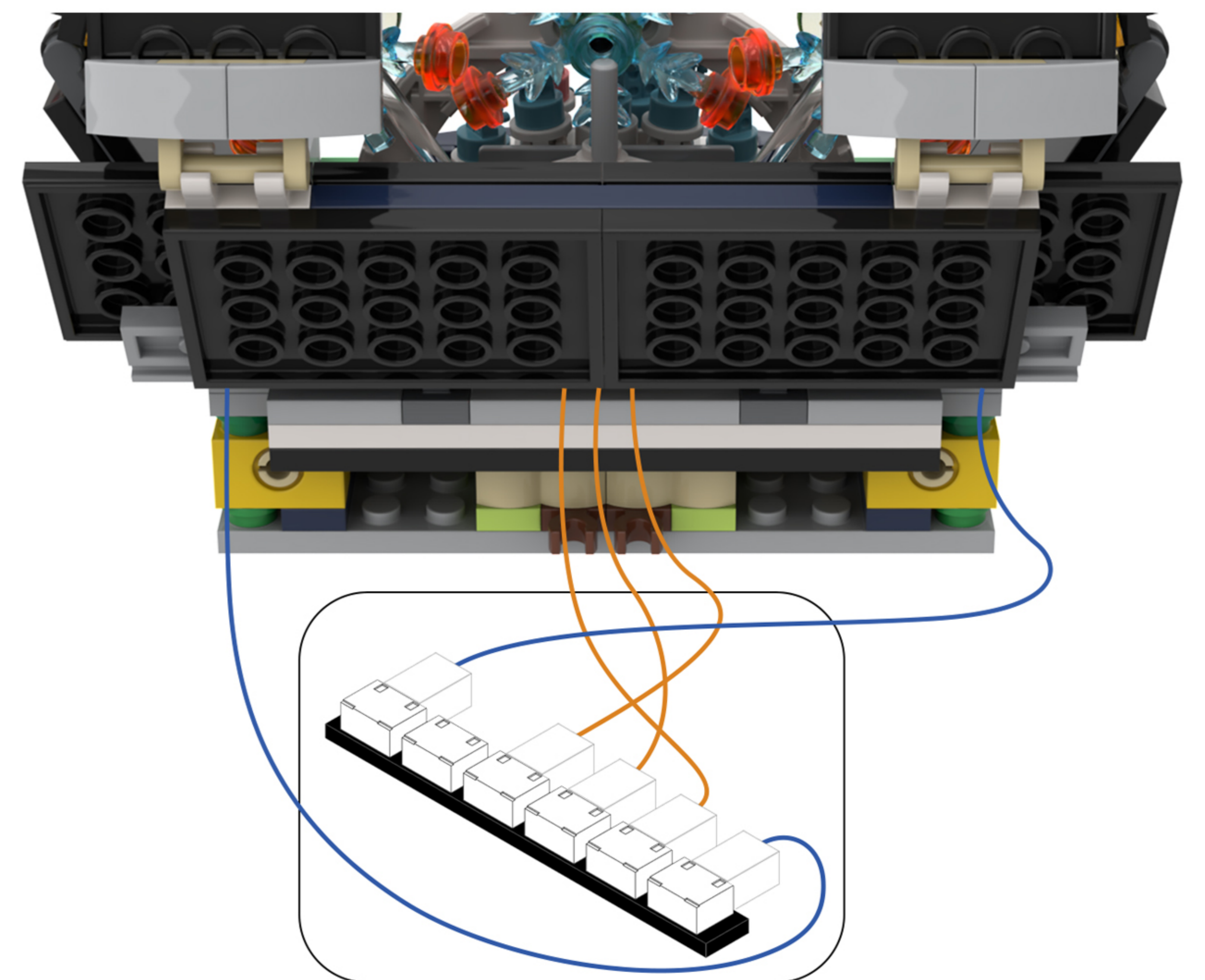
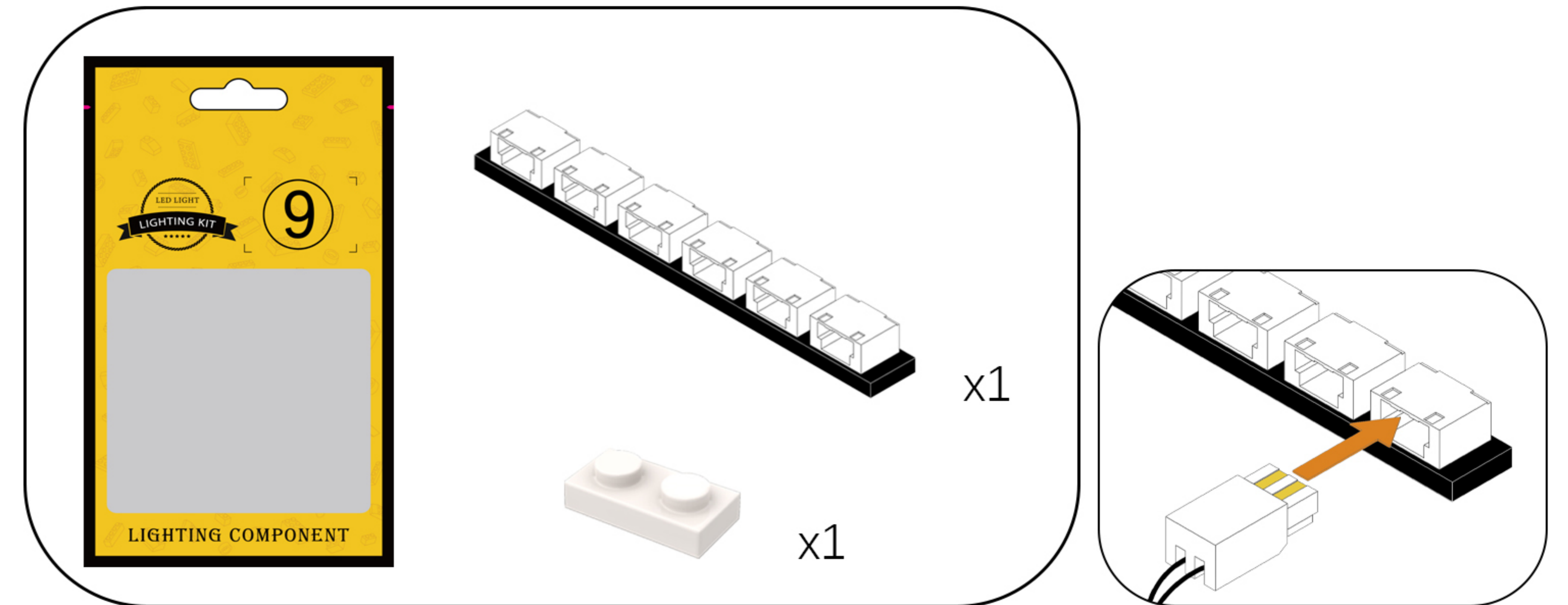

20

EN: Arrange the wires from the three center light strands neatly, then secure the 1×2 baseplate to the building block so that it holds the wires in place.

DE: Ordnen Sie die Drähte der drei mittleren Lichterketten ordentlich an und befestigen Sie dann die 1×2-Grundplatte am Baustein, sodass die Drähte an ihrem Platz gehalten werden.

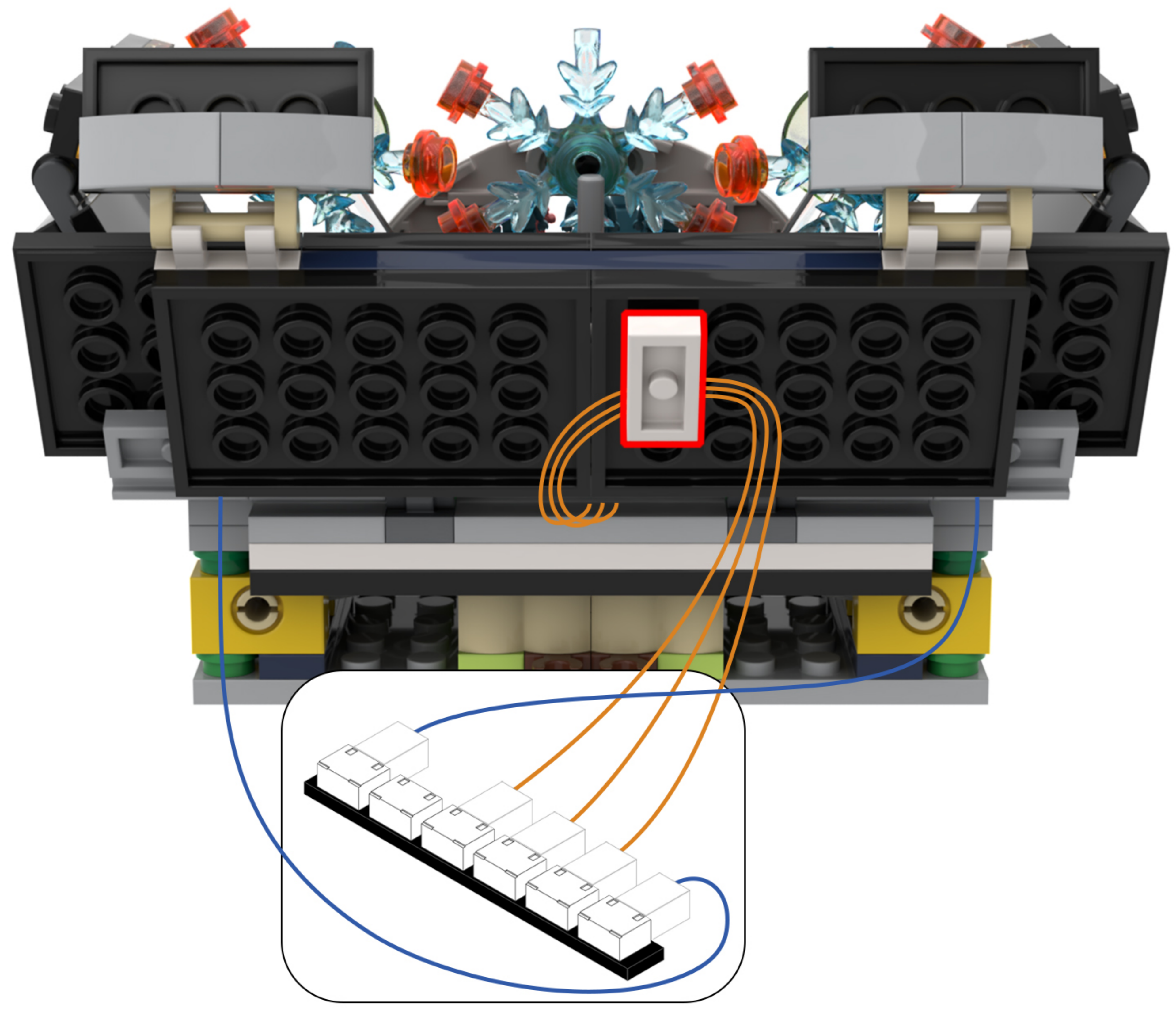

21

EN: Take the connecting cable from Bag No. 8 and connect it to the expansion board.

DE: Nehmen Sie das Verbindungskabel aus Beutel Nr. 8 und schließen Sie es an die Erweiterungskarte an.

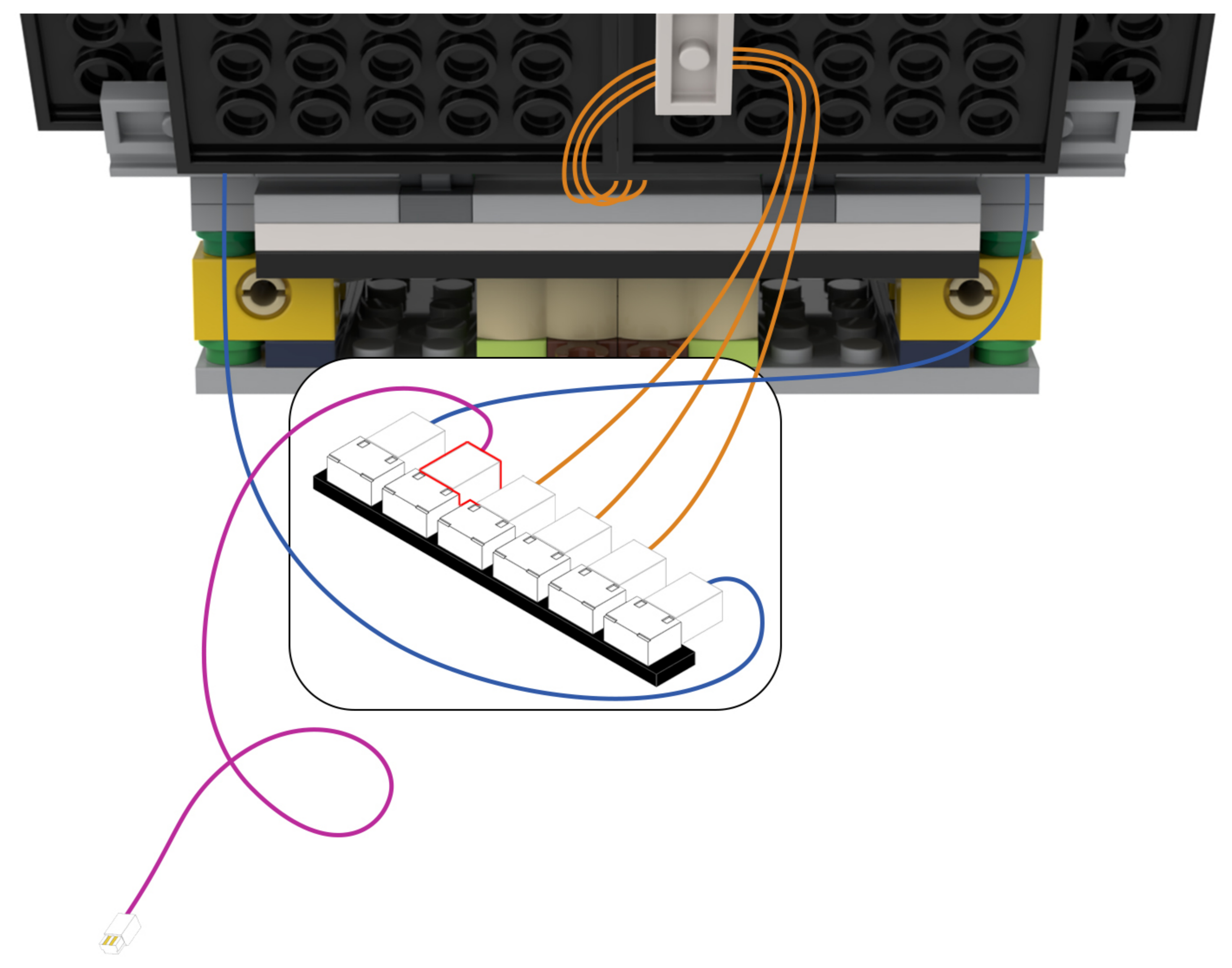
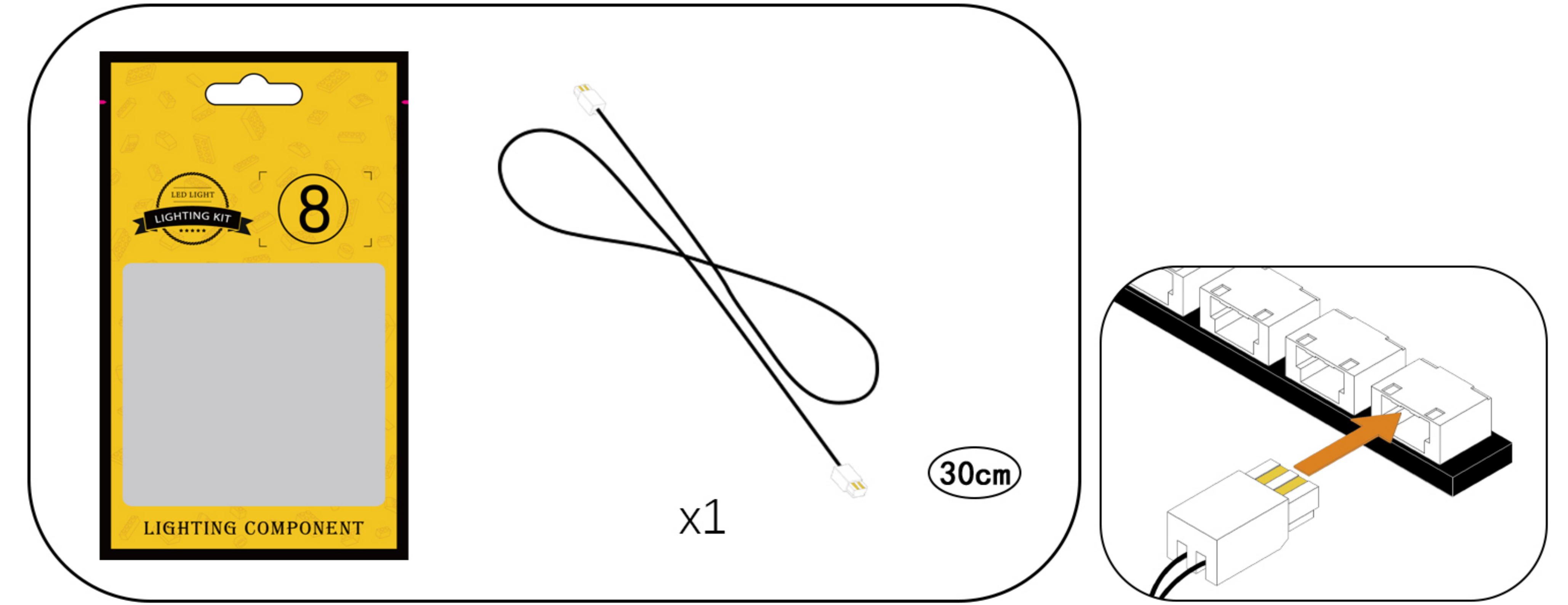

22

EN: Peel off the adhesive backing of the expansion board and attach it to the location shown in the illustration.

DE: Entfernen Sie die Schutzfolie von der Rückseite der Erweiterungsplatte und kleben Sie sie an die in der Abbildung gezeigte Stelle.

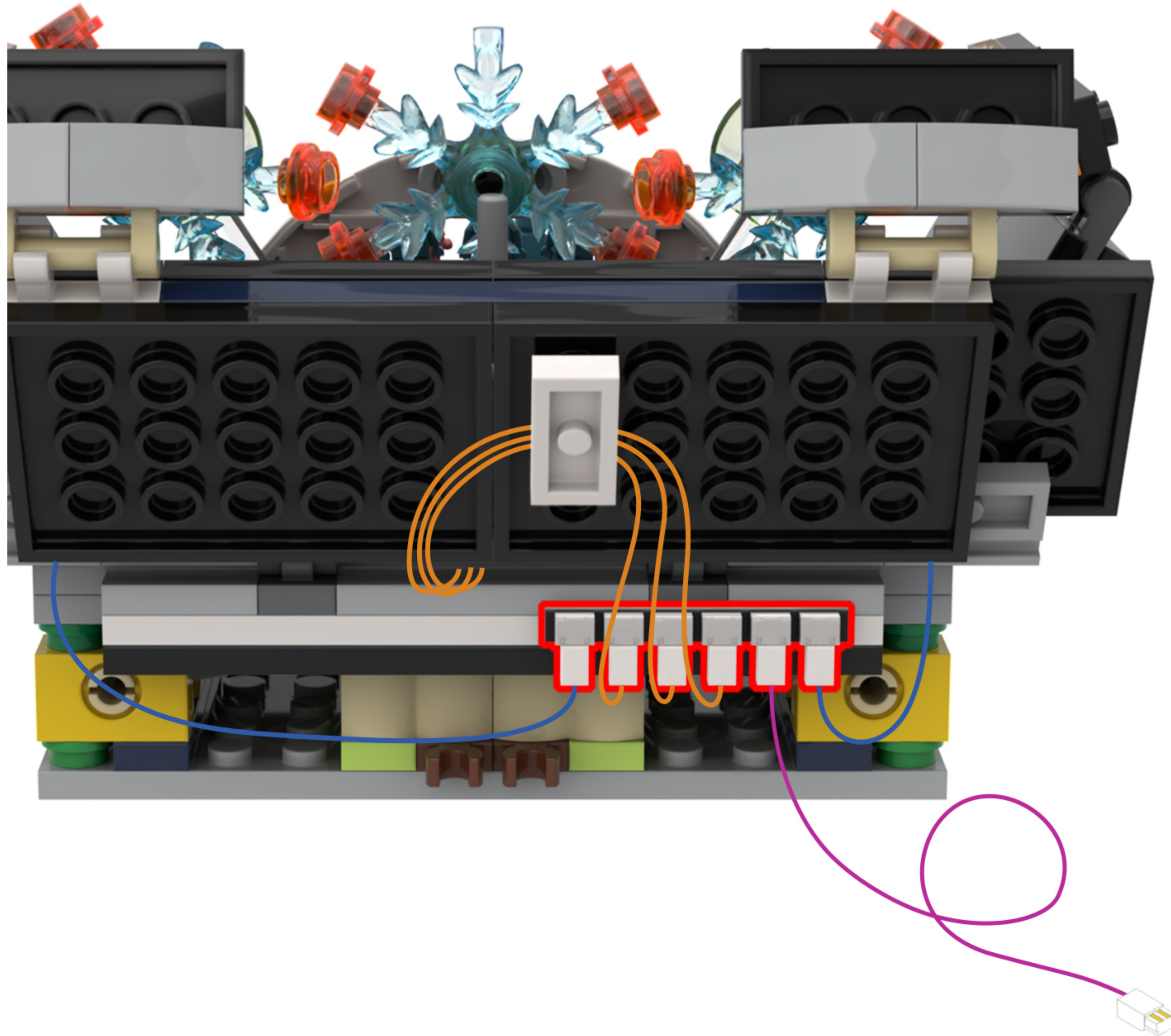

23

EN: The installation of the lighting fixtures on this section of the model is complete.

DE: Die Montage der Leuchten an diesem Abschnitt des Modells ist abgeschlossen.

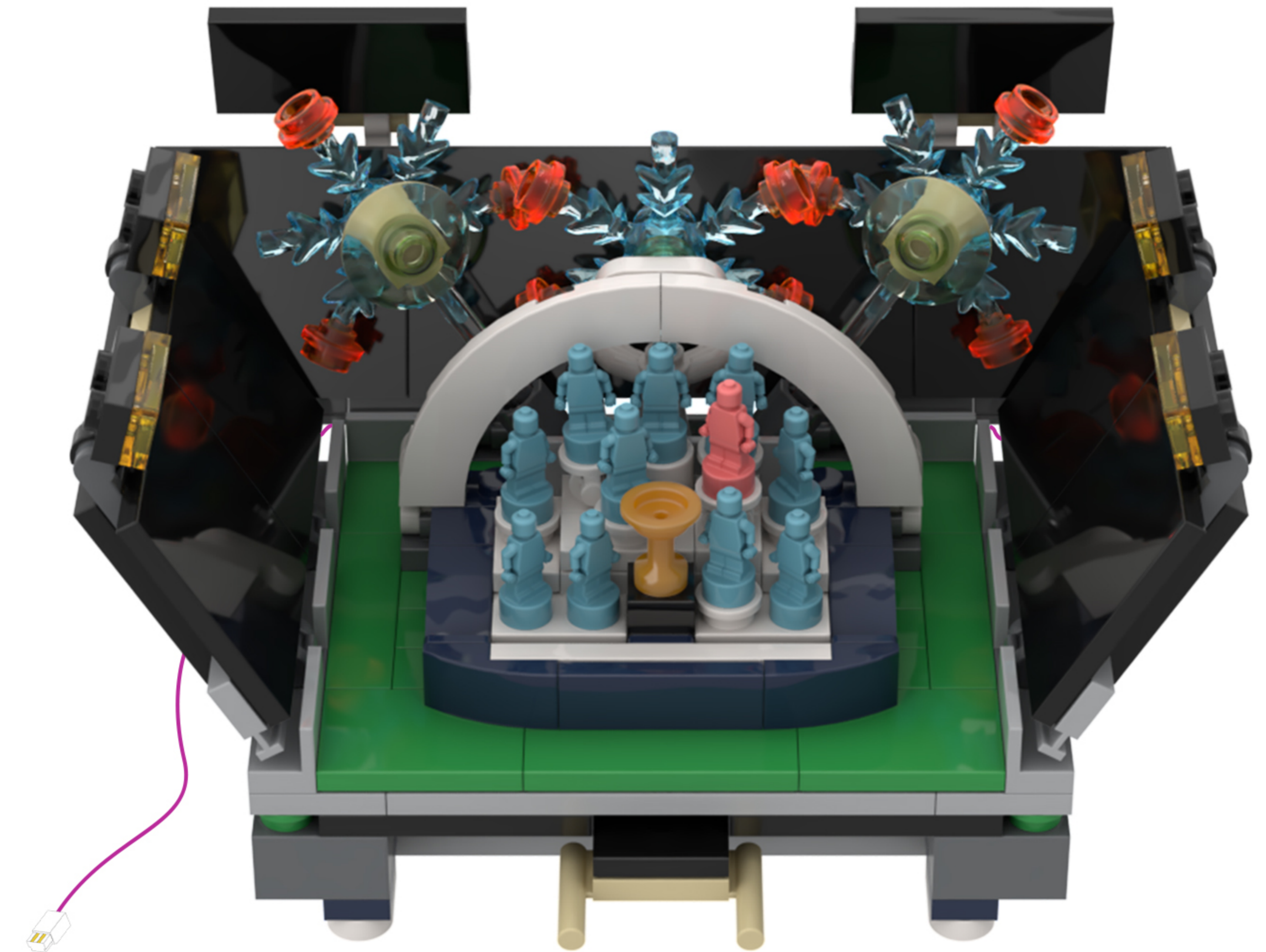

24

EN: Return to the model and look at the brick part highlighted in the figure.

DE: Kehren Sie zum Modell zurück und betrachten Sie das in der Abbildung hervorgehobene Ziegelteil.

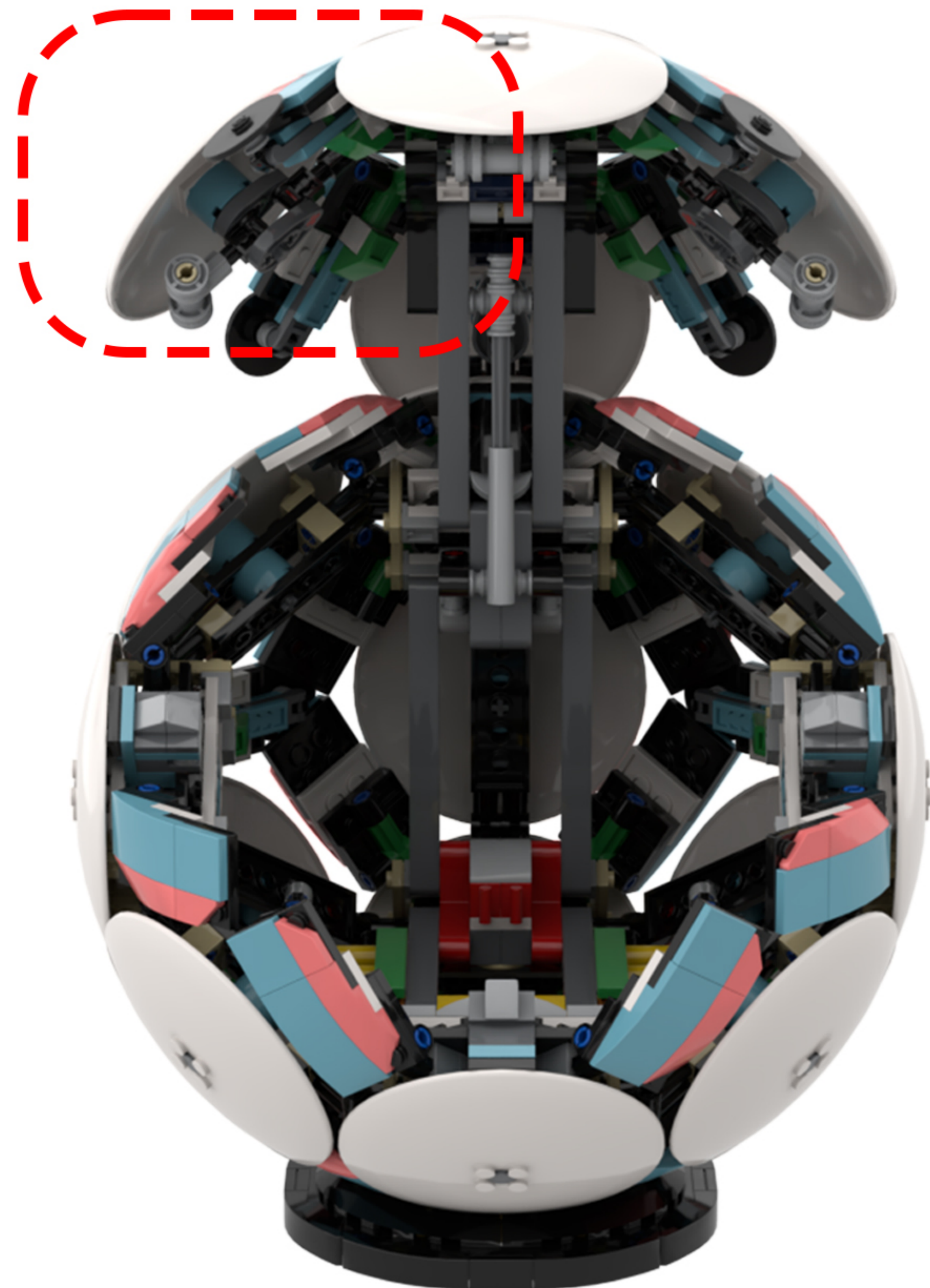

25

EN: Split as shown in the figure.

DE: Wie in der Abbildung gezeigt, teilen Sie es auf.

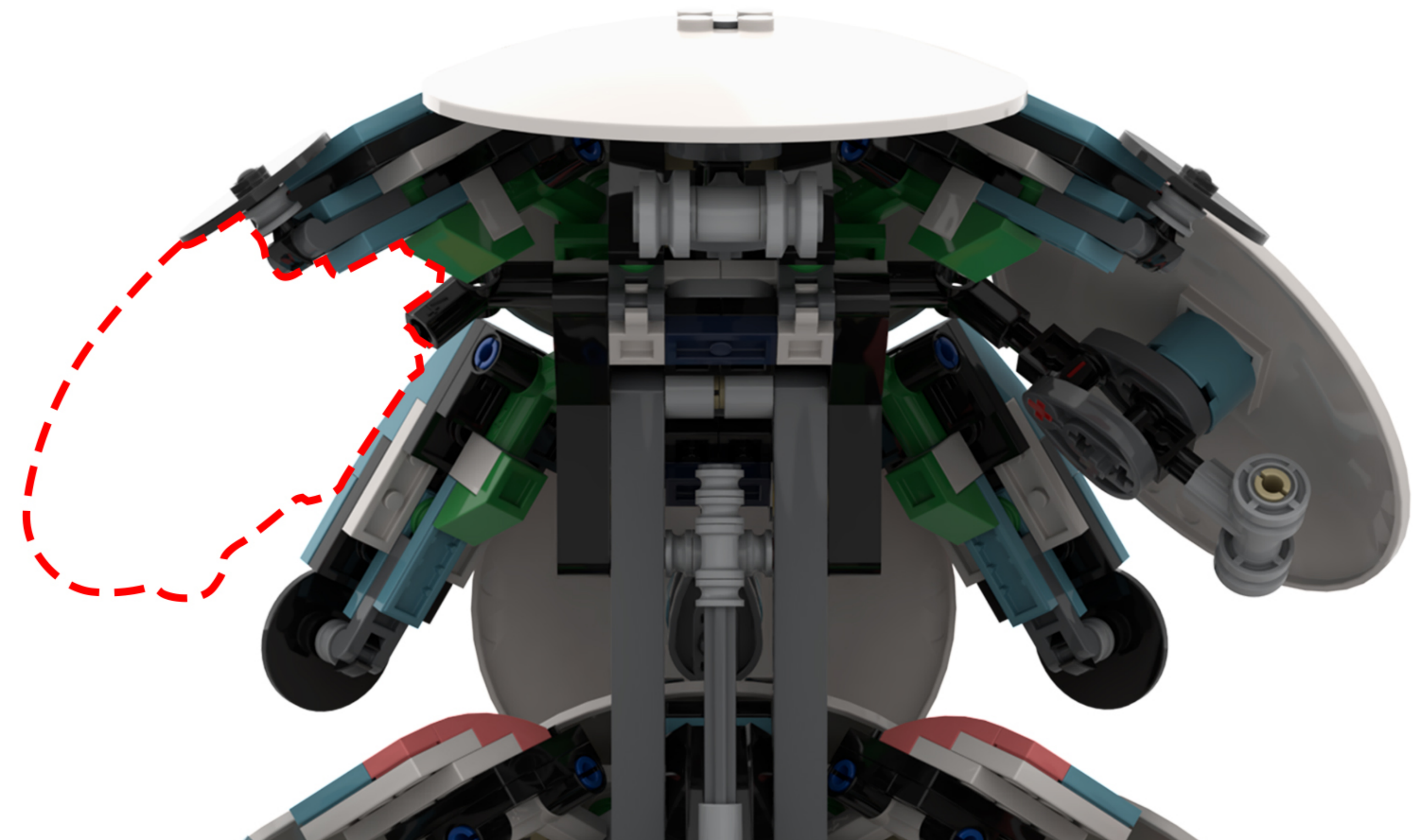

26

EN: Remove the building blocks one by one.

DE: Entfernen Sie die Bausteine nacheinander.

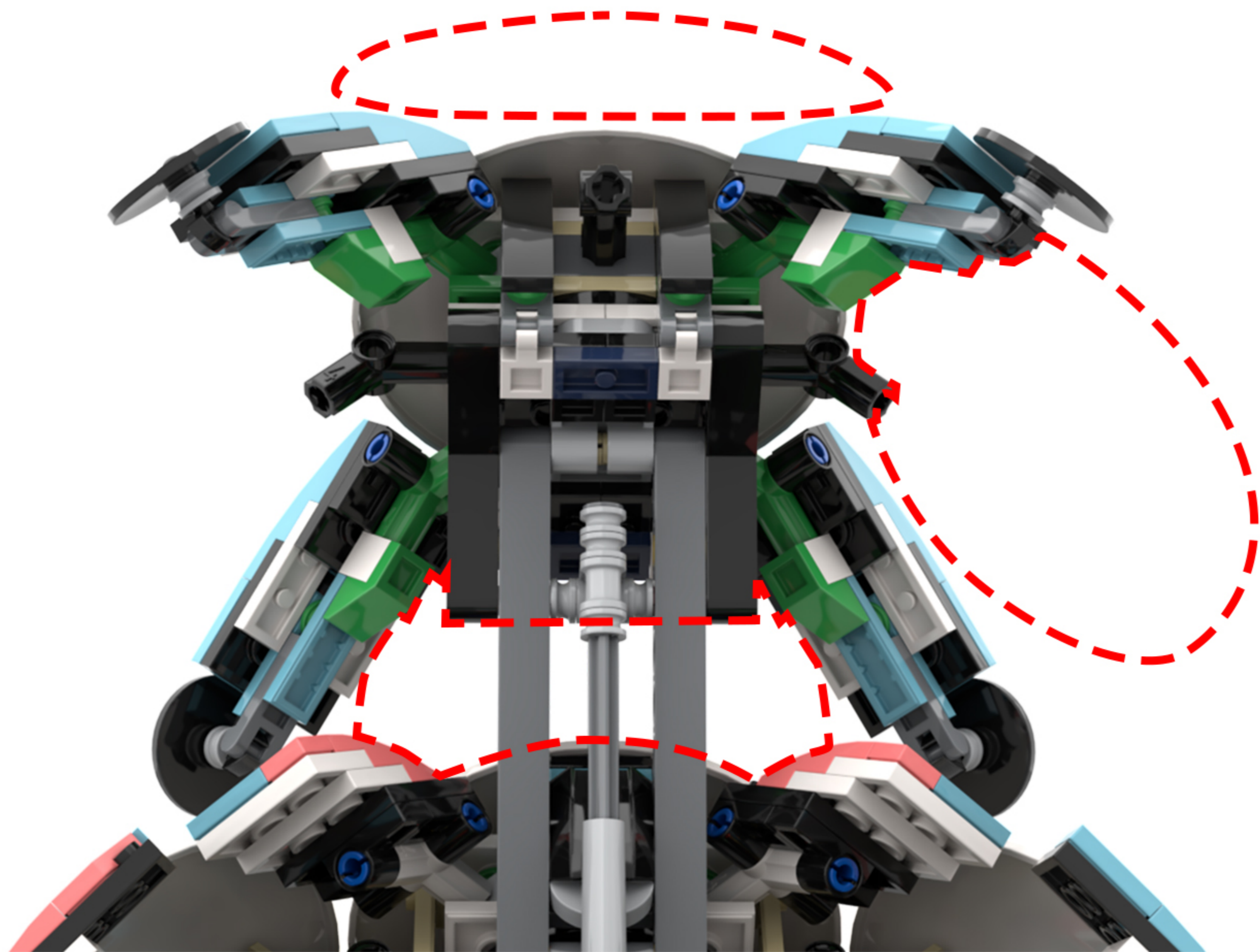
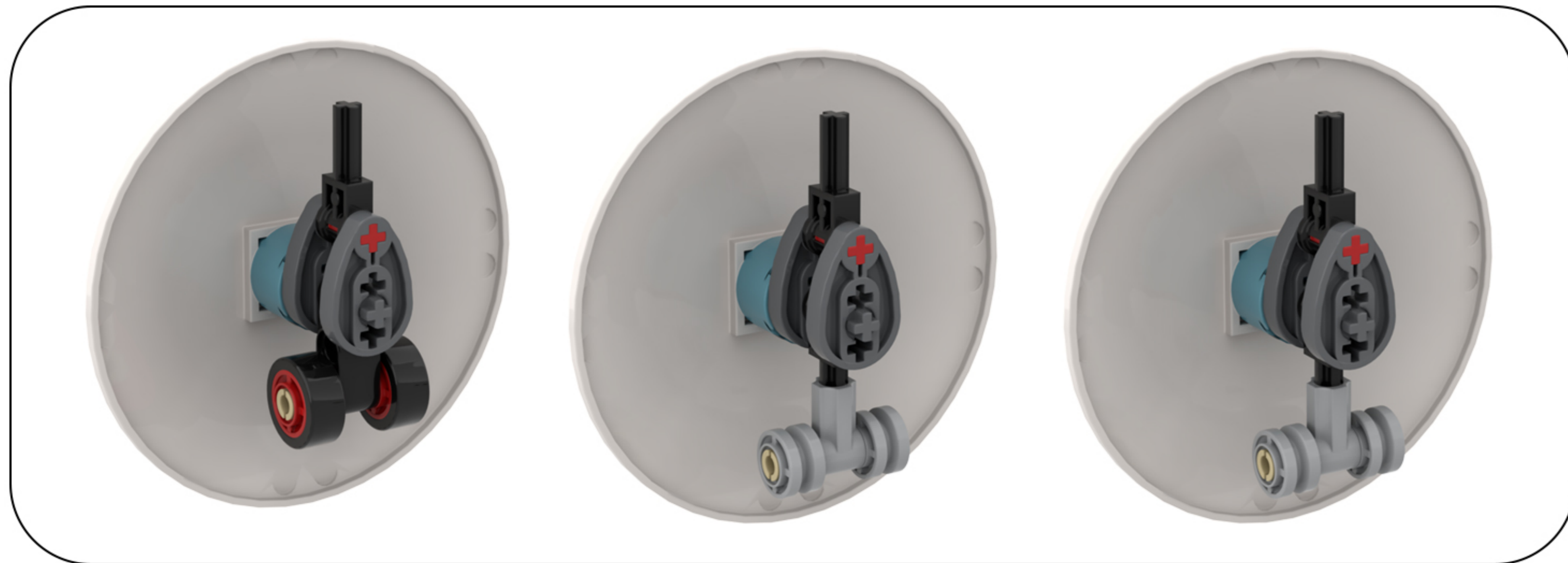

27

EN: Take out the disassembled building blocks; they are all disassembled in the same way. Below, we'll use the one on the left as an example.

DE: Nehmen Sie die zerlegten Bausteine heraus; sie sind alle auf die gleiche Weise zerlegt. Im Folgenden verwenden wir den linken Baustein als Beispiel.

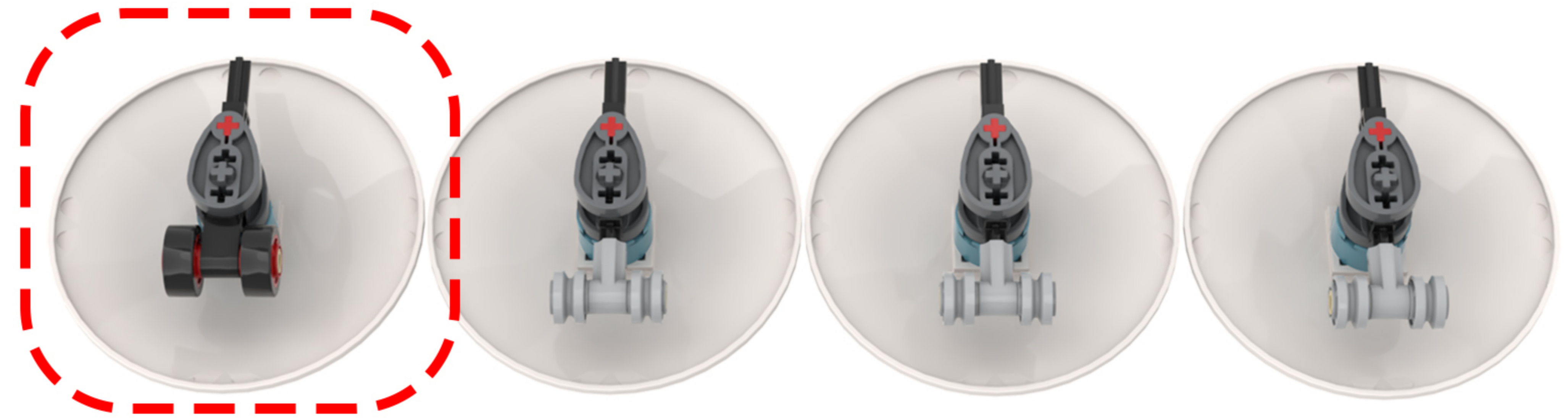

28

EN: Remove the building blocks one by one.

DE: Entfernen Sie die Bausteine nacheinander.

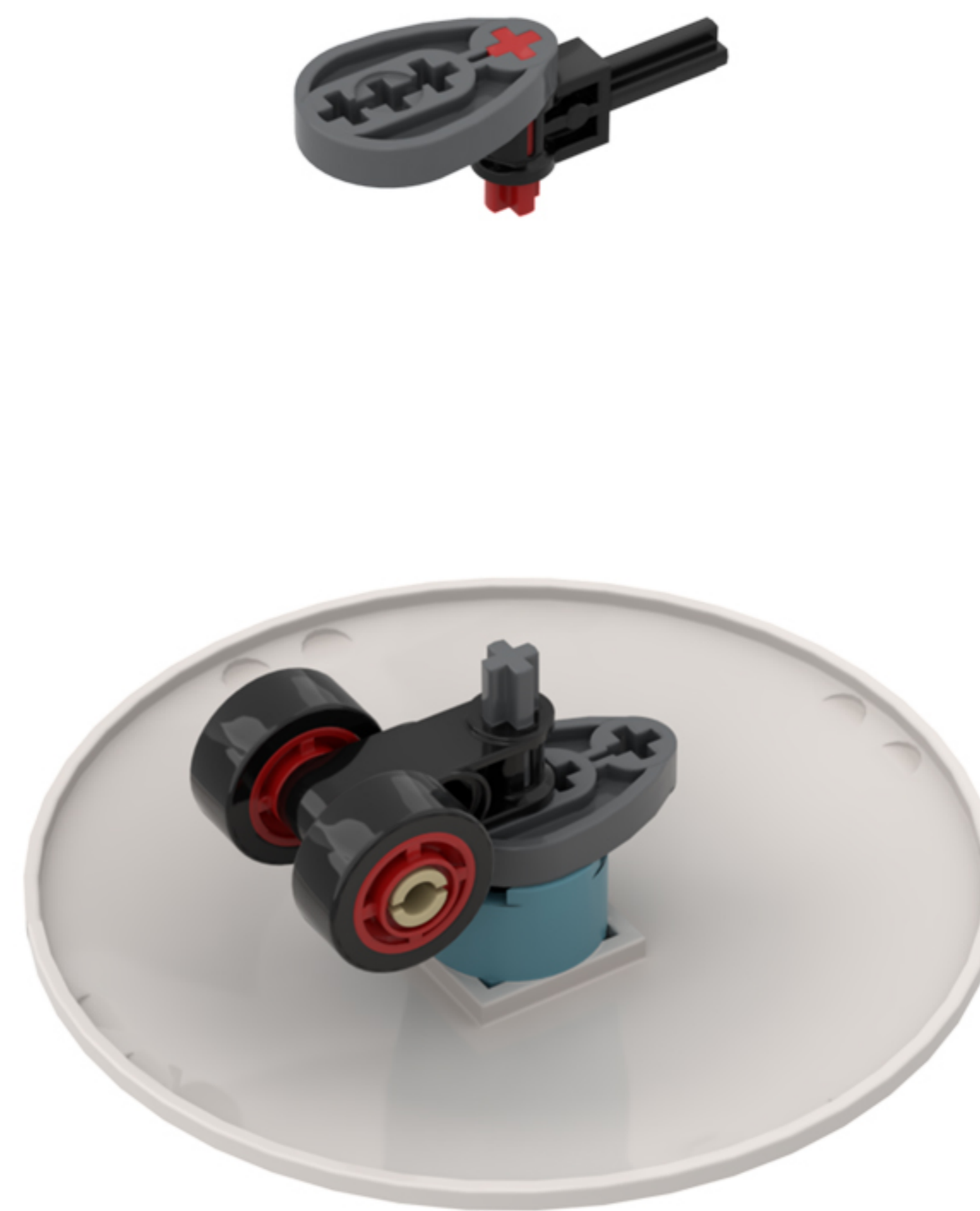
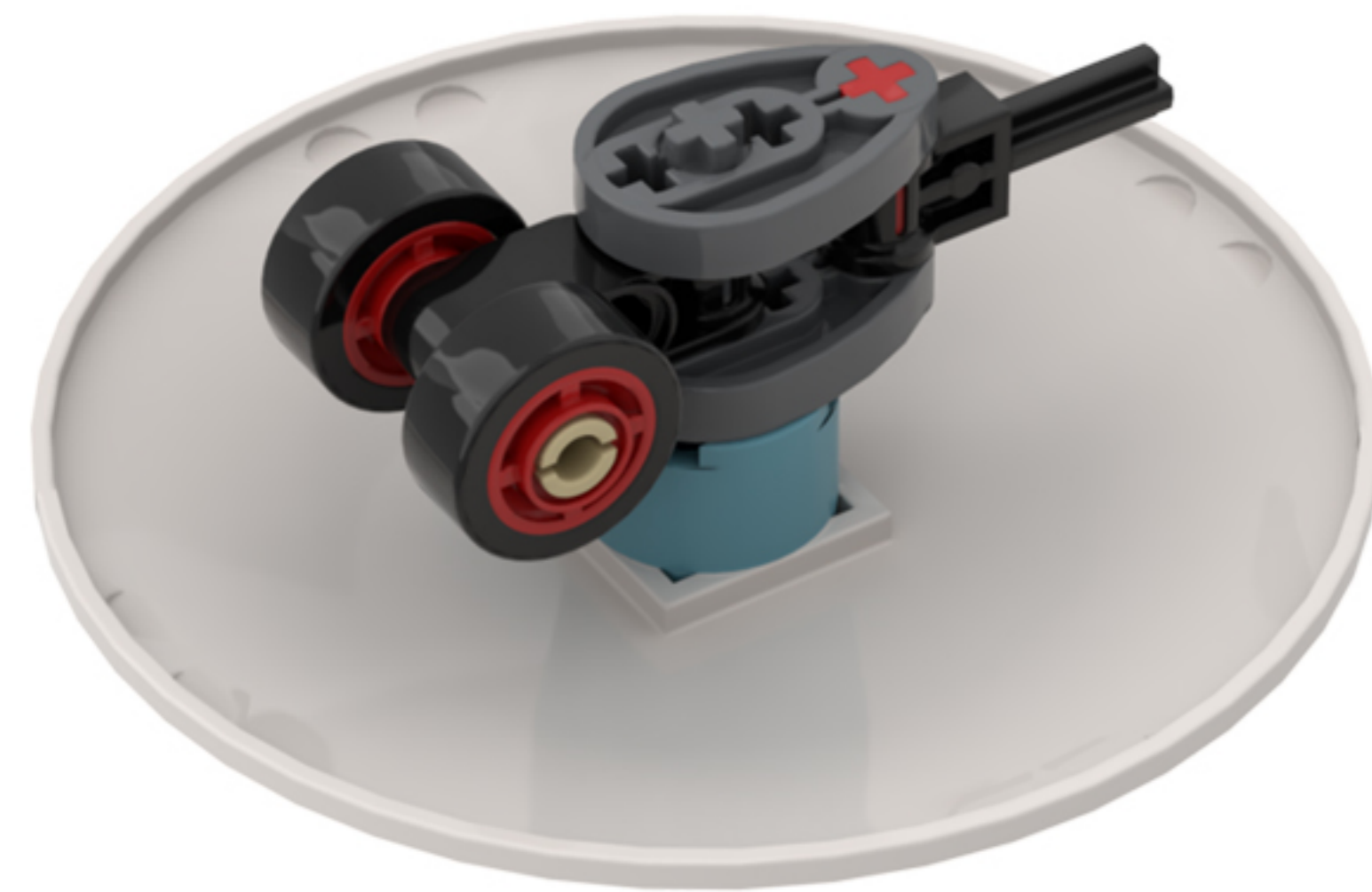

29

EN: Repeat the steps above to disassemble the building blocks one by one.

DE: Wiederholen Sie die oben beschriebenen Schritte, um die Bausteine nacheinander auseinanderzunehmen.

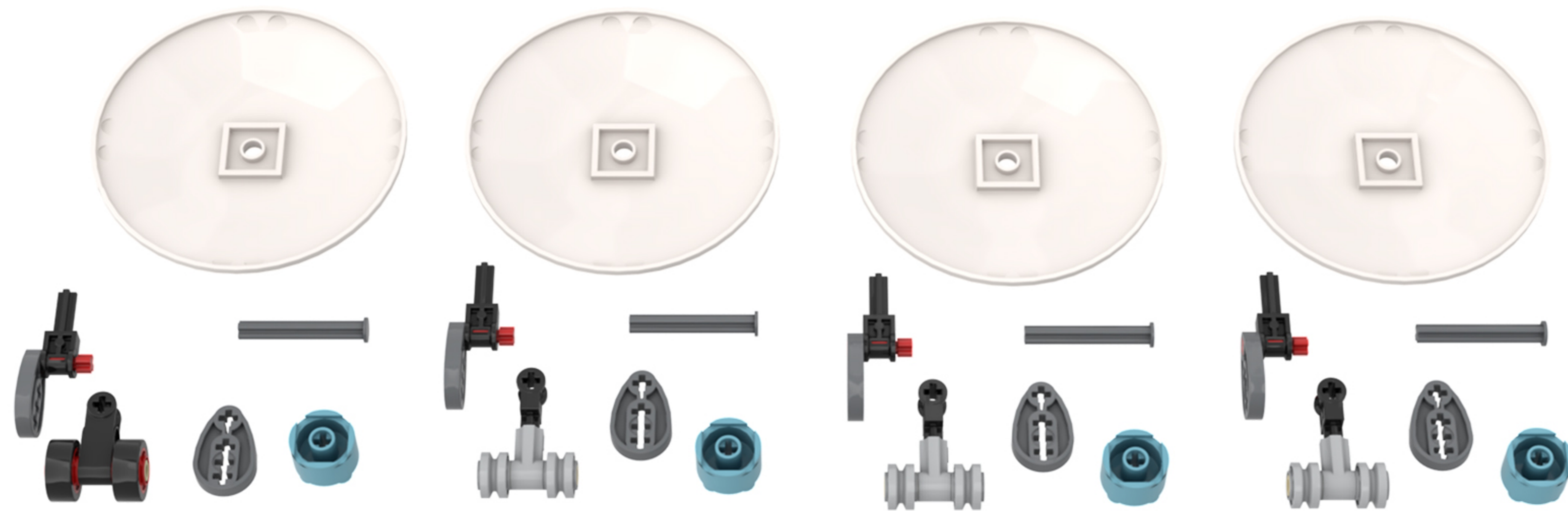

30

EN: Take the light beads from bag #6 and the 2x2 round plate from bag #10, and use the building block on the left as an example to add the lighting decorations.

DE: Nimm die Leuchtperlen aus Beutel Nr. 6 und die runde 2x2-Platte aus Beutel Nr. 10 und füge die Lichtdekorationen anhand des Bauklötzchens auf der linken Seite als Beispiel hinzu.

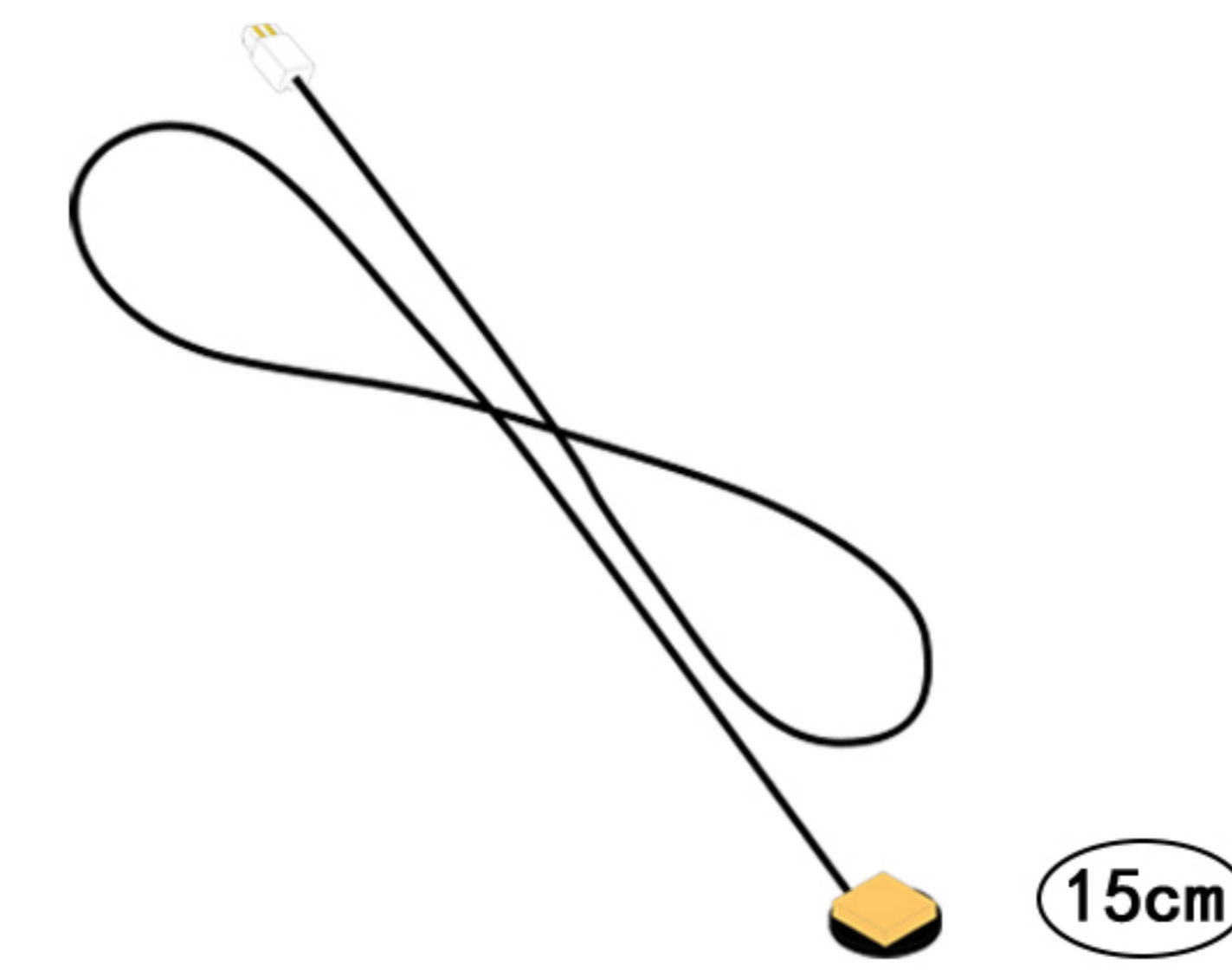
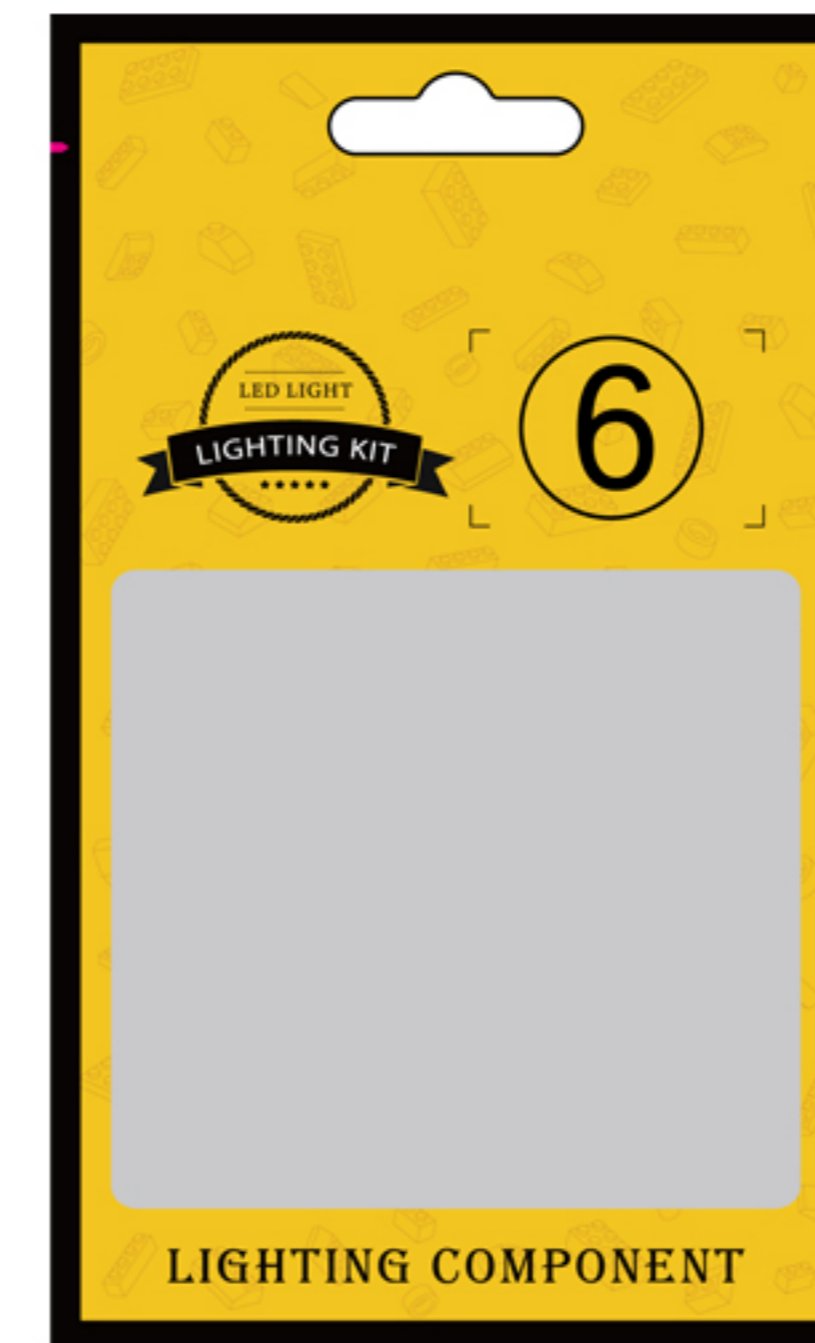

x4

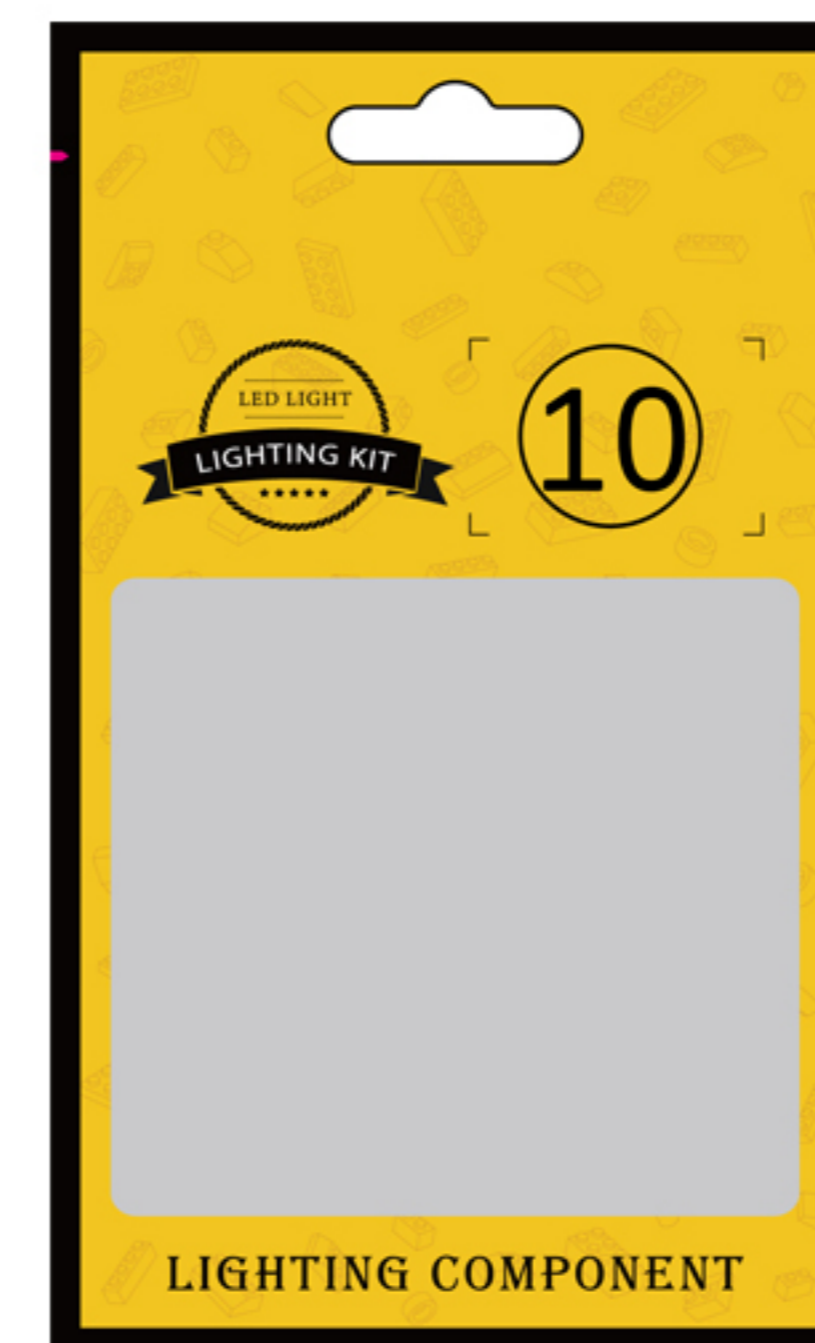

x4

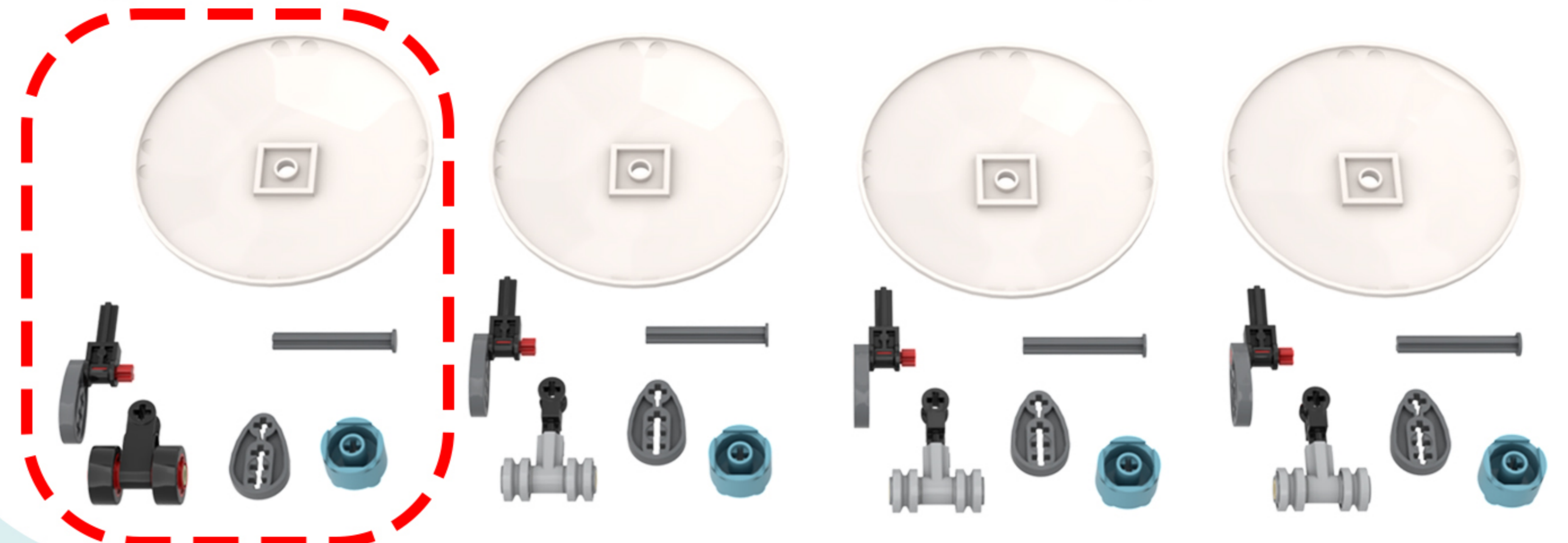

31

EN: Follow these steps in order.

DE: Befolgen Sie diese Schritte der Reihe nach.

- ①. Thread the light beads through the holes in the building blocks.

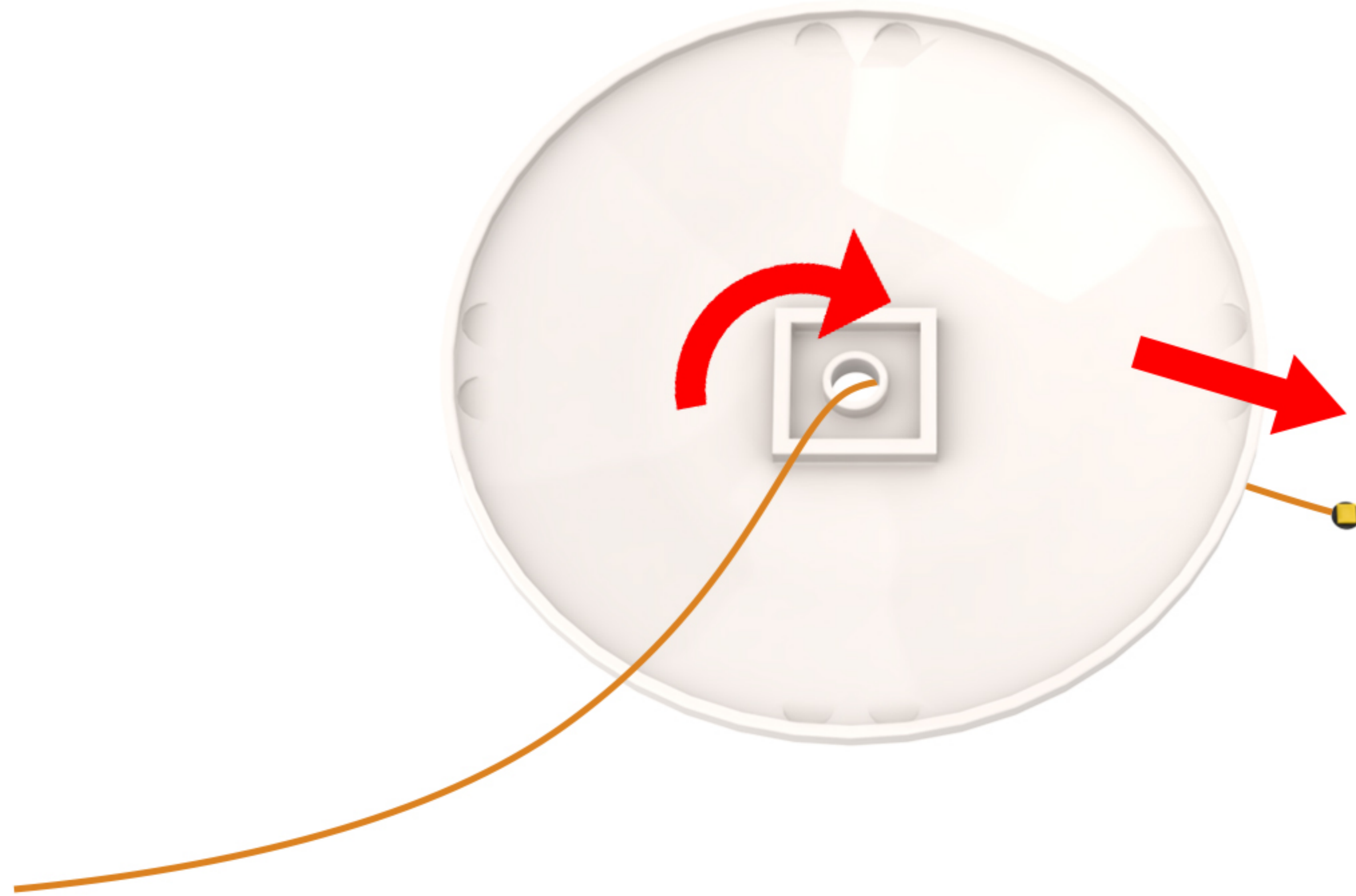

- ②. Flip the model.

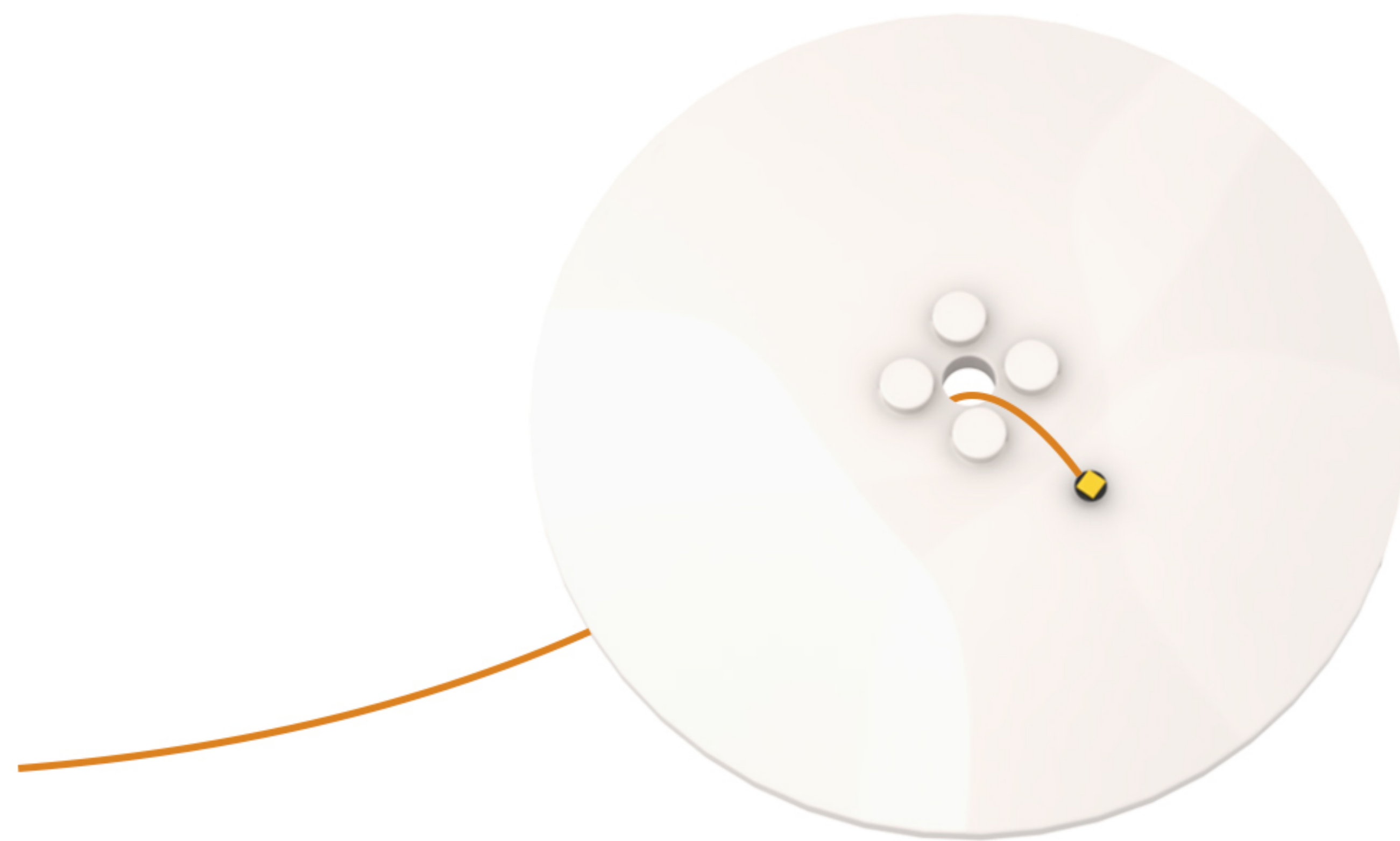
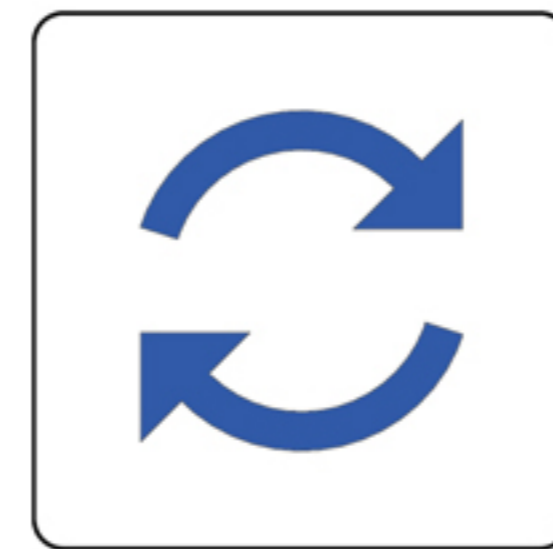

- ③. Take out the disassembled building blocks and reassemble them.

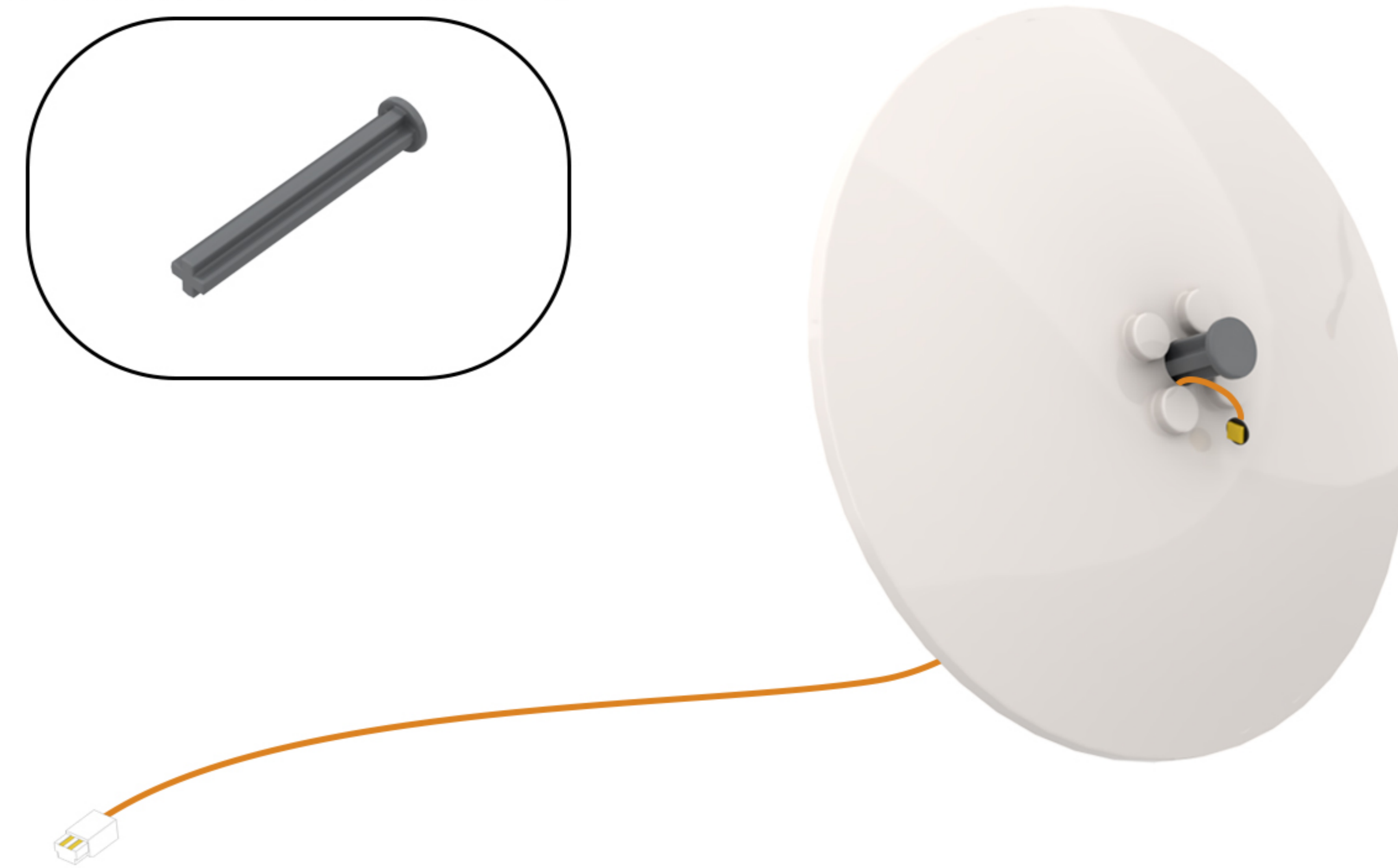
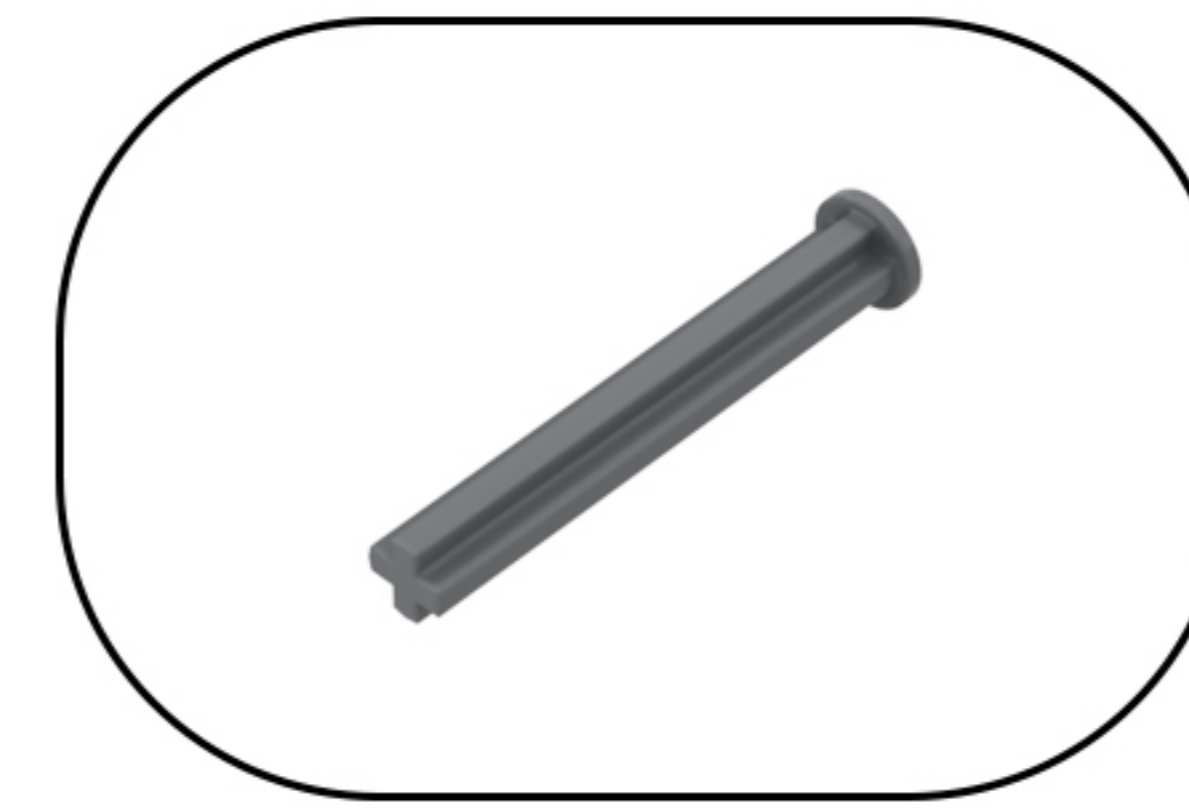

**Note: When reassembling, make sure to route the light cord through the groove in the cross shaft.**

- ④. After reattaching the building block to its original position, place the light fixture on top of it.



32

EN: Follow these steps in order.

DE: Befolgen Sie diese Schritte der Reihe nach.

⑤. Attach the 2×2 round plate to the building block.

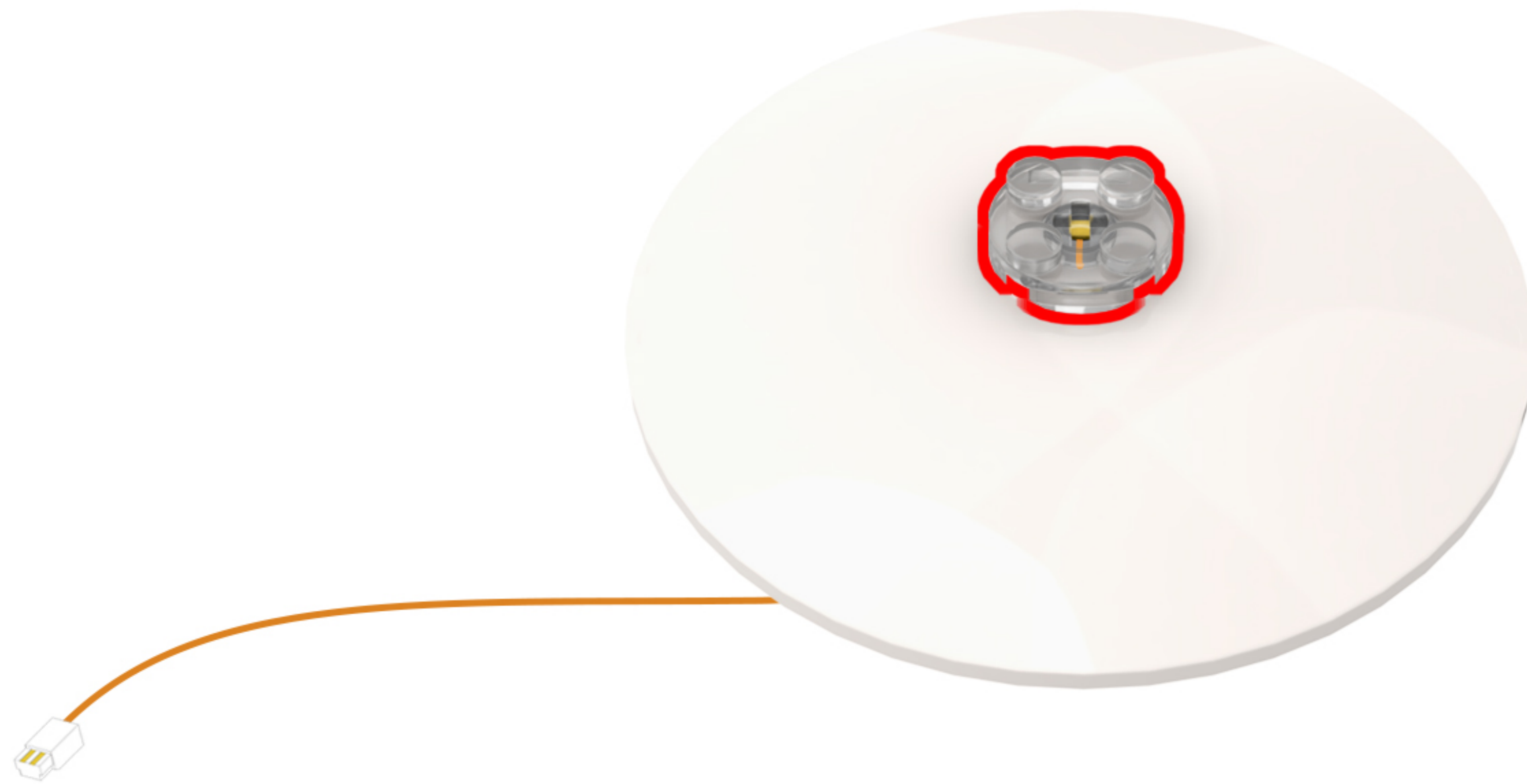

⑥. Flip the model.

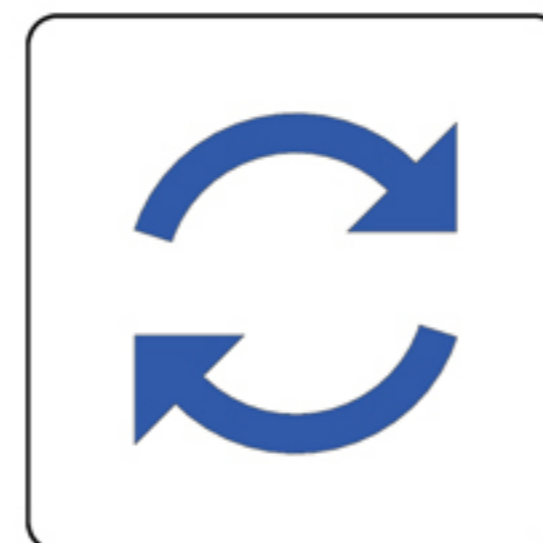
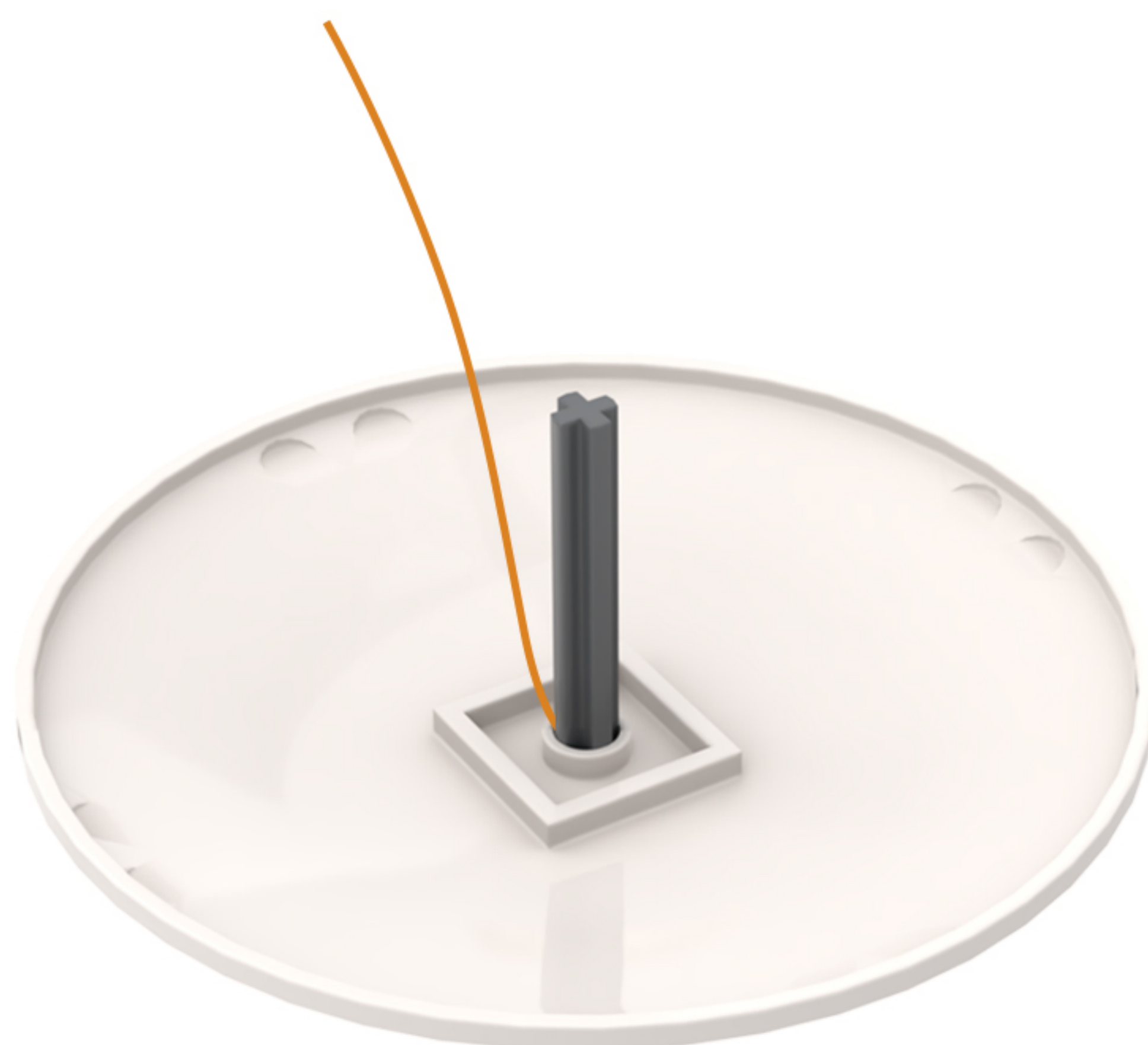

33

EN: Take out the disassembled building blocks and reassemble them in order.

DE: Nehmen Sie die zerlegten Bausteine heraus und setzen Sie sie der Reihe nach wieder zusammen.



x1



x1



x1



x1

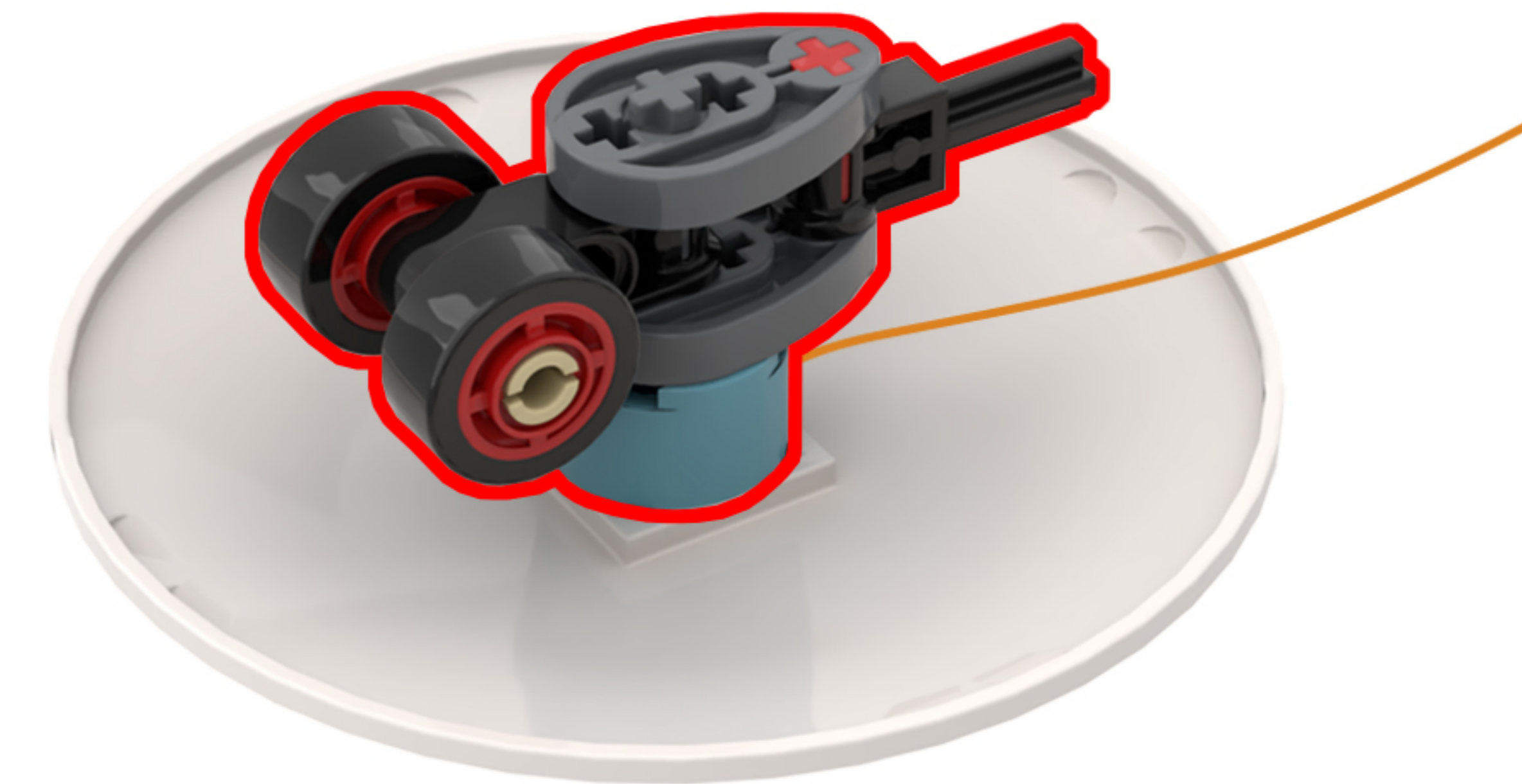

34

EN: Repeat the steps above to install the lights on the other three building blocks.

DE: Wiederholen Sie die oben beschriebenen Schritte, um die Leuchten an den anderen drei Bausteinen anzubringen.

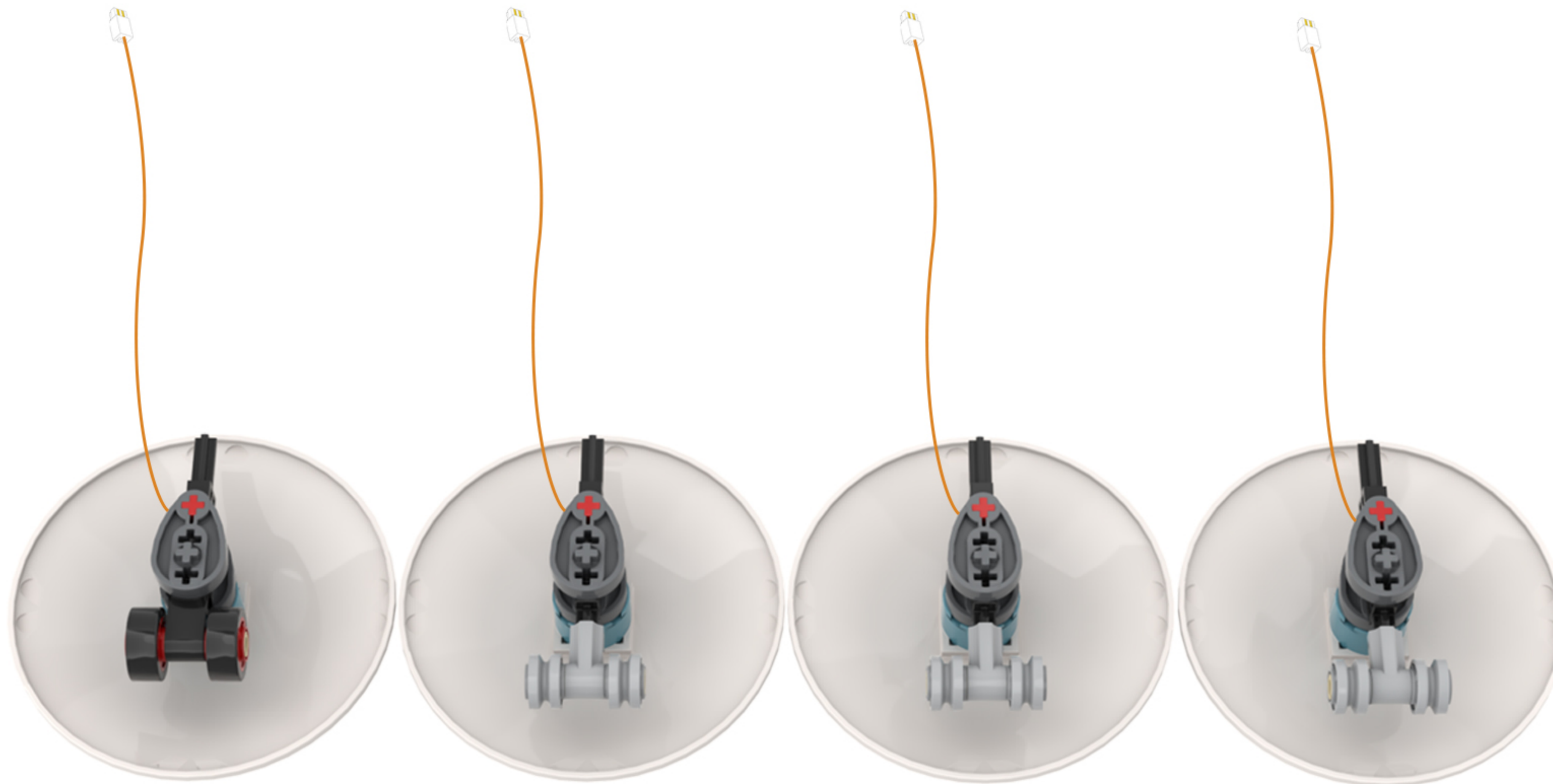

35

EN: Find the building block shown in the picture with the lights attached.

DE: Finde den auf dem Bild gezeigten Baustein, an dem die Lichter angebracht sind.



36

EN: Restore the building blocks.

DE: Stellen Sie die Bausteine wieder her.

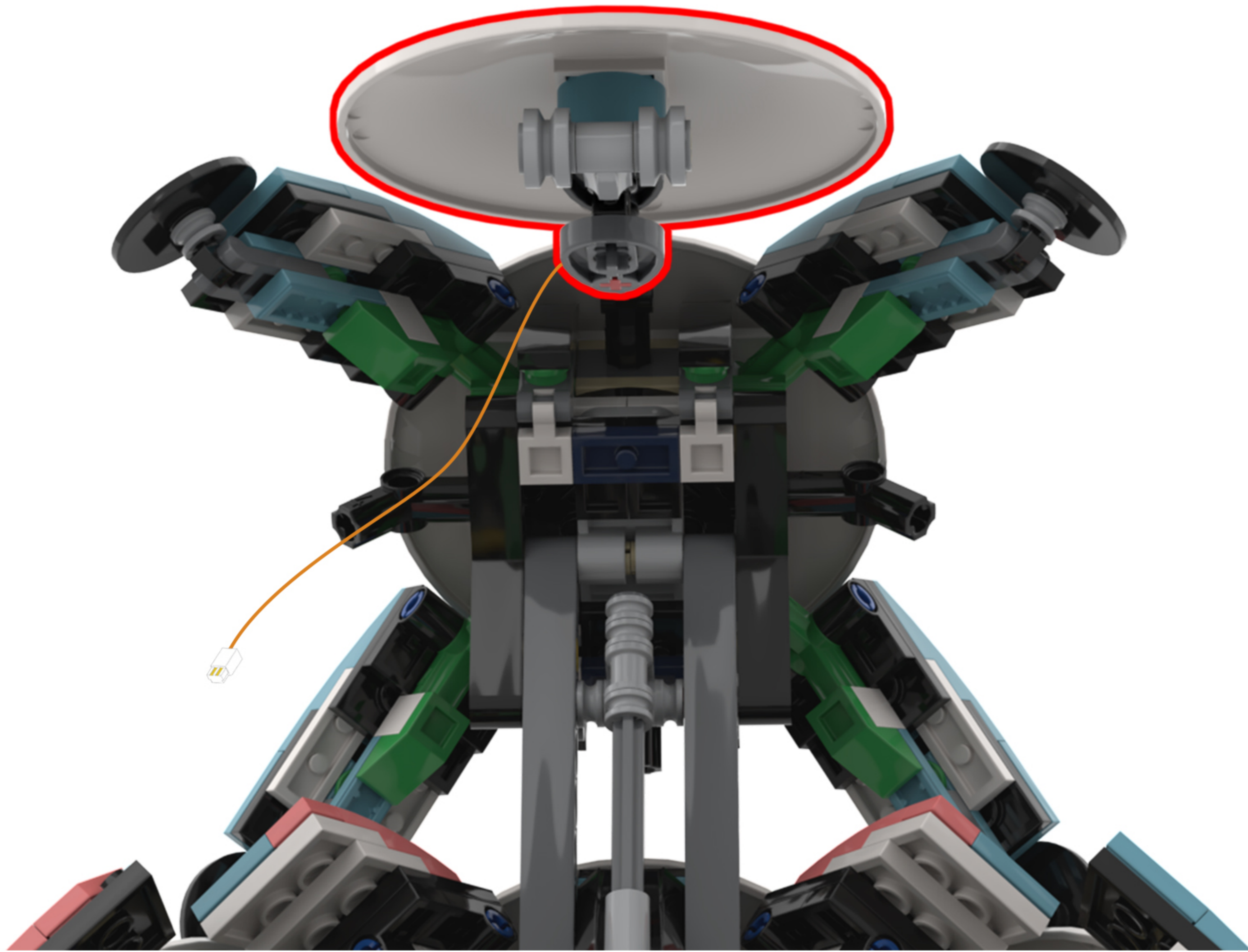

37

EN: Remove the building blocks one by one.

DE: Entfernen Sie die Bausteine nacheinander.

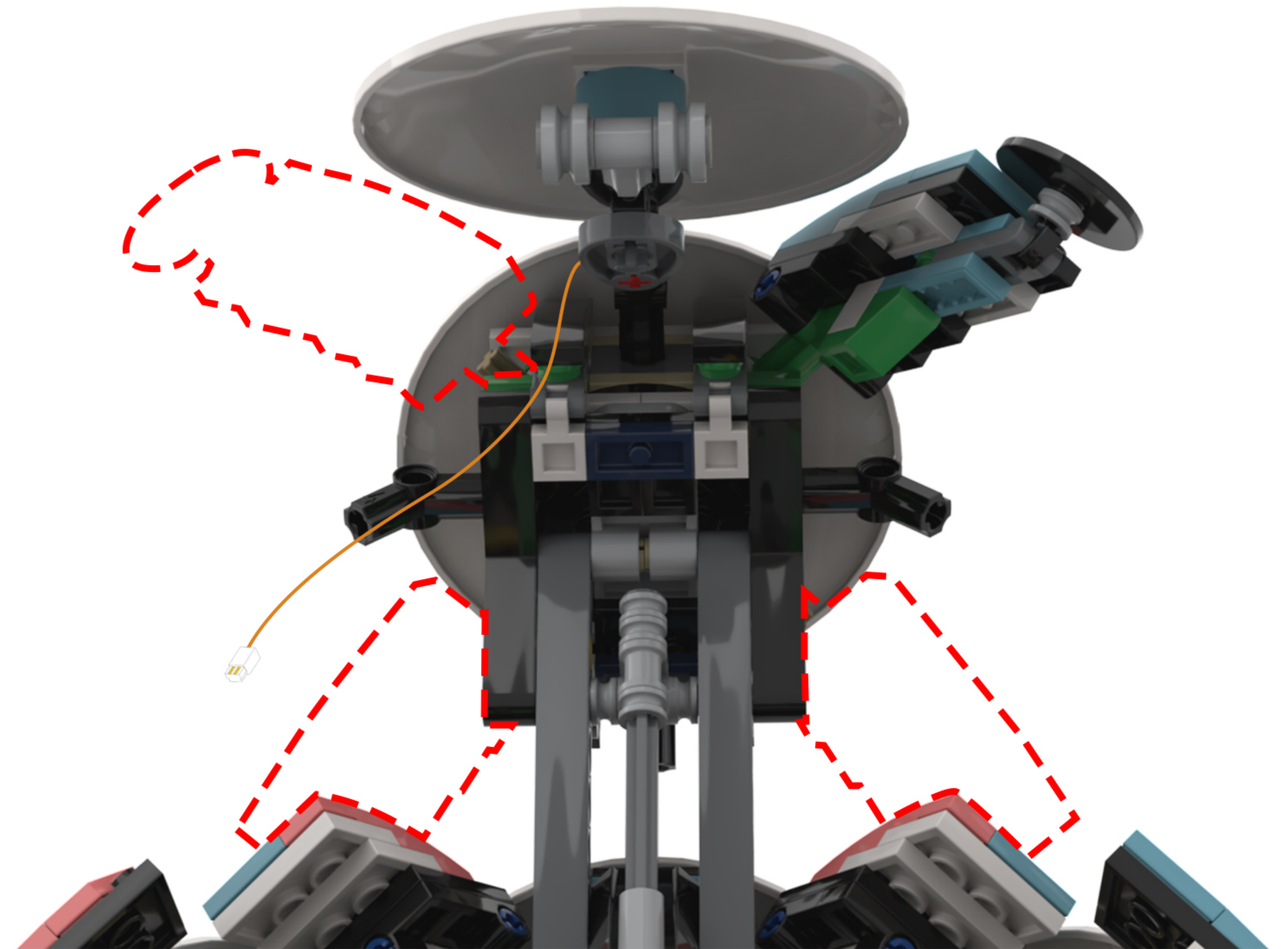
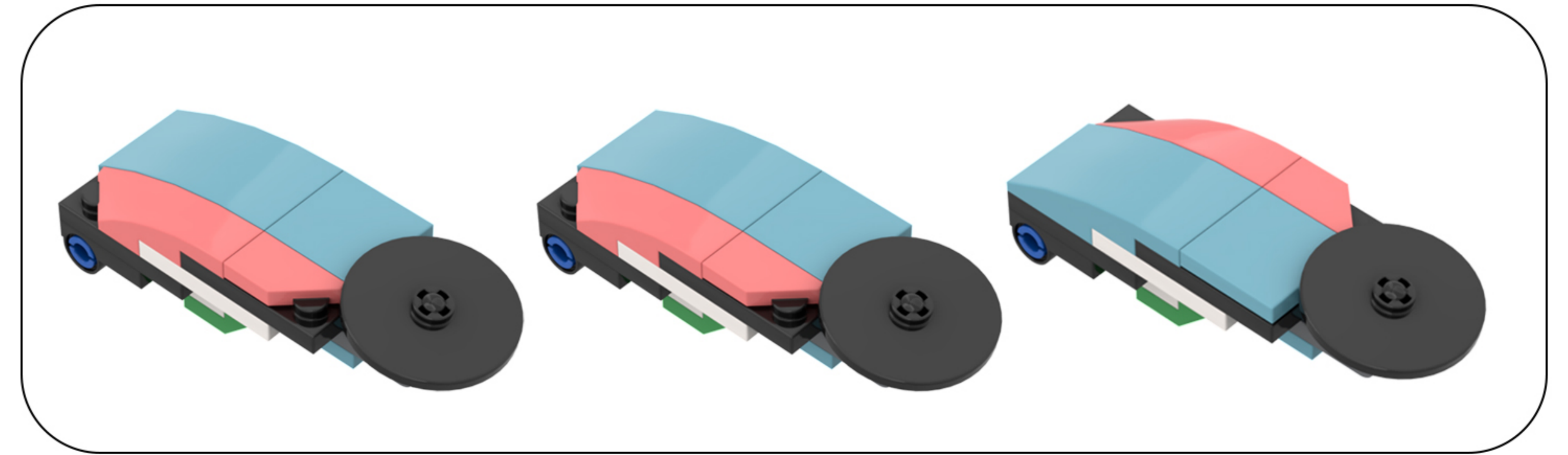

38

EN: Locate this light cord in the diagram.

DE: Suchen Sie dieses Lichtkabel in der Abbildung.

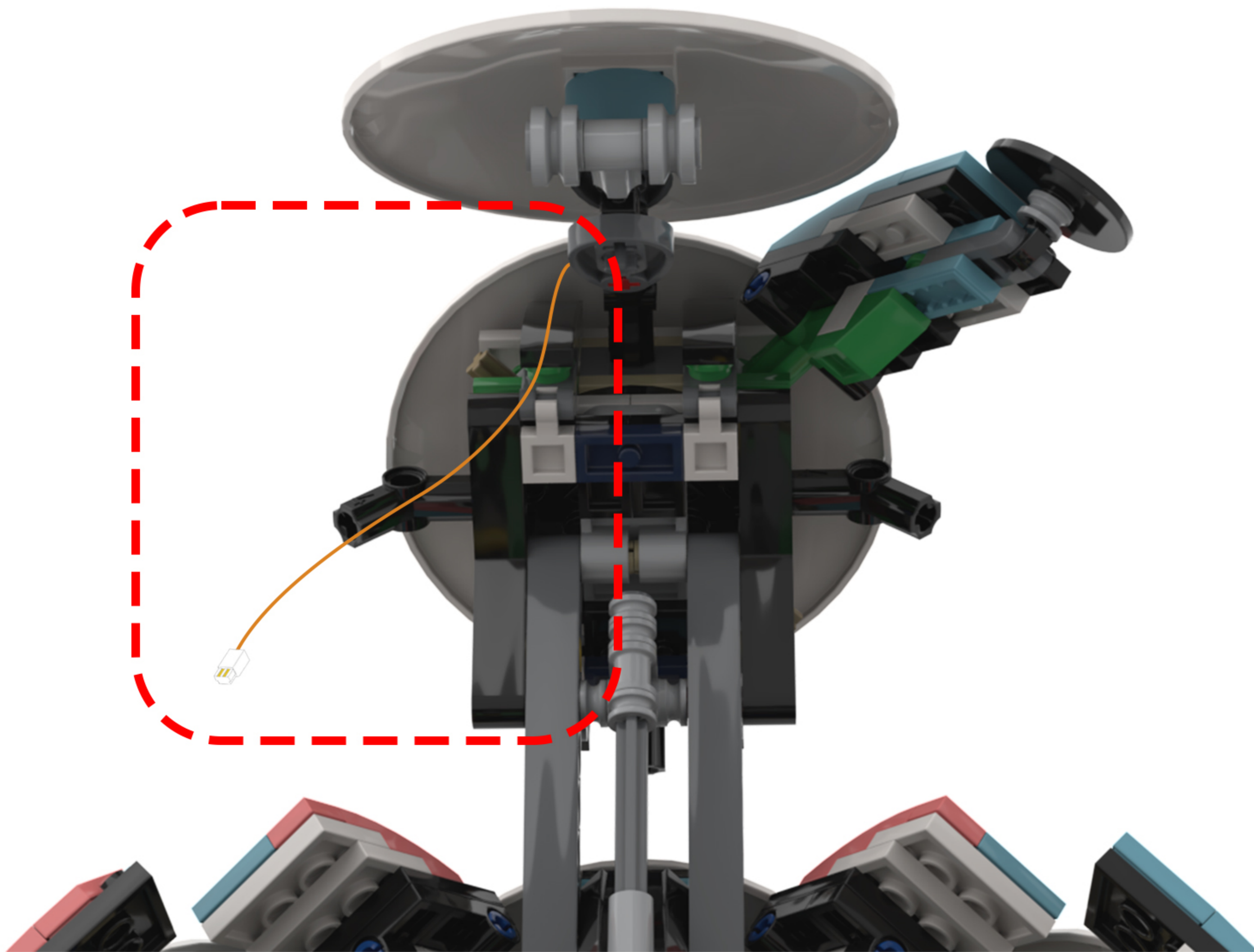

39

EN: Tuck the light cord into the gap in the building block.

DE: Stecken Sie das Kabel der Leuchte in den Spalt im Baustein.

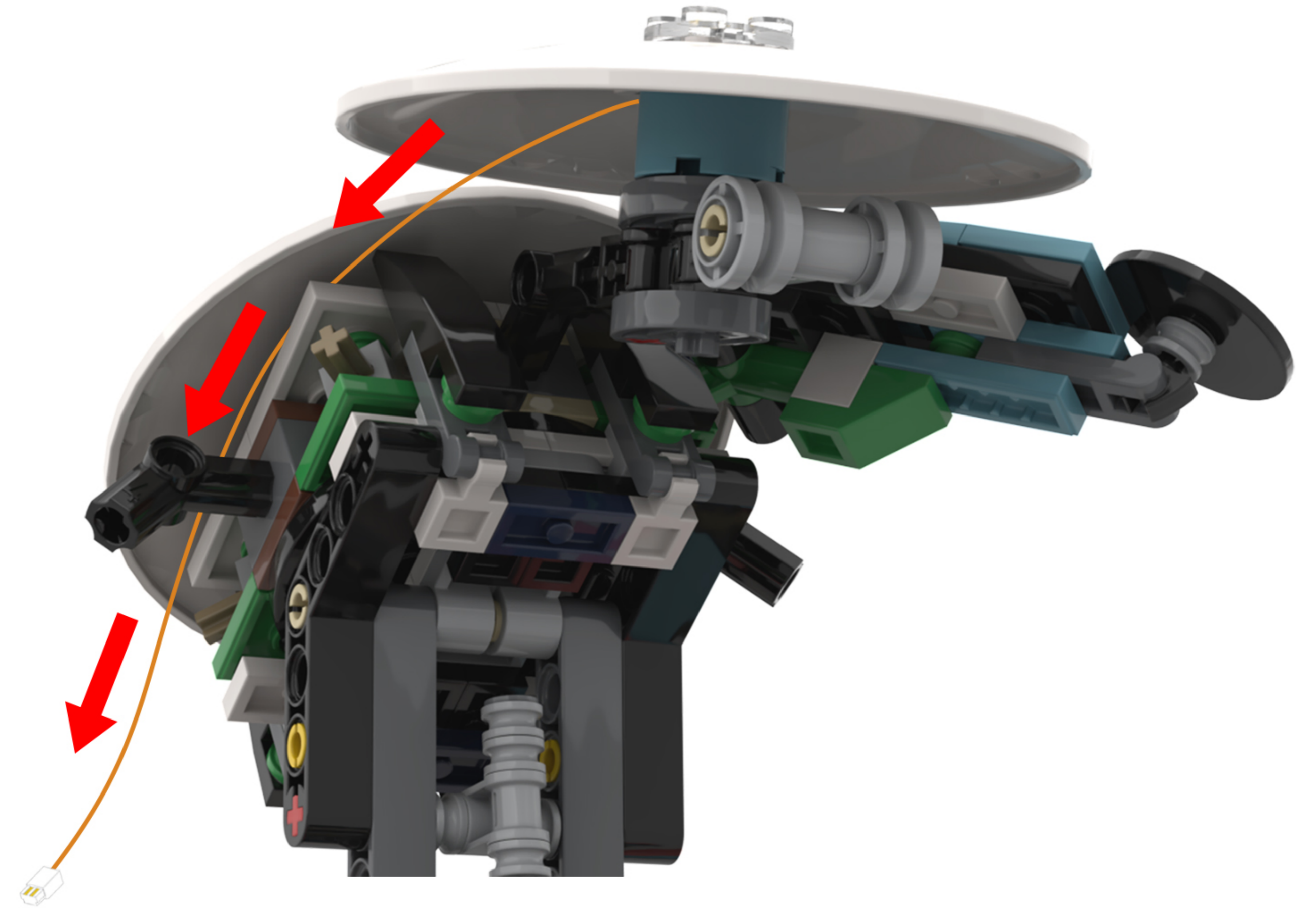

40

EN: Take out the building blocks with the lights attached and reinstall them in their original positions one by one.

DE: Nehmen Sie die Bausteine mit den daran befestigten Leuchten heraus und setzen Sie sie nacheinander wieder an ihren ursprünglichen Positionen ein.

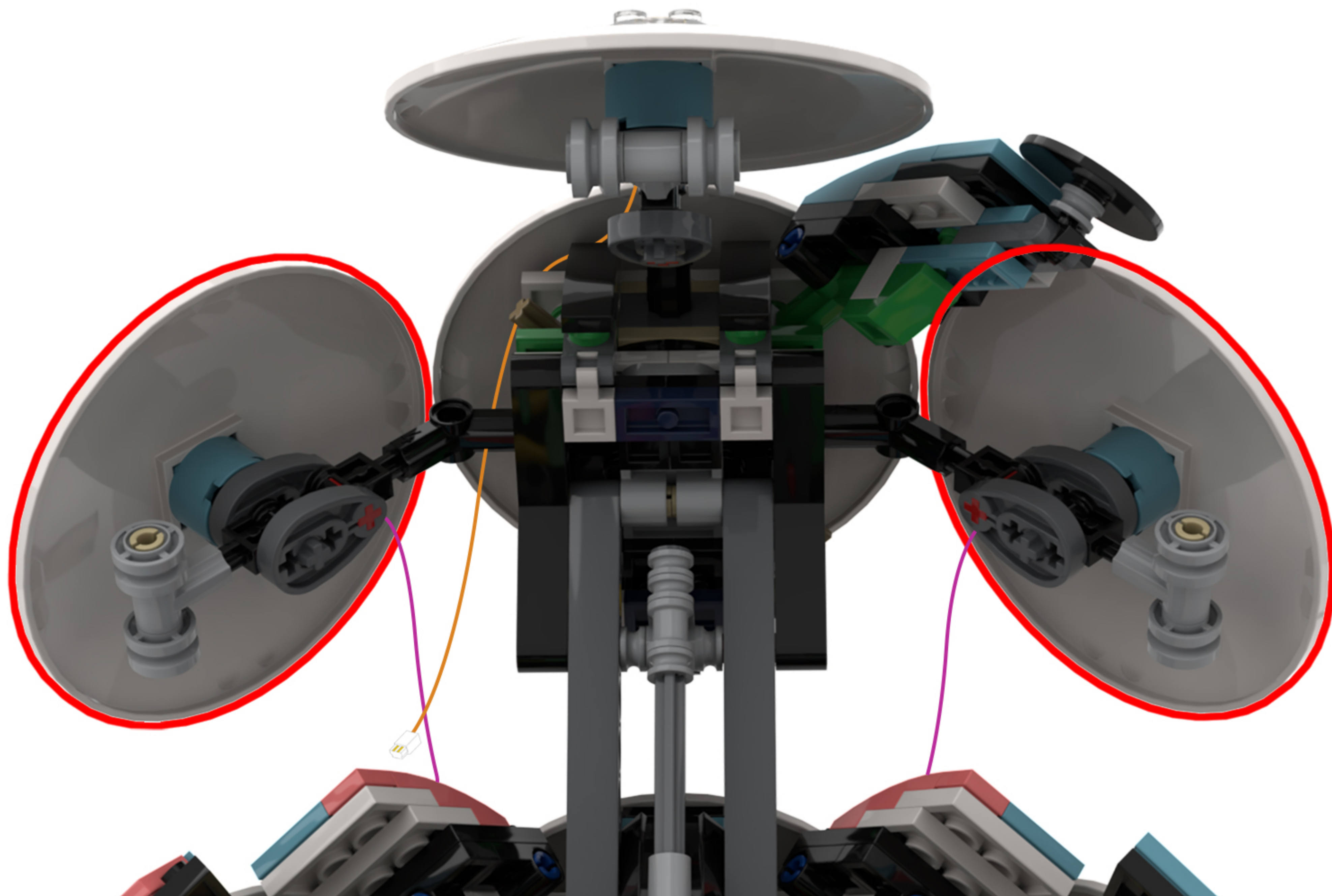
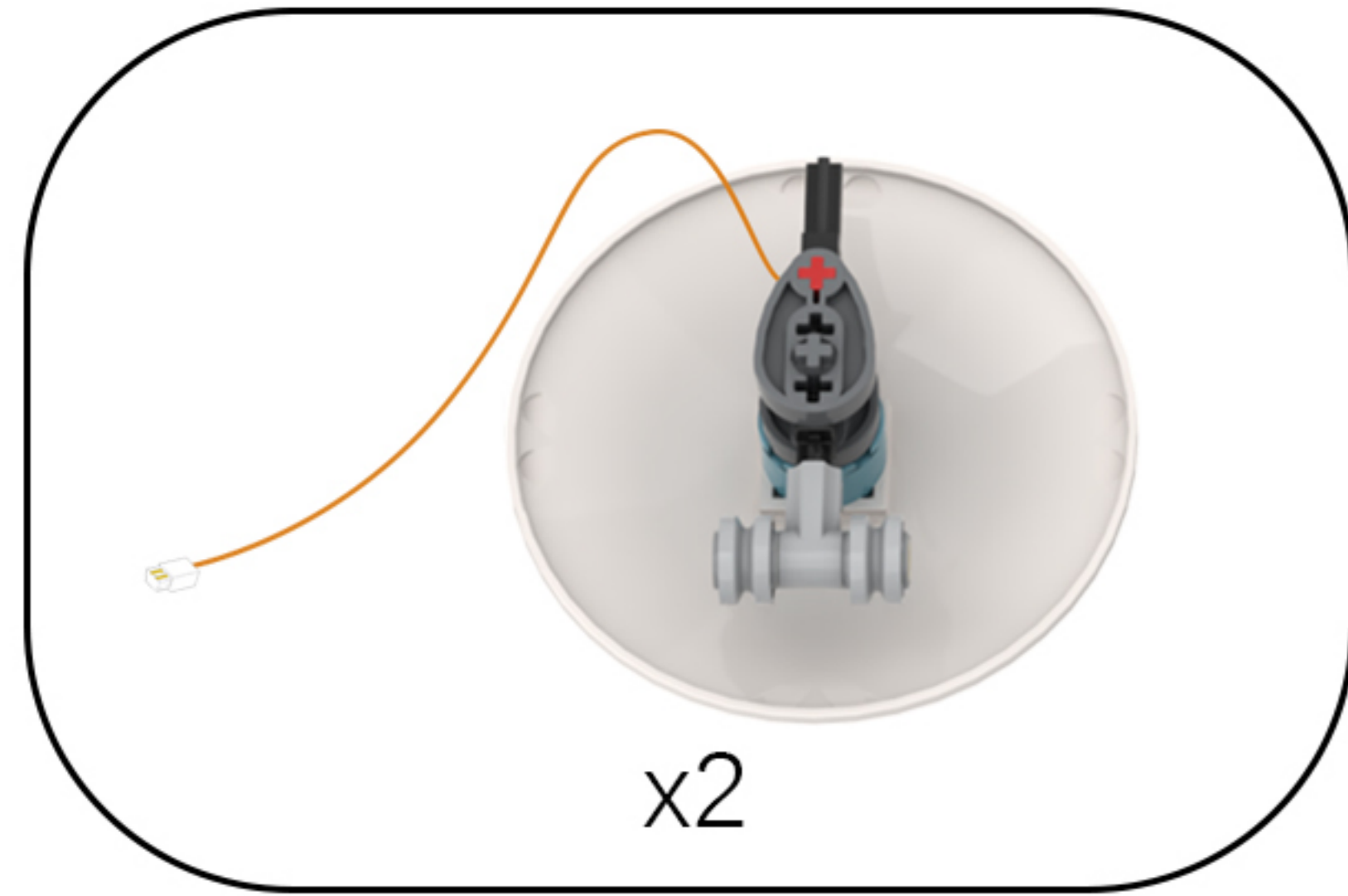

41

EN: Thread the light cord on the left through the hole in the building block.

DE: Führen Sie das Lichtkabel auf der linken Seite durch das Loch im Baustein.

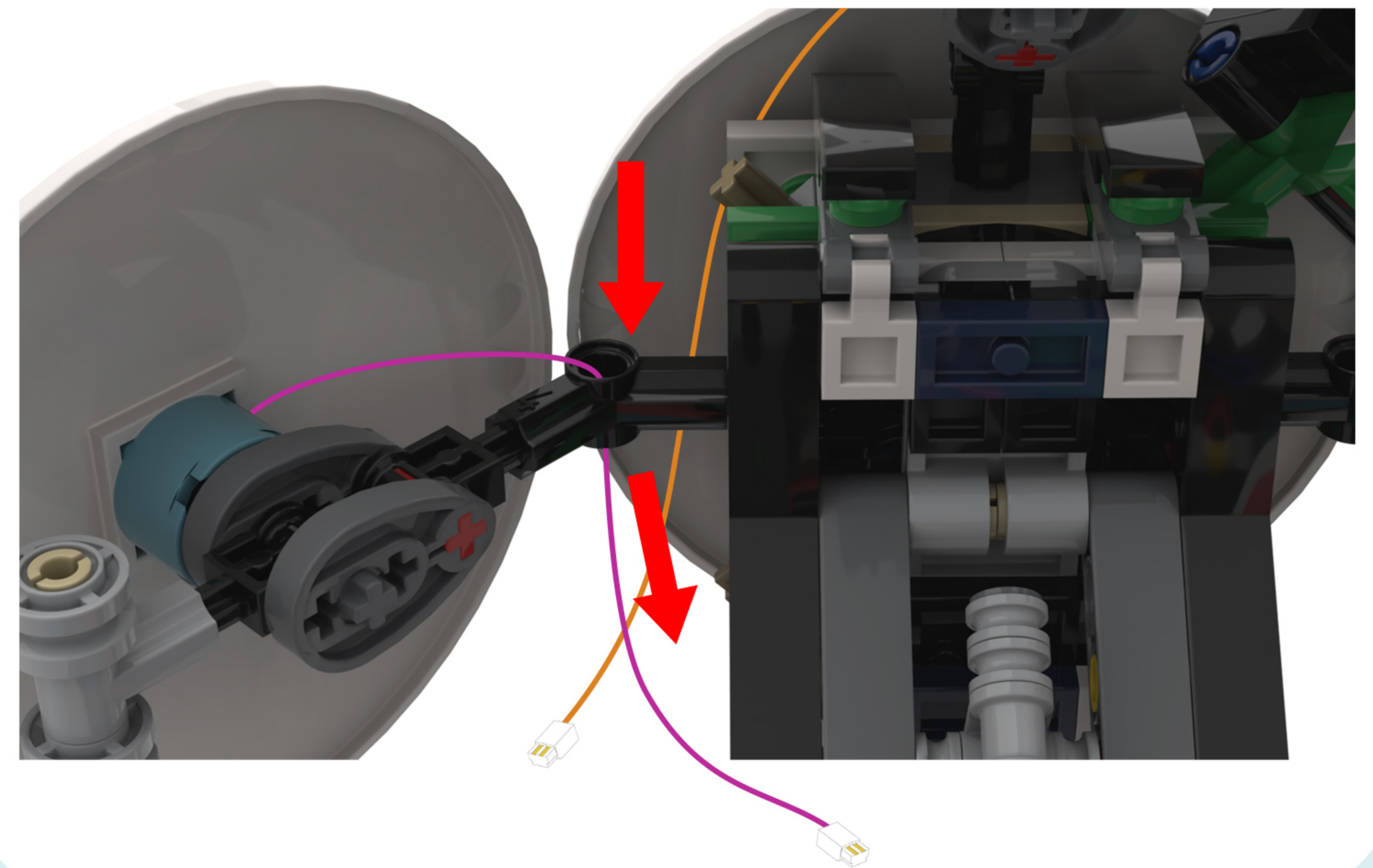
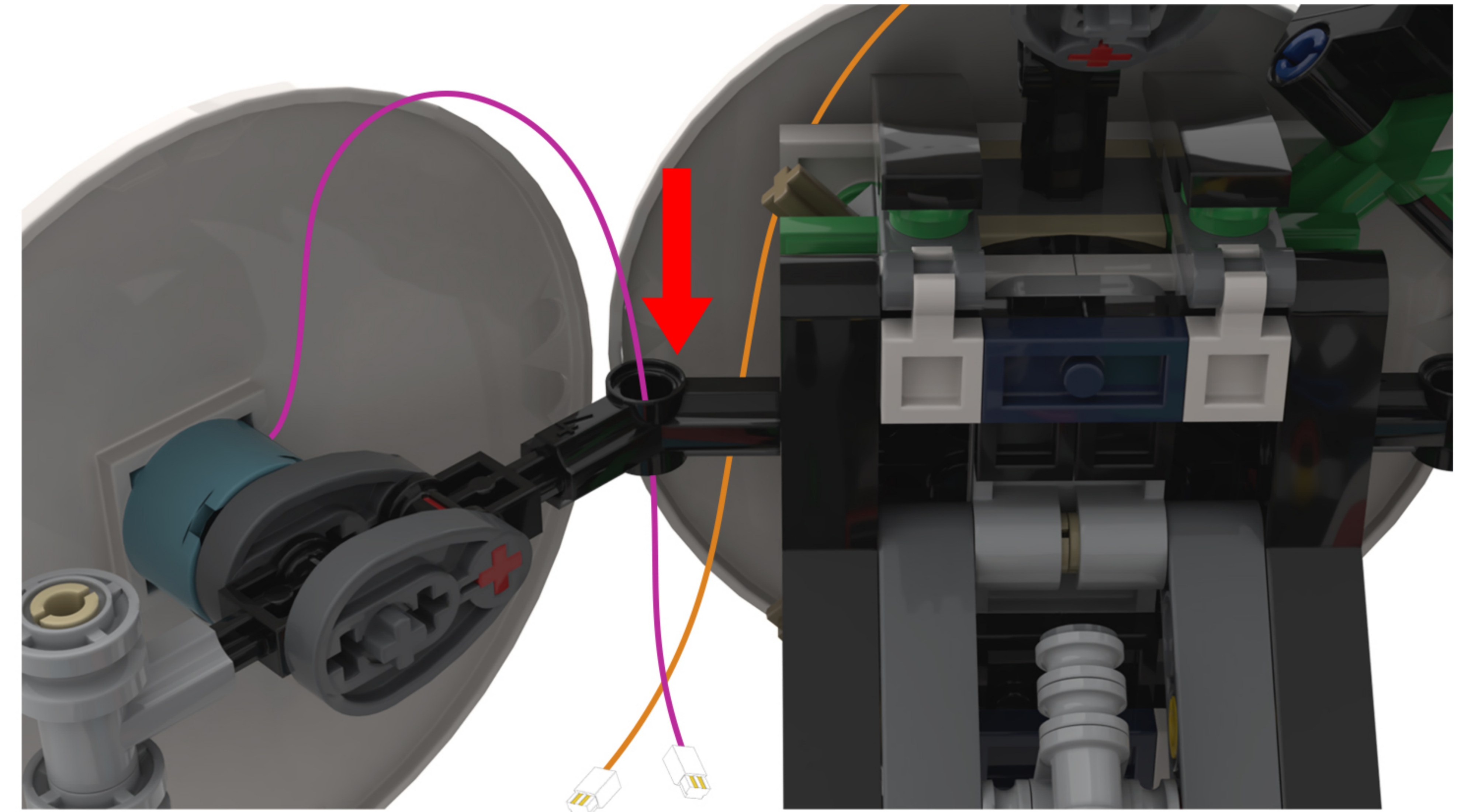

42

EN: Repeat the same steps for the light cord on the right, threading it through the hole in the building block.

DE: Wiederholen Sie die gleichen Schritte für das Lichtkabel auf der rechten Seite und führen Sie es durch das Loch im Baustein.

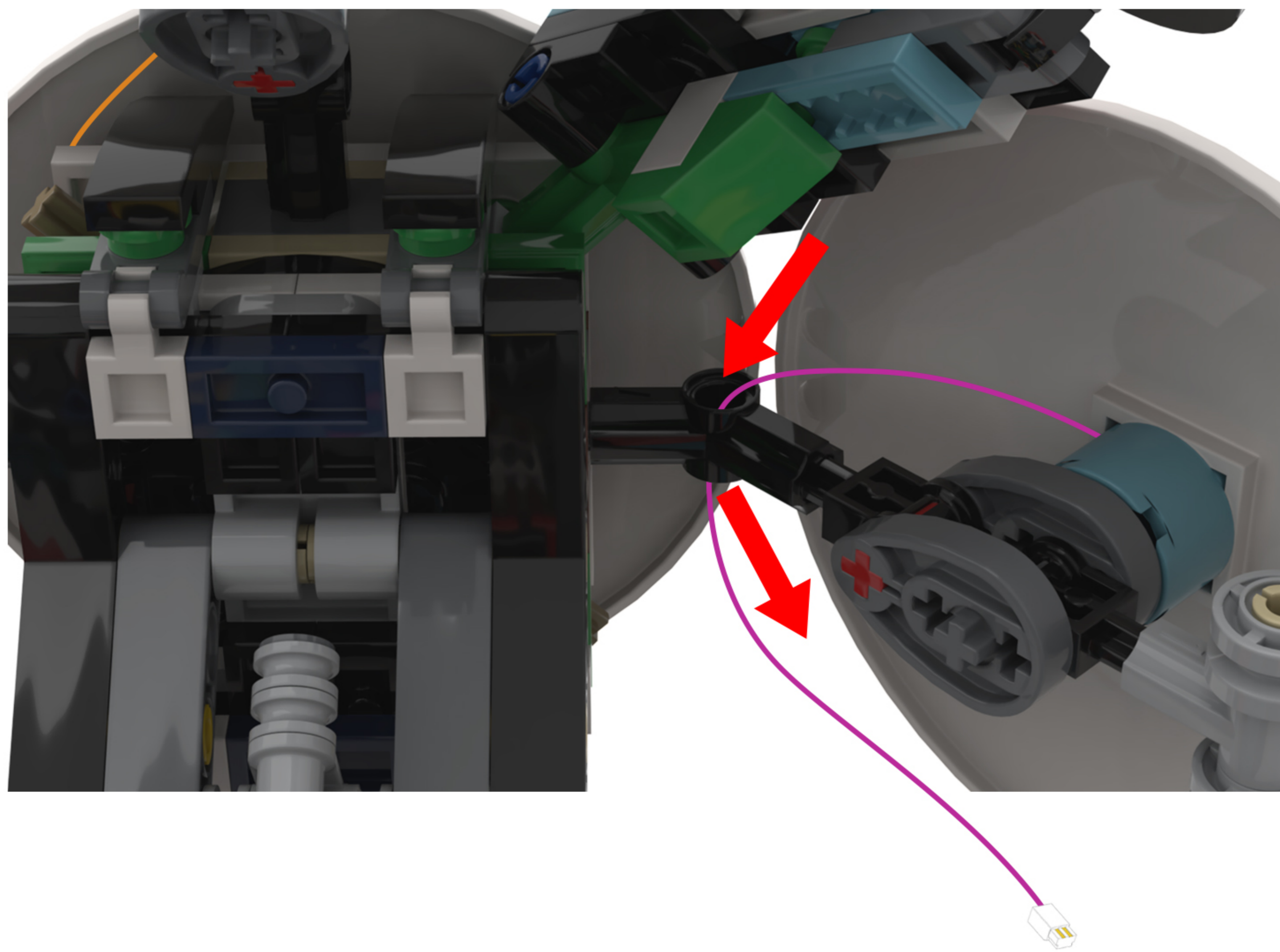

43

EN: Take out the disassembled building blocks and reassemble them in order.

DE: Nehmen Sie die zerlegten Bausteine heraus und setzen Sie sie der Reihe nach wieder zusammen.

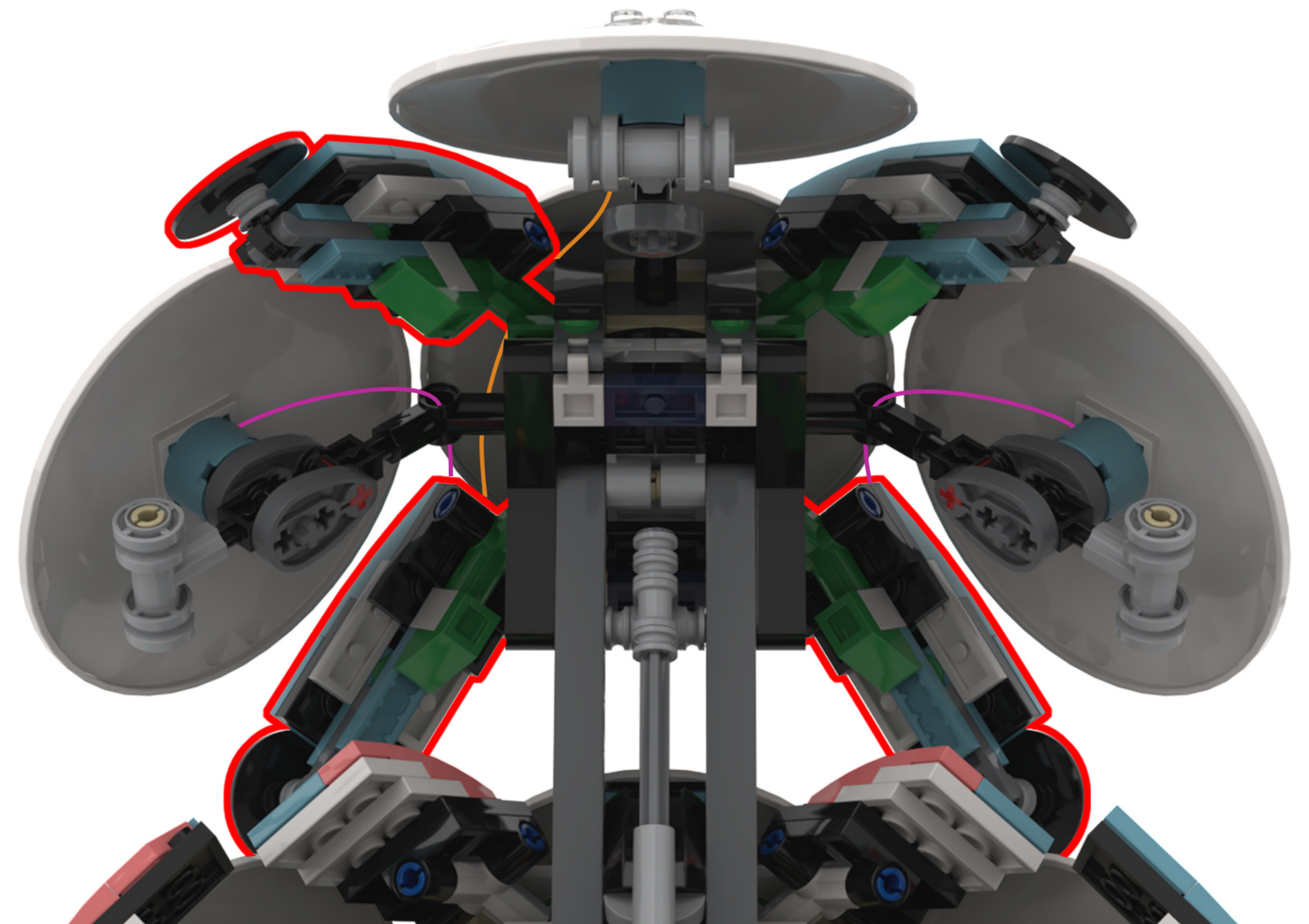
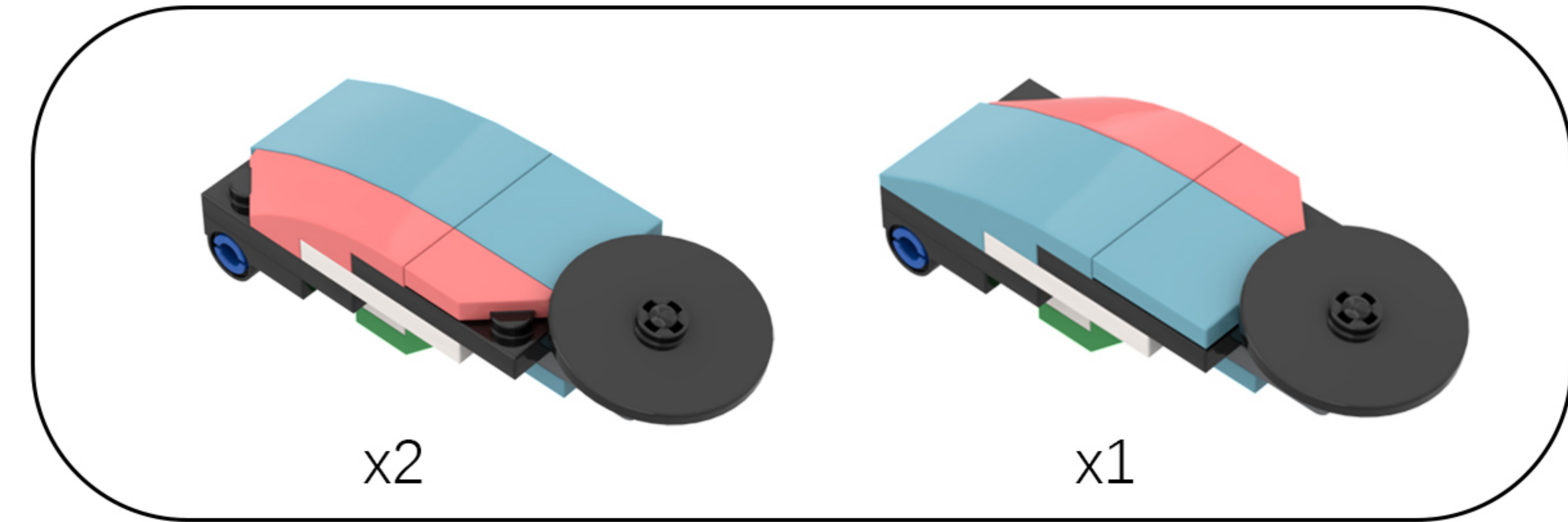

**44** EN: Rotate the model to its back side.  
DE: Drehen Sie das Modell auf die Rückseite.

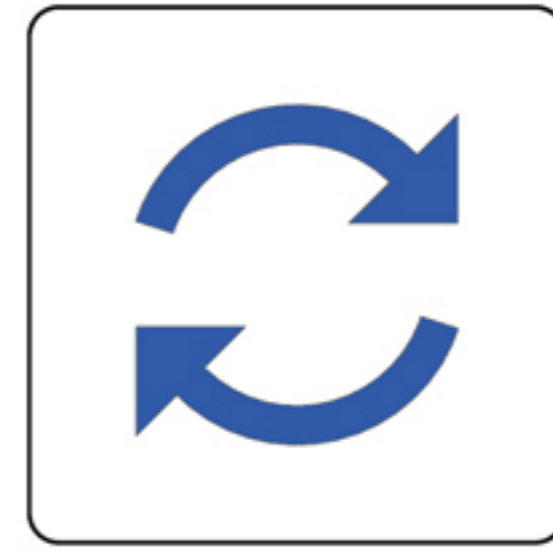

**45** EN: Split as shown in the figure.  
DE: Wie in der Abbildung gezeigt, teilen Sie es auf.

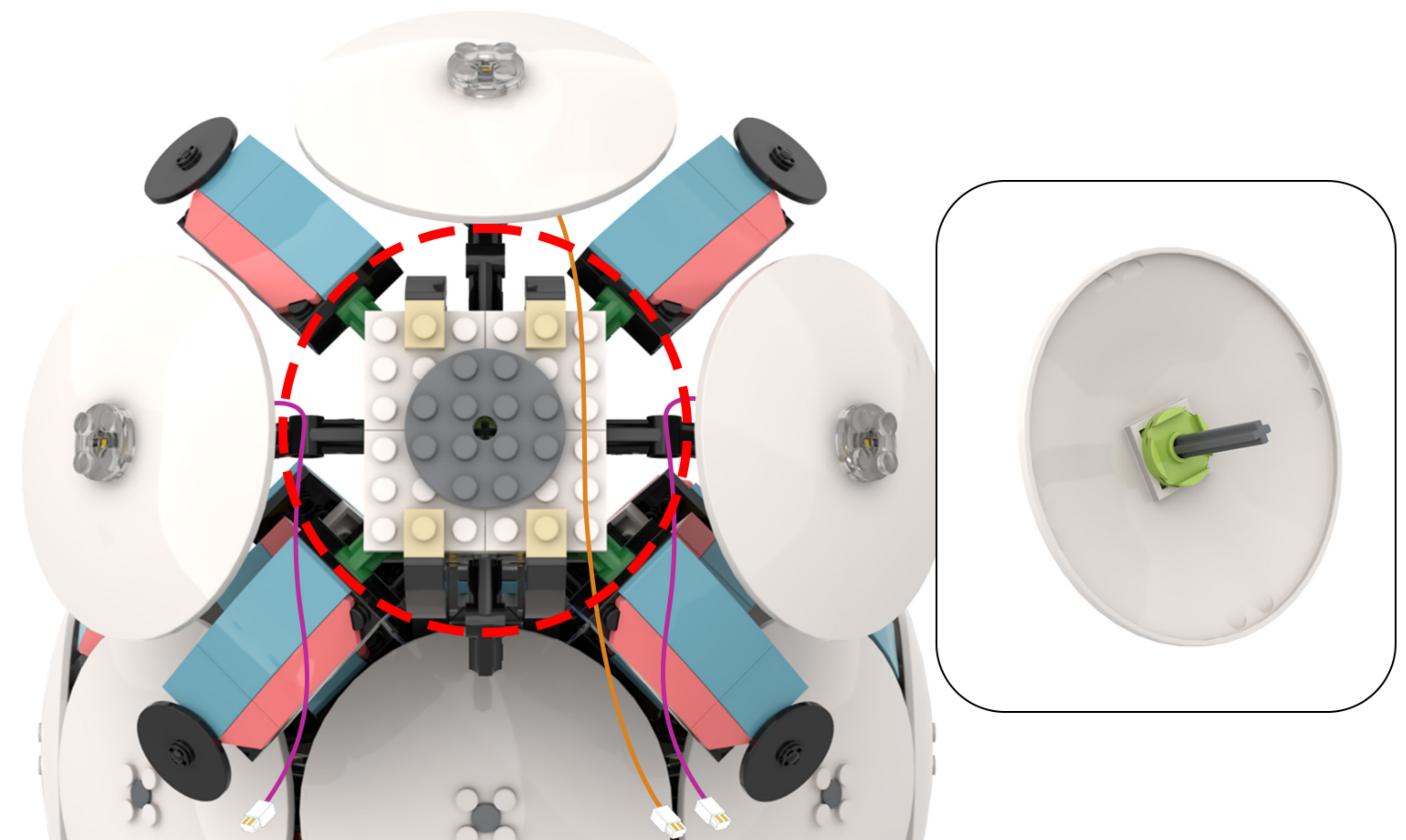

46

EN: Split as shown in the figure.

DE: Wie in der Abbildung gezeigt, teilen Sie es auf.



47

EN: Take the lights from bag #5 and the 2x2 round plate from bag #10, and set aside the disassembled pieces.

DE: Nehmen Sie die Lichter aus Beutel Nr. 5 und die runde 2x2-Platte aus Beutel Nr. 10 heraus und legen Sie die zerlegten Teile beiseite.

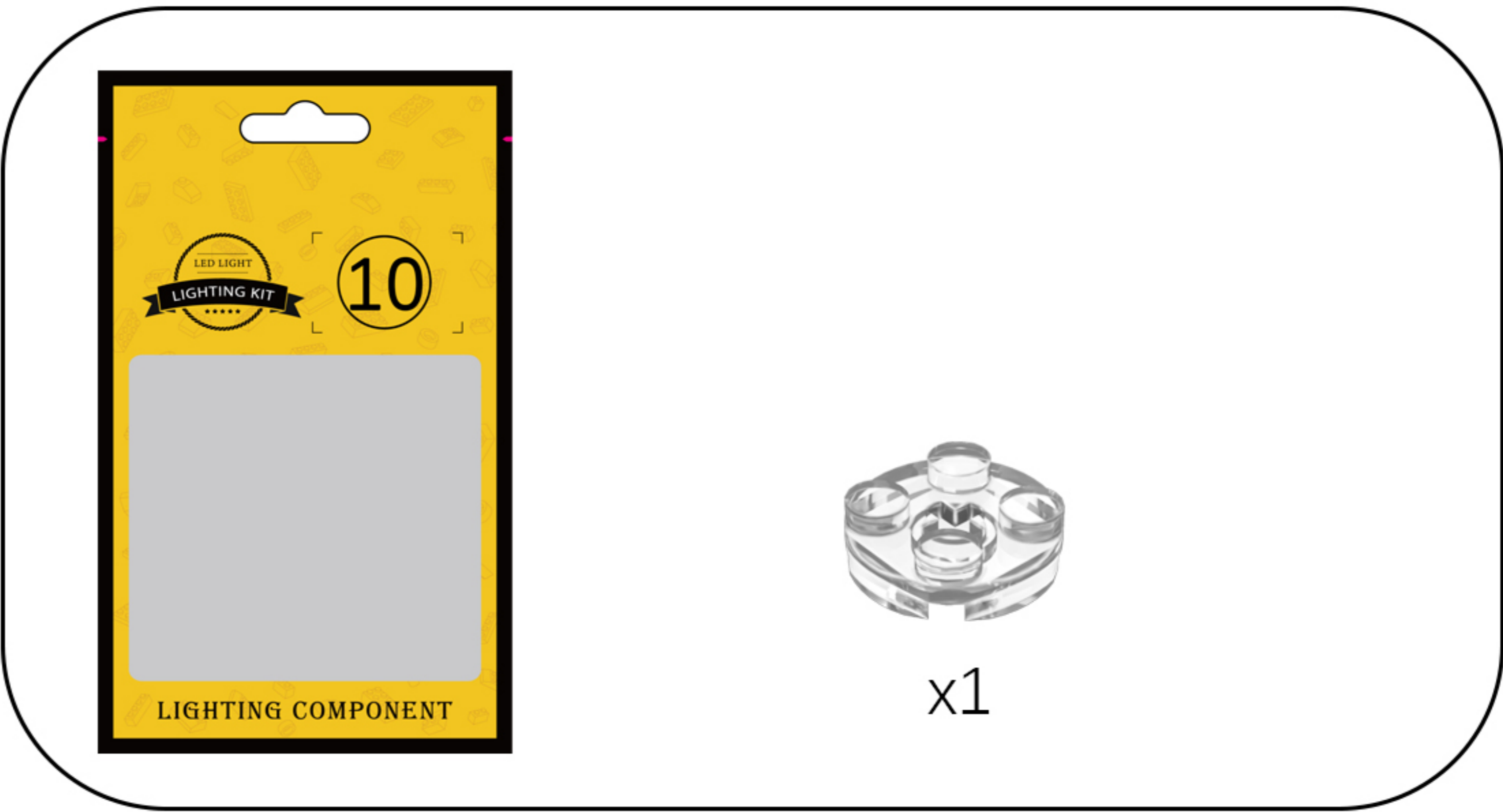
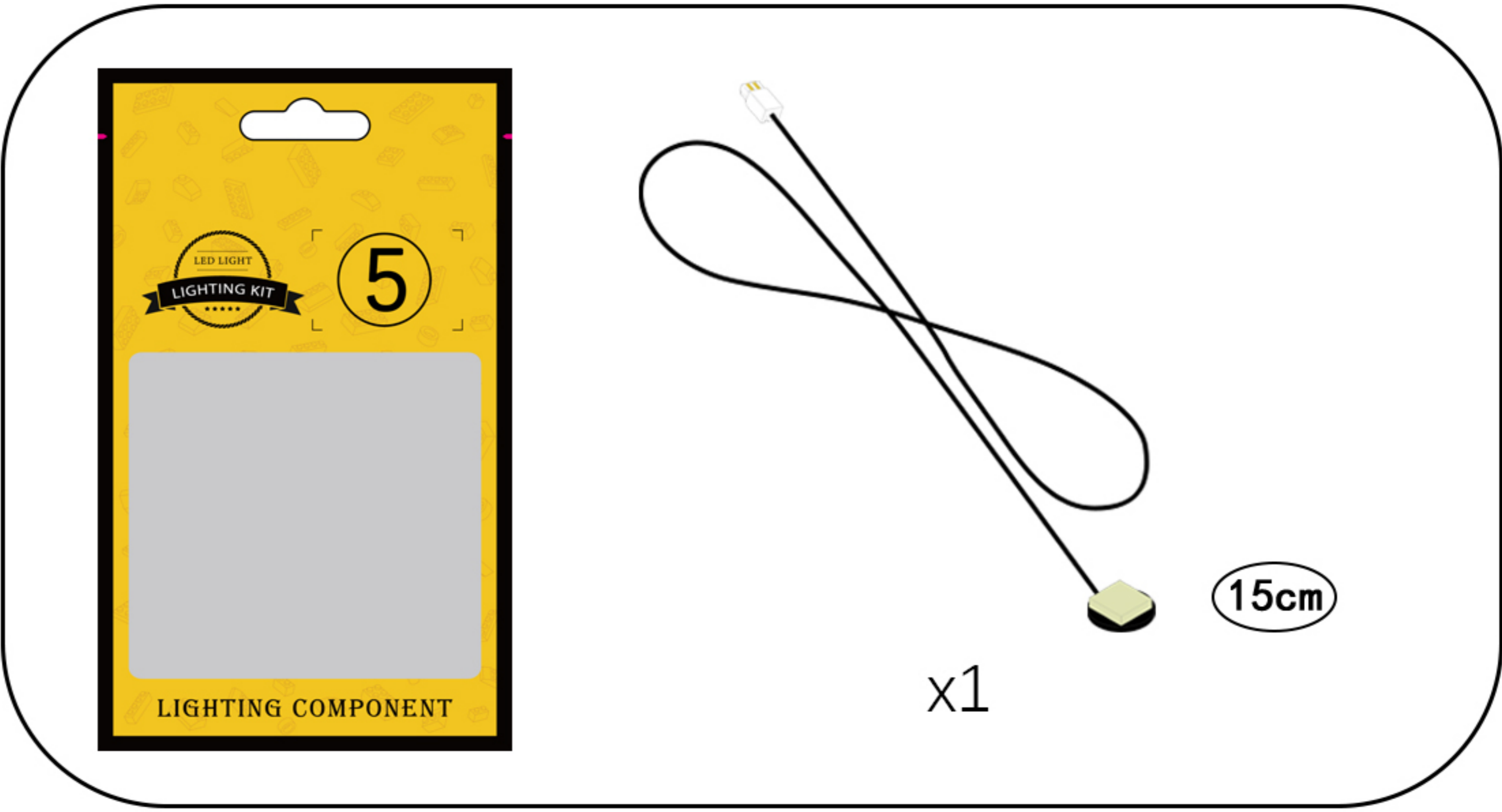

48

EN: Follow these steps in order.

DE: Befolgen Sie diese Schritte der Reihe nach.

- ①. Thread the light beads through the holes in the building blocks.

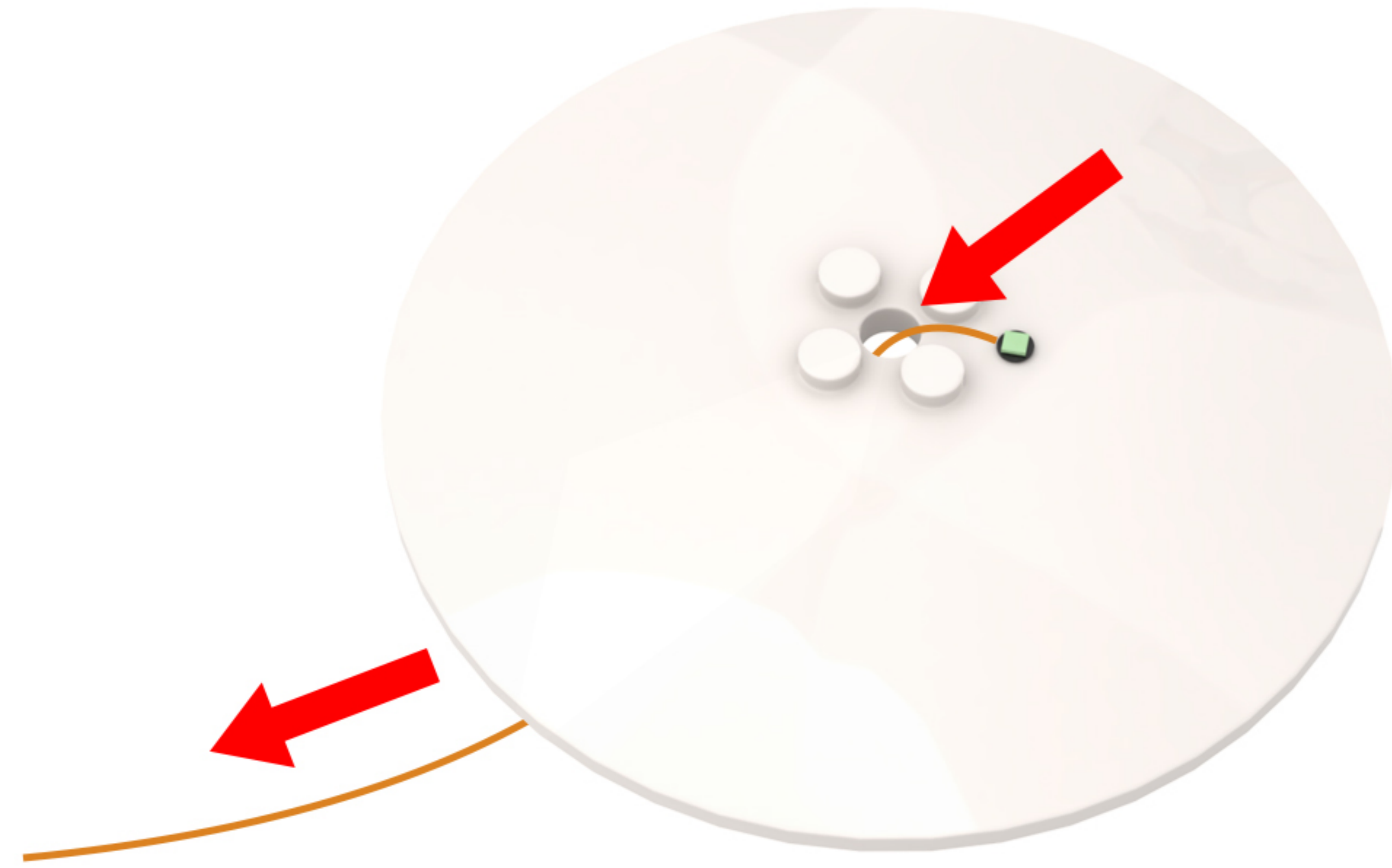

- ②. Take out the disassembled building blocks and reassemble them.

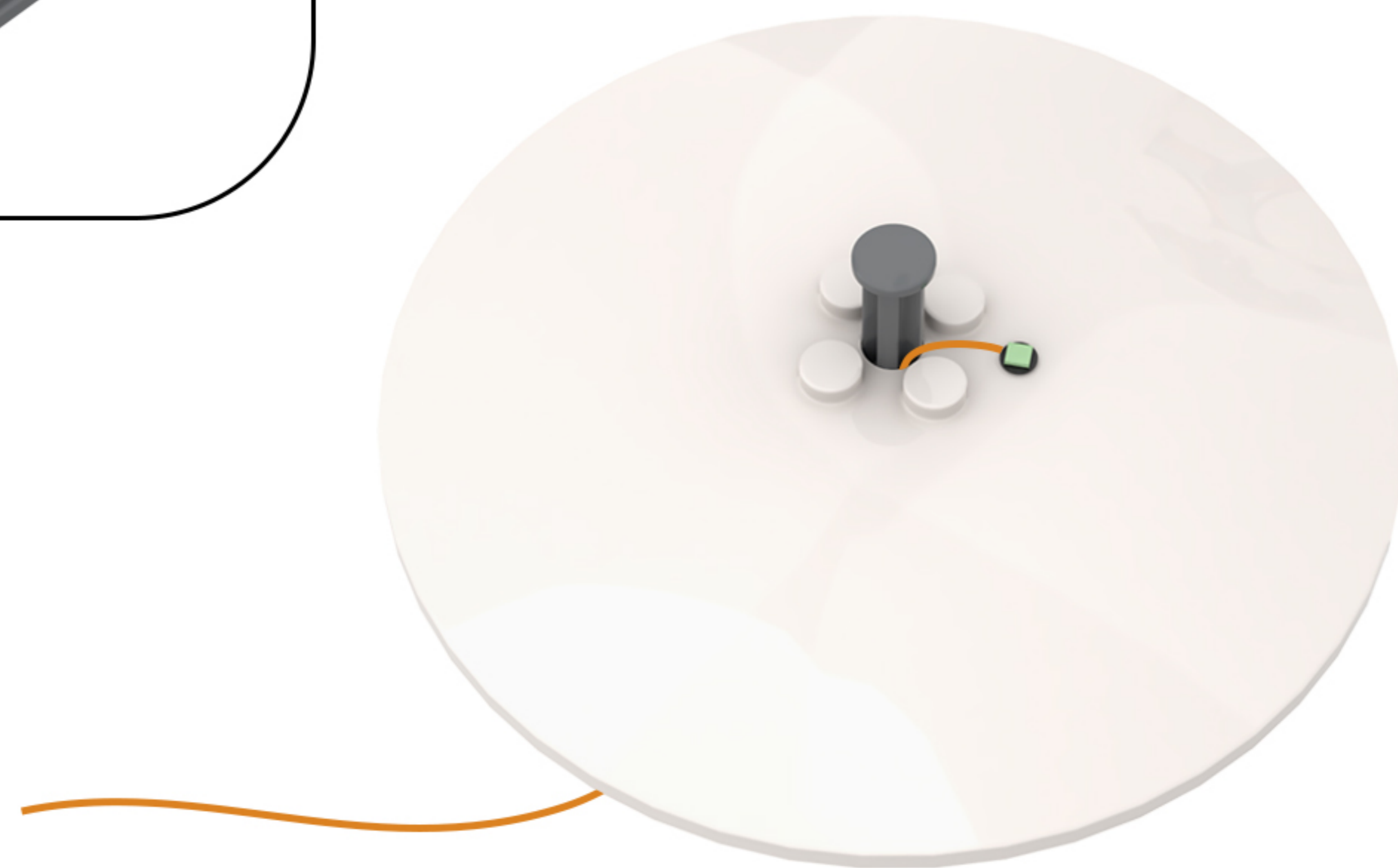

**Note:** When reassembling, make sure to route the light cord through the groove in the cross shaft.

- ③. After reattaching the building block to its original position, place the light fixture on top of it.

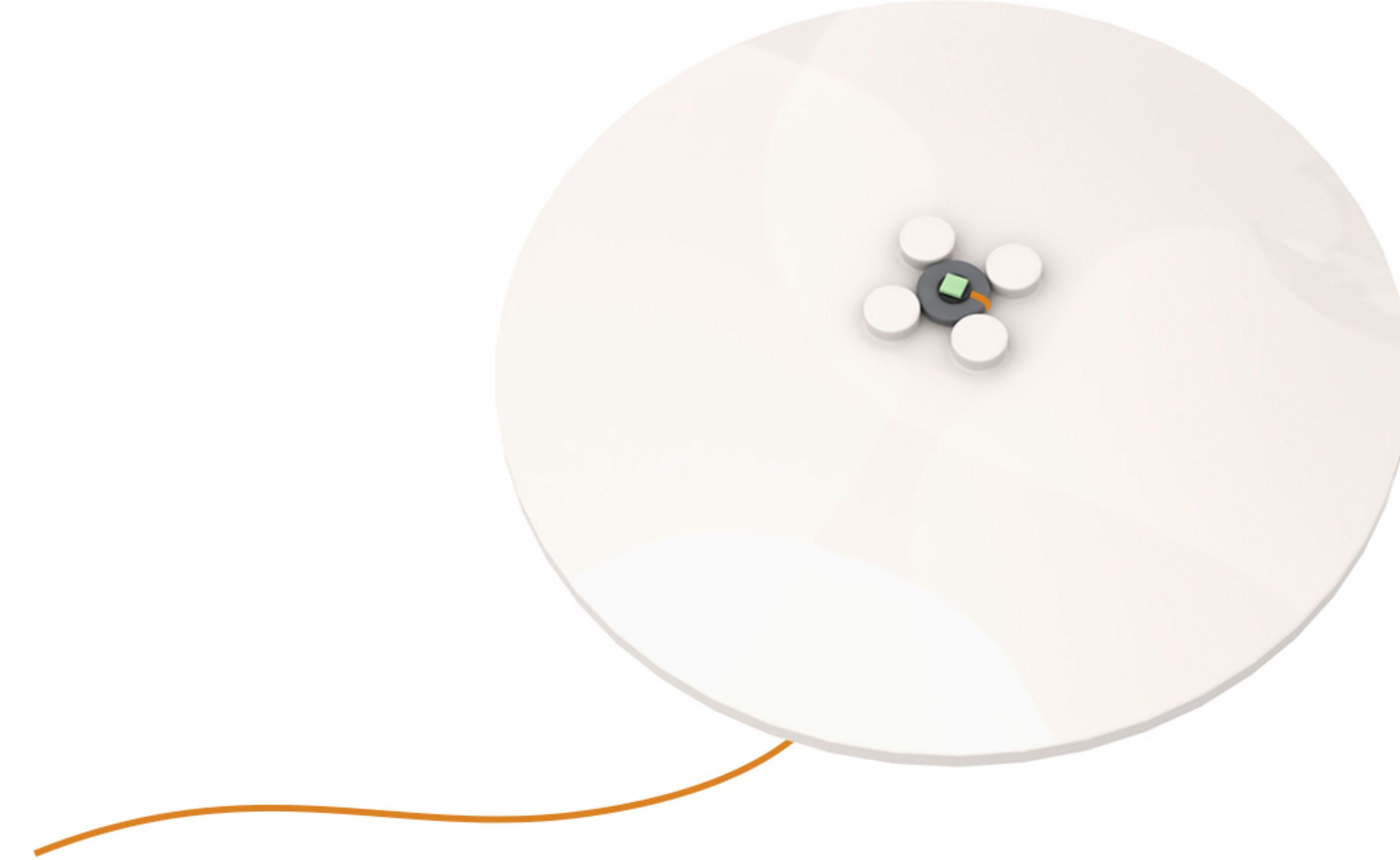

- ④. Attach the 2×2 round plate to the building block.

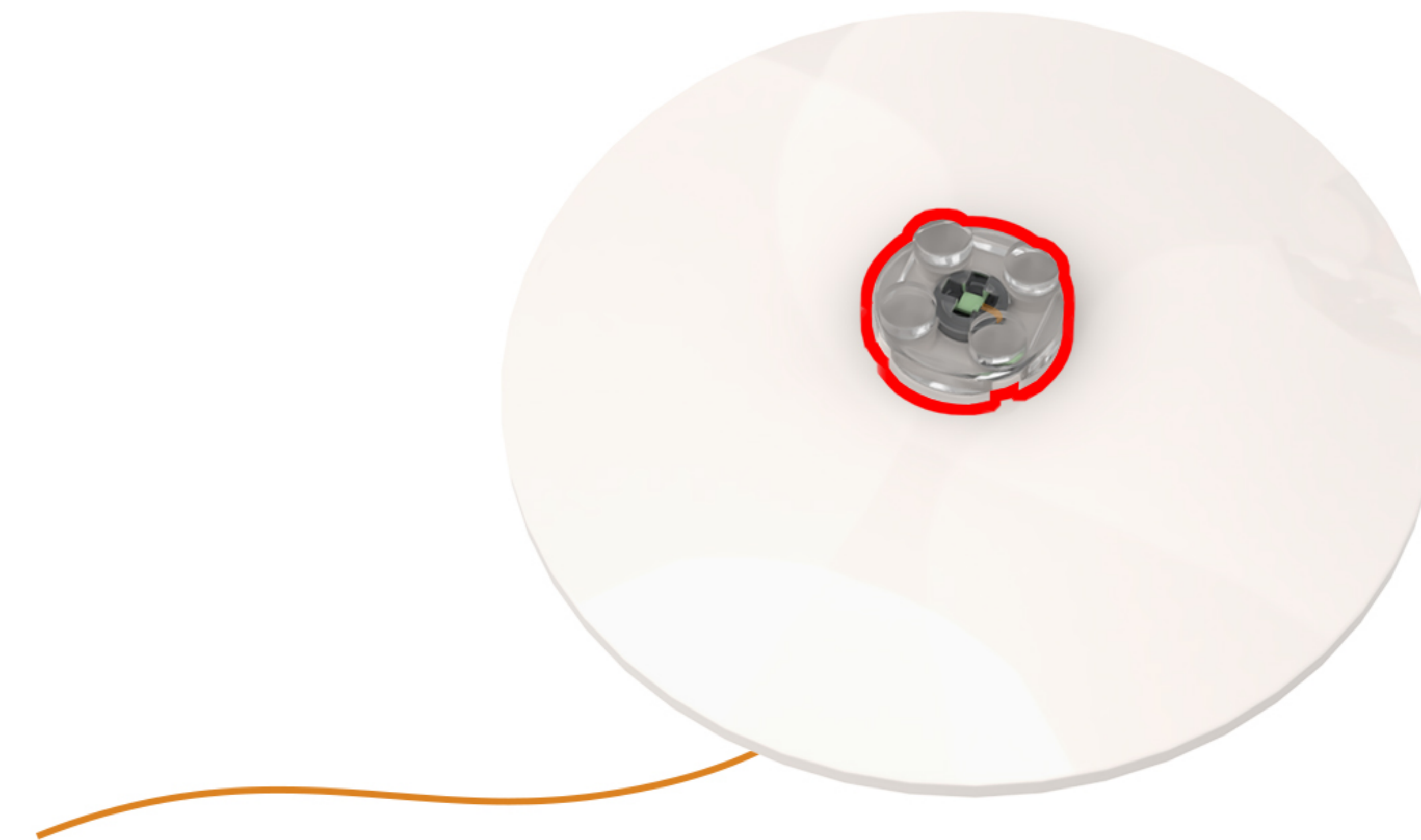

**49** EN: Follow these steps in order.  
DE: Befolgen Sie diese Schritte der Reihe nach.

⑤. Flip the model.

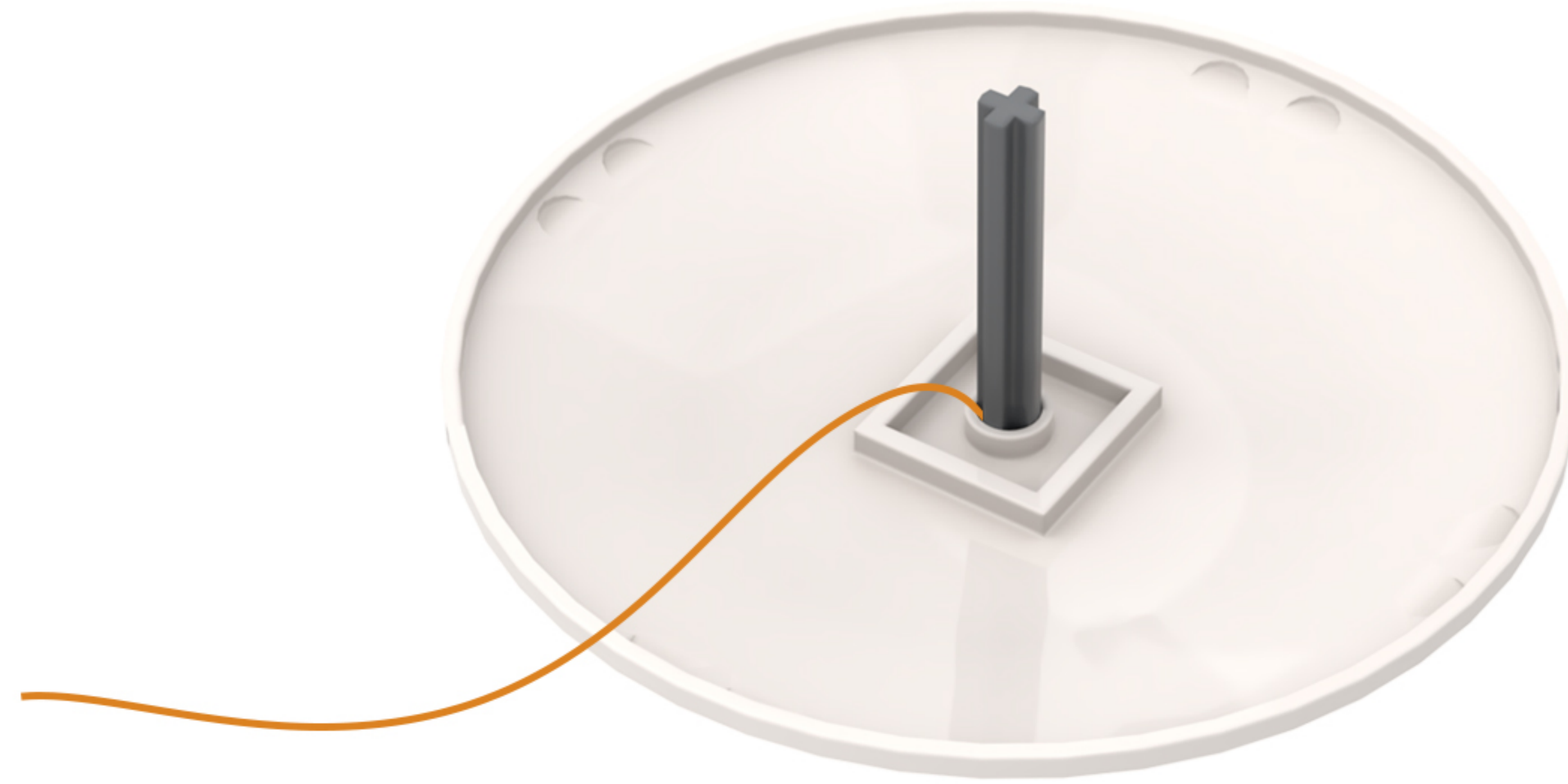
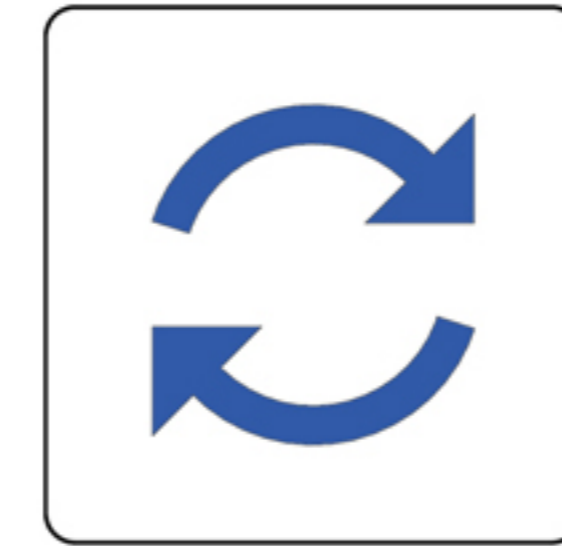

⑥. Take out the disassembled building blocks and reassemble them.

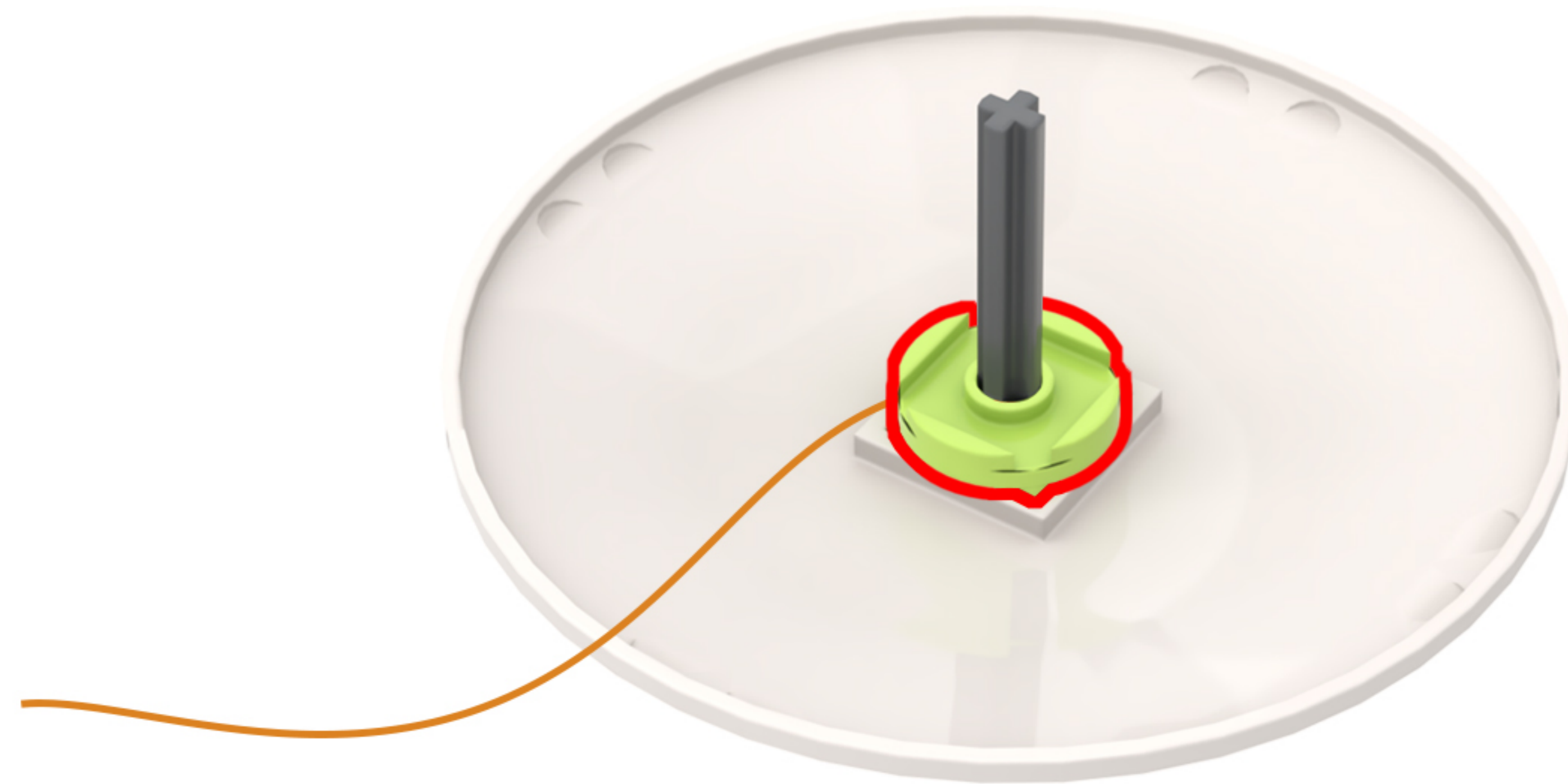
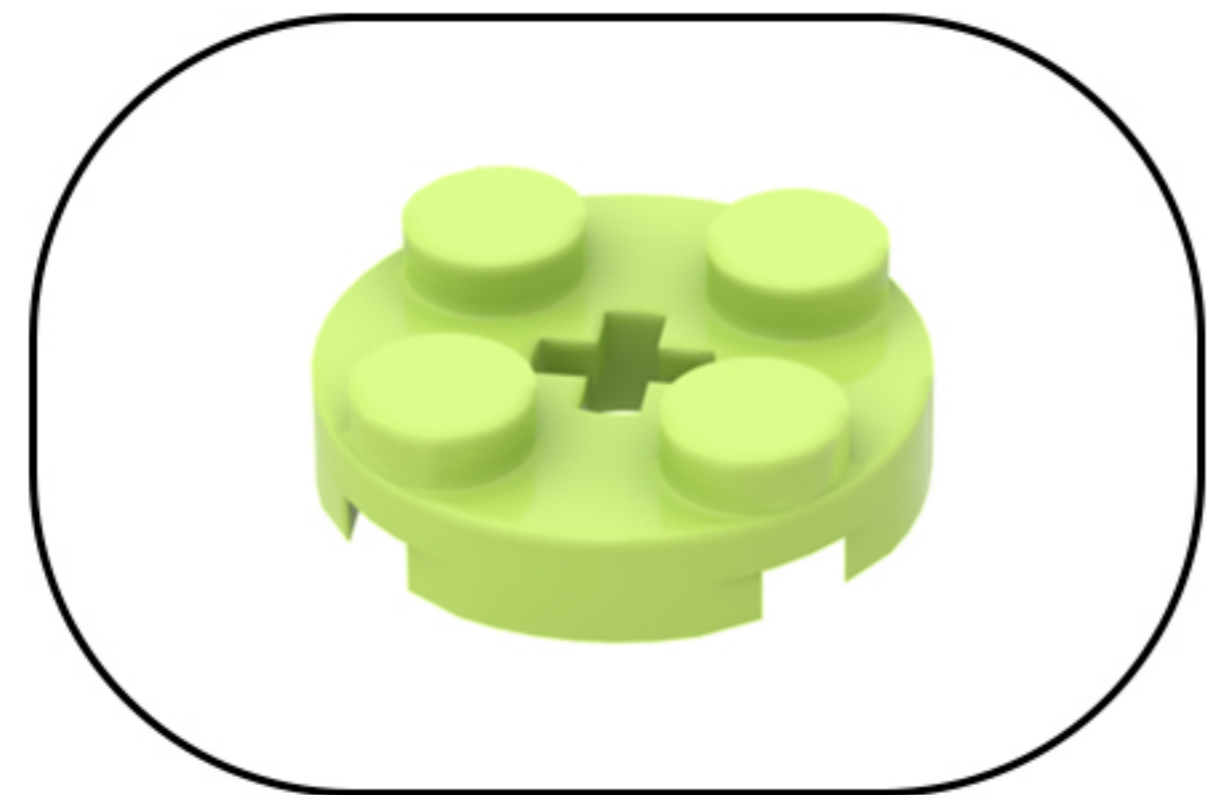

**50** EN: Restore the building blocks.  
DE: Stellen Sie die Bausteine wieder her.

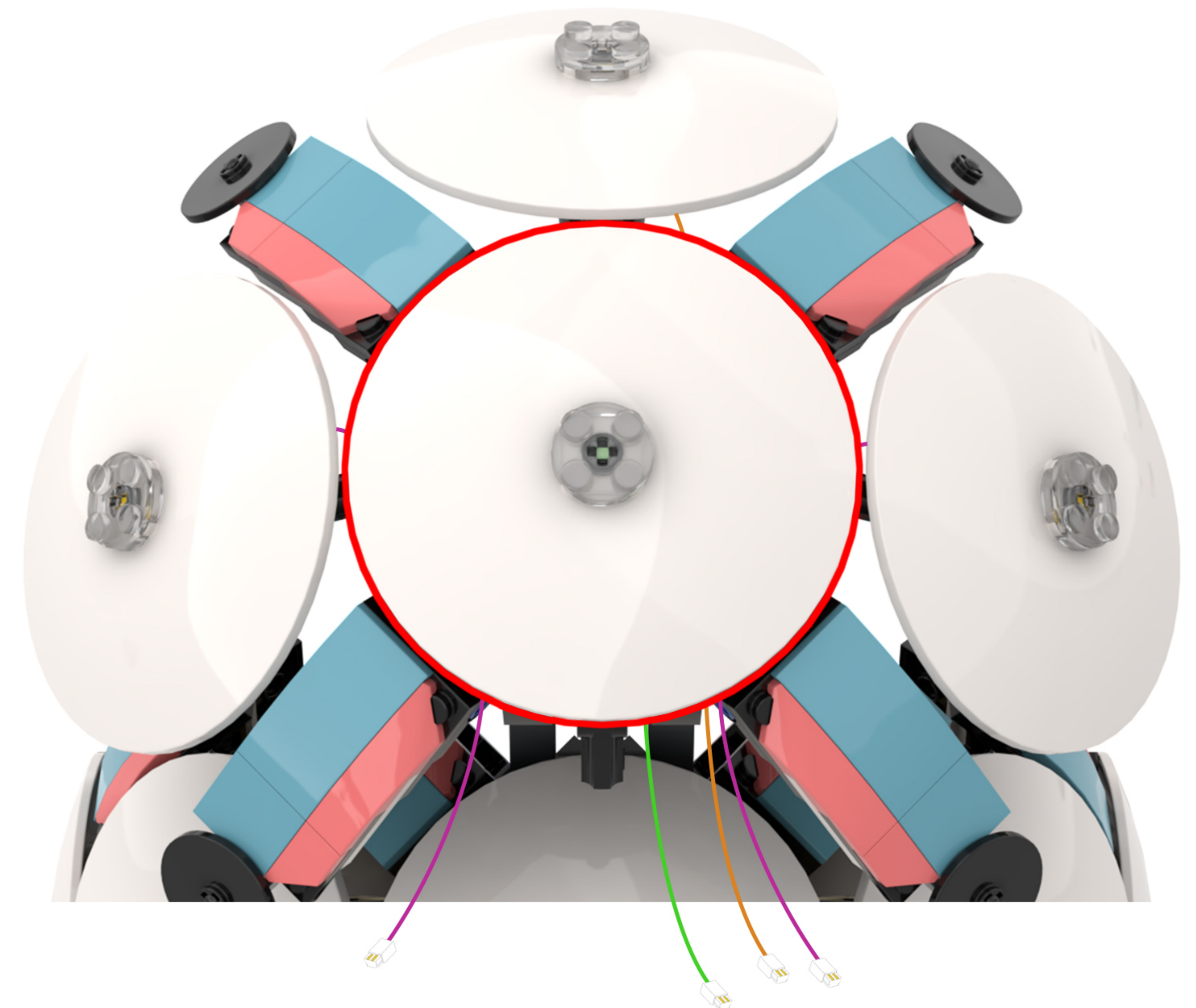

51

EN: Take the expansion board out of Bag No. 9 and connect the four light wires to the expansion board one by one.

DE: Nehmen Sie die Erweiterungsplatine aus Beutel Nr. 9 heraus und schließen Sie die vier Lichtkabel nacheinander an die Erweiterungsplatine an.

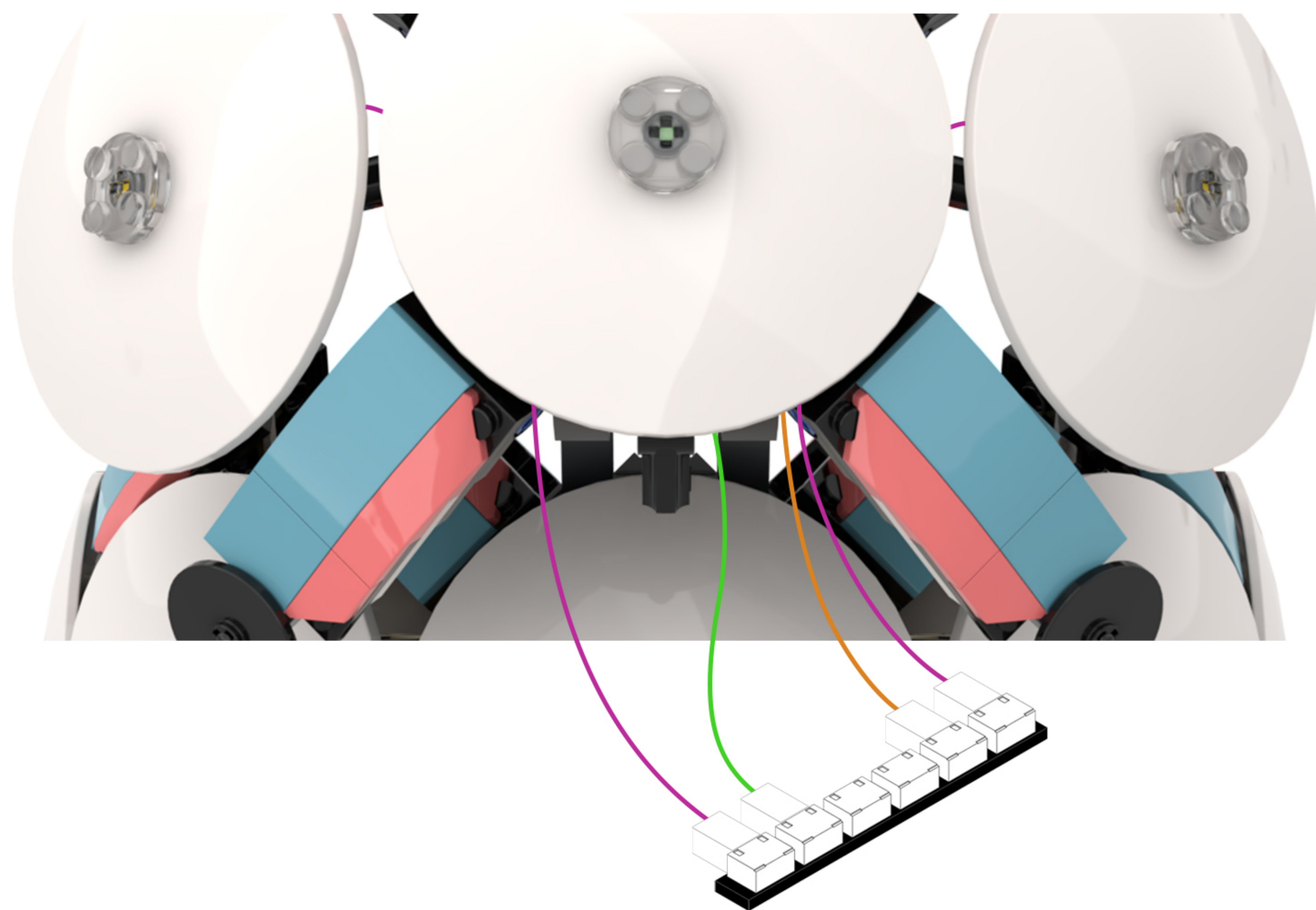
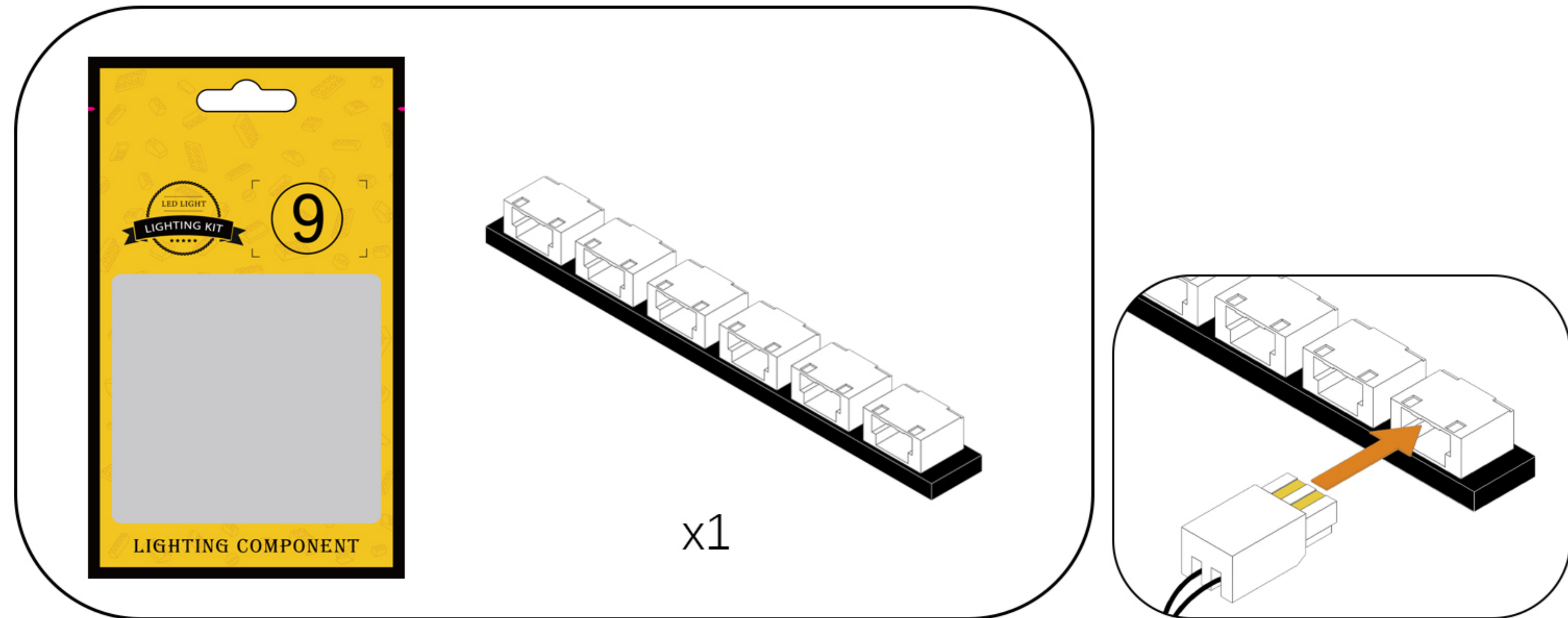

52

EN: Take the connecting cable from Bag No. 8 and connect it to the expansion board.

DE: Nehmen Sie das Verbindungskabel aus Beutel Nr. 8 und schließen Sie es an die Erweiterungskarte an.

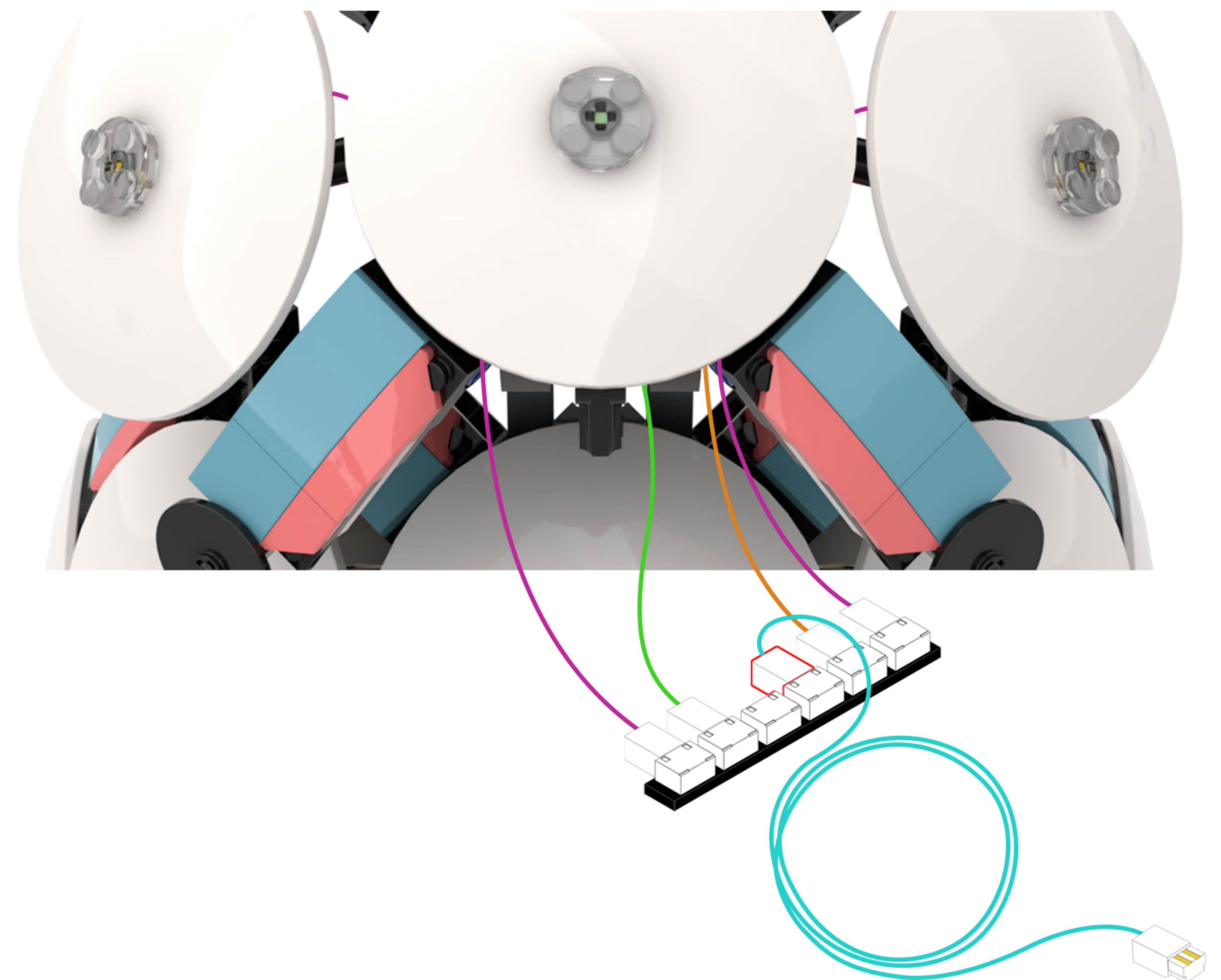
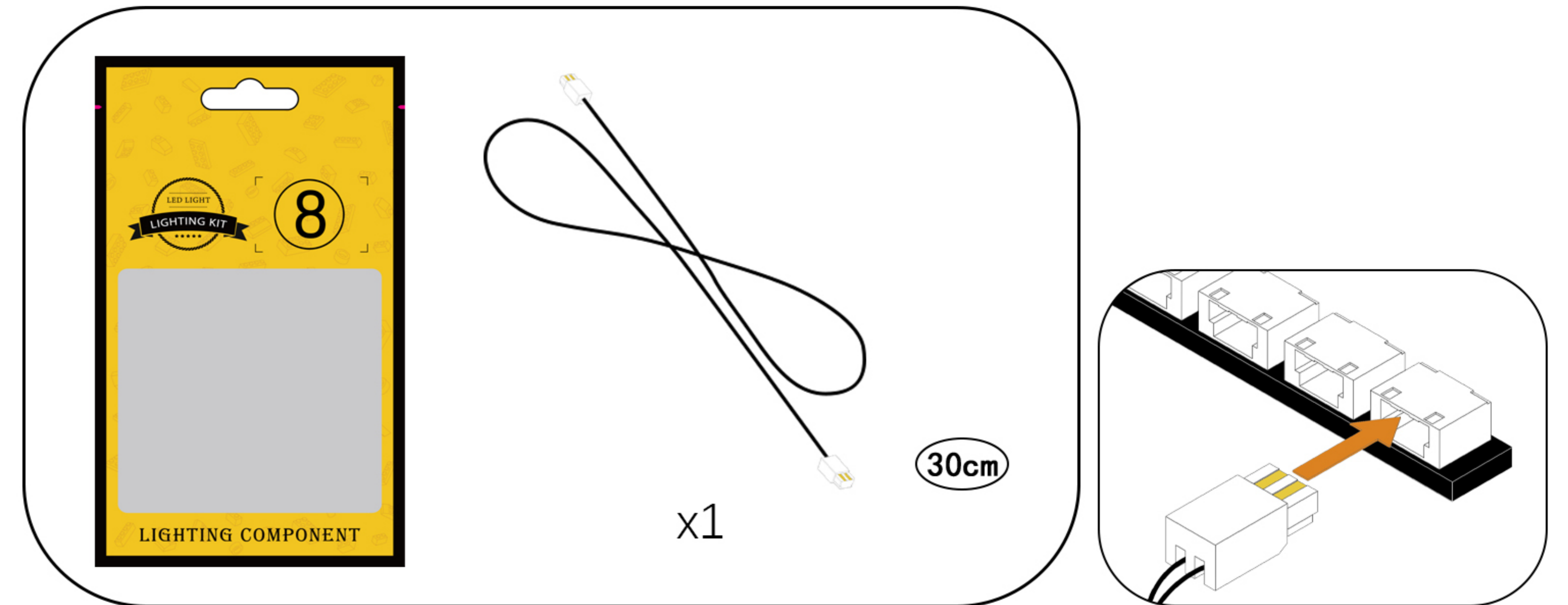

53

EN: Take out the building block with the lights attached and connect its wires to the expansion board.

DE: Nehmen Sie den Baustein mit den daran befestigten Leuchten heraus und schließen Sie dessen Kabel an die Erweiterungsplatine an.

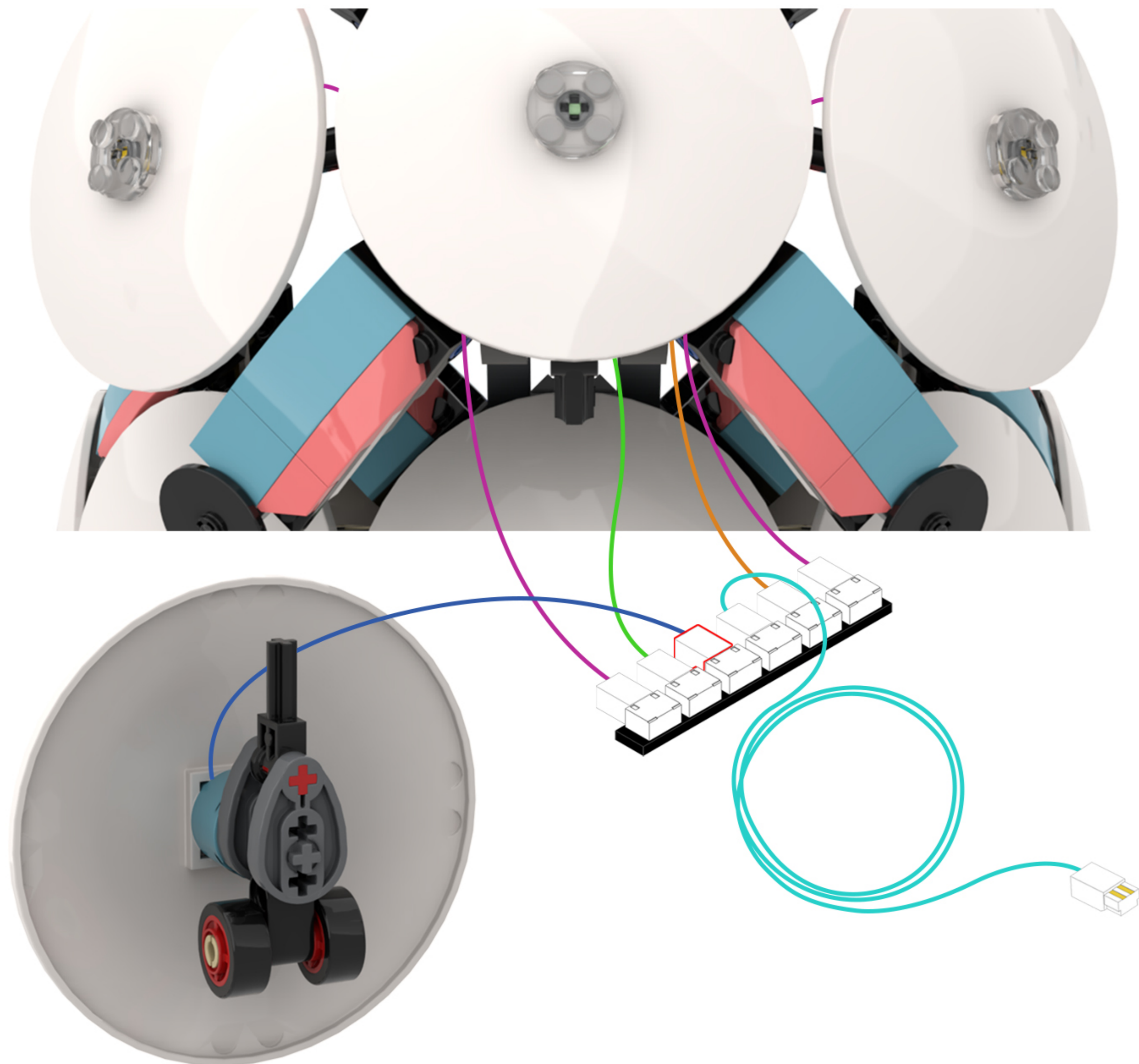
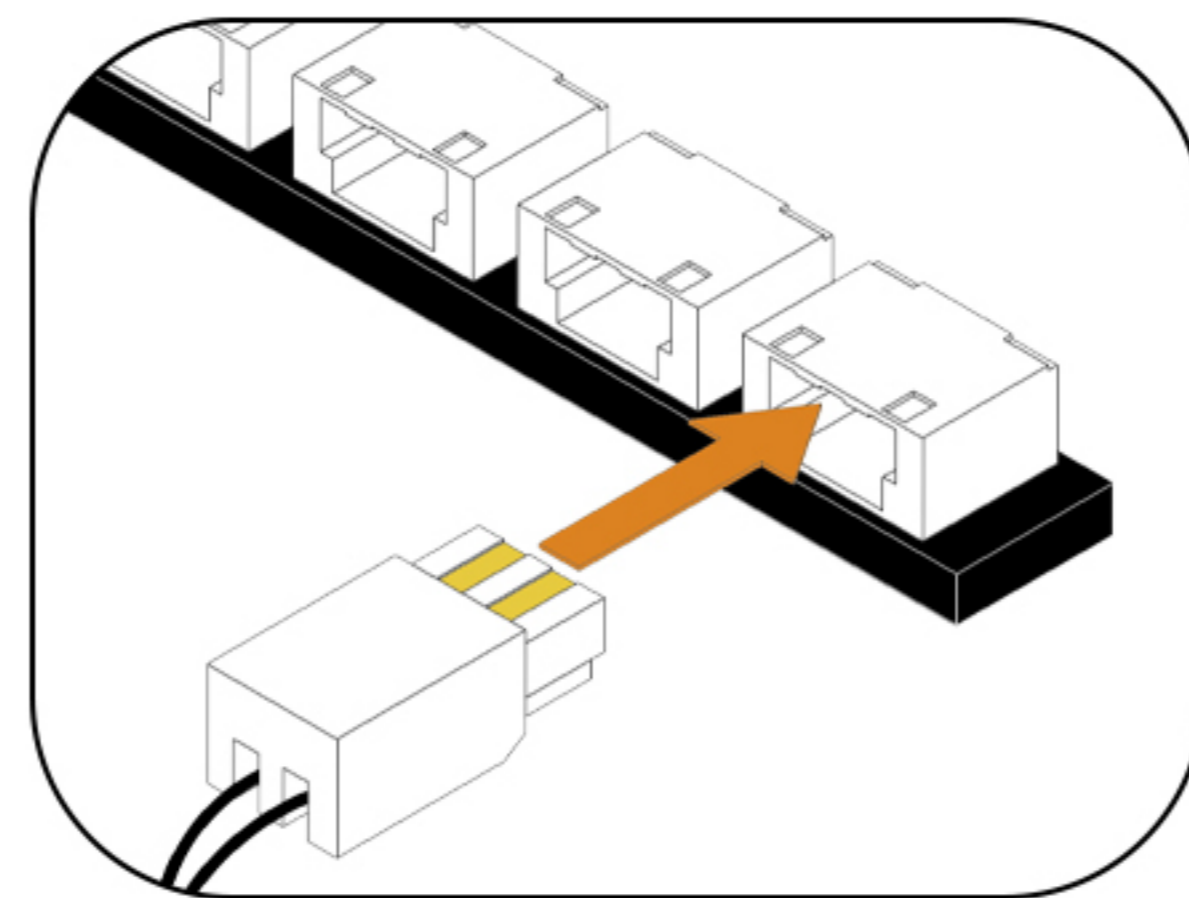
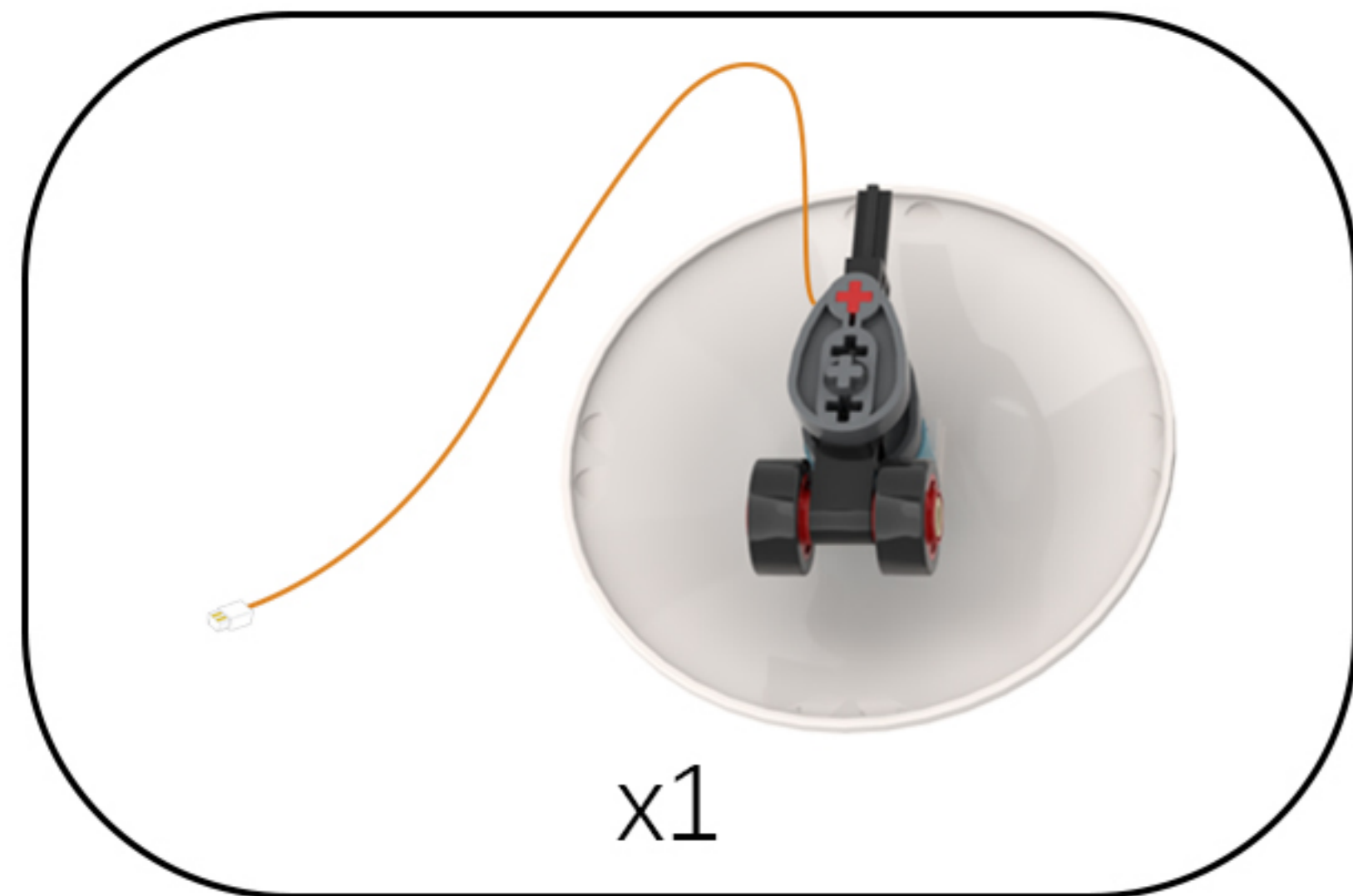

54

EN: Peel off the adhesive backing of the expansion board and attach it to the location shown in the illustration.

DE: Entfernen Sie die Schutzfolie von der Rückseite der Erweiterungsplatte und kleben Sie sie an die in der Abbildung gezeigte Stelle.

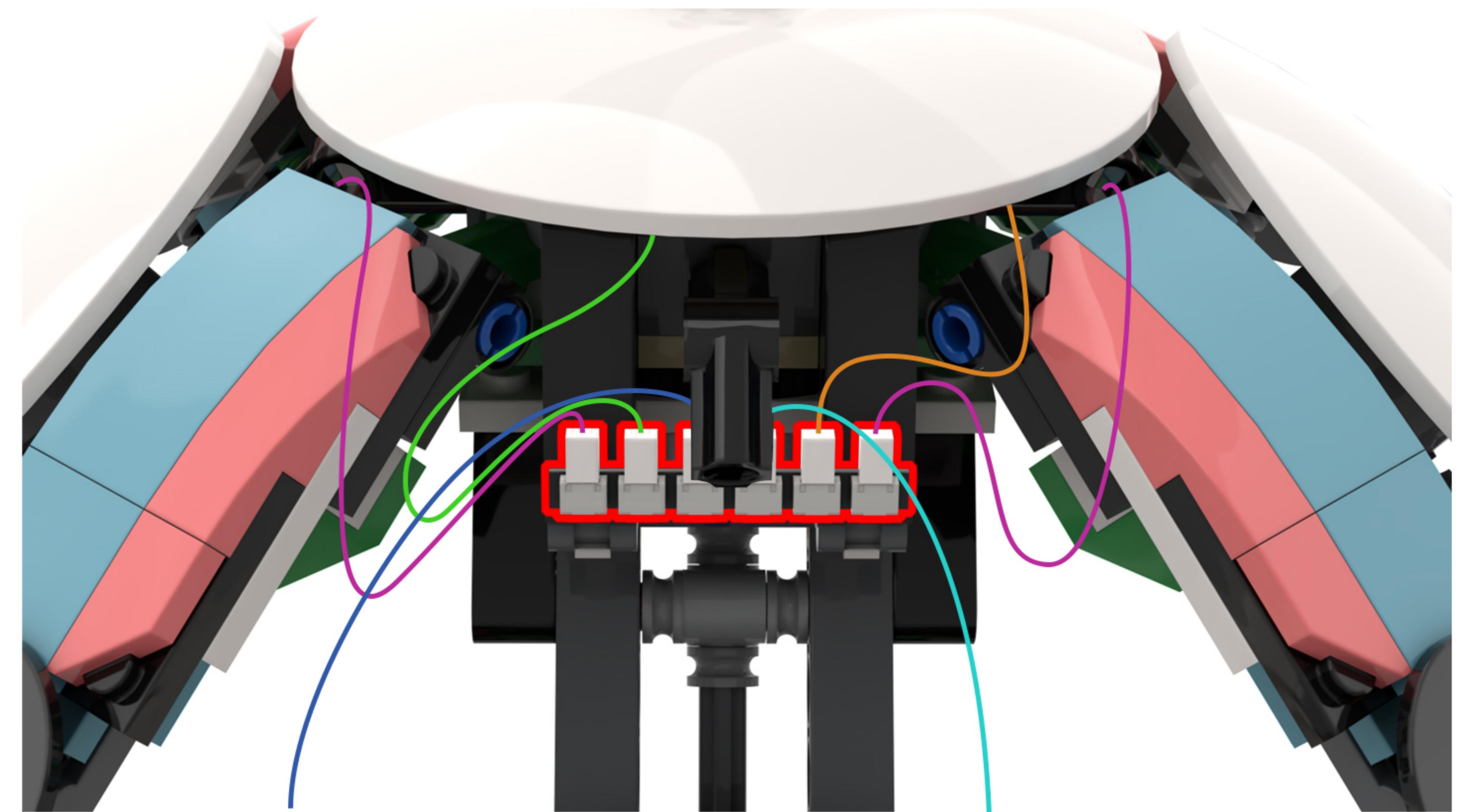
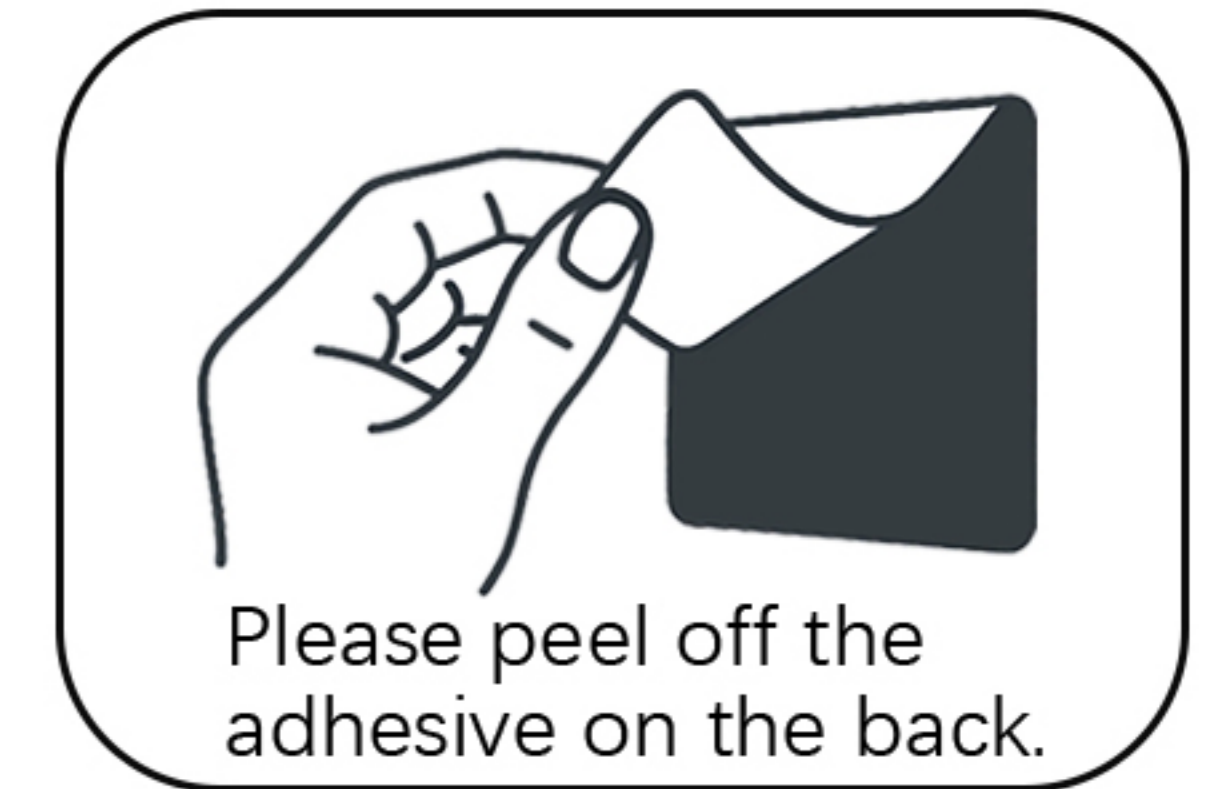

55

EN: Tidy up all the light cords and tuck them into the gaps between the building blocks.

DE: Räume alle Lichtkabel auf und stecke sie in die Lücken zwischen den Bausteinen.

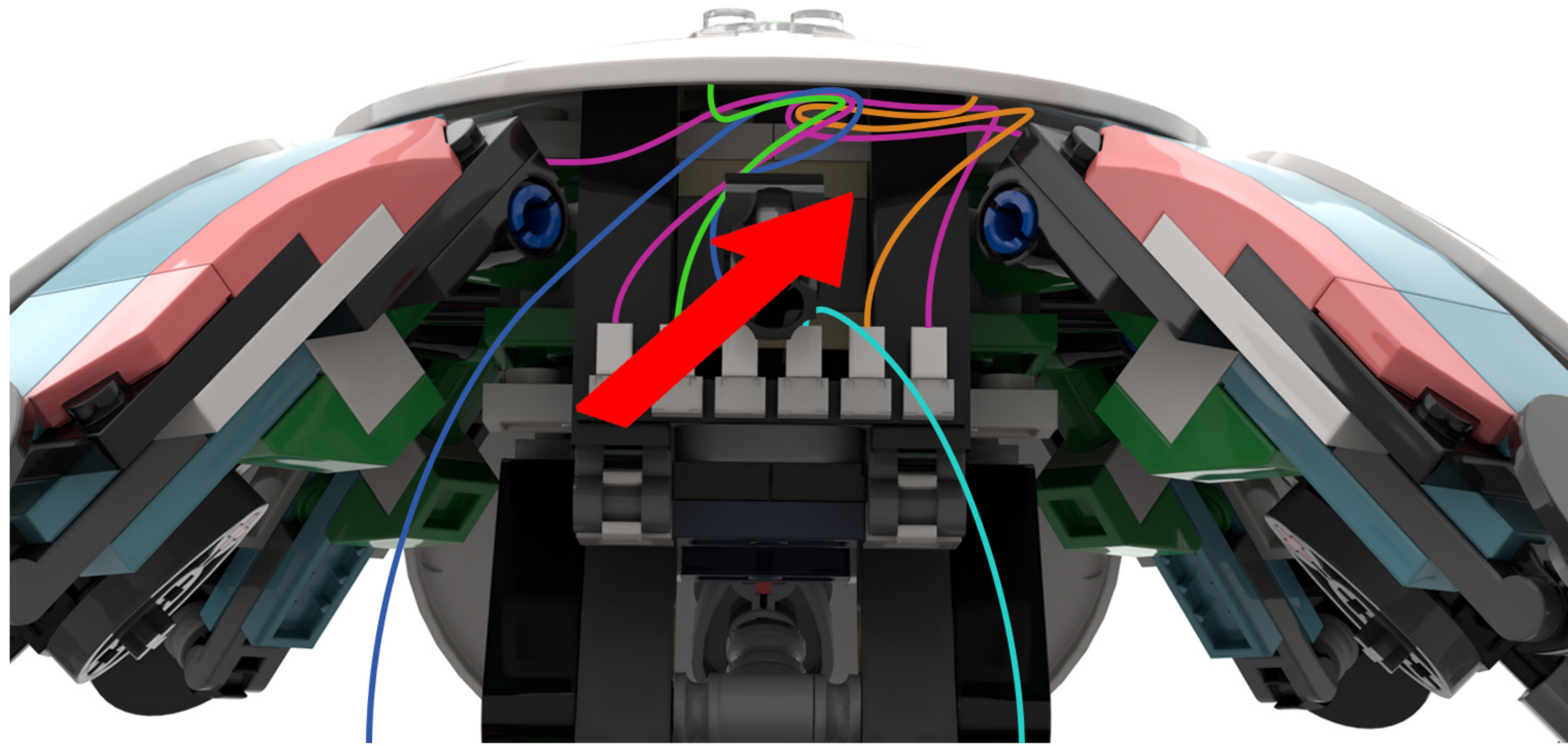

56

EN: Restore the building blocks.

DE: Stellen Sie die Bausteine wieder her.

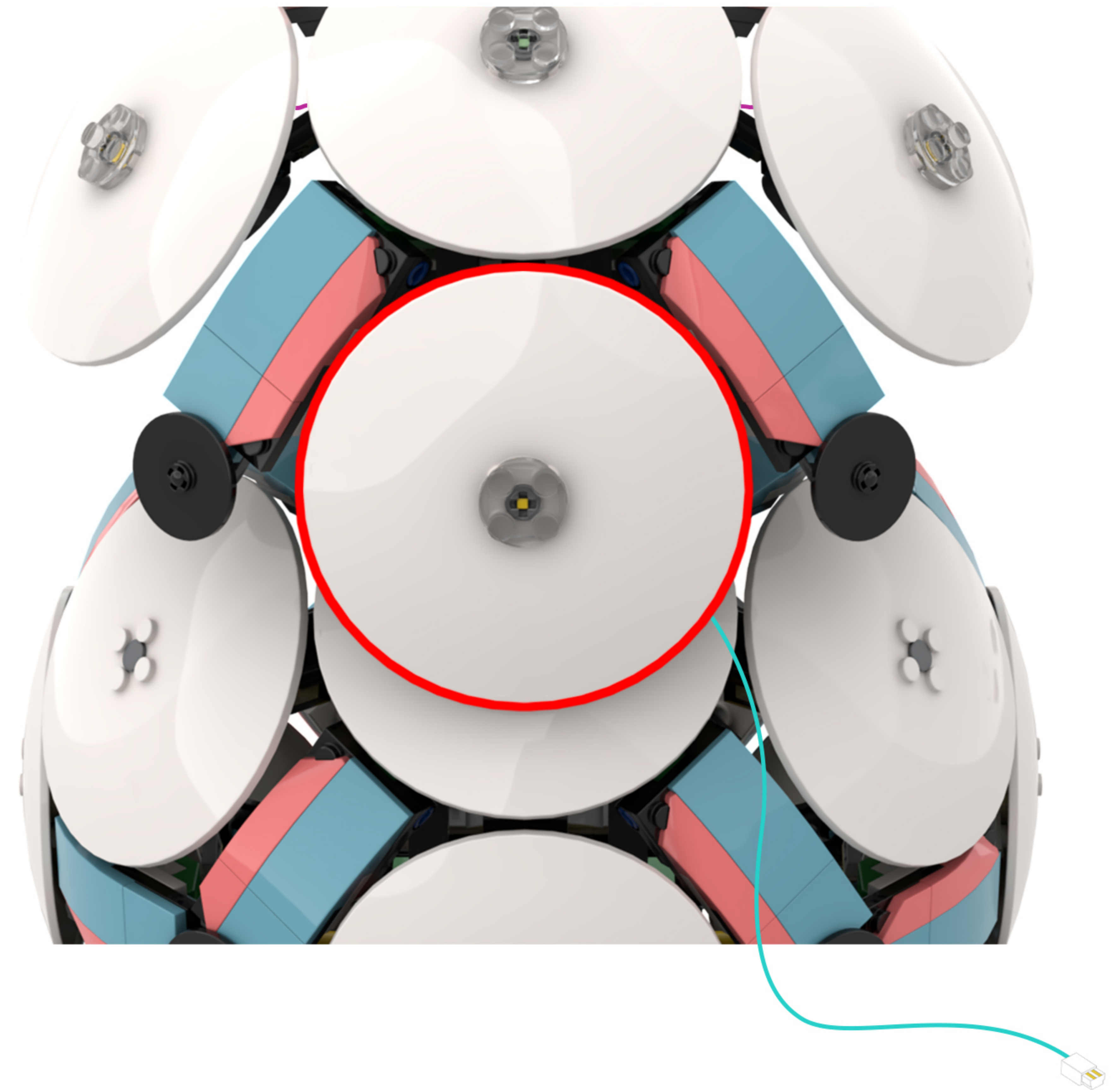

57

EN: Rotate the model to the side.

DE: Drehen Sie das Modell zur Seite.

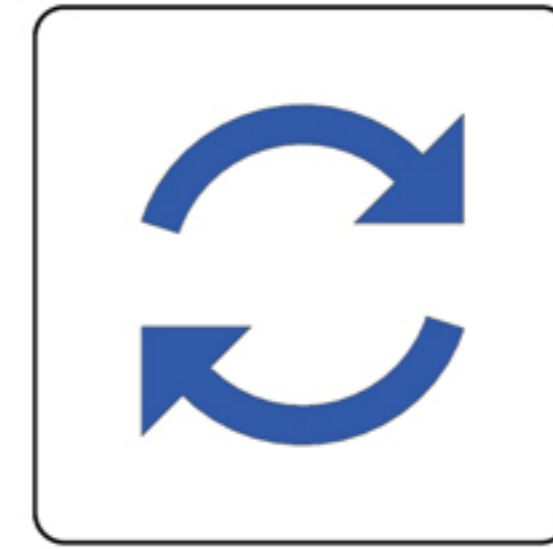

58

EN: Split as shown in the figure.

DE: Wie in der Abbildung gezeigt, teilen Sie es auf.



59

EN: Remove the building blocks one by one.  
DE: Entfernen Sie die Bausteine nacheinander.

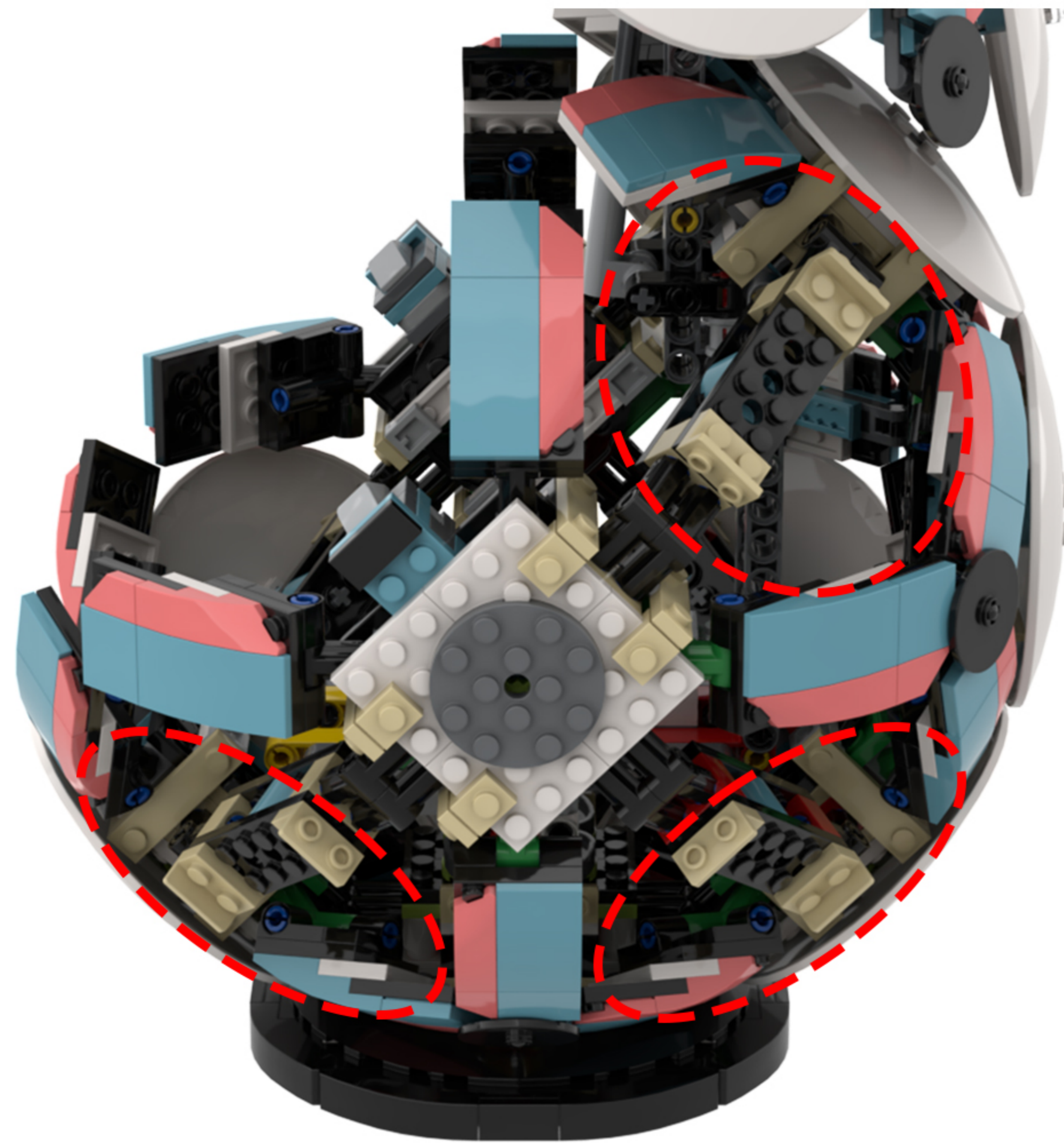
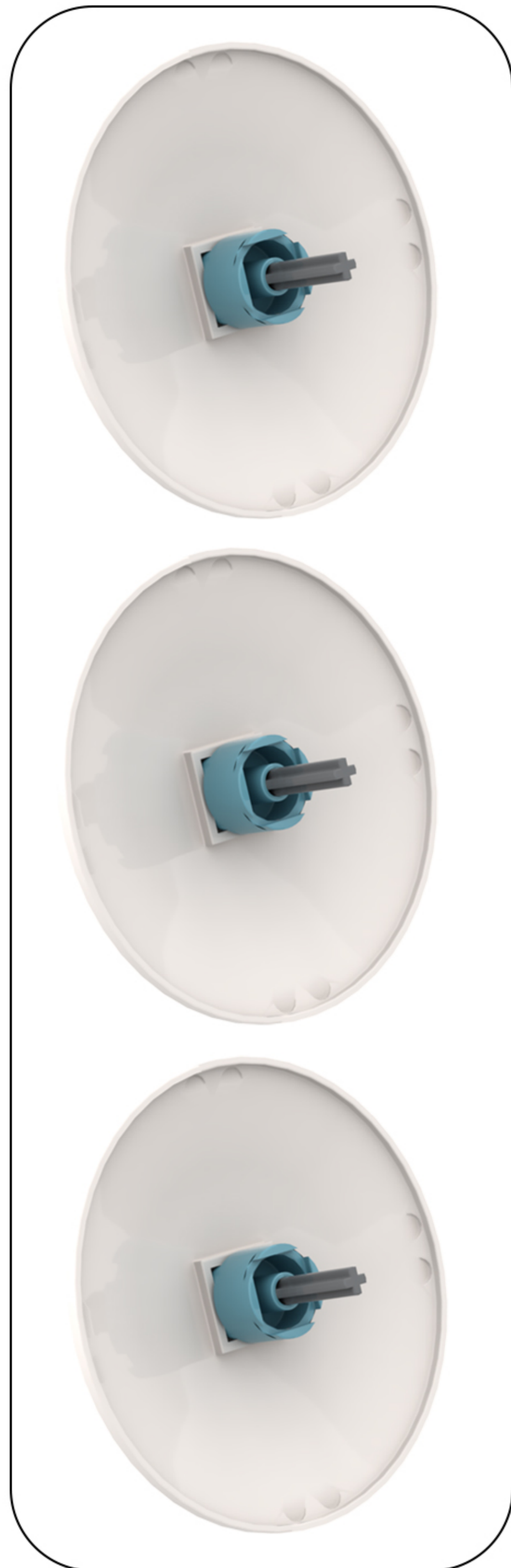

60

EN: Rotate the model to the other side.  
DE: Drehen Sie das Modell auf die andere Seite.

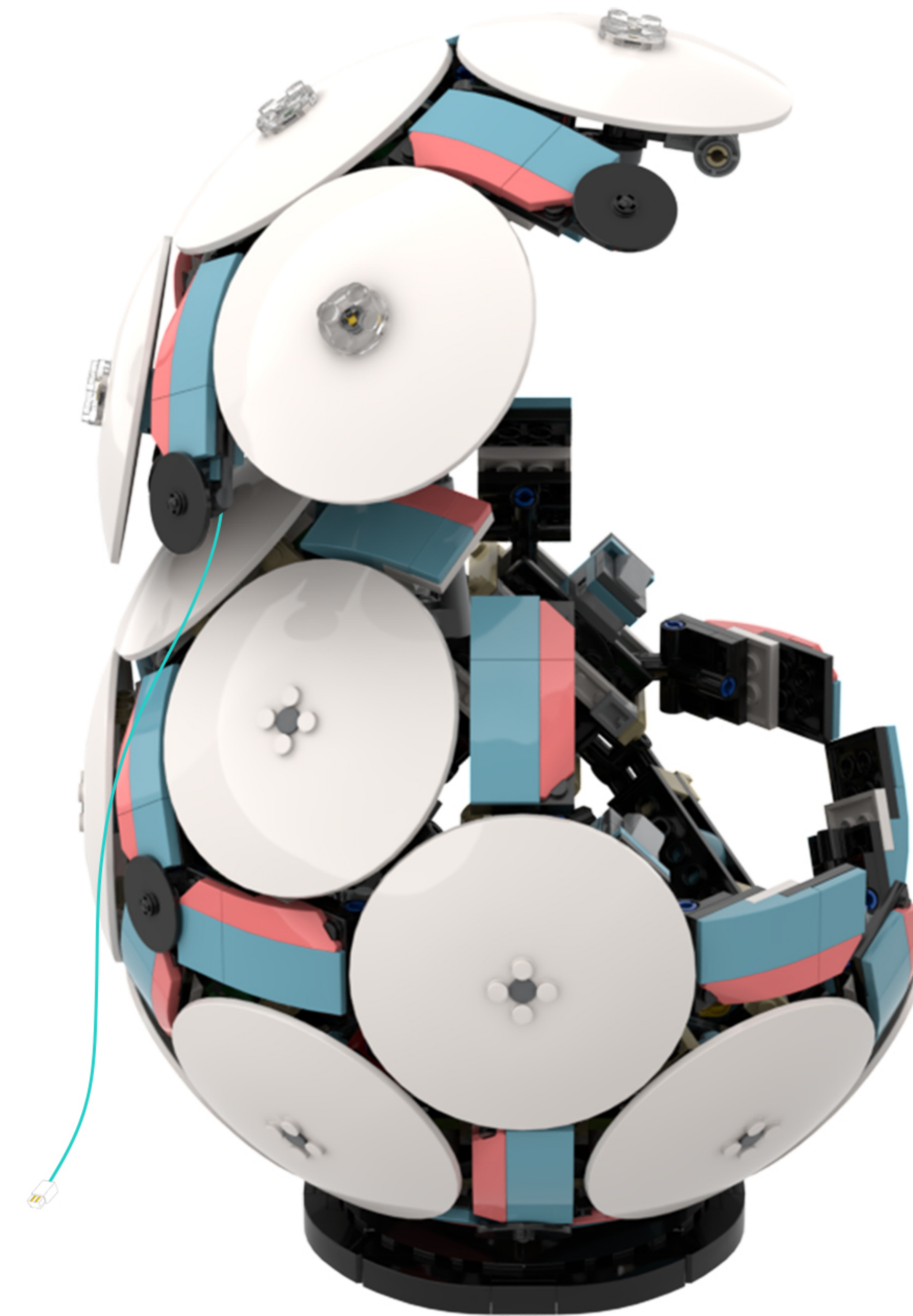

61

EN: Split as shown in the figure.

DE: Wie in der Abbildung gezeigt, teilen Sie es auf.

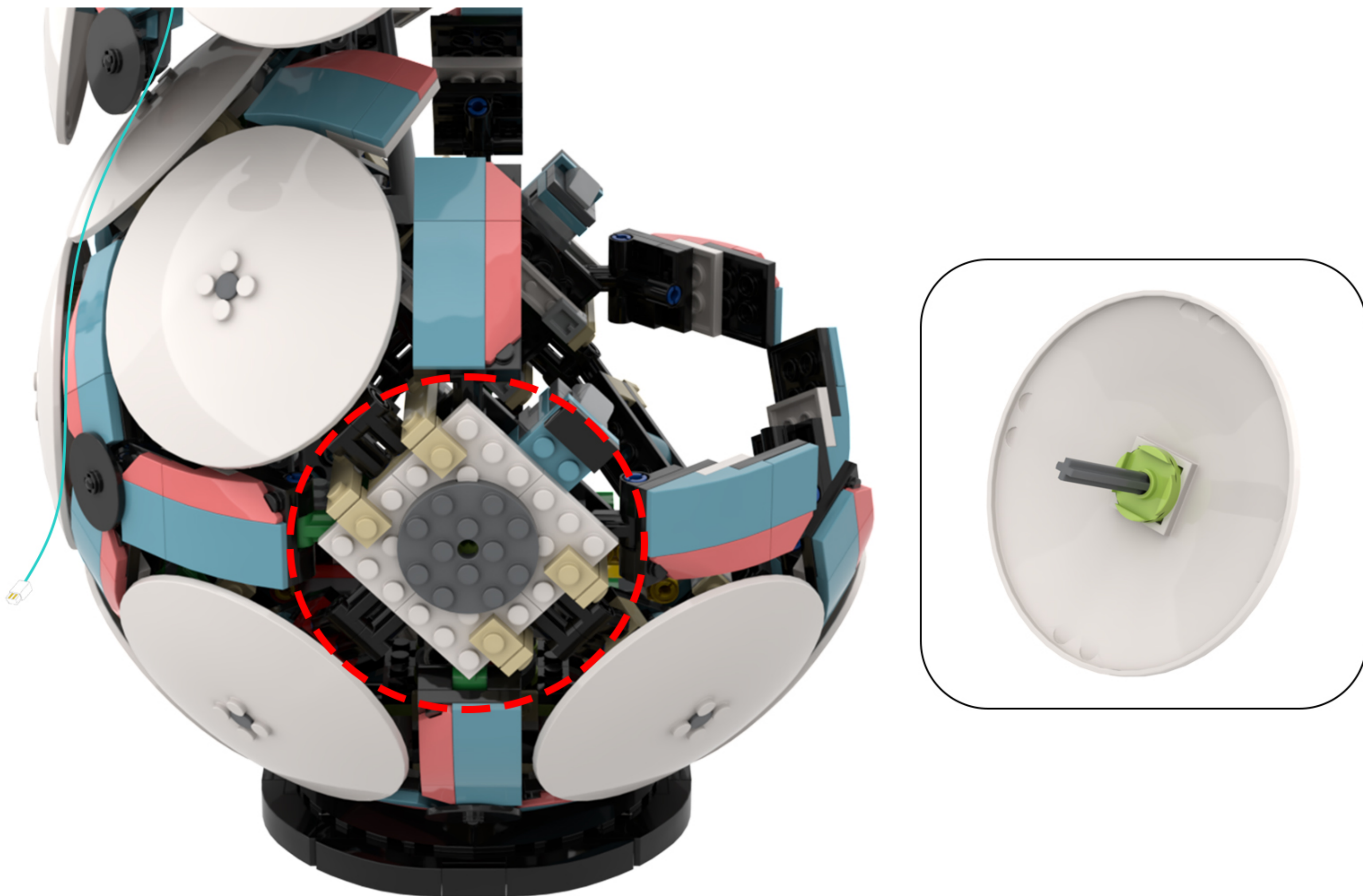

62

EN: Remove the building blocks one by one.

DE: Entfernen Sie die Bausteine nacheinander.

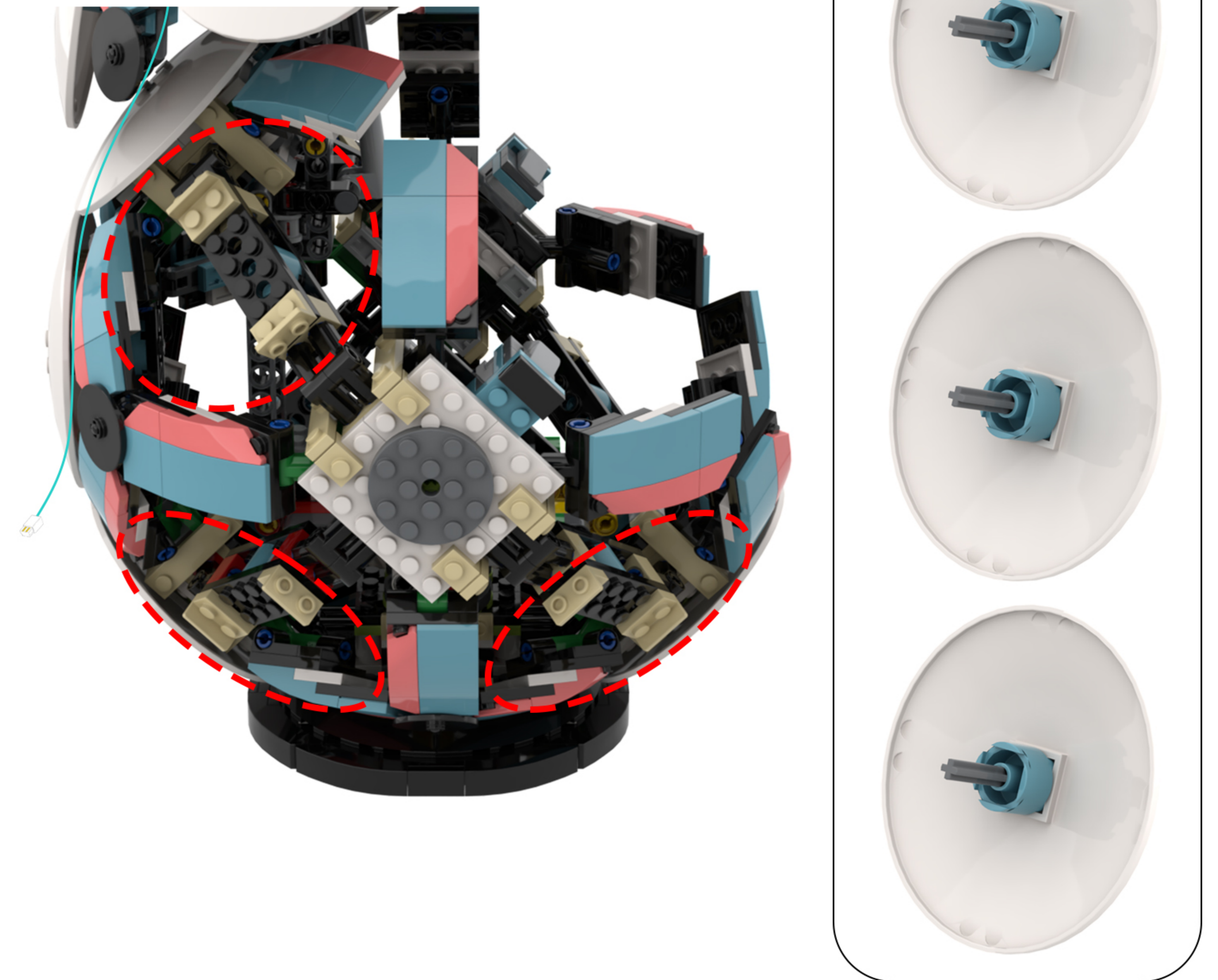

63

EN: Rotate the model to its back side.

DE: Drehen Sie das Modell auf die Rückseite.

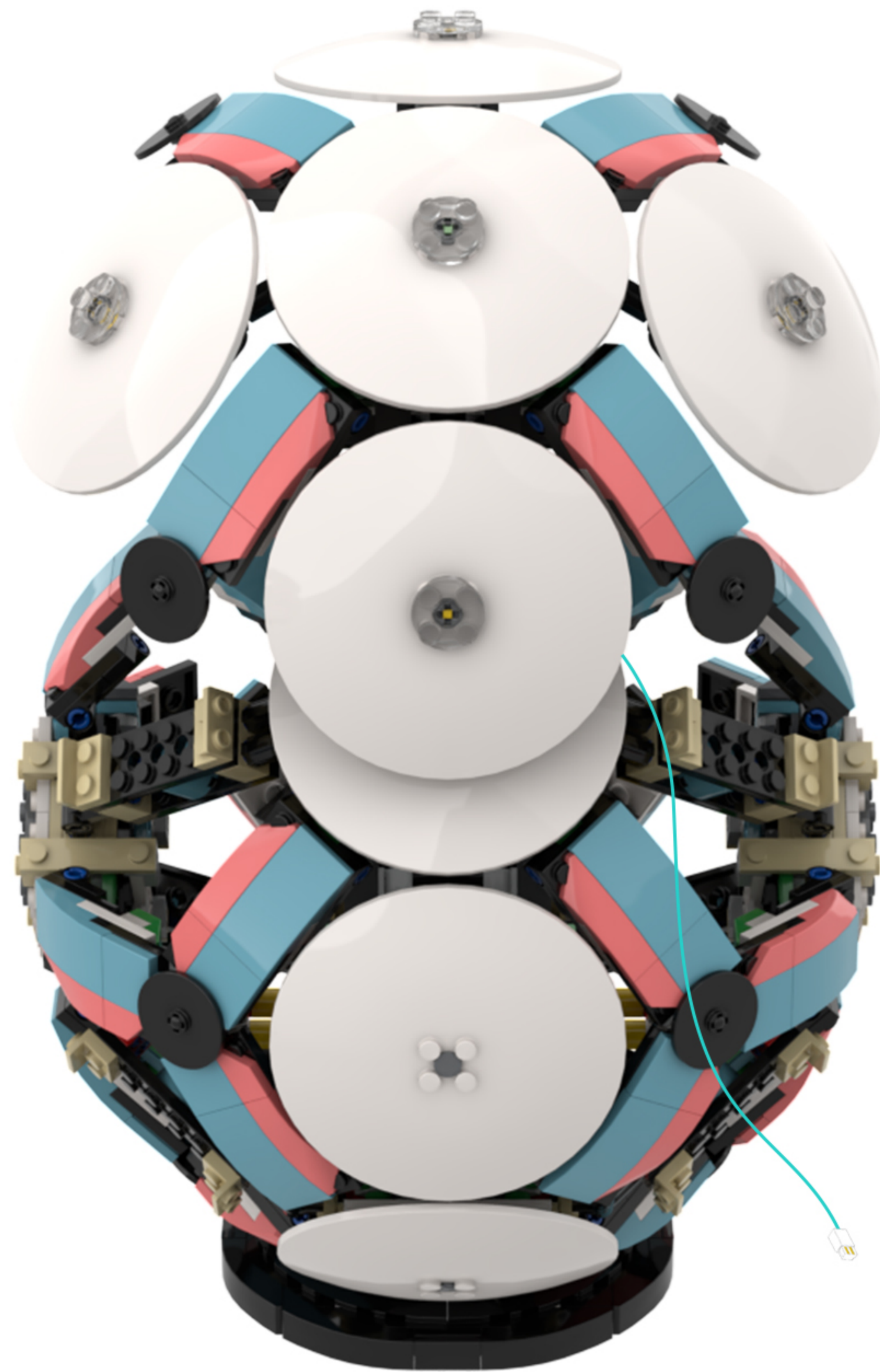
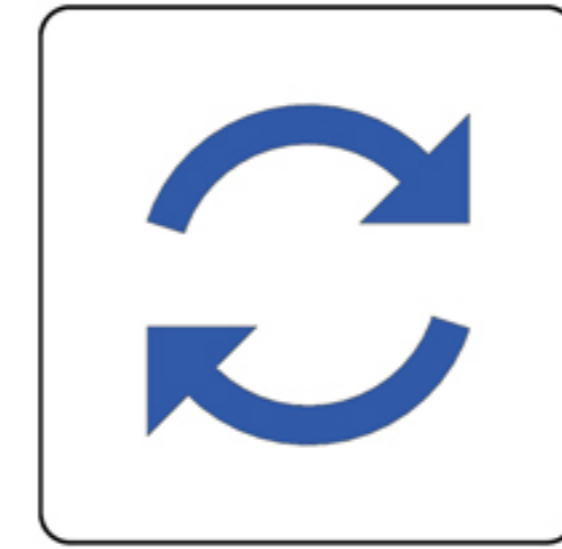

64

EN: Split as shown in the figure.

DE: Wie in der Abbildung gezeigt, teilen Sie es auf.

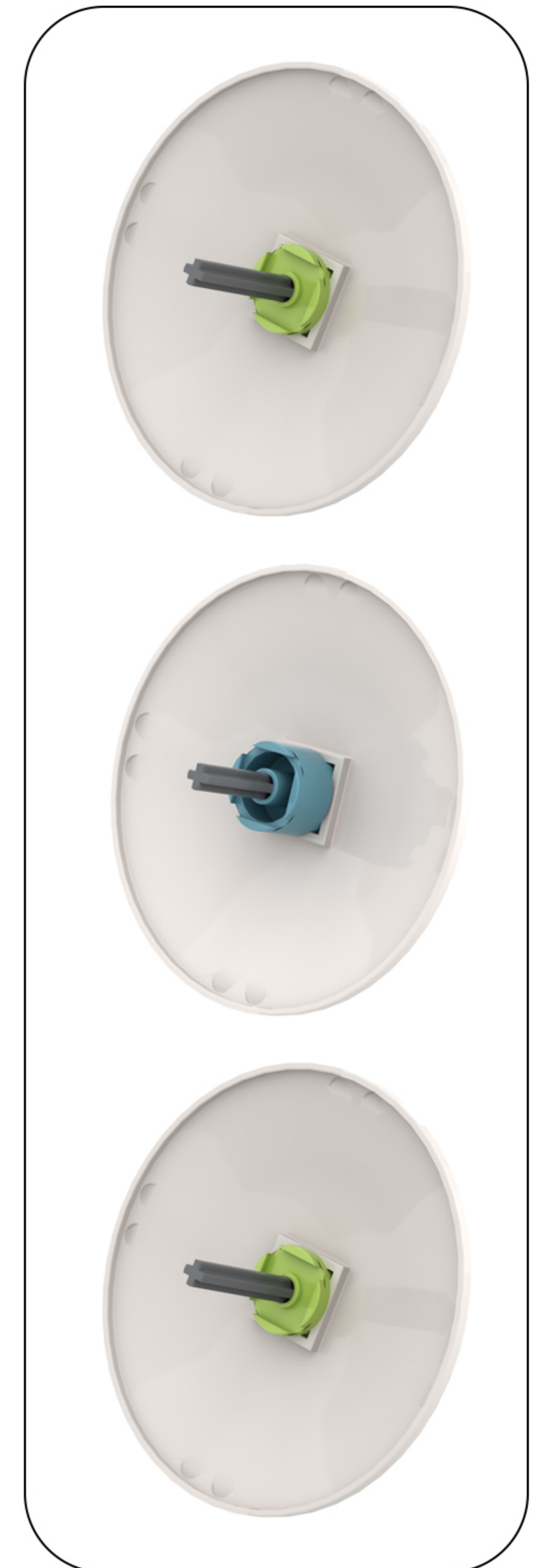
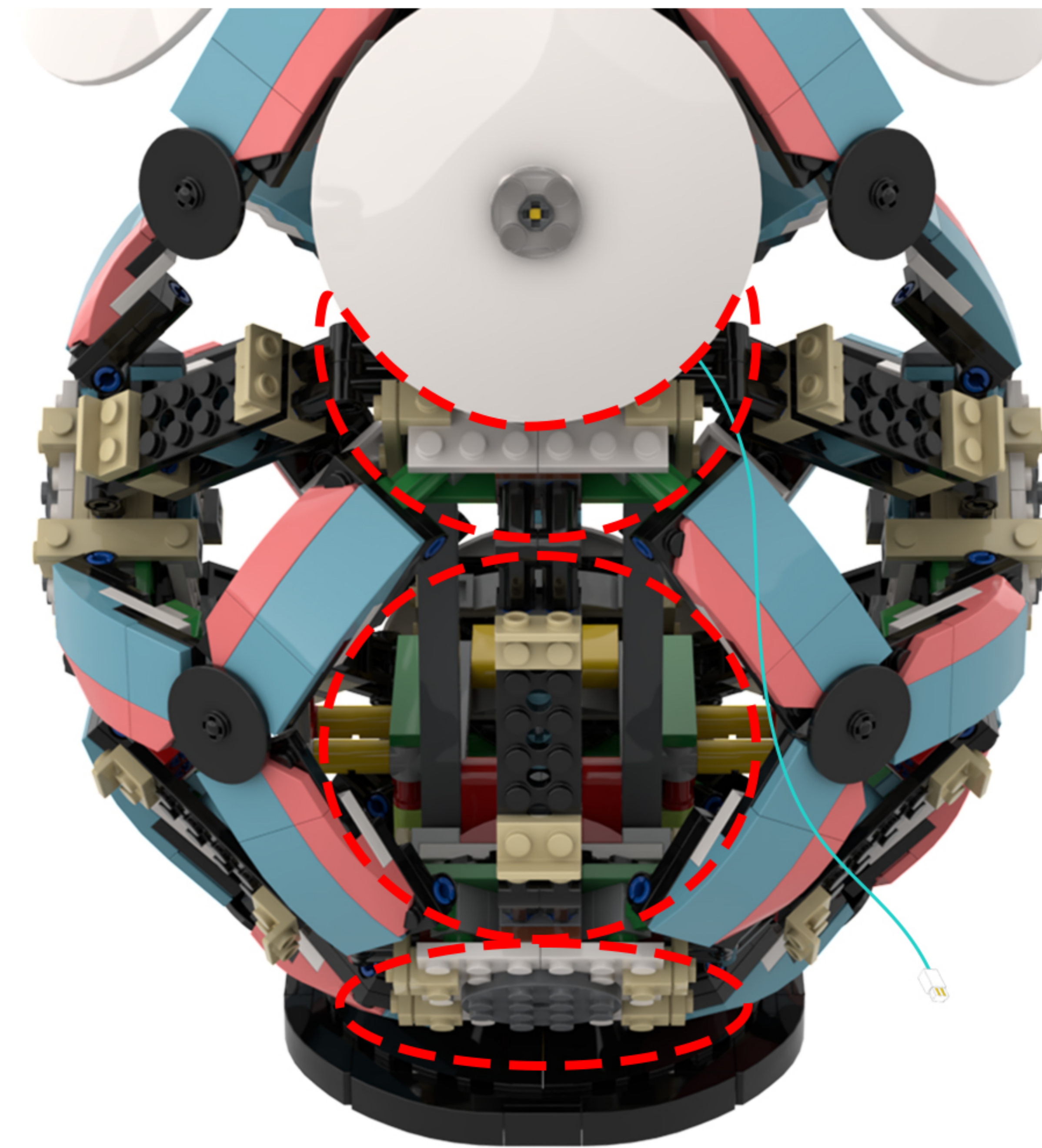

65

EN: Rotate the model to the front view.

DE: Drehen Sie das Modell in die Vorderansicht.

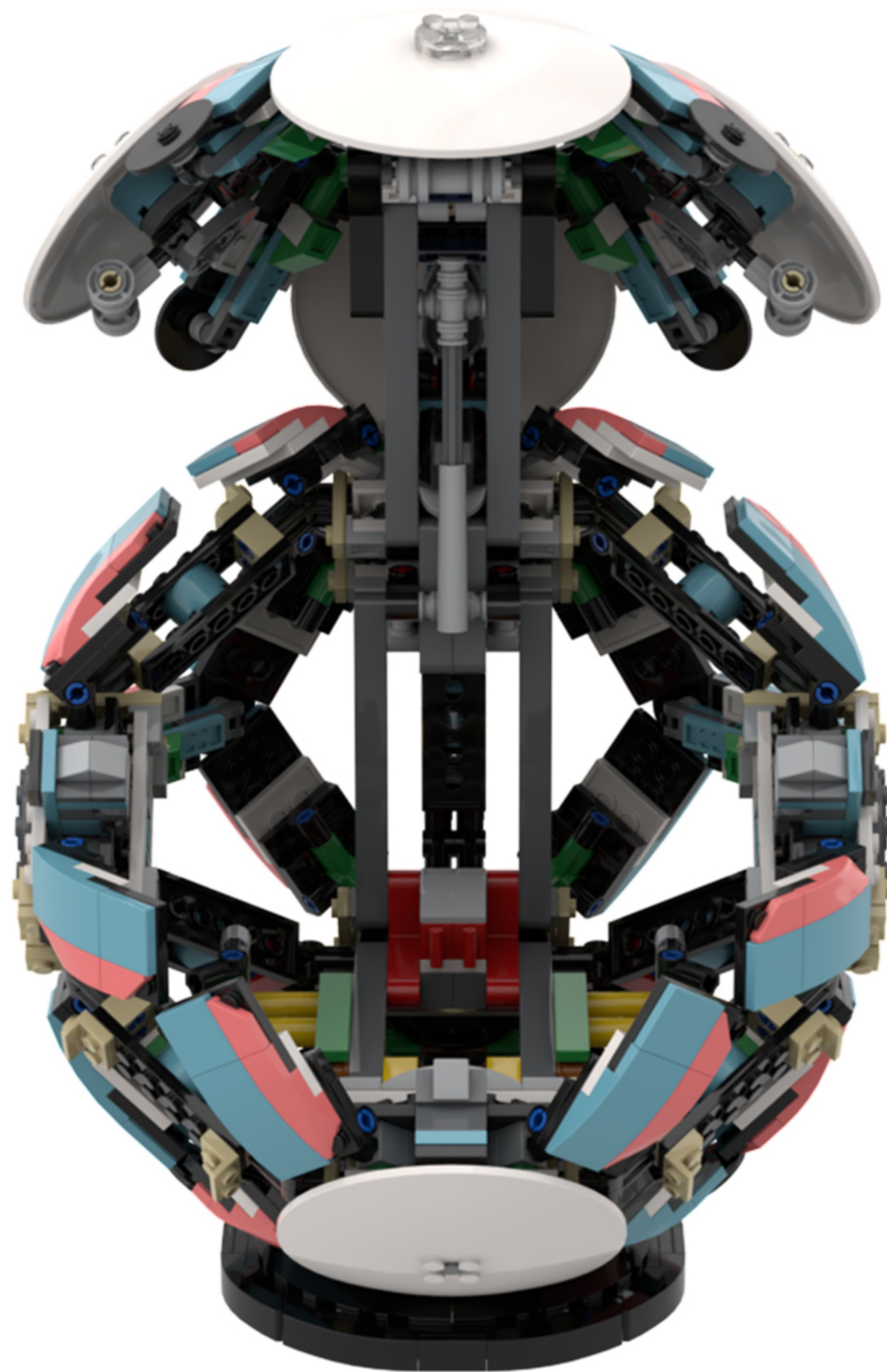
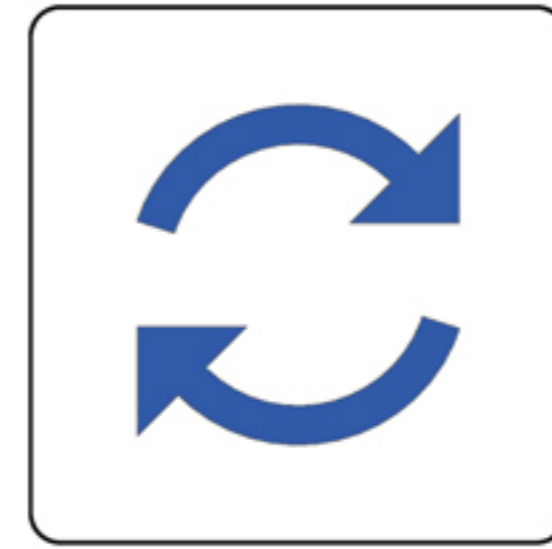

66

EN: Split as shown in the figure.

DE: Wie in der Abbildung gezeigt, teilen Sie es auf.

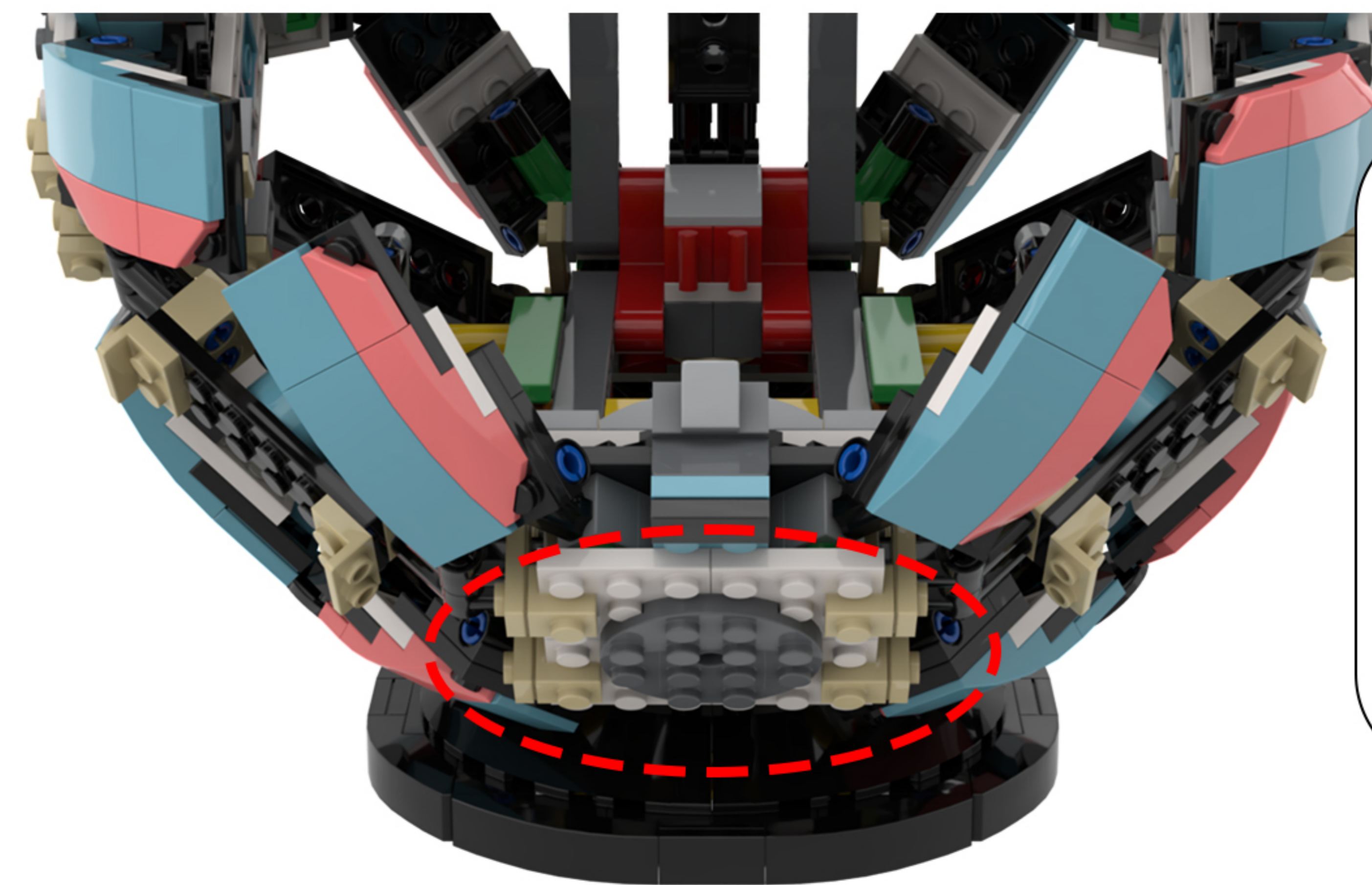

67

EN: Locate this light cord in the diagram.

DE: Suchen Sie dieses Lichtkabel in der Abbildung.

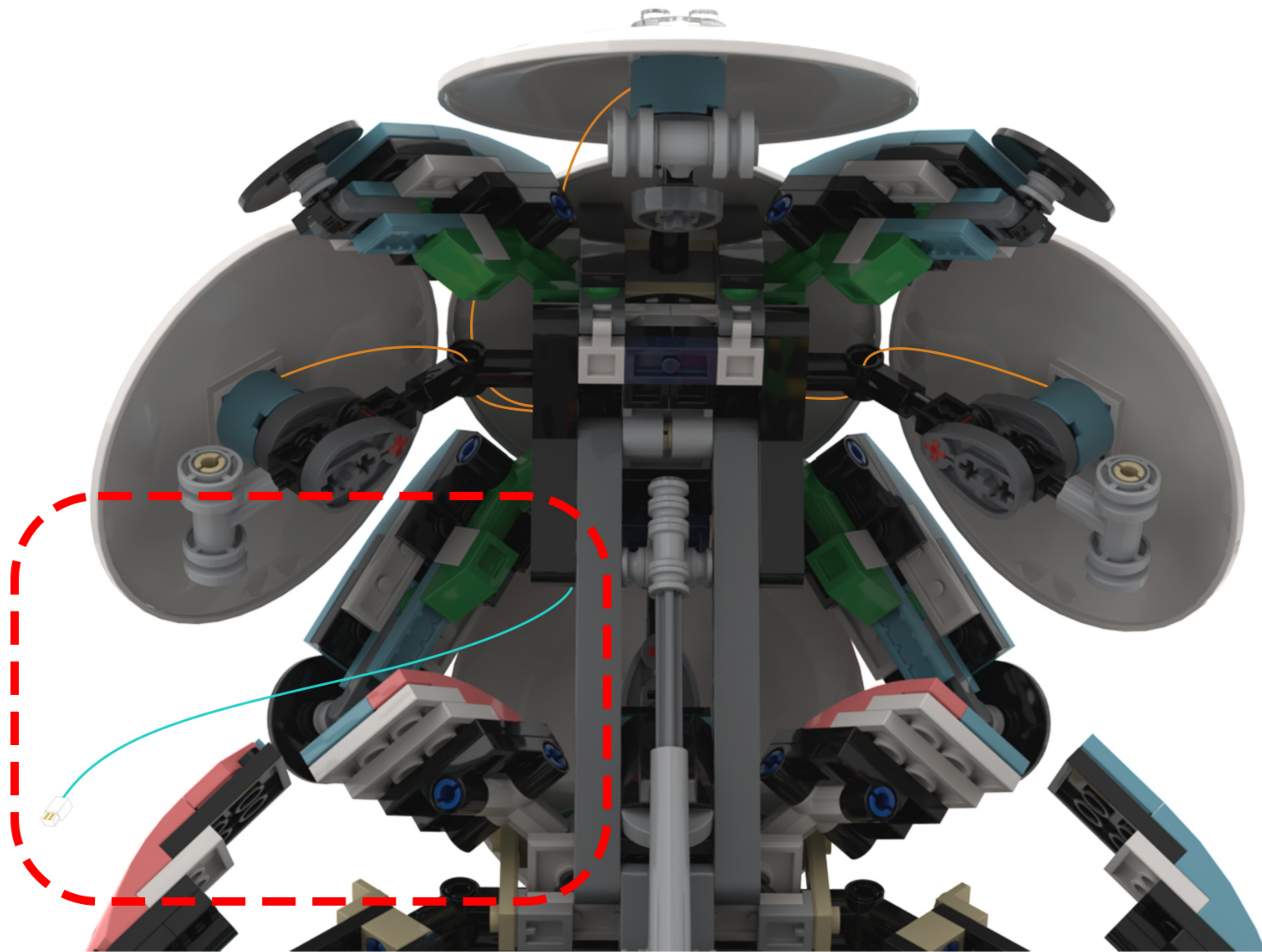

68

EN: Wire as shown in the diagram.

DE: Verdrahten Sie wie in der Abbildung gezeigt.

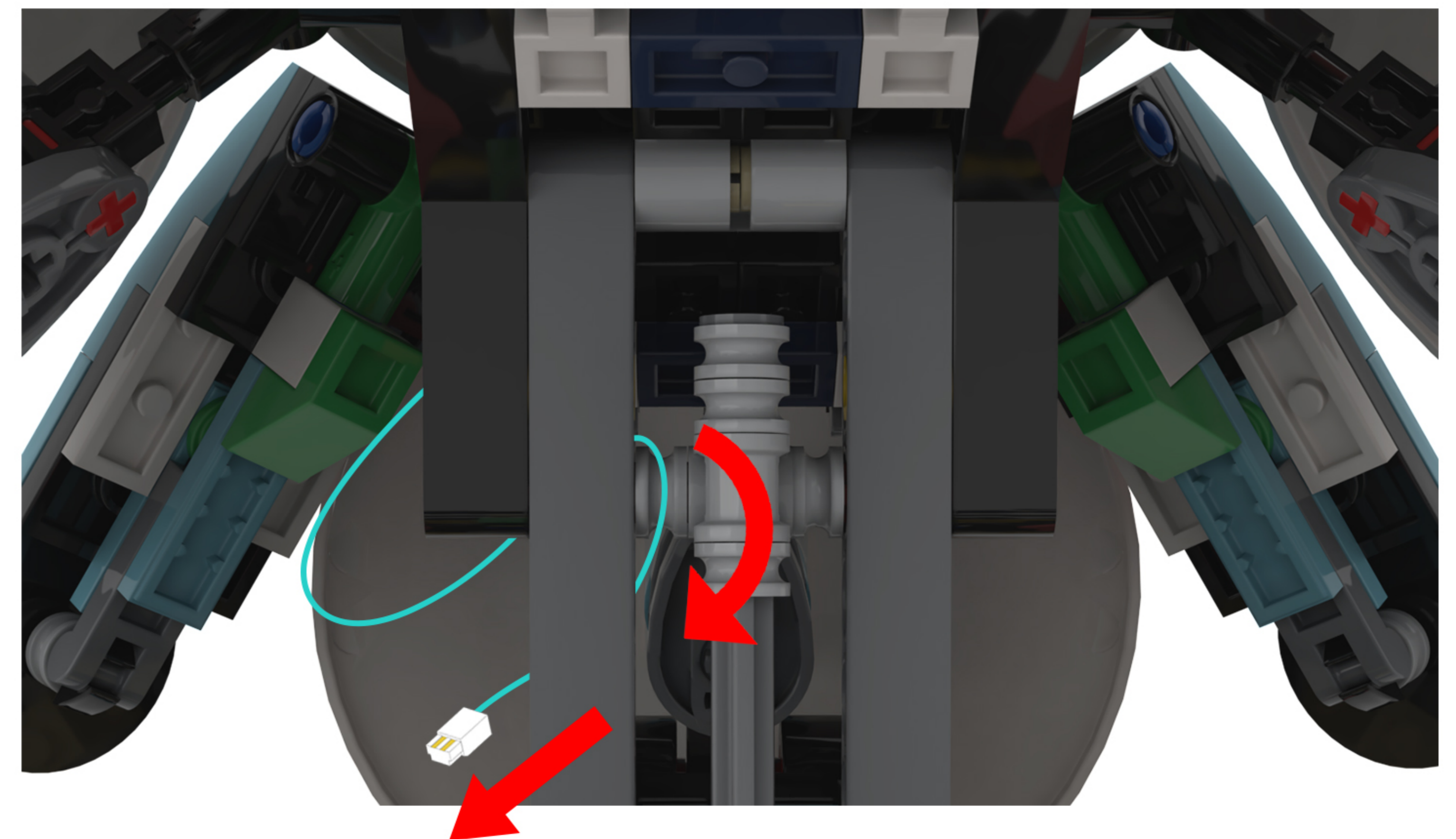
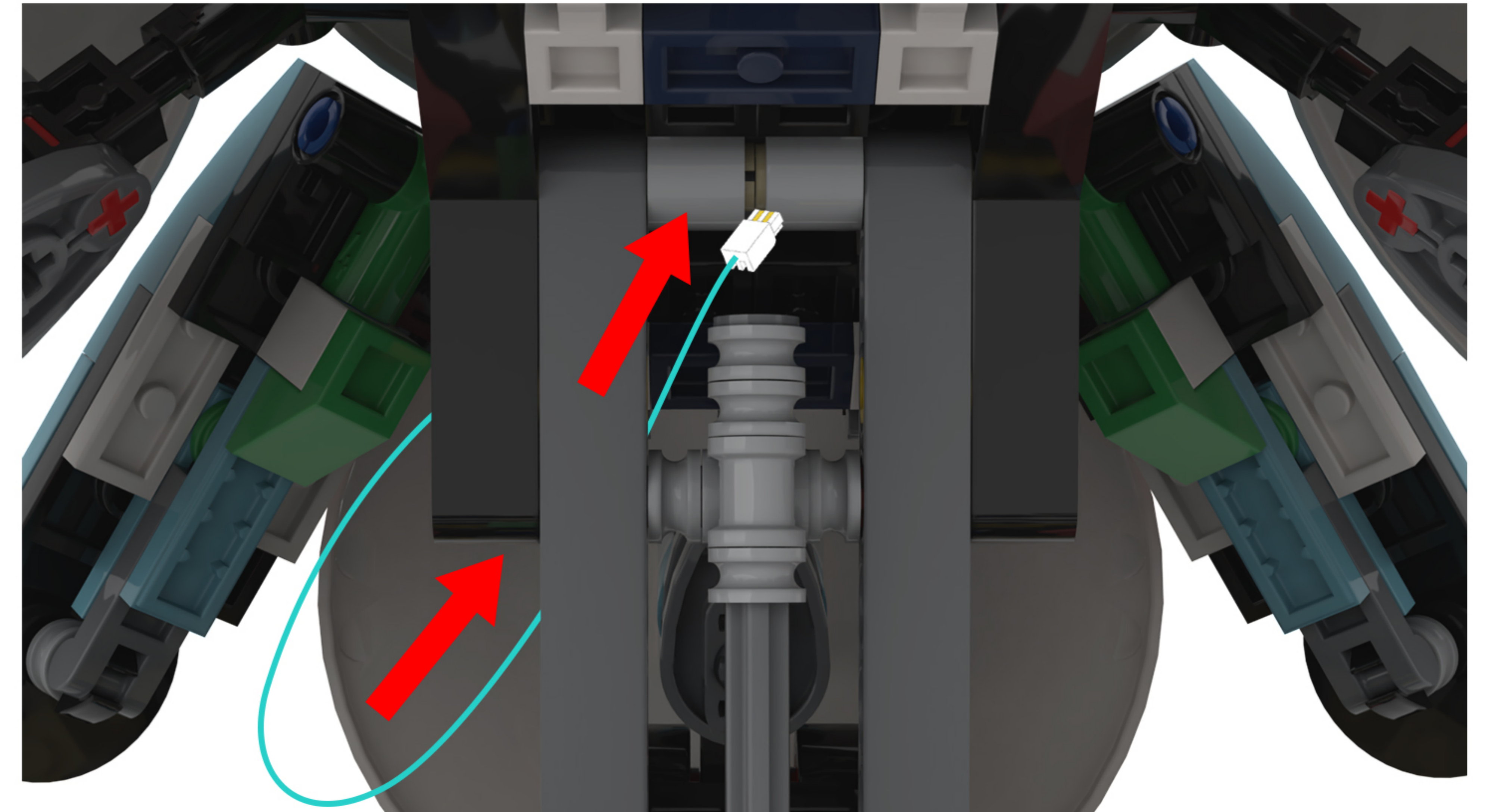

69

EN: Wire as shown in the diagram.

DE: Verdrahten Sie wie in der Abbildung gezeigt.

①. Tighten the light cord.

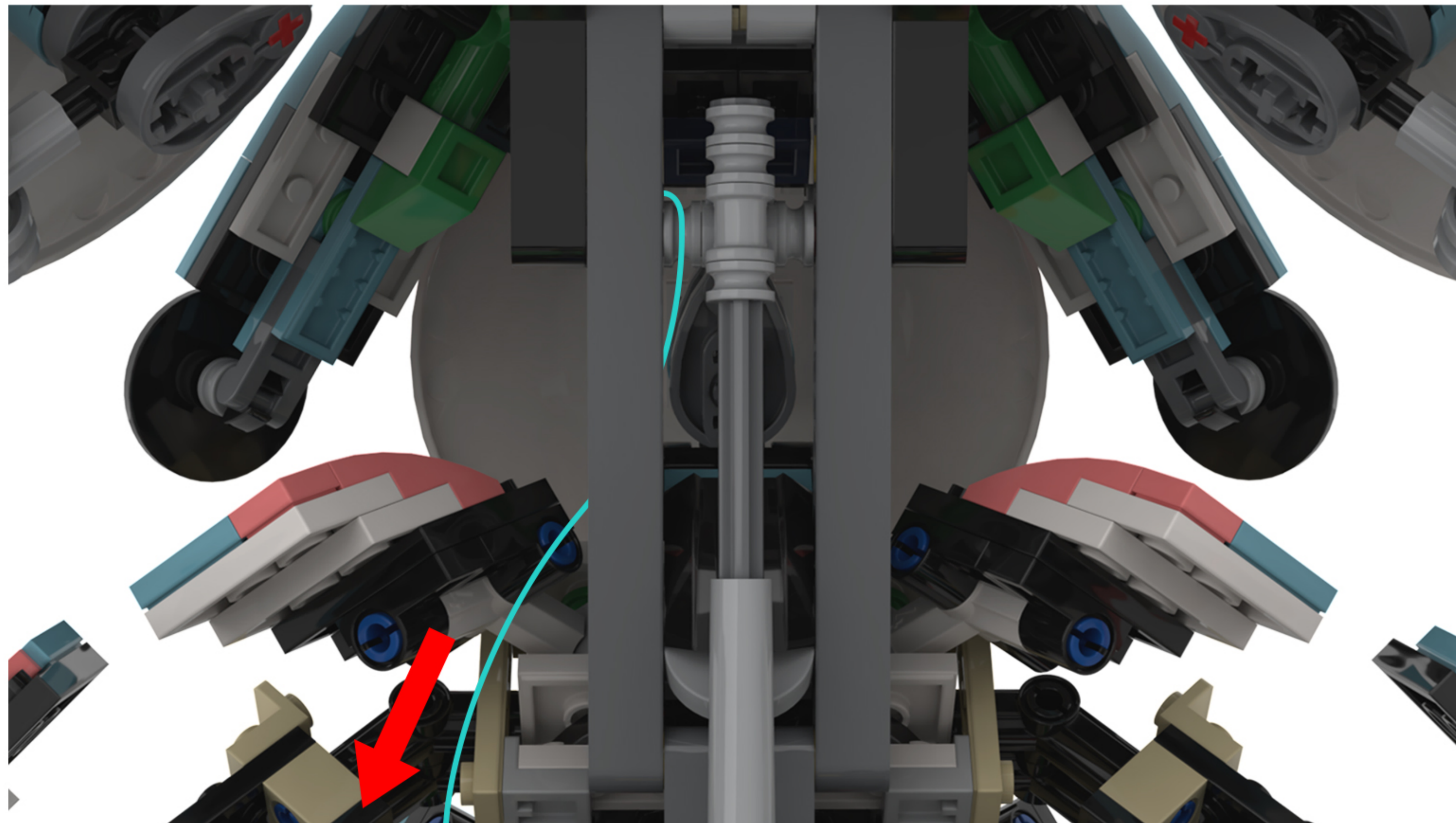

②. Switch to the side view of the model.

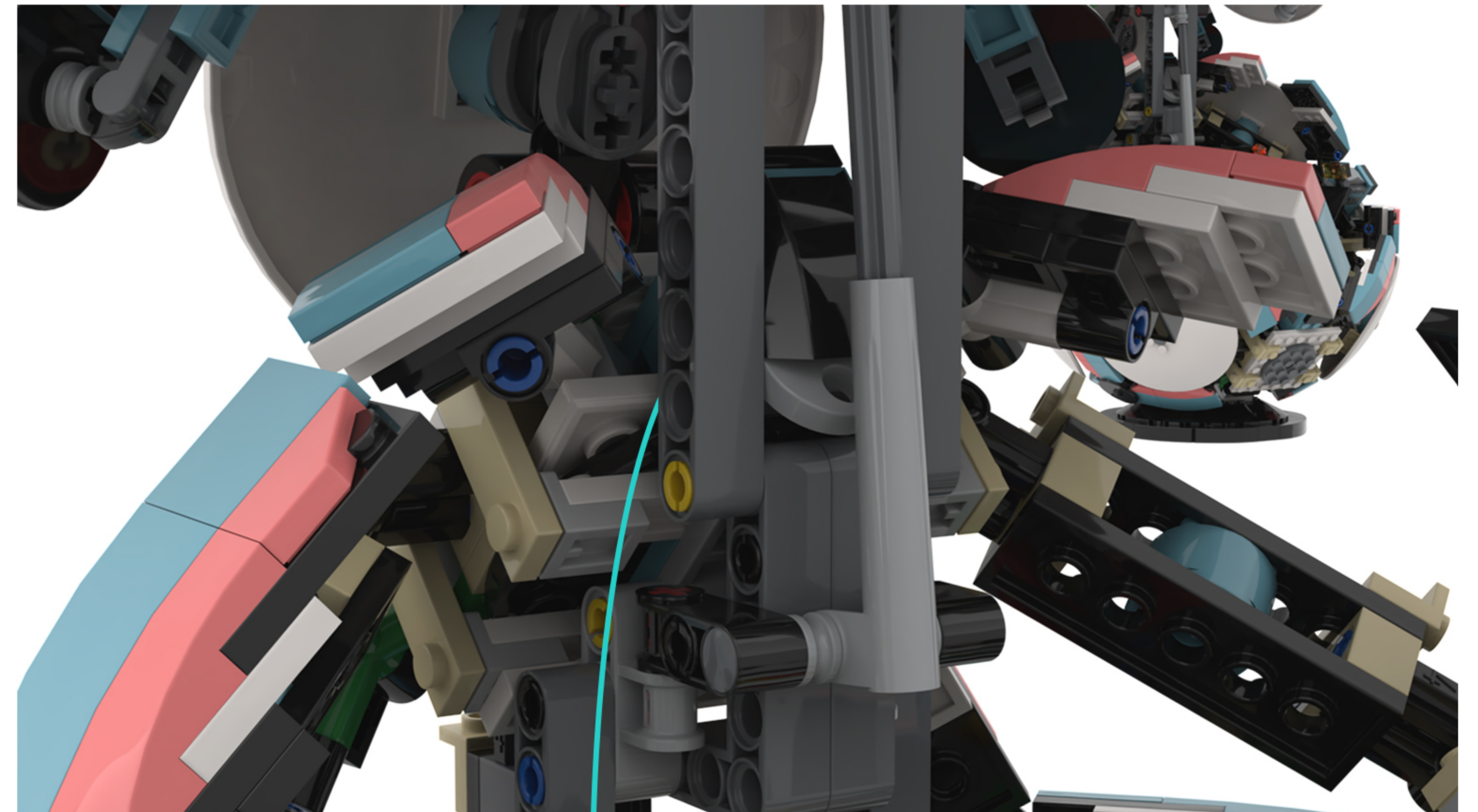

70

EN: Wire as shown in the diagram.

DE: Verdrahten Sie wie in der Abbildung gezeigt.

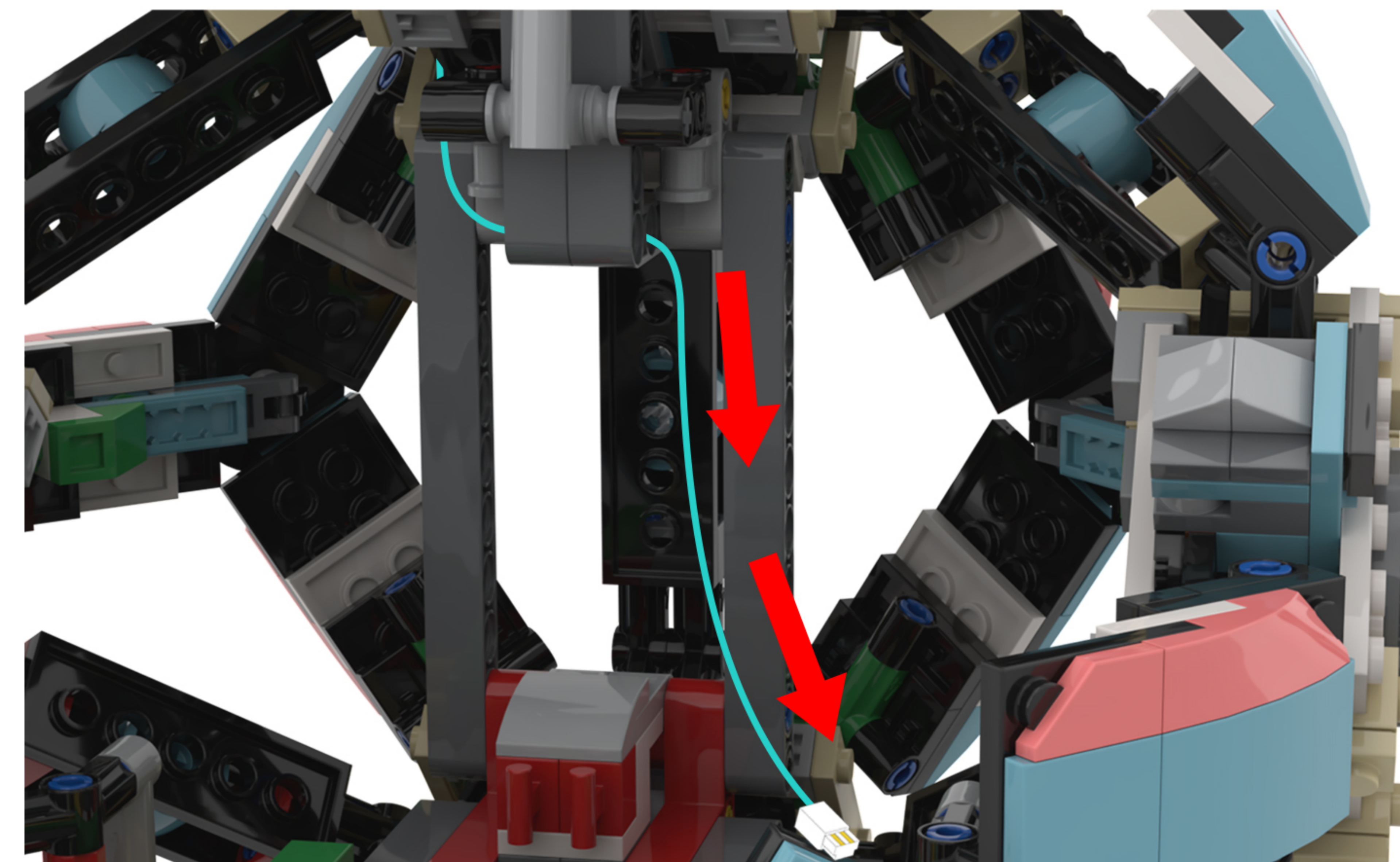
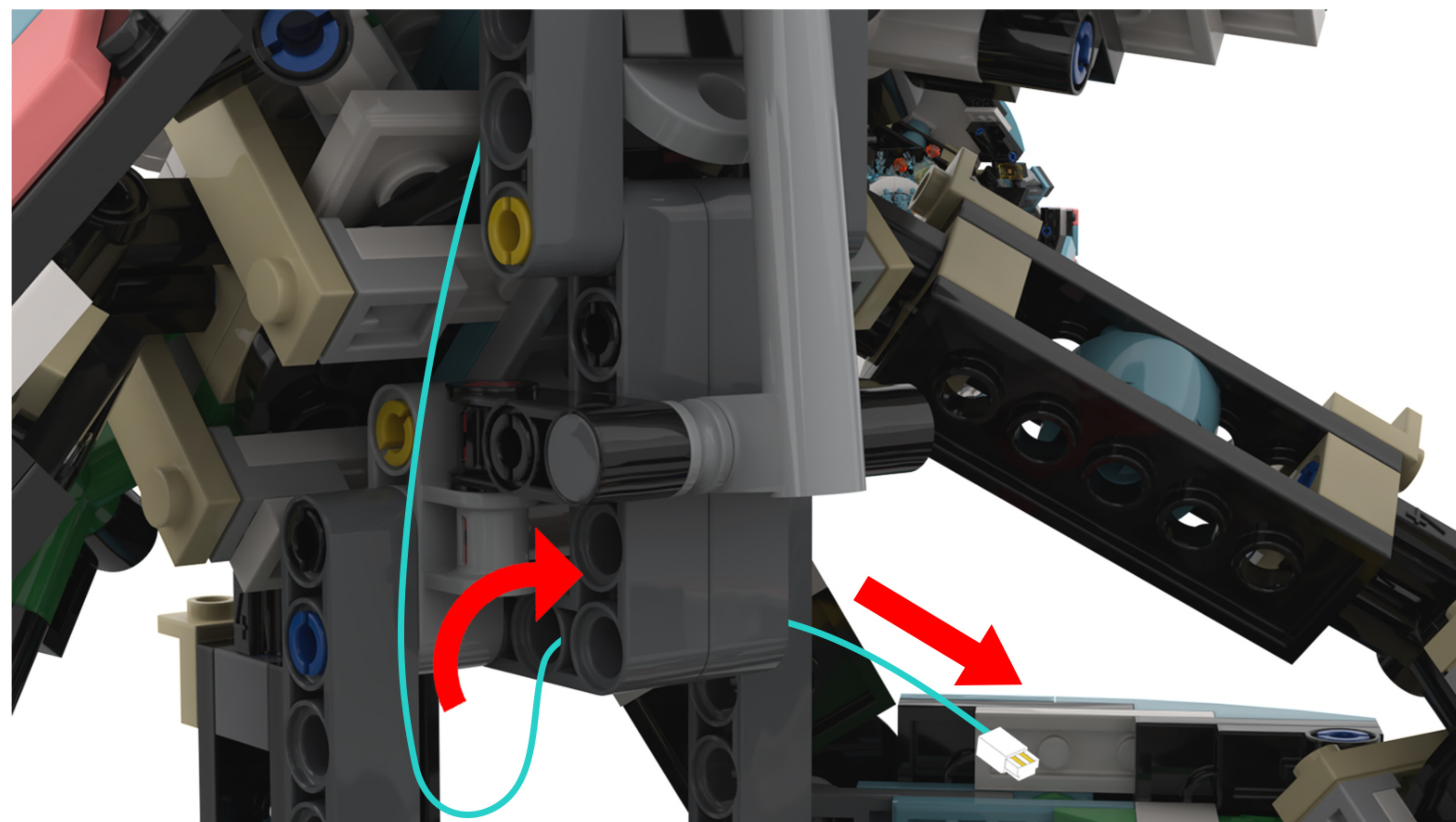

71

EN: Thread the lamp cord through the holes in the building blocks.

DE: Führen Sie das Lampenkabel durch die Löcher in den Bausteinen.

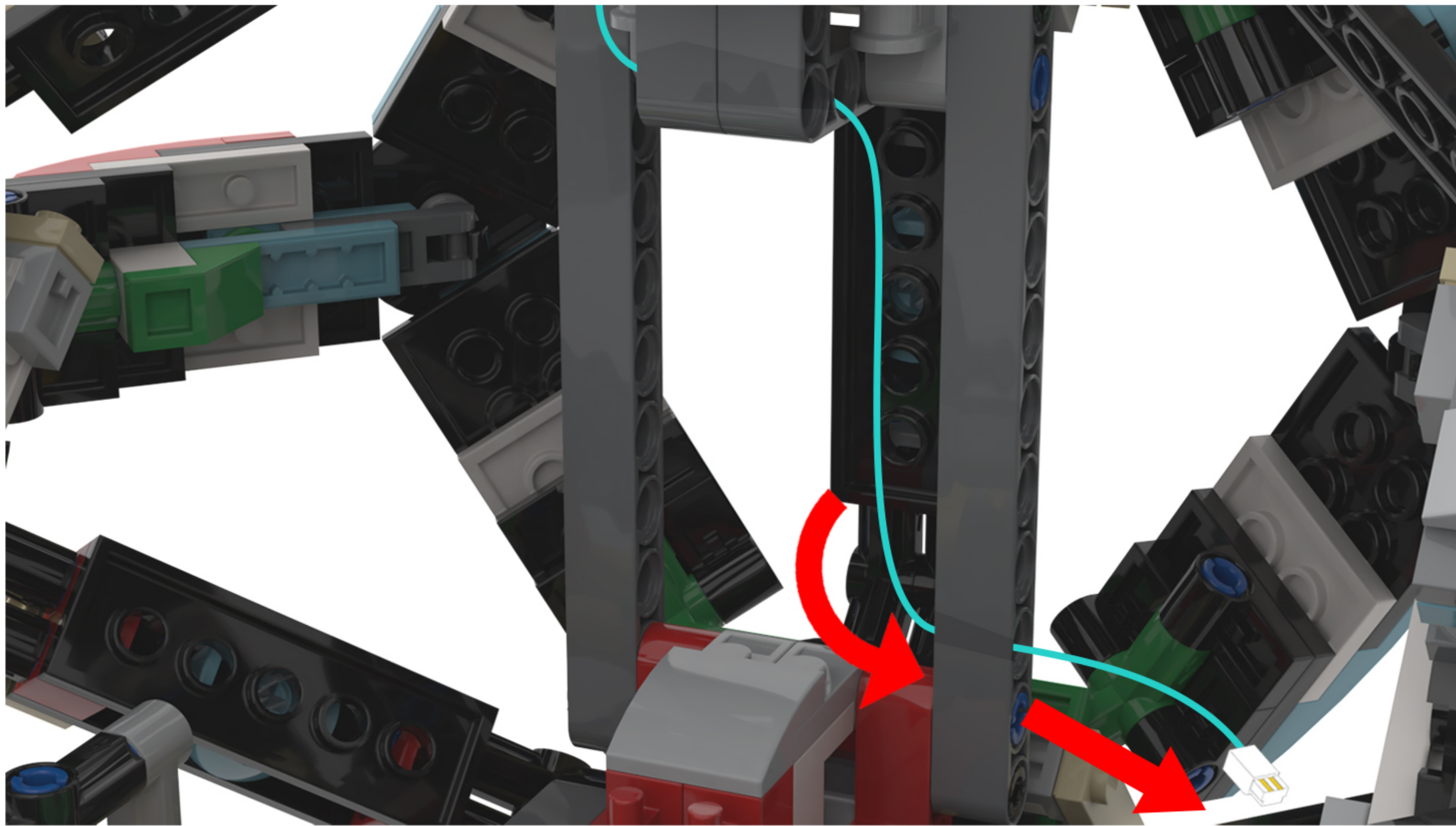

72

EN: Look at the block component highlighted in the image.

DE: Schauen Sie sich die im Bild hervorgehobene Blockkomponente an.

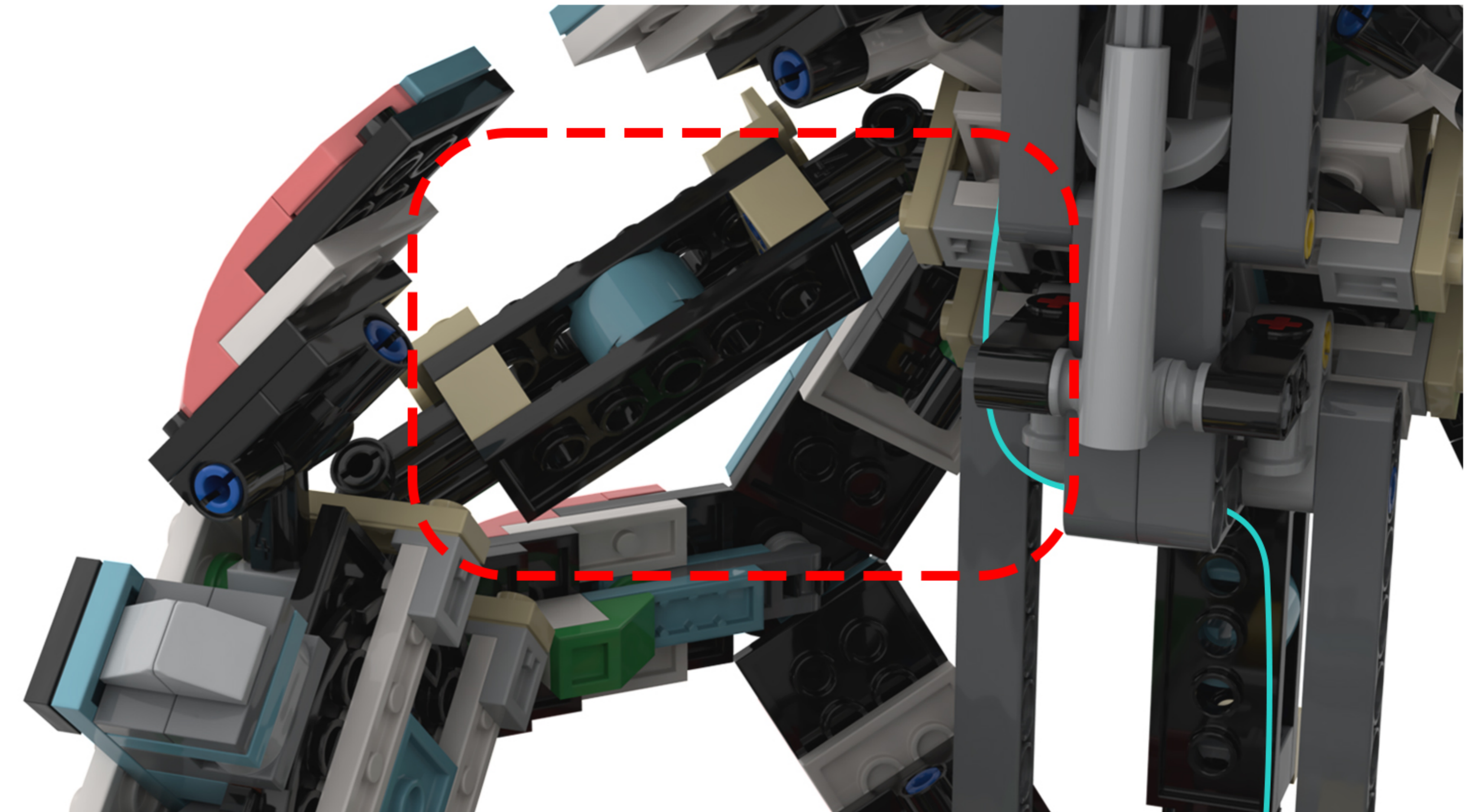

73

EN: Take the COB light strip out of Bag 3, peel off the adhesive backing from one of the strips, and attach it to the building block, starting from the end.

DE: Nimm den COB-Lichtstreifen aus Beutel 3, ziehe die Schutzfolie von einem der Streifen ab und befestige ihn am Baustein, beginnend am Ende.

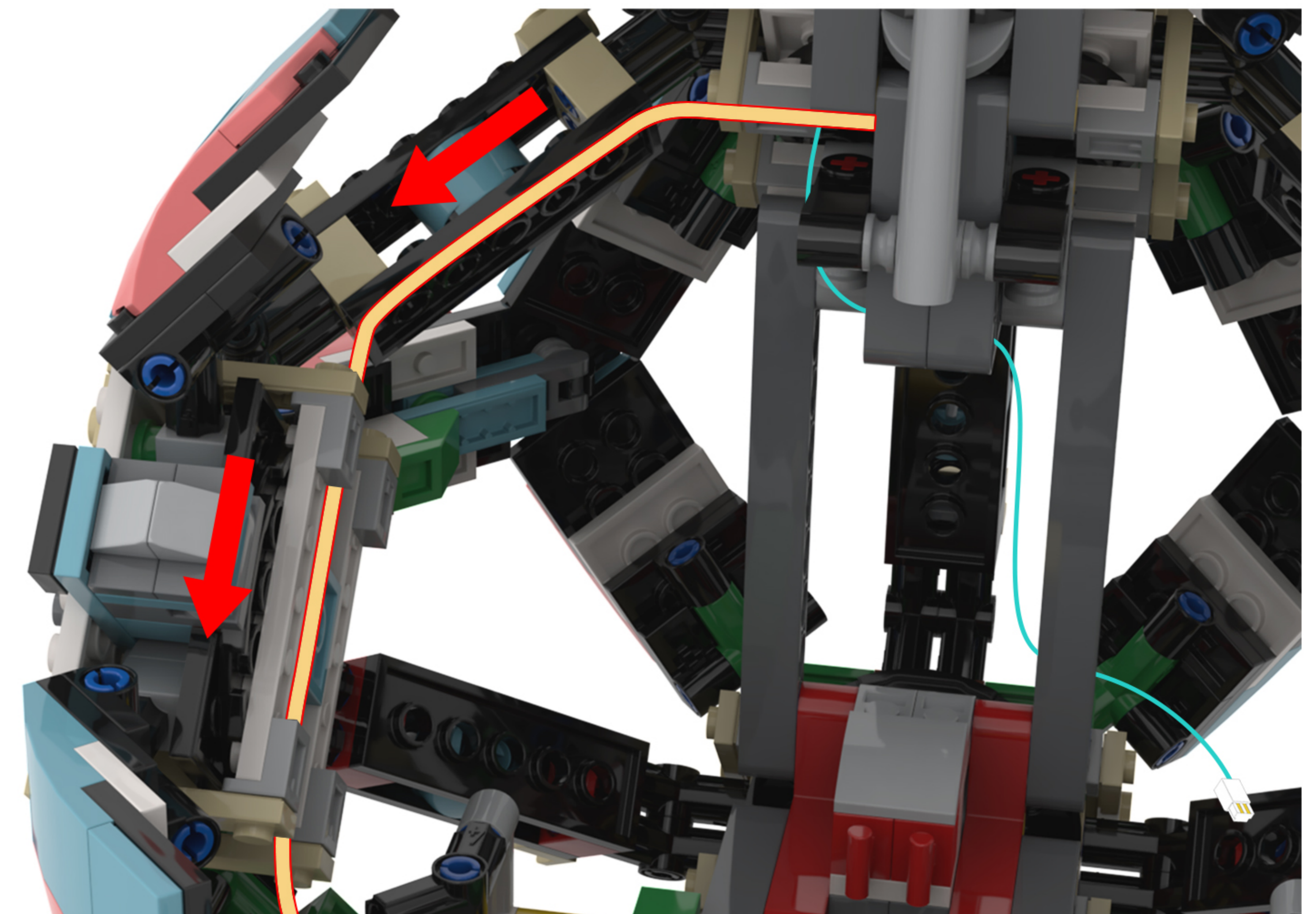
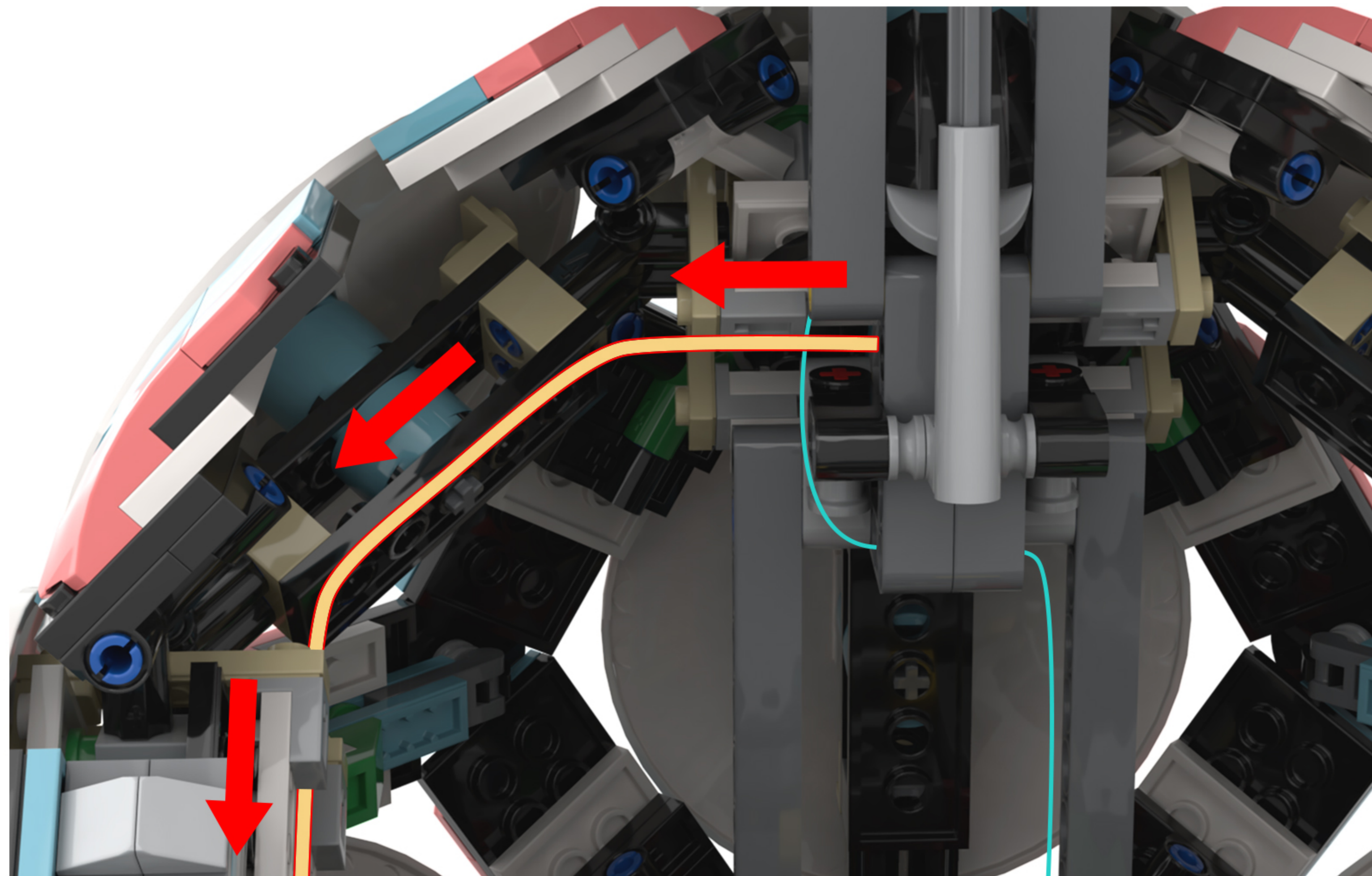
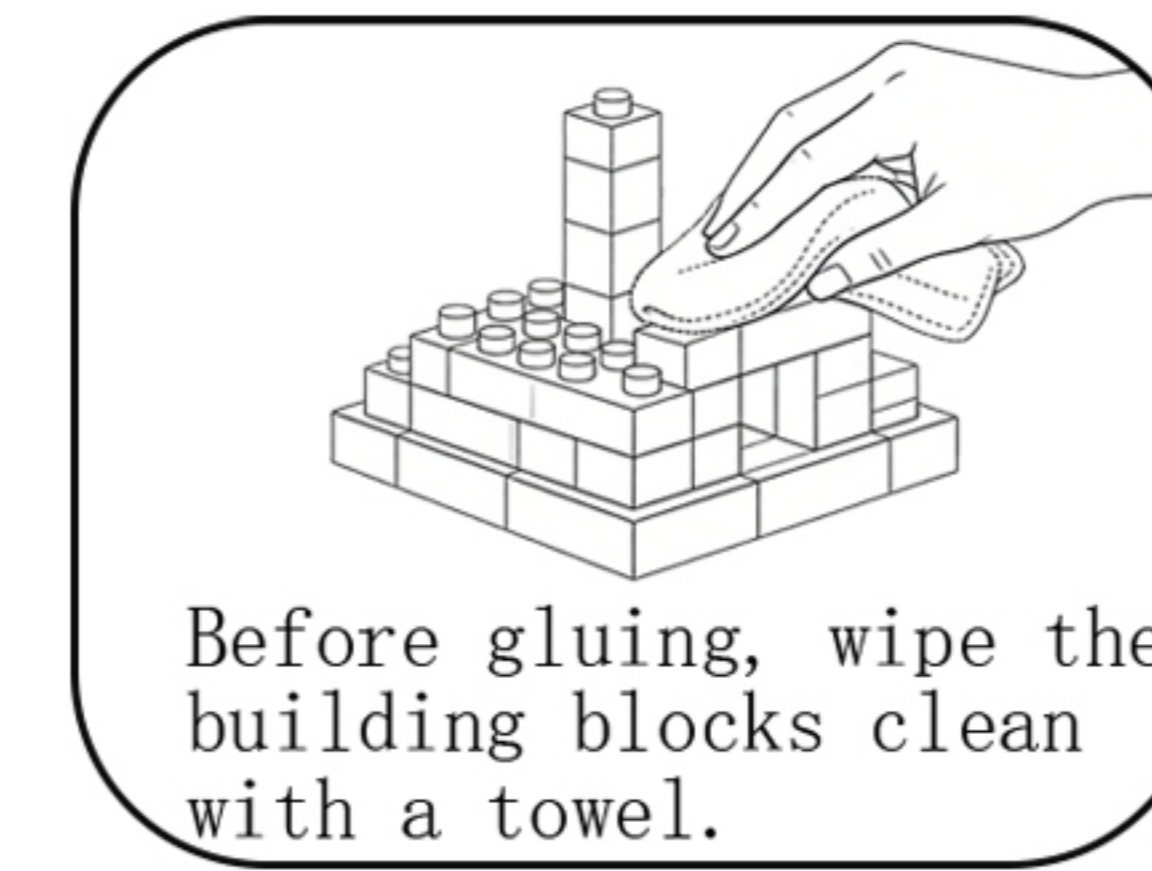
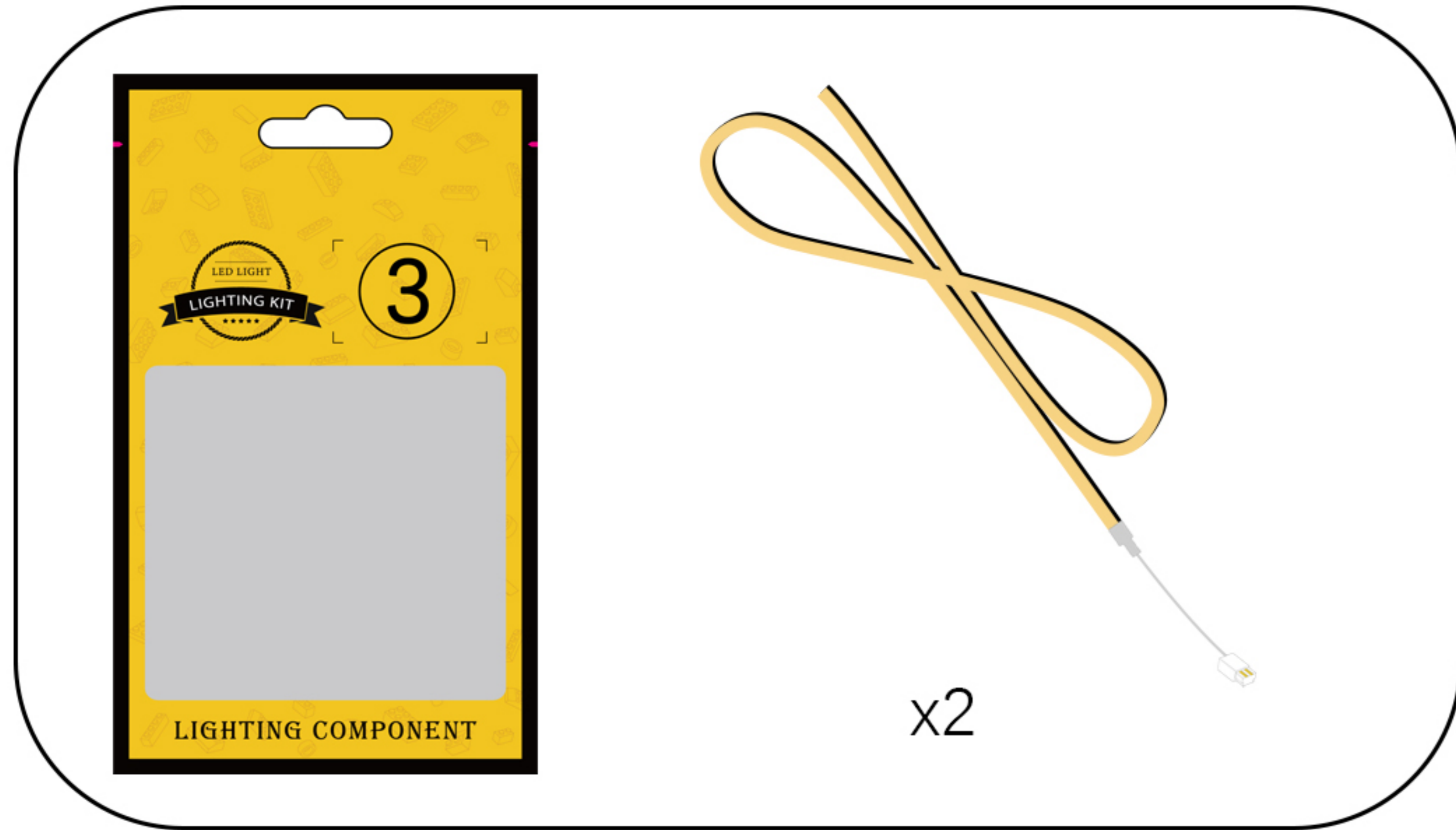

74

EN: Continue attaching the COB light strips to the building blocks.

DE: Befestigen Sie die COB-Lichtleisten weiter an den Bausteinen.

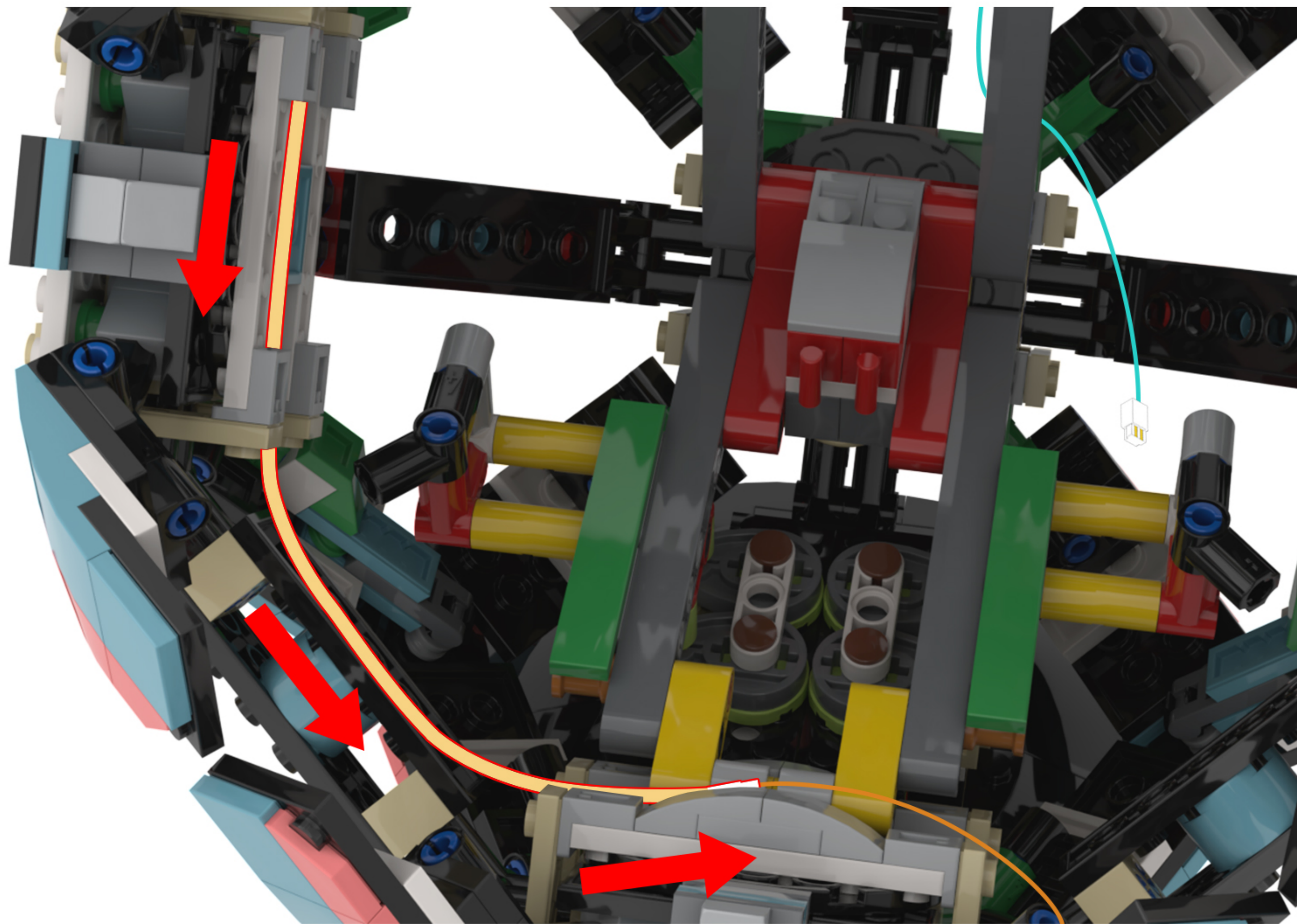

75

EN: Locate this light cord in the diagram.

DE: Suchen Sie dieses Lichtkabel in der Abbildung.

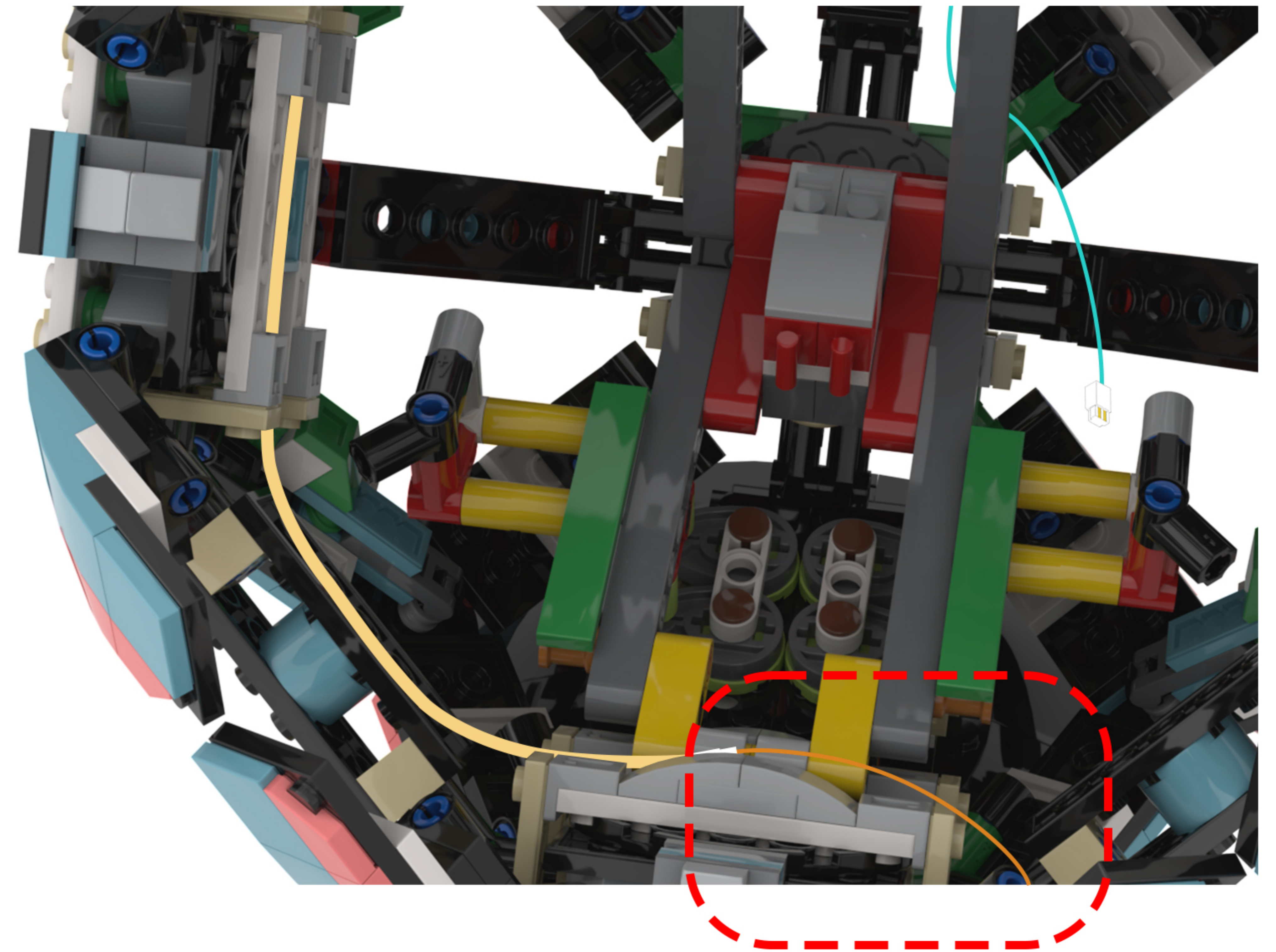

**76**

EN: Run the light cord to the left.

DE: Verlegen Sie das Lichtkabel nach links.

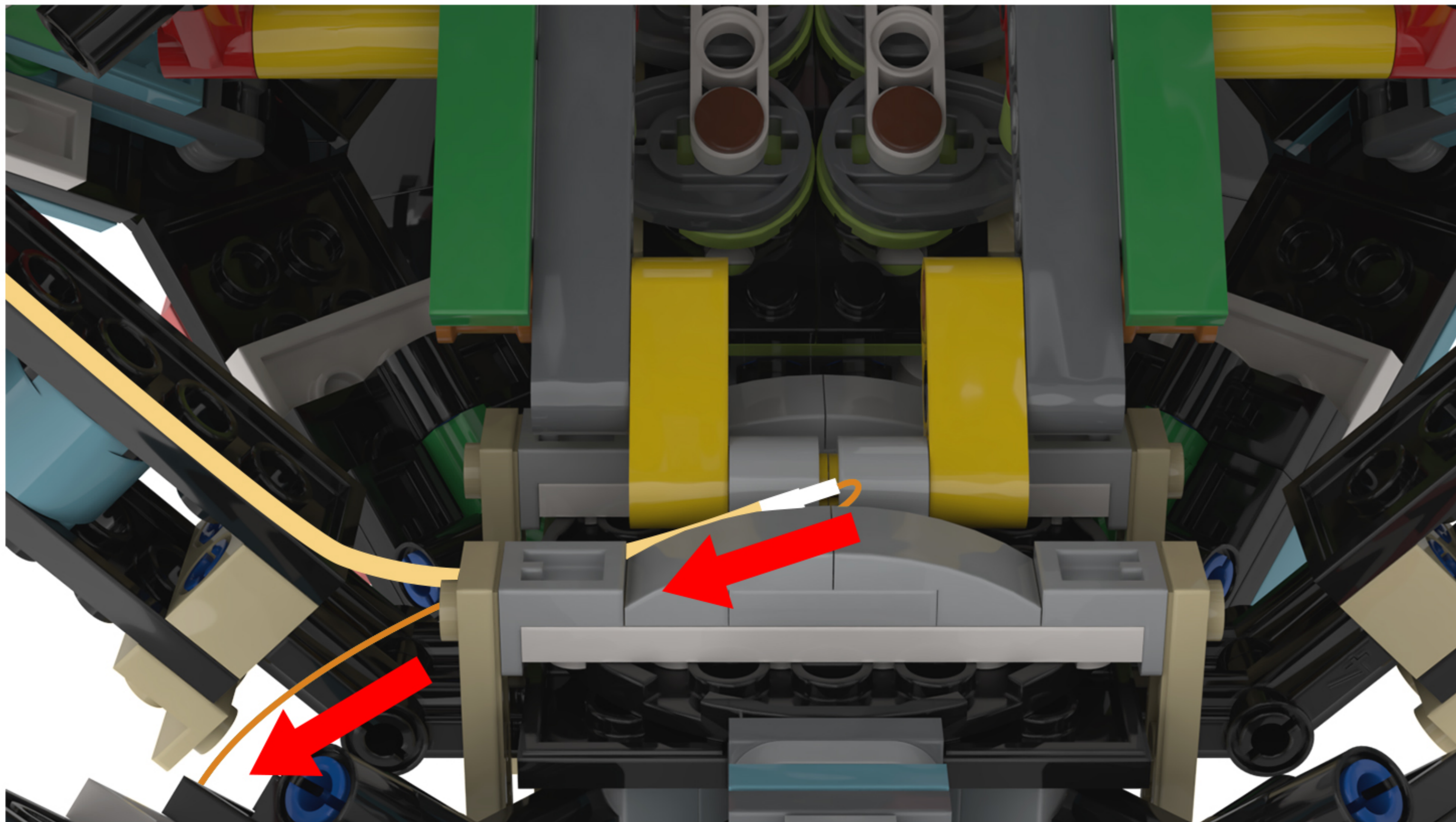

**Note:** The light cord passes through the gap in the building block and exits the model.

**77**

EN: Go to the other side of the model, peel off the adhesive backing from the other COB light strip, and start attaching it to the building blocks from the tail end.

DE: Gehen Sie auf die andere Seite des Modells, ziehen Sie die Schutzfolie vom anderen COB-Lichtstreifen ab und beginnen Sie, ihn vom hinteren Ende her an den Bausteinen anzubringen.

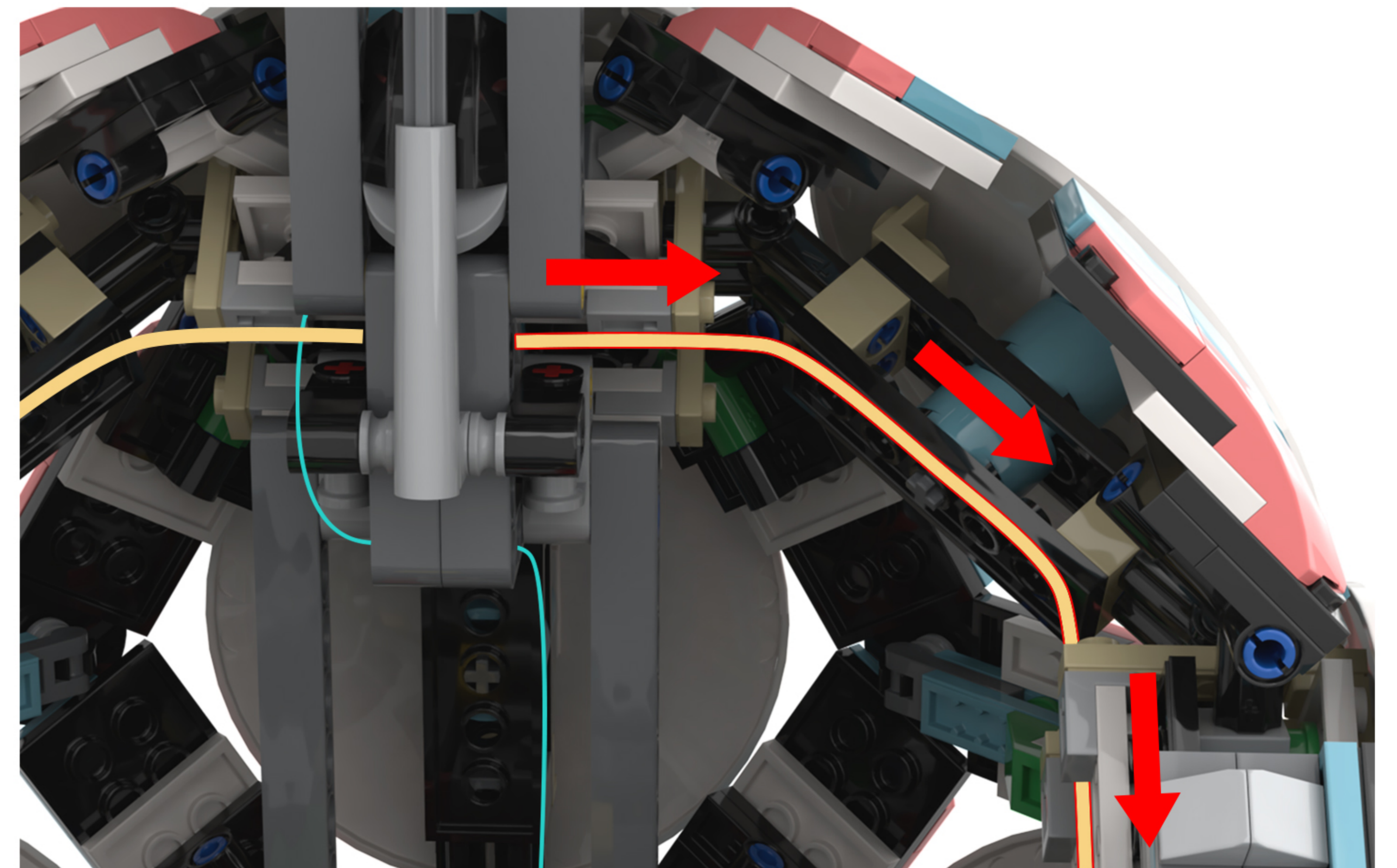

78

EN: Continue attaching the COB light strips to the building blocks.

DE: Befestigen Sie die COB-Lichtleisten weiter an den Bausteinen.

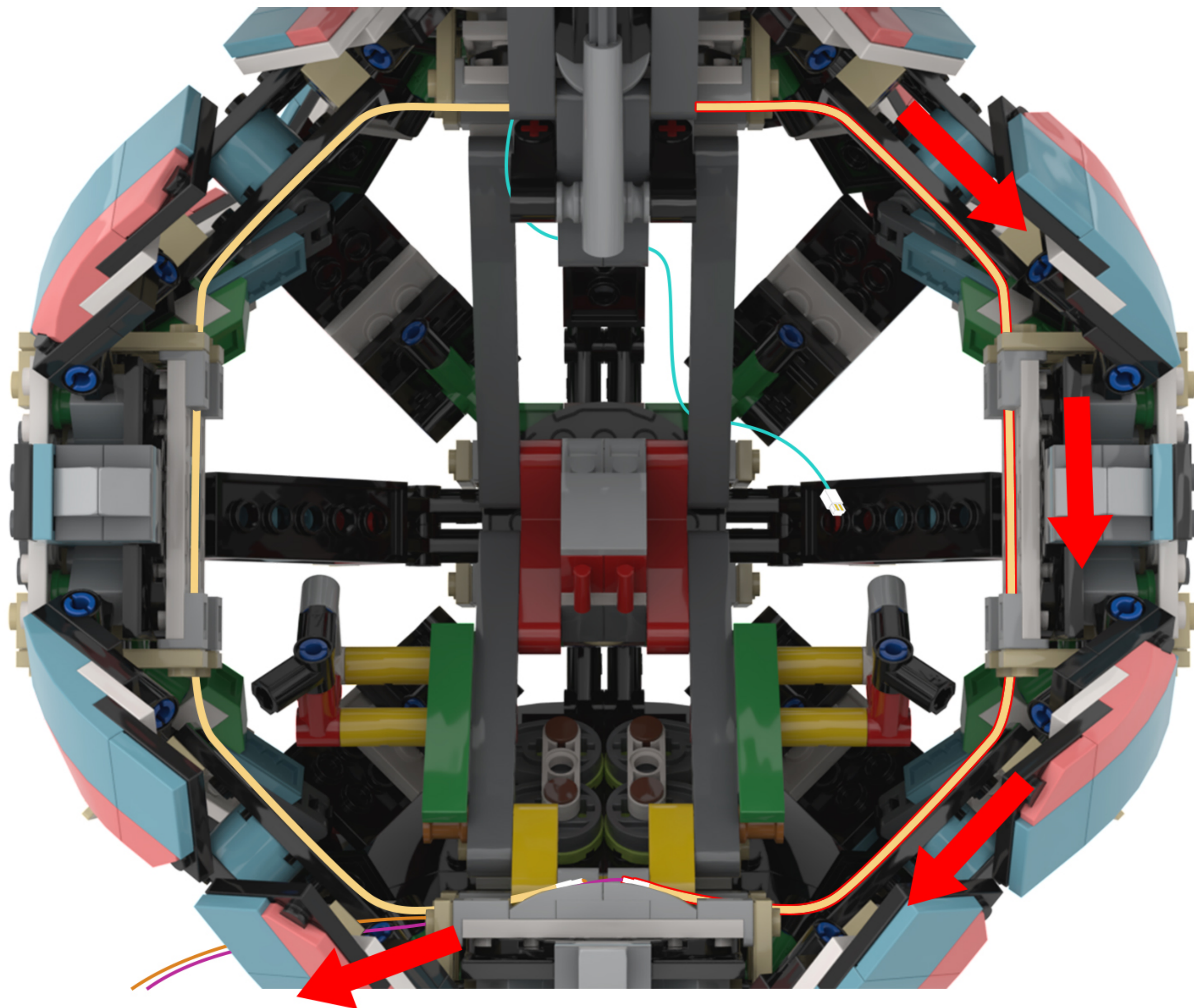

79

EN: Make sure the wiring for both COB light strips is outside the model.

DE: Stellen Sie sicher, dass die Verkabelung beider COB-Lichtleisten außerhalb des Modells verläuft.

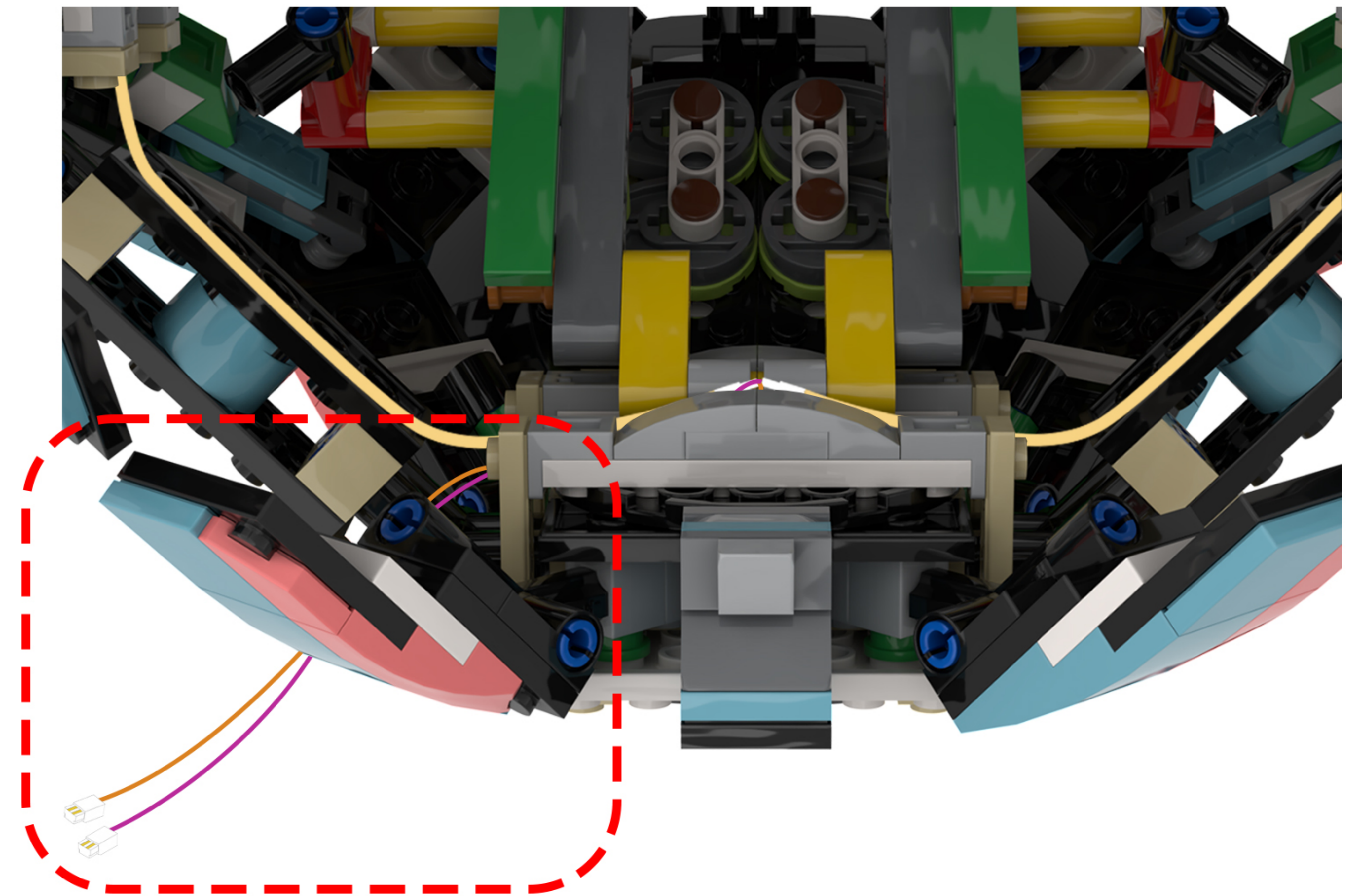

80

EN: Take the connector cable from Bag 7 and connect it to the expansion board in Bag 9.

DE: Nehmen Sie das Verbindungskabel aus Beutel 7 und schließen Sie es an die Erweiterungskarte in Beutel 9 an.

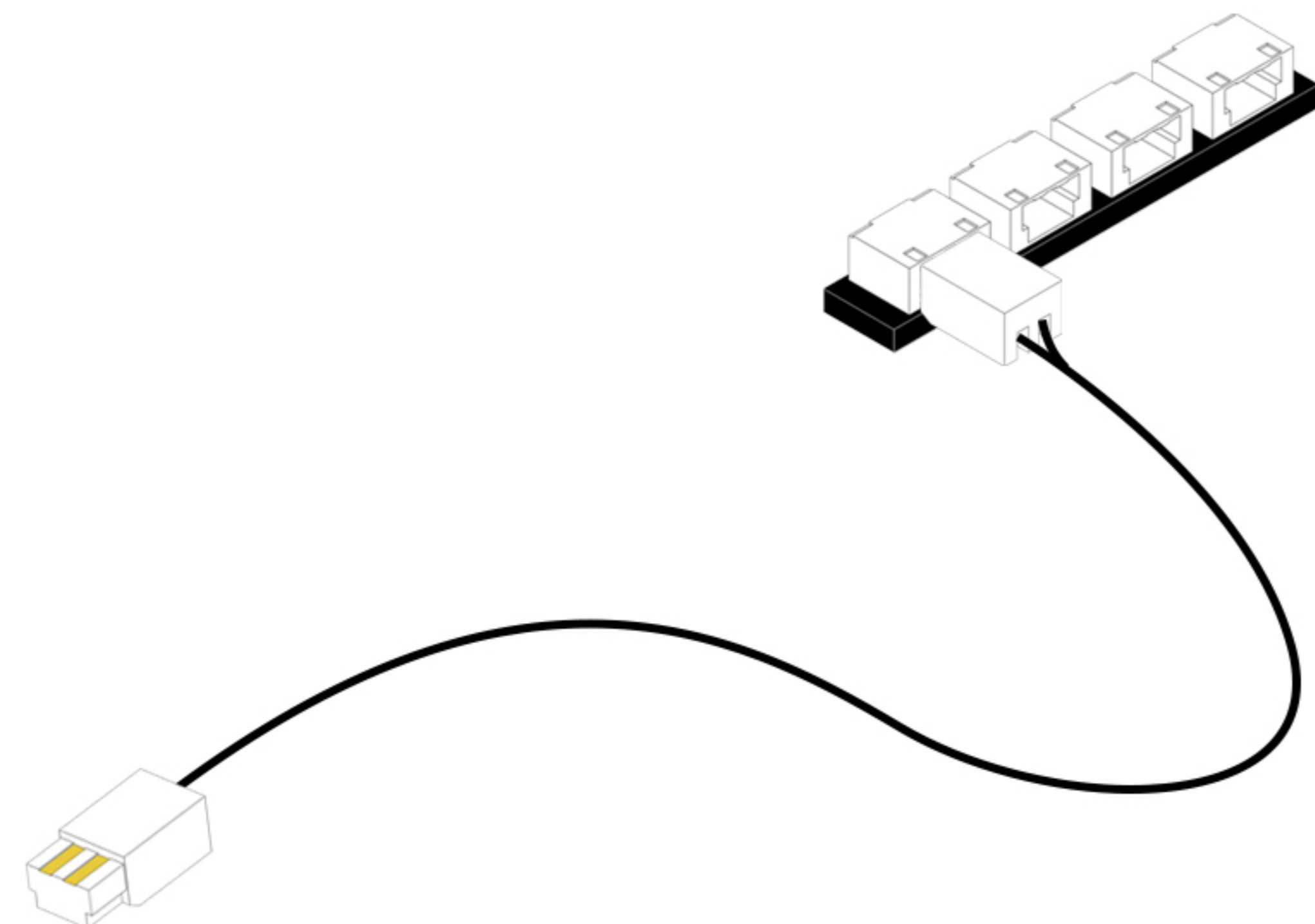
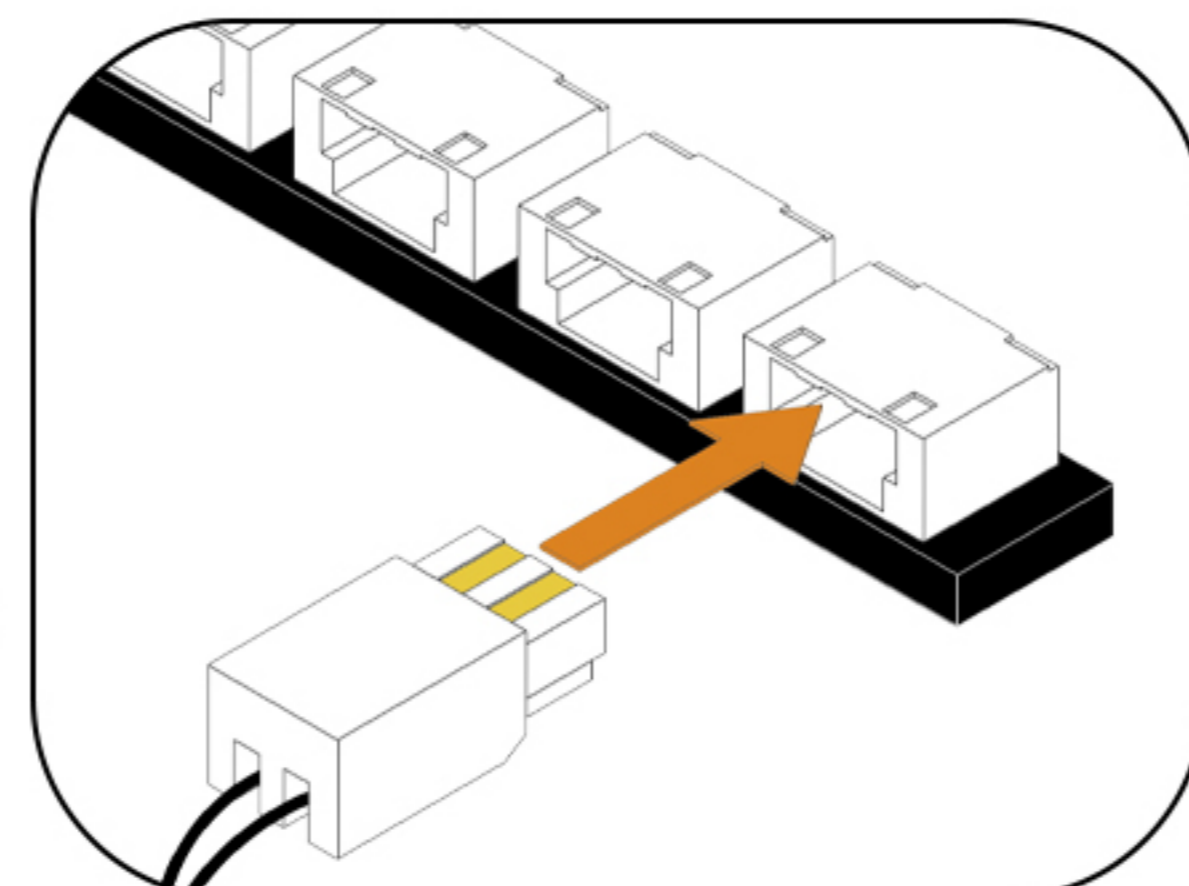
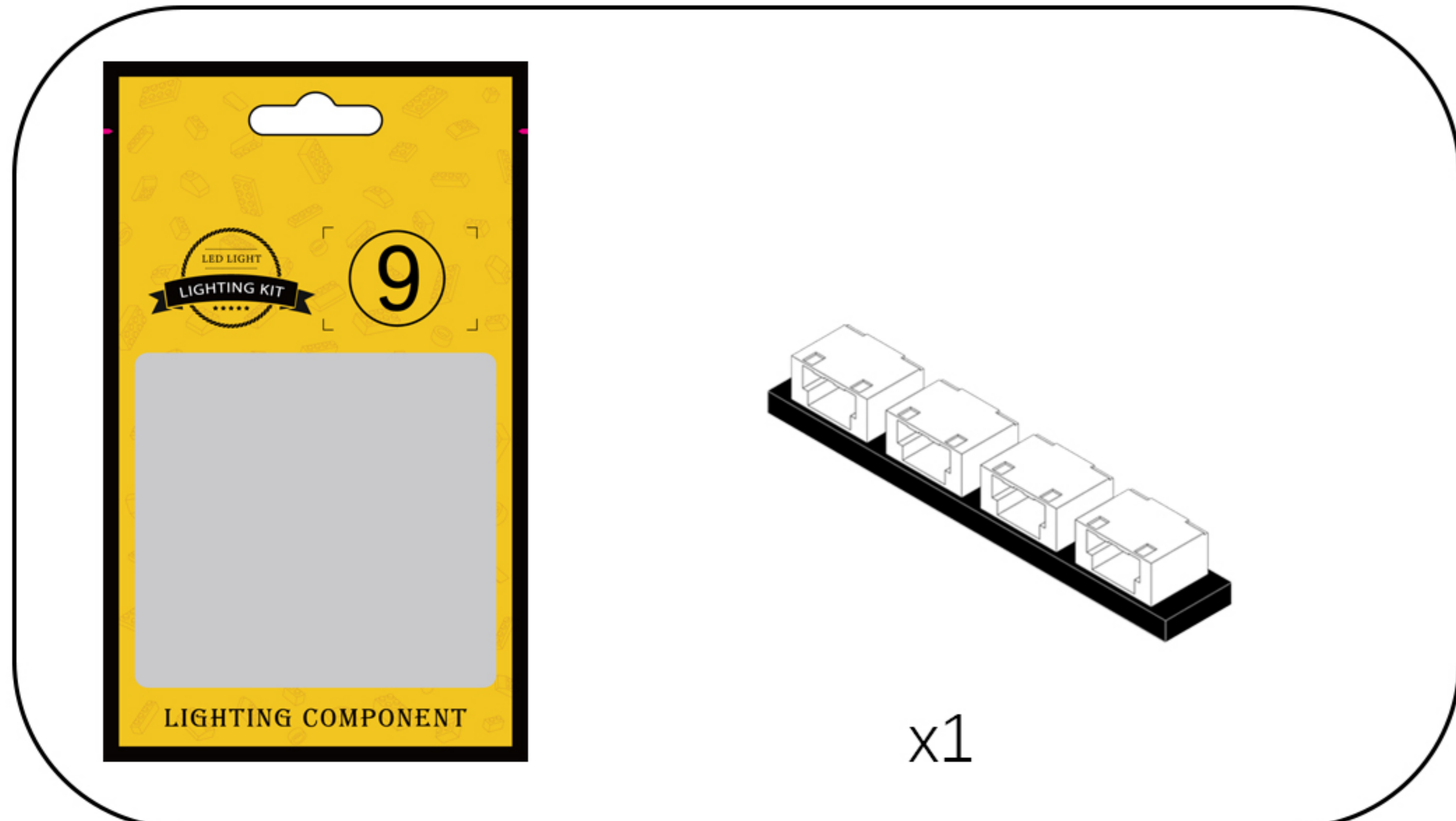
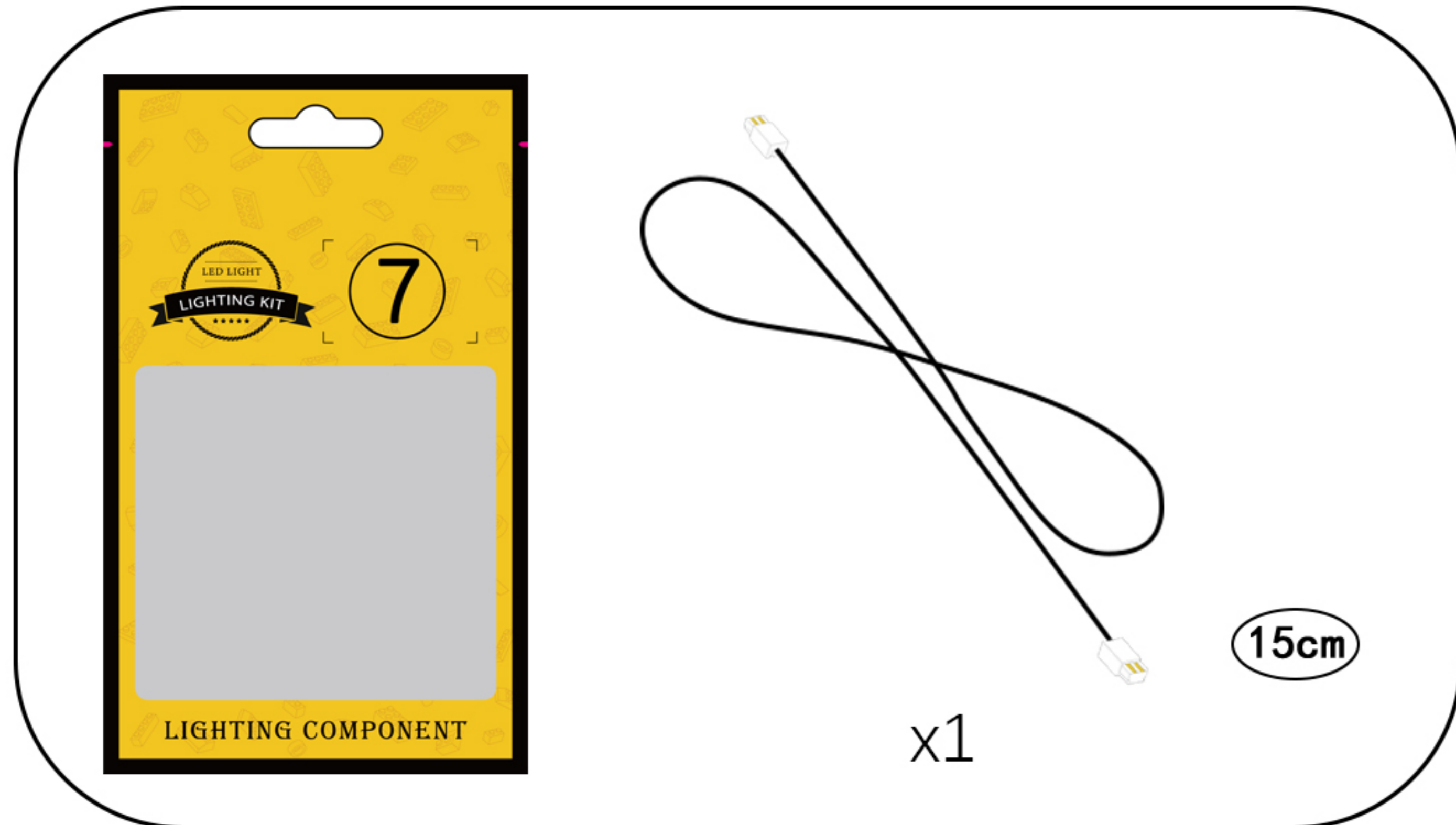

81

EN: Connect the two light cables to the expansion board one after the other.

DE: Schließen Sie die beiden Lichtkabel nacheinander an die Erweiterungskarte an.

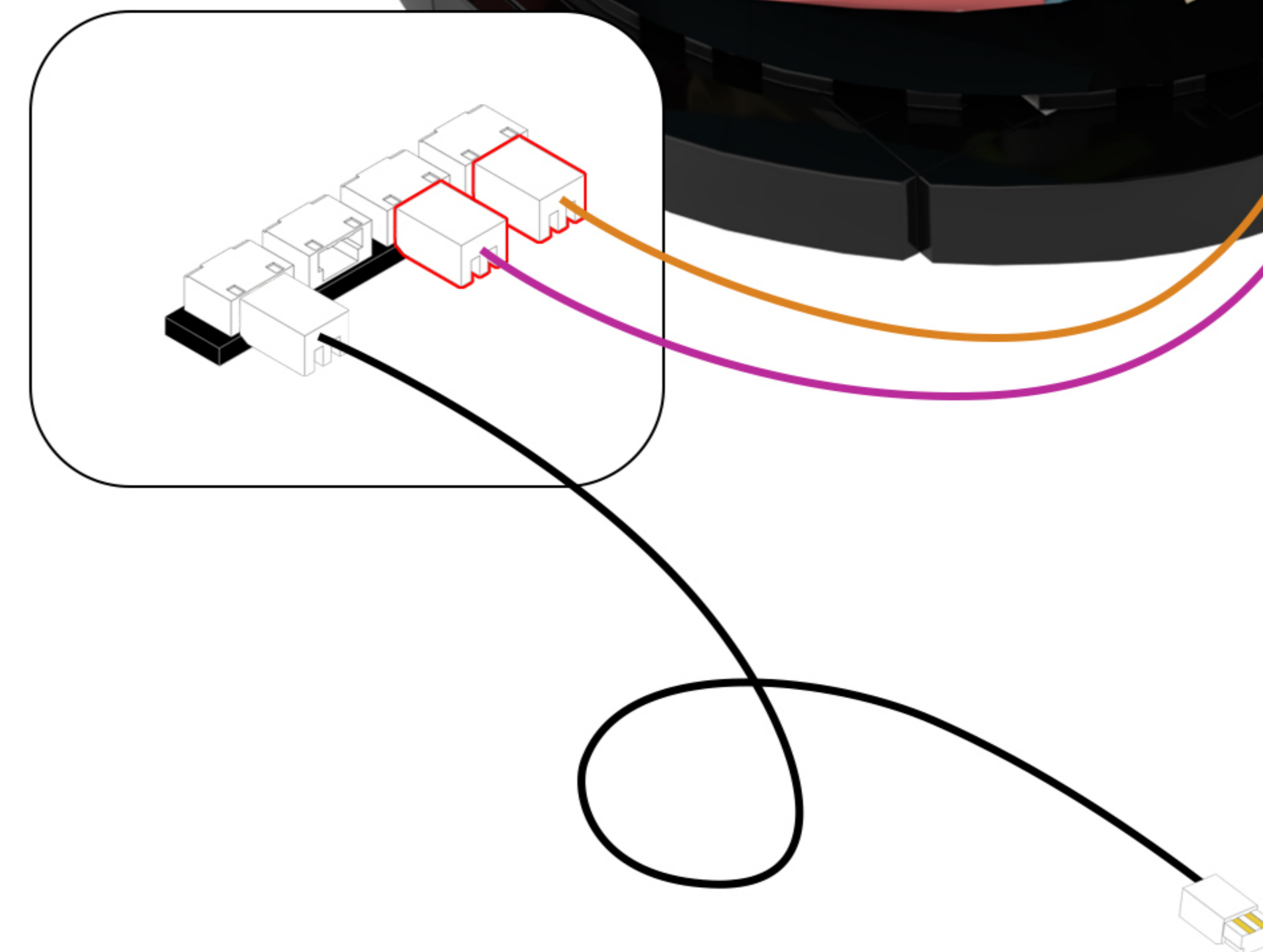
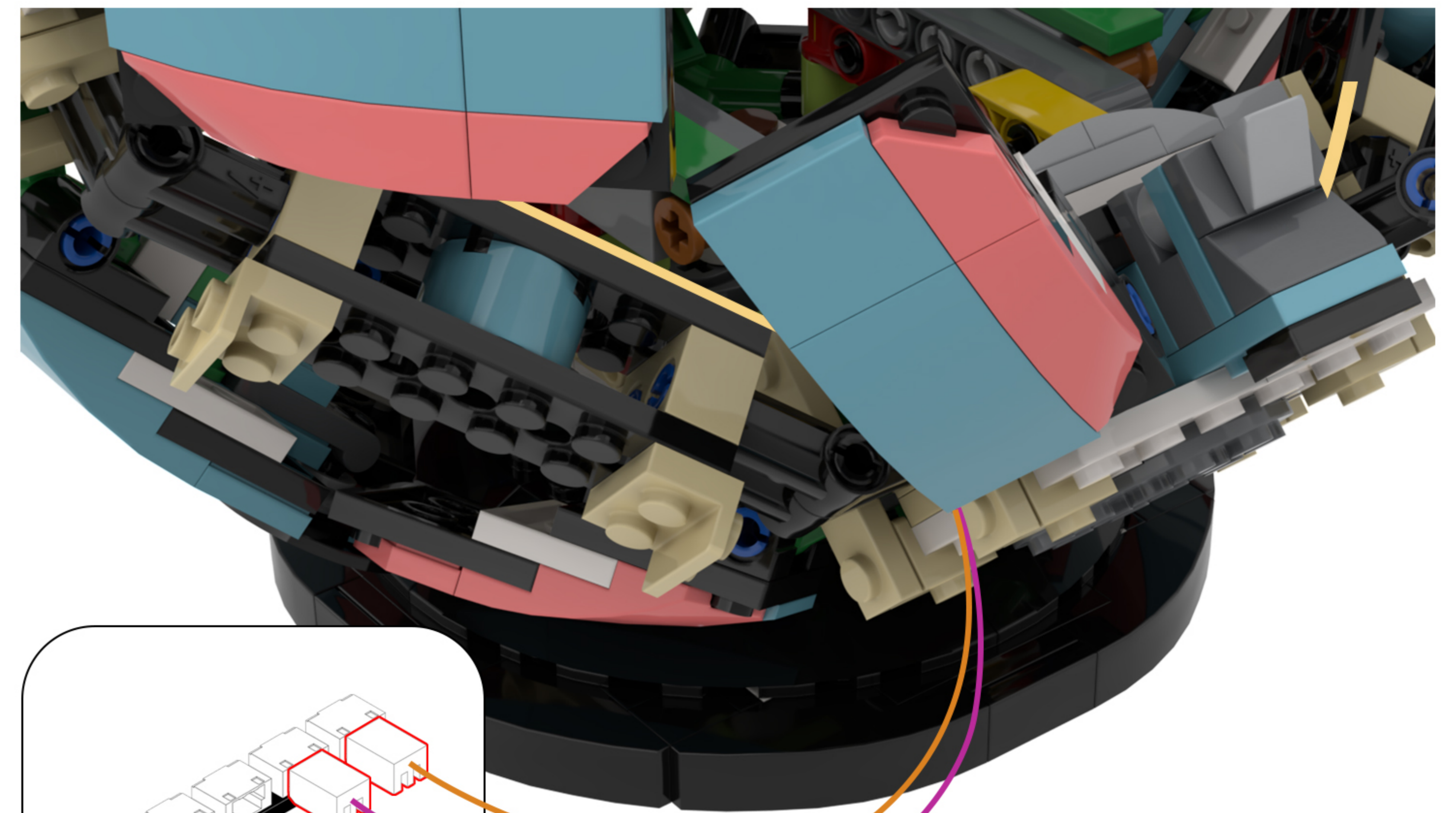
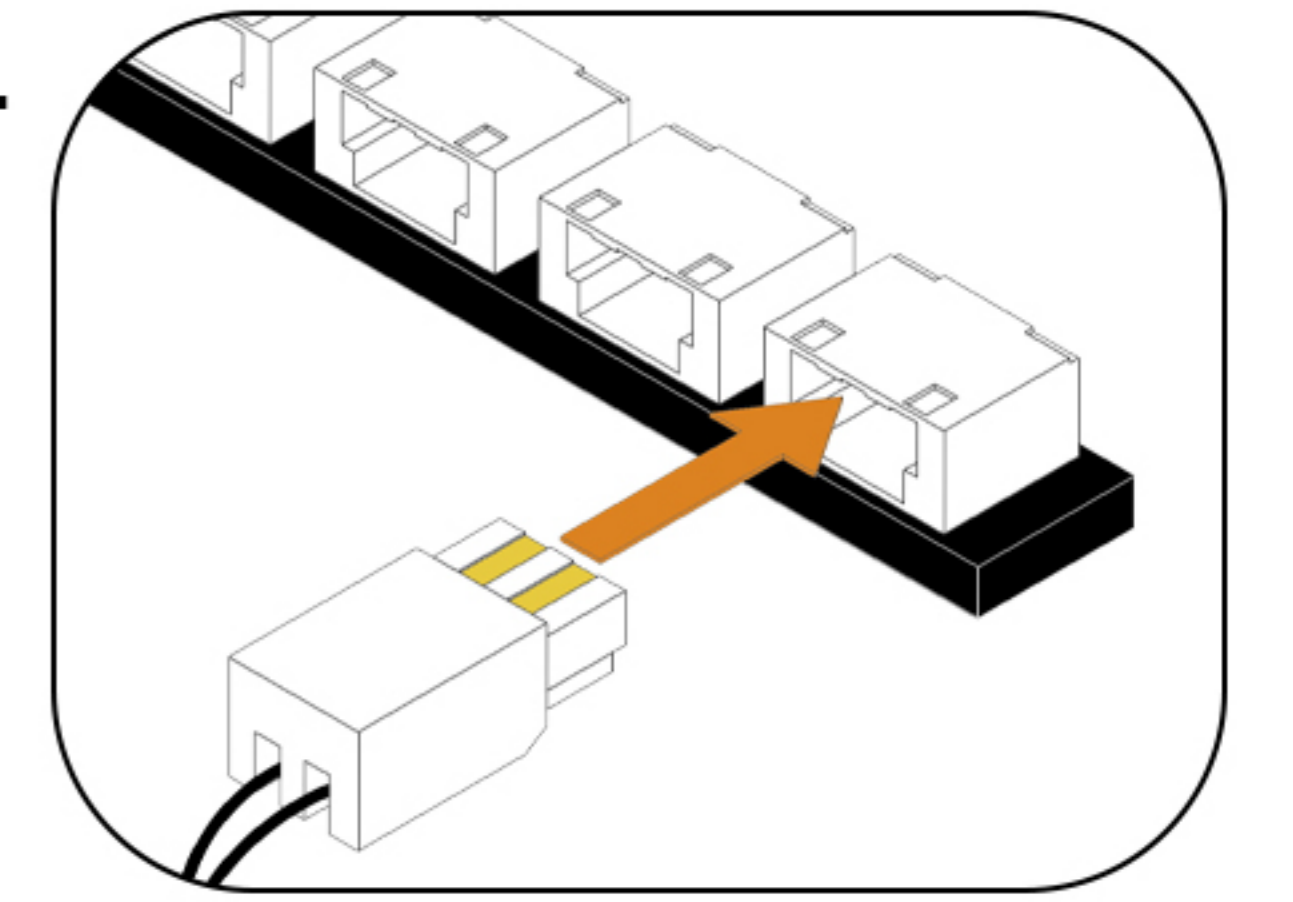

82

EN: Flip the model.

DE: Drehe das Modell um.

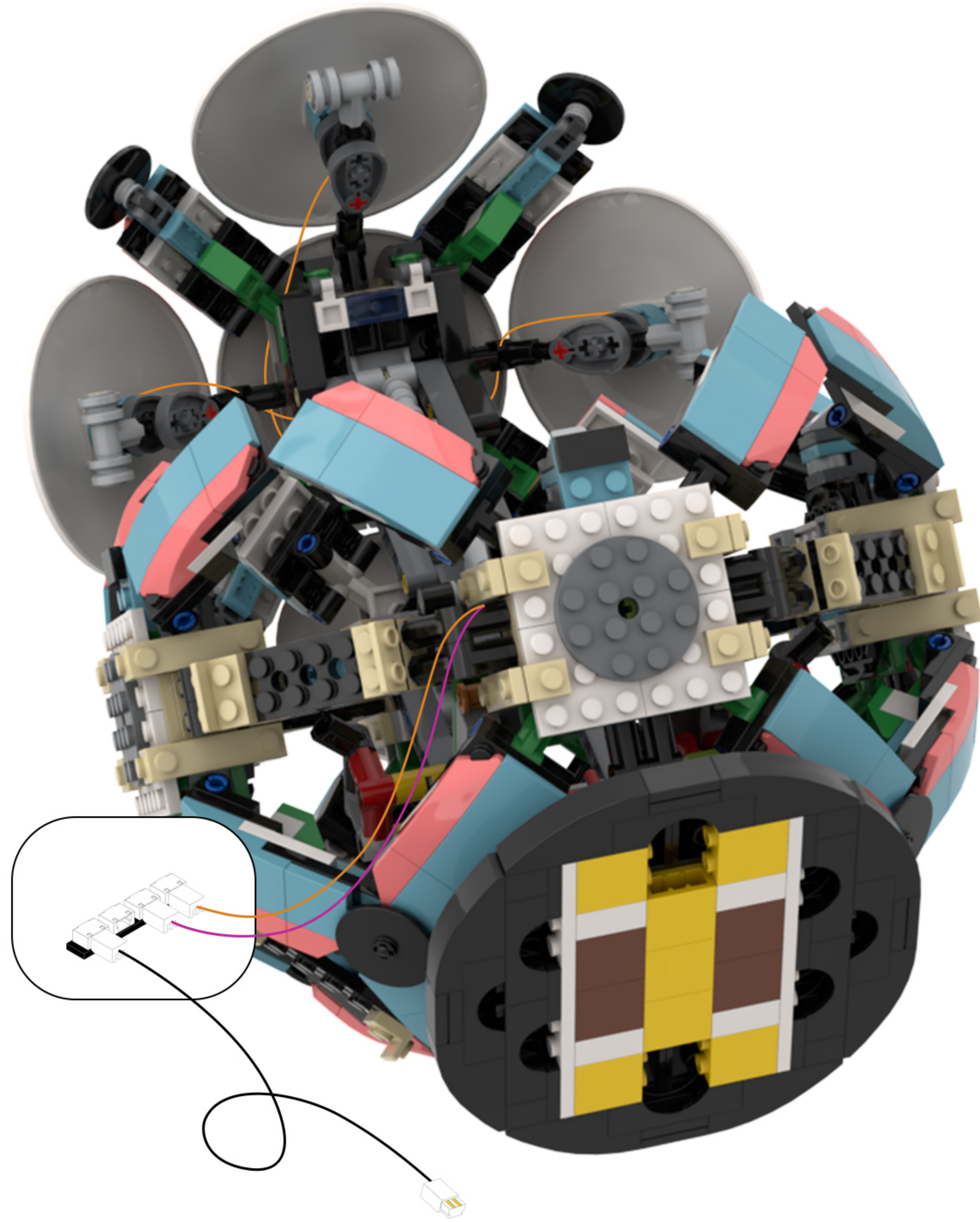

83

EN: Peel off the adhesive backing of the expansion board and attach it to the location shown in the illustration.

DE: Entfernen Sie die Schutzfolie von der Rückseite der Erweiterungsplatte und kleben Sie sie an die in der Abbildung gezeigte Stelle.

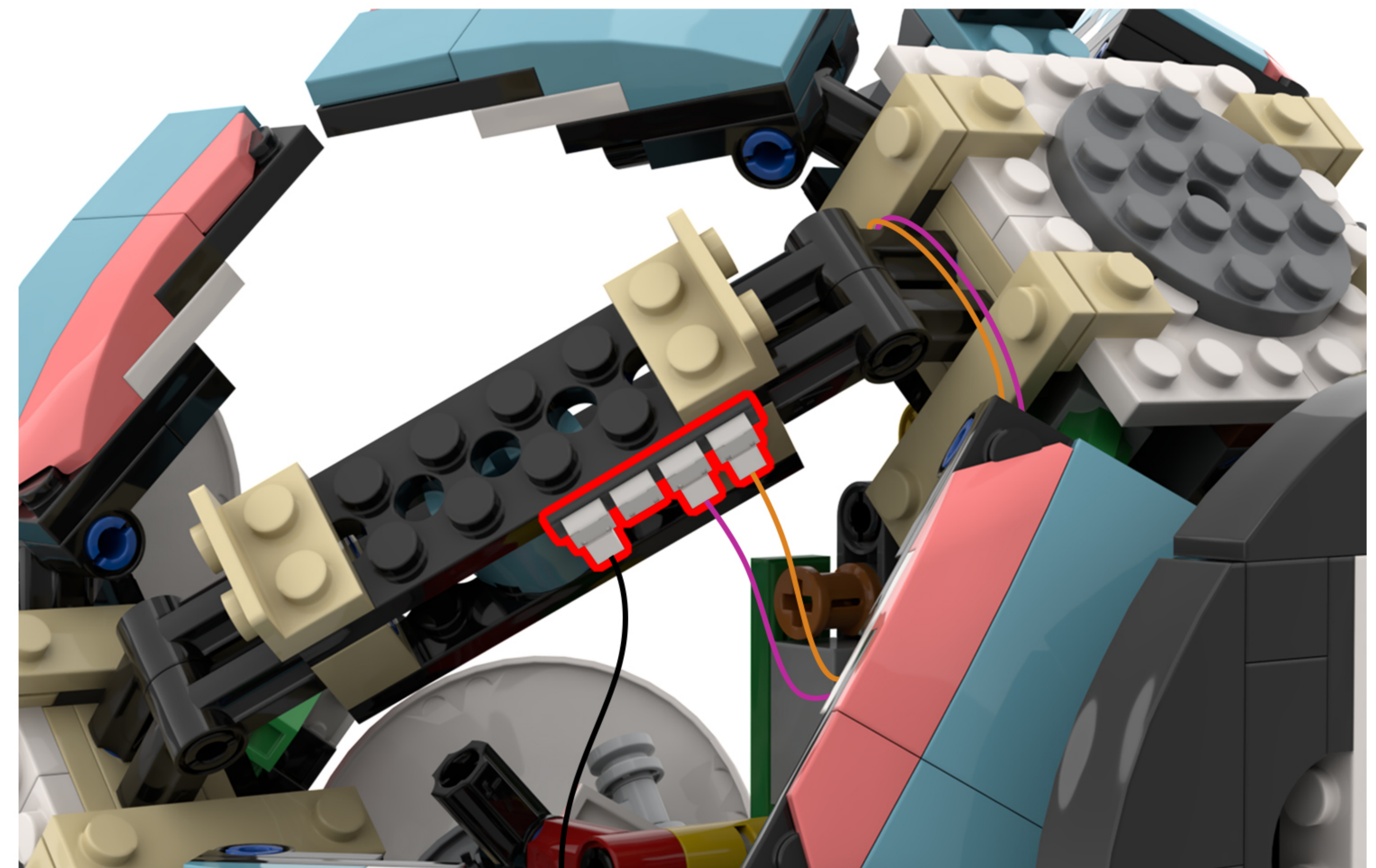
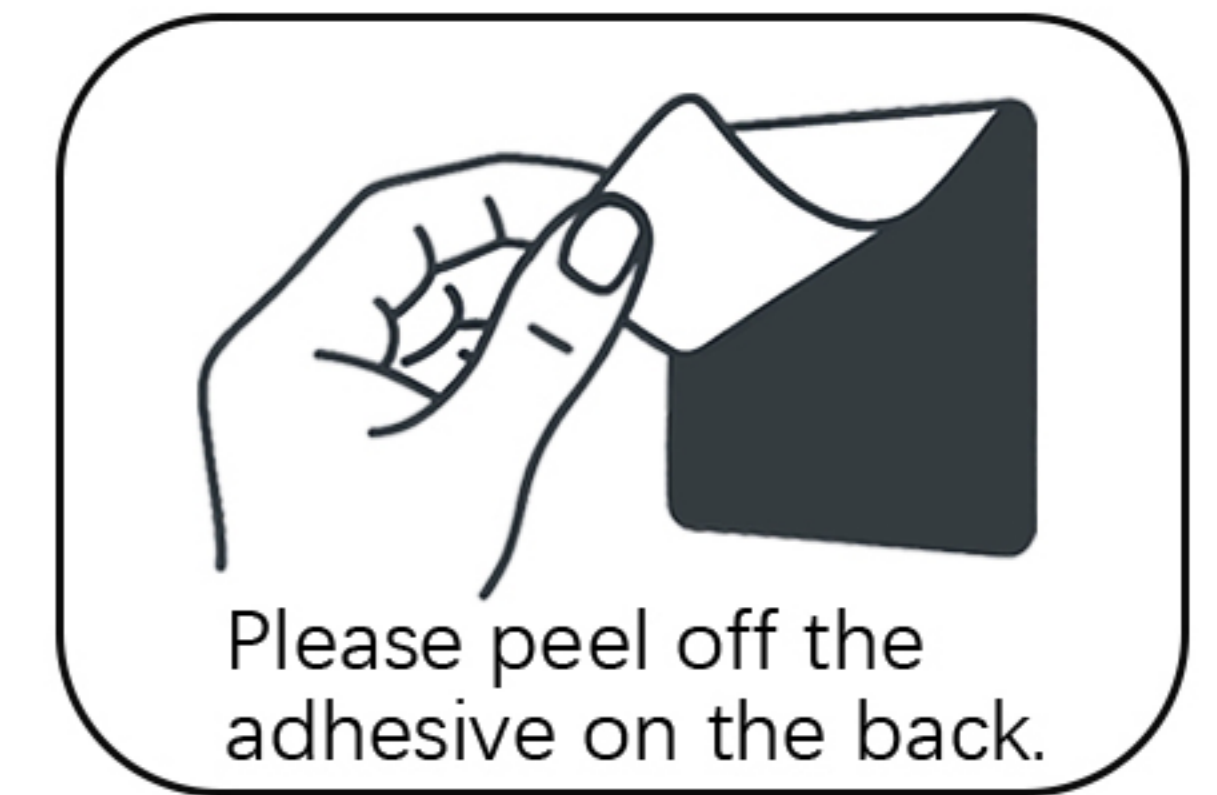

84

EN: Rotate the model to its back side.

DE: Drehen Sie das Modell auf die Rückseite.

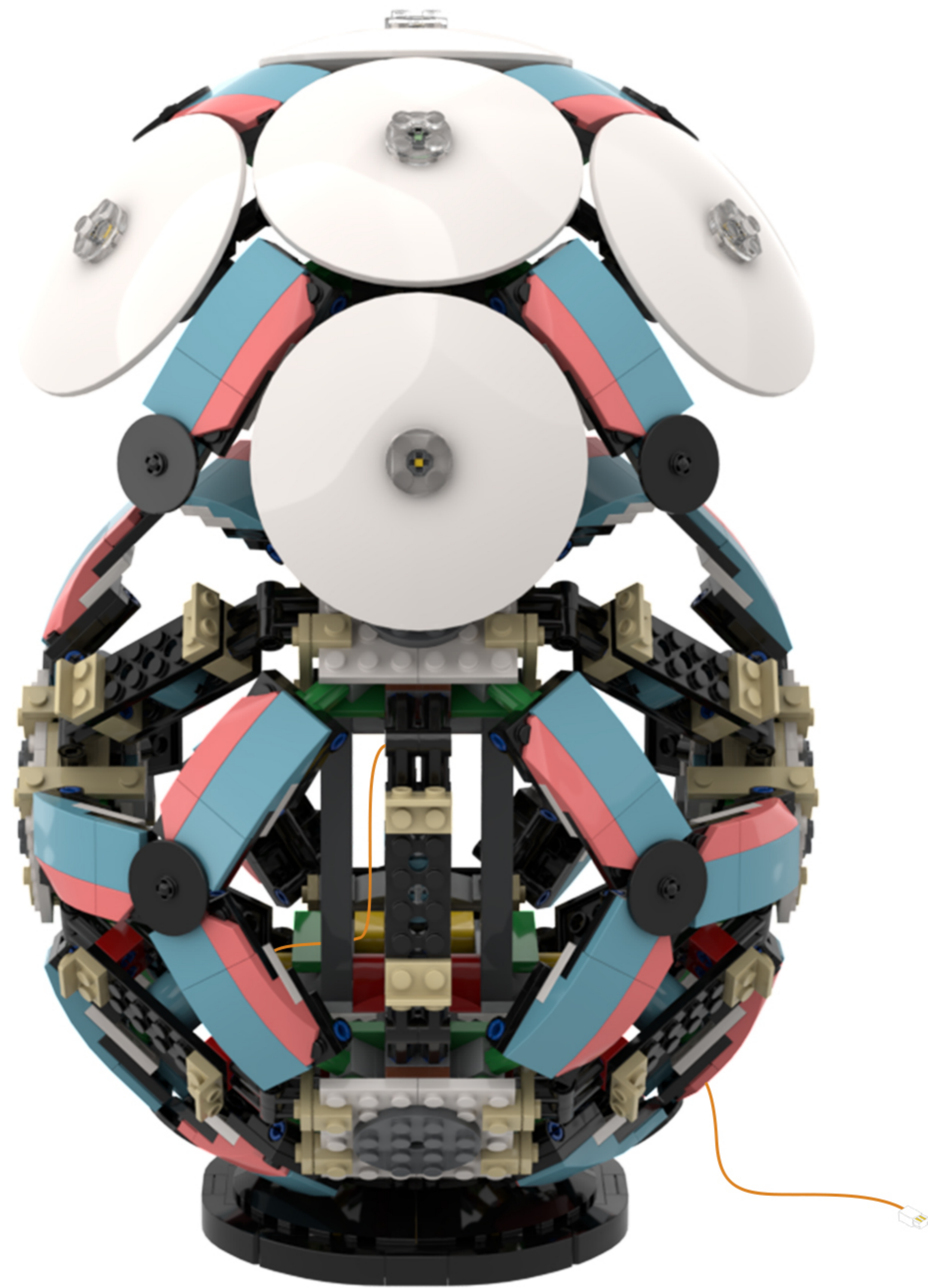
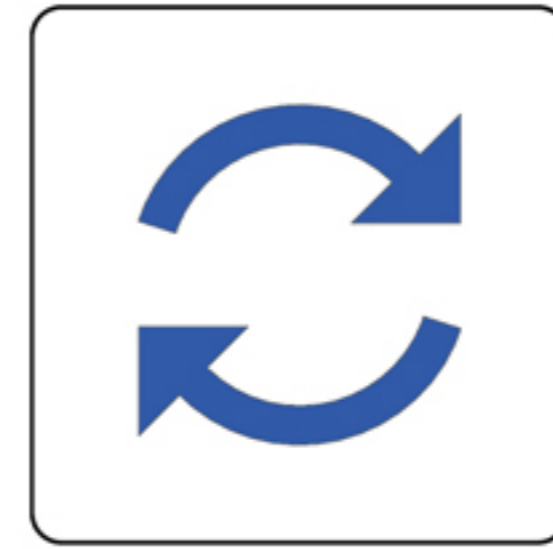

85

EN: Look at the base of the model.

DE: Schauen Sie sich den Sockel des Modells an.

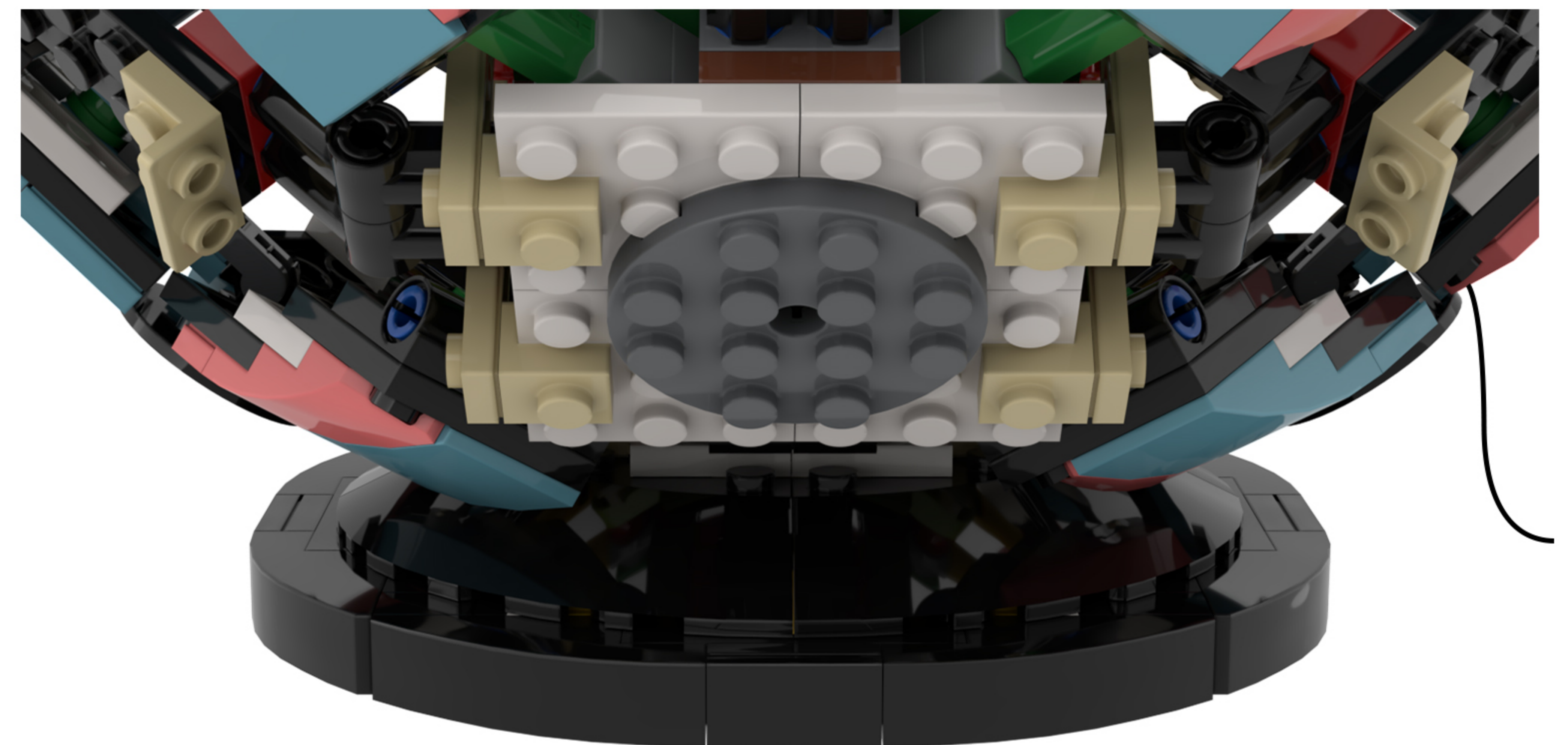

86

EN: Take the COB light strip out of Bag No. 4, peel off the adhesive backing, and attach it to the location shown in the illustration.

DE: Nehmen Sie den COB-Lichtstreifen aus Beutel Nr. 4, ziehen Sie die Schutzfolie ab und bringen Sie ihn an der in der Abbildung gezeigten Stelle an.

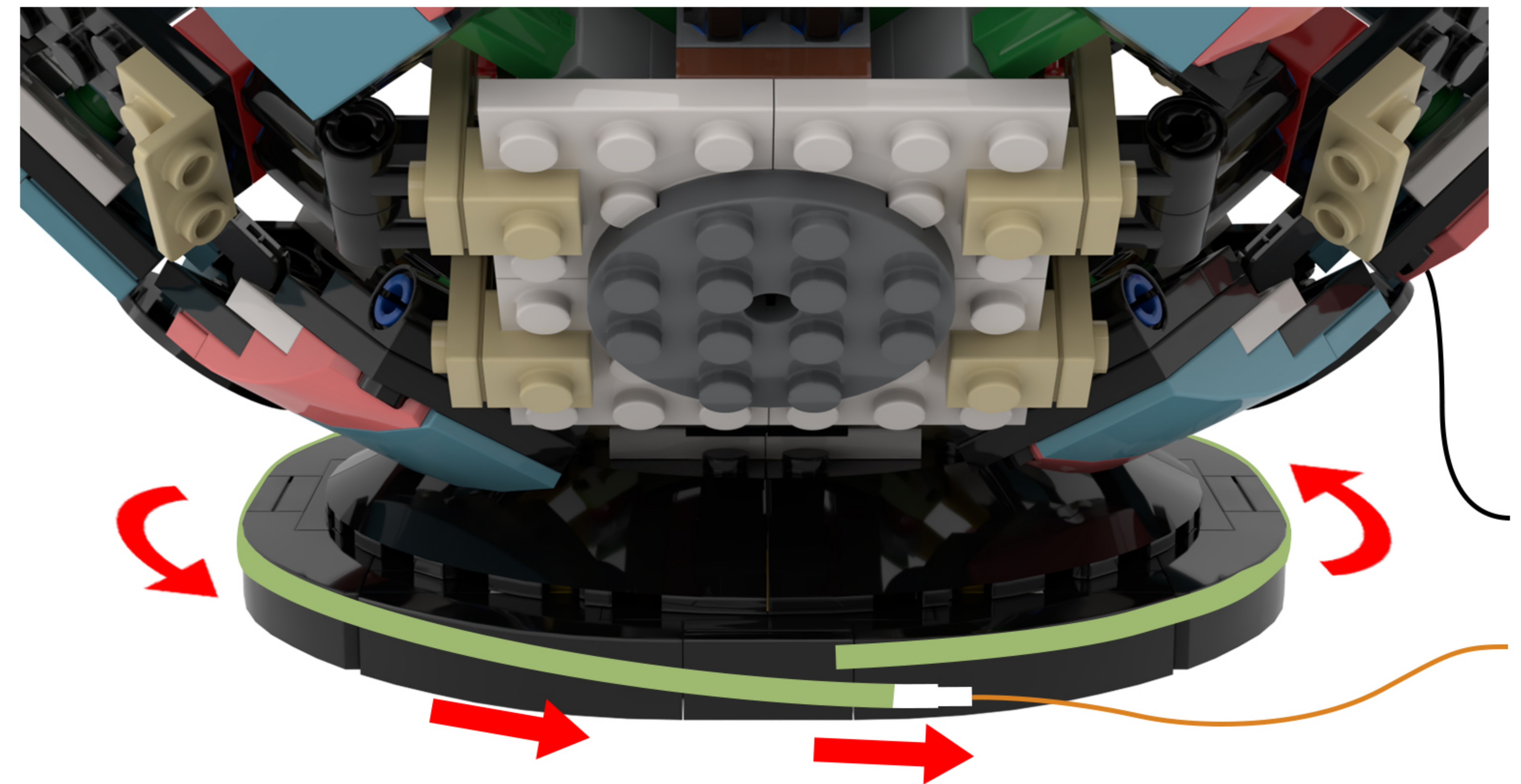
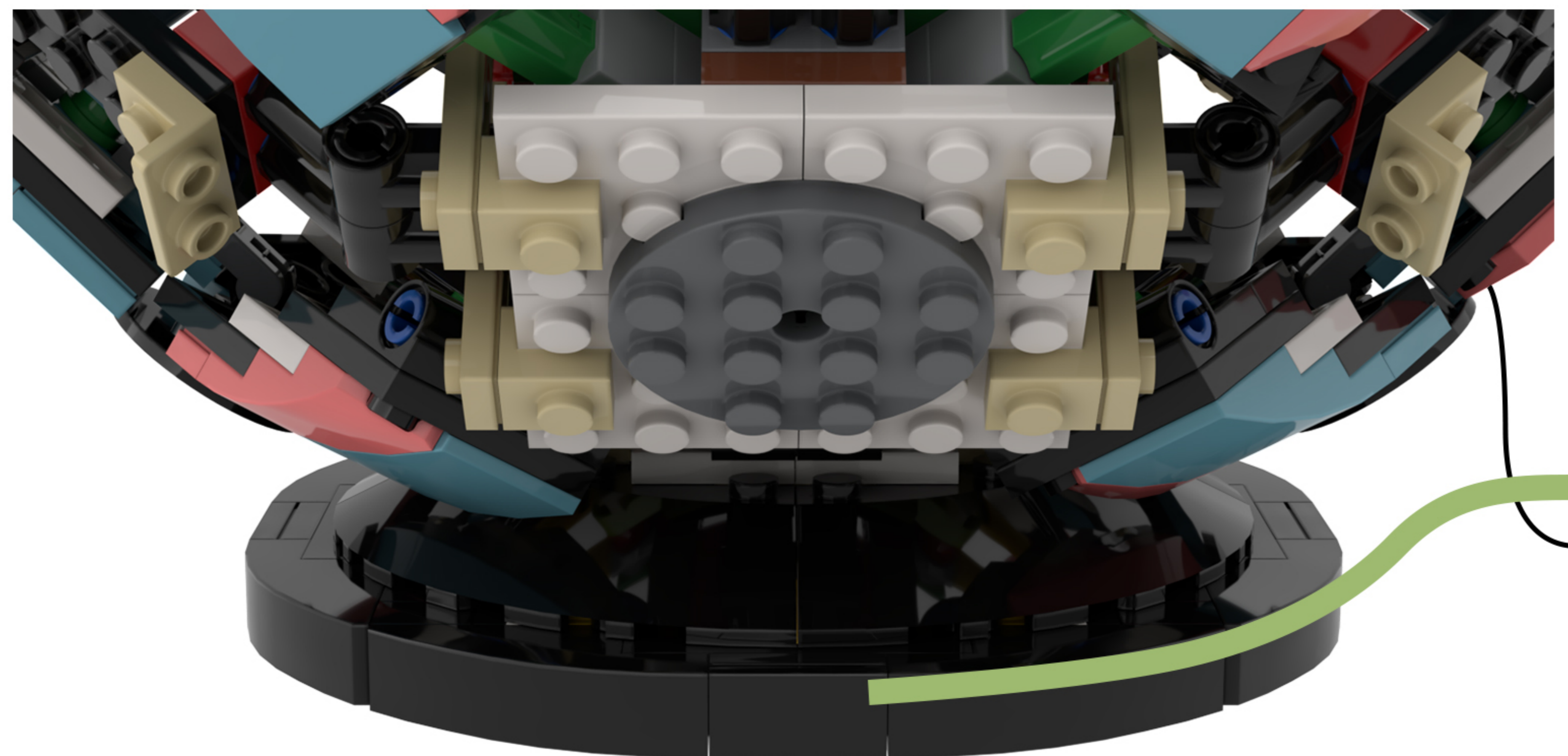
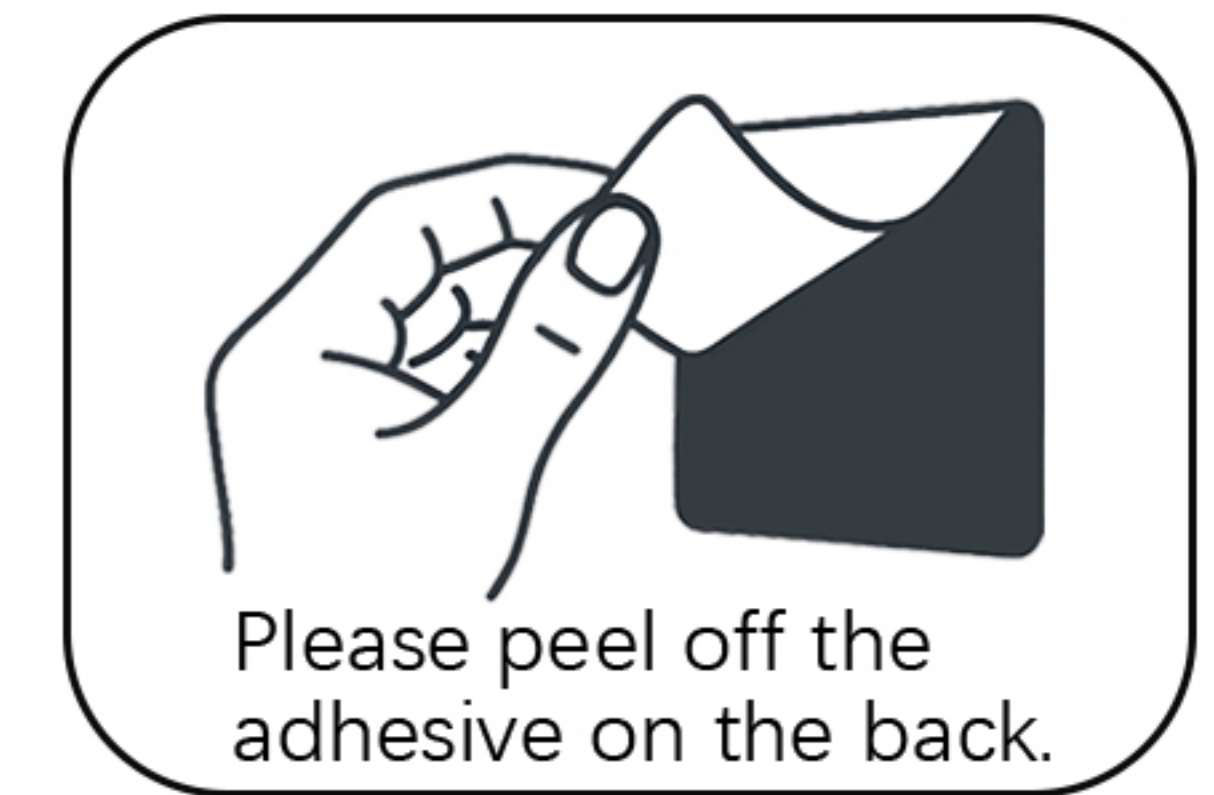
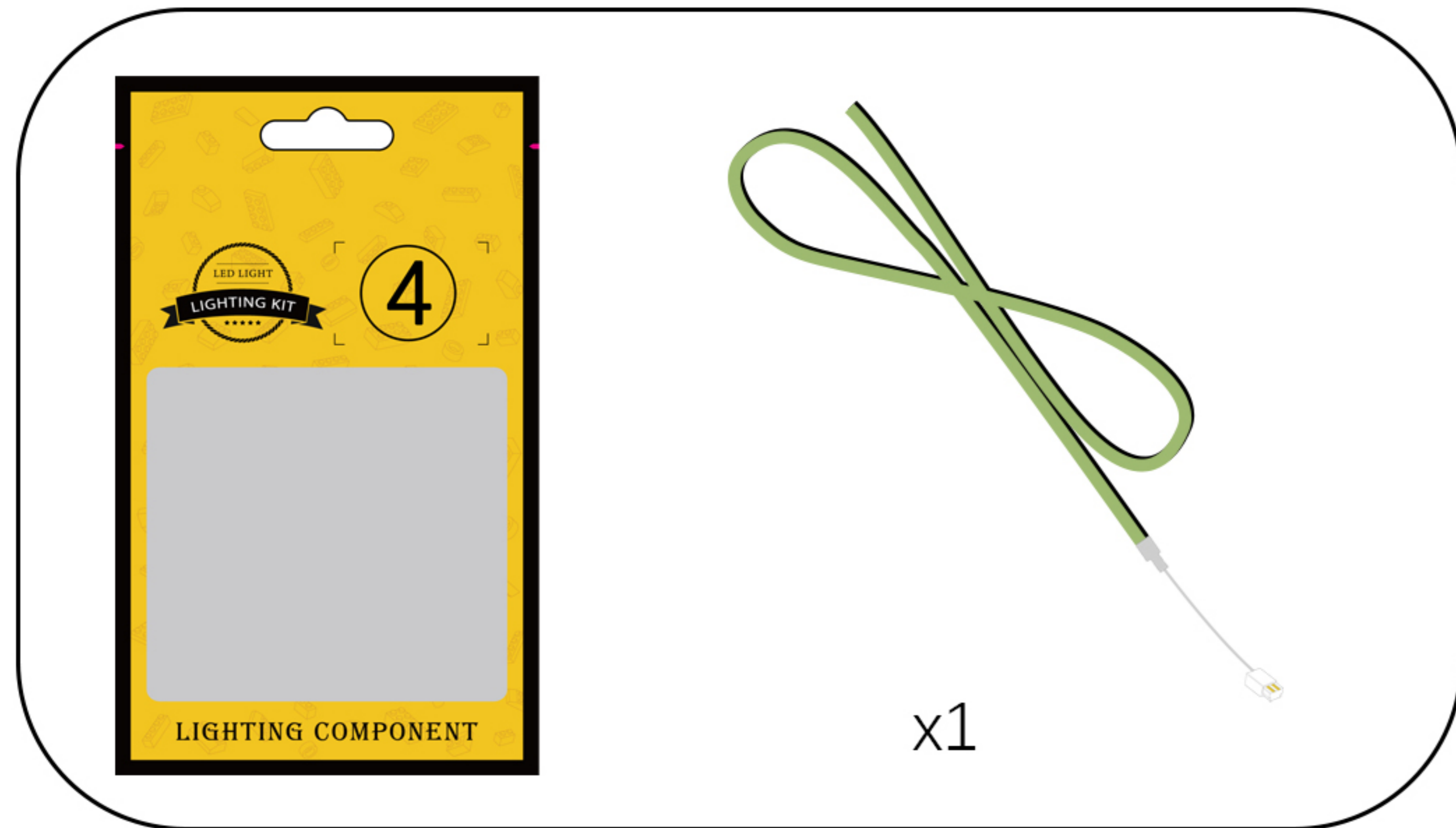

87

EN: Rotate the model to the side.

DE: Drehen Sie das Modell zur Seite.

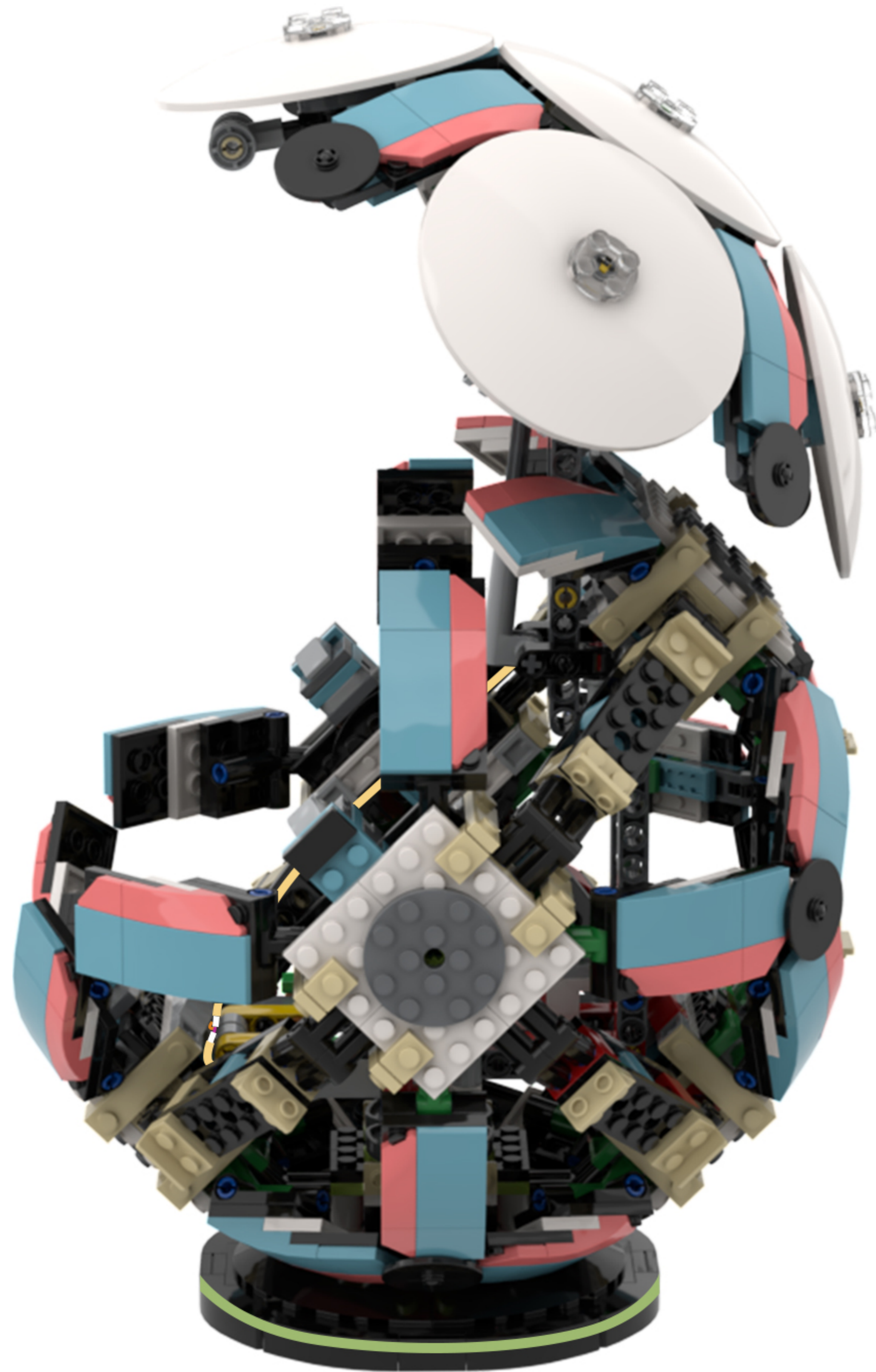
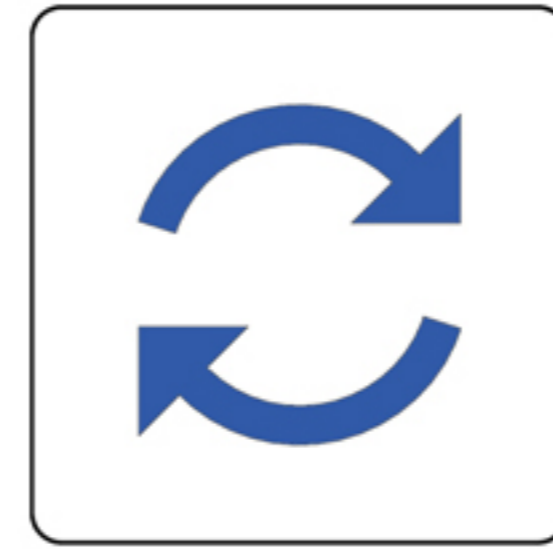

88

EN: Take out the disassembled building blocks and take them apart one by one.

DE: Nimm die zerlegten Bausteine heraus und nimm sie nacheinander auseinander.

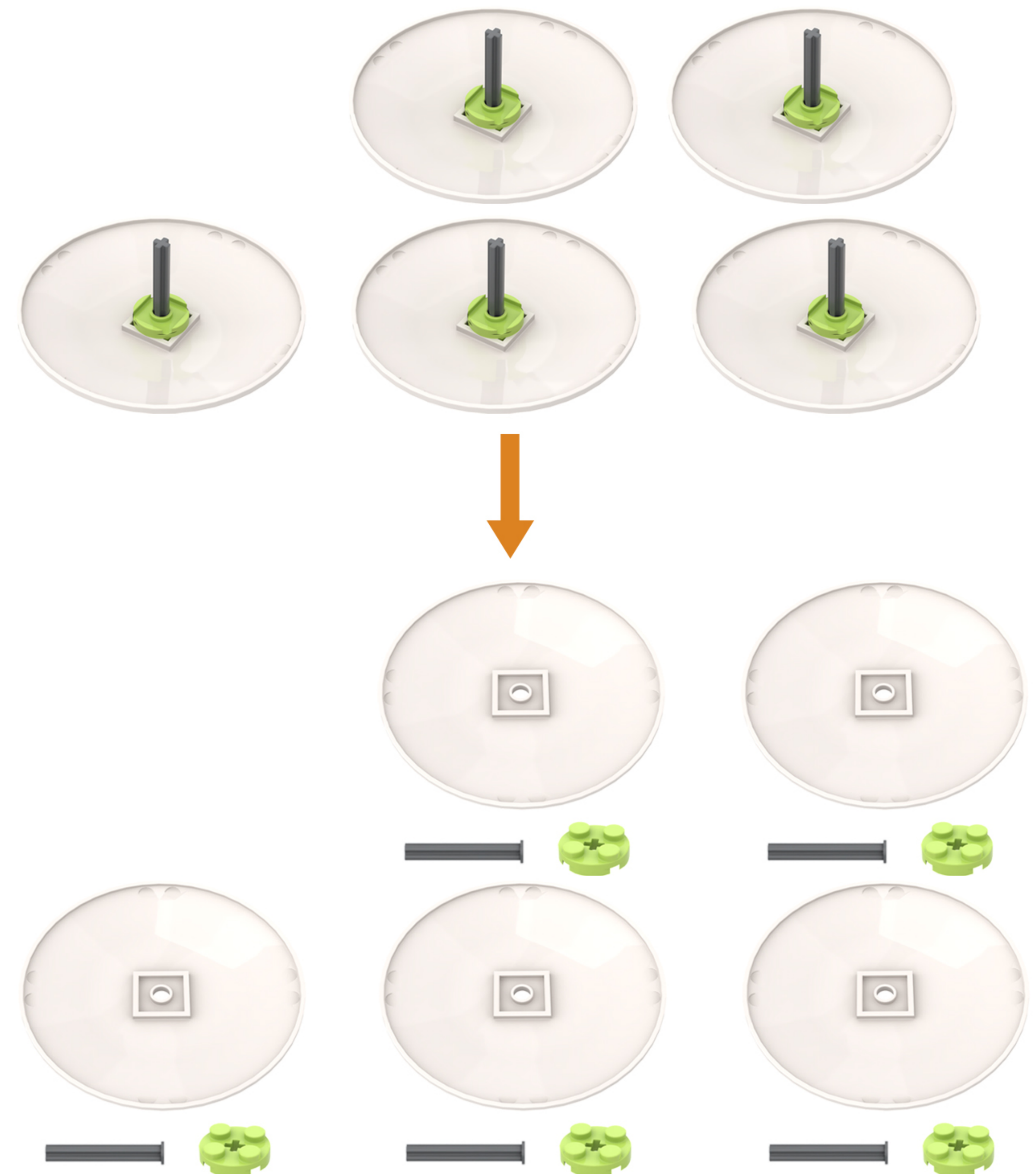
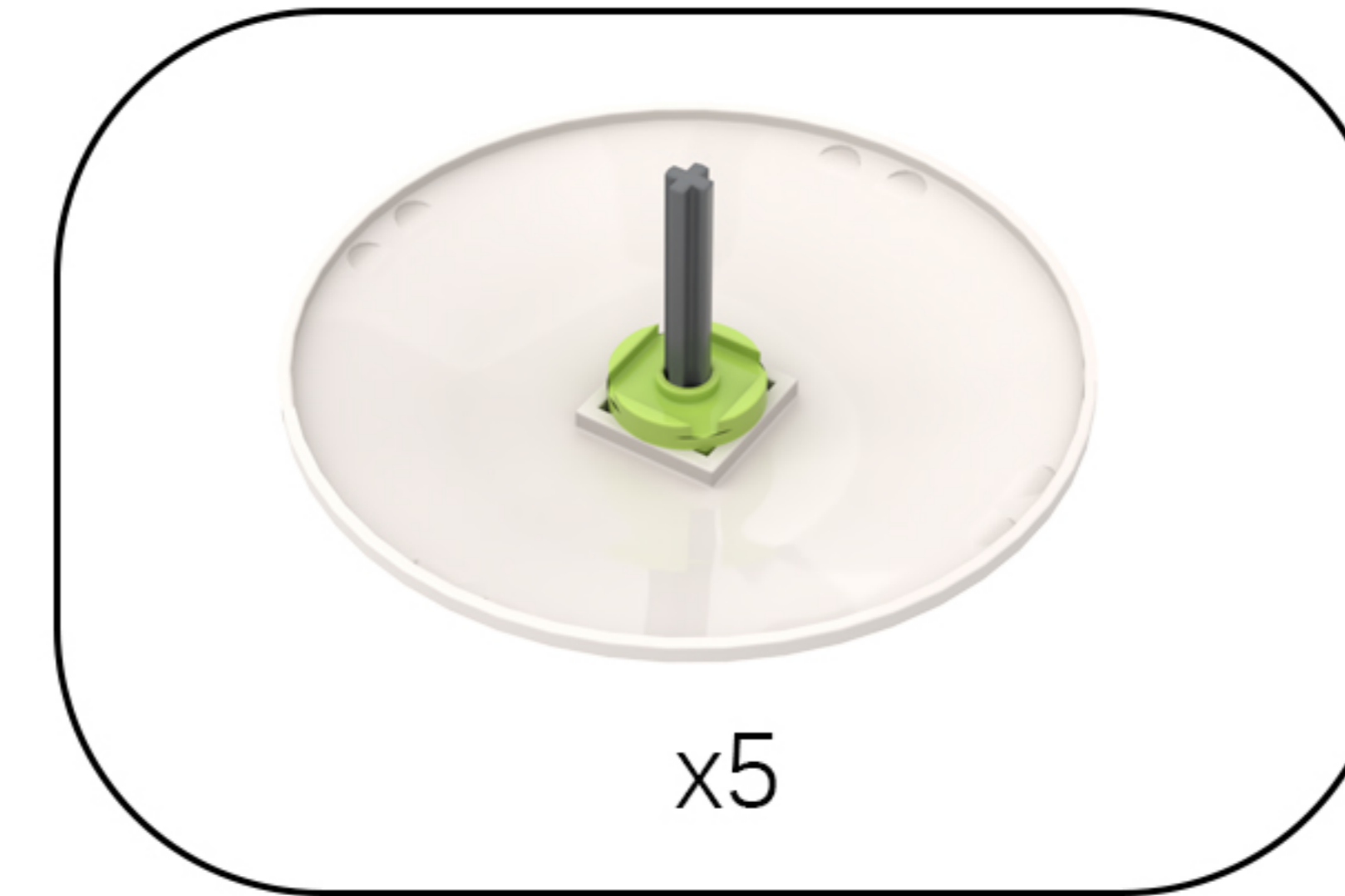

89

EN: Take the light beads from bag #5 and the 2×2 round tiles from bag #10, and use one of them as an example to install the lights.

DE: Nehmen Sie die Leuchtperlen aus Beutel Nr. 5 und die runden 2×2-Steine aus Beutel Nr. 10 und verwenden Sie einen davon als Beispiel für die Montage der Leuchten.

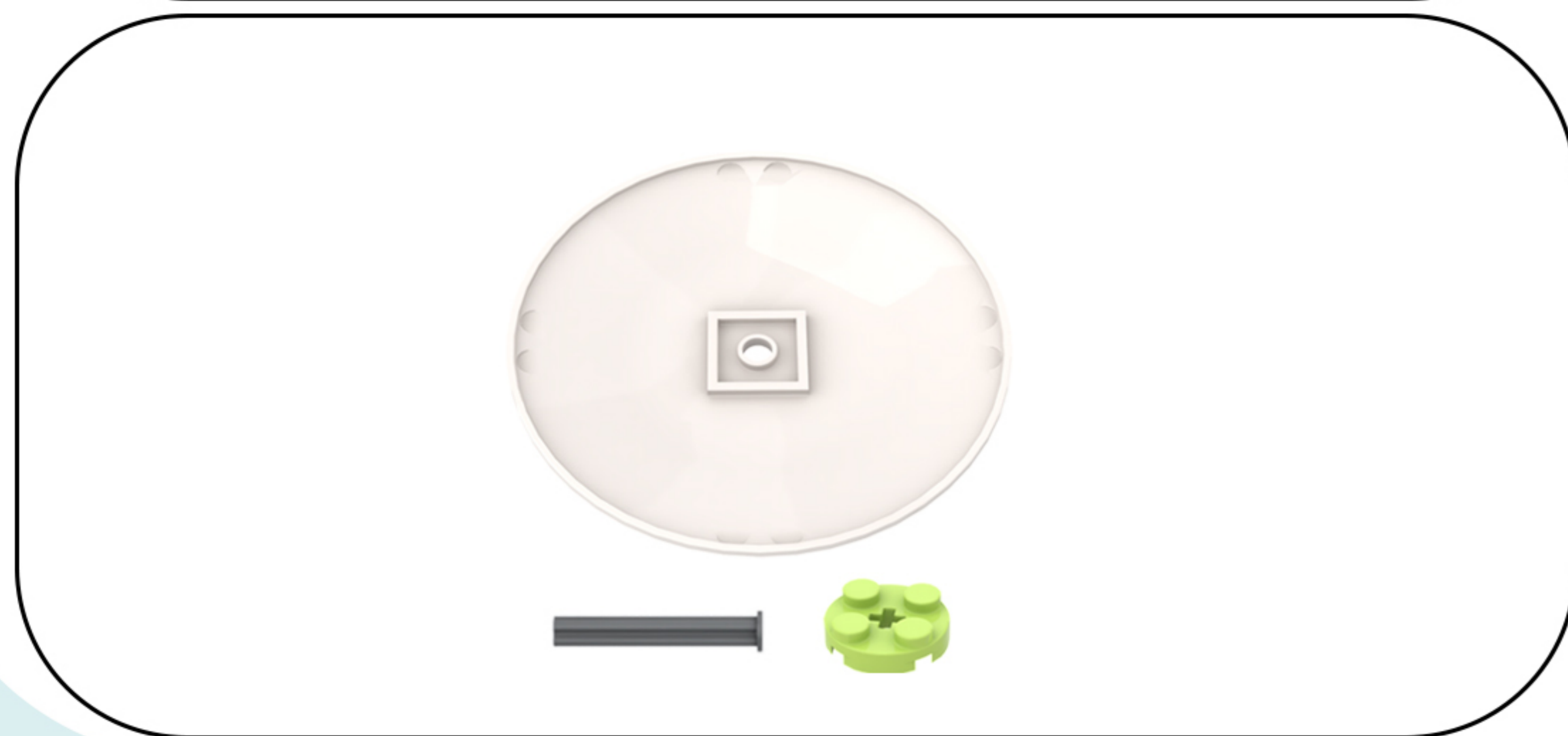
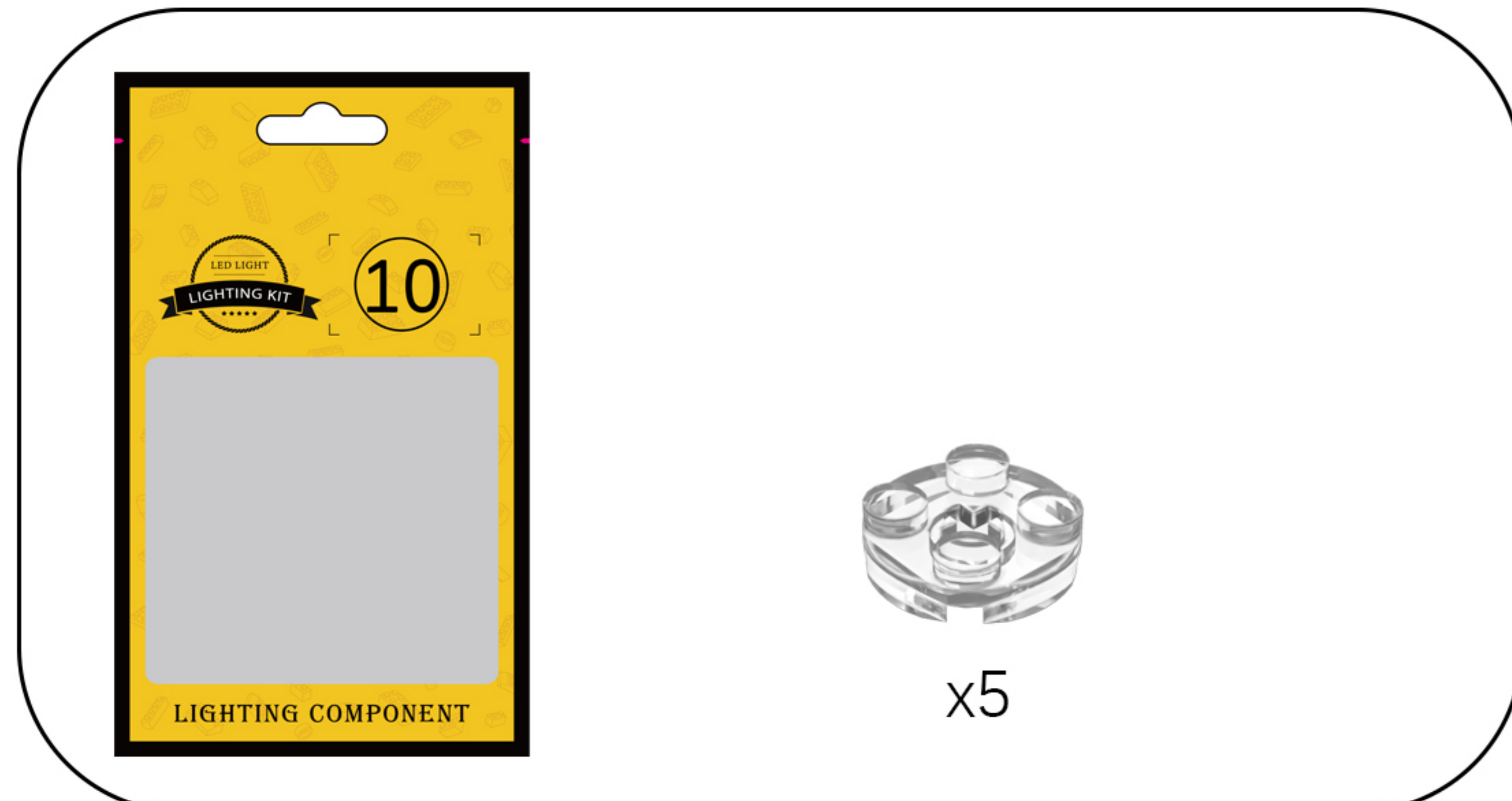
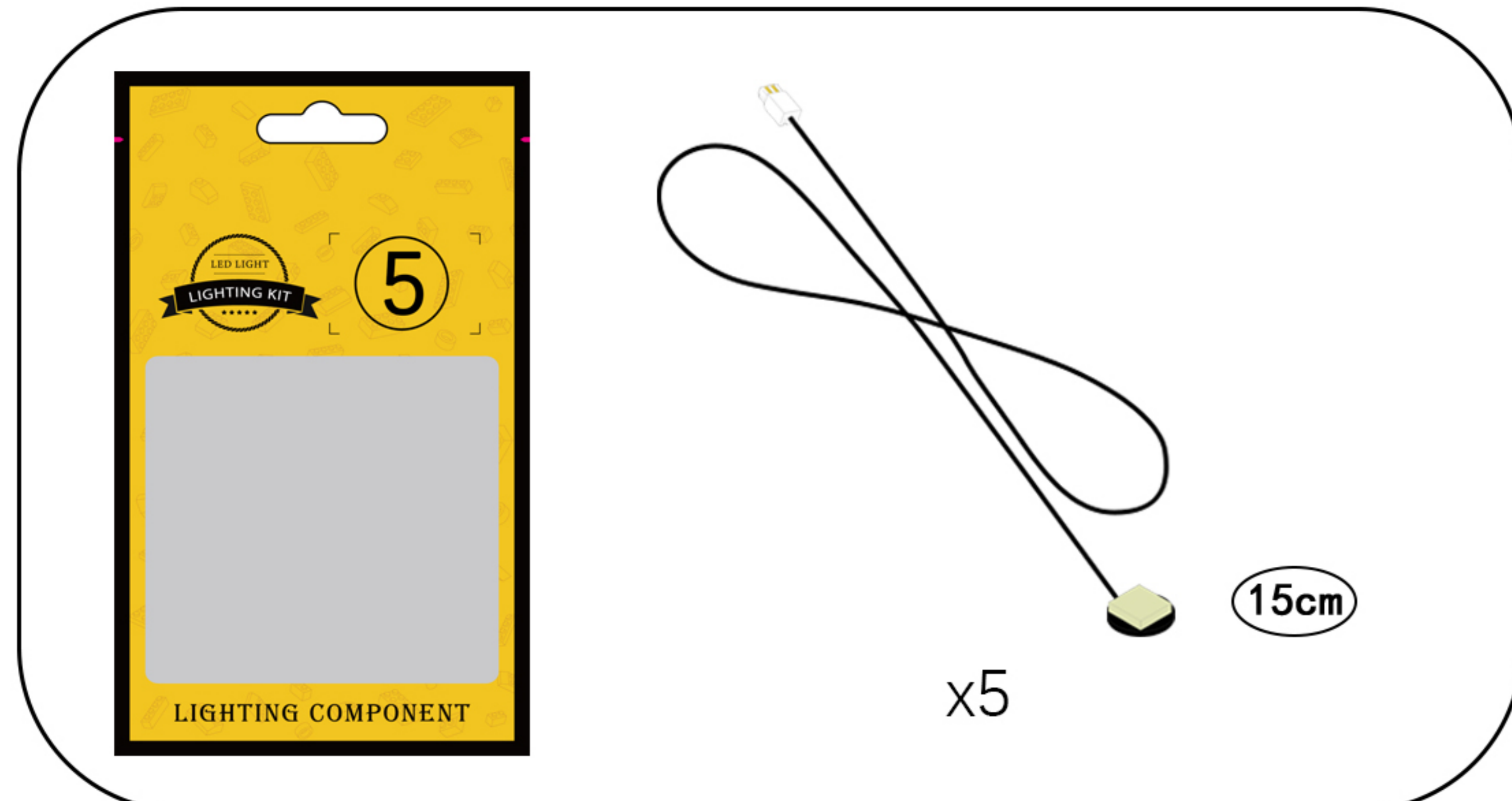

90

EN: Follow these steps in order.

DE: Befolgen Sie diese Schritte der Reihe nach.

- ①. Thread the light beads through the holes in the building blocks.

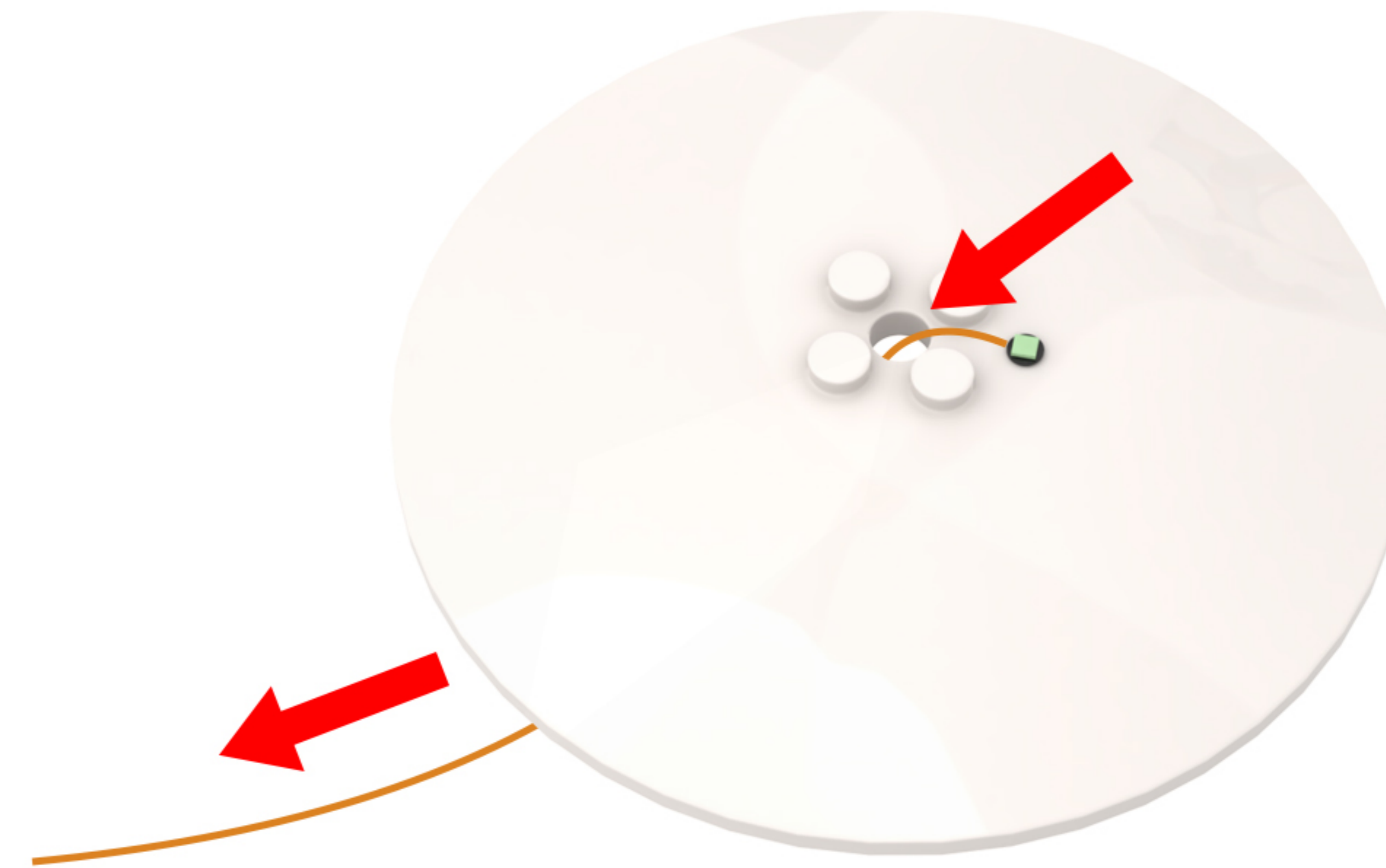

- ②. Take out the disassembled building blocks and reassemble them.

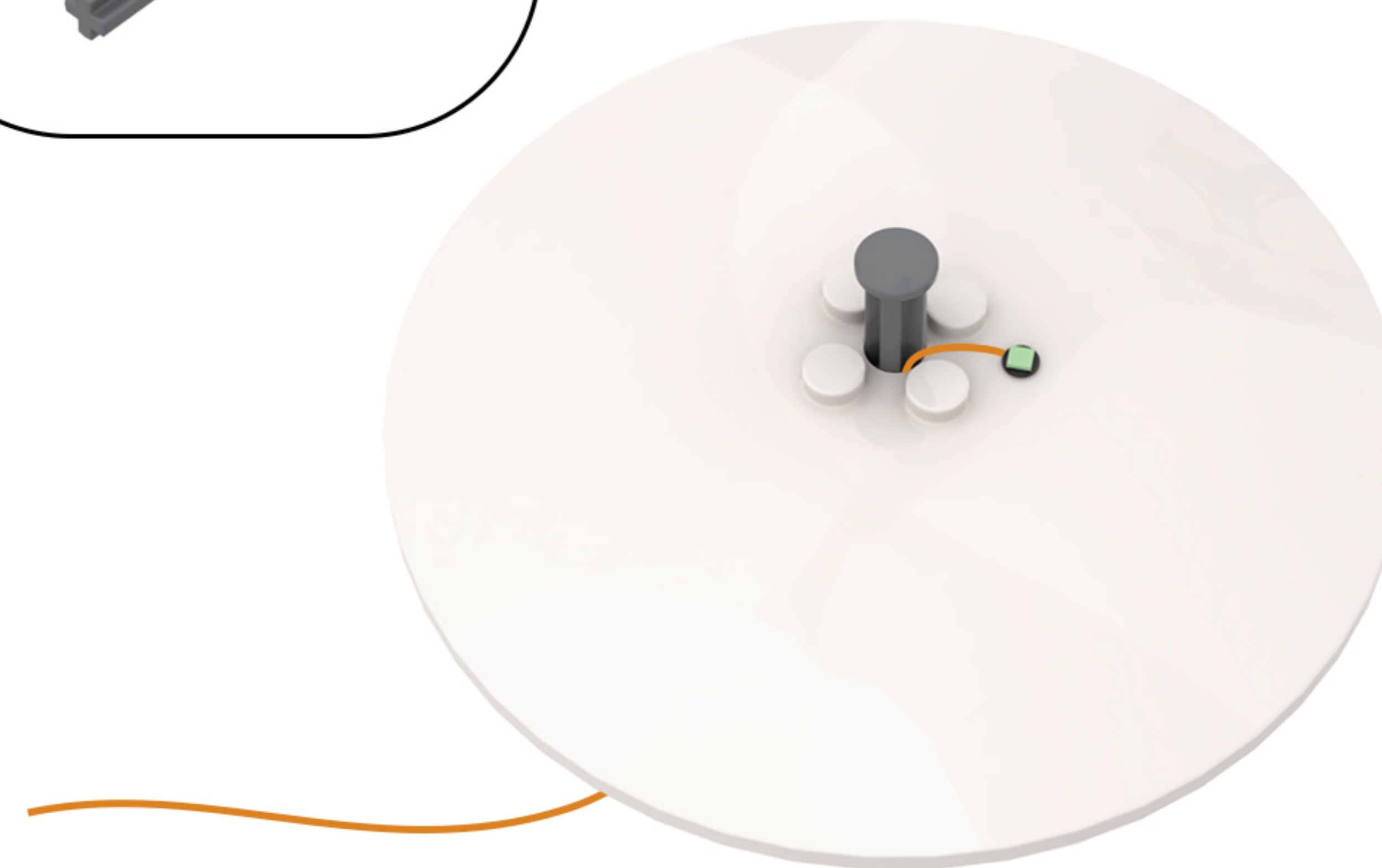
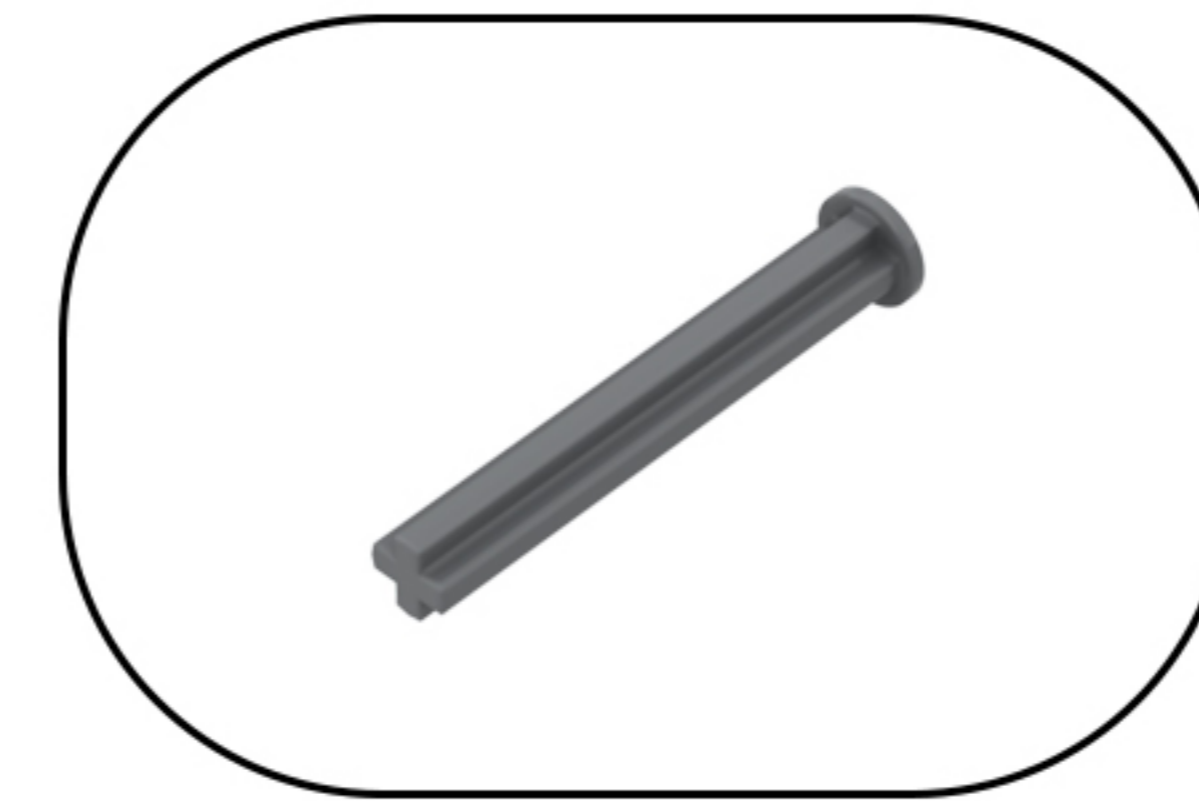

**Note:** When reassembling, make sure to route the light cord through the groove in the cross shaft.

91

EN: Follow these steps in order.

DE: Befolgen Sie diese Schritte der Reihe nach.

③. After reattaching the building block to its original position, place the light fixture on top of it.



④. Attach the 2×2 round plate to the building block.



⑤. Flip the model.

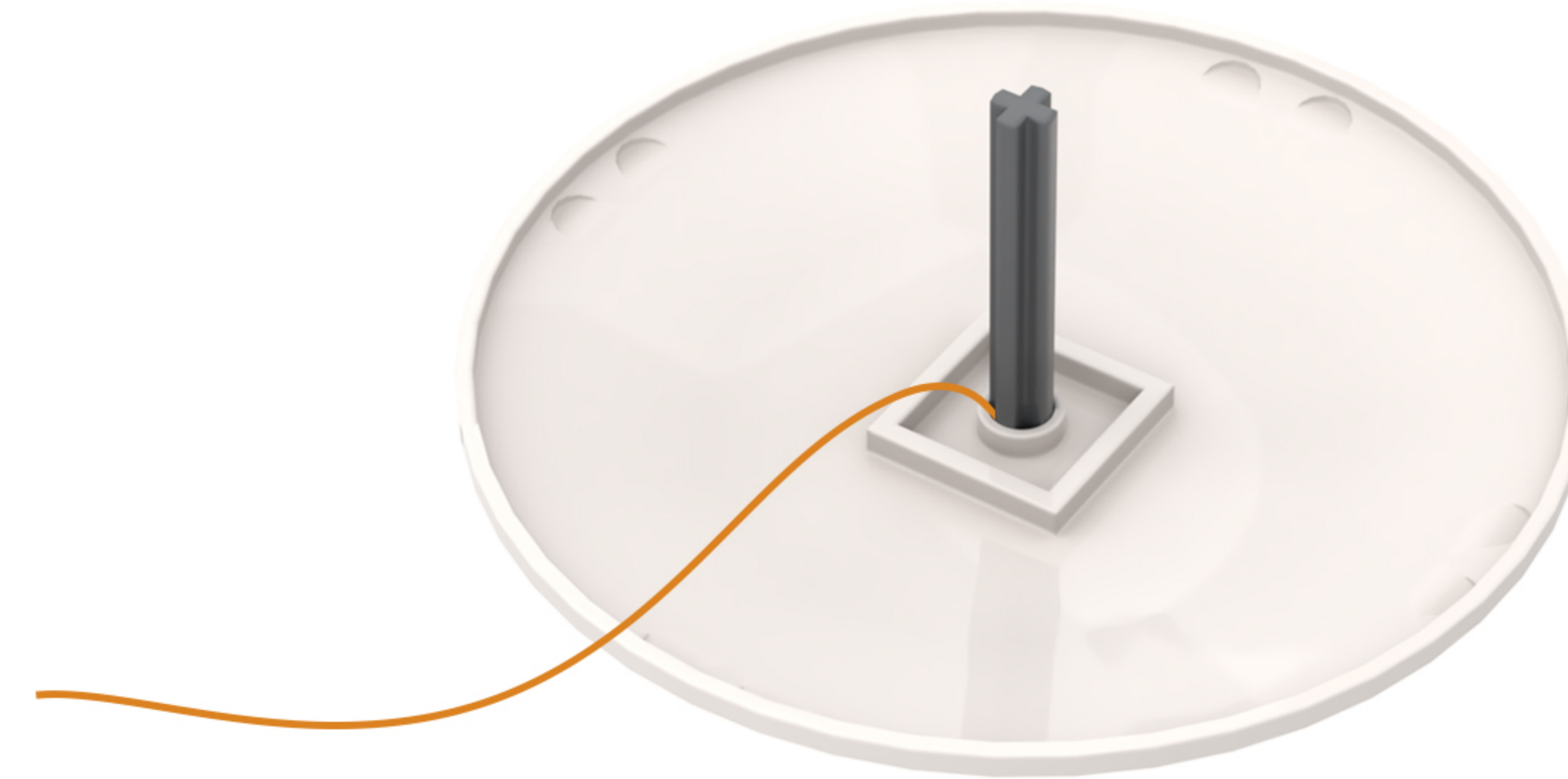

⑥. Take out the disassembled building blocks and reassemble them.

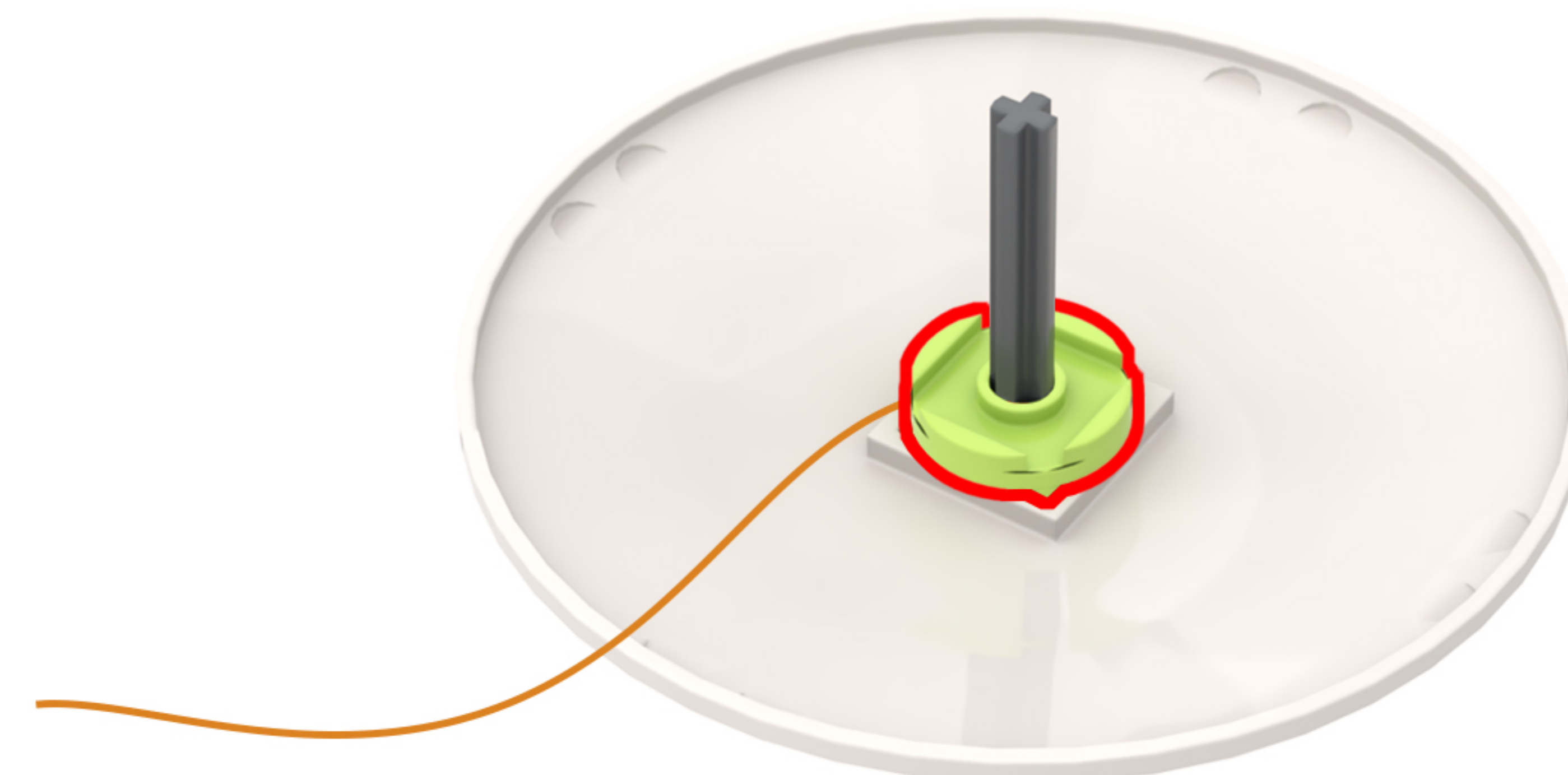
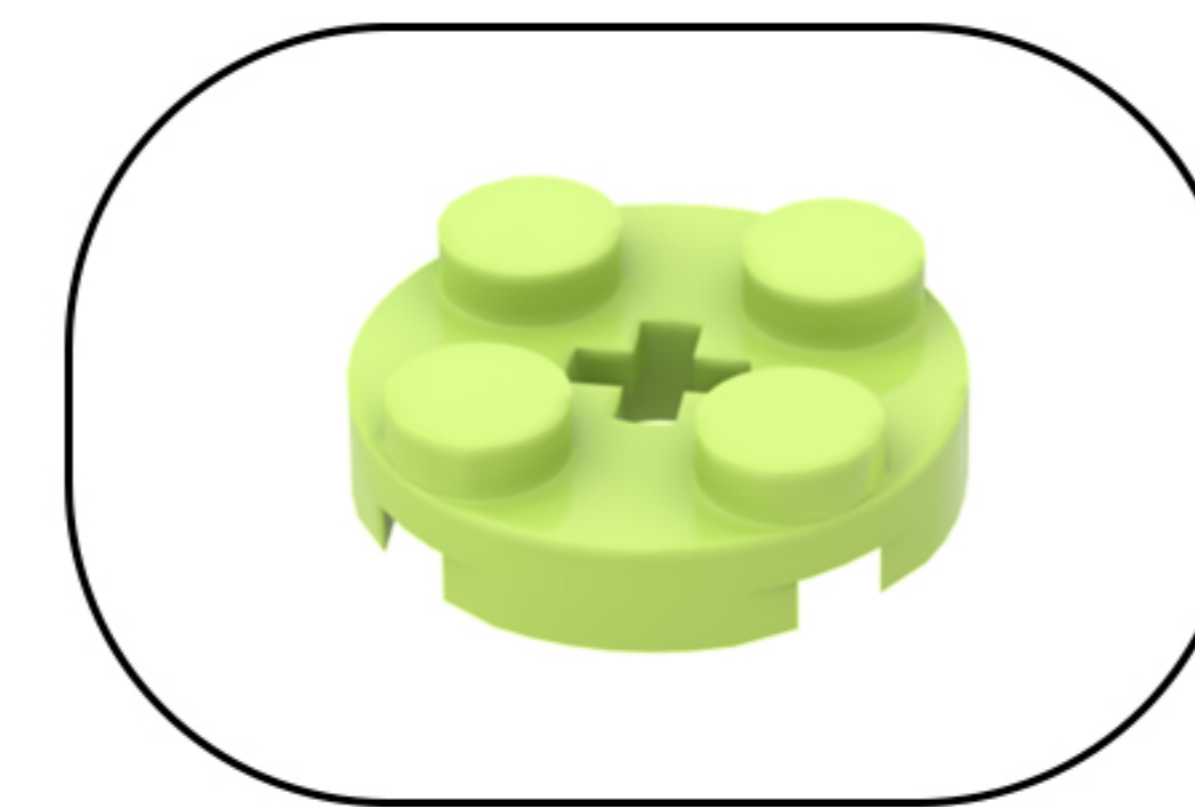

92

EN: Repeat the steps above to obtain 5 light fixtures.

DE: Wiederholen Sie die oben beschriebenen Schritte, um 5 Leuchten zu erhalten.

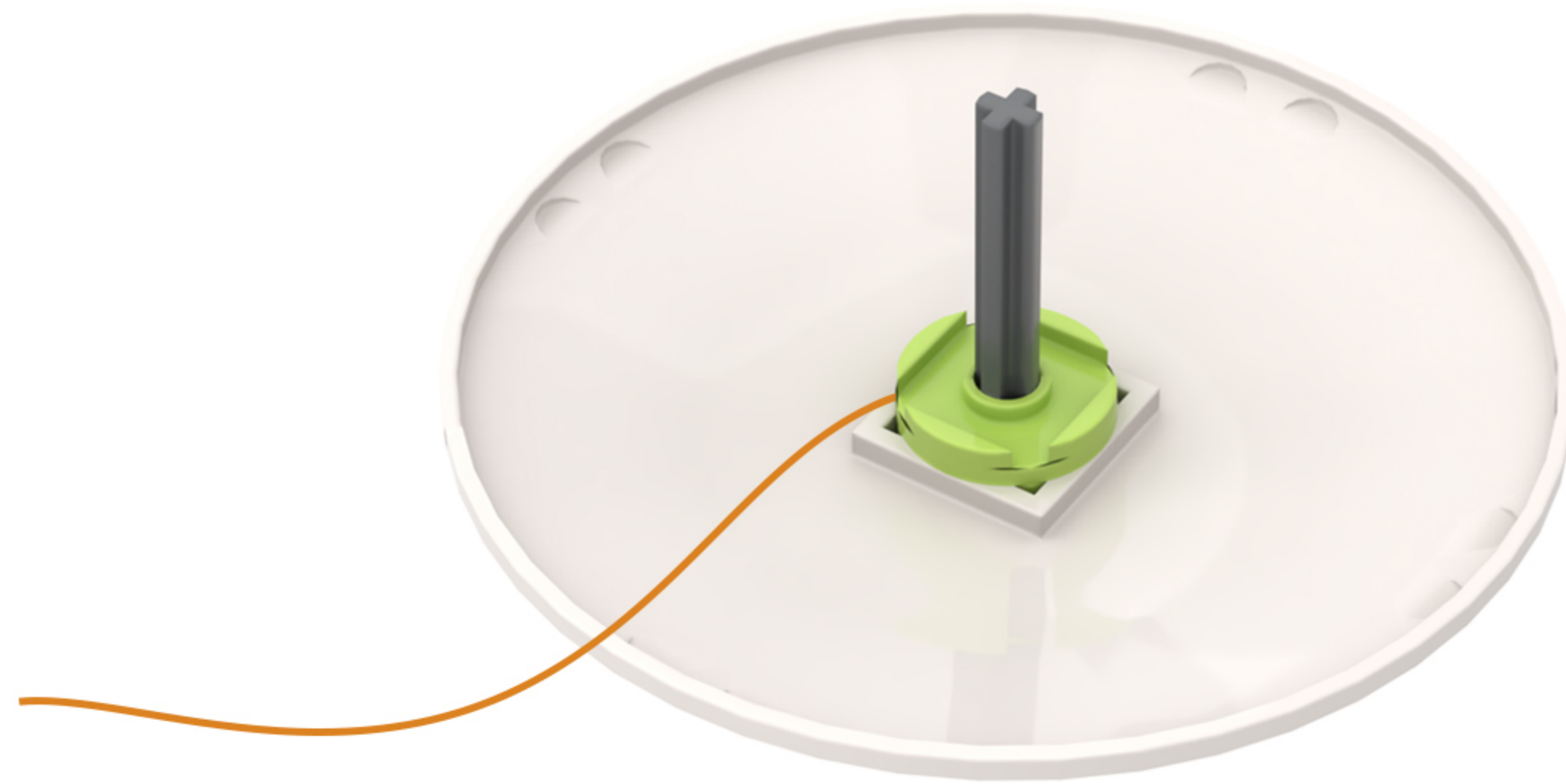

X5

93

EN: Take out the disassembled building blocks and take them apart one by one.

DE: Nimm die zerlegten Bausteine heraus und nimm sie nacheinander auseinander.

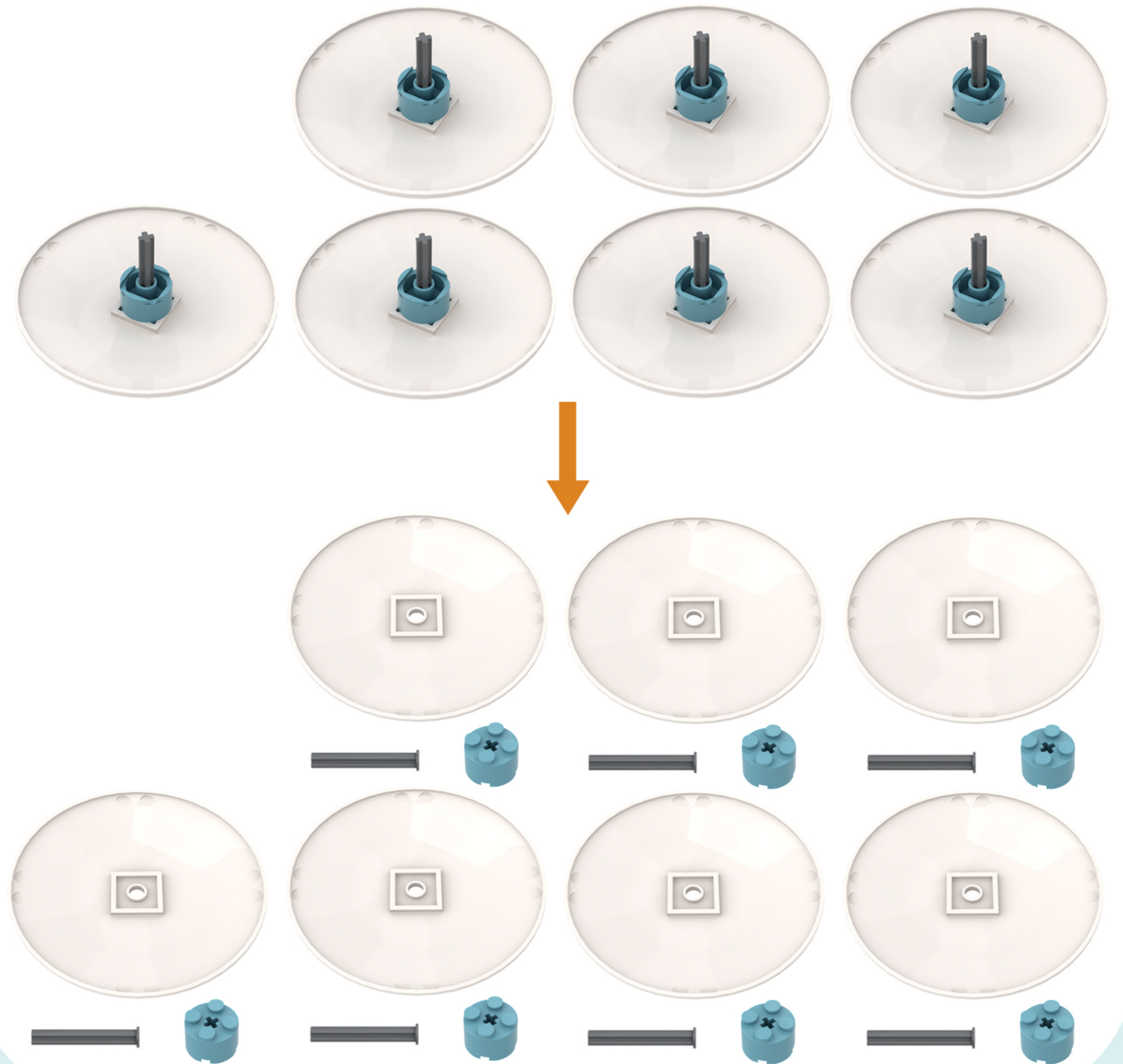
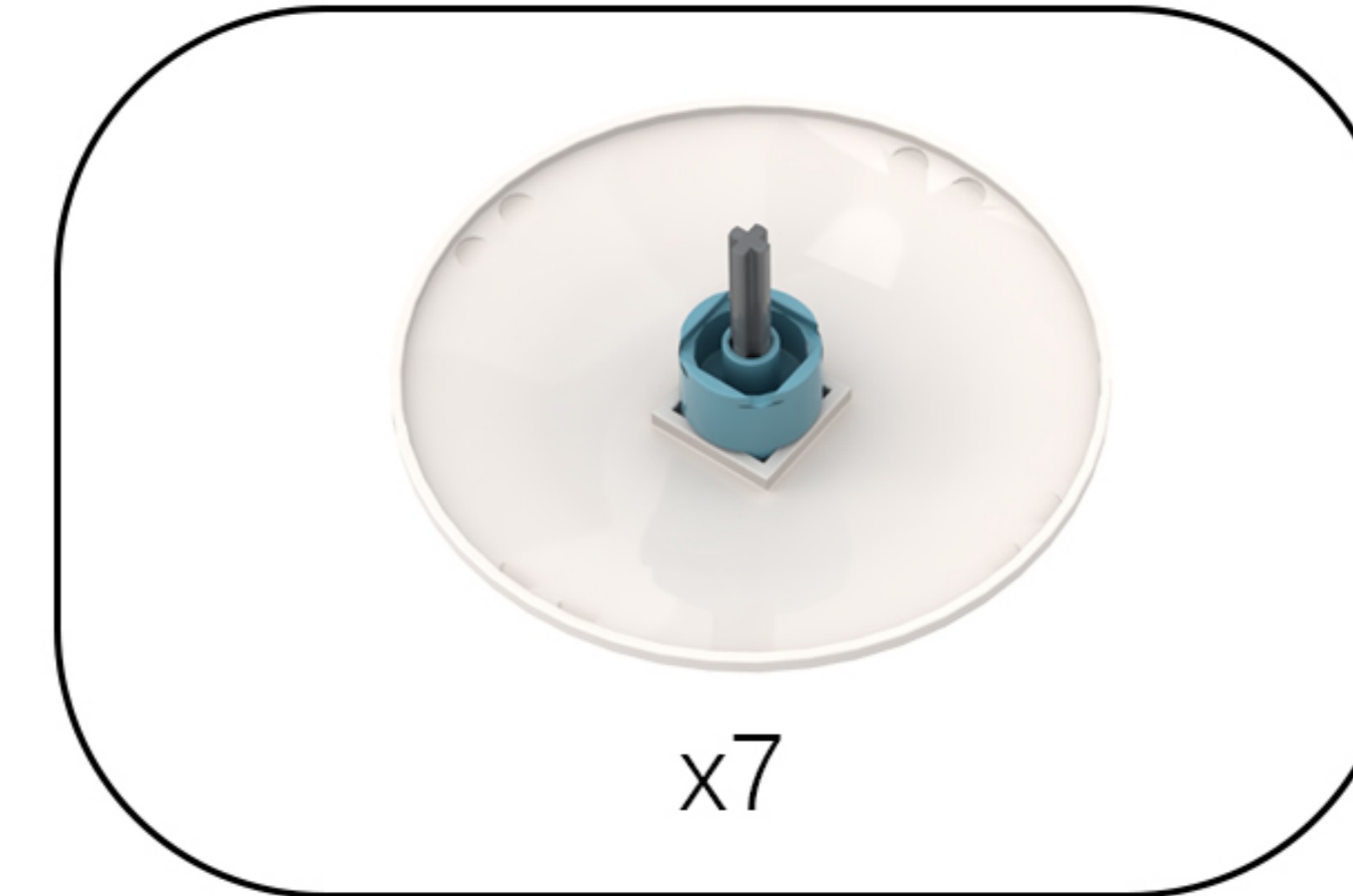

94

EN: Take the light beads from bag #6 and the 2×2 round tiles from bag #10, and use one of them as an example to install the lights.

DE: Nehmen Sie die Leuchtperlen aus Beutel Nr. 6 und die runden 2×2-Steine aus Beutel Nr. 10 und verwenden Sie einen davon als Beispiel für die Montage der Leuchten.

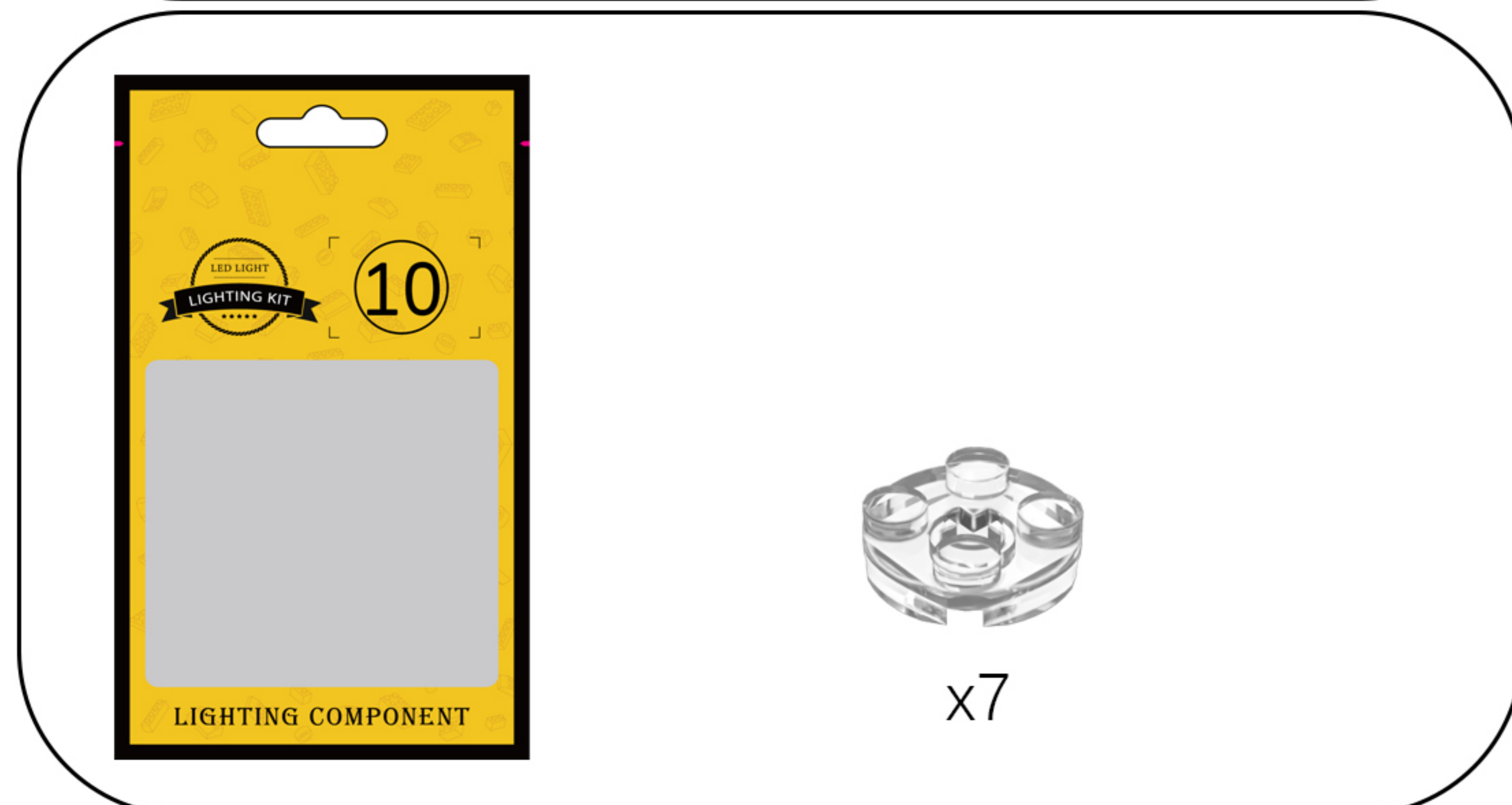
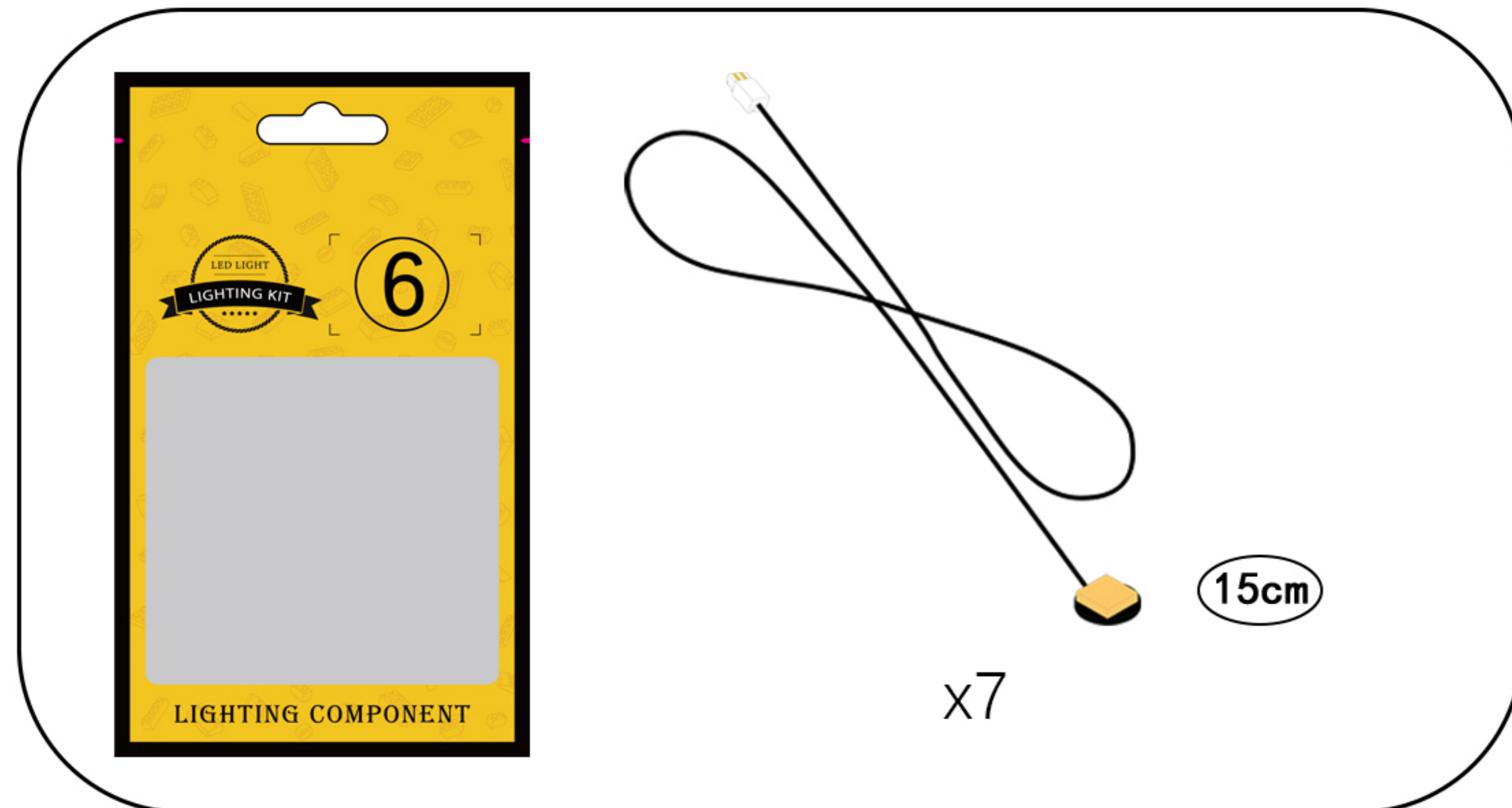

95

EN: Split as shown in the figure.

DE: Wie in der Abbildung gezeigt, teilen Sie es auf.

- ①. Thread the light beads through the holes in the building blocks.

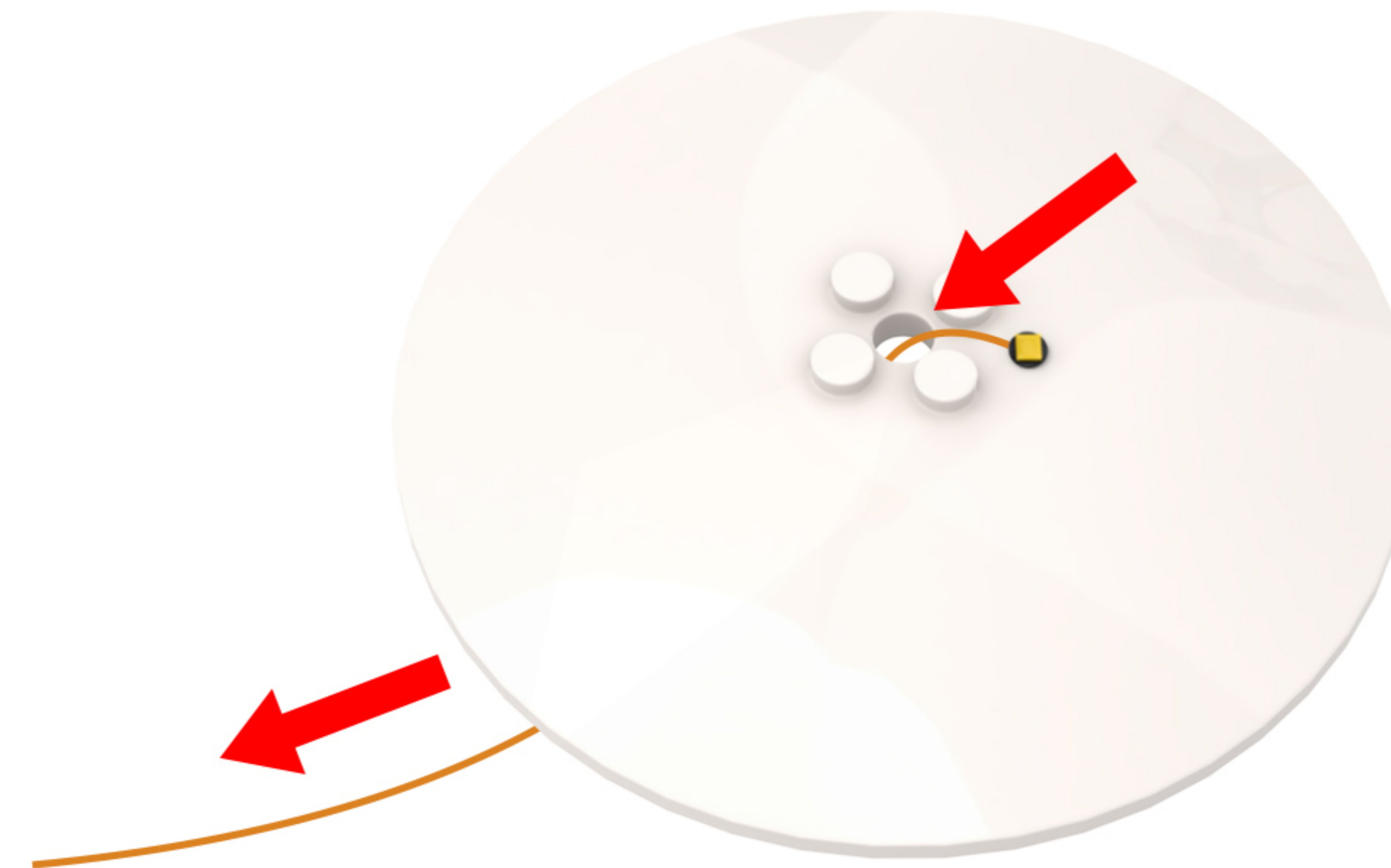

- ②. Take out the disassembled building blocks and reassemble them.

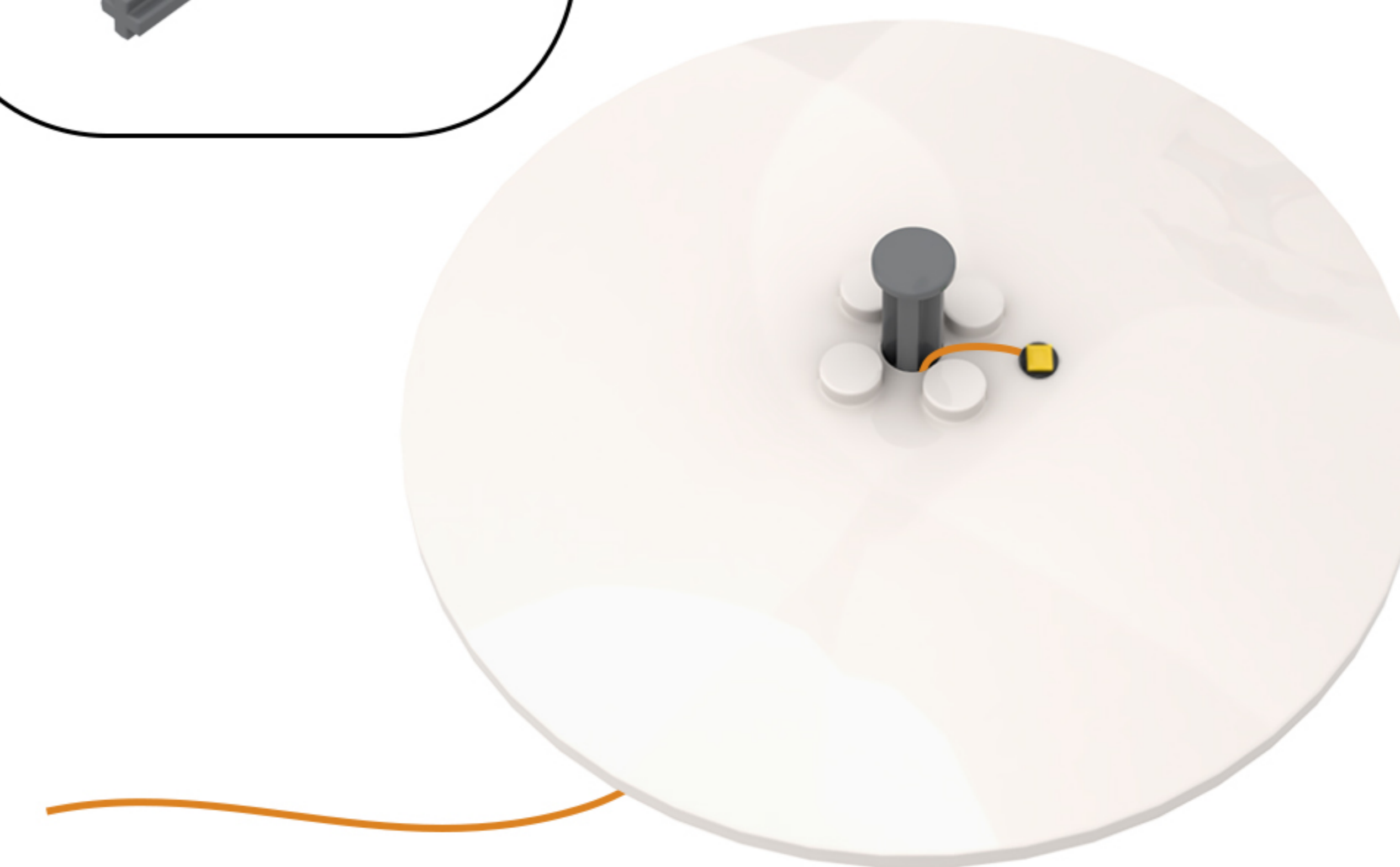
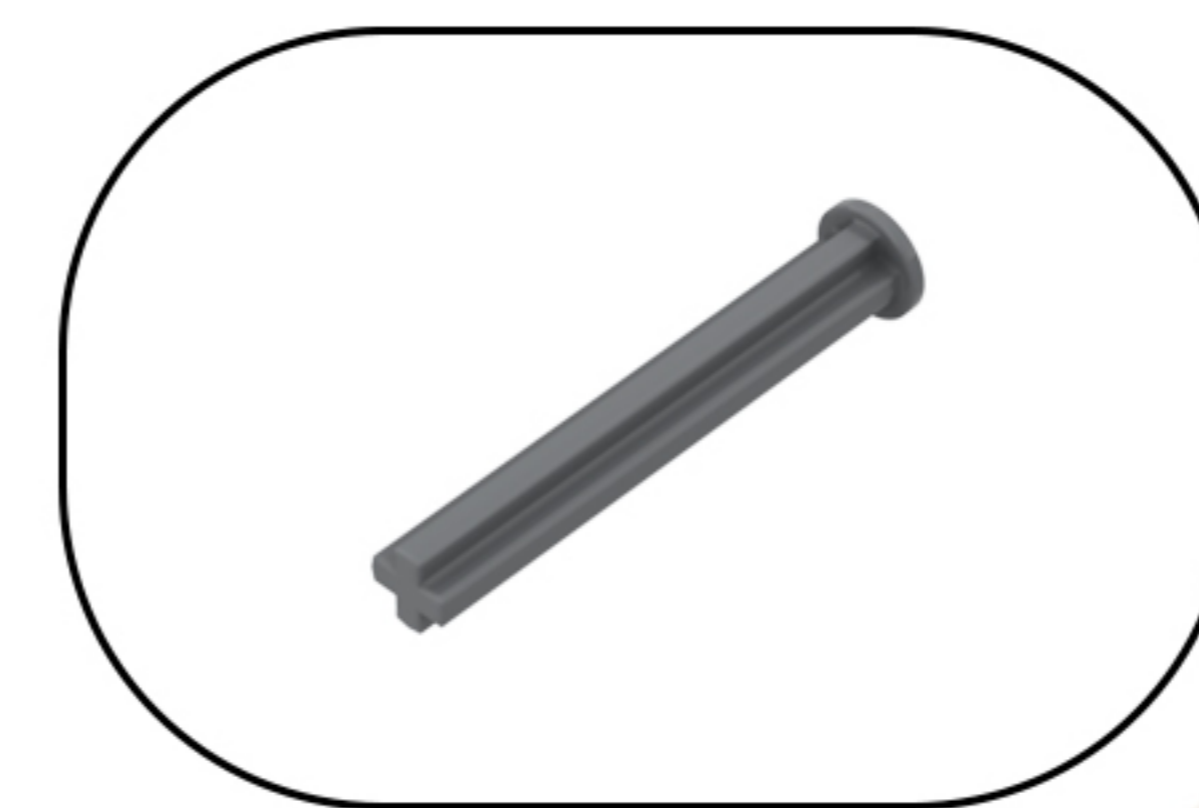

**Note:** When reassembling, make sure to route the light cord through the groove in the cross shaft.

96

EN: Follow these steps in order.

DE: Befolgen Sie diese Schritte der Reihe nach.

③. After reattaching the building block to its original position, place the light fixture on top of it.



④. Attach the 2×2 round plate to the building block.

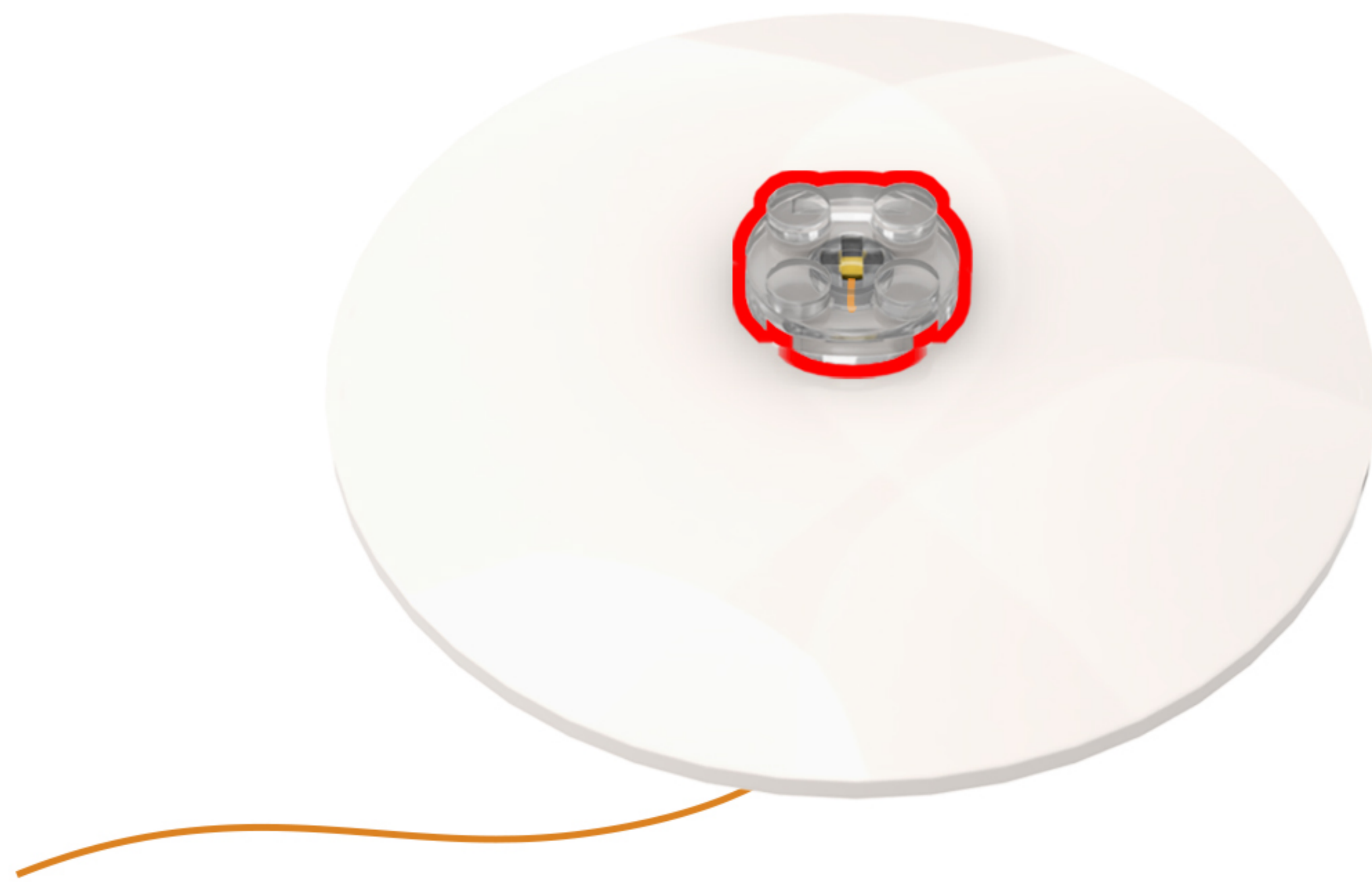

⑤. Flip the model.

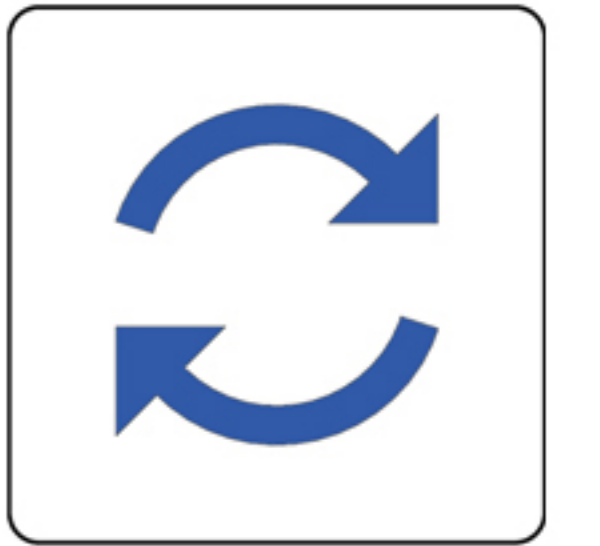
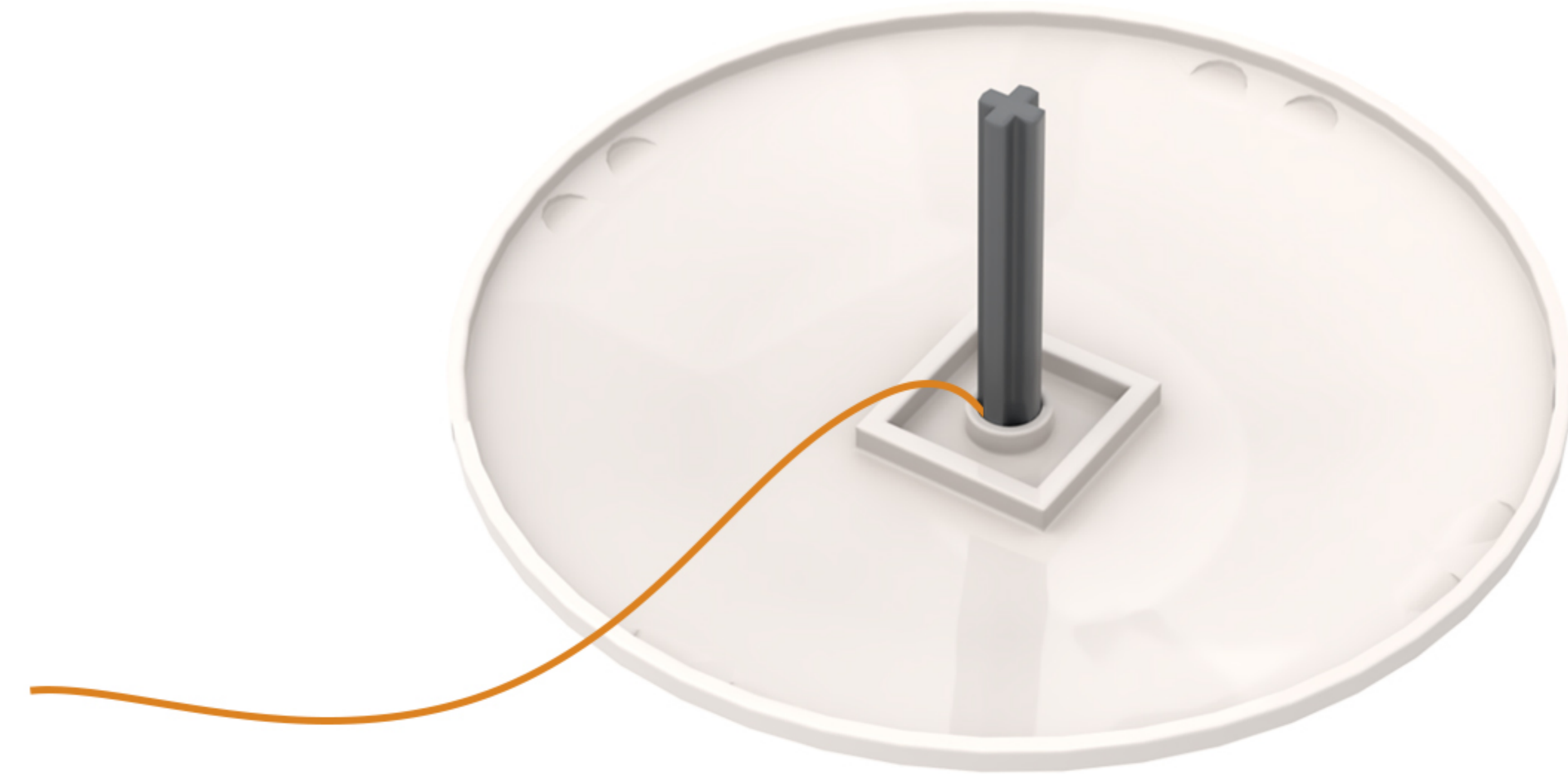

⑥. Take out the disassembled building blocks and reassemble them.

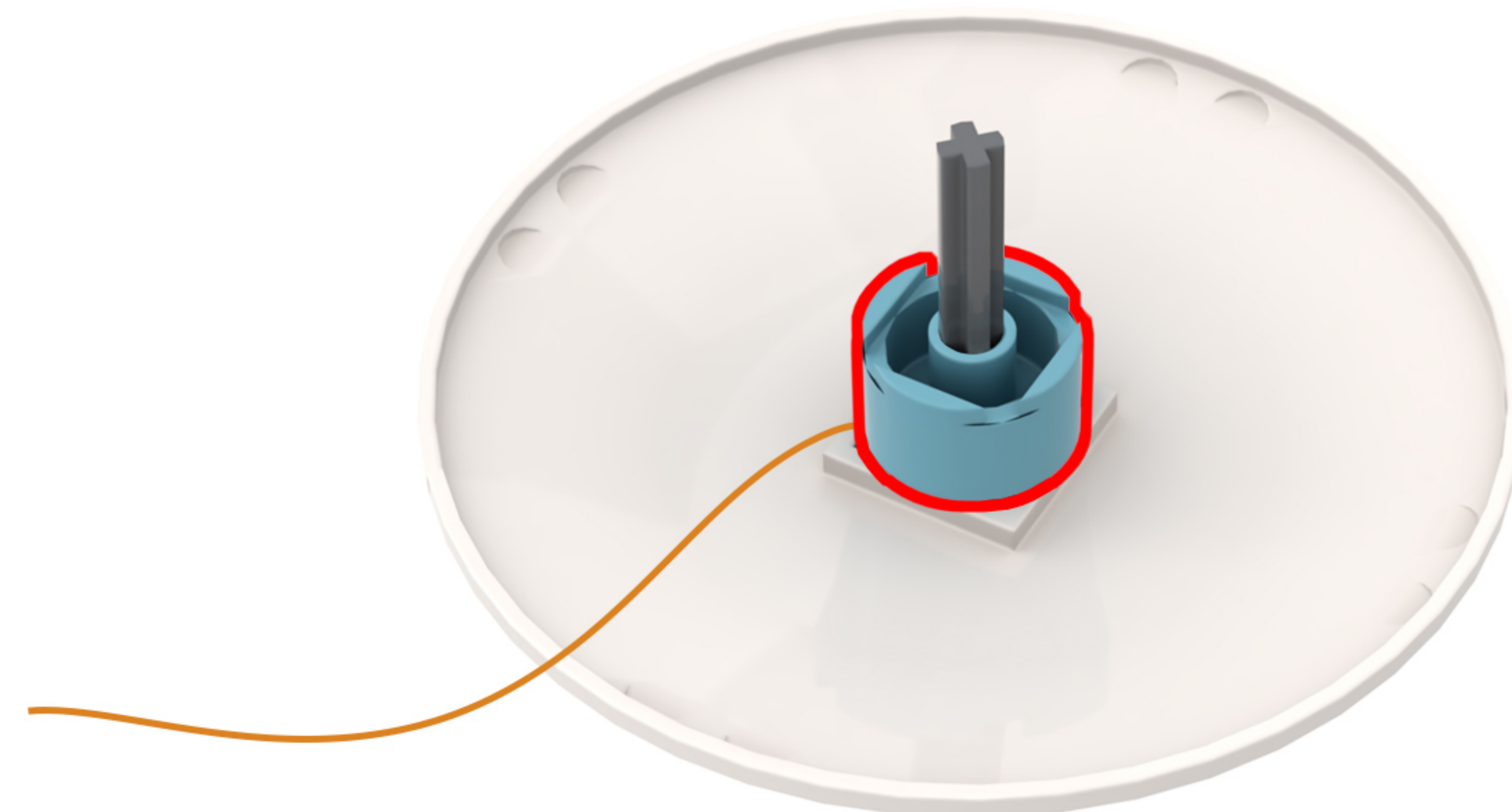
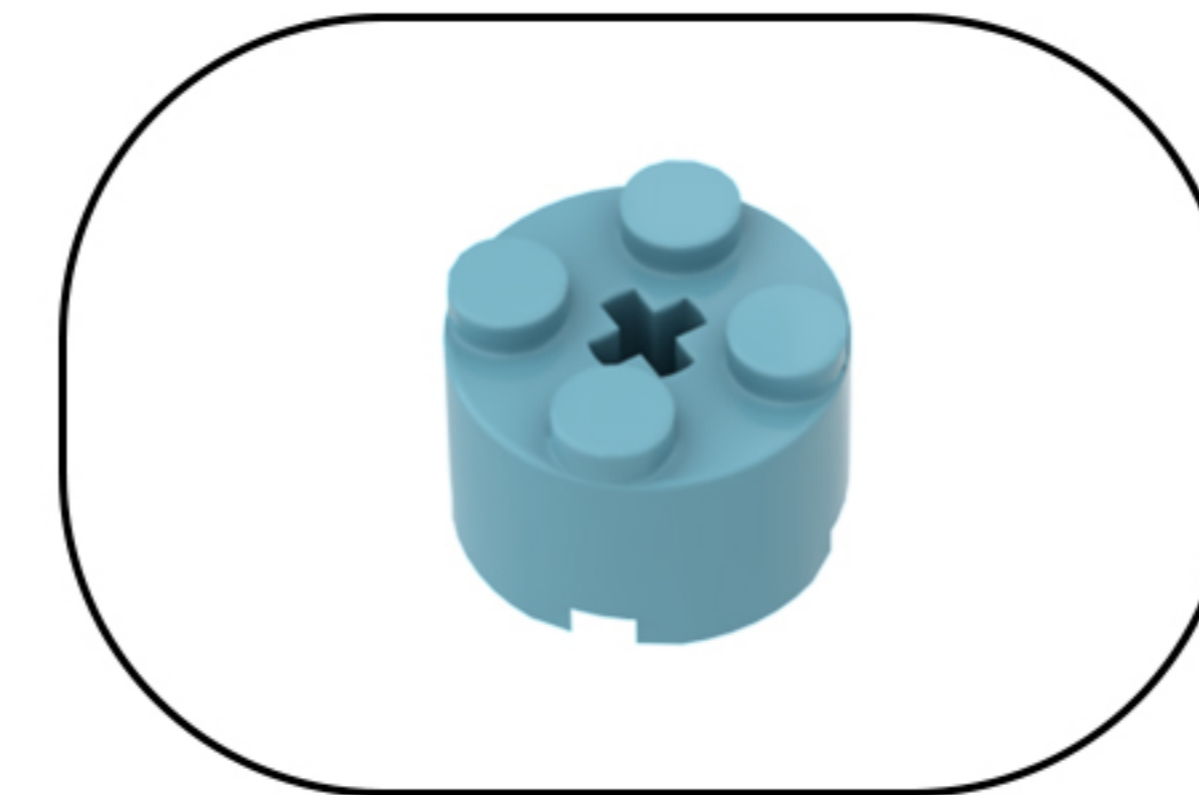

97

EN: Repeat the steps above to obtain 7 light fixtures.

DE: Wiederholen Sie die oben beschriebenen Schritte, um 7 Leuchten zu erhalten.

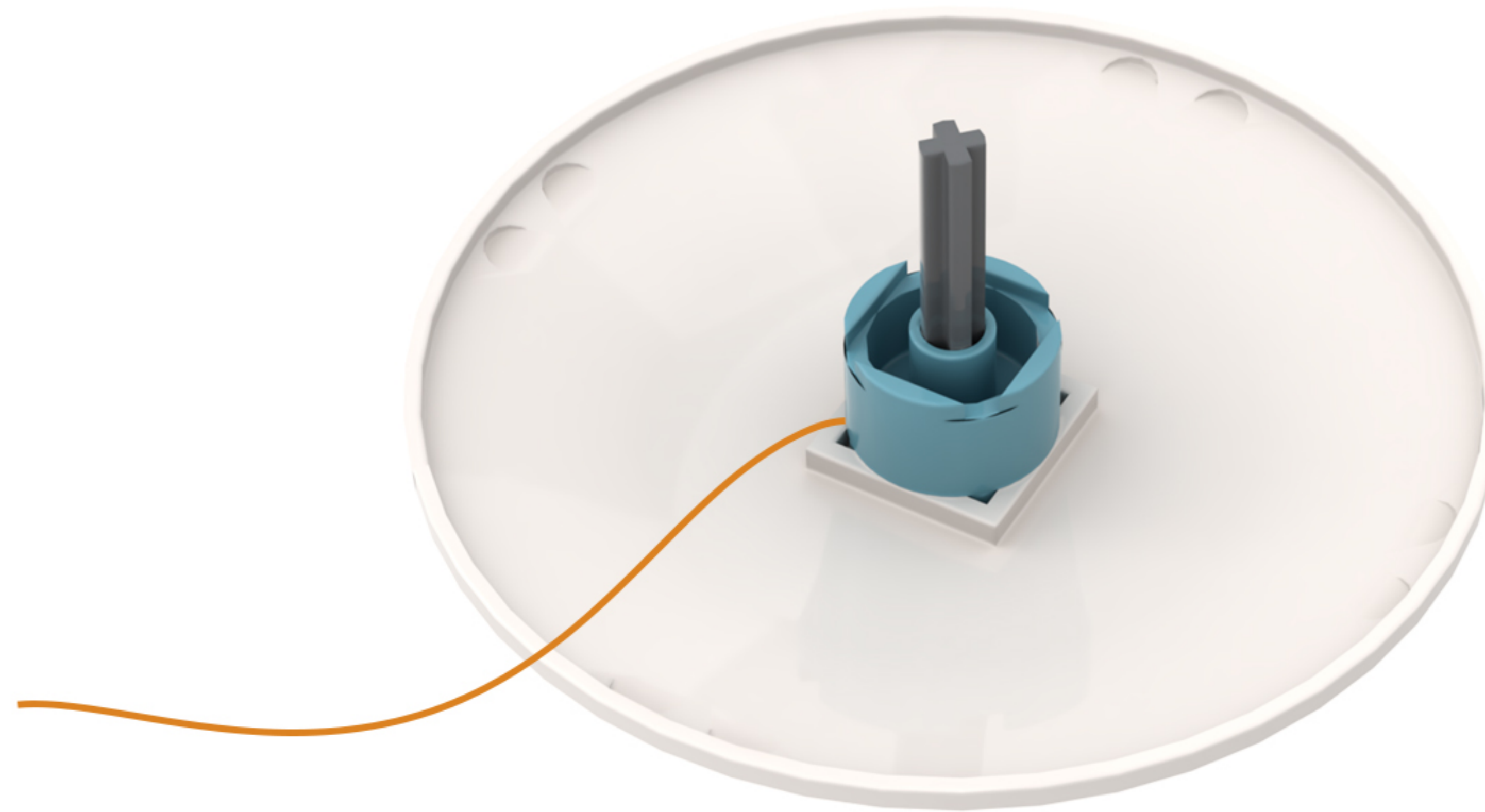

X7

98

EN: Back to the model.

DE: Zurück zum Modell.

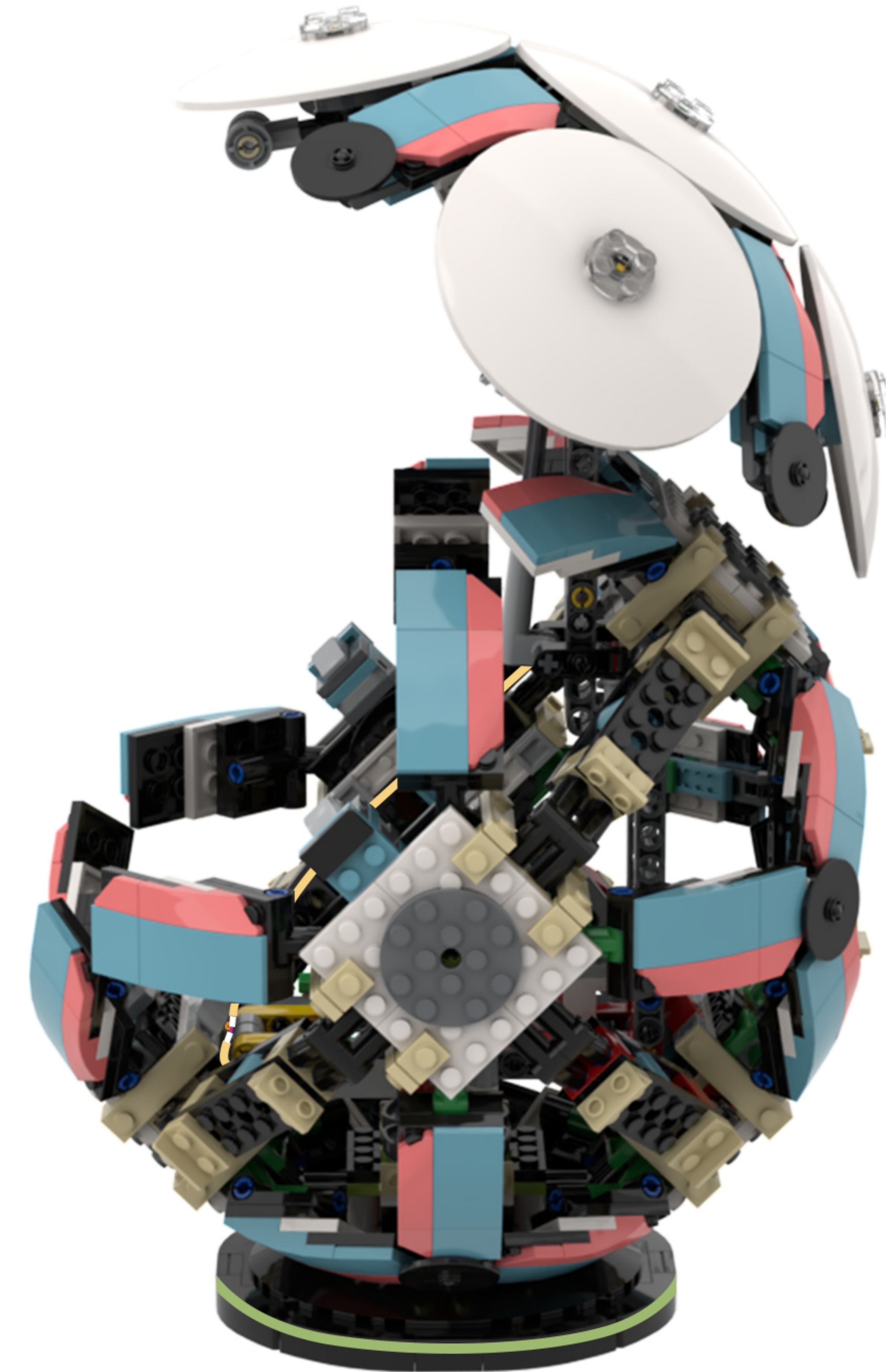

99

EN: Take out the building blocks with the lights attached and reinstall them in their original positions.

DE: Nehmen Sie die Bausteine mit den daran befestigten Lichtern heraus und setzen Sie sie wieder an ihren ursprünglichen Positionen ein.

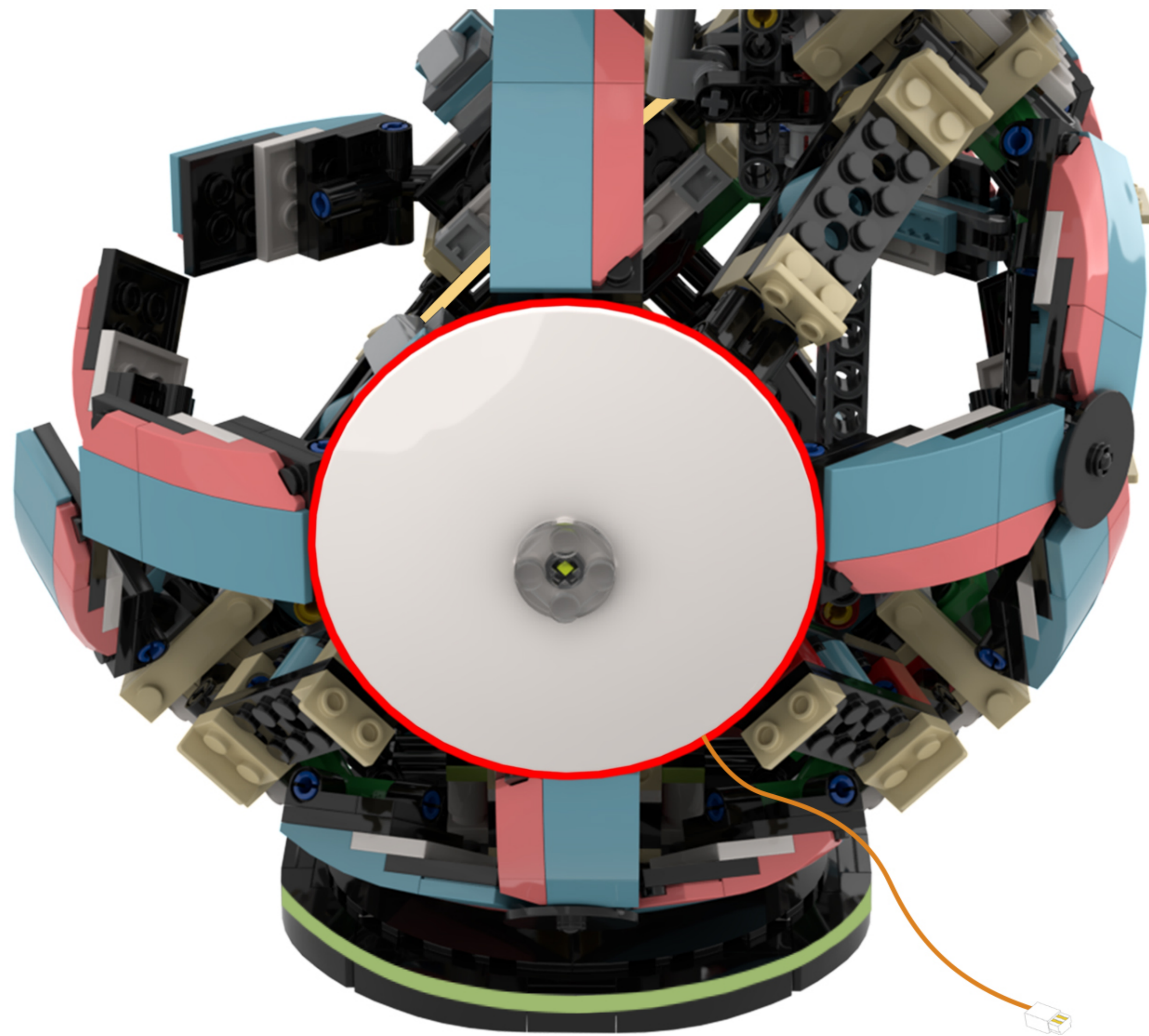
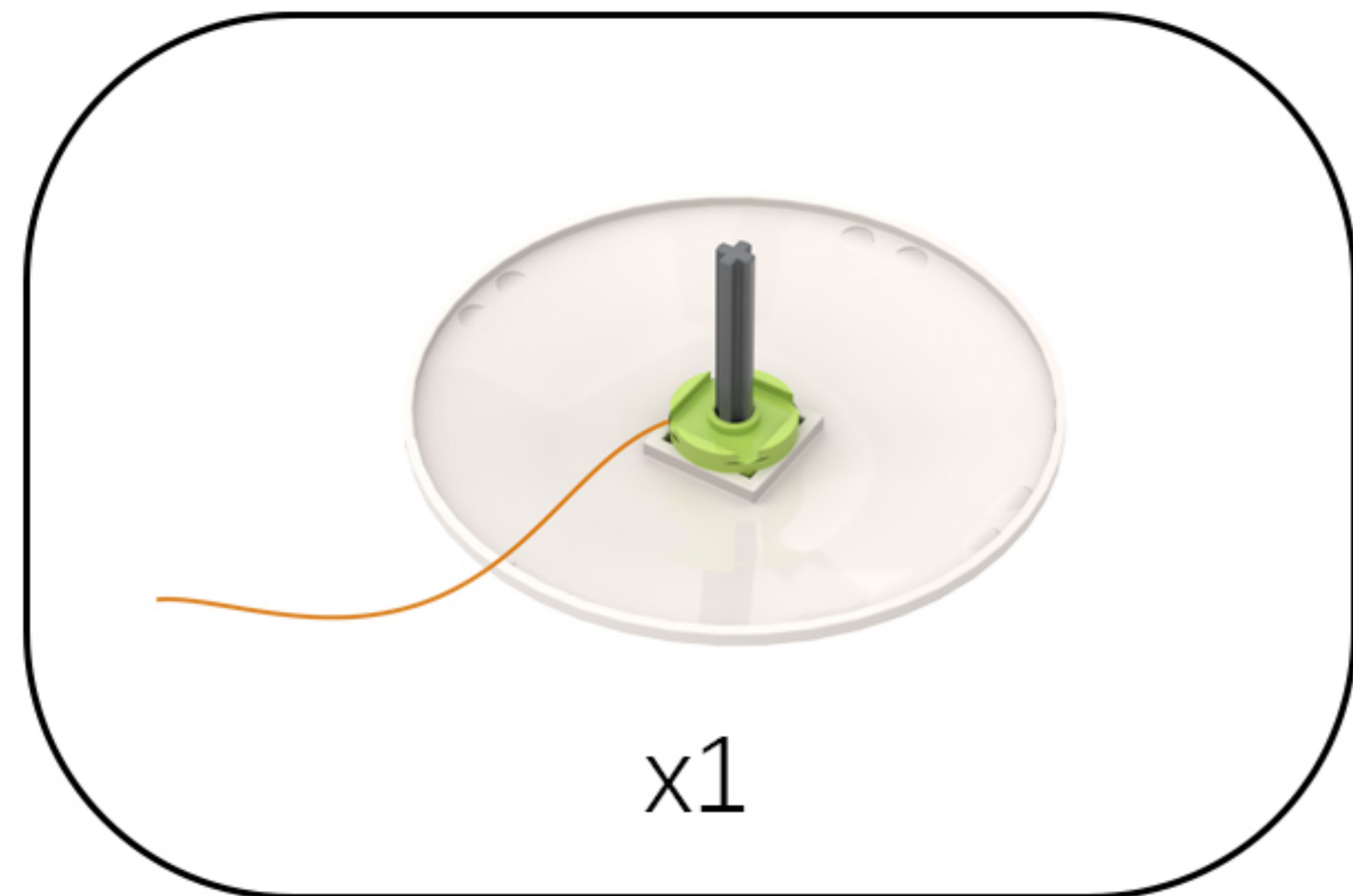

100

EN: Locate this light cord in the diagram.

DE: Suchen Sie dieses Lichtkabel in der Abbildung.

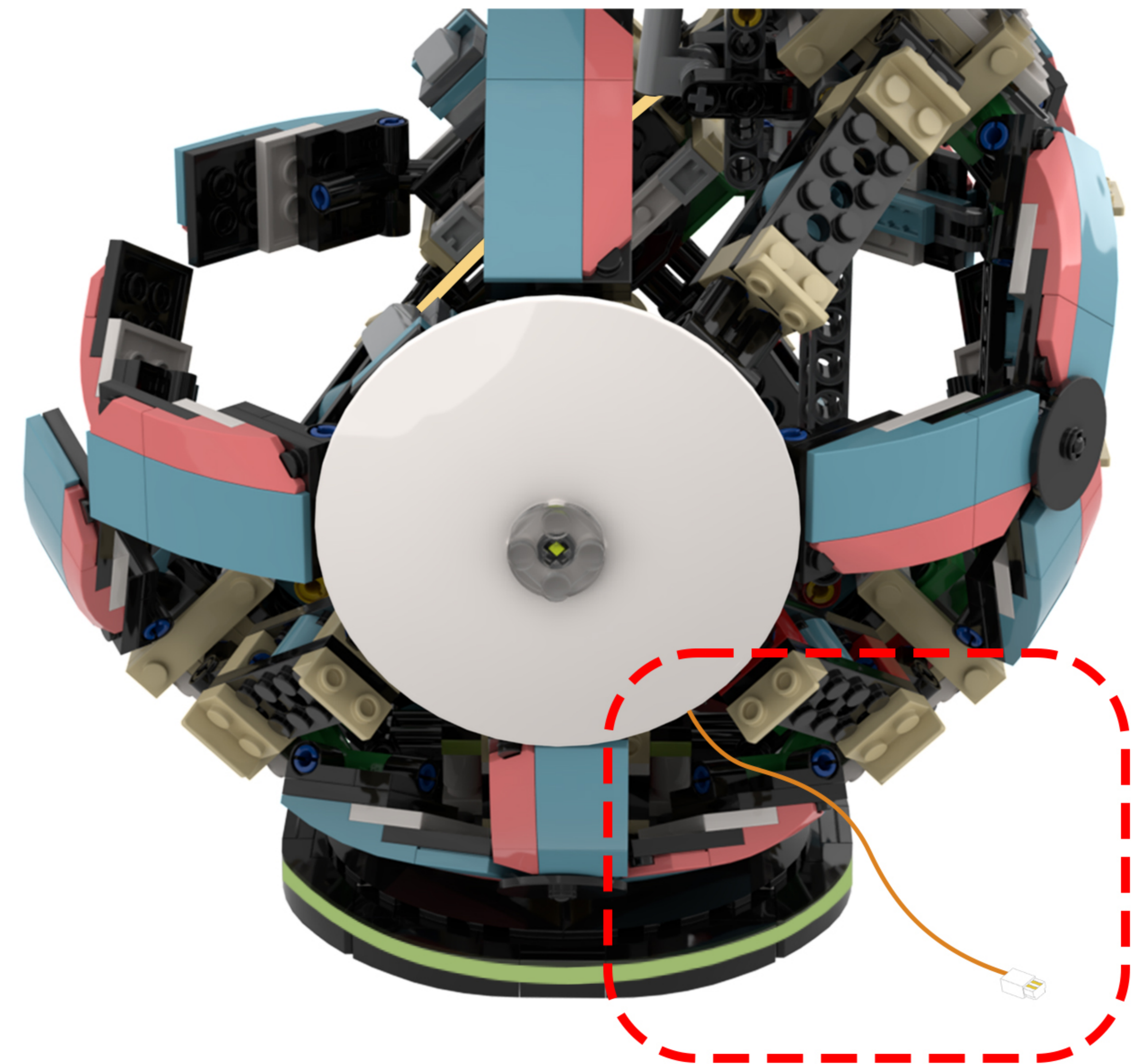

101

EN: Thread the light cord back through and place it inside the model.

DE: Führen Sie das Lichtschnur wieder hindurch und legen Sie es in das Modell.

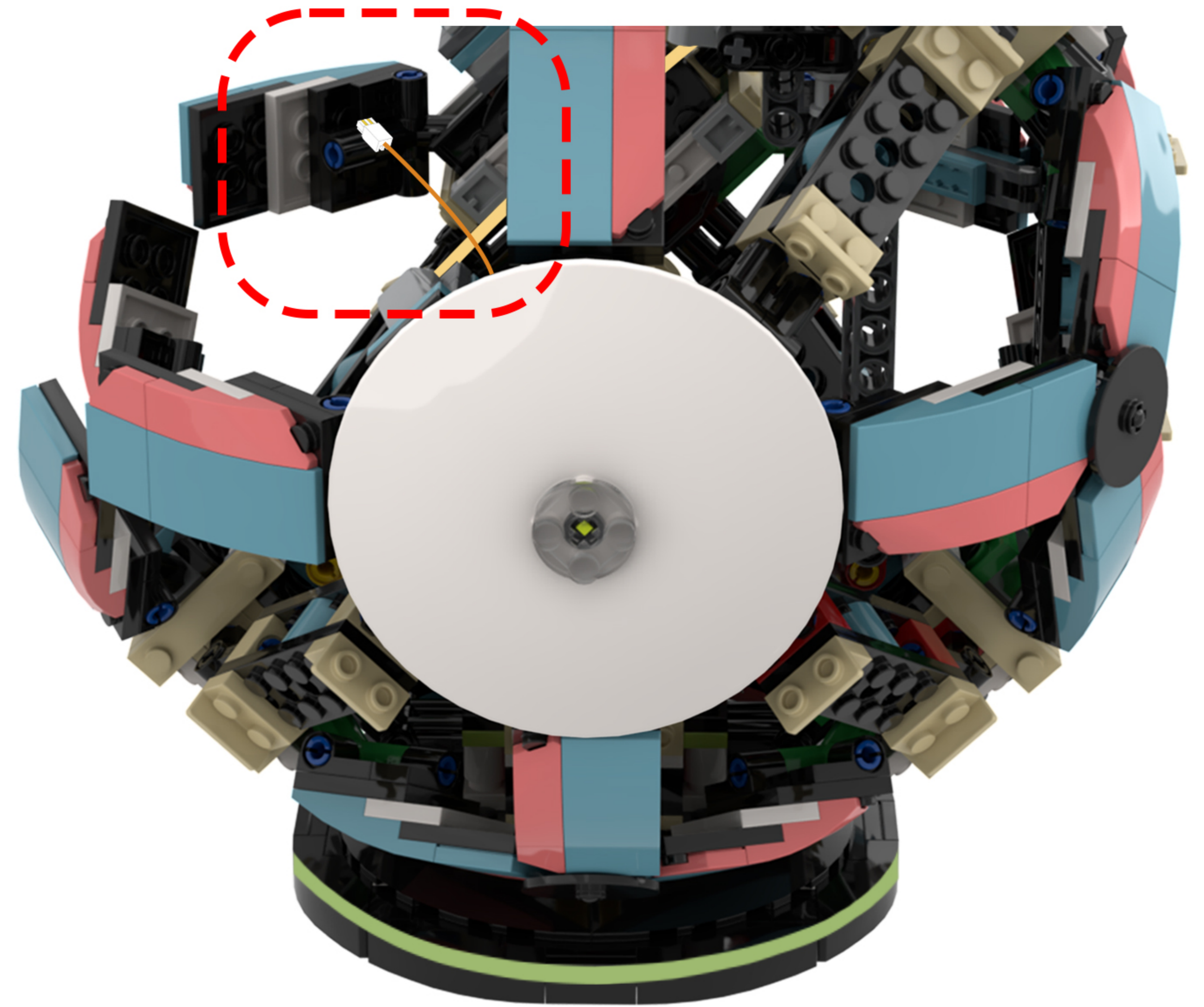
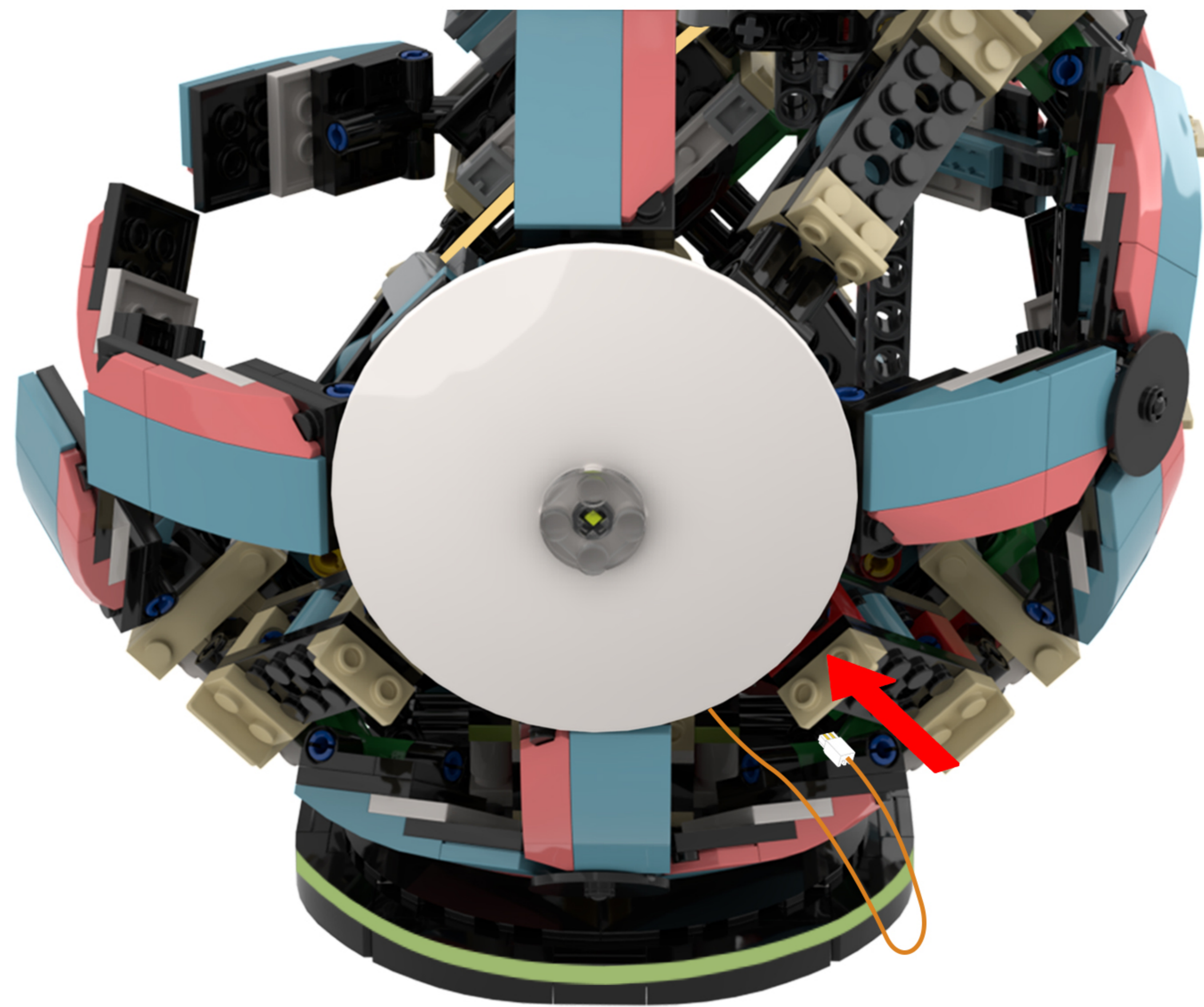

**102**

EN: Take out the building blocks with the lights attached and reinstall them in their original positions one by one.

DE: Nehmen Sie die Bausteine mit den daran befestigten Leuchten heraus und setzen Sie sie nacheinander wieder an ihren ursprünglichen Positionen ein.

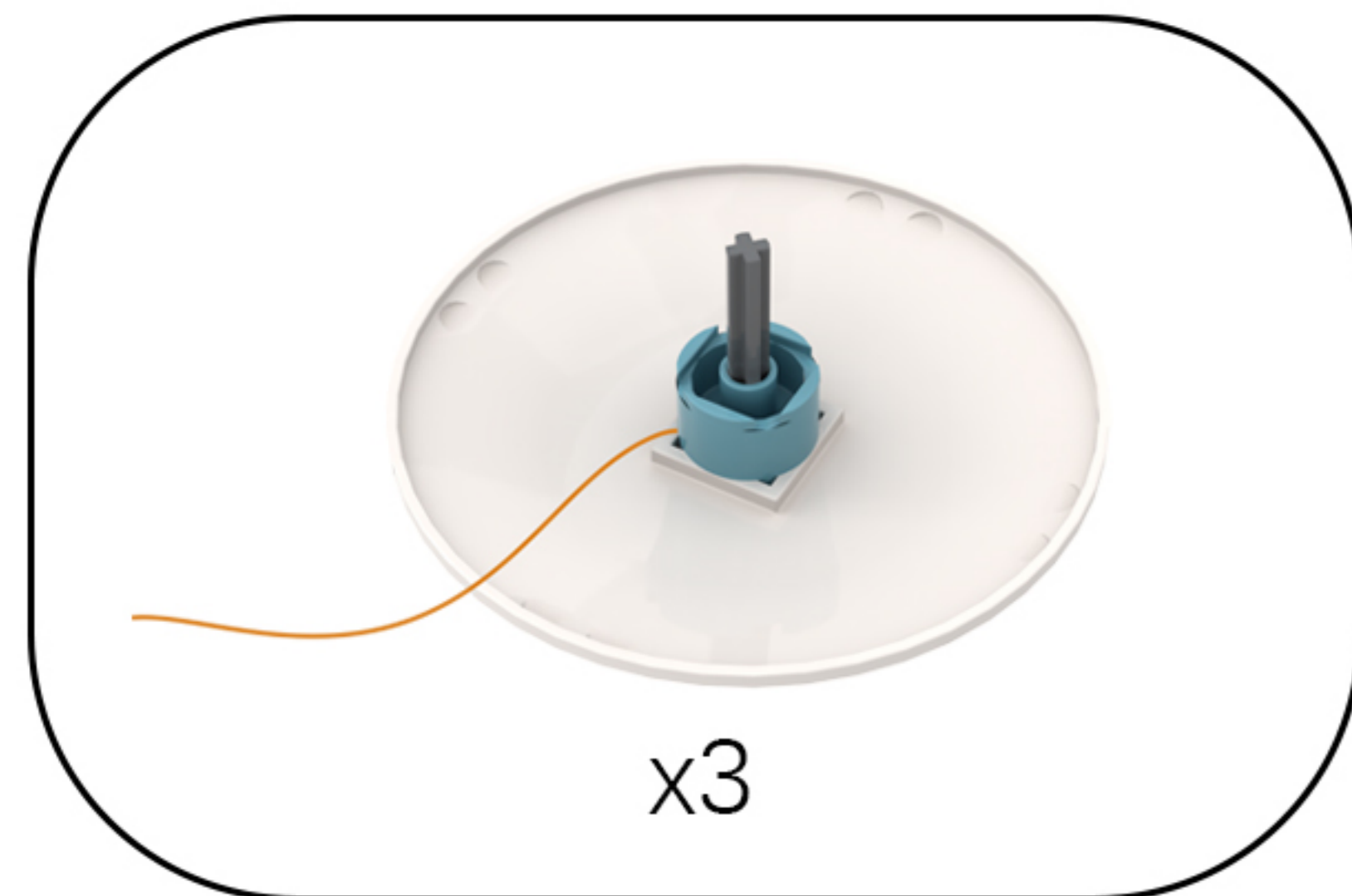

**Note:** All lighting wires for the lighting fixtures should be placed inside the model.

**103**

EN: Rotate the model to its back side.

DE: Drehen Sie das Modell auf die Rückseite.

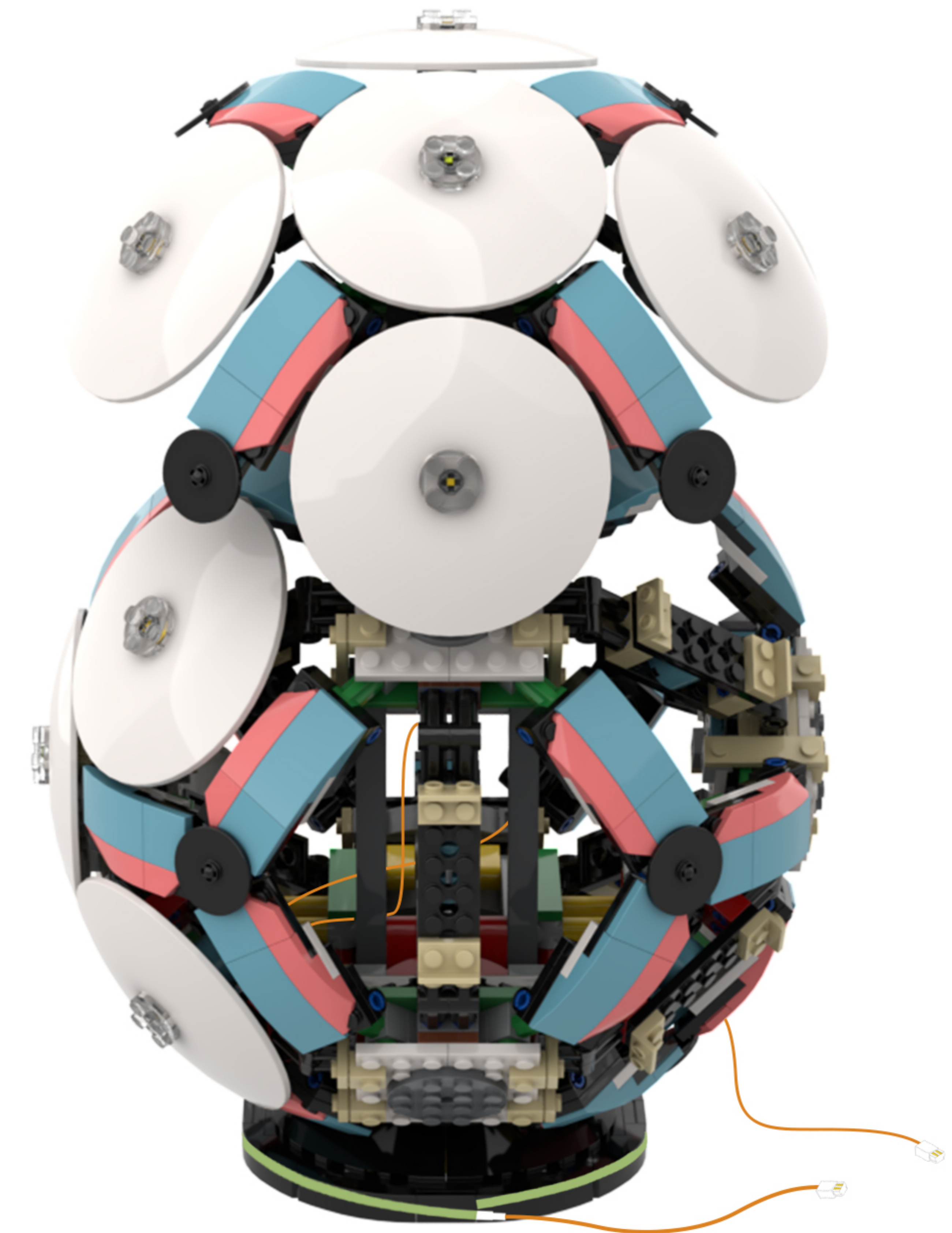

104

EN: Take out the building blocks with the lights attached and reinstall them in their original positions.

DE: Nehmen Sie die Bausteine mit den daran befestigten Lichtern heraus und setzen Sie sie wieder an ihren ursprünglichen Positionen ein.

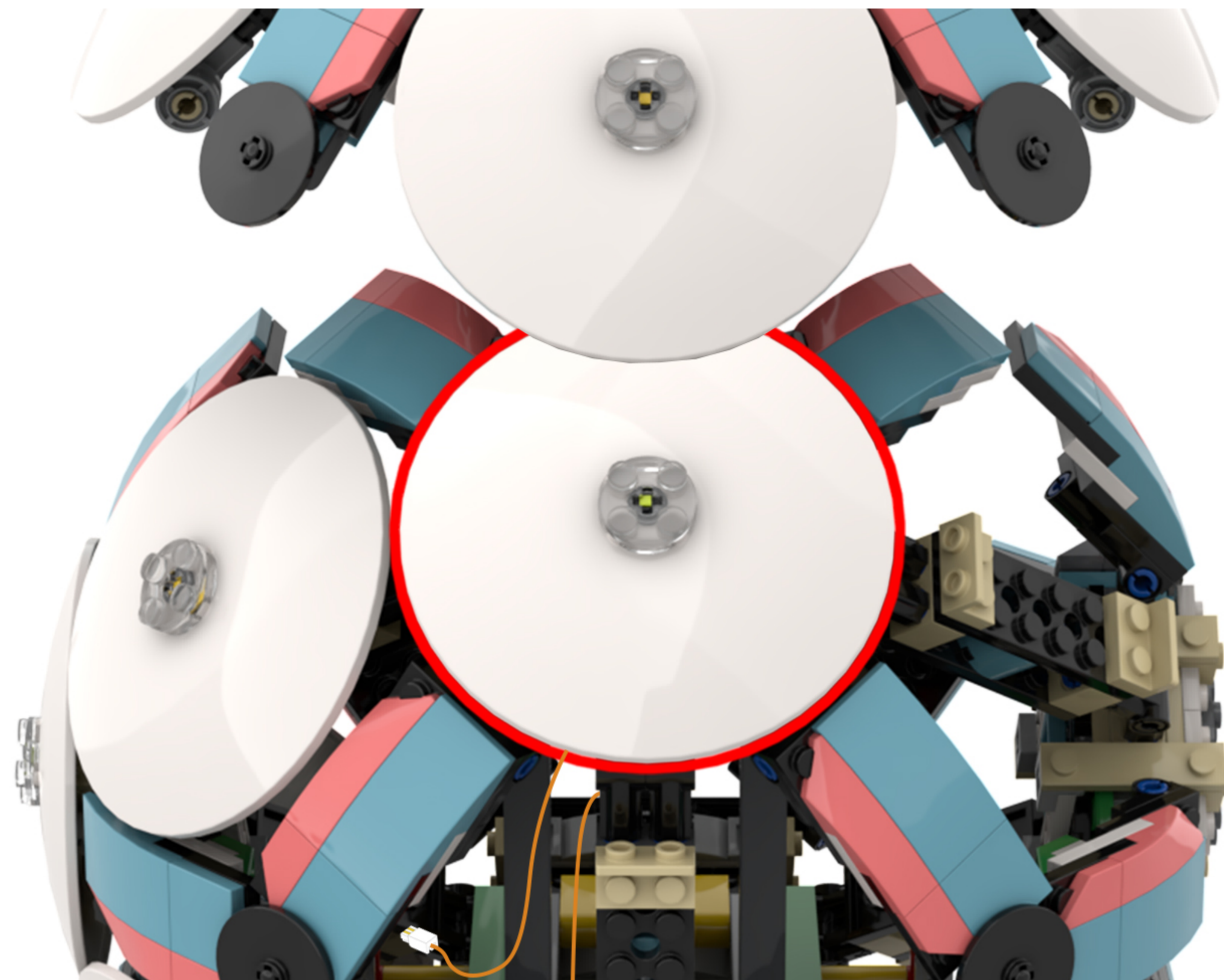
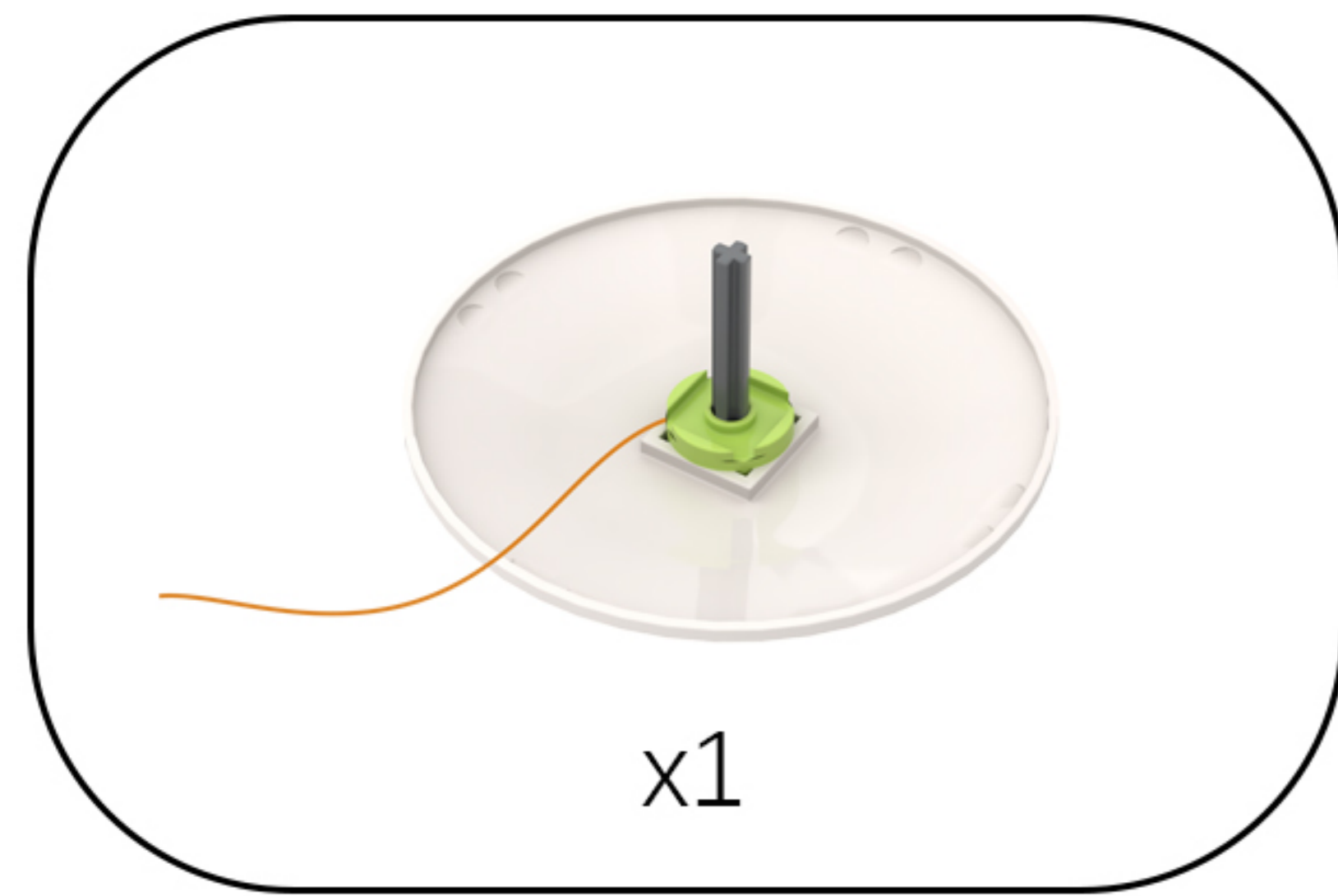

Note: The lighting wires for the light fixtures should be placed inside the model.

105

EN: Take out the building blocks with the lights attached and reinstall them in their original positions.

DE: Nehmen Sie die Bausteine mit den daran befestigten Lichtern heraus und setzen Sie sie wieder an ihren ursprünglichen Positionen ein.

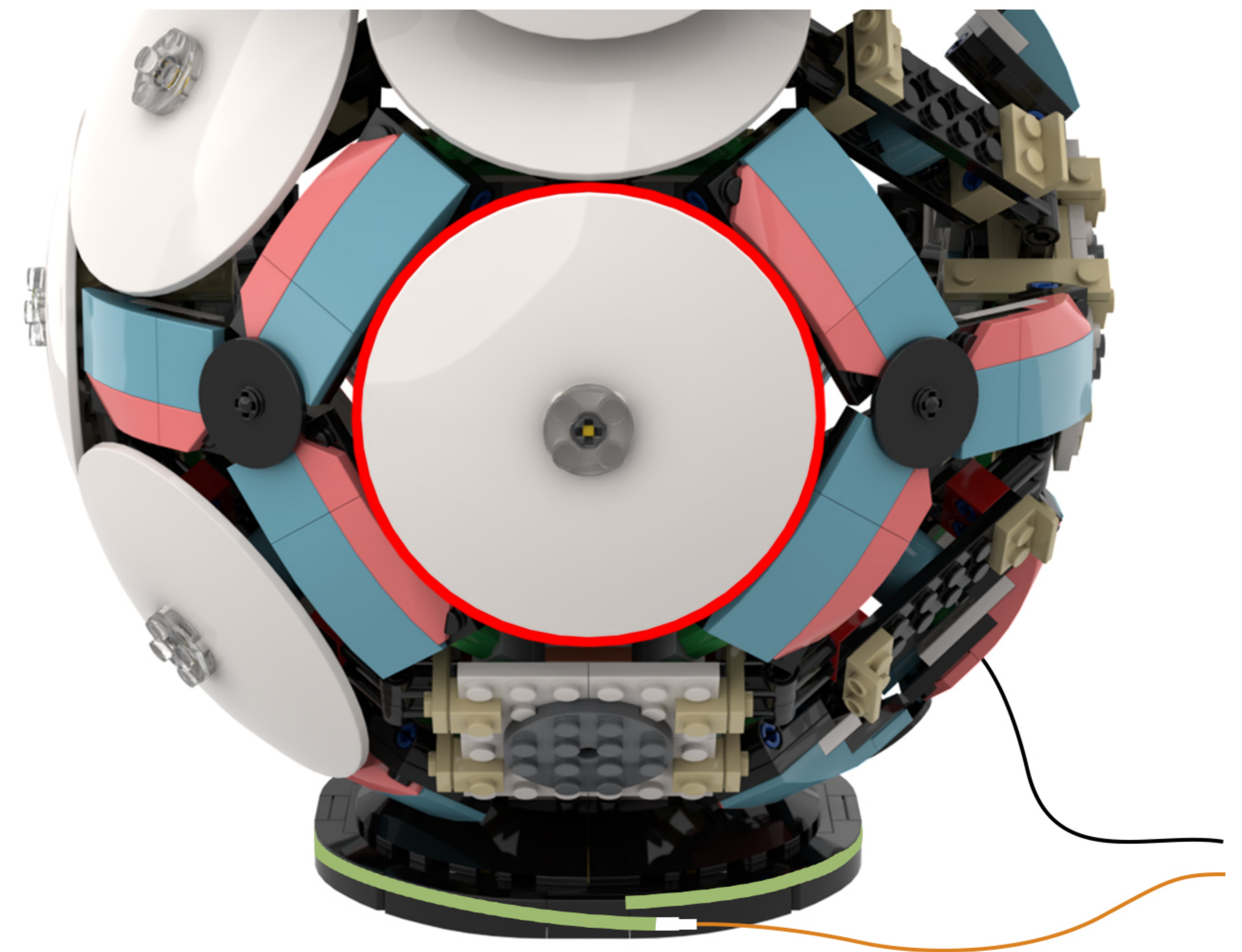
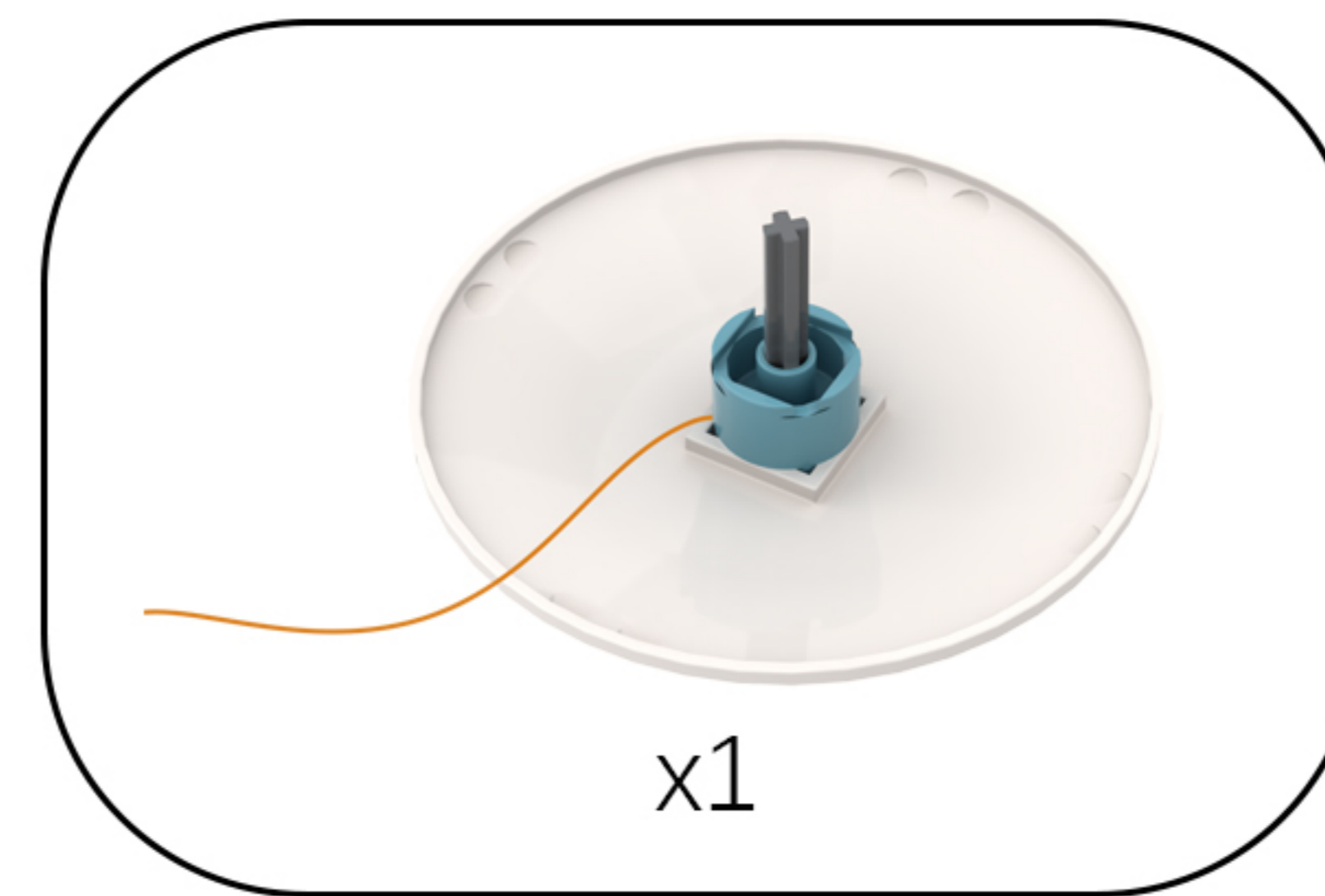

Note: The lighting wires for the light fixtures should be placed inside the model.

106

EN: Rotate the model to the front view.

DE: Drehen Sie das Modell in die Vorderansicht.

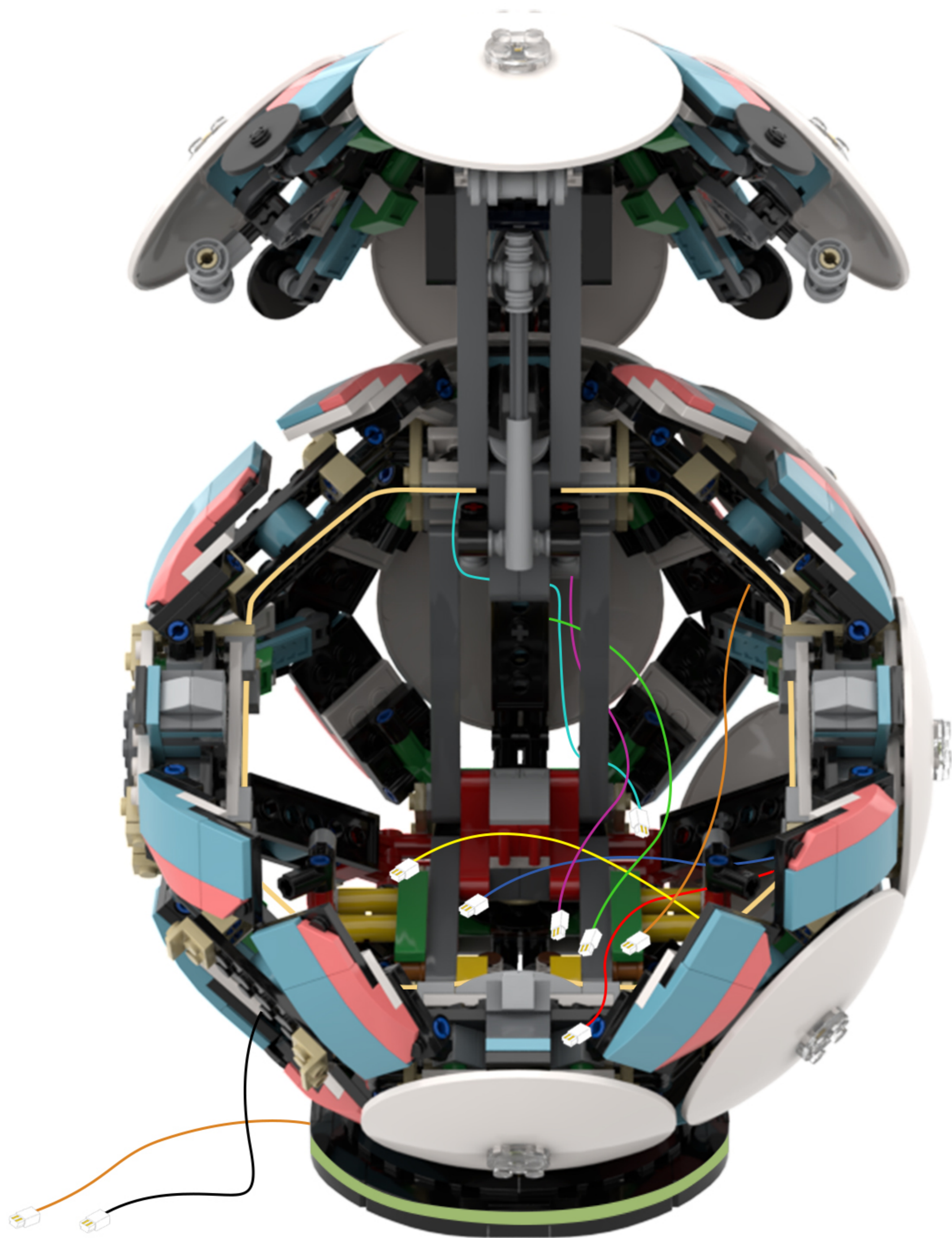
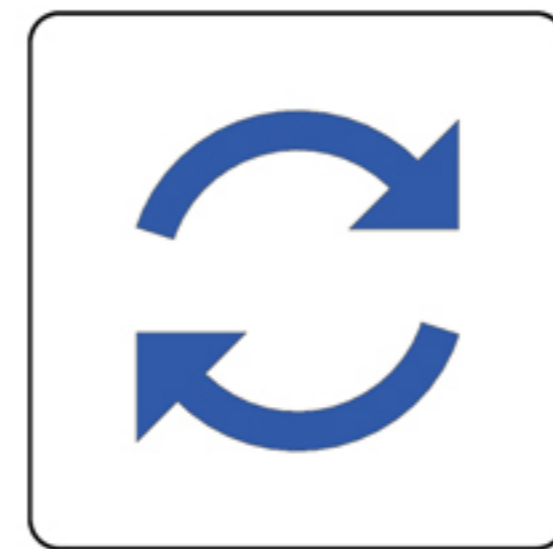

107

EN: Take the two connecting cables from Bag 7 and the expansion board from Bag 9, and connect them together.

DE: Nehmen Sie die beiden Verbindungskabel aus Beutel 7 und die Erweiterungskarte aus Beutel 9 und verbinden Sie diese miteinander.

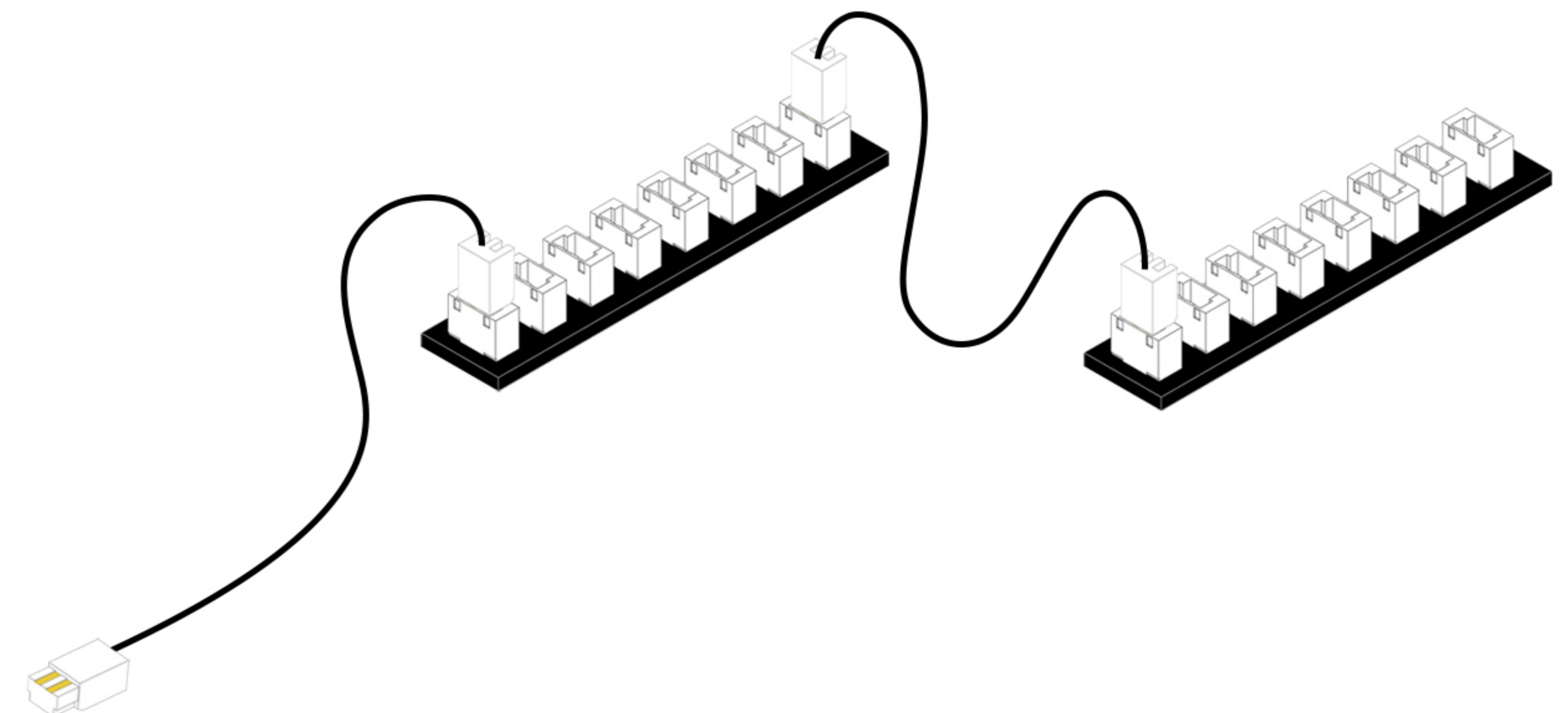
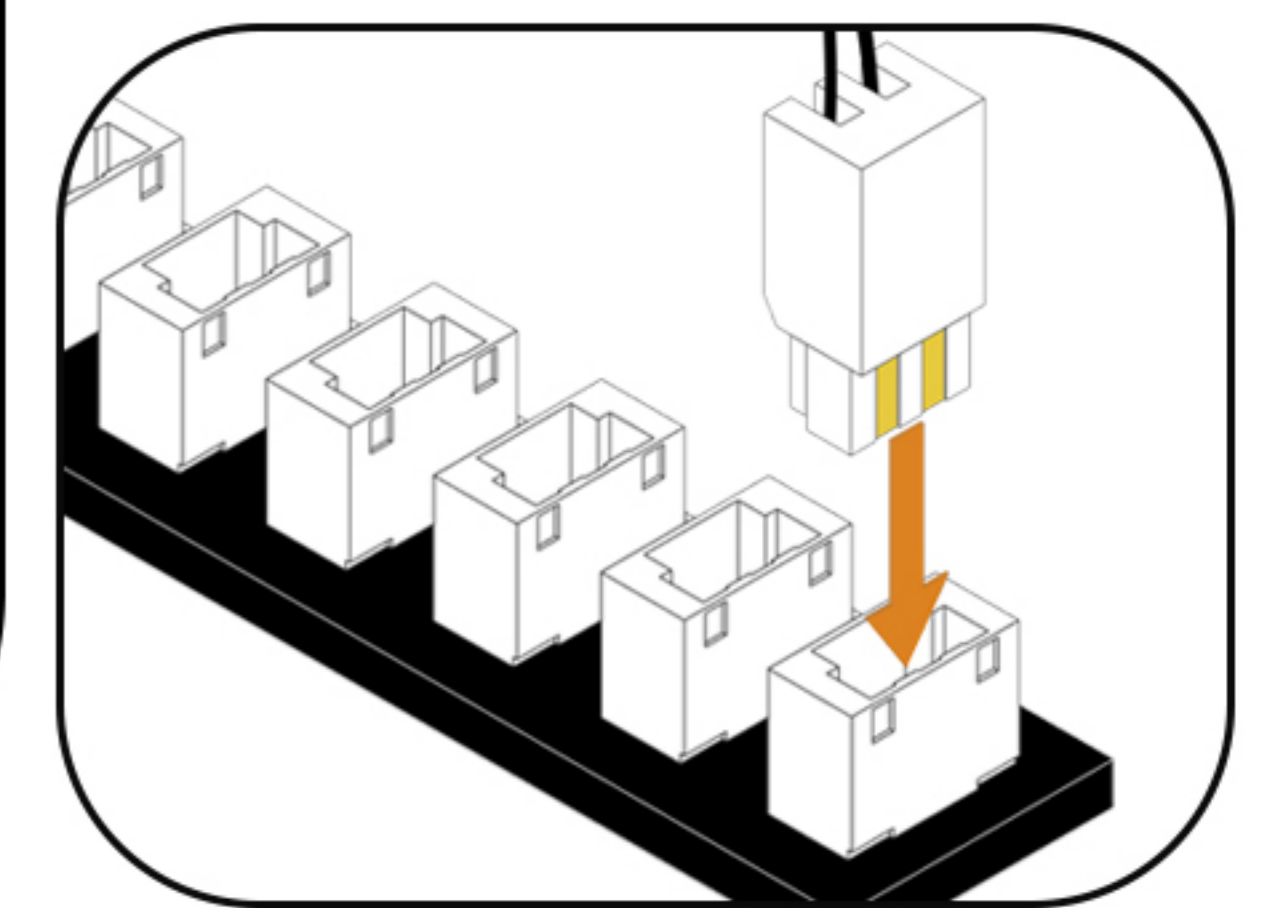
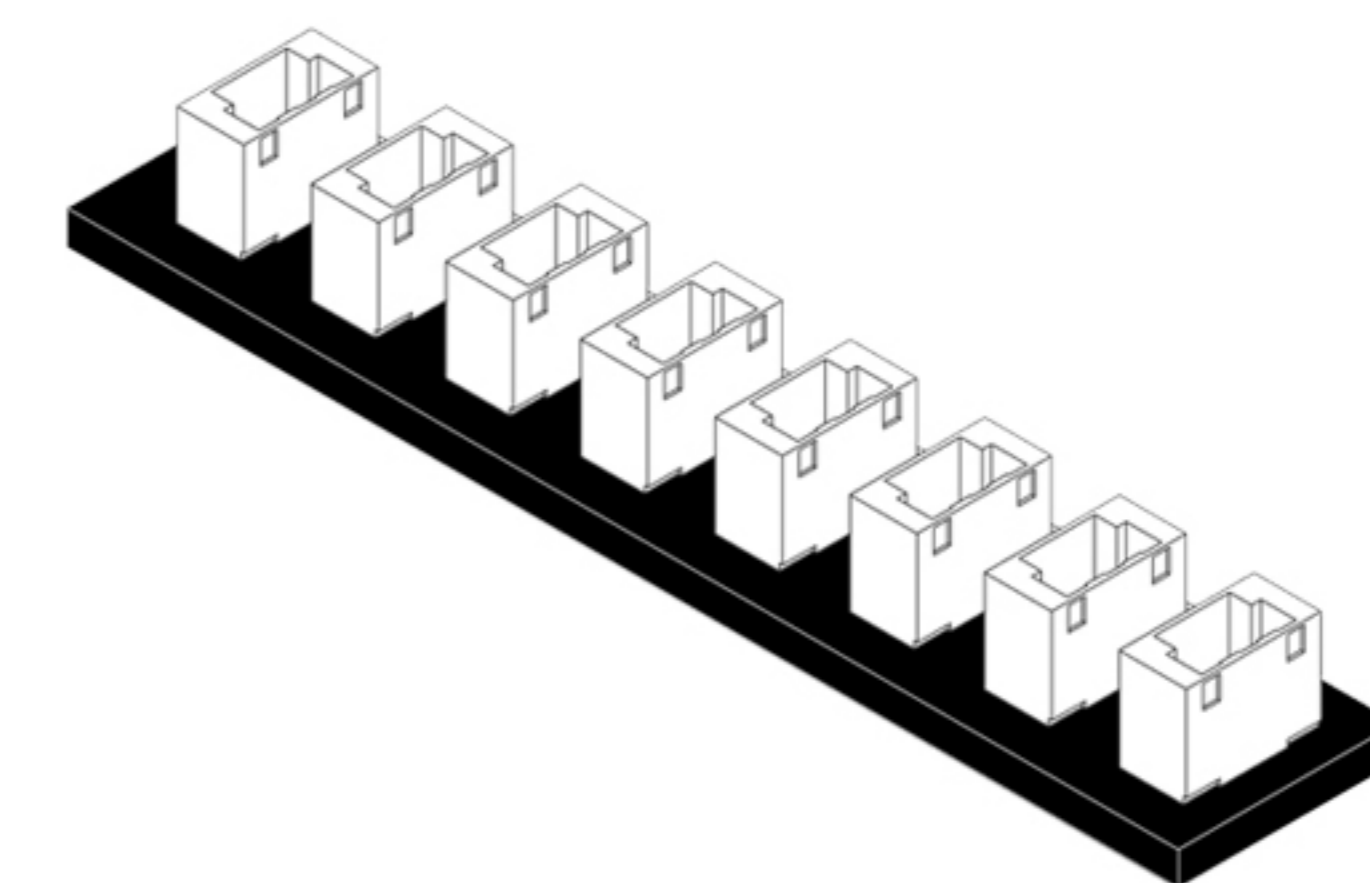
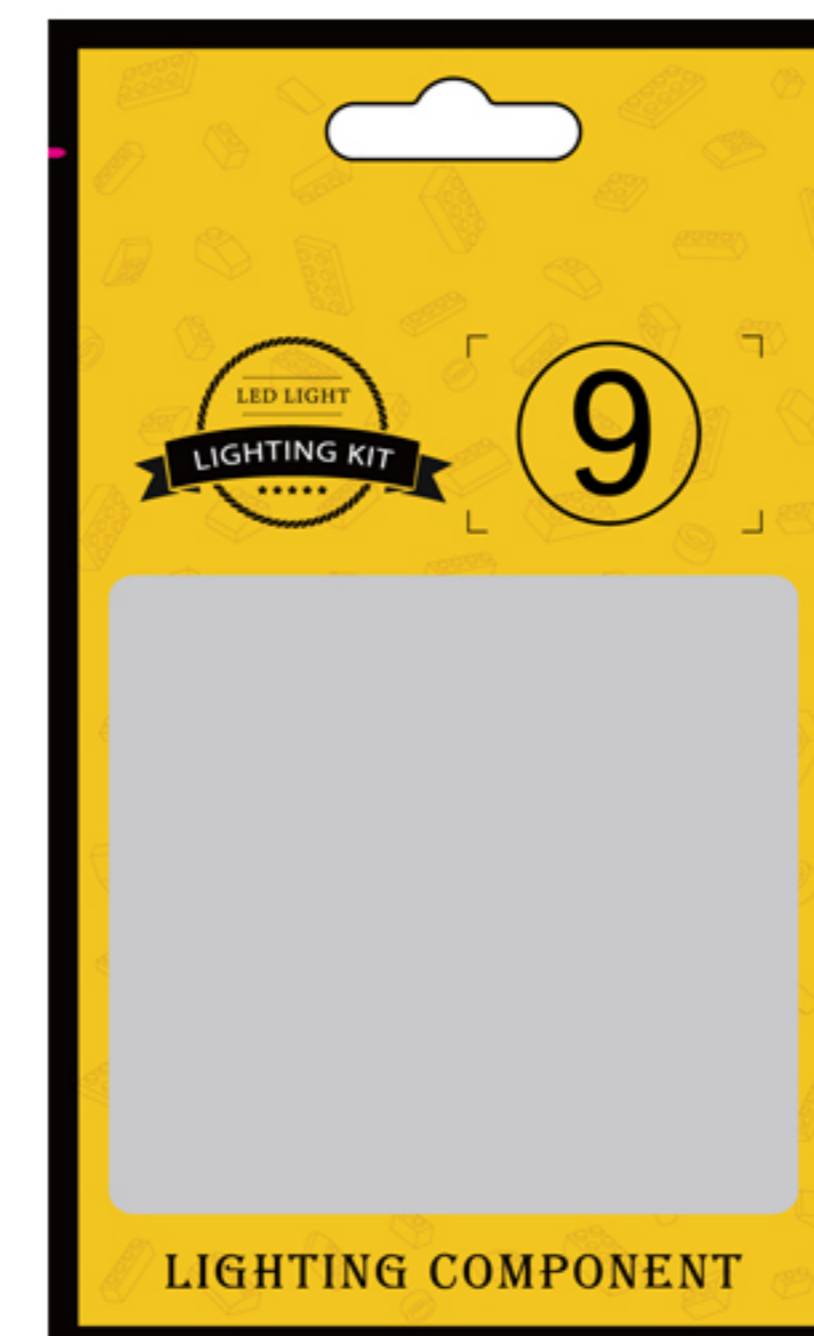
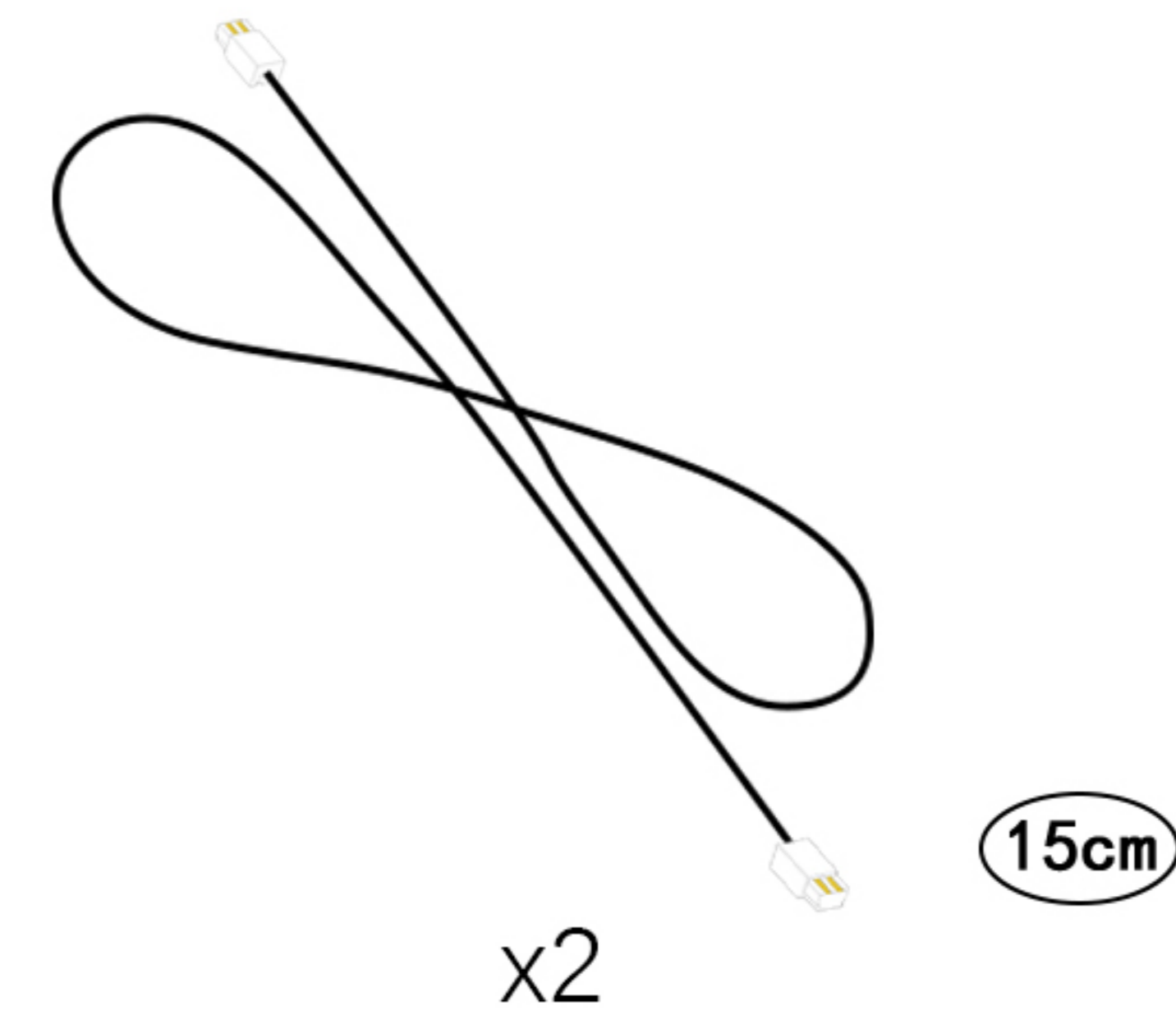
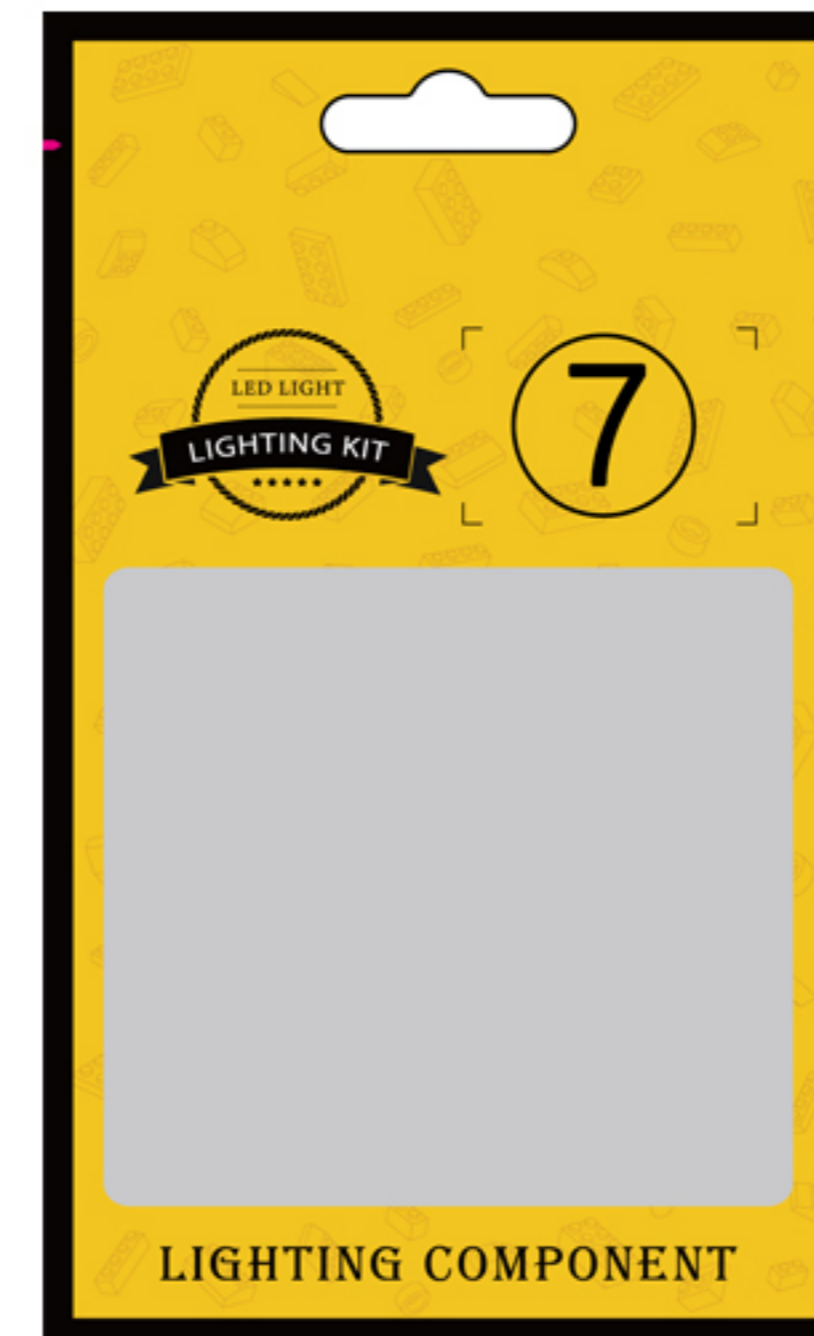

**108**

EN: Find the expansion board shown in the figure.

DE: Suchen Sie die in der Abbildung gezeigte Erweiterungskarte.

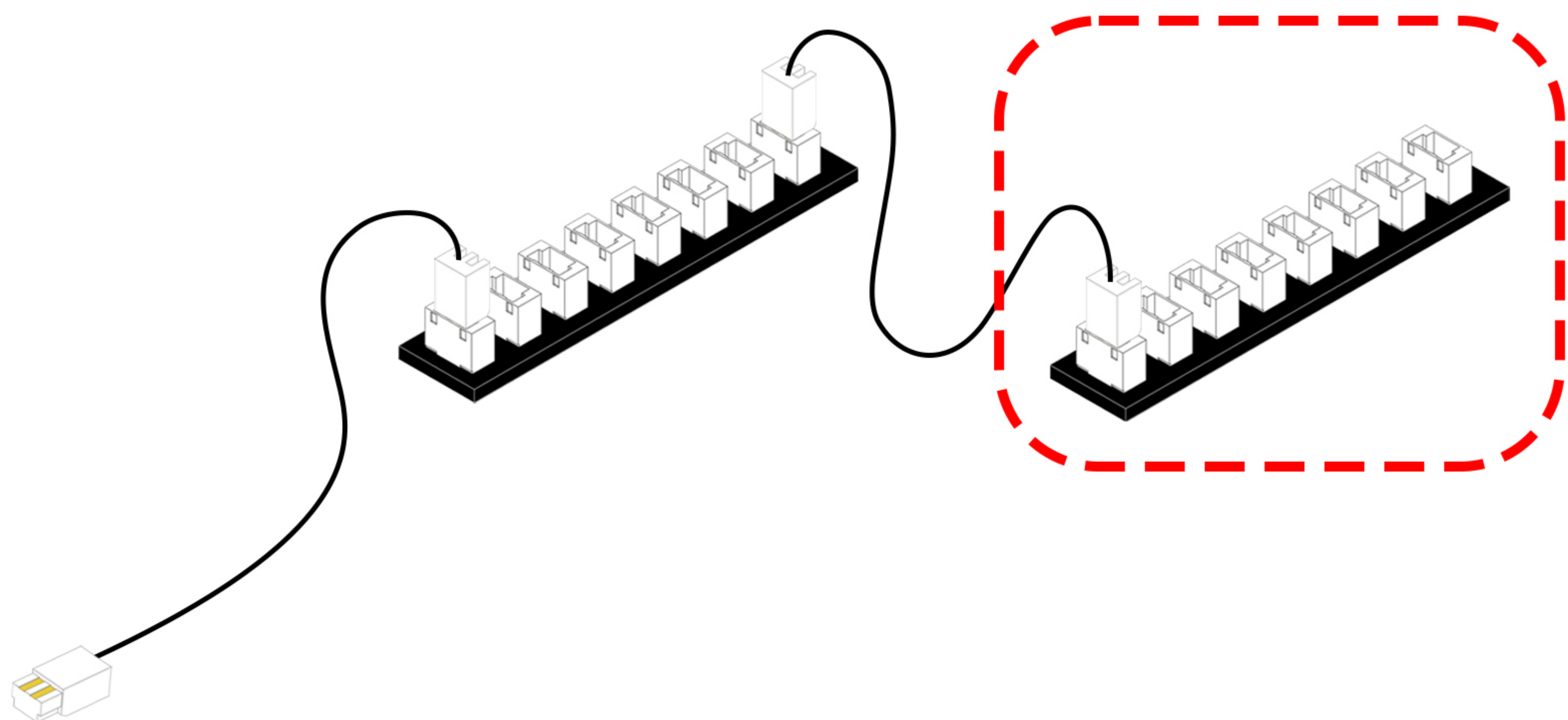
**109**

EN: Connect the seven light wires on the right side of the model to the expansion board in sequence.

DE: Schließen Sie die sieben Lichtkabel auf der rechten Seite des Modells der Reihe nach an die Erweiterungsplatine an.

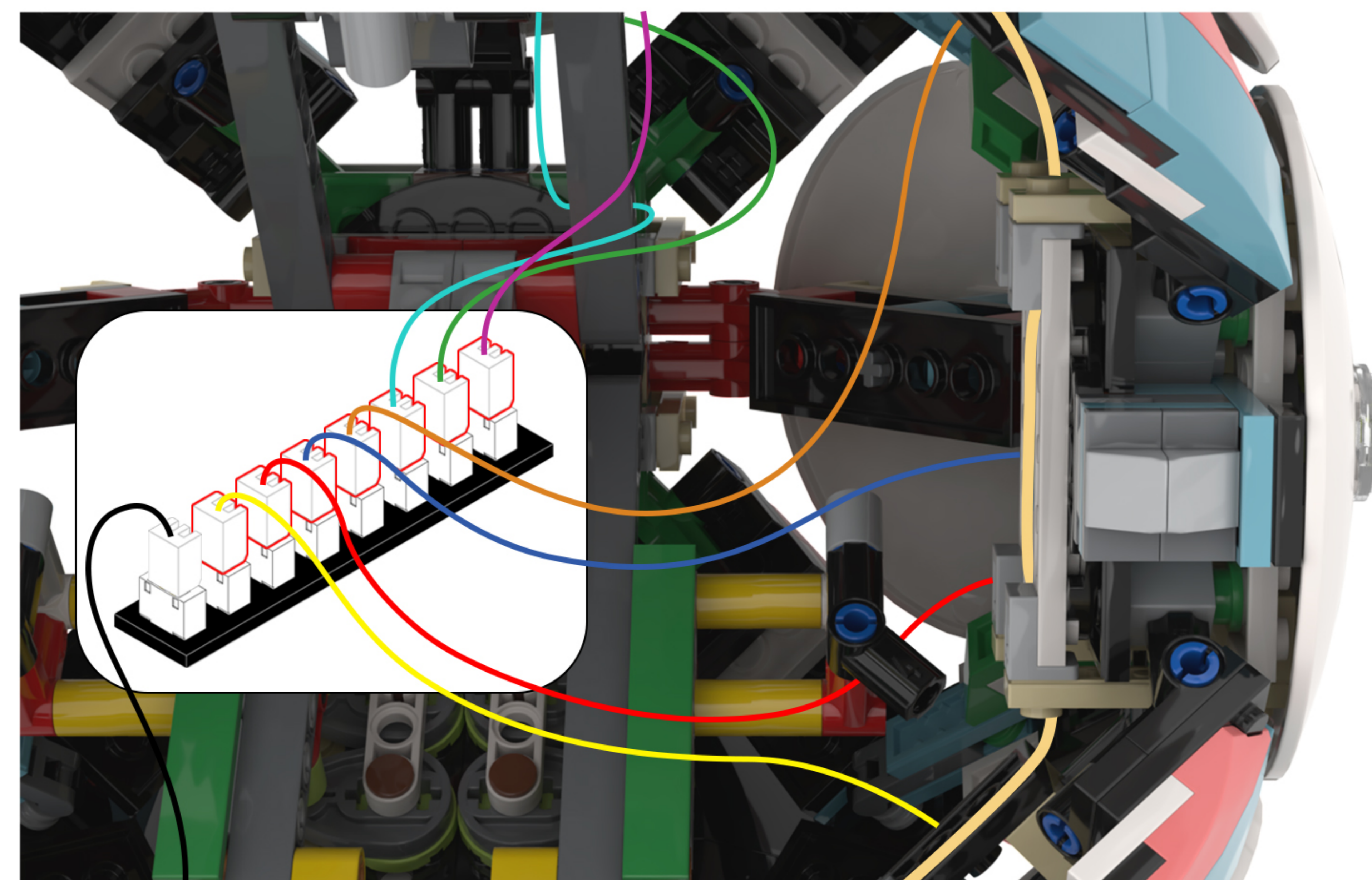
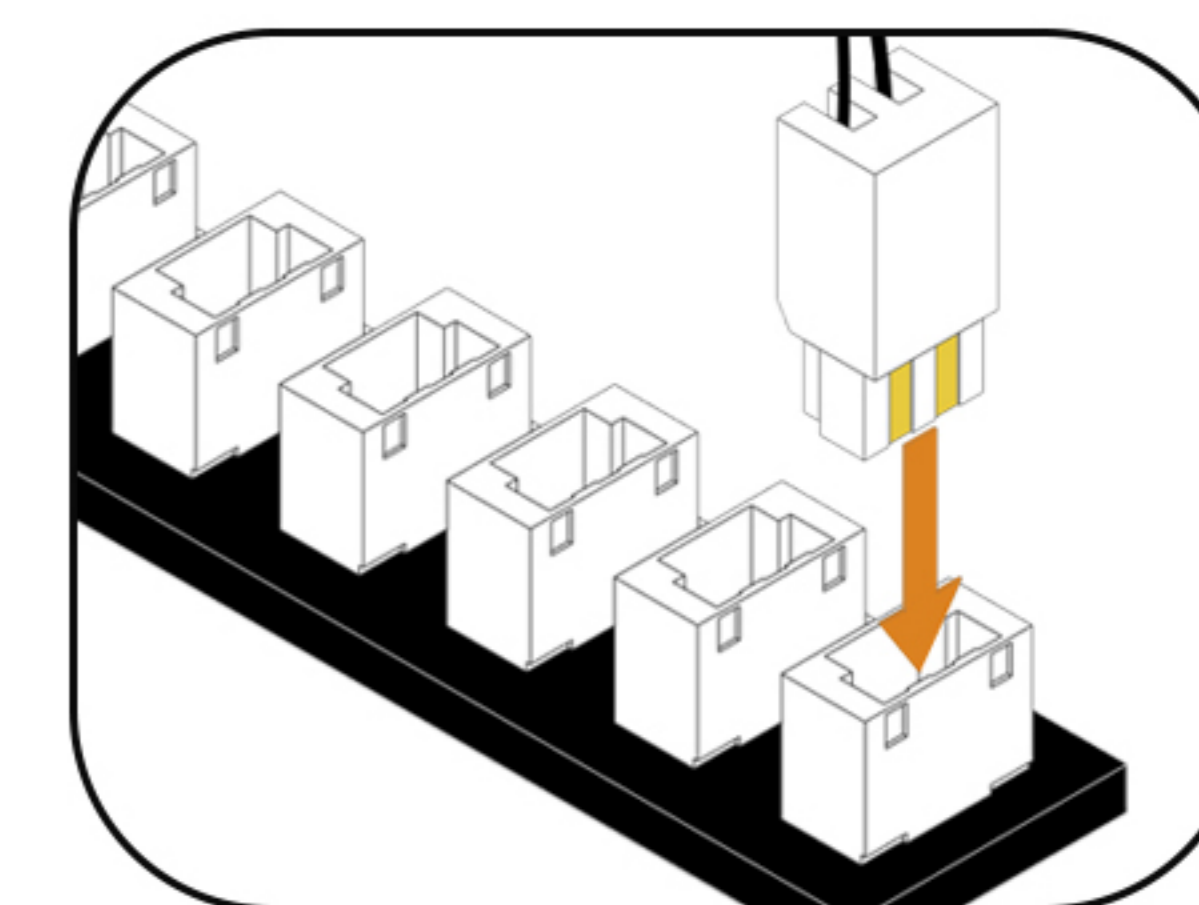

110

EN: Peel off the adhesive backing of the expansion board and attach it to the location shown in the illustration.

DE: Entfernen Sie die Schutzfolie von der Rückseite der Erweiterungsplatte und kleben Sie sie an die in der Abbildung gezeigte Stelle.

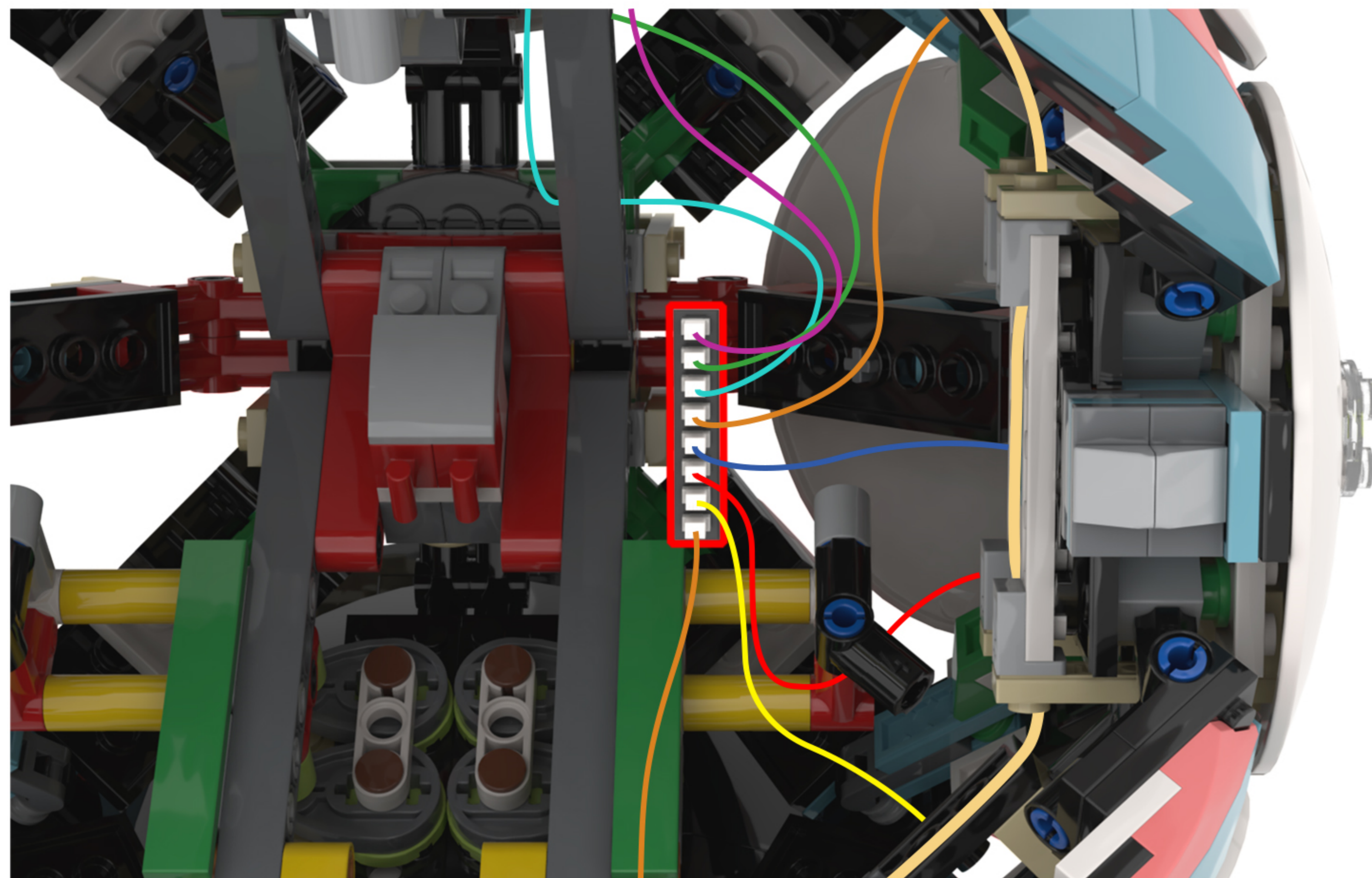

111

EN: Look at the block component highlighted in the image.

DE: Schauen Sie sich die im Bild hervorgehobene Blockkomponente an.

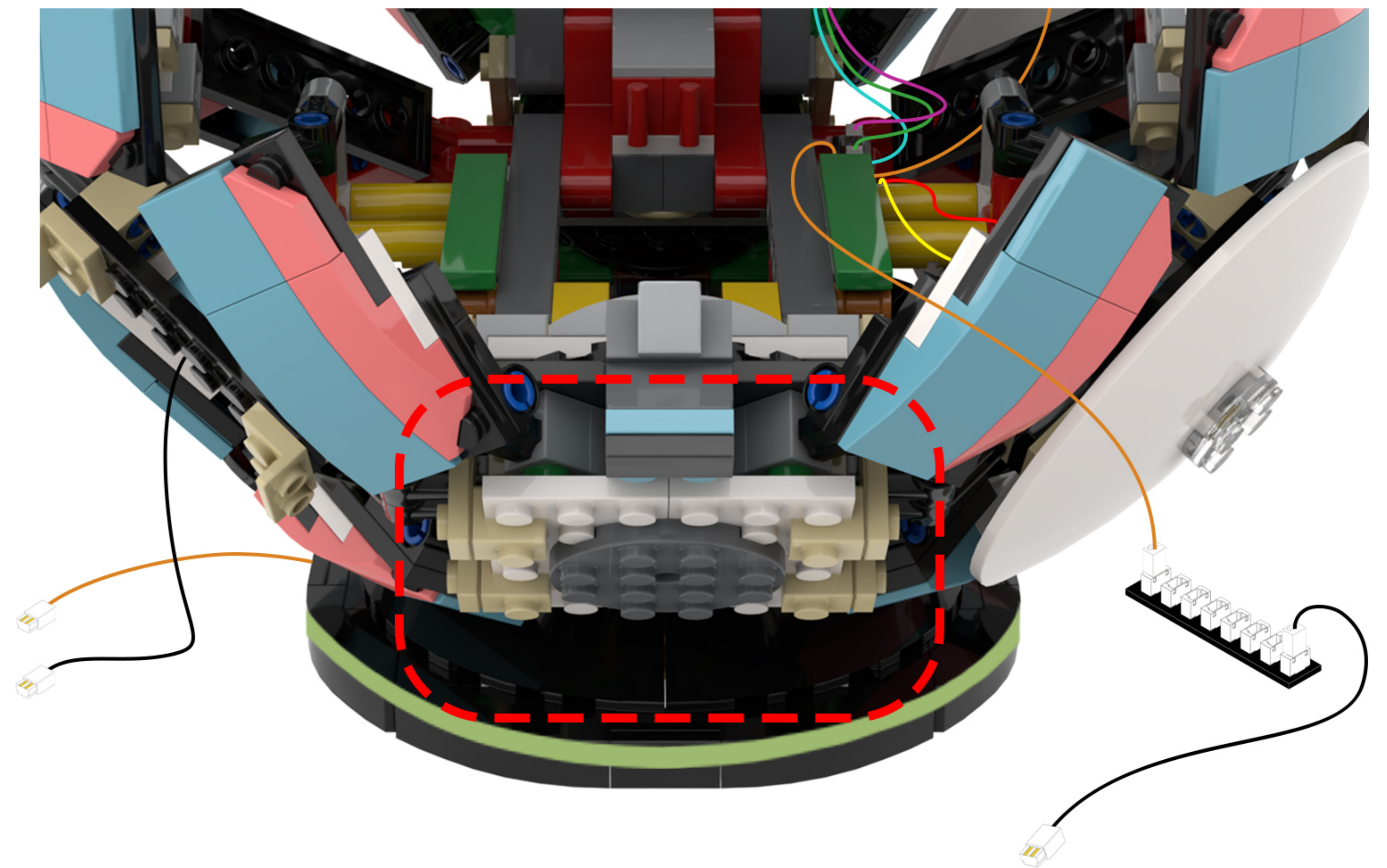

**112** EN: Take out the building blocks with the lights attached and reinstall them in their original positions.

DE: Nehmen Sie die Bausteine mit den daran befestigten Lichtern heraus und setzen Sie sie wieder an ihren ursprünglichen Positionen ein.

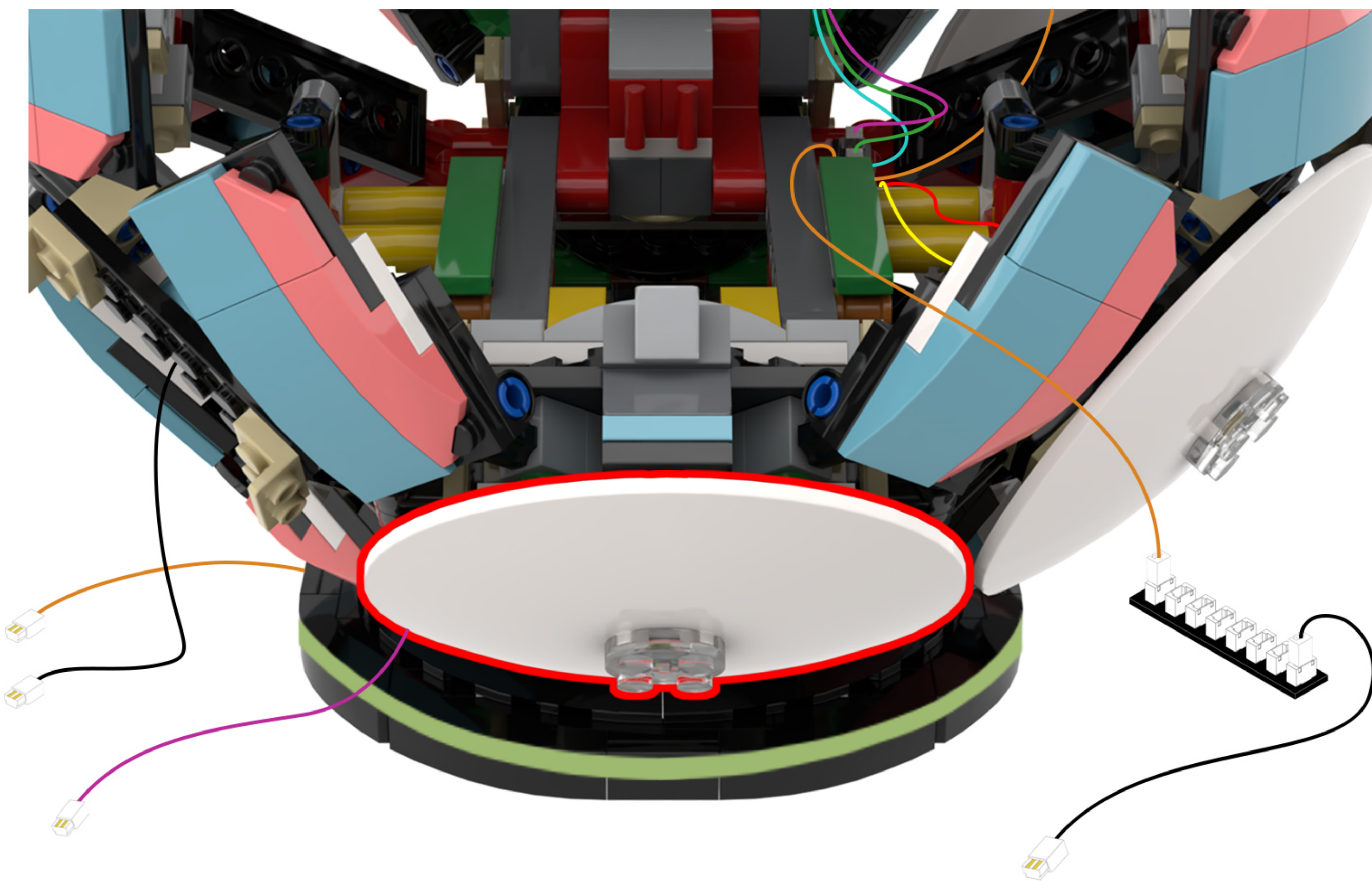
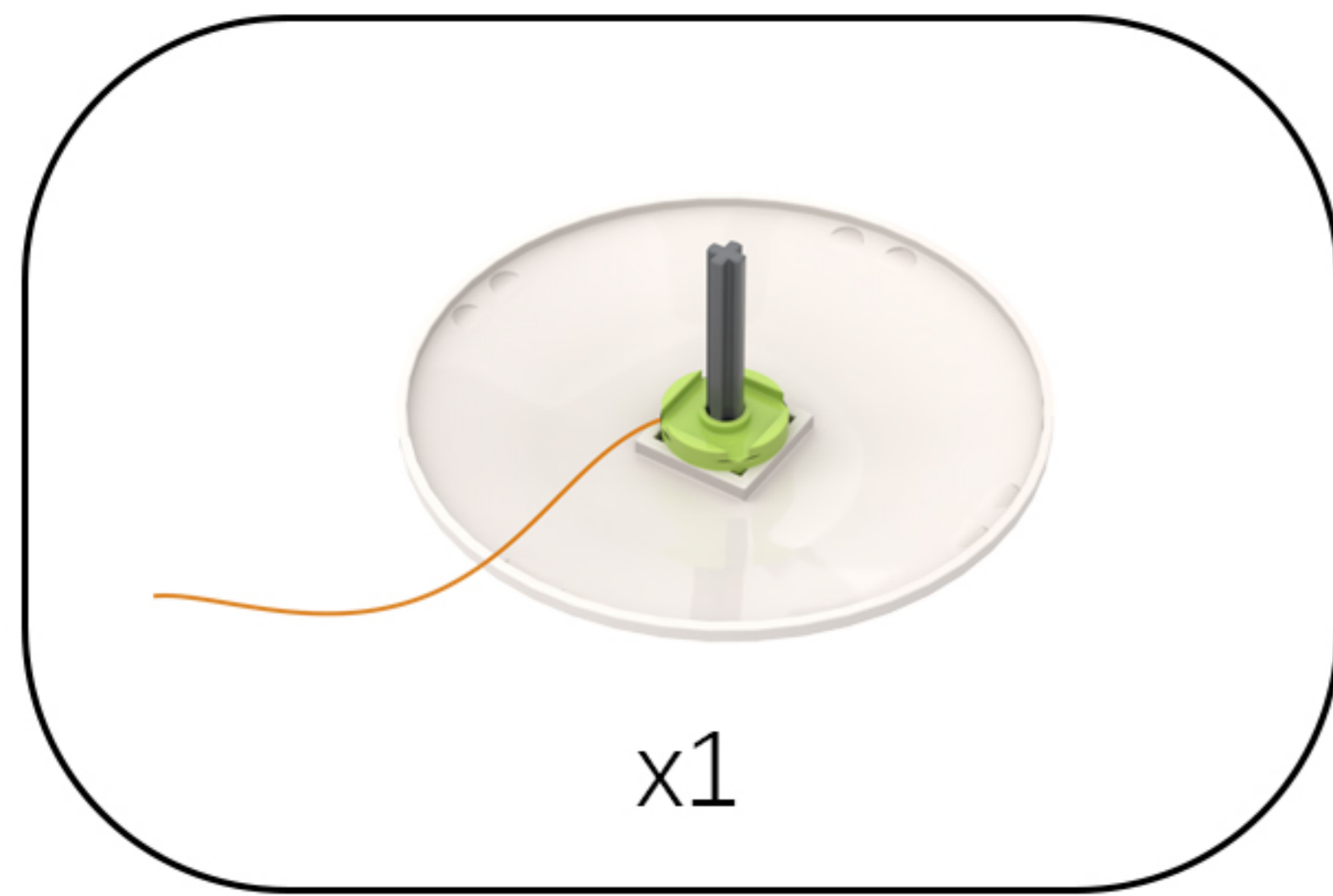

**113** EN: Rotate the model to its back side.  
DE: Drehen Sie das Modell auf die Rückseite.

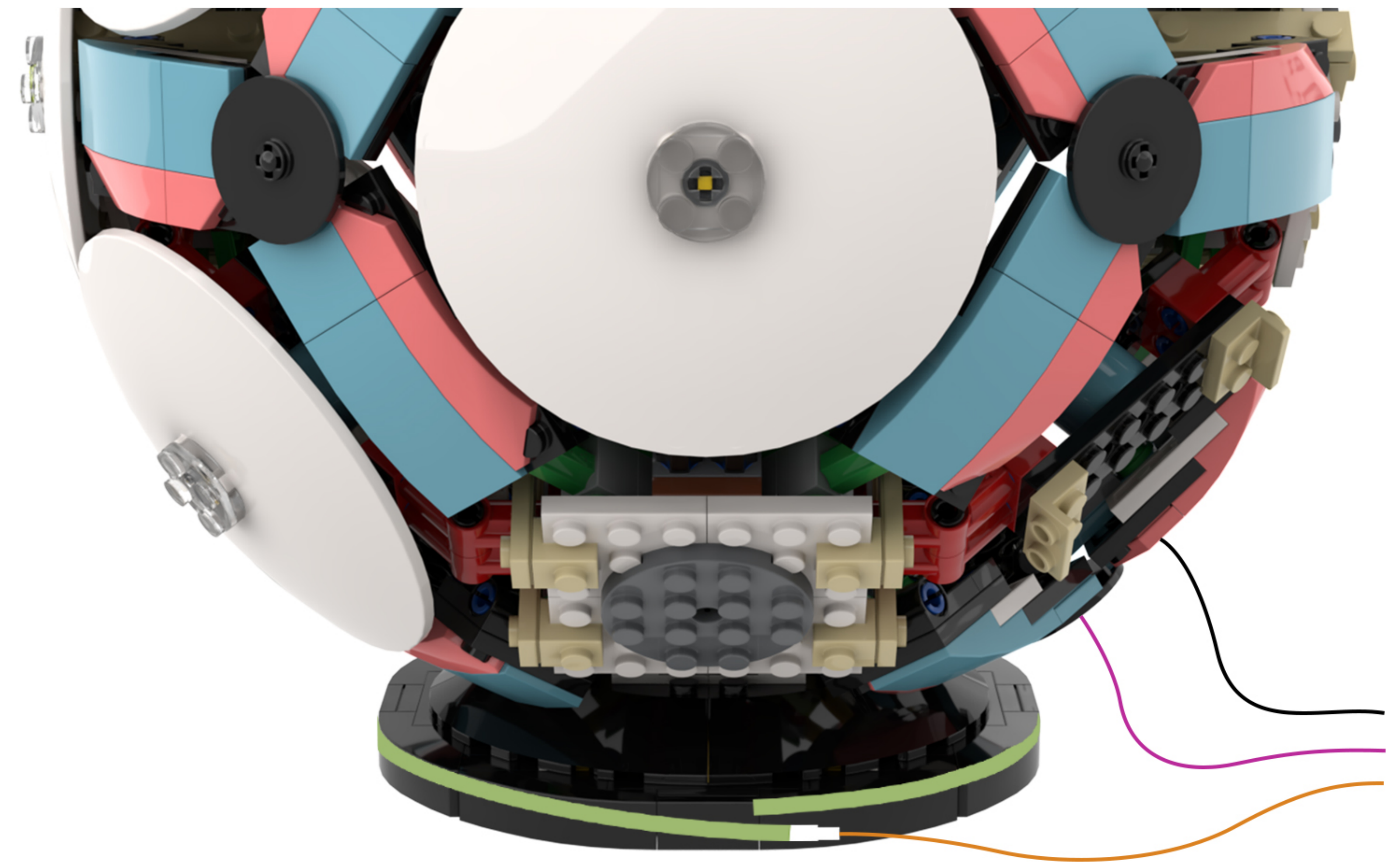

**114**

EN: Take out the building blocks with the lights attached and reinstall them in their original positions.

DE: Nehmen Sie die Bausteine mit den daran befestigten Lichtern heraus und setzen Sie sie wieder an ihren ursprünglichen Positionen ein.

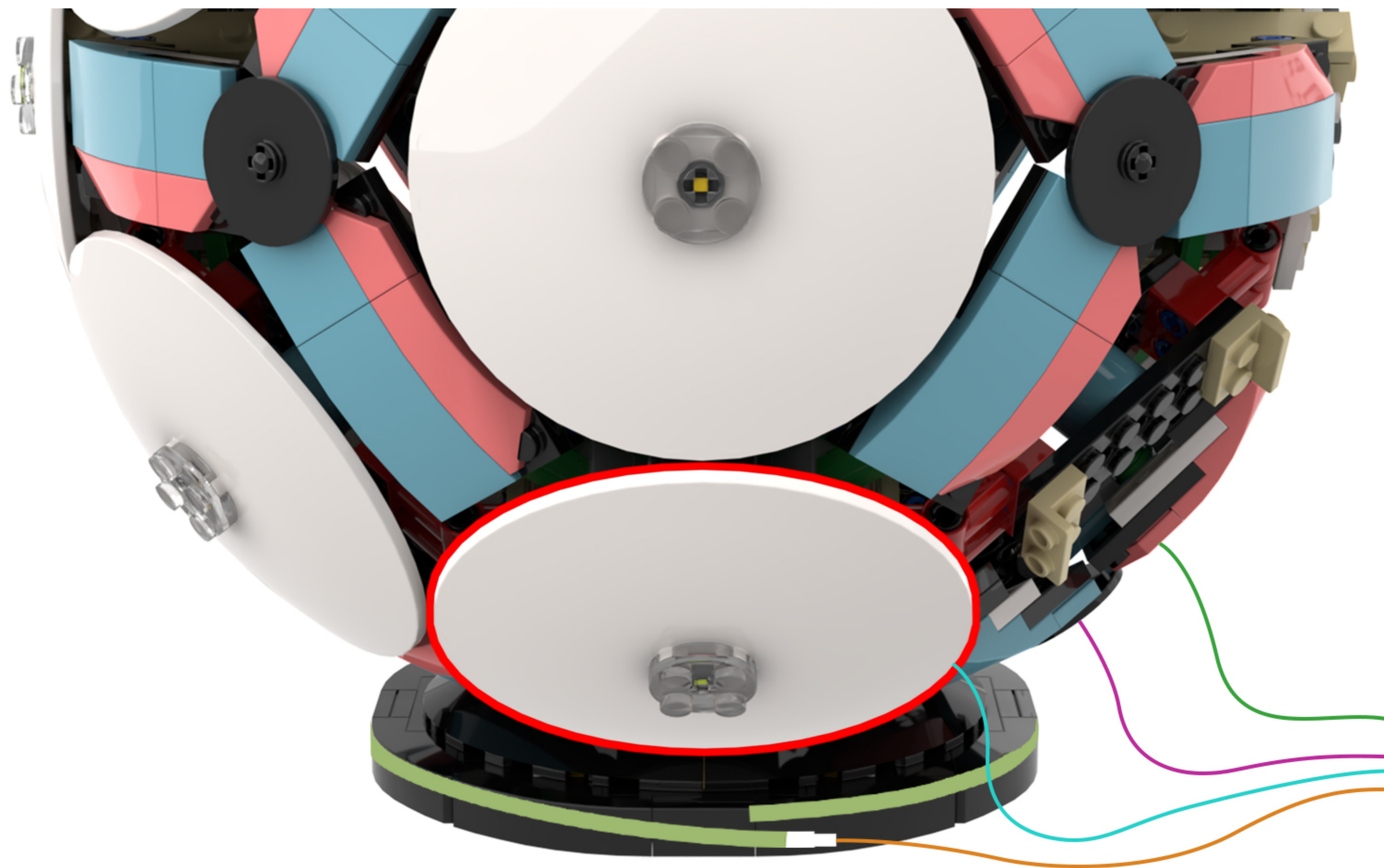
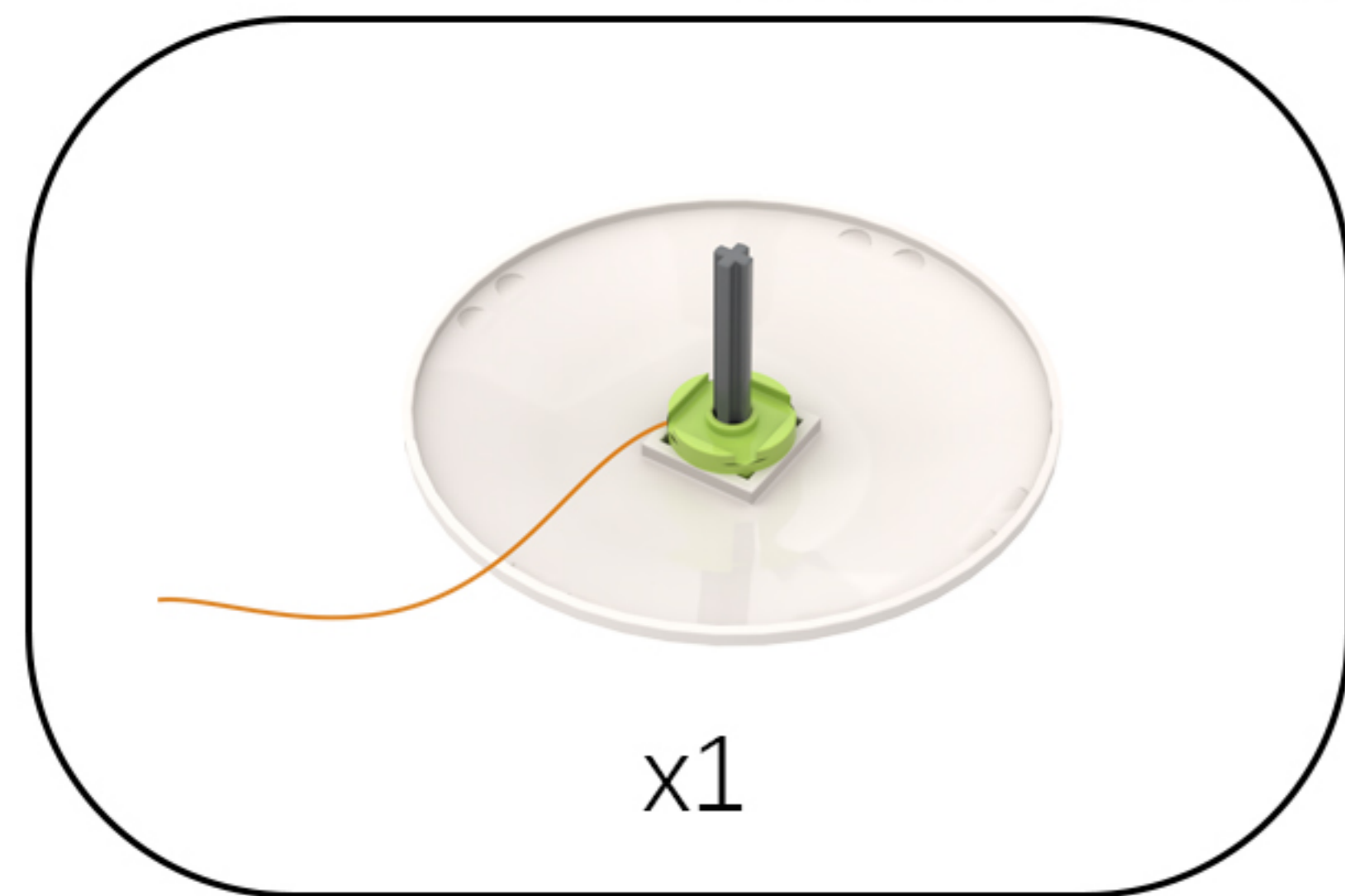
**115**

EN: Rotate the model to the side.

DE: Drehen Sie das Modell zur Seite.

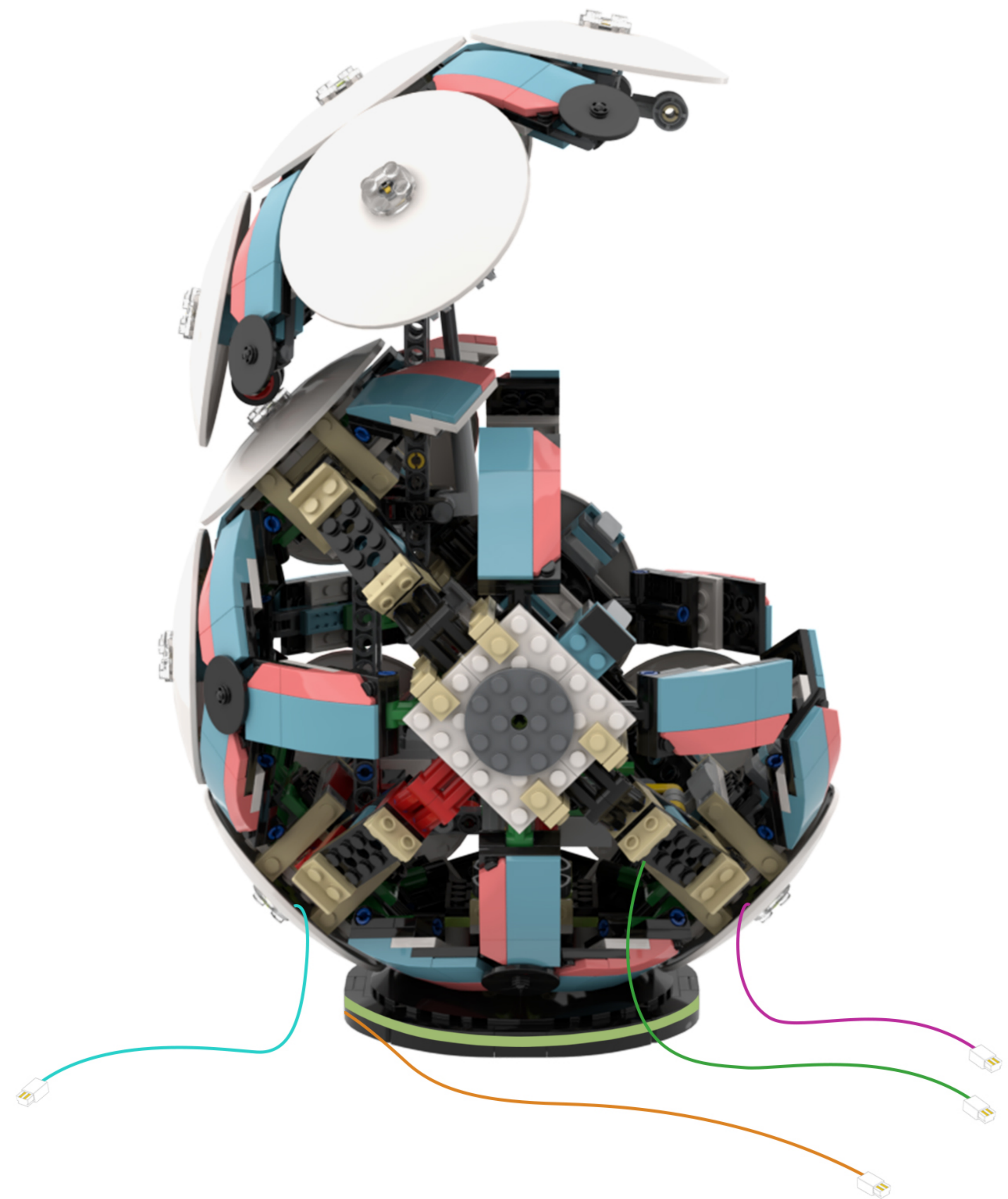

116

EN: Take out the building blocks with the lights attached and reinstall them in their original positions one by one.

DE: Nehmen Sie die Bausteine mit den daran befestigten Leuchten heraus und setzen Sie sie nacheinander wieder an ihren ursprünglichen Positionen ein.

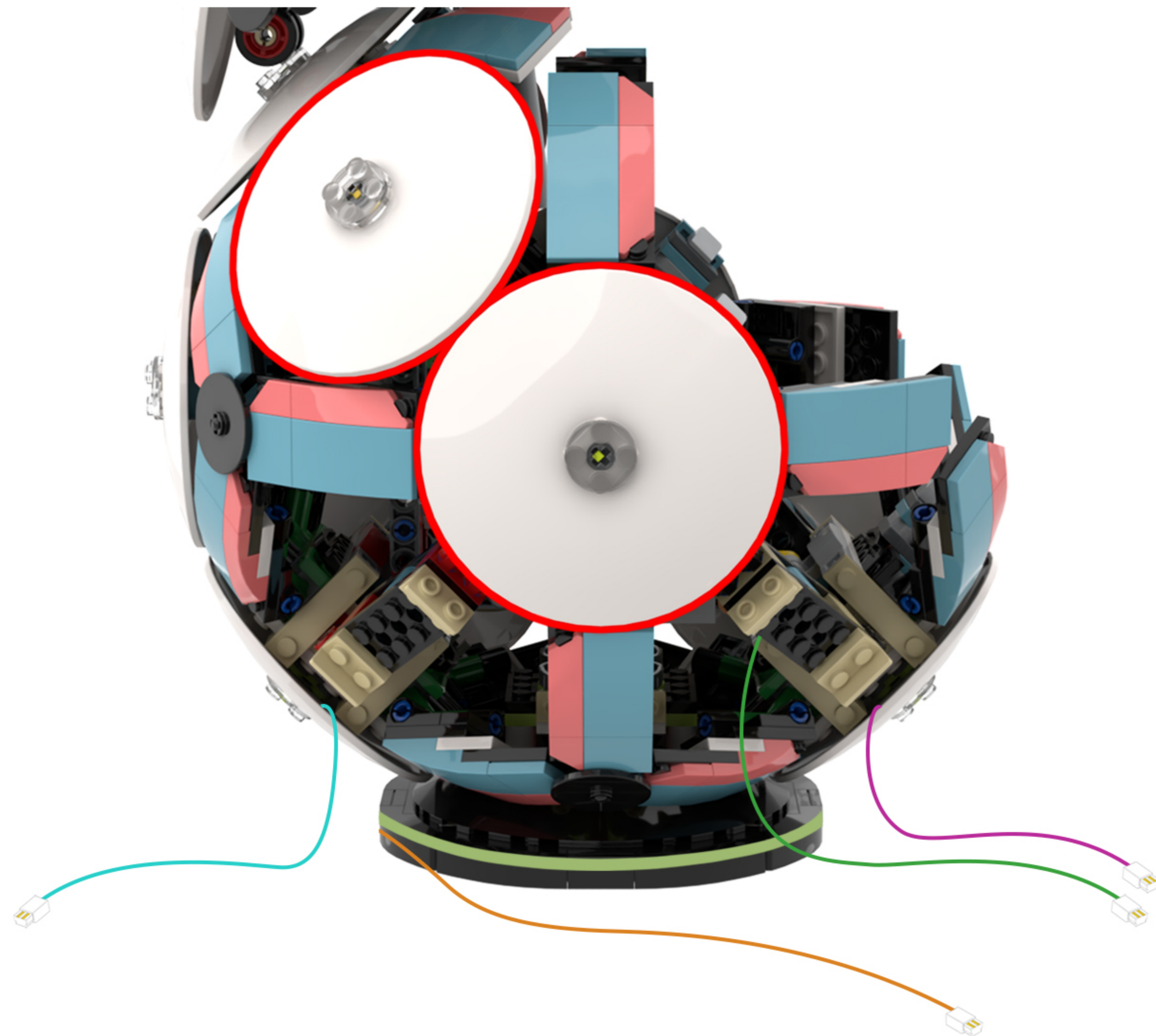
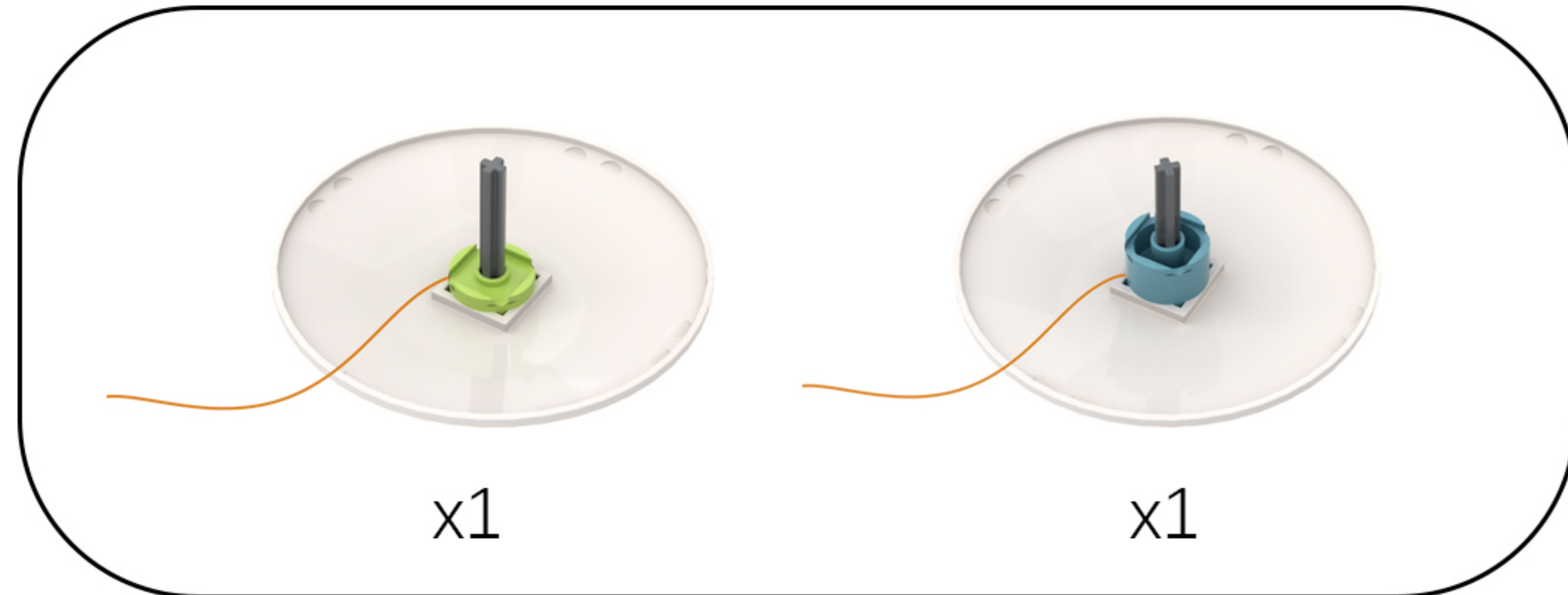

**Note:** The lighting wires for the light fixtures should be placed inside the model.

117

EN: Locate this light cord in the diagram.

DE: Suchen Sie dieses Lichtkabel in der Abbildung.

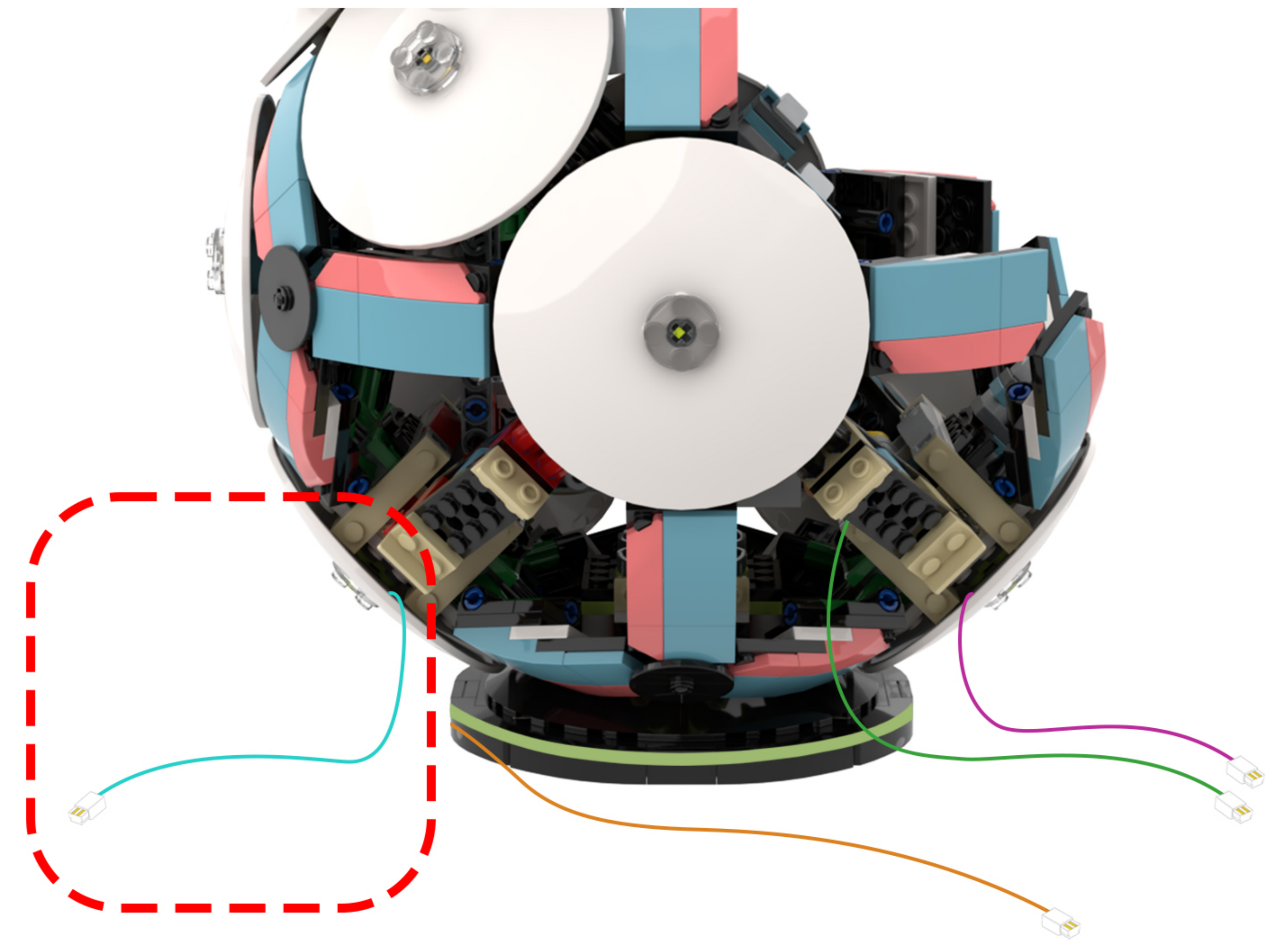

118

EN: Thread the light cord back through and place it inside the model.

DE: Führen Sie das Lichtschnur wieder hindurch und legen Sie es in das Modell.

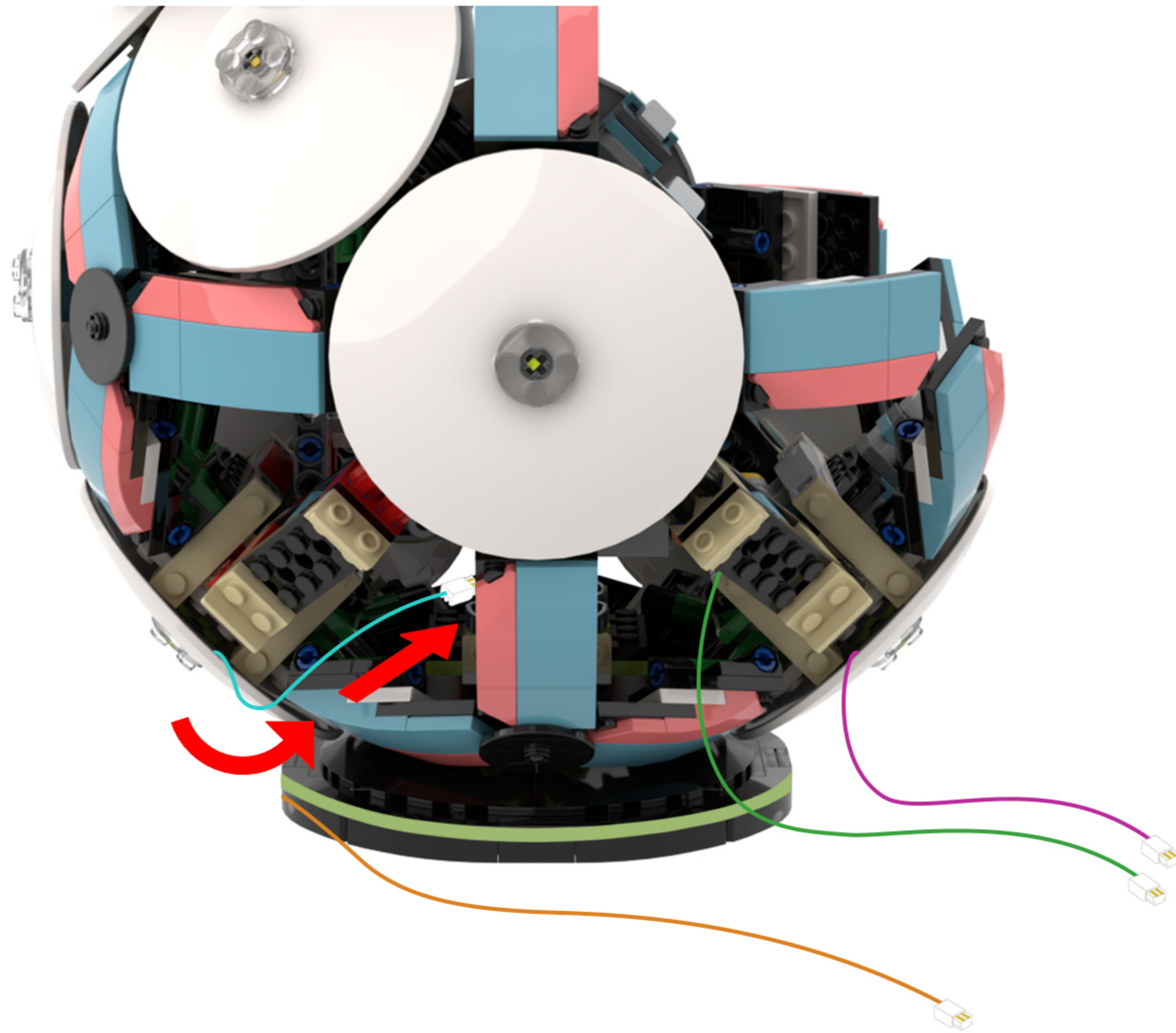

119

EN: Locate this light cord in the diagram.

DE: Suchen Sie dieses Lichtkabel in der Abbildung.

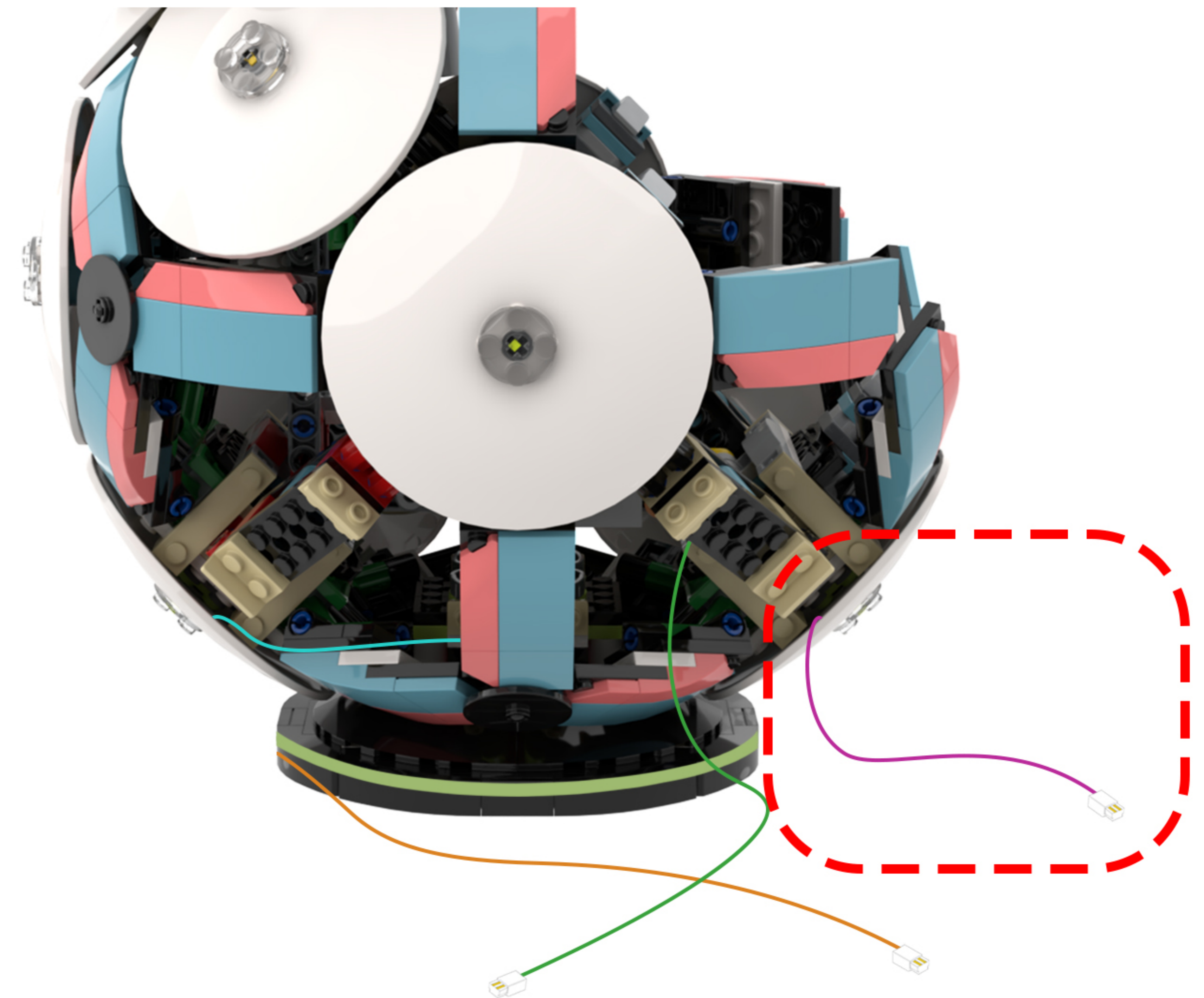

120

EN: Thread the light cord back through and place it inside the model.

DE: Führen Sie das Lichtschnur wieder hindurch und legen Sie es in das Modell.

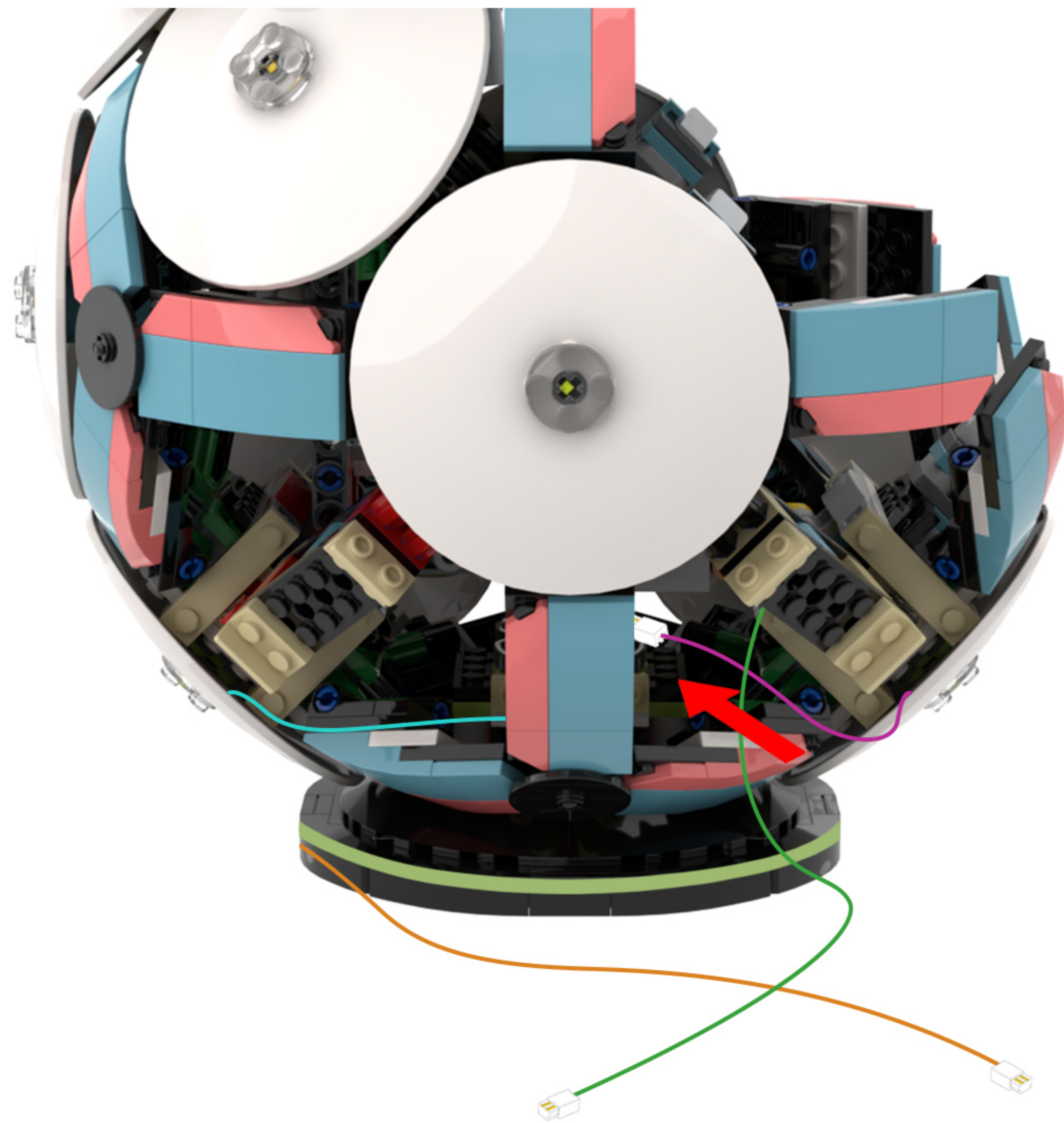

121

EN: Rotate the model to the view shown in the figure.

DE: Drehen Sie das Modell so, dass es der in der Abbildung gezeigten Ansicht entspricht.

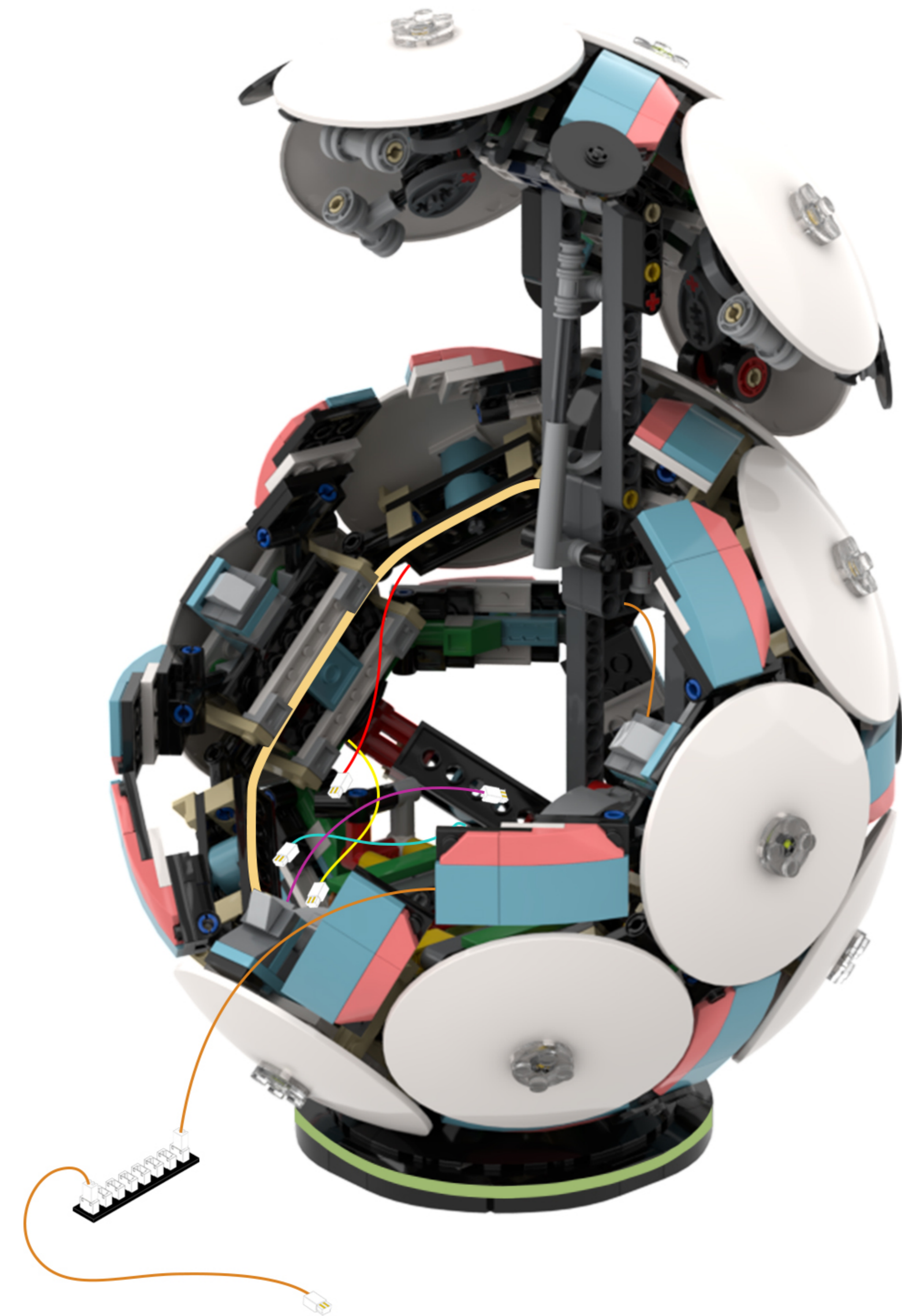

- 122** EN: Find the 8-slot expansion board.  
DE: Suchen Sie die Erweiterungskarte mit 8 Steckplätzen.

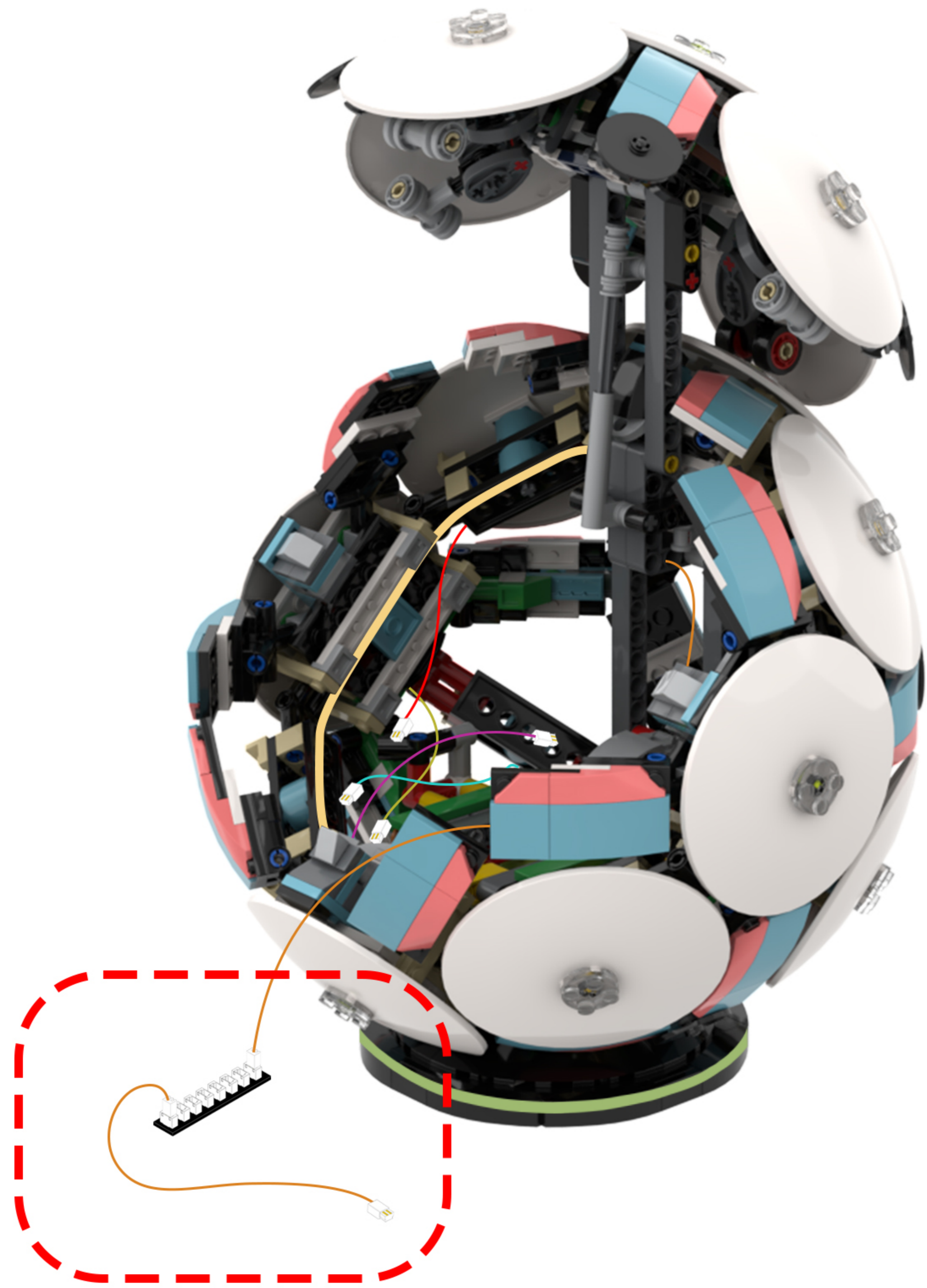

- 123** EN: Connect the four light wires inside the model to the 8-port expansion board in sequence.  
DE: Schließen Sie die vier Lichtkabel im Inneren des Modells der Reihe nach an die 8-Port-Erweiterungskarte an.

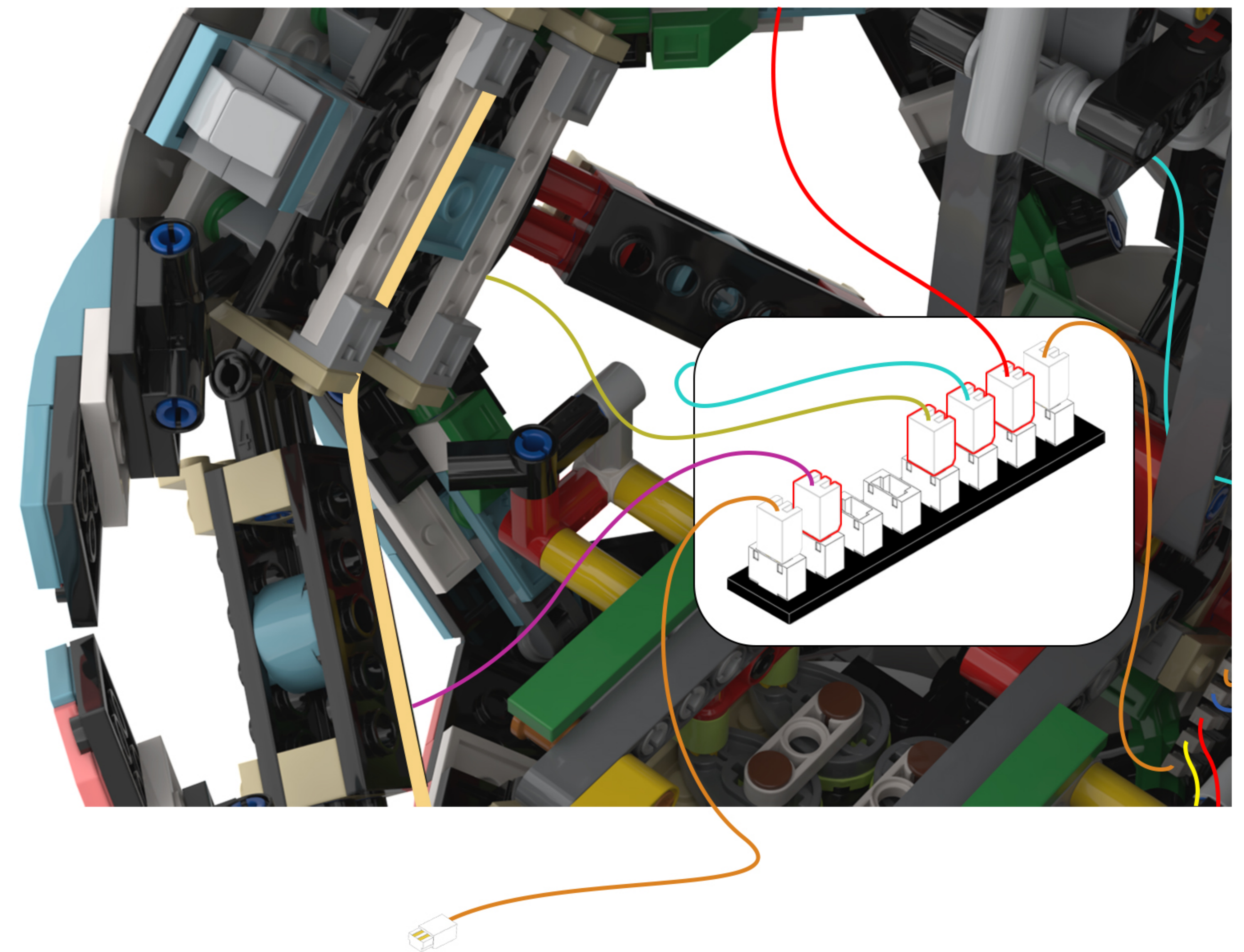
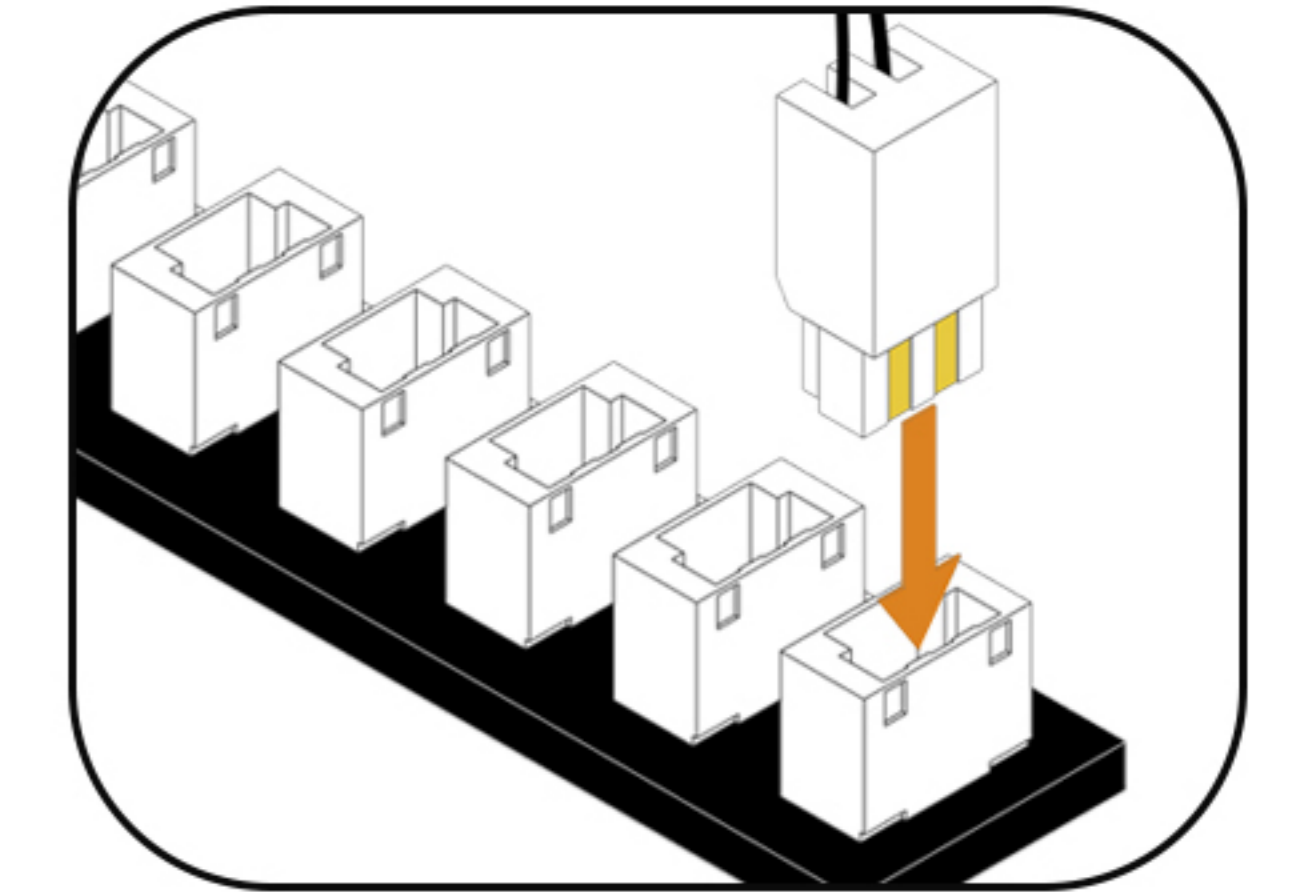

124

EN: Take out the building blocks with the lights attached. First, thread the light wires through the gaps in the blocks one by one, then connect them to the expansion board.

DE: Nehmen Sie die Bausteine mit den daran befestigten Lichtern heraus. Führen Sie zunächst die Lichtkabel nacheinander durch die Öffnungen in den Bausteinen und schließen Sie sie dann an die Erweiterungsplatine an.

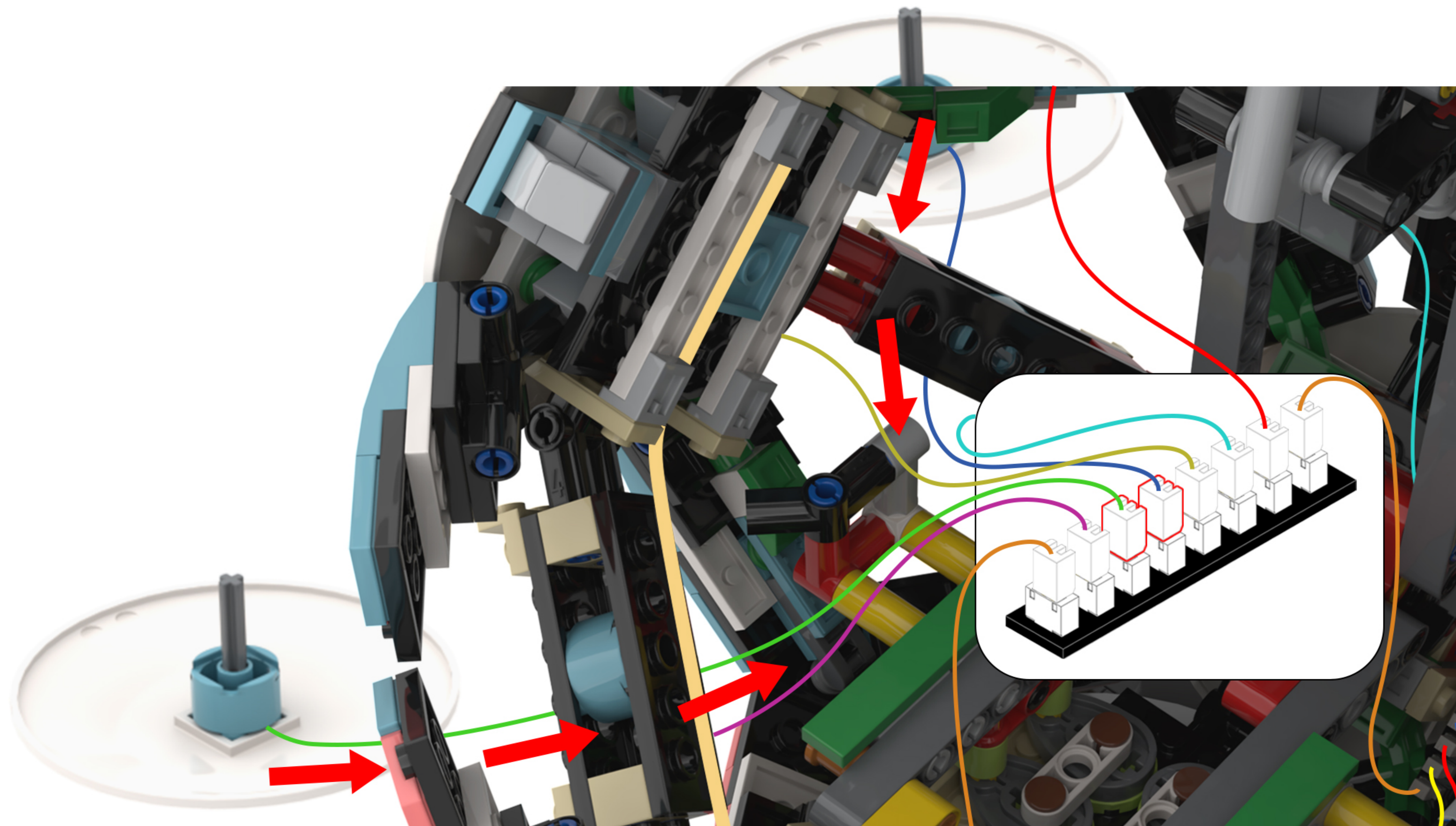
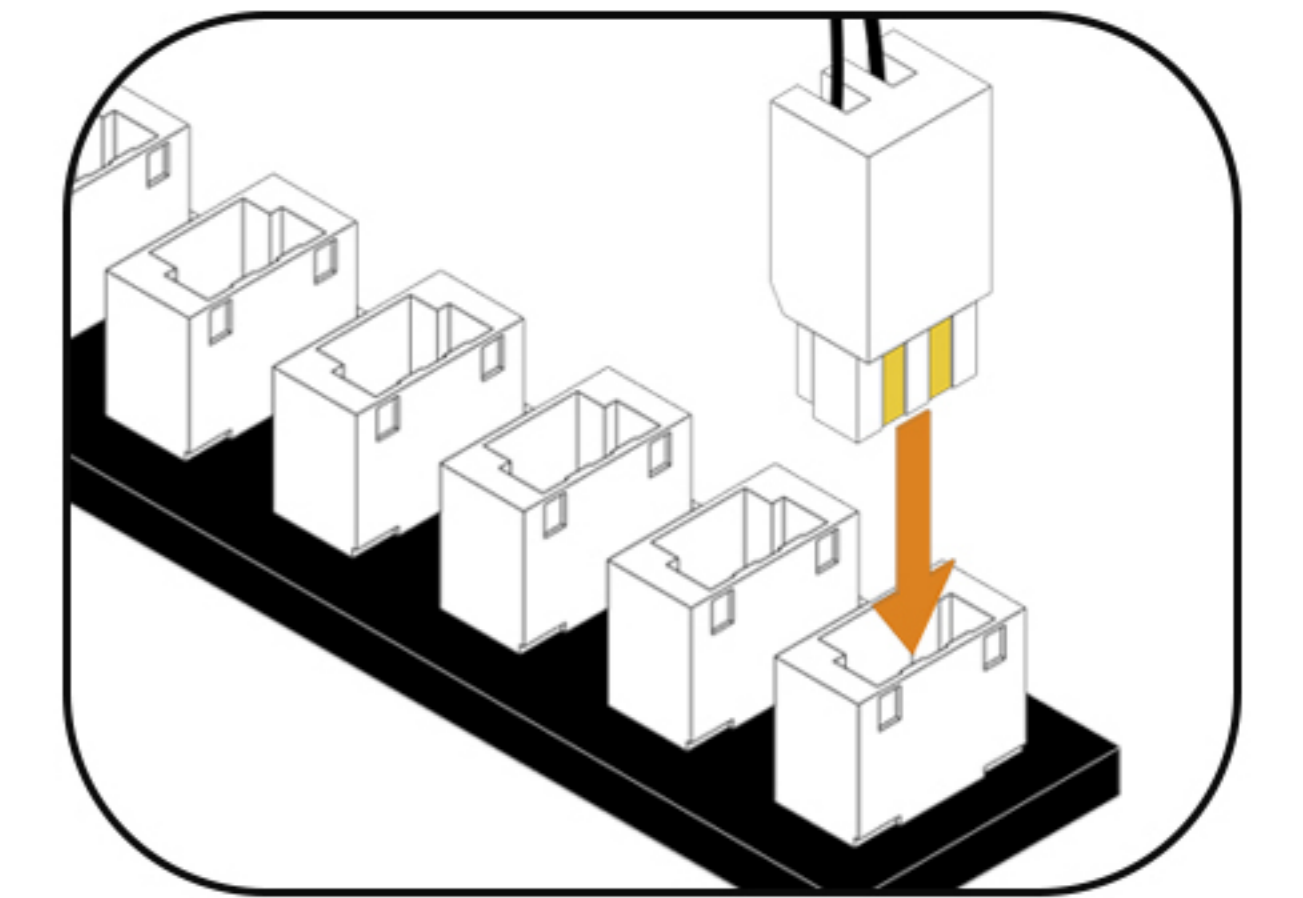
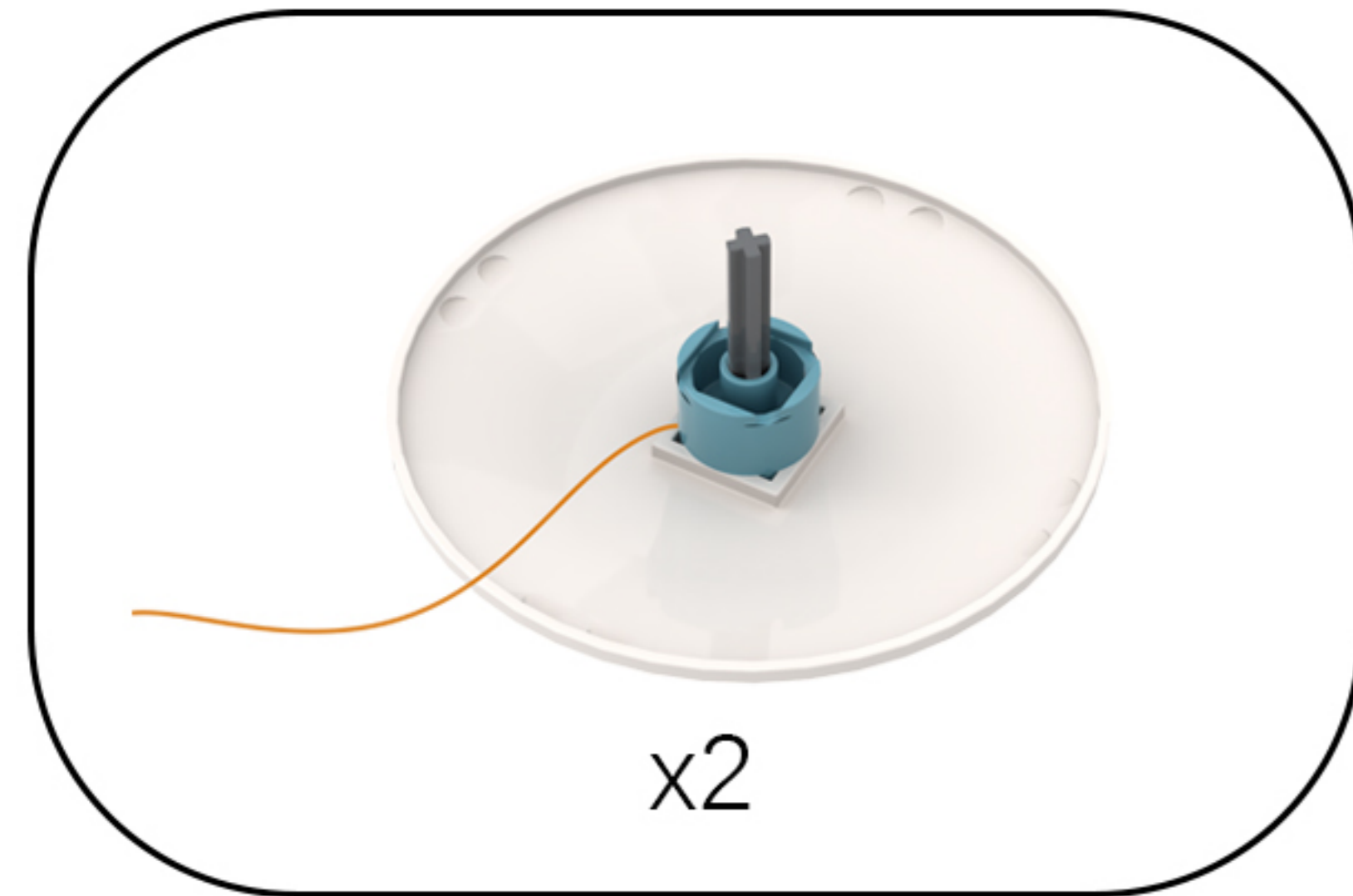

Note: Pay attention to where the two light wires pass through the building blocks.

**125** EN: Rotate the model to the side.  
DE: Drehen Sie das Modell zur Seite.

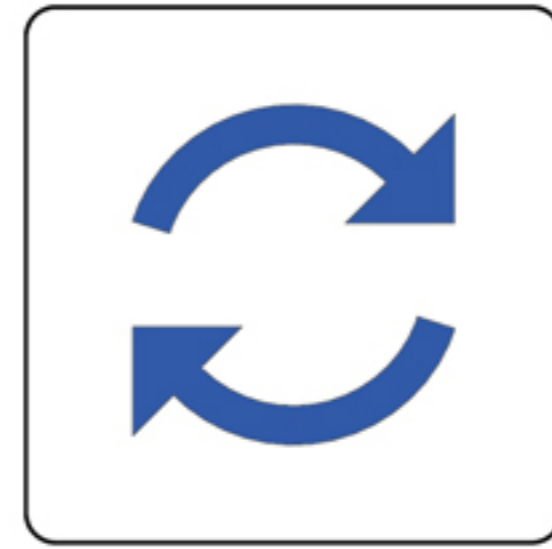

**126** EN: Pull the 8-seat expansion panel out from between the building blocks.  
DE: Ziehen Sie die 8-Sitzer-Erweiterungsplatte aus der Lücke zwischen den Bausteinen heraus.

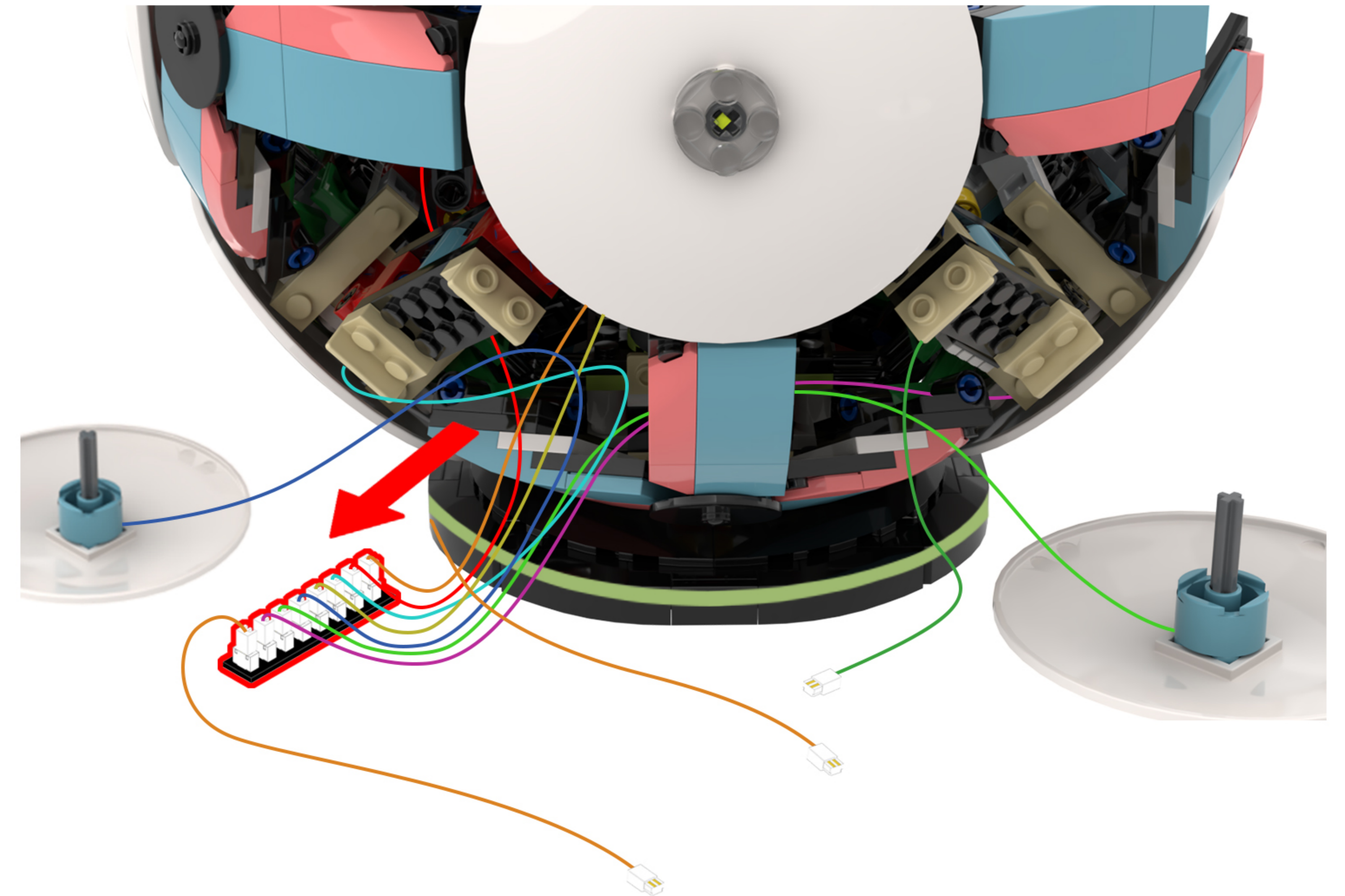

**127** EN: Reassemble the building blocks in sequence.  
DE: Setzen Sie die Bausteine der Reihe nach wieder zusammen.

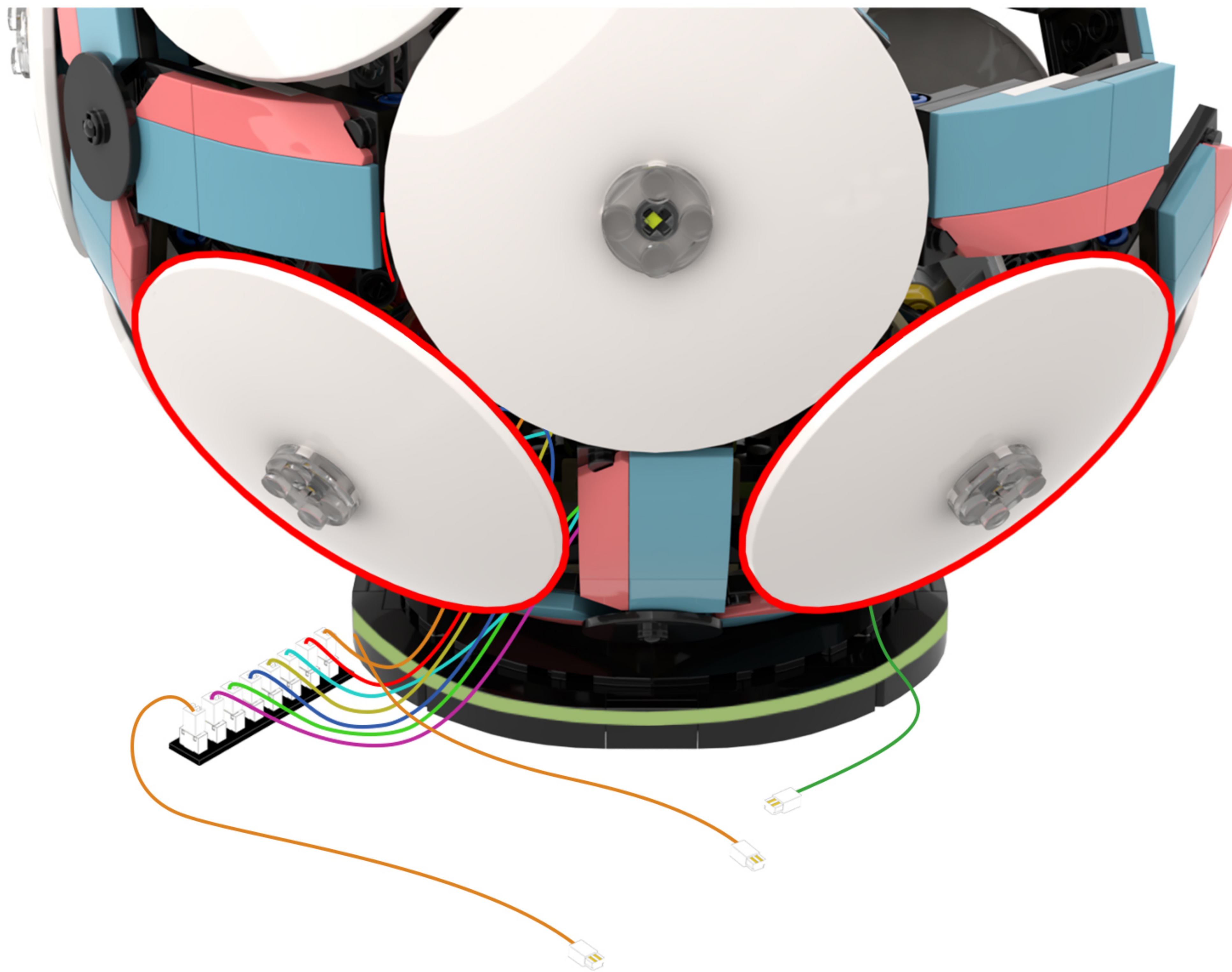

**128** EN: Take out the building blocks with the lights attached and reinstall them in their original positions.  
DE: Nehmen Sie die Bausteine mit den daran befestigten Lichtern heraus und setzen Sie sie wieder an ihren ursprünglichen Positionen ein.

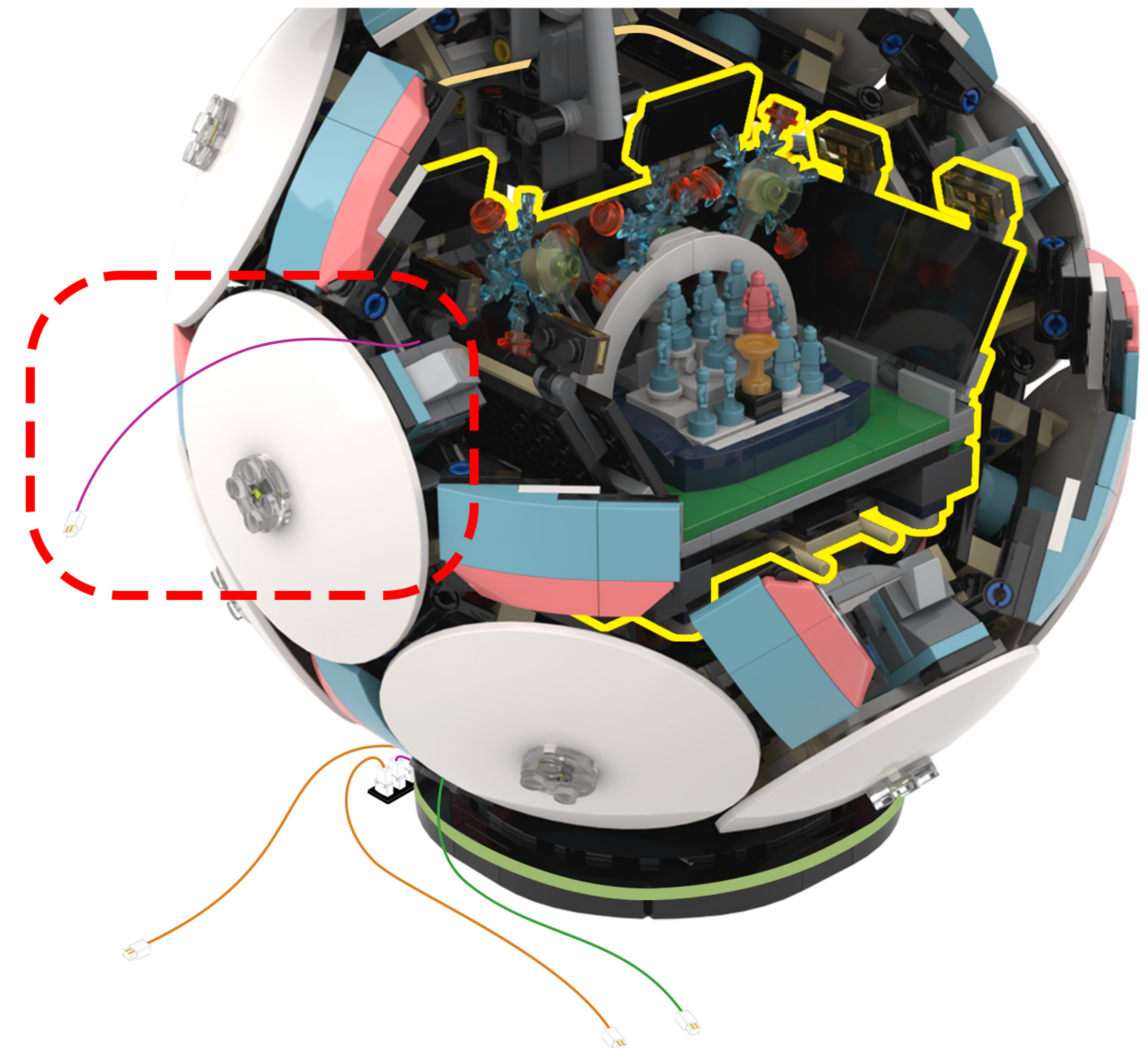
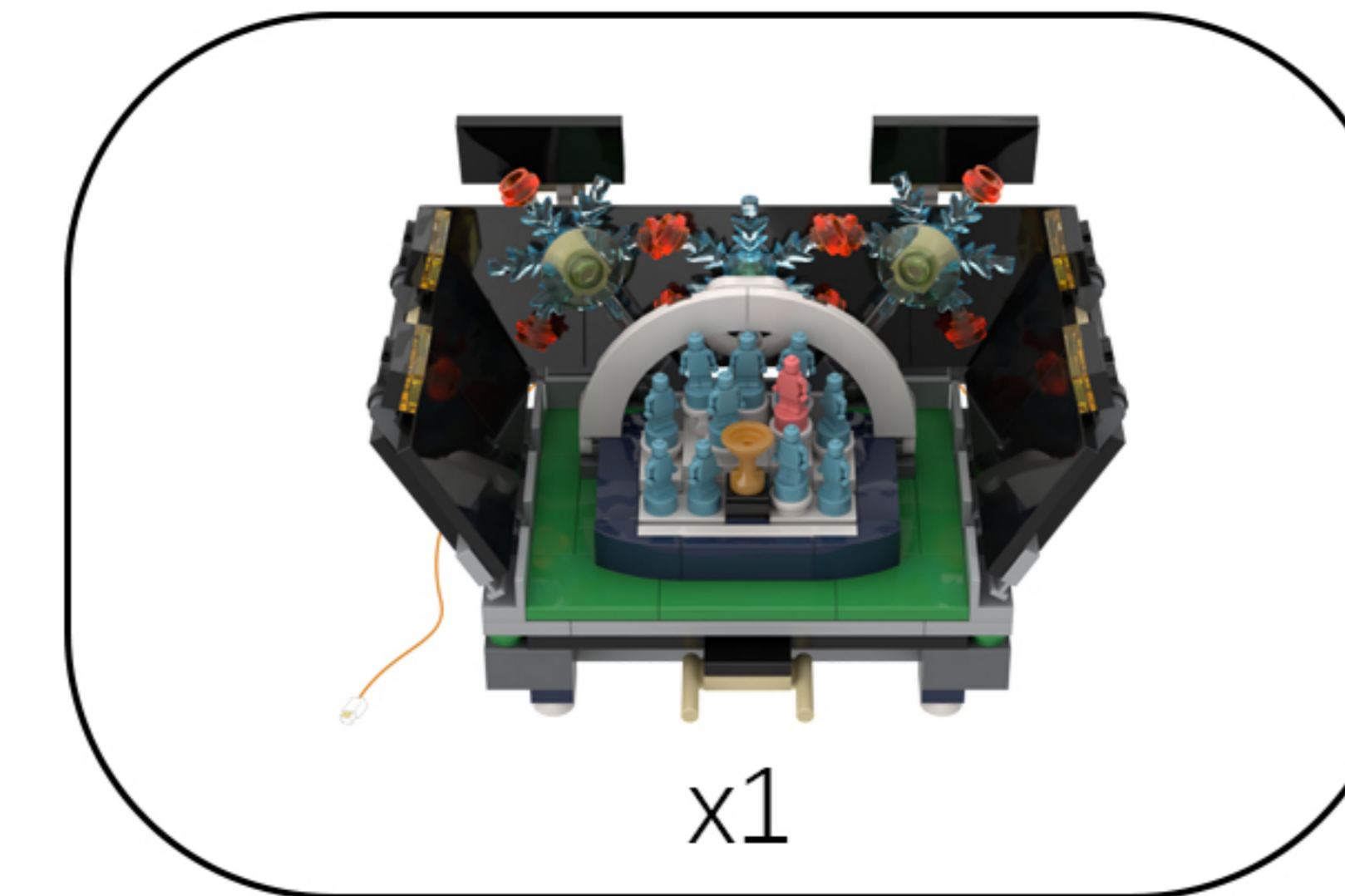

**Note:** Keep the lighting wires outside the model.

129

EN: Rotate the model to the side and locate the light lines shown in the figure.

DE: Drehen Sie das Modell zur Seite und suchen Sie die in der Abbildung gezeigten Lichtlinien.

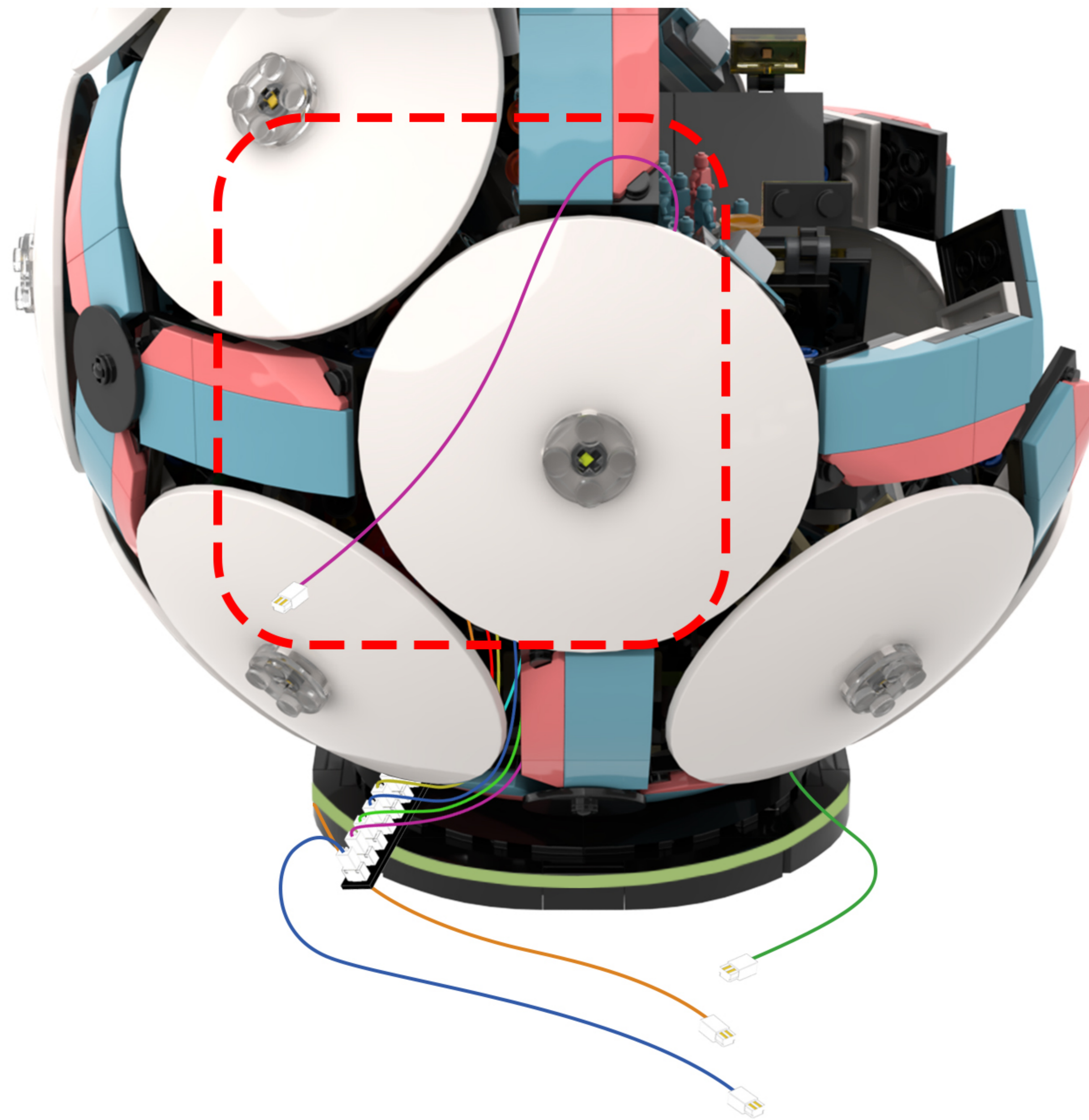

130

EN: Wire as shown in the diagram.

DE: Verdrahten Sie wie in der Abbildung gezeigt.

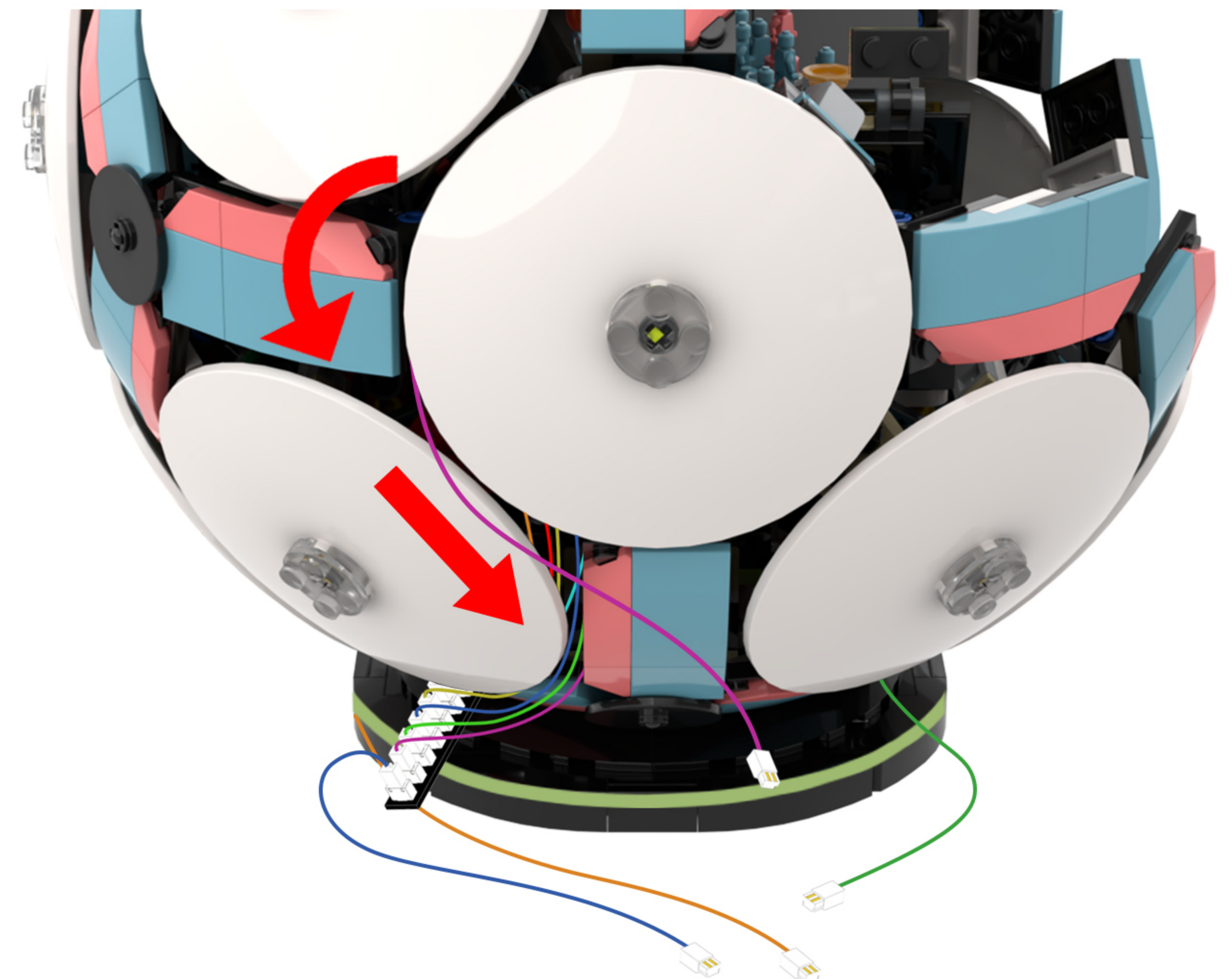
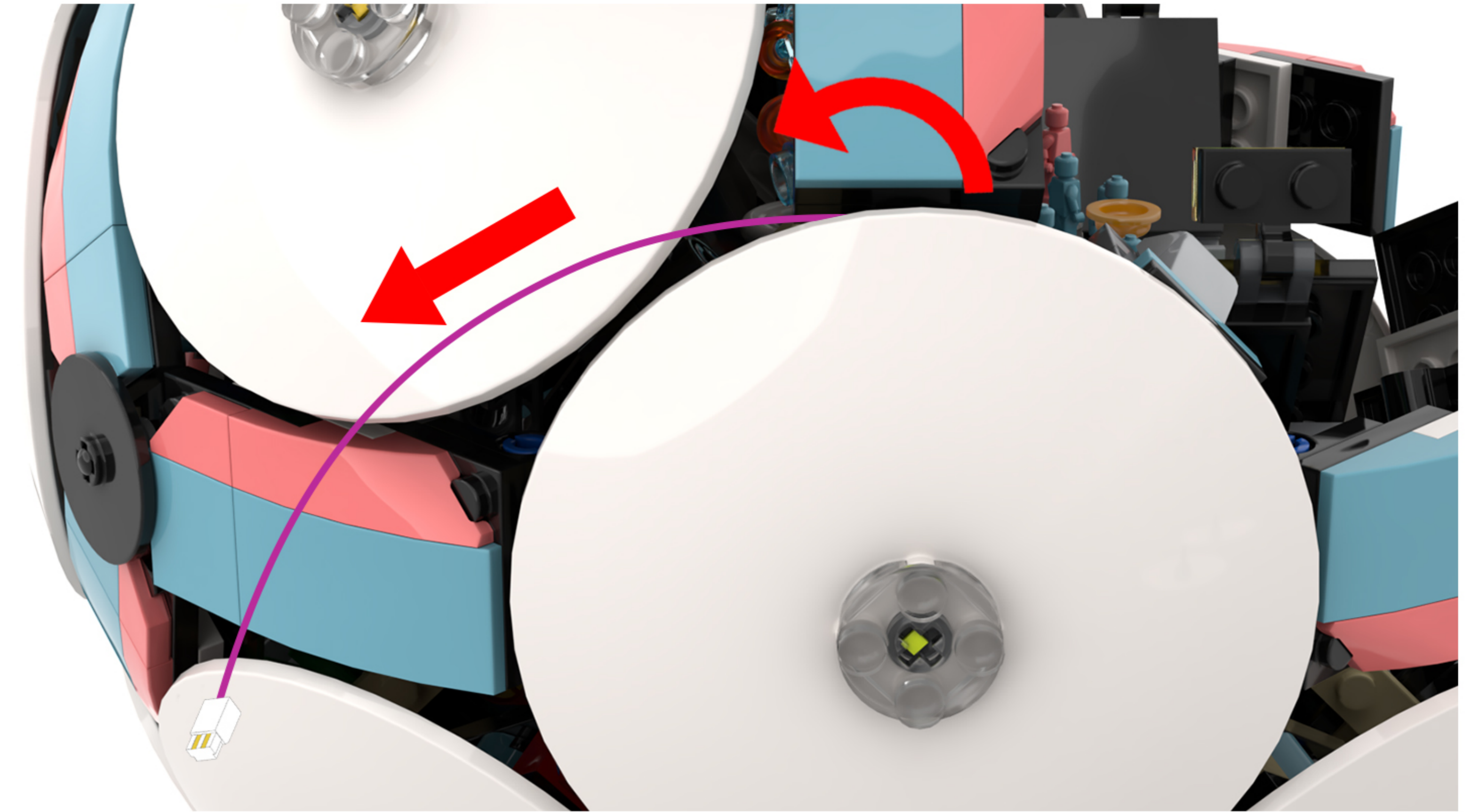

**131** EN: Wire as shown in the diagram.  
 DE: Verdrahten Sie wie in der Abbildung gezeigt.

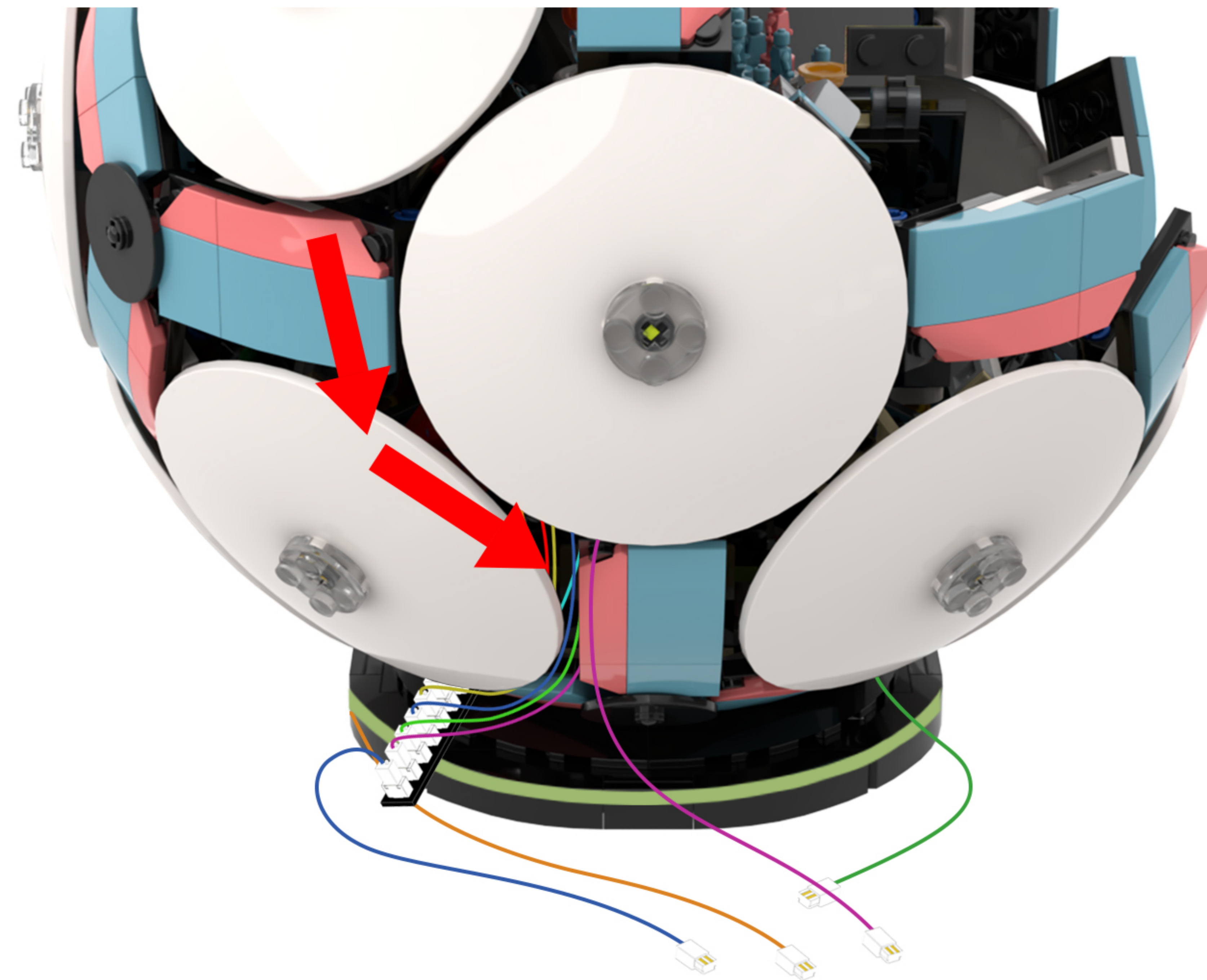

**132** EN: Remove the remote control module and the remote control from bag A03801.  
 DE: Nehmen Sie das Fernbedienungsmodul und die Fernbedienung aus der Tasche A03801 heraus.

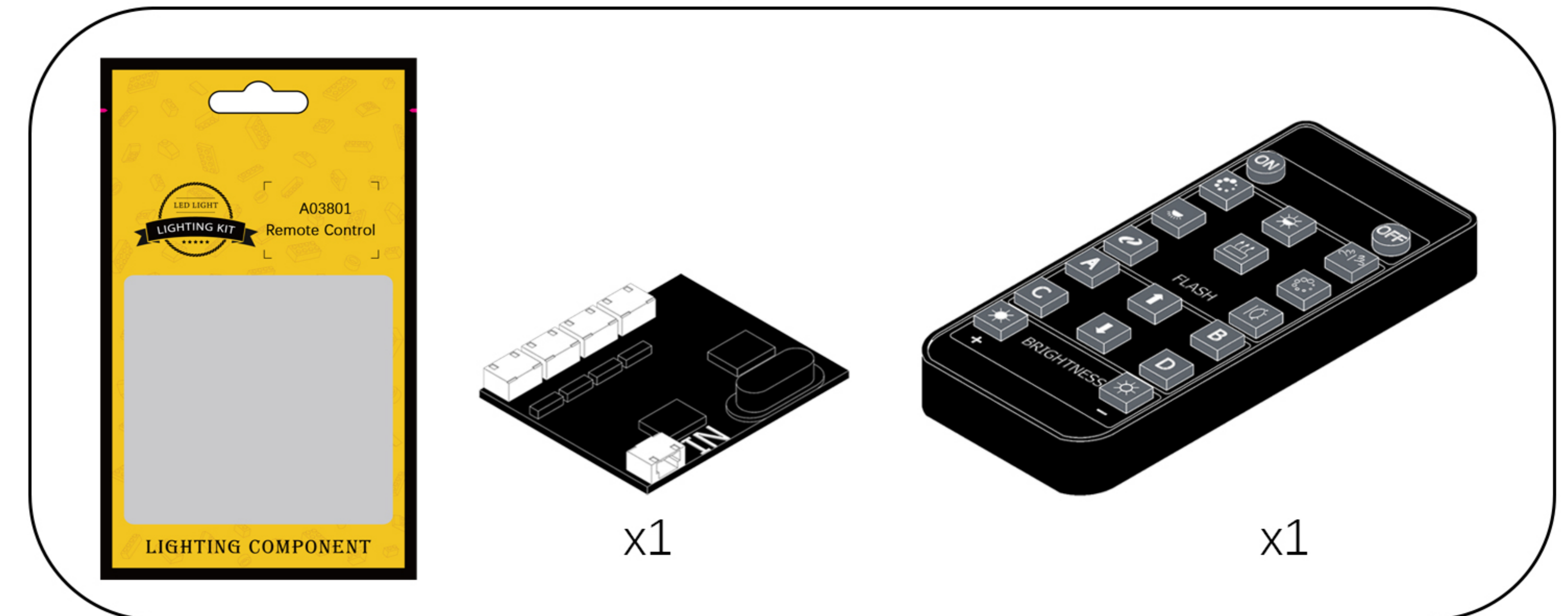

## Remote Control Function Introduce

**ON:** All lights turn on sequentially.  
**OFF:** All lights are off.

☼: A, B, C, D are turned on slowly in sequence.

☼: Breathing light mode.

☼: A and D the light is on and C and B flash alternately.

☼: A the light is on, B, C, D flow light effect I.

☼: A the light is on, B, C, D flow light effect II.

☼: Quickly open from A to D in turn.

☼: A, B, C, D flow light effect.

☼: A, B, C, D flash alternately.



**A:** Turn A on/off.  
**B:** Turn B on/off.  
**C:** Turn C on/off.  
**D:** Turn D on/off.  
 ↑: Increase frequency.  
 ↓: Decrease frequency.

**+**: Brightness+: Increases brightness  
**☼-**: Brightness-: Increases brightness

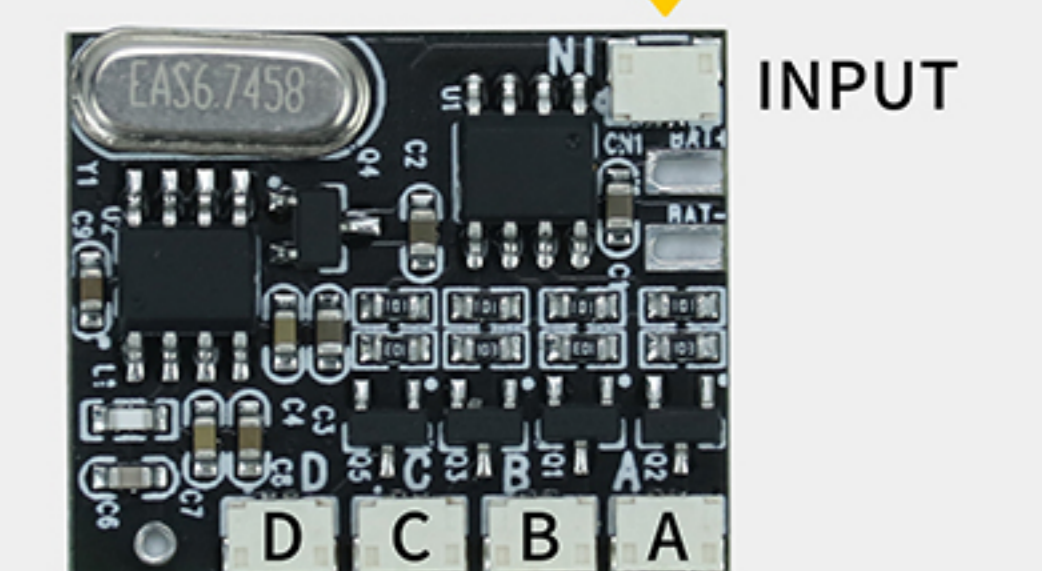

- 133** EN: Instructions for replacing the batteries in the remote control.  
DE: Anleitung zum Batteriewechsel in der Fernbedienung.

### Remote control safety lock and battery model description

Batteries are not included in the remote control, please go to the nearest store to buy CR2025 or CR2032 button batteries to install in the remote control.

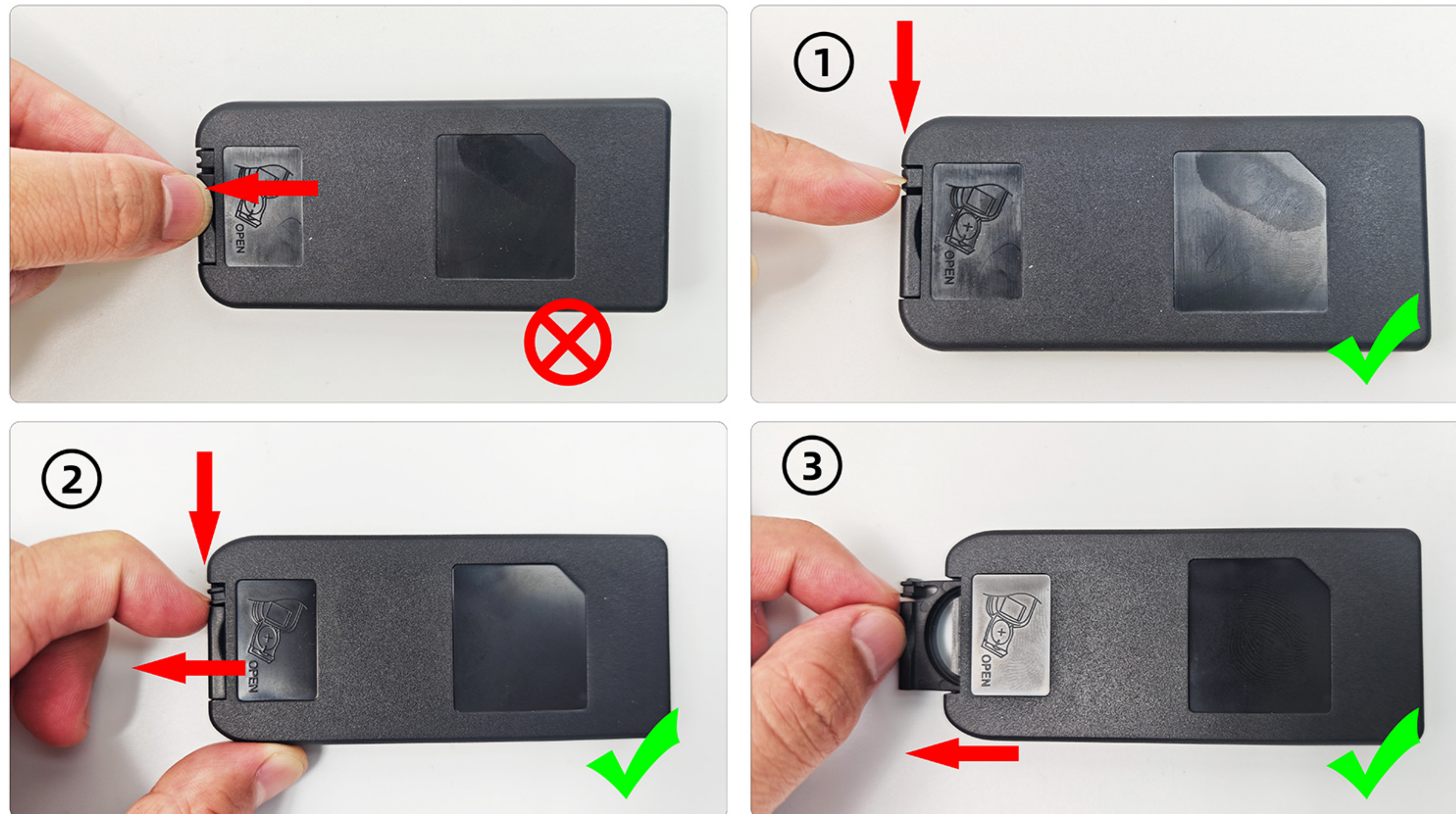

- 134** EN: Connect the four light cables to the expansion board in sequence.  
DE: Schließen Sie die vier Lichtkabel der Reihe nach an die Erweiterungskarte an.

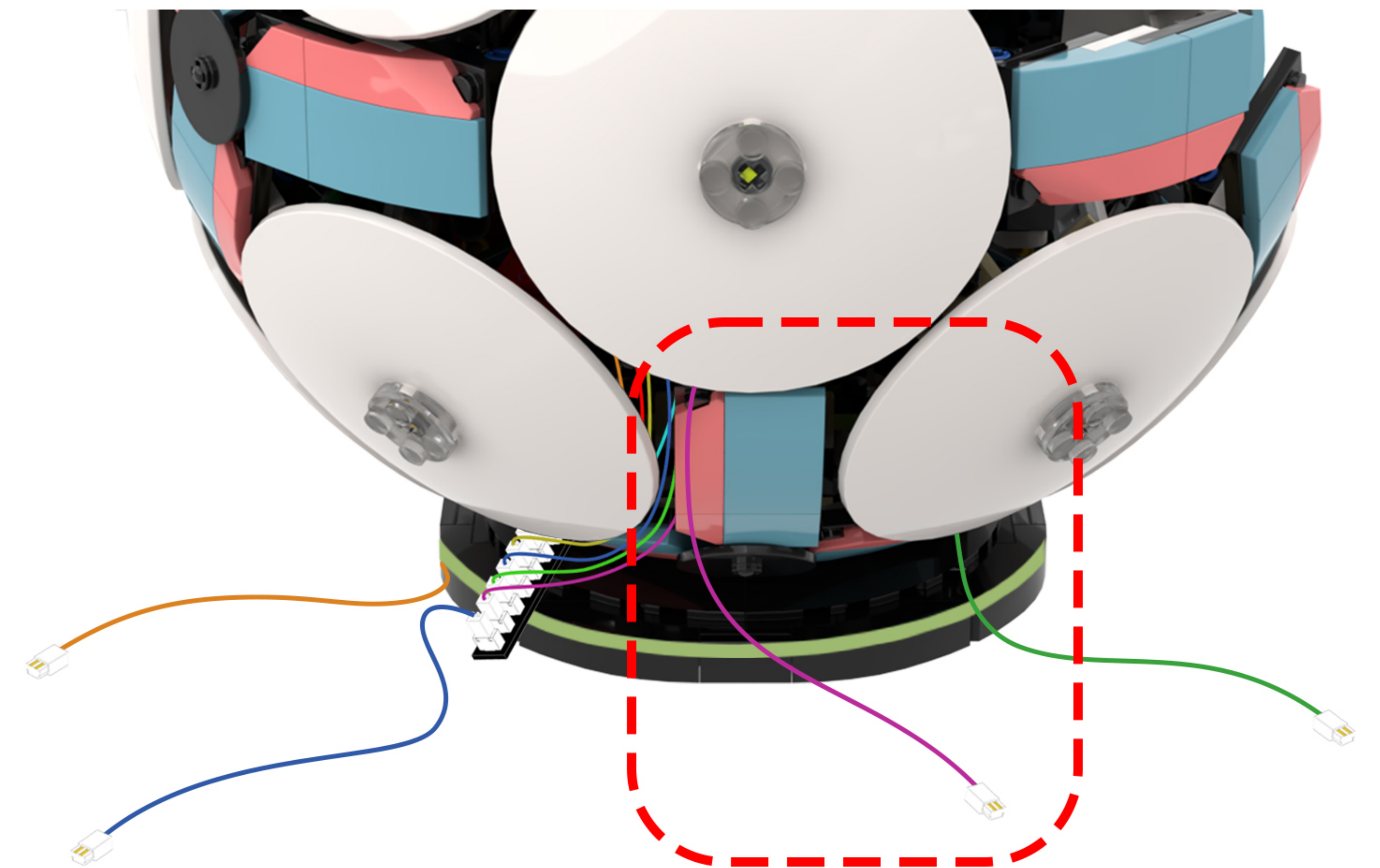

135

EN: Connect the light's wires to Port A on the remote control module.

DE: Schließen Sie die Kabel der Leuchte an Anschluss A des Fernbedienungsmoduls an.

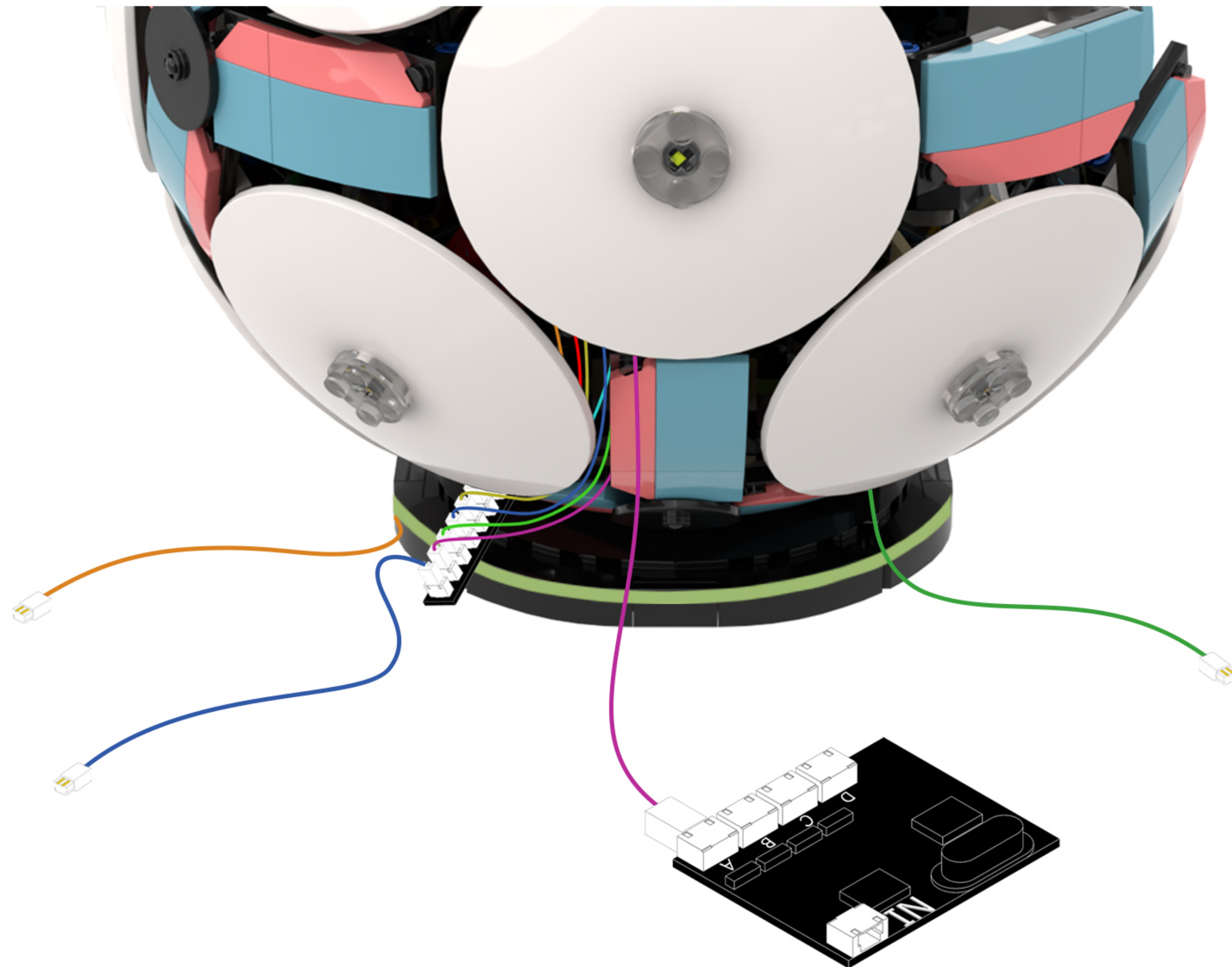
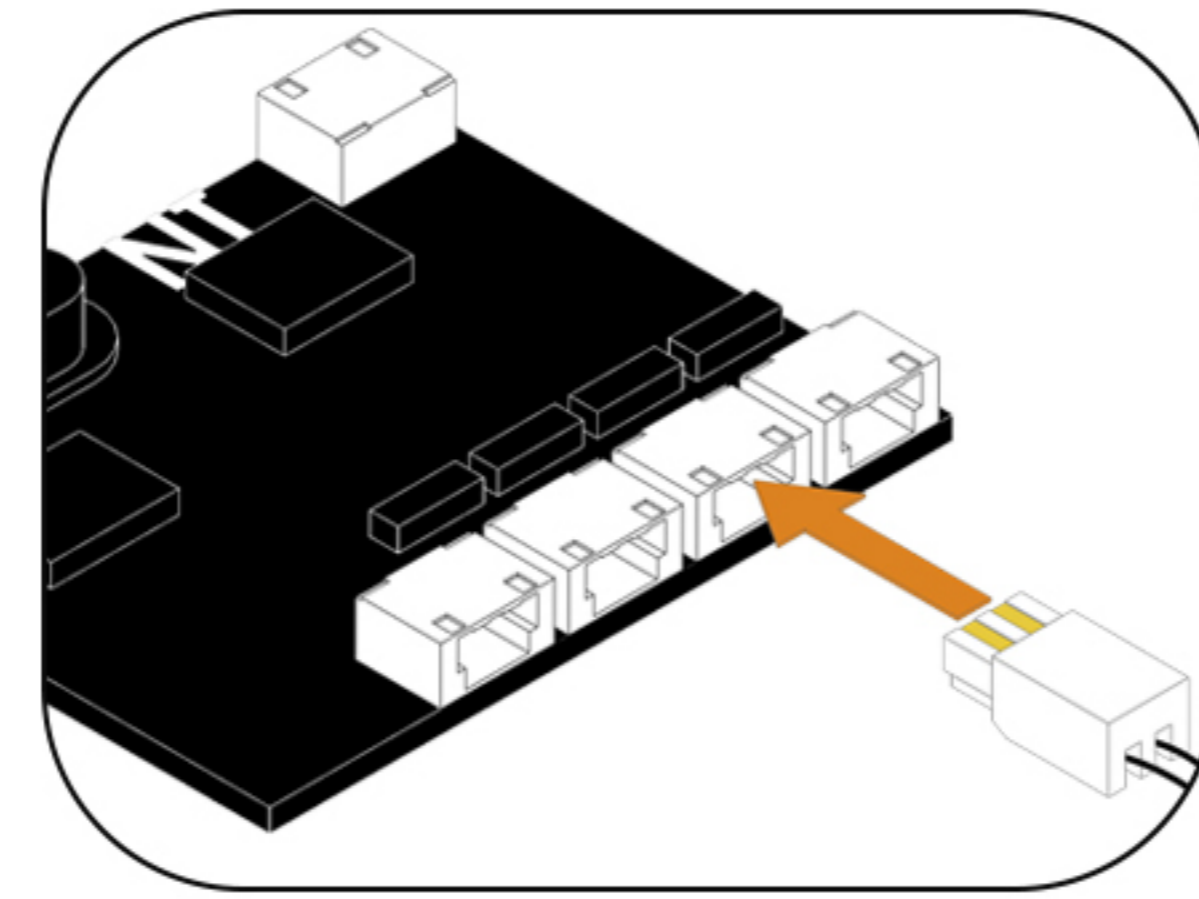

136

EN: Locate this light cord in the diagram.

DE: Suchen Sie dieses Lichtkabel in der Abbildung.

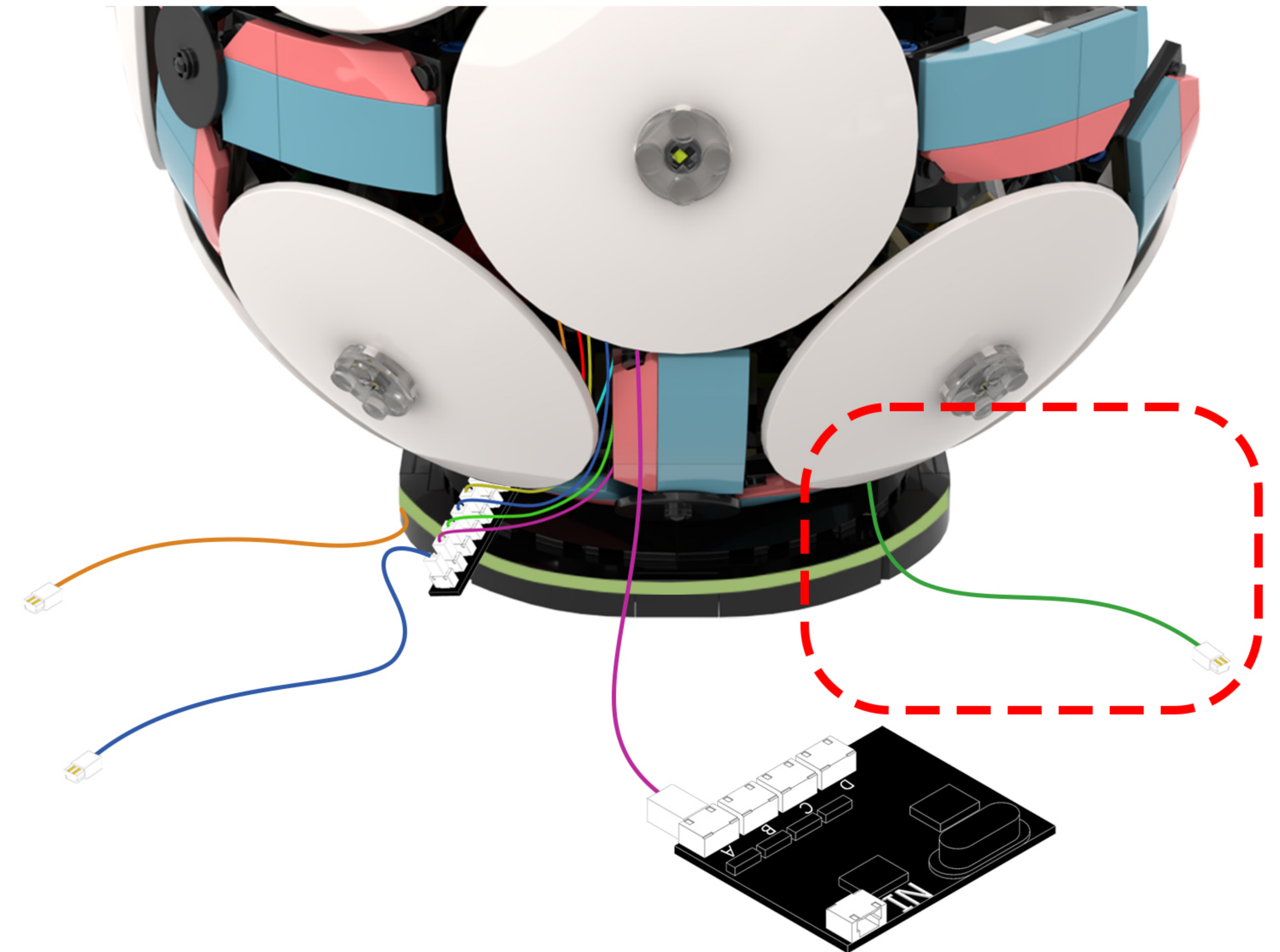

137

EN: Connect the light's wires to Port B on the remote control module.

DE: Schließen Sie die Kabel der Leuchte an Anschluss B des Fernbedienungsmoduls an.

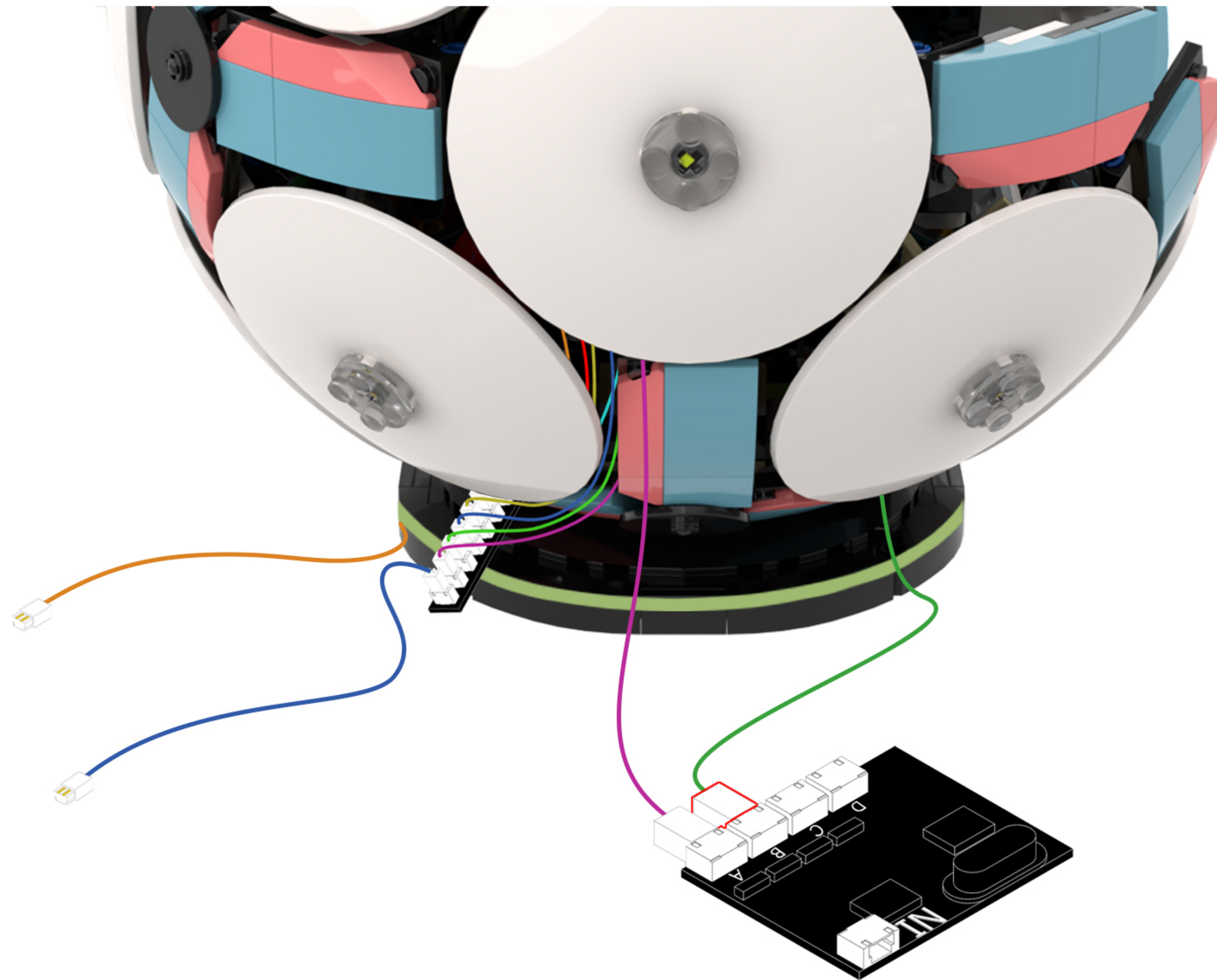
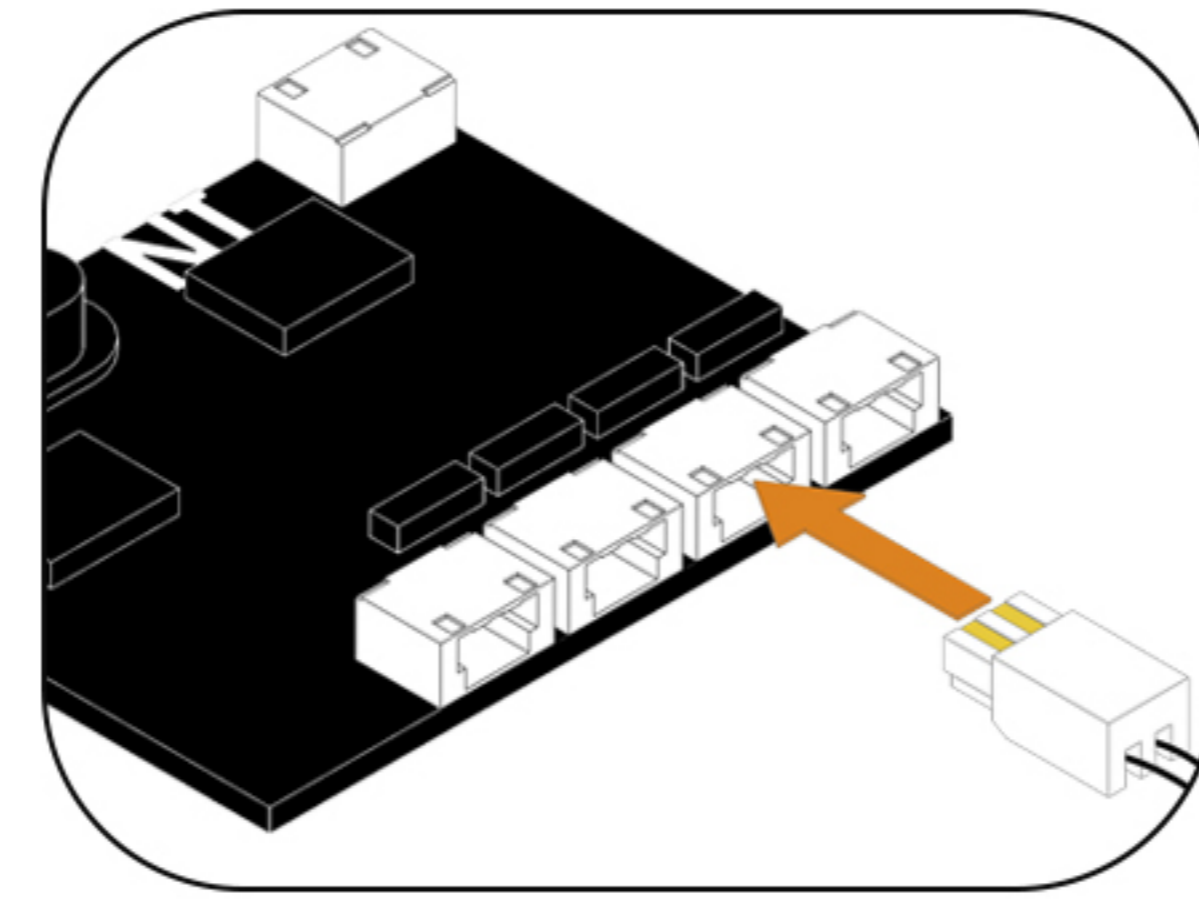

138

EN: Locate this light cord in the diagram.

DE: Suchen Sie dieses Lichtkabel in der Abbildung.

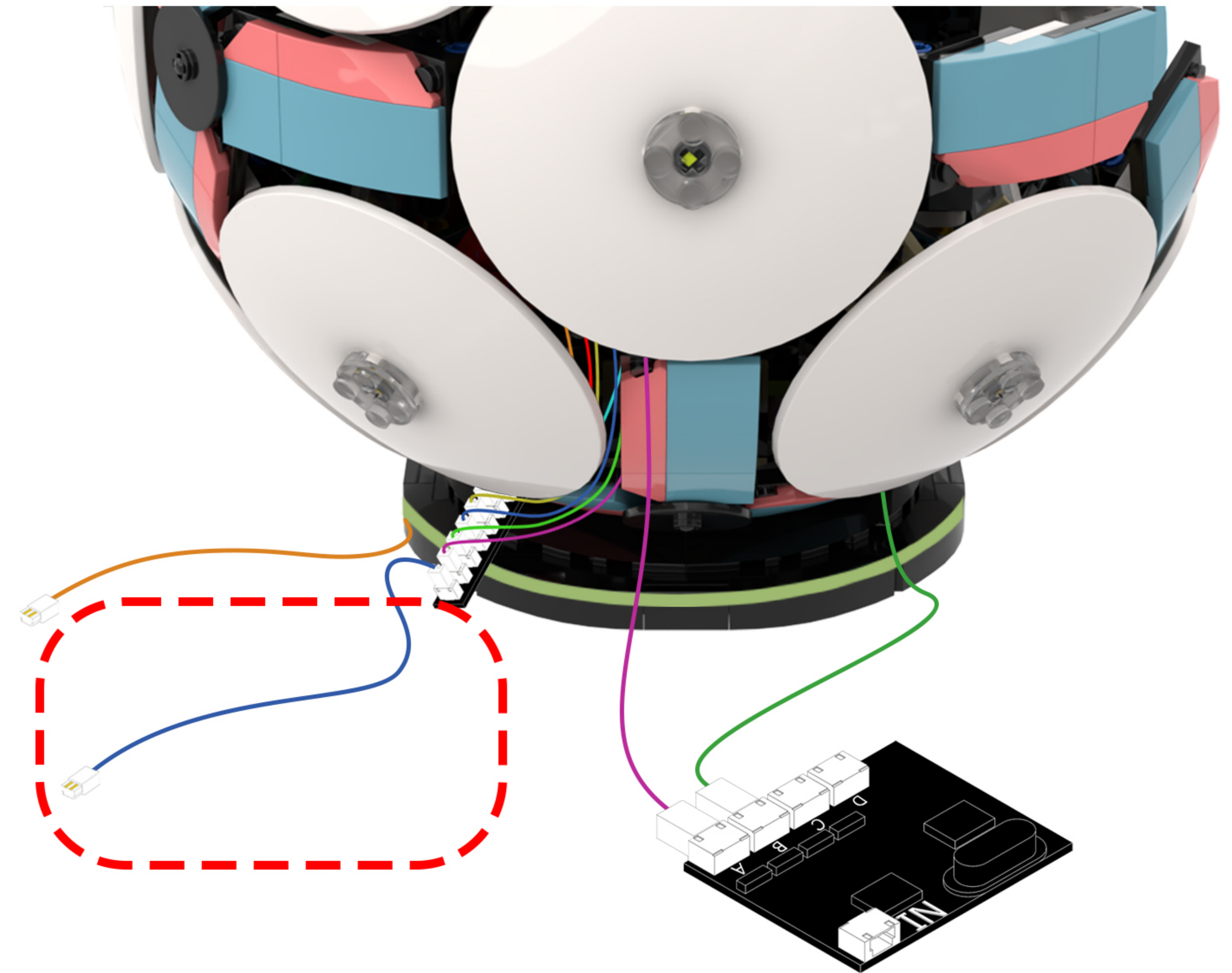

139

EN: Connect the light's wires to Port C on the remote control module.

DE: Schließen Sie die Kabel der Leuchte an Anschluss C des Fernbedienungsmoduls an.

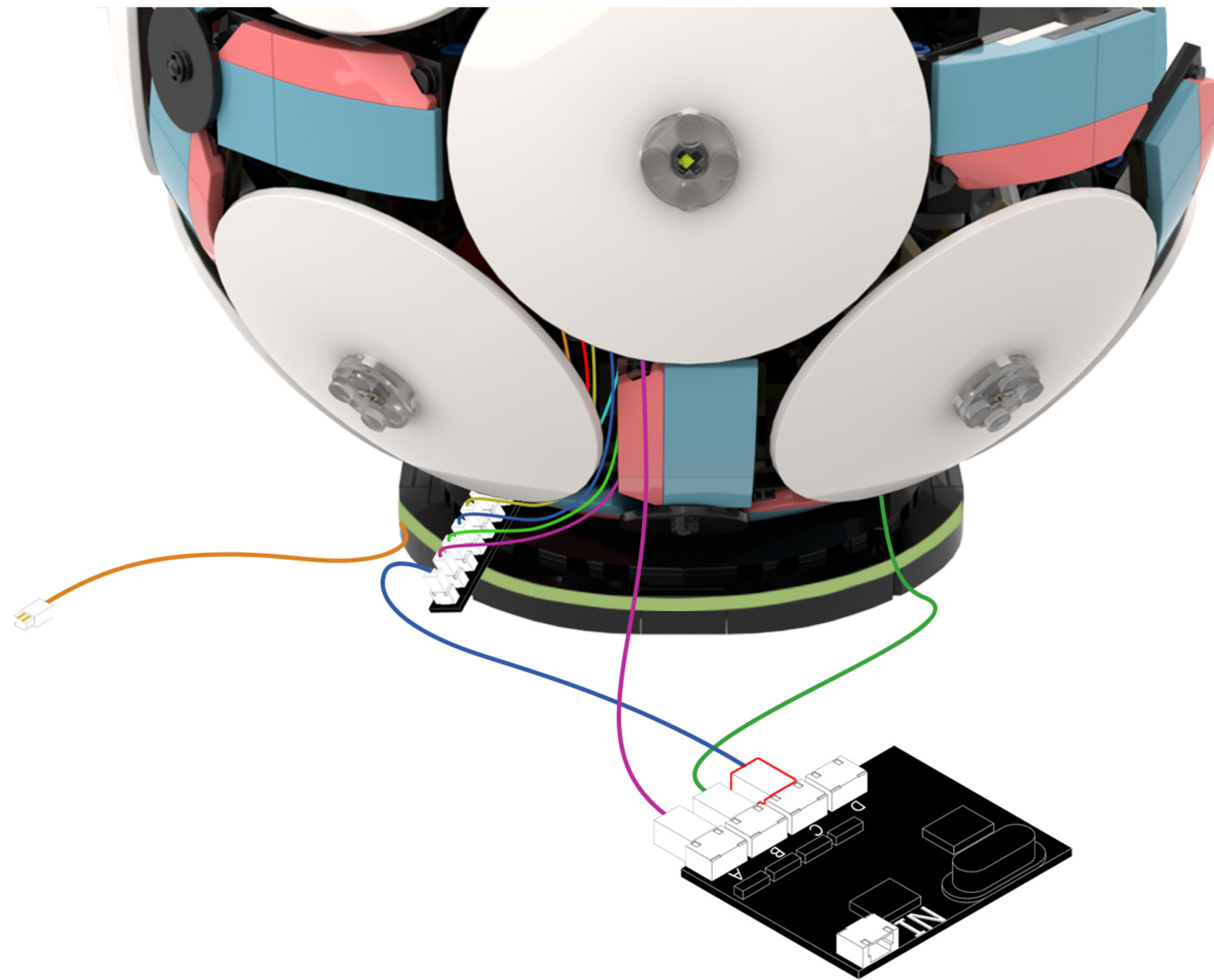
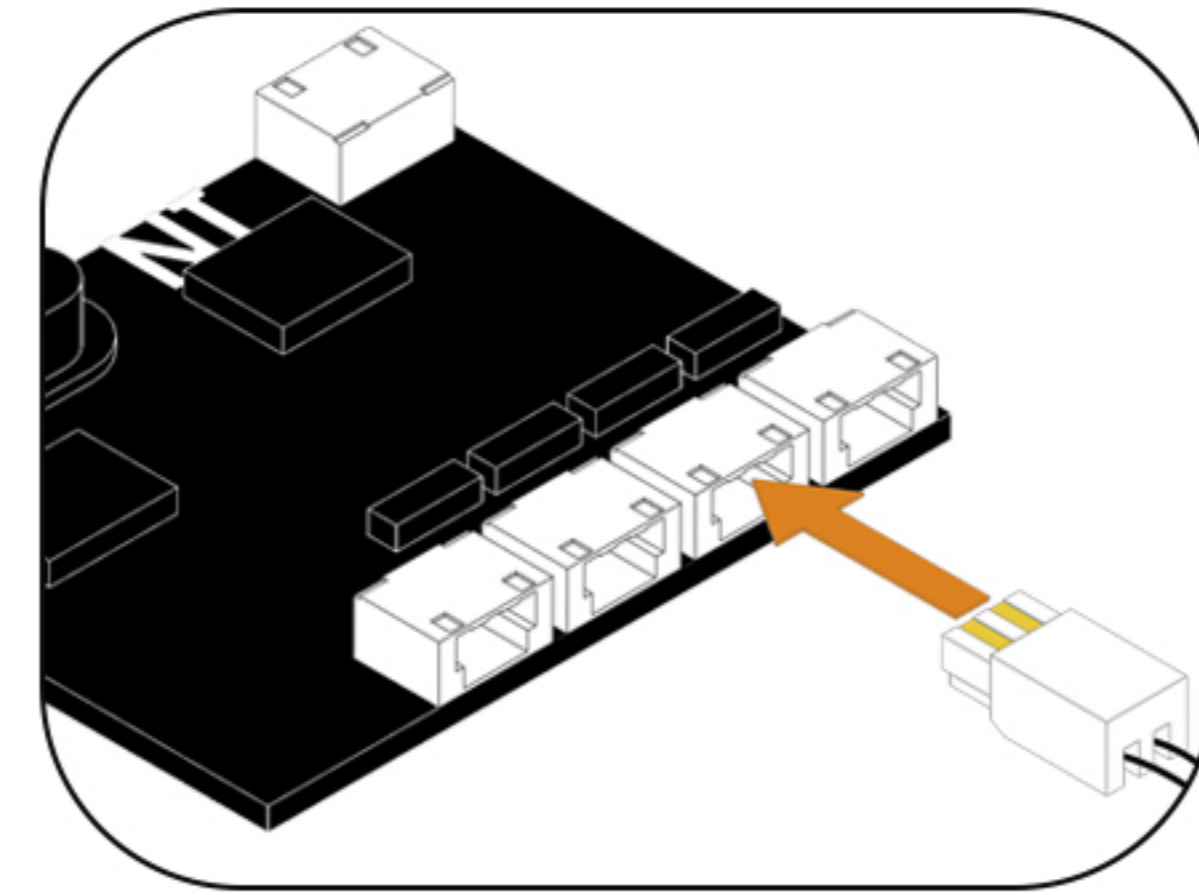

140

EN: Connect the light's wires to Port D on the remote control module.

DE: Schließen Sie die Kabel der Leuchte an Anschluss D des Fernbedienungsmoduls an.

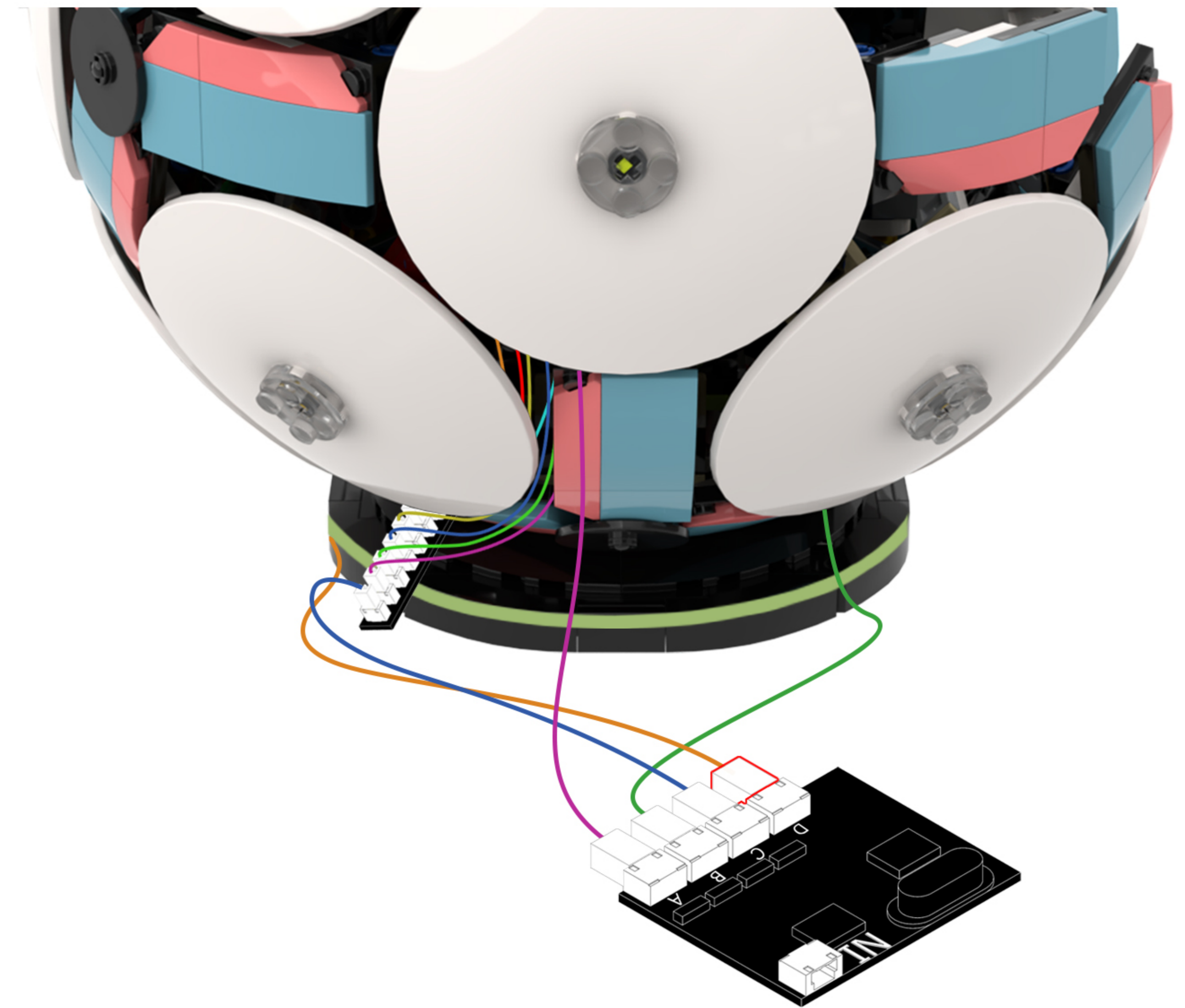
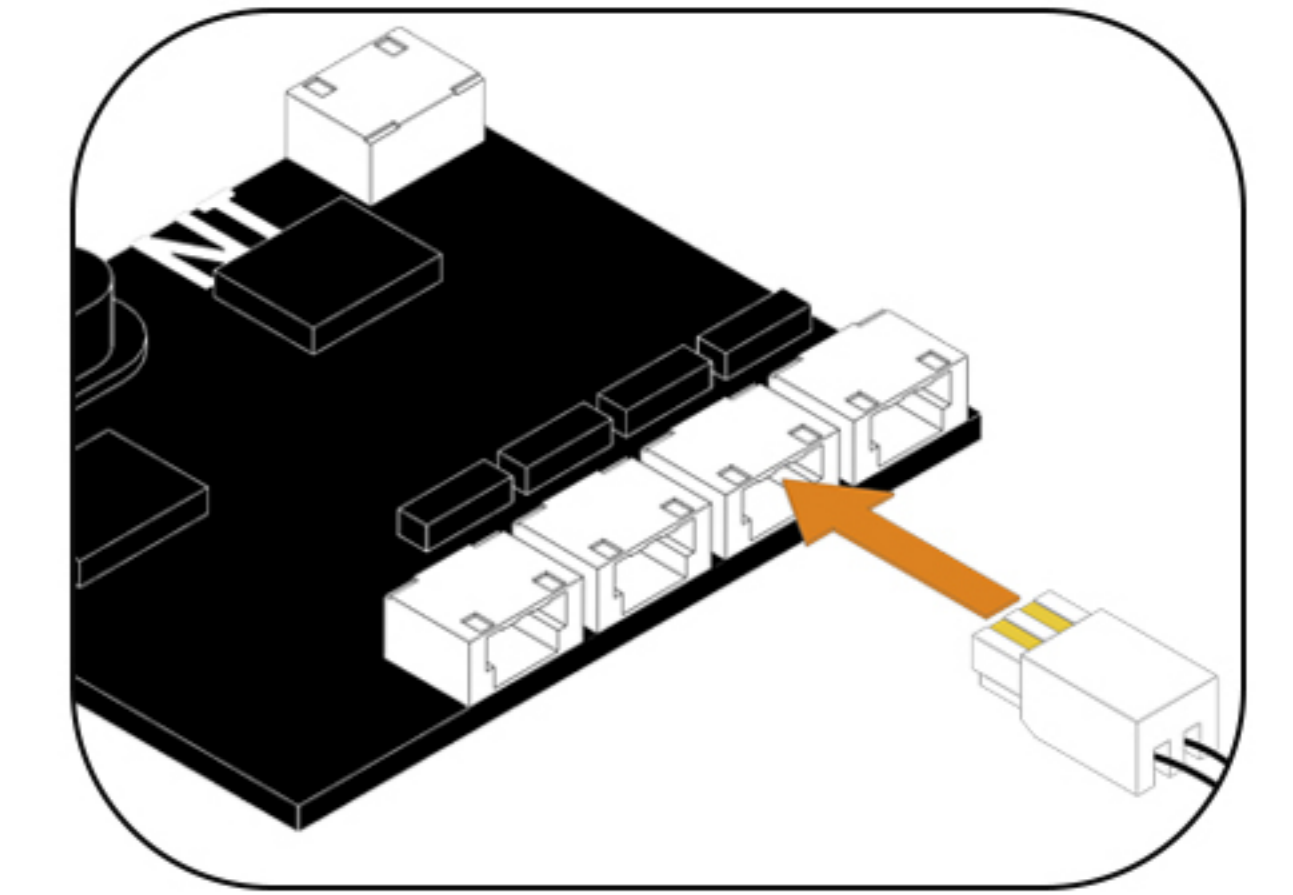

**141** EN: Take the USB power cable out of the box and connect it to the remote control module.

DE: Nehmen Sie das USB-Stromkabel aus der Verpackung und schließen Sie es an das Fernbedienungsmodul an.

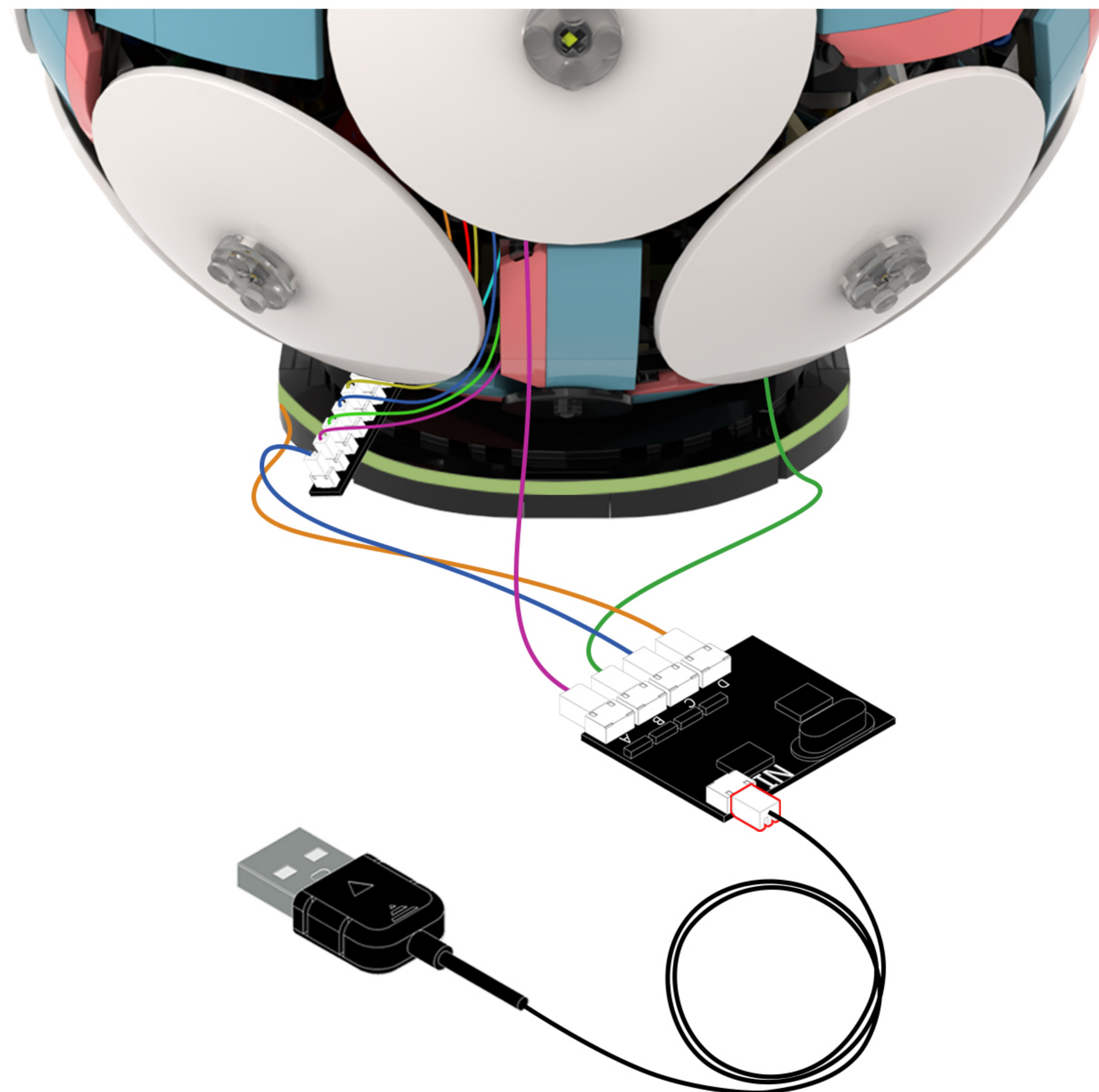
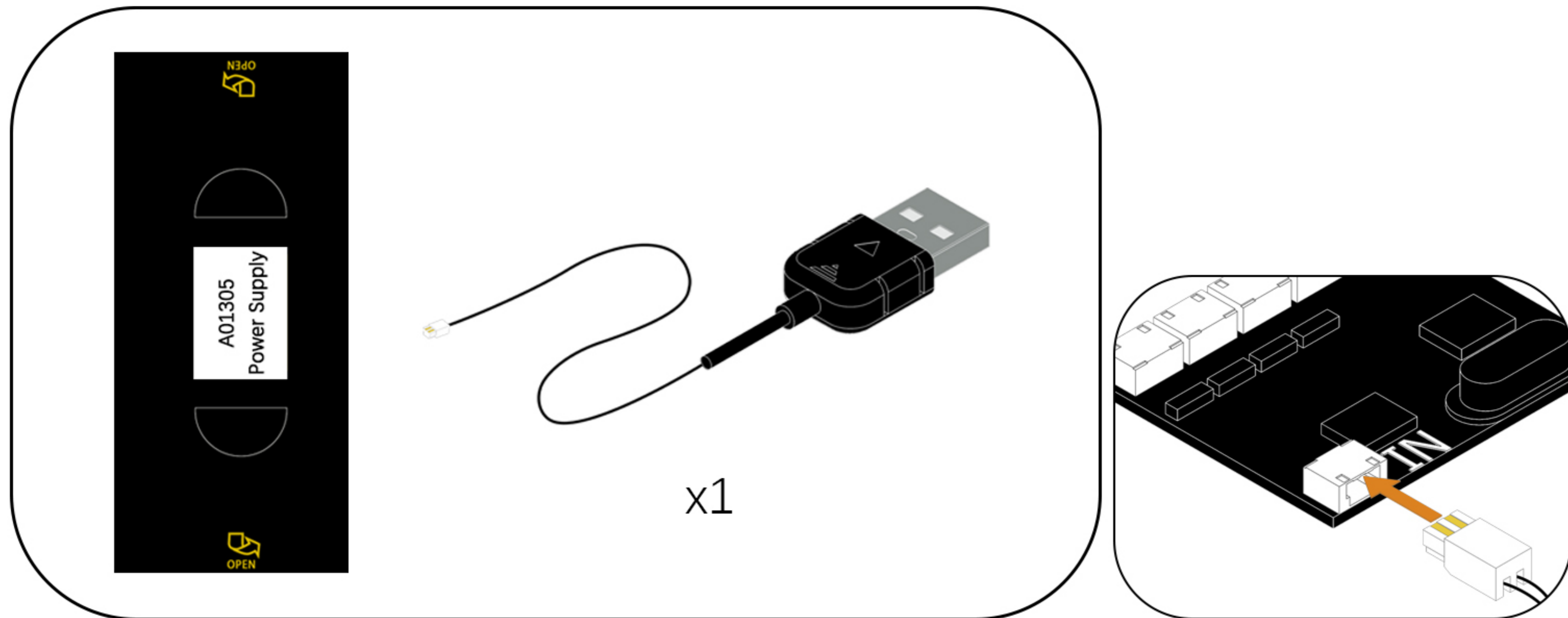

**142** EN: Place the 8-seat expansion panel inside the model.

DE: Setzen Sie die 8-Sitz-Erweiterungskarte in das Modell ein.

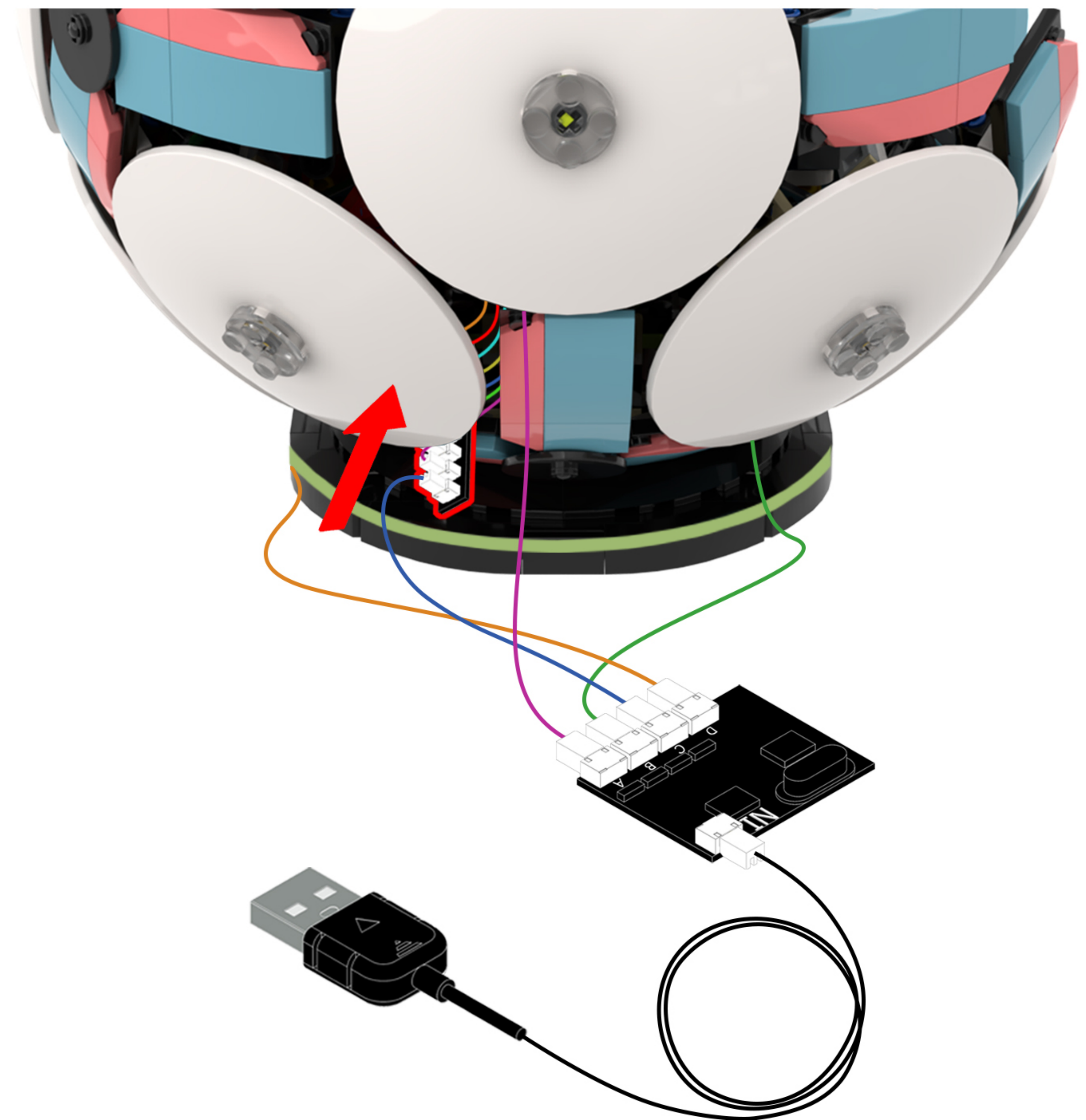

143

EN: Tuck the remote control module inside the model.

DE: Stecken Sie das Fernbedienungsmodul in das Modell.

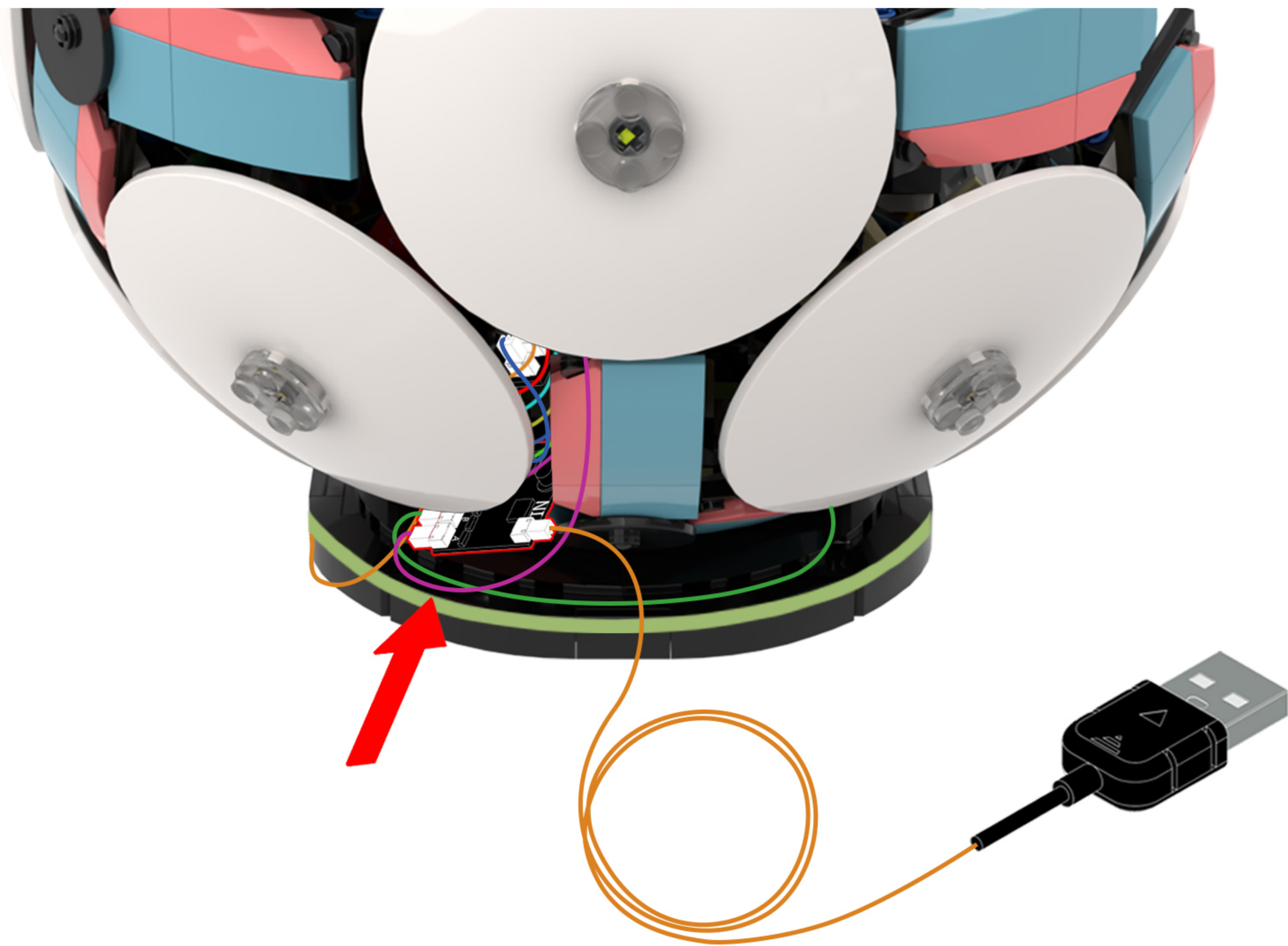

144

EN: Arrange the light wires and place them inside the model.

DE: Verlegen Sie die Lichtkabel und bringen Sie sie im Inneren des Modells an.

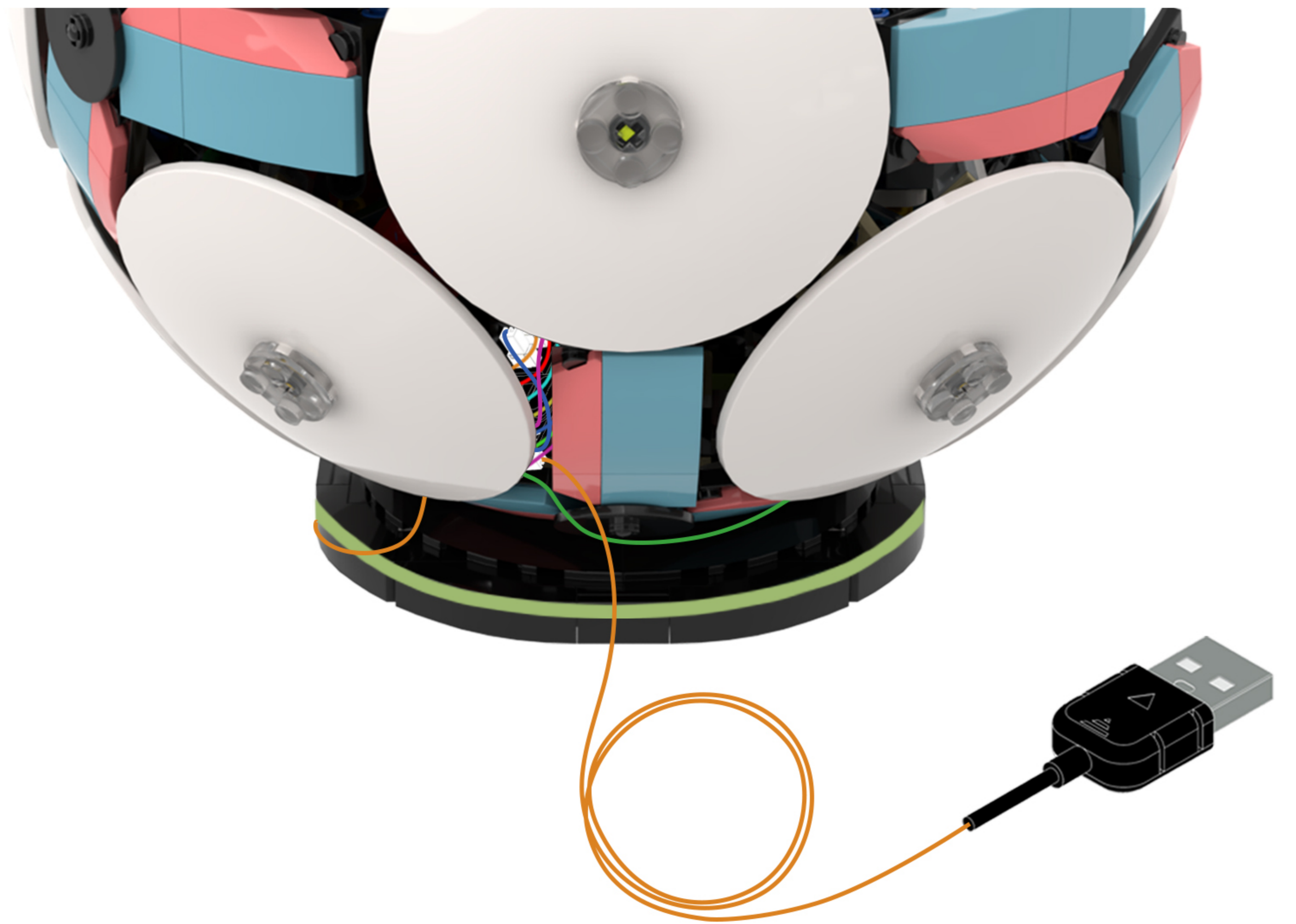

**145** EN: Once installed, connect the power supply and give it a try!

DE: Die Installation ist abgeschlossen. Schließen Sie das Gerät an die Stromversorgung an und probieren Sie es aus!





Above our designers to provide the relevant ideas and instructions. But please move to the following:

- 1: about our company this product parts material, product quality do you have comments and suggestions?
- 2: about this product installation instructions and installation of the degree of difficulty do you have views and suggestions?
- 3: if in the operation of the product we provide ideas encountered any problems, please contact us in a timely manner.

## Tips

If you encounter any installation problems please contact the seller, we will be happy to help you solve!