

# INSTALLATION GUIDE

## 21367 TinTin Moon Rocket (customized version)

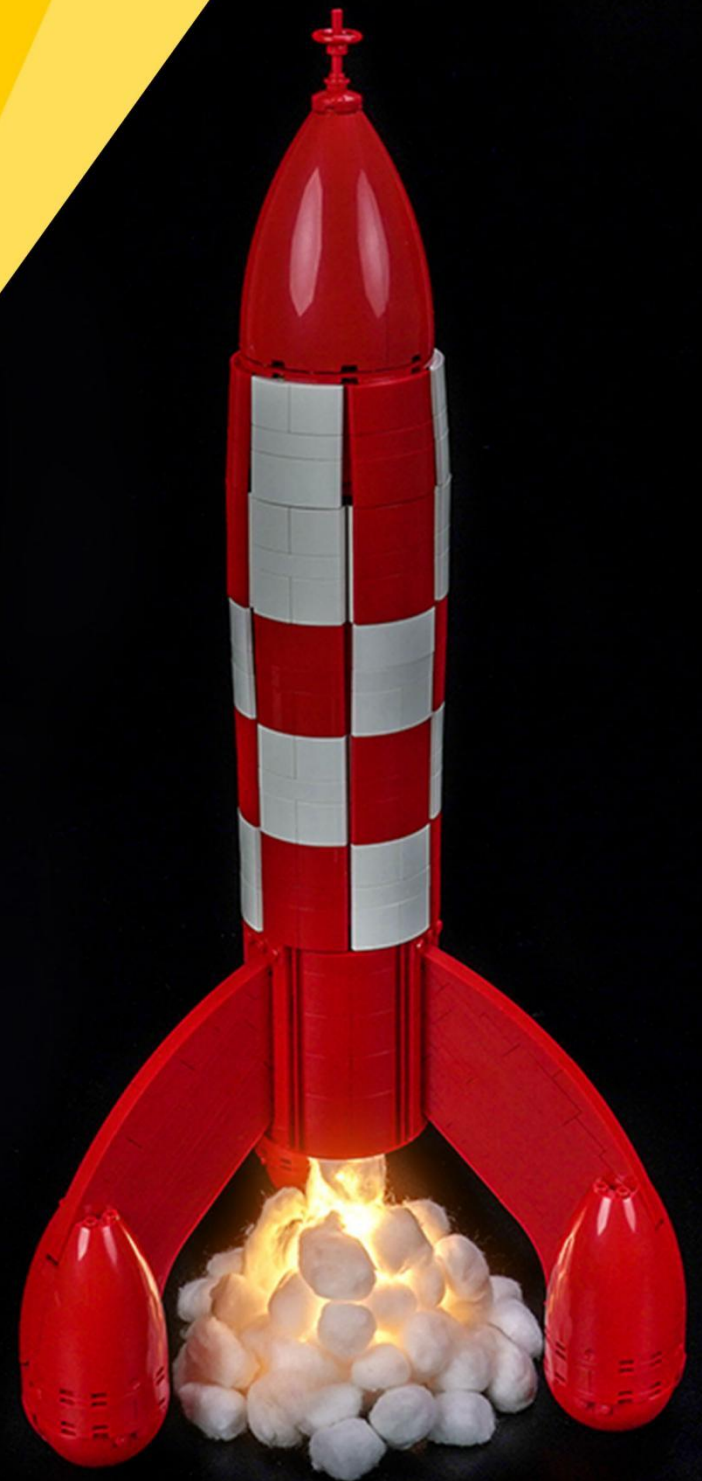

LED light kit compatible with Lego

# Instructions for installing this kit:

This set includes 6 pouches. (The battery case functions similarly, please select your own power source. This article uses a USB power cable.)



(X1)

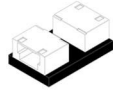

(X1)



(X8)



(X21)



(X20)



(X20)



(X20)

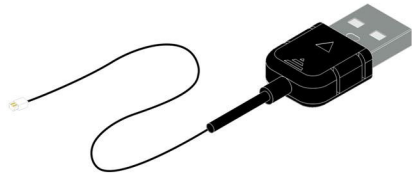
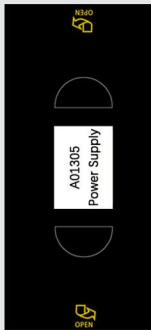

(X1)

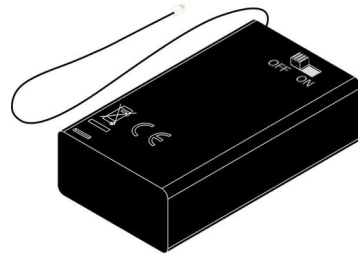

(X1)

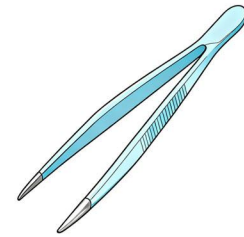

(X1)

This post will complete the light installation in two main sections.

Step 1-test



Step 2-mounting

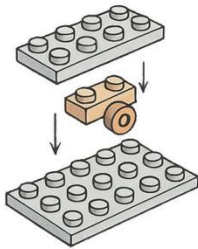

So let's get started!

## Step 1-Test

1

EN: Take out the expansion board from bag 1.

DE: Entfernen Sie das Expansionsbrett aus Tasche 1.

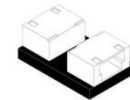
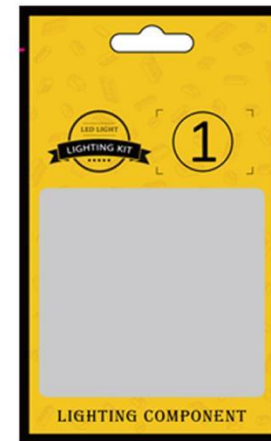

x1

2

EN: Take out the power cord from the box and connect it to the expansion board.

DE: Nehmen Sie das Netzkabel aus der Box und verbinden Sie es mit der Erweiterungsplatte.

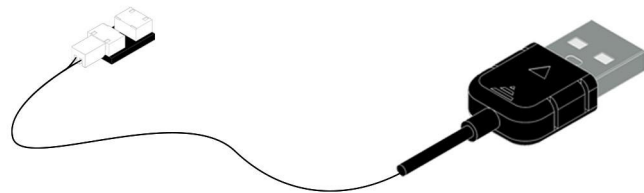
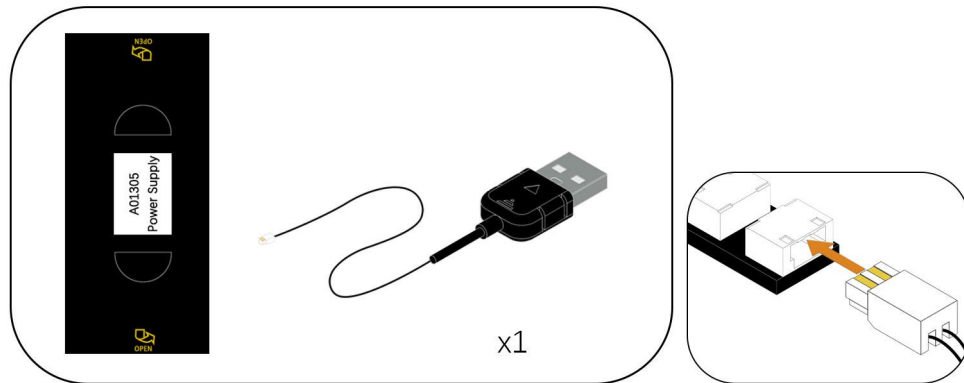

3

EN: Connect the USB power cable to the mobile power supply. (Power supply not included, see the diagram below for power supply options.)

DE: Schließen Sie das USB-Netzkabel an die mobile Stromversorgung an. (Stromversorgung nicht im Lieferumfang enthalten, siehe Abbildung unten für die Stromversorgungsart.)



### USB Connectors to Connect Devices

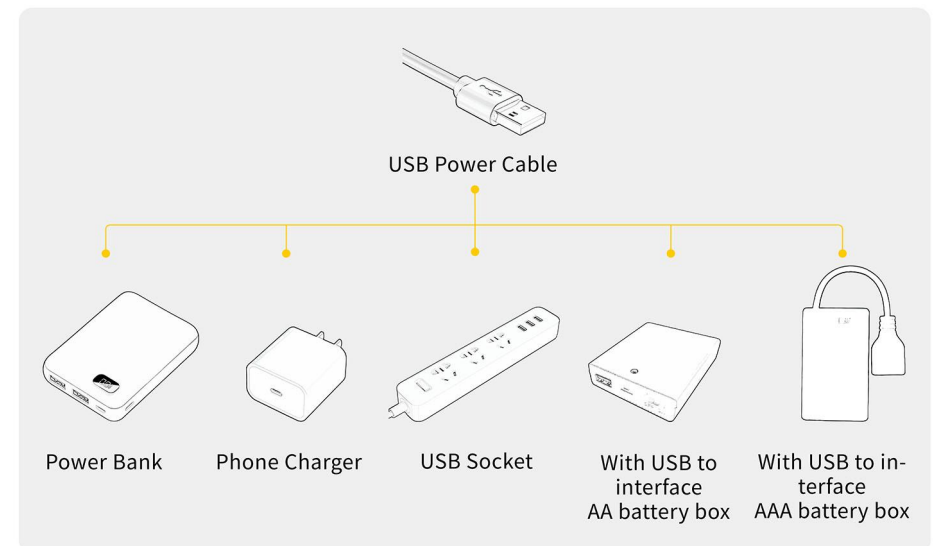

4

EN: Remove the lighting fixture from bag 1, connect it to the expansion board, turn on the power, and check if the lighting fixture is functioning properly. If any problems arise, please contact us immediately.

DE: Entfernen Sie die Leuchte aus Tasche 1, verbinden Sie sie mit der Expansionsplatte, schalten Sie die Strom, und überprüfen, ob die Lichteinrichtung ordnungsgemäß funktioniert. Wenn Probleme auftreten, bitte kontaktieren Sie uns sofort.

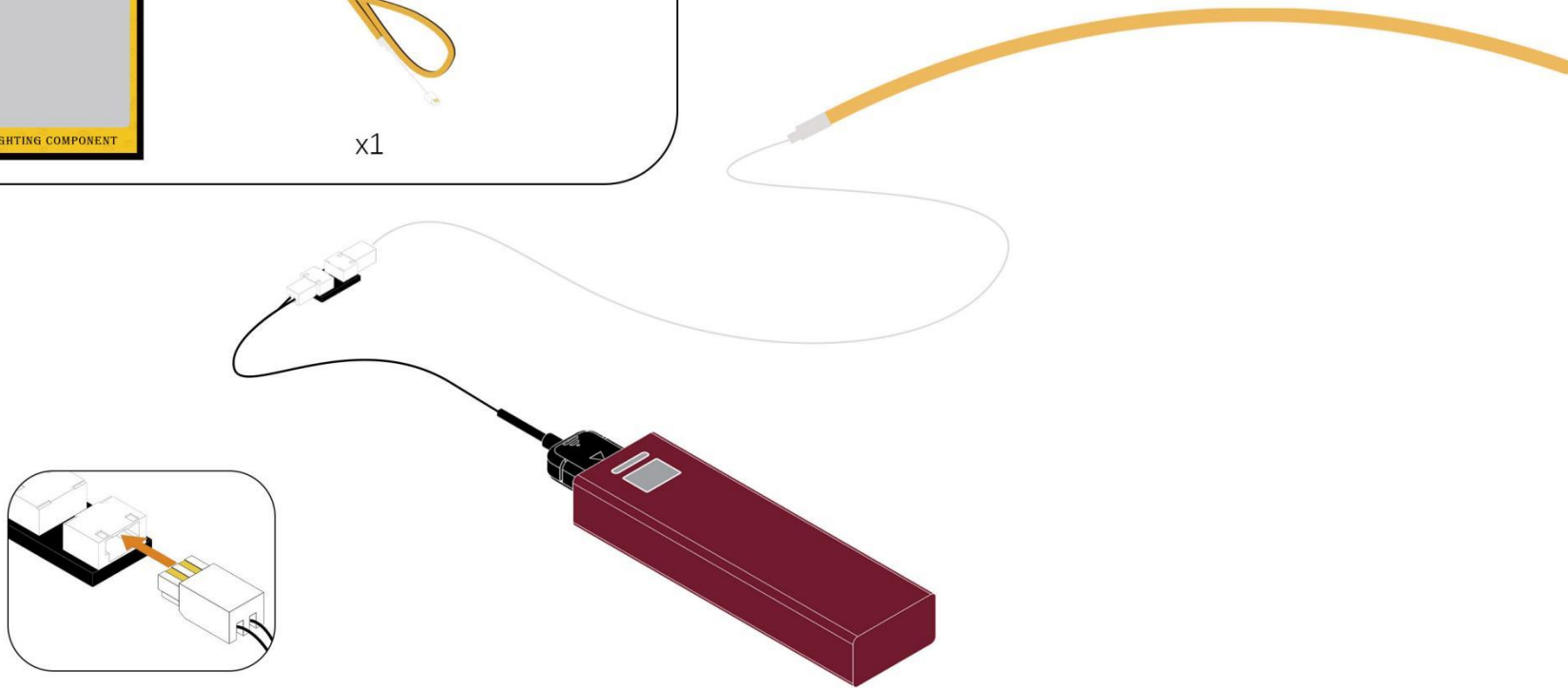
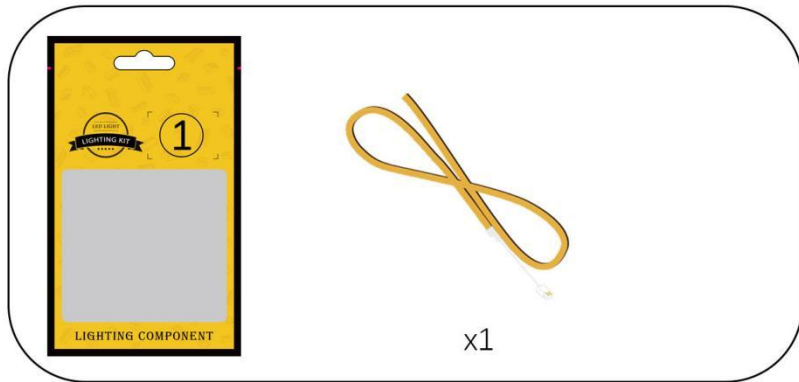

After confirming that there are no abnormalities, temporarily return each part to its original bag.

## Step 2-Mounting.

1

EN: Take out the rocket model.

DE: Nimm das Modell heraus.



2

EN: Take out 8 transparent 2 \* 2 circular plates and 21 transparent 1 \* 1 cylindrical bricks from bag 2, and then assemble them together according to the instructions.

DE: Nehmen Sie 8 transparente 2 \* 2 Kreisplatten und 21 transparente 1 \* 1 zylindrische Ziegelsteine aus Beutel 2 und montieren Sie sie dann gemäß den Anweisungen zusammen.

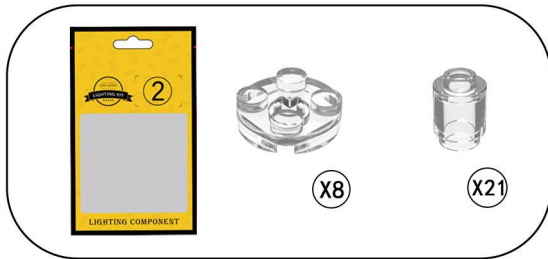

1



2

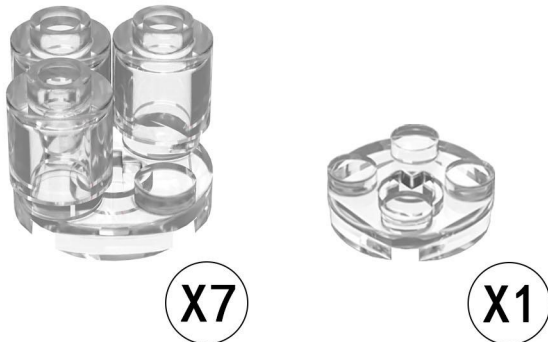

3

EN: Stack and assemble building blocks together.  
DE: Stapel und montiere Bausteine zusammen.

1

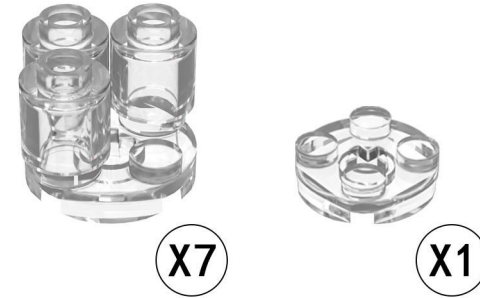

2

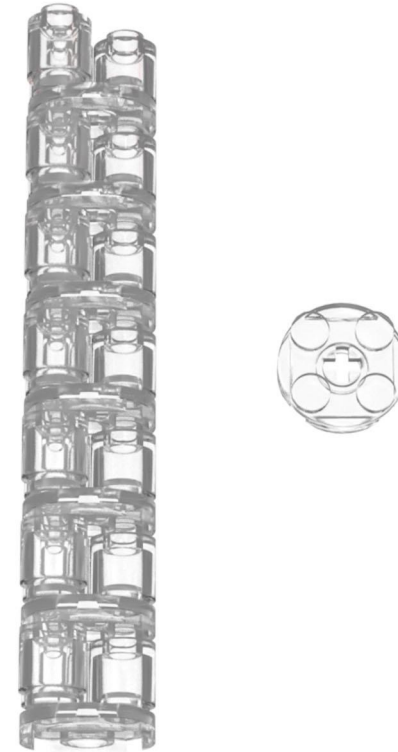

4

EN: Take out the COB light strip from bag 1 and tear off its backing adhesive paper, then fold the light strip in half and stick it together.

DE: Nehmen Sie den COB-Lichtstreifen aus Beutel 1 und reißen Sie sein Rückklebpapier ab, falten Sie den Lichtstreifen in die Hälfte und kleben Sie ihn zusammen.

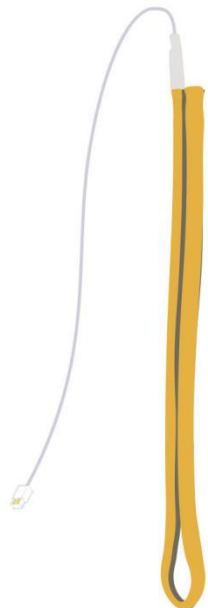
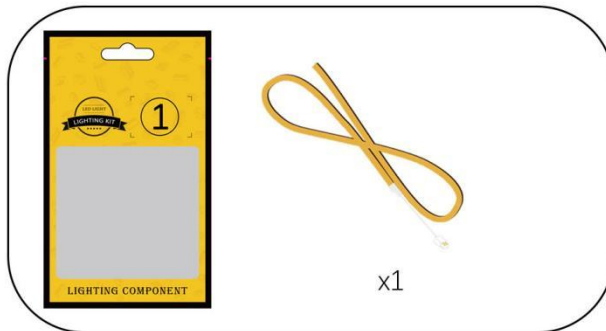

5

EN: Thread the light strip's lead wires through the block from one side to the other.

DE: Führen Sie die Anschlussdrähte des Lichtbands von einer Seite zur anderen durch den Block.

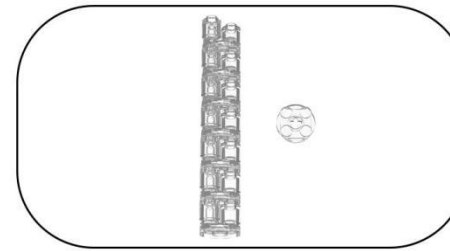

①

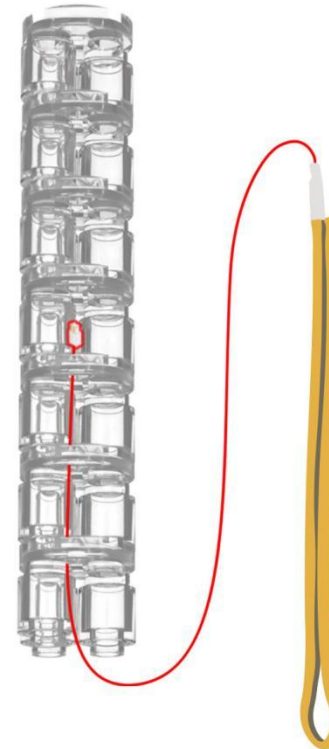

②

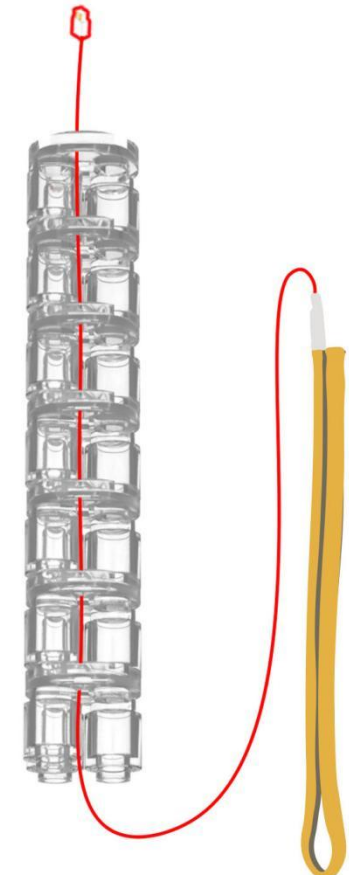

6

EN: Tuck the light strip inside the building blocks.

DE: Stecke den Lichterband in die Bausteine.

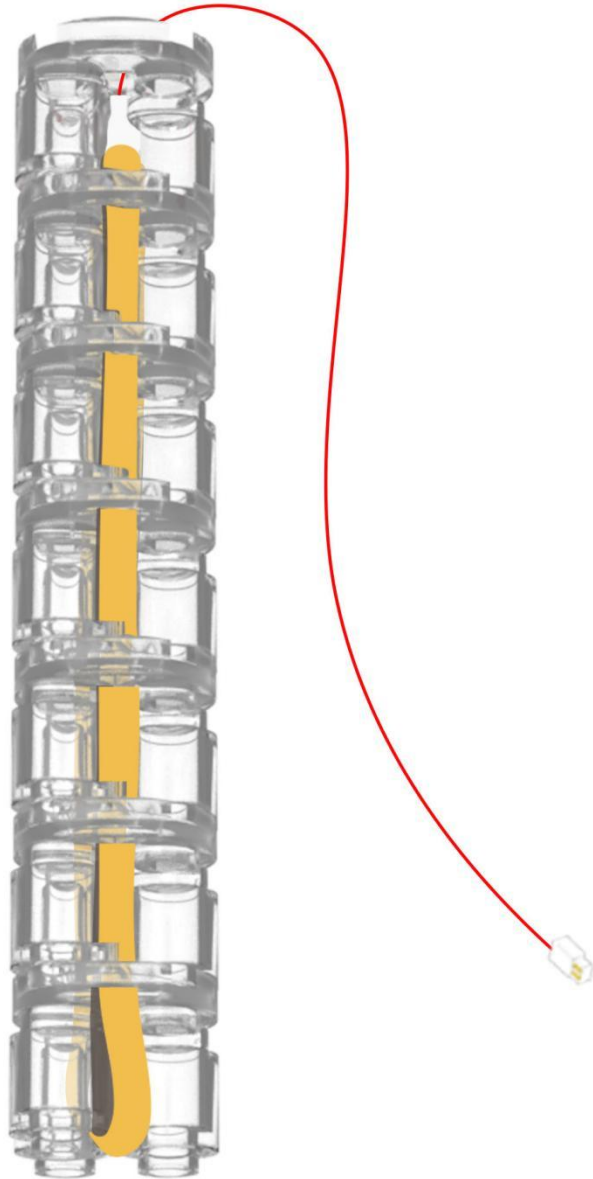

7

EN: Look at the underside of the building block, then attach the circular plate to the bottom.

DE: Schau dir die Unterseite des Bausteins an und befestige dann die runde Platte an der Unterseite.

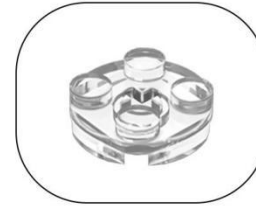

8

EN: Lay the rocket model on its side.

DE: Entfernen Sie das USB-Netz Kabel aus der Box.

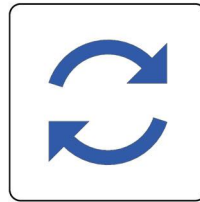

9

EN: Remove the building blocks.

DE: Entferne die Bausteine.



10

EN: Split as shown in the figure.

DE: Teilen Sie es wie in der Abbildung gezeigt.



11

EN: Thread the LED strip through the holes in the circular board.

DE: Führen Sie den LED-Streifen durch die Löcher in der runden Platine.

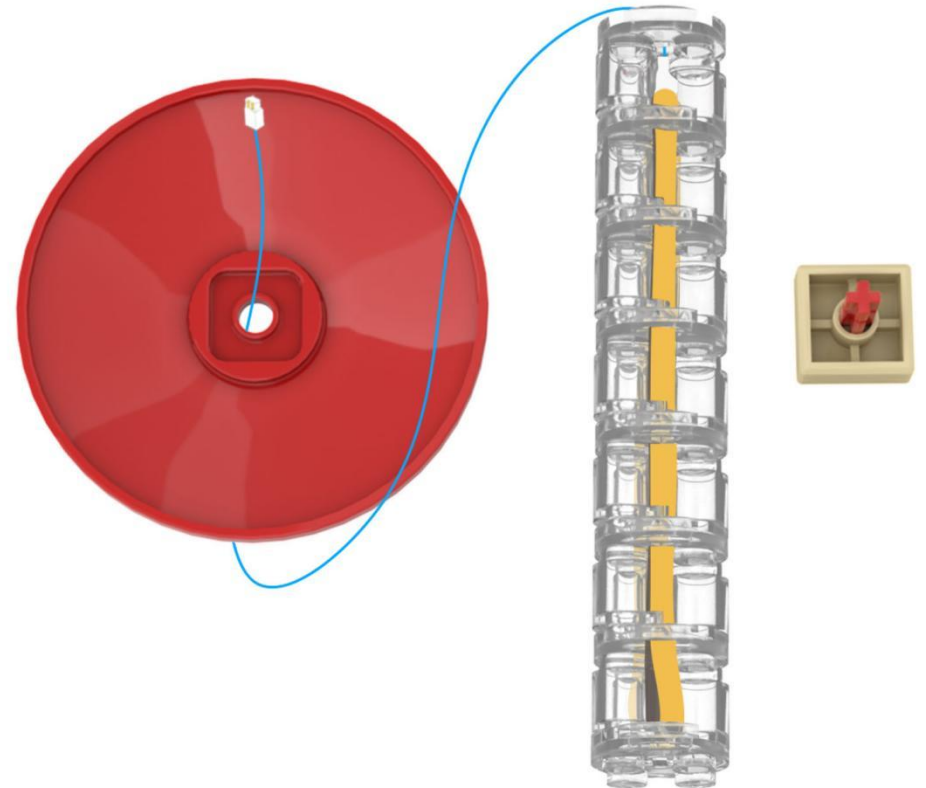
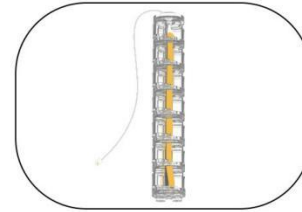

12

EN: Tighten the LED strip, then assemble the building blocks with the circular plate.

DE: Zieh den LED-Streifen fest und setze dann die Bausteine mit der runden Platte zusammen.

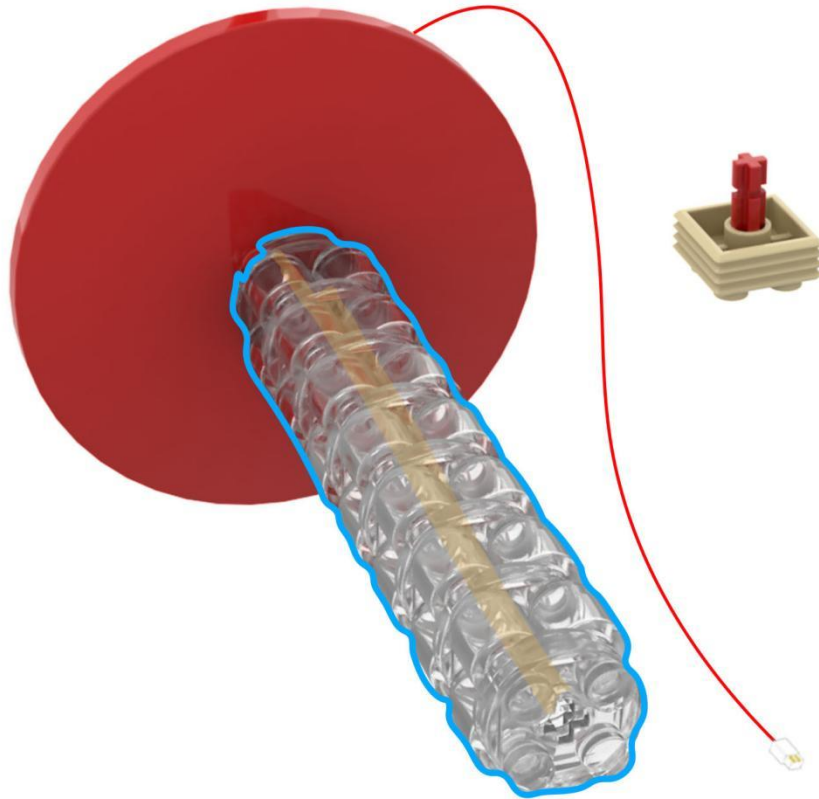

13

EN: Pull the light strip cable to the right, then reassemble the building blocks.

DE: Ziehen Sie das Kabel der Lichtleiste nach rechts und setzen Sie die Bausteine wieder zusammen.

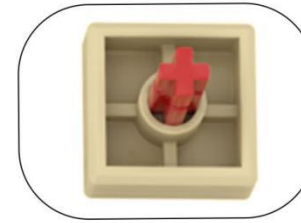

①

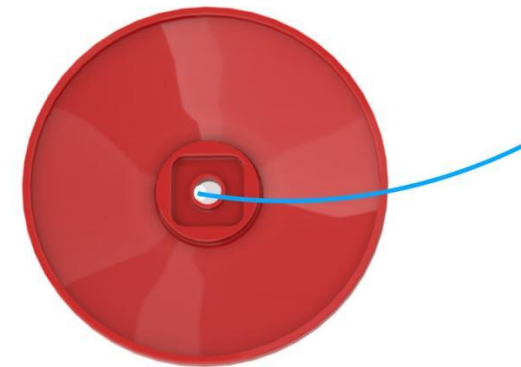

②

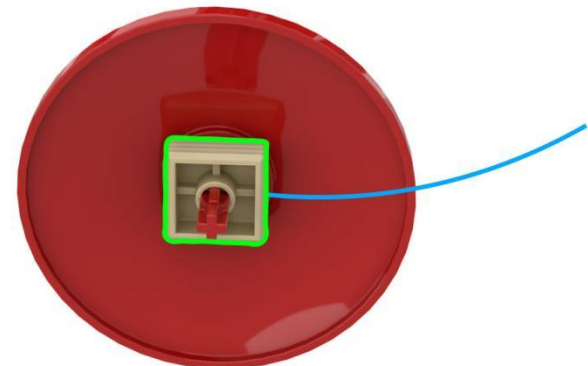

14

EN: Restore the building blocks.

DE: Stelle die Bausteine wieder her.

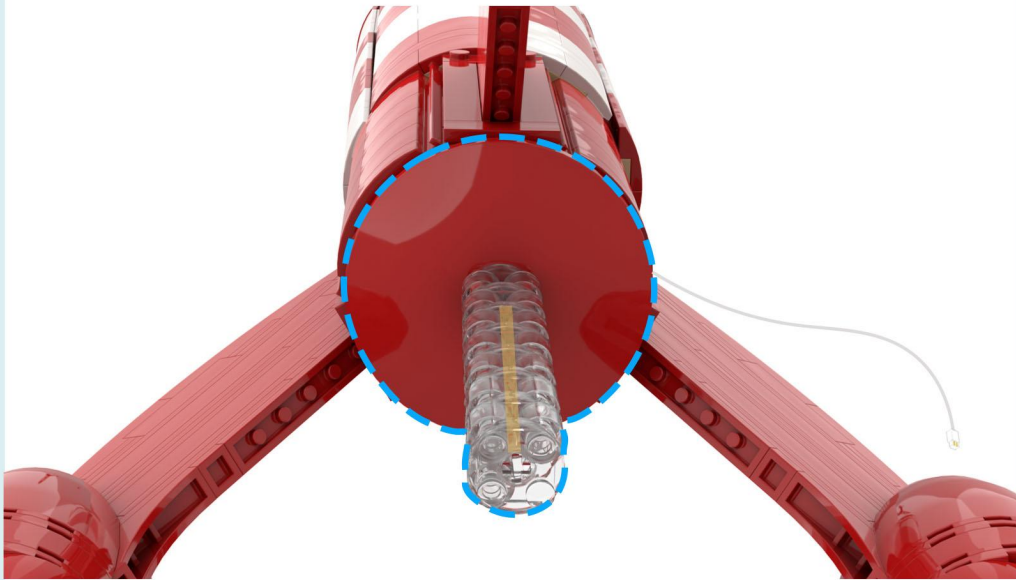

15

EN: Stand the rocket model upright.

DE: Stelle das Raketenmodell aufrecht hin.



16

EN: Use the piece remover to take the building block apart.

DE: Nimm den Baustein mit dem Baustein-Entferner auseinander.

①

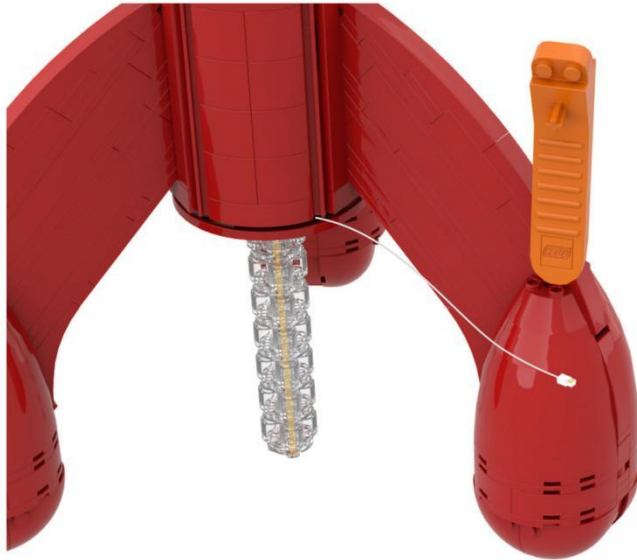

②



17

EN: Take the two expansion boards from Bag 1 and the power cord from the box, then connect them together.

DE: Nehmen Sie die beiden Erweiterungskarten aus Beutel 1 und das Netzkabel aus der Verpackung und verbinden Sie sie miteinander.

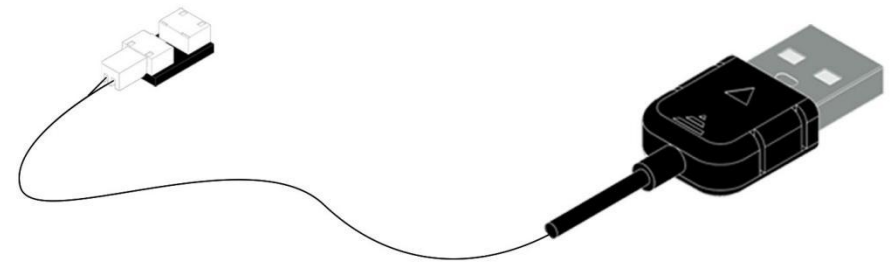
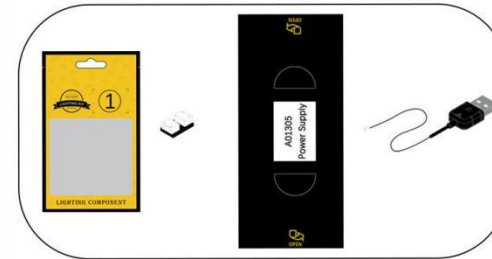

18

EN: Connect the lamp wires to the expansion board.

DE: Schließen Sie die Lampenkabel an die Erweiterungskarte an.

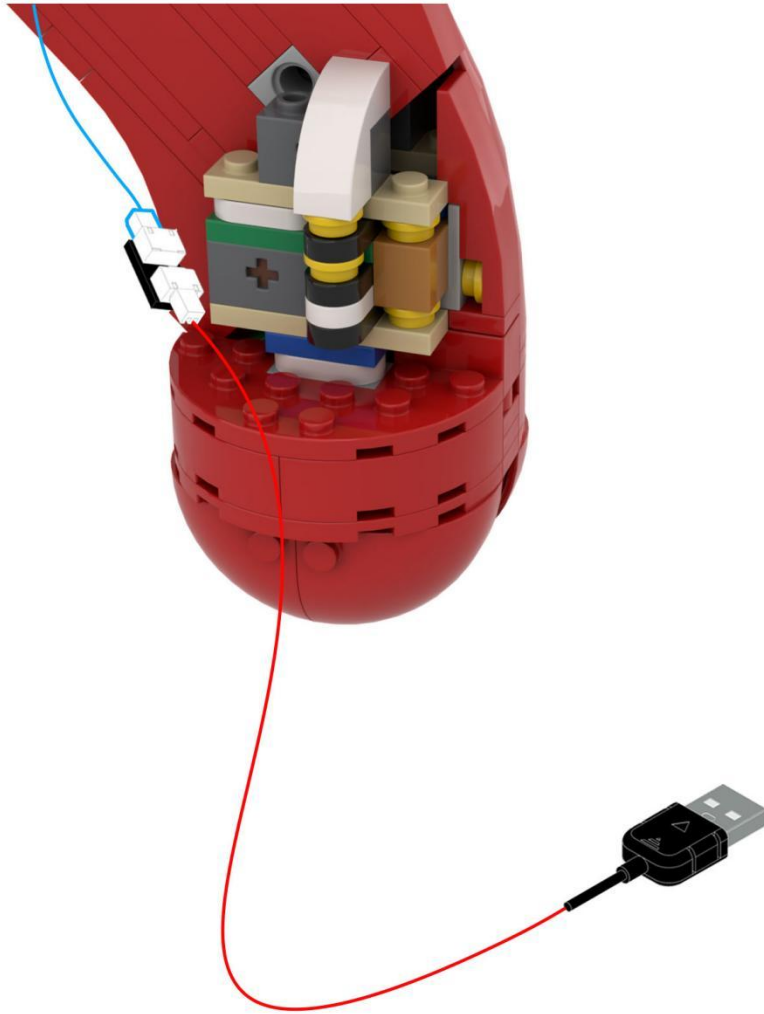

19

EN: Follow the diagram to wire the circuit, then reassemble the red block.

DE: Schließen Sie die Schaltung gemäß der Schaltzeichnung an und bauen Sie anschließend den roten Block wieder zusammen.

①

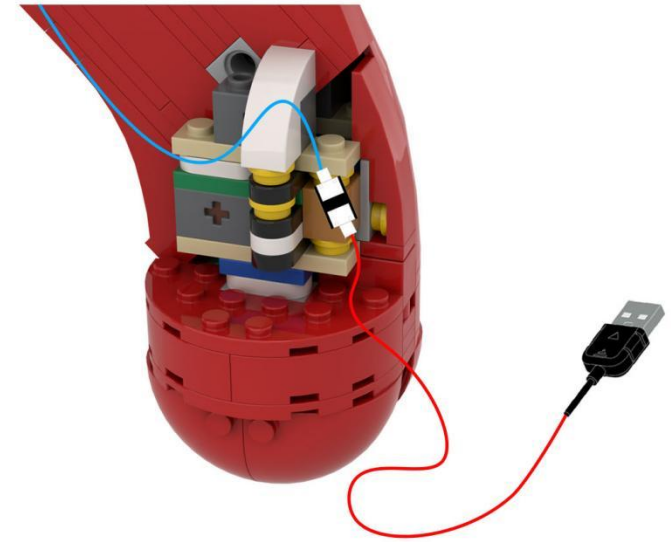

②

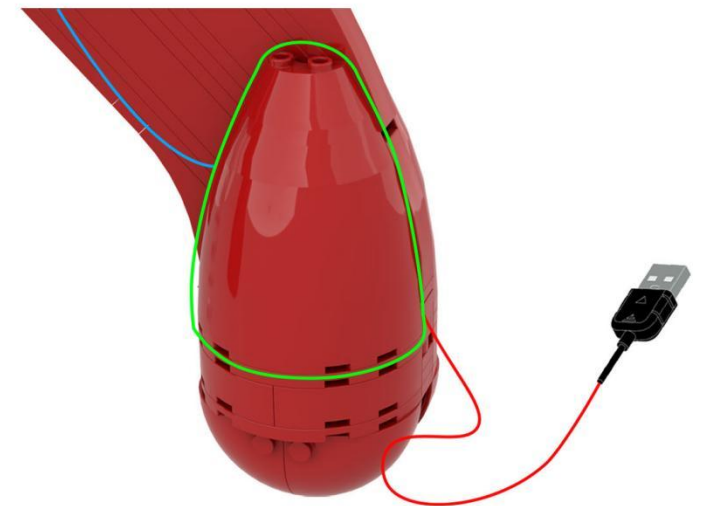

20

EN: Locate the suspended light cord and route it close to the building blocks.

DE: Suchen Sie das Kabel der Hängeleuchte und verlegen Sie es in der Nähe der Bausteine.

①

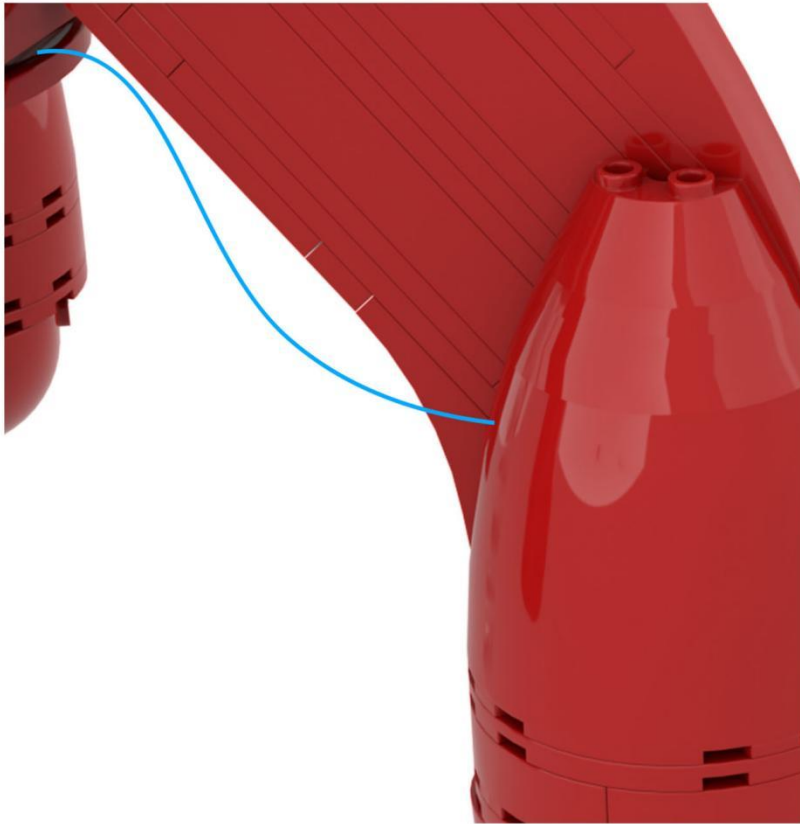

②



21

EN: Take the cotton balls out of Bag 3 and stack them one by one underneath the model, following the instructions.

DE: Nimm die Wattebällchen aus Beutel 3 heraus und staple sie nacheinander unter das Modell, wie in der Anleitung beschrieben.

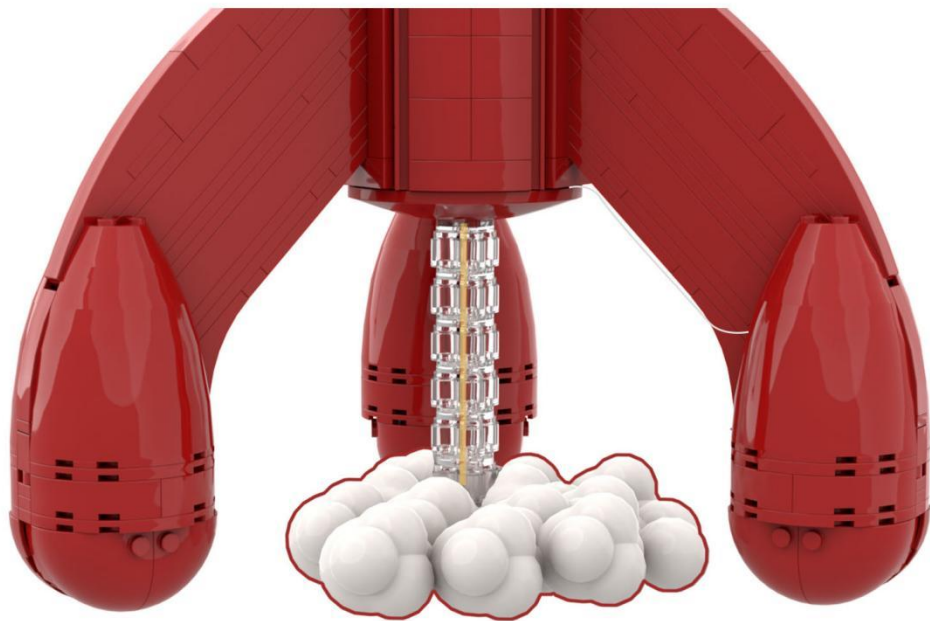

22

EN: Take the cotton balls out of Bag 4 and stack them in order as instructed.

DE: Nimm die Wattebällchen aus Beutel 4 heraus und staple sie wie angegeben.

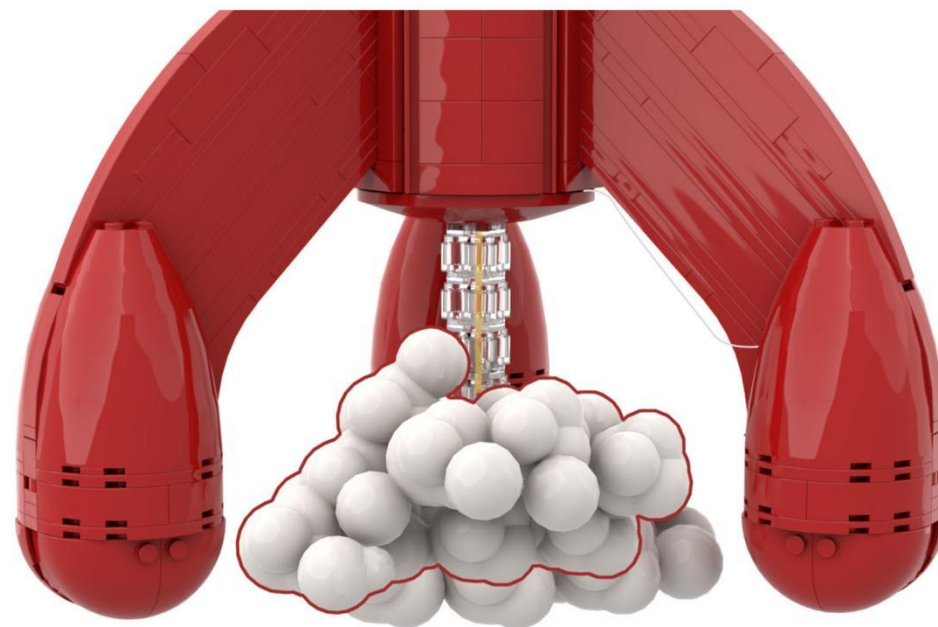

23

EN: Take the cotton balls out of Bag 5 and stack them in order as instructed.

DE: Nimm die Wattebällchen aus Beutel 5 heraus und staple sie wie angegeben in der richtigen Reihenfolge.

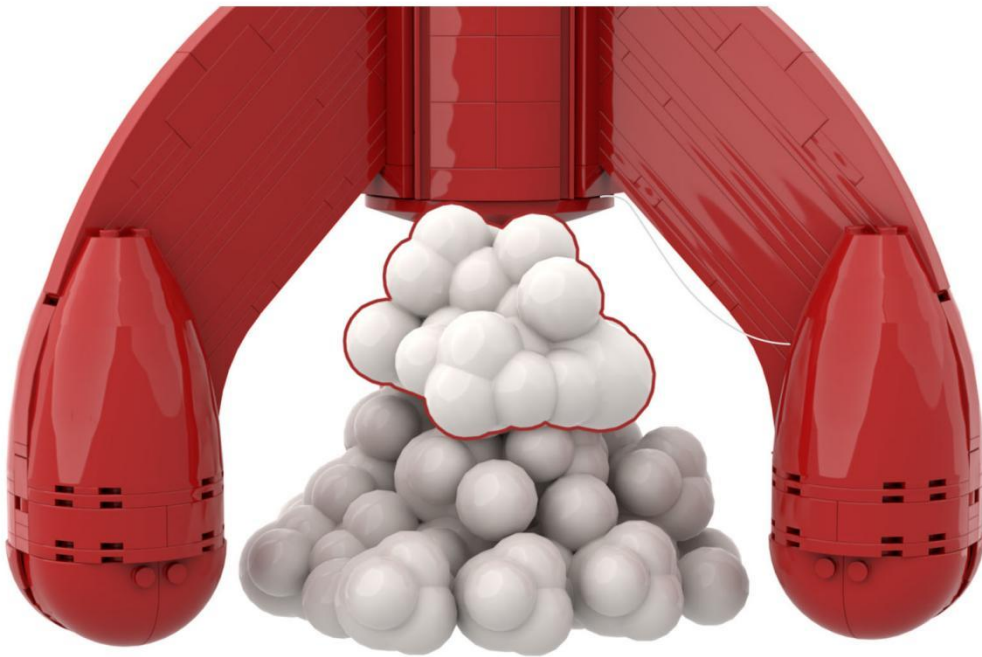

24

EN: Connect the portable power bank and install it as shown in the figure.

DE: Schließen Sie die tragbare Powerbank an und bringen Sie sie wie in der Abbildung gezeigt an.

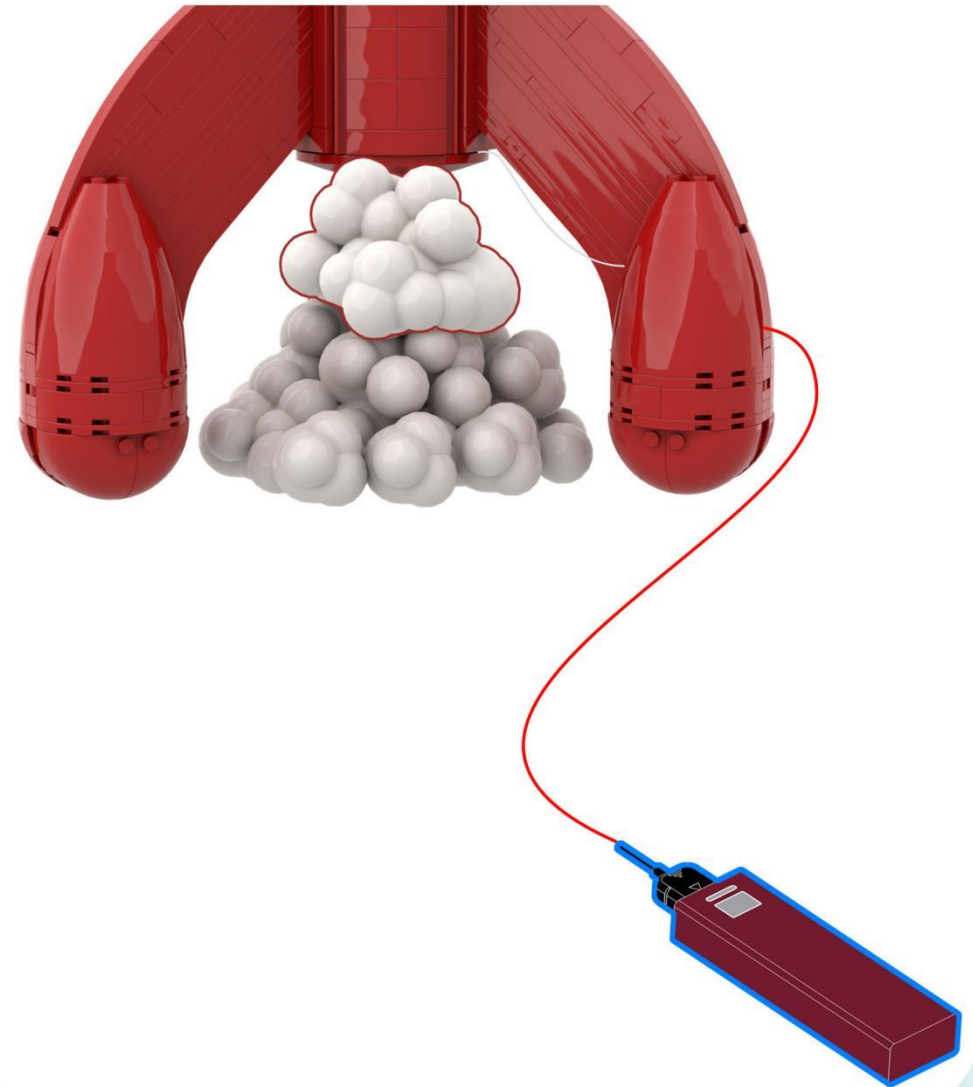

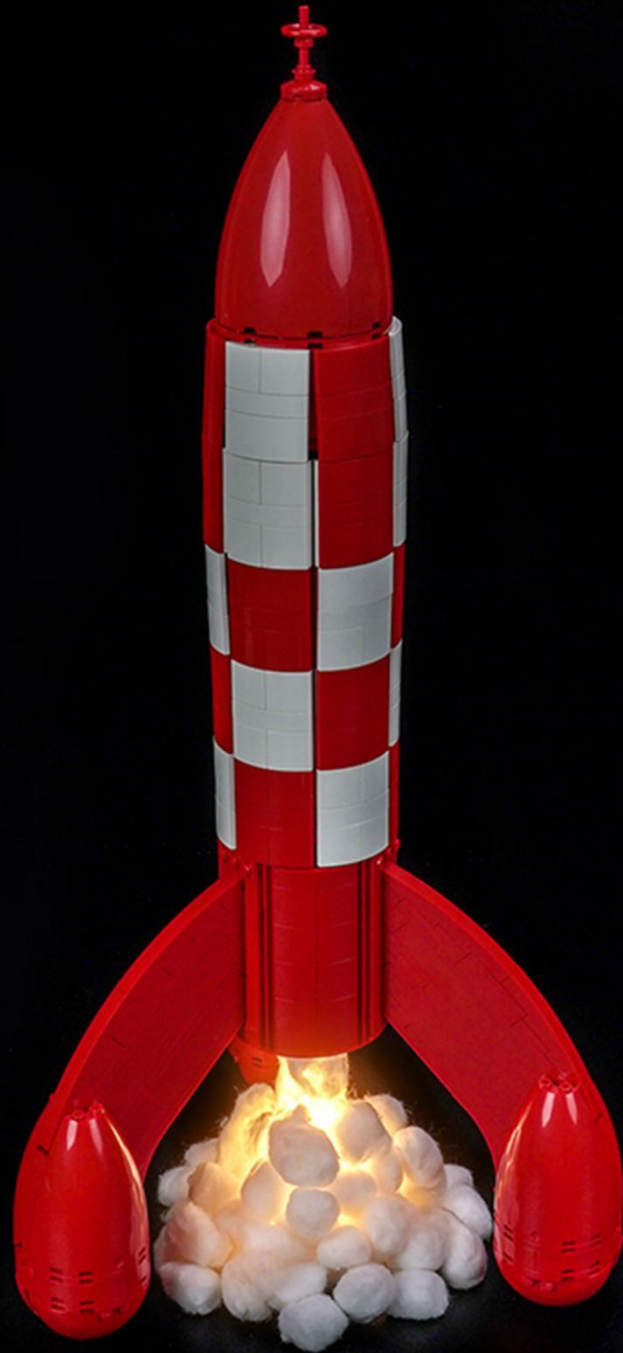

Above our designers to provide the relevant ideas and instructions. But please move to the following:

- 1: about our company this product parts material, product quality do you have comments and suggestions?
- 2: about this product installation instructions and installation of the degree of difficulty do you have views and suggestions?
- 3: if in the operation of the product we provide ideas encountered any problems, please contact us in a timely manner.

## Tips

If you encounter any installation problems please contact the seller, we will be happy to help you solve!