

# INSTALLATION GUIDE

## Germany Postcard 40954



LED light kit compatible with Lego

# Instructions for installing this kit:

This set includes 2 bags. Here is the list.

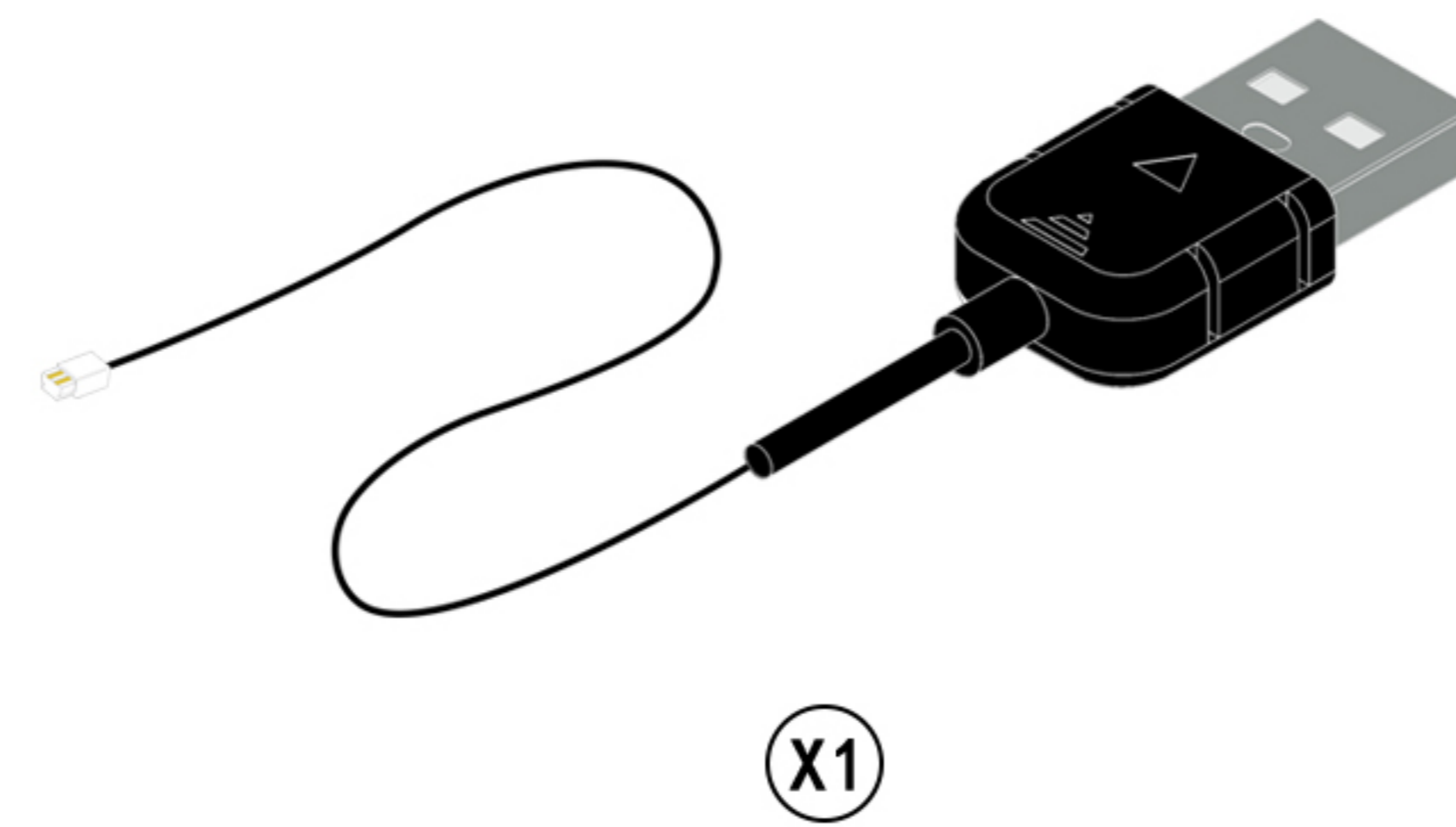
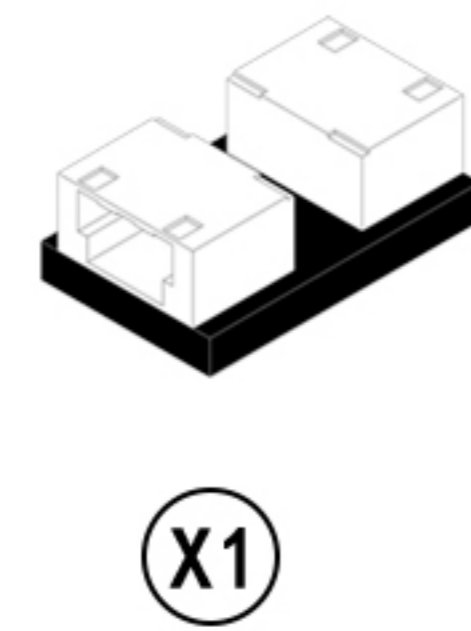
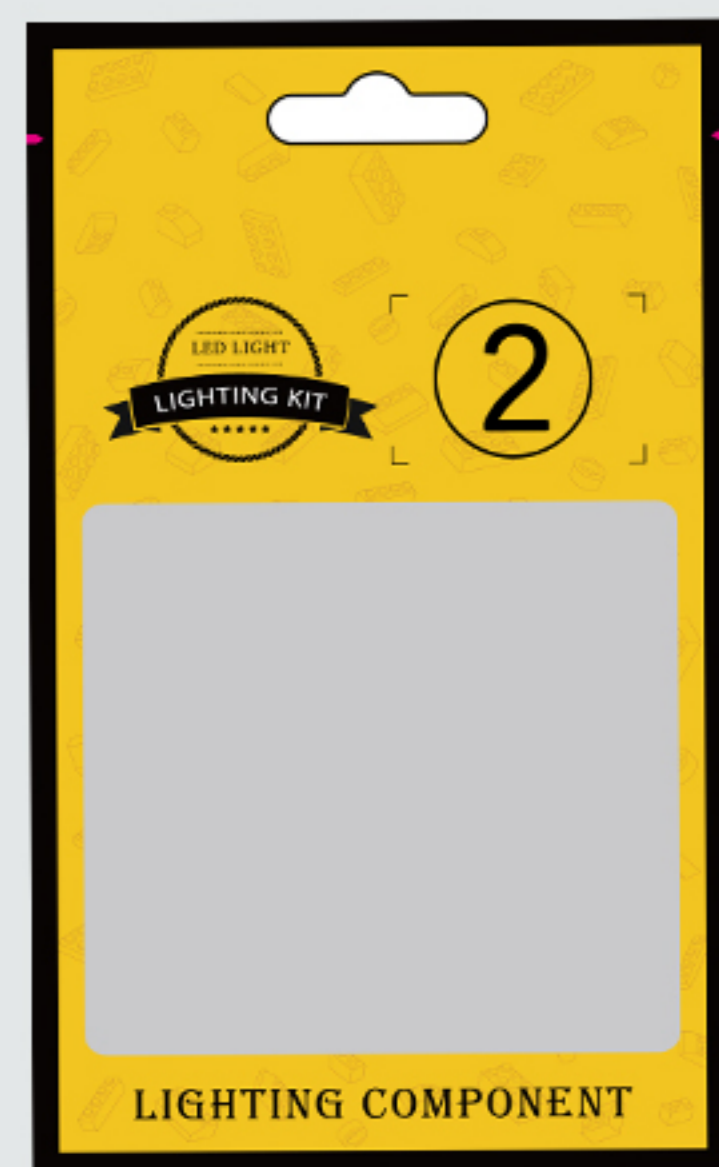
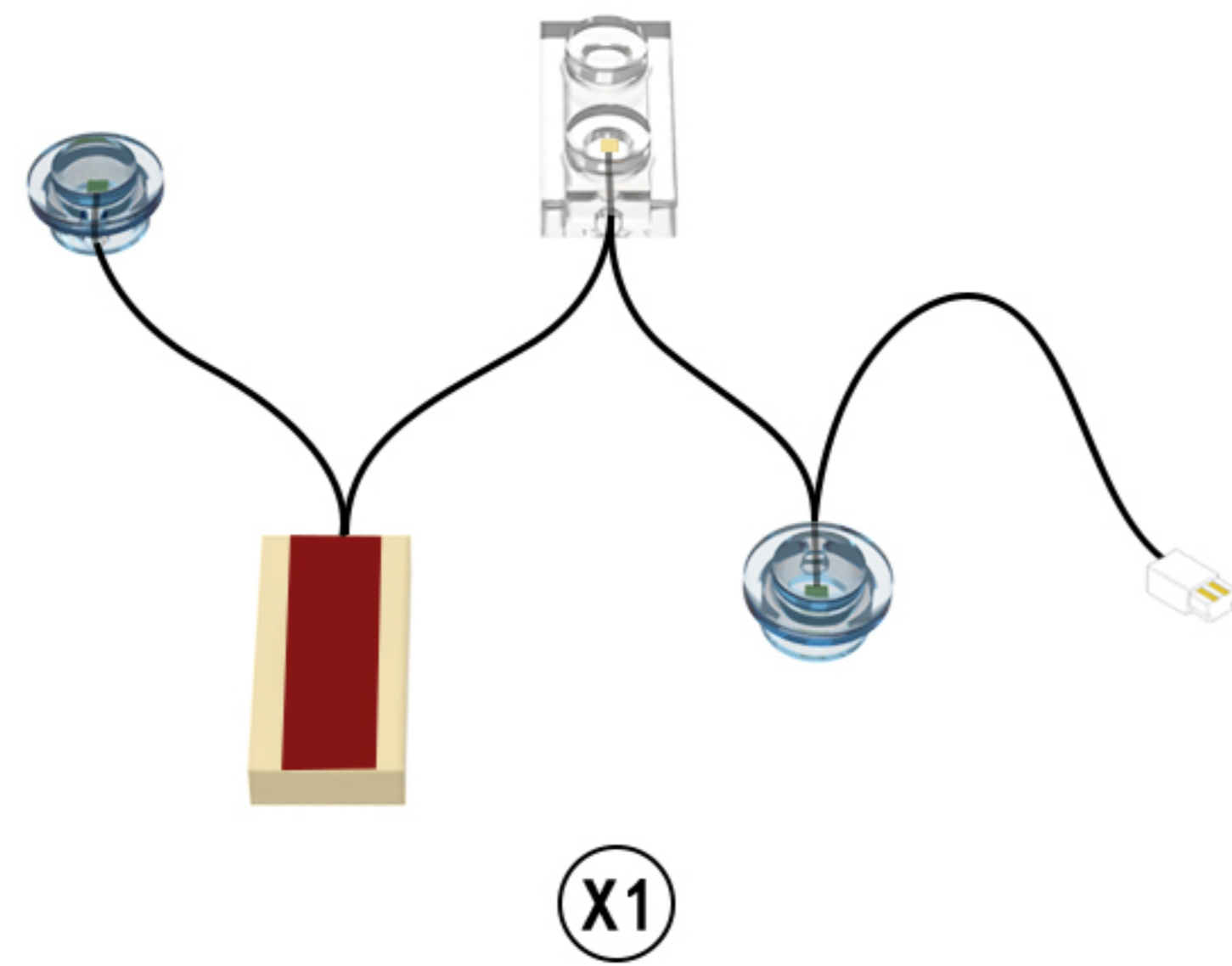
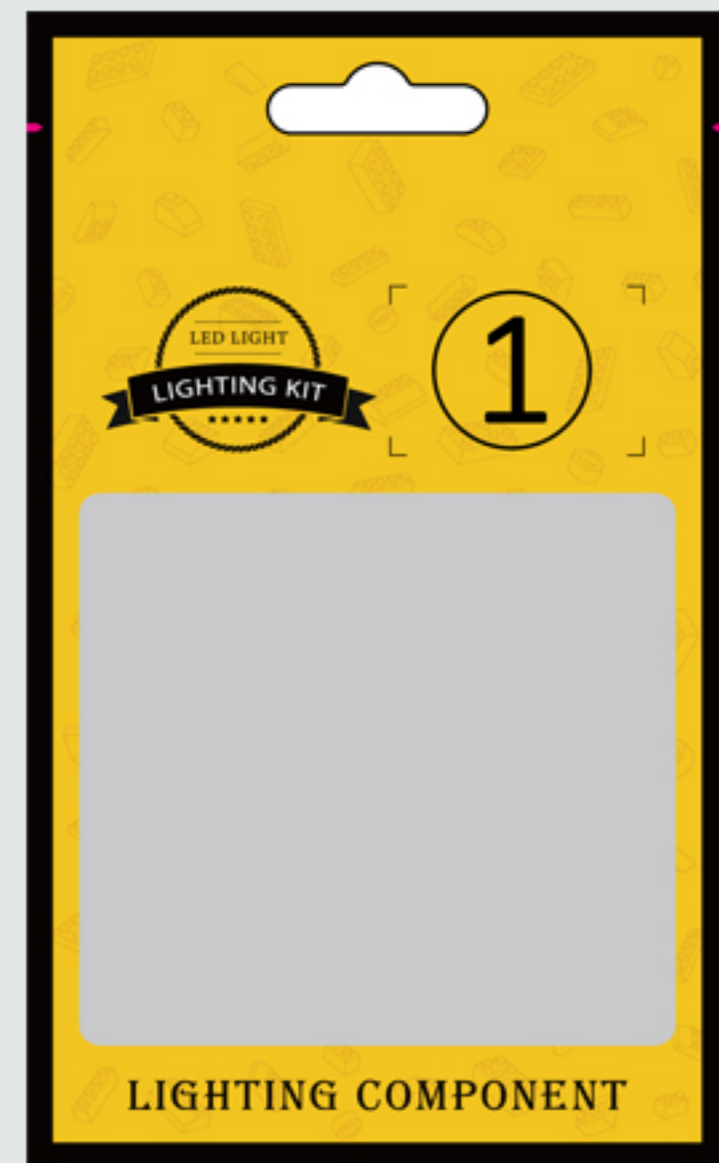

This post will complete the light installation in two main sections.

Step 1-test



Step 2-mounting

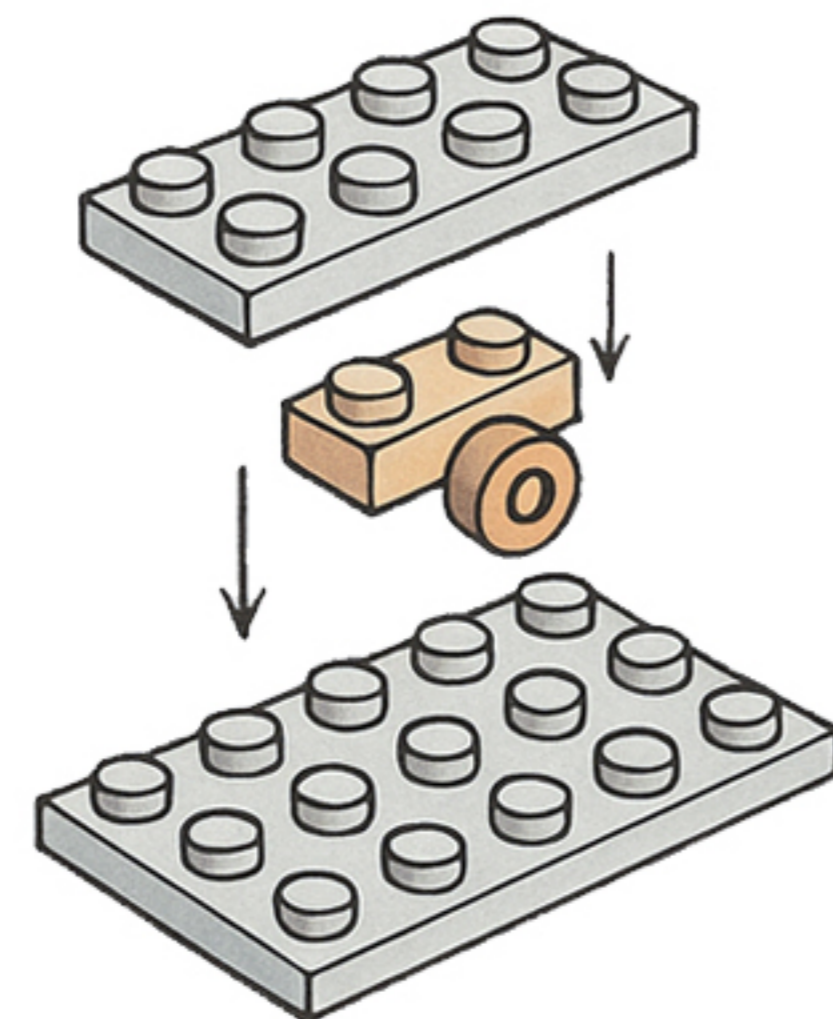

So let's get started!

## Step 1-Test.

1

EN: Remove the expansion board from Bag 2.

DE: Entnehmen Sie die Erweiterungskarte aus Beutel 2.

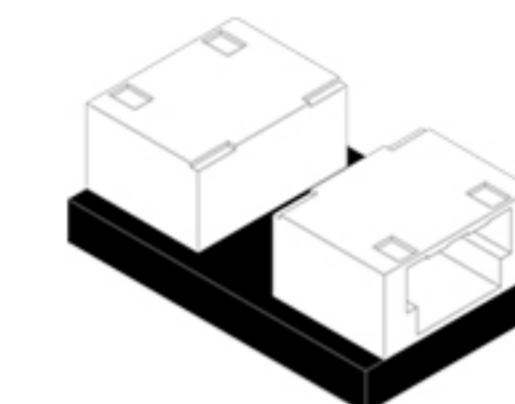

x1

2

EN: Take the USB power cable from Bag 2 and connect it to the expansion board.

DE: Nehmen Sie das USB-Stromkabel aus Beutel 2 und schließen Sie es an die Erweiterungskarte an.

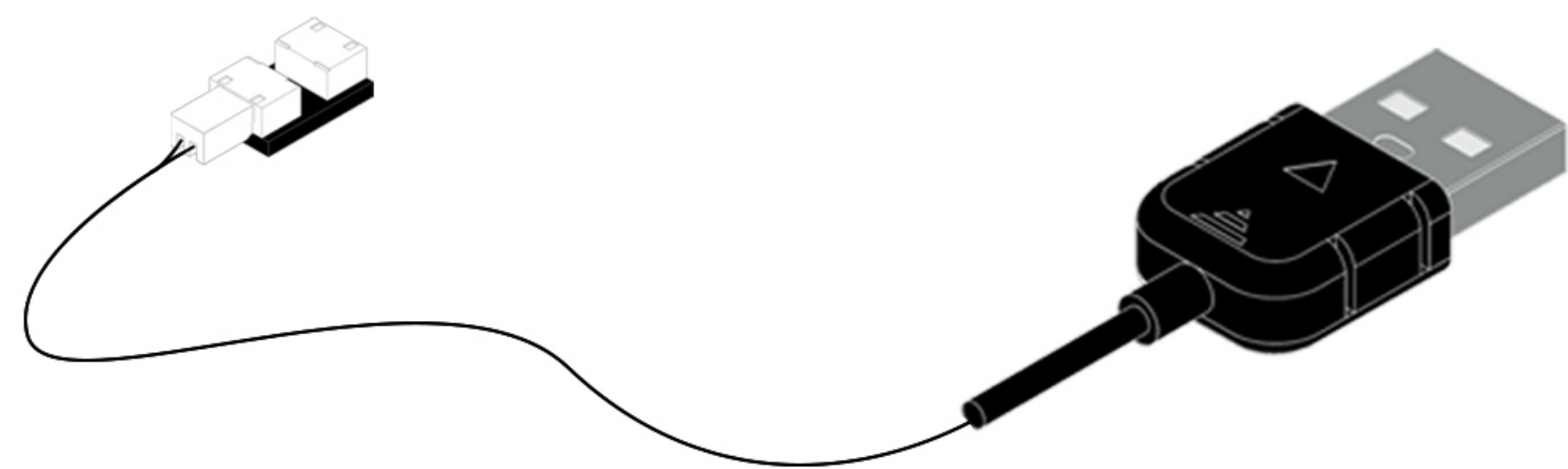
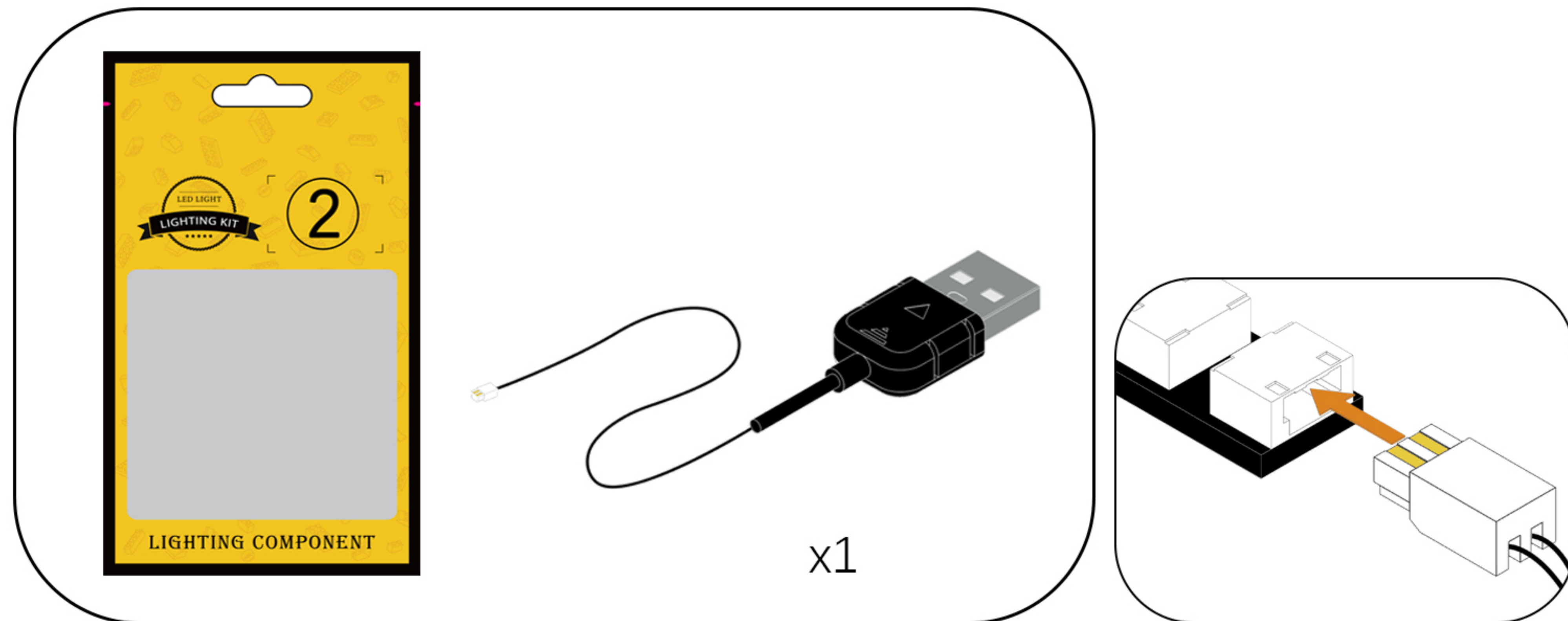

3

EN: Connect the USB power cable to the mobile power supply. (Power supply not included; see the diagram below for power supply options.)

DE: Schließen Sie das USB-Netz-kabel an die mobile Stromversorgung an. (Stromversorgung nicht im Lieferumfang enthalten, siehe Abbildung unten für die Stromversorgungsart.)

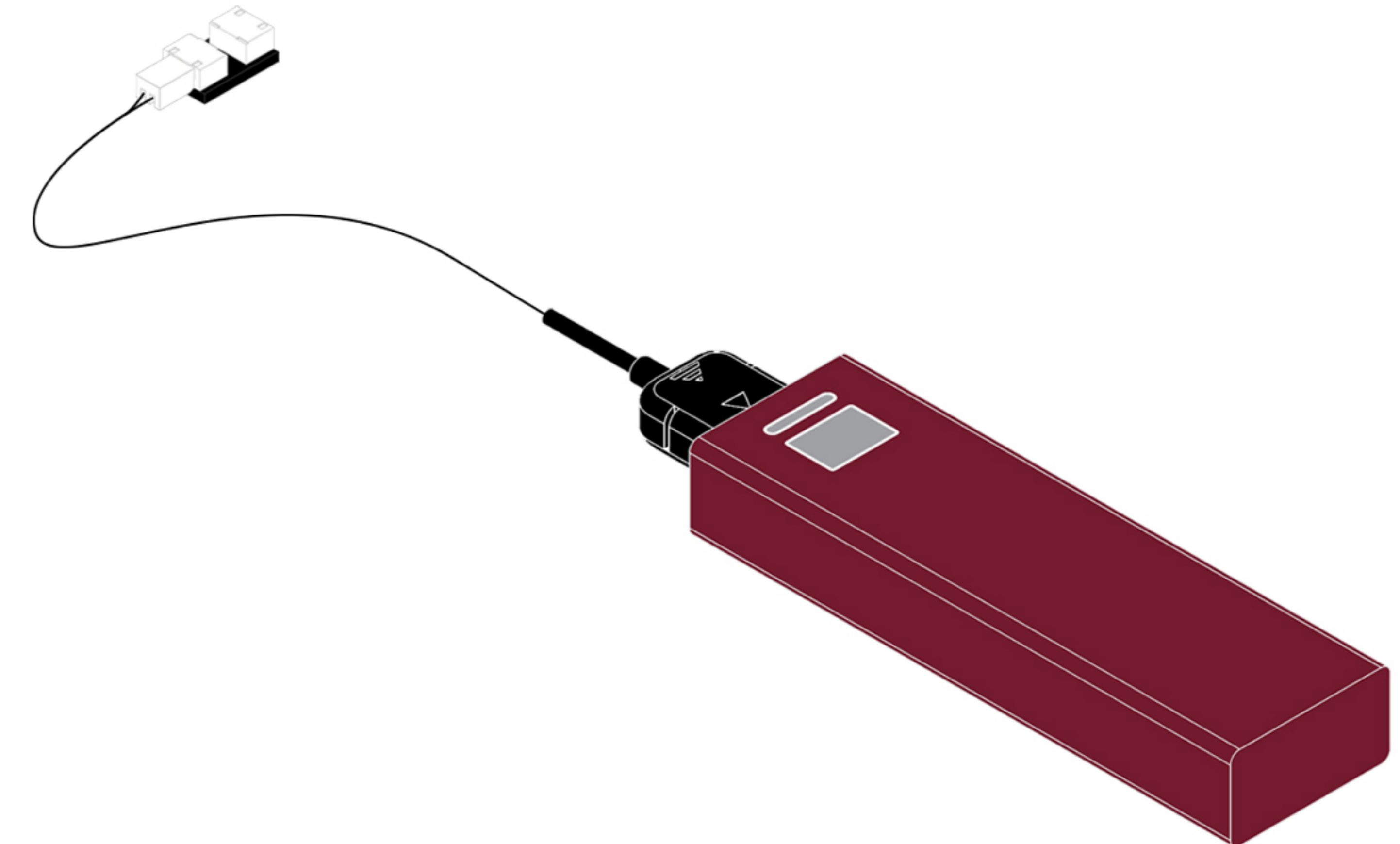

### USB Connectors to Connect Devices

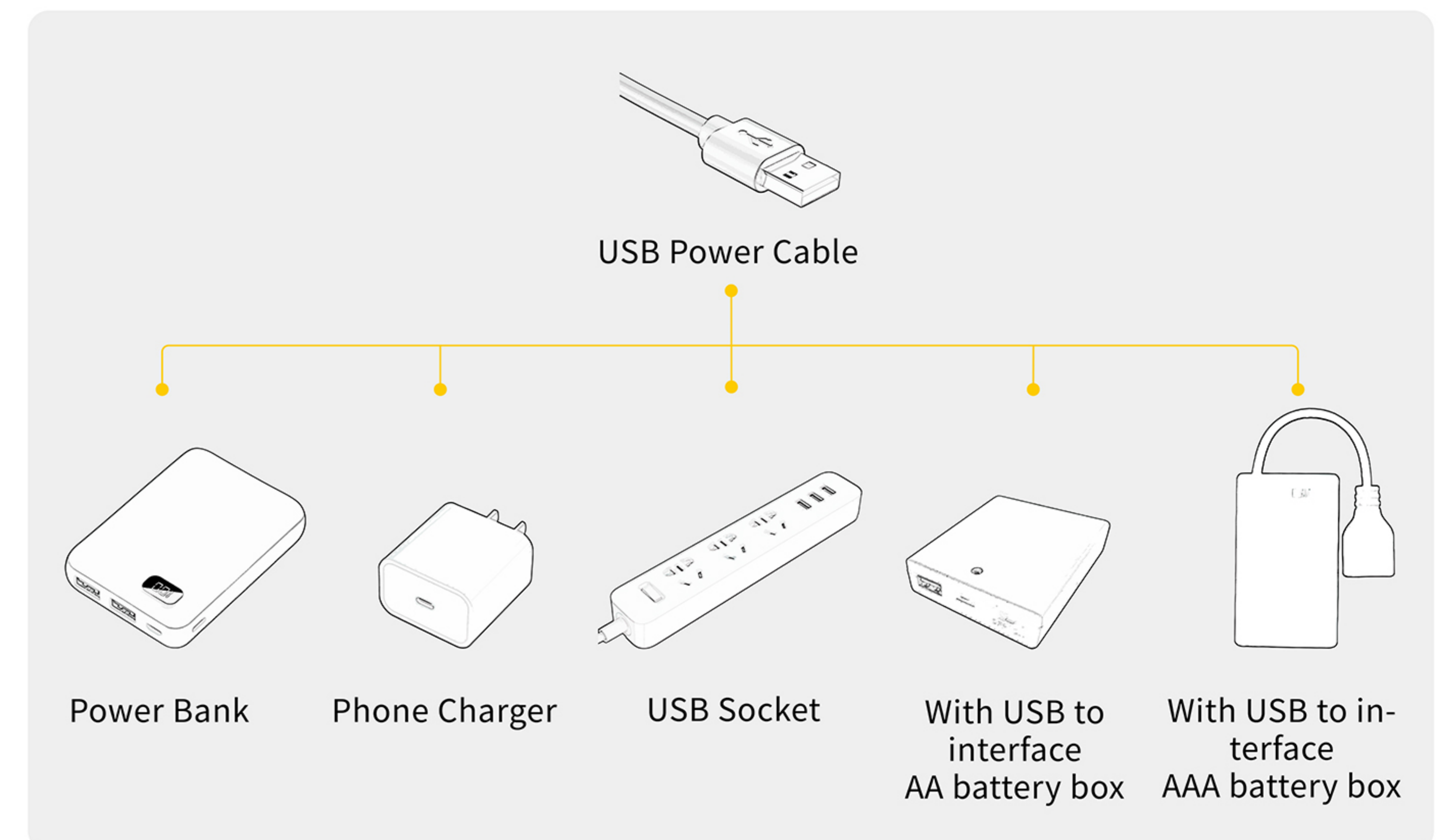

4

EN: Remove the string of lights from Bag 1 and connect it to the expansion board. Turn on the power and check that the lights are working properly. If you notice any issues, please contact us immediately.

DE: Nehmen Sie die Lichterkette aus Beutel 1 heraus und schließen Sie sie an die Erweiterungskarte an. Schalten Sie das Gerät ein und überprüfen Sie, ob die Lichter ordnungsgemäß funktionieren. Sollten Sie Probleme feststellen, kontaktieren Sie uns bitte umgehend.

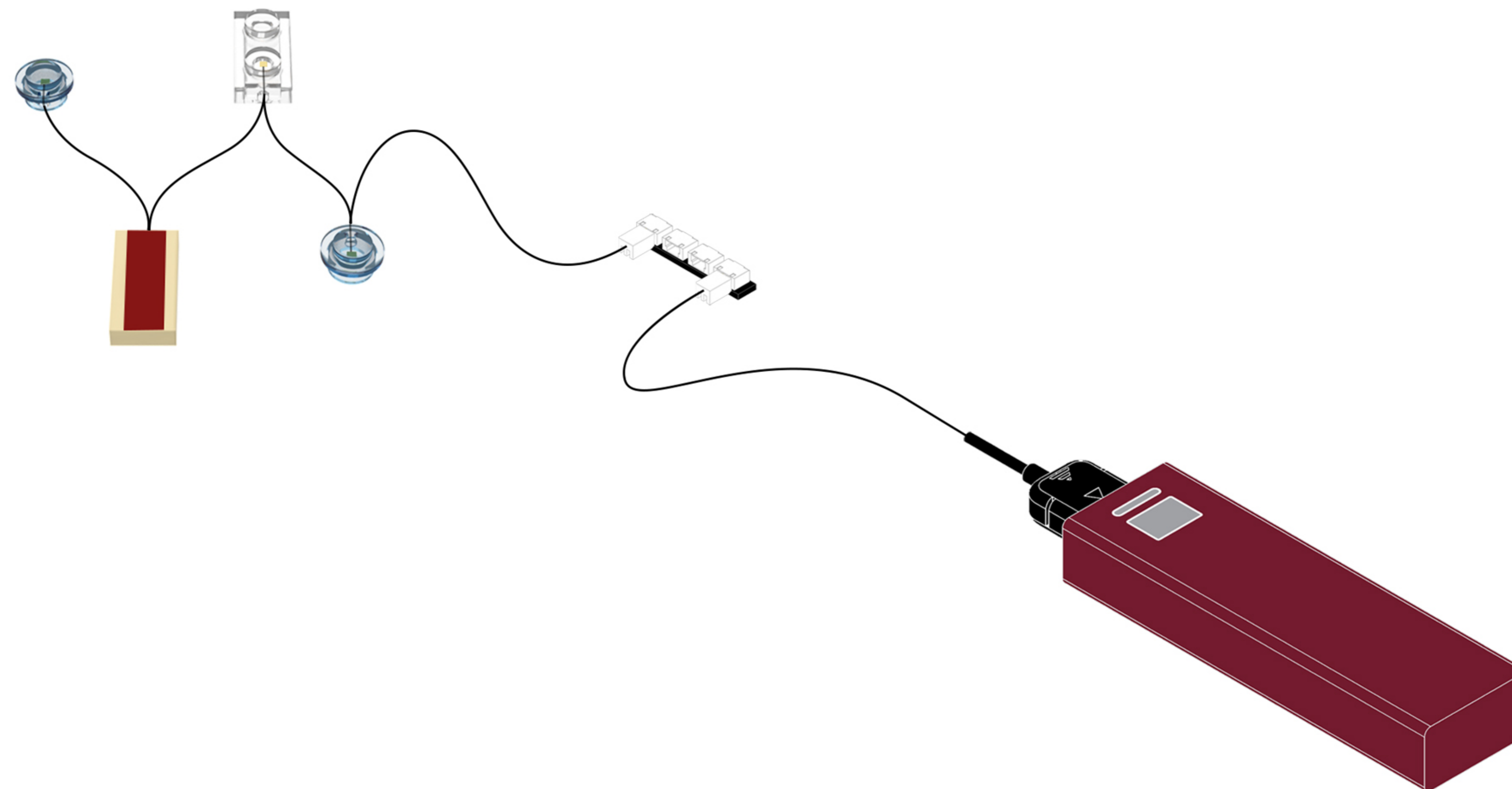
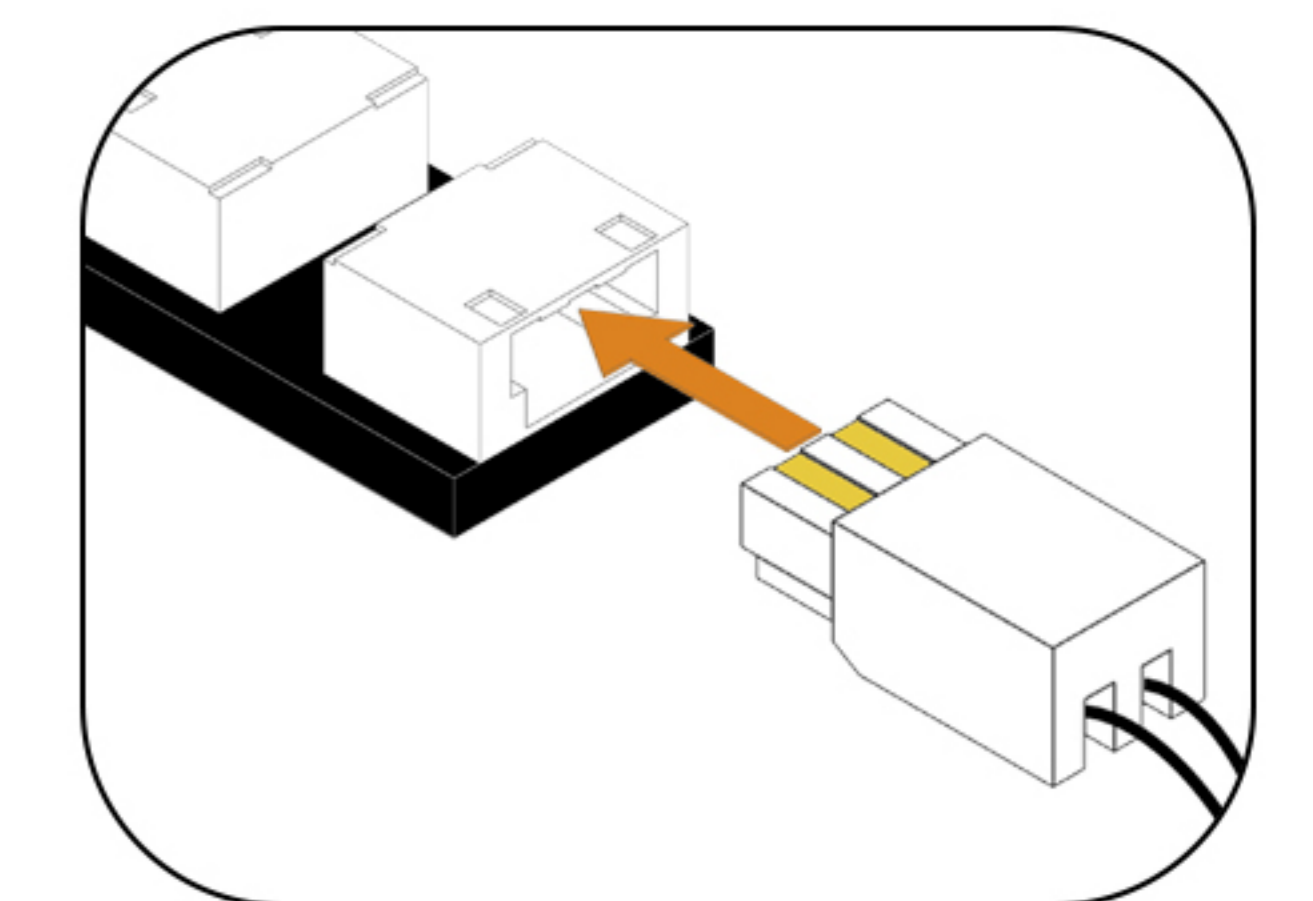
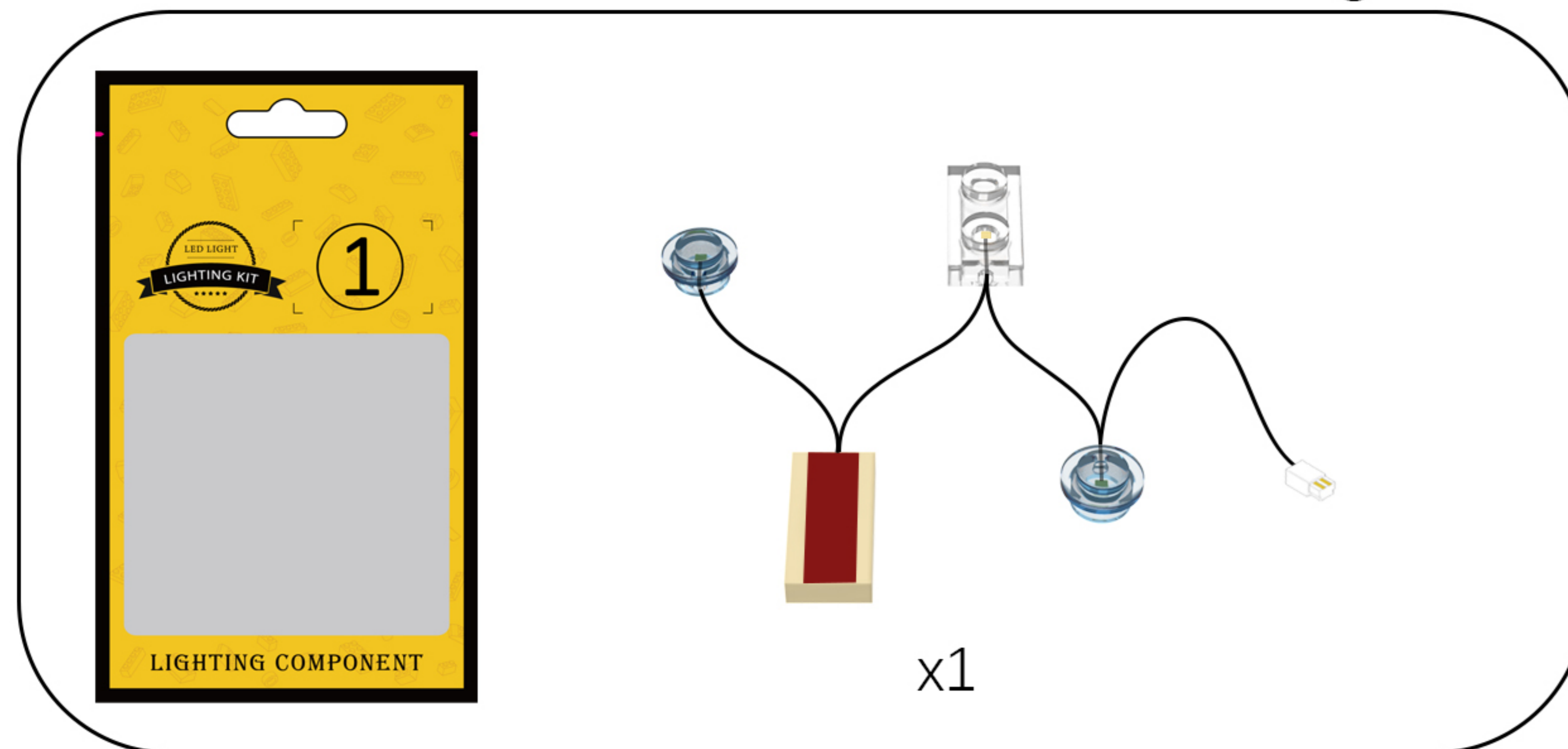

After confirming that there are no abnormalities, temporarily return each part to its original bag.

## Step 2-Mounting.

1

EN: Take out the building block model.

DE: Nimm das Bauklotzmodell heraus.



2

EN: Split as shown in the figure.

DE: Wie in der Abbildung gezeigt, teilen Sie es auf.

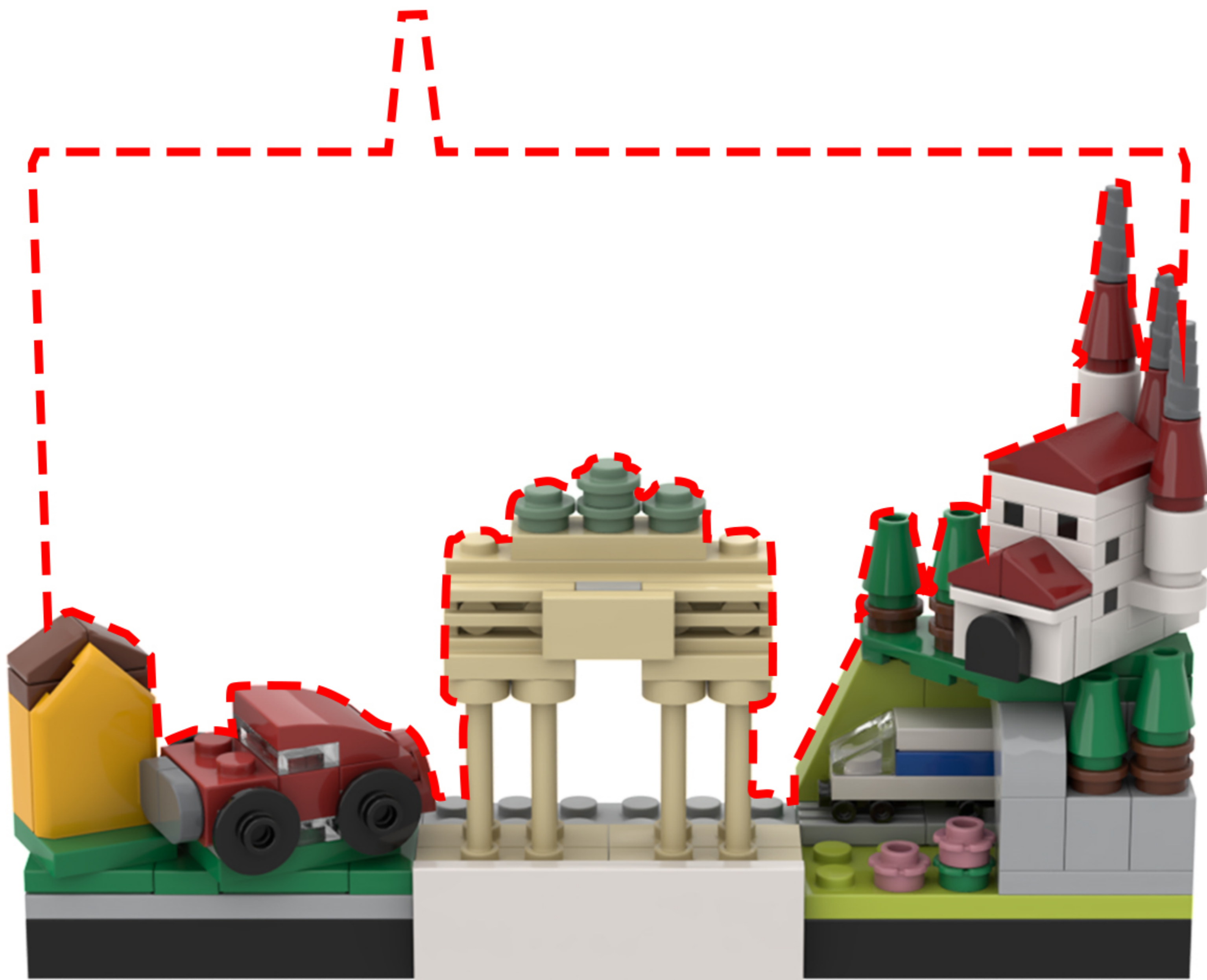

3

EN: Rotate the model to its back side.

DE: Drehen Sie das Modell auf die Rückseite.

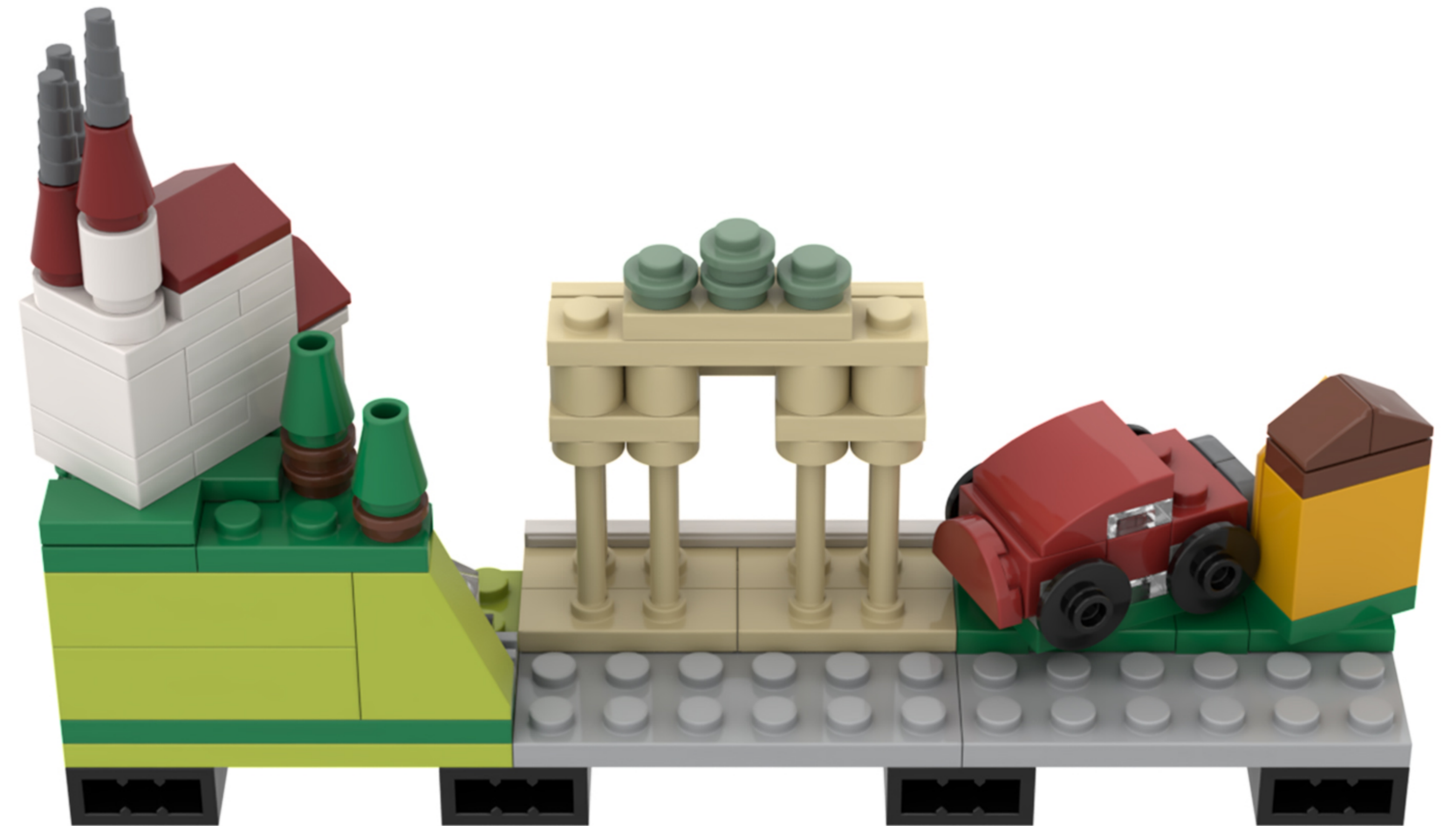

4

EN: Take the string of lights out of Bag 1 and attach the lights to the building blocks.

DE: Nimm die Lichterkette aus Beutel 1 heraus und befestige die Lichter an den Bausteinen.

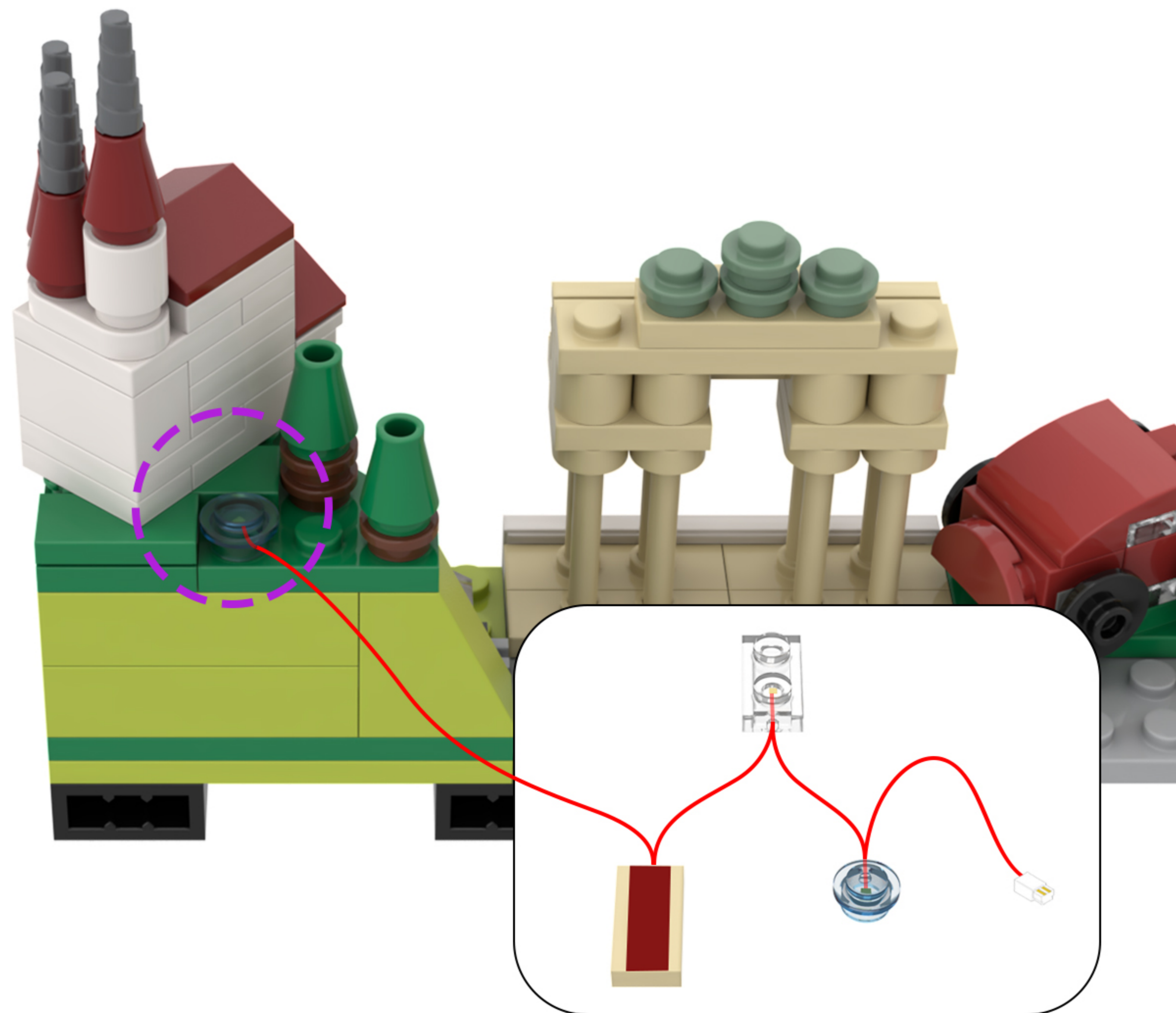
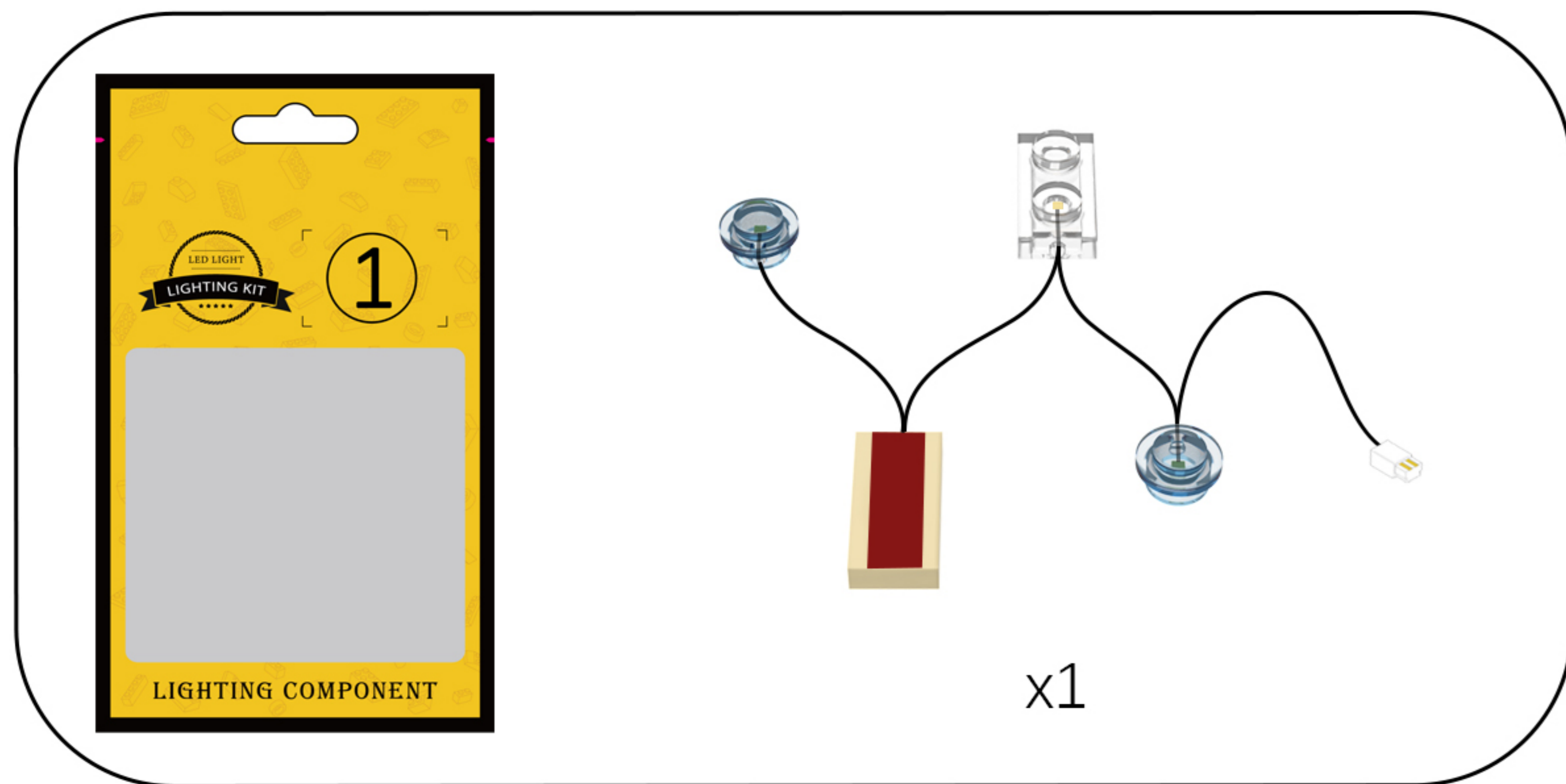

5

EN: Find the lights in the string of lights.

DE: Finde die Lichter in der Lichterkette.

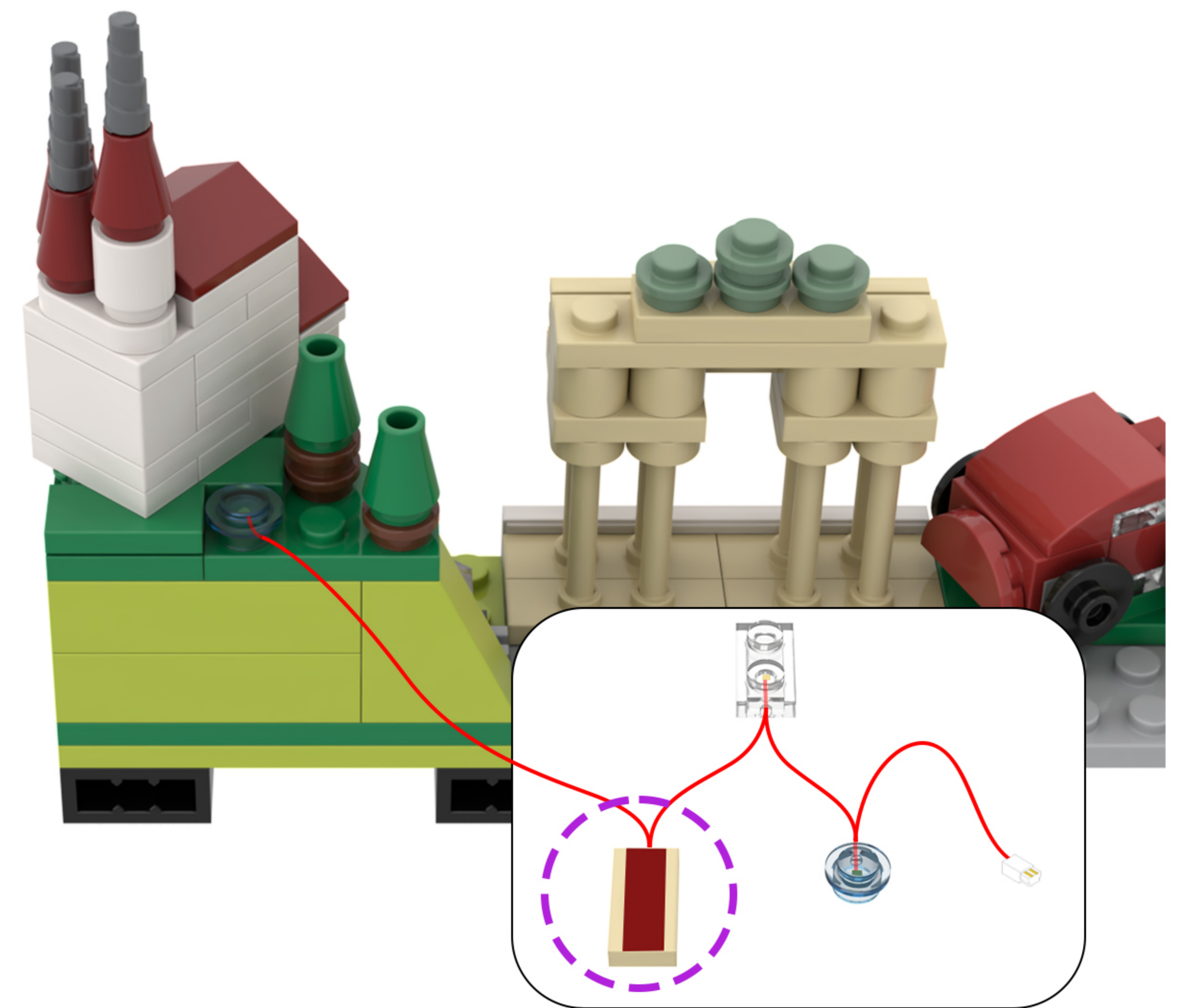

6

EN: Peel off the adhesive backing from the light fixture and attach it to the underside of the building block.

DE: Zieh die Schutzfolie von der Leuchte ab und befestige sie an der Unterseite des Bausteins.

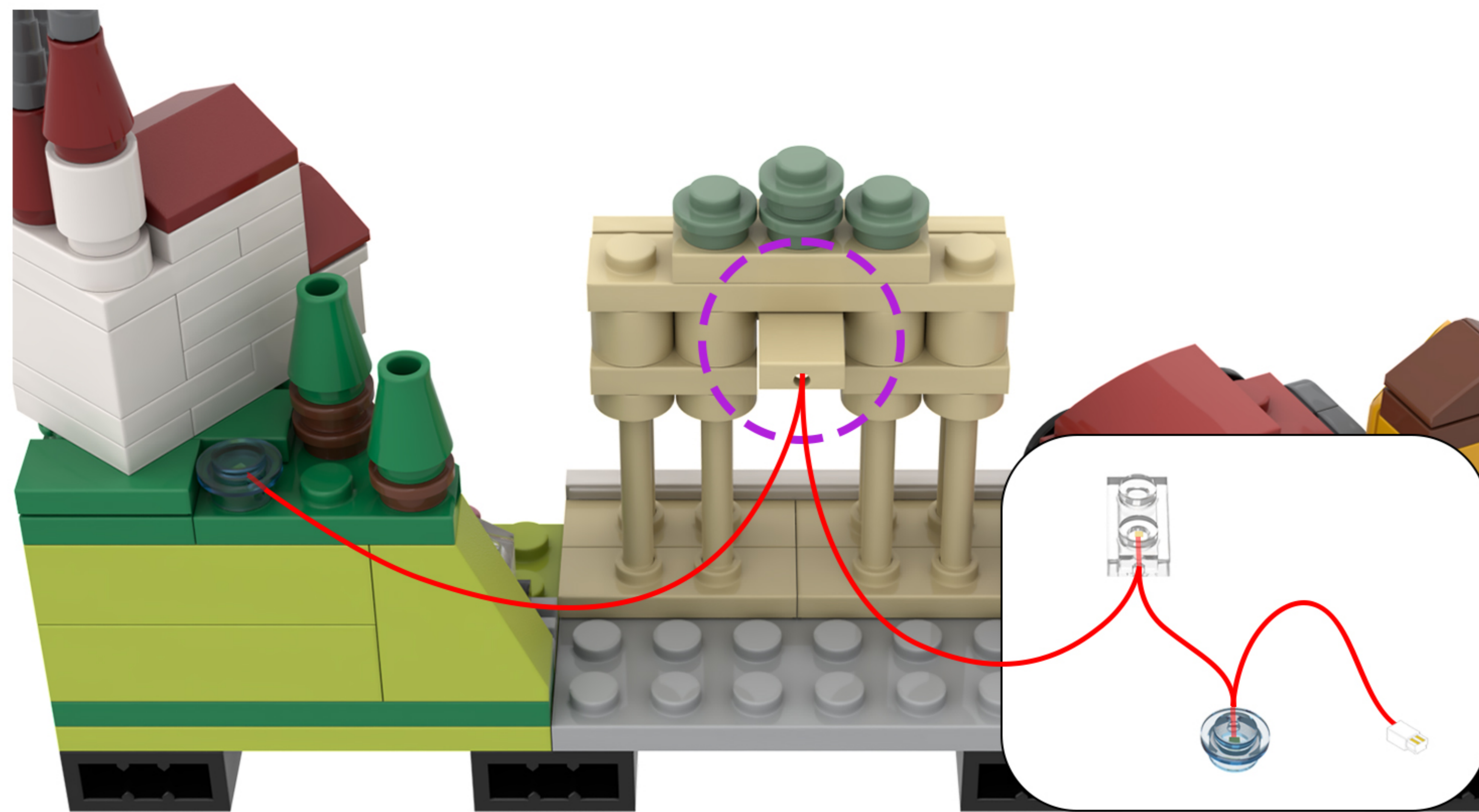

7

EN: Remove the building block car.

DE: Nimm das Bauklötzeauto heraus.

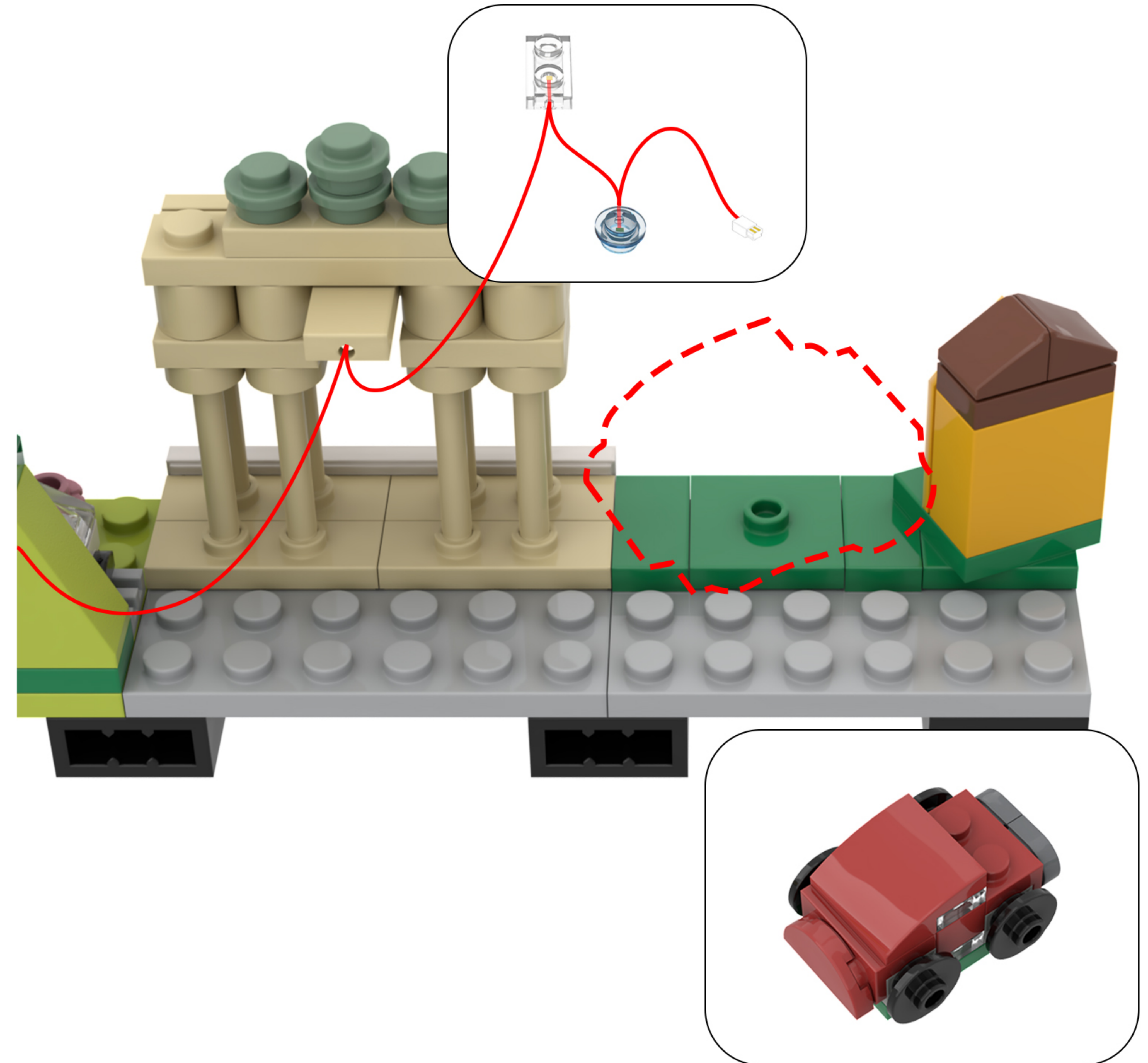

8

EN: Take out the disassembled building blocks and take them apart one by one.

DE: Nimm die zerlegten Bausteine heraus und nimm sie nacheinander auseinander.

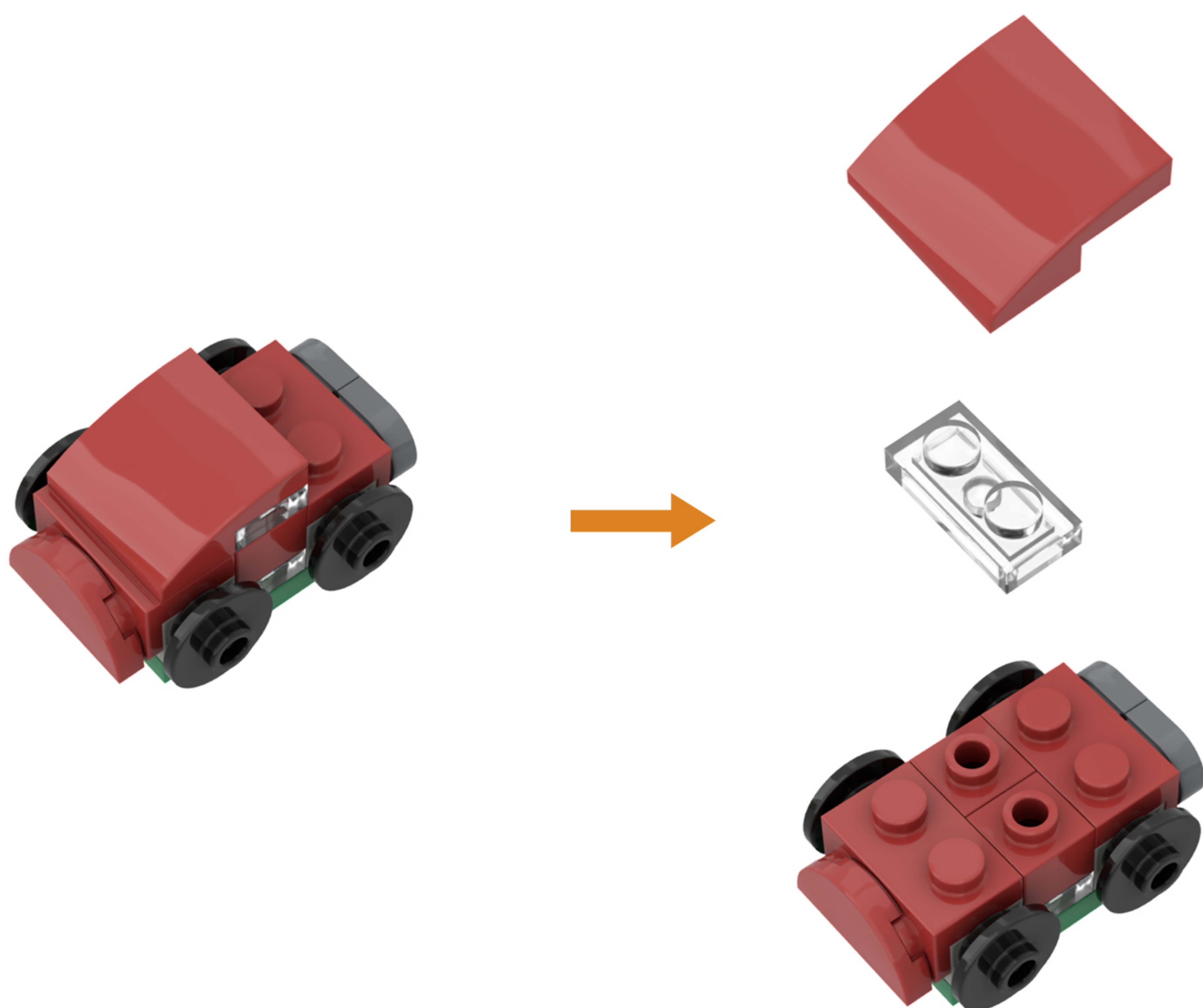
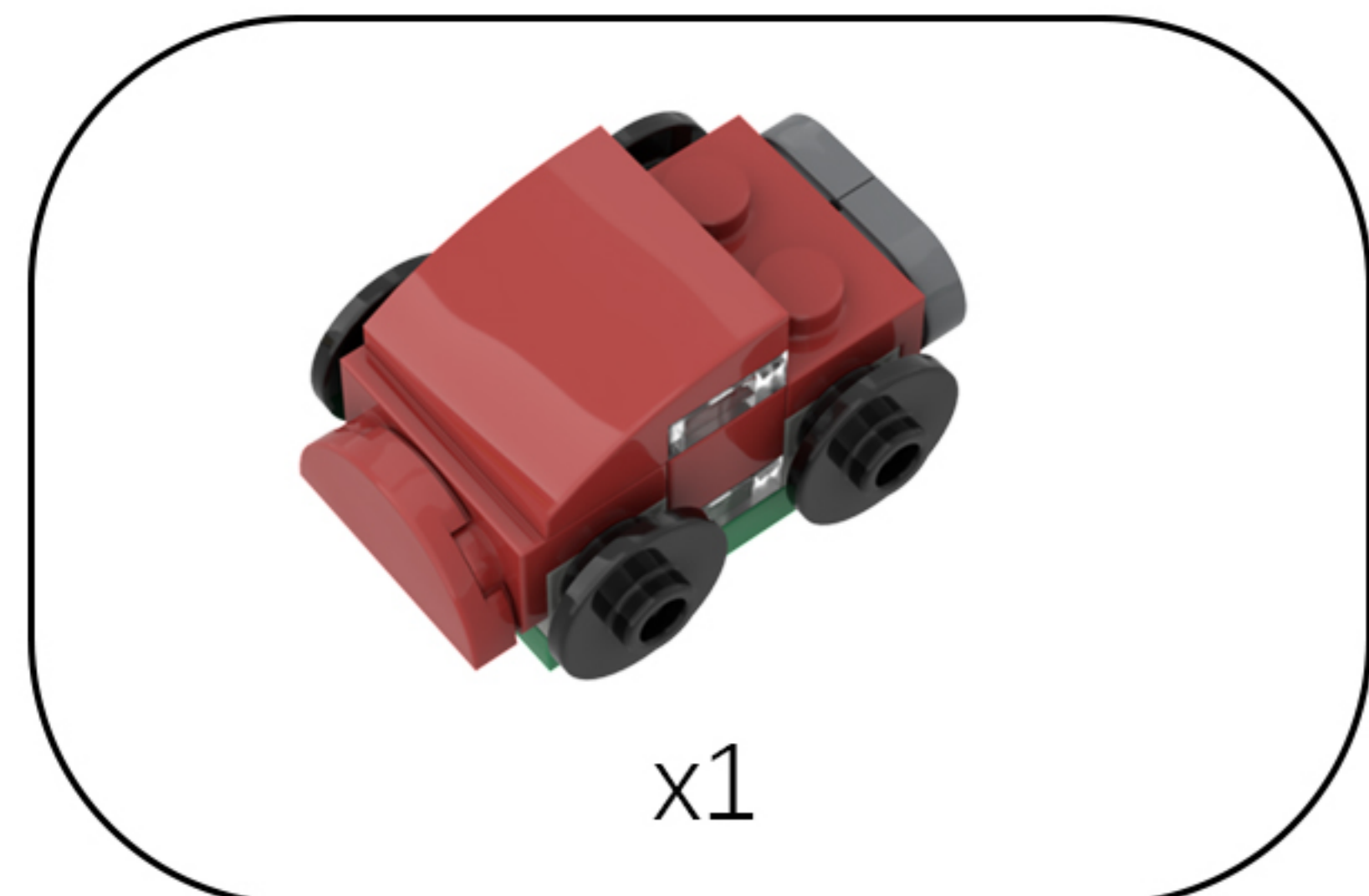

9

EN: Attach the lights from the string to the building blocks.

DE: Befestigen Sie die Lichter der Lichterkette an den Bausteinen.

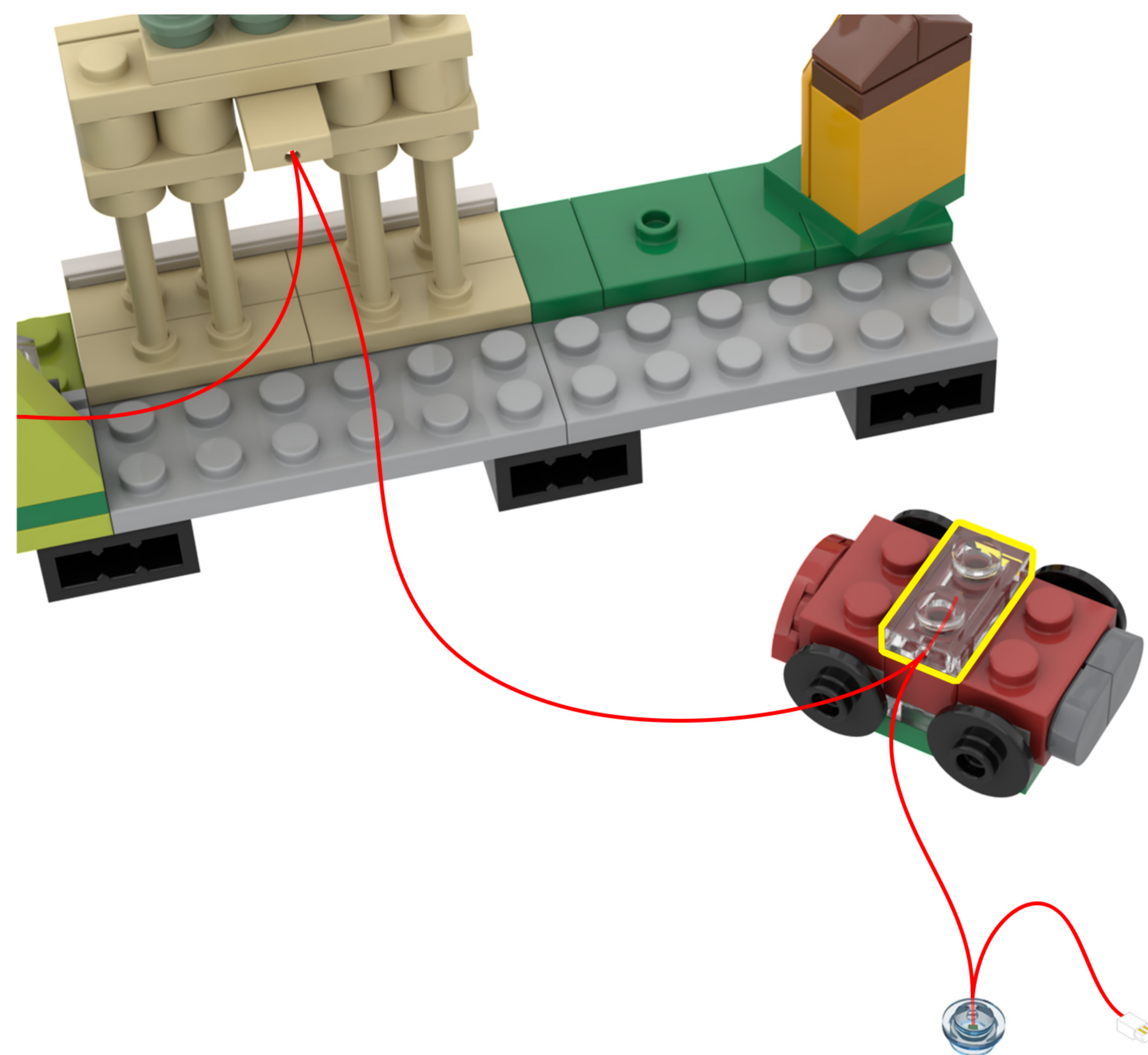

10

EN: Take out the disassembled building blocks and reassemble them.

DE: Nehmen Sie die zerlegten Bausteine heraus und setzen Sie sie wieder zusammen.

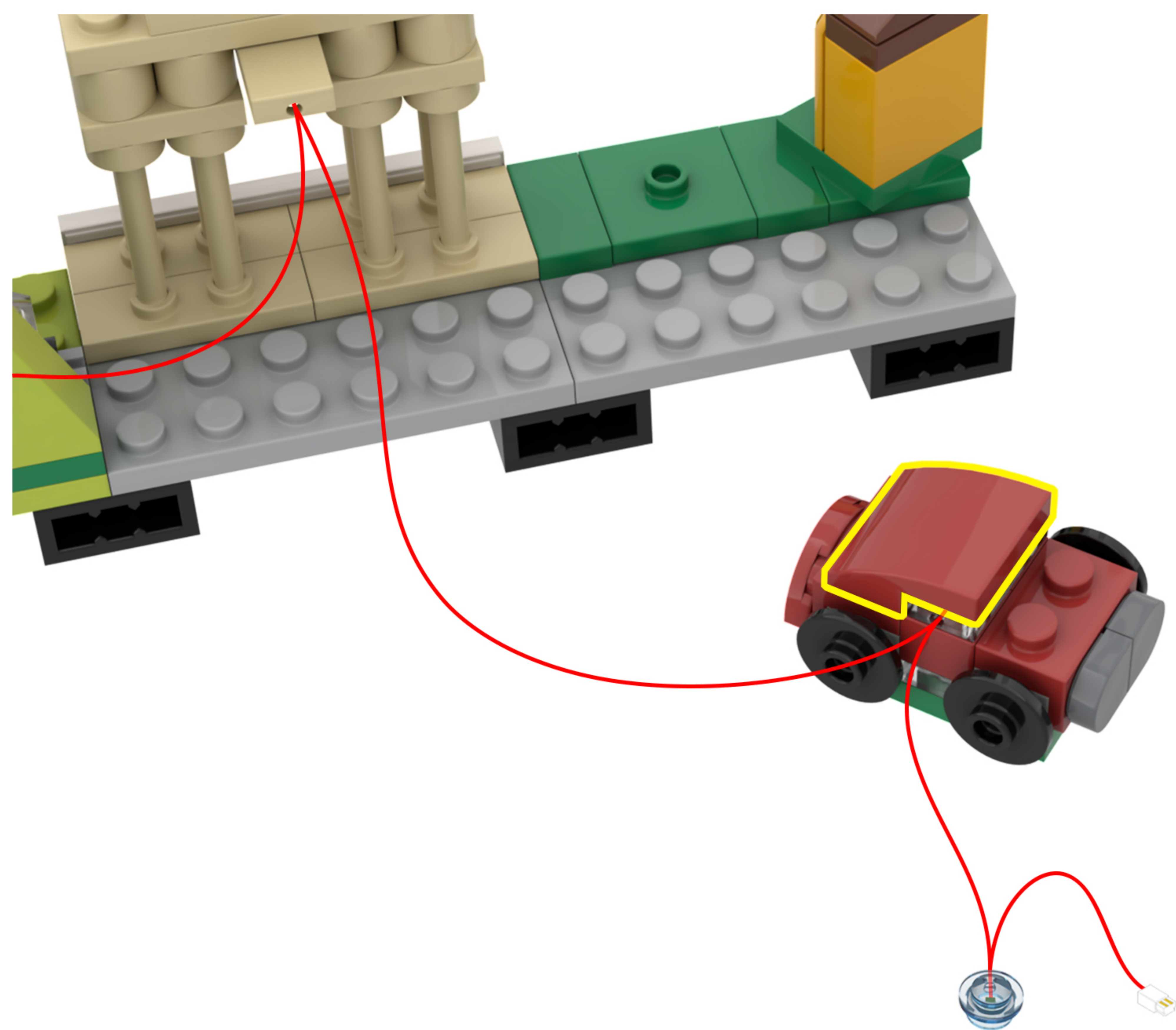
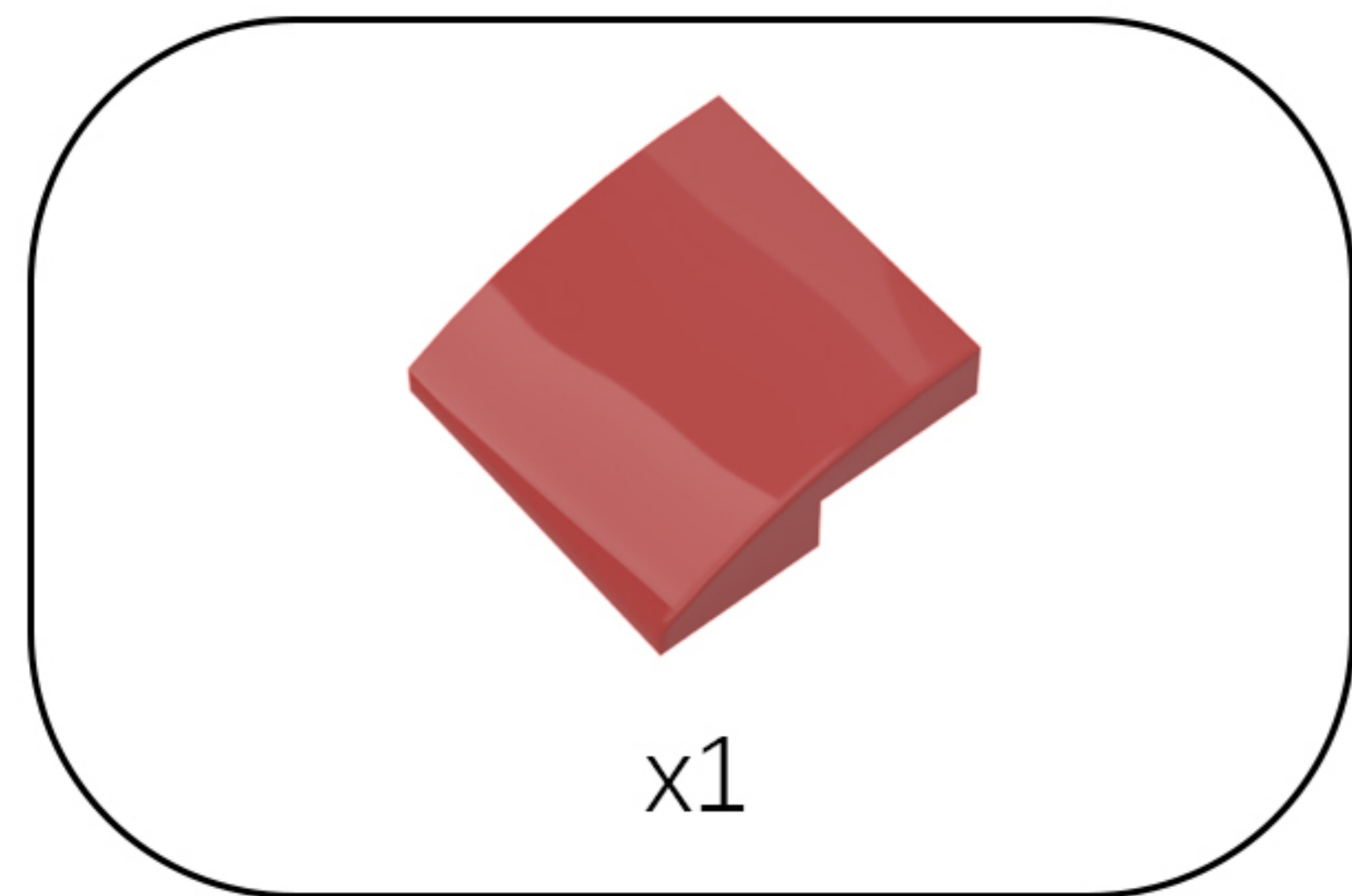

11

EN: Find the wire in the string of lights.

DE: Finde den Draht in der Lichterkette.

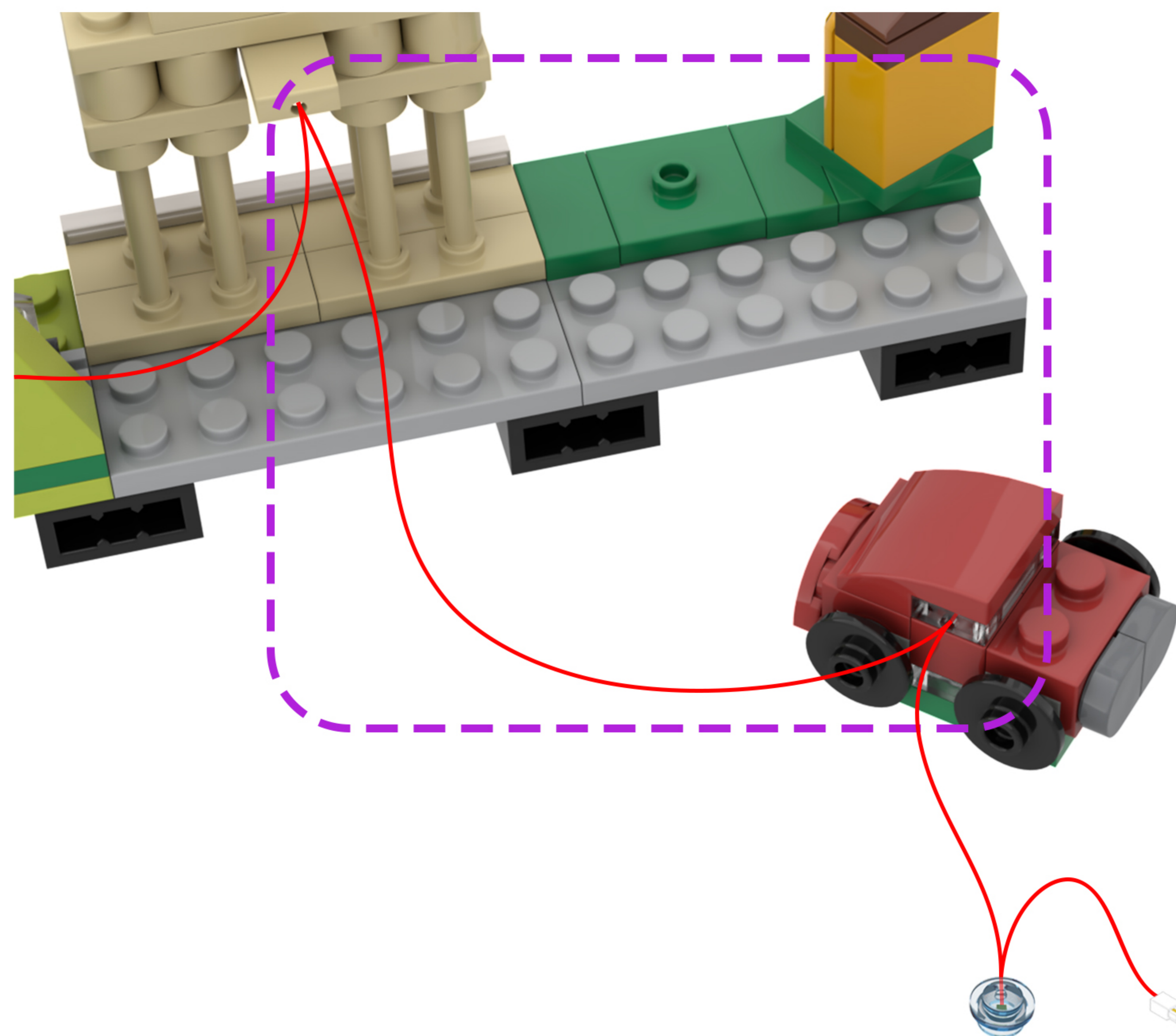

12

EN: Wrap the string of lights around the wheels of the building block car.

DE: Wickle die Lichterkette um die Räder des Bauklötzeautos.

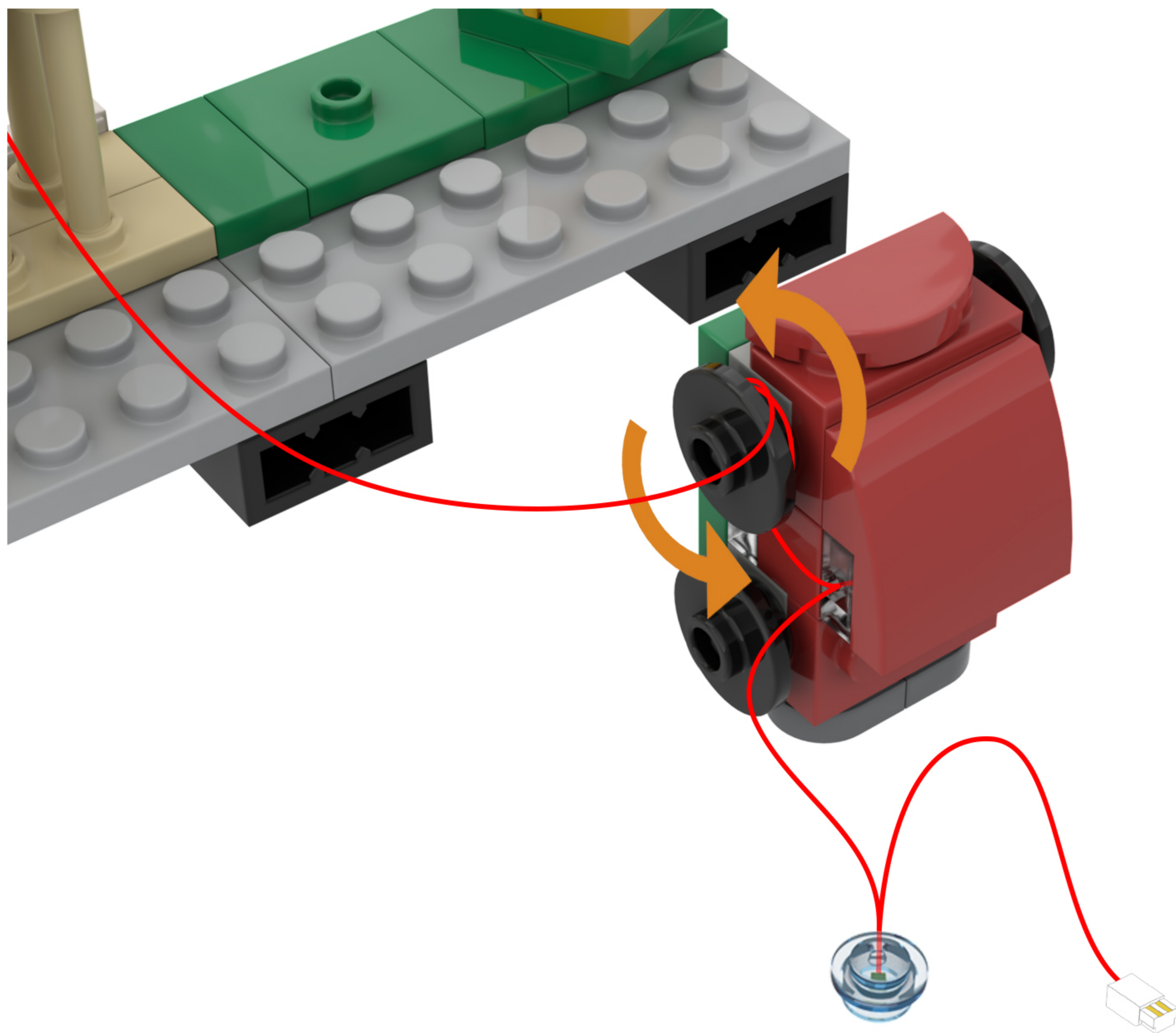

13

EN: Restore the building blocks.

DE: Stellen Sie die Bausteine wieder her.

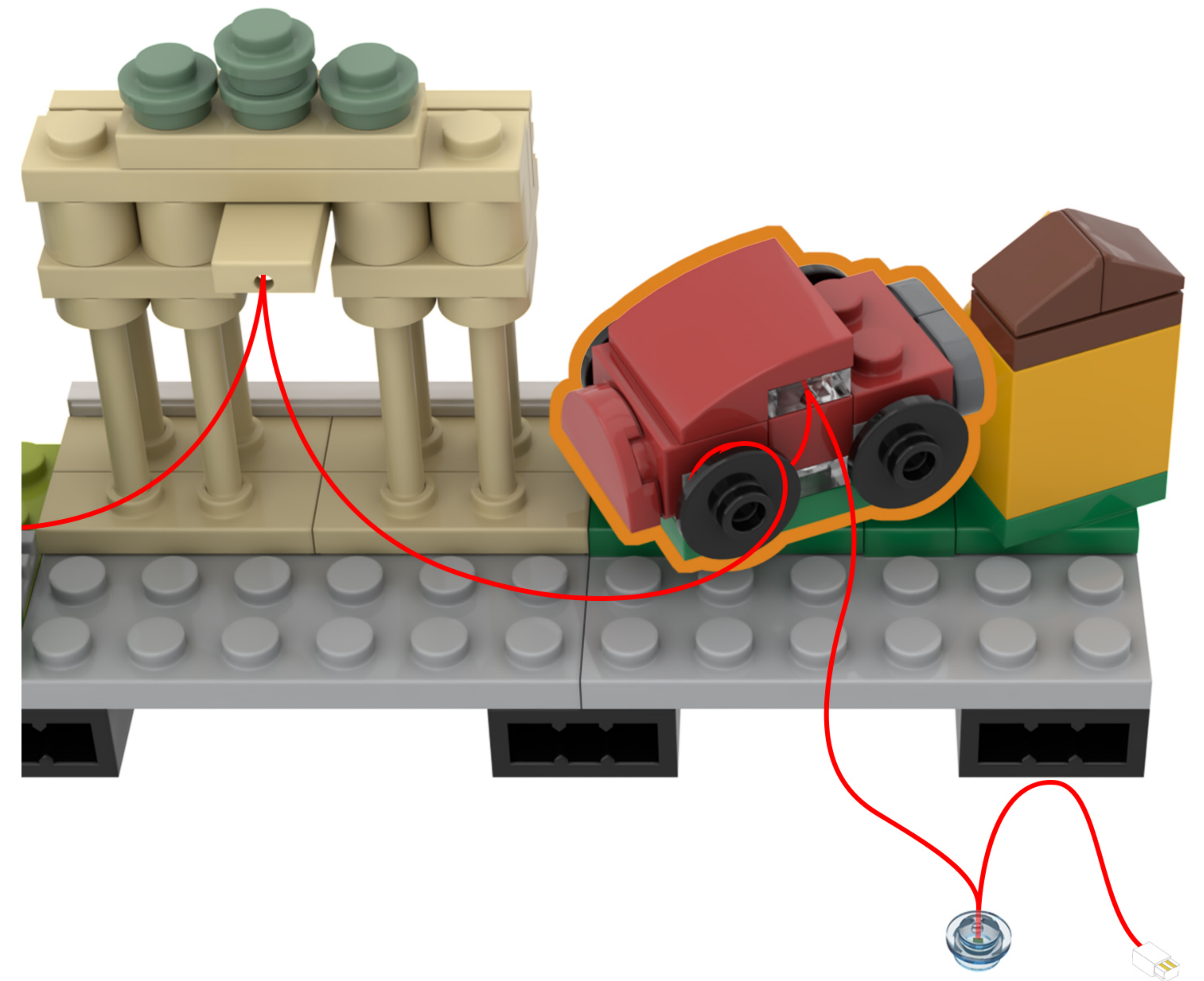

14

EN: Attach the lights from the string to the building blocks.

DE: Befestigen Sie die Lichter der Lichterkette an den Bausteinen.

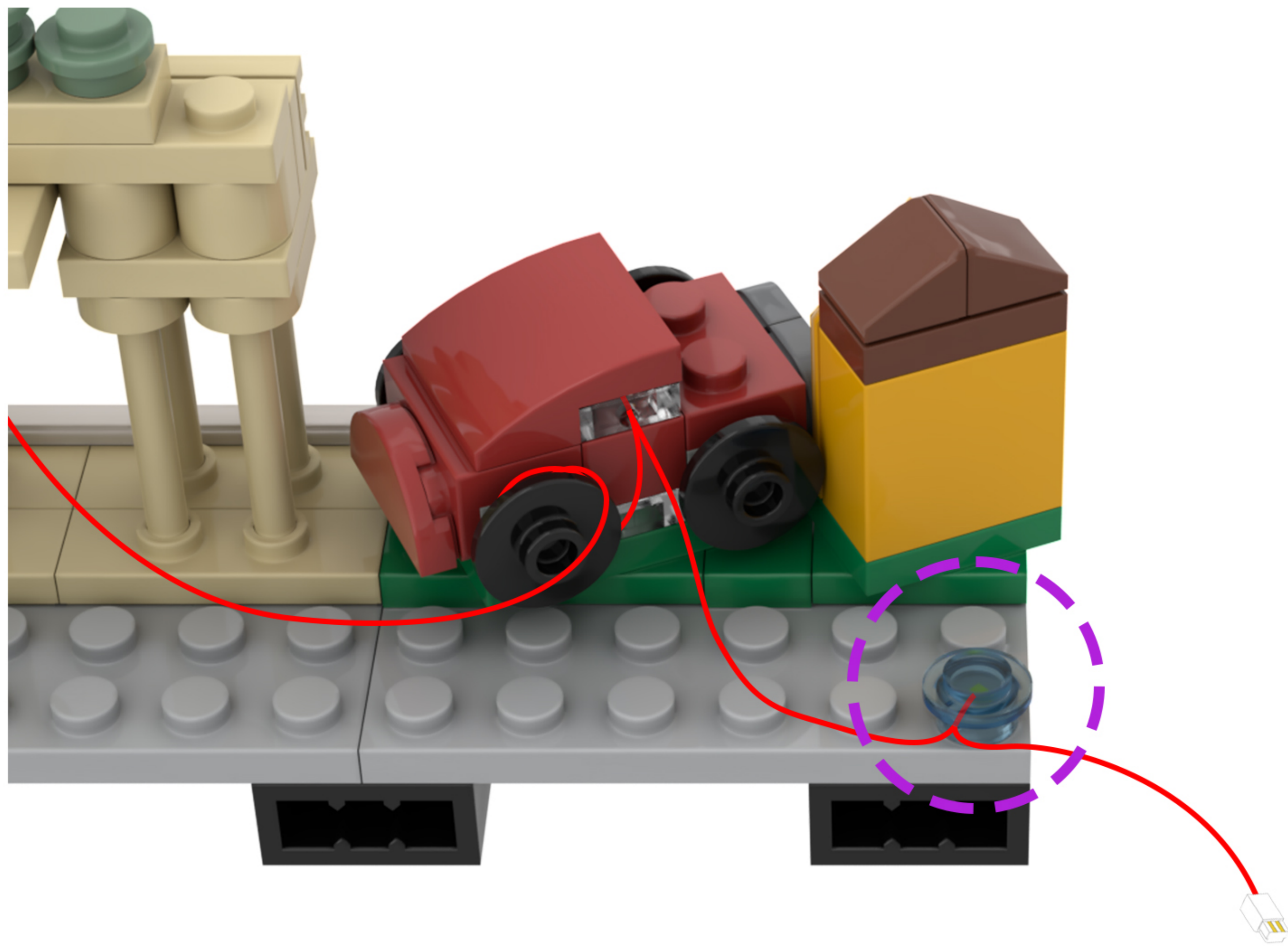

Hint: Route the light cord to the right.

15

EN: Take out the disassembled building blocks and reassemble them.

DE: Nehmen Sie die zerlegten Bausteine heraus und setzen Sie sie wieder zusammen.

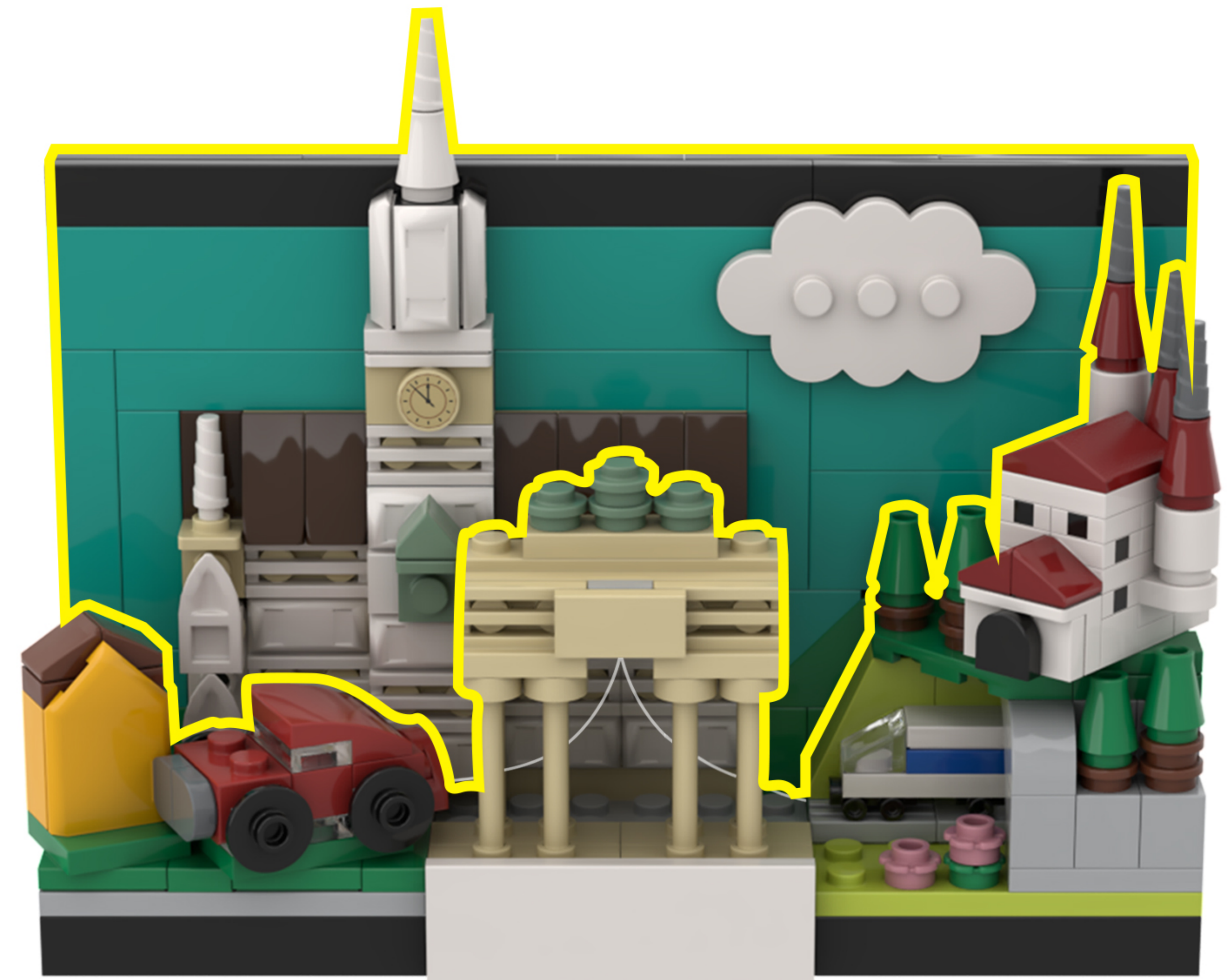
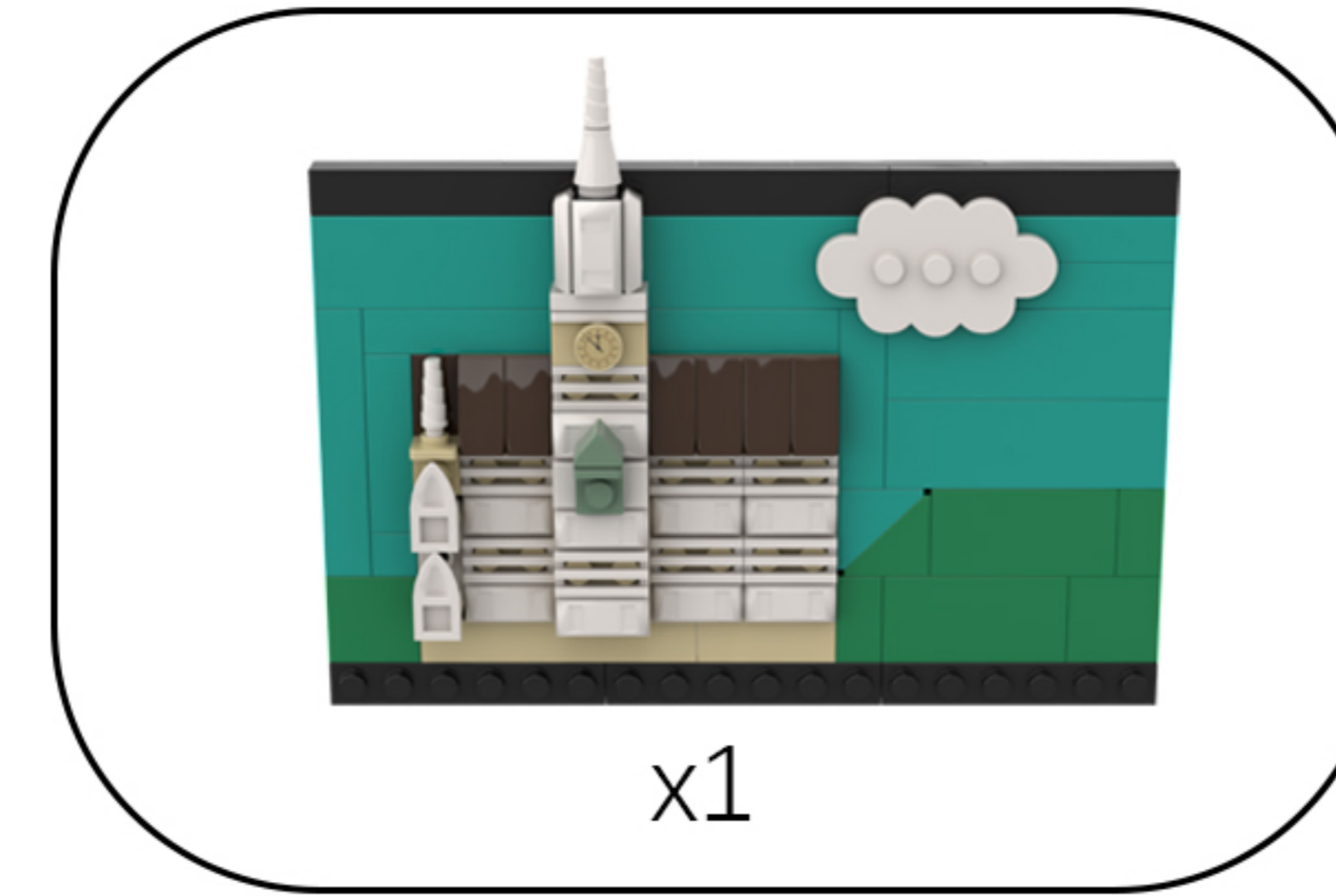

16

EN: Rotate the model to its back side.

DE: Drehen Sie das Modell auf die Rückseite.

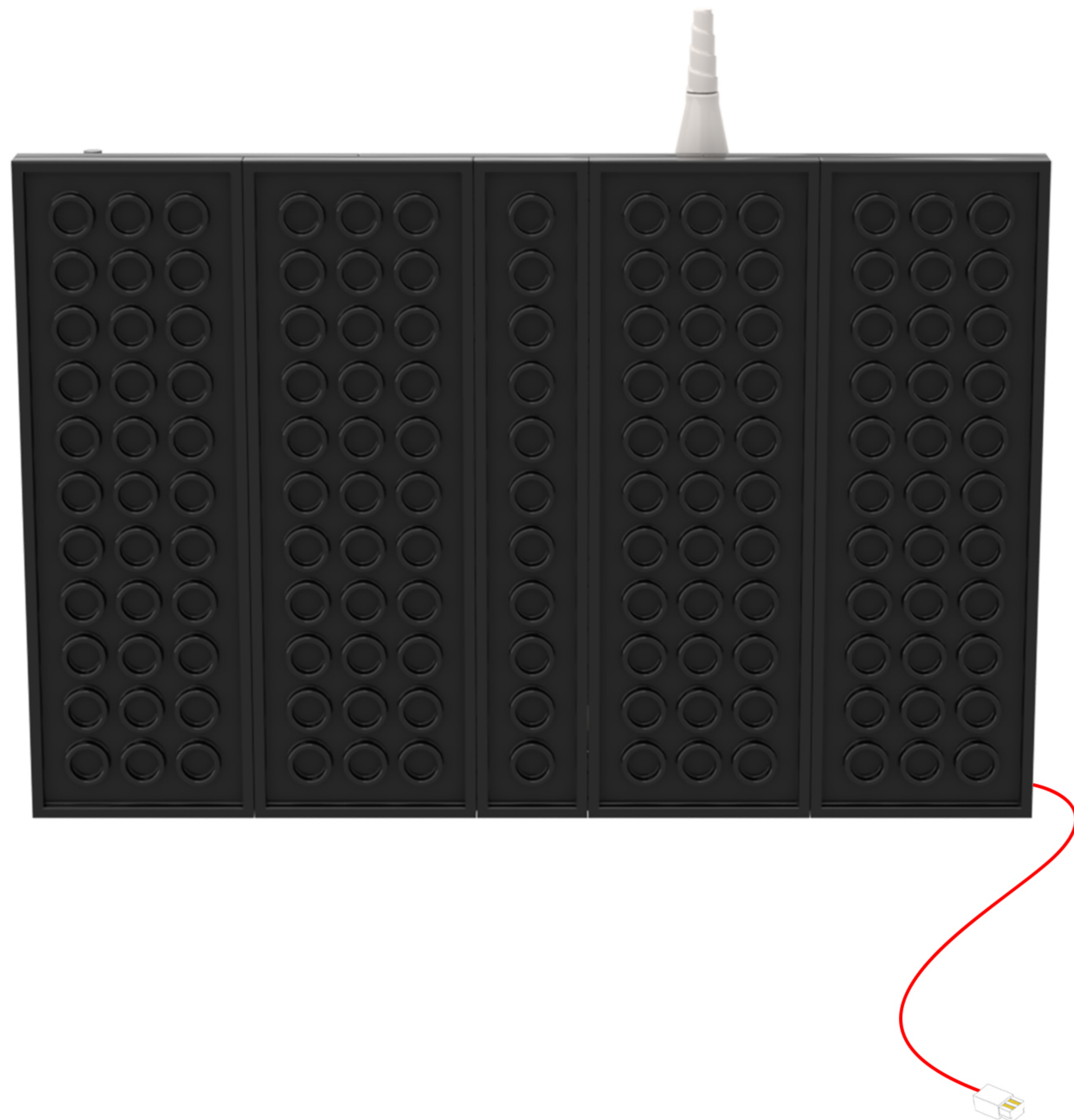
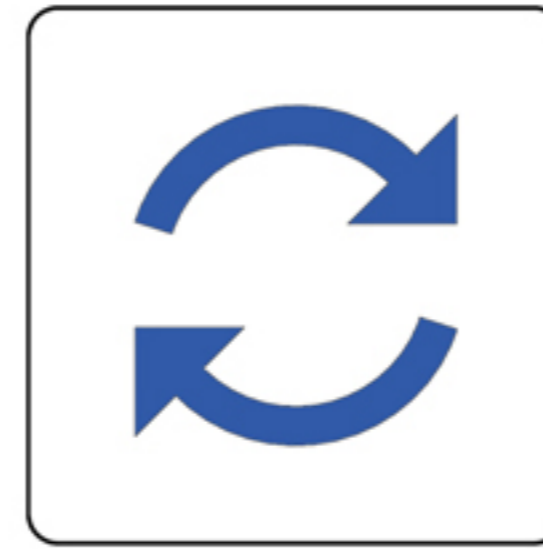

17

EN: Take the expansion board and USB power cable out of Bag 2 and connect them together.

DE: Nehmen Sie die Erweiterungskarte und das USB-Stromkabel aus Beutel 2 und verbinden Sie beide miteinander.

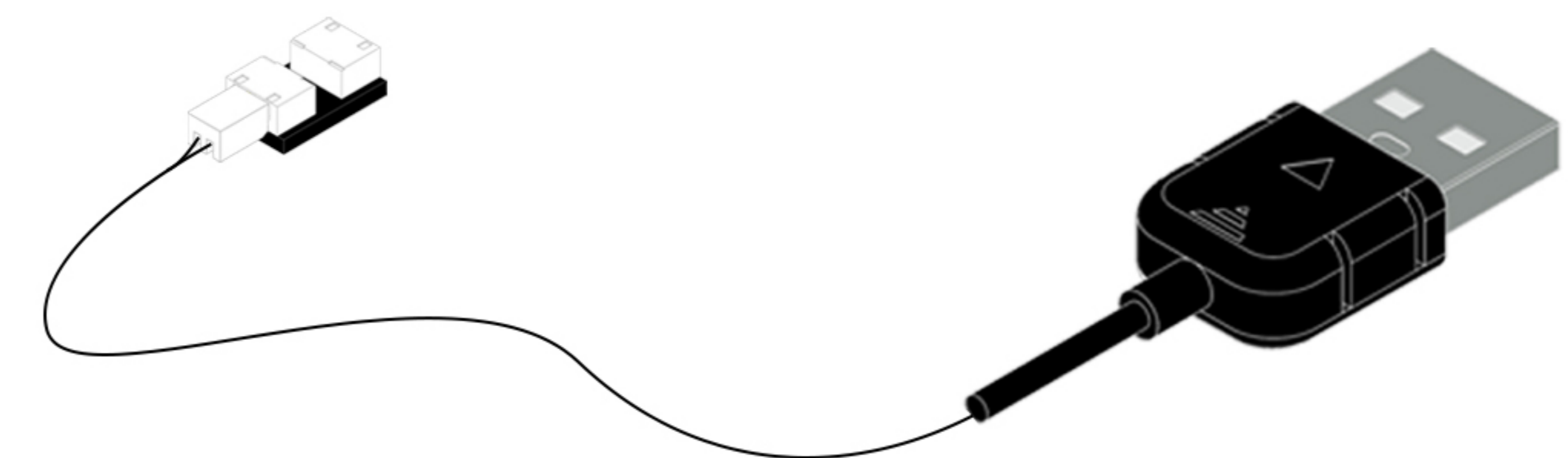
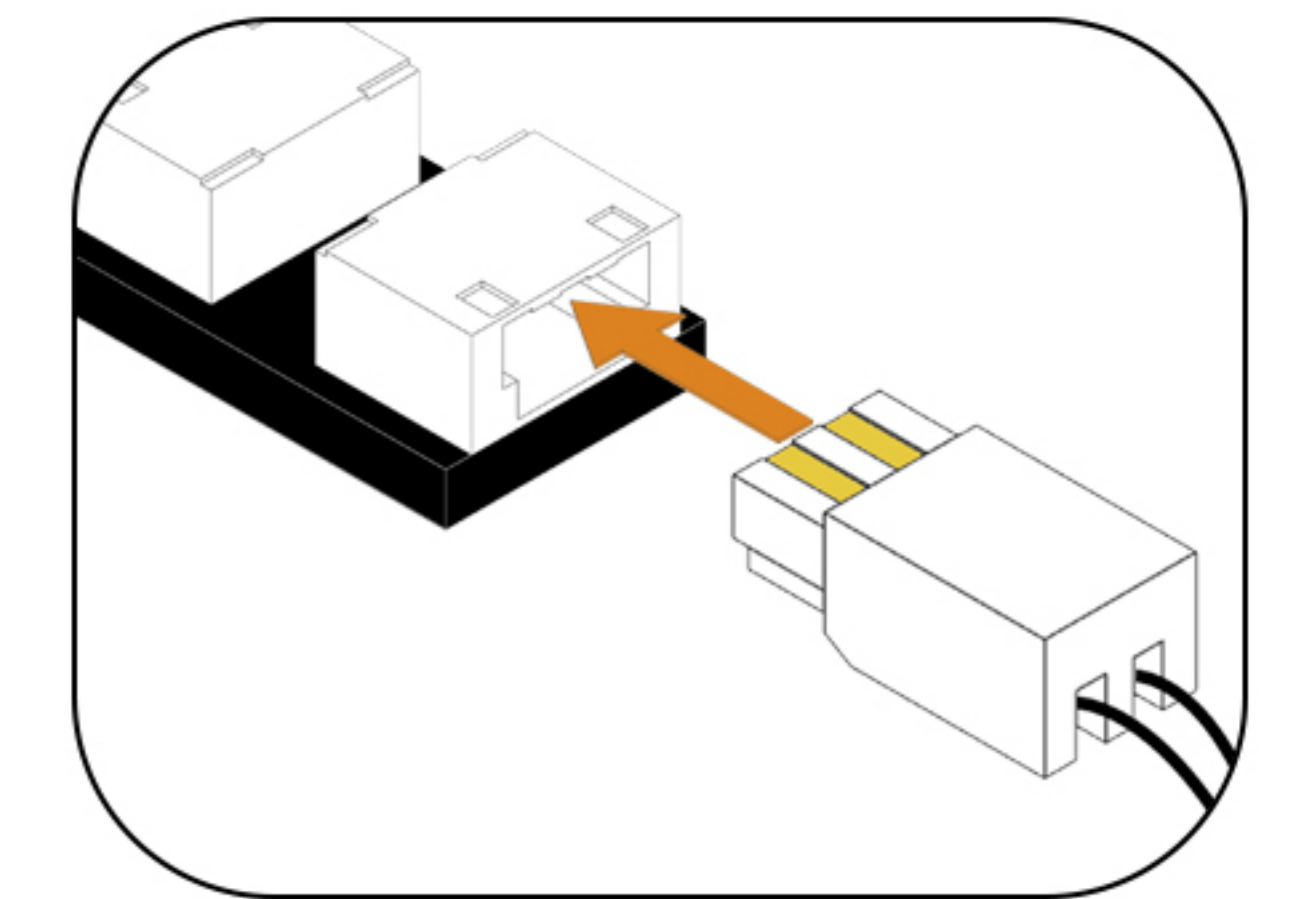
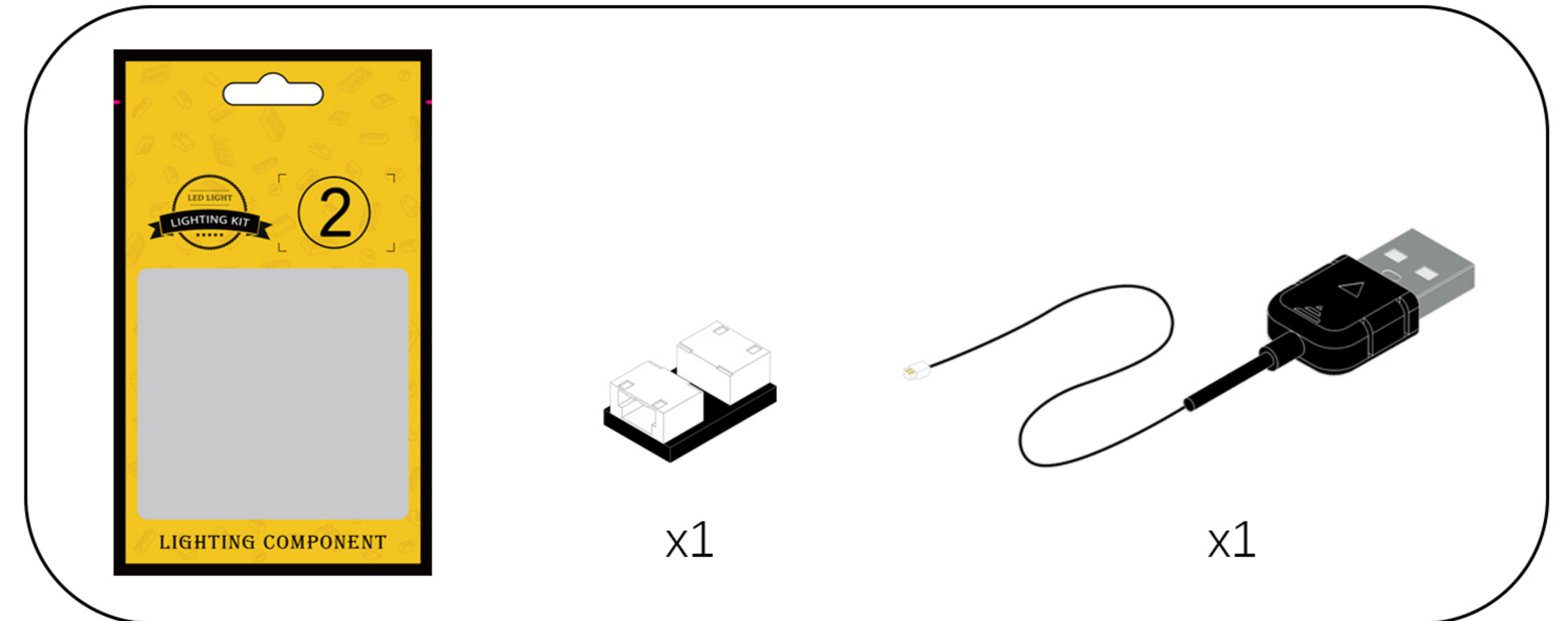

18

EN: Connect the lamp wires to the expansion board.

DE: Verbinden Sie die Lampenkabel mit der Erweiterungskarte.

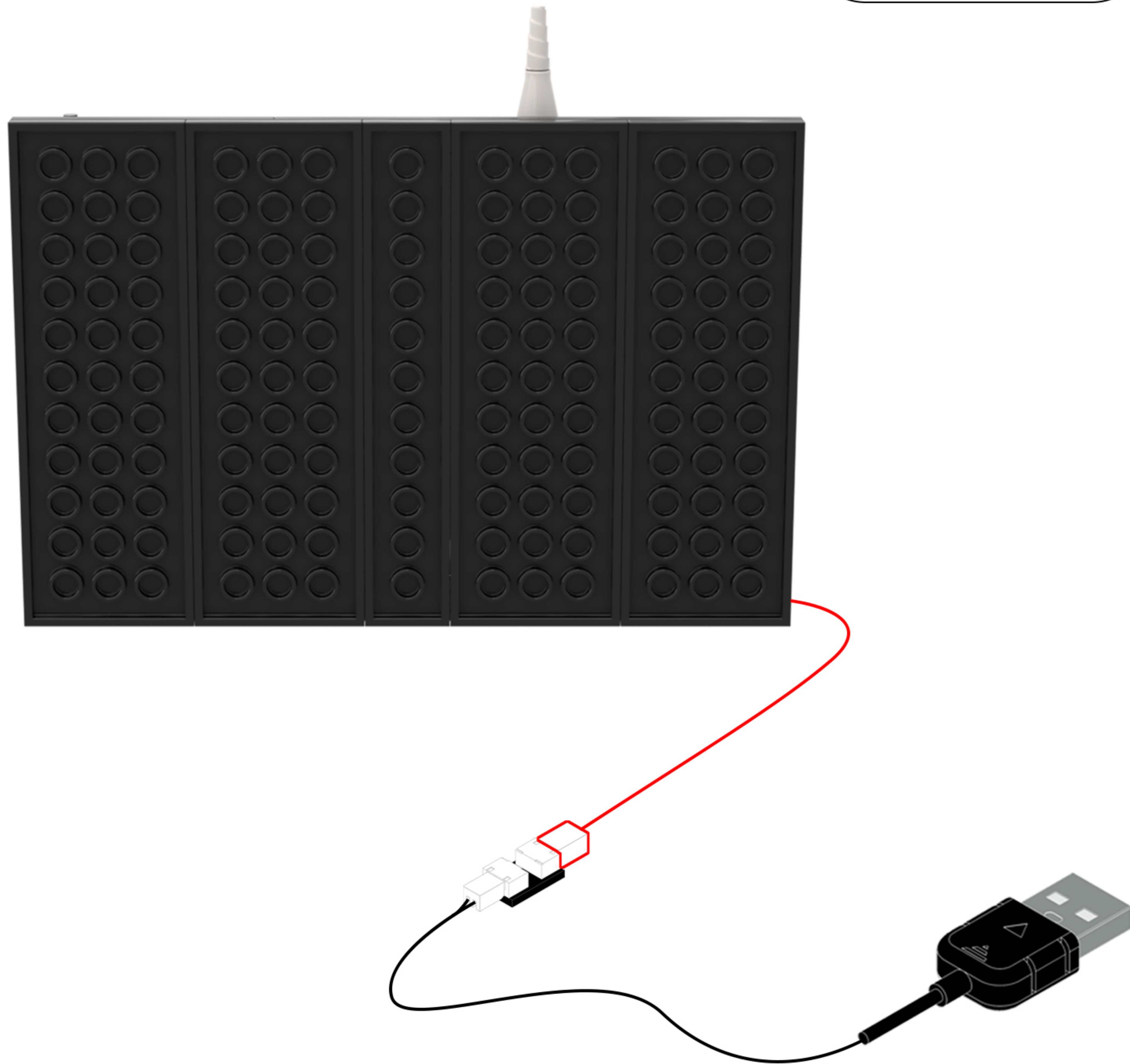
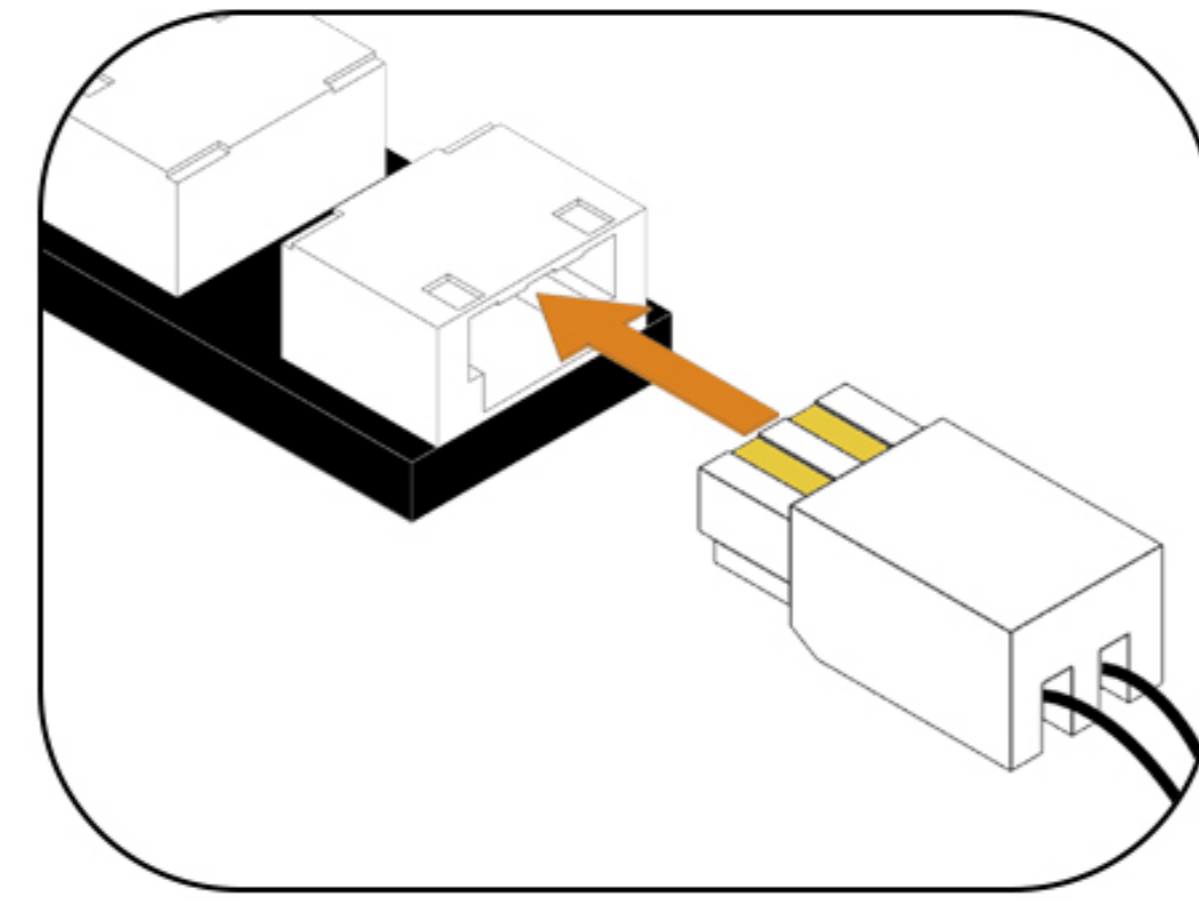

19

EN: Peel off the adhesive backing of the expansion board and attach it to the location shown in the illustration.

DE: Entfernen Sie die Schutzfolie von der Rückseite der Erweiterungsplatte und kleben Sie sie an die in der Abbildung gezeigte Stelle.

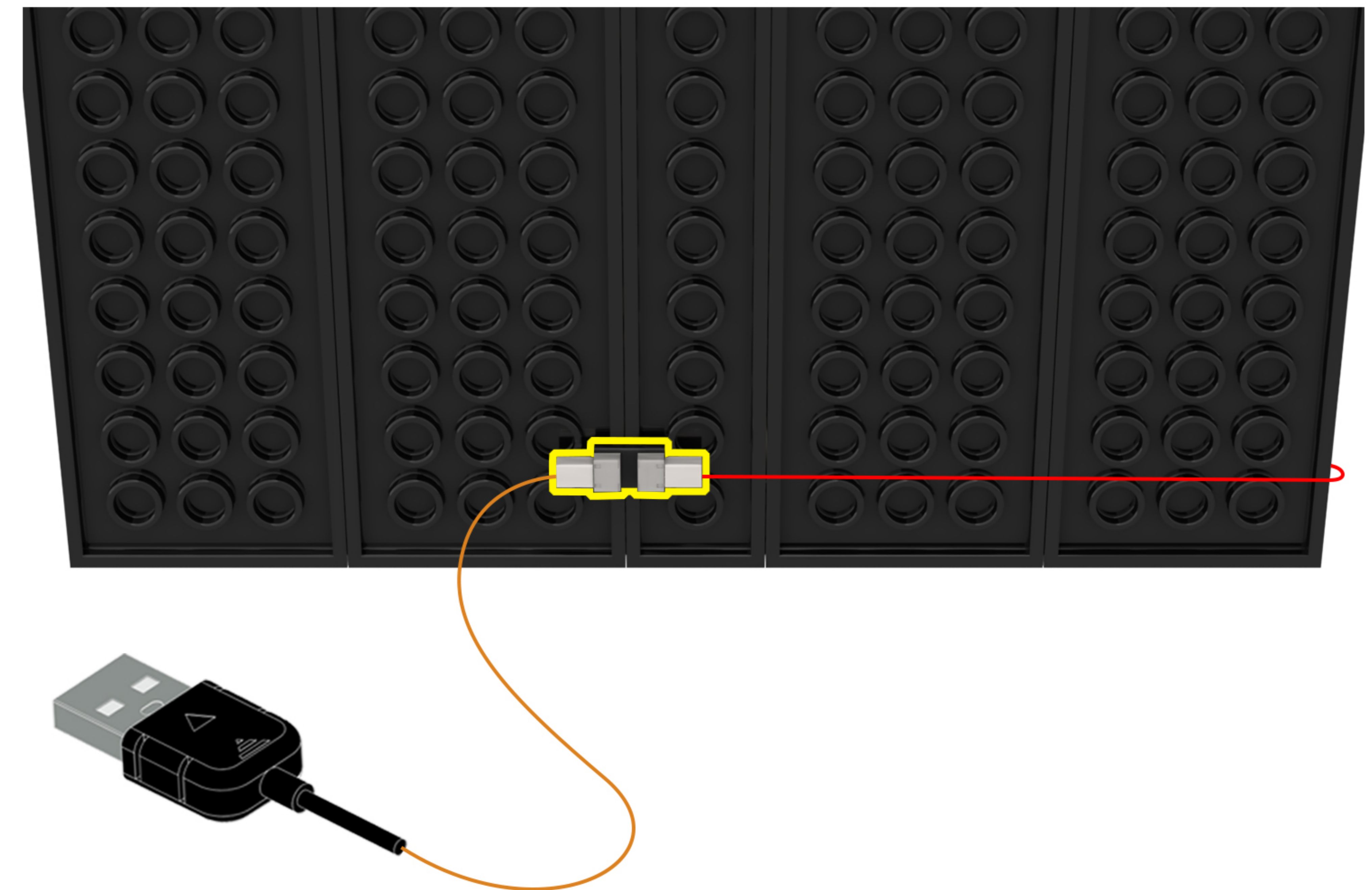

20

EN: Once installed, connect the power supply and give it a try!

DE: Die Installation ist abgeschlossen. Schließen Sie das Gerät an die Stromversorgung an und probieren Sie es aus!





Above our designers to provide the relevant ideas and instructions. But please move to the following:

- 1: about our company this product parts material, product quality do you have comments and suggestions?
- 2: about this product installation instructions and installation of the degree of difficulty do you have views and suggestions?
- 3: if in the operation of the product we provide ideas encountered any problems, please contact us in a timely manner.

## Tips

If you encounter any installation problems please contact the seller, we will be happy to help you solve!