

INSTALLATION GUIDE

72050 Mario Kart – Luigi & Mach 8



LED light kit compatible with Lego

Instructions for installing this kit:

This set includes 9 pouches. (The battery case functions similarly; please select your own power source. This article uses a USB power cable.)

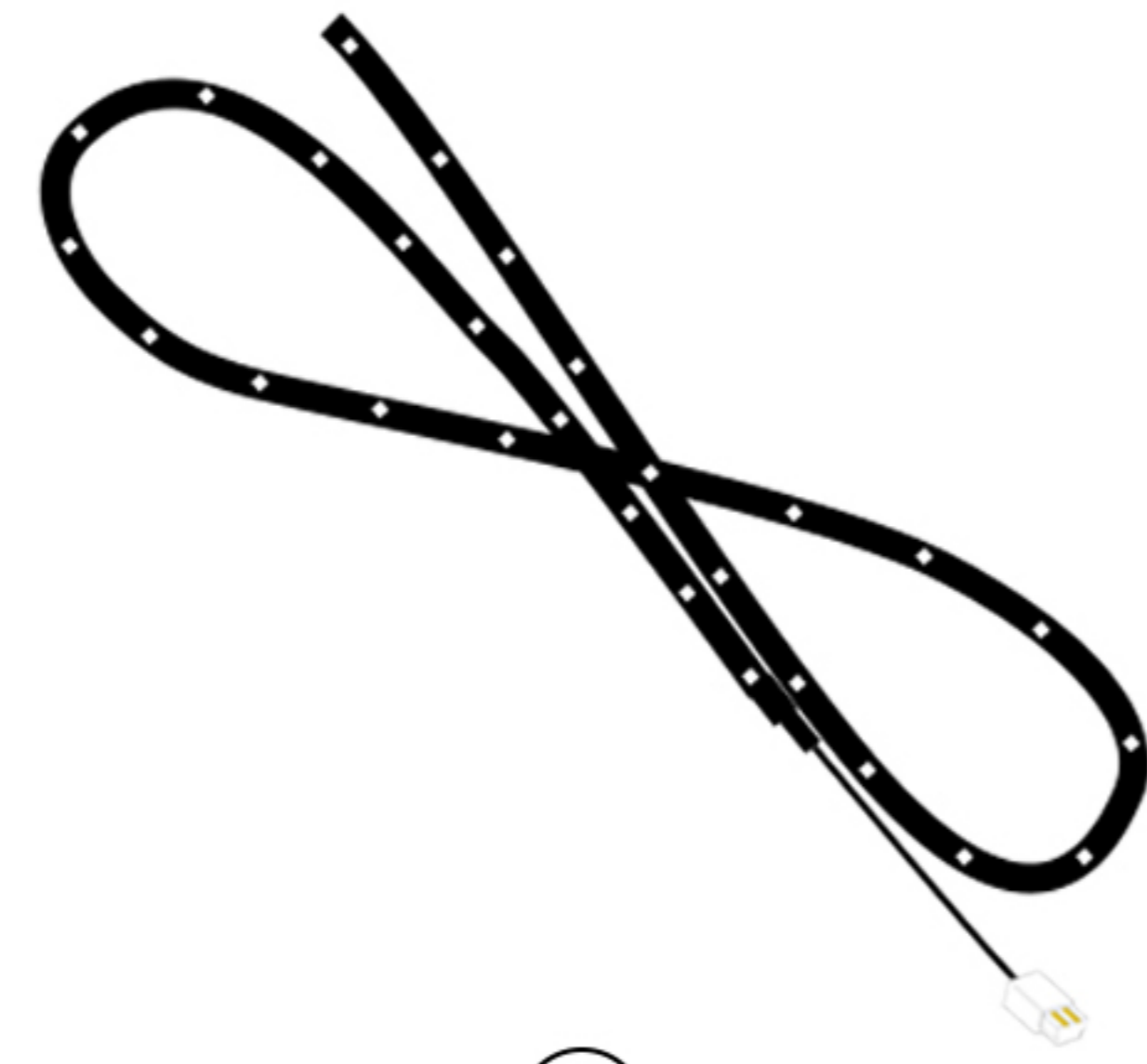
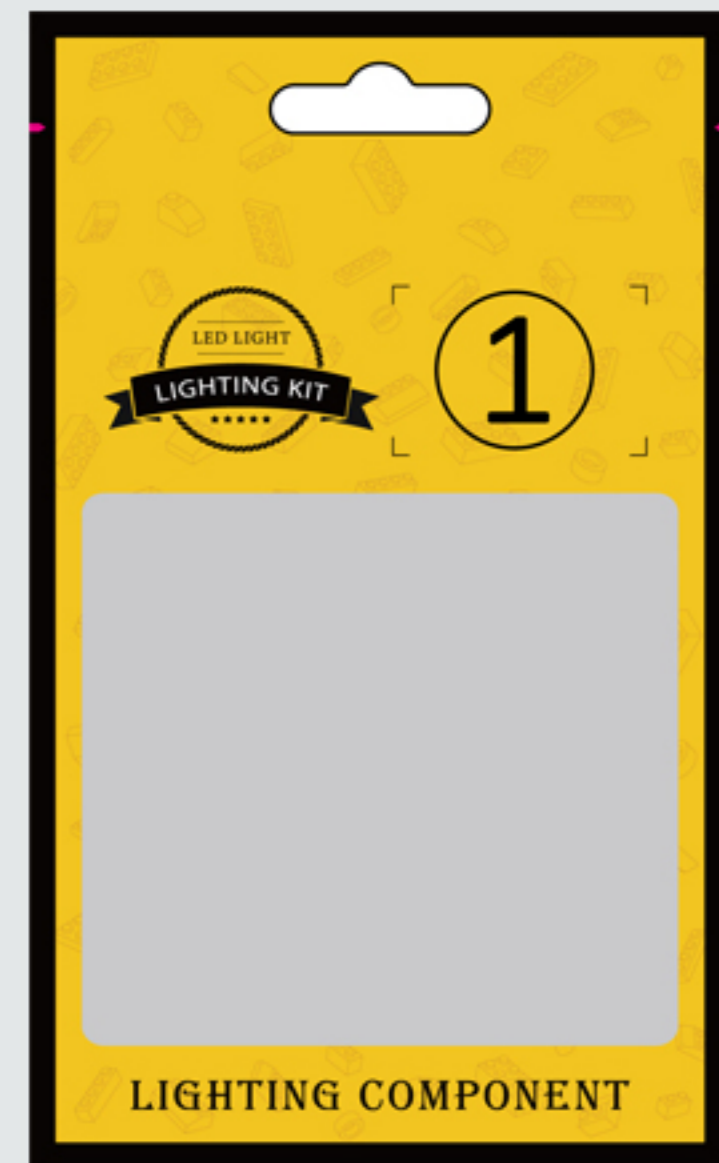

(X2)

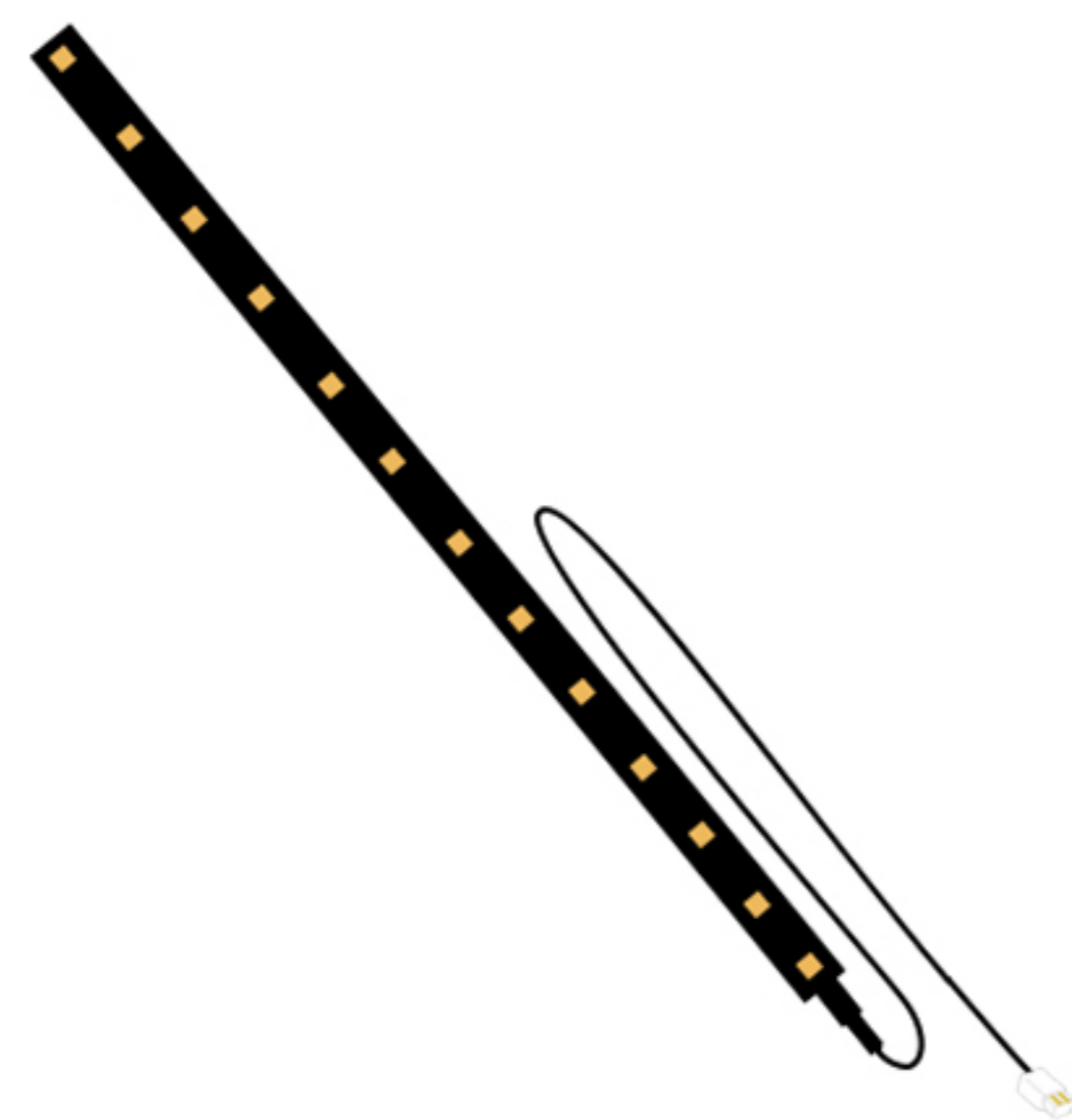

(X2)

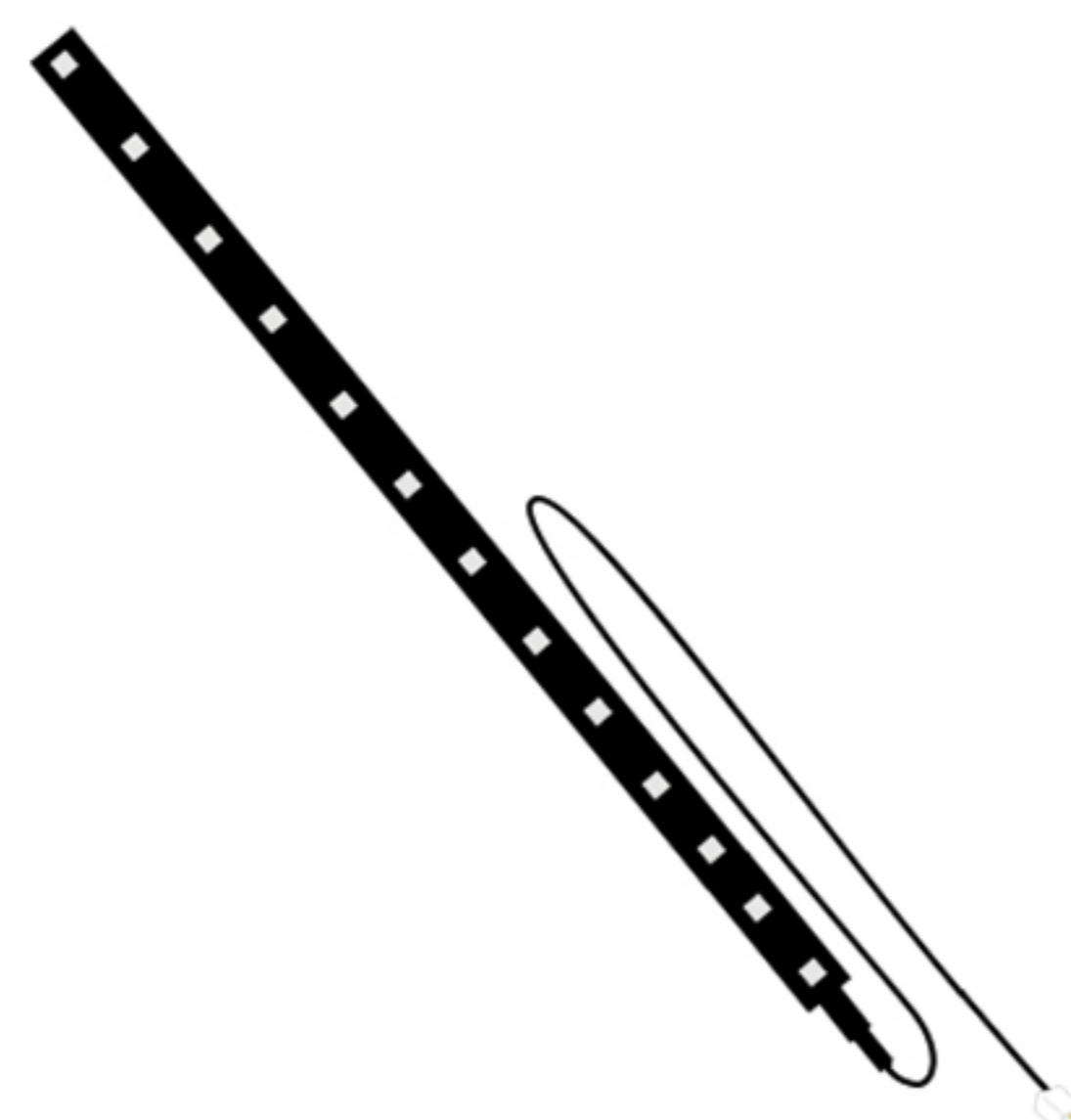

(X1)

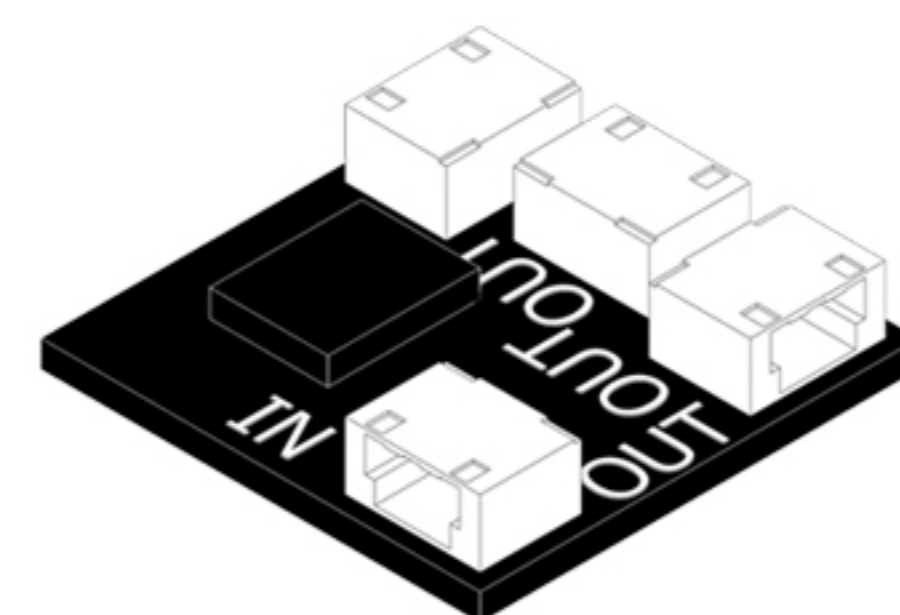

(X1)

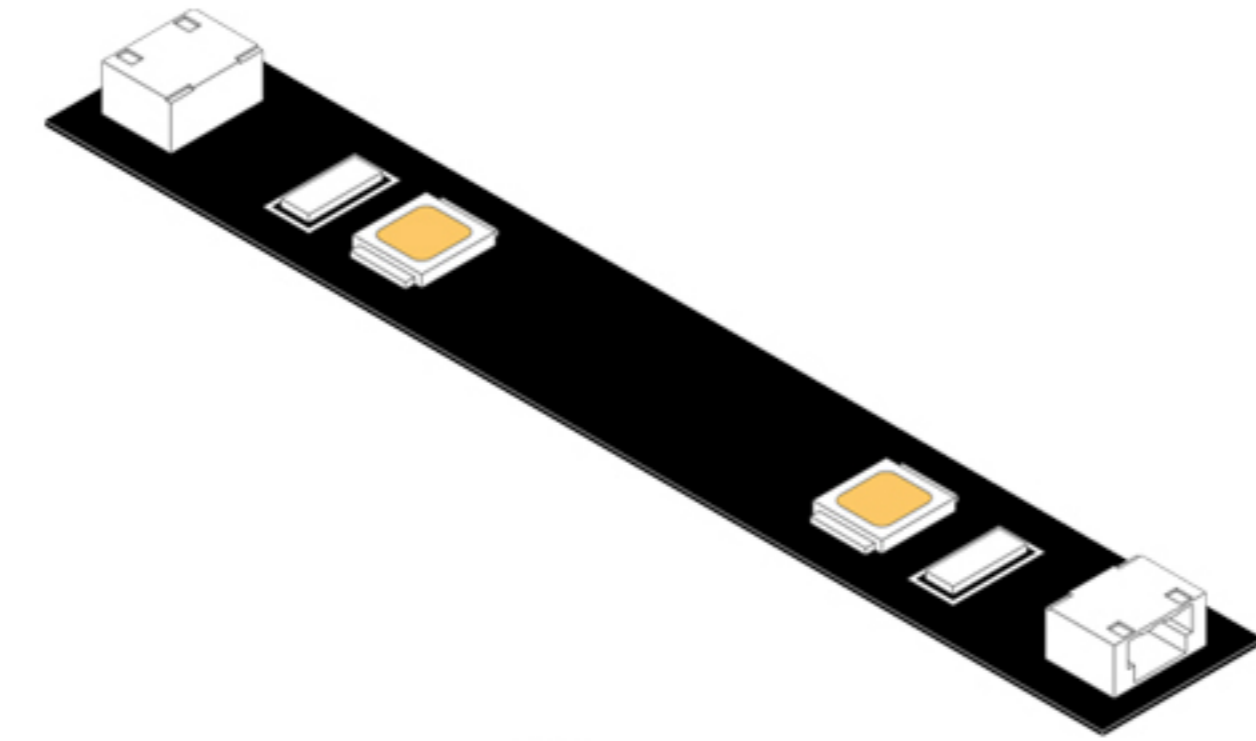

X2

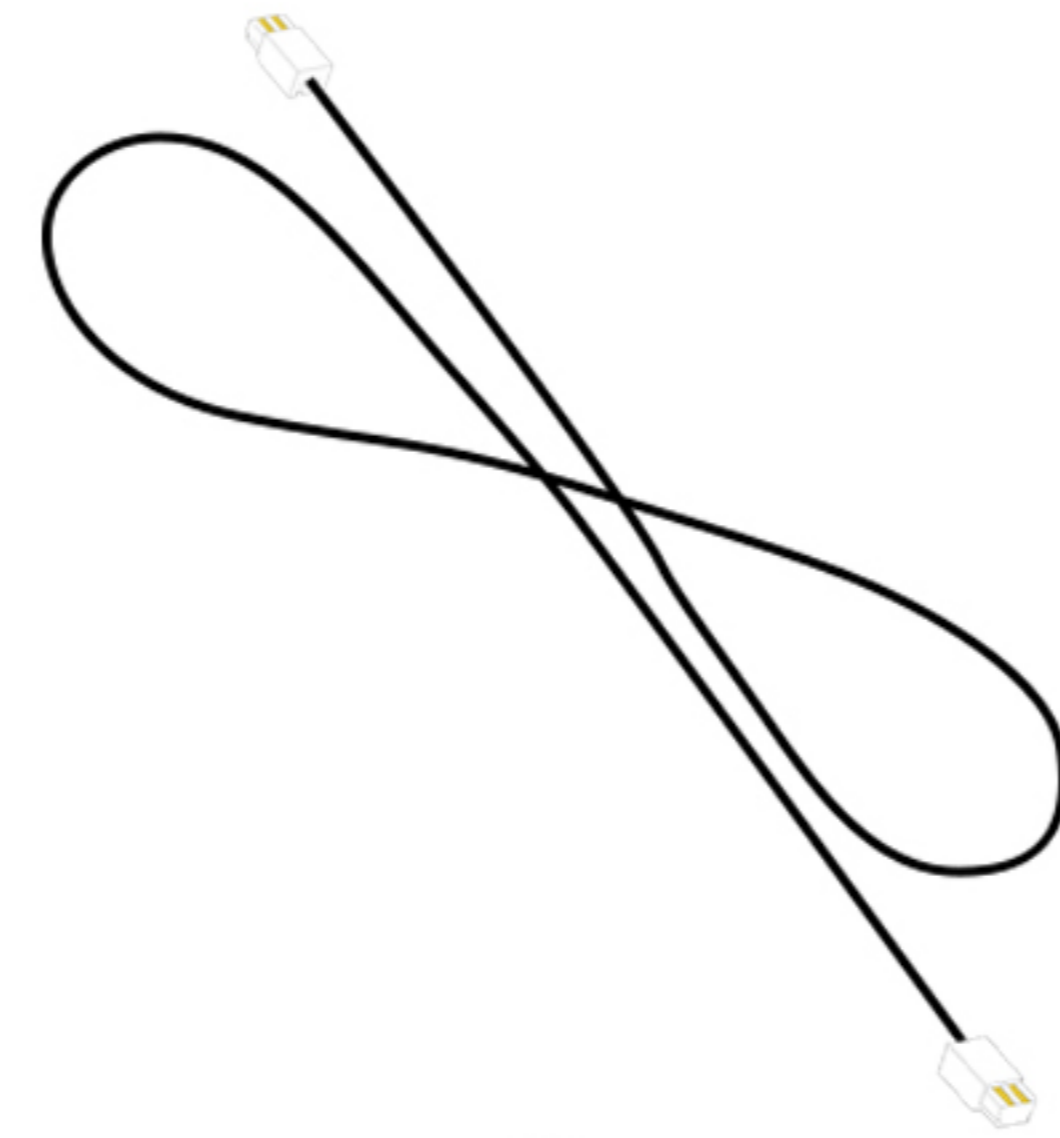

5cm

X2

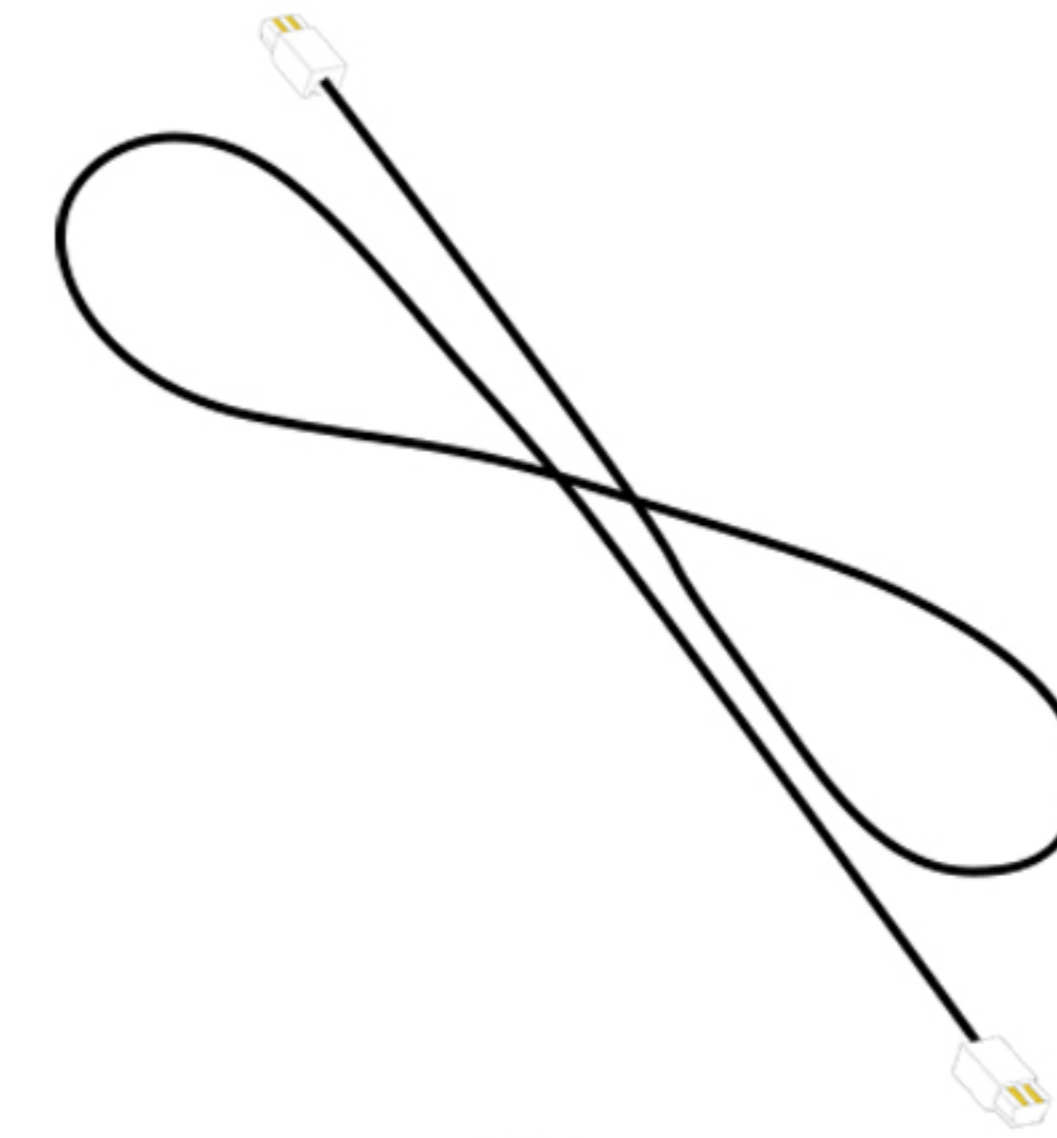

20cm

X2

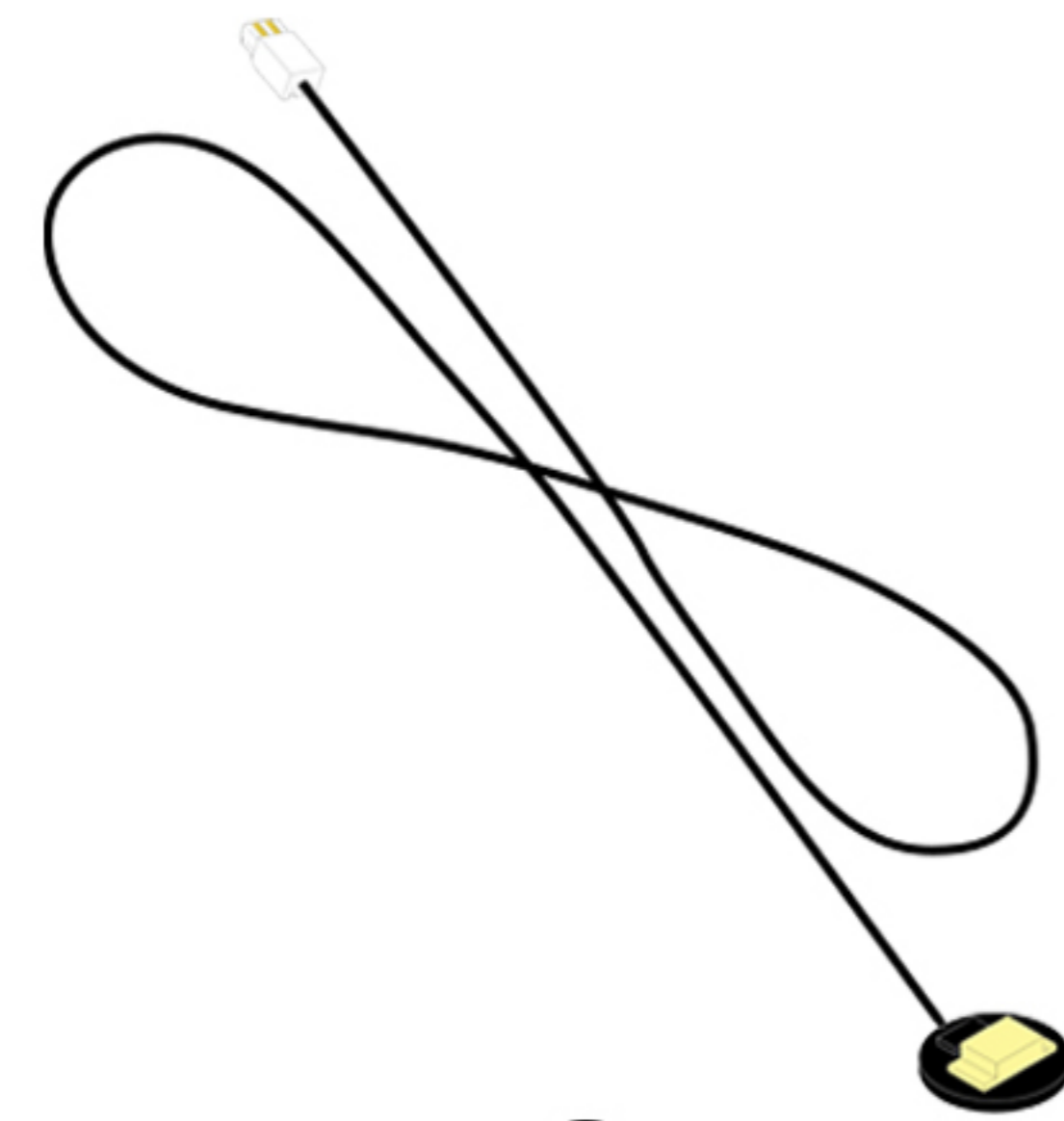

15cm

X2

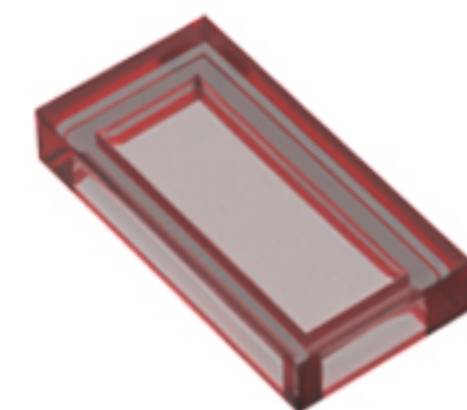
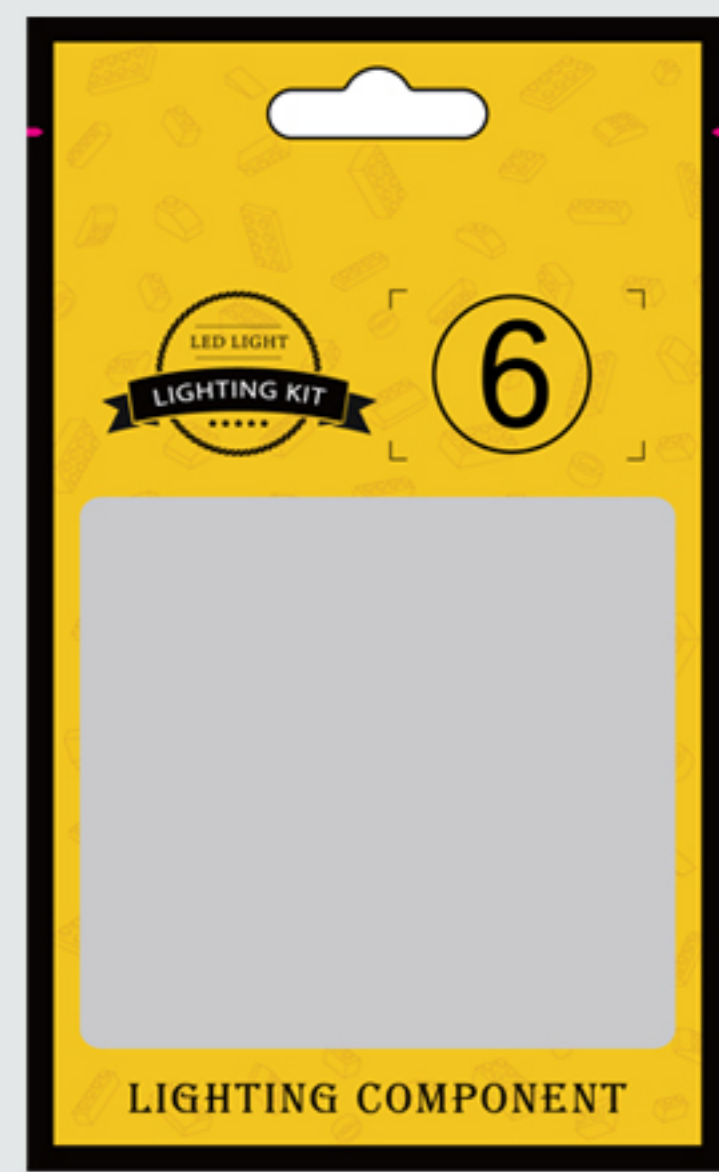

X2

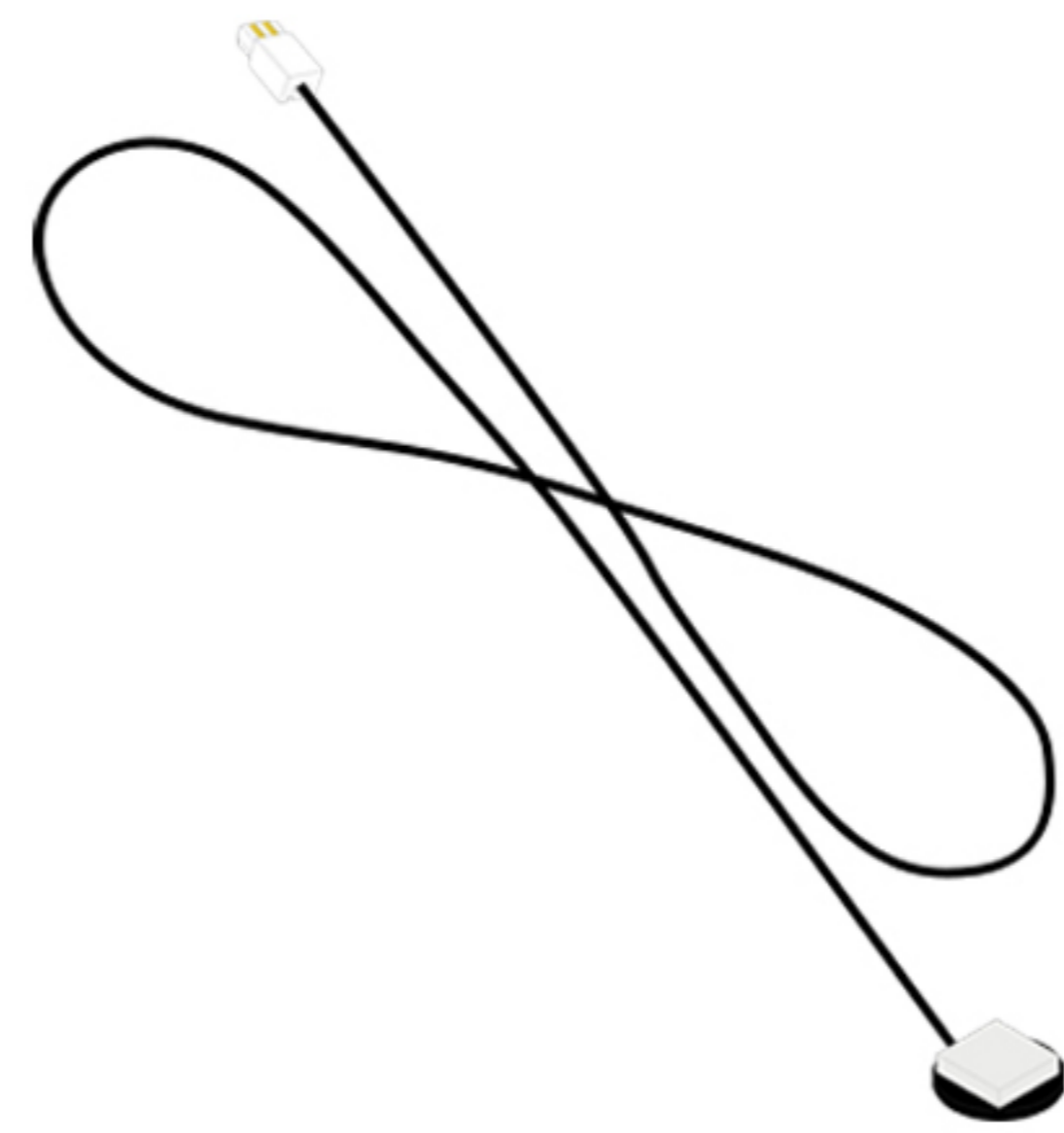

15cm

X2



X2

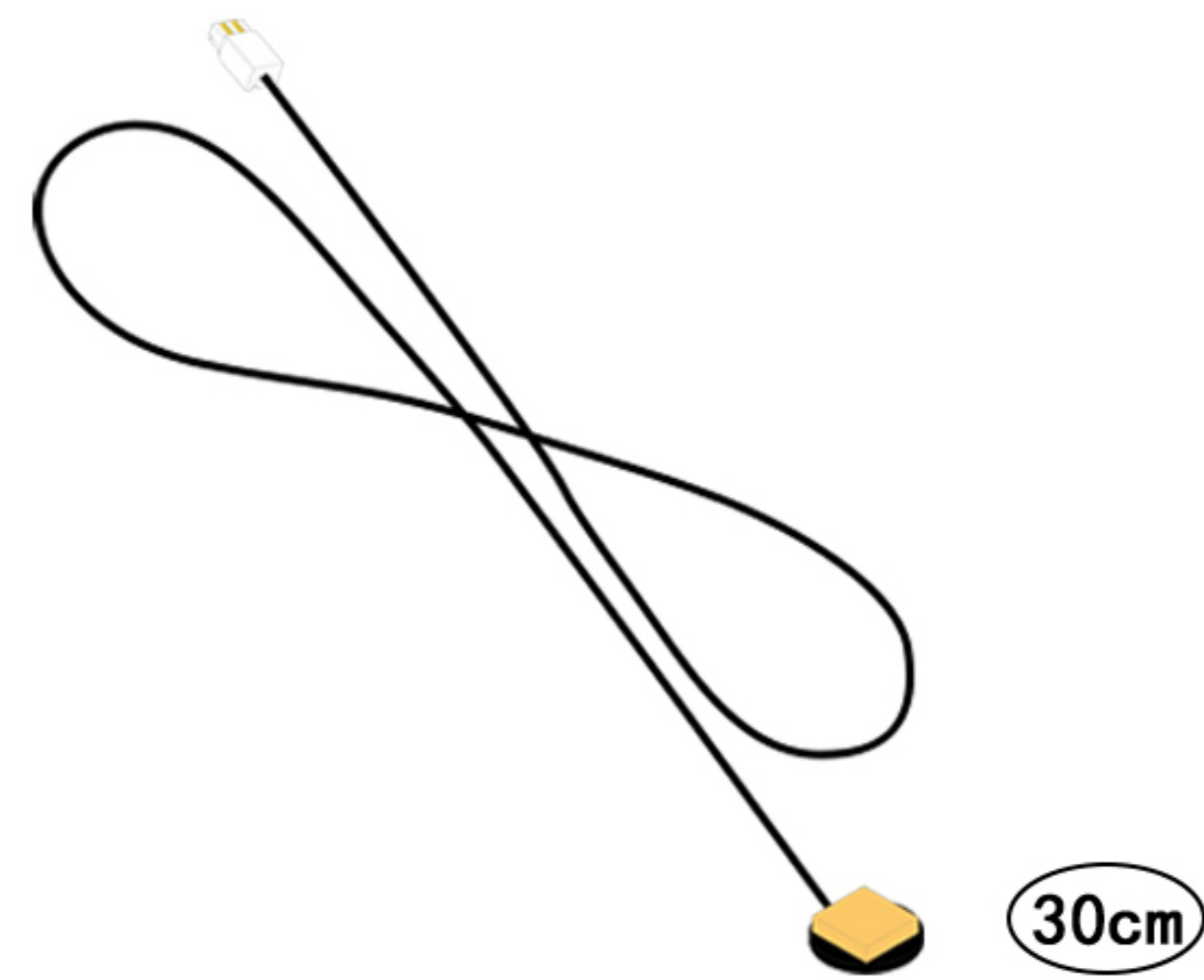

X2

30cm

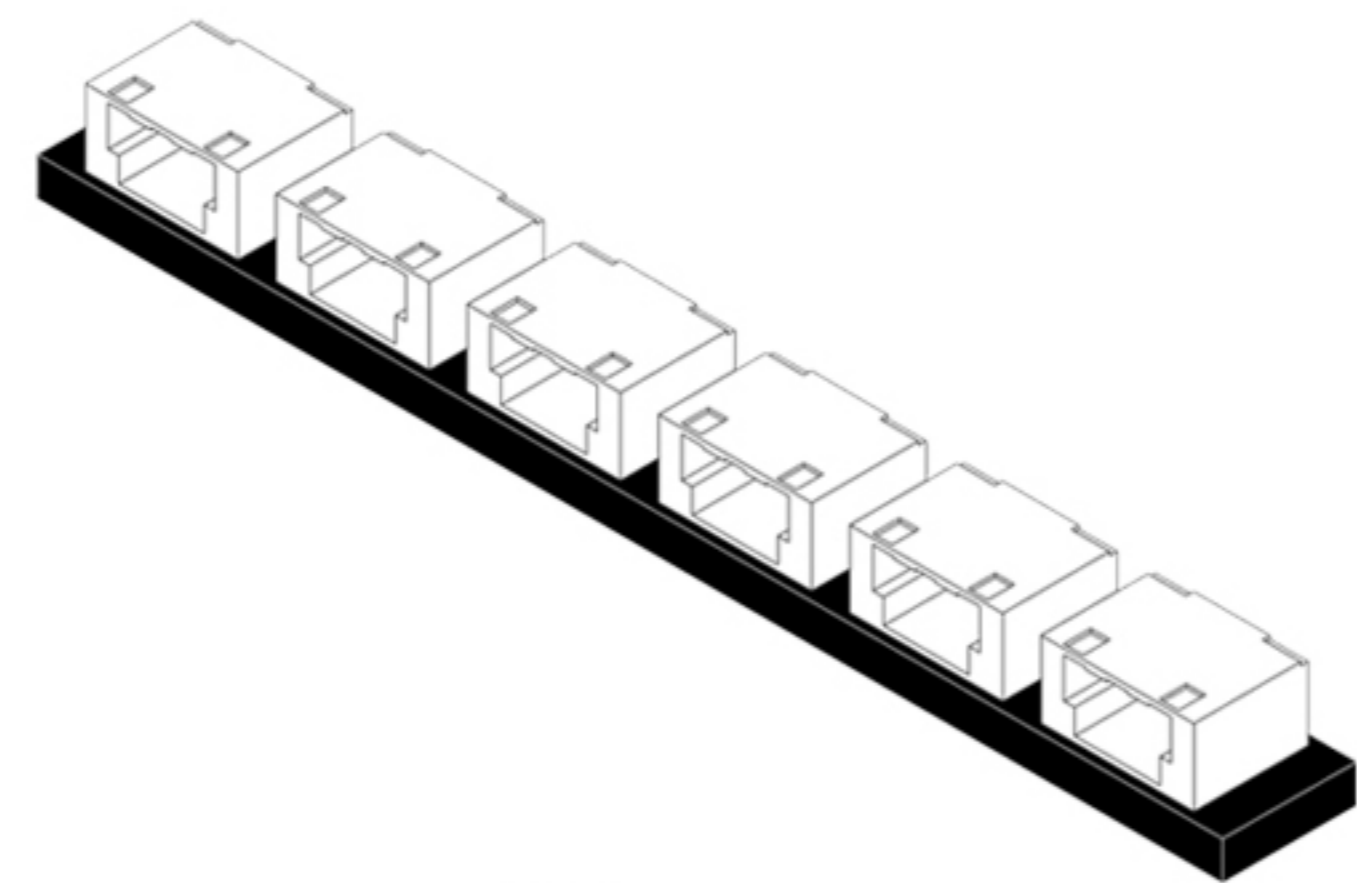

X1

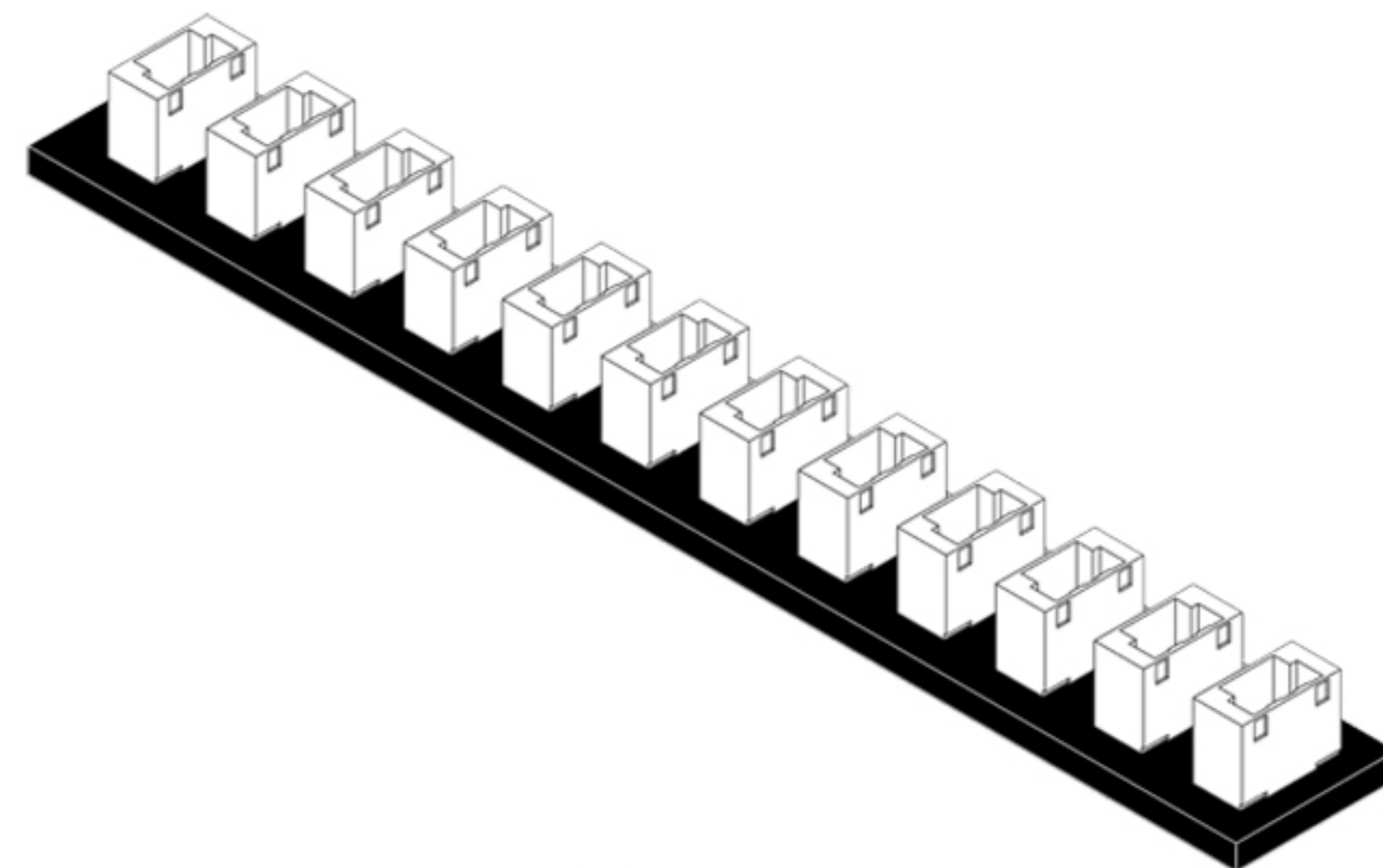

X1

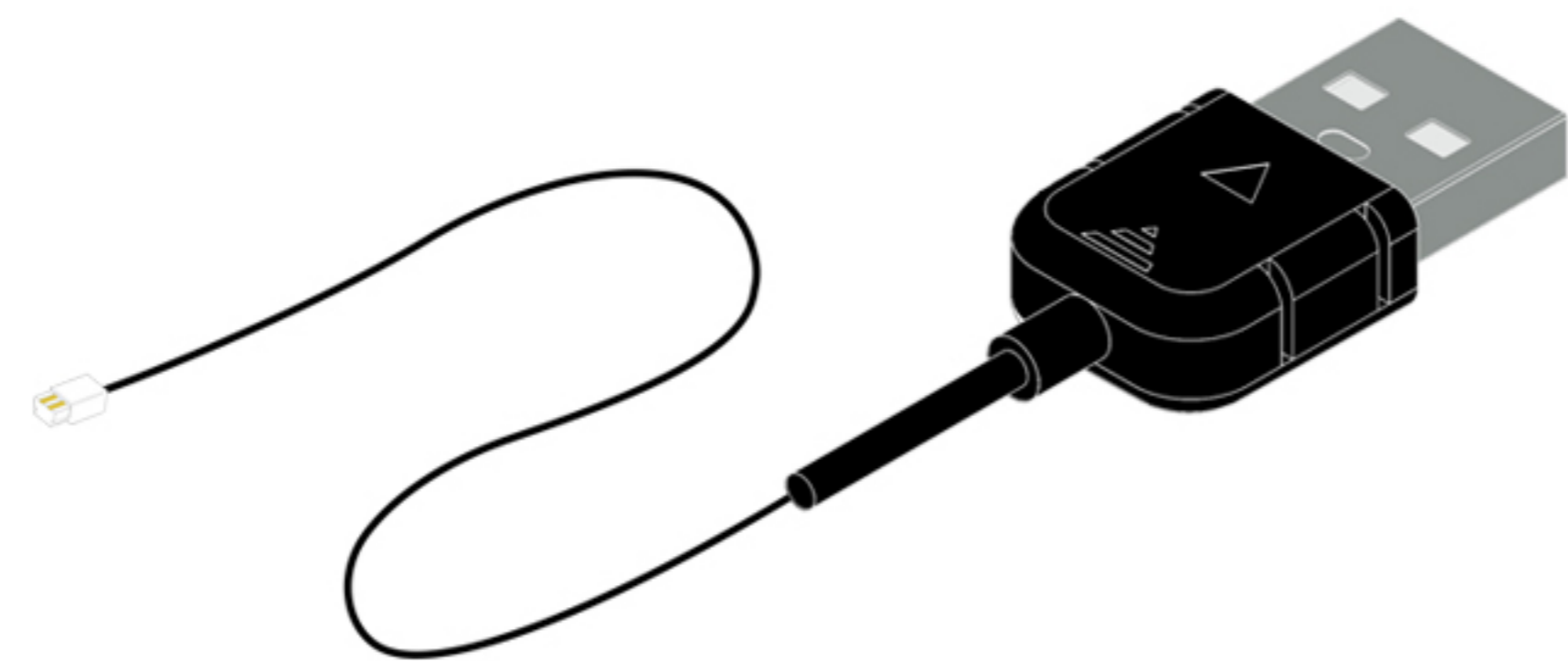
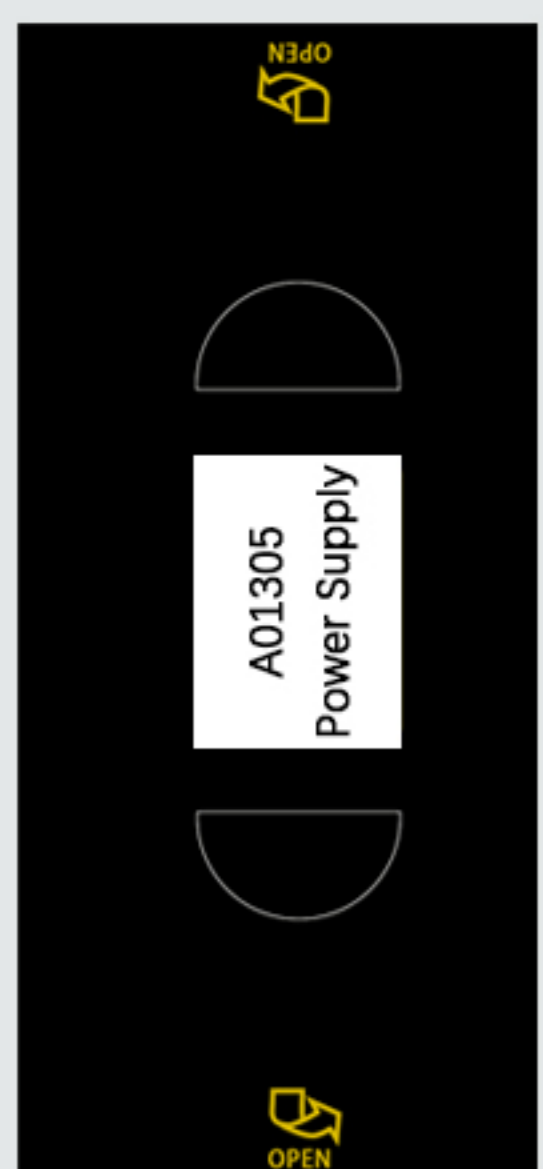

X1

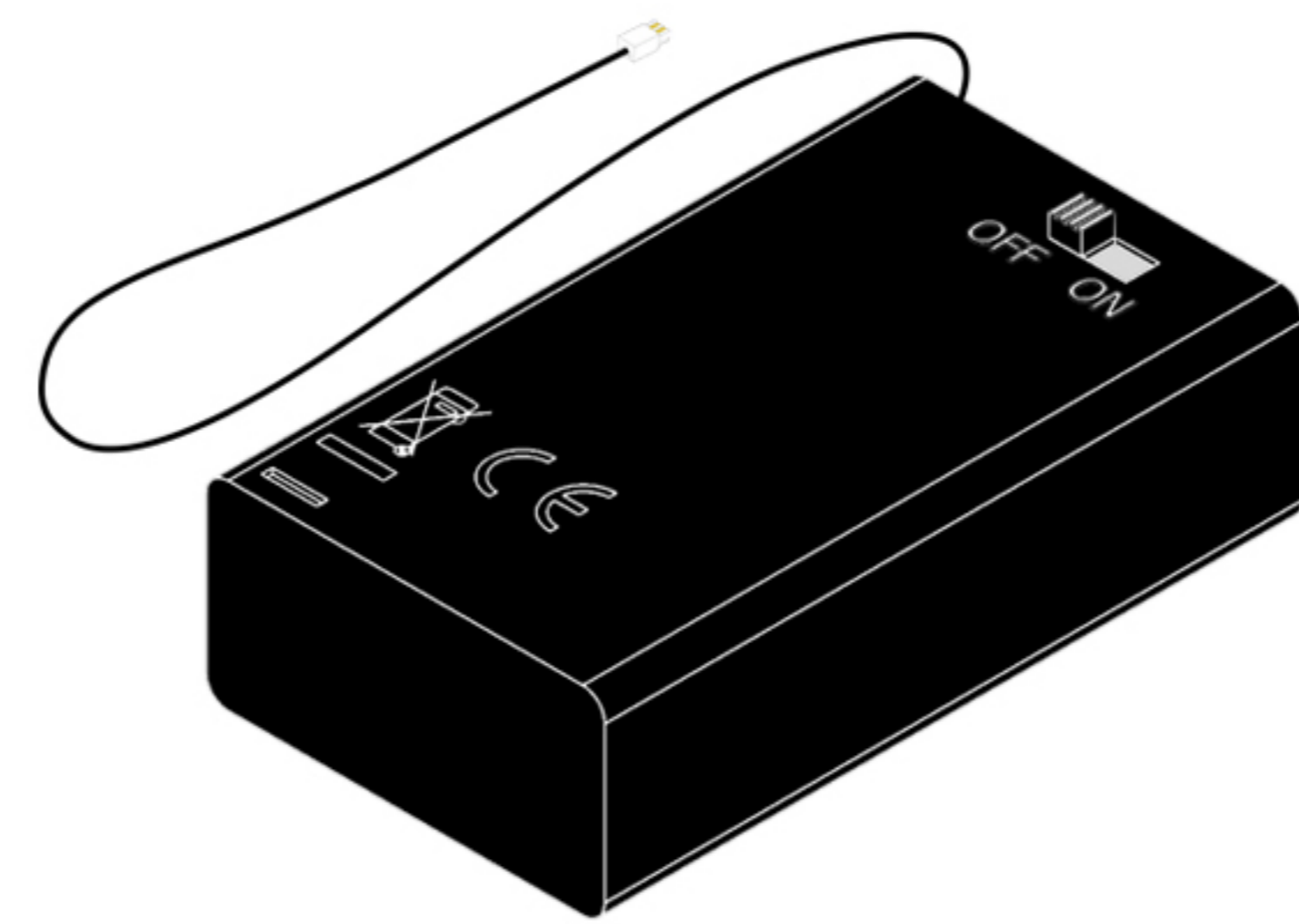

X1

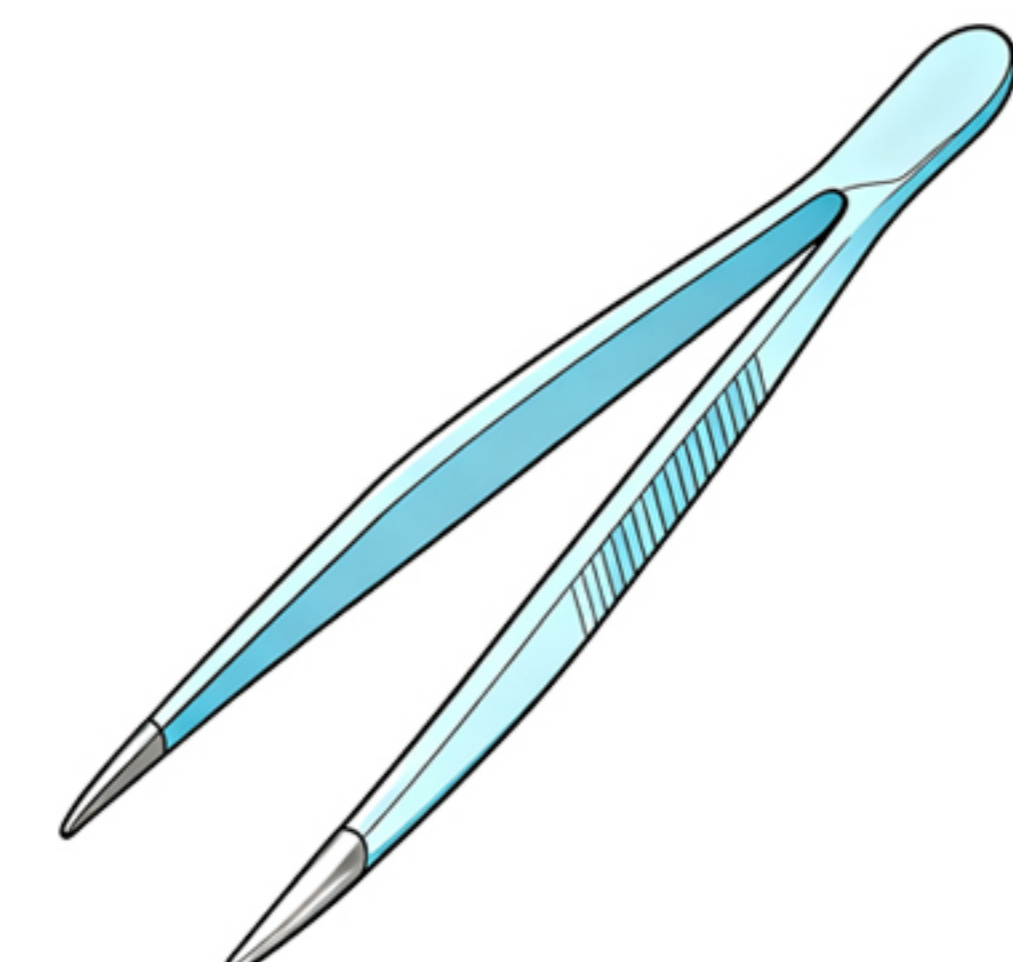

X1

This post will complete the light installation in two main sections.

Step 1-test



Step 2-mounting

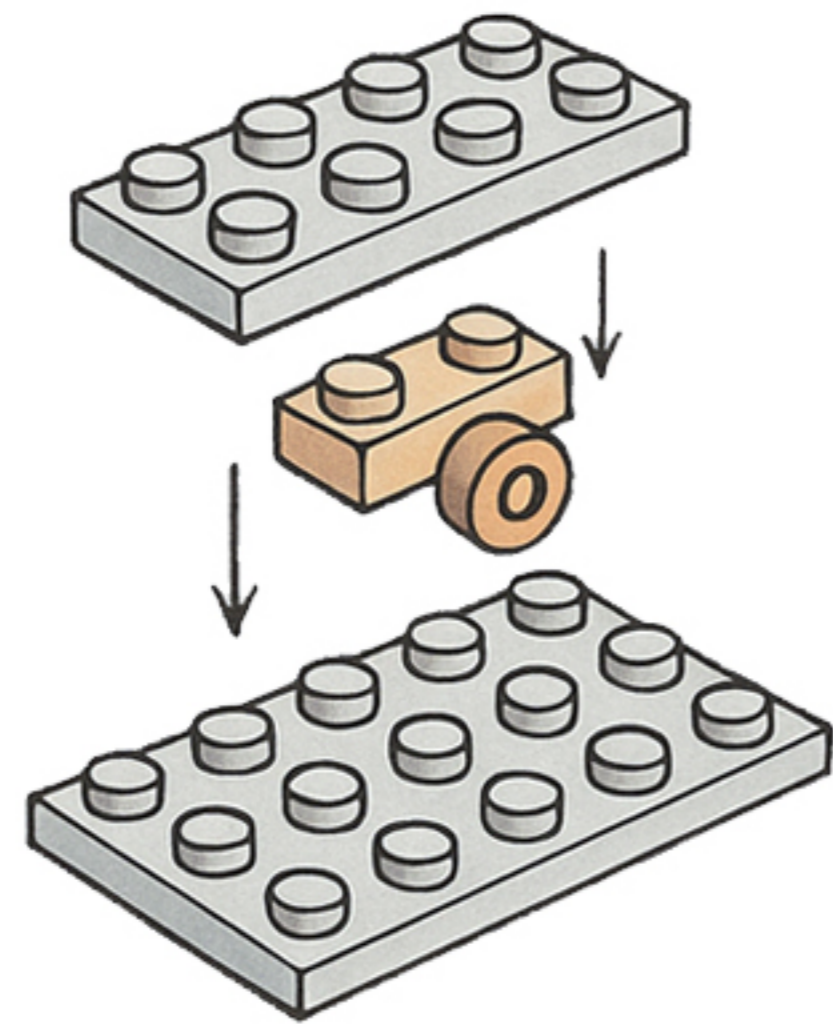

So let's get started!

Step 1-Test.

1

EN: Remove the expansion board from bag #8.

DE: Entnehmen Sie die Erweiterungskarte aus Beutel Nr. 8.

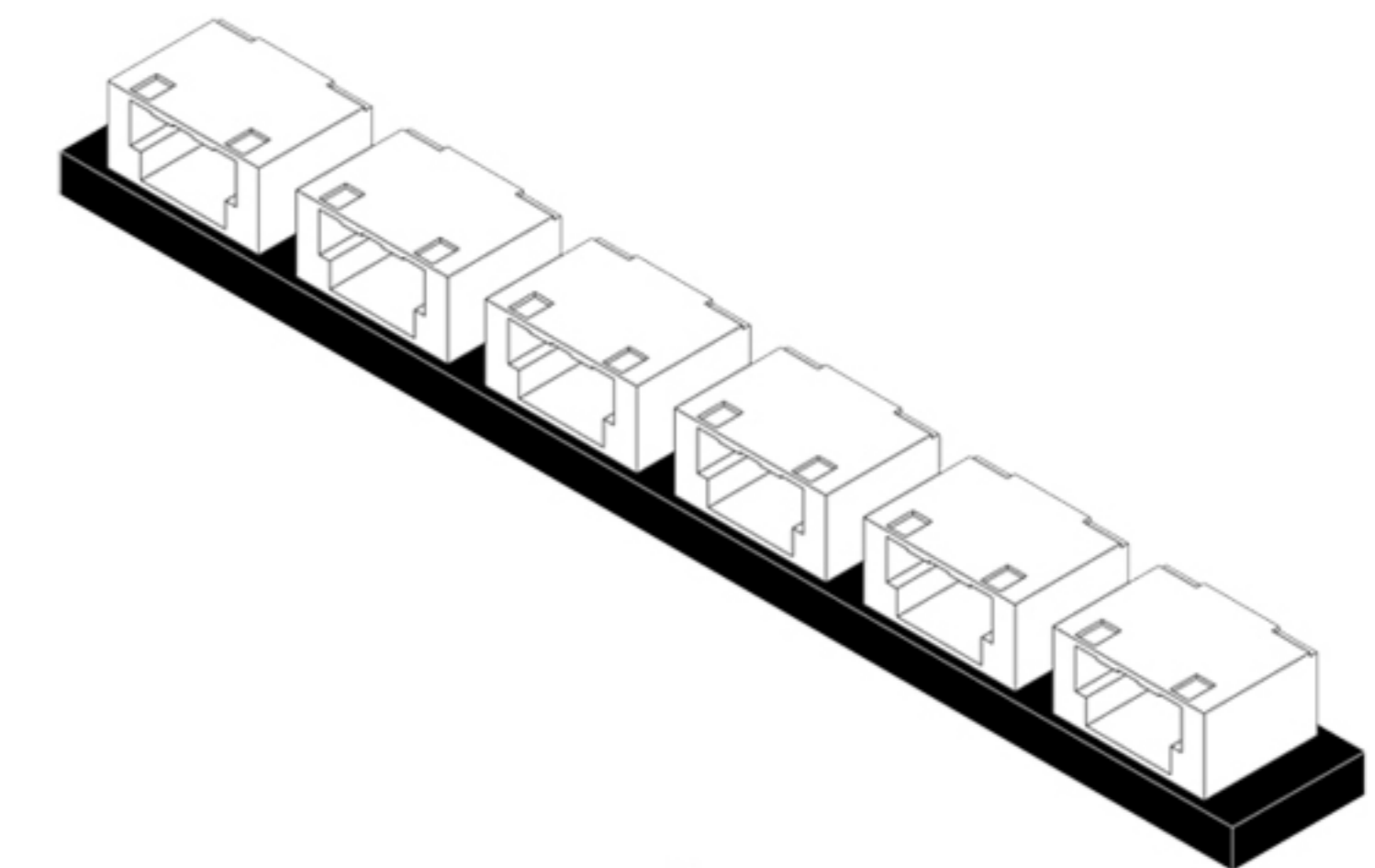

x1

2

EN: Take the USB power cable out of the bag and connect it to the expansion board.

DE: Nehmen Sie das USB-Stromkabel aus der Tasche und schließen Sie es an die Erweiterungskarte an.

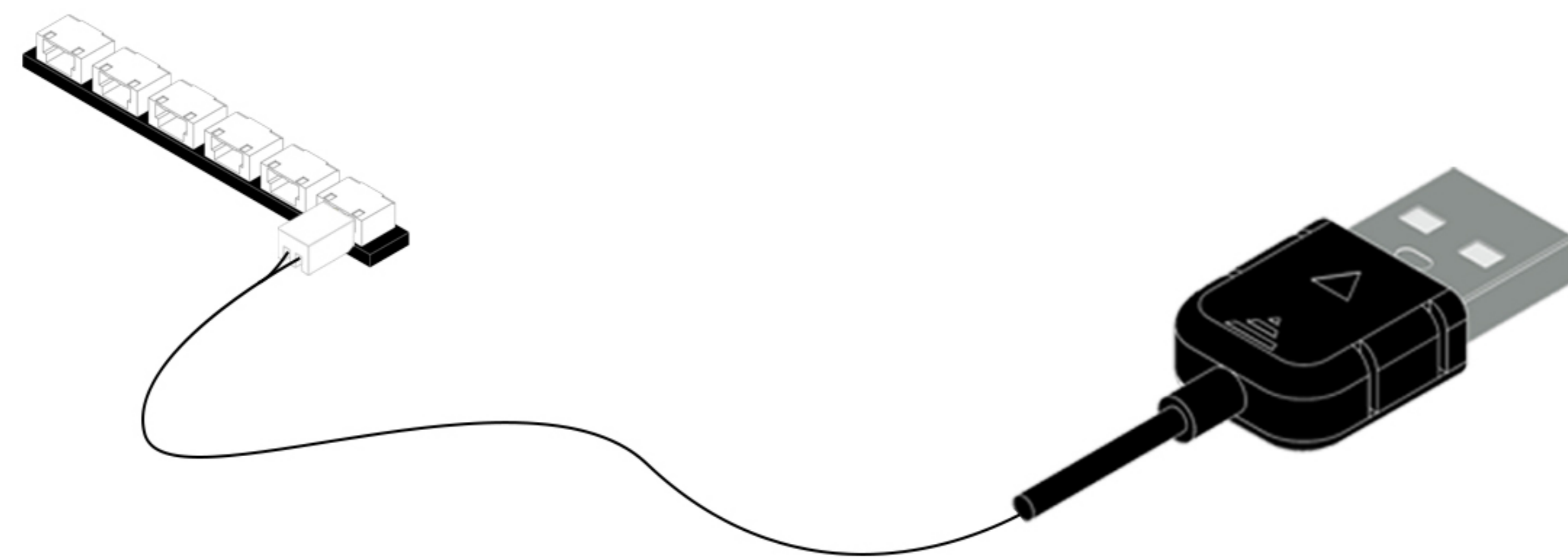
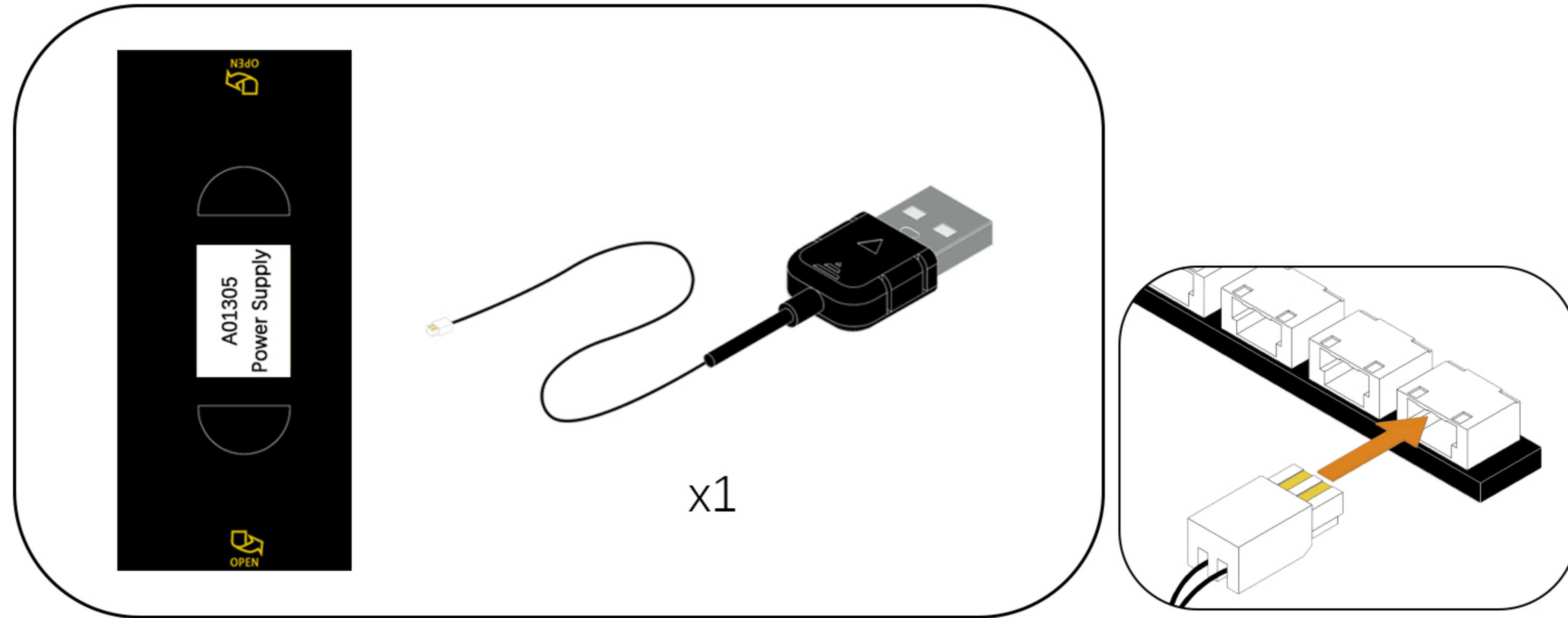

3

EN: Connect the USB power cable to the mobile power supply. (Power supply not included; see the diagram below for power supply options.)

DE: Schließen Sie das USB-Netz Kabel an die mobile Stromversorgung an. (Stromversorgung nicht im Lieferumfang enthalten, siehe Abbildung unten für die Stromversorgungsart.)

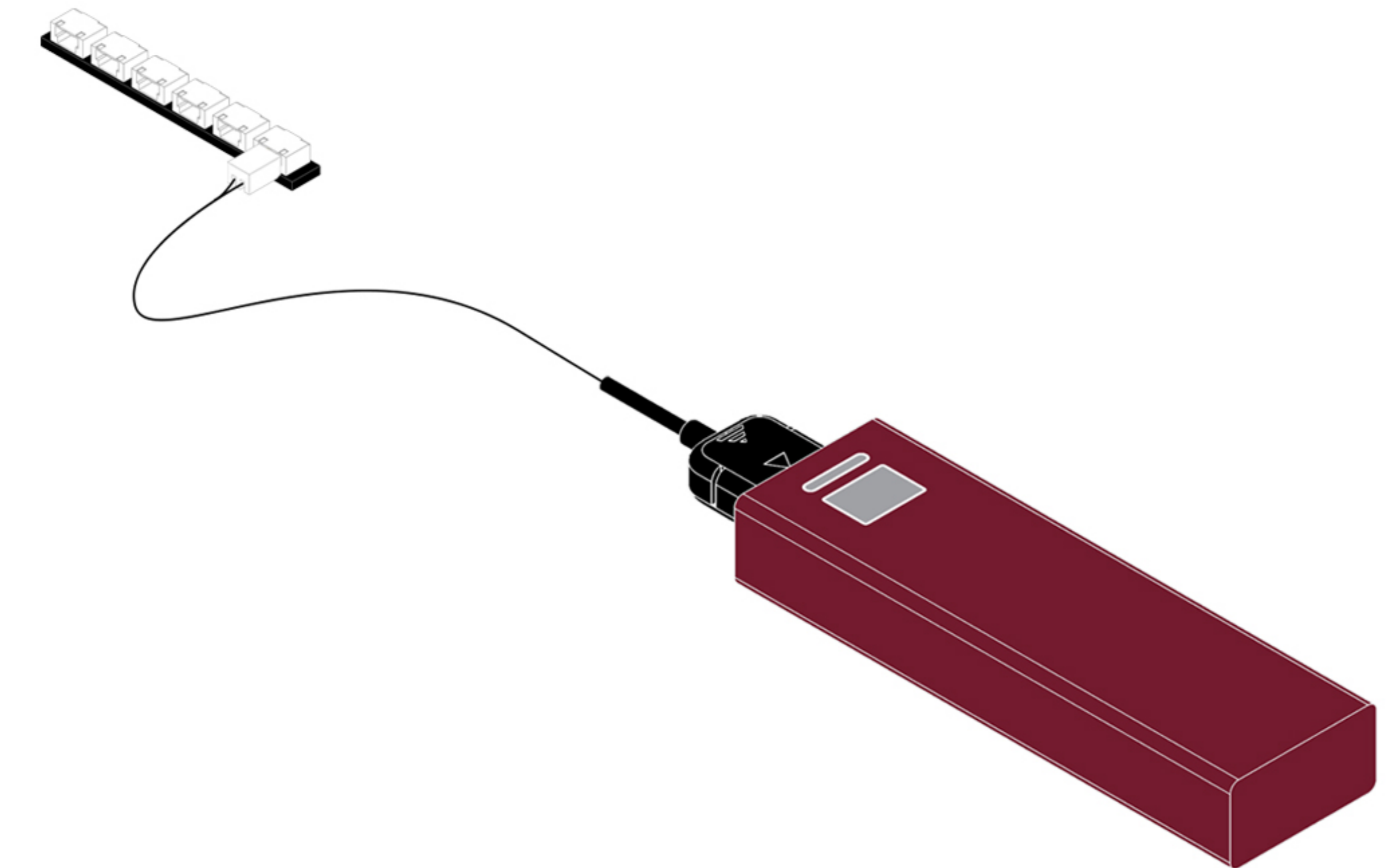

USB Connectors to Connect Devices

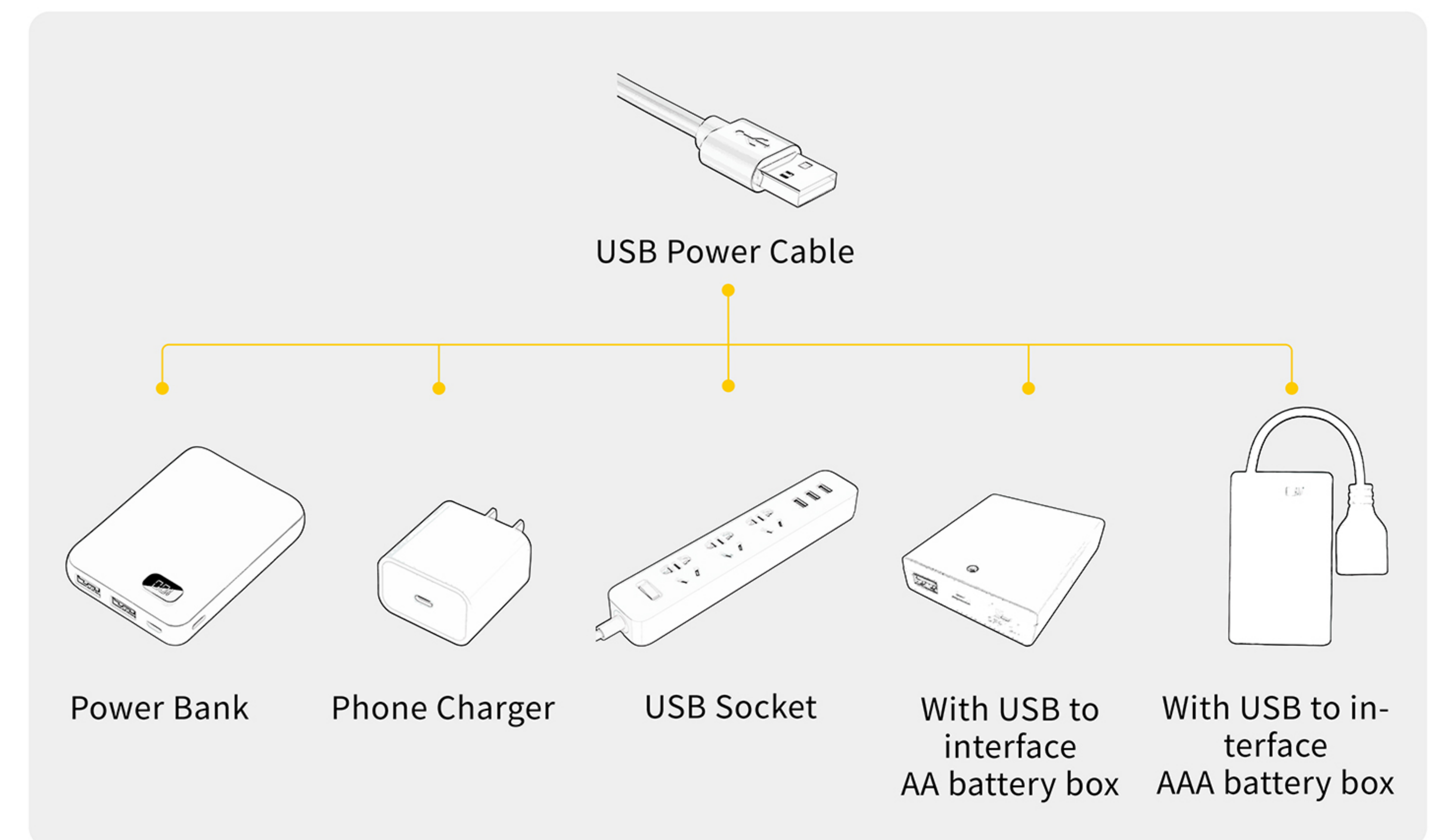

4

EN: Remove the LED strip from Bag 2, connect it to the expansion board, turn on the power, and check that the LED strip is working properly. If you notice any issues, please contact us immediately.

DE: Nehmen Sie den LED-Streifen aus Beutel 2, schließen Sie ihn an die Erweiterungsplatine an, schalten Sie die Stromversorgung ein und überprüfen Sie, ob der LED-Streifen ordnungsgemäß funktioniert. Sollten Sie Probleme feststellen, kontaktieren Sie uns bitte umgehend.

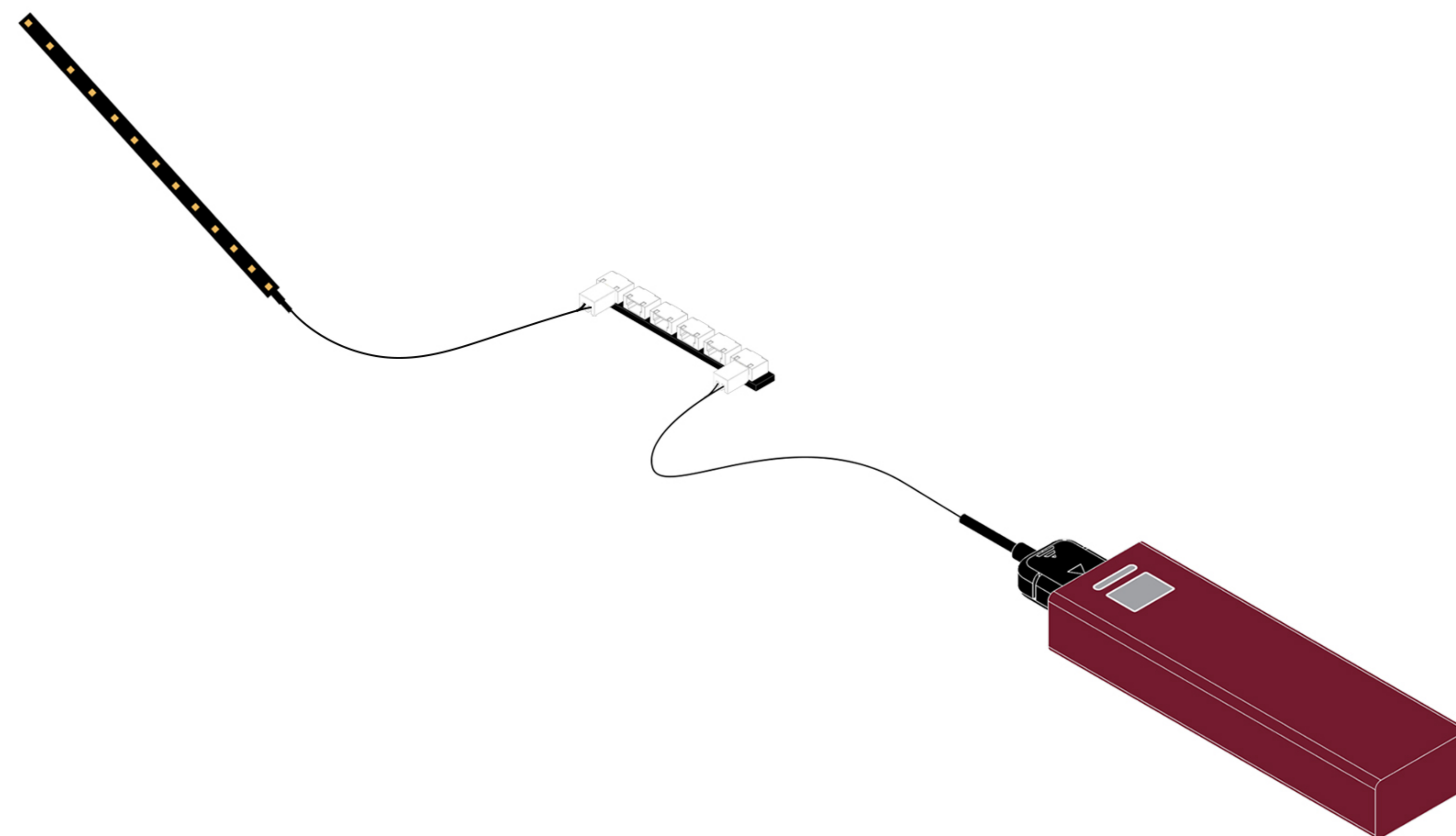
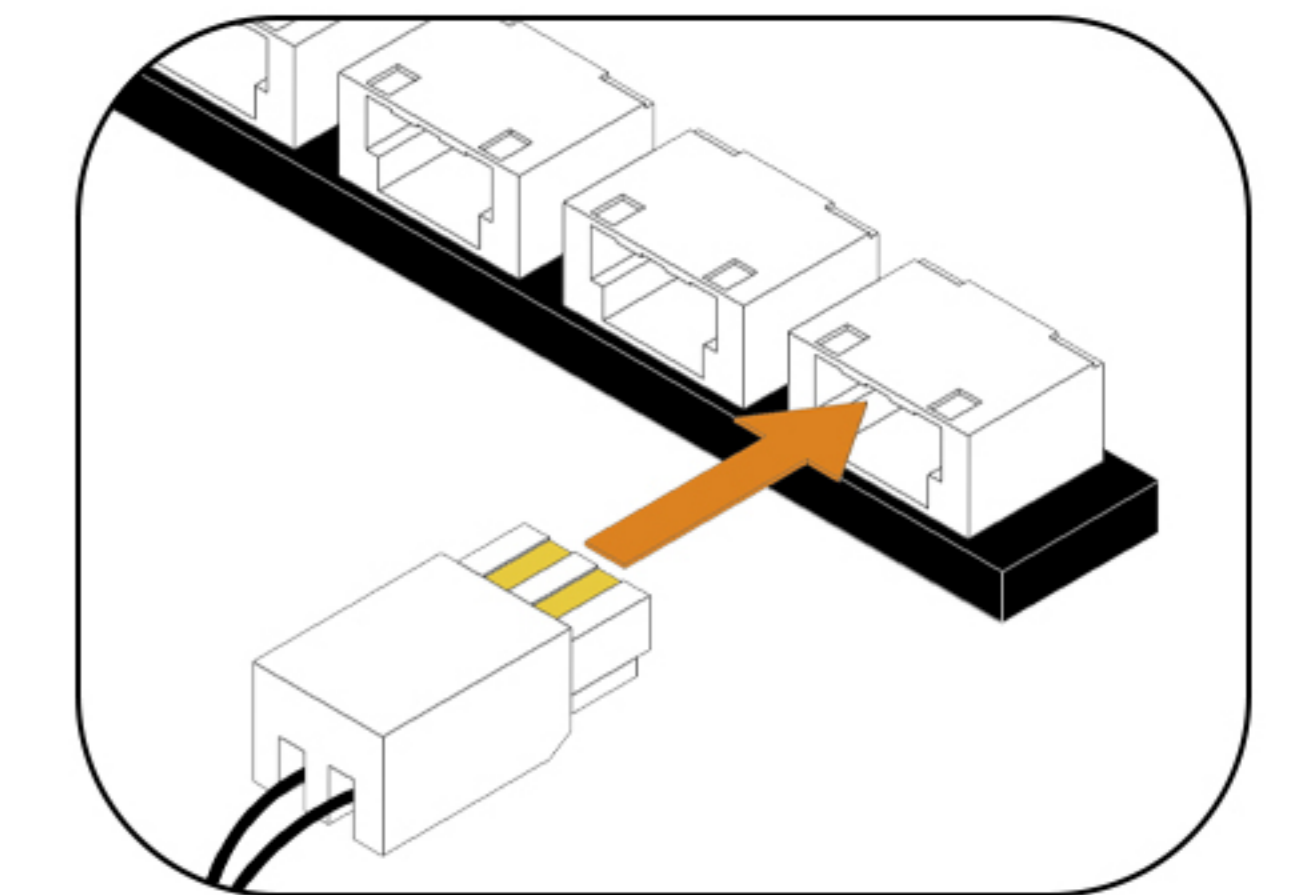
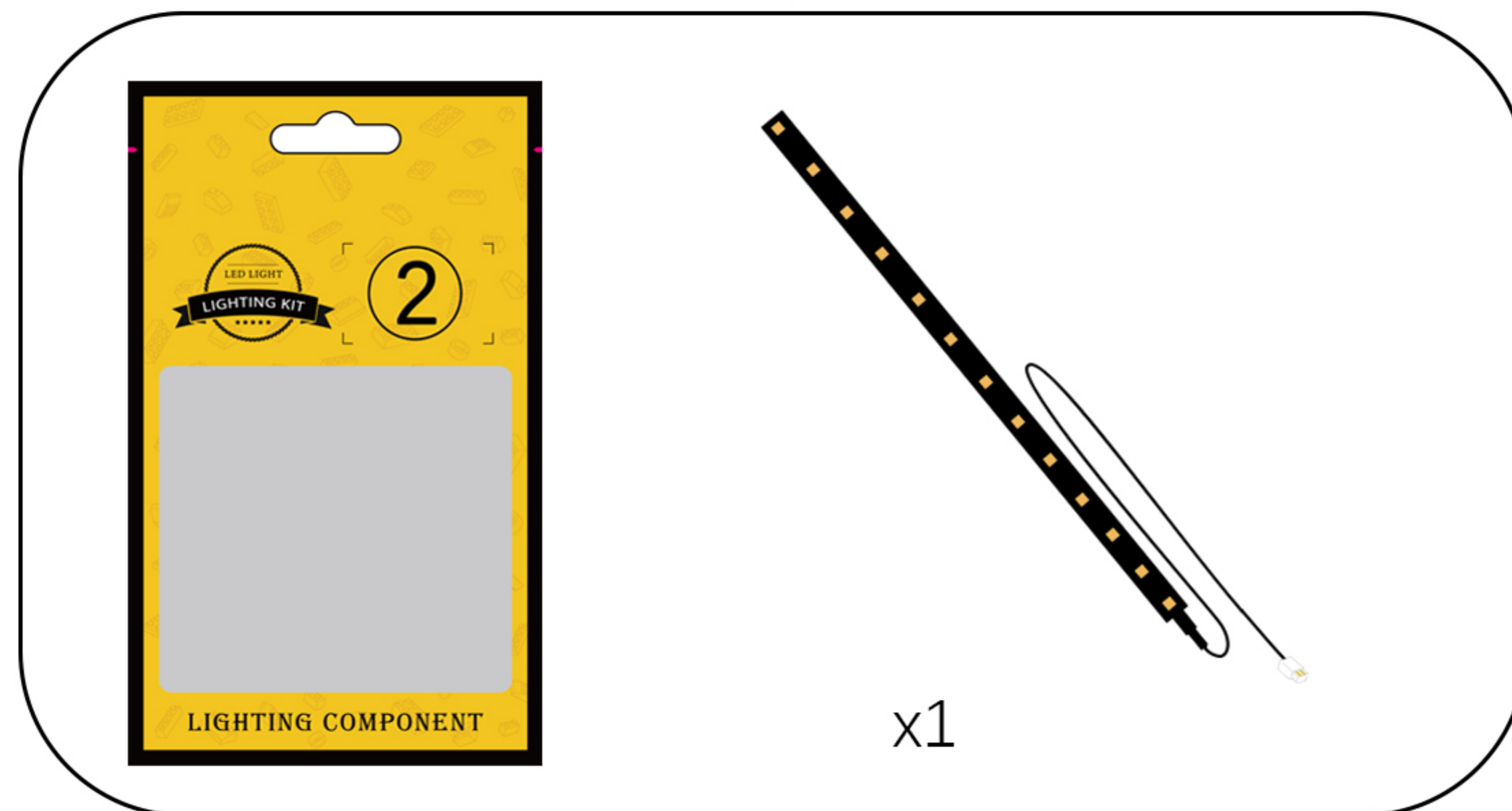

Once you've confirmed there are no issues, temporarily place the light strip and expansion board back in their original bag, then test the lighting fixture.

5

EN: Remove the LED strip from Bag 4, connect it to the USB power cable, turn on the power, and check that the LED strip is working properly. If you notice any issues, please contact us immediately.

DE: Nehmen Sie den LED-Streifen aus Beutel 4, schließen Sie ihn an das USB-Stromkabel an, schalten Sie das Gerät ein und überprüfen Sie, ob der LED-Streifen ordnungsgemäß funktioniert. Sollten Sie Probleme feststellen, kontaktieren Sie uns bitte umgehend.

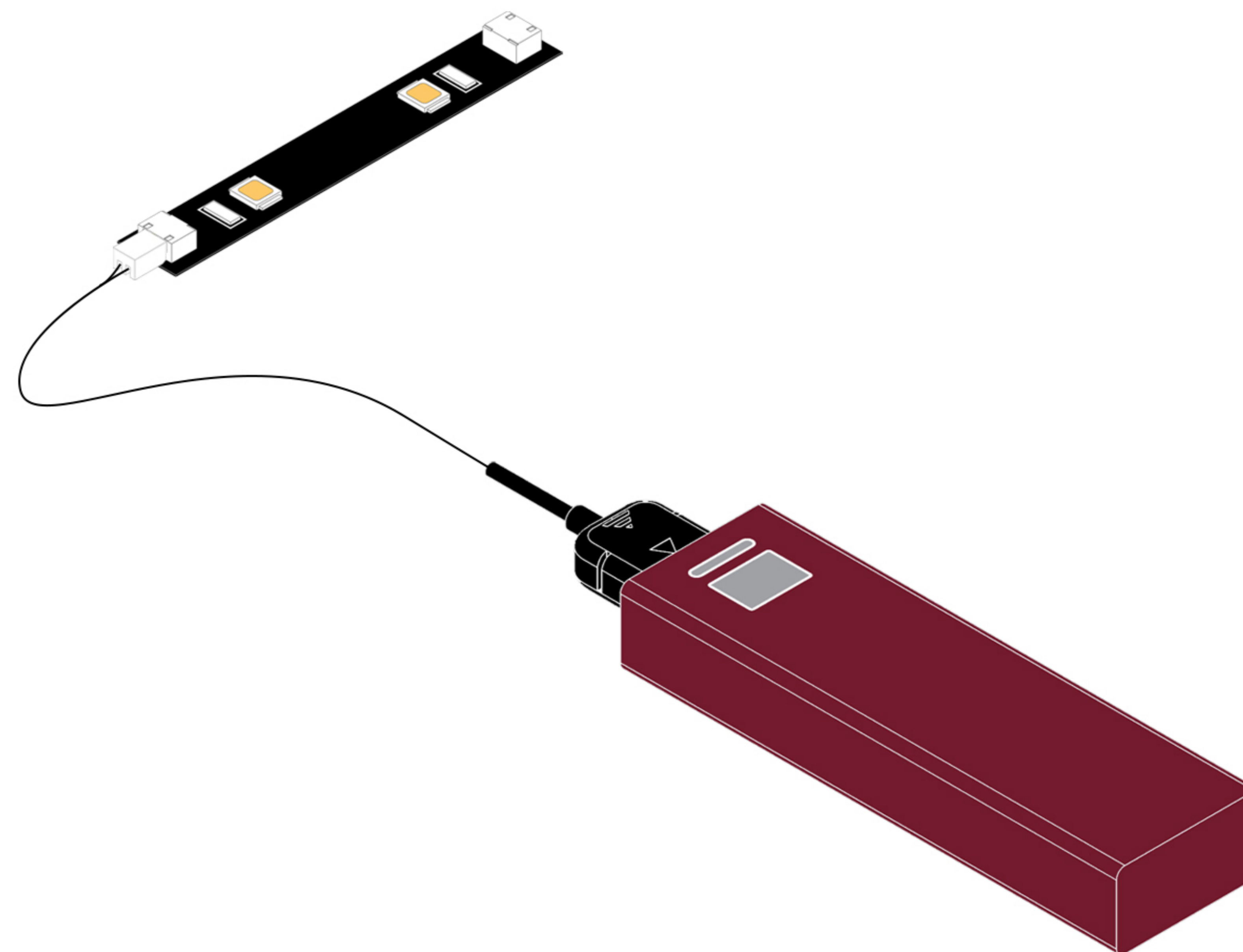
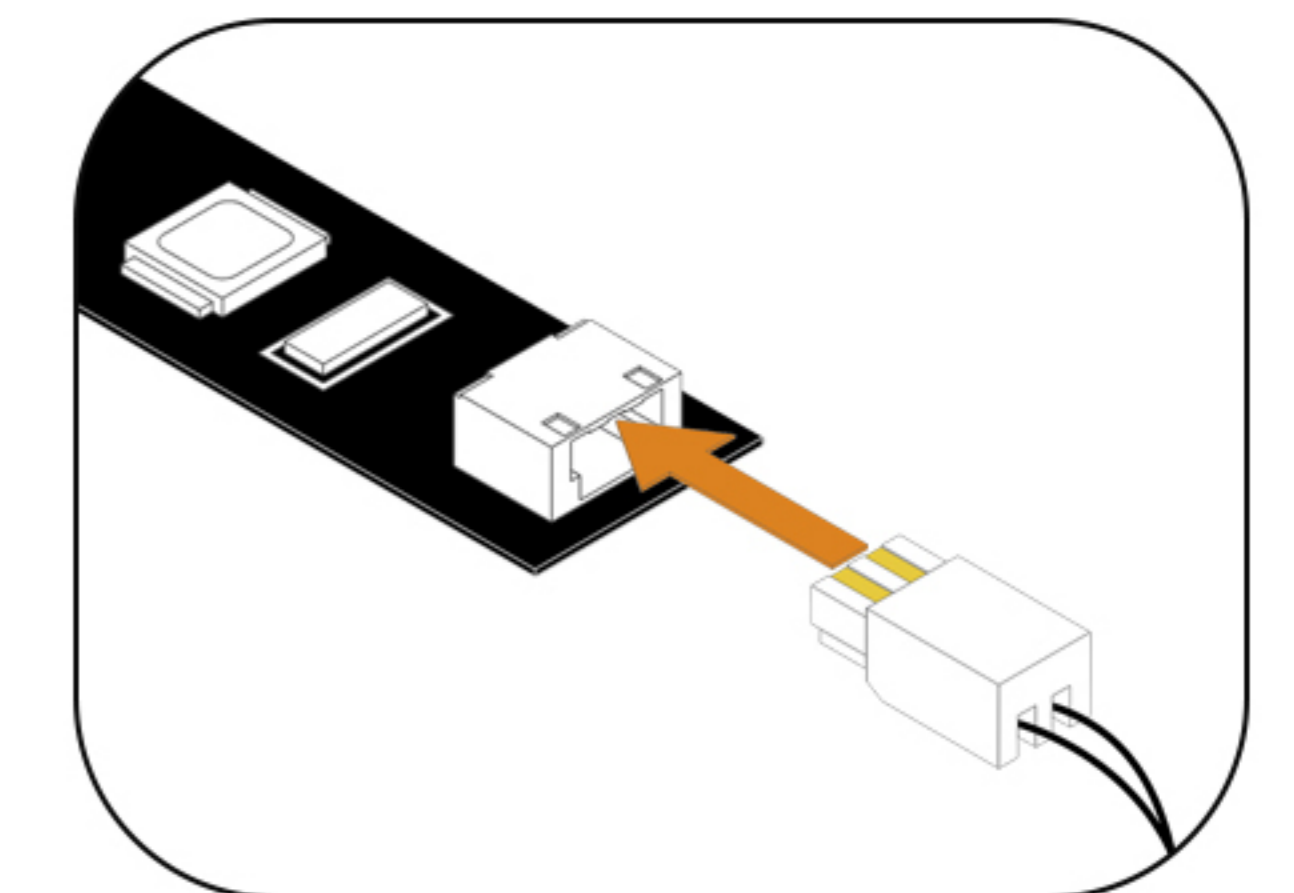
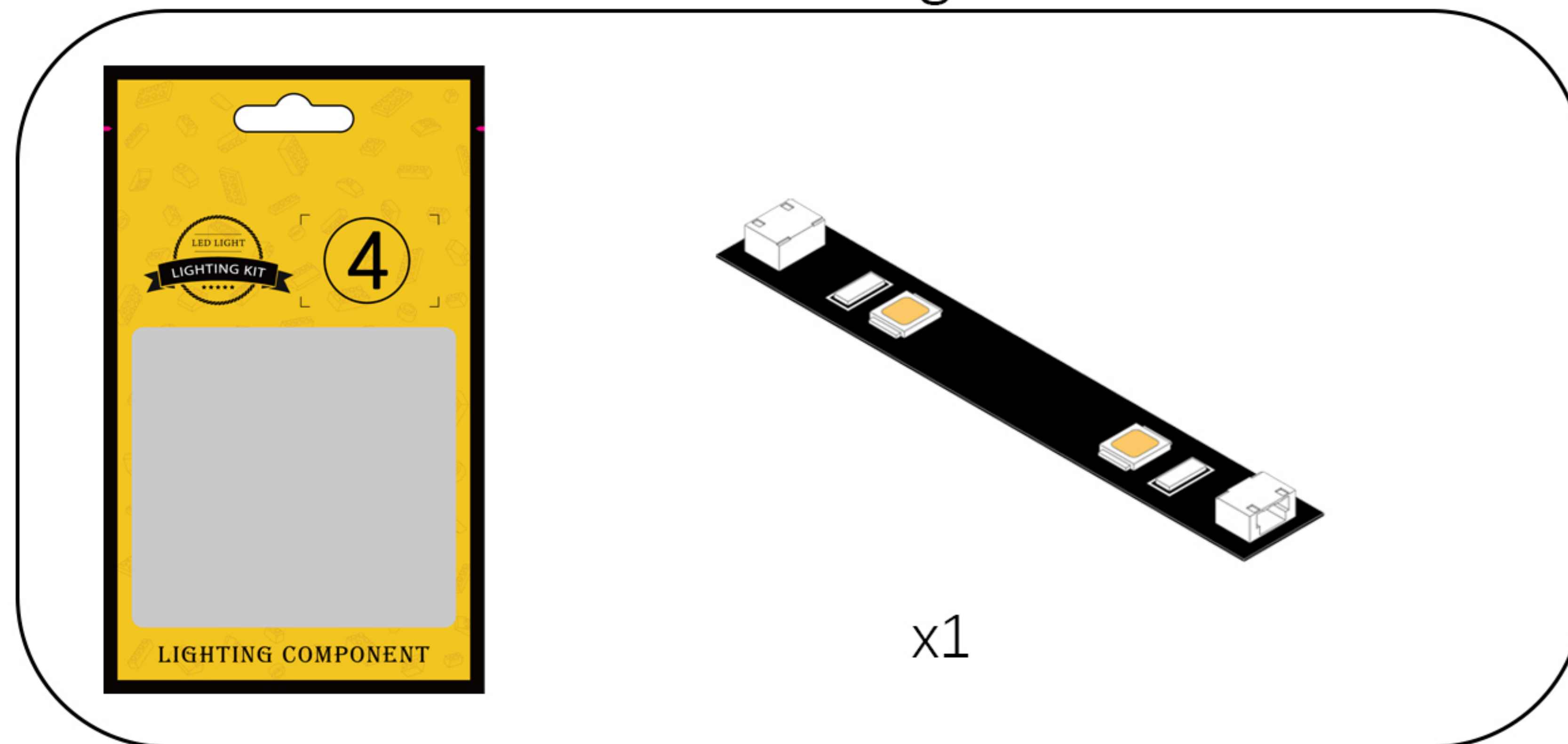

After confirming that there are no abnormalities, temporarily return each part to its original bag.

Step 2-Mounting.

1

EN: Take out the building block model.

DE: Nimm das Bauklotzmodell heraus.



2

EN: Remove the building blocks one by one.

DE: Entfernen Sie die Bausteine nacheinander.

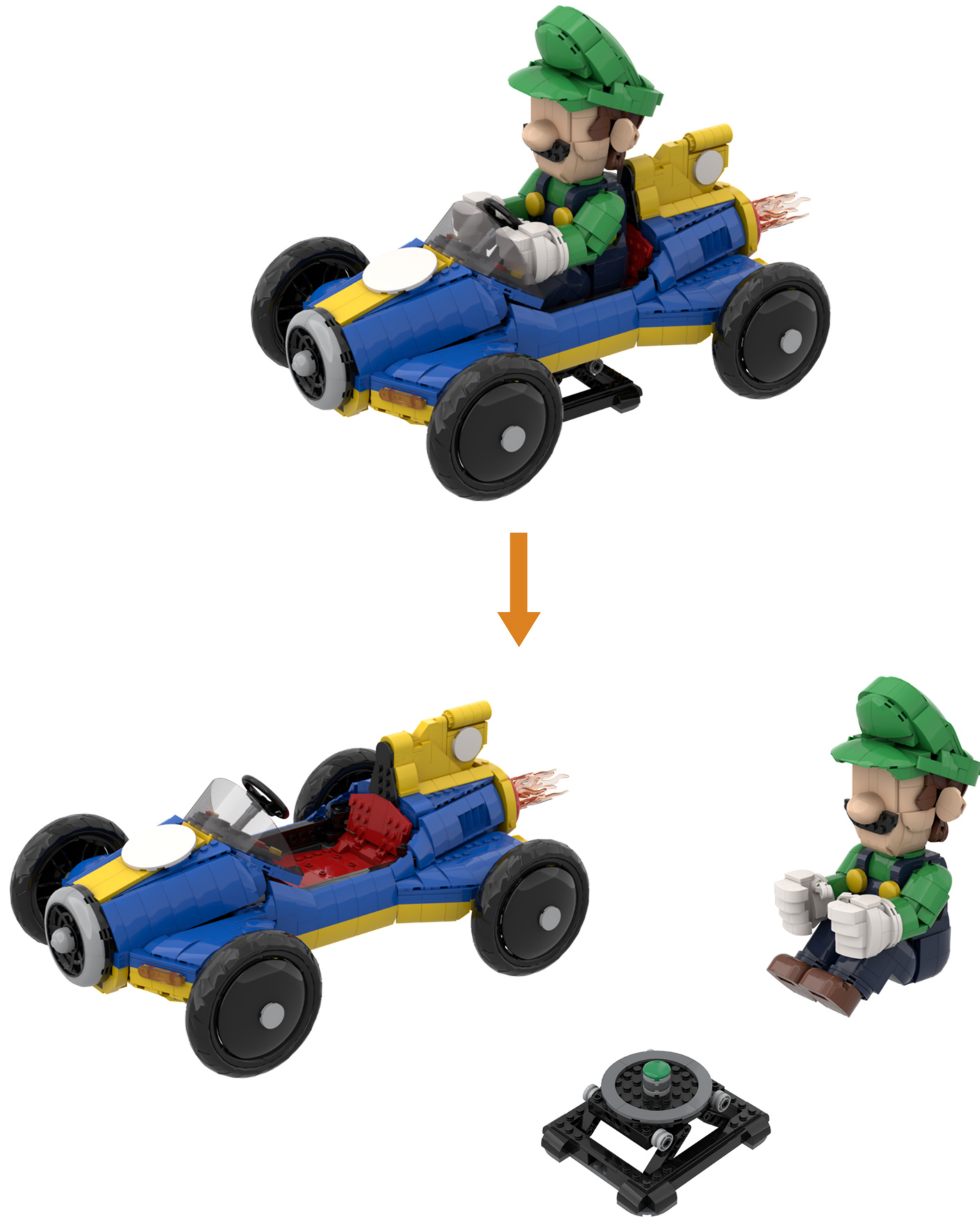

3

EN: Adjust your perspective.

DE: Ändern Sie Ihre Perspektive.



4

EN: Split as shown in the figure.

DE: Wie in der Abbildung gezeigt, teilen Sie es auf.



5

EN: Take out the disassembled building blocks and take them apart one by one.

DE: Nimm die zerlegten Bausteine heraus und nimm sie nacheinander auseinander.

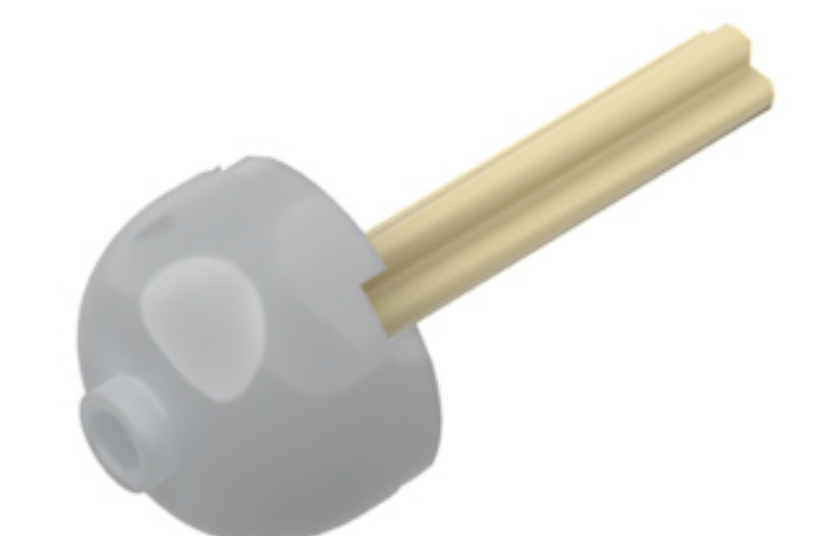
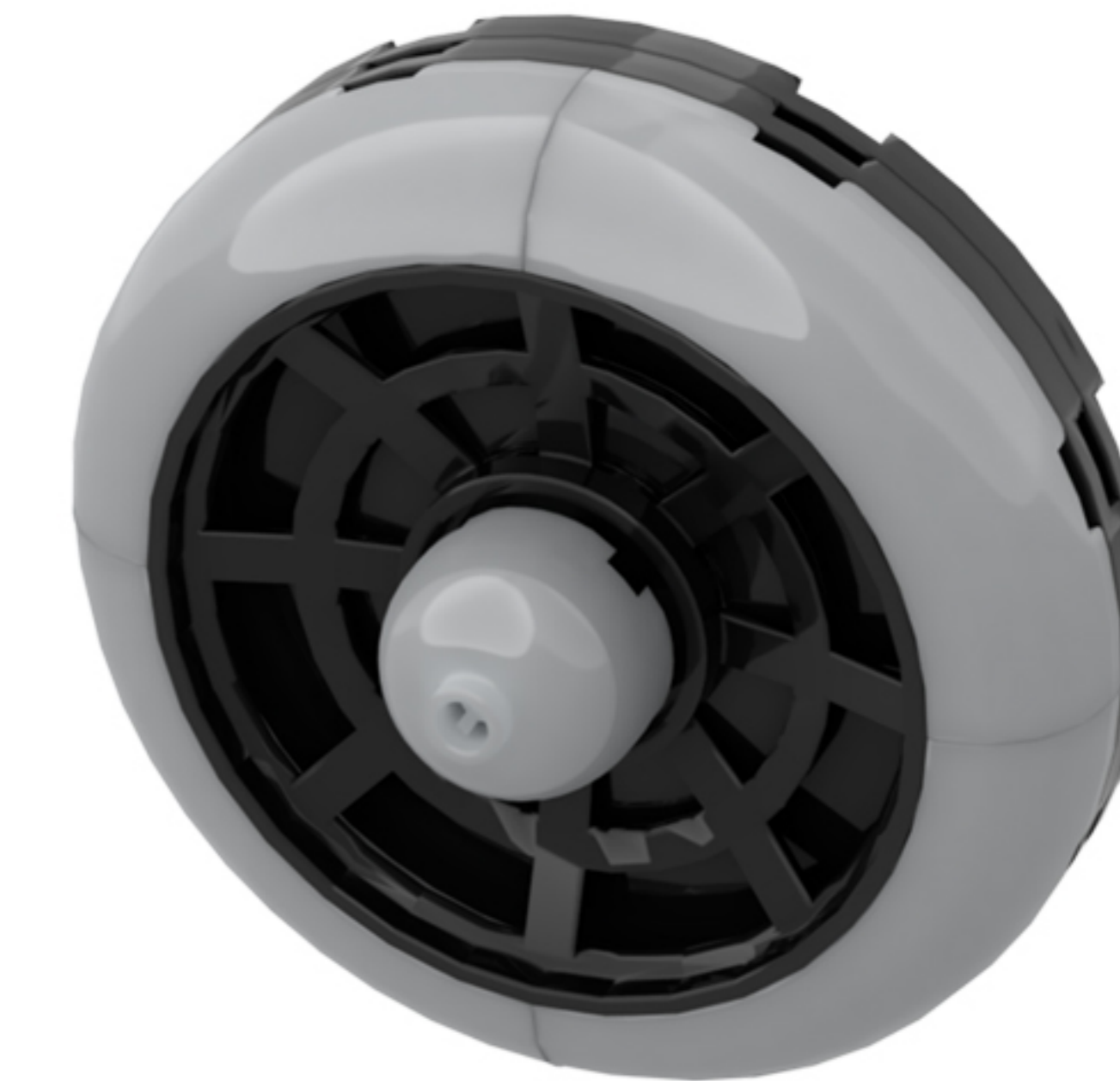
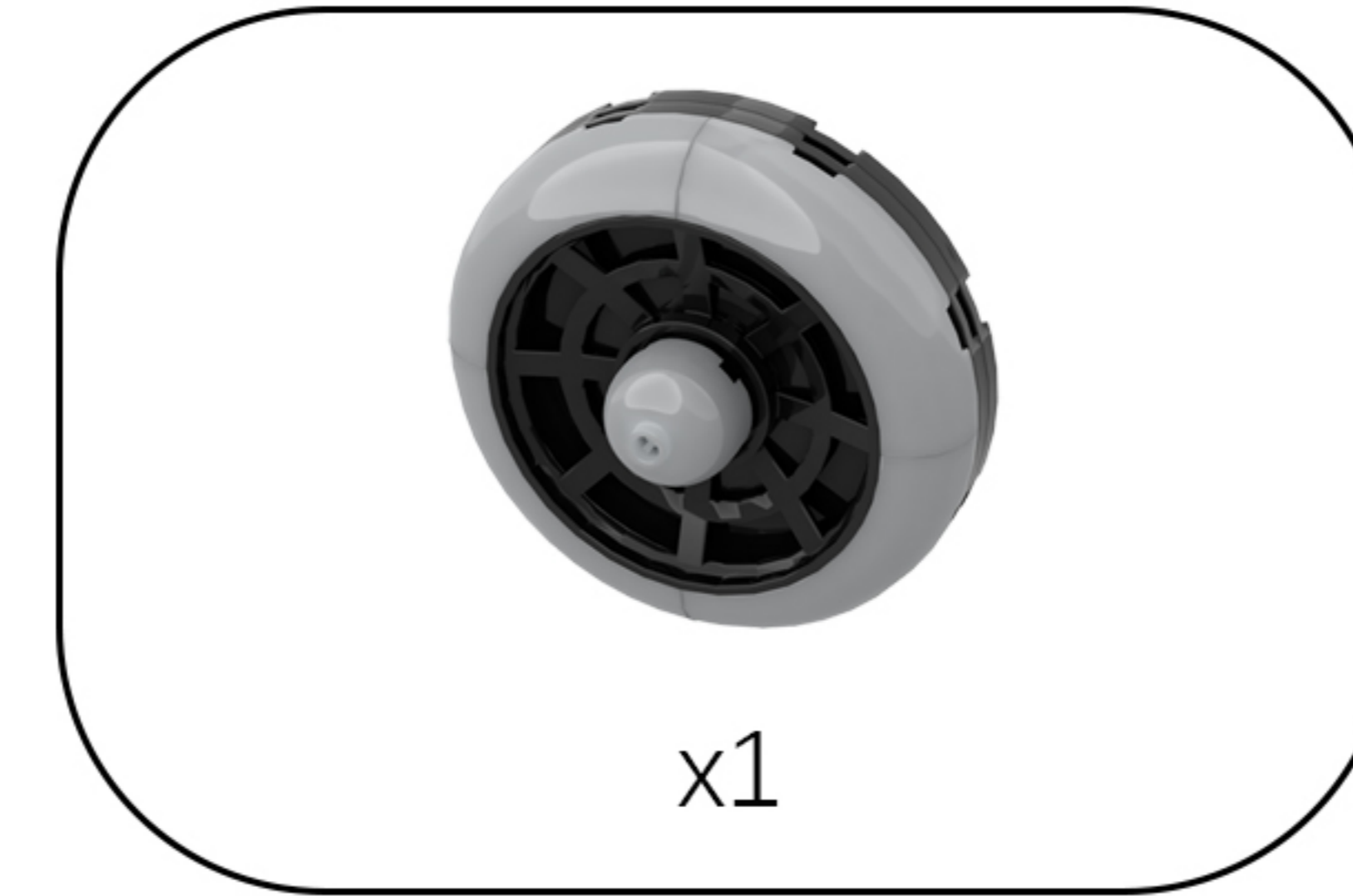

6

EN: Take the string of lights out of Bag 1, peel off the adhesive backing, and attach the end with the wires to the building block.

DE: Nimm die Lichterkette aus Beutel 1, zieh die Schutzfolie ab und befestige das Ende mit den Kabeln am Baustein.

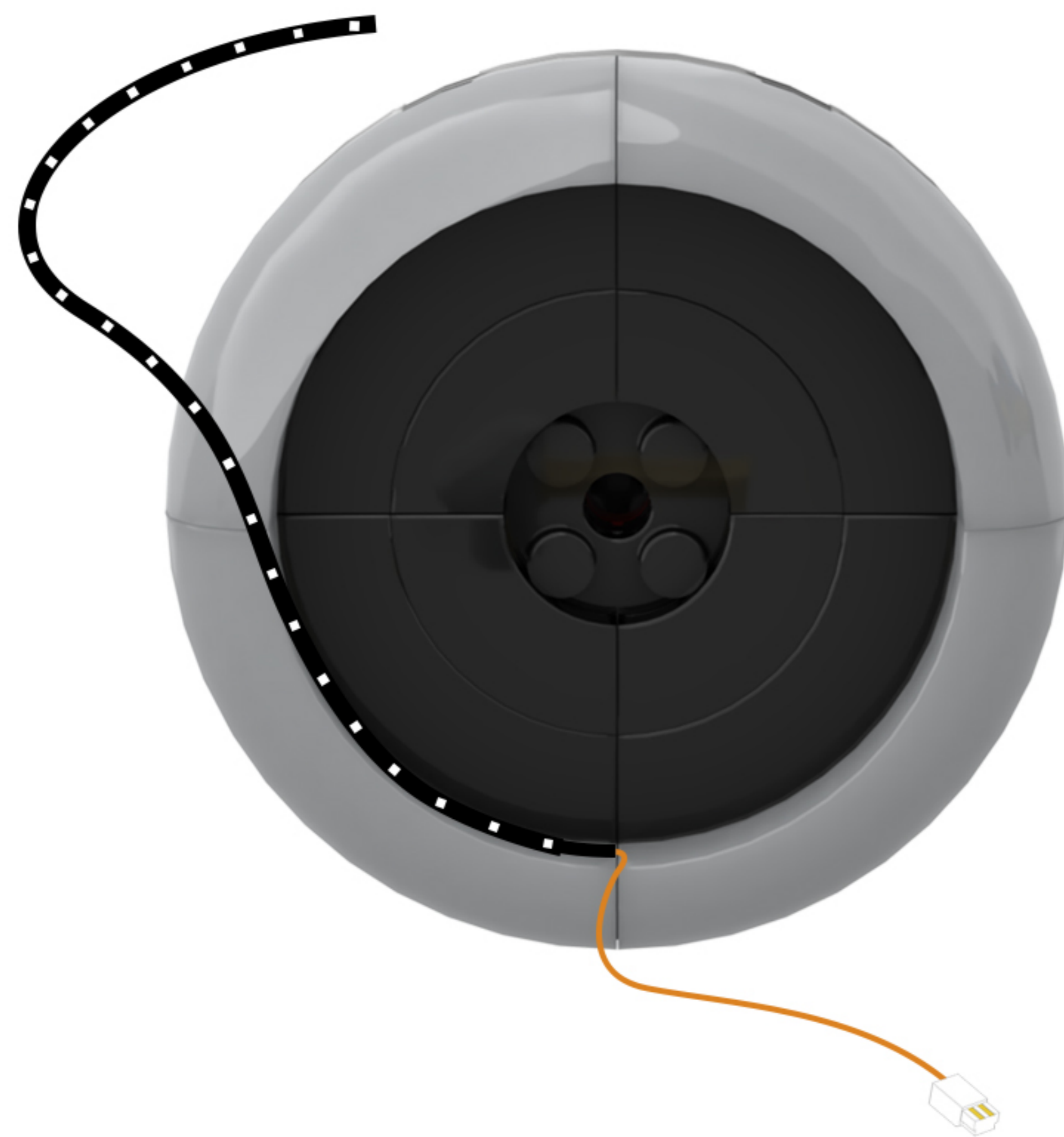
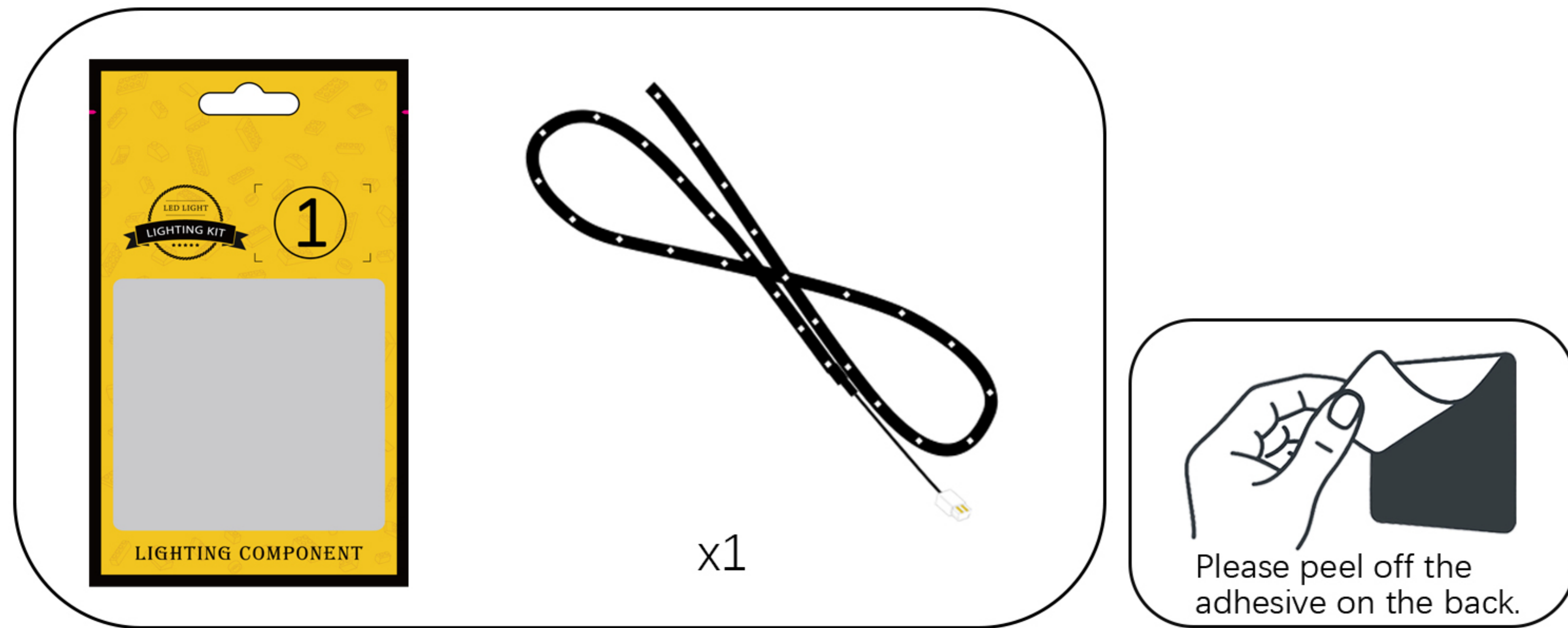

7

EN: Attach all the LED strips to the building blocks.

DE: Befestige alle LED-Streifen an den Bausteinen.

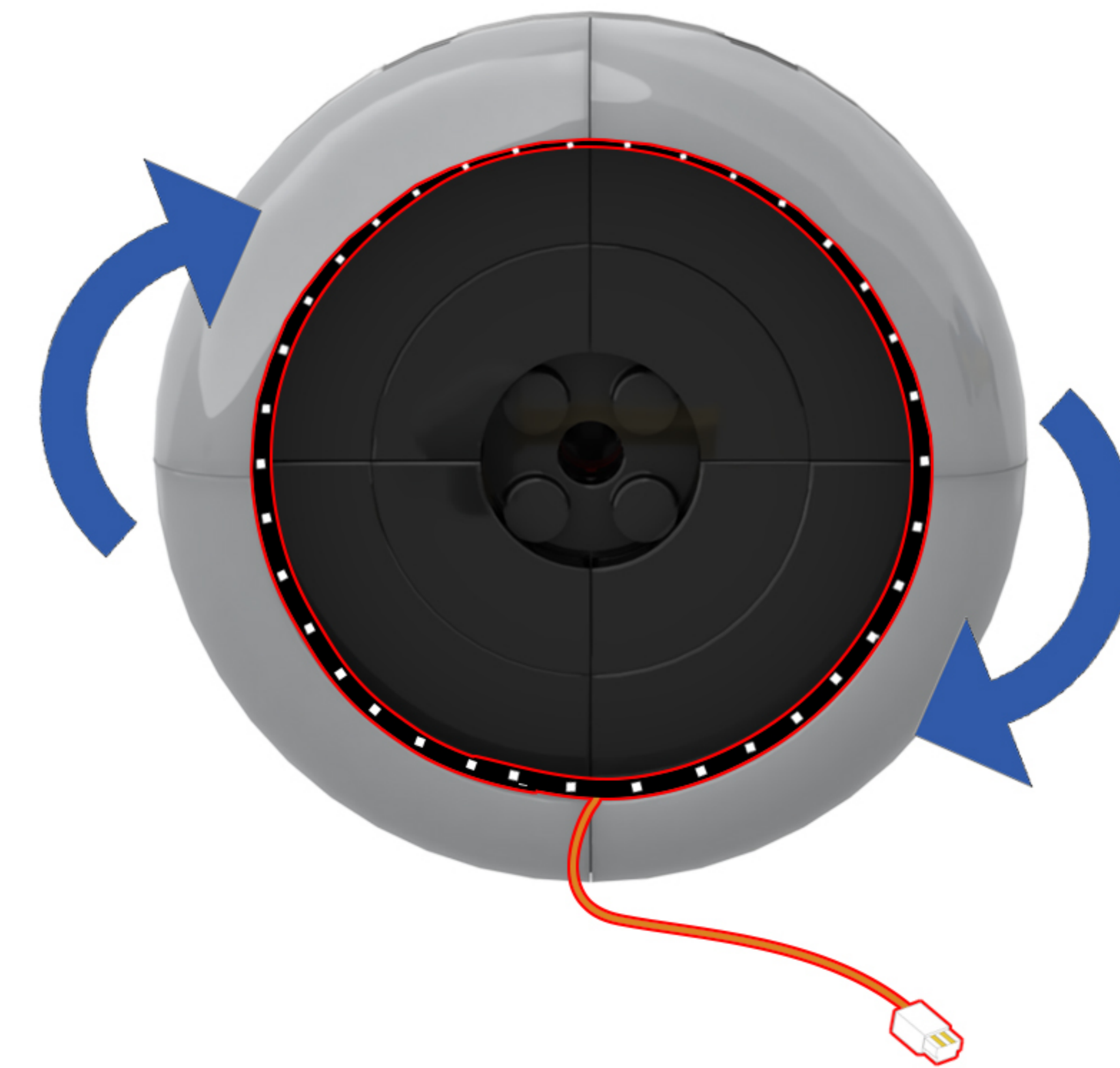

8

EN: Find the building blocks shown in the picture.

DE: Finde die auf dem Bild abgebildeten Bausteine.

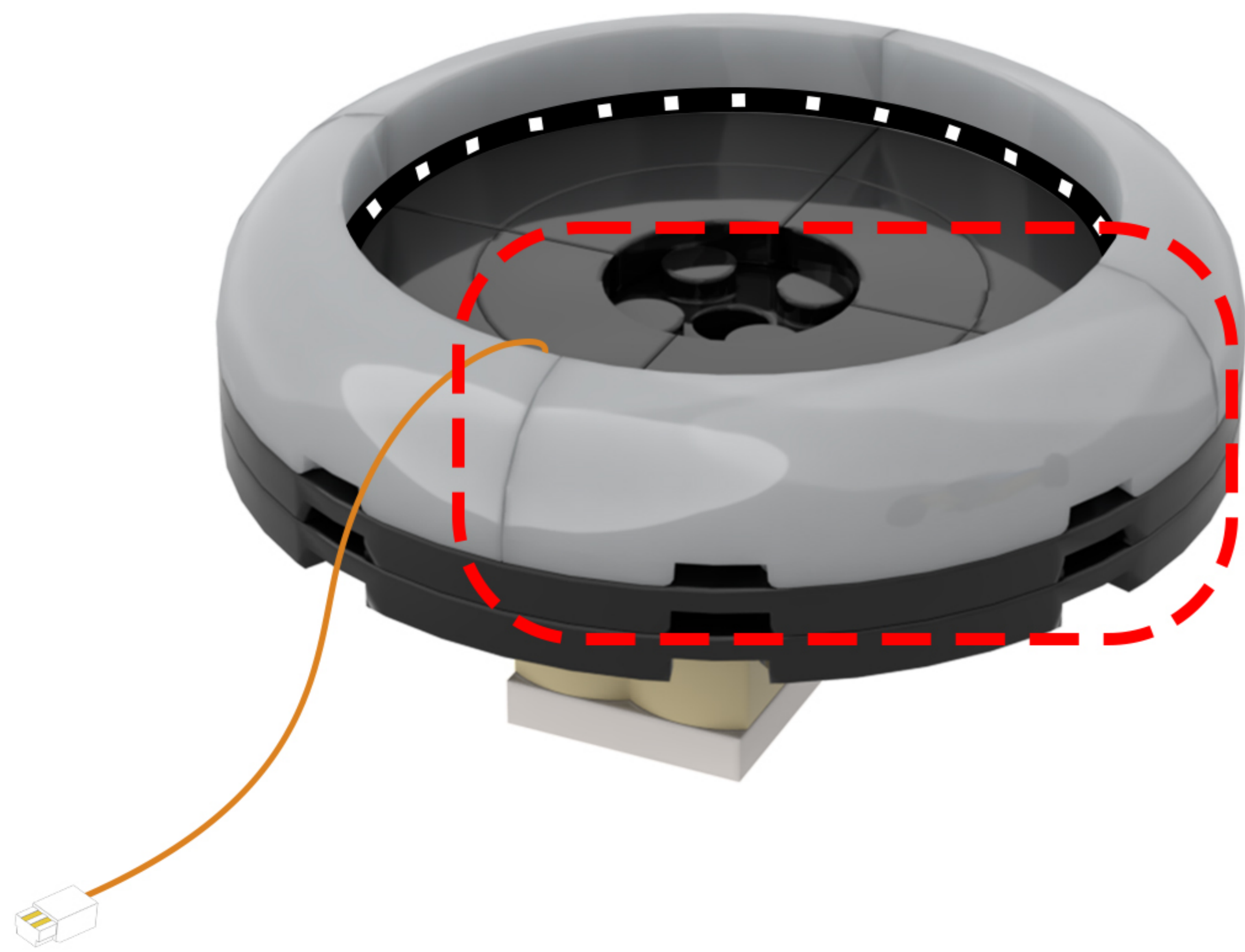

9

EN: Lift the brick piece, but do not remove it completely from the model.

DE: Hebe das Steinchen an, aber nimm es nicht vollständig aus dem Modell heraus.

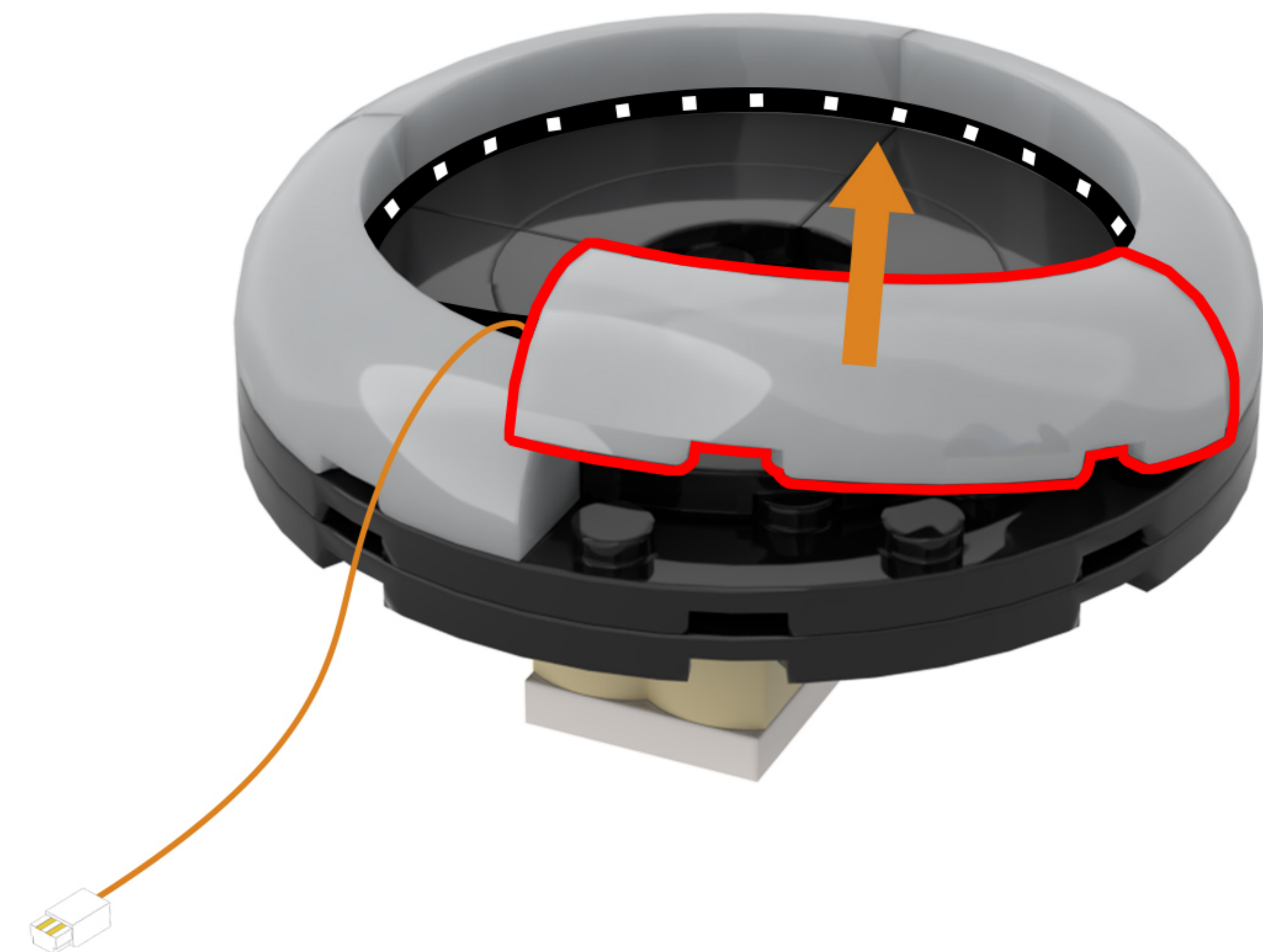

10

EN: Thread the lamp cord through the gaps in the building blocks.

DE: Führen Sie das Lampenkabel durch die Lücken in den Bausteinen.

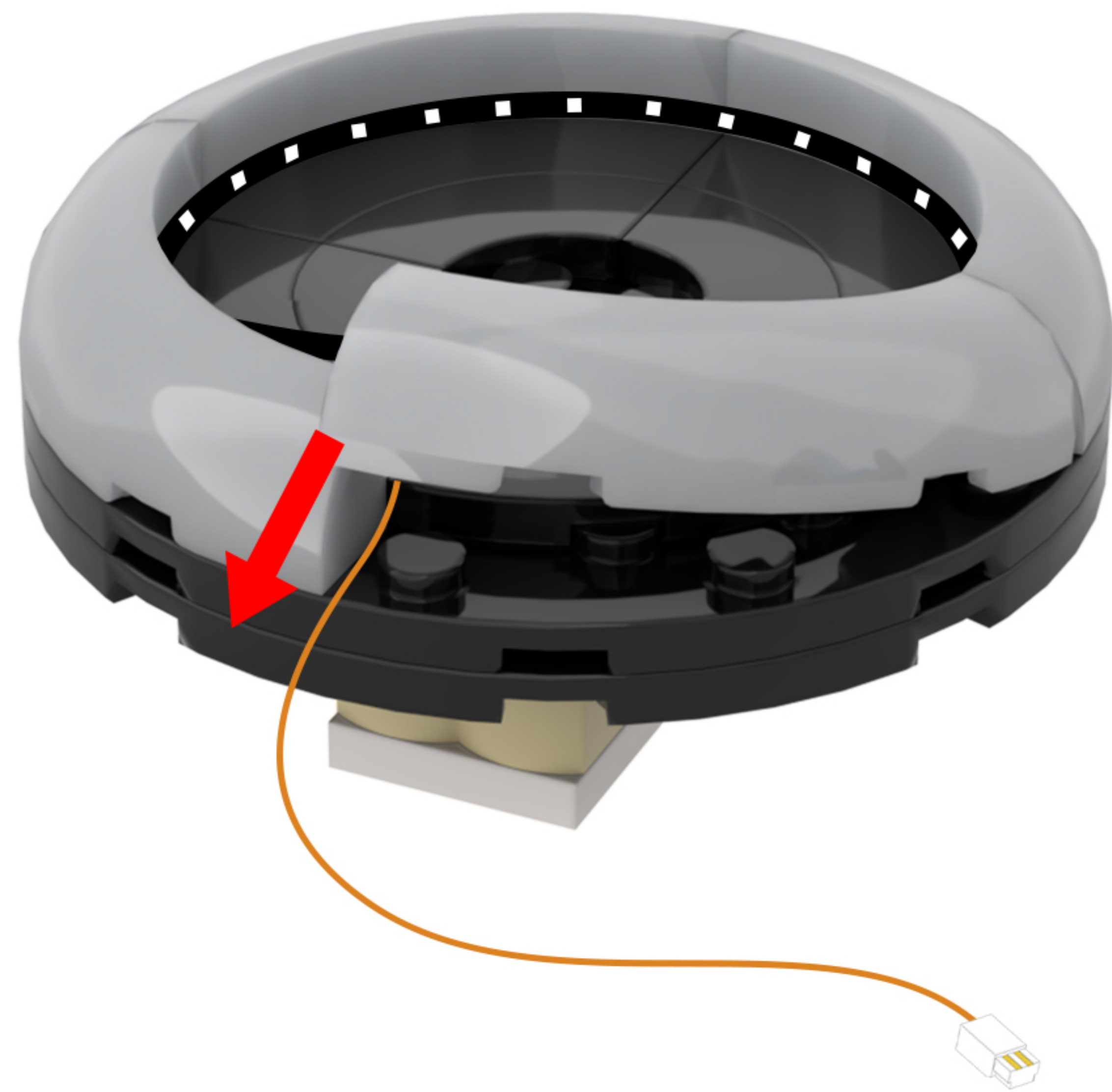

11

EN: Return the building blocks to their original positions so that they press down on the light cord.

DE: Bringen Sie die Bausteine wieder in ihre ursprüngliche Position, sodass sie auf das Lichtkabel drücken.

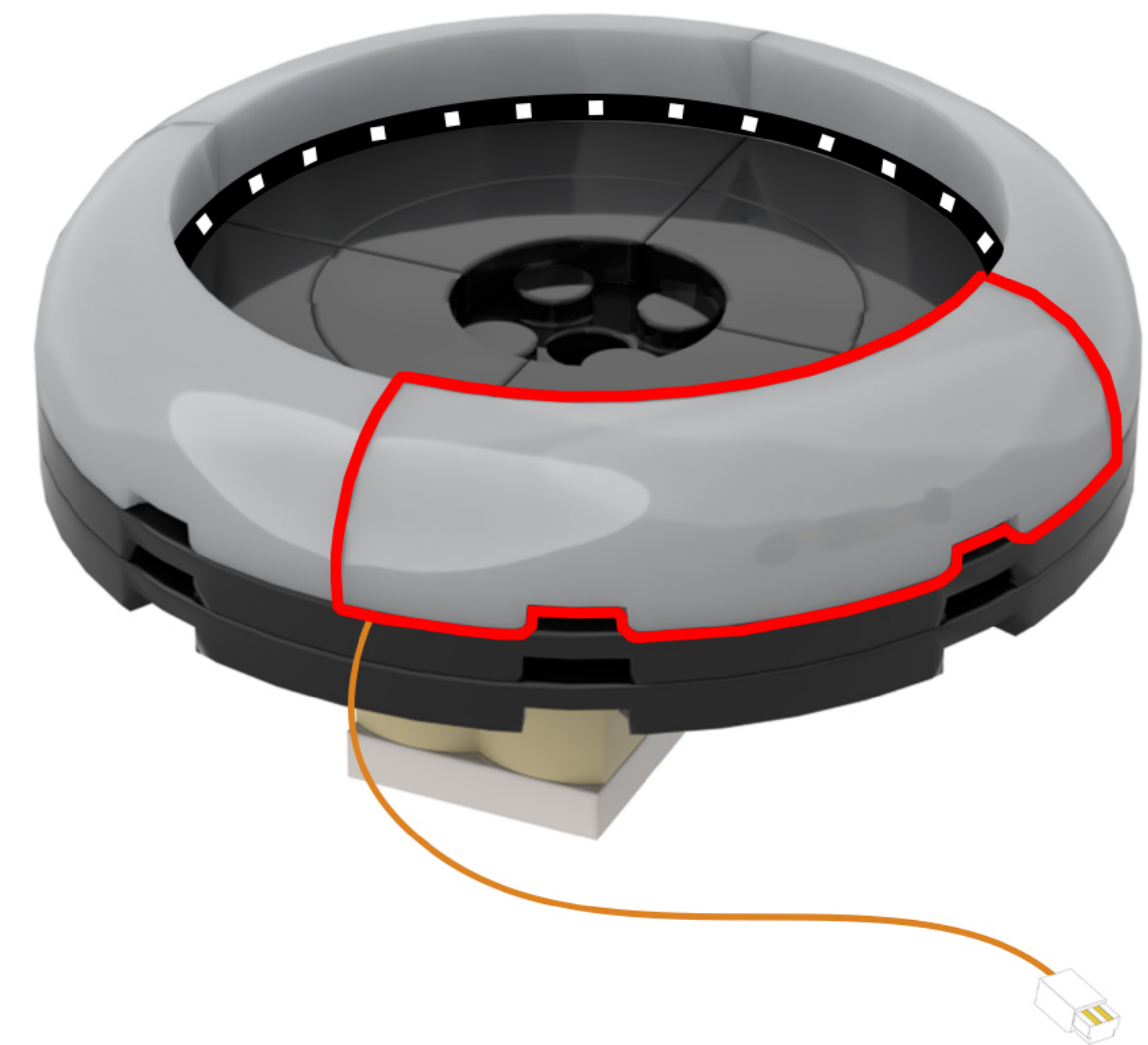

12

EN: Take out the disassembled building blocks and reassemble them in order.

DE: Nehmen Sie die zerlegten Bausteine heraus und setzen Sie sie der Reihe nach wieder zusammen.

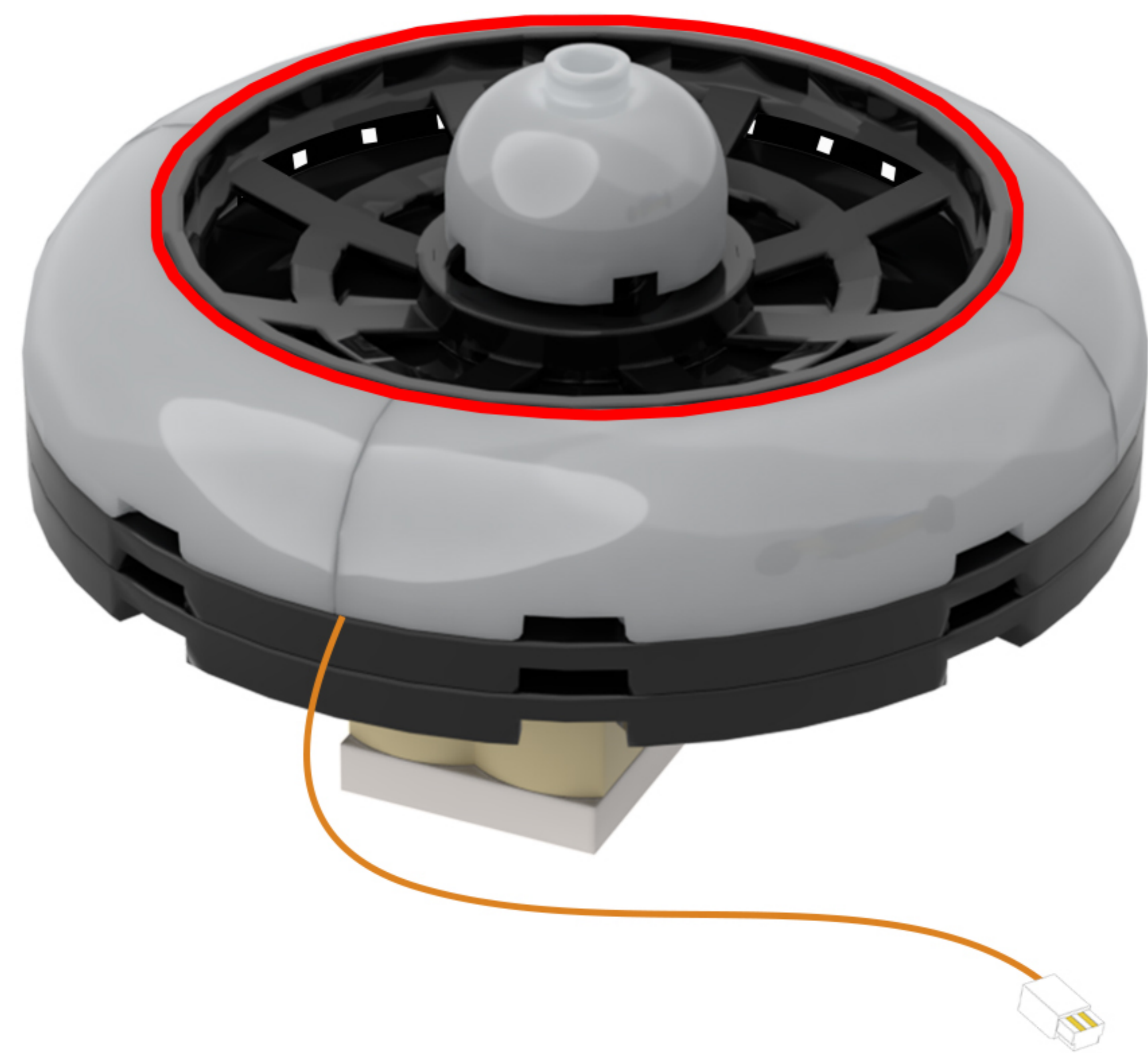
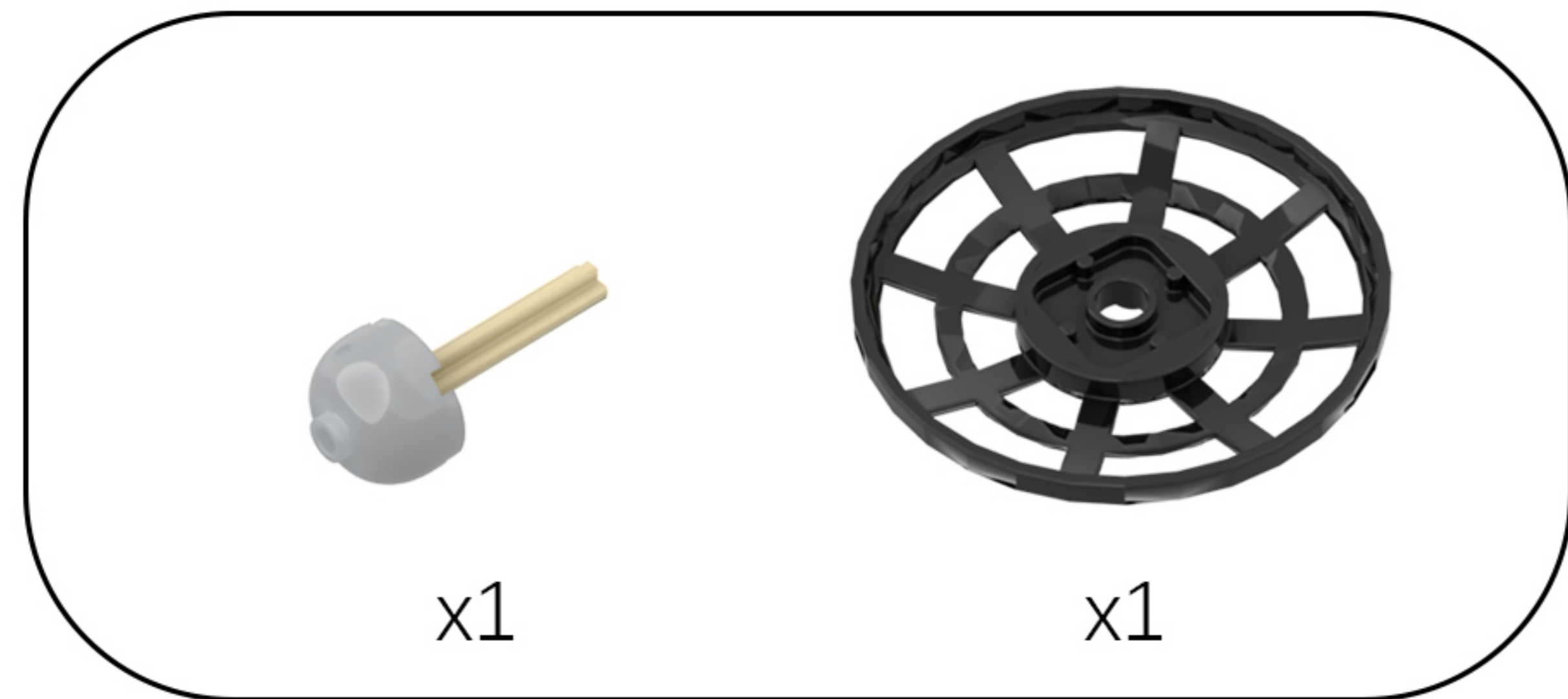

13

EN: Back to the model.

DE: Zurück zum Modell.



14

EN: Thread the lamp cord through the gaps in the building blocks.

DE: Führen Sie das Lampenkabel durch die Lücken in den Bausteinen.

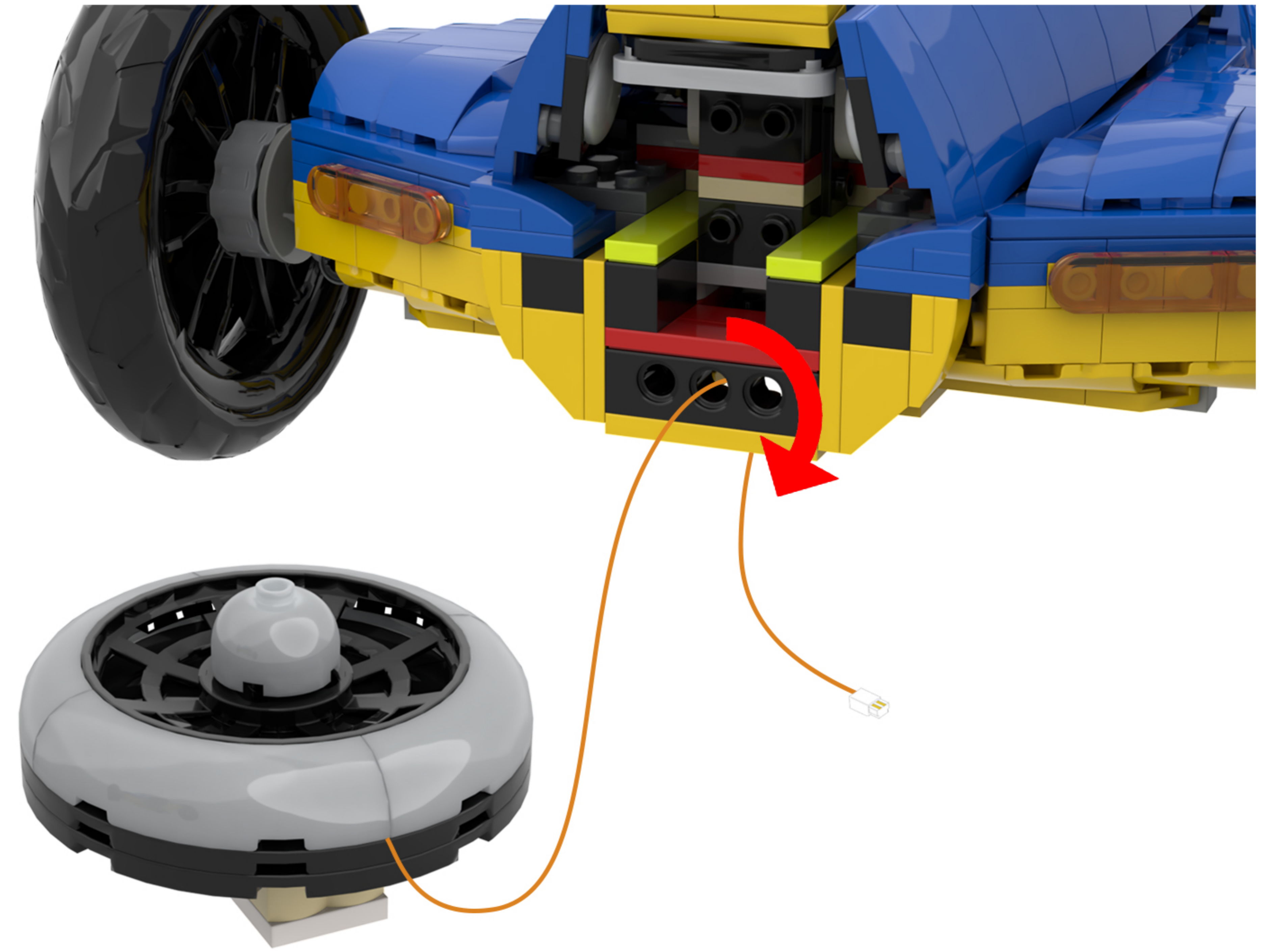
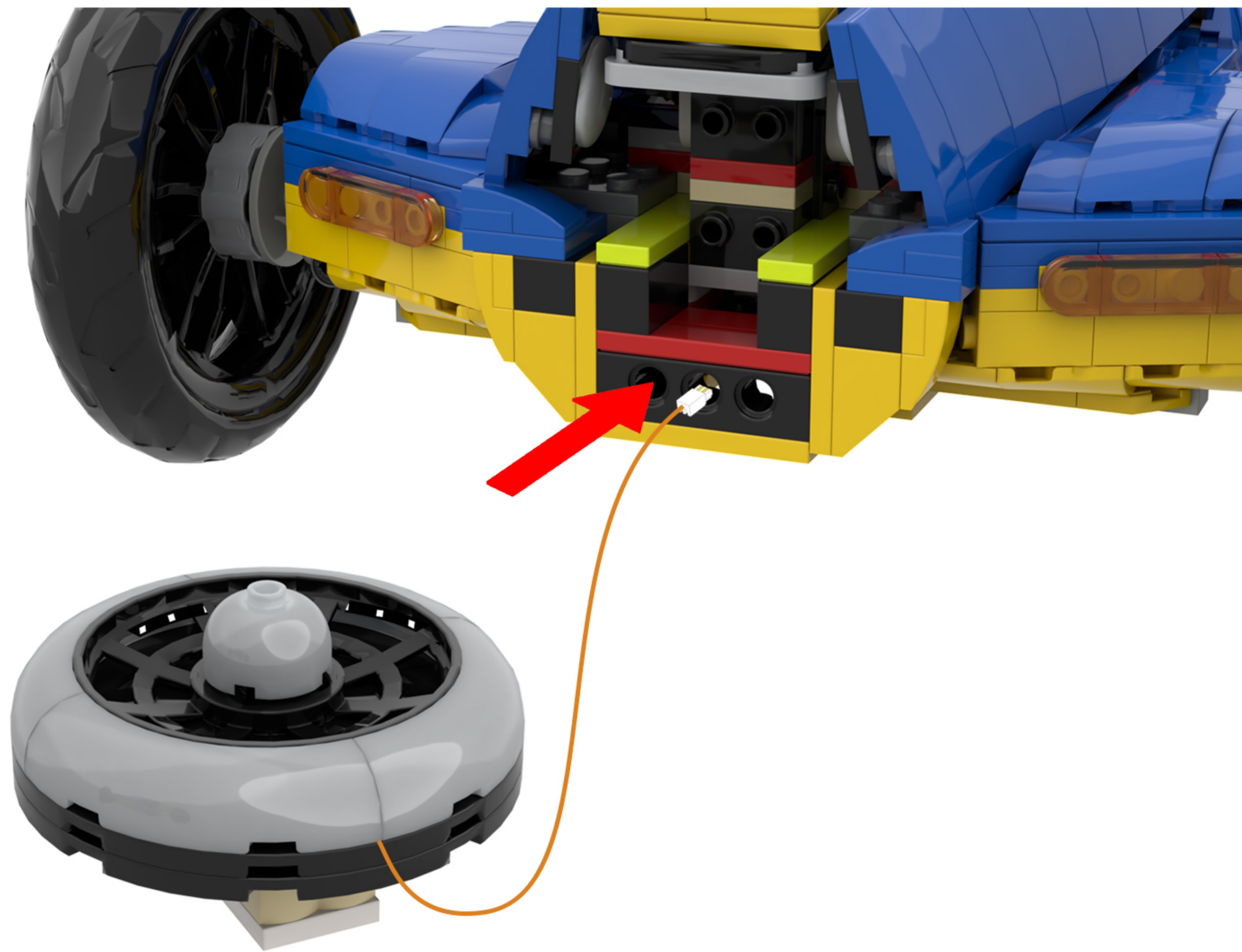

15

EN: Restore the building blocks.

DE: Stellen Sie die Bausteine wieder her.

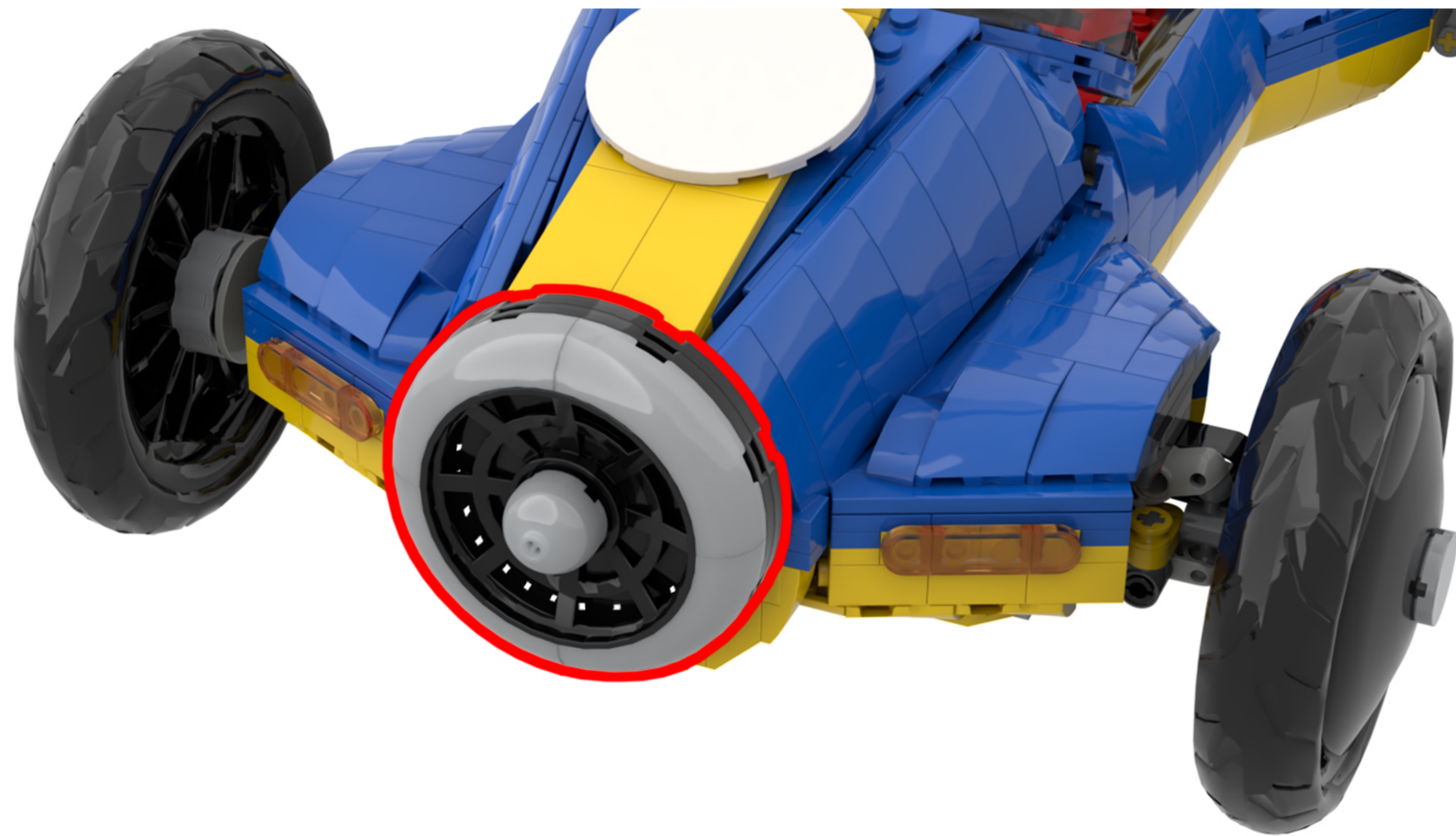

16

EN: Split as shown in the figure.

DE: Wie in der Abbildung gezeigt, teilen Sie es auf.

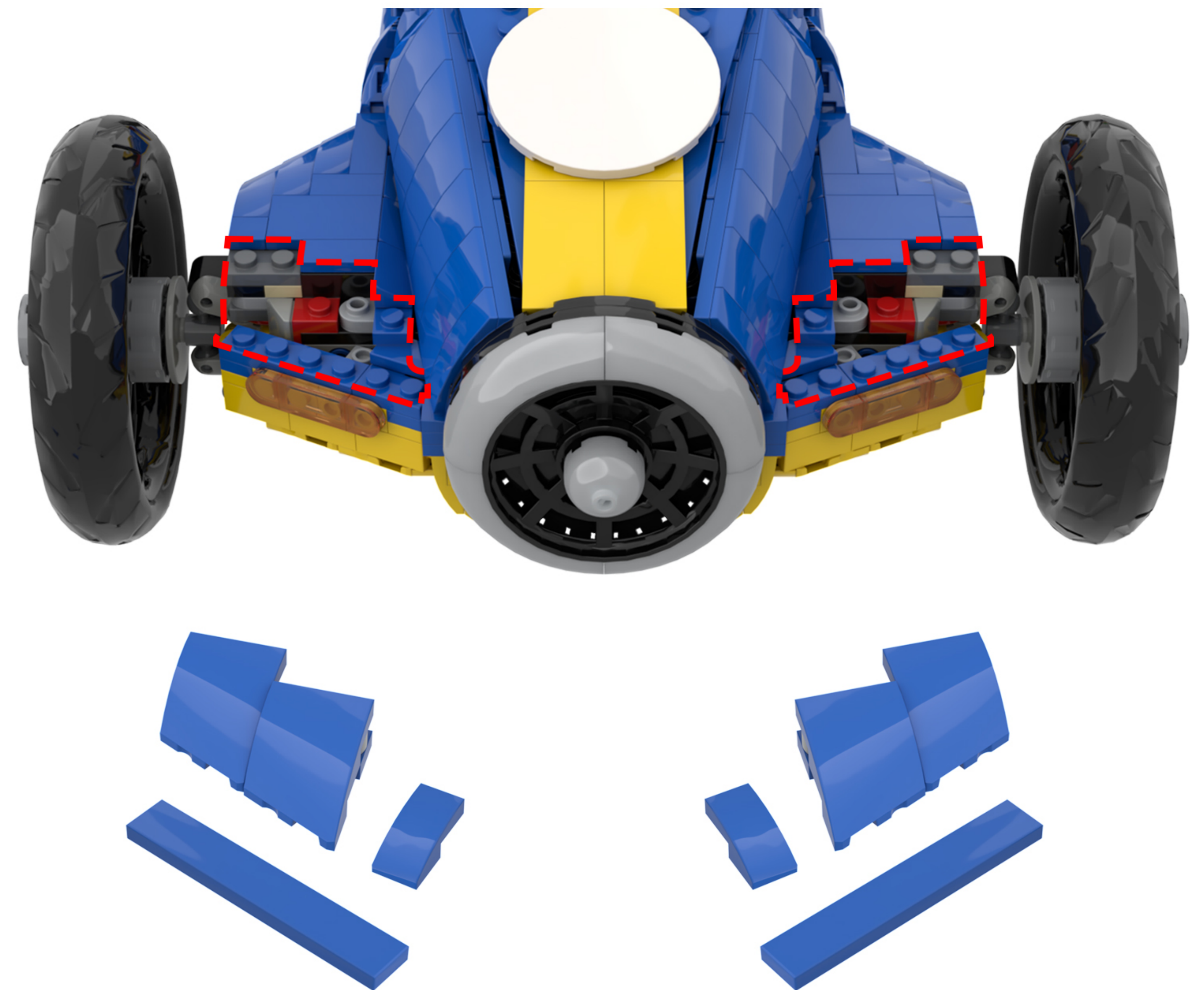

17

EN: Flip the model over so that the bottom is facing up.

DE: Drehen Sie das Modell um, sodass die Unterseite nach oben zeigt.

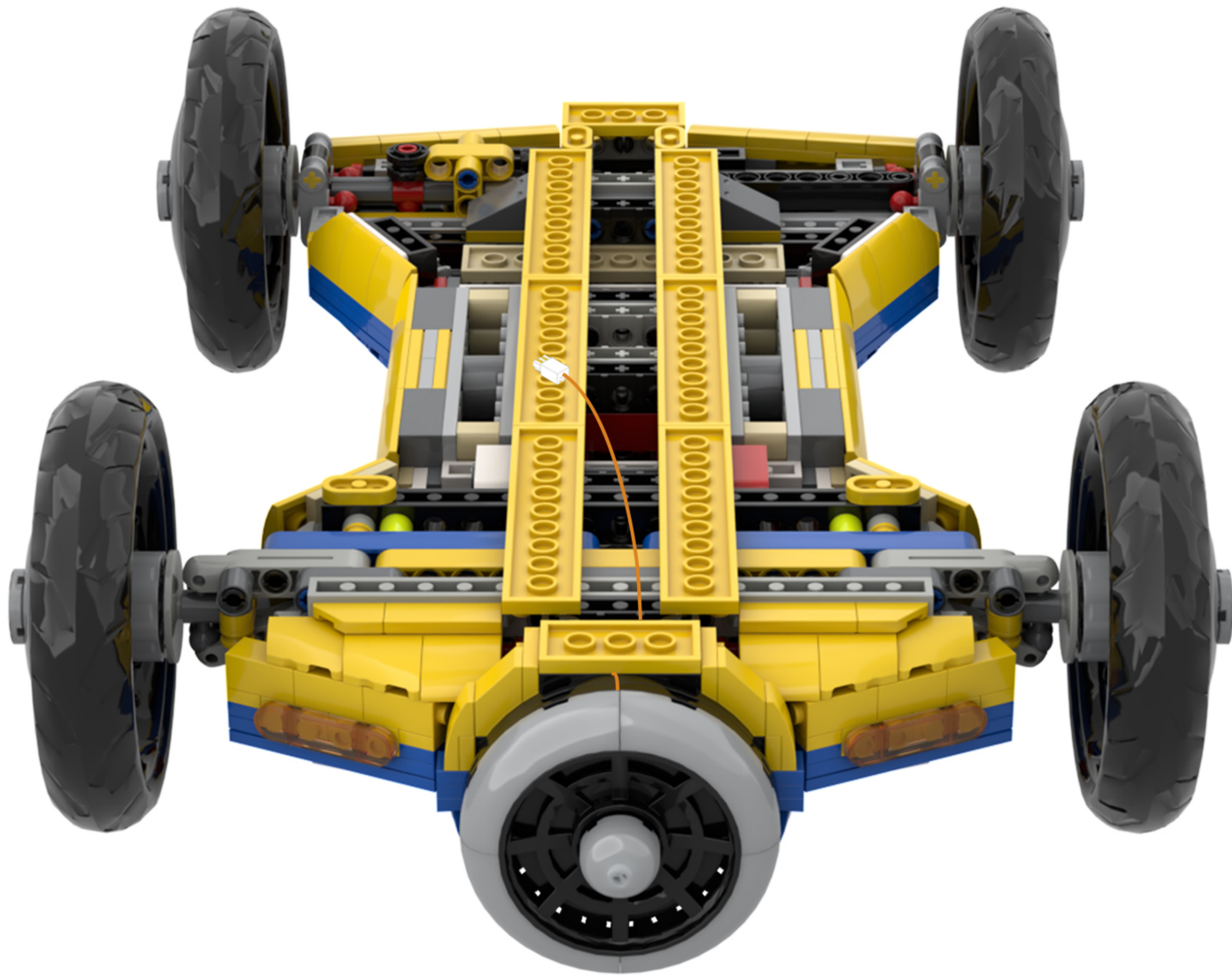

18

EN: Split as shown in the figure.

DE: Wie in der Abbildung gezeigt, teilen Sie es auf.

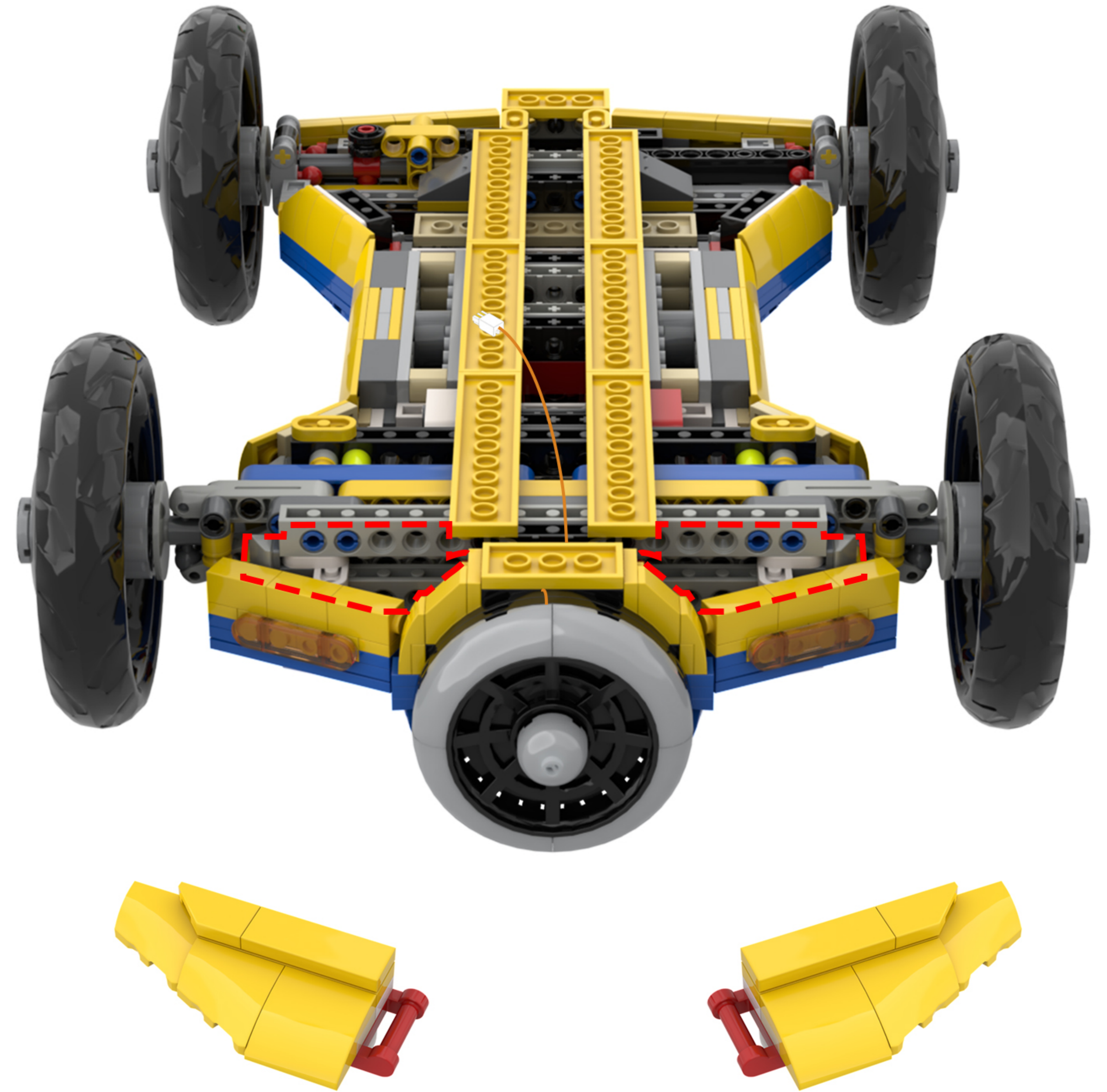

19

EN: Flip the model to restore it to its original state.

DE: Drehen Sie das Modell um, um es in seinen ursprünglichen Zustand zurückzusetzen.

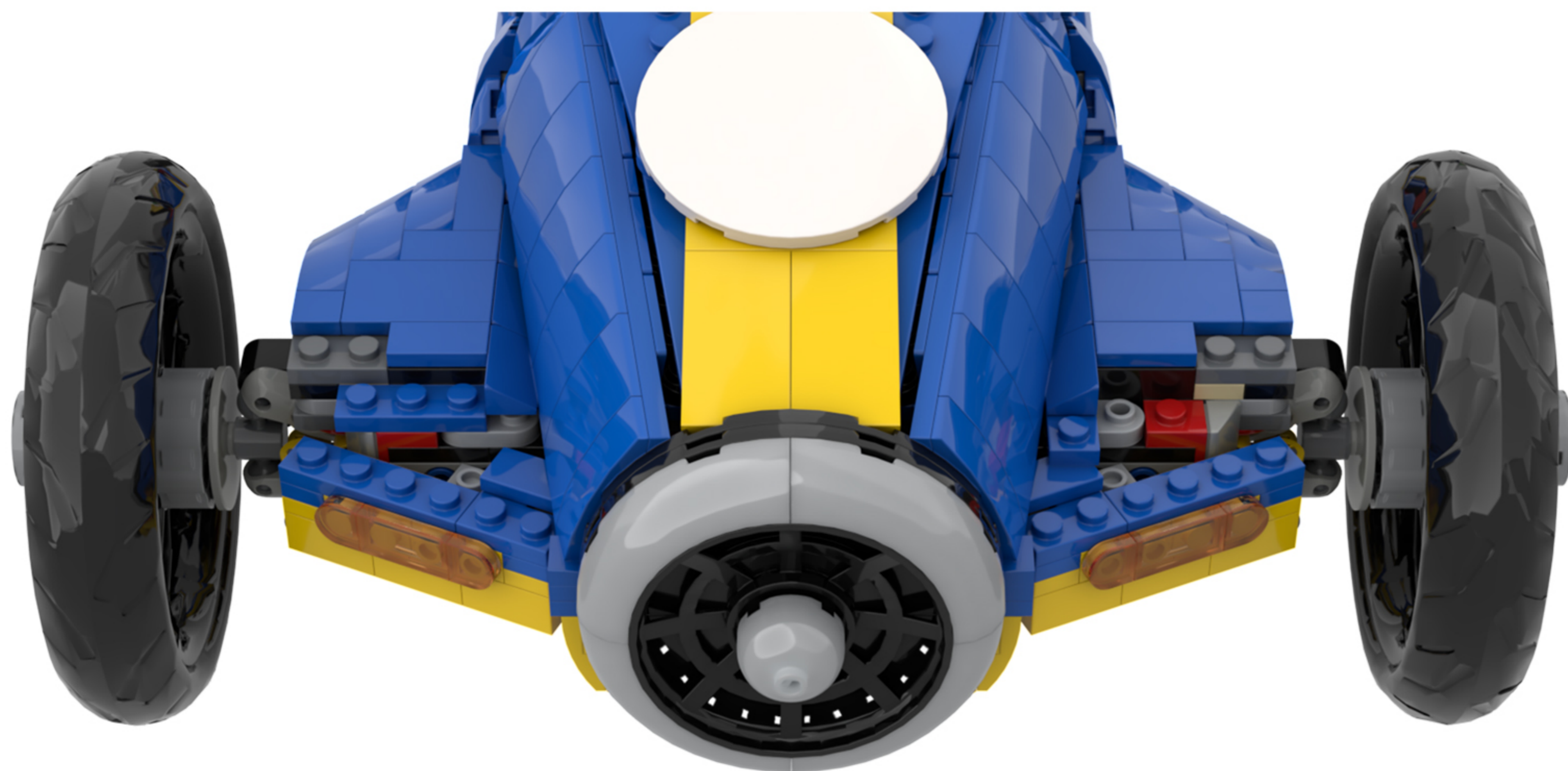
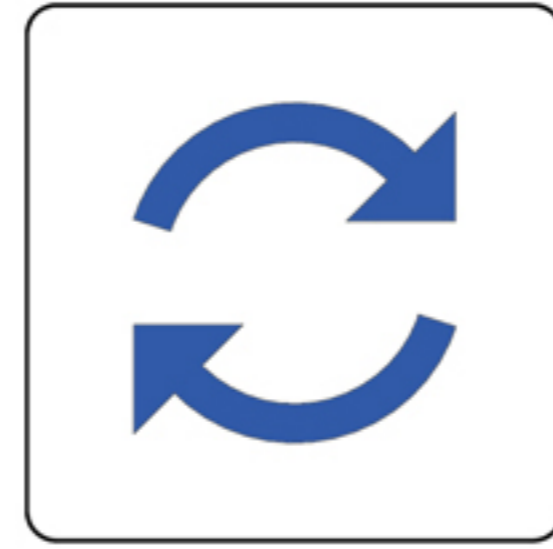

20

EN: Split as shown in the figure.

DE: Wie in der Abbildung gezeigt, teilen Sie es auf.

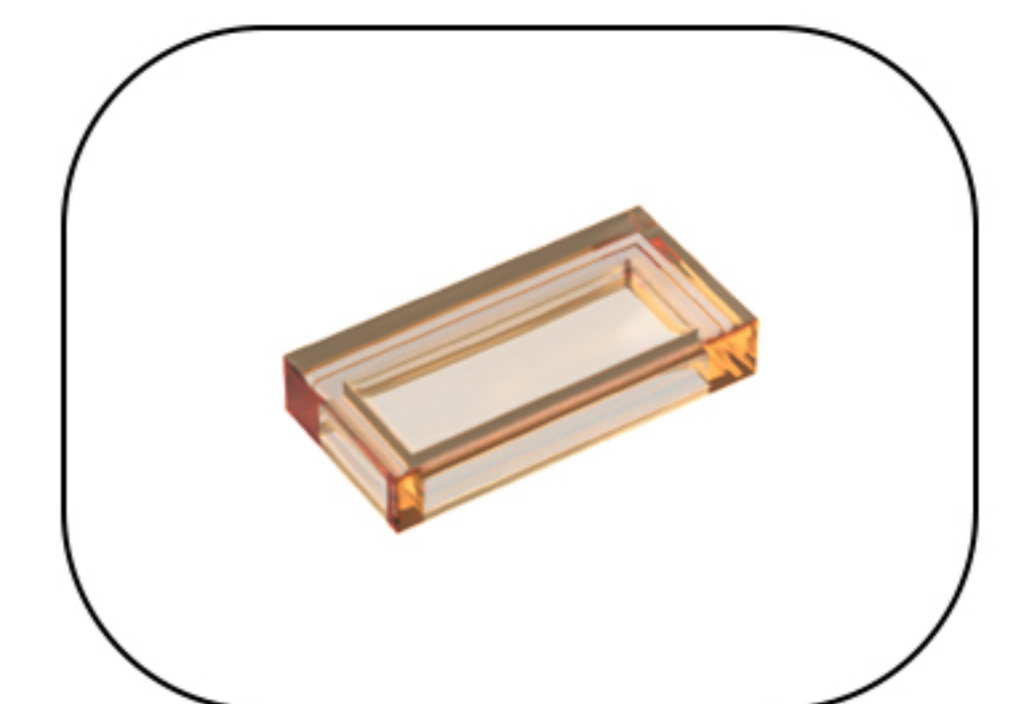
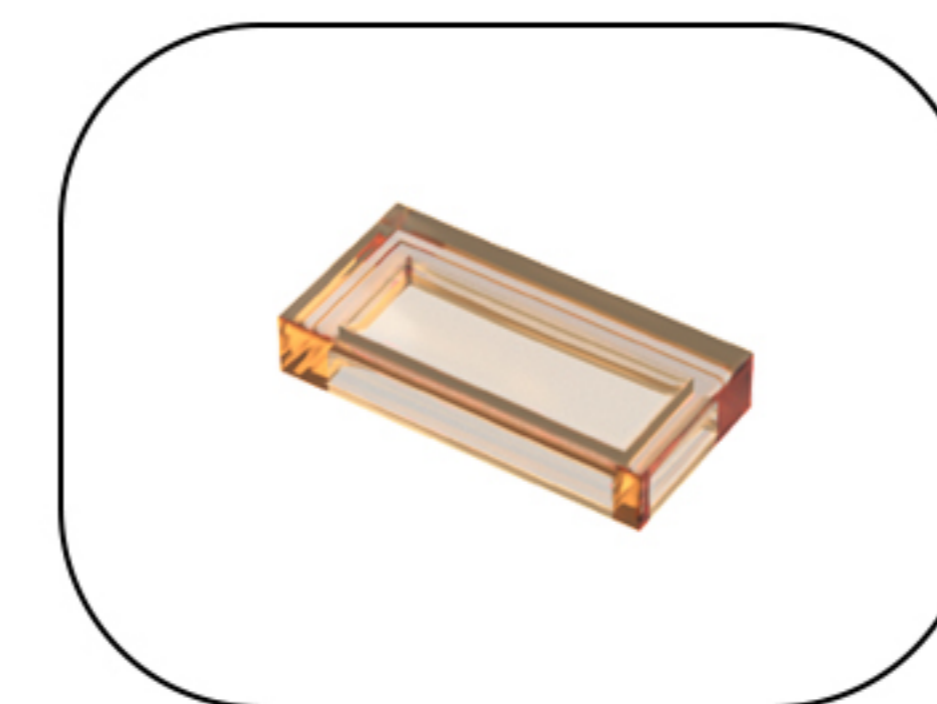
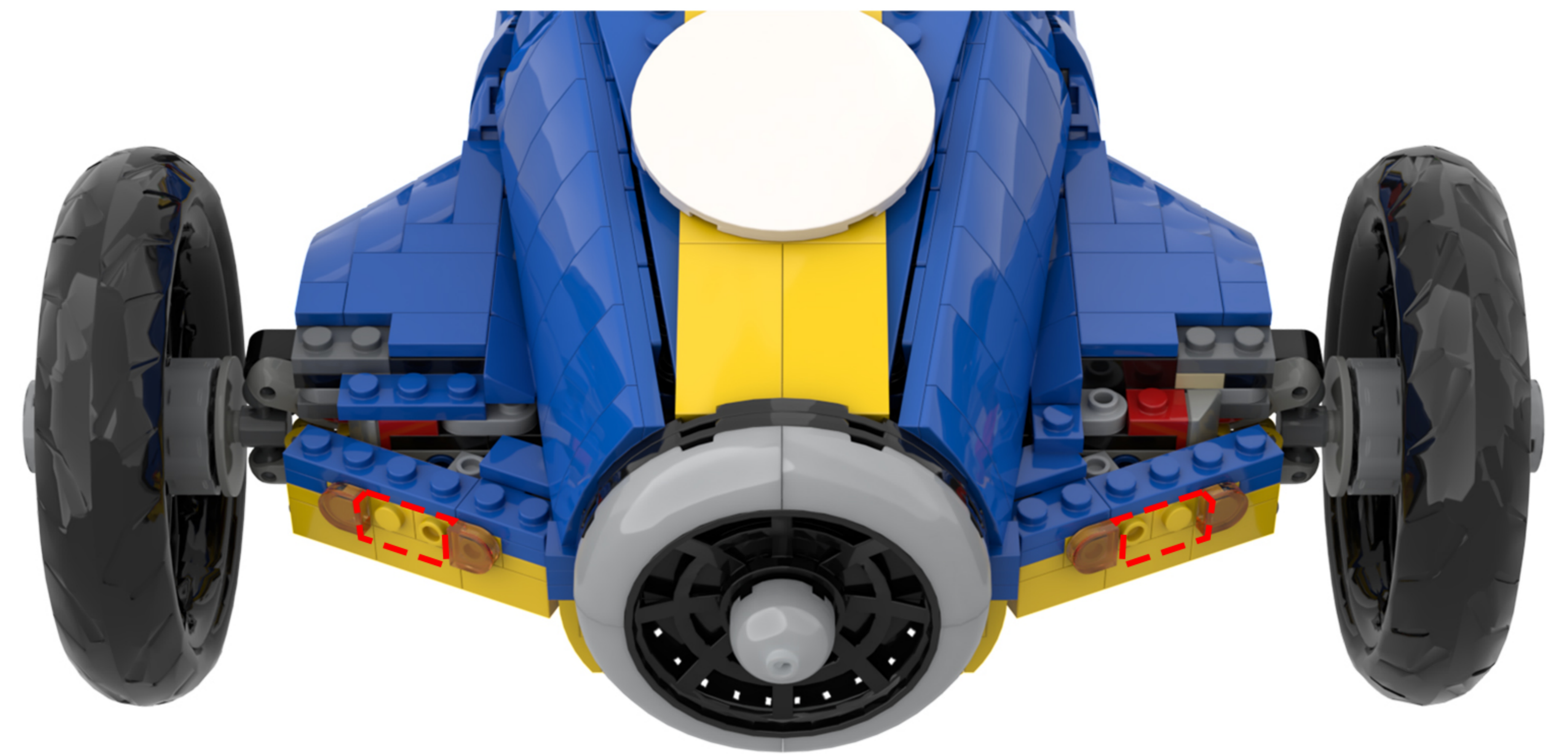

21

EN: Take the light beads out of bag #5 and place them on the building blocks.

DE: Nimm die Leuchtperlen aus Beutel Nr. 5 heraus und setze sie auf die Bausteine.

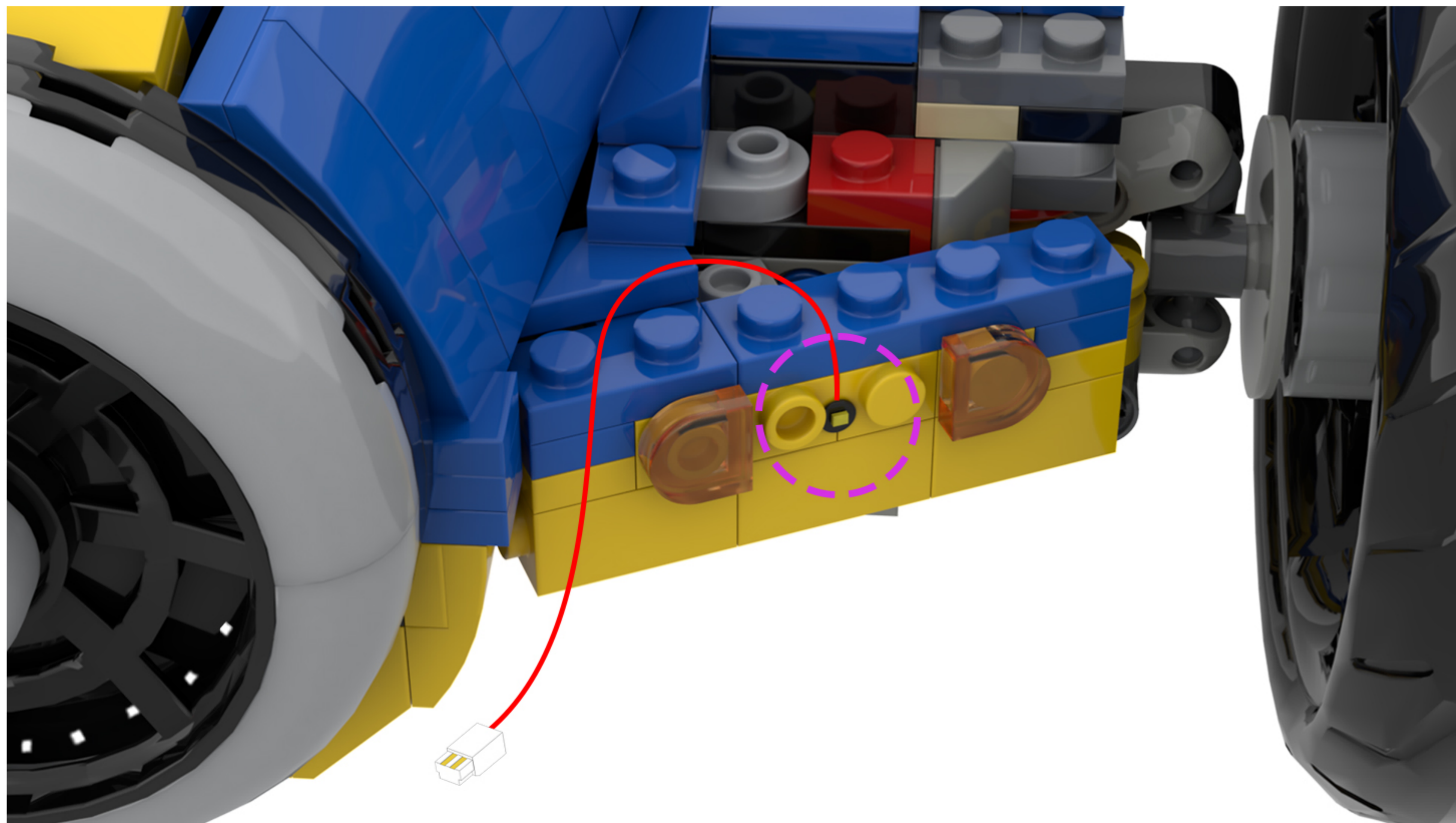
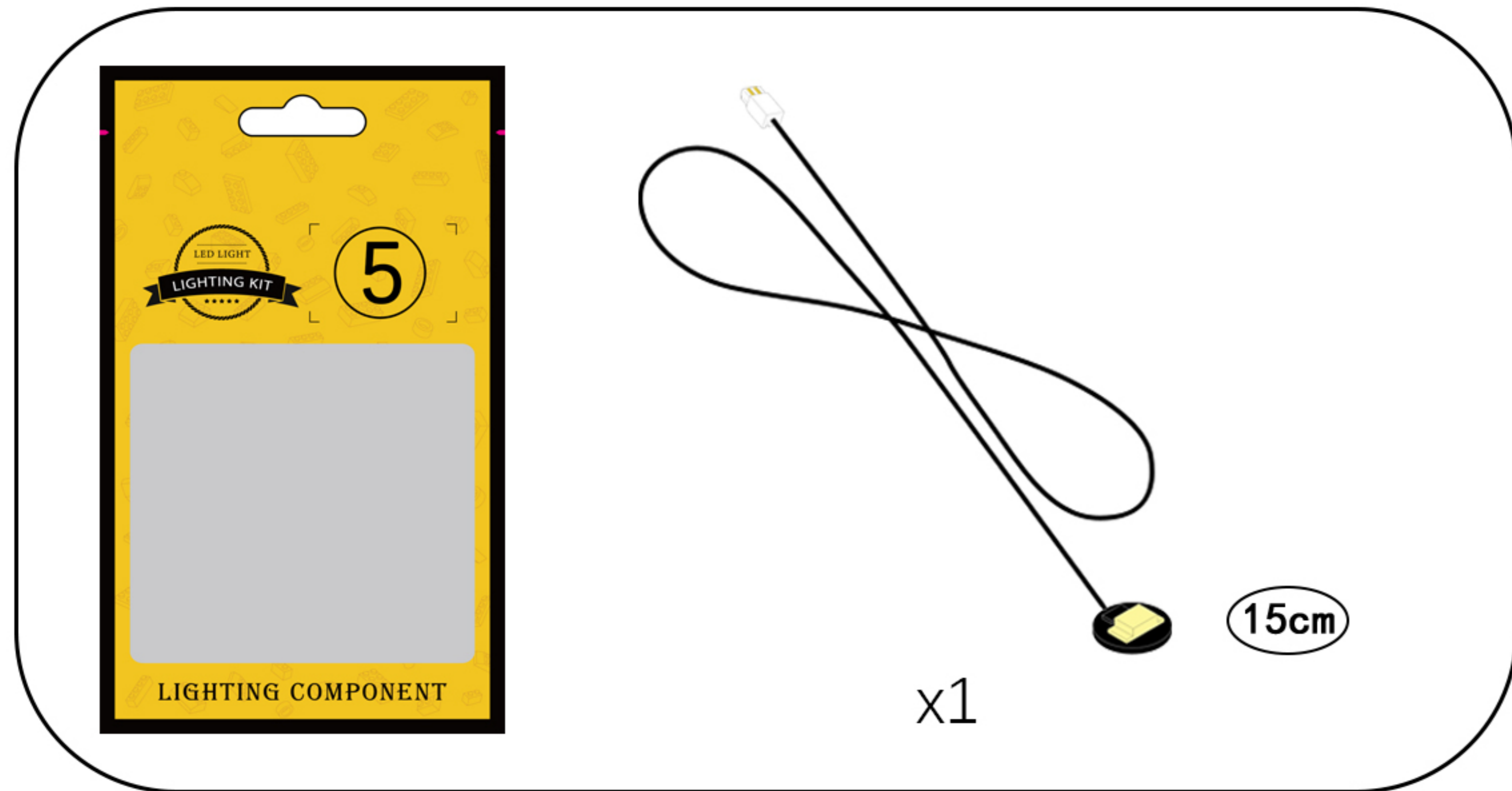

22

EN: Take out the disassembled building blocks, reassemble them, and secure the light cord.

DE: Nehmen Sie die zerlegten Bausteine heraus, setzen Sie sie wieder zusammen und befestigen Sie das Lichtkabel.

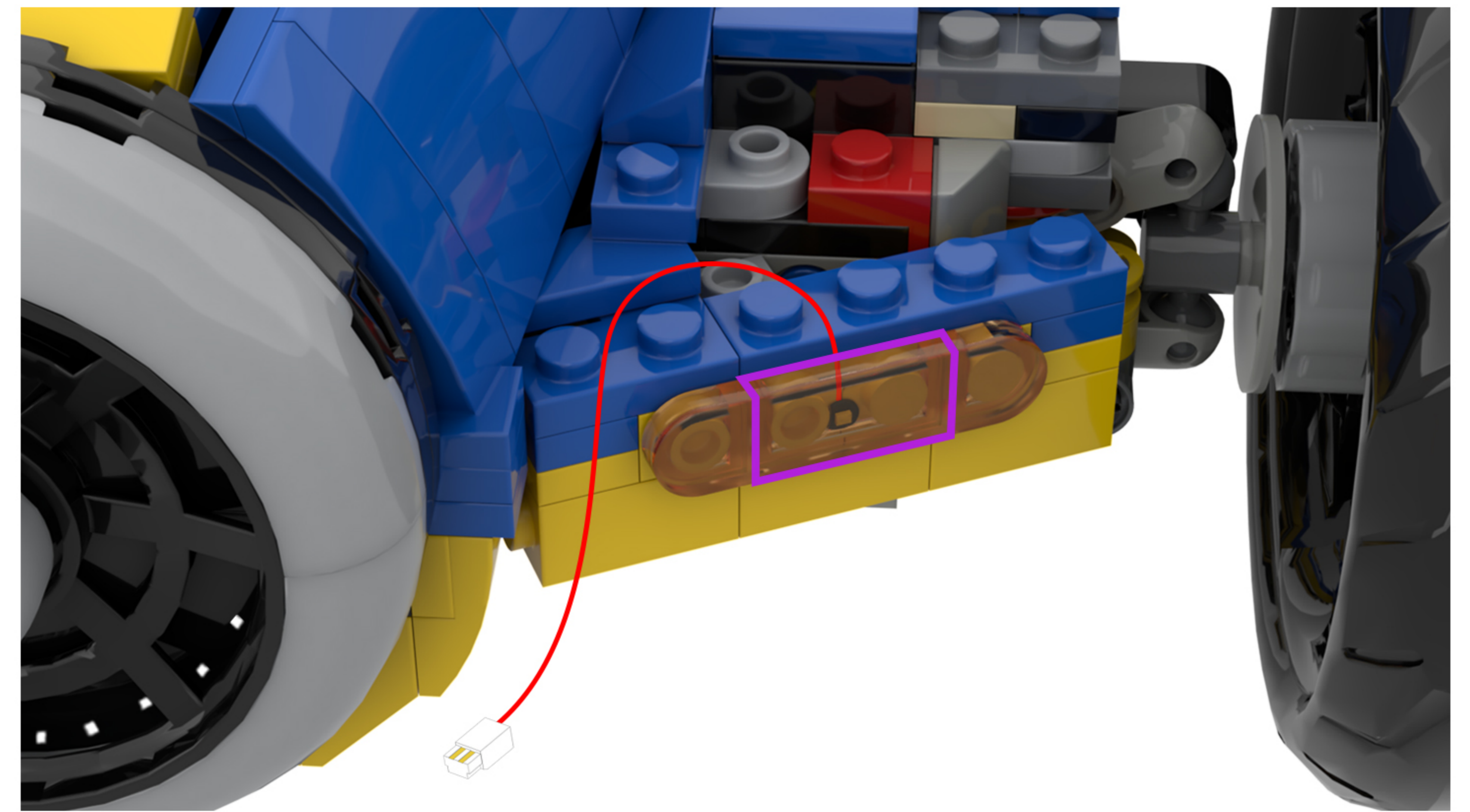
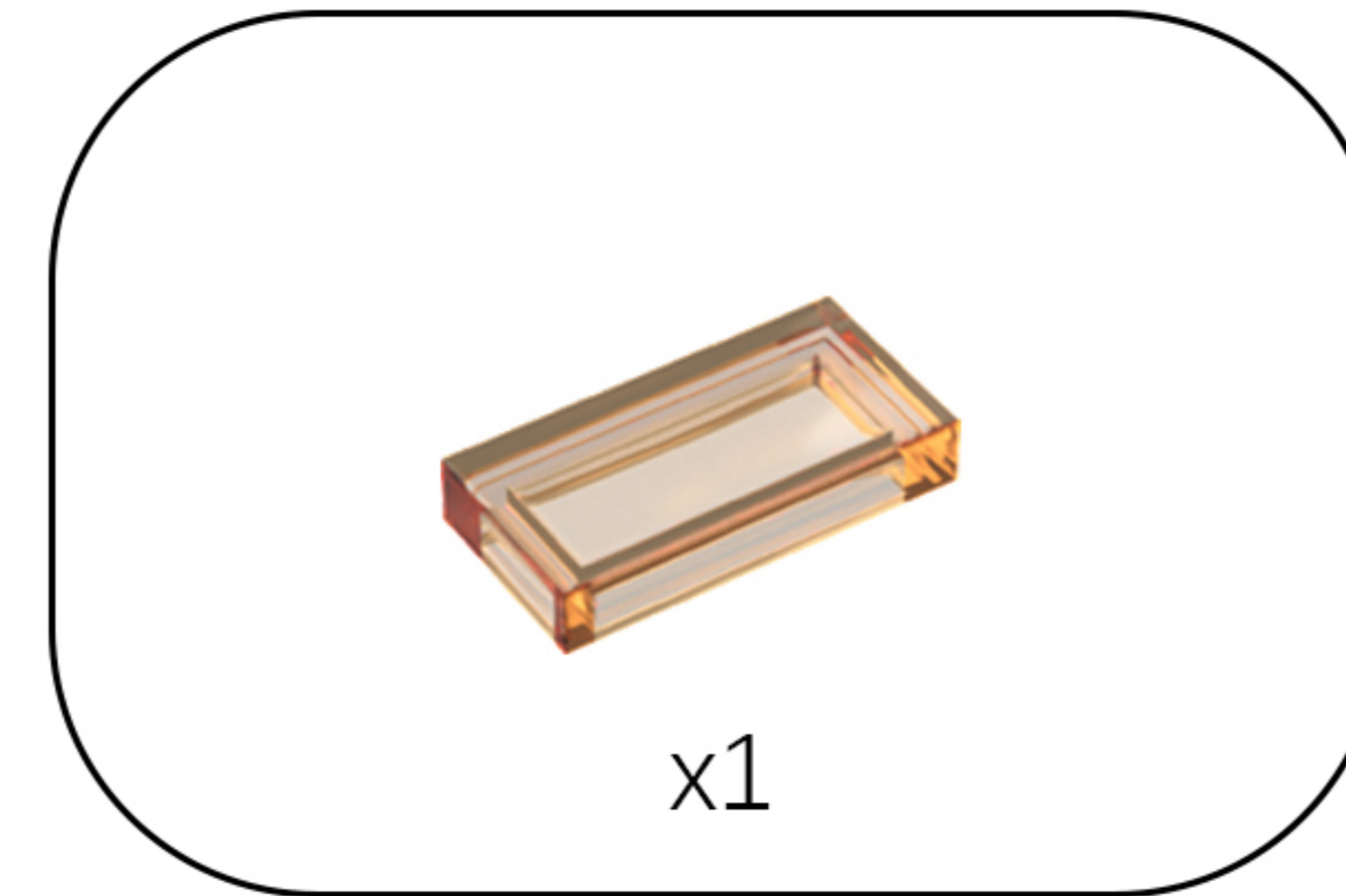

23

EN: Thread the lamp cord through the gaps in the building blocks.

DE: Führen Sie das Lampenkabel durch die Lücken in den Bausteinen.

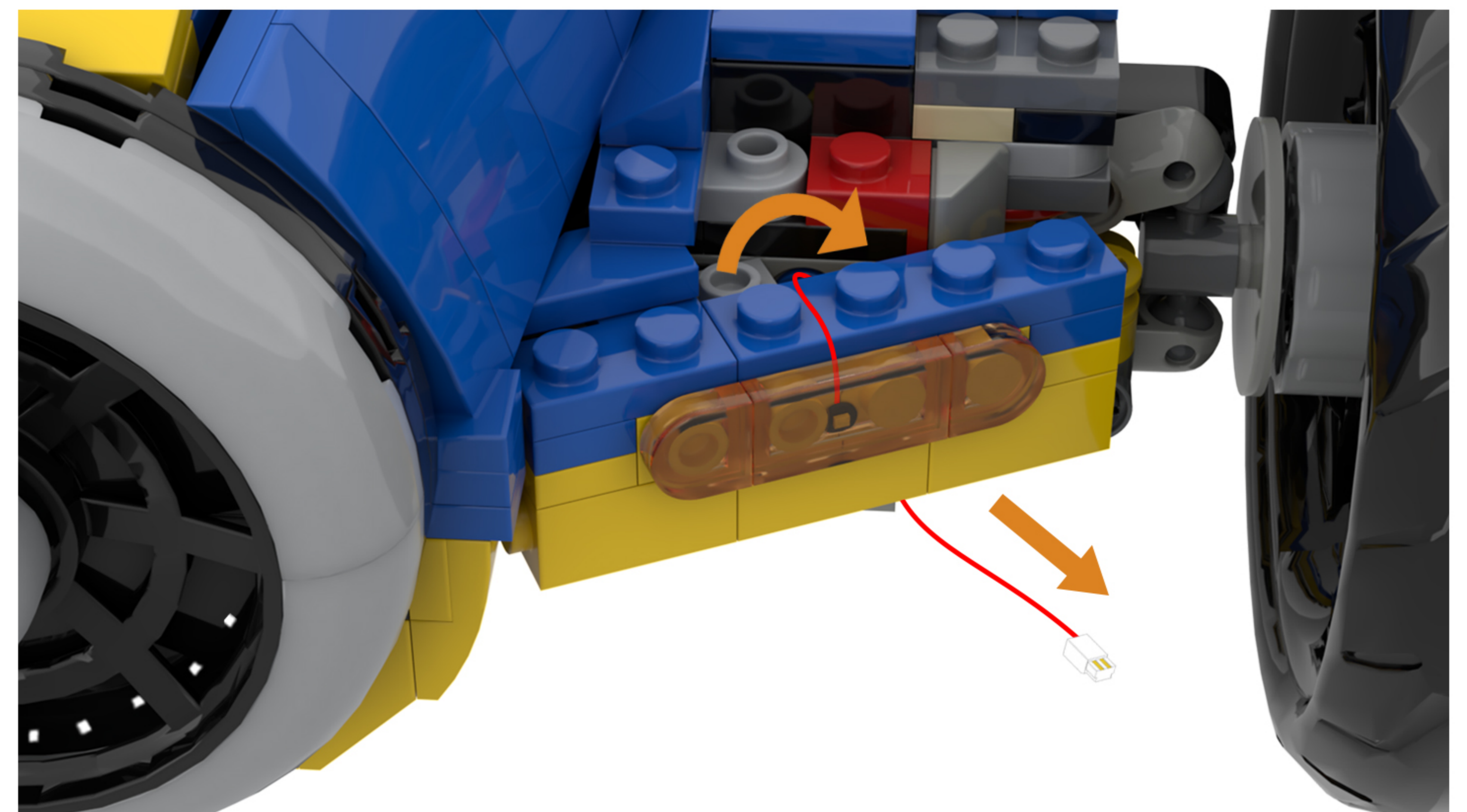
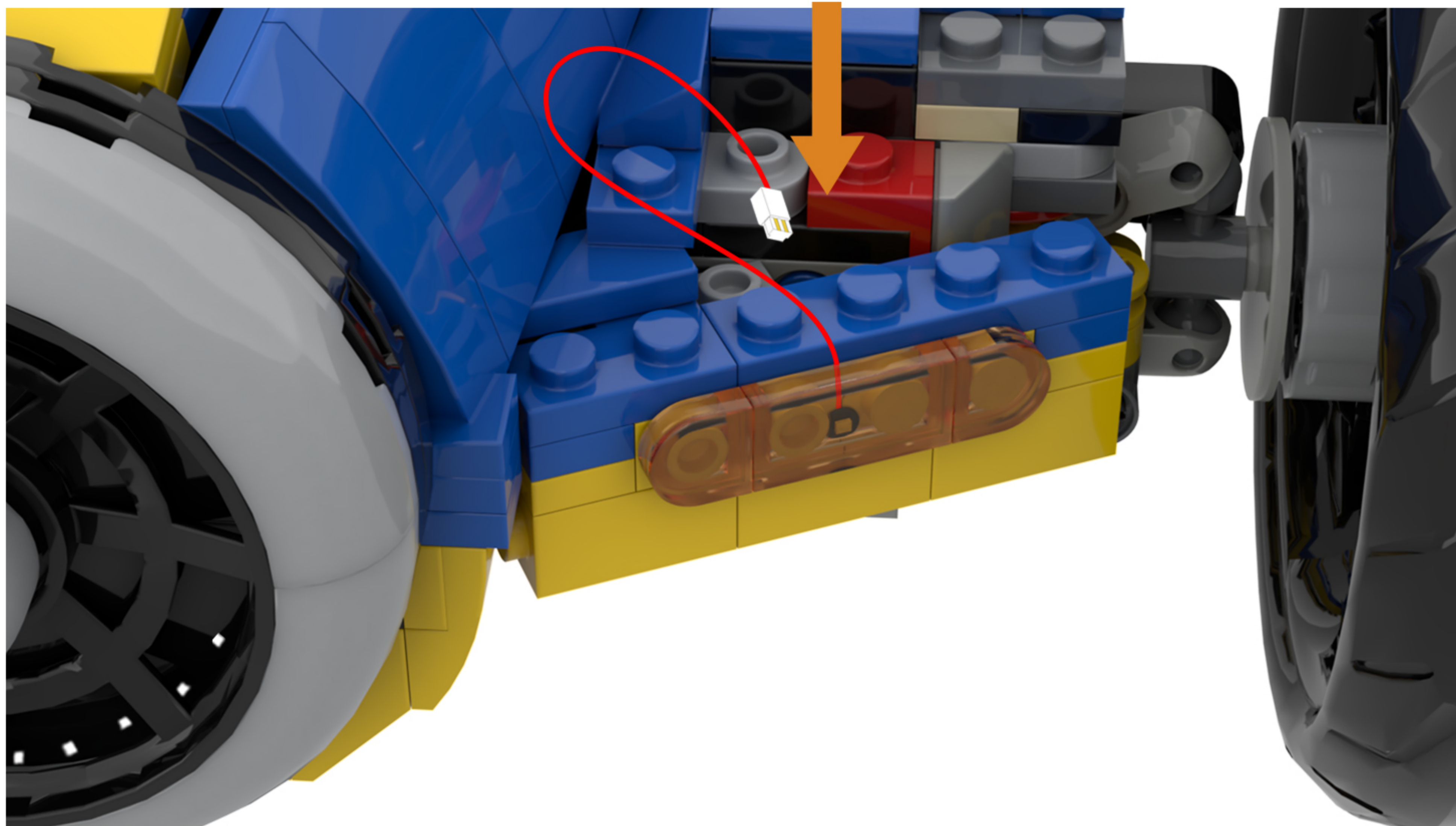

24

EN: Take out the disassembled building blocks and reassemble them in order.

DE: Nehmen Sie die zerlegten Bausteine heraus und setzen Sie sie der Reihe nach wieder zusammen.

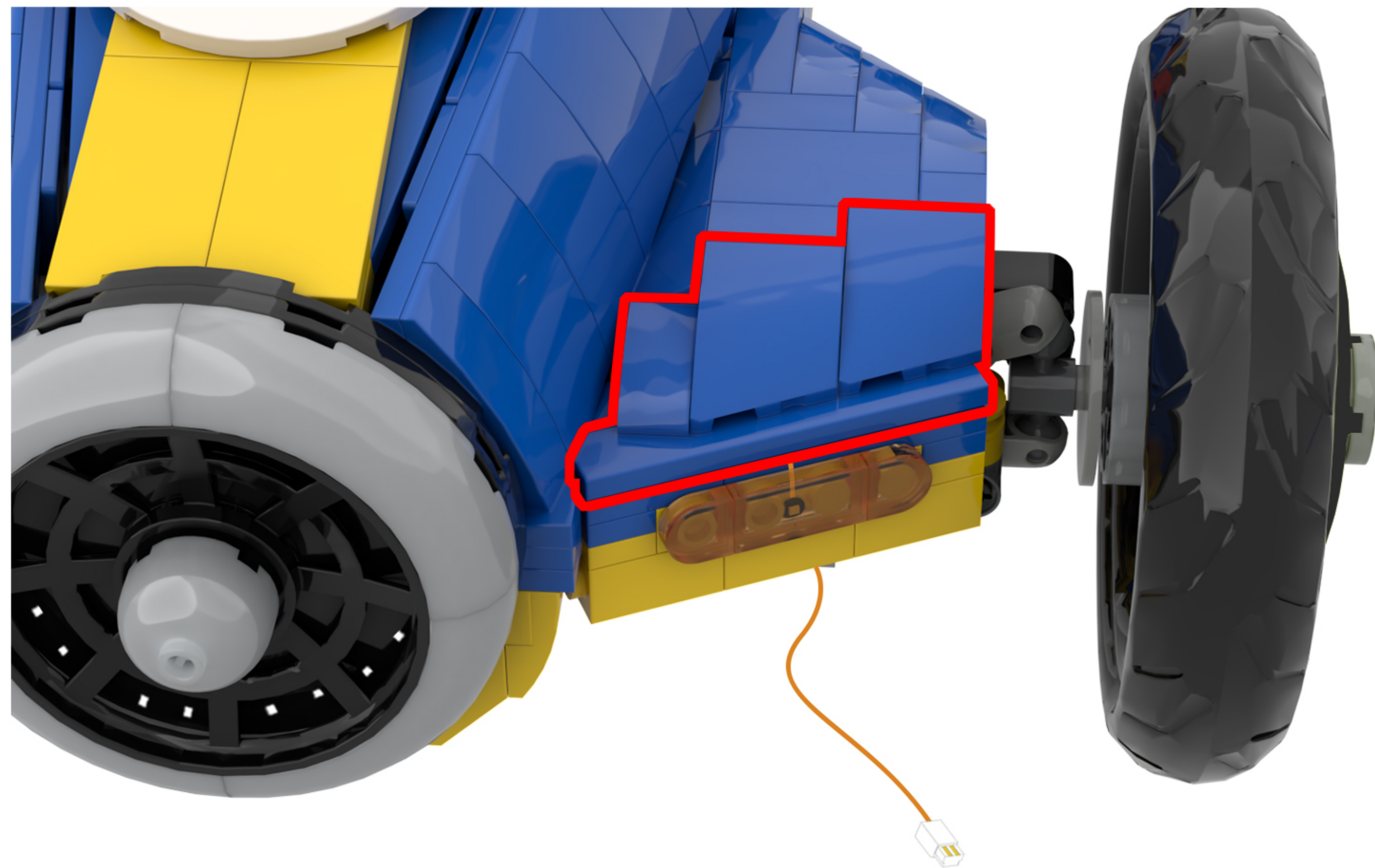
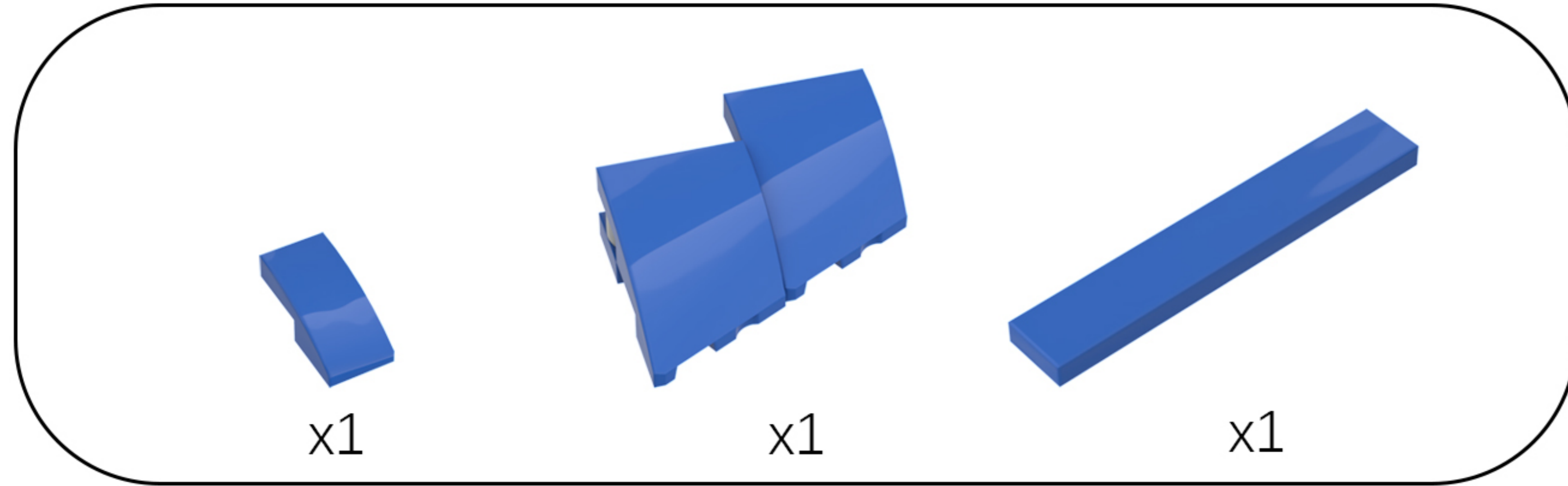

25

EN: Go to the other side of the model.

DE: Geh auf die andere Seite des Modells..

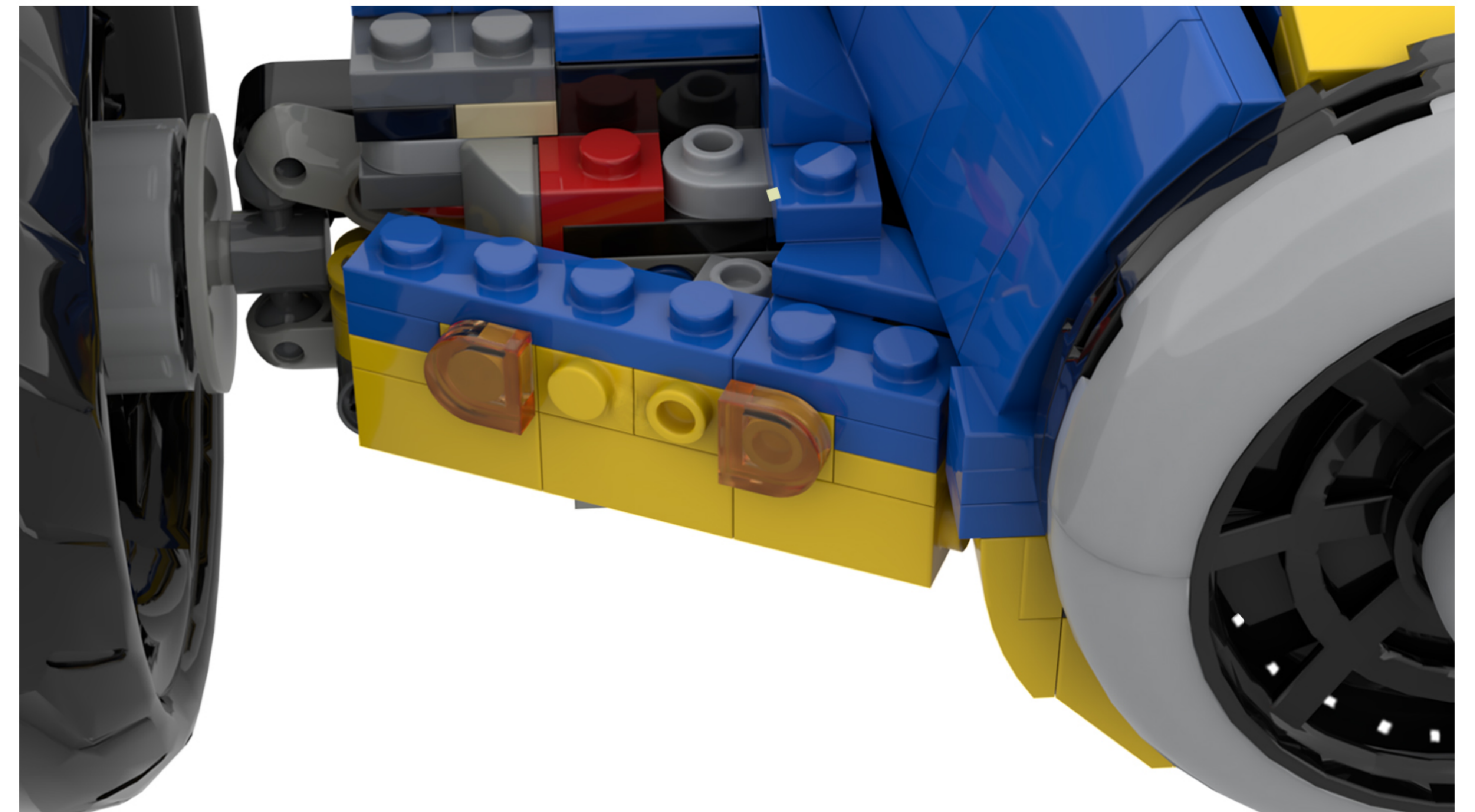

26

EN: Repeat the steps above to install the lighting on the left-hand block.

DE: Wiederholen Sie die oben genannten Schritte, um die Beleuchtung am linken Block anzubringen.

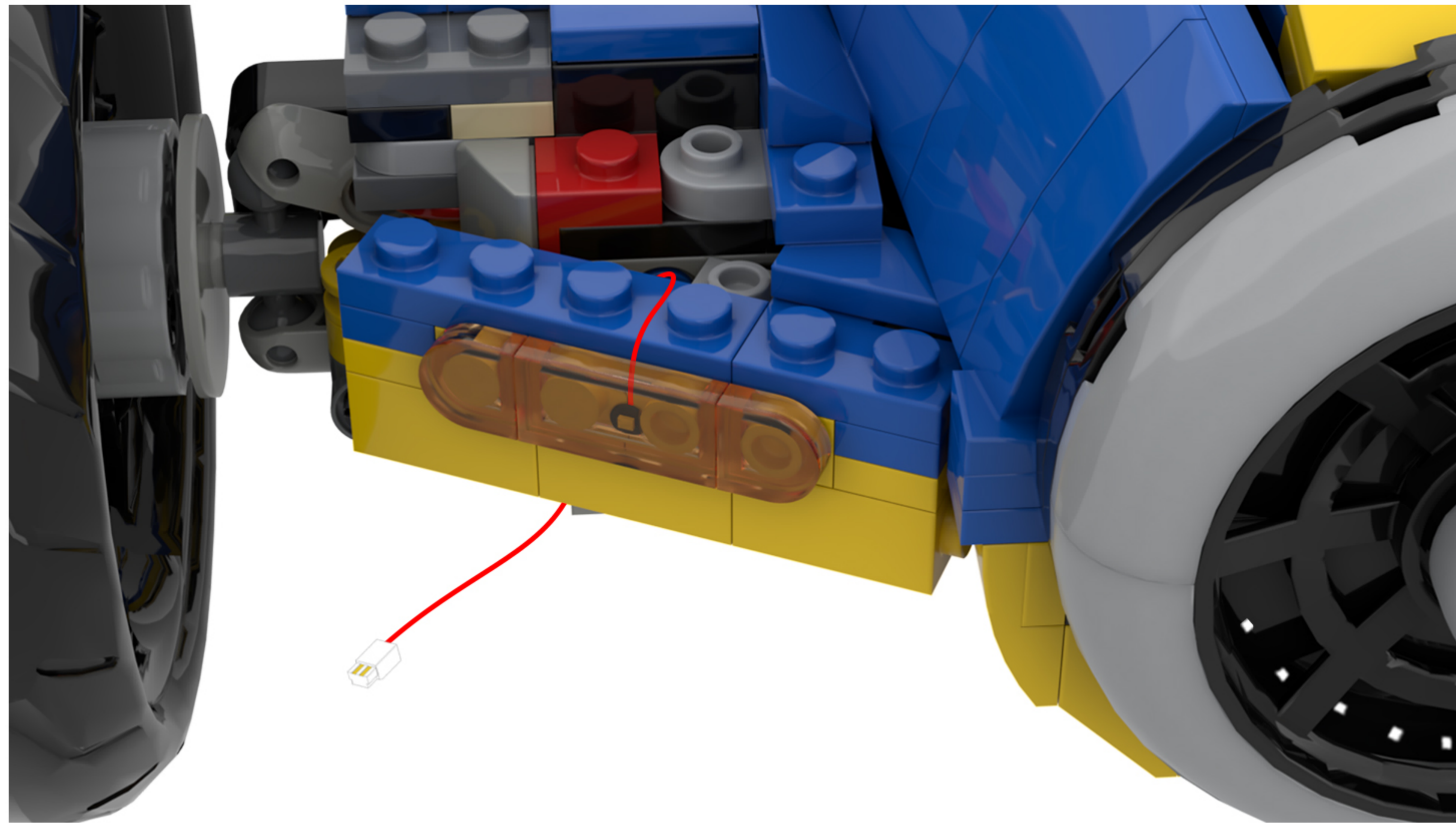

27

EN: Take out the disassembled building blocks and reassemble them in order.

DE: Nehmen Sie die zerlegten Bausteine heraus und setzen Sie sie der Reihe nach wieder zusammen.

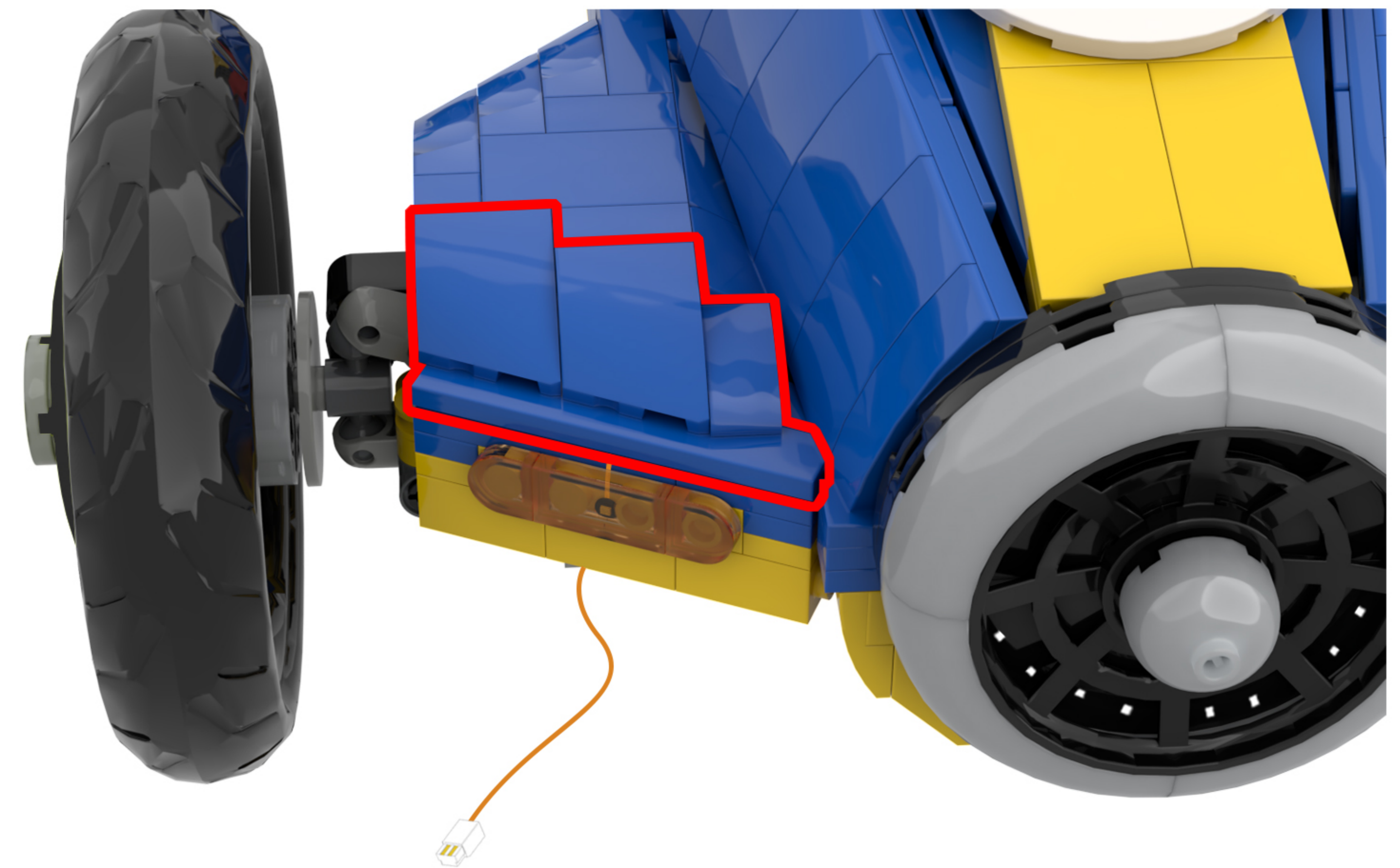
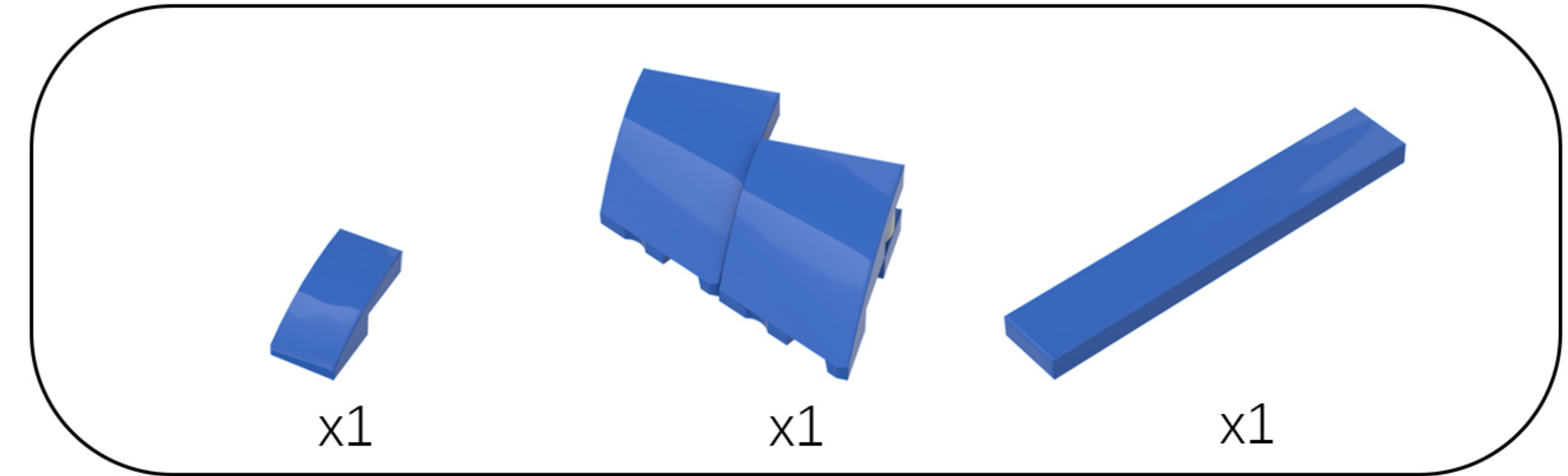

28

EN: Flip the model over so that the bottom is facing up.

DE: Drehen Sie das Modell um, sodass die Unterseite nach oben zeigt.

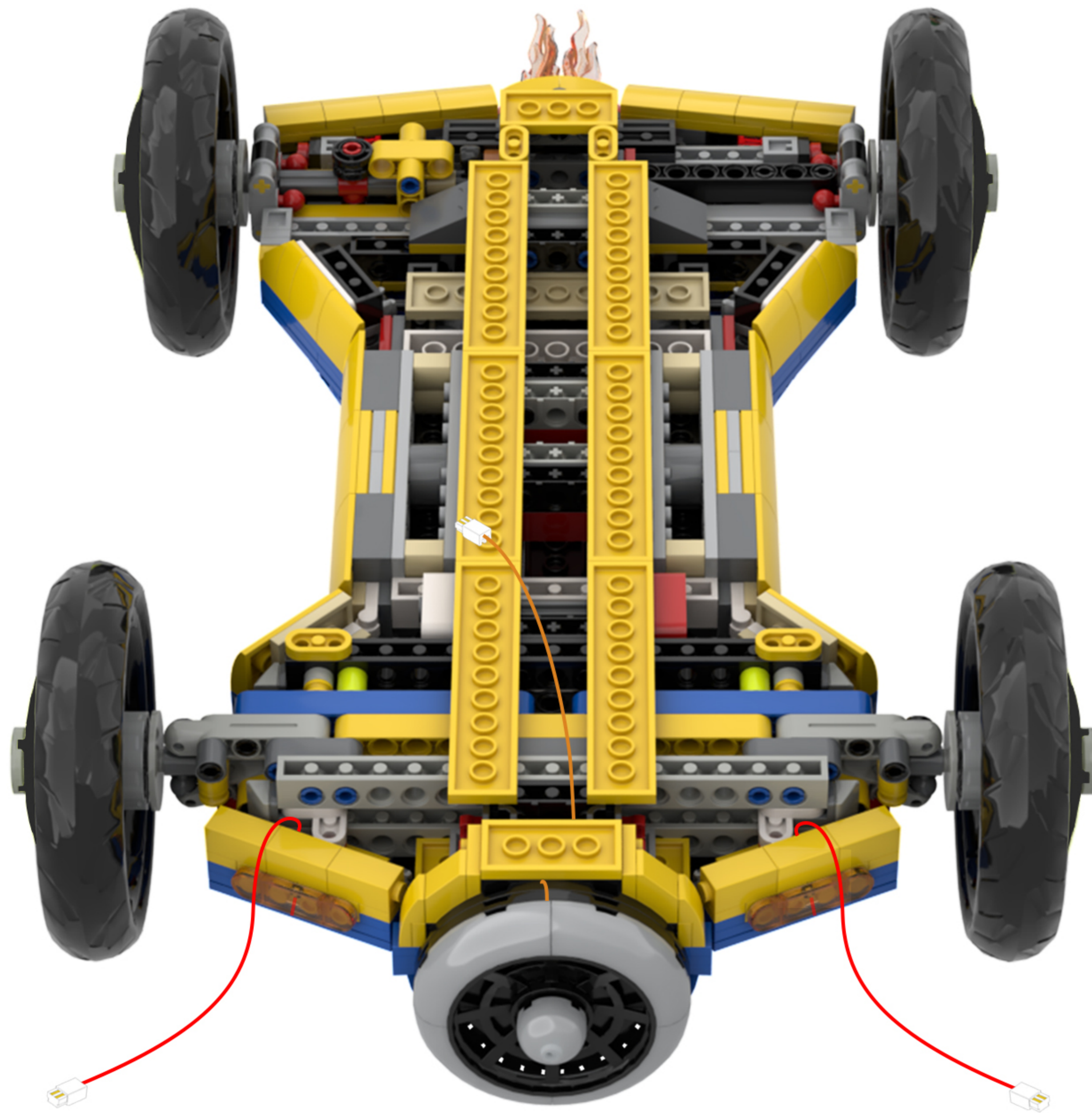

29

EN: Take out the disassembled building blocks, reassemble them, and secure the light cord.

DE: Nehmen Sie die zerlegten Bausteine heraus, setzen Sie sie wieder zusammen und befestigen Sie das Lichtkabel.

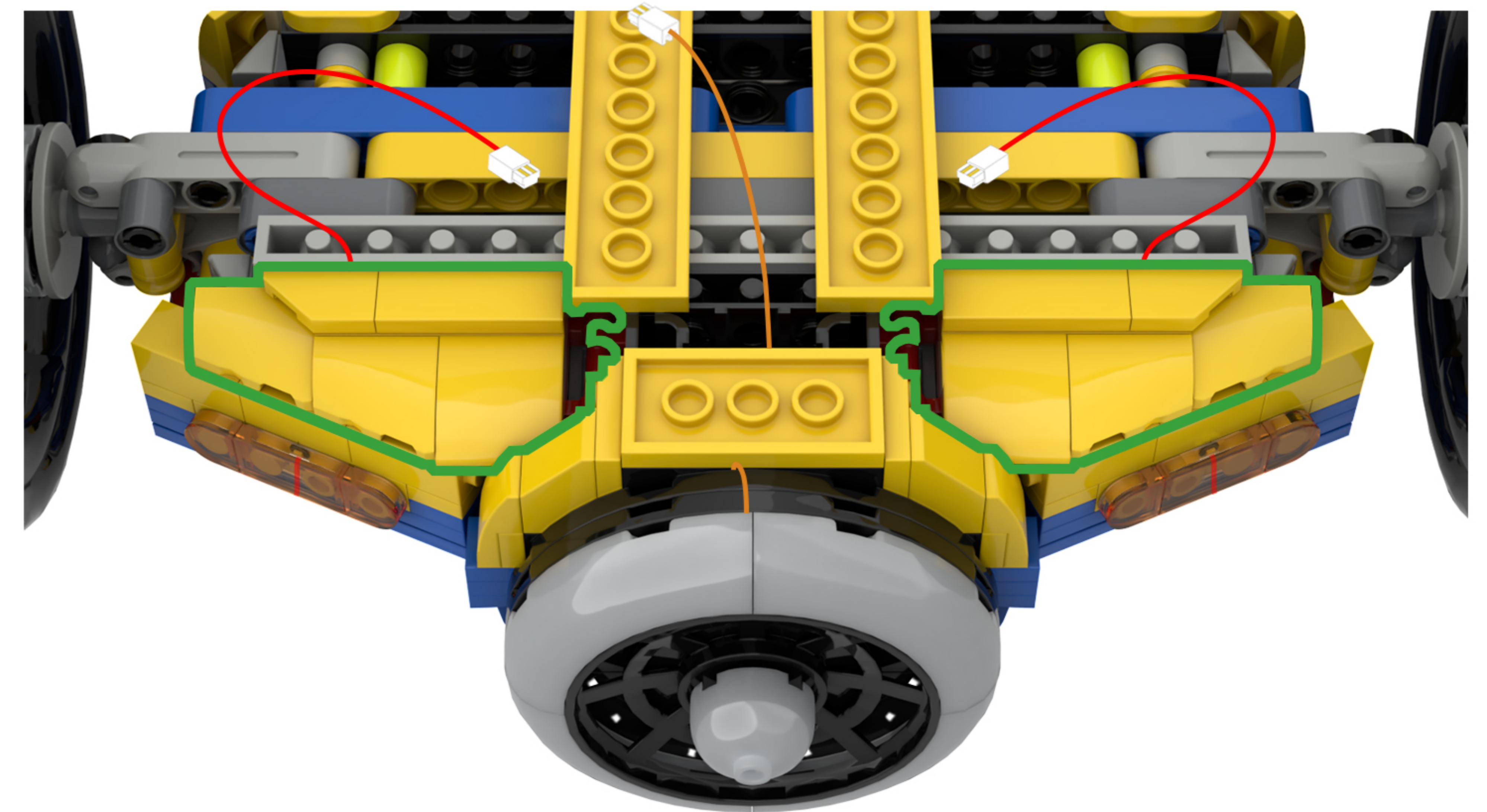
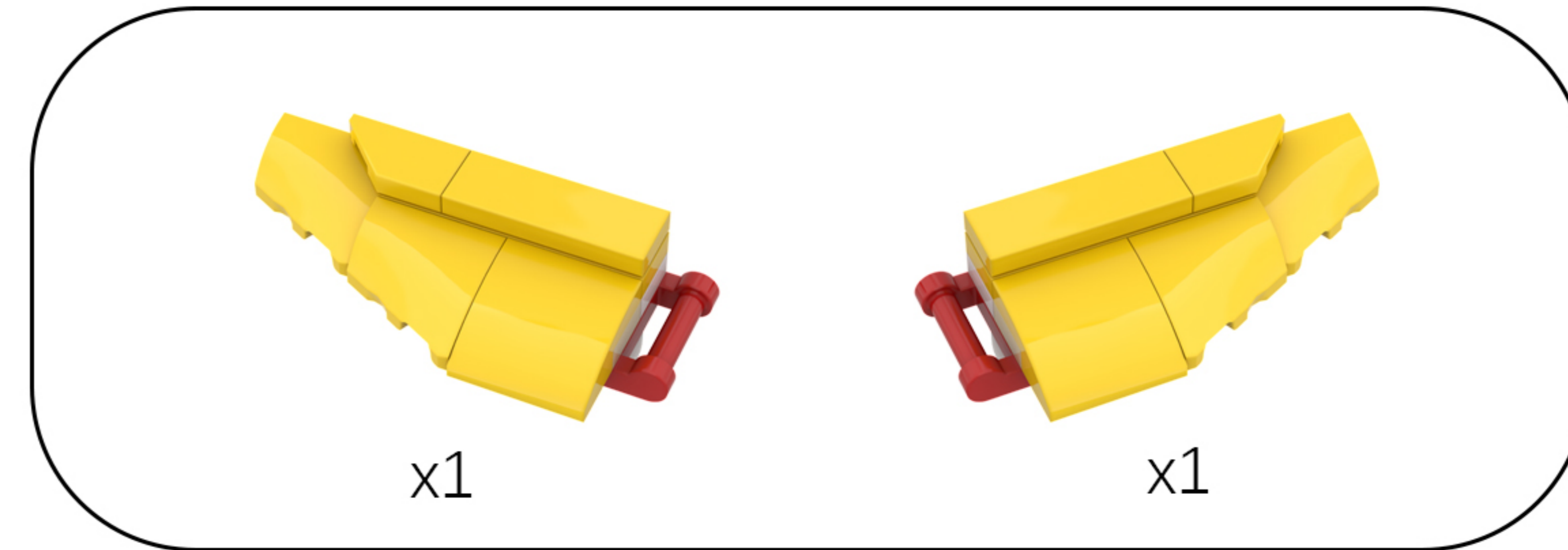

Note: Be careful where the building blocks are pressing against the light cord.

30

EN: Flip the model to restore it to its original state.

DE: Drehen Sie das Modell um, um es in seinen ursprünglichen Zustand zurückzusetzen.

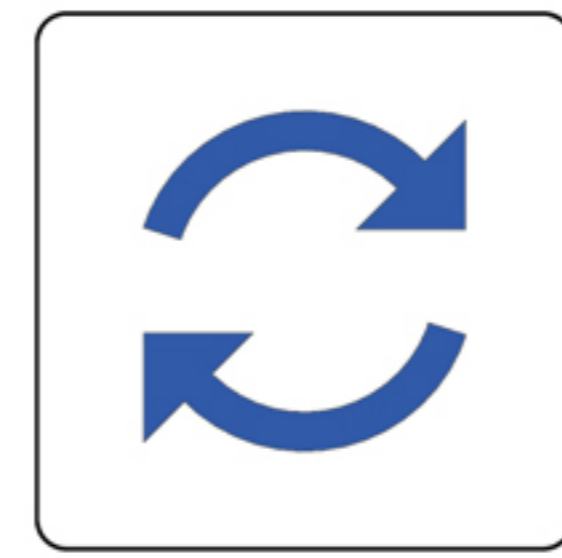

31

EN: Remove the building blocks one by one.

DE: Entfernen Sie die Bausteine nacheinander.

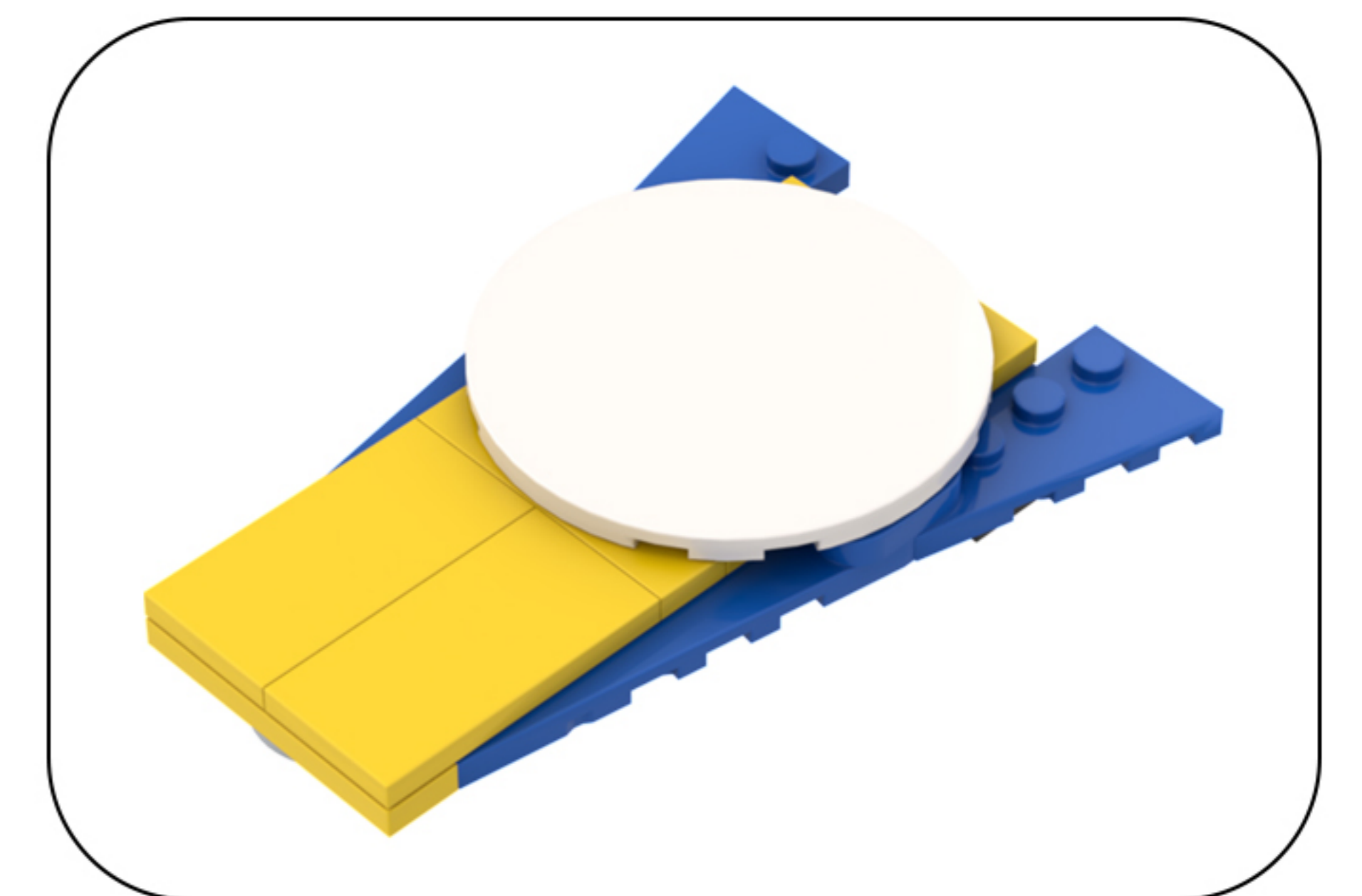
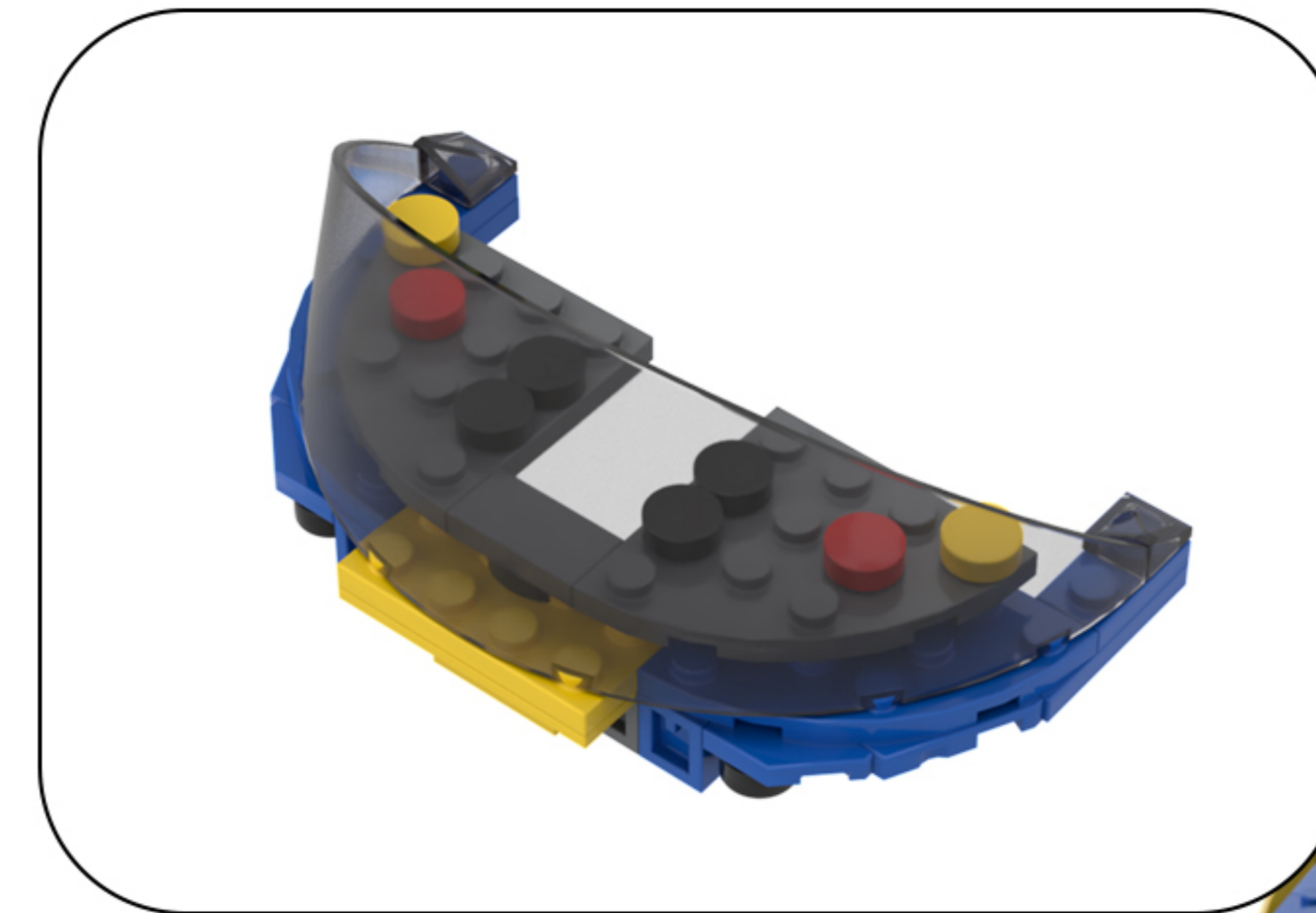

32

EN: Take out the disassembled building blocks and take them apart one by one.

DE: Nimm die zerlegten Bausteine heraus und nimm sie nacheinander auseinander.

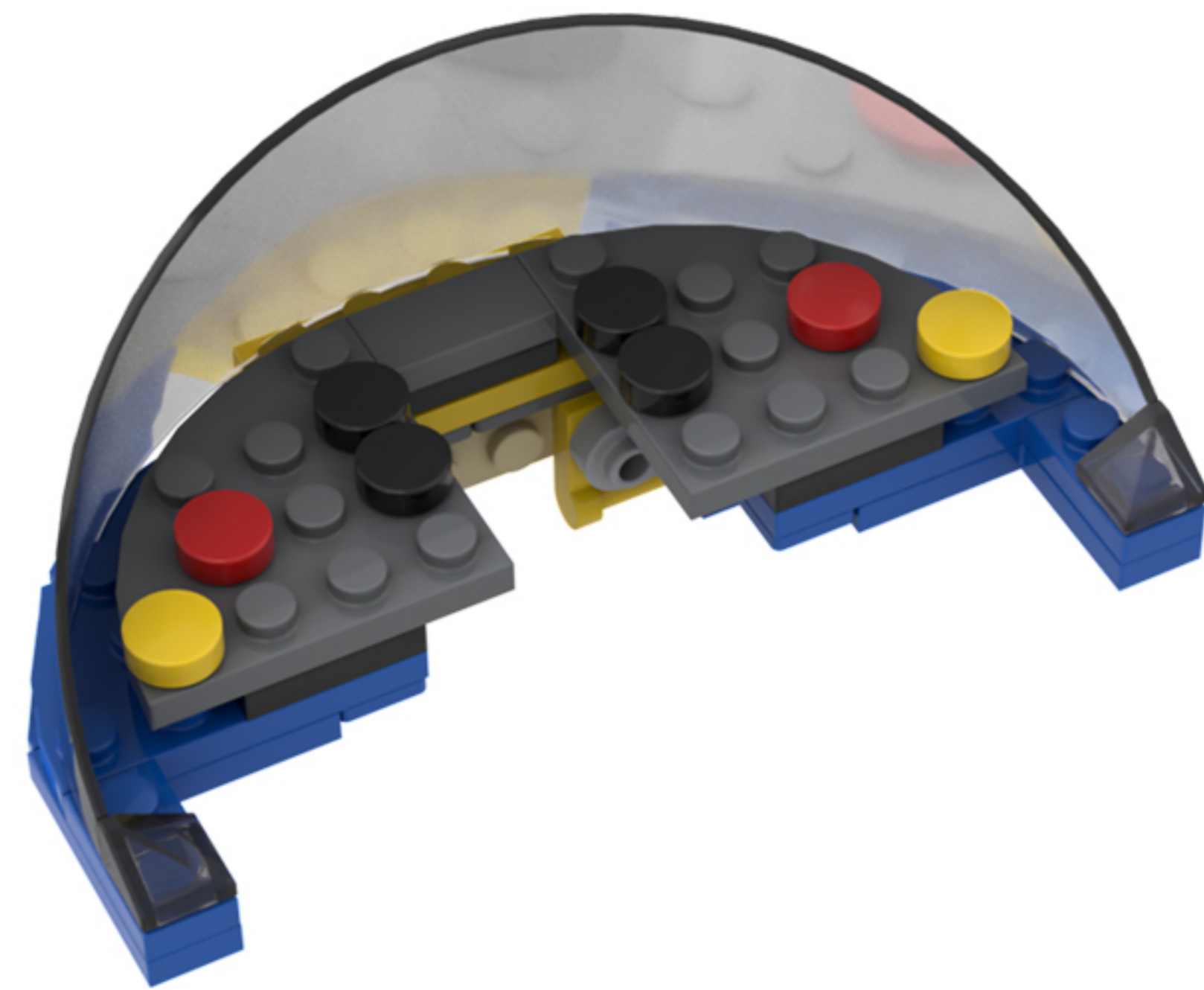
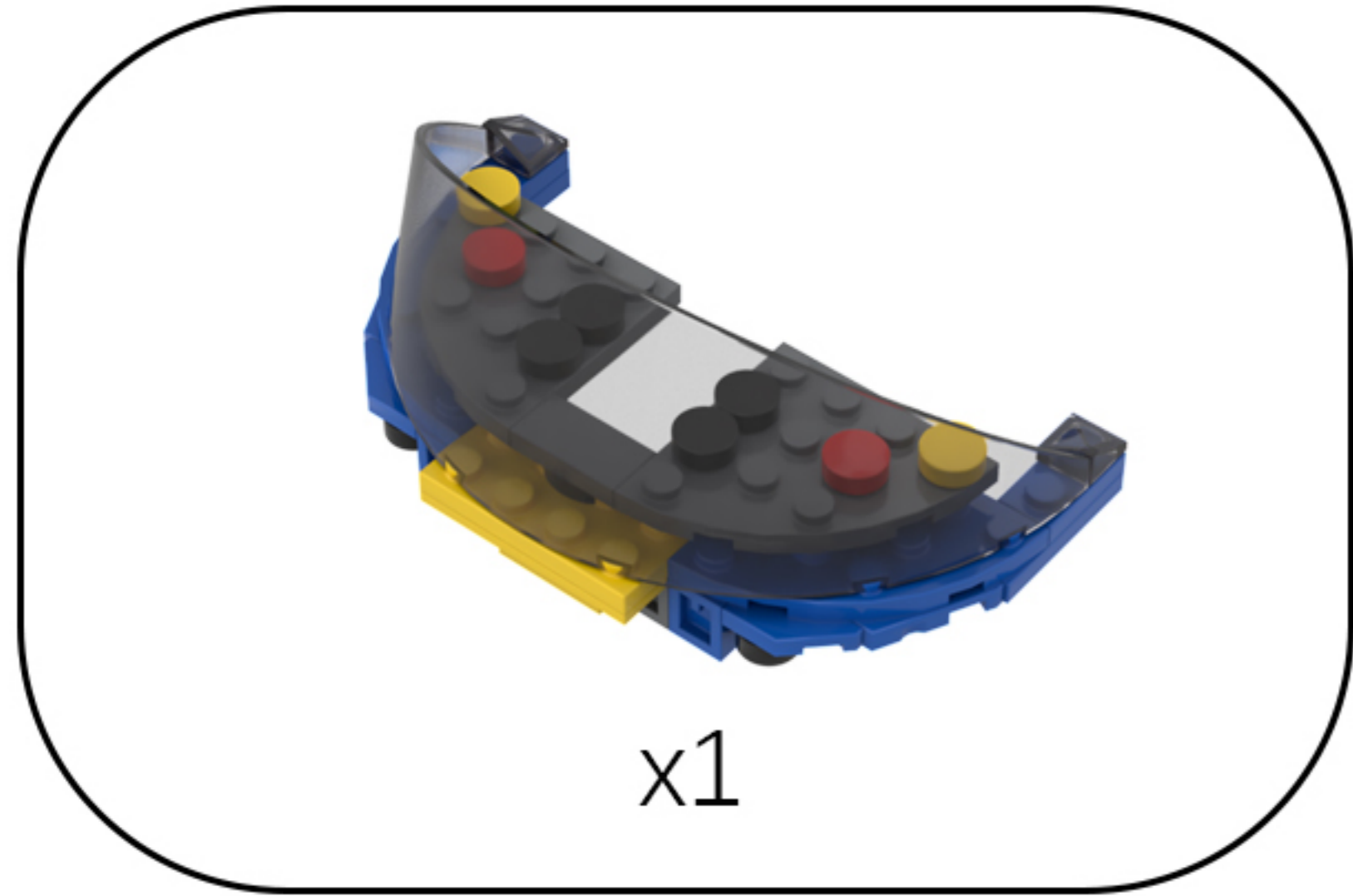

33

EN: Take the light strip and connecting wires out of Bag 4 and connect them together in order.

DE: Nehmen Sie den Lichtstreifen und die Anschlusskabel aus Beutel 4 und verbinden Sie sie der Reihe nach miteinander.

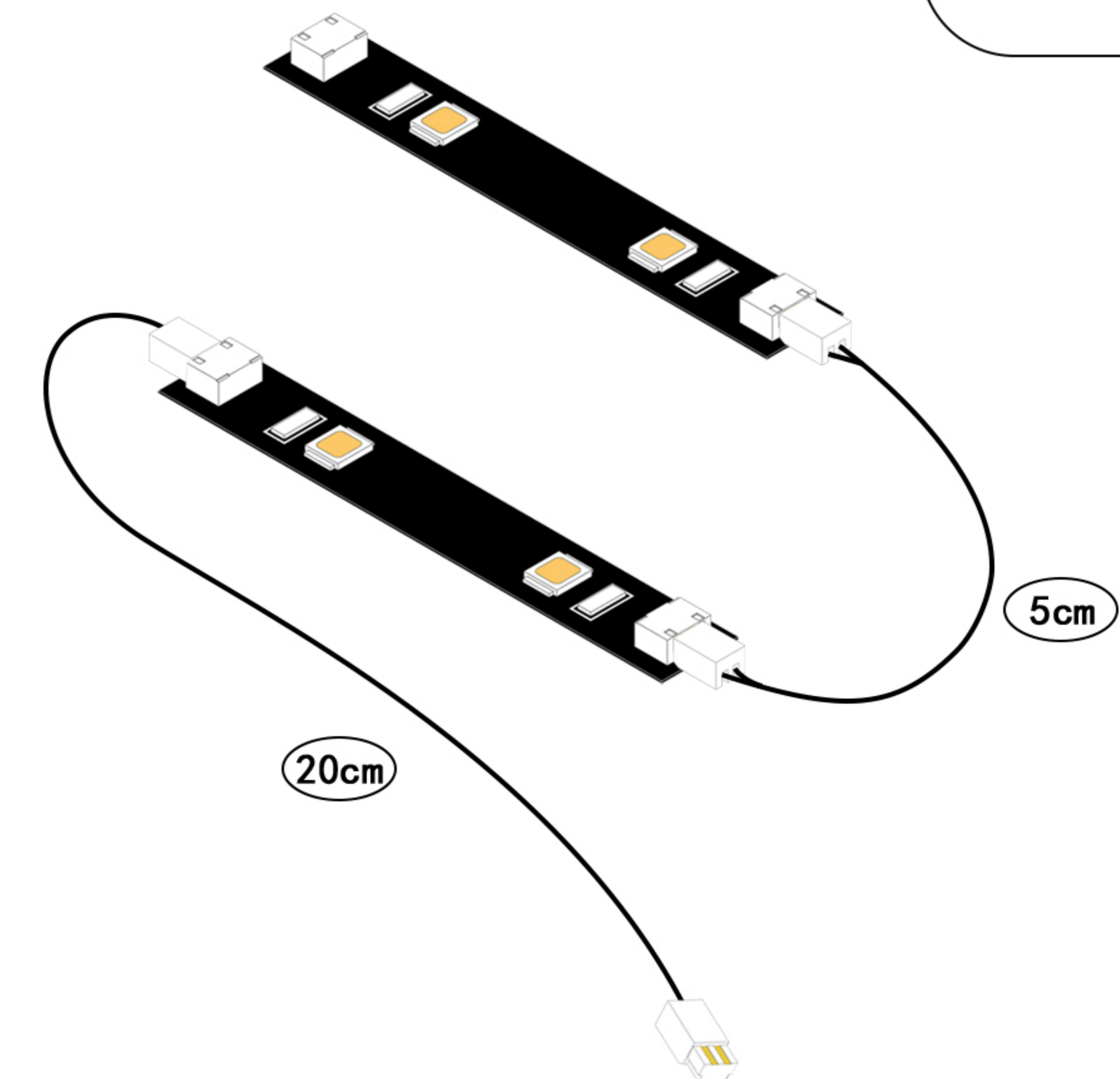
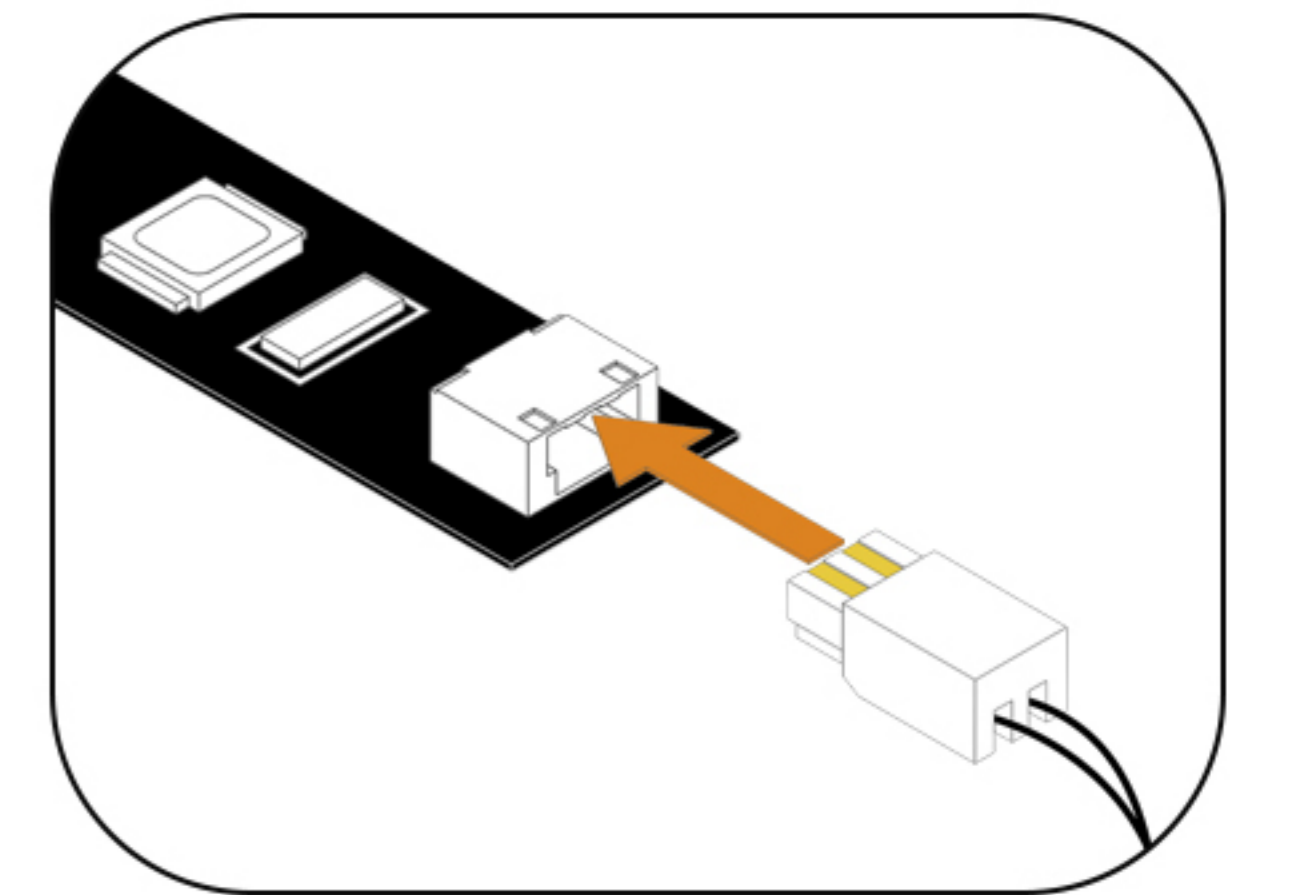
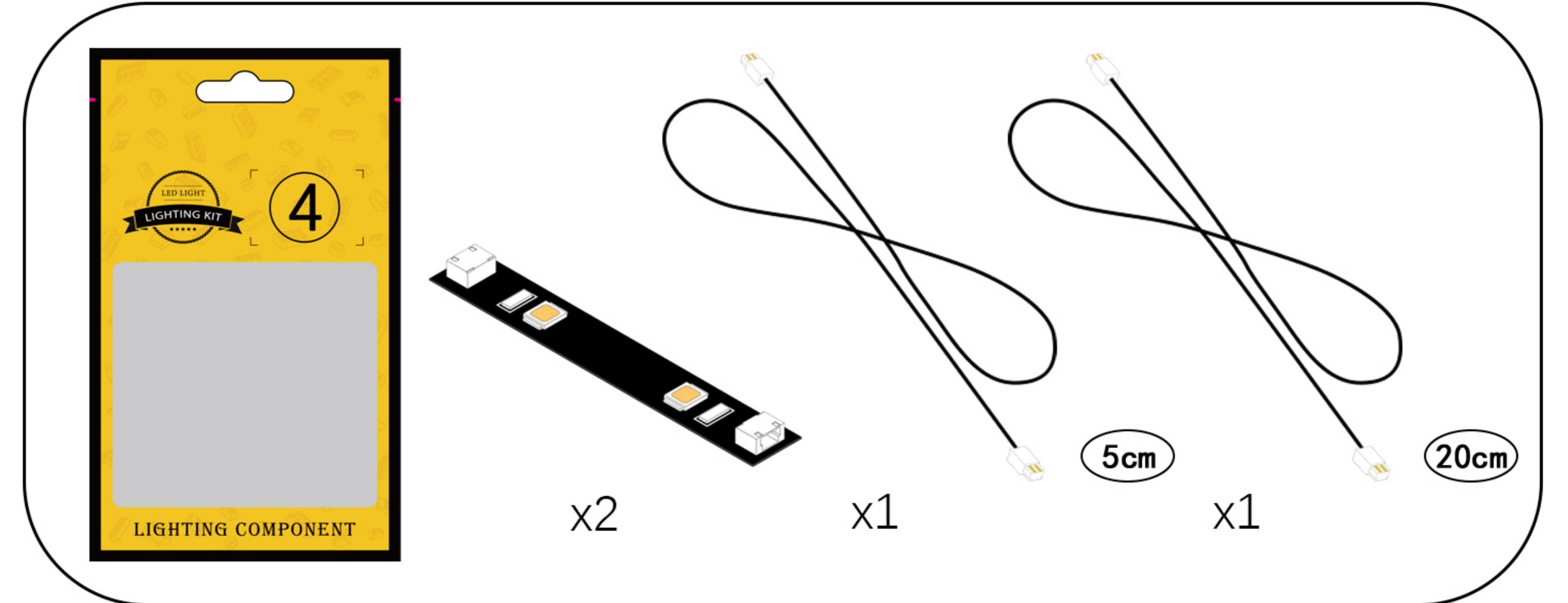

34

EN: Peel off the adhesive backing from the light strip (which has light strips on both ends) and attach it to the location shown in the illustration.

DE: Ziehen Sie die Schutzfolie von der Leuchteleiste ab (die an beiden Enden mit Leuchtstreifen versehen ist) und befestigen Sie sie an der in der Abbildung gezeigten Stelle.

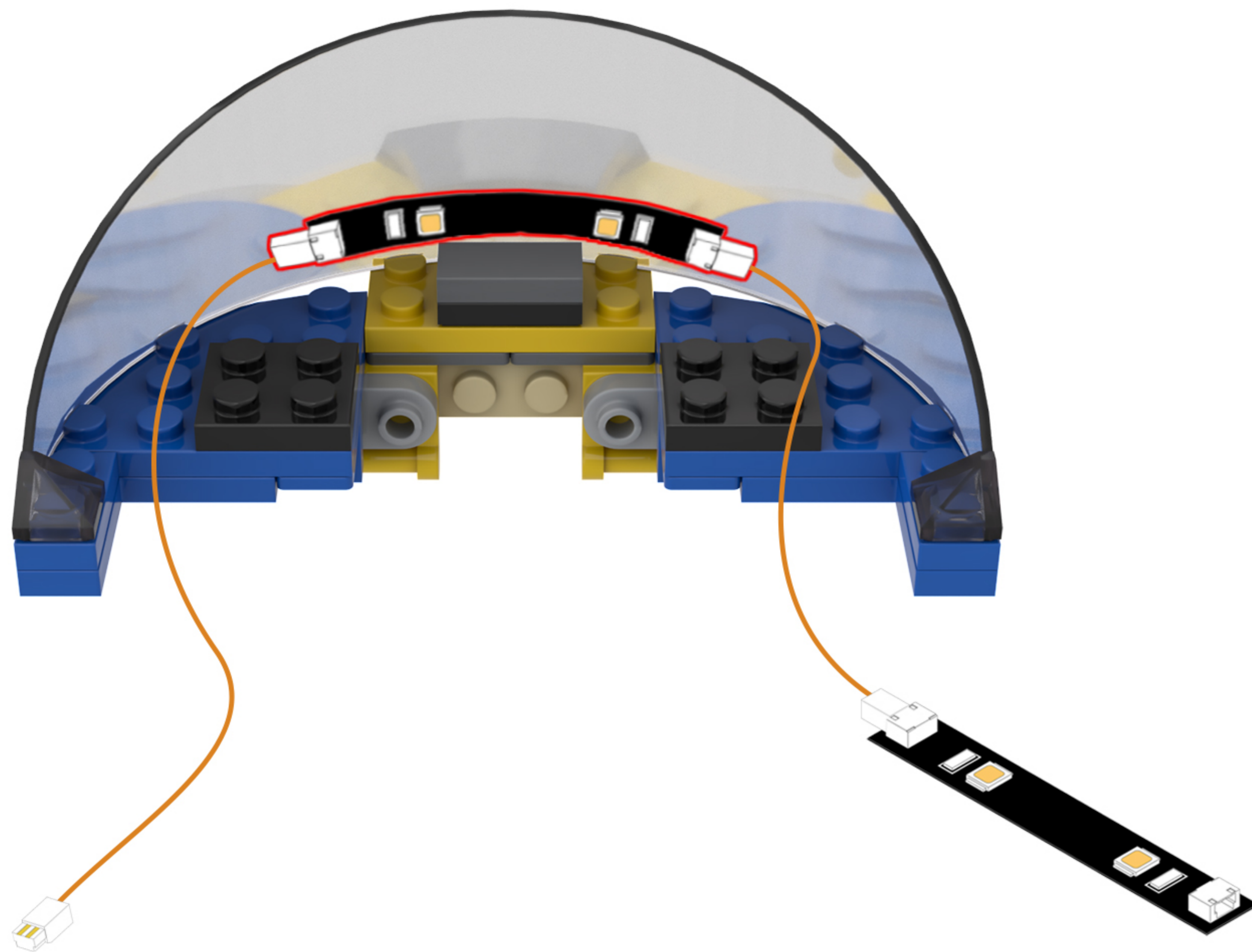

35

EN: Arrange the left-hand light wires as shown in the figure.

DE: Verlegen Sie die linken Lichtkabel wie in der Abbildung gezeigt.

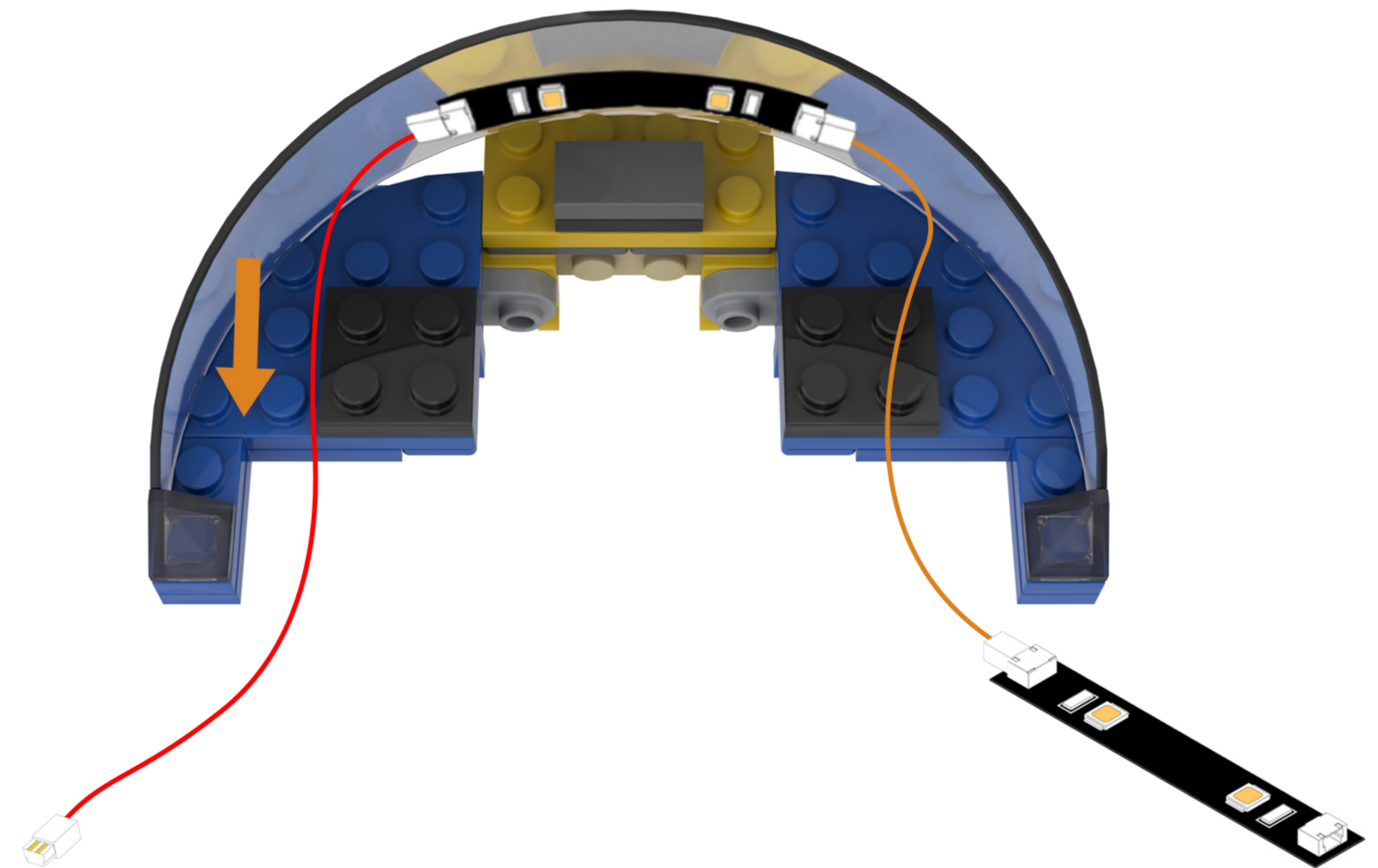

36

EN: Take out the disassembled building blocks and reassemble them.

DE: Nehmen Sie die zerlegten Bausteine heraus und setzen Sie sie wieder zusammen.

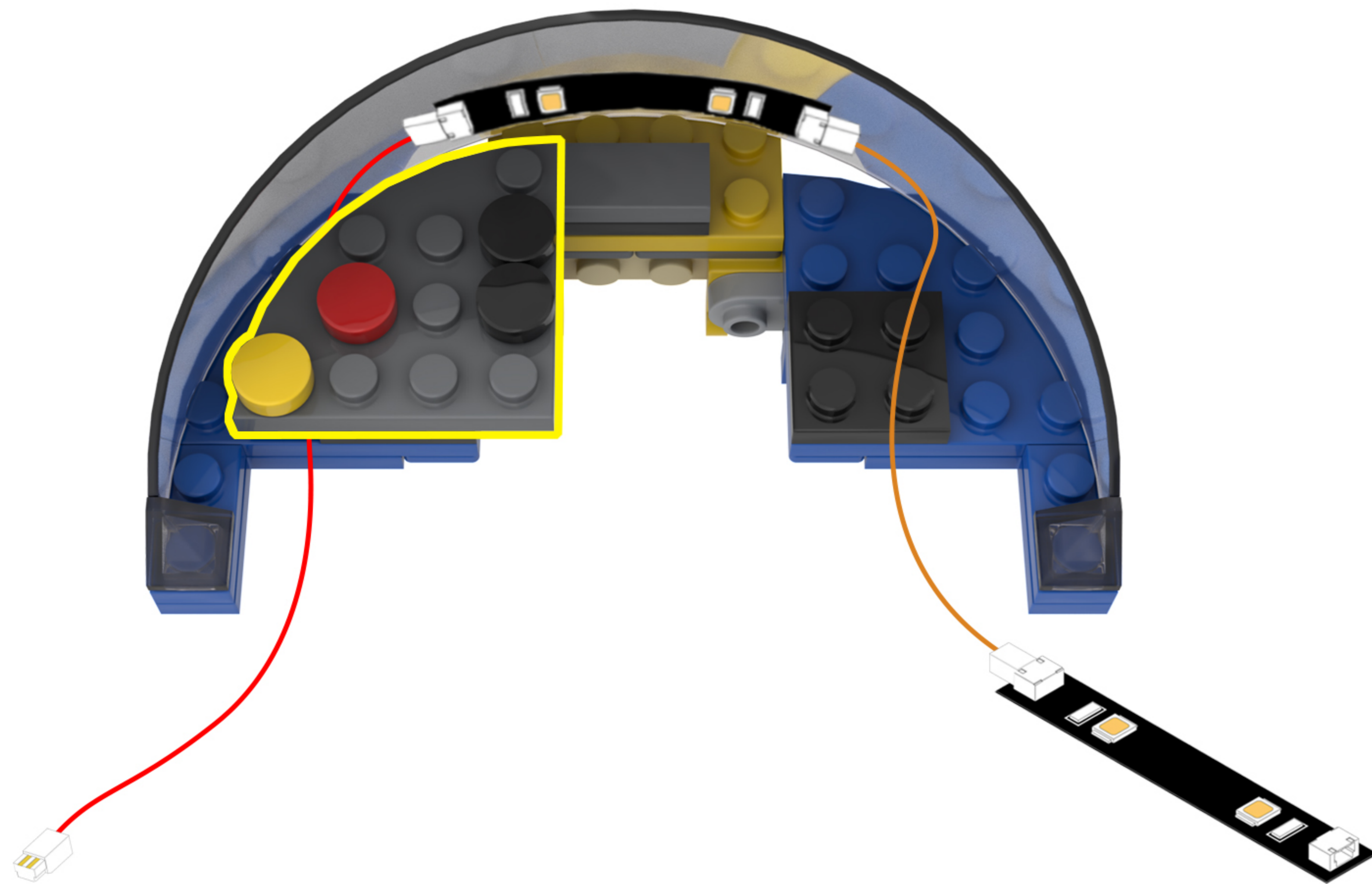
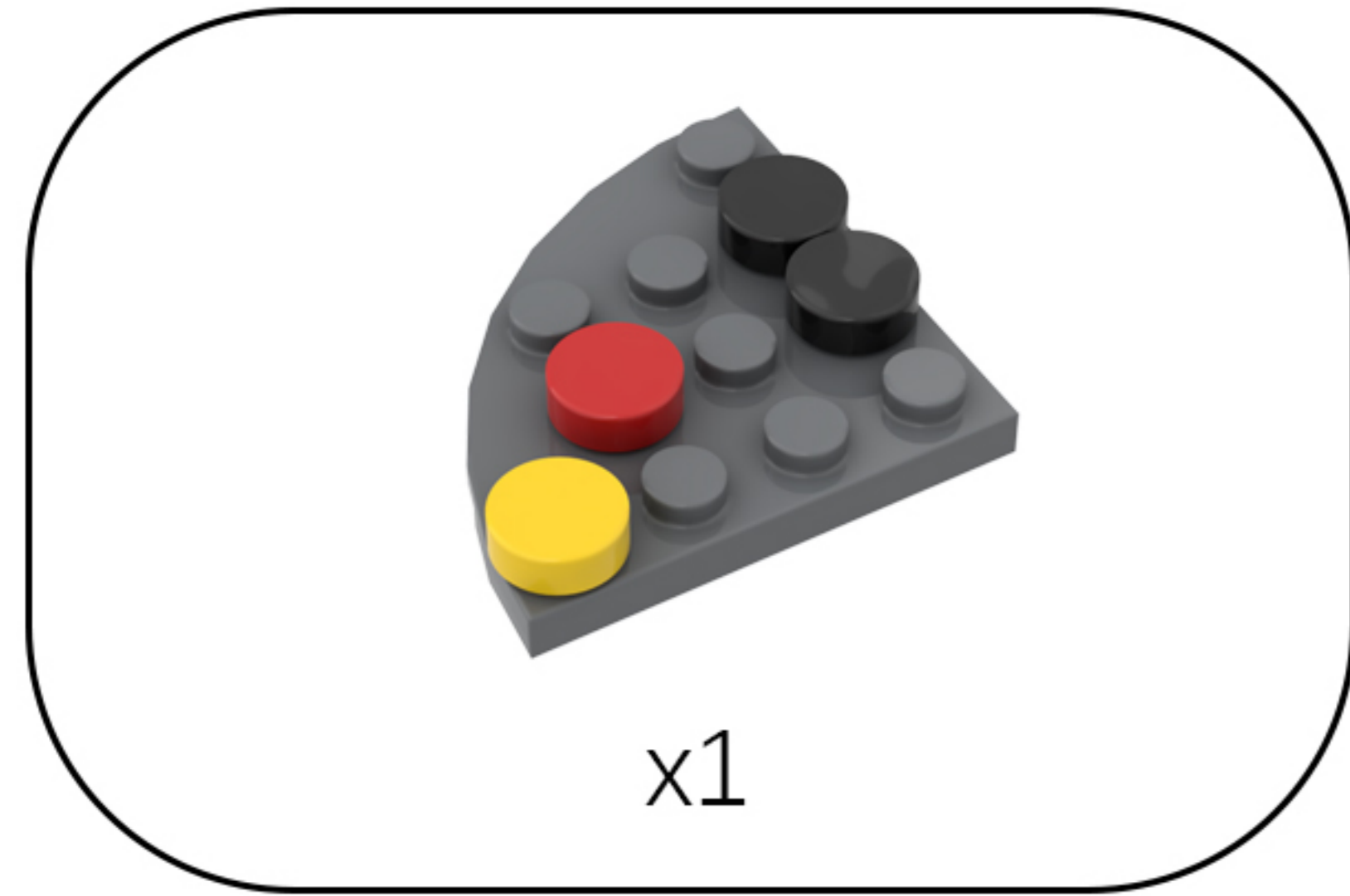

37

EN: Arrange the wires on the right as shown in the figure.

DE: Ordnen Sie die Drahnte auf der rechten Seite wie in der Abbildung gezeigt an.

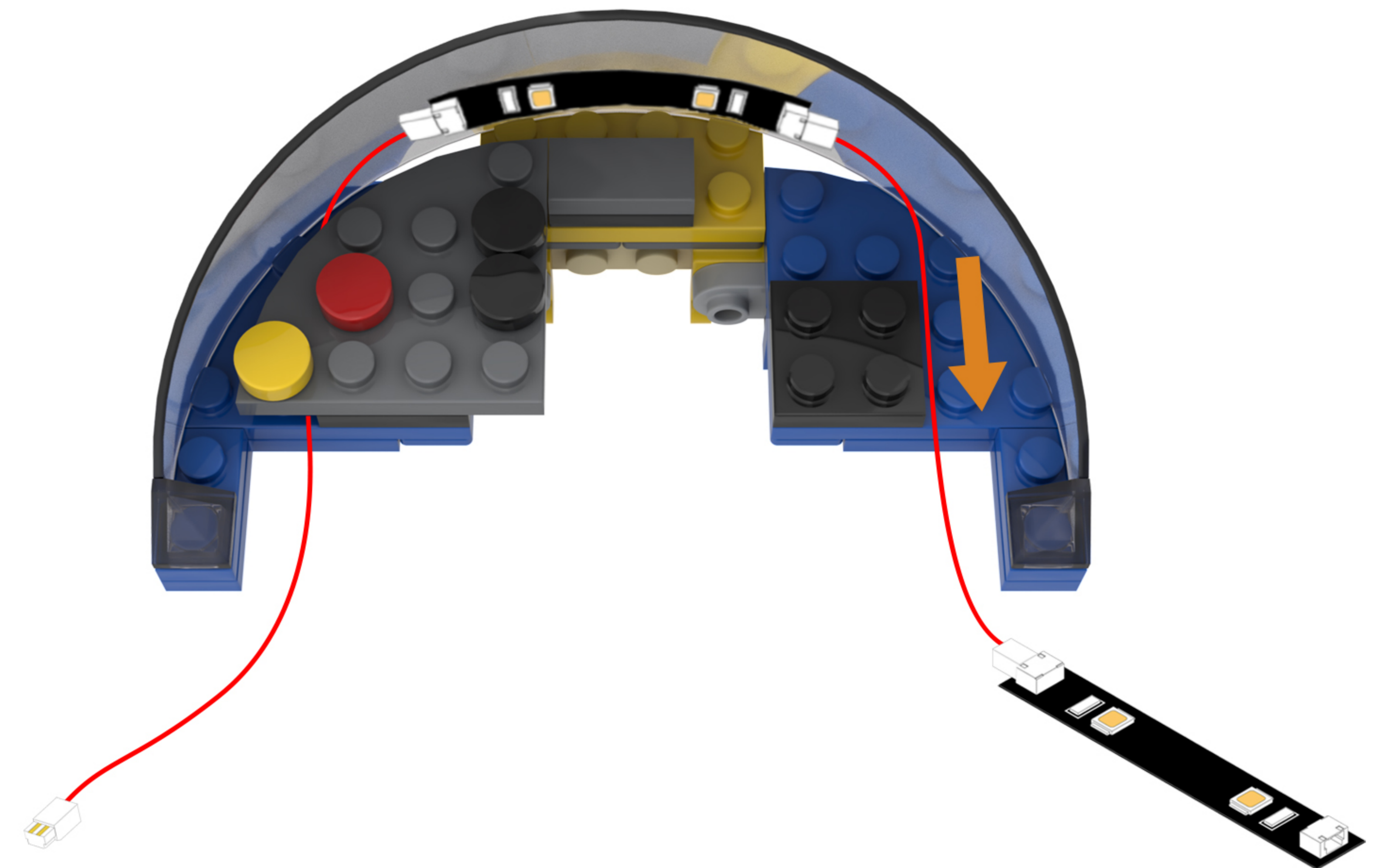

38

EN: Take out the disassembled building blocks and reassemble them.

DE: Nehmen Sie die zerlegten Bausteine heraus und setzen Sie sie wieder zusammen.

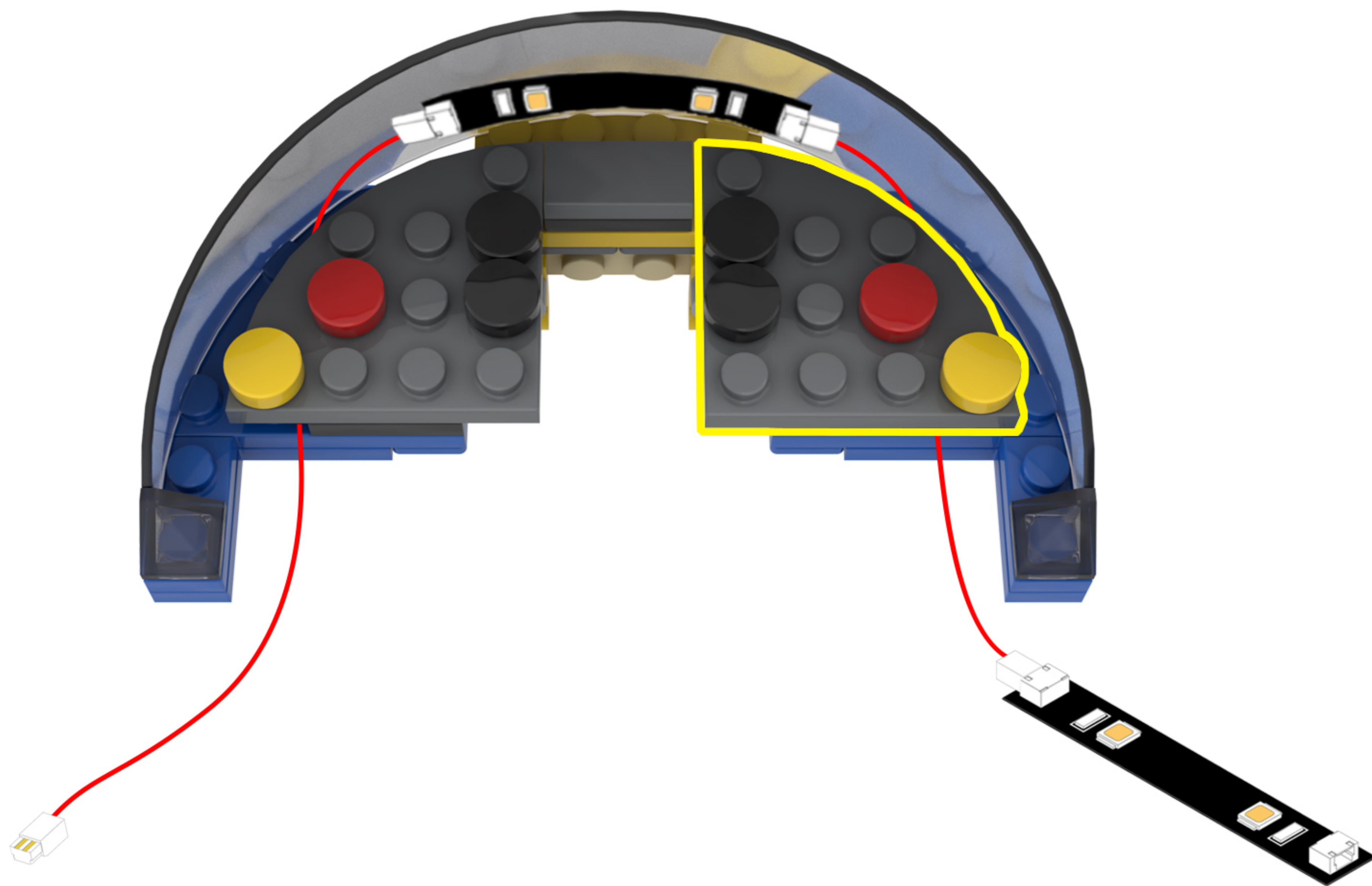
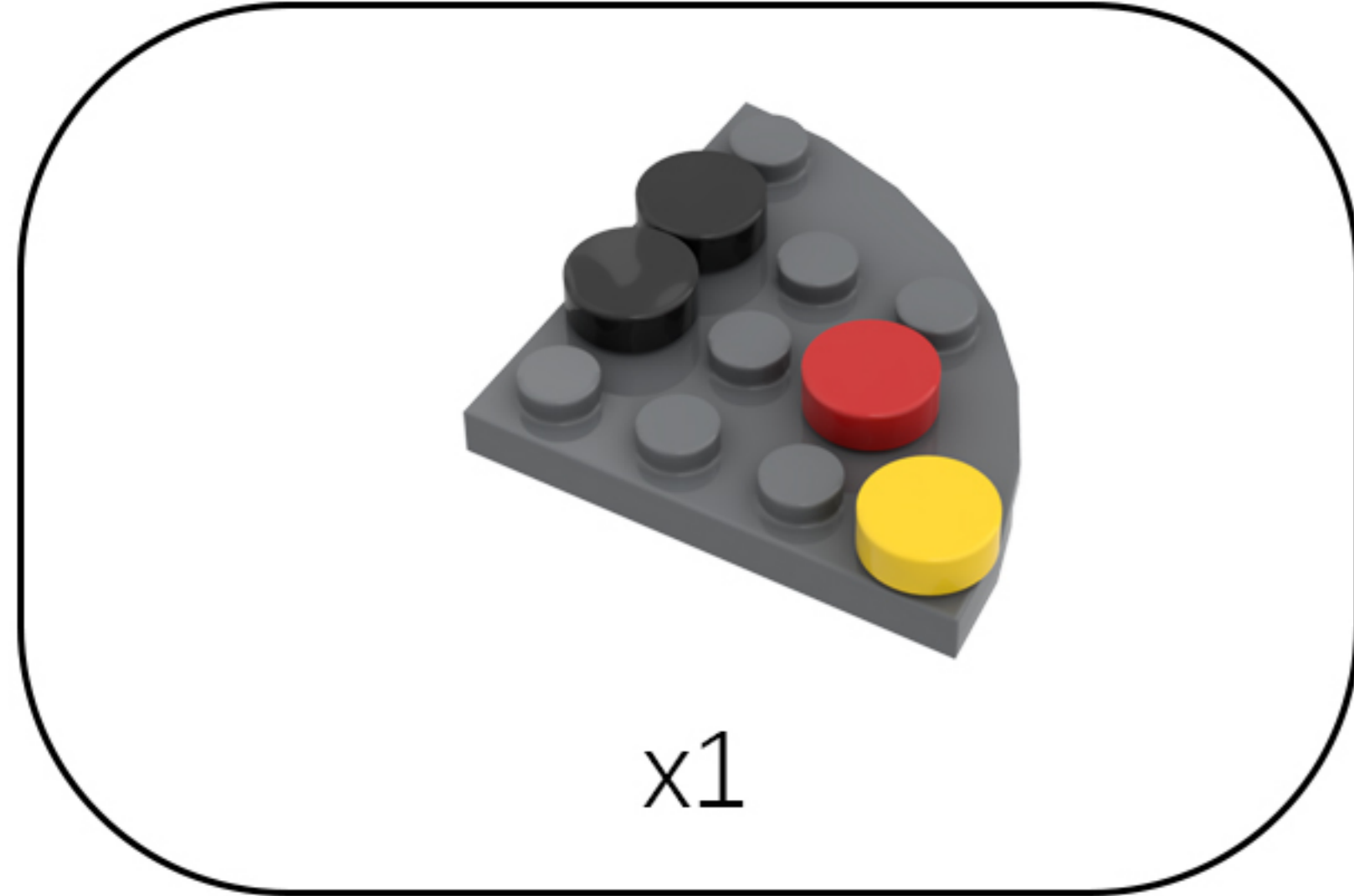

39

EN: Back to the model.

DE: Zurück zum Modell.

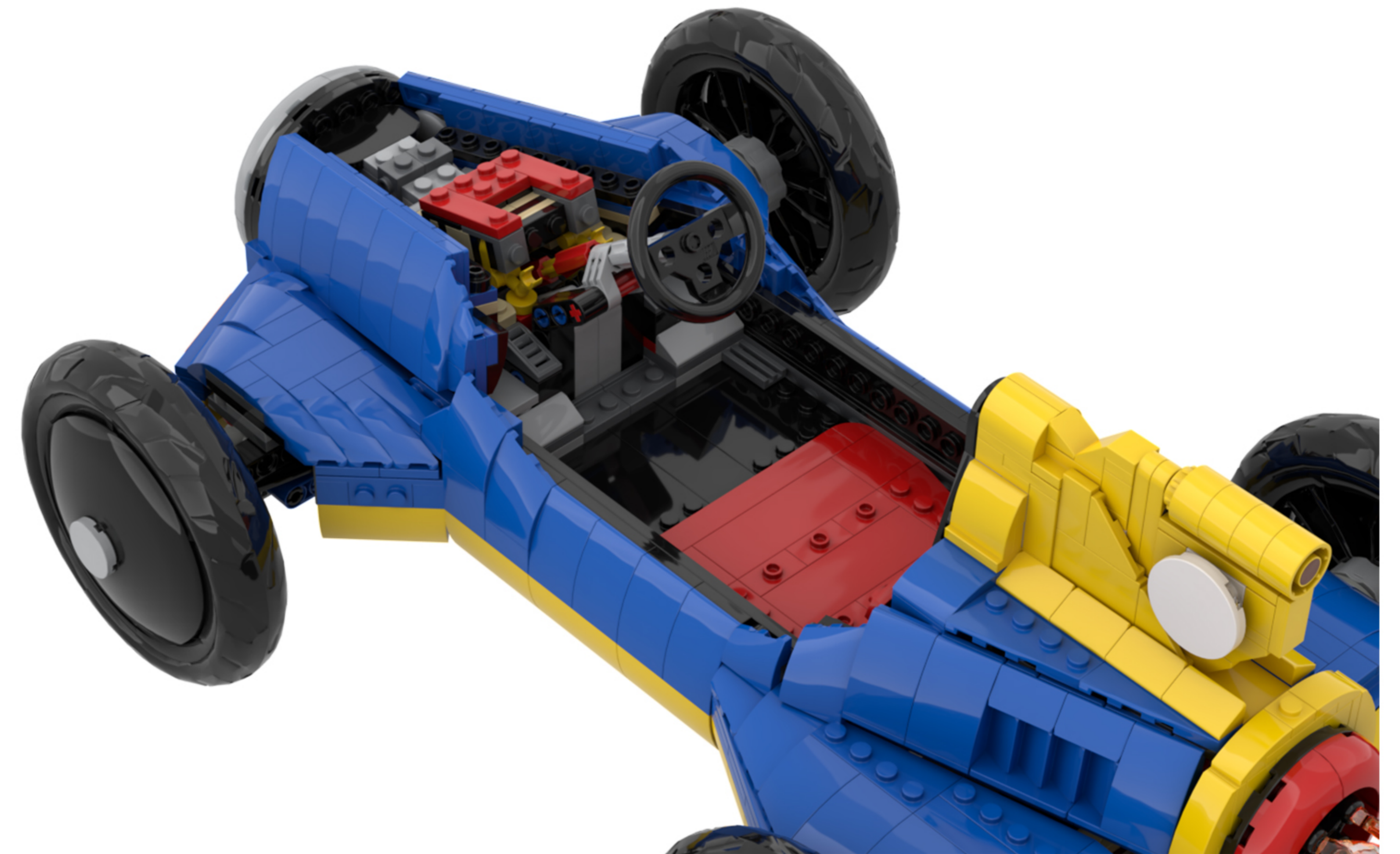

40

EN: Peel off the adhesive backing from the other light strip and attach it to the location shown in the illustration.

DE: Ziehen Sie die Schutzfolie vom anderen Lichtstreifen ab und bringen Sie ihn an der in der Abbildung gezeigten Stelle an.

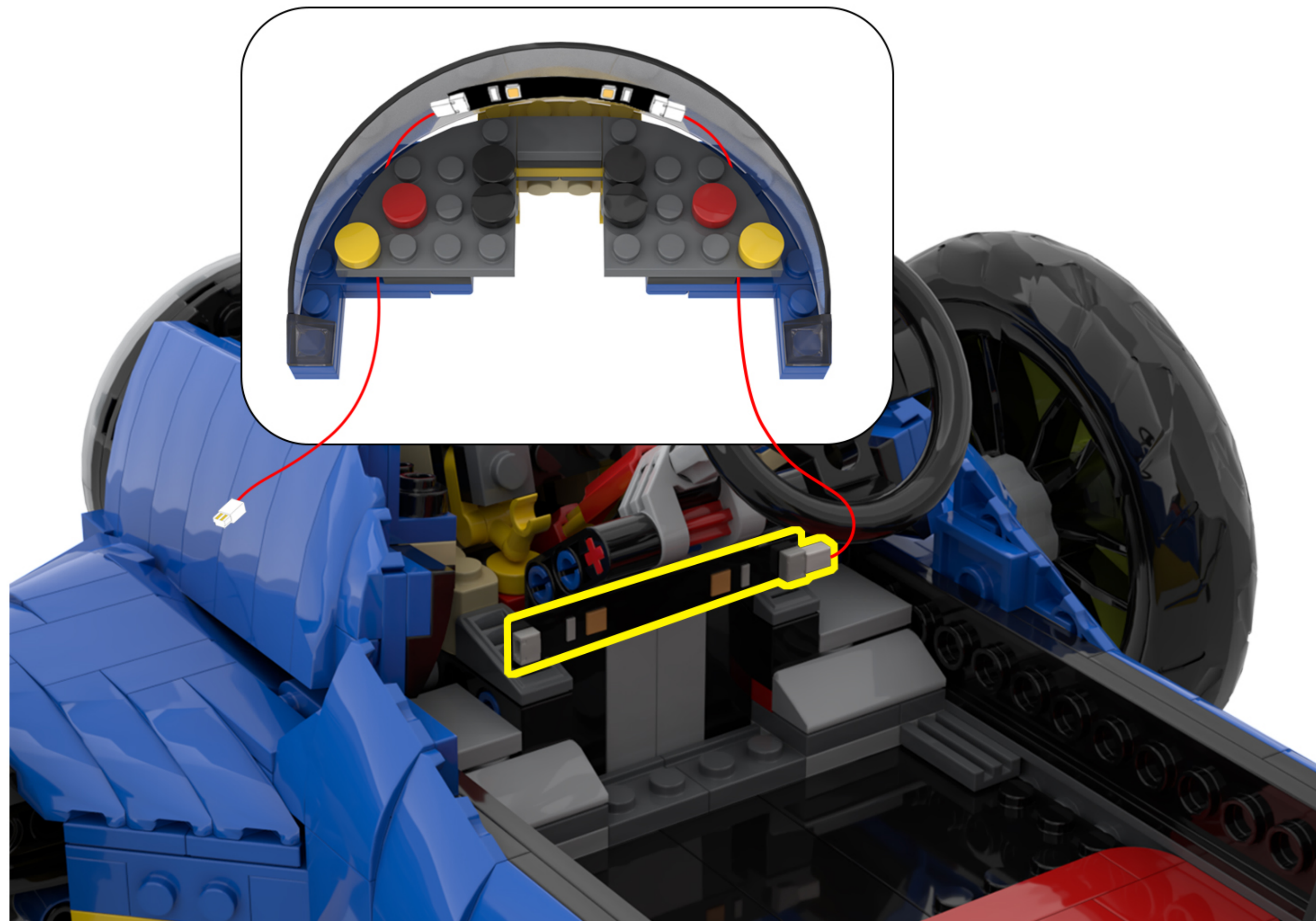

41

EN: Adjust your perspective.

DE: Ändern Sie Ihre Perspektive.

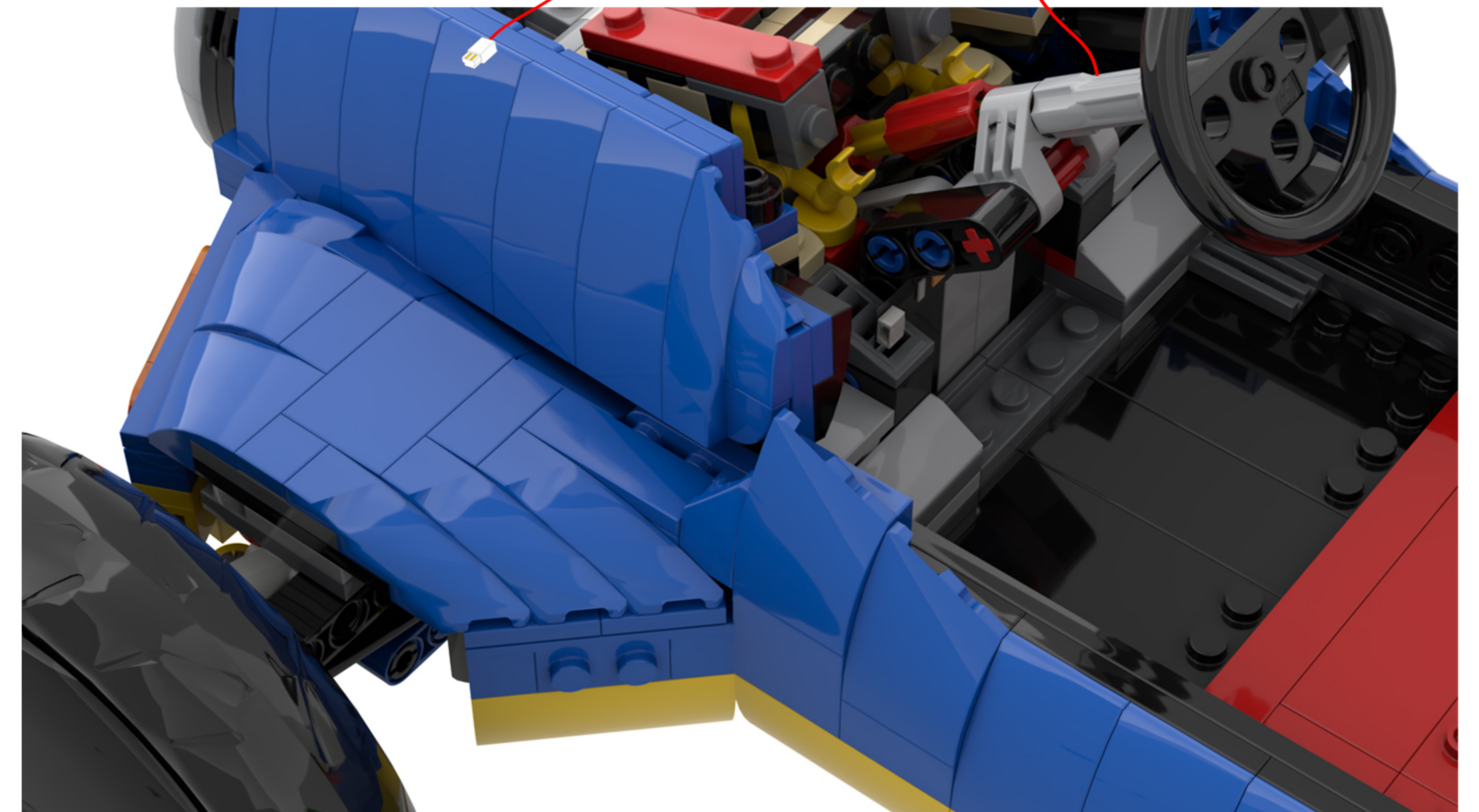
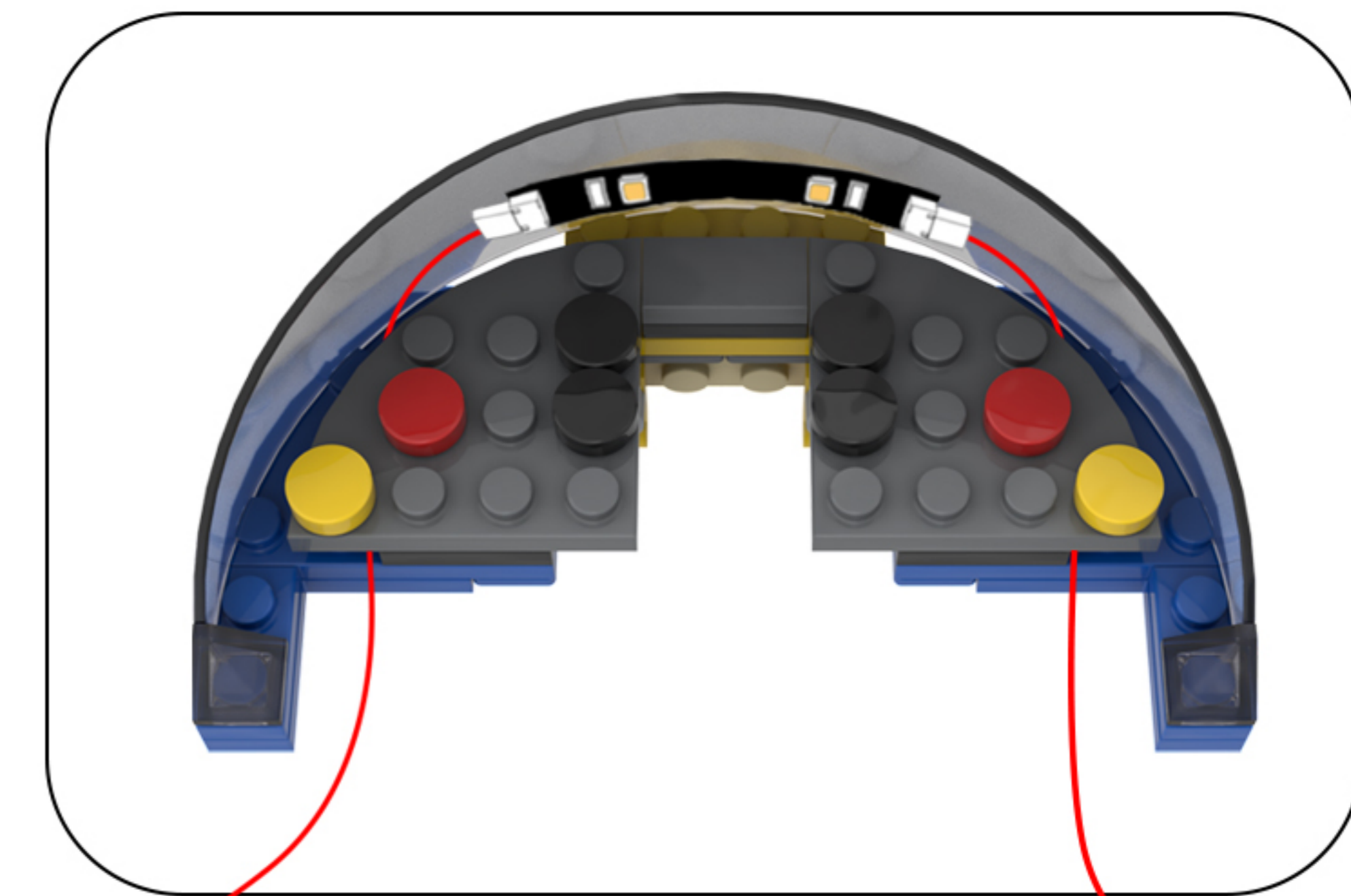

42 EN: Split as shown in the figure.
DE: Wie in der Abbildung gezeigt, teilen Sie es auf.

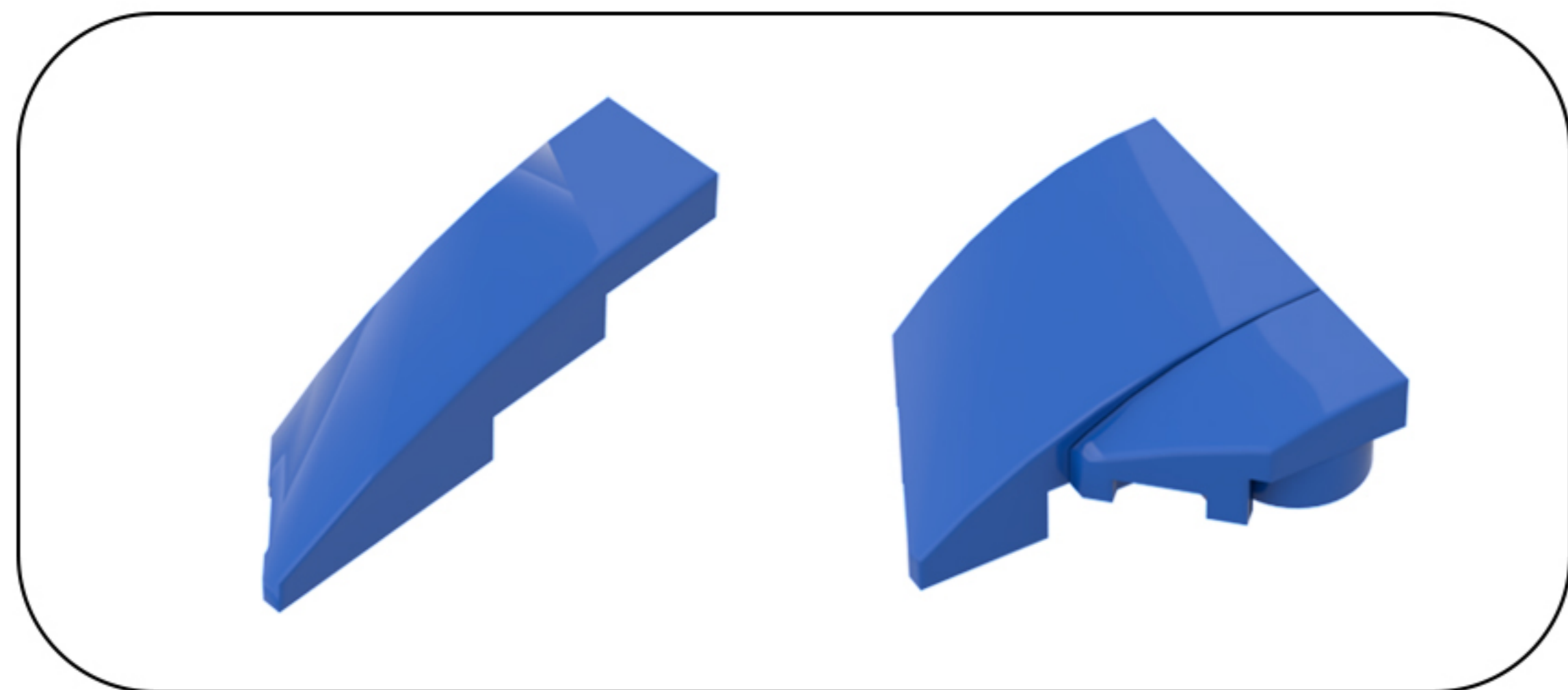
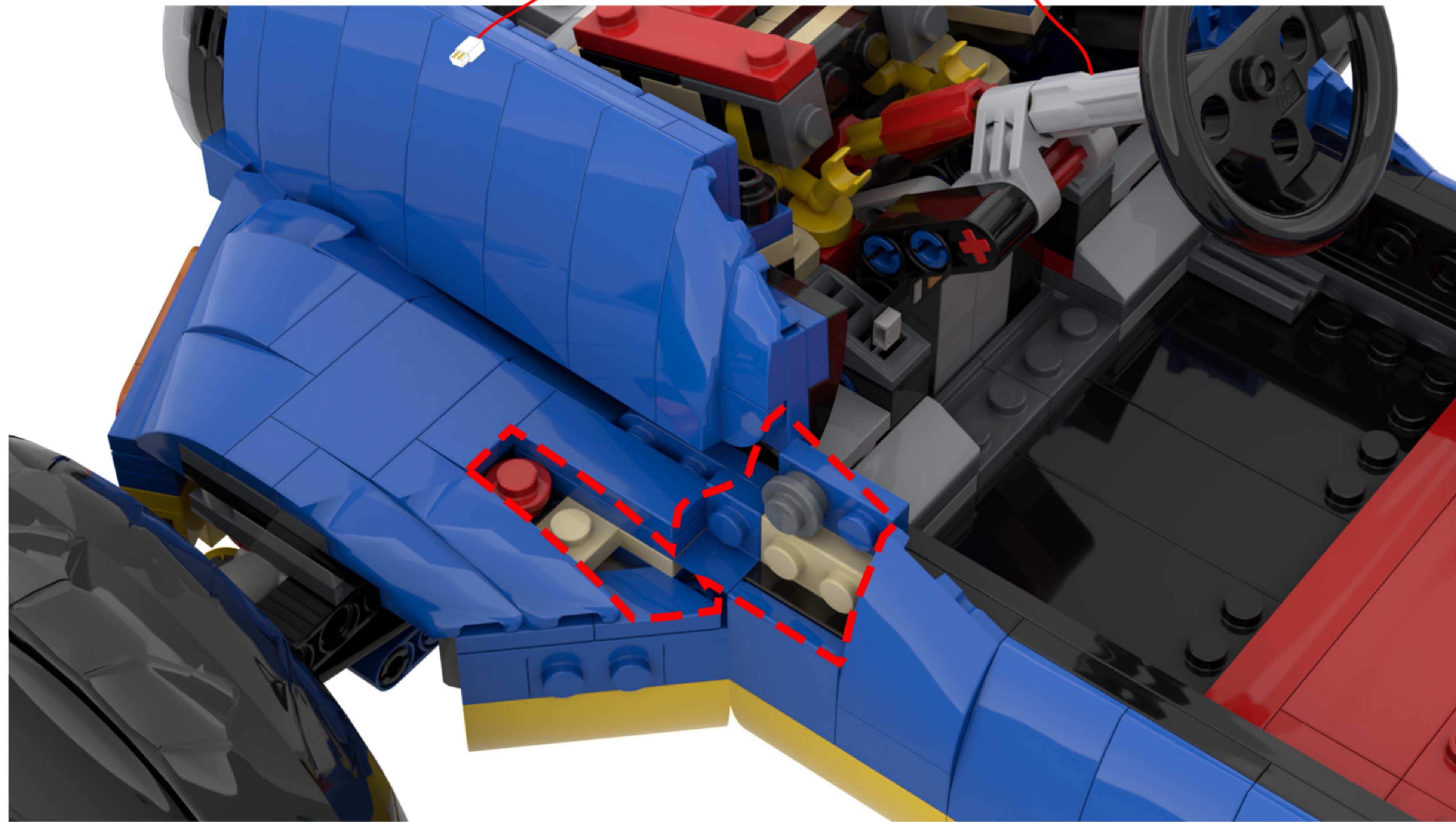
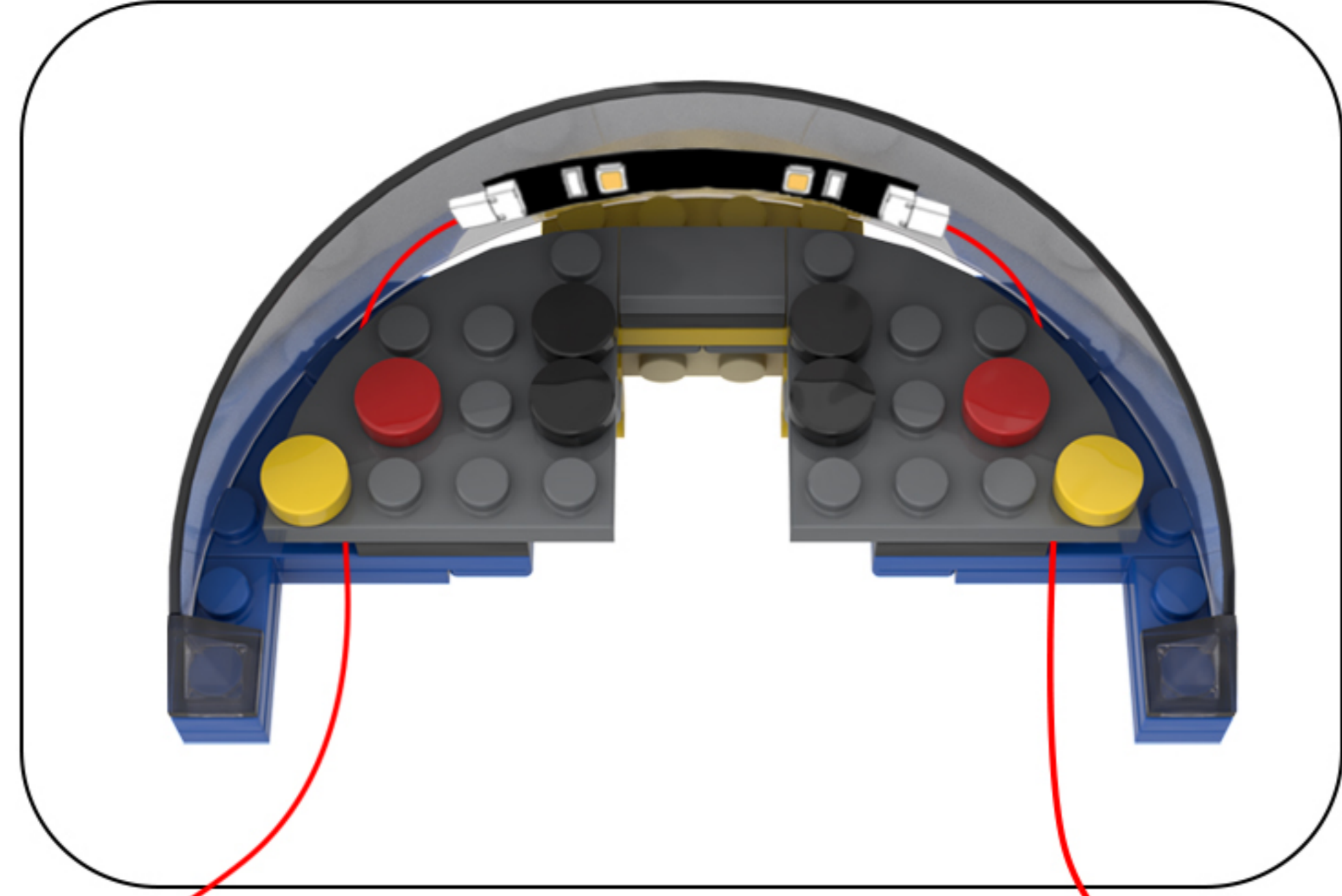

43 EN: Locate this light cord in the diagram.
DE: Suchen Sie dieses Lichtkabel in der Abbildung.

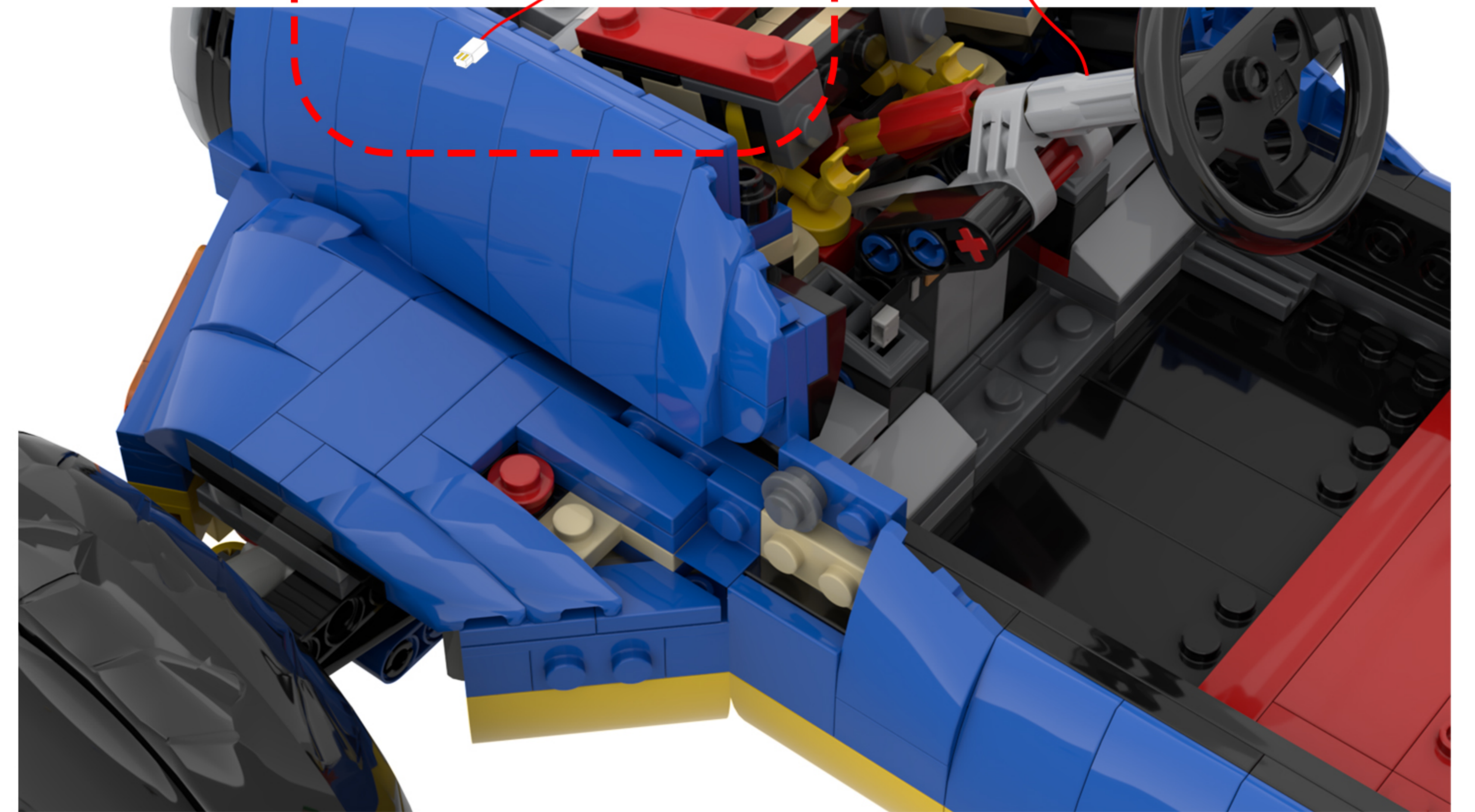
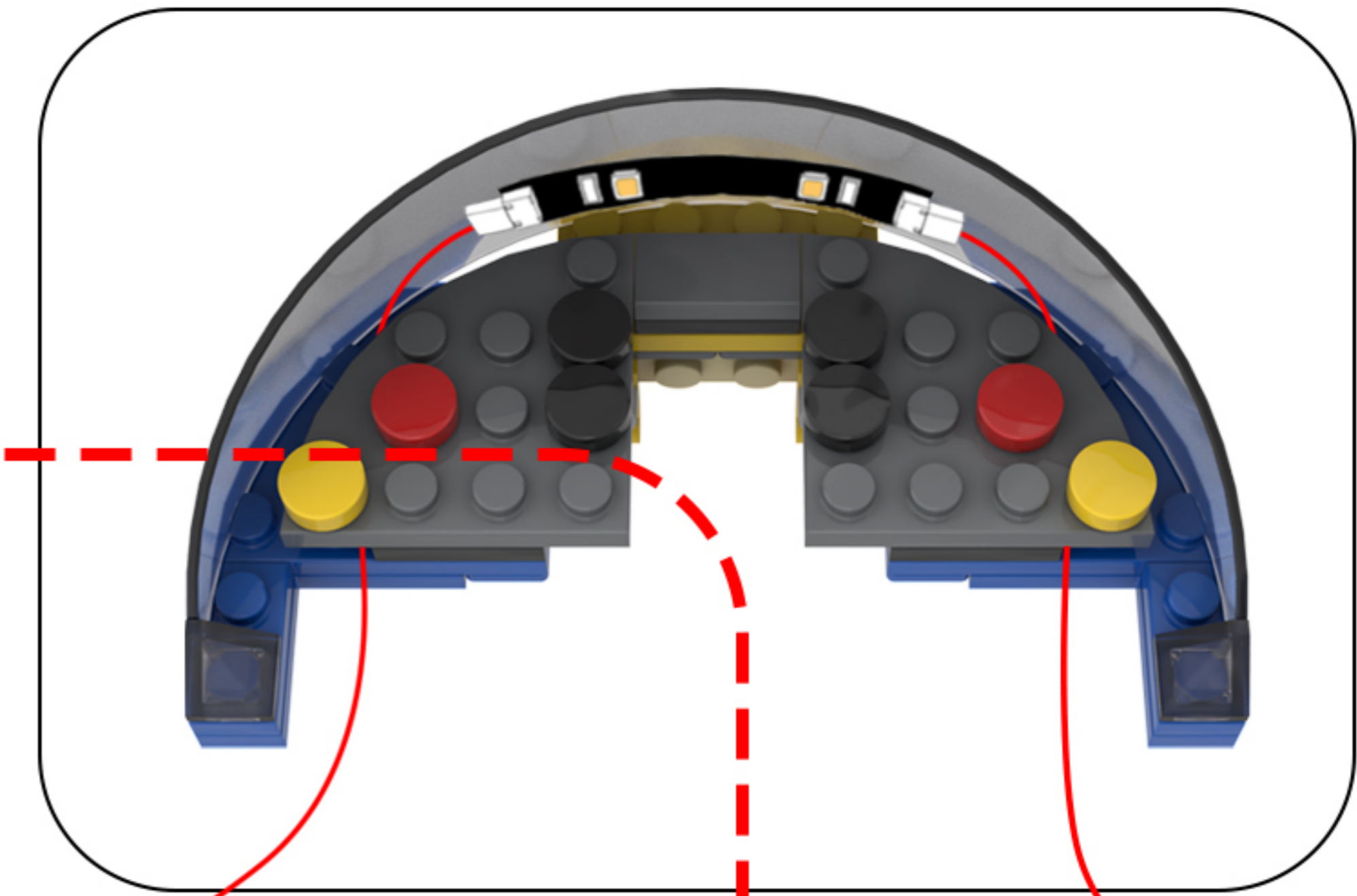

44

EN: Thread the lamp cord through the gaps in the building blocks.

DE: Führen Sie das Lampenkabel durch die Lücken in den Bausteinen.

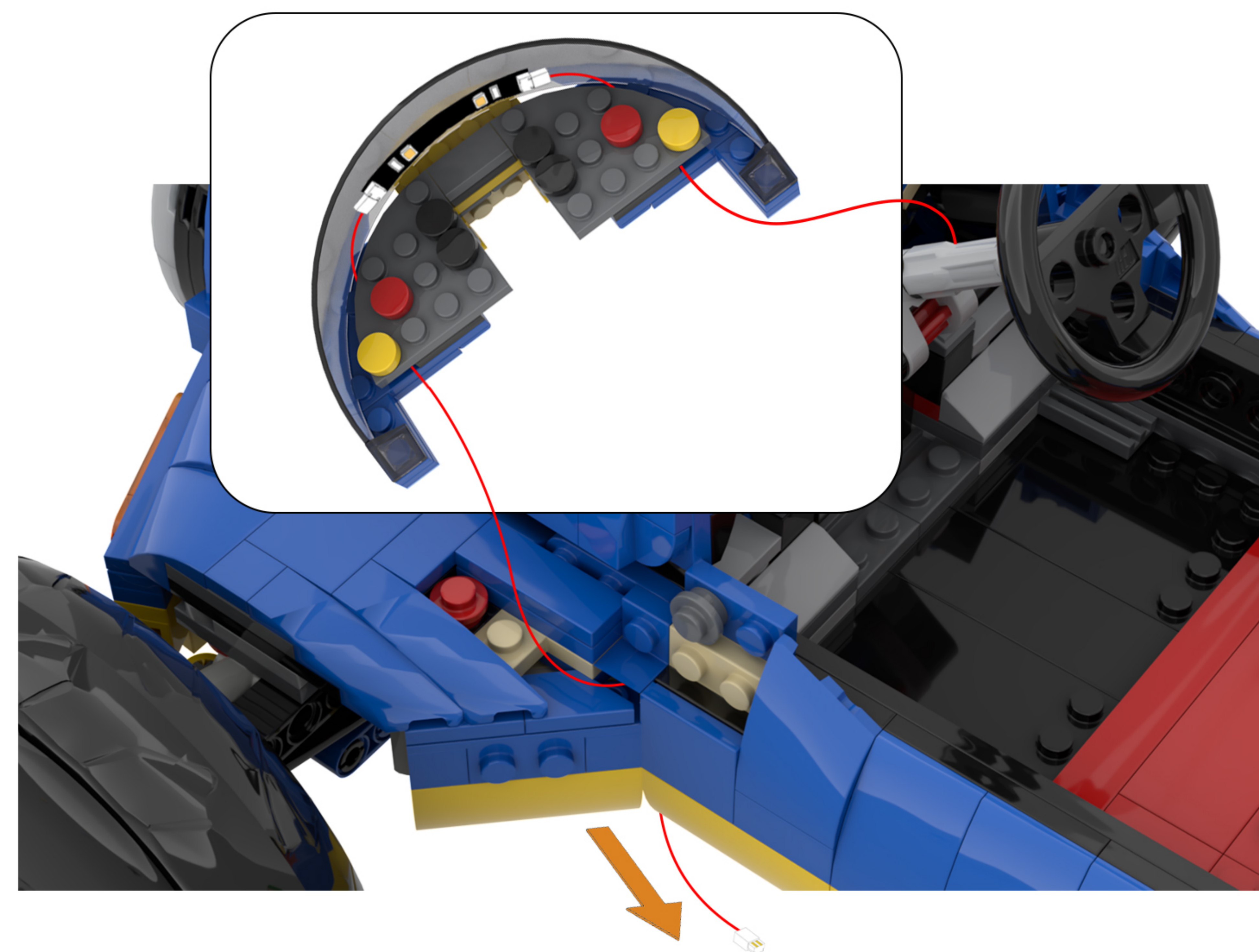
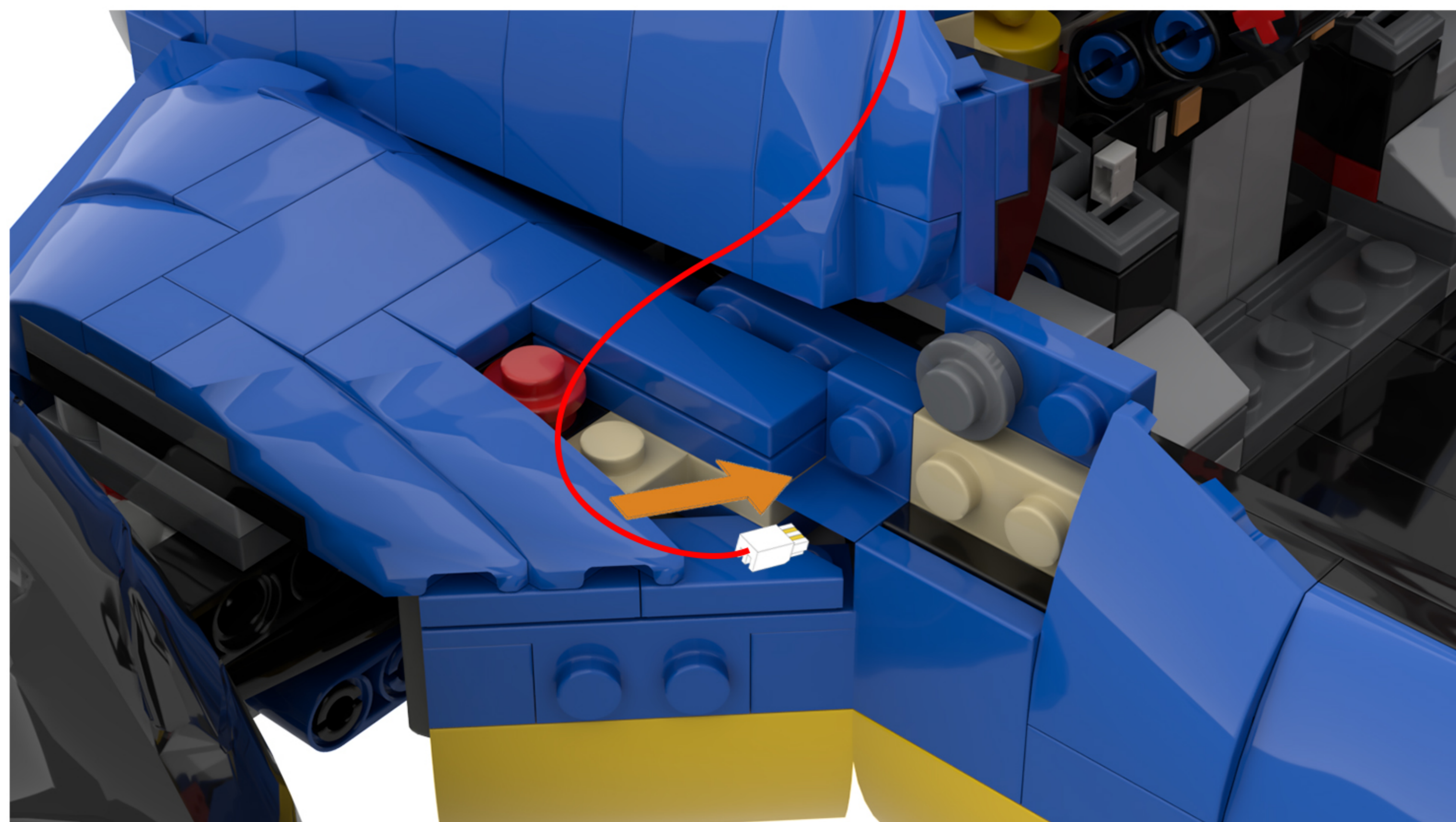

45 EN: Restore the building blocks.
DE: Stellen Sie die Bausteine wieder her.

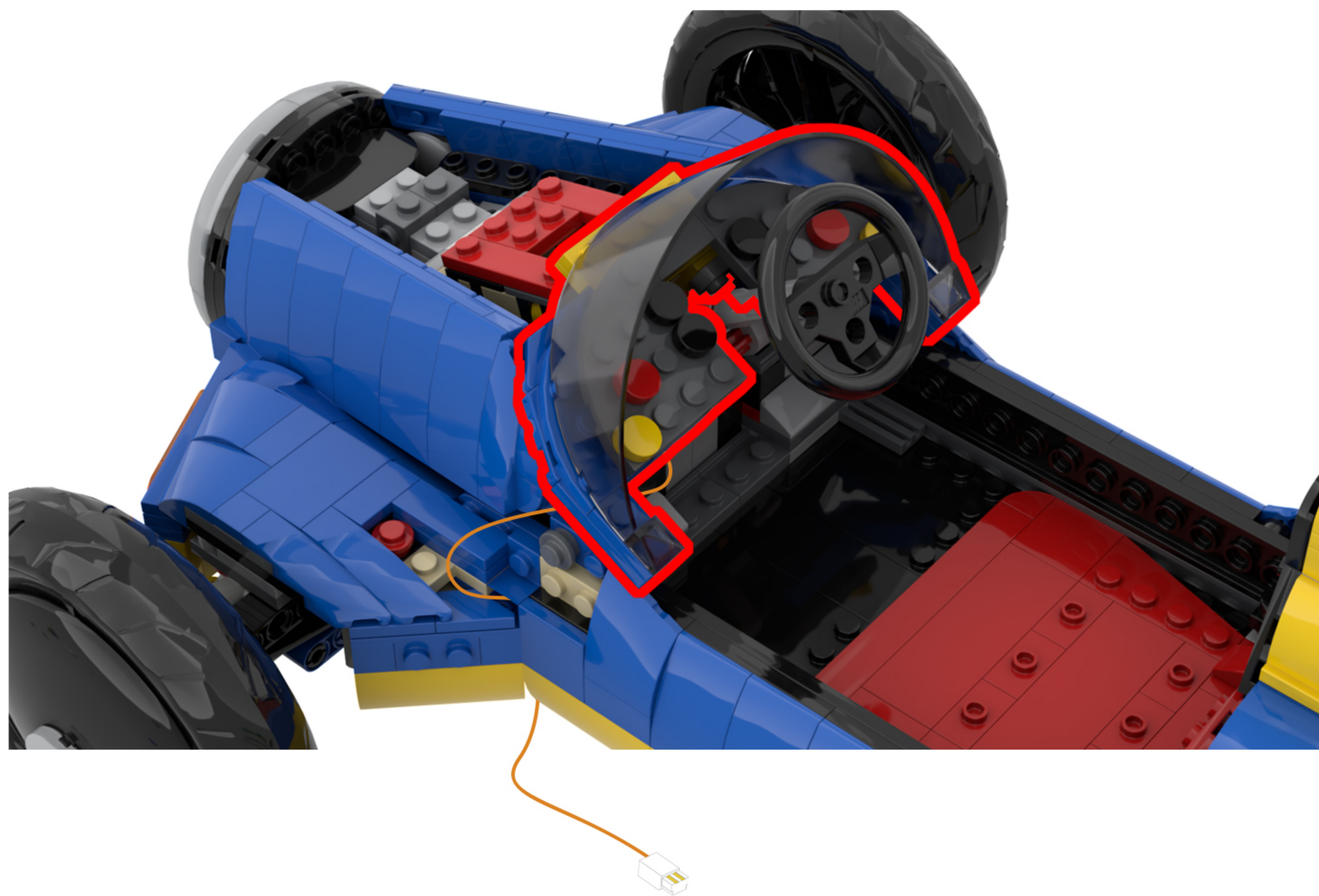

46 EN: Locate this light cord in the diagram.
DE: Suchen Sie dieses Lichtkabel in der Abbildung.

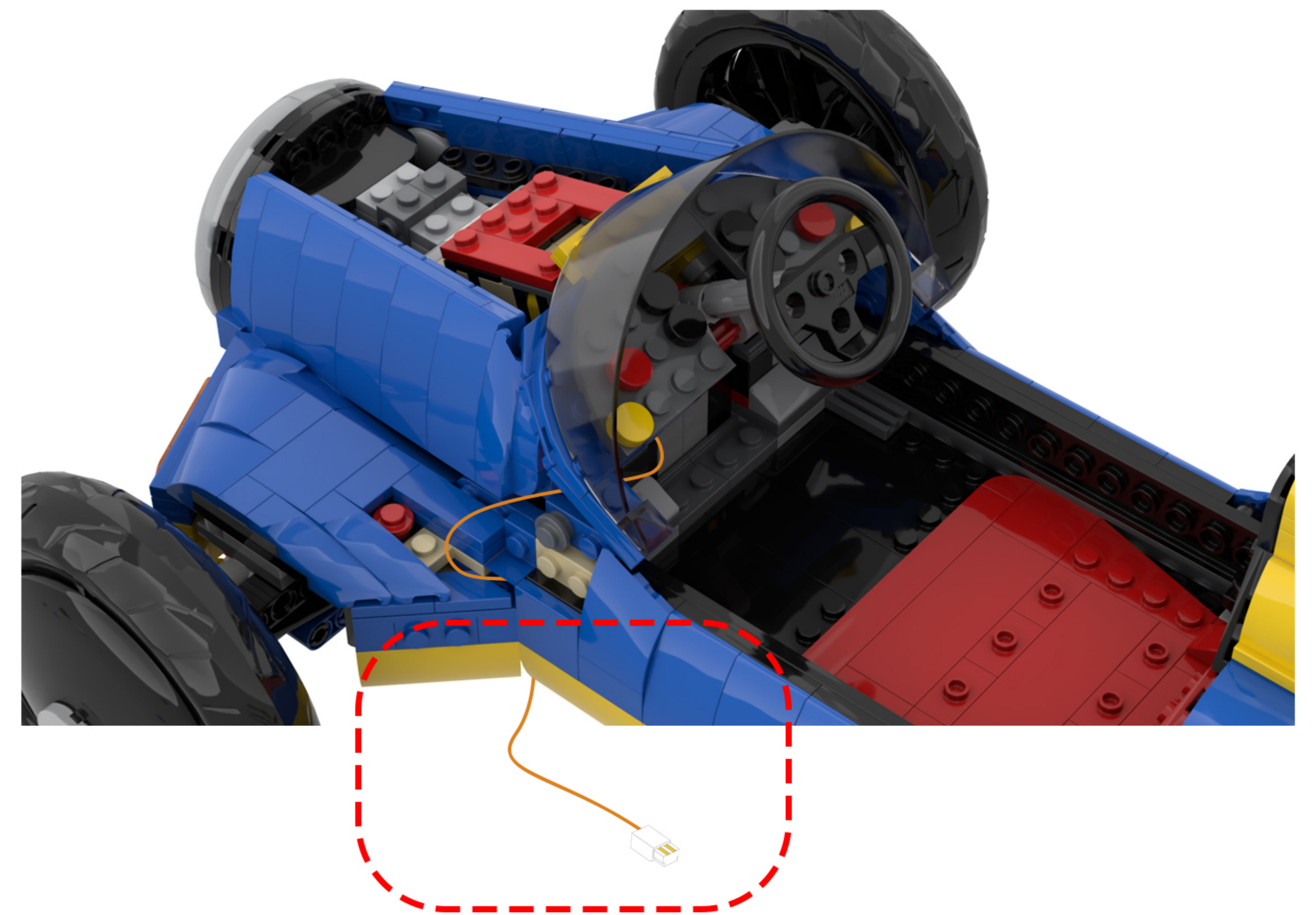

47

EN: Arrange the lighting lines according to the diagram.

DE: Ordnen Sie die Beleuchtungslinien gemäß der Abbildung an.

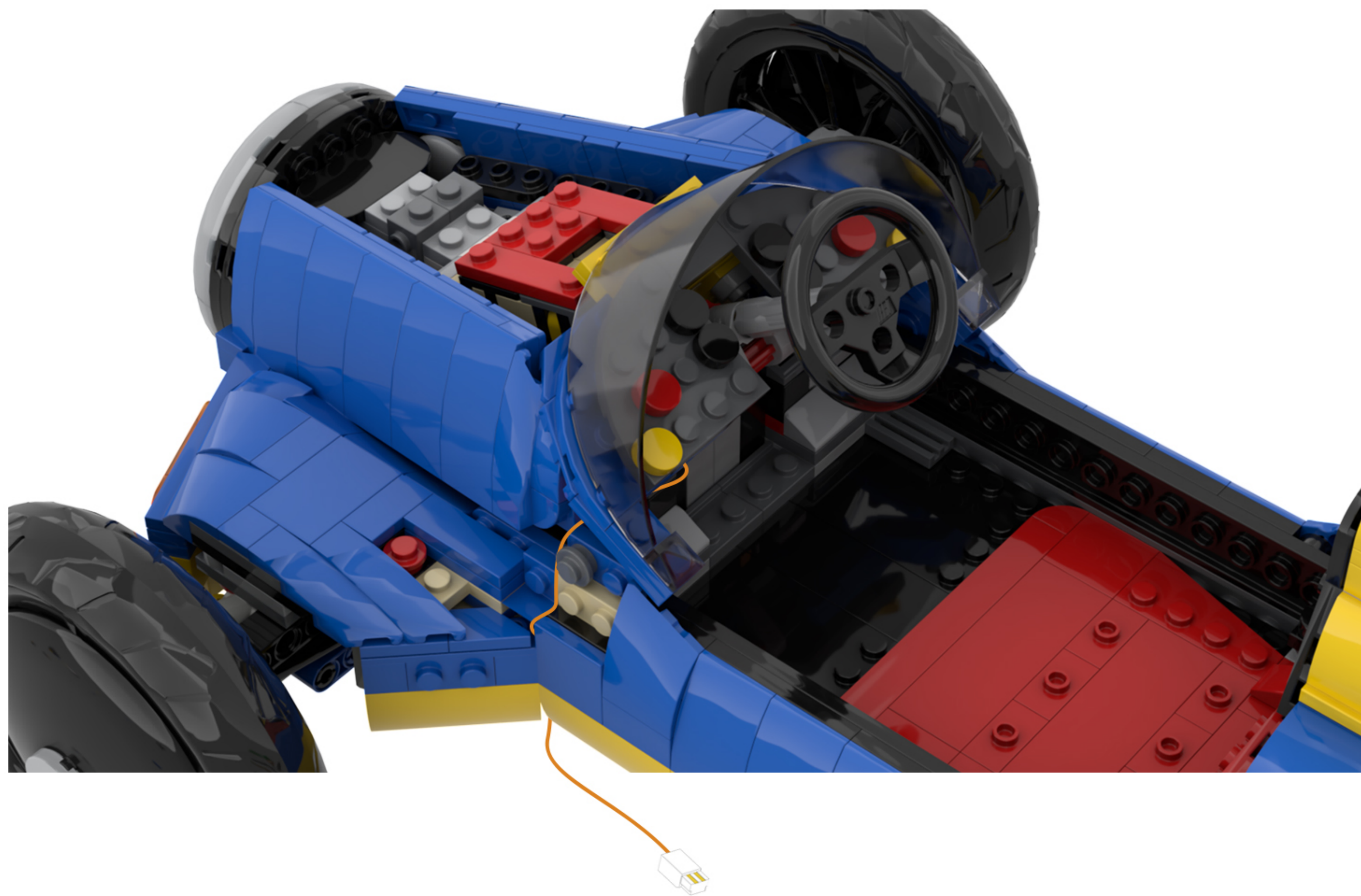
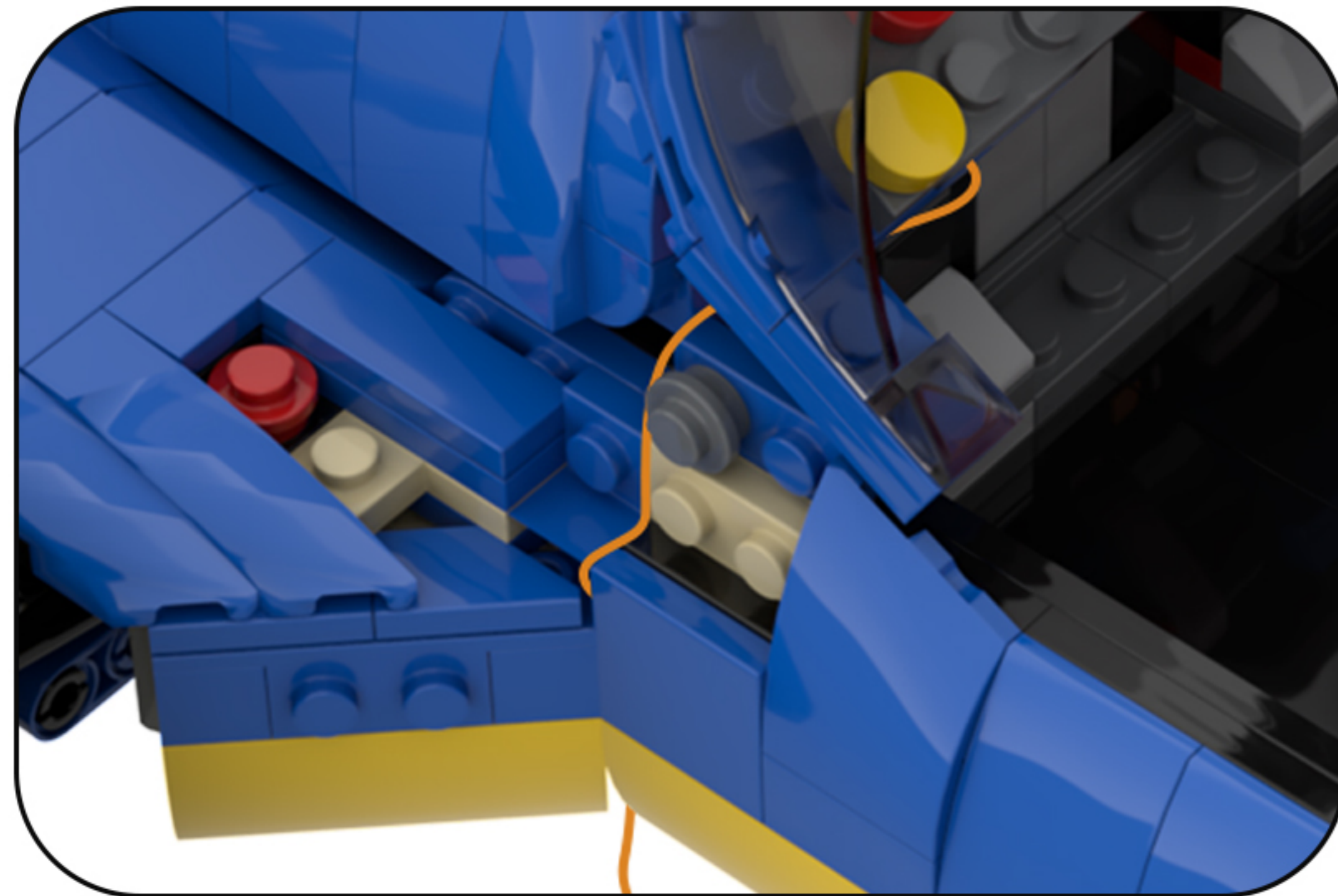

48

EN: Take out the disassembled building blocks, reassemble them, and secure the light cord.

DE: Nehmen Sie die zerlegten Bausteine heraus, setzen Sie sie wieder zusammen und befestigen Sie das Lichtkabel.

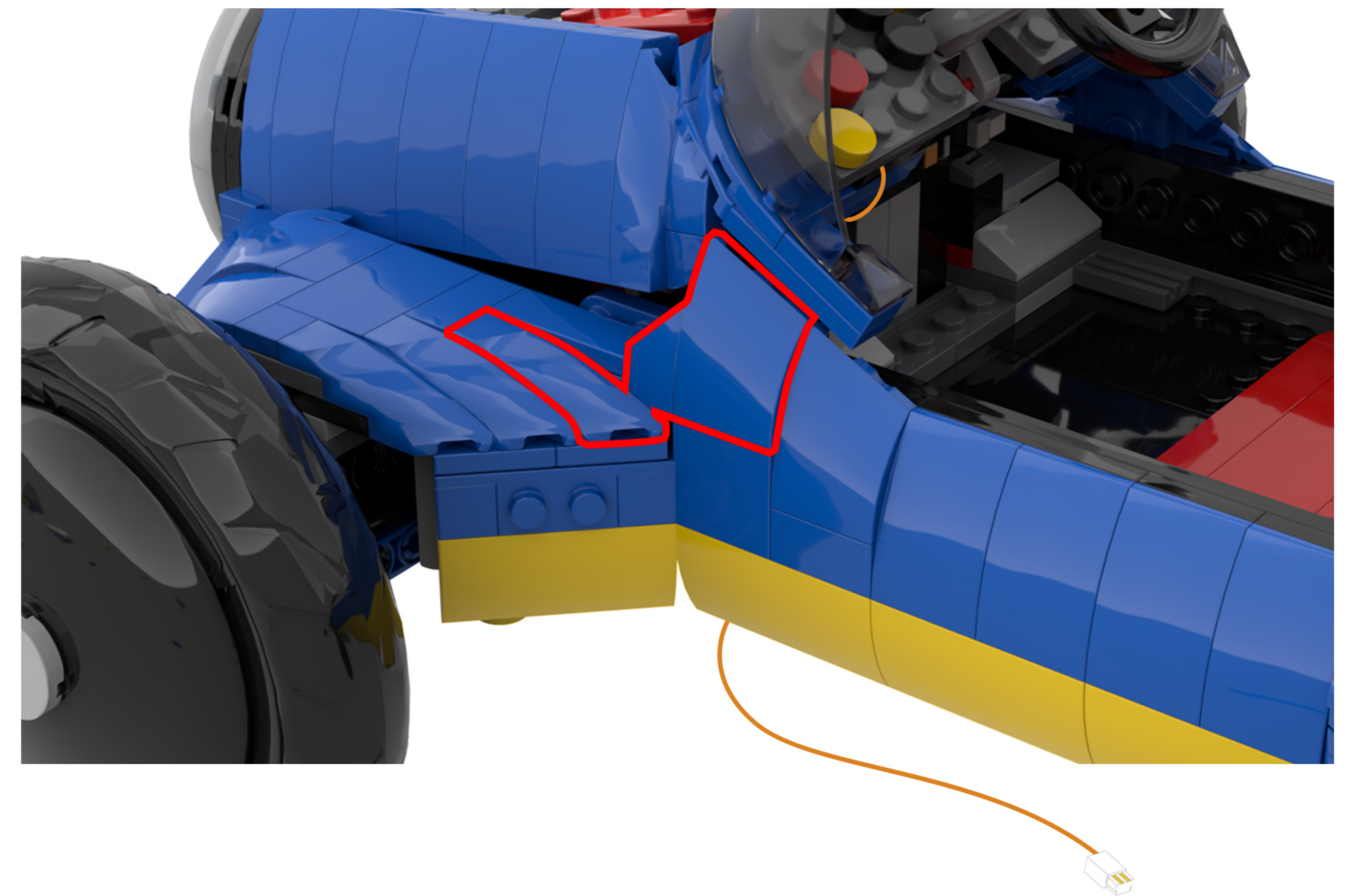
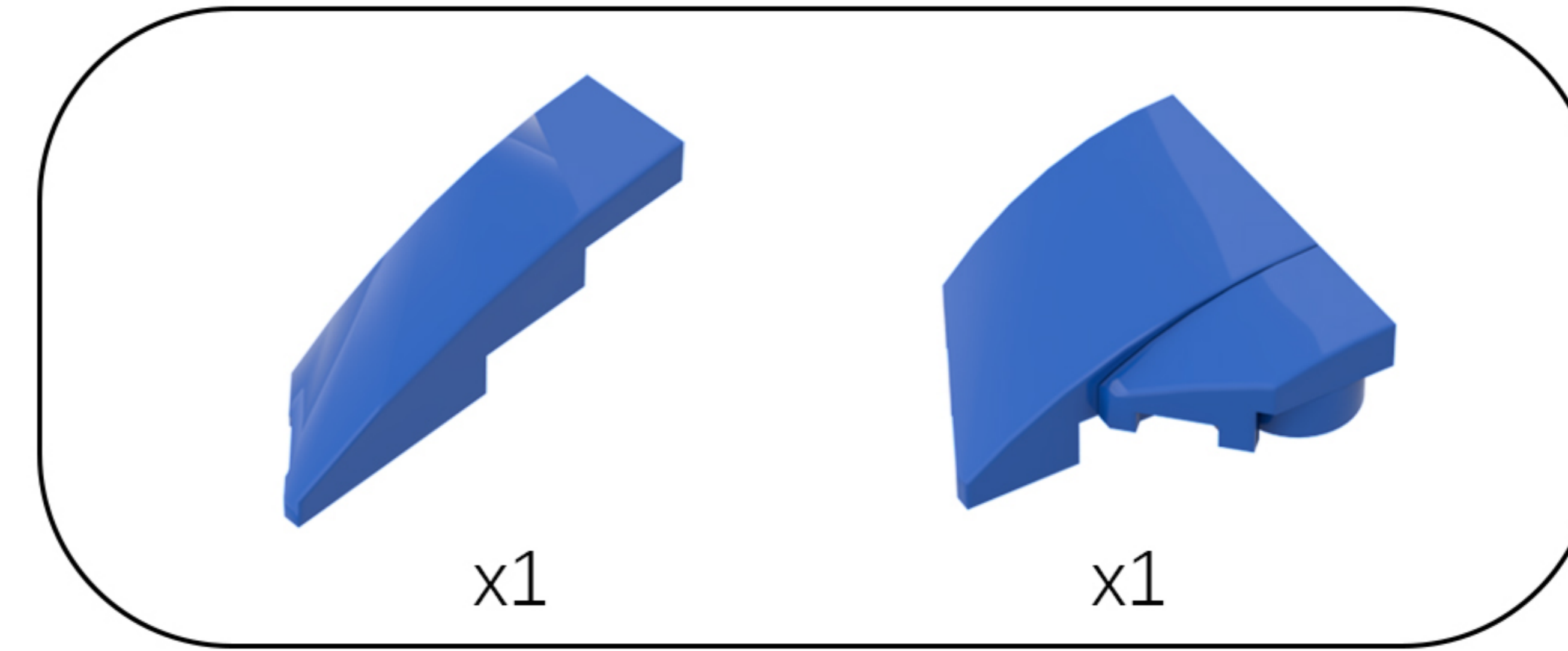

49

EN: Flip the model so that the bottom is facing up, and locate the light lines shown in the figure.

DE: Drehen Sie das Modell so, dass die Unterseite nach oben zeigt, und suchen Sie die in der Abbildung dargestellten Lichtlinien.

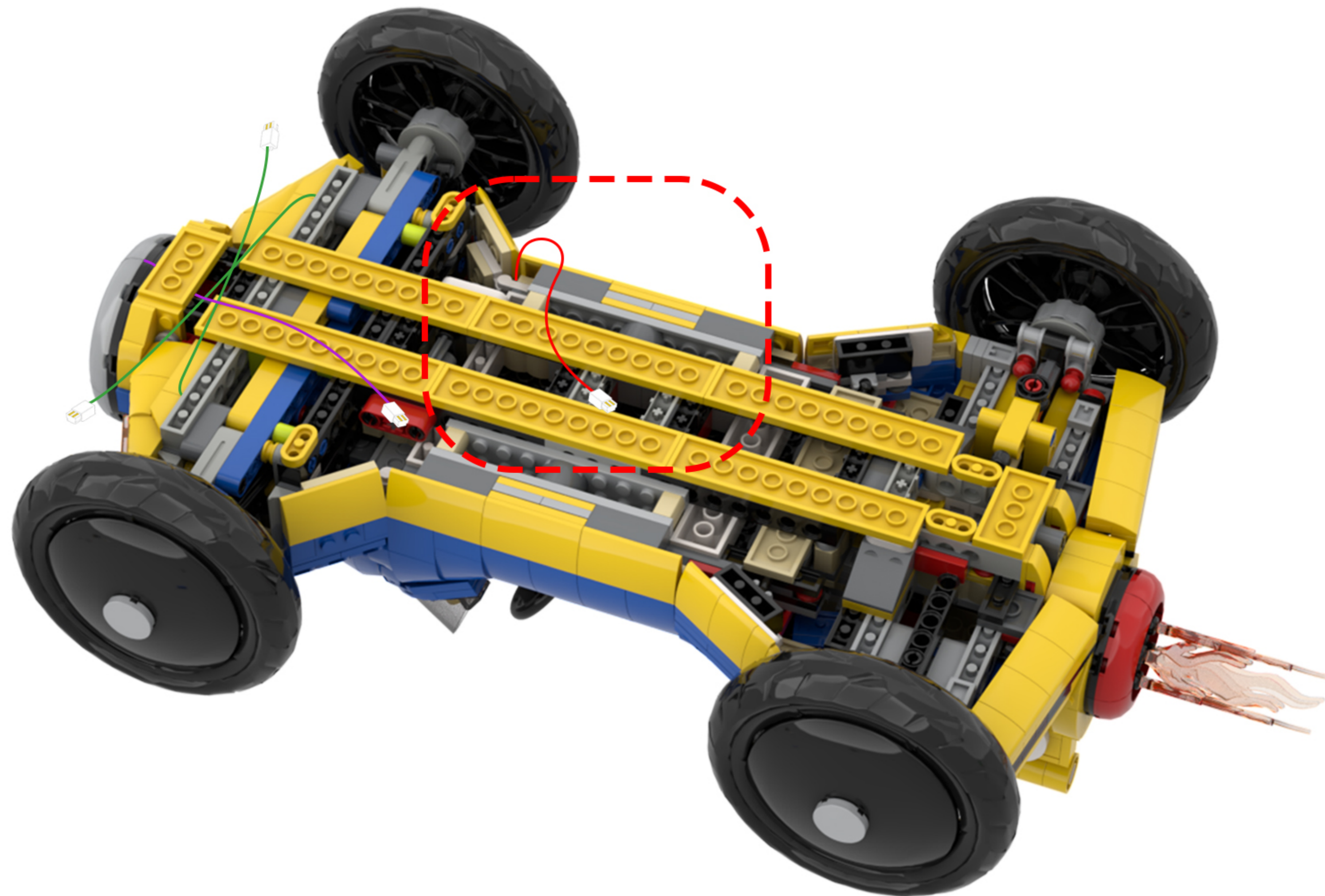

50

EN: Thread the light cord through the holes in the building blocks.

DE: Führen Sie das Lichtschnur durch die Löcher in den Bausteinen.

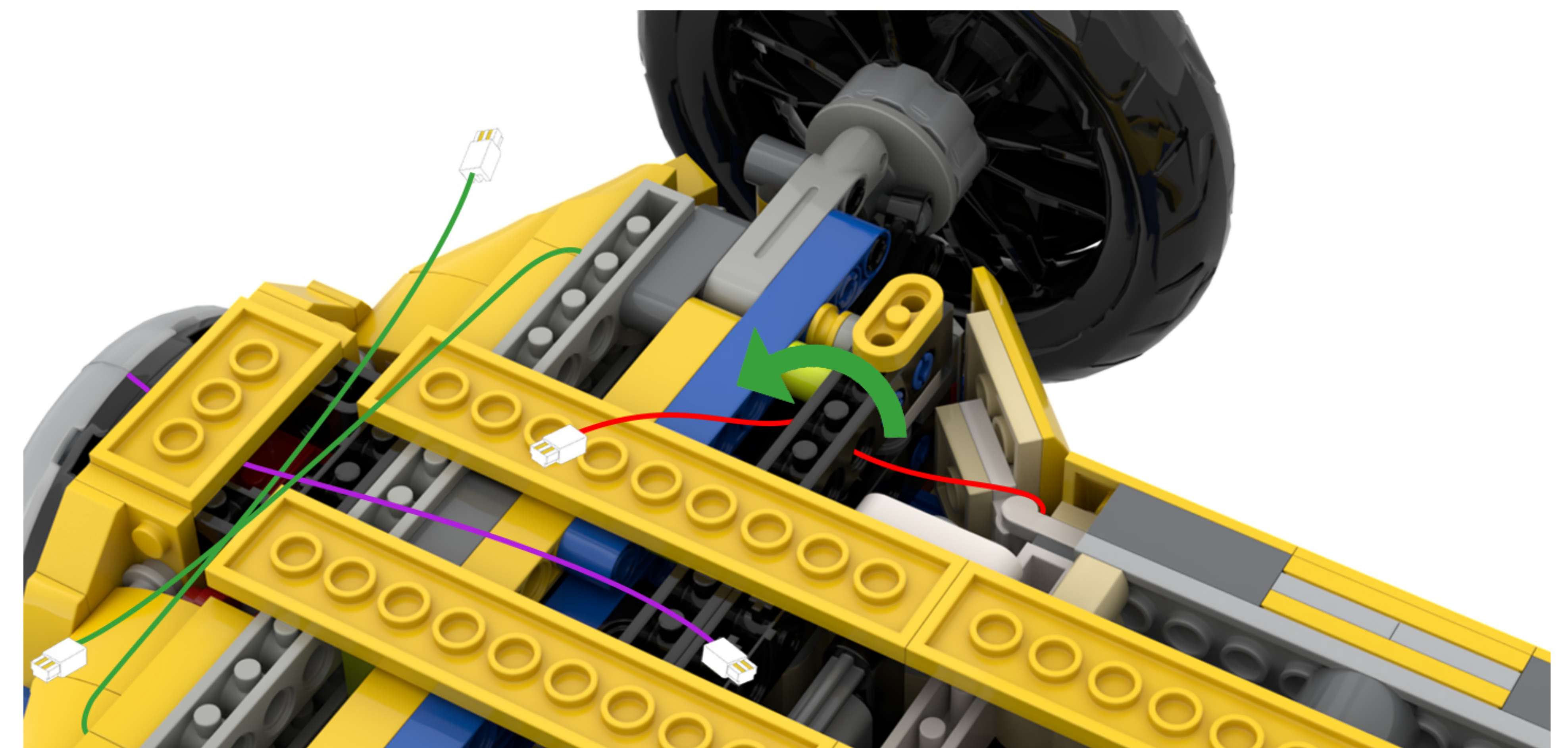
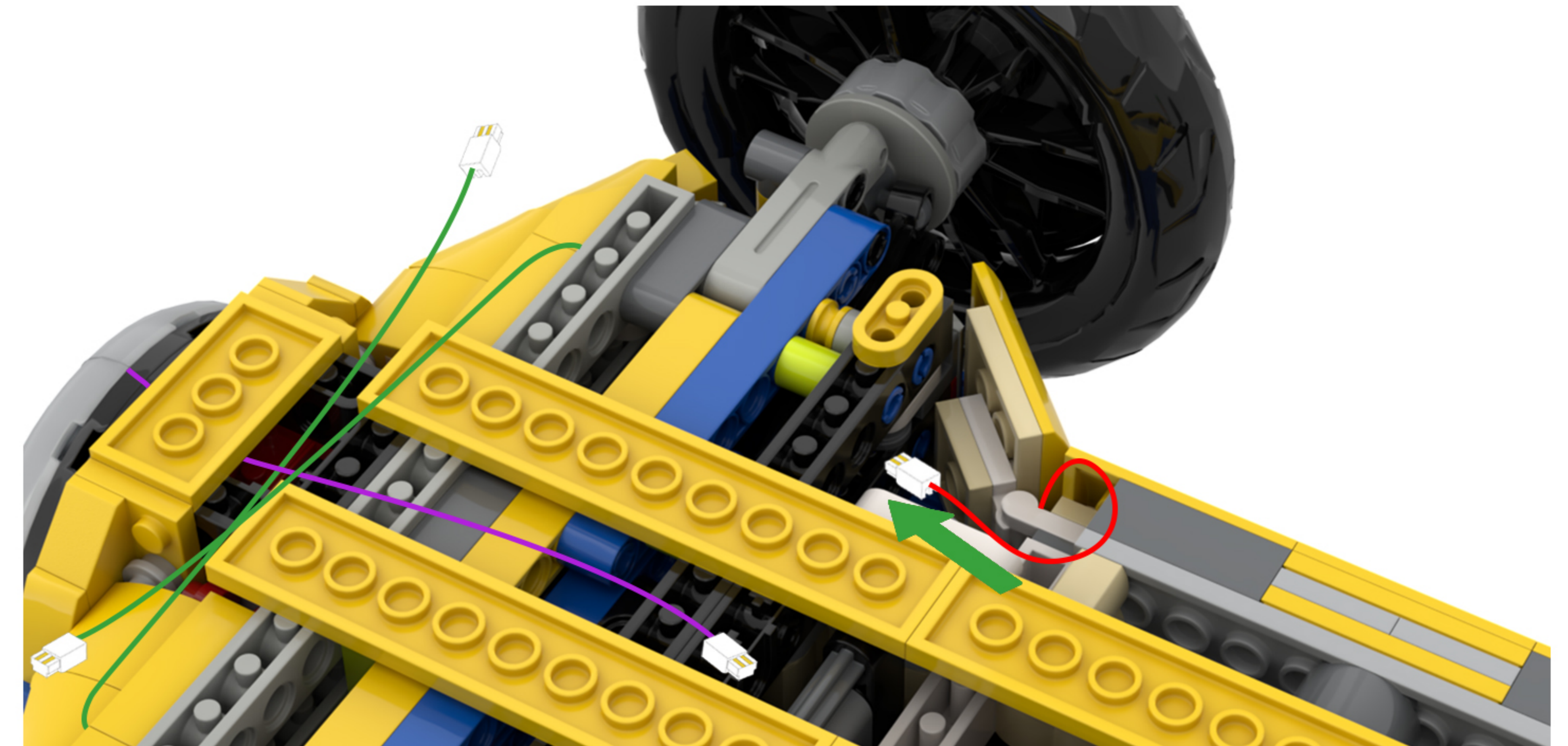

51

EN: Flip the model to restore it to its original state.

DE: Drehen Sie das Modell um, um es in seinen ursprünglichen Zustand zurückzusetzen.



52

EN: Take out the string lights from Bag 1 and the disassembled building blocks.

DE: Nimm die Lichterkette aus Beutel 1 und die zerlegten Bausteine heraus.

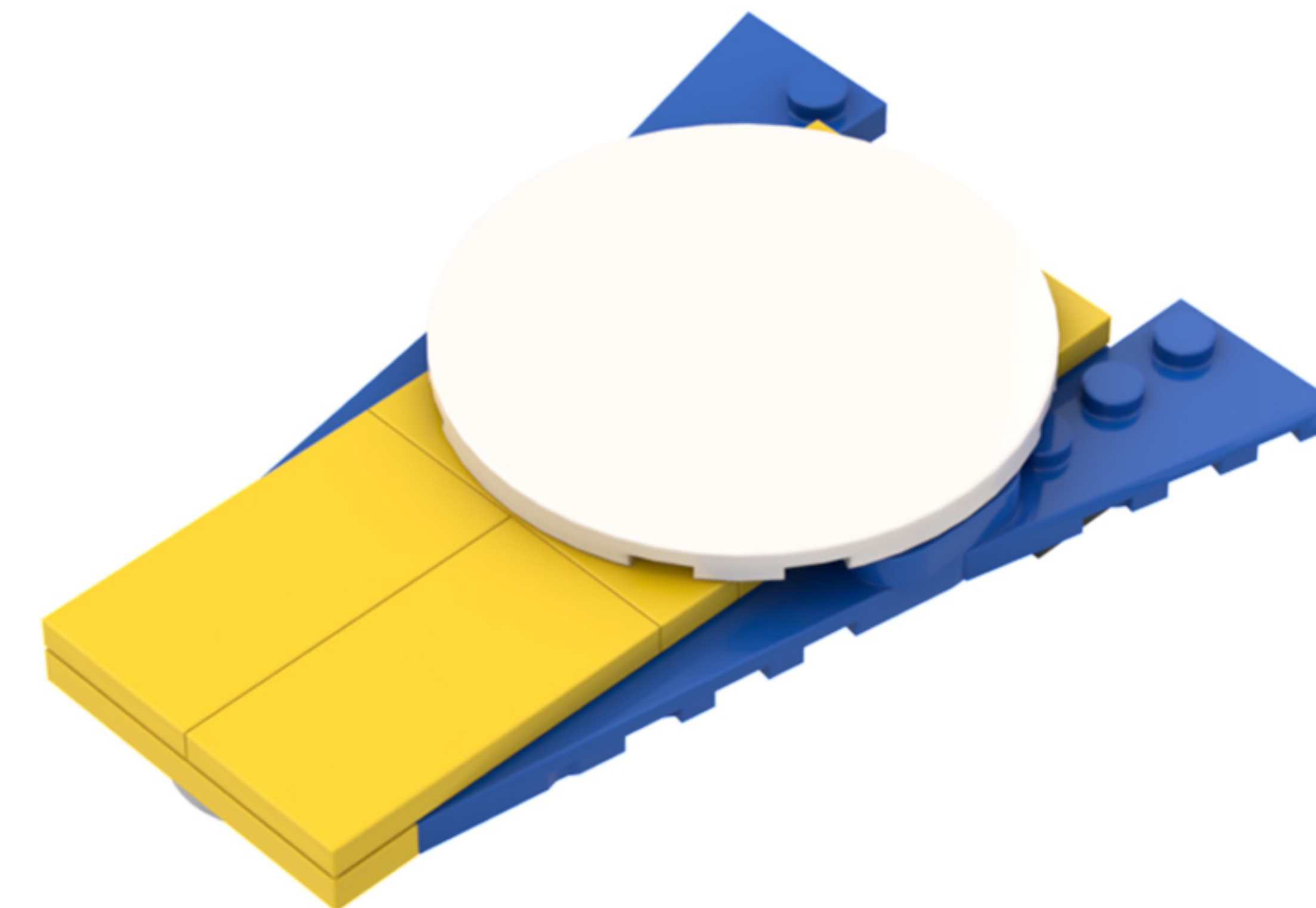
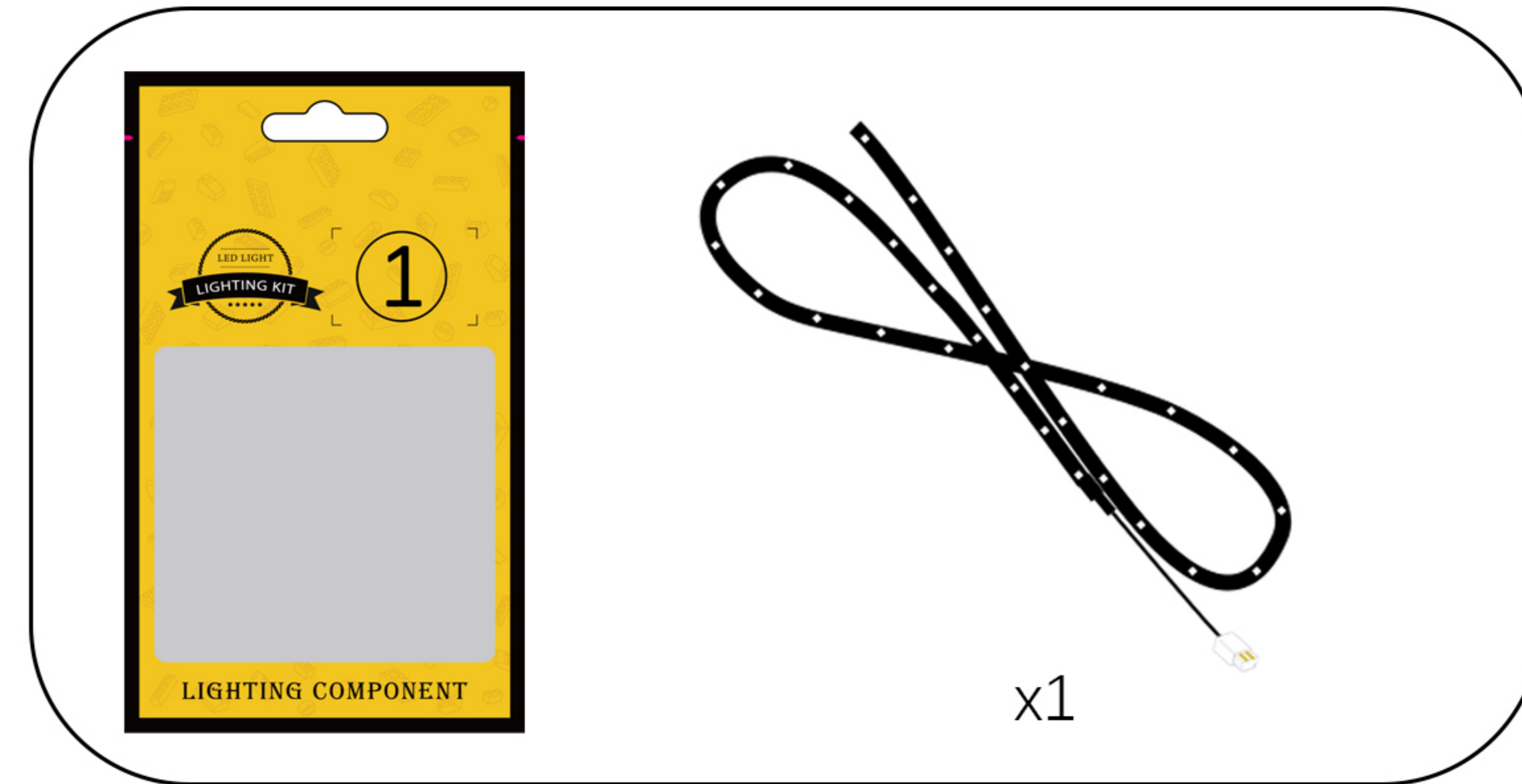

53

EN: Peel off the adhesive backing from the light strip and attach the end with the light wires to the building block first.

DE: Zieh die Schutzfolie vom Leuchtband ab und befestige zuerst das Ende mit den Lichtkabeln am Baustein.

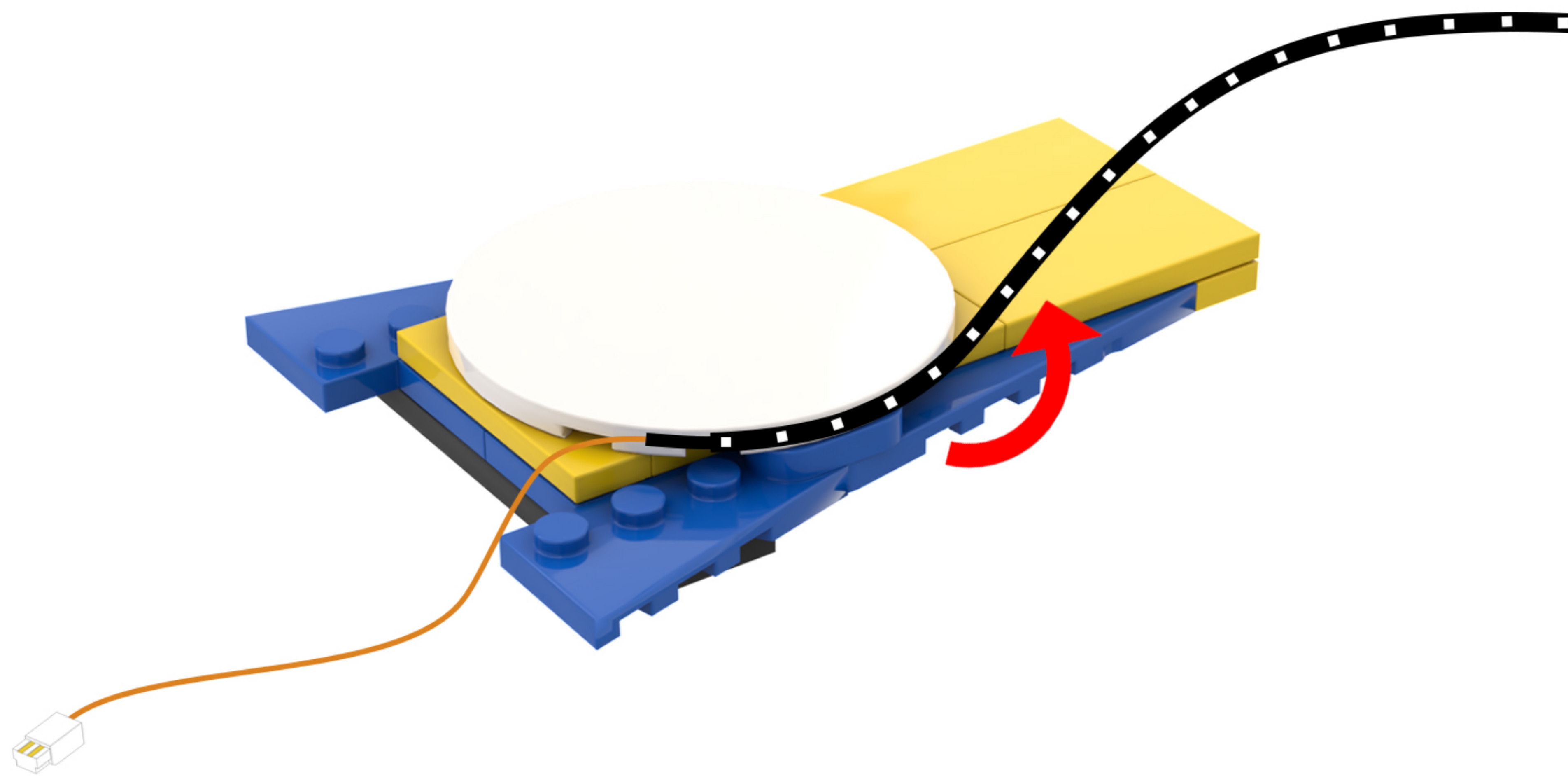

54

EN: Attach all the LED strips to the building blocks.

DE: Befestige alle LED-Streifen an den Bausteinen.

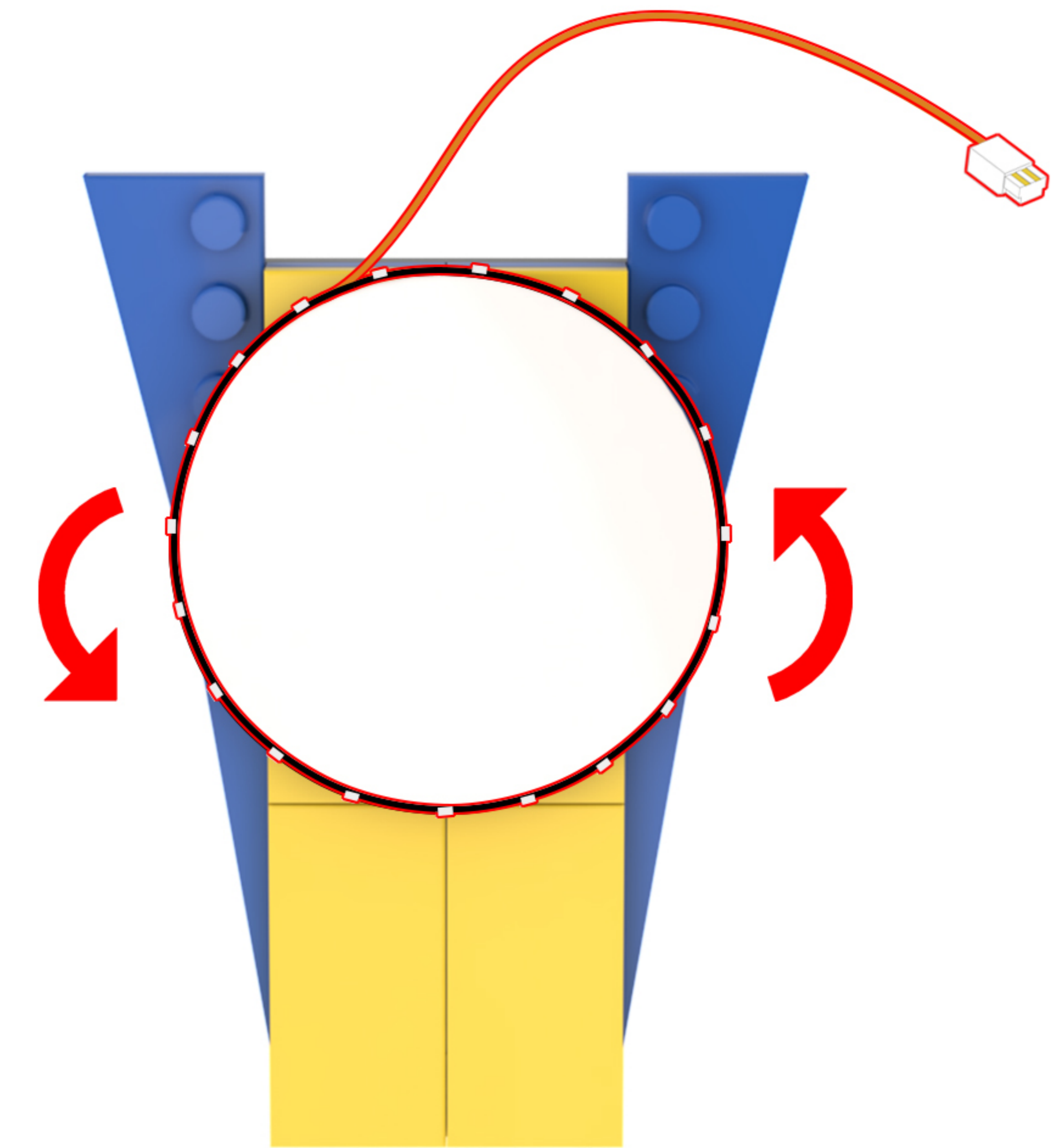

55

EN: Returning to the model, thread the light cord through the gaps in the building blocks.

DE: Kehren Sie zum Modell zurück und führen Sie das Lichtschnur durch die Öffnungen in den Bausteinen.

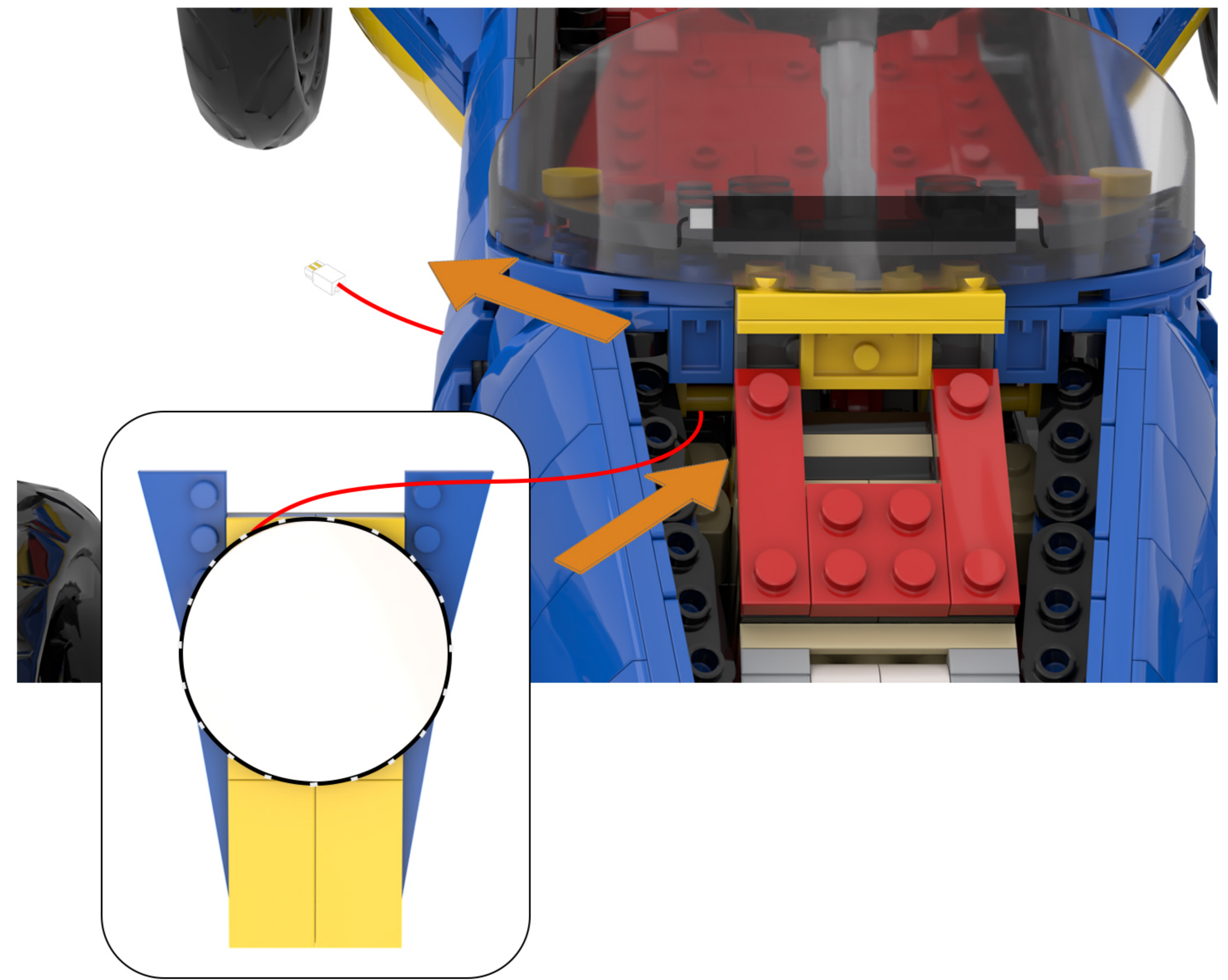
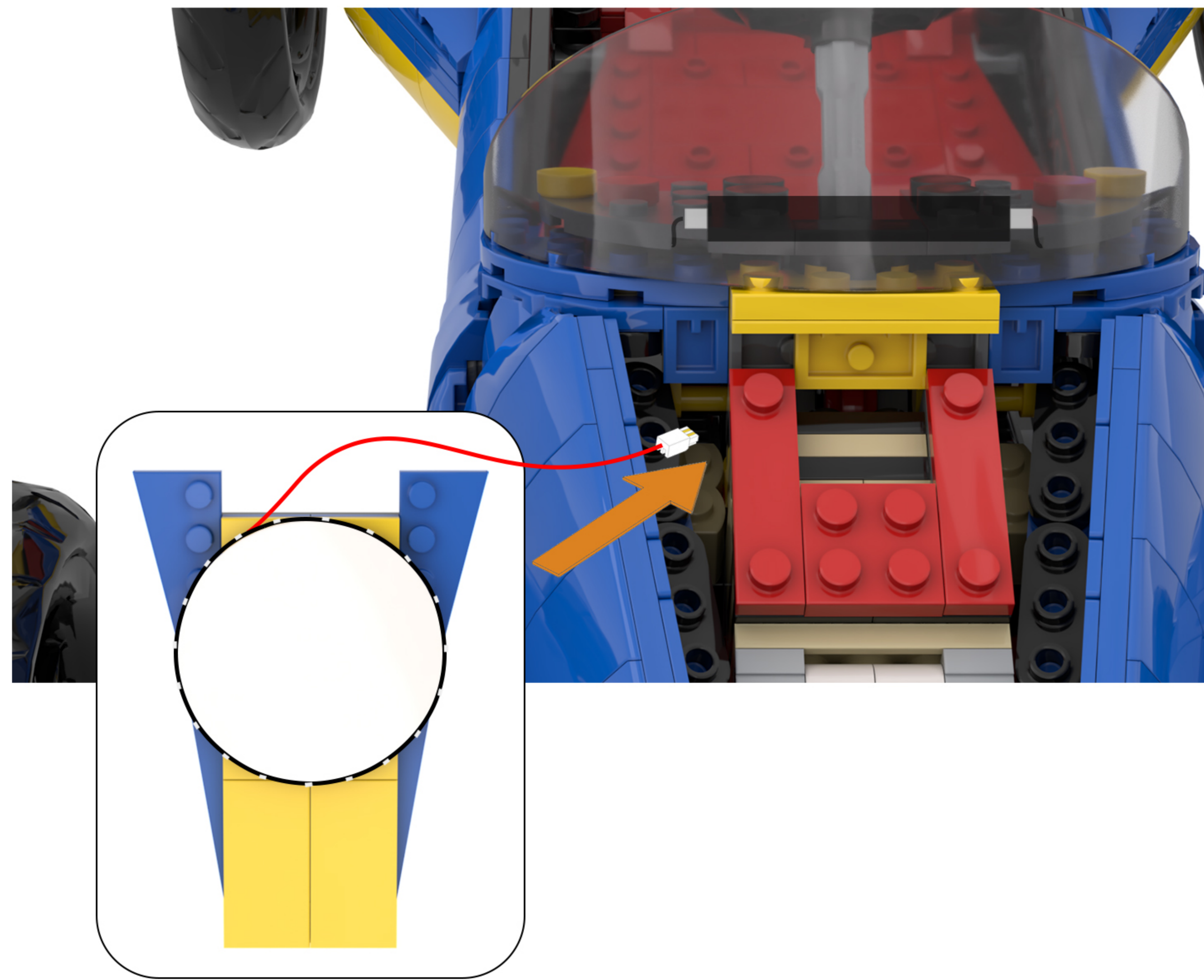

56

EN: Restore the building blocks.

DE: Stellen Sie die Bausteine wieder her.

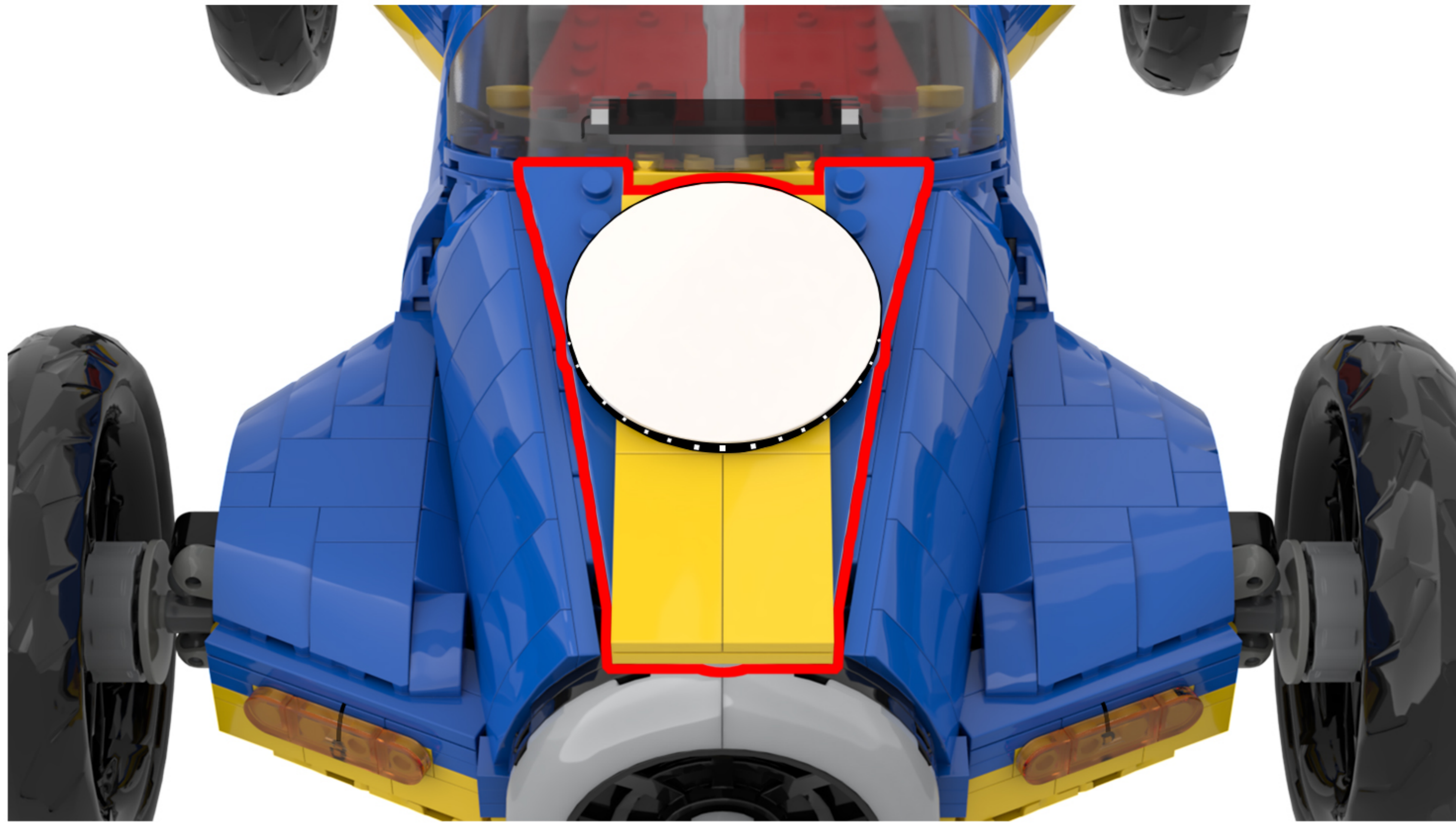

57

EN: Flip the model so that the bottom is facing up, and locate the light lines shown in the figure.

DE: Drehen Sie das Modell so, dass die Unterseite nach oben zeigt, und suchen Sie die in der Abbildung dargestellten Lichtlinien.

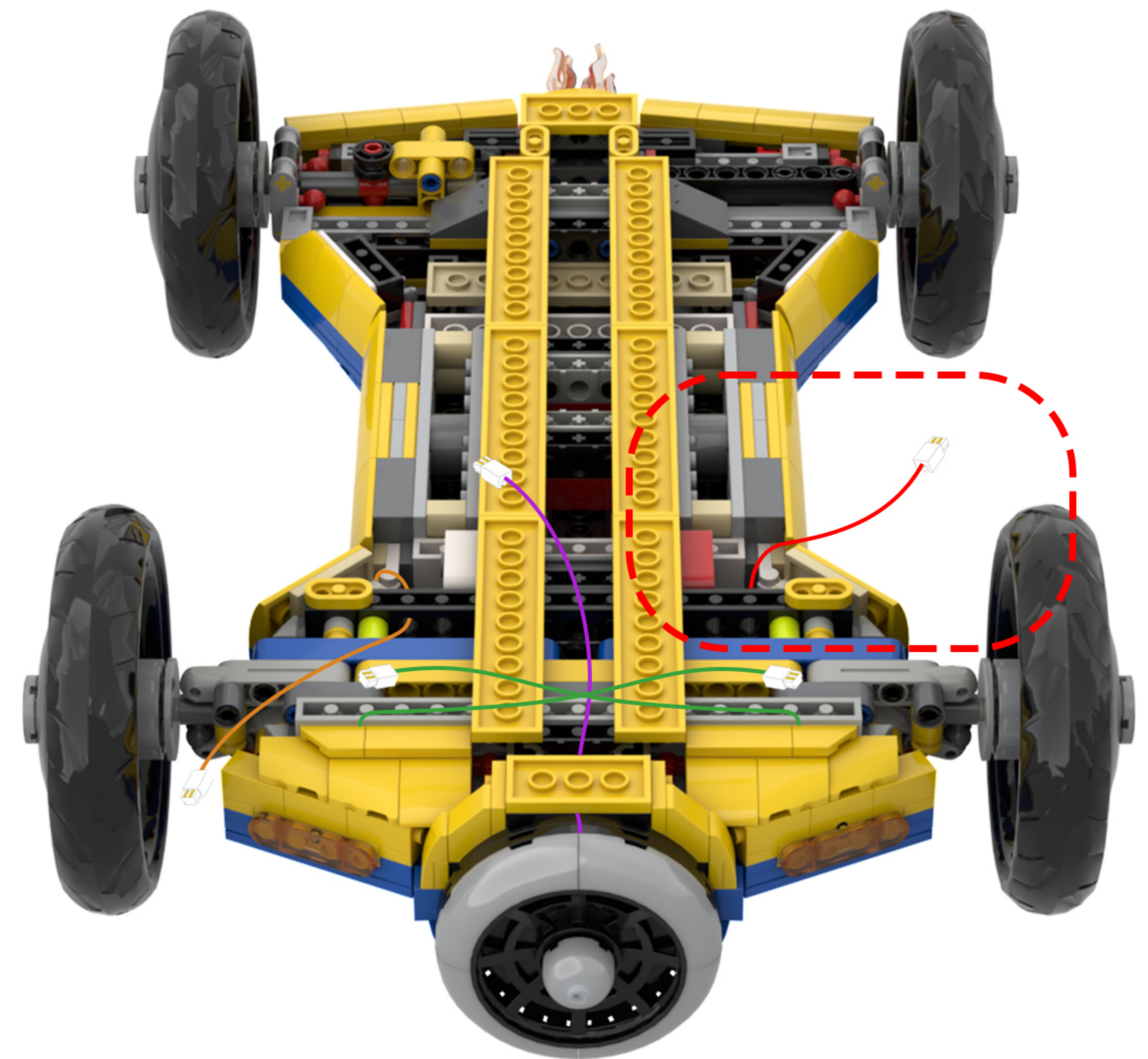
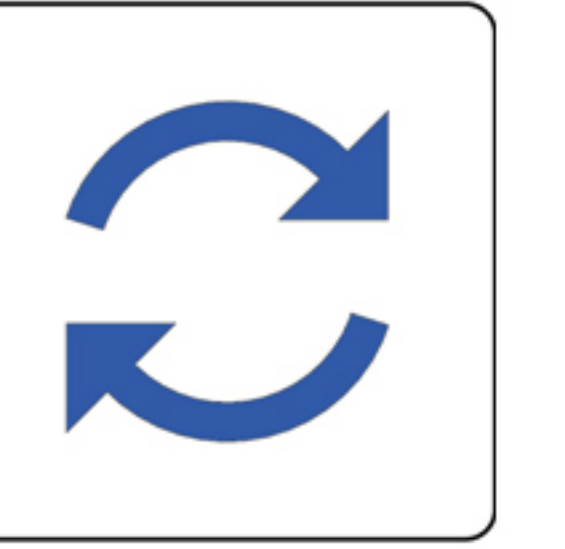

58

EN: Thread the light cord through the holes in the building blocks.

DE: Führen Sie das Lichtschrur durch die Löcher in den Bausteinen.

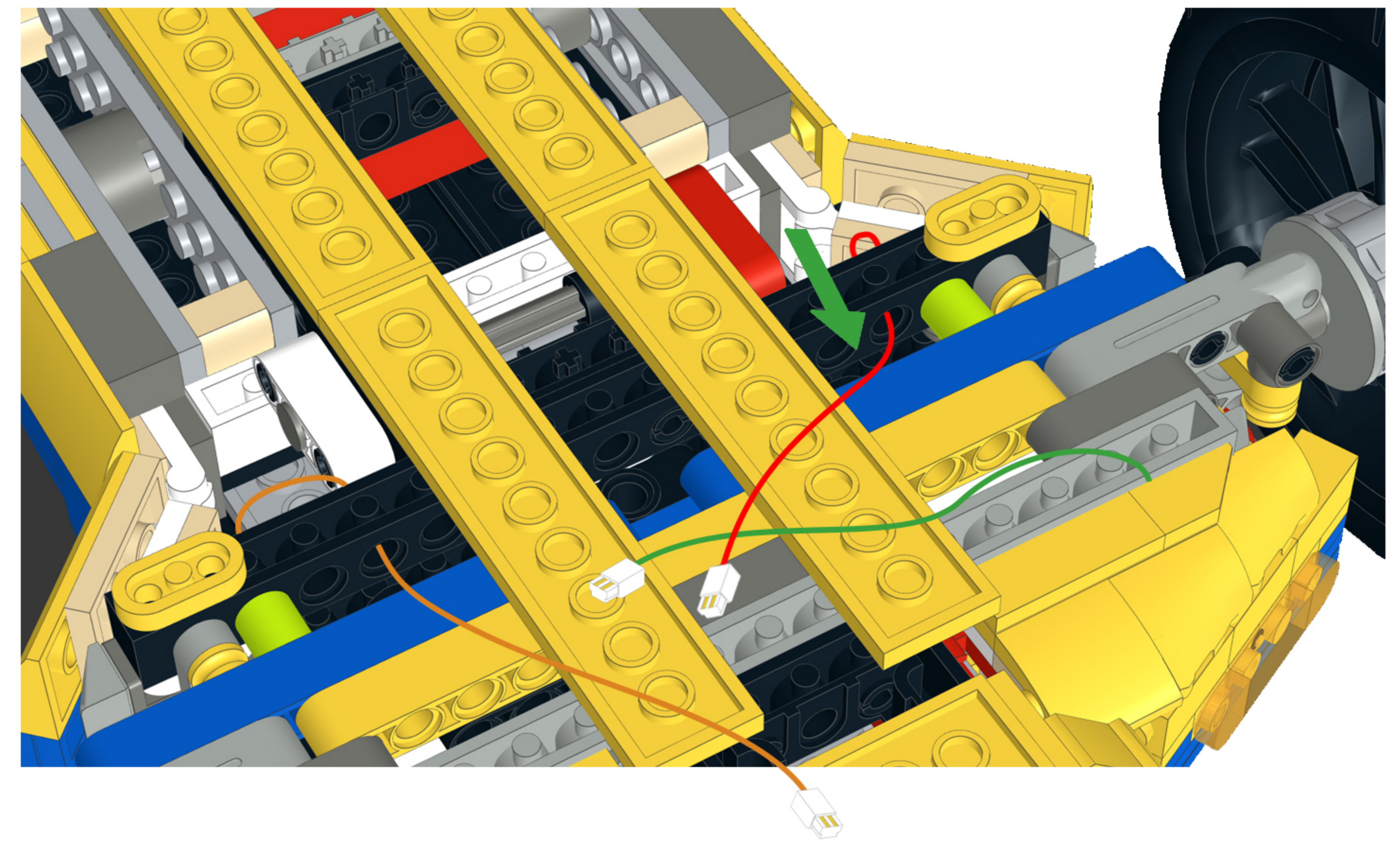
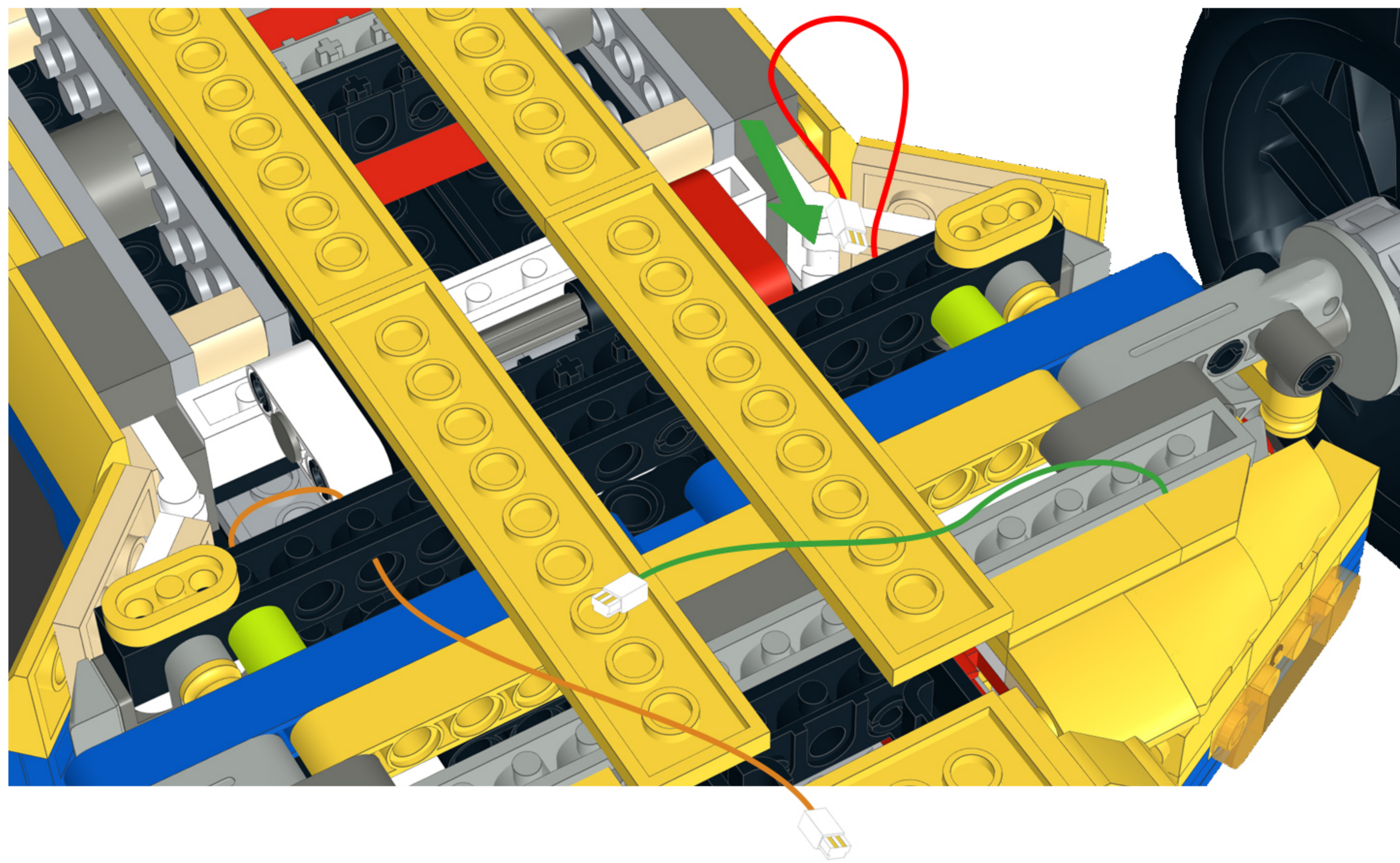

59

EN: Find the 5 light lines in the picture.

DE: Finde die 5 Lichtlinien auf dem Bild.

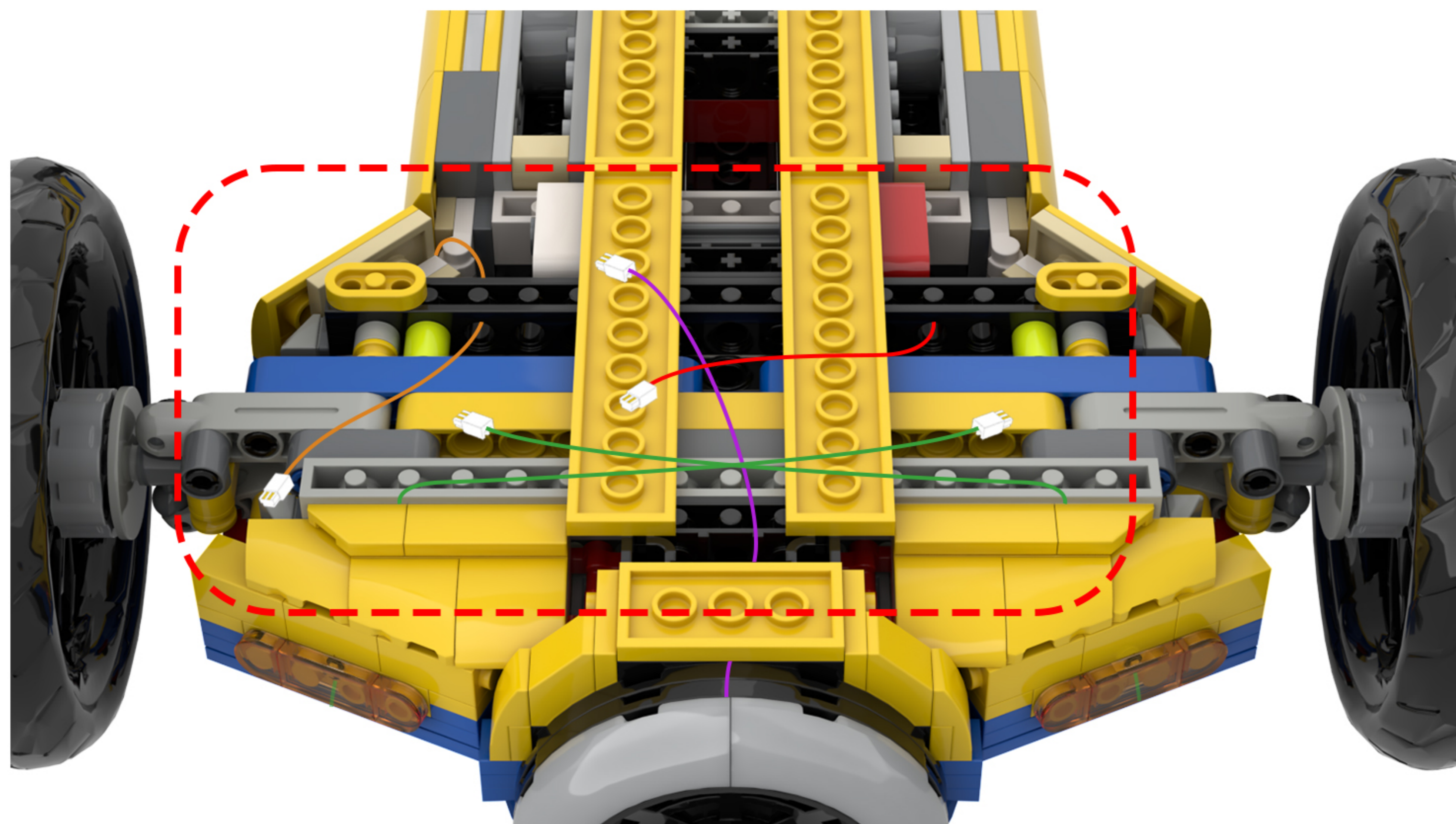

60

EN: Twist the five strands of string lights together.

DE: Verdrehen Sie die fünf Lichtketten miteinander.

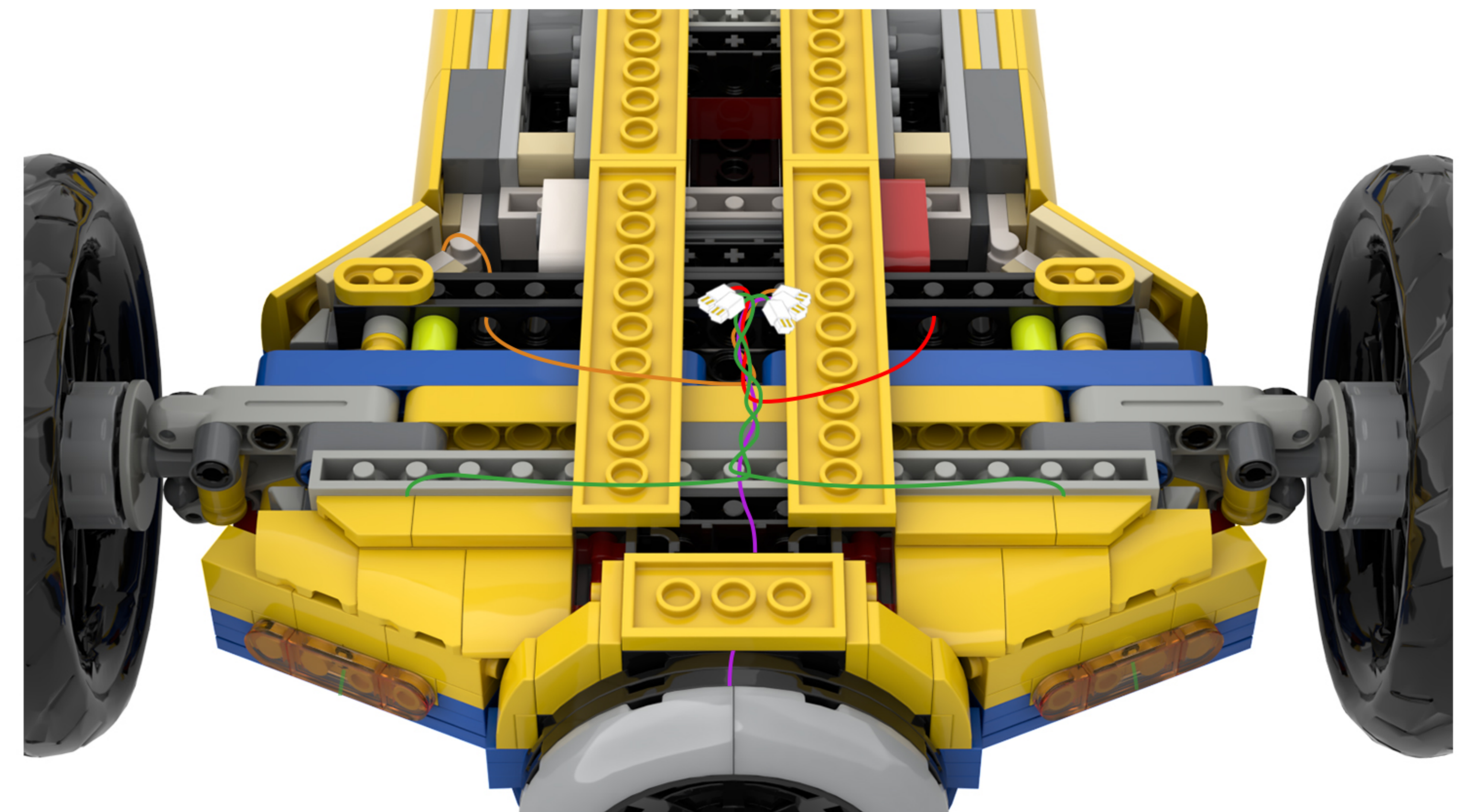

61

EN: Rotate the model to its back side.

DE: Drehen Sie das Modell auf die Rückseite.

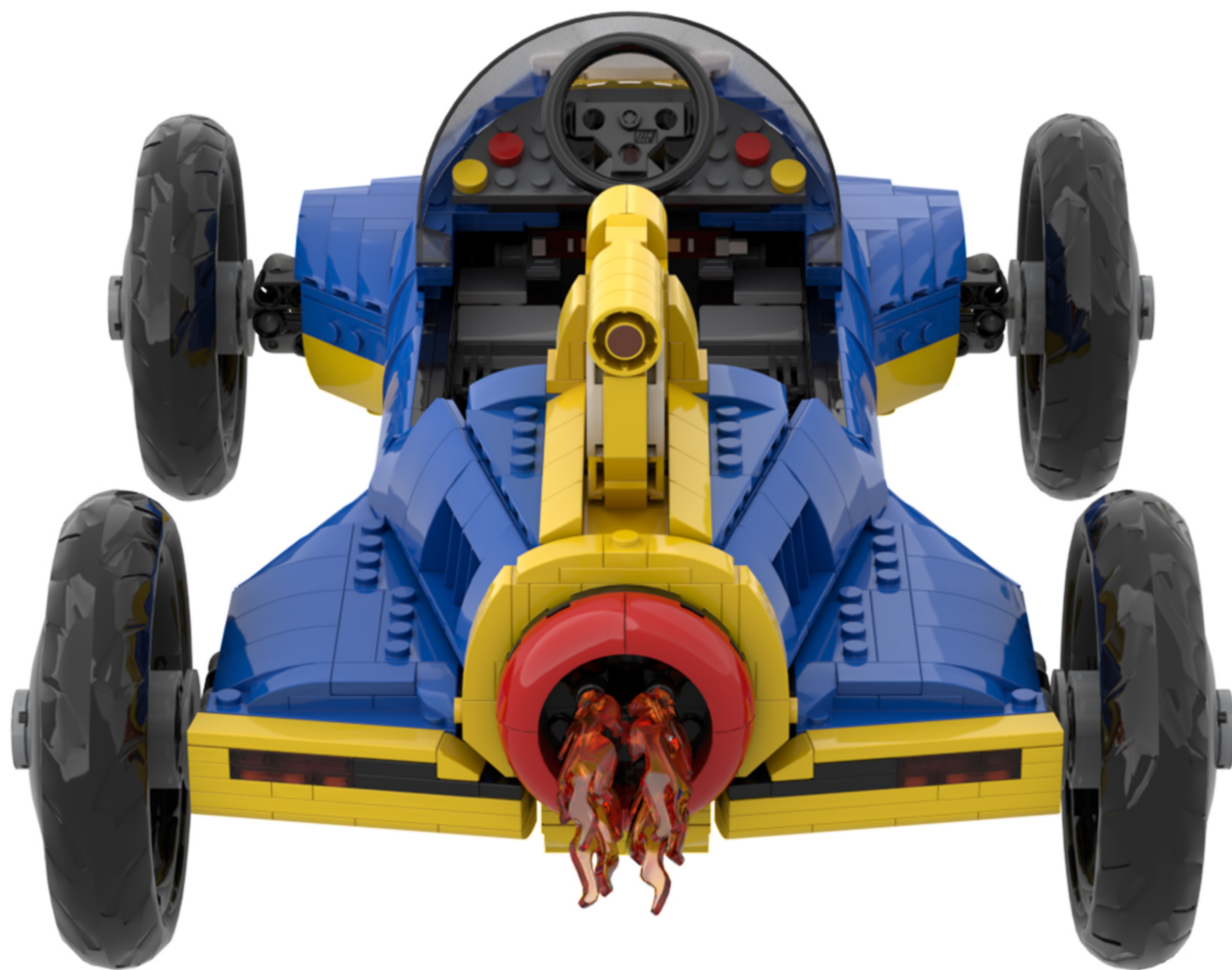
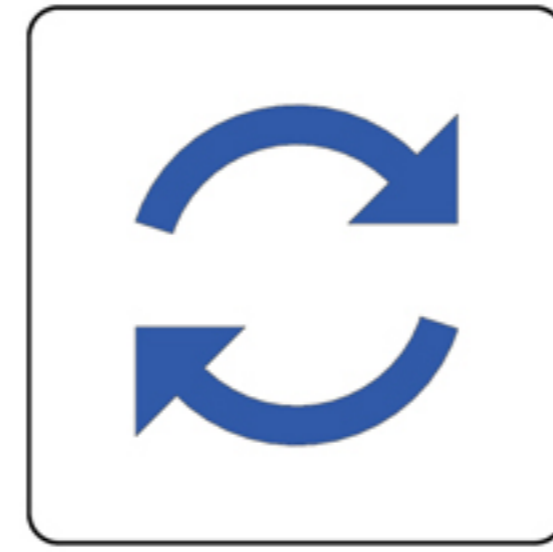

62

EN: Remove the building blocks one by one.

DE: Entfernen Sie die Bausteine nacheinander.

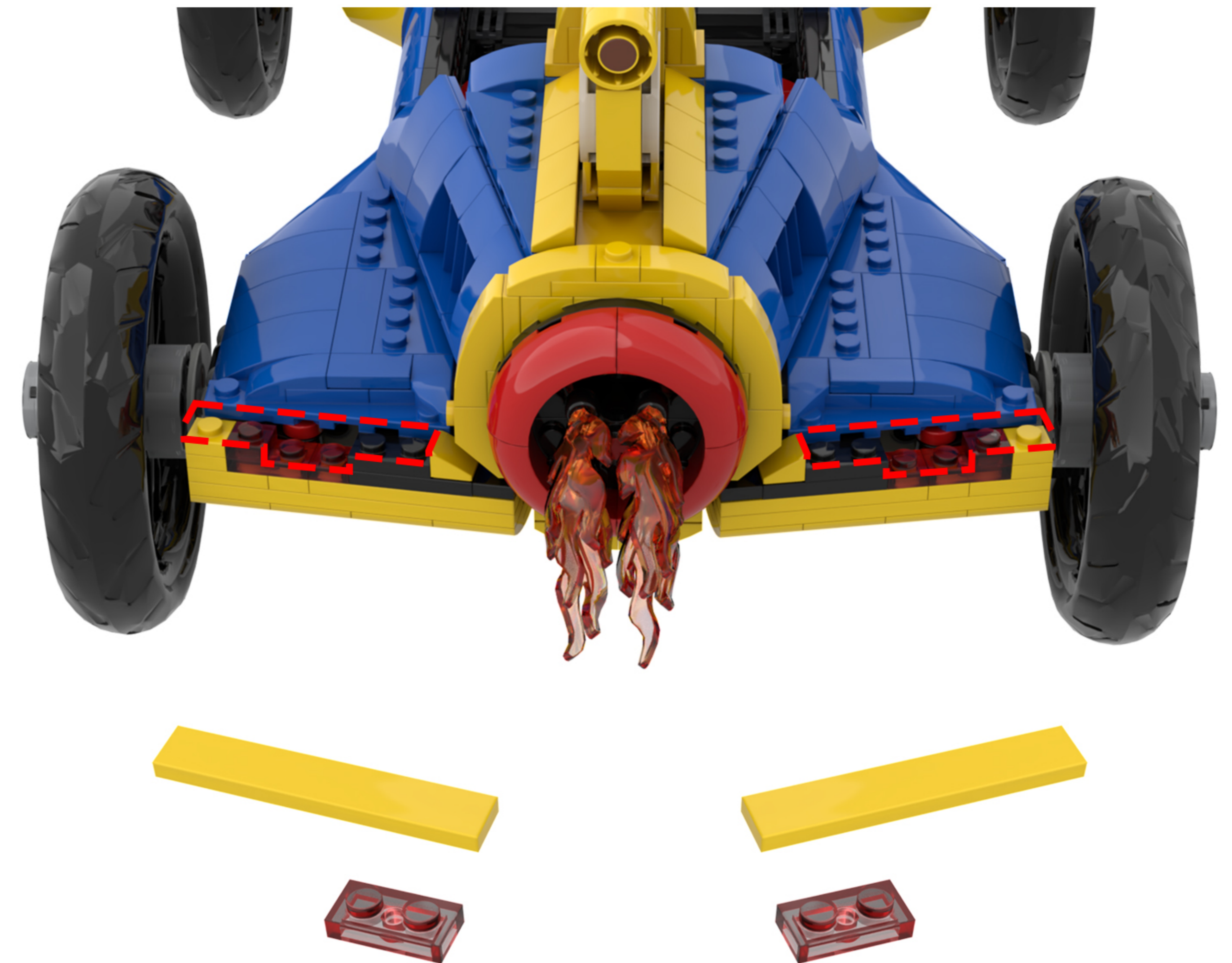

63

EN: Take the light bead from bag #6, thread it through the gap in the building block, and place it in the position shown in the illustration.

DE: Nehmen Sie die Lichterkugel aus Beutel Nr. 6, fädeln Sie sie durch die Öffnung im Baustein und setzen Sie sie an der in der Abbildung gezeigten Stelle ein.

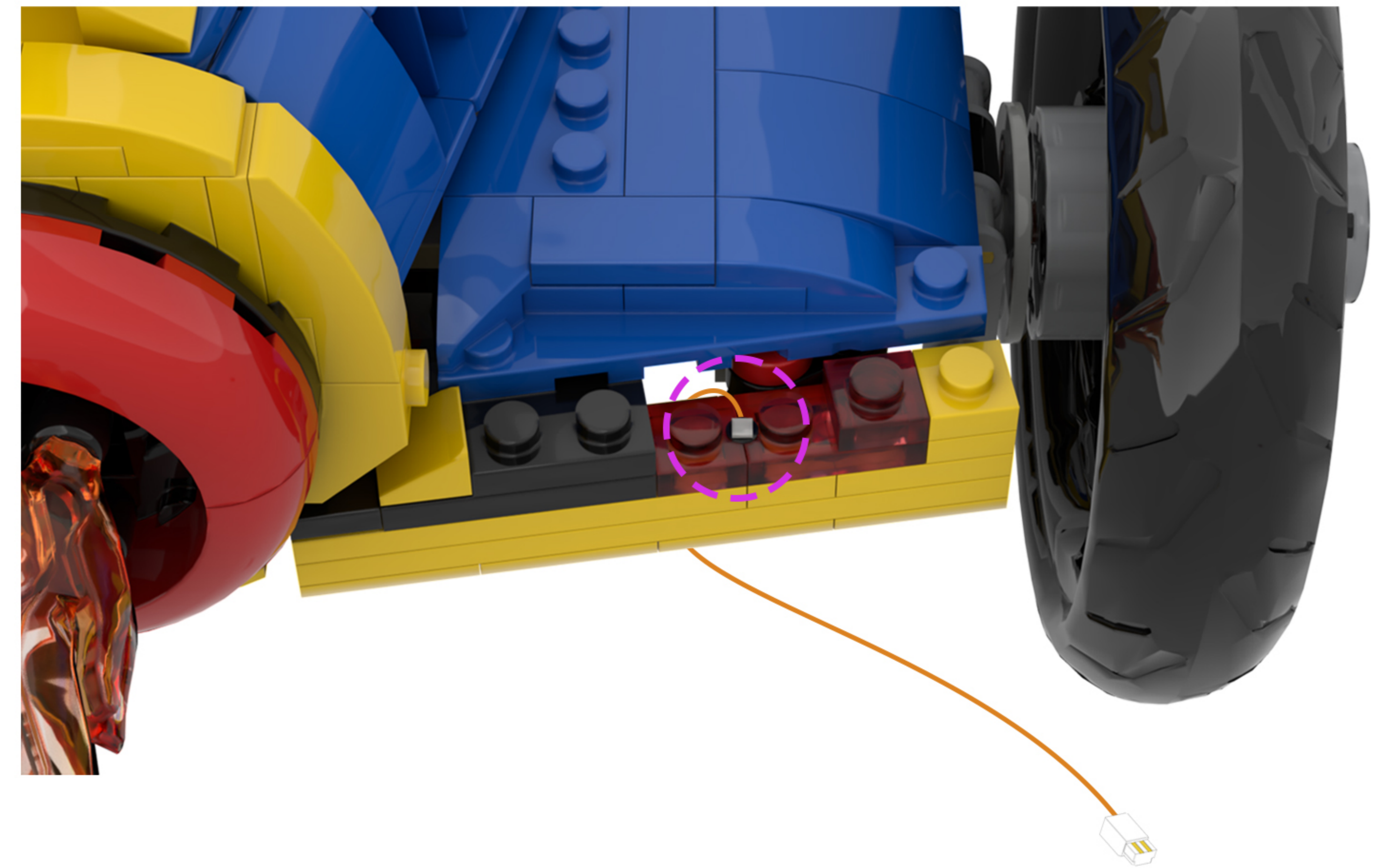
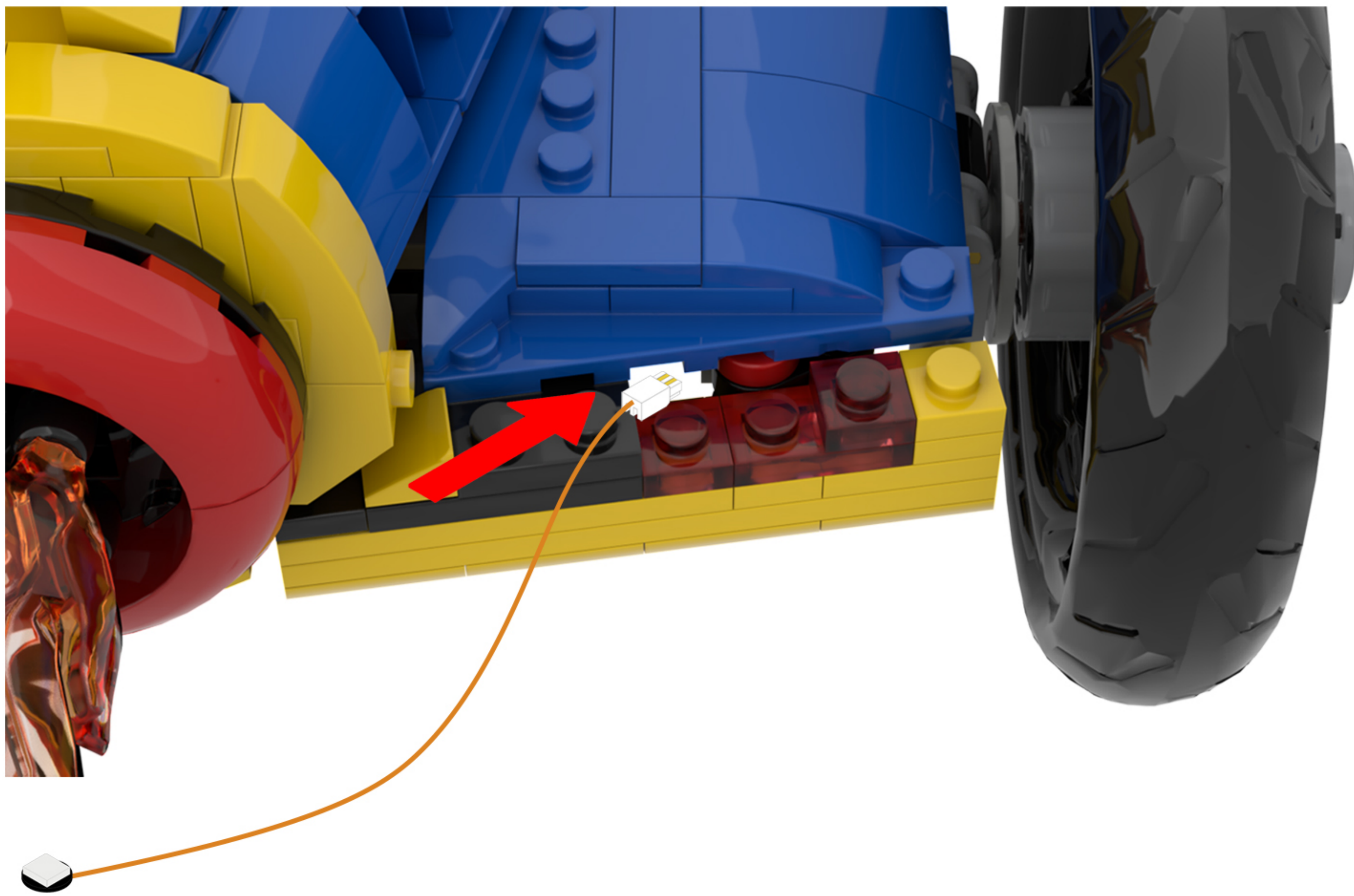
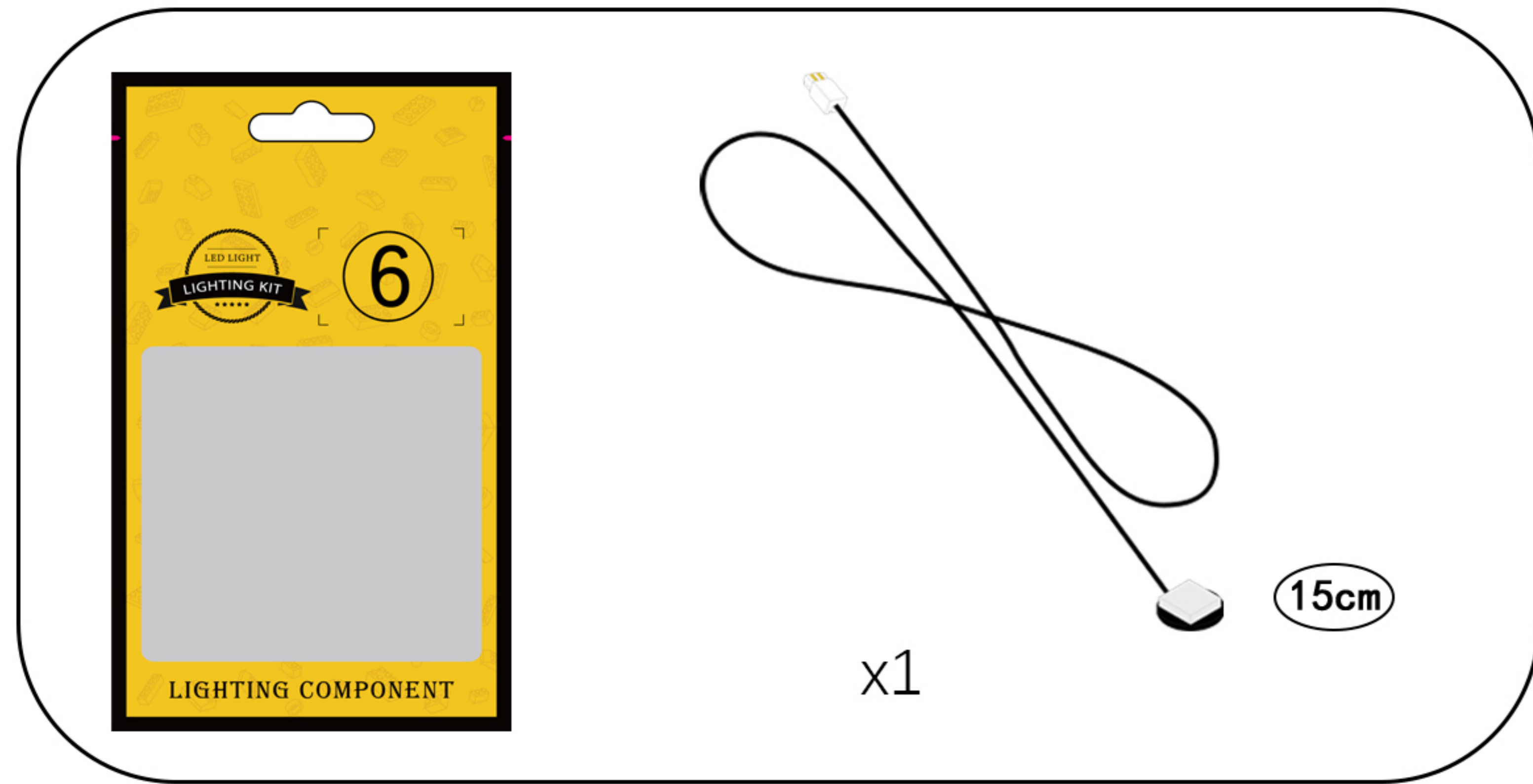

64

EN: Take the 1x2 flat panel from Bag 6 and attach it to the brick, securing the light cord in place.

DE: Nimm die 1x2-Flachplatte aus Beutel 6 und befestige sie am Stein, wobei du das Lichtkabel festklemmst.

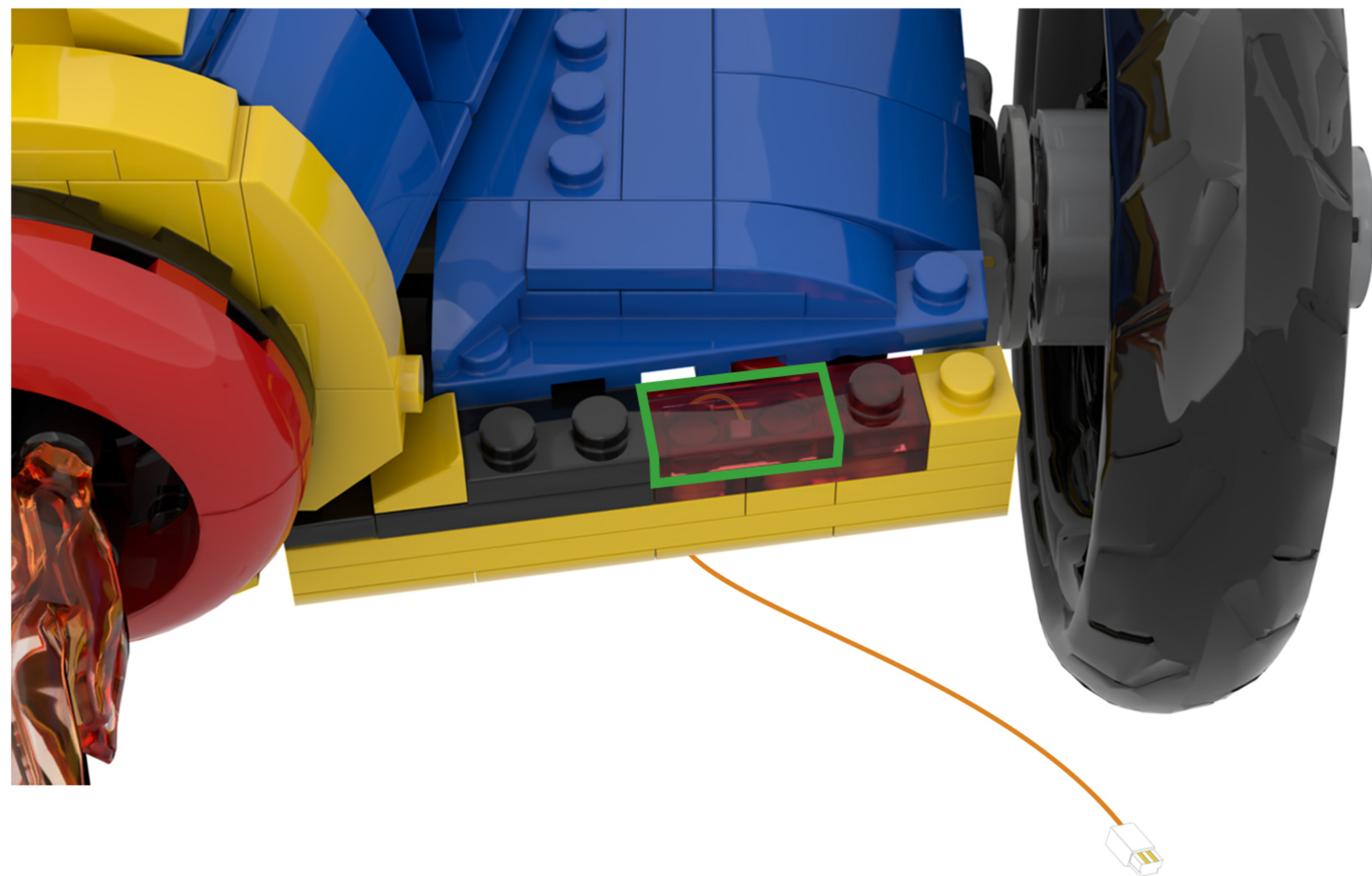
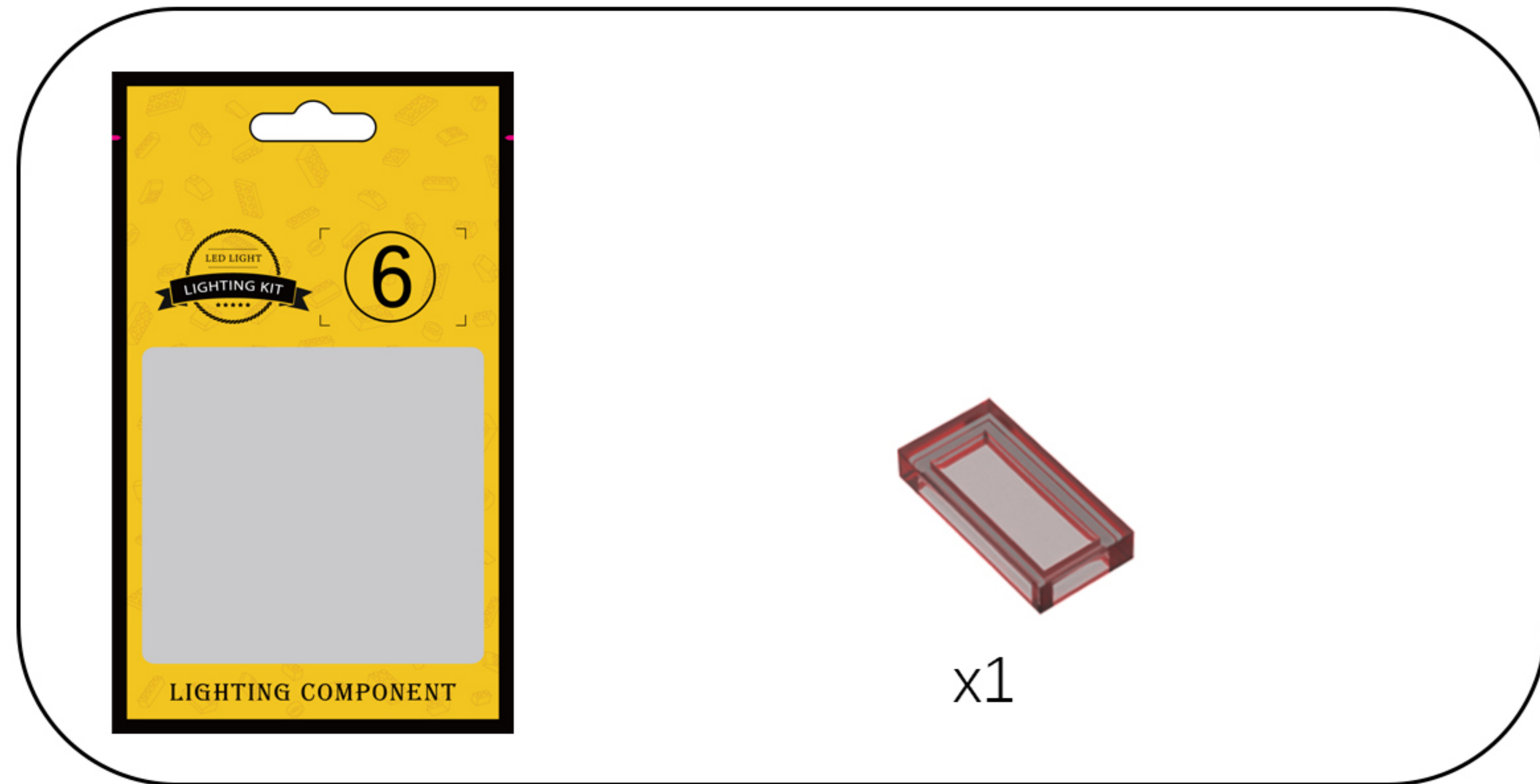

65

EN: Take out the disassembled building blocks and reassemble them.

DE: Nehmen Sie die zerlegten Bausteine heraus und setzen Sie sie wieder zusammen.

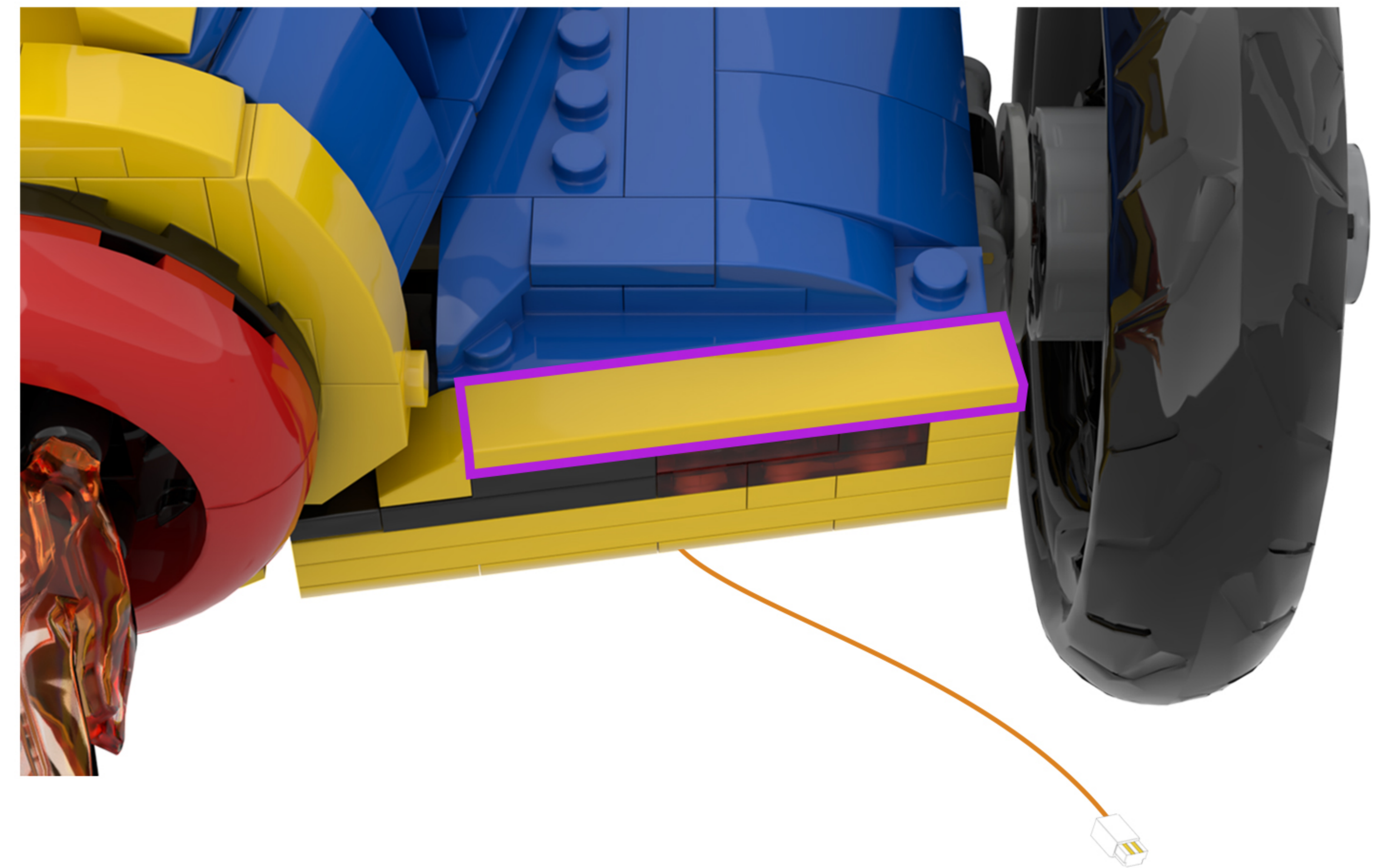
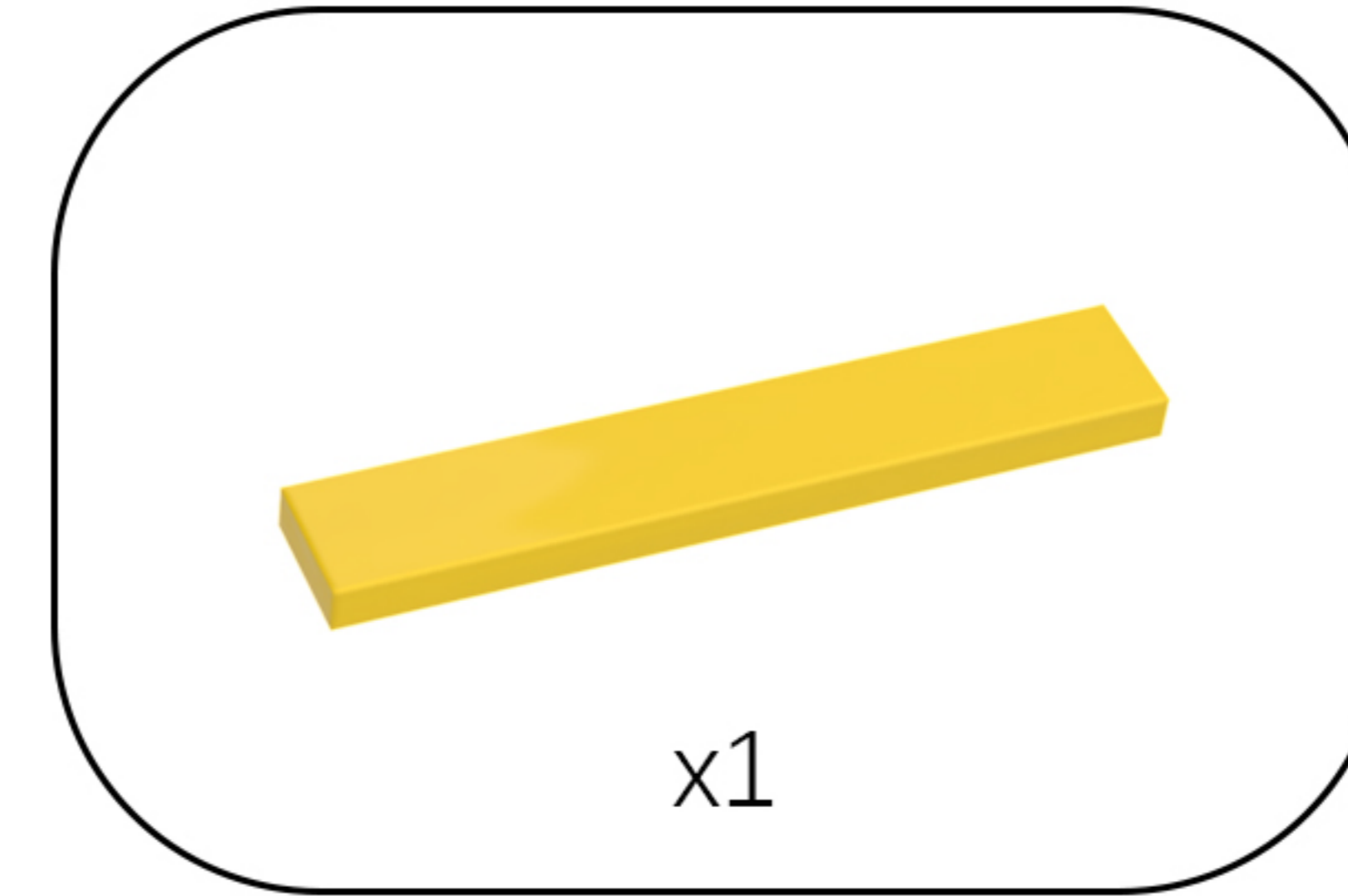

66

EN: Go to the other side of the model.

DE: Geh auf die andere Seite des Modells..

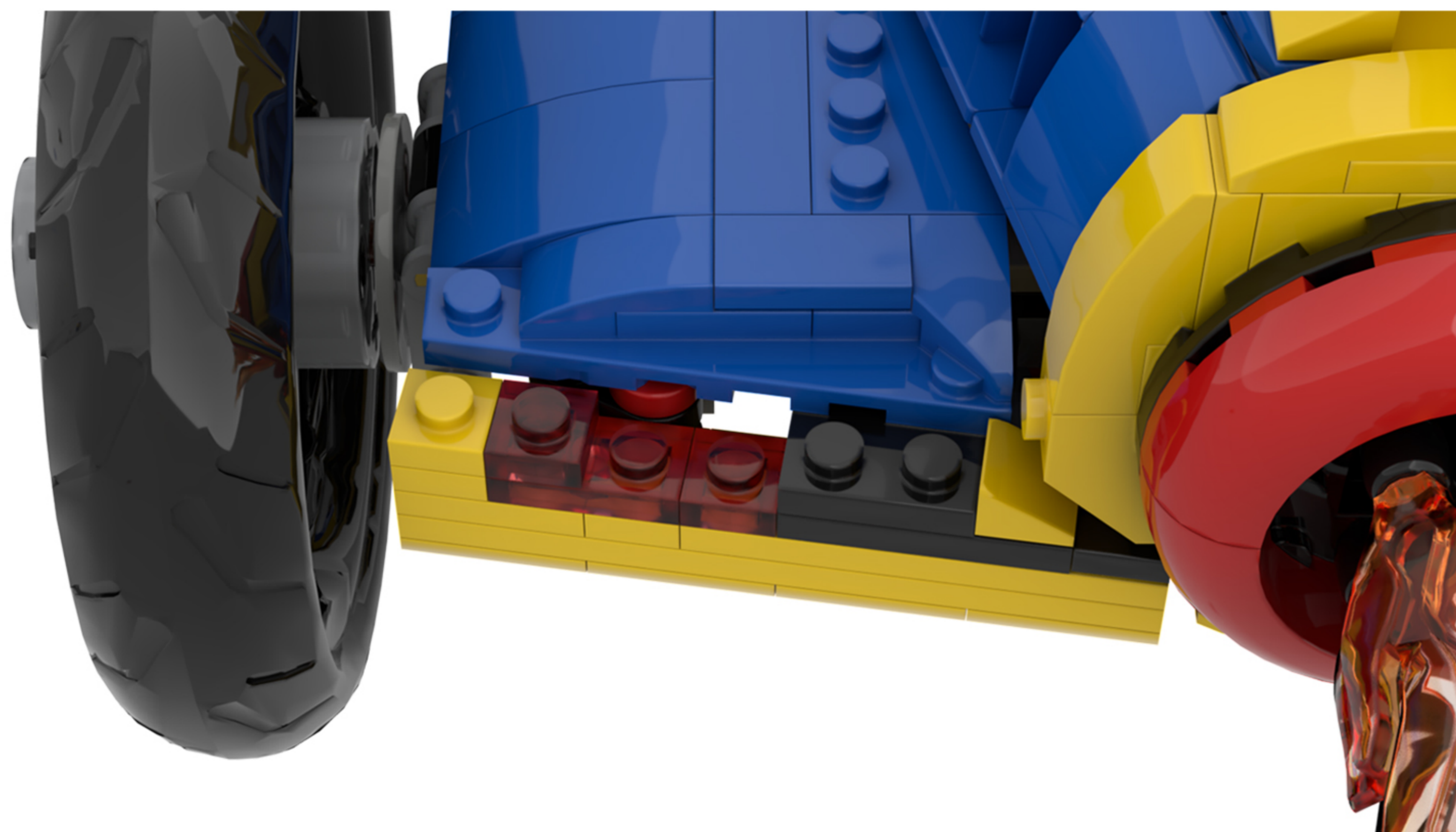

67

EN: Repeat the steps above to install the lighting on the left-hand block.

DE: Wiederholen Sie die oben genannten Schritte, um die Beleuchtung am linken Block anzubringen.

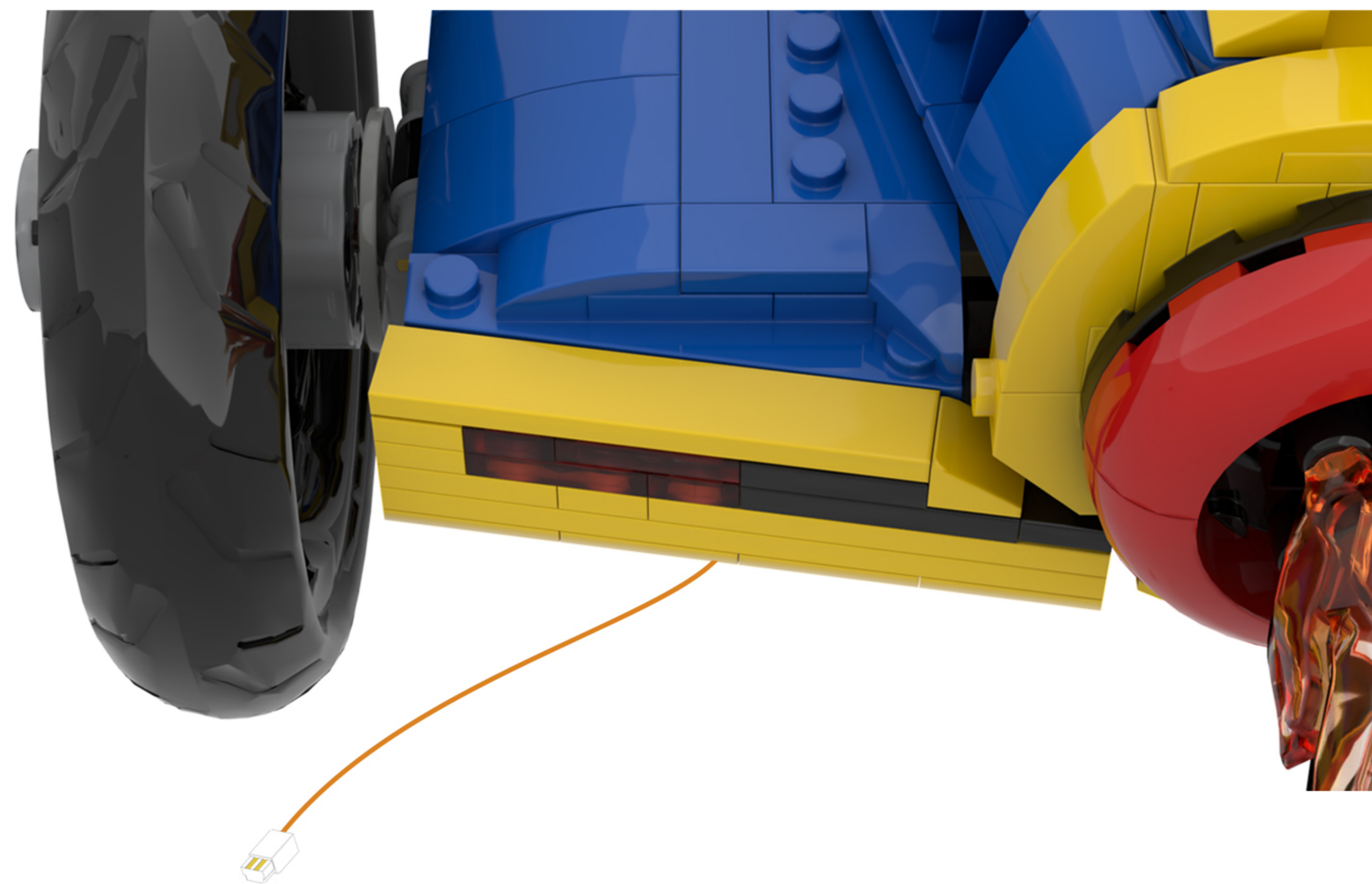

68

EN: Flip the model over so the bottom is facing up, and locate the light line on the left.

DE: Drehen Sie das Modell um, sodass die Unterseite nach oben zeigt, und suchen Sie die helle Linie auf der linken Seite.

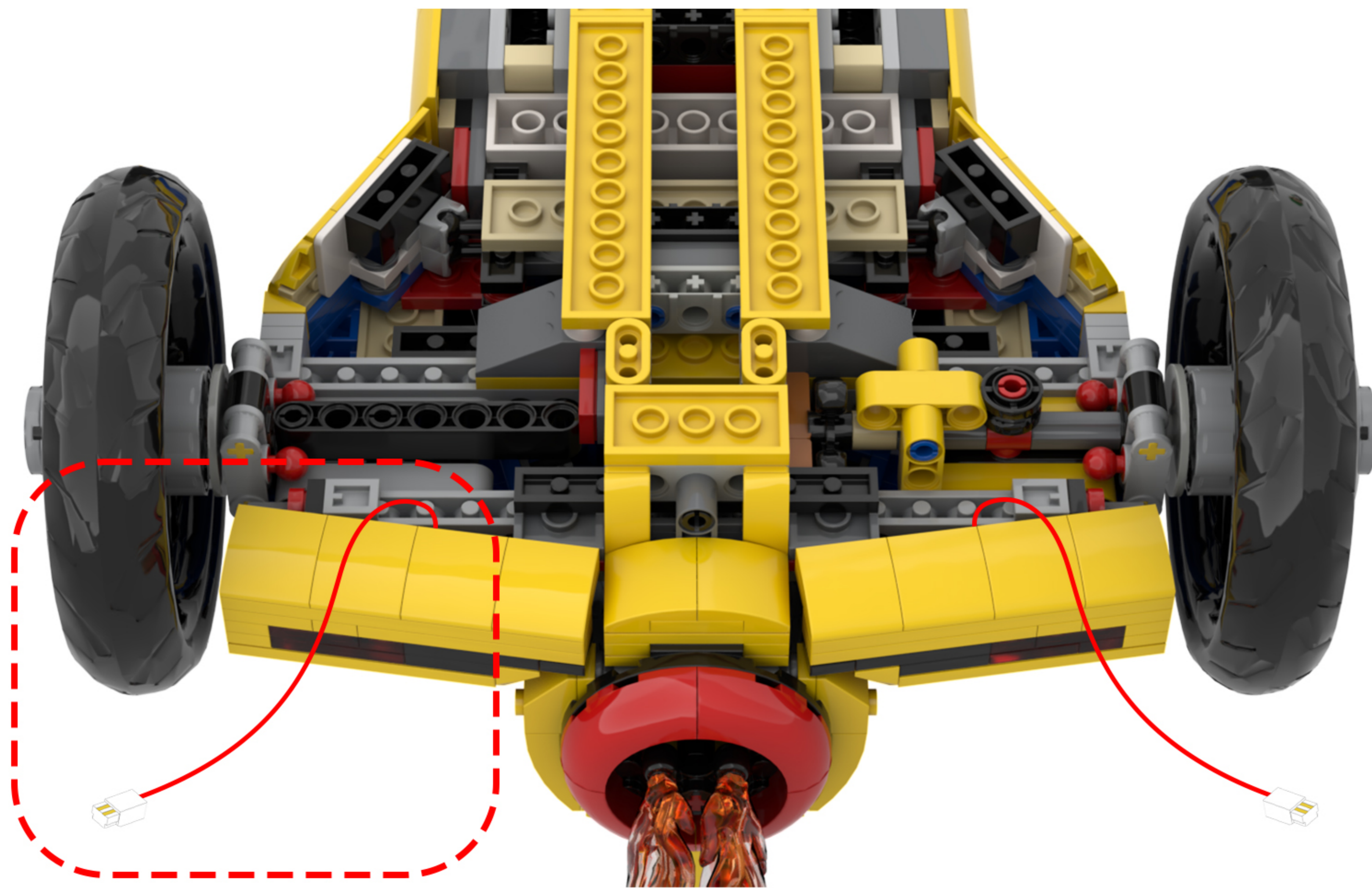
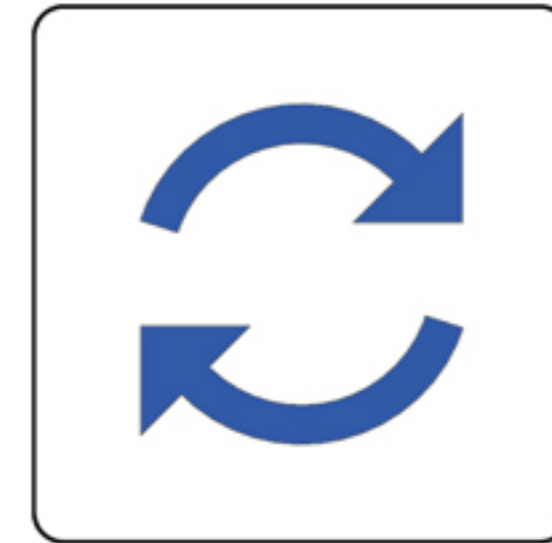

69

EN: Thread the light cord through the holes in the building blocks.

DE: Führen Sie das Lichtschnur durch die Löcher in den Bausteinen.

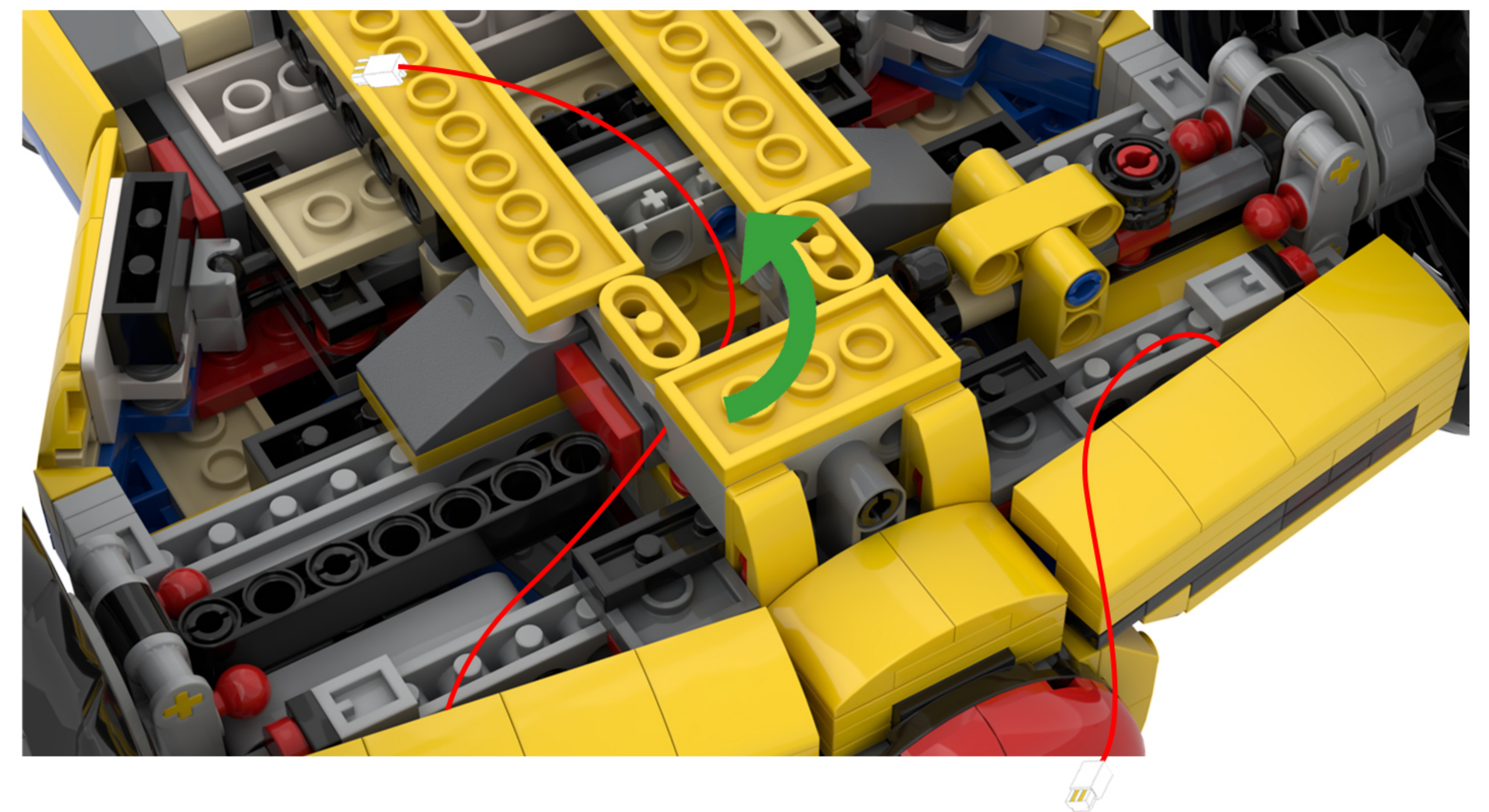
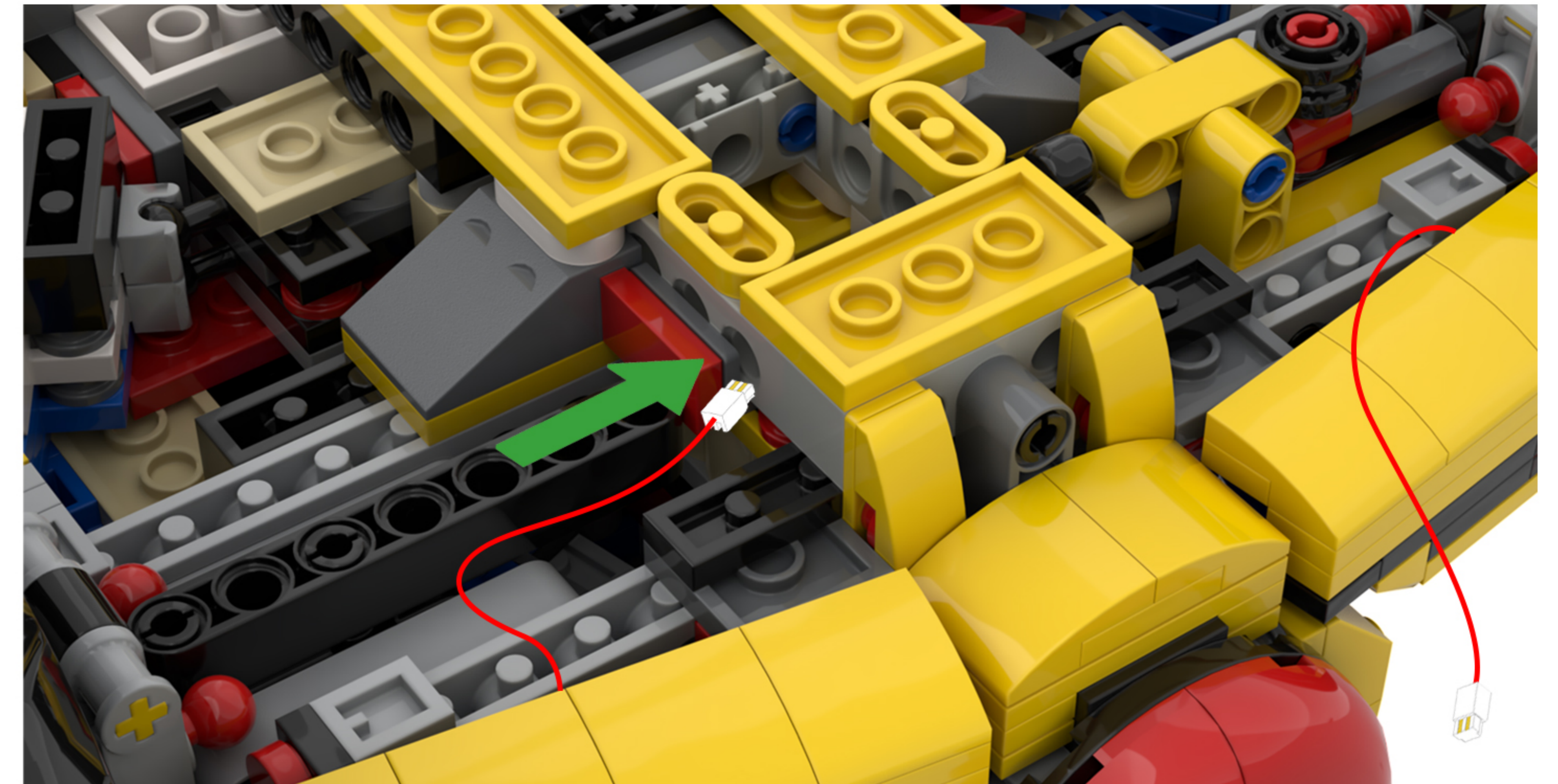

70

EN: Locate this light cord in the diagram.

DE: Suchen Sie dieses Lichtkabel in der Abbildung.

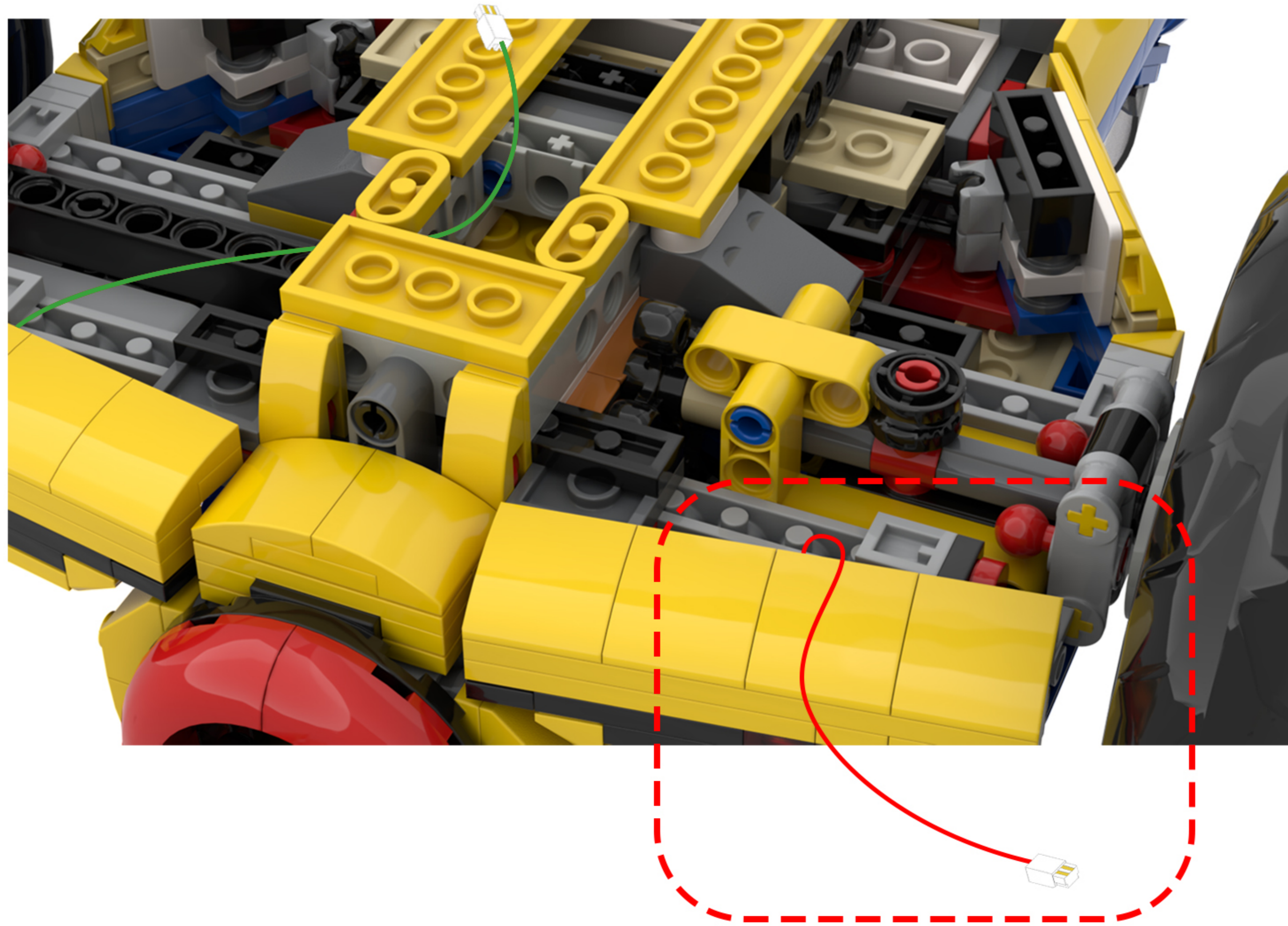

71

EN: Thread the light cord through the holes in the building blocks.

DE: Führen Sie das Lichtschnur durch die Löcher in den Bausteinen.

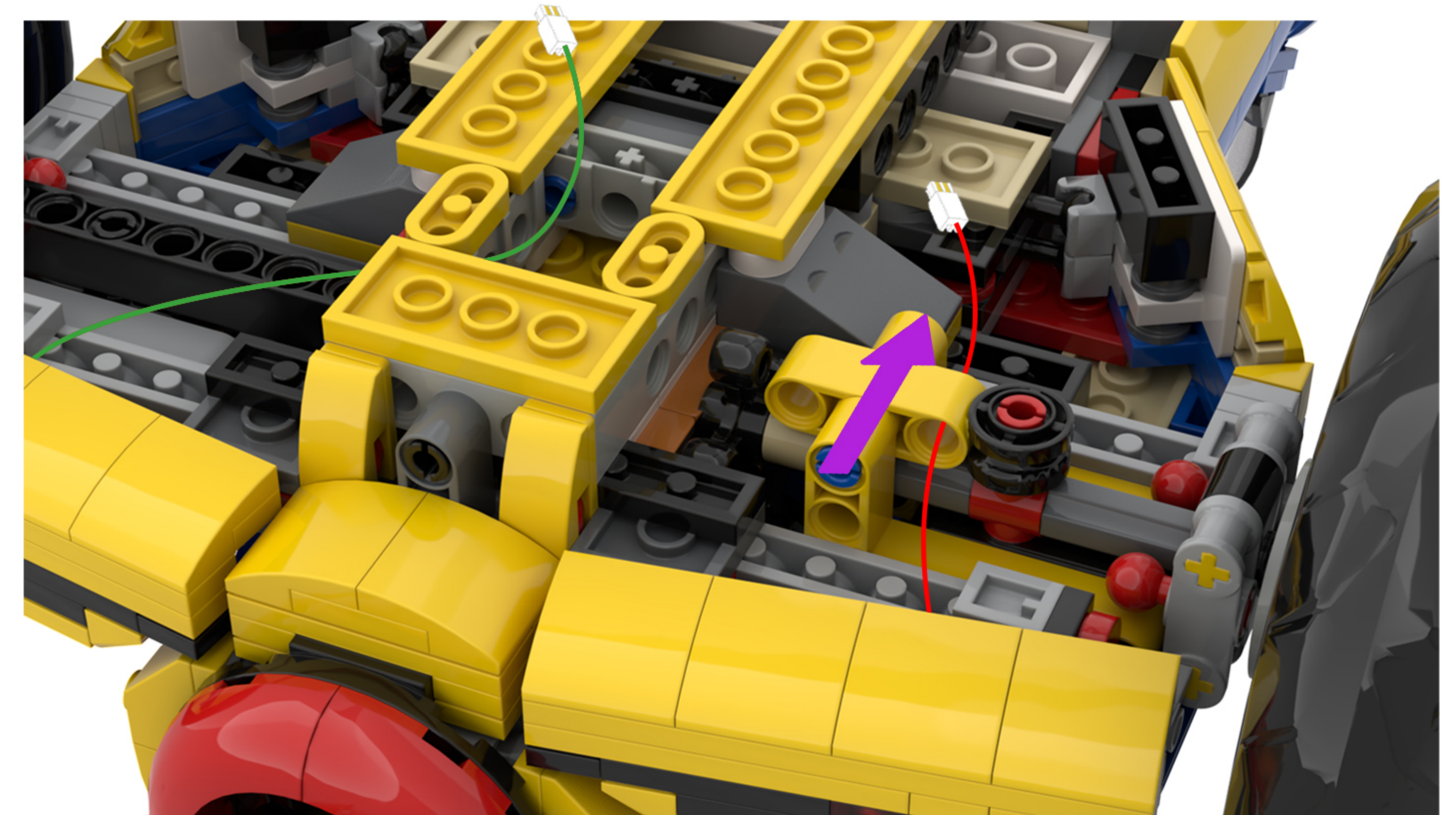

72

EN: Continue threading the light cord through the holes in the building blocks.

DE: Führen Sie das Lichtkabel weiter durch die Löcher in den Bausteinen.

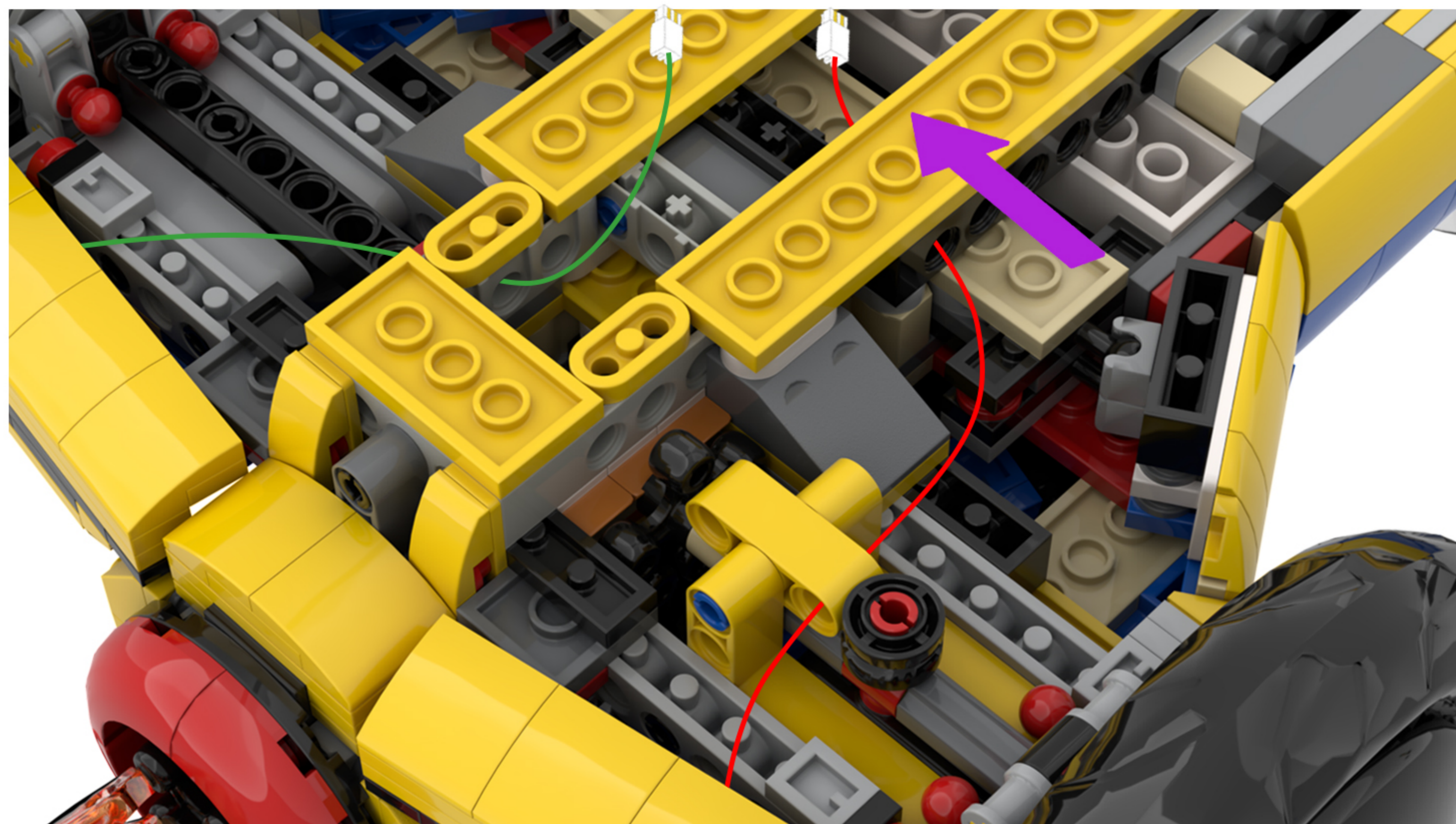

73

EN: Locate the two light wires in the diagram.

DE: Suchen Sie die beiden Lichtkabel in der Abbildung.

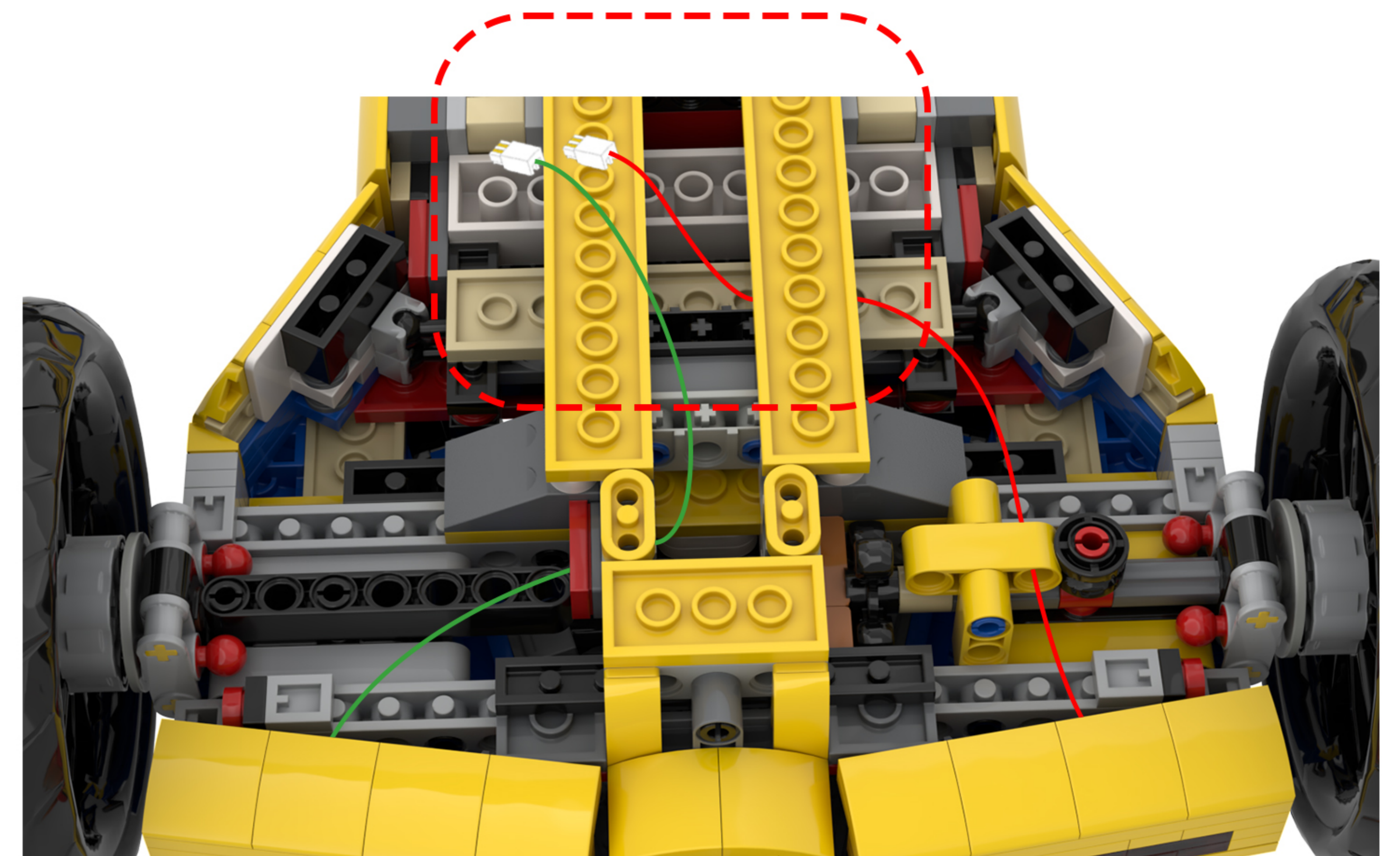

74

EN: Twist the two strands of lighting cord together.

DE: Verdrehen Sie die beiden Lichterkettenstränge miteinander.



75

EN: Flip the model to restore it to its original state.

DE: Drehen Sie das Modell um, um es in seinen ursprünglichen Zustand zurückzusetzen.

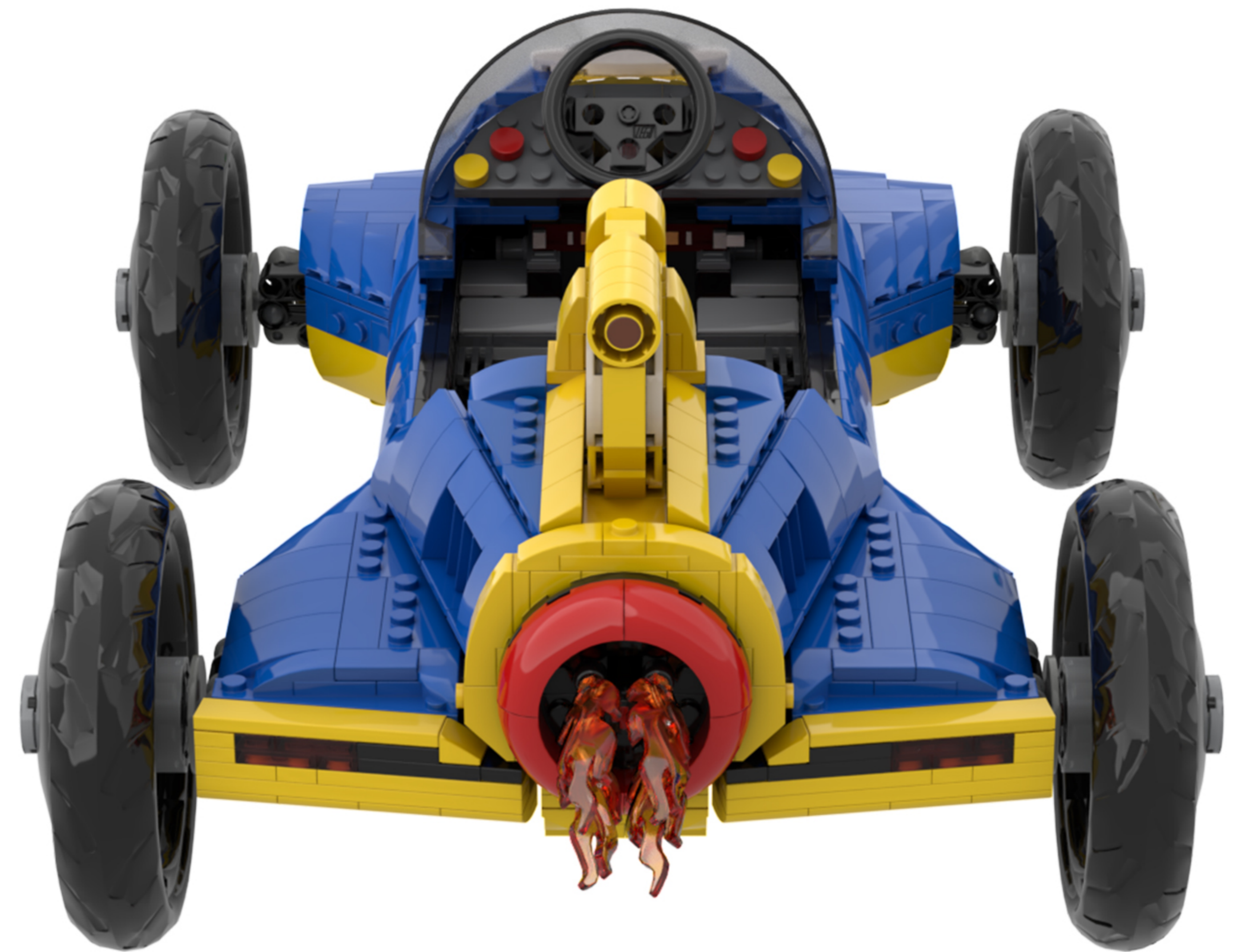

76

EN: Split as shown in the figure.

DE: Wie in der Abbildung gezeigt, teilen Sie es auf.

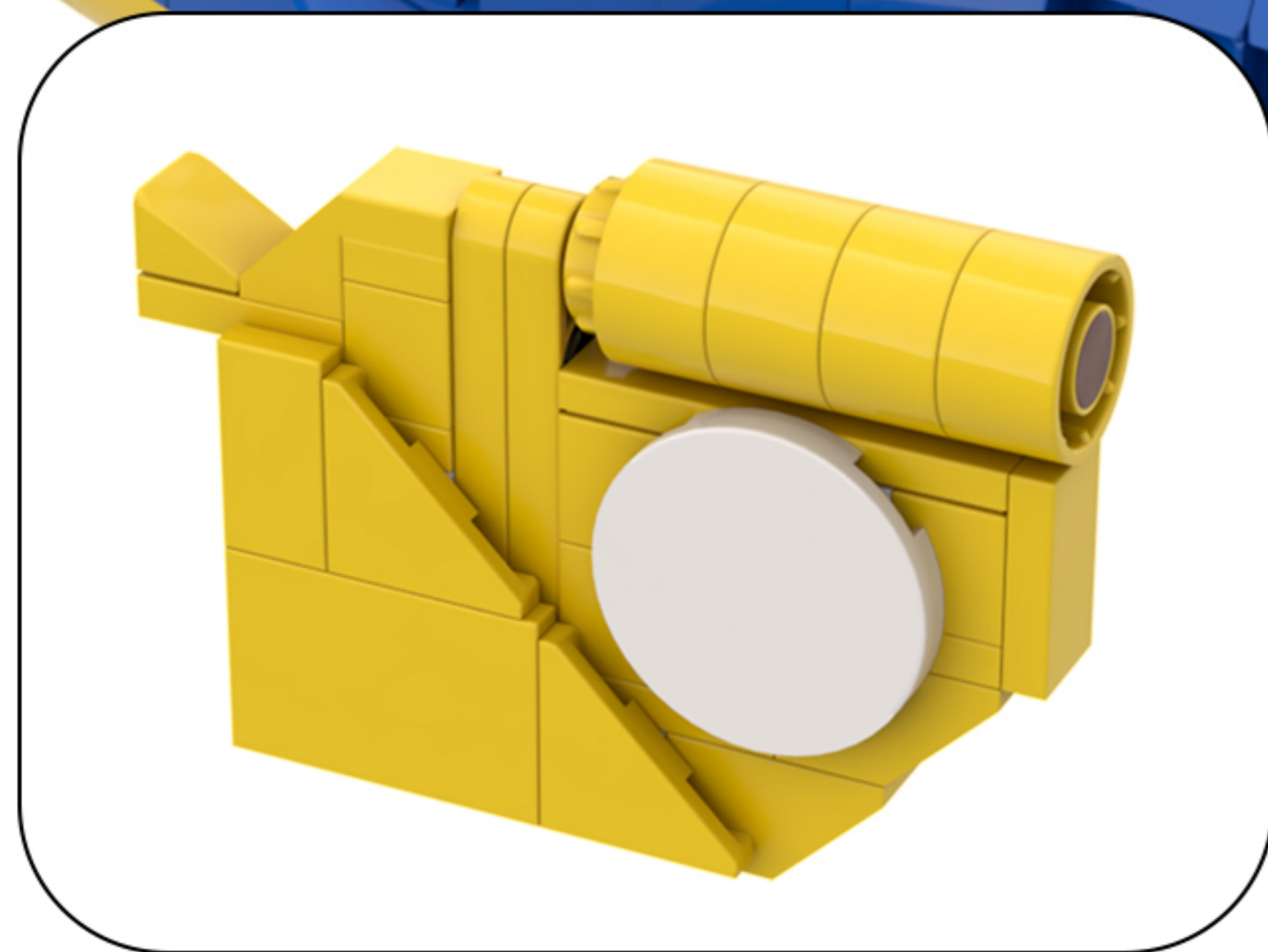
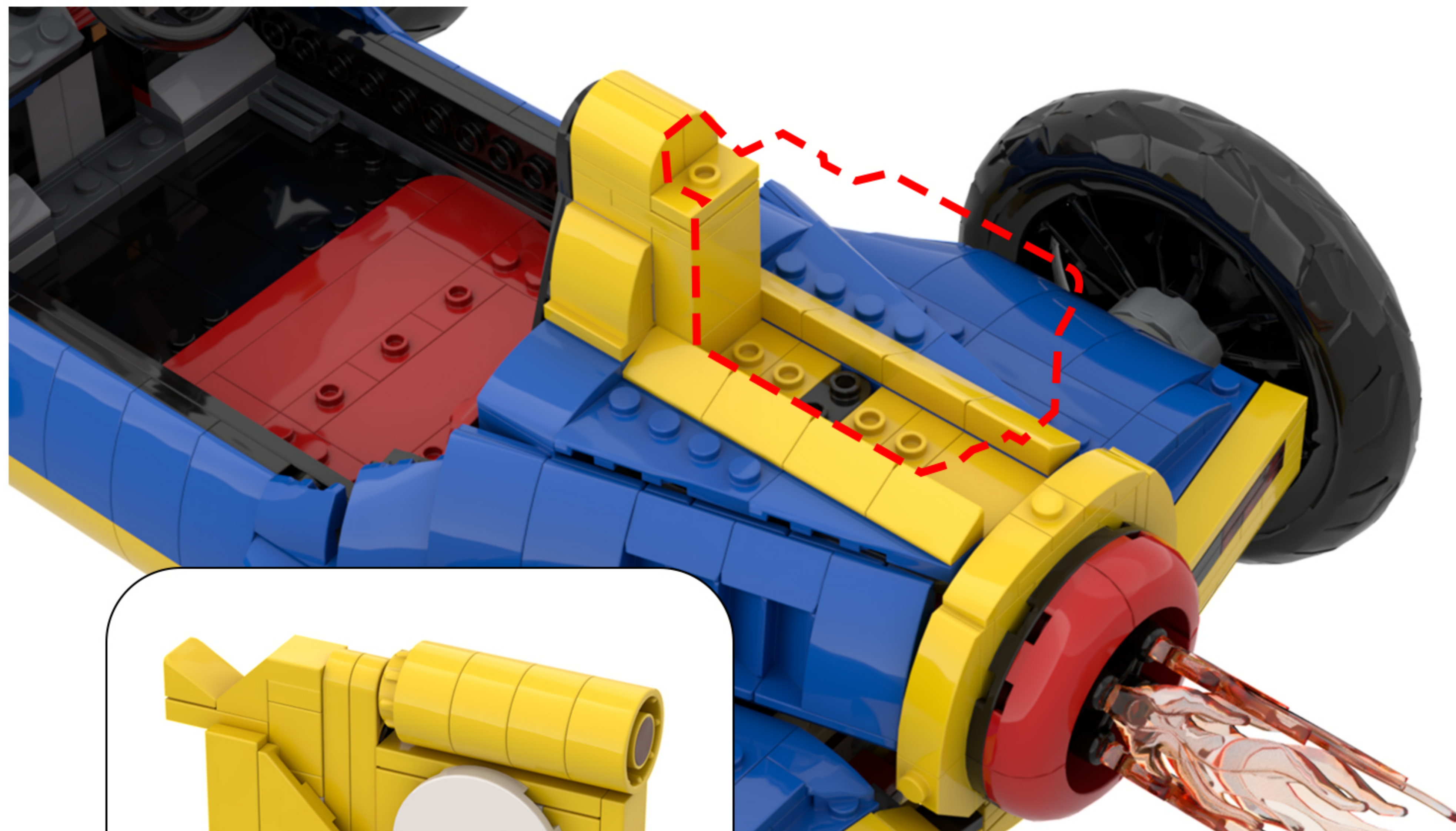

77

EN: Take out the disassembled building blocks and take them apart one by one.

DE: Nimm die zerlegten Bausteine heraus und nimm sie nacheinander auseinander.

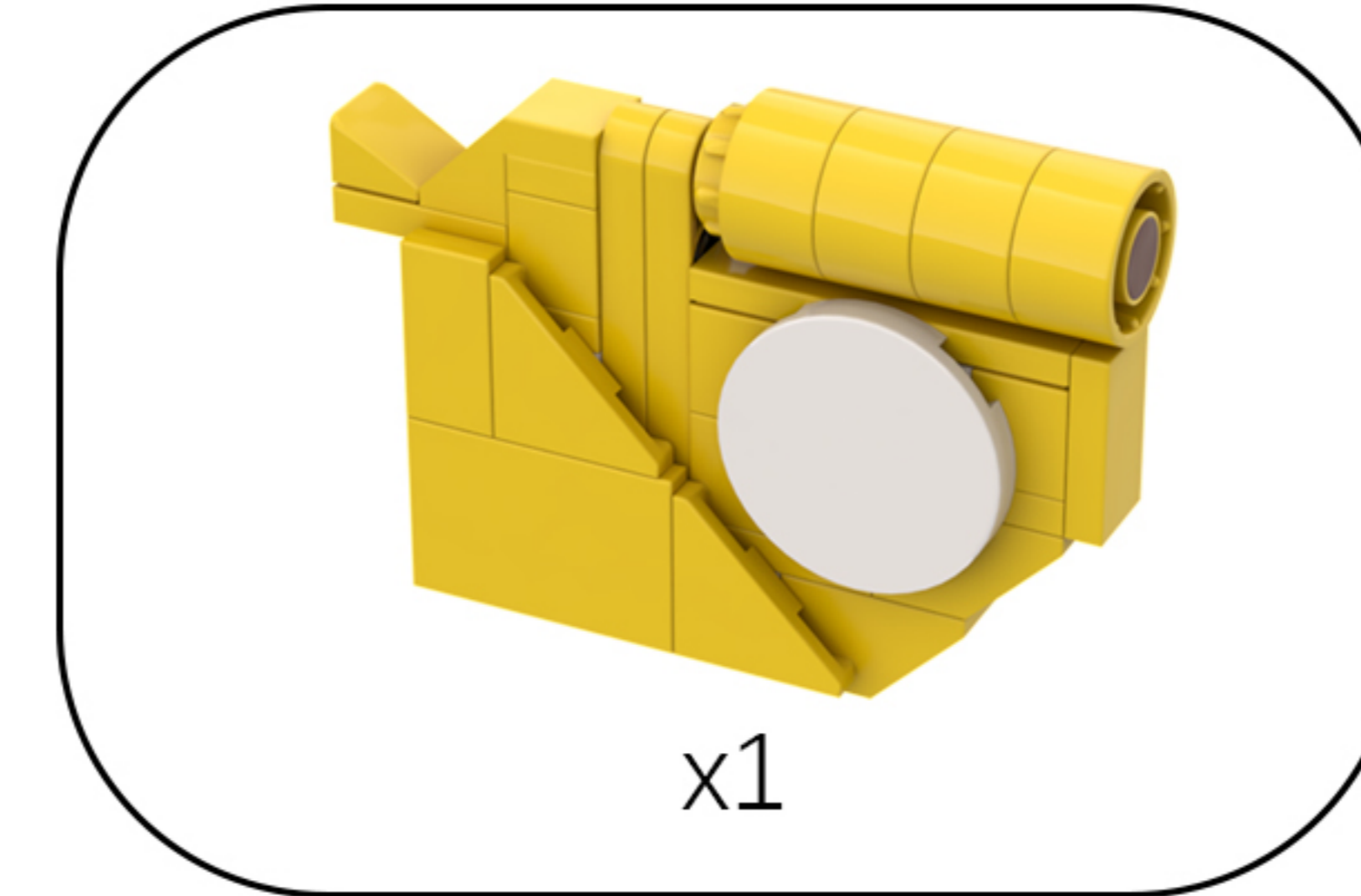

x1

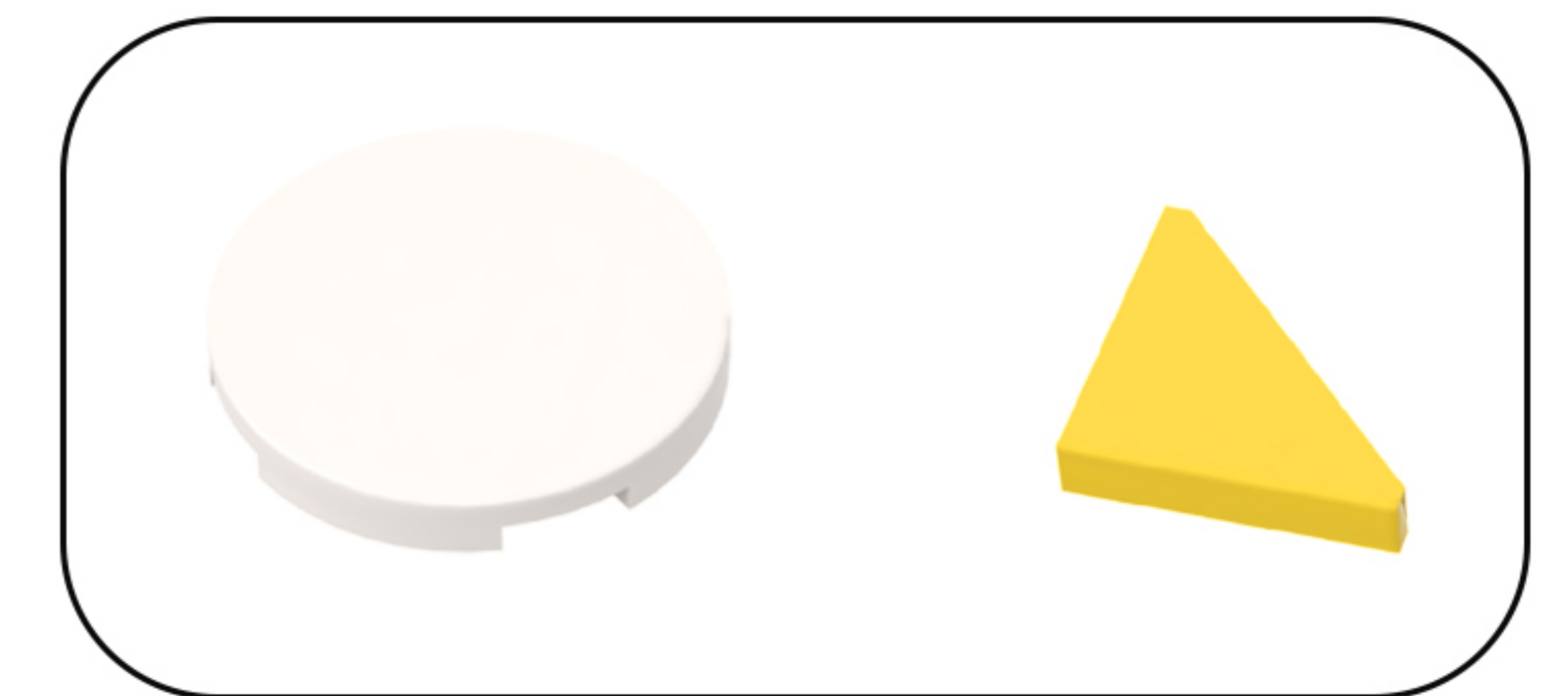
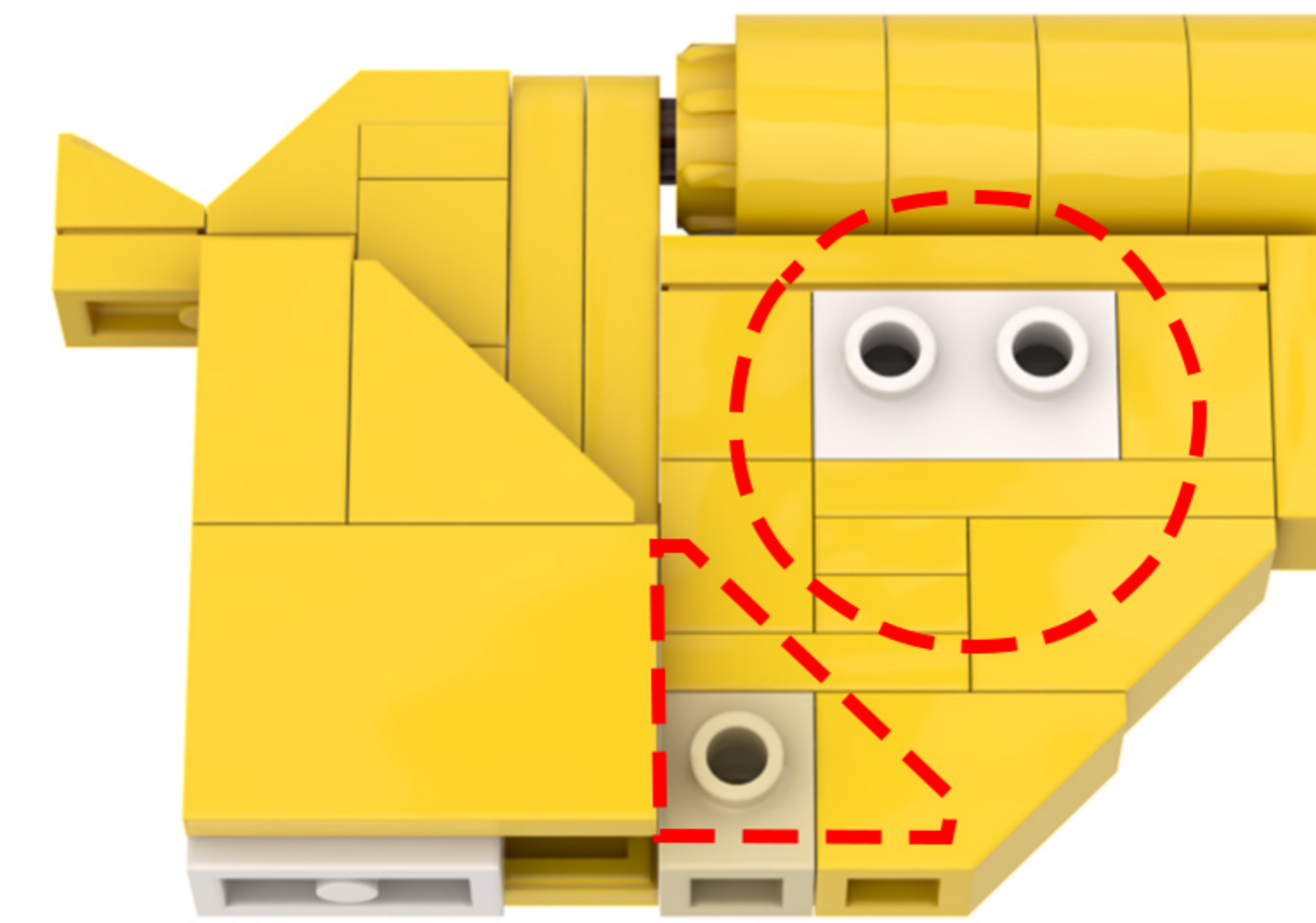

Note: These two blocks were removed from the other side.

78

EN: Take the 2x2 disc and the light brick from bag 7, and follow the instructions step by step.

DE: Nimm die 2x2-Scheibe und den Lichtstein aus Beutel 7 und befolge die Anleitung Schritt für Schritt.

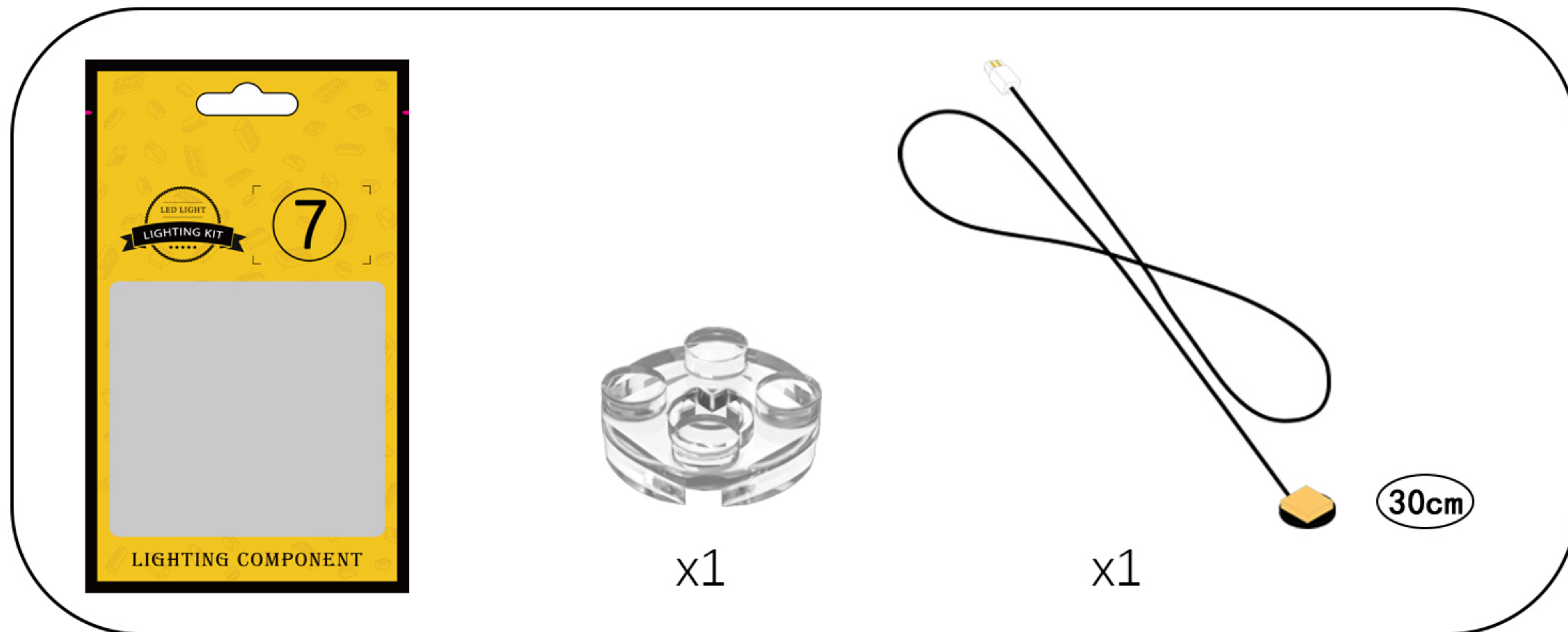

①. Place the light module with the light-emitting side facing down on the building block.

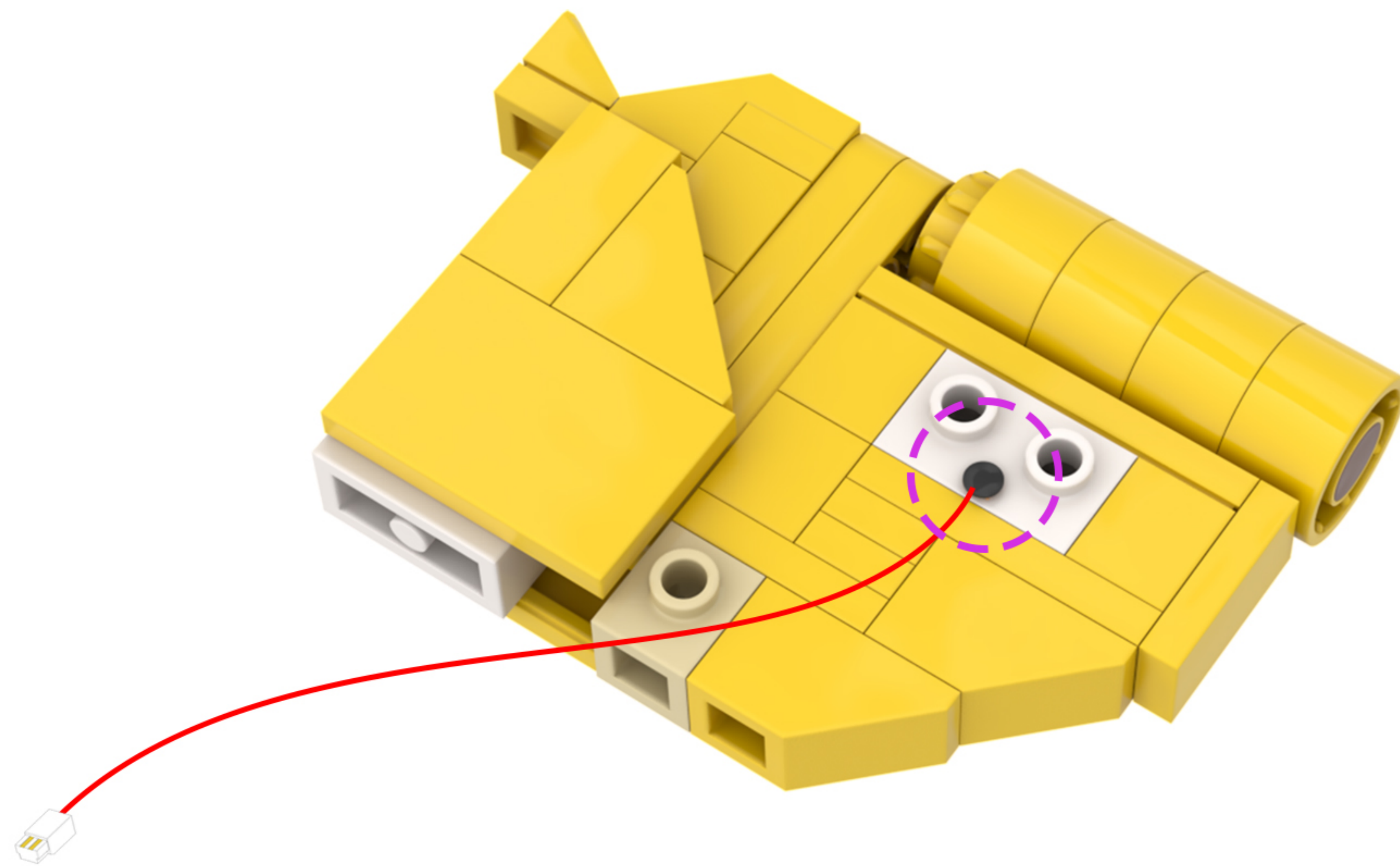

②. Attach the 2x2 disc to the block.

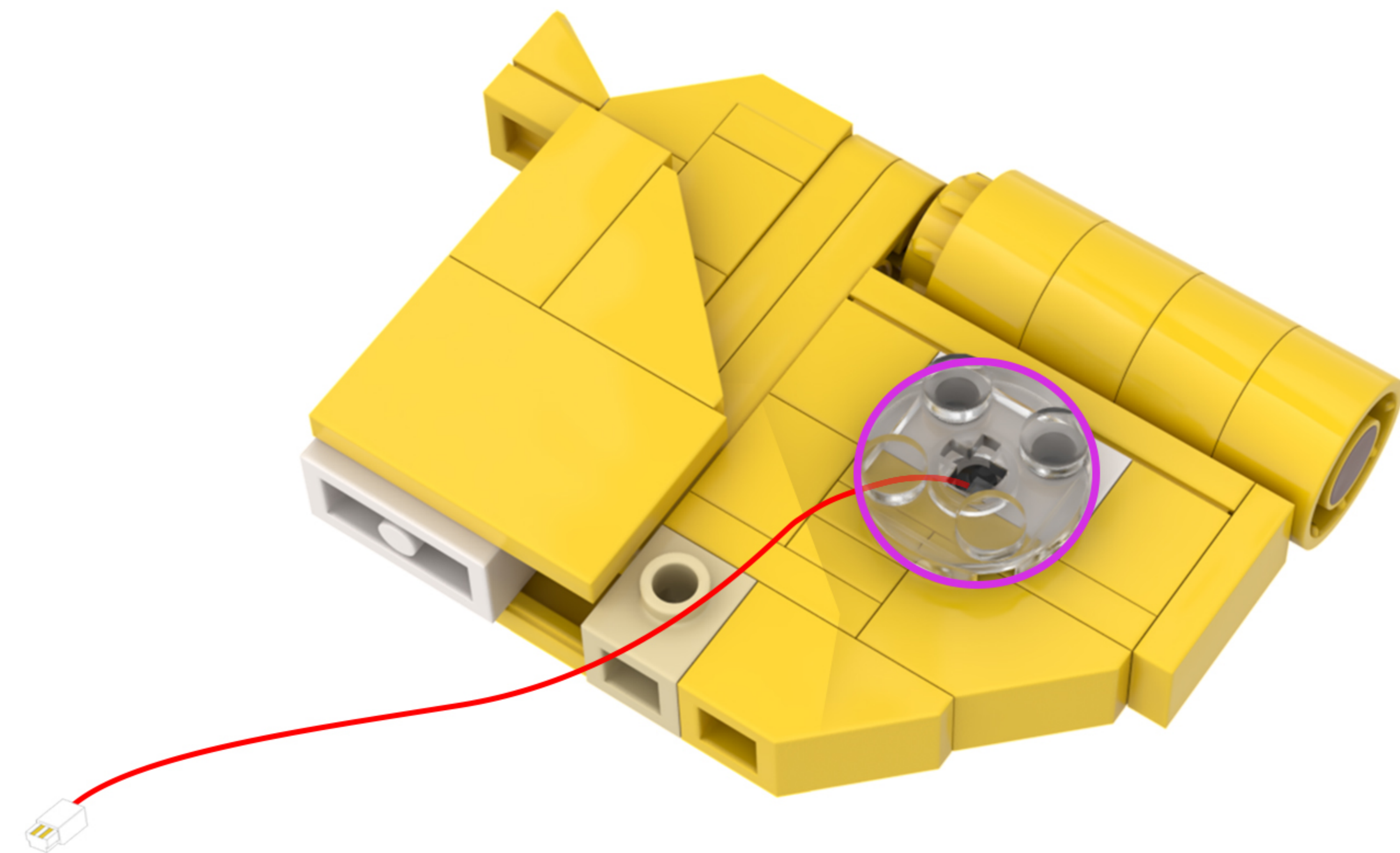

Note: The light cable emerges from the notch at the bottom of the 2x2 disc.

79

EN: Arrange the lighting lines according to the diagram.

DE: Ordnen Sie die Beleuchtungslinien gemäß der Abbildung an.

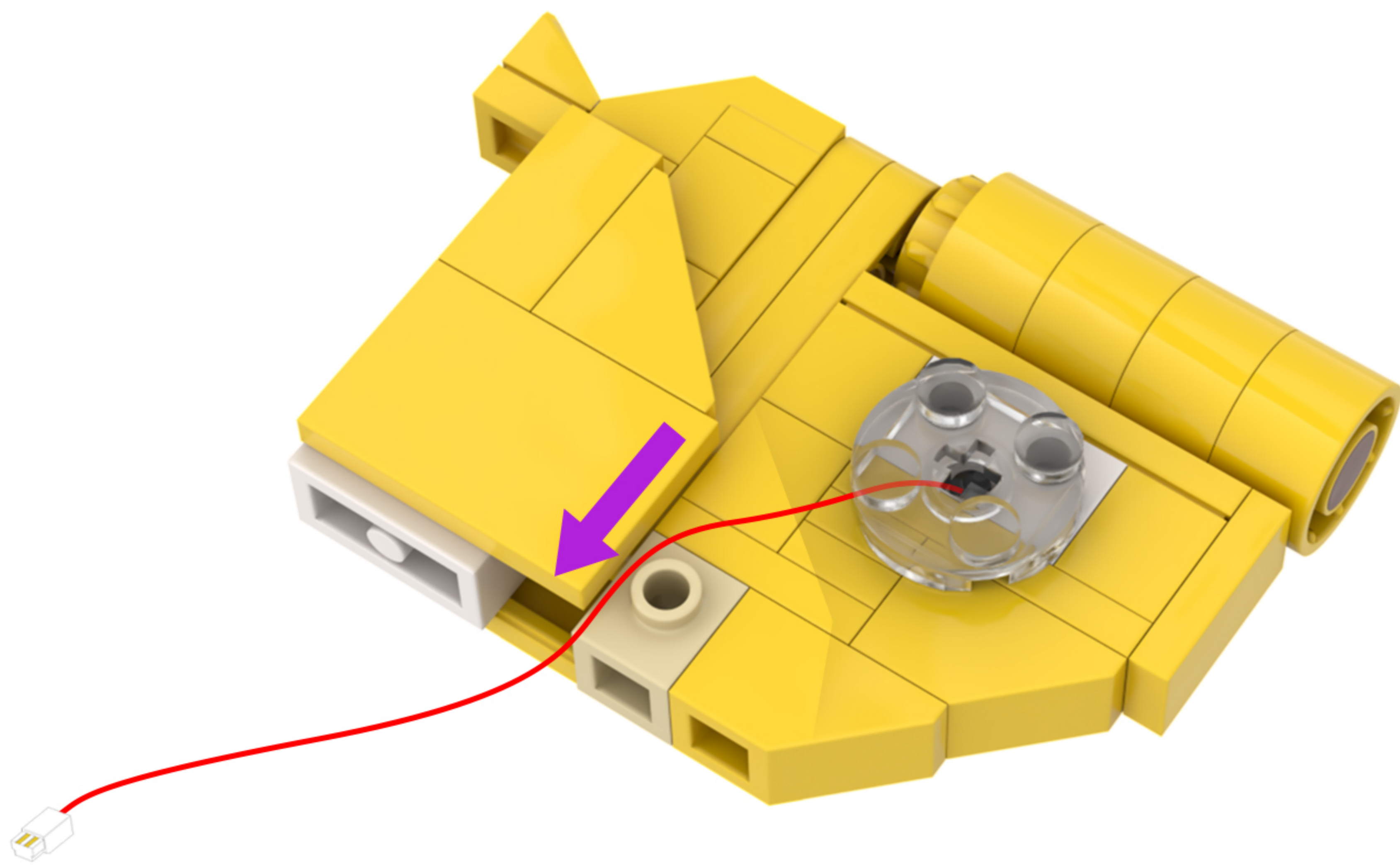

80

EN: Take out the disassembled building blocks, reassemble them, and secure the light cord.

DE: Nehmen Sie die zerlegten Bausteine heraus, setzen Sie sie wieder zusammen und befestigen Sie das Lichtkabel.

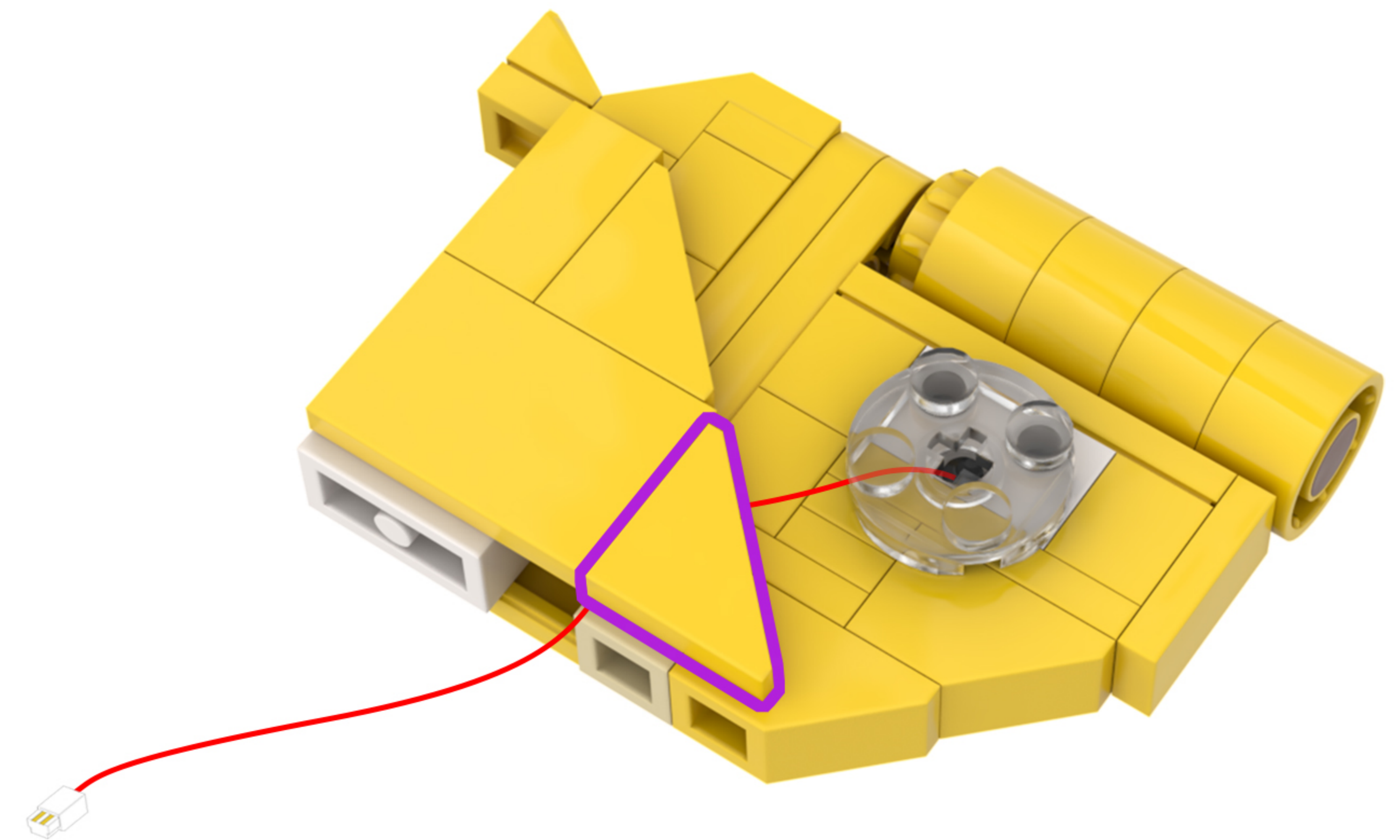
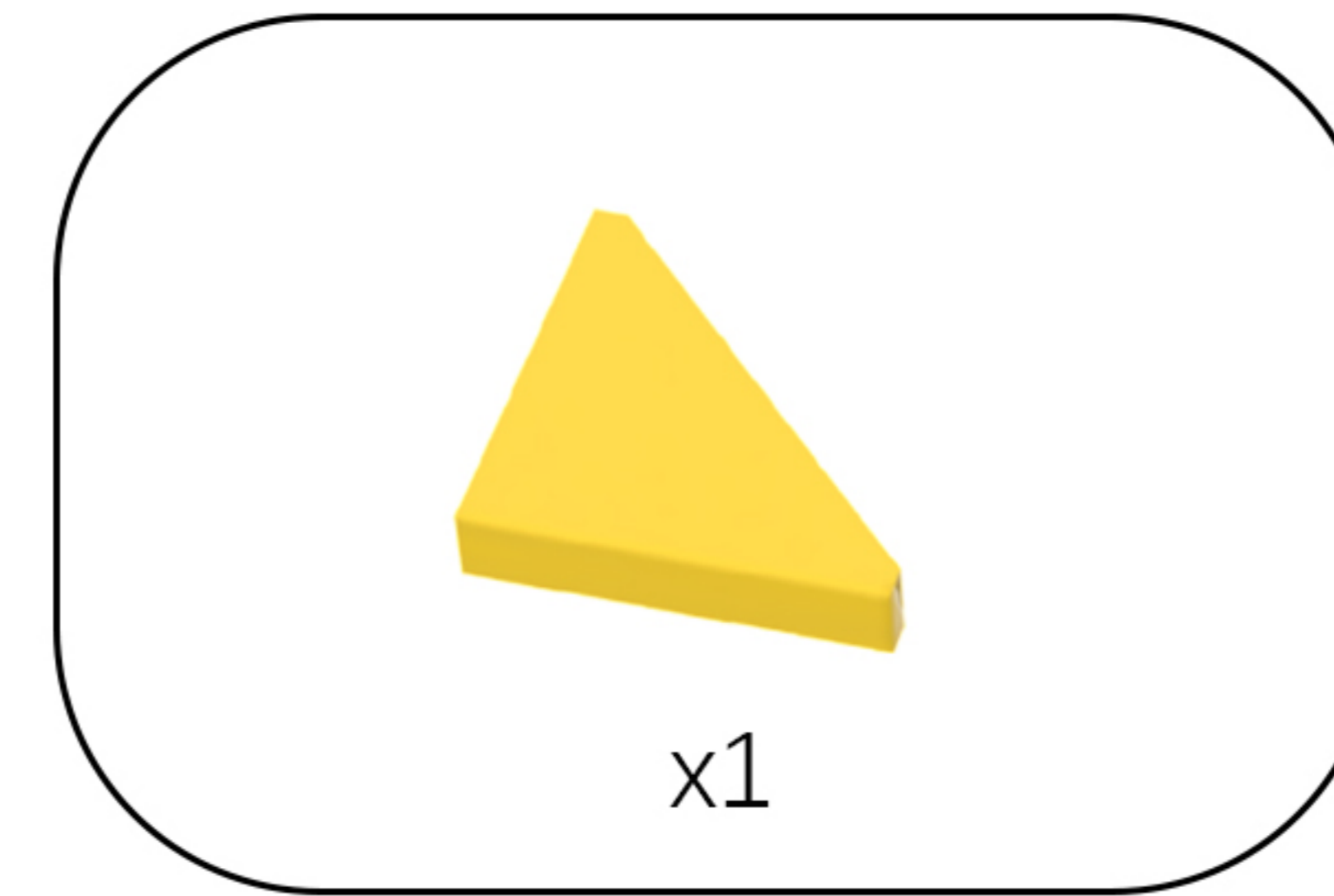

81

EN: Take out the disassembled building blocks and reassemble them.

DE: Nehmen Sie die zerlegten Bausteine heraus und setzen Sie sie wieder zusammen.

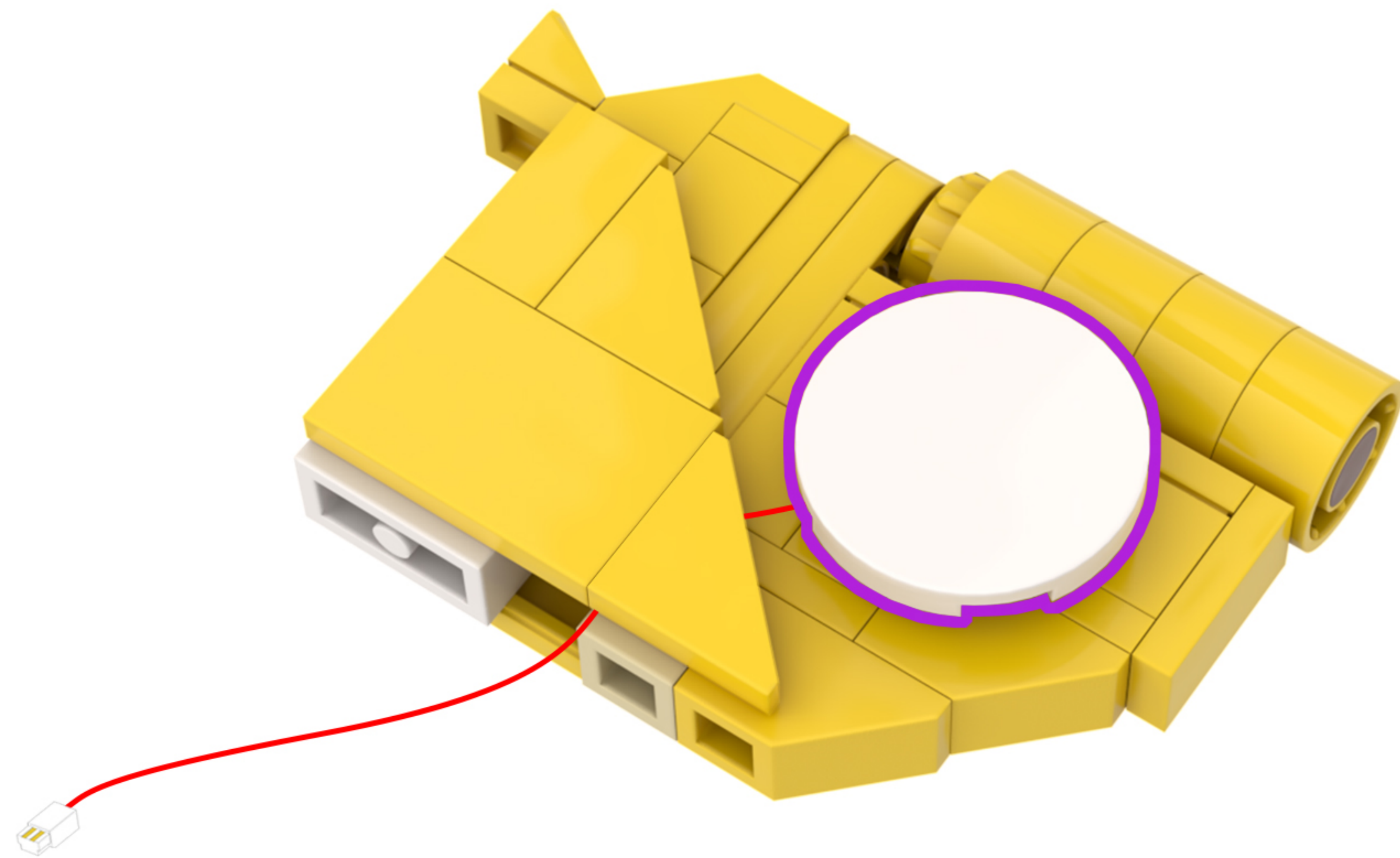
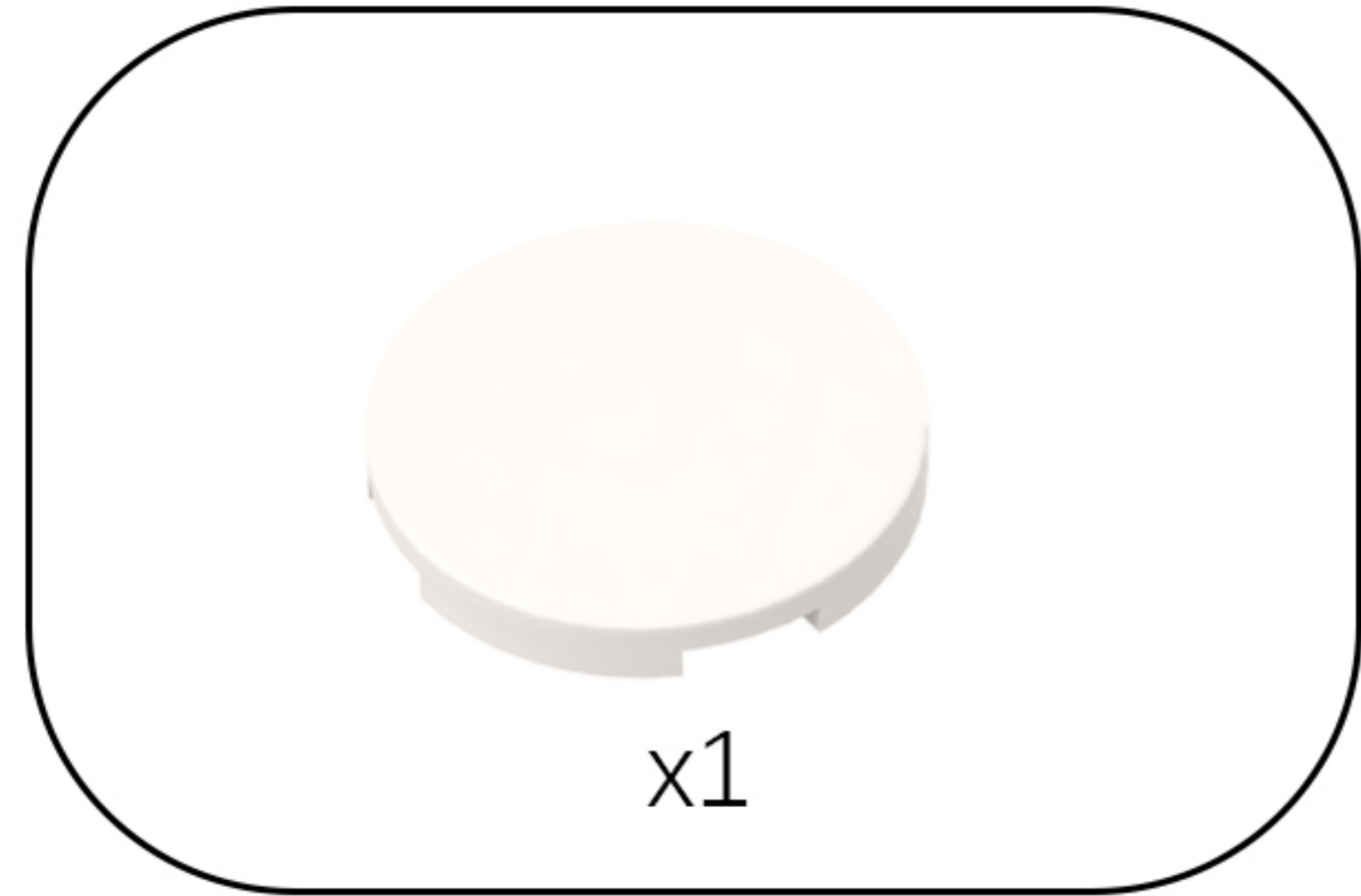

82

EN: Flip the model over to the other side.

DE: Drehen Sie das Modell auf die andere Seite.

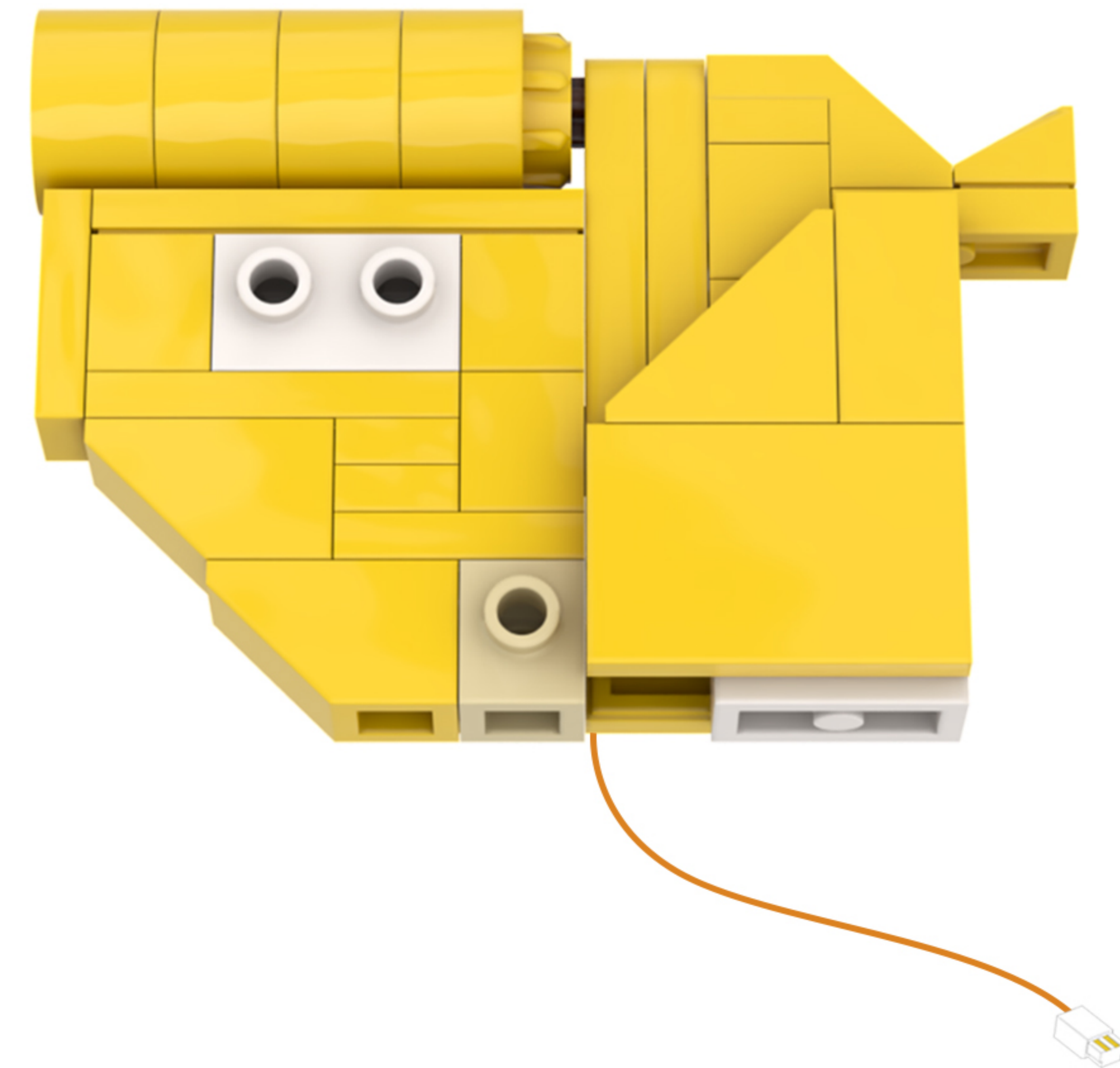
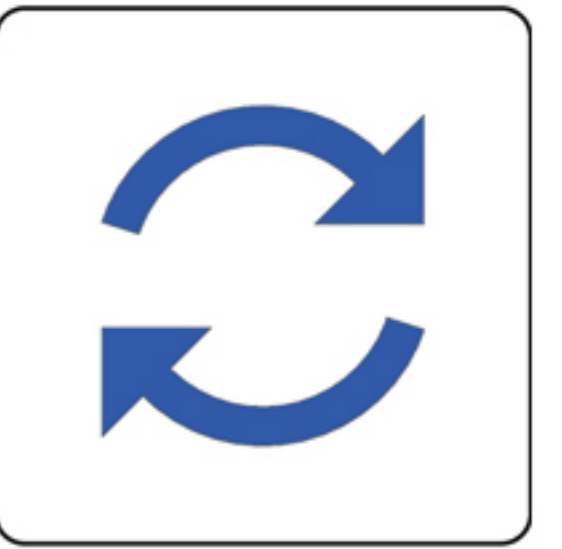

83

EN: Take the 2x2 disc and the light brick from bag 7, and follow the instructions step by step.

DE: Nimm die 2x2-Scheibe und den Lichtstein aus Beutel 7 und befolge die Anleitung Schritt für Schritt.

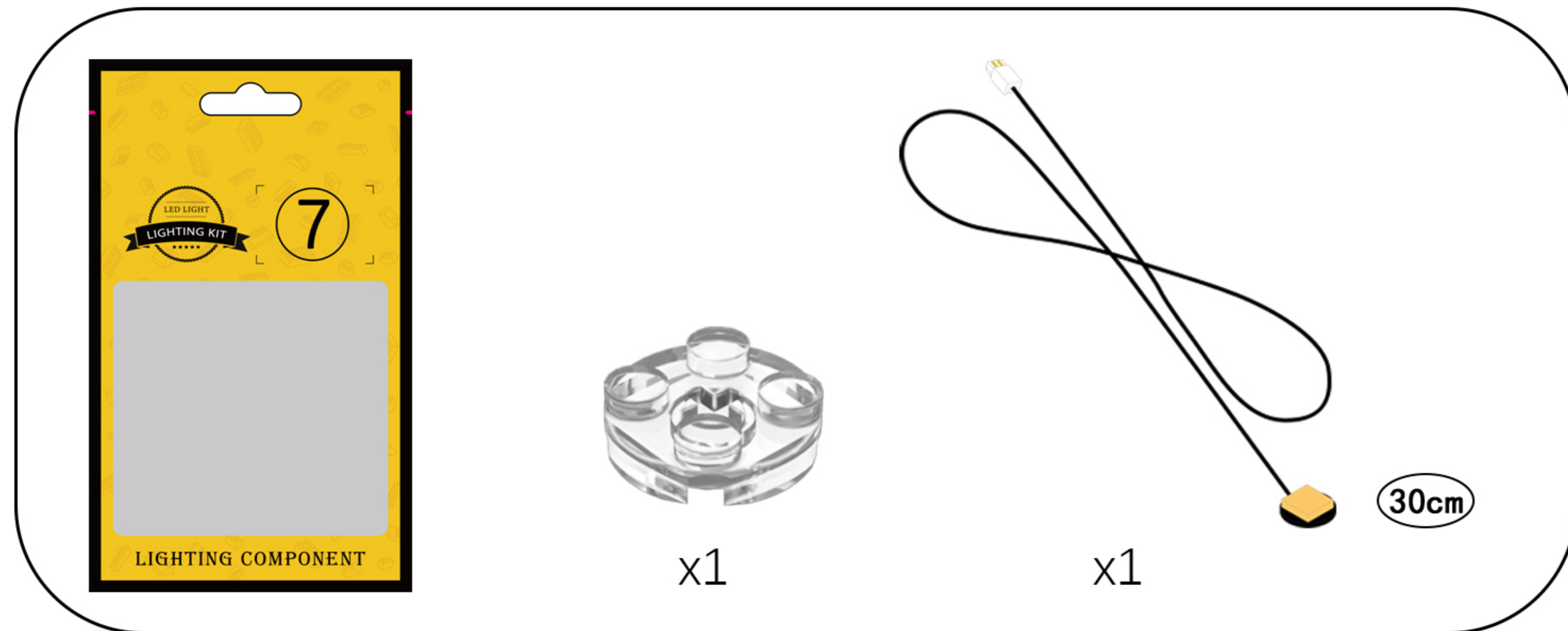

①. Place the light module with the light-emitting side facing down on the building block.

②. Attach the 2x2 disc to the block.

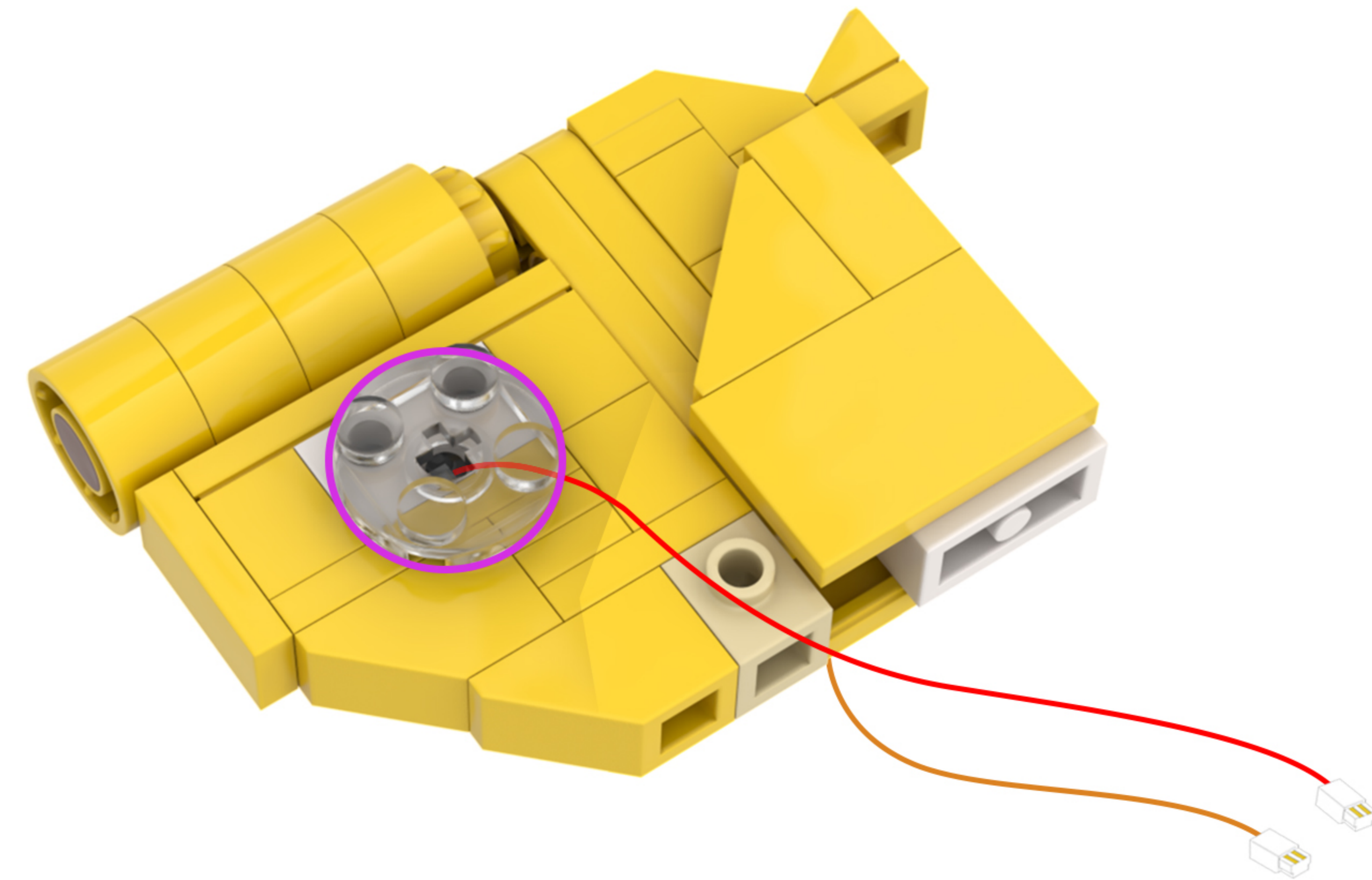
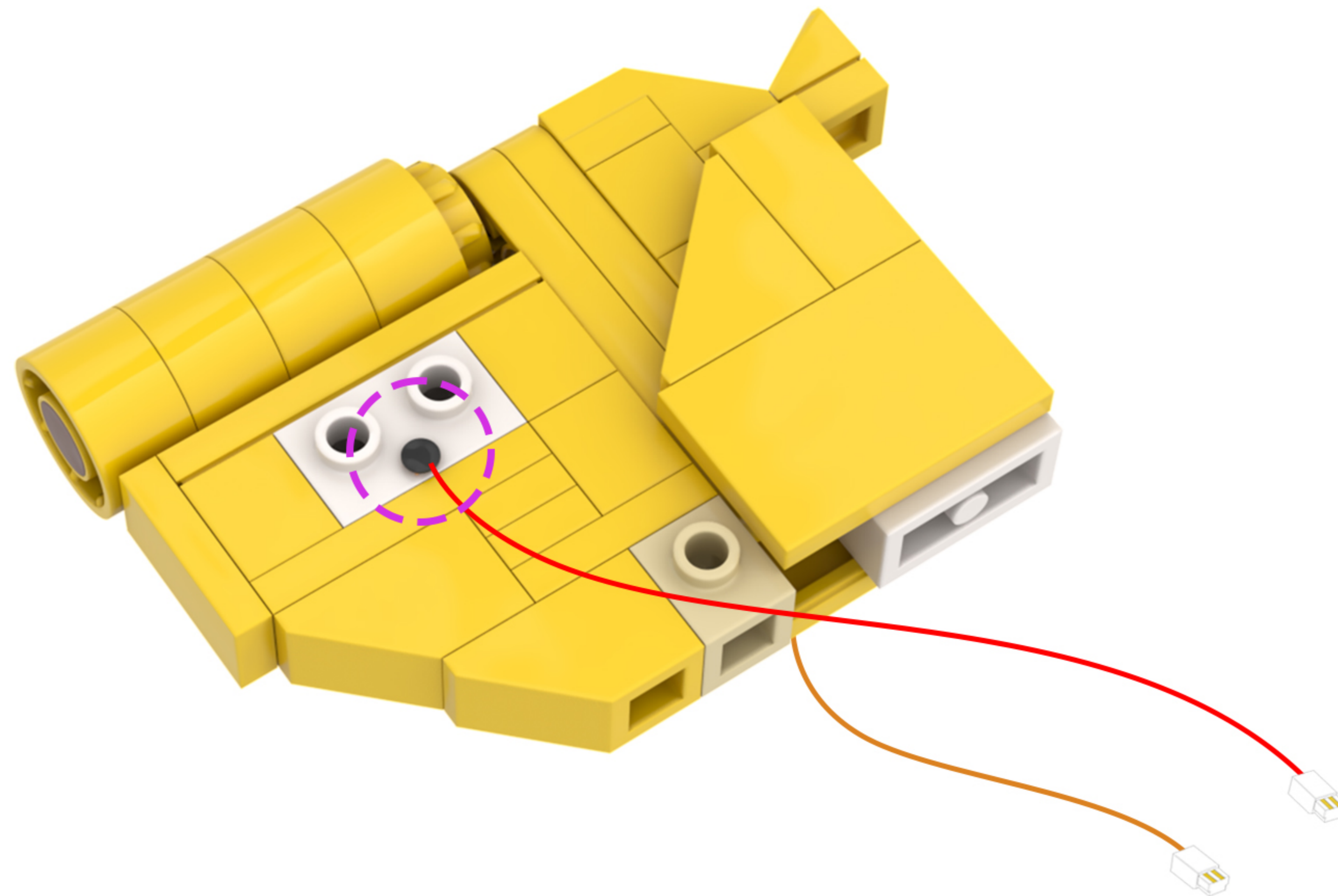

Note: The light cable emerges from the notch at the bottom of the 2x2 disc.

84

EN: Arrange the lighting lines according to the diagram.

DE: Ordnen Sie die Beleuchtungslinien gemäß der Abbildung an.

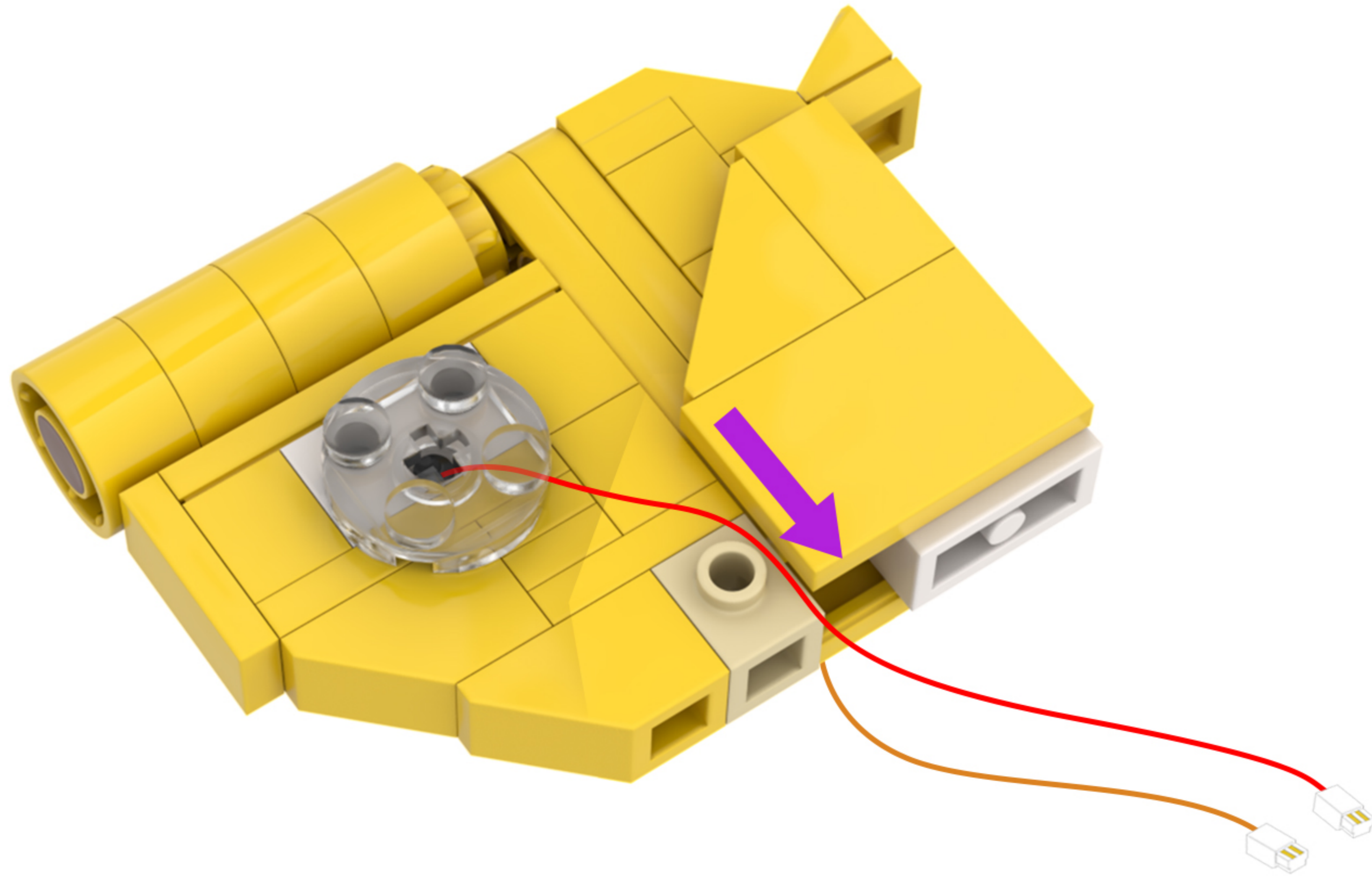

85

EN: Take out the disassembled building blocks, reassemble them, and secure the light cord.

DE: Nehmen Sie die zerlegten Bausteine heraus, setzen Sie sie wieder zusammen und befestigen Sie das Lichtkabel.

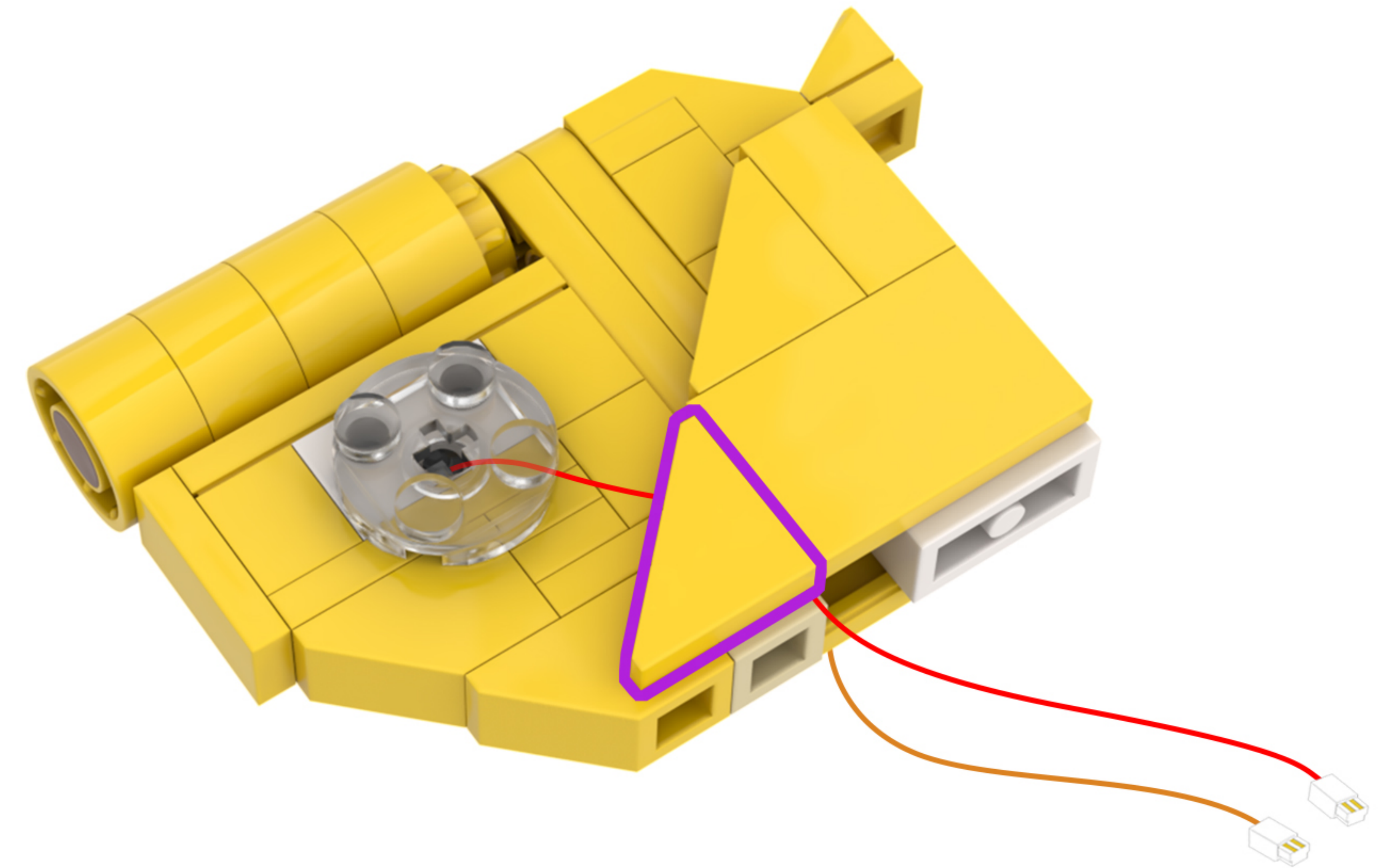
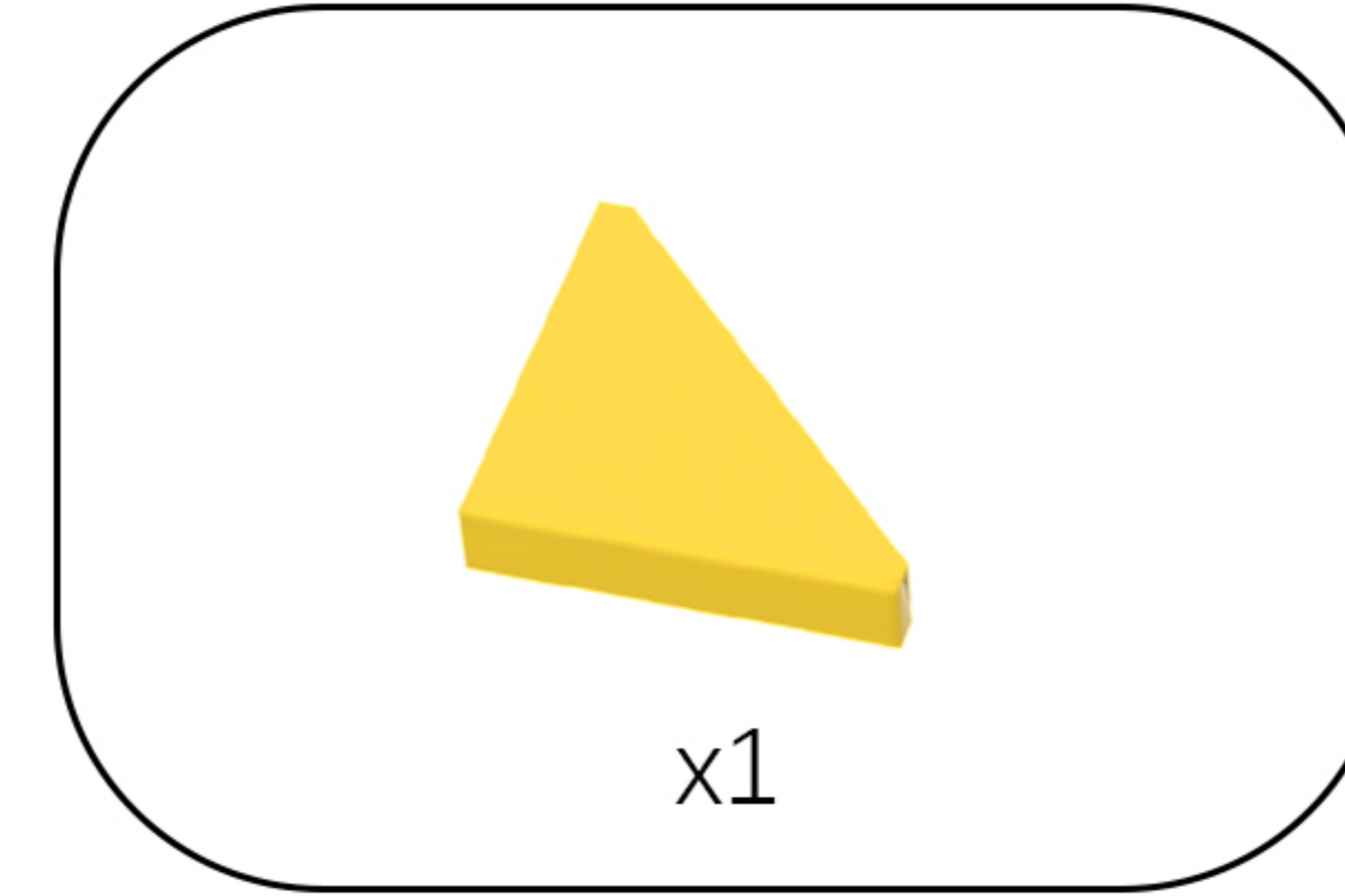

86

EN: Take out the disassembled building blocks and reassemble them.

DE: Nehmen Sie die zerlegten Bausteine heraus und setzen Sie sie wieder zusammen.

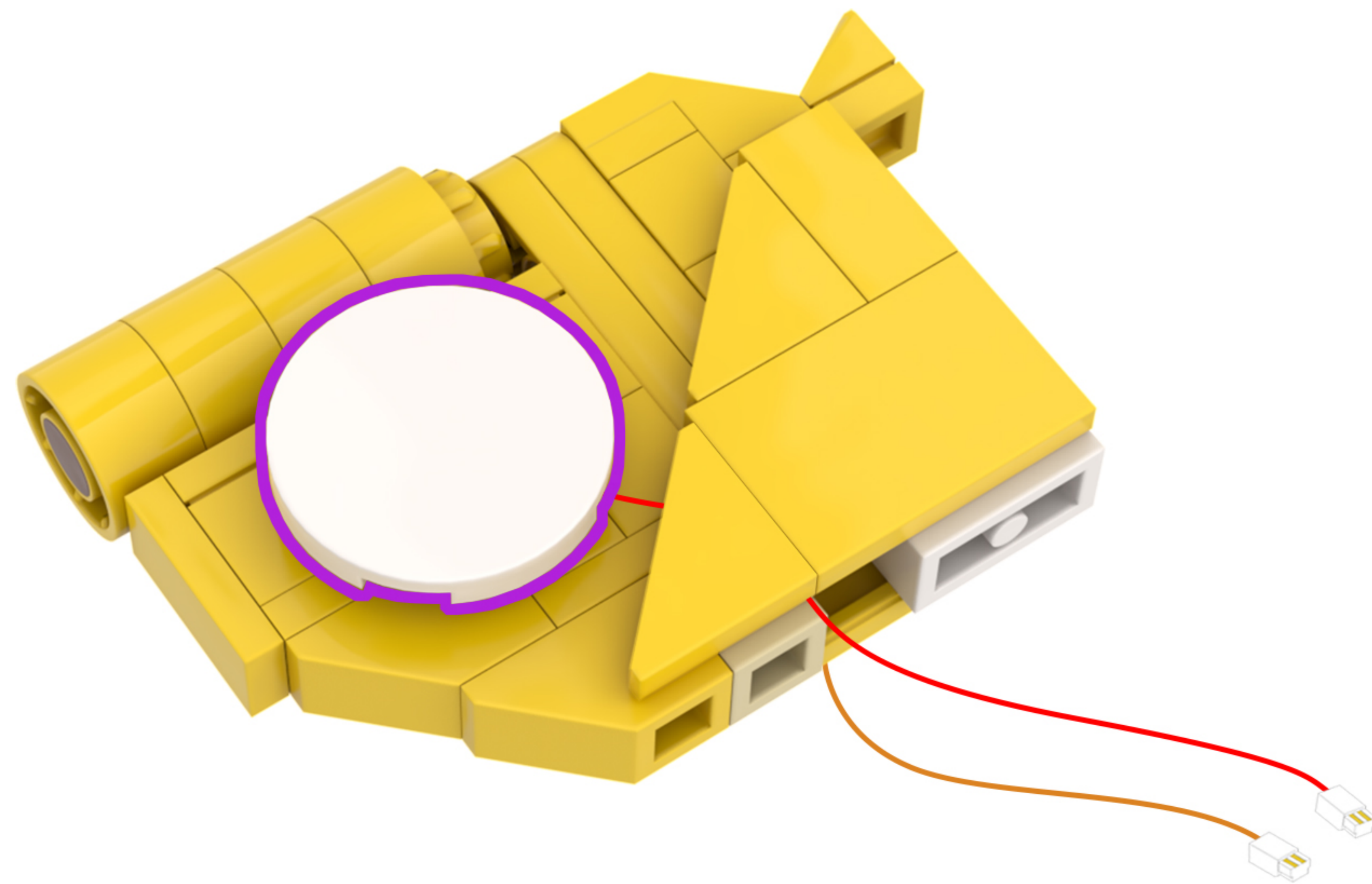
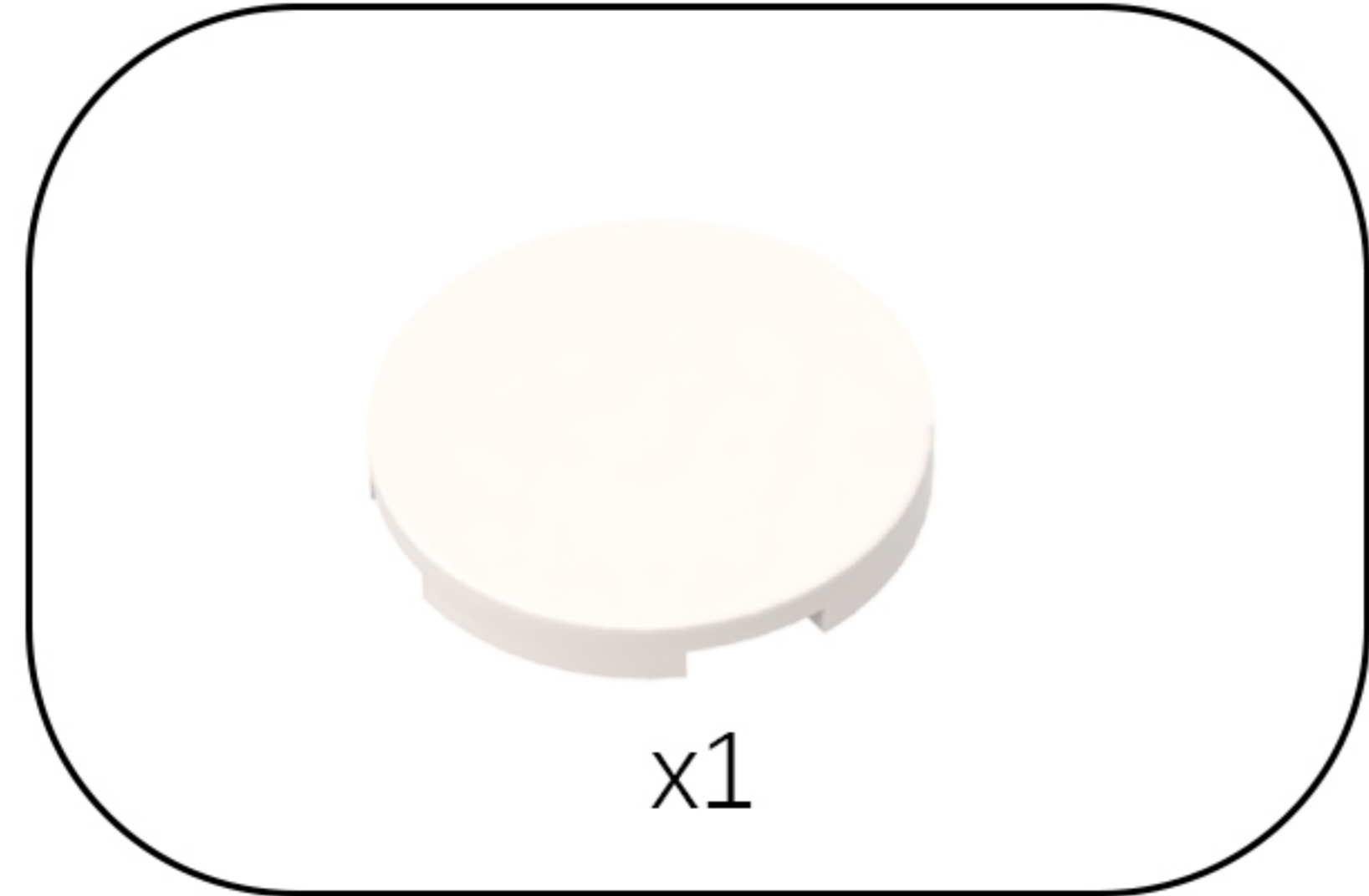

87

EN: Restore the building blocks.

DE: Stellen Sie die Bausteine wieder her.

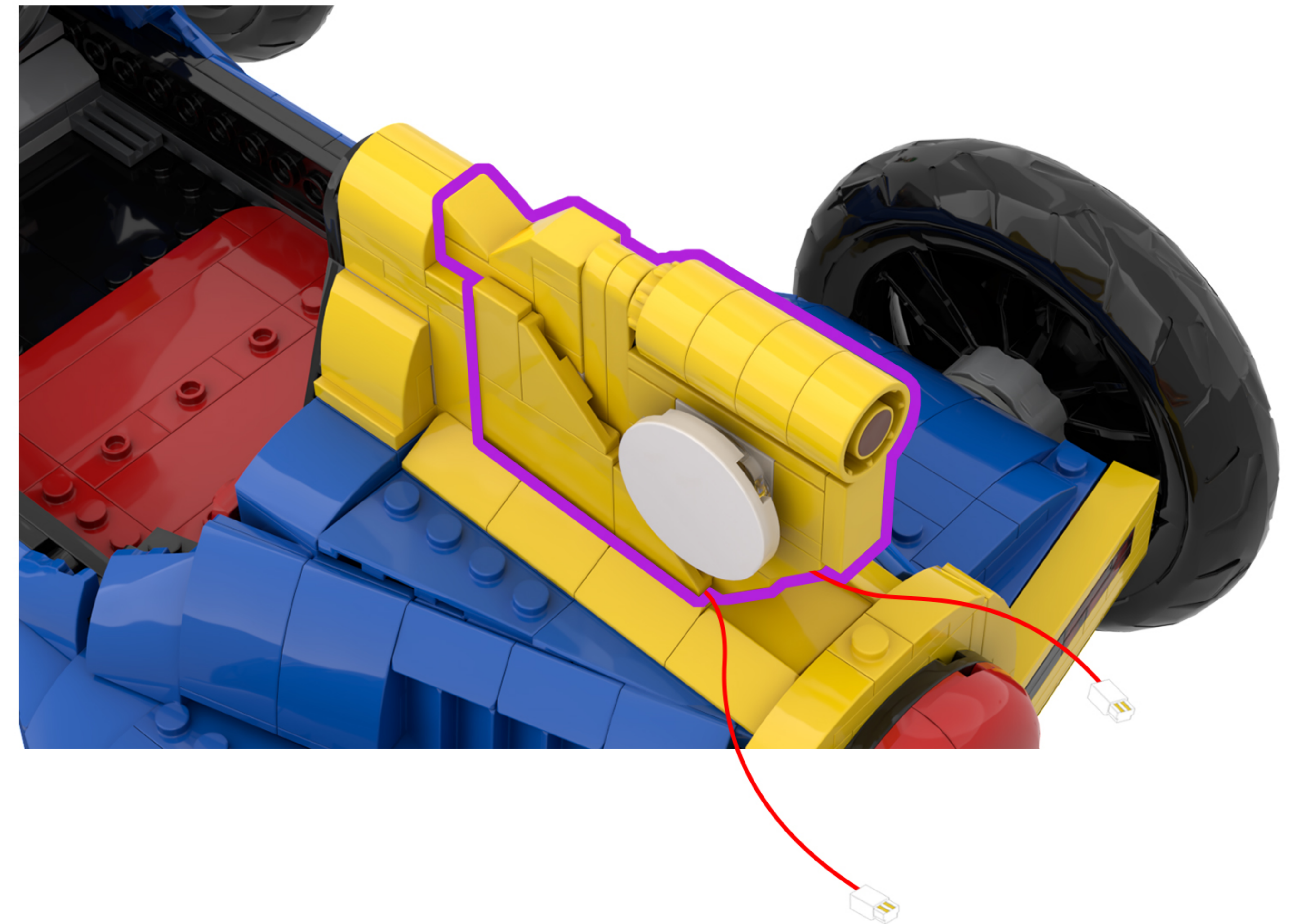

Note: The locations where the two light wires emerge.

88

EN: Locate this light cord in the diagram.

DE: Suchen Sie dieses Lichtkabel in der Abbildung.

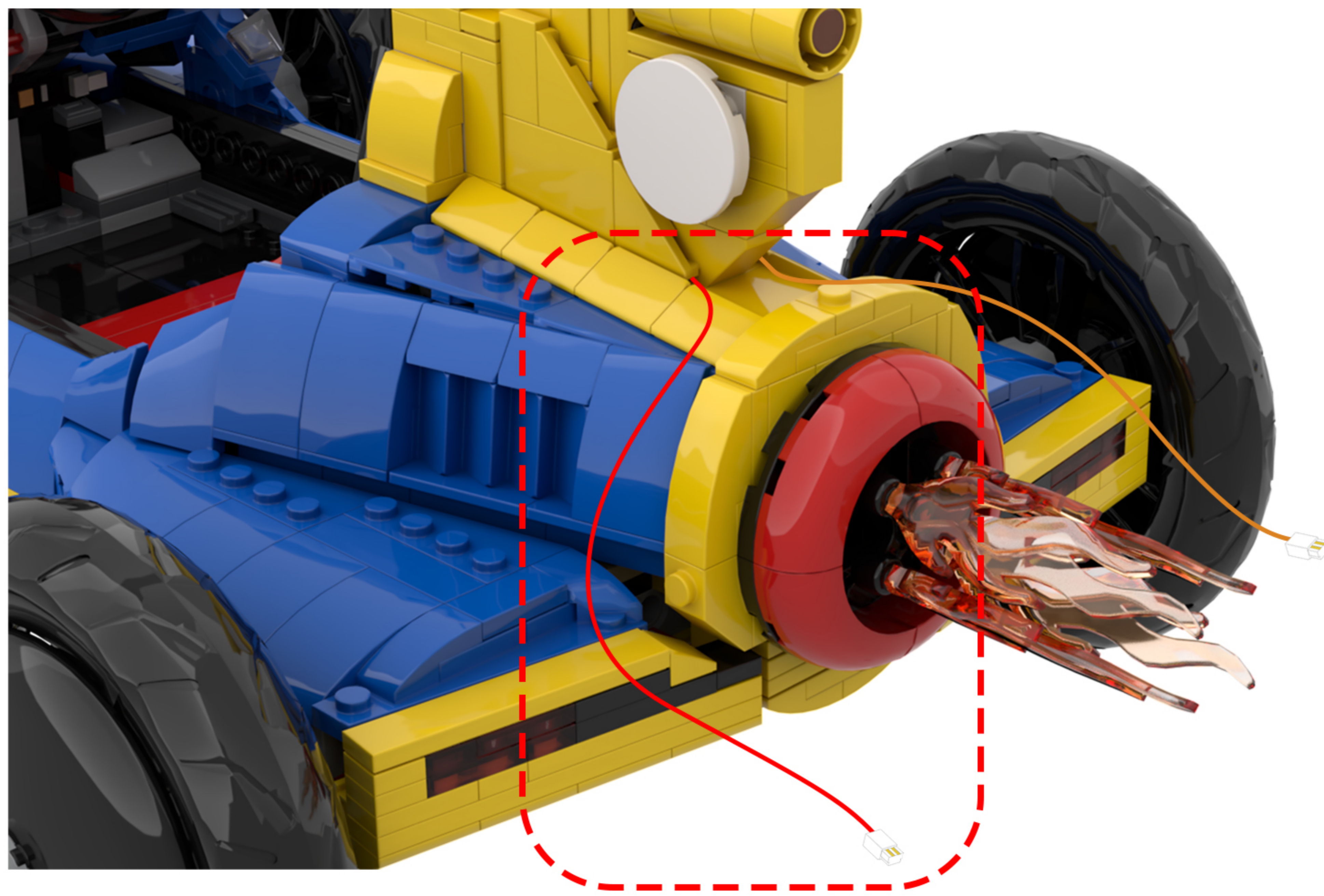

89

EN: Thread the lamp cord through the gaps in the building blocks.

DE: Führen Sie das Lampenkabel durch die Lücken in den Bausteinen.

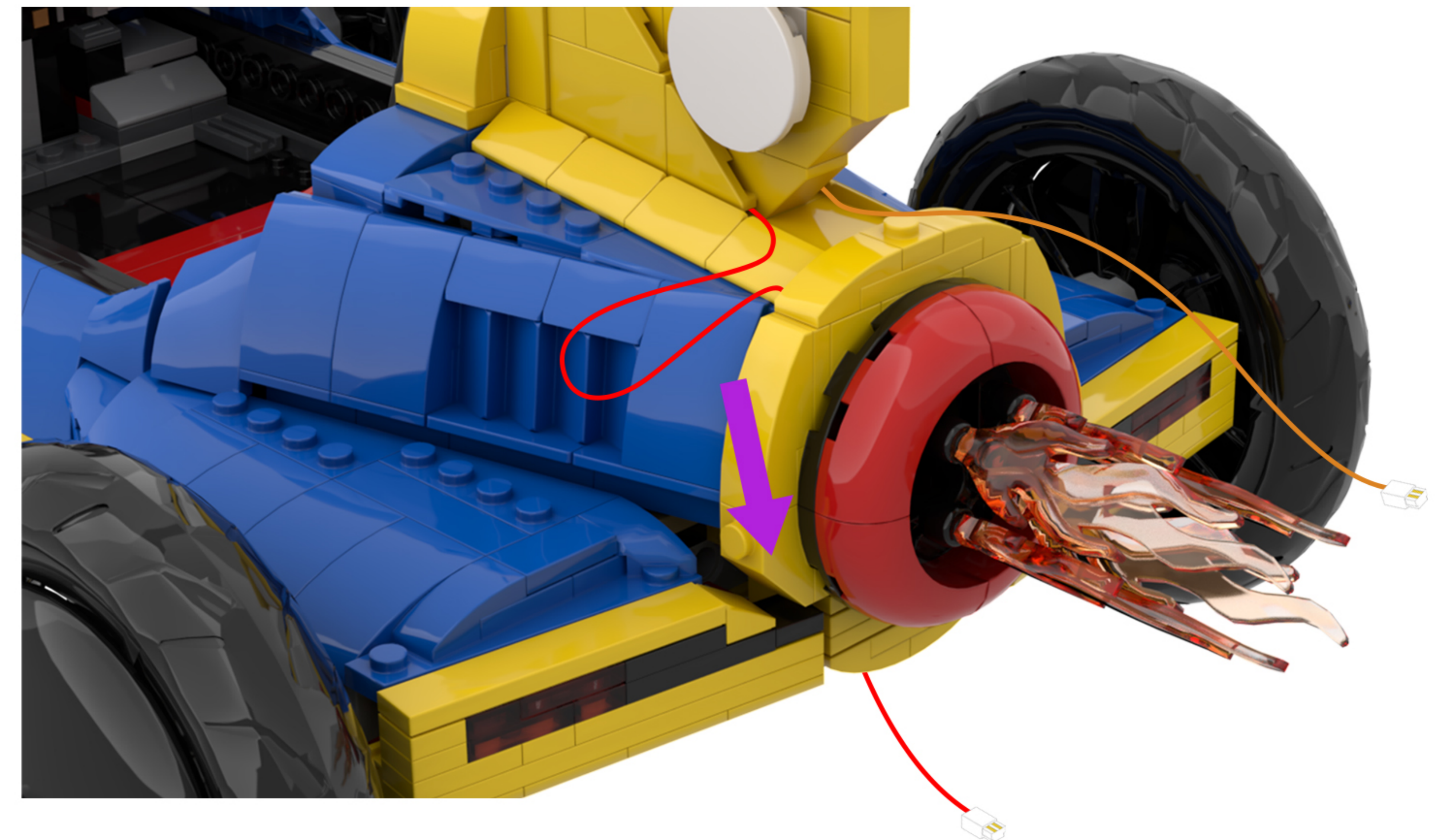
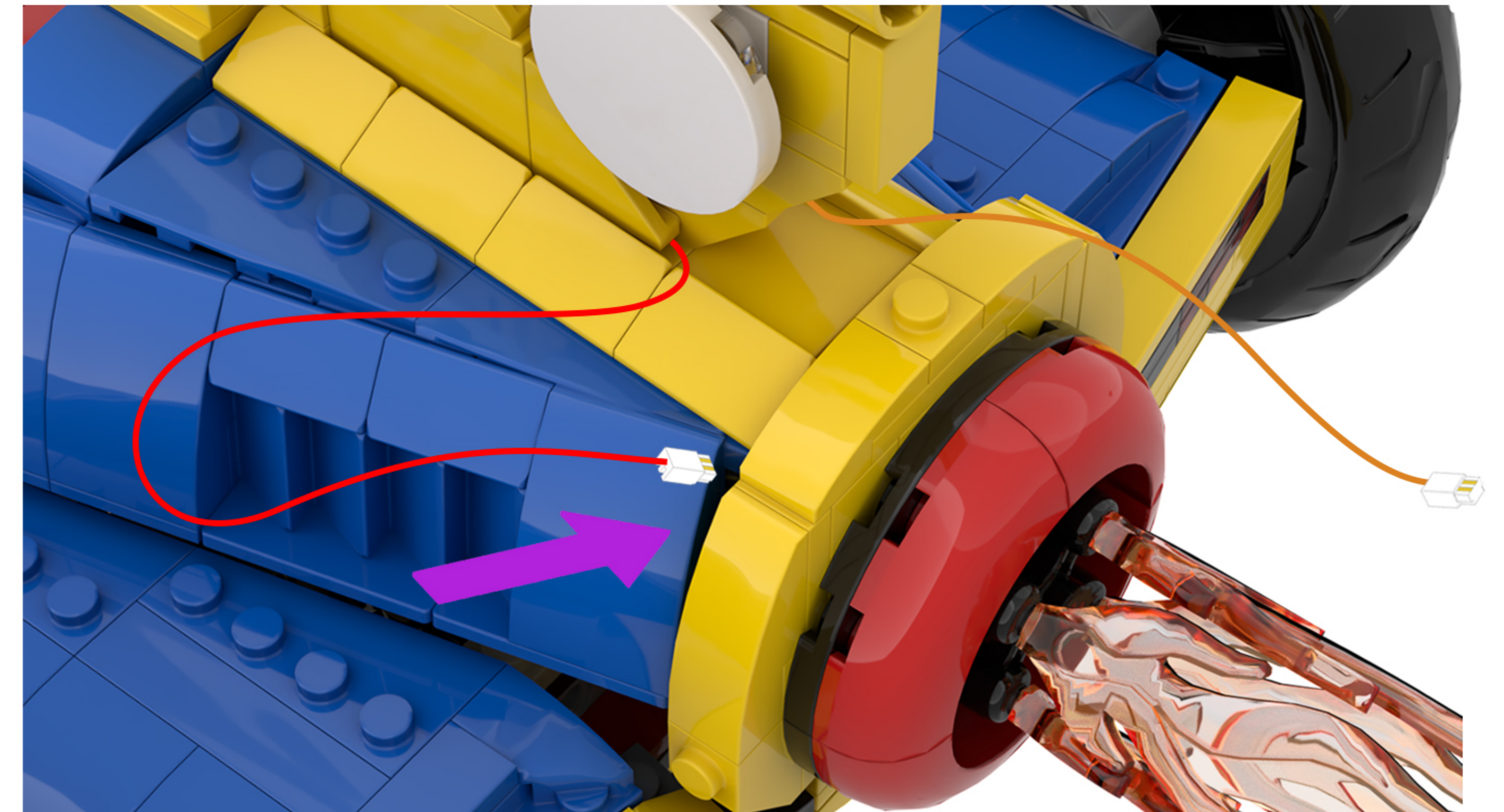

90

EN: Slide the light cord into the gap in the building block.

DE: Schieben Sie das Lichtkabel in den Spalt im Baustein.

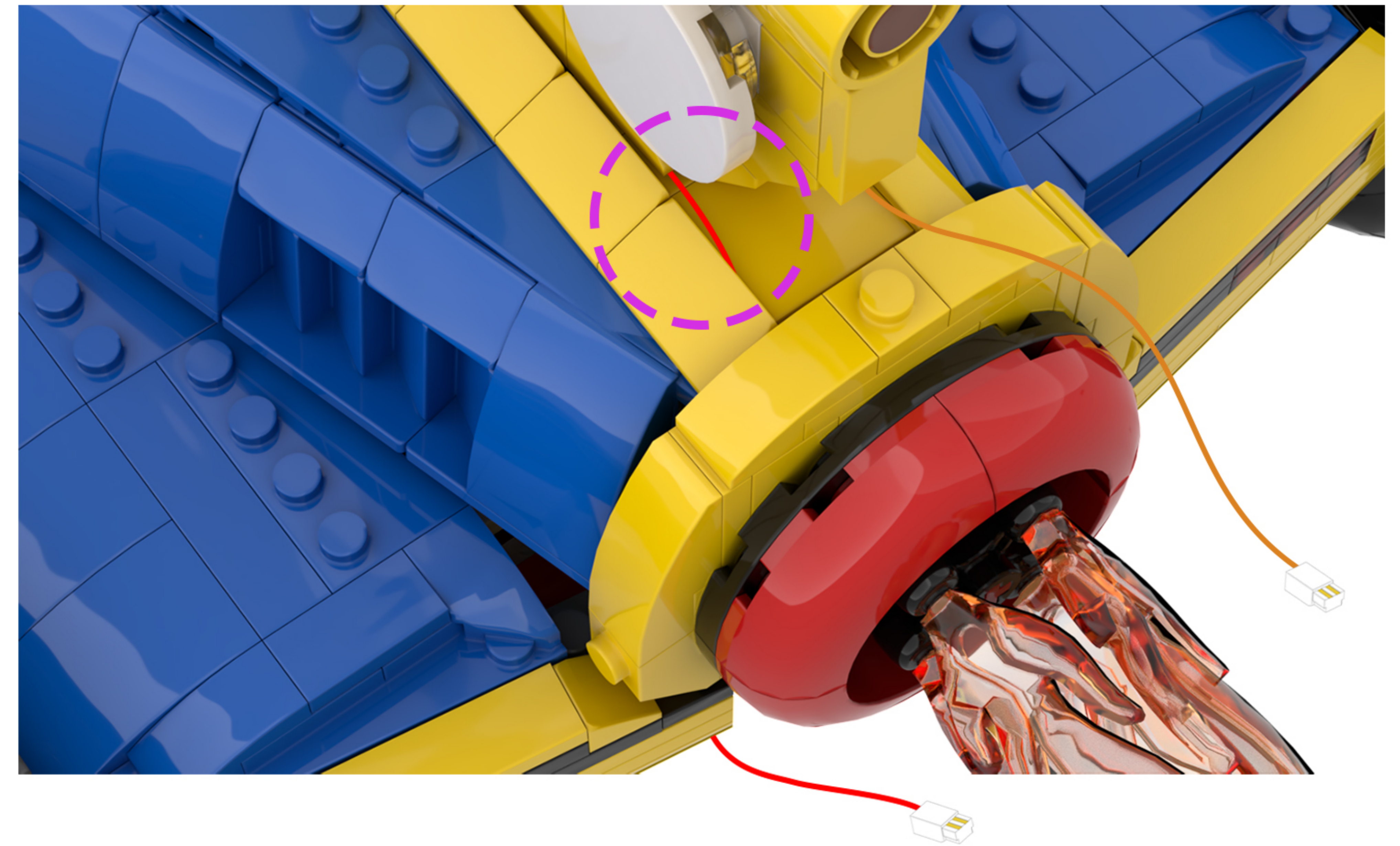
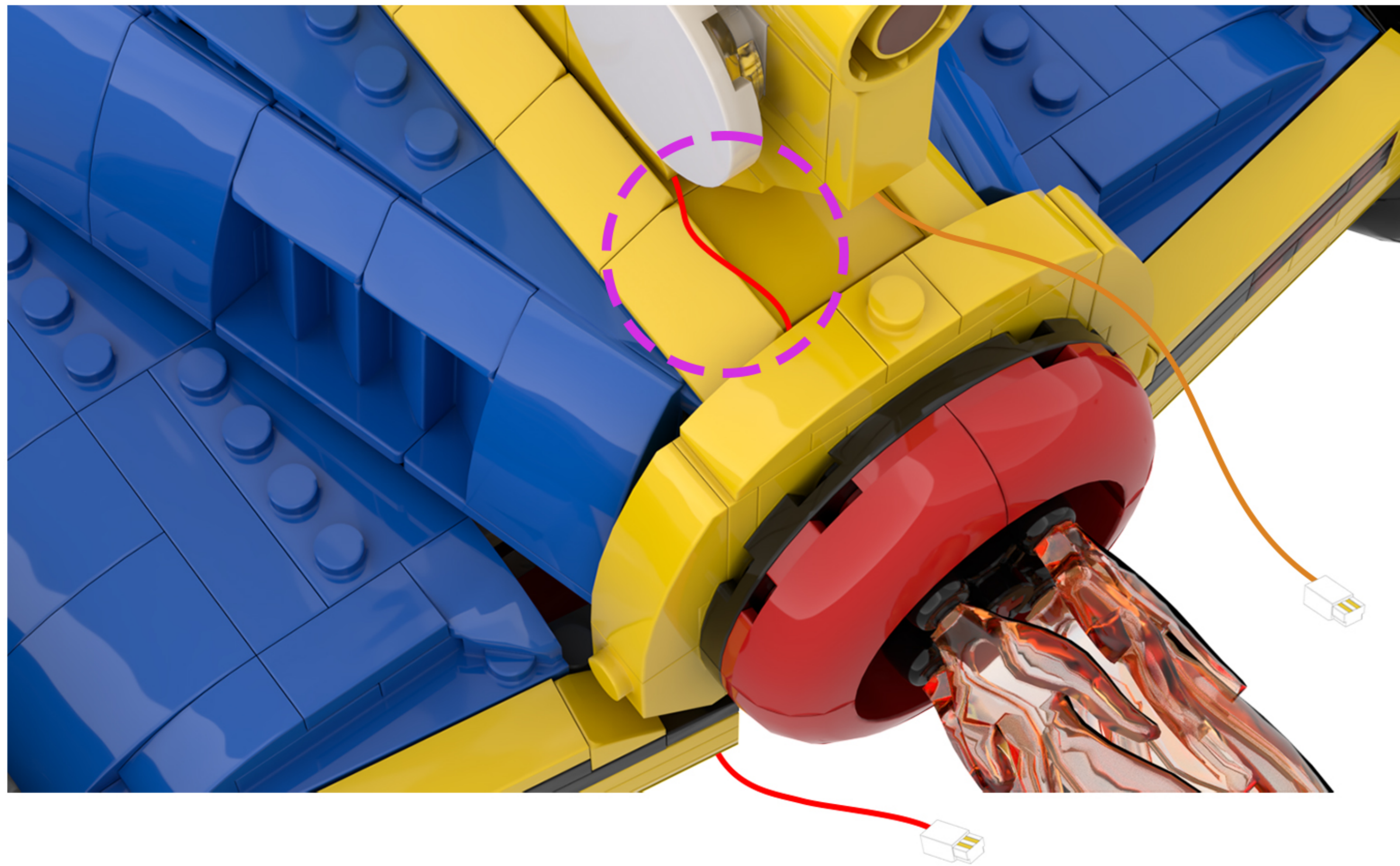

91

EN: Find another light cord.

DE: Such dir ein anderes Lampenkabel.

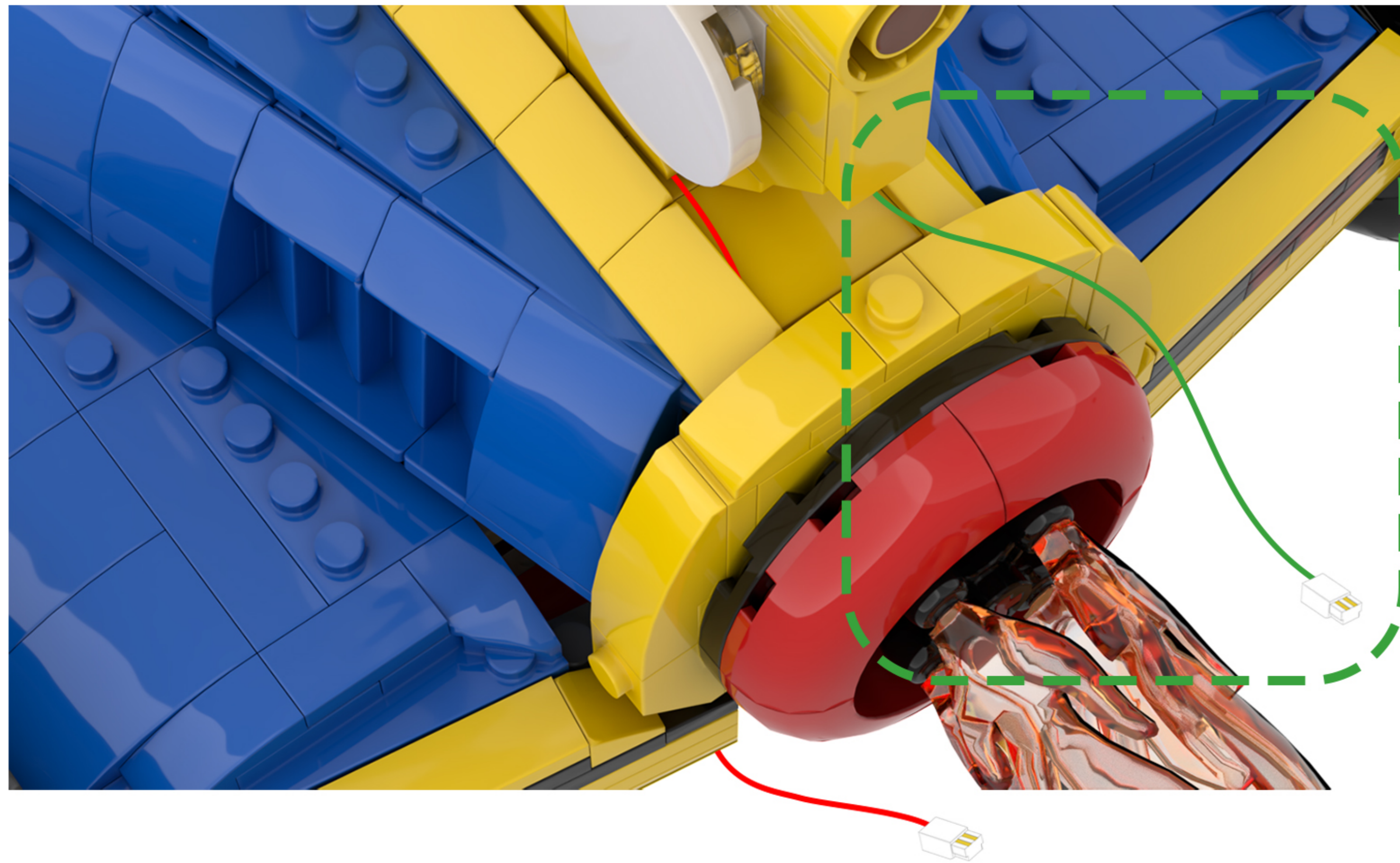

92

EN: Thread the lamp cord through the gaps in the building blocks.

DE: Führen Sie das Lampenkabel durch die Lücken in den Bausteinen.

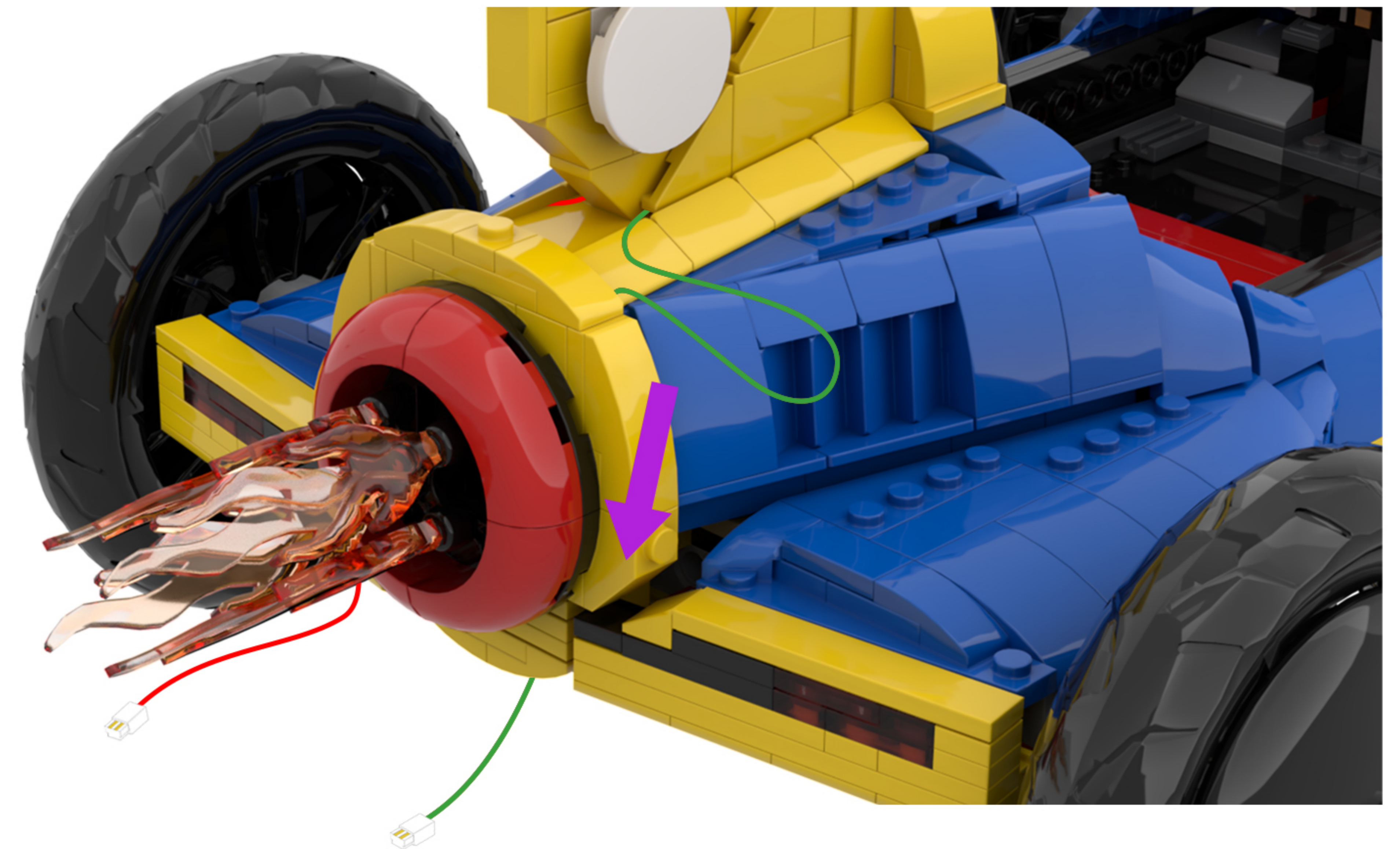
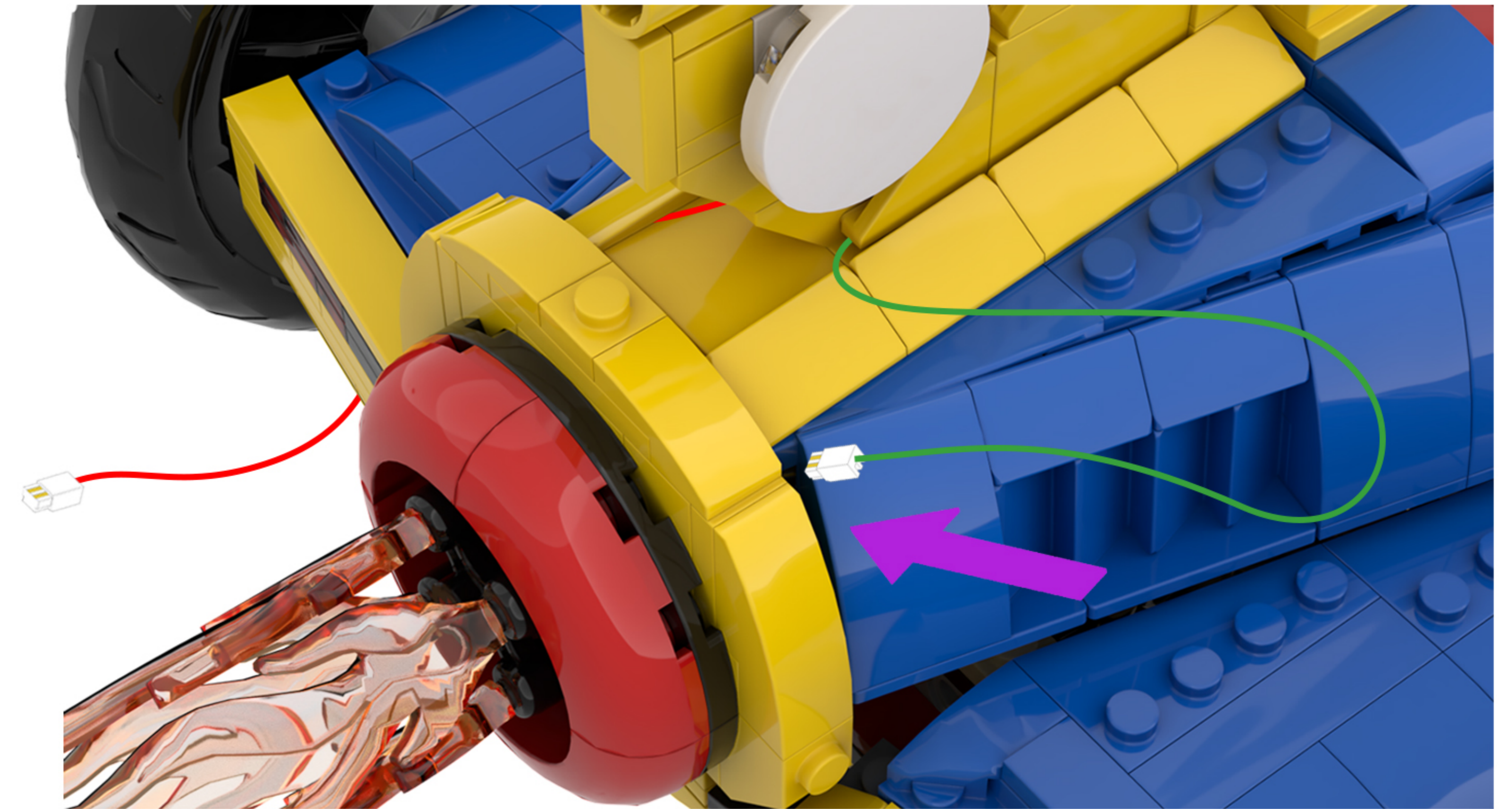

93

EN: Slide the light cord into the gap in the building block.

DE: Schieben Sie das Lichtkabel in den Spalt im Baustein.

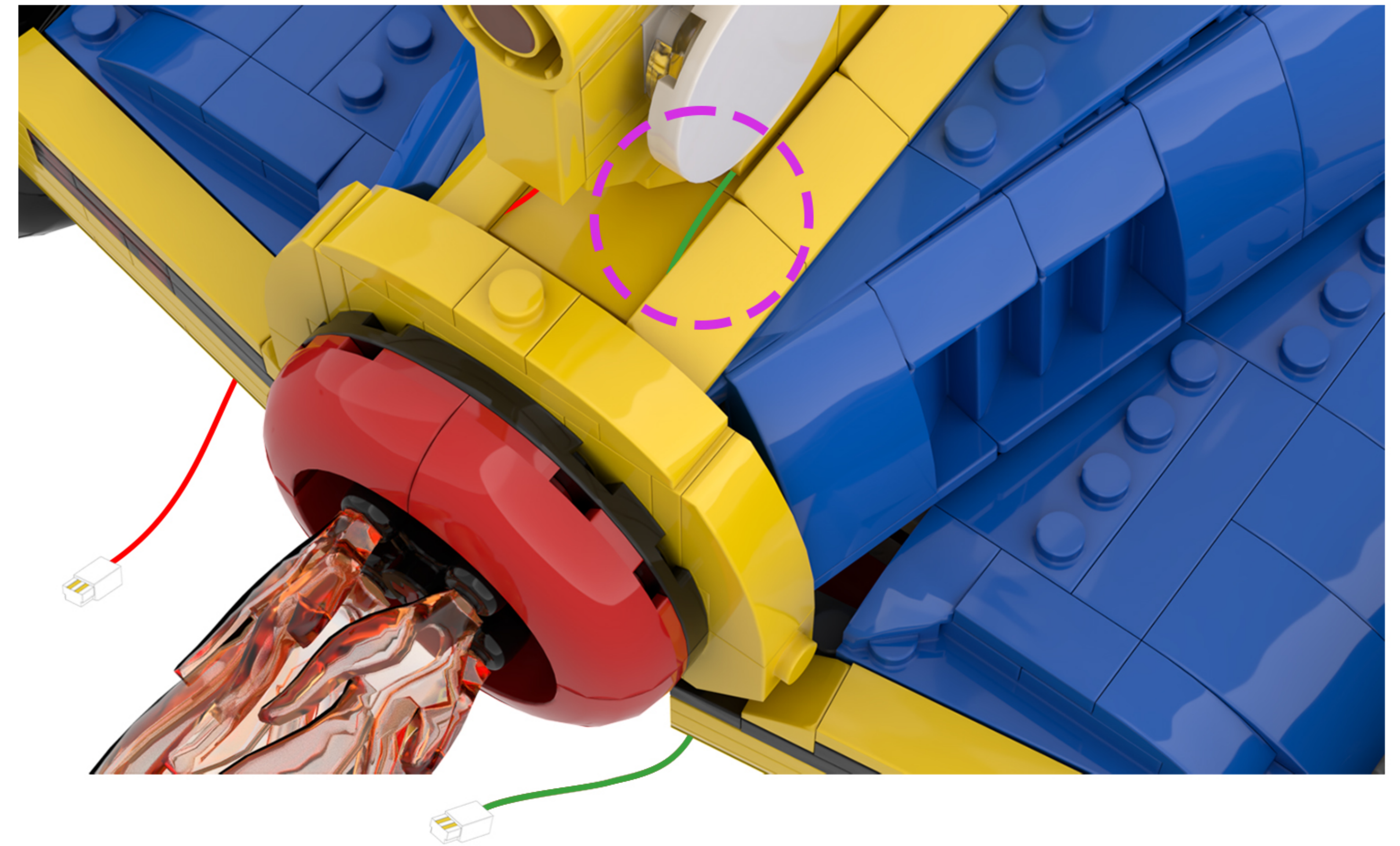
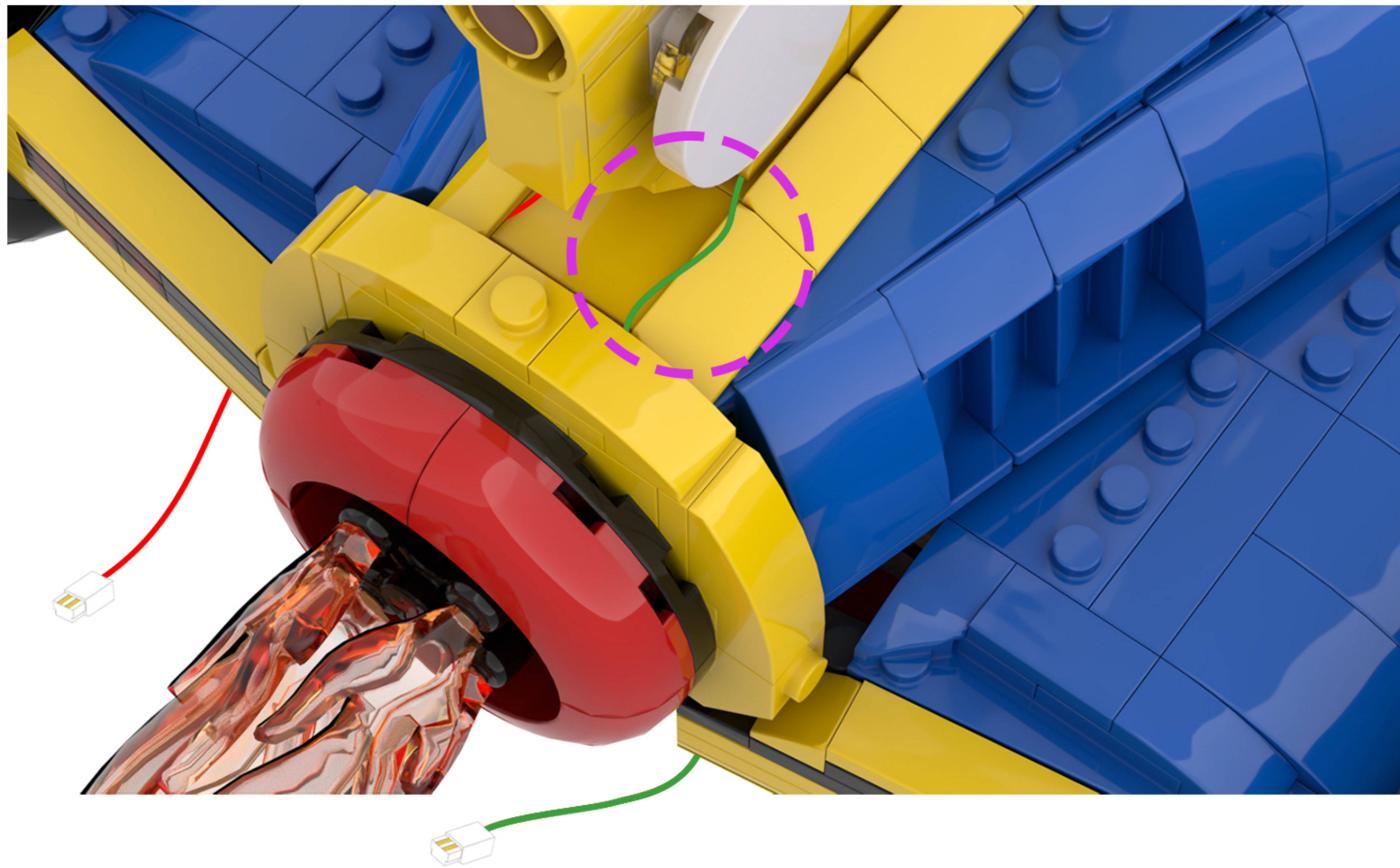

94

EN: Adjust your perspective.

DE: Ändern Sie Ihre Perspektive.

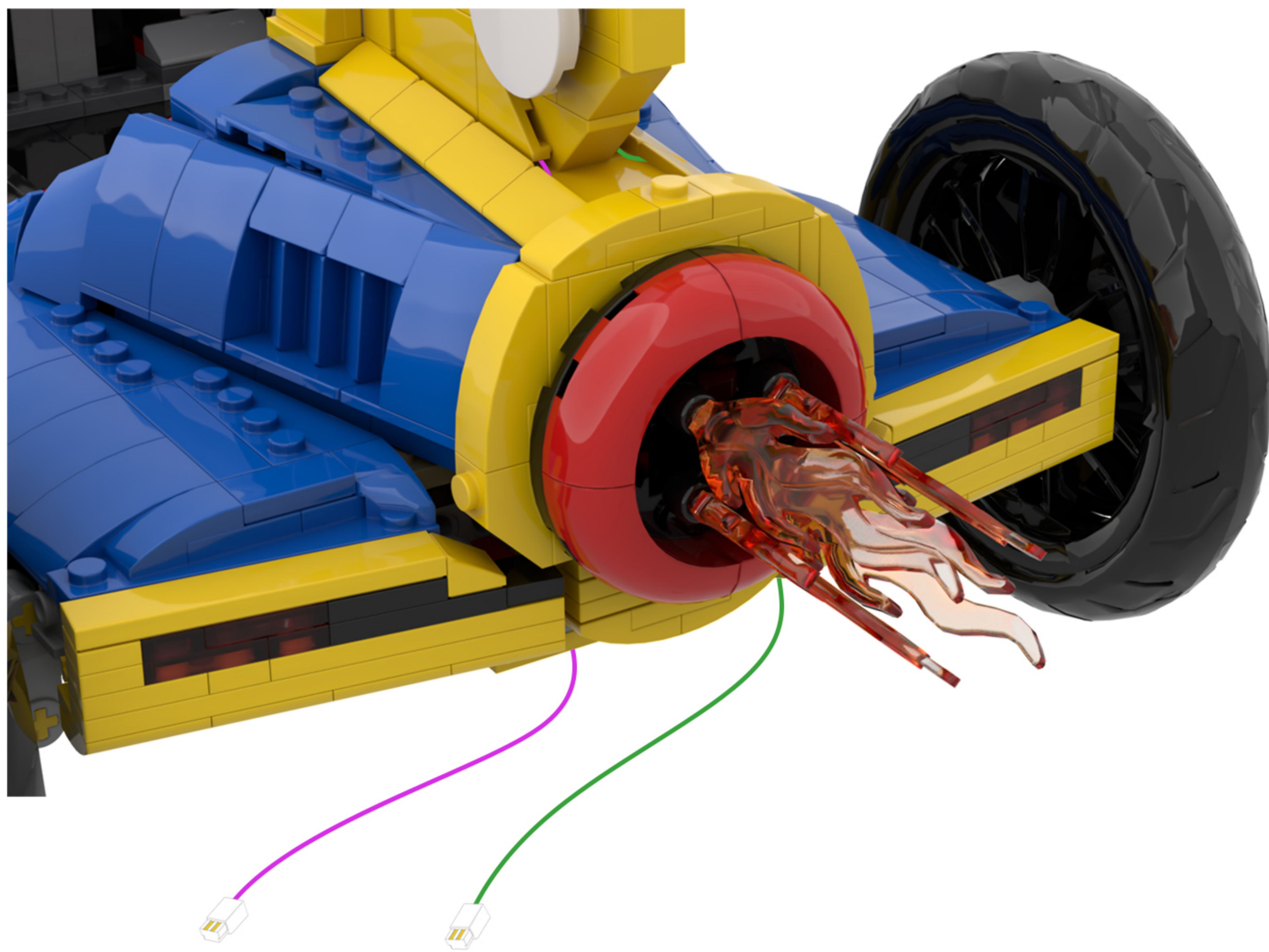

95

EN: Remove the building blocks one by one.

DE: Entfernen Sie die Bausteine nacheinander.



96

EN: Take out the disassembled building blocks and separate them.

DE: Nehmen Sie die zerlegten Bausteine heraus und trennen Sie sie voneinander.

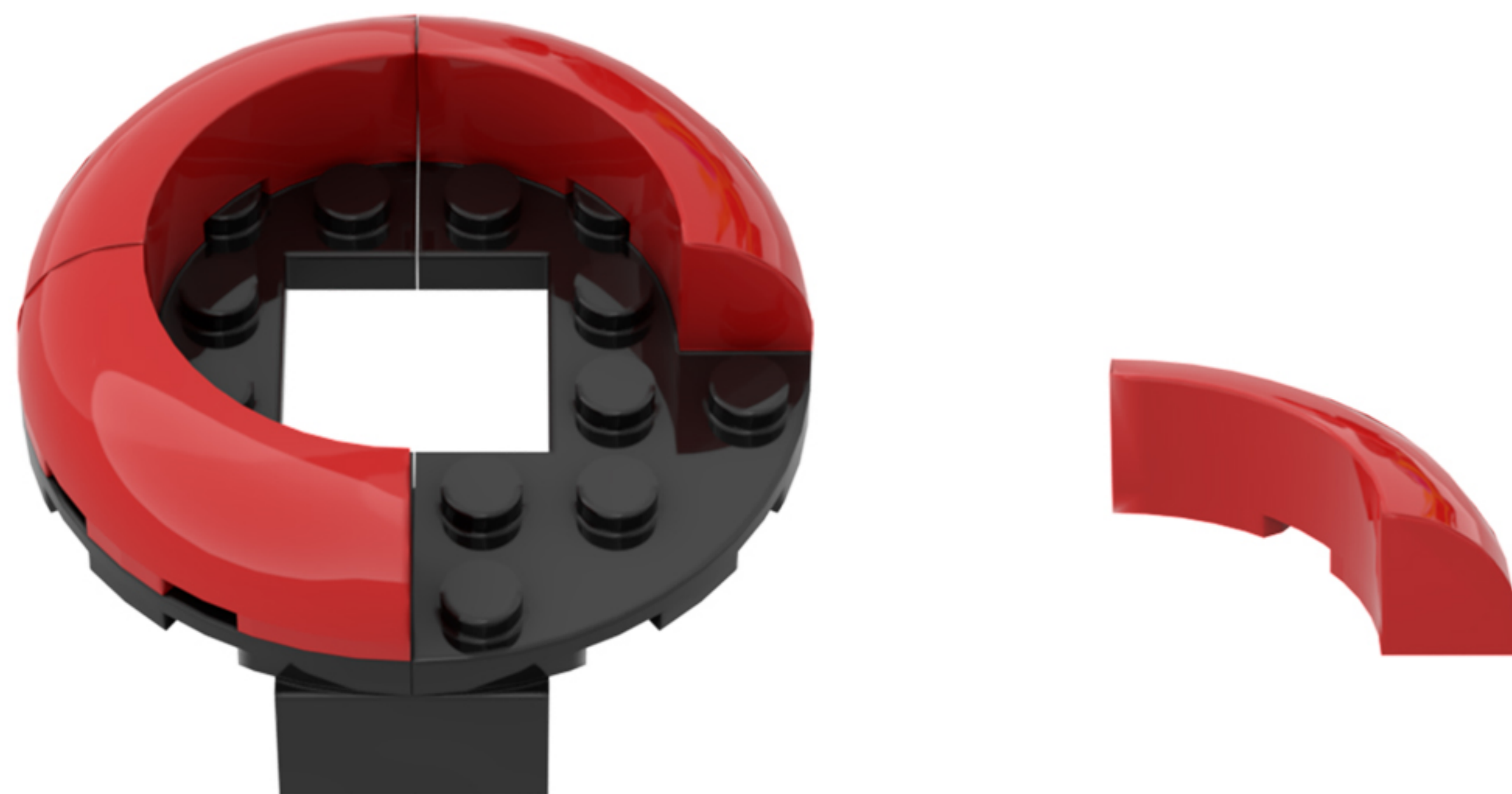
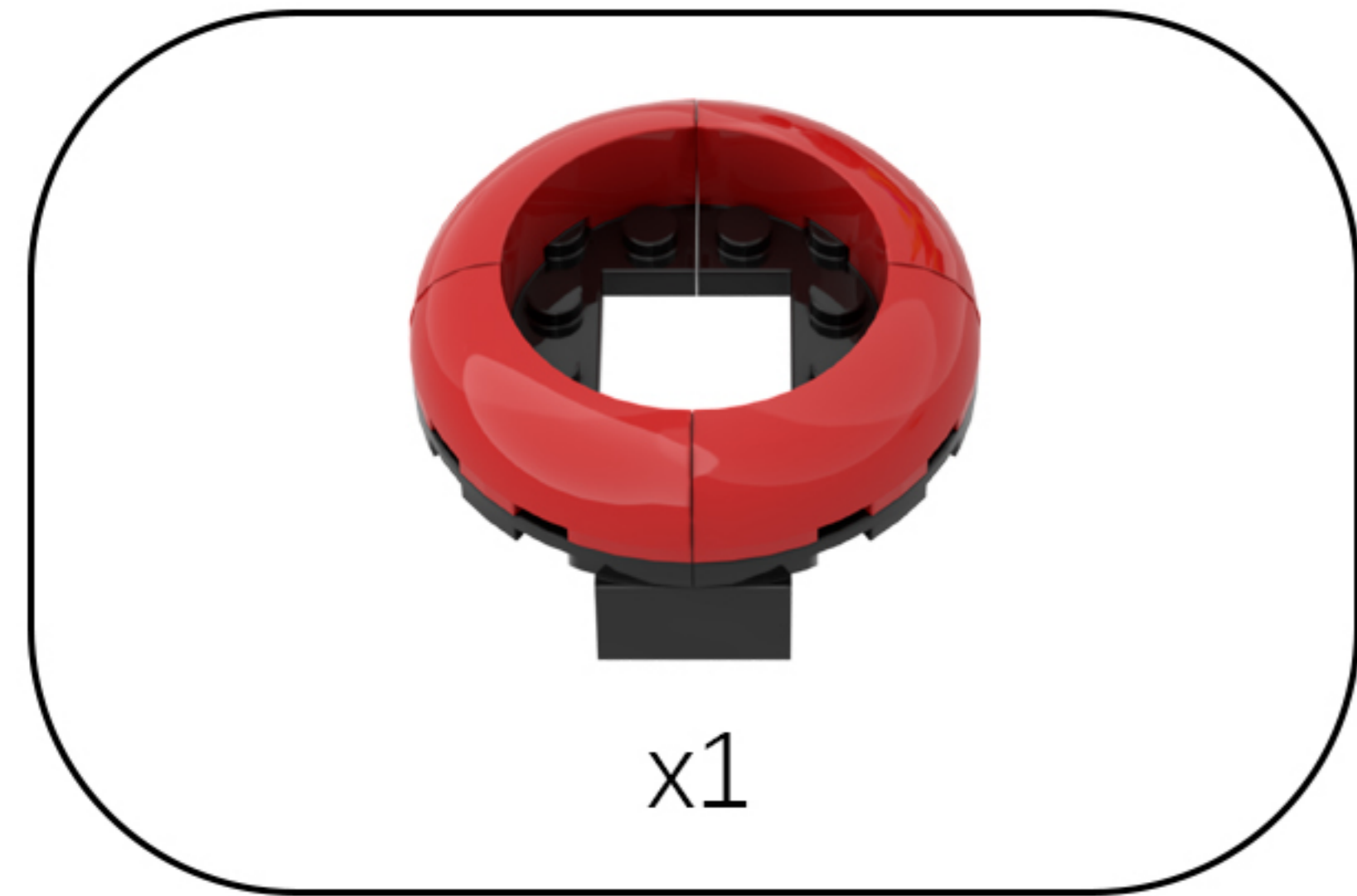

97

EN: Take the string of lights out of Bag 3 and place the end with the power cord on the building block.

DE: Nimm die Lichterkette aus Beutel 3 heraus und befestige das Ende mit dem Netzkabel am Baustein.

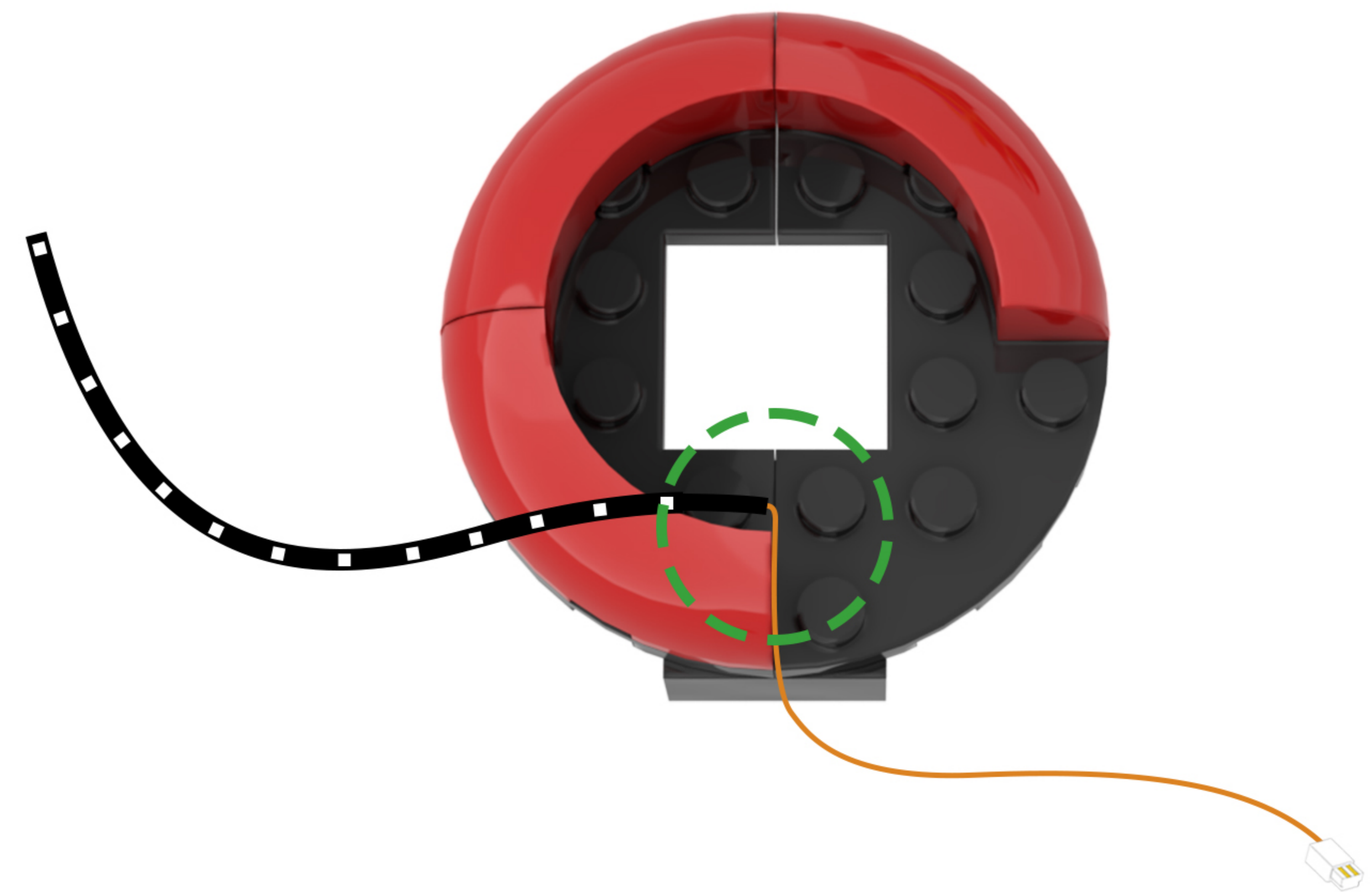
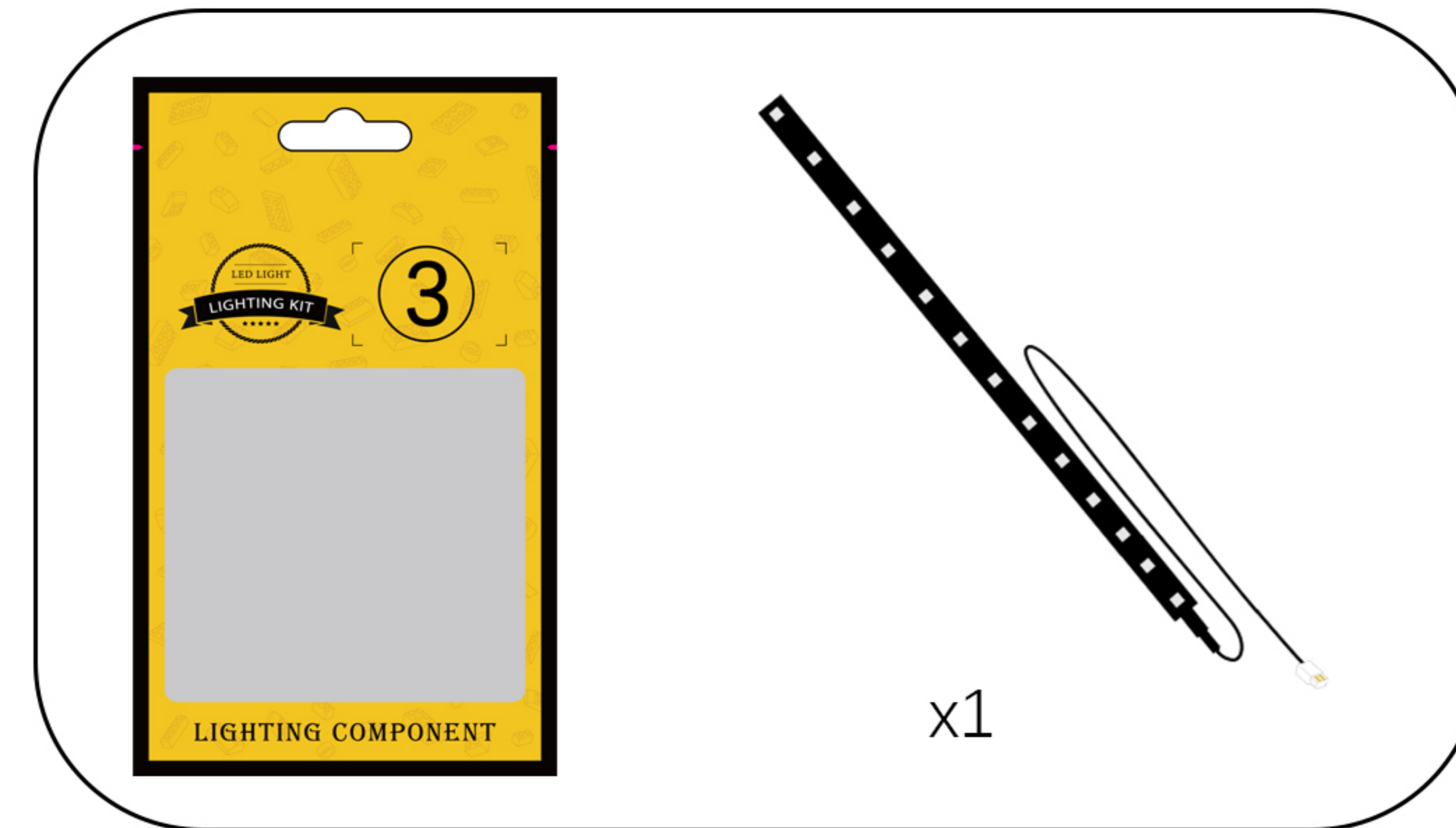

98

EN: Take out the disassembled building blocks, reassemble them, and secure the light cord.

DE: Nehmen Sie die zerlegten Bausteine heraus, setzen Sie sie wieder zusammen und befestigen Sie das Lichtkabel.

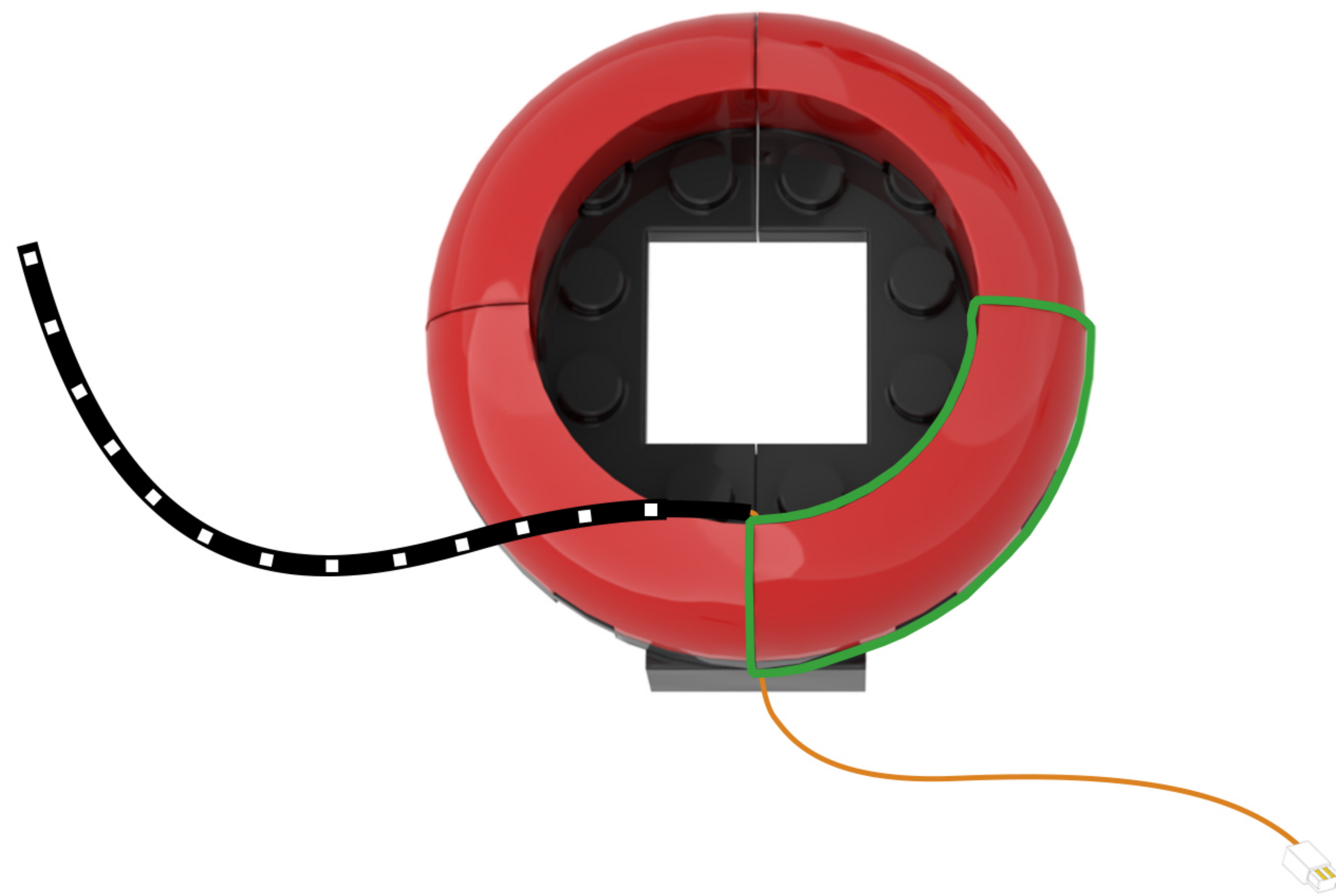
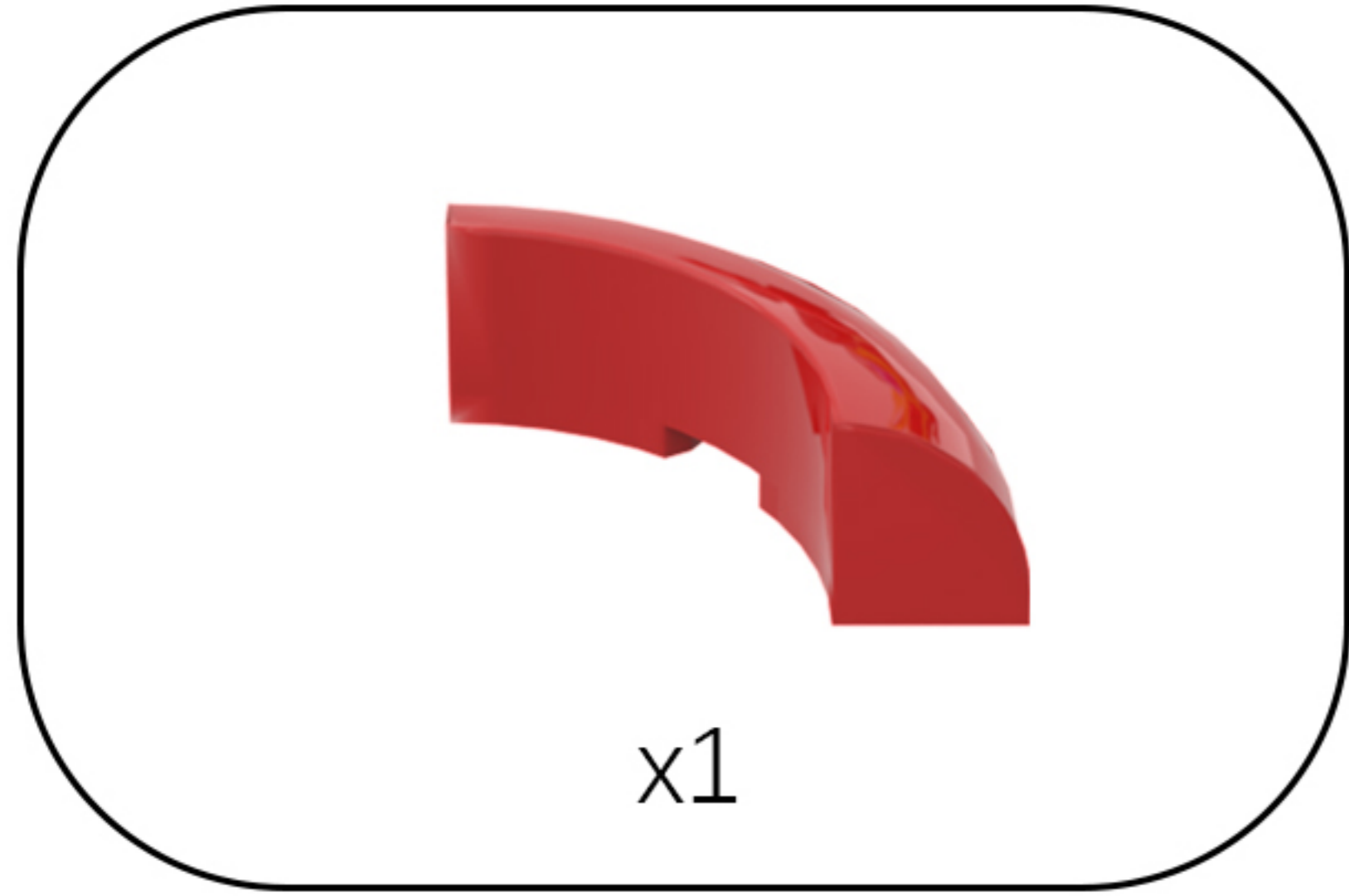

99

EN: Peel off the adhesive backing of the light strip and wrap it around the building block.

DE: Zieh die Schutzfolie vom Leuchtband ab und wickle es um den Baustein.

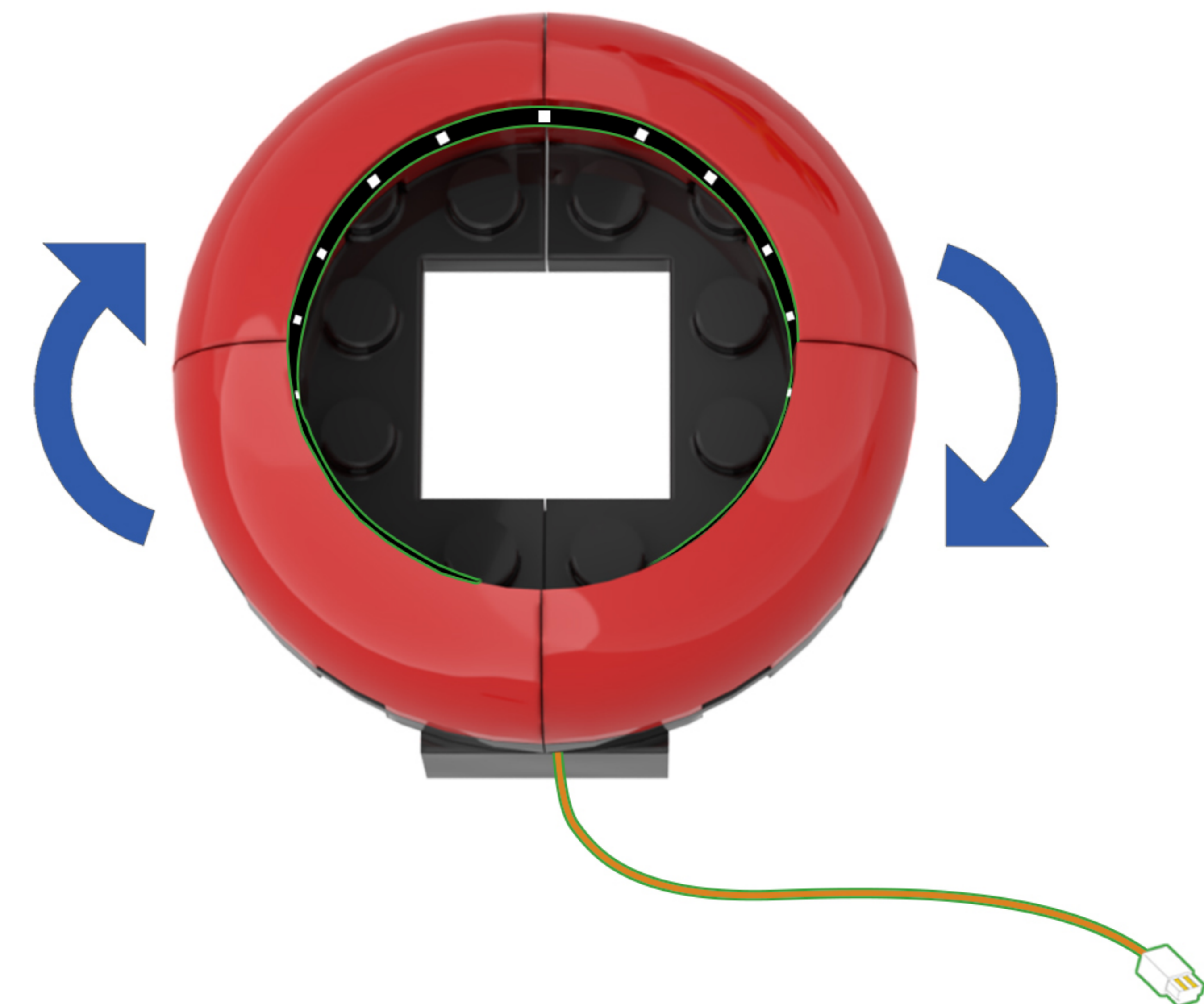

100 EN: Restore the building blocks.
DE: Stellen Sie die Bausteine wieder her.

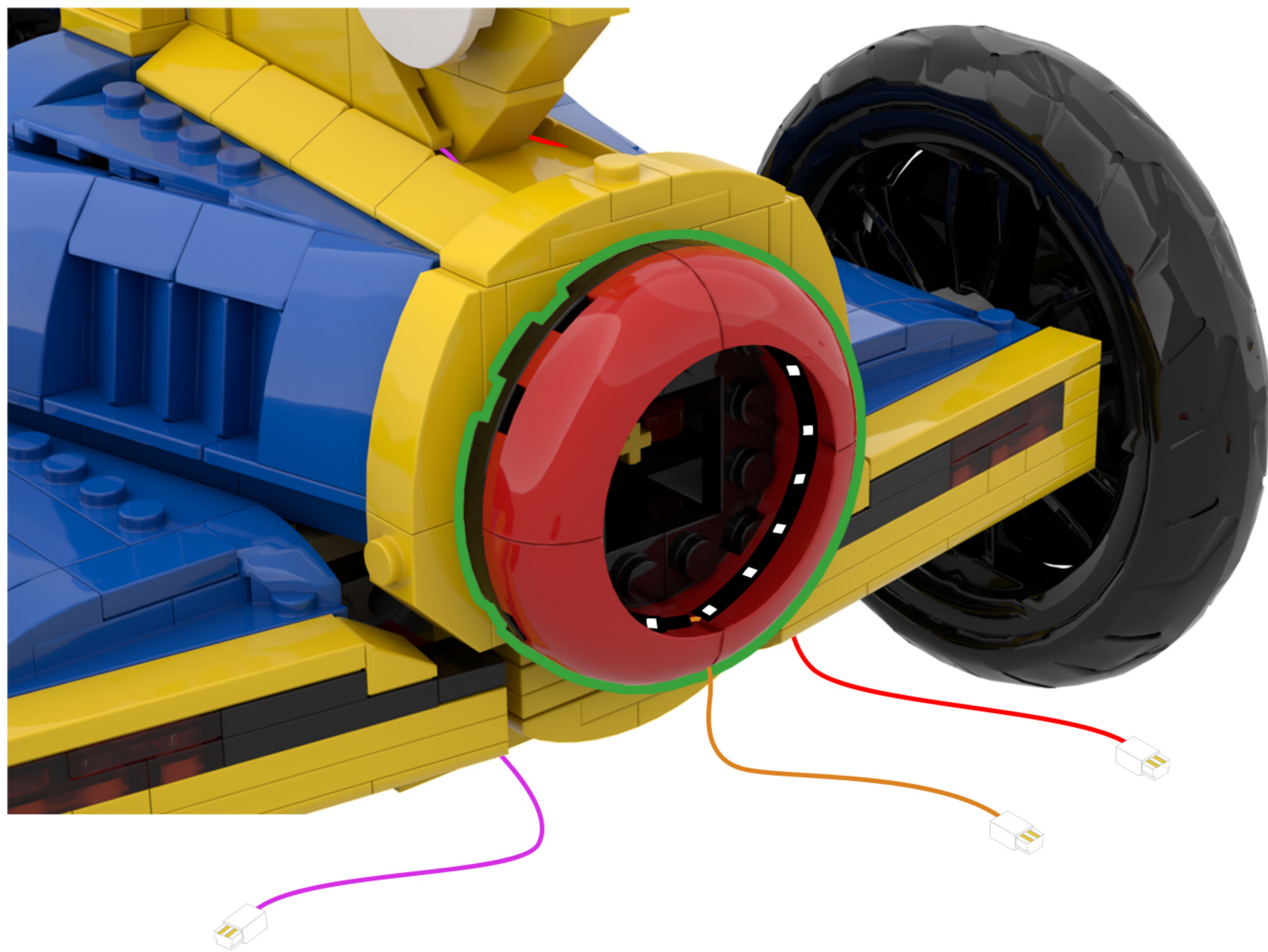

101 EN: Take out the disassembled building blocks and reassemble them.
DE: Nehmen Sie die zerlegten Bausteine heraus und setzen Sie sie wieder zusammen.

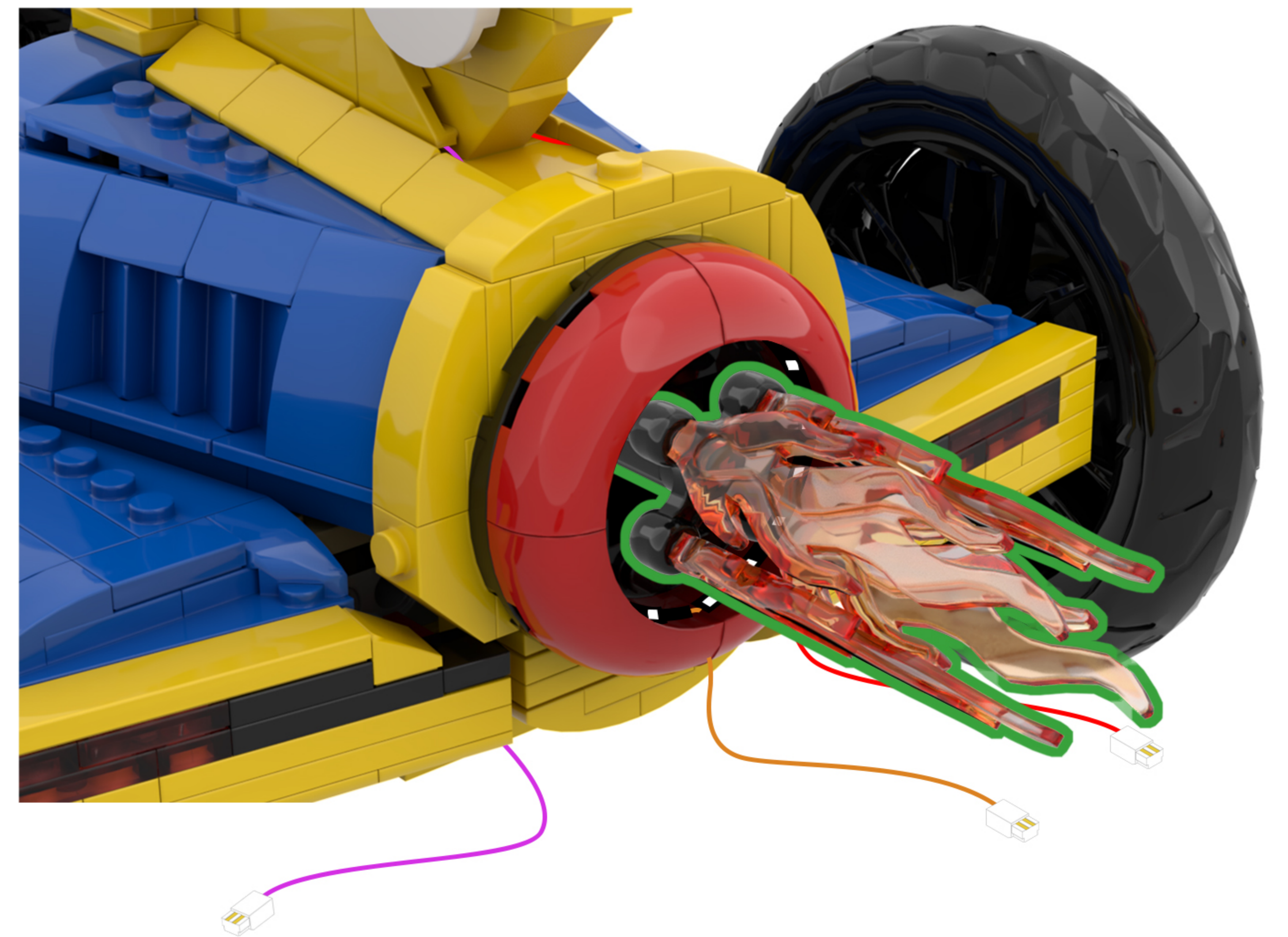
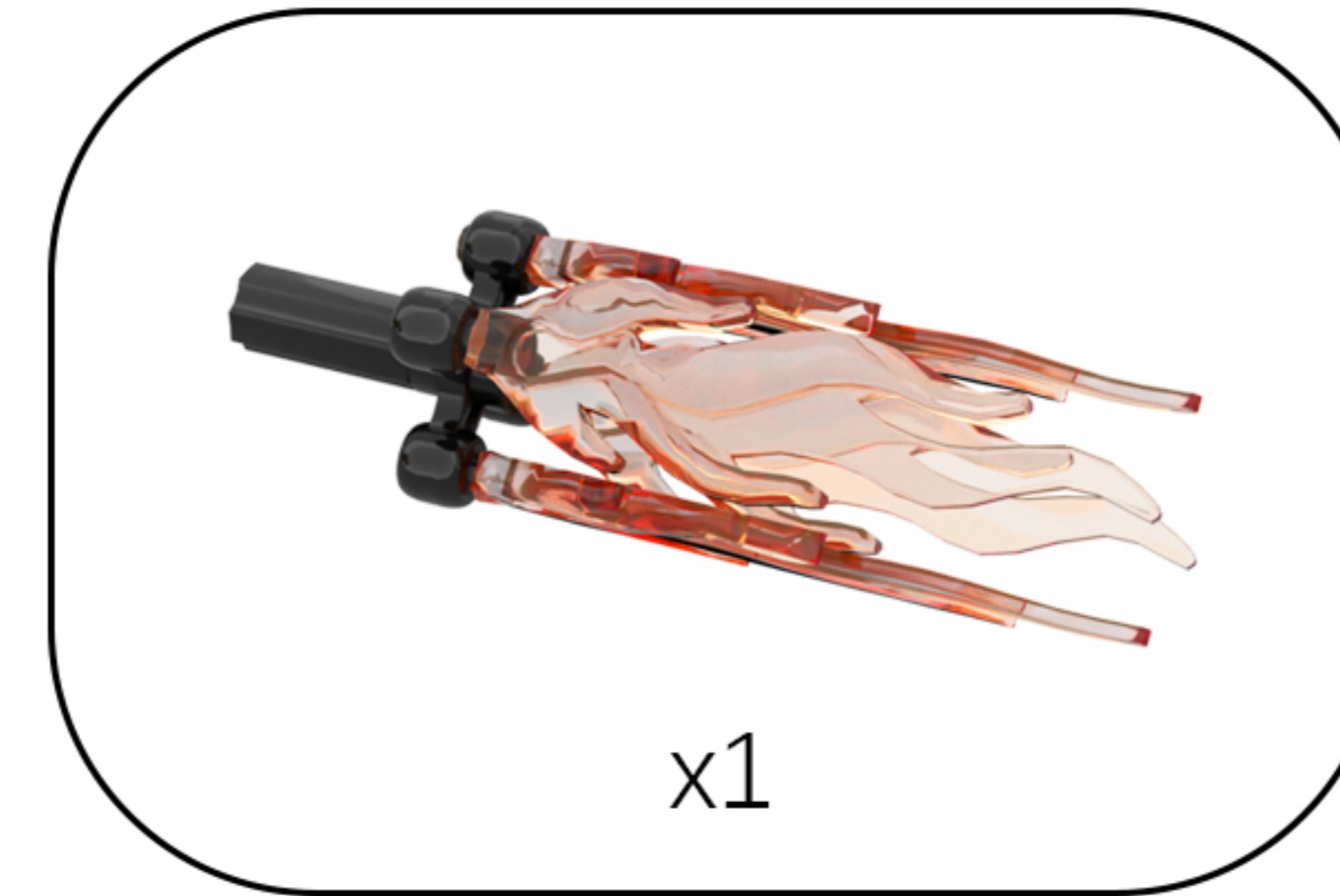

102

EN: Flip the model so that the bottom is facing up, and locate the three light lines shown in the figure.

DE: Drehen Sie das Modell so, dass die Unterseite nach oben zeigt, und suchen Sie die drei in der Abbildung gezeigten hellen Linien.

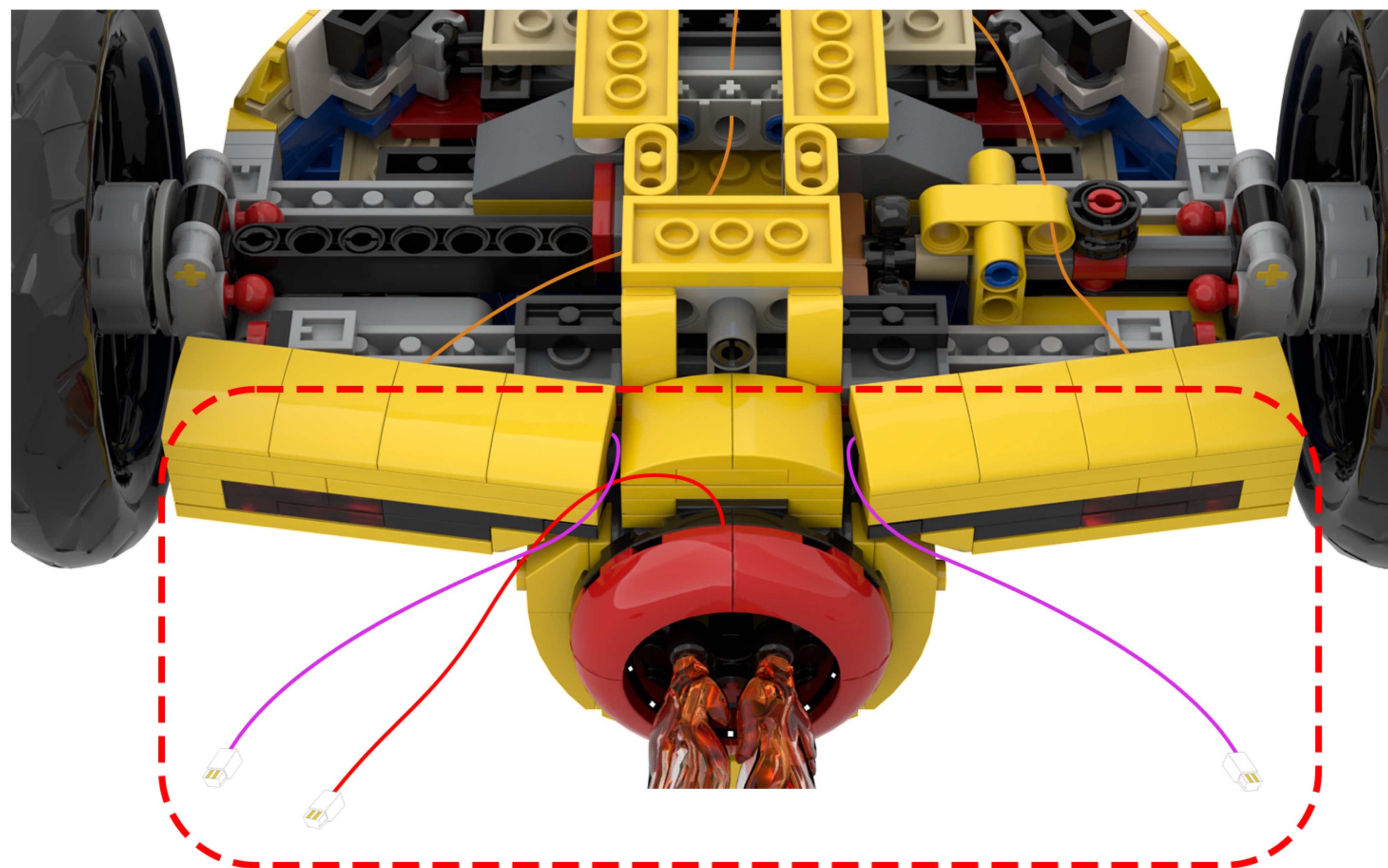
**103**

EN: Thread the three light cords through the holes in the building blocks one after another.

DE: Fädle die drei Lichterketten nacheinander durch die Löcher in den Bausteinen.

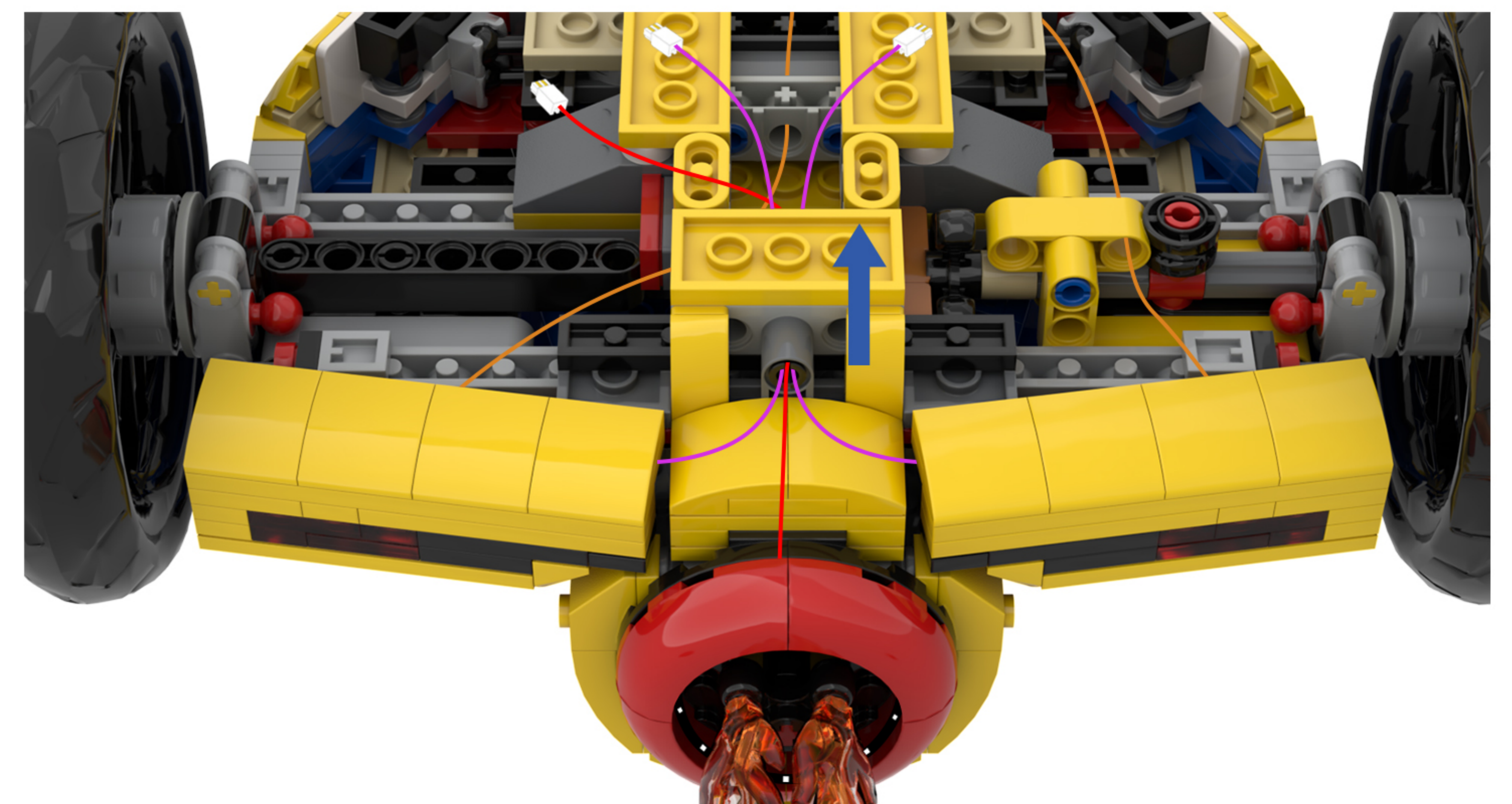
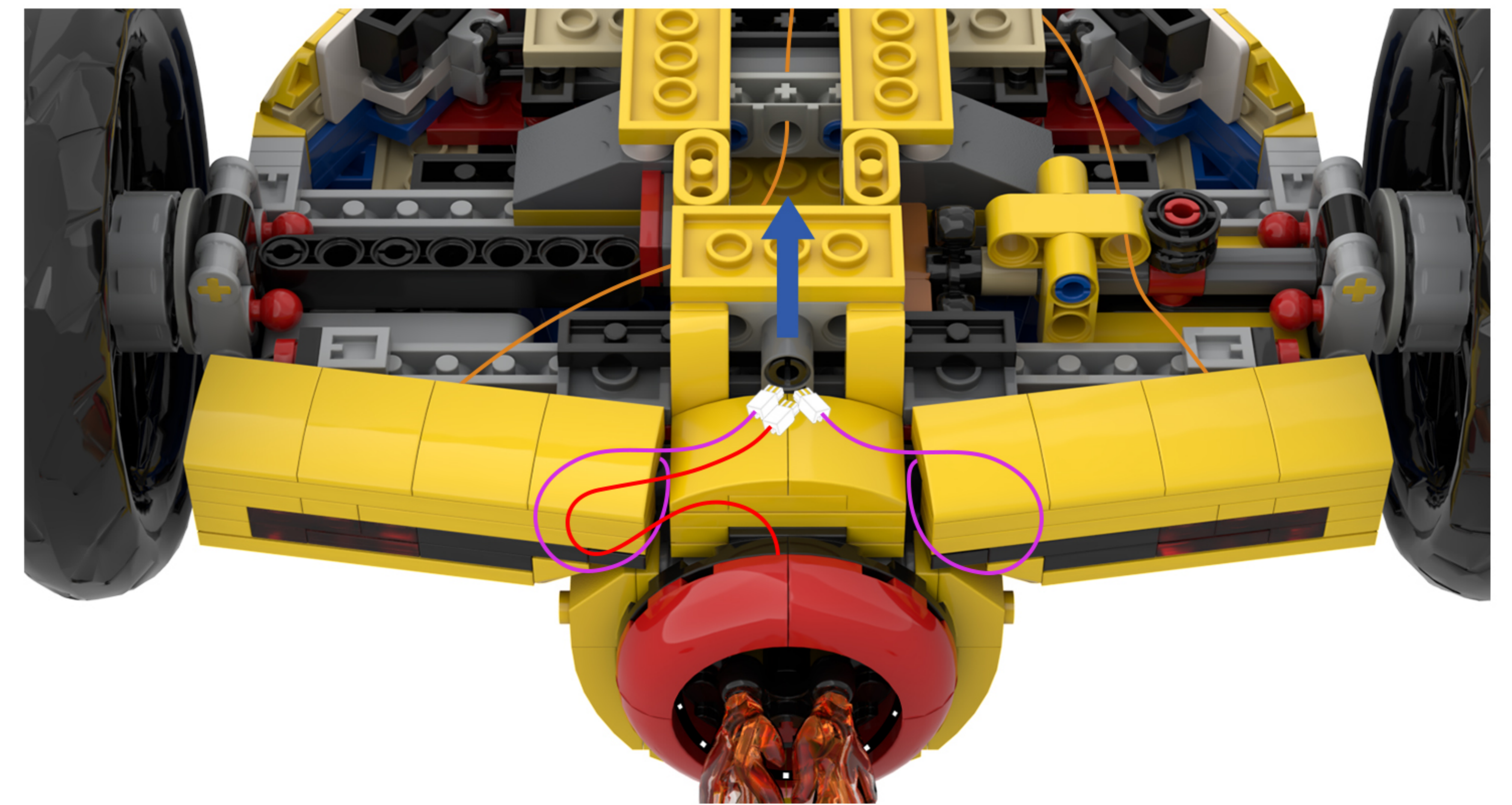

104 EN: Locate this light cord in the diagram.
DE: Suchen Sie dieses Lichtkabel in der Abbildung.

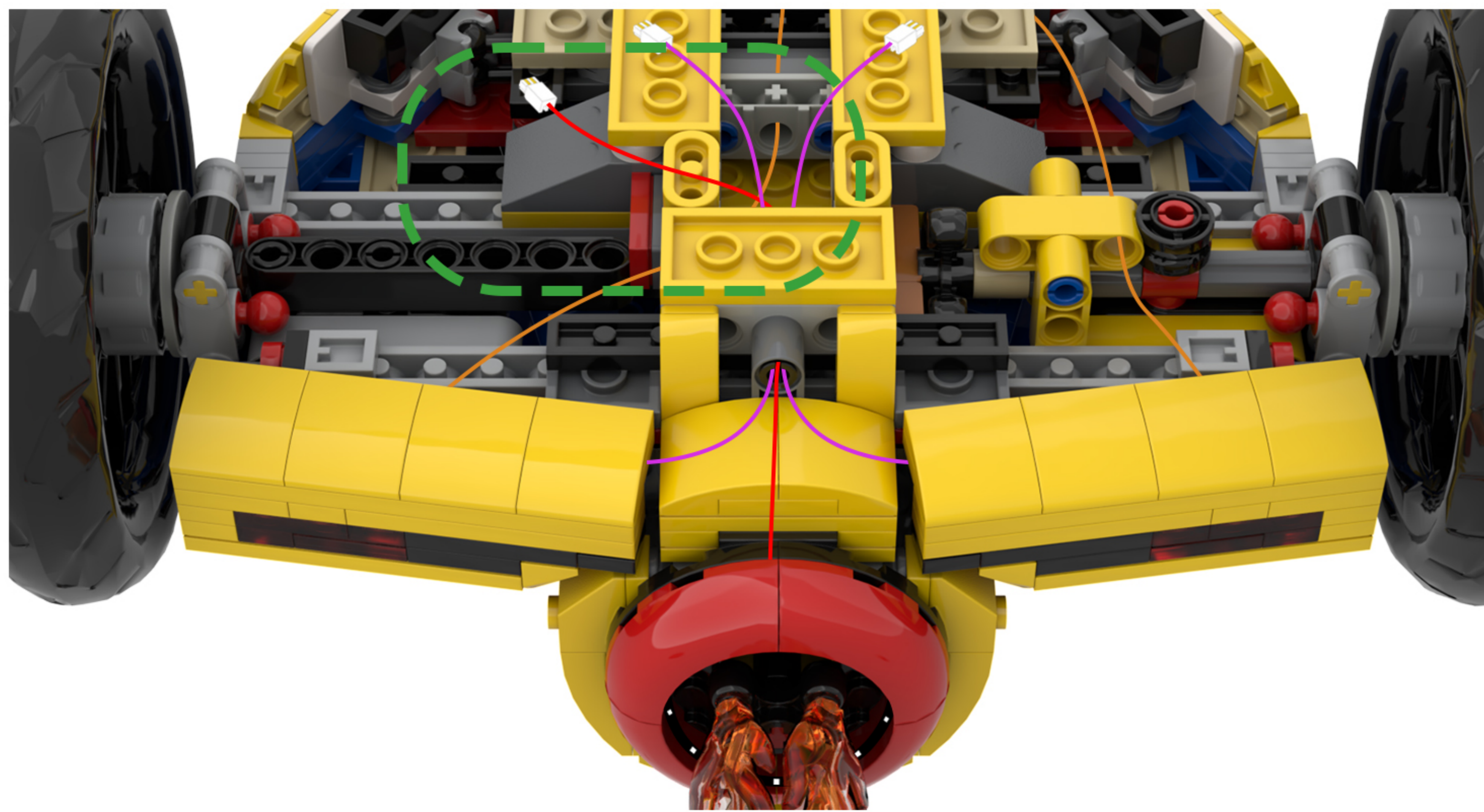

105 EN: Take the flame module out of Bag 3 and connect the lamp wires to it.
DE: Nehmen Sie das Flammenmodul aus Beutel 3 heraus und schließen Sie die Lampenkabel daran an.

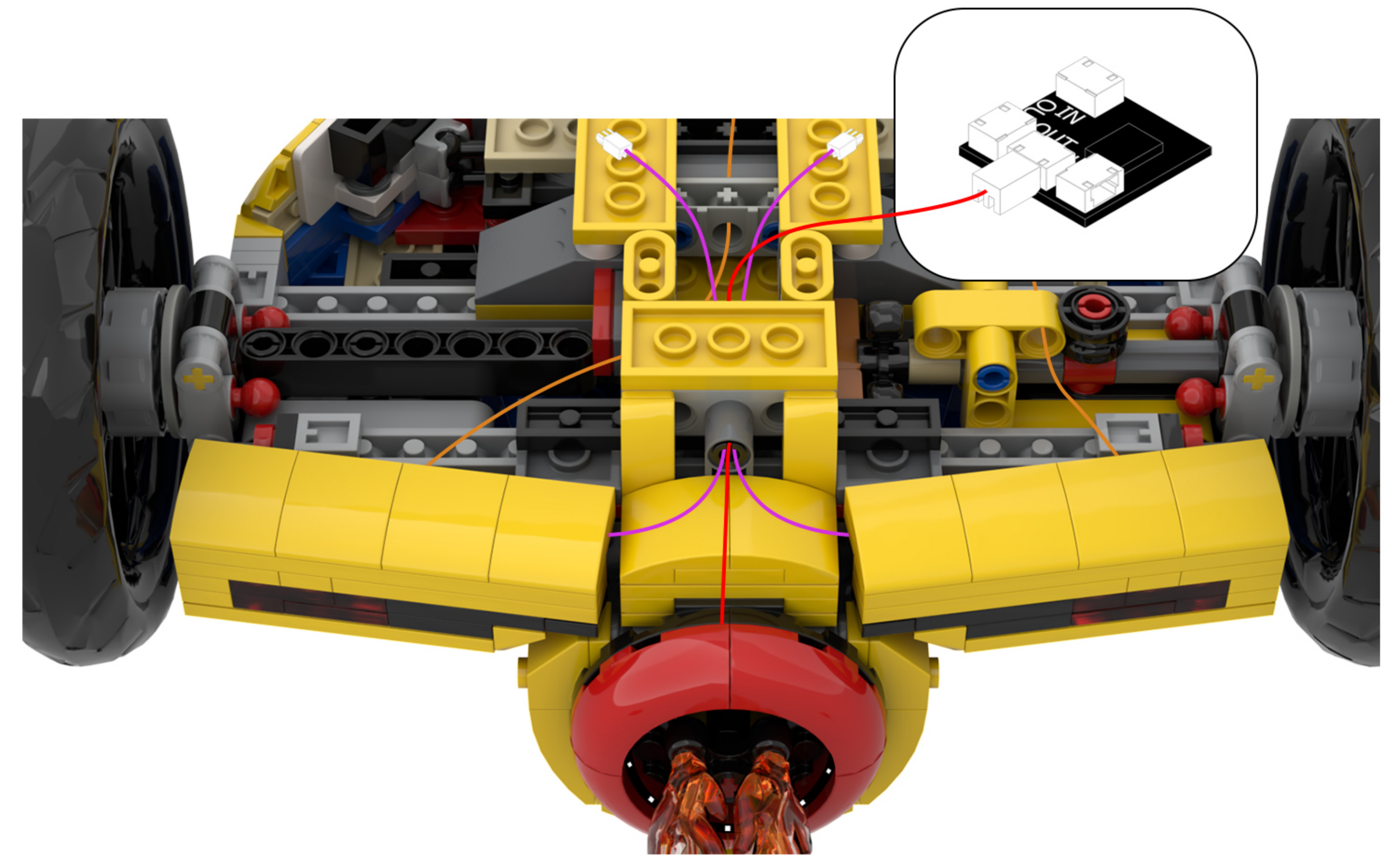
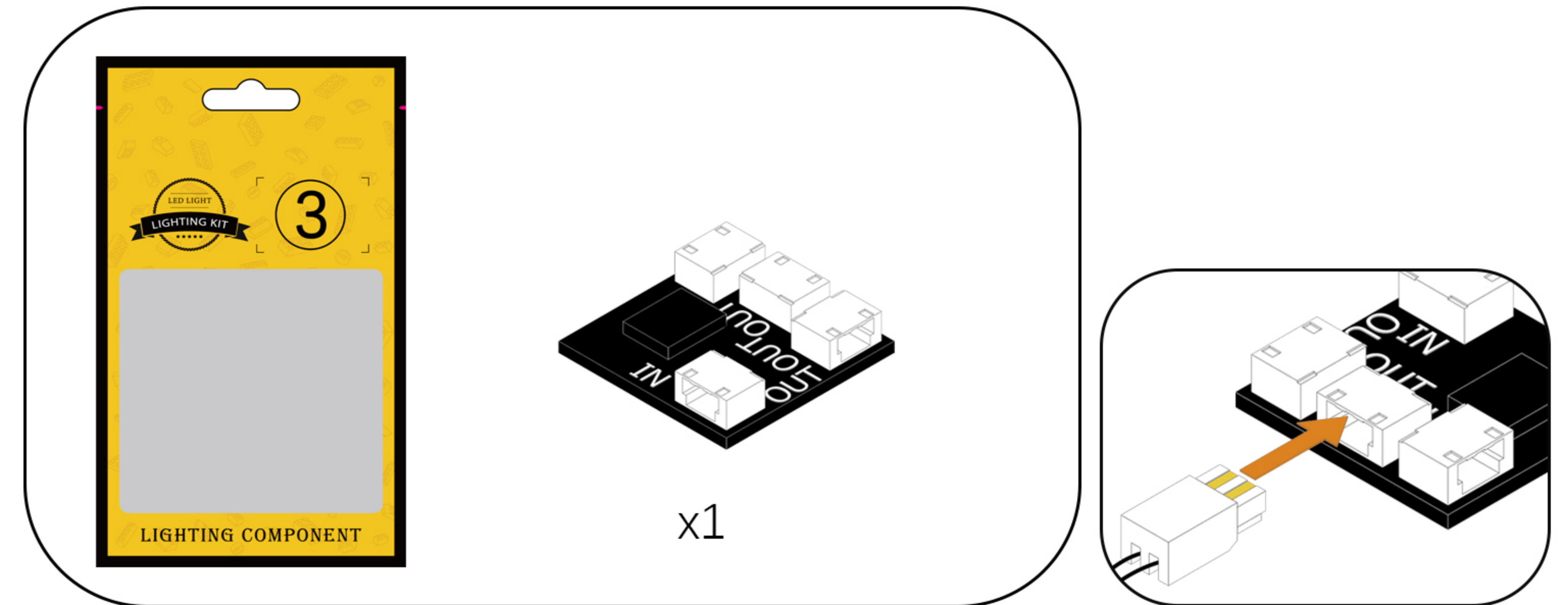

106 EN: Locate the three light wires in the diagram.
DE: Suchen Sie die drei Lichtkabel in der Abbildung.

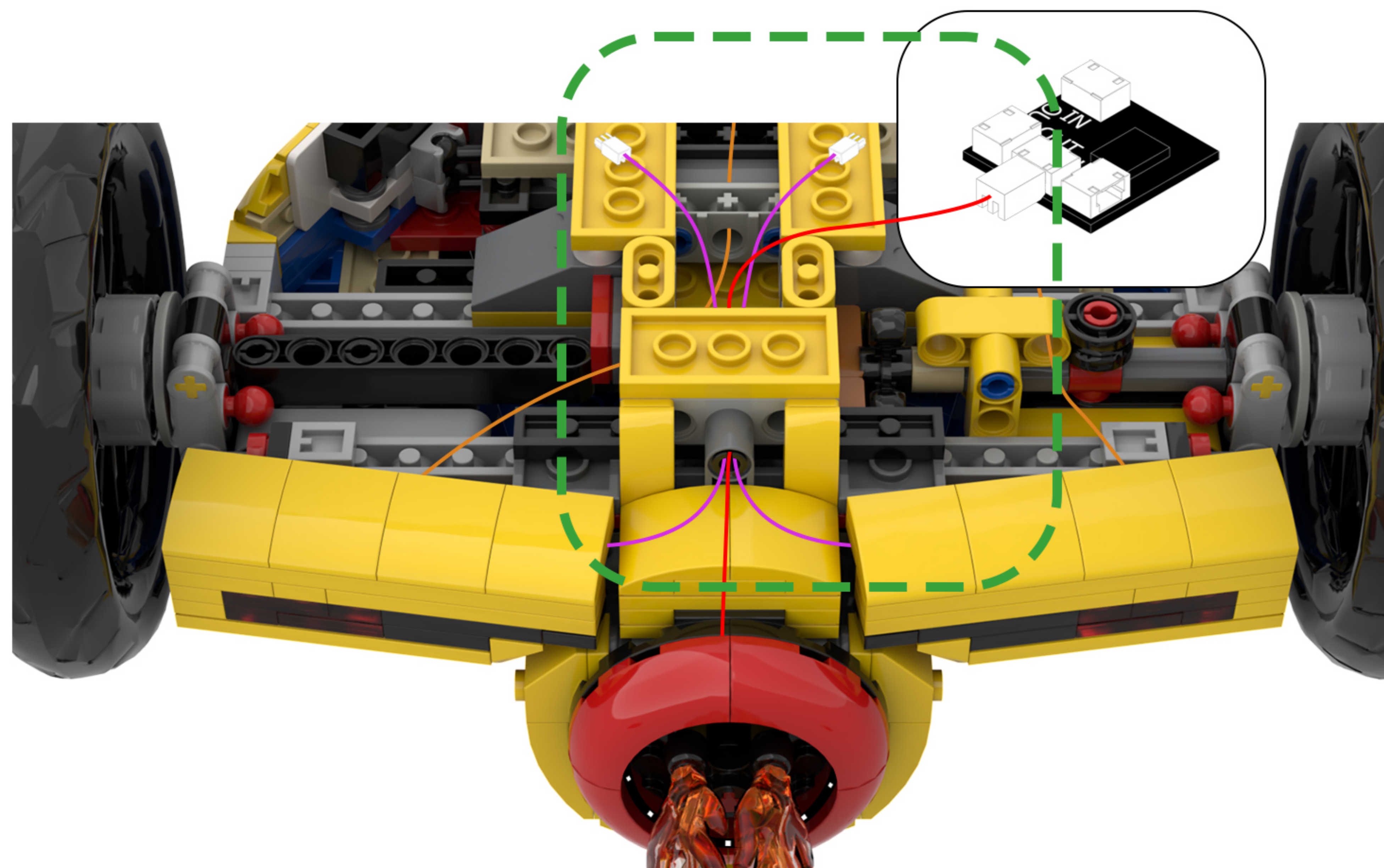

107 EN: Twist the three lamp cords together.
DE: Verdrehen Sie die drei Lampenkabel miteinander.

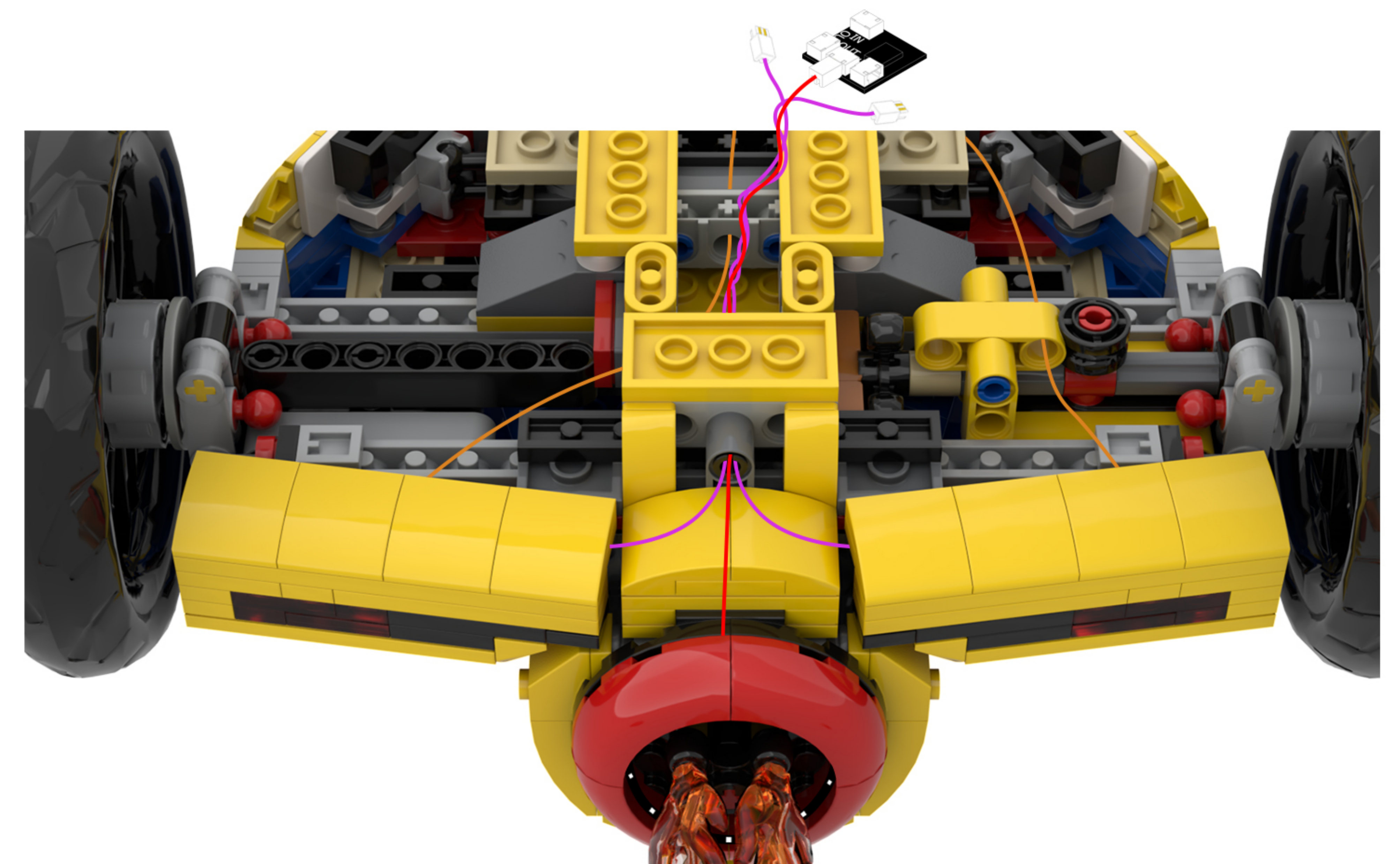

108

EN: Adjust your perspective.

DE: Ändern Sie Ihre Perspektive.

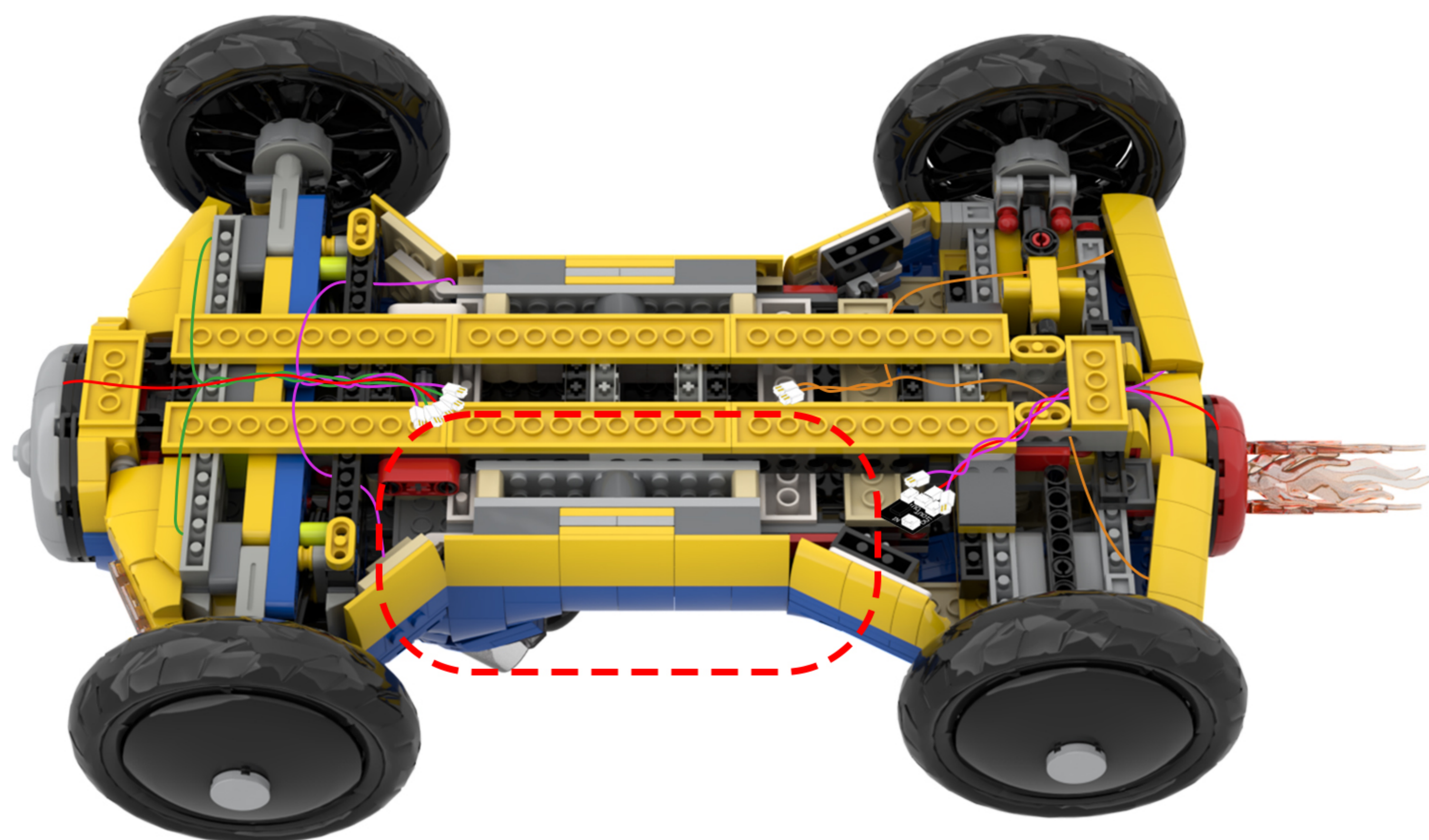

109

EN: Take the light strip out of Bag 2, peel off the adhesive backing from one of the strips, and attach it to the location shown in the diagram.

DE: Nehmen Sie den Lichtstreifen aus Beutel 2, ziehen Sie die Schutzfolie von einem der Streifen ab und bringen Sie ihn an der in der Abbildung gezeigten Stelle an.

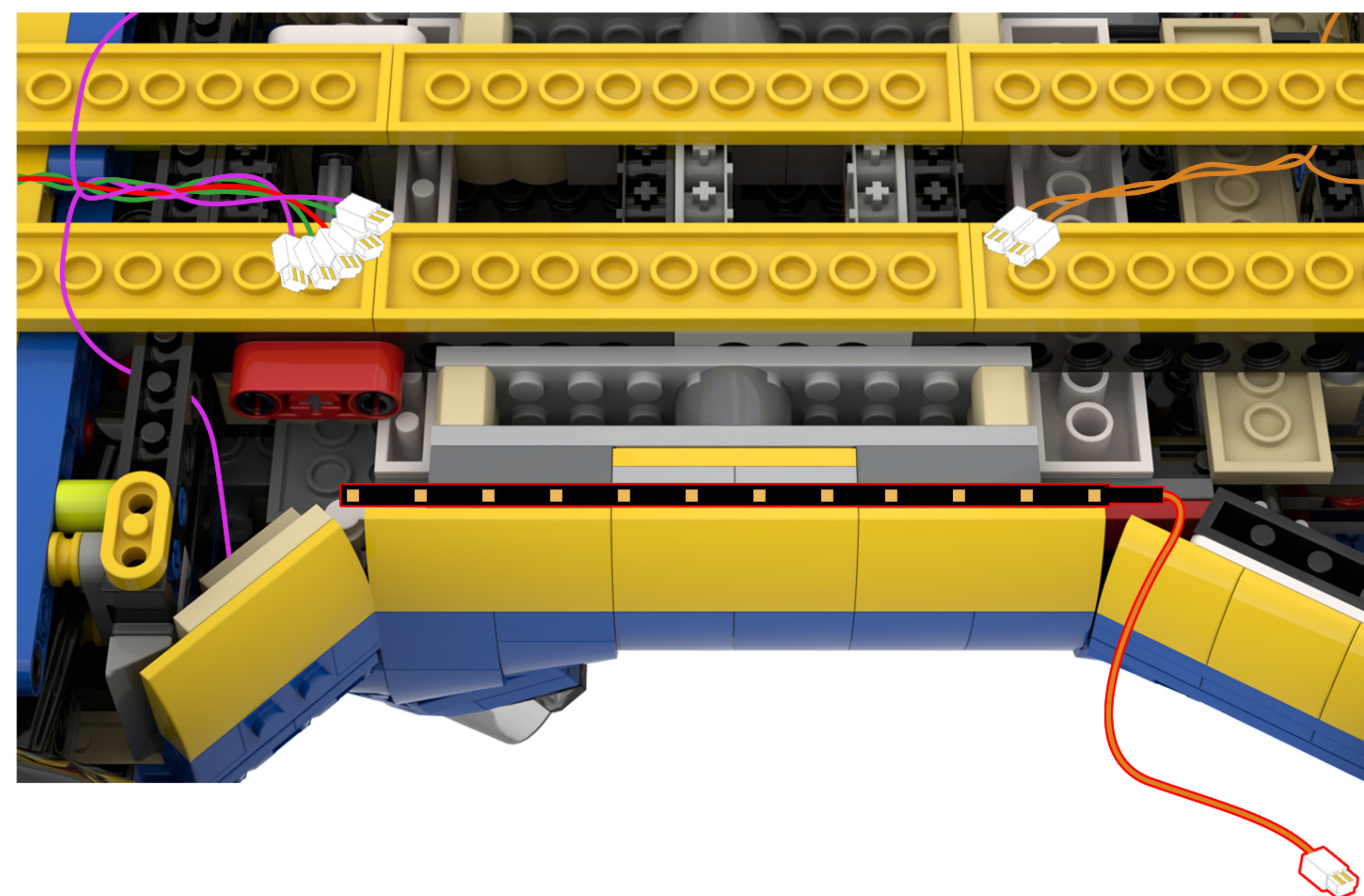
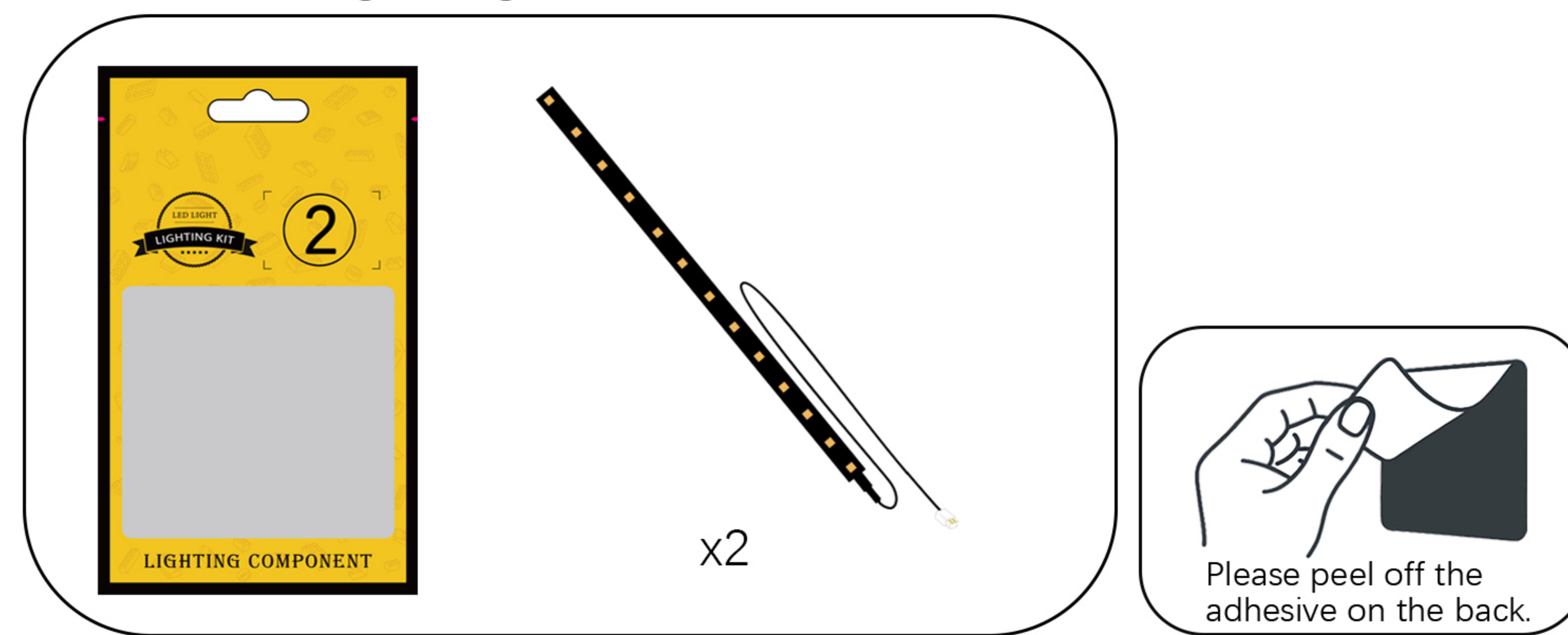

110

EN: Use tweezers to attach the end of the light strip to the building block.

DE: Befestige das Ende des Lichterbands mit einer Pinzette am Baustein.

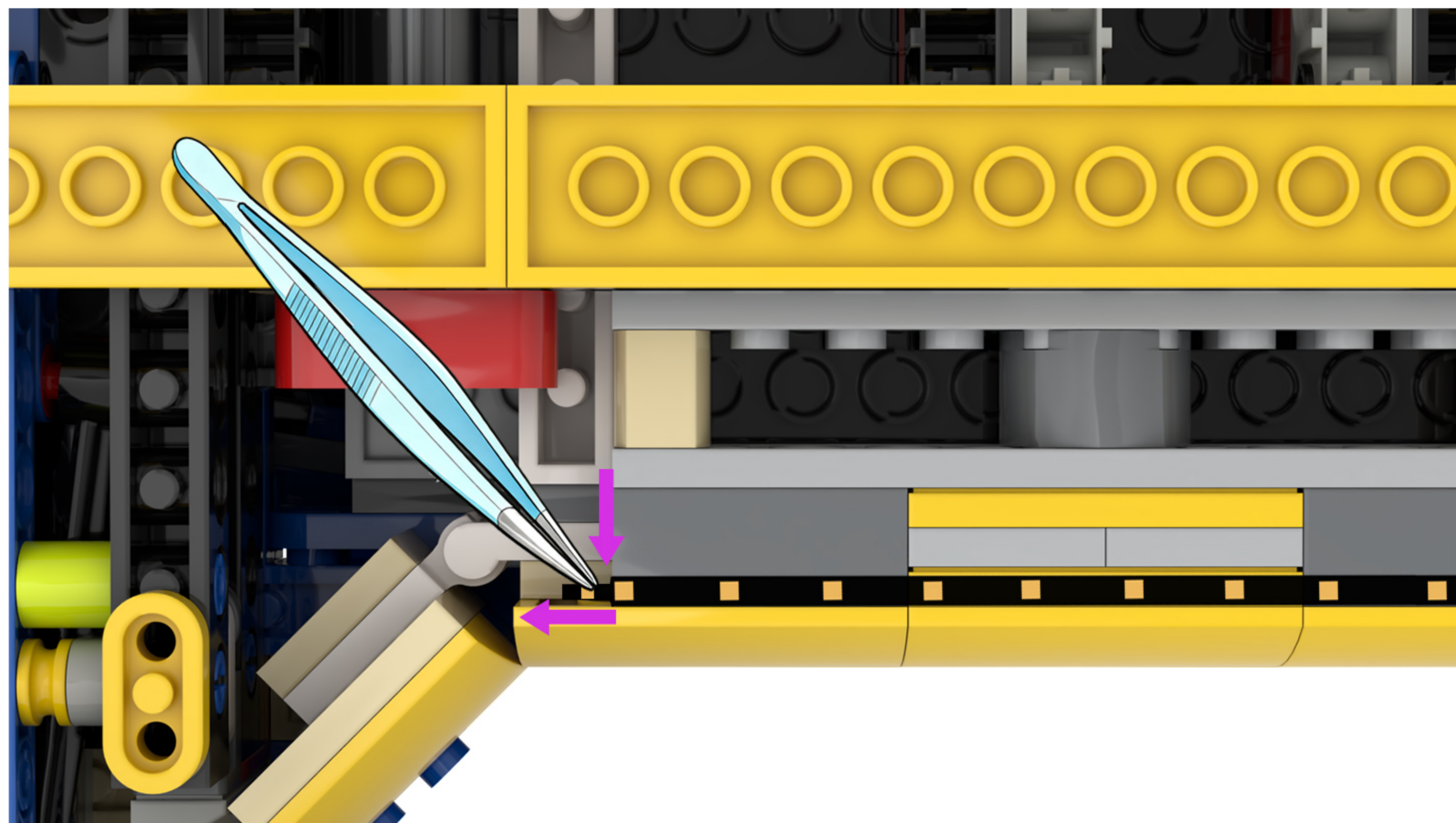

111

EN: Use tweezers to attach the front end of the light strip to the building block.

DE: Befestige das vordere Ende des Lichterbands mit einer Pinzette am Baustein.

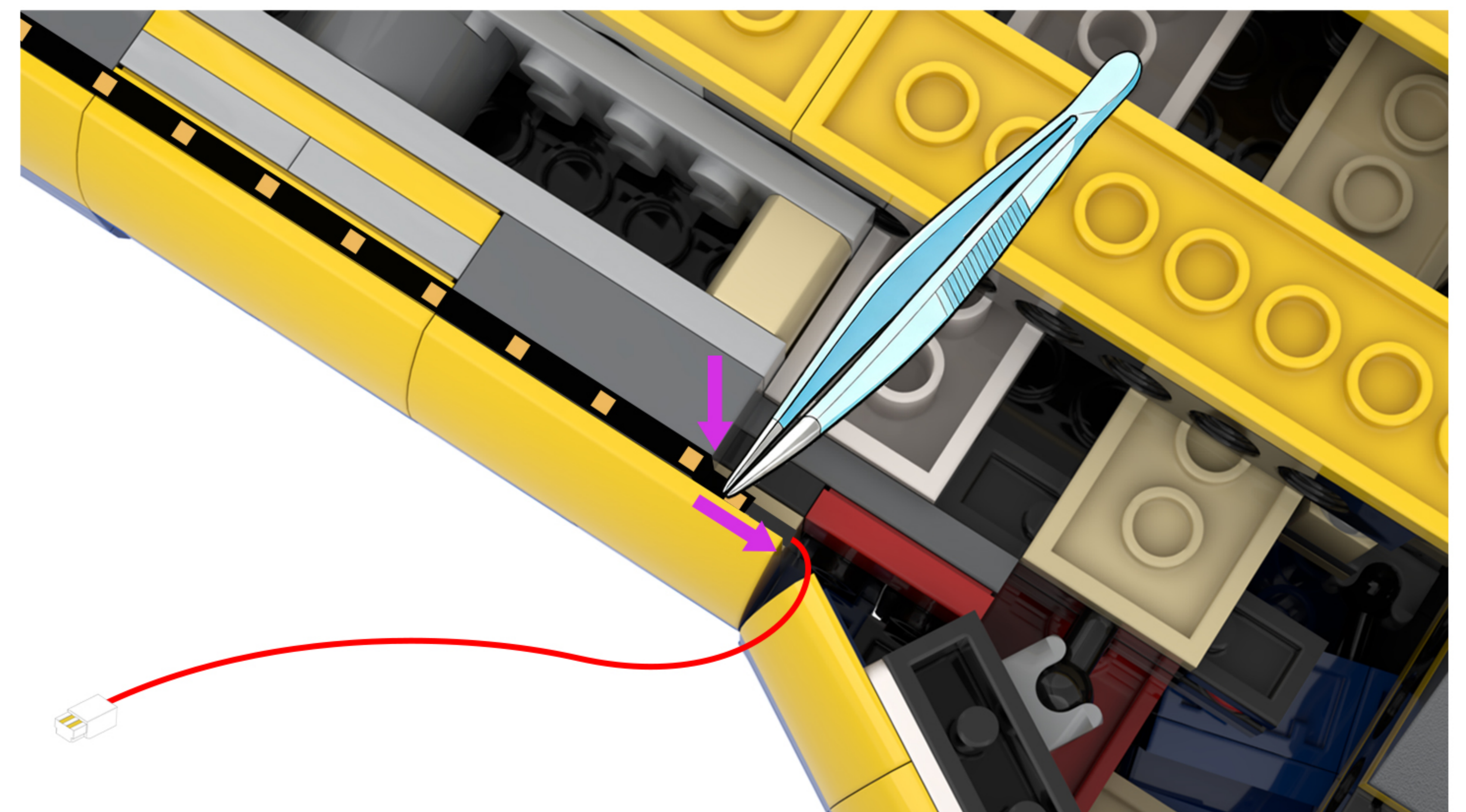

112 EN: Thread the light cord through the holes in the building blocks.
DE: Führen Sie das Lichtschnur durch die Löcher in den Bausteinen.

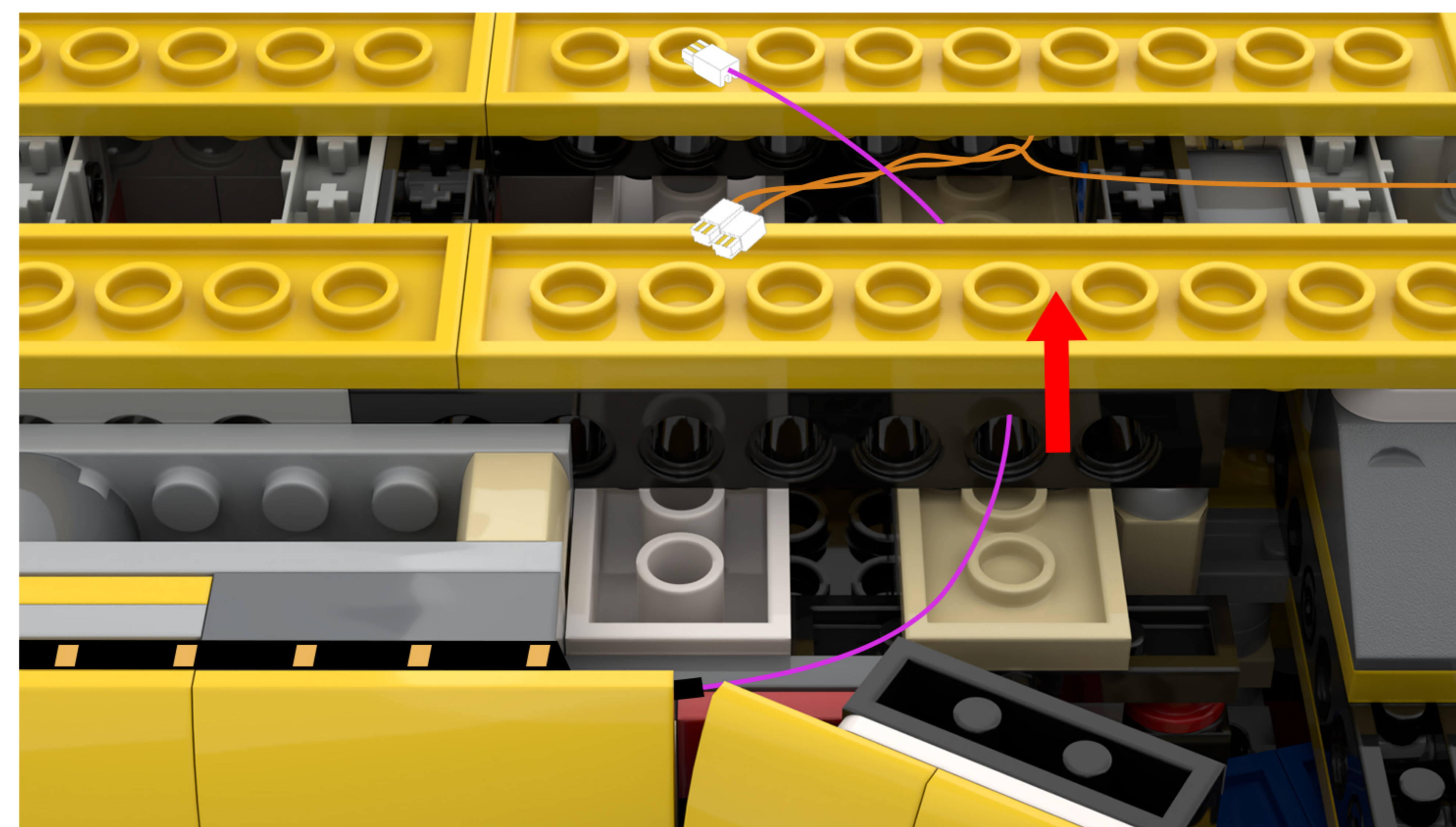
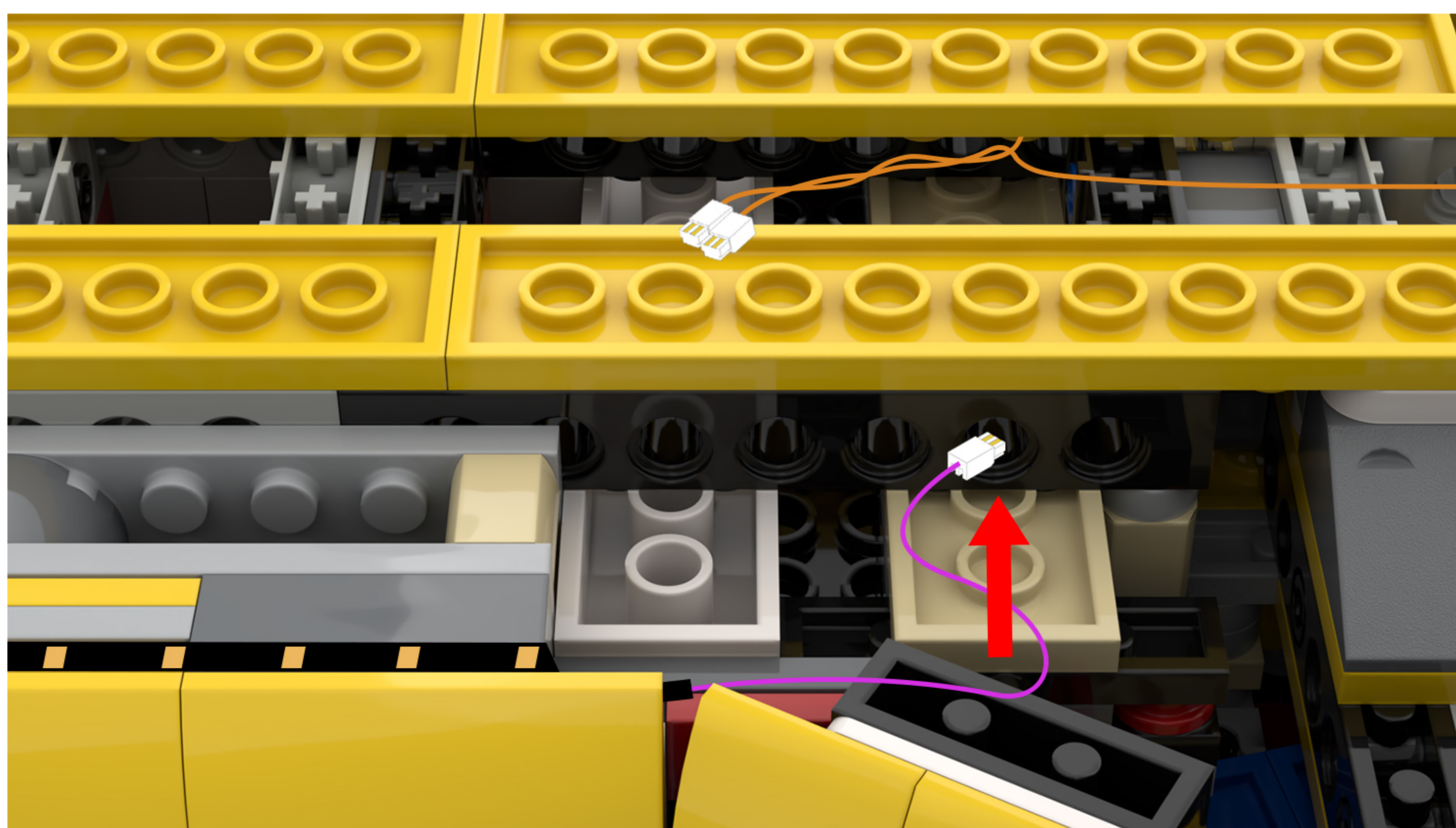

113

EN: Peel off the adhesive backing from the other strip of LED lights and attach it to the location shown in the diagram.

DE: Ziehen Sie die Schutzfolie von dem anderen LED-Streifen ab und befestigen Sie ihn an der in der Abbildung gezeigten Stelle.

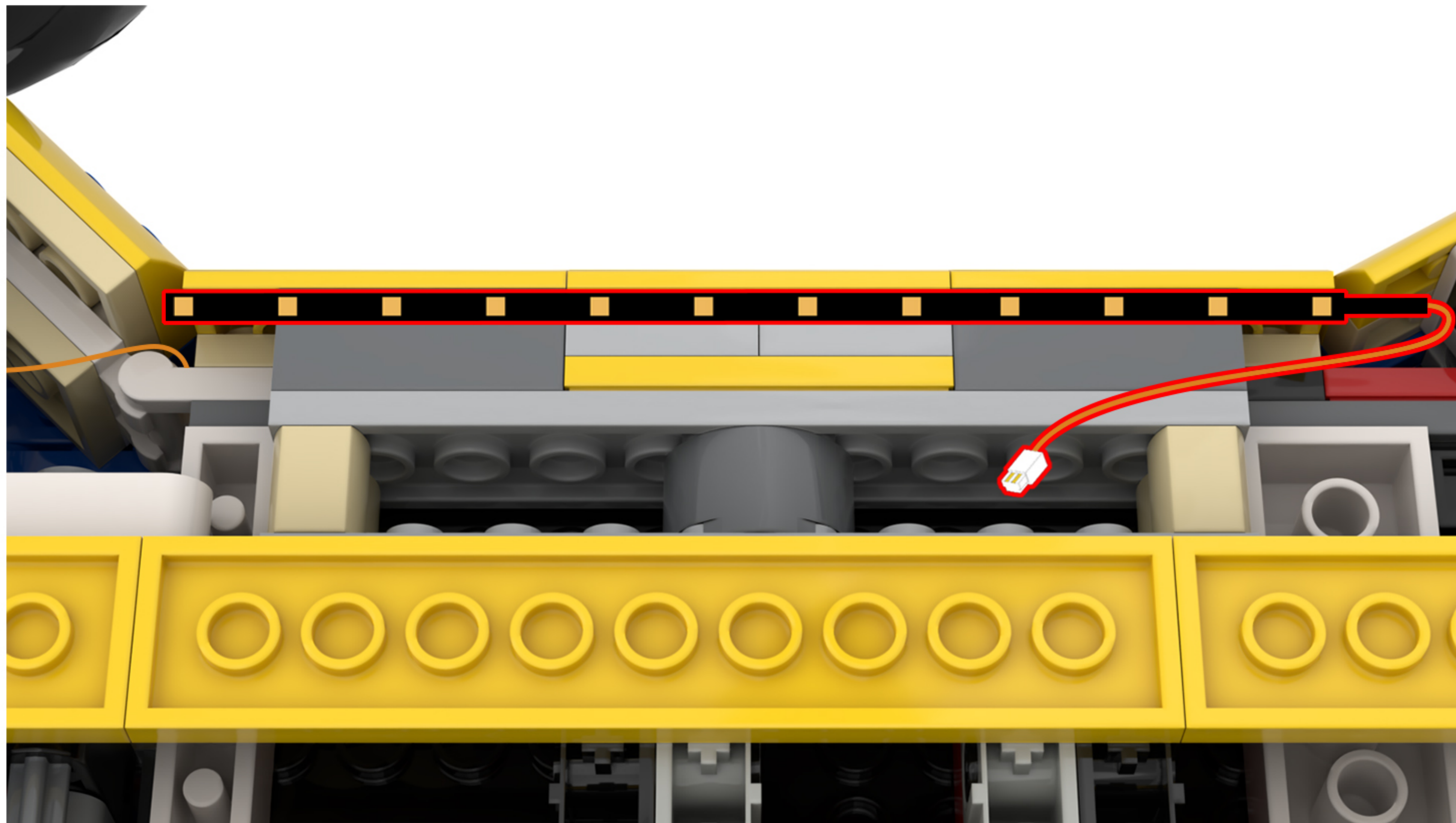

114

EN: Use tweezers to attach both ends of the light strip to the building blocks.

DE: Befestige beide Enden des Lichterbands mit einer Pinzette an den Bausteinen.

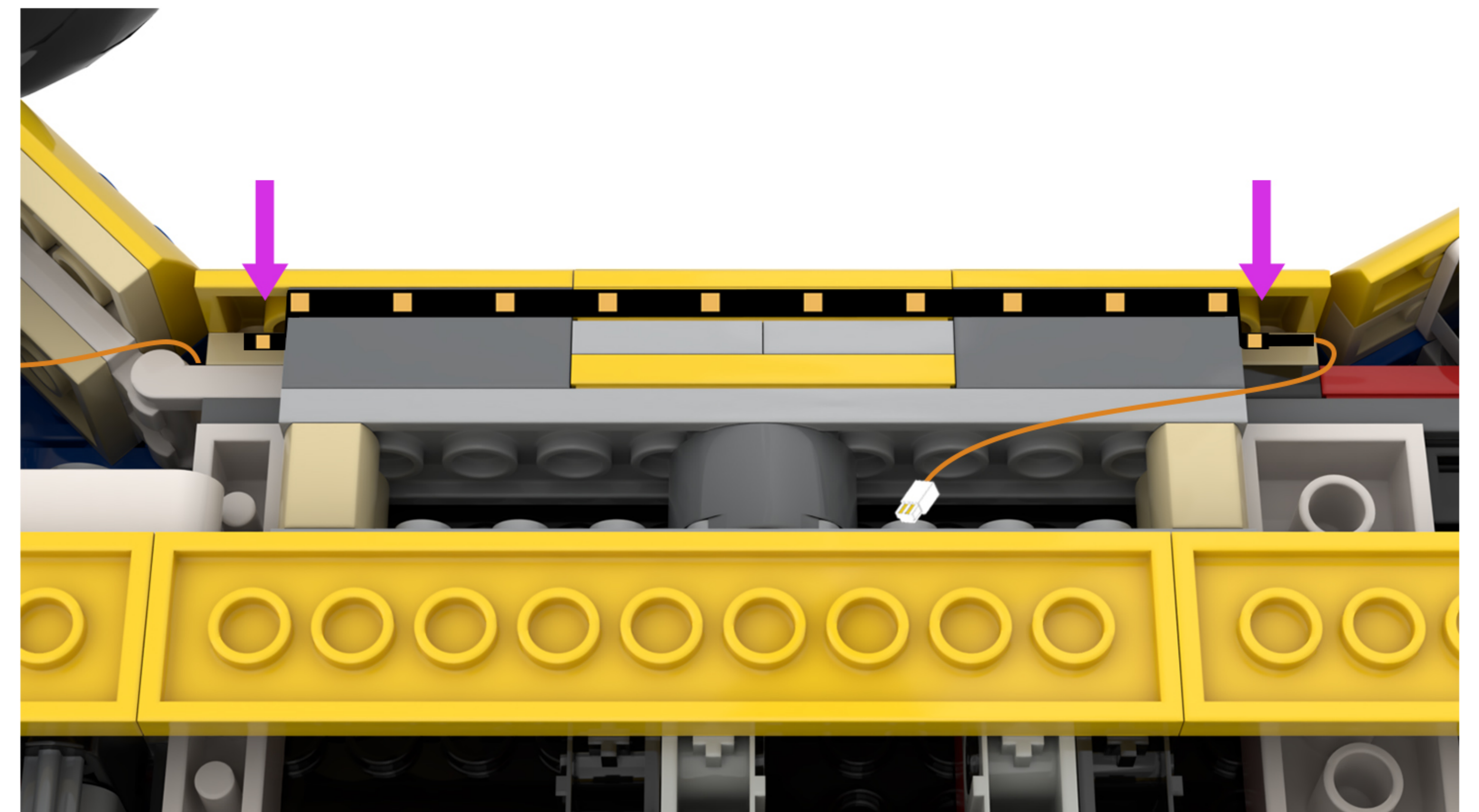

115 EN: Thread the light cord through the holes in the building blocks.
DE: Führen Sie das Lichtschnur durch die Löcher in den Bausteinen.

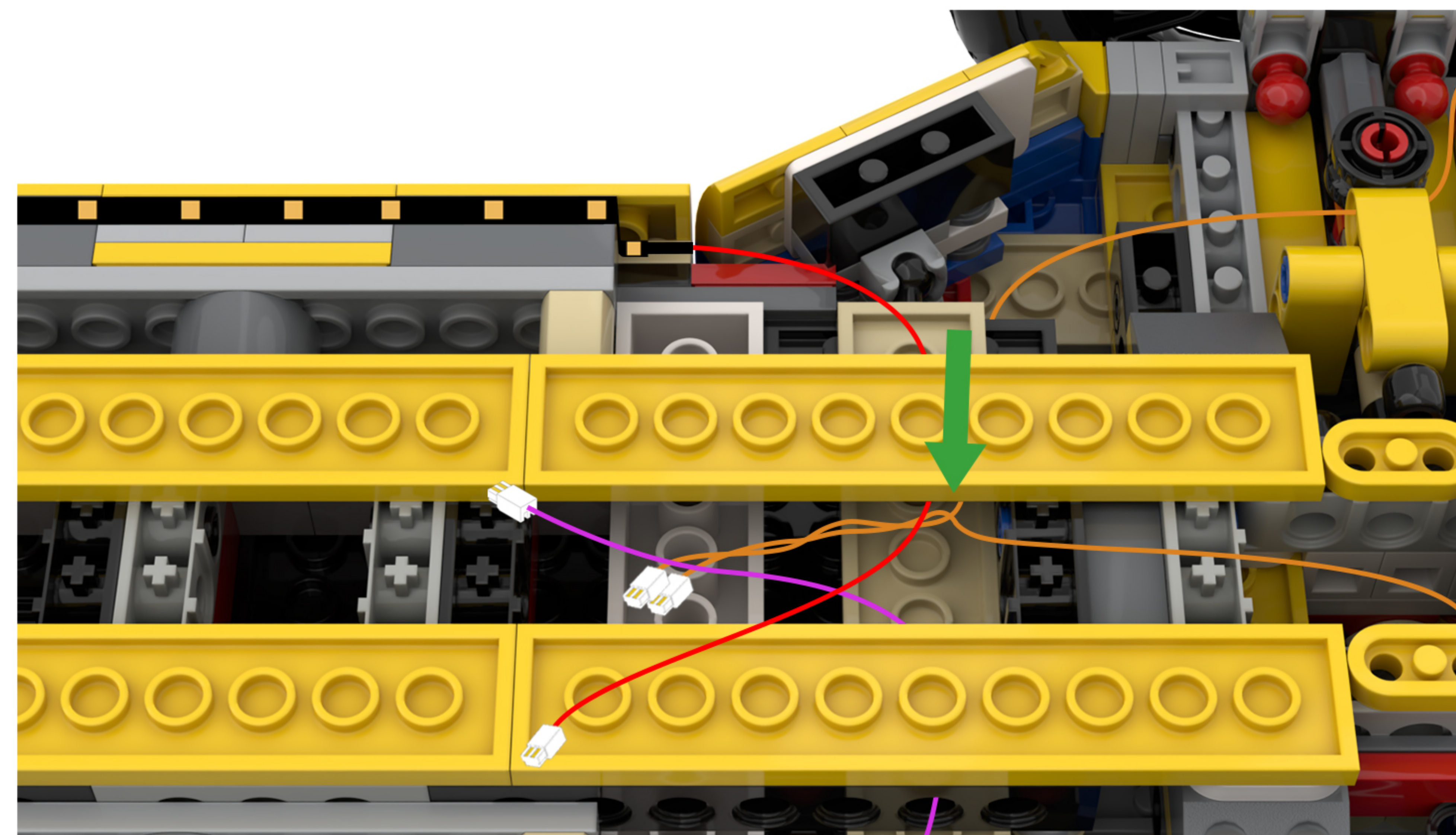
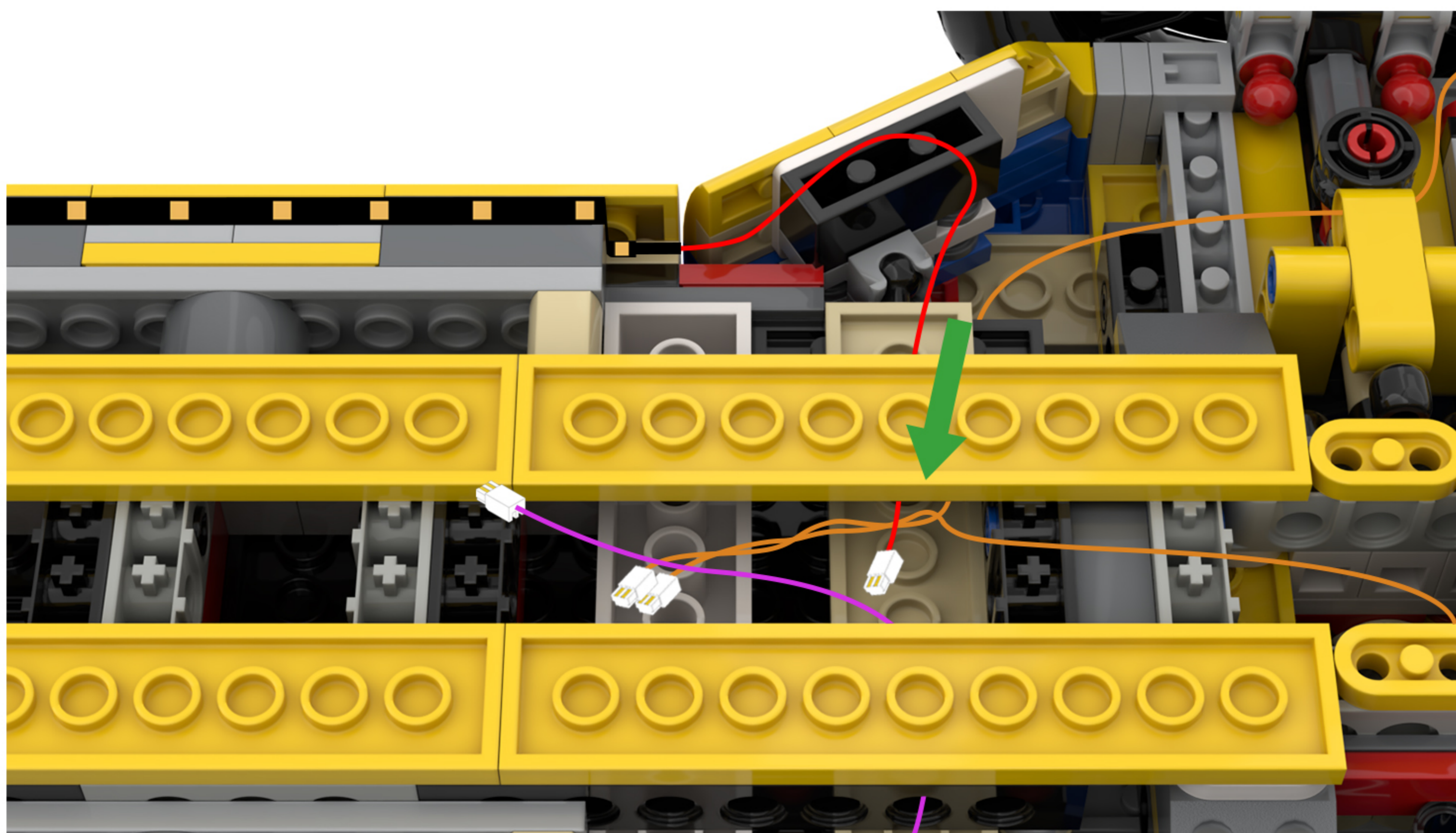

116 EN: Locate the four light wires in the diagram.
DE: Suchen Sie die vier Lichtkabel in der Abbildung.

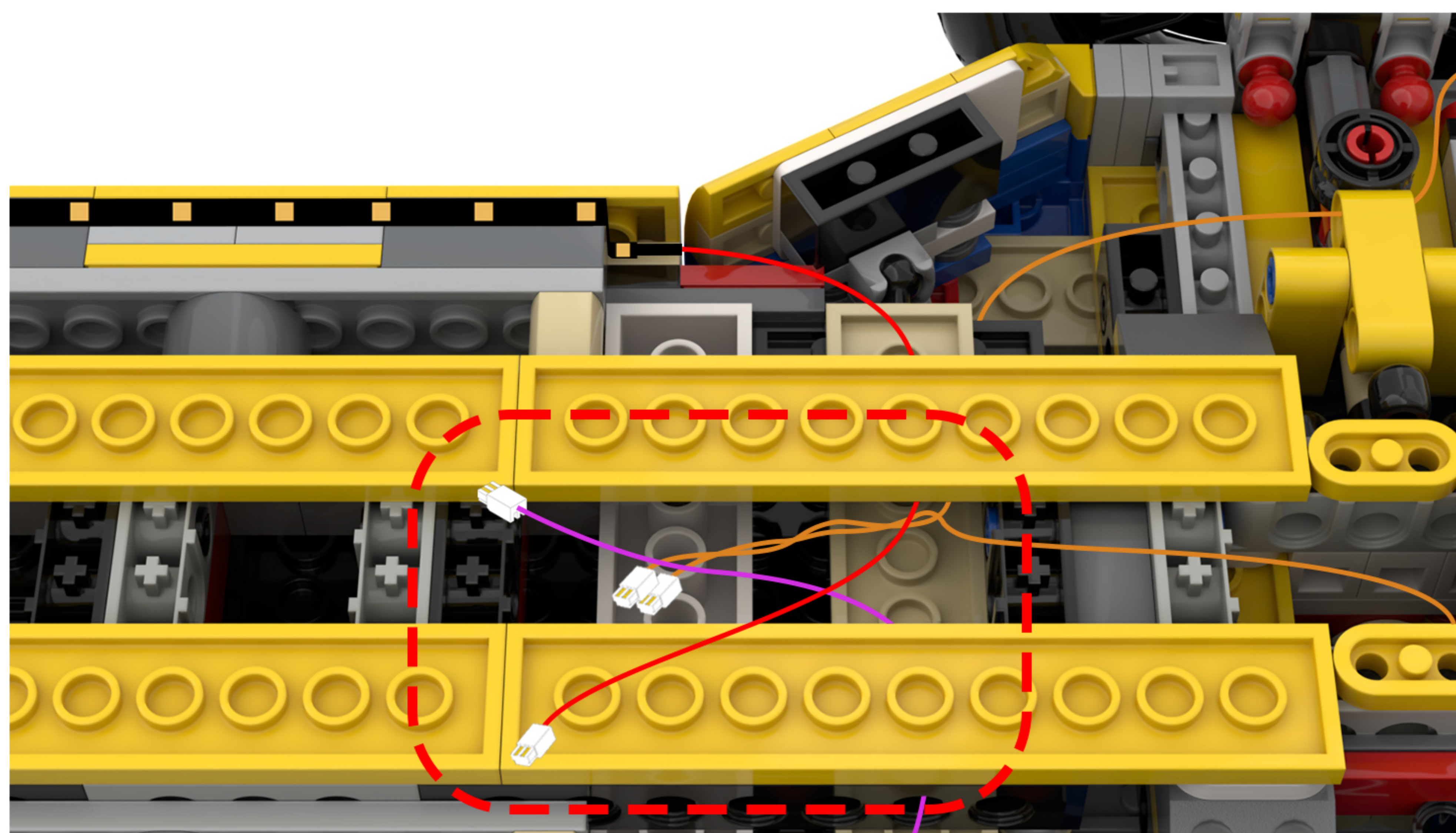

117 EN: Twist the four lamp cords together.
DE: Verdrehen Sie die vier Lampenkabel miteinander.

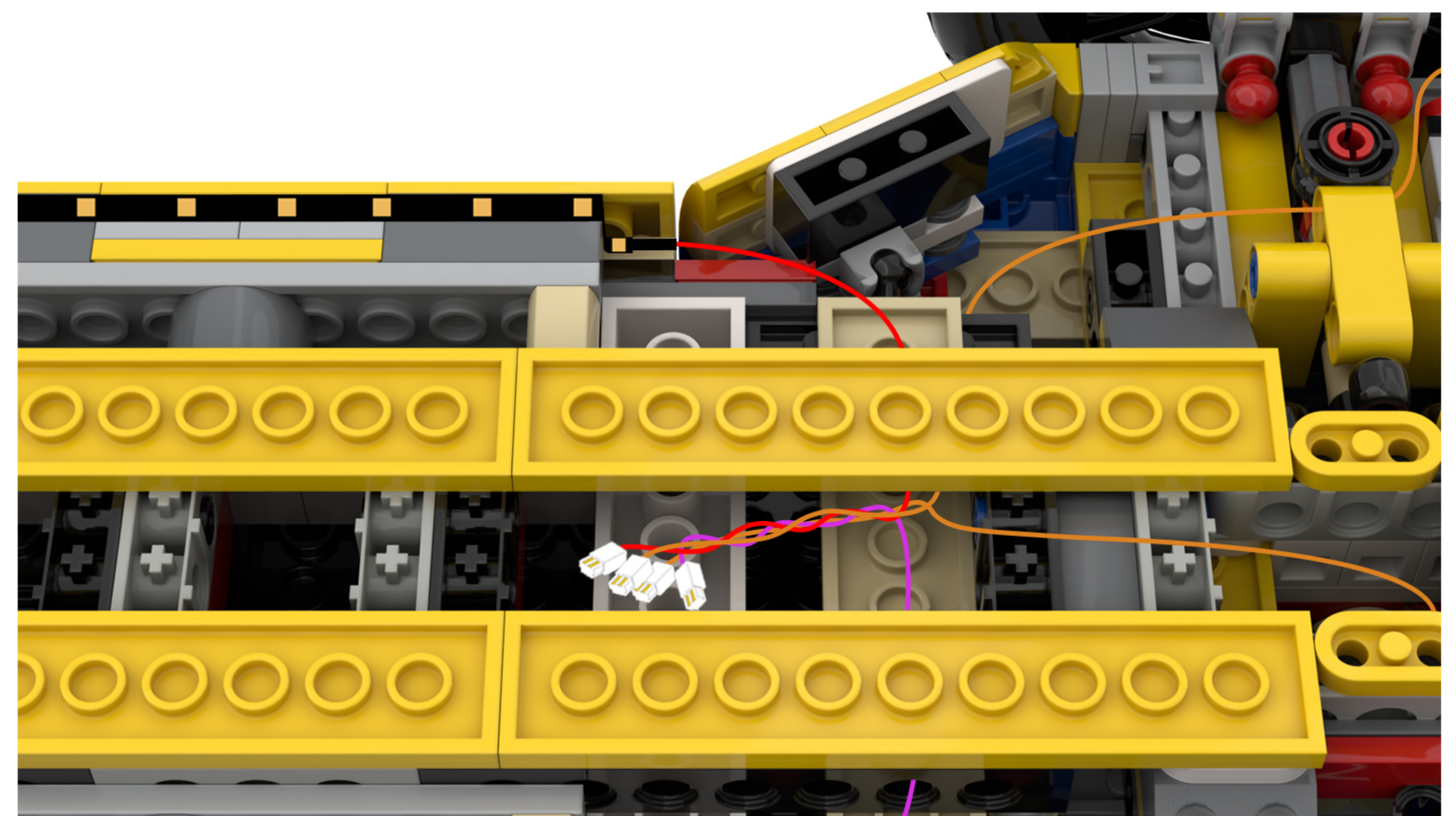

118

EN: Find the five lighting cables on the left side of the model.

DE: Suchen Sie die fünf Beleuchtungskabel auf der linken Seite des Modells.

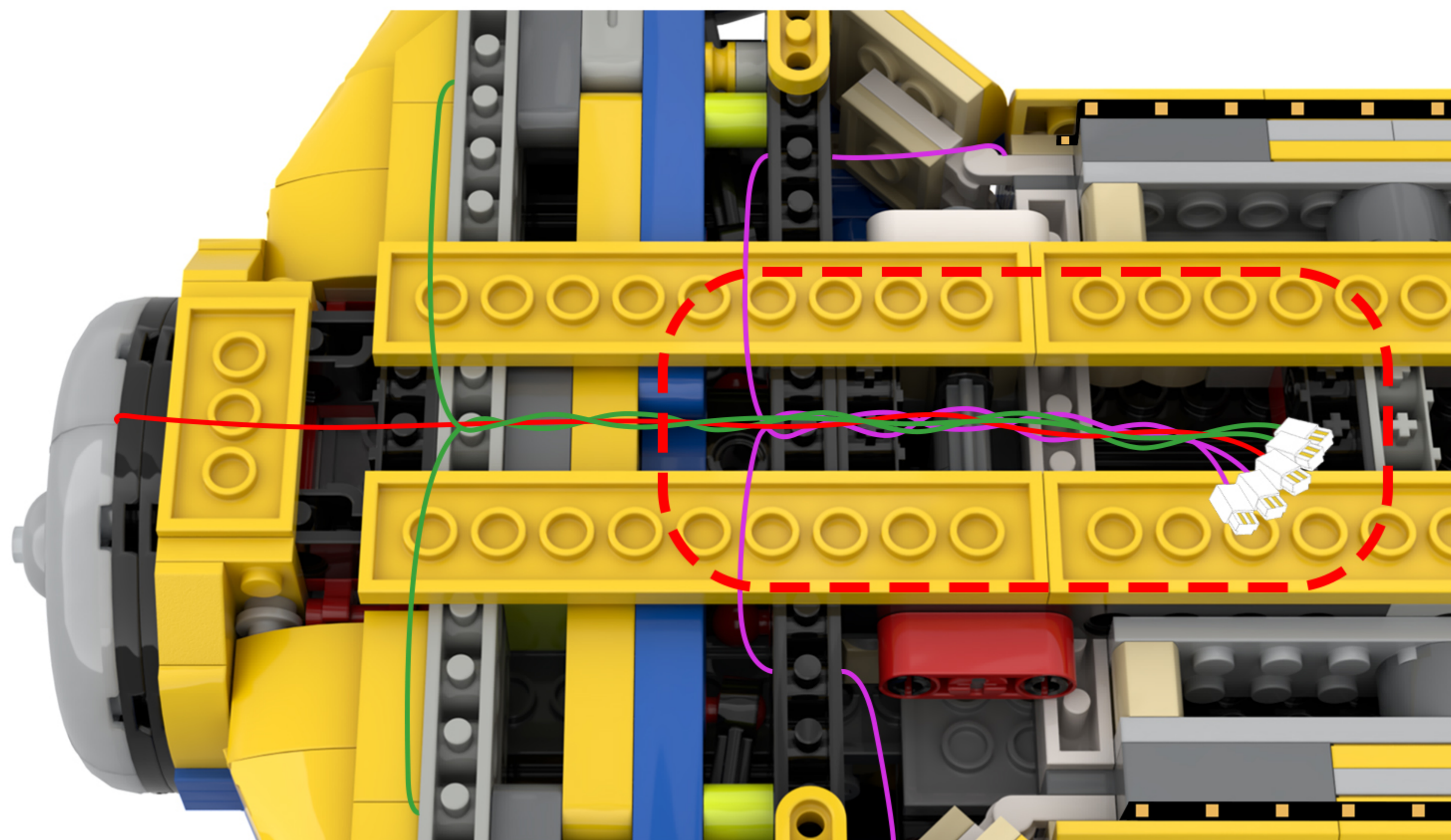

119

EN: Take the 6-port expansion board from Bag 8 and connect the 5 light cables to the expansion board in sequence.

DE: Nehmen Sie die 6-Port-Erweiterungskarte aus Beutel 8 und schließen Sie die 5 Lichtkabel der Reihe nach an die Erweiterungskarte an.

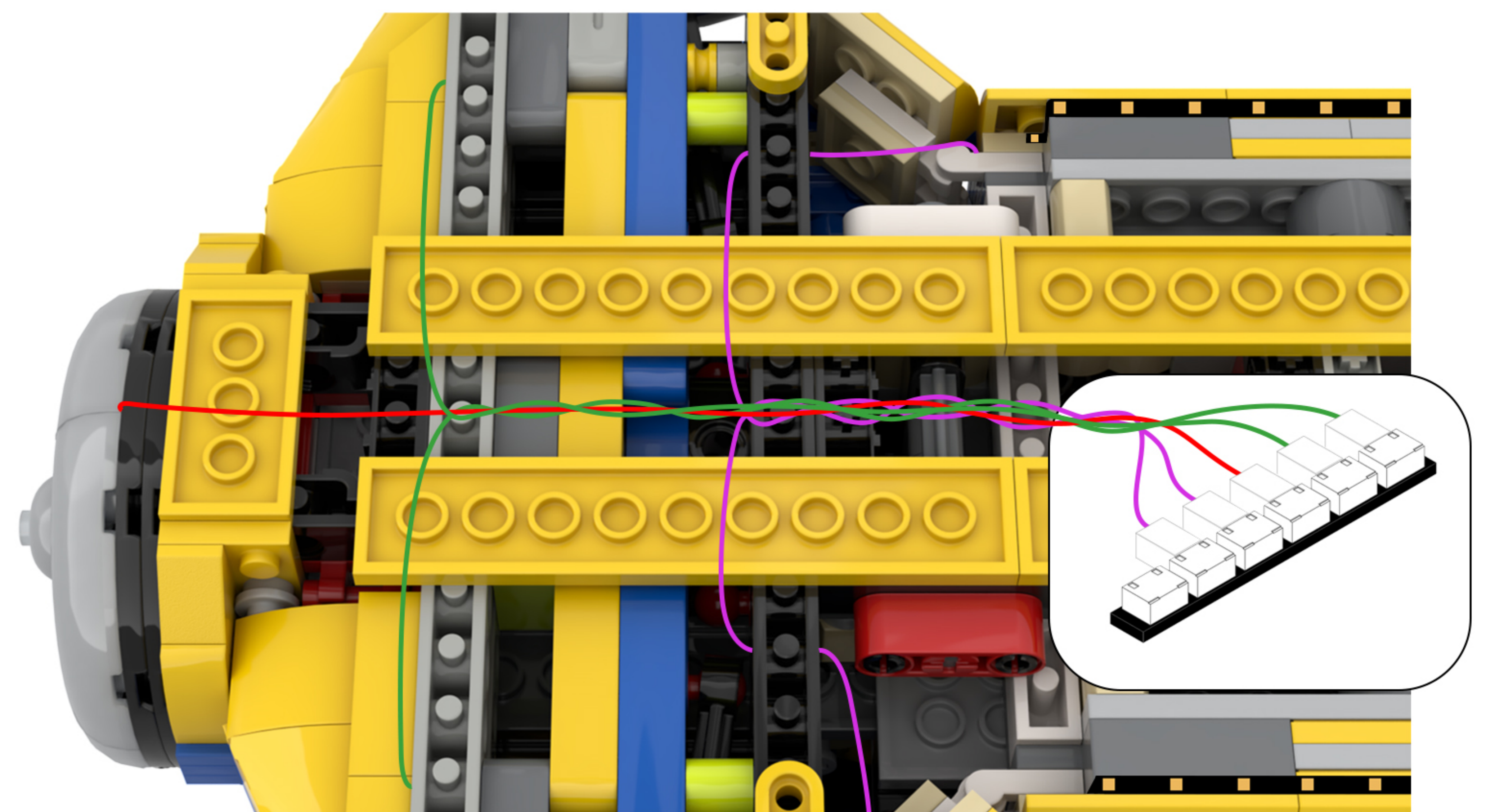
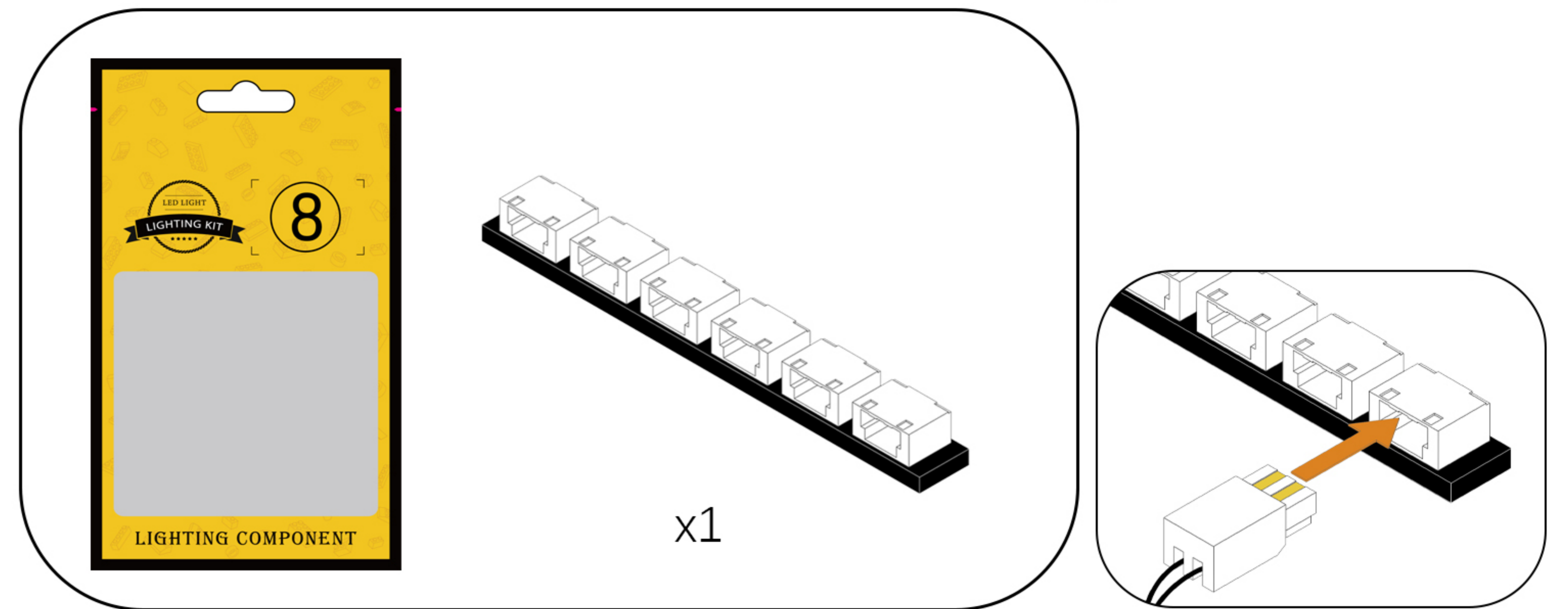

120

EN: Take the 20-cm connector cable from Bag 4 and connect it to the 6-port expansion board.

DE: Nehmen Sie das 20 cm lange Verbindungskabel aus Beutel 4 und schließen Sie es an die 6-Port-Erweiterungskarte an.

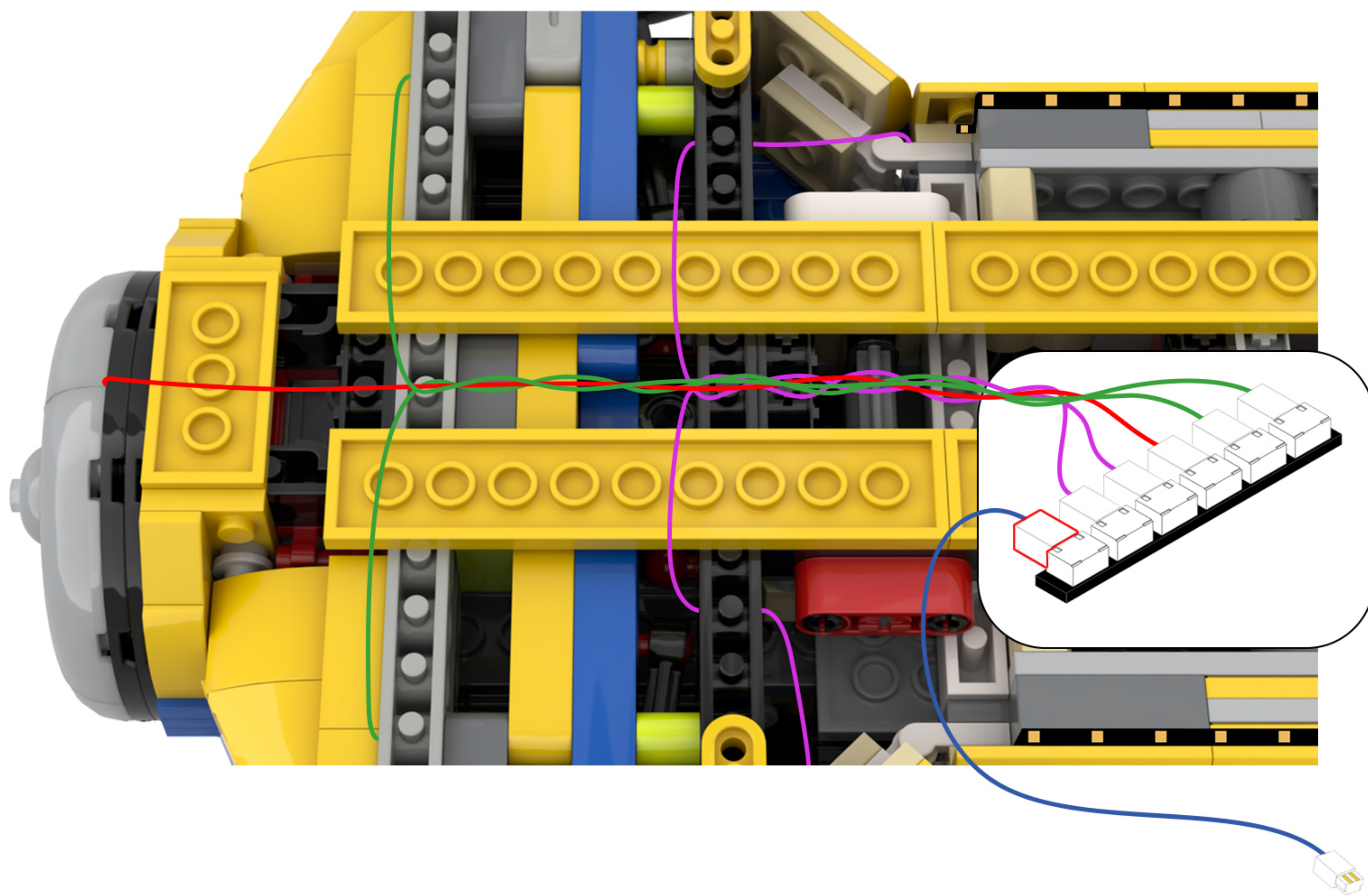
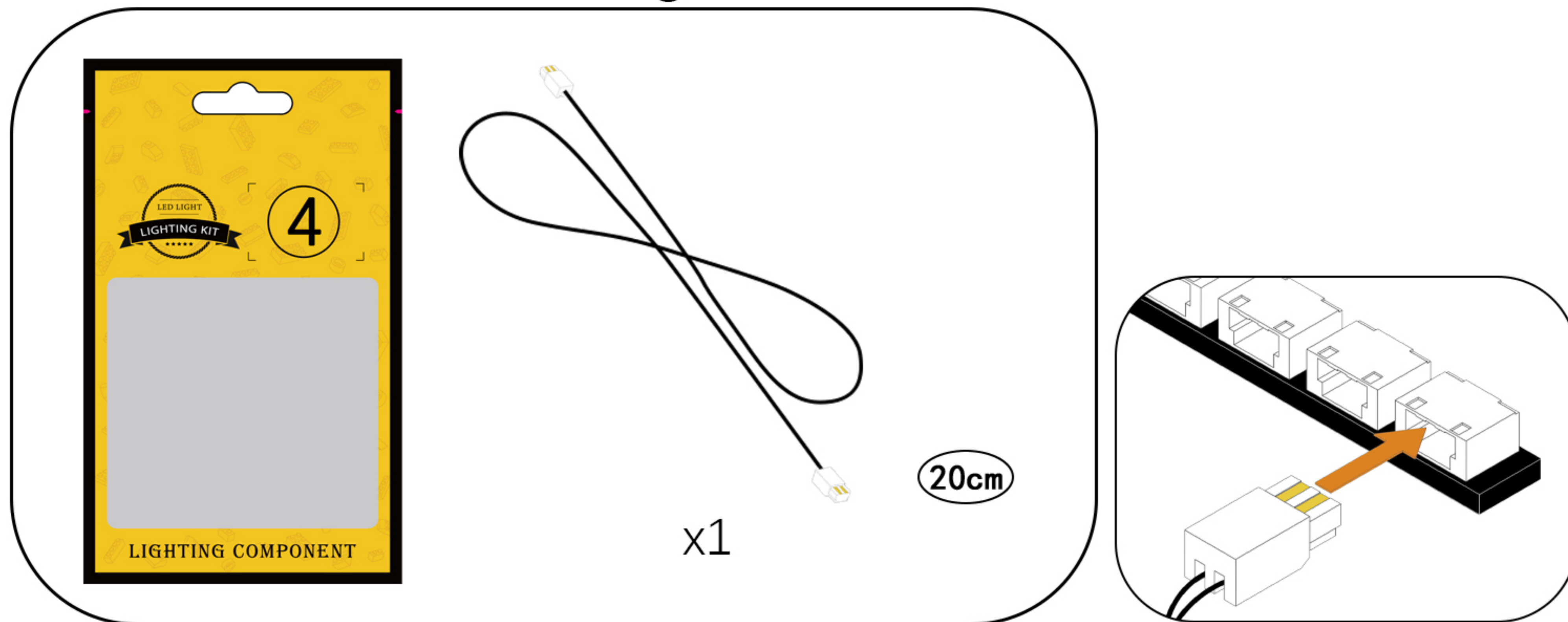

121

EN: Peel off the adhesive backing of the expansion board and attach it to the location shown in the illustration.

DE: Entfernen Sie die Schutzfolie von der Rückseite der Erweiterungsplatte und kleben Sie sie an die in der Abbildung gezeigte Stelle.

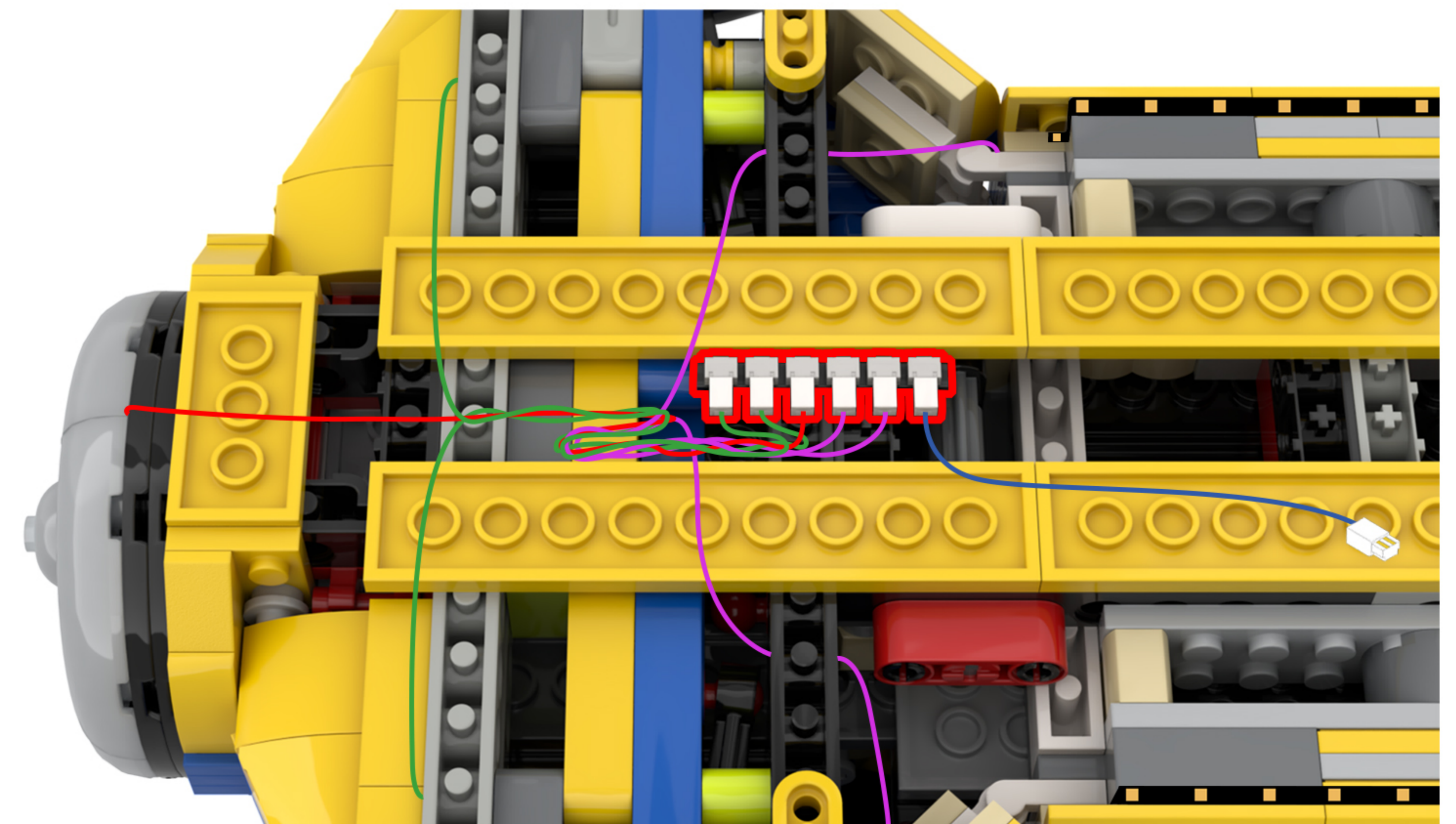

122

EN: Locate the six lighting cables on the right side of the model.

DE: Suchen Sie die sechs Beleuchtungskabel auf der rechten Seite des Modells.

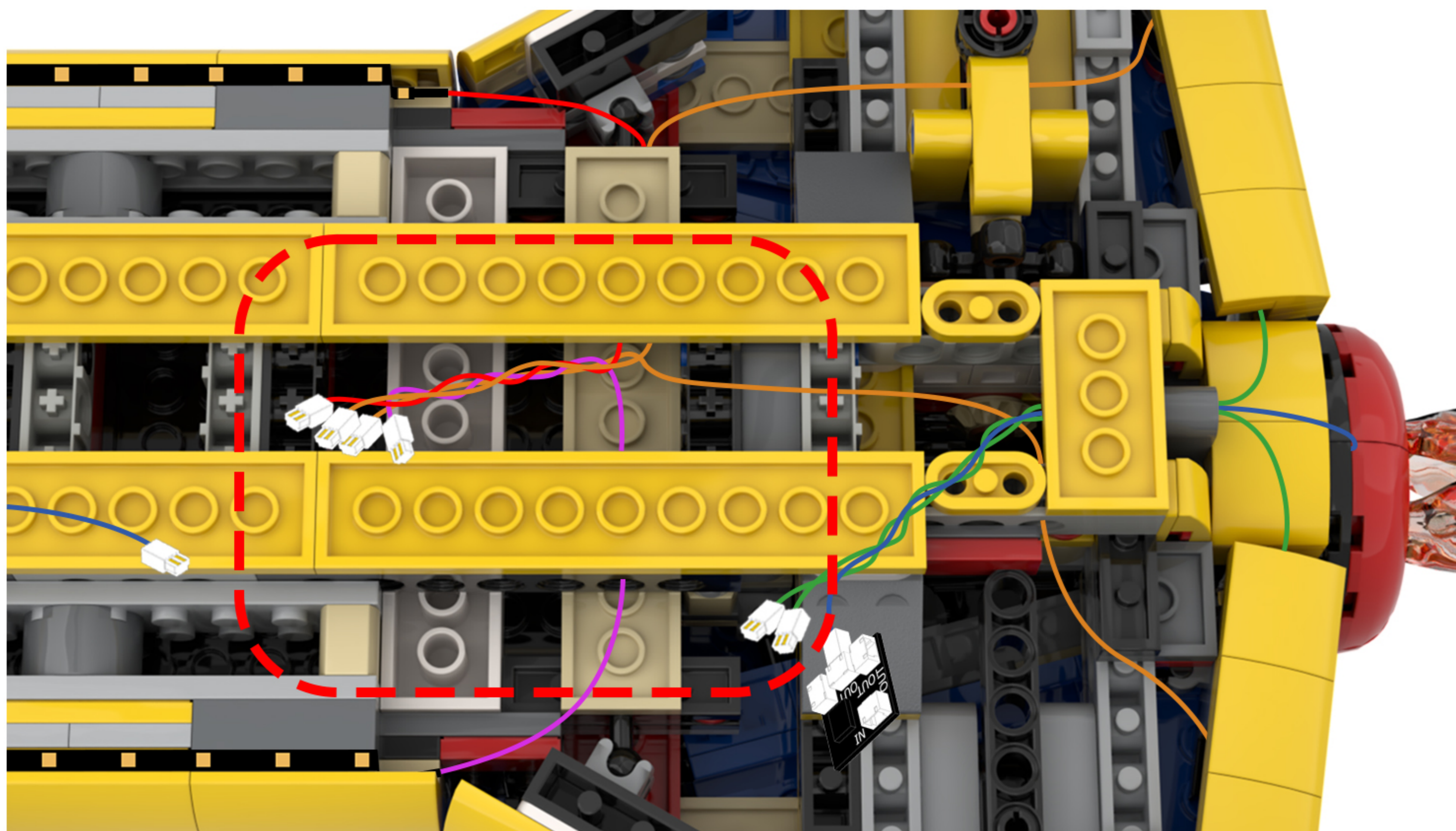

123

EN: Take the 12-port expansion board from Bag 8 and connect the 6 lighting cables to the expansion board in sequence.

DE: Nehmen Sie die 12-Port-Erweiterungskarte aus Beutel 8 und schließen Sie die 6 Beleuchtungskabel der Reihe nach an die Erweiterungskarte an.

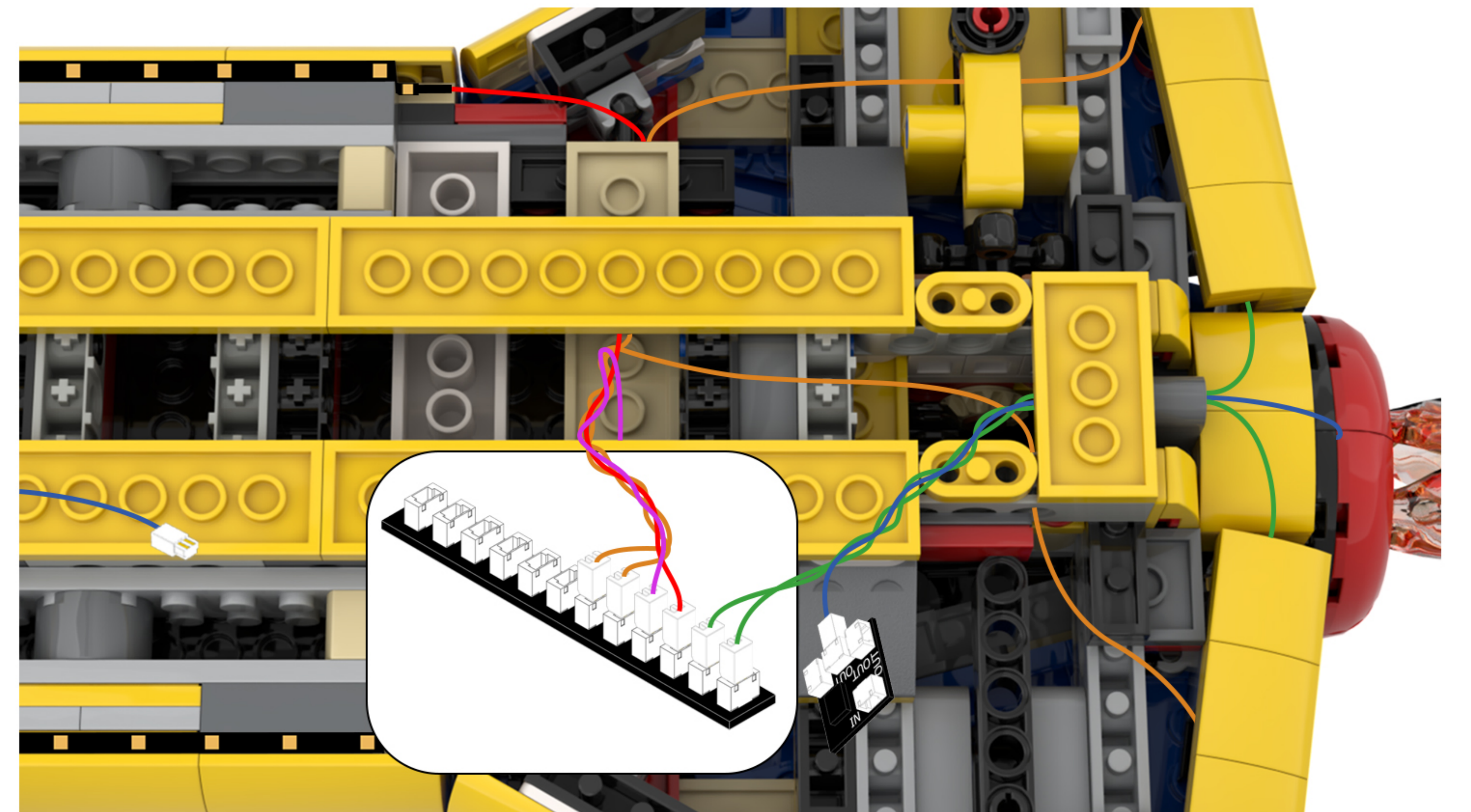
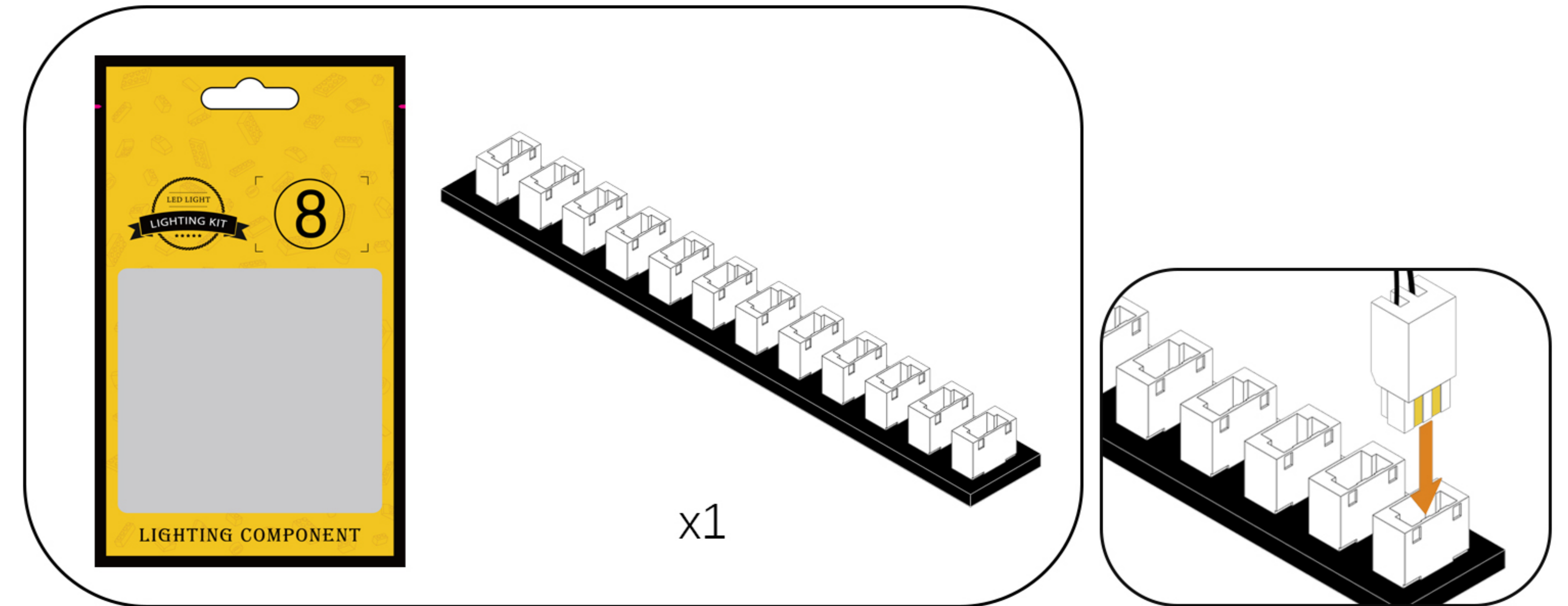

124

EN: Take the 5-cm connector cable from Bag 4 and connect it to the flame module.

DE: Nehmen Sie das 5 cm lange Verbindungskabel aus Beutel 4 und schließen Sie es an das Flammenmodul an.

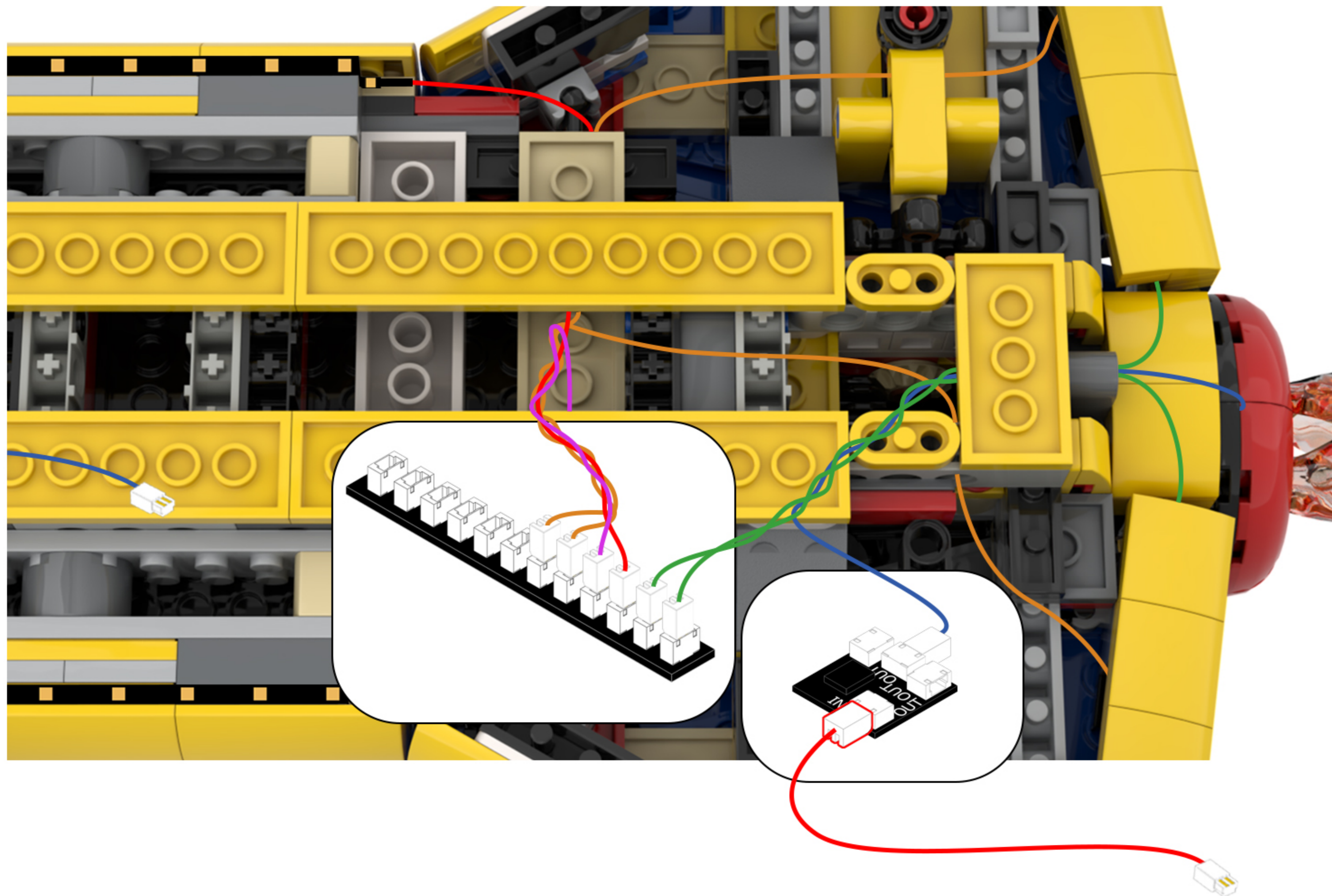
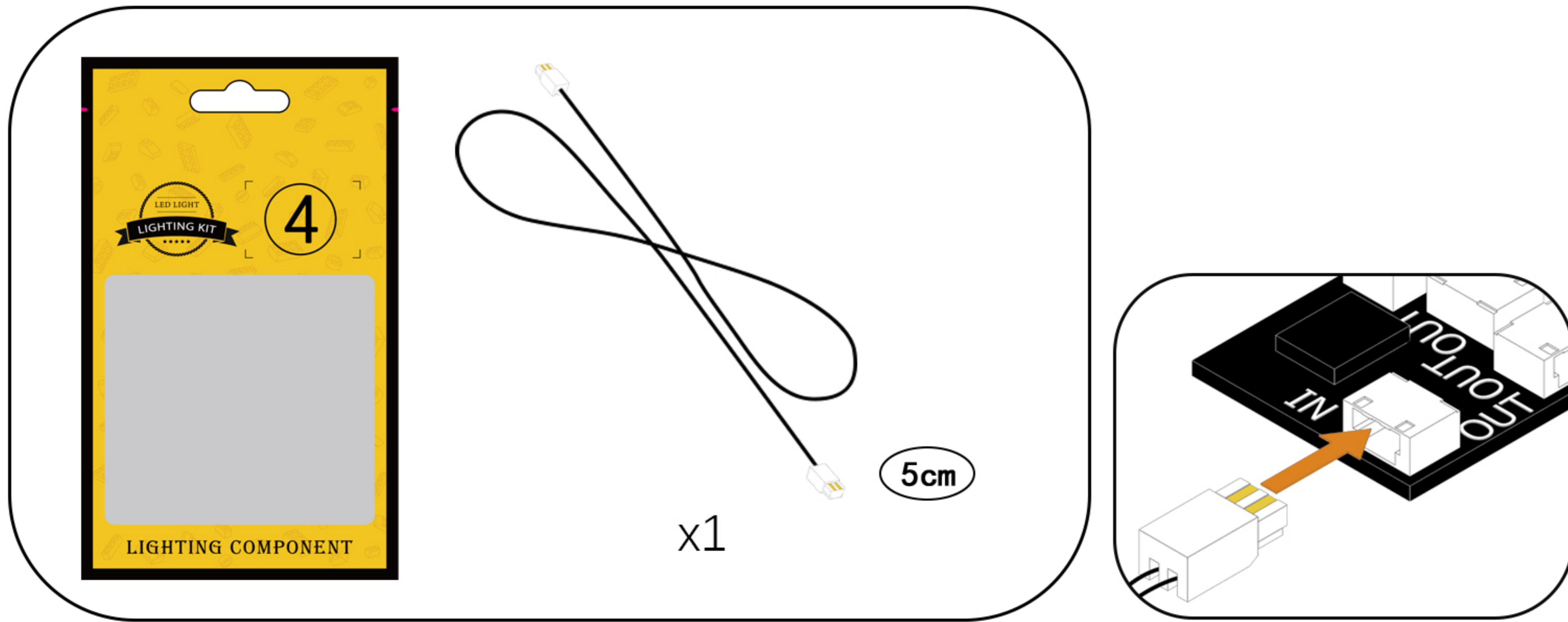

125

EN: Peel off the adhesive backing from the flame module and attach it to the location shown in the illustration.

DE: Ziehen Sie die Schutzfolie vom Flammenmodul ab und bringen Sie es an der in der Abbildung gezeigten Stelle an.

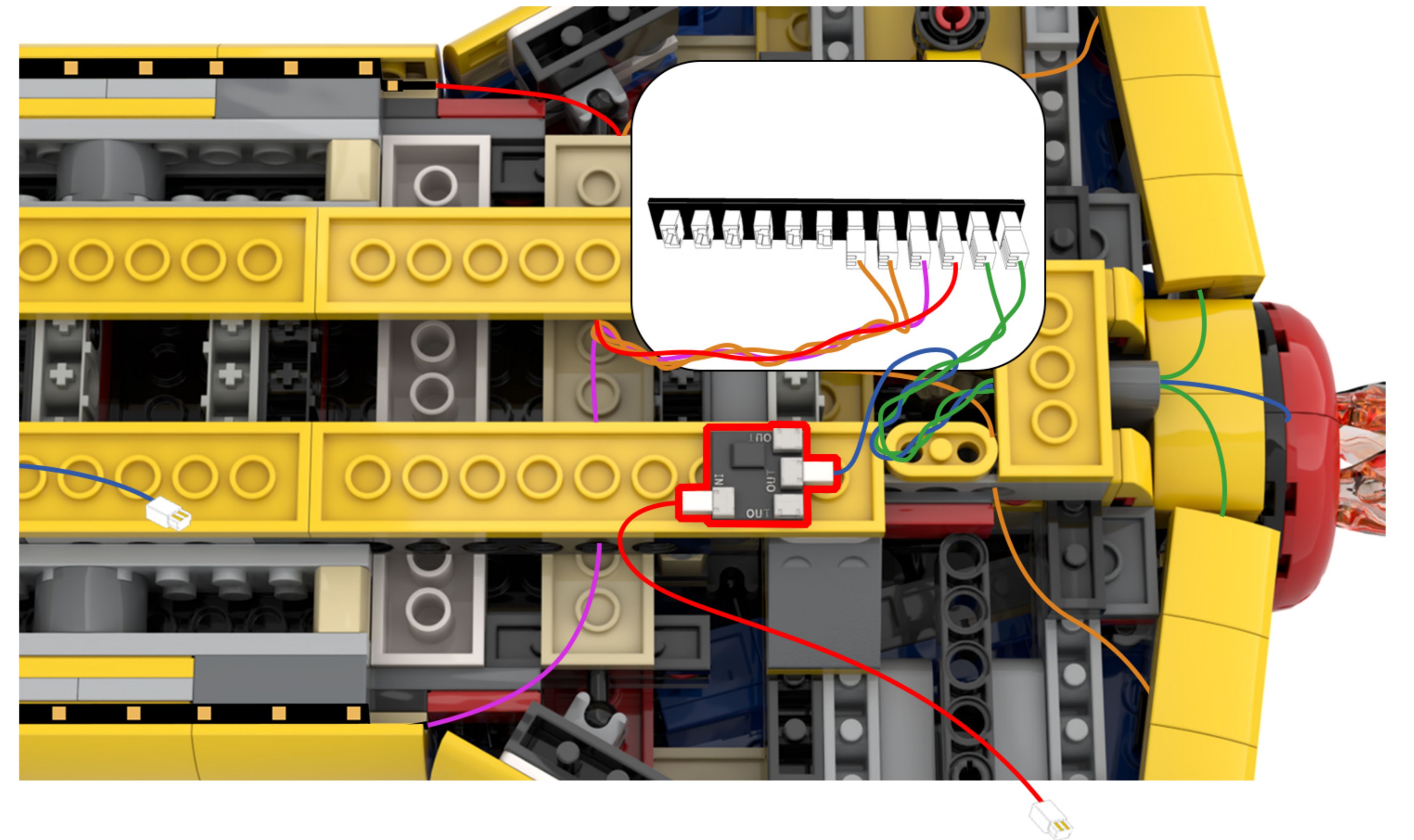

126

EN: Locate the two light wires in the diagram.

DE: Suchen Sie die beiden Lichtkabel in der Abbildung.

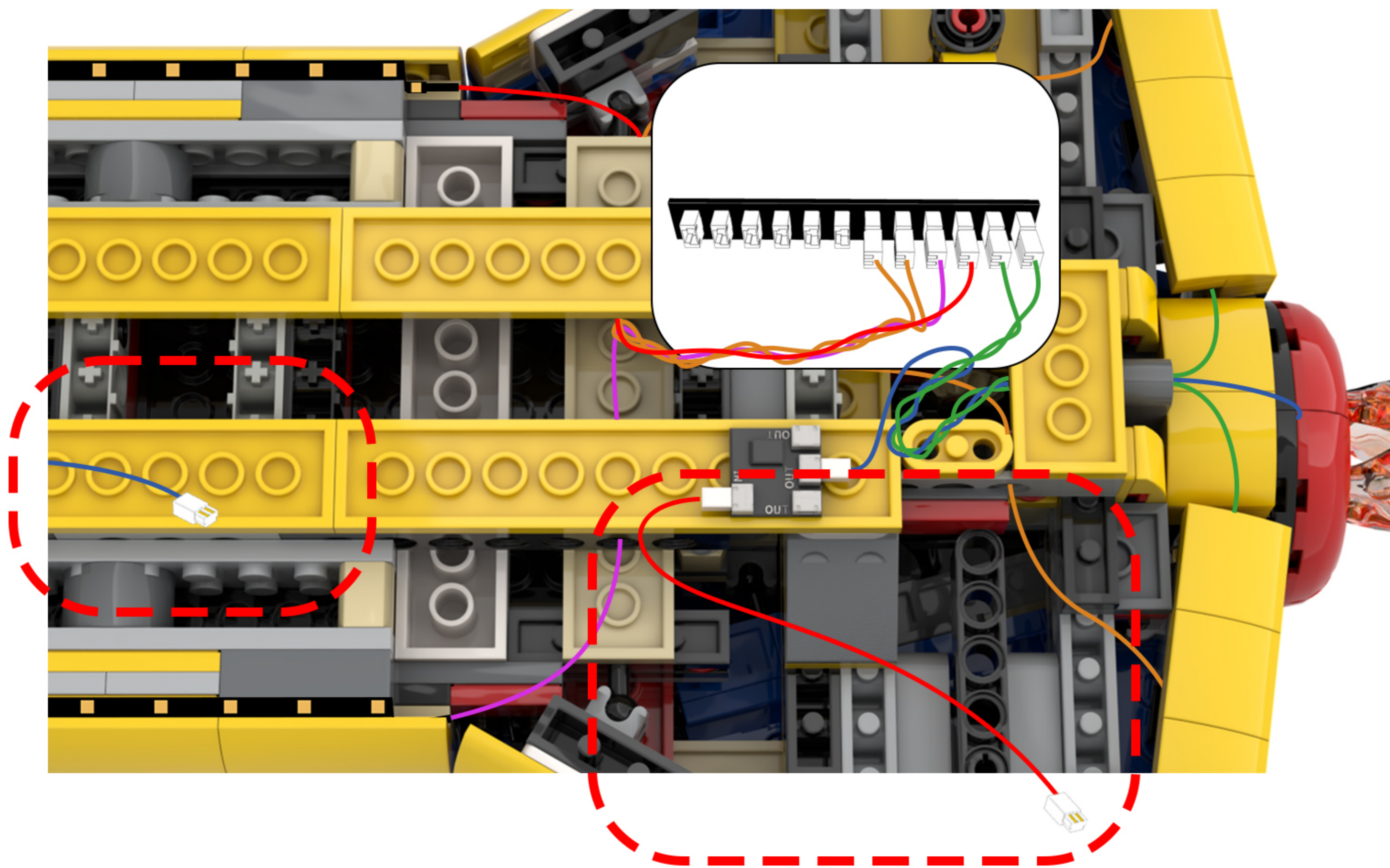

127

EN: Twist the two lamp wires together, then connect them one by one to the 12-port expansion board.

DE: Verdrehen Sie die beiden Lampenkabel miteinander und schließen Sie sie dann nacheinander an die 12-Port-Erweiterungskarte an.

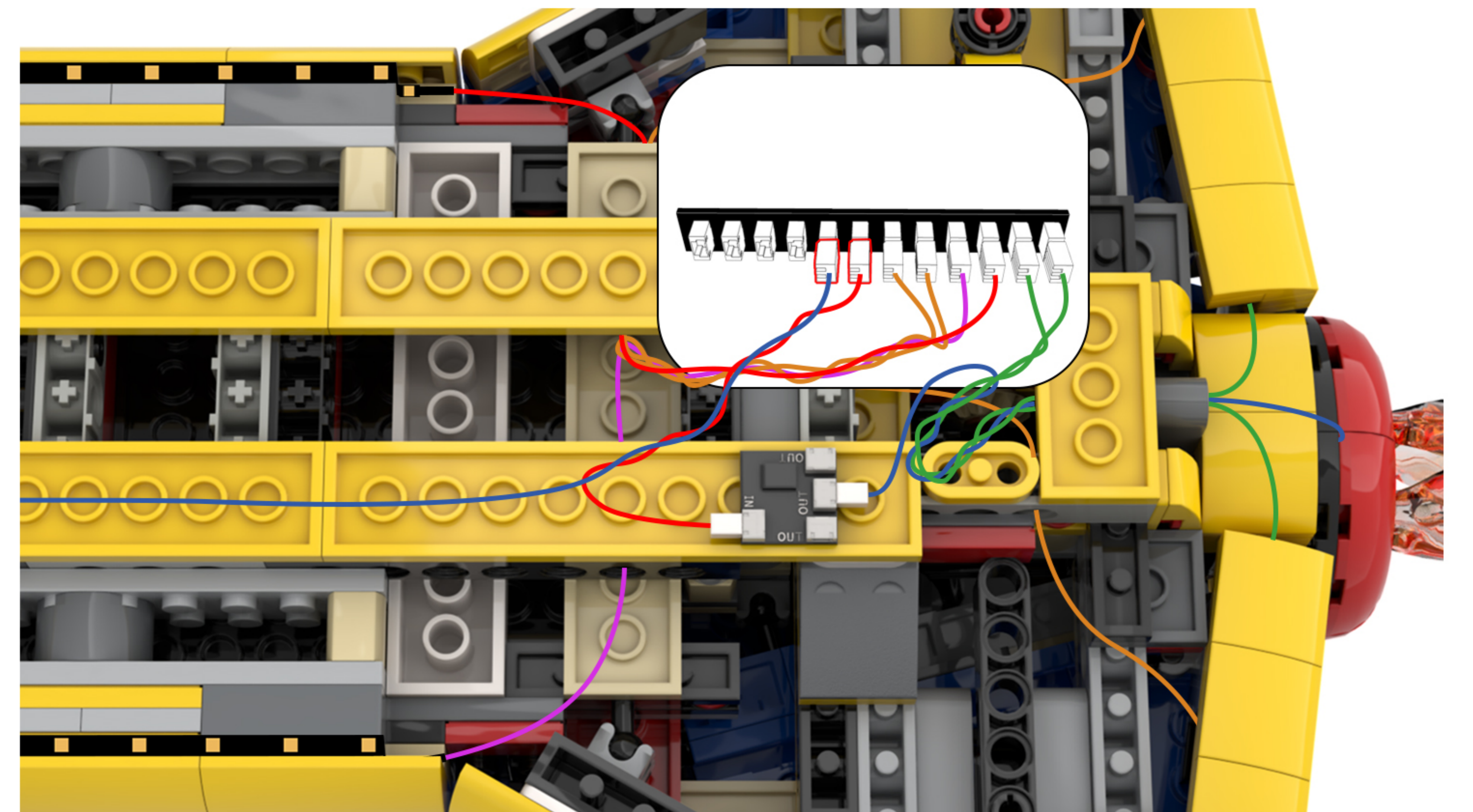
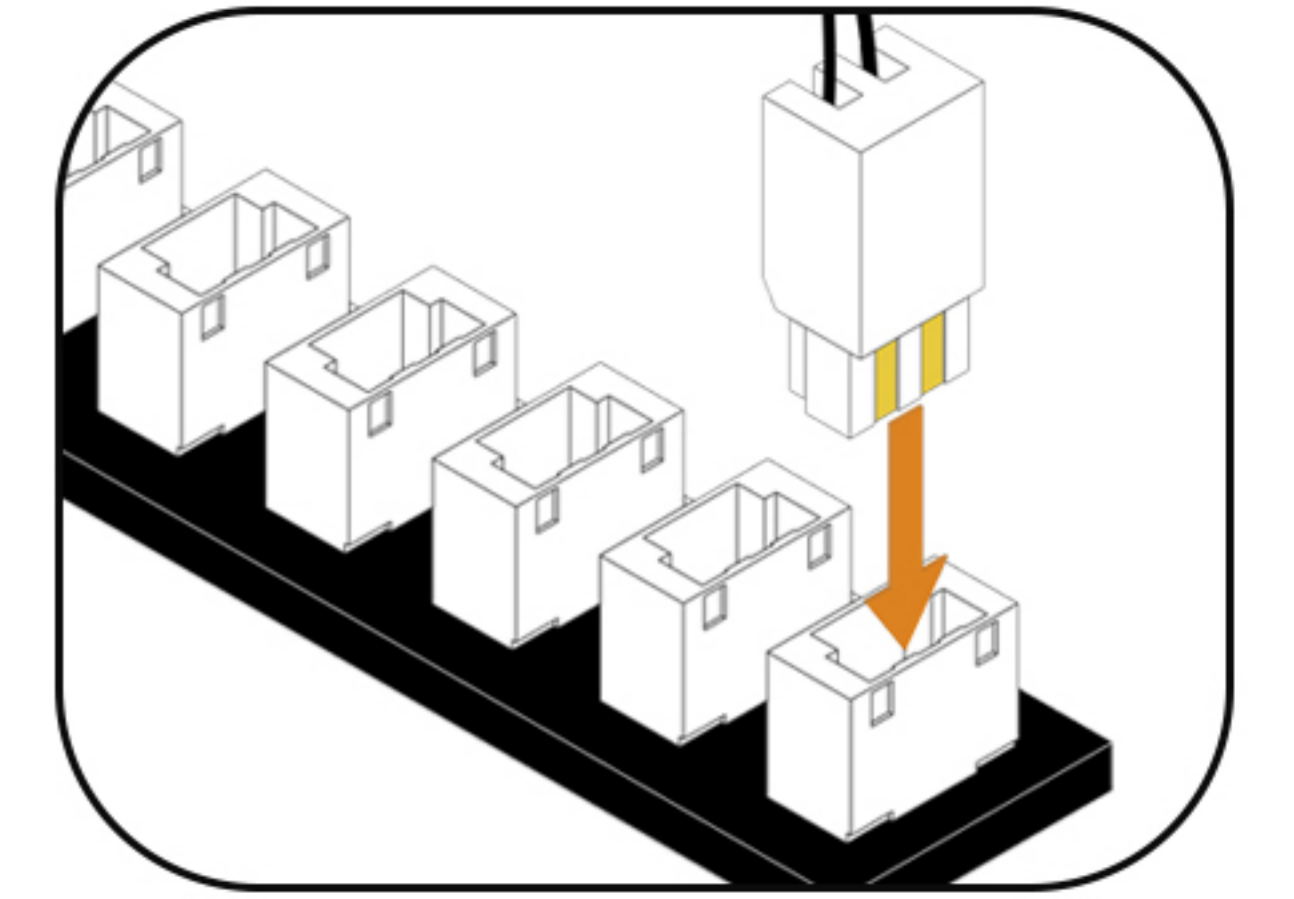

128

EN: Take the USB power cable out of the bag and connect it to the expansion board.

DE: Nehmen Sie das USB-Stromkabel aus der Tasche und schließen Sie es an die Erweiterungskarte an.

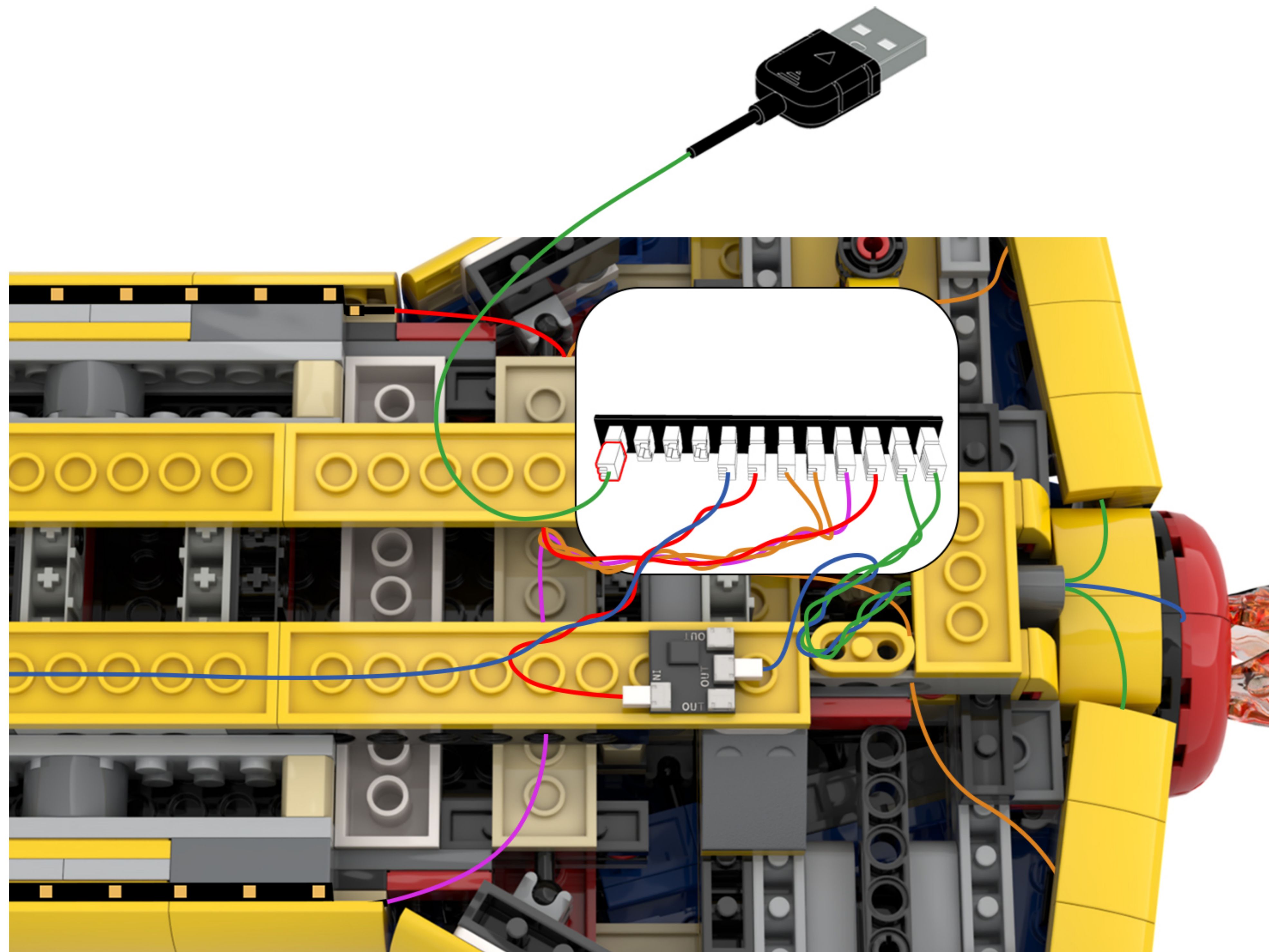
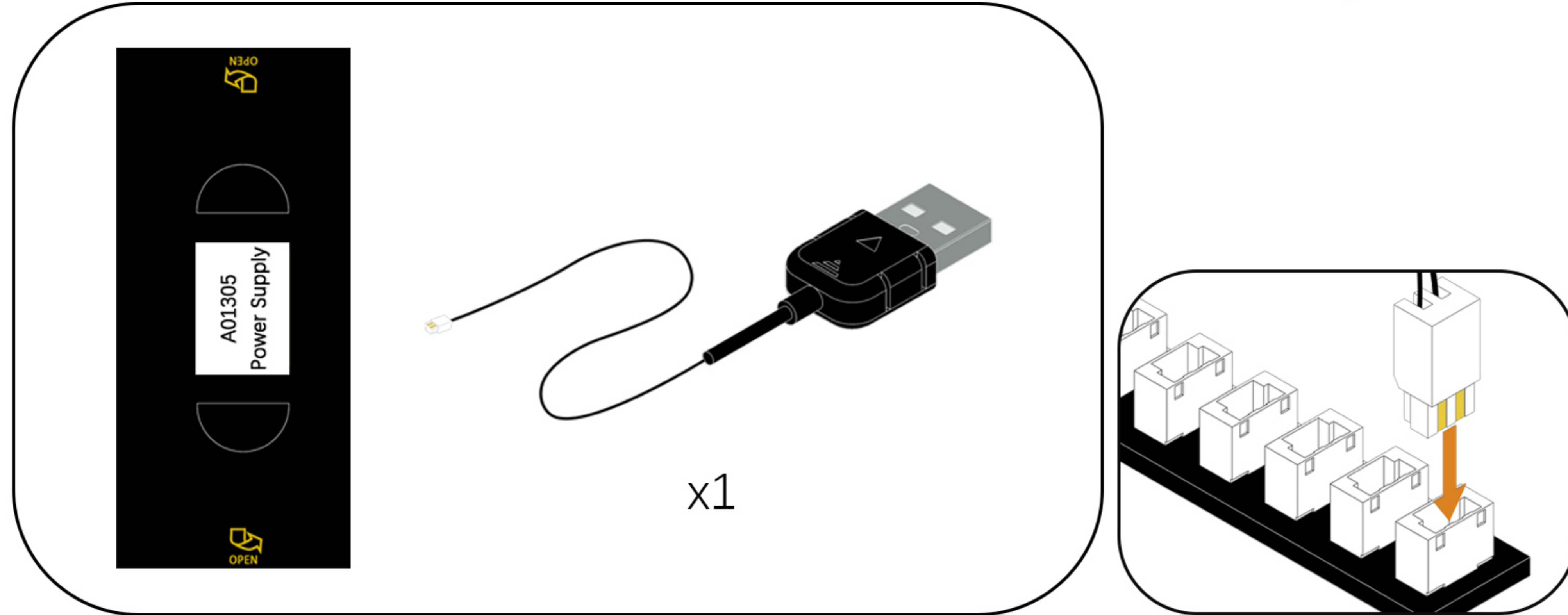

129

EN: Peel off the adhesive backing of the expansion board and attach it to the location shown in the illustration.

DE: Entfernen Sie die Schutzfolie von der Rückseite der Erweiterungsplatte und kleben Sie sie an die in der Abbildung gezeigte Stelle.

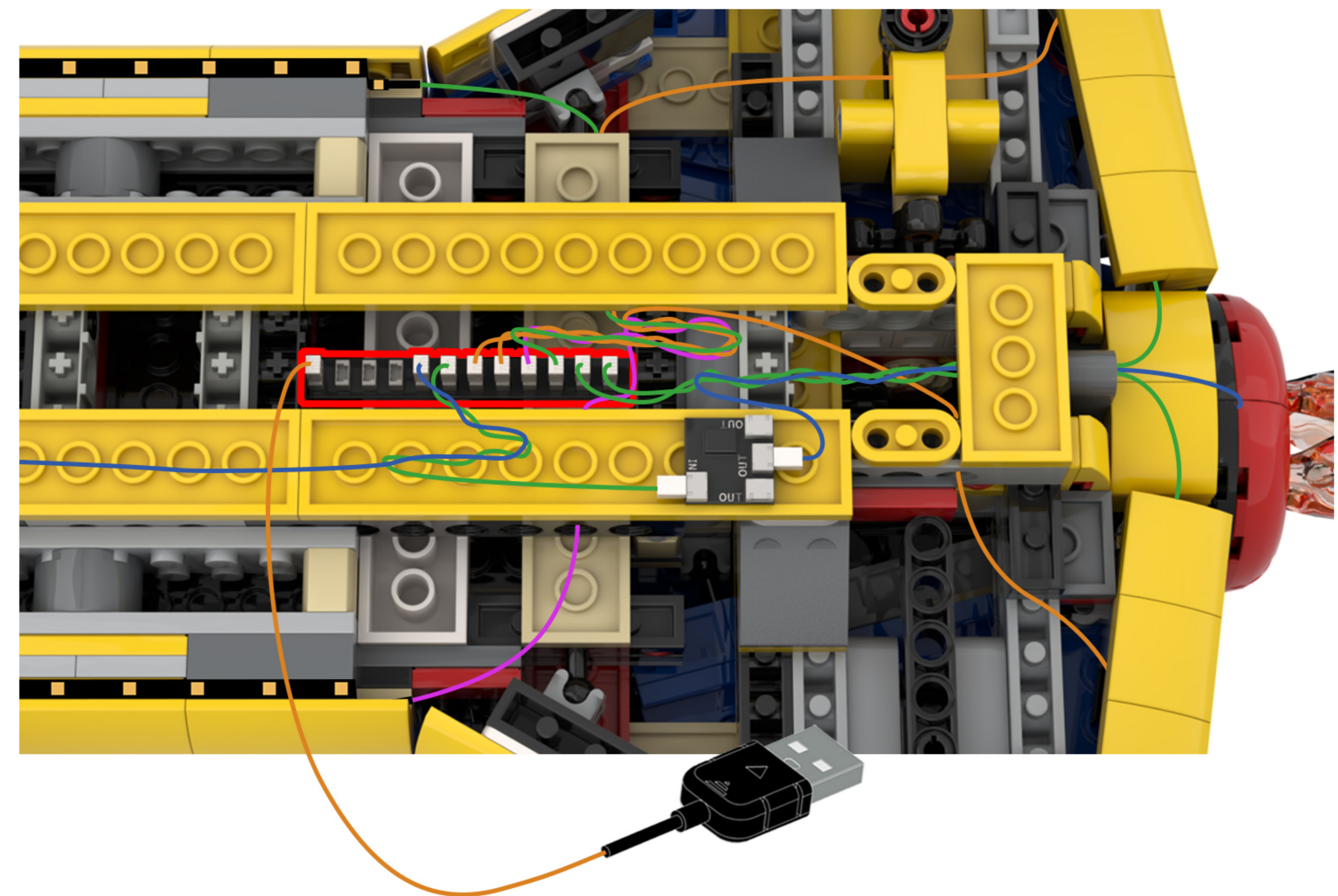

130

EN: Flip the model to restore it to its original state.

DE: Drehen Sie das Modell um, um es in seinen ursprünglichen Zustand zurückzusetzen.

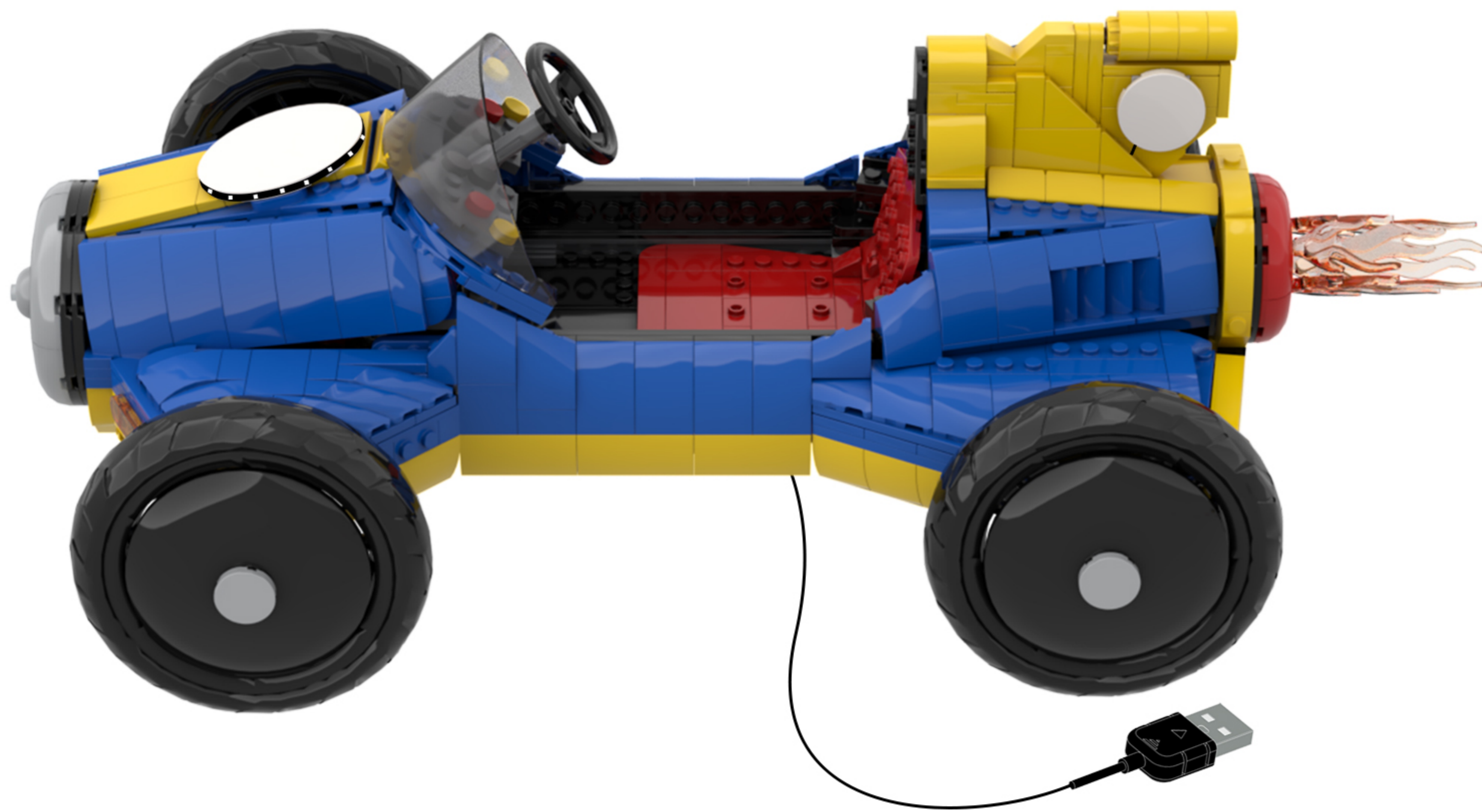

131

EN: Take out the disassembled building blocks and reassemble them.

DE: Nehmen Sie die zerlegten Bausteine heraus und setzen Sie sie wieder zusammen.



132 EN: Once installed, connect the power supply and give it a try!

DE: Die Installation ist abgeschlossen. Schließen Sie das Gerät an die Stromversorgung an und probieren Sie es aus!





Above our designers to provide the relevant ideas and instructions. But please move to the following:

- 1: about our company this product parts material, product quality do you have comments and suggestions?
- 2: about this product installation instructions and installation of the degree of difficulty do you have views and suggestions?
- 3: if in the operation of the product we provide ideas encountered any problems, please contact us in a timely manner.

Tips

If you encounter any installation problems please contact the seller, we will be happy to help you solve!