

INSTALLATION GUIDE

31220 Claude Monet - Bridge over a Pond of Water Lilies

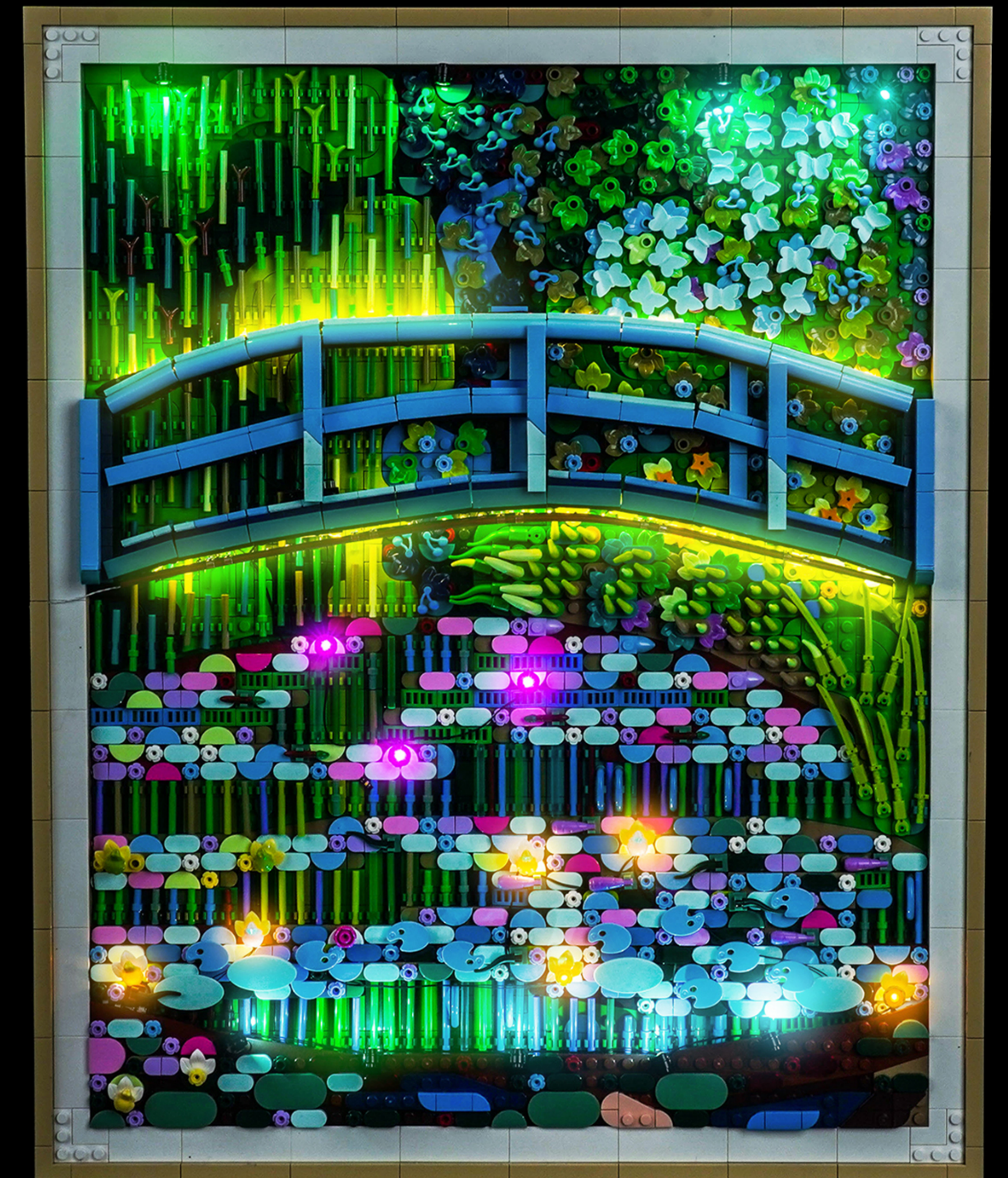

LED light kit compatible with Lego

Instructions for installing this kit:

This set includes 7 pouches. (The battery case functions similarly; please select your own power source. This article uses a USB power cable.)

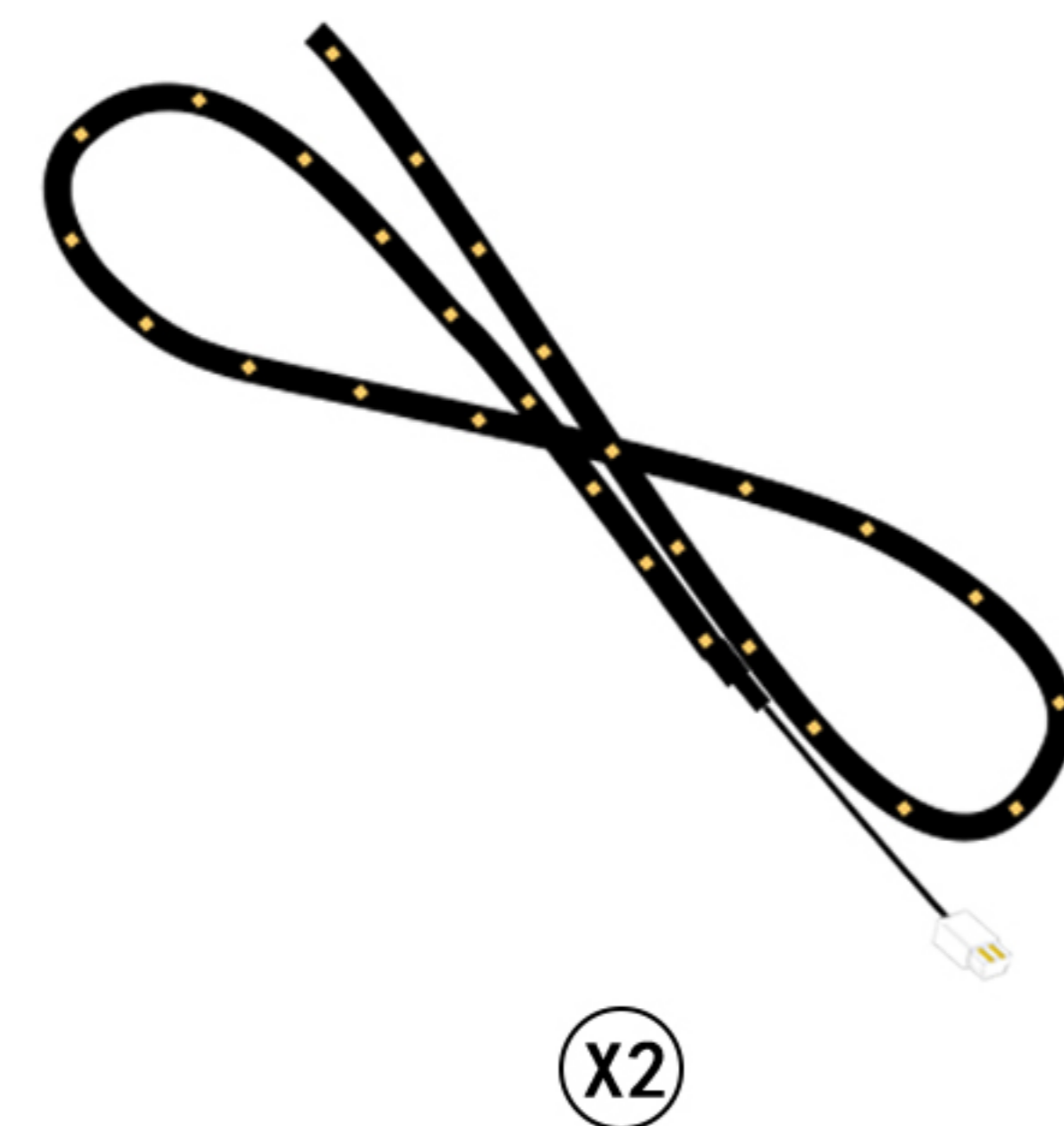
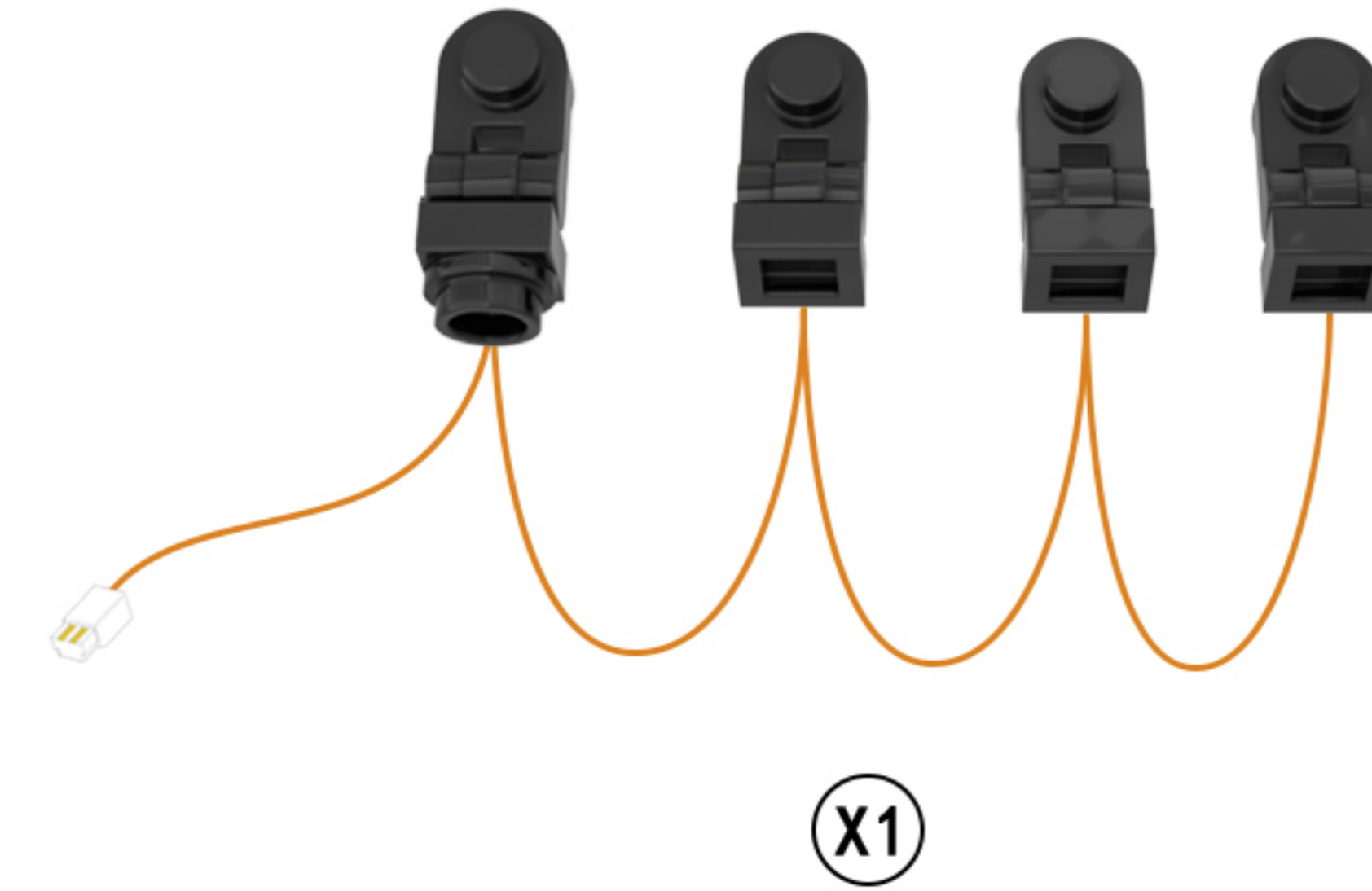
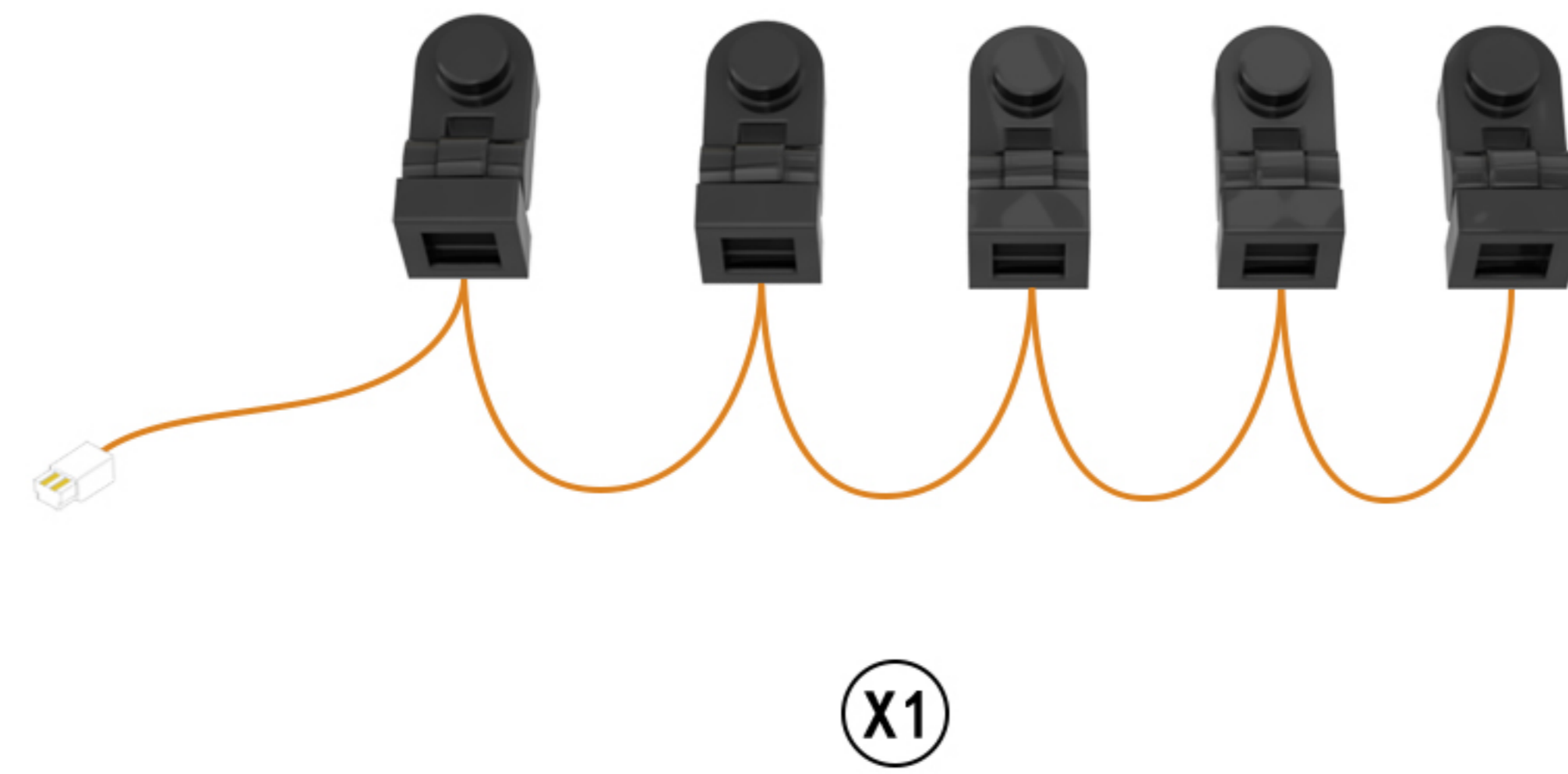
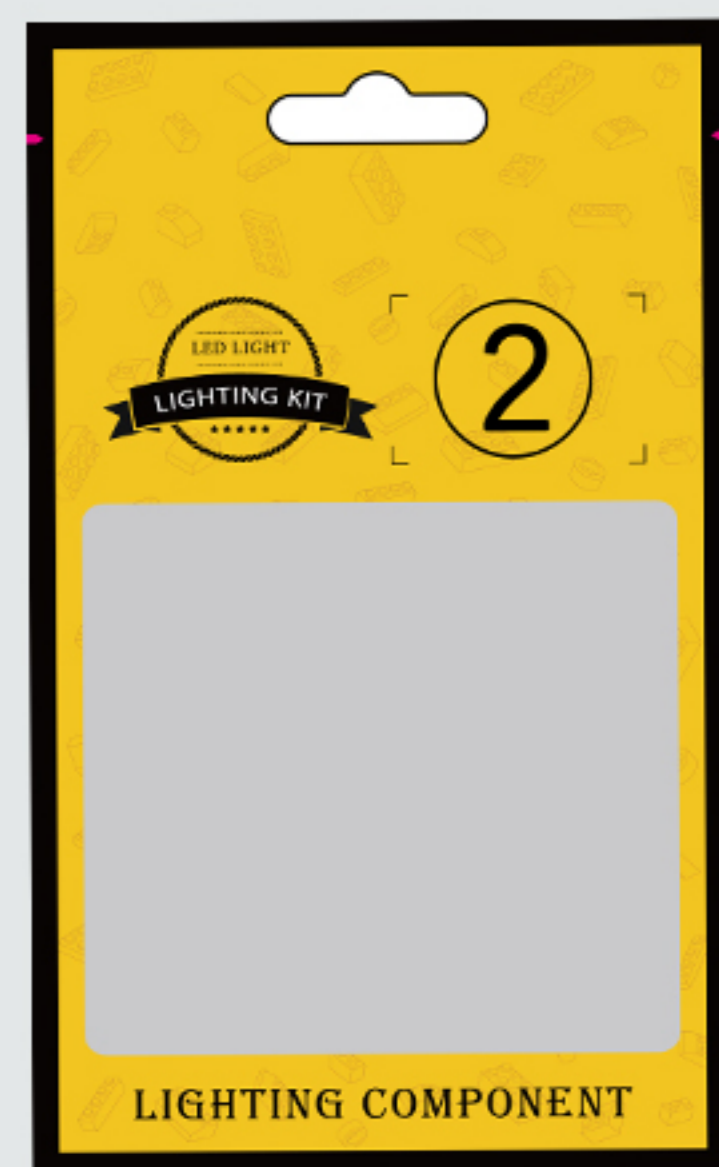
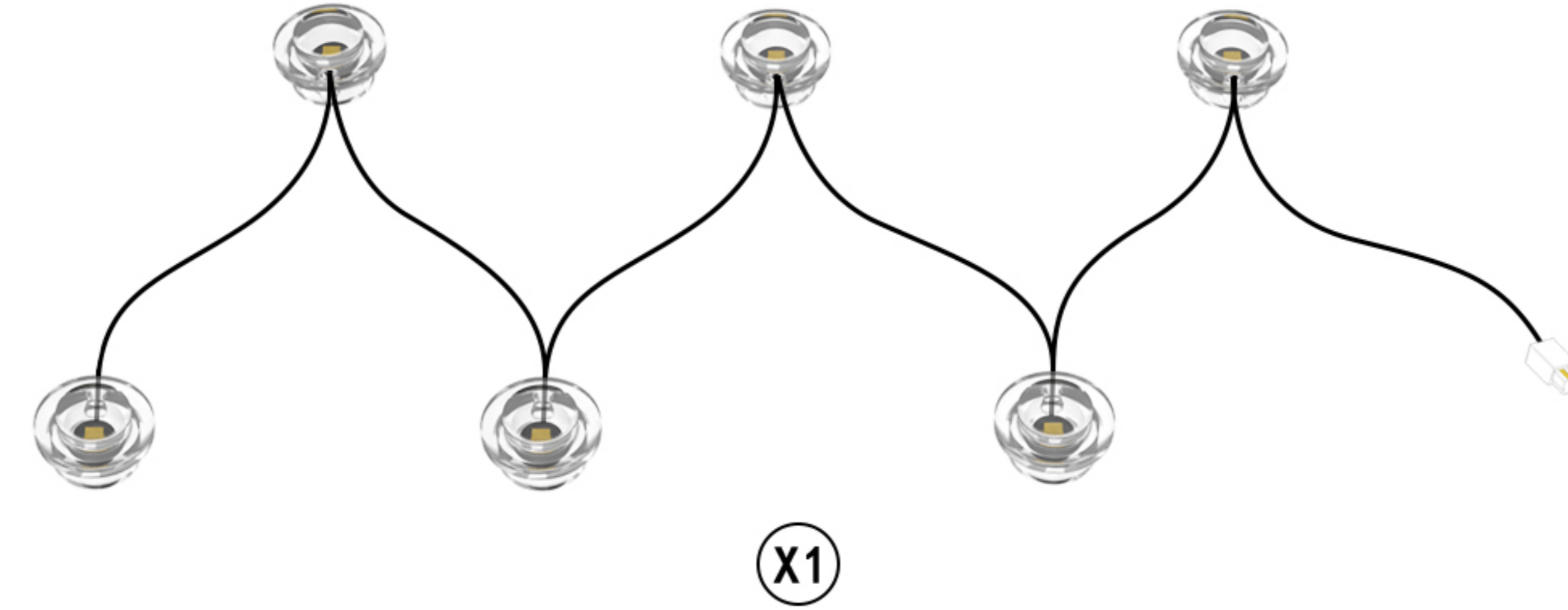
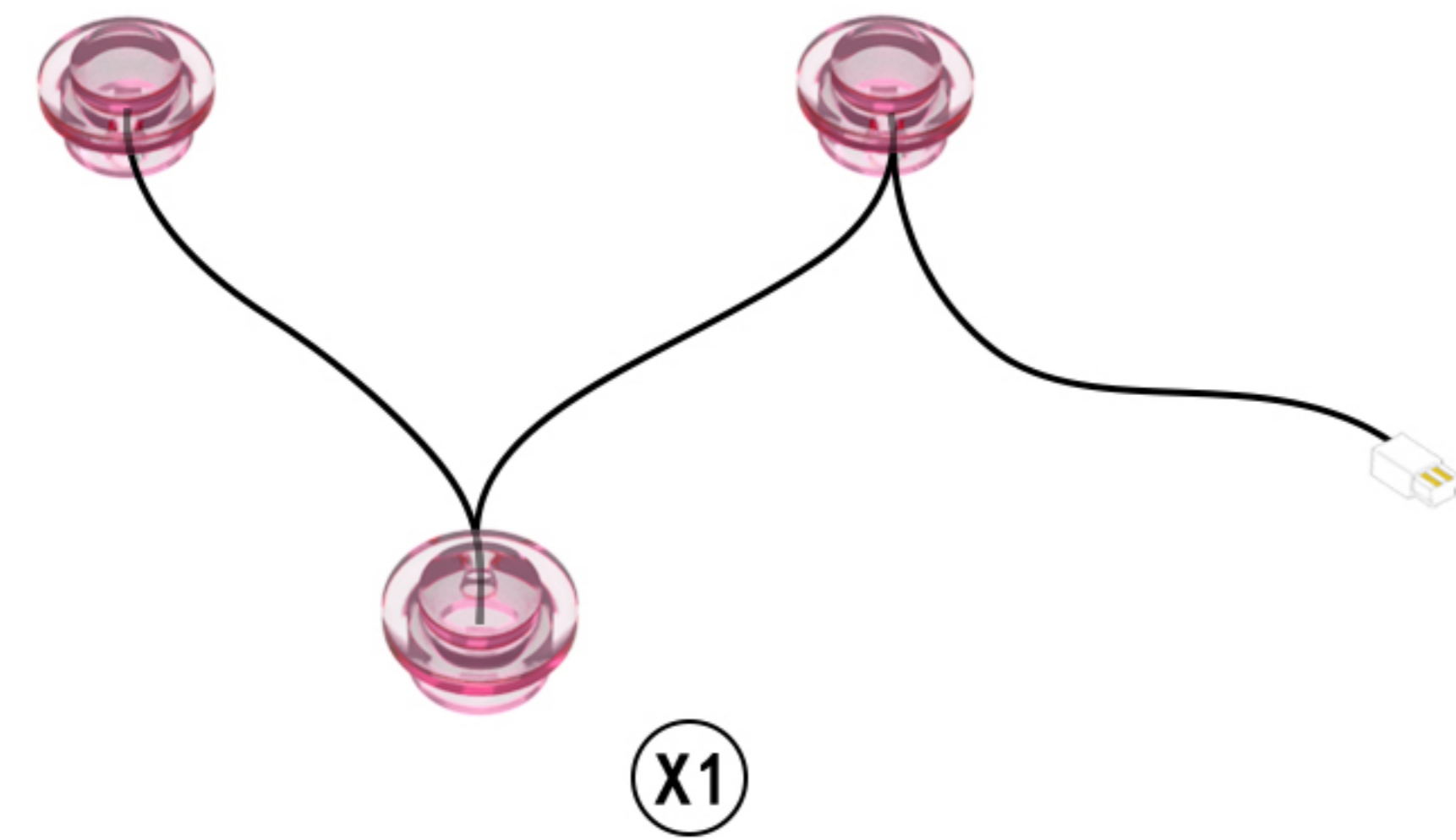

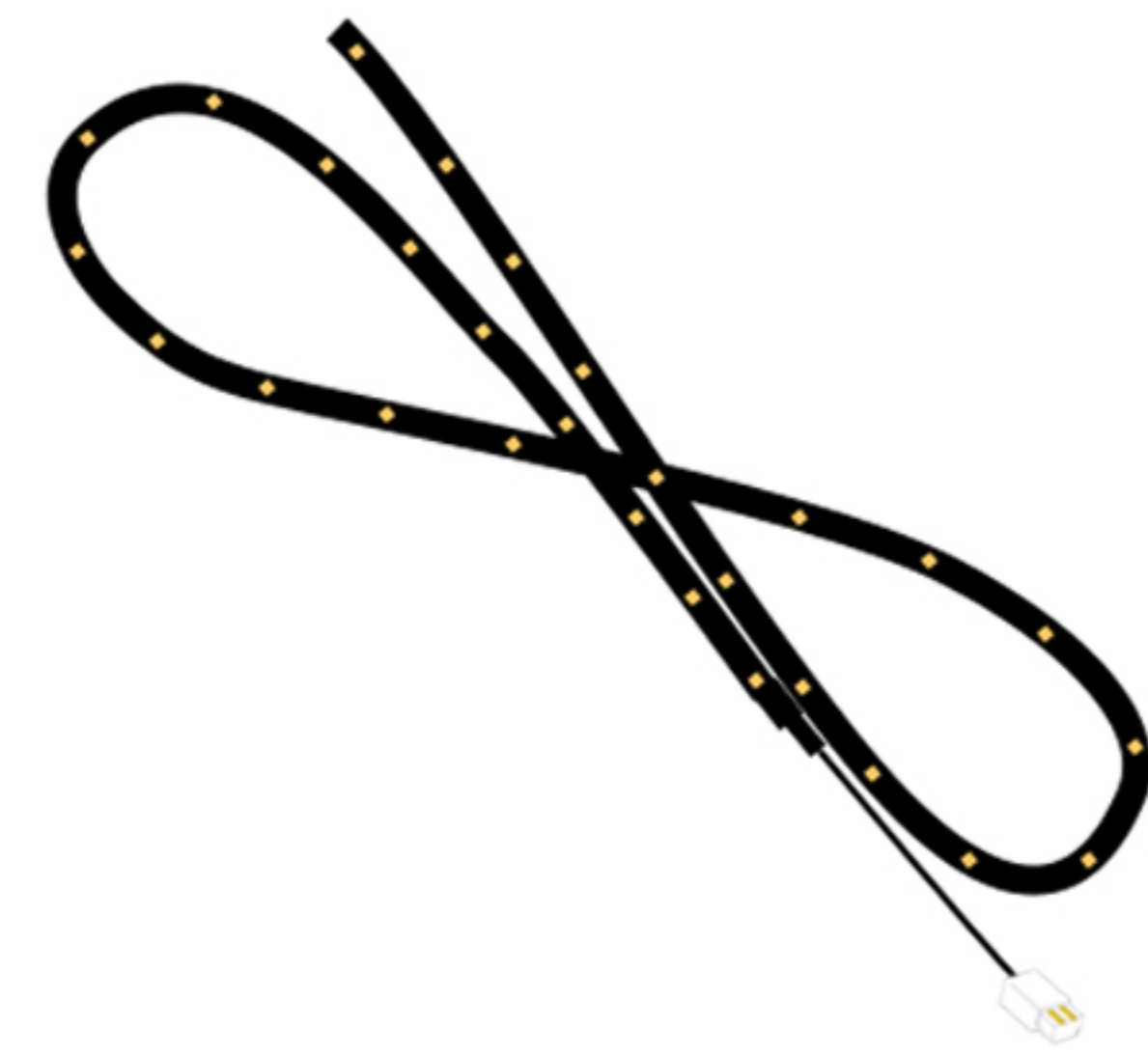
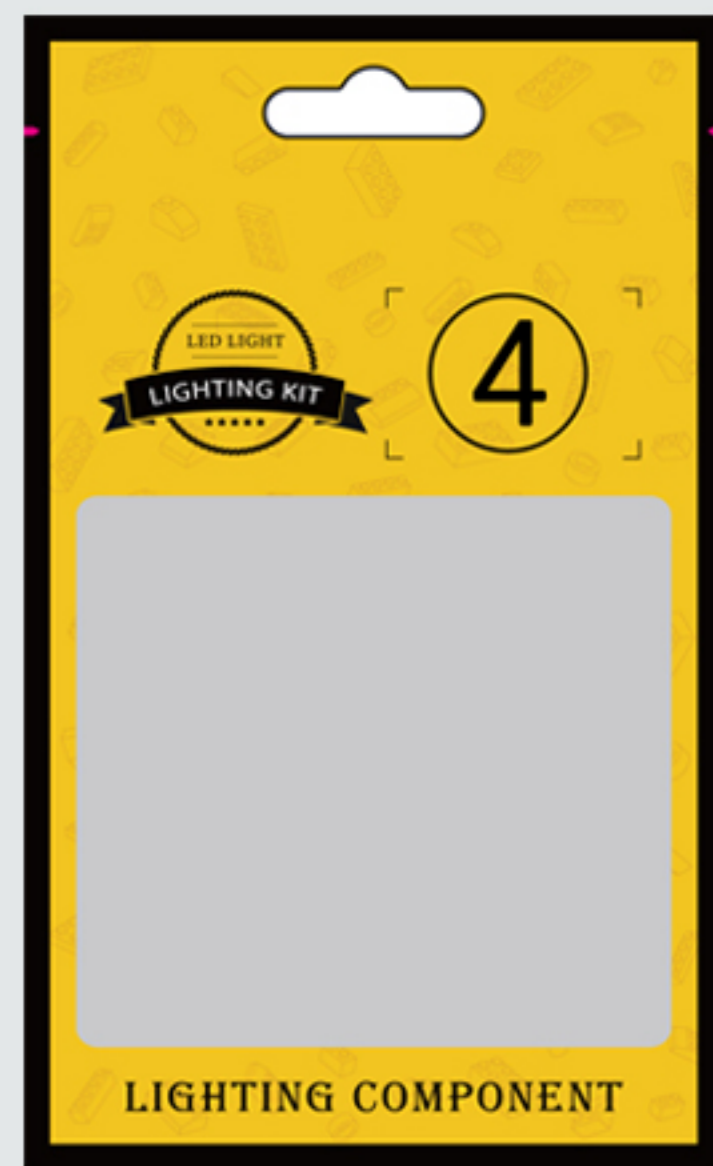

(X1)

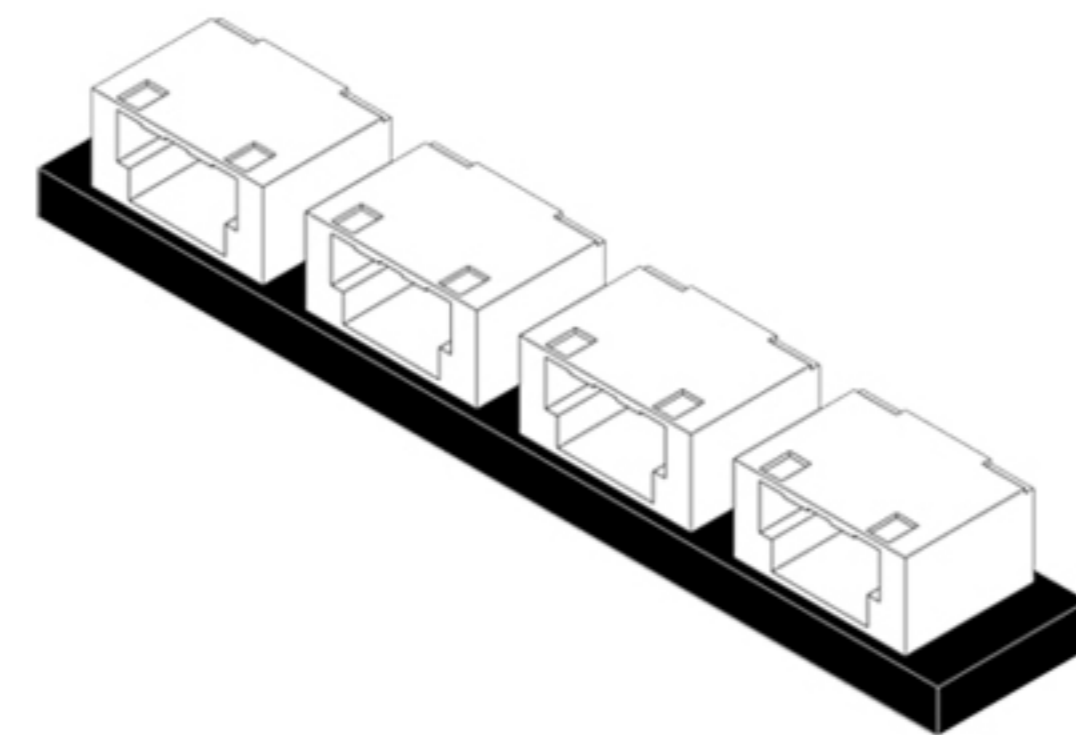

(X3)

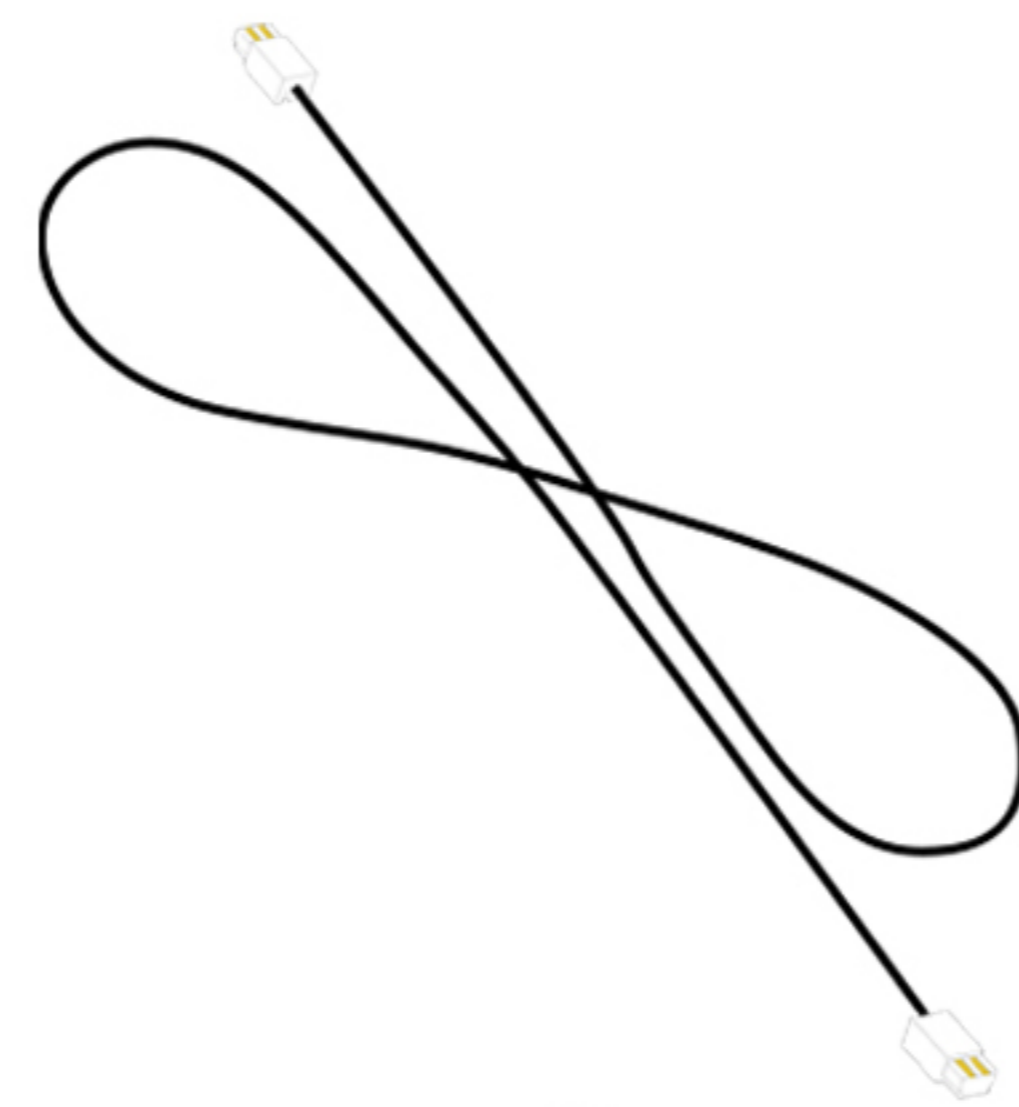

(X2)

(10cm)

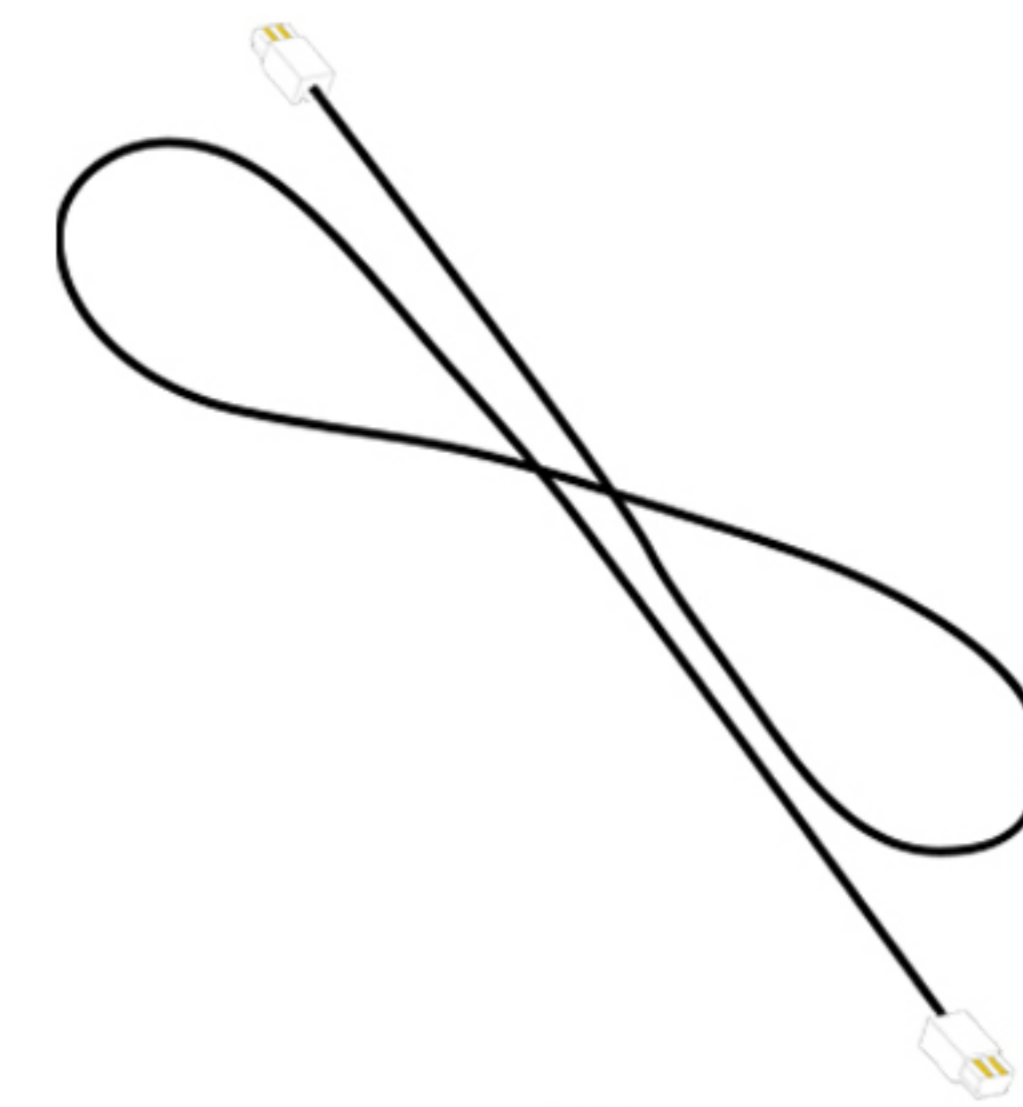

(X1)

(30cm)

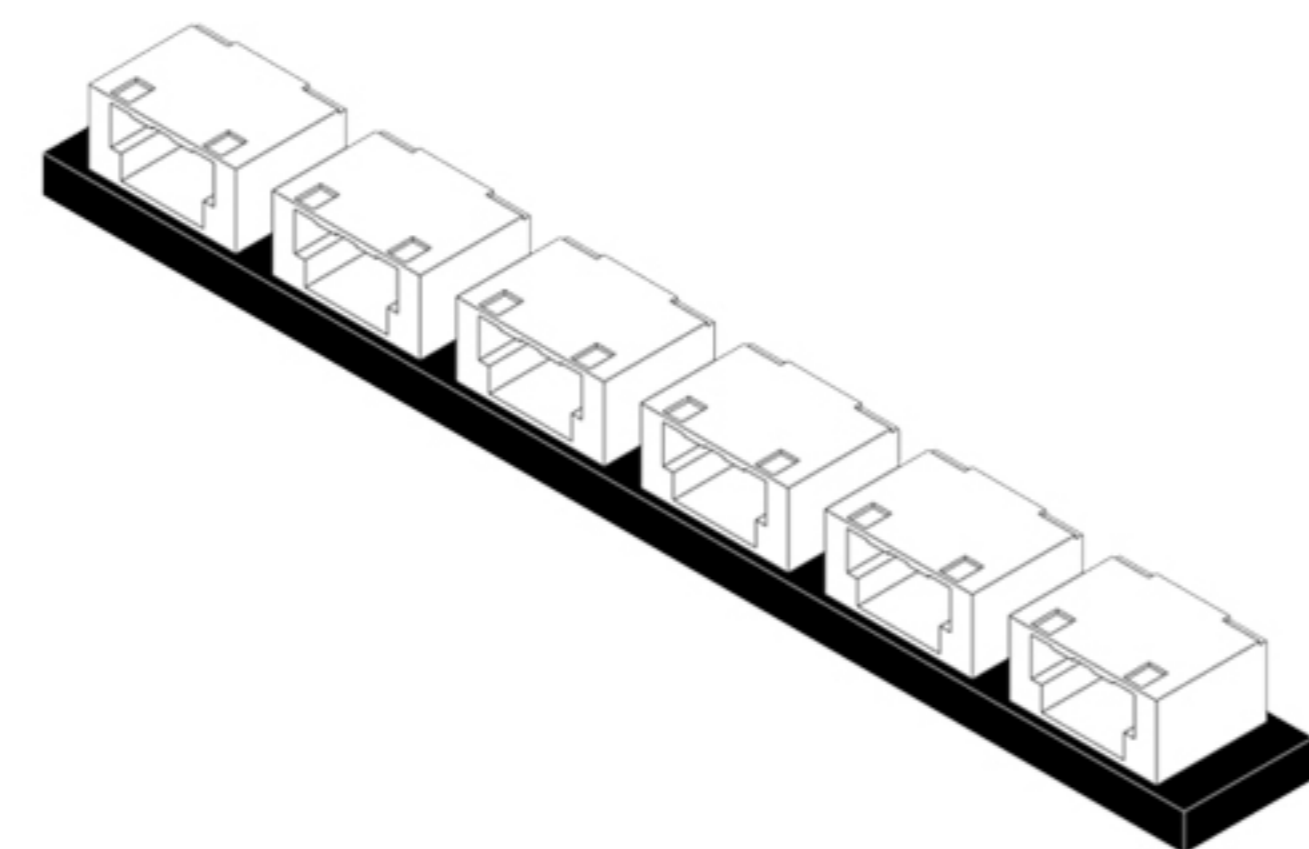
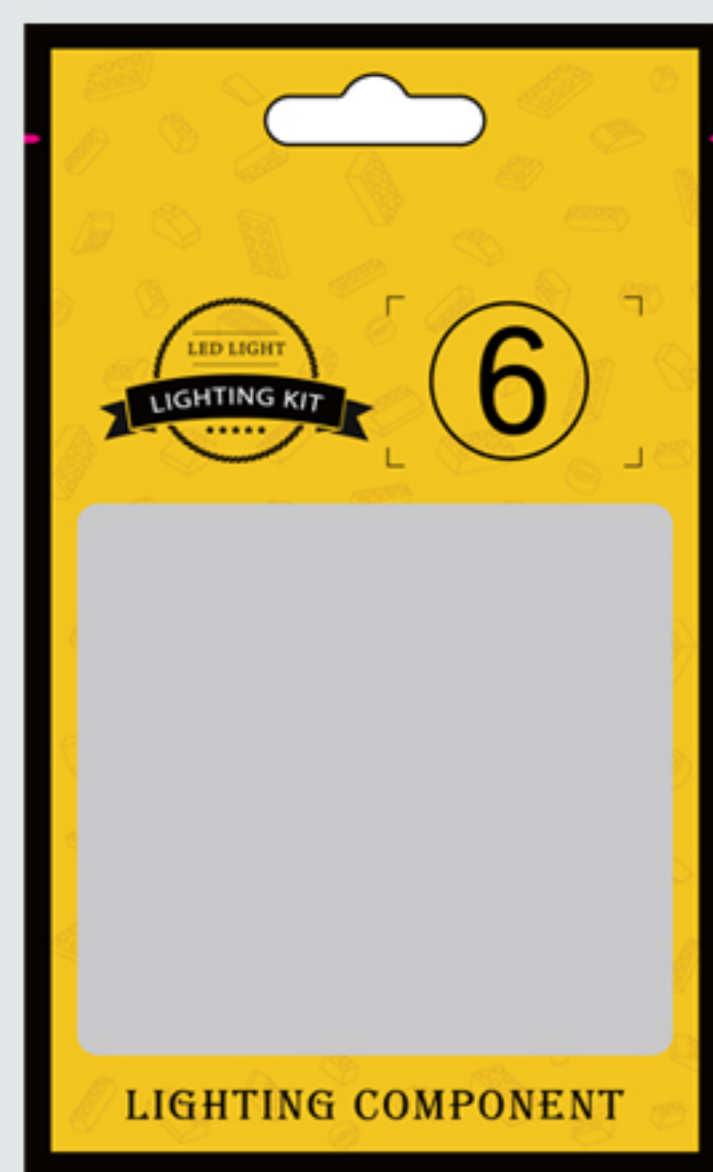

(X1)

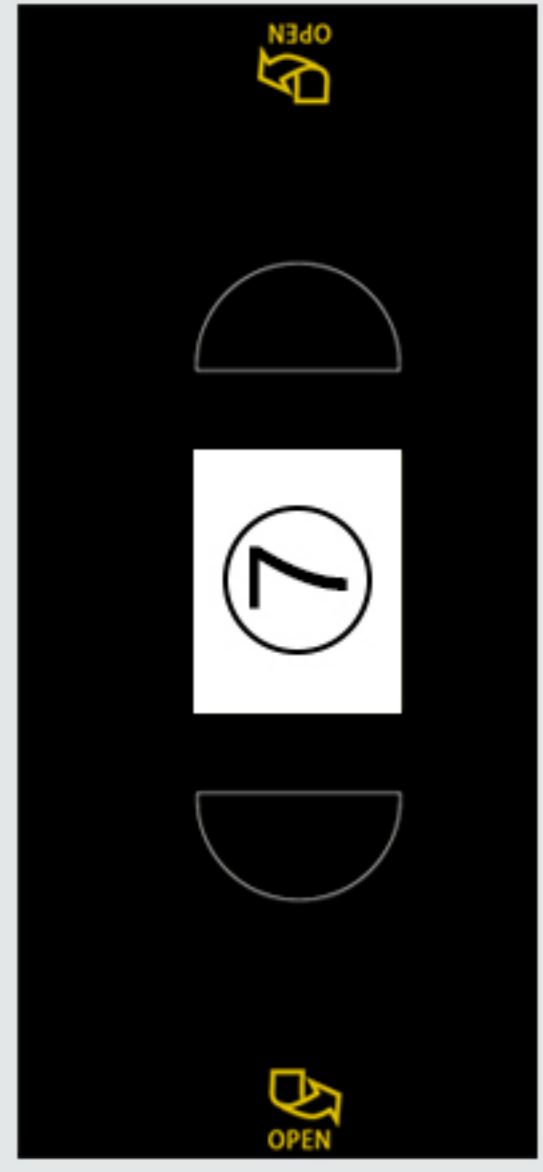

(X1)

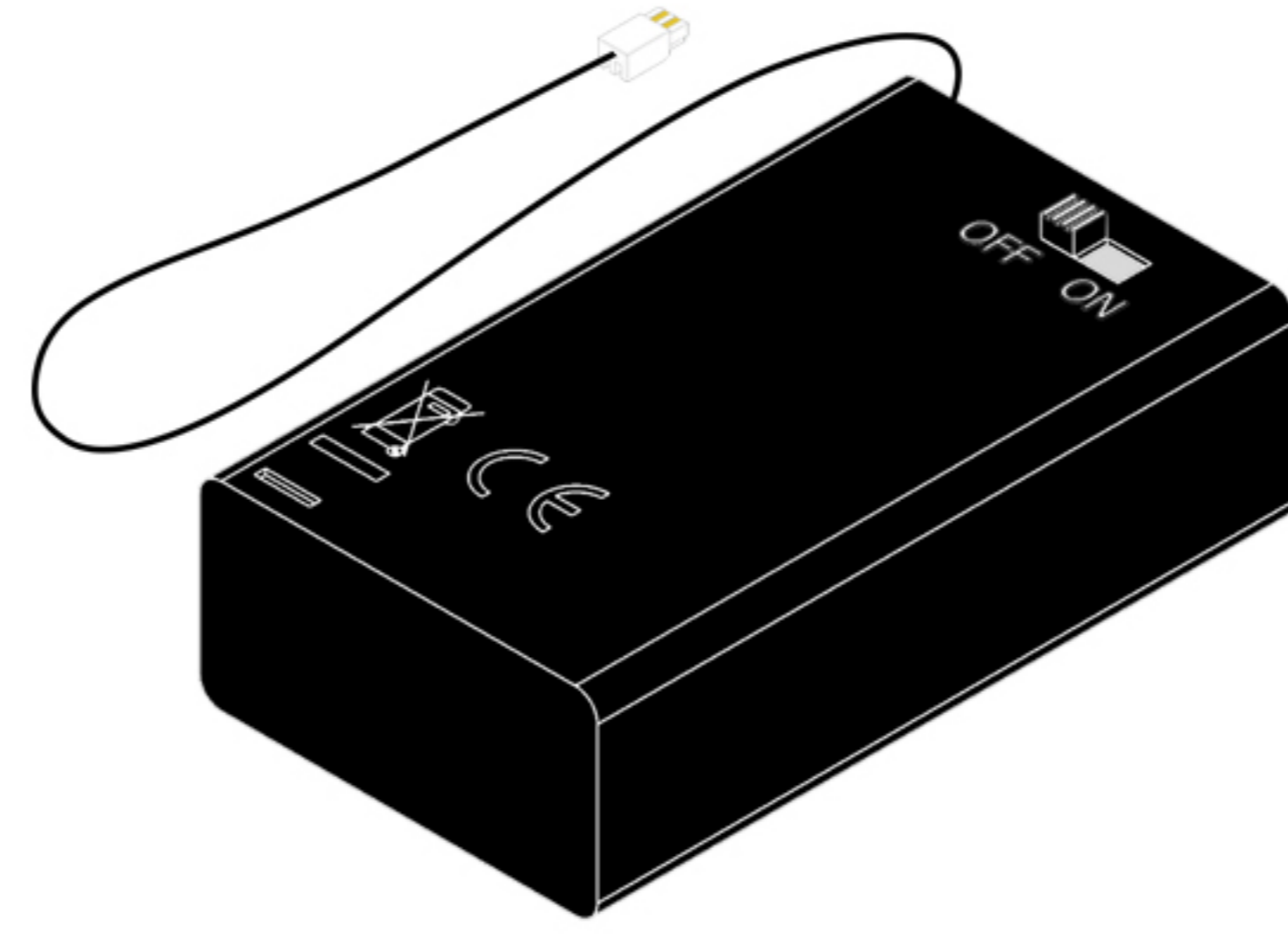

(X1)

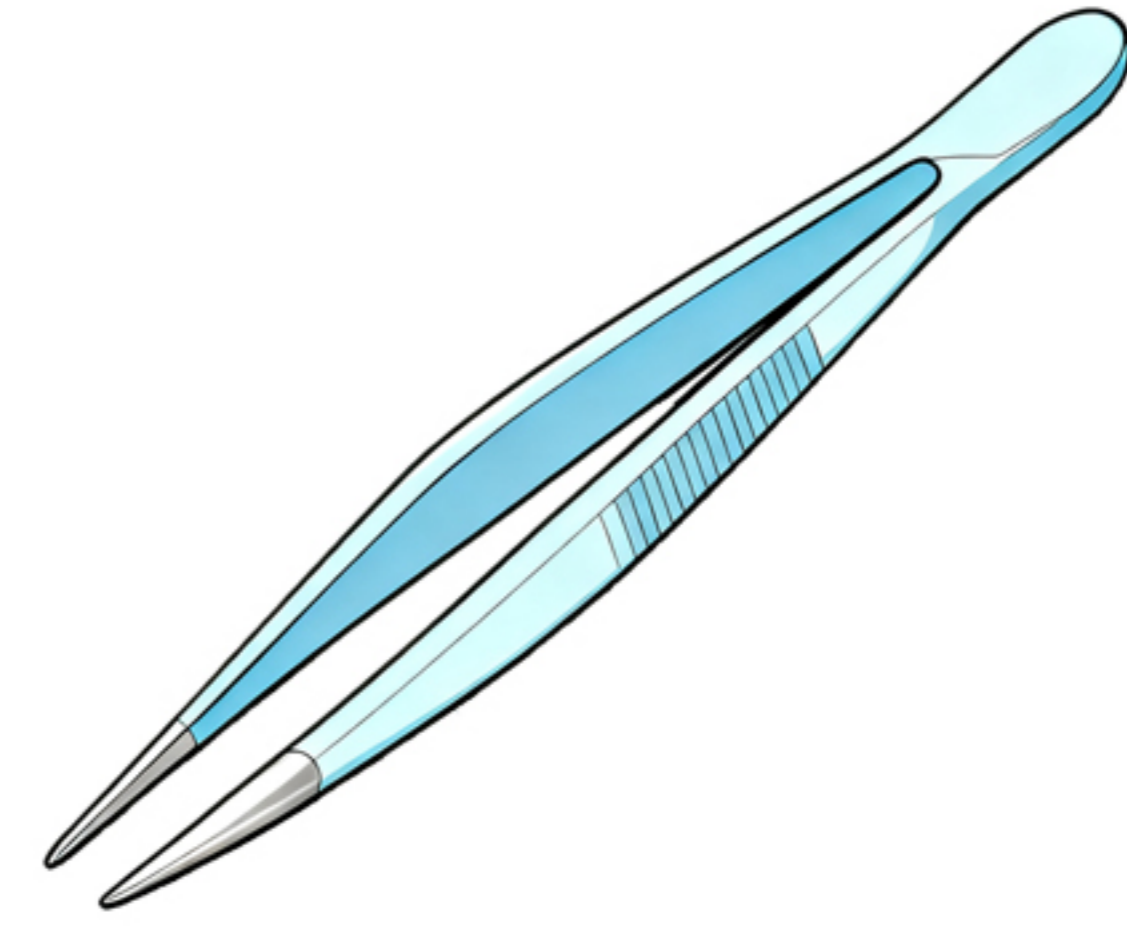

(X1)

This post will complete the light installation in two main sections.

Step 1-test



Step 2-mounting

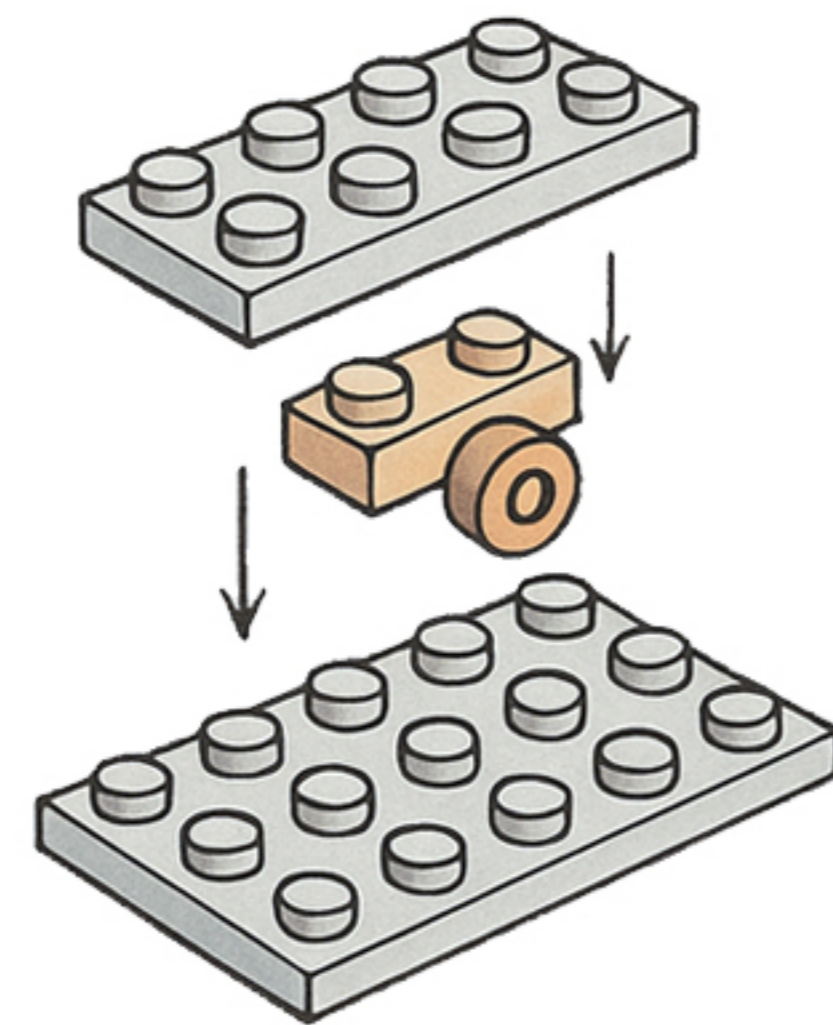

So let's get started!

Step 1-Test.

1

EN: Remove the expansion board from Bag 5.

DE: Entnehmen Sie die Erweiterungskarte aus Beutel 5.

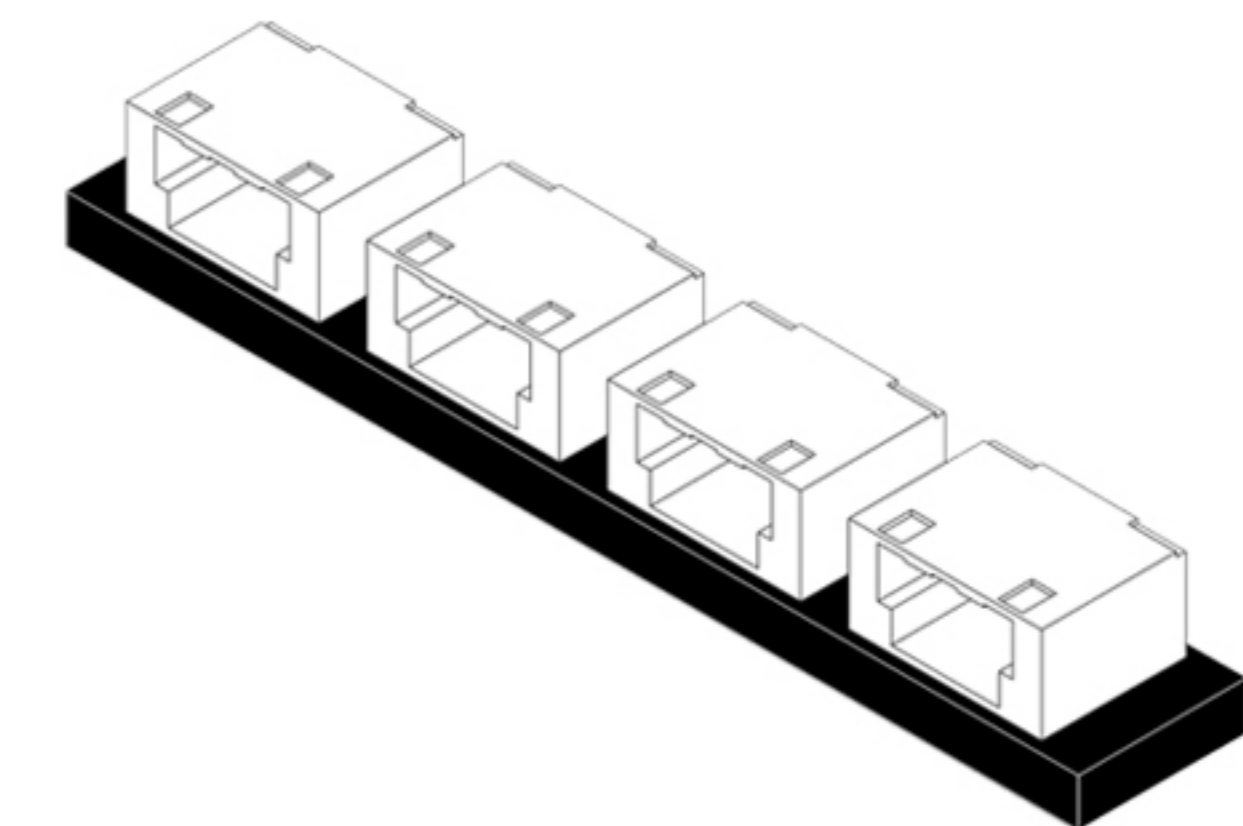

x1

2

EN: Remove the touch-sensitive dimming module from the bag and connect it to the expansion board.

DE: Nehmen Sie das berührungsempfindliche Dimmmodul aus der Verpackung und schließen Sie es an die Erweiterungskarte an.

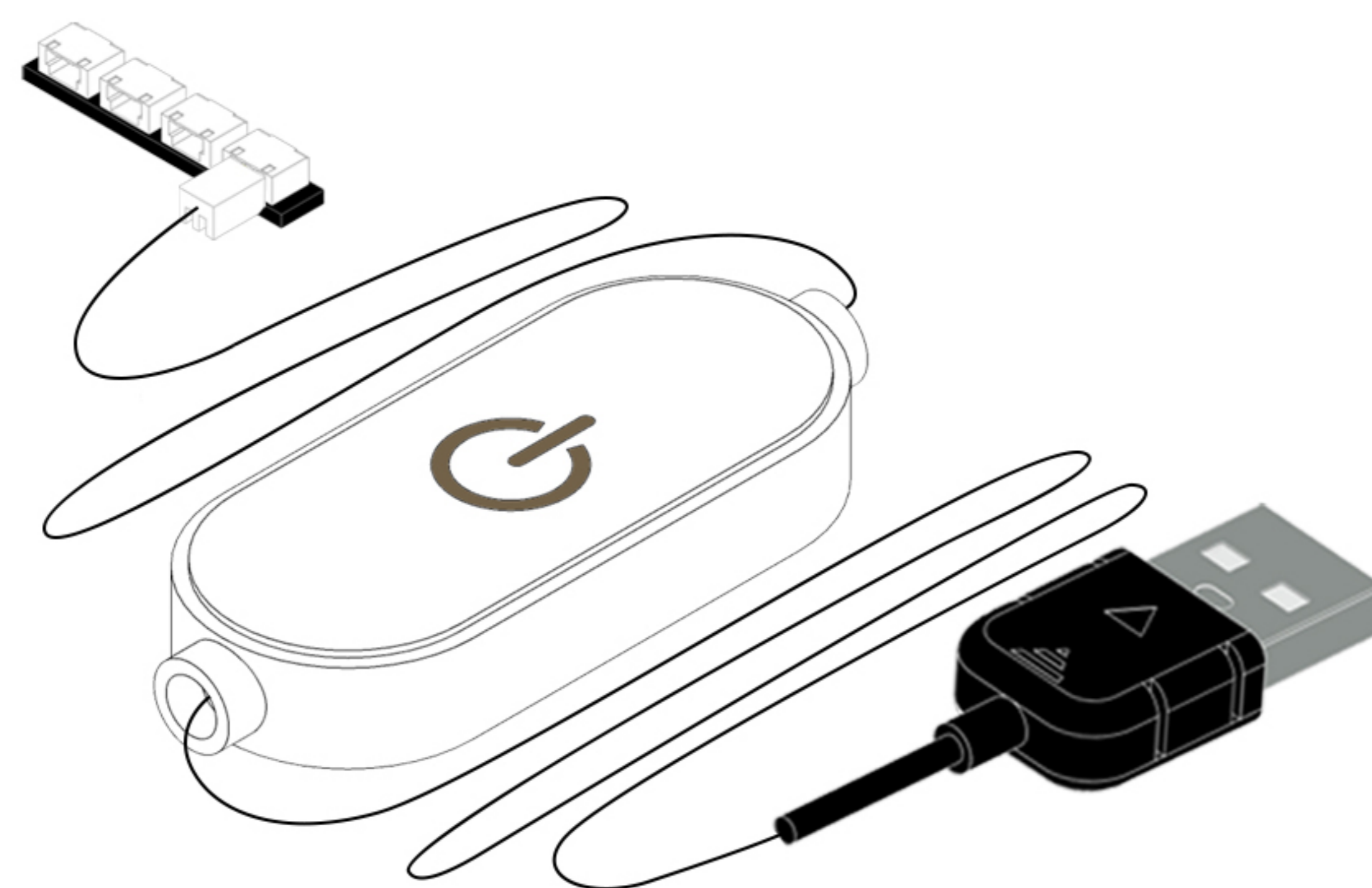
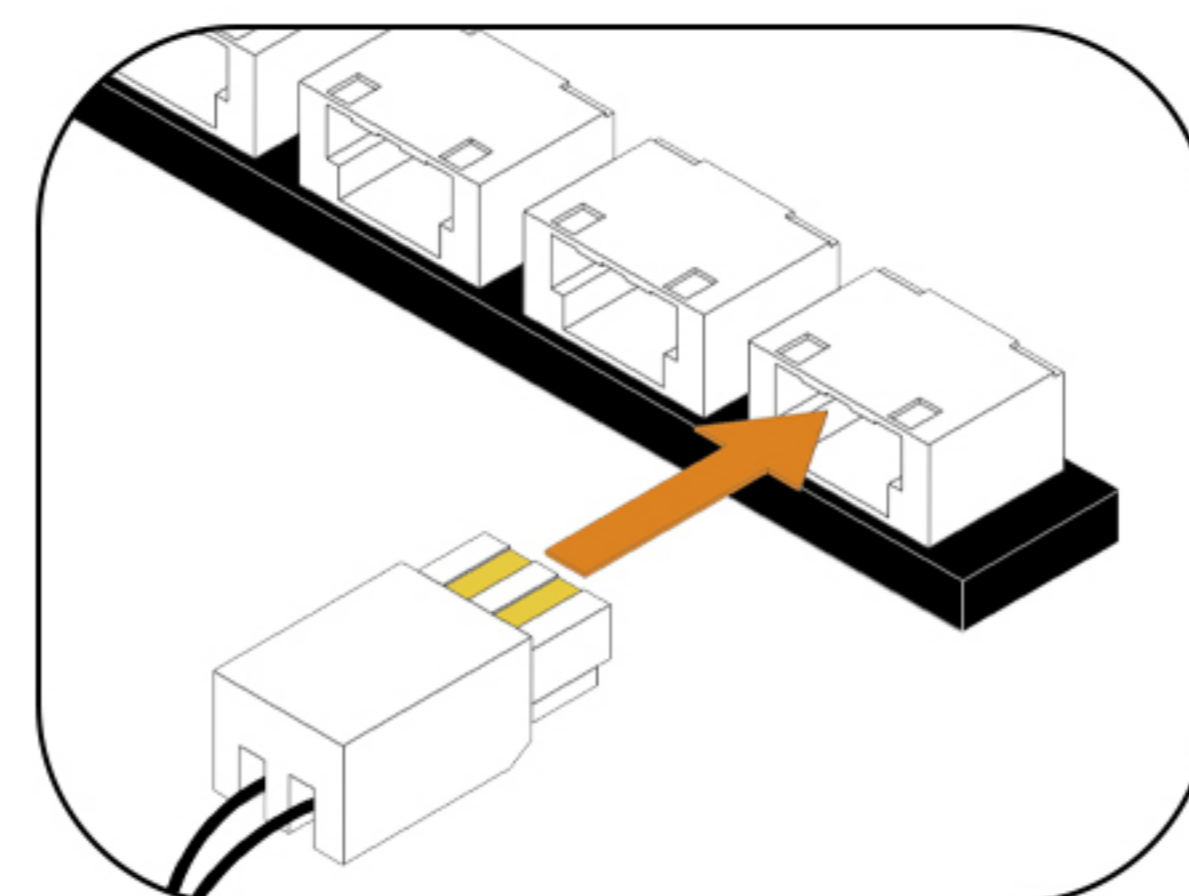
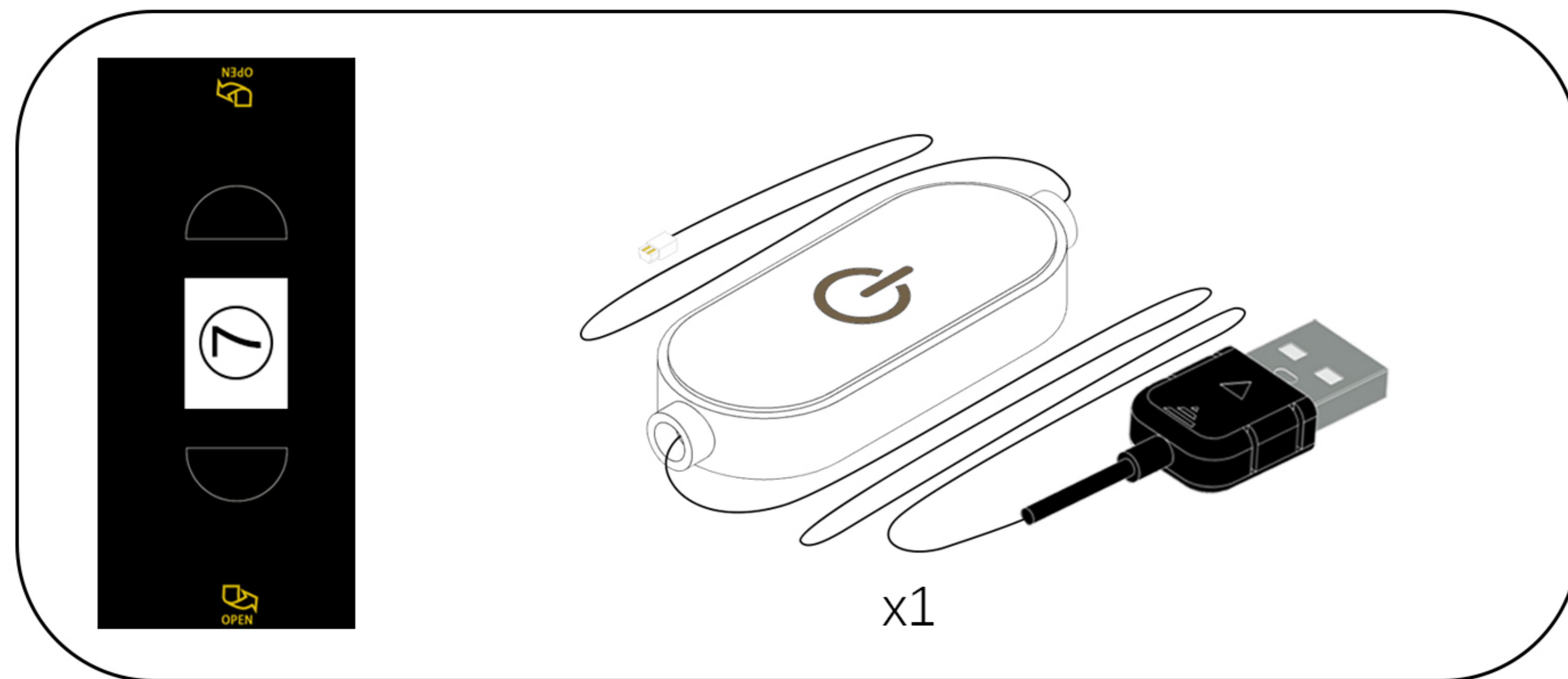

3

EN: Connect the touch-controlled dimming module to a portable power bank. (Power source not included; this guide uses a portable power bank. See the image below for other power options.)

DE: Schließen Sie das berührungsgesteuerte Dimmmodul an eine tragbare Powerbank an. (Stromquelle nicht im Lieferumfang enthalten; in dieser Anleitung wird eine tragbare Powerbank verwendet. Weitere Stromversorgungsoptionen finden Sie in der Abbildung unten.)

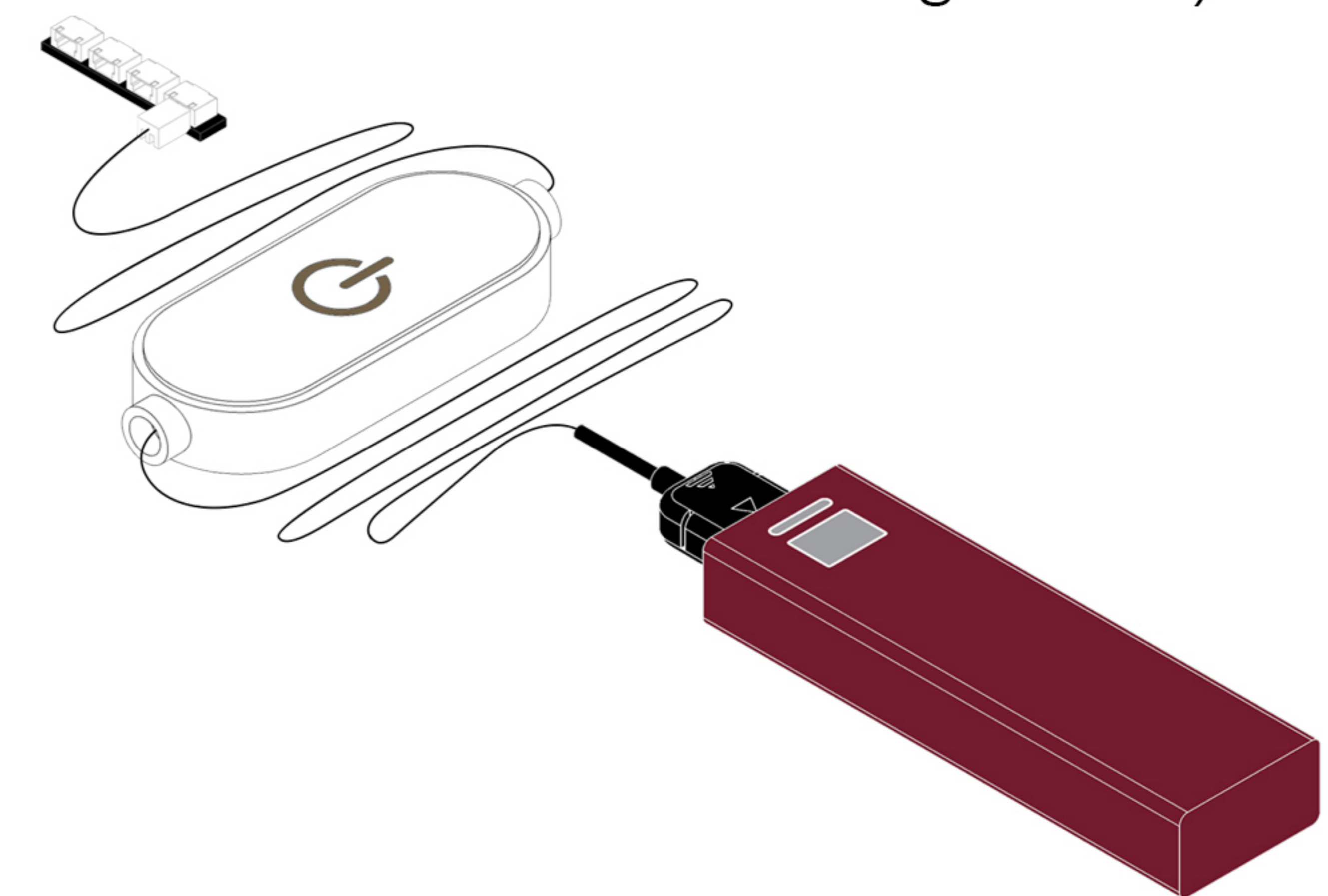

USB Connectors to Connect Devices

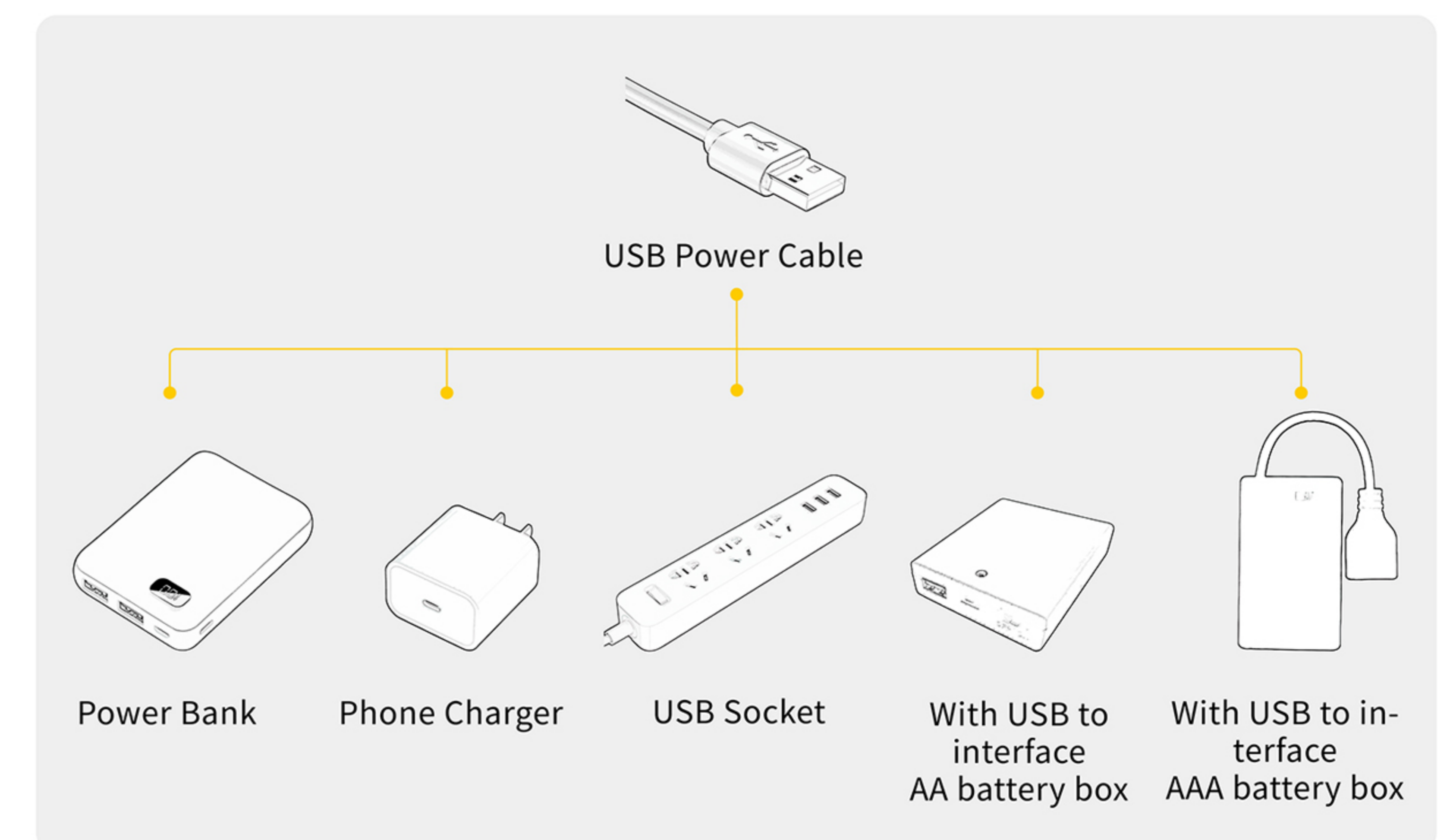

4

EN: Remove the string of lights from Bag 1 and connect it to the expansion board. Turn on the power, touch the dimmer module with your hand to check if the lights are working properly. If you notice any abnormalities, please contact us immediately.

DE: Nehmen Sie die Lichterkette aus Beutel 1 heraus und schließen Sie sie an die Erweiterungsplatine an. Schalten Sie den Strom ein und berühren Sie das Dimmermodul mit der Hand, um zu prüfen, ob die Lichter ordnungsgemäß funktionieren. Sollten Sie Unregelmäßigkeiten feststellen, kontaktieren Sie uns bitte umgehend.

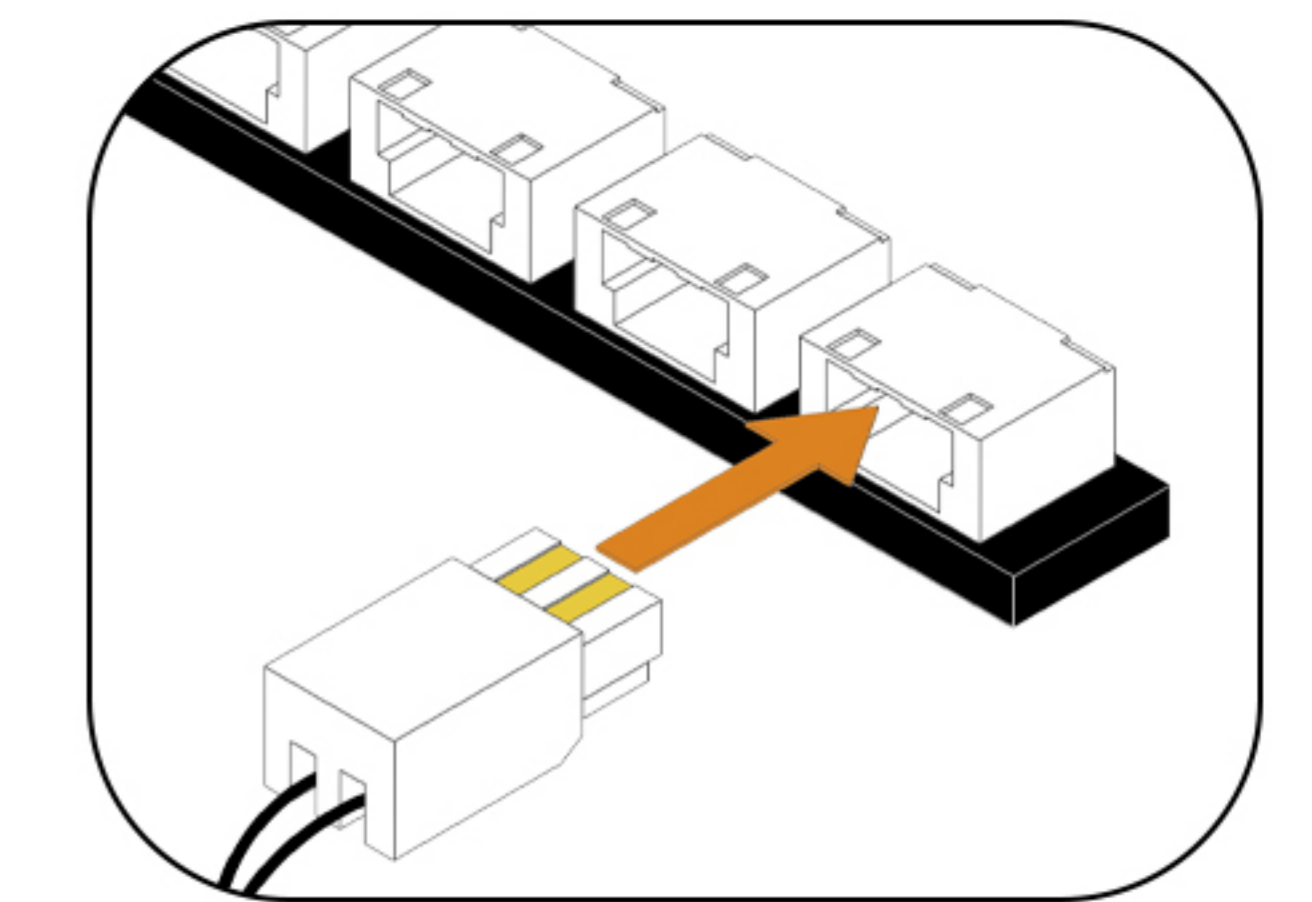
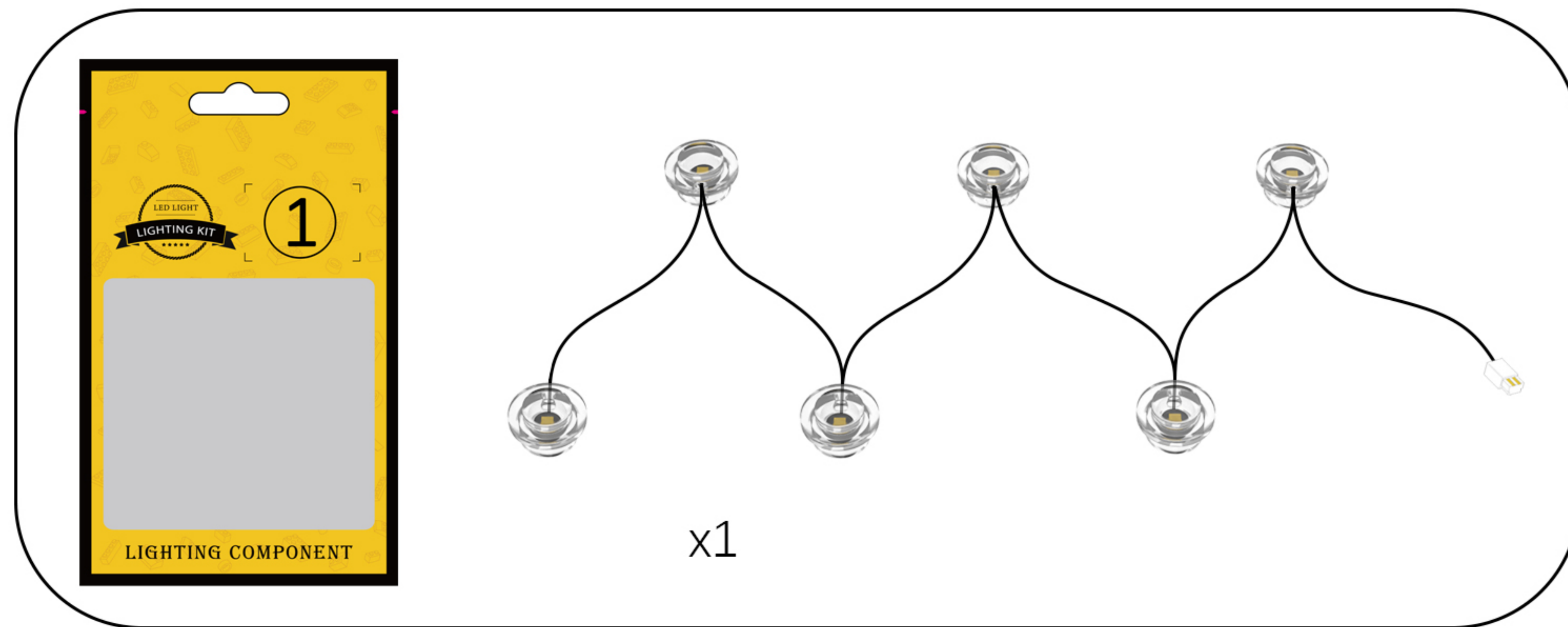

Touch Dimmer Module - 200CM Introduce

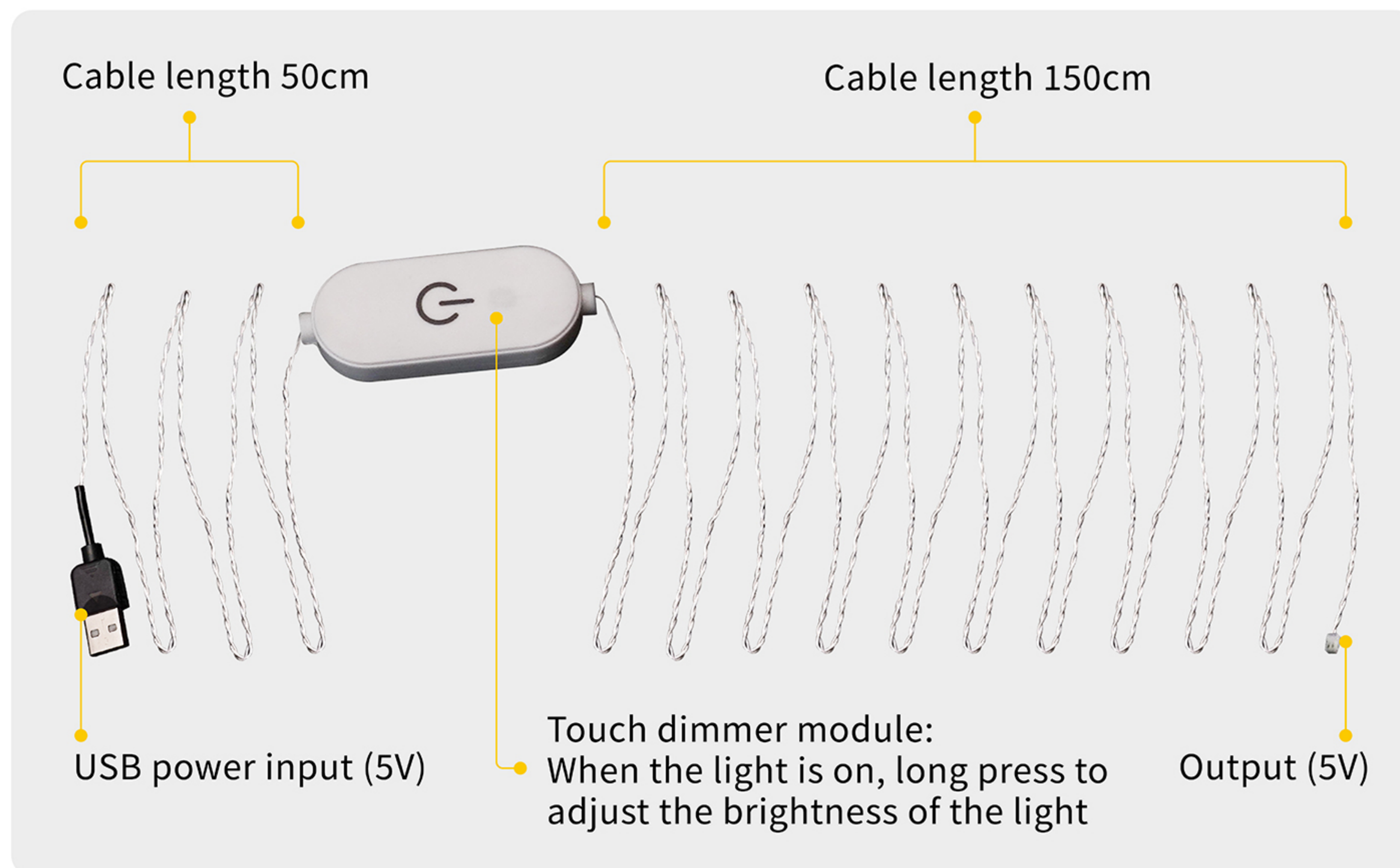

After confirming that there are no abnormalities, temporarily return each part to its original bag.

Step 2-Mounting.

1

EN: Take out the building block model.

DE: Nimm das Bauklotzmodell heraus.

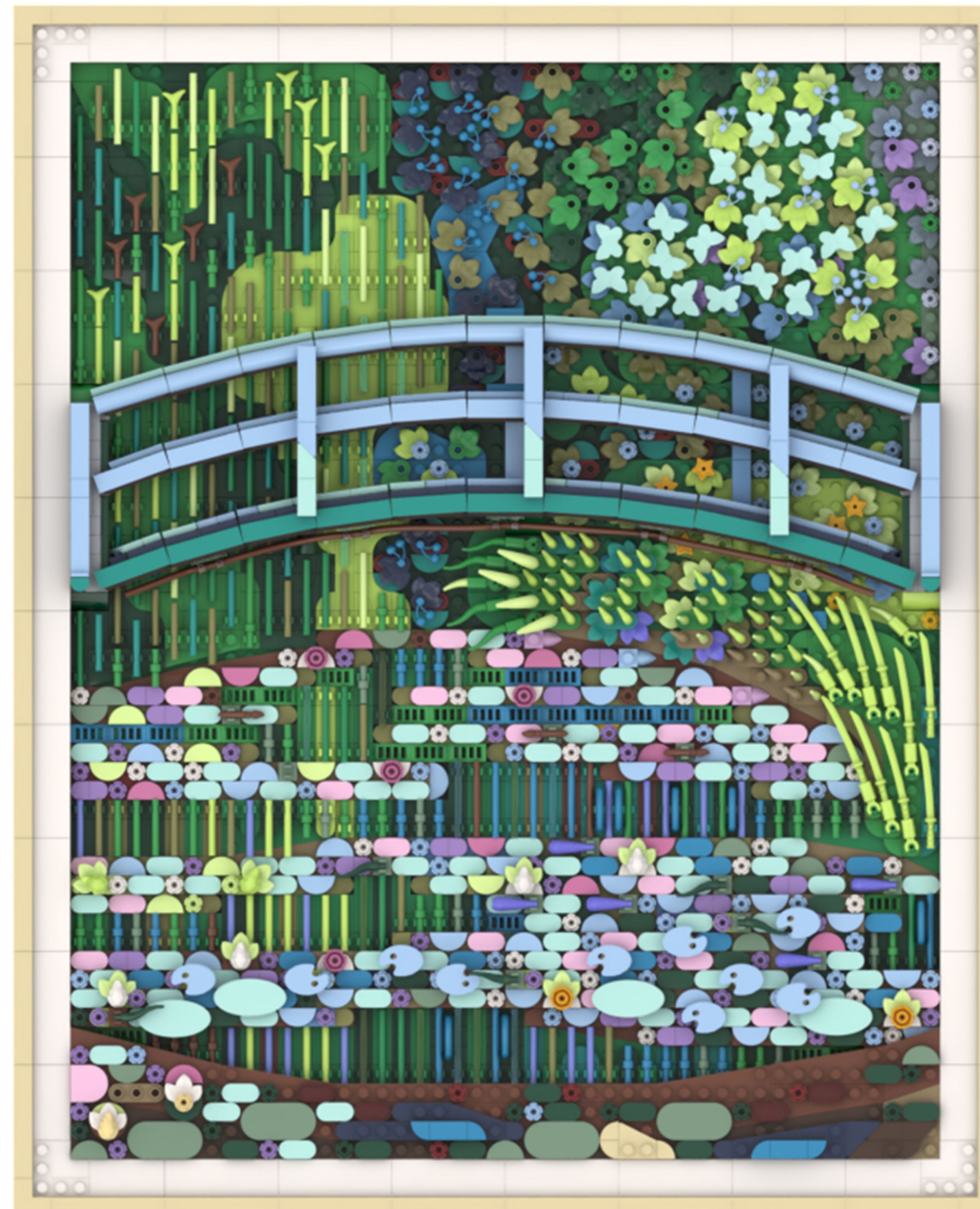

2

EN: Adjust your perspective.

DE: Ändern Sie Ihre Perspektive.

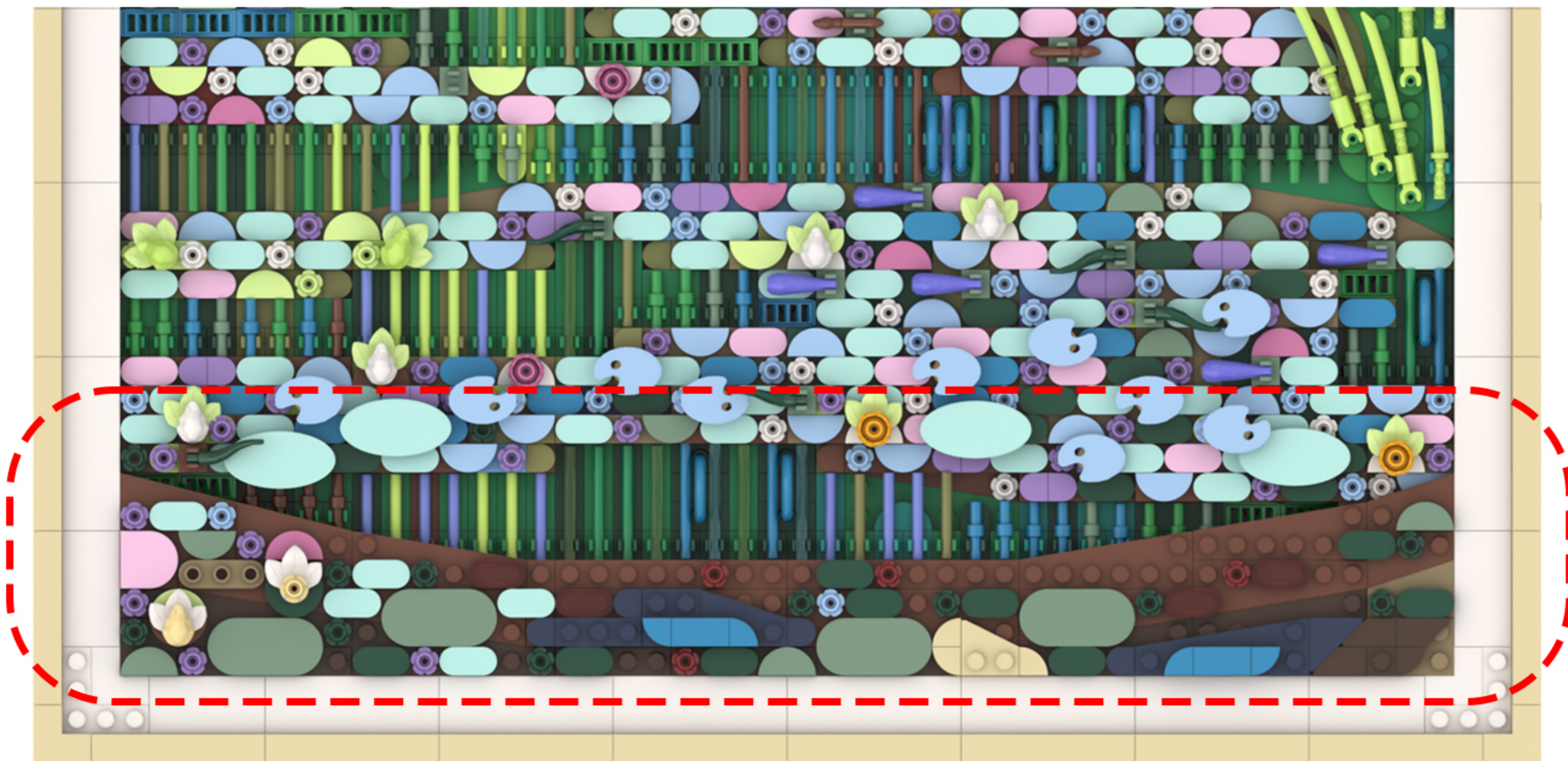

3

EN: Take the string of lights out of Bag 2, untie the zip tie, and locate the decorative lights on the string.

DE: Nimm die Lichterkette aus Beutel 2, löse den Kabelbinder und suche die dekorativen Lichter an der Kette.

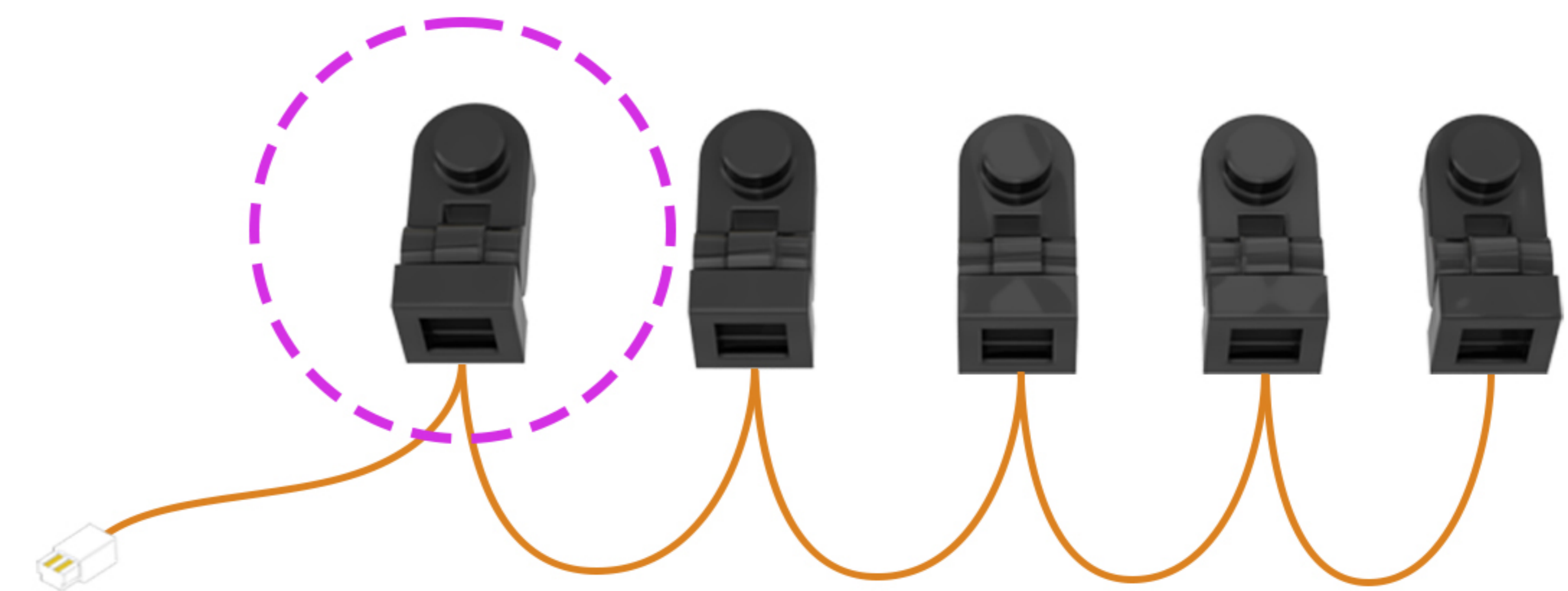
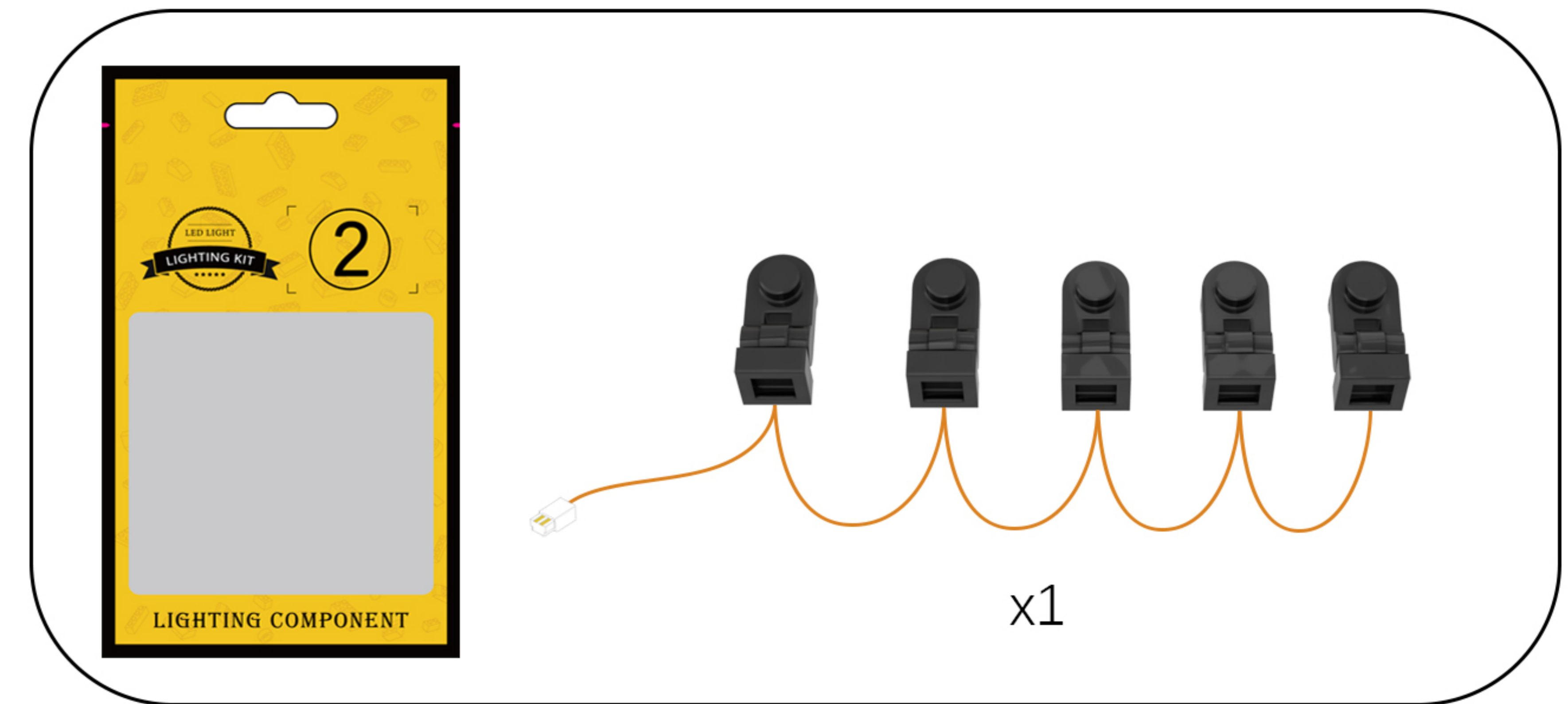

4

EN: Place the lights from the string onto the building blocks.

DE: Befestigen Sie die Lichter der Lichterkette an den Bausteinen.

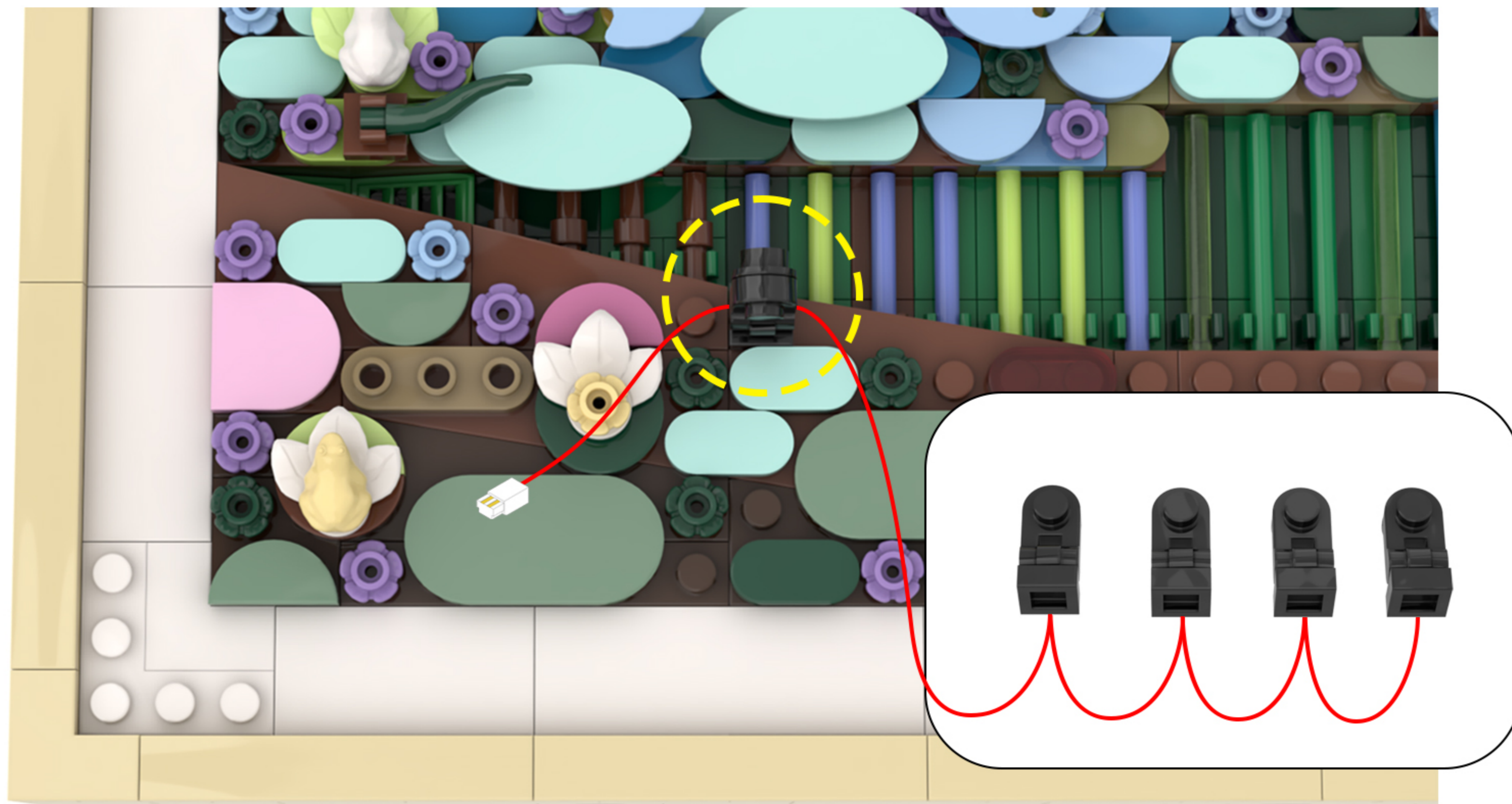

5

EN: Continue attaching the next light from the string to the building block.

DE: Befestige eine weitere Lampe der Lichterkette am Bauklotz.

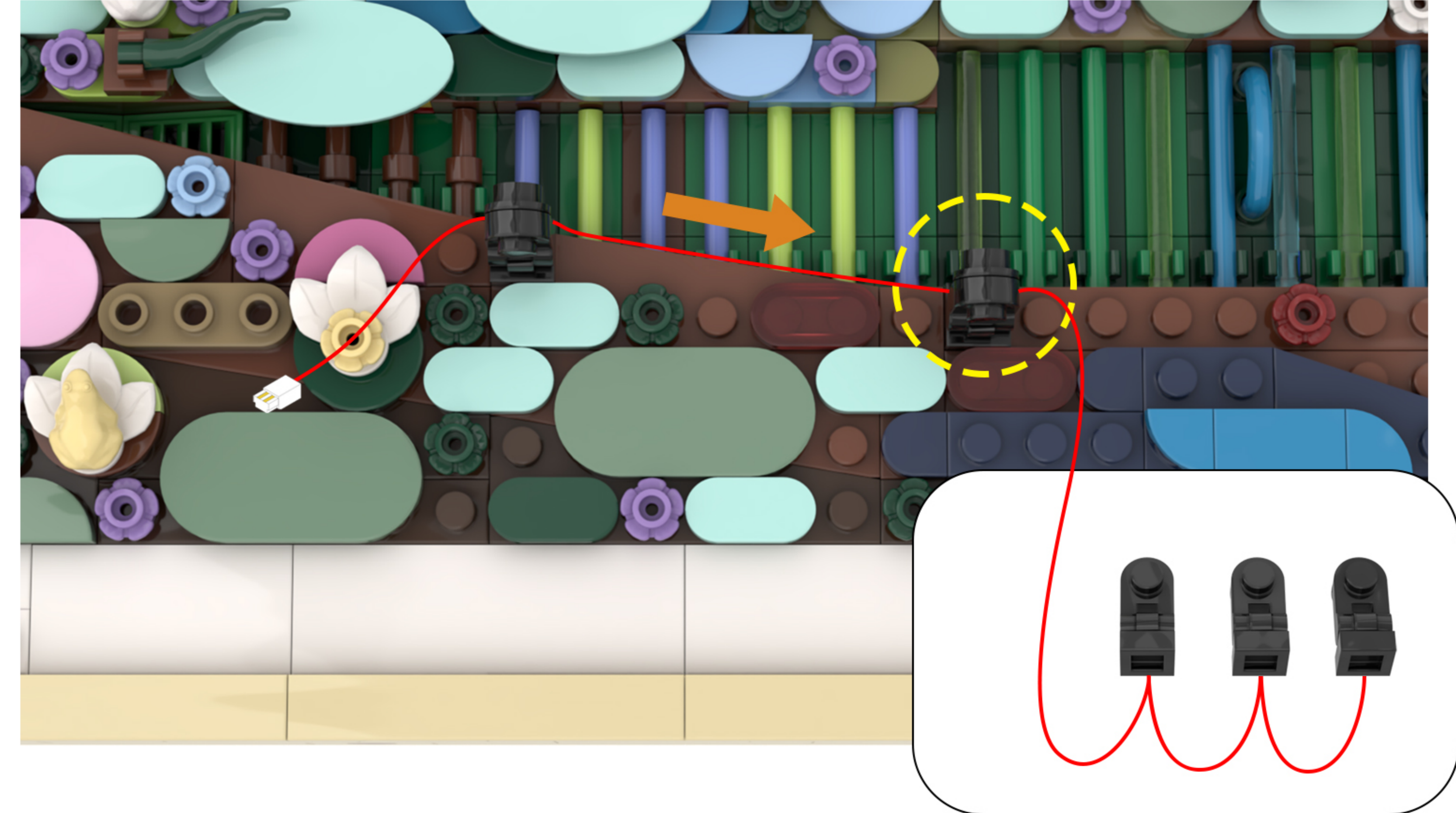

6

EN: Attach the lights from the string to the building blocks one by one.

DE: Befestige die Lichter der Lichterkette nacheinander an den Bausteinen.

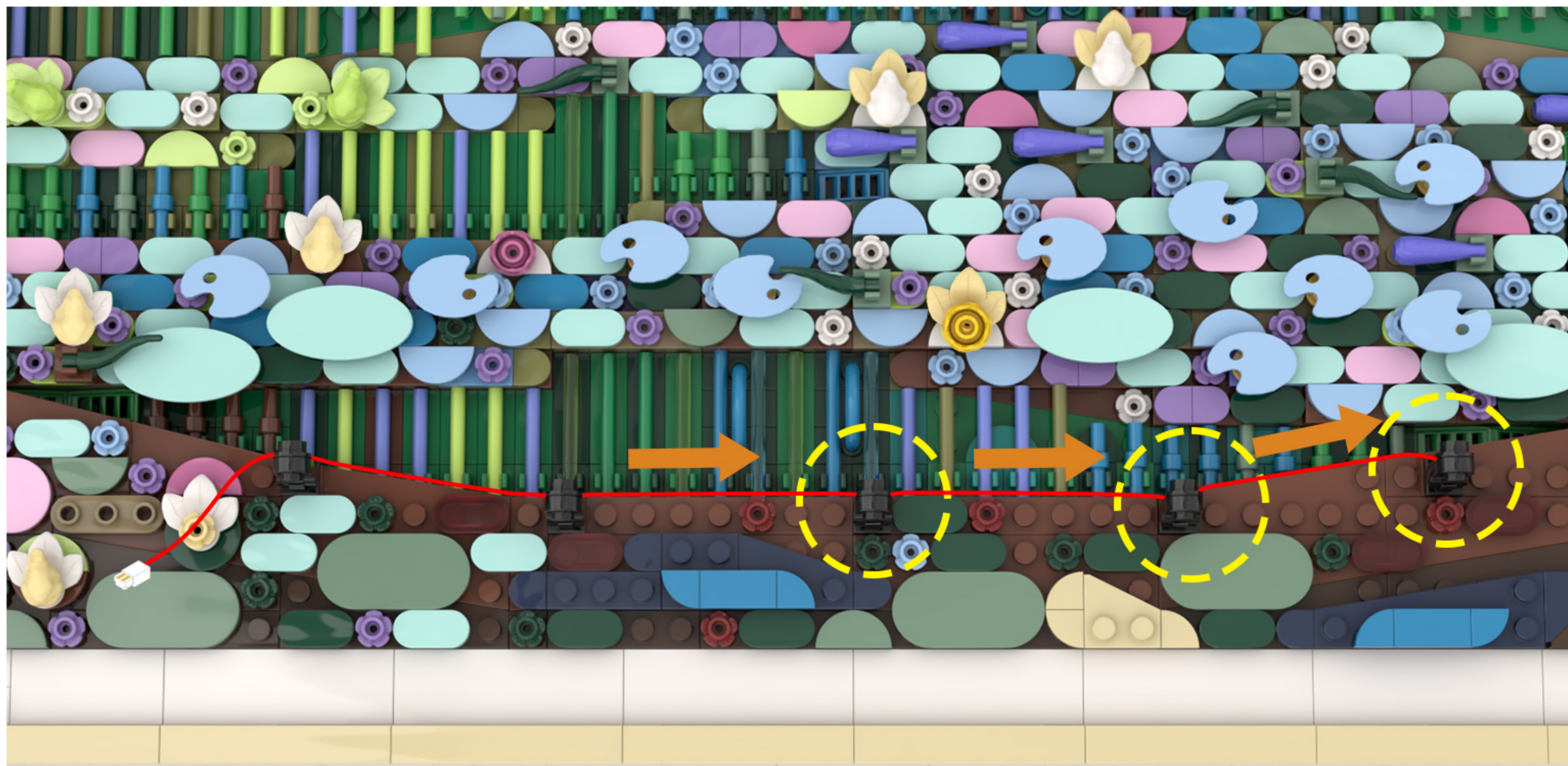

7

EN: Adjust your perspective.

DE: Ändern Sie Ihre Perspektive.



8

EN: Split as shown in the figure.

DE: Wie in der Abbildung gezeigt, teilen Sie es auf.



9

EN: Adjust your perspective.

DE: Ändern Sie Ihre Perspektive.

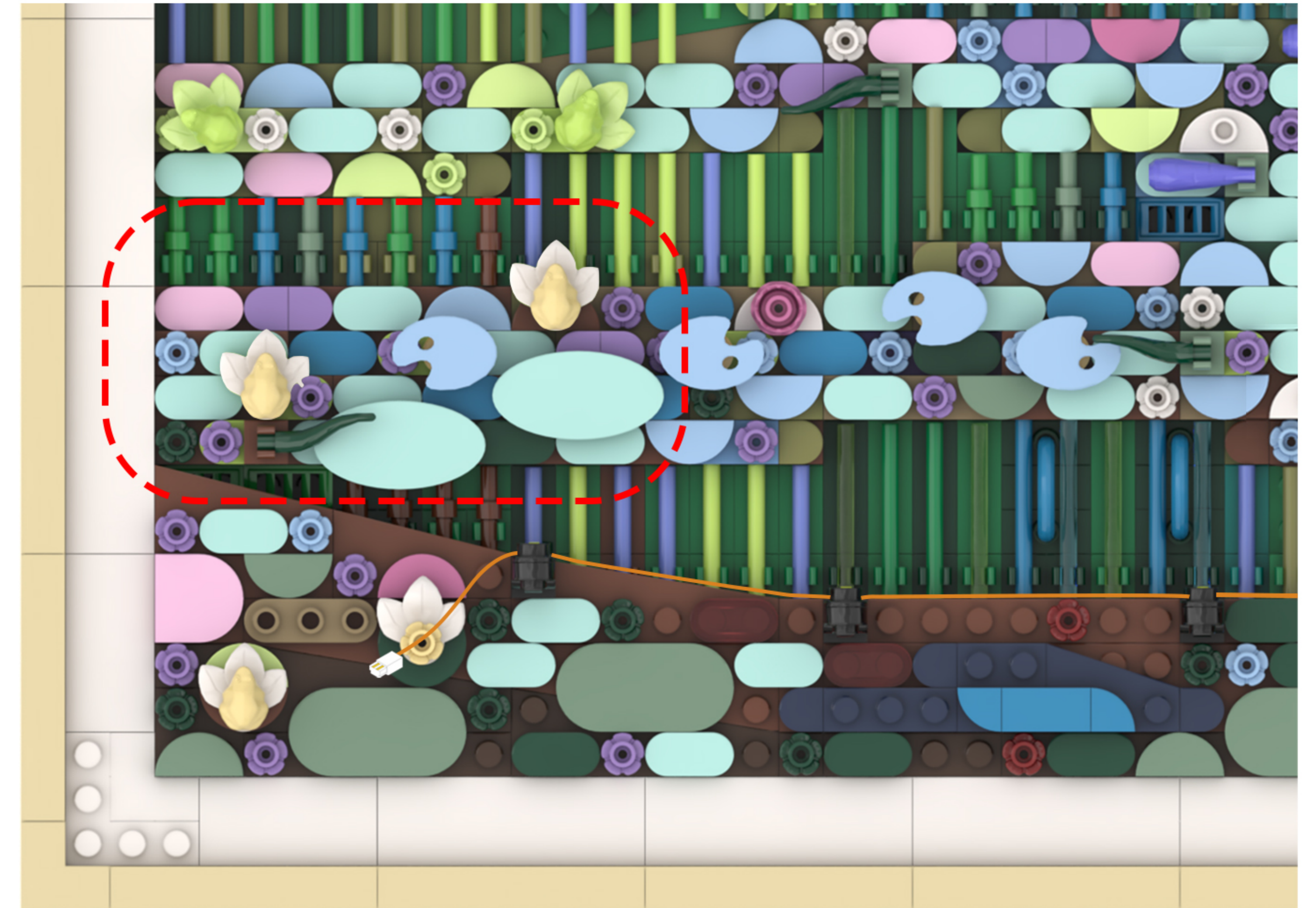

10

EN: Split as shown in the figure.

DE: Wie in der Abbildung gezeigt, teilen Sie es auf.

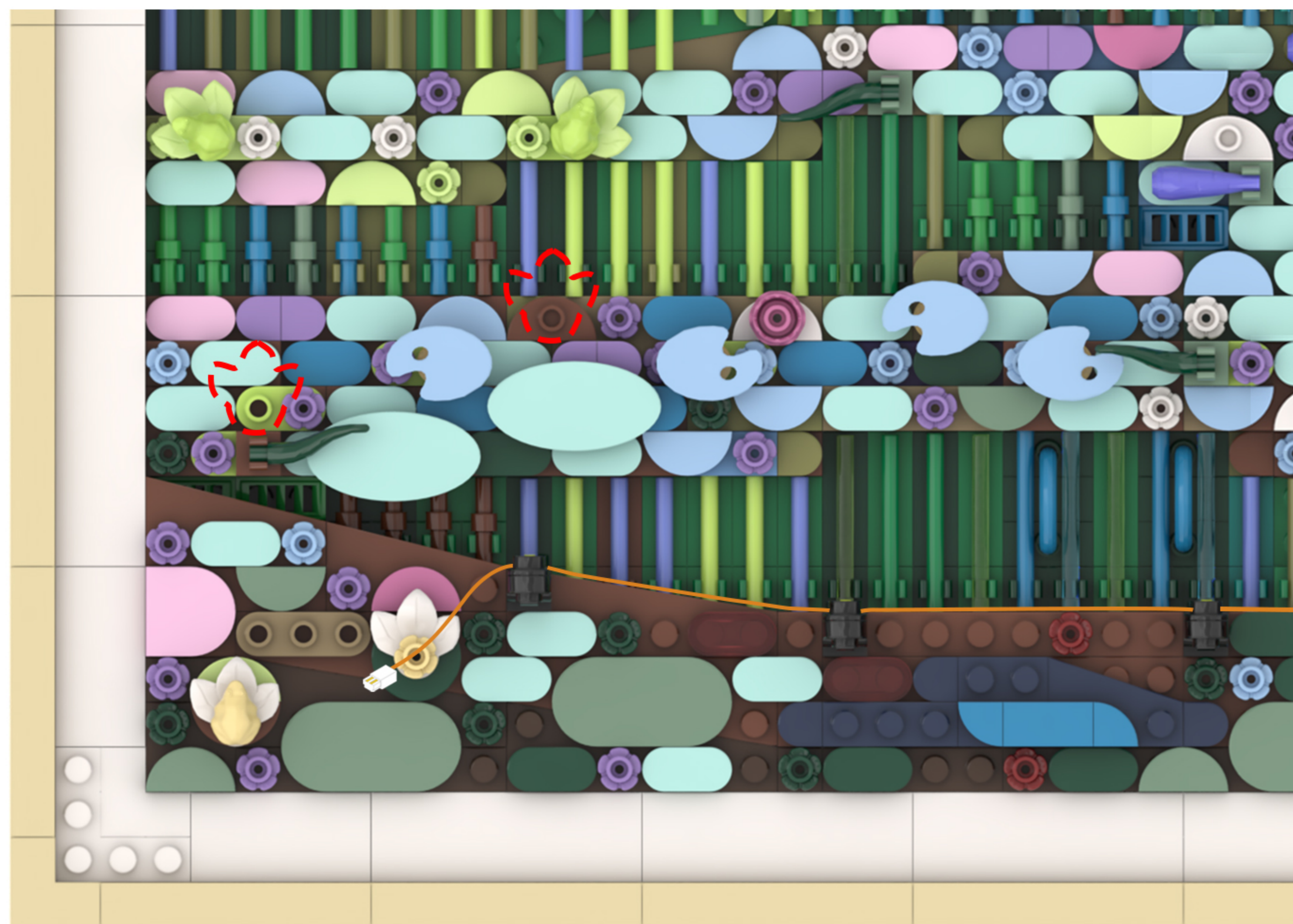
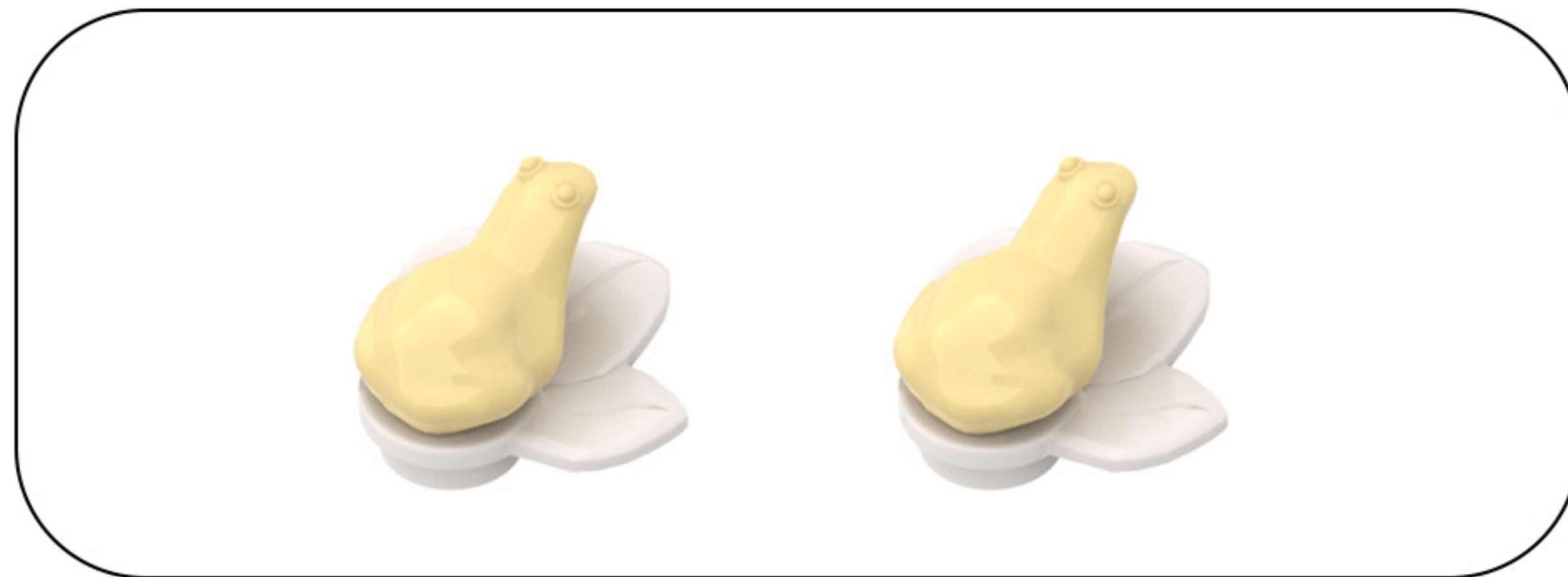

11

EN: Take the string of lights out of Bag 1, untie the zip tie, and locate the decorative lights on the string.
DE: Nimm die Lichterkette aus Beutel 1, löse den Kabelbinder und suche die dekorativen Lichter an der Kette.

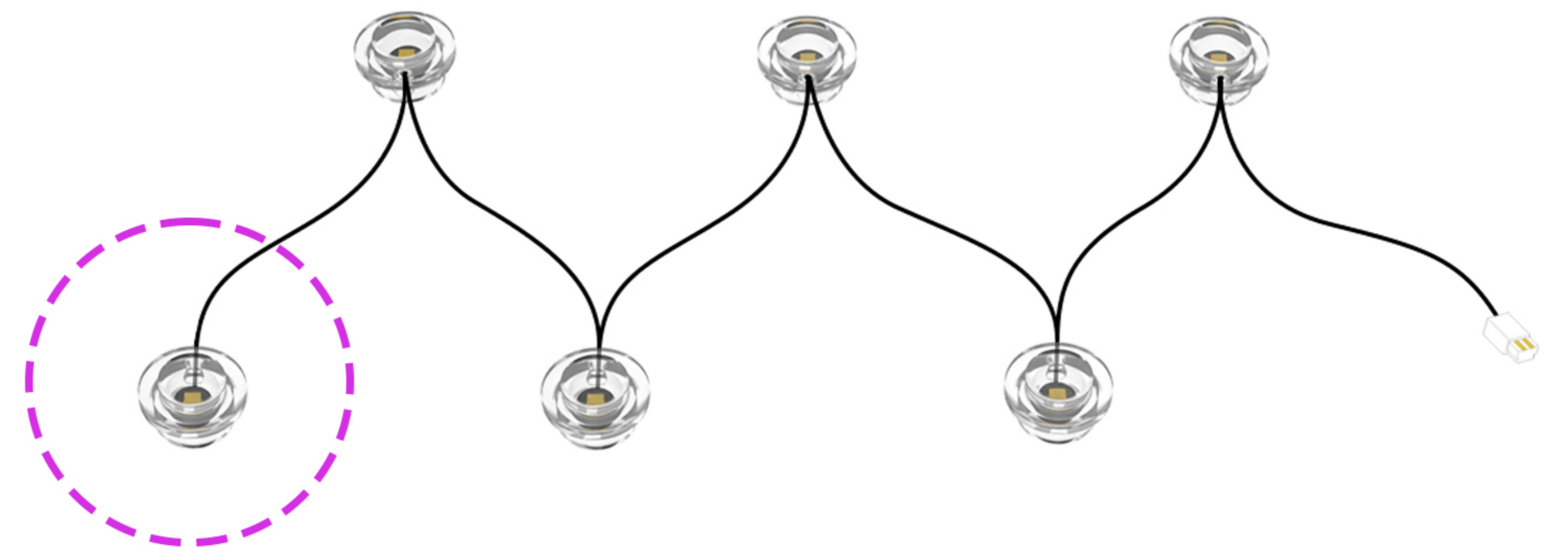
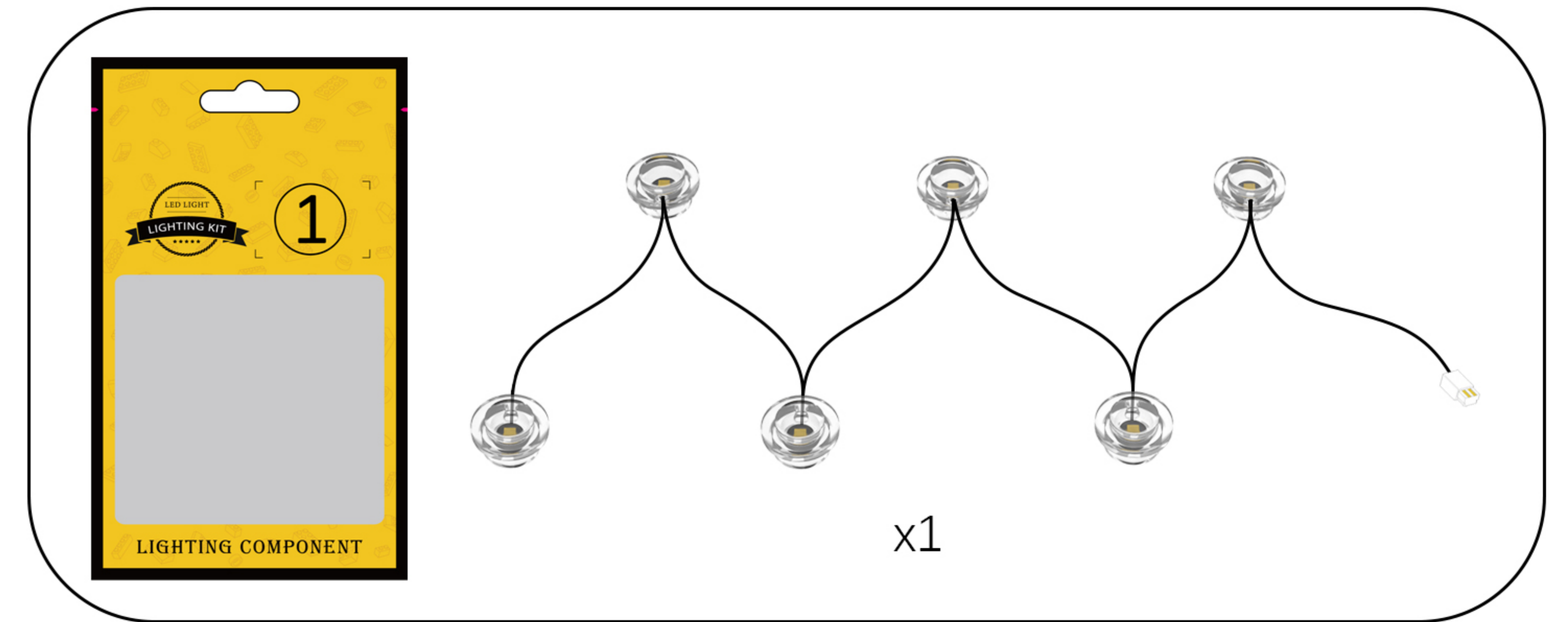

12

EN: Attach the lights from the string to the building blocks.

DE: Befestigen Sie die Lichter der Lichterkette an den Bausteinen.

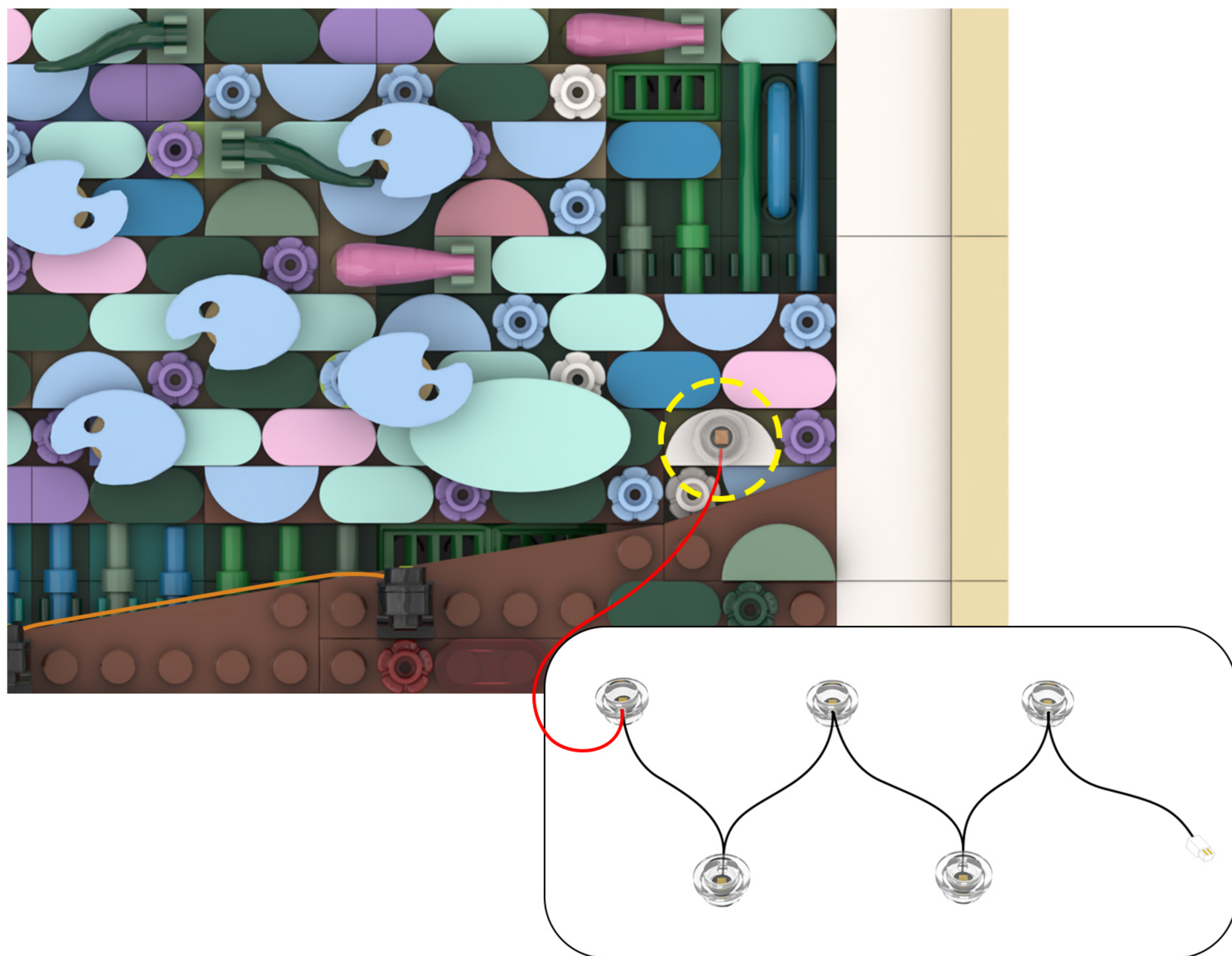

13

EN: Continue attaching the next light from the string to the building block.

DE: Befestige eine weitere Lampe der Lichterkette am Bauklotz.

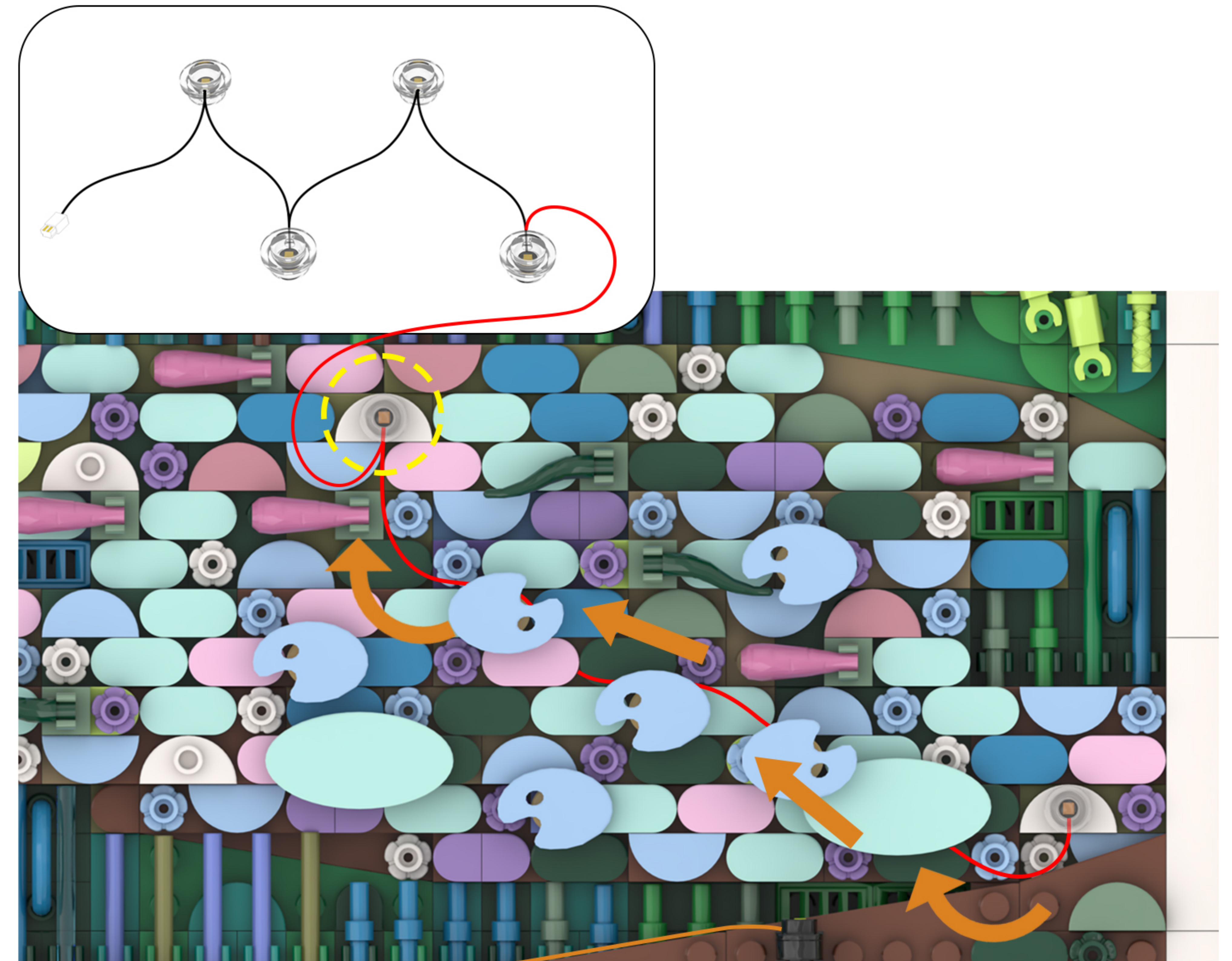

Note: Hide the light cord in the gaps between the building blocks.

14

EN: Continue attaching the next light from the string to the building block.

DE: Befestige eine weitere Lampe der Lichterkette am Bauklotz.

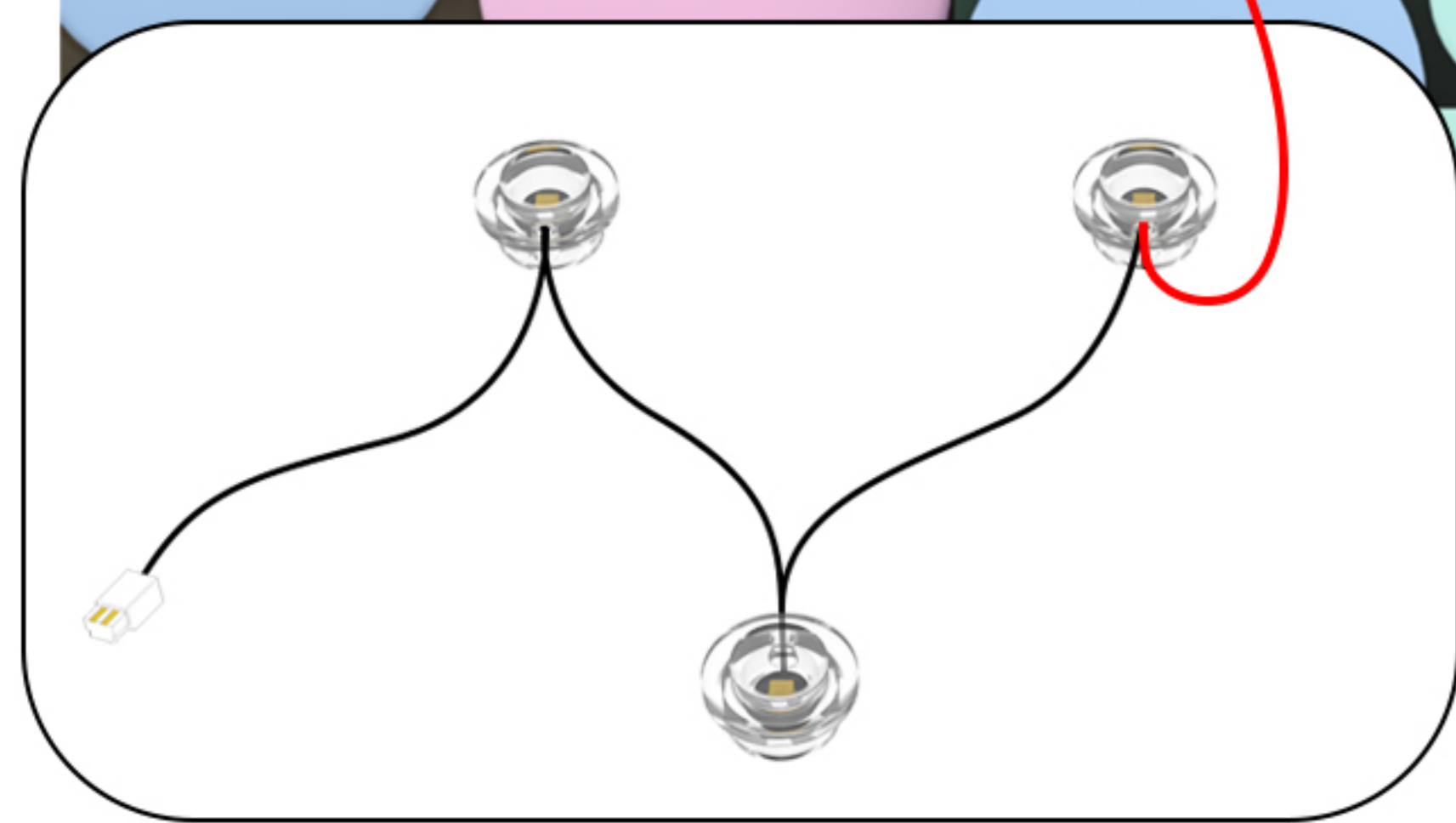
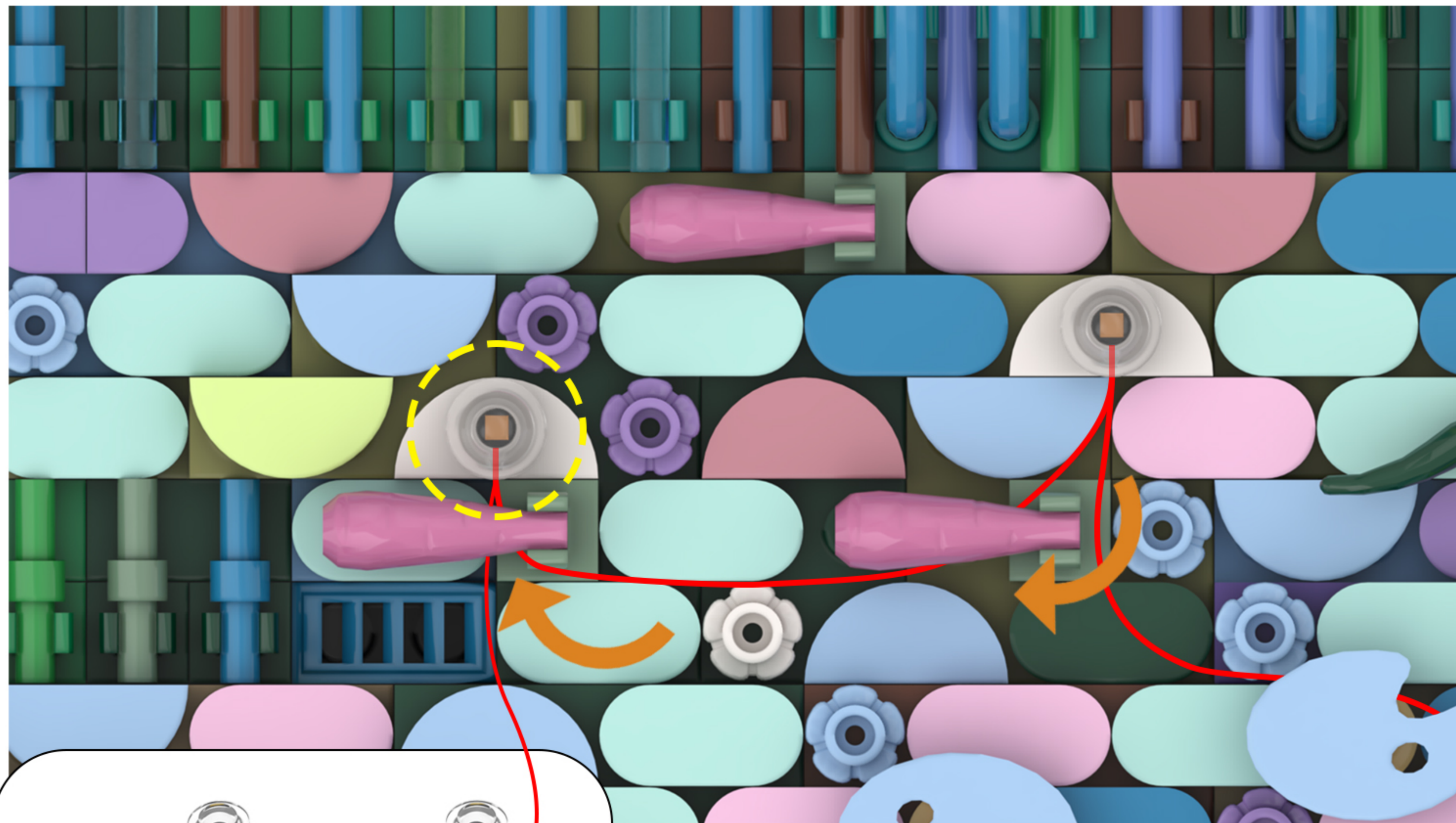

Note: Hide the light cord in the gaps between the building blocks.

15

EN: Continue attaching the next light from the string to the building block.

DE: Befestige eine weitere Lampe der Lichterkette am Bauklotz.

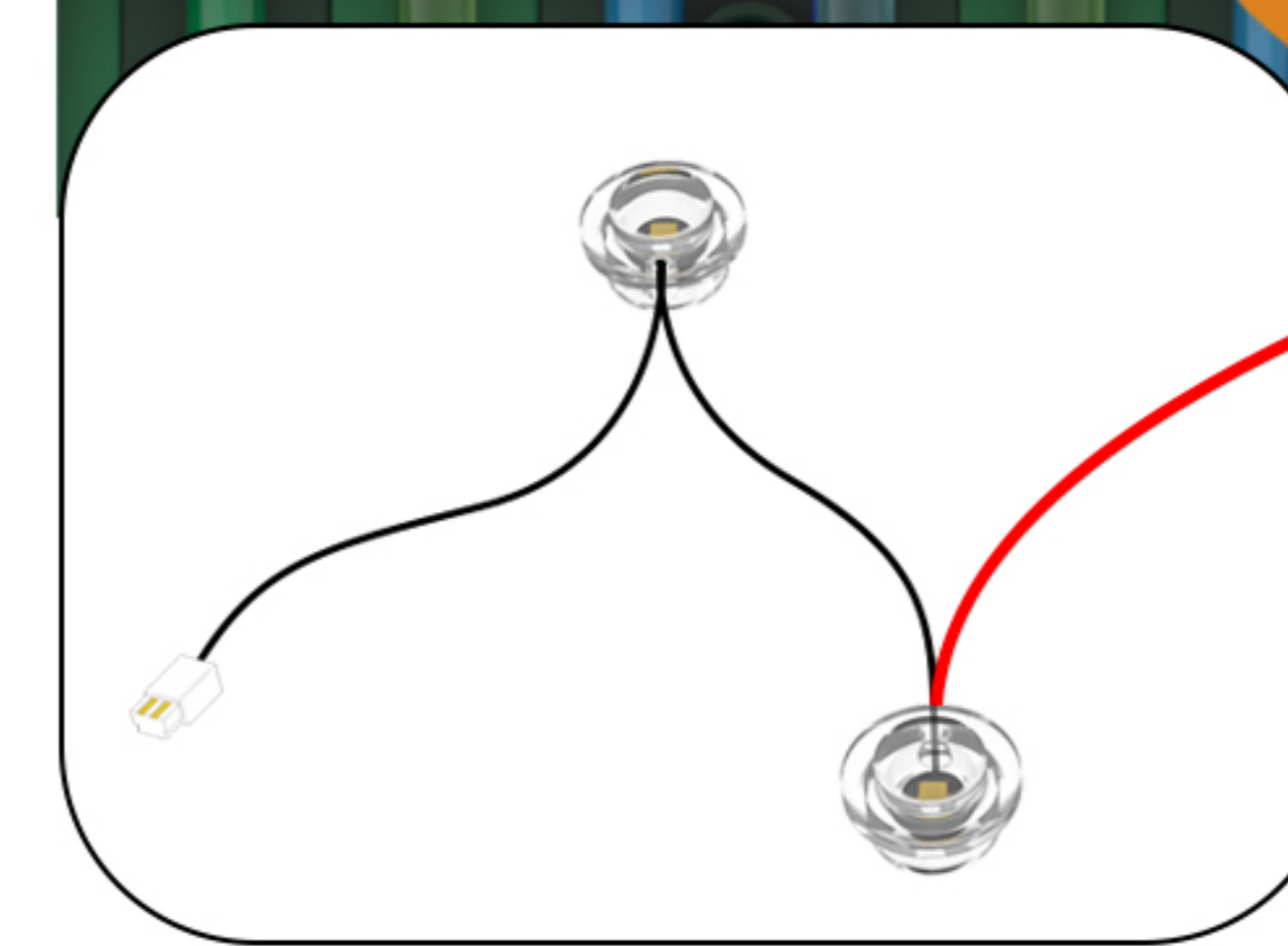
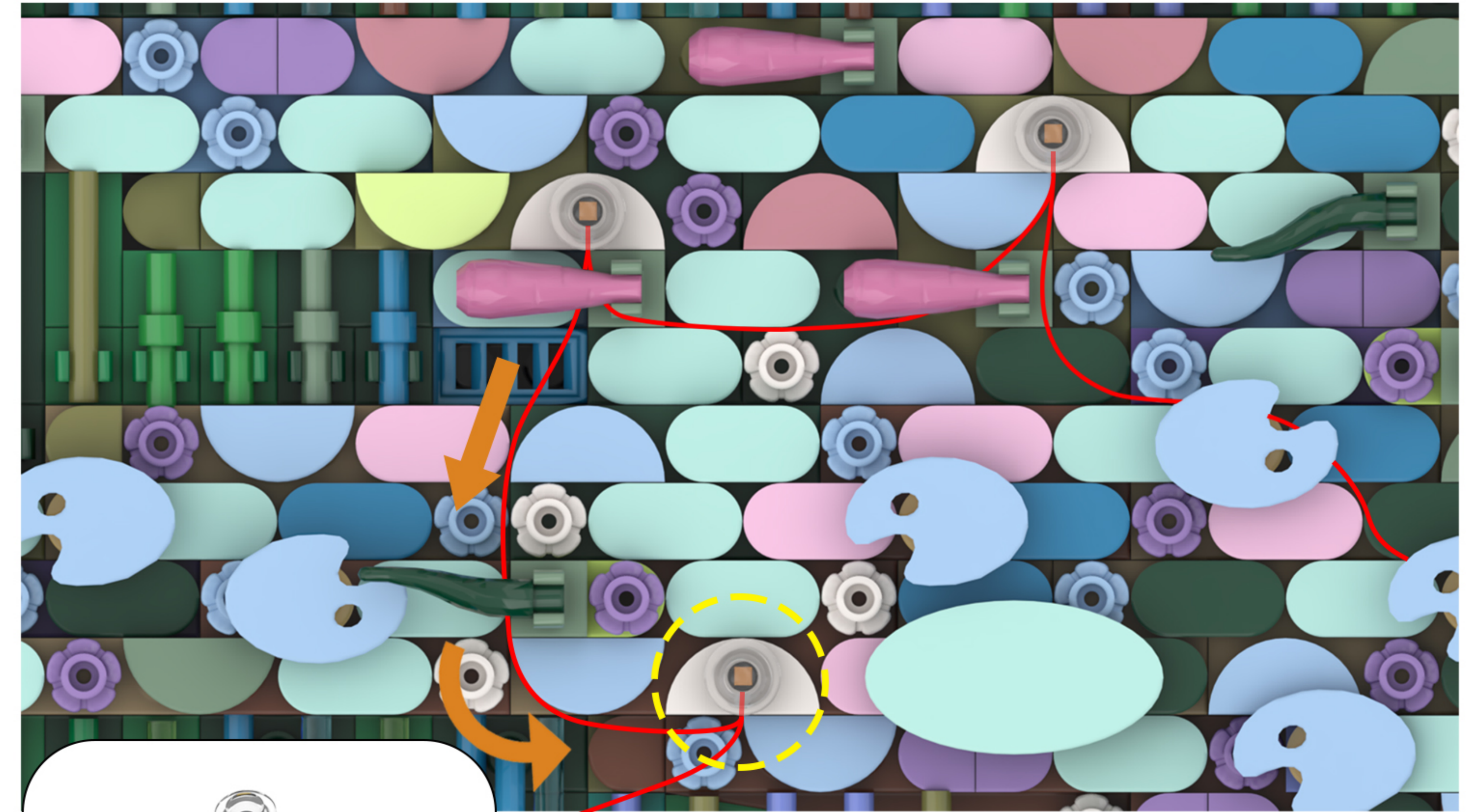

Note: Hide the light cord in the gaps between the building blocks.

16

EN: Continue attaching the next light from the string to the building block.

DE: Befestige eine weitere Lampe der Lichterkette am Bauklotz.

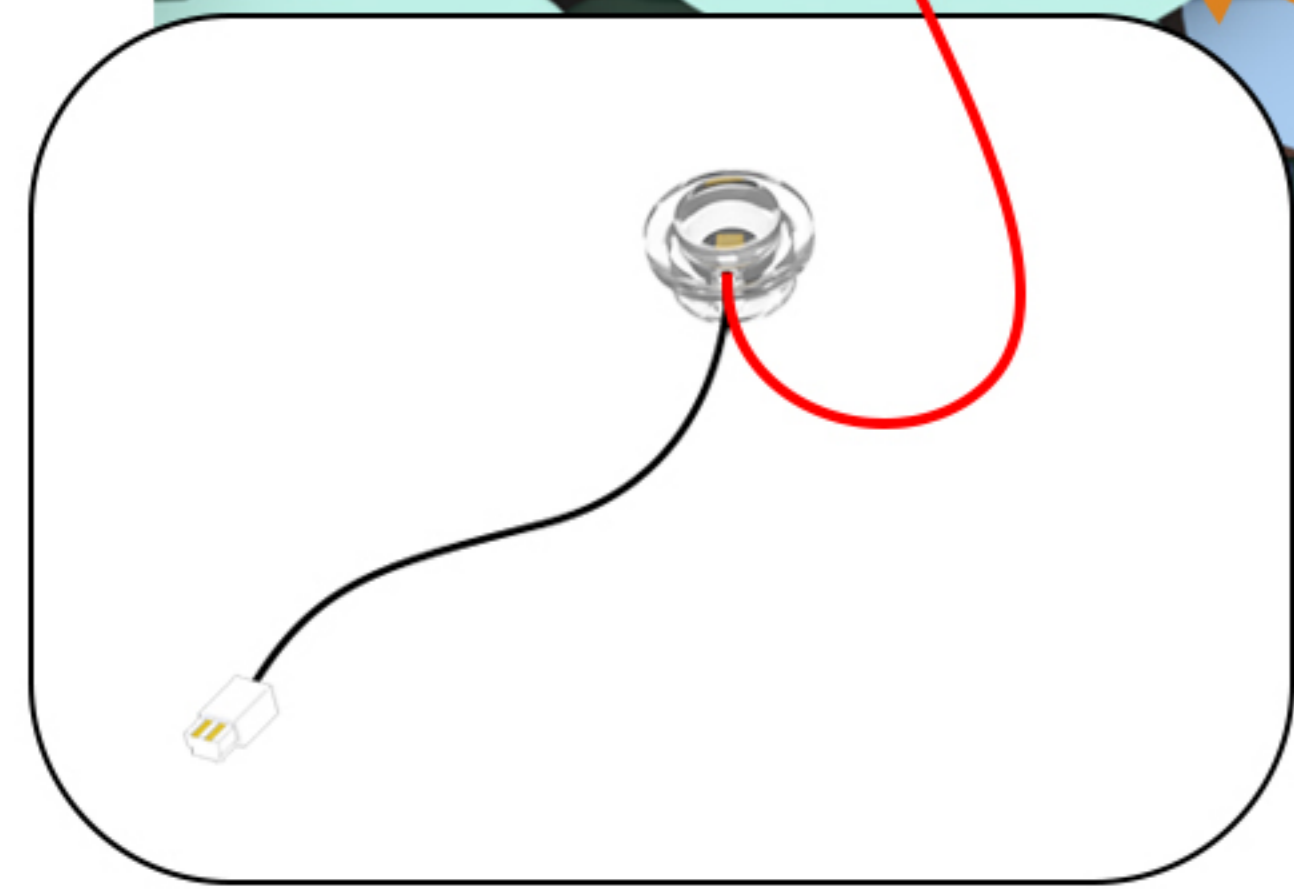
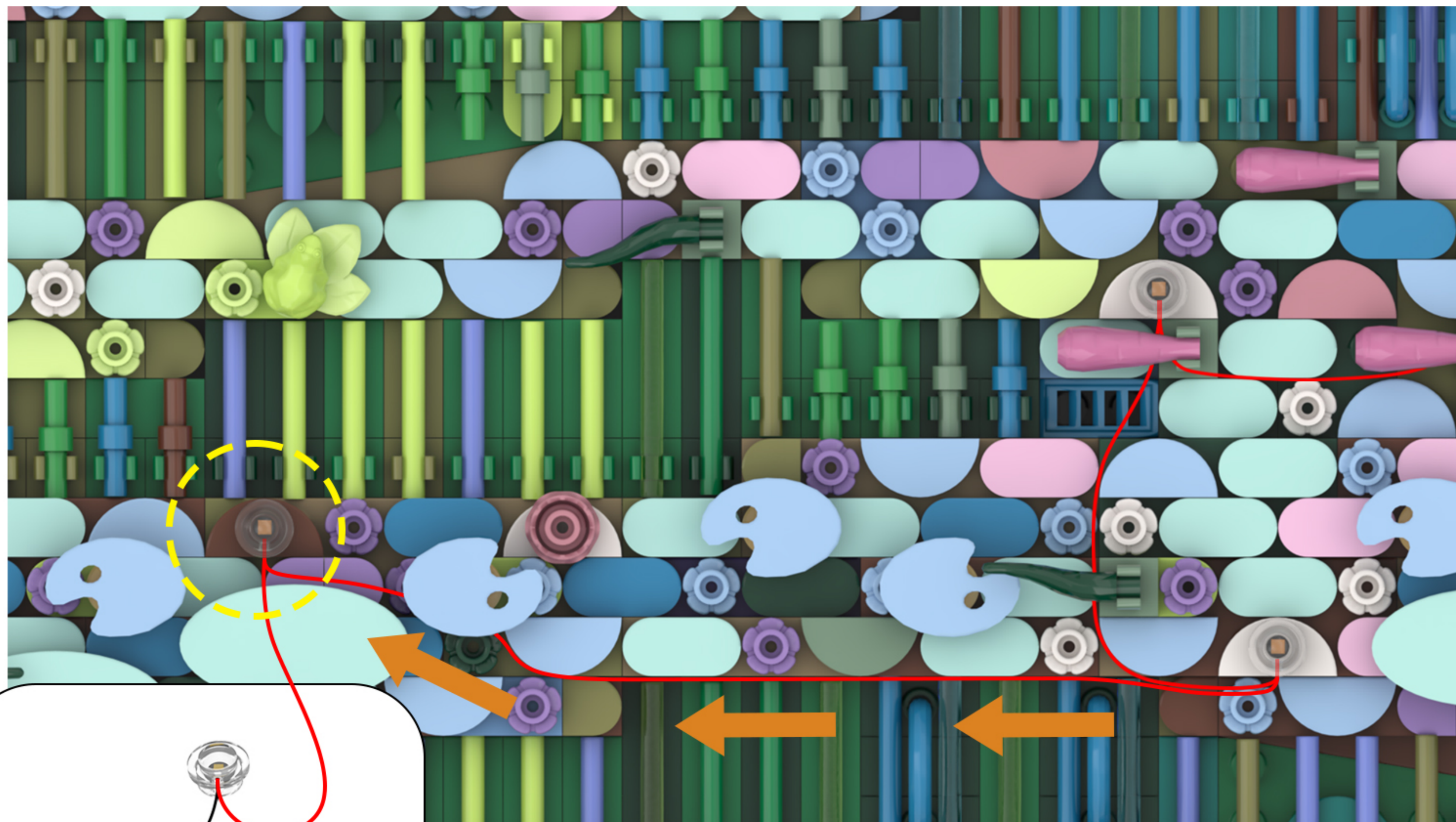

Note: Hide the light cord in the gaps between the building blocks.

17

EN: Attach the last light to the building block.

DE: Befestige die letzte Leuchte am Baustein.

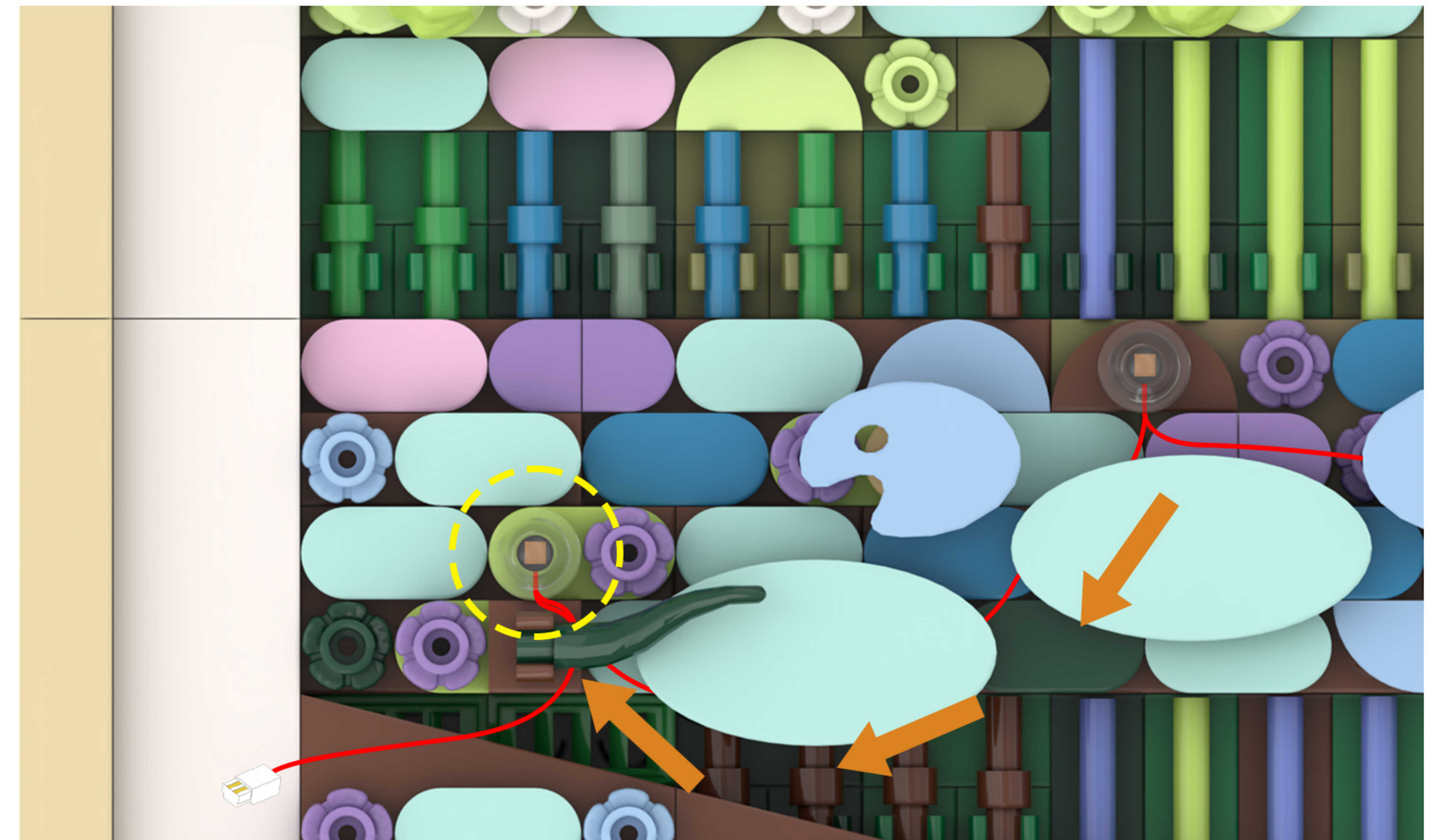

Note: Hide the light cord in the gaps between the building blocks.

18

EN: Take out the disassembled building blocks and reassemble them in order.

DE: Nehmen Sie die zerlegten Bausteine heraus und setzen Sie sie der Reihe nach wieder zusammen.

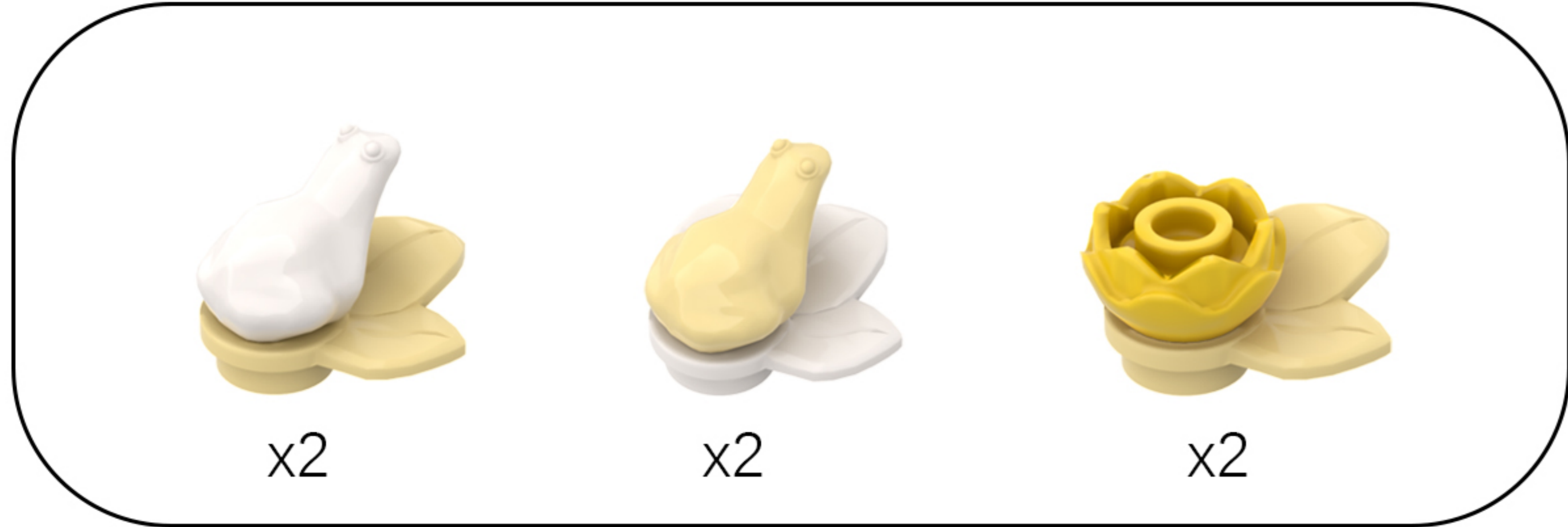

19

EN: Take the expansion board and connecting cable out of Bag 5 and connect them together.

DE: Nehmen Sie die Erweiterungskarte und das Verbindungskabel aus Beutel 5 und verbinden Sie beide miteinander.

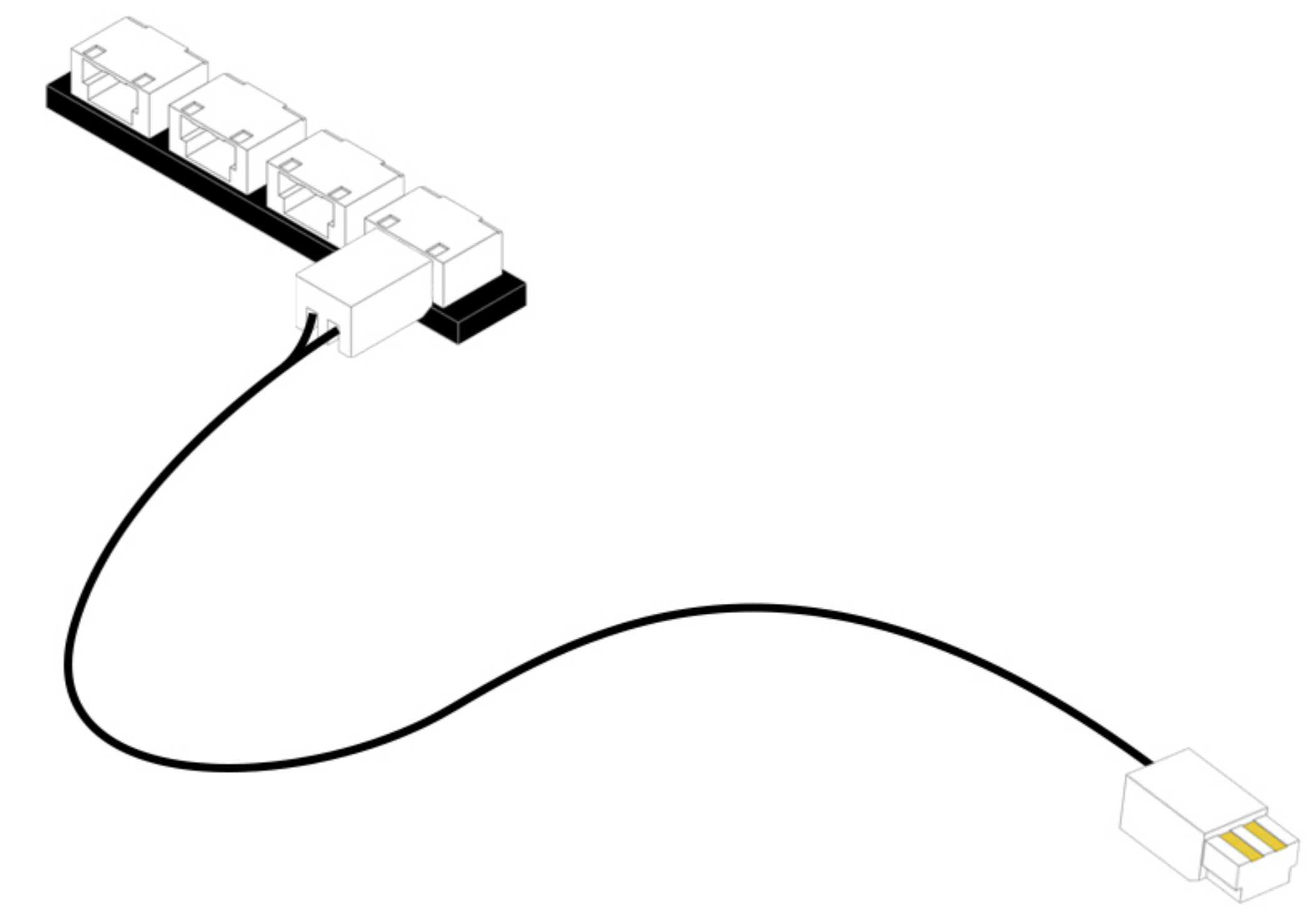
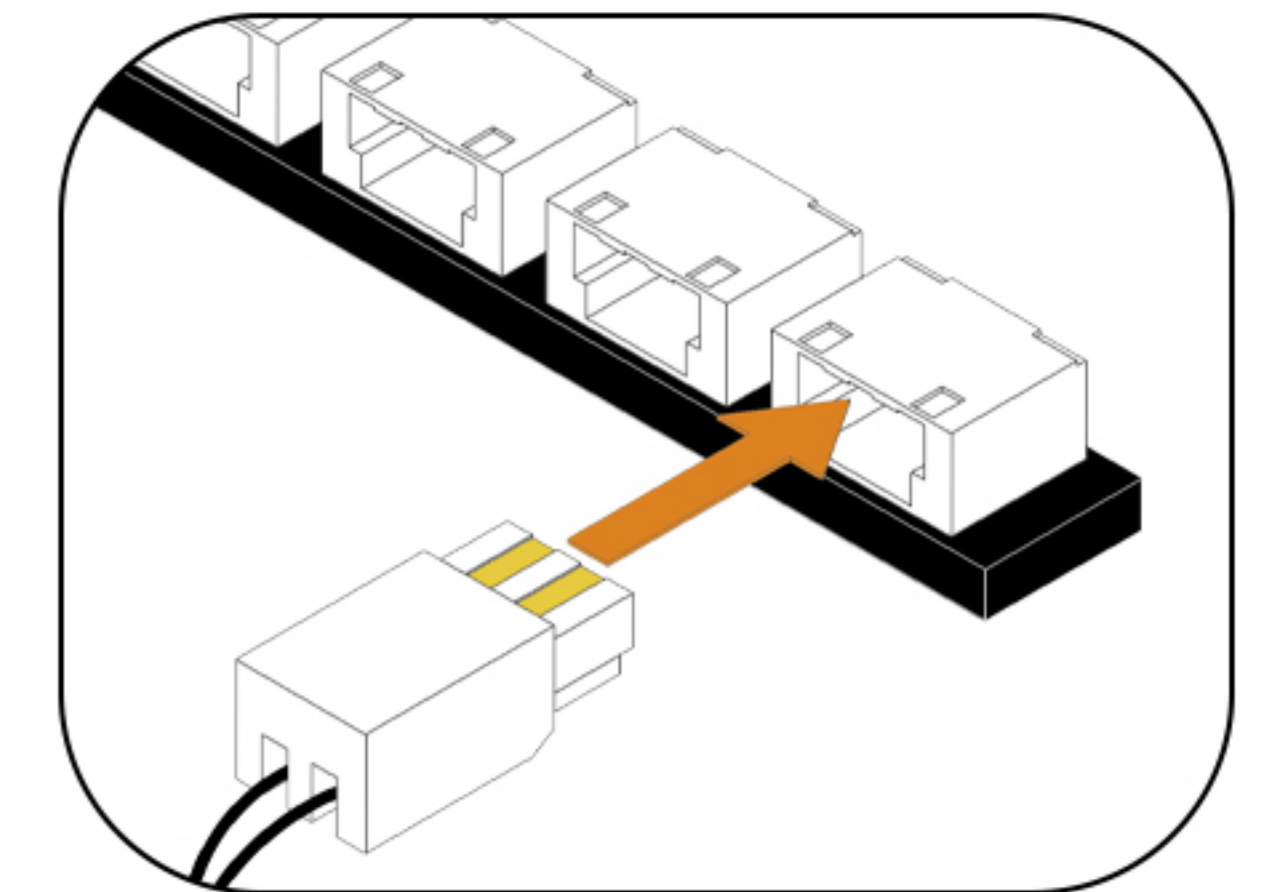
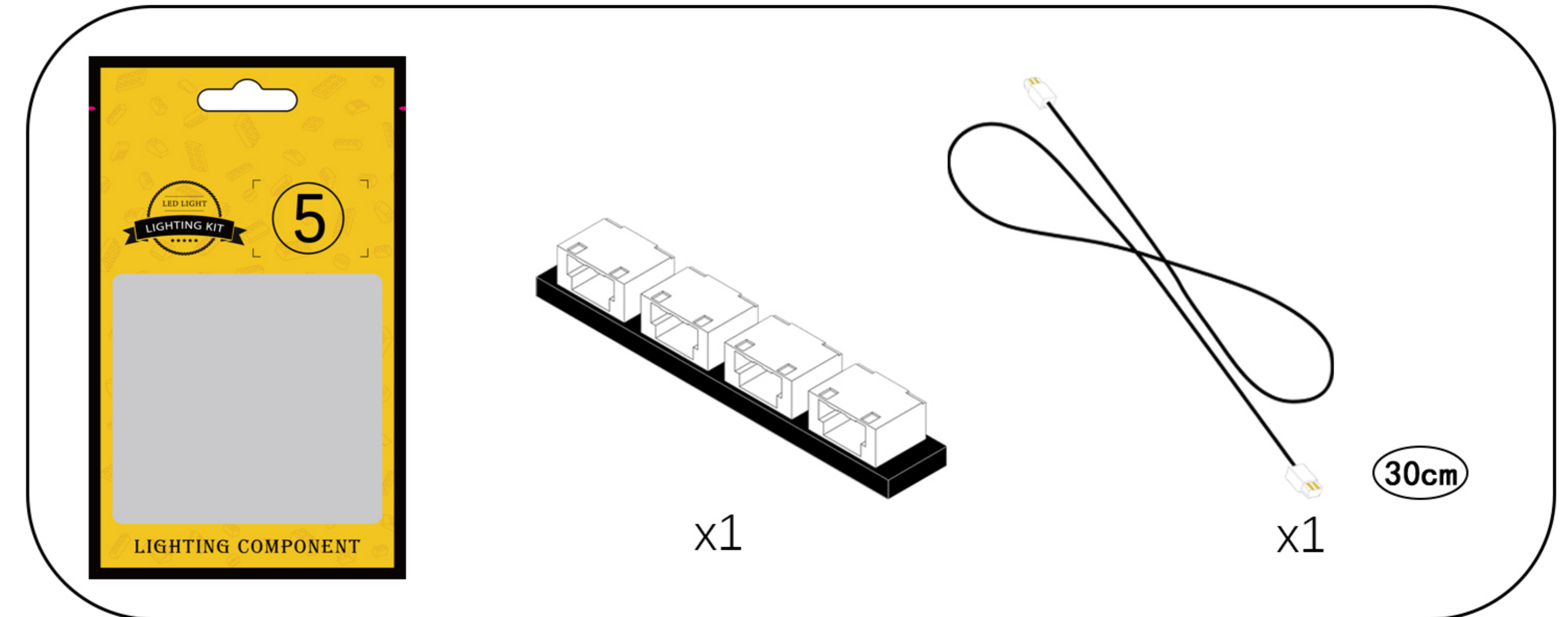

20

EN: Locate the two light-sensing wires shown in the diagram and connect them to the expansion board in sequence.

DE: Suchen Sie die beiden in der Abbildung gezeigten Lichtsensorkabel und schließen Sie sie nacheinander an die Erweiterungskarte an.

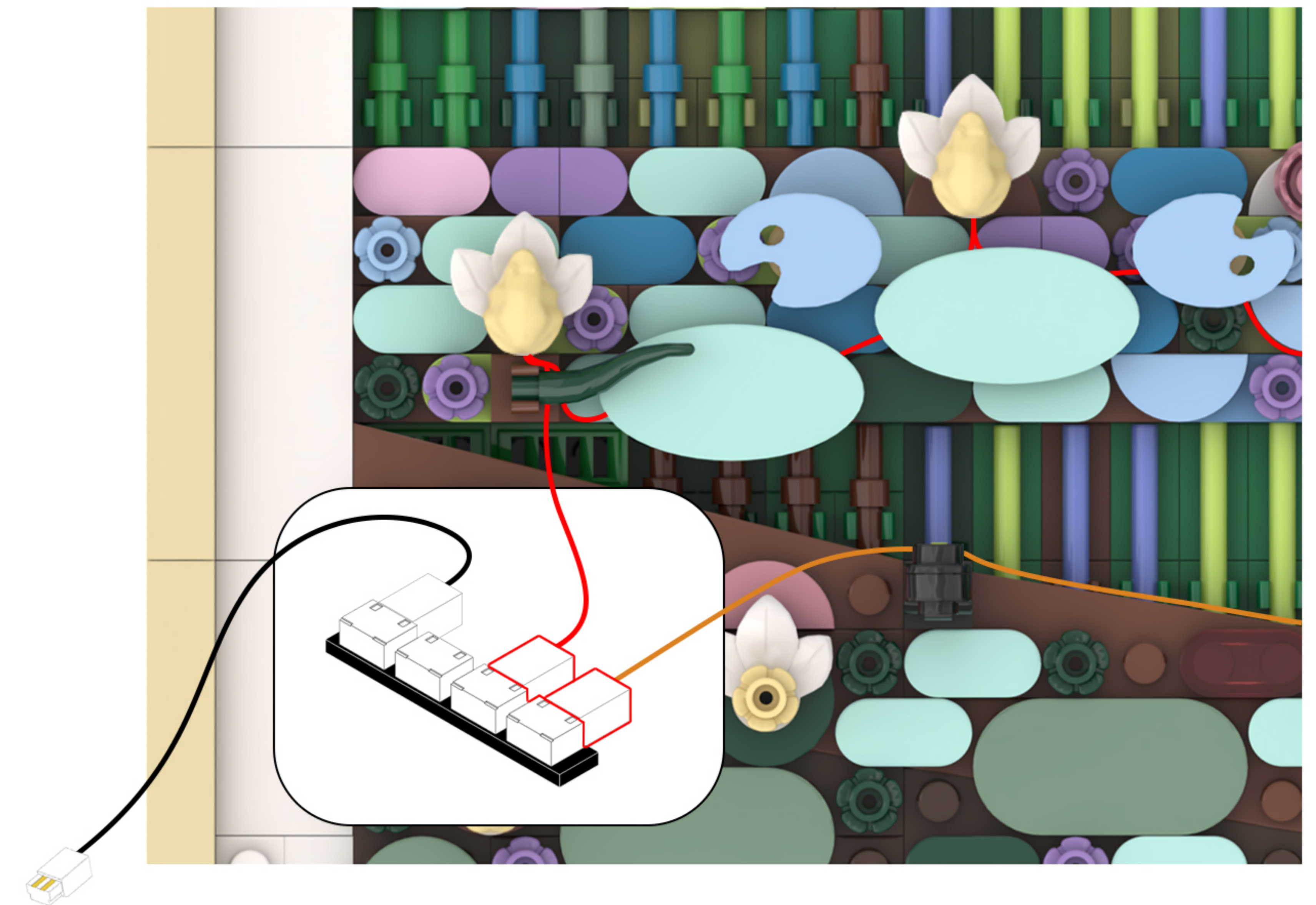
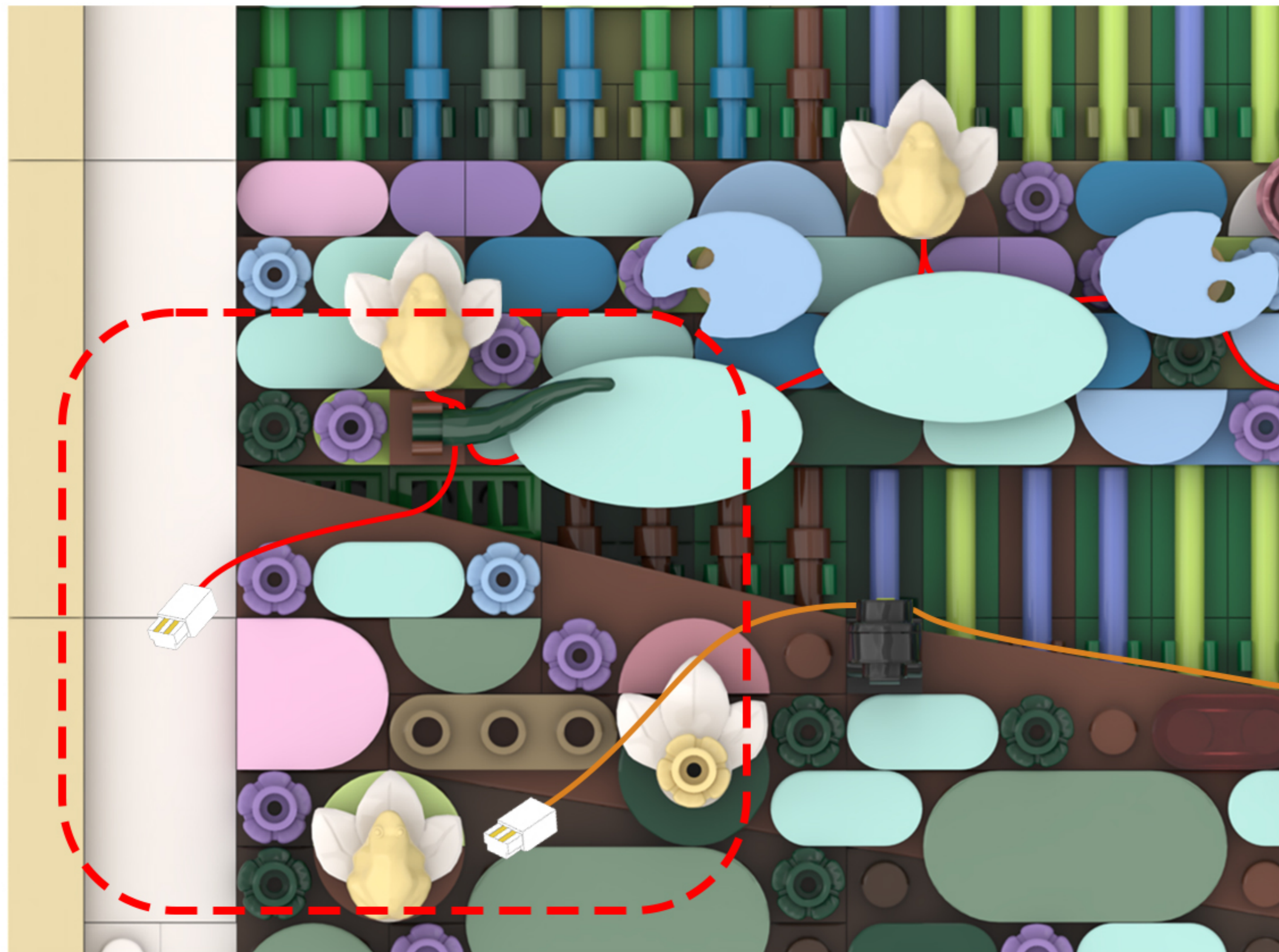
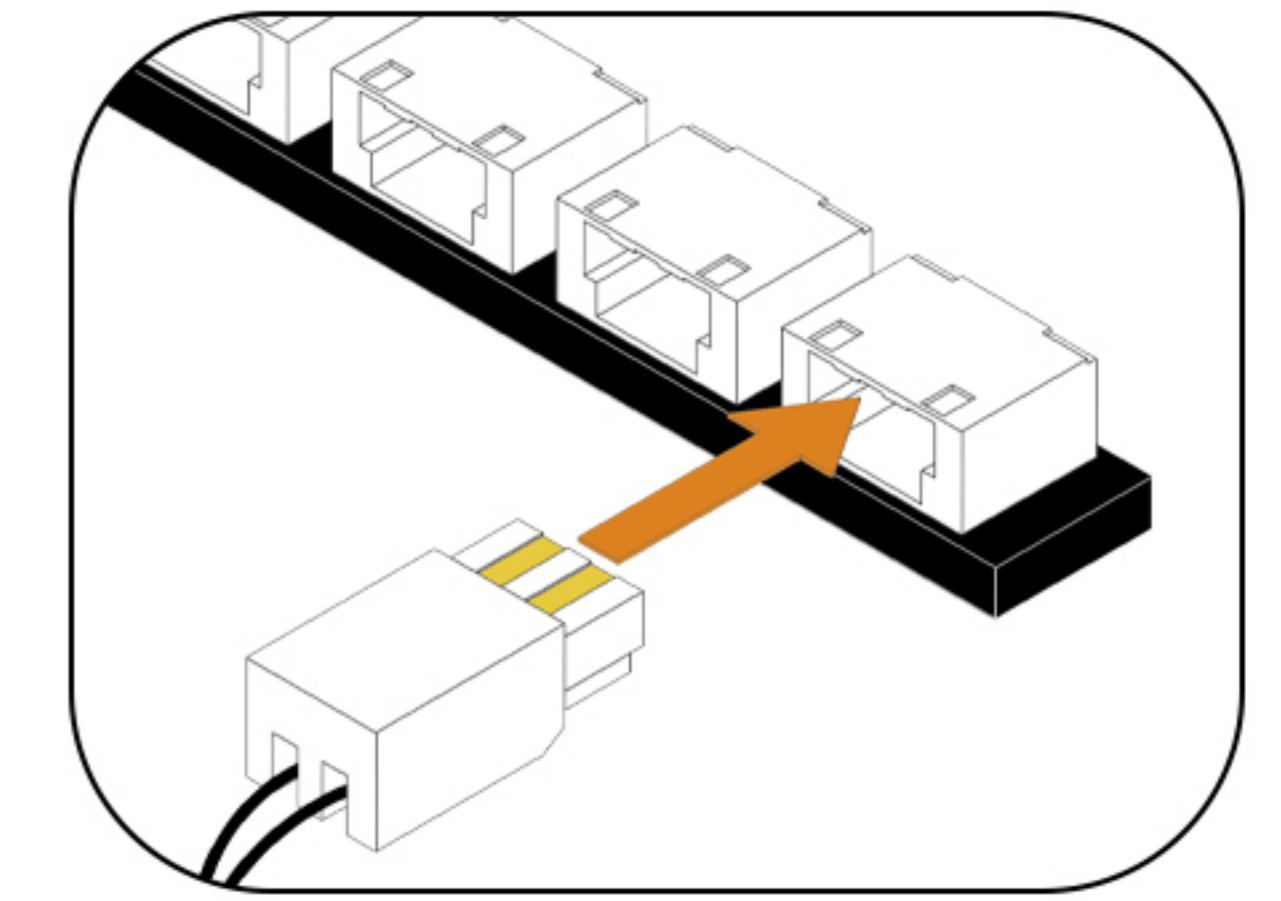

21

EN: Use tweezers to place the expansion plate into the gap in the building block.

DE: Setzen Sie die Erweiterungsplatte mit einer Pinzette in die Aussparung des Bausteins ein.

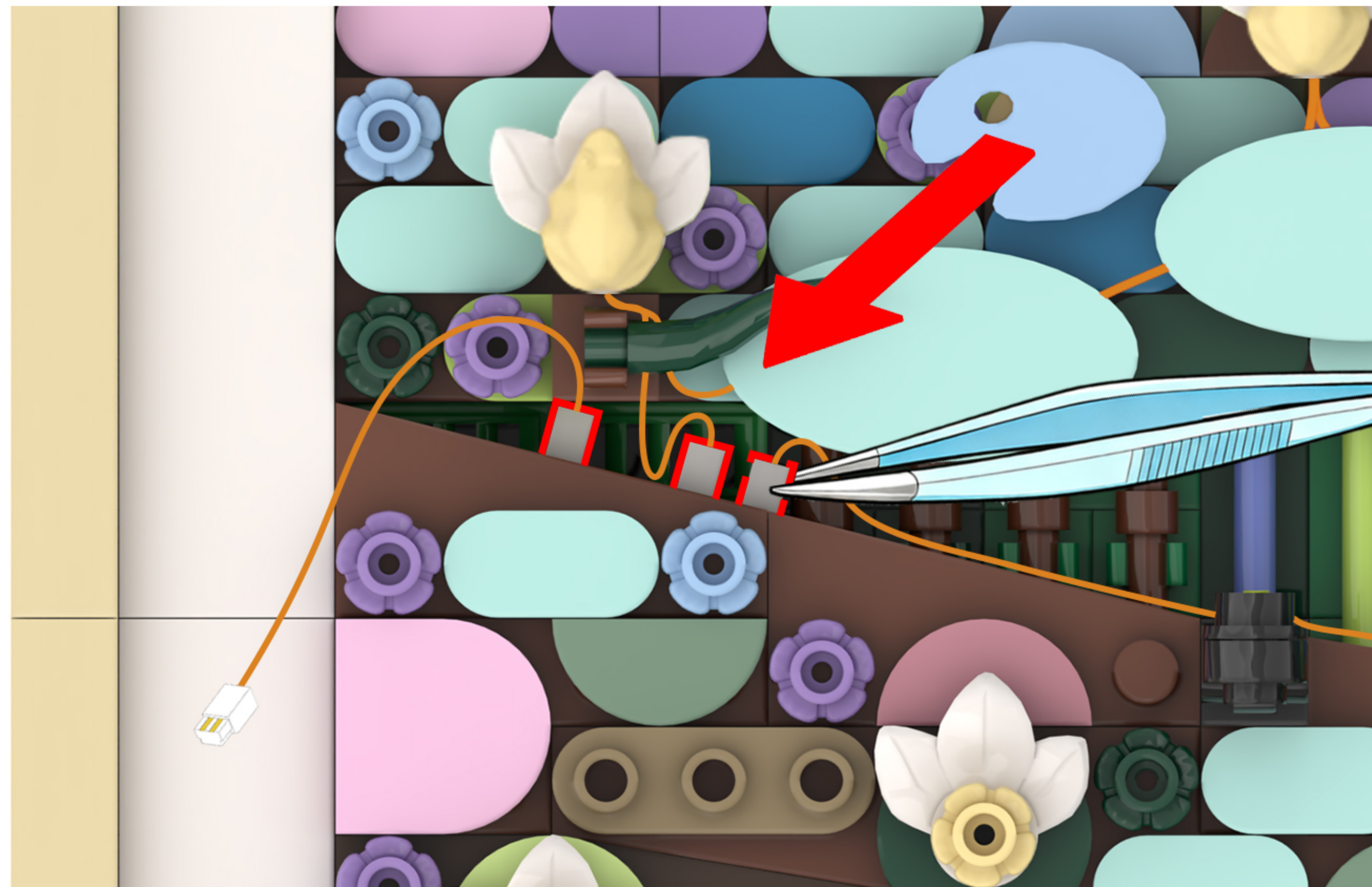

22

EN: Split as shown in the figure.

DE: Wie in der Abbildung gezeigt, teilen Sie es auf.

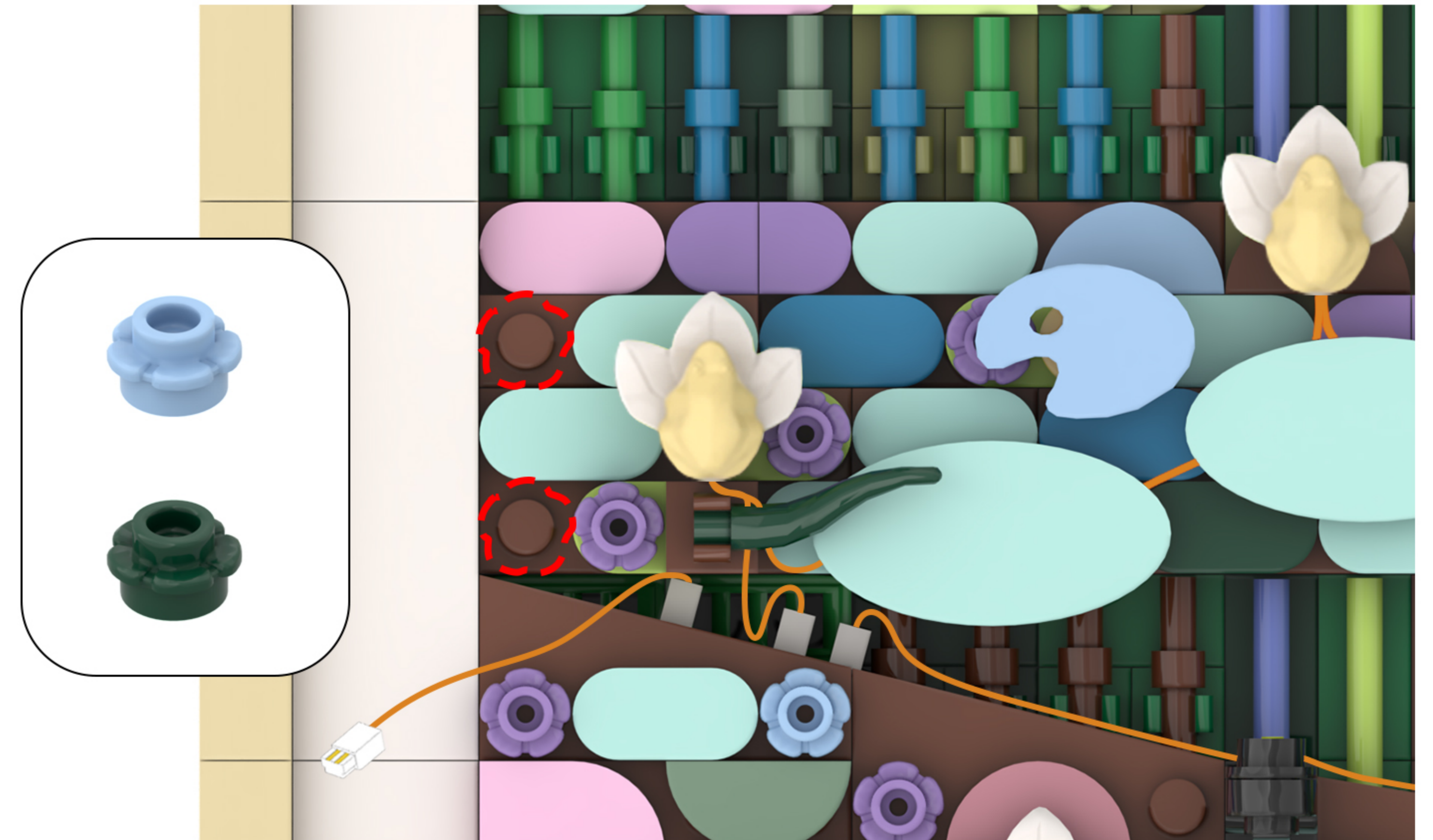

23

EN: Locate this light cord in the diagram.

DE: Suchen Sie dieses Lichtkabel in der Abbildung.

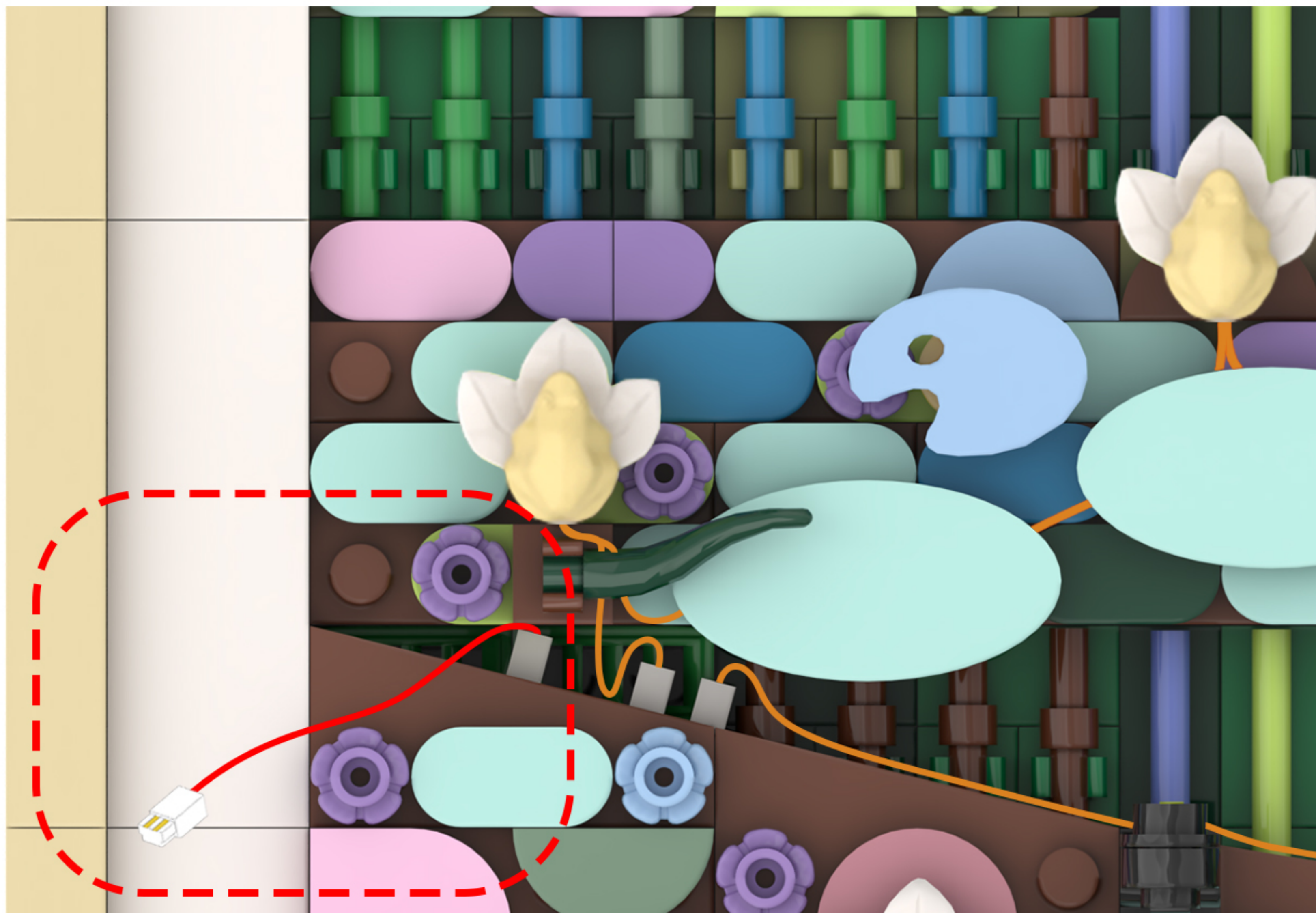

24

EN: Arrange the lighting lines according to the diagram.

DE: Ordnen Sie die Beleuchtungslinien gemäß der Abbildung an.

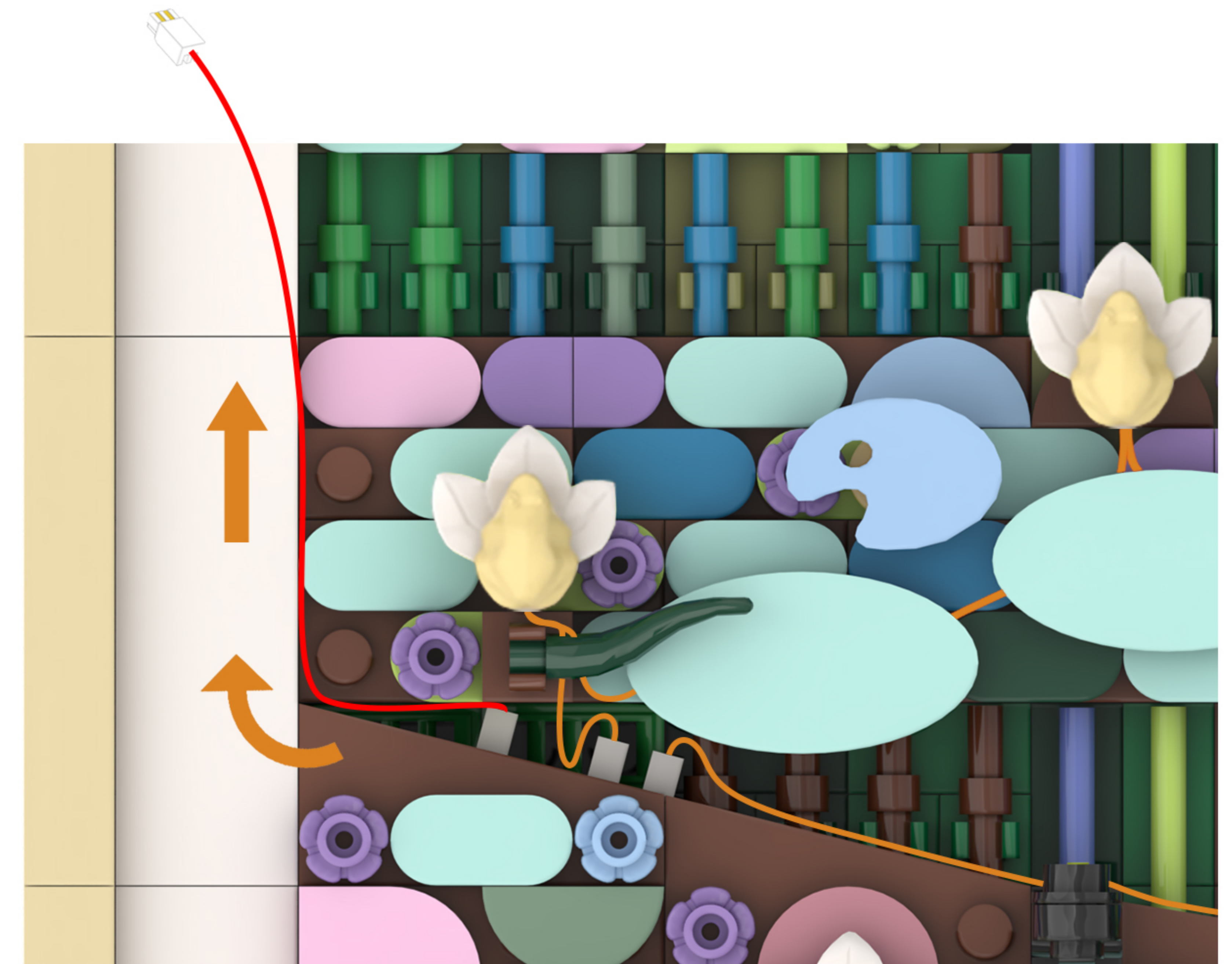

25

EN: Take out the disassembled building blocks, reassemble them, and secure the light cord.

DE: Nehmen Sie die zerlegten Bausteine heraus, setzen Sie sie wieder zusammen und befestigen Sie das Lichtkabel.

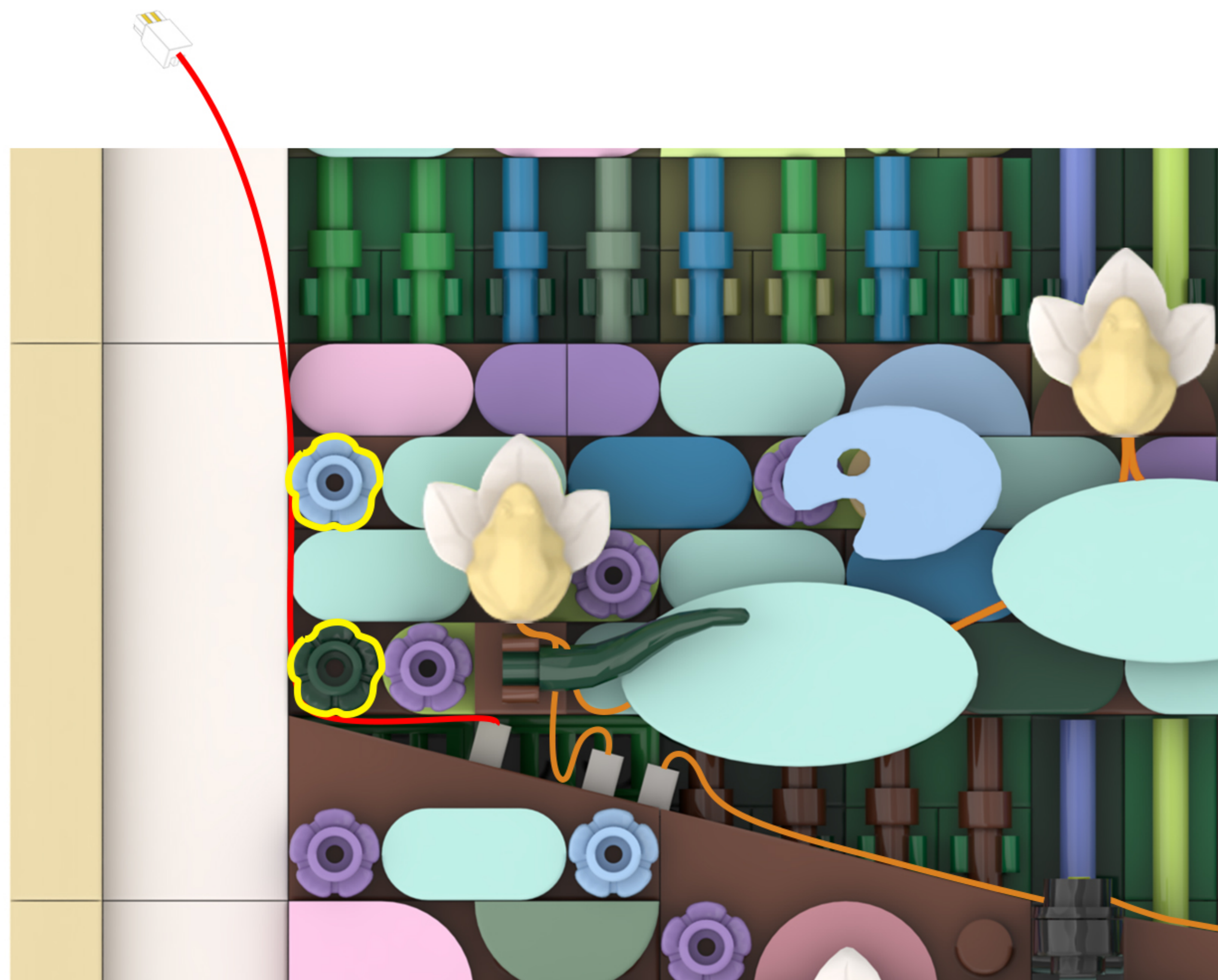
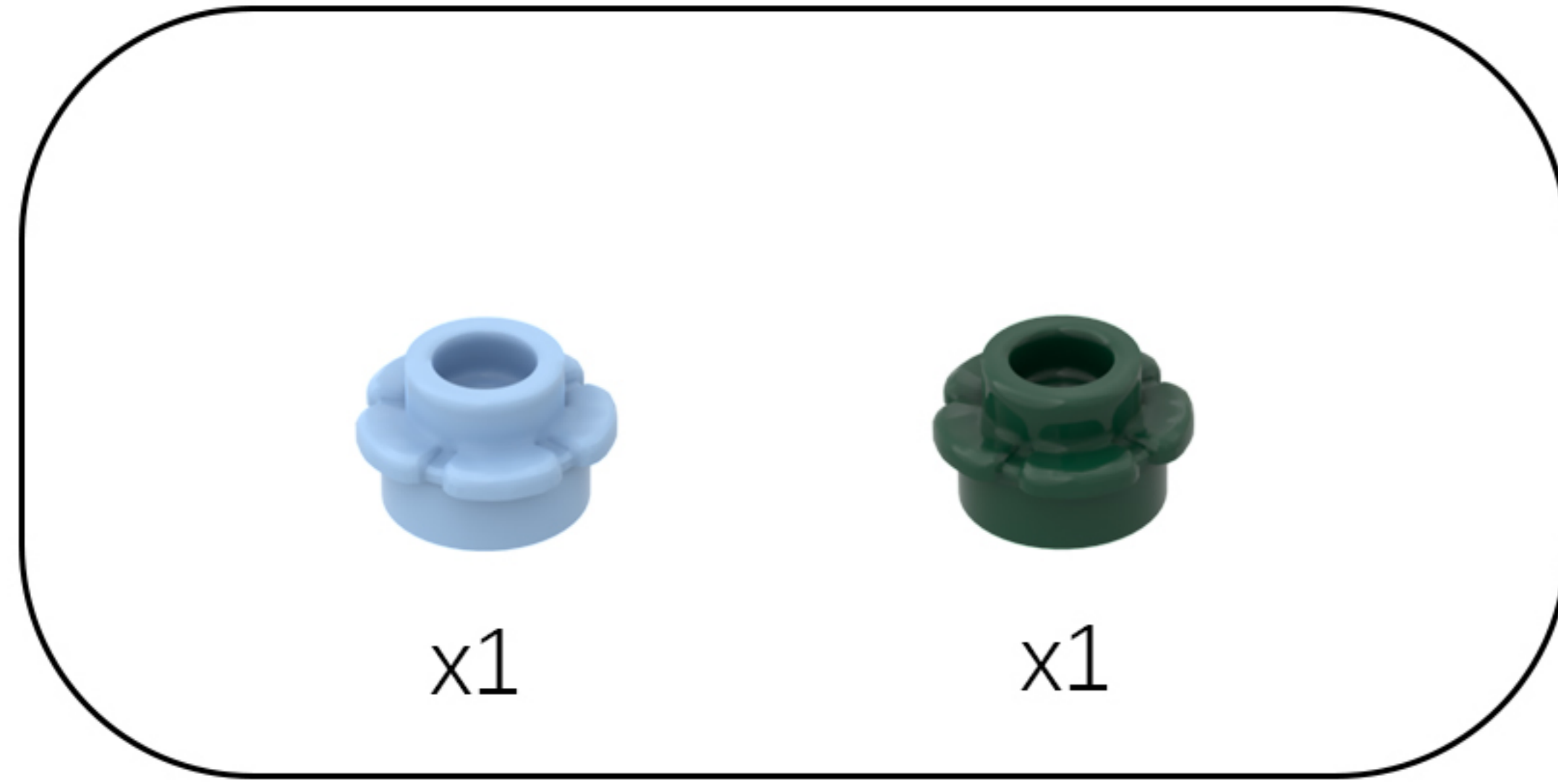

26

EN: Adjust your perspective.

DE: Ändern Sie Ihre Perspektive.

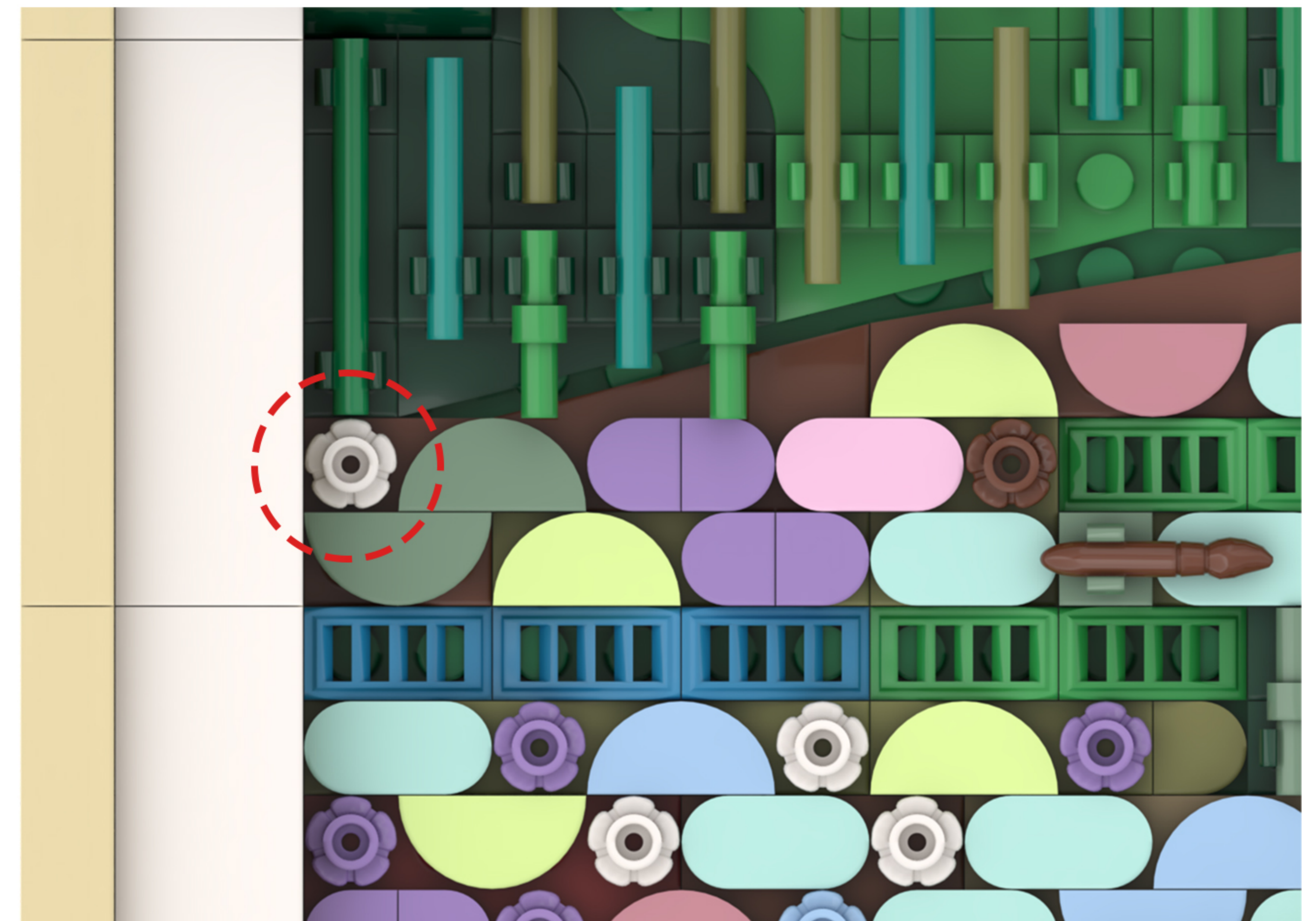
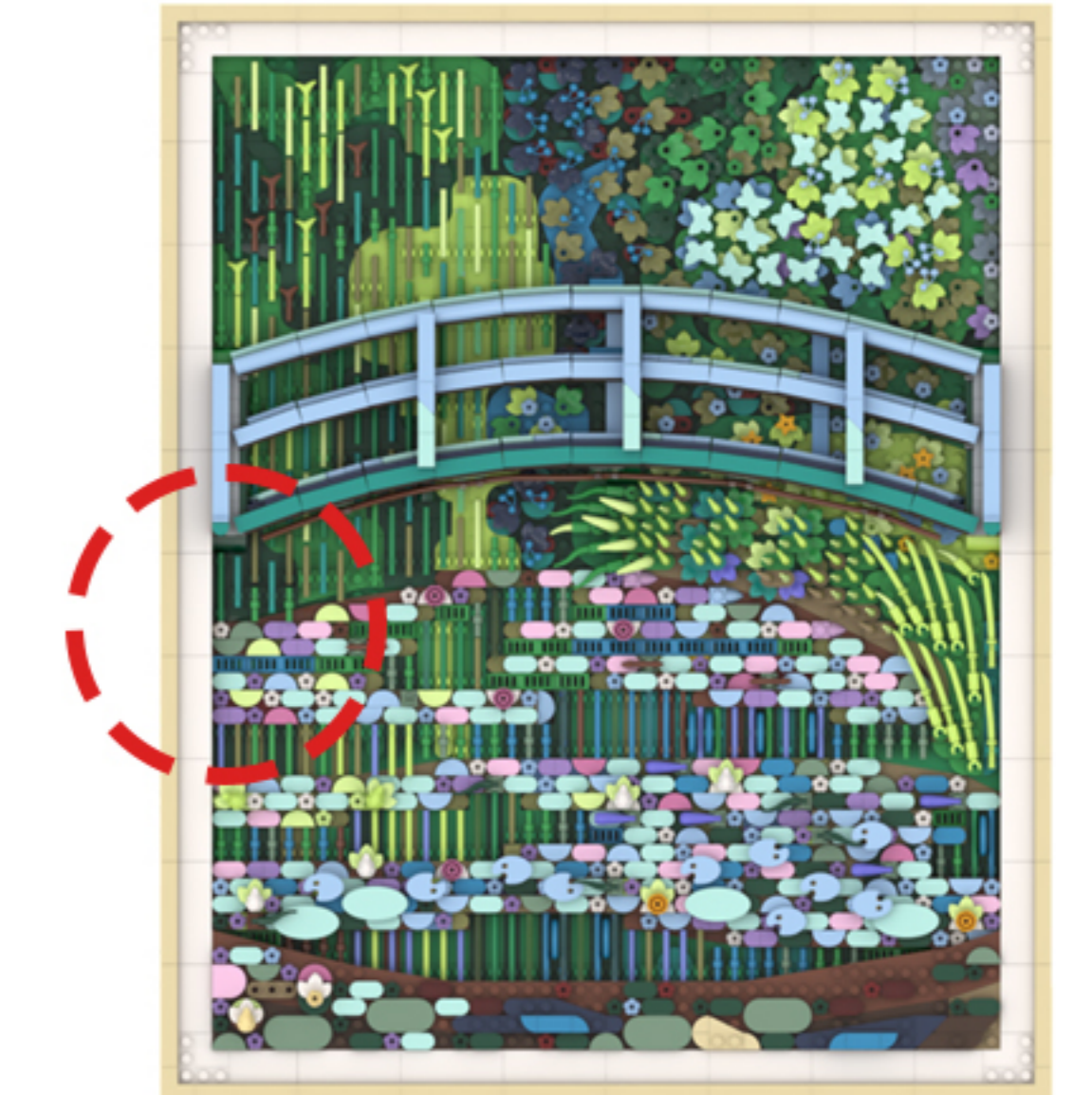

27

EN: Split as shown in the figure.

DE: Wie in der Abbildung gezeigt, teilen Sie es auf.

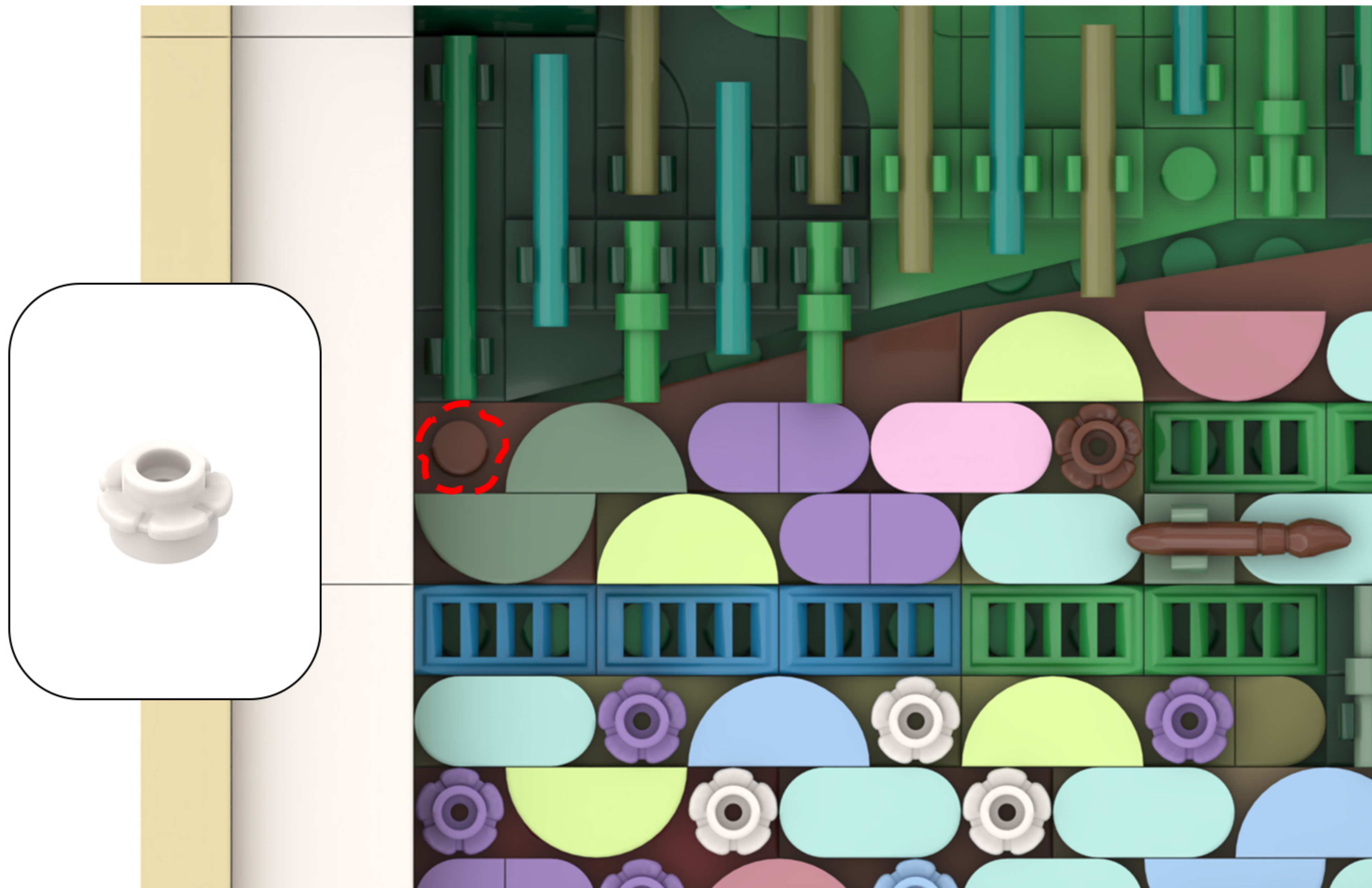

28

EN: Wire as shown in the diagram.

DE: Verdrahten Sie wie in der Abbildung gezeigt.

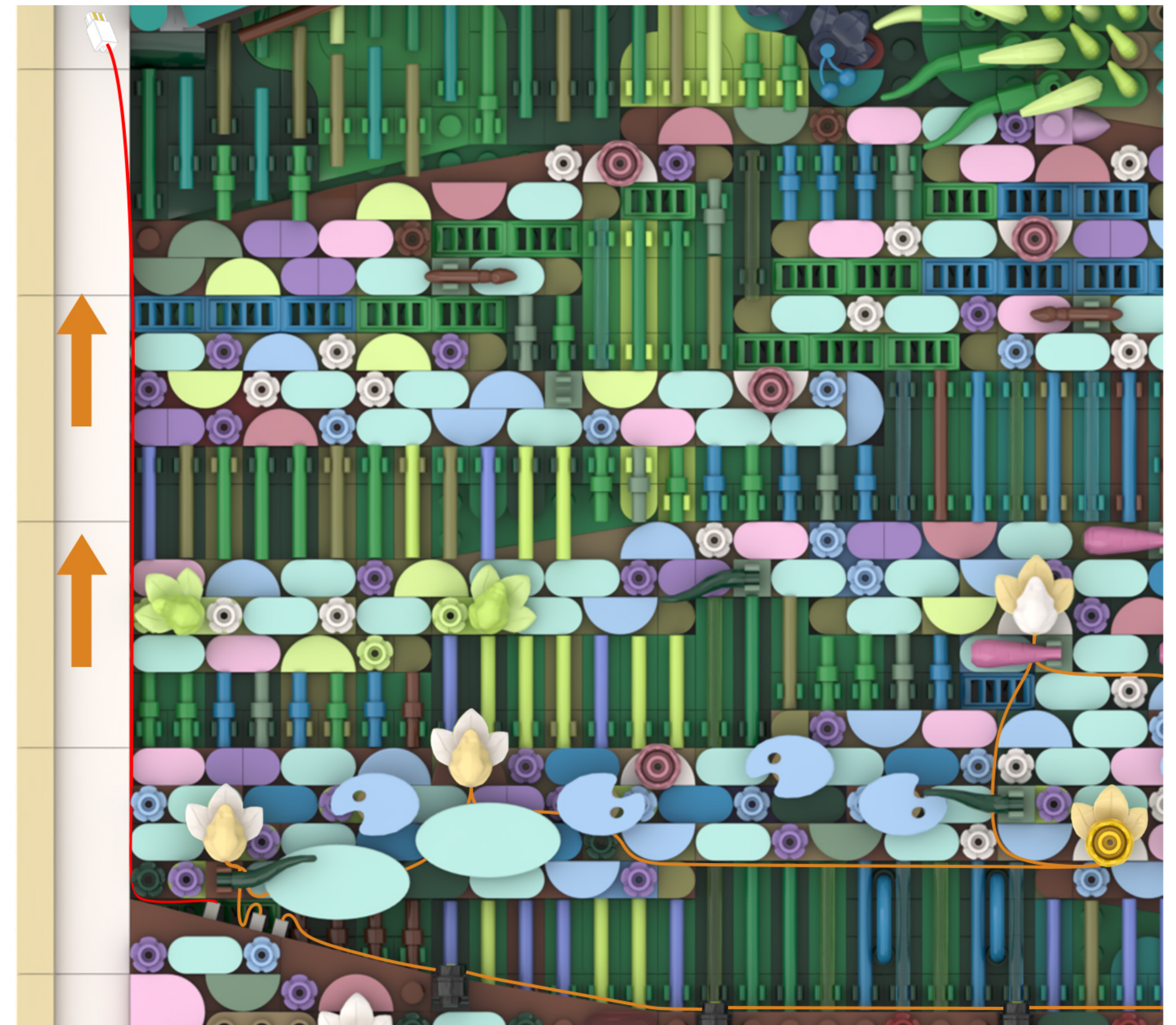

29

EN: Take out the disassembled building blocks, reassemble them, and secure the light cord.

DE: Nehmen Sie die zerlegten Bausteine heraus, setzen Sie sie wieder zusammen und befestigen Sie das Lichtkabel.

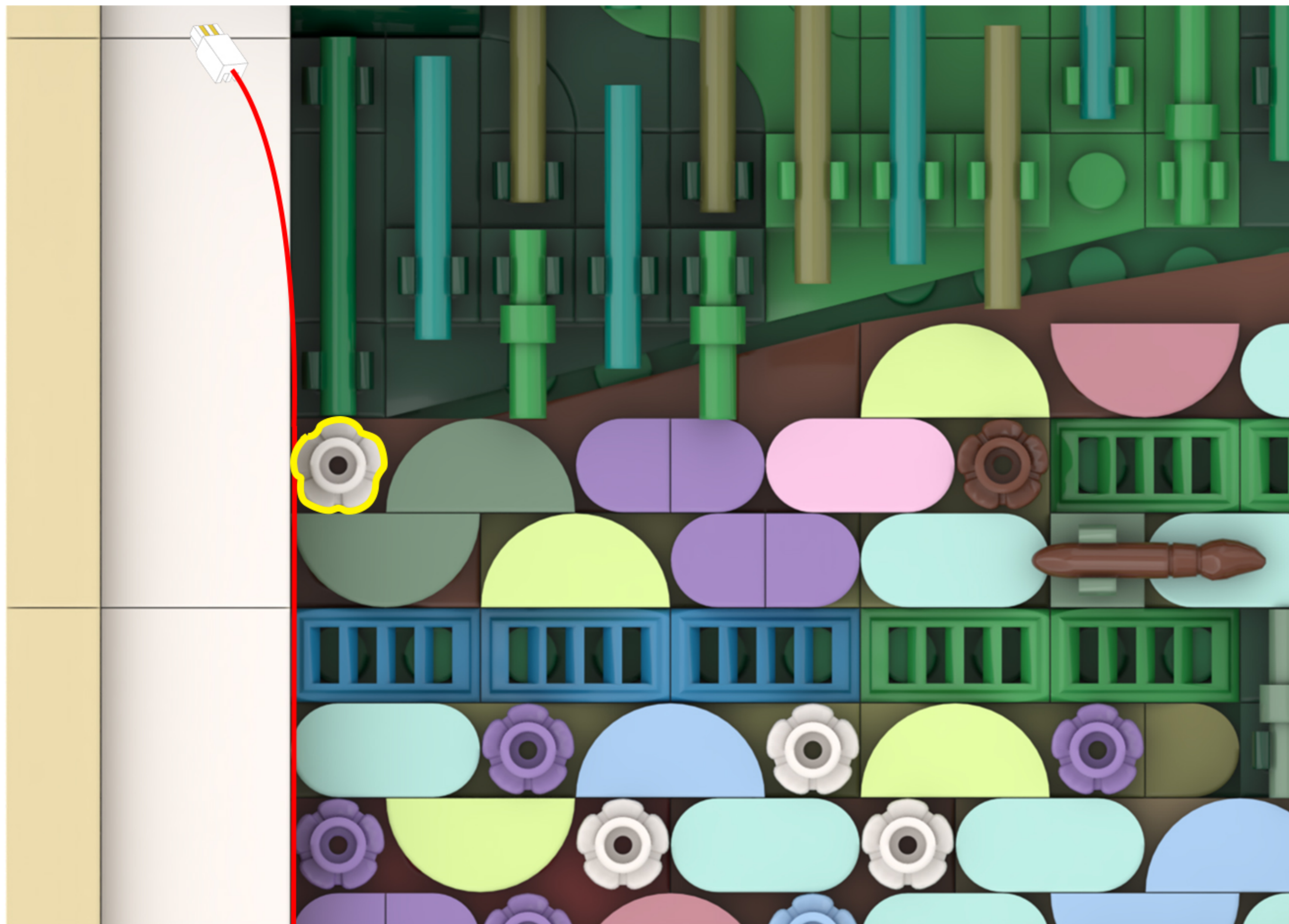
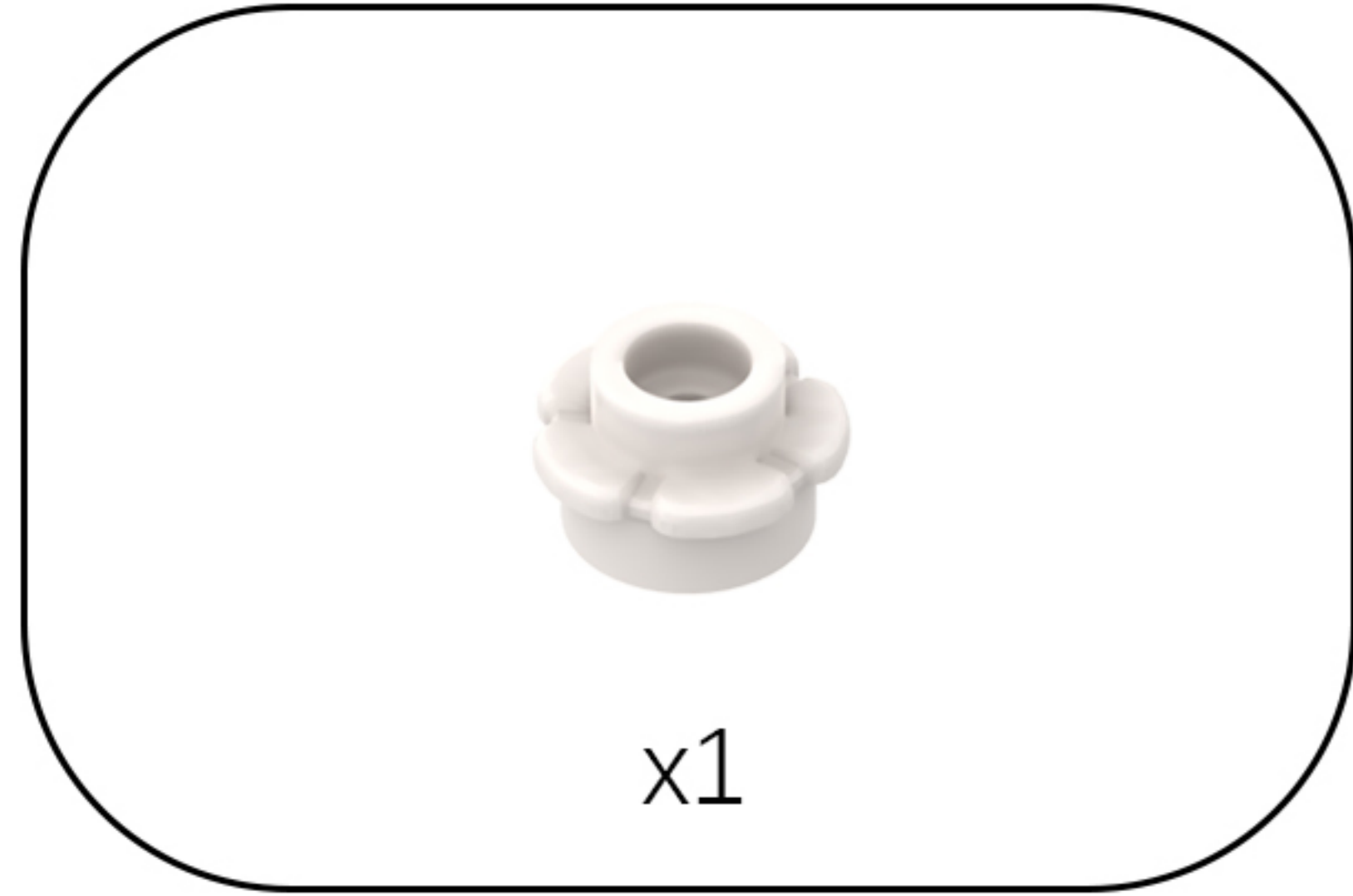

30

EN: Wire as shown in the diagram.

DE: Verdrahten Sie wie in der Abbildung gezeigt.

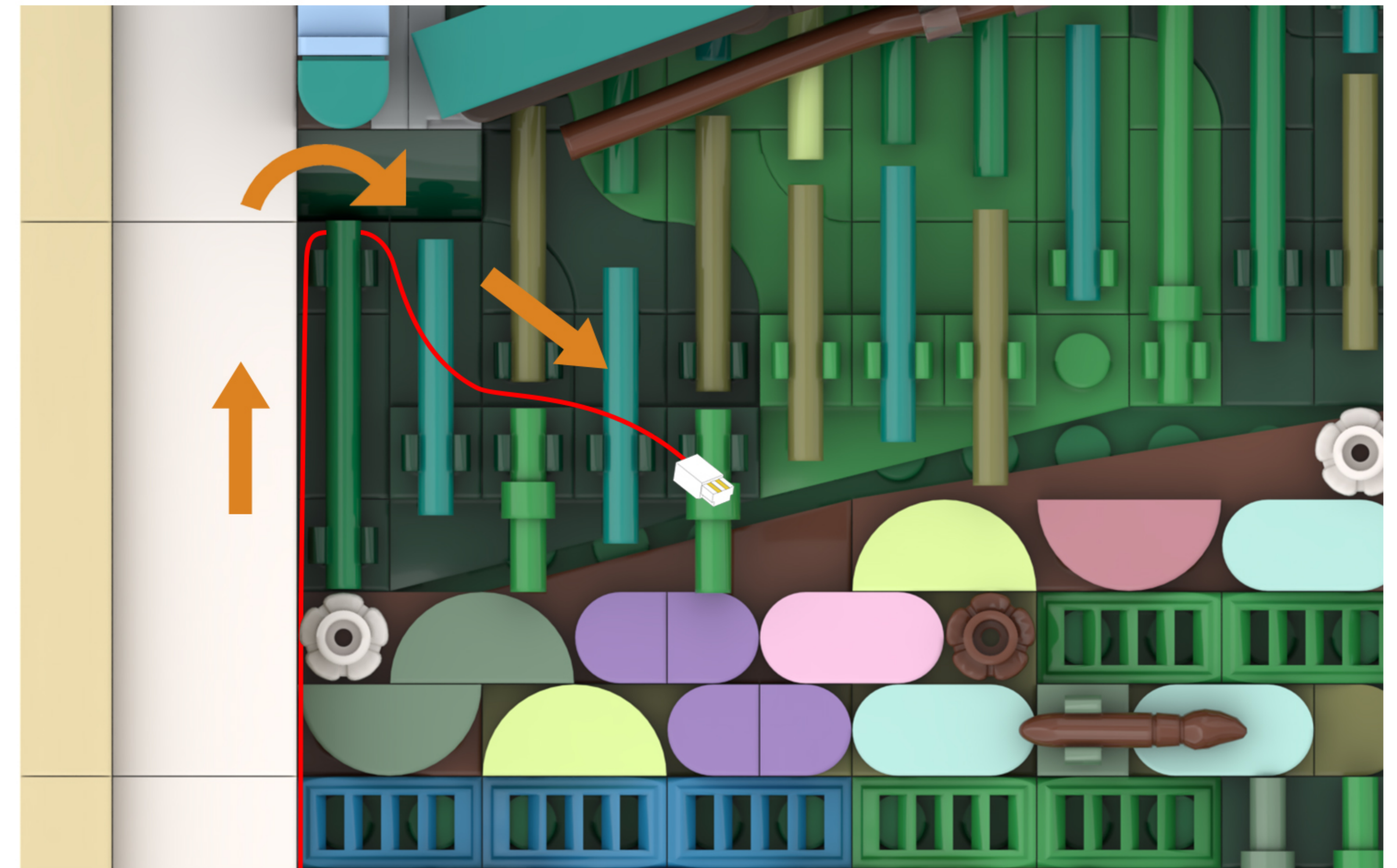

31

EN: Adjust your perspective.

DE: Ändern Sie Ihre Perspektive.

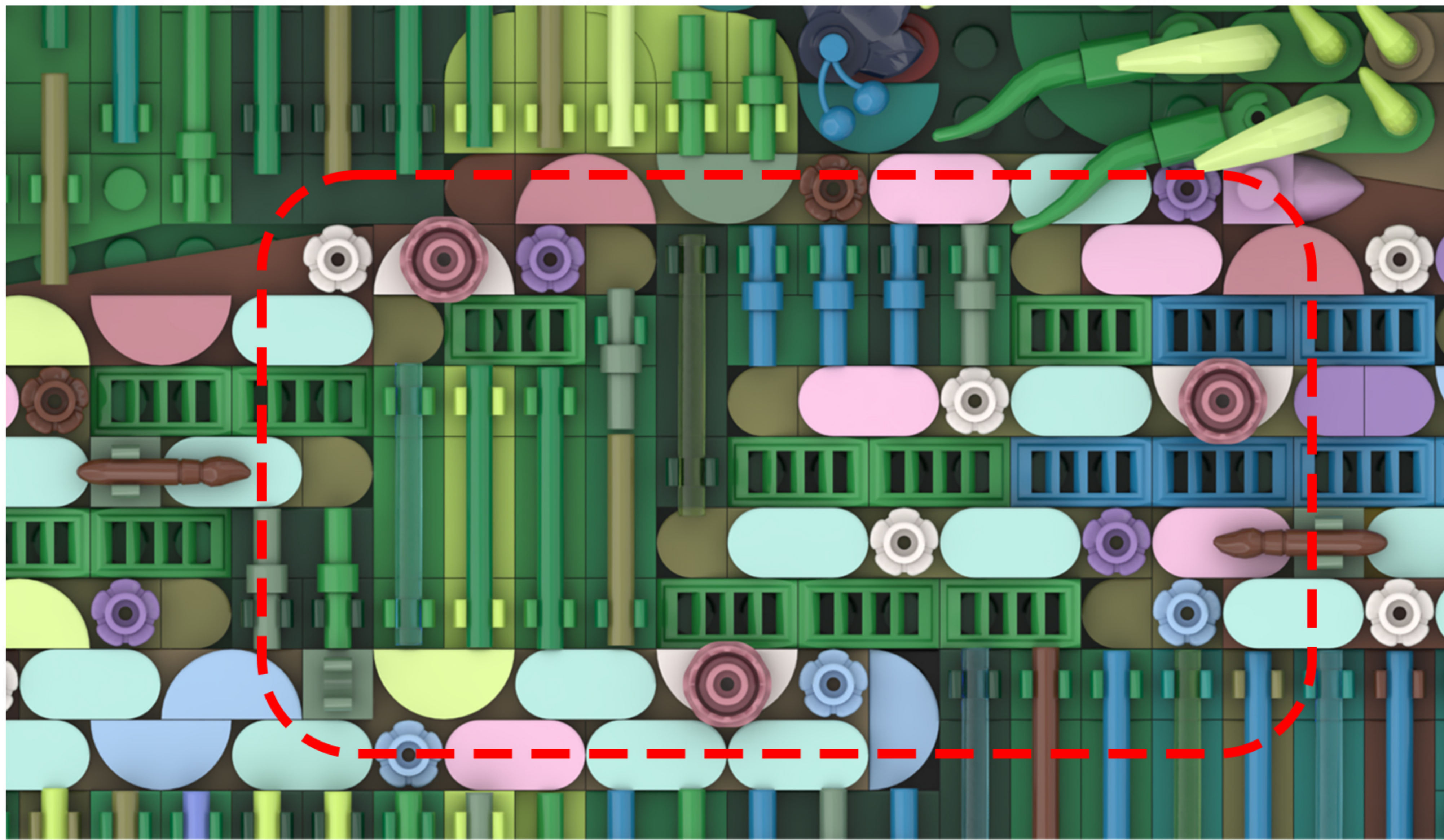
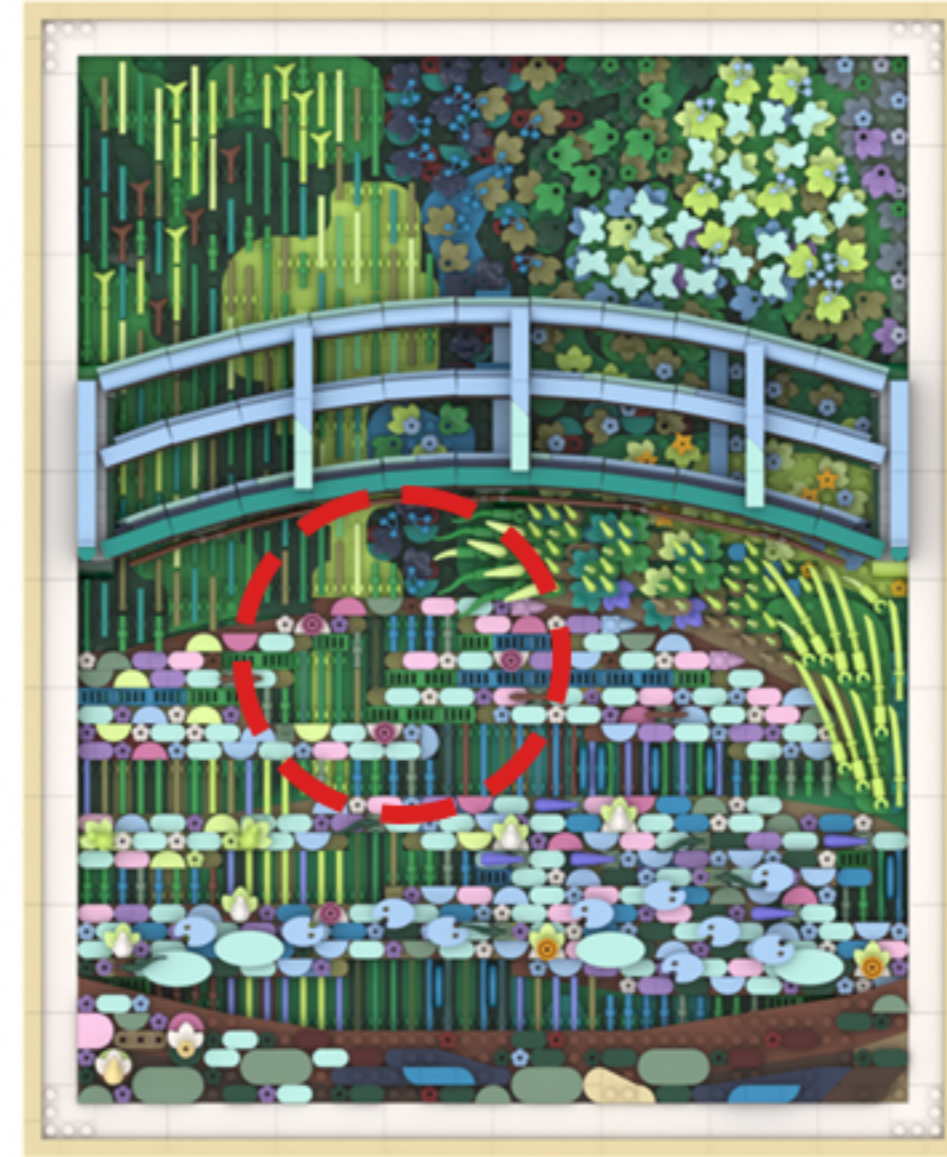

32

EN: Split as shown in the figure.

DE: Wie in der Abbildung gezeigt, teilen Sie es auf.

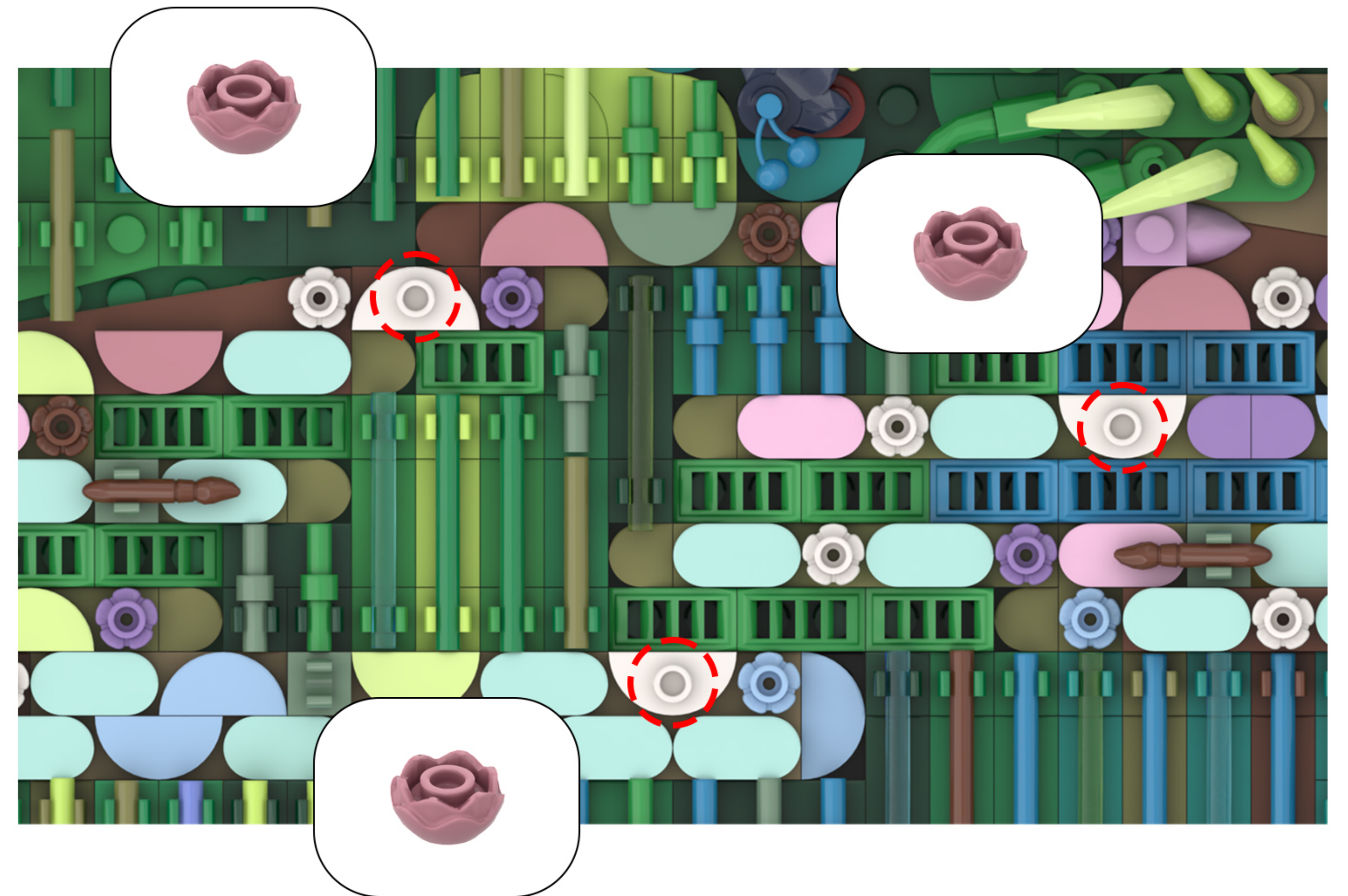

33

EN: Take the string of lights out of Bag 1 and remove the zip tie. Take the disassembled building blocks and attach them to the string of lights in order.

DE: Nimm die Lichterkette aus Beutel 1 und entferne den Kabelbinder. Nimm die zerlegten Bausteine und befestige sie der Reihe nach an der Lichterkette.

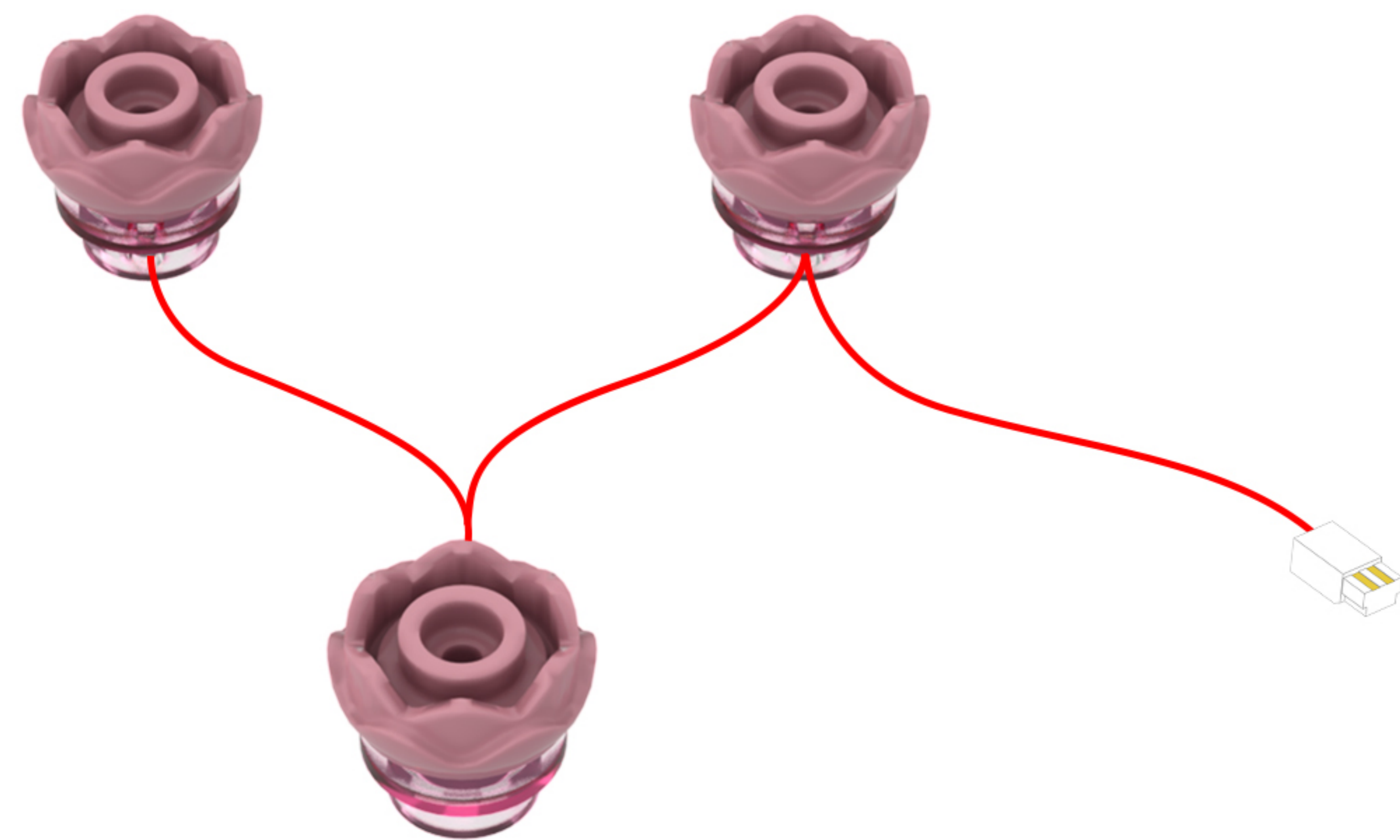
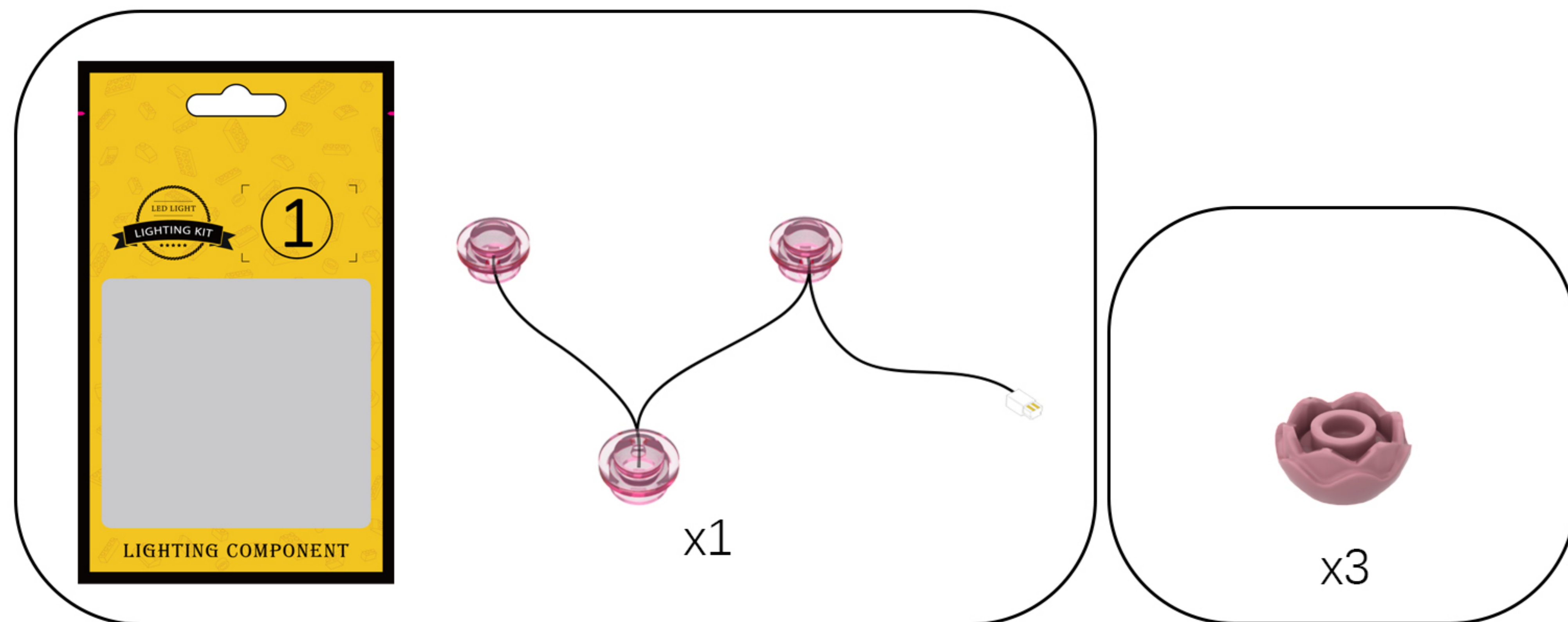

34

EN: Attach the lights from the string to the building blocks.

DE: Befestigen Sie die Lichter der Lichterkette an den Bausteinen.

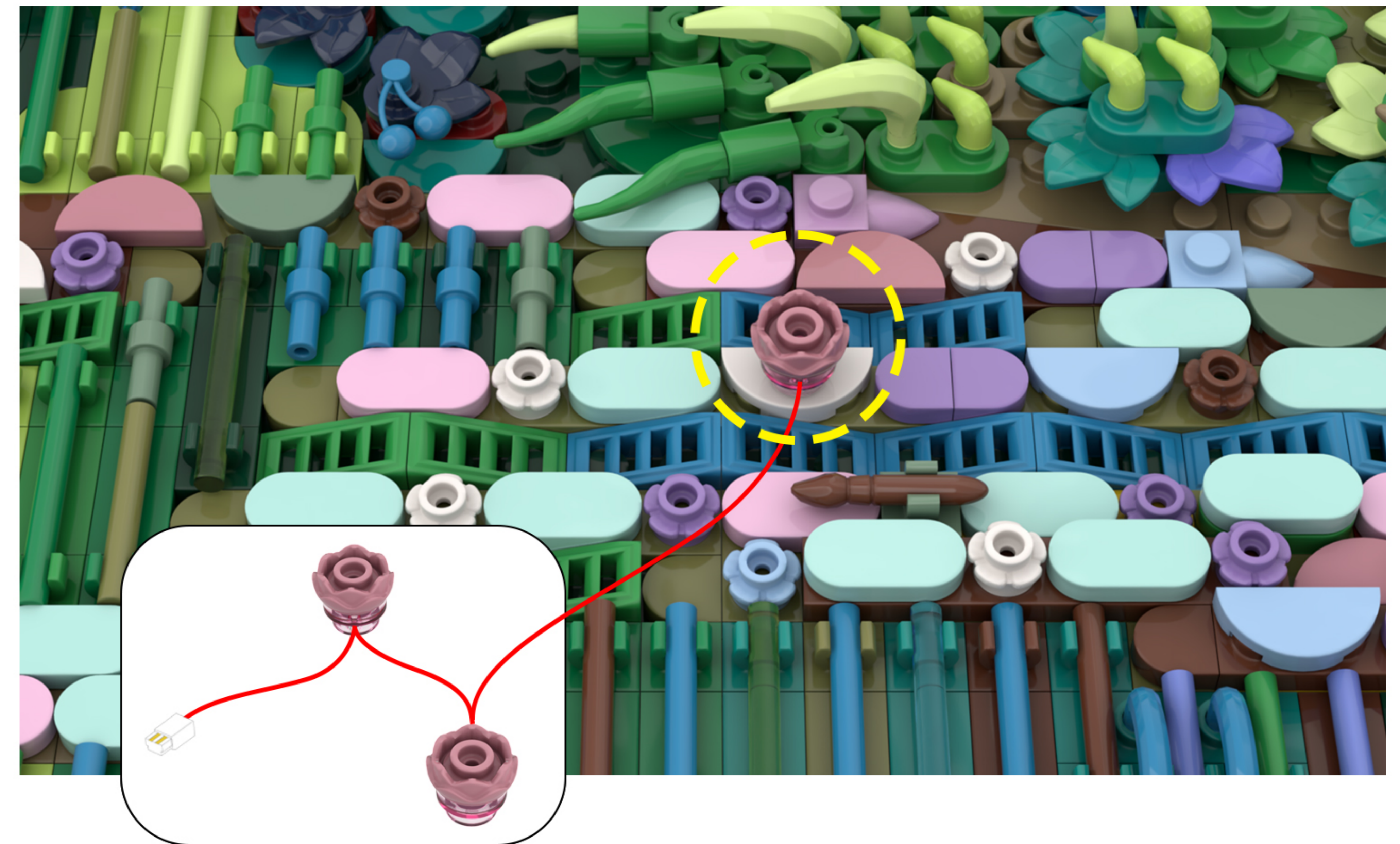

35

EN: Continue attaching the next light from the string to the building block.

DE: Befestige eine weitere Lampe der Lichterkette am Bauklotz.

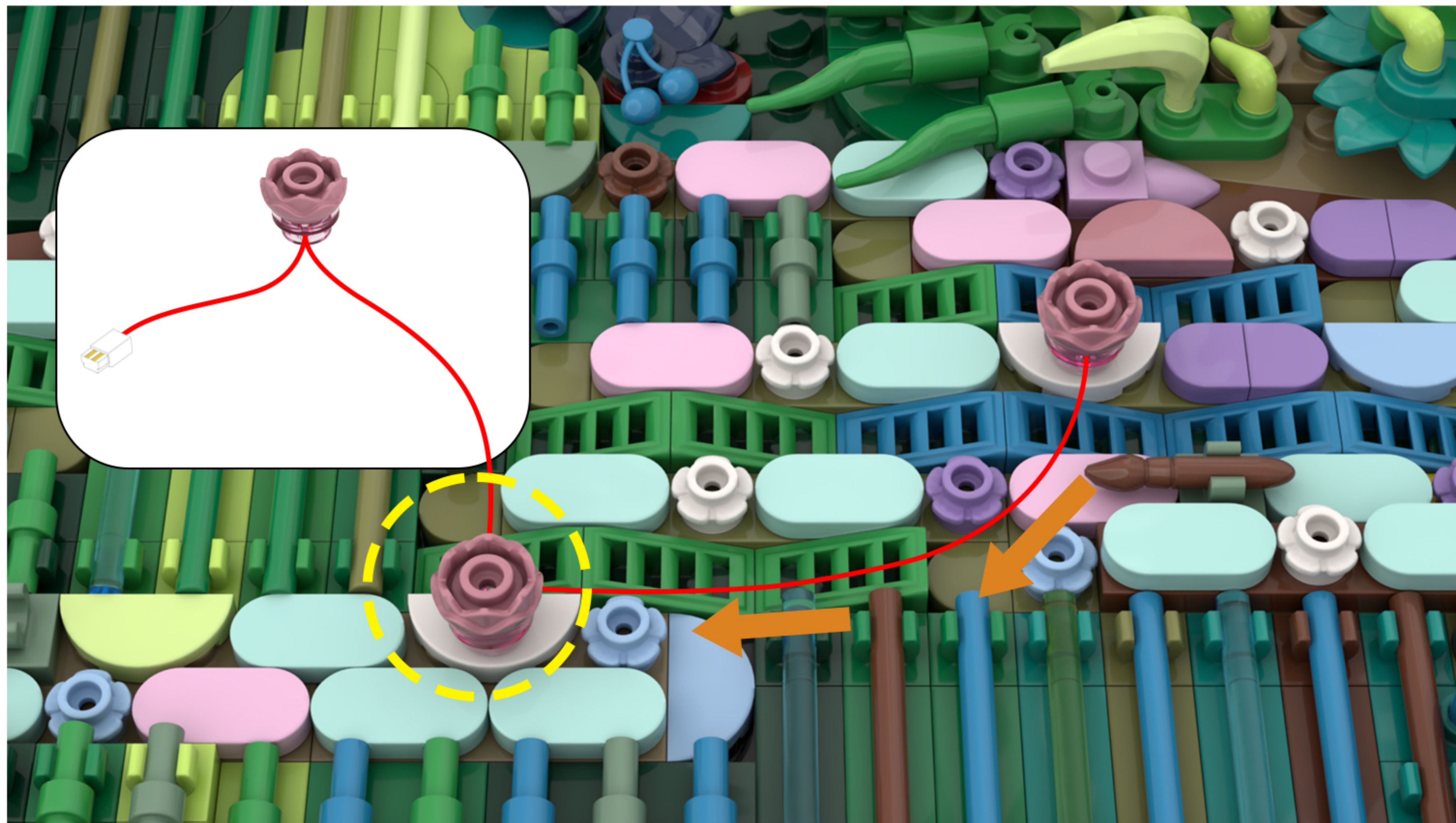

36

EN: Attach the last light to the building block.

DE: Befestige die letzte Leuchte am Baustein.



37

EN: Adjust your perspective.

DE: Ändern Sie Ihre Perspektive.

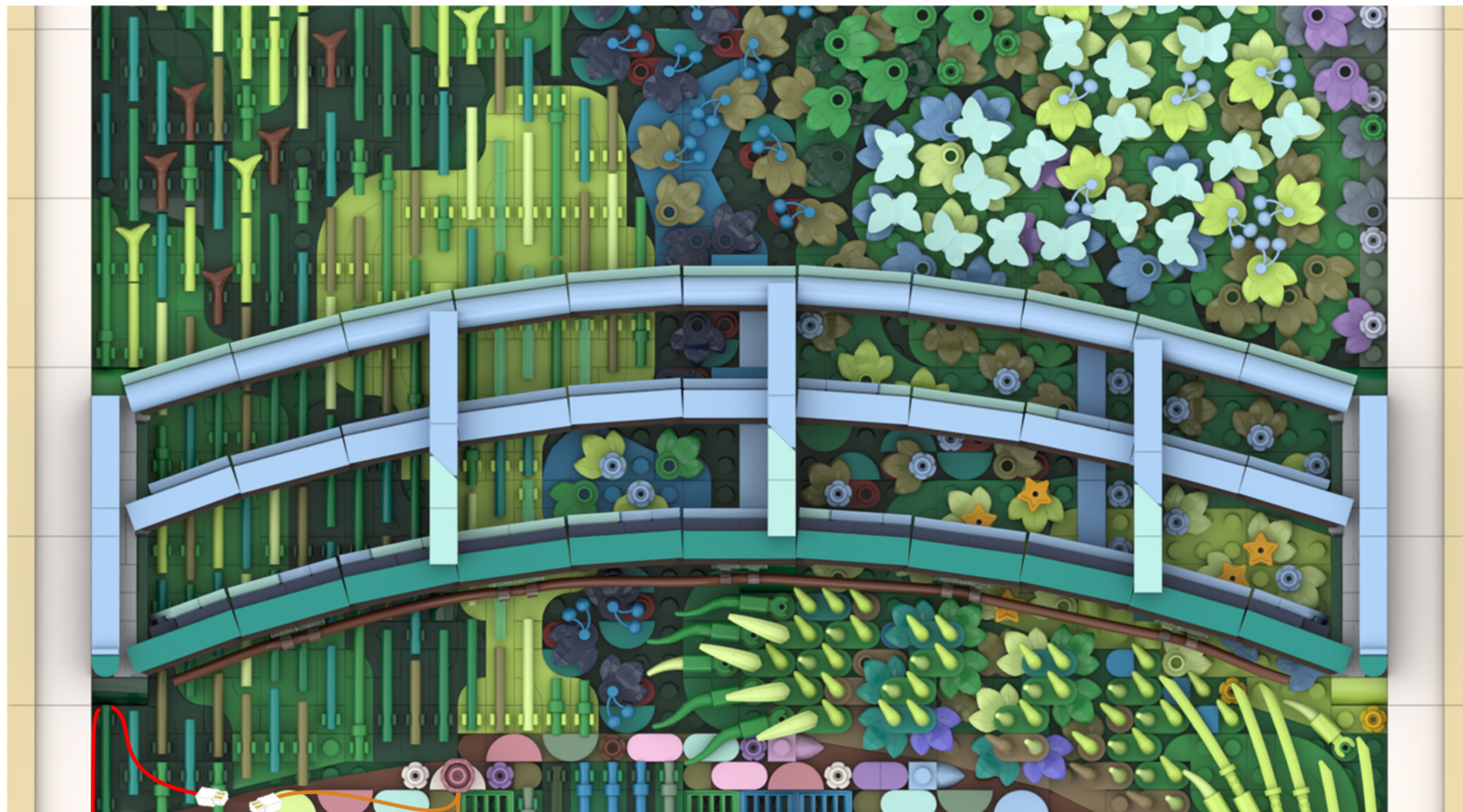

38

EN: Split as shown in the figure.

DE: Wie in der Abbildung gezeigt, teilen Sie es auf.

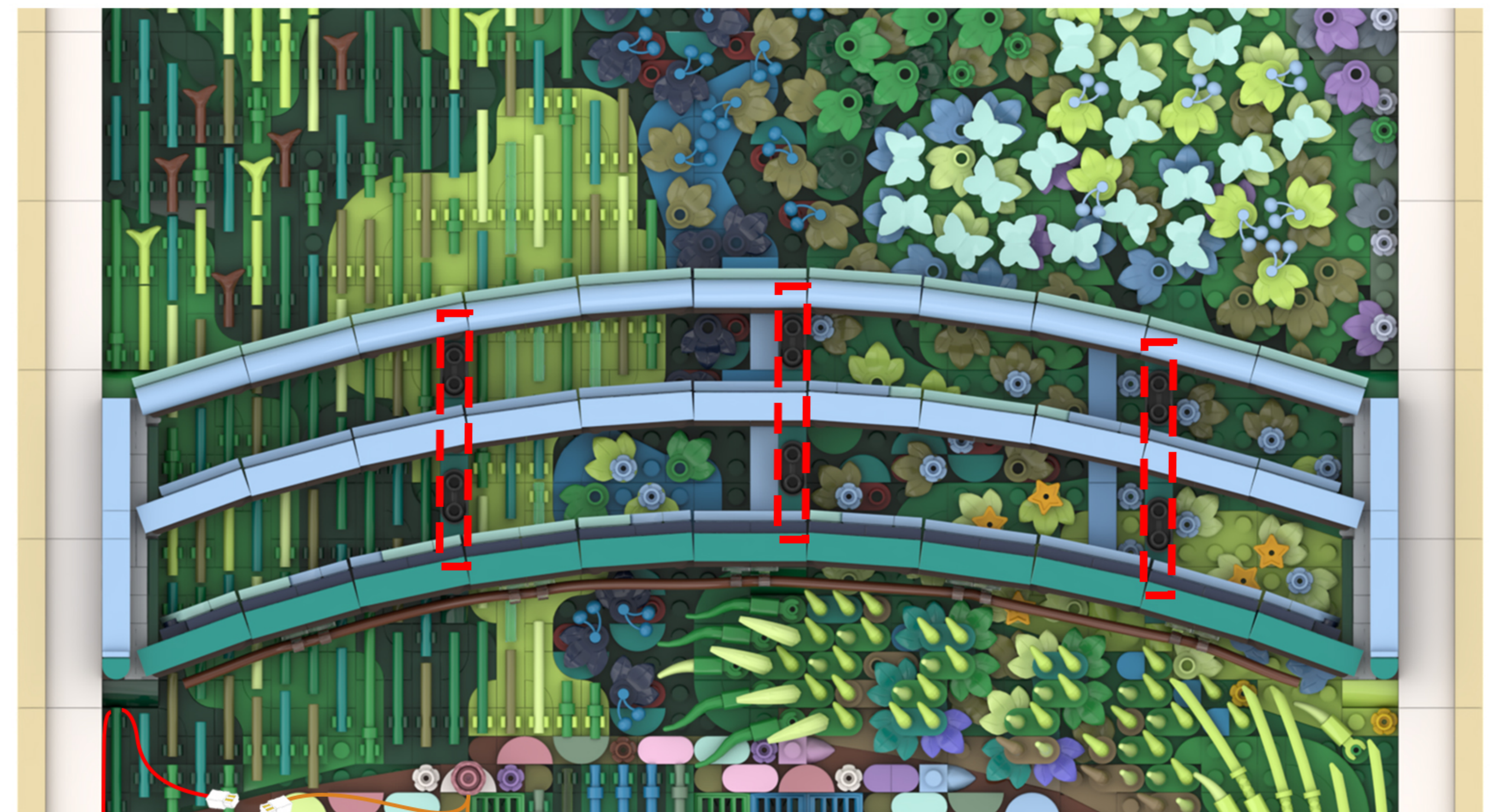
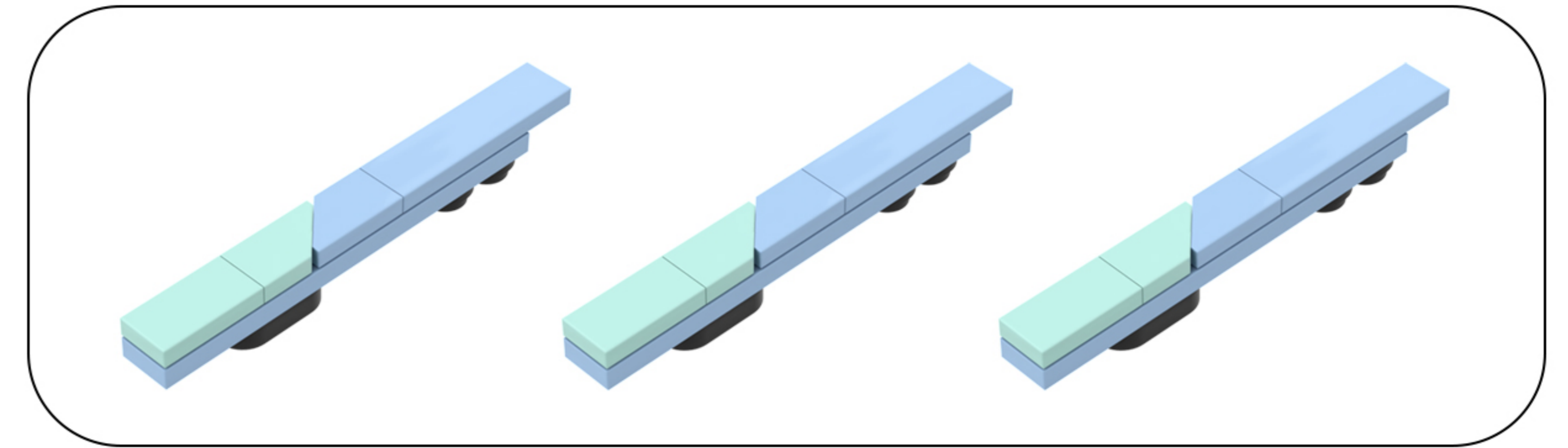

39

EN: Split as shown in the figure.

DE: Wie in der Abbildung gezeigt, teilen Sie es auf.

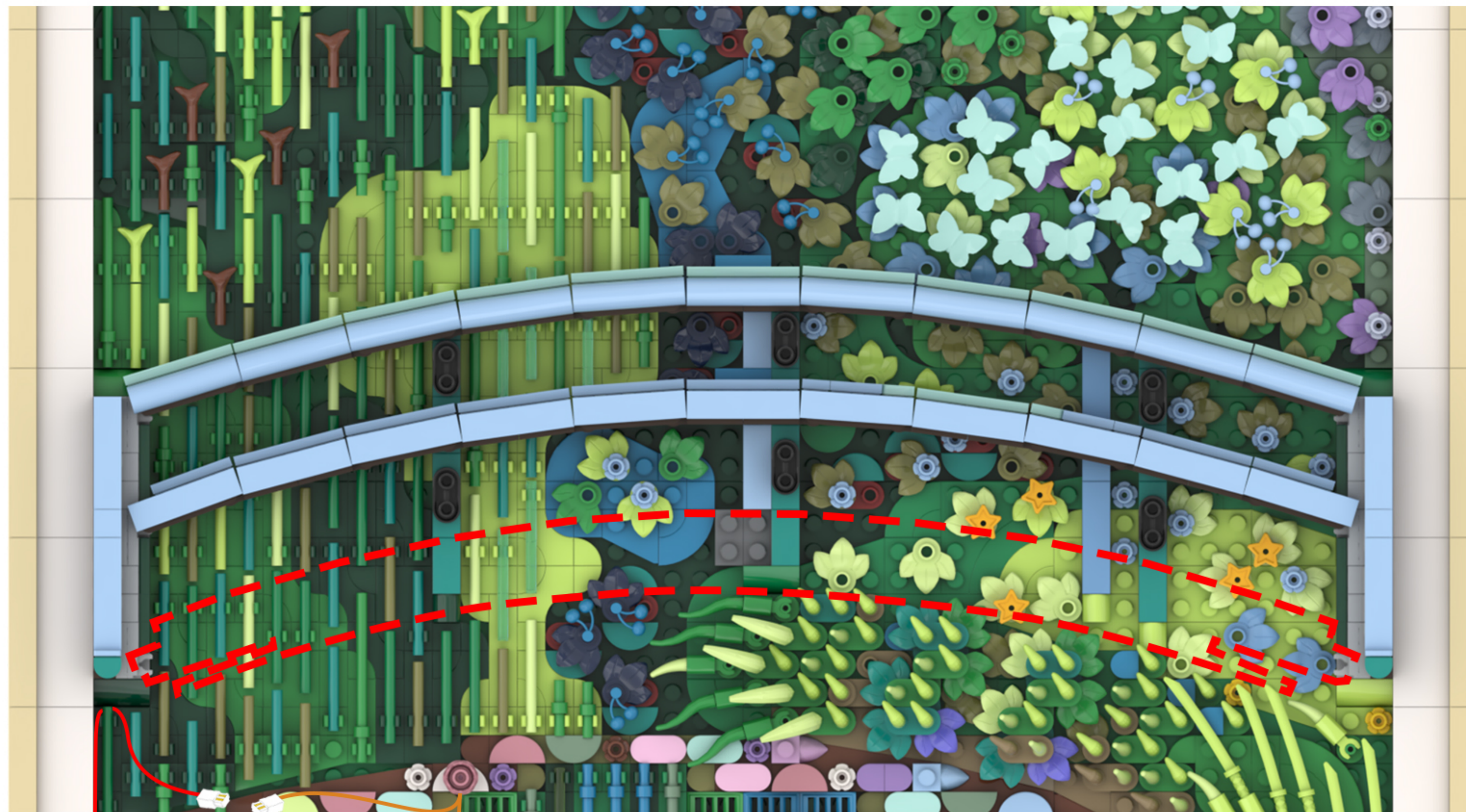
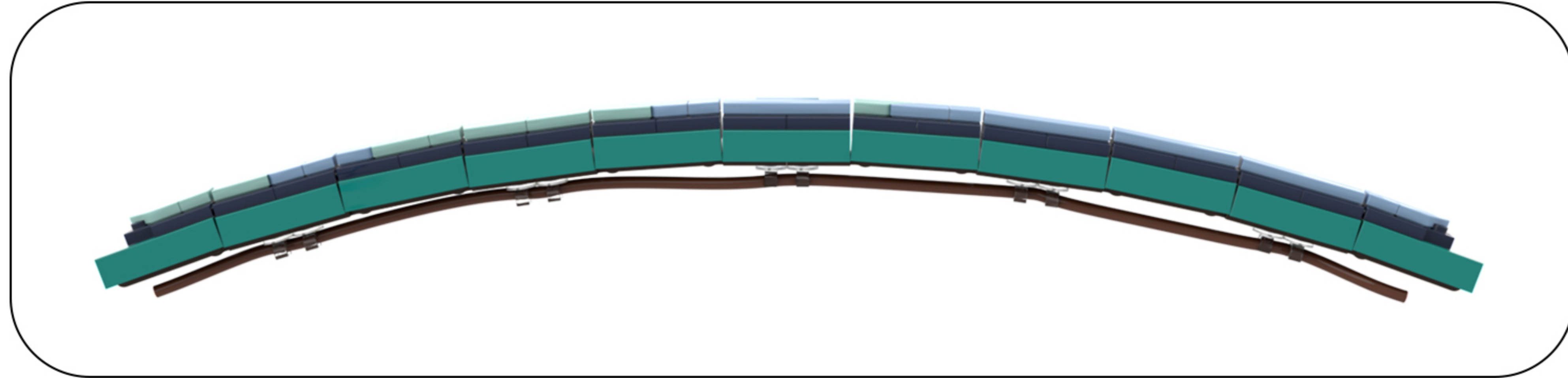

40

EN: Take the disassembled building blocks and turn them over so that the bottom side is facing up.

DE: Nimm die zerlegten Bausteine und drehe sie so, dass die Unterseite nach oben zeigt.

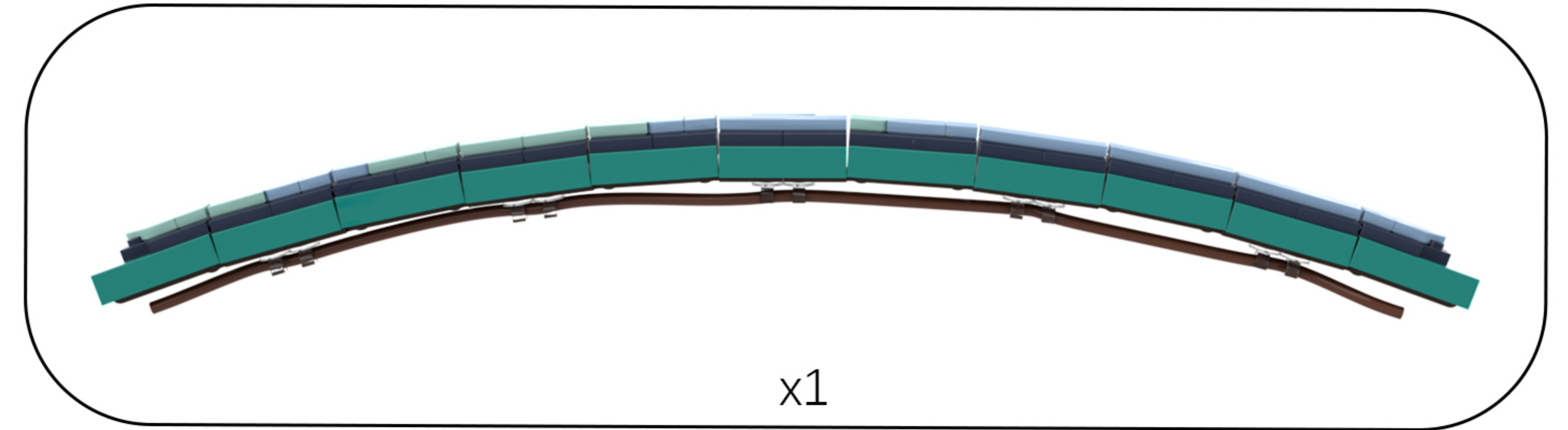

41

EN: Take the string of lights out of Bag 4, peel off the adhesive backing, and first attach the end with the wires to the building block.

DE: Nimm die Lichterkette aus Beutel 4, zieh die Schutzfolie ab und befestige zunächst das Ende mit den Kabeln am Baustein.

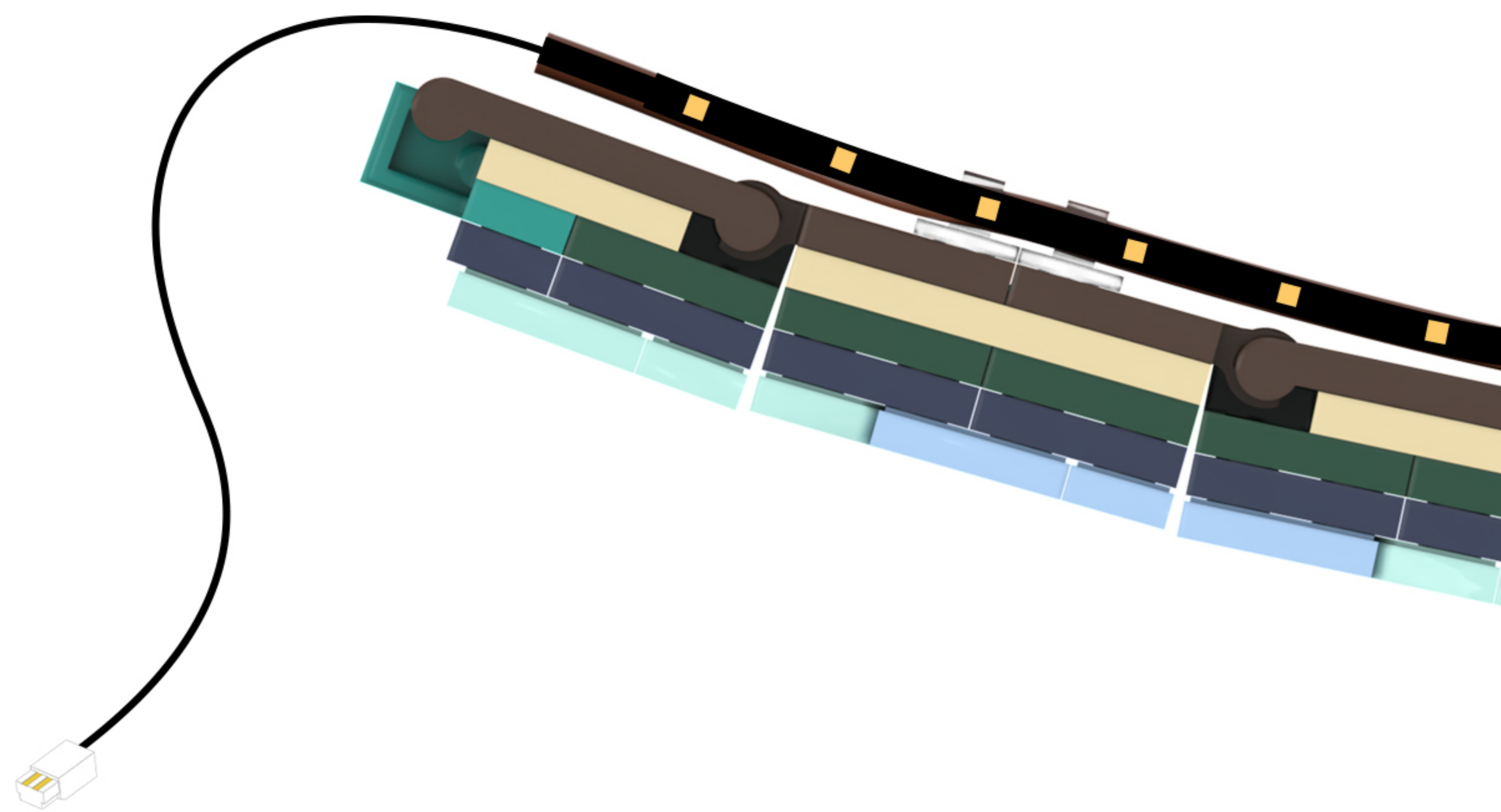
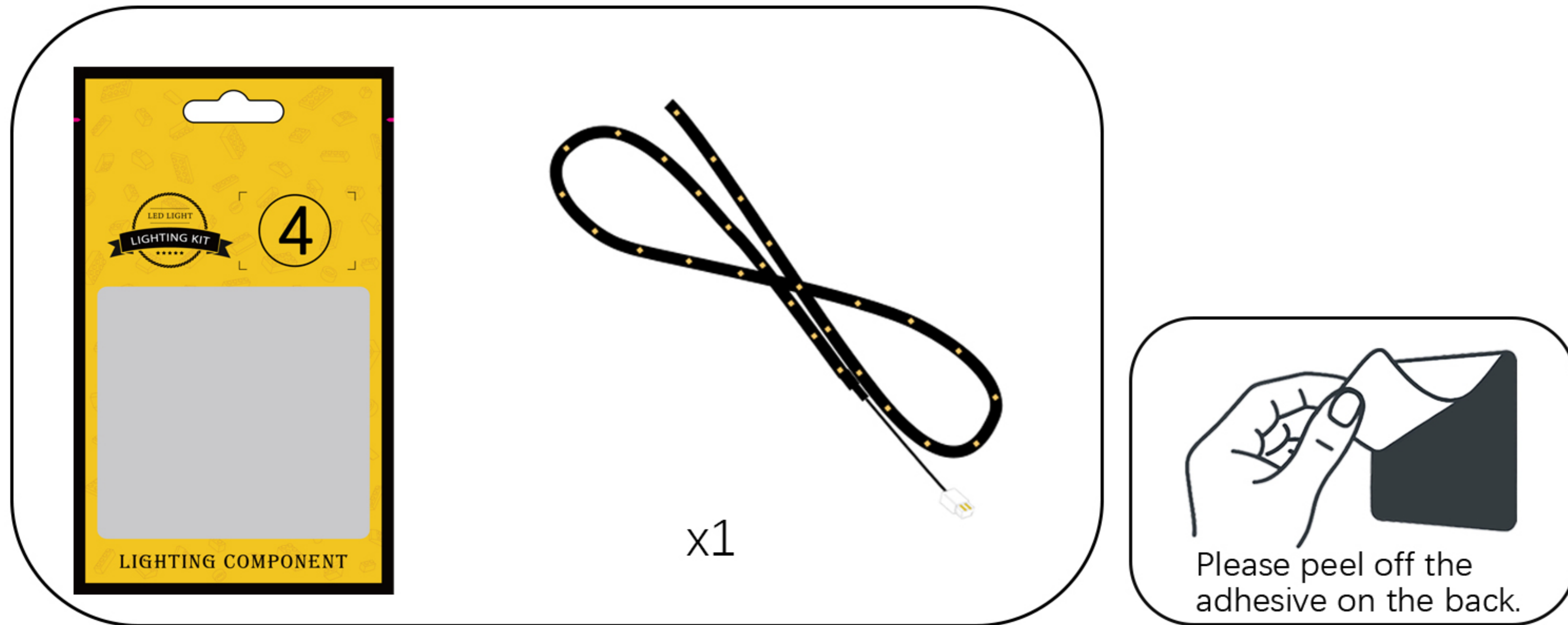

42

EN: Stick all the LED strips onto the building blocks.

DE: Kleben Sie alle LED-Streifen auf die Bausteine.

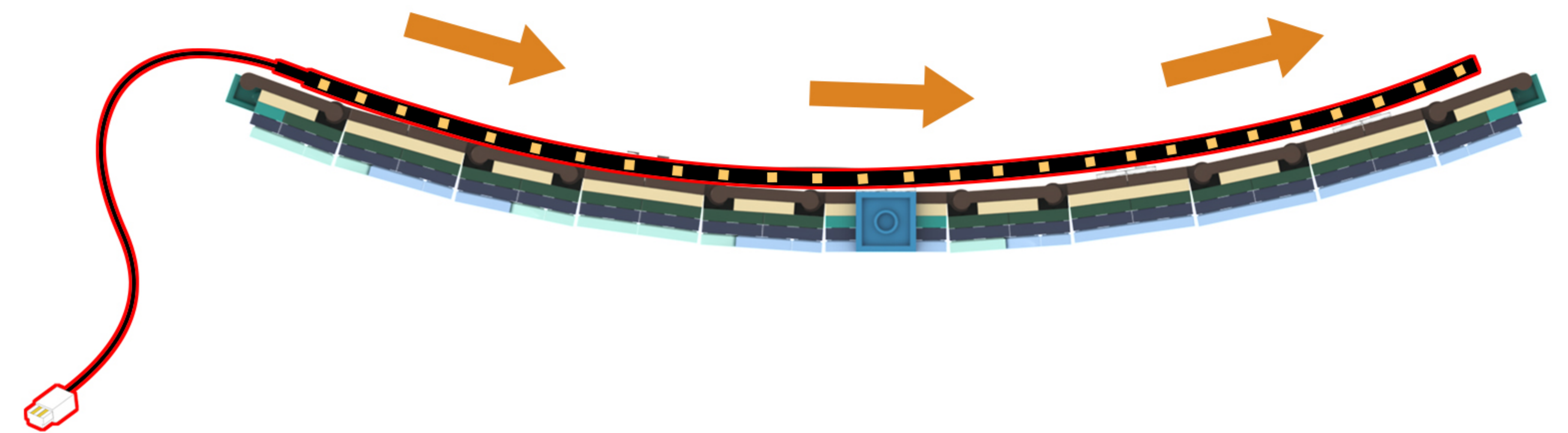

43

EN: Thread the light cord through the holes in the building blocks.

DE: Führen Sie das Lichtschnur durch die Löcher in den Bausteinen.

①

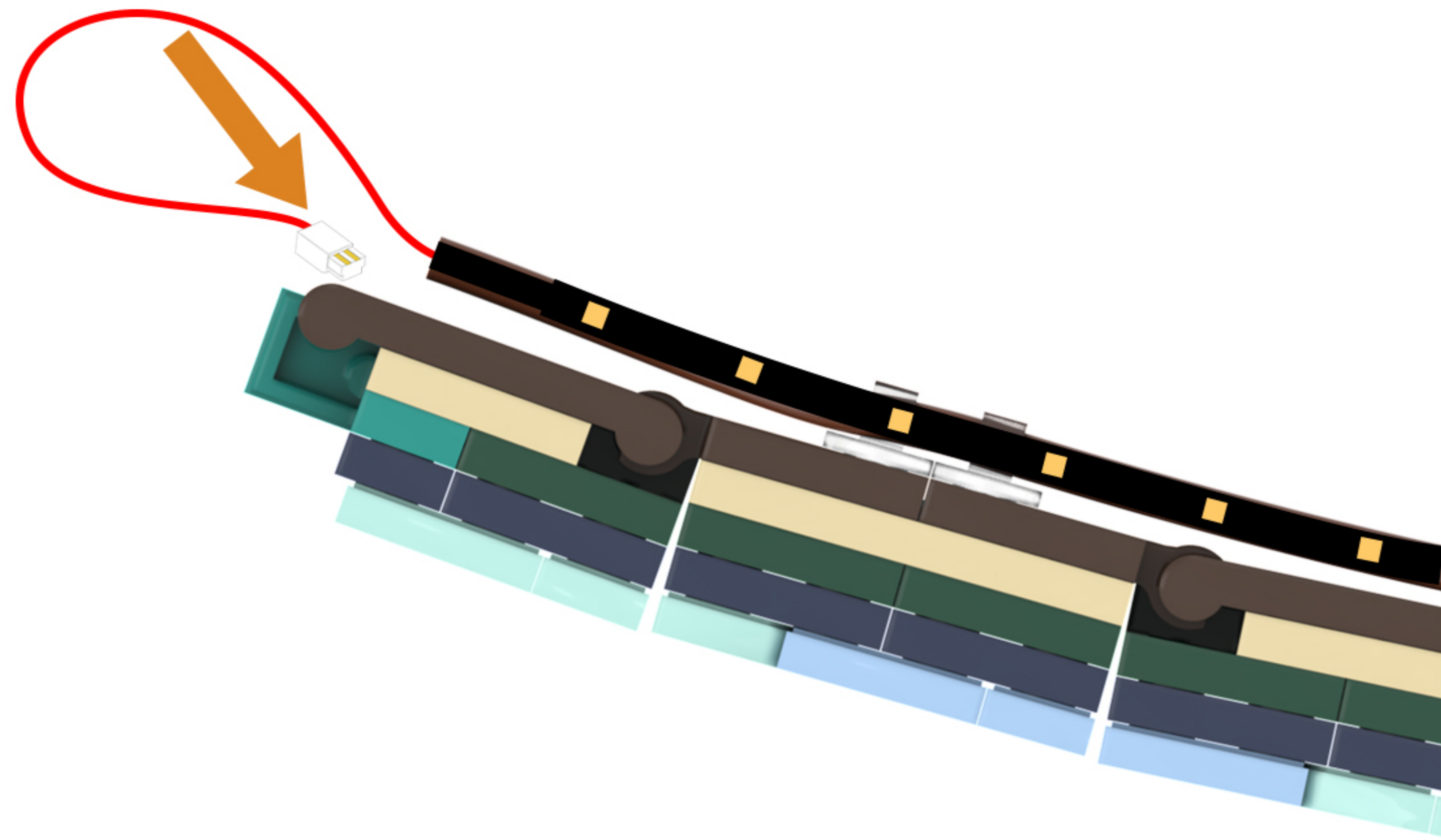

②

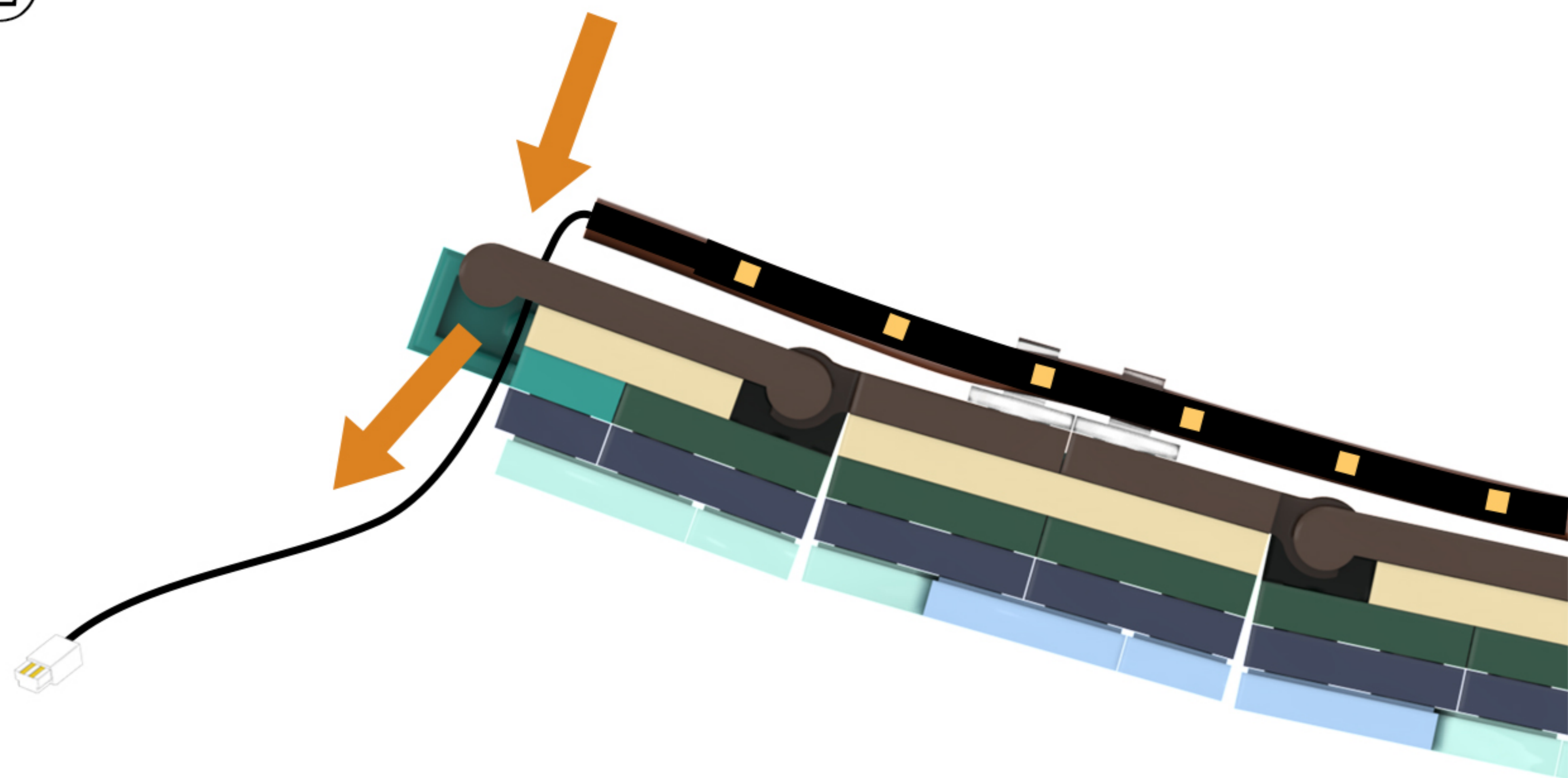

44

EN: Locate the two light wires in the diagram.

DE: Suchen Sie die beiden Lichtkabel in der Abbildung.

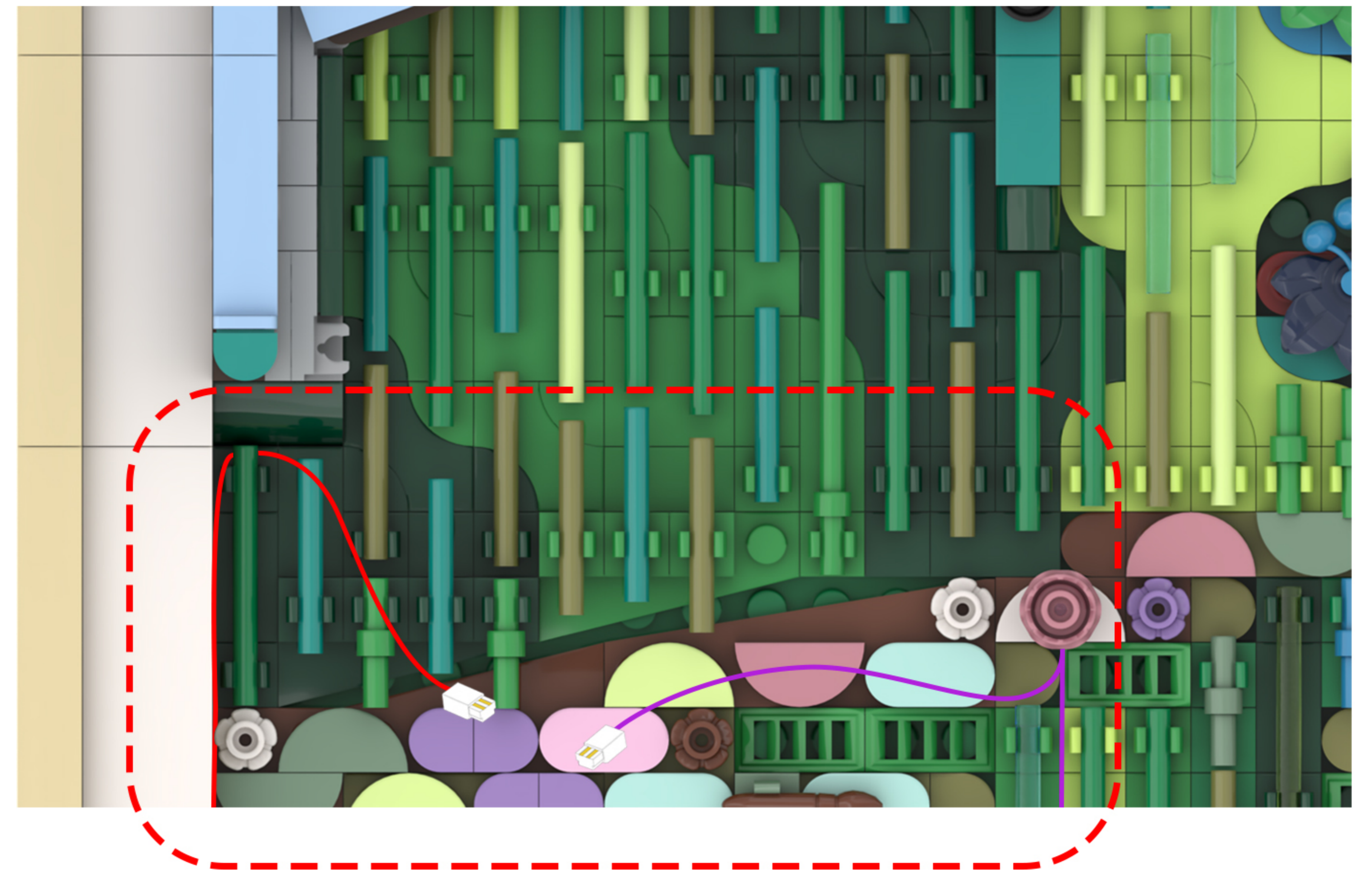

45

EN: First, arrange the two strands of lights as shown in the diagram, then twist them together.

DE: Ordnen Sie zunächst die beiden Lichterketten wie in der Abbildung gezeigt an und verdrehen Sie sie dann miteinander.

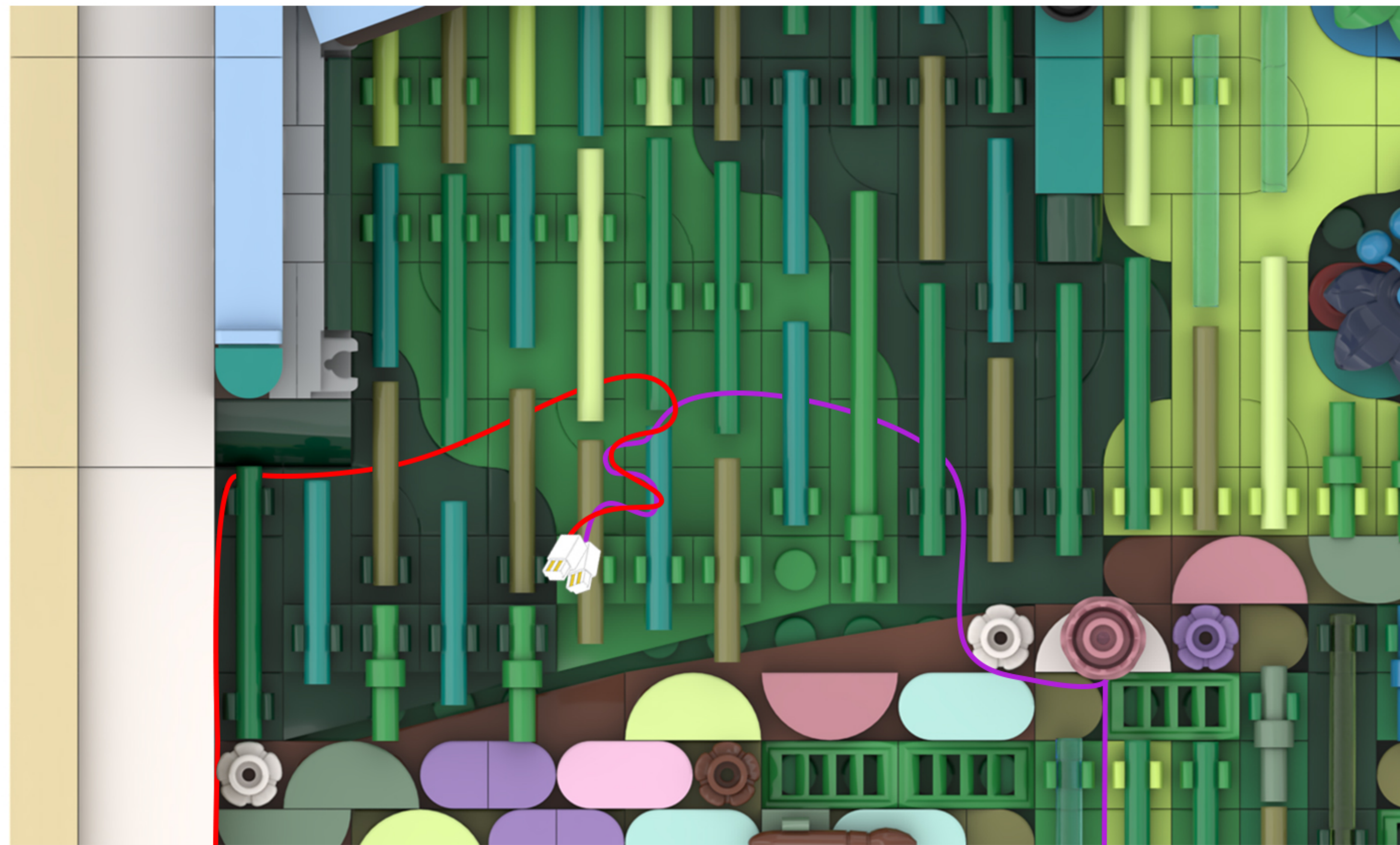

46

EN: Take the expansion board and connecting cable out of Bag 5 and connect them together.

DE: Nehmen Sie die Erweiterungskarte und das Verbindungskabel aus Beutel 5 und verbinden Sie beide miteinander.

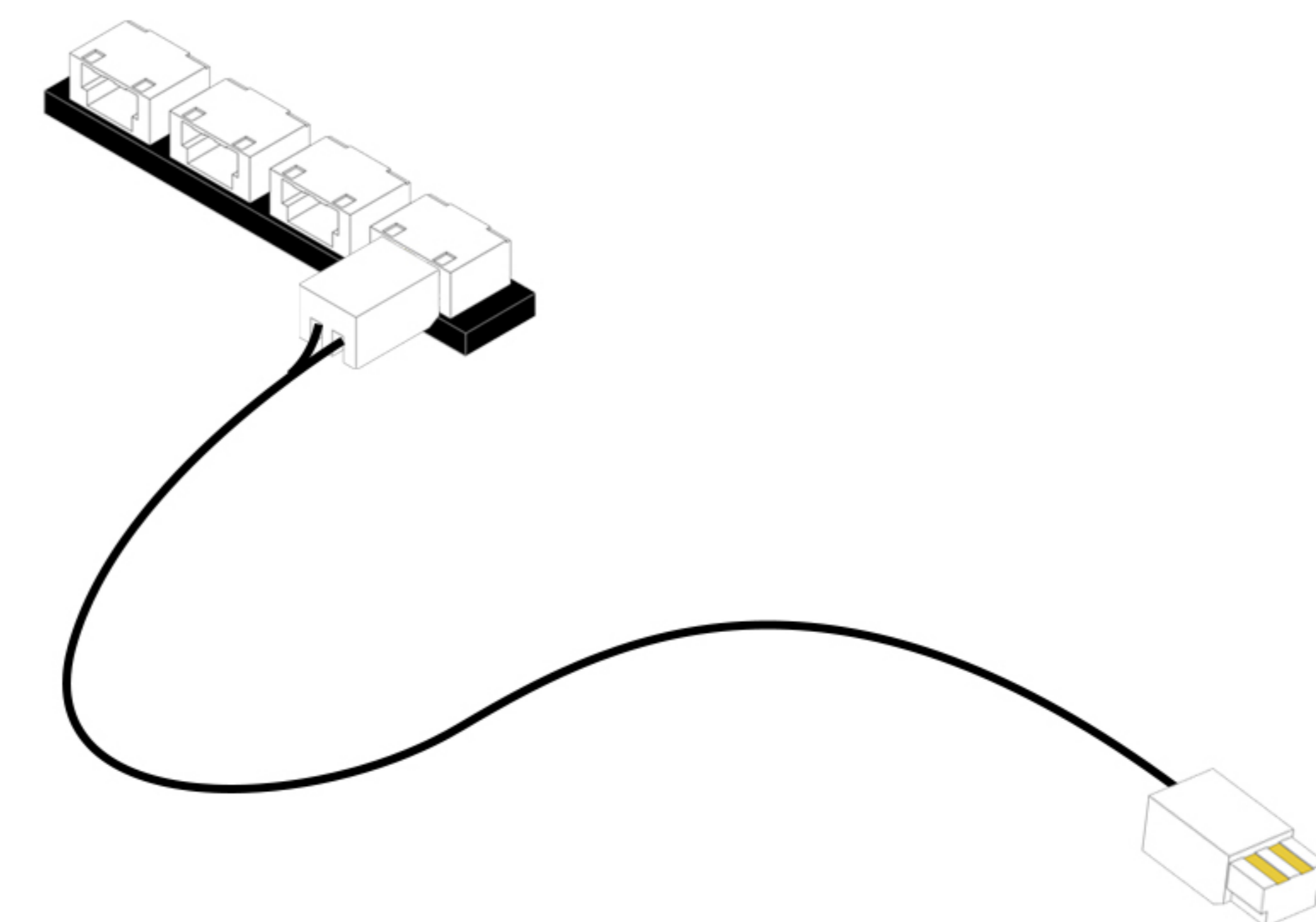
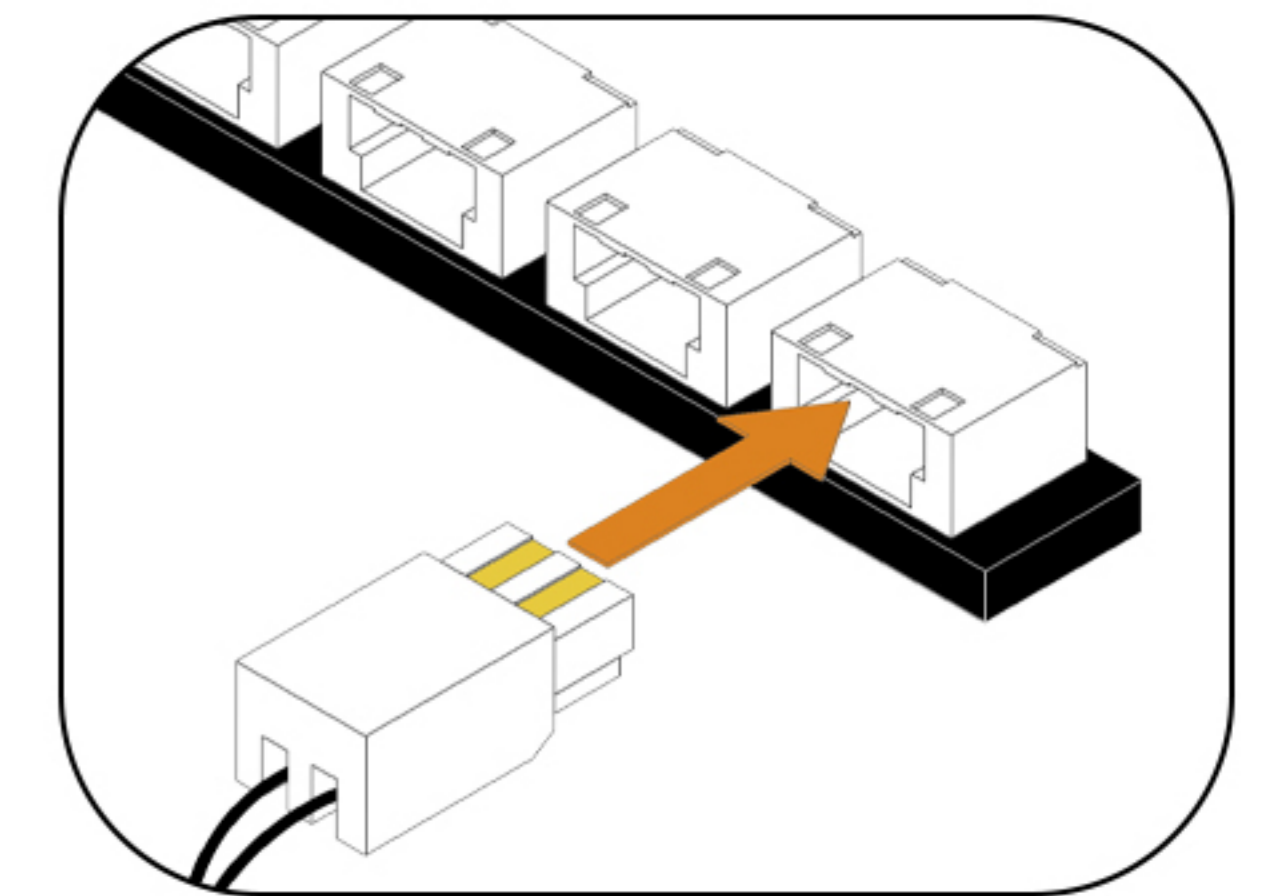
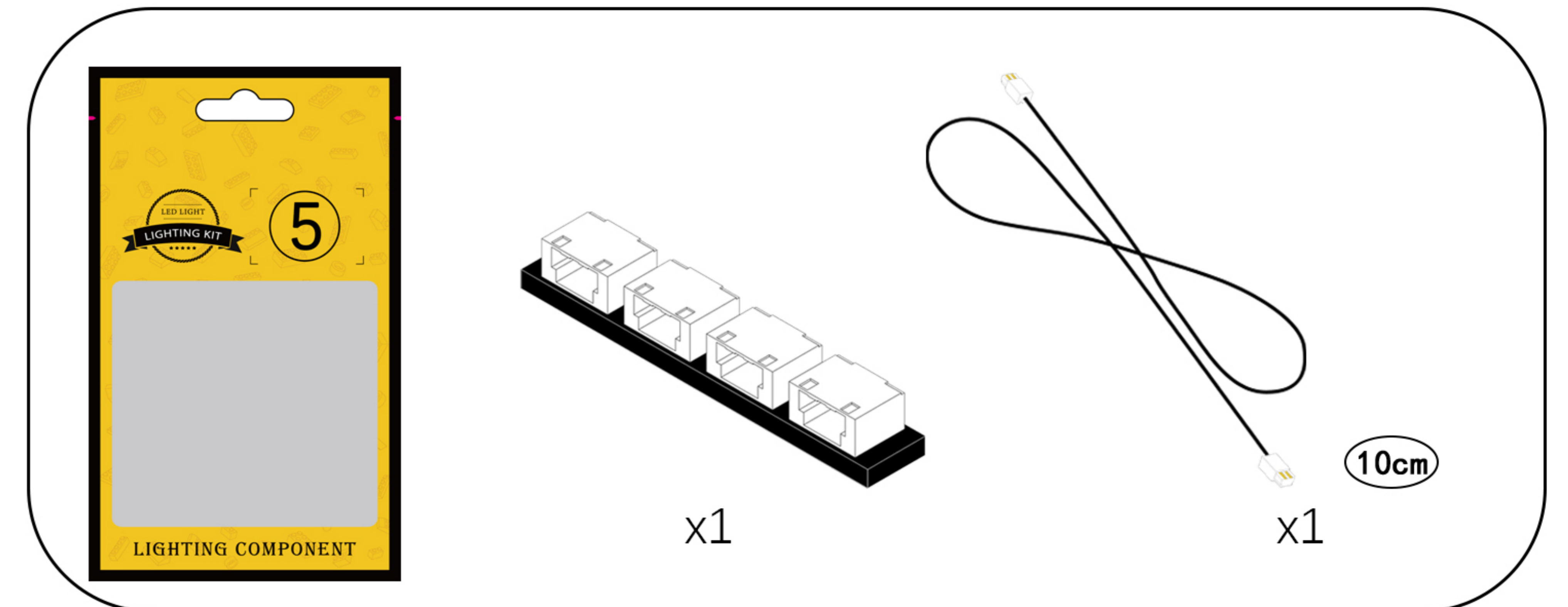

47

EN: Connect the two light cables to the expansion board one after the other.

DE: Schließen Sie die beiden Lichtkabel nacheinander an die Erweiterungskarte an.

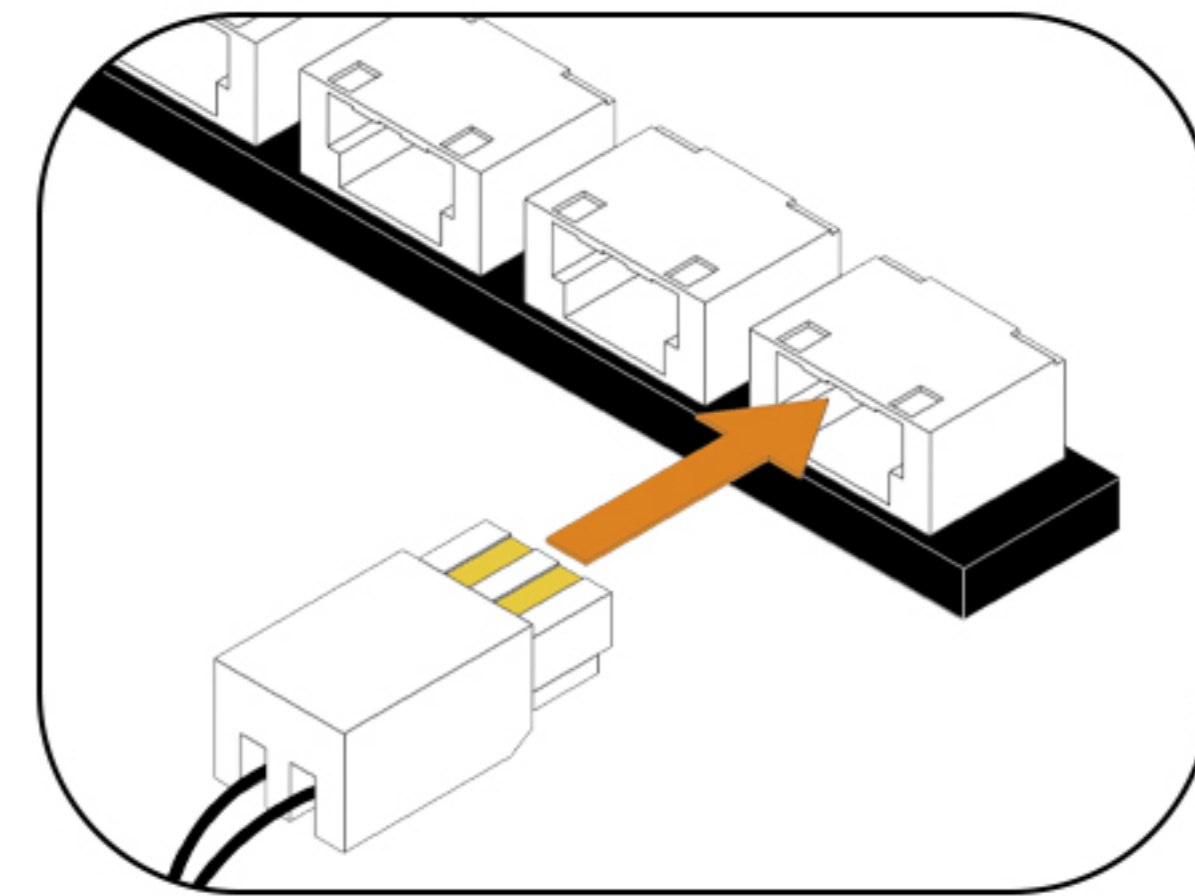

48

EN: Adjust your perspective.

DE: Ändern Sie Ihre Perspektive.

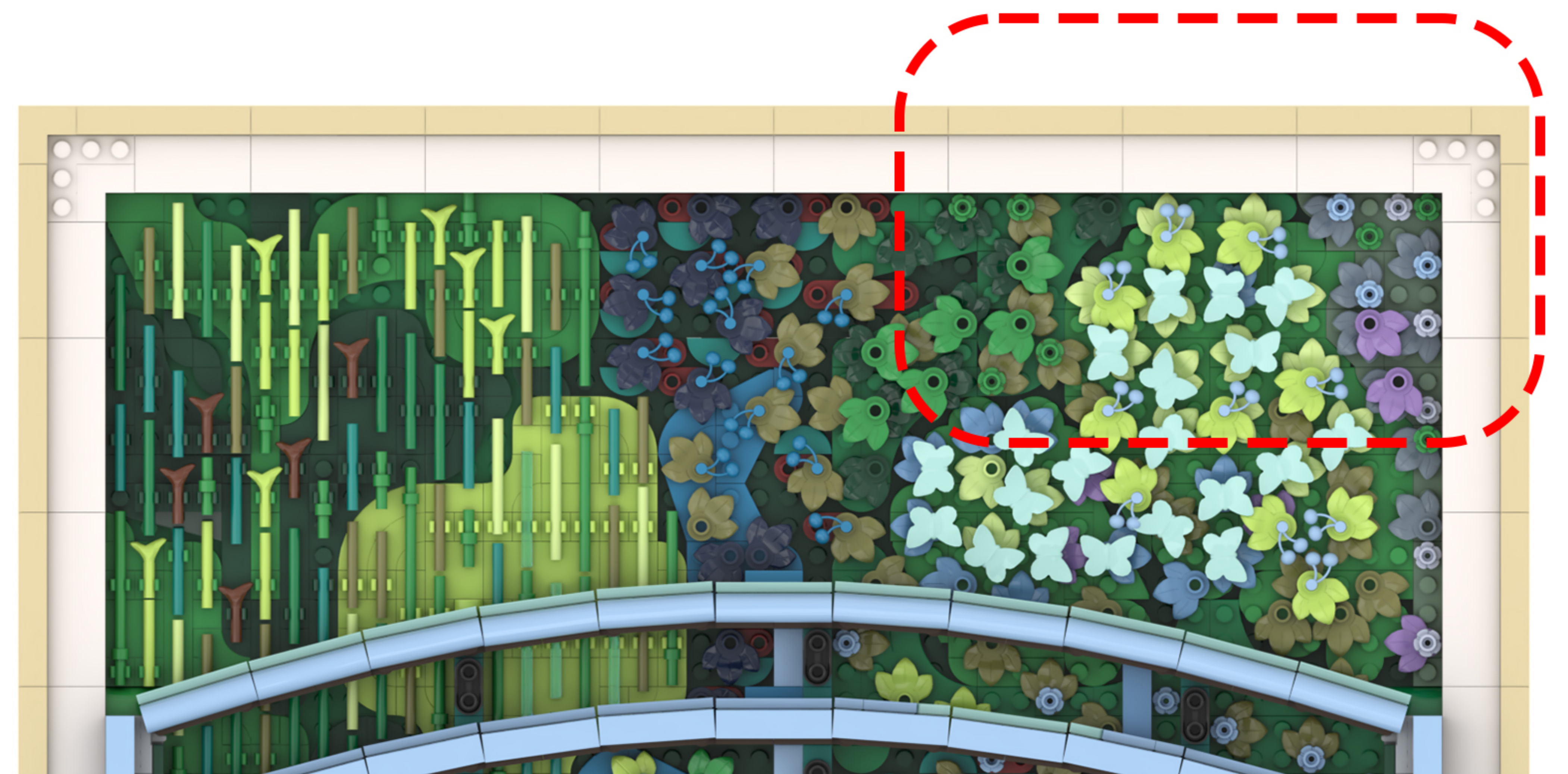

49

EN: Split as shown in the figure.

DE: Wie in der Abbildung gezeigt, teilen Sie es auf.



50

EN: Take the string of lights out of Bag 2, untie the zip tie, and locate the decorative lights on the string.

DE: Nimm die Lichterkette aus Beutel 2, löse den Kabelbinder und suche die dekorativen Lichter an der Kette.

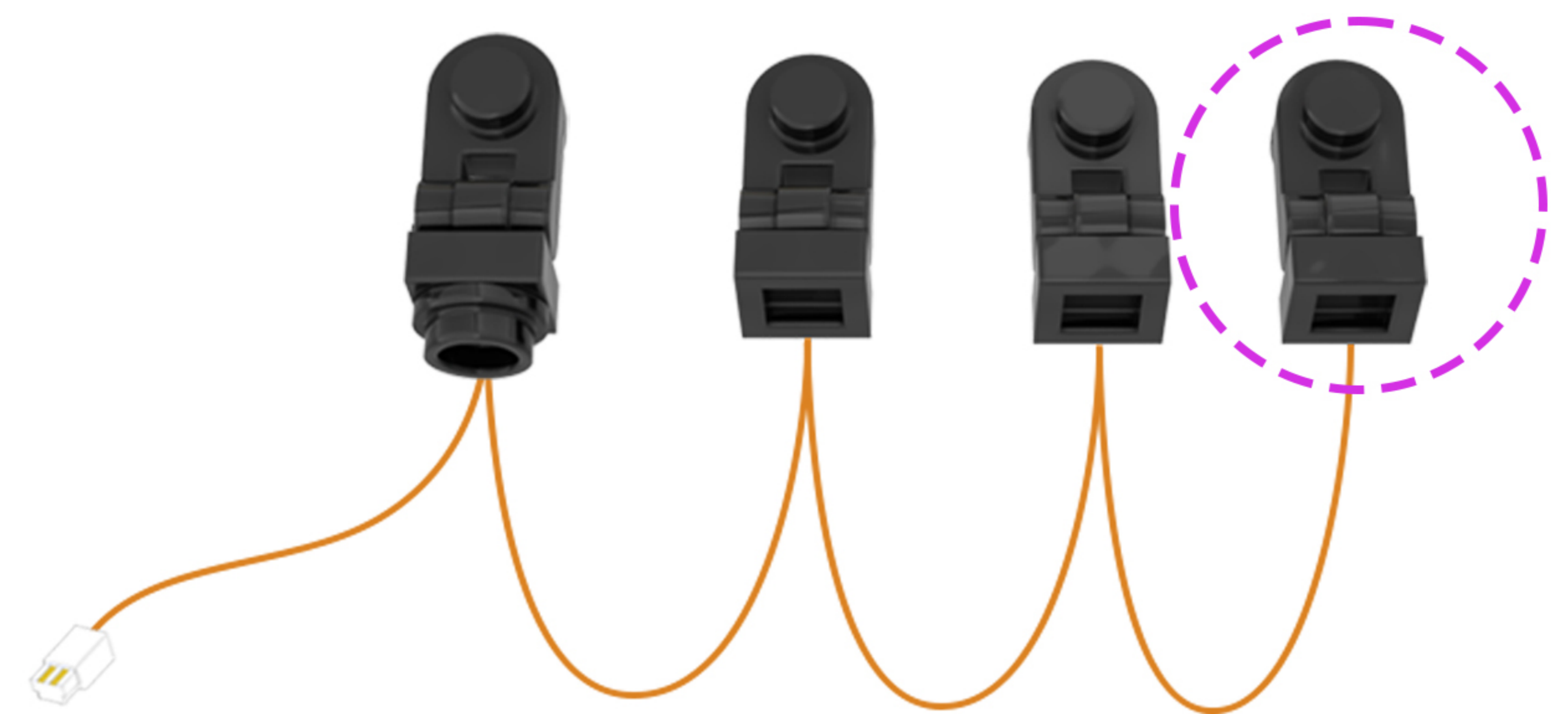
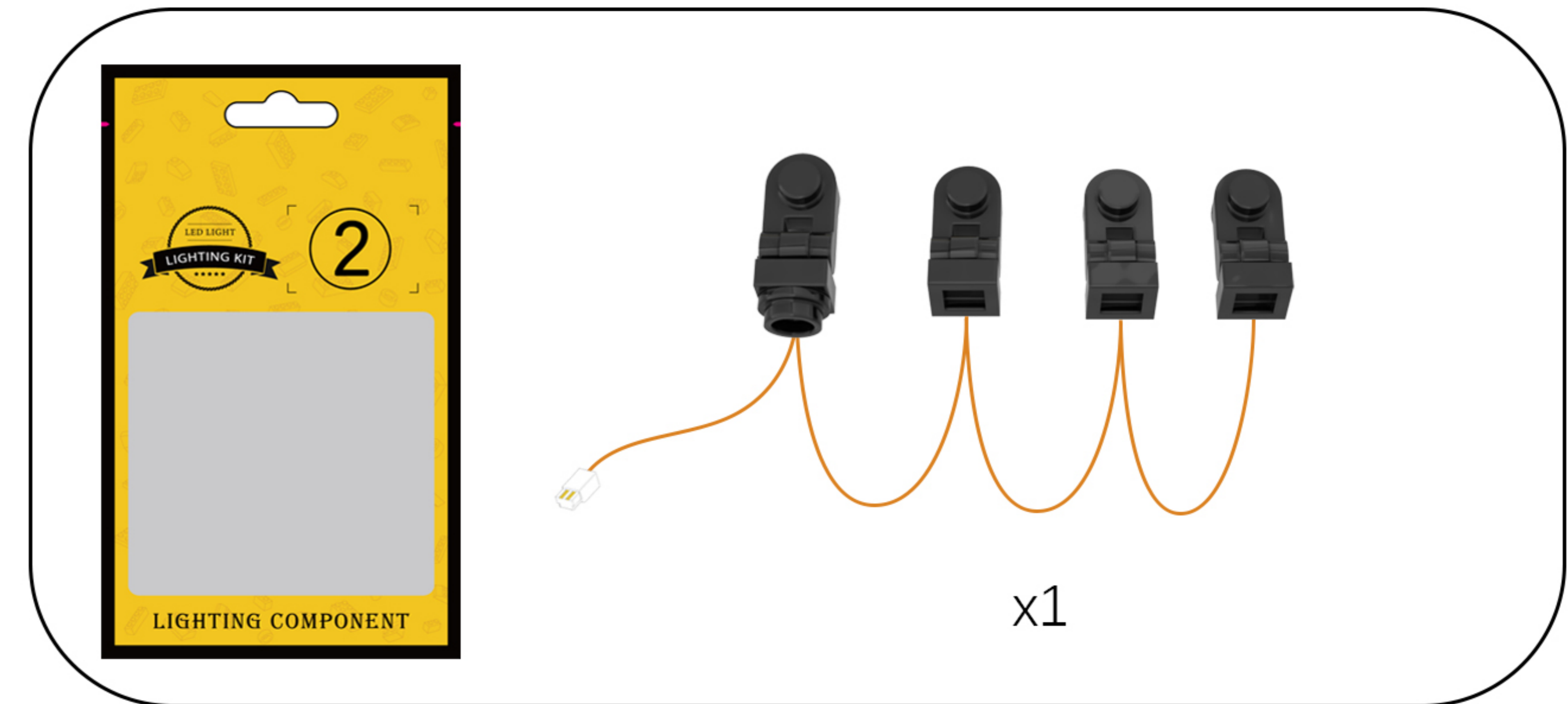

51

EN: Attach the lights from the string to the building blocks.

DE: Befestigen Sie die Lichter der Lichterkette an den Bausteinen.

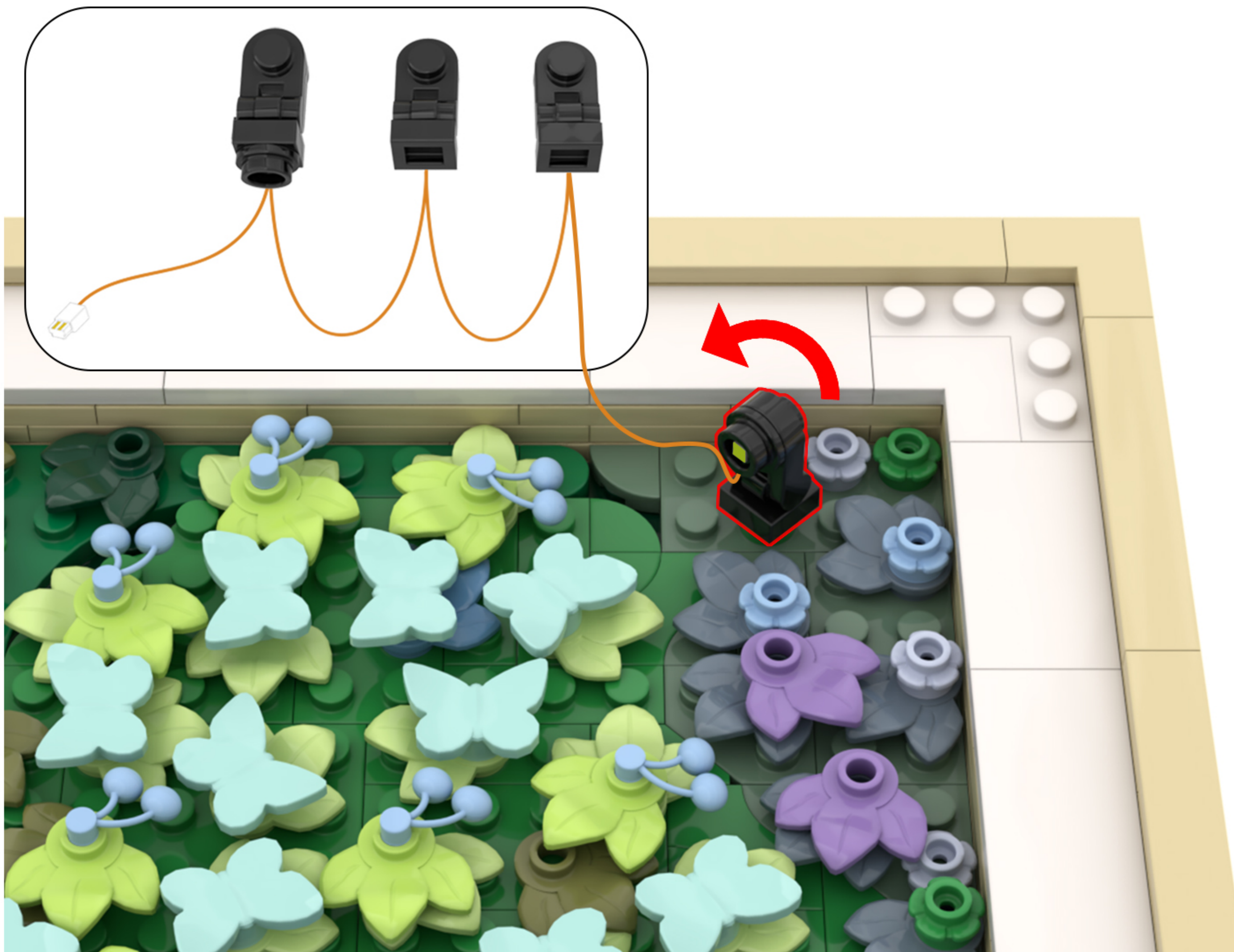

Note: Wire as shown in the diagram.

52

EN: Take out the disassembled building blocks, reassemble them, and secure the light cord.

DE: Nehmen Sie die zerlegten Bausteine heraus, setzen Sie sie wieder zusammen und befestigen Sie das Lichtkabel.

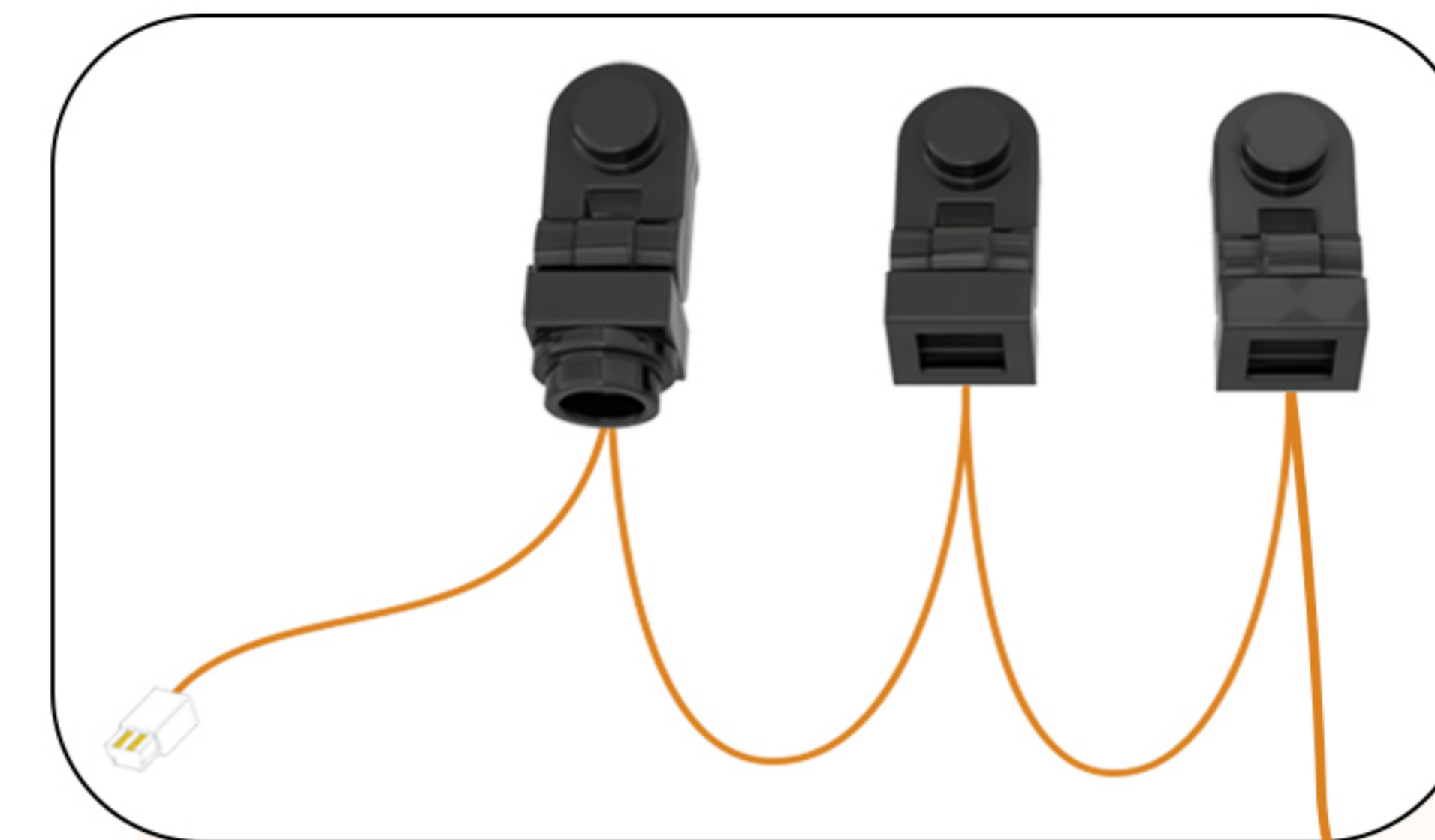
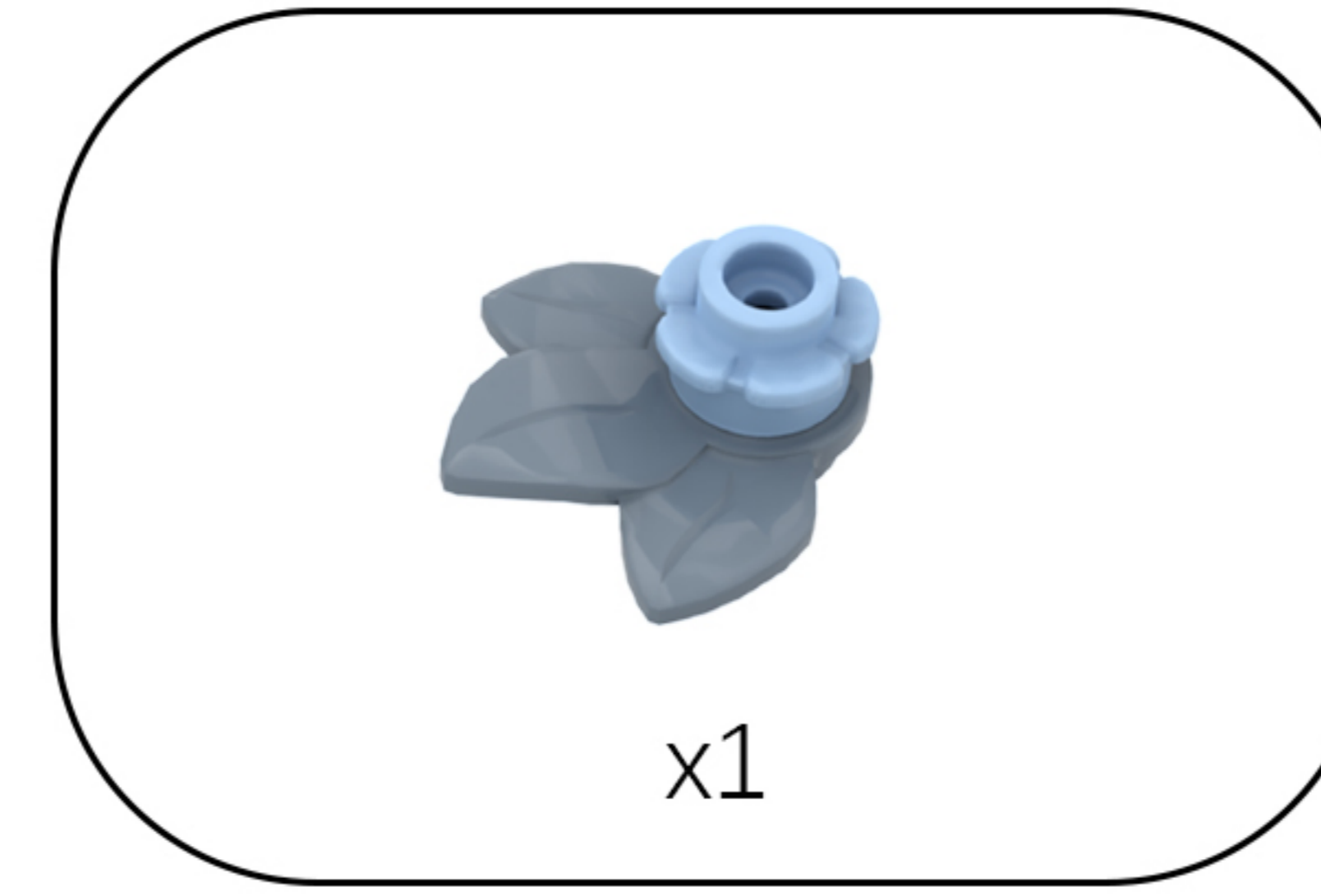

53

EN: Continue attaching the next light from the string to the building block.

DE: Befestige eine weitere Lampe der Lichterkette am Bauklotz.

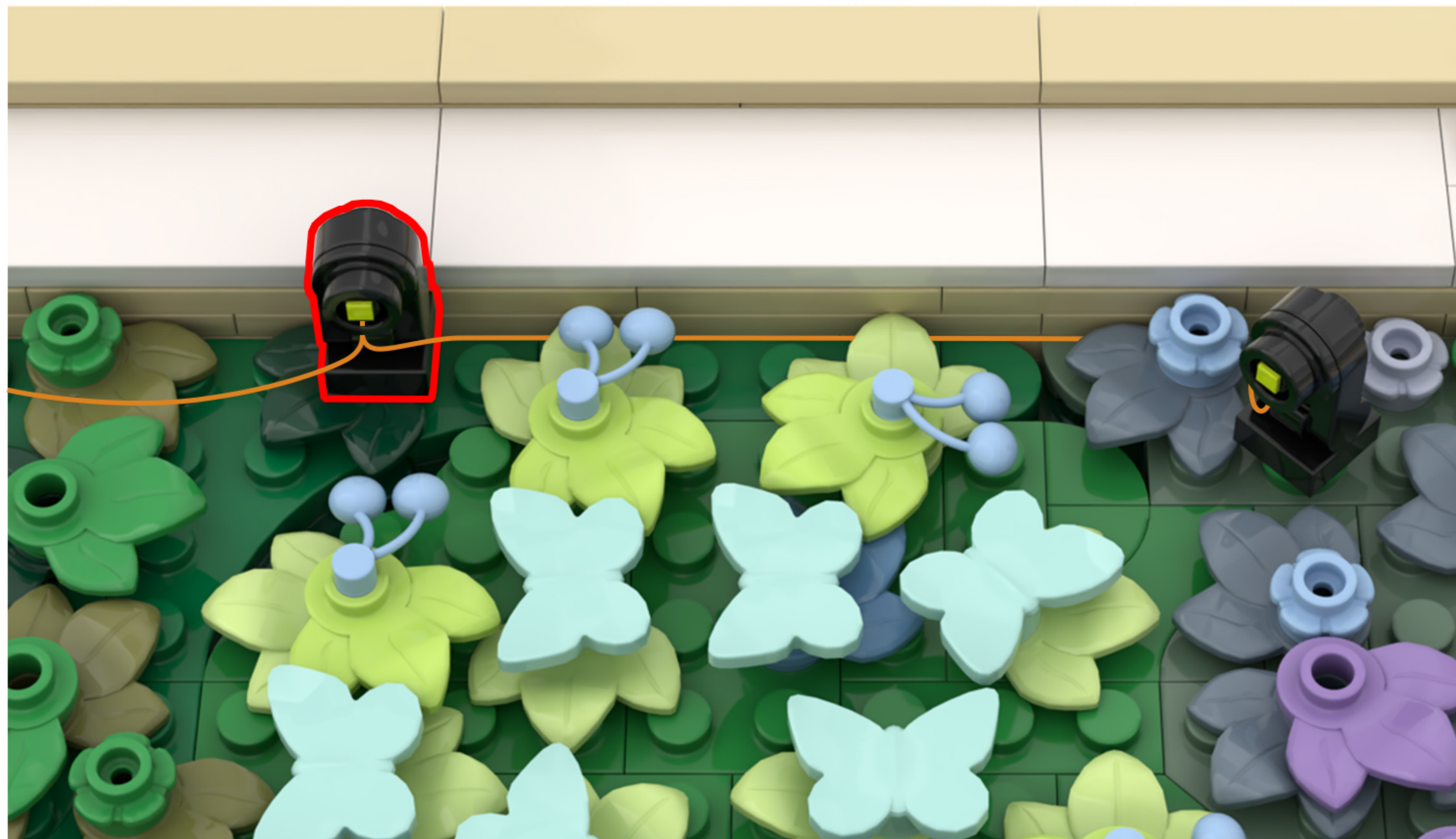

54

EN: Adjust your perspective.

DE: Ändern Sie Ihre Perspektive.

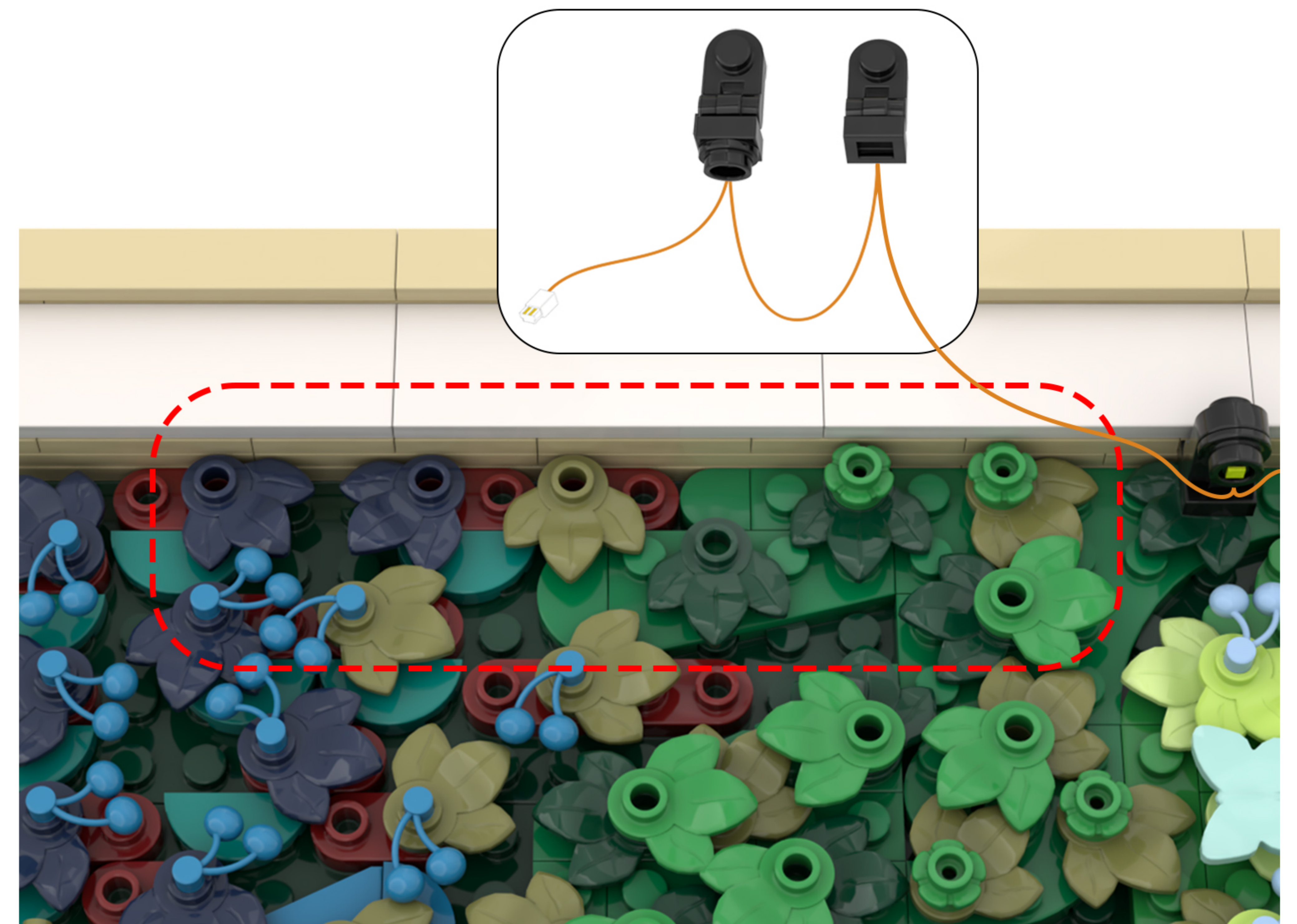

55

EN: Split as shown in the figure.

DE: Wie in der Abbildung gezeigt, teilen Sie es auf.

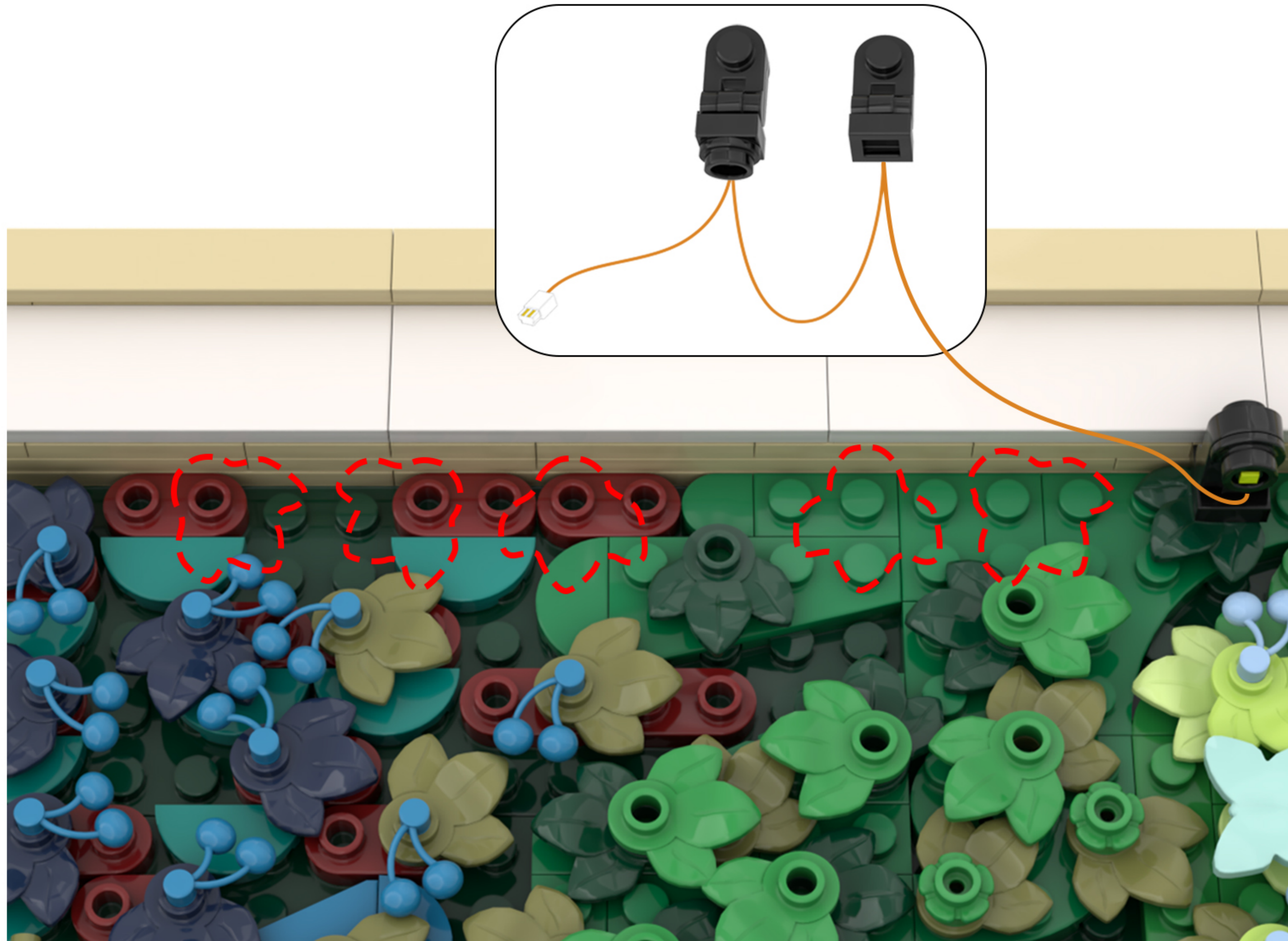

56

EN: Continue attaching the next light from the string to the building block.

DE: Befestige eine weitere Lampe der Lichterkette am Bauklotz.

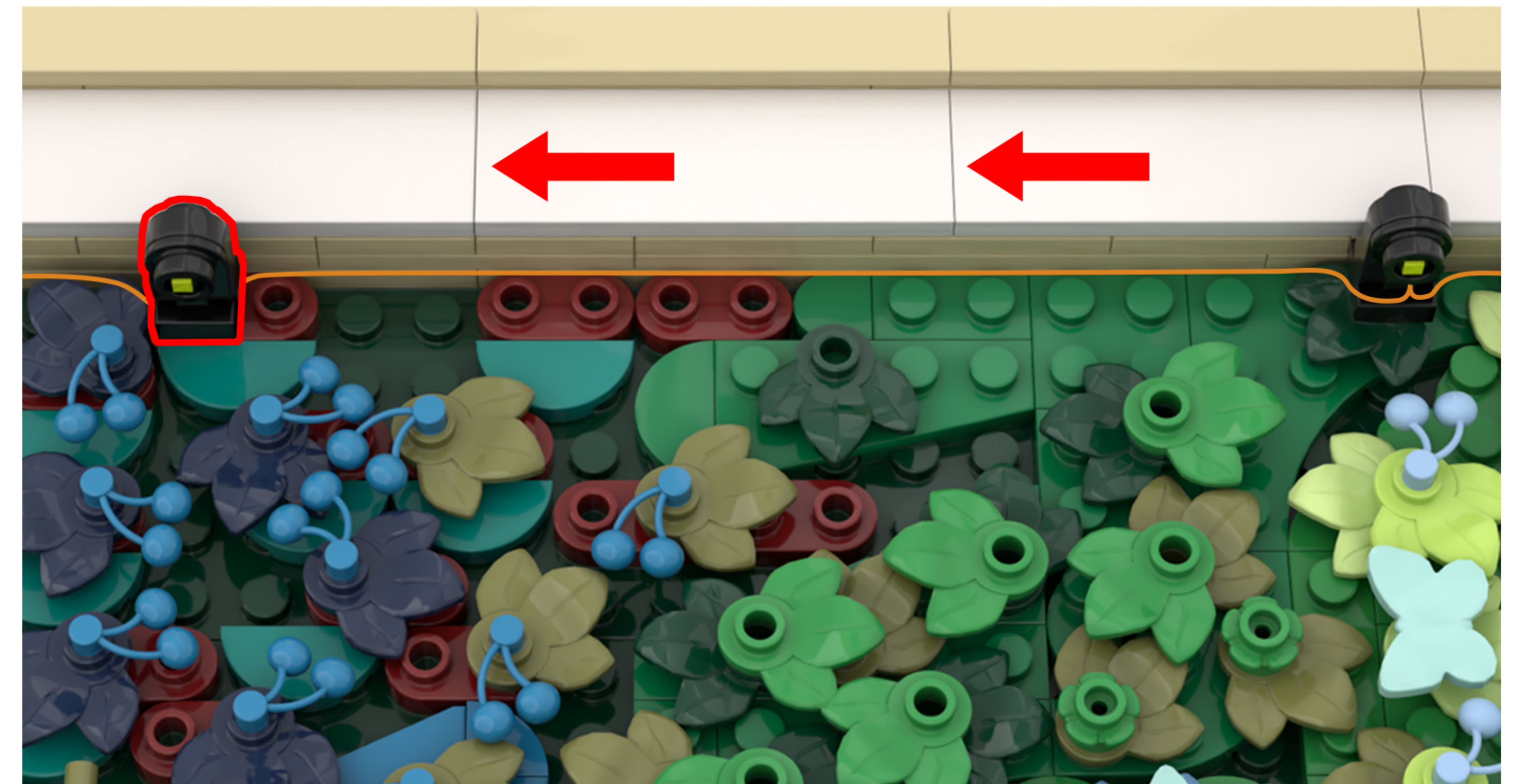

Note: Wire as shown in the diagram.

57

EN: Take out the disassembled building blocks, reassemble them, and secure the light cord.

DE: Nehmen Sie die zerlegten Bausteine heraus, setzen Sie sie wieder zusammen und befestigen Sie das Lichtkabel.

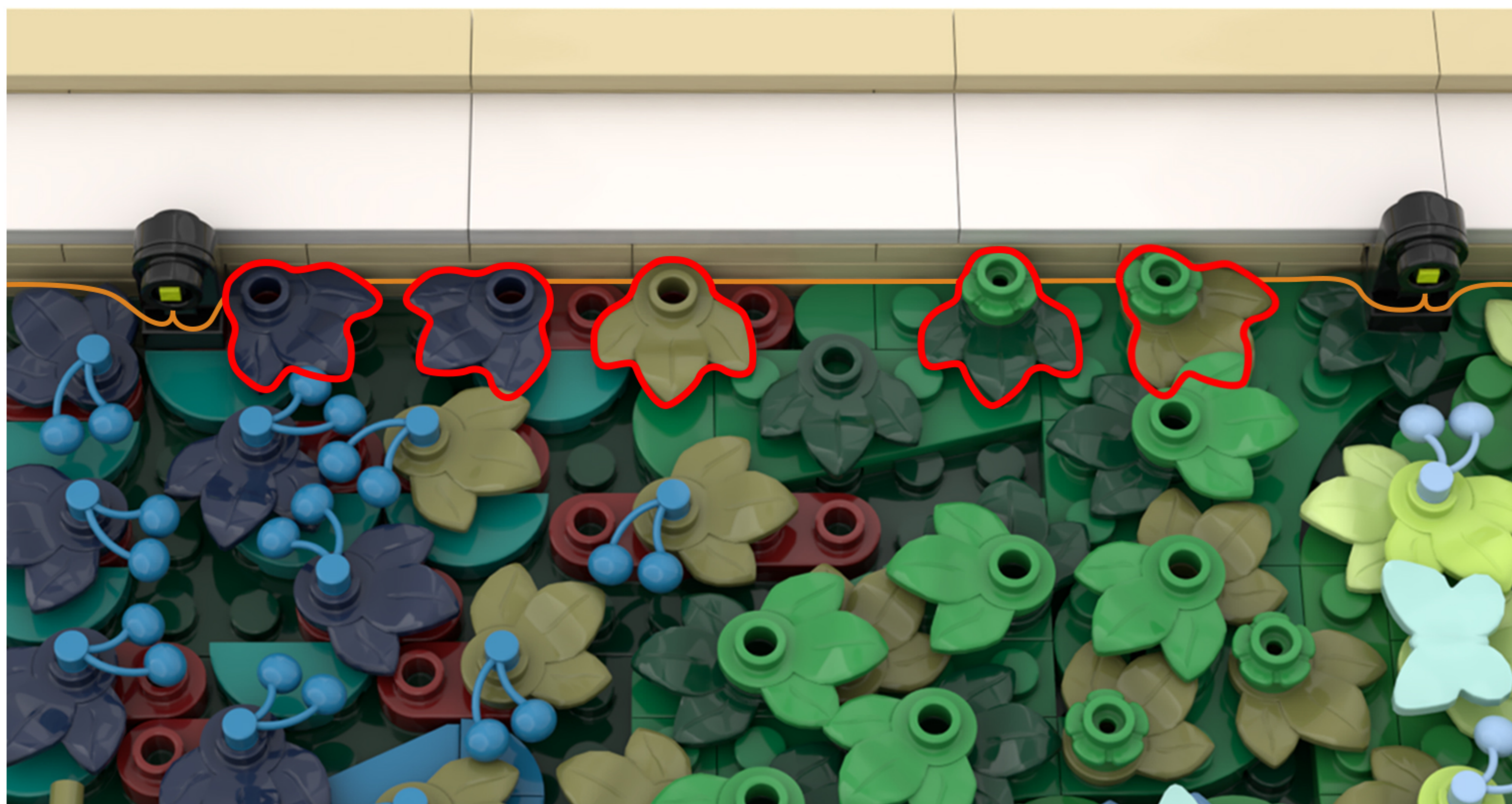
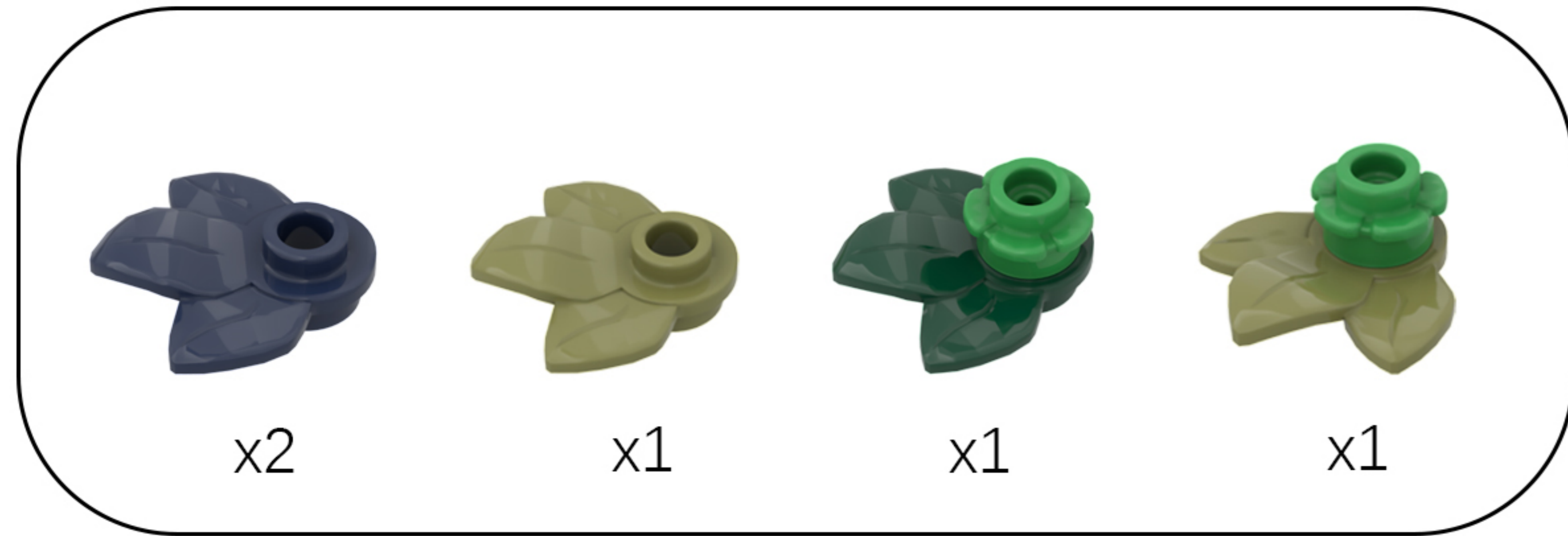

58

EN: Adjust your perspective.

DE: Ändern Sie Ihre Perspektive.

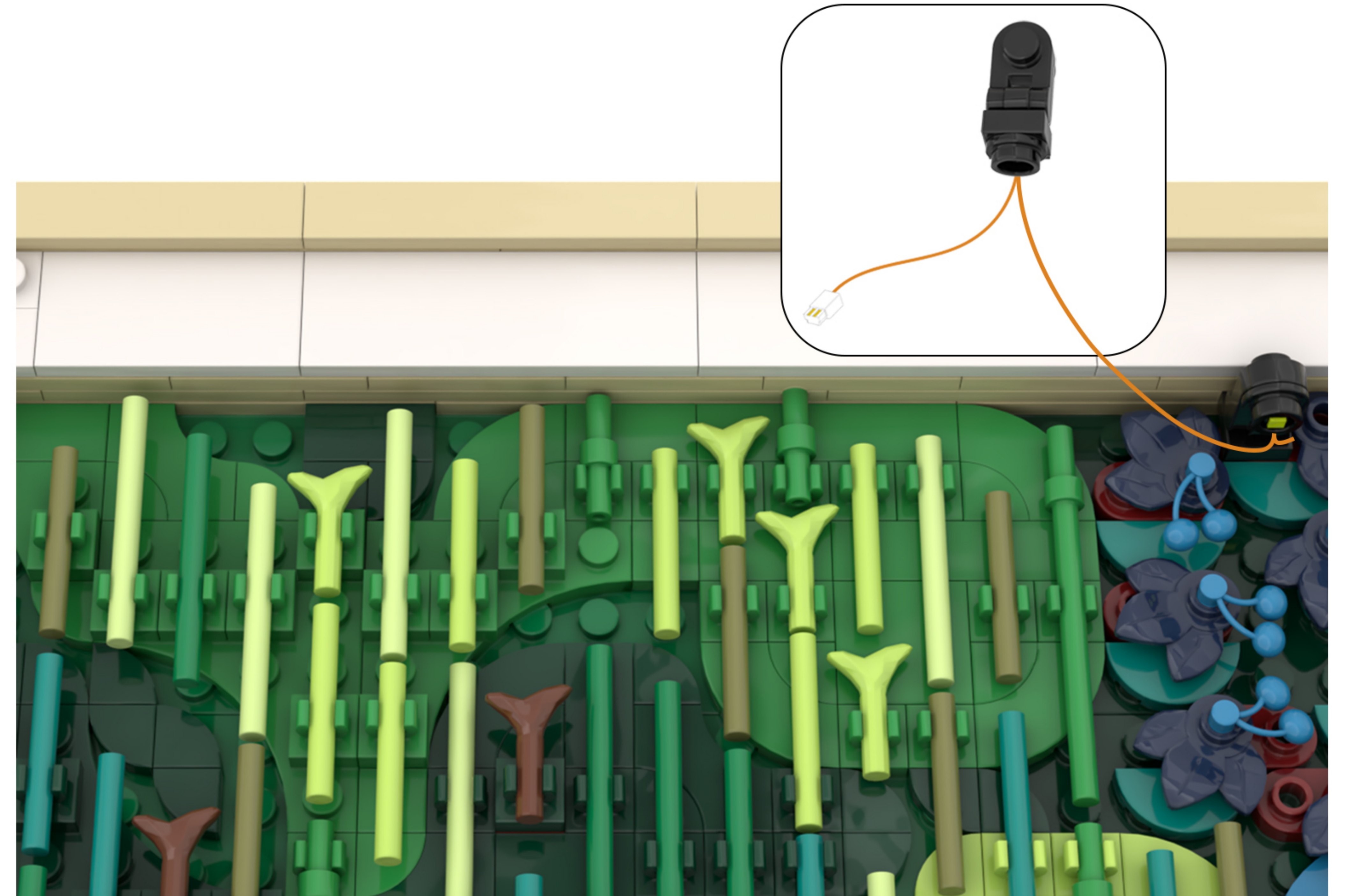

59

EN: Attach the lights from the string to the building blocks.

DE: Befestigen Sie die Lichter der Lichterkette an den Bausteinen.



Note: Wire as shown in the diagram.

60

EN: Locate this light cord in the diagram.

DE: Suchen Sie dieses Lichtkabel in der Abbildung.



61

EN: Run the light cord downward.

DE: Führen Sie das Lichtkabel nach unten.

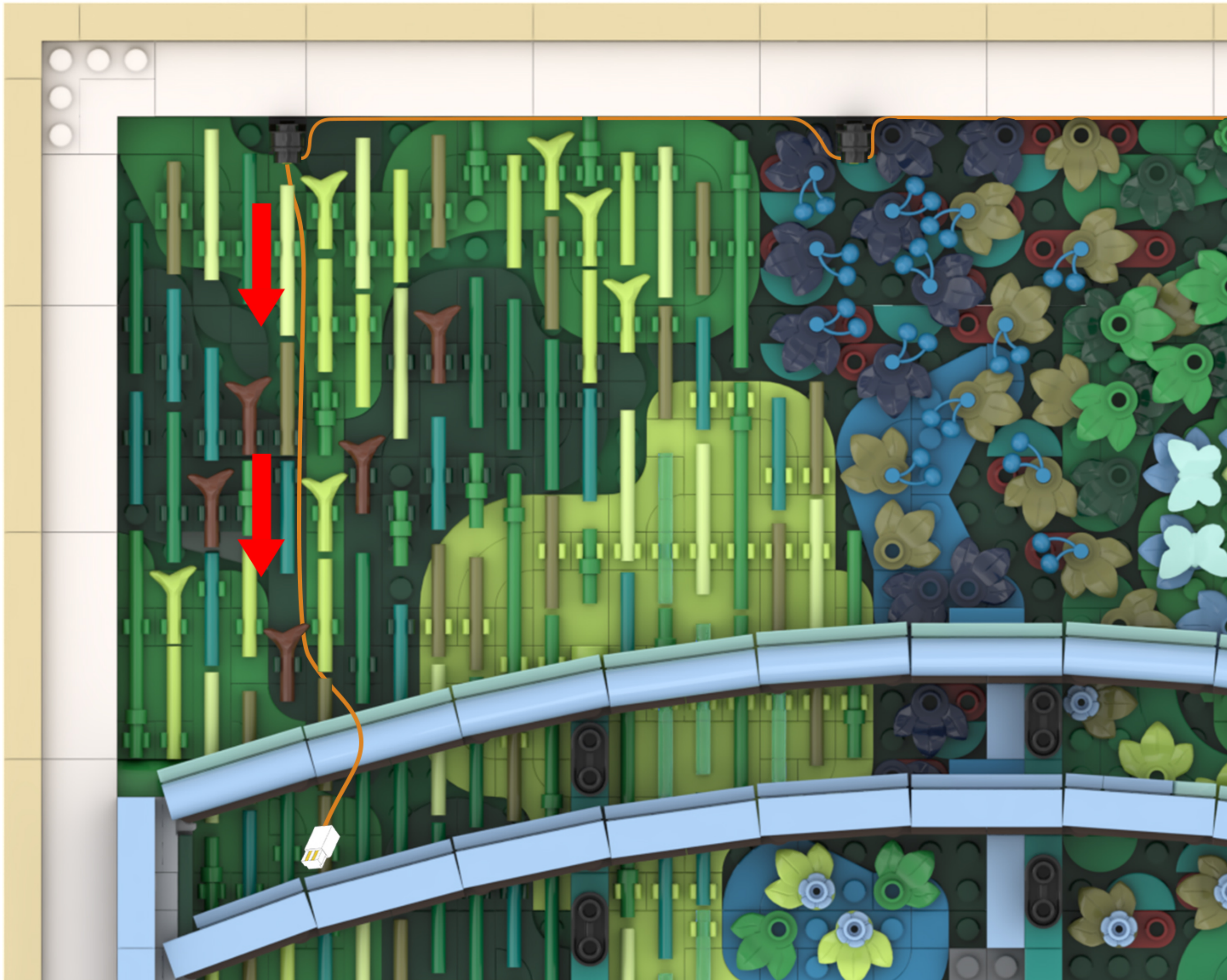

62

EN: Adjust your perspective.

DE: Ändern Sie Ihre Perspektive.

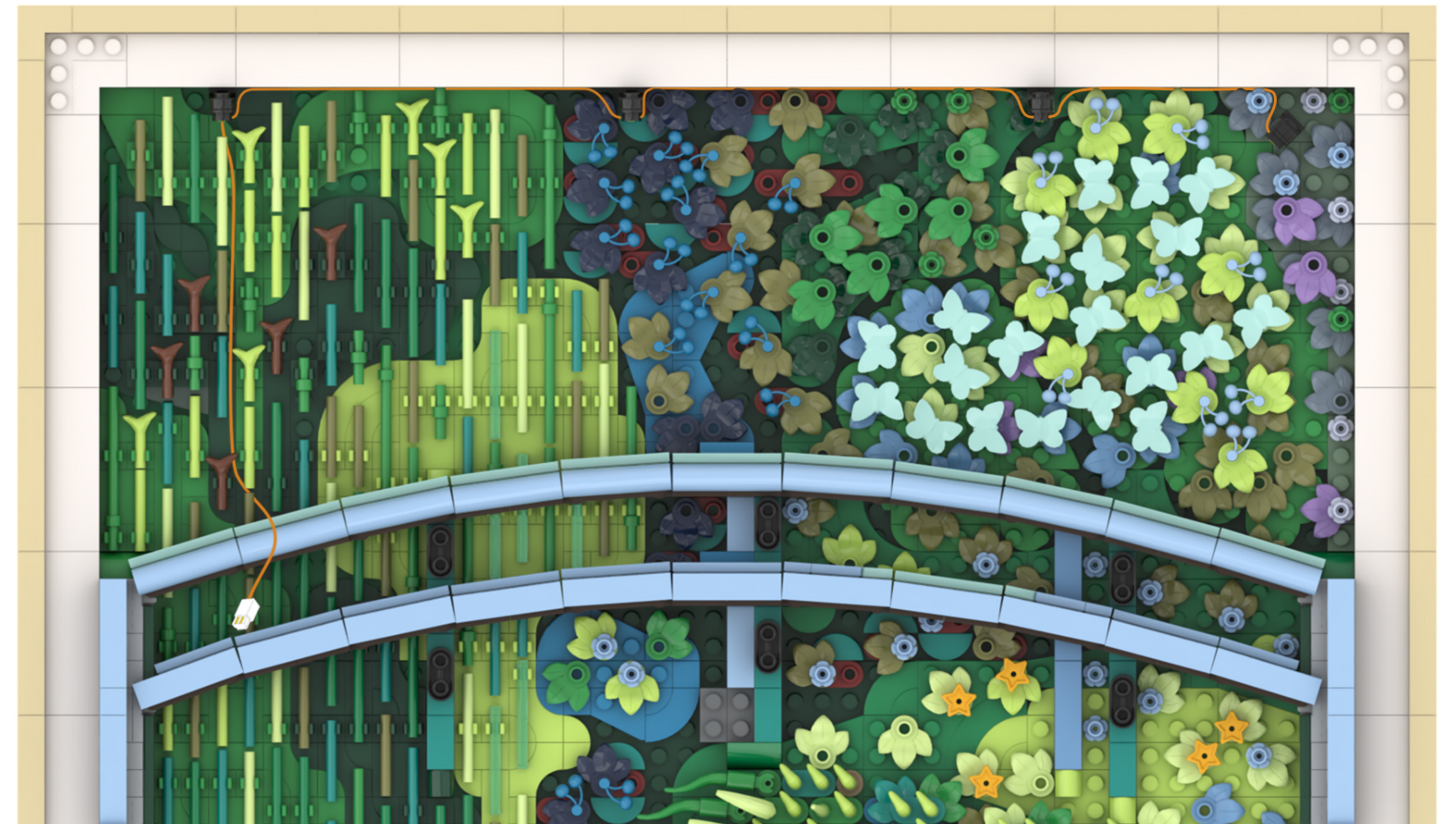

63

EN: Split as shown in the figure.

DE: Wie in der Abbildung gezeigt, teilen Sie es auf.

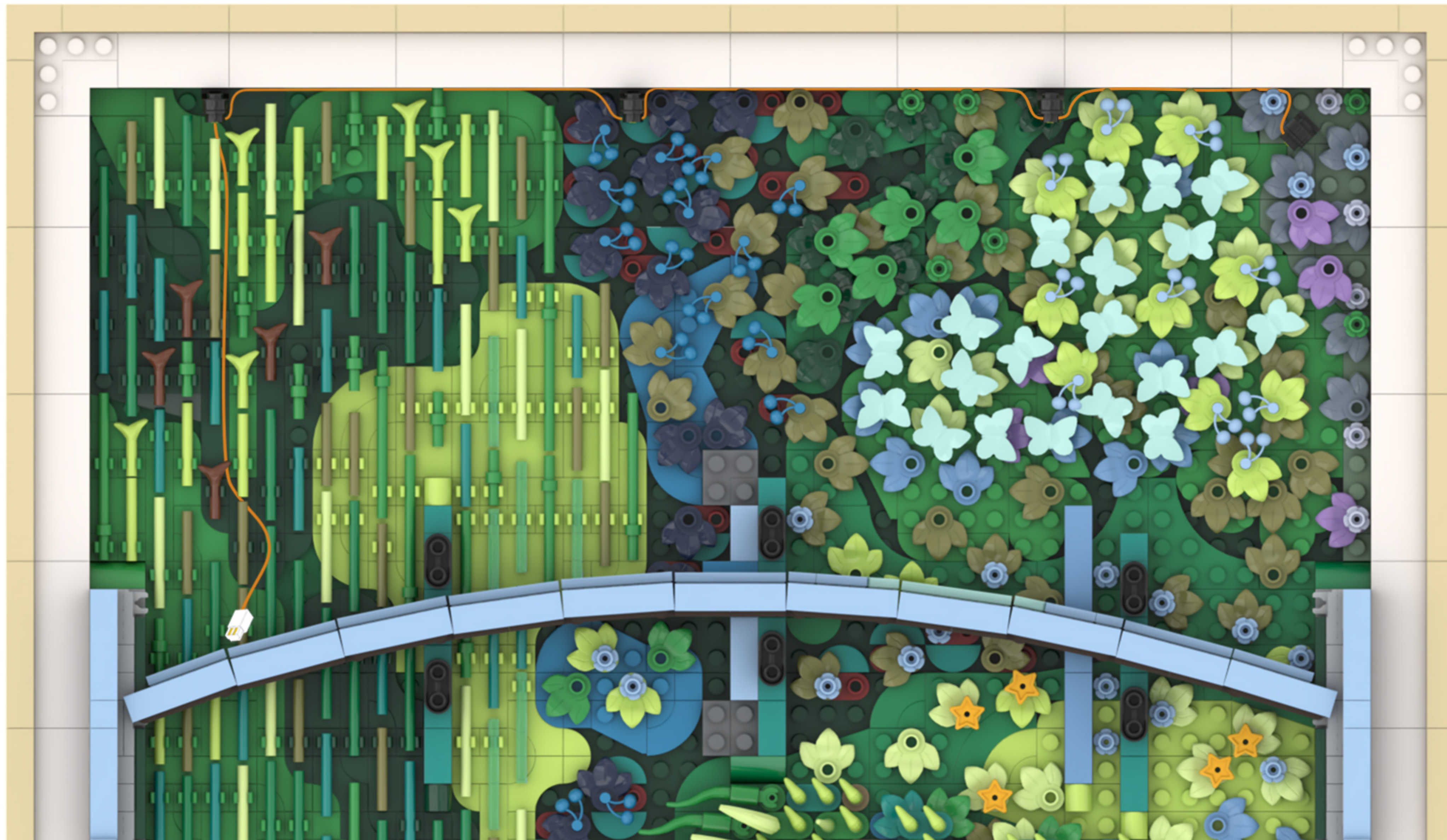
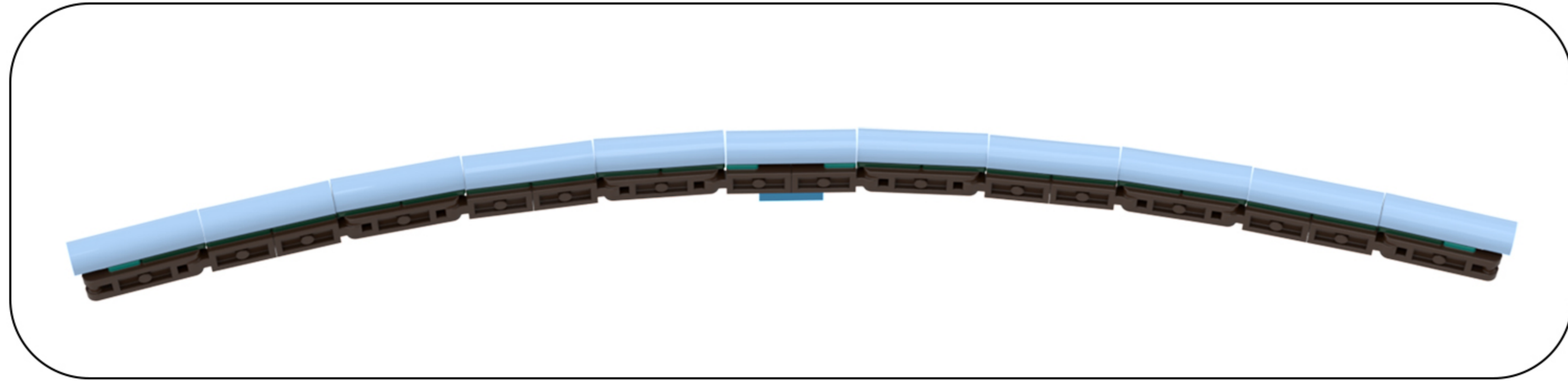

64

EN: Use tweezers to thread the light cord through the gap in the building block.

DE: Führen Sie das Lichtschrur mit einer Pinzette durch die Öffnung im Baustein.

①

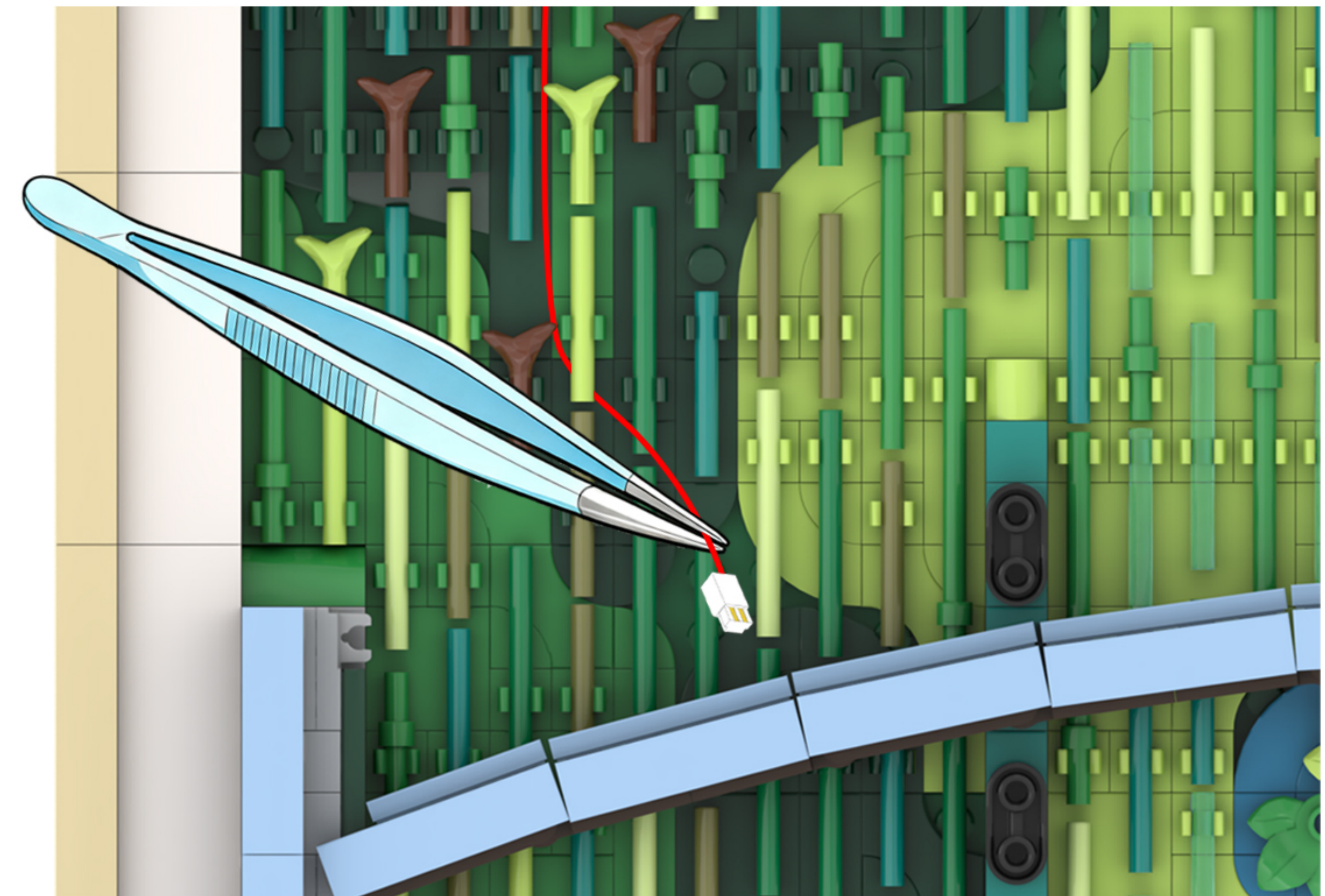

②

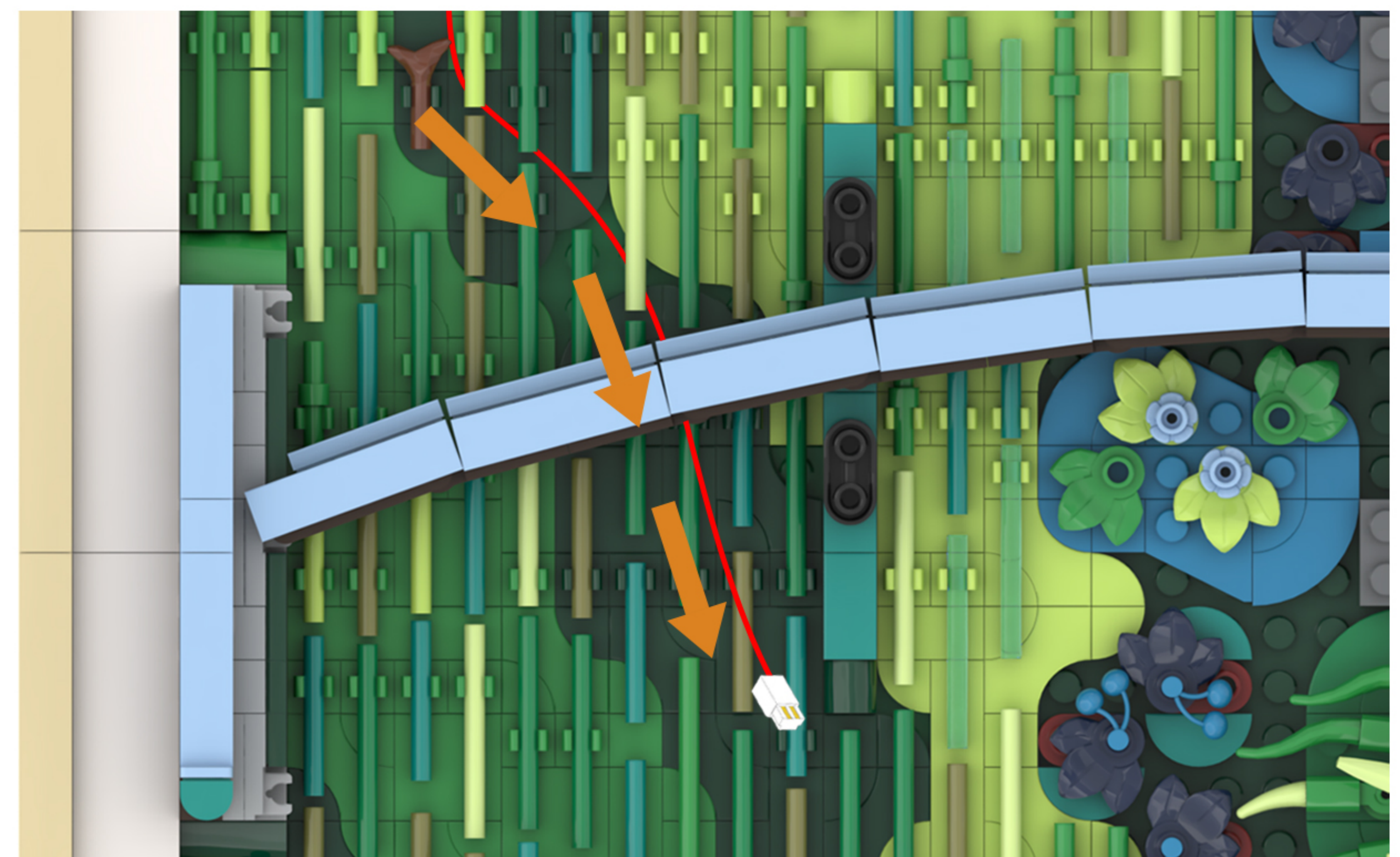

65

EN: Take the disassembled building blocks and turn them over so that the bottom side is facing up.

DE: Nimm die zerlegten Bausteine und drehe sie so, dass die Unterseite nach oben zeigt.

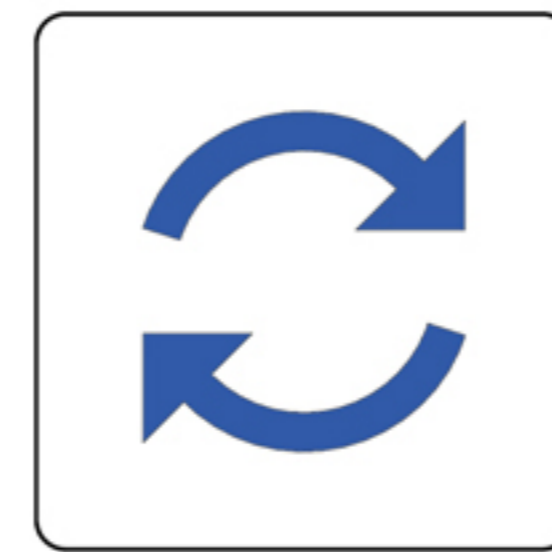
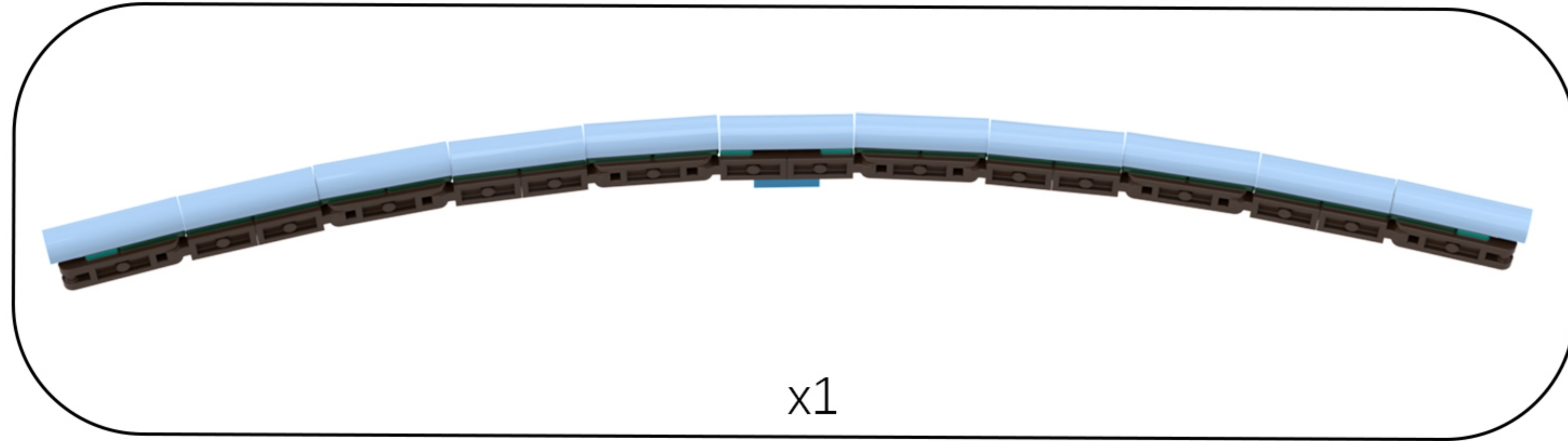

66

EN: Take the LED strip out of Bag 3, peel off the adhesive backing from one of the strips, and first attach the end with the wires to the building block.

DE: Nimm den LED-Streifen aus Beutel 3, ziehe die Schutzfolie von einem der Streifen ab und befestige zunächst das Ende mit den Drähten am Baustein.

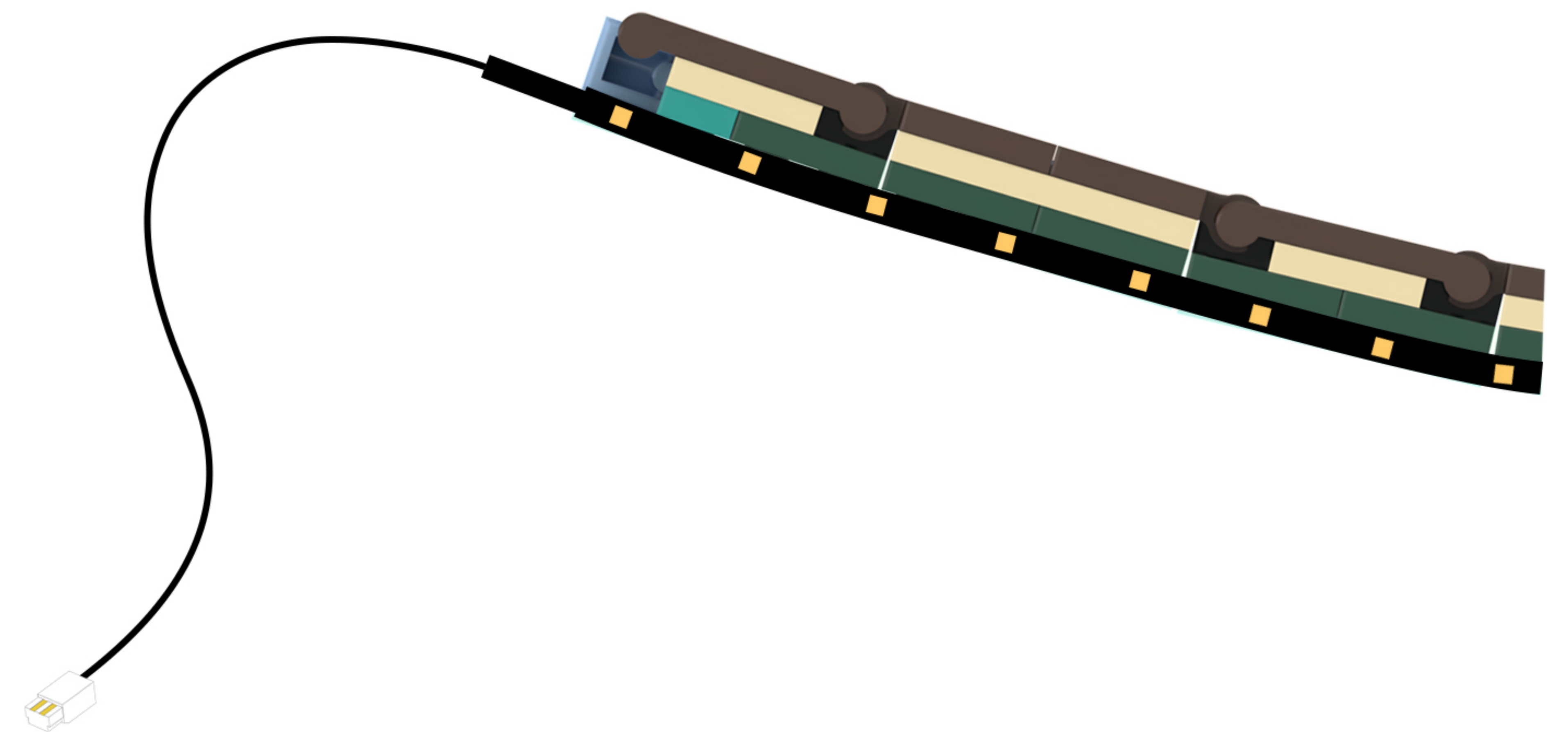
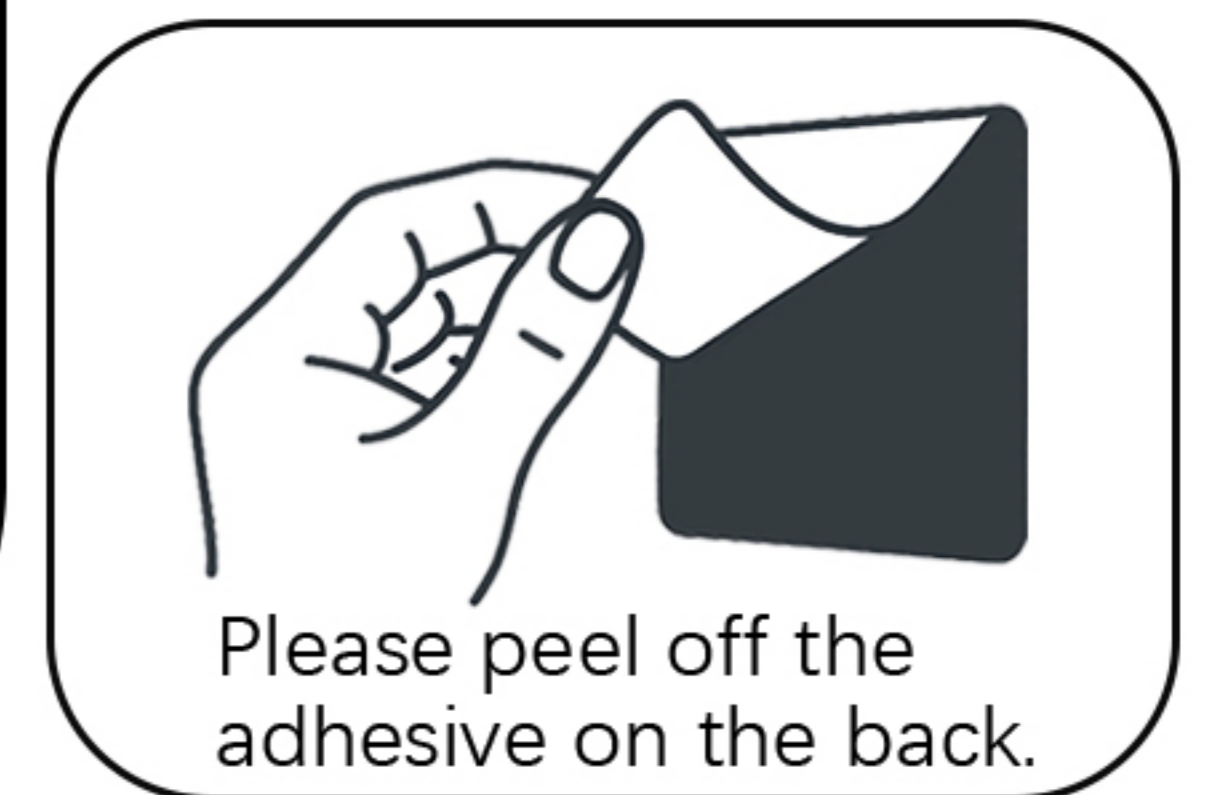
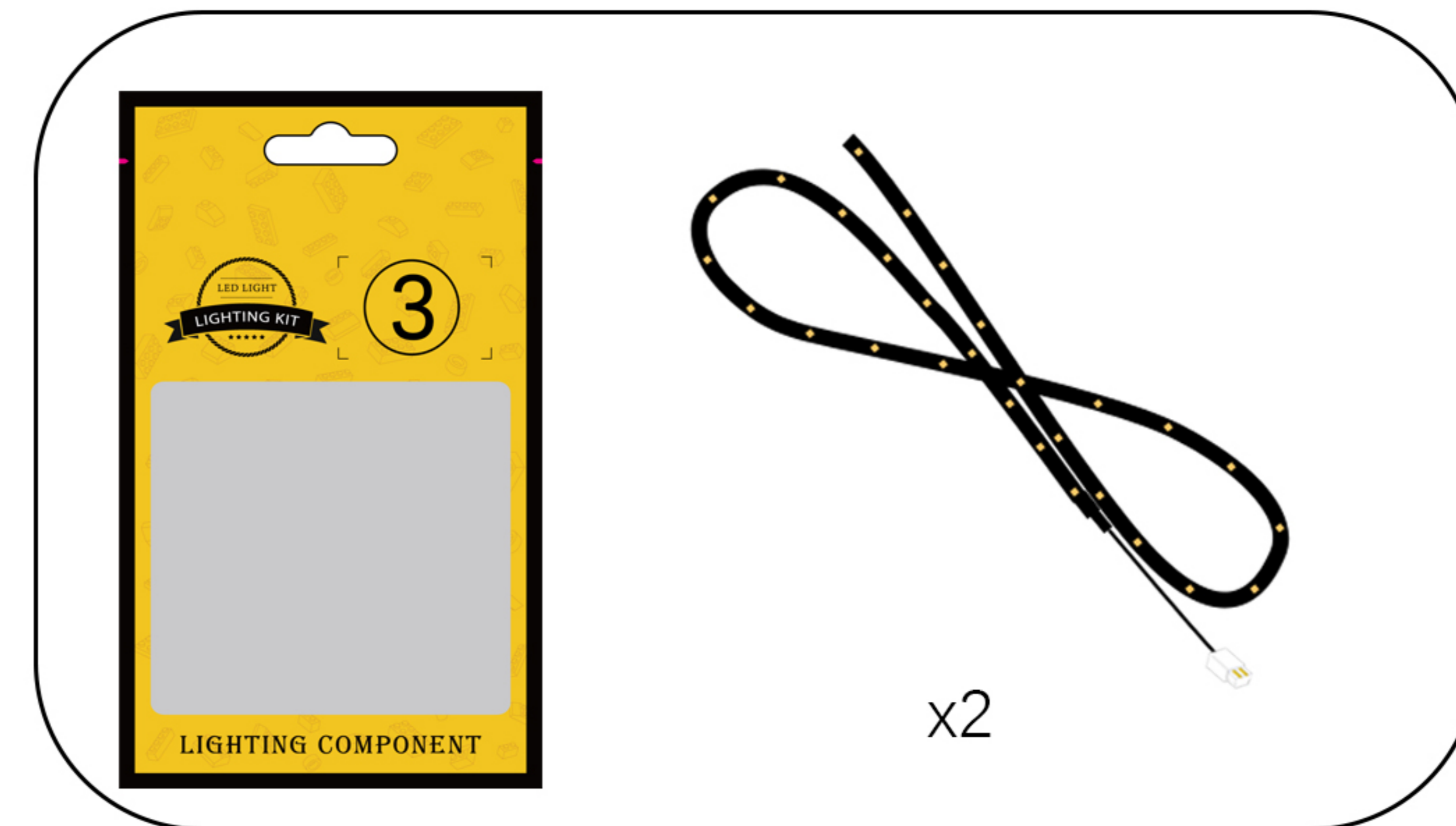

67

EN: Stick all the LED strips onto the building blocks.

DE: Kleben Sie alle LED-Streifen auf die Bausteine.

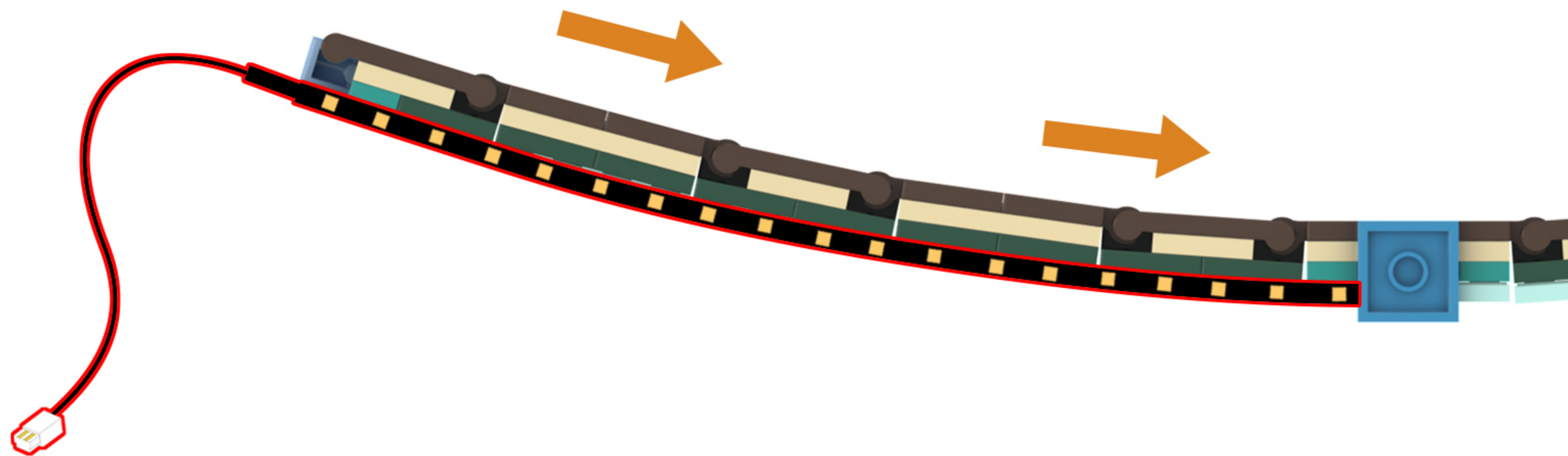

68

EN: Thread the light cord through the holes in the building blocks.

DE: Führen Sie das Lichtschnur durch die Löcher in den Bausteinen.

①

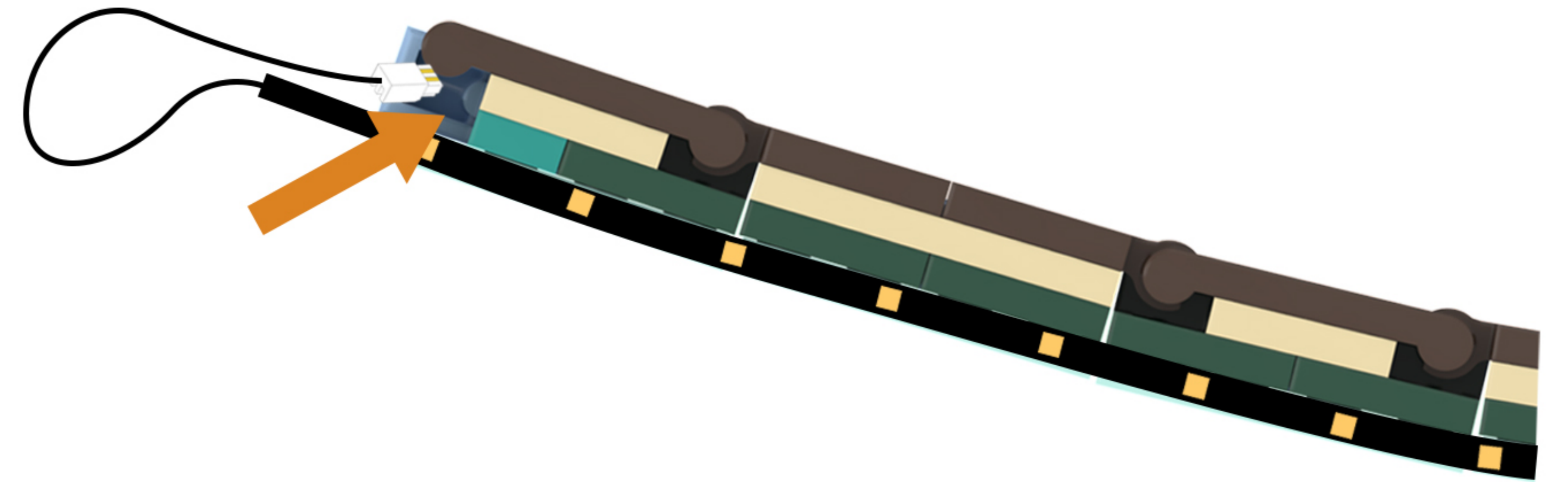

②

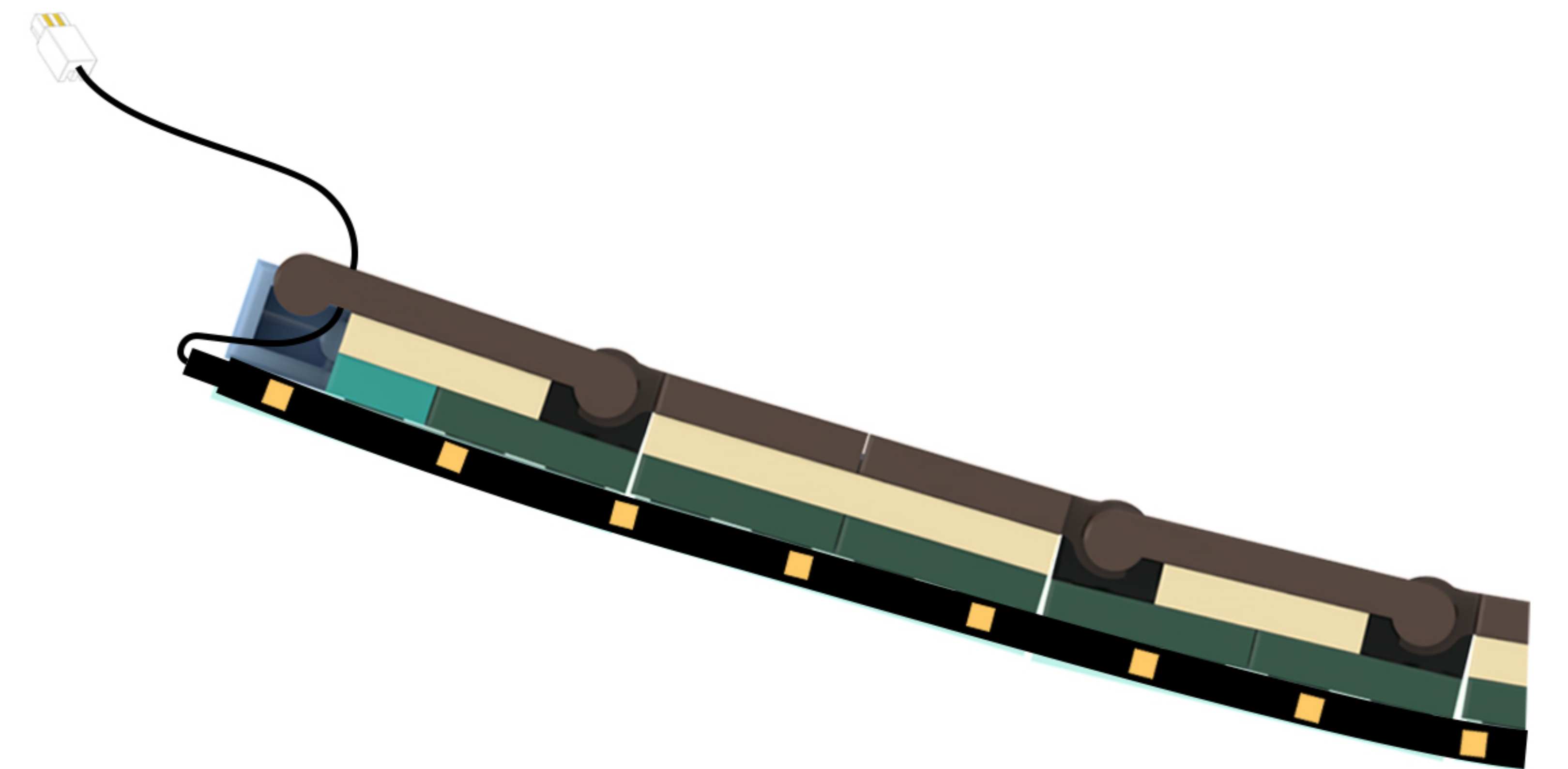

69

EN: Peel off the adhesive backing from the other strip of LED lights and attach it to the building block.

DE: Zieh die Schutzfolie von dem anderen LED-Streifen ab und befestige ihn am Baustein.

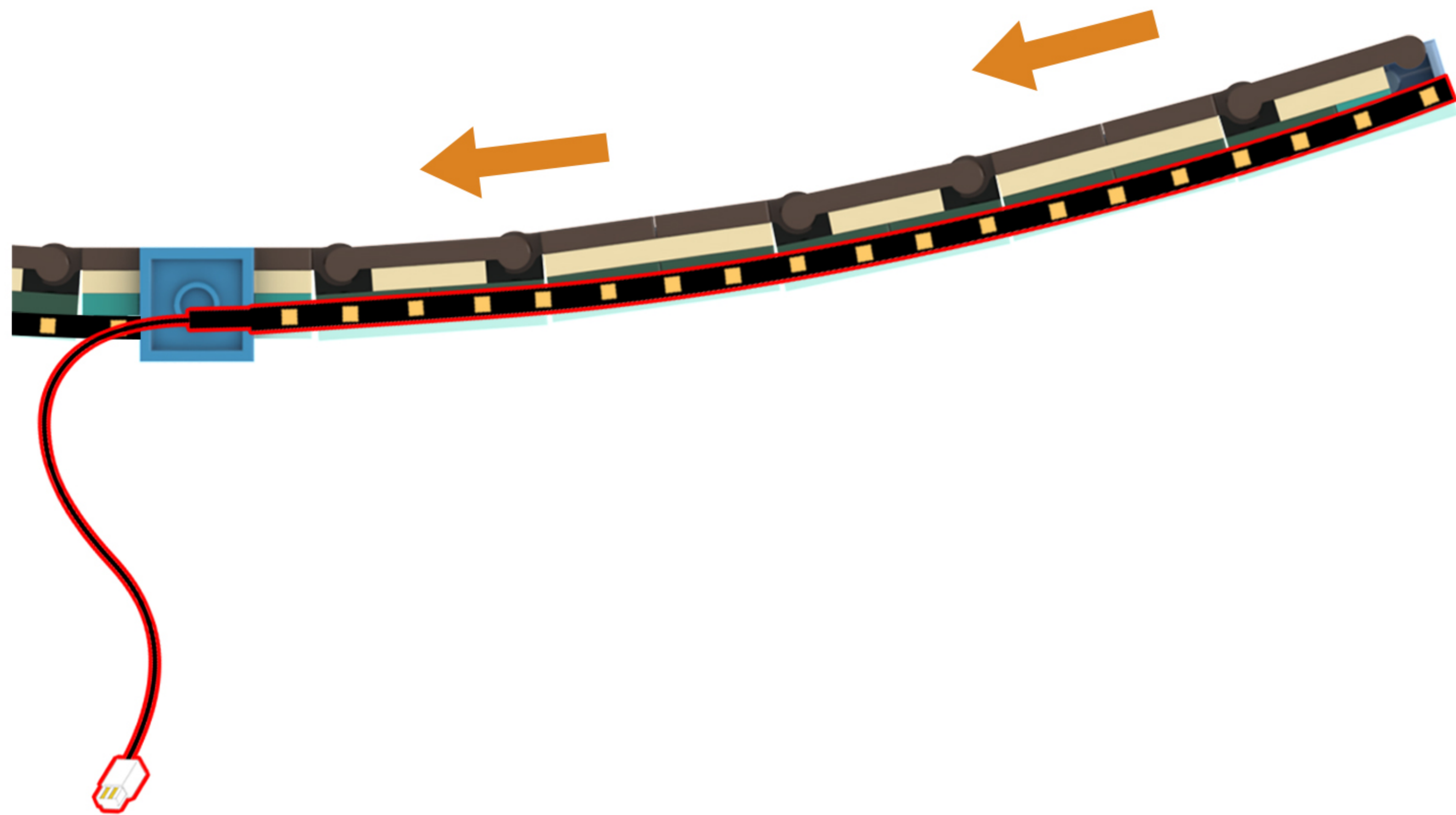

70

EN: Fold back the end of the light strip where it connects to the power cord, then route it to the left.

DE: Klappen Sie das Ende des Lichtbands an der Stelle, an der es mit dem Netzkabel verbunden ist, nach hinten und führen Sie es dann nach links.

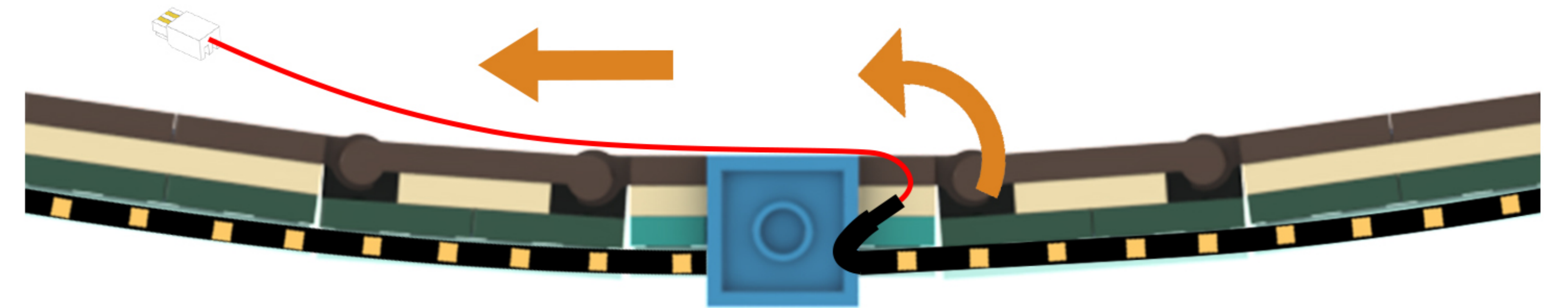

71

EN: Locate the two light wires in the diagram.

DE: Suchen Sie die beiden Lichtkabel in der Abbildung.

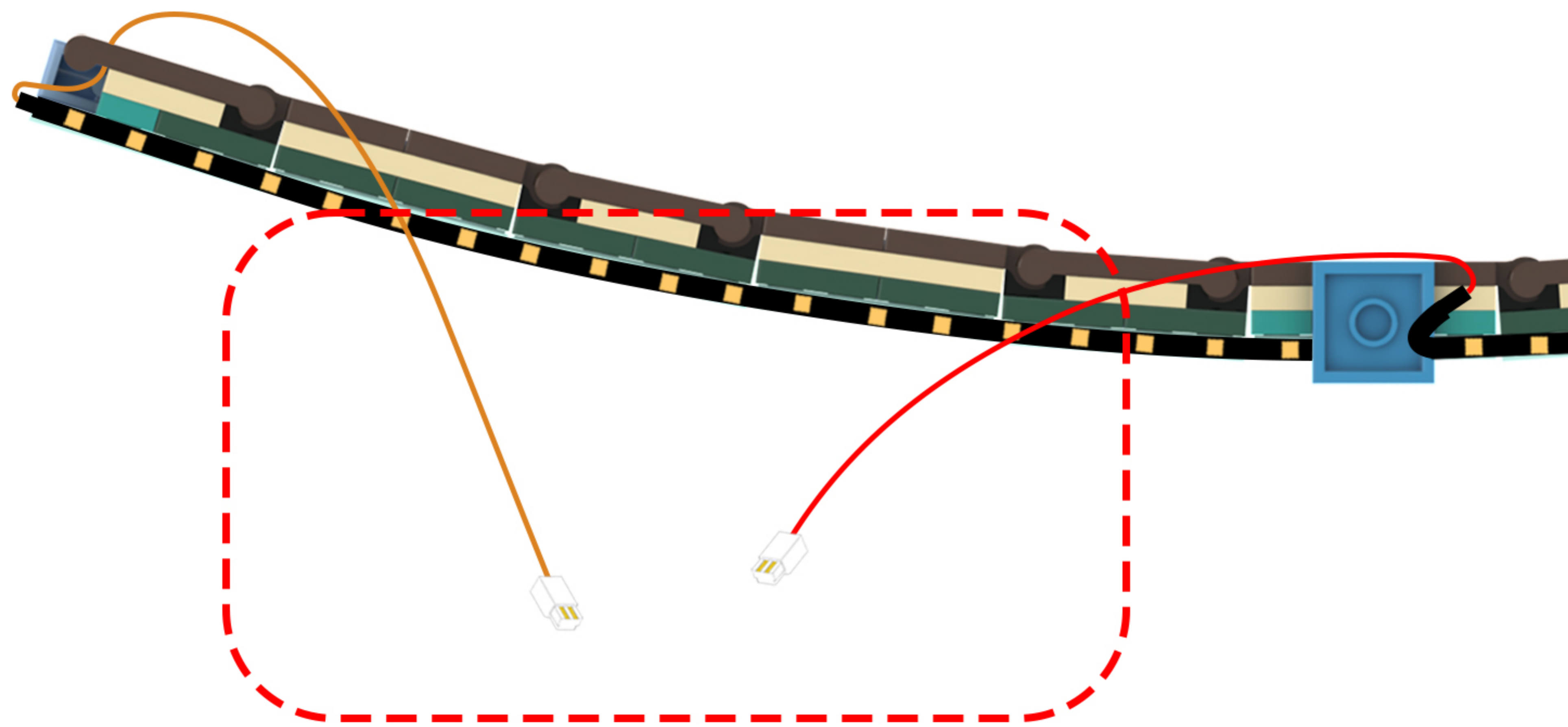

72

EN: Twist the two strands of string lights together.

DE: Verdrehen Sie die beiden Lichterketten miteinander.

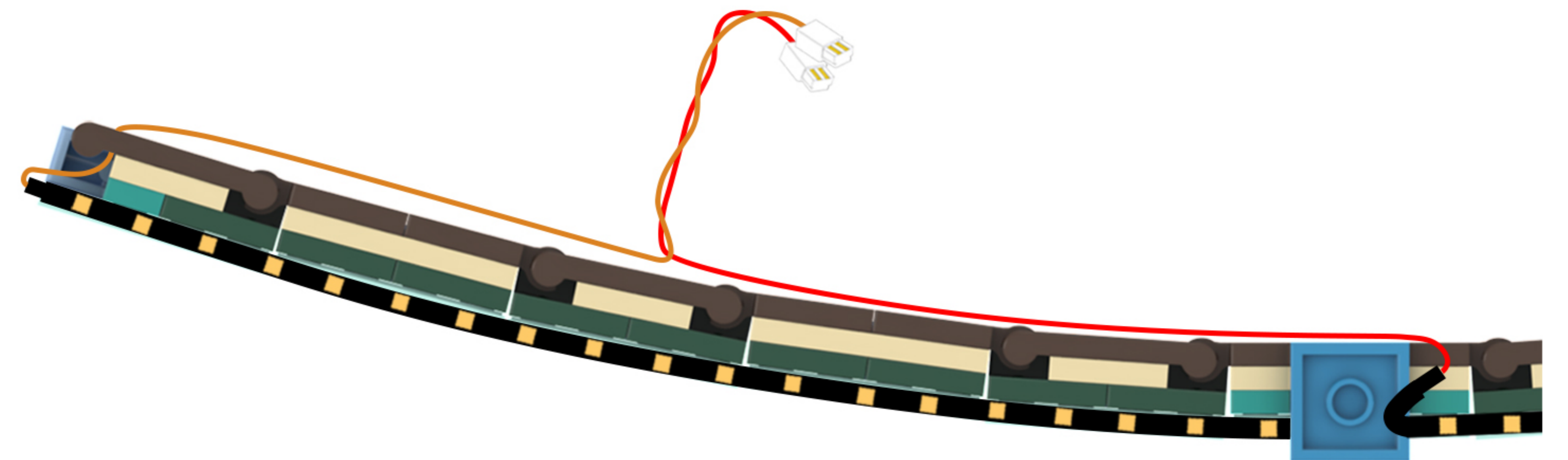

73

EN: Take the expansion board and connecting cable out of Bag 5 and connect them together.

DE: Nehmen Sie die Erweiterungskarte und das Verbindungskabel aus Beutel 5 und verbinden Sie beide miteinander.

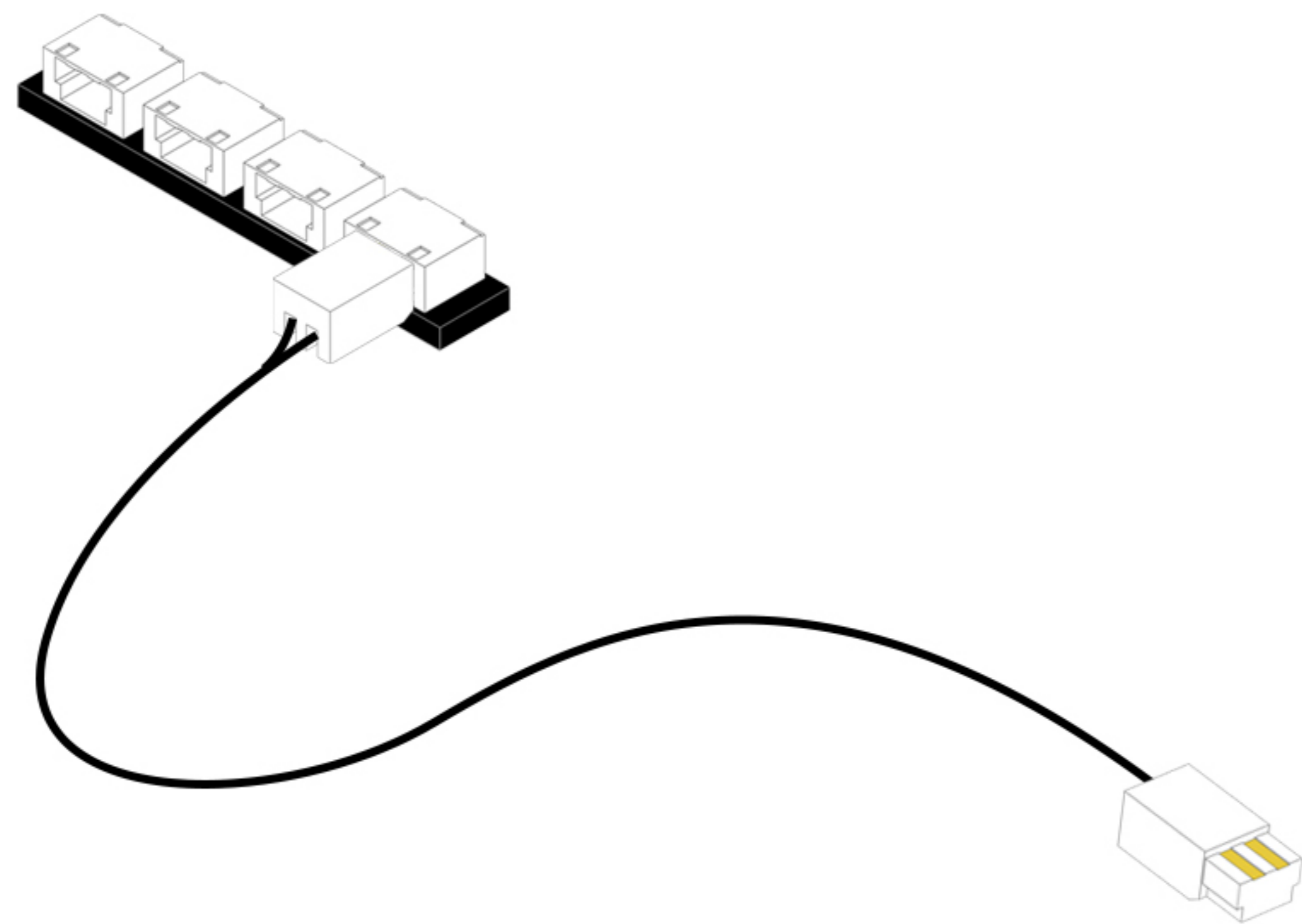
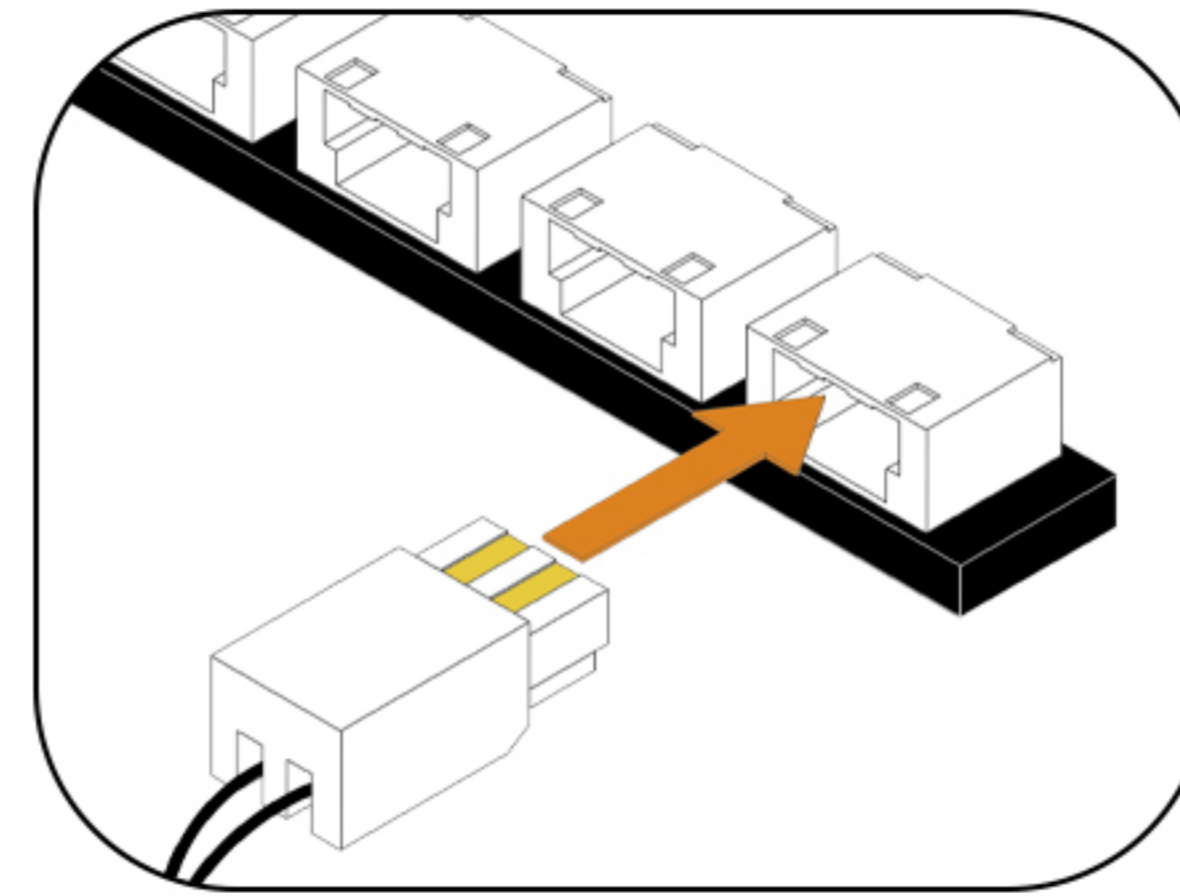
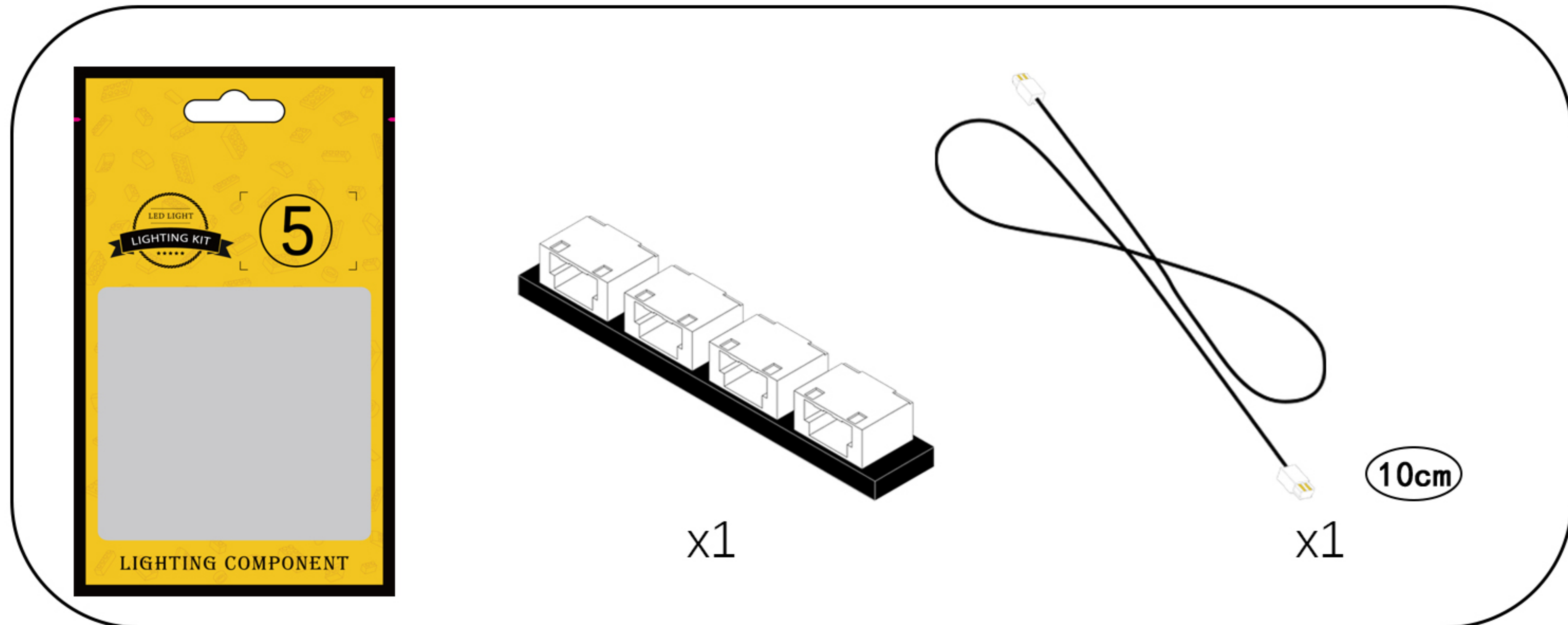

74

EN: Connect the two light cables to the expansion board one after the other.

DE: Schließen Sie die beiden Lichtkabel nacheinander an die Erweiterungskarte an.

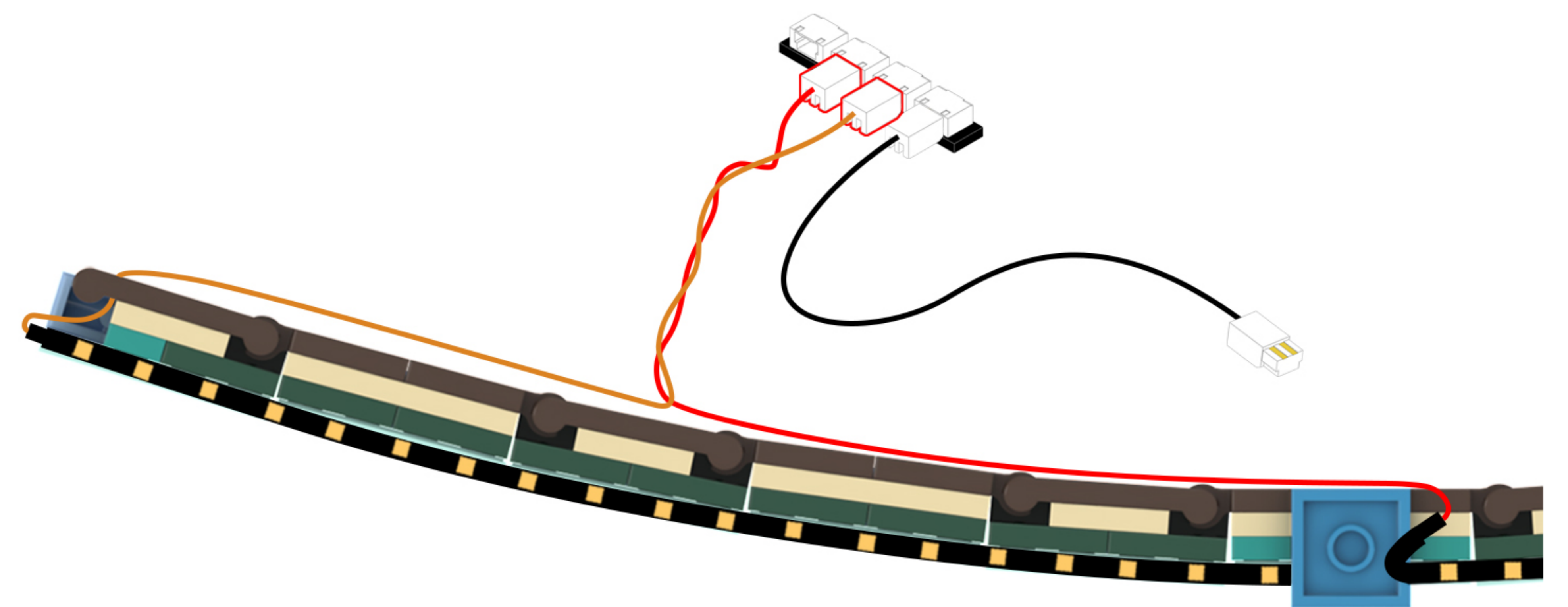
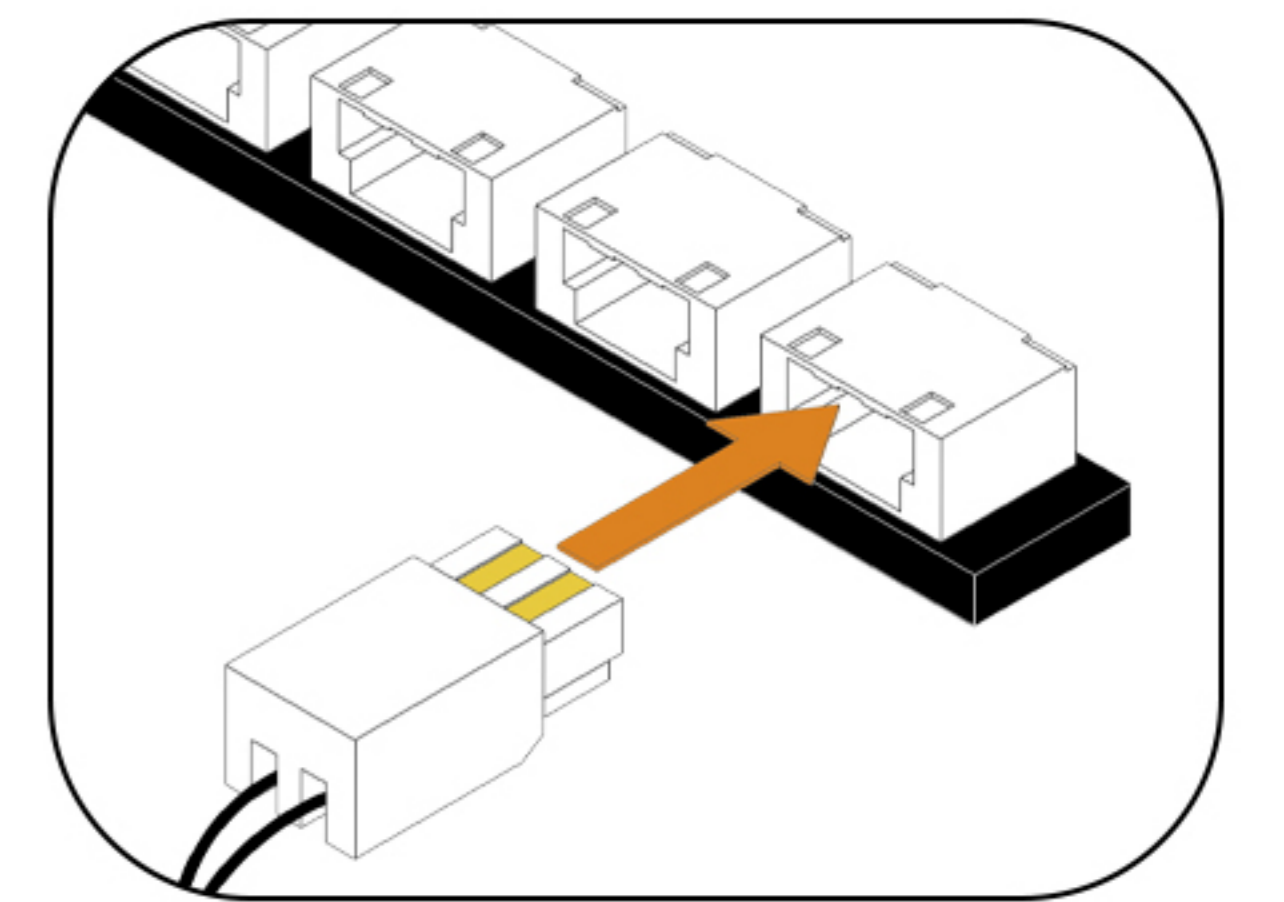

75

EN: Peel off the adhesive backing of the expansion board and attach it to the location shown in the illustration.

DE: Entfernen Sie die Schutzfolie von der Rückseite der Erweiterungsplatte und kleben Sie sie an die in der Abbildung gezeigte Stelle.

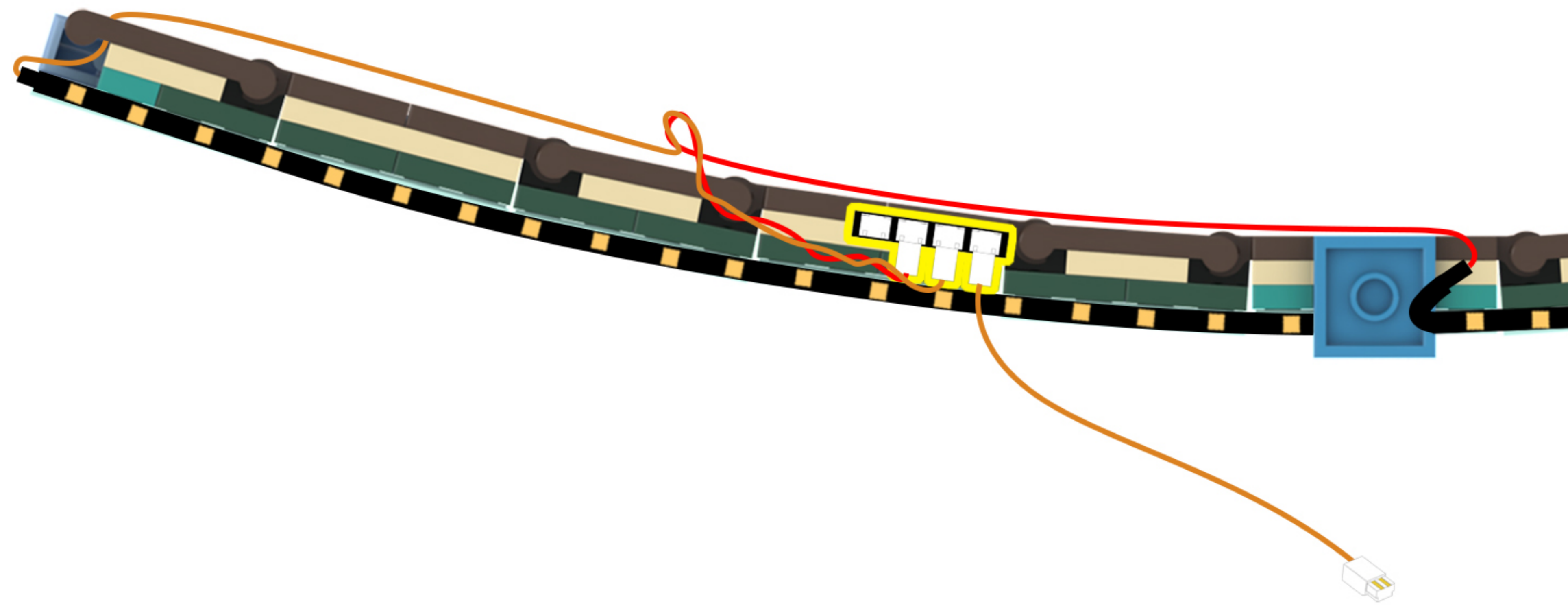

76

EN: Restore the building blocks.

DE: Stellen Sie die Bausteine wieder her.

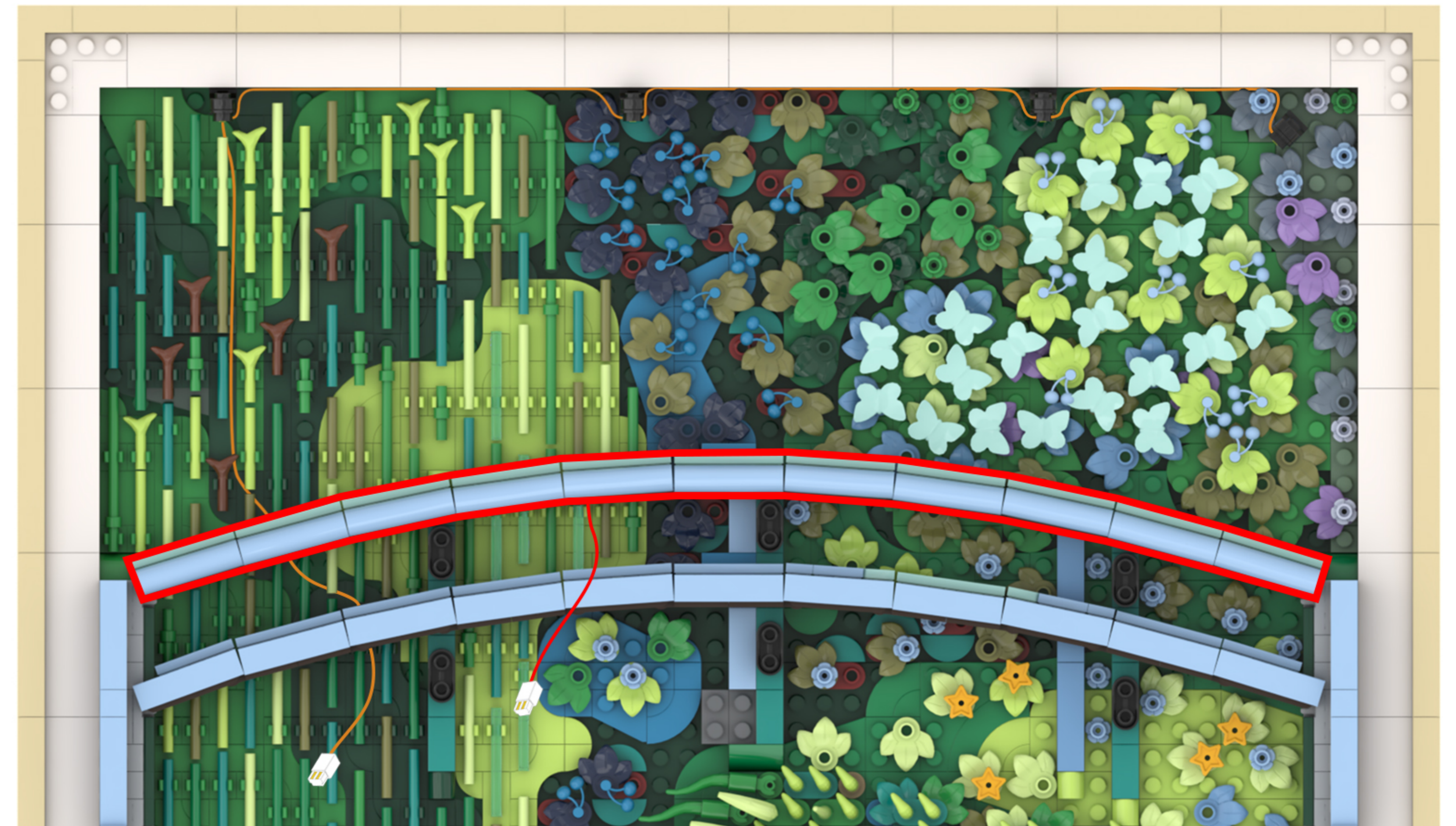

77

EN: Locate this light cord in the diagram.

DE: Suchen Sie dieses Lichtkabel in der Abbildung.

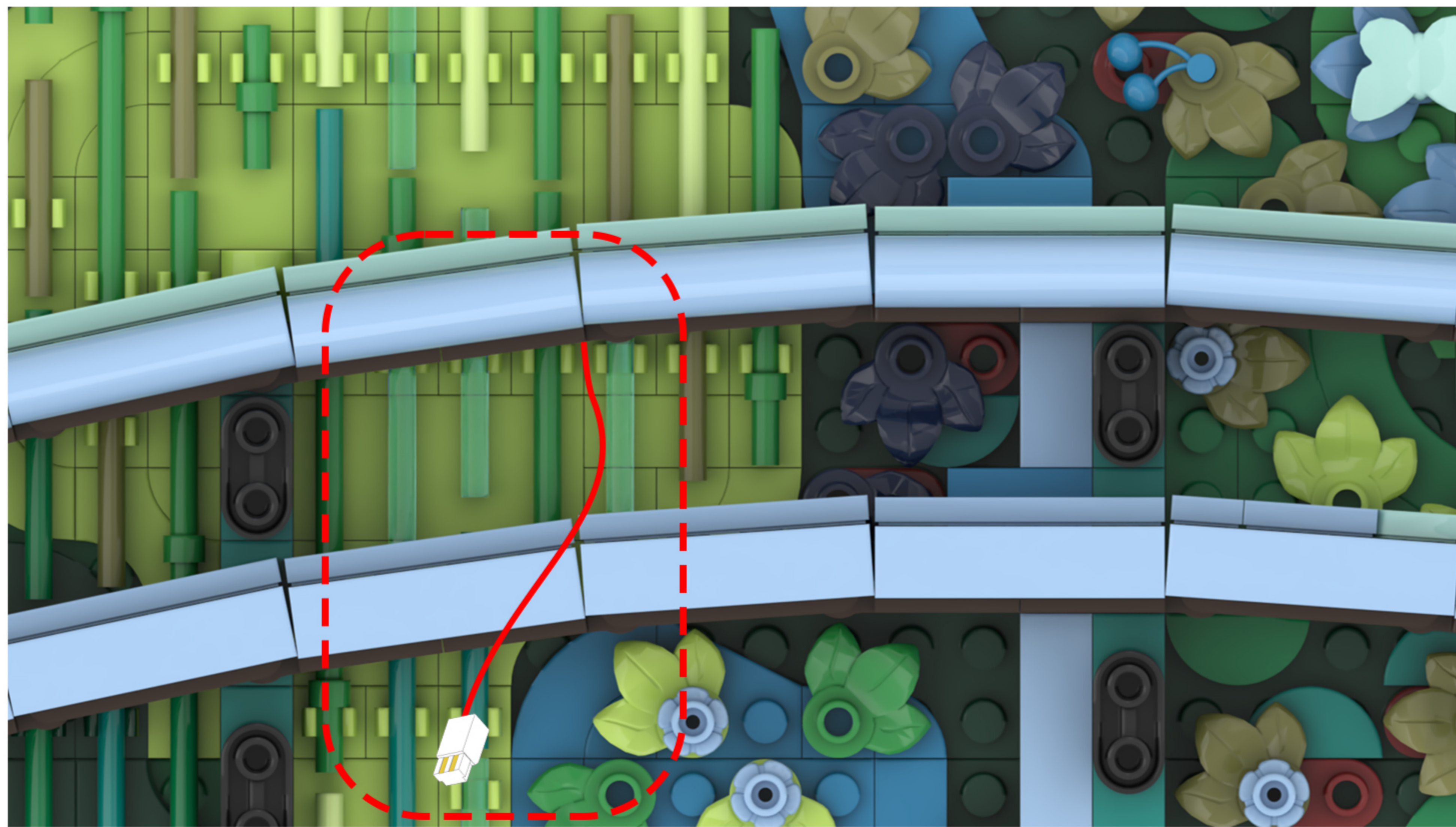

78

EN: Thread the lamp cord through the gaps in the building blocks.

DE: Führen Sie das Lampenkabel durch die Lücken in den Bausteinen.

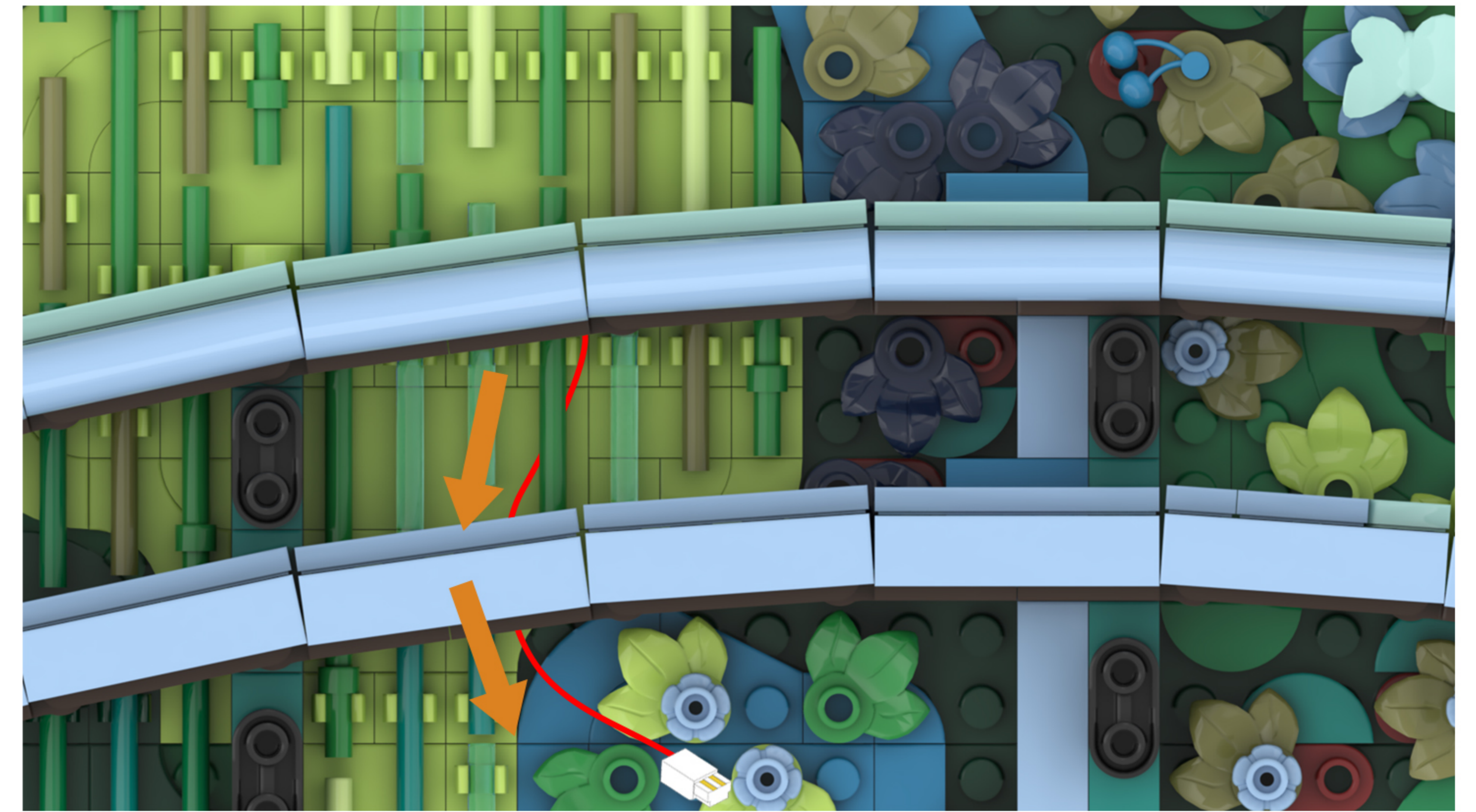

79

EN: Take out the building blocks with the lights attached and reassemble them.

DE: Nimm die Bausteine mit den daran befestigten Lichtern heraus und setze sie wieder zusammen.

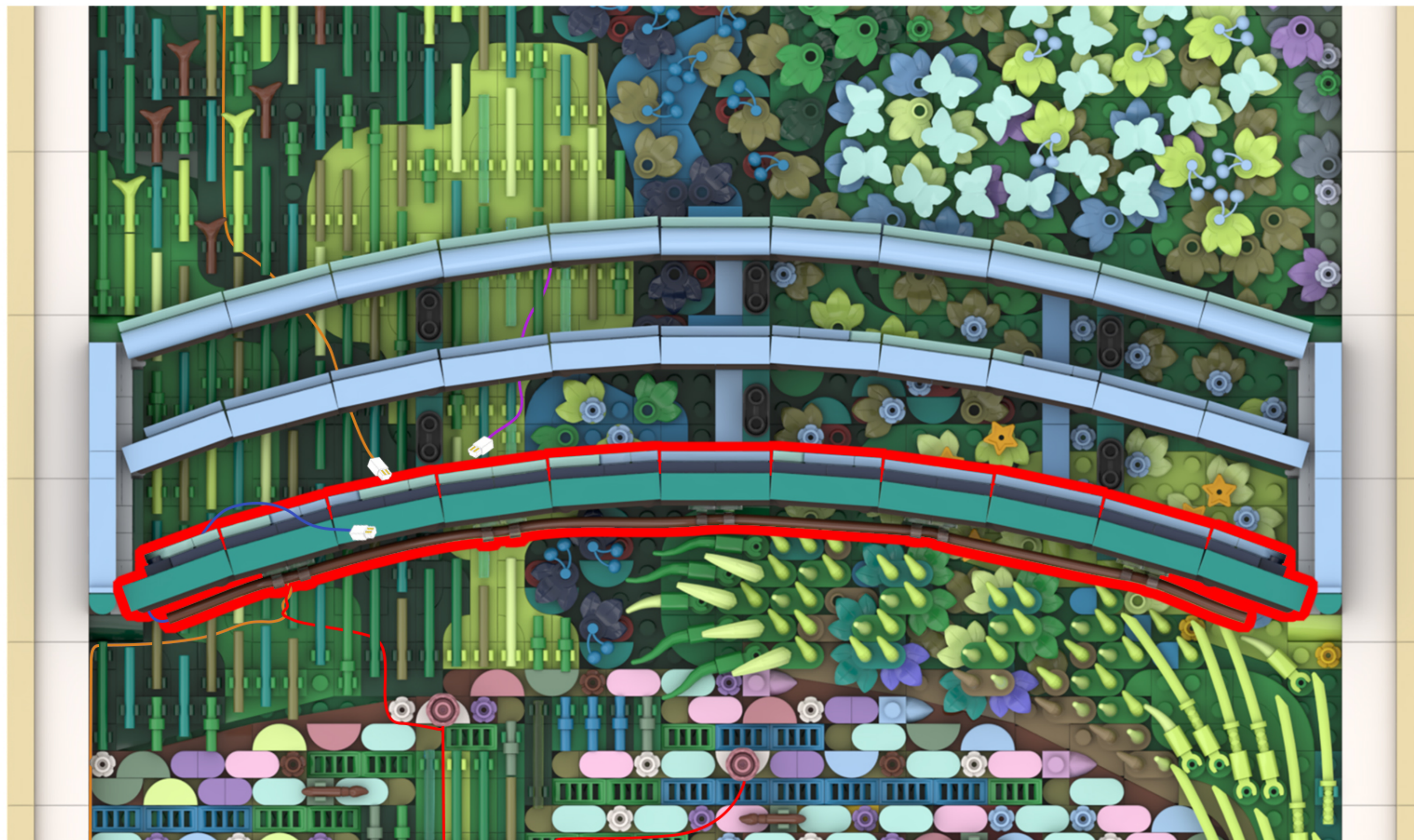
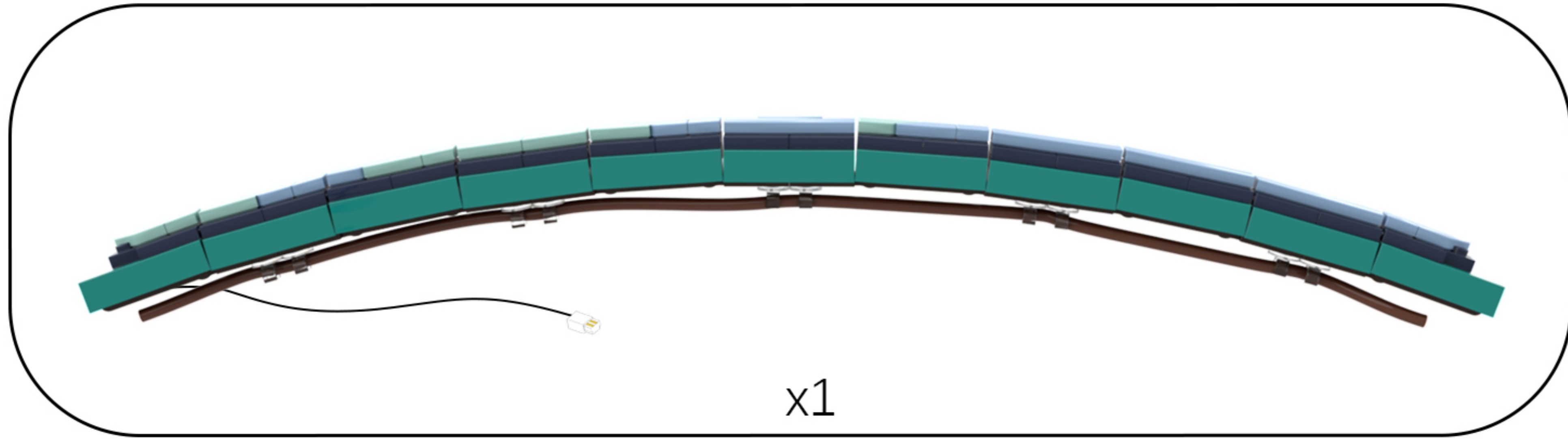

80

EN: Use tweezers to remove the expansion board.

DE: Entfernen Sie die Erweiterungskarte mit einer Pinzette.

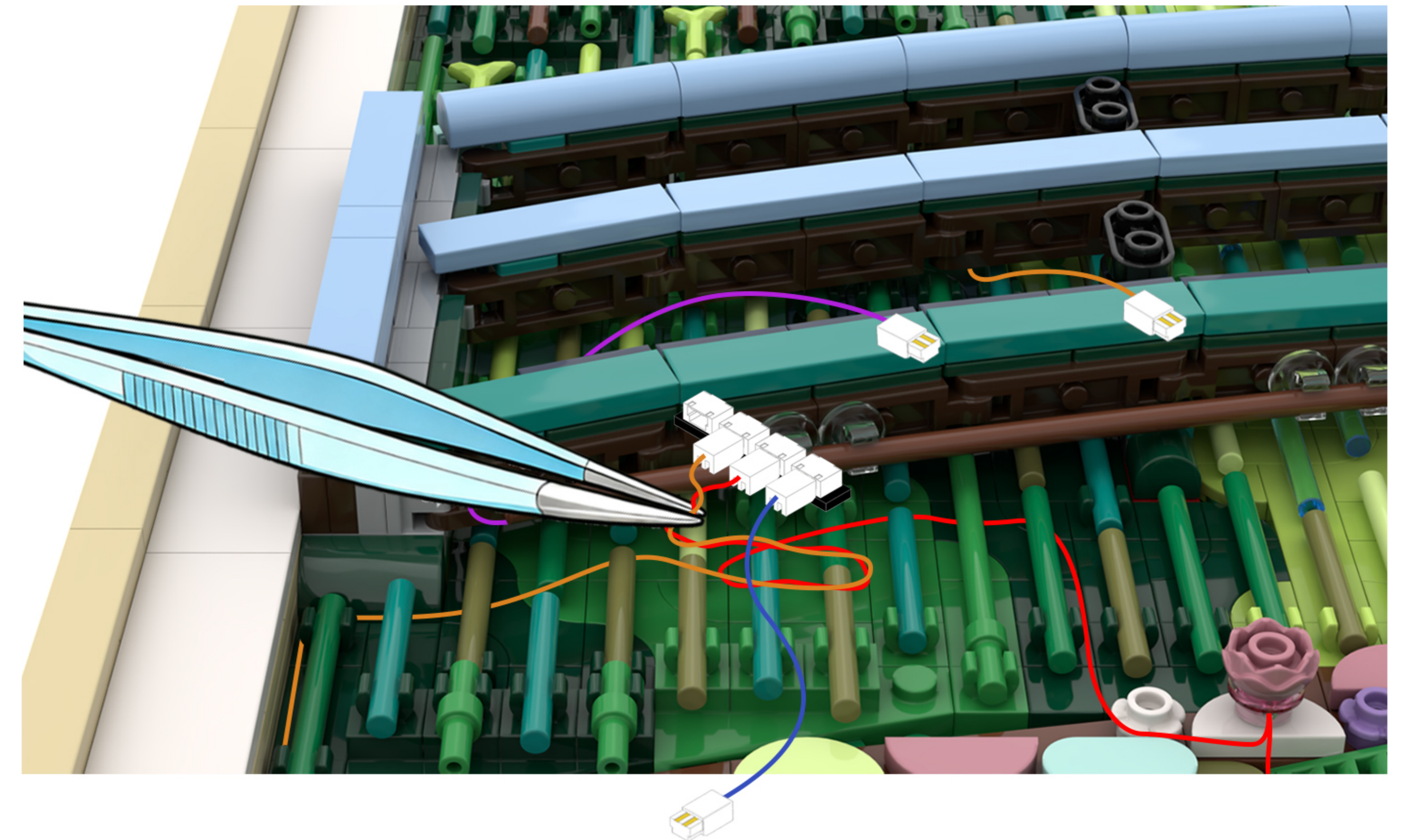

81

EN: Peel off the adhesive backing of the expansion board and attach it to the location shown in the illustration.

DE: Entfernen Sie die Schutzfolie von der Rückseite der Erweiterungsplatte und kleben Sie sie an die in der Abbildung gezeigte Stelle.

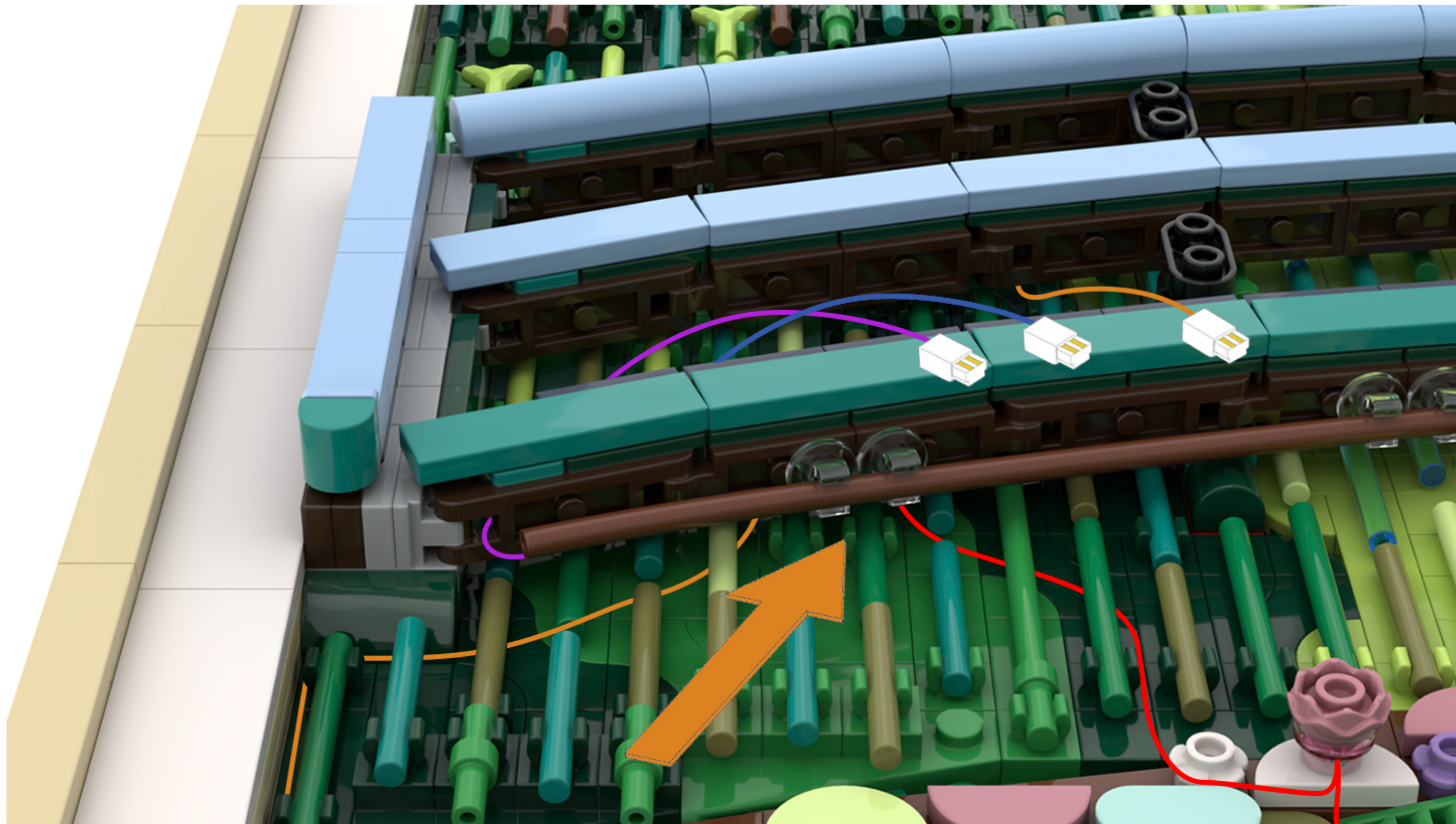

82

EN: Take the touch-controlled dimmer module out of the bag.

DE: Nehmen Sie das berührungsgesteuerte Dimmermodul aus der Verpackung.

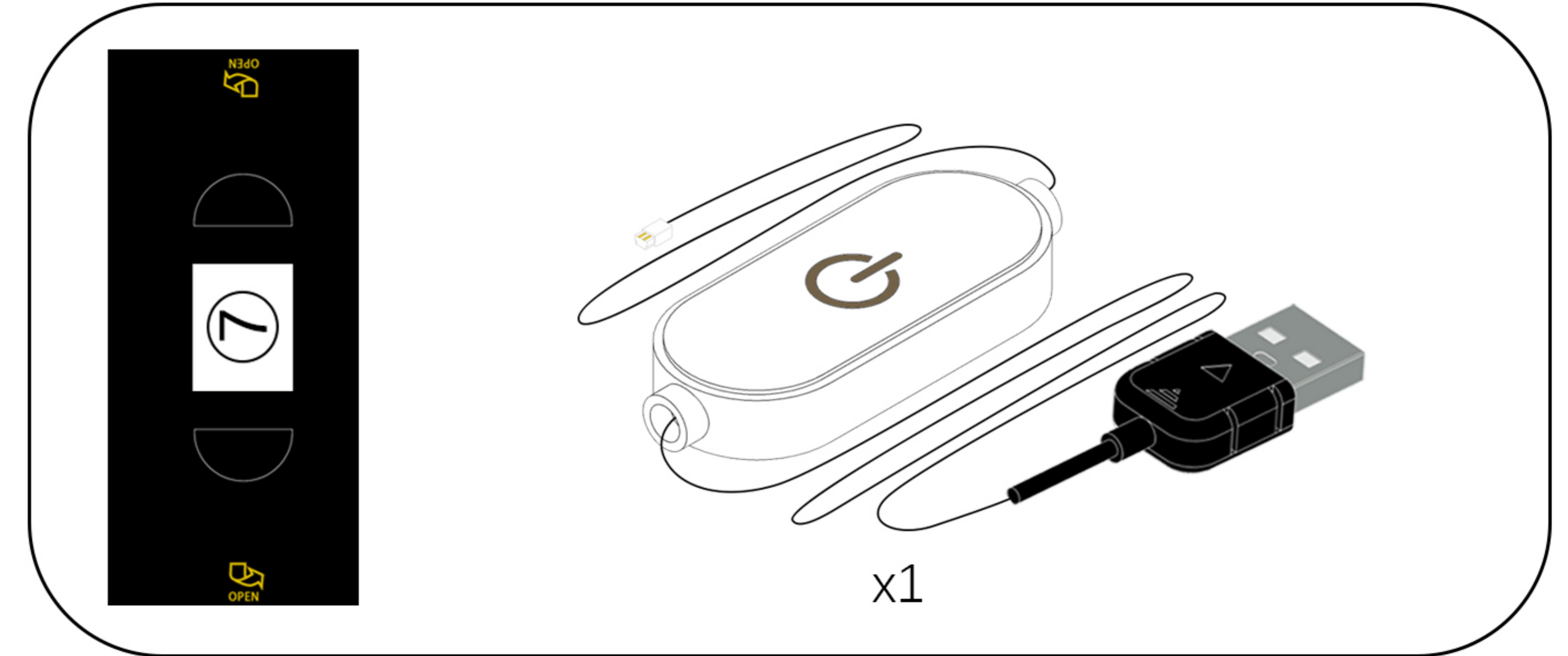

Touch Dimmer Module - 200CM Introduce

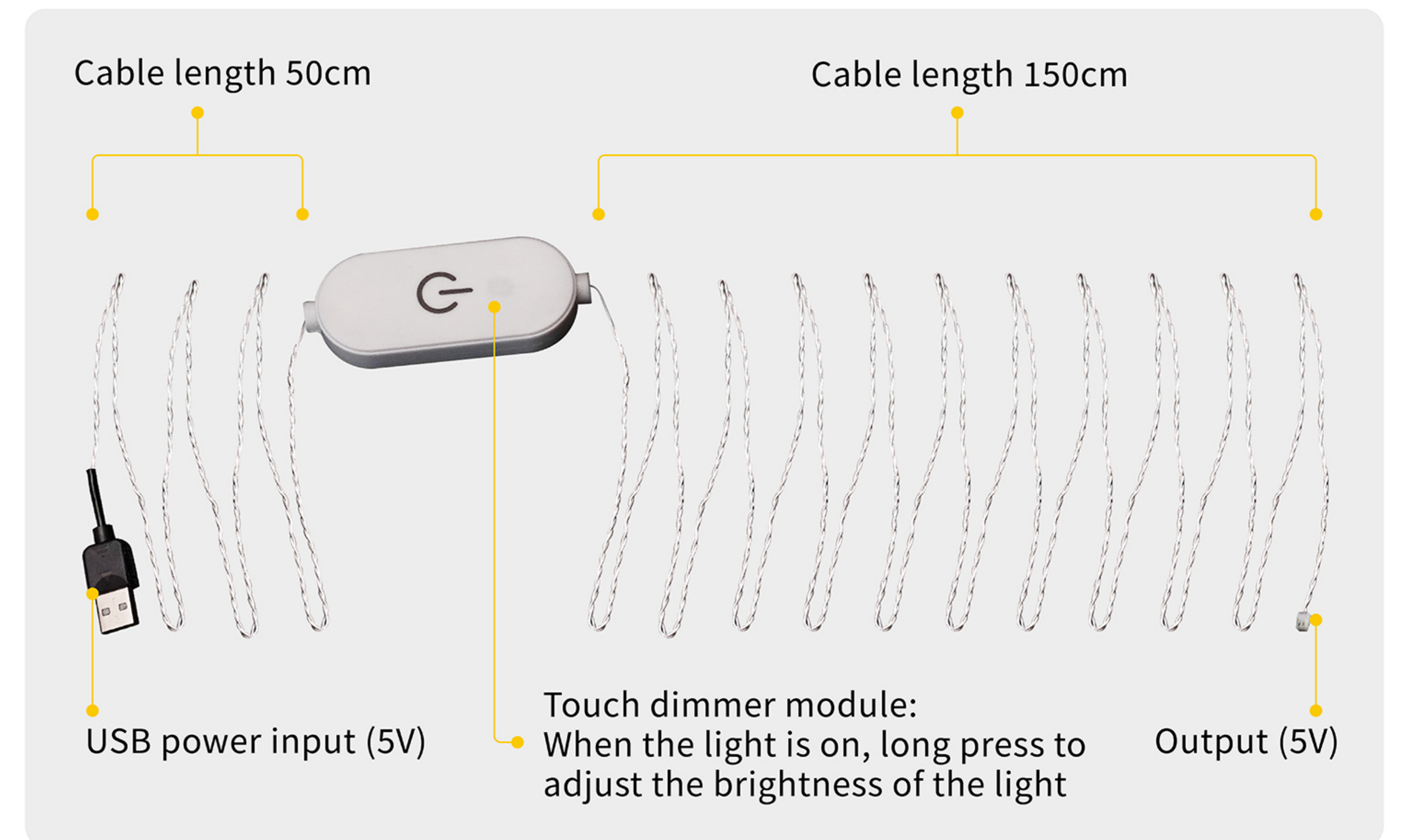

83

EN: Remove the expansion board from Bag 6 and connect the touch dimming module to the expansion board.

DE: Nehmen Sie die Erweiterungskarte aus Beutel 6 und schließen Sie das Touch-Dimmmodul an die Erweiterungskarte an.

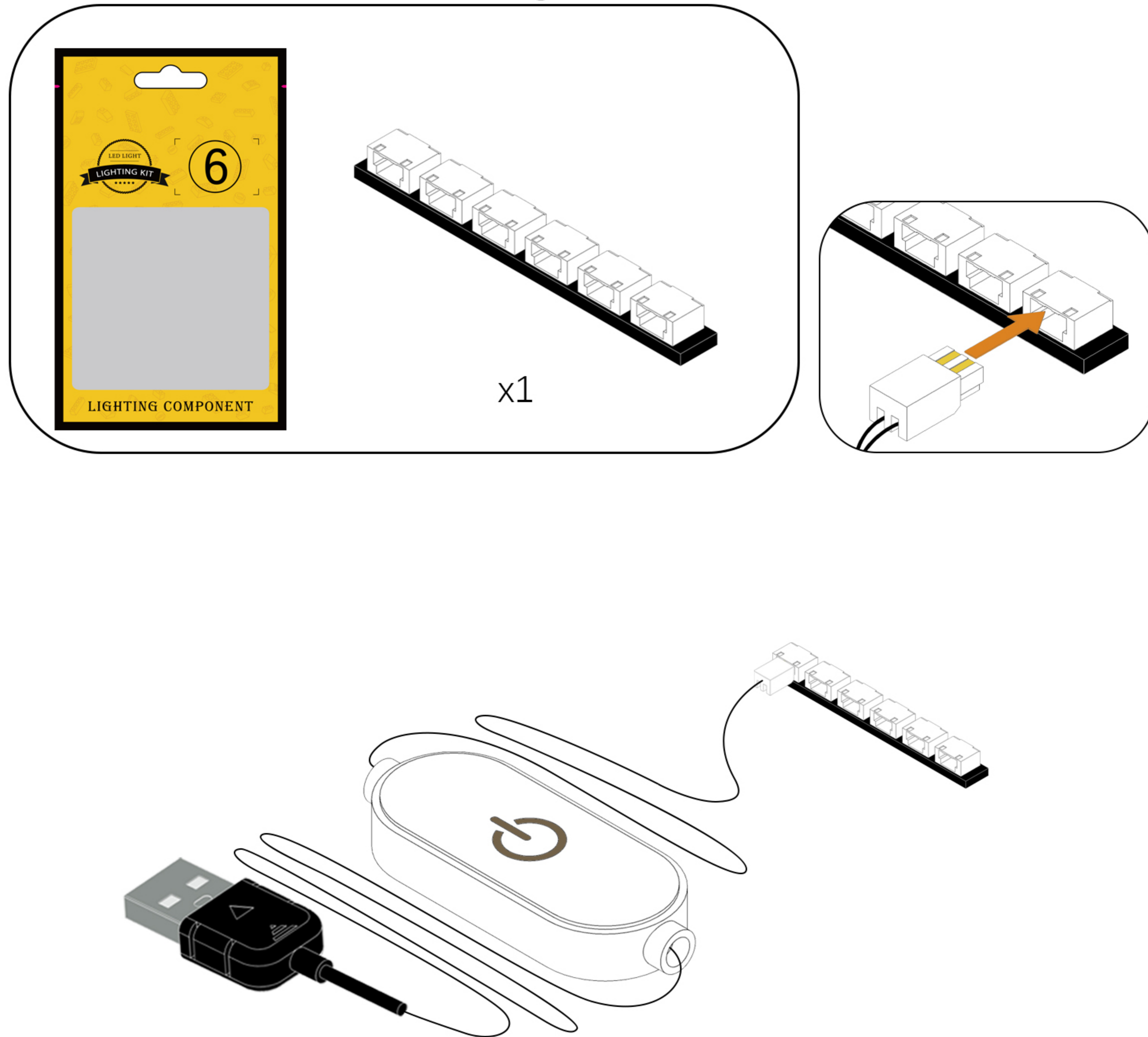

84

EN: Connect the four light cables to the expansion board in sequence.

DE: Schließen Sie die vier Lichtkabel nacheinander an die Erweiterungskarte an.

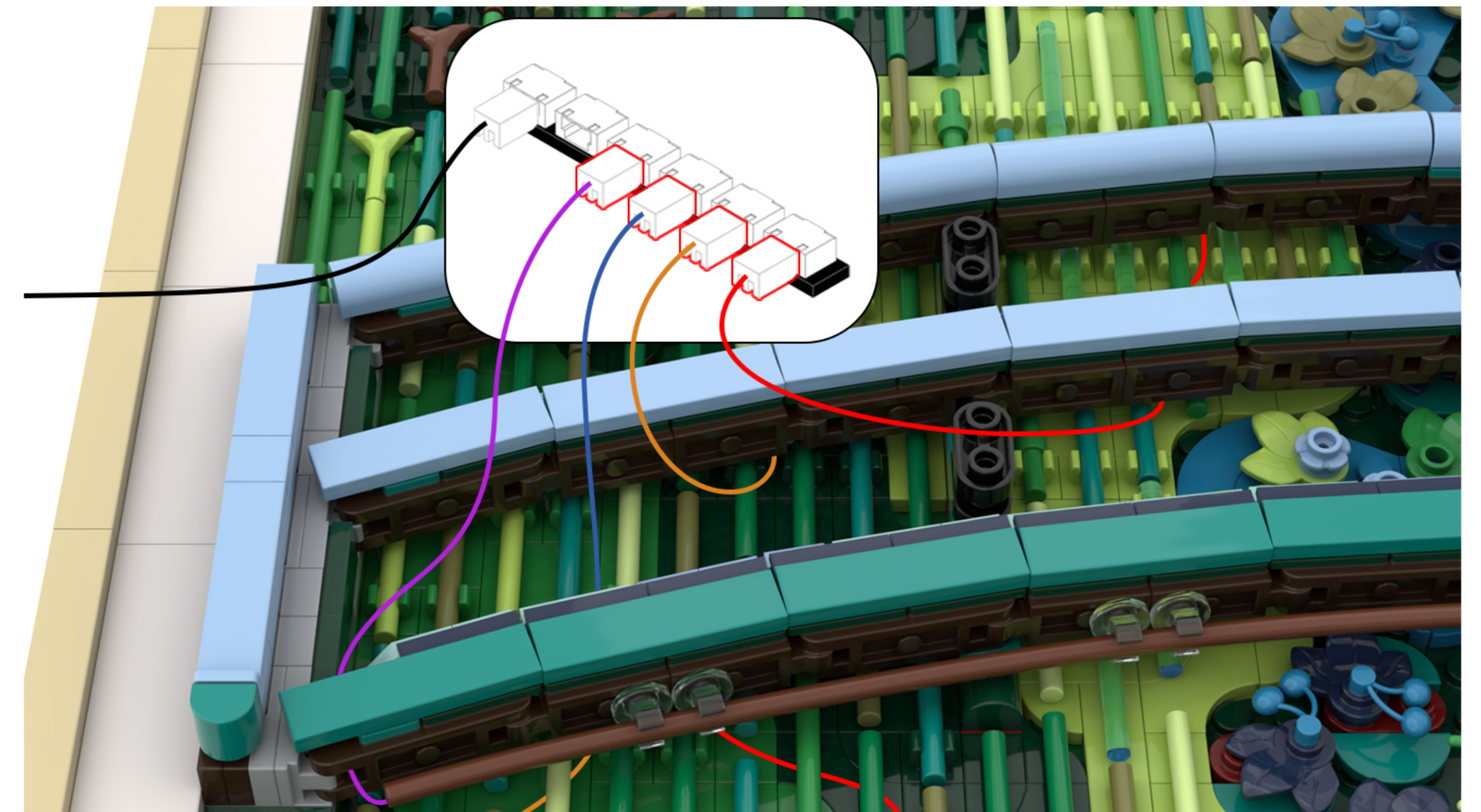
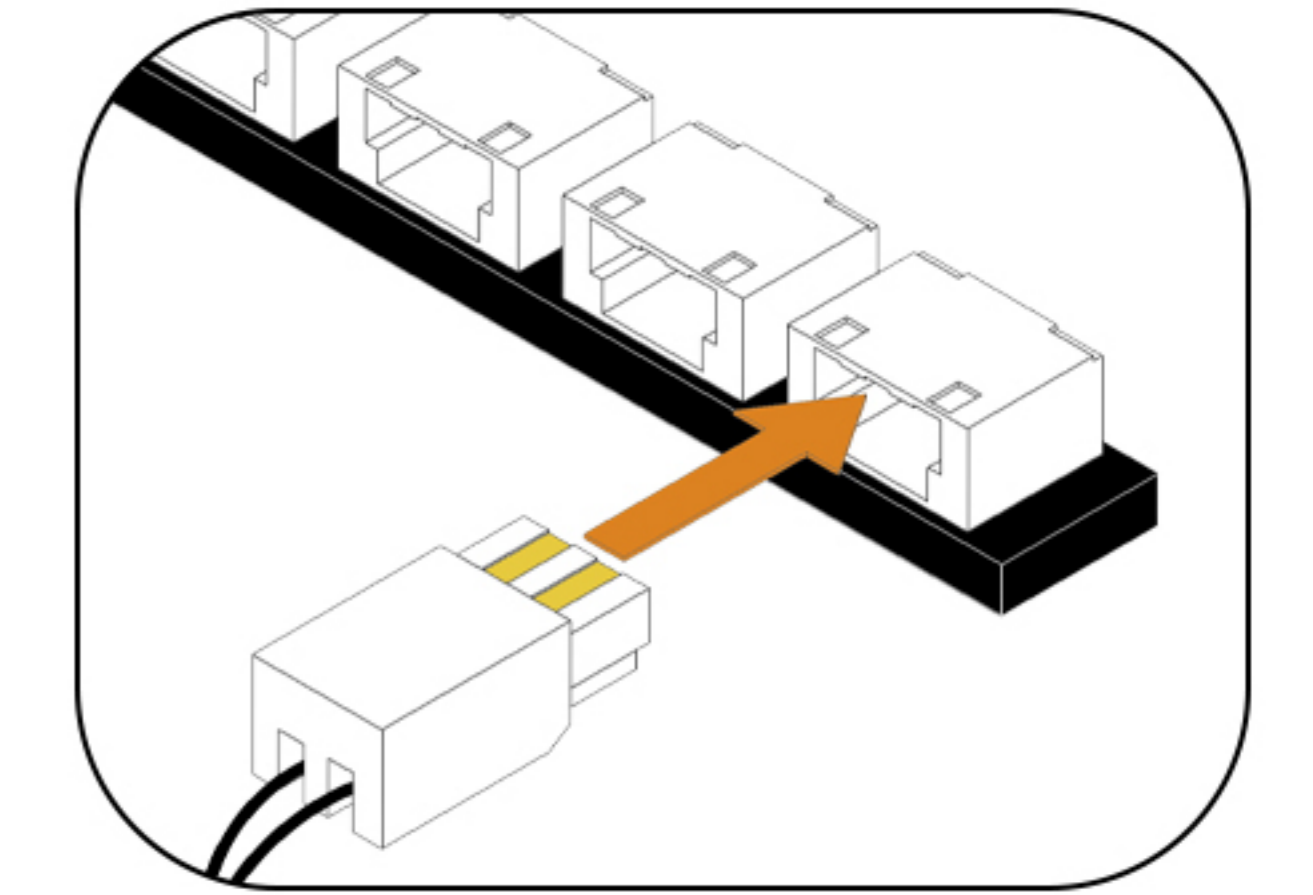

85

EN: Peel off the adhesive backing of the expansion board and attach it to the location shown in the illustration.

DE: Entfernen Sie die Schutzfolie von der Rückseite der Erweiterungsplatte und kleben Sie sie an die in der Abbildung gezeigte Stelle.

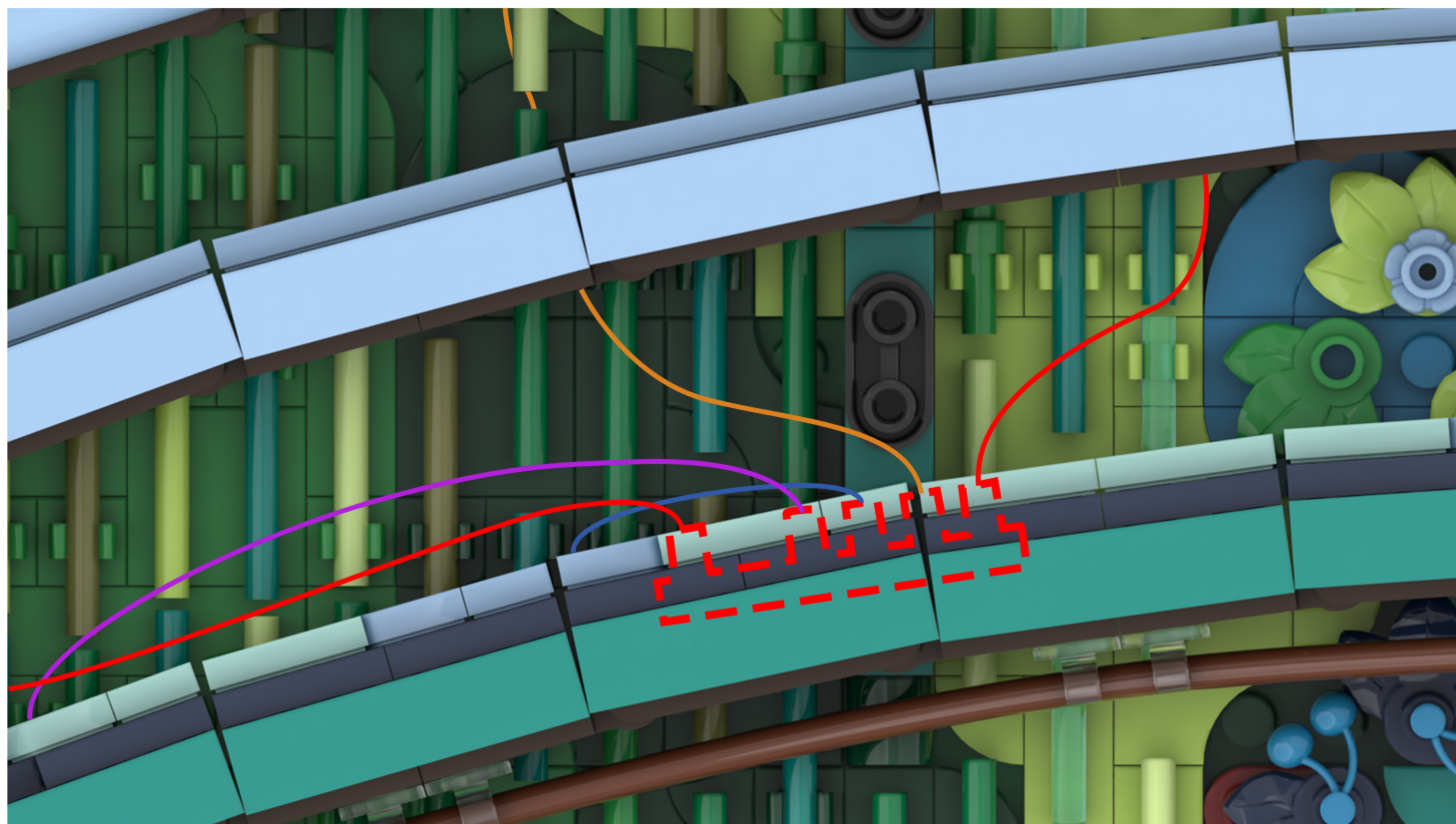

Note: The dotted line indicates the portion of the extension plate that is obscured.

86

EN: Use tweezers to tidy up any exposed lamp wires.

DE: Verwenden Sie eine Pinzette, um freiliegende Lampenleitungen zu verstauen.

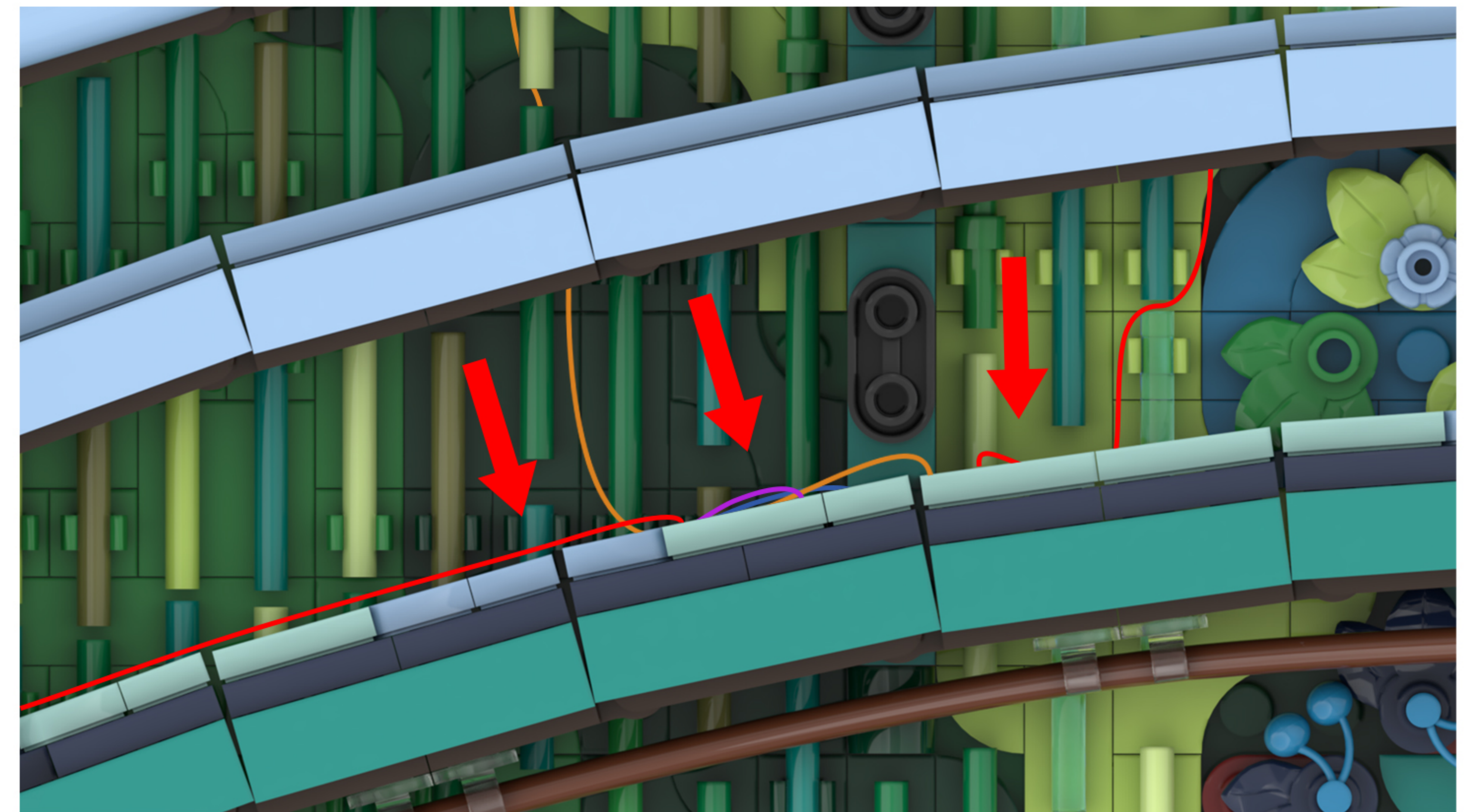

87

EN: Locate the connecting wires on the touch module.

DE: Suchen Sie die Anschlusskabel am Touch-Modul.

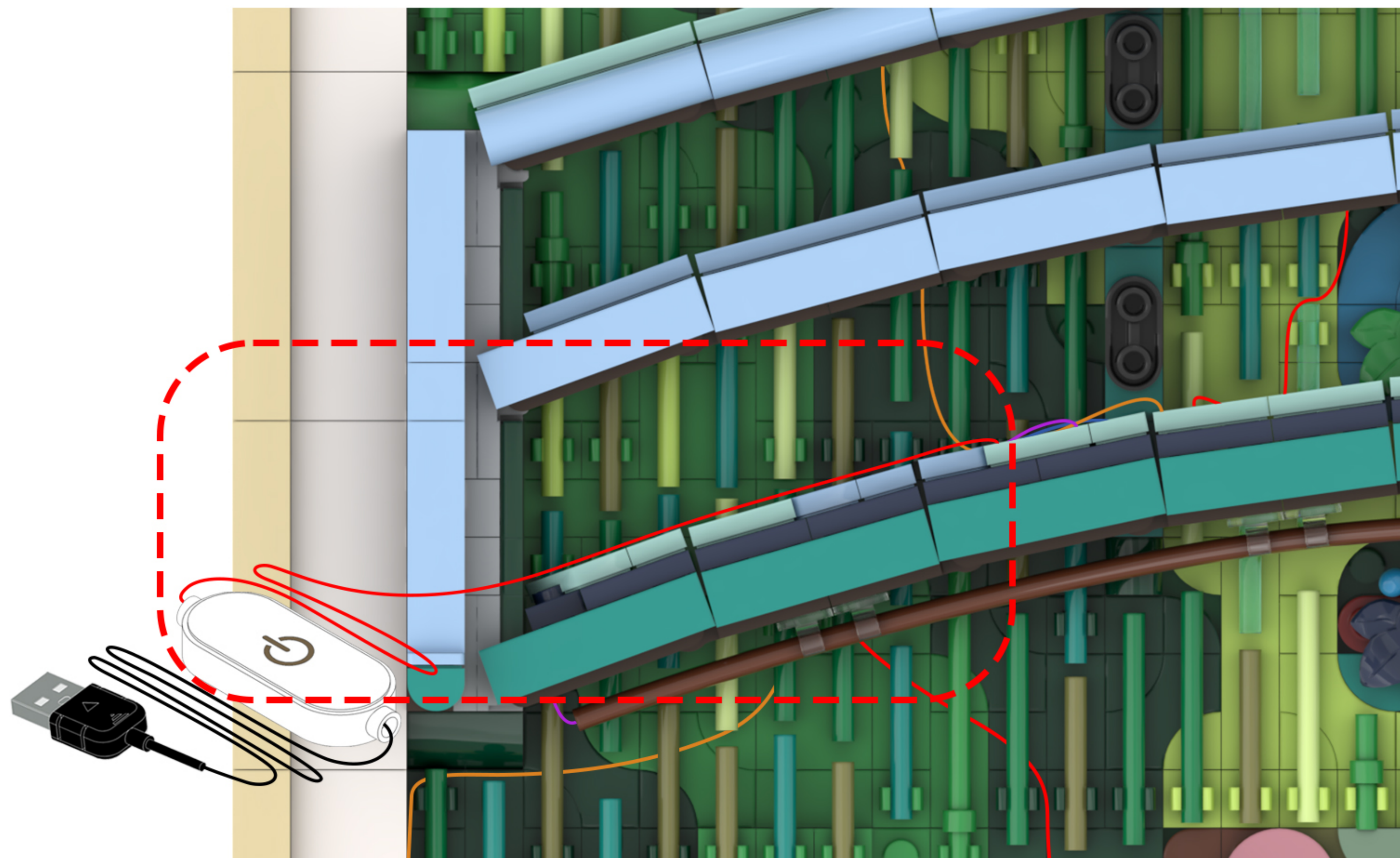

88

EN: Thread the lamp cord through the gaps in the building blocks.

DE: Führen Sie das Lampenkabel durch die Lücken in den Bausteinen.

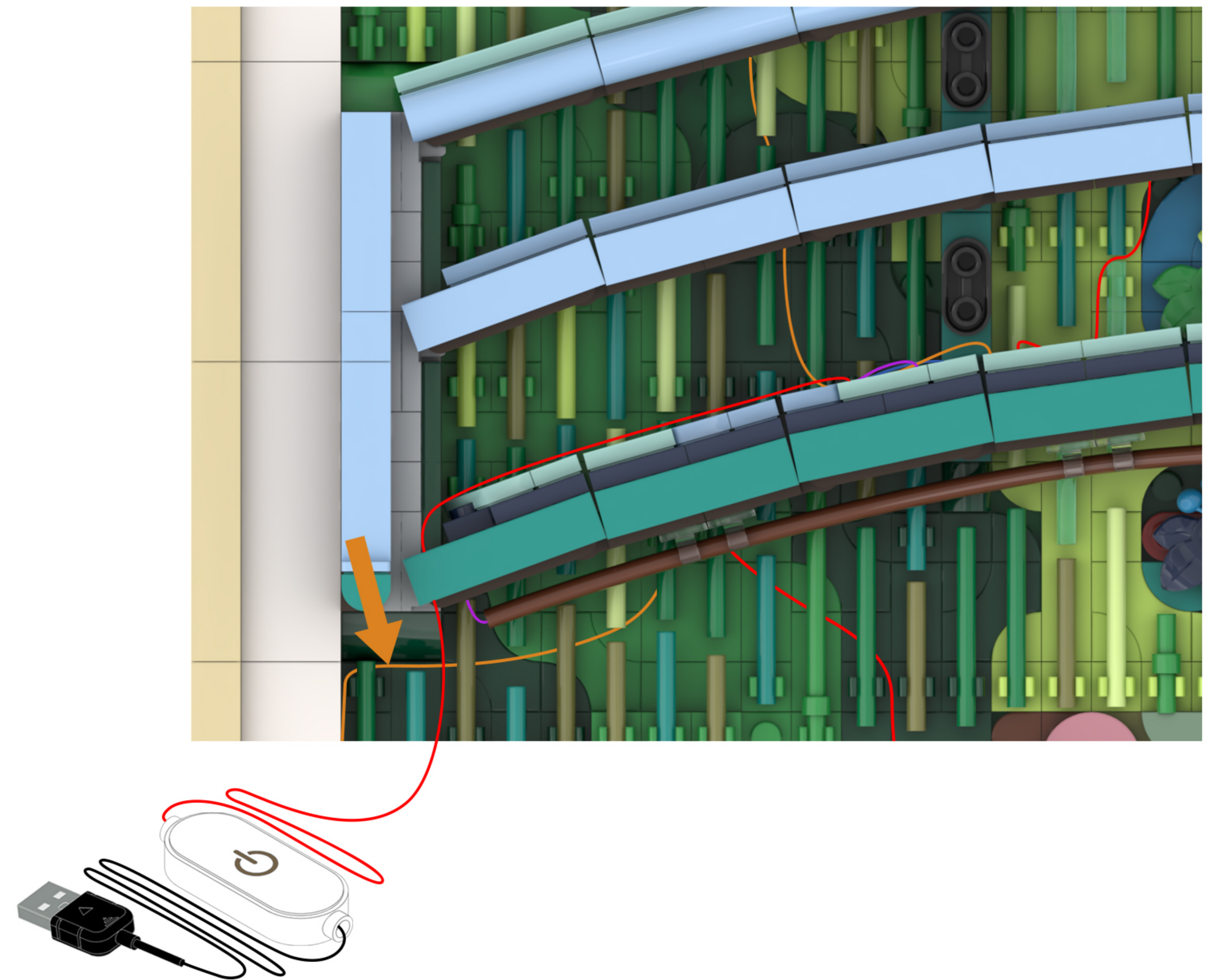

89

EN: Adjust your perspective.

DE: Ändern Sie Ihre Perspektive.

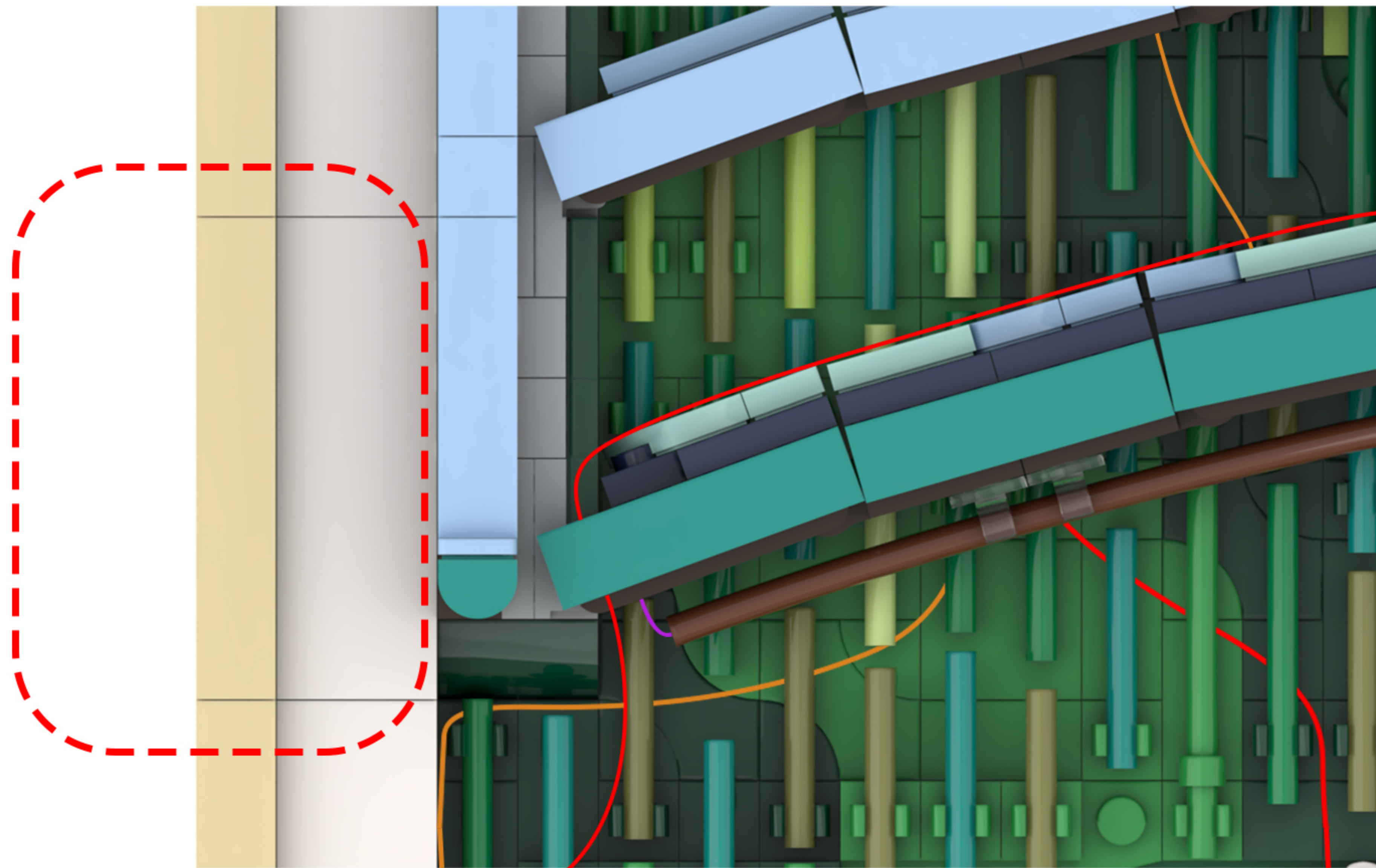

90

EN: Split as shown in the figure.

DE: Wie in der Abbildung gezeigt, teilen Sie es auf.

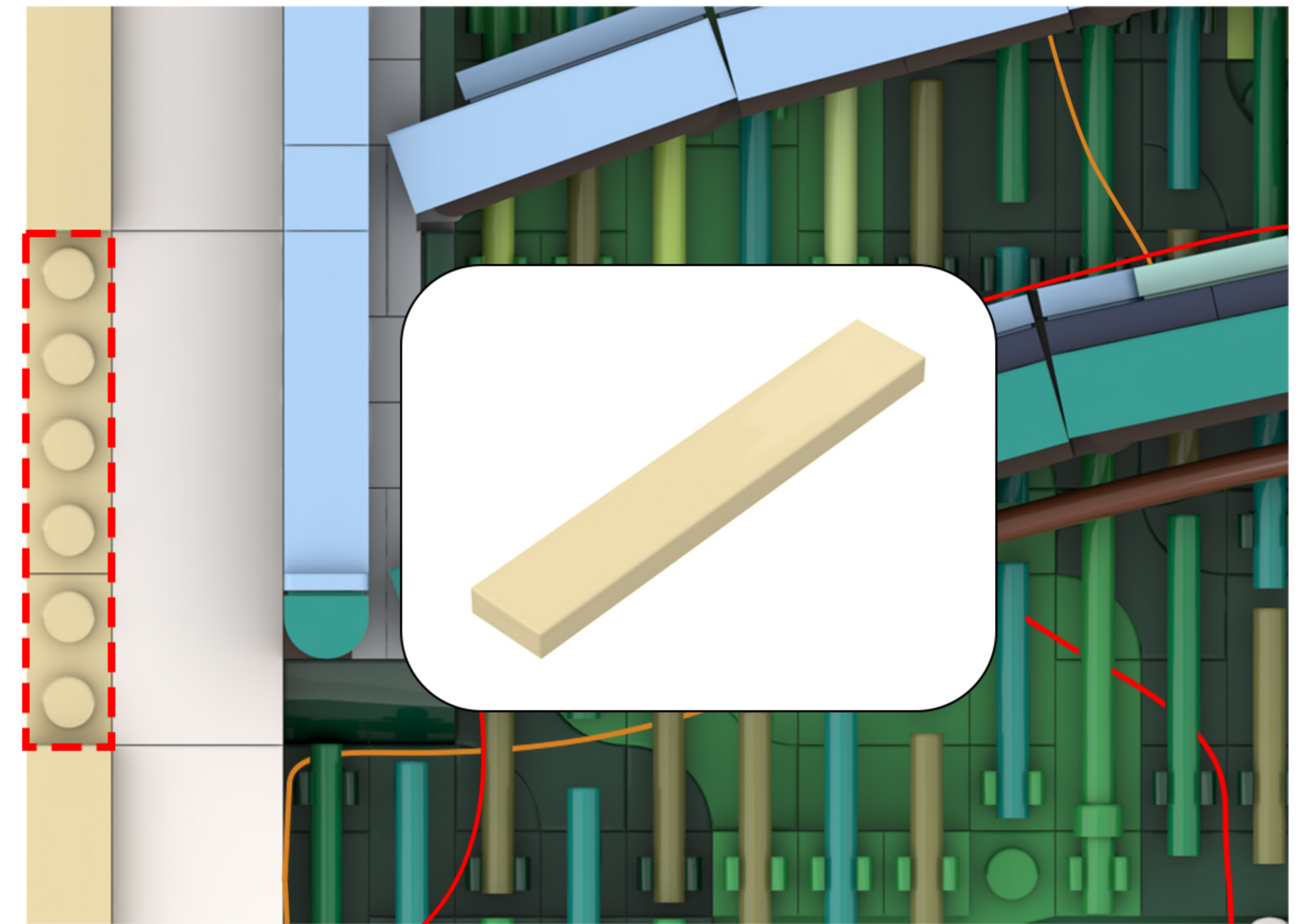

91

EN: Place the light cord between the two protrusions on the building block.

DE: Führen Sie das Lichtkabel zwischen den beiden Vorsprüngen am Baustein hindurch.

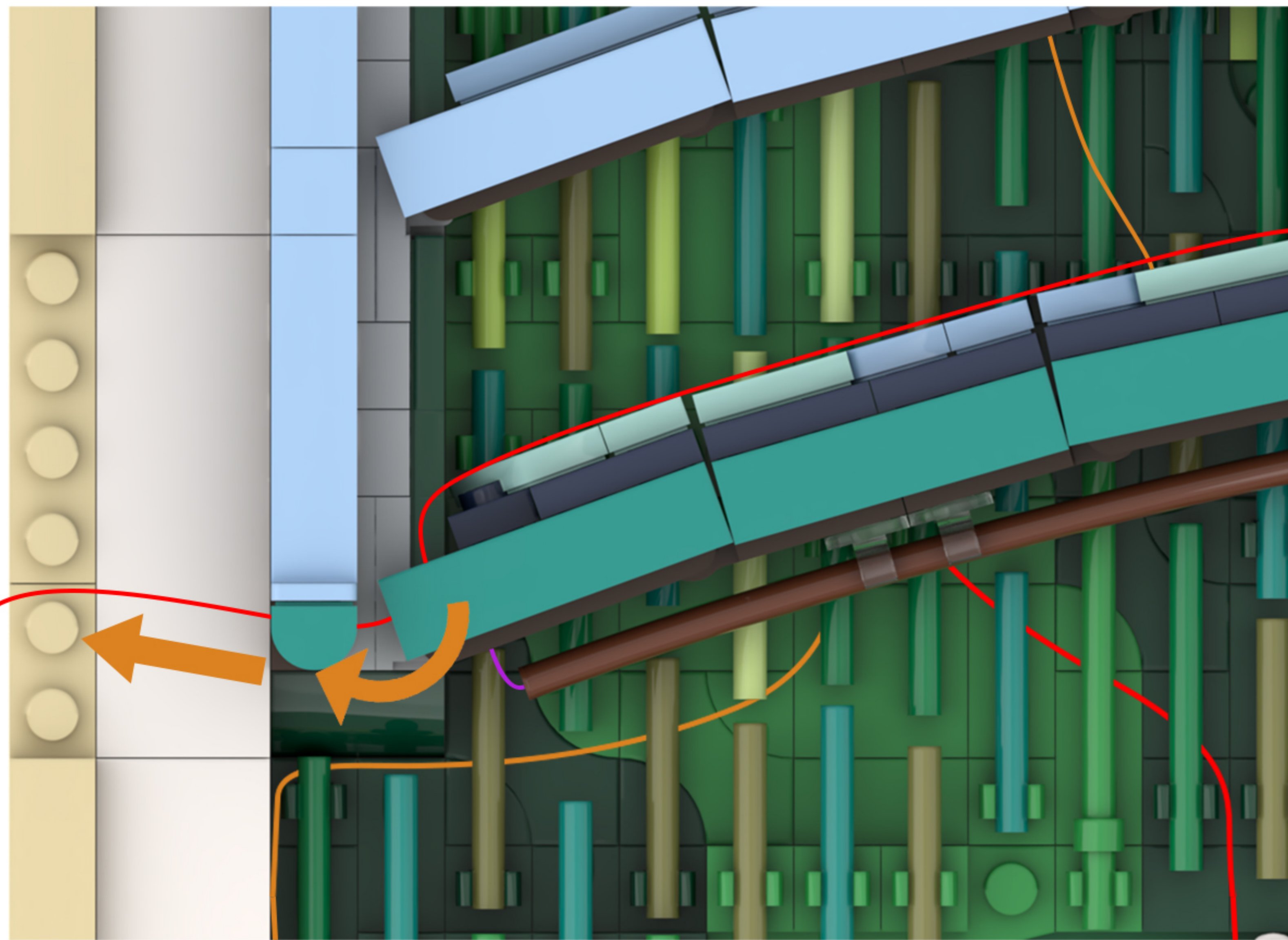

92

EN: Take out the disassembled building blocks, reassemble them, and secure the light cord.

DE: Nehmen Sie die zerlegten Bausteine heraus, setzen Sie sie wieder zusammen und befestigen Sie das Lichtkabel.

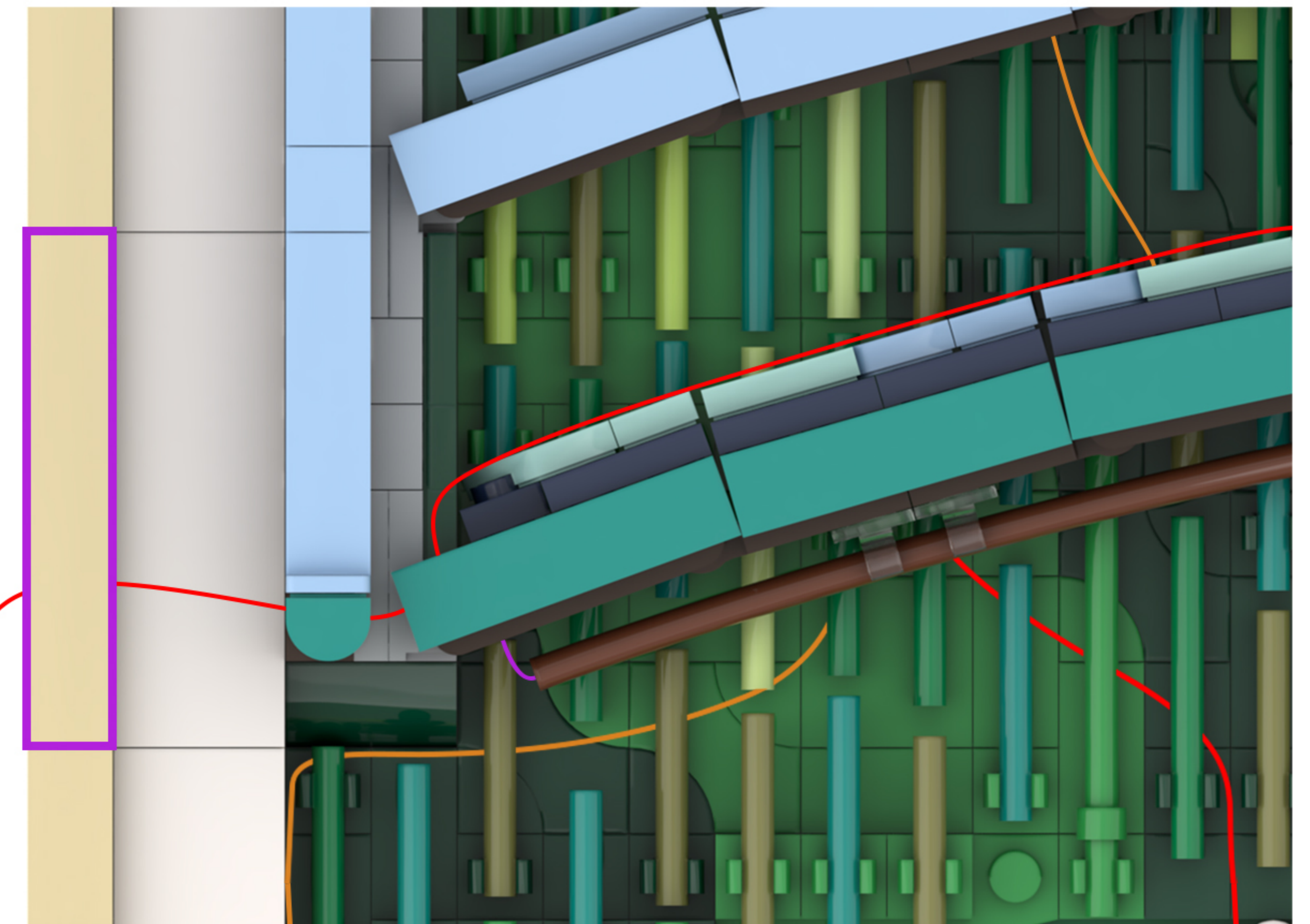
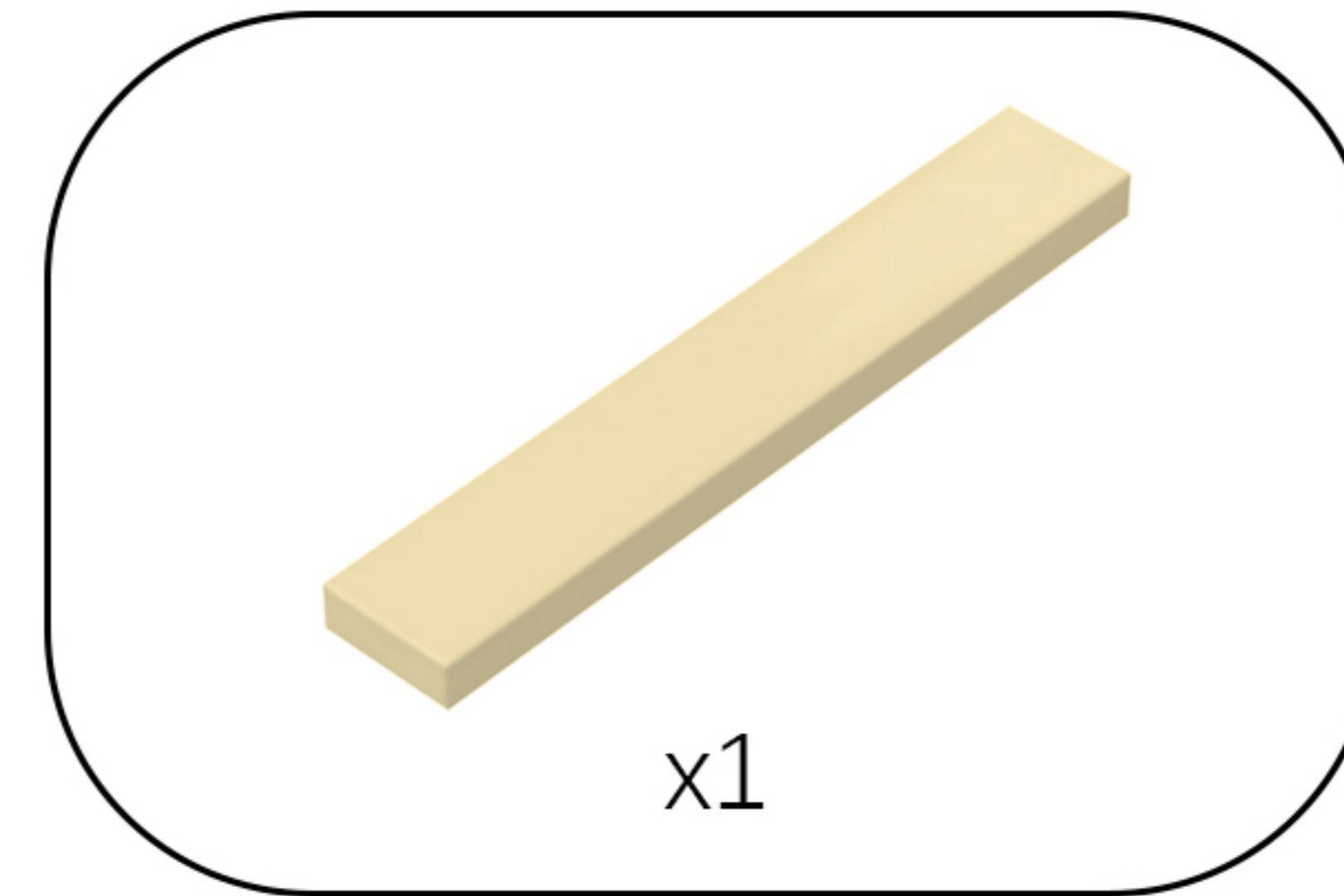

93

EN: Adjust your perspective.

DE: Ändern Sie Ihre Perspektive.

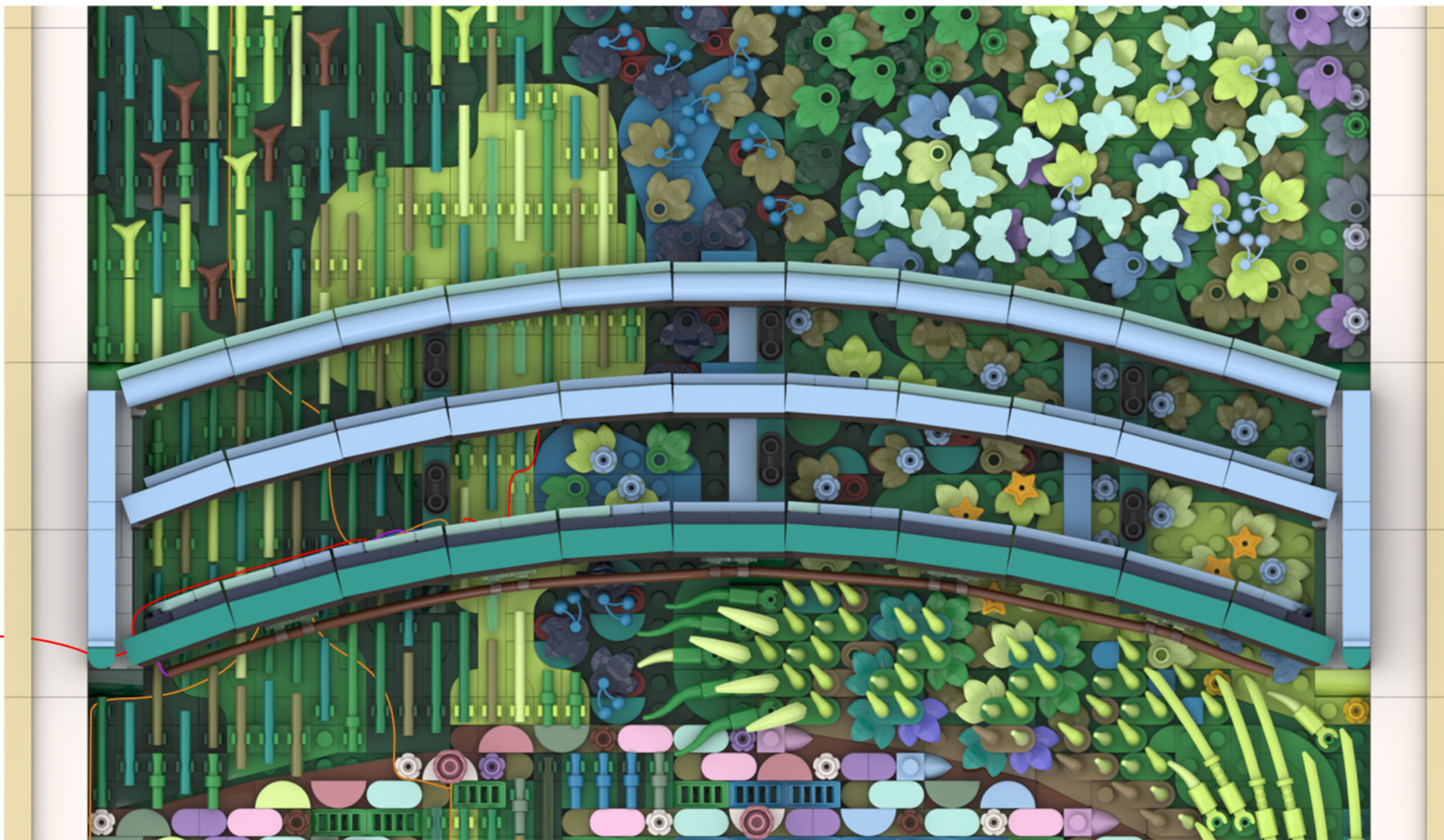

94

EN: Take out the disassembled building blocks and reassemble them.

DE: Nehmen Sie die zerlegten Bausteine heraus und setzen Sie sie wieder zusammen.

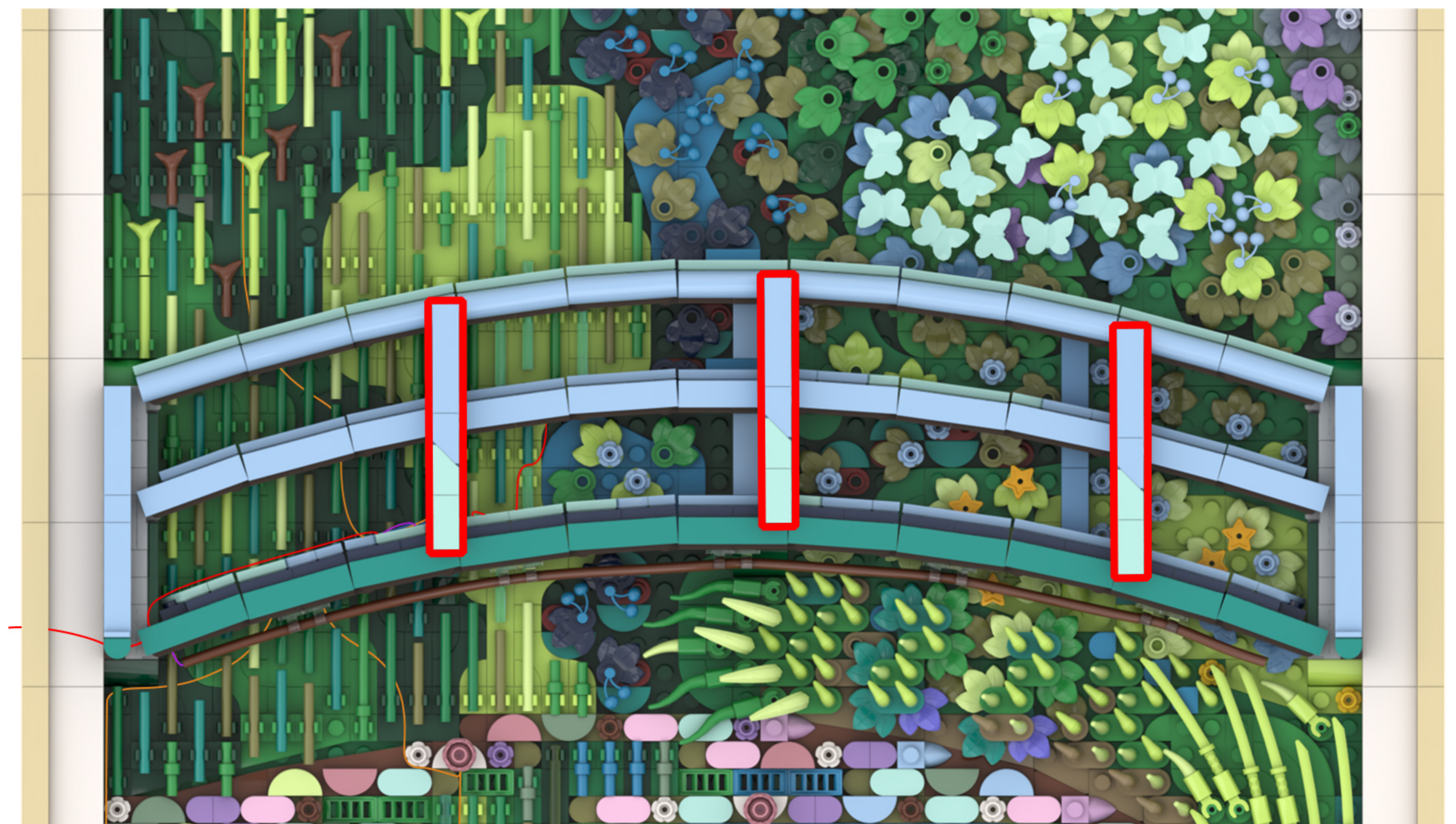
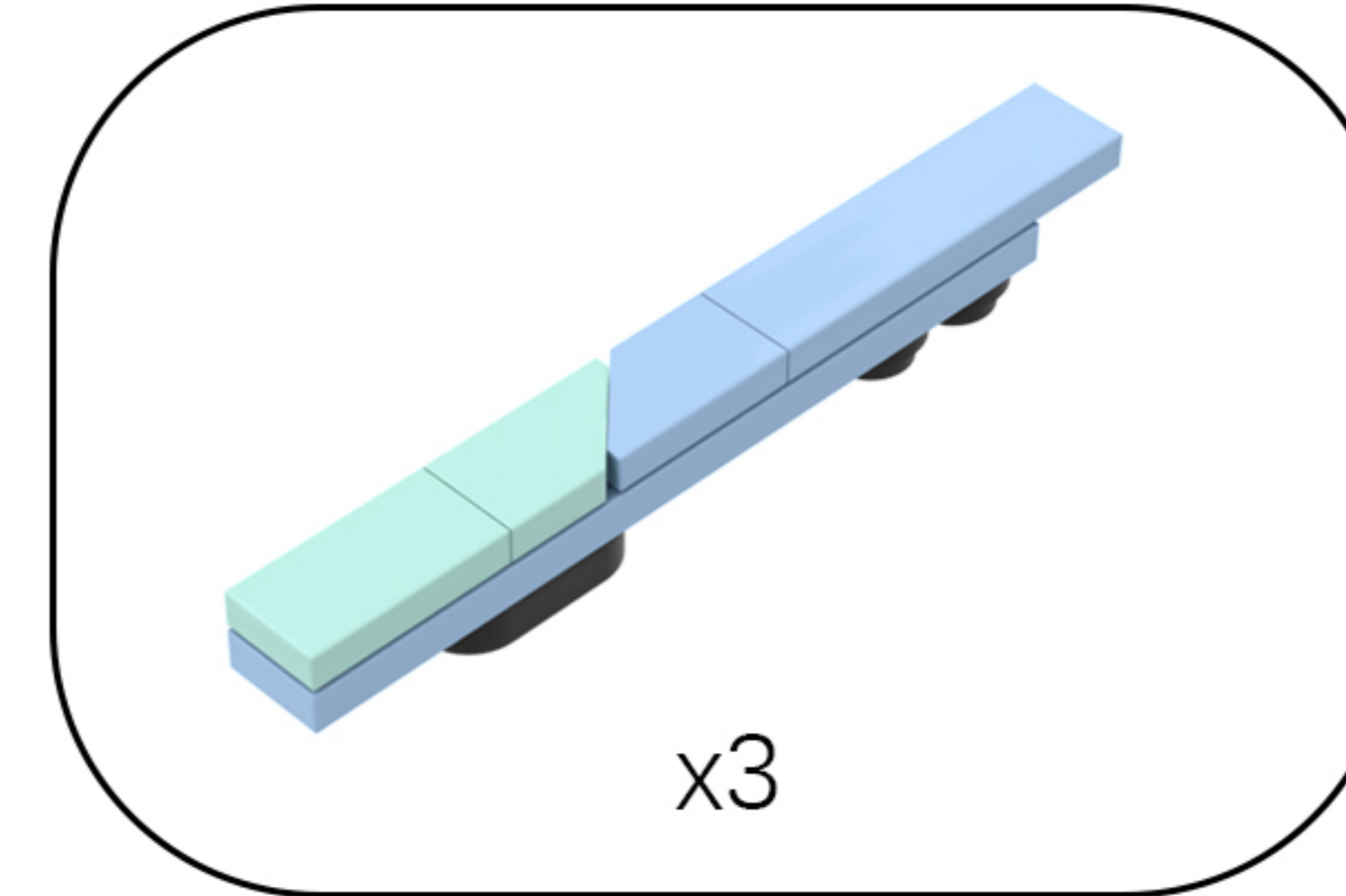

95

EN: Once installed, connect the power supply and give it a try!

DE: Die Installation ist abgeschlossen. Schließen Sie das Gerät an die Stromversorgung an und probieren Sie es aus!

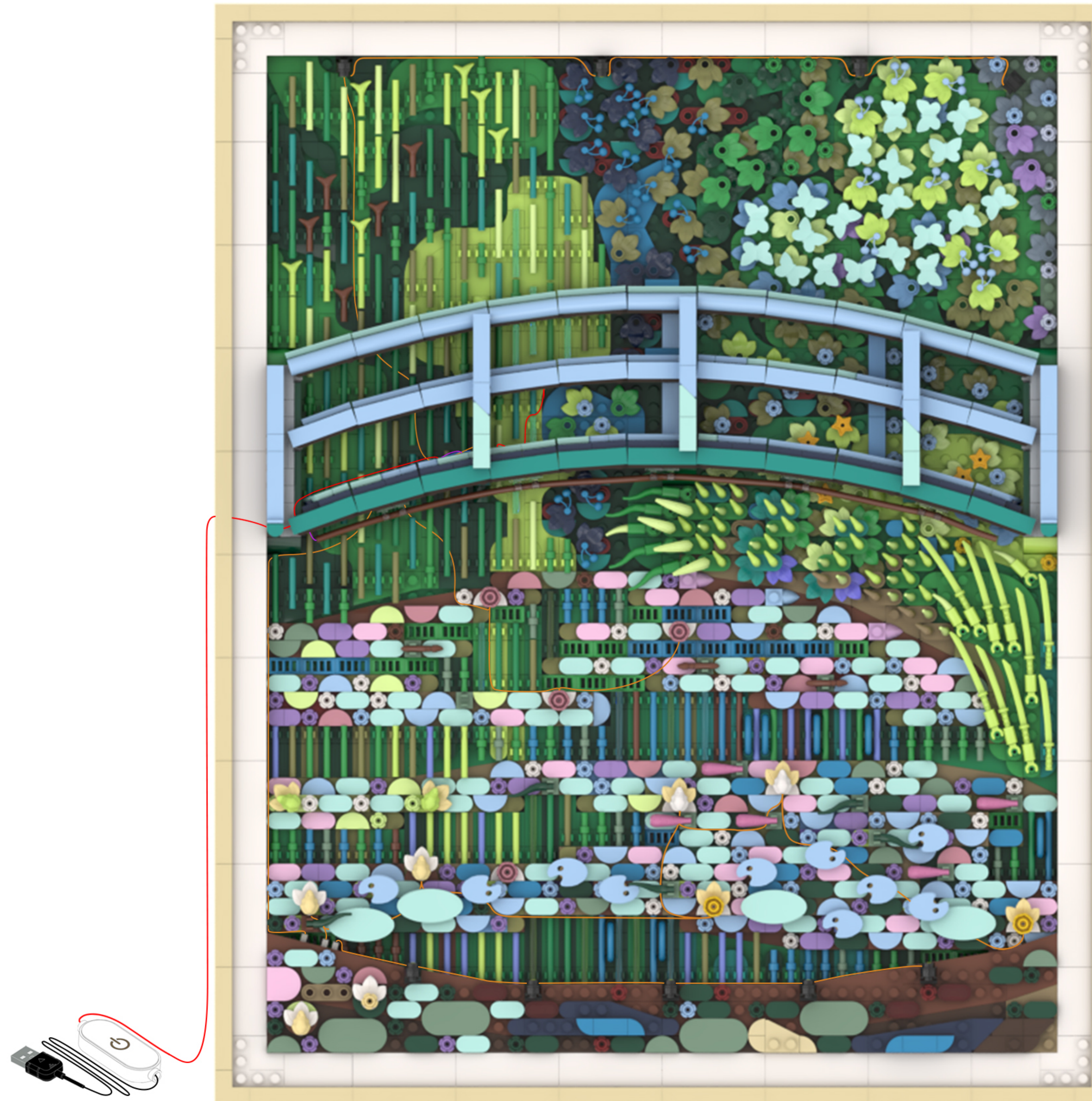

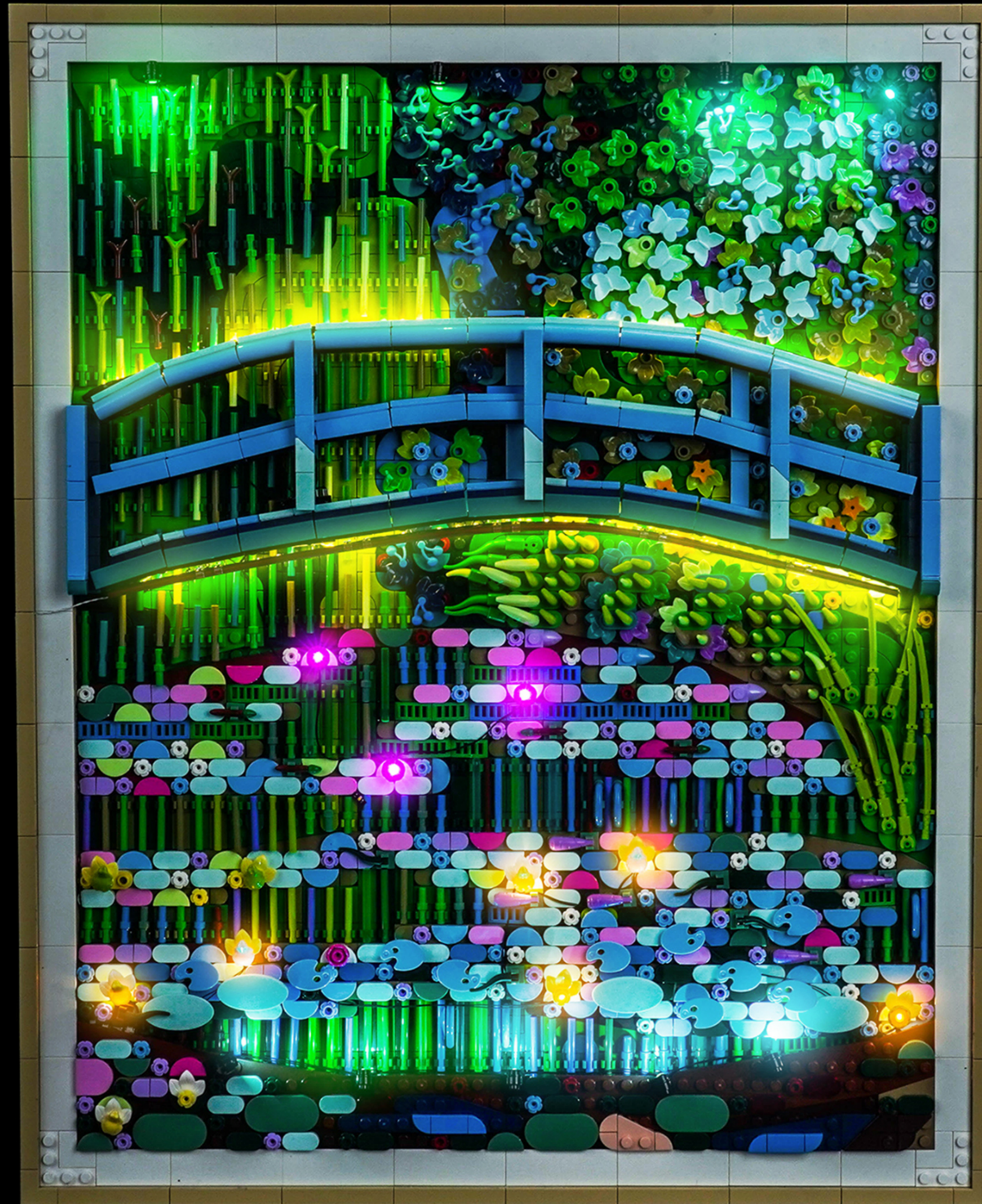

Above our designers to provide the relevant ideas and instructions. But please move to the following:

- 1: about our company this product parts material, product quality do you have comments and suggestions?
- 2: about this product installation instructions and installation of the degree of difficulty do you have views and suggestions?
- 3: if in the operation of the product we provide ideas encountered any problems, please contact us in a timely manner.

Tips

If you encounter any installation problems please contact the seller, we will be happy to help you solve!