

INSTALLATION GUIDE

Kanto Region Badge
Collection 40892



LED light kit compatible with Lego

Instructions for installing this kit:

This set includes 2 bags. Here is the list.

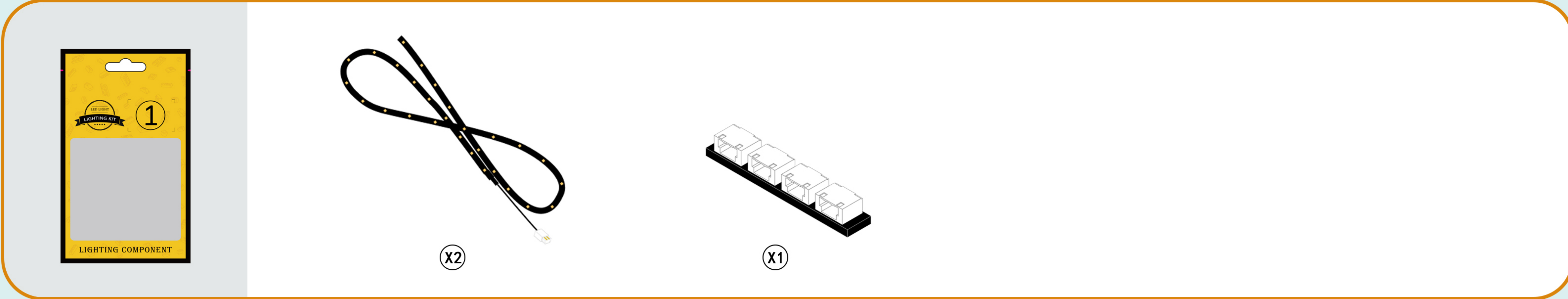

This post will complete the light installation in two main sections.

Step 1-test



Step 2-mounting

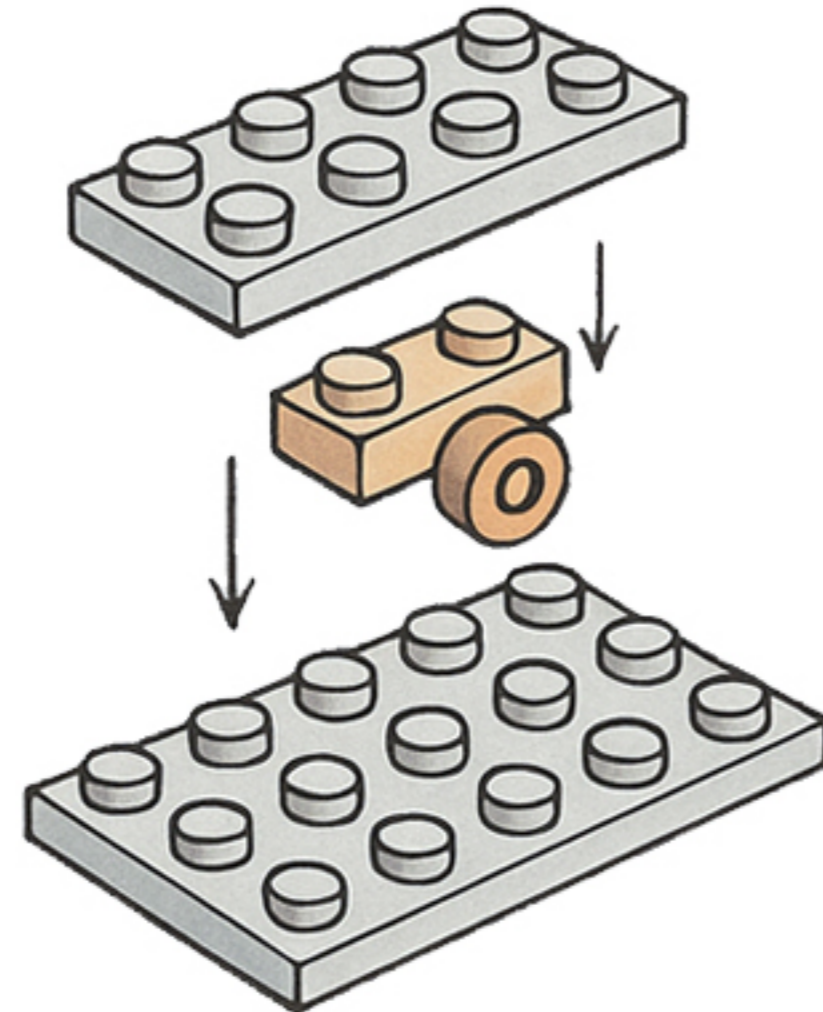

So let's get started!

Step 1-Test.

1

EN: Remove the expansion board from Bag 1.

DE: Entnehmen Sie die Erweiterungskarte aus Beutel 1.

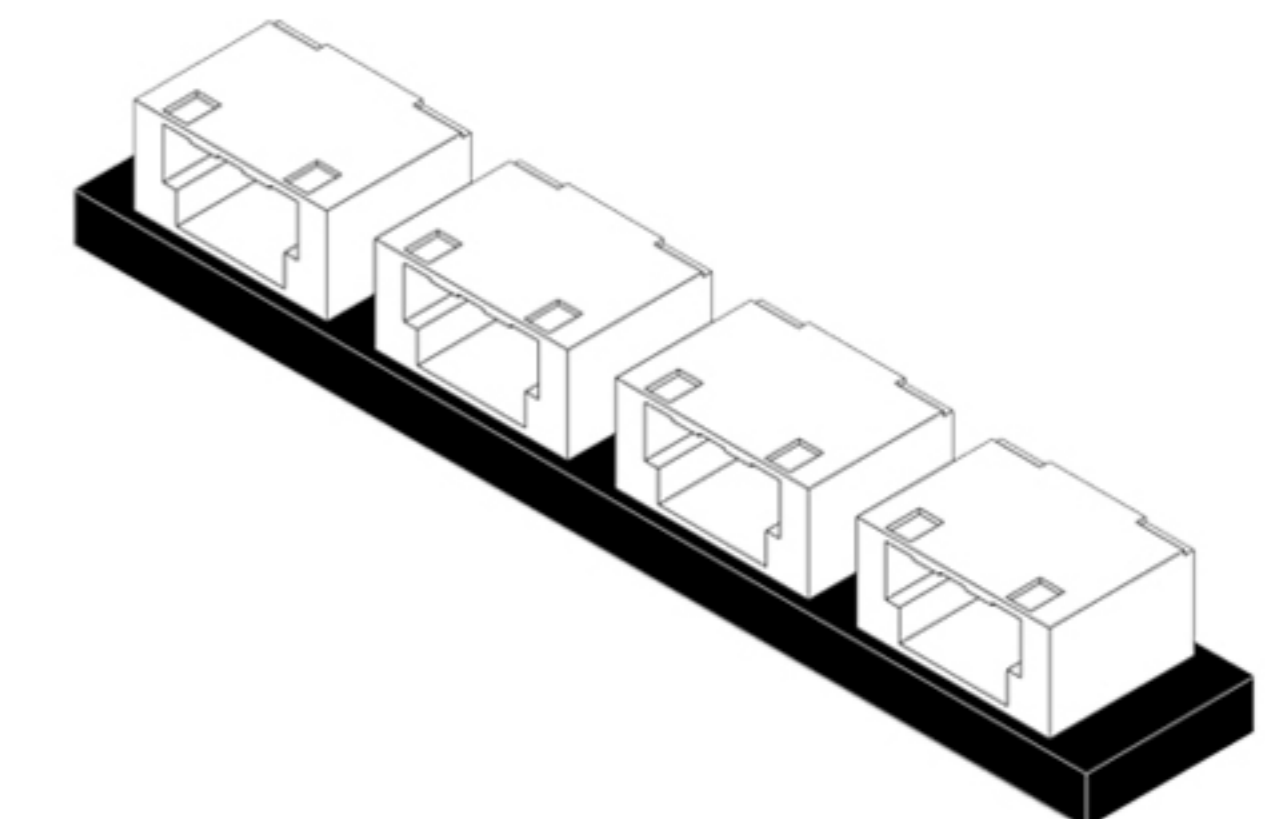
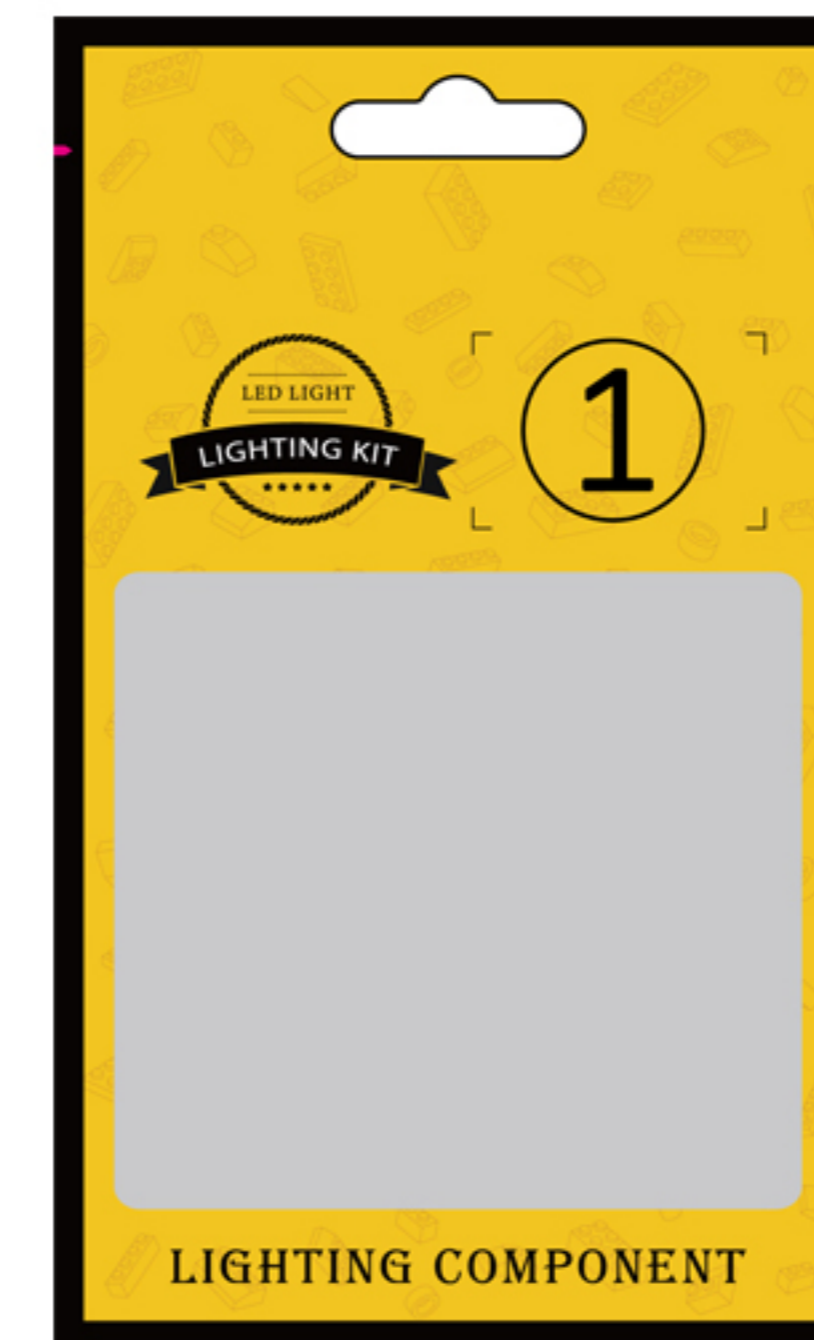

x1

2

EN: Take the USB power cable from Bag 2 and connect it to the expansion board.

DE: Nehmen Sie das USB-Stromkabel aus Beutel 2 und schließen Sie es an die Erweiterungskarte an.

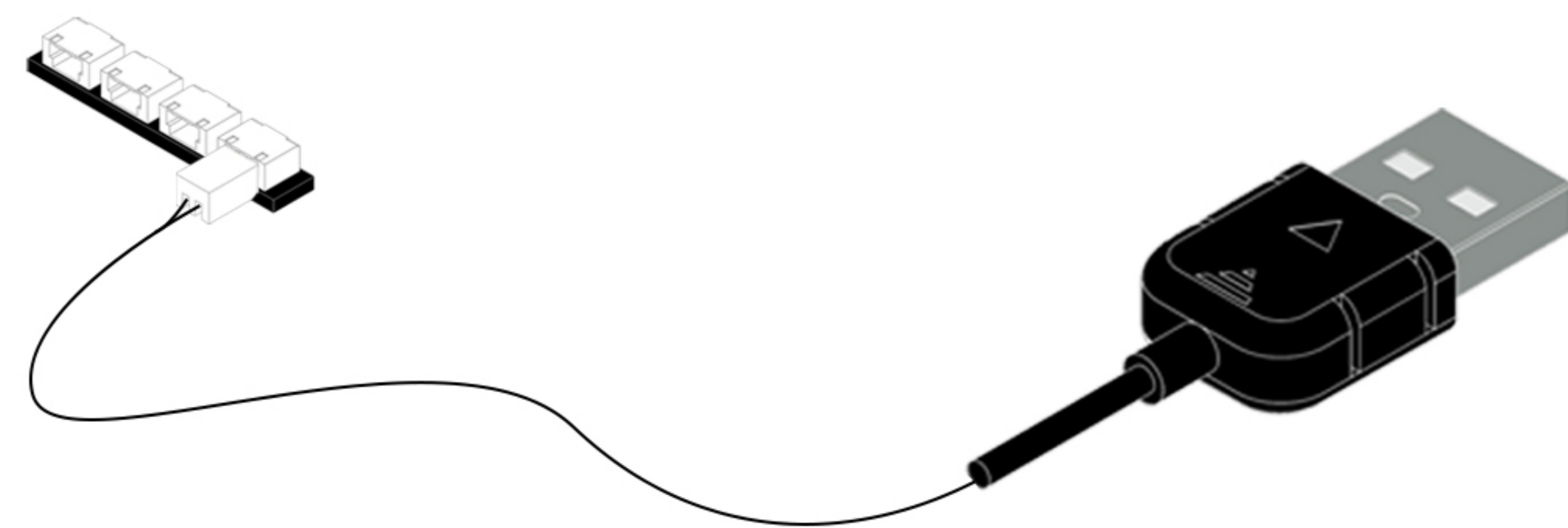
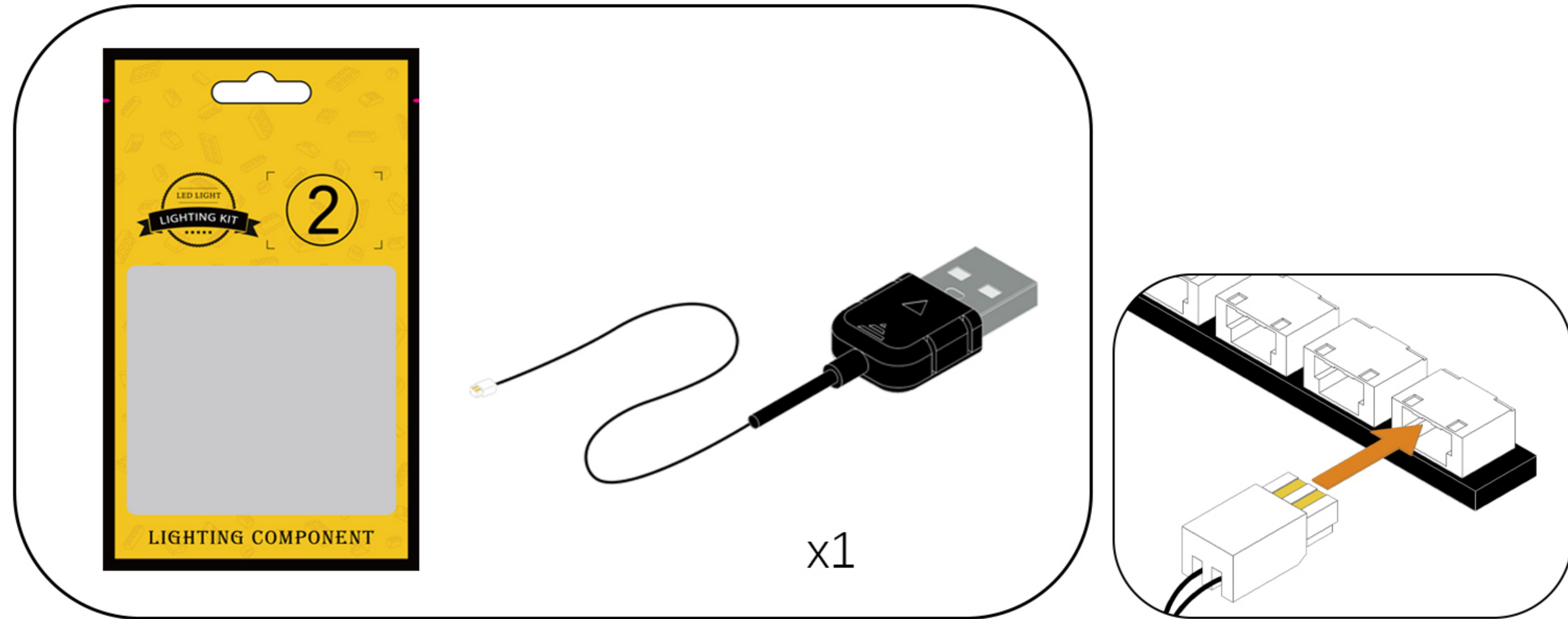

3

EN: Connect the USB power cable to the mobile power supply. (Power supply not included; see the diagram below for power supply options.)

DE: Schließen Sie das USB-Netz-kabel an die mobile Stromversorgung an. (Stromversorgung nicht im Lieferumfang enthalten, siehe Abbildung unten für die Stromversorgungsart.)

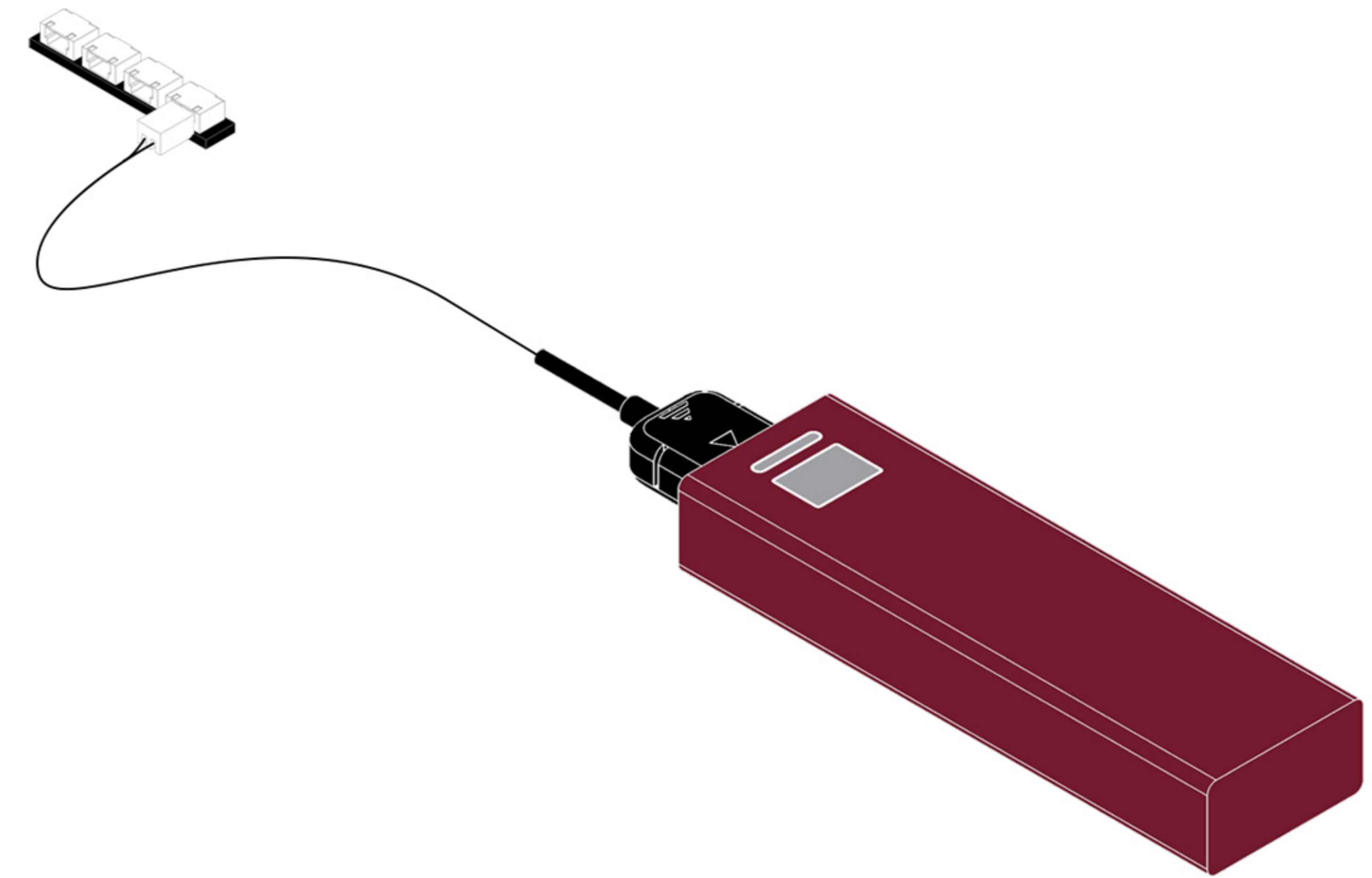

USB Connectors to Connect Devices

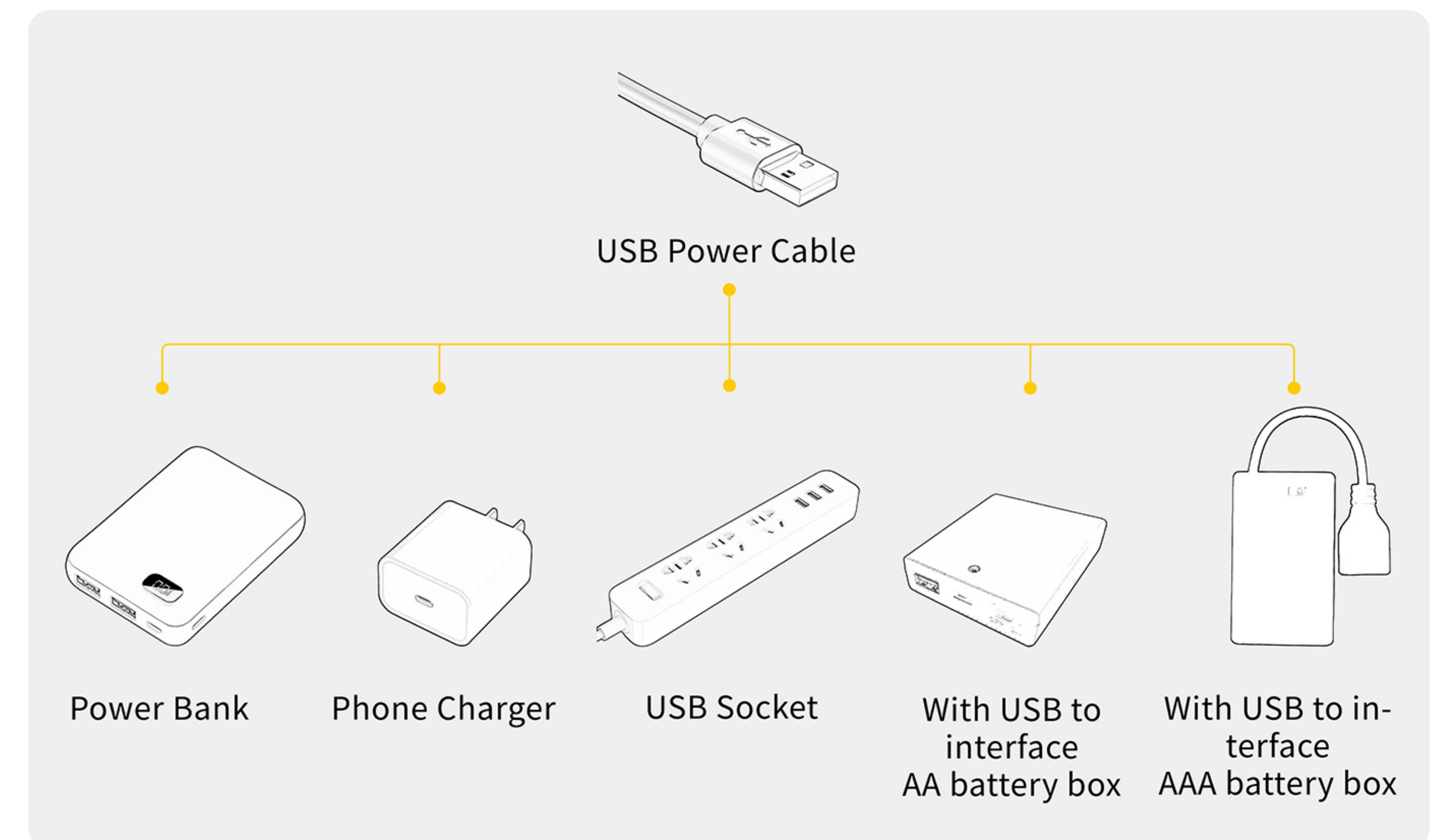

4

EN: Remove the LED strip from Bag 1 and connect it to the expansion board. Turn on the power and check that the LED strip is working properly. If you notice any issues, please contact us immediately.

DE: Nehmen Sie den LED-Streifen aus Beutel 1 und schließen Sie ihn an die Erweiterungsplatine an. Schalten Sie das Gerät ein und überprüfen Sie, ob der LED-Streifen ordnungsgemäß funktioniert. Sollten Sie Probleme feststellen, kontaktieren Sie uns bitte umgehend.

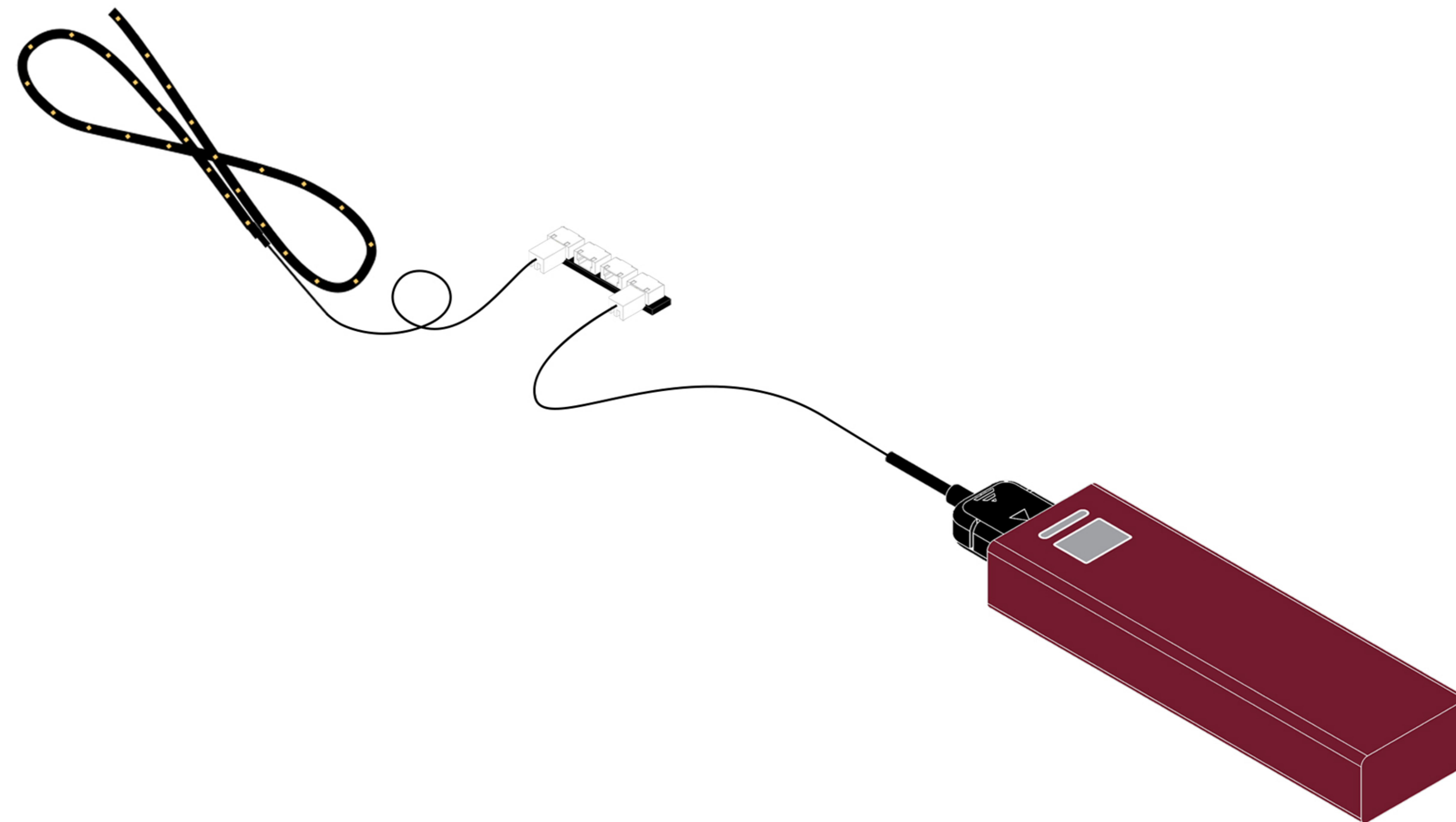
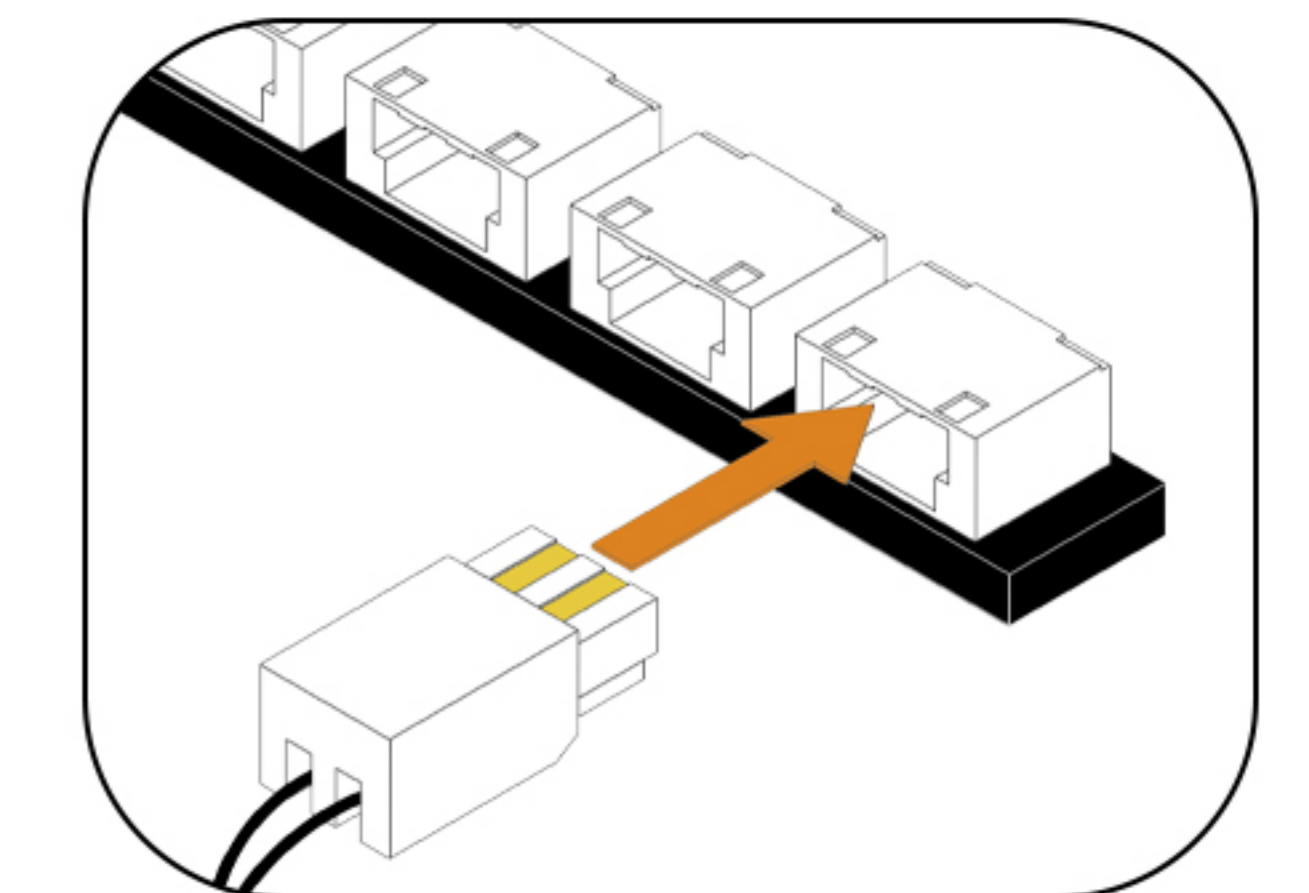
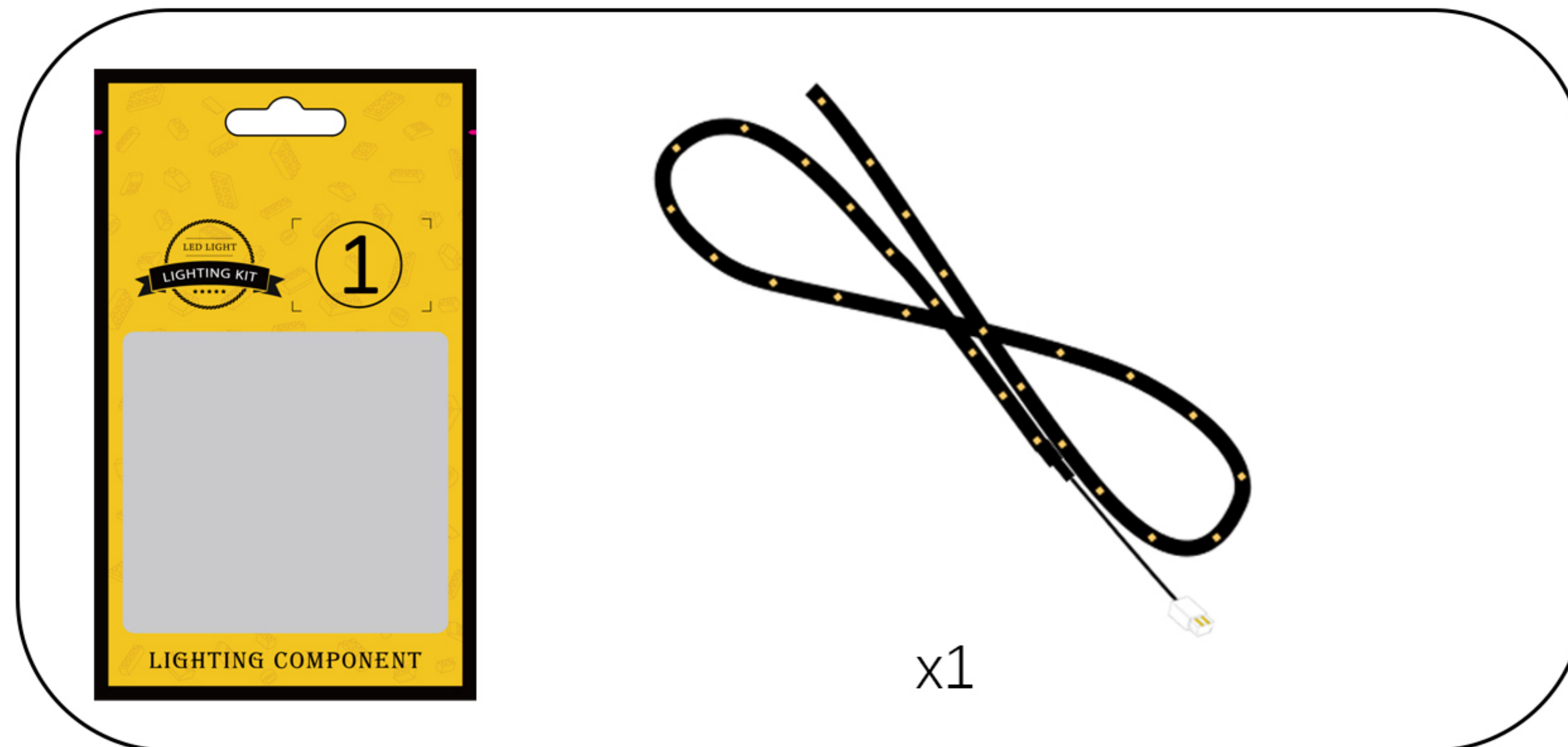

After confirming that there are no abnormalities, temporarily return each part to its original bag.

Step 2-Mounting.

- 1** EN: Take out the building block model.
DE: Nimm das Bauklotzmodell heraus.



2

EN: Open the building blocks.

DE: Öffne die Bausteine.



3

EN: Remove the 8 badges inside.

DE: Entferne die 8 Abzeichen im Inneren.

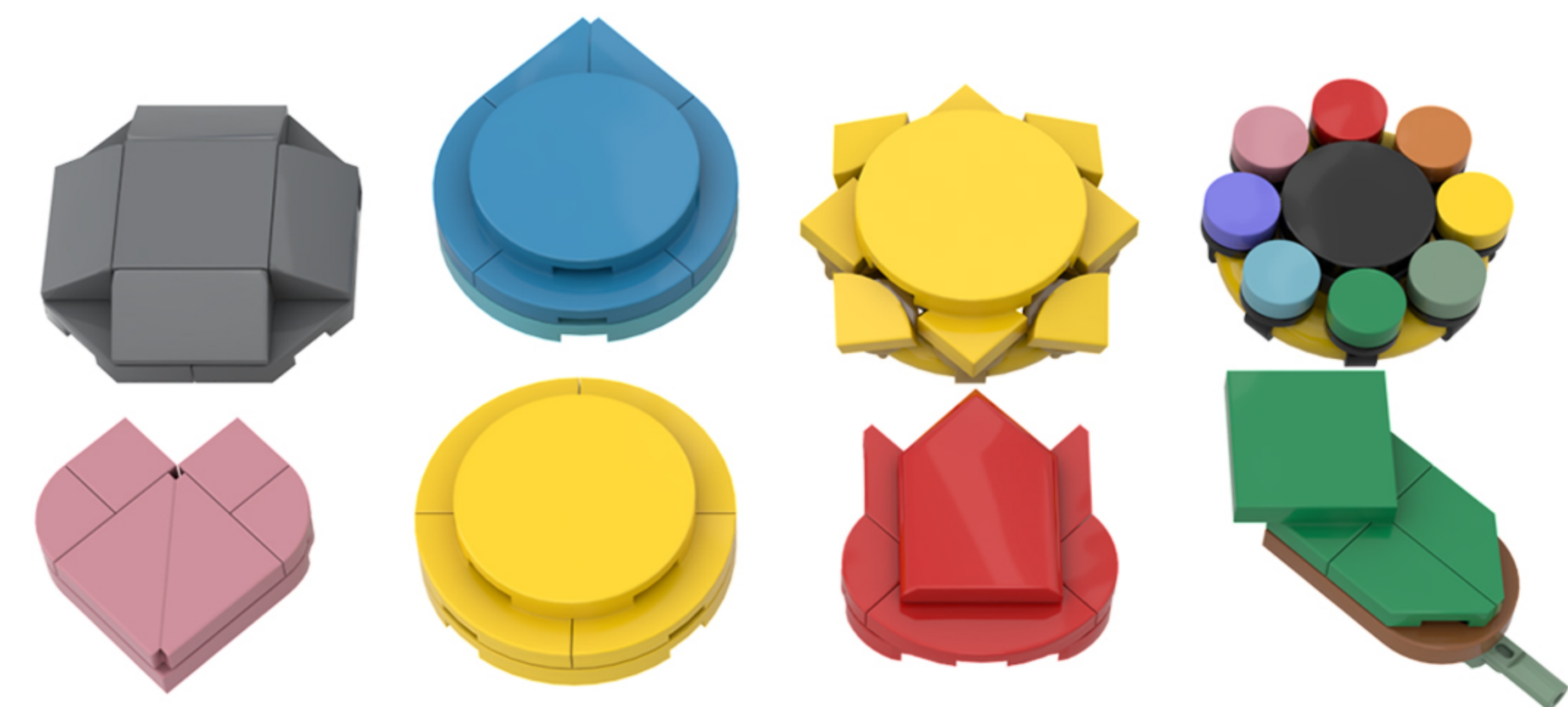
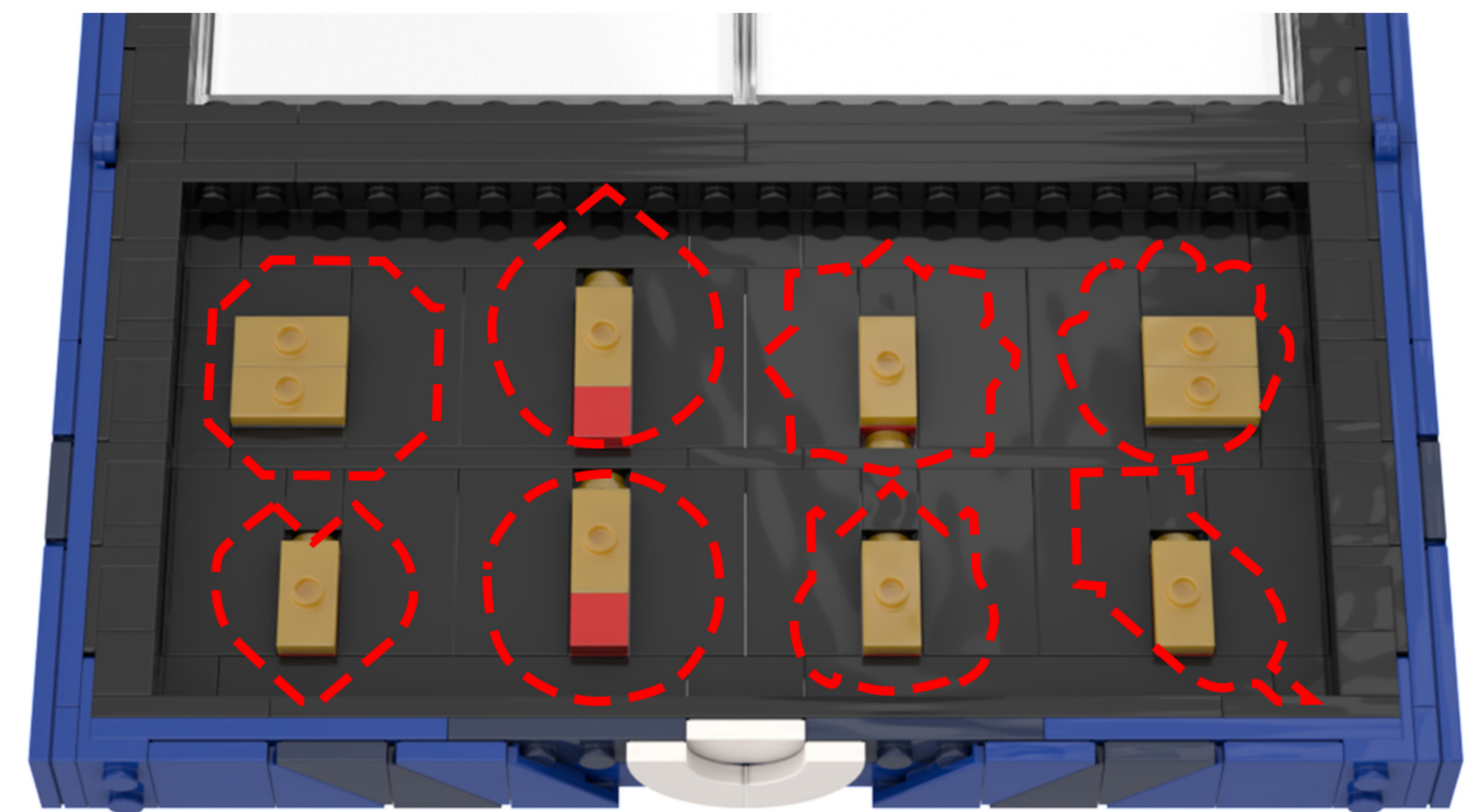

4

EN: Take the light strip out of Bag 1, peel off the adhesive backing from one of the strips, and attach the end with the wires to the building block.

DE: Nimm den Lichtstreifen aus Beutel 1, ziehe die Schutzfolie von einem der Streifen ab und befestige das Ende mit den Drähten am Baustein.

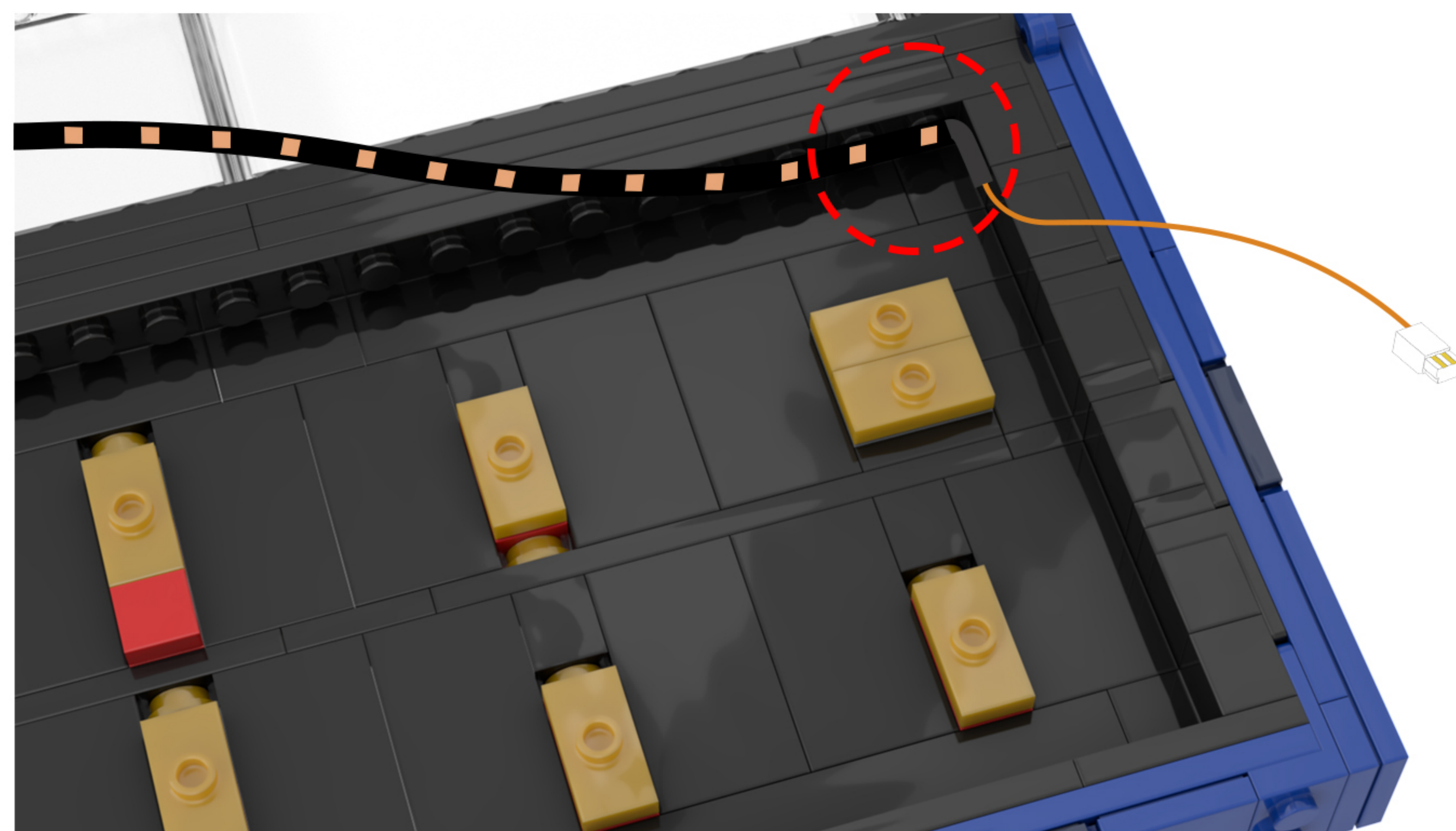
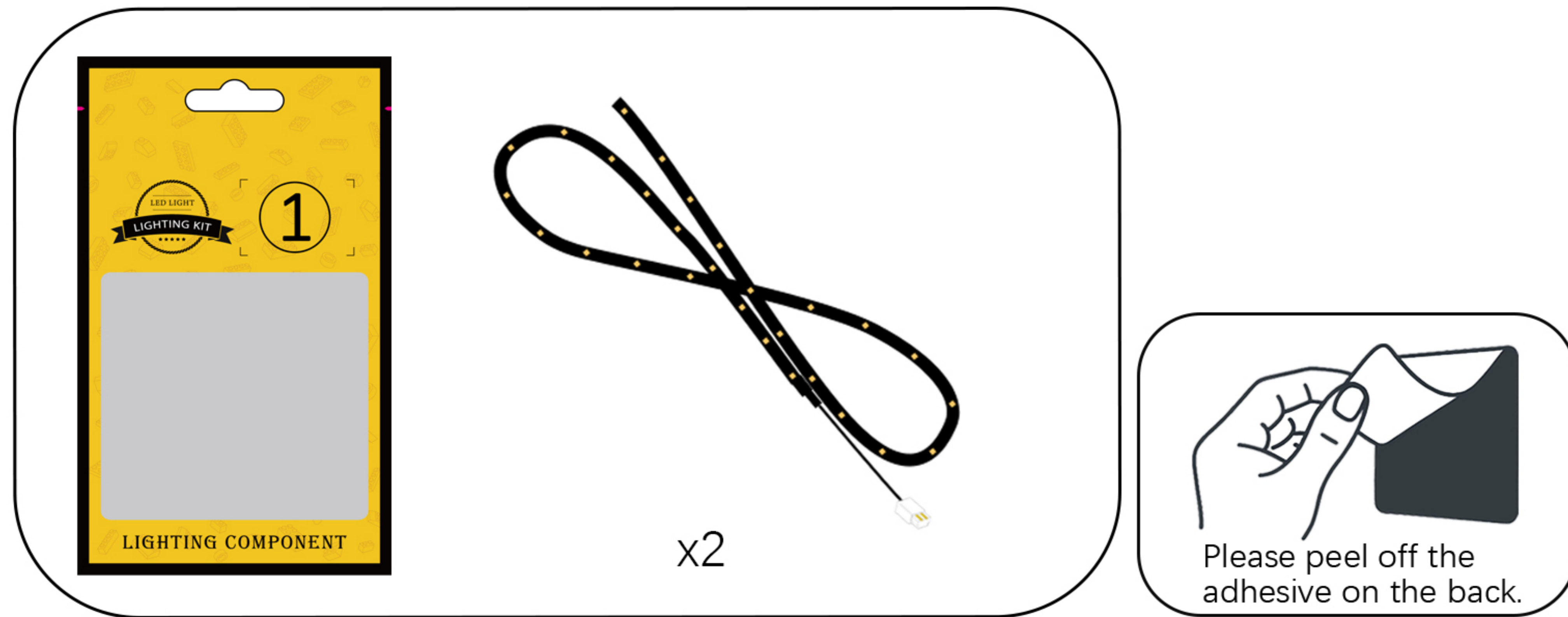

5

EN: Stick the light strips onto the building blocks.

DE: Kleben Sie die Leuchtstreifen auf die Bausteine.

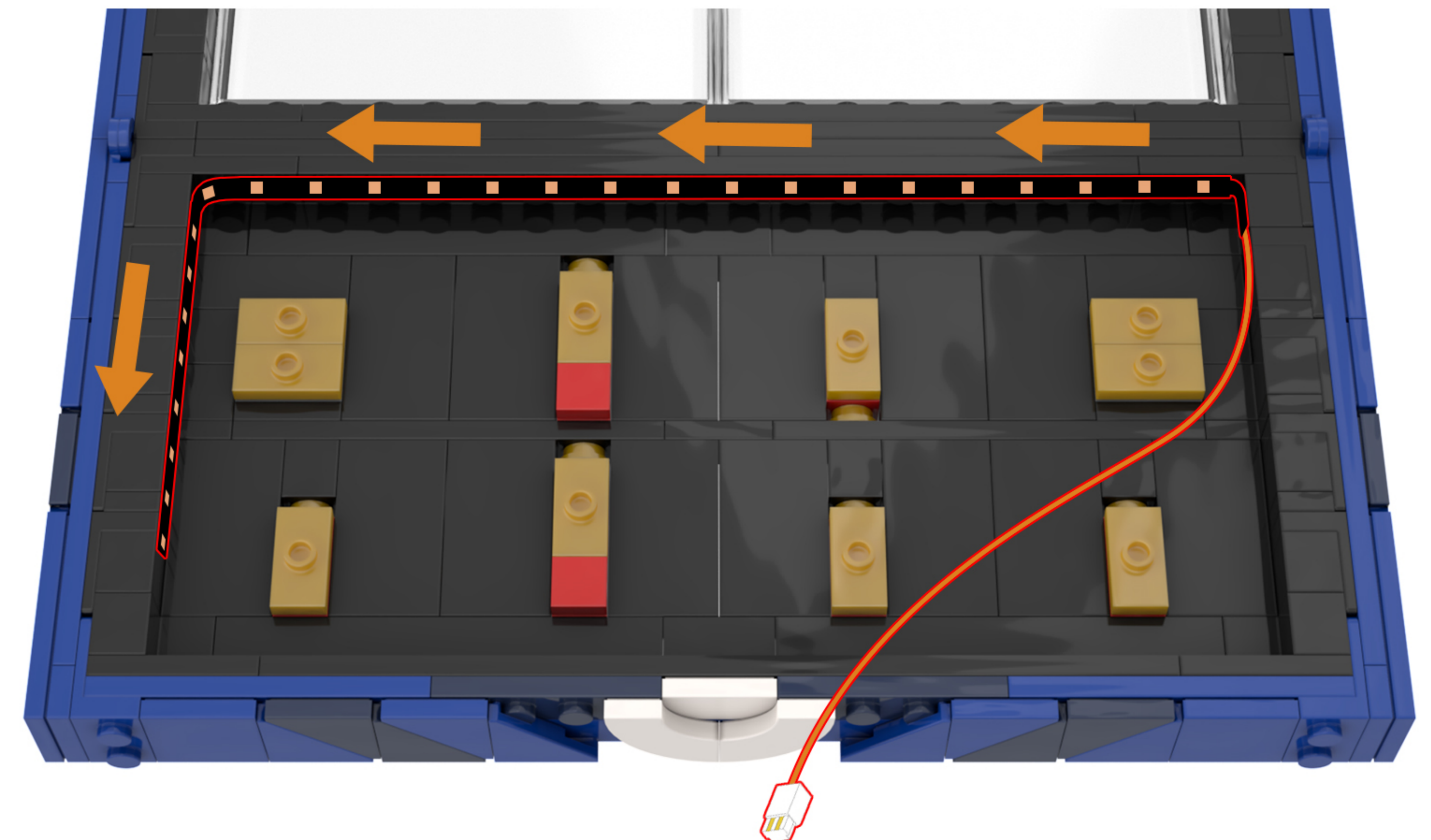

6

EN: Peel off the adhesive backing from the other light strip and attach the end with the wires to the building block.

DE: Zieh die Schutzfolie vom anderen Lichtstreifen ab und befestige das Ende mit den Kabeln am Baustein.

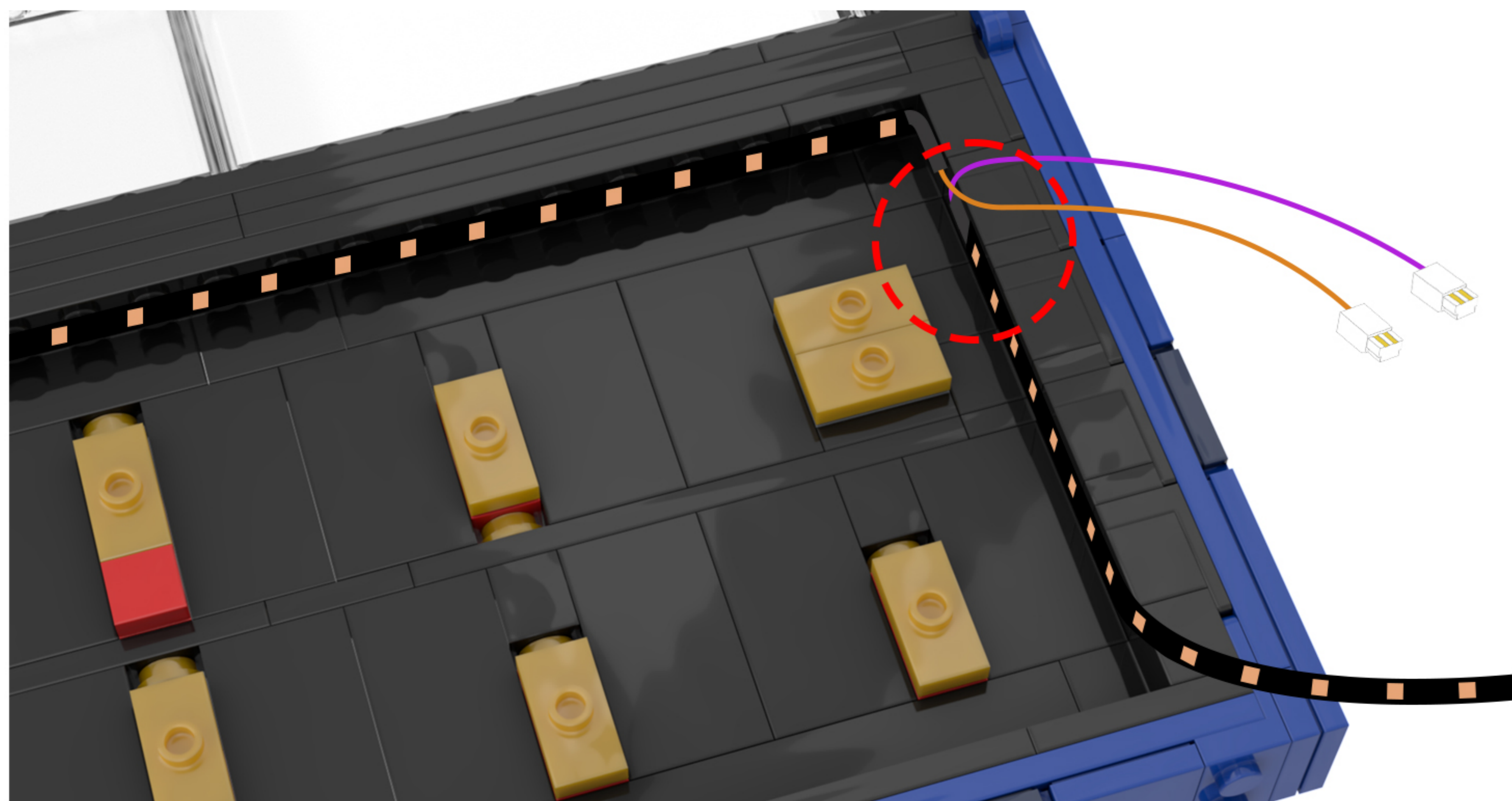

7

EN: Stick the light strips onto the building blocks.

DE: Kleben Sie die Leuchtstreifen auf die Bausteine.

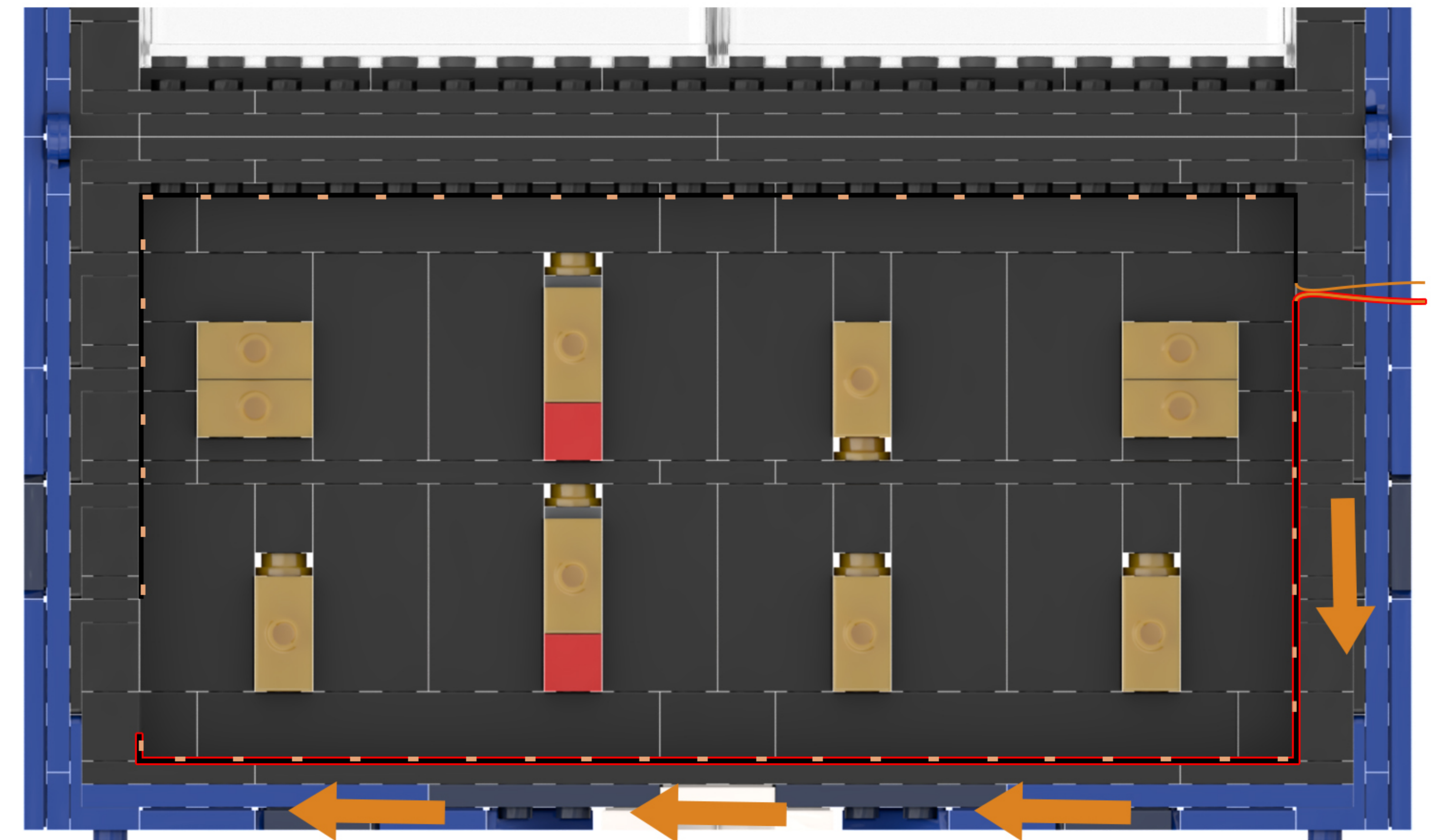

8

EN: Adjust the perspective and dismantle the building blocks.

DE: Passen Sie die Perspektive an und zerlegen Sie die Bausteine.

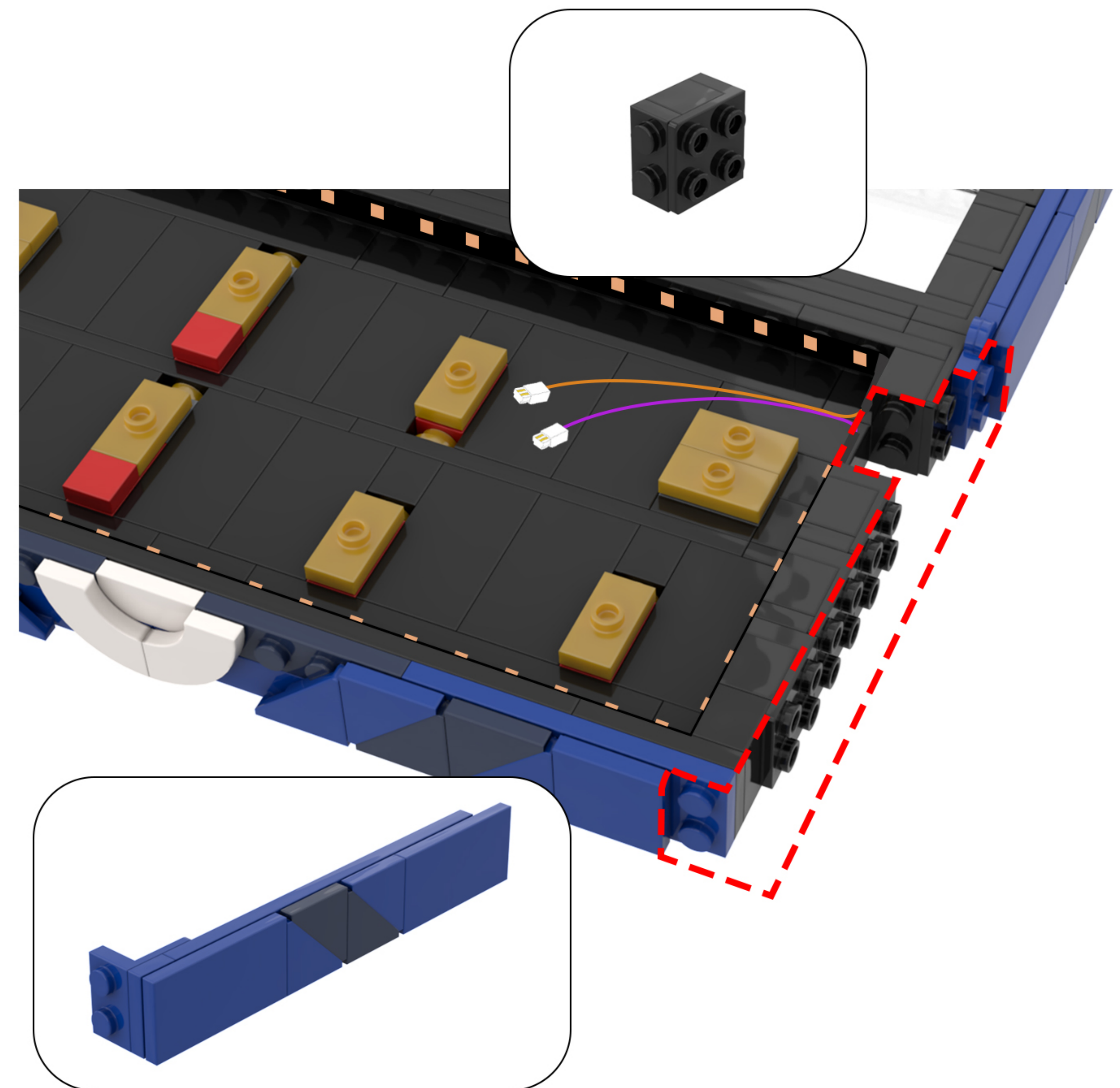
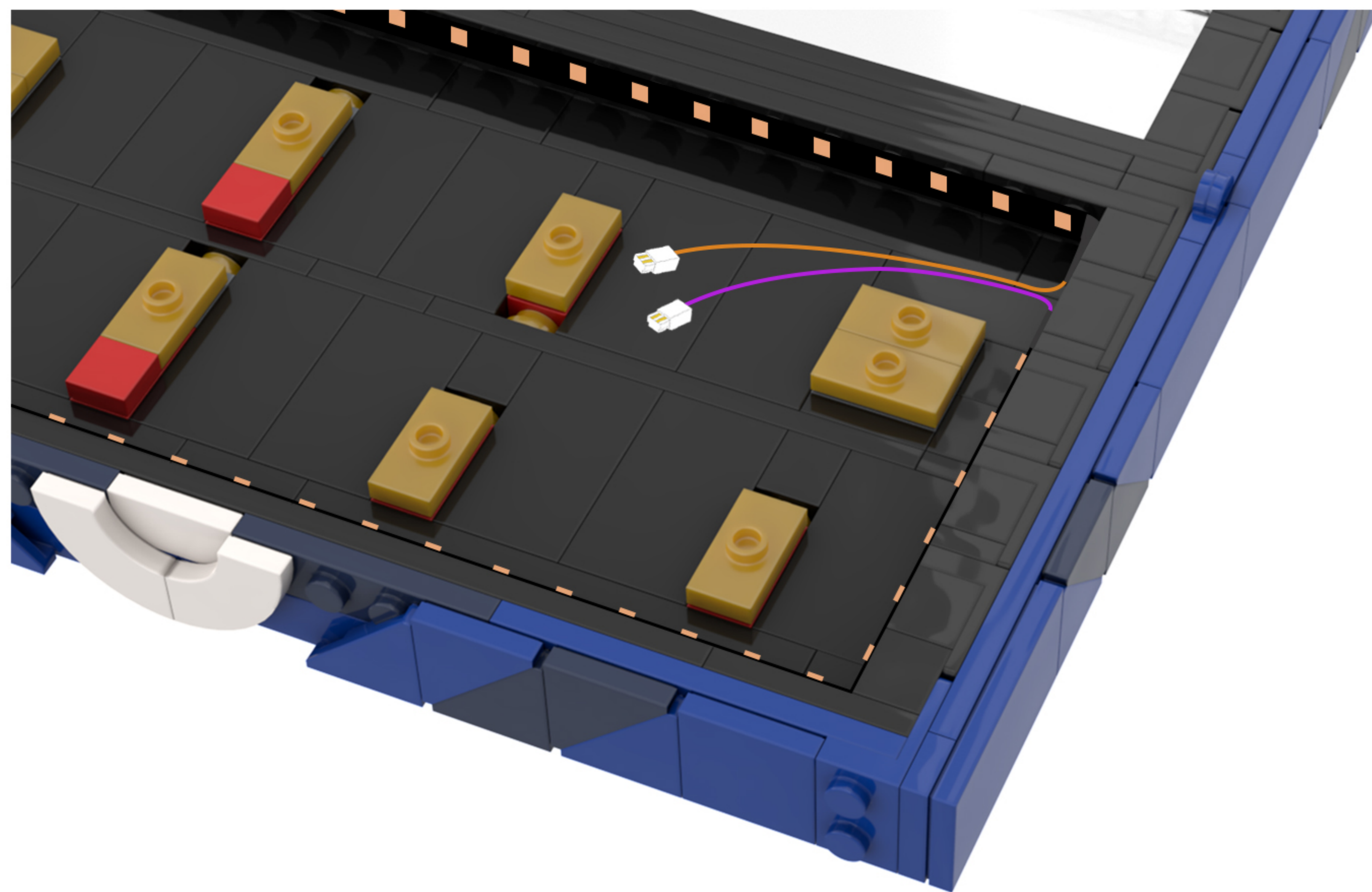

9

EN: Run the two light cables outside the model.

DE: Verlege die beiden Lichtkabel außerhalb des Modells.

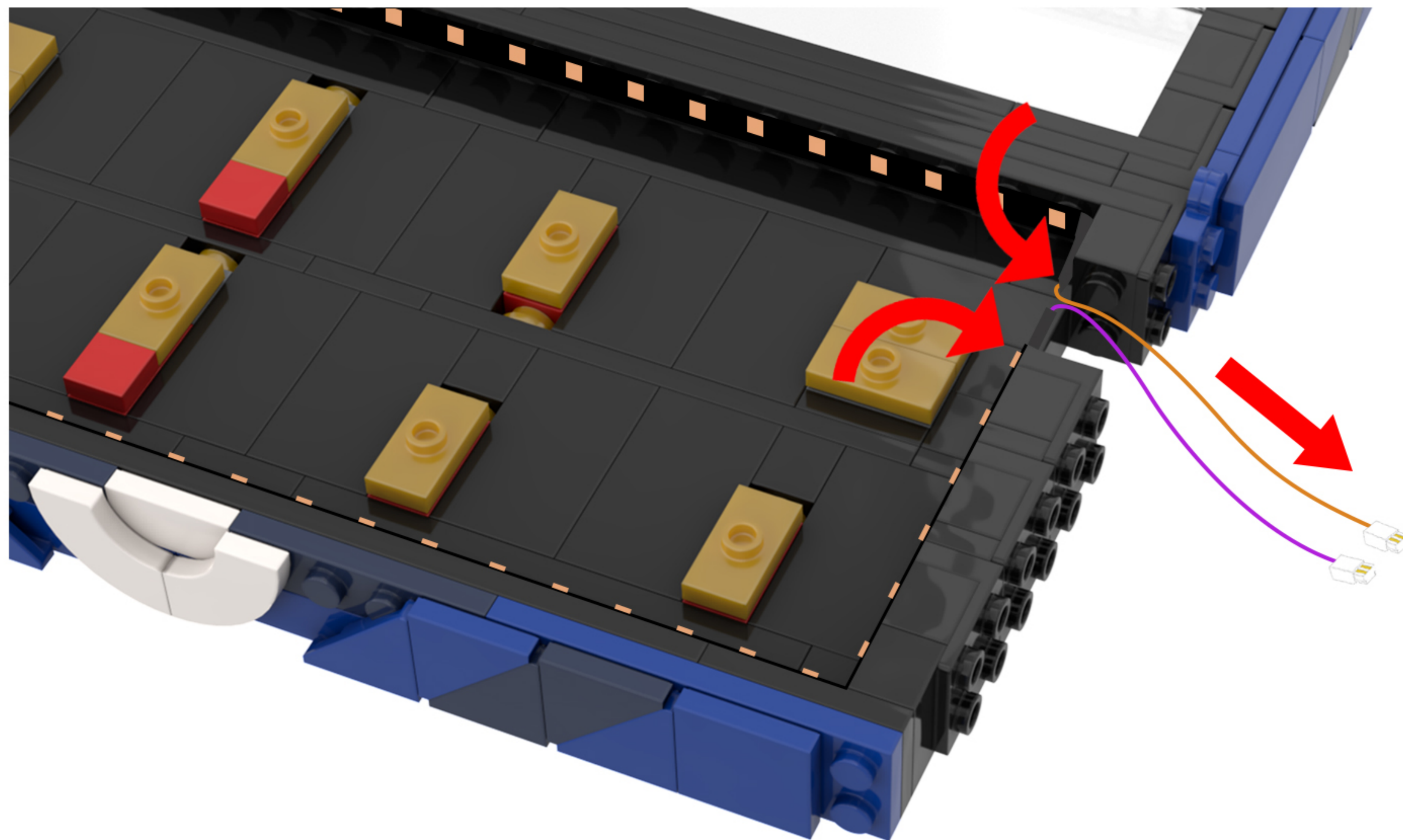

10

EN: Stand the model upright.

DE: Stellen Sie das Modell aufrecht hin.

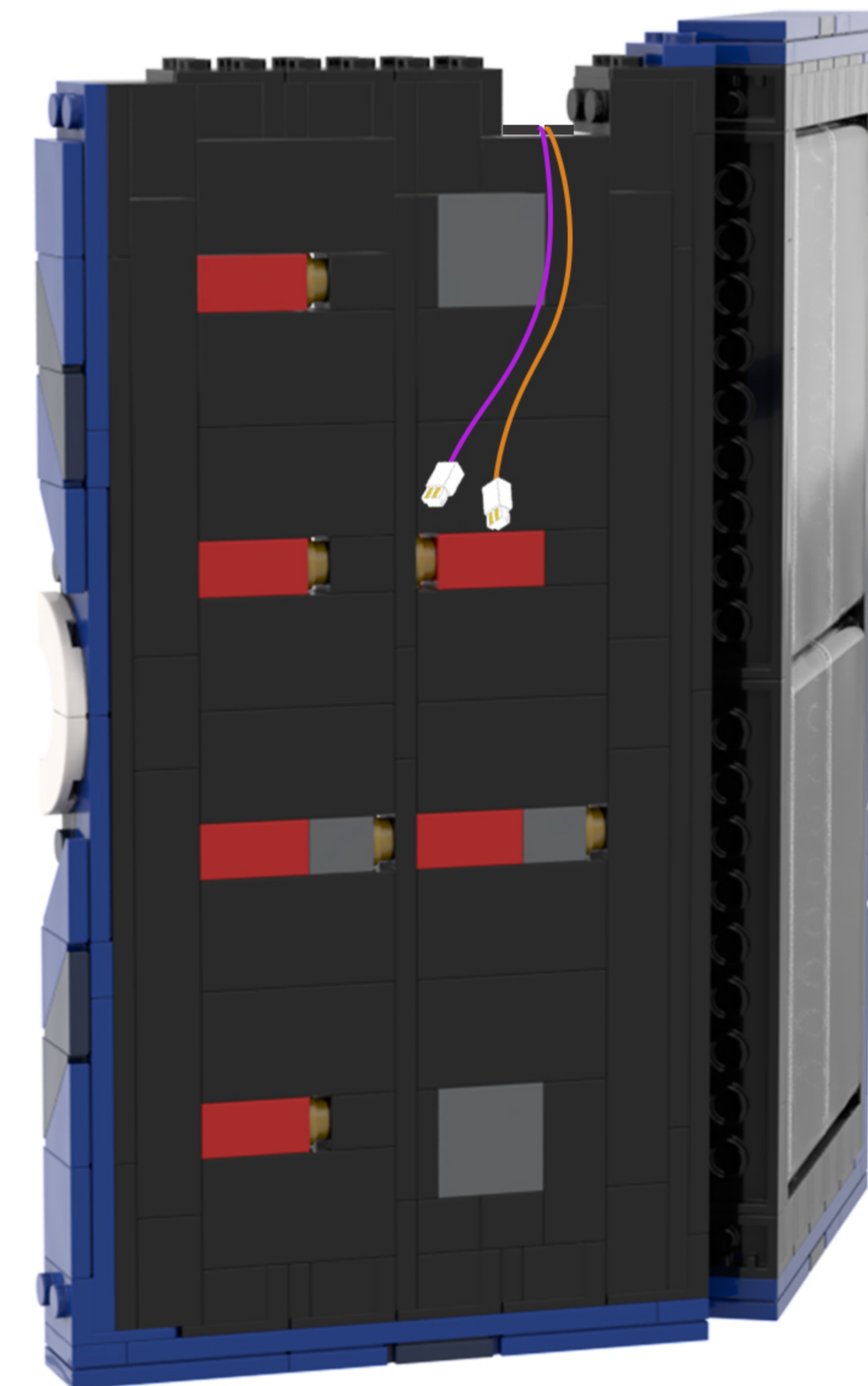
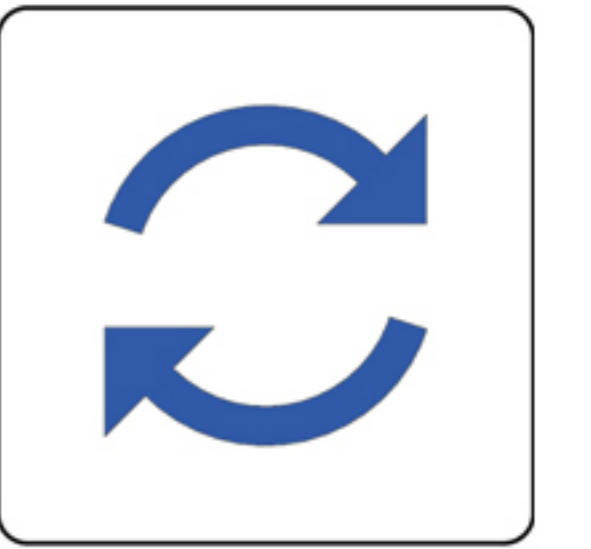

11

EN: Adjust your perspective.

DE: Ändern Sie Ihre Perspektive.

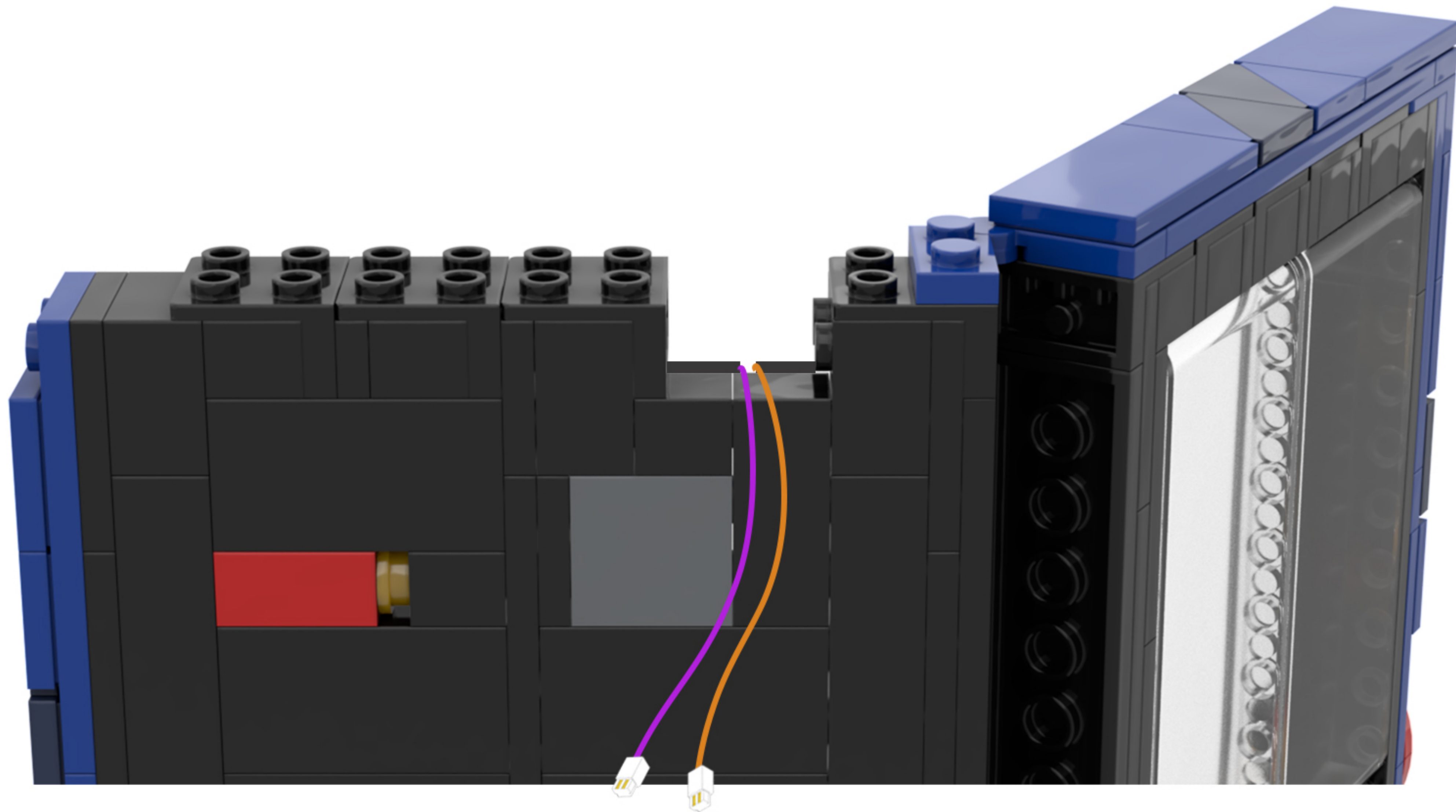

12

EN: Take out the disassembled building blocks, reassemble them, and secure the light cord.

DE: Nehmen Sie die zerlegten Bausteine heraus, setzen Sie sie wieder zusammen und befestigen Sie das Lichtkabel.

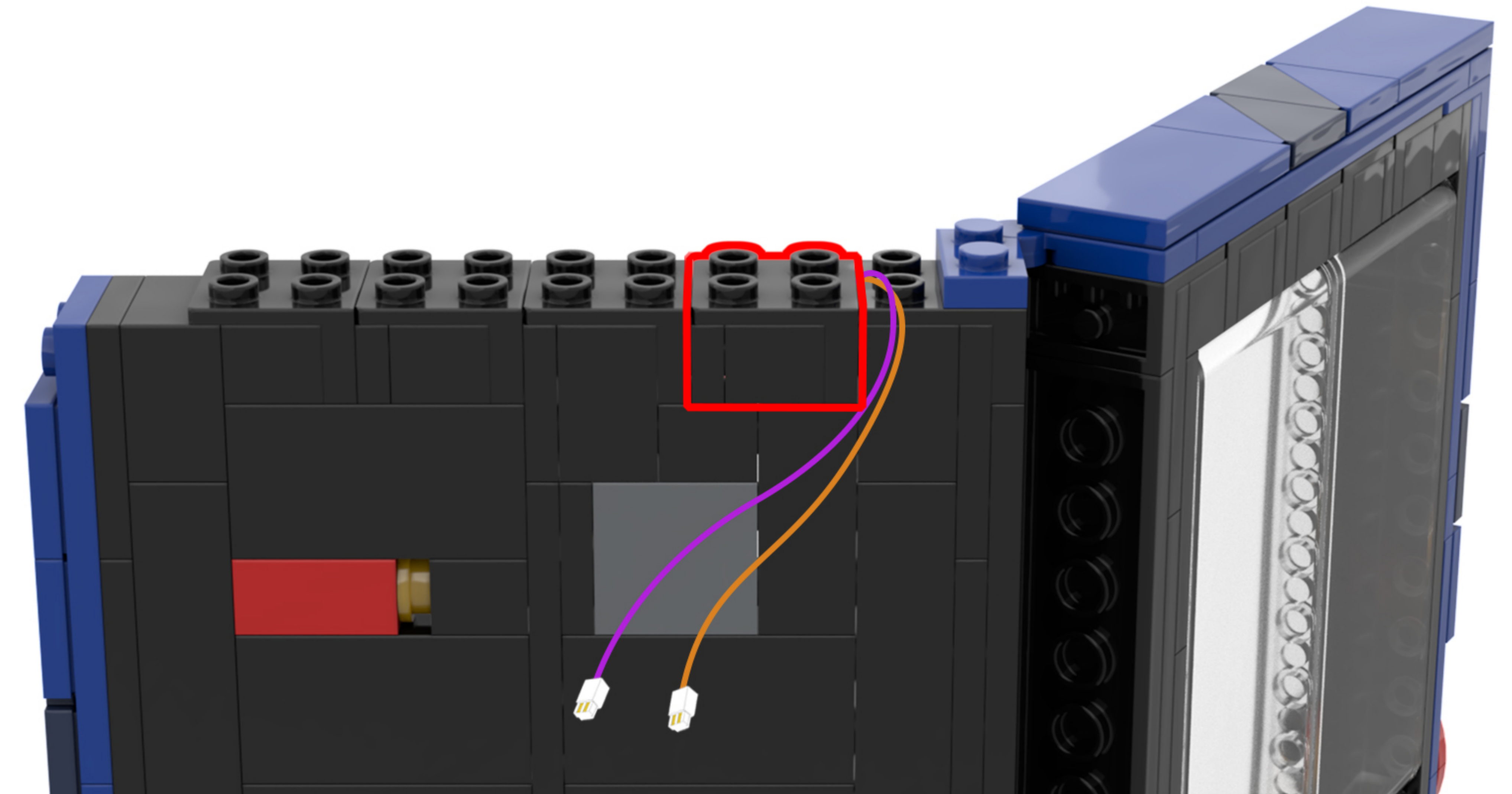
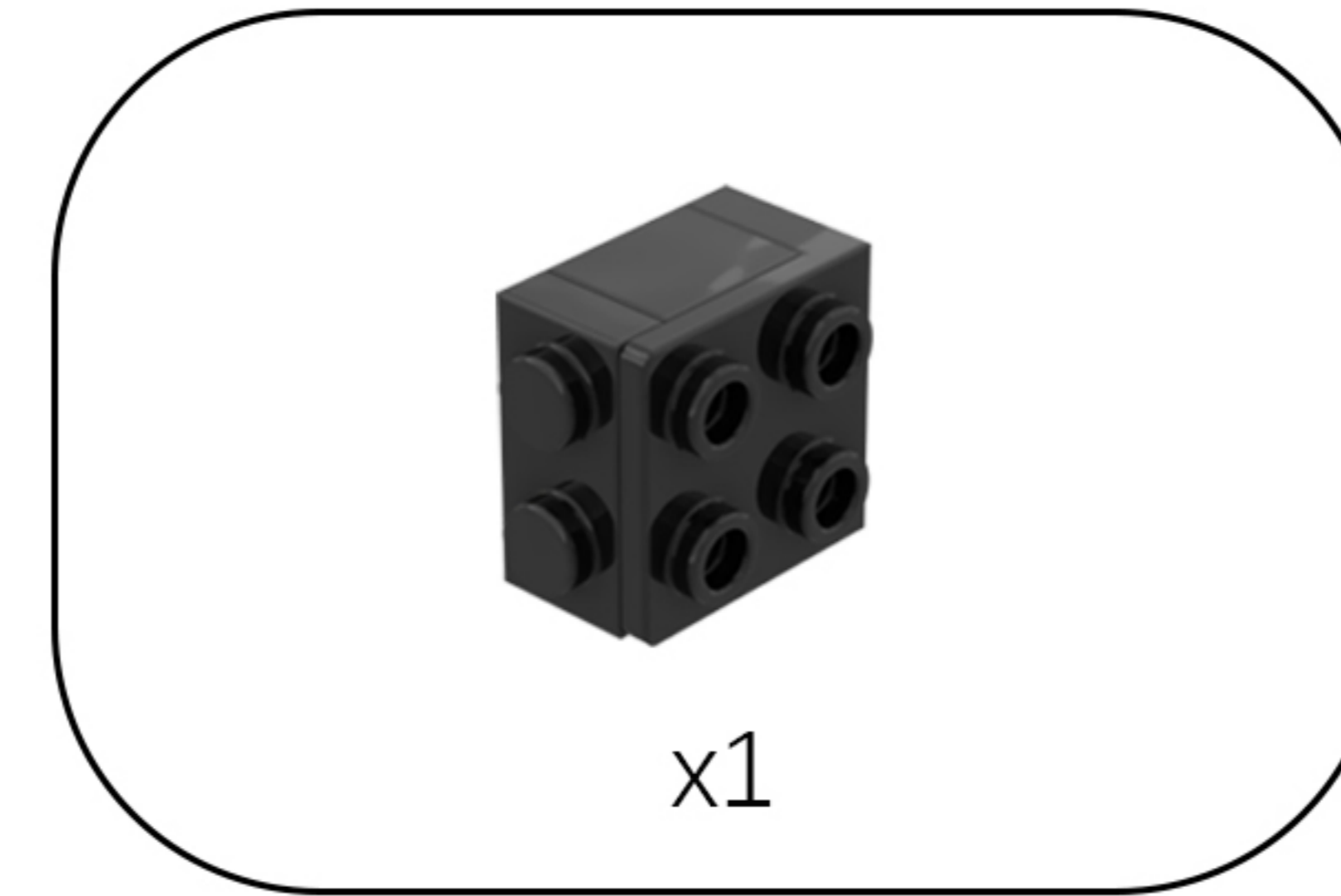

Note: The location where the lamp wires are routed out.

13

EN: Pry apart the connection between the building blocks, but do not separate them completely.

DE: Zieh die Verbindung zwischen den Bausteinen auseinander, aber trenne sie nicht vollständig voneinander.

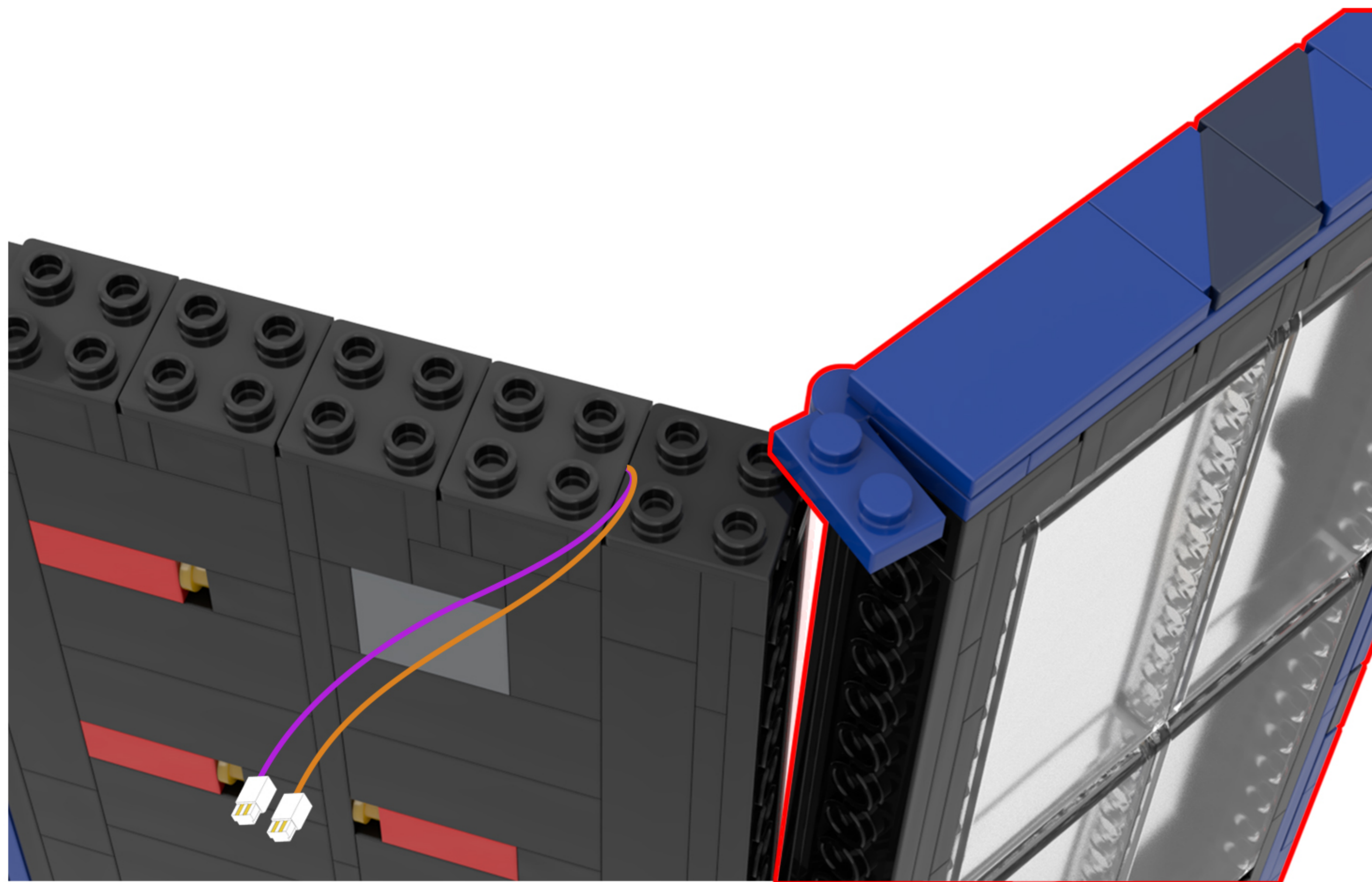

14

EN: Place the two light strips between the two protrusions on the building block.

DE: Setze die beiden Lichtleisten zwischen die beiden Vorsprünge am Baustein.

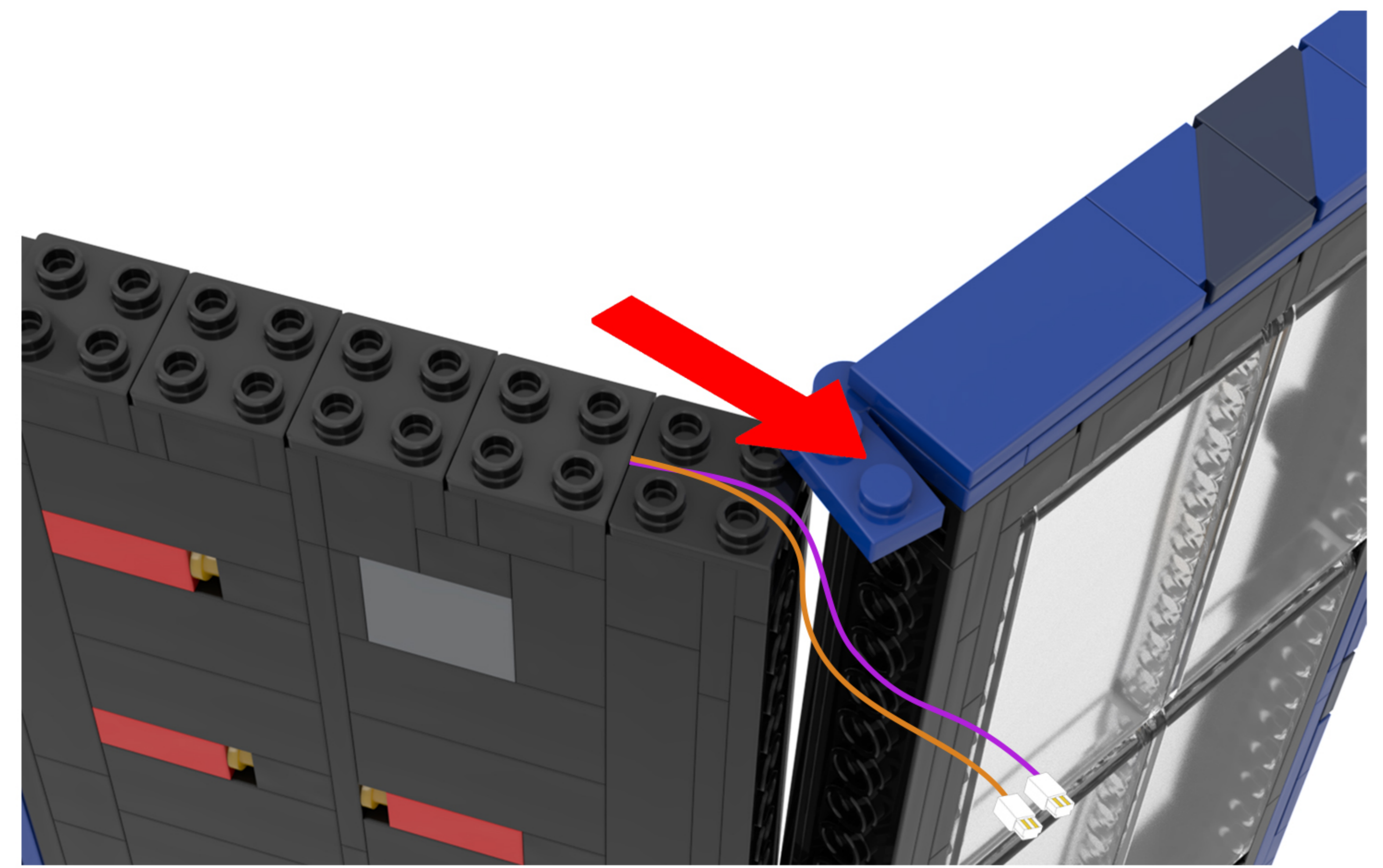

15

EN: Reassemble the building blocks and secure the light cord.

DE: Setzen Sie die Bausteine wieder zusammen und befestigen Sie das Lichtkabel.

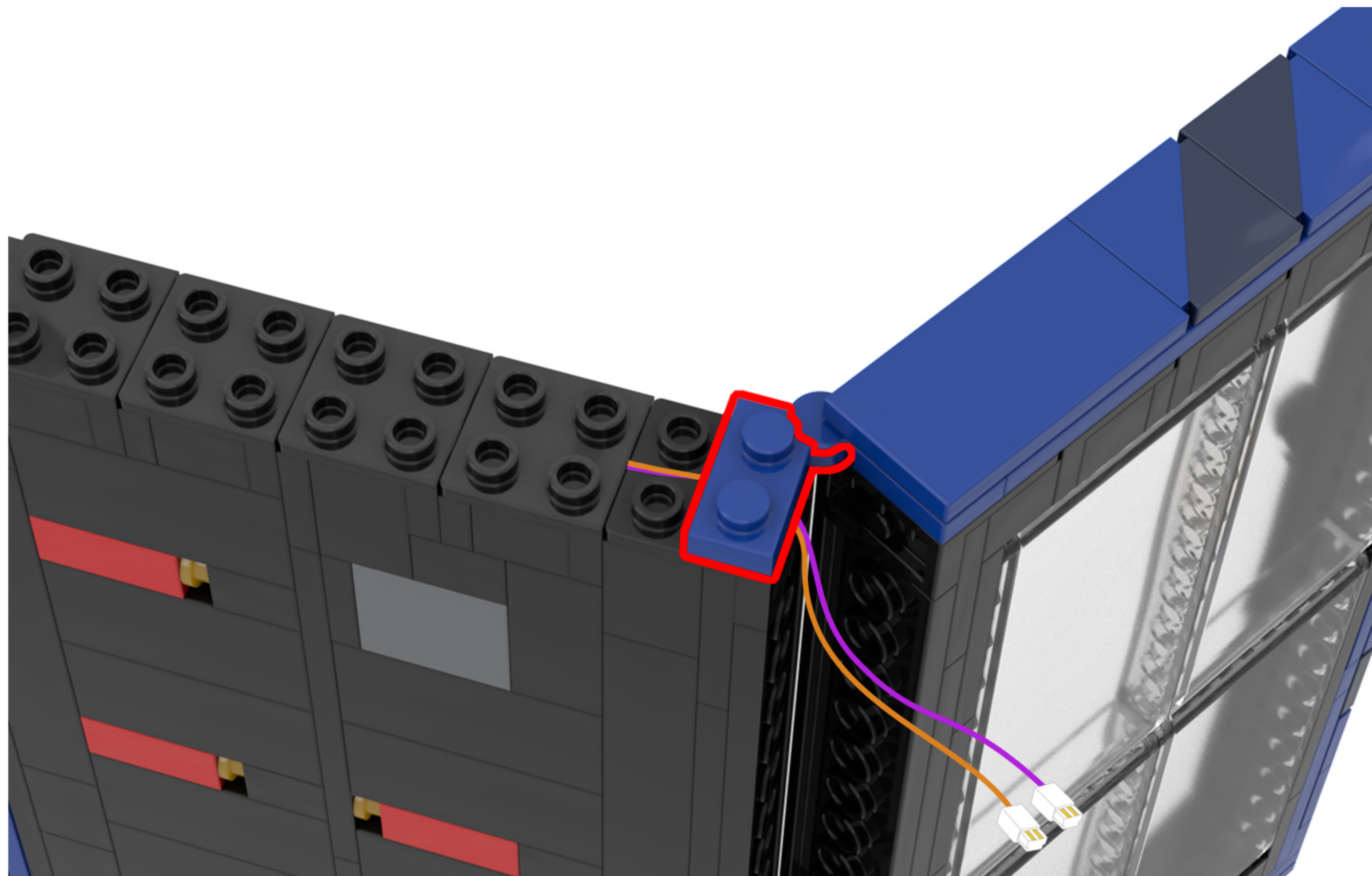

16

EN: Take out the disassembled building blocks and reassemble them.

DE: Nehmen Sie die zerlegten Bausteine heraus und setzen Sie sie wieder zusammen.

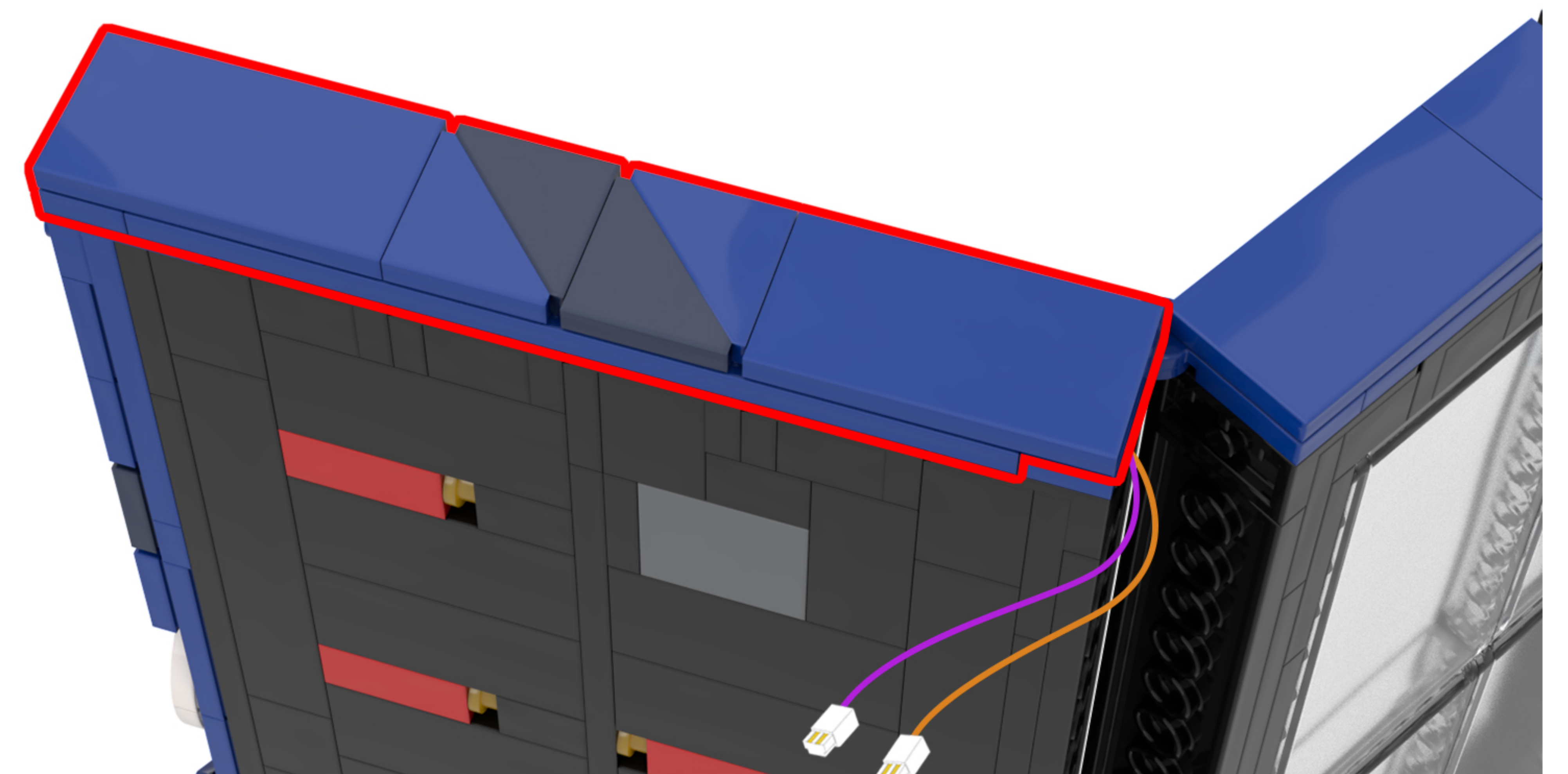
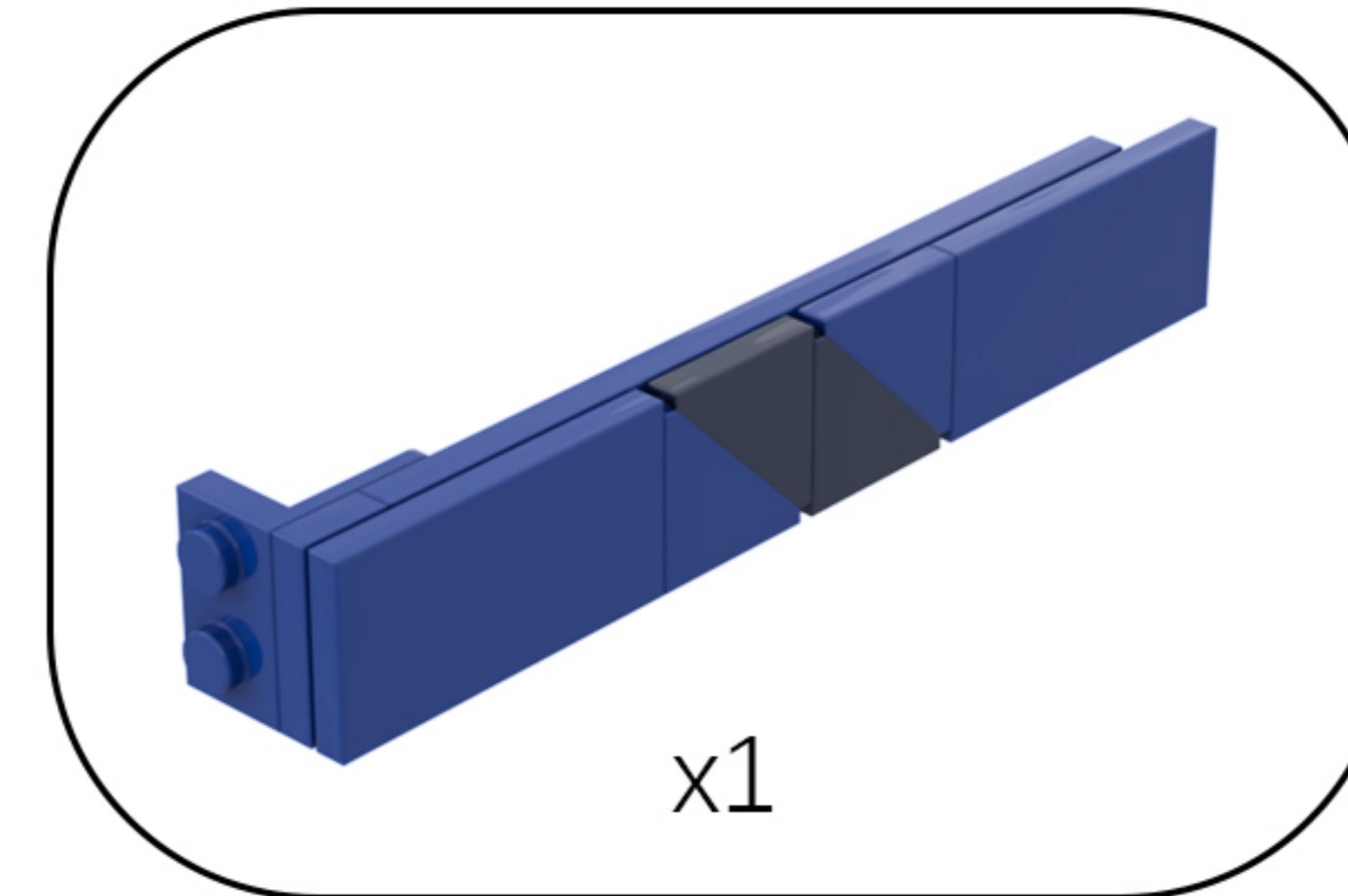

17

EN: Close the open building block and flip the model over to the back.

DE: SchlieÙe den offenen Baustein und drehe das Modell auf die Rückseite.



18

EN: Remove the expansion board from Bag 1 and connect the two light wires to the expansion board one after the other.

DE: Nehmen Sie die Erweiterungskarte aus Beutel 1 und schließen Sie die beiden Lichtkabel nacheinander an die Erweiterungskarte an.

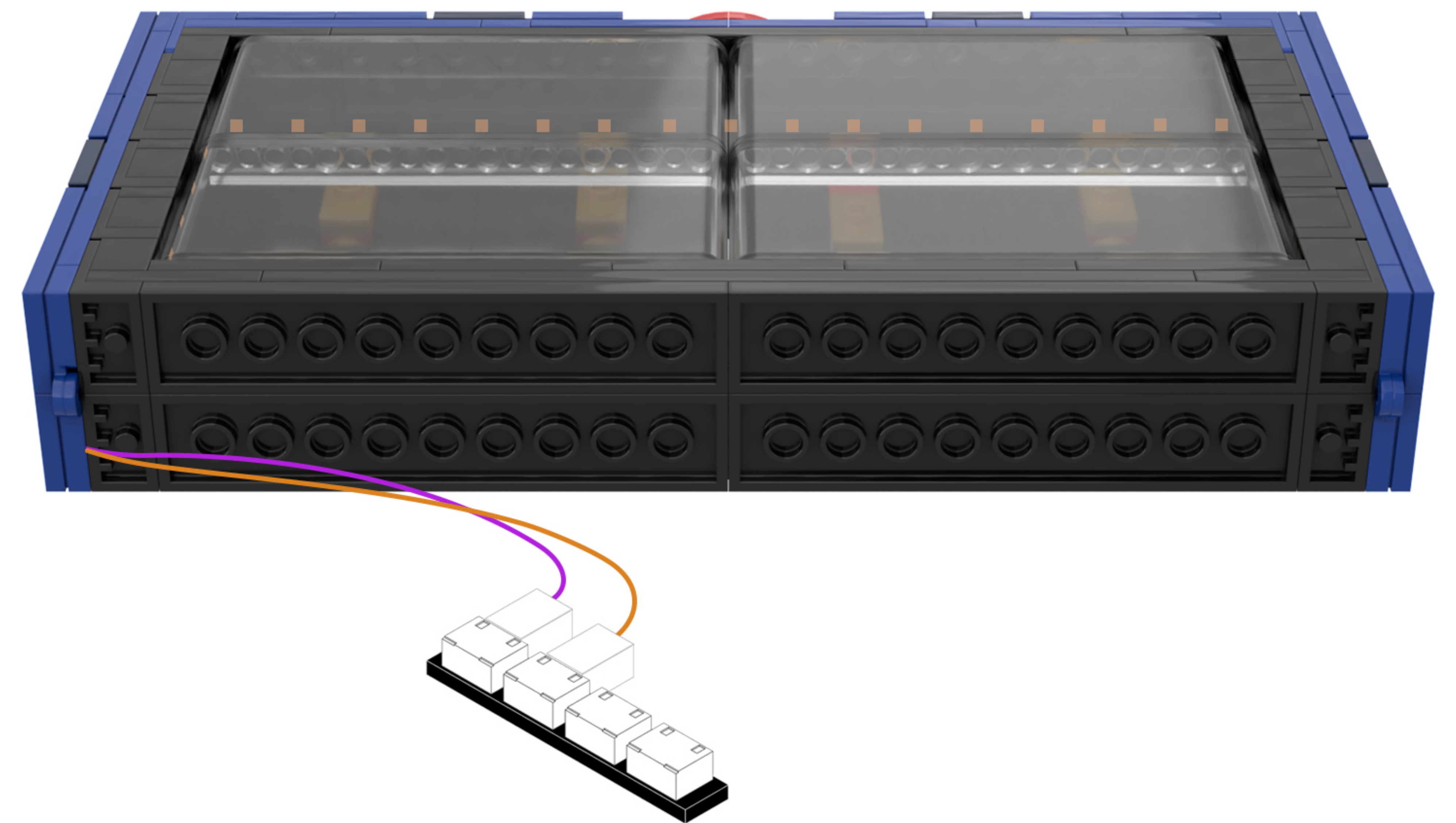
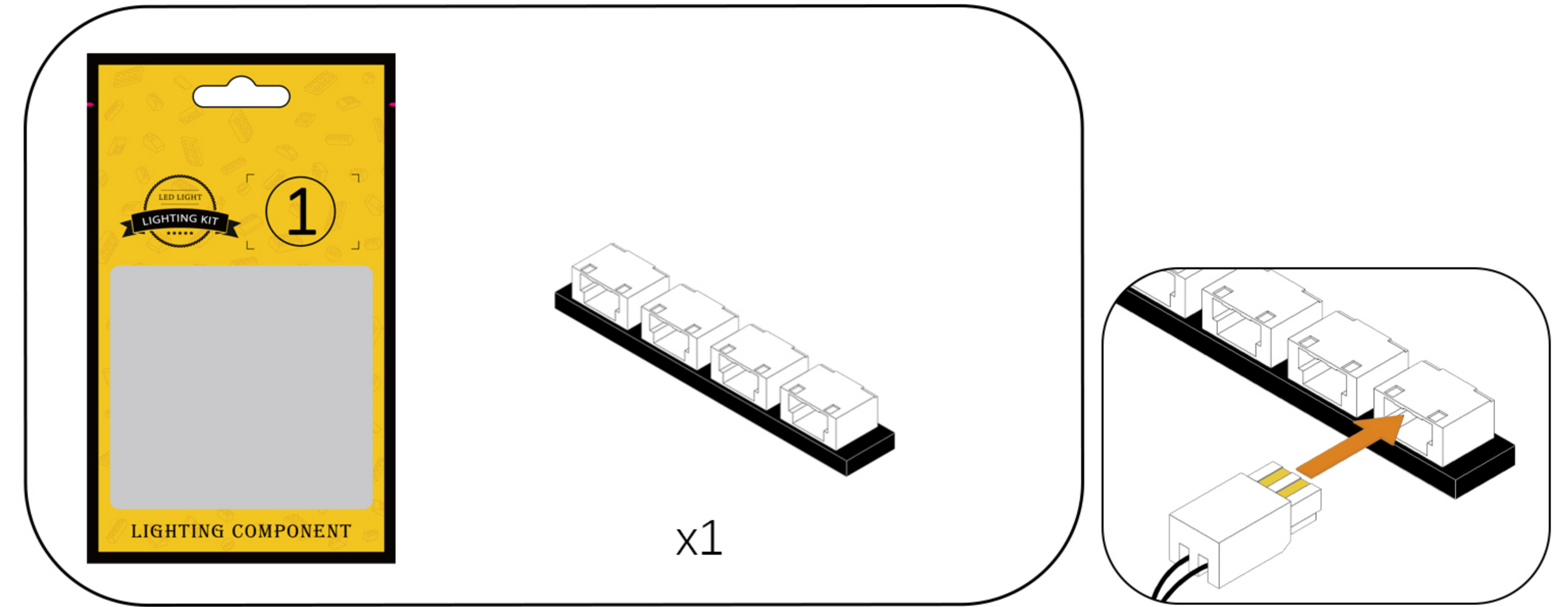

19

EN: Take the USB power cable from Bag 2 and connect it to the expansion board.

DE: Nehmen Sie das USB-Stromkabel aus Beutel 2 und schließen Sie es an die Erweiterungskarte an.

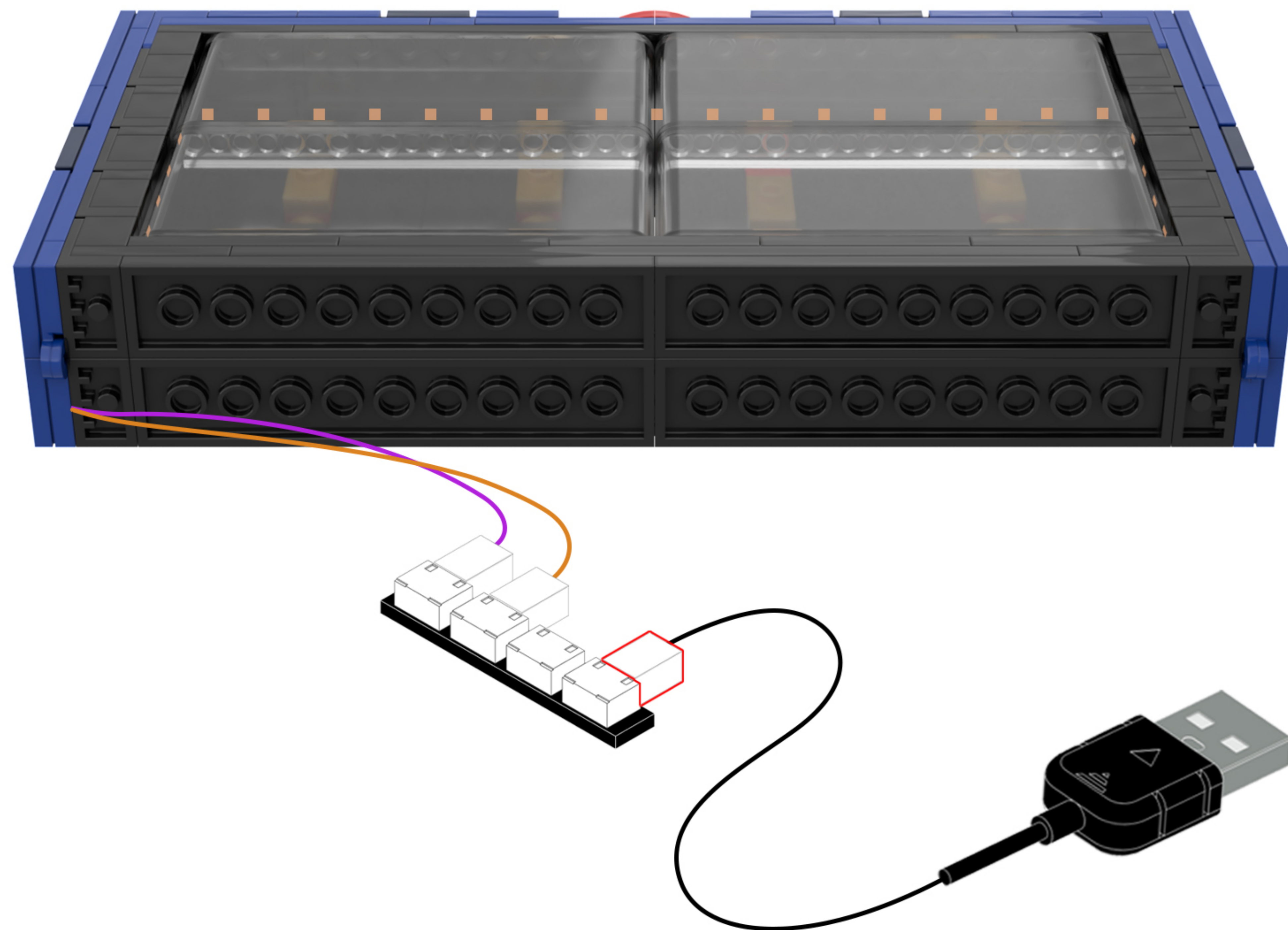
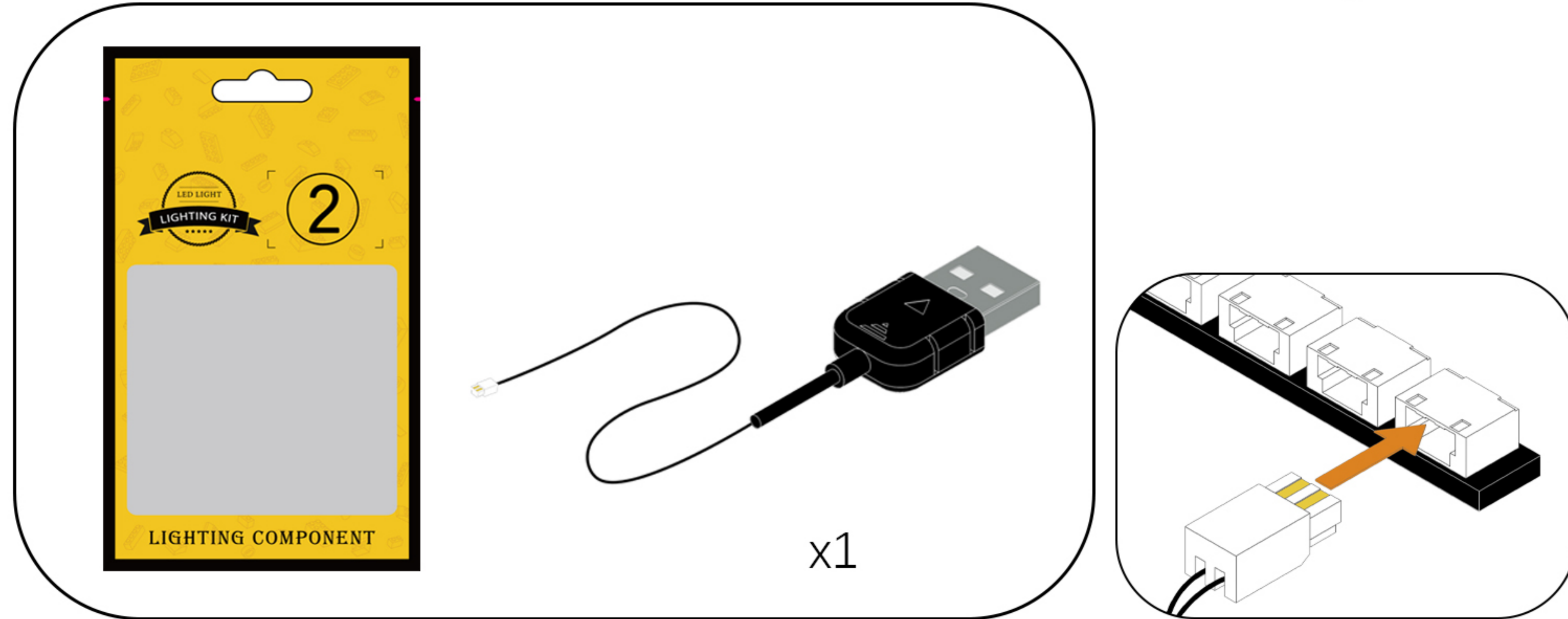

20

EN: Peel off the adhesive backing of the expansion board and attach it to the location shown in the illustration.

DE: Entfernen Sie die Schutzfolie von der Rückseite der Erweiterungsplatte und kleben Sie sie an die in der Abbildung gezeigte Stelle.

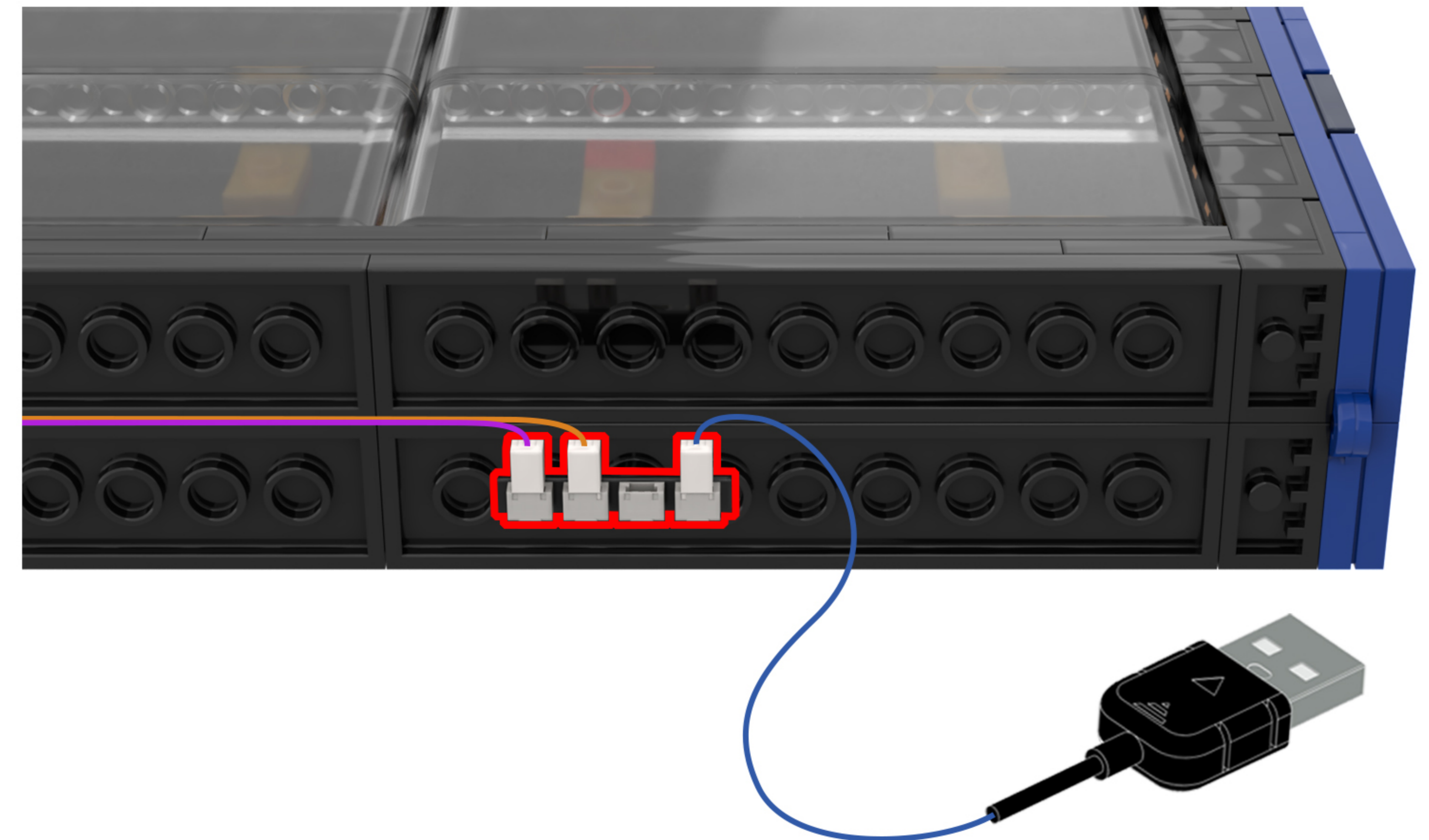

21

EN: Rotate the model to the front view.

DE: Drehen Sie das Modell in die Vorderansicht.

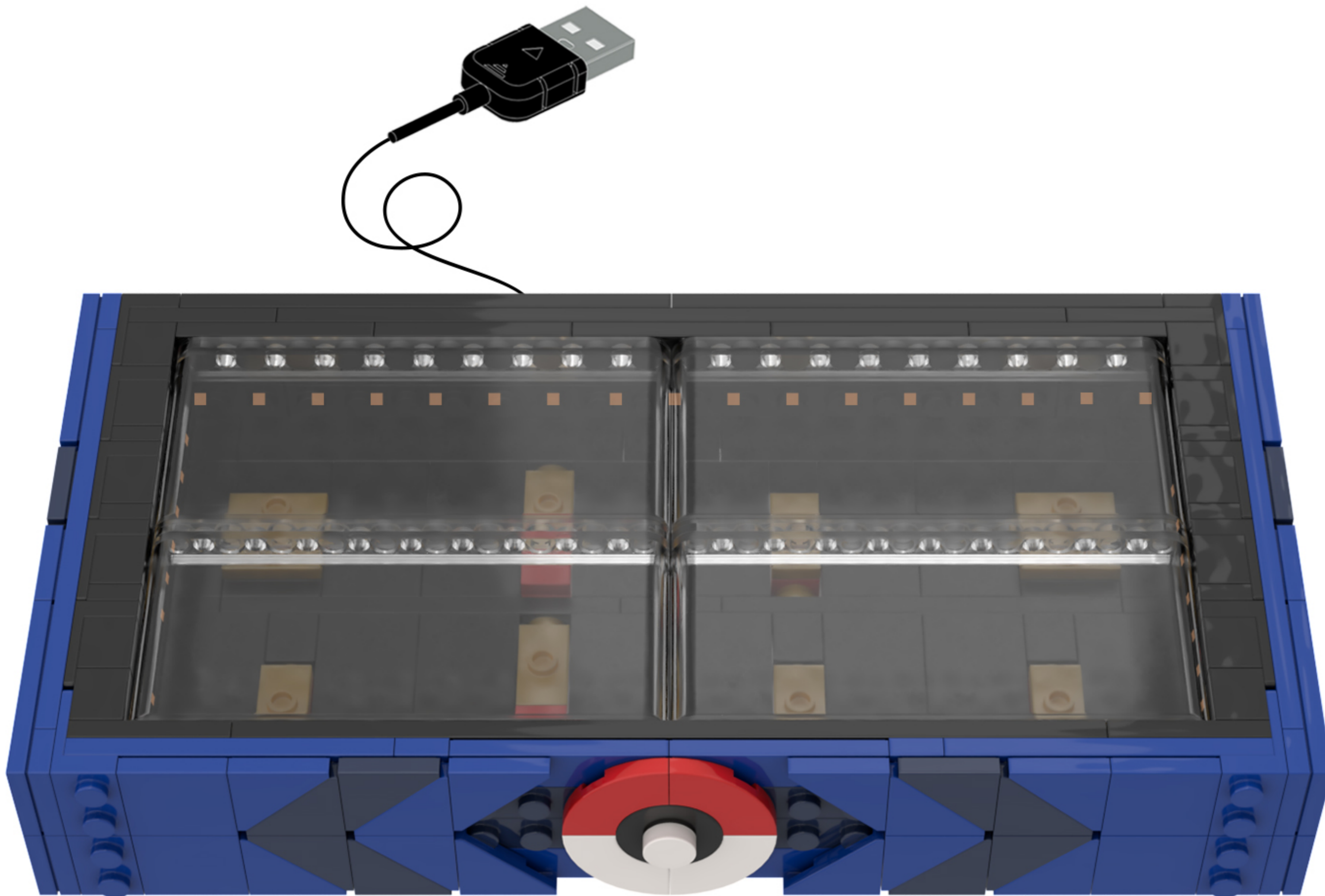
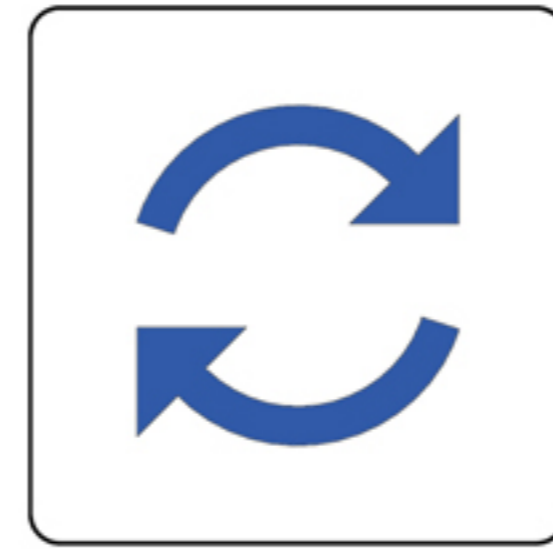

22

EN: Open the building blocks.

DE: Öffne die Bausteine.

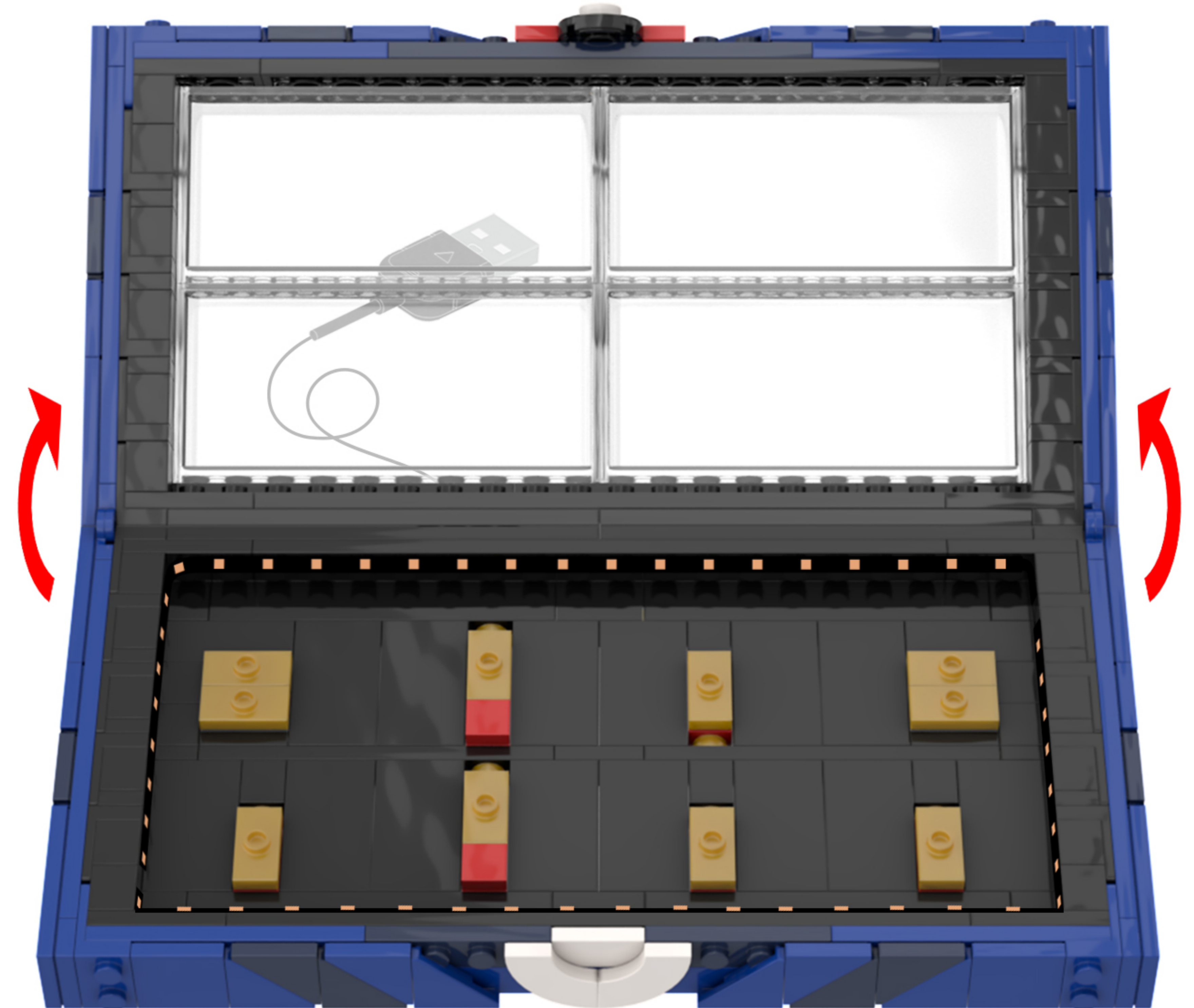

23

EN: Take out the disassembled building blocks and reassemble them.

DE: Nehmen Sie die zerlegten Bausteine heraus und setzen Sie sie wieder zusammen.

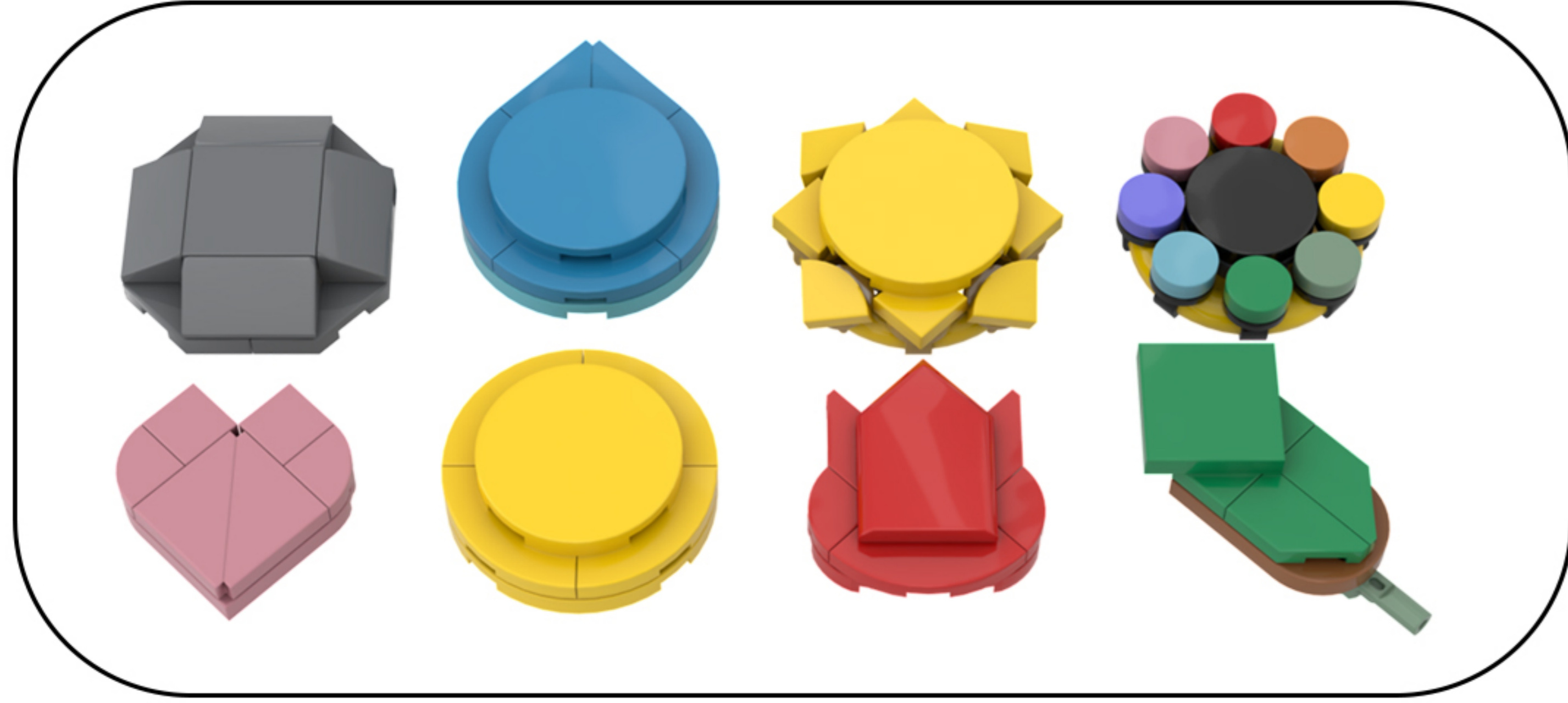

24

EN: Close the open building block.

DE: SchlieÙe den geöffneden Baustein.

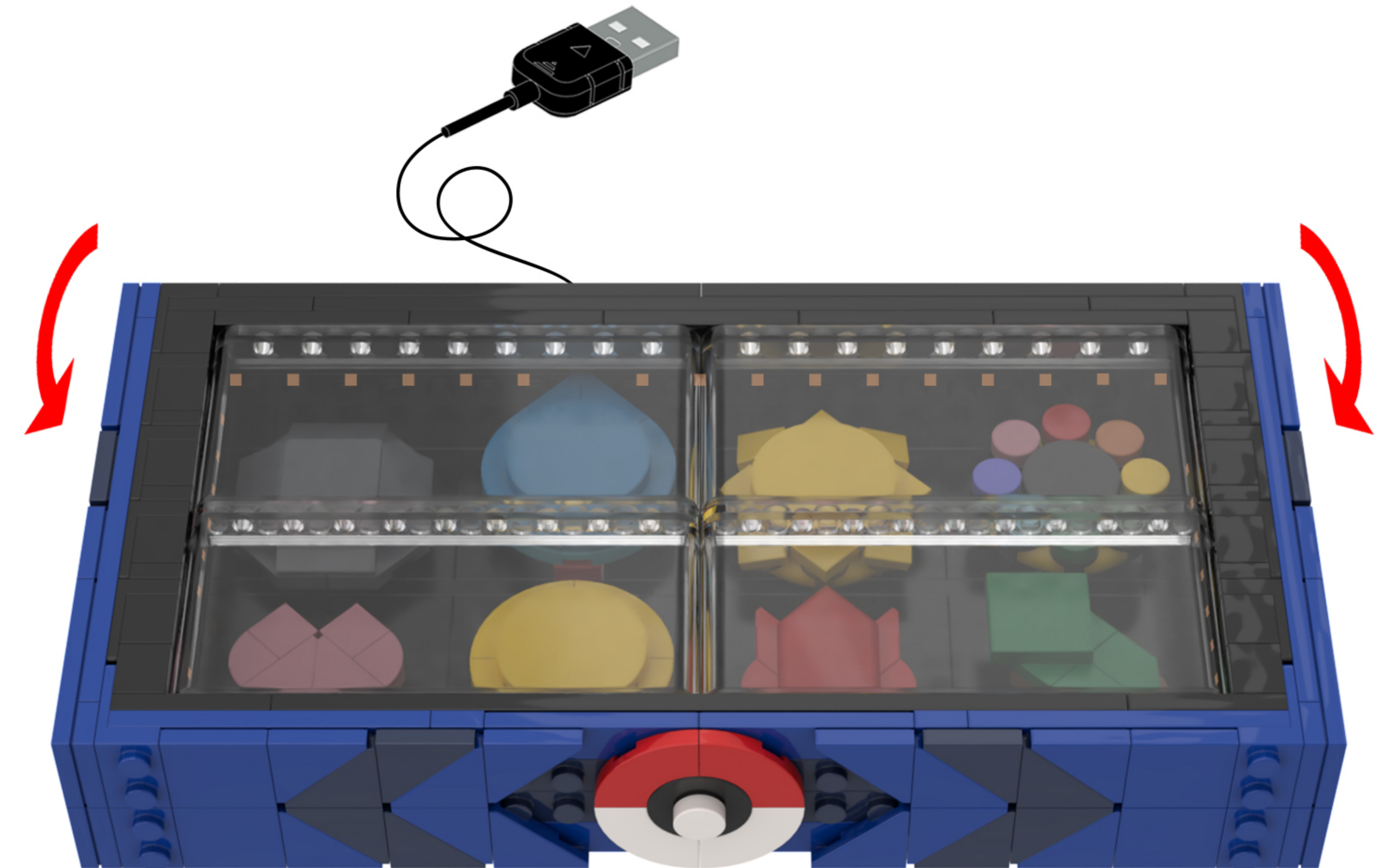

25

EN: Once installed, connect the power supply and give it a try!

DE: Die Installation ist abgeschlossen. Schließen Sie das Gerät an die Stromversorgung an und probieren Sie es aus!

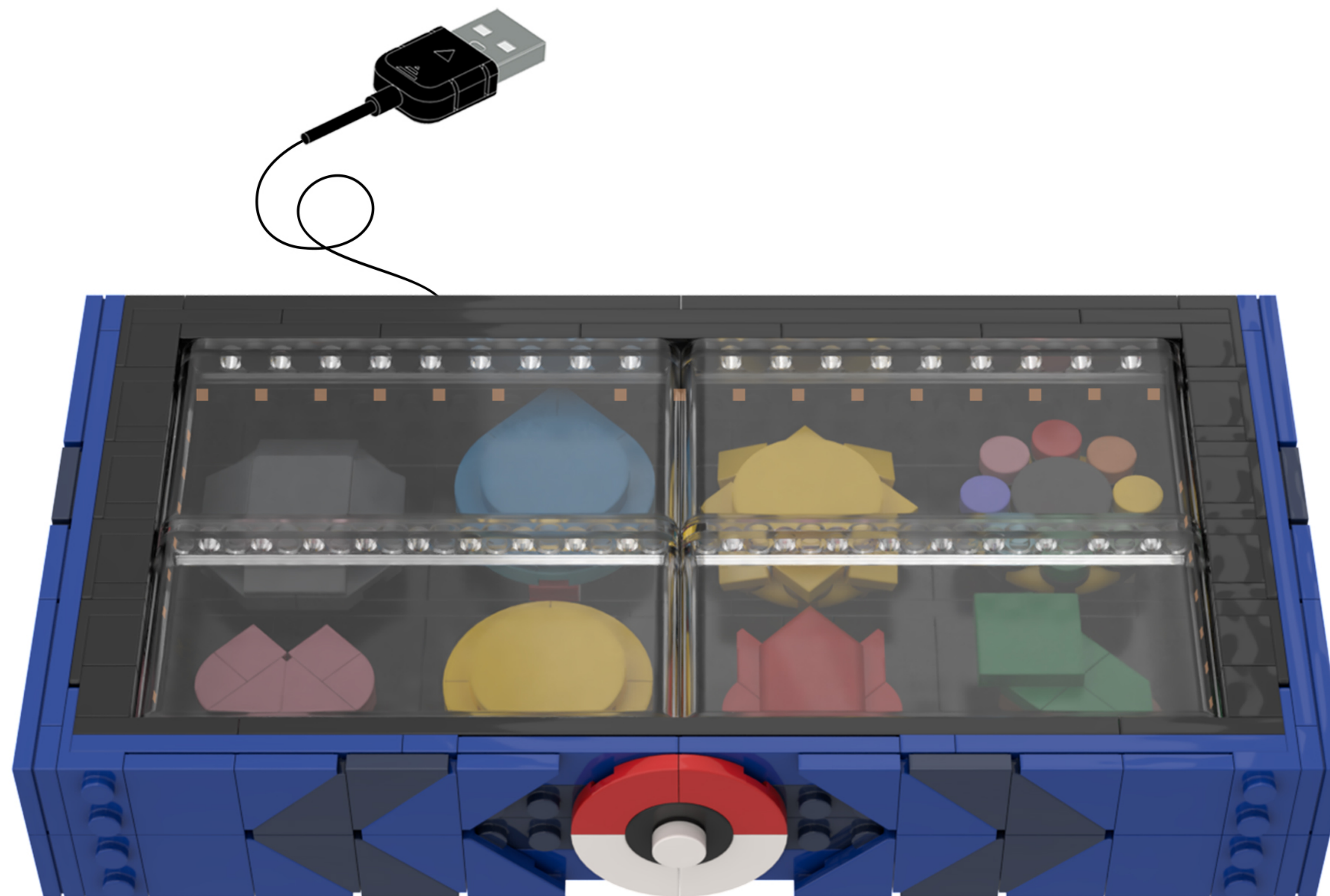

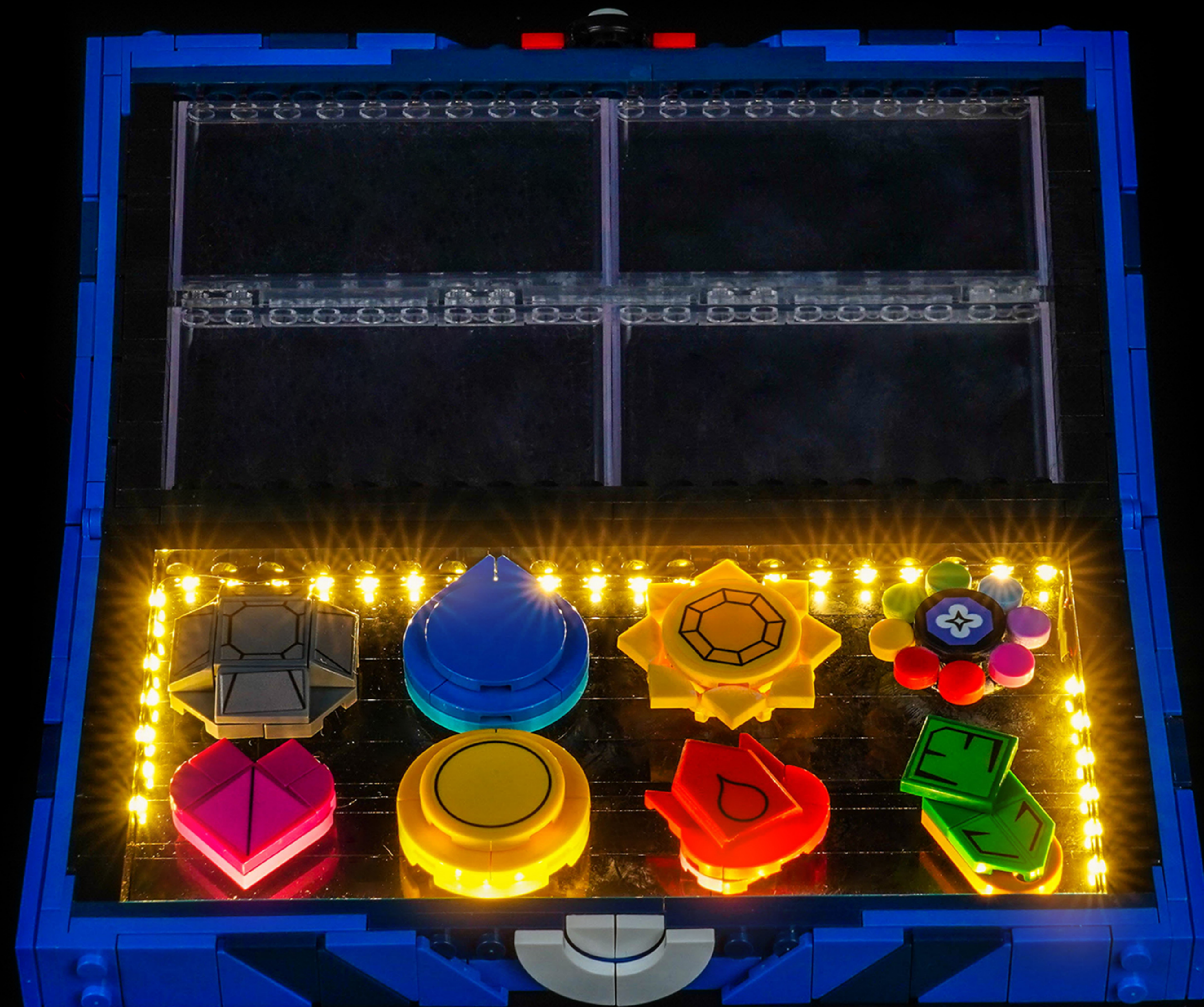

Above our designers to provide the relevant ideas and instructions. But please move to the following:

- 1: about our company this product parts material, product quality do you have comments and suggestions?
- 2: about this product installation instructions and installation of the degree of difficulty do you have views and suggestions?
- 3: if in the operation of the product we provide ideas encountered any problems, please contact us in a timely manner.

Tips

If you encounter any installation problems please contact the seller, we will be happy to help you solve!